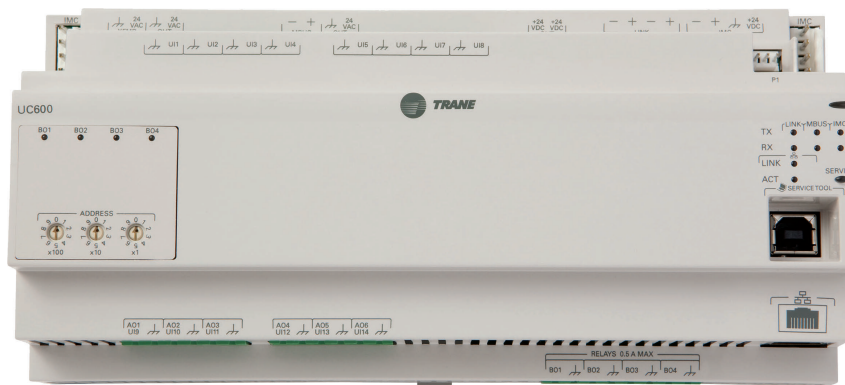




# Installation, Operation, and Maintenance Tracer® UC600 Programmable Controller

Ordering Number: BMUC600AAA0100011



## ⚠ SAFETY WARNING

Only qualified personnel should install and service the equipment. The installation, starting up, and servicing of heating, ventilating, and air-conditioning equipment can be hazardous and requires specific knowledge and training. Improperly installed, adjusted or altered equipment by an unqualified person could result in death or serious injury. When working on the equipment, observe all precautions in the literature and on the tags, stickers, and labels that are attached to the equipment.

April 2020

BAS-SVX45J-EN

TRANE  
TECHNOLOGIES



# Introduction

The Tracer UC600 controller is a multi-purpose, programmable, wireless-compatible device. It is designed to control the following types of equipment:

- Air-handling units (AHUs)
- Rooftop units
- Chillers
- Central heating and cooling plants
- Cooling towers
- Generic input/output (I/O) control

## Warnings, Cautions, and Notices

Safety advisories appear throughout this manual as required. Your personal safety and the proper operation of this machine depend upon the strict observance of these precautions.

The three types of advisories are defined as follows:



Indicates a potentially hazardous situation which, if not avoided, could result in death or serious injury.



Indicates a potentially hazardous situation which, if not avoided, could result in minor or moderate injury. It could also be used to alert against unsafe practices.



Indicates a situation that could result in equipment or property-damage only accidents.

---

<b>⚠ WARNING</b>
<b>Proper Field Wiring and Grounding Required!</b> Failure to follow code could result in death or serious injury. All field wiring <b>MUST</b> be performed by qualified personnel. Improperly installed and grounded field wiring poses <b>FIRE</b> and <b>ELECTROCUTION</b> hazards. To avoid these hazards, you <b>MUST</b> follow requirements for field wiring installation and grounding as described in NEC and your local/state/national electrical codes.

**⚠ WARNING****Personal Protective Equipment (PPE) Required!**

Failure to wear proper PPE for the job being undertaken could result in death or serious injury.

Technicians, in order to protect themselves from potential electrical, mechanical, and chemical hazards, **MUST** follow precautions in this manual and on the tags, stickers, and labels, as well as the instructions below:

- Before installing/servicing this unit, technicians **MUST** put on all PPE required for the work being undertaken (Examples; cut resistant gloves/sleeves, butyl gloves, safety glasses, hard hat/bump cap, fall protection, electrical PPE and arc flash clothing). **ALWAYS** refer to appropriate Safety Data Sheets (SDS) and OSHA guidelines for proper PPE.
- When working with or around hazardous chemicals, **ALWAYS** refer to the appropriate SDS and OSHA/GHS (Global Harmonized System of Classification and Labelling of Chemicals) guidelines for information on allowable personal exposure levels, proper respiratory protection and handling instructions.
- If there is a risk of energized electrical contact, arc, or flash, technicians **MUST** put on all PPE in accordance with OSHA, NFPA 70E, or other country-specific requirements for arc flash protection, **PRIOR** to servicing the unit. **NEVER PERFORM ANY SWITCHING, DISCONNECTING, OR VOLTAGE TESTING WITHOUT PROPER ELECTRICAL PPE AND ARC FLASH CLOTHING. ENSURE ELECTRICAL METERS AND EQUIPMENT ARE PROPERLY RATED FOR INTENDED VOLTAGE.**

**⚠ WARNING****Follow EHS Policies!**

Failure to follow instructions below could result in death or serious injury.

- All Trane personnel must follow the company's Environmental, Health and Safety (EHS) policies when performing work such as hot work, electrical, fall protection, lockout/tagout, refrigerant handling, etc. Where local regulations are more stringent than these policies, those regulations supersede these policies.
- Non-Trane personnel should always follow local regulations.

## Copyright

This document and the information in it are the property of Trane, and may not be used or reproduced in whole or in part without written permission. Trane reserves the right to revise this publication at any time, and to make changes to its content without obligation to notify any person of such revision or change.

## Trademarks

All trademarks referenced in this document are the trademarks of their respective owners.

## Revision History

- Added revised screenshot to Connecting Using Tracer SC/SC+ section.
- Added additional details to Using Pre-packaged Solutions (PPS) section.
- Revised Current Input Method 1 in Commissioning and Troubleshooting in a Powered State section.
- Added Setting Up UC600 BACnet Communication to Configuring Tracer UC600 for BACnet/IP section.



# Table of Contents

Product Overview.....	7
Smoke Control Support (UUKL).....	7
Air-Fi™ Wireless Communications Interface (WCI) Support.....	7
Expansion Module Requirements.....	7
Specifications.....	7
Location of LEDs.....	8
Hardware Terminations.....	8
Additional Ordering Options.....	9
Required Tools for Mounting and Wiring.....	10
Dimensions.....	10
Installing the Tracer UC600 Programmable Controller.....	11
Mounting and Removing Tracer Devices.....	11
Setting Addresses Using Rotary Switches.....	12
Setting the BACnet Device ID.....	12
Device ID Assignment for BACnet MS/TP Devices.....	13
Device ID Assignment for BACnet/IP Devices.....	13
Device ID Assignment for Wireless Devices.....	14
Rotary Dial Address Settings for Non-Trane Front-end Systems.....	14
Tracer UC600 Pre-power Checks.....	15
Resistive Inputs.....	15
Voltage Inputs.....	15
Current Inputs.....	16
Binary Inputs.....	16
Power Budget Check in an Un-powered State.....	18
Calculating AC Power Consumption.....	18
Calculating DC Power Consumption.....	18
Wiring and Powering the Tracer UC600.....	20
Wiring Requirements.....	20
Transformer Requirements.....	20
Tug Test for Terminal Connectors.....	21
Wiring AC Power to Tracer UC600.....	21
UC600 Startup and Power Check.....	22
BACnet MS/TP Link Wiring.....	23
BACnet/IP Wiring.....	23
Wiring Inputs and Outputs.....	24
Providing Low-voltage Power for Inputs/Outputs.....	24
Input and Output Wiring.....	25

Wiring Universal Inputs .....	25
Wiring Binary Inputs.....	25
Wiring 0–10 Vdc Analog Inputs .....	26
Wiring 0–20 mA Analog Inputs .....	27
Wiring Variable Resistance Analog Inputs .....	28
Wiring Trane Zone Sensors .....	29
Wiring Analog Outputs and Pulse Width Modulating Outputs .....	30
Wiring Binary Outputs .....	31
Connecting Pressure Transducer Inputs .....	32
Tracer UC600 Operation .....	34
LED Descriptions and Activities .....	34
Troubleshooting .....	34
Communication Problems .....	34
Output Points .....	35
Connection Problems.....	35
Configuring Tracer UC600 with Tracer TU .....	36
Starting a Session of Tracer TU .....	36
Connecting Using Tracer SC or Tracer SC+.....	36
Appendix A. Installation and Connection Error Conditions .....	38
Upgrading Firmware .....	38
Configuring Tracer UC600 and Creating or Editing Points .....	39
Configuring Tracer UC600 .....	39
Using Pre-packaged Solutions (PPS) .....	40
Creating or Editing Points for the UC600 .....	40
Placing Points in Out-of-Service Mode .....	42
Creating Points to Monitor Communication and TGP2 Programs .....	42
Creating Points for Timed Override (TOV) and */** Functions .....	43
Monitoring and Viewing Status .....	44
Backup.....	44
Transfer Files (Restore).....	45
Setting Up and Maintaining Schedules .....	45
Creating a Weekly Schedule.....	45
Changing the Schedule Default Value.....	47
Adding Exceptions .....	47
Modifying Exceptions .....	49
Deleting Events .....	50
Deleting Exceptions .....	50
Deleting a Schedule .....	51
Custom Graphics .....	51
Graphics Best Practices.....	53
Commissioning and Troubleshooting in a Powered State.....	54



- Resistive Inputs..... 54
- Voltage Inputs..... 55
- Current Inputs..... 55
  - Method 1..... 55
  - Method 2..... 56
- 24 Vac Measurement..... 57
- Binary Inputs: 24 Vac Detect (Methods 1 or 2)..... 58
- Binary Inputs: Based on Analog Output Connection..... 58
- Open-collector Based Binary Sensors..... 59
- Voltage Analog Output..... 59
- Current Analog Output (Methods 1 or 2)..... 60
- Ground Measurements..... 61
- Resources..... 62
- Appendix A: Configuring Tracer UC600 for BACnet/IP..... 63
  - Device ID Assignment for BACnet/IP Devices..... 63
  - Ethernet Network Wiring Specifications..... 63
  - BACnet/IP Network Configuration on Tracer SC or Tracer SC+..... 63
    - Enabling BBMD Functionality on the IP Network..... 63
  - Setting Up Tracer UC600 BACnet Communication with Tracer TU..... 64
    - Establishing a Direct Connection with Tracer TU..... 64
    - Establishing a Network Connection with Tracer TU..... 65
    - Configuring IP Information..... 66
    - Configuring BACnet Information..... 67
    - Setting Up a BDT..... 68
  - Security..... 69
    - Local Network (Firewall) Security..... 69
    - Disable HTTP Communications..... 69
    - Disable Tracer UC600 User Interface (TD7)..... 69



# Product Overview

This section describes the product features, specifications, and agency listings and compliance for the UC600 programmable controller.

## Smoke Control Support (UUKL)

The Tracer UC600 programmable controller is now UL864 certified, making it fully capable of serving as a component of a UUKL smoke control system along with the Tracer SC system controller. For more information, see the "Engineered Smoke Control System Applications Guide" (BAS-APG019).

## Air-Fi™ Wireless Communications Interface (WCI) Support

The Air-Fi™ Wireless Communications Interface (WCI) is an alternative to BACnet® wired communication links. The WCI is a wireless communications component (option) added to Tracer controllers and is compatible with Tracer UC600. Tracer UC600 firmware must be at V4.00.027 or higher for compatibility with WCI.

Refer to the following documentation for more information:

- *Air-Fi™ Wireless Communications Interface Installation Instructions* (X39641264001)
- *Air-Fi™ Wireless Installation, Operation, and Maintenance* (BAS-SVX40)
- *Air-Fi™ Wireless Network Design Best Practices Guide* (BAS-SVX55)

## Expansion Module Requirements

If additional input or output points are needed, the XM30, XM32, XM70, and XM90 expansion modules can be used. The UC600 controller will support up to 120 combined I/O terminations. See the "Tracer Expansion Module IOM," (BAS-SVX46), for application and installation information.

## Specifications

Tracer UC600 conforms to the specifications shown in the following table.

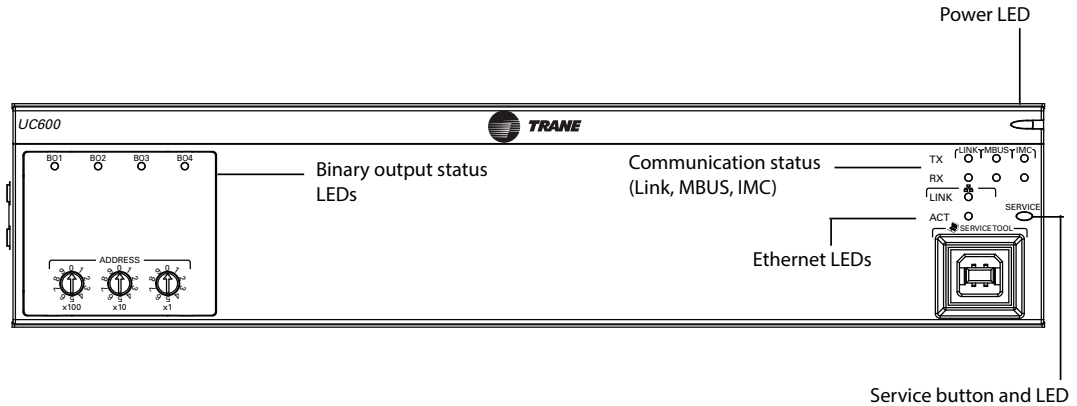
**Table 1. Specifications**

Storage	
Temperature:	-67°F to 203°F (-55°C to 95°C)
Relative humidity:	Between 5% to 95% (non-condensing)
Operating	
Temperature:	-40°F to 158°F (-40°C to 70°C)
Humidity:	Between 5% to 95% (non-condensing)
Power:	Input: 20.4–27.6 Vac (24 Vac, ±15% nominal) 50 or 60 Hz, 26 VA (26 VA plus a maximum of 12 VA for each binary output) Output: 24 Vdc, ±10%, device max load 600 mA
Time Clock:	On-board real time clock with 7 day backup
Mounting weight of controller:	Mounting surface must support 1.3 lb. (0.6 kg)
Environmental rating (enclosure):	NEMA 1
Installation:	UL 840: Category 3
Pollution:	UL 840: Degree 2

## Location of LEDs

Light emitting diodes (LEDs) indicate the operation and communication status of the controller. For detailed information about wiring communication links, refer to the *BACnet Best Practices and Troubleshooting Guide* (BAS-SVX51).

Figure 1. Tracer UC600 LEDs



## Hardware Terminations

Tracer UC600 supports the following hardware terminations:

- Temperature sensors (resistive and thermistor)
- Linear inputs 0–20 mA, such as humidity sensors
- Linear inputs 0–10 Vdc, such as indoor air-quality sensors
- Linear outputs 0–20 mA, such as variable frequency drives
- Linear outputs 0–10 Vdc, such as actuators for dampers and valves
- Pulse outputs, such as electric heat or humidifier control
- Binary outputs, such as fan start/stop
- One 3-wire pressure transducer input
- Pulse accumulator

Table 2. Tracer UC600 device connections

Input/Output type	Quantity	Types	Range	Notes
Universal input	8	Thermistor	10kΩ – Type II, 10kΩ –Type III, 2252Ω – Type II, 20kΩ – Type IV, 100 kΩ	
		Resistive (Setpoint)	100Ω – 1MΩ	
		RTD	Balco™ (Ni-Fe), 1kΩ; 375 (Pt), 385 (Pt), 1kΩ	
		Current	0–20 mA (linear)	
		Voltage	0–20 Vdc (linear)	
		Binary	Dry contact	
		Pulse accumulator	Minimum 20 ms, opened or closed	
Universal Input/ Analog Output	Configure using any combination of analog or binary inputs/analog outputs			



**Table 2. Tracer UC600 device connections (continued)**

Input/Output type	Quantity	Types	Range	Notes
Inputs	6	Thermistor	10k $\Omega$ – Type II, 10k $\Omega$ –Type III, 2252 $\Omega$ – Type II, 20k $\Omega$ – Type IV, 100 k $\Omega$	The UC600 provides 600 mA of DC power for 0–20 mA inputs and/or outputs, and expansion modules.
		Resistive (setpoint)	100 $\Omega$ –1M $\Omega$	
		RTD	Balco™ (Ni-Fe), 1k $\Omega$ ; 375 (Pt), 385 (Pt), 1k $\Omega$	
		Current	0–20 mA (linear)	
		Voltage	0–20 Vdc (linear)	
		Binary	Dry contact	
		Pulse accumulator	Minimum 20 ms, opened or closed	
Outputs		Current	0–20 mA @16 V	
		Voltage	0–10 Vdc @20 mA	
		Pulse	12.5ms to 1 second (12.5ms resolution), 1 second to 60 seconds (0.5 second resolution)	
Binary output	4	Relay (form A) wet	24 Vac, 0.5A maximum	Ranges are given per contact.
Pressure input	1	3-wire	0–5 inwc.	Pressure input supplied with 5 Vdc. Designed for Kavlico™ pressure transducers.
Point total	19			

## Additional Ordering Options

Additional ordering options are available for the Tracer UC600:

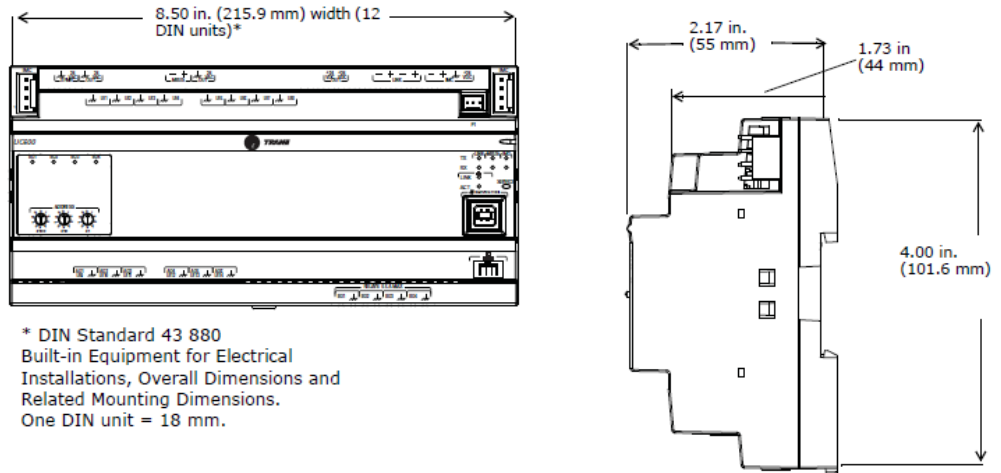
- Tracer TD7 Operator Display (order number: X13651571010)
- TD7 Sealed Ethernet cable (for wet environments) (order number: X19070632020)
- TD7 Display Portable Carry Case (order number: X18210613010)
- TD7 Mounting Bracket (flat surface, fixed position) (order number: X05010511010)
- Tracer XM30 expansion module (order number: X13651537010)
- Tracer XM32 expansion module (order number: X13651563010)
- Tracer XM70 expansion module (order number: X13651568010)
- Tracer XM90 expansion module (order number: X13651673010)
- Tracer BACnet Term (2 pack) (order number: X1365152401)
- Trane Large enclosure 120 Vac with display capable door (order number: X13651552010)
- Trane Large enclosure 230 Vac with display capable door (order number: X13651554010)
- Trane Medium enclosure 120 Vac (order number: X13651559010)
- Trane Medium enclosure 230 Vac (order number: X13651560010)
- Trane Small 10" DIN Rail enclosure (order number: X19091354010)
- Power Supply 24 Vac to 1.4A 24 Vdc for XM modules exceeding UC600 power budget (order number: X1365153801)
- IMC Harness (order number: S3090059462)

## Required Tools for Mounting and Wiring

A 1/8 in. (3 mm), flat-bladed screwdriver is required to perform functions such as setting rotary addressing switches, tightening or loosening screw terminals, and removing or repositioning the controller on DIN rail.

## Dimensions

Figure 2. Tracer UC600 dimensions





# Installing the Tracer UC600 Programmable Controller

This section describes proper installation procedures for the Tracer UC600 order number: BMUC600AAA0100011 (PN: X13651548).

## Mounting and Removing Tracer Devices

Tracer unit controllers and expansion modules should be properly mounted on a DIN rail. Control cabinets that include DIN rails are available from Trane.

To mount or remove the controller from the DIN rail, follow the illustrated instructions. If using a DIN rail from another manufacturer, follow the recommended installation procedures that accompany it.

**Important:** When mounting the controller in a control cabinet, provide adequate spacing between modules to allow for ventilation and heat dissipation.

### NOTICE

#### Enclosure Damage!

Failure to follow instructions below could result in damage to the plastic enclosure. Do not use excessive force to install the controller on the DIN rail. If using another manufacturer's DIN rail, follow their recommended installation.

#### To mount the device:

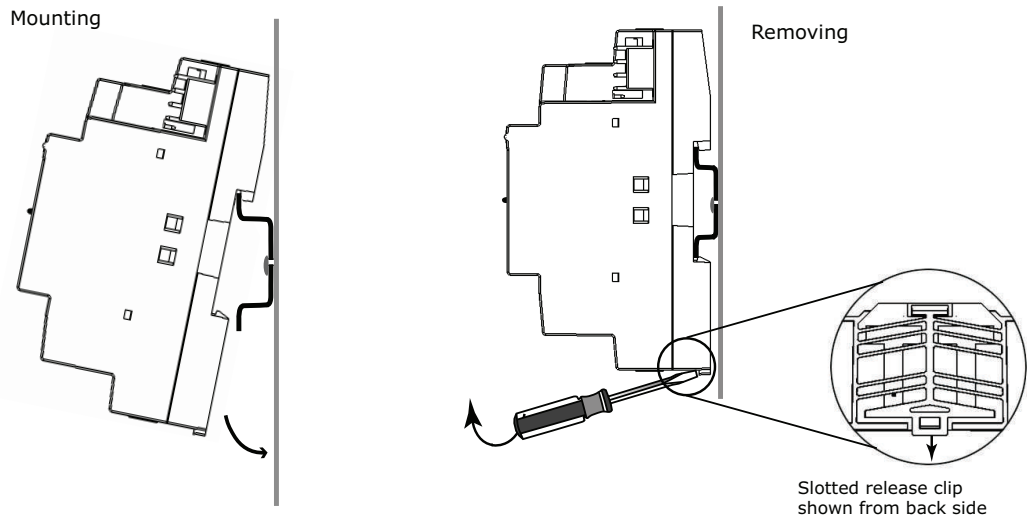
1. Hook device over top of DIN rail.
2. Gently push on lower half of device in the direction of arrow until the release clip clicks into place.

#### To remove/reposition the device:

3. Disconnect all connectors before removing or repositioning.
4. Insert screwdriver into slotted release clip and gently pry upward with the screwdriver to disengage the clip.
5. While holding tension on the clip, lift device upward to remove or reposition.

If repositioned, push on the device until the release clip clicks back into place to secure the device on the DIN rail.

Figure 3. Mounting and removing the device





## Installing the Tracer UC600 Programmable Controller

### Setting Addresses Using Rotary Switches

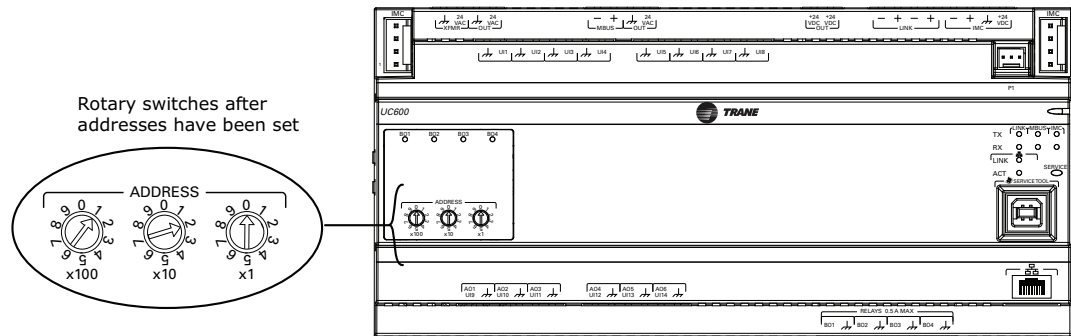
There are three rotary switches on the front of the Tracer UC600 for the purpose of defining a three-digit address when it is installed on a BACnet communications network. The three-digit address setting is used as both the rotary switch value and the BACnet device ID.

For Trane BACnet MS/TP systems, the rotary switch value must be between 1 and 127. Although "0,0,0," is a valid BACnet address, Trane reserves this address for the Tracer SC controller. For non-Trane systems, see . All device addresses on the BACnet MS/TP link must be unique.

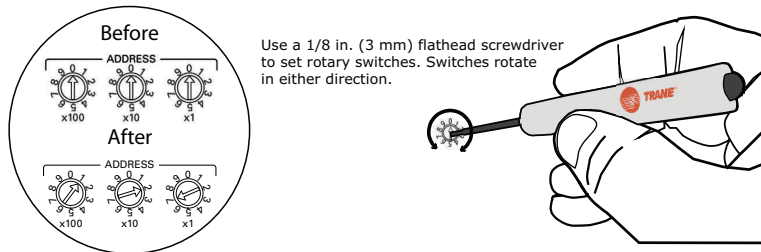
- Before powering up Tracer UC600, set the rotary switch value as shown in the following figure.
- If the Tracer UC600 was previously powered up, do the following if you wish to make changes:
  - Make the preferred changes to the rotary switch value as illustrated in .
  - Power down the Tracer UC600; when re-powered the new rotary switch value should be active.
- For controllers that are connected through BACnet/IP, or wireless via ZigBee™, valid unit controller rotary switch values can range from 001 to 999.

**Note:** Valid rotary switch values used with the Tracer UC600 are 001 to 120 for BACnet MS/TP.

**Figure 4. Setting rotary switch values on UC600**



**Important:** Each Tracer UC600 device on the BACnet link must have a unique rotary switch value, otherwise communication problems will occur.



### Setting the BACnet Device ID

The BACnet device ID uniquely identifies each BACnet device. It can range from 0 to 4194303. Device IDs cannot be shared among devices on the same network. Each Tracer UC600 operates as a device and requires its own device ID, which defaults to the rotary switch value settings.

There are three ways that the BACnet device ID can be set on the Tracer UC600:

- After powering up Tracer UC600 for the first time, the Tracer UC600 device ID will match the rotary switch value.

## Installing the Tracer UC600 Programmable Controller

- When installing a Tracer UC600 on a Tracer SC, the Tracer SC will assign the BACnet device ID based on the Tracer SC rotary address, the link number on which it is installed, and the Tracer UC600 rotary switch value. For example, the Tracer SC will create a BACnet device ID of 101030 under the following conditions:
  - The rotary dials on Tracer UC600 are set to 30 (0,3,0), which is also known as the rotary switch address.
  - The Tracer SC rotary switch value is “0,1,0”.
  - The Tracer UC600 is installed on link 1.
- Soft set the BACnet device ID by using the Tracer TU service tool or the Tracer BACnet Setup tool.

**Important:** *The Tracer UC600 BACnet device ID defaults to the value of the rotary switches if the BACnet device ID has not been soft set. If a device ID has been soft set, the rotary switches are no longer representative of the BACnet device ID.*

*When integrating Tracer UC600 with third party vendors refer to Tracer UC600 Protocol Implementation Conformance Statement (PICS), (BAS-PRG010).*

### Device ID Assignment for BACnet MS/TP Devices

Each unit controller must have a unique BACnet device ID. Tracer® SC automates the process by calculating a unique device ID for each unit controller and then saving the device ID to memory in each device.

BACnet MS/TP device IDs are calculated using the following three sets of values:

- The Tracer SC rotary switch value (1 to 419)
- The Tracer SC BACnet MS/TP link number (1 to 2)
- The unit controller rotary switch value (1 to 127)

The three values are joined together to form the BACnet device ID for the unit controller as shown in the following table.

Tracer SC rotary switch value (21)	0	2	1				
Tracer SC BACnet MS/TP link number (1)				1			
Unit controller rotary switch value (38)					0	3	8
<b>BACnet Device ID: 211038</b>	0	2	1	1	0	3	8

### Device ID Assignment for BACnet/IP Devices

Each unit controller must have a unique BACnet device ID. Tracer SC/SC+ automates the device ID assignment process for Trane unit controllers by calculating a unique device ID for each unit controller and then saving the device ID to memory in each device.

For devices communicating over BACnet/IP, Tracer SC/SC+ calculates the device ID using the BACnet network number defined for Ethernet port 1 and the unit controller rotary switch value. The Tracer SC/SC+ rotary switch value is not used in the device ID calculation for IP devices.

BACnet/IP device IDs are calculated using the following two sets of values:

- The BACnet network number for Ethernet 1. (This number can be changed by the user).
  - Tracer SC defaults the BACnet IP network number as 1, and under most circumstances it is not changed.
- The unit controller rotary switch value (1 to 999). The Tracer SC/SC+ rotary address is not used to calculate BACnet/IP device IDs.

The following table shows this process using a Tracer UC600 unit controller.

BACnet network number Eth port 1 (1)		1			
Unit controller rotary switch value (42)			0	4	2
<b>BACnet/IP Device ID: 01042</b>	0	1	0	4	2



## Installing the Tracer UC600 Programmable Controller

---

### Device ID Assignment for Wireless Devices

For devices connecting over a wireless network, Tracer SC calculates the device ID using the BACnet network number and the rotary switch value of the wireless device.

The example in the following table illustrates this process.

BACnet network number of Tracer SC wireless network (13)	1	3			
Wireless unit controller rotary switch value (001)			0	0	1
<b>Wireless unit controller Device ID set by the Tracer SC (app): 13001</b>	1	3	0	0	1

### Rotary Dial Address Settings for Non-Trane Front-end Systems

For non-Trane front-end systems, the Max Master value must be greater than the unique address settings from the rotary dials. Although 999 is possible from the dials, the maximum allowed number by BACnet is 127.

The Max Master is not adjustable in front-end systems. For example, if the rotary switch value is 101 and the front-end system has a Max Master value of 100, the device will not be discovered.

Many systems have a minimum BACnet device ID value. Ensure that the device ID is greater than this value.

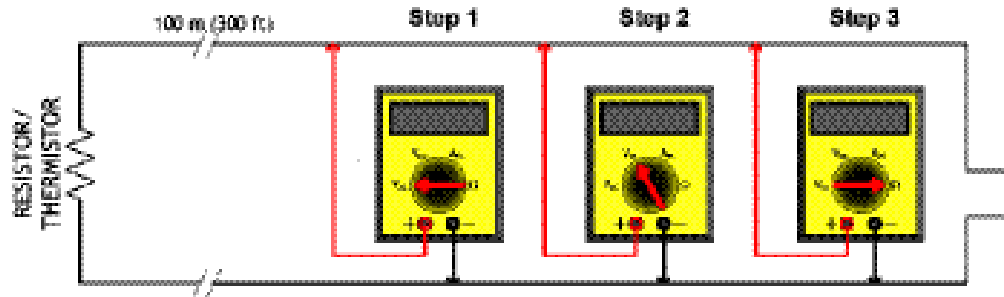
# Tracer UC600 Pre-power Checks

To avoid equipment damage, a pre-power check for inputs and outputs is recommended before applying power to the Tracer UC600. Before applying power, check for the following:

- All thermistors; check for resistance by using a digital multimeter (DMM). At room temperature, the resistance reading will be approximately 11 k $\Omega$  for a Trane thermistor.
- Thumbwheels; range between 189  $\Omega$  and 890  $\Omega$ .
- Binary outputs; check for any shorts.
- Analog outputs; verify that AC voltage is not present and that the load does not have 24 Vac or 120 Vac.

This section provides illustrations and methods of how to check the Tracer UC600 points before connection has been made and power applied. The step numbers in each illustration correspond to the information in each table.

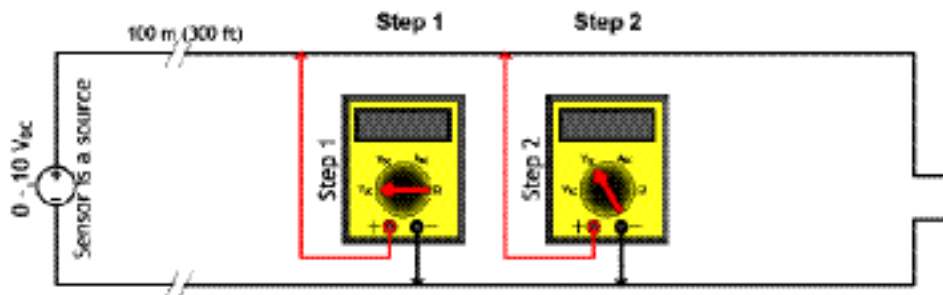
## Resistive Inputs



Checkout Procedure	Measurement	Expected Value
Step 1	Measure AC voltage across the resistive termination.	Vac $\gg$ 0.0 V AC voltage will affect further measurement.
Step 2	Measure DC voltage across the resistive termination.	Vdc $\gg$ 0.0 V DC voltage will affect further measurement.
Step 3	Measure the resistance across the resistive termination.	Compare the measured resistance with the expected value based on the manufacturer's specification and current conditions.

## Voltage Inputs

The sensor senses the voltage and is powered.

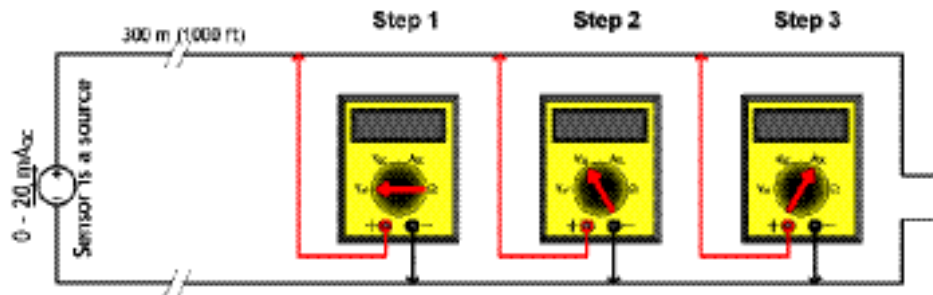


## Tracer UC600 Pre-power Checks

Checkout Procedure	Measurement	Expected Value
Step 1	Measure AC voltage across the voltage input.	VAC $\approx$ 0.0 V AC voltage will affect further measurement.
Step 2	Measure DC voltage across the voltage termination.	Compare the measured voltage with the expected value based on the manufacturer's specification and current conditions.

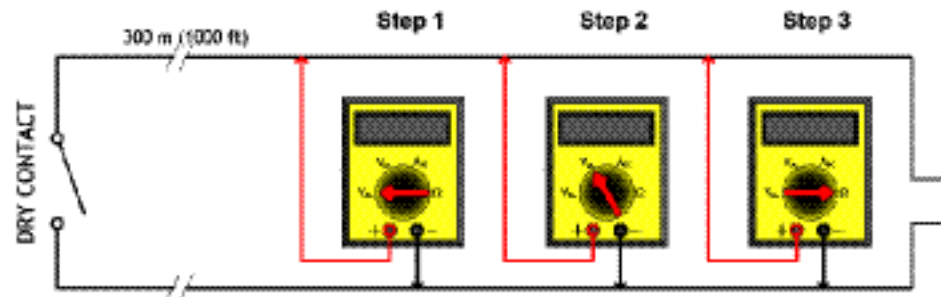
## Current Inputs

The sensor sources 4–20 mA and is powered.



Checkout Procedure	Measurement	Expected Value
Step 1	Measure AC voltage across the current input.	Vac $\approx$ 0.0 V AC voltage will affect further measurement.
Step 2	Measure the DC current across the current input.	Compare the measured current with the expected value based on the manufacturer's specification and current conditions.

## Binary Inputs





**Tracer UC600 Pre-power Checks**

<b>Checkout Procedure</b>	<b>Measurement</b>	<b>Expected Value</b>
Step 1	Measure AC voltage across the resistive termination.	Vac $\approx$ 0.0 V AC voltage will affect further measurement.
Step 2	Measure DC voltage across the resistive termination.	Vdc $\approx$ 0.0 V DC voltage will affect further measurement.
Step 3	Measure the resistance across the resistive termination.	contact open = infinity ( $\infty$ ) contact closed = shorted ( $0 \Omega$ )



# Power Budget Check in an Un-powered State

This section provides information about the power budget consumption for Tracer UC600 in an un-powered state.

## Calculating AC Power Consumption

Tracer UC600, along with the 24 Vac transformer, can draw up to 26 VA AC power. Observe the following rules when calculating AC power:

- Each Tracer UC600 can power a maximum of two additional modules (XM30, XM32, WCI); reserve 8 VA for this application.
- Additional expansion modules require an additional power supply module (PM014).
- Each Tracer UC600 can power a maximum of 10 points, configured as 4-20 mA in/out (loop-powered).

Each of the components in the following table requires a specific amount of power (VA) from the 24 Vac transformer. The following table breaks down the power requirement for each, assuming that:

- Universal inputs (UI) and universal input/outs (UI/O) draw at most, 20 mA.
- Binary outputs (BO) are not loaded; pilot relays are used.
- Expansion modules will draw full power.

**Table 3. UC600 power draw (transformer sizing)**

Component	Quantity and Type of Input/Output	VA Draw Per Input/Output	Maximum Total VA Draw (24 Vac)
Tracer UC600 Board	UC600 (alone)		5.5 VA
	8 Universal Inputs	0.8 VA	6.4 VA
	6 Universal/Analog Outputs	0.8 VA	4.8 VA
	4 Binary Outputs	0.3 VA	1.2 VA
	1 Pressure Input (Kavlico)	0.1 VA	0.1 VA
<b>Subtotal for Tracer UC600</b>			<b>18.0 VA</b>
Tracer TD7 display			21.0 VA
Expansion Modules (Maximum of 2)			8.0 VA
Additional 24 Vac needs, such as actuators and additional VA requirements.			
<b>Total for Tracer UC600 + expansion modules + end devices</b>			<b>47.0 VA + additional 24 Vac</b>

## Calculating DC Power Consumption

Tracer UC600 is capable of providing 600 mA of power. Observe the following rules when budgeting for DC power:

- The UC600 can power a maximum of two small modules (WCIs, expansion modules) and a maximum of 10 points configured as 4-20 mA In/Out (loop powered), simultaneously.
- Include any additional devices where the UC600 is providing 24 Vdc that are not part of the current loop.

Use the following table to help determine your DC power supply needs.

**Note:** If additional 0-20 mA inputs are needed, expansion modules can be powered from a PM014 power supply module instead of the UC600. See the "Tracer Expansion Modules IOM," BAS-SVX46-EN, for more details.

## Power Budget Check in an Un-powered State

**Table 4. DC power budget worksheet**

<b>Component</b>	<b>No. of terminations</b>	<b>mA power draw</b>	<b>Total mA</b>
Base electronics	1	x 146	146
Universal inputs/outputs		x 20	
XM30 expansion module		x 115	
XM32 expansion module		x 100	
WCI (can be powered by 24 Vac)		x 90	
Additional DC powered devices	1	x (varies)	
<b>Total DC power draw must be less than 600 mA</b>			



# Wiring and Powering the Tracer UC600

This section provides how to wire and safely power the Tracer UC600.

**Important:** If problems occur after powering, refer to “Commissioning and Troubleshooting in a Powered State,” p. 54.

**Note:** Before powering the Tracer UC600, review sections “Tracer UC600 Pre-power Checks,” p. 15 and “Power Budget Check in an Un-powered State,” p. 18.

<b>⚠ WARNING</b>
<b>Hazardous Voltage!</b> Failure to disconnect power before servicing could result in death or serious injury. Disconnect all electric power, including remote disconnects before servicing. Follow proper lockout/tagout procedures to ensure the power can not be inadvertently energized. Verify that no power is present with a voltmeter.

<b>⚠ WARNING</b>
<b>Proper Ground Connection Required!</b> Failure to follow instructions below could result in death or serious injury. After installation, ensure that the 24 Vac transformer is grounded through the controller. Measure the voltage between chassis ground and any ground terminal on the controller. Expected result: Vac <4.0 volt.

## Wiring Requirements

To ensure proper operation of the controller, install the power supply circuit in accordance with the following guidelines:

- The controller should receive AC power from a dedicated power circuit; failure to comply may cause the controller to malfunction.
- A dedicated power circuit disconnect-switch must be near the controller, easily accessible by the operator, and marked as the *disconnecting device* for the controller.
- Do not run AC power wires in the same wire bundle with input/output wires; failure to comply may cause the controller to malfunction due to electrical noise.
- 18 AWG copper wire is recommended for the circuit between the transformer and the controller.

## Transformer Requirements

- AC transformer requirements: UL listed, Class 2 power transformer, 24 VAC ±15%, device max load 26 VA. The transformer must be sized to provide adequate power to the UC600 controller (26 VA) and any external device outputs.
- DC power can be used for 4-20 mA devices and up to two expansion modules (XM30, XM32) and one WCI.
- Include in the total power budget any devices that are powered from the 24 VAC terminal.
- CE-compliant installations: The transformer must be CE marked and SELV compliant per IEC standards.

<b>NOTICE</b>
<b>Equipment Damage!</b> Sharing 24 Vac power between controllers could result in equipment damage.

A separate transformer is recommended for each controller. The line input to the transformer must be equipped with a circuit breaker sized to manage the maximum transformer line current. If a single transformer is shared by multiple UC600 controllers:

- The transformer must have sufficient capacity.
- Polarity must be maintained for every UC600 controller powered by the transformer.

If a technician inadvertently reverses polarity between controllers powered by the same transformer, a difference of 24 Vac will occur between the grounds of each controller. The following symptoms could result:

- Partial or full loss of communication on the entire BACnet MS/TP link
- Improper function of UC600 outputs
- Damage to the transformer or a blown transformer fuse

## Tug Test for Terminal Connectors

If using terminal connectors for wiring the controller, strip the wires to expose 1/4 in. (7 mm) of bare wire. Insert each wire into a terminal connector and tighten the terminal screw. A tug test is recommended after tightening terminal screws to ensure that all wires are secure.

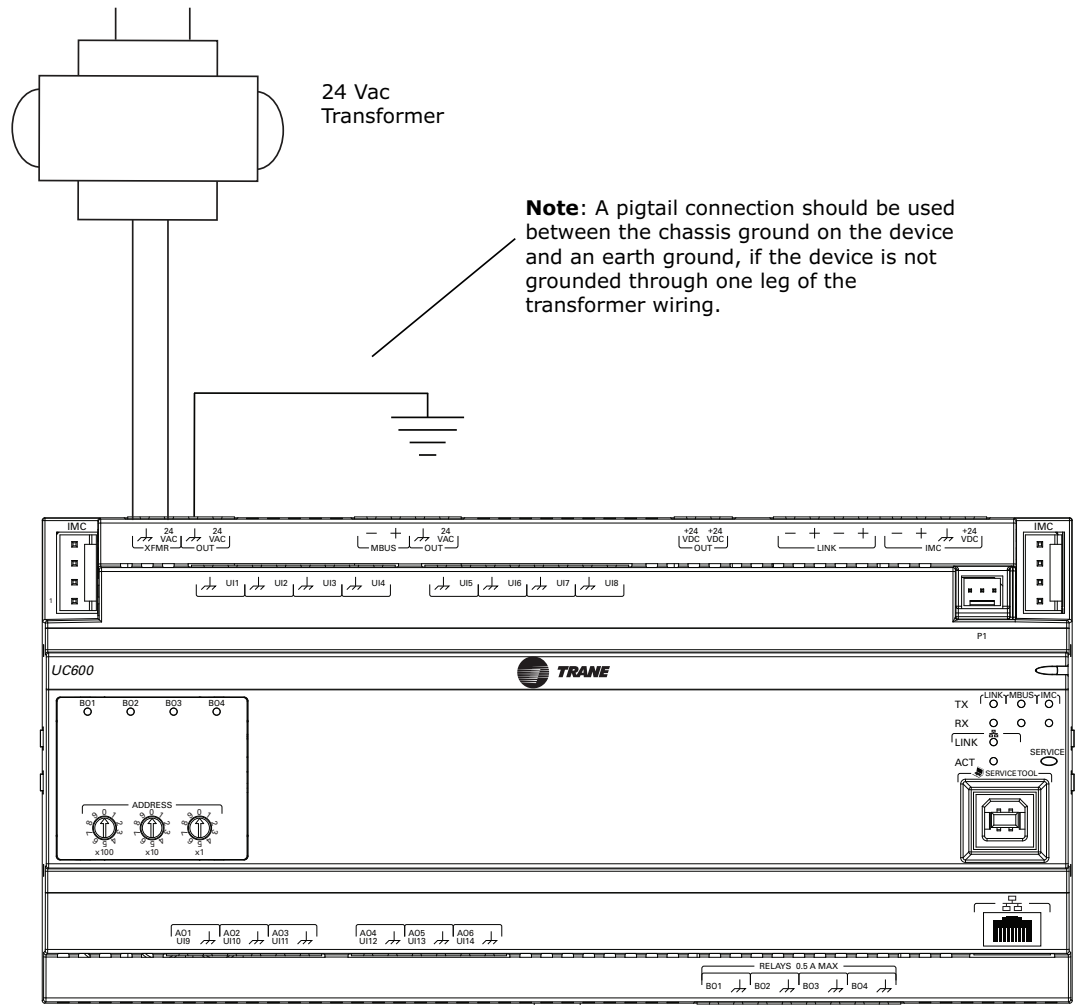
## Wiring AC Power to Tracer UC600

1. Connect both secondary wires from the 24 Vac transformer to the XFMR terminals on the device. Refer to [Figure 5, p. 22](#).
2. Ensure the device is properly grounded.

**Important:** *This device must be grounded for proper operation! The factory-supplied ground wire must be connected from any chassis ground connection on the device to an appropriate earth ground (⏏). The chassis ground connection used may be the 24 Vac transformer input at the device, or any other chassis ground connection on the device.*

**Note:** *The device is not grounded through the DIN rail connection.*

**Figure 5. Wiring AC power to the transformer**



## UC600 Startup and Power Check

1. Verify that the 24 Vac connector and the chassis ground are properly wired.
2. Set a unique and valid address for each device.
3. The BACnet Device ID is set by combining the Tracer SC+ rotary switch address, link number and UC600 rotary switch address, or soft-set through Tracer TU. A unique MAC address is required and set by the rotary address switches of the UC600. Valid rotary switch settings are "001" through "127".

**Important:** A duplicate address or a "000" address will cause communication problems on a BACnet link. The Tracer SC/SC+ will not discover all devices on the link and the installation process will fail after discovery.

The default baud rate is 76.8 kbs.

4. Remove the lockout/tagout from the line voltage power to the electrical cabinet.
5. Apply power to the UC600.

When communication between devices occurs, the transmitting (TX) and receiving (RX) LEDs blink. The following table describes the Tracer UC600 LED activity and indicators.

Power LED	Indicates...
Solid Green	Normal operation.
Blinking Red	Alarm or fault is present.
Solid Red	Low voltage or malfunction.
<b>Sequence on Power-up:</b> Illuminates red, then flashes green, then solid green.	
Service LED	Indicates...
Solid Green	LED has been pressed and remains on until powered down.
Blinking Green	Controller is not accessing application software.
Not illuminated	Normal operation.
<b>Sequence on power-up:</b> Does not illuminate during power-up.	

### BACnet MS/TP Link Wiring

BACnet MS/TP link wiring must be field-supplied and installed in compliance with the National Electrical Code and local codes. In addition, the wire must be of the following type: low-capacitance, 18-gauge, stranded, tinned-copper, shielded, twisted-pair.

**Important:** BACnet links are polarity sensitive; consistent wiring polarity must be maintained between devices.

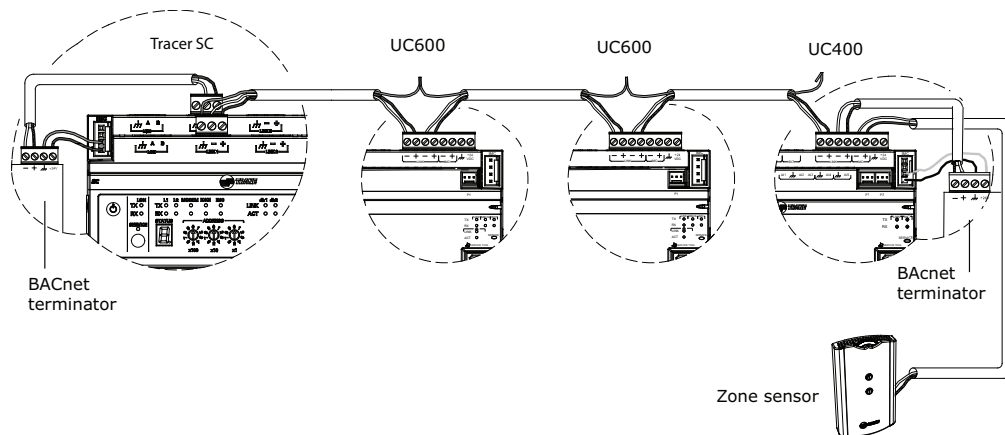
*For more details on this topic, refer to the BACnet Best Practices and Troubleshooting Guide listed under .*

**Note:** A maximum of 20 UC600 controllers are allowed per Tracer SC (10 per MSTP link).

### BACnet/IP Wiring

Tracer UC600 versions 5.0 or higher firmware supports BACnet/IP over an Ethernet network. The controller requires a Cat5 Ethernet cable and an RJ-45 plug connector. See "[Appendix A: Configuring Tracer UC600 for BACnet/IP,](#)" p. 63 for more information.

**Figure 6. BACnet link wiring UC600, UC400, zone sensor**





# Wiring Inputs and Outputs

Wiring and configuration for Tracer UC600 inputs and outputs is described in this section. Refer to the following table for a complete list of device connections and descriptions of each type.

**NOTICE**

**Equipment Damage!**  
Failure to follow instructions below could result in damage to the controller, power transformer, or input/output devices due to inadvertent connections to power circuits. Remove power to the controller before making input/output connections.

All input/output wiring for the Tracer UC600 must meet the following requirements:

- All wiring must be in accordance with the National Electrical Code and local codes.
- Do *NOT* run input/output wires in the same wire bundle with AC-power wires.
- Use only 18–22 AWG (1.02 mm to 0.65 mm diameter), stranded, tinned-copper, shielded, twisted-pair wire.
- Binary output wiring must not exceed 1,000 ft. (300 m).
- Binary input and 0–20 mA input wiring must not exceed 1,000 ft. (300 m).
- Analog and 24 Vdc output wiring distances are dependent on the specifications of the receiving unit. Use shielding for analog and 24 Vdc outputs.
- Thermistor input and 0–10 Vdc input or output wiring must not exceed 300 ft. (100 m).

Type	Inputs	Outputs
Binary	1,000 ft (300 m)	1,000 ft (300 m)
0–20 mA	1,000 ft (300 m)	1,000 ft (300 m)
0–10 Vdc	300 ft (100 m)	300 ft (100 m)
Thermistor/Resistive	300 ft (100 m)	Not applicable

## Providing Low-voltage Power for Inputs/Outputs

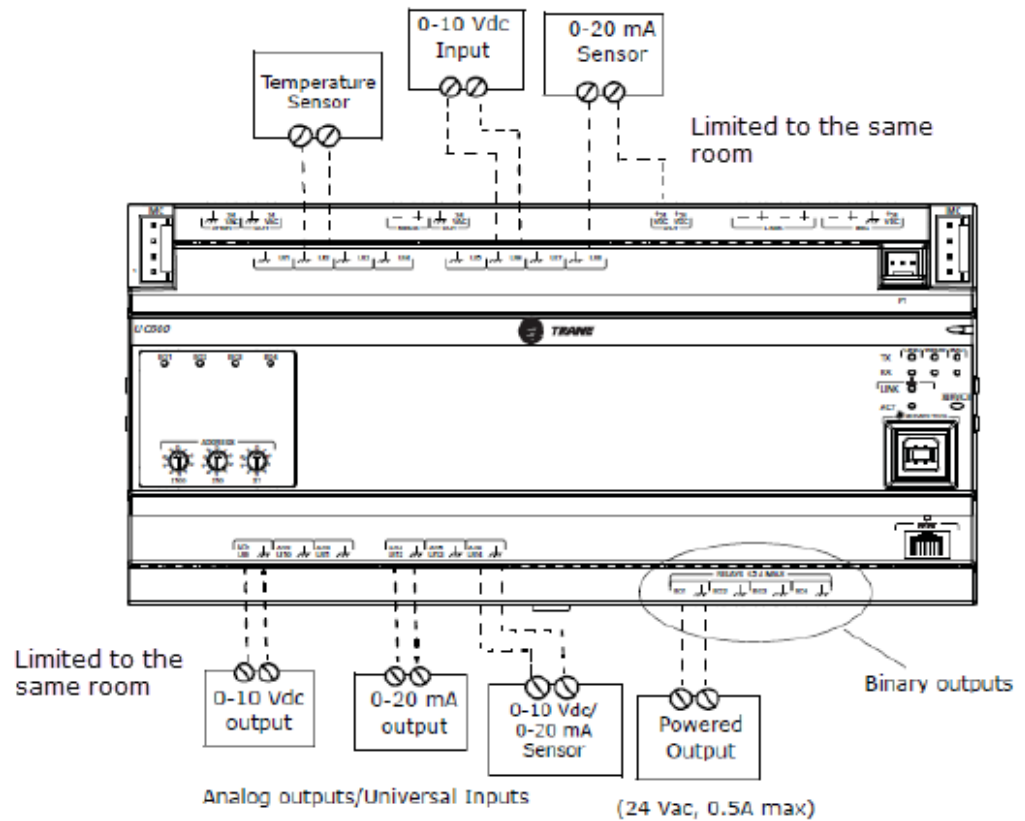
Tracer UC600 is capable of providing low-voltage power to the inputs/outputs. For limitations, refer to [“Calculating AC Power Consumption,” p. 18.](#)

**Note:** *More than one input or output can receive power from a given terminal. However, the only limitation is the total amount of supplied power.*



## Input and Output Wiring

Figure 7. Tracer UC600 wiring example



## Wiring Universal Inputs

Tracer UC600 has a total of 14 universal input and output terminals: eight universal inputs located on the upper tier and six universal input/output terminals on the bottom tier. Refer to "Hardware Terminations," p. 8 for device connections and ranges.

## Wiring Binary Inputs

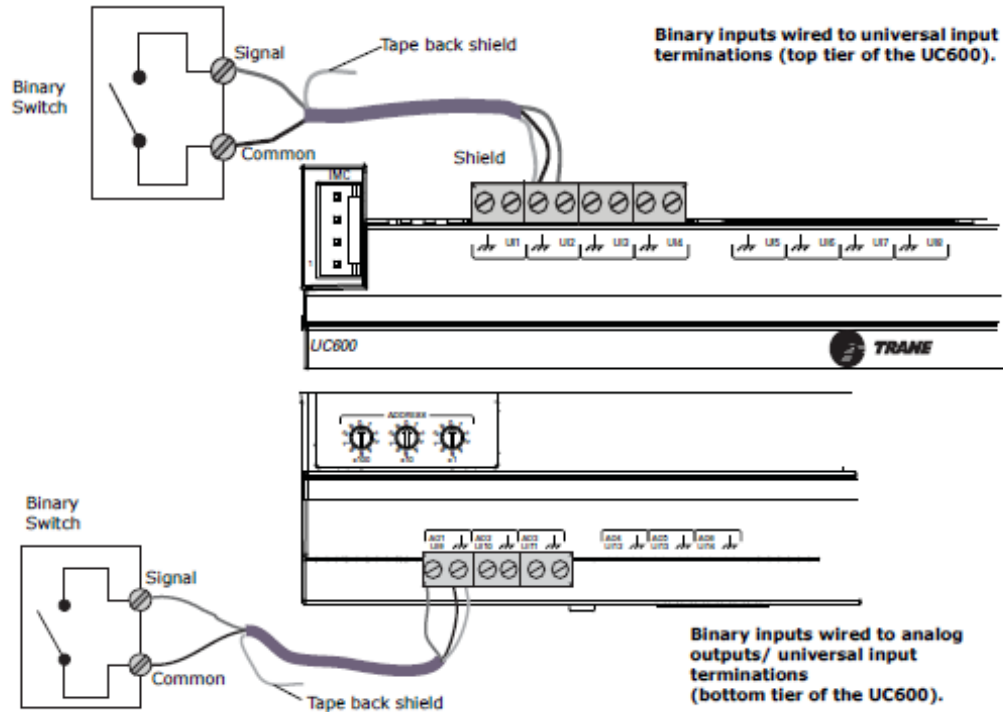
Binary inputs are two-state inputs, such as fan on/off or alarm resets.

1. Connect the common wire to a common terminal as shown below.

**Note:** Because the common terminals are in parallel, wiring can be made to any common terminal.

2. Connect the shield wire to a common terminal at the termination board and tape it back at the input device.
3. Connect the signal wire to an available input terminal.
4. Use the Tracer TU service tool to configure the binary input that references the corresponding hardware termination.

**Figure 8. Wiring binary inputs**



## Wiring 0–10 Vdc Analog Inputs

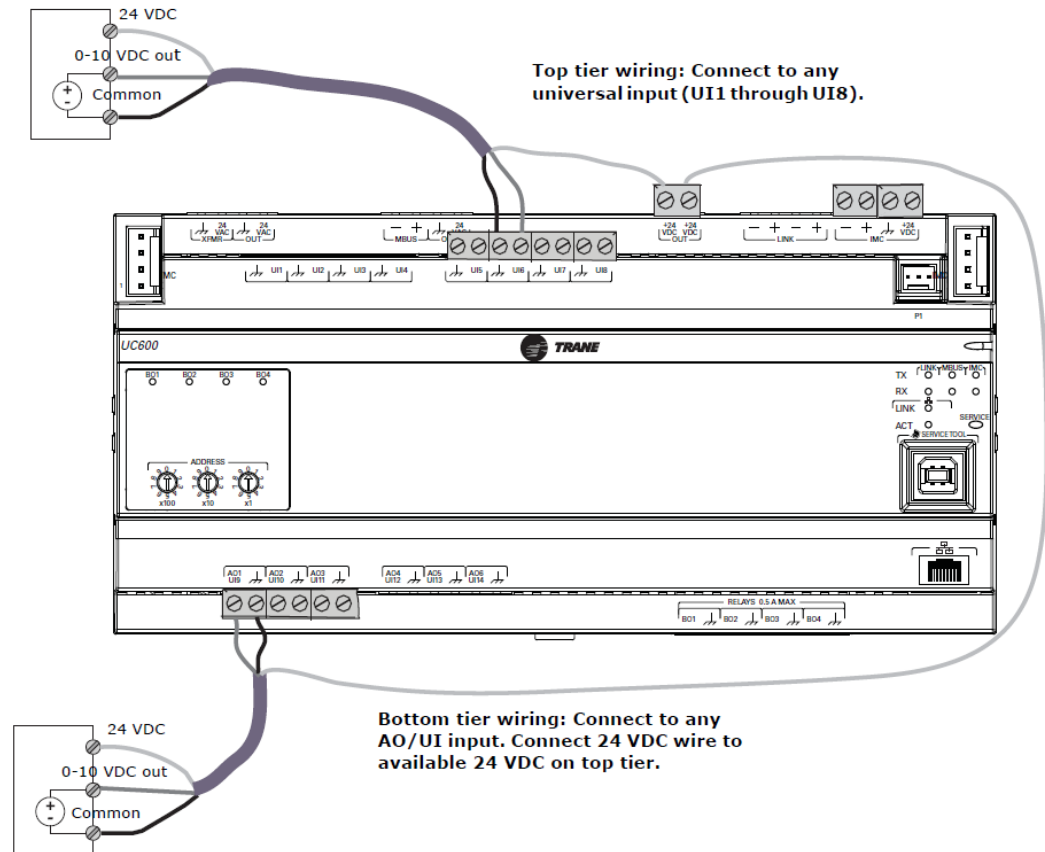
Connect 0–10 Vdc analog inputs to sensors such as indoor air quality sensors and pressure sensors. Wiring can be done on the top tier or the bottom tier by using a combination of universal and analog input terminations.

To wire a 0–10 Vdc analog input:

1. Connect the shield wire (as common connection) to a common terminal as shown in the following figure.
 

**Note:** Do not use the shield/ground conductor to carry current (as from a 24 Vdc source).
2. Connect the signal wire to an available input terminal.
3. Connect the supply wire to a 24 Vdc or 24 Vac terminal as required.
4. Use the Tracer TU service tool to configure the analog input that references the corresponding hardware termination.

**Figure 9. Wiring 0–10 Vdc analog inputs**



## Wiring 0–20 mA Analog Inputs

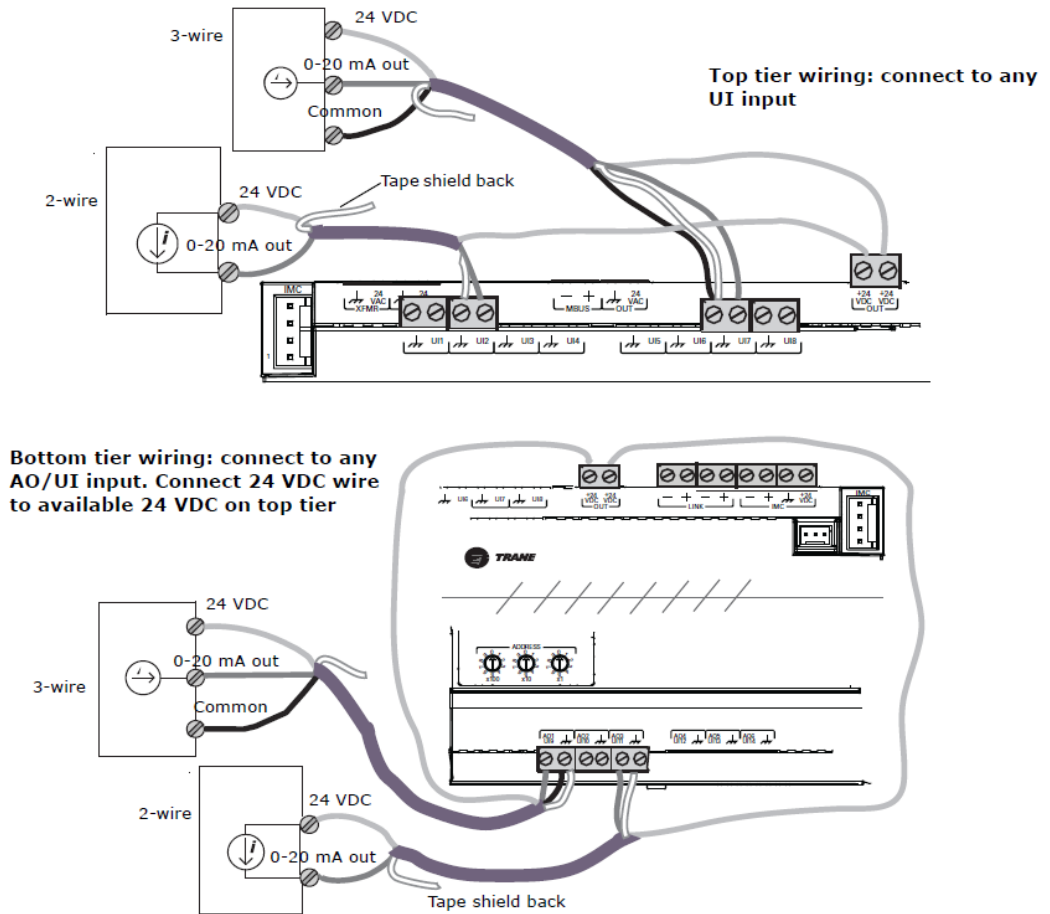
Connect any 0–20 mA analog input to sensors such as humidity sensors and pressure sensors.

1. Connect the shield to a common terminal at the terminal board and tape it back at the input device.

**Note:** Do not use the shield as the common connection. For 3-wire applications, use a 3-conductor cable with shield and for 2-wire applications, use a 2-conductor cable with separate shield.

2. Connect the signal wire to an available input terminal.
3. Connect the supply wire to a 24 Vdc or 24 Vac terminal as required.
4. Use the Tracer TU service tool to configure the analog input that references the corresponding hardware termination.

**Figure 10. Wiring 0–20 mA analog inputs**

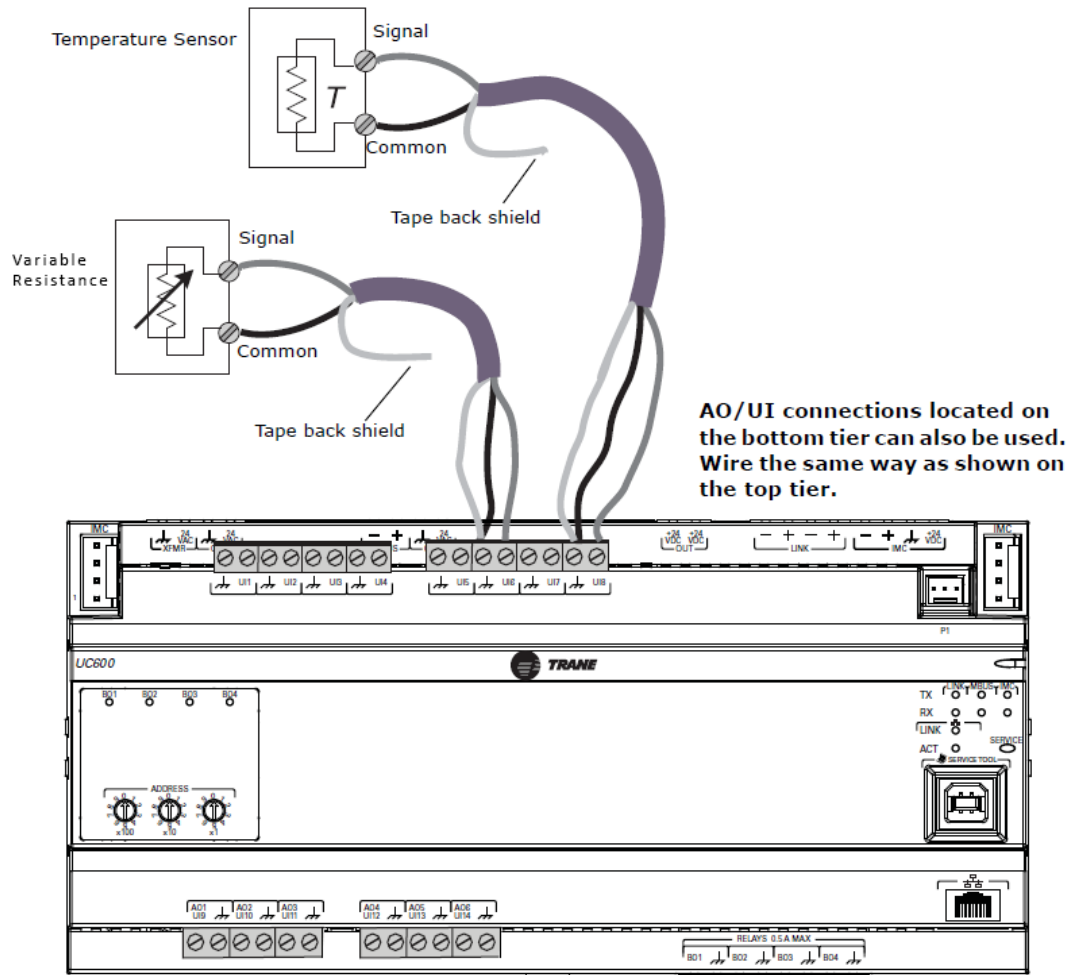


## Wiring Variable Resistance Analog Inputs

Variable resistance analog inputs include 10kΩ thermistors, resistance temperature detectors (RTD), and setpoint thumbwheels on zone sensors. To wire a variable resistance analog input:

1. Connect the shield to a common terminal at the terminal board and tape it back at the input device.
2. Connect the signal wire to an available input terminal.
3. Use the Tracer TU service tool to configure the analog input that references the corresponding hardware termination.

**Figure 11. Wiring variable resistance analog inputs**



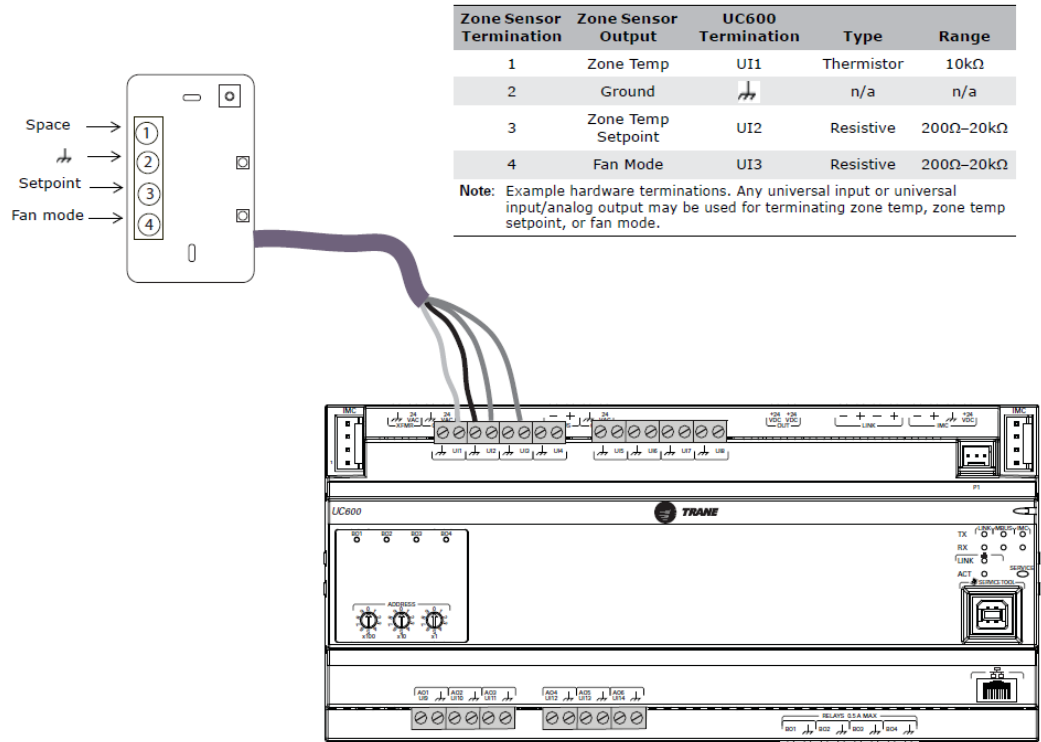
## Wiring Trane Zone Sensors

The table in the following figures shows the terminations on a Trane zone sensor and a typical Tracer UC600 application.

1. Connect the shield to a common terminal at the terminal board device.
 

**Note:** Do not use the shield as the common connection. For 3-wire applications, use a 3-conductor cable with shield and for 2-wire applications, use a 2-conductor cable with separate shield.
2. Connect the zone sensor wires to any available input (UI, UIO) terminals. Use the table in the following figure as an example.
3. Use the Tracer TU service tool to configure the analog input that references the corresponding hardware termination.

Figure 12. Wiring Trane zone sensors

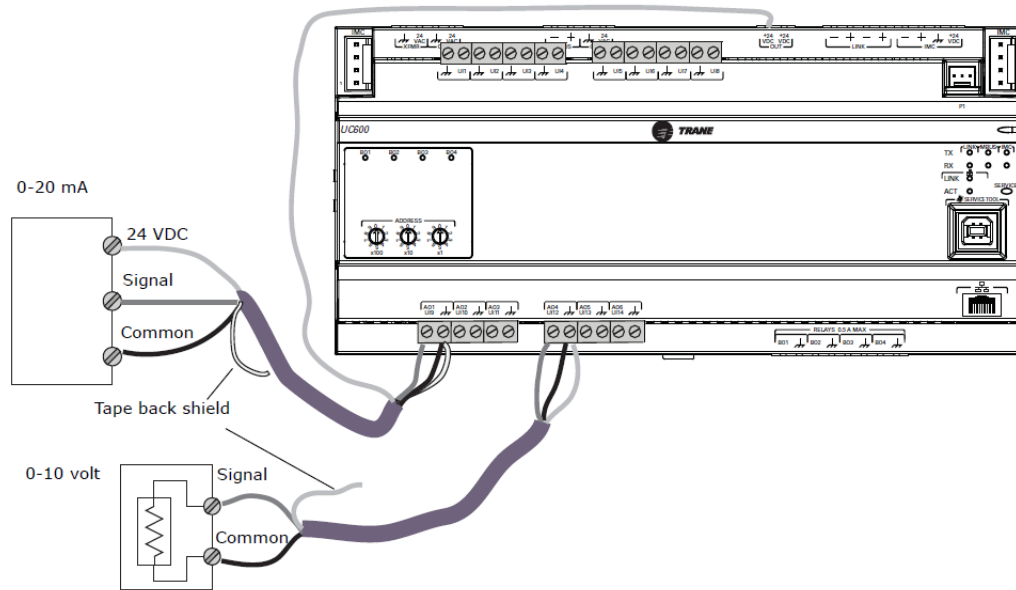


## Wiring Analog Outputs and Pulse Width Modulating Outputs

Tracer UC600 has six analog output terminations. These outputs can be used for 0–10 Vdc outputs or 0–20 mA outputs and to control actuators or secondary controllers. To wire an analog output:

1. Connect the shield to a common terminal at the terminal board and tape it back at the input device.  
*Note: Do not use the shield as the common connection. For 2-wire applications, use a 2-conductor cable with separate shield.*
2. Connect the signal wire to an available output terminal.
3. Connect the supply wire to a 24 Vdc or 24 Vac terminal as required.
4. Use the Tracer TU service tool to configure the analog output that references the corresponding hardware termination.

**Figure 13. Wiring analog outputs**



## Wiring Binary Outputs

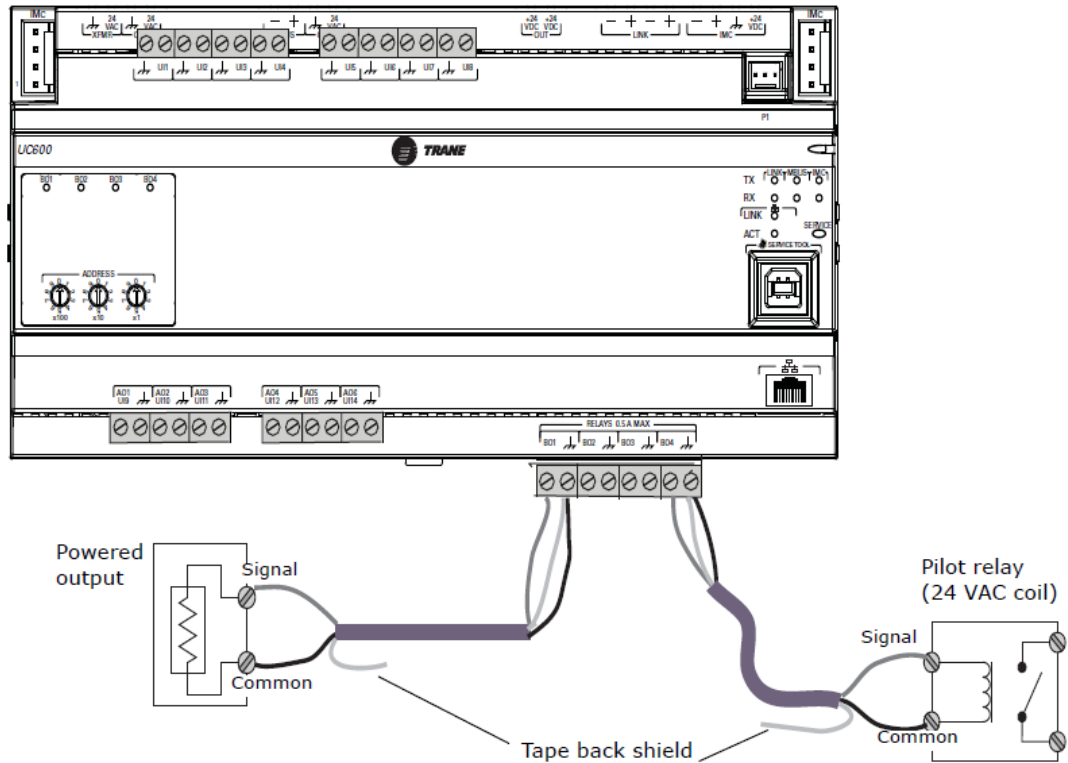
Tracer UC600 has four binary outputs that are used as powered (wet) outputs.

Controlling coil-based loads: Inrush current (the initial surge of a current into a load before it attains normal operating condition) can be three times greater, or more, than the operating current.

**Important:** Use pilot relays for dry contact outputs for load currents greater than 0.5 amperes and use powered outputs for load currents less than 0.5 amperes.

1. Connect the shield to a common terminal at the terminal board and tape it back at the powered output device.
2. Connect the signal wire to an available output terminal.
3. Use the Tracer TU service tool to configure the binary output for binary operation.

Figure 14. Wiring relays (binary outputs)



## Connecting Pressure Transducer Inputs

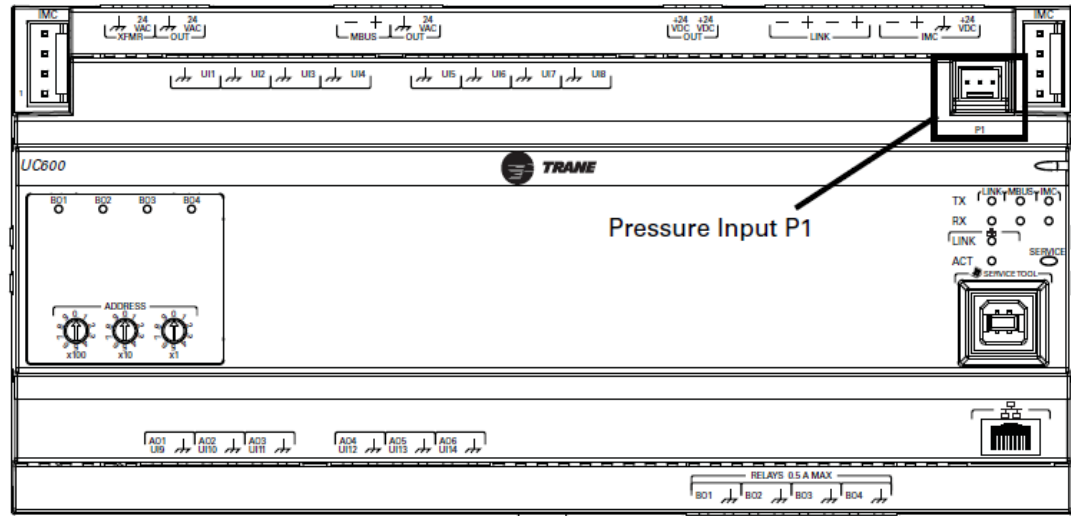
Tracer UC600 is equipped with one 3-pin, 5 Vdc pressure transducer input connection (P1) designed for Kavlico pressure transducers. Transducers measure duct static pressure in the Tracer UC600 equipment (VAV AHUs) that is detected from the connected sensor (mounted near the Tracer UC600).

**Important:** To ensure accurate data transmission, use Kavlico pressure transducers. Contact Trane for more details on pressure transducers.

To connect to the pressure transducer input, press the pressure transducer cable onto the pressure input (P1). Refer to the following figure.



Figure 15. Pressure transducer input on Tracer UC600





# Tracer UC600 Operation

## LED Descriptions and Activities

The following table provides a description of LED activity, indicators, and troubleshooting tips.

**Table 5. LED identification and interpretation**

LED type	LED activity	Indicates...	Troubleshooting/Notes
<b>Power</b>	Solid green	Normal operation	<i>Sequence on power-up:</i> Illuminates red, then flashes green, then solid green.
	Solid red	Low voltage or malfunction	
	Blinking red	Alarm or fault is present ( <i>*see note</i> )	
<b>Communication (Link, MBUS, IMC)</b>	TX (transmit) blinks green	Normal operation; blinks at a fixed rate when transferring data to other devices on the link	TX LED: Regardless of connectivity, the TX will blink as it searches for devices to communicate with.
	RX (receive) blinks yellow	Normal operation; blinks at a fixed rate when receiving data from other devices on the link	
	RX on solid (yellow)	Reverse polarity is present	
	LED not illuminated	The controller is not detecting communication	<ul style="list-style-type: none"> <li>• Cycle the power to reestablish communication.</li> <li>• Verify that the controller is capable of communicating with other devices on the link.</li> <li>• Check polarity and baud rate.</li> </ul>
<b>Service</b>	Solid green	LED has been pressed and remains on until powered down (does not affect normal operation)	
	LED not illuminated	Normal operation	
<b>Binary outputs (BO1 through BO4)</b>	Solid yellow	Relay coil energized	
	LED not illuminated	Relay coil de-energized or No command	
<b>Ethernet</b>	LINK on solid (green)	Valid Ethernet connection	
	ACT flickers (yellow)	Data transmission and reception	

**Note:** Points that are in an alarm state when the notification type is configured as “alarm” will cause the power LED to flash red. If the notification type of a point is configured as “event,” the power LED will not flash when the point is in an alarm state. Modbus is not supported at this time.

## Troubleshooting

The section provides troubleshooting solutions for problems that sometimes occur with the Tracer UC600.

### Communication Problems

**Problem:** Tracer UC600 is not communicating with Tracer SC, but can communicate with Tracer TU using a direct USB connection.

**Possible cause:** The “Soft Set Device ID” check box was unchecked after the Tracer UC600 was installed onto the Tracer SC.

**Possible solution:** Reinstall the Tracer UC600 device onto the Tracer SC.

- Verify that the Tracer UC600 device ID is set to the rotary address, which is found in TracerTU/controller/controller settings/protocol.

- Log on to Tracer SC and navigate to the **Devices** page; select the Tracer UC600 device from the list, then select **replace** from the actions button.

**Alternative cause:** The baud rate changed in the controller settings.

**Solution:** In Tracer TU, open the Controller Settings page. Set the baud rate to match the baud rate on the Tracer SC MS/TP link.

**Alternate Cause:** The rotary switch is not set properly or another device on the same MS/TP link is set to the same rotary address.

**Solution:** Verify that the rotary address is correct. If not, change the address and cycle power. If the device was previously installed in the Tracer SC, the device may need to be "replaced" from the Tracer SC **Devices** page.

**Alternate Solution:** If the device is set to the proper rotary address, then another device(s) could be using the same rotary address on the MS/TP link.

- Power down the Tracer UC600 and discover the link with Tracer SC to see if a duplicate device is present.
- Change address of duplicate device, then reapply power the Tracer UC600. If previously installed, the device may need to be replaced in the Tracer SC.

## Output Points

**Problem:** Output points are not being controlled by the Tracer UC600.

**Possible cause:** The output point was not configured properly in Tracer TU.

**Solution:** Verify the hardware configuration in Tracer TU and change as needed.

**Problem:** The value of an analog point reads correctly in Tracer TU but does not read correctly in the Tracer SC.

**Solution:** Verify that the dimensionality was set properly on the point configuration page of TU. Log on to Tracer SC and navigate to the **Devices** page; select the Tracer UC600 device from the list, then select **replace** from the **actions** button.

**Alternate solution:** Verify that the equipment template is pointing to the proper output point in the Tracer UC600.

**Problem:** The output point is out of service.

**Solution:** Place point in service from either Tracer TU or Tracer SC.

## Connection Problems

**Problem:** Tracer UC600 is not responding, communicating, or is unable to connect with Tracer SC or the Tracer TU service tool.

**Possible cause:** Defective application code in the controller.

**Possible solution:** Reload the application firmware.

- Power down the controller (make sure to disconnect the USB cable).
- Continuously hold down the service button pin while applying power. Press the service button until the power LED illuminates green. Connect with Tracer TU and reload the application firmware.

**Note:** *During the above process, the service LED will be green and the communication status LEDs will be inactive.*



# Configuring Tracer UC600 with Tracer TU

The Tracer TU service tool is comprised of tools that allow users to edit objects, configure equipment, customize TGP2 programs, and create and edit custom graphics. These functions are performed using the Device Navigation Tree and the TU Utility tab. For more detailed information about any of these functions and the TU service tool, refer to *Tracer TU Service Tool Getting Started Guide*, BAS-SVN025.

This section describes:

- Starting a session of TU and establishing a direct USB connection.
- Establishing a connection using Ethernet or LAN.
- Checking and Transferring Application Code.
- Configuring the Tracer UC600.
- Creating and editing points for the Tracer UC600.
- Monitoring and viewing the status of the Tracer UC600.
- Backing up files and replacing corrupt files (Backup and Restore).

## Starting a Session of Tracer TU

If you need to install the TU service tool, refer to the *Tracer TU Service Tool Getting Started Guide* (TTU-SVN01). This document will provide information about features, capabilities, and requirements of Tracer TU.

To start a Tracer TU session:

1. Connect the USB cable directly from the laptop to the Tracer UC600.
2. Click either the **Tracer TU** desktop icon or the **Tracer TU** program item in the Tracer TU group on the **Start** menu.
3. The Tracer TU splash screen appears briefly followed by the **Startup Task Panel** dialog box (see the following figure).
4. Select the **Direction Connection** radio button, if not already selected, for USB.

## Connecting Using Tracer SC or Tracer SC+

The following instructions describe a direct connection using an Ethernet cable (Tracer SC or Tracer SC+) or an indirect connection using an IP address over a local area network (LAN) on which the Tracer SC/SC+ resides. Tracer UC600 must be installed in the Tracer SC/SC+ and communication must be up. If necessary, refer to the *Tracer SC System Controller Installation and Setup Guide*, BAS-SVX31 or *Tracer SC+ System Controller Installation and Setup Guide*, BAS-SVX077.

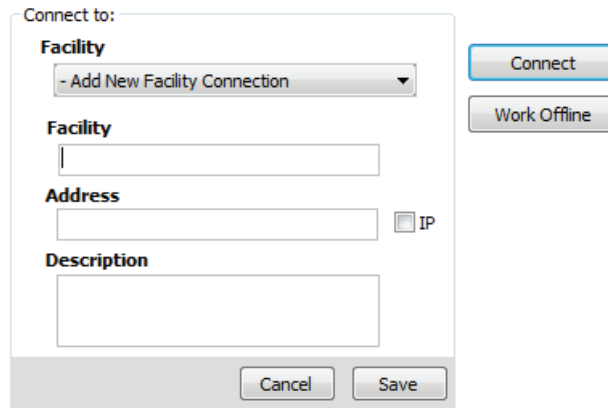
Using an Ethernet cable or a LAN connection requires *Adding a Facility* which is set up from the **Startup Task Panel** dialog box. To add a facility, you must know the IP address assigned to the Tracer SC/SC+. The Tracer UC600 must also be installed onto the Tracer SC/SC+ in order for the Tracer SC/SC+ to pass through by way of an IP address.

To add a new facility:

1. Click either the **Tracer TU** desktop icon or the **Tracer TU** program item in the Tracer TU group on the **Start** menu. The Tracer TU splash screen appears briefly followed by the **Startup Task Panel** dialog box.
2. Select the **Network Connection** radio button.
3. From **Facility** drop-down list (inside the **Connect to** frame), select **Add New Facility Connection** (see the following figure). This action expands the contents by adding additional fields.
4. Enter a facility name, IP address, and a description. (Select the IP check box if port forwarding will be used.)

5. Click **Save**. The facility is now saved and can be selected from the **Facility** down-down list.

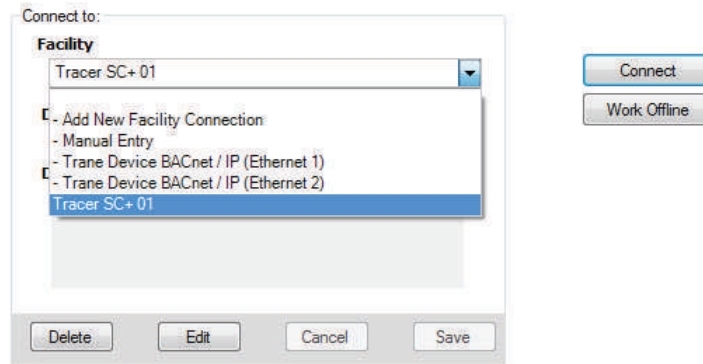
**Figure 16. Add new facility connection box on the startup task panel**



The dialog box is titled "Connect to:". It contains a "Facility" dropdown menu with the option "- Add New Facility Connection" selected. Below this are three text input fields: "Facility", "Address" (with an "IP" checkbox), and "Description". To the right of the dialog are two buttons: "Connect" and "Work Offline". At the bottom of the dialog are "Cancel" and "Save" buttons.

6. From the Facility drop-down list, select the new entry.

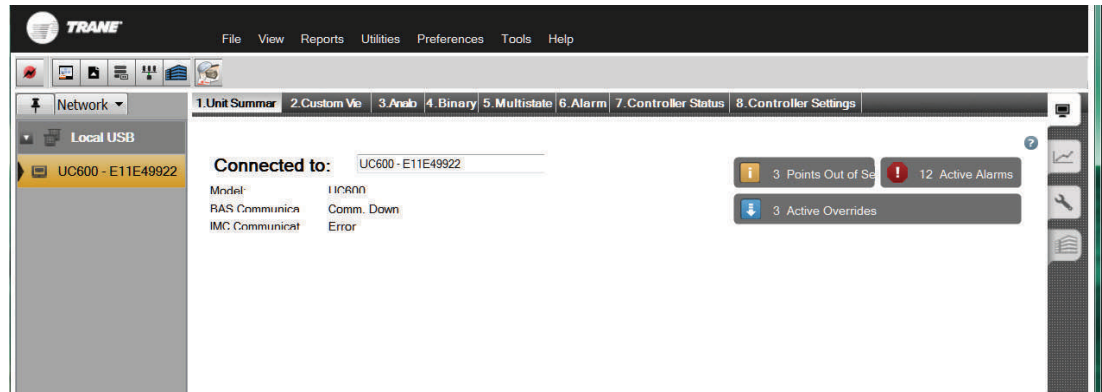
**Figure 17. Connecting to a facility**



The dialog box is titled "Connect to:". The "Facility" dropdown menu is expanded, showing a list of options: "- Add New Facility Connection", "- Manual Entry", "- Trane Device BACnet / IP (Ethernet 1)", "- Trane Device BACnet / IP (Ethernet 2)", and "Tracer SC+ 01" (which is highlighted). To the right of the dialog are two buttons: "Connect" and "Work Offline". At the bottom of the dialog are "Delete", "Edit", "Cancel", and "Save" buttons.

7. Click **Connect**. The Tracer SC/SC+ **Unit Summary** screen appears (see the following figure).
8. From the left navigation menu, click on the Tracer UC600 to which you want to connect.  
**Note:** *Passthru access can only occur if the Tracer UC600 is installed in the Tracer SC/SC+.*

**Figure 18. Unit summary screen**



## Appendix A. Installation and Connection Error Conditions

During installation or initial connection to a controller, you may encounter an error message or error condition. The messages with corrective actions are listed in the following table.

**Table 6. Tracer TU installation and connection error conditions**

Error Message/Condition	Corrective Action
Does not recognize USB hardware.	Respond as follows: <ul style="list-style-type: none"> <li>Install correct USB drivers by reinstalling using Tracer TU Setup.exe.</li> <li>If you get this message and have the correct USB drivers installed, make sure to wait for the controller to completely boot before attaching the USB cable.</li> </ul>
does not respond, or the screen is blank.	The phrase "Connected Local USB" should appear in the lower left hand corner of the screen. If it does not, the connection has been lost. Restart by clicking the Connection icon (lightning bolt) in the upper left of the application window.
Found New Hardware popup message (Windows 7)	Open the <b>Found New Hardware</b> wizard and verify that Tracer UC600 is displayed after " <b>This wizard helps you to install software for...</b> ". If the above text is displayed, select <b>Install the software automatically (Recommended)</b> . If the popup message does not appear, run the Tracer TU installation file: <b>Tracer TU Setup_x.x.xxx.exe</b> .
No application code present	Open the File Transfer Utility in Tracer TU service tool to transfer the Tracer UC600 application firmware.

## Upgrading Firmware

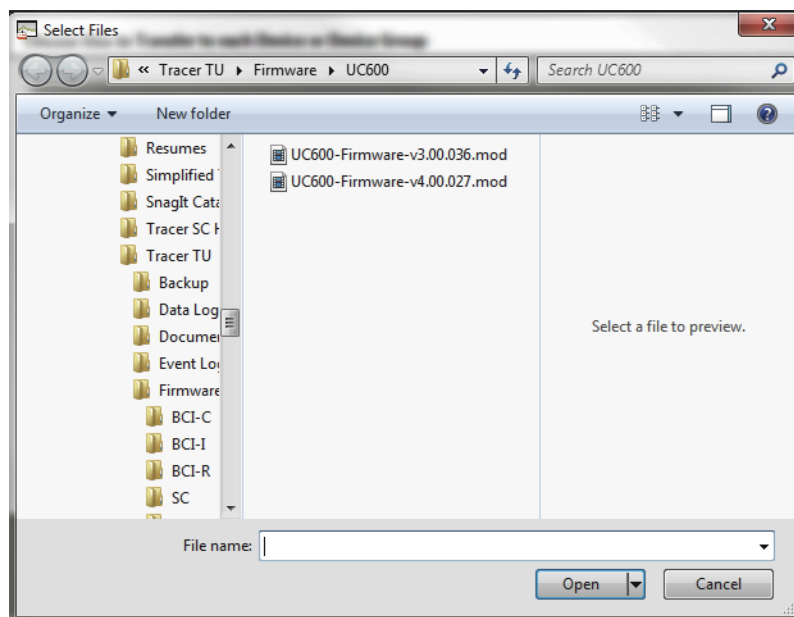
Firmware upgrades require the use of Tracer TU (version 8.0 or higher).

### To upgrade Tracer UC600 firmware:

1. Connect Tracer TU to Tracer UC600 using a USB connection (direct connect).
2. It is not recommended that the firmware be updated using single-link access or connecting through the Tracer SC.
3. Click the file transfer utility icon (📁) located on the upper left portion of Tracer TU, which opens the File Transfer wizard.
4. Select the Tracer UC600 from the **Selected devices** box. Click **Next**.
5. The **Choose files to Transfer to each Device or Device Group** dialog box appears.
6. Click **Browse**, which opens the **Selected files** dialog box.
7. Browse to the Tracer TU/Firmware/UC600 directory which is often found in My Documents.
8. Select the firmware file that has the .mod file extension. Version 2.0 firmware and higher uses the .mod extension (see the following figure).

**Important:** Selecting a lower version of firmware will clear all configuration in the controller.

**Figure 19. Browse for UC600 firmware**



9. Click **Open** to open the file (the firmware file).
10. Click **Start**.
11. Do not close Tracer TU or navigate away from the File Transfer page until the **File Transfer Summary** dialog box appears.
12. When the **File Transfer Summary** dialog box appears, click **Finish**.

## Configuring Tracer UC600 and Creating or Editing Points

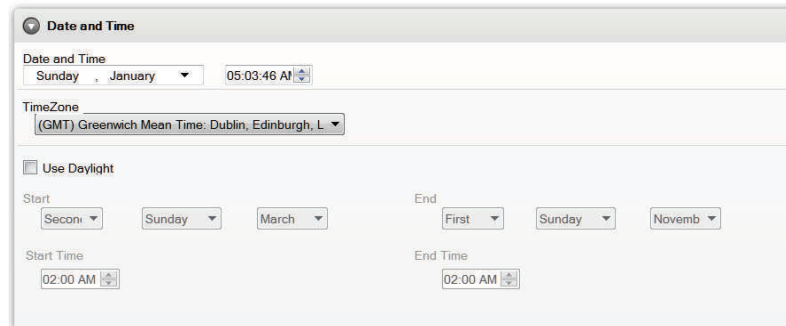
### Configuring Tracer UC600

Use the Tracer TU Controller Settings Utility to configure the Tracer UC600. This utility configures date and time, units of measure, and protocol.

1. Navigate to **Utilities > Status > Controller Settings**. The **Controller Settings** utility opens.
 

**Note:** The content of this screen is based on the type of controller that is connected and the system protocol used to communicate with the controller.
2. Click **Date and Time** to set the preferred date and time formats and then click **Send to Device**.
3. **Optional:** If daylight saving time is observed in the region where the Tracer UC600 resides, select the **Use Daylight** check box. Select dates and time from the drop-down lists that follow (see the following figure).
4. Click **Controller Units** and set the preferred units of measure and then click **Send to Device**.
5. Click **Protocol** to display a list of protocols that the Tracer UC600 uses to communicate with other controllers. For BACnet protocol, specify the **Baud Rate**, and then click **Send to Device**.
6. If the device ID must be set manually (typically for third-party integrations), click **Protocol** again and select the **Use Soft Set Device ID** check box. Enter a device ID, click **Save**, and then cycle the power.
7. To return to the rotary dial Device ID setting, click **Remove Soft Set ID**, click **Save**, and then cycle the power to the controller for changes to take effect.

**Figure 20. Configuring the date and time**




### Using Pre-packaged Solutions (PPS)

Pre-packaged solutions (PPS) is the preferred method to add pre-configured control applications that contain:

- Point configuration
- TGP2 code
- Template for Tracer SC installation
- Pre-defined custom reports
- Standard graphic for air handler unit (AHU)

PPS files for the Tracer UC600 are available for download on the My Ingersoll Rand corporate Intranet Web site and the PPS Configurator tool.

To add points using PPS:

1. Navigate to the Pre-packaged Solutions page from the Trane Hub page: <https://hub.ingersollrand.com/community/communities/trane-building-advantage/pre-packaged-solutions-pps>
2. Locate the Tracer UC600 PPS file, then select to save the file to your hard drive.
3. Open a session of Tracer TU.
4. Click on the **File Transfer Utility**  icon located in the upper left-hand side of the TU window and then click **Next**.
5. Click **Browse** and locate the PPS file that was previously saved. Highlight the file and click **Open**.
6. Click **Start Transfer**. A progress meter displays while the file downloads.
7. Navigate to the **Controller Settings Utility** screen and rename the controller.
8. From the **Controller Settings** screen, select **Protocols**. Verify that the **Softset Device ID** check box is *not checked*.
9. For input and output points, verify and set the appropriate hardware references for each.
10. Commission the AHU controls as normal.
11. Discover and install PPS into Tracer SC.  
The PPS AHUs should auto-install and not require a user-created template.

**Note:** If adding additional points into the PPS programs it is necessary to first auto-install the device in the Tracer SC in order to load the template. Upon installation, the current template can be used as a basis for the custom template that contains the new points. This can be done by editing the template on the Device List page on the Tracer SC UI.

### Creating or Editing Points for the UC600

**Note:** Points are not pre-configured in the Tracer UC600 controller. Refer to [Table 7, p. 42](#) for the maximum number of each point type that can be created in a Tracer UC600.

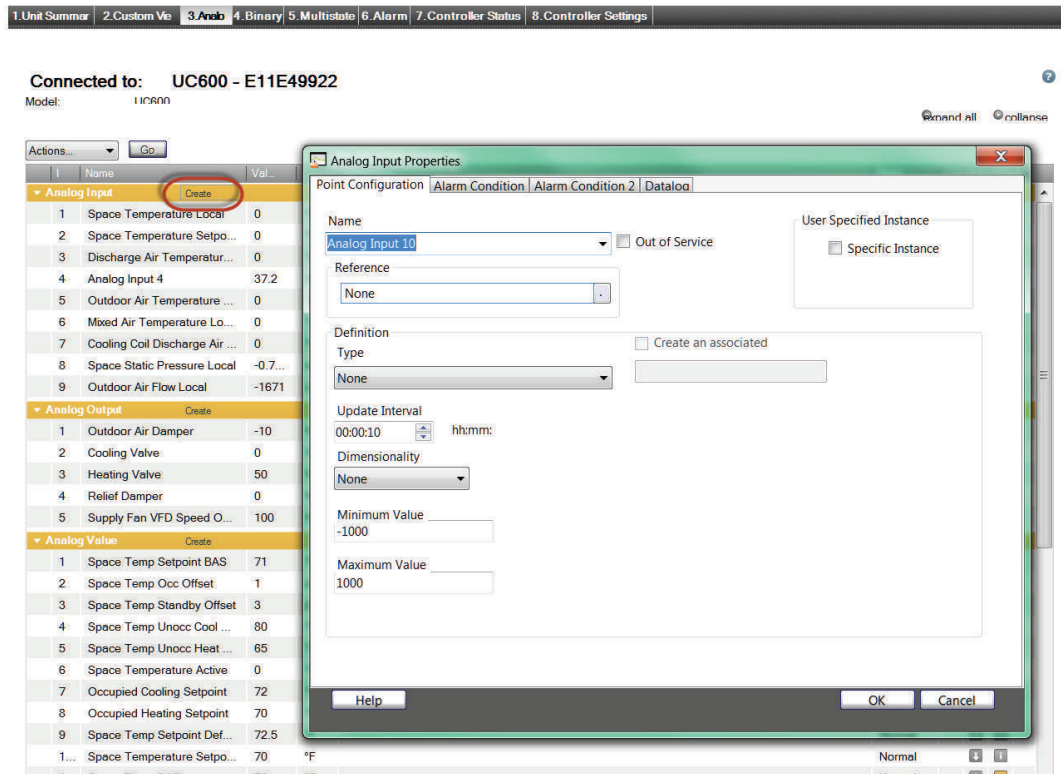
Use the Tracer TU Controller Settings Utility to create and edit points.



### To create a point:

1. Click the Status Utility tab on the right side of the Tracer TU window. The corresponding horizontal member tabs appear across the top of the viewing area.
2. Select the menu option for the type of point to create. Click **Create** on the title bar of the Input, Output, or Value box. The **Point Properties** dialog box appears (see the following figure).
3. In the **Point Properties** dialog box, enter a meaningful name in the **Name** field.
4. Specify a local or remote reference for the point.
5. Enter values for the required and optional settings as necessary and then click **OK**.

**Figure 21. Creating a new point**



6. Click **Save to File** to save the new point configuration or click **Send to Device** to send the new point configuration to the controller.

### To edit, copy, or delete a point:

7. Click the Status Utility tab on the right side of the Tracer TU window. The corresponding horizontal member tabs appear across the top of the viewing area.
8. Select the menu option for the type of point to edit. Select the check box on the left side of the row of the point you want to edit.
9. Select the **Edit** option from the **Action** drop-down menu and then click **Go**.
10. The **Point Properties** dialog box appears.
11. Edit the individual settings you want to change and then click **OK**.
12. Click **Save to File** to save the new point configuration or click **Send to Device** to send the new point configuration to the controller.

**Table 7. Maximum number of points supported in Tracer UC600 by type**

Point Type	Point Maximum
Analog Input	160
Analog Output	80
Analog Value	160
Binary Input	160
Binary Output	80
Binary Value	160
Multistate Input	64
Multistate Output	64
Multistate Value	64

## Placing Points in Out-of-Service Mode

### Inputs/Outputs

The out-of-service mode disconnects the point from its reference, which has the following effect on input and output points:

#### Inputs

An input point no longer obtains the value from its reference; however, you are allowed to write a value to the point. This is primarily used for testing purposes.

#### Outputs

An output point will not push (write) its value to its output reference. The value of the point can be changed without affecting the referenced value.

**Note:** This will require the use of the priority table.

#### Values

Value objects will not accept a written value from applications on the controller, such as TGP2 or schedules. A remote application, such as Tracer TU or Tracer SC, allows you to write to a value object when out-of-service.

**Note:** This will require the use of the priority table.

## Creating Points to Monitor Communication and TGP2 Programs

Multistate points can be created to monitor expansion module (XM) communication, Tracer SC communication, and TGP2 programs as well as program states and results. When multistate input points are created that reference these properties, Tracer TU will automatically define the number of states and the state text, based on the selected property.

**Note:** Tracer TU Version 8.1 and Tracer UC600 Version 3.34 and higher are required for this functionality.

#### To create points for XM communication loss:

1. Open a session of Tracer TU.
2. Select the **Controller Settings Utility** tab from the vertical tab set located on the right side of the Tracer TU window.
3. Select the **Multistate** tab.
4. Click **Create** on the title bar. The **Point Properties** dialog box appears.
5. In the **Point Properties** dialog box, enter a meaningful name in the **Name** field
6. Click on the button in the **Reference** field. The **Reference** dialog box appears.
7. From the **Selection Tree**, select the appropriate XM module located under the **Device** node.
8. After the XM is selected, Communication Status appears in the **Available Properties** frame.

9. Click **Ok**, which returns you to the **Point Configuration** tab. Click **Ok** to return to the Multistate Point page.
10. Click **Send to Device** to send the new point configuration to the controller.

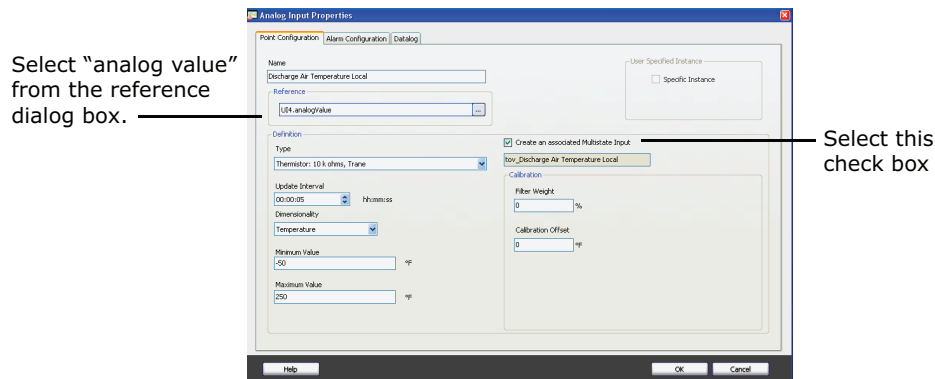
### Creating Points for Timed Override (TOV) and \*/\*\* Functions

Functionality for TOV and \*/\*\* (thumb wheel) functions can be configured for the UC600, UC400, XM70, and XM90. This is required in order for TGP2 when creating programs for TOV and \*/\*\*.

#### Creating Points for TOV Functions

1. Open a session of Tracer TU.
2. Select the **Controller Settings Utility** tab from the vertical tab set located on the right side of the Tracer TU window.
3. Select the **Analog** tab.
4. Click **Create** on the **Analog Value** title bar. The **Point Properties** dialog box appears.
5. In the **Point Properties** dialog box, enter a meaningful name in the **Name** field.
6. Click on the button in the **Reference** field. The Reference dialog box appears.
7. Select a point to reference, then select **analog value** from the **Available Properties** frame. Click **OK**.
8. In the Definition frame, select the **Create an associated Multistate Input** check box.
9. The required multistate input is automatically created (see the following figure).
10. Click **Send to Device** to send the new point configuration to the controller.

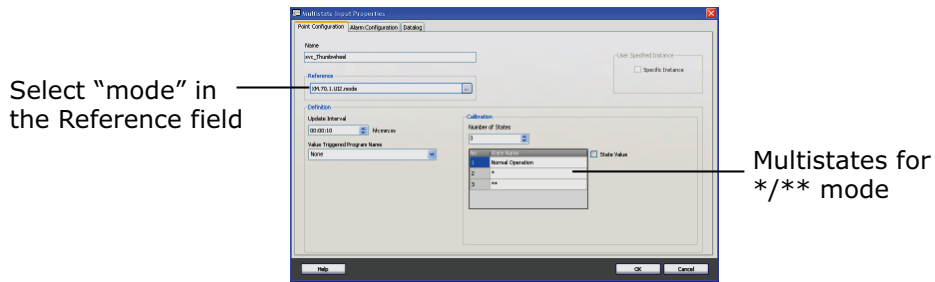
**Figure 22. TOV point configuration**



#### Creating Points for the \*/\*\* Function

1. Complete steps 1 through 6 as described in .
2. In the **Reference** dialog box, select **mode** from the **Available Properties** frame. Click **OK**.
3. In the Definition frame, select the **Create an associated Multistate Input** check box.
4. The required multistate input is automatically created (see the following figure).
5. Click **Send to Device** to send the new point configuration to the controller.

**Figure 23. \*/\*\* Point configuration**

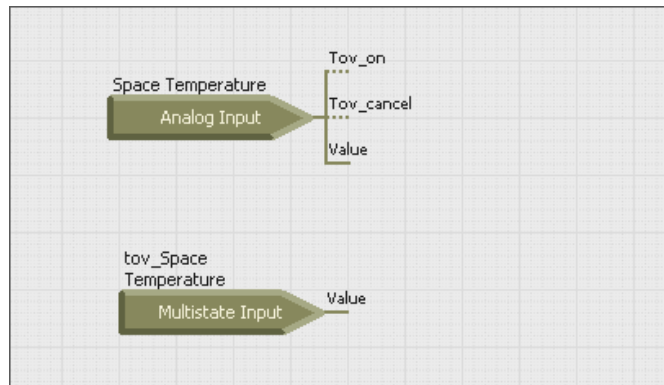


## Enabling TOV and \*/\*\* for TGP2 Programs

1. Open up a session of TGP2.
2. Select the point type from the left side bar; click and drag onto the editing space.
3. Right-click and then choose **Block Properties** from the menu. The **Point Properties** Dialog box appears.
4. Use the check boxes to select either TOV or \*/\*\*, depending on the point.
5. Click **Save**.
6. Continue to build the TGP2 program using the provided TGP2 Editor tools (see the following figure).
7. When finished, name and save your new TGP2 program.

*Note: For additional information, see "TGP2 Applications Guide, BAS-APG008-EN."*

**Figure 24. TGP2 program example**



## Monitoring and Viewing Status

Use the Status Utility tab to monitor and view the details of Tracer UC600 points list, alarms, and controller status.

### To monitor and view details:

1. Select the **Status Utility** tab from the vertical tab set located on the right side of the Tracer TU window.
2. Choose and select a member tab to view its list of information such as data type, value, unit, state, control, and details.

*Note: If viewing alarm status, this tab screen displays up to 100 active alarms. Alarms automatically reset when their condition returns to normal.*

## Backup

When you commission a system, it is strongly recommended that you create a backup file of the

initial configuration settings. If necessary, the backup file can be restored at a later date.

The backup procedure stores TGP2 files, all object configuration, setup files, and BACnet identification files. In addition, the data log configuration is stored in the backup file (data excluded).

**To back up files from the controller:**

1. Click the **Backup Wizard** icon in the upper left corner of the TU window. The **Welcome to the Backup Wizard** opens.
2. Click **Next**. The **Choose From Available Devices** dialog box appears.
3. Select the controller from which you will be backing up files.
4. Click **Browse** to navigate to the directory where the backup file will be saved. Select a location. click **Save**, and then click **Next**.
5. Click **Start**. A dialog box containing a progress meter appears. When the backup process is complete, a confirmation message appears.
6. Click **Finish**.

## Transfer Files (Restore)

You can restore files on the controller with backup or offline controller configurations files in the event that the controller becomes corrupt or must be replaced.

**To restore files to the controller:**

1. Click the **File Transfer Wizard** icon in the upper left corner of the TU window. The **Welcome to the File Transfer Wizard** opens.
2. Click **Next**. The **Choose From Available Devices** dialog box appears.
3. Select the controller that you will be restoring files for.
4. Click **Next** and then click **Browse** to navigate to the directory to locate backup files.
5. Select the appropriate files and then click **Open**. The **File Transfer** dialog box appears.
6. Select the file in the dialog box, and then click **Next**.
7. Click **Start**. A dialog box containing a progress meter appears. When the transfer process is complete, a confirmation message appears.
8. Click **Finish**.

**Note:** Backup files are controller dependent. Backup files made for a Tracer UC600 can only be restored on a Tracer UC600.

## Setting Up and Maintaining Schedules

Tracer UC600 supports three types of schedules: analog, binary, and multistate. Schedules can be set up and maintained in Tracer TU and the Tracer TD7 Display (see "Tracer TD7 Display, Installation, Operation, and Maintenance, "BAS-SVX50").

Schedules are based on a series of "events" that occur on each day of the week. An event is a change in a value at a specific time that can occur during any day of the week.

Each day is independent of the others and always begins with the schedule default value. The schedule default value is applied to each day of the week and is the value that the schedule defaults to at 12:00 a.m. for any given day. In addition to the schedule default, a maximum of ten unique events can be defined for each day of week.

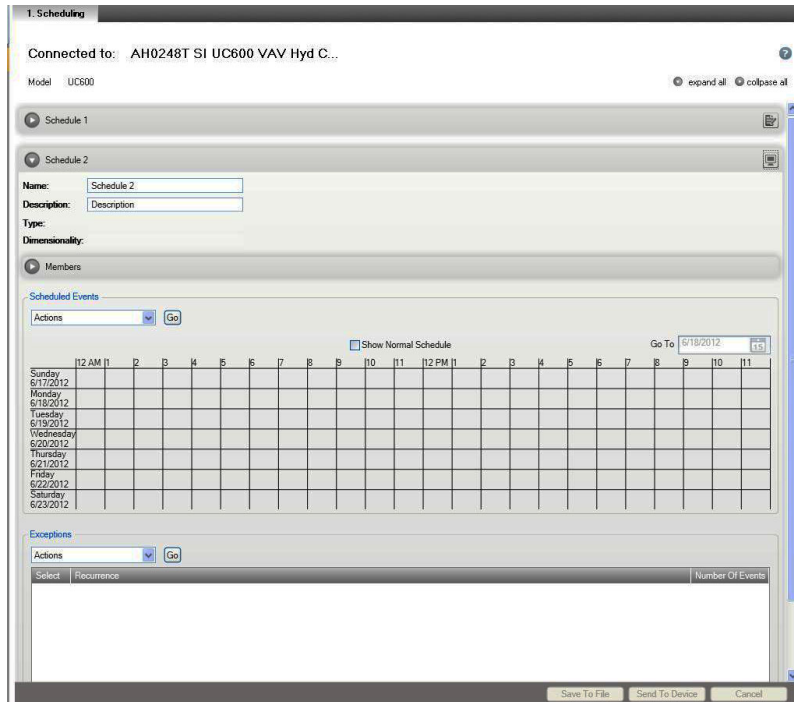
**Note:** Scheduling requires installation of Tracer UC600 version 3.0 or higher firmware.

### Creating a Weekly Schedule

1. Open a session of Tracer TU.
2. Select **Utilities > Equipment > Scheduling**.
3. Expand one of the unused Schedule boxes.
4. Click the Edit icon on the right of the Schedule box to activate the Name and Description

fields .

**Figure 25. Creating a new schedule**

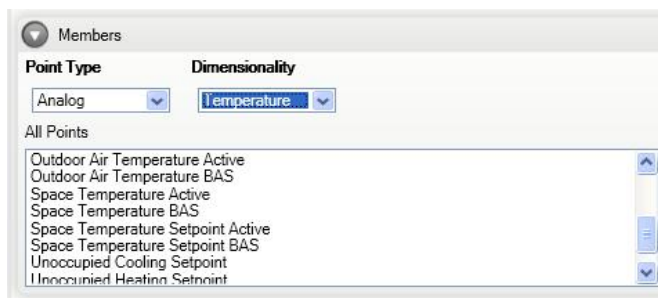


5. Enter a schedule Name and Description. The Type and Dimensionality boxes will be populated based on the selections you make in the Members group box.
6. Expand the Members group box and select the Point Type (Analog, Binary, or Multistate) from the Point Type drop-down list.

The point list is filtered to exclude all points other than the selected type. All members must be the same type.

If you selected analog as the point type, specify a dimensionality from the drop-down list (see the following figure). All analog members must have the same dimensionality.

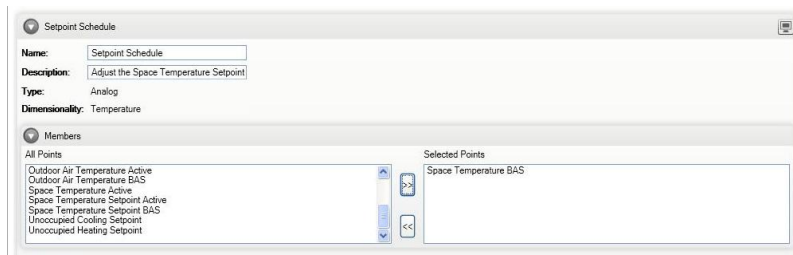
**Figure 26. Specifying member dimensionality**



7. Use the arrow controls to select up to 10 members by transferring points from the **All Points** box to the **Selected Points** box (Step 7).

The first member added will filter the remaining list of available members to display only members with the same point type and units.

**Figure 27. Adding members**



8. Click **Send to Device** to save the schedule. If working offline, click **Save to File**, which will save the schedule to the configuration file.

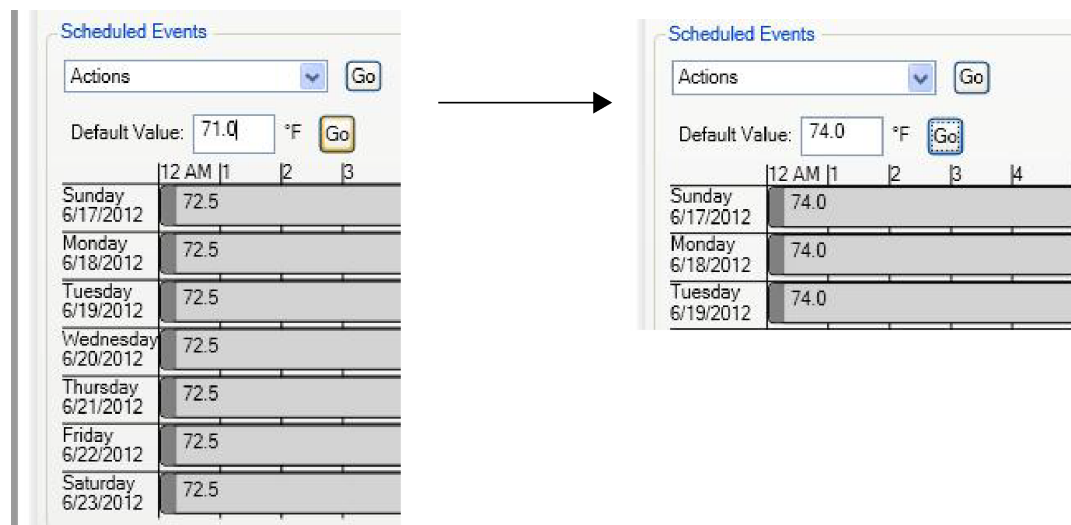
## Changing the Schedule Default Value

1. Open the schedule that in which you want to make changes.

When a schedule is created, the only event in the schedule is the schedule default value. This value occurs every day at midnight and cannot be removed. If the schedule default value is edited, the value applies to each day in the schedule.

2. From the **Default Value** drop-down list select a different value.
3. Click **Go**. The new value is applied to the schedule.

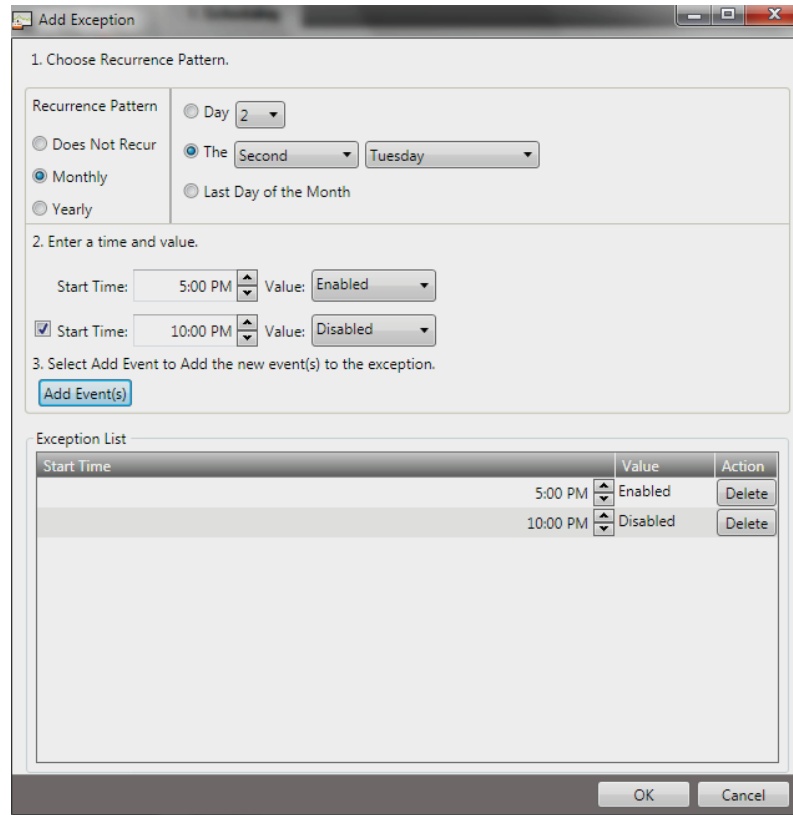
**Figure 28. Changing the schedule default value**



## Adding Exceptions

1. Open the schedule to which you want to add exceptions.
2. From the **Actions** drop-down list Select **Add Exceptions**. Click **Go** to display the **Add Exceptions** dialog box (see the following figure), or access from the Exception list page.

**Figure 29. Adding exceptions**



1. Choose Recurrence Pattern.

Recurrence Pattern  Day 2  Does Not Recur  Monthly  Yearly

The Second Tuesday  Last Day of the Month

2. Enter a time and value.

Start Time: 5:00 PM Value: Enabled

Start Time: 10:00 PM Value: Disabled

3. Select Add Event to Add the new event(s) to the exception.

Add Event(s)

Exception List

Start Time	Value	Action
5:00 PM	Enabled	Delete
10:00 PM	Disabled	Delete

OK Cancel

3. Select **Does Not Recur for a one-time exception** and then select the specific date in the **Occurs on Date** fly-out calendar on the right. Otherwise, select **Monthly** or **Yearly** recurrence options and specify the appropriate recurrence pattern on the right.

**Note:** *Exceptions that occur on the same date each year, such as Christmas Day and New Year's Day, are examples of exceptions that should be set as recurring.*

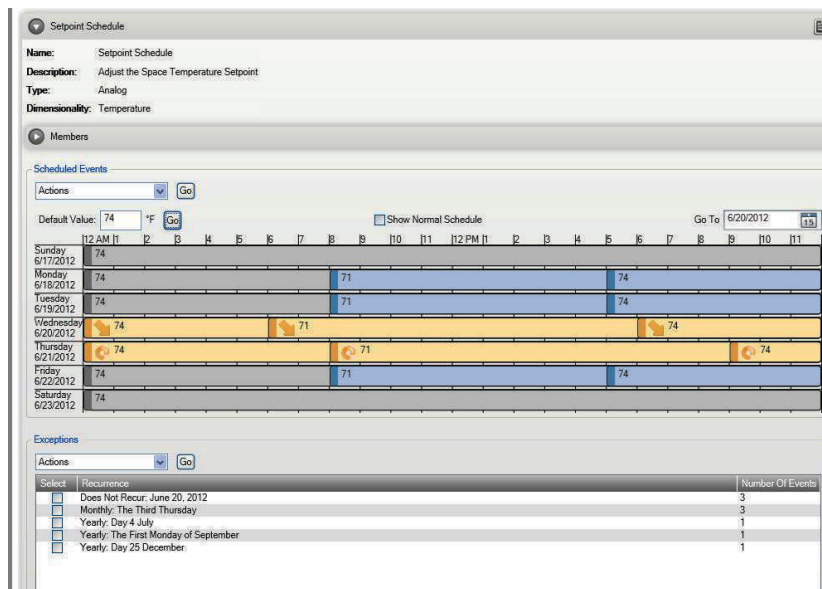
4. Enter the Start Time and Value. A second event can be added by selecting the corresponding check box.
5. Click **Add Event(s)**.  
The event(s) appear in the Exceptions list at the bottom of the dialog box.
6. Repeat steps 4 and 5 to add more events for an exception. Up to 10 events can be added.
7. Click **OK** when you have finished adding all exceptions and events.

**Note:** *It is best practice to add an event at midnight to ensure that the exception is in control of the events for the entire day.*

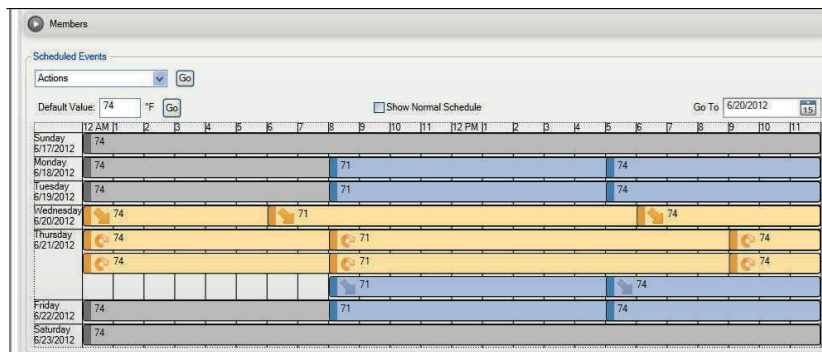


**Figure 30. Typical schedule (resultant) with events and exceptions**

Weekly View

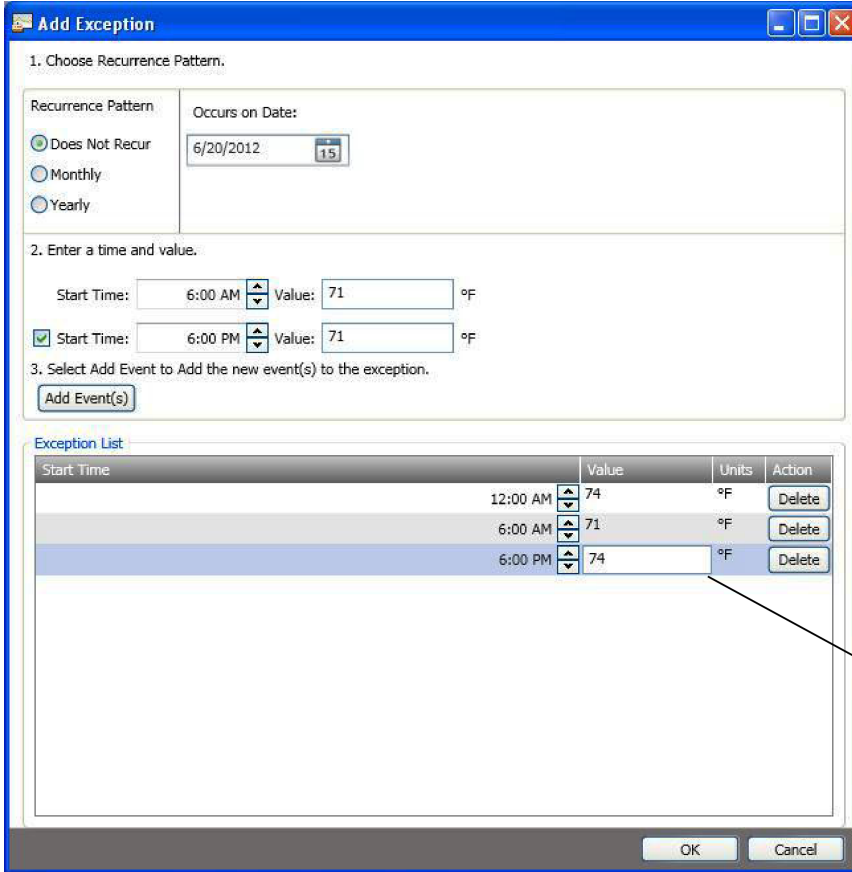


Expanded View (Thursday)



## Modifying Exceptions

1. Open the schedule containing the exception you want to modify.
2. Select an exception from those listed in the Exceptions group box.
3. From **Actions** drop-down list, select **Modify Selected Exception**, then click **Go**.

**Figure 31. Modifying exceptions**


1. Choose Recurrence Pattern.

Recurrence Pattern:  Does Not Recur  Monthly  Yearly

Occurs on Date: 6/20/2012

2. Enter a time and value.

Start Time: 6:00 AM Value: 71 °F

Start Time: 6:00 PM Value: 71 °F

3. Select Add Event to Add the new event(s) to the exception.

Add Event(s)

Start Time	Value	Units	Action
12:00 AM	74	°F	Delete
6:00 AM	71	°F	Delete
6:00 PM	74	°F	Delete

OK Cancel

Edit time or value directly from Exception list

4. Do one of the following to modify the exception:
  - Change the start time and/or the value of an event.
  - Add an event.
  - Delete an event.
5. Click Add Event(s).
6. Repeat above steps as necessary.
7. Click OK when you have finished modifying the events.

## Deleting Events

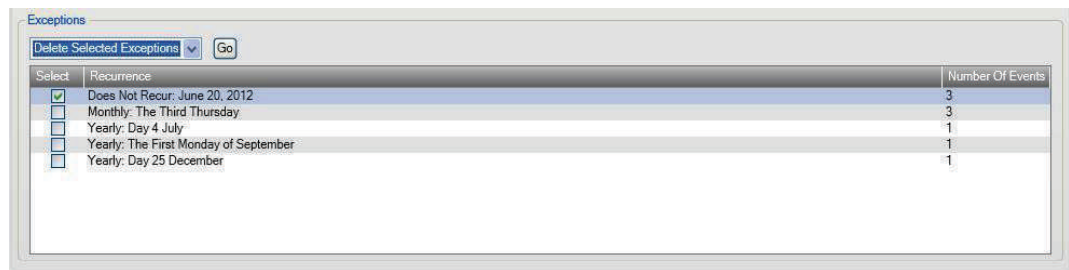
1. Open the schedule from which you want to delete events.
2. From the **Actions** drop-down list in the Events group box, select **Modify Events** and then click **Go**.
3. Click the tab of the first day of the week to which the event belongs.
4. Click the Delete button in the row of the event you want to delete.
5. Repeat for all other affected days.
6. Click OK to return to the schedule.

## Deleting Exceptions

1. Open the schedule containing the exception you want to delete.
2. Select an exception from those listed in the Exceptions group box.

3. From the **Actions** drop-down list, select **Delete Selected Exception** and then click **Go**.

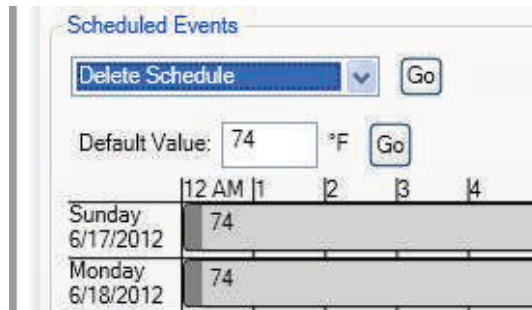
**Figure 32. Deleting an exception**



## Deleting a Schedule

1. Select **Utilities > Equipment > Scheduling** to display the Schedules screen.
2. Expand the Schedule box containing the schedule you want to delete.
3. From the **Actions** drop-down list in the Scheduled Events group box, select **Delete Schedule** and then click **Go** (see the following figure).

**Figure 33. Deleting a schedule**



The schedule is deleted. You can then create a new schedule with a new set of members.

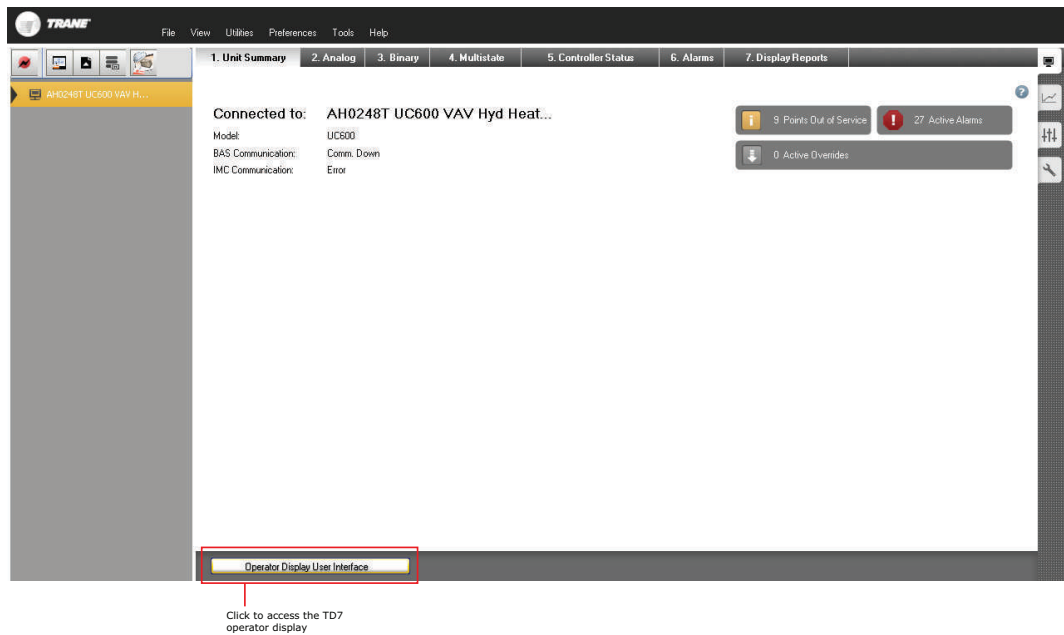
## Custom Graphics

Graphics can be viewed in Tracer TU by accessing the TD7 operator display user interface.

To access, navigate to the Unit Summary screen. Click the **Operator Display User Interface** button located on the bottom left portion of the page. It is not necessary to be connected to a Tracer TD7 Display to view the interface.

**Note:** In order to view the TD7 operator display user interface, you must be connected to the UC600 using a USB cable.

**Figure 34. Accessing the TD7 operator display user interface**

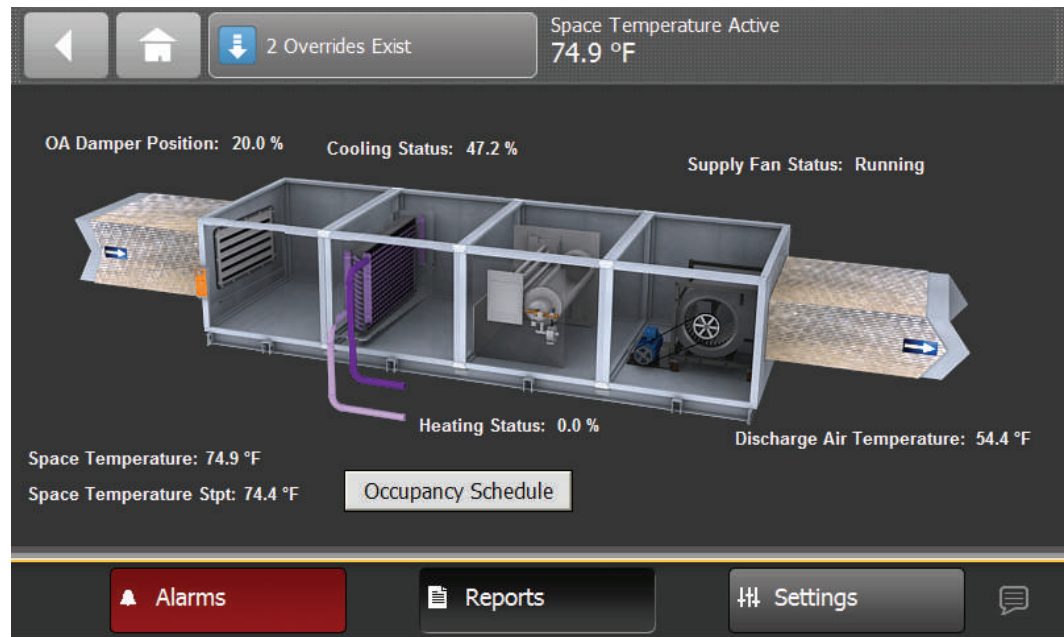


Custom graphics are created and loaded using Tracer Graphics Editor (TGE). See the TGE online help for more information. Standard graphics are available in the most recent Pre-Packaged Solutions (PPS) library at [https://home.ingerrand.com/sites/coe/pps/\\_layouts/15/start.aspx#/SitePages/Home.aspx](https://home.ingerrand.com/sites/coe/pps/_layouts/15/start.aspx#/SitePages/Home.aspx)

Graphics allow you to:

- Perform overrides
- Assign a graphic as your home page
- Link to the Alarms page
- Link to a schedule
- Link to the All Points Report and Custom Reports
- Link to another graphic

**Figure 35. Sample graphic**



## Graphics Best Practices

Individual graphic files cannot exceed 2 megabytes (Mbs). Files that exceed 2 Mbs will cause slow controller performance and increased graphic loading times.

Observe the following best practices:

- Use a graphics software program to save graphics using the following recommended formats: png, jpg, or gif. File formats such as bitmap (bmp) result in much larger file sizes.
- Open the image in a graphics software program and resize the image to smaller dimensions.
- If the image file was created by the Trane Centralized Graphics group or another graphics specialist, request a new image with a file size under 2 Mb.

**Note:** Verify that the image quality is acceptable after saving in one of the recommended formats. JPG and GIF file formats use image compression which can reduce the quality of the image.

# Commissioning and Troubleshooting in a Powered State

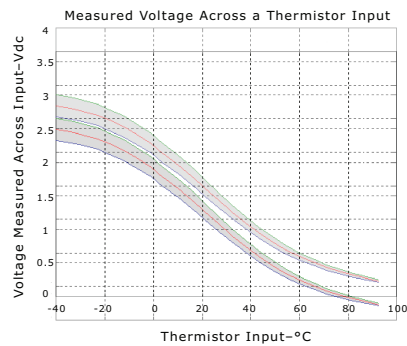
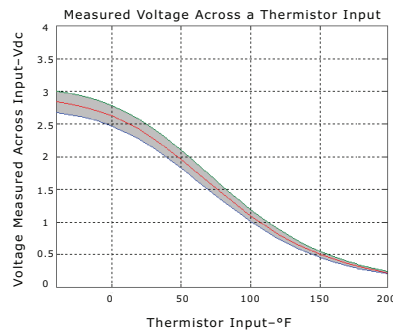
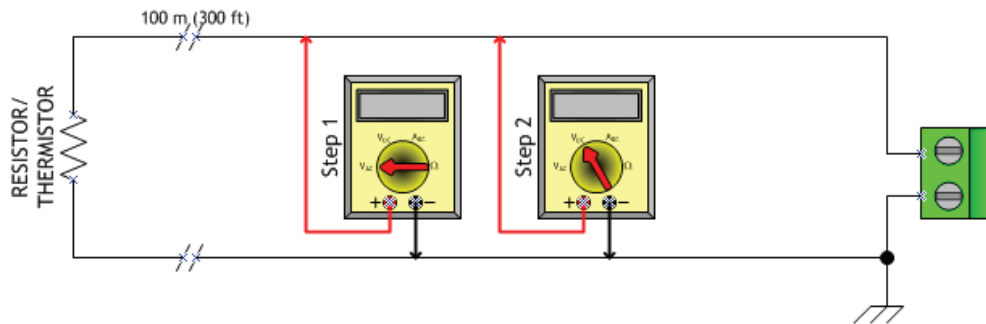
This section provides instructions for testing the Tracer UC600 points after making connection and applying power (indicated in each figure by the terminal connector and the Tracer U600 label). The step numbers or method numbers in each figure correspond to the information in each table.

The following equipment is required in order to test inputs and outputs:

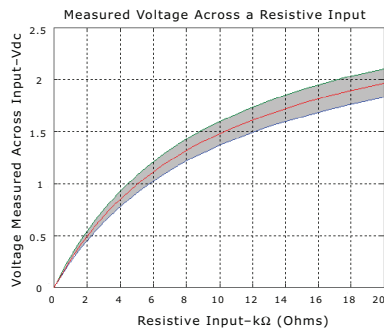
- Digital multimeter (DMM)
- Small flat-bladed screwdriver

## Resistive Inputs

Checkout Procedure	Measurement	Expected Value
Step 1	Measure AC voltage across the resistive termination	VAC $\approx$ 0.0 V AC voltage will affect further measurement
Step 2	Measure DC voltage across the resistive termination	Refer to the charts below

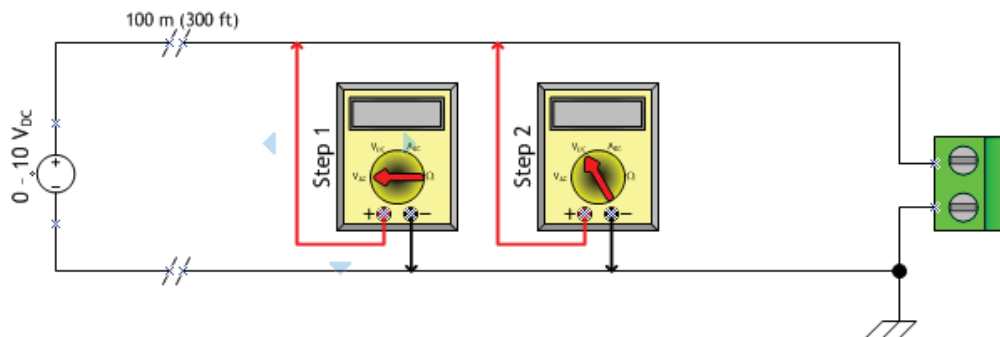


Charts show measurements across thermistor input (Fahrenheit and Celsius) and resistive input.



### Voltage Inputs

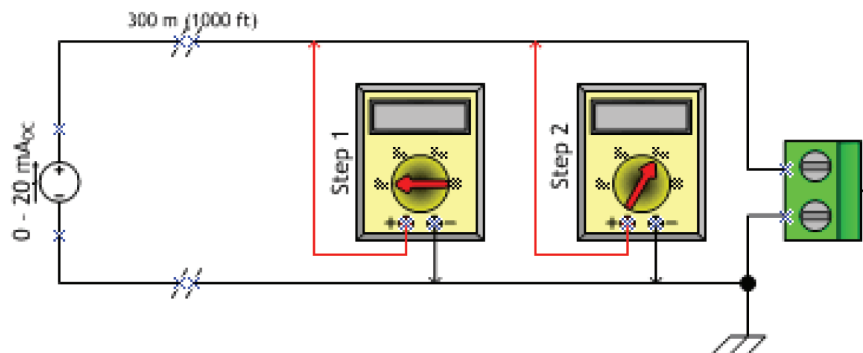
Checkout Procedure	Measurement	Expected Value
Step 1	Measure AC voltage across the voltage termination	VAC $\approx$ 0.0 V AC voltage will affect further measurement
Step 2	Measure DC voltage across the voltage termination	Compare to input status in Tracer TU



### Current Inputs

#### Method 1

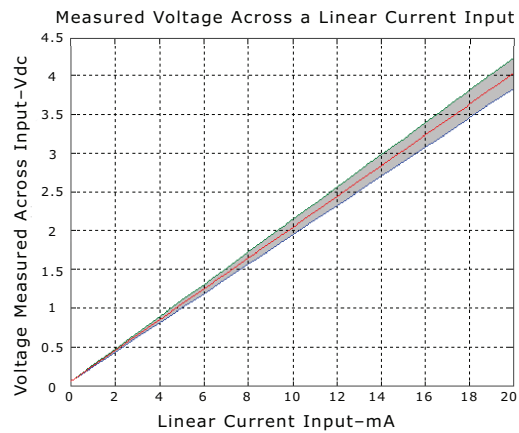
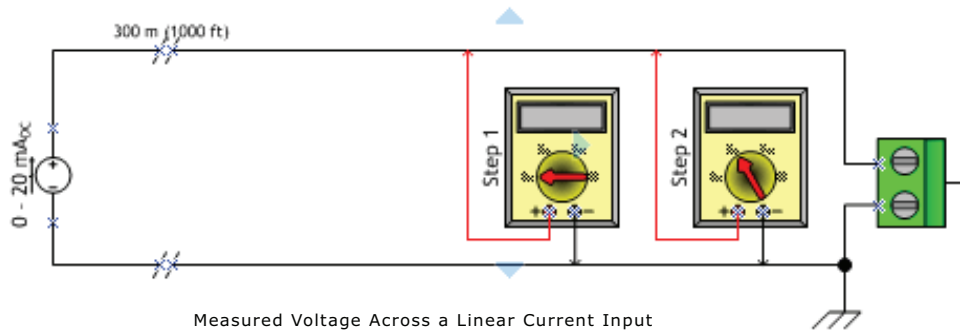
General Information	Checkout Procedure	Measurement	Expected Value
Method 1 capitalizes on the very low input resistance of a DMM in current measurement mode. However, this method affects the value that the expansion module will use while controlling outputs. When the meter is set to current mode, the current flowing into the expansion module circuit will drop to zero or near zero.	Step 1	Measure AC voltage across the current input	VAC $\approx$ 0.0 V AC voltage will affect further measurement
	Step 2	Measure DC current across the current input	Compare to input status in Tracer TU



## Commissioning and Troubleshooting in a Powered State

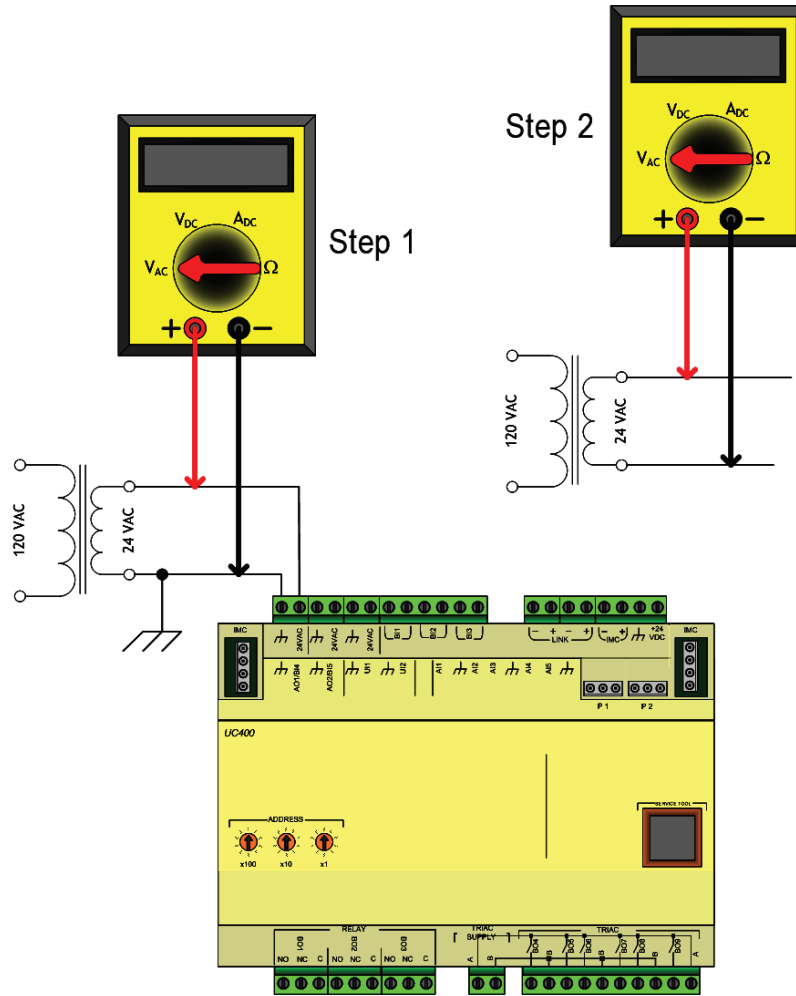
### Method 2

General Information	Checkout Procedure	Measurement	Expected Value
Method 2 is less disruptive to the system. In voltage mode, the DMM affects the circuit less. Additional information is needed to translate the voltage measured to current flowing through the circuit.	Step 1	Measure AC voltage across the voltage input	VAC $\approx$ 0.0 V AC voltage will affect further measurement
	Step 2	Measure DC voltage across the voltage termination	Refer to the chart below





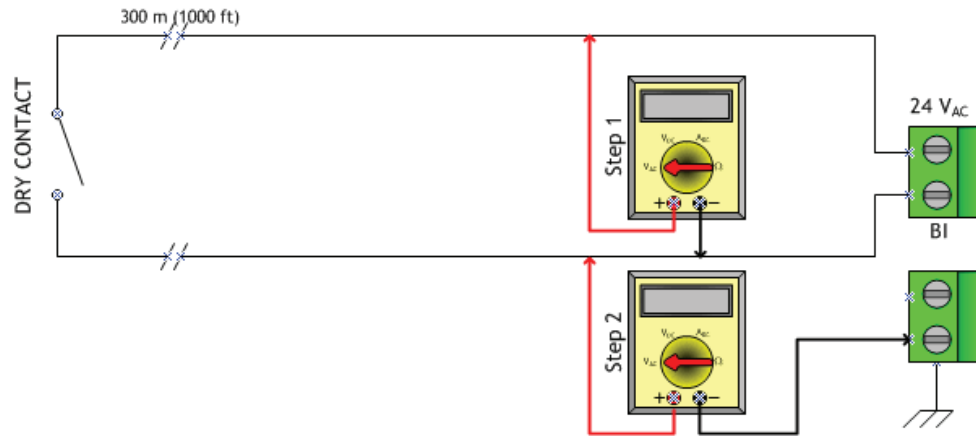
### 24 Vac Measurement



General Information	Checkout Procedure	Measurement	Expected Value
<p>Checking the voltage that powers the UC600 is often a necessary step when commissioning or troubleshooting. Operational issues and LED operation may result in a need to measure the input power.</p> <p>When troubleshooting, it is faster to take measurements while the load is in place. If Step 1 indicates an out-of-specification voltage, disconnect the UC600 and measure the AC voltage across the transformer. These measurements can direct you toward the problem source.</p>	Step 1	Measure AC voltage with the UC600 connected. Perform this measurement while the unit is under load.	$20.0 \text{ Vac} \leq \text{Vac} \leq 30.0 \text{ Vac}$
	Step 2	Measure AC voltage with the UC600 unconnected. Perform this measurement while the unit is not under load.	$20.0 \text{ Vac} \leq 30.0 \leq \text{Vac}$

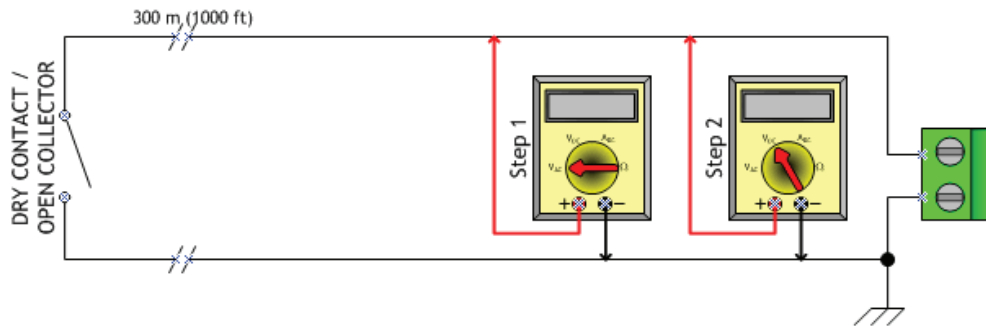
### Binary Inputs: 24 Vac Detect (Methods 1 or 2)

General Information and Checkout Procedure	Measurement	Expected Value
Method 1: Voltage across binary input measured without reference to chassis ground.	Measure AC voltage across the binary input	VAC $\approx$ 0.0 V (state = ON) VAC $\approx$ 24.0 V (state = OFF)
Method 2: Voltage across binary input measured with reference to chassis ground. Any connection with chassis ground symbol can serve as a ground reference for this method.	Measure DC voltage across the binary input	VAC $\approx$ 0.0 V (state = OFF) VAC $\approx$ 24.0 V (state = ON)

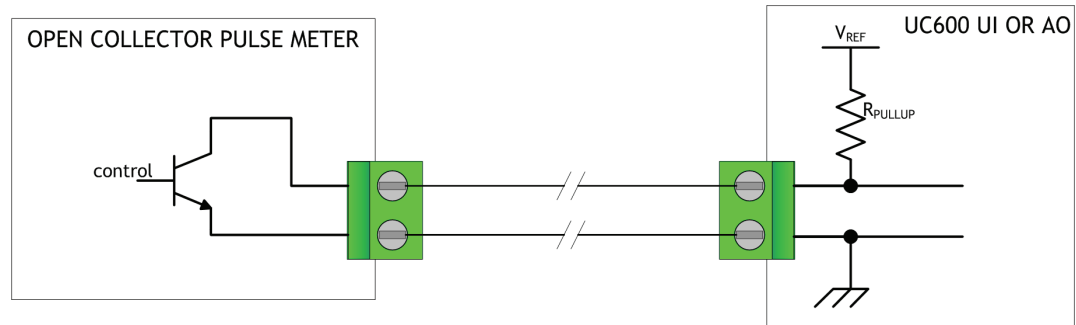


### Binary Inputs: Based on Analog Output Connection

General Information	Checkout Procedure	Measurement	Expected Value
The UC600 module analog output connections can be configured as binary inputs. This can be used only with dry contact or open collector-type sensors.	Step 1	Measure AC voltage across the binary input	Vac $\approx$ 0.0 V AC voltage will affect further measurement
	Step 2	Measure DC voltage across the binary input	Vdc $\leq$ 2.0 V (state = ON) Vdc $\geq$ 2.0 V (state = OFF)



### Open-collector Based Binary Sensors



Measurement Procedure	Expected Value
Measure DC voltage across the binary input	Vdc ≤ 0.2 V (BJT = ON) UI: Vdc ≈ 3.3 V (BJT = OFF) AO: Vdc ≈ 22.0 V (BJT = ON)

Open-collector based binary sensors use a bipolar junction transistor (BJT). This is a three-terminal device in which emitter-to-collector current is controlled by base current as the switching device in place of a relay. The term, open-collector, refers to the collector connection on the transistor itself. Open-collector circuits are used for their low fatigue rate and quick response relative to relay-based outputs.

The circuit within the pulse meter is completed when adding a pull-up resistance and reference voltage. On the UC600, both universal input (UI) and analog output (AO) circuits add the necessary resistance and voltage without external parts.

**Note:** The reference voltage must always be DC.

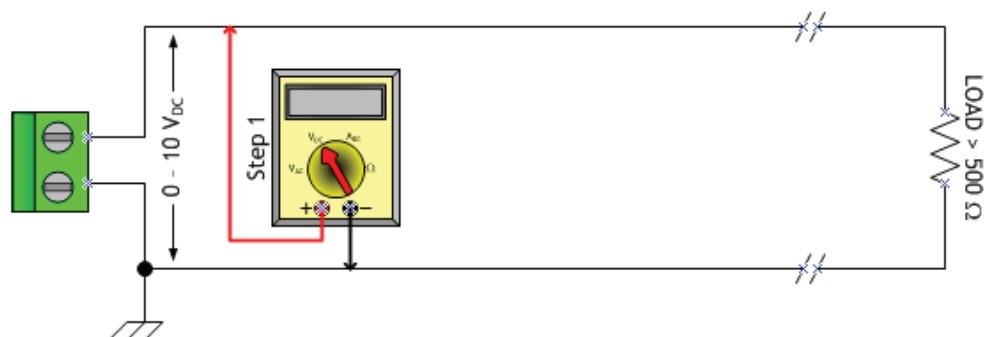
The voltage across the pulse meter terminals will bounce between V<sub>sat</sub> (saturation voltage) of the transistor in the pulse meter and the V<sub>ref</sub> (reference voltage) provided by the UI or AO circuits of the UC600. Most bipolar transistors have a V<sub>sat</sub> of less than 0.2 V<sub>dc</sub>.

The DMM sampling rate may be too slow to measure pulse meter output transitions.

**Note:** Check the specifications of the DMM. It may be necessary to use an oscilloscope to measure the transition voltages.

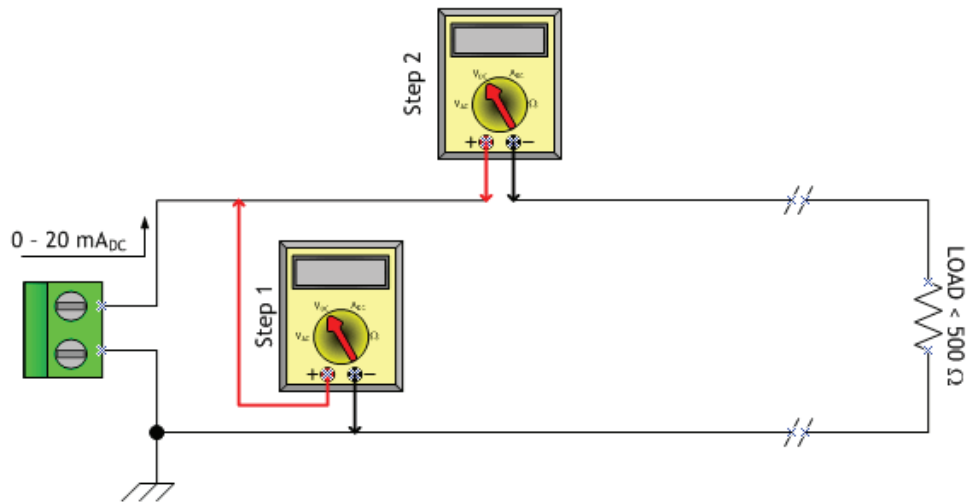
### Voltage Analog Output

Measurement Procedure	Expected Value
Measure DC voltage across the voltage termination	Compare to the expected value based on request from controller. This request may be based on an override of the output value.

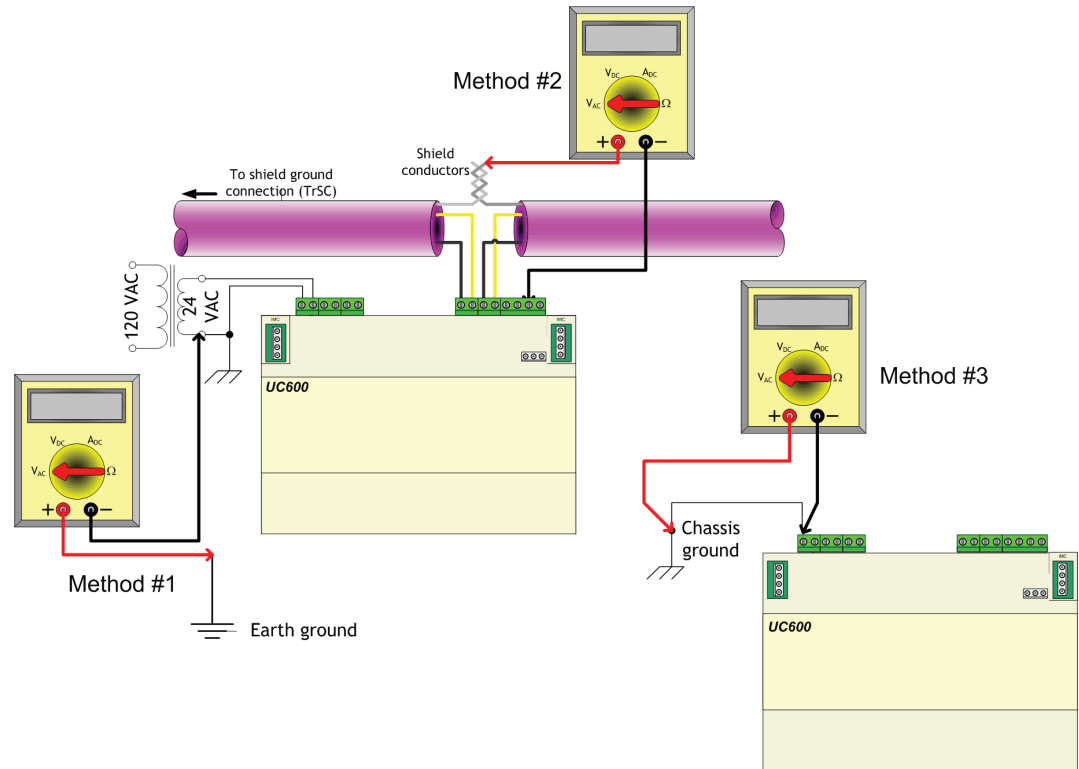


### Current Analog Output (Methods 1 or 2)

General Information and Checkout Procedure	Measurement	Expected Value
Method 1: <b>Shorting the current output-</b> this method leaves the circuit intact, however, it will cause the vast majority of the current to flow through the meter instead of the load ( <b>NOTE LOAD RESISTANCE</b> ).	Measure DC current across the current termination	Compare expected value based on request from controller. This request may be based on an override of the output value.
Method 2: <b>Measuring current directly-</b> this method is most the typical way to measure current and has the advantage of leaving the load in the loop. However, the circuit must be broken when using this method.	Measure DC current across the current termination	Compare expected value based on request from controller. This request may be based on an override of the output value.



## Ground Measurements



General Information and Checkout Procedure	Measurement	Expected Value
<p>Method 1:  <b>AC voltage between shield conductors and device chassis ground</b>— the voltage difference between BACnet MS/TP device chassis ground connections should be close to zero. If the voltage difference is greater than 4.0 Vac, there will be marginal communication or intermittent communication problems. If the voltage difference is greater than 7.0 Vac, some devices will no longer communicate.</p>	<p>Measure AC current across the current termination and confirm that only one end of the shield conductor is tied to the earth ground</p>	<p>Vac ≤ 2.0 V</p>
<p>Method 2:  <b>AC voltage between earth ground and device chassis ground</b>— the chassis ground of the UC600 needs to be connected to earth ground by some route.  <b>Note:</b> Do not assume that the building frame is a valid earth ground.</p>	<p>Measure AC current across the current termination and confirm that only one end of the shield conductor is tied to the earth ground</p>	<p>Vac ≤ 4.0 V                      (Must comply with National Electrical Code™ and local electrical codes)</p>
<p>Method 3:  <b>AC voltage between case (nominal chassis ground) and device chassis ground connector</b>— in this illustration the connection appears as a short. However, it is possible that the chassis ground connection on the controller may actually be connected to the equipment metal some distance away. Use this measurement method if there are communication issues or input stability problems.</p>	<p>Measure AC voltage across the current termination. For this measurement, confirm that <i>only one end</i> of the shield conductor is tied to the earth ground.</p>	<p>Vac ≤ 4.0 V                      (Must comply with National Electrical Code™ and local electrical codes)                      Typically, this should be Vac ≤ 1.0 V</p>



## Resources

For more detailed information, refer to the following documentation:

- *Tracer SC System Controller Installation and Setup* (BAS-SVX31)
- *BACnet Best Practices and Troubleshooting Guide* (BAS-SVX51)
- Tracer Graphical Programming 2 (TGP2) Editor Online Help
- *Tracer Graphical Programming (TGP2) Application Guide* (BAS-APG008)
- Tracer TU Online Help
- *Tracer TU Service Tool Getting Started Guide* (TTU-SVN01)
- Tracer UC600 Installation Instructions (X39641178-01)
- *Tracer XM30 Expansion Module Installation Instructions* (X39641148-01)
- *Tracer XM32 Expansion Module Installation Instructions* (X39641174-01)
- *Tracer Expansion Module Installation, Operation, and Maintenance* (BAS-SVX046)
- *Tracer UC600 Protocol Implementation Conformance Statement (PICS)*, (BAS-PRG010)



# Appendix A: Configuring Tracer UC600 for BACnet/IP

Tracer UC600 controllers with firmware versions 5.0 or higher now support the BACnet/IP protocol.

This appendix provides Tracer UC600 configuration information to enable communication using the BACnet/IP protocol.

## Device ID Assignment for BACnet/IP Devices

Each unit controller must have a unique BACnet device ID. Tracer SC/SC+ automates the device ID assignment process for Trane unit controllers by calculating a unique device ID for each unit controller and then saving the device ID to memory in each device.

For devices communicating over BACnet/IP, Tracer SC/SC+ calculates the device ID using the BACnet network number defined for Ethernet port 1 and the unit controller rotary switch value. The Tracer SC/SC+ rotary switch value is not used in the device ID calculation for IP devices.

BACnet/IP device IDs are calculated using the following two sets of values:

- The BACnet network number for Ethernet 1. (This number can be changed by the user).
  - Tracer SC defaults the BACnet IP network number as 1, and under most circumstances it is not changed.
- The unit controller rotary switch value (1 to 999). The Tracer SC/SC+ rotary address is not used to calculate BACnet/IP device IDs.

The following table shows this process using a Tracer UC600 unit controller.

BACnet network number Eth port 1 (1)		1			
Unit controller rotary switch value (42)			0	4	2
<b>BACnet/IP Device ID: 01042</b>	0	1	0	4	2

## Ethernet Network Wiring Specifications

The Ethernet port supports 10BaseT and 100BaseT Ethernet networks and requires Cat5, Cat5e, or Cat6 rated communication wire. The maximum rated distance between nodes on the network is 328 ft (100 m). The minimum distance between two devices is 1.64 ft (0.5 m).

**Note:** Cable installations must comply with both federal and local codes. Plenum-rated cable is available to meet NEC Article 725, which addresses flame resistance and smoke emission for signal cables

**Important:** Due to the high precision required when performing Ethernet wire terminations, Trane recommends that only qualified technicians with the proper equipment handle all terminations and splicing.

## BACnet/IP Network Configuration on Tracer SC or Tracer SC+

**Important:** IP configuration must be completed before device discovery and installation.

Tracer UC600 supports BACnet BBMD functionality. If the Tracer UC600 is not located on the same IP subnet as the Tracer SC, BACnet BBMD functionality must be enabled on the IP network.

The BACnet network number on Tracer SC/SC+ Ethernet port defaults to 1 and should be suitable for most installations. The BACnet configuration tab of the Tracer SC/SC+ user interface can be used to change the default BACnet network number if needed. For more information, see the "Tracer SC IOM", BAS-SVX31 or "Tracer SC+ System Controller Installation and Setup Guide", BAS-SVX077.

## Enabling BBMD Functionality on the IP Network

The following instructions provide example configuration settings when both the Tracer-App and the Tracer SC-Base both reside on separate subnets and a BBMD is required for both.

### Setting Up UC600 BACnet Communication

Tracer TU provides new enhancements to enable UC600 communication on wired (BACnet MSTP), wireless (BACnet/Zigbee), and BACnet/IP networks. You can:

- Specify either DHCP or a static IP address.
- Enable HTTP communication for remote connectivity.
- Enable browser access to the TD7 Display user interface.
- Specify a Software Device ID, if necessary.
- Enable BACnet/MSTP Communications, BACnet/Zigbee Communications, or BACnet/IP Communications.
- Designate the UC600 as a BBMD and obtain a broadcast distribution table (BDT) by setting the network number and UDP port.

**Note:** Tracer TU V8.6 or higher firmware must be installed on a UC600 that uses this BACnet/IP.

You can set up the UC600 BACnet communication protocol and parameters in the Protocol box on the Controller Settings screen.

1. Select **Utilities > Status > Controller Settings**.
2. Expand the **Protocol** box
3. Select the radio button of the addressing option you prefer in the Addressing box.  
If you choose to specify your own IP address, enter it along with the **Subnet Mask** and **Default Gateway**.
4. Select the **HTTP communications ...** check box and, if desired, the **Enable ... browser** check box in the Security box to enable remote connectivity and browser access to the TD7 Display user interface.
5. Specify a **Software Device ID** if you are installing the UC600 in a third party network.
6. Select the radio button to enable the desired communications option.
7. If you enable BACnet/IP Communications, click **Add BBMD** to enter an IP address and port number for each BBMD device, or click **Get BDT from BBMD** to obtain another BBMD's BDT.
8. Click **Test Communication** after you have finished setting up the BDT to verify communication with the UC600s at the specified IP addresses.

**Note:** The settings in the Advanced box should only be changed under the direction of Trane Technical Support.

## Setting Up Tracer UC600 BACnet Communication with Tracer TU

The procedures in this section describe how to initially connect to Tracer TU through a USB cable, and then make the necessary BACnet/IP configurations in the Protocol group box on the controller settings screen. Upon completion, you can connect to Tracer TU and view Tracer UC600 using the BACnet/IP protocol.

**Note:** Tracer TU V8.6 or higher must be installed on Tracer UC600 to enable BACnet/IP communication. Tracer UC600 firmware must be at V5.0 or higher.

Perform the following tasks in the order in which they are shown.

- Establish a direct connection to Tracer TU.
- Configure IP information
- Configure BACnet information
- Return to the Tracer TU **Startup Task Panel** to connect using the BACnet/IP protocol.

### Establishing a Direct Connection with Tracer TU

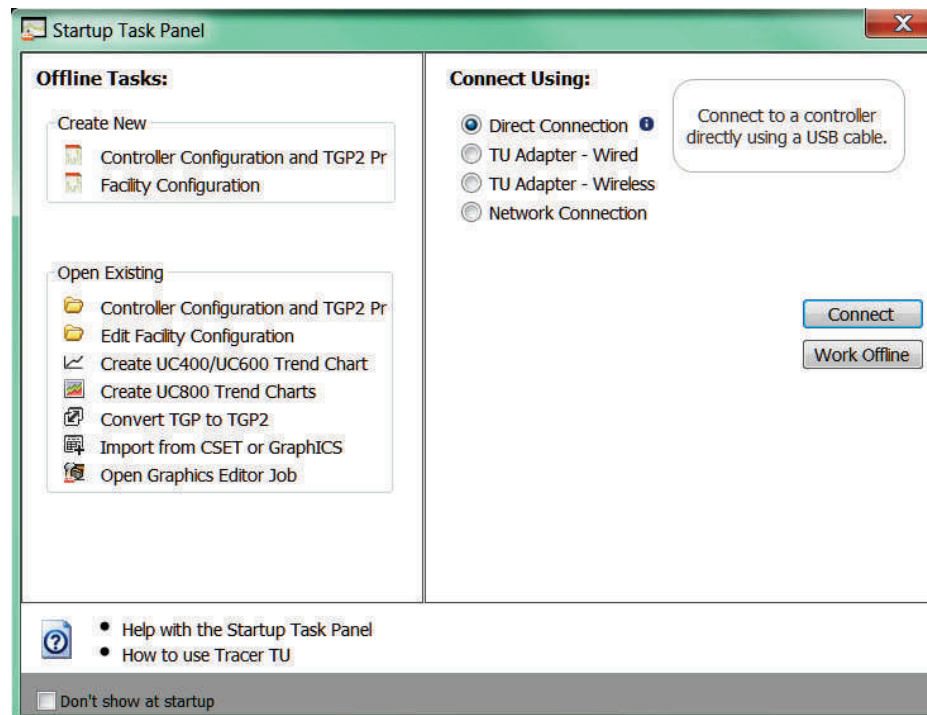
To establish a direct connection:

1. Connect a USB cable between the technician PC and the USB service port of the Tracer UC600 controller. The **Startup Task Panel** dialog box appears.
2. Select the **Direct Connection** radio button.



3. Click **Connect**.

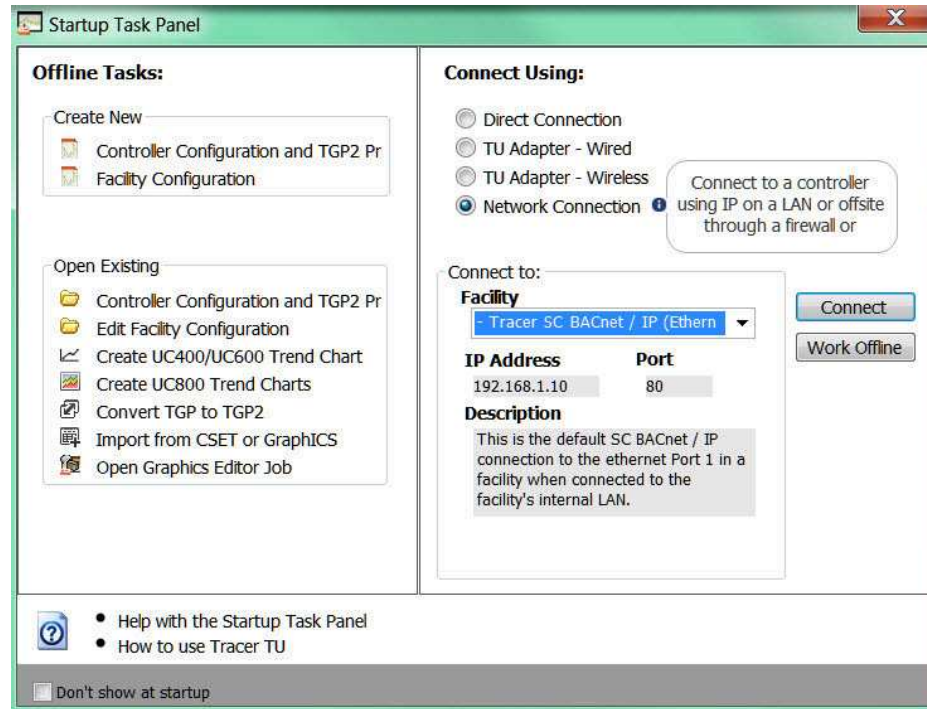
**Figure 36. Establishing a direct connection**



### Establishing a Network Connection with Tracer TU

To establish a network connection:

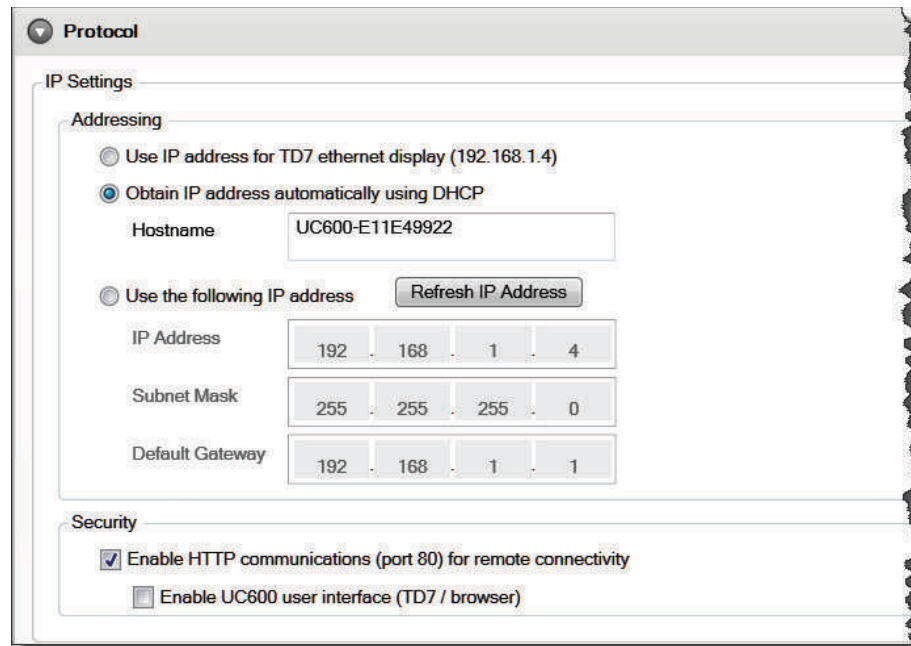
1. In the **Startup Panel** dialog box, select the **Network Connection** radio button.
2. From **Facility** drop-down list (inside the **Connect to** frame), select **IP Ethernet 1 network**.

**Figure 37. Establishing a network connection**


## Configuring IP Information

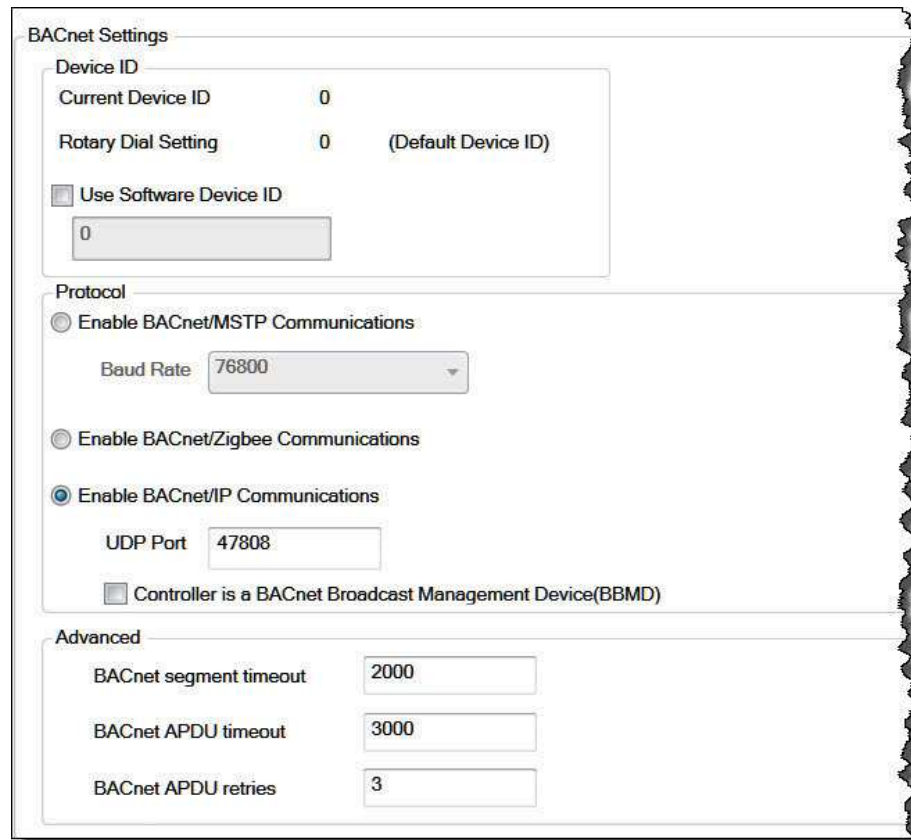
1. Navigate to **Utilities > Status > Controller Settings**. The **Controller Settings** utility opens.
2. Click **Protocol** to display a list of protocols that Tracer UC600 uses to communicate with other controllers.
3. Configure the Tracer UC600 with either a specified static IP address or, if necessary, configure it to automatically acquire its IP address from the network's Dynamic Host Configuration Protocol (DHCP) server. A hostname can be assigned to the device if a dynamic address is being used (see the following figure).
4. In the Security frame, select whether to enable HTTP communications (port 80) for remote communication.
5. Click **Send to Device**.
6. Proceed to "[Configuring BACnet Information](#)," p. 67.

**Figure 38. Configuring IP information**



### Configuring BACnet Information

1. Navigate to the **BACnet Settings** frame.
2. In the Device ID section, use the current device ID or select the **Use Software Device ID** check box and enter the device ID.
3. In the Protocol section, select the **Enable BACnet/IP Communications** radio button, and then assign a UDP Port number. All devices on a BACnet/IP network must have the same UDP port number.
4. Determine whether the Tracer UC600 must be a BBMD. If the device is BBMD, set up a BDT (see ["Setting Up a BDT," p. 68](#)).
5. After all edits are complete, click **Send to Device**.
6. To return to the **Startup Task Panel**, disconnect from Tracer TU and then reconnect.

**Figure 39. Configuring BACnet information**


**BACnet Settings**

**Device ID**

Current Device ID: 0

Rotary Dial Setting: 0 (Default Device ID)

Use Software Device ID

0

**Protocol**

Enable BACnet/MSTP Communications

Baud Rate: 76800

Enable BACnet/Zigbee Communications

Enable BACnet/IP Communications

UDP Port: 47808

Controller is a BACnet Broadcast Management Device (BBMD)

**Advanced**

BACnet segment timeout: 2000

BACnet APDU timeout: 3000

BACnet APDU retries: 3

## Setting Up a BDT

The BACnet protocol requires the use of IP broadcast messages. IP routers do not pass broadcast messages from one subnet to another. BACnet BBMD functionality is used to forward broadcast messages across IP routers to BACnet devices on the remote subnet. BBMDs are not required if all BACnet/IP devices reside on the same subnet.

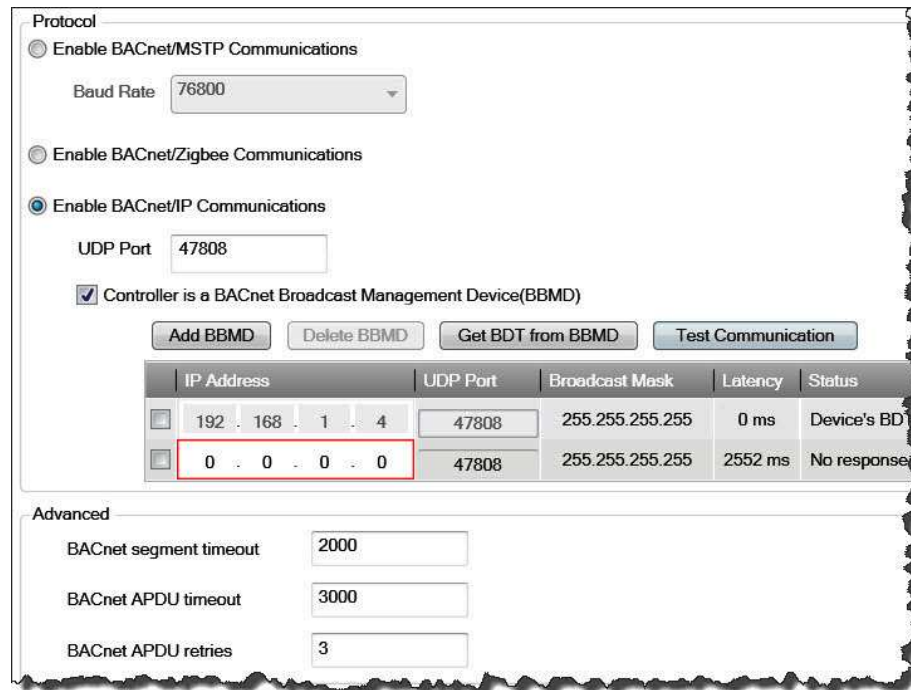
A broadcast distribution table (BDT) is part of the BBMD functionality. A BDT contains the list of IP addresses that identify each BBMD in the BACnet network. All BBMDs should have exactly the same entries in their BDT and must include their own IP address.

**Important:** Only one BBMD per IP subnet is allowed.

**To set up a BDT for Tracer UC600:**

1. Start a session of Tracer TU.
2. Navigate to **Utilities > Status > Controller Settings**. The **Controller Settings** utility opens.
3. Click **Protocol** to display a list of protocols that the UC600 uses to communicate with other controllers. Select the **Controller is a BACnet Broadcast Management Device (BBMD)** check box (see the following figure).

**Figure 40. Setting up a BBMD and BDT**



**Protocol**

Enable BACnet/MSTP Communications

Baud Rate: 76800

Enable BACnet/Zigbee Communications

Enable BACnet/IP Communications

UDP Port: 47808

Controller is a BACnet Broadcast Management Device (BBMD)

Buttons: Add BBMD, Delete BBMD, Get BDT from BBMD, Test Communication

	IP Address	UDP Port	Broadcast Mask	Latency	Status
<input type="checkbox"/>	192 . 168 . 1 . 4	47808	255.255.255.255	0 ms	Device's BD
<input type="checkbox"/>	0 . 0 . 0 . 0	47808	255.255.255.255	2552 ms	No response

**Advanced**

BACnet segment timeout: 2000

BACnet APDU timeout: 3000

BACnet APDU retries: 3

4. Click **Add BBMD**.
5. In the provided fields, enter the IP address of the BBMD device on the remote network.
6. Repeat the BBMD assignment process for all BBMD devices in the BACnet network.
7. Click **Test Communication** to verify.

## Security

Tracer UC600 network security can be enhanced by limiting user access over the IP network, restricting access to HTTPS only, and disabling the user interface through a Web browser. The customer's IT staff should be consulted when setting up enhanced security.

### Local Network (Firewall) Security

Trane controllers do not have built in firewalls and, therefore, rely on the network security infrastructure for protection. Trane recommends placing all IP-enabled devices behind the corporate firewall. When properly configured, firewalls will improve network security.

### Disable HTTP Communications

HTTP is used for Tracer TU network connections and future UC600 BACnet/IP display options. Tracer TU can also connect directly through the USB port, with a Tracer SC, or another Tracer UC600 on the IP network.

For added security, HTTP Port 80 should be disabled if other connection options are viable. This will prevent others from accessing the Tracer UC600 with a web browser or other HTTP applications. HTTP Port 80 is disabled with the Tracer TU service tool.

### Disable Tracer UC600 User Interface (TD7)

If direct Tracer TU network addressing is needed, then access to the user interface through a web browser should be disabled. This is done with the Tracer TU service tool.

**Note:** At this time the Tracer TD7 display option is not available when connecting with the BACnet/IP protocol. This option will be available in a future Tracer UC600 firmware upgrade.



Notes

---



Trane - by Trane Technologies (NYSE: TT), a global innovator - creates comfortable, energy efficient indoor environments for commercial and residential applications. For more information, please visit [trane.com](http://trane.com) or [tranetechnologies.com](http://tranetechnologies.com).

Trane has a policy of continuous product and product data improvements and reserves the right to change design and specifications without notice. We are committed to using environmentally conscious print practices.

BAS-SVX45J-EN 15 Apr 2020  
Supersedes BAS-SVX45H-EN (July 2019)

©2020 Trane