



TABLE OF CONTENTS

Price List Item	Page
Cushion Sizing Chart	2
ROHO® Seat Cushions	3-9
Select Series	3-4
Single Compartment Series	4-5
Dual Compartment Series	5-6
Hybrid Series	6-7
Smart Series	8-9
Other Cushioning Products	9
Specialty Application Products	10
Seating Accessories and Covers	11
ROHO AGILITY® Back Supports	12-22
AGILITY Standard Series	12-19
AGILITY Active Series	20-22
Terms and Conditions	23

ROHO® Cushion Sizing Chart

ROHO DRY FLOATATION® Cushion Sizing Chart for:

- ROHO LOW PROFILE® Single or Dual Compartment Cushion
- ROHO MID PROFILE™ Single or Dual Compartment Cushion
- ROHO HIGH PROFILE® Single or Dual Compartment Cushion
- ROHO ENHANCER® Cushion
- ROHO MID PROFILE Single Compartment with Sensor Ready® Technology
- ROHO HIGH PROFILE Single Compartment with Sensor Ready Technology
- ROHO QUADTRO SELECT® LOW PROFILE Cushion
- ROHO QUADTRO SELECT MID PROFILE Cushion
- ROHO QUADTRO SELECT HIGH PROFILE Cushion
- ROHO CONTOUR SELECT® Cushion

Item numbers for cushions listed for use with the sizing chart include the number of cells used for width and depth. Refer to the model number sections in this price list to determine the correct item number to use. Example: ROHO QUADTRO SELECT HIGH PROFILE cushion - require a cushion to fit a chair size of 20" (51cm) x 18" (45.5cm), select QS1110C.

Chair Size (Inches)	Chair Size (cm)	Number of Cells
10	25.5	5
11 - 12	28 - 30.5	6
13	33	7
14 - 15	35.5 - 38	8
16 - 17	40.5 - 43	9
18 - 19	45.5 - 48	10
20 - 21	51 - 53.5	11
22	56	12
23 - 24	58.5 - 61	13
25	63.5	14
26 - 27	66 - 68.5	15

Note: Availability of cushion sizes varies by model.

Select the correct size ROHO Cushion for your wheelchair

Step 1

Measure the wheelchair seat width and seat depth.

Note: Wheelchair manufacturers' published seat dimensions may vary.

Step 2

Use your wheelchair seat dimensions and the above table to help you determine the number of cells in cushion width and in depth.

ROHO Seat Cushions

- The following cushions are available in both custom modifications and custom sizes.
- Unless otherwise noted, all cushions include cover, pump, repair kit, and operating instructions.
- Class A1 & A2 products are eligible for contracted discounts as per provider purchasing contracts.
- Contact ROHO Customer Support for additional information.

Select Series Cushions

Suggested Retail	Item					HCPCS*
\$482.00	QUADTRO SELECT HIGH PROFILE Cushion: CLASS: A1					E2624
	QS66C	QS87C	QS910C	QS1011C	QS1111C	
	QS67C	QS88C	QS911C	QS1012C	QS1112C	
	QS77C	QS89C	QS912C	QS1013C	QS1113C	
	QS78C	QS810C	QS108C	QS118C	QS1114C	
	QS79C	QS98C	QS109C	QS119C		
	QS710C	QS99C	QS1010C	QS1110C		
	QUADTRO SELECT HIGH PROFILE Cushion: CLASS: A1					
\$536.00	QS128C	QS1212C	QS139C	QS1313C	QS1410C	
	QS129C	QS1213C	QS1310C	QS1314C	QS1411C	
	QS1210C	QS1214C	QS1311C	QS148C	QS1412C	
	QS1211C	QS138C	QS1312C	QS149C	QS1413C	
\$482.00 \$563.00	QUADTRO SELECT HIGH PROFILE Cushion: CLASS: A2					E2624
	QSSMC* Non Stock Small Sizes (11 cells wide or less)					E2638
	QSLGC* Non Stock Large Sizes (12 cells wide or greater)					
\$502.00	QUADTRO SELECT HIGH PROFILE Cushion - Heavy Duty Cover: CLASS: A1					Non-Coded
	QS710HD*	QS910HD	QS109HD	QS1011HD	QS1111HD	
	QS99HD	QS911HD	QS1010HD	QS1110HD		
\$566.00	QUADTRO SELECT HIGH PROFILE Cushion - Heavy Duty Cover: CLASS: A1					Non-Coded
	QS139HD*	QS1312HD*				
\$502.00 \$586.00	QUADTRO SELECT HIGH PROFILE Cushion - Heavy Duty Cover: CLASS: A2					Non-Coded
	QSSMHD* Non Stock Small Sizes (11 cells wide or less)					
	QSLGHD* Non Stock Large Sizes (12 cells wide or greater)					
\$482.00	QUADTRO SELECT MID PROFILE Cushion: CLASS: A1					E2624
	QS77MPC	QS88MPC	QS99MPC	QS109MPC	QS1010MPC	
	QS78MPC	QS89MPC	QS910MPC	QS1010MPC		
\$482.00 \$563.00	QUADTRO SELECT MID PROFILE Cushion: CLASS: A2					E2624 E2638
	QSSMMP* Non Stock Mid Profile Small Sizes (11 cells wide or less)					
	QSLGMPC* Non Stock Mid Profile Large Sizes (12 cells wide or greater)					
\$482.00	QUADTRO SELECT LOW PROFILE Cushion: CLASS: A1					E2624
	QS56LPC*	QS79LPC	QS98LPC	QS109LPC	QS1111LPC	
	QS66LPC	QS87LPC	QS99LPC	QS1010LPC		
	QS67LPC	QS88LPC	QS910LPC	QS1011LPC		
	QS77LPC	QS89LPC	QS911LPC	QS119LPC		
	QS78LPC	QS810LPC	QS108LPC	QS1110LPC		
\$536.00	QUADTRO SELECT LOW PROFILE Cushion: CLASS: A1					E2638
	QS1210LPC	QS1211LPC	QS1212LPC	QS1310LPC	QS1311LPC	
\$482.00 \$563.00	QUADTRO SELECT LOW PROFILE Cushion: CLASS: A2					E2624 E2638
	QSSMLPC* Non Stock Small Sizes (11 cells wide or less)					
	QSLGLPC* Non Stock Large Sizes (12 cells wide or greater)					
\$667.00	QUADTRO SELECT Custom Cushion: CLASS: A2					E2609
	QSCUSTC* Custom Cushion - with cover between 36 and 160 cells. Smaller than 36 cells or greater than 160 cells priced upon request.					

+ Decisions about how to code a product are the responsibility of the provider/supplier. Since Medicare coding is subject to change, the provider should always confirm the HCPCS code and coverage criteria as part of the client assessment process. For coverage criteria in other countries, consult your local Permobil Seating & Positioning distributor.
*May take up to three weeks for shipment.

ROHO Seat Cushions

- The following cushions are available in both custom modifications and custom sizes.
- Unless otherwise noted, all cushions include cover, pump, repair kit, and operating instructions.
- Class A1 & A2 products are eligible for contracted discounts as per provider purchasing contracts.
- Contact ROHO Customer Support for additional information.

Select Series Cushions Continued

Suggested Retail	Item					HCPCS ⁺
\$482.00	CONTOUR SELECT® Cushion: CLASS: A1					
	CS78C	CS810C	CS910C	CS1010C	CS1110C	
	CS88C	CS98C	CS911C	CS1011C	CS1111C	
	CS89C	CS99C	CS109C	CS119C		
\$536.00	CONTOUR SELECT® Cushion: CLASS: A1					E2638
	CS1210C	CS1211C	CS1212C	CS1310C	CS1311C	
\$482.00	CONTOUR SELECT® Cushion: CLASS: A2					E2624
	CSSMC*	Non Stock Small Sizes (11 cells wide or less)				
\$563.00	CSLGC*	Non Stock Large Sizes (12 cells wide or greater)				E2638
\$667.00	CONTOUR SELECT® Cushion: CLASS: A2					E2609
	CSCUSTC* Custom Cushion (multiple valves, deleted cells, cutouts, etc.) with cover between 36 and 160 cells. Smaller than 36 cells or greater than 160 cells priced upon request.					

Single Compartment Series Cushions



\$482.00	HIGH PROFILE® Single Compartment Cushion: CLASS: A1					
	1R66C	1R88C	1R910C	1R1011C	1R1111C	
	1R67C	1R89C	1R911C	1R1012C	1R1112C	
	1R77C	1R810C	1R912C	1R1013C	1R1113C	
	1R78C	1R811C	1R108C	1R118C	1R1114C	
	1R79C	1R98C	1R109C	1R119C		
	1R87C	1R99C	1R1010C	1R1110C		
\$536.00	HIGH PROFILE® Single Compartment Cushion: CLASS: A1					E2623
	1R128C	1R1213C	1R1312C	1R1410C	1R1511C	
	1R129C	1R1214C	1R1313C	1R1411C		
	1R1210C	1R138C	1R1314C	1R1412C		
	1R1211C	1R1310C	1R148C	1R1413C		
	1R1212C	1R1311C	1R149C	1R1414C		
\$482.00	HIGH PROFILE® Single Compartment Cushion: CLASS: A2					E2622
	1RSMC*	Non Stock Small Size (11 cells wide or less)				
\$563.00	1RLGC*	Non Stock Large Sizes (12 cells wide or greater)				E2623
\$502.00	HIGH PROFILE Single Compartment Cushion - Heavy Duty: CLASS: A1					Non-Coded
	1R99HD	1R911HD	1R1010HD	1R1110HD		
	1R910HD	1R109HD	1R1011HD	1R1111HD		
\$556.00	HIGH PROFILE Single Compartment Cushion - Heavy Duty: CLASS: A1					Non-Coded
	1R1210HD	1R1211HD				
\$502.00	HIGH PROFILE Single Compartment Cushion - Heavy Duty: CLASS: A2					Non-Coded
	1RSMHD*	Non Stock Small Sizes (11 cells wide or less)				
\$586.00	1RLGHD*	Non Stock Large Sizes (12 cells wide or greater)				

+ Decisions about how to code a product are the responsibility of the provider/supplier. Since Medicare coding is subject to change, the provider should always confirm the HCPCS code and coverage criteria as part of the client assessment process. For coverage criteria in other countries, consult your local Permobil Seating & Positioning distributor.
 *May take up to three weeks for shipment.

ROHO Seat Cushions

- The following cushions are available in both custom modifications and custom sizes.
- Unless otherwise noted, all cushions include cover, pump, repair kit, and operating instructions.
- Class A1 & A2 products are eligible for contracted discounts as per provider purchasing contracts.
- Contact ROHO Customer Support for additional information.

Single Compartment Series Cushions Continued

Suggested Retail	Item	HCPCS*
\$482.00	MID PROFILE Single Compartment Cushion: CLASS: A1 1R77MPC 1R88MPC 1R99MPC 1R109MPC 1R1011MPC 1R1111MPC 1R78MPC 1R89MPC 1R910MPC 1R1010MPC 1R1110MPC	E2622 
\$482.00 \$563.00	MID PROFILE Single Compartment Cushion: CLASS: A2 1RSMMPC* Non Stock Sizes (11 cells wide or less) 1RLGMPC* Non Stock Large Sizes (12 cells wide or greater)	Non-Coded
\$482.00	LOW PROFILE Single Compartment Cushion: CLASS: A1 1R66LPC 1R79LPC 1R810LPC 1R911LPC 1R1011LPC 1R67LPC 1R87LPC 1R98LPC 1R108LPC 1R119LPC 1R77LPC 1R88LPC 1R99LPC 1R109LPC 1R1110LPC 1R78LPC 1R89LPC 1R910LPC 1R1010LPC 1R1111LPC	E2622 
\$536.00	LOW PROFILE Single Compartment Cushion: CLASS: A1 1R1210LPC 1R1310LPC	E2623
\$482.00 \$563.00	LOW PROFILE Single Compartment Cushion: CLASS: A2 1RSMLPC* Non Stock Small Size (11 cells wide or less) 1RLGLPC* Non Stock Large Size (12 cells wide or greater)	E2622 E2623

Dual Compartment Series Cushions

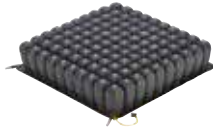
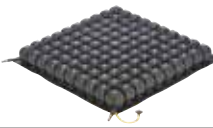
\$504.00	HIGH PROFILE Dual Compartment Cushion: CLASS: A2 2R88C 2R99C 2R109C 2R1012C 2R89C 2R910C 2R1010C 2R119C 2R98C 2R911C 2R1011C 2R1110C	E2624 
\$504.00	LOW PROFILE Dual Compartment Cushion: CLASS: A2 2R88LPC 2R99LPC 2R109LPC 2R1011LPC 2R119LPC 2R89LPC 2R910LPC 2R1010LPC 2R1012LPC 2R1110LPC	E2624 
\$504.00 \$504.00 \$596.00 \$596.00	Non-Stock Dual Compartment Cushion: CLASS: A2 2RSMC* HIGH PROFILE, Non Stock Small Sizes (11 cells wide or less) 2RSMLPC* LOW PROFILE, Non Stock Small Sizes (11 cells wide or less) 2RLGC* HIGH PROFILE, Non Stock Large Sizes (12 cells wide or greater) 2RLGLPC* LOW PROFILE, Non Stock Large Sizes (12 cells wide or greater)	E2624 E2624 E2625 E2625
\$667.00	Custom Dual Compartment Cushion: CLASS: A2 CUSTC* Custom Cushion (multiple valves, deleted cells, cutouts, etc.) with cover between 36 and 160 cells. Smaller than 36 cells or greater than 160 cells priced upon request.	E2609

+ Decisions about how to code a product are the responsibility of the provider/supplier. Since Medicare coding is subject to change, the provider should always confirm the HCPCS code and coverage criteria as part of the client assessment process. For coverage criteria in other countries, consult your local Permobil Seating & Positioning distributor.
 *May take up to three weeks for shipment.

ROHO Seat Cushions

- The following cushions are available in both custom modifications and custom sizes.
- Unless otherwise noted, all cushions include cover, pump, repair kit, and operating instructions.
- Class A1 & A2 products are eligible for contracted discounts as per provider purchasing contracts.
- Contact ROHO Customer Support for additional information.

Dual Compartment Series Cushions Continued

Suggested Retail	Item					HCPCS ⁺
\$482.00	ENHANCER Cushion: CLASS: A1					 E2624
	ENH88C	ENH98C	ENH910C	ENH1010C	ENH1110C	
	ENH89C	ENH99C	ENH109C	ENH1011C		
\$482.00	ENHANCER Cushion: CLASS: A2					E2624
\$563.00	ENHSMC*	Non Stock Small Sizes (11 cells wide or less)				E2638
	ENHLGC*	Non Stock Large Sizes (12 cells wide or greater)				
\$667.00	ENHANCER Cushion: CLASS: A2					E2609
	ENHCUSTC*	Custom Cushion (multiple valves, deleted cells, cutouts, etc.) with cover between 36-160 cells. Smaller than 36 cells or greater than 160 cells priced upon request.				

Hybrid Series Cushions

Hybrid Elite SR[®] Single Compartment Cushion: CLASS: A1								
	Item Number	Fits Chair Size (width x depth)	Item Number	Fits Chair Size (width x depth)	 E2622			
	\$498.00	1RHE1414C-SR	14" x 14" / 36 cm x 36 cm	1RHE1716C-SR			17" x 16" / 43 cm x 41 cm	
	1RHE1415C-SR	14" x 15" / 36 cm x 38 cm	1RHE1717C-SR	17" x 17" / 43 cm x 43 cm				
	1RHE1416C-SR	14" x 16" / 36 cm x 41 cm	1RHE1718C-SR	17" x 18" / 43 cm x 46 cm				
	1RHE1515C-SR	15" x 15" / 38 cm x 38 cm	1RHE1720C-SR	17" x 20" / 43 cm x 51 cm				
	1RHE1516C-SR	15" x 16" / 38 cm x 41 cm	1RHE1816C-SR	18" x 16" / 46 cm x 41 cm				
	1RHE1517C-SR	15" x 17" / 38 cm x 43 cm	1RHE1817C-SR	18" x 17" / 46 cm x 43 cm				
	1RHE1615C-SR	16" x 15" / 41 cm x 38 cm	1RHE1818C-SR	18" x 18" / 46 cm x 46 cm				
	1RHE1616C-SR	16" x 16" / 41 cm x 41 cm	1RHE1820C-SR	18" x 20" / 46 cm x 51 cm				
	1RHE1617C-SR	16" x 17" / 41 cm x 43 cm	1RHE2017C-SR	20" x 17" / 51 cm x 43 cm				
	1RHE1618C-SR	16" x 18" / 41 cm x 46 cm	1RHE2018C-SR	20" x 18" / 51 cm x 46 cm				
	1RHE1620C-SR	16" x 20" / 41 cm x 51 cm	1RHE2020C-SR	20" x 20" / 51 cm x 51 cm				
\$551.00	Hybrid Elite SR[®] Single Compartment Cushion: CLASS: A1					E2623		
	Item Number	Fits Chair Size (width x depth)						
	1RHE2218C-SR	22" x 18" / 56 cm x 46 cm						
	1RHE2220C-SR	22" x 20" / 56 cm x 51 cm						
	1RHE2222C-SR	22" x 22" / 56 cm x 58 cm						
	1RHE2418C-SR	24" x 18" / 61 cm x 46 cm						
	1RHE2420C-SR	24" x 20" / 61 cm x 51 cm						
^Hybrid Elite SR Single Compartment Cushions are also a part of the Smart Series Cushions.								

+ Decisions about how to code a product are the responsibility of the provider/supplier. Since Medicare coding is subject to change, the provider should always confirm the HCPCS code and coverage criteria as part of the client assessment process. For coverage criteria in other countries, consult your local Permobil Seating & Positioning distributor.
 *May take up to three weeks for shipment.

ROHO Seat Cushions

- Unless otherwise noted, all cushions include cover, pump, repair kit, and operating instructions.
- Class A1 & A2 products are eligible for contracted discounts as per provider purchasing contracts.
- Contact ROHO Customer Support for additional information.

Hybrid Series Cushions Continued

Suggested Retail	Item				HCPCS*	
\$498.00	Hybrid Elite® Dual Compartment Cushion: CLASS: A1					
	Item Number	Fits Chair Size (width x depth)	Item Number	Fits Chair Size (width x depth)	 E2622	
	2RHE1414C	14" x 14" / 36 cm x 36 cm	2RHE1716C	17" x 16" / 43 cm x 41 cm		
	2RHE1415C	14" x 15" / 36 cm x 38 cm	2RHE1717C	17" x 17" / 43 cm x 43 cm		
	2RHE1416C	14" x 16" / 36 cm x 41 cm	2RHE1718C	17" x 18" / 43 cm x 46 cm		
	2RHE1515C	15" x 15" / 38 cm x 38 cm	2RHE1720C	17" x 20" / 43 cm x 51 cm		
	2RHE1516C	15" x 16" / 38 cm x 41 cm	2RHE1816C	18" x 16" / 46 cm x 41 cm		
	2RHE1517C	15" x 17" / 38 cm x 43 cm	2RHE1817C	18" x 17" / 46 cm x 43 cm		
	2RHE1615C	16" x 15" / 41 cm x 38 cm	2RHE1818C	18" x 18" / 46 cm x 46 cm		
	2RHE1616C	16" x 16" / 41 cm x 41 cm	2RHE1820C	18" x 20" / 46 cm x 51 cm		
	2RHE1617C	16" x 17" / 41 cm x 43 cm	2RHE2017C	20" x 17" / 51 cm x 43 cm		
	2RHE1618C	16" x 18" / 41 cm x 46 cm	2RHE2018C	20" x 18" / 51 cm x 46 cm		
	2RHE1620C	16" x 20" / 41 cm x 51 cm	2RHE2020C	20" x 20" / 51 cm x 51 cm		
	\$551.00	Hybrid Elite® Dual Compartment Cushion: CLASS: A1				
Item Number		Fits Chair Size (width x depth)	Item Number	Fits Chair Size (width x depth)		E2623
2RHE2218C		22" x 18" / 56 cm x 46 cm	2RHE2418C	24" x 18" / 61 cm x 46 cm		
2RHE2220C		22" x 20" / 56 cm x 51 cm	2RHE2420C	24" x 20" / 61 cm x 51 cm		
2RHE2222C	22" x 22" / 56 cm x 58 cm					
^Hybrid Elite Dual Compartment Cushions are also a part of the Dual Compartment Series Cushions						
\$583.00 \$583.00 \$638.00 \$638.00	ROHO Hybrid Elite Cushion Heavy Duty Cover Options: CLASS: A1					
	1RHEHD-SR*	Hybrid Elite Single Valve Sensor Ready with Heavy Duty Cover, ≥ 20"			Non-Coded	
	2RHEHD*	Hybrid Elite Dual Valve with Heavy Duty Cover, 20" and under				
	1RHEHDLG-SR*	Hybrid Elite Single Valve Sensor Ready with Heavy Duty Cover, ≤ 22"				
2RHEHDLG*	Hybrid Elite Dual Valve with Heavy Duty Cover, 22" and over					
\$460.00	nexus SPIRIT® Cushion: CLASS: A1					
	Item Number	Fits Chair Size with LOW PROFILE Support Pad (width x depth)	Item Number	Fits Chair Size with LOW PROFILE Support Pad (width x depth)	 E2622	
	NS1414C	14" X 14" / 36 cm x 36 cm	NS1717C	17" x 17" / 43 cm x 43 cm		
	NS1416C	14" x 16" / 36 cm x 41 cm	NS1816C	18" x 16" / 46 cm x 41 cm		
	NS1515C	15" x 15" / 38 cm x 38 cm	NS1818C	18" x 18" / 46 cm x 46 cm		
	NS1616C	16" x 16" / 41 cm x 41 cm	NS2018C	20" x 18" / 51 cm x 46 cm		
	NS1618C	16" x 18" / 41 cm x 46 cm				
• Sizes listed represent chair size. Actual cushion size is approximately 1.5" / 3.8 cm deeper to allow for placement between back support canes. • nexus SPIRIT cushion comes standard with a fluid-resistant cover. • Not available in custom width or depth.						
\$492.00	nexus SPIRIT Cushion: CLASS: A2					
	NSDUALC*	Custom option with dual valve pad			E2622	
	NSMPC*	Custom option with MID PROFILE pad				
	NSCUSTC*	Custom option with varying cell height				
* Please specify chair size for both when ordering. • Not available in custom width or depth.						

+ Decisions about how to code a product are the responsibility of the provider/supplier. Since Medicare coding is subject to change, the provider should always confirm the HCPSC code and coverage criteria as part of the client assessment process. For coverage criteria in other countries, consult your local Permobil Seating & Positioning distributor.
 *May take up to three weeks for shipment.

ROHO Seat Cushions

- Unless otherwise noted, all cushions include cover, pump, repair kit, and operating instructions.
- Class A1 & A2 products are eligible for contracted discounts as per provider purchasing contracts.
- Contact ROHO Customer Support for additional information.

Smart Series Cushions

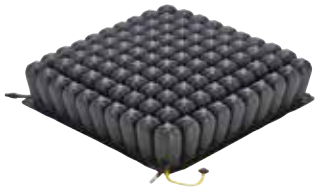
Suggested Retail	Item	HCPCS+	
\$482.00	HIGH PROFILE Single Compartment Cushion with Sensor Ready Technology:		
	CLASS: A1		
	refer to page 2 for sizes (width & depth)		
	1R66H-CA-SR	1R88H-CA-SR	1R911H-CA-SR
	1R67H-CA-SR	1R89H-CA-SR	1R108H-CA-SR
	1R77H-CA-SR	1R810H-CA-SR	1R109H-CA-SR
	1R78H-CA-SR	1R98H-CA-SR	1R1010H-CA-SR
1R79H-CA-SR	1R99H-CA-SR	1R1011H-CA-SR	
1R87H-CA-SR	1R910H-CA-SR	1R1012H-CA-SR	
		E2622	
			
\$536.00	HIGH PROFILE Single Compartment Cushion with Sensor Ready Technology:		
	CLASS: A1		
	1R129H-CA-SR	1R1210H-CA-SR	1R1211H-CA-SR
			1R1212H-CA-SR
		E2622	
\$536.00	HIGH PROFILE Single Compartment Cushion with Sensor Ready Technology:		
	CLASS: A1		
	1R1310H-CA-SR	1R1311H-CA-SR	1R1411H-CA-SR
			1R1511H-CA-SR
		E2623	
\$502.00	HIGH PROFILE Single Compartment Cushion with Sensor Ready Technology with Heavy Duty Cover: CLASS: A1		
	refer to page 2 for sizes (width & depth)		
	1R66H-CH-SR*	1R88H-CH-SR*	1R108H-CH-SR*
	1R67H-CH-SR*	1R89H-CH-SR*	1R109H-CH-SR*
	1R77H-CH-SR*	1R810H-CH-SR*	1R1010H-CH-SR*
	1R78H-CH-SR*	1R98H-CH-SR*	1R1011H-CH-SR*
	1R79H-CH-SR*	1R99H-CH-SR*	1R1012H-CH-SR*
1R87H-CH-SR*	1R911H-CH-SR*		
		E2622	
\$556.00	HIGH PROFILE Single Compartment Cushion with Sensor Ready Technology with Heavy Duty Cover: CLASS: A1		
	1R129H-CH-SR*	1R1210H-CH-SR*	1R1211H-CH-SR*
			1R1212H-CH-SR*
			E2622
\$556.00	HIGH PROFILE Single Compartment Cushion with Sensor Ready Technology with Heavy Duty Cover: CLASS: A1		
	1R1310H-CH-SR*	1R1311H-CH-SR*	1R1411H-CH-SR
			1R1511H-CH-SR
			E2623
\$482.00	MID PROFILE Single Compartment Cushion with Sensor Ready Technology:		
	CLASS: A1		
	1R77M-CA-SR	1R810M-CA-SR	1R108M-CA-SR
	1R78M-CA-SR	1R98M-CA-SR	1R109M-CA-SR
	1R87M-CA-SR	1R99M-CA-SR	1R1010M-CA-SR
	1R88M-CA-SR	1R910M-CA-SR	1R1011M-CA-SR
	1R89M-CA-SR	1R911M-CA-SR	1R1012M-CA-SR
		E2622	
			
\$536.00	MID PROFILE Single Compartment Cushion with Sensor Ready Technology:		
	CLASS: A1		
	1R1210M-CA-SR	1R1211M-CA-SR	1R1212M-CA-SR
		E2622	
\$536.00	MID PROFILE Single Compartment Cushion with Sensor Ready Technology:		
	CLASS: A1		
	1R1310M-CA-SR	1R1311M-CA-SR	
		E2623	

+ Decisions about how to code a product are the responsibility of the provider/supplier. Since Medicare coding is subject to change, the provider should always confirm the HCPCS code and coverage criteria as part of the client assessment process. For coverage criteria in other countries, consult your local Permobil Seating & Positioning distributor.
 *May take up to three weeks for shipment.



ROHO Seat Cushions

- Unless otherwise noted, all cushions include cover, pump, repair kit, and operating instructions.
- Class A1 & A2 products are eligible for contracted discounts as per provider purchasing contracts.
- Contact ROHO Customer Support for additional information.

Smart Series Cushions Continued

Suggested Retail	Item	HCPCS*
\$502.00	MID PROFILE Single Compartment Cushion with Sensor Ready Technology with Heavy Duty Cover: CLASS: A1	
	1R77M-CH-SR* 1R89M-CH-SR* 1R910M-CH-SR* 1R1010M-CH-SR* 1R1110M-CH-SR*	E2622
	1R78M-CH-SR* 1R810M-CH-SR* 1R911M-CH-SR* 1R1011M-CH-SR* 1R1111M-CH-SR*	
	1R87M-CH-SR* 1R98M-CH-SR* 1R108M-CH-SR* 1R1012M-CH-SR* 1R1112M-CH-SR*	
1R88M-CH-SR* 1R99M-CH-SR* 1R109M-CH-SR* 1R119M-CH-SR*		
\$556.00	MID PROFILE Single Compartment Cushion with Sensor Ready Technology with Heavy Duty Cover: CLASS: A1	E2622
	1R1210M-CH-SR* 1R1211M-CH-SR* 1R1212M-CH-SR* 1R1310M-CH-SR* 1R1311M-CH-SR*	E2623
\$168.00	Smart Check® by ROHO: CLASS: A1 SMARTCHECK-01 Set up and push to check device for 1R HIGH PROFILE, MID PROFILE and HYBRID ELITE Sensor Ready cushions	Non-Coded 

Other Cushioning Products

\$332.00	HARMONY® Cushion: CLASS: B		E2607 
	Item Number	Fits Chair Size (width x depth)	
	H1416C	14" x 16" / 36 cm x 41 cm	
	H1616C	16" x 16" / 41 cm x 41 cm	
	H1618C	16" x 18" / 41 cm x 46 cm	
\$140.00	MOSAIC® Cushion: CLASS: B		E2601 
	Item Number	Standard Sizes (width x depth)	
	MOS1616CA	16" x 16" / 41 cm x 41 cm	
	MOS1618CA	16" x 18" / 41 cm x 46 cm	
	MOS1717CA	17" x 17" / 44cm x 44cm	
\$165.00	MOSAIC® Cushion with Heavy Duty Cover: CLASS: B		Non-Coded
	Item Number	Standard Sizes (width x depth)	
	MOS1616HD	16" x 16" / 41 cm x 41 cm	
	MOS1618HD	16" x 18" / 41 cm x 46 cm	
	MOS1717HD	17" x 17" / 44cm x 44cm	
\$210.00	ROHO AirLITE® Cushion: CLASS: B		E2605 
	Item Number	Standard Sizes (width x depth)	
	AL1313HD	13" x 13" / 33 cm x 33 cm	
	AL1315HD	13" x 15" / 33 cm x 38 cm	
	AL1414HD	14" x 14" / 36 cm x 36 cm	
	AL1416HD	14" x 16" / 36 cm x 41 cm	
	AL1515HD	15" x 15" / 38 cm x 38 cm	
	AL1517HD	15" x 17" / 38 cm x 43 cm	
	AL1616HD	16" x 16" / 41 cm x 41 cm	
	AL1618HD	16" x 18" / 41 cm x 46 cm	
	AL1717HD	17" x 17" / 43 cm x 43 cm	
		Item Number	
	AL1718HD	17" x 18" / 43 cm x 46 cm	
	AL1720HD	17" x 20" / 43 cm x 51 cm	
	AL1816HD	18" x 16" / 46 cm x 41 cm	
	AL1818HD	18" x 18" / 46 cm x 46 cm	
	AL1820HD	18" x 20" / 46 cm x 51 cm	
	AL1917HD	19" x 17" / 48 cm x 43 cm	
	AL1919HD	19" x 19" / 48 cm x 48 cm	
	AL2017HD	20" x 17" / 51 cm x 43 cm	
	AL2018HD	20" x 18" / 51 cm x 46 cm	

+ Decisions about how to code a product are the responsibility of the provider/supplier. Since Medicare coding is subject to change, the provider should always confirm the HCPCS code and coverage criteria as part of the client assessment process. For coverage criteria in other countries, consult your local Permobil Seating & Positioning distributor.
*May take up to three weeks for shipment.

Speciality Application Products

- Unless otherwise noted, all cushions include cover, pump, repair kit, and operating instructions.
- Contact ROHO Customer Support for additional information.

Suggested Retail	Item		
\$1,140.00	Personal Recliner Cushioning System: <u>CLASS: A3</u>		
	Item Number	Product Description	
	RECLINERCUSTC*	Custom Recliner Wheelchair cushion, back and seat protection Made to fit per order	
	• Priced upon request if exceeds 320 cells overall		
\$336.00	MINI-MAX® Cushion: <u>CLASS: A3</u>		
	Item Number	Standard Sizes (width x depth)	
	MINI1515C	15" x 15" / 38 cm x 38 cm	
	MINI1616C	16" x 16" / 41 cm x 41 cm	
	MINI1816C	18" x 16" / 46 cm x 41 cm	
	• Custom sizes available. Priced upon request.		
\$218.00	PACK-IT® Cushion: <u>CLASS: A3</u>		
	Item Number	Standard Sizes (width x depth)	
	PACKIT	16.25" x 9.5" / 41.5 cm x 24 cm	
\$330.00 \$168.00	HEAL PAD®: <u>CLASS: A3</u>		
	Item Number		
	HEALPADPR	Heal Pad - Pair	
	HEALPAD	Heal Pad - Single	
	• Fully adjustable. May be used for heel protection. • Does not include cover		
\$122.00	The ADAPTOR® Pad: <u>CLASS: A3</u>		
	Item Number	Standard Size (width x depth)	
	ADAPTOR	9.75" X 13.5" / 25 cm x 34 cm	
	• Self-contained air cells can be cut in sections to fit various surface shapes • Repair kit, pump, and cover not included		
\$278.00	Toilet Seat Cushion: <u>CLASS: A3</u>		
	Item Number	Standard Size	
	SEATTOILET	• Fits all standard toilet seats • Does not include cover	
\$415.00	Shower / Commode Cushion: <u>CLASS: A3</u> (LOW PROFILE® cells only)		
	Item Number	Standard Sizes (width x depth)	
	SEATCMD88LP	14.75" x 14.75" / 37.5 cm x 37.5 cm	
	SEATCMD89LP	14.75" x 16.5" / 37.5 cm x 42 cm	
	SEATCMD99LP	16.5" x 16.5" / 42 cm x 42 cm	
	SEATCMD910LP	16.5" x 18.25" / 42 cm x 46.5 cm	
	SEATCMD1010LP	18.25" X 18.25" / 46.5 cm x 46.5 cm	
SEATCMDCUST	Custom sizes available		
	• Does not include cover		
\$102.00 \$158.00	LTV® Seat Cushion: <u>CLASS: H</u> (non-medical cushion used for additional comfort)		
	Item Number	Standard Sizes (width x depth)	
	LTVC	18" x 16" / 45.5 cm x 40.5 cm - Black Quilted Fabric Cover	
	LTVBLK	18" x 16" / 45.5 cm x 40.5 cm - Black Quilted ULTRALEATHER® Cover	

* May take up to three weeks for shipment.

Seating Accessories and Covers

Suggested Retail	Item		
\$60.00	ROHO Contour Base (used with sling seat): CLASS: C		
	Item Number	Standard Sizes (width x depth)	
	BASE1313	13.25" x 13" / 33.5 cm x 33 cm	
	BASE1515	15.25" x 15" / 38.5 cm x 38.5 cm	
	BASE1715	17" x 15.25" / 43 cm x 38.5 cm	
	BASE1717	17" x 17.5" / 43 cm x 44.5 cm	
\$50.00 (\$76.00: SIMTO)	ROHO Planar Solid Seat Insert (used with any seat): CLASS: C		
	Item Number	Standard Sizes (width x depth)	
	SI1212	11.5" x 11.5" / 29 cm x 29 cm	
	SI1214	11.5" x 13.5" / 29 cm x 34.5 cm	
	SI1414	13.5" x 13.5" / 34.5 cm x 34.5 cm	
	SI1415	13.5" x 14.5" / 34.5 cm x 37 cm	
	SI1416	13.5" x 15.5" / 34.5 cm x 39.5 cm	
	SI1515	14.5" x 14.5" / 37 cm x 37 cm	
	SI1516	14.5" x 15.5" / 37 cm x 39.5 cm	
	SI1517	14.5" x 16.5" / 38 cm x 42 cm	
	SI1616	15.5" x 15.5" / 39.5 cm x 39.5 cm	
	SI1617	15.5" x 16.5" / 39.5 cm x 42 cm	
	SI1618	15.5" x 17.5" / 39.5 cm x 44.5 cm	
	SI1620	15.5" x 19.5" / 39.5 cm x 49.5 cm	
		Item Number	Standard Sizes (width x depth)
		SI1717	16.5" x 16.5" / 42 cm x 42 cm
		SI1718	16.5" x 17.5" / 42 cm x 44.5 cm
	SI1818	17.5" x 17.5" / 44.5 cm x 44.5 cm	
	SI1820	17.5" x 19.5" / 44.5 cm x 49.5 cm	
	SI1822	17.5" x 21.5" / 44.5 cm x 54.5 cm	
	SI1824	17.5" x 23.5" / 44.5 cm x 59.5 cm	
	SI2020	19.5" x 19.5" / 49.5 cm x 49.5 cm	
	SI2022	19.5" x 21.5" / 49.5 cm x 54.5 cm	
	SI2024	19.5" x 23.5" / 49.5 cm x 59.5 cm	
	SI2424	24" x 24" / 61 cm x 61 cm	
	SIMTO*	(Indicate measurements needed)	
	• No weight limit; however the Solid Seat Insert must be properly sized to the cushion and the individual.		
\$54.00 \$54.00 \$74.00 \$74.00 \$62.00 \$74.00 \$64.00 \$74.00 \$62.00	Covers: CLASS: C		
	Item Number	Product Description	
	COV-SSA (size)	Select Series Cushion Cover - Please specify size.	
	COV-A (model/size)	Standard Cushion Cover - Please specify cushion model and size.	
	COV-ACUST (model/size)	Custom Cushion Cover - Please specify cushion model and size.	
	COV-AMTO	Non-Standard Stock Cushion Cover - Please specify cushion model and size.	
	COV-HE (size)	Hybrid Elite Cushion Cover - Please specify cushion model and size.	
	COV-HD (model/size)	Heavy duty, fluid-resistant cover - Available to fit most standard-sized ROHO DRY FLOATATION, Hybrid Elite seat cushions and MOSAIC cushions.	
	COV-NS (size)	nexus SPIRIT Cushion Cover - Please specify size.	
COV-H (size)	HARMONY Cushion Cover - Please specify size.		
COV-HDAL (size)	AirLITE Heavy Duty Cushion Cover - Please specify size.		
\$8.50 \$12.50 \$64.00 \$64.00	Miscellaneous Items: CLASS: C		
	Item Number	Product Description	
	HP45	ROHO Inflation Pump - Single Action	
	HP20	ROHO Inflation Pump - Dual Action	
		Miscellaneous Modifications: CLASS: C	
		Hook & Loop Attachment	
		Drainage Holes	
\$175.00 \$75.00 \$5.00 \$3.10 \$5.00	Repair of ROHO® Products: CLASS: C		
	Item Number	Product Description	
	REPAIR	Repair Charge+	
	LABOR	Diagnostic & Handling Charge	
	A5	Repair Kit	
	V3	Inflation Valve (without rubber stem)	
CV3	Inflation Valve (with rubber stem)		

* May take up to three weeks for shipment.

+ Repairs are only available for neoprene custom products and mattress overlays.

ROHO AGILITY Standard Series Back Support Systems

- All AGILITY Standard Series Back Supports include attachment hardware, cover, pump, and operating instructions.
- Contact Customer Support for additional information.
- AG2 = Minimum Contour, AG3 = Mid Contour, AG6 = Max Contour
- -1 = Quick Release Hardware, -2 = Fixed Hardware, -P = Direct Mount Hardware

ROHO AGILITY Standard Series Sizing Matrix

A – Back Shell Length

A² – Back Shell and Foam Length

B – Back Cane Width Range
(there will be a 1.5cm loss of seat depth if an AGILITY Aluminum is fitted to the smallest wheelchair width within each size range)

C – Inner Width

D – Flat Center Section of Shell

E – Length of Wings

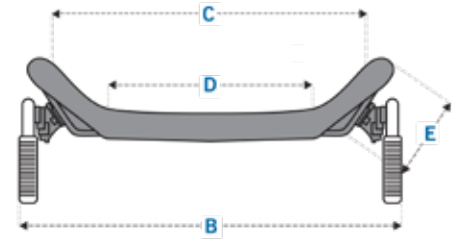
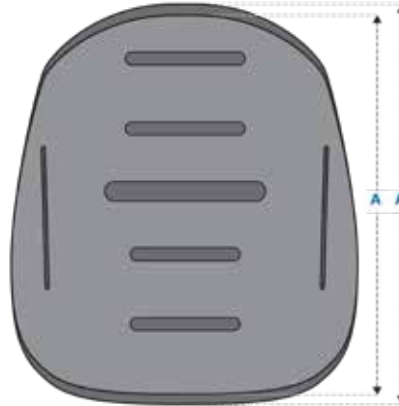

AGILITY Standard Series Minimum Contour Sizing Matrix

NUMBER	A (in.)	A (cm)	A ² (in.)	A ² (cm)	B (in.)	B (cm)	C (in.)	C (cm)	D (in.)	D (cm)	E (in.)	E (cm)
AG2-1410	10"	25.5	13"	33	13" - 14"	33 - 35.5	10.5"	26.5	6"	15	4"	10
AG2-1413	13"	33	16"	40.5	13" - 14"	33 - 35.5	10.5"	26.5	6"	15	4"	10
AG2-1416	16"	40.5	19"	48.5	13" - 14"	33 - 35.5	10.5"	26.5	6"	15	4"	10
AG2-1418	18"	45.5	21"	53.5	13" - 14"	33 - 35.5	10.5"	26.5	6"	15	4"	10
AG2-1510	10"	25.5	13"	33	14" - 15"	35.5 - 38	11.5"	29	6.5"	16.5"	4"	10
AG2-1513	13"	33	16"	40.5	14" - 15"	35.5 - 38	11.5"	29	6.5"	16.5"	4"	10
AG2-1516	16"	40.5	19"	48.5	14" - 15"	35.5 - 38	11.5"	29	6.5"	16.5"	4"	10
AG2-1518	18"	45.5	21"	53.5	14" - 15"	35.5 - 38	11.5"	29	6.5"	16.5"	4"	10
AG2-1610	10"	25.5	13"	33	15" - 16"	38 - 40.5	12"	30.5	7"	18	4"	10
AG2-1613	13"	33	16"	40.5	15" - 16"	38 - 40.5	12"	30.5	7"	18	4"	10
AG2-1616	16"	40.5	19"	48.5	15" - 16"	38 - 40.5	12"	30.5	7"	18	4"	10
AG2-1618	18"	45.5	21"	53.5	15" - 16"	38 - 40.5	12"	30.5	7"	18	4"	10
AG2-1710	10"	25.5	13"	33	16" - 17"	40.5 - 43	13"	33	8"	20.5	4"	10
AG2-1713	13"	33	16"	40.5	16" - 17"	40.5 - 43	13"	33	8"	20.5	4"	10
AG2-1716	16"	40.5	19"	48.5	16" - 17"	40.5 - 43	13"	33	8"	20.5	4"	10
AG2-1718	18"	45.5	21"	53.5	16" - 17"	40.5 - 43	13"	33	8"	20.5	4"	10
AG2-1810	10"	25.5	13"	33	17" - 18"	43 - 45.5	13.5"	34.5	9.5"	24	4"	10
AG2-1813	13"	33	16"	40.5	17" - 18"	43 - 45.5	13.5"	34.5	9.5"	24	4"	10
AG2-1816	16"	40.5	19"	48.5	17" - 18"	43 - 45.5	13.5"	34.5	9.5"	24	4"	10
AG2-1818	18"	45.5	21"	53.5	17" - 18"	43 - 45.5	13.5"	34.5	9.5"	24	4"	10
AG2-1910	10"	25.5	13"	33	18" - 19"	45.5 - 48.5	15"	38	10"	25.5	4"	10
AG2-1913	13"	33	16"	40.5	18" - 19"	45.5 - 48.5	15"	38	10"	25.5	4"	10
AG2-1916	16"	40.5	19"	48.5	18" - 19"	45.5 - 48.5	15"	38	10"	25.5	4"	10
AG2-1918	18"	45.5	21"	53.5	18" - 19"	45.5 - 48.5	15"	38	10"	25.5	4"	10
AG2-2010	10"	25.5	13"	33	19" - 20"	48.5 - 51	16"	40.5	11.5"	29	4"	10
AG2-2013	13"	33	16"	40.5	19" - 20"	48.5 - 51	16"	40.5	11.5"	29	4"	10
AG2-2016	16"	40.5	19"	48.5	19" - 20"	48.5 - 51	16"	40.5	11.5"	29	4"	10
AG2-2018	18"	45.5	21"	53.5	19" - 20"	48.5 - 51	16"	40.5	11.5"	29	4"	10

AGILITY Standard Series Mid Contour Sizing Matrix

NUMBER	A (cm)	A (in.)	A ² (cm)	A ² (in.)	B (cm)	B (in.)	C (cm)	C (in.)	D (cm)	D (in.)	E (cm)	E (in.)
AG3-1410	25.5	10"	33	13"	33-35.5	13" - 14"	26.5	10.5"	15	6"	15	6"
AG3-1413	33	13"	40.5	16"	33-35.5	13" - 14"	26.5	10.5"	15	6"	15	6"
AG3-1416	40.5	16"	48.5	19"	33-35.5	13" - 14"	26.5	10.5"	15	6"	15	6"
AG3-1418	45.5	18"	53.5	21"	33-35.5	13" - 14"	26.5	10.5"	15	6"	15	6"
AG3-1420	51	20"	58.5	23"	33-35.5	13" - 14"	26.5	10.5"	15	6"	15	6"
AG3-1510	25.5	10"	33	13"	35.5-38	14" - 15"	30.5	12"	18	7"	13	5"
AG3-1513	33	13"	40.5	16"	35.5-38	14" - 15"	30.5	12"	18	7"	13	5"
AG3-1516	40.5	16"	48.5	19"	35.5-38	14" - 15"	30.5	12"	18	7"	13	5"
AG3-1518	45.5	18"	53.5	21"	35.5-38	14" - 15"	30.5	12"	18	7"	13	5"
AG3-1520	51	20"	58.5	23"	35.5-38	14" - 15"	30.5	12"	18	7"	13	5"
AG3-1610	25.5	10"	33	13"	38-40.5	15" - 16"	33	13"	20.5	8"	15	6"
AG3-1613	33	13"	40.5	16"	38-40.5	15" - 16"	33	13"	20.5	8"	15	6"
AG3-1616	40.5	16"	48.5	19"	38-40.5	15" - 16"	33	13"	20.5	8"	15	6"
AG3-1618	45.5	18"	53.5	21"	38-40.5	15" - 16"	33	13"	20.5	8"	15	6"
AG3-1620	51	20"	58.5	23"	38-40.5	15" - 16"	33	13"	20.5	8"	15	6"
AG3-1710	25.5	10"	33	13"	40.5-43	16" - 17"	35.5	14"	23	9"	13	5"
AG3-1713	33	13"	40.5	16"	40.5-43	16" - 17"	35.5	14"	23	9"	13	5"
AG3-1716	40.5	16"	48.5	19"	40.5-43	16" - 17"	35.5	14"	23	9"	13	5"
AG3-1718	45.5	18"	53.5	21"	40.5-43	16" - 17"	35.5	14"	23	9"	13	5"
AG3-1720	51	20"	58.5	23"	40.5-43	16" - 17"	35.5	14"	23	9"	13	5"
AG3-1810	25.5	10"	33	13"	43-45.5	17" - 18"	38	15"	25.5	10"	15	6"
AG3-1813	33	13"	40.5	16"	43-45.5	17" - 18"	38	15"	25.5	10"	15	6"
AG3-1816	40.5	16"	48.5	19"	43-45.5	17" - 18"	38	15"	25.5	10"	15	6"
AG3-1818	45.5	18"	53.5	21"	43-45.5	17" - 18"	38	15"	25.5	10"	15	6"
AG3-1820	51	20"	58.5	23"	43-45.5	17" - 18"	38	15"	25.5	10"	15	6"
AG3-1910	25.5	10"	33	13"	45.5-48.5	18" - 19"	40.5	16"	28	11"	13	5"
AG3-1913	33	13"	40.5	16"	45.5-48.5	18" - 19"	40.5	16"	28	11"	13	5"
AG3-1916	40.5	16"	48.5	19"	45.5-48.5	18" - 19"	40.5	16"	28	11"	13	5"
AG3-1918	45.5	18"	53.5	21"	45.5-48.5	18" - 19"	40.5	16"	28	11"	13	5"
AG3-1920	51	20"	58.5	23"	45.5-48.5	18" - 19"	40.5	16"	28	11"	13	5"
AG3-2010	25.5	10"	33	13"	48.5-51	19" - 20"	43	17"	30.5	12"	15	6"
AG3-2013	33	13"	40.5	16"	48.5-51	19" - 20"	43	17"	30.5	12"	15	6"
AG3-2016	40.5	16"	48.5	19"	48.5-51	19" - 20"	43	17"	30.5	12"	15	6"
AG3-2018	45.5	18"	53.5	21"	48.5-51	19" - 20"	43	17"	30.5	12"	15	6"
AG3-2020	51	20"	58.5	23"	48.5-51	19" - 20"	43	17"	30.5	12"	15	6"

AGILITY Standard Series Max Contour Sizing Matrix

AG6-1416	40.5	16"	48.5	19"	33-35.5	13" - 14"	28	11"	15	6"	20.5	8"
AG6-1418	45.5	18"	53.5	21"	33-35.5	13" - 14"	28	11"	15	6"	20.5	8"
AG6-1420	51	20"	58.5	23"	33-35.5	13" - 14"	28	11"	15	6"	20.5	8"
AG6-1516	40.5	16"	48.5	19"	35.5-38	14" - 15"	32	12.5"	20.5	8"	20.5	8"
AG6-1518	45.5	18"	53.5	21"	35.5-38	14" - 15"	32	12.5"	20.5	8"	20.5	8"
AG6-1520	51	20"	58.5	23"	35.5-38	14" - 15"	32	12.5"	20.5	8"	20.5	8"
AG6-1616	40.5	16"	48.5	19"	38-40.5	15" - 16"	33	13"	23	9"	20.5	8"
AG6-1618	45.5	18"	53.5	21"	38-40.5	15" - 16"	33	13"	23	9"	20.5	8"
AG6-1620	51	20"	58.5	23"	38-40.5	15" - 16"	33	13"	23	9"	20.5	8"
AG6-1716	40.5	16"	48.5	19"	40.5-43	16" - 17"	37	14.5"	25.5	10"	23	9"
AG6-1718	45.5	18"	53.5	21"	40.5-43	16" - 17"	37	14.5"	25.5	10"	23	9"
AG6-1720	51	20"	58.5	23"	40.5-43	16" - 17"	37	14.5"	25.5	10"	23	9"
AG6-1816	40.5	16"	48.5	19"	43-45.5	17" - 18"	38	15"	29	11.5"	23	9"
AG6-1818	45.5	18"	53.5	21"	43-45.5	17" - 18"	38	15"	29	11.5"	23	9"
AG6-1820	51	20"	58.5	23"	43-45.5	17" - 18"	38	15"	29	11.5"	23	9"
AG6-1916	40.5	16"	48.5	19"	45.5-48.5	18" - 19"	42	16.5"	30.5	12"	23	9"
AG6-1918	45.5	18"	53.5	21"	45.5-48.5	18" - 19"	42	16.5"	30.5	12"	23	9"
AG6-1920	51	20"	58.5	23"	45.5-48.5	18" - 19"	42	16.5"	30.5	12"	23	9"
AG6-2016	40.5	16"	48.5	19"	48.5-51	19" - 20"	43	17"	32	12.5"	23	9"
AG6-2018	45.5	18"	53.5	21"	48.5-51	19" - 20"	43	17"	32	12.5"	23	9"
AG6-2020	51	20"	58.5	23"	48.5-51	19" - 20"	43	17"	32	12.5"	23	9"

ROHO AGILITY Standard Series Back Support Systems

- All AGILITY Standard Series Back Supports include attachment hardware, cover, pump, and operating instructions.
- Refer to pages 12 & 13 for sizing and back dimension information.
- AG2 = Minimum Contour, AG3 = Mid Contour, AG6 = Max Contour
- -1 = Quick Release Hardware, -2 = Fixed Hardware, -P = Direct Mount Hardware
- Contact ROHO Customer Support for additional information.

AGILITY Standard Series - Minimum Contour

Suggested Retail	Item					HCPCS ⁺
\$474.00	AGILITY Minimum Contour Back System with Quick Release Hardware with Foam Only: CLASS: M					
	AG2-1410F-1	AG2-1516F-1	AG2-1710F-1	AG2-1816F-1	AG2-1918F-1	E2611
	AG2-1413F-1	AG2-1518F-1	AG2-1713F-1	AG2-1818F-1	AG2-2010F-1	
	AG2-1416F-1	AG2-1610F-1	AG2-1716F-1	AG2-1910F-1	AG2-2013F-1	
	AG2-1418F-1	AG2-1613F-1	AG2-1718F-1	AG2-1913F-1	AG2-2016F-1	
	AG2-1510F-1	AG2-1616F-1	AG2-1810F-1	AG2-1916F-1	AG2-2018F-1	
	AG2-1513F-1	AG2-1618F-1	AG2-1813F-1			
\$567.00	AGILITY Minimum Contour Back System with Quick Release Hardware with Foam and Lumbar Pad: CLASS: M					
	AG2-1410FL-1	AG2-1516FL-1	AG2-1710FL-1	AG2-1816FL-1	AG2-1918FL-1	E2613
	AG2-1413FL-1	AG2-1518FL-1	AG2-1713FL-1	AG2-1818FL-1	AG2-2010FL-1	
	AG2-1416FL-1	AG2-1610FL-1	AG2-1716FL-1	AG2-1910FL-1	AG2-2013FL-1	
	AG2-1418FL-1	AG2-1613FL-1	AG2-1718FL-1	AG2-1913FL-1	AG2-2016FL-1	
	AG2-1510FL-1	AG2-1616FL-1	AG2-1810FL-1	AG2-1916FL-1	AG2-2018FL-1	
	AG2-1513FL-1	AG2-1618FL-1	AG2-1813FL-1			
\$662.00	AGILITY Minimum Contour Back System with Quick Release Hardware with Air Only: CLASS: M					
	AG2-1410A-1	AG2-1516A-1	AG2-1710A-1	AG2-1816A-1	AG2-1918A-1	E2620
	AG2-1413A-1	AG2-1518A-1	AG2-1713A-1	AG2-1818A-1	AG2-2010A-1	
	AG2-1416A-1	AG2-1610A-1	AG2-1716A-1	AG2-1910A-1	AG2-2013A-1	
	AG2-1418A-1	AG2-1613A-1	AG2-1718A-1	AG2-1913A-1	AG2-2016A-1	
	AG2-1510A-1	AG2-1616A-1	AG2-1810A-1	AG2-1916A-1	AG2-2018A-1	
	AG2-1513A-1	AG2-1618A-1	AG2-1813A-1			
\$662.00	AGILITY Minimum Contour Back System with Quick Release Hardware with Air and Lumbar Pad: CLASS: M					
	AG2-1410AL-1	AG2-1516AL-1	AG2-1710AL-1	AG2-1816AL-1	AG2-1918AL-1	E2615
	AG2-1413AL-1	AG2-1518AL-1	AG2-1713AL-1	AG2-1818AL-1	AG2-2010AL-1	
	AG2-1416AL-1	AG2-1610AL-1	AG2-1716AL-1	AG2-1910AL-1	AG2-2013AL-1	
	AG2-1418AL-1	AG2-1613AL-1	AG2-1718AL-1	AG2-1913AL-1	AG2-2016AL-1	
	AG2-1510AL-1	AG2-1616AL-1	AG2-1810AL-1	AG2-1916AL-1	AG2-2018AL-1	
	AG2-1513AL-1	AG2-1618AL-1	AG2-1813AL-1			
\$474.00	ROHO AGILITY Minimum Contour Back System with Fixed Hardware with Foam Only: CLASS: M					
	AG2-1410F-2	AG2-1516F-2	AG2-1710F-2	AG2-1813F-2	AG2-1916F-2	E2611
	AG2-1413F-2	AG2-1610F-2	AG2-1713F-2	AG2-1816F-2	AG2-2010F-2	
	AG2-1416F-2	AG2-1613F-2	AG2-1716F-2	AG2-1910F-2	AG2-2013F-2	
	AG2-1510F-2	AG2-1616F-2	AG2-1810F-2	AG2-1913F-2	AG2-2016F-2	
	AG2-1513F-2					



⁺ Decisions about how to code a product are the responsibility of the provider/supplier. Since Medicare coding is subject to change, the provider should always confirm the HCPCS code and coverage criteria as part of the client assessment process. For coverage criteria in other countries, consult your local Permobil Seating & Positioning distributor.

ROHO AGILITY Standard Series Back Support Systems

- All AGILITY Standard Series Back Supports include attachment hardware, cover, pump, and operating instructions.
- Refer to pages 12 & 13 for sizing and back dimension information.
- AG2 = Minimum Contour, AG3 = Mid Contour, AG6 = Max Contour
- -1 = Quick Release Hardware, -2 = Fixed Hardware, -P = Direct Mount Hardware
- Contact ROHO Customer Support for additional information.

AGILITY Standard Series - Minimum Contour Continued

Suggested Retail	Item	HCPCS ⁺
\$567.00	AGILITY Minimum Contour Back System with Fixed Hardware with Foam and Lumbar Pad: CLASS: M	
	AG2-1410FL-2 AG2-1516FL-2 AG2-1710FL-2 AG2-1813FL-2 AG2-1916FL-2	
	AG2-1413FL-2 AG2-1610FL-2 AG2-1713FL-2 AG2-1816FL-2 AG2-2010FL-2	E2613
	AG2-1416FL-2 AG2-1613FL-2 AG2-1716FL-2 AG2-1910FL-2 AG2-2013FL-2	
	AG2-1510FL-2 AG2-1616FL-2 AG2-1810FL-2 AG2-1913FL-2 AG2-2016FL-2	
	AG2-1513FL-2	
\$662.00	AGILITY Minimum Contour Back System with Fixed Hardware with Air Only: CLASS: M	
	AG2-1410A-2 AG2-1516A-2 AG2-1710A-2 AG2-1813A-2 AG2-1916A-2	
	AG2-1413A-2 AG2-1610A-2 AG2-1713A-2 AG2-1816A-2 AG2-2010A-2	E2620
	AG2-1416A-2 AG2-1613A-2 AG2-1716A-2 AG2-1910A-2 AG2-2013A-2	
	AG2-1510A-2 AG2-1616A-2 AG2-1810A-2 AG2-1913A-2 AG2-2016A-2	
	AG2-1513A-2	
\$662.00	AGILITY Minimum Contour Back System with Fixed Hardware with Air and Lumbar Pad: CLASS: M	
	AG2-1410AL-2 AG2-1516AL-2 AG2-1710AL-2 AG2-1813AL-2 AG2-1916AL-2	
	AG2-1413AL-2 AG2-1610AL-2 AG2-1713AL-2 AG2-1816AL-2 AG2-2010AL-2	E2615
	AG2-1416AL-2 AG2-1613AL-2 AG2-1716AL-2 AG2-1910AL-2 AG2-2013AL-2	
	AG2-1510AL-2 AG2-1616AL-2 AG2-1810AL-2 AG2-1913AL-2 AG2-2016AL-2	
	AG2-1513AL-2	

AGILITY Standard Series - Mid Contour

\$673.00	AGILITY Mid Contour Back System with Quick Release Hardware with Air Only: CLASS: M	E2620
	AG3-1410A-1 AG3-1516A-1 AG3-1620A-1 AG3-1813A-1 AG3-1918A-1	
	AG3-1413A-1 AG3-1518A-1 AG3-1710A-1 AG3-1816A-1 AG3-1920A-1	
	AG3-1416A-1 AG3-1520A-1 AG3-1713A-1 AG3-1818A-1 AG3-2010A-1	
	AG3-1418A-1 AG3-1610A-1 AG3-1716A-1 AG3-1820A-1 AG3-2013A-1	
	AG3-1420A-1 AG3-1613A-1 AG3-1718A-1 AG3-1910A-1 AG3-2016A-1	
\$673.00	AGILITY Mid Contour Back System with Quick Release Hardware with Air and Lumbar Pad: CLASS: M	
	AG3-1410AL-1 AG3-1516AL-1 AG3-1620AL-1 AG3-1813AL-1 AG3-1918AL-1	
	AG3-1413AL-1 AG3-1518AL-1 AG3-1710AL-1 AG3-1816AL-1 AG3-1920AL-1	
	AG3-1416AL-1 AG3-1520AL-1 AG3-1713AL-1 AG3-1818AL-1 AG3-2010AL-1	E2615
	AG3-1418AL-1 AG3-1610AL-1 AG3-1716AL-1 AG3-1820AL-1 AG3-2013AL-1	
	AG3-1420AL-1 AG3-1613AL-1 AG3-1718AL-1 AG3-1910AL-1 AG3-2016AL-1	
AG3-1510AL-1 AG3-1616AL-1 AG3-1720AL-1 AG3-1913AL-1 AG3-2018AL-1		
AG3-1513AL-1 AG3-1618AL-1 AG3-1810AL-1 AG3-1916AL-1 AG3-2020AL-1		



⁺ Decisions about how to code a product are the responsibility of the provider/supplier. Since Medicare coding is subject to change, the provider should always confirm the HCPCS code and coverage criteria as part of the client assessment process. For coverage criteria in other countries, consult your local Permobil Seating & Positioning distributor.

ROHO AGILITY Standard Series Back Support Systems

- All AGILITY Standard Series Back Supports include attachment hardware, cover, pump, and operating instructions.
- Refer to pages 12 & 13 for sizing and back dimension information.
- AG2 = Minimum Contour, AG3 = Mid Contour, AG6 = Max Contour
- -1 = Quick Release Hardware, -2 = Fixed Hardware, -P = Direct Mount Hardware
- Contact ROHO Customer Support for additional information.

AGILITY Standard Series - Mid Contour Continued

Suggested Retail	Item	HCPCS ⁺
\$673.00	AGILITY Mid Contour Back System with Fixed Hardware with Air Only: CLASS: M	
	AG3-1410A-2 AG3-1516A-2 AG3-1616A-2 AG3-1810A-2 AG3-1913A-2	
	AG3-1413A-2 AG3-1516A-2 AG3-1710A-2 AG3-1813A-2 AG3-1916A-2	E2620
	AG3-1416A-2 AG3-1610A-2 AG3-1713A-2 AG3-1816A-2 AG3-2010A-2	
	AG3-1510A-2 AG3-1613A-2 AG3-1716A-2 AG3-1910A-2 AG3-2016A-2	
	AG3-1513A-2	
\$673.00	AGILITY Mid Contour Back System with Fixed Hardware with Air and Lumbar: CLASS: M	
	AG3-1410AL-2 AG3-1516AL-2 AG3-1710AL-2 AG3-1813AL-2 AG3-1916AL-2	
	AG3-1413AL-2 AG3-1610AL-2 AG3-1713AL-2 AG3-1816AL-2 AG3-2010AL-2	E2615
	AG3-1416AL-2 AG3-1613AL-2 AG3-1716AL-2 AG3-1910AL-2 AG3-2013AL-2	
	AG3-1510AL-2 AG3-1616AL-2 AG3-1810AL-2 AG3-1913AL-2 AG3-2016AL-2	
	AG3-1513AL-2	

AGILITY Standard Series - Max Contour

\$792.00	AGILITY Max Contour Back System with Quick Release Hardware: CLASS: M				Air Only E2620	
	Air Only Item Number		Air and Lumbar Pad Item Number		Air & Lumbar E2615	
	AG6-1416A-1	AG6-1720A-1	AG6-1416AL-1	AG6-1720AL-1		
	AG6-1418A-1	AG6-1816A-1	AG6-1418AL-1	AG6-1816AL-1		
	AG6-1420A-1	AG6-1818A-1	AG6-1420AL-1	AG6-1818AL-1		
	AG6-1516A-1	AG6-1820A-1	AG6-1516AL-1	AG6-1820AL-1		
	AG6-1518A-1	AG6-1916A-1	AG6-1518AL-1	AG6-1916AL-1		
	AG6-1520A-1	AG6-1918A-1	AG6-1520AL-1	AG6-1918AL-1		
	AG6-1616A-1	AG6-1920A-1	AG6-1616AL-1	AG6-1920AL-1		
	AG6-1618A-1	AG6-2016A-1	AG6-1618AL-1	AG6-2016AL-1		
	AG6-1620A-1	AG6-2018A-1	AG6-1620AL-1	AG6-2018AL-1		
	AG6-1716A-1	AG6-2020A-1	AG6-1716AL-1	AG6-2020AL-1		
	AG6-1718A-1		AG6-1718AL-1			
\$792.00	AGILITY Max Contour Back System with Fixed Hardware: CLASS: M					Air Only E2620
	Air Only Item Number		Air and Lumbar Pad Item Number			Air & Lumbar E2615
	AG6-1416A-2	AG6-1816A-2	AG6-1416AL-2	AG6-1816AL-2		
	AG6-1516A-2	AG6-1916A-2	AG6-1516AL-2	AG6-1916AL-2		
	AG6-1616A-2	AG6-2016A-2	AG6-1616AL-2	AG6-2016AL-2		
AG6-1716A-2		AG6-1716AL-2				

⁺ Decisions about how to code a product are the responsibility of the provider/supplier. Since Medicare coding is subject to change, the provider should always confirm the HCPCS code and coverage criteria as part of the client assessment process. For coverage criteria in other countries, consult your local Permobil Seating & Positioning distributor.

ROHO AGILITY Standard Series Back Support Systems

- All AGILITY Standard Series Back Supports include attachment hardware, cover, pump, and operating instructions.
- Refer to pages 12 & 13 for sizing and back dimension information.
- AG2 = Minimum Contour, AG3 = Mid Contour, AG6 = Max Contour
- -1 = Quick Release Hardware, -2 = Fixed Hardware, -P = Direct Mount Hardware
- Contact ROHO Customer Support for additional information.



AGILITY Standard Series - Max Contour Continued

Suggested Retail	Item	HCPCS+
\$792.00	AGILITY Max Contour Back System with Direct Mount Hardware with Air (Compatible with Permobil Power Wheelchairs with compatible Corpus Seating): CLASS: M	E2620
	AG6-1416A-P AG6-1520A-P AG6-1716A-P AG6-1818A-P AG6-1920A-P	
	AG6-1418A-P AG6-1616A-P AG6-1718A-P AG6-1820A-P AG6-2016A-P	
	AG6-1420A-P AG6-1618A-P AG6-1720A-P AG6-1916A-P AG6-2018A-P	
	AG6-1516A-P AG6-1620A-P AG6-1816A-P AG6-1918A-P AG6-2020A-P	
	AG6-1518A-P	
	AGILITY Max Contour Back System with Direct Mount Hardware with Air and Lumbar (Compatible with Permobil Power Wheelchairs with compatible Corpus Seating): CLASS: M	
AG6-1416AL-P AG6-1520AL-P AG6-1716AL-P AG6-1818AL-P AG6-1920AL-P		
AG6-1418AL-P AG6-1616AL-P AG6-1718AL-P AG6-1820AL-P AG6-2016AL-P		
AG6-1420AL-P AG6-1618AL-P AG6-1720AL-P AG6-1916AL-P AG6-2018AL-P		
AG6-1516AL-P AG6-1620AL-P AG6-1816AL-P AG6-1918AL-P AG6-2020AL-P		
AG6-1518AL-P		

AGILITY Standard Series - Custom Back Support

\$1,888.00	AGILITY Custom Back		E2617
\$1,992.00	AG2CUSTC* Minimum Contour	Contact Customer Support for details	
\$2,308.00	AG3CUSTC* Mid Contour	Contact Customer Support for details	
	AG6CUSTC* Max Contour	Contact Customer Support for details	

AGILITY Standard Series - Laterals

\$436.00	AGILITY Back System Lateral Pads: CLASS: M				
	SWING-AWAY with Curved Pad				
		Pad Size	Pad Size		Offset Type
	AG-LATSA-M-FL	Medium	4 T x 4 L		Flush
	AG-LATSA-M-OF	Medium	4 T x 4 L		Offset
	AG-LATSA-M-OF1	Medium	4 T x 4 L		1" / 2.5 cm Offset
	AG-LATSA-M-OF2	Medium	4 T x 4 L		2" / 5 cm Offset
	AG-LATSA-L-FL	Large	4 T x 5 L		Flush
	AG-LATSA-L-OF	Large	4 T x 5 L		Offset
	AG-LATSA-L-OF1	Large	4 T x 5 L		1" / 2.5 cm Offset
	AG-LATSA-L-OF2	Large	4 T x 5 L		2" / 5 cm Offset
	AG-LATSA-X-FL	X-Large	5 T x 5 L		Flush
	AG-LATSA-X-OF	X-Large	5 T x 5 L		Offset
AG-LATSA-X-OF1	X-Large	5 T x 5 L	1" / 2.5 cm Offset		
AG-LATSA-X-OF2	X-Large	5 T x 5 L	2" / 5 cm Offset		
\$195.00	FIXED with Flat Pad				
		Pad Size	Pad Size		Offset Type
	AG-LATFX-M-FL	Medium	4 T x 4 L		Flush
	AG-LATFX-M-OF	Medium	4 T x 4 L		Offset
	AG-LATFX-L-FL	Large	4 T x 5 L		Flush
	AG-LATFX-L-OF	Large	4 T x 5 L		Offset
	AG-LATFX-X-FL	X-Large	5 T x 5 L		Flush
AG-LATFX-X-OF	X-Large	5 T x 5 L	Offset		

+ Decisions about how to code a product are the responsibility of the provider/supplier. Since Medicare coding is subject to change, the provider should always confirm the HCPCS code and coverage criteria as part of the client assessment process. For coverage criteria in other countries, consult your local Permobil Seating & Positioning distributor.
 *May take up to three weeks for shipment.

ROHO AGILITY Standard Series Back Support Systems

- All AGILITY Standard Series Back Supports include attachment hardware, cover, pump, and operating instructions.
- Refer to sizing chart on pages 12 & 13.
- AG2 = Minimum Contour, AG3 = Mid Contour, AG6 = Max Contour
- Contact ROHO Customer Support for additional information.

AGILITY Standard Series - Headrests

Suggested Retail	Item
\$189.00	Therafin Headrest for ROHO AGILITY Back Support Systems: CLASS: M AG-HRPAD-SM Small (5" Height x 8" Width)
	AG-HRPAD-MED Medium (5" Height x 10" Width)
	AG-HRPAD-LG Large (5" Height x 14" Width)
\$232.00	Therafin Headrest for ROHO AGILITY Back Support Systems: CLASS: M AG-HRPAD-BRKT Multi-Axis Headrest Hardware
	AGILITY Headrest: CLASS: C AG-HR-BRKT Universal Headrest Adaptor Plate
\$102.00	AG-HR-UT Headrest bracket and unitrack to fit 15"- 20" width
\$20.00	AG-HR-UT14 Headrest bracket and unitrack to fit 14" width



AGILITY Standard Series - Replacements

AGILITY Back Replacement Covers - Standard: CLASS: C																																																													
	<table border="0"> <tr> <th>Minimum Contour</th> <th>Mid Contour</th> <th>Max Contour</th> </tr> </table>	Minimum Contour	Mid Contour	Max Contour																																																									
Minimum Contour	Mid Contour	Max Contour																																																											
Minimum and Mid Contours: \$72.00	COV-AG2-1410 COV-AG2-1810 COV-AG3-1410 COV-AG3-1810 COV-AG6-1416																																																												
	COV-AG2-1413 COV-AG2-1813 COV-AG3-1413 COV-AG3-1813 COV-AG6-1418																																																												
	COV-AG2-1416 COV-AG2-1816 COV-AG3-1416 COV-AG3-1816 COV-AG6-1420																																																												
	COV-AG2-1418 COV-AG2-1818 COV-AG3-1418 COV-AG3-1818 COV-AG6-1616																																																												
	COV-AG2-1513 COV-AG2-1910 COV-AG3-1420 COV-AG3-1820 COV-AG6-1618																																																												
	COV-AG2-1610 COV-AG2-1913 COV-AG3-1510 COV-AG3-1910 COV-AG6-1620																																																												
	COV-AG2-1613 COV-AG2-1916 COV-AG3-1513 COV-AG3-1916 COV-AG6-1816																																																												
	COV-AG2-1616 COV-AG2-1918 COV-AG3-1518 COV-AG3-1918 COV-AG6-1818																																																												
	COV-AG2-1618 COV-AG2-2010 COV-AG3-1610 COV-AG3-1920 COV-AG6-1820																																																												
	COV-AG2-1710 COV-AG2-2013 COV-AG3-1613 COV-AG3-2010 COV-AG6-1920																																																												
	COV-AG2-1713 COV-AG2-2016 COV-AG3-1616 COV-AG3-2013 COV-AG6-2016																																																												
	COV-AG2-1716 COV-AG2-2018 COV-AG3-1618 COV-AG3-2016 COV-AG6-2018																																																												
	COV-AG2-1718 COV-AG3-1620 COV-AG3-2018 COV-AG6-2020																																																												
	COV-AG2-1718 COV-AG3-1710 COV-AG3-2020																																																												
	COV-AG2-1718 COV-AG3-1713																																																												
	Max Contour: \$82.50	COV-AG2-1616 COV-AG2-1918 COV-AG3-1518 COV-AG3-1918 COV-AG6-1818																																																											
COV-AG2-1618 COV-AG2-2010 COV-AG3-1610 COV-AG3-1920 COV-AG6-1820																																																													
COV-AG2-1710 COV-AG2-2013 COV-AG3-1613 COV-AG3-2010 COV-AG6-1920																																																													
COV-AG2-1713 COV-AG2-2016 COV-AG3-1616 COV-AG3-2013 COV-AG6-2016																																																													
COV-AG2-1716 COV-AG2-2018 COV-AG3-1618 COV-AG3-2016 COV-AG6-2018																																																													
COV-AG2-1718 COV-AG3-1620 COV-AG3-2018 COV-AG6-2020																																																													
COV-AG2-1718 COV-AG3-1710 COV-AG3-2020																																																													
COV-AG2-1718 COV-AG3-1713																																																													
COV-AG2-1718 COV-AG3-1716																																																													
COV-AG2-1718 COV-AG3-1810																																																													
COV-AG2-1718 COV-AG3-1813																																																													
COV-AG2-1718 COV-AG3-1816																																																													
COV-AG2-1718 COV-AG3-1818																																																													
COV-AG2-1718 COV-AG3-1910																																																													
\$62.00	AGILITY Minimum Contour Replacement Foam: CLASS: C																																																												
	<table border="0"> <tr> <th colspan="3">Item Number For Foam With No Cut Out</th> <th colspan="3">Item Number For Foam With Cut Out</th> </tr> <tr> <td>AG2FO-1410</td> <td>AG2FO-1710</td> <td>AG2FO-1910</td> <td>AG2FC-1410</td> <td>AG2FC-1710</td> <td>AG2FC-1910</td> </tr> <tr> <td>AG2FO-1413</td> <td>AG2FO-1713</td> <td>AG2FO-1913</td> <td>AG2FC-1413</td> <td>AG2FC-1713</td> <td>AG2FC-1913</td> </tr> <tr> <td>AG2FO-1416</td> <td>AG2FO-1716</td> <td>AG2FO-1916</td> <td>AG2FC-1416</td> <td>AG2FC-1716</td> <td>AG2FC-1916</td> </tr> <tr> <td>AG2FO-1418</td> <td>AG2FO-1718</td> <td>AG2FO-1918</td> <td>AG2FC-1418</td> <td>AG2FC-1718</td> <td>AG2FC-1918</td> </tr> <tr> <td>AG2FO-1513</td> <td>AG2FO-1810</td> <td>AG2FO-2010</td> <td>AG2FC-1513</td> <td>AG2FC-1810</td> <td>AG2FC-2010</td> </tr> <tr> <td>AG2FO-1610</td> <td>AG2FO-1813</td> <td>AG2FO-2013</td> <td>AG2FC-1610</td> <td>AG2FC-1813</td> <td>AG2FC-2013</td> </tr> <tr> <td>AG2FO-1613</td> <td>AG2FO-1816</td> <td>AG2FO-2016</td> <td>AG2FC-1613</td> <td>AG2FC-1816</td> <td>AG2FC-2016</td> </tr> <tr> <td>AG2FO-1616</td> <td>AG2FO-1818</td> <td>AG2FO-2018</td> <td>AG2FC-1616</td> <td>AG2FC-1818</td> <td>AG2FC-2018</td> </tr> <tr> <td>AG2FO-1618</td> <td></td> <td></td> <td>AG2FC-1618</td> <td></td> <td></td> </tr> </table>	Item Number For Foam With No Cut Out			Item Number For Foam With Cut Out			AG2FO-1410	AG2FO-1710	AG2FO-1910	AG2FC-1410	AG2FC-1710	AG2FC-1910	AG2FO-1413	AG2FO-1713	AG2FO-1913	AG2FC-1413	AG2FC-1713	AG2FC-1913	AG2FO-1416	AG2FO-1716	AG2FO-1916	AG2FC-1416	AG2FC-1716	AG2FC-1916	AG2FO-1418	AG2FO-1718	AG2FO-1918	AG2FC-1418	AG2FC-1718	AG2FC-1918	AG2FO-1513	AG2FO-1810	AG2FO-2010	AG2FC-1513	AG2FC-1810	AG2FC-2010	AG2FO-1610	AG2FO-1813	AG2FO-2013	AG2FC-1610	AG2FC-1813	AG2FC-2013	AG2FO-1613	AG2FO-1816	AG2FO-2016	AG2FC-1613	AG2FC-1816	AG2FC-2016	AG2FO-1616	AG2FO-1818	AG2FO-2018	AG2FC-1616	AG2FC-1818	AG2FC-2018	AG2FO-1618			AG2FC-1618		
	Item Number For Foam With No Cut Out			Item Number For Foam With Cut Out																																																									
	AG2FO-1410	AG2FO-1710	AG2FO-1910	AG2FC-1410	AG2FC-1710	AG2FC-1910																																																							
	AG2FO-1413	AG2FO-1713	AG2FO-1913	AG2FC-1413	AG2FC-1713	AG2FC-1913																																																							
	AG2FO-1416	AG2FO-1716	AG2FO-1916	AG2FC-1416	AG2FC-1716	AG2FC-1916																																																							
	AG2FO-1418	AG2FO-1718	AG2FO-1918	AG2FC-1418	AG2FC-1718	AG2FC-1918																																																							
	AG2FO-1513	AG2FO-1810	AG2FO-2010	AG2FC-1513	AG2FC-1810	AG2FC-2010																																																							
	AG2FO-1610	AG2FO-1813	AG2FO-2013	AG2FC-1610	AG2FC-1813	AG2FC-2013																																																							
	AG2FO-1613	AG2FO-1816	AG2FO-2016	AG2FC-1613	AG2FC-1816	AG2FC-2016																																																							
	AG2FO-1616	AG2FO-1818	AG2FO-2018	AG2FC-1616	AG2FC-1818	AG2FC-2018																																																							
	AG2FO-1618			AG2FC-1618																																																									

ROHO AGILITY Standard Series Back Support Systems

- All AGILITY Standard Series Back Supports include attachment hardware, cover, pump, and operating instructions.
- Refer to sizing chart on pages 12 & 13.
- AG2 = Minimum Contour, AG3 = Mid Contour, AG6 = Max Contour
- Contact ROHO Customer Support for additional information.

AGILITY Standard Series - Replacements Continued

Suggested Retail	Item					
	AGILITY Mid Contour Replacement Foam with Cut Out: CLASS: C					
\$62.00	AG3FC-1410	AG3FC-1510	AG3FC-1616	AG3FC-1810	AG3FC-1910	AG3FC-2010
	AG3FC-1413	AG3FC-1513	AG3FC-1618	AG3FC-1813	AG3FC-1916	AG3FC-2013
	AG3FC-1416	AG3FC-1518	AG3FC-1620	AG3FC-1816	AG3FC-1916	AG3FC-2016
	AG3FC-1418	AG3FC-1610	AG3FC-1710	AG3FC-1818	AG3FC-1918	AG3FC-2018
	AG3FC-1420	AG3FC-1613	AG3FC-1713	AG3FC-1820	AG3FC-1920	AG3FC-2020
	ROHO AGILITY Max Contour Replacement Foam with Cut Out: CLASS: C					
\$72.00	AG6FC-1416	AG6FC-1616	AG6FC-1620	AG6FC-1818	AG6FC-1920	AG6FC-2018
	AG6FC-1418	AG6FC-1618	AG6FC-1816	AG6FC-1820	AG6FC-2016	AG6FC-2020
	AG6FC-1420					
	AGILITY Back Support System Replacement Components: CLASS: C					
\$210.00	AG-HDWR-QR	QUICK RELEASE CANE CLAMP, AGILITY BACK PAIR				
\$210.00	AG-HDWR-FX	FIXED CANE CLAMP, AGILITY BACK PAIR				
\$210.00	AG-HDWR-DM14	DIRECT MOUNT HDWR AGILITY 14W				
\$210.00	AG-HDWR-DM15	DIRECT MOUNT HDWR AGILITY 15W				
\$210.00	AG-HDWR-DM16	DIRECT MOUNT HDWR AGILITY 16W				
\$210.00	AG-HDWR-DM17	DIRECT MOUNT HDWR AGILITY 17W				
\$210.00	AG-HDWR-DM18	DIRECT MOUNT HDWR AGILITY 18W				
\$210.00	AG-HDWR-DM19	DIRECT MOUNT HDWR AGILITY 19W				
\$210.00	AG-HDWR-DM20	DIRECT MOUNT HDWR AGILITY 20W				
\$210.00	AGCCBA-LG-PR	LARGE CANE CLAMP, AGILITY BACK PAIR One-piece cane clamp fits greater than 1" and less than 1.25" (2.5 to 3.0 cm) circular diameter canes, canes with a squared key feature, or oval canes				
\$20.00	AG-LUMBAR	LUMBAR PAD, AGILITY BACK				
\$10.50	AG-WRENCH	ALLEN WRENCH, 4 MM AGILITY BACK				

Back Support Accessories

ROHO Privacy Shield			
	Item Number	Sizes (width x height)	Fits Wheelchair Sizes (width x depth)
\$58.00	PS14*	10" x 14"	13" - 15"
	PS16*	13" x 14"	15.5" - 17"
	PS18*	15" x 14"	17.5" - 19"
	PS20*	17" x 14"	19.5" - 21"

*May take up to three weeks for shipment.

ROHO AGILITY Active Series Back Support Systems

- All AGILITY Active Series Carbon Back supports include attachment hardware, a cover, pump, and operating instructions.
- Contact ROHO Customer Support for additional information.
- AG2 = Minimum Contour, AG3 = Mid Contour

AGILITY Active Series: Carbon Sizing Matrix

- A¹ – Back Shell Length
- A² – Foam Length
- B – Outside Cane to Outside Cane
- C – Inner Foam Width
- D – Flat Center Section
- E¹ – Length of Wings, Shell
- E² – Length of Wings, Foam
- F – Shell Depth
- G – Inner Foam Depth

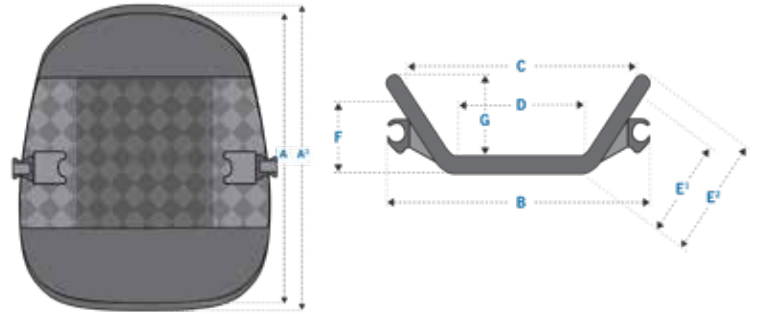

Minimum Contour Sizing Matrix

Number	A ¹	A ²	B	C	D	E ¹	E ²	F	G
AG2-1410	10" (25.5 cm)	12" (30.5 cm)	14" (35.5 cm)	11" (28 cm)	6" (15 cm)	4" (10 cm)	5.5" (14 cm)	3" (7.5 cm)	3" (7.5 cm)
AG2-1413	13" (33 cm)	15" (38 cm)	14" (35.5 cm)	11" (28 cm)	6" (15 cm)	4" (10 cm)	5.5" (14 cm)	3" (7.5 cm)	3" (7.5 cm)
AG2-1416	16" (40.5 cm)	18" (45.5 cm)	14" (35.5 cm)	11" (28 cm)	6" (15 cm)	4" (10 cm)	5.5" (14 cm)	3" (7.5 cm)	3" (7.5 cm)
AG2-1510	10" (25.5 cm)	12" (30.5 cm)	15" (38 cm)	12" (30.5 cm)	7" (18 cm)	4" (10 cm)	5.5" (14 cm)	3" (7.5 cm)	3" (7.5 cm)
AG2-1513	13" (33 cm)	15" (38 cm)	15" (38 cm)	12" (30.5 cm)	7" (18 cm)	4" (10 cm)	5.5" (14 cm)	3" (7.5 cm)	3" (7.5 cm)
AG2-1516	16" (40.5 cm)	18" (45.5 cm)	15" (38 cm)	12" (30.5 cm)	7" (18 cm)	4" (10 cm)	5.5" (14 cm)	3" (7.5 cm)	3" (7.5 cm)
AG2-1610	10" (25.5 cm)	12" (30.5 cm)	16" (40.5 cm)	13" (33 cm)	8" (20.5 cm)	4" (10 cm)	5.5" (14 cm)	3" (7.5 cm)	3" (7.5 cm)
AG2-1613	13" (33 cm)	15" (38 cm)	16" (40.5 cm)	13" (33 cm)	8" (20.5 cm)	4" (10 cm)	5.5" (14 cm)	3" (7.5 cm)	3" (7.5 cm)
AG2-1616	16" (40.5 cm)	18" (45.5 cm)	16" (40.5 cm)	13" (33 cm)	8" (20.5 cm)	4" (10 cm)	5.5" (14 cm)	3" (7.5 cm)	3" (7.5 cm)
AG2-1710	10" (25.5 cm)	12" (30.5 cm)	17" (43 cm)	14" (35.5 cm)	9" (23 cm)	4" (10 cm)	5.5" (14 cm)	3" (7.5 cm)	3" (7.5 cm)
AG2-1713	13" (33 cm)	15" (38 cm)	17" (43 cm)	14" (35.5 cm)	9" (23 cm)	4" (10 cm)	5.5" (14 cm)	3" (7.5 cm)	3" (7.5 cm)
AG2-1716	16" (40.5 cm)	18" (45.5 cm)	17" (43 cm)	14" (35.5 cm)	9" (23 cm)	4" (10 cm)	5.5" (14 cm)	3" (7.5 cm)	3" (7.5 cm)
AG2-1810	10" (25.5 cm)	12" (30.5 cm)	18" (45.5 cm)	15" (38 cm)	10" (25.5 cm)	4" (10 cm)	5.5" (14 cm)	3" (7.5 cm)	3" (7.5 cm)
AG2-1813	13" (33 cm)	15" (38 cm)	18" (45.5 cm)	15" (38 cm)	10" (25.5 cm)	4" (10 cm)	5.5" (14 cm)	3" (7.5 cm)	3" (7.5 cm)
AG2-1816	16" (40.5 cm)	18" (45.5 cm)	18" (45.5 cm)	15" (38 cm)	10" (25.5 cm)	4" (10 cm)	5.5" (14 cm)	3" (7.5 cm)	3" (7.5 cm)

Mid Contour Sizing Matrix

Number	A ¹	A ²	B	C	D	E ¹	E ²	F	G
AG3-1410	10" (25.5 cm)	12" (30.5 cm)	14" (35.5 cm)	12" (30.5 cm)	6" (15 cm)	5.25" (13 cm)	6.75" (17 cm)	4" (10 cm)	4" (10 cm)
AG3-1413	13" (33 cm)	15" (38 cm)	14" (35.5 cm)	12" (30.5 cm)	6" (15 cm)	5.25" (13 cm)	6.75" (17 cm)	4" (10 cm)	4" (10 cm)
AG3-1416	16" (40.5 cm)	18" (45.5 cm)	14" (35.5 cm)	12" (30.5 cm)	6" (15 cm)	5.25" (13 cm)	6.75" (17 cm)	4" (10 cm)	4" (10 cm)
AG3-1510	10" (25.5 cm)	12" (30.5 cm)	15" (38 cm)	13" (33 cm)	7" (18 cm)	5.25" (13 cm)	6.75" (17 cm)	4" (10 cm)	4" (10 cm)
AG3-1513	13" (33 cm)	15" (38 cm)	15" (38 cm)	13" (33 cm)	7" (18 cm)	5.25" (13 cm)	6.75" (17 cm)	4" (10 cm)	4" (10 cm)
AG3-1516	16" (40.5 cm)	18" (45.5 cm)	15" (38 cm)	13" (33 cm)	7" (18 cm)	5.25" (13 cm)	6.75" (17 cm)	4" (10 cm)	4" (10 cm)
AG3-1610	10" (25.5 cm)	12" (30.5 cm)	16" (40.5 cm)	14" (35.5 cm)	8" (20.5 cm)	5.25" (13 cm)	6.75" (17 cm)	4" (10 cm)	4" (10 cm)
AG3-1613	13" (33 cm)	15" (38 cm)	16" (40.5 cm)	14" (35.5 cm)	8" (20.5 cm)	5.25" (13 cm)	6.75" (17 cm)	4" (10 cm)	4" (10 cm)
AG3-1616	16" (40.5 cm)	18" (45.5 cm)	16" (40.5 cm)	14" (35.5 cm)	8" (20.5 cm)	5.25" (13 cm)	6.75" (17 cm)	4" (10 cm)	4" (10 cm)
AG3-1710	10" (25.5 cm)	12" (30.5 cm)	17" (43 cm)	15" (38 cm)	9" (23 cm)	5.25" (13 cm)	6.75" (17 cm)	4" (10 cm)	4" (10 cm)
AG3-1713	13" (33 cm)	15" (38 cm)	17" (43 cm)	15" (38 cm)	9" (23 cm)	5.25" (13 cm)	6.75" (17 cm)	4" (10 cm)	4" (10 cm)
AG3-1716	16" (40.5 cm)	18" (45.5 cm)	17" (43 cm)	15" (38 cm)	9" (23 cm)	5.25" (13 cm)	6.75" (17 cm)	4" (10 cm)	4" (10 cm)
AG3-1810	10" (25.5 cm)	12" (30.5 cm)	18" (45.5 cm)	16" (40.5 cm)	10" (25.5 cm)	5.25" (13 cm)	6.75" (17 cm)	4" (10 cm)	4" (10 cm)
AG3-1813	13" (33 cm)	15" (38 cm)	18" (45.5 cm)	16" (40.5 cm)	10" (25.5 cm)	5.25" (13 cm)	6.75" (17 cm)	4" (10 cm)	4" (10 cm)
AG3-1816	16" (40.5 cm)	18" (45.5 cm)	18" (45.5 cm)	16" (40.5 cm)	10" (25.5 cm)	5.25" (13 cm)	6.75" (17 cm)	4" (10 cm)	4" (10 cm)

ROHO AGILITY Active Series Back Support Systems

- All AGILITY Active Series Aluminum Back supports include attachment hardware, a cover, and operating instructions.
- Contact ROHO Customer Support for additional information.
- AG2 = Minimum Contour, AG3 = Mid Contour

AGILITY Active Series: Aluminum Sizing Matrix

- A¹ – Back Shell Length
- A² – Foam Length
- B – Outside Cane to Outside Cane
- C – Inner Foam Width
- D – Flat Center Section
- E¹ – Length of Wings, Shell
- E² – Length of Wings, Foam
- F – Shell Depth
- G – Inner Foam Depth

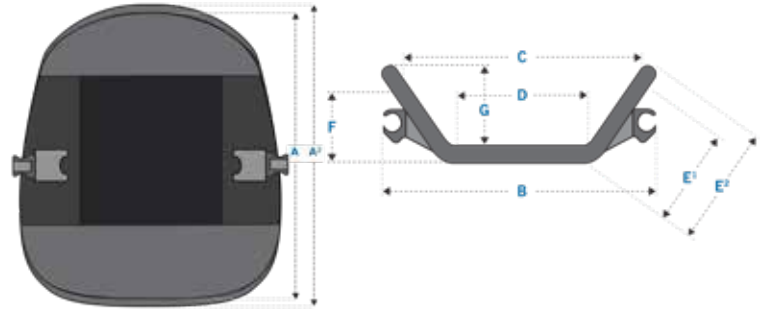

Minimum Contour Sizing Matrix

Number	A ¹	A ²	B	C	D	E ¹	E ²	F	G
AG2-1408F-2A	8" (20.5 cm)	9" (23 cm)	14" (35.5 cm)	11" (28 cm)	6" (15 cm)	4" (10 cm)	5.5" (14 cm)	3" (7.5 cm)	3" (7.5 cm)
AG2-1410F-2A	10" (25.5 cm)	12" (30.5 cm)	14" (35.5 cm)	11" (28 cm)	6" (15 cm)	4" (10 cm)	5.5" (14 cm)	3" (7.5 cm)	3" (7.5 cm)
AG2-1508F-2A	8" (20.5 cm)	9" (23 cm)	15" (38 cm)	12" (30.5 cm)	7" (18 cm)	4" (10 cm)	5.5" (14 cm)	3" (7.5 cm)	3" (7.5 cm)
AG2-1510F-2A	10" (25.5 cm)	12" (30.5 cm)	15" (38 cm)	12" (30.5 cm)	7" (18 cm)	4" (10 cm)	5.5" (14 cm)	3" (7.5 cm)	3" (7.5 cm)
AG2-1608F-2A	8" (20.5 cm)	9" (23 cm)	16" (40.5 cm)	13" (33 cm)	8" (20.5 cm)	4" (10 cm)	5.5" (14 cm)	3" (7.5 cm)	3" (7.5 cm)
AG2-1610F-2A	10" (25.5 cm)	12" (30.5 cm)	16" (40.5 cm)	13" (33 cm)	8" (20.5 cm)	4" (10 cm)	5.5" (14 cm)	3" (7.5 cm)	3" (7.5 cm)
AG2-1708F-2A	8" (20.5 cm)	9" (23 cm)	17" (43 cm)	14" (35.5 cm)	9" (23 cm)	4" (10 cm)	5.5" (14 cm)	3" (7.5 cm)	3" (7.5 cm)
AG2-1710F-2A	10" (25.5 cm)	12" (30.5 cm)	17" (43 cm)	14" (35.5 cm)	9" (23 cm)	4" (10 cm)	5.5" (14 cm)	3" (7.5 cm)	3" (7.5 cm)
AG2-1808F-2A	8" (20.5 cm)	9" (23 cm)	18" (45.5 cm)	15" (38 cm)	10" (25.5 cm)	4" (10 cm)	5.5" (14 cm)	3" (7.5 cm)	3" (7.5 cm)
AG2-1810F-2A	10" (25.5 cm)	12" (30.5 cm)	18" (45.5 cm)	15" (38 cm)	10" (25.5 cm)	4" (10 cm)	5.5" (14 cm)	3" (7.5 cm)	3" (7.5 cm)

Mid Contour Sizing Matrix

Number	A ¹	A ²	B	C	D	E ¹	E ²	F	G
AG3-1408F-2A	8" (20.5 cm)	9" (23 cm)	14" (35.5 cm)	12" (30.5 cm)	6" (15 cm)	5.25" (13 cm)	6.75" (17 cm)	4" (10 cm)	4" (10 cm)
AG3-1410F-2A	10" (25.5 cm)	12" (30.5 cm)	14" (35.5 cm)	12" (30.5 cm)	6" (15 cm)	5.25" (13 cm)	6.75" (17 cm)	4" (10 cm)	4" (10 cm)
AG3-1508F-2A	8" (20.5 cm)	9" (23 cm)	15" (38 cm)	13" (33 cm)	7" (18 cm)	5.25" (13 cm)	6.75" (17 cm)	4" (10 cm)	4" (10 cm)
AG3-1510F-2A	10" (25.5 cm)	12" (30.5 cm)	15" (38 cm)	13" (33 cm)	7" (18 cm)	5.25" (13 cm)	6.75" (17 cm)	4" (10 cm)	4" (10 cm)
AG3-1608F-2A	8" (20.5 cm)	9" (23 cm)	16" (40.5 cm)	14" (35.5 cm)	8" (20.5 cm)	5.25" (13 cm)	6.75" (17 cm)	4" (10 cm)	4" (10 cm)
AG3-1610F-2A	10" (25.5 cm)	12" (30.5 cm)	16" (40.5 cm)	14" (35.5 cm)	8" (20.5 cm)	5.25" (13 cm)	6.75" (17 cm)	4" (10 cm)	4" (10 cm)
AG3-1708F-2A	8" (20.5 cm)	9" (23 cm)	17" (43 cm)	15" (38 cm)	9" (23 cm)	5.25" (13 cm)	6.75" (17 cm)	4" (10 cm)	4" (10 cm)
AG3-1710F-2A	10" (25.5 cm)	12" (30.5 cm)	17" (43 cm)	15" (38 cm)	9" (23 cm)	5.25" (13 cm)	6.75" (17 cm)	4" (10 cm)	4" (10 cm)
AG3-1808F-2A	8" (20.5 cm)	9" (23 cm)	18" (45.5 cm)	16" (40.5 cm)	10" (25.5 cm)	5.25" (13 cm)	6.75" (17 cm)	4" (10 cm)	4" (10 cm)
AG3-1810F-2A	10" (25.5 cm)	12" (30.5 cm)	18" (45.5 cm)	16" (40.5 cm)	10" (25.5 cm)	5.25" (13 cm)	6.75" (17 cm)	4" (10 cm)	4" (10 cm)

ROHO AGILITY Active Series Back Support Systems

- All AGILITY Active Series Back supports include attachment hardware, a cover, and operating instructions. All AGILITY Active Series Carbon back supports also include a pump.
- Refer to page 20-21 for sizing and back dimension information.
- Contact ROHO Customer Support for additional information.
- AG2 = Minimum Contour, AG3 = Mid Contour

AGILITY Active Carbon Back Support

Suggested Retail	Item	HCPCS*
\$995.00	AGILITY Active Carbon Minimum Contour Back System with Air Only: CLASS: M	E2620 plus Carbon Upgrade
	AG2-1410A-2CB AG2-1510A-2CB AG2-1610A-2CB AG2-1710A-2CB AG2-1810A-2CB	
	AG2-1413A-2CB AG2-1513A-2CB AG2-1613A-2CB AG2-1713A-2CB AG2-1813A-2CB	
	AG2-1416A-2CB AG2-1516A-2CB AG2-1616A-2CB AG2-1716A-2CB AG2-1816A-2CB	
\$995.00	AGILITY Active Carbon Mid Contour Back Support System with Air Only: CLASS: M	E2620 plus Carbon Upgrade
	AG3-1410A-2CB AG3-1510A-2CB AG3-1610A-2CB AG3-1710A-2CB AG3-1810A-2CB	
	AG3-1413A-2CB AG3-1513A-2CB AG3-1613A-2CB AG3-1713A-2CB AG3-1813A-2CB	
	AG3-1416A-2CB AG3-1516A-2CB AG3-1616A-2CB AG3-1716A-2CB AG3-1816A-2CB	

AGILITY Active Aluminum Back Support

\$610.00	AGILITY Active Aluminum Minimum Contour Back System with Foam Only: CLASS: M	E2620
	AG2-1408F-2A AG2-1508F-2A AG2-1608F-2A AG2-1708F-2A AG2-1808F-2A AG2-1410F-2A AG2-1510F-2A AG2-1610F-2A AG2-1710F-2A AG2-1810F-2A	
\$610.00	AGILITY Active Aluminum Mid Contour Back System with Foam Only: CLASS: M	
	AG3-1408F-2A AG3-1508F-2A AG3-1608F-2A AG3-1708F-2A AG3-1808F-2A AG3-1410F-2A AG3-1510F-2A AG3-1610F-2A AG3-1710F-2A AG3-1810F-2A	

AGILITY Active Series Replacements (Non-Coded)

\$62.00	AGILITY Active Carbon Replacement Foam: CLASS: C					
	AG2FC-1410CB	AG2FC-1610CB	AG2FC-1810CB	AG3FC-1410CB	AG3FC-1610CB	AG3FC-1810CB
	AG2FC-1413CB	AG2FC-1613CB	AG2FC-1813CB	AG3FC-1413CB	AG3FC-1613CB	AG3FC-1813CB
	AG2FC-1416CB	AG2FC-1616CB	AG2FC-1816CB	AG3FC-1416CB	AG3FC-1616CB	AG3FC-1816CB
	AG2FC-1510CB	AG2FC-1710CB		AG3FC-1510CB	AG3FC-1710CB	
	AG2FC-1513CB	AG2FC-1713CB		AG3FC-1513CB	AG3FC-1713CB	
AG2FC-1516CB	AG2FC-1716CB		AG3FC-1516CB	AG3FC-1716CB		
\$62.00	AGILITY Active Aluminum Replacement Foam: CLASS: C					
	AG2FO-1408AC	AG2FO-1608AC	AG2FO-1808AC	AG3FO-1408AC	AG3FO-1608AC	AG3FO-1808AC
	AG2FO-1410AC	AG2FO-1610AC	AG2FO-1810AC	AG3FO-1410AC	AG3FO-1610AC	AG3FO-1810AC
	AG2FO-1508AC	AG2FO-1708AC		AG3FO-1508AC	AG3FO-1708AC	
	AG2FO-1510AC	AG2FO-1710AC		AG3FO-1510AC	AG3FO-1710AC	
\$93.00	AGILITY Active Series Back Support Replacement Covers: CLASS: C					
	COV-AG2-1408CB	COV-AG2-1516CB	COV-AG2-1713CB	COV-AG3-1408CB	COV-AG3-1516CB	COV-AG3-1713CB
	COV-AG2-1410CB	COV-AG2-1608CB	COV-AG2-1716CB	COV-AG3-1410CB	COV-AG3-1608CB	COV-AG3-1716CB
	COV-AG2-1413CB	COV-AG2-1610CB	COV-AG2-1808CB	COV-AG3-1413CB	COV-AG3-1610CB	COV-AG3-1808CB
	COV-AG2-1416CB	COV-AG2-1613CB	COV-AG2-1810CB	COV-AG3-1416CB	COV-AG3-1613CB	COV-AG3-1810CB
	COV-AG2-1508CB	COV-AG2-1616CB	COV-AG2-1813CB	COV-AG3-1508CB	COV-AG3-1616CB	COV-AG3-1813CB
	COV-AG2-1510CB	COV-AG2-1708CB	COV-AG2-1816CB	COV-AG3-1510CB	COV-AG3-1708CB	COV-AG3-1816CB
	COV-AG2-1513CB	COV-AG2-1710CB		COV-AG3-1513CB	COV-AG3-1710CB	

Terms and Conditions

1. Definitions:

- i. Buyer" shall mean the purchaser of any ROHO® Products.
- ii. Intellectual Property" means all copyrights, trademarks, trade names, patents, trade and corporate names, trade secrets, know how, formulas, technical information and other intellectual property rights concerning the Products.
- iii. "Person" shall mean an individual, association, joint venture, partnership, corporation, limited liability company, organization or other entity.
- iv. "Product" shall mean any goods sold by ROHO.
- v. "ROHO" shall mean ROHO, Inc., an Illinois corporation, all of its subsidiaries, its successors and assigns.

2. To the extent that the terms of any written agreement, signed by both ROHO and Buyer, are inconsistent with the provisions appearing hereon, the provisions of such executed agreement shall control. Except as provided herein, the provisions appearing hereon may not be altered or amended in any way except in writing signed by both ROHO and Buyer. ROHO's acceptance of any purchase order for Product submitted by Buyer to ROHO is expressly limited to Buyer's acceptance of all of the provisions hereof and any provisions contained in any document heretofore or hereafter submitted by Buyer to ROHO, which are in addition to or different from the provisions hereof, shall not become a part of the agreement between ROHO and Buyer unless said provisions are expressly agreed to in writing by ROHO; nor shall ROHO's filling of any purchase order submitted by Buyer for Products be construed as an acceptance of any such additional or different provisions.

3. Buyer's right to market, promote, sell or otherwise distribute ROHO Products is non-exclusive. Buyer agrees not to market, promote sell, or otherwise distribute ROHO Products outside of the United States, its territories and possessions.

4. Buyer agrees, at all times, to comply with the Product operation manual and other documents and guidelines produced and distributed by ROHO and shall not use, sell or otherwise distribute any Product for any purpose or use for which Product has not been designed or contrary to manufacturer and/or ROHO specifications. Buyer shall deliver all Products sold with its applicable operation manual, other documents and guidelines and all applicable accessories. Buyer agrees that all individuals dealing with the Products on its behalf will be trained in the selection of the appropriate Product and the individual setup and/or adjustment of the Products. Buyer shall insure that its customers and/or the customers' caregiver fully understand how to perform said setup and/or adjustments, all instructions and all warnings associated with the use of the Product and the fact that the use of any Product for any purpose or in any manner other than which it has been designed or any use inconsistent with the operation manual is strictly prohibited.

Buyer shall inform all of its customers about ROHO's standard Product warranties. Buyer shall not make any representations or statements inconsistent with the Product's operation manual, documents, guidelines and ROHO's standard Product warranties.

5. Buyer shall indemnify and hold ROHO, its officers, directors, employees, successors and assigns, harmless from any liability for any claim or action made upon or brought against ROHO, etc., by any Person, of whatever form or nature, including attorneys fees and other costs of legal defense, which may be sustained or incurred as a result of any acts or omissions of Buyer, or any of its directors, officers, employees or agents, including but not limited to:

- i. Reach of any provision of these terms and conditions;
- ii. Negligence or other tortuous actions;
- iii. Representations or statements for Product usage or alterations not specifically authorized in writing by ROHO; and
- iv. Violations of any laws, orders, regulations or ordinances.

Buyer shall, at its own expense, maintain comprehensive general liability insurance for bodily injury or death and property damage. This requirement shall in no way limit the liability of Buyer to ROHO. Buyer is responsible for any claims of damage or injury attributable to Buyer's actions.

6. Buyer recognizes that the Intellectual Property is an asset owned by ROHO and remains the property of ROHO. Buyer shall not:

- i. Use or permit the use of the Intellectual Property for any purpose other than as provided herein;
- ii. Permit any other Person to use the Intellectual Property;
- iii. Transfer or encumber the Intellectual Property;
- iv. Make or allow to be made any changes or alterations in the Intellectual Property, operations manual or other Product documents and guidelines;
- v. Remove, alter or deface any patent numbers, trade names, trademarks, notices, serial numbers, labels, tags, warning labels or other identifying marks, symbols or legends impressed on or affixed to any Product or container or package;
- vi. Disclose to others any information it receives from ROHO which is not generally known and available in the industry; or
- vii. Misrepresent ROHO or the Products.

7. The agreement between ROHO and Buyer is an Illinois contract and shall be governed by Illinois laws. ROHO and Buyer consent to the jurisdiction and venue of the Court sitting in St. Clair County, Illinois and waive the defense of inconvenient forum.

8. Pricing subject to change at ROHO's discretion with a 30-day notice.



SEATING + POSITIONING

Permobil Seating and Positioning
100 N. Florida Avenue • Belleville, IL 62221
Toll Free: 800-736-0925 • Local: 618-277-9173 • Fax: 618-277-6518
Permobilus.com • orders.roho@permobil.com

© 2019 Permobil. Products may be covered by one or more U.S. and foreign patents and trademarks, including: ADAPTOR®, AGILITY®, AIRLITE®, CONTOUR SELECT®, DRY FLOATATION®, ENHANCER®, HARMONY®, HEAL PAD®, HIGH PROFILE®, Hybrid Elite®, Hybrid Elite SR®, LOW PROFILE®, LTV®, MID PROFILE™, MINI-MAX®, MOSAIC®, nexus SPIRIT®, PACK-IT®, QUADTRO SELECT®, ROHO®, Sensor Ready®, and Smart Check®.

ULTRALEATHER® is a registered trademark of Ultrafabrics, LLC.

Product information is changed as needed; current product information is available at Permobilus.com.

ROHO, Inc. is part of Permobil Seating and Positioning.