

GRAPHIC OPERATION TERMINAL

GOT SIMPLE Series

User's Manual

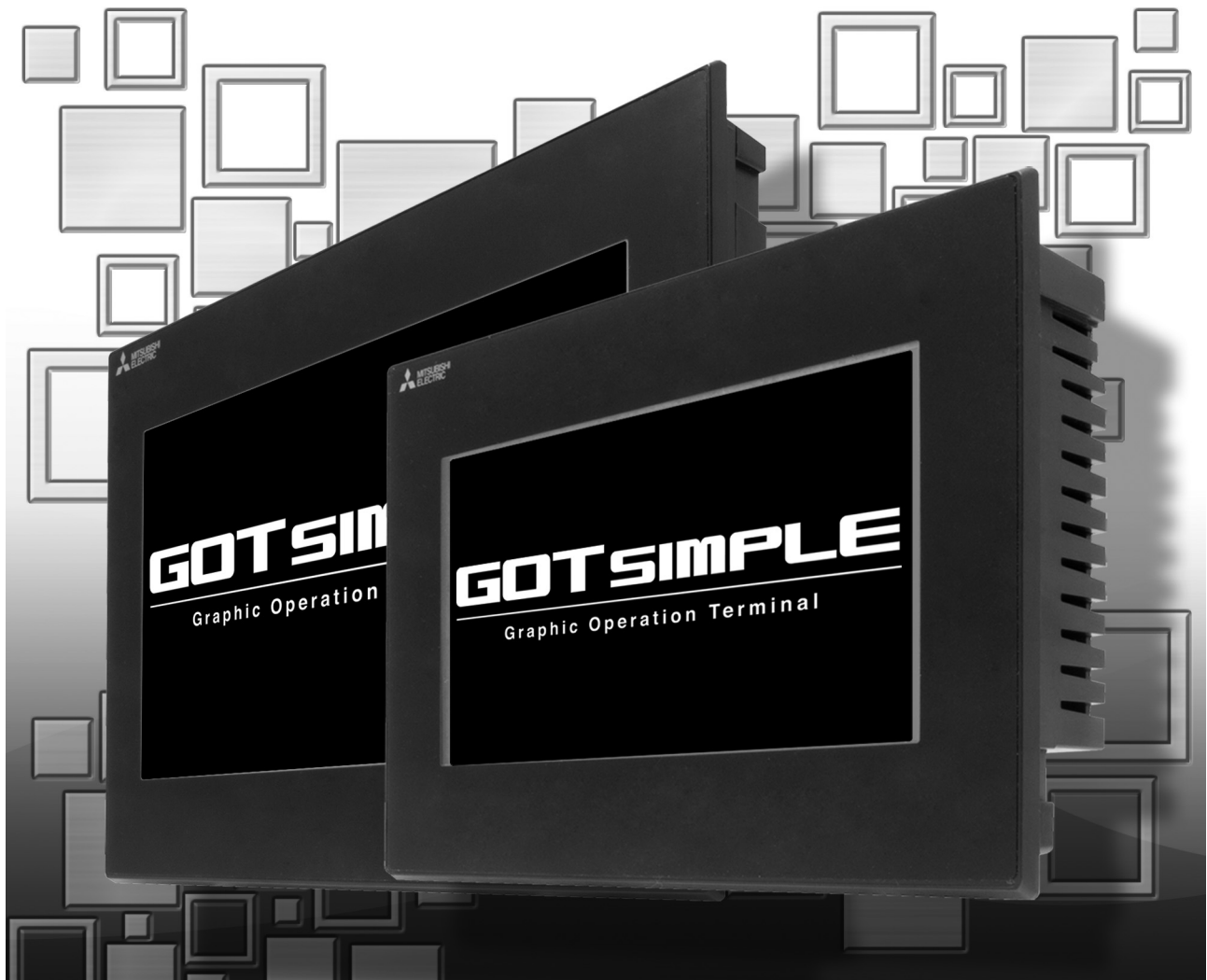

● SAFETY PRECAUTIONS ●

(Always read these precautions before using this equipment.)

Before using this product, please read this manual and the relevant manuals introduced in this manual carefully and pay full attention to safety to handle the product correctly.

The precautions given in this manual are concerned with this product.

In this manual, the safety precautions are ranked as "WARNING" and "CAUTION".



Indicates that incorrect handling may cause hazardous conditions, resulting in death or severe injury.



Indicates that incorrect handling may cause hazardous conditions, resulting in medium or slight personal injury or physical damage.

Note that the  caution level may lead to a serious accident according to the circumstances. Always follow the instructions of both levels because they are important to personal safety.

Please save this manual to make it accessible when required and always forward it to the end user.

[DESIGN PRECAUTIONS]

WARNING

- Some failures of the GOT or cable may keep the outputs on or off. Some failures of a touch panel may cause malfunction of the input objects such as a touch switch. An external monitoring circuit should be provided to check for output signals which may lead to a serious accident. Not doing so can cause an accident due to false output or malfunction.
- Do not use the GOT as the warning device that may cause a serious accident. An independent and redundant hardware or mechanical interlock is required to configure the device that displays and outputs serious warning. Not doing so can cause an accident due to false output or malfunction.
- When the GOT detects its backlight failure, the GOT disables the input operation on the touch switch(s). Thus, operators cannot operate the GOT with touches. The GOT backlight failure can be checked with a system signal of the GOT.
- Even when the display section has dimmed due to a failure of the liquid crystal section or the backlight on the GOT, the input operation of the touch switches may still be enabled. This may cause an incorrect operation of the touch switches. For example, if an operator assumes that the display section has dimmed because of the screen save function and touches the display section to cancel the screen save, a touch switch may be activated.

[DESIGN PRECAUTIONS]

WARNING

- The display section of the GOT is an analog-resistive type touch panel. Simultaneous pressing of two or more areas on the display section may activate the switch between those areas. Do not press two or more areas simultaneously on the display section. Doing so may cause an accident due to incorrect output or malfunction.
- When programs or parameters of the controller (such as a PLC) that is monitored by the GOT are changed, be sure to shut off the power of the GOT promptly and power on the GOT again. Not doing so can cause an accident due to false output or malfunction.
- If a communication fault (including cable disconnection) occurs during monitoring on the GOT, communication between the GOT and PLC CPU is suspended and the GOT becomes inoperative. A system where the GOT is used should be configured to perform any significant operation to the system by using the switches of a device other than the GOT on the assumption that a GOT communication fault will occur. Not doing so can cause an accident due to false output or malfunction.

CAUTION

- Do not bundle the control and communication cables with main-circuit, power or other wiring. Run the above cables separately from such wiring and keep them a minimum of 100mm apart. Not doing so noise can cause a malfunction.
- Do not press the GOT display section with a pointed material as a pen or driver. Doing so can result in a damage or failure of the display section.
- When the GOT is connected to the Ethernet network, the available IP address is restricted according to the system configuration.
 - When multiple GOTs are connected to the Ethernet network:
Do not set the IP address (192.168.3.18) for the GOTs and the controllers in the network.
 - When a single GOT is connected to the Ethernet network:
Do not set the IP address (192.168.3.18) for the controllers except the GOT in the network.
Doing so can cause the IP address duplication. The duplication can negatively affect the communication of the device with the IP address (192.168.3.18). The operation at the IP address duplication depends on the devices and the system.
- Turn on the controllers and the network devices to be ready for communication before they communicate with the GOT. Failure to do so can cause a communication error on the GOT.
- When the GOT is subject to shock or vibration, or some colors appear on the screen of the GOT, the screen of the GOT might flicker.

[MOUNTING PRECAUTIONS]

WARNING

- Be sure to shut off all phases of the external power supply used by the system before mounting or removing the GOT main unit to/from the panel. Not doing so can cause the unit to fail or malfunction.

[MOUNTING PRECAUTIONS]

CAUTION

- Use the GOT in the environment that satisfies the general specifications described in this manual. Not doing so can cause an electric shock, fire, malfunction or product damage or deterioration.
- When mounting the GOT to the control panel, tighten the mounting screws in the specified torque range (0.36N·m to 0.48N·m) with a Phillips-head screwdriver No.2. Undertightening can cause the GOT to drop, short circuit or malfunction. Overtightening can cause a drop, short circuit or malfunction due to the damage of the screws or the GOT.
- Remove the protective film of the GOT. When the user continues using the GOT with the protective film, the film may not be removed.
- Operate and store the GOT in environments without direct sunlight, high temperature, dust, humidity, and vibrations.
- Do not use the GOT in an environment with oil or chemicals. Doing so may cause failure or malfunction due to the oil or chemical entering into the GOT.

[WIRING PRECAUTIONS]

WARNING

- Be sure to shut off all phases of the external power supply used by the system before wiring. Failure to do so may result in an electric shock, product damage or malfunctions.

CAUTION

- Please make sure to ground FG terminal of the GOT power supply section by applying 100Ω or less which is used exclusively for the GOT. Not doing so may cause an electric shock or malfunction.
- Correctly wire the GOT power supply section after confirming the rated voltage and terminal arrangement of the product. Not doing so can cause a fire or failure.
- Tighten the terminal screws of the GOT power supply section in the specified torque range (0.5N·m to 0.6N·m). Undertightening can cause a short circuit or malfunction. Overtightening can cause a short circuit or malfunction due to the damage of the screws or the GOT.
- Exercise care to avoid foreign matter such as chips and wire offcuts entering the GOT. Not doing so can cause a fire, failure or malfunction.
- Plug the communication cable into the GOT interface or the connector of the connected unit, and tighten the mounting screws and the terminal screws in the specified torque range. Undertightening can cause a short circuit or malfunction. Overtightening can cause a short circuit or malfunction due to the damage of the screws or unit.

[TEST OPERATION PRECAUTIONS]

WARNING

- Before performing the test operations of the user creation monitor screen (such as turning ON or OFF bit device, changing the word device current value, changing the settings or current values of the timer or counter, and changing the buffer memory current value), read through the manual carefully and make yourself familiar with the operation method. During test operation, never change the data of the devices which are used to perform significant operation for the system. False output or malfunction can cause an accident.

[STARTUP/MAINTENANCE PRECAUTIONS]

WARNING

- When power is on, do not touch the terminals. Doing so can cause an electric shock or malfunction.
- Before starting cleaning or terminal screw retightening, always switch off the power externally in all phases.
Not doing so can cause the unit to fail or malfunction.
Undertightening can cause a short circuit or malfunction.
Overtightening can cause a short circuit or malfunction due to the damage of the screws or unit.

CAUTION

- Do not disassemble or modify the unit. Doing so can cause a failure, malfunction, injury or fire.
- Do not touch the conductive and electronic parts of the unit directly. Doing so can cause a unit malfunction or failure.
- The cables connected to the unit must be run in ducts or clamped. Not doing so can cause the unit or cable to be damaged due to the dangling, motion or accidental pulling of the cables or can cause a malfunction due to a cable connection fault.
- When unplugging the cable connected to the unit, do not hold and pull from the cable portion. Doing so can cause the unit or cable to be damaged or can cause a malfunction due to a cable connection fault.
- Do not drop the module or subject it to strong shock. A module damage may result.
- Before touching the unit, always touch grounded metals, etc. to discharge static electricity from human body, etc. Not doing so can cause the unit to fail or malfunction.

[TOUCH PANEL PRECAUTIONS]

CAUTION

- For the analog-resistive film type touch panels, normally the adjustment is not required. However, the difference between a touched position and the object position may occur as the period of use elapses. When any difference between a touched position and the object position occurs, execute the touch panel calibration.
- When any difference between a touched position and the object position occurs, other object may be activated. This may cause an unexpected operation due to incorrect output or malfunction.

[PRECAUTIONS WHEN THE DATA STORAGE IS IN USE]

WARNING

- If the SD card mounted on drive A of the GOT is removed while the GOT is accessed, processing for the GOT might be interrupted about for 20 seconds. The GOT cannot be operated during this period. The functions that run in the background including a screen updating, alarm, logging, scripts, and others are also interrupted. Since this interruption makes an impact to the system operation, it might cause failure. After inhibiting access to the SD card on the GOT utility screen, check that the SD card access LED is off and remove the SD card.

[PRECAUTIONS WHEN THE DATA STORAGE IS IN USE]

CAUTION

- If the data storage mounted on the GOT is removed while the GOT is accessed, the data storage and files are damaged. To remove the data storage from the GOT, check that the access to the data storage in SD card access LED, the system signal, and others is not performed.
- When removing the SD card from the GOT, make sure to support the SD card by hand as it may pop out. Failure to do so may cause the SD card to drop from the GOT, resulting in a failure or break.
- Before removing the USB device from the GOT, follow the procedure for removal on the utility screen of the GOT. After the successful completion dialog is displayed, remove the USB device by hand carefully. Failure to do so may cause the USB device to drop from the GOT, resulting in a failure or break.

[DISPOSAL PRECAUTIONS]

CAUTION

- When disposing of this product, treat it as industrial waste.

[TRANSPORTATION PRECAUTIONS]

CAUTION

- Make sure to transport the GOT main unit and/or relevant unit(s) in the manner they will not be exposed to the impact exceeding the impact resistance described in the general specifications of this manual, as they are precision devices. Failure to do so may cause the unit to fail. Check if the unit operates correctly after transportation.
- When fumigants that contain halogen materials such as fluorine, chlorine, bromine, and iodine are used for disinfecting and protecting wooden packaging from insects, they cause malfunction when entering our products. Please take necessary precautions to ensure that remaining materials from fumigant do not enter our products, or treat packaging with methods other than fumigation (heat method). Additionally, disinfect and protect wood from insects before packing products.

INTRODUCTION

Thank you for choosing Mitsubishi Graphic Operation Terminal (Mitsubishi GOT).
Read this manual and make sure you understand the functions and performance of the GOT thoroughly in advance to ensure correct use.

CONTENTS

SAFETY PRECAUTIONS	A - 1
INTRODUCTION	A - 7
CONTENTS	A - 7
About Manual	A - 13
Quick Reference	A - 14
Abbreviations and Generic Terms	A - 15

1. OVERVIEW

1.1 Features.....	1 - 2
1.1.1 Rough procedure	1 - 3

2. SYSTEM CONFIGURATION

2.1 Overall Configuration	2 - 1
2.2 Component List.....	2 - 1
2.2.1 GOT	2 - 2
2.2.2 Option	2 - 2

3. SPECIFICATIONS

3.1 General Specifications.....	3 - 1
3.2 Performance Specifications	3 - 2
3.3 Power Supply Specifications	3 - 3
3.4 GOT Connector Specifications	3 - 4
3.4.1 RS-232 interface.....	3 - 4
3.4.2 RS-422 interface.....	3 - 4

4. PART NAME

4.1 Front Panel	4 - 1
4.2 Back Panel.....	4 - 2
4.3 Bottom	4 - 3

5. EMC DIRECTIVE

5.1 Overview.....	5 - 1
5.1.1 Conforming standards in the EMC Directive	5 - 1
5.2 EMC Directive Requirements	5 - 2
5.2.1 Installing the GOT on the control panel	5 - 2
5.2.2 Installing a noise filter (power supply line filter)	5 - 3
5.2.3 System configuration	5 - 4
5.2.4 Connection of power cables and ground cables.....	5 - 4
5.2.5 Fabricating a connection cable.....	5 - 5

5.2.6	Grounding a cable	5 - 7
-------	-------------------------	-------

6. INSTALLATION

6.1	Control Panel Inside Dimensions for Mounting GOT	6 - 1
6.2	Panel Cutting Dimensions	6 - 2
6.3	Mounting Position	6 - 2
6.4	Control Panel Temperature and Mounting Angle	6 - 3
6.5	Installation Procedure	6 - 4

7. WIRING

7.1	Power Supply Wiring	7 - 2
7.1.1	Cable types and wire end processing	7 - 2
7.1.2	Wiring example	7 - 3
7.1.3	GOT's ground	7 - 3
7.1.4	The cause of malfunctions related wiring/Remedy	7 - 4
7.2	Wiring Inside and Outside the Panel	7 - 6
7.2.1	Wiring inside	7 - 6
7.2.2	Outside the panel.....	7 - 6
7.2.3	Attaching surge killers to control equipment	7 - 7

8. OPTION

8.1	SD Card	8 - 1
8.1.1	Applicable SD card	8 - 1
8.1.2	Installation/removal procedure of SD card.....	8 - 1

9. UTILITY FUNCTION

9.1	Utility Execution	9 - 1
9.2	Utility Function List.....	9 - 2
9.3	Utility Display	9 - 3
9.3.1	Display operation of main menu	9 - 5
9.3.2	Utility basic configuration	9 - 7
9.3.3	Basic operation of settings change.....	9 - 8

10. LANGUAGE SETTING (LANGUAGE)

10.1	Display language setting.....	10 - 1
10.1.1	Display language setting function	10 - 1
10.1.2	Language setting operation	10 - 1

11. COMMUNICATION INTERFACE SETTING (COMMUNICATION SETTING)

11.1	Standard I/F Setting	11 - 1
11.1.1	Standard I/F functions.....	11 - 1
11.1.2	Standard I/F display operation	11 - 1
11.1.3	Display contents of standard I/F	11 - 2
11.1.4	Detail information setting operation	11 - 4
11.1.5	Channel setting operation.....	11 - 7
11.1.6	Driver setting operation.....	11 - 8
11.2	GOT IP Address Setting	11 - 9
11.2.1	Standard	11 - 9

11.2.2	Display operation of GOT IP address	11 - 9
11.2.3	Setting operation	11 - 10
11.3	Communication Monitor	11 - 11
11.3.1	Communication monitor functions	11 - 11
11.3.2	Communication monitor display operation	11 - 11
11.3.3	Screen display content	11 - 12
11.4	Ethernet Check	11 - 14
11.5	Setting the Transparent Mode	11 - 16
11.6	Keyword	11 - 17
11.6.1	Keyword functions	11 - 17
11.6.2	Keyword display operation	11 - 17
11.6.3	Regist	11 - 18
11.6.4	Delete	11 - 21
11.6.5	Clear	11 - 23
11.6.6	Protect	11 - 25

12. DISPLAY AND OPERATION SETTINGS (GOT SET UP)

12.1	Display Settings	12 - 1
12.1.1	Display setting functions	12 - 1
12.1.2	Display operation of display setting	12 - 2
12.1.3	Display setting operations	12 - 3
12.2	Operation Setting (Settings for Operation)	12 - 5
12.2.1	Operation setting functions	12 - 5
12.2.2	Display operation of operation setting	12 - 6
12.2.3	Setting operation of operation	12 - 7
12.2.4	Position correction of the touch panel (touch panel calibration setting)	12 - 9
12.2.5	Setting the utility call keys	12 - 11
12.3	Inherent Information	12 - 13
12.3.1	Setting function for inherent information	12 - 13
12.3.2	Display operation of inherent information	12 - 13
12.3.3	Setting operation for inherent information	12 - 13

13. SECURITY LEVEL AND OPERATOR SETTINGS (SECURITY SETTING)

13.1	Security Level Authentication	13 - 1
13.2	Operator Authentication	13 - 3
13.2.1	Operator information management	13 - 3
13.2.2	Password change	13 - 13
13.2.3	Function setting	13 - 15
13.3	Login/Logout	13 - 17

14. CLOCK SETTINGS AND BATTERY STATUS DISPLAY (TIME SETTING AND DISPLAY)

14.1	Time Setting and Display	14 - 1
14.1.1	Time setting and display functions	14 - 1
14.1.2	Clock display and setting operation	14 - 1
14.1.3	Clock setting operations	14 - 2

15. CONTROL OF VARIOUS DATA (DATA CONTROL)

15.1	Data Storage Location	15 - 1
15.1.1	Data type and storage location	15 - 1
15.1.2	Checking version of basic system application	15 - 3
15.2	System Application Information	15 - 4
15.3	Resource Data Information	15 - 6
15.3.1	Alarm information.....	15 - 6
15.3.2	Recipe information.....	15 - 12
15.3.3	Logging information	15 - 21
15.3.4	Image file management	15 - 28
15.4	SD Card Access	15 - 33
15.4.1	Functions of SD card access.....	15 - 33
15.4.2	Display operation of SD card access.....	15 - 33
15.4.3	Operation of SD card access.....	15 - 33
15.5	SD Card Format.....	15 - 34
15.6	Clear data	15 - 36
15.6.1	Clear data functions.....	15 - 36
15.6.2	Clear data display	15 - 36
15.6.3	Clear data operation	15 - 36
15.7	Data Copy.....	15 - 37
15.7.1	Display operation of data copy	15 - 37
15.7.2	Operation of data copy	15 - 38

16. GOT SELF CHECK (DEBUG)

16.1	Device Monitor Function	16 - 1
16.1.1	System configuration	16 - 1
16.1.2	Devices that can be monitored	16 - 2
16.1.3	Precautions.....	16 - 2
16.1.4	Display operation of device monitor.....	16 - 3
16.1.5	Information displayed on the device monitor screen and key functions	16 - 4
16.1.6	Basic operation of device monitor.....	16 - 6
16.1.7	Device registration	16 - 7
16.1.8	Quick test.....	16 - 10
16.2	FX List Editor	16 - 14
16.2.1	Display operation of FX list editor	16 - 14
16.2.2	Specifications.....	16 - 16
16.2.3	Access range	16 - 17
16.2.4	Precautions.....	16 - 17
16.2.5	Display operation	16 - 18
16.2.6	Operation procedures	16 - 20
16.2.7	Selection and operation of modes	16 - 22
16.2.8	Displaying sequence programs	16 - 23
16.2.9	Searching commands/devices.....	16 - 25
16.2.10	Writing commands	16 - 27
16.2.11	Changing operands, set values	16 - 30
16.2.12	Deleting commands	16 - 31
16.2.13	Sequence program all clear.....	16 - 32
16.2.14	PLC diagnostics.....	16 - 33
16.2.15	Parameter setting	16 - 35

16.2.16	Keyword	16 - 37
16.2.17	List monitor	16 - 39
16.2.18	Action for an incorrect key input	16 - 40
16.2.19	Error messages and corrective actions	16 - 41
16.3	FX3U-ENET-ADP Communication Setting Function	16 - 42
16.3.1	Specifications	16 - 42
16.3.2	Display operation of FX3U-ENET-ADP communication setting function	16 - 43
16.3.3	Setting operation	16 - 44

17. MAINTENANCE

17.1	Touch Panel Calibration	17 - 1
17.2	Touch Panel Check	17 - 3
17.3	Clean	17 - 5

18. INSTALLING PACKAGE DATA BY USING AN SD CARD

18.1	Installation Method When the GOT is Turned On.....	18 - 1
------	----------------------------------------------------	--------

19. INSTALLATION OF BOOTOS AND BASIC SYSTEM APPLICATION

19.1	BootOS and Basic System Application to be Installed	19 - 1
19.2	Prior Preparations for Installing BootOS and System Application	19 - 2

20. MAINTENANCE AND INSPECTION

20.1	Daily Inspection	20 - 2
20.2	Periodic Inspection	20 - 2
20.3	Cleaning Method.....	20 - 3
20.4	Backlight Shutoff Detection.....	20 - 4
20.4.1	Backlight shutoff detection and external alarm	20 - 4

21. TROUBLESHOOTING

21.1	GOT Restoration Sheets	21 - 1
------	------------------------------	--------

22. CONNECTION

22.1	Connecting to Mitsubishi Products	22 - 1
22.1.1	Ethernet connection.....	22 - 1
22.1.2	Direct CPU connection	22 - 1
22.1.3	Computer link connection	22 - 1
22.1.4	CC-Link connection (via G4)	22 - 1
22.1.5	Inverter connection	22 - 1
22.1.6	Servo amplifier connection	22 - 1
22.1.7	Multi-channel function.....	22 - 1
22.1.8	FA transparent function	22 - 1
22.2	Connecting to Non-Mitsubishi Products.....	22 - 2
22.2.1	Connecting to SIEMENS PLC	22 - 2
22.3	Connecting to Peripheral Devices	22 - 2
22.3.1	Bar code reader connection	22 - 2
22.3.2	Printer connection.....	22 - 2

23. APPENDIX

Appendix.1 External Dimensions..... 23- 1

REVISIONS

WARRANTY

About Manual

The following manuals related to this product are available.
Refer to each manual in accordance with the intended use.

■ Screen creation software manuals

Manual name	Manual number (Model code)
GT Works3 Installation Instructions	-
GT Designer3 (GOT2000) Help	-
GT Converter2 Version3 Operating Manual for GT Works3	SH-080862ENG (1D7MB2)

■ Connection manuals

Manual name	Manual number (Model code)
GOT2000 Series Connection Manual (Mitsubishi Product) For GT Works3 Version1	SH-081197ENG (1D7MJ8)
GOT2000 Series Connection Manual (Non Mitsubishi Product 1) For GT Works3 Version1	SH-081198ENG (1D7MJ9)
GOT2000 Series Connection Manual (Non Mitsubishi Product 2) For GT Works3 Version1	SH-081199ENG (1D7MK1)
GOT2000 Series Connection Manual (Microcomputer, MODBUS Products, Peripherals) For GT Works3 Version1	SH-081200ENG (1D7MK2)

■ GOT SIMPLE series manuals

Manual name	Manual number (Model code)
GOT SIMPLE Series User's Manual	JY997D52901

Quick Reference

■ Creating projects

Obtaining the specifications and operation methods of GT Designer3	GT Designer3 (GOT2000) Help
Setting available functions on GT Designer3	
Creating a screen displayed on the GOT	
Obtaining useful functions to increase efficiency of drawing	
Setting details for figures and objects	
Setting functions for the data collection or trigger action	
Setting functions to use peripheral devices	
Simulating a created project on a personal computer	

■ Connecting a controller to the GOT

Obtaining information of Mitsubishi products applicable to the GOT	GOT2000 Series Connection Manual (Mitsubishi Product) For GT Works3 Version1
Connecting Mitsubishi products to the GOT	
Connecting multiple controllers to one GOT (Multi-channel function)	
Establishing communication between a personal computer and a controller via the GOT (FA transparent function)	
Obtaining information of Non-Mitsubishi products applicable to the GOT	• GOT2000 Series Connection Manual (Non Mitsubishi Product 1) For GT Works3 Version1 • GOT2000 Series Connection Manual (Non Mitsubishi Product 2) For GT Works3 Version1
Connecting Non-Mitsubishi products to the GOT	
Obtaining information of peripheral devices applicable to the GOT	GOT2000 Series Connection Manual (Microcomputer, MODBUS Products, Peripherals) For GT Works3 Version1
Connecting peripheral devices including a bar code reader to the GOT	

■ Transferring data to the GOT

Writing data to the GOT	GT Designer3 (GOT2000) Help
Reading data from the GOT	
Verifying an editing project to a GOT project	

■ Others

Obtaining the specifications and operation methods of GT Designer3	GOT SIMPLE Series User's Manual
Setting available functions on GT Designer3	
Creating a screen displayed on the GOT	GOT SIMPLE Series User's Manual
Obtaining useful functions to increase efficiency of drawing	GT Designer3 (GOT2000) Help

Abbreviations and Generic Terms

■ GOT

Abbreviations and generic terms		Description	
GOT SIMPLE Series	GS21	GS2110-W	GS2110-WTBD
		GS2107-W	GS2107-WTBD
GOT2000 Series	GT27	GT2712-S	GT2712-STBA, GT2712-STWA, GT2712-STBD, GT2712-STWD
		GT2710-S	GT2710-STBA, GT2710-STBD
		GT2710-V	GT2710-VTBA, GT2710-VTWA, GT2710-VTBD, GT2710-VTWD
		GT2708-S	GT2708-STBA, GT2708-STBD
		GT2708-V	GT2708-VTBA, GT2708-VTBD
	GT23	GT2310-V	GT2310-VTBA, GT2310-VTBD
		GT2308-V	GT2308-VTBA, GT2308-VTBD
GT SoftGOT2000		GT SoftGOT2000 Version1	

■ Option

Abbreviations and generic terms	Description
SD card	L1MEM-2GBSD, L1MEM-4GBSD

■ Software

(1) Software related to GOT

Abbreviations and generic terms	Description
GT Works3	SW1DNC-GTW3-J, SW1DND-GTW3-J, SW1DNC-GTW3-E, SW1DND-GTW3-E, SW1DND-GTW3-C
GT Designer3 Version1	Screen drawing software GT Designer3 for GOT2000/GOT1000 series
GT Designer3	Screen drawing software for GOT2000 series included in GT Works3
GT Designer3 (GOT2000)	
GT Designer3 (GOT1000)	Screen drawing software for GOT1000 series included in GT Works3
GT Simulator3	Screen simulator GT Simulator3 for GOT2000/GOT1000/GOT900 series

(2) Other software

Abbreviations and generic terms	Description
GX Works2	SW□DNC-GXW2-J (-JA, -JAZ) type programmable controller engineering software (□ indicates a version.)
GX Simulator2	GX Works2 with the simulation function
GX Simulator	SW□D5C-LLT-J (-JV) type ladder logic test tool function software package (SW5D5C-LLT (-V) or later versions) (□ indicates a version.)
GX Developer	SW□D5C-GPPW-J (-JV)/SW□D5F-GPPW (-V) type software package (□ indicates a version.)
GX LogViewer	SW□DNN-VIEWER-J type software package (□ indicates a version.)
PX Developer	SW□D5C-FBDQ-J type FBD software package for process control (□ indicates a version.)
MT Works2	Motion controller engineering environment MELSOFT MT Works2 (SW□DNC-MTW2-J) (□ indicates a version.)
MT Developer	SW□RNC-GSV type integrated start-up support software for motion controller Q series (□ indicates a version.)
MR Configurator2	SW□DNC-MRC2-J type servo configuration software (□ indicates a version.)
MR Configurator	MRZJW□-SETUP type servo configuration software (□ indicates a version.)
FR Configurator	Inverter setup software (FR-SW□-SETUP-WJ) (□ indicates a version.)
NC Configurator	CNC parameter setting support tool NC Configurator
FX Configurator-FP	Parameter setting, monitoring, and testing software packages for FX3U-20SSC-H (SW□D5CFXSSCJ) (□ indicates a version.)
FX3U-ENET-L Configuration tool	FX3U-ENET-L type Ethernet module setting software (SW1D5-FXENETL-J)
RT ToolBox2	Robot program creation software (3D-11C-WINJ)
MX Component	MX Component Version□ (SW□D5C-ACT-J, SW□D5C-ACT-JA) (□ indicates a version.)
MX Sheet	MX Sheet Version□ (SW□D5C-SHEET-J, SW□D5C-SHEET-JA) (□ indicates a version.)
QnUDVCPULCPU Logging Configuration Tool	QnUDVCPULCPU Logging Configuration Tool (SW1DNN-LLUTL-J)

■ Others

Abbreviations and generic terms	Description
SIEMENS	Siemens AG
PLC	Programmable controller manufactured by each corporation

1. OVERVIEW

■1. About GOT

A GOT is installed on the panel surface of a control panel or operating panel and connects to the PLC within the control panel. The GOT carries out switch operation, lamp display, data display, message display, etc.

For the display screen, two kinds of screens are available: user screen and utility screen.

(1) User screen

The user screen is a screen drawn by drawing software. The objects "Touch switch", "Lamp display", "Comment display", and "Numeric display" can be arbitrarily arranged on the display. Moreover, multiple screens created within drawing software can be individually selected or overlapped for the display.

For details, refer to the following.

▣ GT Designer3 (GOT2000) Help

(2) Utility Screen

The utility screen is a factory drawn horizontal screen that cannot be edited. The utility screen can be displayed on the GOT by installing the standard monitor OS from drawing software or an SD card to the GOT. Such as [Brightness] and [Time setting] can be set from the utility screen.

For details, refer to the following.

▣ 9. to 21.

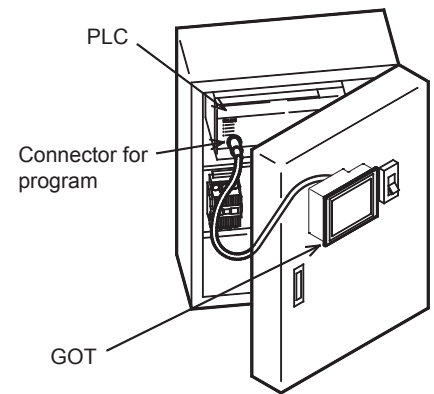

1.1 Features

Monitoring for turning on or off bit devices of a PLC, forcibly turning on or off the bit devices of a PLC, monitoring the word device set value/current value and changing that numeric values are easily made.

- (1) The display unit is used for engineers' stage replacement, setting change and troubleshooting or for operation guidance to an operator.**
 - Monitor
 - Forcibly turning on or off
 - Set value change
 - Trouble check
- (2) Improved monitoring performance and connectivity to FA devices**
 - Multiple languages are displayed using the Unicode2.1-compatible fonts and beautiful characters are drawn using the TrueType and high quality fonts
 - Two types of display modes are available: 65536-color display and monochrome
A fine and beautiful full-color display which shows even small characters clearly, is enabled in the 65536-color display by adopting the high intensity, wide viewing angle and high definition TFT color liquid crystal display. (Also compatible with digital screen displays with 65536 colors, BMP, etc.)
High speed monitoring through high speed communication at maximum of 115.2kbps
 - High speed display and high speed touch switch response
 - The operation performance is improved by the analog touch panel.
- (3) More efficient GOT operations including screen design, startup, adjustment, management and maintenance works**
 - The 9MB built-in flash memory is included as standard.
 - SD card interface is included as standard.
 - RS-232 interface is included as standard.
 - RS-422 interface is included as standard.
 - USB interface (device) is included as standard.
 - Ethernet interface is included as standard.
 - System font types are increased by the adoption of the font installation system.
 - Four types of alarms (system alarm, user alarm, alarm history and alarm popup display) are integrated, and realizing an efficient alarm notification.
- (4) Enhanced support of FA setup tools**
 - Transferring or monitoring the sequence programs using the personal computer connected to GOT, during connection to L, Q, QnA, or FX series PLC CPU (FA transparent function)

1.1.1 Rough procedure

The following shows the procedures before operating a GOT and the descriptions of each item.

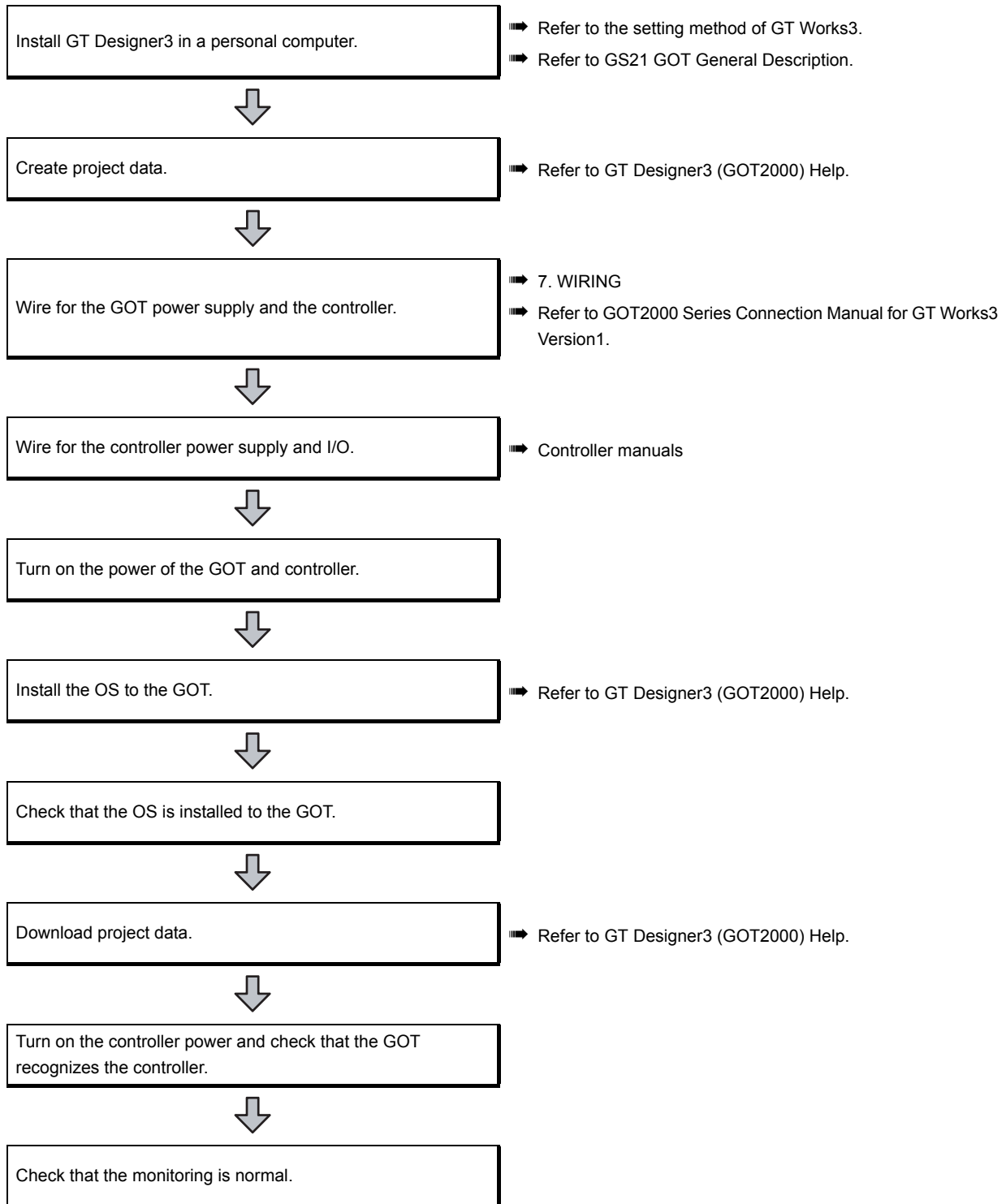

2. SYSTEM CONFIGURATION

2.1 Overall Configuration

The overall configuration of GOT is as follows.

For the connection methods applicable to GS series and cable, refer to the following.

➡ GOT2000 Series Connection Manual For GT Works3 Version1

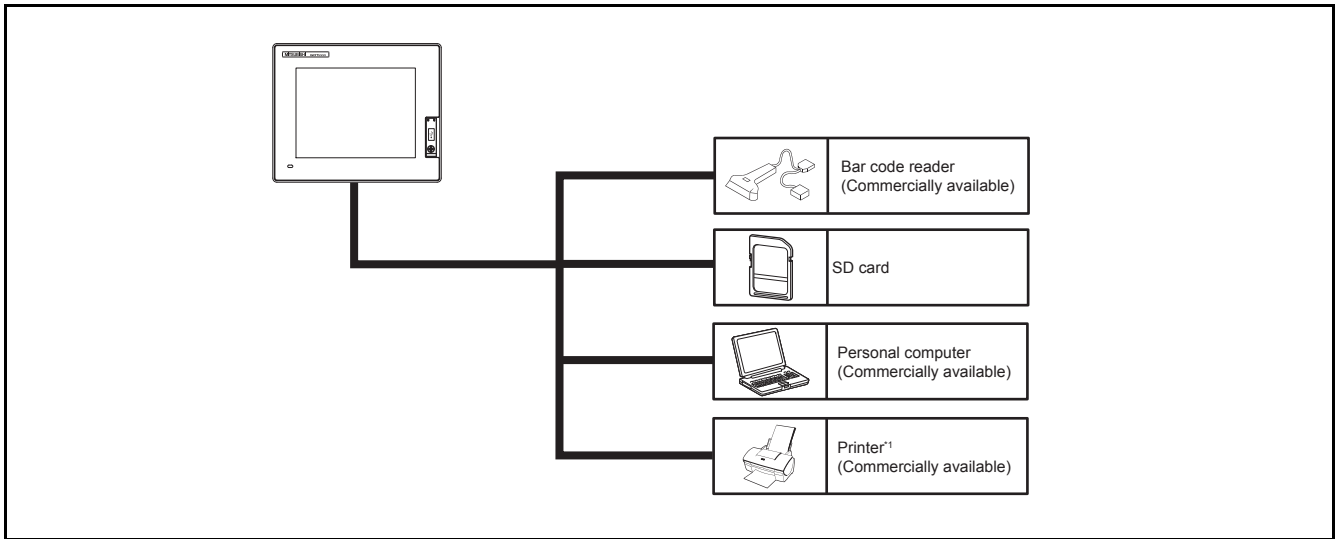

*1 Only hard copy of the screen can be printed.

2.2 Component List

(1) Explanation of the GOT model name

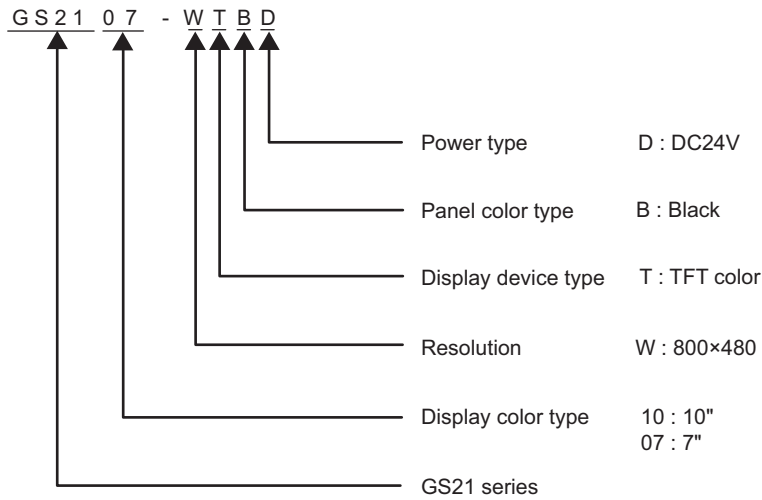

2.2.1 GOT

Product name	Model	Specifications
GOT	GS2110-WTBD	10" [800 × 480 dots], TFT color liquid crystal, 65536 colors 24VDC, Memory capacity: 9MB, built-in Ethernet interface
	GS2107-WTBD	7" [800 × 480 dots], TFT color liquid crystal, 65536 colors 24VDC, Memory capacity: 9MB, built-in Ethernet interface

2.2.2 Option

■ 1. Connection cables for MITSUBISHI PLCs (Sold separately)

Product name	Model	Cable length	Description	
RS-422 Cable	FXCPU direct connection cable, FX expansion board connection cable	GT01-C10R4-8P	1m	For connecting FXCPU (MINI DIN 8 pins connector) and GOT For connecting FXCPU expansion board (MINI DIN 8 pins connector) and GOT
		GT01-C30R4-8P	3m	
		GT01-C100R4-8P	10m	
		GT01-C200R4-8P	20m	
		GT01-C300R4-8P	30m	
	QnA/A/FXCPU direct connection cable, computer link connection cable	GT01-C30R4-25P	3m	QnA/A motion controller (A series)
		GT01-C100R4-25P	10m	For connecting FXCPU (D-Sub 25 pins connector) and GOT
		GT01-C200R4-25P	20m	For connecting FA-CNV□CBL and GOT
		GT01-C300R4-25P	30m	For connecting serial communication unit (AJ71QC24(N)-R4) and GOT
	Computer link connection cable	GT09-C30R4-6C	3m	For connecting computer link unit/serial communication unit and GOT
		GT09-C100R4-6C	10m	
		GT09-C200R4-6C	20m	
GT09-C300R4-6C		30m		
RS-232 cable	QCPU direct connection cable	GT01-C30R2-6P	3m	For connecting QCPU and GOT
	FX expansion board connection cable, FX special adaptor connection cable	GT01-C30R2-9S	3m	For connecting FXCPU expansion board (D-Sub 9 pins connector) and GOT
				For connecting FXCPU special adaptor (D-sub 9 pins connector) and GOT
	FX special adaptor connection	GT01-C30R2-25P	3m	For connecting FXCPU special adaptor (D-sub 25 pins connector) and GOT
	Computer link connection cable	GT09-C30R2-9P	3m	For connecting computer link unit/serial communication unit and GOT
GT09-C30R2-25P		3m		

■ 2. Connection cables for SIEMENS PLCs (Sold separately)]

Product name	Model	Cable length	Description
RS-232 cable	GT09-C30R20801-9S	3m	For connecting SIEMENS HMI Adapter and GOT

■ 3. SD card (Sold separately)

Product name	Model	Description
SD card	L1MEM-2GBSD	SD memory card 2GB
	L1MEM-4GBSD	SDHC memory card 4GB
	-	Commercially-available SD card*1

*1 Some models with the operations checked by our company are usable. For the operation-checked models, refer to "Operation Check Results of Third Party SD Cards on GT14 Model" (Hime-T-P-0089) separately available, or contact your local distributor.

■4. Drawing software (Sold separately)

Product name	Model	Description	
GOT screen creation software MELSOFT GT Works3 Version1	SW1DND-GTWK3-J	Standard license product	
	SW1DND-GTWK3-JC	Site license product *2	
	SW1DND-GTWK3-JA	Multiple-license product *1	
	SW1DND-GTWK3-JAZ	Additional license product *1	
	SW1DND-GTWK3-JV	Standard license product (For upgrading version) (For upgrading version of user's GT Designer2/ GT Works2 to the latest one)	
FA integration engineering software MELSOFT iQ Works *3*4	SW1DND-IQWK-J	Standard license product	
	SW1DNC-IQWK-J		

- *1 If you need two licenses or more, request the number of licenses. For details, consult your local Mitsubishi representative.
- *2 Up to 200 licenses can be registered per site license product. However, this applies only to the same corporation or business facility where the product is purchased.
- *3 Site license products, multiple-license products, and additional license products can be provided. For details, refer to MELSOFT iQ Works catalog <L(NA)08232ENG>.
- *4 This product includes the following software.
- System management software [MELSOFT Navigator]
 - PLC engineering software [MELSOFT GX Works2]
 - Motion controller engineering software [MELSOFT MT Works2]
 - Servo setup software [MELSOFT MR Configurator2]
 - GOT screen creation software [MELSOFT GT Works3]
 - Robot programming software [MELSOFT RT ToolBox2 mini]

■5. PC connection cable (Sold separately)

Product name	Model	Cable length	Description
Project data transfer cable	GT09-C30USB-5P	3m	For connecting GOT (USB Mini-B) and personal computer (USB)

■6. Bar code reader (Sold separately)

Product name	Model	Description
Bar code	-	Commercially-available bar code reader*1

- *1 Some models with the operations checked by our company are usable. For the operation-checked models, contact your local distributor.

3. SPECIFICATIONS

3.1 General Specifications

Item	Specifications					
Operating ambient temperature	0 to 50°C					
Storage ambient temperature	-20 to 60°C					
Operating/Storage ambient humidity	10 to 90%RH, non-condensing (The wet bulb temperature is 39°C) When the ambient temperature exceeds 40°C, maintain the absolute humidity at 40°C and 90%.					
Vibration resistance	Conforms to IEC 61131-2	Under intermittent vibration	Frequency	Acceleration	Half amplitude	Sweep Count
			5 to 8.4Hz	-	3.5mm	10times each in X, Y and Z directions
		8.4 to 150Hz	9.8m/s ²	-	-	
		Under continuous vibration	5 to 8.4Hz	-		1.75mm
8.4 to 150Hz	4.9m/s ²	-				
Shock resistance	Conforms to IEC 61131-2 (147m/s ² , 3times each in the X, Y, and Z directions)					
Operating atmosphere	Must be free of lamp black, corrosive gas, flammable gas, or excessive amount of electroconductive dust particles. Must be no direct sunlight. (Same as for saving)					
Operating altitude ^{*1}	2000m (6562ft) max.					
Overvoltage category ^{*2}	II or less					
Pollution degree ^{*3}	2 or less					
Cooling method	Self-cooling					
Grounding	Class D grounding (100Ω or less), To be connected to the panel when grounding is not possible.					

- *1 Do not use or store the GOT under pressures higher than the atmospheric pressure of altitude 0m (0ft.). Failure to observe this instruction may cause a malfunction. When the air inside the control panel is purged by pressurization, the surface sheet may be lifted by high pressure. As a result, the touch panel may be difficult to press, and the sheet may be peeled off.
- *2 This indicates the section of the power supply to which the equipment is assumed to be connected between the public electrical power distribution network and the machinery within the premises. Category II applies to equipment for which electrical power is supplied from fixed facilities. The surge voltage withstand level for up to the rated voltage of 300V is 2500V.
- *3 This index indicates the degree to which conductive pollution is generated in the environment where the equipment is used. In pollution degree 2, only non-conductive pollution occurs but temporary conductivity may be produced due to condensation.

3.2 Performance Specifications

The following shows the performance specifications.

Item	Specifications		
	GS2110-WTBD	GS2107-WTBD	
Display section*1	Type	TFT color liquid crystal	
	Screen size	10"	7"
	Resolution	800 × 480 [dots]	
	Display size	W222(8.74) × H132.5(5.22) [mm](inch) (Horizontal format)	W154(6.06) × H85.9(3.38) [mm](inch) (Horizontal format)
	Display character	16-dot standard font: 50 characters × 30 lines (Horizontal format)	
	Display color	65536 colors	
	Brightness	32-level adjustment	
Backlight	LED-type (no replacement required) Backlight off/screen saving time can be set.		
Touch panel*2	Type	Analog-resistive film type	
	Key size	Minimum 2 × 2 [dots] (per key)	
	Number of points touched simultaneously	Simultaneous 2-point presses prohibited (Only one point can be touched.)	
	Life	1 million times (operating force 0.98N max.)	
Memory	C drive	Flash memory (Internal) (9Mbytes), for storing project data, OS	
		Life (Number of write times) 100,000times	
Built-in interface	RS-422	RS-422, 1ch Transmission speed: 115200/57600/38400/19200/9600/4800bps Connector shape: D-sub 9 pins (Female) Application: For communicating with controllers Terminating resistor: 330Ω fixed	
	RS-232	RS-232, 1ch Transmission speed: 115200/57600/38400/19200/9600/4800bps Connector shape: D-sub 9 pins (Male) Application: For communication with controllers and a bar code reader For PC connection (Project data upload/download, FA transparent function)	
	Ethernet	Data Transfer method: 100BASE-TX, 10BASE-T, 1ch Connector shape: RJ-45 (modular jack) Application: For communication with controllers For PC connection (Project data upload/download, FA transparent function)	
	USB	USB (Full Speed 12Mbps) 1ch Connector shape: Mini-B Application: For PC connection (Project data upload/download, FA transparent function)	
	SD card	Conforms to the SD standard, 1ch Supported memory card: SDHC memory card, SD memory card Application: Project data upload/download, logging data save	
Buzzer output	Single tone (LONG/SHORT/OFF adjustable)		
Protective structure*3	IP65F (only the front part of the panel)		
External dimensions	W272(10.71) × H214(8.43) × D56(2.21) [mm] (inch)	W206(8.11) × H155(6.11) × D50(1.97) [mm] (inch)	
Panel cutting dimensions	W258(10.16) × H200(7.88) [mm] (inch) (Horizontal format)	W191(7.52) × H137(5.40) [mm](inch) (Horizontal format)	
Weight	Approx. 1.3kg (Excluding mounting fixtures)	Approx. 0.9kg (Excluding mounting fixtures)	
Compatible software package (Version of GT Designer3)	Version1.104J or later		

- *1 Bright dots (always lit) and dark dots (unlit) may appear on a liquid crystal display panel. It is impossible to completely avoid this symptom, as the liquid crystal display comprises of a great number of display elements. Flickers and partial discoloration may be generated on the liquid crystal display panel due to individual differences of panels. Please note that these phenomena appear due to its characteristic and are not caused by product defect.
- *2 The touch panel is an analog-resistive type. Simultaneous pressing of two or more areas on the touch panel may activate the switch between those areas. Do not press two or more areas simultaneously on the touch panel.
- *3 Note that this does not guarantee all users' operation environment. In addition, the product may not be used in environments under exposition of oil or chemicals for a long period of time, or in environments filled with oil-mist.

3.3 Power Supply Specifications

Item	Specifications	
	GS2110-WTBD	GS2107-WTBD
Input power supply voltage	24VDC (+10% -15%), ripple voltage 200mV or less	
Power consumption	7.6W (317mA/24V) or less	6.5W (271mA/24V) or less
At backlight off	3.8W (158mA/24V) or less	3.8W (158mA/24V) or less
Inrush current	17A or less (6ms, 25°C, at the maximum load)	
Permissible instantaneous power failure time	Within 5ms	
Noise immunity	Conforms to IEC61000-4-4, 2kV (power supply line)	
Dielectric withstand voltage	350VAC for 1 minute (across power supply terminals and earth)	
Insulation resistance	500VDC across power terminals and earth, 10 MΩ or more by an insulation resistance tester	

POINT

Operation at momentary power failure

The GOT continues to operate even upon 5ms or shorter instantaneous power failure.

The GOT stops operating if there is extended power failure or voltage drop, while it automatically resumes operation as soon as the power is restored.

3.4 GOT Connector Specifications

The following shows the specifications of connectors for the GOT.
 Refer to this section for creating a connection cable by the user.

3.4.1 RS-232 interface

The following shows the connector for the RS-232 interface of the GOT. For the connection cable connector of the GOT side, use a connector and a connector cover which can be connected to the GOT connector.

1. Connector specifications

GOT	Connector type	Connector model	Manufacturer
GS series	D-sub 9 pins (Male) Inch screw type	17LE-23090-27(D3CC)	DDK Ltd.

2. Connector pin arrangement

GOT main part connector
 see from the front

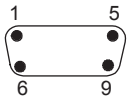

D-Sub 9pin male

3.4.2 RS-422 interface

The following shows the connector for the RS-422 interface of the GOT.
 For the connection cable connector of the GOT side, use a connector and a connector cover which can be connected to the GOT connector.

1. Connector model

GOT	Connector type	Connector model	Manufacturer
GS series	D-sub 9 pins (Female) M2.6 mm screw type	17LE-13090-27(D3AC)	DDK Ltd.

2. Connector pin arrangement

GOT main part connector
 see from the front

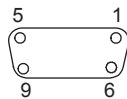

D-Sub 9pin female

4. PART NAME

4.1 Front Panel

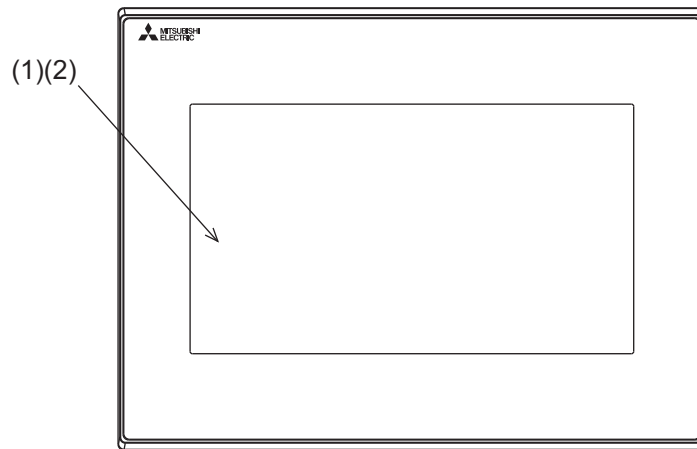

No.	Name	Specifications
(1)	Display section	Displays the utility screen and the user creation screen.
(2)	Touch panel	For operating the touch switches in the utility screen and the user creation screen

4.2 Back Panel

GS2110-WTBD

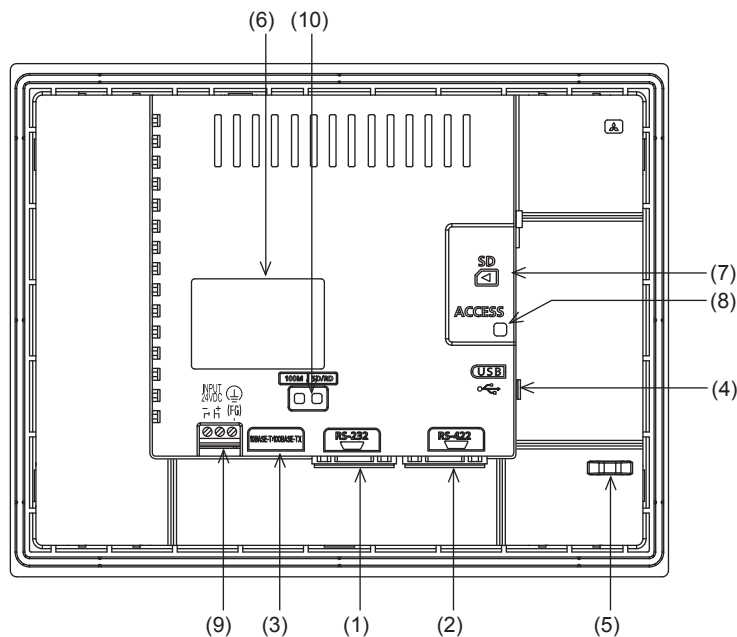

GS2107-WTBD

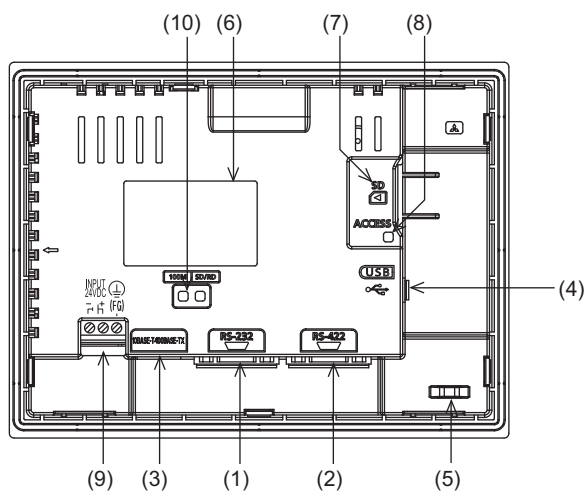

No.	Name	Specifications
(1)	RS-232 interface	For communicating with controller (PLC, microcomputer board, RFID, etc) or personal computer (OS installation, project data download, FA transparent) (D-sub 9-pin male)
(2)	RS-422 interface	For communicating with controller (PLC, microcomputer board, etc) (D-sub 9-pin female)
(3)	Ethernet interface	For Ethernet communication with controller (PLC, microcomputer board, etc) (RJ-45 connector)
(4)	USB interface	USB interface (host) for data transfer and saving
(5)	Hole for preventing the USB cable from unplugging	Hole for preventing the USB cable from unplugging with a banding band
(6)	Rating plate (nameplate)	Model name, current consumption, production number, hardware version, and BootOS version are described.
(7)	SD card interface	Interface for mounting an SD card to the GOT
(8)	SD card access LED	ON: SD card is accessed, OFF: SD card is not accessed
(9)	Power terminal	Power terminal and FG terminal (for power supply (24VDC) to GOT and grounding)
(10)	Ethernet communication status LED	SD RD: Green light while data are being sent or received, 100M: Green light when the transmission speed is 100Mbps

4.3 Bottom

GS2110-WTBD

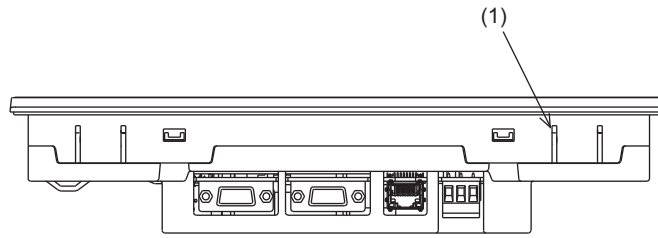

GS2107-WTBD

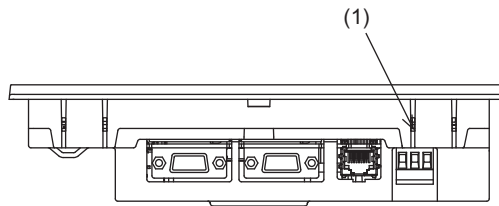

No.	Name	Specifications
(1)	Hole for unit installation fittings	Hole for the inserting installation fittings (accessory) during the GOT installation to the panel (4 holes at top and bottom)

5. EMC DIRECTIVE

5.1 Overview

For the products sold in European countries, the conformance to the EMC Directive, which is one of the European Directives, has been a legal obligation since 1996.

Manufacturers, who recognize that their products comply with the EMC Directive must declare that their products comply with the Directives and put a CE mark on the products.

■ 1. Sales representative in Europe

The sales representative in Europe is as shown below.

Company name: Mitsubishi Electric Europe BV

Address: Gothaer strasse 8, 40880 Ratingen, Germany

5.1.1 Conforming standards in the EMC Directive

The GOT complies with the following standards in the EMC Directive.

Applied standard	Test standard	Test details	Standard value
EN61131-2 : 2007	CISPR16-2-3 Radiated noise* ¹	Test for measuring electromagnetic emissions from the product	<ul style="list-style-type: none"> 30 MHz to 230 MHz QP: 30 dBμV/m (measured at 30 m)^{*2*3} 230MHz to 1000MHz QP: 37 dBμV/m (measured at 30 m)^{*2*3}
	IEC61000-4-2 Electrostatic immunity* ¹	Immunity test in which static electricity is applied to the cabinet of the equipment	<ul style="list-style-type: none"> Contact discharge: \pm4 kV Aerial discharge: \pm8 kV
	IEC61000-4-3 Radiated electromagnetic field, amplitude modulation* ¹	Immunity test in which an electric field is applied to the product	80 MHz to 1000 MHz: 10 V/m 1.4GHz to 2GHz: 3V/m 2.0GHz to 2.7GHz: 1V/m (80% amplitude modulation at 1 kHz)
	IEC61000-4-4 Fast transient burst noise* ¹	Immunity test in which burst noise is applied to the power cables and the signal lines	Power cable: 2 kV Digital I/O (24V or higher): 1kV Digital I/O (less than 24 V): 250 V or higher Analog I/O (signal lines): 250 V or higher
	IEC61000-4-5 Surge immunity* ¹	Immunity test in which lightning surge is applied to the product	<ul style="list-style-type: none"> AC power type Power cable (between cable and ground): \pm2 kV Power cable (between cables): \pm1 kV Data communication port: \pm1 kV DC power type Power cable (between cable and ground): \pm0.5kV Power cable (between cables): \pm0.5kV Data communication port: \pm1 kV
	IEC61000-4-6 Conducted RF immunity* ¹	Immunity test in which a noise induced on the power cable and the signal lines is applied	Power cable: 10V Data communication port: 10 V
	IEC61000-4-8 Power supply frequency magnetic field immunity	Test for checking normal operations under the circumstance exposed to the ferromagnetic field noise of the power supply frequency (50/60 Hz)	30 A/m

*1 The GOT is an open type device (designed to be integrated in equipment).

Make sure to install the GOT on a control panel.

This test item is conducted in the condition where the GOT is installed on a control panel and combined with the MITSUBISHI PLC.

*2 QP: Quasi-peak value, Mean: Average value

*3 This test item is conducted in the following conditions.

- 30 MHz to 230 MHz
QP: 40 dB μ V/m (measured at 10 m)
- 230MHz to 1000MHz
QP: 47 dB μ V/m (measured at 10 m)

5.2 EMC Directive Requirements

The EMC Directive requires the following.

- Strong electromagnetic waves are not emitted to the outside.: Emission (Electromagnetic interference)
- The product is not affected by the electromagnetic waves from the outside.: Immunity (Electromagnetic sensitivity)

To comply with the EMC Directive, this section explains the precautions for configuring equipment integrating the GOT. The data described herein are produced with our best, based on the regulation requirements and standards obtained by Mitsubishi. However, the data do not guarantee that the whole equipment produced according to the data comply with the above directive.

The manufacturer of the equipment must determine the method to comply with the EMC Directive and conformance to the directive.

5.2.1 Installing the GOT on the control panel

The GOT is an open type device (designed to be integrated in equipment).

Make sure to install the GOT in a control panel.

This restriction ensures safety and also has a large effect of suppressing noise generated from the GOT by using the control panel.

■ 1. Control panel

- The control panel must be conductive.
- When fixing a top or bottom plate of the control panel with bolts, do not coat the plate and bolt surfaces so that they contact each other.
Connect the door and the box using a thick grounding cable to ensure the low impedance under high frequency.
- To ensure electric conductivity in the large area as much as possible between an inner plate and the control panel, do not coat the fixing bolt area of the inner plate and the control panel.
- Ground the control panel using a thick grounding cable to ensure the low impedance under high frequency.
- The diameter of cable holes on the control panel must be 10 cm or less.

If the diameter of the hole is 10 cm or more, radio waves may leak.

To reduce the chance of radio waves leaking out, ensure that the space between the control panel and its door is as small as possible.

Pasting the following EMI gasket directly on the painted surface seals the space, reducing the leak of electric waves.

Manufacturer	Series name	Contact
KITAGAWA INDUSTRIES CO., LTD.	RFSG series (Recommended Product)	0587-34-3651

Our test has been carried out on a panel having the damping characteristics of 37 dB max. and 30 dB mean (measured by 3m method with 30 to 300 MHz).

■ 2. Connection of power and ground cables

Ground the GOT and connect power supply cables as shown below.

(1) Wiring the ground cable

Provide a ground point near the GOT.

Ground the frame ground terminal (FG terminal) of the GOT with the thickest and shortest cable as possible.

(2) Ground cable length

The ground cable length must be 30 cm or shorter.

The FG terminals pass the noise generated in the PLC system to the ground.

Therefore, ensure an impedance as low as possible.

Since the ground cables relieve the noise, the cables themselves carry a large noise.

Thus, short wiring prevents the cable from acting as an antenna.

(A long conductor is an antenna radiating noise more efficiently.)

(3) Treatment of the power cable and the ground cable

Twist the ground cable led from the ground point with the power cable.

Twisting with the ground cable relieves more noise from the power cable to the ground.

When a noise filter is installed to the power cable, twisting the power cable and the ground cable may not be required.

5.2.2 Installing a noise filter (power supply line filter)

A noise filter is a part to effectively reduce conducted noise.

Except some models, installation of a noise filter to the power supply lines is not necessary. However, installing the noise filter can reduce conducted noise.

The noise filter is effective to reduce conducted noise in the band of 10 MHz or less.

Use a noise filter equivalent to the following noise filters (double π -type filters).

Model	Manufacturer	Rated current	Rated voltage
FN343-3/05	SCHAFFNER	3A	250V
FN660-6/06	SCHAFFNER	6A	
RSHN-2003	TDK	3A	

1. Precautions

The following shows the precautions for installing a noise filter.

(1) Prohibition of bundling cables

Do not bundle the input and output cables of the noise filter.

Bundling the cables induces the noise from the output-side cable into the input-side cable where noise has been eliminated by the noise filter.

Wire the input and output cables separately.

Bundling the input and output cables induces noise.

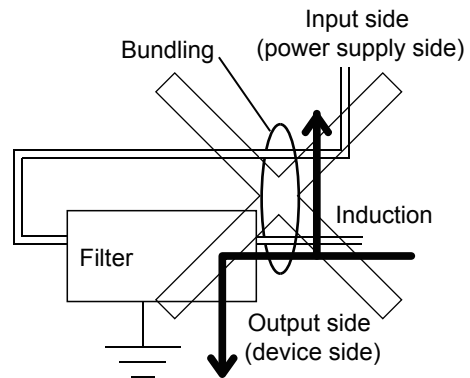
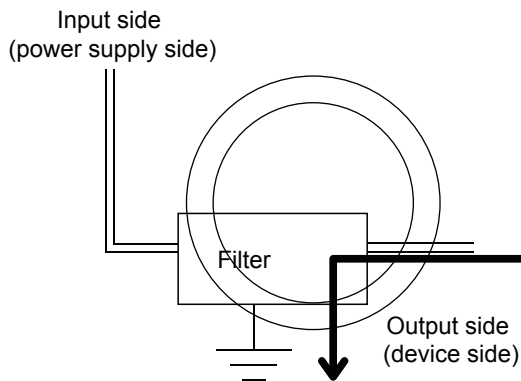

(2) Grounding the noise filter

Connect the ground terminal of the noise filter to the control panel with a short cable as much as possible (approximately 10 cm).

5.2.3 System configuration

1. GOT

Use the following GOTs having a CE mark on the rating plate.
The following models are compliant with the EMC Directive at factory shipment.
When any GOT other than the following does not comply with the EMC Directive.

Product name	Model
GS2110	GS2110-WTBD
GS2107	GS2107-WTBD

2. Connection type

The following table lists the connection types compliant with the EMC Directive.

○: Compliant with EMC Directive, ×: Not compliant with EMC Directive

Connection type ^{*1}	GS21
Ethernet connection	○
Direct CPU connection	○
Computer link connection	○
Other connections (Connection with non-Mitsubishi PLC, inverter, servo amplifier)	○ ^{*2}

*1 For the details of each connection type, refer to the following manual.

➡ GOT2000 Series Connection Manual (GT Works3 Version1) for the controller used

*2 When connecting the GOT to other controllers such as a non-Mitsubishi PLC, fabricate connection cables and configure the system following the EMC Directive specifications.

➡ 4. Non-Mitsubishi PLC, inverter, and servo amplifier connections

POINT

Connected devices

When connecting the GOT to a non-Mitsubishi PLC, refer to the manual about the EMC Directive compliance of the connected device (such as a PLC and a microcomputer).

5.2.4 Connection of power cables and ground cables

Carry out wiring and connect the power and ground cables according to the following instruction.
By the different wiring or connection method, the system may not comply with EMC Directive.

1. Wiring method

For connection of power cables and ground cables, refer to the following.
Ground the frame ground terminal (FG terminal) of the GOT with the thickest and shortest cable as possible.

➡ 7.2 Wiring Inside and Outside the Panel

5.2.5 Fabricating a connection cable

Fabricate the cables used for the GOT by the methods as shown in this section. The fabrication requires a ferrite core, cable clamp, and cable shielding materials. The following products have passed the Mitsubishi EMC Directive compliance test.

- ZCAT3035-1330 ferrite core (TDK Corporation)
- AD75CK-type cable clamp (Mitsubishi Electric Corporation)

1. Ethernet connection

(1) Ethernet cable

Strip off the sheath at both ends of the cable as shown in the figure below to expose braided shield for grounding. The braided shield sections are used for grounding with a cable clamp.

➡ 5.2.6 Grounding a cable

- Connecting to the Ethernet interface of the GOT

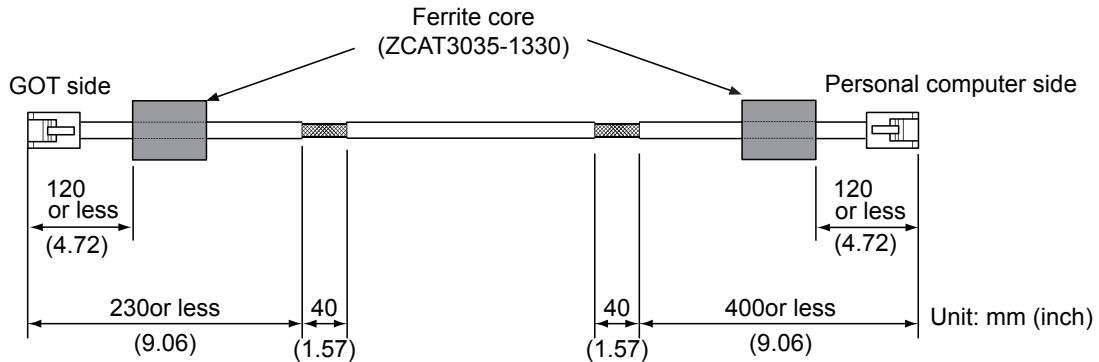

2. Direct CPU connection

(1) RS-232 cable and RS-422 cable

Install a ferrite core to the cable in the positions as shown in the figure below.

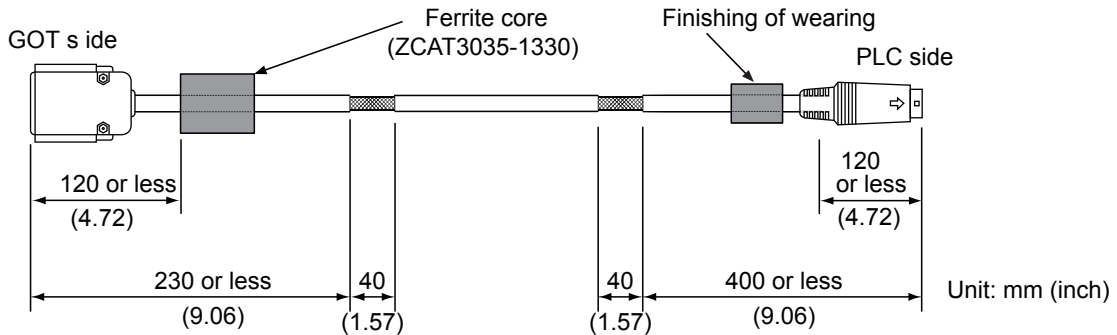

3. Computer link connection

(1) RS-232 cable and RS-422 cable

Strip off the sheath at both ends of the cable as shown in the figure below to expose braided shield sections for grounding. The braided shield sections are used for grounding with a cable clamp.

➡ 5.2.6 Grounding a cable

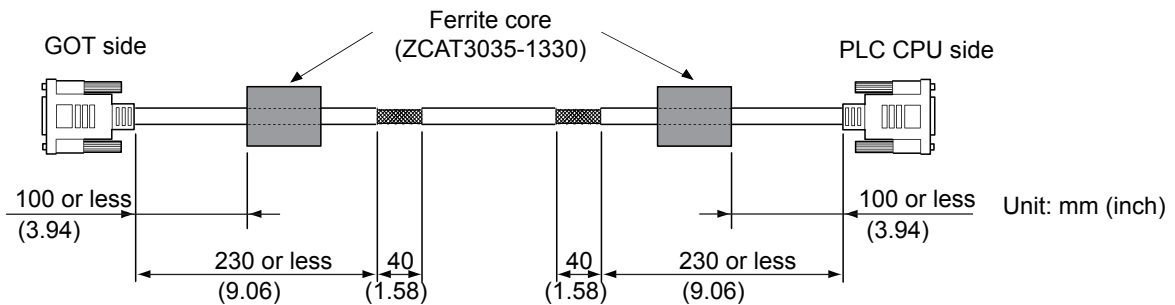

4. Non-Mitsubishi PLC, inverter, and servo amplifier connections

Create the cables (RS-232 cable, RS-422/485 cable) for connecting the GOT and a controller by yourself. For how to create a cable, refer to the following.

➡ GOT2000 Series Connection Manual For GT Works3 Version1

POINT

Treatment of the RS-232 cable and RS-422/485 cable

When the GOT is connected to a controller, configure the system according to the EMC Directive specifications for the controller.

The following shows the recommended instructions to comply with the EMC Directive.

However, the manufacturer of the equipment must determine the method to comply with the EMC Directive and conformance to the directive.

(1) RS-422/485 cable

- When connecting each signal wire (except SG and FG wires), twist two signal wires as shown below.

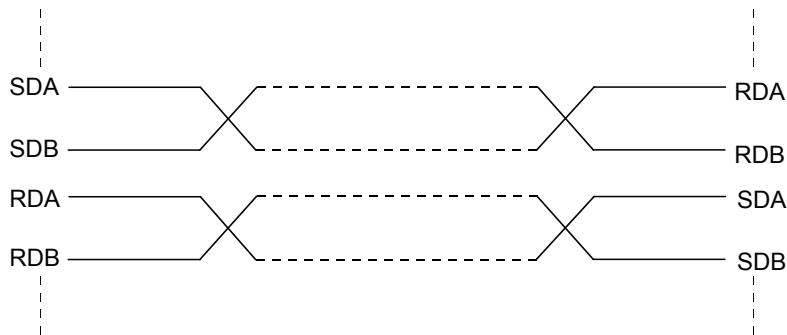

- Connect two or more SG wires.

(2) RS-232 cable

- Twist each signal wire (except SG and FG wires) with the SG wire.

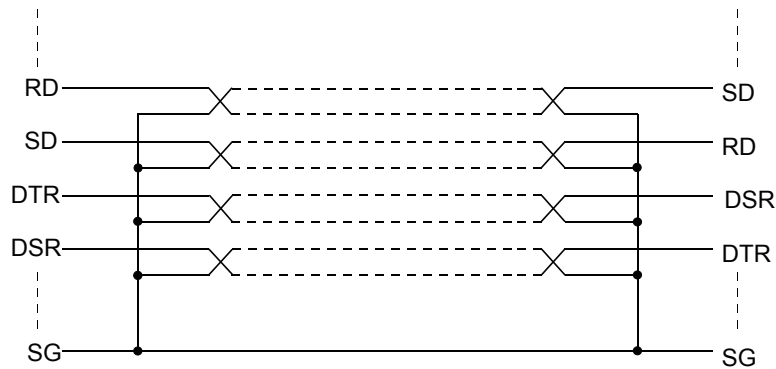

- Install a ferrite core to the cable in the positions as shown in the figure below.
- Strip off the sheath at the both ends of the cable as shown in the figure below to expose braided shield for grounding. The braided shield sections are used for grounding with a cable clamp.

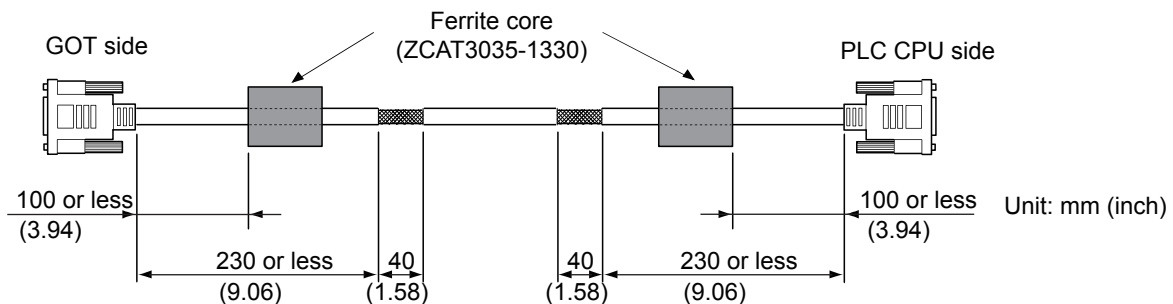

5.2.6 Grounding a cable

■1. Grounding method

Ground the cable and ground cable to the control panel where the GOT and the PLC are installed.
Ground the braided shield section of the cable to the control panel with the cable clamp (AD75CK).

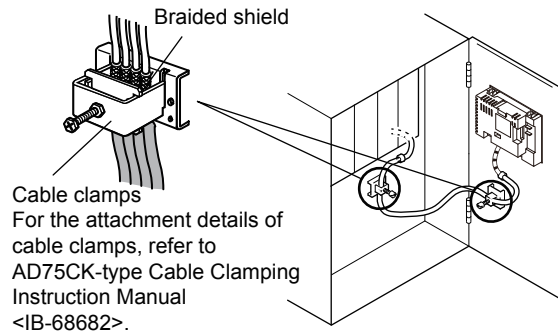

To ground a bus connection cable, ground the braided cable for grounding to the control panel by tightening a screw.

■2. Precautions

Do not arrange the cable clamp close to the other cables that are not clamped.
The noise from the control panel may enter the cable clamp and adversely affect the GOT.

6. INSTALLATION

MOUNTING PRECAUTIONS

WARNING

- Be sure to shut off all phases of the external power supply used by the system before mounting or removing the GOT main unit to/from the controller.
Not doing so can cause the unit to fail or malfunction.

MOUNTING PRECAUTIONS

CAUTION

- Use the GOT in the environment that satisfies the general specifications described in this manual.
Not doing so can cause an electric shock, fire, malfunction or product damage or deterioration.
- Never drop cutting chips and electric wire chips into the ventilation window of the GOT when you drill screw holes or perform wiring.
Otherwise, fire, failure or malfunction may be caused.
- Connect connection cables securely to the specified connectors while the power is turned OFF.
Imperfect connection may cause malfunction or failure.
- Operate and store the GOT in environments without direct sunlight, dust, lamp black, conductive dust, corrosive gas, combustible gas, high temperature, condensation, wind, rain, vibrations and impacts.
Electric shock, fire, malfunction, product damage or deterioration can be caused.
- Tighten the mounting screws within the specified torque range.
Undertightening can cause the GOT to drop, short circuit or malfunction. In addition, undertightening can disable waterproof or oil proof effect.
Overtightening can cause a drop, short circuit or malfunction due to the damage of the screws or the GOT. In addition, the waterproof effect and oilproof effect may not be available due to the "distortion" of GOT or panel.

6.1 Control Panel Inside Dimensions for Mounting GOT

Mount the GOT onto the control panel while considering the following control panel inside dimensions.
(If the vertical format is selected, the dimension, which is rotated 90 degrees clockwise looking from the display section side, is required.)

POINT

Applicable cable

Some cables may need to be longer than the specified dimensions when connecting to the GOT.
Therefore, consider the connector dimensions and bending radius of the cable as well for installation.

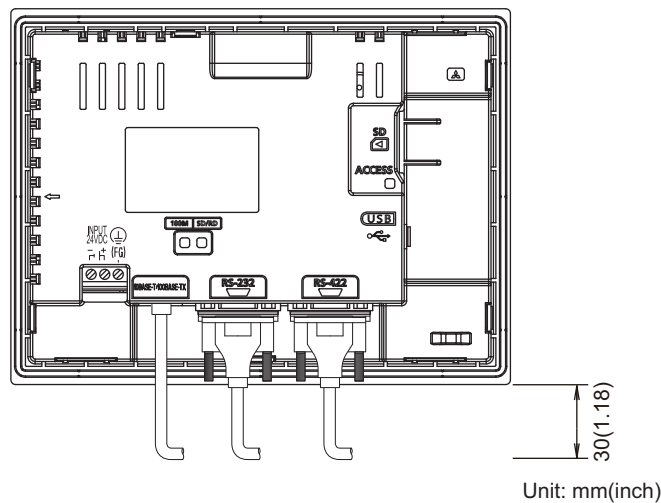

6.2 Panel Cutting Dimensions

Cut holes in the following dimensions on the panel.
Ensure 10mm of space in upper and lower parts of the panel for mounting fixtures.

- Horizontal format (If the vertical format is selected, the dimension must be rotated 90 degrees.)

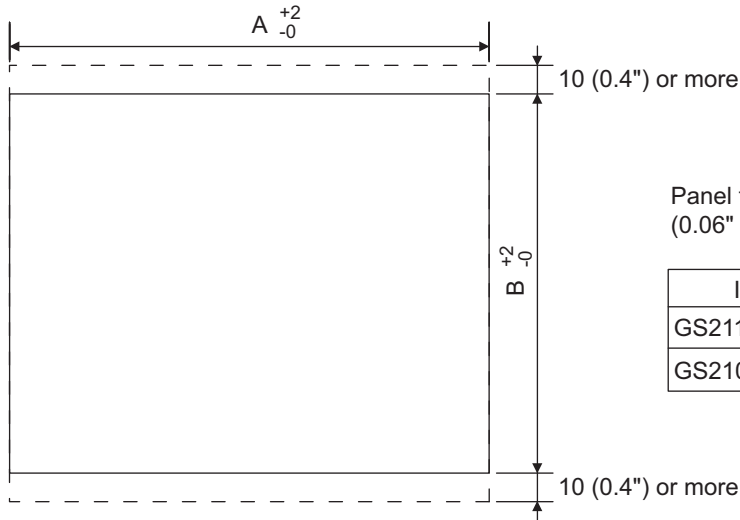

Panel thickness: 1.6 to 4mm
(0.06" to 0.15")

Item	A	B
GS2110-WTBD	258 (10.16")	200 (7.88")
GS2107-WTBD	191 (7.52")	137 (5.4")

Unit: mm (inch)

6.3 Mounting Position

When mounting the GOT, the following clearances must be maintained from other structures and devices.

- Horizontal format (If the vertical format is selected, the dimension, which is rotated 90 degrees clockwise looking from the display section side, is required.)

Installation Environment	A, D [mm] (inch)	B [mm] (inch)	C [mm] (inch)	E [mm] (inch)
In the presence of radiated-noise or heat-generating equipment nearby	50mm (1.97") or more	80mm (3.14") or more*1	50mm (1.97") or more*2	100mm (3.94") or more
In the absence of radiated-noise or heat-generating equipment nearby	20mm (0.79") or more	20mm (0.79") or more	20mm (0.79") or more	20mm (0.79") or more

*1 Vertical Format...50mm (1.97") or more

*2 Vertical Format...80mm (3.14") or more

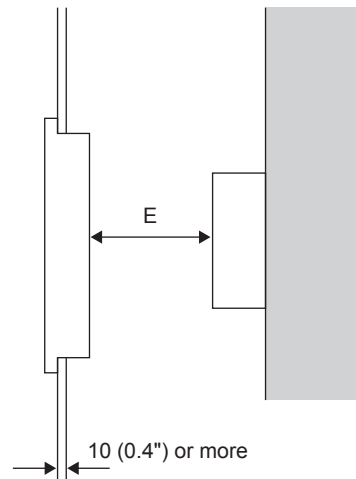
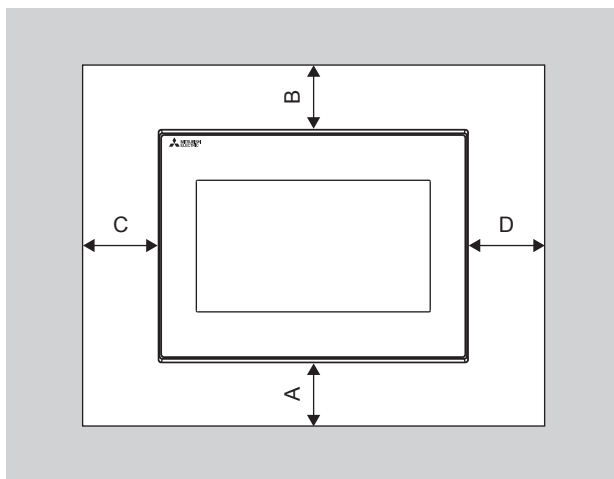

6.4 Control Panel Temperature and Mounting Angle

When mounting the main unit to a control panel or similar fixture, set the GOT display section as shown below.

1. Horizontal installation

When the temperature inside the control panel is 40 to 50°C, the mounting angle should be in the range from 60 to 105 degrees.

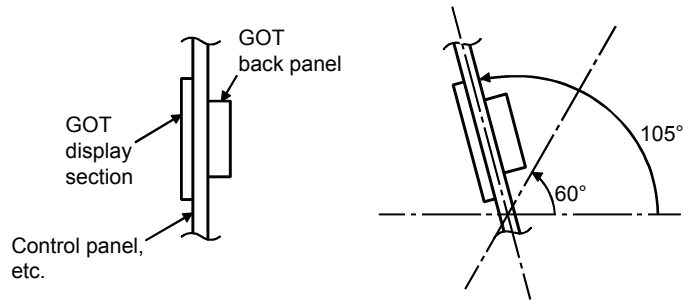

The GOT will have a longer lifetime if used within the mounting angles shown above. Ideally, the temperature inside the control panel should not exceed 0 to 40°C.

2. Vertical installation

When the temperature inside the control panel is 40 to 50°C, the mounting angle should be in the range from 60 to 105 degrees.

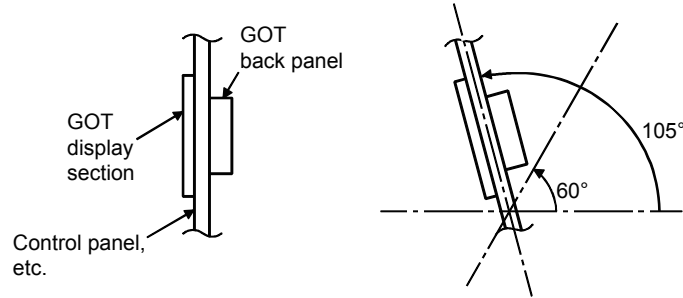

The GOT will have a longer lifetime if used within the mounting angles shown above. Ideally, the temperature inside the control panel should not exceed 0 to 40°C.

6.5 Installation Procedure

The GOT is designed to be embedded into a panel. Mount the GOT by following the procedure below. Refer to "6.2 Panel Cutting Dimensions" for the panel cutting dimensions. In addition, the thickness of the installation panel face must be 1.6 to 4mm.

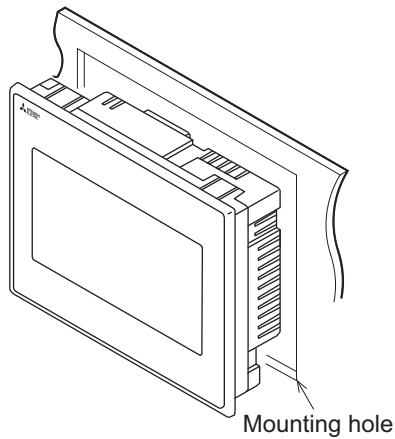

- Step 1.** Inserting into the panel face
Insert the GOT from the front side of the panel.

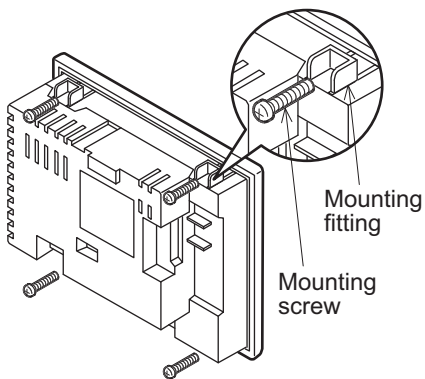

- Step 2.** Fixing the GOT
Engage the hook of the mounting fixture (accessory) to the unit fixing hole of the GOT and fix them by tightening the mounting screws (accessory) in the torque range of 0.36 to 0.48N·m.

- Step 3.** A protection film is attached on the display section of GOT prior to shipment. Remove the film when the installation is completed.

POINT

Check that the packing is firmly attached with the GOT.
If the packing is loose, attach the packing to the GOT securely.

POINT

Cautions on installation

(1) Tightening the mounting screw

Tighten the mounting screw within the specified torque.

Under tightening can cause the GOT to drop. In addition, undertightening can disable waterproof or oil proof effect.

Failure to do so may damage the unit, or distort the panel and make a surface waviness on the display area, leading to deterioration of the visibility or incorrect input from the touch panel. In addition, undertightening can disable waterproof or oil proof effect.

- Specified torque range: 0.36 to 0.48N·m

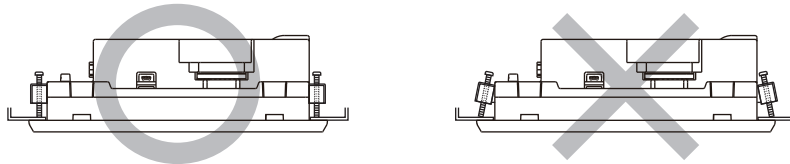

(2) Installation panel surface

Make sure that the panel surface is free from warpage, flaws and irregularities. Warpage, flaws and irregularities may disable the waterproof effect.

Select proper panel thickness under consideration of the panel strength.

(For example, the panel strength may be insufficient depending on the panel material and dimensions even if the panel thickness is acceptable.

Insufficient panel strength may cause warpage depending on the installation positions of the GOT and other equipment.)

7. WIRING

WIRING PRECAUTIONS

WARNING

- Be sure to shut off all phases of the external power supply used by the system before wiring. Failure to do so may result in an electric shock, product damage or malfunctions.
- Please make sure to ground FG terminal of the GOT power supply section by applying 100Ω or less which is used exclusively for the GOT. Not doing so may cause an electric shock or malfunction.
- Correctly wire the GOT power supply section after confirming the rated voltage and terminal arrangement of the product. Not doing so can cause a fire or failure.
- Tighten the terminal screws of the GOT power supply section in the specified torque range. Undertightening can cause a short circuit or malfunction. Overtightening can cause a short circuit or malfunction due to the damage of the screws or the GOT.
- Exercise care to avoid foreign matter such as chips and wire offcuts entering the GOT. Not doing so can cause a fire, failure or malfunction.

WIRING PRECAUTIONS

CAUTION

- Plug the communication cable into the connector to be connected, and tighten the mounting screws and the terminal screws in the specified torque range. Undertightening can cause a short circuit or malfunction. Overtightening can cause a short circuit or malfunction due to the damage of the screws or unit.

This chapter describes the wiring to the GOT power supply section.
For the connection with a PLC, refer to the following.

⇒ GOT2000 Series Connection Manual For GT Works3 Version1

For the dimensional drawing of connection cables, refer to the following.

⇒ Appendix.1 External Dimensions

POINT

General preventive measures against noise

There are two kinds of noises: Radiated noise that is transmitted into the air and Conductive noise that is directly transmitted along connected lines. Countermeasures must be taken considering both kinds of noises and referring to the following 3 points.

(1) Protecting against noise

- (a) Keep signal lines away from noise sources such as a power cable or a high-power drive circuit.
- (b) Shield the signal lines.

(2) Reducing generated noise

- (a) Use a noise filter, etc. to reduce the level of the noise generated due to a source such as a high-power motor drive circuit.
- (b) Attach surge killers to the terminals on the no fuse breakers (NFB), electromagnetic contactors, relays, solenoid valves, and generators to suppress noise interference.

(3) Releasing noise to the ground

- (a) Make sure to connect the ground cable to the ground.
- (b) Use a short and thick cable to lower its ground resistance.
- (c) Ground the power system and the control system separately.

7.1 Power Supply Wiring

Connect the power supply to the power terminals on the back panel of the GOT.
 Use a specified size power supply wire to prevent voltage drop, and tighten the terminal screws firmly to a specified torque.
 Do not exceed the number of wires that are allowed to be connected.
 Secure the wires to prevent stress from being directly applied to the terminal block or wire connections.

7.1.1 Cable types and wire end processing

Process the end of the electrical wire (solid or stranded), or attach a ferrules with plastic sleeve to the wire end.
 Terminal screws should be tightened to between 0.3 to 0.5N·m. Terminal screws must be secured to prevent a loose connection thus avoiding a malfunction.
 When tightening terminal screws, do not exceed the specified torque. Failure to do so may cause equipment failures or malfunctions.

1. Electrical wire size

Electrical wire size		
Solid wire	Stranded wire	Ferrules with plastic sleeve
0.5 to 2.5mm ² AWG20 to AWG14	0.5 to 2.5mm ² AWG20 to AWG14	0.5 to 2.5mm ² AWG20 to AWG14

2. Wire end processing

(1) Connecting the wire directly

- (a) Twist the end of the stranded wire. Make sure there are no wire whiskers.
- (b) Do not solder the wire end.

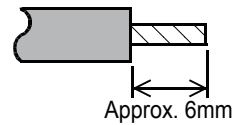

(2) Using a ferrules with plastic sleeve to connect the wire

A wire with a too thick of a wire sheath may not fit the insulation sleeve. Refer to the outline drawing for how to select the proper size wire.

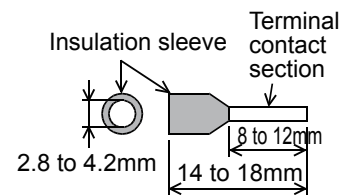

Manufacturer	Model	Crimper type
Phoenix Contact Inc.	AI 0.75-8BU (0.5 to 0.75mm ²)	CRIMPFOX UD6
	AI 1.0-8RD (0.75 to 1.0mm ²)	
	AI 1.5-8BK (1.0 to 1.5mm ²)	
	AI 2.5-8BU (1.5 to 2.5mm ²)	

3. Tools

Use a small driver with a straight, untapered blade as shown on the right to tighten the power terminals.

Manufacturer	Model
Phoenix Contact Inc.	SZS 0.6 × 3.5

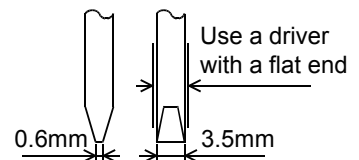

7.1.2 Wiring example

Connect the power supply to the power terminals on the back panel of the GOT.

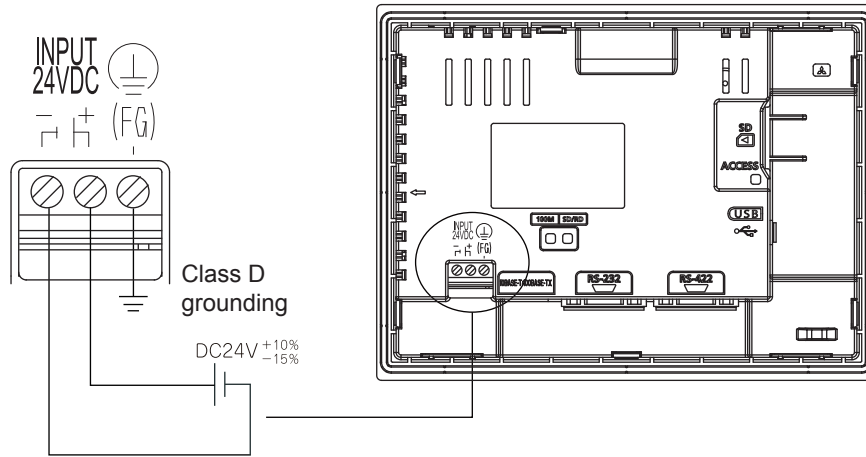

Tightening torque for the power terminals

0.5 to 0.6N·m

7.1.3 GOT's ground

1. Grounding the GOT and other devices

Make sure to carry out the followings for grounding.

- Carry out the independent grounding if possible.
Provide class D (class 3) grounding. (Ground resistance must be 100Ω or less.)
- If the independent grounding is impossible, carry out the shared grounding as shown in fig.2) below.

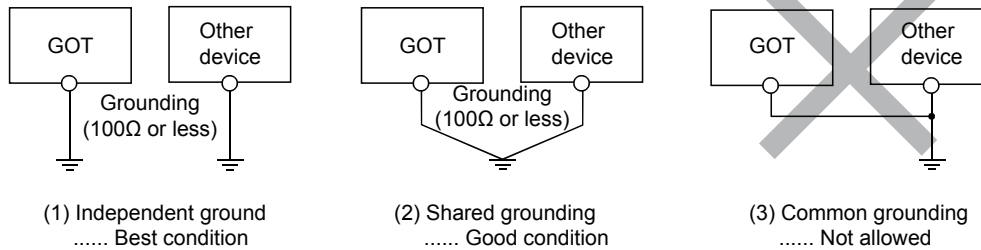

- Use the cable of 2mm² or longer for grounding.
Set the grounding point closer to the GOT to make the grounding cable short as possible.

7.1.4 The cause of malfunctions related wiring/Remedy

Grounding of the GOT may cause electric potential difference and noise interference, which may result in GOT malfunctions. These problems may be resolved by taking the following measures.

■ 1. Wiring path of the GOT's ground cable and power line

Bundling the GOT's ground cable and power line together can cause interference noise, which may result in malfunctions.

Keeping the GOT's ground cable and power line away from each other will help minimize noise interference.

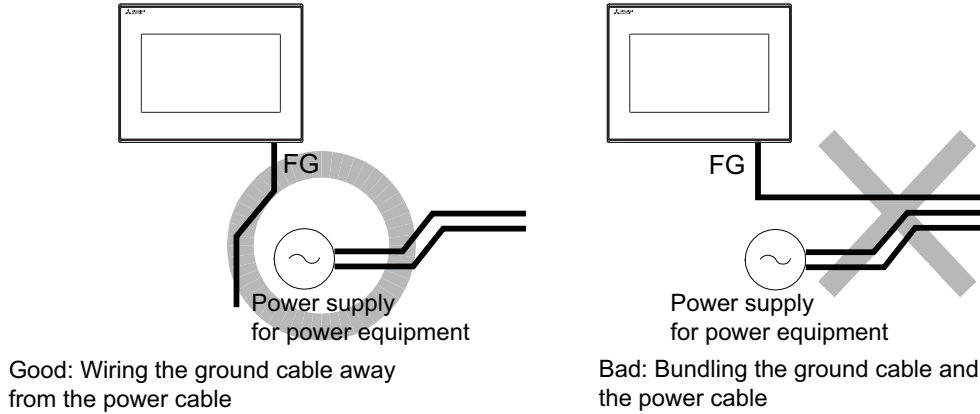

■ 2. Connecting the ground cable from the panel that houses control equipment to the panel to which the GOT is grounded

When running a single ground cable from the panel that houses such piece of control equipment as a sequencer to the panel to which the GOT is grounded, the ground cable may have to be directly connected to the terminal on the GOT.

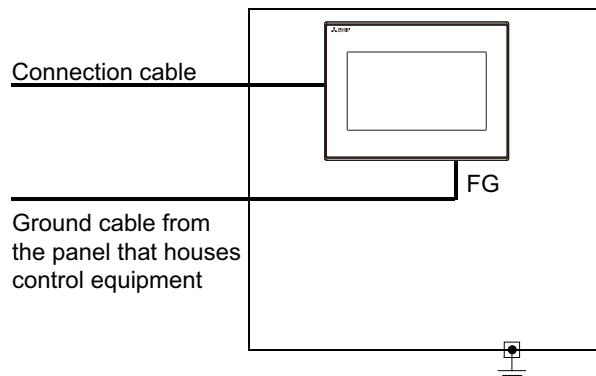

If electric potential difference between the ground points created by it causes malfunctions, lowering the voltage as shown in Remedy 1 below may solve the problem.

- Remedy 1 (Refer to the figures Remedy 1-1 and 1-2 below.)
 If the electric potential difference between the ground cable and the panel that houses the GOT is creating problems, connect the ground cable to the panel also.
 If the wiring method as shown in Remedy 1-1 is not feasible, follow Remedy 1-2.

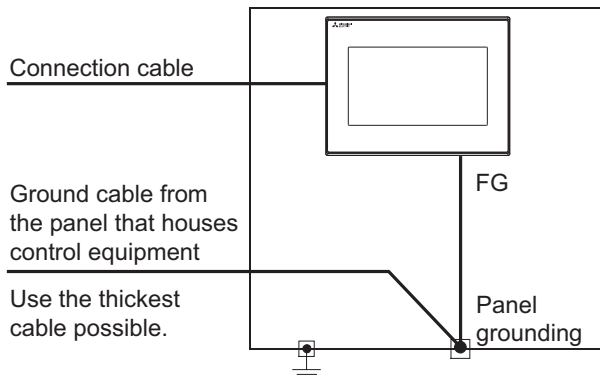

Remedy1-1

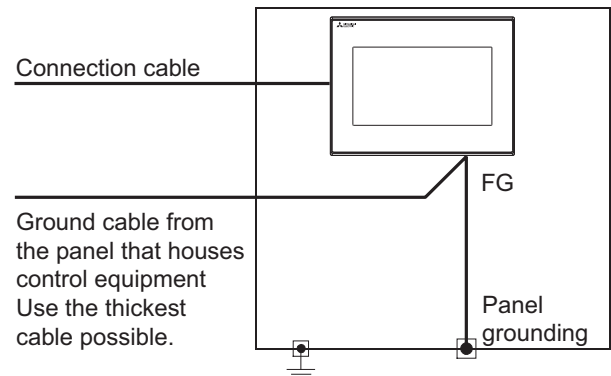

Remedy1-2

If taking Remedy 1 worsens noise interference, taking Remedy 2 may alleviate it.

- Remedy 2 (Refer to the figures Remedy 2-1 and 2-2 below.)
 Attach a ferrite core to the cable if noise from the GOT panel has adverse effects on the GOT when Remedy 1 is taken.
 Wind the wire around the ferrite core several times (approx. 3times), if a ferrite core is used.
 If the wiring method as shown in Remedy 2-1 is not feasible, follow Remedy 2-2.

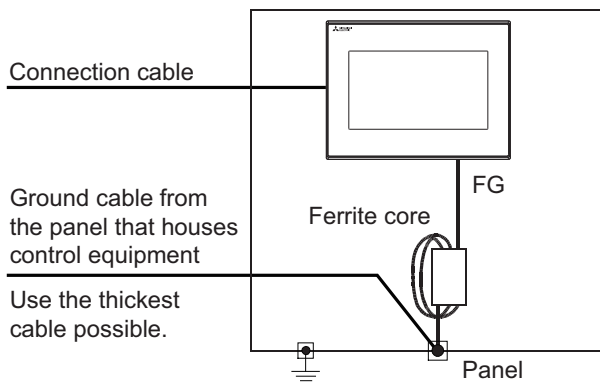

Remedy2-1

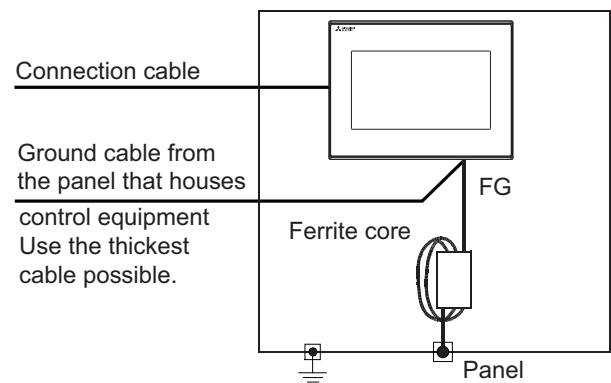

Remedy2-2

7.2 Wiring Inside and Outside the Panel

7.2.1 Wiring inside

Run power lines, servo amplifier drive wires, and communication cables so that they do not cross each other. Noise interference that is generated by cables that cross each other may cause malfunctions. Surge suppressors are an effective way to filter out surge noise that is generated from no fuse breakers (NFB), electromagnetic contactors (MC), relays (RA), solenoid valves, and induction motors. Refer to the section to follow for surge killers.

➡ 7.2.3 Attaching surge killers to control equipment

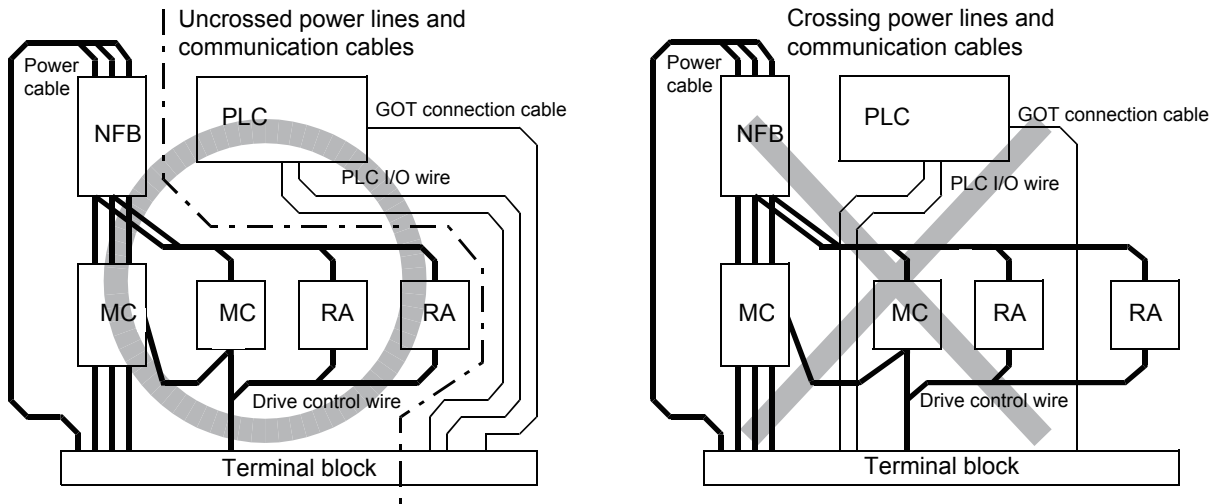

7.2.2 Outside the panel

To pull the power line and communication cable out of the panel, make two pullout holes away from each other and pull the cables through. Putting both cables through the same pullout hole will increase noise interference.

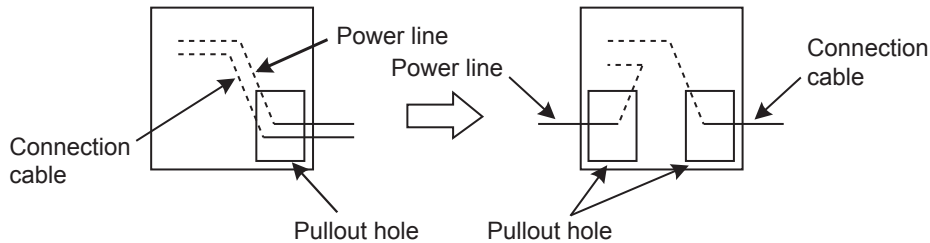

Keep the power line and communication cable inside the duct at least 100mm away from each other. If that is not possible, the use of a metal separator inside the duct can reduce noise interference.

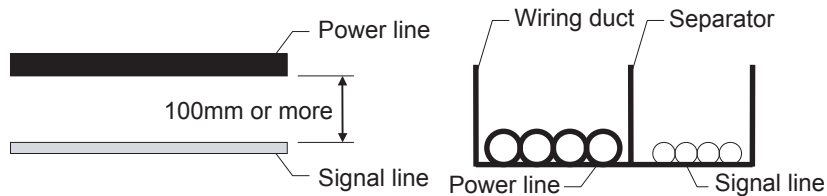

7.2.3 Attaching surge killers to control equipment

If communication errors happen in synch with the on/off signals from certain control equipment (referred to as "load" hereafter) such as no fuse breakers, electromagnetic contactors, relays, solenoid valves, and induction motors, surge noise interference is suspected.

If this problem happens, keep the ground cable and communication cable away from the load.

If that is not possible, an installation of a surge killer will help reduce noise interference.

Place the surge killer as close to the load as possible.

Remedy for AC inductive load

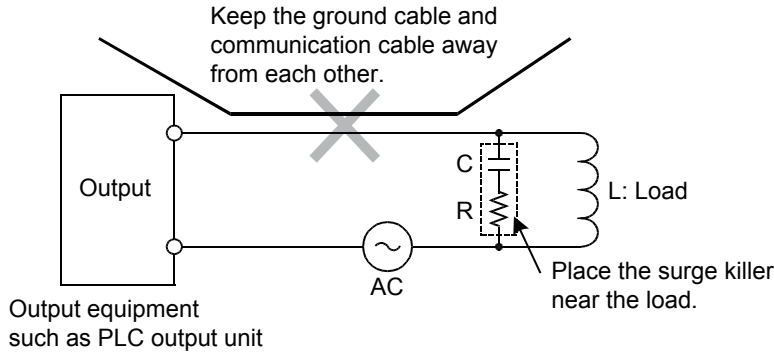

Remedy for DC inductive load

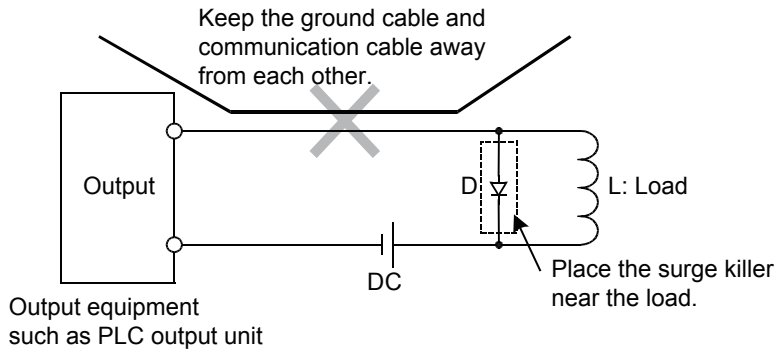

8. OPTION

8.1 SD Card

The SD card is used to transfer the OS or project data and to save the data of the alarm history function.
For details, refer to the following.

⇒ 15. CONTROL OF VARIOUS DATA (DATA CONTROL)

8.1.1 Applicable SD card

The following SD cards are applicable for GOT.

Model	Specifications
L1MEM-2GBSD	SD memory card 2GB
L1MEM-4GBSD	SDHC memory card 4GB
-	Commercially-available SD card*1

*1 Some models with the operations checked by our company are usable. For the operation-checked models, refer to "Operation Check Results of Third Party SD Cards on GT14 Model" (Hime-T-P-0089) separately available, or contact your local distributor.

8.1.2 Installation/removal procedure of SD card

Install/remove the SD card when the power supply of the GOT is OFF or [Access inhibit] is set in the [SD card access] setting of the GOT.

■ 1. Installation

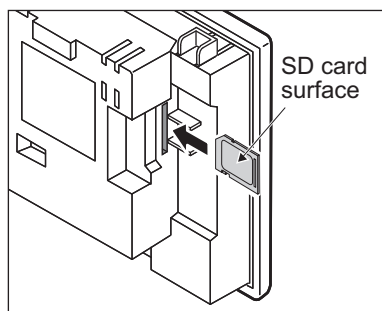

Step 1. Touch [Main Menu] → [Data] → [SD card access] → [Permissions] to set [Access inhibit].

⇒ 15.4 SD Card Access

Check that the SD card access LED turns off.
When the SD card access LED is off, the SD card can be installed or removed even when the GOT is on.

Step 2. Insert a SD card into the SD card interface with its front side (nameplate side) outside.

Step 3. Touch [SD card access] → [Access inhibit] to set [Permissions].
Check that the SD card access LED turns on.

2. Removal

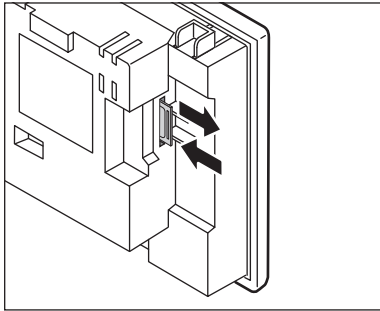

Step 1. Touch [Main Menu] → [Data] → [SD card access] → [Permissions] to set [Access inhibit].

➡ 15.4 SD Card Access

Check that the SD card access LED turns off.

When the SD card access LED is off, the SD card can be installed or removed even when the GOT is on.

Step 2. Push the SD card all the way inside and leave your finger once, then remove the SD card.

POINT

Precautions when removing the SD card

- Do not pull out the SD card or power OFF the GOT while the SD card access LED is lit. To do so may cause data corruption or malfunction.
- When removing the SD card from the GOT, make sure to support the SD card by hand as it may pop out. Failure to do so may cause the SD card to drop from the GOT, resulting in a failure or break.

9. UTILITY FUNCTION

Utility is a function, which carries out connection of GOT and controller, screen display and operation method settings, program/data control and self-check etc.

9.1 Utility Execution

For utility execution, utility has to be displayed by installing BootOS and package data in the C drive (built in flash memory). There are following two methods for installing BootOS and package data.

1) GT Designer3→GOT

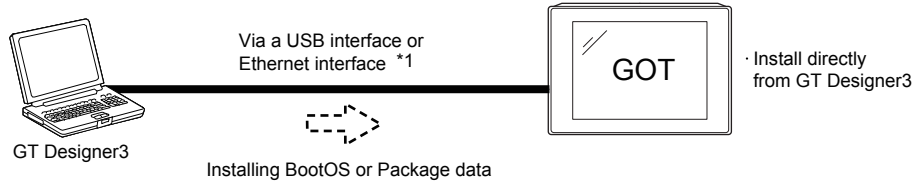

2) GT Designer3→SD card→GOT

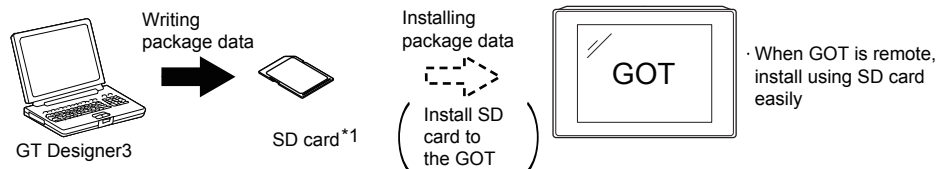

Refer to the following for the installation which uses GT Designer3.

⇒ GT Designer3 (GOT2000) Help

For the installation methods of package data with an SD card, refer to the following.

⇒ 18. INSTALLING PACKAGE DATA BY USING AN SD CARD

9.2 Utility Function List

The items in the following list can be set/operated on the utility screens.

Item		Functions overview	Reference	
Language		Switching message languages	➡ 10.	
Comm. Setting	Standard I/F	Assigning channel number and communication driver to communication interface	➡ 11.1	
	GOT IP Address	Configuring GOT Ethernet setting	➡ 11.2	
	Comm. Monitor	Checking the serial communication port communication	➡ 11.3	
	Ethernet check	Checking the Ethernet communication port communication	➡ 11.4	
	Transparent mode	Setting the channel No. to be used for the communication for the FA transparent function	➡ 11.5	
	Keyword	Setting or deleting sequence program protection key words and canceling sequence program protection status for the FXCPU connection	➡ 11.6	
GOT setup	Display	Setting the title display period	➡ 12.1	
		Setting the screen save time		
		Adjusting brightness		
	Operation	Setting the buzzer sound	➡ 12.2	
		Setting the window move buzzer		
		Setting the key reaction speed		
Touch panel calibration				
	Setting the utility call keys			
Unique info	Setting the GOT ID No.	➡ 12.3		
Security Setting	Security level	Changing the security level	➡ 13.1	
	Operator	Operator management	➡ 13.2	
		Password change		
		Function setting		
Login/Logout		➡ 13.3		
Time setting	Time setting	➡ 14.1		
Data	OS information	System application information, displaying property, checking data	➡ 15.2	
	Resource Data	Alarm info.	Deleting or copying alarm log files Converting alarm log files in G1A format → CSV/TXT format	➡ 15.3.1
		Recipe info.	Converting recipe files in G1P format → CSV/TXT format Converting CSV/TXT format → Recipe files in G1P format Deleting or copying recipe files	➡ 15.3.2
		Logging info.	Converting logging files in G1L format → CSV/TXT format Deleting or copying logging files	➡ 15.3.3
		Image file	Deleting or copying hard copy files	➡ 15.3.4
	SD card access	Setting the access permission of the SD card	➡ 15.4	
	SD card format	Formatting the SD card	➡ 15.5	
	Clear data	Clearing the project data and resource data on the GOT	➡ 15.6	
	Data copy	Transferring the project data or OS to the SD card	➡ 15.7	
	Debug	Device monitor	Device monitor of PLC, test function, current value change of the buffer memory and the buffer memory monitor of intelligent module	➡ 16.1
FX list editor		Changing parameters and sequence program of FX PLC	➡ 16.2	
FX3U-ENET-ADP		Configuring the communication setting for FX3U-ENET-ADP stored in the FXCPU	➡ 16.3	
Maintenance	Touch panel calibration	Displaying the screen for cleaning the display	➡ 17.1	
	Touch panel check	Checking the touch panel operation	➡ 17.2	
	Clean	Displaying the screen for cleaning the display	➡ 17.3	

9.3 Utility Display

To display setting screens for each utility, the main menu has to be displayed first.

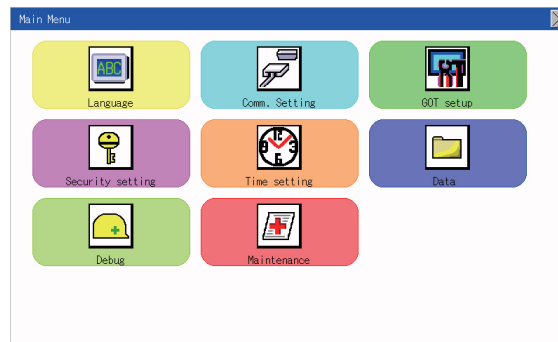

(1) Main menu

The menu items that can be set at the GOT utility are displayed.

Touching a menu item in the main menu will display the setting screen or following selection screen for the item.

(2) System message switch button

This button switches the language used for the utility or system alarms.

When touching the [Language] button, the Select Language screen is displayed.



Step 1. Touch the language button of a desired language and touch the [OK] button to select the language.

Step 2. Touching the [×] button switches the language on the utility to the selected one.

POINT

(1) When starting the GOT without selecting any language or the selected language and the installed fonts are not matched

The following screen will be displayed.

Touching the button of a desired language restarts the GOT and the language is switched to the selected one.



(2) Selectable languages

The system message switch button is displayed only for the selectable languages.

The selectable languages differ depending on the fonts installed in the GOT.

For the relation between the selectable languages and the fonts, refer to the following.

➡ GT Designer3 (GOT2000) Help

(3) System language switching using the device

The system language can be switched using the system language switching device set with GT Designer3. For the setting method of the system language switching device, refer to the following.

➡ GT Designer3 (GOT2000) Help

9.3.1 Display operation of main menu

The following four types of operation can display the main menu.

(Display the main menu after installing the standard monitor OS from GT Designer3 to the GOT built in flash memory.)

(1) When project data is undownloaded

After the GOT is turned on, a dialog box for notifying of absence of project data is displayed. After the dialog box is displayed, touch the [OK] button to display the main menu.

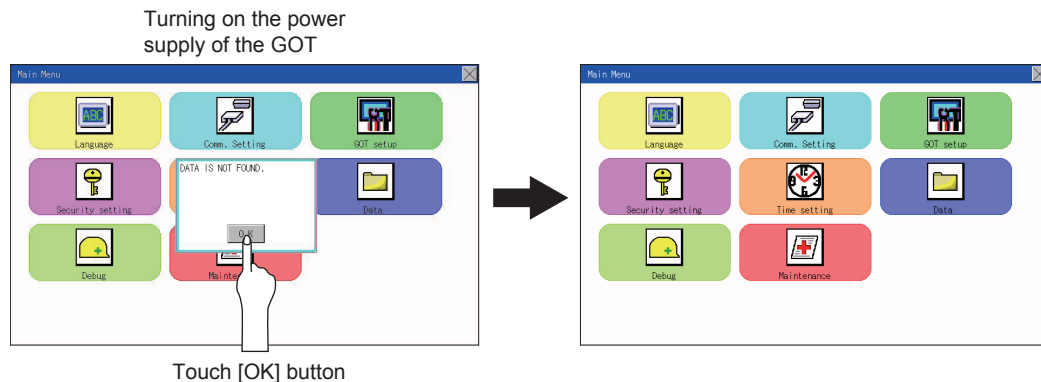

(2) When touching utility call key

If you touch the utility call key while user-created screen is displayed, the main menu is displayed. The utility call key is set in the position on the GOT screen upper left corner at factory shipment.

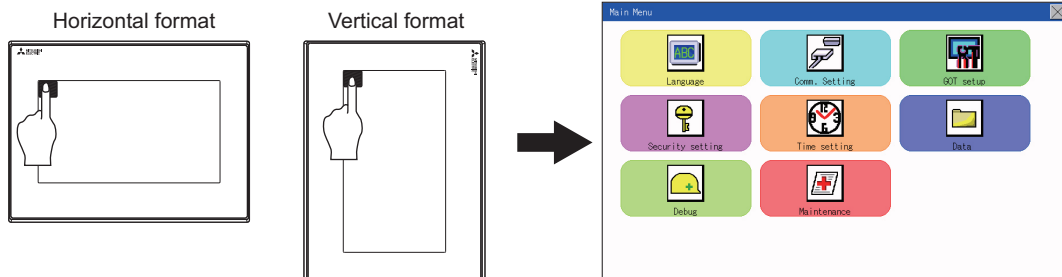

*1 The utility function windows appear in the horizontal format, and this format cannot be changed.

The utility call key can be set by the GOT utility or GT Designer3. For the setting method of the utility call key, refer to the following.

- ➡ 12.2.5 Setting the utility call keys
- ➡ GT Designer3 (GOT2000) Help

POINT

(1) Prohibited simultaneous 2-point presses

Do not touch 2 points or more on the GOT screen simultaneously. Touching 2 points or more simultaneously may activate a part other than the touched point.

(2) Press time of the utility call key

When having set [Press time] of the utility call key setting screen to other than "0 (s)", keep pressing the touch panel for the period set to [Press time] or more before leaving the finger from the touch panel.

For utility call key setting, refer to the following.

- ➡ 12.2.5 Setting the utility call keys

(3) When the utility call key is not set

Even when the utility call key is not set (set to the zero point), you can display the main menu by performing the following operation.

- Pressing the special function switch set on the user-created screen

(3) When touching special function switch (utility)

If you touch the special function switch (utility) while user-created screen is displayed, the main menu is displayed. The special function switch (utility) can be set as a touch switch that is displayed on a user-created screen by GT Designer3.

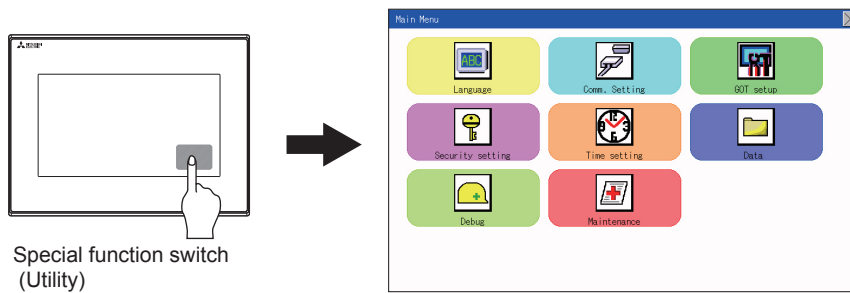

For the details of the special function switch, refer to the following.

➡ GT Designer3 (GOT2000) Help

POINT

When limiting the display and operation of the utility

When limiting the display and operating users, set a password to the GOT using GT Designer3. If a user tries to display the main menu of the utility, the password is displayed. Refer to the following for the details related to the password setting.

➡ GT Designer3 (GOT2000) Help

9.3.2 Utility basic configuration

The basic configuration of utility is as follows.

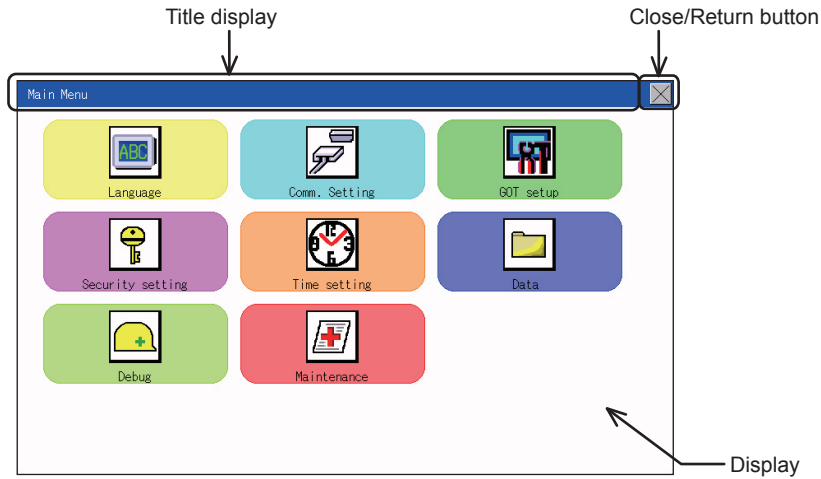

(1) Title display

The screen title name is displayed in title display part.

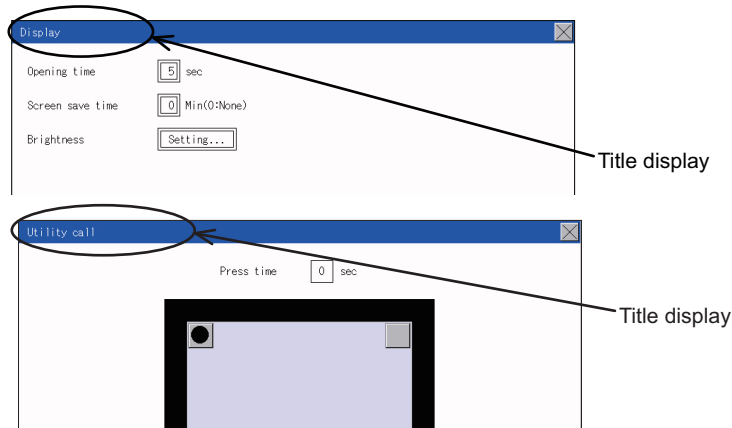

(2) Close/Return button

When a middle screen of the layers is displayed, if the [×] (Close/return) button in the right corner of screen is touched, returns to the previous screen.

If this button is touched when directly displayed from monitor screen, the screen is closed and returns to monitor screen.

(3) Scroll button

For screens in which the content does not fit on one screen page, there is a right or down scroll button on the screen.

▲▼ ◀▶ Scroll one line/column.

▲▼ ◀▶ Scroll window.

9.3.3 Basic operation of settings change

1. Change of setting value

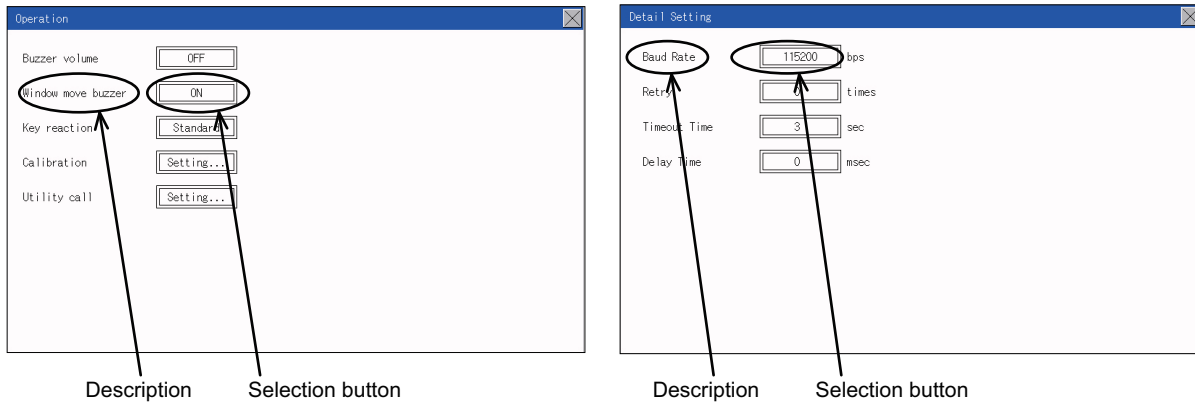

(1) Setting item, select button

Touch the select button to change the settings.
The setting methods differ depending on the setting items.
The following types of setting method are available.

(a) Switching the setting value

The button repeats **SHORT** **LONG** **OFF** every time it is pressed.

(b) Enter the setting value with a keyboard.

Use these keys to enter numerical values. Touch the button to display a keyboard on the GOT screen.
For the keyboard operations, refer to the next page.

(c) Move to another setting screen.

Touch the button to move to each setting screen.
For the setting method of each setting item, refer to the setting operation of each setting screen.

(2) [×] (Close/Return) button

Reflect or cancel the changed settings.

(a) [×] (Close/Return) button

Touching this button closes the screen. Depending on the setting item, the GOT restarts.
Touch the [×] button, and then the dialog box shown below is displayed.
(If no setting is changed, the dialog is not displayed.)
Operate following the message of the dialog box.

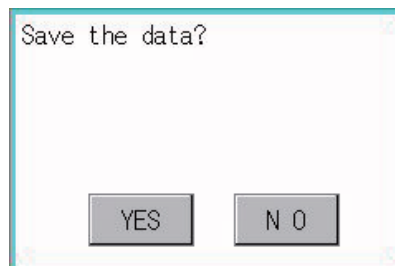

■2. Keyboard operations

- Step 1.** Touch the numerical value to be changed.
- Step 2.** The keyboard for entering numerical values and a cursor are displayed.
The display position of the keyboard differs depending on the position of the touched numerical value.
(The keyboard is displayed at a position that does not disturb users to input numerical values.)

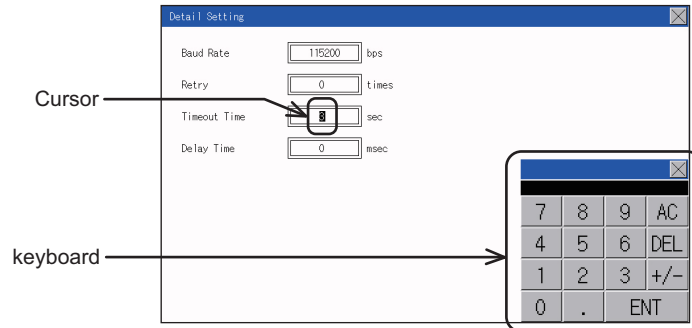

- Step 3.** Input numerical value by the keyboard.
- [0] to [9] Key: Enter numerical values.
 - [Enter] Key: Completes the numerical value input and closes the keyboard.
 - [Cancel] Key: Cancels the numerical value input and closes the keyboard.
 - [Del] Key: Deletes one character.
 - [AC] Key: Deletes all characters.
 - [*] key and the keys which are not mentioned do not function.
- Step 4.** Touching the [Enter] key completes the numerical value input and closes the keyboard.

10. LANGUAGE SETTING (LANGUAGE)

10.1 Display language setting

10.1.1 Display language setting function

This function allows display language selection.
The items which can be set are shown below.

Item	Description	Setting range
Language	Display language in which the utility functions and dialog windows are displayed can be selected or confirmed in this menu	Japanese/English/Chinese <At factory shipment: Chinese>

10.1.2 Language setting operation

■1. Language

Main Menu

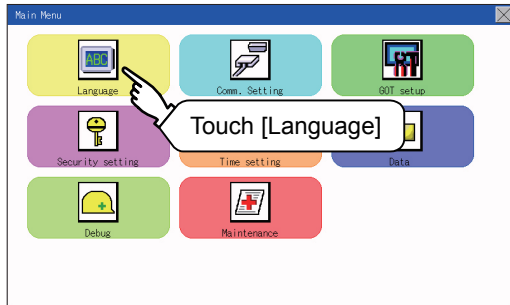

Step 1. Touch [Language] to bring up the set up screen.

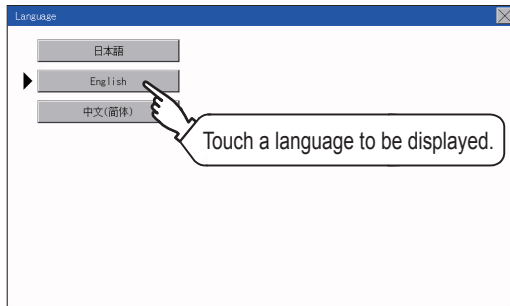

Step 2. Select a display language by touching the corresponding button.



Step 3. After changing the setting, touch the [X] button.
The setting is saved and the setting screen is closed.

POINT

Switching the display language of the utility by devices

Any device can be used for switching the display language of the utility. For details, refer to the following.

➡ GT Designer3 (GOT2000) Help

When using devices to switch the display language of the utility, it does not change even if the display language is switched from the GOT utility screen.

11. COMMUNICATION INTERFACE SETTING (COMMUNICATION SETTING)

The following communication interfaces can be set.

	Item	Functions overview	Reference
Comm. Setting	Standard I/F	Assigning channel number and communication driver to communication interface	➡ 11.1
	GOT IP Address	Configuring GOT Ethernet setting	➡ 11.2
	Comm. Monitor	Checking the serial communication port communication	➡ 11.3
	Ethernet check	Checking the Ethernet communication port communication	➡ 11.4
	Transparent mode	Setting the channel No. to be used for the communication for the FA transparent function	➡ 11.5
	Keyword	Setting or deleting sequence program protection key words and canceling sequence program protection status for the FXCPU connection	➡ 11.6

11.1 Standard I/F Setting

11.1.1 Standard I/F functions

Function	Description
Channel no. display	Displays the channel number (CH No) that has been assigned by drawing
Communication driver display	Displays the communication driver that has been assigned by drawing software
Communication parameters display	Displays the communication parameters of the controllers that has been assigned by drawing software

11.1.2 Standard I/F display operation

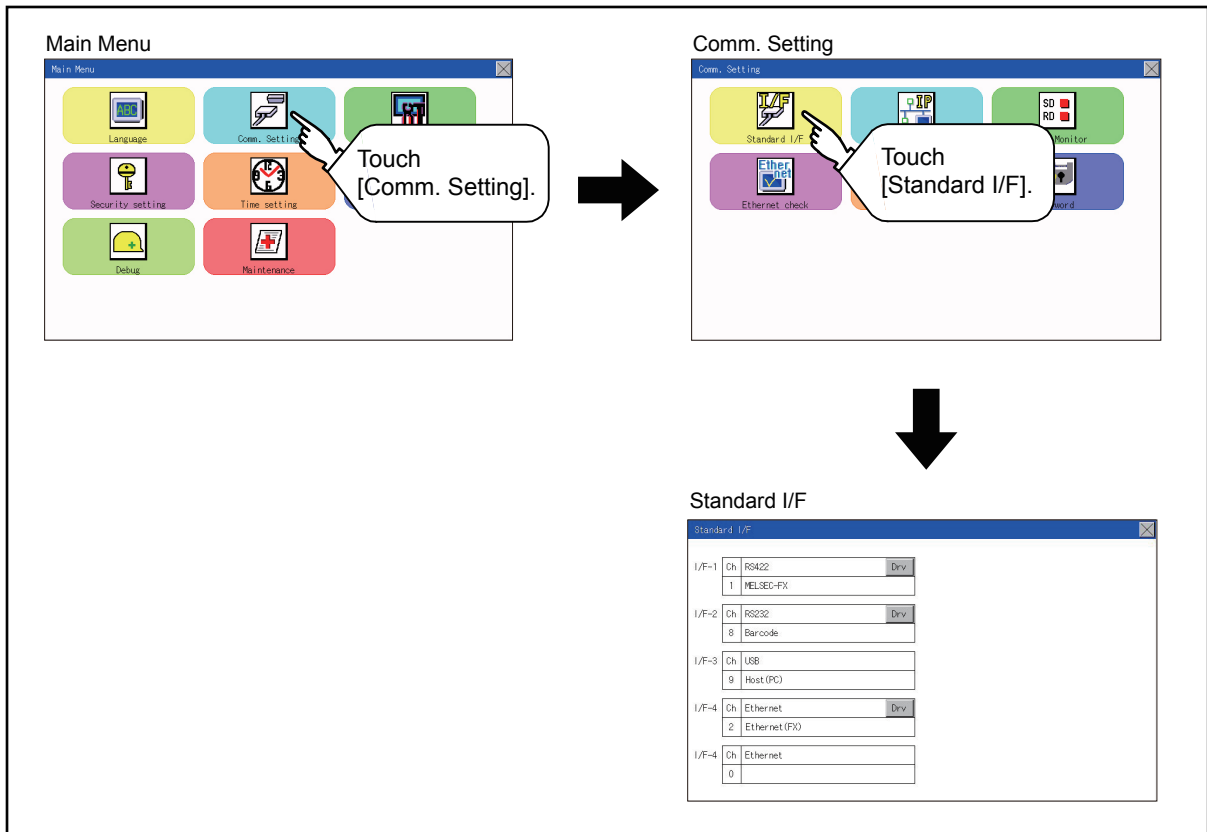

11.1.3 Display contents of standard I/F

Described below are the display items on the standard I/F setting menu and their functions.

1. Display item

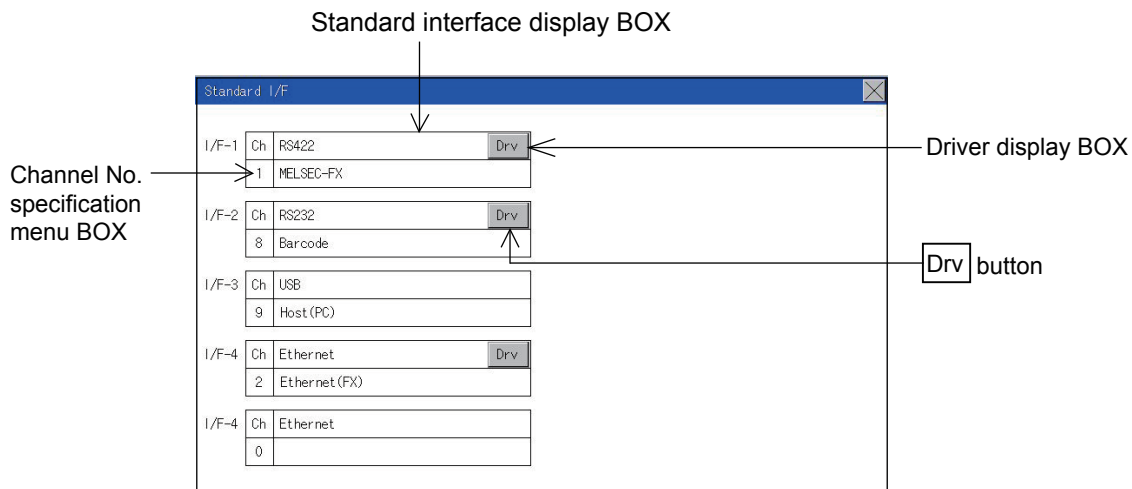

(1) Standard interface display BOX

The standard interface includes the following four types.

Standard I/F-1(RS422): For communication with PLC, microcomputer and other equipment

Standard I/F-2(RS232): For communication with PLC, PC (drawing software), modem, other equipment, bar code reader and transparent

Standard I/F-3(USB): For communication with PC (drawing software) and transparent

Standard I/F-4(Ethernet): For communication with PC (drawing software) and other equipment

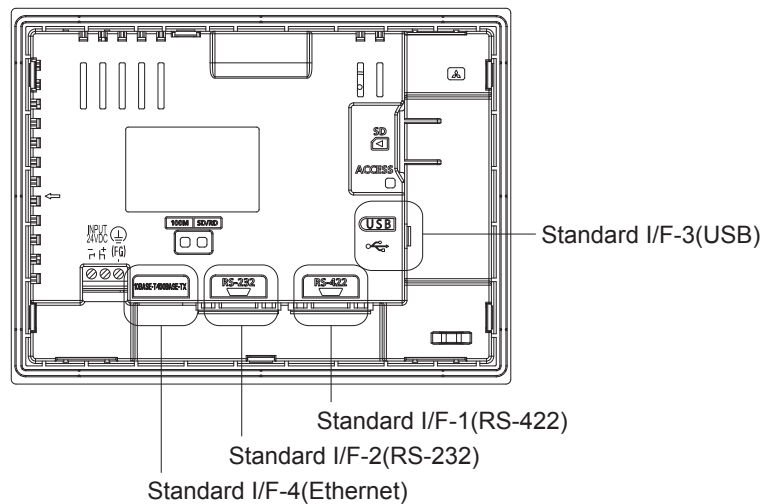

(2) Channel No. specification menu BOX

Set a channel number to be used by the standard interface.

11.1.5 Channel setting operation

For the detail of the drivers which can be assigned to each channel, refer to this section (3).

- 0: Set when the communication interface is not used.
- 1, 2: Set when connecting to a controller.
- 8: Set when connecting to a bar code reader or RFID.
- 9:*1 Set when connecting to a PC (drawing software).
- *: Set this channel when the gateway function (except when the connection with controllers is the Ethernet connection) or the Ethernet download function is used.

- "9" is automatically set to the standard I/F-3(USB).

(3) Driver display BOX

- (a) The driver display box displays the names of communication drivers assigned to channels or the communication drivers set in the communication settings of drawing software.
For details of the communication drivers to be displayed, refer to the following.
- ▣ GT Designer3 (GOT2000) Help
- (b) "Disuse" is displayed in the driver display box in the following cases:
- The communication driver is not installed.
 - ▣ 15.2 System Application Information
 - "0" is set in the channel number specification menu box.
- (c) The channel number of the standard I/F-3(USB) is fixed to "9".

(4) Drv button

Displays the driver setting screen.

Select the driver to use on the driver setting screen.

- ▣ 11.1.6 Driver setting operation

The Drv button is displayed in the following case.

- When a channel number other than channel 0 or 9 is set to the standard I/F-1, standard I/F-2, and standard I/F-4

POINT**Precautions for communication between GOT and connected devices****(1) Installing [Communication driver] and downloading [Communication Settings]**

To perform communication with the connected device, the following actions are necessary.

- 1) Installing communication drivers (Up to 2 drivers)
- 2) Assigning channel numbers and communication drivers to communication interfaces
- 3) Downloading contents (project data) assigned in step 2)

Perform 1), 2) and 3) with drawing software.

Standard I/F Setting			
	CH No.	Driver	
I/F-1: RS422/485	1	MELSEC-FX	Detail Setting...
I/F-2: RS232	8	Barcode	Detail Setting...
I/F-3: USB	9	Host (PC)	
I/F-4: Ethernet	0	None	Detail Setting...

For details, refer to the following.

- ▣ GT Designer3 (GOT2000) Help

(2) When the communication settings have not been downloaded

If the communication settings have not been downloaded with drawing software, set the communication settings on the drawing software or in the GOT utility screen.

11.1.4 Detail information setting operation

1. For Standard I/F-1(RS422) and Standard I/F-2(RS232)

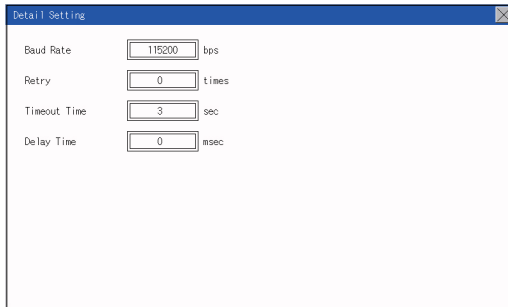
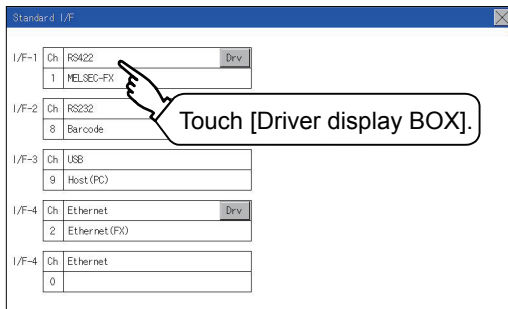

Step 1. Touch each driver display box of the standard I/F-1 and standard I/F-2.

Step 2. The screen jumps to the detailed information screen and the communication parameter will appear.

Step 3. Touch the numerical values of baud rate to switch them repeatedly.

Ex. 4800bps → 9600bps → 19200bps

The numerical values are set using the ten-key depending on the setting.



"0" to "9":

Use these keys to enter numerical values.

Enter "0" to disable the screen saver function.

"ESC":

Closes the ten-key window without saving any value entered

"AC":

Deletes the entire string of numerical characters that are being entered

"DEL":

Deletes a digit from a string of numerical characters that are being entered

"ENT":

Enters the value for the clock that has been entered and closes the ten-key pad window

" +/- ":

Switches between positive and negative values (Only positive values are valid for the clock setting.)

".":

Invalid key (not used)

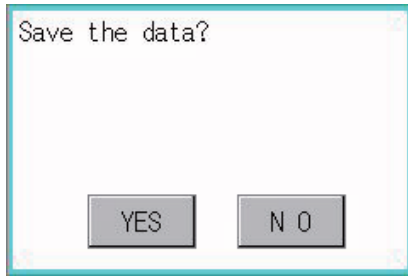

Step 4. Touch the [×] button to display the window confirming whether to save the settings.



Step 5. Touch the [YES] button to save the settings and restart. Touch the [NO] button to discard the changes.

POINT

Communication parameters

The types of items that are in the communication parameter setting menu depend on the type of communication driver that is installed on the GOT in use.

Refer to the section below for the setting contents of various drivers.

➡ GT Designer3 (GOT2000) Help

■ 2. For Standard I/F-4(Ethernet)

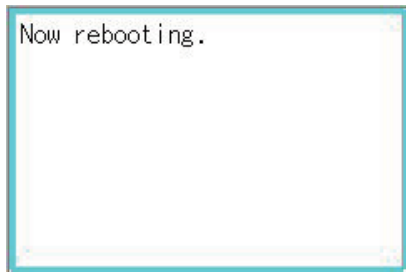
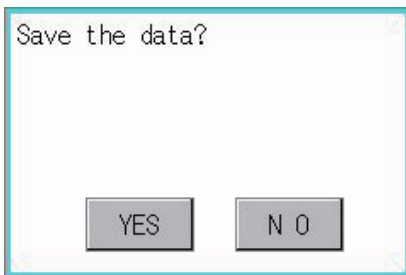
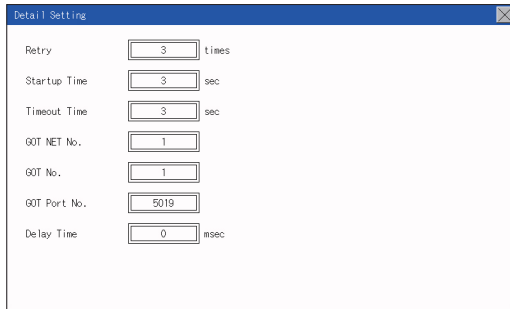
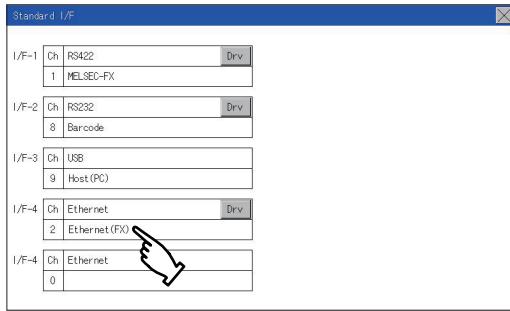

Step 1. Touch the driver display box of a communication parameter to be set.

Step 2. The screen is switched to the communication detail setting. Set the communication parameter on this screen.

GOT IP address setting

➡ 11.2 GOT IP Address Setting

Step 3. When the [×] button is touched, it returns to the previous screen.

Step 4. Touch the [×] button to display the window confirming whether to save the settings.

Step 5. Touch the [YES] button to save the settings and restart. Touch the [NO] button to discard the changes.

POINT

Communication parameter setting by drawing software

Set the communication parameter for each communication driver by selecting [Common] → [Controller Setting].

➡ GT Designer3 (GOT2000) Help

11.1.5 Channel setting operation

1. Channel number setting operation

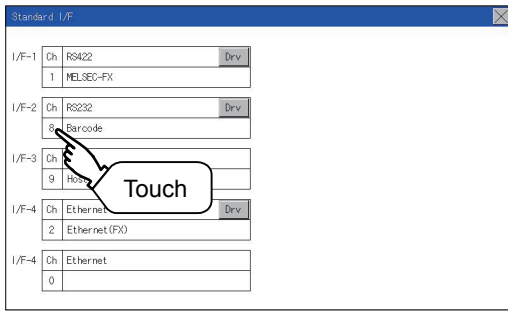

Step 1. Touch the channel No. specification menu box to be set.

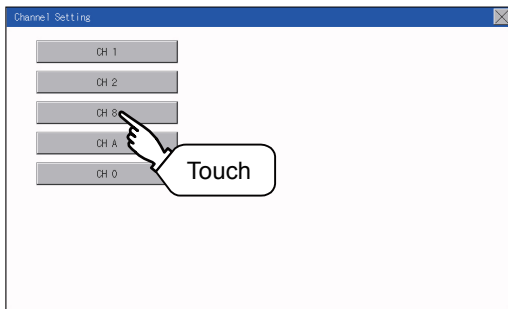

Step 2. When the channel setting window appears, select the channel number.

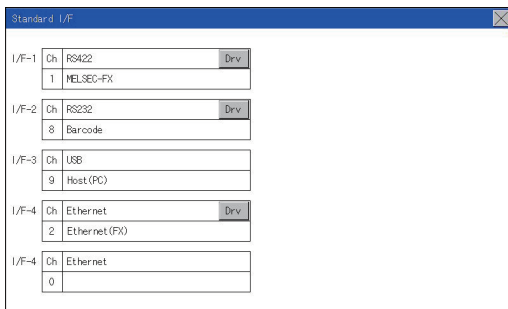

Step 3. When the channel number is selected, the settings are fixed and the window returns to the previous one. Therefore, touch the [×] button.

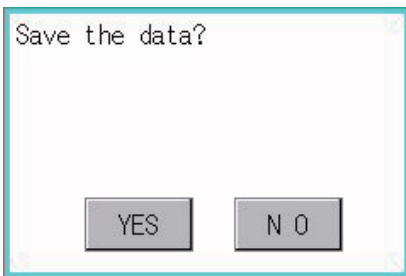

Step 4. Touch the [×] button to display the window confirming whether to save the settings.



Step 5. Touch the [YES] button to save the settings and restart. Touch the [NO] button to discard the changes.

11.1.6 Driver setting operation

1. Driver setting operation

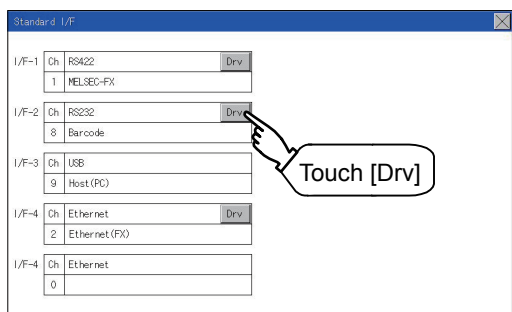

Step 1. Touch [Drv] button to bring up the driver setting window.

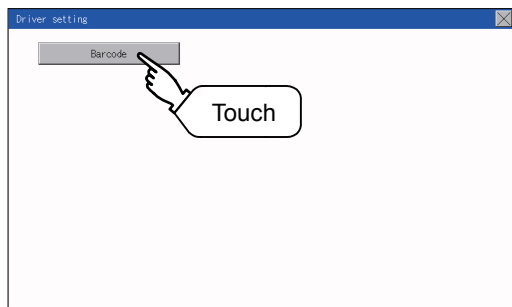

Step 2. The available driver names are displayed on the driver setting screen. Select the driver to use.

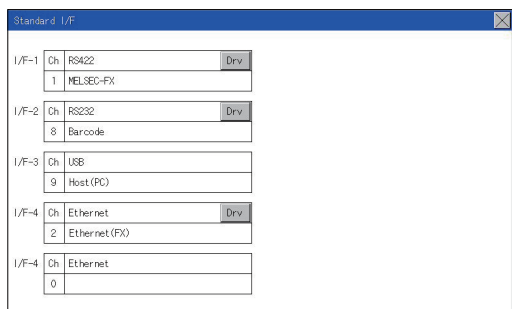

Step 3. When the channel number is selected, the settings are fixed and the window returns to the previous one. Therefore, touch the [×] button.

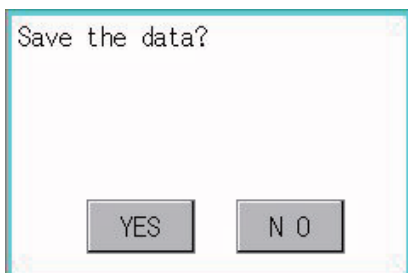

Step 4. Touch the [×] button to display the window confirming whether to save the settings.

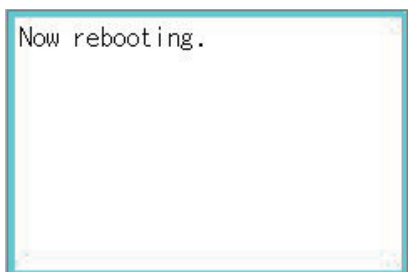

Step 5. Touch the [YES] button to save the settings and restart. Touch the [NO] button to discard the changes.

11.2 GOT IP Address Setting

This section describes the GOT Ethernet setting.

The GOT Ethernet setting can also be set with drawing software. For details, refer to the following.

➡ GT Designer3 (GOT2000) Help

11.2.1 Standard

The table below shows the communication setting items and setting range.

Communication setting items	Setting range	Remark
IP Address	0.0.0.1 to 223.255.255.254	If a value outside the setting range is entered, the error message "SET NUMBER IS INCORRECT." appears.
Subnet Mask ^{*1}	192.0.0.0 to 255.255.255.252	
Default gateway ^{*1}	0.0.0.1 to 223.255.255.254	

*1 Set the value "0.0.0.0" when not using the subnet mask and default gateway.

11.2.2 Display operation of GOT IP address

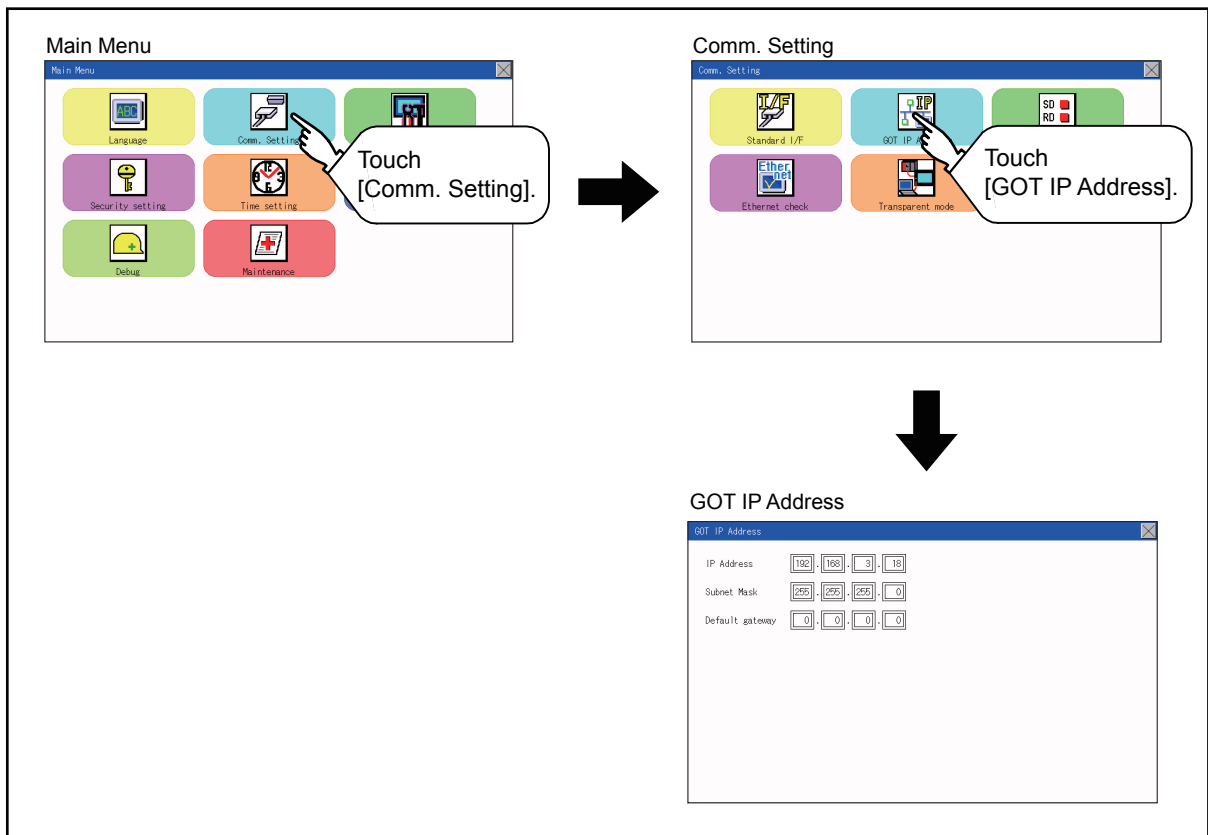

11.2.3 Setting operation

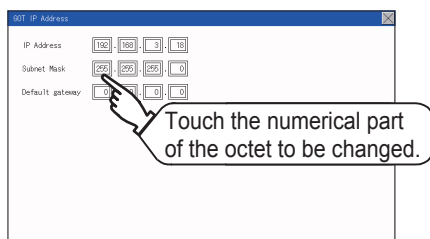

Step 1. Touch the numerical part of the octet to be changed among the 1st to 4th octets.

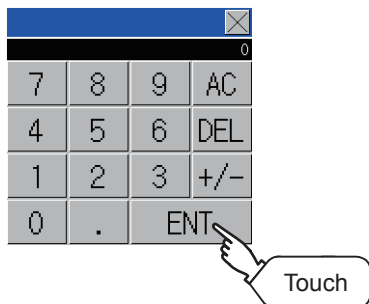

Step 2. When the ten-key pad appears, enter a numerical value in up to 3 digits, and touch the **ENT** key. If a numerical value outside the setting range is entered, the following error message appears. Enter a numerical value again.

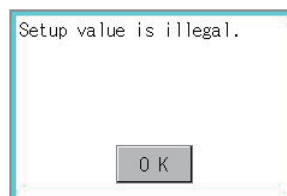

For the details of the setting range, refer to the following.

➡ 16.3.1 Specifications

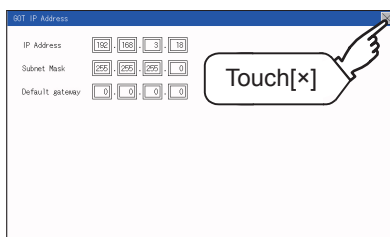

Step 3. The changed IP address is displayed. Touch the **[x]** key.

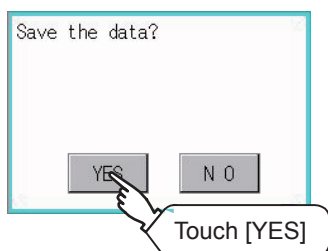

Step 4. When the screen shown on the left appears, touch the **[YES]** key.

11.3 Communication Monitor

11.3.1 Communication monitor functions

Function	Description
Communication port-selection status display	Indicates the connection status of Standard I/F-1 and I/F-2.
Communication status display	Displays the communication status (SD: send, RD: receive)
Communication error status display	Displays an error message when a communication error occurs

11.3.2 Communication monitor display operation

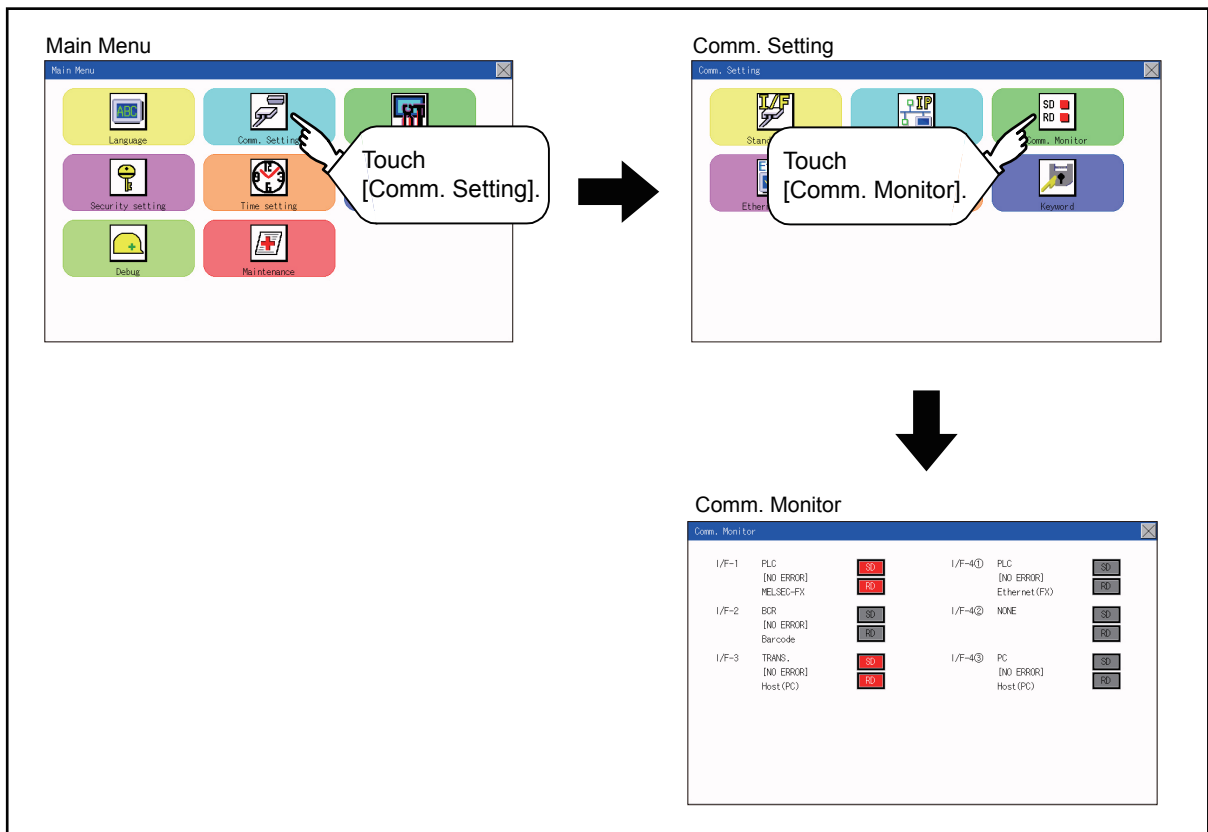

11.3.3 Screen display content

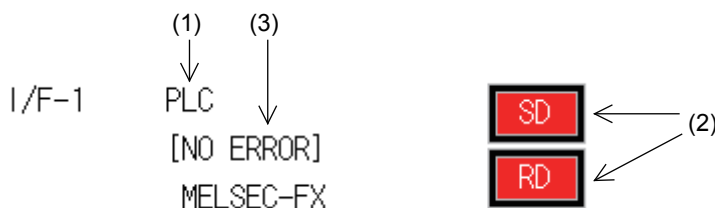

(1) Connection status of the communication ports



Indicates the connection status of Standard I/F-1 and I/F-2.

Listed in the table below are display items and the connection status (channel number).

Display item	Channel number	Remark
PLC	Ch1	"PLC" appears when connected to a controller (PLC or microcomputer)
Barcode	Ch8	"BCR" appears when connected to a bar code reader
TRANS.	Ch9	"TRANS." appears when the controller that is allocated to one of the communication ports supports the transparent mode "TRANS." automatically changes to "PC" when communicating with drawing software
Host(PC)	Ch9	"PC" appears when the controller that is allocated to one of the communication ports does not support the transparent mode
Printer	ChA	Appears when connected to a printer.

(2) Communication status

Displays the communication status of each communication port.

The SD and RD symbols appear in white on red ( , ) while data are being sent or received, and in black on gray ( , ) at other times. They may appear lit depending on the communication status.

The SD and RD symbols on the screen indicate normal communication or cable disconnection.

Setting example

Port	Channel number	Controller type
I/F-1	Ch1	MELSEC-FX
I/F-2	Ch8, Ch9	-

(a) [During normal communication (with connection to a device that supports the transparent mode)]



The SD and RD symbols for I/F-1

(b) [When the connecting cable with the controller is disconnected]

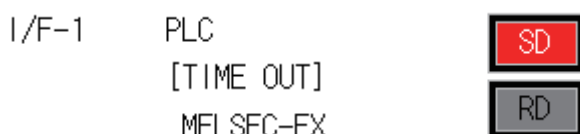

Only the SD symbol next to I/F-1 blinks.

(3) Communication error status

Communication error status of each port is displayed on this screen.

The following table describes the communication status that each display item shows.

Display item	Status	Action
NO ERROR	No error	Communication is executed normally.
ERR Ovr.	Overrun error	The receive data is sent continuously with a short interval. Let the baud rate (communication speed) be equivalent between the GOT and counterpart equipment.
ERR Frm.	Framing error	The communication frames of GOT and PLC are inconsistent. Confirm the communication settings of GOT and PLC, such as data length, stop bit and baud rate.
ERR Prt.	Parity error	The parity check conditions of GOT and PLC are inconsistent. Let the parity check condition (odd or even) of GOT and PLC be consistent.
ERR Text	Text error	The sum data is inconsistent. Or the contents of the receive data are not consistent with the send command from the GOT. Let the communication settings and contents of data be consistent between the GOT and counterpart equipment. (If NAK is received while the GOT is connected to the microcomputer board, a text error occurs.)
TIME OUT	Communication timeout	Though receiving is started, receive data is not sent. Check the wiring between the GOT and its communication target. (When the GOT is connected to the microcomputer board, confirm the terminator, CR, wiring, etc.)
ERR Line	Control line error	The control line is not operating correctly. Confirm the wiring of the control line.
ERR Cmd.	Command error	A command contained in the receive data is not consistent with the send command from the GOT.

11.4 Ethernet Check

1. Ethernet check function

The Ethernet status check function sends a ping to check the connection status of Ethernet.

2. Display operation of Ethernet check

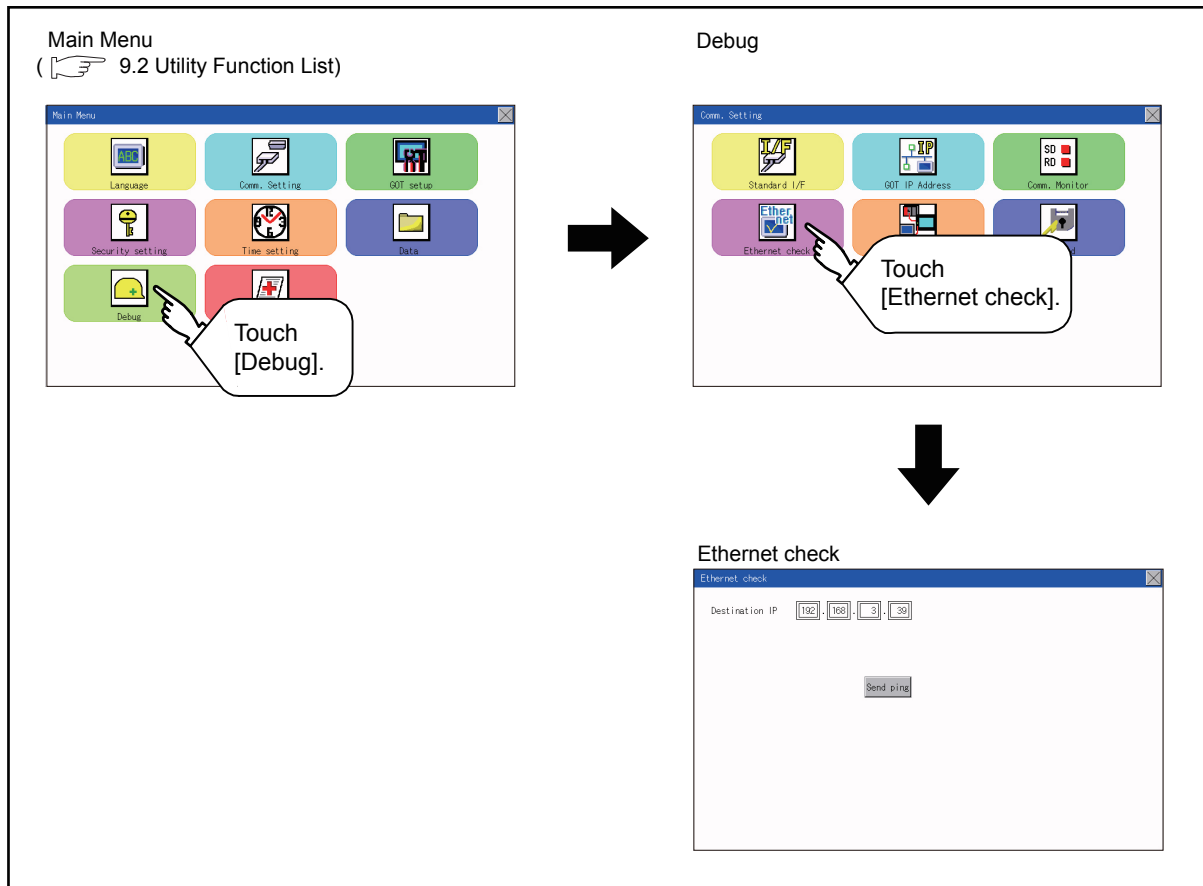

■3. Operation of Ethernet status check

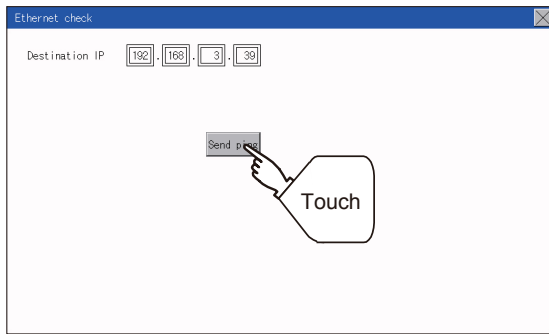
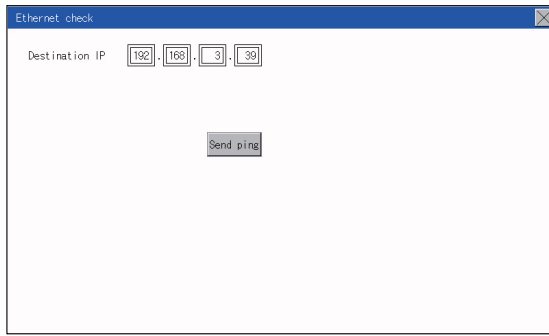

Step 1. If the select button of [Destination IP] is touched, a keyboard is displayed. Enter the IP address of the other terminal with the keyboard.
<Default: 192.168.3.39>

Step 2. If the [Send ping] button is touched, a ping is sent to the IP address entered in [Destination IP]. The timeout time is 5sec.

- When the communication is completed
The [Response received.] dialog box is displayed.
- When a communication error occurs
The [Timeout occurred.] dialog box is displayed.

11.5 Setting the Transparent Mode

1. Function of the transparent mode

When using the multi-channel function, the channel No. of a controller to which the FA transparent function is executed can be set. For the multi-channel function and the FA transparent function, refer to the following.

➡ GOT2000 Series Connection Manual (Mitsubishi Product) For GT Works3 Version1

Function	Description	Setting range
ChNo.	The channel No. of a controller to which the FA transparent function is executed can be set.	1/2 (Default: 1)

2. Display operation the transparent mode setting

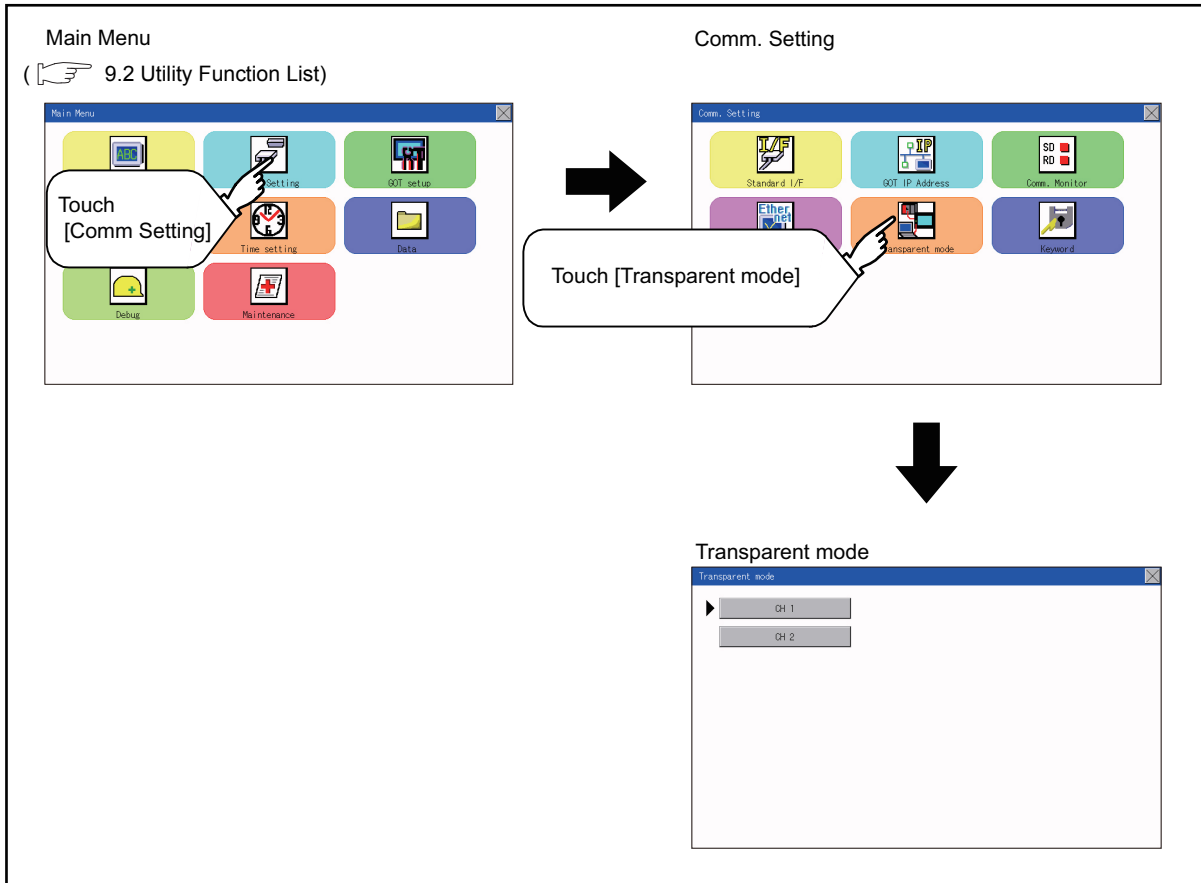

3. Operation the transparent mode

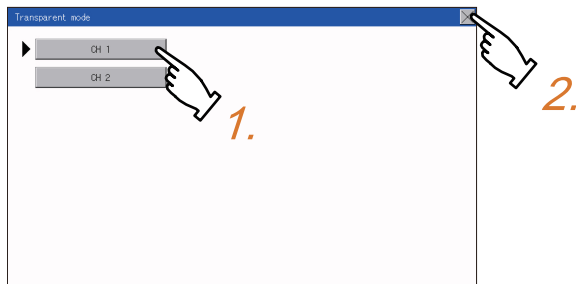

Step 1. When the transparent ChNo. (numerical part) on the left is touched, the screen for selecting a communication driver is displayed. Select the channel to execute the FA transparent function.

Step 2. If the [×] button is touched, it returns to the GOT setup screen.

11.6 Keyword

11.6.1 Keyword functions

The operation related to a keyword of the FX series PLC can be performed.

Function	Description
Regist	Keyword is registered.
Delete	Registered keyword is deleted.
Clear	Keyword protection is cleared.
Protect	A keyword with cleared protection is reactivated for protection.

11.6.2 Keyword display operation

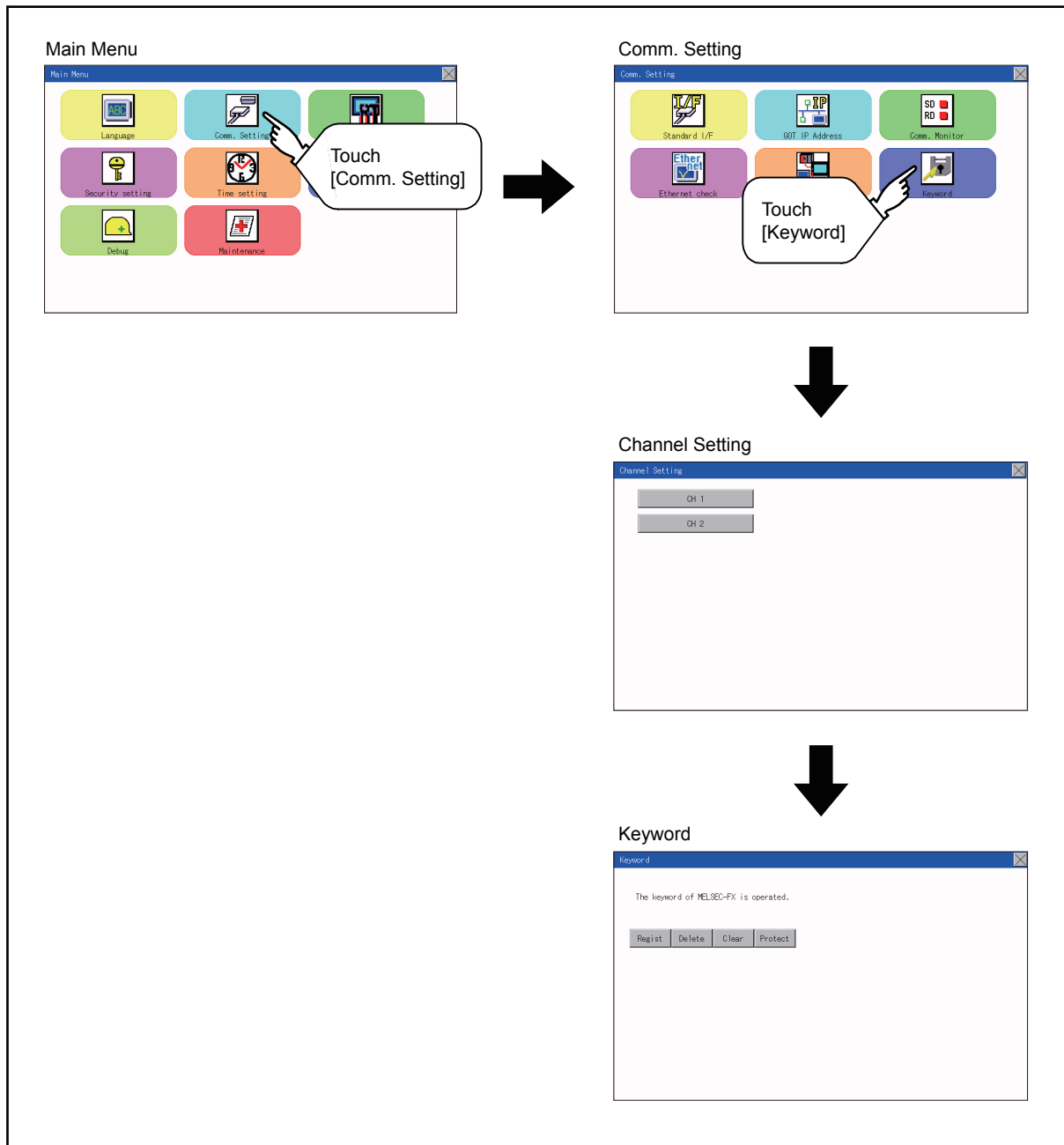

11.6.3 Regist

Keyword is registered.



Step 1. Touch "Regist" to display the selection screen for the registration.
For the FX series PLC, which is not compatible with Customer Keyword, the keyword entry screen of [Step3] is displayed. Start the operation from [Step3].
For the Customer Keyword compatible models, refer to the manual of the PLC to be used.

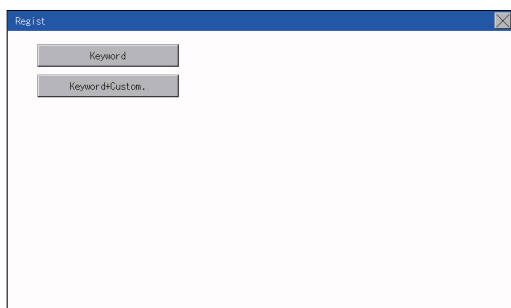

Step 2. Select [Keyword] or [Keyword+Custom].
To register only Keyword and 2nd keyword, touch [Keyword].
To register Customer Keyword, touch [Keyword+Custom].

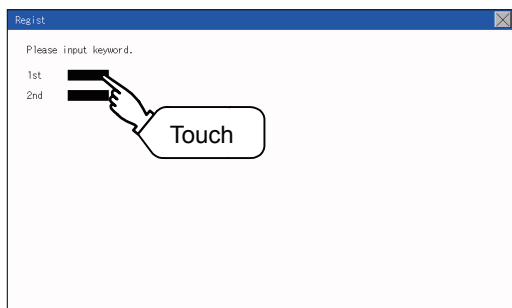

Step 3. Input a keyword.
Touch the display part of the keyword to be registered.

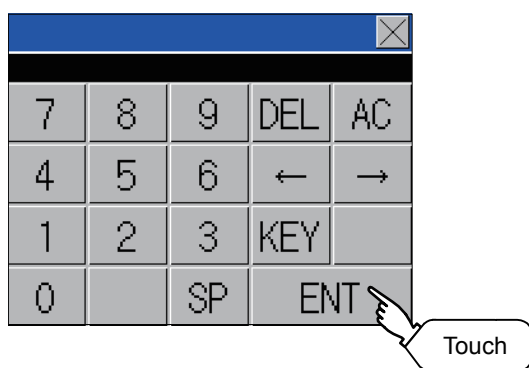

Step 4. The keyboard for entering a keyword is displayed. Character types to be input can be changed by touching the [KEY] button. Enter a keyword and touch the [ENT] key.
For the keyword, 8 digits from 0 to 9 or A to F must be set.

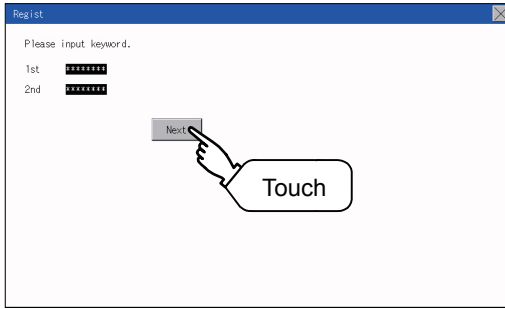

Step 5. After completing the keyword entry, touch [Next].
When [Keyword+Custom] is selected on the selection screen for the registration, the Customer Keyword entry screen is displayed. Enter it in the same way as for Keyword and 2nd keyword.

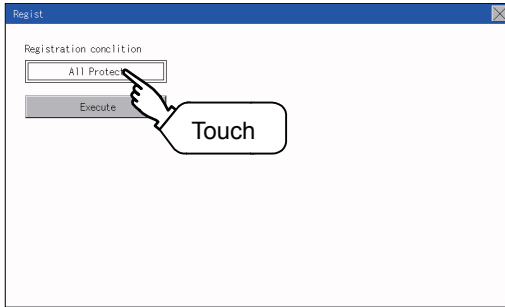

Step 6. Set Registration conciliation. Touch Registration conciliation to change the setting contents.

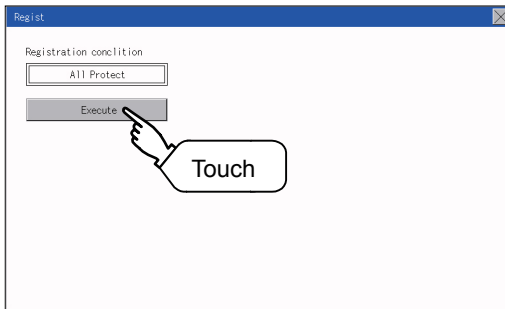

Step 7. After setting Registration conciliation, touch the [Execute] key. The registration of the keyword is completed.

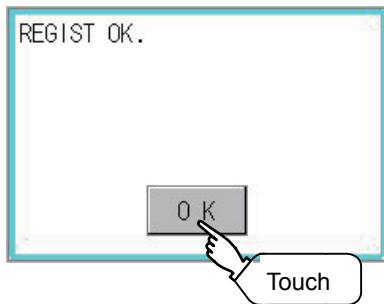

Step 8. The registration of the keyword is completed. Touch [OK].

POINT

(1) Selection availability of Registration conciliation

The following table lists the PLCs that can select Registration conciliation.

Target PLC	Setting	
	When keyword and 2nd keyword are registered	When only keyword is registered
FX PLC compatible with 2nd keyword ^{*1}	Registration options ^{*2} can be selected.	Registration options ^{*2} cannot be selected.
FX PLC not compatible with 2nd keyword ^{*1}	-	

*1 Refer to the manual for the PLC in use for the models that are compatible with the 2nd keyword.

*2 Registration options can be selected among "R/W Protect", "Write Protect", or "All online operation protection". For access restrictions of each setting, refer to the manual of the PLC to be used.

(2) Selection of keyword protection level

For the devices which can perform the online operation of FX PLC, 3 levels of protection can be set.

When the monitoring or setting change by online devices is needed, set the keyword taking the following into consideration.

(a) When only keyword is registered

Protection level is selected by the head character of keyword.

All Protect: Set the keyword starting with one of A, D to F, or 0 to 9.

Read/incorrect write protection: Set the keyword starting with B.

Erroneous write prohibition: Set the keyword starting with C.

(b) When keyword and 2nd keyword are registered

(3) Applicability of monitoring for each keyword protection level

The applicability of monitoring for each protection level is as follows.

Item	When only keyword is registered			When keyword and 2nd keyword are registered			Keyword unregistered/ protection canceled	
	All operation protect	Read/Incorrect write protection	Erroneous write prohibition	All online operation protection	R/W Protect	Write Protect		
Device monitoring	○	○	○	×	○	○	○	
Device change	T, C setting values and file register (from D1000)	× ^{*1}	× ^{*1}	× ^{*1}	×	○	○	○
	Other than the above	○	○	○	×	○	○	○

*1 When the T, C set values are specified indirectly, changing devices is available.

(4) Difference between "All online operation protection" and "All Protect"

When "All online operation protection" is selected, both device display and input by the programming tool or GOT are prohibited.

When "All Protect" is selected, device display and input are possible although operations by the programming tool are all prohibited.

11.6.4 Delete

Registered keyword is deleted.

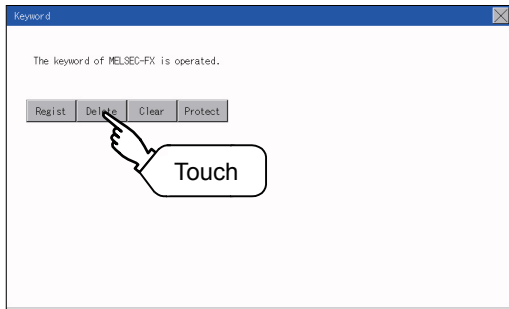

Step 1. Touch [Delete] to display the keyword entry screen.

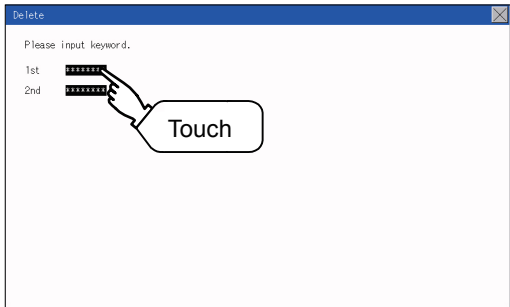

Step 2. Input a keyword.
Touch the display part of the registered keyword.

Target PLC	Setting
FX PLC compatible with 2nd keyword	Input a keyword to be deleted.
FX PLC not compatible with 2nd keyword	Input a keyword to be deleted only into "keyword". "2nd keyword" is ignored.

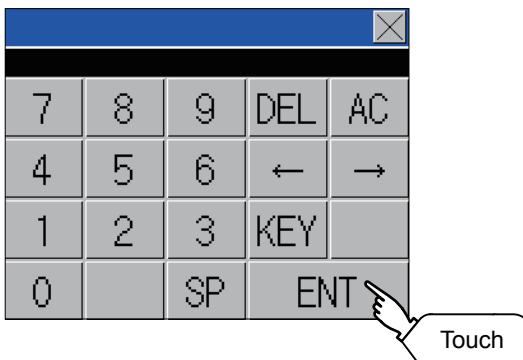

Step 3. The keyboard for entering a keyword is displayed. Enter a keyword and touch the [ENT] key. Character types to be input can be changed by touching the [KEY] button.

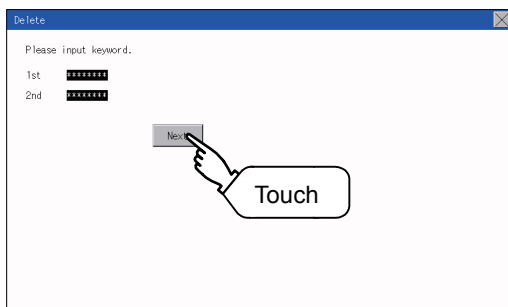

Step 4. After completing the keyword entry, touch [Next].

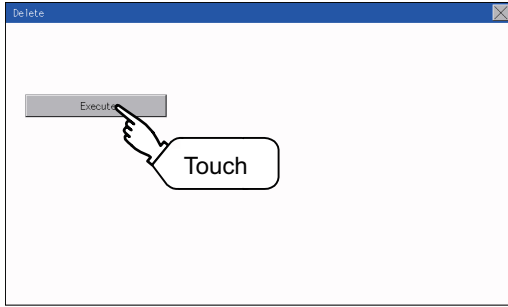

Step 5. Touch the [Execute] key.

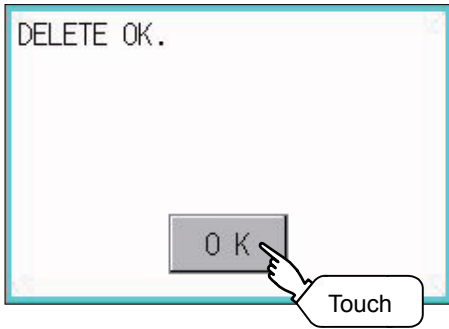

Step 6. The keyword is deleted.
Touch [OK].

11.6.5 Clear

To access an FX PLC where a keyword has been registered, keyword protection is cleared.

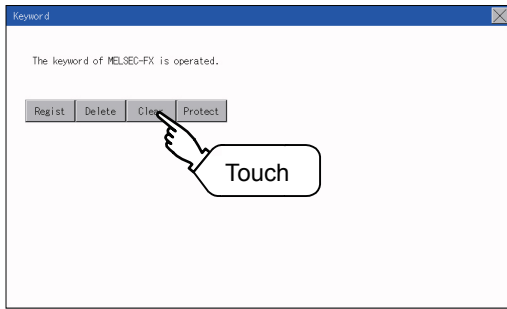

Step 1. Touch [Clear] to display the keyword entry screen.

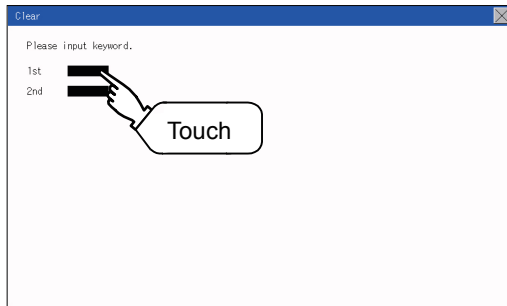

Step 2. Input a keyword.
Touch the display part of the registered keyword.

Target PLC	Setting
FX PLC compatible with customer keyword	Input a keyword or customer keyword to clear the protection.
FX PLC compatible with 2nd keyword	Input a keyword to clear the protection.
FX PLC not compatible with 2nd keyword	Input a keyword into "keyword" to clear the protection. "2nd keyword" is ignored.

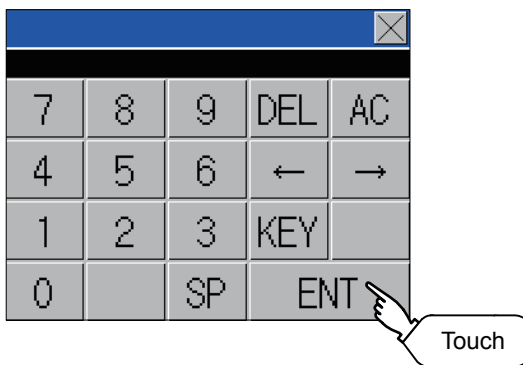

Step 3. The keyboard for entering a keyword is displayed. Enter a keyword and touch the [ENT] key. Character types to be input can be changed by touching the [KEY] button.

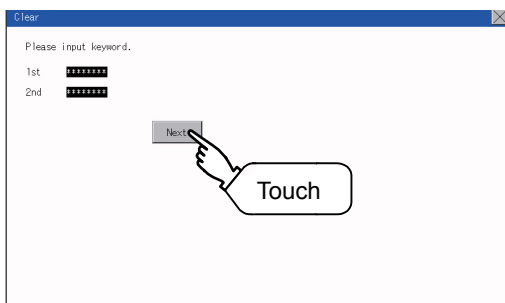

Step 4. After completing the keyword entry, touch [Next].

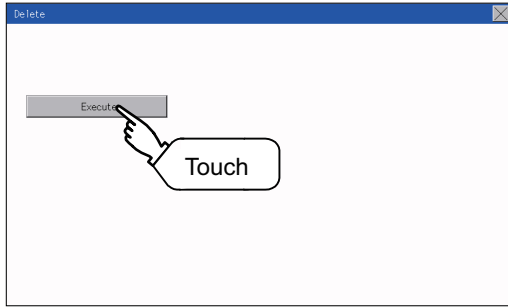

Step 5. Touch the [Execute] key.

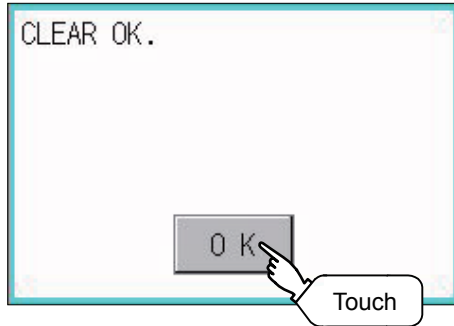

Step 6. The protection is cleared.
Touch [OK].

11.6.6 Protect

A keyword with cleared protection is reactivated for protection. Keyword protection function is valid when the 2nd keyword is registered.

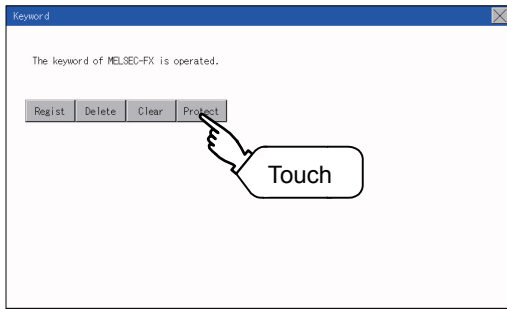

Step 1. Touch [Protect] to switch to the keyword protection status.

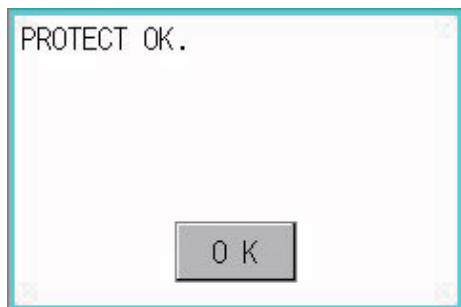

Step 2. The keyword is protected.
Touch [OK].

12. DISPLAY AND OPERATION SETTINGS (GOT SET UP)

The setting screens related to the display or operation can be displayed from the utility screen. In the setting screen for display and the setting screen for operation, the following settings can be set.

Item	Description	Reference
Display settings	Setting the title display period and screen saving time	➡ 12.1.1
	Brightness	
Operation settings	Setting buzzer volume, window move buzzer, and key reaction speed	➡ 12.2.3
	Touch panel calibration	➡ 12.2.4
	Utility call key	➡ 12.2.5

12.1 Display Settings

12.1.1 Display setting functions

Setting regarding display is possible.

The items which can be set are described below. If touch the each item part, the respective setting becomes possible.

Item	Description	Setting range
Opening time	The title display period at the main unit boot can be set.	0 to 60 seconds ^{*2} (At factory shipment: 5 seconds)
Screen save time	The period from the user stops the touch panel operation till the screen save function starts can be set.	0 to 60 minutes (At factory shipment: 0 minute)
Brightness	Brightness can be adjusted. ➡ ■■2. Brightness	-

*1 Even if 0 is set, the title screen is still displayed. The title screen is always displayed for 4 seconds or more (depending on the project data).

POINT

(1) Display setting by GT Designer3

Set title display period, screen save time and screen save backlight by selecting [Common] → [GOT Environmental Setting] → [GOT Setup] on GT Designer3.

When change a part of the setting, change the setting by the GOT display setting after downloading the project data.

➡ GT Designer3 (GOT2000) Help

(2) Screen save time

By using the system information function, the screen save function can forcibly enabled from a controller (Forced Screen Saver Disable Signal) or the screen saving time set in the utility can be disabled (Automatic Screen Saver Disable Signal).

➡ GT Designer3 (GOT2000) Help

12.1.2 Display operation of display setting

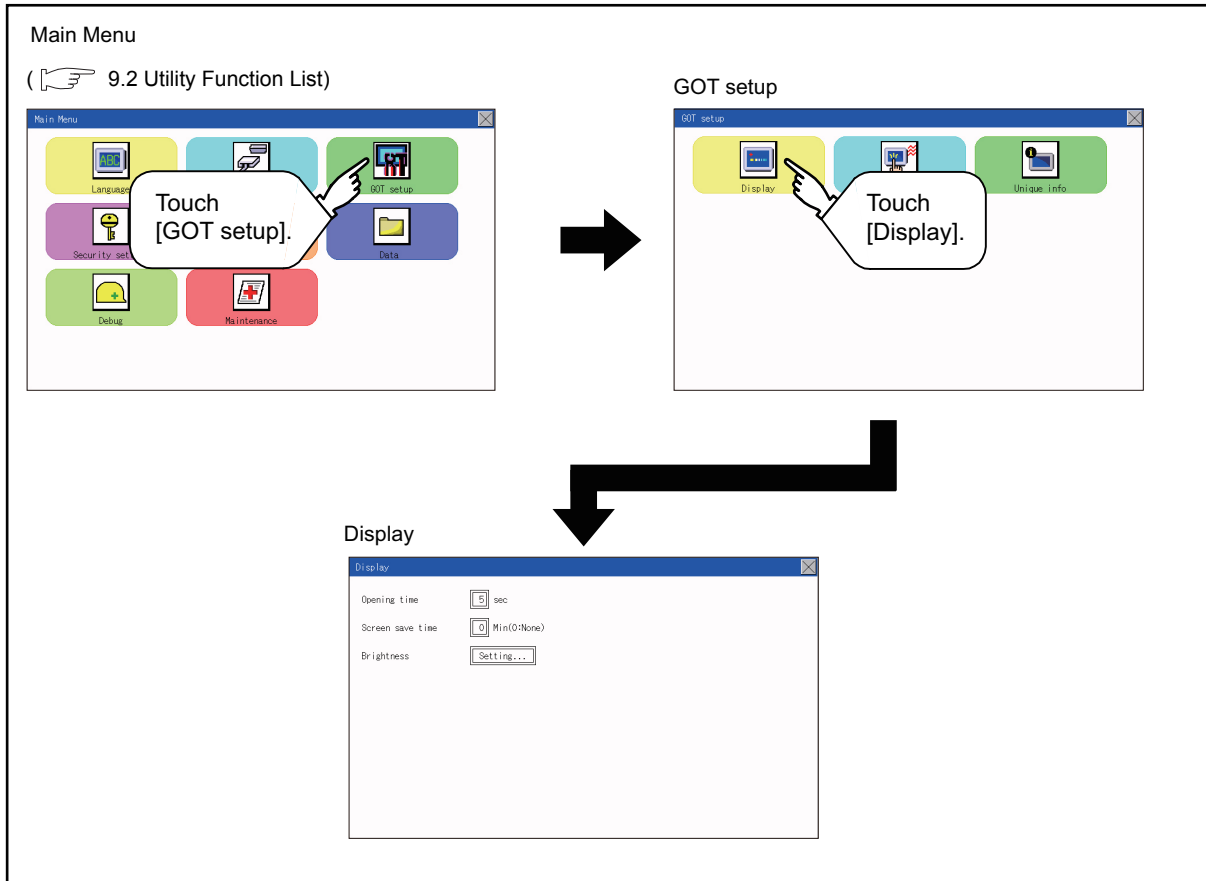

12.1.3 Display setting operations

■ 1. The title display period and screen saving time

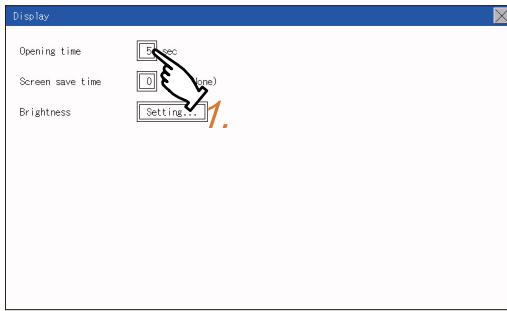

Step 1. If the setting items (numbers) are touched, a keyboard is displayed. Input numeric with the keyboard.

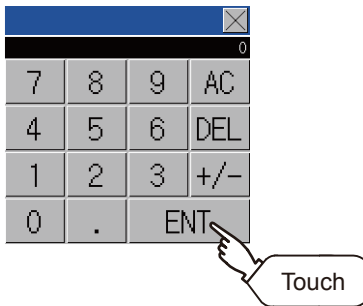

Step 2. Set the title display period with the ten-key pad window and touch "ENT".

■2. Brightness

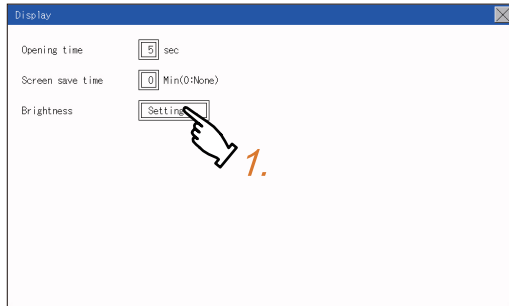

Step 1. Touch [Brightness] to bring up the Brightness setting window.

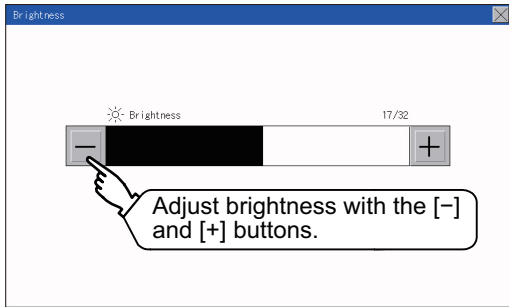

Step 2. Touch the [+] and [-] buttons to adjust the brightness of the screen.

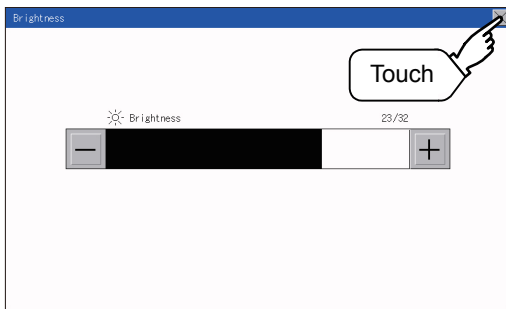

Step 3. Touch the [×] button to reflect the setting.

12.2 Operation Setting (Settings for Operation)

12.2.1 Operation setting functions

Setting regarding GOT operation can be set.

The items which can be set are described below. If touch the each item part, the respective setting becomes possible.

Function	Description	Setting range
Buzzer volume	Buzzer volume setting can be changed.	OFF/SHORT/LONG (At factory shipment: SHORT)
Window move buzzer	Whether turn ON/OFF buzzer when move window can be selected.	ON/OFF (At factory shipment: ON)
Key reaction	The touch panel sensitivity when touching the GOT screen can be set. (For preventing chattering)	± 0 to $+120^{*1}$
Calibration	Calibrates the touch panel sensitivity ➡ 12.2.4 Position correction of the touch panel (touch panel calibration setting)	-
Utility call	Utility call key setting screen can be displayed ➡ 12.2.5 Setting the utility call keys	-

*1 The more the value set for [Key reaction] is high, the more the key reaction speed slows.

"Key reaction" [ms]	Standard (± 0)	+10	+20	+40	+80	+120
---------------------	----------------------	-----	-----	-----	-----	------

For example, when the GOT recognizes touching the GOT screen once as touching the screen twice, set a higher value for [Key reaction].

POINT

Operation setting by GT Designer3

Set buzzer volume and window move buzzer volume by selecting [Common] → [GOT Environmental Setting] → [GOT Setup] of GT Designer3.

When change a part of the setting, change the setting by the GOT display setting after downloading the project data.

➡ GT Designer3 (GOT2000) Help

12.2.2 Display operation of operation setting

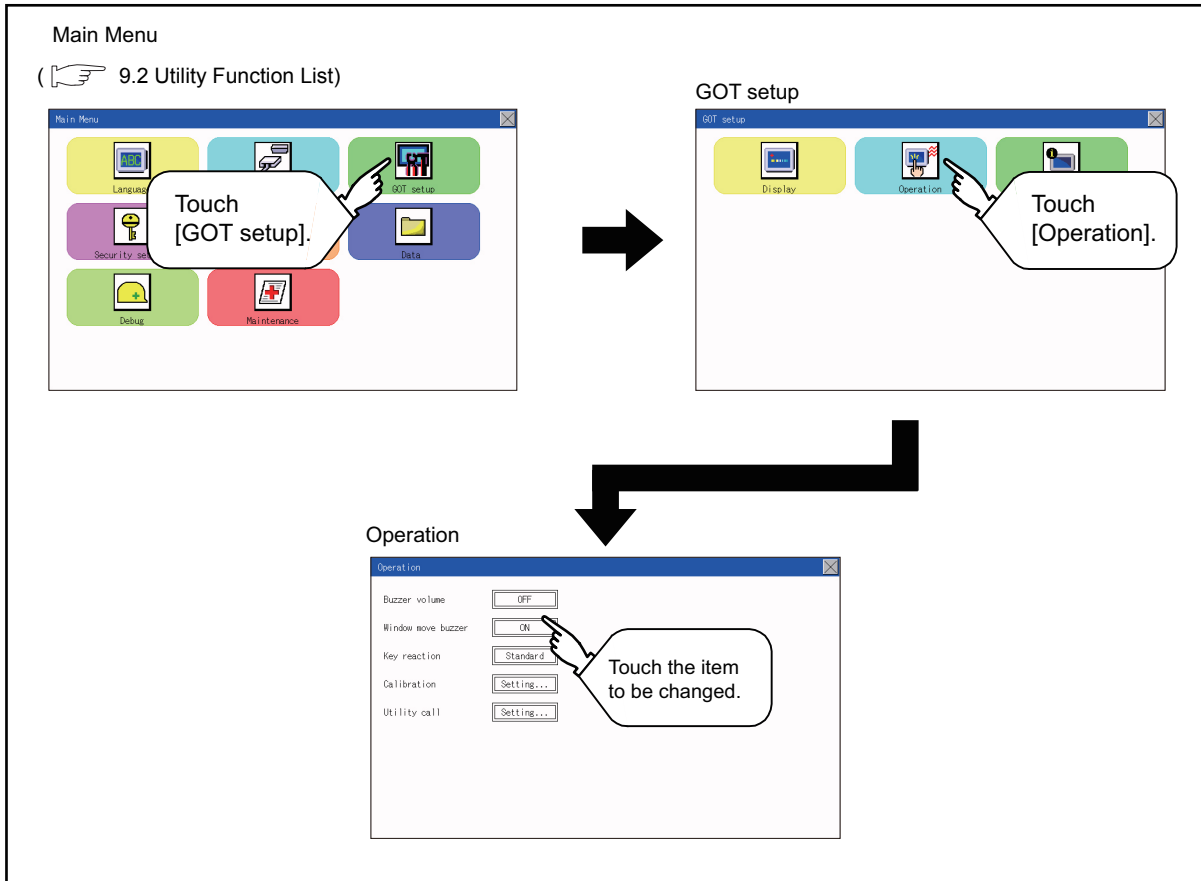

12.2.3 Setting operation of operation

■1. Buzzer volume



Step 1. Touch a setting item to change the setting.

(Buzzer volume: SHORT LONG OFF)

Step 2. Touch the [x] button to save the changes.

■2. Window move buzzer

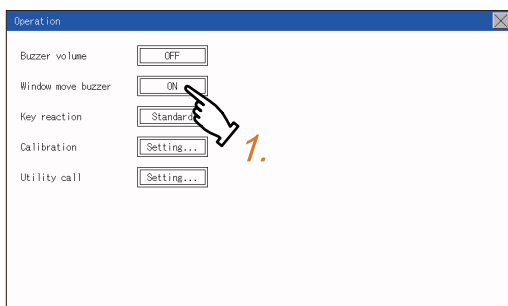

Step 1. Touch a setting item to change the setting.

(Window move buzzer: ON OFF)

Step 2. Touch the [x] button to save the changes.

■ 3. Key reaction setting

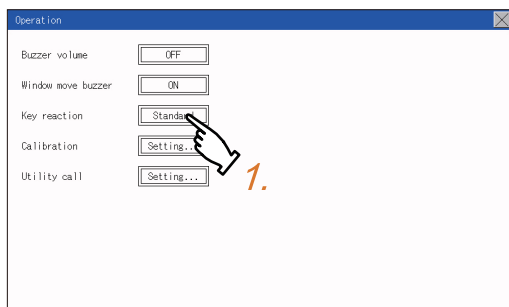

Step 1. If touch the setup item, the setup contents ^{*1} are changed.

Step 2. After changing the setting, touch the [×] button.
The setting is saved and the setting screen is closed.

*1 The more the value set for [Key reaction] is high, the more the key reaction speed slows.

"Key reaction" [ms]	Standard (±0)	+10	+20	+40	+80	+120
---------------------	---------------	-----	-----	-----	-----	------

For example, when the GOT recognizes touching the GOT screen once as touching the screen twice, set a higher value for [Key reaction].

12.2.4 Position correction of the touch panel (touch panel calibration setting)

1. Touch panel calibration setting function

Touch panel reading error can be corrected.

Normally the adjustment is not required, however, the difference between a touched position and the object position may occur as the period of use elapses.

When any difference between a touched position and the object position occurs, correct the position with this function.

Before adjustment

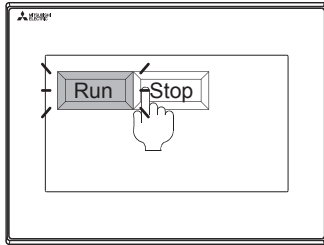

The [Run] will operate though you intended to touch the [Stop] button.

After adjustment

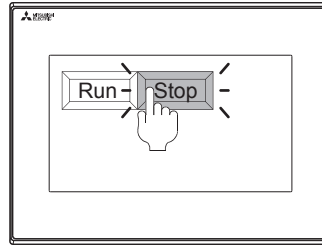

The [Stop] button can be touched without fail.

2. Touch panel calibration setting display operation

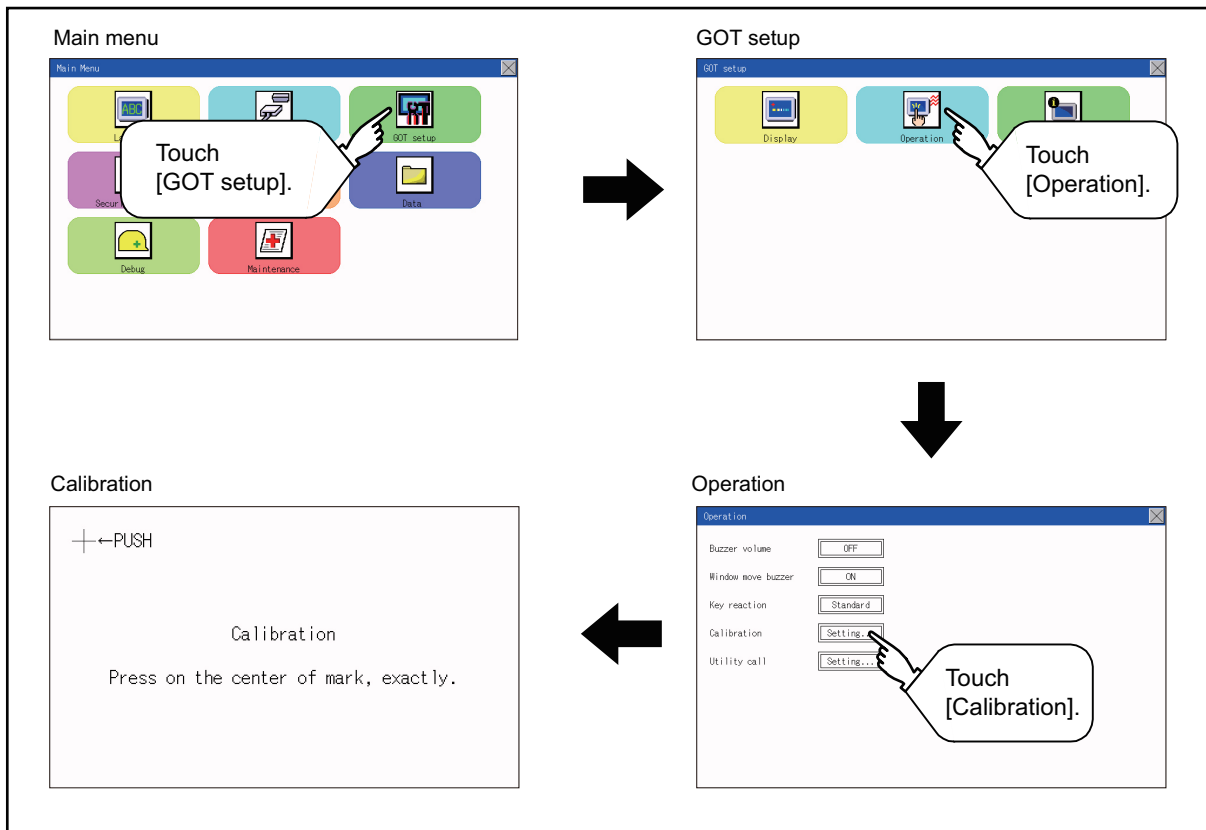

■3. Touch panel calibration operation

Touch [+] displayed on the screen with the finger one by one to make the setting.

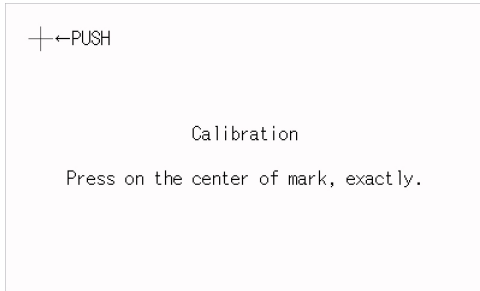

Step 1. Touch the center of [+] displayed on the upper left precisely.

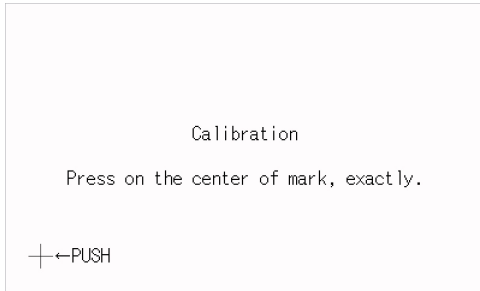

Step 2. Touch [+] displayed on the lower left.

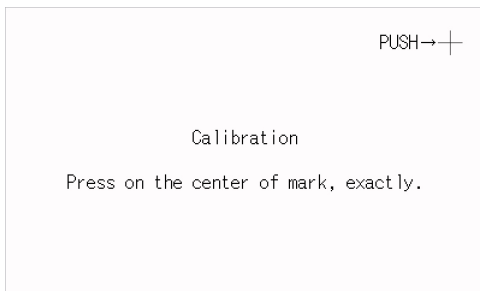

Step 3. Touch [+] displayed on the upper right.

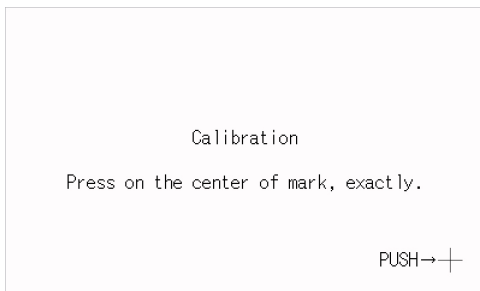

Step 4. Touch [+] displayed on the lower right.

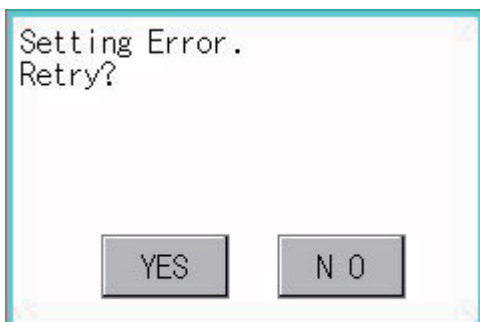

Step 5. When the precise touch could not be made, touch the [YES] button to make the setting from Step1 again.

12.2.5 Setting the utility call keys

1. Utility call key setting function

The key position for calling the main menu of the utility can be specified.
For the key position, the specification of 1 point from 4 corners on the screen, or no specification (0 point), can be set.
By keeping pressing the screen, a setting to switch the screen to the utility is available.
This prevents a switching to the utility by an unintentional operation.

POINT

Operation setting by GT Designer3

Set the utility call key by selecting [Common] → [GOT Environmental Setting] → [GOT Setup] from GT Designer3.

When change a part of the setting, change the setting by the GOT display setting after downloading the project data.

➡ GT Designer3 (GOT2000) Help

2. Utility call key display operation

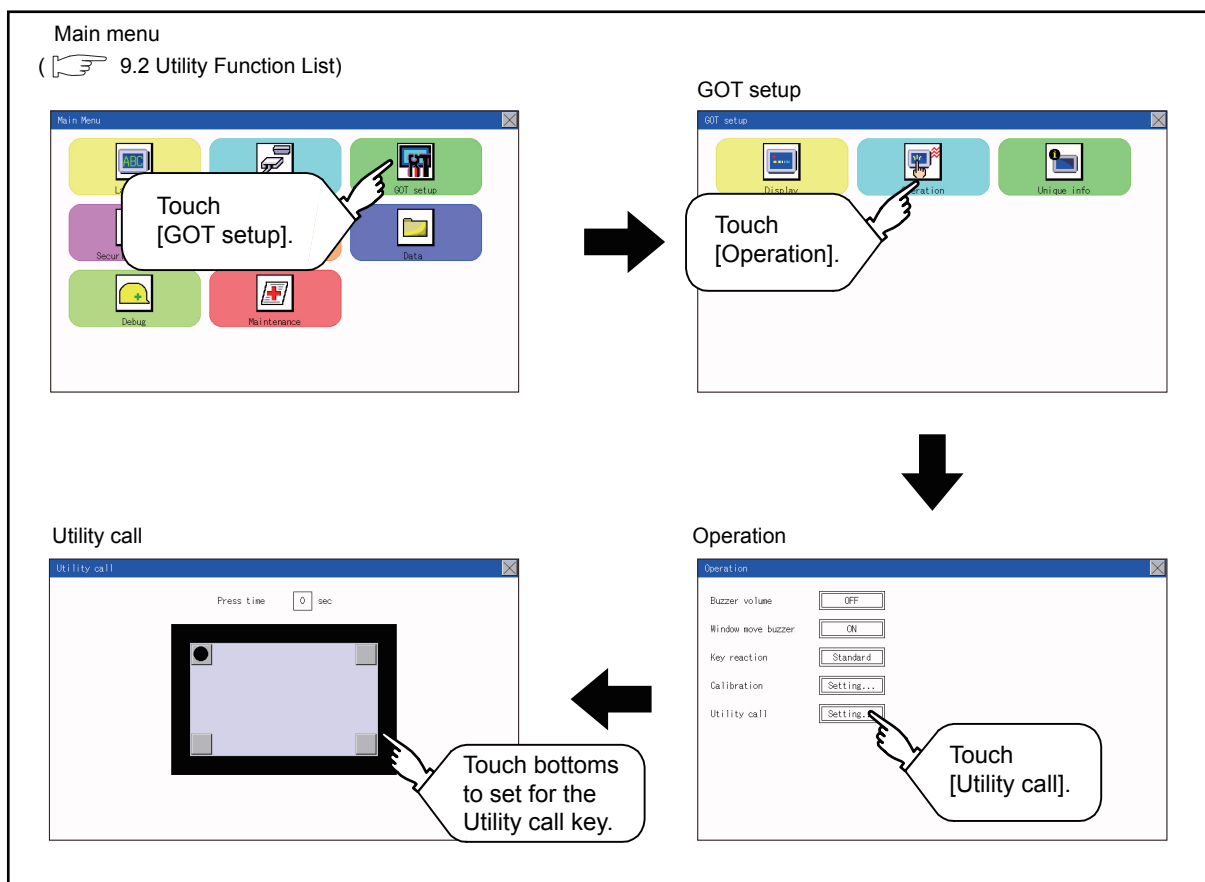

■ 3. Utility call key setting operation

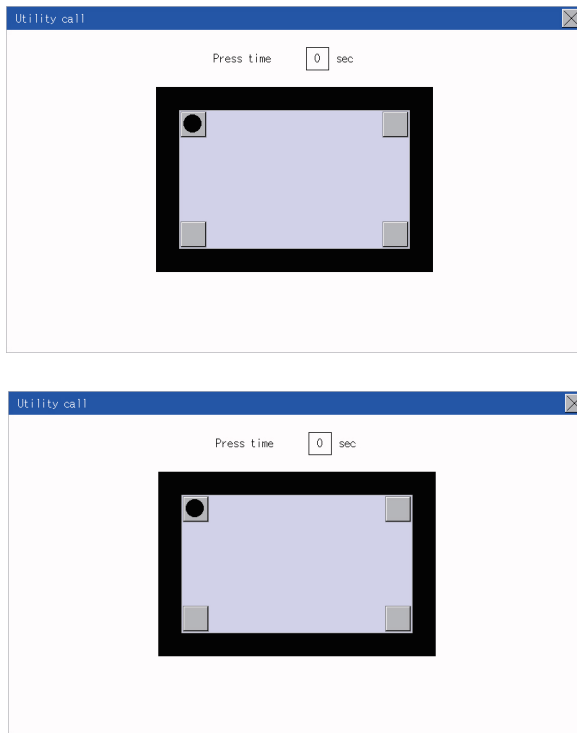

Step 1. Touch or displayed at the four corners of the setting screen. The button repeats  every time it is pressed. Change the part to be set as a key position to .

For the key position, 0 or 1 point can be specified.

Step 2. When setting 1 point, specify the time to switch to the utility in case of keeping pressing the key position. Touch the time input area.

Step 3. Touching the input area displays a keyboard. Input numeric with the keyboard.

Step 4. Touch the [×] button to save the changes.

POINT

(1) When the utility call key is not set (set to 0-point)

Even when the utility call key is not set (set to the zero point), you can display the main menu by performing the following operation.

- Pressing the special function switch set on the user-created screen

➡ 9.3.1 Display operation of main menu

(2) Precautions on using the alarm popup display

When [Display Position Switching] is set to [Yes] in the alarm popup display setting, set either of the following for the utility call key.

Setting the position of the utility call key to the upper-right or lower-left corner

Setting [Press Time] of the utility call key to 1 or more seconds

When [Press Time] is set to 0 and the key position is set to the lower-left corner, the operation is as described below. If the positions of the key and the alarm popup display overlap, the utility screen appears by switching the display position of the alarm popup display.

For the alarm popup display, refer to the following.

➡ GT Designer3 (GOT2000) Help

(3) When limiting the display and operation of the utility

When limiting the display and operating users, set a password to the GOT using GT Designer3. If a user tries to display the main menu of the utility, the password is displayed. Refer to the following for the details related to the password setting.

➡ GT Designer3 (GOT2000) Help

12.3 Inherent Information

12.3.1 Setting function for inherent information

Configure inherent information settings.

Item	Description	Setting range
GOT ID No.	Set the ID No. as the inherent information for the GOT.	0 to 32767 <Default: 0>

12.3.2 Display operation of inherent information

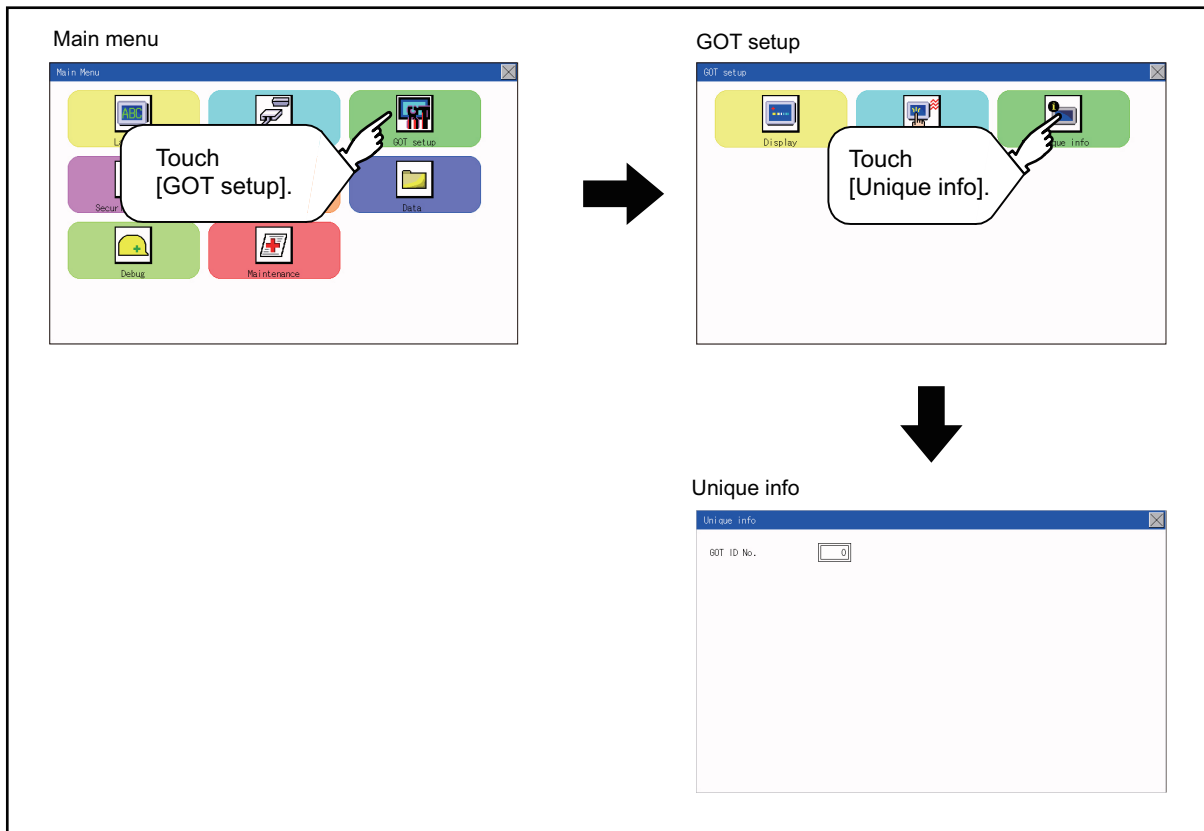

12.3.3 Setting operation for inherent information



- Step 1.** If touching the setting items, keyboard is displayed. Input numeric with the keyboard.
- Step 2.** If touch the [×] button, the GOT restarts and operates with the changed settings.

13. SECURITY LEVEL AND OPERATOR SETTINGS (SECURITY SETTING)

13.1 Security Level Authentication

1. Security level change functions

Changes the security level to the same security level set by each object or screen switch.
To change the security level, enter the password for the security level set with GT Designer3.

➡ GT Designer3 (GOT2000) Help

POINT

Restrictions on screen display

The security level change screen cannot be displayed when project data do not exist in GOT.
Change the security level after downloading the project data to GOT.

2. Display operation of security level change

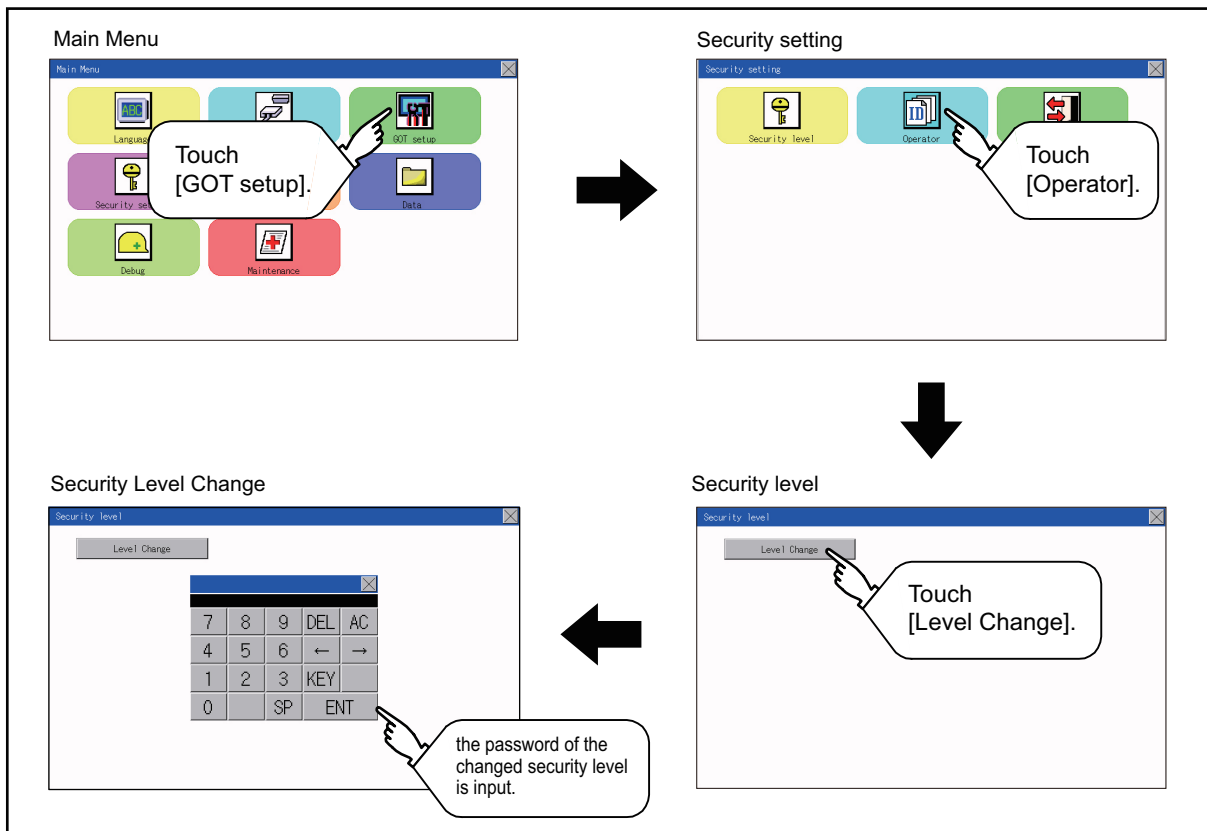

■3. Security level change operation

(1) Input operation of password

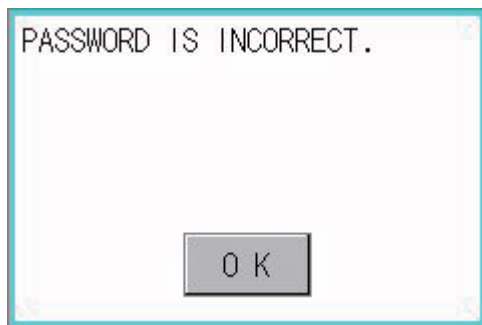
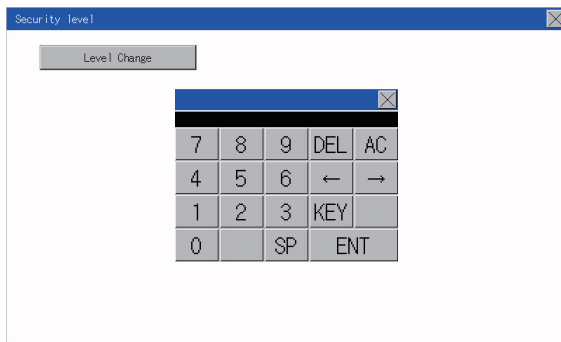

Step 1. By touching [0] to [9], [A] to [F] key, the password of the changed security level is input. Character types to be input can be changed by touching the [KEY] button.

Step 2. When correcting the input character, touch [Del] key to delete the correcting character and input the password again.

Step 3. After inputting password, touch the [Enter] key. When the password is not matched, displays the error message.

Step 4. If [OK] button is touched it returns to the password input screen again.

Step 5. If the [×] button is touched, it returns to the security setting screen.

POINT

About forgetting to return to the original level after changing security level temporarily

When use GOT after temporarily changing the security level, do not forget to return the security level to the original level.

13.2 Operator Authentication

13.2.1 Operator information management

1. Operator management

(1) Operator management function

The function enables displaying a list of the operator information and adding, changing, or deleting the operator information to be used.

A password for operator authentication can be changed when the password is out of date.

Functions for the operator authentication (automatic logout time, authentication method, password expiration date, etc.) can be set.

For details of the operator authentication functions, refer to the following.

➡ GT Designer3 (GOT2000) Help

Function	Description	Reference page
Operator info.	Enables adding, editing, deleting, importing, and exporting the operator information.	➡ 13-3, 13-6
Add	Add operator information to the GOT.	➡ 13-6
Edit	Edit the operator information stored in the GOT.	➡ 13-9
Delete	Delete the operator information stored in the GOT.	➡ 13-10
Restore	Restore the current operator information to the previous saved one.	➡ 13-11
Import	Import the operator information that is already exported to an SD card to the GOT.	➡ 13-11
Export	Export the operator information stored in the GOT to an SD card.	➡ 13-12
Password change	Enables changing passwords to be used for login and logout in/out of the GOT.	➡ 13-13
Function	Enables setting the automatic logout time and password expiration date.	➡ 13-15

(2) Display operation of operator management

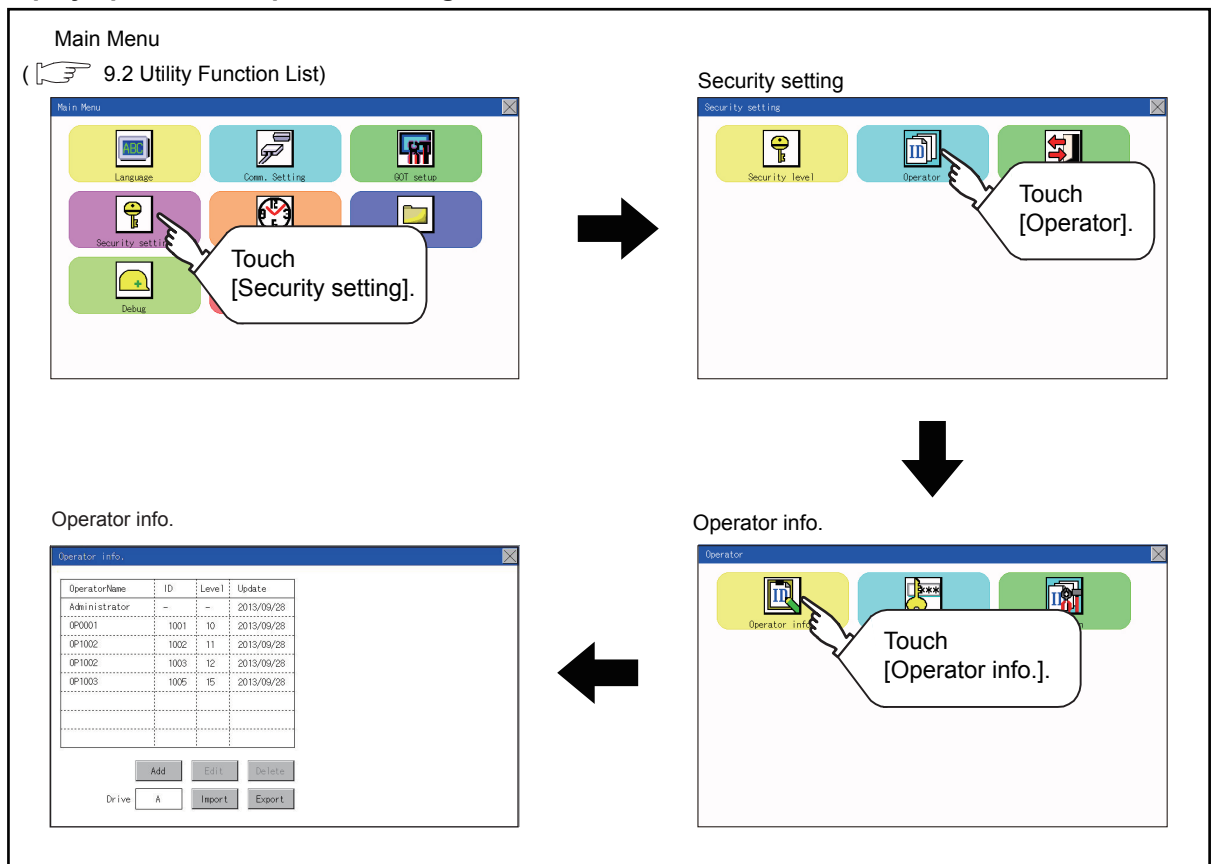

(3) Display example of operator management

(a) Operator information management screen

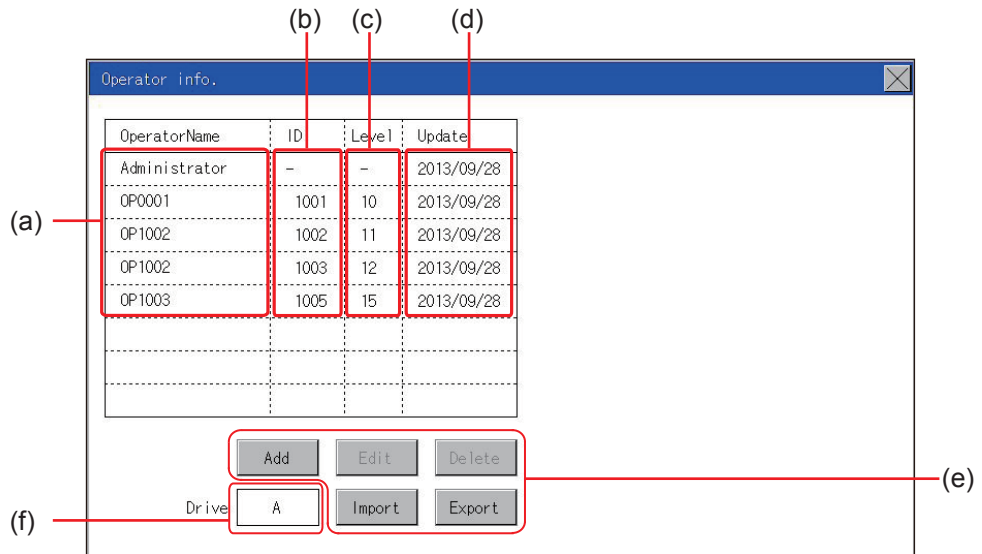

No.	Item	Description
(a)	Operator Name	Displays operator names.
(b)	ID	Displays operator IDs.
(c)	Level	Displays security levels for operators.
(d)	Update	Displays the last updated dates of the operator information.
(e)	Operation keys	Execution keys for each function
(f)	Drive in use	Displays and sets the storage location for imported and exported operator information. To switch the drive, touch the key. (A: Standard SD card) Only when the drive E is installed on the GOT, the user can switch the drive in use.

(b) Operator information edit screen

Touch the [Add] button or touch the [Edit] button with the operator information selected on the Operator information management screen, and then the Operator information edit screen is displayed. The operator information can be edited.

The screenshot shows a dialog box titled "Operator edit" with a close button in the top right corner. It contains five input fields, each with a red box around it and a red line pointing to a label on the right:

- OperatorName: OP1002 (a)
- Operator ID: 1002 (b)
- Level: 11 (c)
- Password: [masked with asterisks] (d)
- Expiration: Terminable (e)

A "Save" button is located at the bottom center of the dialog.

No.	Item	Description
(a)	Operator Name	The operator name to be edited is displayed or input an operator name to be added. (Up to 16 alphanumeric characters)
(b)	Operator ID	The operator ID to be edited is displayed or input an operator name to be added. (Setting range: 1 to 32766, Maximum number of registrations: 255)
(c)	Level	Displays the security level for the operator or input the security level for an operator to be added. (0 to 15)
(d)	Password	Input a password. (Up to 16 alphanumeric characters)
(e)	Expiration	Switches the setting of the item disabled and enabled.

(4) Operator management operation

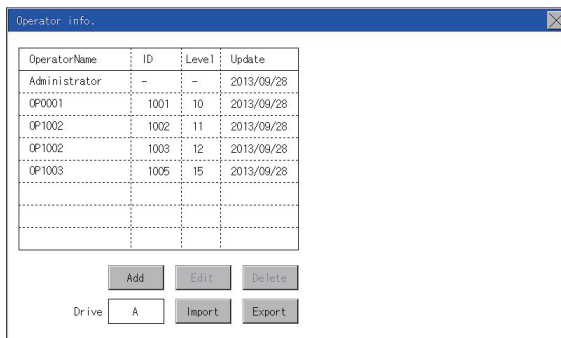
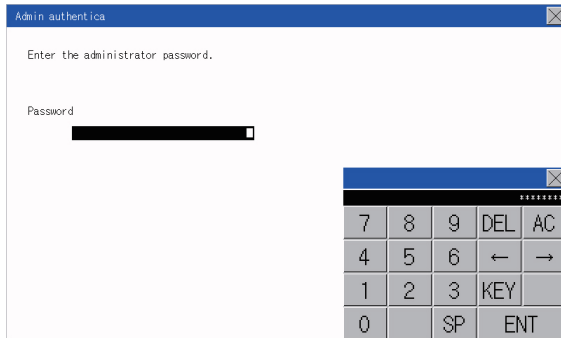
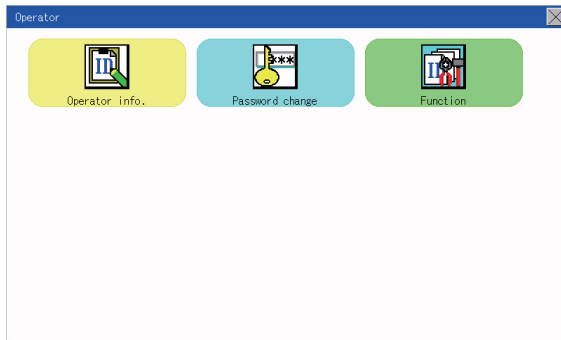

Step 1. Touch [Operator] → [Operator info.].

Step 2. The Admin password authentication screen is displayed, and then input the administrator password. Character types to be input can be changed by touching the [KEY] button. When the input is completed, touch the [Enter] key.

Step 3. When the administrator password is correctly input, the Operator information management screen is displayed. For operation of operating switches, refer to the following.
[Add]

➡ This section (4) (a)

[Edit]

➡ This section (4) (b)

[Delete]

➡ This section (4) (c)

[Import]

➡ This section (4) (d)

[Export]

➡ This section (4) (e)

Step 4. Touching the [×] button displayed on the upper right returns to the previous screen.

- (a) Add operation
Add operator information to the GOT.

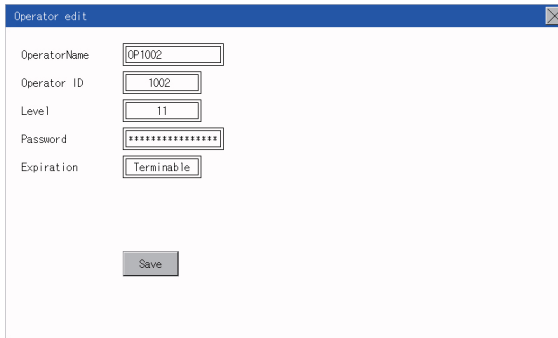
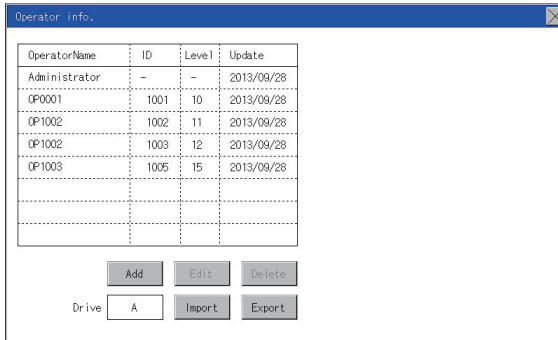

Step 1. Touch the [Add] button.

Step 2. The Operator information edit screen is displayed, and then touch an item to be edited.
 (a) OperatorName
 (b) OperatorID
 (c) Level
 (d) Password
 (e) Expiration

- (a) If the operator name is touched, a keyboard is displayed. Input an operator name with the keyboard.
 Character types to be input can be changed by touching the [KEY] button.
 When the input is completed, touch the [ENT] key.
- (b) If the operator ID is touched, a keyboard is displayed. Input an operator ID.
 Character types to be input can be changed by touching the [KEY] button.
 When the input is completed, touch the [ENT] key.
- (c) If the level is touched, a keyboard is displayed. Input an operator level.
 Character types to be input can be changed by touching the [KEY] button.
 When the input is completed, touch the [ENT] key.
 When the level of the operator being login is changed during editing the operator information, a new level is not reflected until you log out of the GOT once and log in the GOT again.

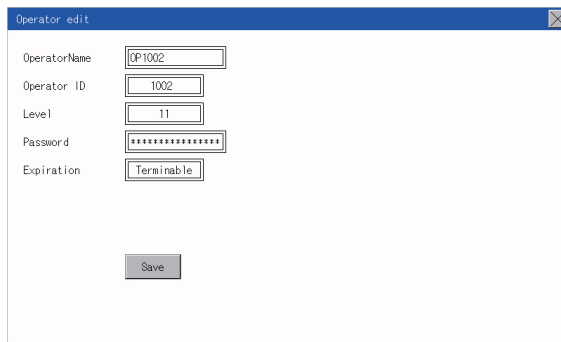
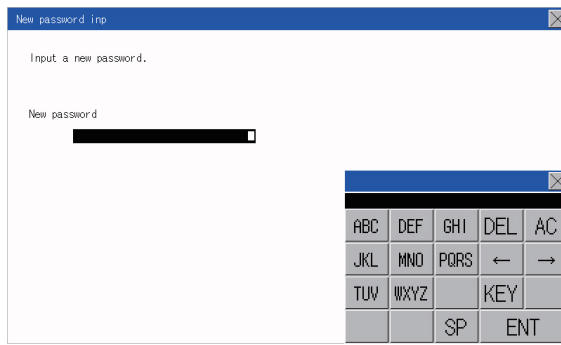

- (d) For changing passwords during editing, touch the password. A keyboard is displayed, and then input a password. When the input is completed, touch the [ENT] key. When the password input is completed, the New password input confirmation dialog box is displayed. Input the same password.
- (e) For switching the setting of [Make a permanent password], touch the [Expiration] dialog box to switch the setting.
[Terminable] ⇄ [Permanent]

Step 3. When the [Save] button is touched after all items are input, the input operator information is saved. Touching the [×] button displayed on the upper right returns to the previous screen.

- (b) Edit operation
Edit the operator information stored in the GOT.

OperatorName	ID	Level	Update
Administrator	-	-	2013/09/28
CP1001	1001	10	2013/09/28
CP1002	1002	11	2013/09/28
CP1002	1003	12	2013/09/28
CP1003	1005	15	2013/09/28

Buttons: Add, Edit, Delete, Drive, A, Import, Export

OperatorName: CP1002
Operator ID: 1002
Level: 11
Password: *****
Expiration: Terminable
Save

Step 1. Select the operator information to be edited with touching the operator information.

Step 2. Touch the [Edit] button.

Step 3. The Operator information edit screen is displayed, and then touch an item to be edited.

- (a) Level
- (b) Password
- (c) Expiration

For how to edit operator information, refer to the following.

➡ This section (4)

Step 4. When the [Save] button is touched after all items are input, the input operator information is saved. Touching the [×] button displayed on the upper right returns to the previous screen.

- (c) **Deletion operation**
Delete the operator information stored in the GOT.

OperatorName	ID	Level	Update
Administrator	-	-	2013/09/28
OP001	1001	10	2013/09/28
OP1002	1002	11	2013/09/28
OP1002	1003	12	2013/09/28
OP1005	1005	15	2013/09/28

Buttons: Add, Edit, Delete, Import, Export

Step 1. Select the operator information to be deleted with touching the operator information.

Step 2. Touching the [Delete] button deletes the selected operator information. Touching the [×] button displayed on the upper right returns to the previous screen.

- (d) **Import operation**
Import the operator information that is already exported to an SD card to the GOT.

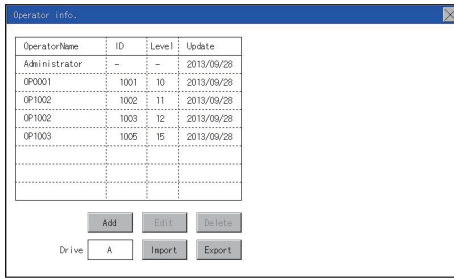

OperatorName	ID	Level	Update
Administrator	-	-	2013/09/28
OP1001	1001	10	2013/09/28
OP1002	1002	11	2013/09/28
OP1002	1003	12	2013/09/28
OP1003	1005	15	2013/09/28

Buttons: Add, Edit, Delete, Drive A, Import, Export

Step 1. Touch the [Import] button.

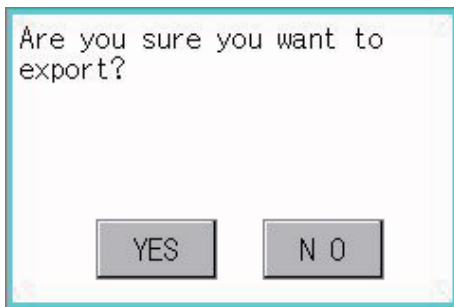

Step 2. The dialog box shown left is displayed. When the [YES] button is touched, the Admin password authentication screen is displayed. Input the administrator password. Character types to be input can be changed by touching the [KEY] button. When the input is completed, touch the [Enter] key.

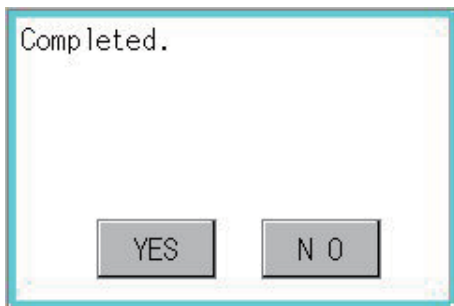

Step 3. When the administrator password is correctly input, the dialog box shown left is displayed and the operator information stored in an SD card is imported to the GOT.

- (e) **Export operation**
Export the operator information stored in the GOT to an SD card.

OperatorName	ID	Level	Update
Administrator	-	-	2013/09/28
OP0001	1001	10	2013/09/28
OP1002	1002	11	2013/09/28
OP1002	1003	12	2013/09/28
OP1003	1005	15	2013/09/28

Buttons: Add, Edit, Delete, Drive: A, Import, Export

Step 1. Touch the [Export] button.

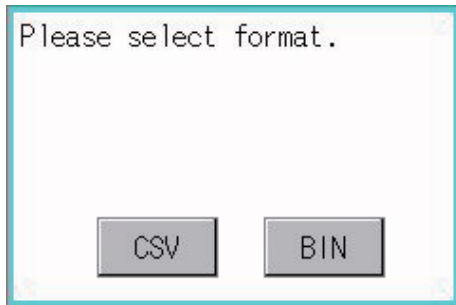

Step 2. The dialog box shown left is displayed.

Step 3. Touch the following buttons according to the output format for the file.

Binary file:
[BINARY] button
CSV file:
[CSV] button

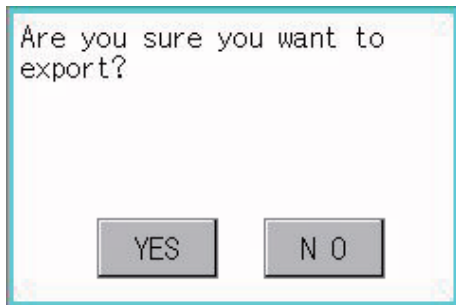

Step 4. The dialog box shown left is displayed. When the [YES] button is touched, the Admin password authentication screen is displayed. Input the administrator password. Character types to be input can be changed by touching the [KEY] button.

When the input is completed, touch the [Enter] key.

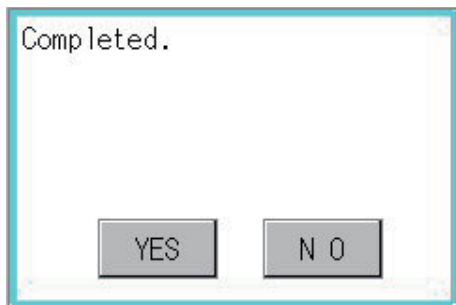

Step 5. When the administrator password is correctly input, the dialog box shown left is displayed and the operator information stored in the GOT is exported to an SD card. (file name: AUTHINF.G2U)

13.2.2 Password change

(1) Password change function

The passwords to be used for the operator authentication can be changed.

For the password change, log into the GOT in advance with the operator name corresponding to the password to be changed.

(2) Display operation of password change

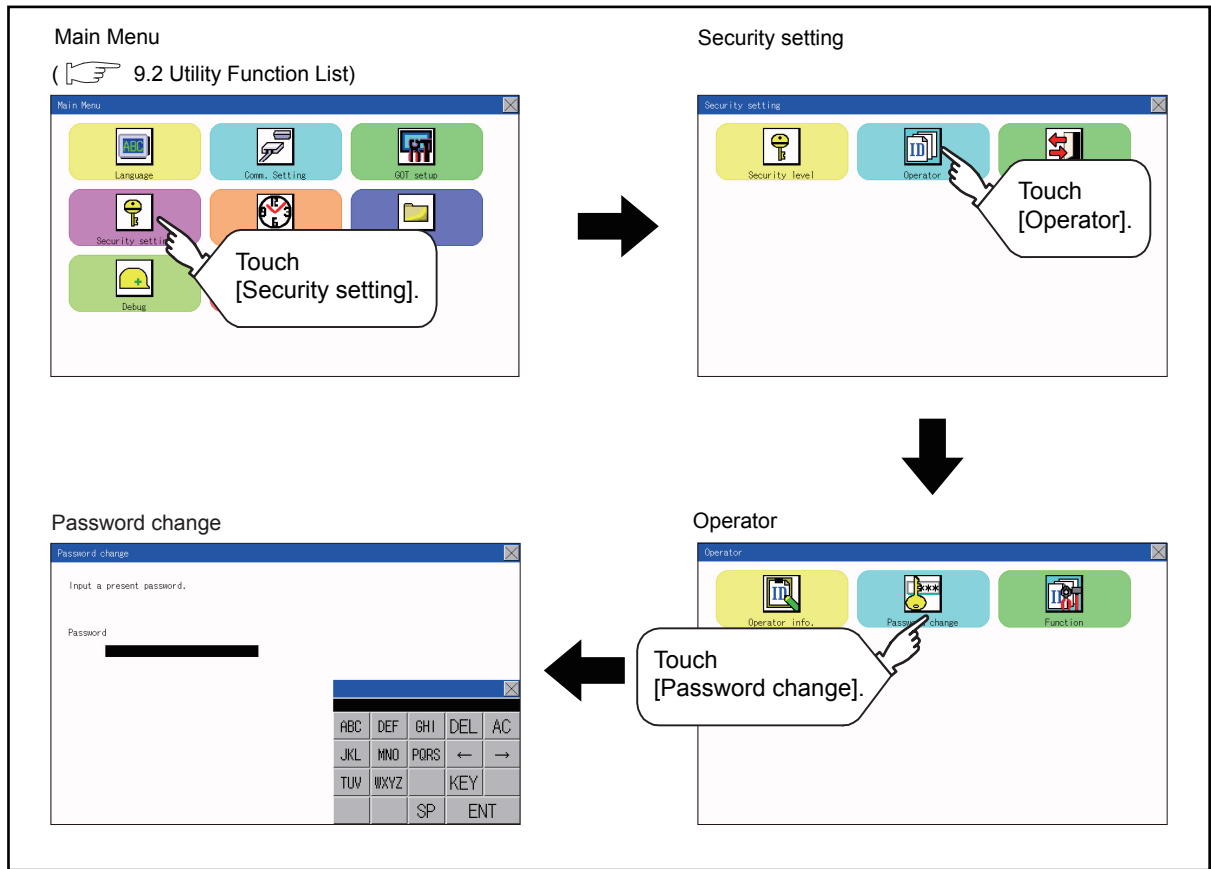

(3) Password change operation

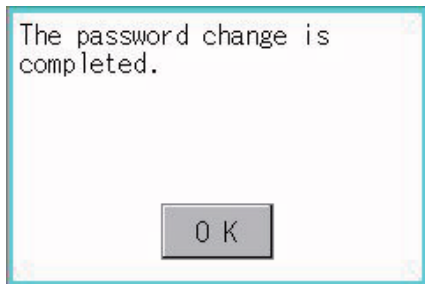
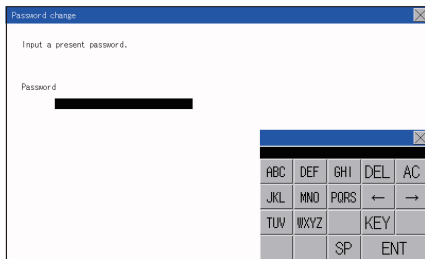
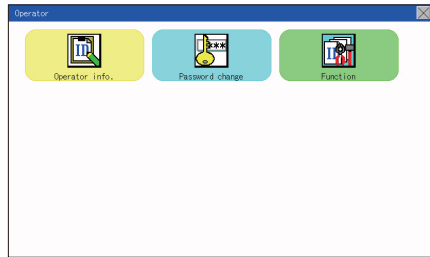
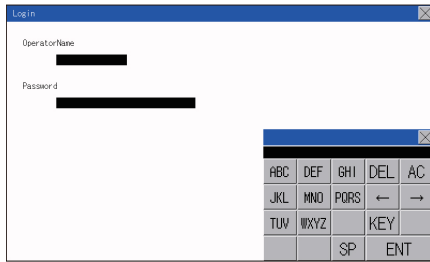

Step 1. Touch [Security setting] → [Login/Logout] to log into the GOT with the operator ID whose password is to be changed.

Step 2. Touch [Password change] in the operator setting menu, and then the Password change dialog box is displayed.

Step 3. Input the current password on the Password change dialog box. Character types to be input can be changed by touching the [KEY] button.

When the input is completed, touch the [Enter] key.

Step 4. Input a new password.

Step 5. After inputting a new password, input the new password again.

Step 6. When the new password is correctly input, the dialog box shown left is displayed and the password is changed.

13.2.3 Function setting

(1) Function setting function

The functions for the operator information can be set. The following items can be set.

Item	Description	Reference page
Auth method	The authentication method is fixed to the password authentication.	➡ 13-17
Auto logout time	The time from when the last time the GOT is operated until when you automatically log out of the GOT can be set. (1 to 60 minutes, 0 is invalid.)	➡ 13-16
Expiration date	Set the item for regularly changing the password to be used for the operator authentication. (1 to 1000 days, 0 is invalid.) When the password is out of date after setting the password, the GOT requests the password change.	➡ 13-16

(2) Display operation of function setting

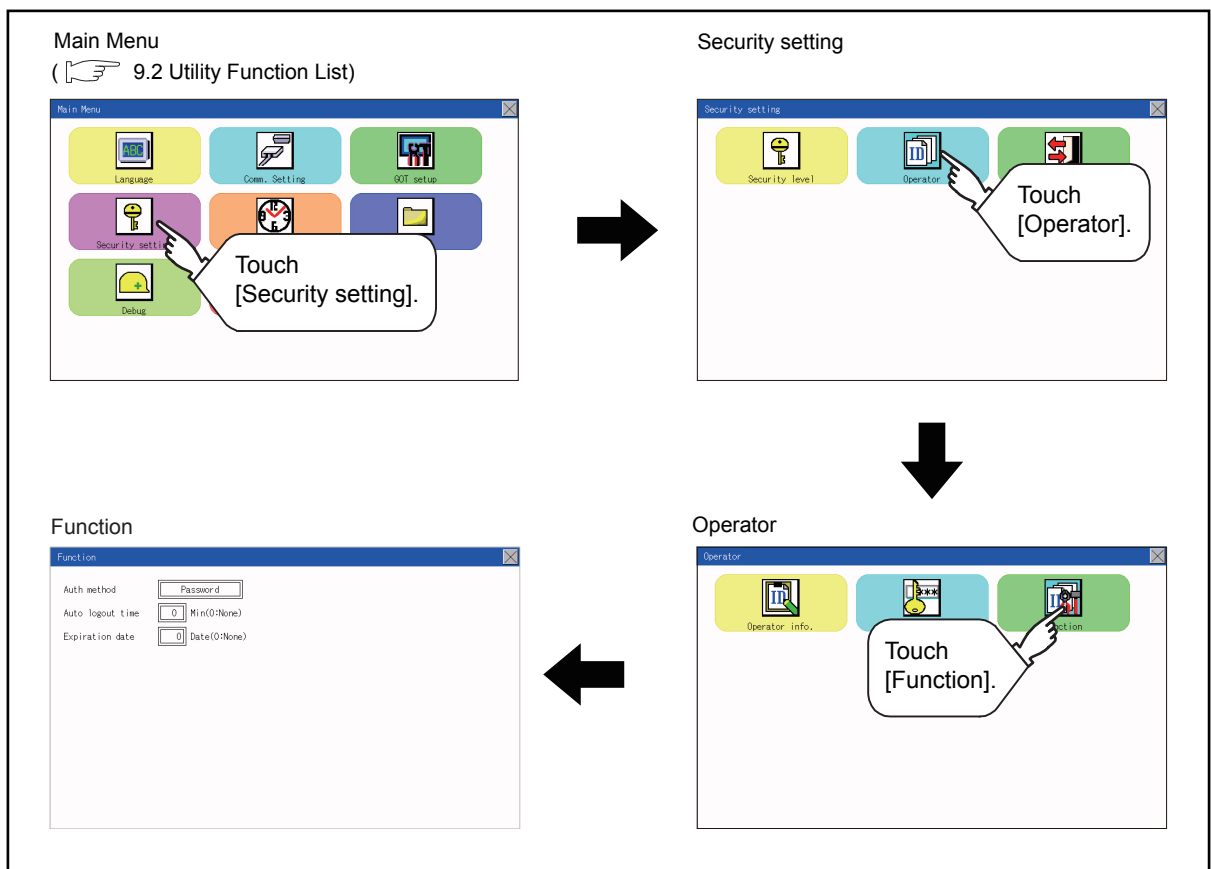

(3) Function setting operation

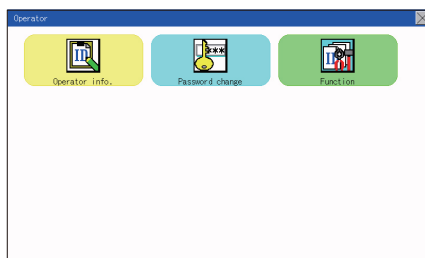
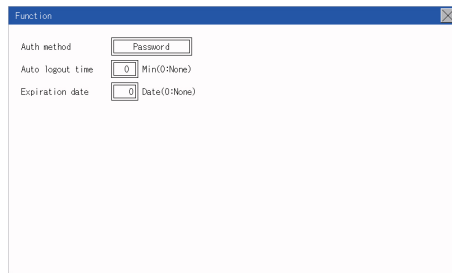
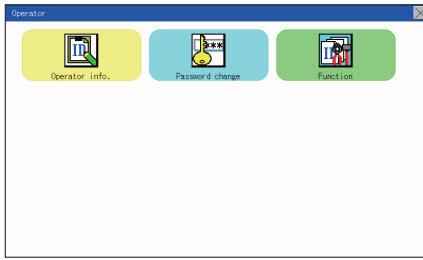

Step 1. Touch [Operator] → [Function], and then the Admin password authentication dialog box is displayed.

Step 2. When the administrator password is correctly input, the Function setting screen is displayed.

Touch an item to be set.

(a) Auto logout time

(b) Expiration date

(a) Touch [Auto logout time], and then the Auto logout time edit dialog box is displayed. Input the time.

When the input is completed, touch the [ENT] key.

(b) Valid byte count

Set the valid byte count for external authentication ID.

(Only available when [External auth] is set as the authentication method.)

Step 3. Touching the [×] button displayed on the upper right returns to the previous screen.

13.3 Login/Logout

To manage the operator or change the password, log into the GOT.

■ 1. Display operation of login/logout

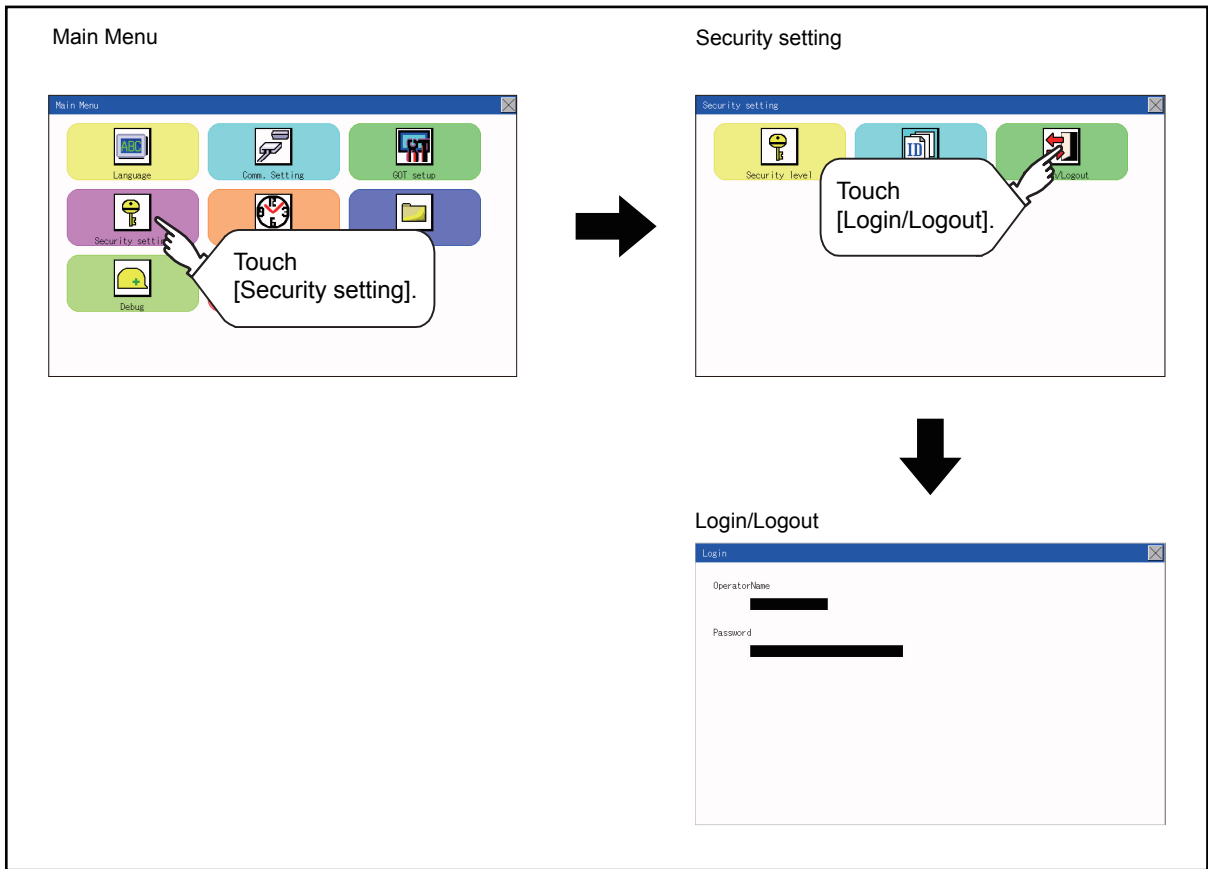

■ 2. Operation of login/logout

(1) Login

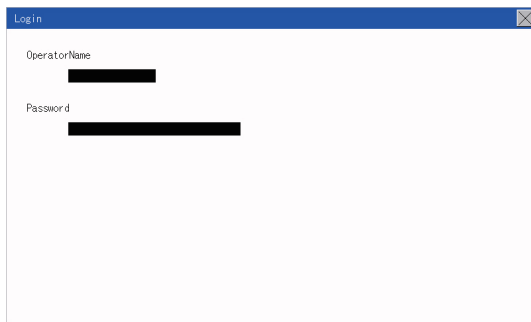

Step 1. Log into the GOT by inputting an operator name and its password.

(2) Logout

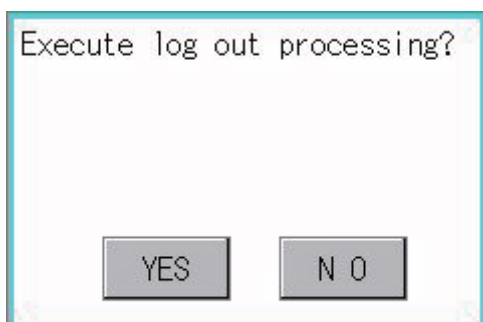

Step 1. Touch [Security setting] → [Login/Logout], and then the screen shown left is displayed. Touch the [YES] button.

14. CLOCK SETTINGS AND BATTERY STATUS DISPLAY (TIME SETTING AND DISPLAY)

The clock data (date and time) are displayed and set in the clock setting menu.

14.1 Time Setting and Display

14.1.1 Time setting and display functions

Time settings and displaying of the status of GOT built-in battery are possible.

Function	Description
Time setting	Carry out the display and setup of PLC CPU clock data.

14.1.2 Clock display and setting operation

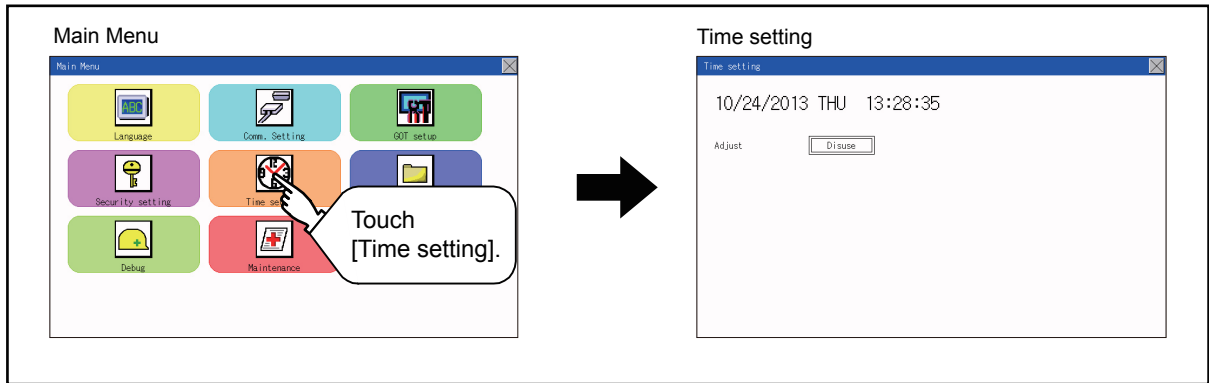

14.1.3 Clock setting operations

1. Clock display

Displays and sets up the clock data on the GOT.

When setting the clock data, change the clock data on the GOT and controller unless the clock setting is "Disuse".

If you fail to change the clock data on the controller, the clock data on the GOT is not changed as well.

When the GOT is not connected to the controller or is connected the controller which does not have the clock data, set the clock setting to "Disuse" first, and then change the clock data.

The setup methods of clock data are shown below.?

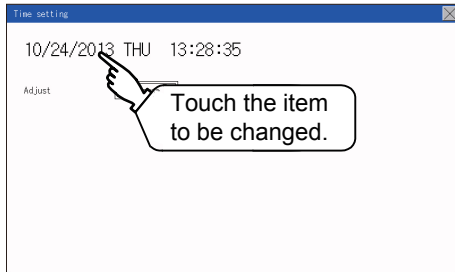

Step 1. Touch either the date or time to be changed.



Step 2. Enter date or time on the ten-key pad.
The day of the week is displayed automatically according to the input date.

"0" to "9":

Use these keys to enter numerical values

"ESC":

Closes the ten-key window without saving any value entered for the date or time

"AC":

Deletes the entire string of numerical characters that are being entered

"DEL":

Deletes a digit from a string of numerical characters that are being entered

"ENT":

Enters the value for the date or clock that has been entered and closes the ten-key pad window

" +/- ":

Switches between positive and negative values. (Only positive values are valid for the date or clock setting.)

".":

Invalid key (not used)

Step 3. Set [Time setting]. Touch a setting item to change the setting. [Use]  [Disuse]
Use: Acquires the time information from an external device.
Disuse: Does not acquire the time information from an external device.

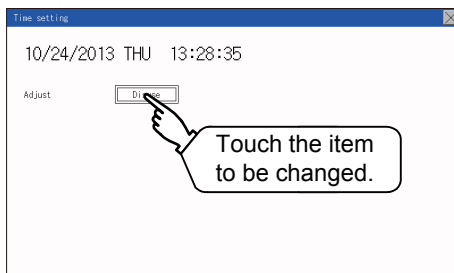

Step 4. After changing the settings, touch the [X] button to save the changes and close the setting window.

15. CONTROL OF VARIOUS DATA (DATA CONTROL)

A system application, project data (screen data), or alarm data which is written in the GOT or SD card can be displayed, and the data can be transferred between the GOT and SD card. The format of the SD card is also possible.

15.1 Data Storage Location

15.1.1 Data type and storage location

1. System

The data storage location and transferring (write/read) route for each data type are shown below. Also, the data storage locations are shown below.

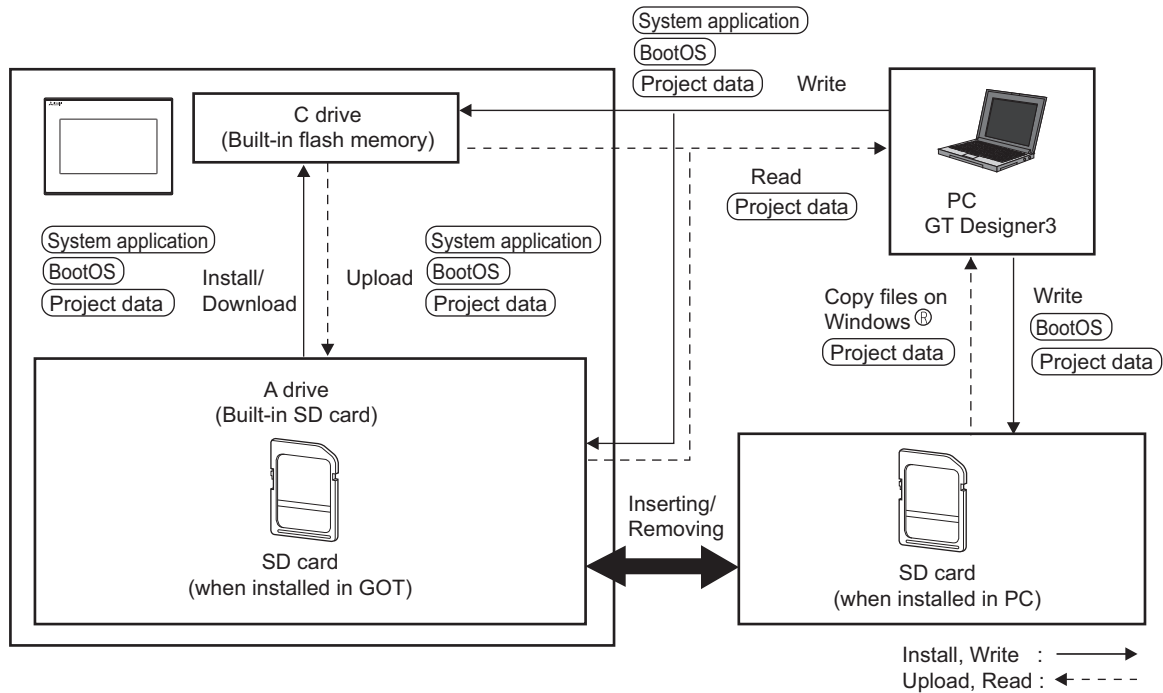

The data of the build in flash memory (Project data, etc.) can be saved even if the battery voltage becomes low.

Item	Data type	Storage location
(BootOS)	BootOS	Built in flash memory (C drive)
(System application)*1	Basic system application	Standard SD card (A drive)
	Communication driver	
	Advanced system application	Built in flash memory (C drive)*2
(Project data)*1	Project data	Standard SD card (A drive)
	(Including recipe setting, alarm conditions, time action, and GOT setup.)	Built in flash memory (C drive)*2

*1 The SD card can be used from Utility.

➡ 15.2 System Application Information

*2 When using the project data stored in the Standard SD Card (A drive) with the GOT, hold the SD card installed to the GOT.

■2. At maintenance

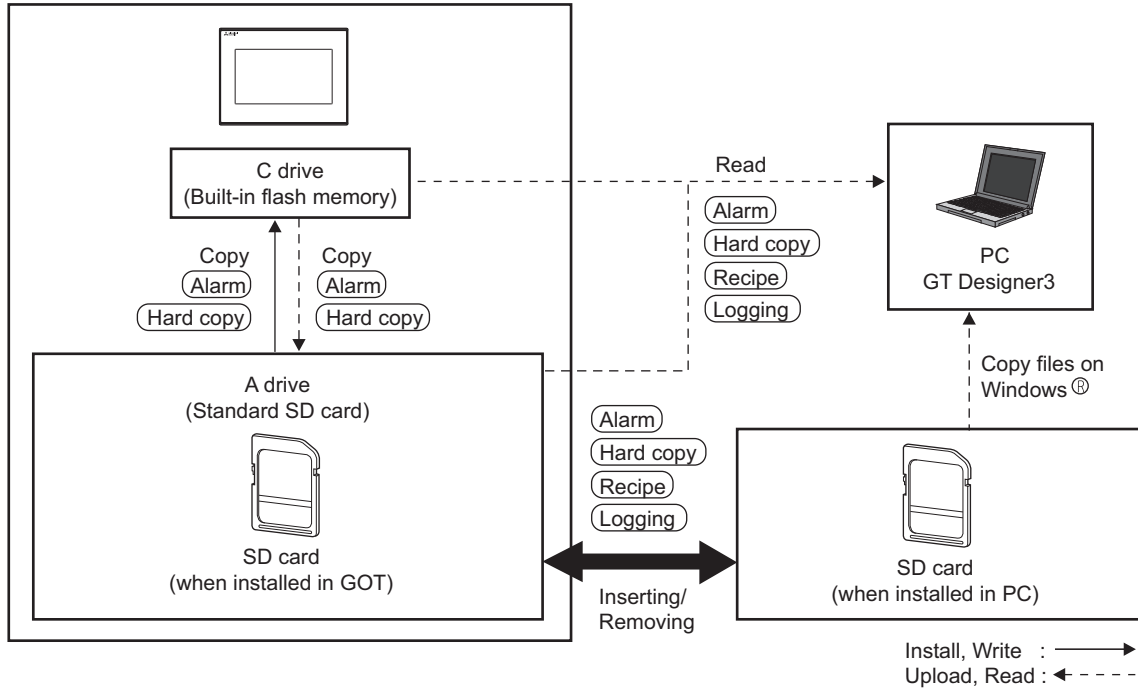

Item	Data type	Storage location
Alarm	Alarm data (Advanced alarm log file, alarm log file)	Standard SD card (A drive) C drive (Built-in flash memory)
Recipe	Recipe data (Advanced recipe file, Recipe file)	
Logging	Logging (Logging file)	
Hard copy	Image file (Hard copy function)	

POINT

Checking available space of the storage memory

To save resource data, check available space of the storage memory.

15.1.2 Checking version of basic system application

Confirm the basic system application version carefully when installing the BootOS and basic system application. When the basic system application is installed, the GOT checks and compares the basic system application version automatically.

(1) When install BootOS

When the BootOS to be installed has the older major version, GOT displays the installation disapproving message to cancel the installation so that the older version may not be written.

(Even when the version of the BootOS to be installed has the same or later version, the version information and the dialog box for selecting continue/not continue will be displayed.)

(2) When install basic system application or communication driver

When a basic system application or communication driver has already been installed, the version information of the basic system application which has been installed and the dialog box for selecting whether to continue the installation or not will be displayed.

Moreover, when the different versions will coexist among all applications (basic system application and communication driver) by installing the basic system application, the installation disapproving dialog box will be displayed and the installation process is canceled.

(3) When download project data

The GOT automatically compares the version between the project data to be downloaded and the installed basic system application.

When the versions are different, the dialog box confirming whether to install the basic system application together is displayed.

When downloading the project data from an SD card, storing the project data and basic system application beforehand is recommended.

The version of each system application installed in the GOT can be checked by displaying the property of the system application information screen.

Kind	Version
BootOS	01.00.010.-B
Basic System Application	01.00.000
MELSEC-FX	01.00.000
Ethernet(FX)	01.00.000
Std. 16dotFont_JPN(Gothic)	01.00.000
Std. 12dotFont_JPN	01.00.000
True Type Numerical(7-seg.)	01.00.000
True Type Numerical(Gothic)	01.00.000

Explanation of OS version

01.00.00.B

└─ BootOS version

(Appears only when the property of the BootOS is displayed.)

└─ Minor version

└─ Major version

For the display operation of the screen, refer to the following.

➡ 15.2 System Application Information

POINT

Version confirmation of BootOS by rating plate

Confirm the version of BootOS installed in the GOT at product shipment by rating plate of GOT rear face.

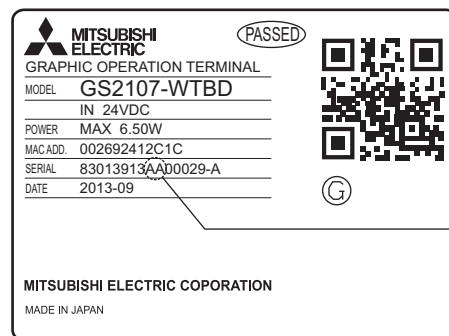

AA

└─ Boot OS version

└─ Hardware Version

15.2 System Application Information

1. Function of system application information

Each file name or folder name of BootOS and package data stored in each drive (A: Standard SD card or C: Built-in flash memory) can be displayed in a list.

Also, each file can be installed and updated.

Function	Description	Reference page
Information display of files and folders	Displays the kind, name, data size, creation date and time of the file or folder.	➡ 15-5

POINT

(1) Precautions when basic system application file is used

When the boot drive of the basic system application is set to "A: Standard SD card", a basic system application file cannot be installed or updated.

2. Display operation of system application information

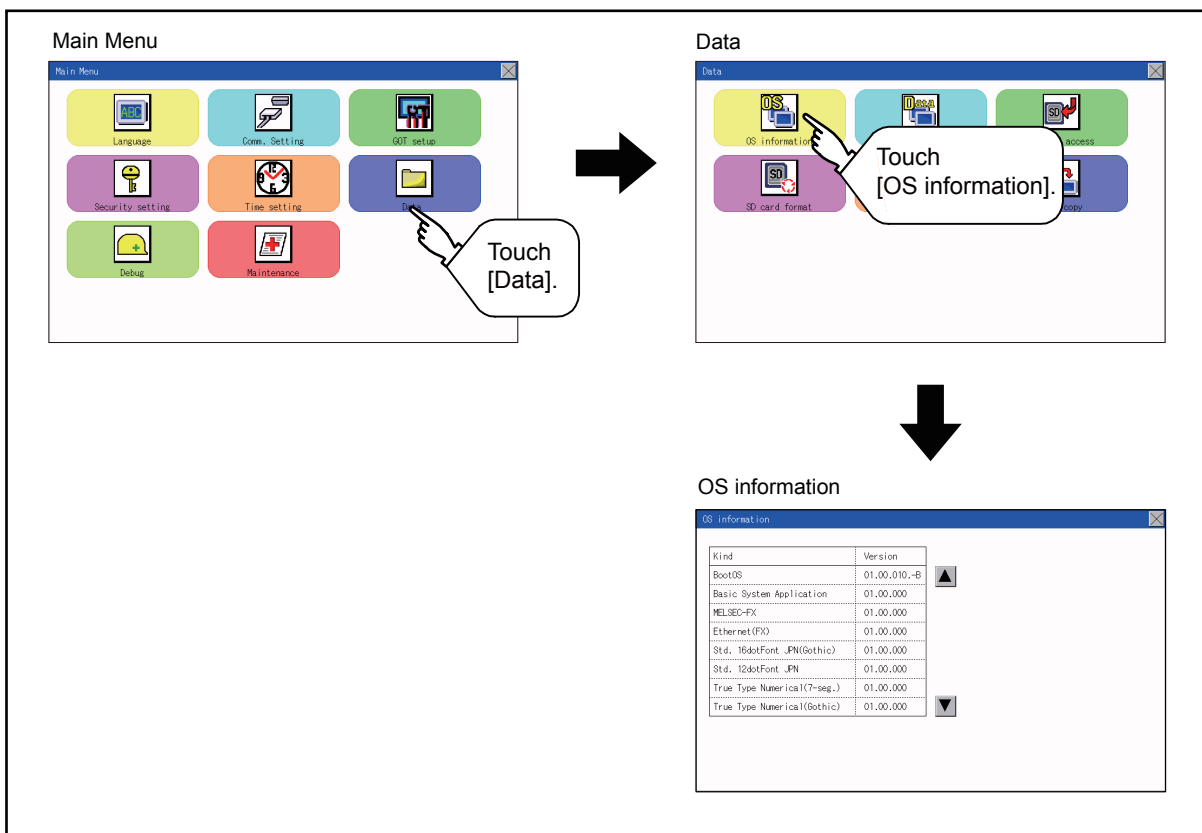

3. Display example of system application information

OS information Storage file/folder display screen

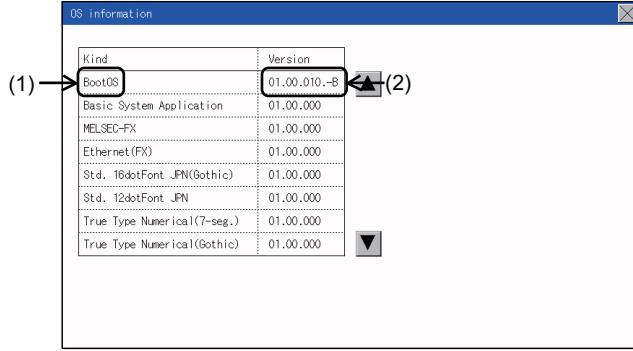

No.	Item	Description
(1)	Name	Displays the file name or folder name in the selected drive or folder. When the number of the characters of the file name or folder name exceeds 20, the 21th character and later are not displayed.
(2)	Version information	Displays the software version.

15.3 Resource Data Information

15.3.1 Alarm information

■ 1. Function of alarm information

Advanced alarm log files and alarm log files stored in each drive (A: Standard SD card or C: Built-in flash memory) is displayed.

The functions below can be carried out for files.

For details of the advanced alarms, refer to the following manual.

➡ GT Designer3 (GOT2000) Help

Function	Description	Reference page
Information display of files and folders	Displays name, data size, creation date and time of file or folder.	➡ 15-7, 15-8
G2A → CSV conversion	Converts the G1A file of an advanced alarm log file to a CSV file.	➡ 15-9
G2A → TXT conversion	Converts the G1A file of an advanced alarm log file to a TXT file.	➡ 15-9
Del	Deletes the file.	➡ 15-10
Copy	Copies the file.	➡ 15-11

■ 2. The display operation of alarm information

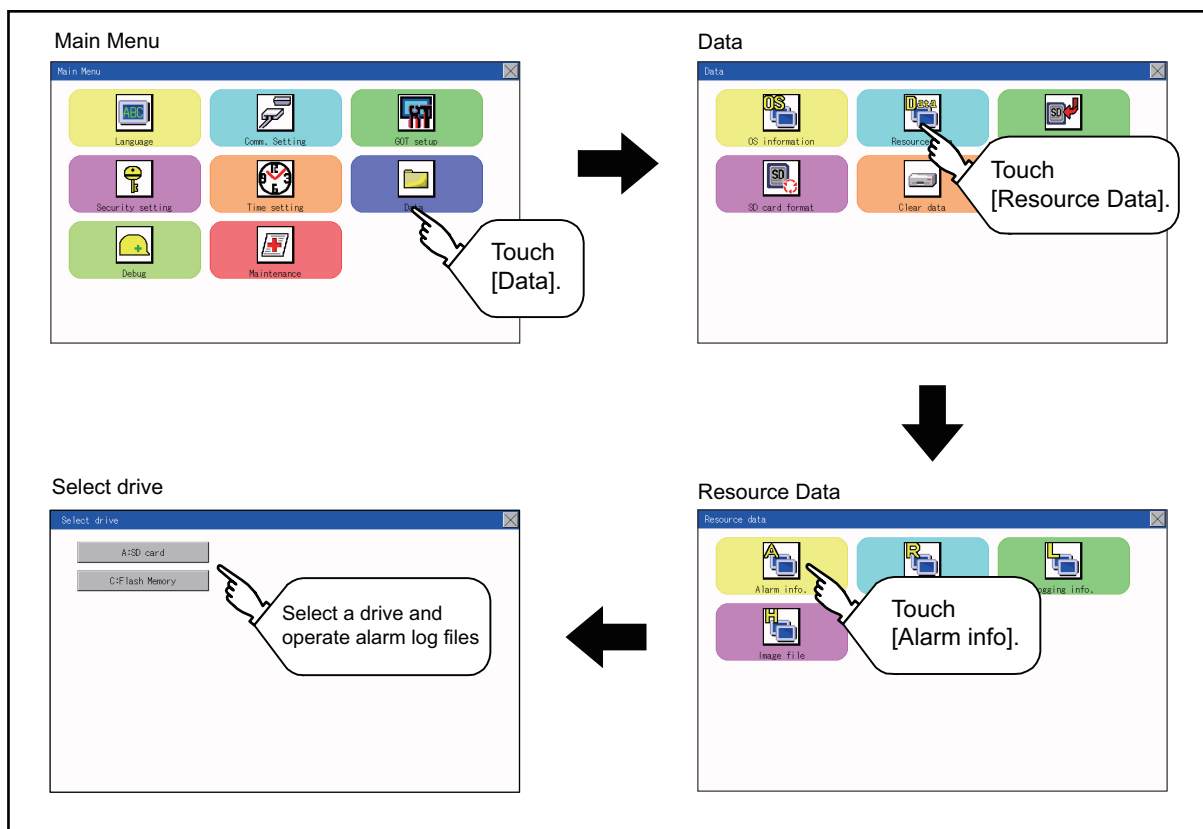

3. The display example of alarm information

Alarm information screen

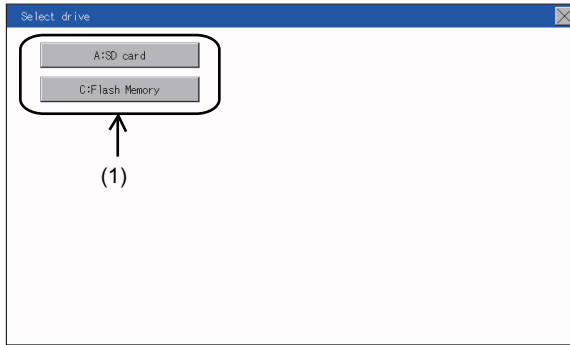

Alarm information: Storage file/folder display screen

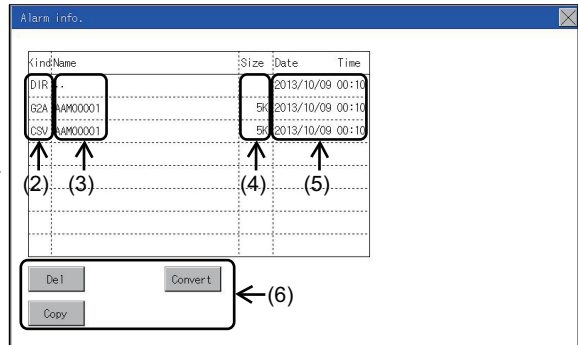

No.	Item	Description
(1)	Select drive	The drive which displays file or folder can be selected. When an SD card is not installed, the following drives are not displayed. • SD card: [A: Standard SD card]
(2)	Kind	Indicates whether the displayed name is file or folder. Displays the extension for a file and "DIR" for a folder.
(3)	Name	Displays the file name or folder name. For the long file/folder name, entire part may not be displayed. Confirm the non-displayed part with the [Copy] button, etc. ➡ ■ 4. Alarm information operation After confirmation, touch the [Cancel] button to cancel the operation.
(4)	Size	Displays the size of the file displayed in Name.
(5)	Date, Time	Displays the creation date and time of each file.
(6)	Operation switch	Execution switch of each function.

POINT

(1) Display of creation date and time

The creation date and time display is not updated even if a file is created or updated while displaying the alarm information display screen.

If the screen currently displayed is closed (by moving the screen to the folder of the upper hierarchy, etc.) and the same screen is displayed again, the updated contents are displayed.

4. Alarm information operation

(1) The display operation of alarm information

Alarm information screen

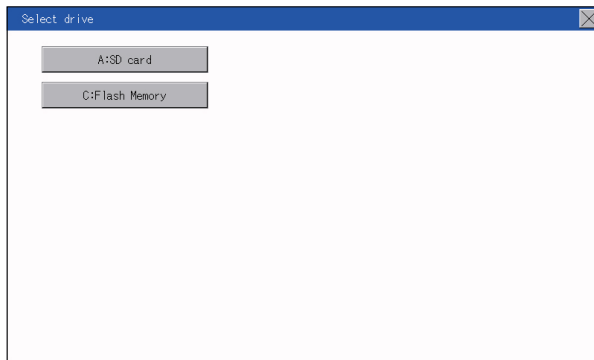

Alarm information: Storage file/folder display screen

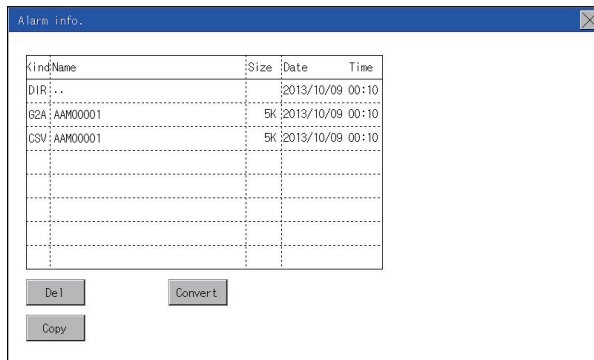

Step 1. If touch a drive of [Select drive], the information of the touched drive is displayed.

Step 2. If touch a folder name, the information of the touched folder is displayed.

Step 3. If touch a folder of ". .", the information of the folder of the one upper hierarchy is displayed.

Step 4. If touch the ▲ ▼ button of the scrollbar, the screen scrolls up/down by one line.

If touch the ▲ ▼ button, the screen scrolls up/down by one screen.

Step 5. If a file name is touched, the file is selected.

Step 6. For operations of G1A → CSV conversion, G1A → TXT conversion, deletion, copy, and graph, refer to the following.

G1A → CSV, G1A → TXT

➡ This section (2)

Delete

➡ This section (3)

Copy

➡ This section (4)

Step 7. If touch the [×] button, the screen is closed.

(2) **G2A → CSV conversion operation, G2A → TXT conversion operation**

The selected G1A file is converted to a CSV file or TXT file.

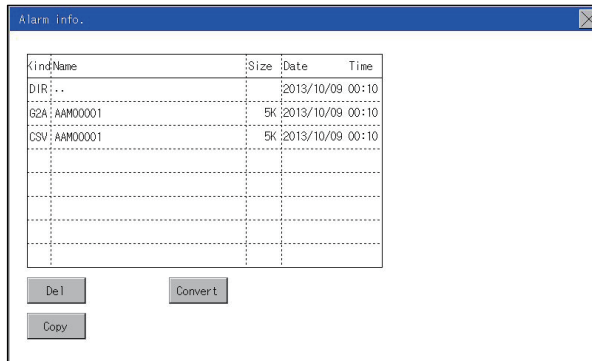

Step 1. Touch the G2A file to be converted to a CSV file or TXT file.

Step 2. Touch [Convert].

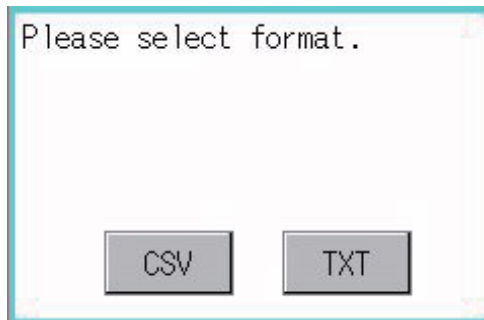

Step 3. The following dialog box is displayed when touching the following button according to the file type to convert to.

- CSV file:
[CSV] button
- TXT file:
[TXT] button

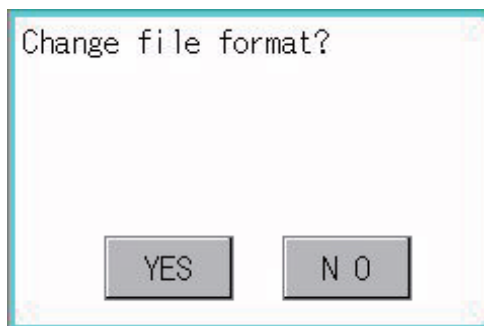

Step 4. Touch the [OK] button. The file is overwritten with the converted file.

(3) Deletion operation

Deletes the selected file.

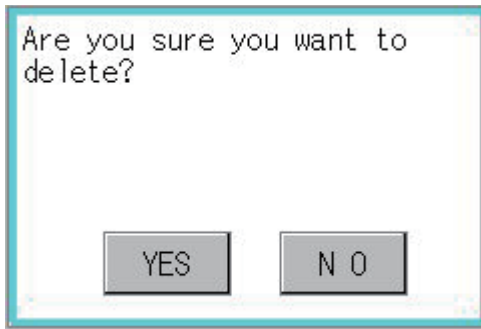

Step 1. Touch the file to be deleted.

Step 2. If touch the [Delete] button, the dialog box mentioned left is displayed.
If the [YES] button is touched, the file is deleted.
If the [NO] button is touched, the deletion is canceled.

(4) Copy operation
Copies the selected file.

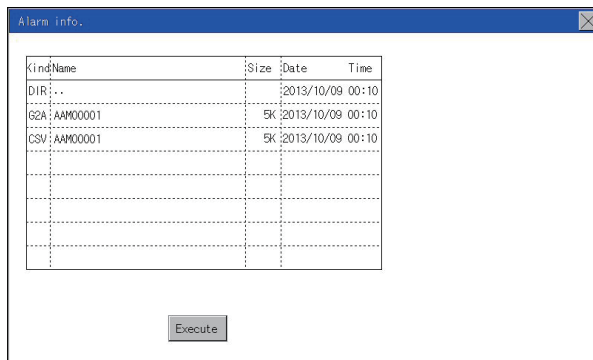
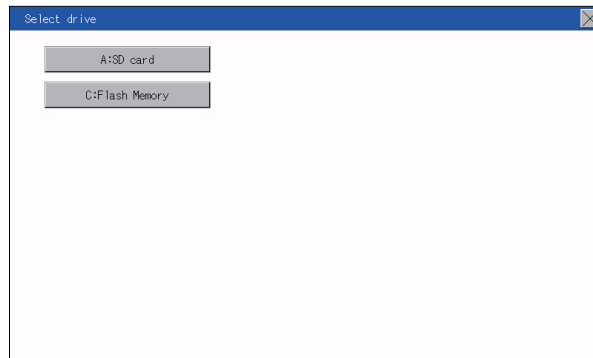
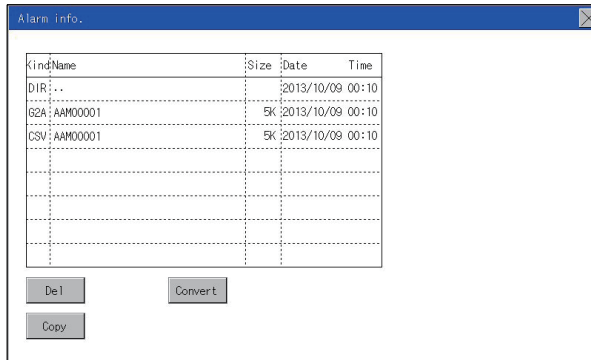

- Step 1.** Touch the file to be copied.
- Step 2.** If the [Copy] button is touched, the Select drive screen is displayed.

- Step 3.** Select a drive.

- Step 4.** Select the copy destination folder and touch [Execute]. The file is copied.

15.3.2 Recipe information

POINT

Before using recipe information

For writing/reading into/from a controller with this function or editing of recipe files on the personal computer, refer to the following.

Specifications and operating procedure are described.

➡ GT Designer3 (GOT2000) Help

1. Function of recipe information

The recipe file used in the recipe function can be copied, deleted, and output in a file.

In addition, it is possible to writing/reading into/from a controller by using this function, without creating the screen to operate the recipe. (Recipe setting of GT Designer3 is required.)

Function	Description	Reference page
Recipe information screen	Information display of files and folders	➡ 15-14 15-15
	G2P → CSV conversion	➡ 15-16
	G2P → TXT conversion	➡ 15-16
	CSV/TXT → G2P conversion	➡ 15-17
	Del	➡ 15-18
	Copy	➡ 15-19

■2. Display operation of recipe information

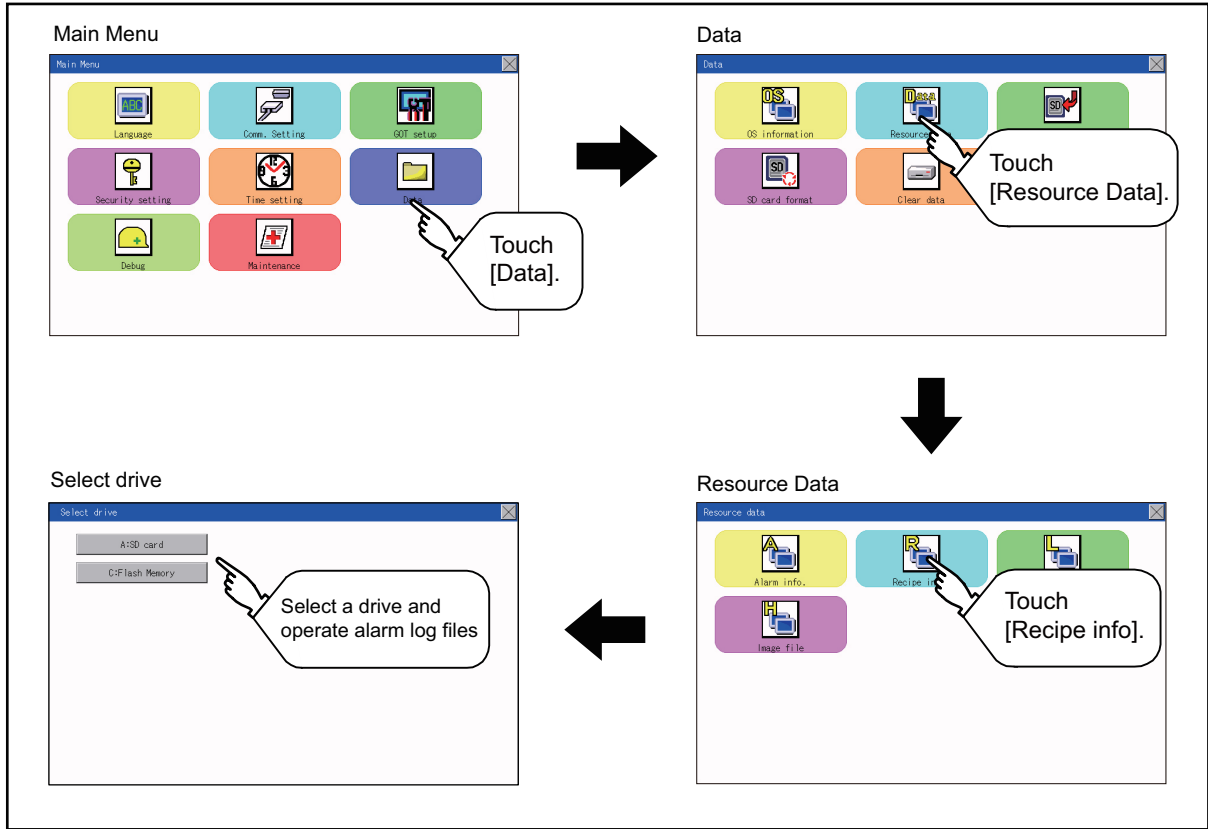

3. Example of advanced recipe information display

(1) Recipe information screen

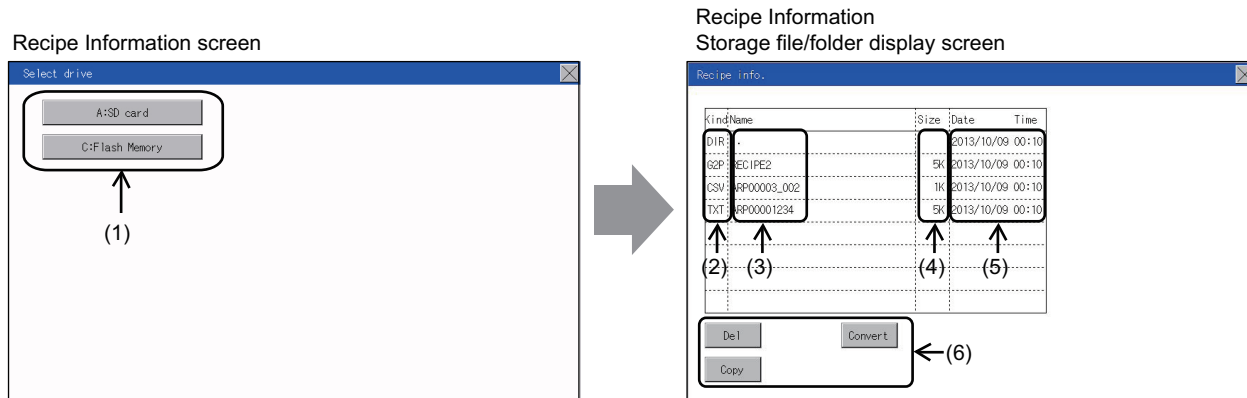

No.	Item	Description
(1)	Select drive	The target drive can be selected. (Even if an SD card is not installed, this message appears.)
(2)	Kind	Indicates whether the displayed name is file or folder. Displays the extension for a file and "DIR" for a folder.
(3)	Name	Displays the file name or folder name. For the long file/folder name, entire part may not be displayed.
(4)	Size	Displays the size of the file displayed in Name.
(5)	Date, Time	Displays the creation date and time of each file.
(6)	Operation switch	Execution switch of each function.

POINT

(1) About the displayed file

The files other than that for recipe are not displayed on the recipe information screen.

■4. Recipe information operation

(1) Display operation of recipe information

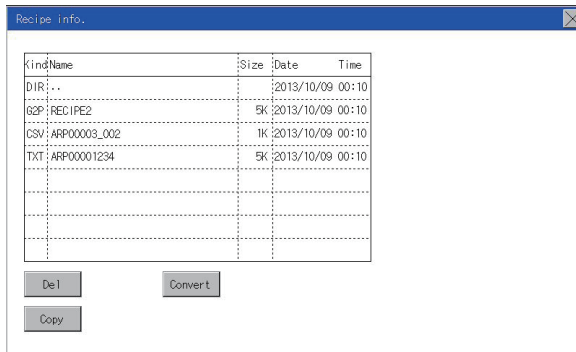

- Step 1.** If touch a drive of [Select drive], the information of the touched drive is displayed.
- Step 2.** If touch a folder name, the information of the touched folder is displayed.
- Step 3.** If touch a folder of ". .", the information of the folder of the one upper hierarchy is displayed.
- Step 4.** If touch the ▲▼ button of the scrollbar, the screen scrolls up/down by one line.
If touch the ▲▼ button, the screen scrolls up/down by one screen.
- Step 5.** If a file name is touched, the file is selected.
- Step 6.** For operation of operating switches, refer to the following.
G2P → CSV, G2P → TXT
➡ This section (2)
CSV/TXT → G2P
➡ This section (3)
Delete
➡ This section (4)
Copy
➡ This section (5)
- Step 7.** If touch the [×] button, the screen is closed.

(2) G2P → CSV conversion operation, G2P → TXT conversion operation

A recipe file (G2P file) is converted to a CSV file or Unicode text file that can be displayed/edited on a personal computer.

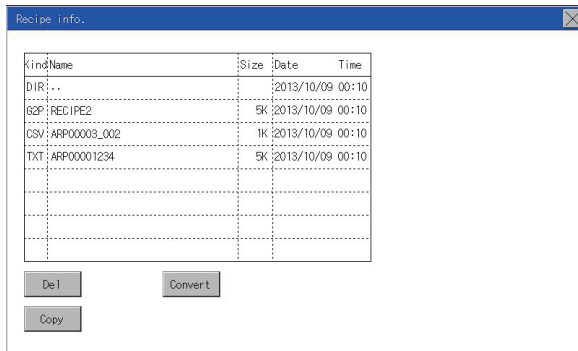

Step 1. Touch the G2P file to be converted to a CSV file or TXT file.

Step 2. Touch [Convert].

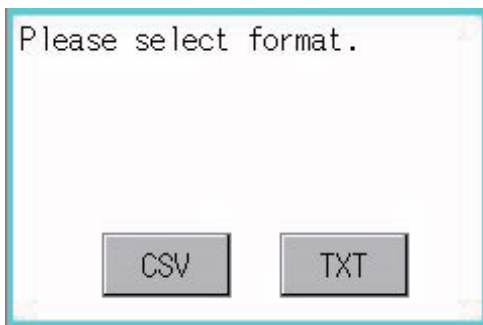

Step 3. Touch the following button in accordance with destination file type.

- CSV file:
[CSV] button
- TXT file:
[TXT] button

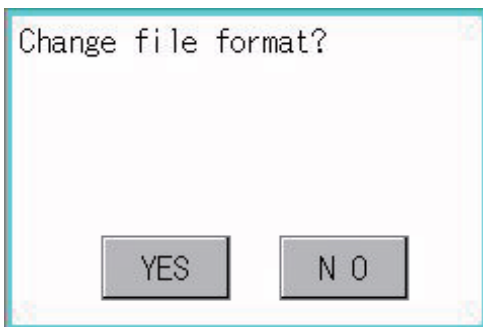

Step 4. Touch the [OK] button. The file is overwritten with the converted file.

(3) CSV/TXT → G2P conversion operation

A CSV file or Unicode text file is converted to a recipe file (G1P file).

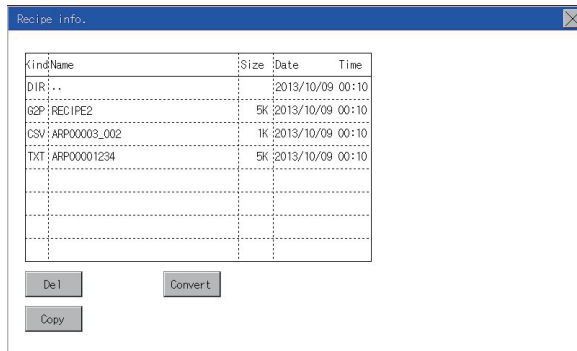

Step 1. To select the file, touch the CSV file or TXT text file to be converted to a G2P file.

Step 2. Touch the [Convert] button.

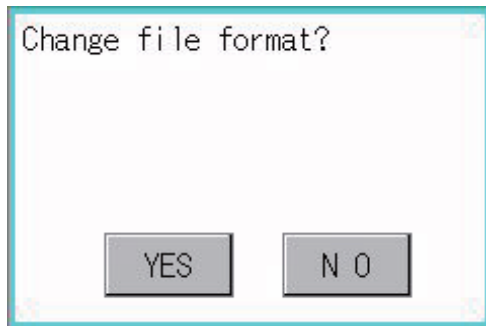

Step 3. If the [OK] button is touched, the file is overwritten with the converted file.

(4) Deletion operation

Folders and files to be used on recipe are deleted.

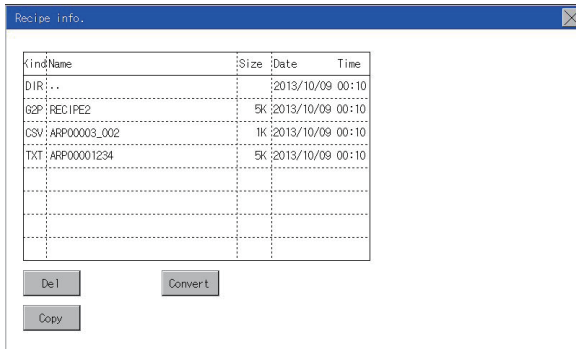

Step 1. Touch the folder or file to be deleted.

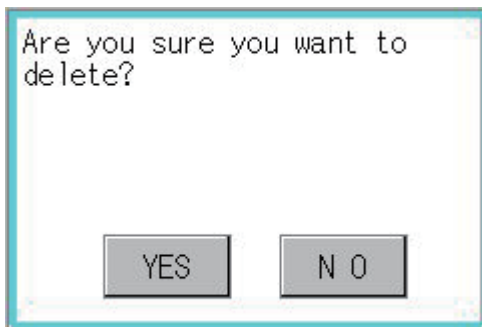

Step 2. If touch the [Delete] button, the dialog box mentioned left is displayed.
If the [YES] button is touched, the file or folder is deleted.
(While executing, [Processing...] message appears on the screen.)
If the [NO] button is touched, the deletion is canceled.

(5) Copy operation

Files to be used in recipe are copied.

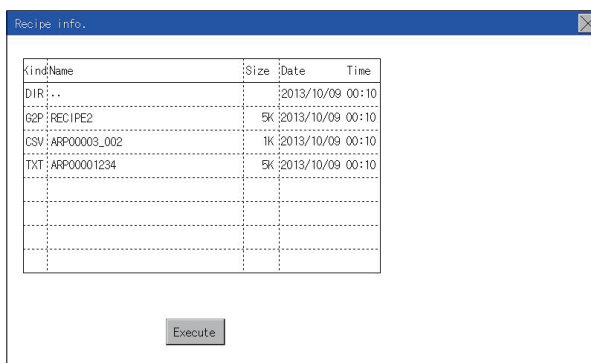
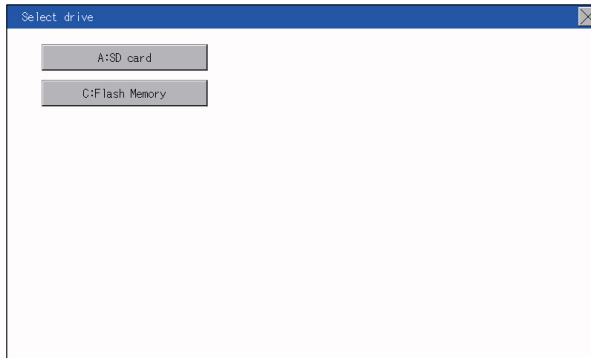
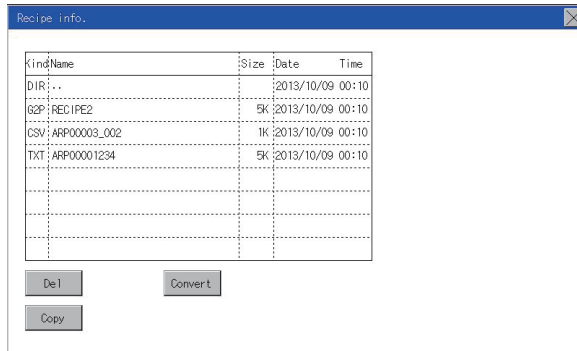

Step 1. Touch the file to be copied.

Step 2. If the [Copy] button is touched, the Select drive screen is displayed.

Step 3. Select a drive.

Step 4. Select the copy destination folder and touch [Execute]. The file is copied.

■ 5. Precautions

(1) Precautions for operation

- (a) Precautions during folder/file operation (Create/Delete/Copy/File output, etc.)
Even if the access to the SD card is inhibited while the GOT is processing folders and files, the processing continues. (Example: Even if the access to the SD card is inhibited while the GOT is creating a folder, the folder is created.)
Therefore, do not pull out the SD card while the "Processing..." message is on the screen after the access to the SD card is inhibited.
- (b) While GOT is accessing to other file (Alarm data, etc)
When folder/file processing for the recipe is executed while the GOT is in access to other file (SD card access LED ON), the GOT executes folder/file processing for the recipe after the processing for other file has completed.
Therefore, it may take some time to finish the process of the recipe folder/file. (The "Processing..." message is displayed on the screen.)

POINT

Estimation of processing time

The process may take time depending on the setting of advanced recipe file to be operated. (The more number of blocks increases, the longer it takes to process recipe folder/file.)

The process for creating the first file may take time depending on the setting of advanced recipe file.

15.3.3 Logging information

1. Function of logging information

Logging files created with the logging function can be copied, deleted or renamed, etc. Without using a personal computer, you can manage logging files on the GOT.

For details of the logging function, refer to the following.

➡ GT Designer3 (GOT2000) Help

Function	Description	Reference page
Information display of files and folders	Displays name, data size, creation date and time of file or folder.	➡ 15-22 15-23
G2L → CSV conversion	Converts a G1L file of a logging file to a CSV file.	➡ 15-24
G2L → TXT conversion	Converts a G1L file of a logging file to a Unicode text file.	➡ 15-24
Del	Deletes the file or folder.	➡ 15-25
Copy	Copies the file.	➡ 15-26

2. Display operation of logging information

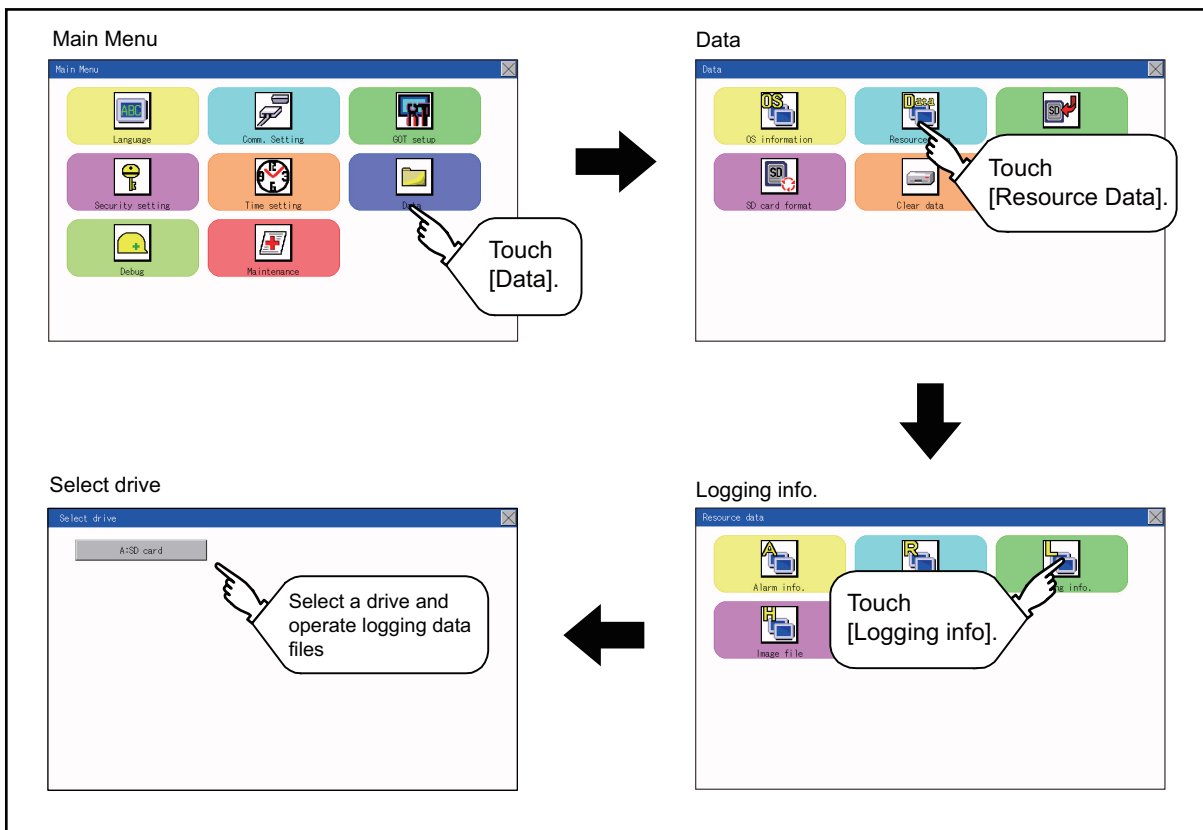

■ 3. Example of logging information display

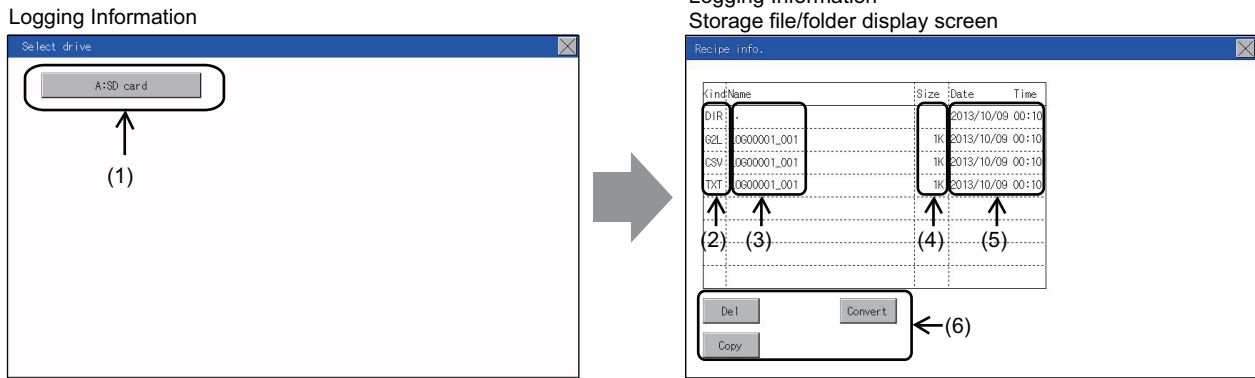

No.	Item	Description
(1)	Select drive	The target drive can be selected. (Even if an SD card is not installed, this message appears.)
(2)	Kind	Indicates whether the displayed name is file or folder. Displays the extension for a file and "DIR" for a folder.
(3)	Name	Displays the file name or folder name. For the long file/folder name, entire part may not be displayed.
(4)	Size	Displays the size of the file displayed in Name.
(5)	Date, Time	Displays the creation date and time of each file.
(6)	Operation switch	Execution switch of each function.

POINT

(1) About the displayed file

The files other than that for logging are not displayed on the logging information screen.

■4. Logging information operation

(1) Display operation of logging information

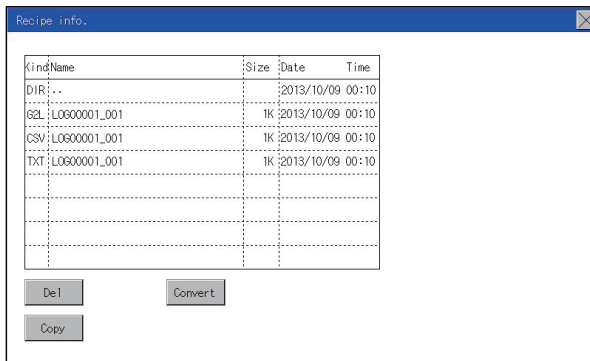

Step 1. If touch a drive of [Select drive], the information of the touched drive is displayed.

Step 2. If touch a folder name, the information of the touched folder is displayed.

Step 3. If touch a folder of ". .", the information of the folder of the one upper hierarchy is displayed.

Step 4. If touch the ▲▼ button of the scrollbar, the screen scrolls up/down by one line.
If touch the ▲▼ button, the screen scrolls up/down by one screen.

Step 5. If a file name is touched, the file is selected.

Step 6. For operation of operating switches, refer to the following.

G2L → CSV, G2L → TXT

⇒ This section (2)

Delete

⇒ This section (3)

Copy

⇒ This section (4)

Step 7. If touch the [×] button, the screen is closed.

(2) G2L → CSV conversion operation, G2L → TXT conversion operation

A logging file (G2L file) is converted to a CSV file or Unicode text file that can be displayed/edited on a personal computer.

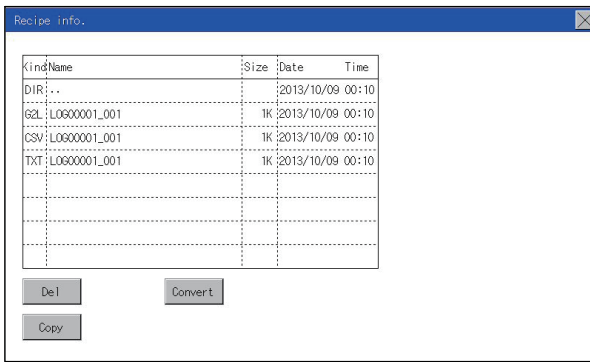

Step 1. Touch the G2L file to be converted to a CSV file or TXT file.

Step 2. Touch [Convert].

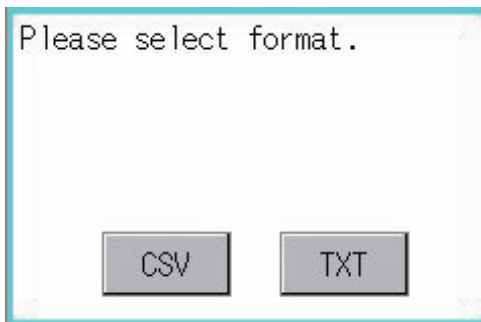

Step 3. Touch the following button in accordance with destination file type.

- CSV file:
[CSV] button
- TXT file:
[TXT] button

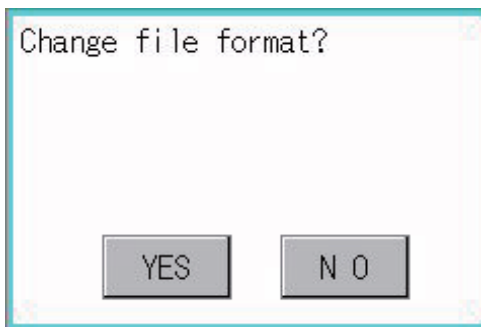

Step 4. Touch the [OK] button. The file is overwritten with the converted file.

(3) Deletion operation

Folder and file to be used on logging are deleted.

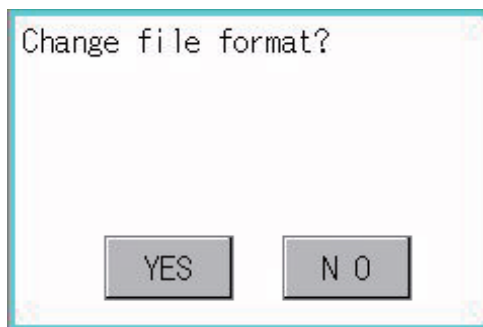
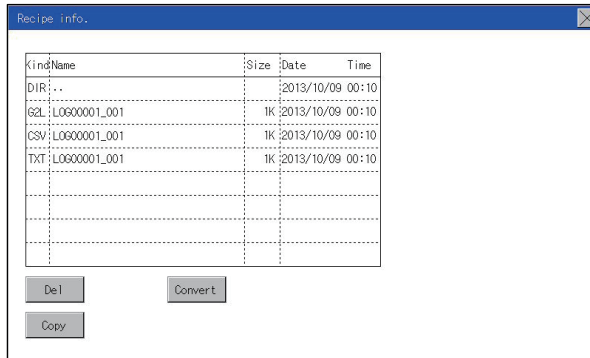

Step 1. Touch the folder or file to be deleted.

Step 2. If touch the [Delete] button, the dialog box mentioned left is displayed. If the [YES] button is touched, the file or folder is deleted. (While executing, [Processing...] message appears on the screen.) If the [NO] button is touched, the deletion is canceled.

(4) Copy operation

Folder to be used in logging is copied.

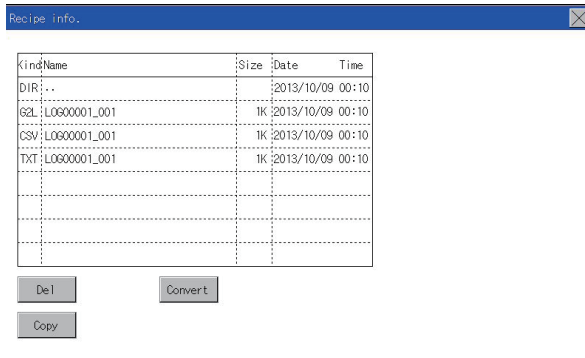

Step 1. Touch the file to be copied.

Step 2. If the [Copy] button is touched, the Select drive screen is displayed.

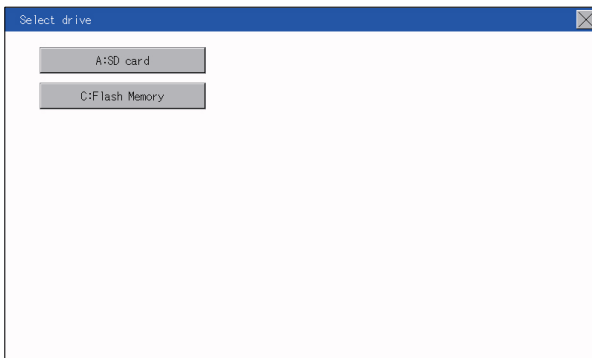

Step 3. Select a drive.

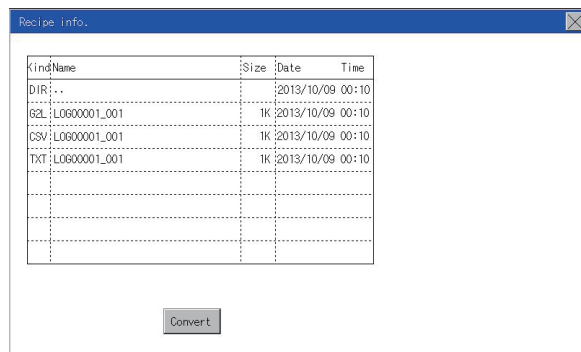

Step 4. Select the copy destination folder and touch [Execute]. The file is copied.

■ 5. Precautions

(1) Precautions for operation

- (a) Precautions during folder/file operation (Create/Delete/Copy/File output, etc.)
Even if the access to the SD card is inhibited while the GOT is processing folders and files, the processing continues.
(Example: Even if the access to the SD card is inhibited while the GOT is creating a folder, the folder is created.)
Therefore, do not pull out the SD card while the "Processing..." message is on the screen after the access to the SD card is inhibited.
- (b) While GOT is accessing to other file (Alarm data, etc)
When folder/file processing for the logging is executed while the GOT is in access to other files (SD card access LED ON), the GOT executes folder/file processing for the logging after the processing for other files is completed.
Therefore, it may take some time to finish the process of the logging folder/file.
(The "Processing..." message is displayed on the screen.)

15.3.4 Image file management

1. Function of image file management

Deletes, copies, and moves the file created by the hard copy function.
For details of the hard copy function, refer to the following.

➡ GT Designer3 (GOT2000) Help

Function	Description	Reference page
Information display of files and folders	Displays the kind, name, data size, creation date and time of the file or folder.	➡ 15-29 15-30
Delete	Deletes the file.	➡ 15-31
Copy	Copies the file.	➡ 15-32

2. Display operation of image file management

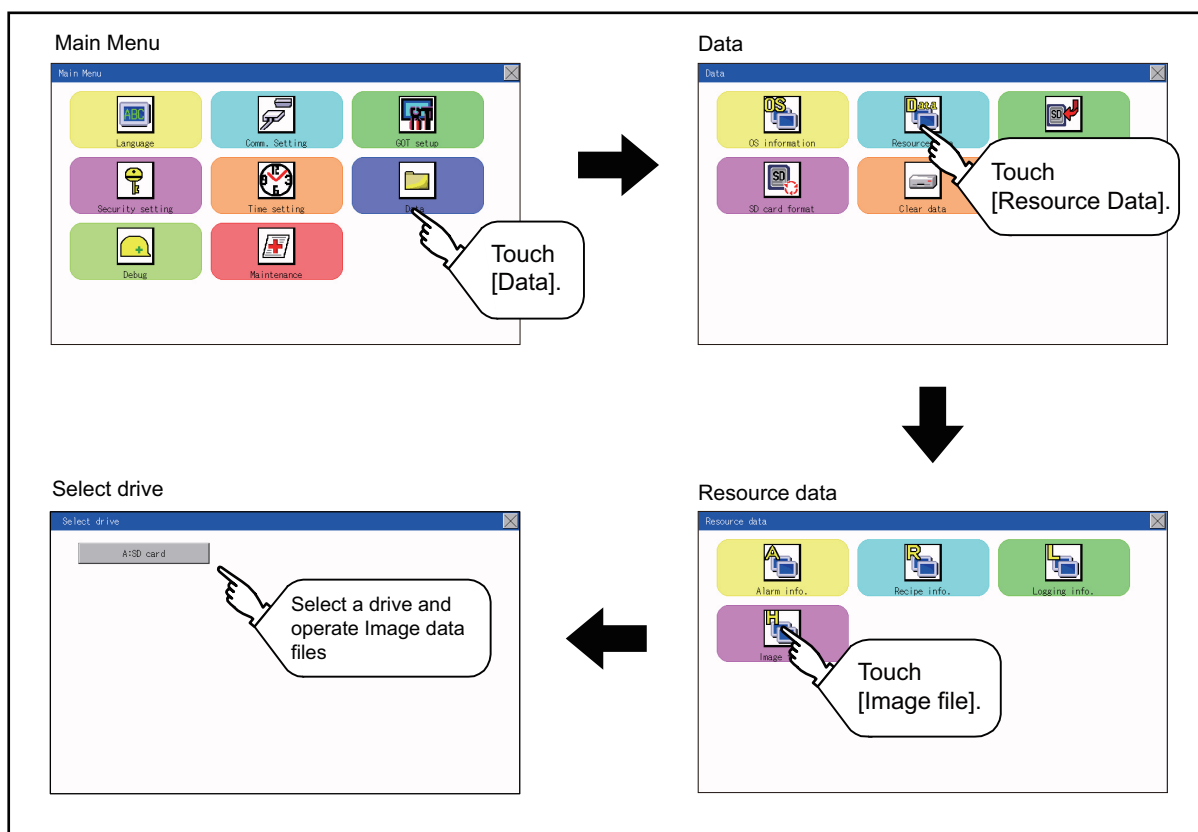

3. Display example of image file management

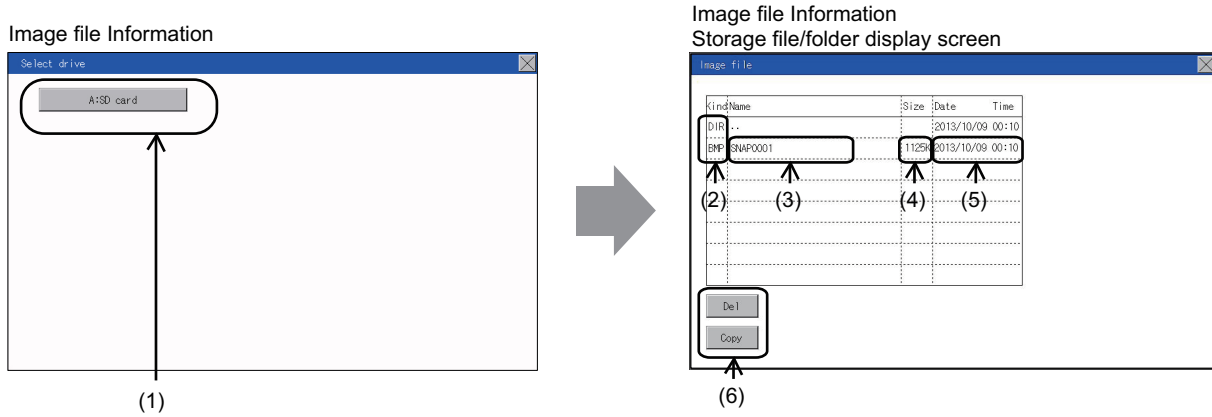

No.	Item	Description
(1)	Select drive	The drive which displays file or folder can be selected. When an SD card is not installed, the following drives are not displayed. • SD card: [A: Standard SD card]
(2)	Kind	Indicates whether the displayed name is file or folder. Displays the extension for a file and "DIR" for a folder.
(3)	Name	Displays the file name or folder name. For the long file/folder name, entire part may not be displayed. Confirm the non-displayed part with the [Copy] button, etc. ➡ (3) Copy operation After confirmation, touch the [Cancel] button to cancel the operation.
(4)	Size	Displays the size of the file displayed in Name.
(5)	Date, Time	Displays the creation date and time of each file.
(6)	Operation switch	Execution switch of each function.

POINT

(1) Display of creation date and time

The creation date and time display is not updated even if a file is created or updated while the image file management screen is displayed. To display the updated creation date and time, close the screen currently displayed (by moving to the upper hierarchy folder, etc.) and display the screen again.

■ 4. Operation of image file management

(1) Display operation of image file management

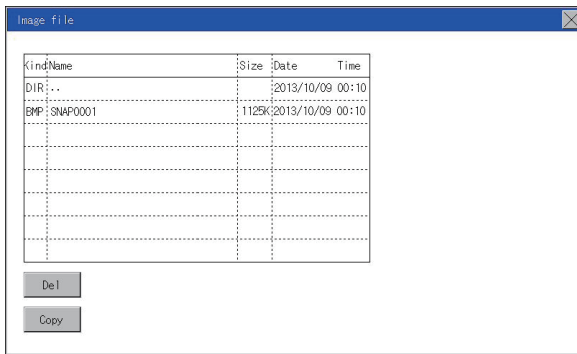

Step 1. If touch a drive of [Select drive], the information of the touched drive is displayed.

Step 2. If touch a folder name, the information of the touched folder is displayed.

Step 3. If touch a folder of ". .", the information of the folder of the one upper hierarchy is displayed.

Step 4. If touch the ▲▼ button of the scrollbar, the screen scrolls up/down by one line.
If touch the ▲▼ button, the screen scrolls up/down by one screen.

Step 5. If a file name is touched, the file is selected.

Step 6. For the operations of the delete, copy, and rename, refer to the following.

Delete

➡ This section (2)

Copy

➡ This section (3)

Step 7. If touch the [×] button, the screen is closed.

(2) Deletion operation
Deletes the selected file.

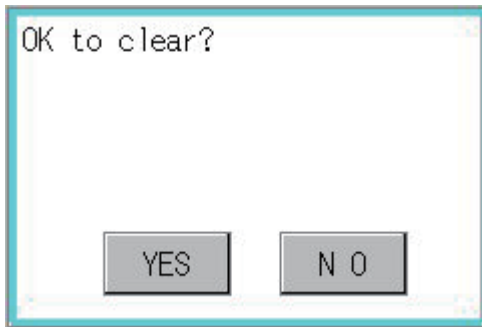
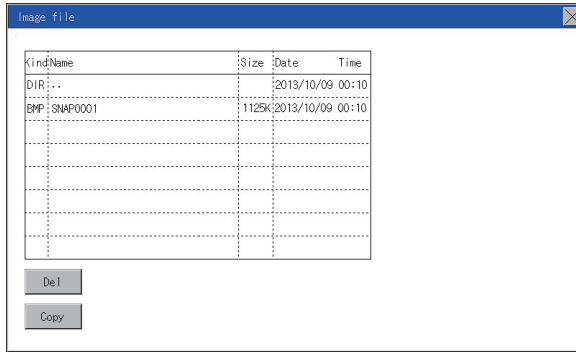

Step 1. Touch the file to be deleted.

Step 2. If touch [Delete] button, the screen mentioned left is displayed.
If the [YES] button is touched, the file is deleted.
If the [NO] button is touched, the deletion is canceled.

(3) Copy operation

Copies the selected file.

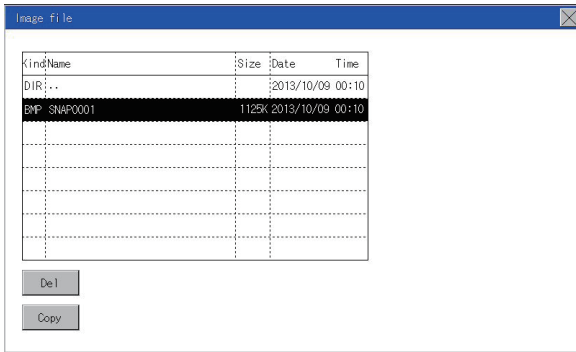

Step 1. Touch the file to be copied.

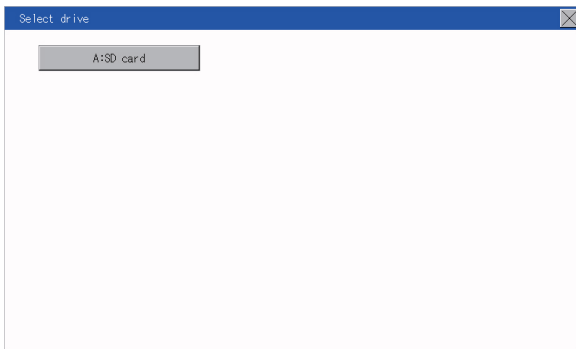

Step 2. If the [Copy] button is touched, the Select drive screen is displayed. Select a drive.

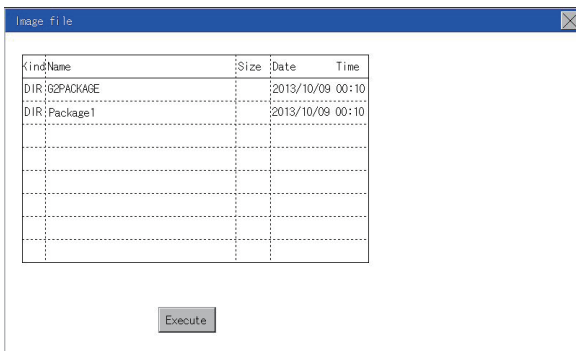

Step 3. If the copy destination folder is touched, the screen display is changed to the folder of copy destination. At this time, it cannot be copied into the same folder where the file exists. Select other folders.

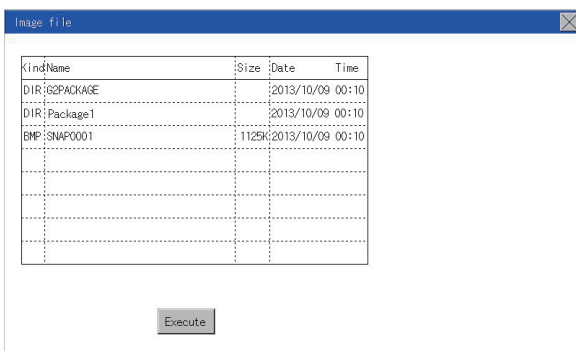

Step 4. If touch the [Execute] button, the file is copied.

15.4 SD Card Access

15.4.1 Functions of SD card access

When the GOT is turned on, an SD card can be installed or removed to/from the GOT without damage to the data in the SD card.

15.4.2 Display operation of SD card access

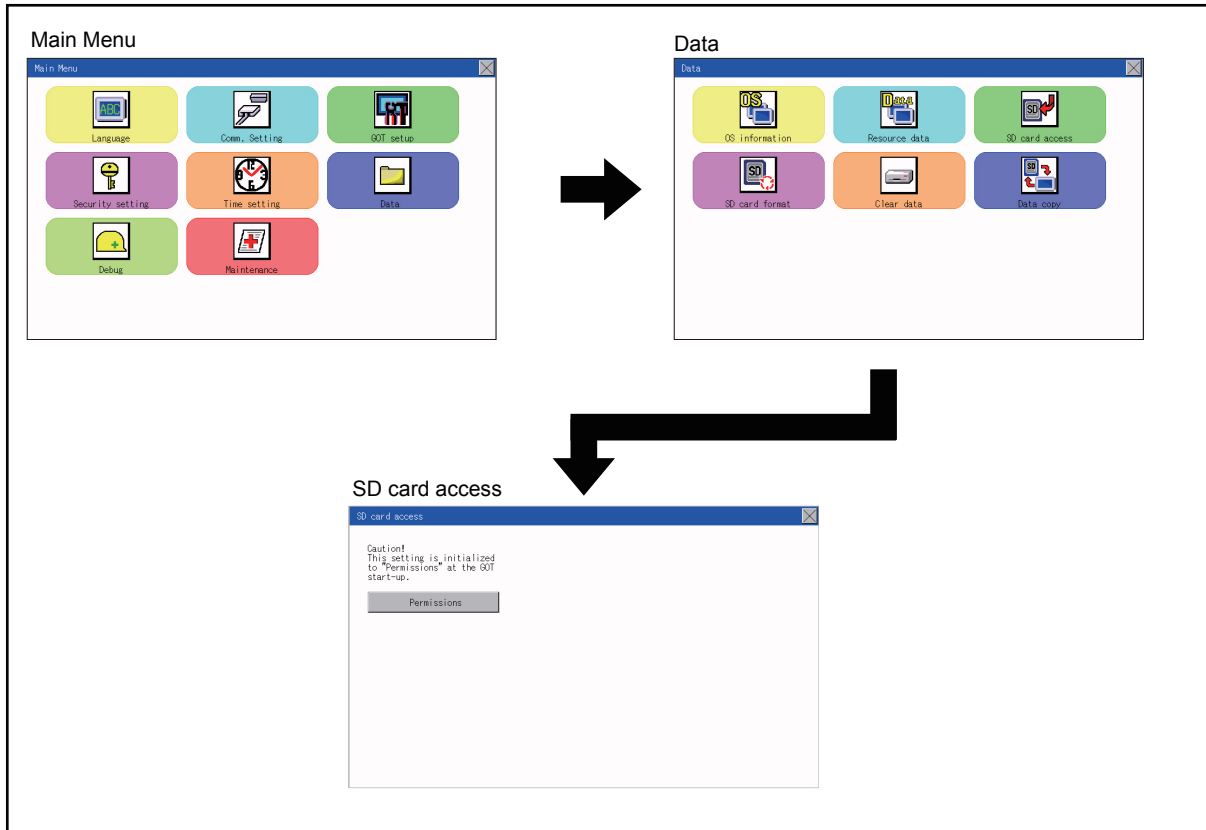

15.4.3 Operation of SD card access

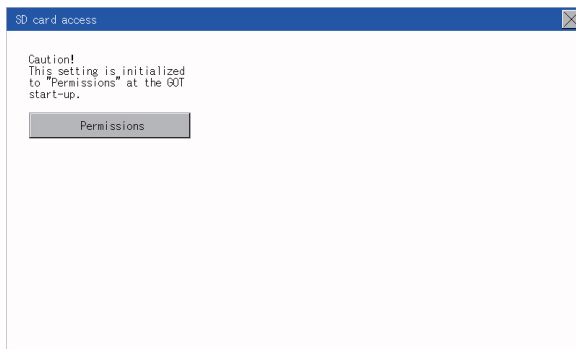

- Step 1.** Touch a setting item to change the setting.
[Permissions] ↻ [Access inhibit]
When installing or removing an SD card, always set [Access inhibit].

15.5 SD Card Format

■ 1. Function of SD card format

An SD card is formatted.

■ 2. Display operation of SD card format

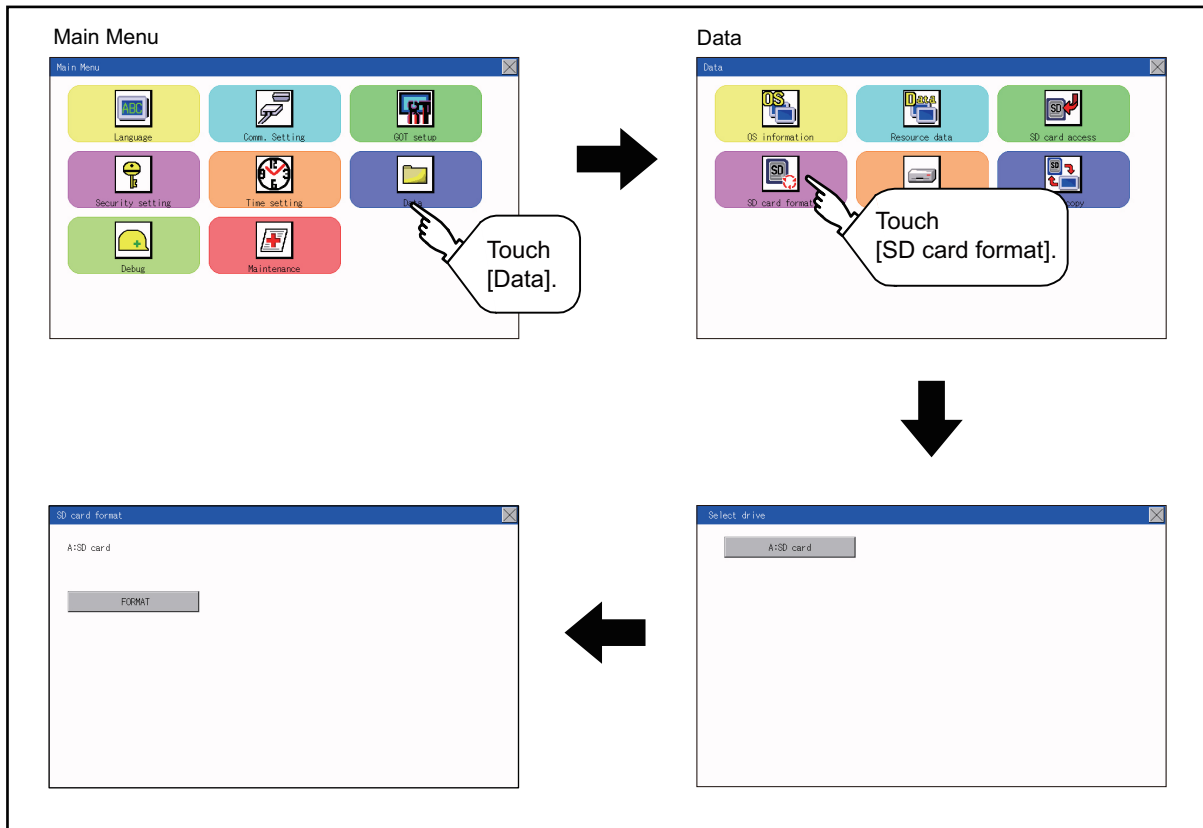

3. Operation of SD card format

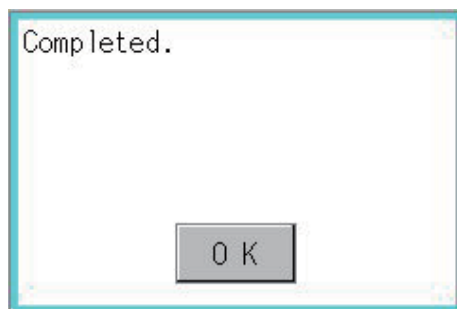
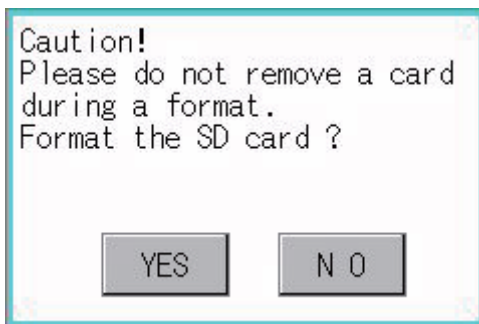
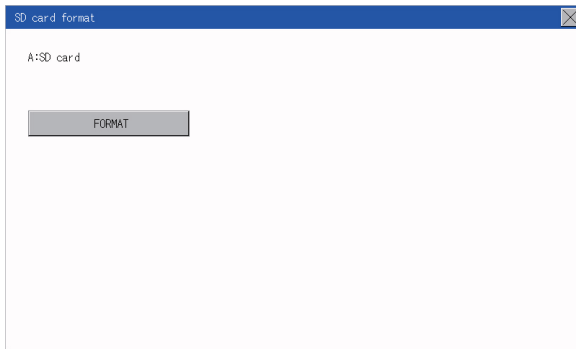
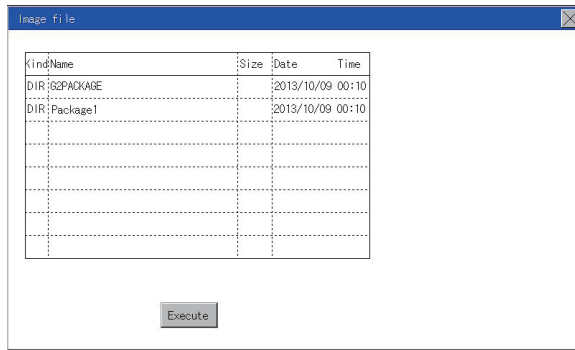

POINT

Restrictions on formatting

- When using an unformatted SD card in the GOT, format it by a personal computer. The GOT cannot format the unformatted SD card.
- The format of the GOT does not change the file system (Example: FAT16) of the SD card and inherits the file system before the format.

Step 1. Install an SD card to the GOT.
For installation/removal procedure of an SD card, refer to the following.

- ➡ 8.1.2 Installation/removal procedure of SD card

Step 2. Touch and select the drive to format by drive selection.

Step 3. If touch the [FORMAT] button, the password input screen is displayed.

Step 4. Type and touch the [Enter] key. The dialog box shown on the left will appear. (The password is fixed to 1111.)
Confirm the contents of the dialog box, and touch the [YES] button to format the SD card.
To cancel the format, touch the [NO] button.

Step 5. When the formatting is completed, the completion dialog mentioned left is displayed.

Step 6. To close the dialog box, touch the [OK] button.

15.6 Clear data

15.6.1 Clear data functions

This function deletes the project data and resource data that are written to the GOT.

15.6.2 Clear data display

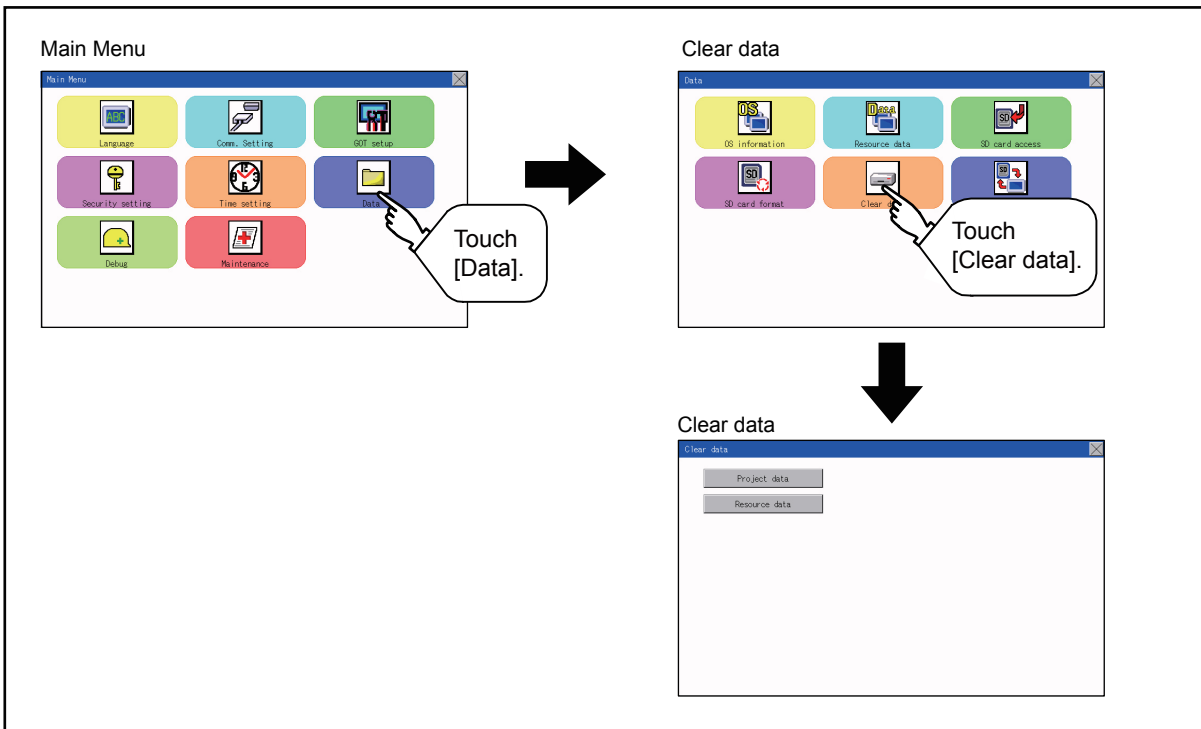

15.6.3 Clear data operation

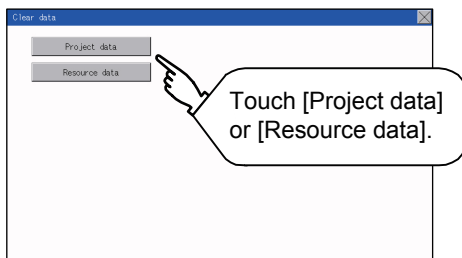

Step 1. Touch the type of data on the screen to be deleted.

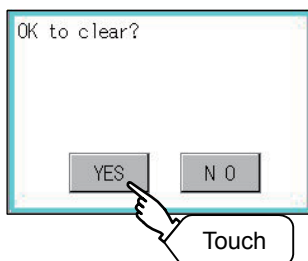

Step 2. The dialog box on the left is displayed for confirmation. Touch the [YES] button to delete the data, or the [NO] button to cancel.

POINT

Canceling deletion

Data deletion cannot be canceled once the [YES] button is pressed at the confirm deletion prompt.

Double check before touching the [YES] button.

15.7 Data Copy

The project data and basic system application are transferred by using an SD card.

POINT

Copy from the memory board to the GOT

Copying from the memory board to the GOT when turning on the power to the GOT.
Refer to the following.

➡ 18.1 Installation Method When the GOT is Turned On

15.7.1 Display operation of data copy

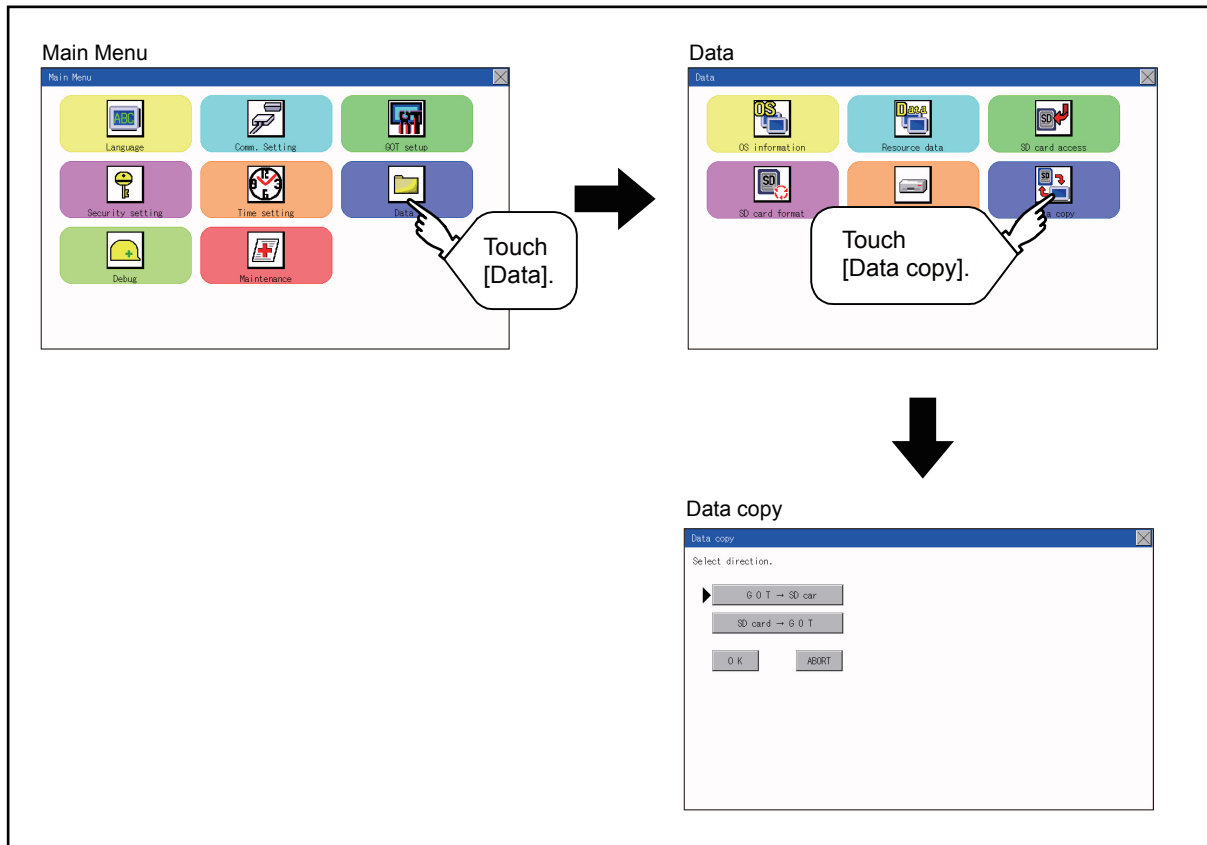

15.7.2 Operation of data copy

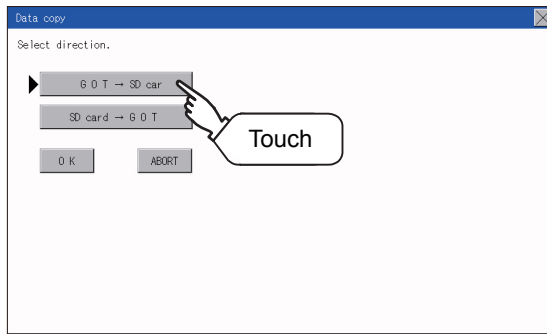

Step 1. Select the copy direction.
The selection mark is displayed on the side of the selected key.

GOT → SD card:
Copy from the GOT to the memory board

SD card → GOT:
Copy from the SD card to the GOT

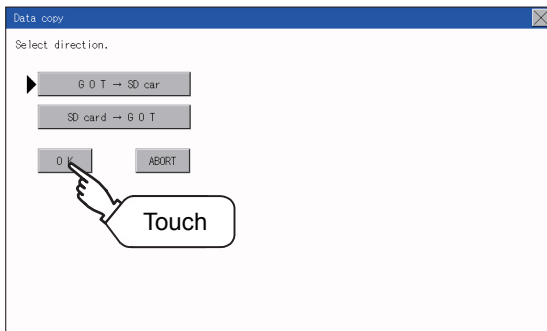

Step 2. After selecting the direction, touch the [OK] button. To abort copy, touch the [ABORT] button.

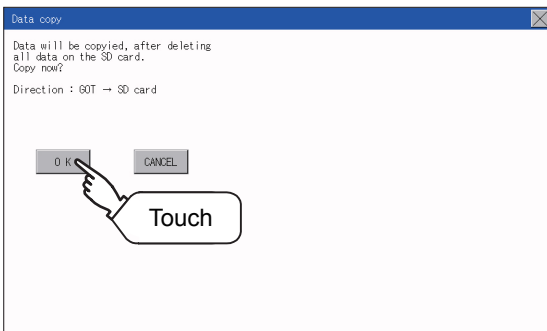

Step 3. Confirm the copy direction and copy target.
When they are set correctly, touch the [OK] button. To change the setting, touch the [CANCEL] button.

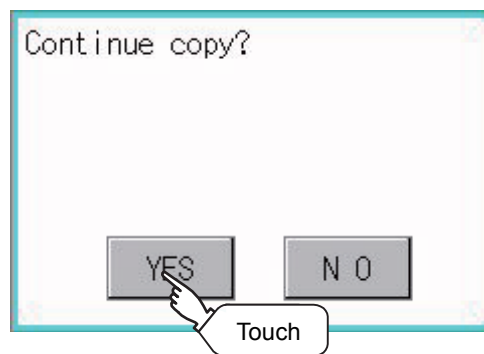

Step 4. The dialog box on the left is displayed for confirmation.
Touch the [YES] button to start copying and [NO] button to abort.

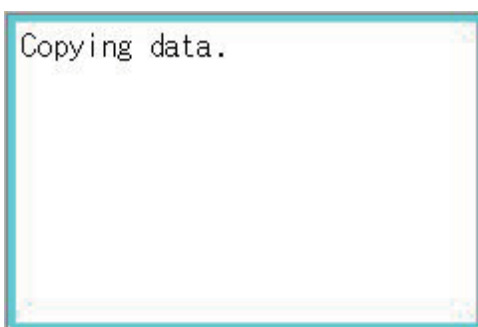

Step 5. While the copy is executed, the dialog box on the left is displayed.



Step 6. Copy is completed.
 If the [ESC] button is touched, the screen is closed.
 If an error occurs during copy, an error message appears.
 For details of error messages, refer to the following.

➡ **Error display**

When only the project data was copied to the GOT, touch the [ESC] button to restart the GOT and display the user-created screen.

When the basic system application was copied, the GOT will automatically start up and display the user-created screen.

(If the project data does not exist, a message appears to notify that the project data does not exist.)

POINT

When installing or removing an SD card

Always set [Permissions] on the GOT. For details, refer to the following.

➡ 15.4 SD Card Access

1. Error display

When copying is not available between the GOT and the SD card, check the following contents according to the GOT error display.

Error message	Remedy
SD card is not attached.	Install an SD card to the GOT.
GOT type is unmatch.	The model set for the data in the SD card does not match with that of the copy target GOT. Use the same model data as that of the copy target GOT.
Write protection switch ON.	The write protection switch of the SD card is ON. Turn off the write protection switch.
Available package data is notexisted.	There is no data to be a copy target in the copy source. Store the data to be copied in the copy source and copy it again.

16. GOT SELF CHECK (DEBUG)

The debug includes functions to check the PLC system status and to improve troubleshooting efficiency. The following is available as the debug.

Item	Description	Reference
Device monitor	For a controller connected to the GOT, forcibly turning on or off devices of the controller and changing the set value or present value are available.	➡ 16 - 1
FX list editor	The sequence program of FX PLC can be list edited.	➡ 16 - 14
FX3U-ENET-ADP communication setting function	The communication set value of the FX3U-ENET-ADP stored in the CPU can be changed.	➡ 16 - 42

16.1 Device Monitor Function

For a controller connected to the GOT, forcibly turning on or off devices of the controller and changing the set value or present value are available.

16.1.1 System configuration

This section describes the controller names and connection types between the GOT and a controller that are applicable to the device monitor function.

For details of communication units and cables for each connection type, refer to the following manual.

➡ GOT2000 Series Connection Manual For GT Works3 Version1

1. Target controller

Controller	Connection type
QCPU (Q mode)	Direct CPU connection, Computer link connection, CC-Link(G4) connection
QnACPU	Direct CPU connection, Computer link connection
FX CPU	Direct CPU connection

2. Required system application

System application	Version	
Basic system application	-	
Communication driver	MELSEC-Q/L/QnA	-
	MELSEC-FX	-
	CC-Link(G4)	-

POINT

Checking method of the version of basic system application and communication driver

Check the version of the basic system application and communication driver installed in the GOT at [System Application Information] of the utility.

Refer to the following for details.

➡ 15.2 System Application Information

16.1.2 Devices that can be monitored

For further information about the monitor device names that can be monitored and the scope, see the following:

➡ GT Designer3 (GOT2000) Help

16.1.3 Precautions

(1) Monitoring and testing real number data

Real number data cannot be monitored and tested.

All word devices containing real number data are monitored in integer data (binary data).

(2) Monitoring devices in 32-bit (two-word) module

When monitoring word devices (T, C, D, W, etc.) in 32-bit (two-word) module, those with 32 bits of data remaining are monitored.

Devices with 16 bits (one-word) of data remaining are not monitored.

If an odd number is specified for the first monitor device number, the last device number of the specified controller will not be displayed.

(Example) When the data entry of the QnACPU is monitored in units of 32 bits from odd numbers (D1, D3...)

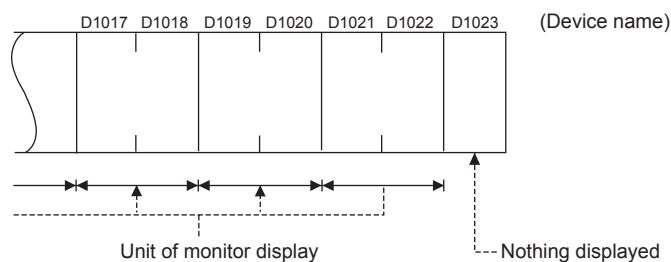

(3) Changing the timer/counter set values of QnACPU

The timer/counter set values of QnACPU whose date on the CPU rating plate is after [9707B] can be changed.

<Information on the rating plate>

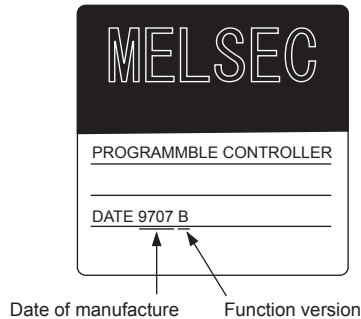

16.1.4 Display operation of device monitor

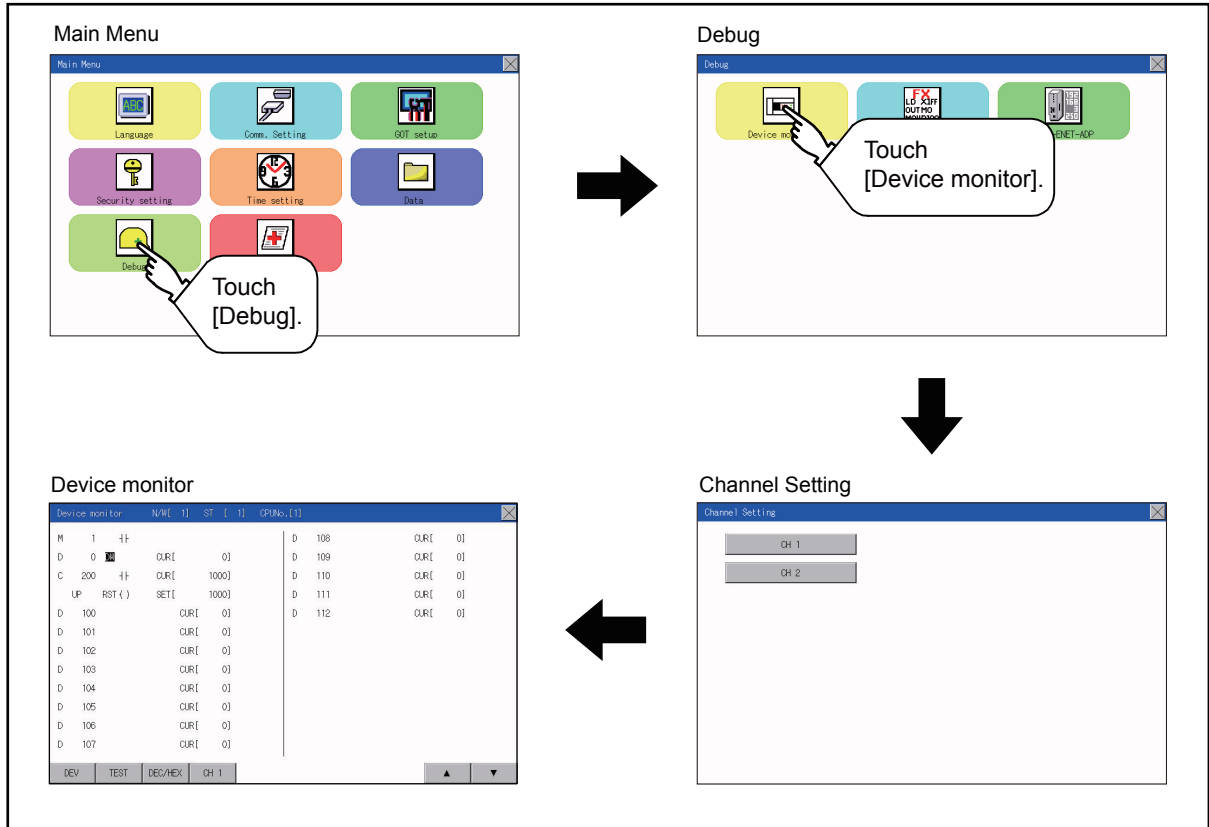



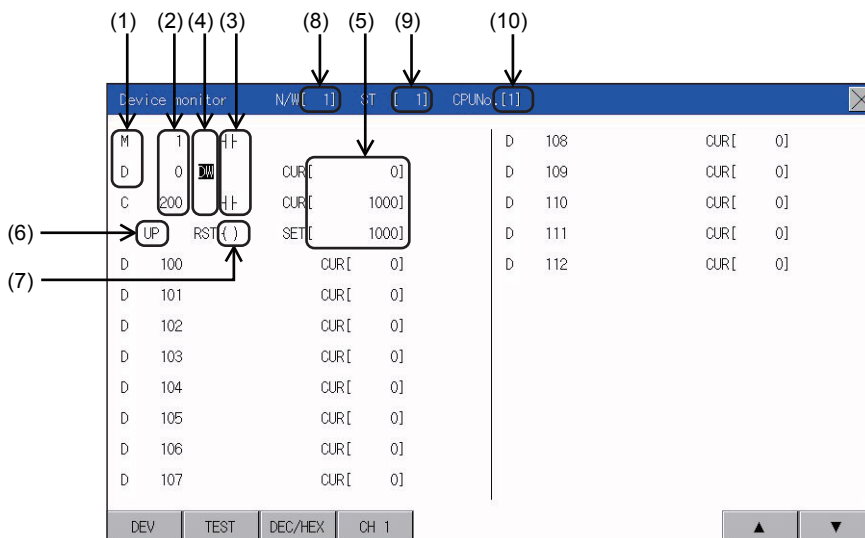

16.1.5 Information displayed on the device monitor screen and key functions

1. Device monitor screen

The information displayed on the device monitor screen is described below.



No.	Item	Settings
1)	Device name	Displays the device name.
2)	Device No.	Displays the device number.
3)	Bit device ON/OFF Timer/Counter contact ON/OFF	Displays ON/OFF information of bit devices and timer/counter contacts  : ON  : OFF
4)	Data type	DW : Indicates that the device value is a 32-bit (two-word) module. Nothing displayed: Indicates that the device value is a 16-bit (one-word) module.
5)	Present value of word device Present value and set value of timer/ counter*1	[Decimal number] 16-bit (one-word) module: Six digits (including a digit for a sign) are displayed. (Display example: -12345) 32-bit (two-word) module: Ten digits (including a digit for a sign) are displayed. (Display example: -123456789) [Hexadecimal number] 16-bit (one-word) module: Four digits are displayed. (Display example: H AB12) 32-bit (two-word) module: Eight digits are displayed. (Display example: H ABCDE123)
6)	Counting method	Displays the counting method when registering the counters from C200 to C255. UP: Up count mode DOWN: Down count mode
7)	Reset coil ON/OFF	Displays the reset coil state when registering the timer/counter for the FXCPU.  : ON  : OFF
8)	N/W	Sets or displays the network No. when the PLC is on the network.
9)	ST	Sets or displays the station No. when the station No. is assigned to the PLC.
10)	CPU No.	0 to 4: This item must be set only when the GOT is connected to the Q series CPU in the multiple CPU system or QnUCPU. Changing the CPU No. cancels the registration for all the devices.  16.1.7 Device registration

■2. Key functions

The following table describes the key functions displayed on the device monitor screen.

Key switch	Function
DEV	Switches the screen to the device registration key window for registering devices to be monitored. ➡ 16.1.7 Device registration
TEST	Switches the quick test mode between enabled and disabled states. ➡ 16.1.8 Quick test
DEC/HEX	Switches the numerical notation of word device values between decimal and hexadecimal numbers.
▲ ▼	Scrolls the data list up and down by one line and displays the devices before or after the device which is currently registered and placed in the top or bottom line. ▲: Scrolls the list up by one line to display the device number right before the device number displayed in the top line. ▼: Scrolls the list down by one line to display the device number right after the device number displayed in the bottom line.
×	Exits the device monitor, and then the screen returns to the debug screen.

16.1.6 Basic operation of device monitor

The following explains basic operations of the device monitor.

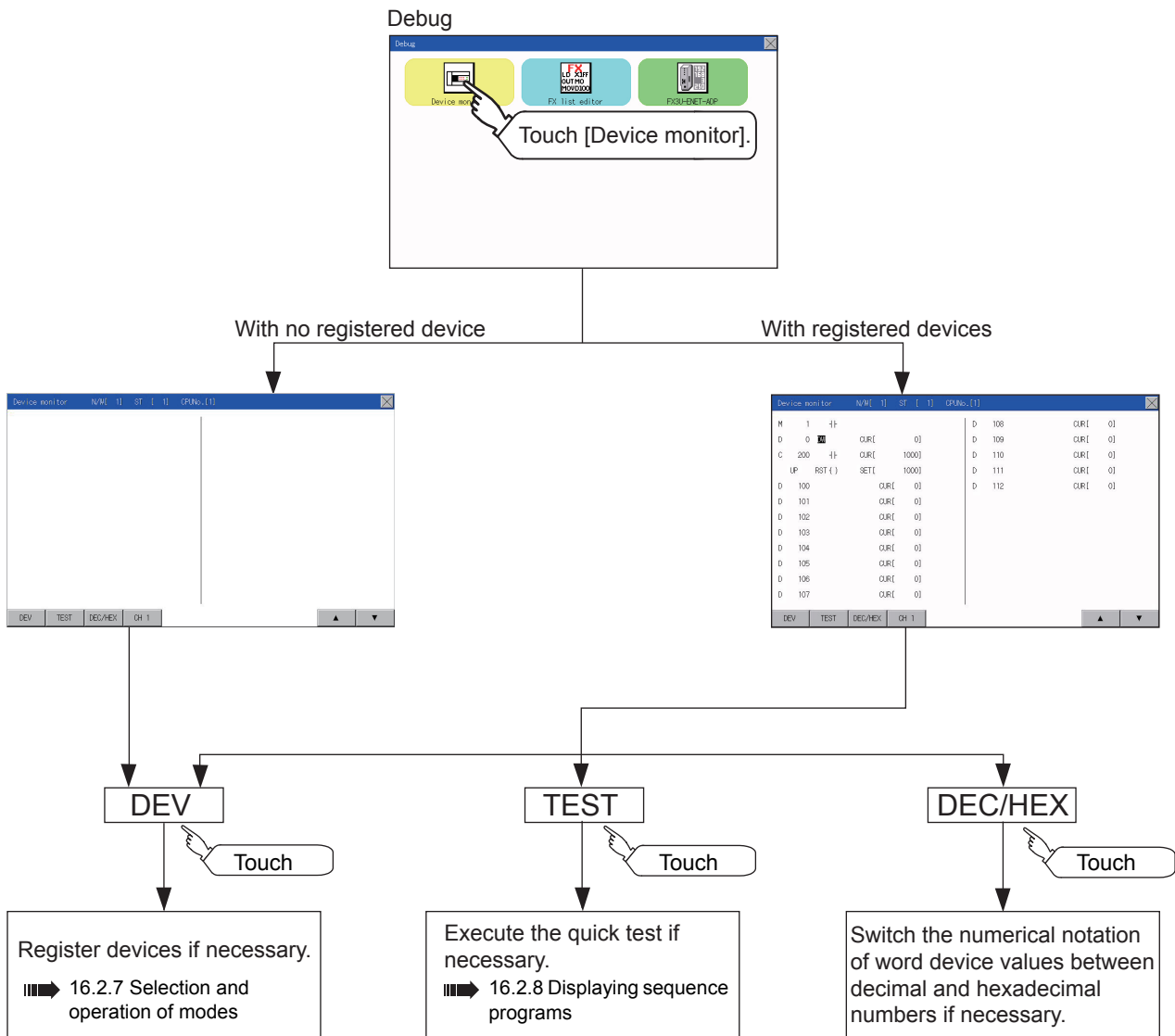

16.1.7 Device registration

The following explains the procedures for device registration.

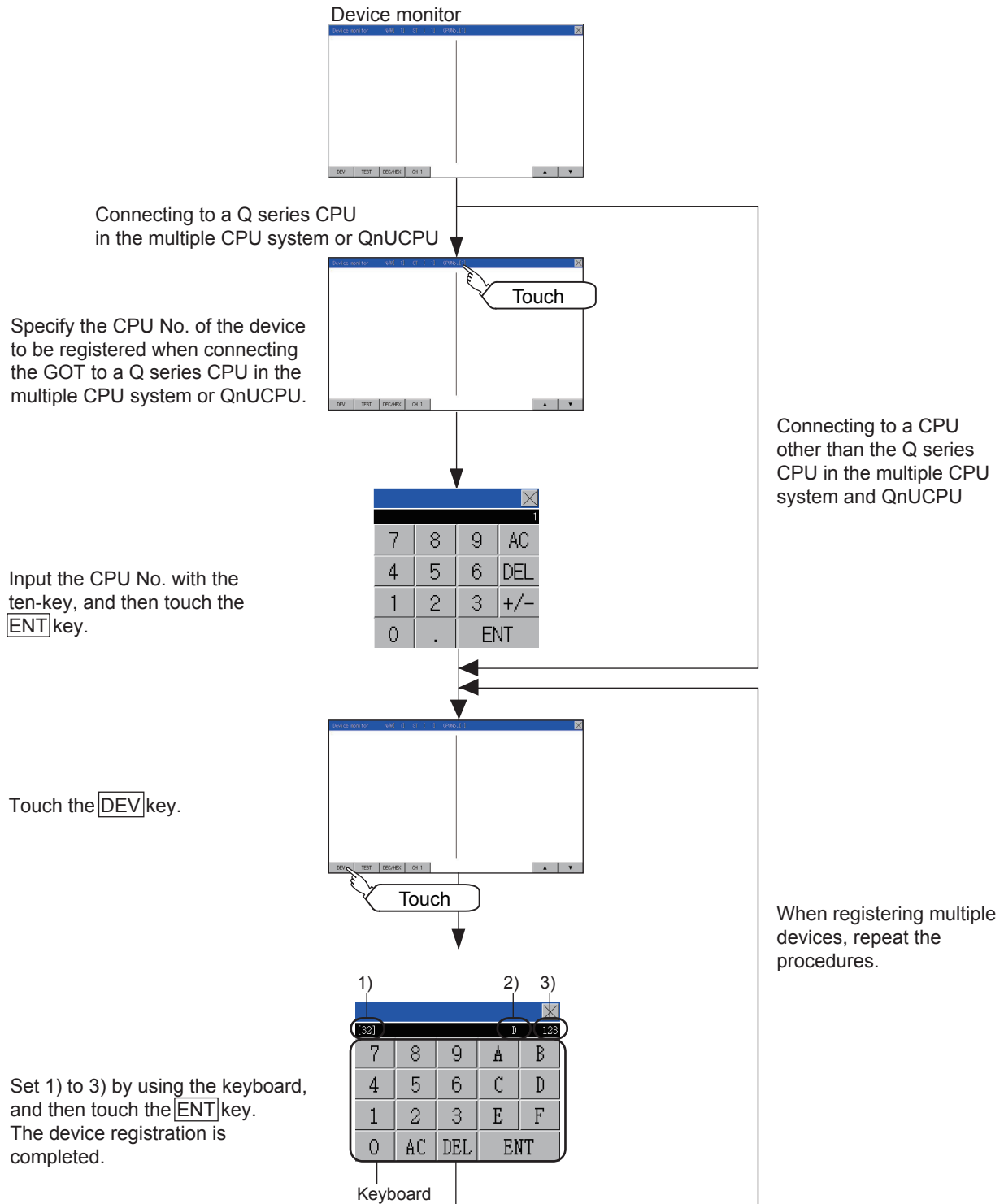

For the keyboard operations, refer to the next page.

No.	Item	Settings
1)	Data type	32 : Indicates that the device value is a 32-bit (two-word) module. Nothing displayed: Indicates that the device value is a 16-bit (one-word) module.
2)	Device name	Set the device name and device number to be monitored.
3)	Device No.	

POINT

Keyboard operations

(1) Keyboard functions

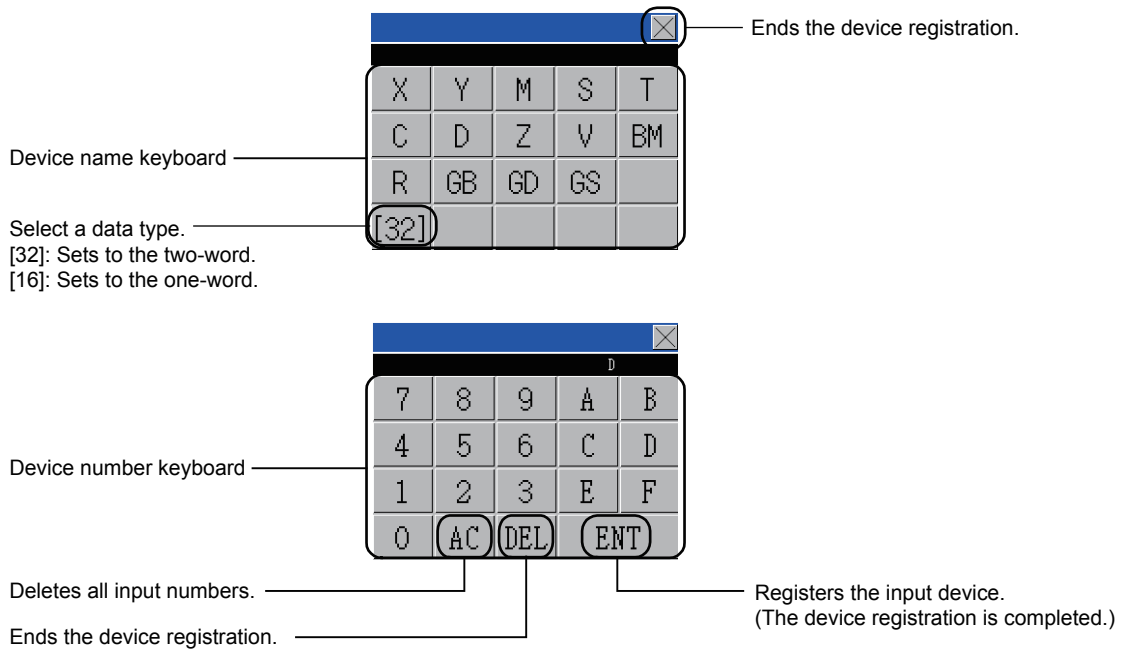

(2) Input procedures

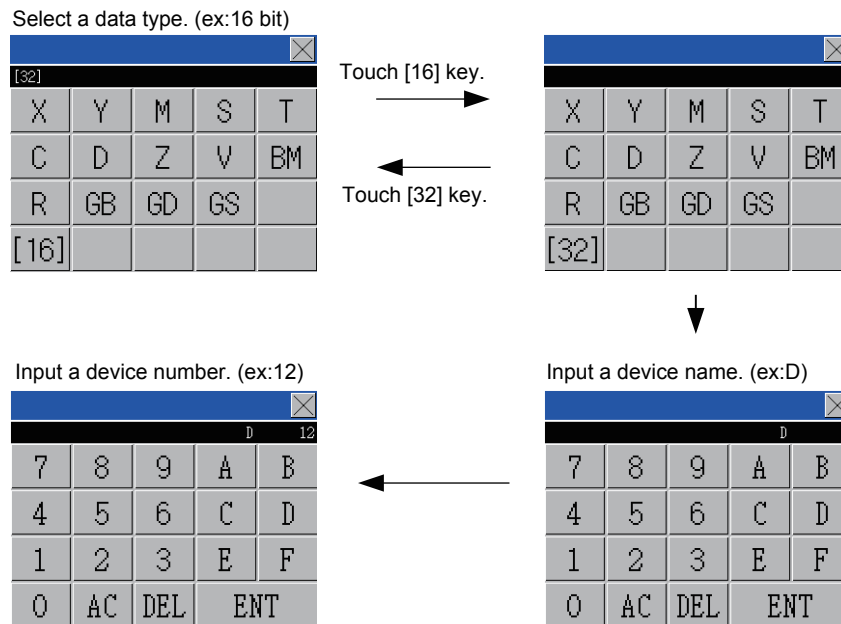

The device registration is completed by touching the [ENT] key.



POINT

Precautions for device registration

(1) Data type

Device monitor screens display the data type as shown below.

- DW : 32-bit (two-word) module
- Nothing displayed : 16-bit (one-word) module

(2) CPU No. specification

Changing the CPU No. after registering devices cancels the registration for all the devices.
Check the CPU No. before registering the devices.

(3) Station No. specification

Changing the station No. after registering devices cancels the registration for all the devices.
Check the station No. before registering the devices.

(4) Holding registered devices

The registration for the devices is not canceled after exiting the device monitor.
Restarting the GOT cancels the registration for all the devices.

(5) The number of registered devices

The number of registered devices must be within the maximum number of devices that can be displayed on the GOT.

For registering an additional device, the registration for the device in the top line is canceled and the additional device is displayed in the bottom.

16.1.8 Quick test

WARNING

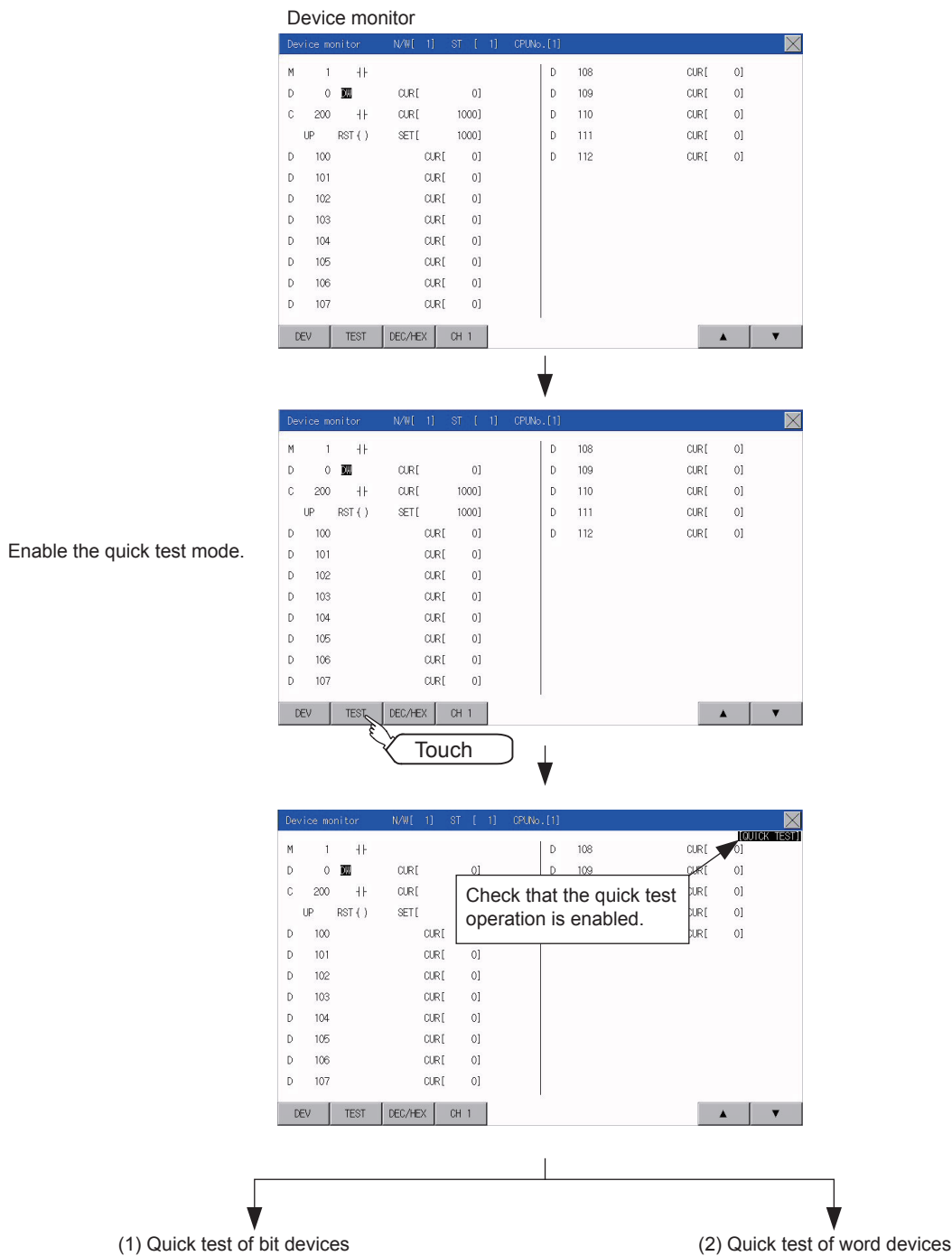

- Before performing the quick test operations of device monitor (such as turning ON or OFF bit device, changing the word device current value, changing the settings or current values of the timer or counter), read through the manual carefully and make yourself familiar with the operation method.
During quick test operation, never change the data of the devices which are used to perform significant operation for the system. False output or malfunction can cause an accident.

The quick test operation procedure for monitor devices is described below.







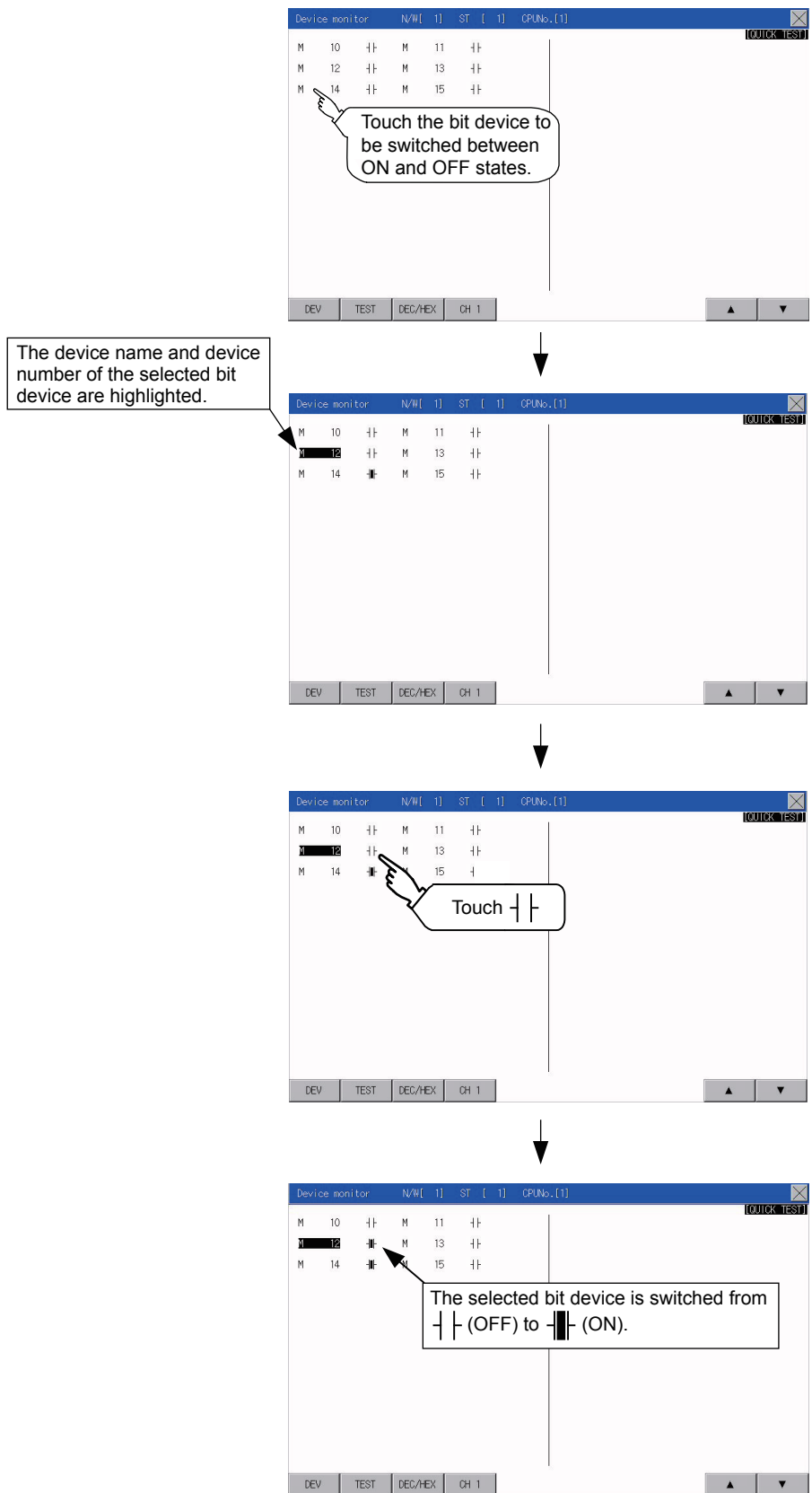

(1) Quick test of bit devices

(Operation example)

Change the status of bit device M12 from OFF  to ON .





The screenshots show the 'Device monitor' window with the following data:

DEV	TEST	DEC/HEX	CH 1
M 10		M 11	
M 12		M 13	
M 14		M 15	

Callout 1: Touch the bit device to be switched between ON and OFF states.

Callout 2: The device name and device number of the selected bit device are highlighted.

Callout 3: Touch .

Callout 4: The selected bit device is switched from  (OFF) to  (ON).

(2) Quick test of word devices

(Operation example)

Change the device value of word device D200 from 43 to 100.

Conditions: Data range: 16 bits, device value display format: decimal number

Device monitor

DEV	TEST	DEC/HEX	CH 1
D 199	CUR[1]		
D 200	CUR[43]		
D 201	CUR[50]		

Touch the device value to be changed.

Input a device value by using the keyboard.
Input "100" for the operation example.

Device monitor

DEV	TEST	DEC/HEX	CH 1
D 199	CUR[1]		
D 200	CUR[43]		
D 201	CUR[50]		

7 8 9 AC
4 5 6 DEL
1 2 3 +/-
0 . ENT

Touch [ENT] key.

Device monitor

DEV	TEST	DEC/HEX	CH 1
D 199	CUR[1]		
D 200	CUR[100]		
D 201	CUR[50]		

7 8 9 AC
4 5 6 DEL
1 2 3 +/-
0 . ENT

The device value of D200 is changed from 43 to 100.

POINT

When the cursor is displayed

When the cursor is displayed, touch the [▲] or [▼] key to move the cursor to the upper or lower registered device.

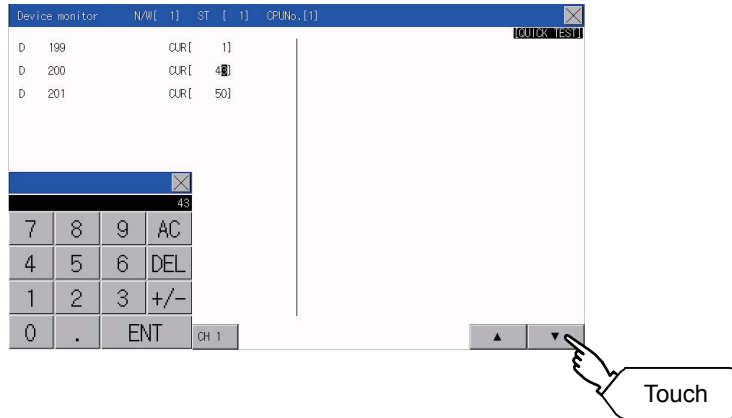

16.2 FX List Editor

The MELSEC-FX list editor can change the sequence programs on the FX PLC.

16.2.1 Display operation of FX list editor

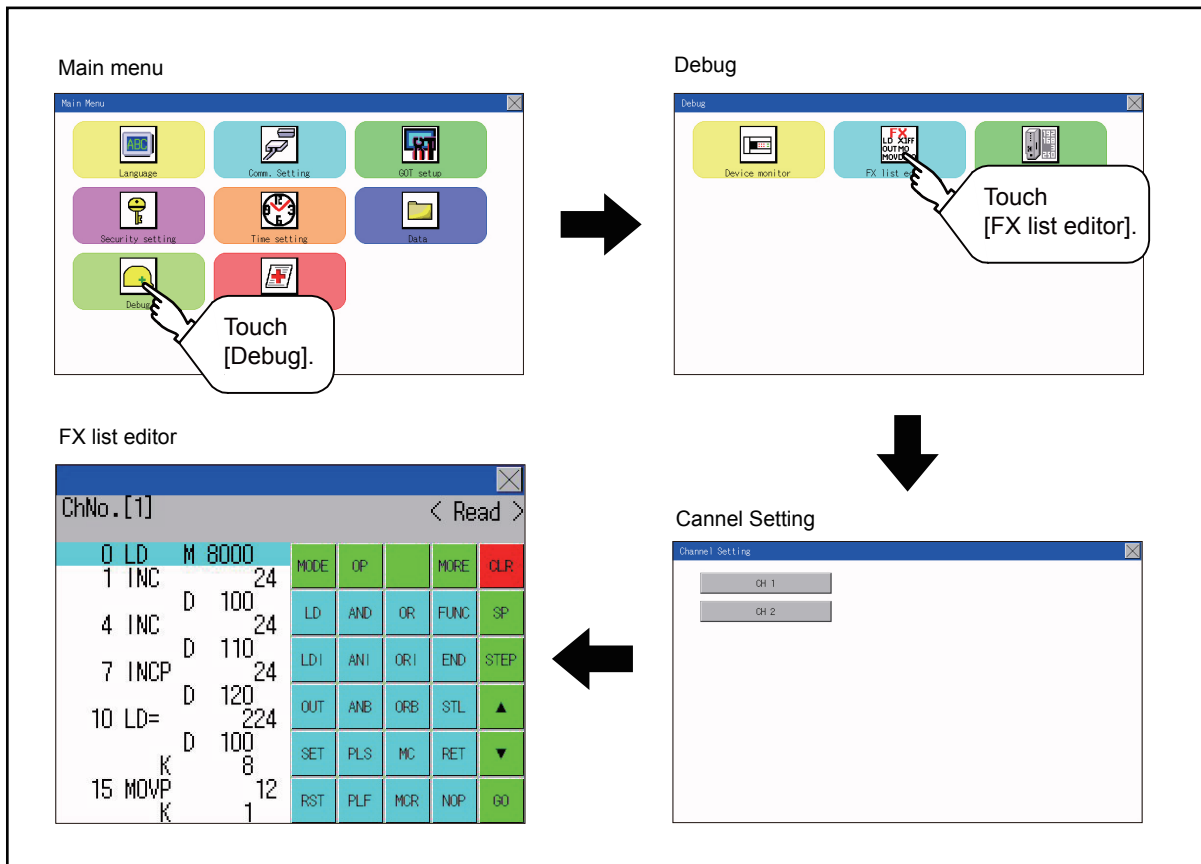

1. Parameters and sequence programs are easy to maintain.

You can check or partly correct, change or add FX PLC parameters and sequence programs simply by operating keys. You can easily edit sequence programs without preparing any peripheral unit other than the GOT.

(Example of changing sequence program commands)



2. Errors that occur during list editing can be checked easily.

Error messages, error codes, and number of steps for errors that occur in the FX PLC can be checked. Details can be checked immediately even for errors that occur during list editing.

Error message	Detail	Step
I/O configuration error	1010	
PC/HPP communication error	6201	

3. Commands and devices can be searched and displayed.

Commands and devices used in sequence programs can be searched. The correction position can be searched for cases such as when you want to correct a specific device.

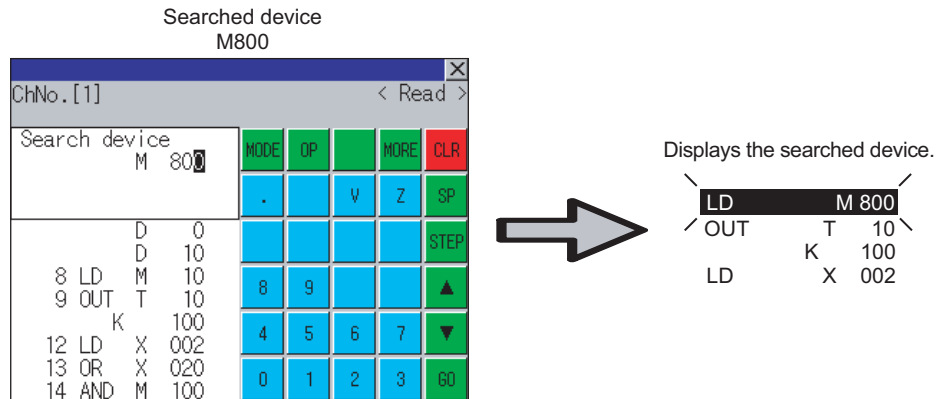

16.2.2 Specifications

1. System configuration

This section describes the system configuration of the MELSEC-FX list editor.

For the setting method in each connection form, used communication unit/cable and cautions on connection form, refer to the following manual.

GOT2000 Series Connection Manual For GT Works3 Version1

2. Controllers that can be edited with the MELSEC-FX list editor

Target controller
FX CPU

3. Functions list and monitor conditions

The following shows the memory that can be monitored by the MELSEC-FX list editor and the FX PLC status conditions.

(○: Can be monitored △: Can be monitored under certain conditions ×: Cannot be monitored)

Function		Memory that can be monitored *2				FX PLC status	Reference
		Built-in memory	RAM memory cassette	EEPROM memory cassette, flash memory cassette	EPROM memory cassette		
Reading sequence programs	Displaying sequence programs	○	○	○	○	RUN/STOP	➡ 16.2.8
	Searching commands/devices						➡ 16.2.9
Writing sequence programs	Writing commands					For Stop only	➡ 16.2.10
	Changing operands/set values						➡ 16.2.12
Inserting commands		○	○	△*1	×		➡ 16.2.10
Deleting commands							➡ 16.2.12
Sequence program all clear							➡ 16.2.13
PLC diagnostics		○	○	○	○		➡ 16.2.14
Parameter setting	Display	○	○	○	○	For Stop only	➡ 16.2.15
	Setting	○	○	△*1	×		
Keyword		○	○	○	○	RUN/STOP	➡ 16.2.16

*1 The operation is available only when the protect switch is OFF.

*2 The available memory differs depending on the FX PLC being used. For details, refer to the following.

➡ The hardware manual of the FX PLC being used

16.2.3 Access range

The access range is the same as the access range when the GOT is connected to a controller.
For details of the access range, refer to the following.

- ▶▶ GT Designer3 (GOT2000) Help
GOT2000 Series Connection Manual (Mitsubishi Product) For GT Works3 Version1

16.2.4 Precautions

(1) Using other peripheral equipment for sequence program/parameter change

When using the MELSEC-FX list editor, do not change programs or parameters in the PLC CPU from other peripheral equipment.

If programs or parameters are changed, exit the MELSEC-FX list editor once and start the MELSEC-FX list editor again.

If the program on one PLC is changed carelessly from multiple units of peripheral equipment (including GOT), the contents of the program in the PLC CPU and the peripheral equipment may not be the same, resulting in an unintended operation of the PLC CPU.

(2) Sequence program change

Stop the FX PLC before changing (writing, inserting, deleting) a sequence program or changing parameters.
Operation is not possible with the FX PLC running.

(3) If you press the [GO] key but the system does not proceed to the next operation (for example, a search)

Check the input contents (applied instruction number, device value, etc.).

(4) When using list monitor

Only devices to be used for basic instructions can be monitored.

The status of devices (word, bit) to be used for application instructions cannot be monitored.

16.2.5 Display operation

1. Operation to display

The following describes the outline for displaying the operation screen of the MELSEC-FX list editor.

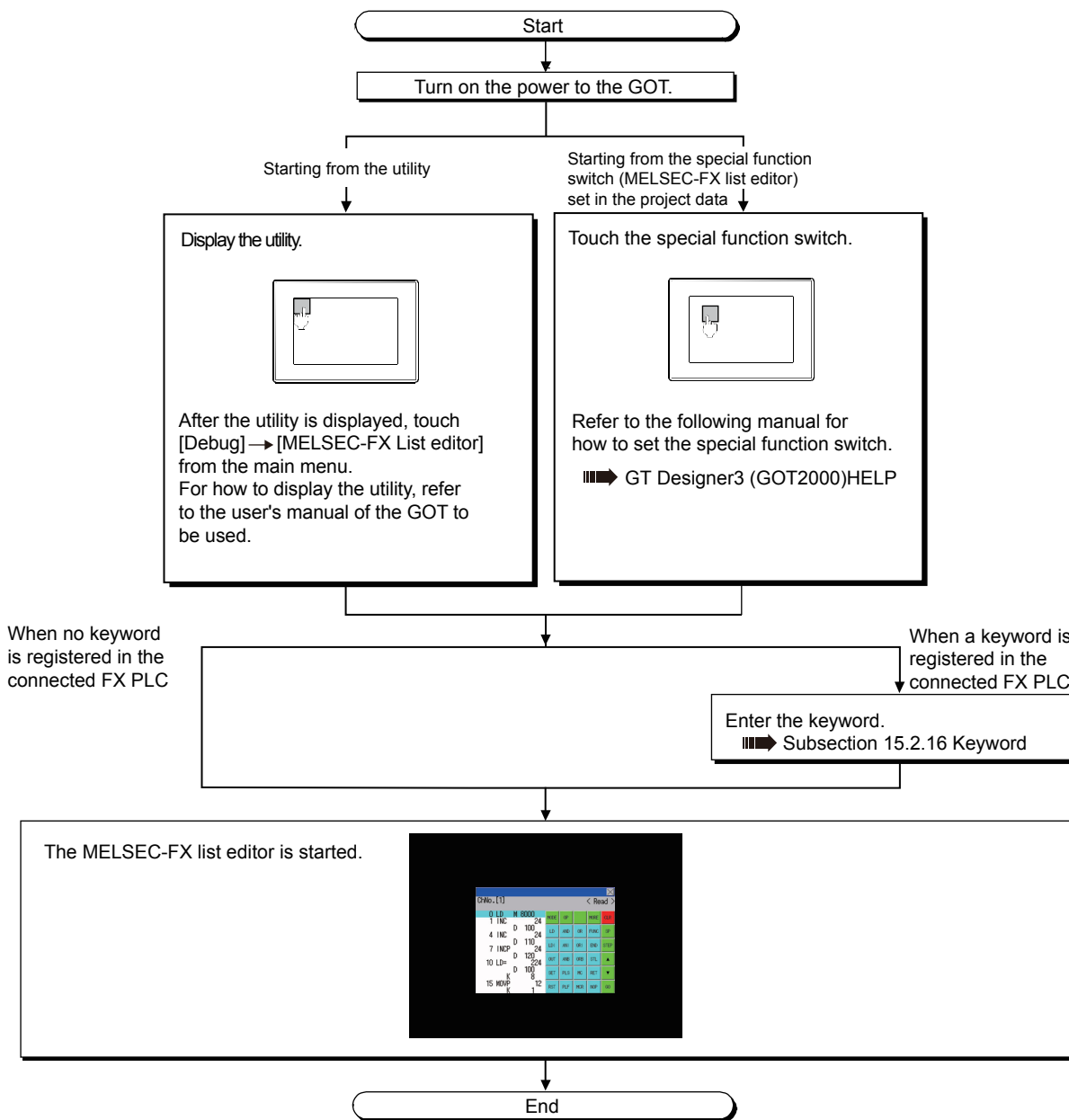

POINT

(1) How to display the utility

For how to display the utility, refer to the following.

➡ 9.2 Utility Function List

(2) If the project data has not been downloaded

The MELSEC-FX list editor can be started from the utility even if the project data has not been downloaded to the GOT.

2. Changing screens

This section describes how to change the screen.

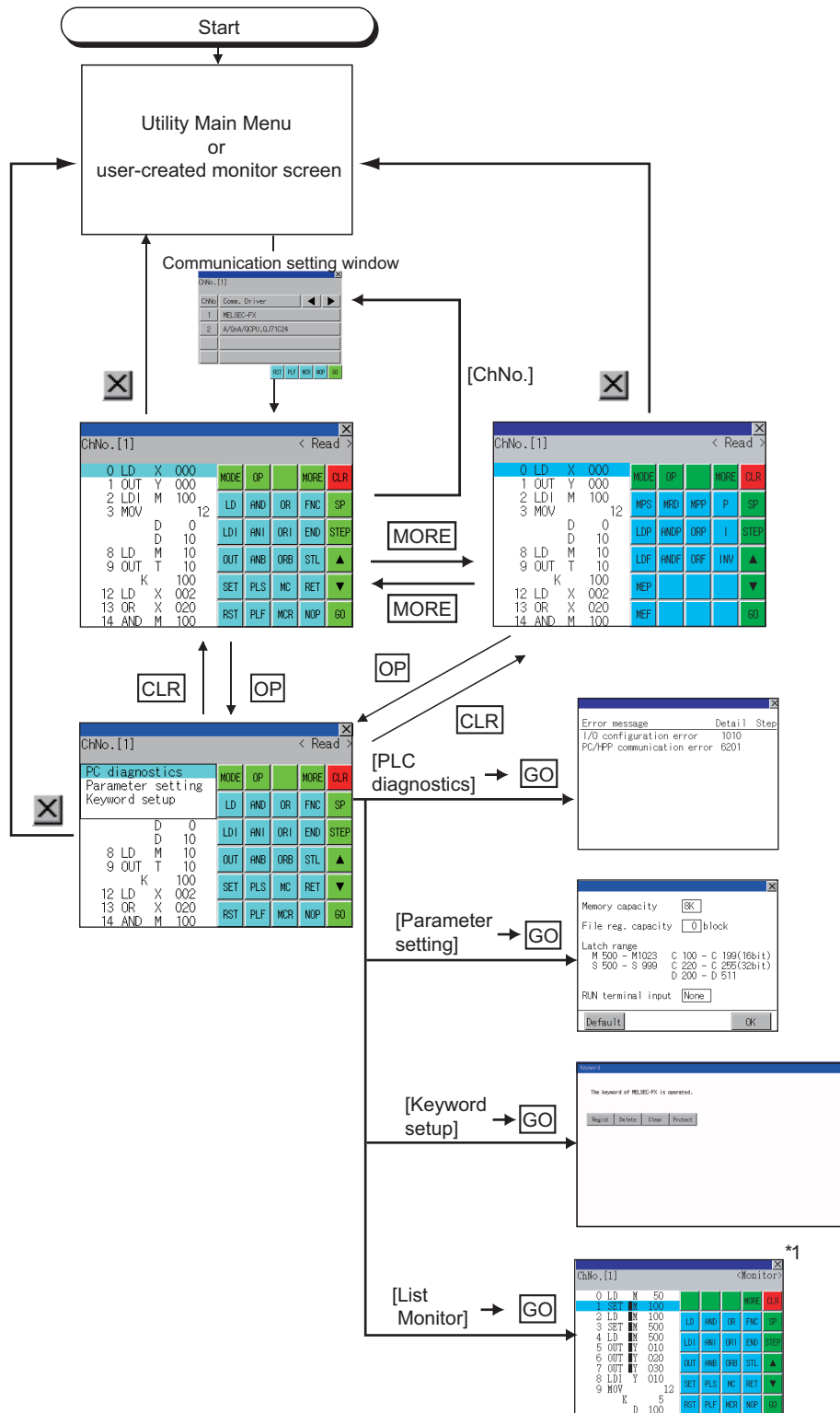

*1 With setting special function switches (FX list monitor), the list monitor can be started on the monitor screen. When the list monitor is started on the monitor screen, the list editor cannot be used. For how to set special function switches, refer to the following.

➡ GT Designer3 (GOT2000) Help

16.2.6 Operation procedures

This section describes the contents of the MELSEC-FX list editor and the key functions displayed on the screen.

1. Key arrangement and a list of key functions

The arrangement and functions of the keys displayed on the MELSEC-FX List Editor window are described below.

2. Displayed contents

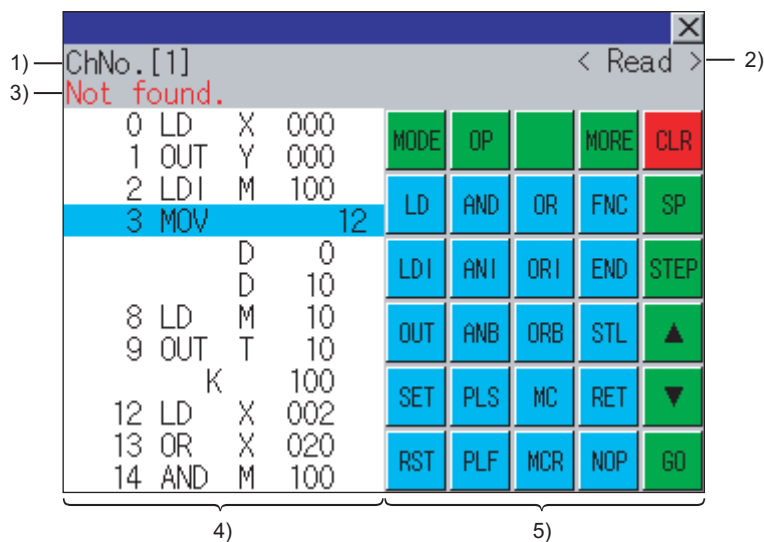

No.	Item	Display contents
1)	Channel No	Displays the currently selected channel number. Touching "ChNo." displays the communication setting window. The communication setting window is not displayed if the MELSEC-FX list editor is started from the FX ladder monitor.
2)	Mode	Displays a mode for MELSEC-FX list editor. ➡ 16.2.7 Selection and operation of modes [Monitor] is displayed when the list monitor is executed. ➡ 16.2.17 List monitor
3)	Error message	Displays the contents of errors that occur with the MELSEC-FX list editor. ➡ 16.2.19 Error messages and corrective actions
4)	List display area	Displays the sequence program in list format (12 digits). The position (line) that can be edited is displayed with a bar.
5)	Key area	Displays the keys that can be used with the MELSEC-FX list editor.

3. Key functions

The table below shows the functions of the keys that are used for the operation on the MELSEC-FX list editor screen.

Key	Function
ChNo. [1]	Displays the currently selected channel number. The communication setting window is not displayed if the MELSEC-FX list editor is started from the FX ladder monitor.
MODE	Selects a mode for MELSEC-FX list editor. ➡ 16.2.7 Selection and operation of modes
OP	Displays the PLC diagnostics, parameter setting, and keyword selection menu.
MORE	Switches between command keyboard 1 and command keyboard 2. ➡ 4. Keyboard switching
CLR	When inputting commands: Cancels the key input when only part of the command has been input. ➡ 16.2.18 Action for an incorrect key input When option menu is displayed: Closes the option menu. Commands cannot be deleted with this key. ➡ 16.2.12 Deleting commands
SP	Space key. This key is used when setting timers and counters, writing applied commands, etc.
STEP	Displays the list from a specified step number when the step number is input.
▲ ▼	Moves the list display area bar up and down and switches the line being edited.
GO	Determines the key operation.
LD to INV, 0 to 9, etc.	Inputs commands, device names, etc. The key contents depend on the input contents. The commands that can be used differ depending on the target FX PLC. Refer to the manual for the FX PLC to be used.
⊗	Exits the MELSEC-FX list editor.

4. Keyboard switching

Touching the MORE button switches the command keyboard 1 and command keyboard 2.

When you touch the button for a keyboard function, the optimum keyboard for input for that function is displayed automatically.

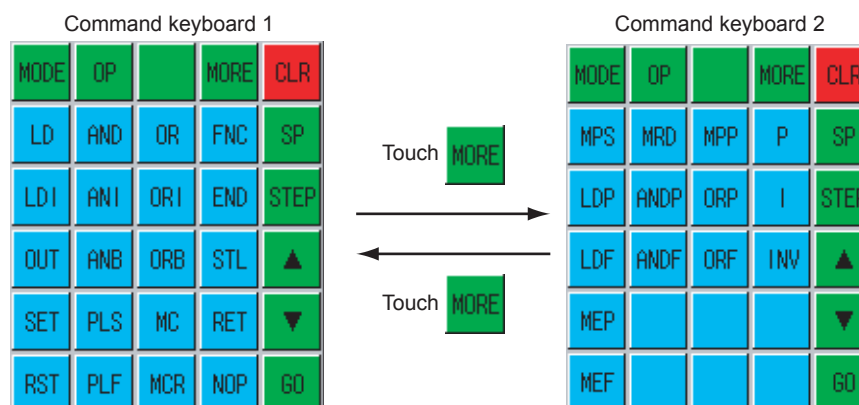

16.2.7 Selection and operation of modes

The MELSEC-FX list editor has four modes: READ, WRITE, INSERT, and DELETE.

Select an appropriate mode for the intended operation.

For more information on the mode to select, refer to the function operations from subsection 15.3.8.

1. How to change modes

Touch the MODE button.

Each time you touch this button, the mode changes.

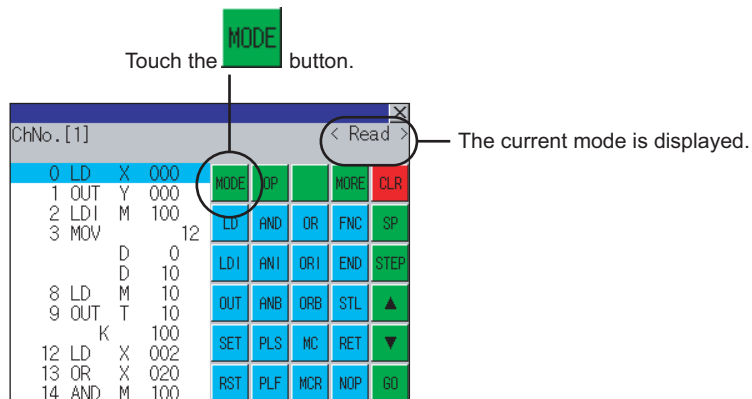

2. In the case the mode cannot be changed

In the following cases, the mode can be changed to the READ mode only.

If you try to change to other than READ mode, an error message is displayed.

To change to other than READ mode, take the action below.

Error message	Cause	Corrective action
PLC is running	The FX PLC is in the RUN status.	Stop the FX PLC.
Can not write.	The protect switch of the EEPROM memory cassette is on.	Switch off the protect switch of the EEPROM memory cassette.
	The EPROM memory cassette is enabled.	Set a memory other than EPROM as the memory to write to.

16.2.8 Displaying sequence programs

Sequence programs are read from the FX PLC to the GOT and displayed.
There are two displaying methods: specifying the step number, and scrolling one screen at a time.

1. Display using cursor keys

(1) Operation

Scroll with  OR 

(2) Example

Scroll one line upward or downward.

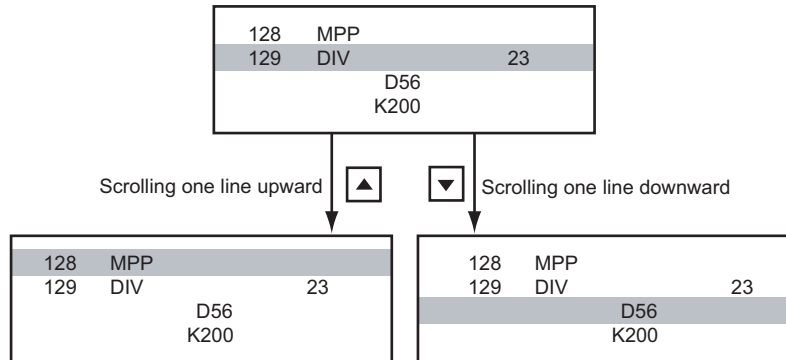

2. Display specifying the step number

(1) Operation

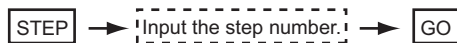

(2) Example

Displaying step number 123.

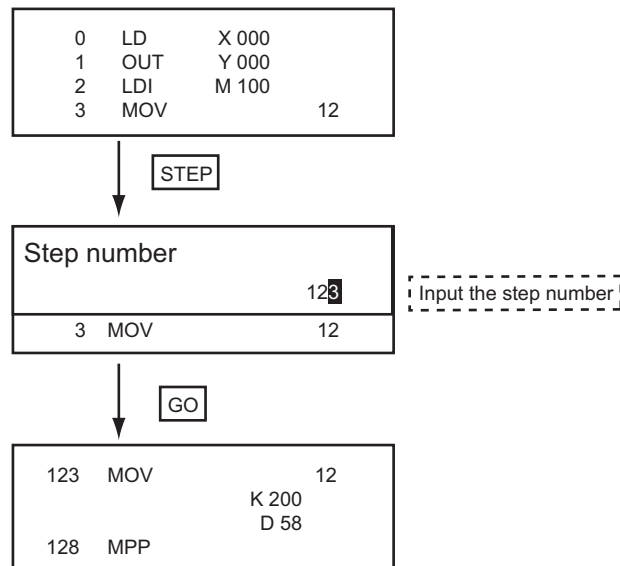

POINT

When the specified step number is the operand of an applied instruction

If the specified step number is a timer (T) or counter (C) set value or the operand of an applied instruction, that command section is displayed at the head.

■3. Display scrolling one screen at a time

(1) Operation

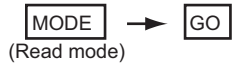

(2) Example

Displaying with scrolling one screen at a time.

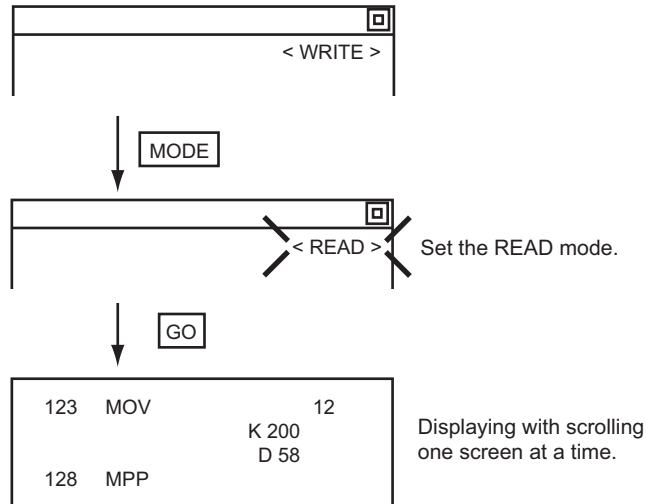

16.2.9 Searching commands/devices

Displays a command or device by searching it in sequence program from Step 0.

1. Command search

(1) Operation



- *1 If the command you want to search for is not on the keyboard, touch the **MORE** key to switch to the other keyboard. When searching for an applied instruction, touch the **FNC** key and input the applied instruction number. When searching for a label, touch **P** or **I** and input the pointer number.

➡ 16.2.10 Writing commands

- *2 Input only when searching for commands requiring a device name and device number.

- *3 After the search results are displayed, you can continue searching with the same conditions by touching the **GO** key. Touching any key other than the **GO** key ends the search.

(2) Example

Searching for LD M8000

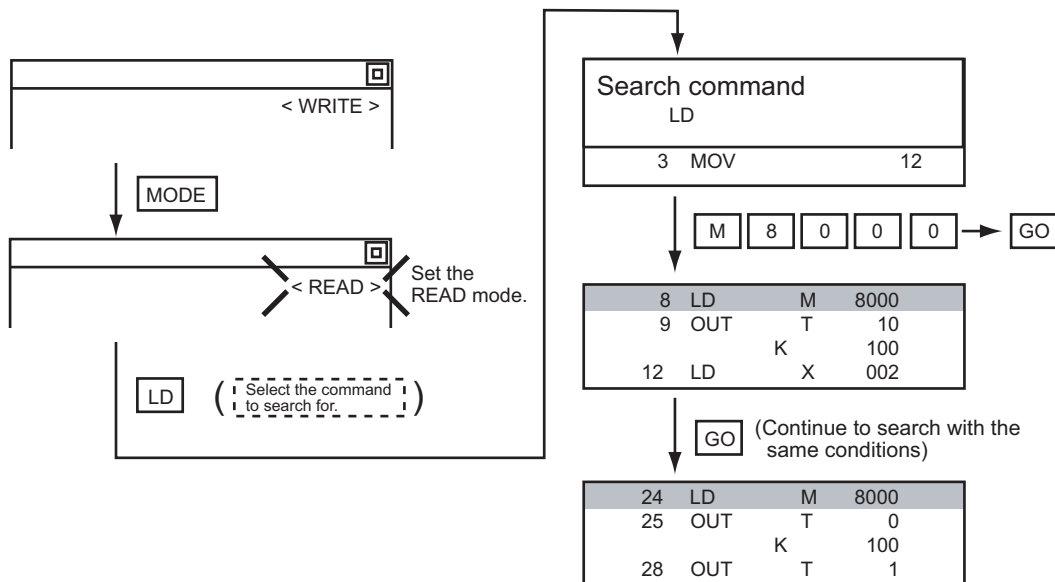

POINT

Pointer (P, I) searches

For pointer searches, only labels are searched.

Pointers specified as operands in applied instructions are not searched.

2. Device search

(1) Operation

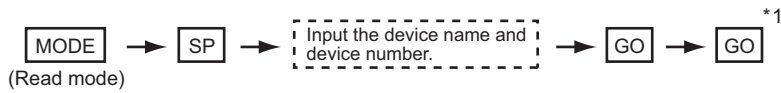

*1 After the search results are displayed, you can continue searching with the same conditions by touching the **GO** key. Touching any key other than the **GO** key ends the search.

(2) Example

Searching for LD M8000

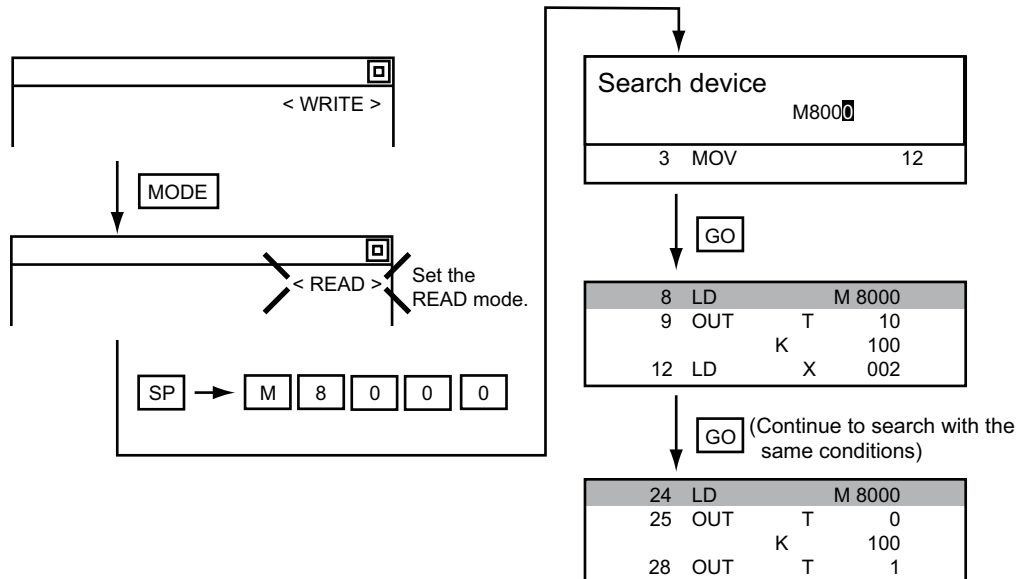

POINT

Devices that cannot be searched

The following devices cannot be searched.

- Pointers, interrupt pointers
- Constant K, constant H, constant E
- Digit specification of bit device
- Special function unit/block buffer memory
- Devices specified with the operand of an applied instruction

Pointers and interrupt pointers can be searched for with command searches.

➡ **1. Command search**

16.2.10 Writing commands

Writes a sequence program to the FX PLC. (Overwrite/Insert)

1. Writing basic commands

(1) Operations

- (a) Inputting command only (Ex.: ANB, ORB command etc.)

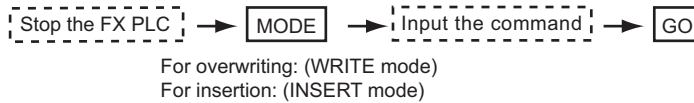

- (b) Inputting command and device (LD, AND commands etc.)

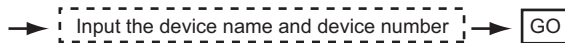
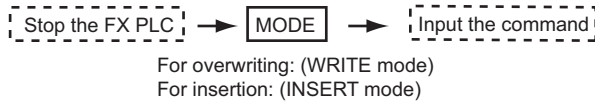

- (c) Inputting command, No. 1 device, No. 2 device (MC, OUT (T, C) commands, etc.)

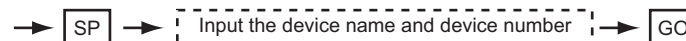
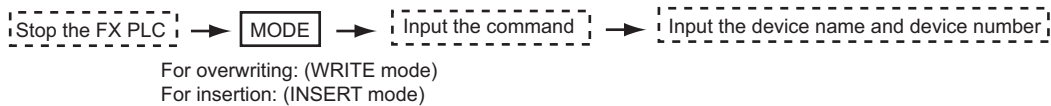

POINT

Moving the cursor to the position to write the command

When starting to write a command, place the cursor on the command line (the line on which the step number is displayed).

You cannot write a command with the cursor on an operand or set value line.

2	LDI	M	100	} Command line (Place the cursor on this line.)
3	MOV		12	
		D	0	} Operand, set value line (Cannot operate on this line.)
		D	10	

(2) Example

- (a) Writing ORB command

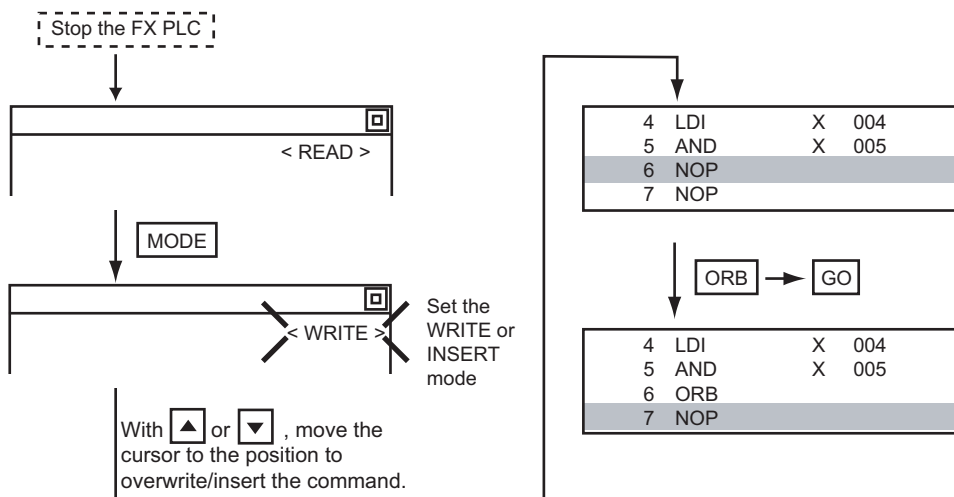

(b) Inputting LD X000

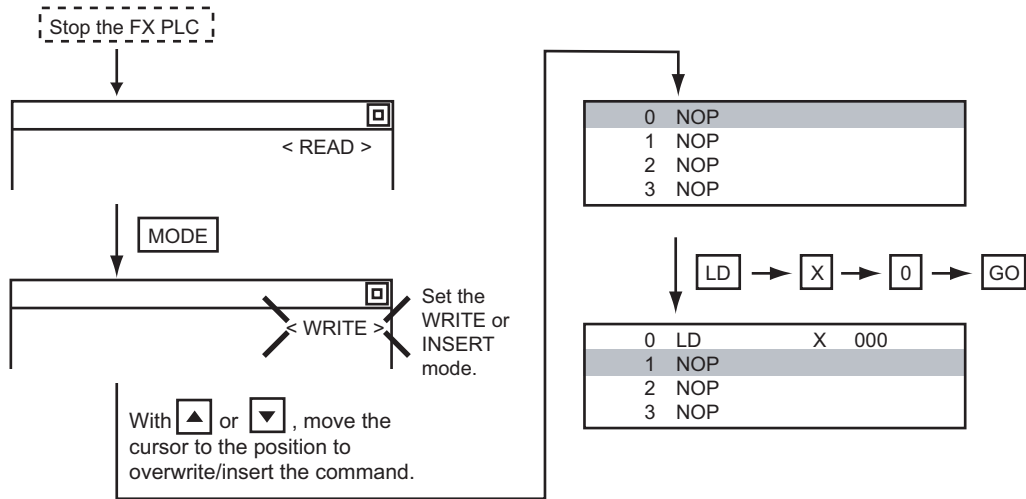

(c) Inputting OUT T100 K19

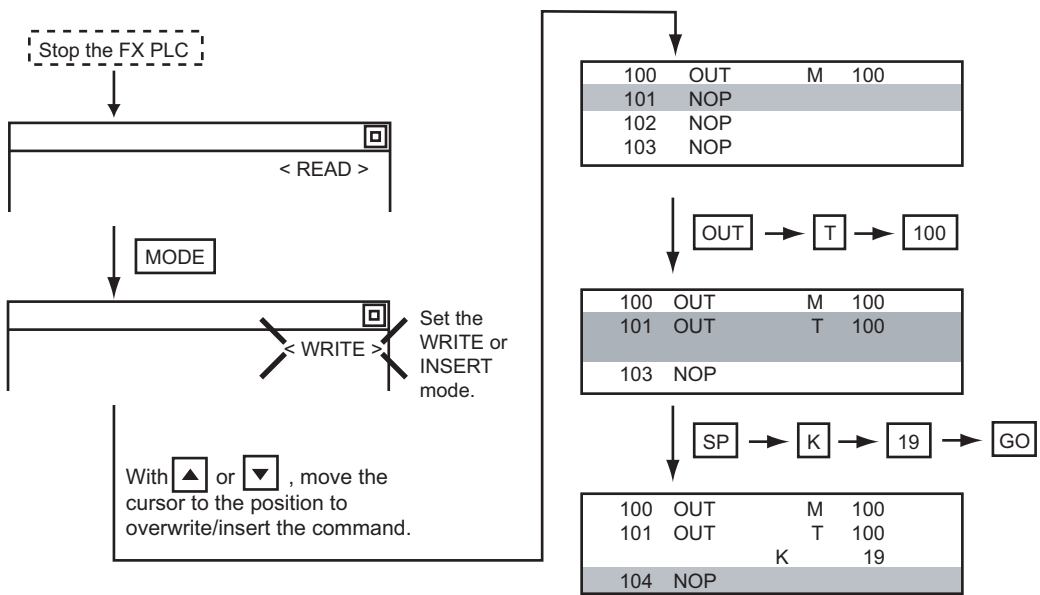

2. Writing applied instructions

(1) Operation

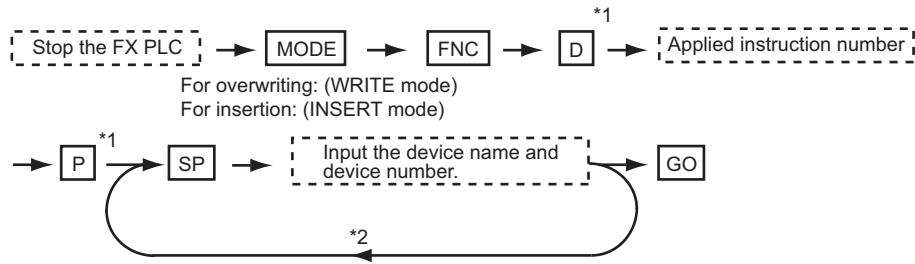

*1 **D** (double word command) and **P** (pulse execution format command) can also be input after the applied instruction number is input.

*2 Inputting in the order **P** → **D** is also possible.

*3 When a command specifies multiple devices for operations, input the **SP** key followed by the device name and device number.

POINT

(1) Moving the cursor to the position to write the command

When starting to write a command, place the cursor on the command line (the line on which the step number is displayed).

You cannot write a command with the cursor on any other line.

2	LDI	M	100	} Command line (Place the cursor on this line.)
3	MOV		12	
		D	0	} Operand, set value line (Cannot operate on this line.)
		D	10	

(2) Commands using a text string constant for a command operand (such as ASC command)

With the MELSEC-FX list editor, text string constants cannot be written as operands. (such as ASC commands)

Use GX Developer for writing such commands.

(2) Example

Input "DMOVP D0 D2".

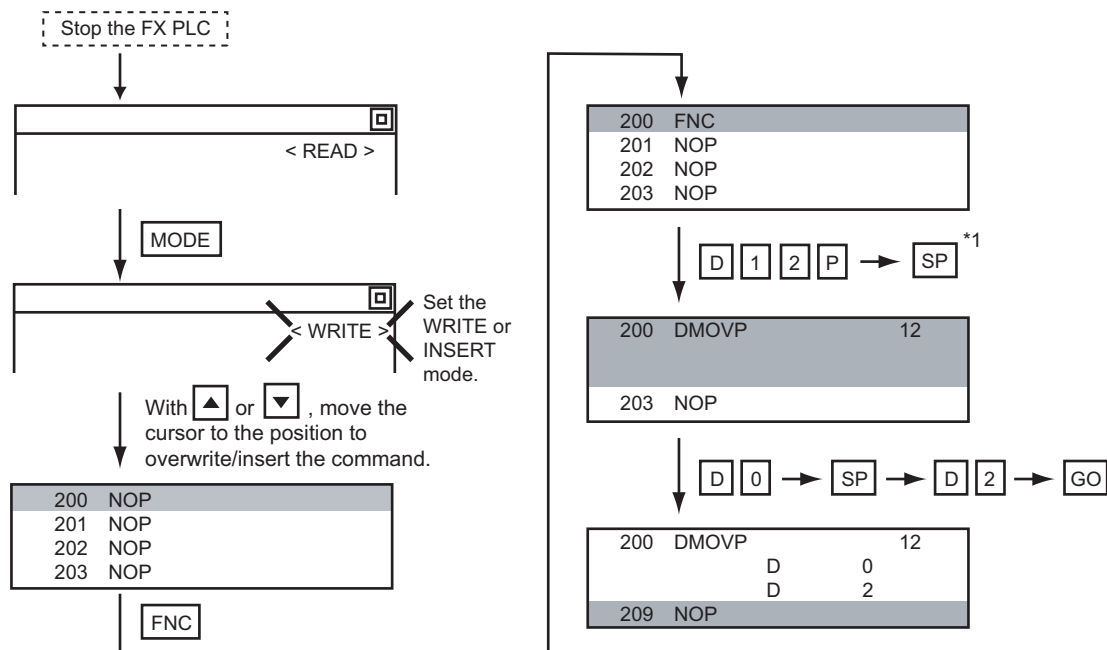

16.2.11 Changing operands, set values

Changes the operand section of an applied instruction and OUT (T, C) command set value.

1. Operation

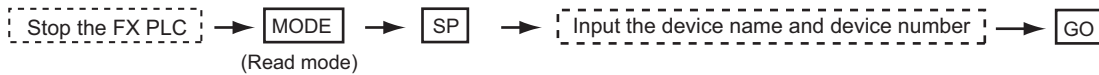

- *1 For decimal numbers, input K, then the number.
For hexadecimal numbers, input H, then the number.

POINT

Moving the cursor to the line on which the operand or set value is to be changed

When starting to change an operand or a set value, place the cursor on the line of the operand or set value to be changed (the line on which the step number is not displayed).

If you place the cursor on the command line, the input operation is not possible.

2. Example

Changing "MOV D0 D10" to "MOV D0 D123"

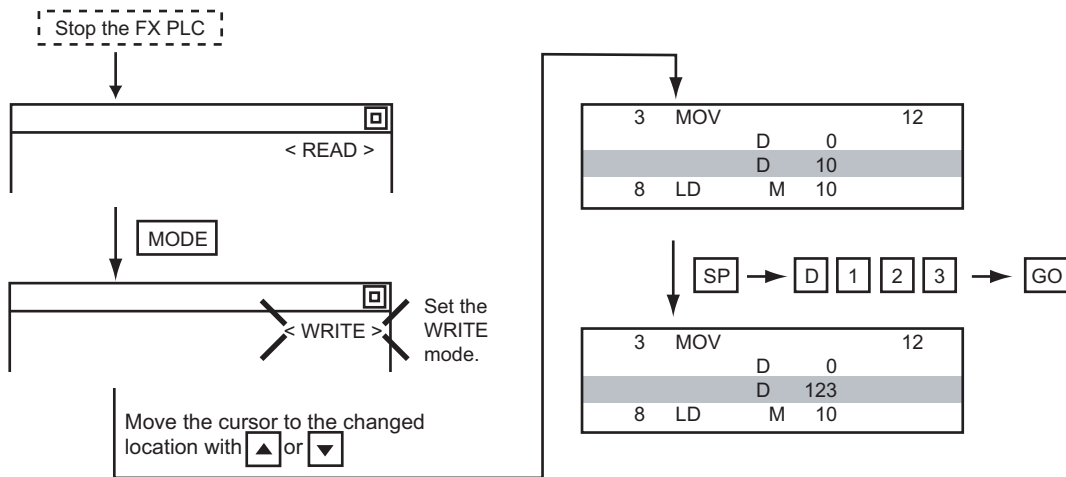

16.2.12 Deleting commands

Deletes one command at a time from a sequence program.

1. Operation

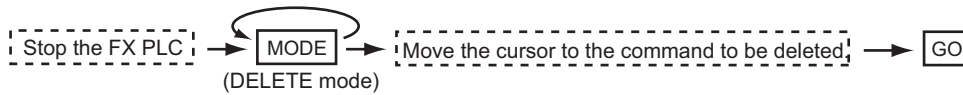

POINT

When moving the cursor to the position where the command is to be deleted.

Place the cursor on the command line (the line on which the step number is displayed).

You cannot delete the command if the cursor is placed on the line of an operand or set value.

2. Example

Deleting "OUT T10 K100"

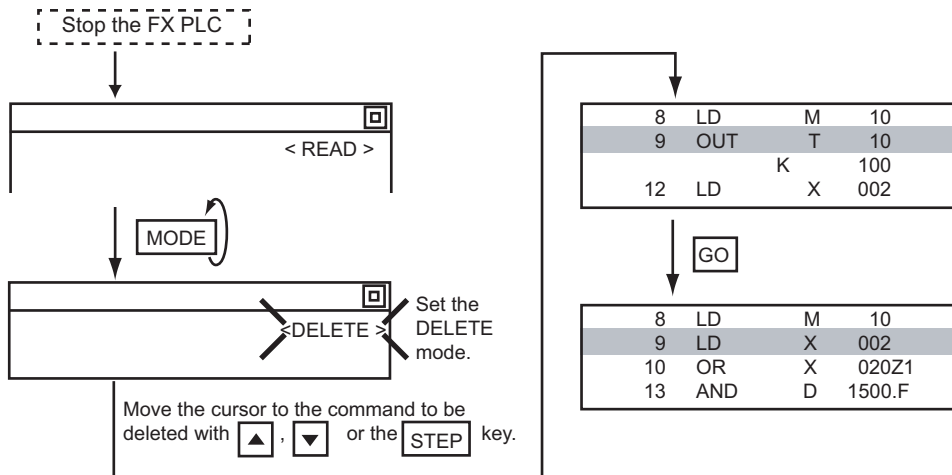

16.2.13 Sequence program all clear

Clears all the sequence programs.

1. Operation

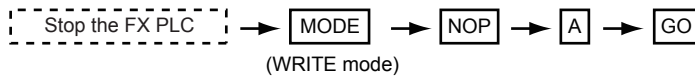

2. Example

Clears all the sequence programs.

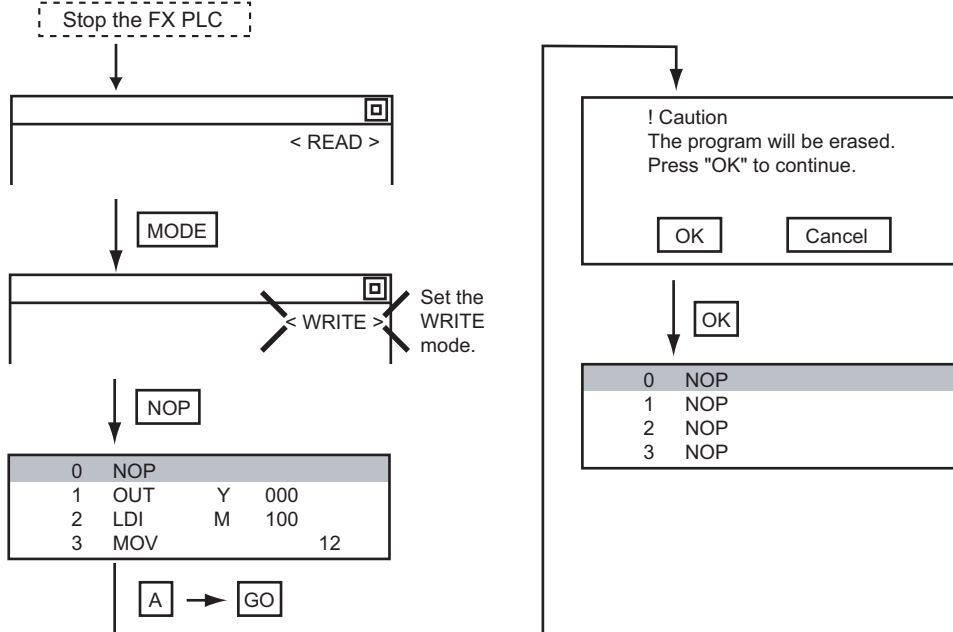

POINT

Items cleared when All Clear for a sequence program is performed

When All Clear is executed, the parameters before program execution are initialized and Latch Clear is executed.

The memory space becomes the default value, the comment area a 0 block, the file register space a 0 block, and keywords unregistered.

After All Clear, set the above parameters etc. again.

16.2.14 PLC diagnostics

Displays the FX PLC error message, error code, and step at which the error occurred.

1. Operation

OP → [PLC diagnostics] → GO

↓ OP → Select [PLC diagnostics] with ▲ or ▼

↓ GO

Error message	Detail	Step
I/O configuration error	1010	
PC/HPP communication error	6201	

2. PLC diagnostics screen

The following describes the contents displayed on the PLC diagnostics screen and the function of on-screen key.

(1) Displayed contents

Error message	Detail	Step
I/O configuration error	1010	
PC/HPP communication error	6201	

1) 2) 3)

No.	Item	Display contents
1)	Error message	Displays the error message. (I/O configuration error/PLC hardware error/PC/HPP communication error/Serial communication error/Parameter error/Syntax error/Circuit error/Operation error)
2)	Detail	Displays the error code.
3)	Step	Displays the step number in the sequence program at which the error occurred. (This is displayed only for a syntax error, circuit error, or operation error.)

POINT

Error details

For details of the FX PLC errors, refer to the following.

➡ Programming manual for the FXCPU used

(2) Key function

The table below shows the functions of the keys that are used for the operation on the PLC diagnostics screen.

Key	Function
	Exits the PLC diagnostics.

16.2.15 Parameter setting

Sets FX PLC parameters.

1. Parameters that can be changed and change targets

(1) Parameters that can be changed

The parameters that can be changed with the MELSEC-FX list editor and the target FX PLCs are as follows.

○ : Can be set/changed × : Cannot be set/changed

Item	Target CPU								
	FX0(S) /FX0N	FX1	FX2(C)	FX1S	FX1N(C)	FX2N(C)	FX3S	FX3G(C)	FX3U(C)
Memory space setting	×	○	○	×	×	○	○	○	○
File register space setting	○*1	×	○	○	○	○	○	○	○
Latch range setting	×	○	○	×	×	○	×	×	○
RUN terminal setting	×	×	×	○	○	○	○	○	○
Initialization of parameters	○	○	○	○	○	○	○	○	○

*1 When connecting an FX0(S), set "0". Setting other than "0" causes a parameter error.

*2 When the parameters are initialized, the display on the MELSEC-FX list editor is different from the FX PLC default values, but do not change the latch range. Changing the latch range causes an error.

(2) Change targets

When a memory cassette is mounted, the parameters in the memory cassette are targeted for changes.

2. Operation

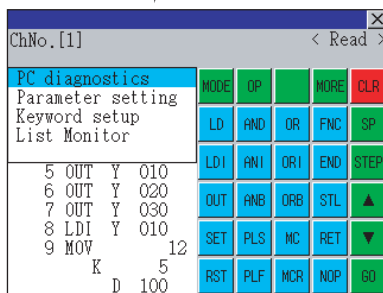
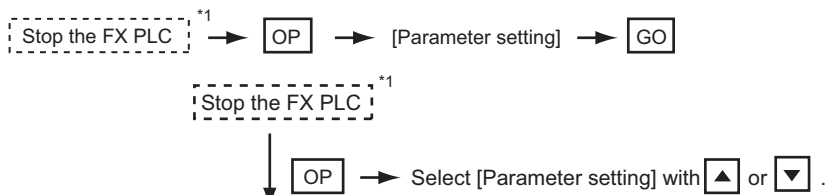

GO

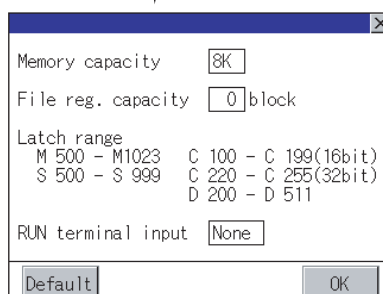

*1 When checking parameters (not changing), it is not necessary to stop the PLC.

3. Parameter setting screen

The following describes the contents displayed on the PLC diagnostics screen and the function of on-screen key.

(1) Displayed contents

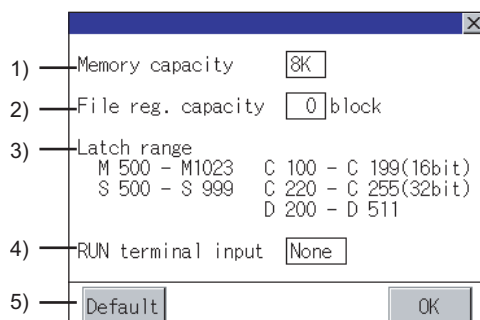

No.	Item	Display contents
1)	Memory capacity	Sets the memory space (number of steps). If you touch the <input type="checkbox"/> *K section, you can change the memory space.
2)	File reg. capacity	Sets the memory space (number of blocks) allocated to the file register. Touch the <input type="checkbox"/> section and input the number of blocks.
3)	Latch range	Sets the latch range (power failure hold area). Touch the number display section and input the value.
4)	RUN terminal input	Sets whether or not to use one of the FX PLC input terminals for RUN input. Touch the <input type="checkbox"/> section and set the device to be set for the RUN terminal.
5)	Default	Initializes the parameters

POINT

(1) Memory space for kana comments after changing memory space, file register space

If the memory space is set smaller than the total of the file register space and kana comment space, the kana comment space is automatically reduced.

(With the MELSEC-FX list editor, the kana comment space is not displayed.)

Note that if any setting as described below is made, the kana comment space is reduced.

(Settings that reduce kana comment space and the kana comment space after setting change)

Settings resulting in $Nm < Nf \times 500 + Nk \times 500 + 500$

$$\text{Kana comment space (steps) after setting change} = \frac{Nm - Nf \times 500 - 500}{500}$$

Nm: Memory space after change (steps)

Nf: File register space after change (blocks)

Nk: Comment space before change (blocks)

(2) Settable range and default value

The settable range and the default value depend on the FX PLC type.

For details of the settable range and the default value, refer to the following.

➡ Programming manual for the FX PLC used

(2) Key functions

The table below shows the functions of the keys that are used for the operation on the parameter setting screen.

Key	Function
<input type="button" value="Default"/>	Initializes the parameters
<input type="button" value="OK"/>	Completes the changed setting contents.
<input type="button" value="✕"/>	Ends parameter setting.

16.2.16 Keyword

Registers, deletes, releases protection for, and sets protection for the FX PLC keywords.

1. Function usability of the MELSEC-FX list editor for keyword protection levels

The functions that can be used with the MELSEC-FX list editor depend on the keyword protection level.

○: Available, ×: Unavailable

Function	Keyword protection level				Reference	
	All operation protect (All on-line operation protect)* ²	Read/Incorrect write protection (Read/write protect)* ²	Erroneous write prohibition (Write protect)* ²	Keyword not registered/keyword protection canceled		
Reading sequence programs	Displaying sequence programs	×	×	○	○	➡ 16.2.8
	Searching commands/devices	×	×	○	○	➡ 16.2.9
Writing sequence programs	Writing commands	×	×	×	○	➡ 16.2.10
	Changing operands/set values	×	×	×	○	➡ 16.2.12
Inserting commands		×	×	×	○	➡ 16.2.10
Deleting commands		×	×	×	○	➡ 16.2.12
Sequence program all clear		×	×	×	○	➡ 16.2.13
PLC diagnostics		○* ¹	○	○	○	➡ 16.2.14
Parameter setting		×	×	×	○	➡ 16.2.15

*1 When the 2nd keyword is set to an FX PLC that supports 2nd keyword, it becomes "×" (cannot be used).

*2 The names within the parentheses () are for when a keyword + 2nd keyword is set.

2. Operation

→ [Keyword setup] →

↓
 → Select [Keyword setup] with or .

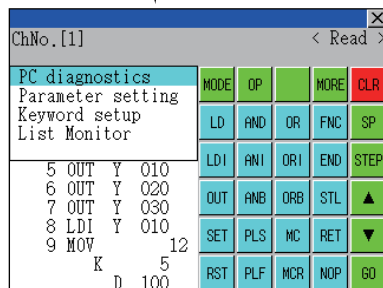

↓



■ 3. Keyword screen and protection level

When [Keyword setup] is selected with the MELSEC-FX list editor, the keyword screen is displayed.
For the keyword operation, refer to the following.

⇒ 11.6 Keyword

POINT

Keywords

For details of the keyword, refer to the following.

⇒ Programming manual for the FX PLC used

16.2.17 List monitor

The status of contacts and coils in a sequence program is displayed.

1. Operation

OP → [List Monitor] → GO

↓
 OP → Select [List Monitor] with ▲ or ▼.

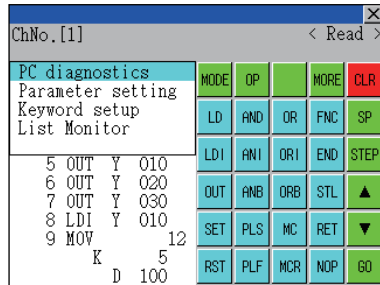

↓
 GO

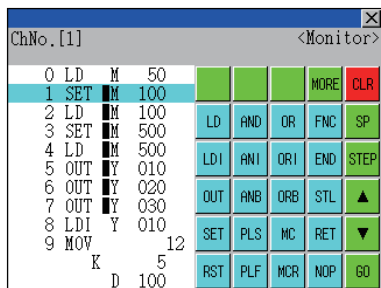

When the list monitor is started on the FX list editor screen, the step numbers displayed on the FX list editor screen is displayed on the list monitor screen.

POINT

Starting list monitor with special function switches (FX list monitor)

With setting special function switches (FX list monitor), the list monitor can be started on the monitor screen.

When the list monitor is started on the monitor screen, the list editor cannot be used.

For how to set special function switches, refer to the following.

➡ GT Designer3 (GOT2000) Help

2. Displays and key functions

The following describes the displays for the list monitor.

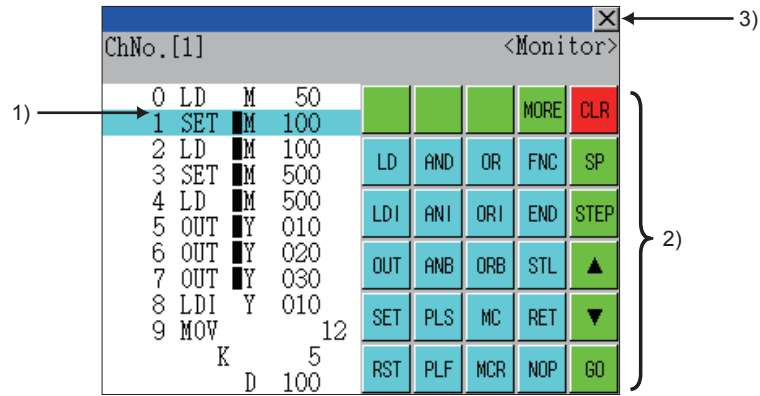

No.	Item	Display contents
1)	List display area*1	The status of contacts and coils is displayed on the left of device displays.
2)	Keys	The same operations as in the READ mode of the FX list editor can be executed. ➡ 16.2.8 Displaying sequence programs
3)	[X]	Ends the list monitor. (When the list monitor is executed on the FX list editor screen, the screen is switched to the FX list editor screen.)

*1 The status of contacts and coils is displayed as below.

Type of instruction	Description	Status	
		■ Displayed	■ Not displayed
LD, AND, OR (Contact instruction (Normal open))	Contact	ON	OFF
LDI, ANI, ORI (Contact instruction (Normal close))	Contact	OFF	ON
OUT, SET	TC: Coil	ON	OFF
	Except TC: Contact	ON	OFF
RST	TC: Reset	ON	OFF
	Word device	Value: 0	Value: Except 0
	Except TC and word device: Contact	OFF	ON
MC, STL	Contact	ON	OFF
LDP, ANDP, ORP, LDF, ANDF, ORF (Rise or fall contact instruction)	Not monitored	Always ■ not displayed	

16.2.18 Action for an incorrect key input

If an incorrect key is input, cancel the input contents.

1. Operations

(1) Before touching the GO key (before reading/writing the input contents)

Before touching the GO key, touch the CLR key.

(2) After touching the GO key (after reading/writing the input contents)

Write the command again.

➡ 15.3.10 Writing commands

Commands finalized by writing and inserting operations are revised (overwritten) with the program writing.

16.2.19 Error messages and corrective actions

This section describes the error messages displayed when the MELSEC-FX list editor is executed, and corrective action.

Error message	Description	Corrective action
Can not display while protected.	The all-operation protect, anti-plagiarism, or incorrect write protect keyword is set.	<ul style="list-style-type: none"> • Check the protected operation. • Clear the keyword protection or delete the keyword. ■▶ 16.2.16 Keyword
Can not operate while protected.		
PLC parameter error.	An FX PLC parameter is defective.	Set correct parameters in the FX PLC.
PLC communications error.	The communication with the FX PLC is defective.	<ul style="list-style-type: none"> • Check the FX PLC, cable, and GOT for abnormality. • Check whether the communication settings are correct or not.
PLC is running.	A writing operation etc. has been made while the FX PLC is running.	Stop the FX PLC.
Can not write.	<ul style="list-style-type: none"> • The memory to write to is EPROM. • The protect switch of the EEPROM is on. 	<ul style="list-style-type: none"> • Set other than EPROM for the memory to write to. • Switch off the protect switch of the EEPROM.
Step number is out of a range.	The specified step number exceeded the maximum number.	Specify a step number below the maximum value.
Not found.	The specified command cannot be found.	Proceed to the next operation.
Not found.	The specified device cannot be found.	Proceed to the next operation.
Step overflow.	The program may exceed the available space. (Writing is not executed.)	Check the program memory space and delete commands to keep it within the space. ■▶ 16.2.12 Deleting commands
Command error.	An invalid command (non-existent command) was specified.	Input the correct command.

POINT

How to erase an error message

An error message is not erased even if the cause of the error is eliminated.

To erase an error message, touch a key on the MELSEC-FX list editor screen.

16.3 FX3U-ENET-ADP Communication Setting Function

In GX Works2, the communication set value of the FX3U-ENET-ADP stored in the CPU can be changed. This function is not available when the communication set value of the FX3U-ENET-ADP is not set in advance in the CPU.

POINT

Communication setting in the CPU

In GX Works2, set in advance the communication set value of the FX3U-ENET-ADP to the CPU. For the details of the communication setting, refer to the following.

➡ FX3U-ENET-ADP User's manual

16.3.1 Specifications

1. System configuration

This section describes the system configuration of the FX3U-ENET-ADP communication setting function. For the setting method in each connection form, used communication unit/cable and cautions on connection form, refer to the following manual.

➡ GOT2000 Series Connection Manual For GT Works3 Version1

2. Required basic system application

Operating system		Version
Basic system application		-
Communication driver	MELSEC-FX	-

3. Connection type

(○: Applicable, △: Partly restricted, ×: Inapplicable)

Function		Connection type between GOT and controller	
Name	Description	Direct CPU connection	GOT multidrop connection
FX3U-ENET-ADP communication setting function	The communication set value of the FX3U-ENET-ADP stored in the CPU can be changed.	○	×

4. Communication setting items

The table below shows the communication setting items and setting range.

Communication setting items	Setting range	Remark
IP address	0.0.0.1 to 223.255.255.254	If a value outside the setting range is entered, the error message "SET NUMBER IS INCORRECT." appears.
Subnet mask pattern*1	192.0.0.0 to 255.255.255.252	
Default router IP address*1	0.0.0.1 to 223.255.255.254	

*1 Set the value "0.0.0.0" when not using the subnet mask pattern and default router IP address.

16.3.2 Display operation of FX3U-ENET-ADP communication setting function

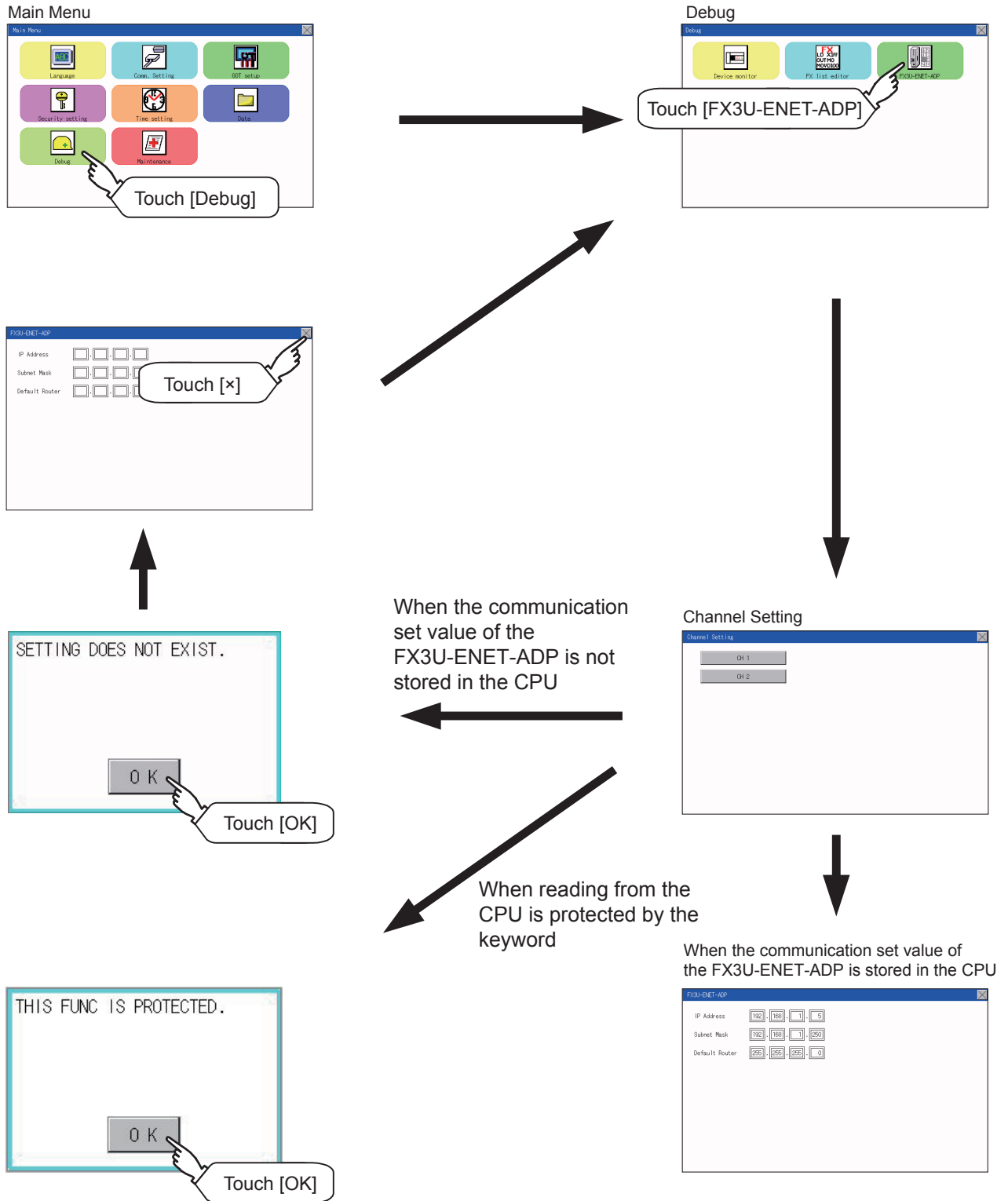

16.3.3 Setting operation

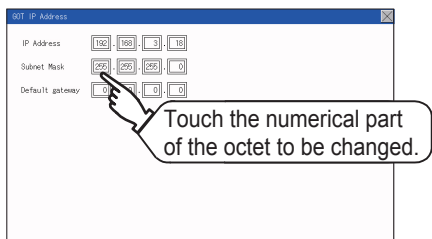

Step 1. Touch the numerical part of the octet to be changed among the 1st to 4th octets.

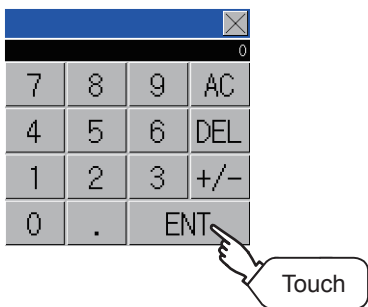

Step 2. When the ten-key pad appears, enter a numerical value in up to 3 digits, and touch the **ENT** key.

If a numerical value outside the setting range is entered, the following error message appears. Enter a numerical value again.

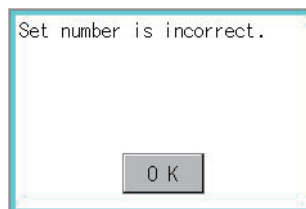

For the details of the setting range, refer to the following.

➡ 16.3.1 Specifications

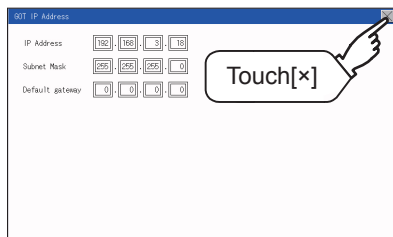

Step 3. The changed IP address is displayed. At this time, the changed communication set value of the FX3U-ENET-ADP is not written to the CPU. Touch the **[×]** key.

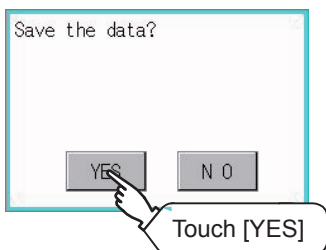

Step 4. When the screen shown on the left appears, touch the **ESC** key.

Continued to next page

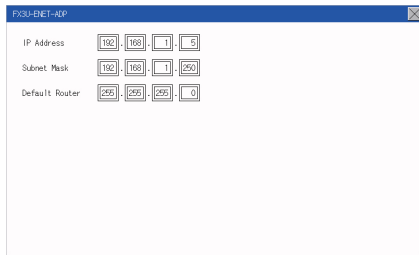

Step 5. When the screen shown on the left appears, the changed communication set value of the FX3U-ENET-ADP is written normally to the CPU. For making valid the contents of setting, turn OFF the power of the CPU, and then turn it ON again. Change the setting of the subnet mask pattern and default router IP address using the same procedure if necessary. An error message appears in the following cases. Touch the **OK** key to return to the step 1., and perform the setting procedure again.

- When the CPU is running
The following error message appears. Stop the running status of the CPU.

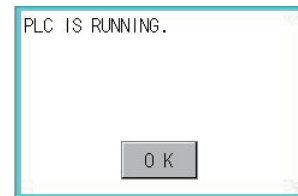

- When a communication error occurs
Set the communication between the GOT and the CPU to the normal status.

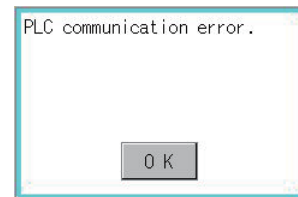

- When the memory cassette is write-protected
Set to OFF the write-protect switch of the memory cassette.

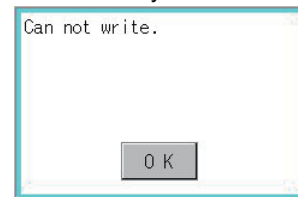

- When writing to the CPU is protected by the keyword
Clear the protection by the keyword against writing.



POINT

When the CPU stores the symbolic information

When the setting such as IP address is changed using this function and then the program is read by the programming tool from the CPU that stores the symbolic information, the following warning appears. However, the changed value is read correctly. Convert and compile the project again.

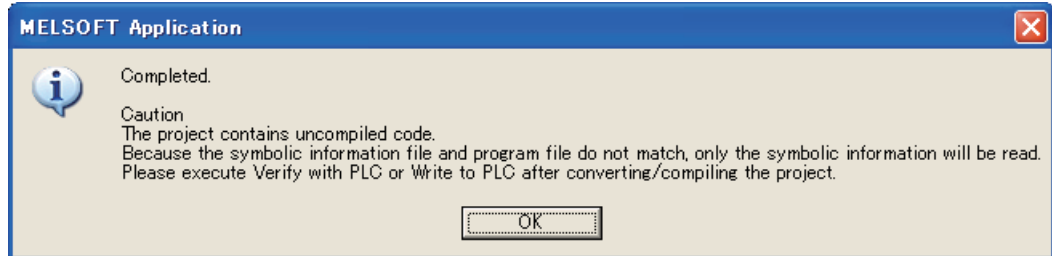

17.1 Touch Panel Calibration

1. Touch panel calibration setting function

Touch panel reading error can be corrected.

Normally the adjustment is not required, however, the difference between a touched position and the object position may occur as the period of use elapses.

When any difference between a touched position and the object position occurs, correct the position with this function.

Before adjustment

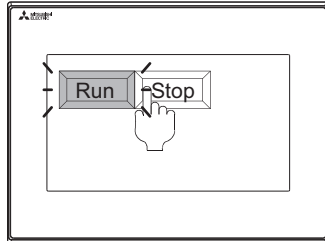

The [Run] will operate though you intended to touch the [Stop] button.

After adjustment

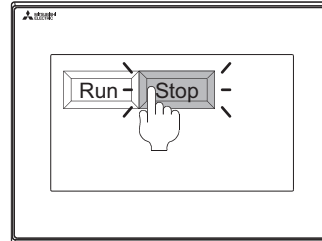

The [Stop] button can be touched without fail.

2. Touch panel calibration setting display operation

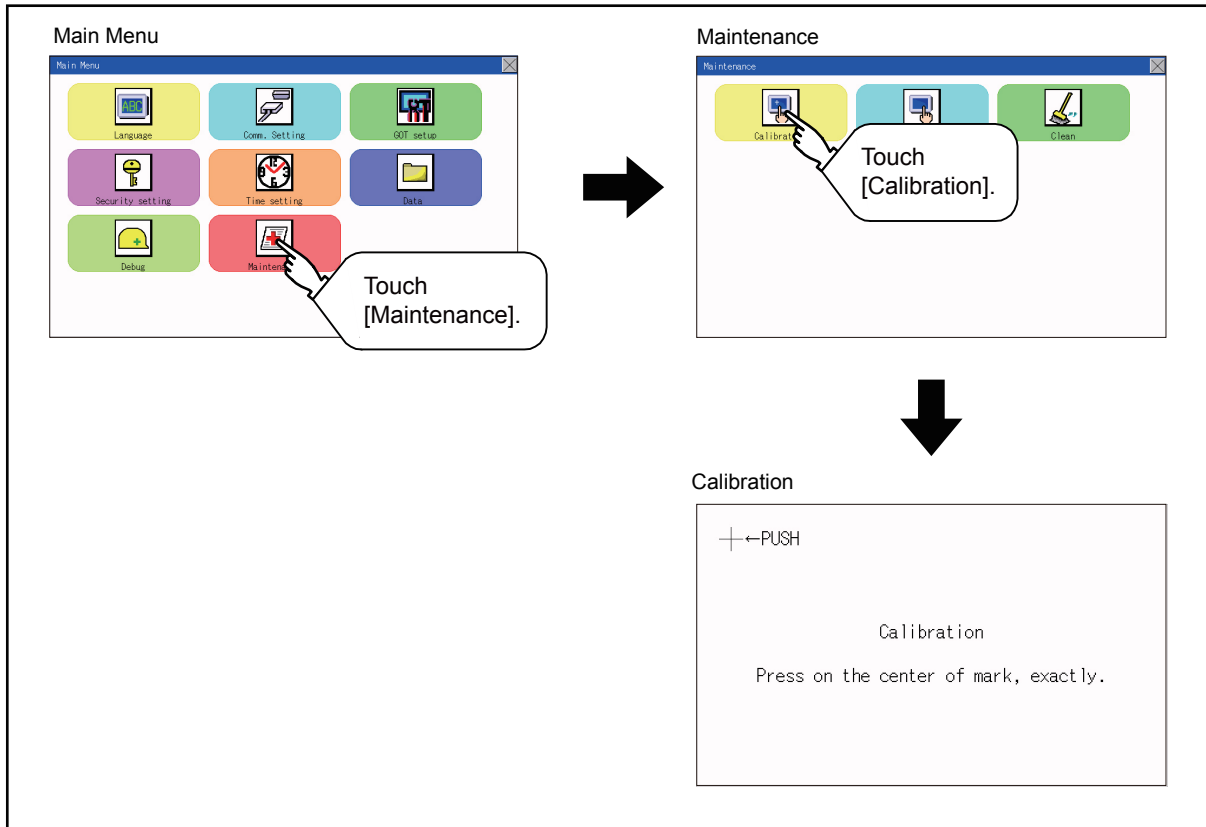

■3. Touch panel calibration operation

Touch [+] displayed on the screen with the finger one by one to make the setting.

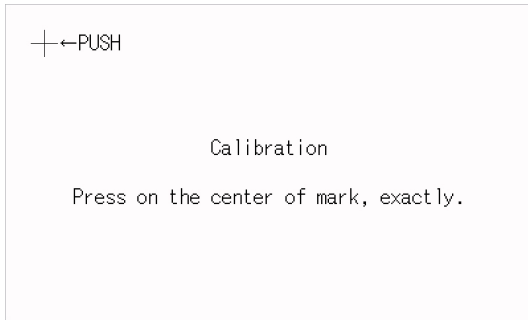

Step 1. Touch the center of [+] displayed on the upper left precisely.

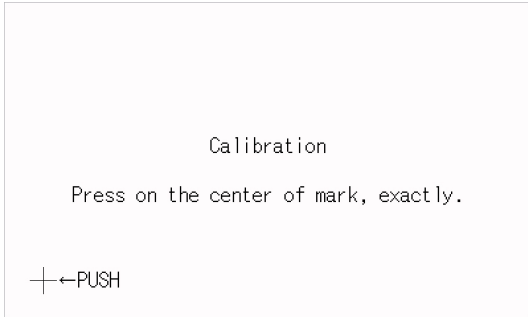

Step 2. Touch [+] displayed on the upper left.

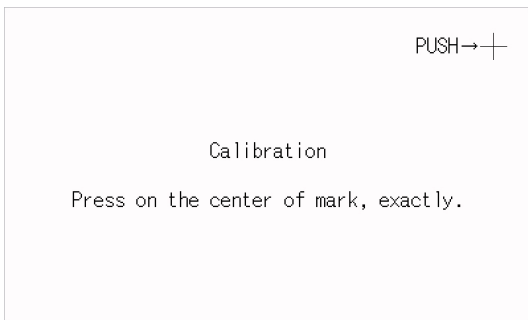

Step 3. Touch [+] displayed on the upper right.

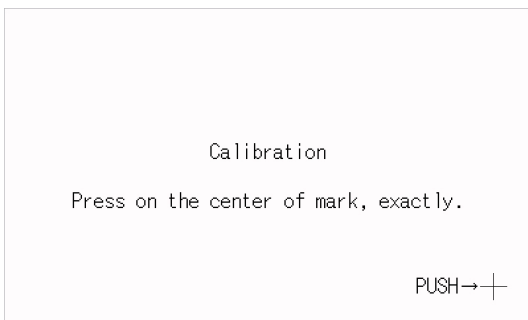

Step 4. Touch [+] displayed on the lower right.

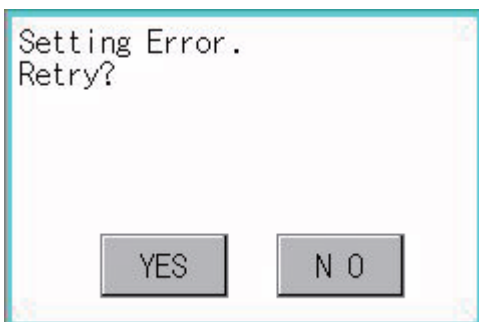

Step 5. When the precise touch could not be made, touch the [YES] button to make the setting from Step1 again.

17.2 Touch Panel Check

1. Touch panel check function

Touch panel check function checks whether there is no dead zone area of 2 dots × 2 dots.

2. Display operation of Touch panel check

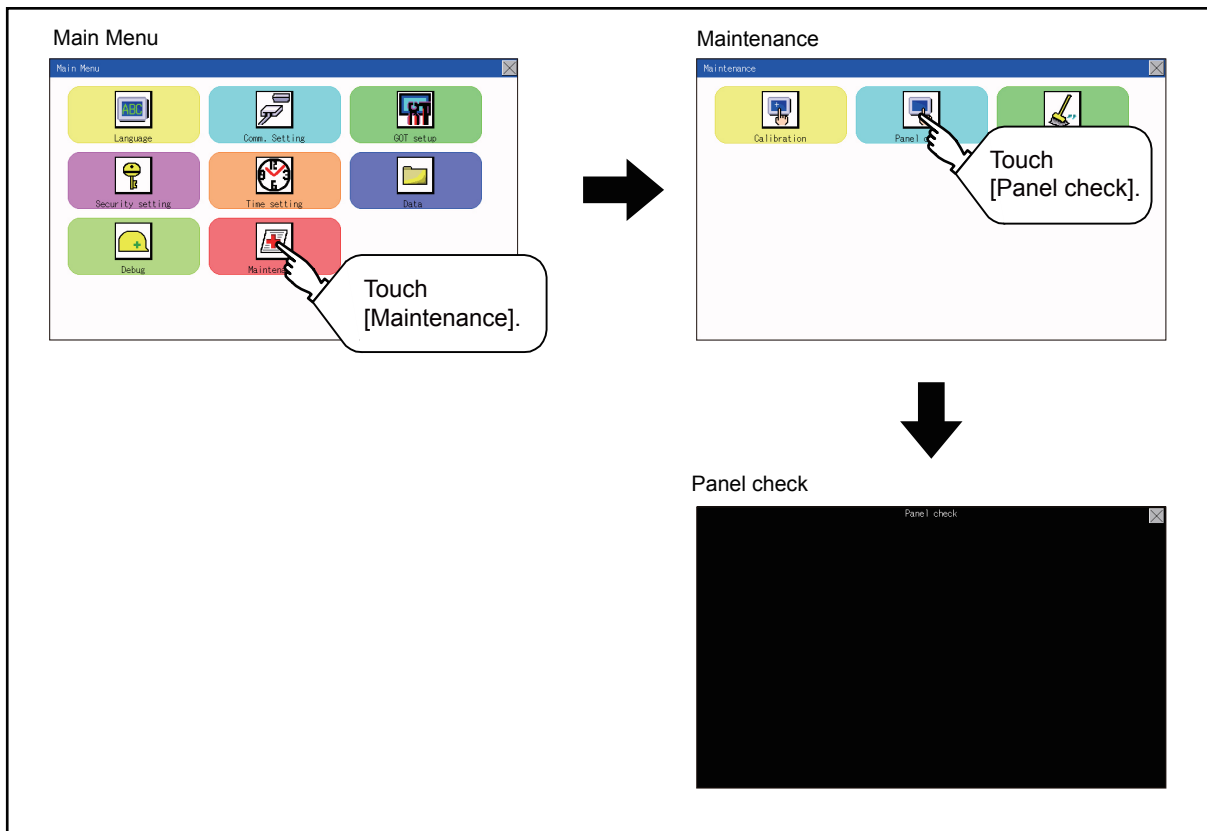

POINT

Notes on Touch panel check

If the touched part is not filled with yellow color, there are the following two possible causes.

1. Display part failure
2. Touch panel failure

In that case, contact your local Mitsubishi (Electric System) Service.

■ 3. Touch panel check operations

If touch [Panel check] of self-check, a black-filled screen is displayed over the entire screen area.

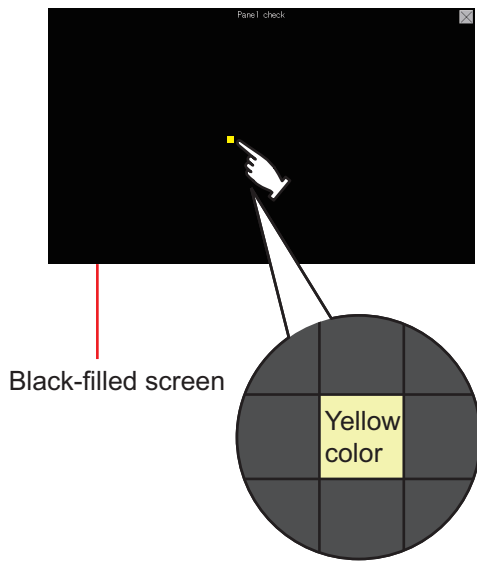

Step 1. Touch a part of the screen.
The touched part becomes a yellow-filled display. Up to 40 parts becomes yellow-filled displays.

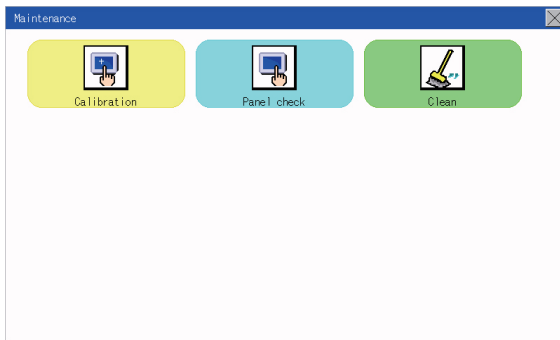

Step 2. If [×] on the upper right is touched, the screen returns to the self-check.

POINT

Checking the upper left part of the screen

Only the upper left part of the screen cannot be filled with yellow.

If the screen returns to the self-check by touching the upper left part, judge that the upper left area operates normally.

17.3 Clean

In utility, the screen can be set as not to be effected by touching the screen when clean with clothes.
For cleaning method, refer to the following.

⇒ 20.3 Cleaning Method

1. Display operation of clean

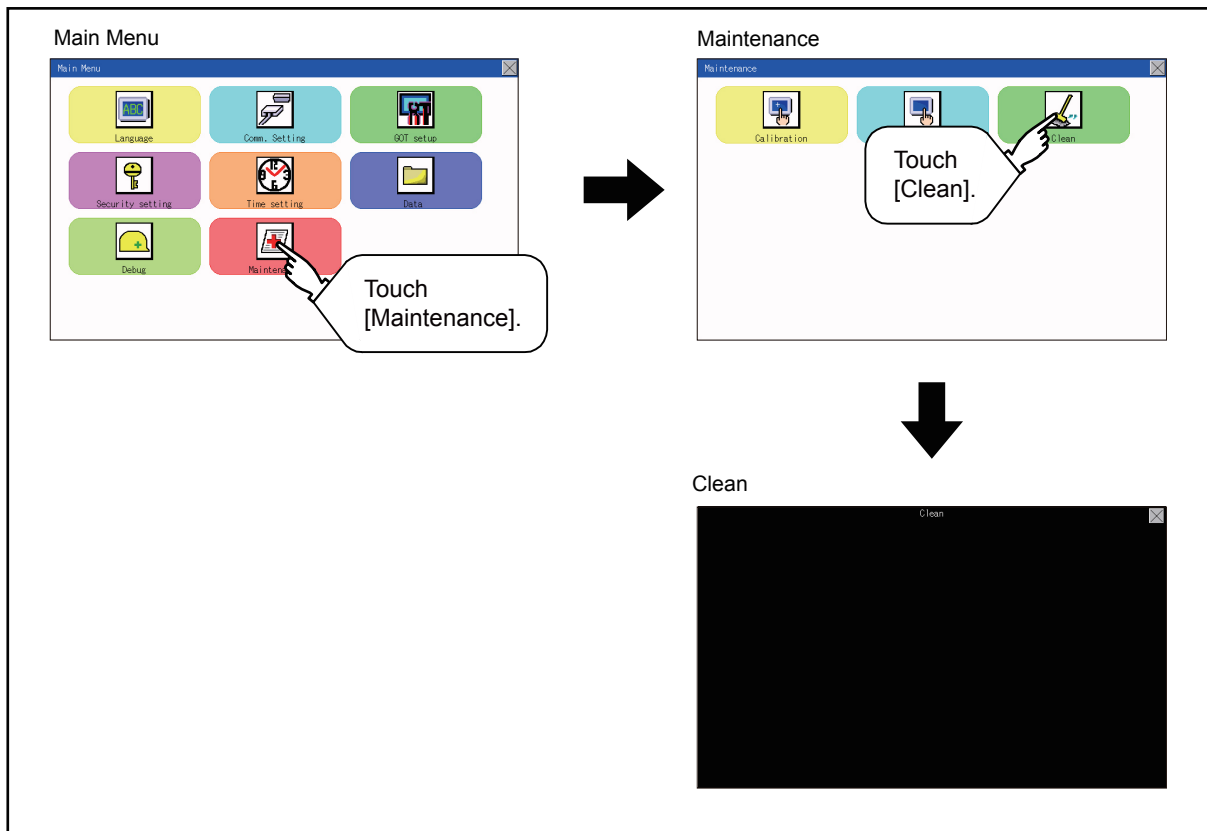

2. Display operation of clean

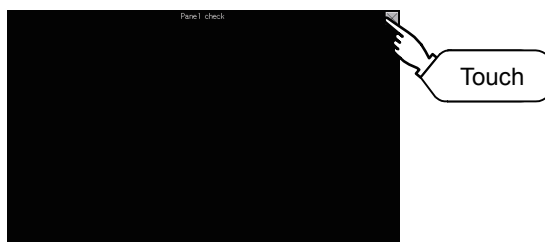

Step 1. Touching the [×] key closes the screen. Even if touch points other than the upper left corner and upper right corner of the screen, the GOT does not operate.

For details of cleaning method, refer to the following.

⇒ 20.3 Cleaning Method

18. INSTALLING PACKAGE DATA BY USING AN SD CARD

The package data stored in an SD card can be installed to the GOT by performing the following procedure.
For storing method of the package data to an SD card, refer to the following.

➡ GT Designer3 (GOT2000) Help

18.1 Installation Method When the GOT is Turned On

■ 1. Operation procedure

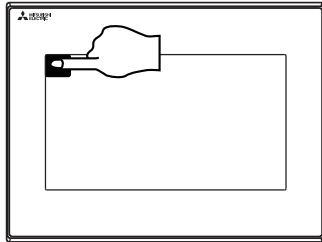

Step 1. Power OFF the GOT, and attach the SD card which stores the basic system application and communication driver to the GOT.

Step 2. While touching the upper left corner of the GOT screen, power ON the GOT.

Step 3. When the screen shown on the left appears, select the [Data copy].

For details of install, refer to the following.

➡ 15.7 Data Copy

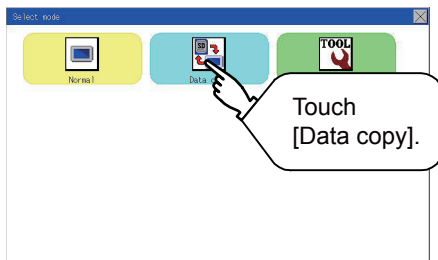

19. INSTALLATION OF BOOTOS AND BASIC SYSTEM APPLICATION

To execute the GOT utility, install the BootOS and system applications on the C drive (built-in flash memory) of the GOT, or set the boot drive of the package data to [A: Standard SD card] and insert an SD card with the package data into the GOT. (BootOS is installed in the GOT at factory shipment. It is not necessary to install BootOS when upgrading of it is unnecessary.)

This chapter explains the installation using GOT.

GT Designer3 → SD card → GOT

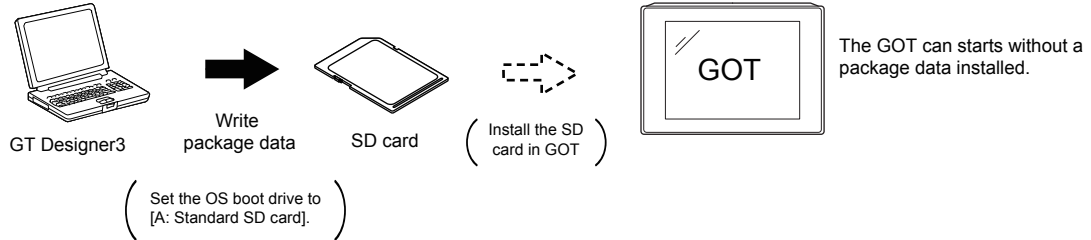

GOT → SD card → GOT

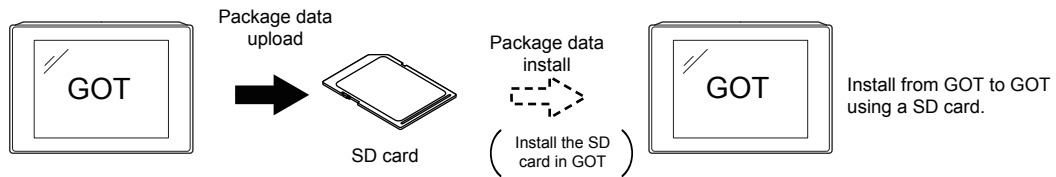

Refer to the following for the installation which uses GT Designer3.

➡ GT Designer3 (GOT2000) Help

19.1 BootOS and Basic System Application to be Installed

Under-mentioned BootOS and basic system application are necessary to execute utility.

System application name	Function overview
BootOS	Required for the control of GOT and the communication between PC and GOT. Installed at factory shipment. (BootOS can also be installed from GT Designer3. When BootOS is installed, the GOT is initialized and goes to the status at factory shipment. When BootOS needs to be reinstalled, the basic system application has to be installed in the GOT.)
System application	Required for the GOT operation as the monitoring function of GOT, installation and deletion of the system application or project data, touch key control or display function of the screen and guidance. Required for display and operation of the user-created screen and utility screen. Not installed in GOT at factory shipment. Install it from GT Designer3 or an SD card.

19.2 Prior Preparations for Installing BootOS and System Application

For the installation using GOT, the data storage that is storing BootOS or the system application is required. There are the following three methods for the installation of BootOS and system application.

(1) [To Memory Card] from GT Designer3

⇒ GT Designer3 (GOT2000) Help

(2) Uploading from another GOT (the package data has been installed)

⇒ 18. INSTALLING PACKAGE DATA BY USING AN SD CARD

(3) Using an SD card that stores data with OS boot drive set to A drive

⇒ GT Designer3 (GOT2000) Help

POINT

Precautions when installing BootOS and the package data into an SD card

When installing BootOS and the package data into the SD card, be sure to execute by the utility of another GOT or GT Designer3.

The installation is not executed properly with the SD card to which data is uploaded from the utility of GOT or copied by software other than GT Designer3.

Note the available capacity of the SD card.

The available capacity of BootOS and system applications can be confirmed by [To Memory Card] or [Write Option] of GT Designer3.

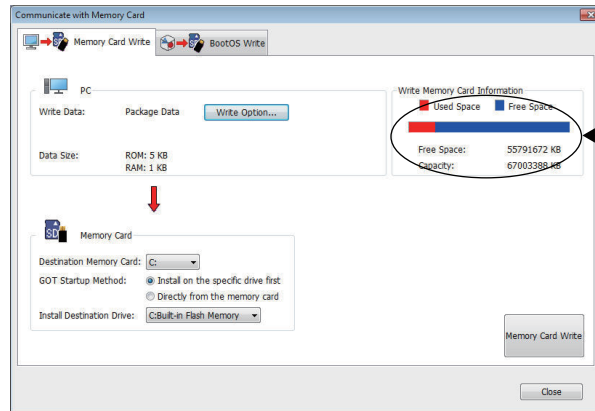

Write Option

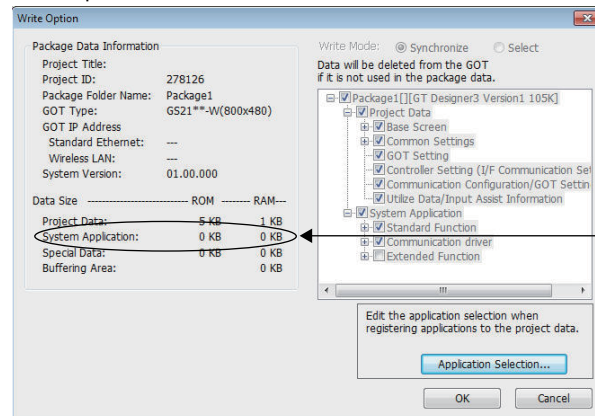

20. MAINTENANCE AND INSPECTION

STARTUP AND MAINTENANCE PRECAUTIONS	 WARNING
<ul style="list-style-type: none">• When power is on, do not touch the terminals. Doing so can cause an electric shock or malfunction.• Connect the battery correctly. Do not discharge, disassemble, heat, short, solder or throw the battery into the fire. Incorrect handling may cause the battery to generate heat, burst or take fire, resulting in injuries or fires.• Before starting cleaning or terminal screw retightening, always switch off the power externally in all phases. Not doing so can cause the unit to fail or malfunction. Undertightening can cause a short circuit or malfunction. Overtightening can cause a short circuit or malfunction due to the damage of the screws or unit.	

STARTUP AND MAINTENANCE PRECAUTIONS	 CAUTION
<ul style="list-style-type: none">• Do not disassemble or modify the unit. Doing so can cause a failure, malfunction, injury or fire.• Do not touch the conductive and electronic parts of the unit directly. Doing so can cause a unit malfunction or failure.• The cables connected to the unit must be run in ducts or clamped. Not doing so can cause the unit or cable to be damaged due to the dangling, motion or accidental pulling of the cables or can cause a malfunction due to a cable connection fault.• When unplugging the cable connected to the unit, do not hold and pull from the cable portion. Doing so can cause the unit or cable to be damaged or can cause a malfunction due to a cable connection fault.• Before touching the unit, always touch grounded metals, etc. to discharge static electricity from human body, etc. Not doing so can cause the unit to fail or malfunction.	

DISPOSAL PRECAUTIONS	 CAUTION
<ul style="list-style-type: none">• When disposing of this product, treat it as industrial waste.	

The GOT does not include consumable components that will cause the shorten life.
However, the liquid crystal screen and backlight have life length.
For the life of the LCD screen or backlight, refer to the following.

- ▣ 3.2 Performance Specifications

20.1 Daily Inspection

1. Daily inspection items

Item	Inspection Item		Inspection Method	Criterion	Corrective action
1	GOT mounting status		Check for loose mounting screws.	Securely mounted	Retighten screws within the specified torque range
2	Connection status	Loose terminal screws	Retighten screws with screwdriver	Not loose	Retighten terminal screws
		Proximate solderless terminals	Visual check	Proper space	Correction
		Loose connectors	Visual check	Not loose	Retighten connector fixing screws
3	Usage status	Foreign material attachment	Visual check	No foreign matter sticking	Remove, clean

20.2 Periodic Inspection

1. Yearly or half-yearly inspection items

The following inspection should also be performed when equipment has been moved or modified or the wiring changed.

Item	Inspection Item		Inspection Method	Criterion	Action
1	Surrounding environment	Ambient temperature	Make measurement with thermometer or hygrometer. Measure corrosive gas.	0 to 50°C	For use in control panel, temperature inside control panel is ambient temperature
		Ambient humidity		10 to 90%RH	
		Atmosphere		No corrosive gas	
2	Power supply voltage check		24VDC Measure voltage across terminals.	20.4 to 26.4VDC	Change supply power
3	Mounting status	Looseness	Move module	Should be mounted firmly	Retighten screws
		Foreign material attachment	Visual check	No foreign matter sticking	Remove, clean
4	Connection status	Loose terminal screws	Retighten screws with screwdriver	Not loose	Retighten terminal screws
		Proximate solderless terminals	Visual check	Proper space	Correction
		Loose connectors	Visual check	Not loose	Retighten connector fixing screws

20.3 Cleaning Method

Use the GOT always in a clean condition.

To clean the GOT, wipe the dirty part with a soft cloth using neutral detergent.

For the display operation of the [Clean] screen, refer to the following.

▶▶▶ 17.3 Clean

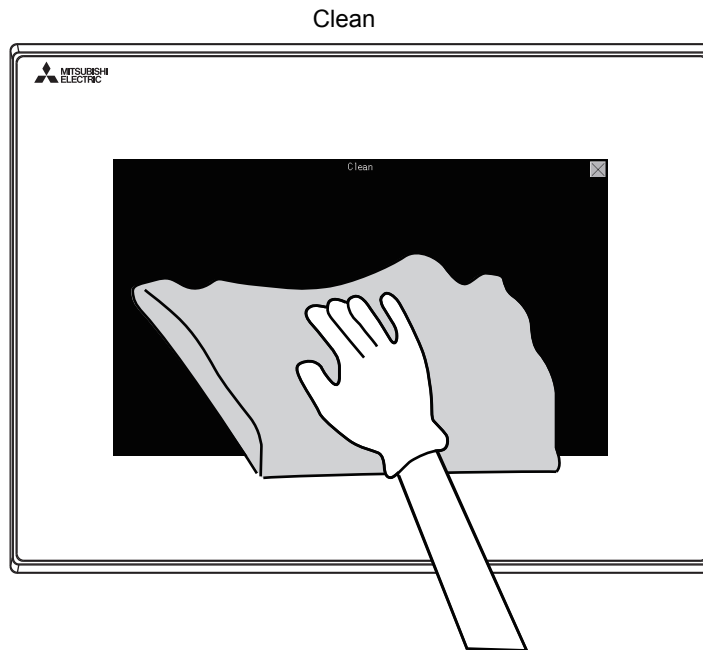

POINT

Precautions for cleaning

Do not use chemicals such as thinner, organic solvents and strong acids, since they may cause the protective sheet to be deformed or the dissolvable paint on the surface to peel off.

In addition, do not use spray solvents since they may cause the electrical failure of the GOT and peripheral devices.

20.4 Backlight Shutoff Detection

A GOT has a built-in backlight for the liquid crystal display.

When a GOT detects the backlight shutoff, the POWER LED alternately flashes with orange/green color.

The brightness of the backlight degrades as the usage period passes. Replace the backlight when it is shut off or the display gets blurry.

For the replacement of the backlight, contact your local distributor.

(1) Backlight life

The usage period of the backlight can be extended by setting [Screen saving backlight off] in the GOT utility function (GOT setup). For details, refer to the following.

➡ 12. DISPLAY AND OPERATION SETTINGS (GOT SET UP)

20.4.1 Backlight shutoff detection and external alarm

When the GOT has detected that the backlight is shut off, the system information set by using drawing software is turned on. The information of the backlight shutoff can be output from a PLC to an external device (such as lamp and buzzer) by using the system information.

An alarm for prevention of touch operation should be set and the external interlock should also be set for the dangerous load.

For system information details, refer the following.

➡ GT Designer3 (GOT2000) Help

POINT

(1) Example of alarm for external devices (such as lamp and buzzer)

System information is used to output the backlight shutoff detection signal from a FX series PLC to an external device.

Condition: The write device is D20 and all data is used (the [Select All] button on the setting screen of drawing software is clicked) for the system information assignment.

D36 b14: Backlight shutoff detection (System number 2-2)

This signal turns on when the backlight shutoff is detected.

This signal is used in a sequence programs shown below.

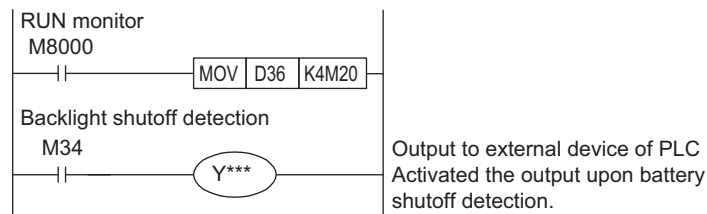

*indicates the output number at which the external device is connected.

(2) Caution when the backlight is shut off

Even when the backlight is shut off, the touch keys are available.

Replace the dead backlight as soon as possible.

21. TROUBLESHOOTING

This chapter describes the GOT restoration sheets and the lists of error messages and system alarms.

21.1 GOT Restoration Sheets

This section describes how to restore the GOT that operates improperly in the check sheet format. The following describes how to use each sheet.

- (1) When the GOT does not operate or operates improperly (GOT status check sheet)**

When the GOT does not operate or operates improperly, check the cause of a malfunction by following the GOT status check sheet and take corrective actions.
After the GOT is restored, see how the GOT works.
- (2) When wiring needs to be modified (GOT installation status check sheet)**

When the check (1) is performed and then noise and other failures generated by improper wiring of the GOT are considered as the cause of the malfunction, modify the wiring by following the GOT installation status check sheet.
After the GOT is restored, see how the GOT works.
- (3) When corrective actions other than the above (1) and (2) are required (System configuration check sheet)**

If the GOT still does not operate or operates improperly even though the check (1) and (2) are performed and the corrective actions are taken, write the system configuration used on the system configuration check sheet and contact your local distributor.
When sending the actual product, attach the GOT restoration sheets (GOT status check sheet, GOT installation status check sheet, and System configuration check sheet) which are checked in this section.
Keep a copy of each sheet.

1. GOT status check sheet

Start the check from (1) GOT status.
Follow the instructions in the corrective action column.

(1) GOT status

Phenomenon	Cause/Status	Corrective action
(a) Frequency of a case where the GOT does not operate or the screen is not displayed properly		
<input type="checkbox"/> Always	Frequency: () Example: Once a month	Go to (1)-(b).
<input type="checkbox"/> Sometimes		
(b) The display of an error code (system alarm)		
<input type="checkbox"/> Can be confirmed	Error code (system alarm): () Example: 460 Communication unit error	Take corrective actions for the confirmed error code (system alarm) and error message. If the status does not change even after the corrective actions are taken, go to (1)-(c).
<input type="checkbox"/> Cannot be confirmed		Go to (1)-(c).
(c) Screen display		
<input type="checkbox"/> The screen is entirely black.	The possible cause is a failure of the liquid crystal or an error of the BootOS.	Take corrective actions in the following order. 1) Re-install the BootOS. 2) Re-install the standard monitor OS. When the GOT is still not restored after Action 1) and 2) are taken, perform the following. 3) Re-install the CoreOS and the standard monitor OS in this order. If the GOT is still not restored, go to (5) Actual product investigation.
<input type="checkbox"/> The screen is entirely white.	The possible cause is a hardware failure of the GOT.	Go to (5) Actual product investigation.
<input type="checkbox"/> A line appears on the screen.	The possible cause is a hardware failure of the GOT. Example: A vertical line appears on the screen.	Go to (5) Actual product investigation.
<input type="checkbox"/> Other display errors		
<input type="checkbox"/> The screen is frozen.	The screen display is not updated and the screen cannot be operated.	Go to (1)-(e).
(d) Buzzer sound		
<input type="checkbox"/> No buzzer sound	Buzzer sound: () Example: The buzzer repeats in the rhythm of "beep-beep-beep, beep, beep-beep".	Go to (2) Status where the GOT screen is frozen.
<input type="checkbox"/> Beeps randomly		
<input type="checkbox"/> Beeps in a pattern		
<input type="checkbox"/> Beeps without a pause	The possible cause is the activated buzzer output signal. When the reading device of the system information is set, the device may be turned on and the buzzer output signal may be activated.	Check the setting of the reading device. When the buzzer output signal has no error, proceed to (2) Status where the GOT screen is frozen.

(2) Status where the GOT screen is frozen (When the screen operation stops)

Phenomenon	Cause/Status	Corrective action
(a) Switching to the utility		
<input type="checkbox"/> Enabled	Error code (system alarm): () Example: 460 Communication unit error	When the system alarm display function can be used, take corrective actions for the displayed error code (system alarm). Otherwise, go to (2)-(b).
<input type="checkbox"/> Disabled	The system alarm display function cannot be used.	Go to (2)-(c).
(b) I/O check with the utility of the GOT		
<input type="checkbox"/> Communication fault	Display contents: () Example: A message that indicates the possible cause is a connection failure is displayed.	Go to (2)-(c).
<input type="checkbox"/> No error	Hardware such as the communication interface has no error.	Go to (3) PLC CPU status.
(c) Objects that are not displayed on the monitor screen		
<input type="checkbox"/> Exists	Detail: ()	Go to (3) PLC CPU status.
<input type="checkbox"/> None	Example: The numerical display is not displayed.	

(3) PLC CPU status

Phenomenon	Cause/Status	Corrective action
(a) PLC error		
<input type="checkbox"/> Always	The possible cause is CONTROL-BUS. ERROR, SP. UNIT LAY. ERROR, or other errors. Error code (system alarm): () Example: 1204 CPU H/W fault	Go to the following. ➡ 21.1
<input type="checkbox"/> Sometimes	The possible cause is noise or a hardware failure. Frequency: () Example: Once a month Error code (system alarm): () Example: 1204 CPU H/W fault	Go to (4) GOT restoration procedure.
<input type="checkbox"/> Normal operation	-	

(4) GOT restoration procedure

Follow the procedures in order from (a) and check if the GOT is restored.
If the GOT is still not restored, go to the next step.

Check item	Cause	Corrective action
(a) The GOT is restored by using the reset switch on the GOT. <input type="checkbox"/> Restored <input type="checkbox"/> Not restored (Go to (b).)	It may be a temporary malfunction due to noise.	Take the corrective action described in (4)-(h).
(b) The GOT is restored by powering on and off the GOT.* ¹ <input type="checkbox"/> Restored <input type="checkbox"/> Not restored (Go to (c).)		
(c) The GOT is restored by resetting or powering on and off the PLC CPU. <input type="checkbox"/> Restored <input type="checkbox"/> Not restored (Go to (d).)		
(d) The GOT is restored by powering on and off the GOT and the PLC CPU simultaneously. <input type="checkbox"/> Restored <input type="checkbox"/> Not restored (Go to (e).)		
(e) The GOT is restored by reconnecting cables. <input type="checkbox"/> Restored <input type="checkbox"/> Not restored (Go to (f).)	The possible cause is a cable connection fault.	Connect cables securely. When the error occurs again, go to (5) Actual product investigation.
(f) The GOT is restored by reinstalling project data. <input type="checkbox"/> Restored <input type="checkbox"/> Not restored (Go to (g).)	In such a case where the GOT is powered off during installation of project data or OS, the data may be corrupted.	Do not power off the GOT during data transmission. When the error occurs again, go to (5) Actual product investigation.
(g) The GOT is restored by reinstalling OS. <input type="checkbox"/> Restored <input type="checkbox"/> Not restored (Go to (h).)		
(h) The GOT is restored by taking corrective actions against noise described in the corrective action column. <input type="checkbox"/> Restored <input type="checkbox"/> Not restored (Go to (i).)	It may be a temporary malfunction due to noise.	Take corrective actions by following the GOT installation status check sheet.
(i) The GOT is not restored even after the corrective actions in (a) to (h) are taken.	-	Go to (5) Actual product investigation.

*1 Before powering on the GOT again (OFF → ON), make sure to power off the PLC.

(5) Actual product investigation

When the GOT still operates improperly even after the corrective actions described above are taken, contact your local distributor.

Depending on the error status, the actual product may need to be returned to us.

In that case, attach the GOT status check sheet, GOT installation status check sheet, and system configuration check sheet (Write down your system configuration used on the sheet).

2. GOT installation status check sheet

Check the actual installation status of the GOT used according to the GOT installation status described in the upper rows of items (1) to (7).



When the corrective actions described in the lower rows need to be taken, take the actions.

Only when the corrective actions are taken, put a check mark in the check box of "Effective" or "Ineffective" depending on the results of the actions.

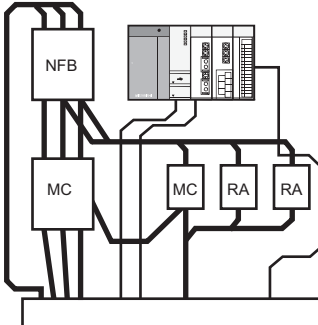
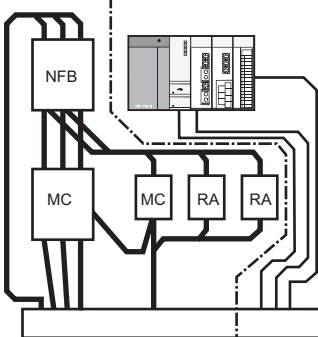
(1) Wiring inside

<p>Actual status</p>		<p>Power lines such as power supply cables or servo amplifier drive cables and communication cables are crossed each other in the wiring duct in the control panel.</p>	<input type="checkbox"/> Crossed <input type="checkbox"/> Not crossed
<p>Corrective action for when the cables are crossed each other</p>		<p>Wiring the power lines and the communication cables to keep them away from each other in the control panel will help minimize noise interference.</p>	<input type="checkbox"/> Effective <input type="checkbox"/> Ineffective

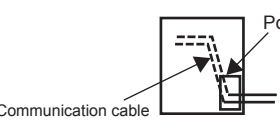
(2) Outside the panel

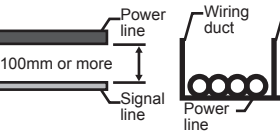
<p>Actual status</p>		<p>Power lines and communication cables are bundled together.</p>	<input type="checkbox"/> Bundled <input type="checkbox"/> Not bundled
<p>Corrective action for when they are bundled</p>	<p>Figure A</p>  <p>Figure B</p> 	<p>Setting outlets of the power lines and the communication cables separately, as shown in Figure A, will help minimize noise interference. In the duct, keeping the communication cables away from the power lines or using a metal separator, as shown in Figure B, can reduce noise interference.</p>	<input type="checkbox"/> Effective <input type="checkbox"/> Ineffective

(3) Wiring of the GOT's FG cables and power lines

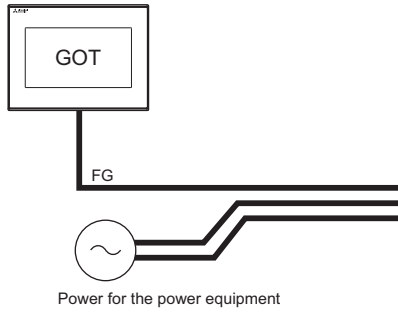
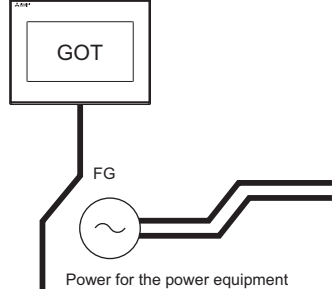
<p>Actual status</p> 	<p>The GOT's FG cables and power lines are bundled together.</p>	<input type="checkbox"/> Bundled <input type="checkbox"/> Not bundled
<p>Corrective action for when they are bundled</p> 	<p>Keeping the GOT's FG cables and power lines away from each other will help minimize noise interference.</p>	<input type="checkbox"/> Effective <input type="checkbox"/> Ineffective

(4) Countermeasures to prevent surges

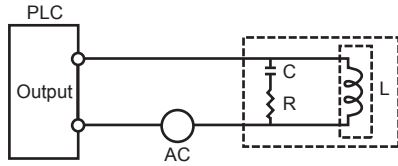
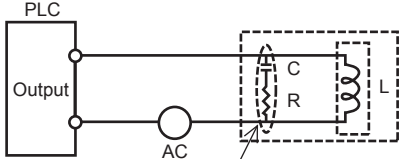
<p>Actual status</p> 	<p>Surge suppressors are used for wiring equipment (loads) such as no fuse breakers, electromagnetic contactors, relays, solenoid valves, and induction motors.</p> <p>(When surge suppressors are used, write their models and the names of devices for which the surge suppressors are used in the following table.)</p>	<input type="checkbox"/> Used <input type="checkbox"/> Not used
<p>Corrective action for when surge suppressors are not used</p>  <p>The surge suppressor must be attached close to the load</p>	<p>Using surge suppressors on the wiring near loads can reduce interference of the GOT surge.</p>	<input type="checkbox"/> Effective <input type="checkbox"/> Ineffective

Entry columns for surge suppressors

Model of surge suppressor	Device for which the surge suppressor is used

(5) Installation status

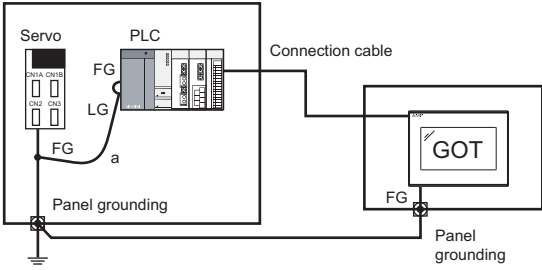
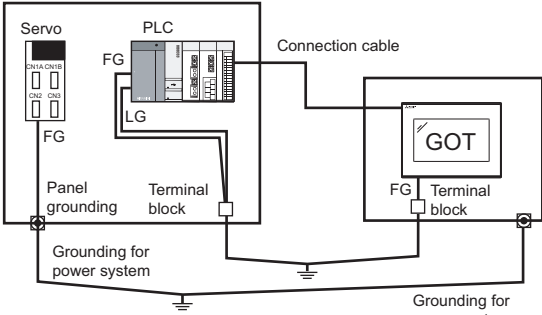
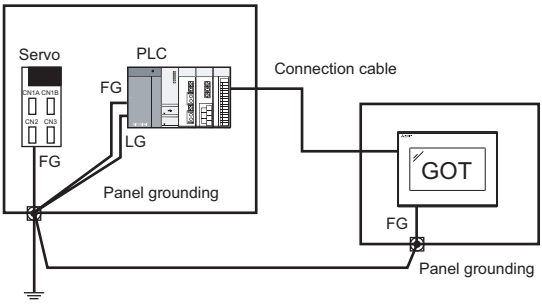
<p>Actual status</p> 	<p>The FG cables of control equipment (such as a PLC) and power equipment (such as a servo amplifier) are connected each other as shown in a.</p>	<p><input type="checkbox"/> True <input type="checkbox"/> False</p>
<p>Corrective action for when it is true</p> <p>Figure A</p>  <p>Figure B</p> 	<p>Carry out the independent grounding at two points as shown in Figure A. Independent grounding will help minimize noise interference. If the independent grounding is impossible, carry out the shared grounding as shown in Figure B.</p>	<p><input type="checkbox"/> Effective <input type="checkbox"/> Ineffective</p>

(6) Grounding status of the control panel where the GOT is installed

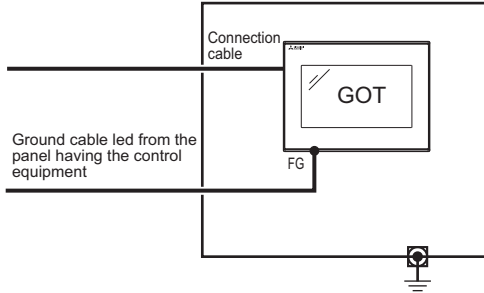
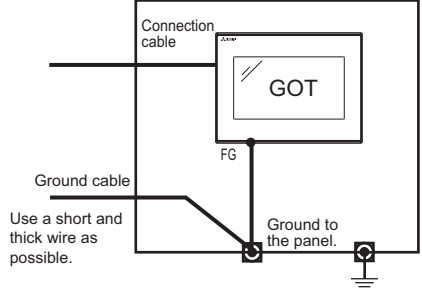
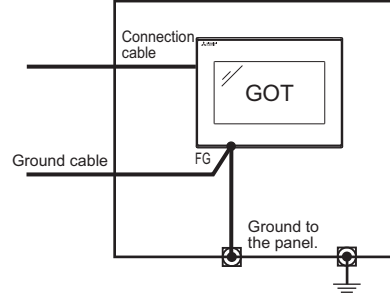
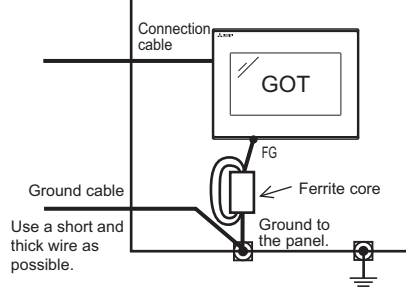
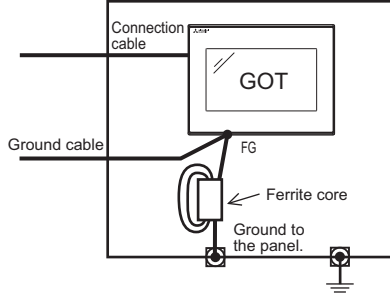
<p>Actual status</p> 	<p>A ground cable is led from the control panel where control equipment such as a PLC is installed to the control panel where the GOT is installed.</p>	<p><input type="checkbox"/> True <input type="checkbox"/> False</p>
<p>Figure A</p>  <p>Use a short and thick wire as possible.</p> <p>Figure B</p> 	<p>Connecting a ground cable to the panel where the GOT is installed as shown in Figure A reduces electric potential difference between the ground points, which may avoid malfunction of the GOT. If the wiring shown in Figure A cannot be carried out, perform the wiring as shown in Figure B.</p>	<p><input type="checkbox"/> Effective <input type="checkbox"/> Ineffective</p>
<p>Corrective action for when it is true</p> <p>Figure C</p>  <p>Use a short and thick wire as possible.</p> <p>Figure D</p> 	<p>Attaching a ferrite core to the ground cable connected to the control panel where the GOT is installed, as shown in Figure C, will help minimize noise interference. If the wiring shown in Figure C cannot be carried out, perform the wiring as shown in Figure D.</p>	<p><input type="checkbox"/> Effective <input type="checkbox"/> Ineffective</p>

(7) Power supply system

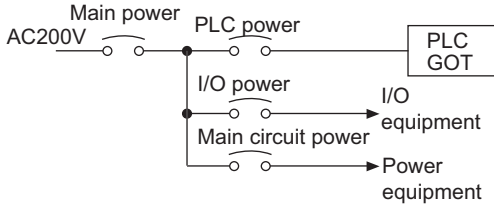
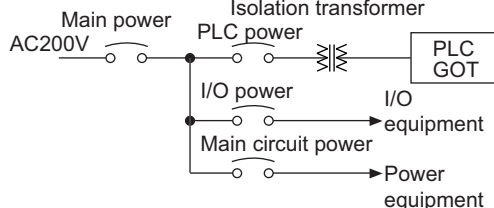
<p>Actual status</p> 	<p>I/O equipment (such as a relay) and power equipment (such as a servo amplifier) use the power supply in the same system as the one of the GOT.</p>	<p><input type="checkbox"/> True <input type="checkbox"/> False</p>
<p>Corrective action for when it is true</p> 	<p>Carry out the wiring with the power supply of the GOT separated from the one of the I/O equipment and power equipment and connect an isolation transformer. This will help minimize noise interference.</p>	<p><input type="checkbox"/> Effective <input type="checkbox"/> Ineffective</p>

3. System configuration check sheet

Write the model of each unit in the following square brackets ([]).

(1) System configuration of the GOT			
(a) GOT		[]
(b) Communication interface		[]
(c) Cable between the PLC and GOT		[]
(d) Cable length		[m]

(2) System configuration of the PLC			
(a) Power supply unit		[]
(b) CPU module		[]
(c) Serial communication unit	<input type="checkbox"/> Used	[]
/computer link unit	<input type="checkbox"/> Not used		
(d) Network unit	<input type="checkbox"/> Used	[]
	<input type="checkbox"/> Not used		
(e) Interrupt module	<input type="checkbox"/> Used	[]
	<input type="checkbox"/> Not used		
(f) Positioning module	<input type="checkbox"/> Used	[]
	<input type="checkbox"/> Not used		
(g) Number of extended PLC stages		[stages]
(h) When other units or devices are used, write their names.			

Entry column for writing the status of the phenomenon (when the GOT still operates improperly after corrective actions are taken)

(3) Write the details of the error operations. (Such as when the GOT screen is frozen or the screen is displayed improperly)

22. CONNECTION

This chapter describes connection types which are supported by GOT SIMPLE series.

In each reference manual, two icons,  and , are given in this manual.

 refers to the connection types supported by the GOT SIMPLE series.

 refers to the connection types unsupported by the GOT SIMPLE series.

For the connectors on the GOT side, refer to the following.

- ➡ 3.4 GOT Connector Specifications

22.1 Connecting to Mitsubishi Products

The following connection types are supported.

22.1.1 Ethernet connection

For details, refer to the following.

- ➡ GOT2000 Series Connection Manual (Mitsubishi Product) For GT Works3 Version1
5. ETHERNET CONNECTION

22.1.2 Direct CPU connection

For details, refer to the following.

- ➡ GOT2000 Series Connection Manual (Mitsubishi Product) For GT Works3 Version1
6. DIRECT CONNECTION TO CPU

22.1.3 Computer link connection

For details, refer to the following.

- ➡ GOT2000 Series Connection Manual (Mitsubishi Product) For GT Works3 Version1
7. COMPUTER LINK CONNECTION

22.1.4 CC-Link connection (via G4)

For details, refer to the following.

- ➡ GOT2000 Series Connection Manual (Mitsubishi Product) For GT Works3 Version1
13. CC-Link CONNECTION (Via G4)

22.1.5 Inverter connection

For details, refer to the following.

- ➡ GOT2000 Series Connection Manual (Mitsubishi Product) For GT Works3 Version1
14. INVERTER CONNECTION

22.1.6 Servo amplifier connection

For details, refer to the following.

- ➡ GOT2000 Series Connection Manual (Mitsubishi Product) For GT Works3 Version1
15. SERVO AMPLIFIER CONNECTION

22.1.7 Multi-channel function

For details, refer to the following.

- ➡ GOT2000 Series Connection Manual (Mitsubishi Product) For GT Works3 Version1
19. Multi-channel Function

22.1.8 FA transparent function

For details, refer to the following.

- ➡ GOT2000 Series Connection Manual (Mitsubishi Product) For GT Works3 Version1
20. FA TRANSPARENT FUNCTION

22.2 Connecting to Non-Mitsubishi Products

22.2.1 Connecting to SIEMENS PLC

For details, refer to the following.

- ➡ GOT2000 Series Connection Manual (Non Mitsubishi Product 2) For GT Works3 Version1
14. CONNECTION TO SIEMENS PLC

22.3 Connecting to Peripheral Devices

22.3.1 Bar code reader connection

For details, refer to the following.

- ➡ GOT2000 Series Connection Manual
(Microcomputer, MODBUS Products, Peripherals) For GT Works3 Version1
8. BAR CODE READER CONNECTION

22.3.2 Printer connection

For details, refer to the following.

- ➡ GOT2000 Series Connection Manual
(Microcomputer, MODBUS Products, Peripherals) For GT Works3 Version1
14. PRINTER CONNECTION

23. APPENDIX

Appendix.1 External Dimensions

■ 1. GS2110-WTBD

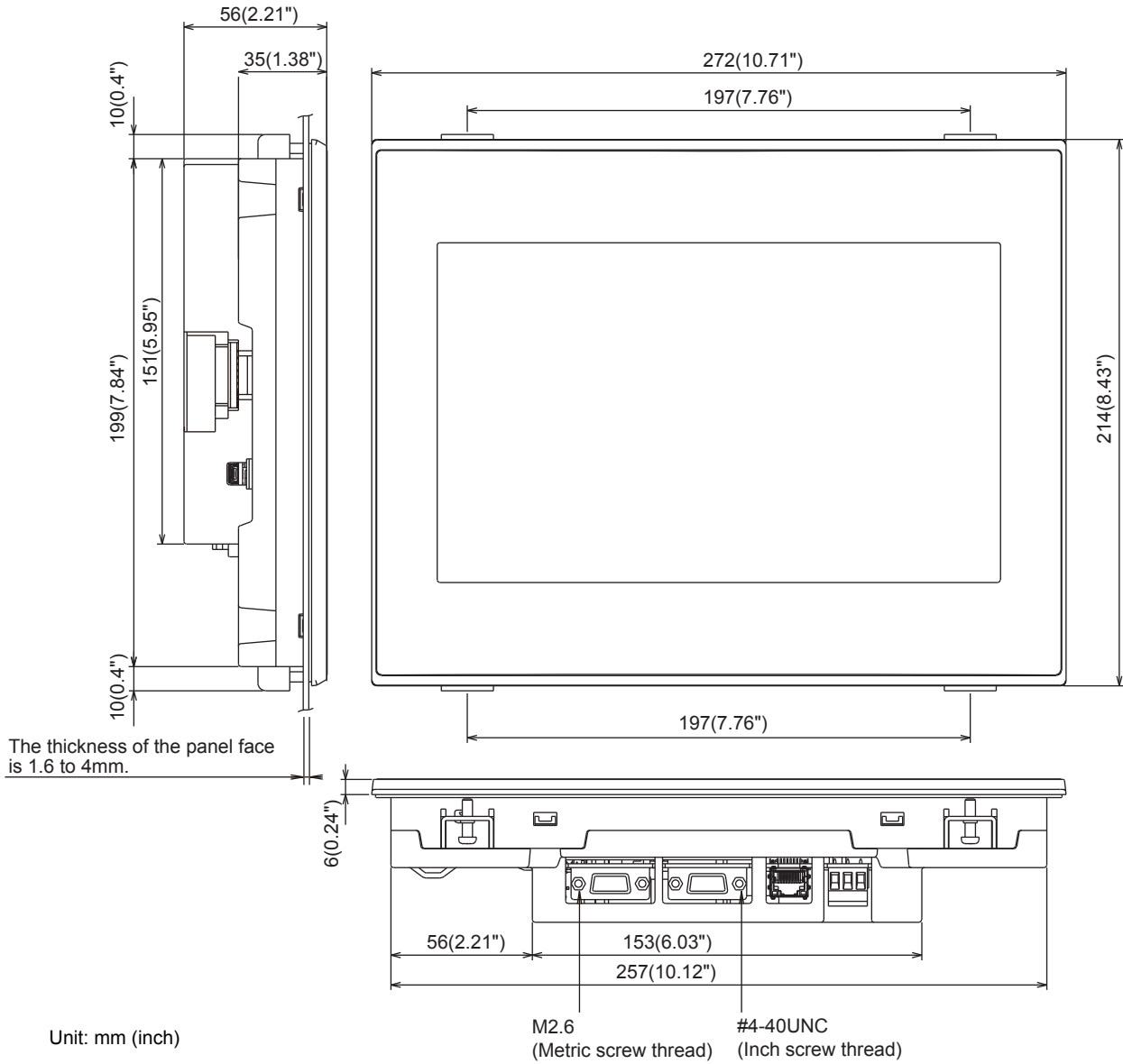

■ 2. GS2107-WTBD

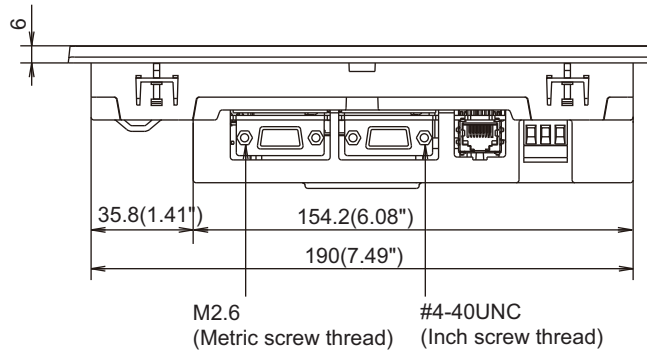
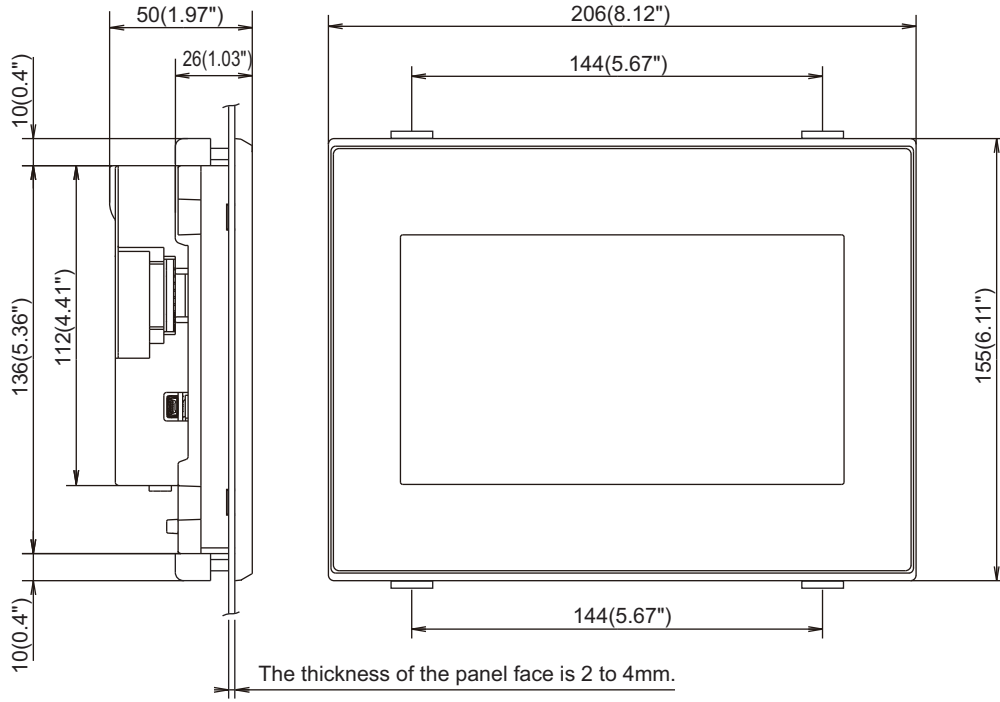

Unit: mm (inch)

3. Communication cable

GT01-C30R4-25P

Unit: mm (inch)

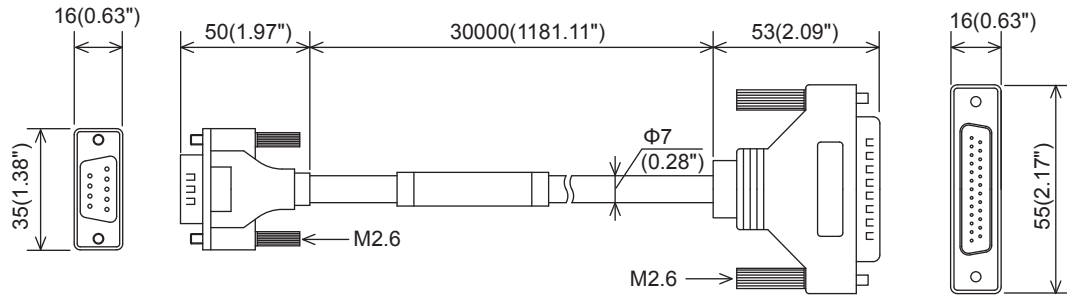

GT01-C□□□R4-25P

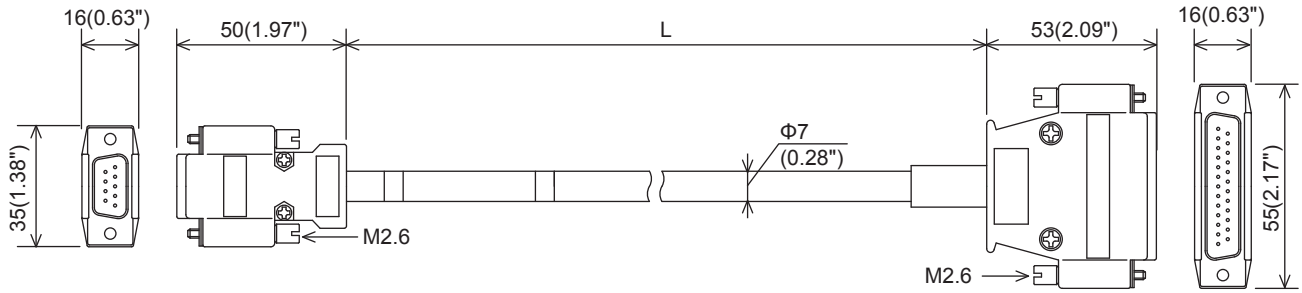

□□□ value	L length (mm (inch))
100	10000 (393.7")
200	20000 (787.4")
300	30000 (1181.1")

GT01-C□□□R4-8P

Unit: mm (inch)

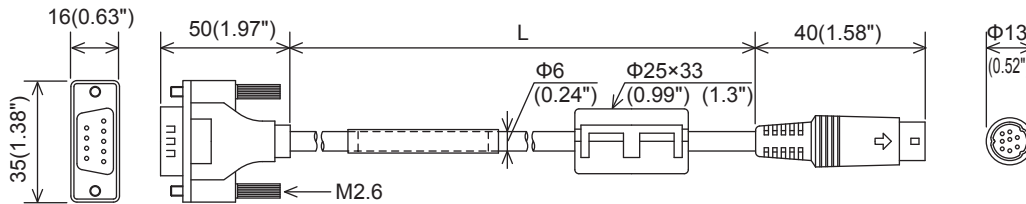

□□□ value	L length (mm (inch))
10	1000 (39.37")
30	3000 (118.11")
100	10000 (393.7")
200	20000 (787.4")
300	30000 (1181.1")

Unit: mm (inch)

GT01-C30R2-25P

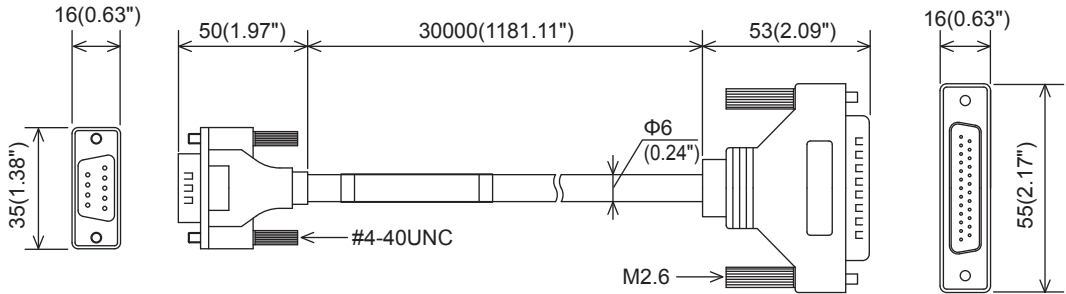

GT01-C30R2-9S

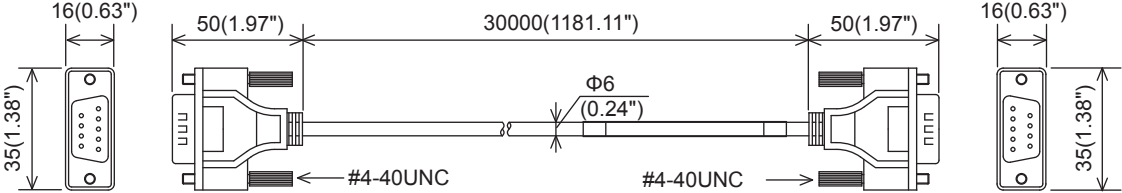

GT01-C30R2-6P

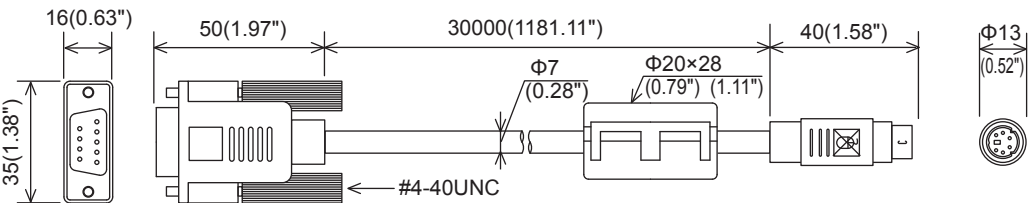

WARRANTY

Please confirm the following product warranty details before using this product.

1. Gratis Warranty Term and Gratis Warranty Range

If any faults or defects (hereinafter "Failure") found to be the responsibility of Mitsubishi occurs during use of the product within the gratis warranty term, the product shall be repaired at no cost via the sales representative or Mitsubishi Service Company. However, if repairs are required onsite at domestic or overseas location, expenses to send an engineer will be solely at the customer's discretion. Mitsubishi shall not be held responsible for any re-commissioning, maintenance, or testing on-site that involves replacement of the failed module.

[Gratis Warranty Term]

The gratis warranty term of the product shall be for thirty-six (36) months after the date of purchase or delivery to a designated place.

Note that after manufacture and shipment from Mitsubishi, the maximum distribution period shall be six (6) months, and the longest gratis warranty term after manufacturing shall be forty-two (42) months. The gratis warranty term of repair parts shall not exceed the gratis warranty term before repairs.

[Gratis Warranty Range]

- (1) The customer shall be responsible for the primary failure diagnosis unless otherwise specified.
If requested by the customer, Mitsubishi Electric Corporation or its representative firm may carry out the primary failure diagnosis at the customer's expense.
The primary failure diagnosis will, however, be free of charge should the cause of failure be attributable to Mitsubishi Electric Corporation.
- (2) The range shall be limited to normal use within the usage state, usage methods and usage environment, etc., which follow the conditions and precautions, etc., given in the instruction manual, user's manual and caution labels on the product.
- (3) Even within the gratis warranty term, repairs shall be charged for in the following cases.
 1. Failure occurring from inappropriate storage or handling, carelessness or negligence by the user. Failure caused by the user's hardware or software design.
 2. Failure caused by unapproved modifications, etc., to the product by the user.
 3. When the Mitsubishi product is assembled into a user's device, Failure that could have been avoided if functions or structures, judged as necessary in the legal safety measures the user's device is subject to or as necessary by industry standards, had been provided.
 4. Failure that could have been avoided if consumable parts designated in the instruction manual had been correctly serviced or replaced.
 5. Replacing consumable parts such as the battery, backlight and fuses.
 6. Failure caused by external irresistible forces such as fires or abnormal voltages, and Failure caused by force majeure such as earthquakes, lightning, wind and water damage.
 7. Failure caused by reasons unpredictable by scientific technology standards at time of shipment from Mitsubishi.
 8. Any other failure found not to be the responsibility of Mitsubishi or that admitted not to be so by the user.

2. Onerous repair term after discontinuation of production

- (1) Mitsubishi shall accept onerous product repairs for seven (7) years after production of the product is discontinued.
Discontinuation of production shall be notified with Mitsubishi Technical Bulletins, etc.
- (2) Product supply (including repair parts) is not available after production is discontinued.

3. Overseas service

Overseas, repairs shall be accepted by Mitsubishi's local overseas FA Center. Note that the repair conditions at each FA Center may differ.

4. Exclusion of loss in opportunity and secondary loss from warranty liability

Regardless of the gratis warranty term, Mitsubishi shall not be liable for compensation to damages caused by any cause found not to be the responsibility of Mitsubishi, loss in opportunity, lost profits incurred to the user by Failures of Mitsubishi products, special damages and secondary damages whether foreseeable or not, compensation for accidents, and compensation for damages to products other than Mitsubishi products, replacement by the user, maintenance of on-site equipment, start-up test run and other tasks.

5. Changes in product specifications

The specifications given in the catalogs, manuals or technical documents are subject to change without prior notice.

6. Product application

- (1) In using the Mitsubishi graphic operation terminal, the usage conditions shall be that the application will not lead to a major accident even if any problem or fault should occur in the graphic operation terminal device, and that backup and fail-safe functions are systematically provided outside of the device for any problem or fault.
- (2) The Mitsubishi graphic operation terminal has been designed and manufactured for applications in general industries, etc. Thus, applications in which the public could be affected such as in nuclear power plants and other power plants operated by respective power companies, and applications in which a special quality assurance system is required, such as for Railway companies or Public service purposes shall be excluded from the graphic operation terminal applications.
In addition, applications in which human life or property that could be greatly affected, such as in aircraft, medical applications, incineration and fuel devices, manned transportation equipment for recreation and amusement, and safety devices, shall also be excluded from the graphic operation terminal range of applications.
However, in certain cases, some applications may be possible, providing the user consults the local Mitsubishi representative outlining the special requirements of the project, and providing that all parties concerned agree to the special circumstances, solely at our discretion.
In some of three cases, however, Mitsubishi Electric Corporation may consider the possibility of an application, provided that the customer notifies Mitsubishi Electric Corporation of the intention, the application is clearly defined and any special quality is not required.

GOT is a registered trademark of Mitsubishi Electric Corporation.

Microsoft, Windows, Windows NT, Windows Server, Windows Vista, and Windows 7 are registered trademarks or trademarks of Microsoft Corporation in the United States and other countries.

Adobe and Adobe Reader are registered trademarks of Adobe Systems Incorporated.

Pentium and Celeron are a registered trademarks of Intel Corporation in the United States and other countries.

Ethernet is a registered trademark of Xerox Corporation in the United States.

MODBUS is a trademark of Schneider Electric SA.

VNC is a registered trademark of RealVNC Ltd. in the United States and other countries.

Other company and product names herein are either trademarks or registered trademarks of their respective owners.

GOT SIMPLE series User's Manual

JY997D52901A

When exported from Japan, this manual does not require application to the Ministry of Economy, Trade and Industry for service transaction permission.

mitsubishi ELECTRIC CORPORATION

HEAD OFFICE : TOKYO BUILDING, 2-7-3 MARUNOUCHI, CHIYODA-KU, TOKYO 100-8310, JAPAN
NAGOYA WORKS : 1-14, YADA-MINAMI 5-CHOME, HIGASHI-KU, NAGOYA, JAPAN

Specifications subject to change without notice. Printed in Japan, January 2014.

HEADQUARTERS		EUROPEAN REPRESENTATIVES		EUROPEAN REPRESENTATIVES		EURASIAN REPRESENTATIVES	
Mitsubishi Electric Europe B.V. Gothaer Straße 8 D-40880 Ratingen Phone: +49 (0)2102 / 486-0 Fax: +49 (0)2102 / 486-1120	EUROPE	GEVA Wiener Straße 89 A-2500 Baden Phone: +43 (0)2252 / 85 55 20 Fax: +43 (0)2252 / 488 60	AUSTRIA	Beijer Electronics SIA Ritausmas iela 23 LV-1058 Riga Phone: +371 (0)6 / 784 2280 Fax: +371 (0)6 / 784 2281	LATVIA	TOO Kazpromavtomatika UL. ZHAMBYLA 28, KAZ-100017 Karaganda Phone: +7 7212 / 50 10 00 Fax: +7 7212 / 50 11 50	KAZAKHSTAN
Mitsubishi Electric Europe B.V. Radlická 751/113e Avenir Business Park CZ-158 00 Praha 5 Phone: +420 251 551 470 Fax: +420 251 551 471	CZECH REP.	000 TECHNIKON Prospect Nezavisimosti 177-9 BY-220125 Minsk Phone: +375 (0)17 / 393 1177 Fax: +375 (0)17 / 393 0081	BELARUS	Beijer Electronics UAB Goštautų g. 3 LT-48324 Kaunas Phone: +370 37 262707 Fax: +370 37 455605	LITHUANIA	MIDDLE EAST REPRESENTATIVE	
Mitsubishi Electric Europe B.V. 25, Boulevard des Bouvets F-92741 Nanterre Cedex Phone: +33 (0)1 / 55 68 55 68 Fax: +33 (0)1 / 55 68 57 57	FRANCE	ESCO DRIVES Culliganlaan 3 BE-1831 Diegem Phone: +32 (0)2 / 717 64 60 Fax: +32 (0)2 / 717 64 61	BELGIUM	ALFATRADE Ltd. 99, Paola Hill Malta-Paola PLA 1702 Phone: +356 (0)21 / 697 816 Fax: +356 (0)21 / 697 817	MALTA	I.C. SYSTEMS Ltd. 23 Al-Saad-Al-Alee St. EG-Sarayat, Maadi, Cairo Phone: +20 (0) 2 / 235 98 548 Fax: +20 (0) 2 / 235 96 625	EGYPT
Mitsubishi Electric Europe B.V. Westgate Business Park, Ballymount IRL-Dublin 24 Phone: +353 (0)1 4198800 Fax: +353 (0)1 4198890	IRELAND	KONING & HARTMAN B.V. Woluwelaan 31 BE-1800 Vilvoorde Phone: +32 (0)2 / 257 02 40 Fax: +32 (0)2 / 257 02 49	BELGIUM	INTEHSIS SRL bld. Traian 23/1 MD-2060 Kishinev Phone: +373 (0)22 / 66 4242 Fax: +373 (0)22 / 66 4280	MOLDOVA	GIRIT CELADON Ltd. 12 Haomanir Street IS-42505 Netanya Phone: +972 (0)9 / 863 39 80 Fax: +972 (0)9 / 885 24 30	ISRAEL
Mitsubishi Electric Europe B.V. Viale Colleoni 7 Palazzo Sirio I-20864 Agrate Brianza (MB) Phone: +39 039 / 60 53 1 Fax: +39 039 / 60 53 312	ITALY	INEA RBT d.o.o. Stegne 11 SI-1000 Ljubljana Phone: +386 (0)1 / 513 8116 Fax: +386 (0)1 / 513 8170	BOSNIA AND HERZEGOVINA	HIFLEX AUTOM. B.V. Wolweverstraat 22 NL-2984 CD Ridderkerk Phone: +31 (0)180 / 46 60 04 Fax: +31 (0)180 / 44 23 55	NETHERLANDS	ILAN & GAVISH Ltd. 24 Shenkar St., Kiryat Ariet IL-49001 Petah-Tikva Phone: +972 (0)3 / 922 18 24 Fax: +972 (0)3 / 924 0761	ISRAEL
Mitsubishi Electric Europe B.V. Nijverheidsweg 23a NL-3641RP Mijdrecht Phone: +31 (0) 297250350	NETHERLANDS	AKHNATON 4, Andrei Ljapchev Blvd., PO Box 21 BG-1756 Sofia Phone: +359 (0)2 / 817 6000 Fax: +359 (0)2 / 97 44 06 1	BULGARIA	KONING & HARTMAN B.V. Energieweg 1 NL-2627 AP Delft Phone: +31 (0)15 260 99 06 Fax: +31 (0)15 261 9194	NETHERLANDS	CEG LIBAN Cebaco Center/Block A Autostrade DORA Lebanon-Beirut Phone: +961 (0)1 / 240 445 Fax: +961 (0)1 / 240 193	LEBANON
Mitsubishi Electric Europe B.V. ul. Krakowska 50 PL-32-083 Balice Phone: +48 (0) 12 347 65 00 Fax: +48 (0) 12 347 65 01	POLAND	INEA CR Losinjska 4 a HR-10000 Zagreb Phone: +385 (0)1 / 36 940 - 01/ -02/ -03 Fax: +385 (0)1 / 36 940 - 03	CROATIA	Beijer Electronics AS Postboks 487 NO-3002 Drammen Phone: +47 (0)32 / 24 30 00 Fax: +47 (0)32 / 84 85 77	NORWAY	AFRICAN REPRESENTATIVE	
Mitsubishi Electric Europe B.V. 52, bld. 1 Kosmodamianskaya emb. RU-115054 Moscow Phone: +7 495 / 721 2070 Fax: +7 495 / 721 2071	RUSSIA	AutoCont C. S. S.R.O. Kačkova 1853/3 CZ-702 00 Ostrava 2 Phone: +420 595 691 150 Fax: +420 595 691 199	CZECH REPUBLIC	Fonseca S.A. R. João Francisco do Casal 87/89 PT-3801-997 Aveiro, Esqueira Phone: +351 (0)234 / 303 900 Fax: +351 (0)234 / 303 910	PORTUGAL	ADROIT TECHNOLOGIES 20 Waterford Office Park 189 Witkoppen Road ZA-Fourways Phone: +27 (0)11 / 658 8100 Fax: +27 (0)11 / 658 8101	SOUTH AFRICA
Mitsubishi Electric Europe B.V. Carretera de Rubi 76-80 Apdo. 420 E-08190 Sant Cugat del Vallés (Barcelona) Phone: +34 (0) 93 / 5653131 Fax: +34 (0) 93 / 5891579	SPAIN	HANS FÖLSGAARD A/S Theilgaardstr. 1 DK-4600 Køge Phone: +45 4320 8600 Fax: +45 (0)46 / 75 56 26	DENMARK	SIRIUS TRADING & SERVICES SRL Aleea Lacul Morii Nr. 3 RO-060841 Bucuresti, Sector 6 Phone: +40 (0)21 / 430 40 06 Fax: +40 (0)21 / 430 40 02	ROMANIA		
Mitsubishi Electric Europe B.V. (Scandinavia) Fjellievägen 8 SE-22736 Lund Phone: +46 (0) 8 625 10 00 Fax: +46 (0) 46 39 70 18	SWEDEN	HANS FÖLSGAARD A/S Theilgaardstr. 1 DK-4600 Køge Phone: +45 4320 8600 Fax: +45 (0)46 / 75 56 26	DENMARK	INEA SR d.o.o. Ul. Karadjordjeva 12/217 SER-11300 Smederevo Phone: +386 (026) 461 54 01	SERBIA		
Mitsubishi Electric Turkey Elektrik Ürünleri A.Ş. Fabrika Otomasyon Merkezi Şerifali Mahallesi Nutuk Sokak No.5 TR-34775 Ümraniye-İSTANBUL Phone: +90 (0)216 / 526 39 90 Fax: +90 (0)216 / 526 39 95	TURKEY	Beijer Electronics A/S Lykkegardsvej 17 DK-4000 Roskilde Phone: +45 (0)46 / 75 76 66 Fax: +45 (0)46 / 75 56 26	DENMARK	SIMAP SK (Západné Slovensko) Jána Derku 1671 SK-911 01 Trenčín Phone: +421 (0)32 743 04 72 Fax: +421 (0)32 743 75 20	SLOVAKIA		
Mitsubishi Electric Europe B.V. Travellers Lane UK-Hatfield, Herts. AL10 8XB Phone: +44 (0)1707 / 28 87 80 Fax: +44 (0)1707 / 27 86 95	UK	Beijer Electronics OY Vanha Nurmijärventie 62 FIN-01670 Vantaa Phone: +358 (0)207 / 463 500 Fax: +358 (0)207 / 463 501	FINLAND	INEA RBT d.o.o. Stegne 11 SI-1000 Ljubljana Phone: +386 (0)1 / 513 8116 Fax: +386 (0)1 / 513 8170	SLOVENIA		
Mitsubishi Electric Europe B.V. Dubai Silicon Oasis United Arab Emirates - Dubai Phone: +971 4 3724716 Fax: +971 4 3724721	UAE	PROVENDOR OY Teljänkatu 8 A3 FIN-28130 Pori Phone: +358 (0) 2 / 522 3300 Fax: +358 (0) 2 / 522 3322	FINLAND	Beijer Electronics Automation AB Box 426 SE-20124 Malmö Phone: +46 (0)40 / 35 86 00 Fax: +46 (0)40 / 93 23 01	SWEDEN		
Mitsubishi Electric Corporation Tokyo Building 2-7-3 Marunouchi, Chiyoda-ku Tokyo 100-8310 Phone: +81 (3) 3218-2111 Fax: +81 (3) 3218-2185	JAPAN	UTECO A.B.E.E. 5, Mavrogenou Str. GR-18542 Piraeus Phone: +30 (0)211 / 1206-900 Fax: +30 (0)211 / 1206-999	GREECE	OMNI RAY AG Im Schörl 5 CH-8600 Dübendorf Phone: +41 (0)44 / 802 28 80 Fax: +41 (0)44 / 802 28 28	SWITZERLAND		
Mitsubishi Electric Automation, Inc. 500 Corporate Woods Parkway Vernon Hills, IL 60061 Phone: +1 (847) 478-2100 Fax: +1 (847) 478-0328	USA	MELTRADE Kft. Fertő utca 14. HU-1107 Budapest Phone: +36 (0)1 / 431-9726 Fax: +36 (0)1 / 431-9727	HUNGARY	OOO "CSC-AUTOMATION" 4-B, M. Raskovoy St. UA-02660 Kiev Phone: +380 (0)44 / 494 33 44 Fax: +380 (0)44 / 494-33-66	UKRAINE		