

AS-Interface Maintenance Troubleshooting Guide

Edition 4





G10 ultra-compact module—the perfect solution for space-limited applications.

Visit www.pepperl-fuchs.us for datasheets, manuals, software tools, newsletters, and product cross reference.



www.youtube.com/PepperlFuchsUSA
Visit our YouTube channel for informative videos.



www.twitter.com/PepperlFuchsUSA
Follow us on Twitter.

Contents

AS-Interface handheld programmer	5 - 7
How to set module address with handheld programmer	5
How to read module profile with handheld programmer	6
How to read inputs and set outputs on AS-Interface module(s)	6
LED functionality	8 - 12
I/O modules	8
K12 or equivalent consortium safety monitors	10
KE4 safety monitor	11
K20, K30 Ethernet gateways	12
Troubleshooting	13 - 14
K20, K30 gateways	13 - 14
Replacing failed modules	15 - 18
Replacing failed standard module(s)	15
Replacing single safety module(s) configured in K12 or consortium safety monitors	16
Replacing single safety module(s) reported on KE4 safety controller	17
Replacing single safety module(s) reported on K30 gateway	18
Replacing failed safety monitors	19 - 21
K12 safety monitor	19
KE4 safety monitor	20
K20, K30 gateway	21
Extending AS-Interface networks	22 - 24
Built-In advanced diagnostics K20, K30 gateways	25 - 26
Power supplies	27 - 28
Helpful wiring hints	29 - 34
Common problems and solutions	35



AS-Interface – Economical, Easy, and High Performing

AS-Interface minimizes installation effort, has a comprehensive diagnostic function, and enables flexible system enhancements. AS-Interface is an open installation system that is recognized and accepted around the world. Pepperl+Fuchs and many manufacturers offer a wide range of compatible products.

AS-Interface handheld programmer

A handheld programmer can program any AS-Interface module. It can also be used as a diagnostic tool to read a module profile, set parameters, read inputs, and set outputs.



YouTube video available on *How to Use AS-Interface Handheld Programmer*:
visit: <http://www.sensing.net/asi-solutions/vid1>
or scan the QR code with your smart phone or tablet.



How to set module address with handheld programmer?

1. Connect module to handheld device.
2. Press "**ADR**" button to display current address of module.
3. Use arrow "**↑↓**" buttons to choose new address.
4. Press "**PRG**" button to set the address.
5. Press "**ADR**" button to confirm new address got stored.

All AS-Interface modules have profiles. Typically, module profiles are made up of ID, ID1, ID2, and IO.

NOTE: Certain older modules (AS-Interface specification 2.0) may have reduced profiles with only ID and IO.

Model: VAZ-PK-1.5M-V1-G



This addressing cable can be used on most AS-Interface modules using the addressing jack.

Model: VBP-HH1-V3.0

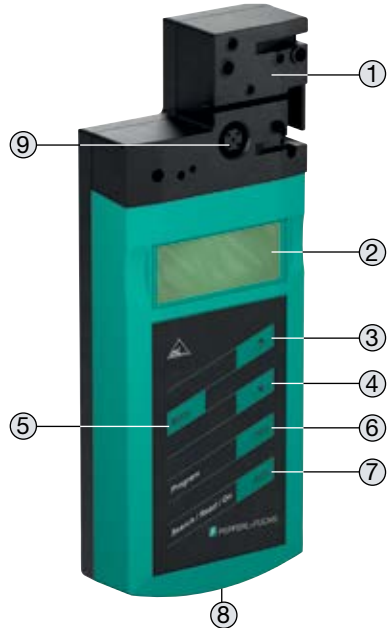

- ① AS-Interface connection adapter
- ② LCD display
- ③ Up arrow button (↑)
- ④ Down arrow button (↓)
- ⑤ Mode button (**MODE**)
- ⑥ Program button (**PRG**)
- ⑦ Address button (**ADR**)
- ⑧ Charger connector
- ⑨ Port to connect VAZ-PK-1.5M-V1-G cable

How to read module profile with handheld programmer?

1. Connect module to handheld device.
2. Press "**ADR**" button.
3. Press "**MODE**" button each time to see the corresponding values that make up the module profile.

ID ID1 ID2 IO

How to read inputs and set outputs on AS-Interface module(s)?

During commissioning of an installation, you can check inputs or set outputs on an AS-Interface module.

1. Connect module to handheld device.
2. Press "**ADR**" button.
3. Change mode to DATA by pressing the "**MODE**" button 4x or 7x depending on module type. (Menu will repeat if you go too far.)
4. Use arrow "↑ ↓" buttons to select output value.
5. Press and hold "**PRG**" button to turn outputs on.
6. Press and hold "**ADR**" button to read inputs.

Refer to the following charts to determine the hexadecimal equivalent needed to enable the corresponding inputs or outputs on a module.

NOTE: The number of inputs/outputs on an AS-Interface module varies. However, the maximum number is 4 inputs and 4 outputs.

Data Bits	D3	D2	D1	D0
Inputs	I4	I3	I2	I1
Outputs	O4	O3	O2	O1











































Hex Value	0	1	2	3	4	5	6	7	8	9
Inputs	None	I1	I2	I1 I2	I3	I1 I3	I2 I3	I1 I2 I3	I4	I4 I1
Outputs	None	O1	O2	O1 O2	O3	O1 O3	O2 O3	O1 O2 O3	O4	O4 O1

Hex Value	A	B	C	D	E	F
Inputs	I4 I2	I4, I2 I1	I4, I3	I4 I3 I1	I4 I3 I2	I4 I3 I2 I1
Outputs	O4 O2	O4 O2 O1	O4 O3	O4 O3 O1	O4 O3 O2	O4 O3 O2 O1

LED functionality

I/O modules

Refer to the following charts to help diagnose, maintain, and troubleshoot LEDs on the most typical discrete AS-Interface modules.

LED	G10	G11	G12	Indication	Meaning
PWR AS-i				Off	No power
				On (Green)	Normal
				Flashing (Green)	Address 0 (FAULT LED on) or peripheral fault (FAULT LED flashing)
PWR/ FAULT				Off	No power
				Off	Normal
				On (Green)	Normal
				On (Red)	No AS-Interface communication; check address
				Flashing (Red)	Peripheral fault; check I/O
				Alternating (Red/Yellow)	Address 0
				Alternating (Red/Green)	Peripheral fault; check I/O
AUX				OFF	No AUX power; check black AS-Interface cable
				ON	Normal
I In				OFF	Input OFF; no AUX power or wire broken
				ON	Input ON
O Out				OFF	Output OFF; no AUX power or output not set by PLC
				ON	Output ON
				ON	Output shorted/overloaded (if supported by module)

G10

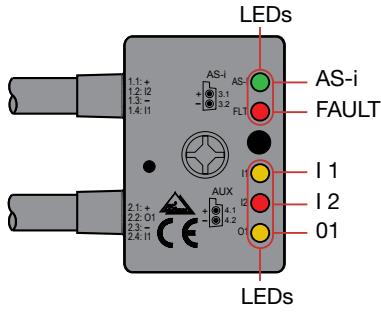

Ultra-compact modules fit in confined spaces

G11

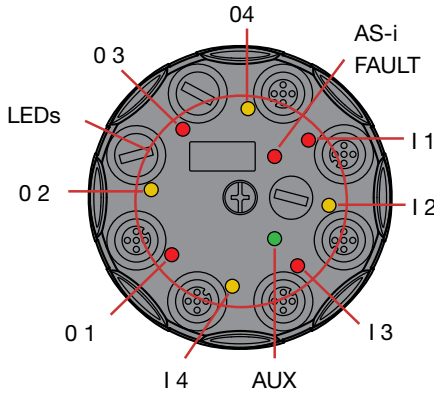

Innovative, versatile, robust modules

G12

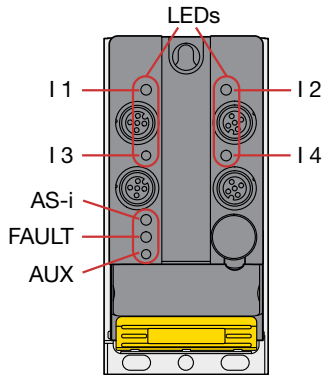

Flat modules for mounting without tools

LED functionality

K12 or equivalent consortium safety monitors

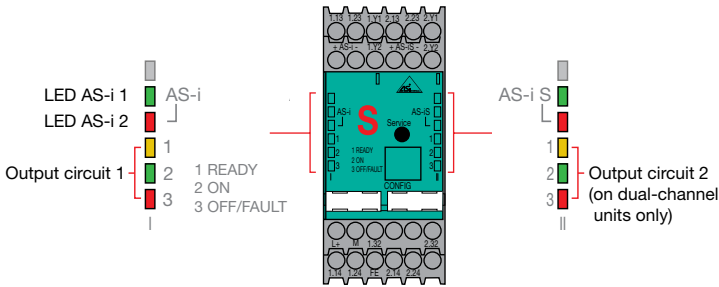

Refer to the following chart to help diagnose, maintain, and troubleshoot LEDs on K12 or consortium versions of the safety monitors.

LED	Indication	Meaning
AS-i 1	Off	No 30 V AS-Interface connection to AS-i+ and AS-i- terminals
	On (Green)	Normal
AS-i 2	Off	Normal operation
	On (Red)	No AS-Interface communication or monitor address not stored in gateway/scanner
1 READY	On (Yellow)	Waiting for start condition or door unlock condition
	Flashing (Yellow)	Safety module test, local acknowledge required, or diagnostic stop enabled
2 ON	On (Green)	Contacts of the output switching elements closed
	Flashing (Green)	Delay time runs in event of Stop Category 1
3 OFF/FAULT	On (Red)	Contacts of the output switching elements open
	Flashing (Red)	Error on level of the monitored AS-Interface components
1 READY 2 ON 3 OFF/FAULT	Simultaneously flashing rapidly	Internal device error; power cycle is required
1 READY 2 ON 3 OFF/FAULT	Cycling slowly	Learning safety code sequences
1 READY 2 ON 3 OFF/FAULT	Off	No 24 V supply connected to L+ and M terminals

LED functionality

KE4 safety monitor (VAS-2A8L-KE4-8SE)

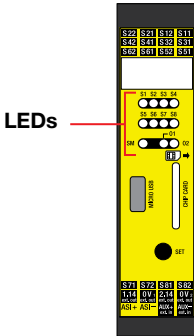

1. "YELLOW" has higher priority than "RED" and "GREEN" and will be displayed preferentially.
2. If "CONFIG ERROR" and "PERIPHERAL FAULT" occur simultaneously, only "CONFIG ERROR" is displayed.
3. "RED" has higher priority than "YELLOW".

LED	Indication	Meaning
SM ¹		AS-Interface supply power not OK
		Protective mode and ASIMON active
		Protective mode active
		Configuration mode active
	1 Hz	Configuration mode and ASIMON active
	2 Hz	At least 1 device in state red flashing or yellow flashing
	1 Hz	Service button, state: teach-error
AS-i M ²		Off-line, monitor mode
	1 Hz	Peripheral fault without config error
		Config error, auto addressing <i>not</i> possible
	2 Hz	Config error, auto addressing possible
	1 Hz	Master: protective mode, no error
O1, O2 ³		Output (O1, O2) off
	1 Hz	Restart inhibit
	8 Hz	Rectifiable fault condition
		Output (O1, O2) on
		No auxiliary voltage
SM, AS-i M, O1, O2	1 Hz	Competing master active

LED functionality

K20, K30 Ethernet gateways

Refer to the following chart to help diagnose, maintain, and troubleshoot LEDs for Ethernet AS-Interface gateways.

LED	Indication	Meaning
Power	● On (Green)	Power on
Ethernet	● On (Green)	Ethernet Active
Config Error	● On (Red)	One slave missing or extra slave on the network
	● Flashing (Red)	Peripheral fault on network
U AS-i	● On (Green)	AS-Interface network is sufficiently powered
AS-i Active	● On (Green)	AS-Interface network operating normally in either configuration or protected mode
PRG Enable	● On (Green)	Exactly one slave is missing in protected operating mode and automatic addressing is allowed
PRJ Mode	● On (Yellow)	AS-Interface master is in configuration mode

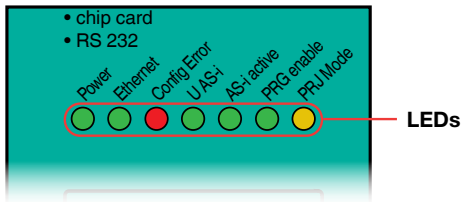

Troubleshooting

K20, K30 gateways

What are the two most common error codes on the gateway 2-digit, 7-segment display?

40 – Offline phase: Gateway displays OFF-LINE by host

Check Points

- No power to AS-Interface network, causing it to be offline
- Network has been taken offline manually using gateway display or toggling F0 bit in the PLC output image.

41 – Detection phase: Gateway remains in this state until at least one node is found.

Check Points

- Place nodes on network, making sure there are no duplicate addresses.
- Check to ensure that exactly one power supply is used for each AS-Interface segment.

HINT: This can be easily verified by powering down each of the AS-Interface power supplies, one at a time.

- The PWR LEDs on all of the nodes within each segment should turn off.
- The U-AS-i LED on the segment connected to the AS-Interface gateway/scanner should turn off.
- Make sure the AS-Interface power supply is not being used to power auxiliary devices.
HINT: Disconnect the auxiliary power supply.
 - Walk around to every AS-Interface node and make sure that the AUX LED is off

Troubleshooting

K20, K30 gateways

How can I resolve a solid red "Configuration Error" LED on my gateway?

A red "Config Error" LED will appear on the gateway indicating that the detected configuration in the gateway is currently not the active configuration.

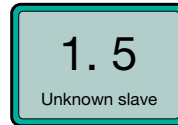

Use the six steps to turn off the red "Config Error" LED on the gateway

1. Config Error LED ON

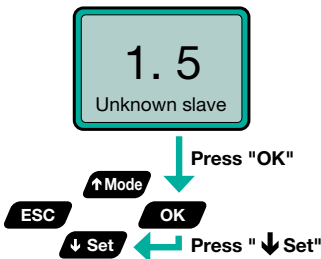

2. Select "Quick Setup" Mode

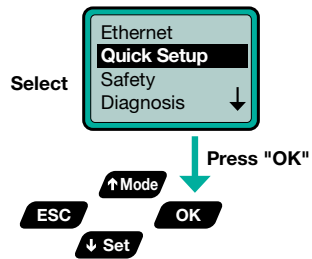

3. Review Message

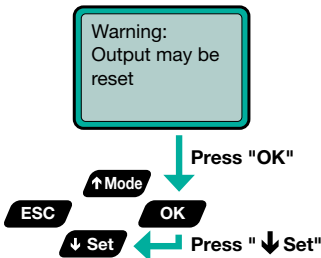

4. Select "Store + Run" Mode

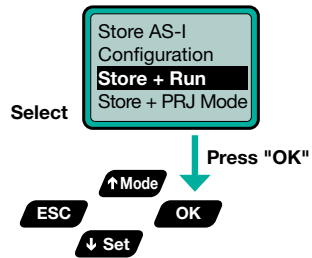

5. Select "OK" Mode

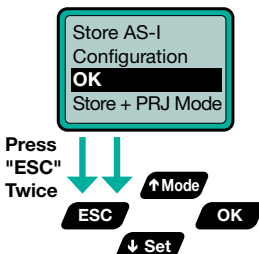

6. Configuration Completed

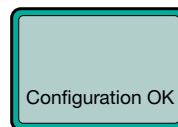

"Config Error" LED is OFF

Replacing failed module(s)

Replacing failed standard modules

IMPORTANT: Making sure module profile(s) are identical is critical when replacing failed modules. The new module profile must be identical to the failed module. This includes: ID, ID1, ID2, and IO values. It also must be set to address 0 before connection.

How to replace a single failed node?

1. Remove failed module.
2. Connect new module.

How to replace multiple failed nodes?

1. Remove all failed modules.
2. Connect the handheld programmer and manually assign addresses to all but one replacement module.
3. The last replacement module can receive its address automatically.

Replacing single safety module(s) configured in K12 or consortium safety monitors

NOTE: The following procedure can be applied when the safety module is configured in any K12 or any equivalent consortium safety monitor.

How is failed safety module reported on K12 safety monitor?

- Check Points:
- PWR AS-I LED is off
 - FAULT LED is ON (red)
 - Module has been configured with non-zero address

What is procedure for replacing single failed safety module configured in a K12 safety monitor?

1. Remove failed safety node.

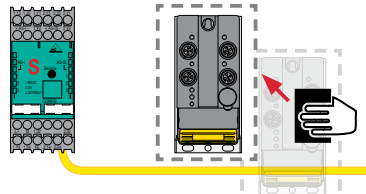

2. Press "Service" button on all affected safety monitors. LEDs 1, 2, and 3 will cycle slowly on safety monitor.

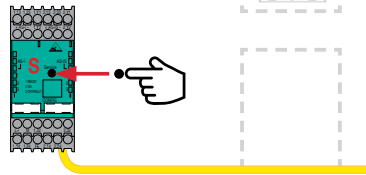

3. Reconnect replacement safety node. **Important:** Make sure the safety device is in the released state such that the full safety-code sequence can be received by the safety monitor.

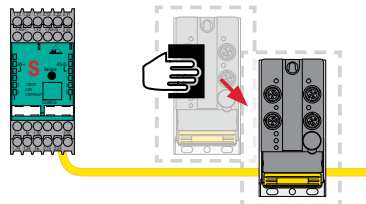

4. Press "Service" button again on all affected safety monitors. If successful, LEDs 1, 2, 3 will turn off and the safety monitor will start normally.

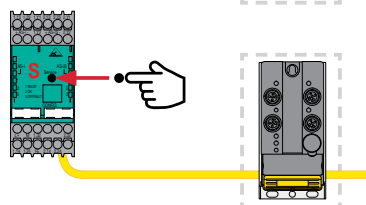

5. Press safety device in and then release it one more time and system can be restarted.



To watch a YouTube video on
How to Replace a Failed AS-Interface Safety at Work Module:
www.sensing.net/asi-solutions/vid2
 or scan the QR code with your smart phone or tablet.



Important: A detailed procedure for exchanging multiple failed safety modules can be found in Section 11.4.1 on p 45 of the user manual.

http://files.pepperl-fuchs.com/selector_files/navi/productInfo/doct/tdoct3645__eng.pdf

Replacing single safety module(s) reported on KE4 safety controller

How is failed safety module reported on KE4 safety controller?

Configuration error in the form of LED pattern appears.

What is procedure for replacing single failed safety module configured in a KE4 safety controller?

1 Remove failed safety node.

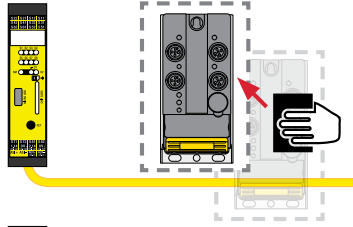

2. Press "Set" button for approximately one second until the SM LED turns from green to amber.

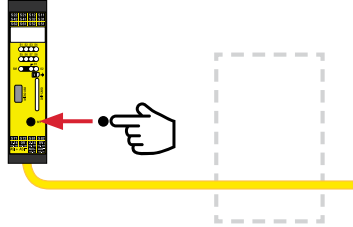

3. Reconnect replacement safety node.
IMPORTANT: Make sure the safety device is in the released state such that the full safety-code sequence can be received by the safety monitor.

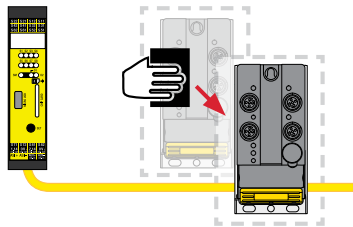

4. Press "Set" button again until S1-S8 LEDs illuminate to amber.

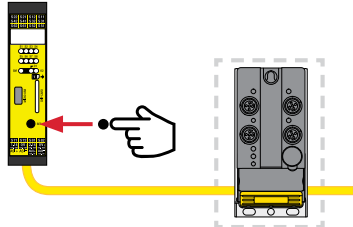

5. Press safety device in and then release it one more time and the system can be restarted.



To watch a YouTube video on
How to Replace a Failed AS-Interface Safety at Work Module:
www.sensing.net/asi-solutions/vid2
or scan the QR code with your smart phone or tablet.



Replacing single safety module(s) reported on K30 gateway

How is failed safety module reported on K30 gateway?

Graphic display on gateway reports a x.x missing slave error even though the module is on the network.

What is procedure for replacing single failed safety module configured in a K30 gateway?

1. Remove failed safety node.
2. Reconnect replacement safety node.
3. Display reports: safety error-emergency shutdown
NOTE: This is displayed due to new and old safety module coding sequences differing.
4. Press OK.
5. Drill down to AS-I Safety. Select OK.
6. Teach Safety. Select OK.
7. Select Single Slave.
8. Select the network on which the replacement module will reside.
9. Select the address for the failed safety node that needs to be retaught.
10. Press the safety device in and then release it one more time to restart the system.



To watch a YouTube video on
How to Replace a Failed AS-Interface Safety at Work Module:
www.sensing.net/asi-solutions/vid2
or scan the QR code with your smart phone or tablet.



Replacing failed safety monitors

K12 safety monitor

NOTE: The following procedure can be applied to K12 safety monitor or any equivalent consortium safety monitors.

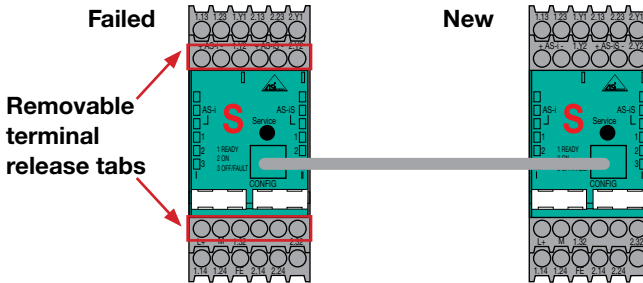

Assume that the K12 safety monitor on the left has failed.

IMPORTANT: In order for this process to be successful, the replacement safety monitor must be new or unvalidated.

1. Power everything down.
2. Remove bottom removable terminal block from the failed safety monitor.
NOTE: The removable terminal block connected to L1+ and M.
3. Use VAS-SIMON-RJ45 jumper cable to connect failed K12 safety monitor (on the left) to replacement K12 safety monitor (on the right).
CAUTION: Do not use a conventional Ethernet cable. Using an incorrect cable can result in damage to the memory chips inside the K12 safety monitor.
4. Connect bottom terminal block to replacement K12 safety monitor (on the right).
5. Move top removable terminal block from left to the right to supply AS-Interface power to safety monitor.
6. Observe the LEDs on the replacement K12 safety monitor (right).
 - A. READY LED (**AMBER**) indicates transfer of the configuration. LED remains on for the duration of transfer which may take 10-15 seconds.
 - B. ON LED (**GREEN**) and READY LED (**AMBER**) illuminate at the same time to indicate that transfer process is successful.
7. Power cycle K12 safety monitor (on the right) to restart.
8. Verify operation of new K12 safety monitor, making sure the program operates properly.



To watch a YouTube video on
How to Replace an AS-Interface Safety Monitor:
www.sensing.net/asi-solutions/vid3
 or scan the QR code with your smart phone or tablet.



KE4 safety monitor

NOTE: The following procedure can only be applied to KE4 safety monitor (VAS-2A8L-KE4-8SE).

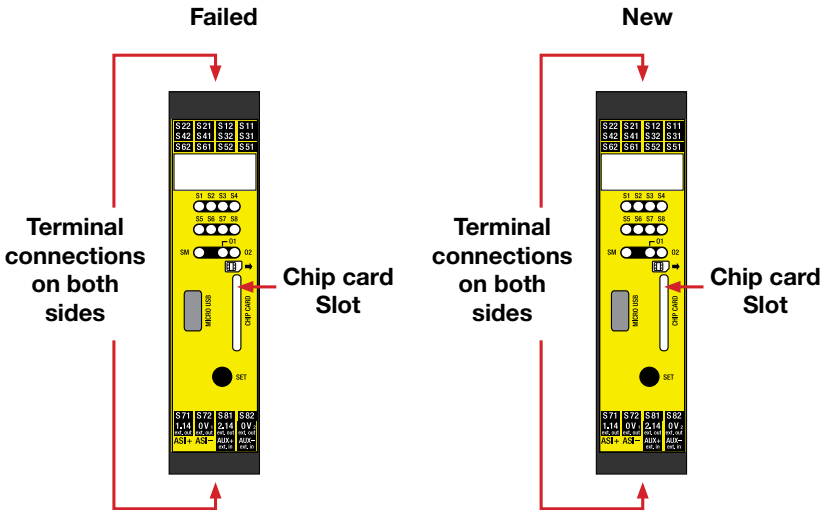

NOTE: The following procedure can only be applied to KE4 safety monitor (VAS-2A8L-KE4-8SE).

Assume that the KE4 safety monitor fails. In order for this process to be successful, the replacement safety monitor must have an empty memory in order to take the memory from the memory card.

1. Power everything down.
2. Remove existing chip card from the failed controller and insert chip card in replacement monitor.
3. Remove all terminals from failed monitor.
4. Take failed KE4 monitor off of DIN rail and replace it with its replacement.
5. Insert all of the terminal connections.
6. Reapply power to monitor.



To watch a YouTube video on
How to Replace an AS-Interface Safety Controller.
www.sensing.net/asi-solutions/vid6
 or scan the QR code with your smart phone or tablet.



K20, K30 gateway

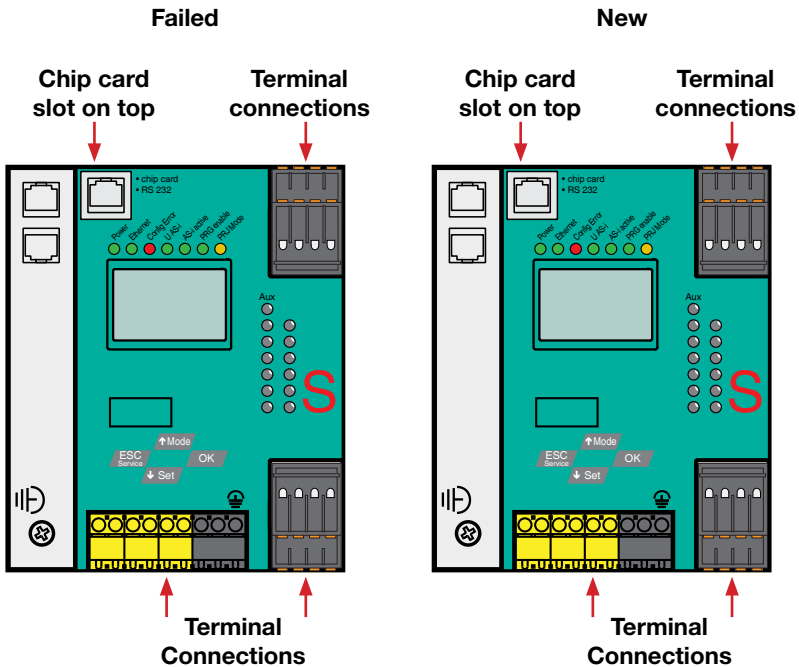

NOTE: The following procedure can only be applied to K20, K30 gateways.

Assume that the K30 gateway fails. In order for this process to be successful, the replacement gateway must have an empty memory in order to take the memory from the memory card.

1. Power everything down.
2. Remove existing chip card from failed controller and insert chip card in the replacement controller.
3. Remove all terminals from failed controller.
4. Take failed K30 gateway off of DIN rail and replace it.
5. Insert all of the terminal connections.
6. Reapply power to the controller.



To watch a YouTube video on
 AS-Interface Safety Monitor with Gateway:
www.sensing.net/asi-solutions/vid7
 or scan the QR code with your smart phone or tablet.



Extending AS-Interface networks

When should repeaters be used to extend AS-Interface networks?

When applications require AS-interface networks to extend beyond 100 meters, consider using a repeater. The network segments remain at 100 meter lengths, however the repeater regenerates the signal, such that now the network can be extended another 100 meters. The following diagram shows how a linear network introduces a repeater at the end of a segment such that the network can be extended farther.

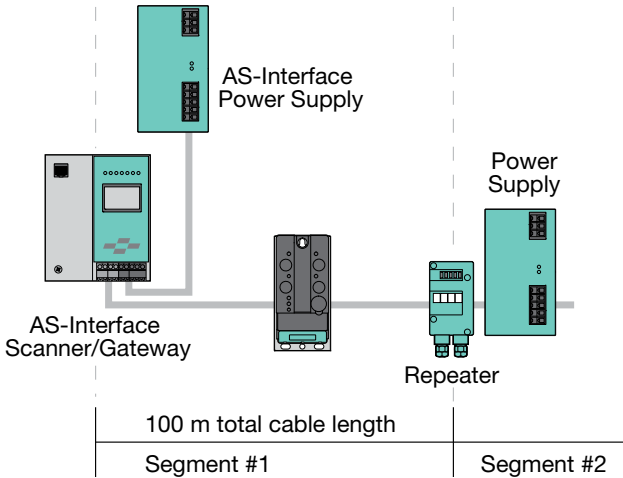

NOTE: Repeaters add a second segment to the AS-Interface network. Since only communication can pass through the repeater, a second power supply is required in each segment. Never put more than one power supply on a segment.

LED Functionality

(VAR-G4F Repeaters)

Refer to the following chart to help diagnose, maintain, and troubleshoot LEDs on an AS-Interface advanced repeater.

What type of repeater do I need to use to extend my AS-Interface network?

Only "advanced" repeaters should be considered when extending AS-Interface networks. Both VAR-G4F (field-mounted repeaters) and VAR-KE3-TERM (enclosure-mounted repeaters with termination switch built in) have a faster response time, which is required to couple long segments together.

LED	Indication	Meaning
PWR	○ Off	No power supply connected
	● On (Green)	Normal
FAULT	○ Off	Normal
	● On (Red)	No communication



To watch a YouTube video on
Using an AS-Interface Repeater:
www.sensing.net/asi-solutions/vid4
 or scan the QR code with your smart phone or tablet.



How can I use a repeater and terminator to extend an AS-Interface network segment to 200 m?

Existing AS-Interface networks may test the 100 meter segment limits. Network segments beyond 100 meters can be affected by reflections. In these cases, terminators may need to be introduced on the network segment to reduce these reflections. However, using terminators can result in signal amplitudes getting reduced. Thus, terminators should only be considered once it has been confirmed that reflections are resulting within a network segment.

Recommended terminators are VAZ-G10-TERM. Terminators get added at the opposite end of the segment as far away as possible from the power supply. Only one terminator can be used per segment.

NOTE: Terminators will not correct problems caused by noise or bad AS-Interface cable.

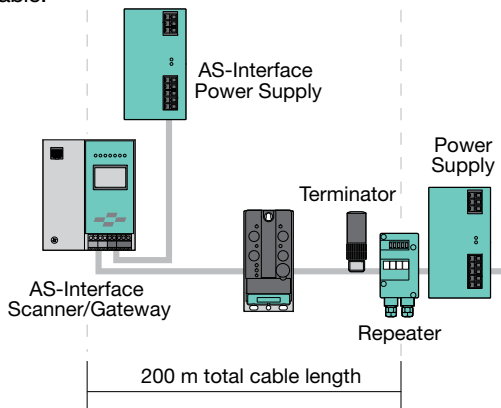

To watch a YouTube video on
AS-Interface Segments and Networks:
www.sensing.net/asi-solutions/vid5
 or scan the QR code with your smart phone or tablet.



How can a terminator improve signal quality?

The following section helps diagnose LEDs on the terminator

VAZ-G10-TERM resistors have a G10 design. They include two different termination trays in one housing. In most cases, Z1 offers the right impedance for most topologies. However, if reflections persist, termination resistor Z2 can be tried for further signal quality improvement.

Two LEDs per terminator monitor the status of each supply voltage. These LEDs are useful diagnostics that ensure expected voltage levels are retained on the AS-Interface network where the terminator is placed.

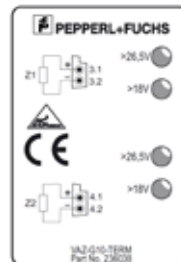

Z1 = Typical

Z2 = Backup

Built-in advanced diagnostics

K20, K30 gateways

Gateways have advanced diagnostic features that help with troubleshooting network problems.

All advanced diagnostics are found by selecting **DIAGNOSIS** on the display.

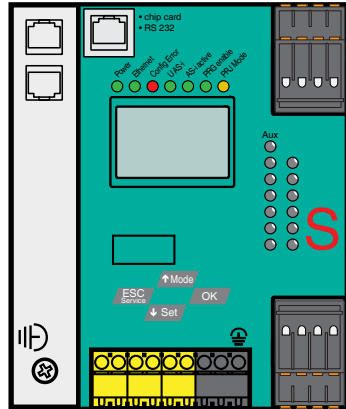

Error counters

DIAGNOSIS > ERROR COUNTERS > AS-i Circuit 1 or 2

Telegram repetitions for each AS-Interface slave can be monitored. These counters increment every time there is a corrupted data telegram. This makes it possible to judge the quality of the AS-Interface network, even if only a few corrupted telegrams occurred and the AS-Interface slave did not cause any configuration errors.

NOTE: Single retries cannot be detected using the gateway. (Minimal count increments are by two.)

IMPORTANT: Error counters displayed for a node do not guarantee that the existing problem is with that particular node. An AS-Interface network is connected to all nodes, therefore a wiring problem on a single node can affect the entire network.

When six consecutive retries get recorded on any node, it appears in the LCS (list of corrupted slaves) with an X next to the node address. This node causes a configuration error on the network.

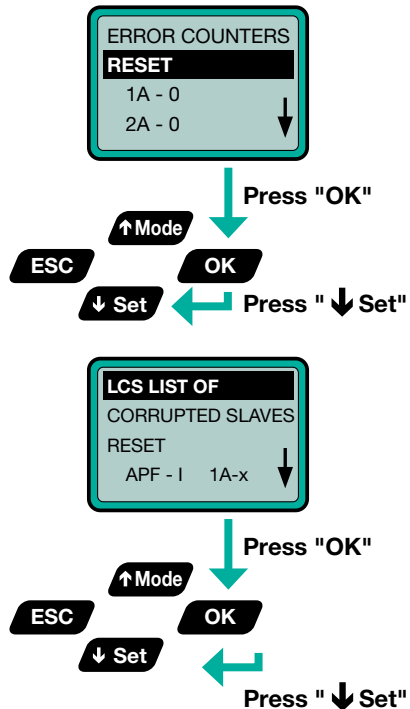

How can I stop the number of retry counters from accumulating?

Check points: Typically, only one AS-Interface node is the cause of the problem.

- Check miswired components in remote panels.
- Connect nodes one at a time.

HINT: When the node just added starts generating retries anywhere on the network, the issue is probably in the wiring to that node.

Fault detector

By selecting **DIAGNOSIS > FAULT DETECTOR > AS-I Circuit 1 or 2**

Gateways have duplicate address detection. To use this feature, the power supply must be connected directly to the dedicated terminal (labeled +PWR-) on the gateway.

The fault detector provides the ability to determine the following:

1. Duplicate Address (DUP ASI ADR) - If two slaves in one AS-i-Circuit have the same address.
2. Earth Fault (EFLT) - An earth or ground fault has occurred. Check to make sure that AS-i + or - is not touching machine ground anywhere.
3. Over Voltage (OVRV): A power spike occurred on AS-Interface such that the AS-Interface voltage was too high.
4. Noise (NOIS): Noise was detected. Route AS-Interface cable away from potential noise sources.

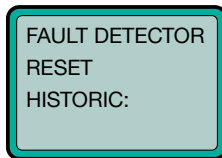

ADDITIONAL DIAGNOSTICS TO CONSIDER ADDING

- List of corrupted AS-Interface slaves (LCS)
- Offline phase for configuration
- Ground fault monitor
- Current monitoring of power supply

Power supplies

Power supplies used for AS-Interface are specifically designed for this network. No standard DC power supply can be used unless it first goes through a power conditioner. Exactly one AS-Interface power supply is required for each segment.

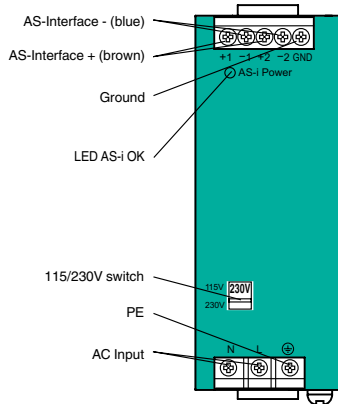

The following three diagrams show typical configurations of AS-Interface networks with AS-Interface power supplies.

Dual network gateway with (DMD) built-in decoupling coils connected to standard power supply.

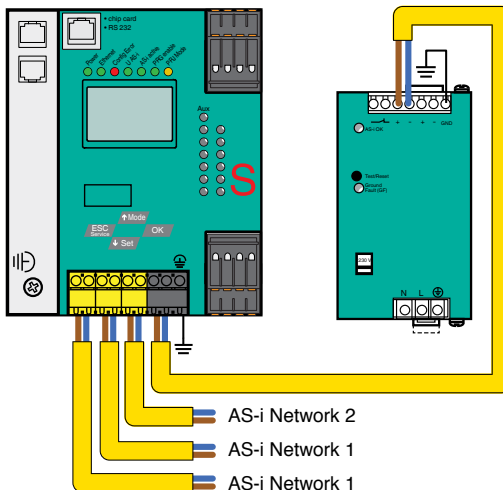

Terminal	Signal /Description
+ ASI 1-	Connection to AS-i circuit 1
+ ASI 2-	Connection to AS-i circuit 2
ASI + PWR-	Supply voltage for AS-i circuits (max. 8 A)
FG	Function ground

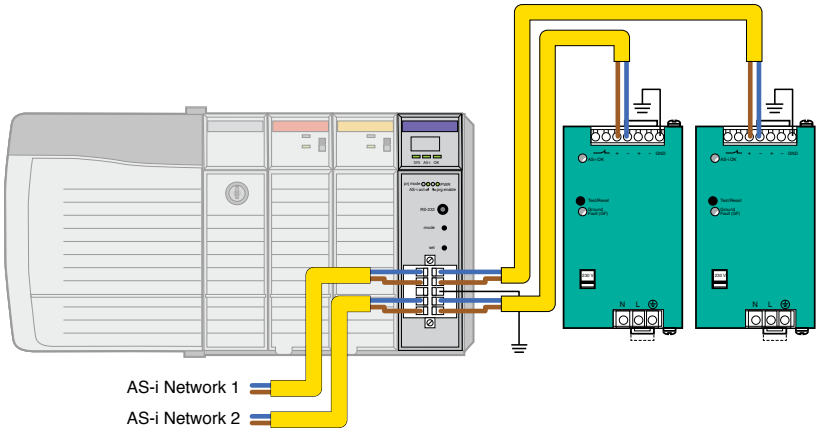

Dual network A-B ControlLogix scanner card connected to two power supplies with ground fault detection.



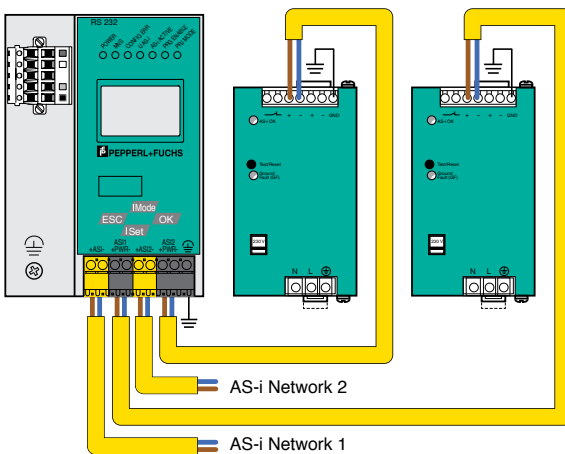

Dual network gateway with duplicate address detection connected to two standard AS-Interface power supplies.

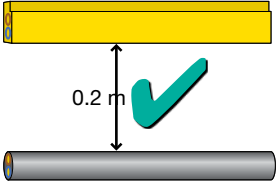

Helpful wiring hints

DO	DON'T
<p>Separate AS-Interface cable and noisy cable by at least 0.2 m.</p> 	<p>Don't run AS-Interface cable parallel to potential noise sources.</p> 

DO	DON'T
<p>Separate the black and yellow flat cables. Outputs connected to drives or motors can cause black AUX cable to be noisy.</p> 	<p>Don't fasten yellow AS-Interface and black auxiliary cable on top of each other.</p> 

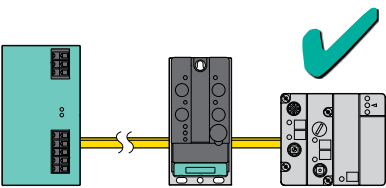
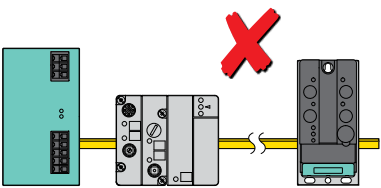
DO	DON'T
<p>Place the AS-Interface power supply at one end of the network and terminator/tuner at the other end.</p> 	<p>Don't locate terminator/tuner next to the AS-Interface power supply.</p> 

Helpful wiring hints

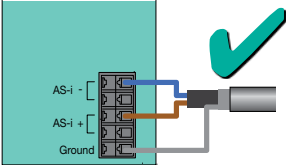
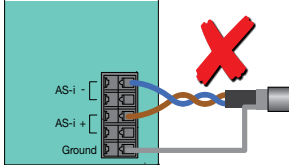
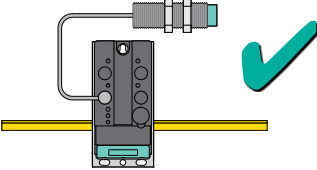
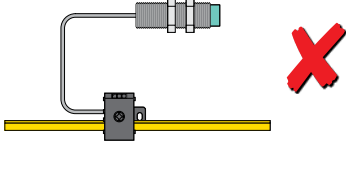
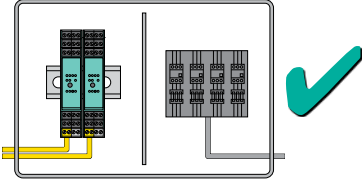
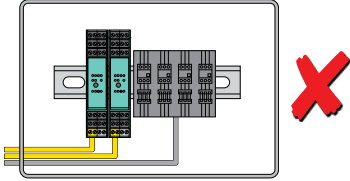
DO	DON'T
<p>Use correct wiring practices when using shielded cable including cable length reduction to 80 m max and land shield on GND terminal on power supply.</p> 	<p>Don't use noncompliant or out-of-specification AS-Interface cable i.e., twisted, shielded, or wrong impedance.</p> 
<p>Power only AS-Interface certified devices with the AS-Interface cable. AS-Interface devices have special filtering components that safely pull power from the network.</p> 	<p>Don't power standard devices with AS-Interface cable.</p> 
<p>Keep the AS-Interface components on one side of the panel and high-frequency drive components on the other. Separate them with a metal divider, if possible, and make sure cables do not exit at the same location.</p> 	<p>Don't place AS-Interface and noisy components next to each other in a panel.</p> 

Helpful wiring hints

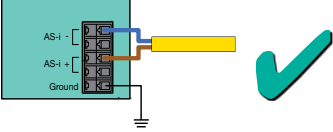
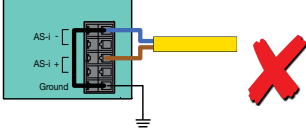
DO	DON'T
<p>Allow the AS-Interface signal to float properly. AS-Interface derives much of its noise immunity from this floating signal. Tying one lead to ground will interfere with the AS-Interface communication.</p>	<p>Don't ground AS-Interface anywhere on the network under any circumstances.</p>
	

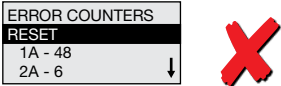
DO	DON'T
<p>Use the AS-Interface analyzer to ensure that the network is error free. Capturing the network health during project buyoff can relieve machine builders of future liability if changes are made.</p>	<p>Don't neglect to check the number of retries on the AS-Interface network.</p>
	

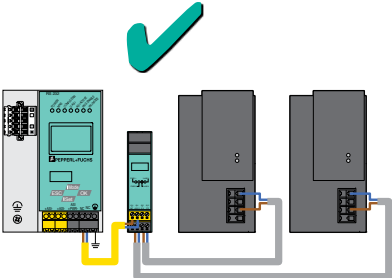
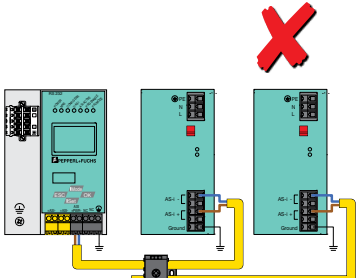
DO	DON'T
<p>For redundancy, use two standard 30 V power supplies connected to a power conditioner.</p>	<p>Don't use more than one AS-Interface power supply on a network.</p>
	

Helpful wiring hints

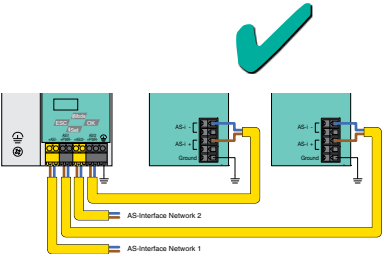
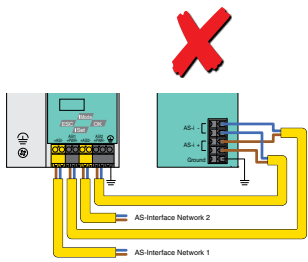
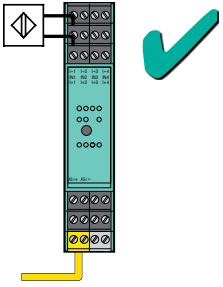
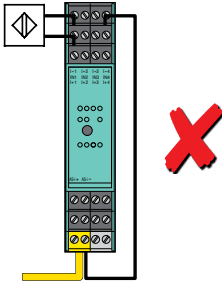
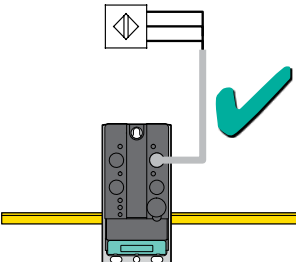
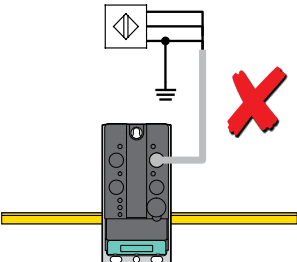

Helpful wiring hints

DO	DON'T
<p>Use the dual-channel power conditioner, VAN-KE2-2PE, or use two separate power supplies, one for each network.</p> 	<p>Don't use one power supply to power two networks.</p> 
<p>Use these terminals to provide power to sensors and other input type devices only.</p> 	<p>Don't use the input power terminals (IN+, IN-) for anything other than what they were designed for; powering sensors.</p> 
<p>Allow the AS-Interface module to completely power inputs connected to the module if designed to do so. If the resistance to ground is <math>< 10 \text{ M}\Omega</math>, inputs should be powered externally.</p> 	<p>Don't ground input signals that are powered by the AS-Interface network through the I/O modules.</p> 

Helpful wiring hints

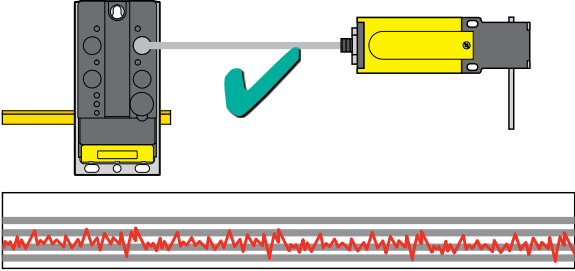
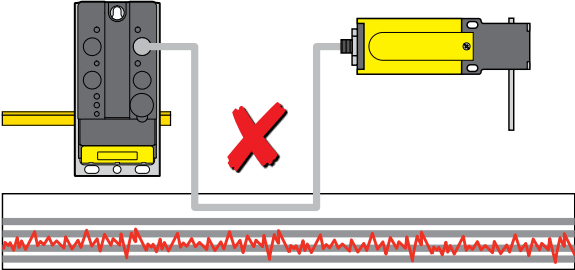
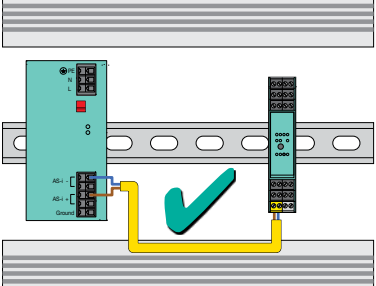
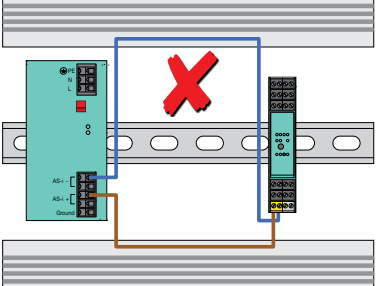
DO	DON'T
<p>Place AS-Interface safety modules as close as possible to safe inputs or use Safety at Work components with direct communication to AS-Interface. The safety sequence runs over safe input lines and any disruption of this sequence can cause nuisance shutdowns.</p>	<p>Don't run inputs connected to safety modules with long cables or run inputs close to potential noise sources.</p>
	
<p>Do run the AS-Interface conductors together, preferably in the same jacket. This eliminates current loops and allows proper noise rejection to occur on the network.</p>	<p>Don't run the AS-i + and AS-i - wires apart in the same enclosure.</p>
	

Common Problems and Solutions

What kind of network performance and update time(s) can I expect from an AS-Interface network?

- Update time per module is 150 μ s.
- The formula for scan time is $150 \mu\text{s} \times (\text{number of addresses} + 2)$.
 - Single addresses require one scan.
 - Dual addresses (A & B) require two scans.
 - Dual addresses (A & B) 3.0 4-in/4-out require two scans for inputs and four scans for outputs.
 - Analog modules (2.1) require seven scans per point.
 - Analog modules (3.0) require three or four scans per point.

My network is unstable. What are possible causes, and how do I fix them?

1. AS-Interface cable length could be too long or noncompliant cable was used.
2. AS-Interface cable length is measured as the sum of the trunk cable and all drops. The AS-Interface specification, though conservative, is 100 m maximum. Exceeding this length could result in unnecessary retries by the AS-Interface scanner/gateway.
3. Reduce the segment length by adding a repeater and power supply. Make sure that new segments are under the 100 m limit.

NOTE: When "over length" network problems occur, the nodes closest to the AS-Interface master/scanner are often those that are most affected.

The node is addressed correctly and connected to the network. The PWR LED is red and the AS-Interface scanner can't see the node. What do I do?

Check for duplicate addresses. Use gateways or safety monitors with duplicate address detection. If these gateways are wired properly (see pg.19), problems can be found easily. If this feature is not available, read the LDS (List of Detected Slaves) and check the nodes on the network. These addresses must match exactly. Disconnect duplicate and see if node appears. If so, a node with the same address exists somewhere else on the network.

I connected a new AS-Interface module to the network and stored the configuration. It won't communicate. What could be the problem?

Check in the *AS-Interface Reference and Buyer's Guide* for the minimum master specification you must have to use this module properly.

- If a node has 4 in/4 out and extended addressing, it can only be used on M4 (3.0) masters.
- Nodes with extended addressing that are used on 2.0 (M0, M1, M2) masters must leave parameter bit P3 on and data bit D3 off. These bits, used to toggle between A/B addresses in spec. 2.1, are defined only as data bits in earlier specs. Changing these bits will cause the nodes to go offline.

Your automation, our passion.

Explosion Protection

- Intrinsically Safe Barriers
- Signal Conditioners
- Fieldbus Infrastructure
- Remote I/O Systems
- HART Interface Solutions
- Wireless Solutions
- Level Measurement
- Purge and Pressurization Systems
- Industrial Monitors and HMI Solutions
- Electrical Explosion Protection Equipment
- Solutions for Explosion Protection

Industrial Sensors

- Proximity Sensors
- Photoelectric Sensors
- Industrial Vision
- Ultrasonic Sensors
- Rotary Encoders
- Positioning Systems
- Inclination and Acceleration Sensors
- AS-Interface
- Identification Systems
- Logic Control Units

www.pepperl-fuchs.com

Subject to modifications · © Pepperl+Fuchs

Printed in USA · Part No. 912040

TDOCT-B008AUSA 03/16