

Student Guide

For

Electronic Snap Circuits®

Model SC-300R/500R/750R

***Hands-on Program for Basic Electricity
and Electronics***

*Prepared by the Educational Division of
Elenco® Electronics, Inc.
Wheeling, IL 60090 U.S.A.*



Copyright © 2020 Elenco® Electronics, Inc.

REV-B 753307

TABLE OF CONTENTS

Snap Circuits® Project Manuals	2
---	---

Preface	2
----------------	---

PART I (All models)

Chapter 1: Basic Components & Circuits

1-1 Electricity	4
1-2 Wires	5
1-3 Batteries	6
1-4 The Switch	7
1-5 The Lamp	7, 8
1-6 The Base Grid	8-10
1-7 Series and Parallel Circuits	10-12
1-8 Short Circuits	13
1-9 Solder	13
1-10 Schematics	14
Summary & Quiz	15

Chapter 2: Motors & Electricity

2-1 Motors	17, 18
2-2 Motor Circuits	18-21
2-3 Fuses	21
2-4 Your Electric Company	22
2-5 Static Electricity	23
2-6 Types of Lamps	24
2-7 Types of Switches	24
2-8 Electricians	24
Summary & Quiz	25

Chapter 3: Resistance

3-1 Resistors	27
3-2 LEDs	27-29
3-3 Resistors in Series & Parallel	29, 30
3-4 Resistance	31
3-5 The Adjustable Resistor	31, 32
3-6 The Photo Resistor	32, 33
3-7 Resistance of Water	33, 34
3-8 Introduction to Logic	34
3-9 Digital Electronics	35
Summary & Quiz	36

Chapter 4: Capacitors

4-1 Capacitors	38-40
4-2 Capacitor Circuits	40, 41
4-3 Capacitors in Series & Parallel	42, 43
Summary & Quiz	43

Chapter 5: Transistors	44
5-1 More About LEDs	45
5-2 Transistors	46
5-3 Transistor Basics	47, 48
5-4 More Transistor Circuits	48-50
5-5 Human Transistor	51
5-6 Motor as Generator	51
5-7 Microphone	52
Summary & Quiz	53

Chapter 6: Oscillators & Electronic Sound

6-1 Electronic Sound	54, 55
6-2 Oscillators	56, 57
6-3 Whistle Chip	57
6-4 Oscillator Circuits	58-60
Summary & Quiz	60

Chapter 7: Integrated Circuits

7-1 The ICs in Snap Circuits®	62, 63
7-2 Description of all projects using ICs	64-66
Summary & Quiz	67

Chapter 8: Electromagnetism & Radio

8-1 AC	69
8-2 Transformers	69, 70
8-3 Inductance & Antennas	70, 71
8-4 Radio	71, 72
8-5 Radio Circuits	72, 73
Summary & Quiz	73

PART II

(only used in Models SC-500R & SC-750R)

Chapter 9: Meters, Transformers & FM Radio

9-1 Meters	74
9-2 Meter Circuits	75
9-3 More About Transformers	76-78
9-4 Transformers in Oscillators	78-80
9-5 More About FM Radio	80-83
9-6 More About FM Radio	83, 84
9-6 When Wires are not Wires	84
Summary & Quiz	85

Chapter 10: Diodes & Applications

10-1 More About Diodes	86-89
10-2 Digital Displays	89-91
10-3 Recording IC	92, 93
Summary & Quiz	94

Chapter 11: Electronic Switches

11-1 Relays	95-99
11-2 Silicon Controlled Rectifiers	99-101
11-3 Voltage Dividers & Current Dividers	101, 102
Summary & Quiz	102

PART III (only used in Model SC-750R)

Chapter 12: Electromagnetism

12-1 Magnetism	103
12-2 An Electronic Magnet	104
12-3 Magnetic Fields	106-109
12-4 Electromagnet Oscillators	109, 110
12-5 The Anti-Capacitor	110, 111
12-6 More About Motors	112
Summary & Quiz	113

Chapter 13: Sun Power

13-1 Born in the Space Program	114, 115
13-2 How Your Solar Cell Works	115-117
13-3 More Solar Cell Circuits	117-119
13-4 Our Solar Future	120
Summary & Quiz	121

Chapter 14: More Circuits & New Ways to Look at Them

14-1 Vibration Switch	122
14-2 Other Applications	125, 126
14-3 The Snap Circuits® Computer Interface	127-130
Summary & Quiz	131

Summary of Components

132-134

Definition of Terms

135-137

For Further Reading

137

THE SNAP CIRCUITS® PROJECT MANUALS

The Snap Circuits® project manuals include lots of useful information in addition to the projects themselves, as listed below. The project manuals summarize much of the lesson in the Student Guide while adding troubleshooting information.

The Model SC-300R contains two project manuals, the Model SC-500R contains three, and the Model SC-750R contains four. Note that the parts lists and information about the parts is spread across all the project manuals. The DO's and DON'Ts of Building Circuits section of the manual with the highest numbered projects is the most thorough.

First Project Manual contains:

1. Parts List (partial, continued in other manuals)
2. **How To Use It** - brief description of how to make connections and understand the circuit drawings.
3. **About Your Snap Circuits® Parts** - brief description of what each component does (partial, continued in other manuals).
4. **DO's and DON'Ts of Building Circuits** - brief but important guidelines for building circuits (additional guidelines are in other manuals).
5. **Basic & Advanced Troubleshooting** - systematic testing procedure for identifying damaged parts (continued in other manuals).
6. Project Listing
7. Projects 1-101

Much of the text in all chapters is color-coded green and blue so that instructors can easily adapt the course based on the skills and interests of the students. The orange boxes are more advanced material while the brown boxes are considered additional/background material, either can generally be omitted without a significant impact on the course.

Other Project Manuals contain:

1. Parts List (partial, continued from first manual)
2. **How To Use It** - brief description of how to make connections and understand the circuit drawings.
3. **About Your Snap Circuits® Parts** - brief description of what each component does (partial, continued from first manual).
4. **DO's and DON'Ts of Building Circuits** - brief but important guidelines for building circuits.
5. **Basic & Advanced Troubleshooting** - systematic testing procedure for identifying damaged parts (continued from first manual).
6. Project Listing
7. Projects 102 and up

Preface

This booklet is an introduction to the exciting world of electronics. Following the "Learn by Doing®" concept, electronics will be easy to understand by using Snap Circuits® to actually build circuits as you learn about them. This booklet emphasizes the practical applications of electronics, without bogging down in mathematics.

Why learn about electronics? Electronics plays an important and increasing role in our everyday lives,

and so some basic knowledge of it is good for everyone. Learning about it teaches how to do scientific investigation, and the projects develop basic skills needed in today's world.

The first pages of the Snap Circuits® project manuals contain a brief description of the parts in Snap Circuits®, along with brief guidelines for building circuits.

- If you have the **SC-300R** version, you may wish to purchase the **UC-50 Upgrade Kit** to continue to Part II of this manual. The **UC-70 Upgrade Kit** will allow you to continue to Parts II & III of this manual.
- If you have the **SC-500R** version, you may wish to purchase the **UC-80 Upgrade Kit** to continue to Part III of this manual. Upgrade kits can be purchased online: www.snapcircuits.net

CHAPTER 1: BASIC COMPONENTS & CIRCUITS

Learn
By Doing®

What is electricity? Nobody really knows. We only know how to produce it, understand its properties, and how to control it. It can be created by chemistry (batteries), magnetism (generators), light (solar cells), friction (rubbing a sweater), and pressure (piezoelectric crystals).

Electricity is energy that can be used to save us effort (electric toothbrushes and dishwashers), heat things (electric heaters and microwave ovens), make light (light bulbs), and send information (radio and television). But electricity can also be dangerous if abused (electric shock).



Batteries

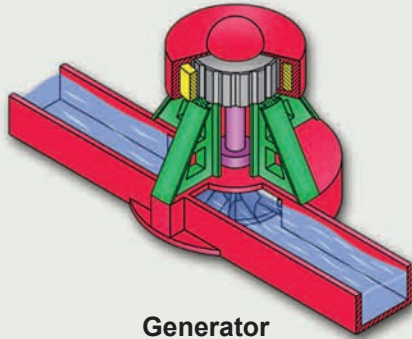

Generator



Solar Cells



Rubbing a Sweater



Piezoelectric Crystal

In this section you will learn about basic electrical components and circuits. By building circuits using Snap Circuits®, you will begin to understand the electrical world.



Electric Toothbrush

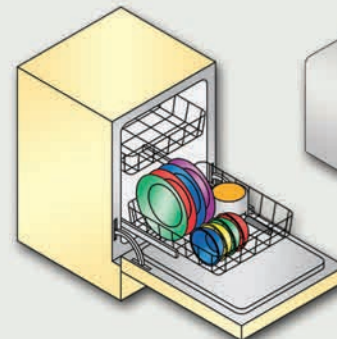

Dishwasher



Microwave Oven



Light Bulb



Radio

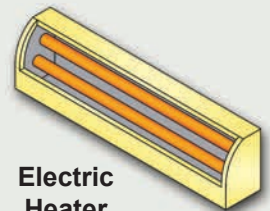

Electric Heater

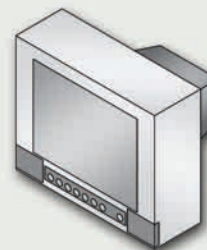

Television



Electric Shock

1-1 Electricity

The name electricity came from the Greek name for amber, the material in which electrical effects were first observed. What do you think of electricity as being? **Electricity** is one of the fundamental forces of nature. At its most basic level, it is an attraction and repulsion between sub-atomic (very, very, very, very tiny) particles within a material.

This attraction/repulsion is referred to as an **electrical charge**; it is similar to and closely related to magnetism. These attractions/repulsions are extremely powerful but are so well balanced out at the sub-atomic level that they have almost no effect on our lives.

As an example, electrical attraction is about 1,000 times more powerful than gravity (gravity is what causes things to fall to the ground when you drop them). However electrical attraction is so completely balanced out that you don't notice it, while gravity effects are always apparent because they are not balanced out.

Gravity is actually the attraction between objects due to their weight (or technically, their mass). This effect is extremely small and can be ignored unless one of the objects is as big as a planet (like the earth). Gravity attraction never goes away and is seen every time you drop something. Electrical charge, though usually balanced out perfectly, can move around and change quickly.

For example, think about how two sweaters can cling to each other when you take them out of the dryer. This is due to an electric charge that has built up between them. There is also a gravity attraction between the sweaters, but it is always extremely small.

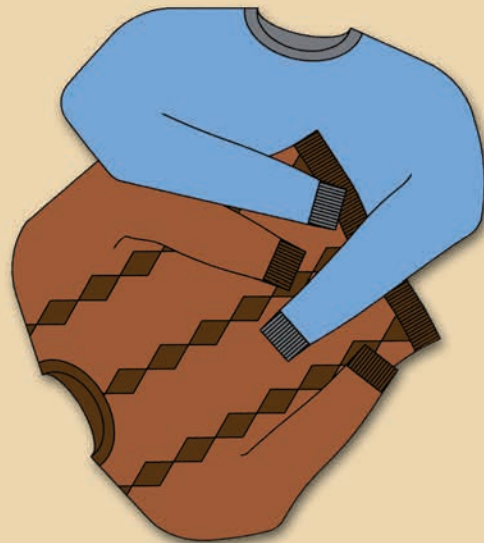

Electronics is the science of working with and controlling electricity. Many work-saving appliances like dishwashers, hairdryers, and drills are electrical but not electronic. Electronic products use electricity to control themselves, using parts like resistors, capacitors, and transistors. Electrical appliances are only controlled mechanically.

Most products you bring from your old house to your new house are electronic (such as TVs, computers, touch-tone phones, radios, most battery operated products), but not all (such as hairdryers, electric power tools).

A good way to think of the difference between electrical and electronic products is to think about moving into a new house. Most products in the empty house are electrical (such as all the wiring and switches in the walls, rotary phones, dishwashers, electric ovens, air conditioners, most types of thermostats).

Electricity is the movement of sub-atomic particles (with their electrical charges) through a material due to an electrical charge outside the material. Electricity will be easier to understand if you think of the flow of electricity through circuits as water flowing through pipes.

1-2 Wires

Wires can be thought of as large, smooth pipes that allow water to pass through easily. Wires are made of metals, usually copper, that offer very low resistance to the flow of electricity.

The **electric current** is a measure of how fast electricity is flowing in a wire, just as the water current describes how fast water is flowing in a pipe. It is expressed in **amperes** (A, named after Andre Ampere who studied the relationship between electricity and magnetism) or **milliamps** (mA, 1/1000 of an ampere).

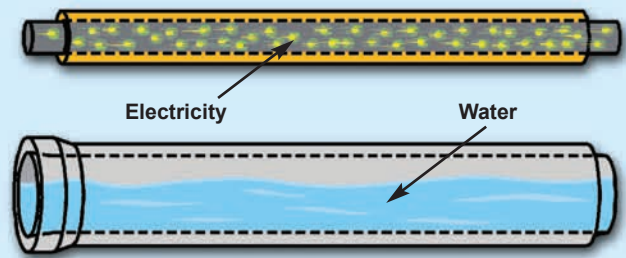

With Snap Circuits® the wires you will use have been shaped into snap wire strips, to make interconnection easy. These work the same as any other wires you might find in your house, since they are made of metal.

Introducing New Parts

If you have the Snap Circuits® parts nearby then pull out the wires and look at them. They have numbers such as 2, 3, 4, 5, 6 or 7 depending on the length of the wire connection. There is also a 1-snap wire that is used as a spacer or for interconnection between different layers.

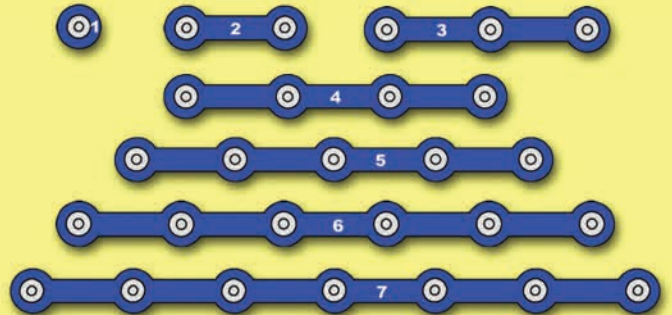

Wires can generally be as long as desired without affecting circuit performance, just as using garden hoses of different lengths has little effect on the water pressure as you water your garden. However there are cases where the length and size of a pipe does matter, such as in the water lines for your entire city or in an oil refinery. Similarly, wire length and size are important for electric power lines transporting electricity from a power plant in a remote area to a city, and in circuits used in radio or satellite communication.

If you were to look inside an electronic device in your home (make sure it's not plugged in) you might see a lot of wires of different colors. The actual wires are all the same color of metal, but they have a protective covering over them. The colors are used to easily identify which wire is which during assembly and repair of the circuit.

The covering is also used to prevent different parts of a circuit from connecting accidentally.

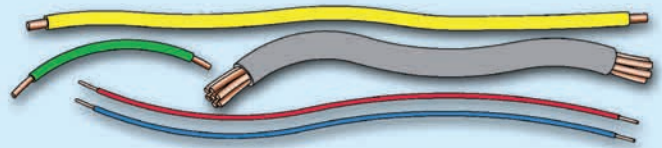

Try to imagine the total length of wire used in all the products in your home!

1-3 Batteries



To make water flow through a pipe we need a pump. To make electricity flow through wires we use a battery. A battery creates an electrical charge across wires. It does this by using a chemical reaction and has the advantage of being simple, small, and portable.

Voltage is a measure of how strong the electric charge from your battery is, and is similar to the water pressure. It is expressed in volts (V, and named after Alessandro Volta who invented the battery in 1800). Notice the “+” and “-” signs on the battery. These indicate which direction the battery will “pump” the electricity, similar to how a water pump can only pump water in one direction.

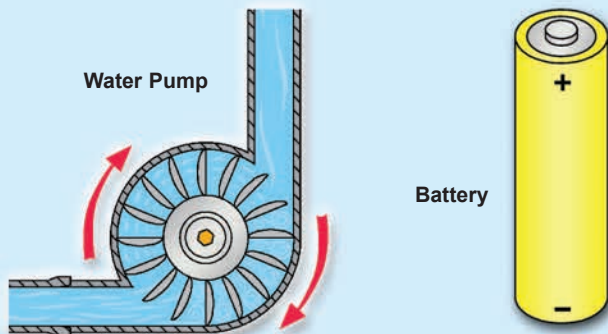

The 0V or “-” side of the battery is often referred to as “ground”, since in house or building wiring it is connected to a rod in the ground as protection against lightning.

Battery power is much easier to use in electronics than the electricity that powers your home. This is because most electronic circuits only need a low voltage source to operate; all the electricity produced by your electric company comes at a higher voltage, which must be converted down. If a circuit is given too much voltage then its components will be damaged. It is like having the water in your faucet come out at higher pressure than you need, and it splashes all over the room. If water in a pipe is at too high of pressure then the pipe may burst. Batteries are selected to give your circuit just the voltage it needs.

Introducing New Parts

Your Snap Circuits® uses two sets of two 1.5V batteries in a holder (snap part B1, actual batteries are not included). Notice that just to the right of the battery holder pictured below is a symbol, the same symbol you see on the battery holder. Engineers are not very good at drawing pictures of their parts, so when engineers draw pictures of their circuits they use symbols like this to represent them.

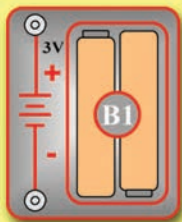

Battery Holder (B1)



Battery Symbol

Batteries are made from materials like zinc and magnesium dioxide, electricity flows as these react with each other. As more material is used up by the reaction, the battery voltage is slowly reduced until eventually the circuit no longer functions and you have to replace the batteries. Some batteries, called rechargeable batteries (such as the batteries in your cell phone), allow you to reverse the chemical reaction using another electric source. That way the batteries can last through years of use.

Try to count how many batteries are in your home, your count will probably be low. Many products that use your house power also have batteries to retain clock or programmed information during brief power outages (such as computers and VCRs).

1-4 The Switch



Since you don't want to waste water when you are not using it, you have a faucet or valve to turn the water on and off. Similarly, you use a switch to turn the electricity on and off in your circuit. A switch connects (the "closed" or "on" position) or disconnects (the "open" or "off" position) the wires in your circuit.

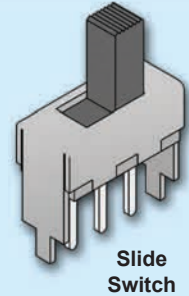
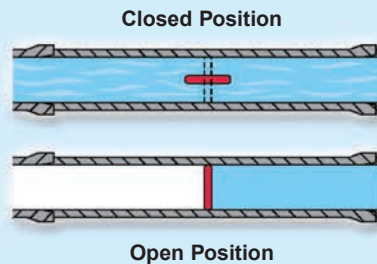

Slide Switch

Introducing New Parts

Just as the plumbing industry has a wide range of valves for different situations, there are many types of switches used in electronics. The type shown below is called a slide switch, because you slide it back and forth to turn it on and off. Snap Circuits® includes one of these (part S1), shown below. As with the battery, the slide switch is represented by a symbol, shown to its right. If you have the snap circuits parts nearby, take out the switch and look at it.

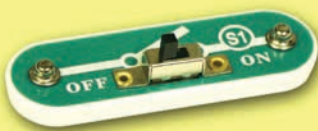

Slide Switch (S1)



Slide Switch Symbol

Introducing New Parts

Another type of switch is the press switch, and Snap Circuits® also includes one of these (part S2). When you press down the two pieces of metal touch, so electricity can flow. When you let go of it, the electricity stops. Its symbol is marked on the snap part, though on many professional electronics drawings both slide and press switches use the symbol for the slide switch because they really perform the same function.

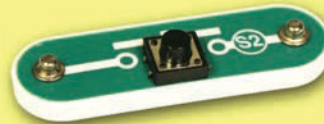

Press Switch (S2)



Press Switch Symbol

You can think of slide and press switches like the water faucet in your kitchen (which pours out water until you turn it off) and a water fountain in a school or movie theater (which only squirts out water as long as you are pressing the button).

Switches in modern electronics come in many diverse forms. Try to count how many are in your home or car; you will be amazed. There are slide, press, membrane, rotary, push-button, and other switches controlling nearly everything.

1-5 The Lamp



In a **lamp** electricity is converted into light, the brightness of the lamp increases as more electric current flows through it. You can think of a lamp as a water meter, since it is showing us how much current is flowing in a circuit just as a water meter shows how much water is flowing in a pipe.

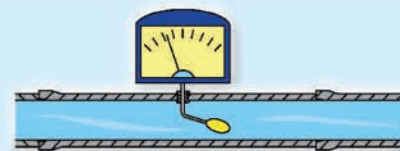

Water Meter

Introducing New Parts

Snap Circuits® includes two different lamps (parts L1 and L2, shown below). If you have the parts with you, take them out and look at them.



2.5V Lamp (L1)

6V Lamp (L2)

Just as there are different types of water meters to work with different pressures and volumes of water, there are also different lamps. Lamp L1 is a low-pressure meter, and works with voltages (electrical

pressures) of up to 2.5V. Higher voltages than that will damage the bulb, so always make sure to use the correct lamp. Lamp L2 is for higher pressures of up to 6V, and won't be nearly as bright as L1 if the pressure is only 2.5V.

The electrical symbol for a lamp is shown here, it is the same for both lamps but the voltage will be indicated as needed. The lamp sockets are the same for both parts; only the bulbs and markings are different.



Lamp Symbol

While occasionally lamps are used to indicate how much electricity is flowing in a circuit, they are mostly used to light our homes, businesses, and streets. Although scientists had been experimenting with electricity for years, the first practical use of electricity occurred when inventor Thomas Edison used it to light a bulb similar to

these. For many years electricity was used almost exclusively for lighting. That has since changed. Now only a small percentage of the electricity produced in the United States is used for lighting with the rest going to a vast range of uses in everyday life that Edison would never have imagined.

1-6 The Base Grid

The water in your home flows through pipes mounted in the walls and floors of your home, and similarly the electricity in your house flows through wires mounted in the walls and ceilings of your home. But the wires in your walls take a lot of hard work to install and then can't be moved.

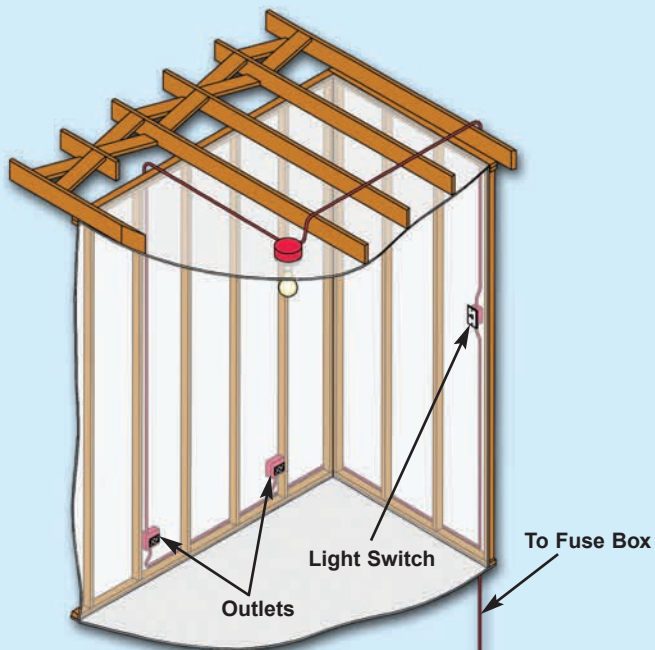

Most products that use electricity are small, easy to move, and easy to build. That is because they have almost all of their components and wires mounted on "circuit boards" such as these:

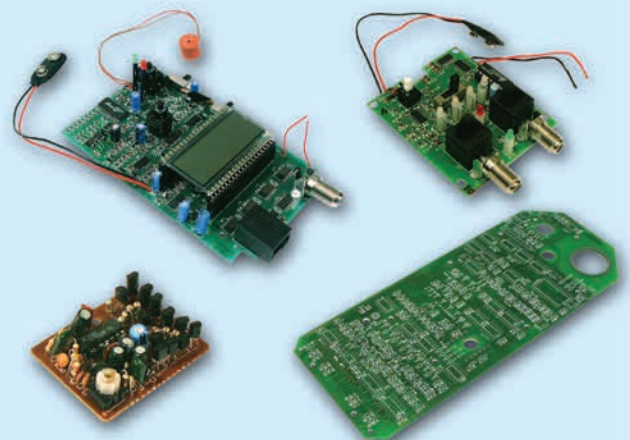

Boards like these are used in almost all electronic products, look inside any radio or computer and you will find them. Note that the "wires" connecting parts mounted on the circuit board are literally "printed" on the surface of the board; hence circuit boards all are called "printed circuit boards" or PCBs.

Introducing New Parts

In the same manner Snap Circuits® uses a clear plastic base grid with evenly spaced posts to mount the snap parts and wires and to keep them together neatly. It has rows labeled A-G and columns labeled 1-10 to easily identify points in your circuit. You don't need the base to build your circuits, but just try building one of the larger circuits without it! The base grid is shown here, next to a picture of a typical circuit industry board before parts are mounted.

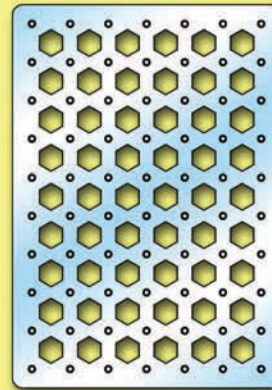

Base Grid



PC Board

Experiments

So far we've talked about wires, batteries, switches, lamps, and circuit boards; now it's time to put them together to form a circuit. Consider this circuit (which is project 1 on page 8 of the first project manual):

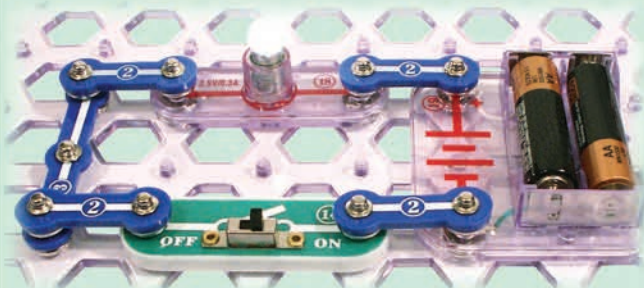
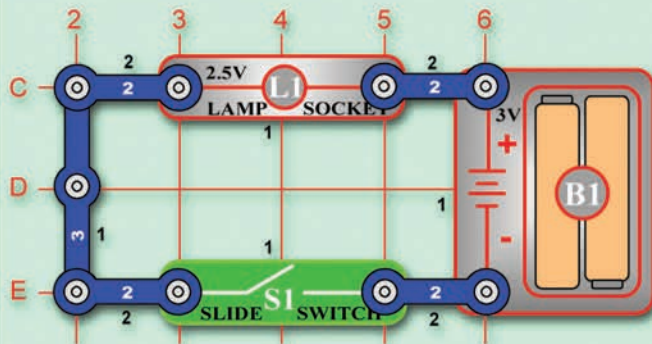

Turning on the switch turns on the lamp. This circuit is the same circuit used to turn on a lamp in your home. The only differences are the batteries are really power from the electric company, the lamp is larger and bright enough to light up the room, the switch is really a switch on the wall, and the snap wires are really wires in the wall and the cord to the lamp.

You can think of the electricity flowing through the battery, lamp, switch, and wires in the above circuit as if it were water flowing through a pump, water meter, valve, and pipes:

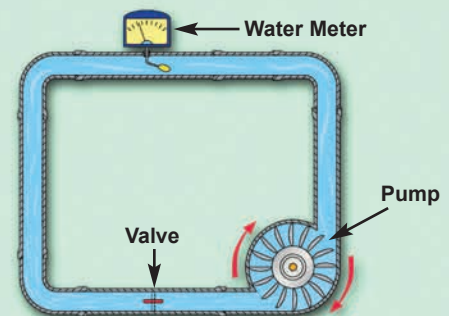

Note that each of the Snap Circuits® in the project manuals has a box next to it so that you can mark off the circuits as you build them.

In electronics, the “on” position of a switch is also called the “closed” position. Similarly, the “off” position is also called the “open” position. This is because the symbol for a slide switch is similar to the symbol for a door in an architect’s drawing of a room:

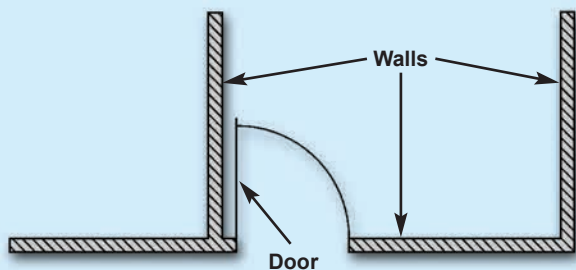

The electronics symbol for a slide switch should be thought of as a door to a circuit, which swings open when the switch is off. The “door” to the circuit is closed when the switch is on. This is shown here in drawings using the part symbols:

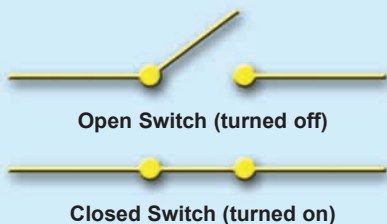

In case you haven’t noticed, the batteries produce 3V and the lamp is made for voltages up to 2.5V. Don’t worry, you will not damage your bulb. The voltage rating of the batteries (1.5V from each battery) is actually the voltage they produce when the electric current flowing from them is low, as the circuit current increases the voltage produced by the batteries is reduced. Think again of the lamp as a water meter - the lamp is bright so there must be lots of current flowing, hence the voltage is lower and the lamp is safe. You can see from the water diagram that with only a pump, an open valve, and a meter there is nothing to slow down the water flow and the pump will move the water as fast as it can.

Why does the battery voltage drop as current increases? Remember that a battery produces electricity from a chemical reaction. Not only is there a limited amount of the chemicals in a small battery (batteries slowly get weaker as you use them), but also not all of the material can react together at the same time.

If your instructor has a meter to measure voltage, ask him or her to measure the battery voltage with the switch on and off. You will see the voltage drop to under 2.5V when the switch is on.

1-7 Series vs. Parallel Circuits

There are two ways of arranging parts in a circuit, in series or in parallel. Here are examples:

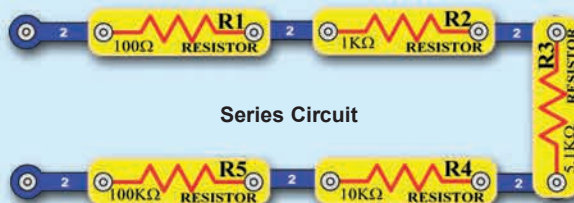

Series Circuit

The parts within these series and parallel sub-circuits may be arranged in different ways without changing what the circuit does. So these sub-circuits are the same as the ones above:

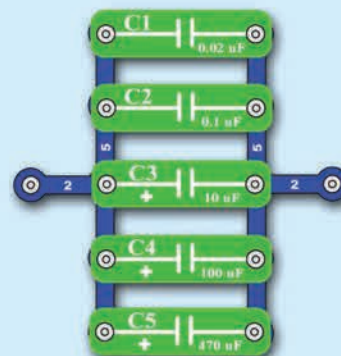

Parallel Circuit



Series Circuit

Large circuits are made of combinations of smaller series and parallel circuits. For example, these small sub-circuits:

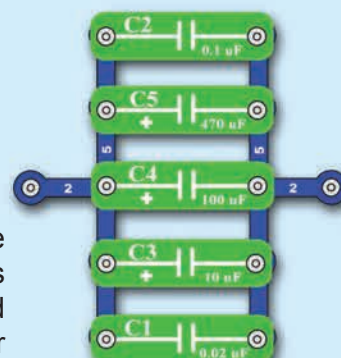

Parallel Circuit

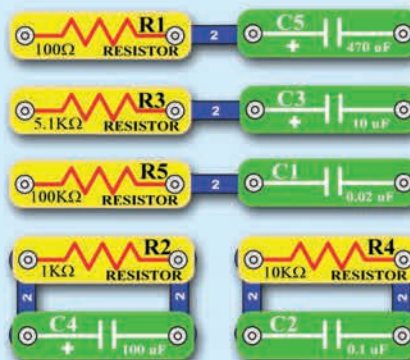

May be combined into this larger circuit:

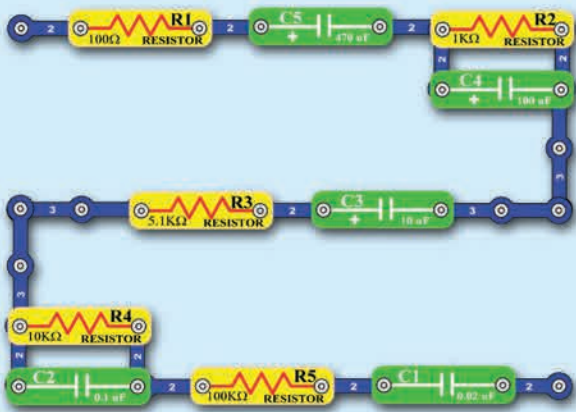

If you rearrange the parts in the sub-circuits, the circuit is still the same:

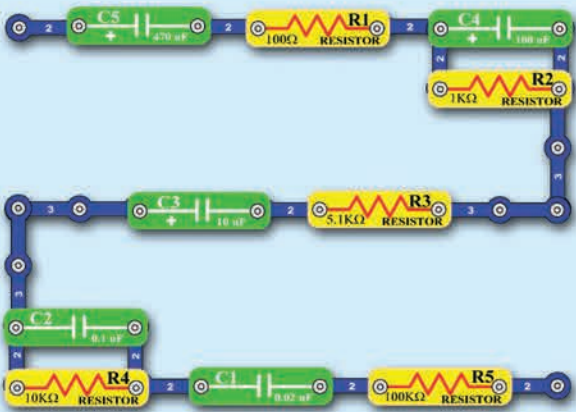

If you rearrange the order of the sub-circuits, the circuit is also the same:

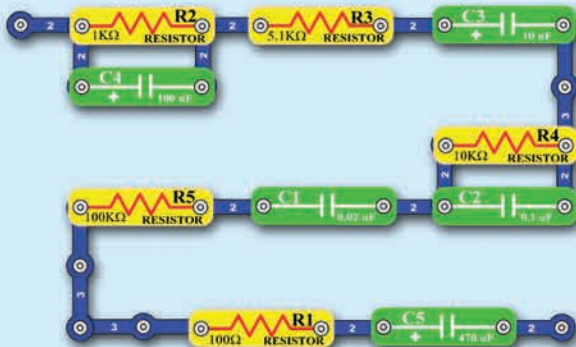

But if you rearrange the parts between sub-circuits, the circuit is different:

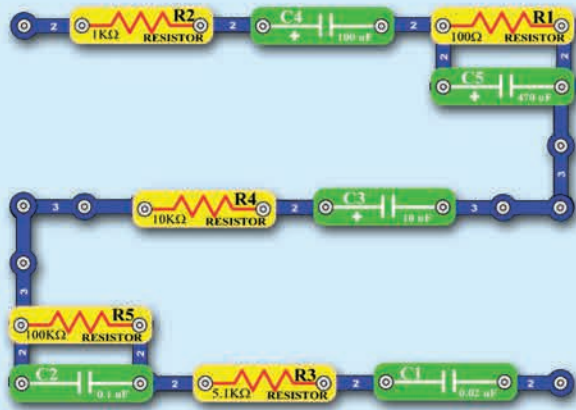

Experiments

Consider this circuit (which is project 152 on page 22 of the “Experiments 102-305” manual):

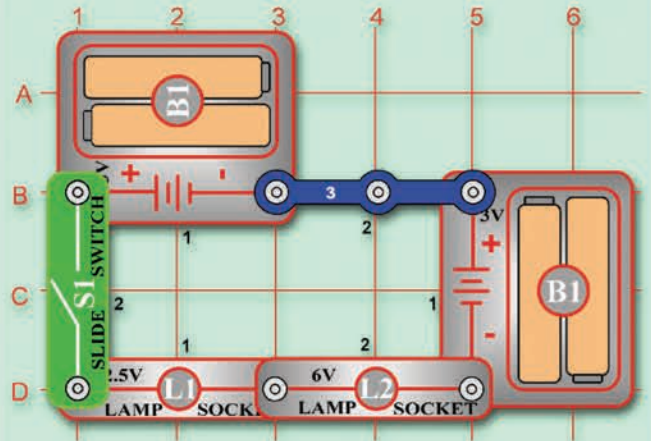

If the switch is on, both lamps will light. If one of the bulbs is broken then neither will be on, because the lamps are in series. The strings of small Christmas lights are wired in series; if one bulb is damaged then the entire string does not work.

This circuit uses two sets of batteries, these add together in a series circuit to produce 6V. Likewise, while 6V is well beyond the 2.5V rating of lamp L1, this voltage gets split between lamps L1 and L2 and so L1 will not be damaged. L2 is a 6V lamp made for higher voltage and current, so it will not be nearly as bright in this circuit as L1.

When the circuit has been off for a while, turn on the switch and watch the lamps closely. Notice how L2 takes longer to get bright while L1 gets very bright initially but becomes less bright as L2 turns on. Why?

Lamps like these are made with a special type of wire that gets hot enough to glow. L1 turns on faster because its wire heats up faster than L2's.

This effect may be easier to see if you replace one of the battery holders with a 3-snap wire.

Experiments

Consider this circuit (which is project 153):

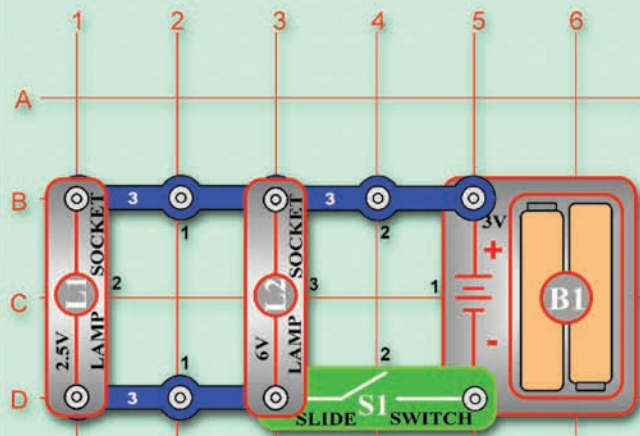

If the switch is on, both lamps will light. If one of the bulbs is broken then the other will still be on, because the lamps are in parallel. Most of the lights in your house are wired like this; if a bulb is

broken on one lamp then the other lamps are not affected.

In this circuit you could swap the locations of the lamps with each other (because they are both in parallel) or the batteries with the switch (they are both in series), but if you swap the switch with one of the lamps then the circuit will be different. All electric circuits are made up of combinations of series and parallel circuits, from simple ones like these to the most complex computers.

Note that in project 153 the lamps have the same brightness as in project 152 even though only one battery set is used. This is because the full battery voltage is applied to both lamps. This may seem more efficient than the method in project 152, but the current to light the lamps is the same so it is draining the batteries twice as fast.

For all of the Snap Circuits® projects, the parts may be arranged in different ways without changing the circuit. The order of parts connected in series or in parallel does not matter - what matters is how combinations of these sub-circuits are arranged together. For example, in project 152 you may swap the locations of the switch or lamps without affecting the circuit operation in any way because they are all connected in series.

The choice of whether to use a series or parallel configuration in a circuit depends on the application, but will usually be obvious. For example the overhead lights in the rooms of your home are all connected in parallel so that you can have light on in some rooms and off in others, but within each room the light and switch are connected in series so the switch can control the light.

Experiments

Now consider this circuit (which is project 103):

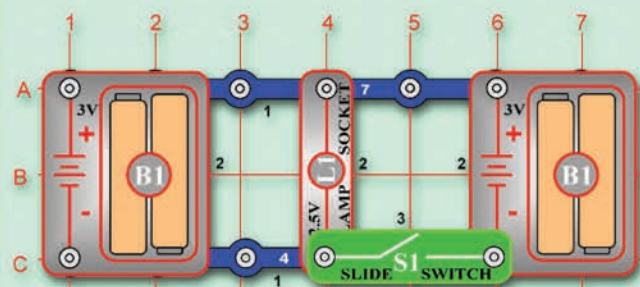

With the switch off, the lamp will be bright even with only one set of batteries connected. If the switch is turned on then the lamp will be even brighter. This will be more apparent if the batteries on the left side are weak and those on the right side are new.

Batteries are placed in parallel when the voltage is high enough but the circuit needs more current than one group of batteries can supply. Think of each battery as a storage tank that supplies water. If you put two in parallel, you can get more water (current), but the pressure (voltage) stays the same.

1-8 Short Circuits

Every circuit will include a power source (the batteries), a resistance (which might be a resistor, lamp, motor, integrated circuit, etc.), and wiring paths between them and back.

When wires from different parts of a circuit connect accidentally then we have a “**short circuit**”. You’ve probably heard this term in the movies; it usually means trouble.

A short circuit is a wiring path that bypasses the circuit resistance, creating a **no-resistance path across the batteries**. This will damage components and/or quickly drain your batteries. Be careful not to make short circuits when building your circuits. Always check your wiring before turning on a circuit.

The name “short circuit” refers to how the current through the circuit bypasses (jumps around) other components in the circuit. It is the “easiest” path through the circuit, it is not always the “shortest”.

Here are some examples:

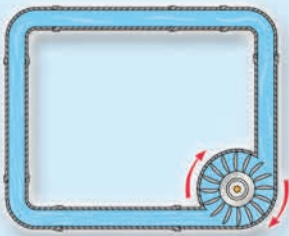
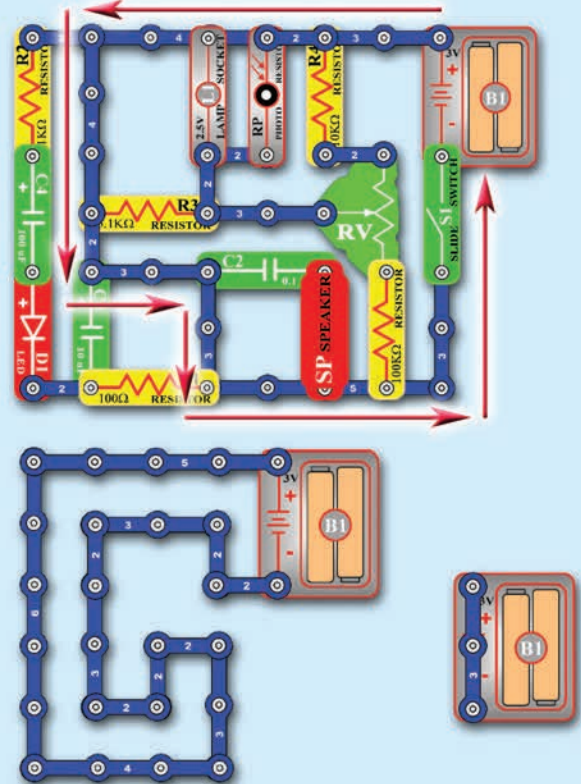

In a short circuit, there is nothing to limit the current in a circuit. However the chemical reaction in a battery cannot supply unlimited current, so the battery voltage drops to zero volts. This is called “overloading” the batteries. This overload produces heat and damages the batteries. Think of this as a pump pumping water in a loop as fast as it can until it burns out.

1-9 Solder

Solder is used to make electrical connections to components on a printed circuit board. It is a special metal made mostly of tin that melts at relatively low temperature (about 500°F). Solder is applied and melted around a joint where a connection is being made; it creates a solid bond between the metals.

The placement of parts onto circuit boards and the application of solder to connect and hold them in place are usually done automatically with special machines. In fact, the microprocessors used in modern computers are so finely designed that they are almost impossible to solder by hand.



Soldering Iron



Solder



Before Soldering



After Soldering

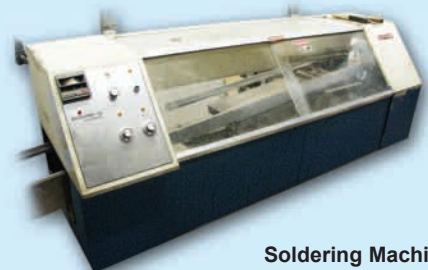

Soldering Machine

1-10 Schematics



The circuit diagrams in the Snap Circuits® manuals are easy to understand and build your circuits from. But what if you wanted to write down your own circuit? These diagrams are not very easy to draw. There are also many ways of building the same circuit. For example, you could use a jumper wire instead of a 2-snap wire.

The Snap Circuits® diagrams give you more information than you really need. They tell you how to build it, when all you really need to know is how it will work. You can find your own way to build it.

Notice the symbols marked on the parts. Those symbols are used in engineering circuit diagrams, which are called **schematics**. For example, snap circuits project 153 is shown here with an engineering schematic for it:

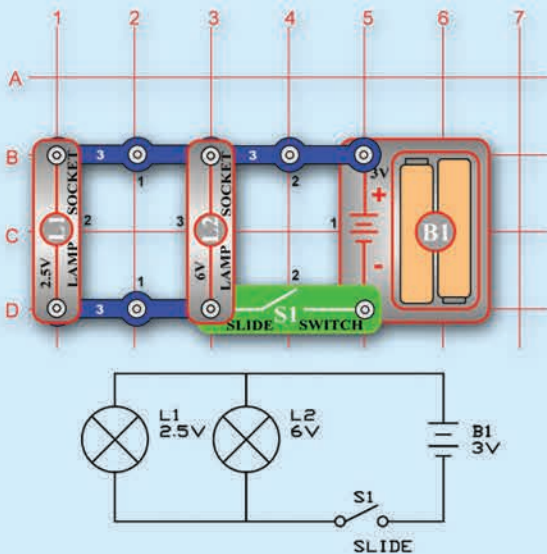

Schematics are easy to draw, and the part symbols used are international standards. Note that wires in a schematic are just lines, and can be as long as you like. Schematics are a flexible way of drawing circuits, and can be re-drawn in many different ways. For example, the above schematic could also be drawn as:

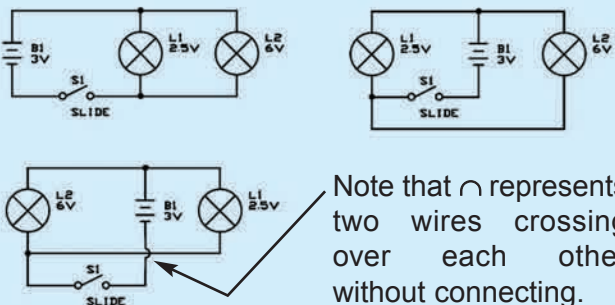

Note that  represents two wires crossing over each other without connecting.

Here are some more schematic examples:

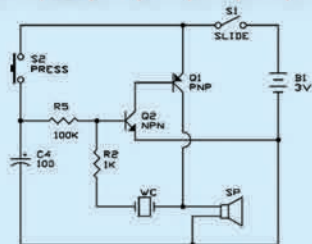
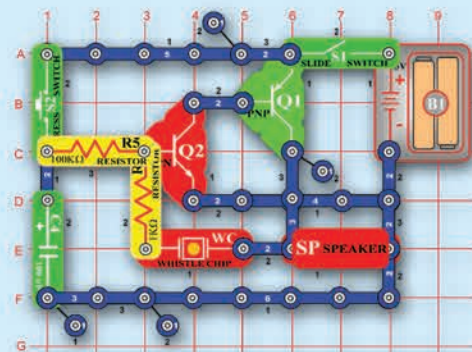
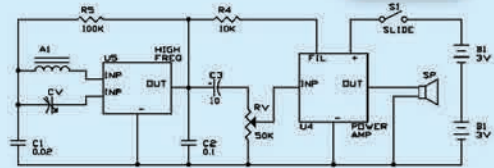
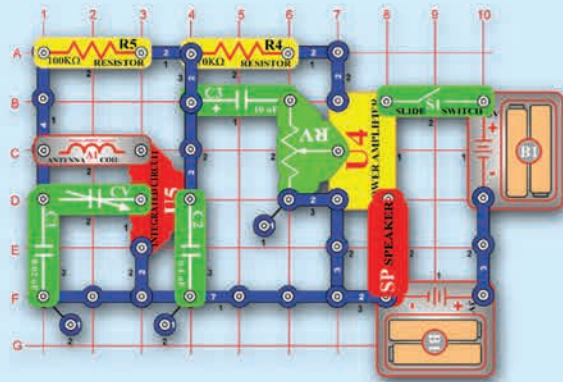
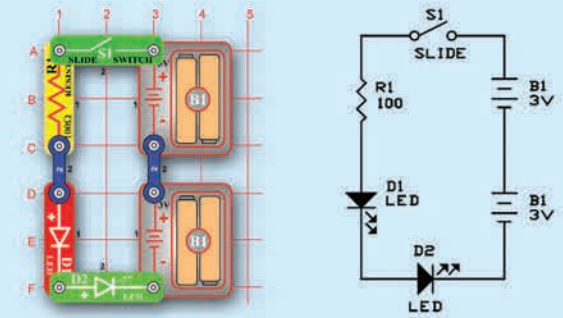

It is important to understand schematics, since many circuit designs are common and can be found in books. Almost all new circuits designed are similar to some circuit that already exists. Many products sold today come with schematics of their designs to assist in troubleshooting problems.

Quick Quiz



1. Draw a schematic for a circuit that consists of three lamps powered by a battery.
2. For each room in your home, make a schematic drawing showing how the lamps and switches controlling them are connected together.

Summary

Summary of Chapter 1:

1. The electric current is a measure of how much electricity is flowing in a wire, and is expressed in Amperes.
2. The voltage is a measure of the electric pressure exerted into a wire or circuit by a battery or other power source, and is expressed in volts.
3. Switches are used to turn on or turn off the flow of electricity in a circuit.
4. A light bulb converts electricity into light.
5. Most electronic products have components mounted on circuit boards with the wires literally printed on the board surface.
6. Electrical circuits are all combinations of series and parallel configurations.
7. A short circuit is a no-resistance path across a power source, and causes damage to components and batteries.
8. Solder is a special metal that is melted to make solid electrical connections.
9. Schematics are engineering drawings of circuits using symbols.

Quiz

Chapter 1 Practice Problems

1. The flow of electricity is measured in _____.
A. gallons B. minutes C. amperes D. volts
2. To turn on a switch, you _____ it.
A. voltage B. open C. pressurize D. close
3. Three of the choices below are the same circuit with the parts arranged in different ways. Which choice is a different circuit?

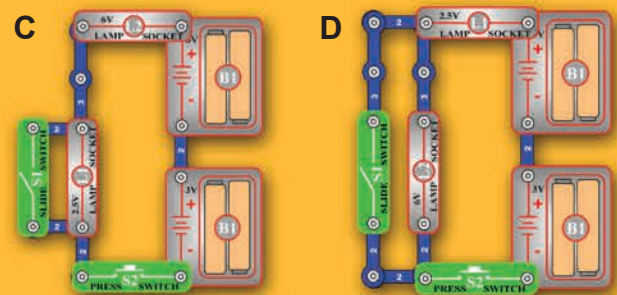
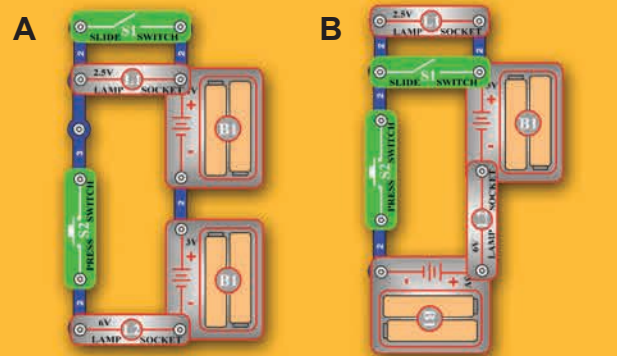

4. Which of these is a short circuit?

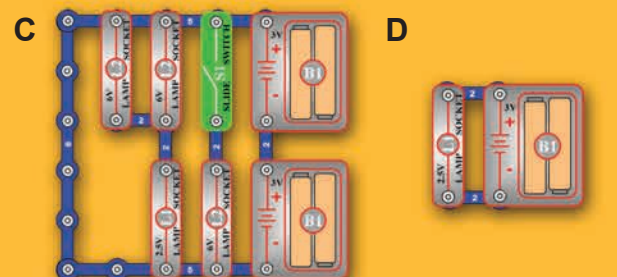
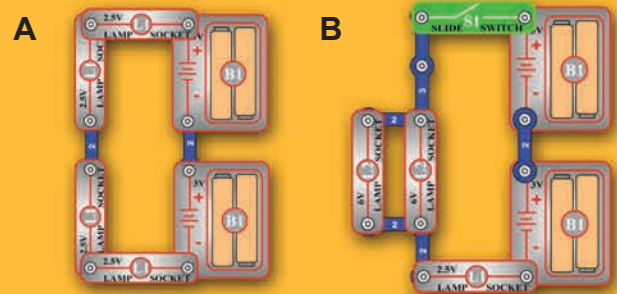

Answers: 1. C, 2. D, 3. D, 4. C

CHAPTER 2: MOTORS & ELECTRICITY

Learn
By Doing®

In this chapter you will learn about generators and motors. A generator uses mechanical motion to create electricity and a motor uses electricity to create mechanical motion. This statement may not seem important to you but it is actually the foundation of our present society. Nearly all of the electricity used in our world is produced at enormous generators driven by steam or water pressure. Wires

are used to efficiently transport this energy to homes and businesses where it is used. Motors convert the electricity back into mechanical form to drive machinery and appliances. **The most important aspect of electricity in our society** - more important than the benefits of the Internet - **is that it allows energy to be easily transported over distances.**

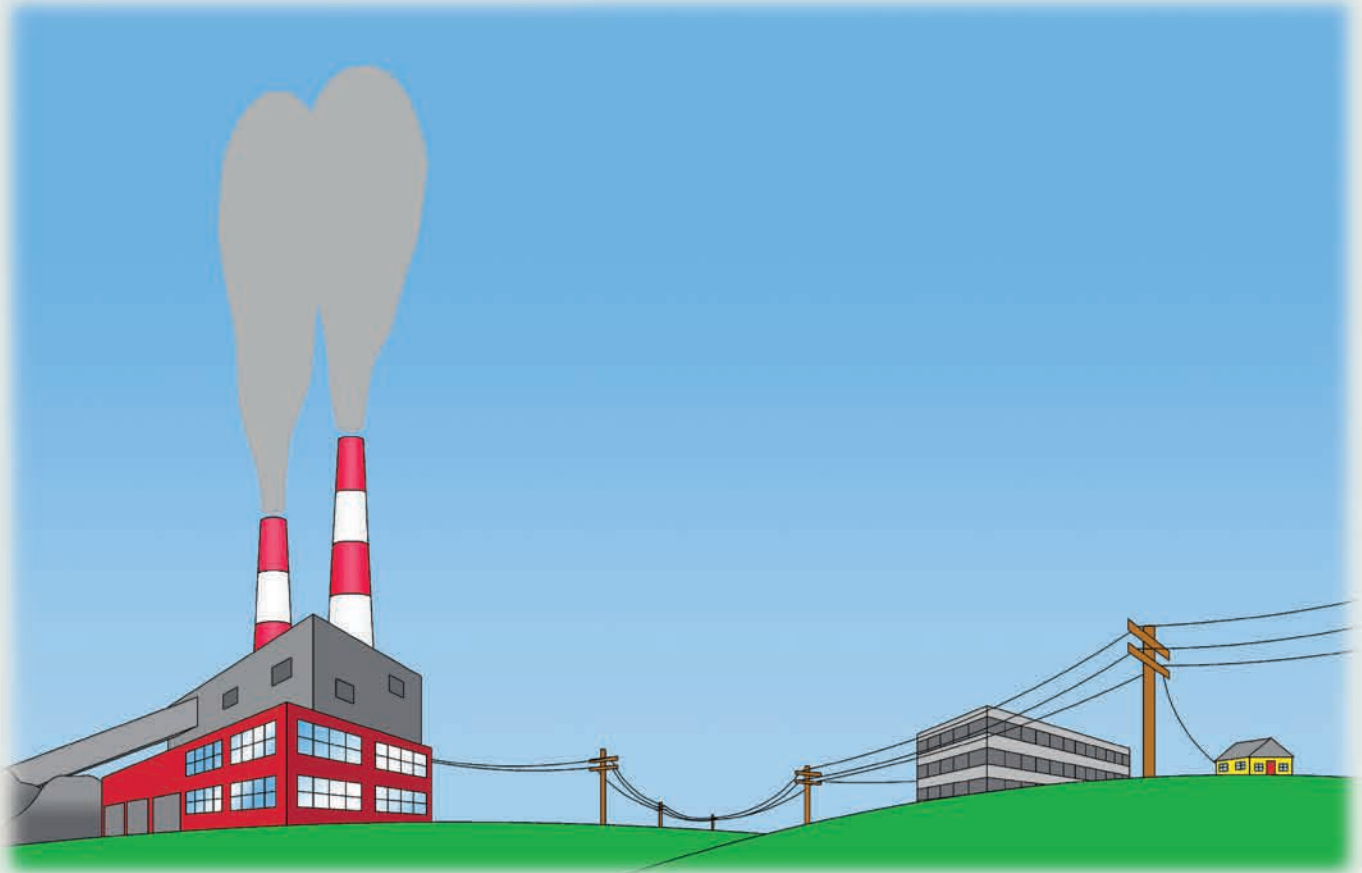

Note that “distances” includes not just large distances but also tiny distances. Try to imagine a plumbing structure of the same complexity as the circuitry inside a portable radio - it would have to be

large because we can't make water pipes so small. Electricity allows complex designs to be made very small.



2-1 Motors

Water flowing under pressure in a pipe or a fast-moving stream can be used to turn a paddlewheel. If the paddlewheel was linked to a fan blade then you could use the water pressure to turn the fan, perhaps to cool yourself on a hot day. If the water was flowing very fast due to high pressure, then you could get the fan moving fast enough it might create a strong airflow like a propeller on a plane.

A similar thing happens in a motor, with electricity instead of water. A motor converts electricity into mechanical motion.

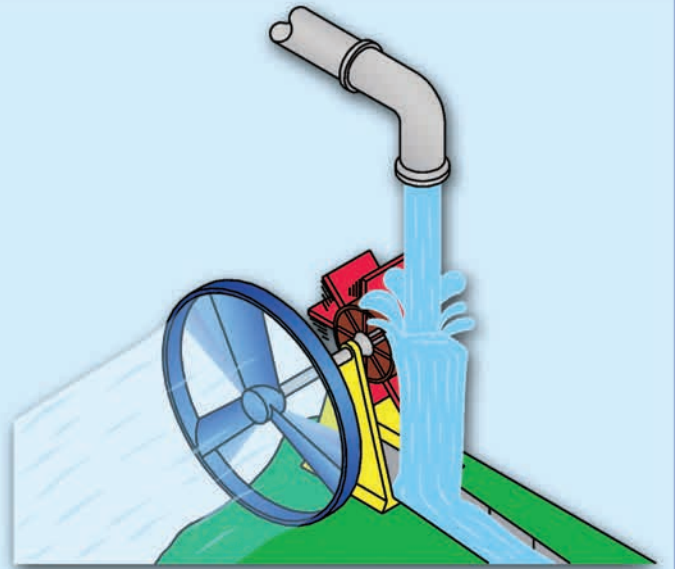

Introducing New Parts

Snap Circuits® includes one motor, shown here with its symbol. Snap Circuits® also includes a fan, which is used with the motor. An electric current in the motor will turn the shaft and the motor blades, and the fan blade if it is on the motor.

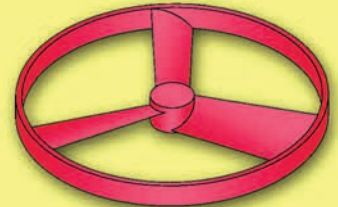
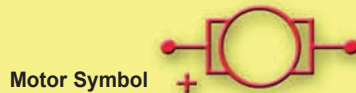

How does electricity turn the shaft in the motor? The answer is magnetism. Electricity is closely related to magnetism, and an electric current flowing in a wire has a magnetic field similar to that of a very, very tiny magnet. Inside the motor is a coil of wire with many loops, if a large electric current flows through the loops the magnetic effects become concentrated enough to move a small magnet. The motor also has a small magnet, on a shaft. When electricity moves the magnet, the shaft spins. If the fan is on the motor shaft then its blades will create airflow.

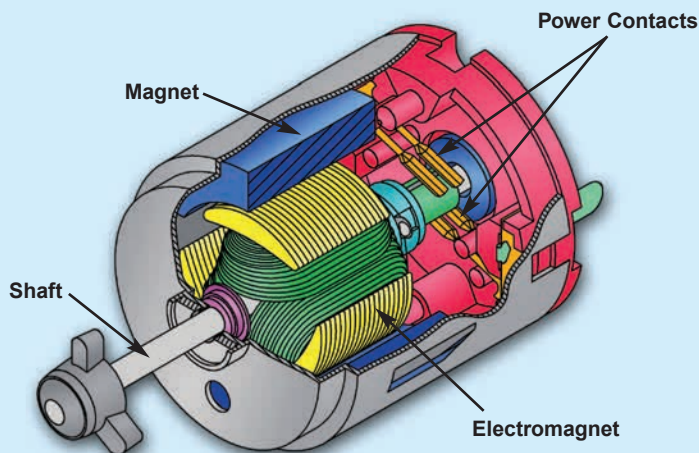

Experiments

Consider this circuit (which is project 2):

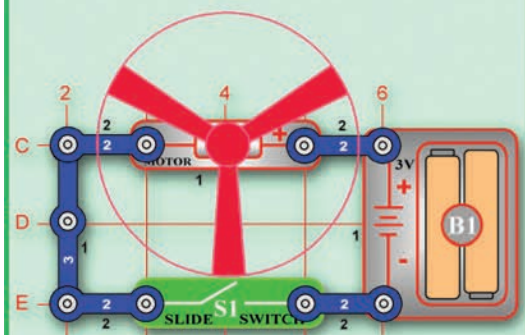

When the switch is on, current flows from the batteries through the motor making it spin. The fan blades will force air to move past the motor. Be careful not to touch the motor or fan when it is spinning at high speed.

Motors are used in all electric powered equipment requiring rotary motion, such as a cordless drill, electric toothbrush, and toy trains. An electric motor is much easier to control than gas or diesel engines.

The electromagnetic effect described above also works in reverse - spinning a magnet next to a coil of wire will produce an electric current in that wire. This is what happens in a **generator**, which uses mechanical motion to create electricity. In an electric power plant, high-pressure water (from a dam) or steam (heated by burning oil or coal) is used to spin a paddlewheel linked to magnets. The magnets create an electric current in a coil of wire, which is used to power our cities.

In theory, you could connect your Snap Circuits® motor directly to the 2.5V lamp and spin the fan blade with your fingers to light the lamp. In reality, it would be impossible for you to spin the motor fast

enough to produce enough current to get even a glimmer of light from the lamp.

To summarize, **a generator uses mechanical motion to create electricity and a motor uses electricity to create mechanical motion.**

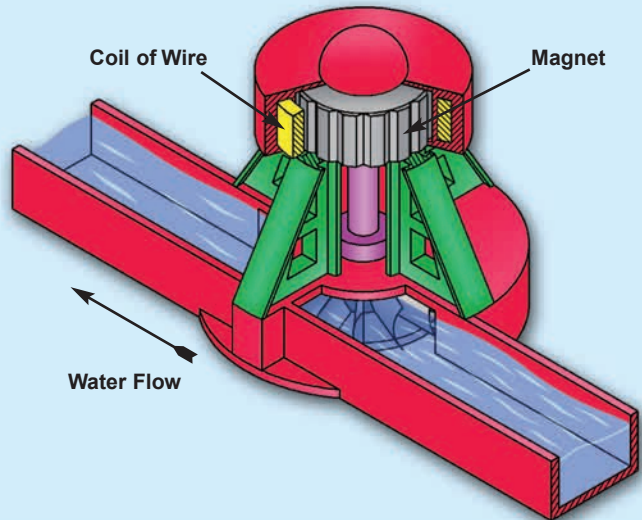

2-2 Motor Circuits

Experiments

Consider this circuit (which is project 5):

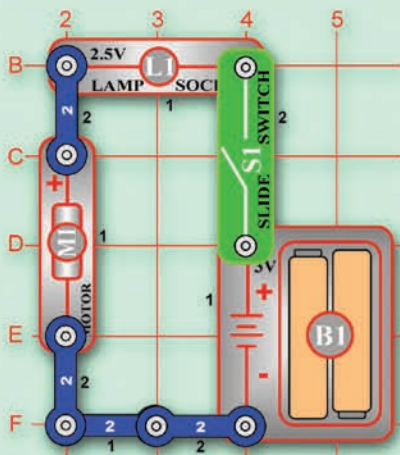

If the switch is on, the lamp will light and the fan will spin.

The lamp and motor are in series, so the voltage from the batteries will get divided between them. In this circuit more of the voltage will be used at the lamp than at the motor.

If the fan was not on the motor then the motor would spin much faster but the lamp would not be as bright. The motor needs more voltage to spin faster, so there is less voltage available to light the lamp.

Consider this circuit (which is project 6):

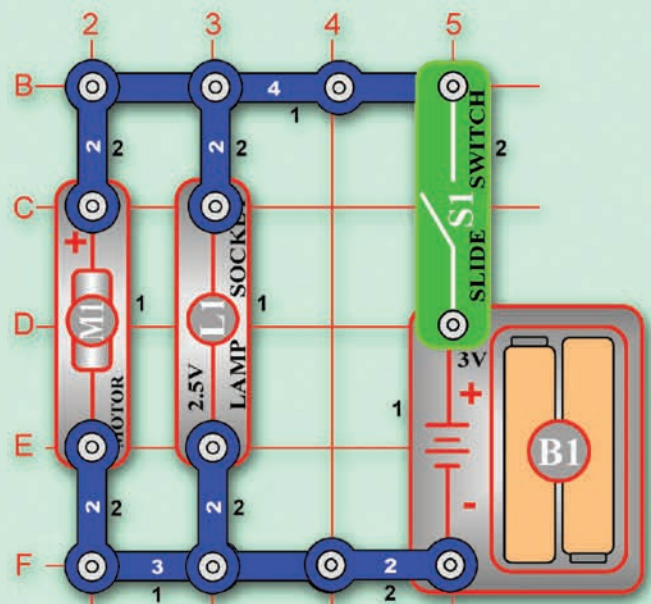

If the switch is on, the lamp will light and the fan will spin. This circuit has the lamp and motor in parallel, so the full voltage from the batteries would be applied to both. So the fan would spin faster than for the circuit in project 5, which divided the battery voltage between the lamp and motor.

Experiments

Now consider this circuit (which is project 80), with the fan on the motor:

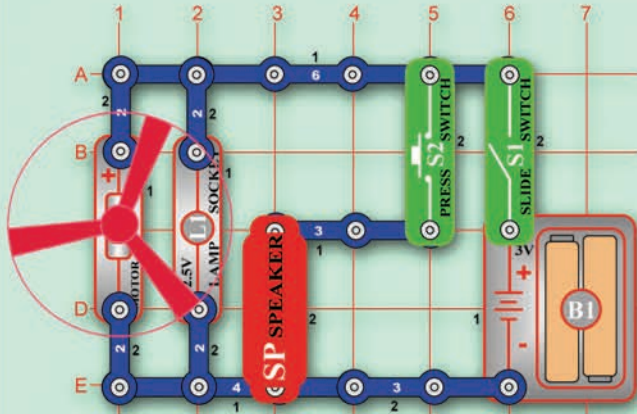

In this circuit the lamp will not be at full brightness, even though the full battery voltage is applied to it. Do you know why?

Remember that as the circuit current increases, the voltage produced by a battery is reduced. The motor draws a high current, very high when it first starts up with the fan on. The chemical reaction in the batteries can't supply such a high current, so the battery voltage (electrical pressure) drops.

If your instructor has a meter to measure voltage, ask him to measure the battery voltage with the slide switch on and off. You would see the voltage drop to under 2.5V when the switch is on.

Push the press switch to add the speaker to the circuit and increase the circuit current even more. This will make the lamp less bright. Take the fan off the motor and turn on the switch again. The lamp will be brighter now. It doesn't take as much current to spin the motor without the fan, so the battery voltage doesn't drop much.

You know that the AA batteries used to power your snap circuits have + and - markings on them, called **polarity** markings. The chemical reaction in the batteries only makes the electric current flow in one direction. To make the current flow in the other direction you just reverse the batteries (all batteries in the same circuit must be reversed). The motor also has + and - markings, because if the direction

of current flow through is reversed than the motor will spin in the opposite direction (reversing the electric current reverses the magnetic field generated, which reverses the direction the shaft spins). The lamp, switch, and wires have no such + and - markings on them because they work the same regardless of which way the current is flowing.

Experiments

Consider this circuit (which is project 262):

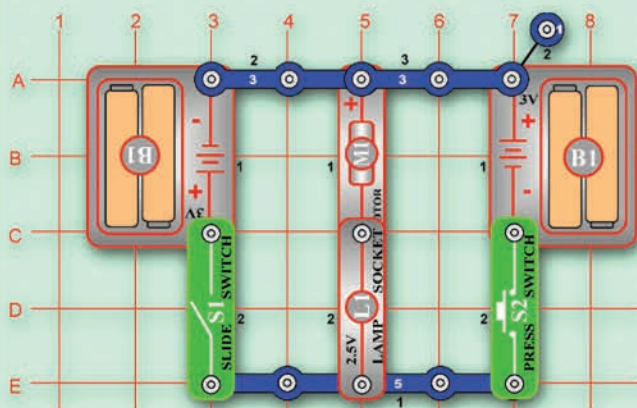

If the slide switch is on, the fan will spin to the left. If the press switch is on, the fan will spin to the right. The slide and press switches apply opposite voltages to the circuit. The lamp lights in either case, since it is not affected by the direction of current flow.

What happens if both switches are on? Nothing happens, just as if both were off. The opposite voltages from the batteries cancel each other out. Think of this as two pumps trying to pump water through a pipe in opposite directions.

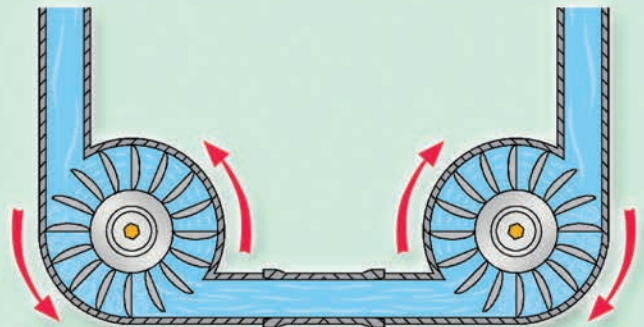

Experiments

Consider this circuit (which is project 11):

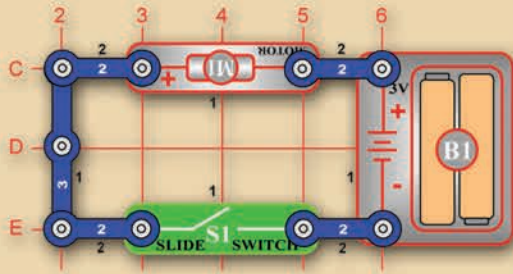

If the switch is turned off when the motor is spinning at full speed, the fan will rise into the air. Be careful not to touch the motor or fan while it is spinning at high speed. In this circuit the fan blades suck in air and push it down to the table.

If you hold a sheet of paper above the fan, you will see it get sucked toward the fan.

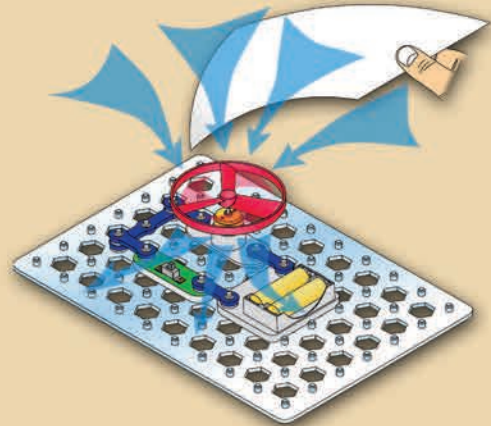

How does the fan rise? Think first about how you swim. When your arms or legs push water behind you, your body moves ahead. A similar effect occurs in a helicopter - the spinning blades push air down, and create an upward force on the blades. If the blades are spinning fast enough, the upward force will be strong enough to lift the helicopter off the ground.

While the switch is on, the motor rotation locks the fan on the motor shaft. The fan does not spin fast enough to lift the entire circuit off the ground. Sometimes there may be enough lift to make the base grid hover around the table like a puck on an air hockey table.

When the motor is turned off, the fan unlocks from the shaft. The fan rises into the air like a helicopter, since it is no longer held down by the weight of the full circuit.

If the motor polarity were reversed (+ on the right), the fan would never fly. The fan blades are sucking in air around the motor and pushing it straight up. If you hold a sheet of paper above the fan, you will see it get pushed up and away from the fan.

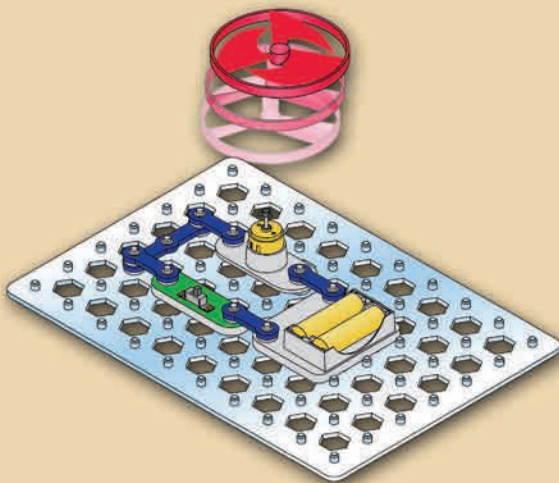
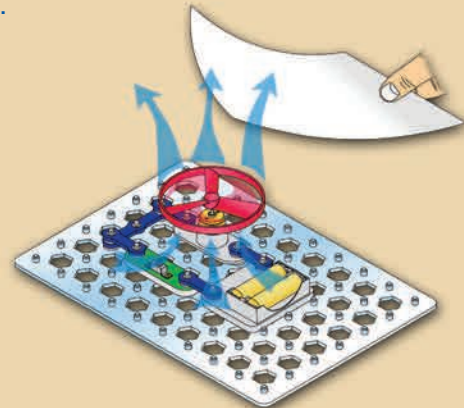

Experiments

Consider this circuit (which is project 12):

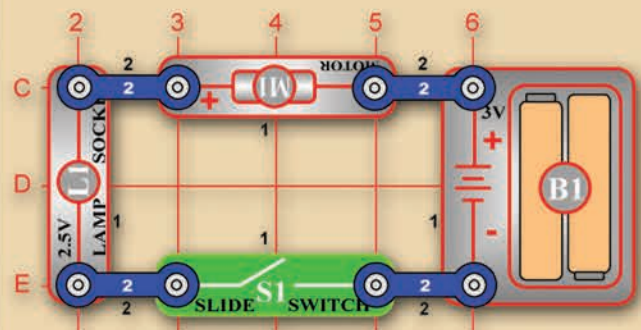

By placing the lamp in series with the motor, the voltage at the motor is reduced. The motor speed will be reduced, so the fan will probably not fly off.

Experiments

Consider this circuit (which is project 13):

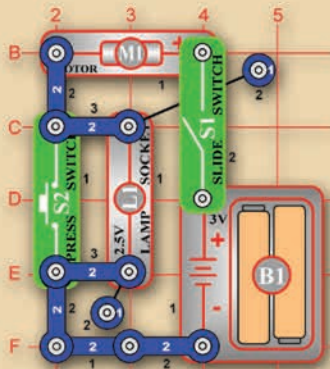

If the slide switch (S1) is on, the fan spins and the lamp lights. If the press switch (S2) is also on, then the fan will spin faster but the lamp will be off. In this case, the full battery voltage is applied to the motor, instead of being divided between the motor and lamp.

This is one way of controlling the speed of a fan. Commercial fans do not use this method because the lamp produces heat and wastes energy. Commercial fans change the amount of voltage applied to the motor using other methods.

2-3 Fuses



Occasionally electronic products/components break due to people using them incorrectly, accidents, natural storms, bad design, or component failures. Often the problem is a short circuit, which results in an excessively high current flow. This high current can overheat components in the product enough to damage them, make them

explode, or start a fire.

A **fuse** is usually a special wire that breaks (“blows”) when too much current flows through it. A “blown fuse” shuts down the product before anything can overheat or cause a fire. Although a “**blown fuse**” prevents the product from working, fuses are easy to replace.

Experiments

Imagine that one of the 2-snap wires in the previous circuit is a fuse (as in project 14):

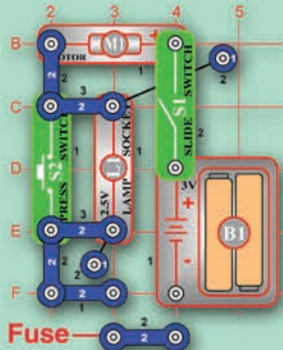

If the circuit is operating properly then the “fuse” acts as a 2-snap wire. However if the motor breaks and suddenly becomes a short circuit while both switches are on, then there will be nothing to limit the current in the circuit. A very high current will flow from the batteries, and would damage them if it continues. This excessively high current will “blow” the fuse, creating an open circuit just like turning off the slide switch would do. This will protect the batteries from damage. The motor can then be repaired and the fuse replaced.

Fuses are very important and most electronic products have one. Products using electricity supplied by the electric company are usually required to have them because the high voltages and currents available here can cause severe damage and fires. Small battery-powered products usually do not have fuses because the batteries in them are not powerful enough to cause harm.

While many fuses must be replaced when blown, flipping a switch can reset some types. Every home has an electrical box of such fuses, to isolate any problems in one room from the rest of the house and your neighbors. But these fuses protecting your home take a much higher current to “blow” them than a fuse used in a radio.

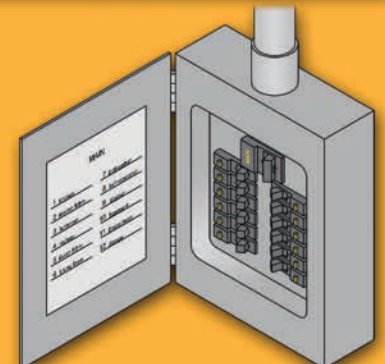

2-4 Your Electric Company

Batteries are widely used because they are easy-to-use, safe, and portable. For example, Snap Circuits® can be used on a camping trip in a remote wilderness as long as you have batteries. You can even take along spare batteries because they are small and easy to carry.

What if you wanted to take a microwave oven on the camping trip? A microwave oven uses a lot of electricity, so the batteries for it would be large, heavy, expensive, and wouldn't last long. Heavy, high-power products like microwave ovens are not moved often.

Only a tiny portion of the electricity used in our world comes from batteries. The rest is produced at enormous electric power plants, operated by your local electric company. The electricity from these power plants is available at the electrical outlets in the walls of your home.

The cost of electricity from the electric company is much less than the cost of electricity from batteries.

The voltage of the electricity supplied by the electric company is 120V, much higher than the voltage of the batteries in Snap Circuits®. This is available at each of the electrical outlets in your home. The current available is very large, since it must power products like dishwashers and TVs.

A “**blackout**” occurs when part of a city is cut off from the power plants supplying it with electricity. The city will appear “black” from the air at night, since there are no electric lights on. This is usually due to accidents or storms, but is also done to confuse attacking bombers in war.

A “**brownout**” occurs when power plants cannot supply enough current to a city during high demand, and must reduce the voltage below 120V. This sometimes occurs on hot days in summer when everyone is using their air conditioners.

Our lives are much easier and more fun by having such power available by simply plugging into an electrical outlet. This amount of electricity is also very dangerous, and it will kill anyone who abuses it. While accidents involving electricity are rare, they kill people every year. **Never put anything into an electrical outlet except an electrical plug.** Battery-powered products are safe, since small batteries are too weak to hurt people.

The protective plastic around the wires to plug in a lamp are all that protects you from the full power of electricity. Damaged electrical cords should always be unplugged and repaired. Remember that electricity travels through water, so don't use electric products while taking a bath (battery-powered products are fine).

Your home has fuses that automatically turn off the electricity in your home if there is an electrical problem, such as a short circuit. These fuses prevent electrical problems in your home from affecting your neighbors, but they do not protect you.

2-5 Static Electricity

You may have noticed that sometimes you can get an electric “zap” in your home or school, how clothes stick together when you take them out of the dryer, or when taking off a wool sweater on a dry day. Occasionally differences in electrical charge build up between things, called static electricity. The things, which might include your body, are storing electrical charge. They might store a very small amount of electrical charge at high voltage. This is just like a cloud storing electrical charge before a thunderstorm.

The name “static” is used to describe the electrical charge build-up because the charge is not moving

around to disperse. “Static cling” refers to how clothes sometimes cling to each other in the dryer, due to static electricity. Static electricity in the atmosphere causes the “static” (erratic noises) you hear on your AM radio when reception is poor.

Static “zaps” occur when an electrical current flows to equalize the charge difference. Though the voltage might be high, the current is small and the duration is short. The actual “zap” occurs because the voltage is high enough to “jump” across a high-resistance material (usually air), making a small spark as it happens.

Though the “zap” might sting you briefly, these effects do not harm people. However, these static zaps can damage some types of sensitive electronic components and electronics

manufacturers have to protect against it. Such protection includes static wrist straps, conductive floor matting, and humidity control. The parts in Snap Circuits® will not be damaged by static.



Anti-Static Wrist Strap



Anti-Static Floor Mat



Anti-Static Ankle Strap



In the same way, clouds can build up a static electrical charge. This charge might become very large, and it is spread out over the enormous volume of the clouds. Lightning occurs when this electrical charge discharges into the ground, and can be very destructive. Lightning is looking for the lowest-resistance path from the clouds to the ground.

Do you know why you often “see” lightning before you “hear” it? It is because light travels faster than sound.

Since people have less resistance than air, standing in an open field during a thunderstorm is very dangerous. Houses and other buildings have “**lightning rods**” to protect them, which are metal bars from the roof into the ground. Their purpose is to encourage lightning to go through the rods to the ground, instead of going through the house to the ground.

Large aircraft can build up a large electrical charge during a long flight. A wire similar to a lightning rod is usually connected to an aircraft shortly after landing, as a precaution against static zap.

Static Electricity Example:

Comb your hair vigorously with a plastic comb and hold the comb near some little (1cm x 1cm) scraps of paper to pick them up OR tilt the comb near a slow, steady stream of water from a faucet and see how the water bends towards it.

Quick Quiz



1. List all the products in your home that use an electric motor.
2. Name some examples of static electricity.

2-6 Types of Lamps

The lamps in Snap Circuits® are **incandescent** type, the same as the larger lamps in your home. The bulbs contain a special high-resistance wire, called the **filament**. When an electric current passes through it the wire gets so hot that it glows. Heat is also produced, and the glass bulb prevents the filament from reacting with oxygen in the air and burning. When the voltage rating of an incandescent bulb is exceeded, the filament gets so hot it burns out. Filaments are usually made of tungsten, since ordinary copper would melt.

The **fluorescent** light bulbs that come in white 4 ft. tubes are the standard room lights for offices and schools. They pass electric current through a gas, usually neon. This gas emits light as the electricity

passes through it, similar to how a tungsten wire does. Although larger and more expensive than ordinary incandescent lamps, they are more efficient at converting electricity into light.

The difference in heat produced between incandescent and fluorescent light bulbs might surprise you. Find a fluorescent bulb and feel the heat coming off it; you won't feel much. Find an incandescent lamp THAT HAS BEEN OFF FOR A WHILE and turn it on. Feel the heat it produces; it soon becomes too hot to touch. Only about 5% of the electricity used by incandescent bulbs is converted into light. Without the more efficient fluorescent bulbs, our society of office buildings might have been much different.

2-7 Types of Switches



Push Button



Rotary



Rocker

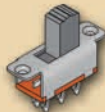

Slide

The slide and press switches included in Snap Circuits® are simple switches, more complex types are also available. Switches come in almost every shape and size imaginable. There are membrane, rocker, rotary, DIP, locking, and non-locking types just to name a few.

Very often, a single switch is used to make many different connections. The combinations of connections for a switch are indicated in the symbol for it. Here are some examples:

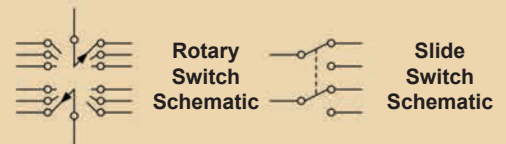

2-8 Electricians

There are many different ways of using electricity, so there are many types of people who work directly with it. The main categories are electricians and engineers/technicians. Although many people think of these as being the same career, they are actually very different. They attend different schools, use different tools, and work in different places.

Electricians are the people who install electrical wiring into homes and businesses. Electricians deliver the electricity to your home to be used. It takes a lot more electricity to operate everything in a building than to operate a computer or radio, so safety is very important and the equipment they use can handle high levels of voltage and current. Buildings are not easy to re-wire, so the wiring must be reliable and safe for many years.

Electricians are trained in union and trade schools. Local government licenses them because buildings must be wired as per strict local building codes to be sure they will be safe even after many years.

Electrical/electronics engineers and technicians design and develop products that will use the electricity that electricians have brought to them. Voltages and currents are much lower and safer, but circuits can be much more complex (like computers) and technologies change quickly. Electronic products are mass-produced in factories, unlike building wiring which must be installed in the building. Engineers are trained in colleges and technicians are trained in trade schools. Government does not regulate them but products must meet industry safety standards.

Summary

Summary of Chapter 2:

1. An electric current flowing in a wire has a magnetic field.
2. A generator uses mechanical motion to create electricity and a motor uses electricity to create mechanical motion.
3. A fuse is a special wire that breaks when an excessively high current flows through it, used for safety.
4. Electrical outlets are 120V, and can supply enough current to kill people.
5. Static electricity can cause clothes to stick together. Lightning occurs when static electricity in clouds discharges into the ground.
6. Only a small amount of the electricity used by light bulbs is converted into light, the rest becomes heat.

Quiz

Chapter 2 Practice Problems

1. Fuses are needed for all of the following reasons except:
 - A. They improve circuit performance.
 - B. To prevent an electrical problem from starting a fire.
 - C. To limit the current in a circuit.
 - D. People don't always use products correctly.
2. All of the following are caused by static electricity except:
 - A. Lightning
 - B. Erratic noises interrupting music on your AM radio.
 - C. Clothes sticking together in the dryer.
 - D. Blackouts
3. Which circuit will spin the fan the fastest? Which will spin fan the slowest?

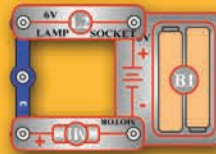

A

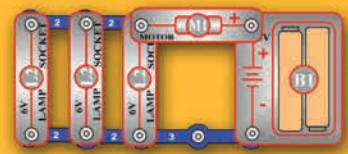

B

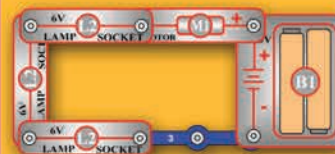

C

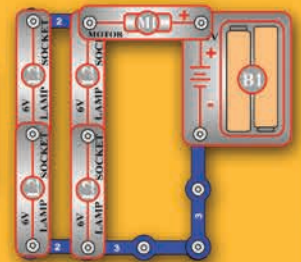

D

4. Which circuit will make the lamp the brightest?



A

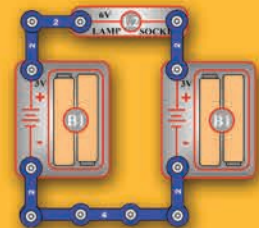

B



C

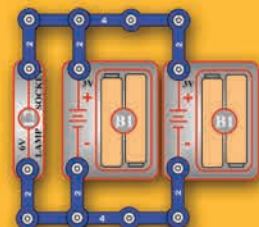

D

Answers: 1. A, 2. D, 3. B/C, 4. A

CHAPTER 3: RESISTANCE

Learn
By Doing®

All of the circuits and components studied in chapters 1 and 2 are commonly used by electricians, though the actual parts used will be for much higher voltages and currents than the Snap Circuits® parts representing them. Electricians are concerned with getting the electricity to where it will be used as efficiently as possible, without wasting energy.

In consumer products like toys, radios, and computers, electronics engineers and technicians want to control how it is used.

In this chapter you will learn about resistors, which are used to limit and control the flow of electricity. As an example of how important resistors are in electronics, consider a typical AM/FM radio:

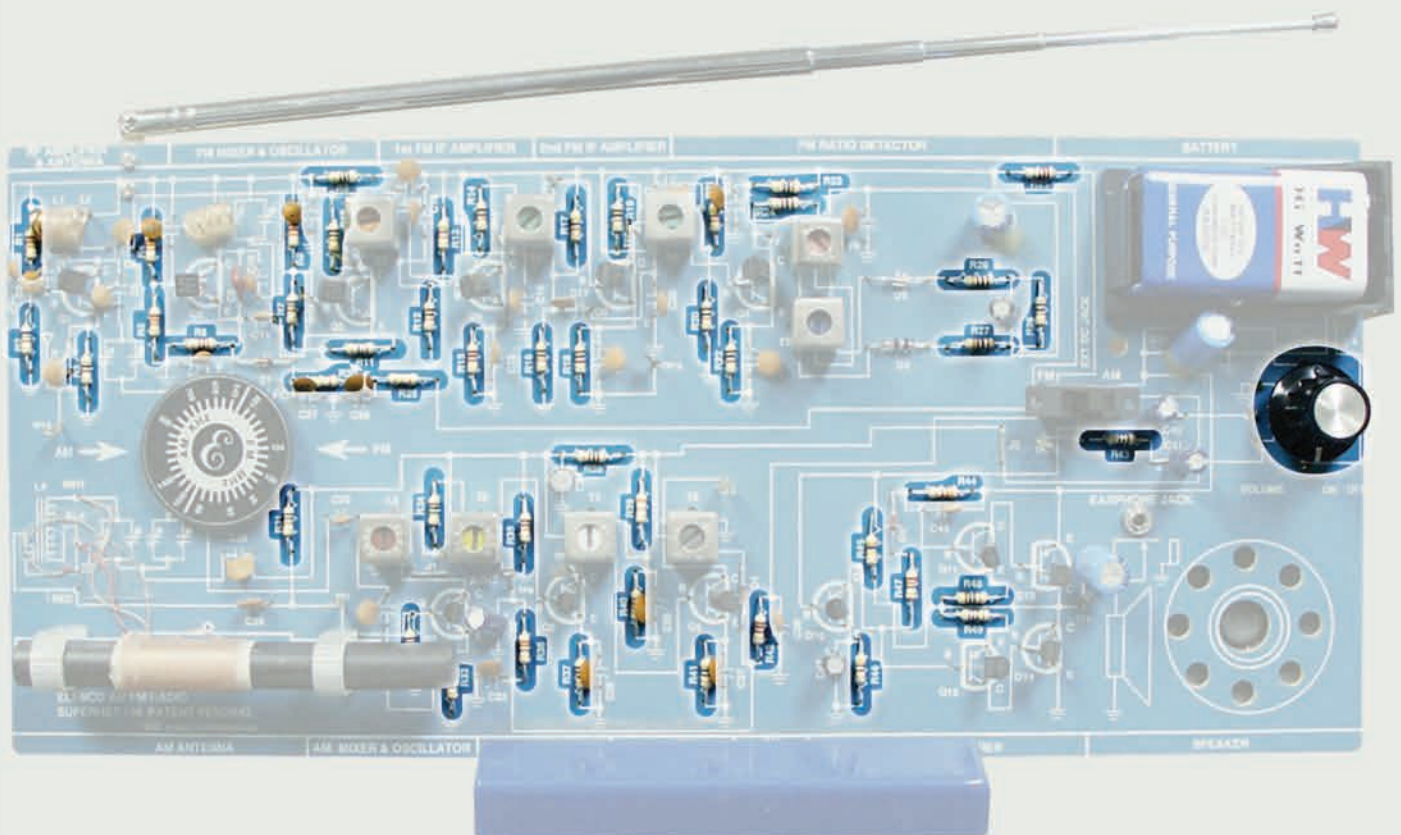

This radio contains 50 resistors, which are highlighted. The radio needs every one to operate properly. Televisions contain hundreds of resistors, and computers contain even more.

3-1 Resistors



Why is the water pipe that goes to your kitchen faucet smaller than the one that comes into your house from the water company? And why is it much smaller than the main water line that supplies water to your entire town? The reason is that you don't need so much water. The pipe size limits the water flow to what you actually need.

Electricity works in a similar manner, except that wires have so little resistance that they would have to be very, very thin to limit the flow of electricity. They would be hard to handle and break easily. But the water flow through a large pipe could also be limited by filling a section of the pipe with rocks (a thin screen would keep the rocks from falling over), which would slow the flow of water but not stop it.

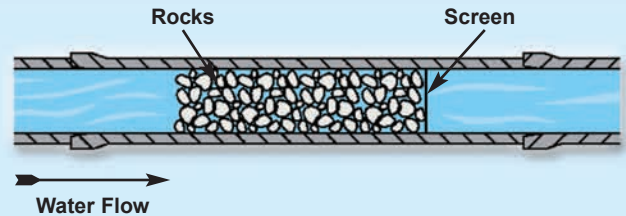

Resistors are like rocks for electricity, they control or limit how much electric current flows. The resistance, expressed in **ohms** (Ω , named after George Ohm) or kilohms ($K\Omega$, 1000 ohms) is a measure of how much a resistor resists the flow of electricity.

To increase the water flow through a pipe you can increase the water pressure or use less rocks. To increase the electric current in a circuit you can increase the voltage or use a lower value resistor.

Introducing New Parts

Snap Circuits® includes five resistors: 100Ω (R1), $1K\Omega$ (R2), $5.1K\Omega$ (R3), $10K\Omega$ (R4), and $100K\Omega$ (R5). If you have the parts with you, take them out and look at them.



The symbol for the resistor is this squiggly line:

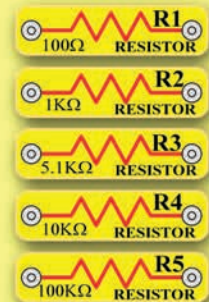

Resistors R1 - R5

3-2 LEDs



The Snap Circuits® lamps you have (parts L1 and L2) need a high current to be bright, and can be thought of as high current meters since their brightness is an indication of how much current is flowing in a circuit. Even the smallest resistor included in Snap Circuits® will limit the current such that the lamps would not light at all. So you need a low current meter.

Light Emitting Diodes (LEDs) may be thought of as one-way, low-current meters. Like light bulbs,

their brightness increases as the current through them is increased. But they are made from different materials and so have other characteristics. They are more sensitive than light bulbs and become bright at much smaller currents, but will be damaged by high currents (which is why they should always be used with resistors or other parts to limit the current). They can be made to produce specific colors of light, usually red, green, or yellow. They also completely block current flow in one direction.

Introducing New Parts

Snap Circuits® includes both a red and a green LED. The arrow in the symbol of the part includes which direction it allows current to flow in (referred to as the forward direction):



Red LED (D1)



Green LED (D2)

LED Symbols

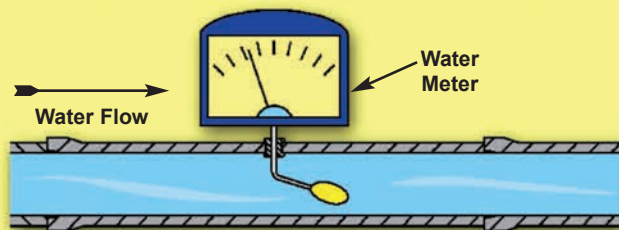

Experiments

Consider this simple circuit (which is project 7):

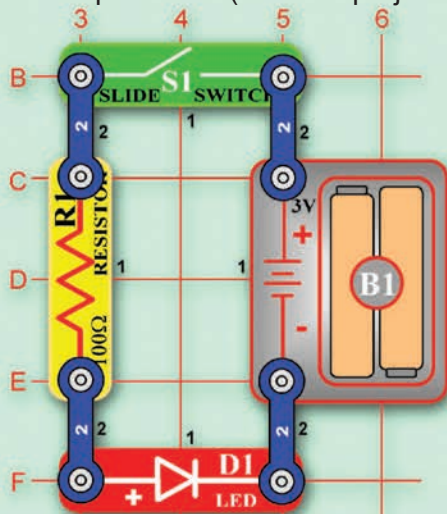

If the switch is on, the LED (D1) will light. The resistor limits the current so that the LED is not damaged (never place an LED directly across the battery). The LED is just like a lamp here, except that it would not be as bright and would use less battery power. Also, an LED appears much brighter when viewed from above than from the side. LEDs concentrate most of their light in one direction, unlike a light bulb which emits light nearly equally in all directions.

If the resistor value in the circuit were increased, the LED would become much dimmer. For example, if the 100Ω resistor (R1) was replaced with the 10KΩ resistor (R4), the LED light could only be seen if the room was very dark.

Experiments

What would happen if the LED position were reversed, in a circuit like this:

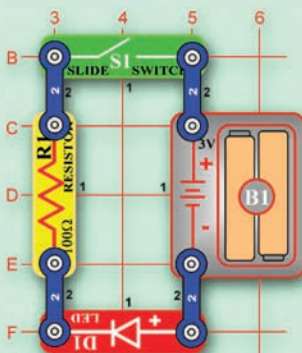

Nothing will happen. The LED prevents any current from flowing, and the LED will be off.

Other Snap Circuits® projects related to this subject: 175

Experiments

For another example, consider this circuit (which is project 276; be sure the fan is on the motor):

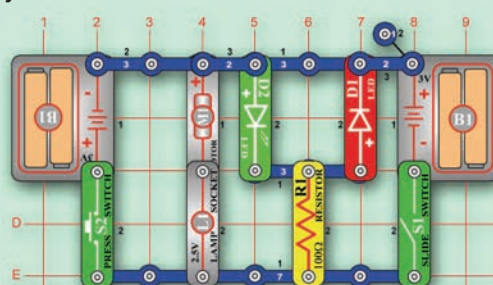

The two sets of batteries will drive the fan in opposite directions, depending on which switch is turned on. Only one LED will light, indicating direction. Unlike the LEDs, the lamp has no polarity and will light in either case. Note that if both switches are on, a short circuit is created and nothing will happen (but the batteries get weaker).

Experiments

Now consider this circuit (which is project 102, redrawn):

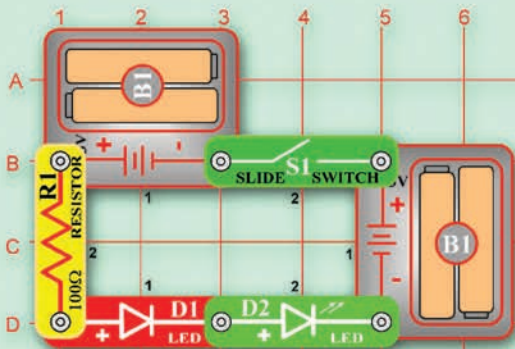

The LEDs would have the same brightness. The same current will flow through both, since they are in series.

Can you guess why this circuit uses two sets of batteries instead of just one? Each LED has a “turn-on” threshold of about 1.5V that must be exceeded before current will start to flow, after that the brightness depends on the current. When two LEDs are in series the combined threshold is 3V, so one set of batteries will not exceed the threshold by any noticeable degree. This threshold is due to the semiconductor material used in its construction.

LEDs are used as indicator lights in a wide range of electronic products. They are more efficient than ordinary light bulbs and so use less electricity to be seen. But they cannot handle high currents, and so cannot be used to light up a room like light bulbs do.

3-3 Resistors in Series & Parallel

Consider these two mini-circuits:

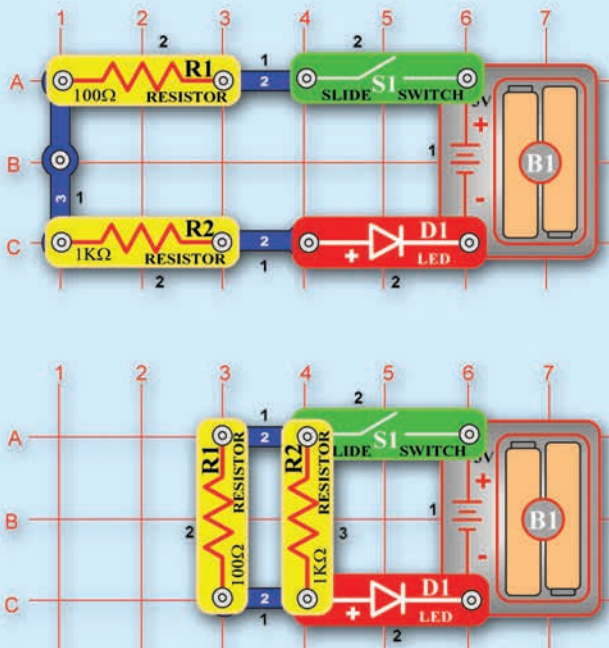

The first circuit has the 100Ω and 1KΩ resistors in series, the second circuit has them in parallel. Which circuit will make the LED brighter?

Just think of the resistors as rock piles slowing down the flow of water in a pipe:

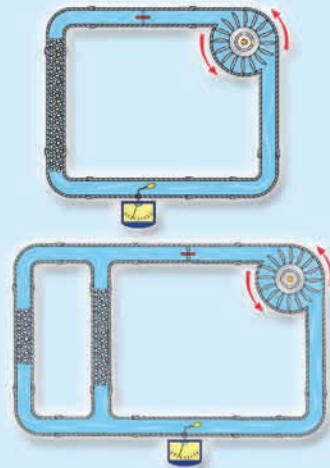

From the water diagrams, it should be easy to see that the circuit with the resistors in parallel will have the brighter LED. You can build these mini-circuits with your snap circuits parts to prove this.

Placing resistors in series increases the total resistance, and so decreases the current to the LED. Resistors in series add together. **Placing resistors in parallel decreases the total resistance**, and so increases the current to the LED.

Advanced students can compute the total resistance as follows:

$$R_{\text{series}} = R_1 + R_2 + R_3 + \dots \quad \frac{1}{R_{\text{parallel}}} = \frac{1}{R_1} + \frac{1}{R_2} + \frac{1}{R_3} + \dots$$

The total series resistance is greater than the biggest resistor, and the total parallel resistance is smaller than the smallest resistor.

Experiments

As a review, consider this circuit (which is project 173):

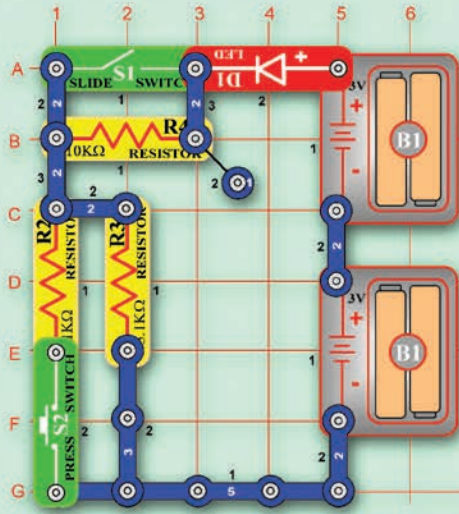

If the slide switch (S1) is on, then the LED will be on but not very bright as the 5.1K resistor limits the current. Turning off the slide switch places the 10K resistor in series and the LED becomes very dim. If both switches are on, the 1K resistor is in parallel with the 5.1K and so the LED becomes very bright.

You've learned that when you increase resistance in a circuit, less current flows (making an LED dimmer). This relationship between voltage, current, and resistance is the most important one in electronics. It is known as **Ohm's Law** (after George Ohm who discovered it in 1828):

$$\text{Current} = \frac{\text{Voltage}}{\text{Resistance}}$$

The most basic rules for analyzing circuits as known as **Kirchhoff's Laws** (known after Gustav Kirchhoff, who stated them in 1847):

1. The total voltages driving a circuit must equal the voltage drops within it.
2. All current flowing into a point must flow out of it.

The "**power**" of electricity is a measure of how much energy is moving through a wire. It is expressed in **Watts** (W, after James Watt for his work with engines). It is a combination of the electrical voltage (pressure) and current:

$$\text{Power} = \text{Voltage} \times \text{Current}$$

OR

$$\text{Power} = \frac{\text{Voltage} \times \text{Voltage}}{\text{Resistance}}$$

Resistor Color Code:

You may have seen the colored bands on the resistors and may be wondering what they mean. They are the method for marking the value of resistance on the part. The first ring represents the first digit of the resistor's value. The second ring represents the second digit of the resistor's value. The third ring tells you the power of ten to multiply by, (or the number of zeros to add). The fourth and final ring represents the construction tolerance. Most resistors have a gold band for a 5% tolerance. The colors below are used to represent the numbers 0 through 9.

COLOR	VALUE
Black	0
Brown	1
Red	2
Orange	3
Yellow	4
Green	5
Blue	6
Violet	7
Gray	8
White	9



Use the color code to check the values of the five snap circuits resistors. They are all 5% tolerance.

3-4 Resistance

Just what is Resistance? Take your hands and rub them together very fast. Your hands should feel warm. The friction between your hands converts your effort into heat. **Resistance** is the electrical

You can also compare resistors to the friction with the ground when you walk. If there is too much friction (like two feet of snow) you have to go very

slow or get stuck. If there is too little friction (like ice) then you have no control and will slip and fall.

Resistors are made from carbon and can be constructed with different resistive values, such as the five parts included in Snap Circuits®. If a large amount of current is passed through a resistor then it will become warm due to the electrical friction. Resistors get warm because they exert control by wasting power as heat. Light bulbs use a small piece of a highly resistive material called tungsten. Enough current is passed through this tungsten to heat it until it glows white hot, producing light.

Electric stoves and heaters use resistors to change electricity into heat.

friction between an electric current and the material it is flowing through; it is the loss of energy from sub-atomic particles as they move through the material.

slow or get stuck. If there is too little friction (like ice) then you have no control and will slip and fall.

Metal wires have some electrical resistance, but it is very low (less than 1Ω per foot) and can be ignored in almost all circuits. Materials, such as metals, which have low resistance are called **conductors**. The best conductor material known is silver, but it is too expensive to be widely used. Copper is second best, and it is used in most wires and printed circuit boards in the electronics industry.

Materials such as paper, plastic, and air have extremely high values of resistance and are called **insulators**.

Experiments

You can use Snap Circuits® to test whether materials are conductors or insulators. Consider this simple circuit (which is project 9):

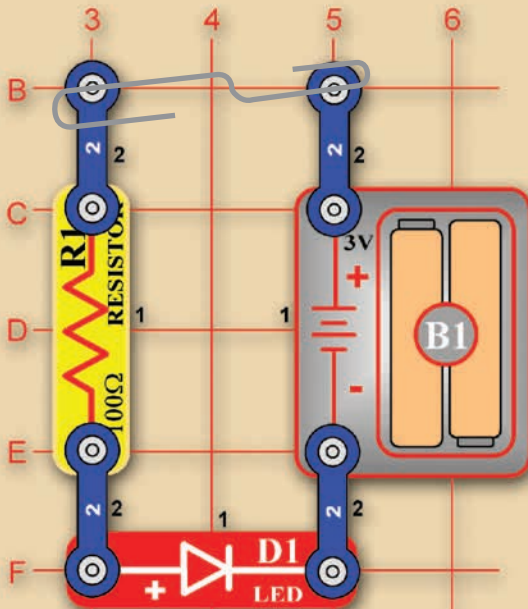

Place any material across the 2-snap wires (the circuit shows a paperclip). If the LED is bright then it is a conductor, if the LED is off then it is an insulator.

3-5 The Adjustable Resistor

A switch is used to turn the electricity on and off just like a valve is used to turn the water on and off. But there are many times when you want some water but don't need all that the pipe can deliver, so you control the water by adjusting an opening in the pipe with a faucet. Unfortunately, you can't adjust the thickness of an already thin wire. But you could also control the water flow by forcing the water through an adjustable length of rocks, as in the rock arm shown below.

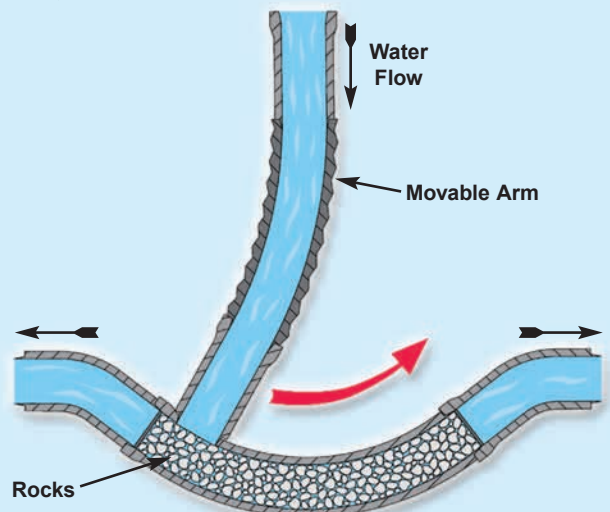

Introducing New Parts

In electronics we use an adjustable resistor. This is a normal resistor (50KΩ in Snap Circuits®) with an additional arm contact that can move along the resistive material and tap off a portion of it.

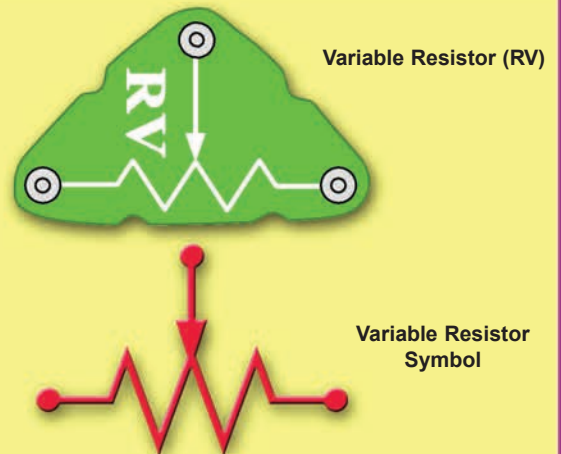
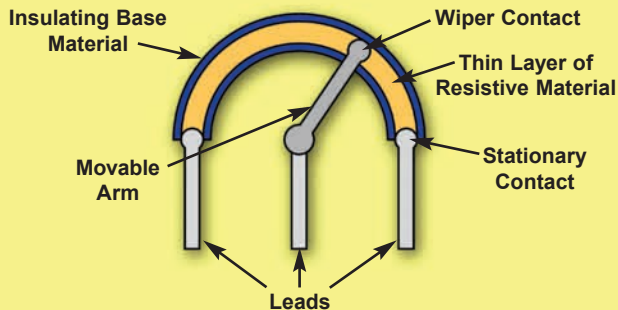

Experiments

Consider this circuit (which is project 172):

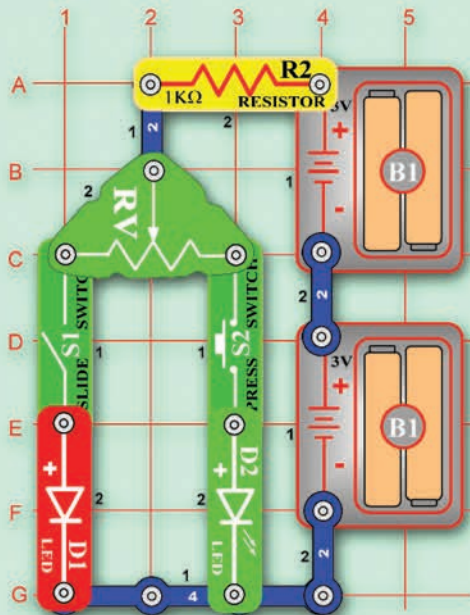

If the slide switch and the press switch are both on, moving the adjustable resistor's control lever around will adjust the brightness of the LEDs. When the adjustable resistor is set to one side, that side will have low resistance and its LED will be

bright while the other side will have high resistance and its LED will be dim or off. The 1K resistor (R2) limits the current so the LEDs cannot be damaged.

This circuit can also be thought of as if it were water flowing through pipes:

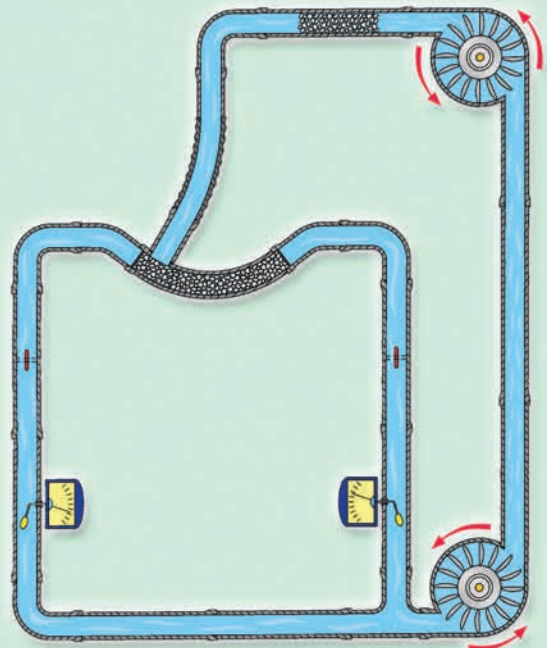

3-6 The Photo Resistor

Some materials, such as Cadmium Sulfide, change their resistance when light shines on them. Electronic parts made with these light-sensitive

materials are called photoresistors. Their resistance decreases as the light becomes brighter.

Introducing New Parts

Snap Circuits® includes one photoresistor. Its resistance value changes from nearly infinite in total darkness to about $1\text{K}\Omega$ when bright light shines directly on it. Note that a black plastic case partially shields the Cadmium Sulfide part.



Photo Resistor (RP)

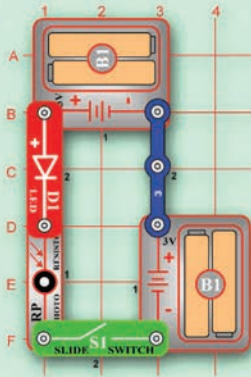

Photo Resistor Symbol



Experiments

Consider this circuit (which is project 272):



The brightness of the LED depends on how much light shines directly on the photoresistor. If the photoresistor were held next to a flashlight or other bright light, then the LED would be very bright.

Photoresistors are used in applications such as streetlamps, which come on as it gets dark due to night or a severe storm.

Thermistors: Resistors can also be made to change resistance as the temperature changes. These are called thermo-resistors. They are used in applications like electronic thermometers, or to compensate for other circuit characteristics that are changing with temperature.

Thermistors can also be made to act as fuses. At low currents they have only slight resistance and don't affect a circuit. High currents (due to a short circuit) cause them to heat up and greatly increase resistance, limiting the current to prevent damage.

A thermistor like this is inside each of the battery holders in Snap Circuits®:

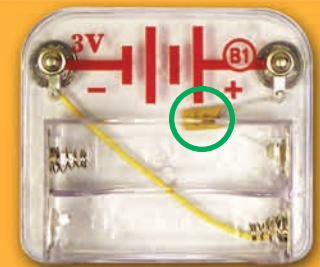

This thermistor will activate to limit current if a short circuit occurs for more than a few seconds. Running the motor for long periods will sometimes activate it, since the motor draws a high current.

3-7 Resistance of Water

Experiments

Consider this circuit (which is project 166):

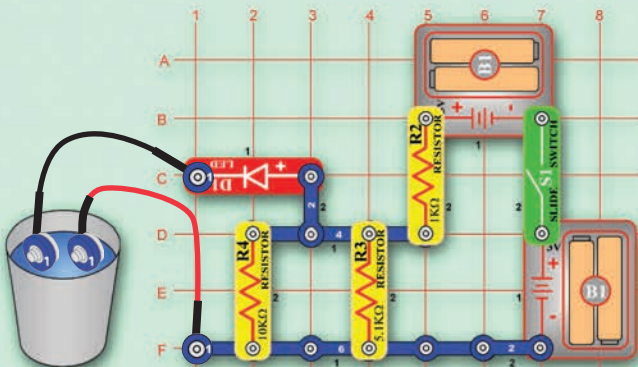

If the loose ends of the jumper wires are placed into a cup of water, the LED will be dimly lit. The circuit was designed so that the LED acts as a water detector. The brightness depends on your local water supply. If more water were added to the cup, the LED brightness would increase slightly. Adding more water is like placing more "water resistors" in parallel; and so decreases the total

resistance. Pure water (like distilled water) has very high resistance, but drinking water has impurities mixed in that lower the resistance. What would happen if salt was added to the cup and dissolved in the water?

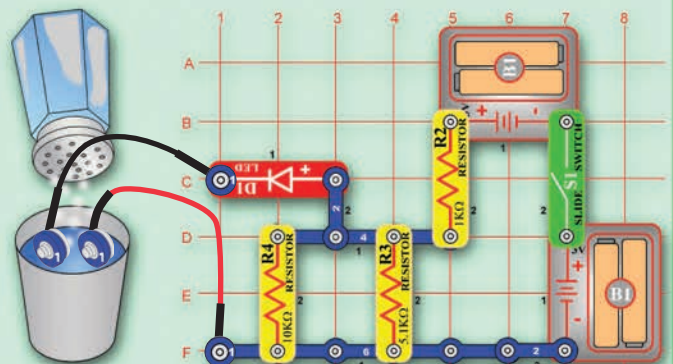

Dissolving salt in water decreases the resistance of the water, so the LED would get brighter. It could be used as a salt-water detector. Adding more water to dilute the salt could reduce the brightness.

Nearly all electricity produced eventually becomes heat. All currents flowing through resistors produce heat in them. Light from a lamp

or TV produces heat in whatever it shines on. All the circuits in a computer produce heat, and most computers have vents to get this heat out.

3-8 Introduction to Logic

Experiments

Consider this circuit (which is project 47):

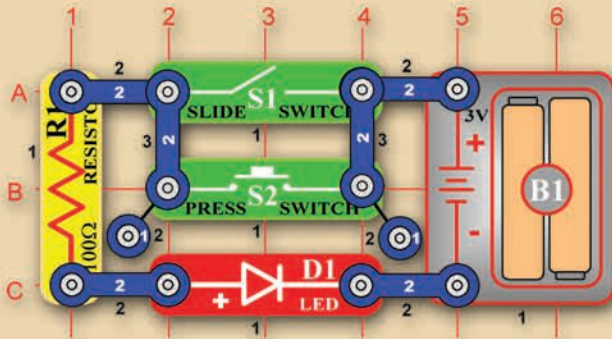

If the slide switch OR the press switch is on, the LED lights up. This is called an OR circuit. While this may seem very simple and boring, it represents an important concept in electronics. Two switches like this may be used to turn on a light in your house. You could also have more than two switches and the circuit would function the same way.

Now consider this circuit (which is project 48):

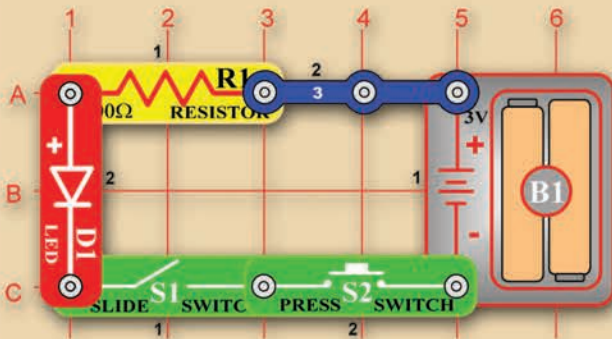

If the slide switch AND the press switch are on, the LED lights up. This is called an AND circuit. Two switches like this may be used to turn on the same light in your house, the room switch and the master switch in the electrical box.

AND and OR circuits are the basic building blocks of today's computers, though transistors are used instead of switches and LEDs. Combinations of AND and OR circuits are used to add and multiply numbers together.

Now consider this circuit (which is project 49):

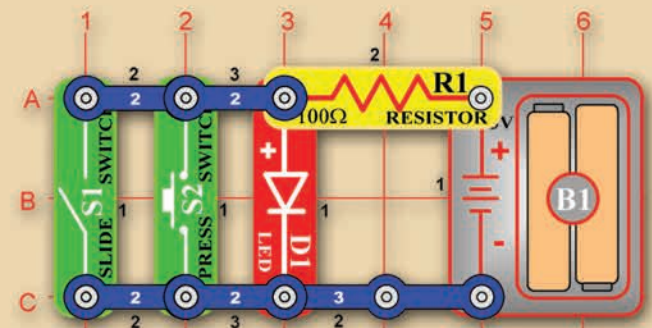

This circuit is the counter-part to the OR circuit, the LED lights in the opposite combinations of that circuit. Engineers called it a NOR circuit (short for "NOT this OR that").

Now consider this circuit (which is project 50):

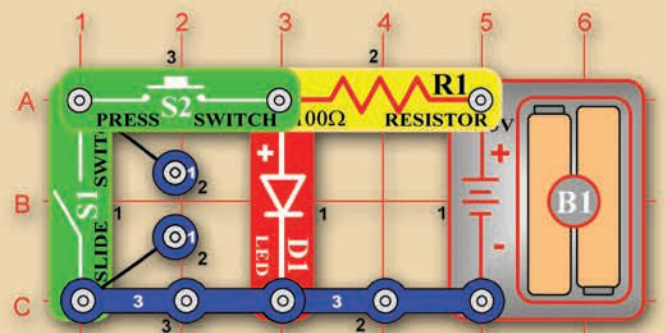

This circuit is the counter-part to the AND circuit, the LED lights in the opposite combinations of that circuit. It is called a NAND circuit (short for "NOT this AND that"). This circuit can also have more or less than two inputs, though when it only has one input it is referred to as a NOT circuit.

OR, AND, NOR, NAND and NOT circuits are all important building blocks in modern computers.

3-9 DIGITAL ELECTRONICS

Suppose you wanted to keep a record of how the temperature outside was changing throughout the day. You could use a thermometer to measure it, and watch it continuously or just check it every hour and write it down. Your results might look something like this:

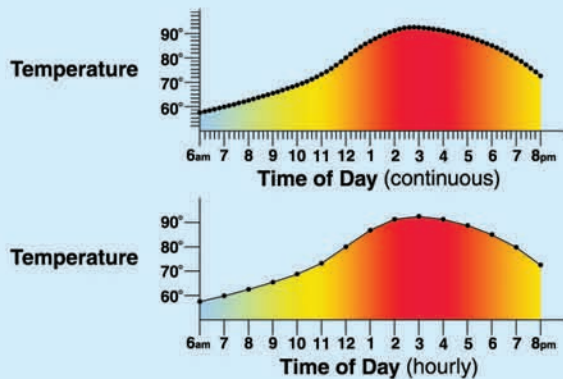

Checking it once an hour gave you a very good record of how the temperature was changing throughout the day, with much less effort than watching it all day long.

Digital electronics uses a series of numbers to represent an electrical signal. If your thermometer was electronic it might increase an output voltage as the temperature increased. It would be hard to store what that voltage was throughout the day, but easy to measure it and store it as a series of numbers. The series of numbers could be converted back into a continuous voltage later.

The accuracy of your digital representation depends on how accurately and how often you measured the original voltage. For example, you could get a better or worse representation of your temperature:

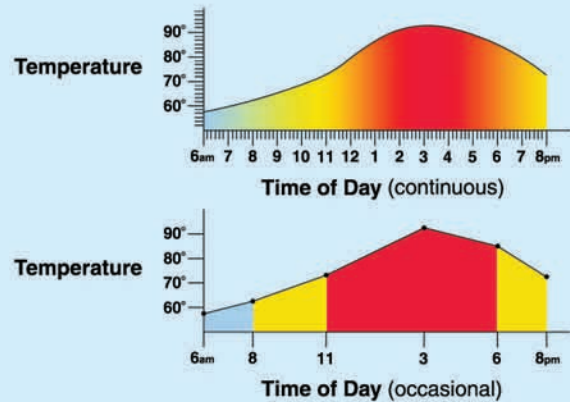

Sometimes it is easier to process information as a digital series of numbers (computers), and sometimes it is easier to use a continuously changing voltage (AM radios). Many products use both methods on the same information but at different times. The disadvantage of digital systems is that they are more complex since they have to store and process all the numbers. The advantages are that IC technology makes it inexpensive to store and process information, and digital systems are more protected from interference.

Computers store numbers in memory using vast arrays of transistors that are switched on or off. The OR, AND, NOR, NAND, and NOT gates are actually made up of transistors. These gates are used to add and multiply large numbers in tiny pieces to form the processing functions in computers.

Quick Quiz



1. Draw a schematic for a circuit using a battery set, an LED, a 50K Ω adjustable resistor, and a 1K Ω resistor. The LED must have adjustable brightness, and must never have less than 1K Ω in series with it.

Summary

Summary of Chapter 3:

- Resistors are used to limit and control the current in a circuit.
- Resistance is a measure of how much something opposes the flow of electricity in a circuit, and is expressed in ohms.
- Light emitting diodes (LEDs) are one-way, low-current light bulbs. They have a turn-on threshold of about 1.5V.
- Placing resistors in series increases the total resistance. Placing resistors in parallel decreases the total resistance.
- In a circuit, the current equals the voltage divided by the resistance. This is known as Ohm's Law.
- Power measures how much energy is moving through a circuit, it equals the voltage multiplied by the current and is expressed in Watts.
- Materials which have very low resistance are called conductors. Materials which have very high values of resistance and are called insulators.
- Photoresistors change their resistance when light shines on them.
- All currents flowing through resistors produce heat in them.
- OR, AND, NOR, NAND and NOT circuits are basic building blocks of computers.
- Digital electronics uses numbers to represent an electronic signal. The accuracy of the digital representation depends on how accurately and how often the original signal was measured.
- Computers store numbers using arrays of transistors that are switched on or off.

Quiz

Chapter 3 Practice Problems

- The following are characteristics of an LED except:
 - They block current flow in one direction.
 - They get brighter as current increases.
 - They can handle very high currents.
 - They can emit different colors of light.
- To increase the current through a circuit, you . . .
 - Increase the resistance.
 - Decrease the watts.
 - Increase the ohms.
 - Increase the voltage.
- Which circuit will be the brightest? Which will be the dimmest?



A



B



C

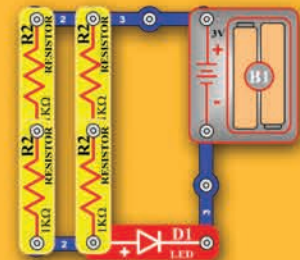

D

- Which circuit will be the brightest?



A



B

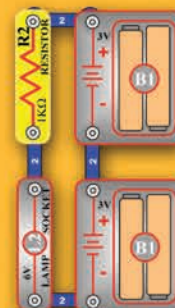

C



D

Answers: 1. C, 2. D, 3. C/B, 4. A

CHAPTER 4: CAPACITORS

Learn
By Doing®

Capacitors are components, which can store electric charge, an ability that makes them useful in many types of circuits. They can delay changes to a circuit, allowing things to happen slowly or in sequence. They are essential to filtering and tuning circuits, and

in many electronic products they are the most common component. As an example of how important capacitors are in electronics, consider a typical AM/FM radio (shown below). It contains 41 capacitors, which are highlighted.

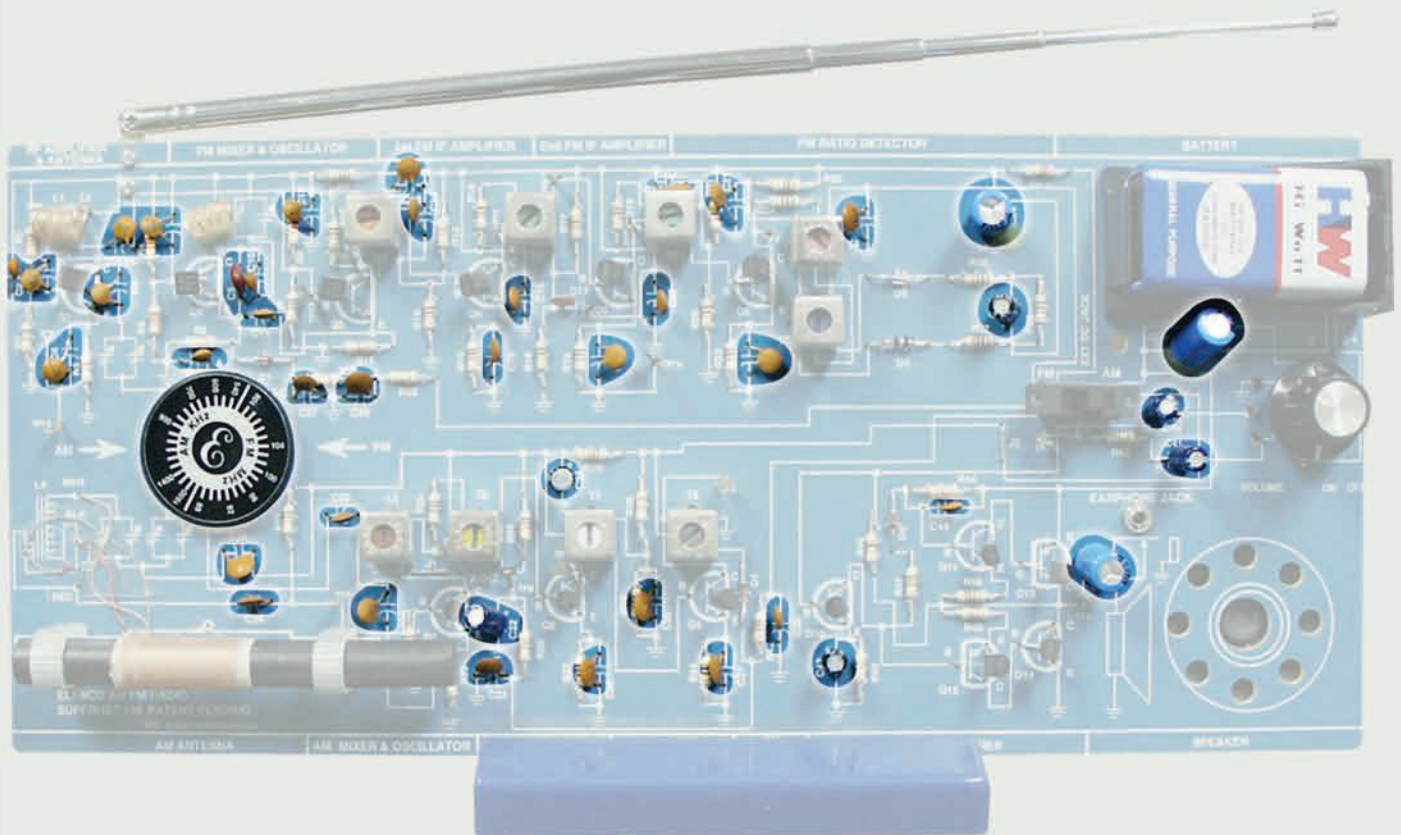

In this chapter you will learn about the different types of capacitors, how they work, and how they are used in circuits. It will be fascinating to see how these simple components make electronics work.

4-1 Capacitors

Capacitors are electrical components that can store electricity for periods of time. When a capacitor has a difference in voltage (electrical pressure) across it, it is "**charged**". A capacitor is charged by having a one-way current flow through it for a short period of time. It can be discharged by letting a current flow in the opposite direction out of the capacitor. A capacitor may be thought of as a water tank that has a strong rubber diaphragm sealing off each side of the tank, as shown below:

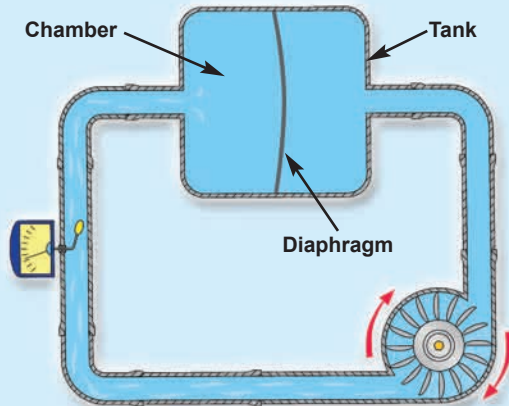

The pipe might have a plunger on one end (or a pump somewhere else in the piping circuit) that pushes water against the diaphragm. The water in the pipe would then force the rubber to stretch out until the force of the rubber pushing back on the water was equal to the force of the plunger. The rubber would be charged and ready to push the plunger back. If the plunger is released the rubber will discharge and move back to its original position, until there is no more pressure on it.

Capacitors act the same as the rubber diaphragm just described. When a voltage (electrical pressure) is placed on one side, electrical charge "piles up" on that side of the capacitor until the voltage pushing back matches the voltage applied. The capacitor is then charged to that voltage. If the charging voltage were then decreased the capacitor would discharge. If both sides of the capacitor were connected together with a wire then the capacitor would rapidly discharge and the voltage across it would become zero (no charge).

Because of their ability to store electric charge, capacitors can block slow changing voltages and pass fast changing ones. This allows capacitors to isolate parts of a circuit from each other while letting signals move between them.

What would happen if the plunger in the drawing above was wiggled in and out many times each second? The water in the pipe would be pushed by the diaphragm and then sucked back by the diaphragm. Since the movement of the water (current) is back and forth (alternating) it is called an alternating current or AC. The capacitor will

therefore pass an alternating current with little resistance. When the push on the plunger was only toward the diaphragm, the water on the other side of the diaphragm moved just enough to charge the pipe (a transient or temporary current). Just as the pipe blocked a direct push, a capacitor blocks a direct current (DC). Current from a battery is an example of direct current. An example of alternating current is the 60 cycle (60 wiggles per second) current from the electrical outlets in the walls of your house.

There are many different types of capacitors made using many different materials, but their basic construction is the same. The wires (leads) connect to two or more metal plates that are separated by high resistance materials called dielectrics. The dielectric is the material that holds the electric charge (pressure), just like the rubber diaphragm holds the water pressure. Dielectric materials include air, paper, mylar, and thin films of oxides.

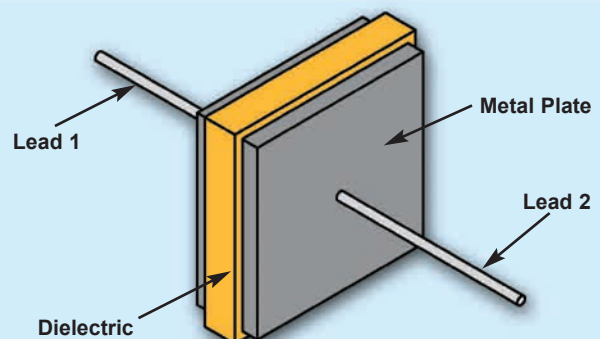

A rubber diaphragm in a pipe could be made with different size and stiffness depending on how much water it was to hold and how much pressure it could handle without bursting.

Similarly, capacitors are described for their capacity for holding electric charge, called their capacitance, and their ability to withstand electrical pressure (voltage) without damage. Capacitor characteristics are controlled by varying the number and size of the metal-dielectric layers, the thickness of the dielectric layers, and the type of material used.

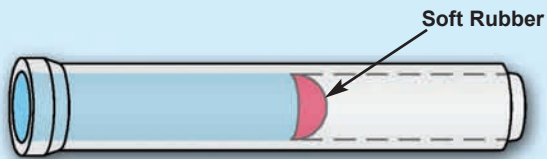

Large Capacity, Low Pressure

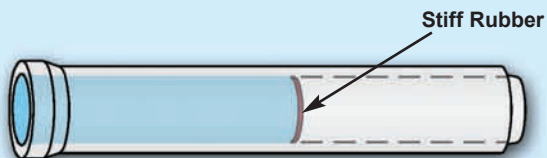

Low Capacity, but can withstand High Pressure

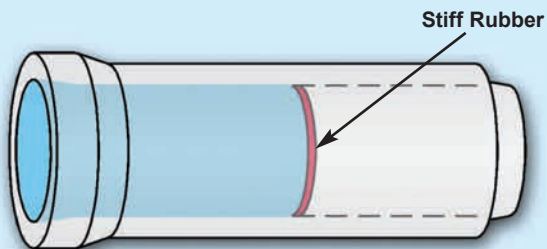

High Capacity and can withstand High Pressure

Capacitance is expressed in **farads** (F, named after Michael Faraday whose work in electromagnetic induction led to the development of today's electric motors and generators). However a 1 Farad capacitor would be about the size of a room, so electronics uses **microfarads** (μF , millionths of a farad).

Introducing New Parts

Snap Circuits® includes two mylar or ceramic capacitors ($0.02\mu\text{F}$ and $0.1\mu\text{F}$). Take them out and look at them if they are with you.

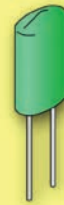

$0.02\mu\text{F}$ Capacitor (C1)



$0.1\mu\text{F}$ Capacitor (C2)

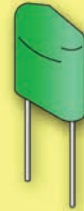

Mylar Capacitor Symbol

Introducing New Parts

Snap Circuits® also includes three electrolytic capacitors ($10\mu\text{F}$, $100\mu\text{F}$, and $470\mu\text{F}$). These parts use special dielectrics to get high capacitance into a small part. Take them out and look at them if they are with you.



$10\mu\text{F}$ Capacitor (C3)



$100\mu\text{F}$ Capacitor (C4)

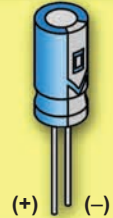

$470\mu\text{F}$ Capacitor (C5)



Electrolytic Capacitor Symbol

Note that the electrolytic capacitors (only) have a "+" polarity marking on them, the "+" side should always be connected to the higher voltage.

Introducing New Parts

Snap Circuits® also includes one variable capacitor. Take it out and look at it if the parts are with you.

This capacitor has movable plates, so the capacitance can be adjusted between 0.00004 and 0.00022 μ F. It is only used in high frequency radio circuits for tuning.



Variable Capacitor (CV)



Variable Capacitor Symbol

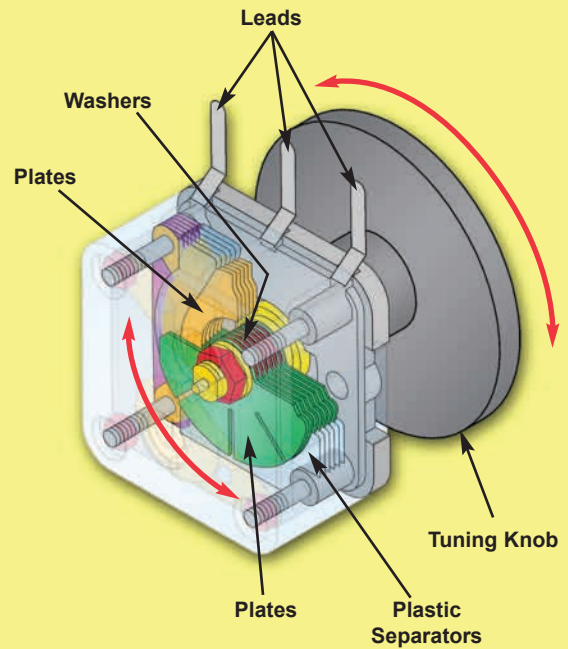

4-2 Capacitor Circuits

Experiments

With the help of Snap Circuits®, capacitors will be easy to understand. Consider the circuit below (which is project 203).

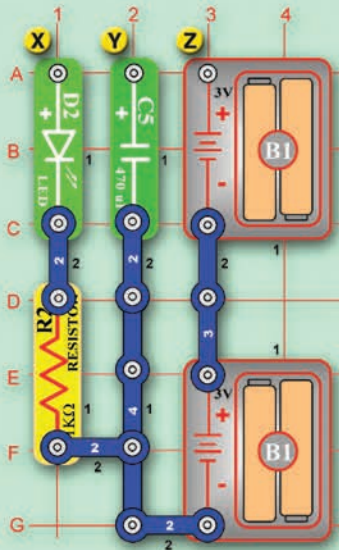

If points Y and Z in this circuit were connected for a moment, then the 470 μ F capacitor would be filled up with electricity from the batteries. If points X and Y were then connected (instead of points Y and Z), the green LED would be lit for a few seconds

and then go dim. The electricity stored in the capacitor gets discharged, creating a current through the LED and resistor.

Electricity was stored in the capacitor, and then used to light the LED. Because of this ability, capacitors may be thought of as rechargeable batteries. But capacitors are not very efficient at storing electricity - the 470 μ F lit the LED for only a few seconds while the batteries are used to run all your projects! That is because capacitors store electrical energy while batteries store chemical energy.

If the 470 μ F capacitor was replaced with the 100 μ F capacitor in the preceding circuit (as per project 204), the circuit would work the same way but the LED would go out much faster. Lower value capacitors cannot store as much electrical energy as larger value parts.

If the 1K Ω resistor was replaced with the 100 Ω resistor (as per project 205), the LED would get brighter but go out faster. The lower resistance allows a higher current to flow, which discharges the capacitor faster.

You can also imagine the preceding circuit as if it were water flowing through pipes, as shown.

If the left valve is open, the pump pushes water into the diaphragm. If the right valve is open, the diaphragm will push back the water through the rocks and water meter.

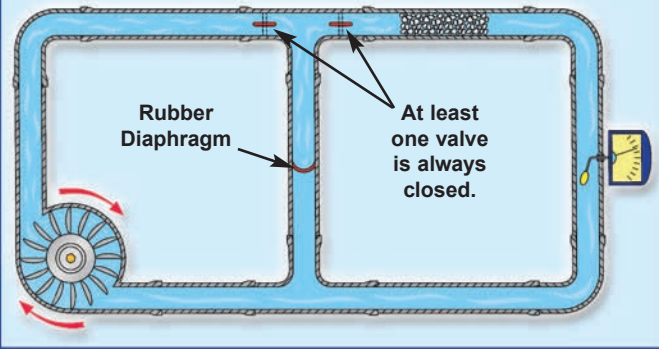

Experiments

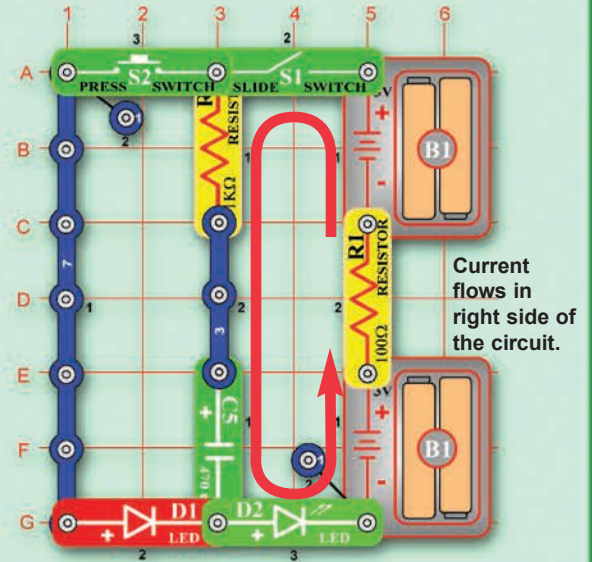

With both switches off, the capacitor holds its charge but no current flows. If the press switch were pressed, a current would then flow through the left side of the circuit. The red LED would be bright for a moment and then go dim as the capacitor discharges through it.

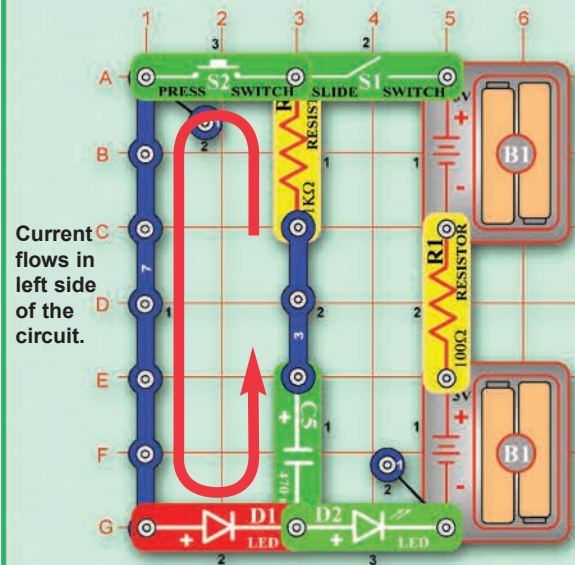

The capacitor value ($470\mu\text{F}$) sets how much electrical charge can be stored, and the resistor value ($1\text{K}\Omega$) sets how quickly that charge can be stored or released.

Experiments

As another example, consider this circuit (which is project 235):

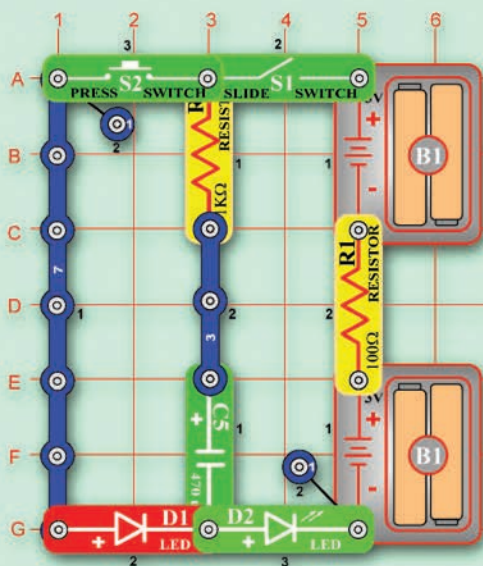

If the slide switch was turned on for a few seconds and then turned off, a current would flow through the right side of the circuit. The green LED would be bright for a moment and then go dim as the capacitor charges up.

There is a relationship between the component values and the charging and discharging times. **The charge/discharge times are proportional to both the capacitance and the resistance in the charge/discharge paths!**

4-3 Capacitors in Series & Parallel

Experiments

Now consider this circuit (which is project 165):

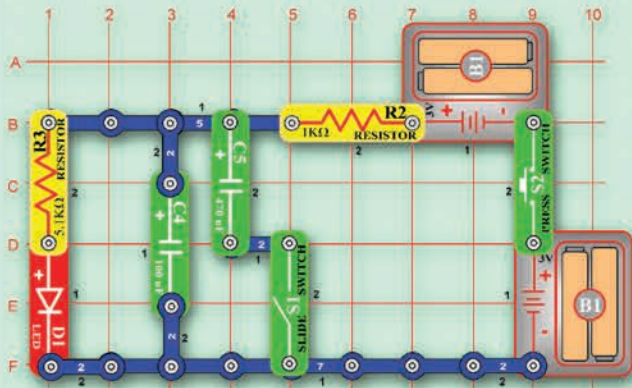

When the press switch is pressed there is a small delay before the LED gets bright, as the capacitor charges up. When the press switch is released there is a delay before the LED goes off, as the capacitor discharges. If the capacitors were removed from this circuit, the LED would be bright whenever the press switch is on. The capacitors slow down this circuit, by delaying the full effects of the press switch.

The LED delays will be much longer and easier to see if the slide switch is on, because then the larger 470µF capacitor is also in the circuit. When capacitors are placed in parallel like this, the overall capacitance is increased because there is more room to store electric charge in.

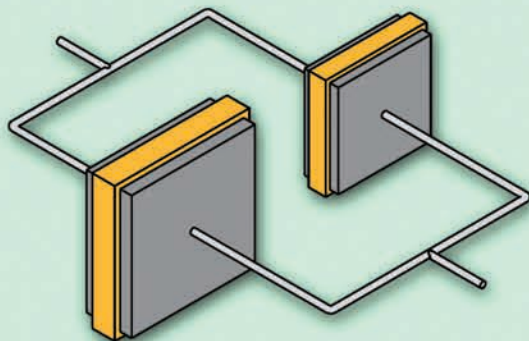

Now consider this circuit (which is project 164):

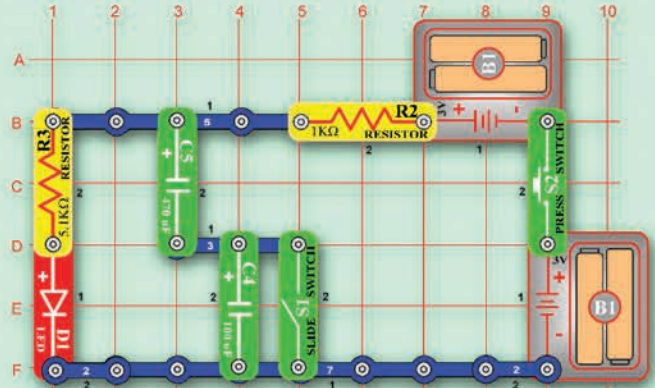

If the slide switch is off, both capacitors are in the circuit. This circuit is just like the last one except that now the slide switch is used to place the two capacitors in series. When capacitors are in series like this, the overall capacitance is decreased because this is like increasing the dielectric thickness. In terms of water pipes, you could think of capacitors in series as adding together the stiffness of their rubber diaphragms.

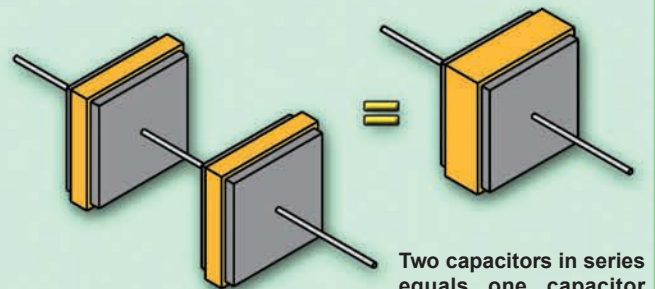

Two capacitors in series equals one capacitor with a thicker dielectric.

Notice that how capacitors combine is opposite to how resistors combine. **When parts are placed in series, resistance increases but capacitance decreases. When parts are placed in parallel, resistance decreases but capacitance increases.**

Advanced students can compute the total capacitance as follows:

$$C_{\text{parallel}} = C1 + C2 + C3 + \dots \quad \frac{1}{C_{\text{Series}}} = \frac{1}{C1} + \frac{1}{C2} + \frac{1}{C3} \dots$$

For example, a 100µF and a 470µF in parallel act like a 570µF. A 100µF and a 470µF in series act like an 82µF.

Experiments

Now consider this circuit (which is project 296):

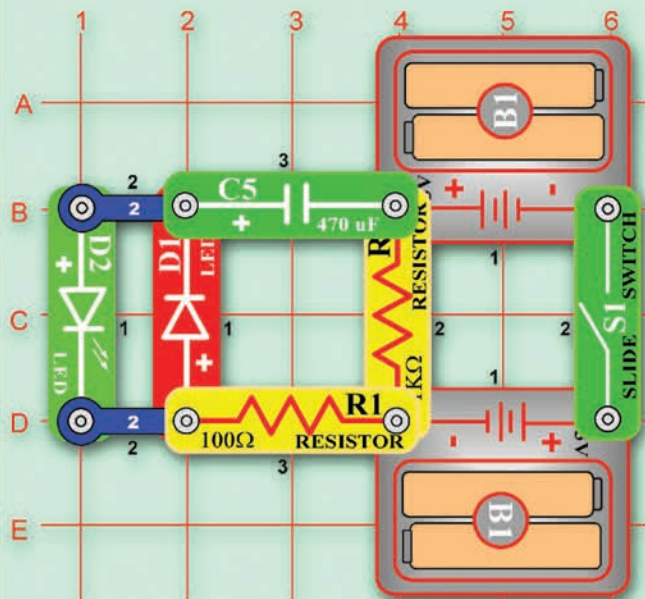

In this circuit the $470\mu\text{F}$ capacitor is placed backwards, its “+” side should normally be towards the higher voltage at the batteries. While the switch is on, current will flow and light the green LED even after the $470\mu\text{F}$ is charged up. This is because high-value capacitors “leak” when they are placed in a circuit backwards. The lower value parts will leak much less or not at all. If the $470\mu\text{F}$ was flipped around (so the “+” is on the right), then no current will flow after it charges up.

This circuit also demonstrates how LEDs allow current to flow in only one direction. The green LED flashes bright when the $470\mu\text{F}$ charges up, and the red LED flashes when the $470\mu\text{F}$ discharges.

Summary

Summary of Chapter 4:

1. Capacitors are components that can store electricity for periods of time.
2. Capacitance measures how much electrical charge may be stored in a capacitor, and is usually expressed in microfarads (μF).
3. Capacitors block slow changing voltages and pass fast changing ones.
4. Capacitor charge/discharge times are proportional to the resistance and capacitance in the charge/discharge paths.
5. Placing capacitors in series reduces the capacitance, and placing capacitors in parallel increases the capacitance.

Quiz

Chapter 4 Practice Problems

1. A _____ is charged by having a one-way current flow through it.
 - A. Faraday
 - B. Capacitor
 - C. Resistor
 - D. Dielectric
2. Capacitor characteristics are controlled by . . .
 - A. the material used.
 - B. the number of metal-dielectric layers.
 - C. the thickness of the dielectric layers.
 - D. all of the above.
3. Which of these sub-circuits will have the highest total capacitance?

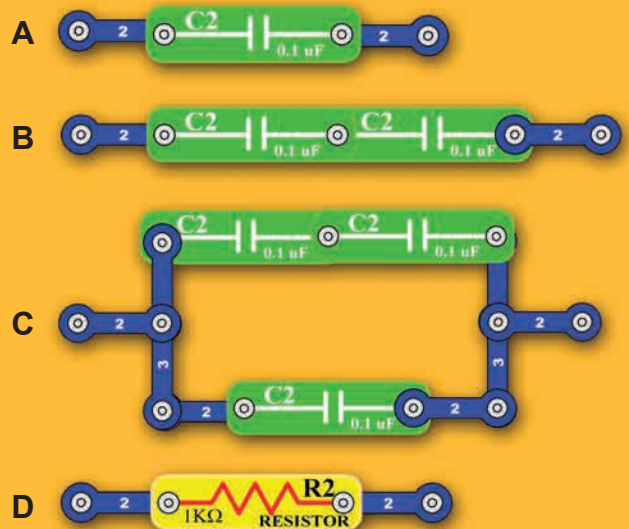

4. Which of these sub-circuits will charge up the fastest?

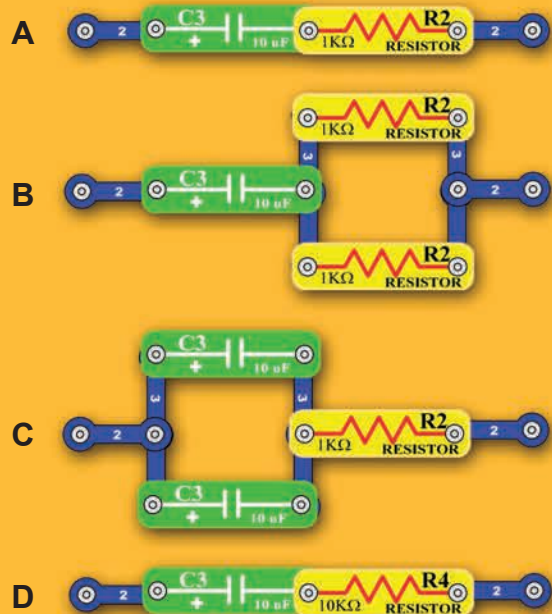

Answers: 1. B, 2. D, 3. C, 4. B

CHAPTER 5: TRANSISTORS

Learn
By Doing®

The invention of the transistor proved to be one of the great discoveries of the 20th century. Originally developed to replace the large and inefficient

vacuum tube amplifiers used in early radios, the little transistor is now used in ways its inventors could never have imagined.

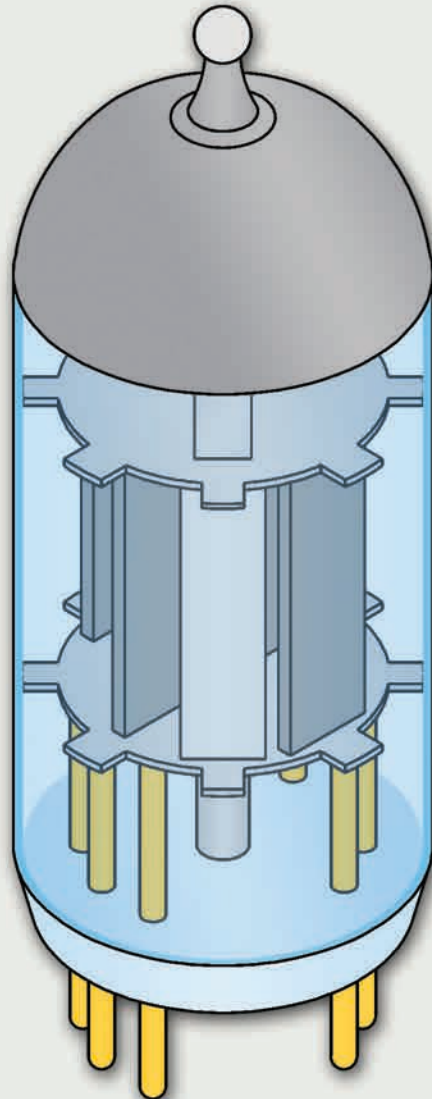

Vacuum Tube



Transistor

The transistor was first developed in 1949 at Bell Telephone Laboratories, the name being derived from “transfer resistor”. It has since transformed the world. Although it is mostly used in amplifier and switching circuits, engineers have used complex combinations of these circuits to create amazing new technologies.

Improvements in semiconductor manufacturing processes have allowed transistors to be miniaturized, leading to the development of today’s computers. The importance flexibility of transistors should be obvious just by the number of Snap Circuits® projects that use them.

In this chapter you will learn how transistors work, and how they are used in many types of circuits.

5-1 More About LEDs



Earlier we told you that LEDs are like low-current one-way lamps. But they also have other important differences.

Experiments

Consider these two mini-circuits:

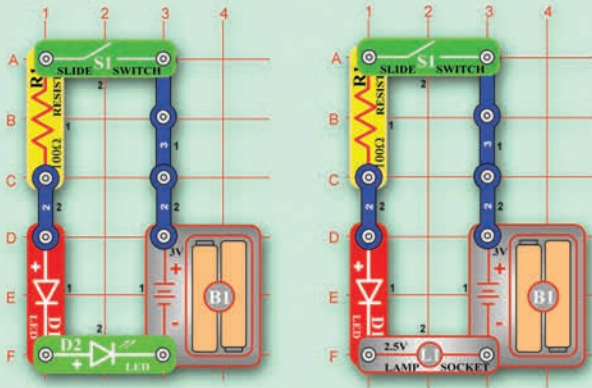

If you build these mini-circuits you will see that nothing happens in the first while the red LED is on in the second. There isn't enough voltage to turn on the green LED or the lamp while also lighting the red LED.

The difference is that the green LED (and the red LED too) has a turn-on voltage level while the lamp does not. Instead of thinking of an LED as a water meter, think of it as a check valve like this:

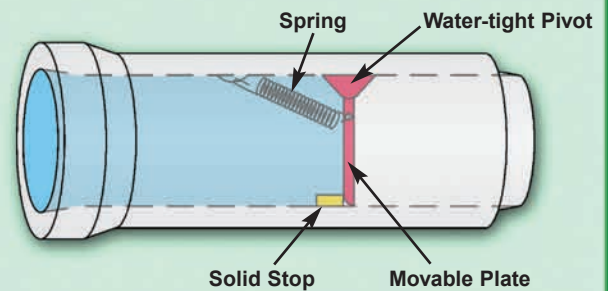

The small spring in the drawing represents a turn-on level of pressure that must be exceeded before any current can flow. The solid stop in the drawing prevents current from flowing in the other direction.

LEDs are made from materials called **semiconductors**, so-called because they have more resistance than metal conductors but less than insulators. Most semiconductors are made of Silicon but Gallium Arsenide is usually used in LEDs. Their key advantage is that by using special manufacturing processes their resistance is decreased under certain operating conditions.

The semiconductor manufacturing processes create two regions of permanent electrical charge, quite different from charging a capacitor. The effect is that once the voltage exceeds a small turn-on level (0.7V for Silicon, 1.5V for Gallium Arsenide LEDs) the resistance becomes very low in one direction (so low that the current flow must be limited by other resistances in the circuit to prevent damage).

Diodes: Diodes are used to block current in one direction. Most diodes are made of silicon and have a turn-on level of about 0.7V. LEDs (light emitting diodes) are a special type of diode made from Gallium Arsenide. LEDs have a higher turn-on level (about 1.5V) and also emit light.

The symbol for a diode is similar to the LED symbol:



The green and red LEDs are the only diodes used in Snap Circuits®.

5-2 Transistors



The transistor is best described as a current amplifier - it uses a small amount of current to control a large amount of current.

Introducing New Parts

Snap Circuits® includes one NPN-type and one PNP-type transistor, made of the semiconductor silicon. These are the most widely used types of transistors. They have three connection points, called the emitter, base, and collector.



NPN



PNP

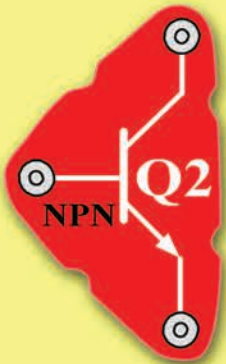

NPN



PNP

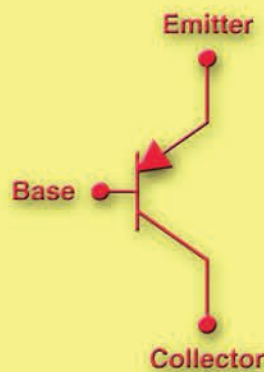
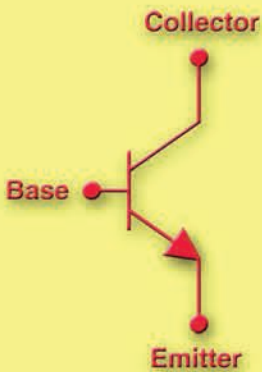

Like LEDs, transistors only allow current to flow in one direction. The small arrow in the symbol near the emitter indicates which direction the current will flow through the transistor.

In water pipe terms, the NPN may be thought of as the lever pivot shown here:

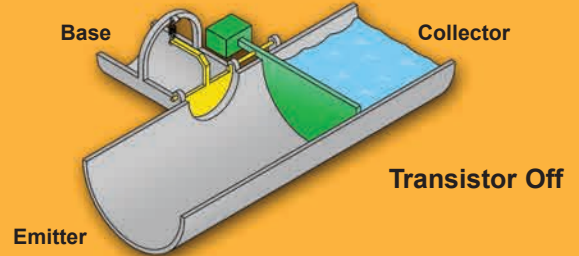

Transistor Off

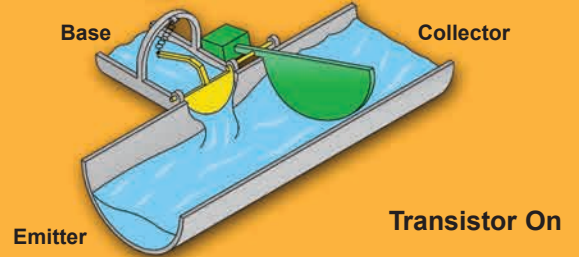

Transistor On

Notice that it includes a check valve that is connected to a lever arm. A small amount of current pushes on the check valve, which turns and opens the lever arm. But before this current can start to flow it must have enough water pressure to overcome the spring in the check valve (about 0.7V). If the base pipe is much smaller than the collector and emitter pipes, then a small base current flowing in will allow a large collector current to flow.

The PNP is just like the NPN, but the currents flow in opposite directions:

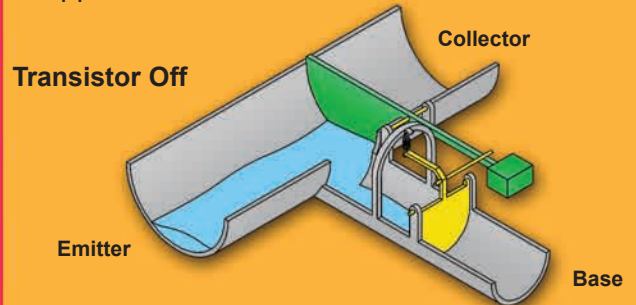

Transistor Off

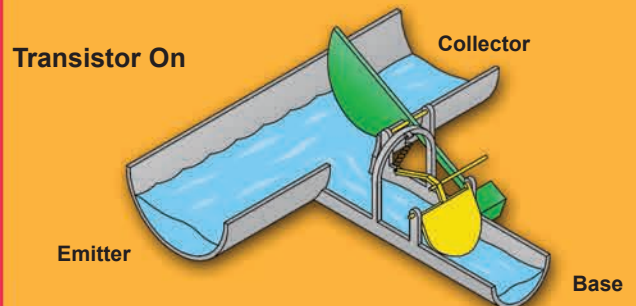

Transistor On

In transistors the emitter, base, and collector are different regions of permanent electrical charge, producing the effects described above for the lever pivot. The properties and uses of transistors will become clear after some examples.

5-3 Transistor Basics

Experiments

Consider this mini-circuit:

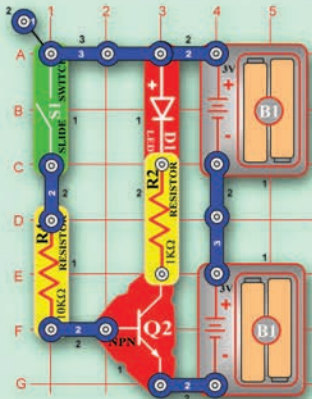

A small current through the switch will activate a larger current through the LED. This is a simple example of how transistors are used as electronic switches.

You're probably thinking "Instead of using a transistor, why not just put the LED in series with the switch?" But what if you wanted to have the same switch control 100 LEDs, each with the same brightness as the one in this circuit? With transistors you can, since the same switch can be used to control 100 separate transistors with their LEDs.

Experiments

Consider this circuit (which is project 124):

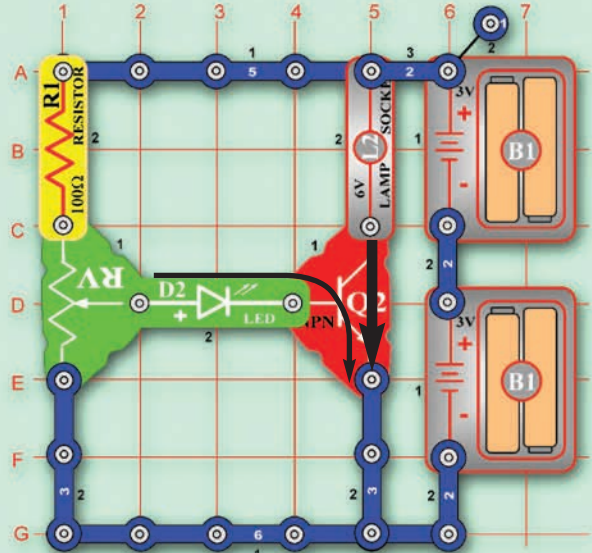

If the adjustable resistor is set so that the green LED is on, the lamp will also be on. When a small current flows between the transistor base and emitter, a larger (amplified) current flows between the transistor collector and emitter.

Experiments

Consider this circuit (which is project 215):

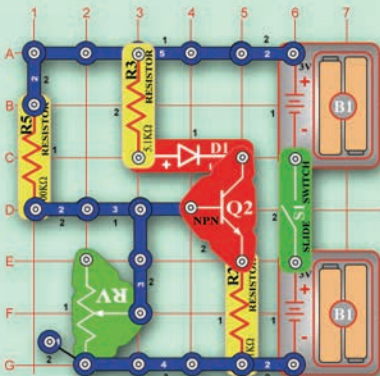

The adjustable resistor controls the current into the transistor, and can set the LED to any brightness desired. This is the standard transistor circuit for amplifiers. To minimize the distortion in the signal being amplified, the adjustable resistor will usually be set so that the LED is at half brightness.

Experiments

The PNP transistor works in almost the same way, the only difference is that current flows into its emitter and out of the base and collector. For example, consider this circuit (which is project 125):

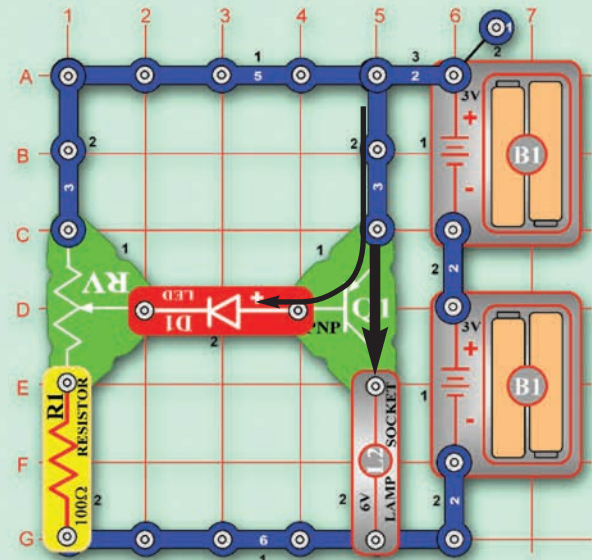

This circuit uses the same parts (except for the transistor), only they are arranged differently.

Experiments

Now compare lamp brightness in these two PNP circuits (which are projects 128 and 129):

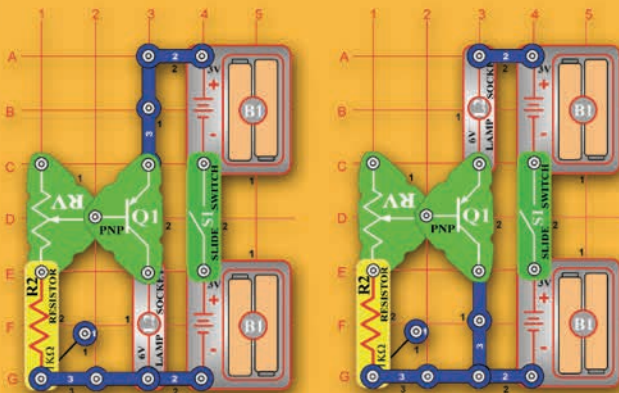

The lamp is brighter when it is connected to the transistor's collector (project 128). When the lamp is connected to the emitter it reduces the emitter-base current, which sets the emitter-collector current.

Now compare lamp brightness in the NPN-versions of the same circuits (which are projects 130 and 131, or variations of them):

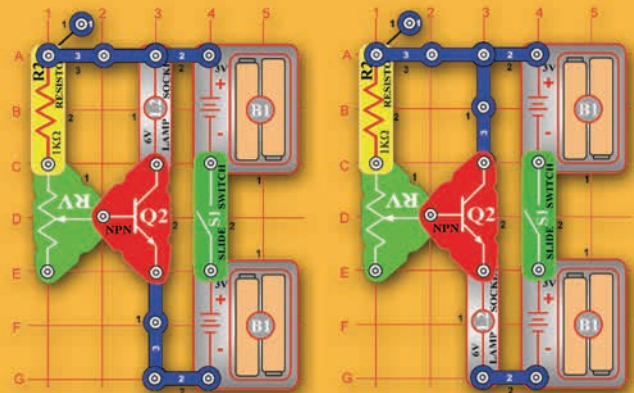

The lamp is brighter when it is connected to the transistor's collector (left circuit), and these circuits are about as bright as the PNP-versions. This is because both transistors are made from the same material, silicon.

Experiments

Next, consider this circuit (which is project 253, or a variation of it):

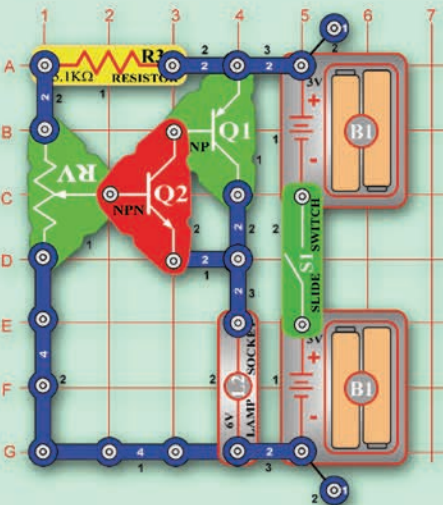

This circuit uses two transistors, and combines their amplifying power. As a result, the lamp is bright across more of the adjustable resistor's range than in the previous circuits. When the adjustable resistor is set for full brightness, the brightness is limited by the lamp itself (not by the transistors).

5-4 More Transistor Circuits

Experiments

Transistors are used in a wide range of applications. These are just some examples.

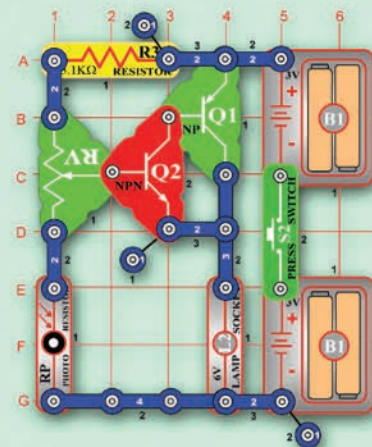

This circuit (which is project 107) uses light to control a lamp. If the adjustable resistor is initially set so the lamp just lights, then the lamp will be bright when the room gets dark. Light changes the resistance of the photoresistor, which controls the current to the transistors and lamp.

Experiments

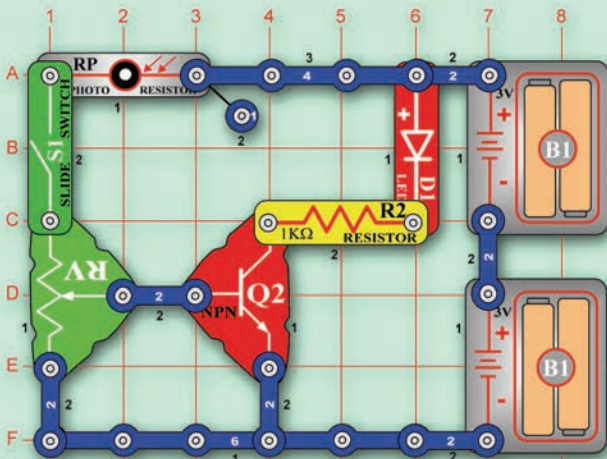

This circuit (which is project 261) uses the photoresistor as a motion detector. If the adjustable resistor is set so the LED just lights, waving your hand over the circuit will cause the LED to flicker.

Experiments

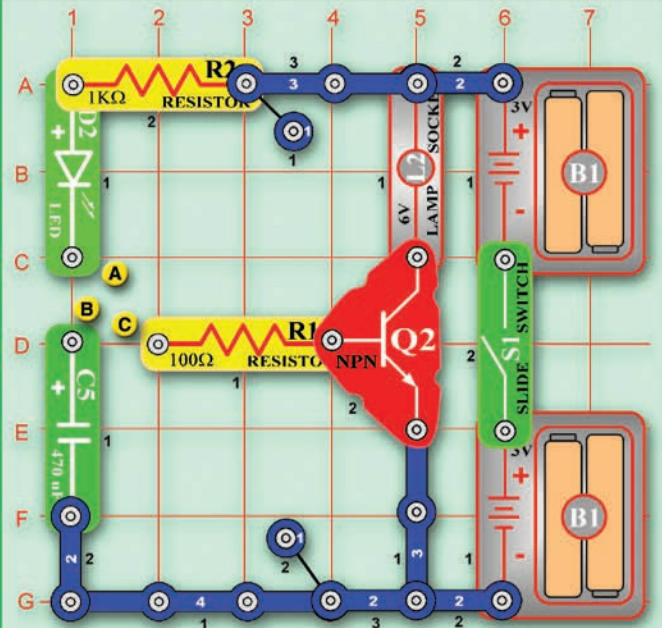

This circuit (which is project 252) is another example of how capacitors store electricity. If the green LED and capacitor are connected with a 2-snap wire (points A and B on the drawing), the LED will flash as the capacitor charges up. If the 100Ω resistor and capacitor are then connected (points B and C on the drawing), the lamp will flash as the capacitor turns on the transistor by discharging through it.

Experiments

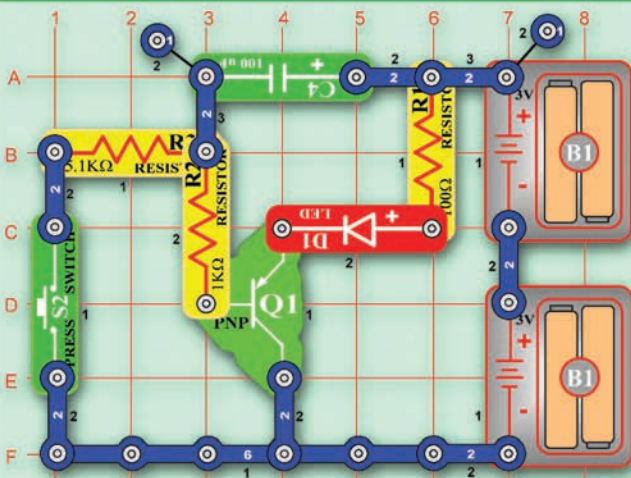

This circuit (which is project 256) can be used as a light dimmer. When you turn off a light (by releasing the switch), this circuit keeps the light on for a few seconds to light your way as you leave the room. Electricity is stored in the capacitor, and released to the transistor when the switch is turned off.

The same circuit could also be used in a wristwatch. When you press the button to read the time in the dark, a light comes on and automatically turns off after a few seconds to avoid draining the battery.

Experiments



This circuit (which is project 300) is a light dimmer with an adjustable delay. The adjustable resistor controls how long the lamps stay on for after the press switch is released. If the 470μF capacitor were placed on top of the 100μF (so both are in parallel), the turn-off delay would be much longer.

Experiments

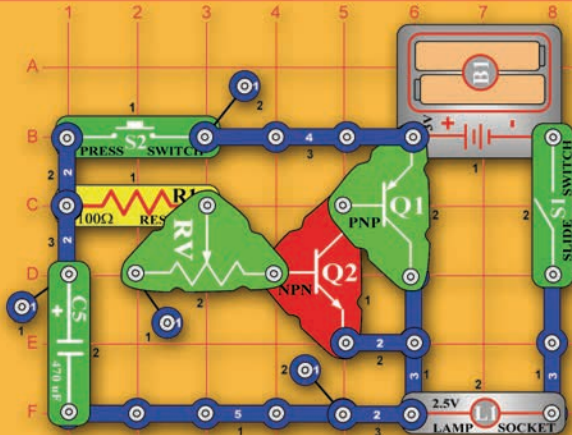

This circuit (which is project 302) is another light dimmer with adjustable delay. In this circuit all the electricity stored in the capacitor will discharge through the transistor, the adjustable resistor controls how quickly it is discharged. It can be released quickly to make the lamp brighter, or slowly to keep it on longer.

Experiments

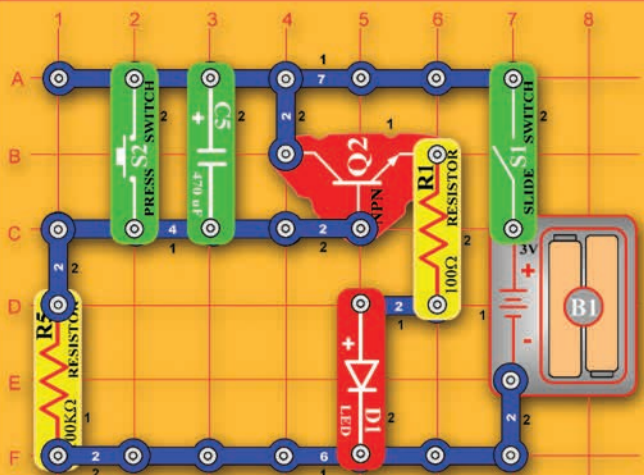

This circuit (which is project 225) has an important difference from the other ones. When the slide switch is turned on, the LED is on for a while and slowly gets dim. Resetting the slide switch can't turn it back on. Current flows while the 470µF capacitor charges up, once it is charged it blocks current to the transistor. Pressing the press switch instantly discharges the capacitor and the LED can light again.

The fastest way to discharge a capacitor is to place a wire across it. Capacitor discharge time is controlled by the circuit resistance, and a wire has very little resistance.

Experiments

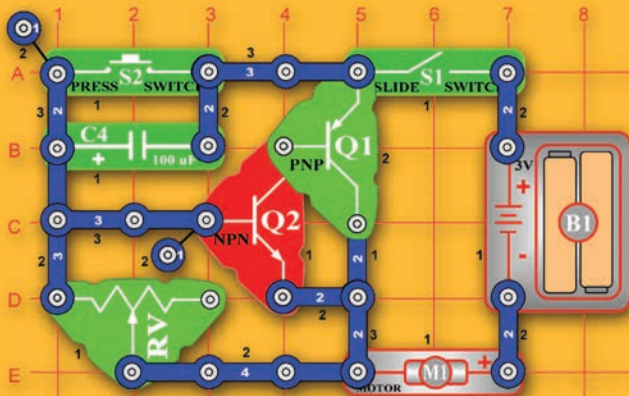

This circuit (which is project 263) uses transistors and a capacitor to control a motor (use the fan) instead of a lamp. It works the same way, with the adjustable resistor controlling how long it stays on. The fan speed slowly drops as the capacitor discharges.

As you have seen, transistors are useful in many different types of circuits.

Other Snap Circuits® projects related to transistors: 105, 126, 127, 132, 133, 168, 169, 170, 171, 195, 196, 216, 222, 223, 224, 226, 227, 254, 257, 264, 280, 281, 282, 283, 291, 292, 301, 303, 304, and 305.

Quick Quiz



1. Draw/build a circuit that works the same as project 215 but uses a PNP transistor instead of an NPN transistor.

5-5 Human Transistor

Experiments

Now consider this circuit (which is project 246):

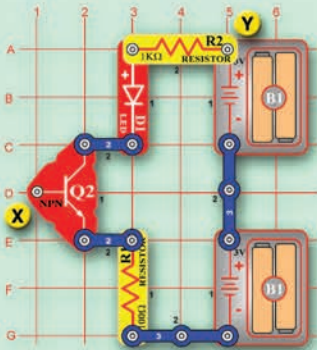

This circuit is missing a key component - you. If you place your fingers across the points marked X and Y, the LED will light. It will get brighter if you wet your fingers, since that will make a better connection.

You saw earlier that water conducts electricity. Since your body is made of water, it should not surprise you that your body can also conduct

electricity. Although your body has high resistance (usually more than $100\text{K}\Omega$), this transistor circuit is sensitive enough to be activated by it.

This circuit is similar to touch-lamps sold in stores, but those lamps only need one finger to touch them. The circuit could be changed to put the touch points next to each other, so it could be turned on with one finger (this is project 247):



Actually, touch-activated products will usually interweave the contacts so that it is easy to touch both at the same time:



5-6 Motor as Generator

Experiments

Now consider this circuit (which is project 118):

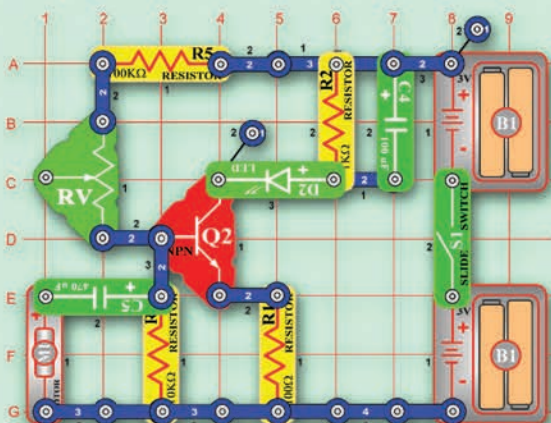

This circuit is an example of using mechanical motion to create electricity, using a generator. If you spin the motor CLOCKWISE with your fingers, the green LED will flash. Give it a good, fast spin and leave the fan off.

The motor shaft you spin has a magnet on it,

surrounded by a coil of wire. The spinning magnet has a magnetic field, which creates an electric current in the coil. Your fingers can't spin the motor very fast, so only a small current is created.

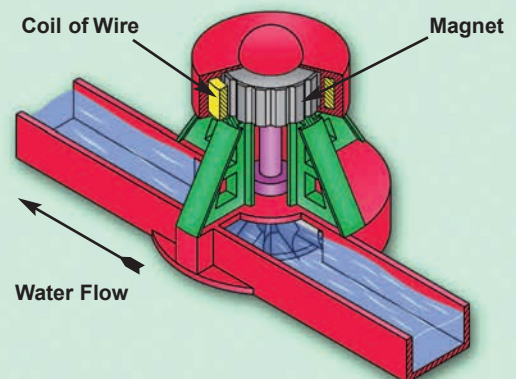

The resistors and capacitors in this circuit were chosen so that even a small motor current can light the LED. Since the middle connection on the adjustable resistor is not used, it acts as only a $50\text{K}\Omega$ resistor and cannot be adjusted.

5-7 Microphone

Introducing New Parts

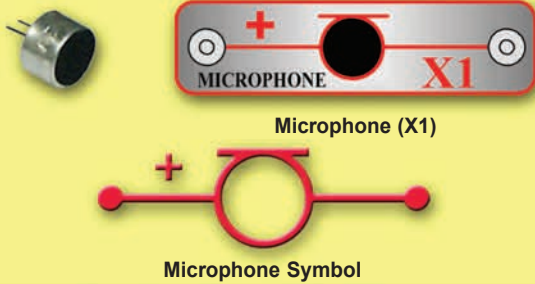

This part acts like a resistor that changes when exposed to sound waves. This change in resistance will change the current through a circuit when sound waves apply pressure to its surface. This action is similar to squeezing a garden hose and watching the water through it decrease. The side with a "+" mark should always be placed toward the higher voltage.

Experiments

Consider this circuit (which is project 273):

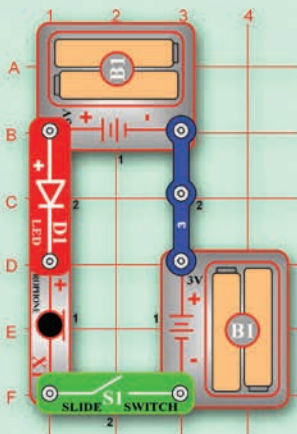

If you blow on the microphone, the LED brightness changes.

Consider this circuit (which is project 109):

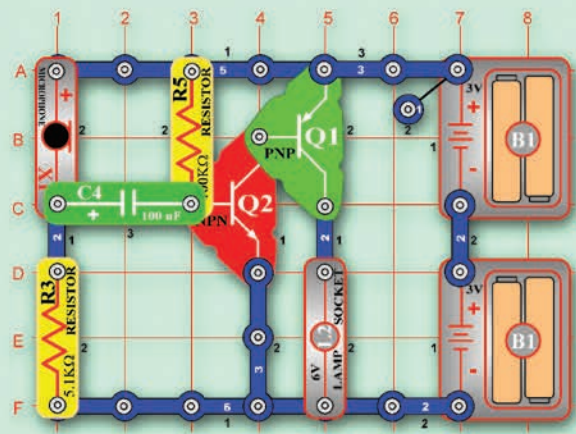

Current flows through the 100KΩ resistor to turn on the transistors and lamp. Blowing on the microphone diverts current away from the transistors and the lamp shuts off briefly.

Summary

Summary of Chapter 5:

1. The resistance of semiconductors may be controlled by their operating conditions.
2. Semiconductors have a turn-on level (0.7V for silicon), after which the resistance becomes very low in one direction.
3. Transistors have three connection points, called the emitter, base, and collector.
4. The transistor is a current amplifier, it uses a small amount of current to control a large amount of current.
5. When a small current flows into the base and out of the emitter in an NPN transistor, a larger current flows into the collector and out of the emitter. In a PNP transistor, current flows into the emitter and out of the base and collector.
6. A microphone is a resistor that changes when exposed to sound. This change in resistance will change the current through a circuit when sound waves apply pressure to its surface.

Quiz

Chapter 5 Practice Problems

1. In a transistor, the _____ will have the most current flowing through it.
 - A. Emitter
 - B. Base
 - C. Collector
 - D. Vacuum tube
2. The following are advantages of transistors except . . .
 - A. they can be miniaturized.
 - B. they can amplify signals.
 - C. their resistance can be changed by adjusting the voltage in the circuit.
 - D. it has zero resistance under certain operating conditions.
3. Which circuit will light the LED?

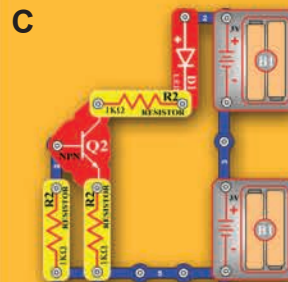
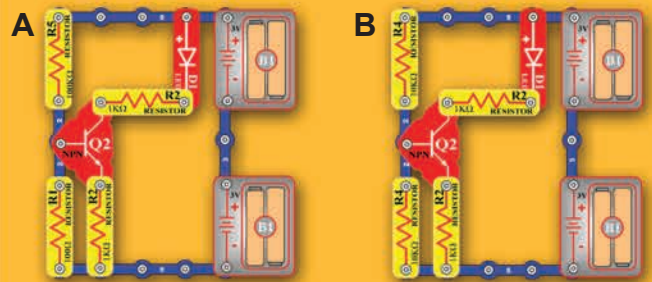

D All three.

4. Which circuit will light the lamp?

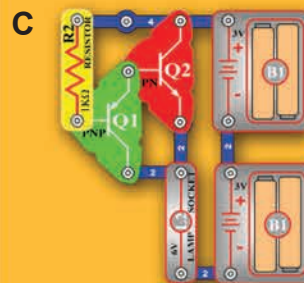
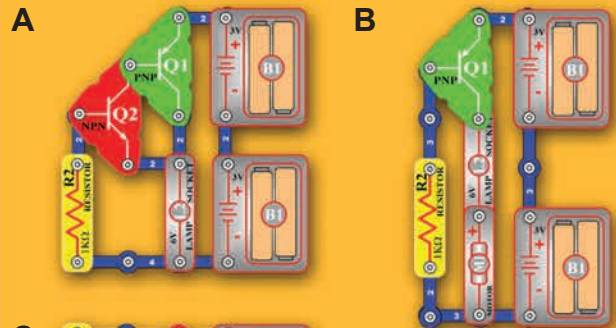

D All three.

Answers: 1. A, 2. D, 3. B, 4. B

CHAPTER 6: OSCILLATORS & ELECTRONIC SOUND

Learn
By Doing®

Your electronic stereo and radio are powered by electricity and play music, so how does electricity make sound? In this chapter you will find out. You will also learn about oscillator circuits, and build some simple ones using snap circuits.

Oscillators are used in all radios, TVs, and electronic communications equipment to set the transmitter or receiver frequency. Different types of oscillators are used as timing references in computers and almost all complex electronic products. It would be hard to

count how many oscillator circuits are in your home since there are different types and they can be hard to identify.

Oscillators can be among the most difficult electronic circuits to design, due to the tight requirements placed on them by today's communications technology. They usually don't use a lot of components, but the way they are arranged is complex and often difficult to analyze. But they are fun to learn about.

6-1 Electronic Sound

Introducing New Parts

Snap Circuits® includes a speaker:



(SP SPEAKER)

Speaker (SP)



Speaker Symbol

A **speaker** converts electricity into sound. It does this by using the energy of a changing electrical signal to create mechanical vibrations (using a coil and magnet similar to that in the motor). These vibrations create variations in air pressure, called sound waves, which travel across the room. You "hear" sound when your ears feel these air pressure variations.

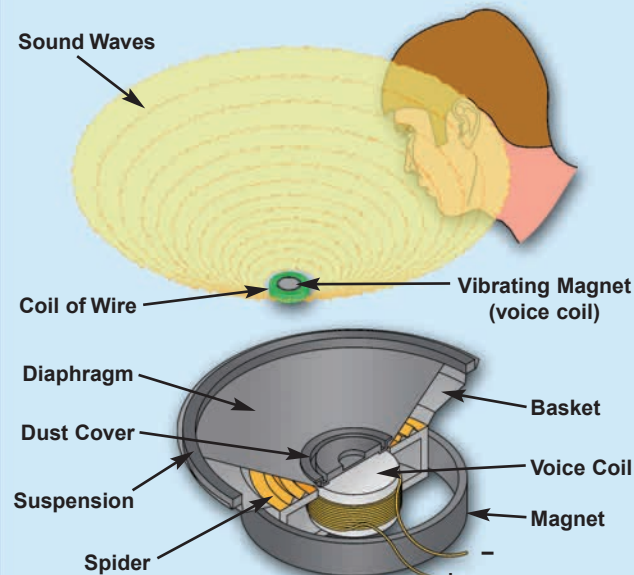

A speaker can only create sound from a **CHANGING** electrical signal, for unchanging electrical signals it acts like an 8Ω resistor. (An unchanging signal does not cause the magnet in the speaker to move, so no sound waves are created).

Experiments

For example, compare these two mini-circuits:

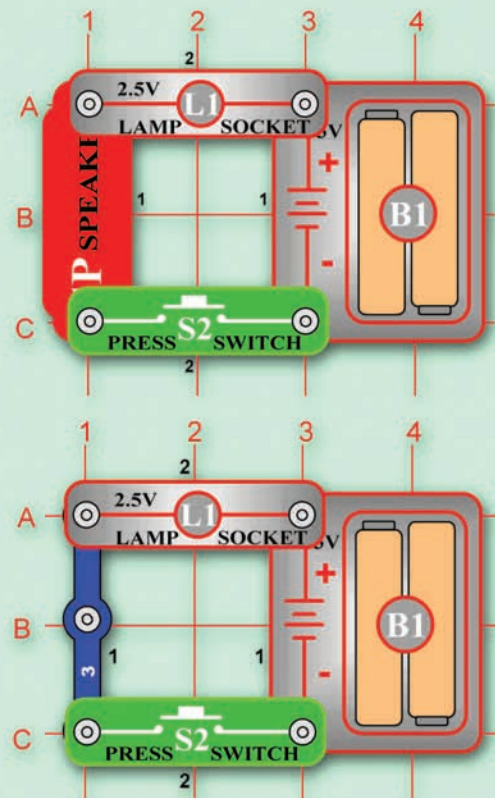

When you press or release the press switch, you hear static from the speaker. When you hold the press switch down, the speaker is silent and the lamp is not as bright as the circuit without it.

What is Sound? **Sound** is a variation in air pressure created by a mechanical vibration. For a demonstration of this, lay one of your stereo speakers on the floor, place your hand on it, and turn up the volume. You should feel the speaker vibrate. Now place a piece of paper on the speaker; if the volume is loud enough, you will see the paper vibrate.

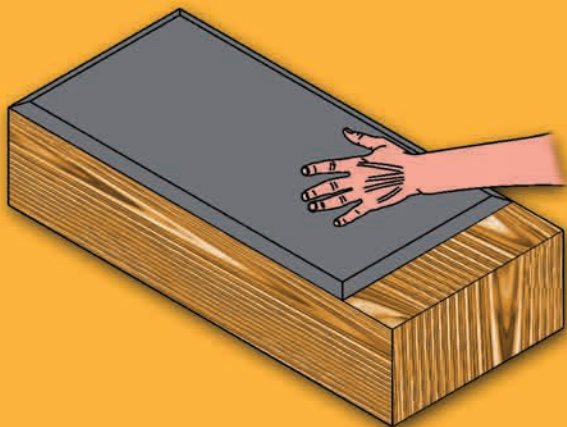

You can compare sound waves from your voice to waves in a pond. When you speak the movements in your mouth create sound waves just as tossing a rock into the pond creates water waves. Sound waves travel through air as water waves travel across the pond. If someone is nearby then their ears will feel the pressure variations caused by your sound waves just as a small boat at the other side of the pond will feel the water waves. When you say a word you create a sound wave with energy at various frequencies, just as tossing a handful of various-sized rocks into the pond will create a complicated water wave pattern.

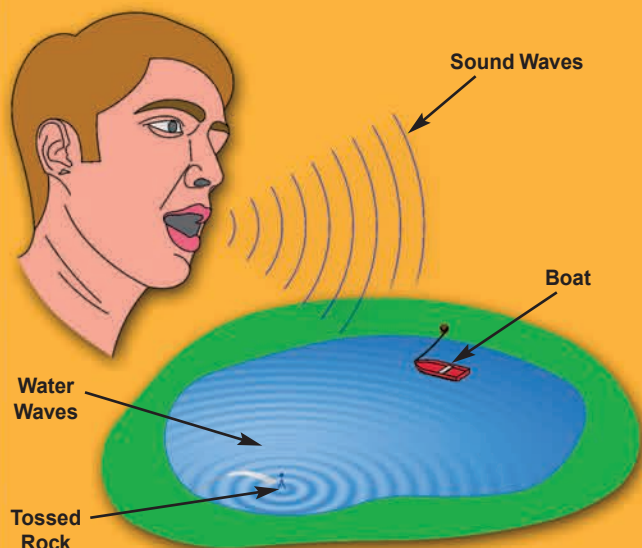

Nearly all sound waves have their energy spread unevenly across a range of frequencies.

What is Music? *Music* is when sounds occur in an orderly and controlled manner forming a pattern with their energy concentrated at specific frequencies, usually pleasant to listen to. *Noise* is when the sounds occur in an irregular manner with their energy spread across a wide range of frequencies, usually annoying to hear (static on a radio is a good example). Notice how some people refer to music that they don't like as noise.

Another way to think of this is that the ear tries to estimate the next sounds it will hear. Music with a beat, a rhythm, and familiar instruments can be thought of as very predictable, so we find it pleasant to listen to. Notice also that we always prefer familiar songs to music that we are hearing for the first time. Sudden, loud, unpredictable sounds (such as gunfire, a glass breaking, or an alarm clock) are very unnerving and unpleasant. Most electronic speech processing systems being developed use some form of speech prediction filters.

The musical world's equivalent to frequency is *pitch*. The higher the frequency, the higher the pitch of the sound. Frequencies above 3000 Hz can be considered to provide *treble* tone. Frequencies about 300 Hz and below provide *bass* tone. *Loudness* (the musical term) or *amplitude* (the electronics term) is increased by simply sending more electrical power to the speaker.

Alexander Graham Bell used a microphone and a speaker to make the first telephone in 1876. Although many parts of it have been replaced by new technology, the basic design of his electromechanical system was so good that it is still used today.

6-2 Oscillators

Experiments

Consider this circuit (which is project 259):

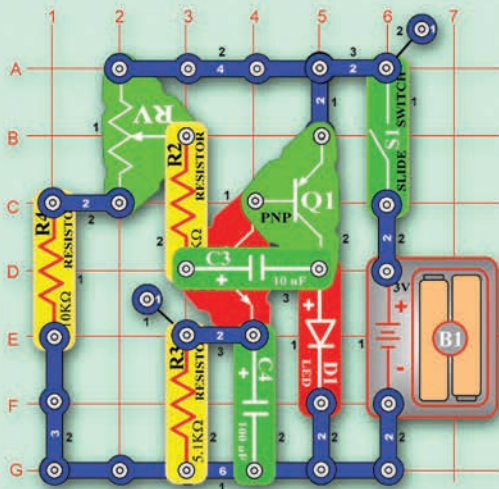

In this circuit the red LED will be flashing, the flash rate is controlled by the adjustable resistor. Although the LED might appear to be solid at the highest setting of the adjustable resistor, it is actually flashing at a faster rate than your eyes can see. Here the LED flash rate can be adjusted from less than once a second up to 30 times a second. This flash rate is called the frequency.

This type of circuit is called an **oscillator** circuit, it uses **feedback** to set and control the frequency. The basic circuit uses the NPN transistor to control the current to the red LED. However, the 10µF capacitor FEEDS part of the output signal BACK to the input. The result is that the NPN transistor will turn the current to the LED on and off in a repeating cycle. The flash rate is controlled by the resistor and capacitors in the circuit, such as the adjustable resistor.

Why do your eyes see only a solid light when the LED is flashing at a fast rate? The reason is that your eyes cannot adjust fast enough. They continue to see what they have just seen. That is the basis for the entire movie and television industries.

In a movie theater, film frames are flashed on the screen at a fast rate (usually 24 per second). A timing mechanism makes a light bulb flash just as the center of a frame is passing in front of it. Your eyes see this fast series of flashes as a continuous movie.

If the speaker is placed directly over the LED (use a 1-snap with it, as in project 260), then you can both hear and see the oscillator effects:

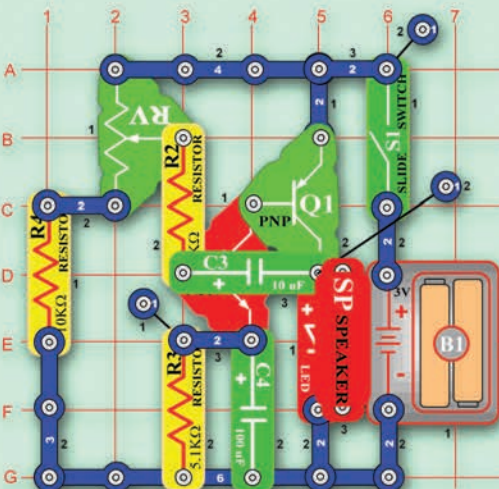

Frequency measures how fast something repeats. It is expressed in **Hertz** (Hz, named after Heinrich Hertz for his work in electromagnetism), **kilohertz** (kHz, 1,000 Hz), or **megahertz** (MHz, 1,000,000 Hz). The range of frequencies that can be heard by the human ear is approximately 16 to 16,000 Hz, and is referred to as the **audio** range.

Experiments

Consider this circuit (which is project 236):

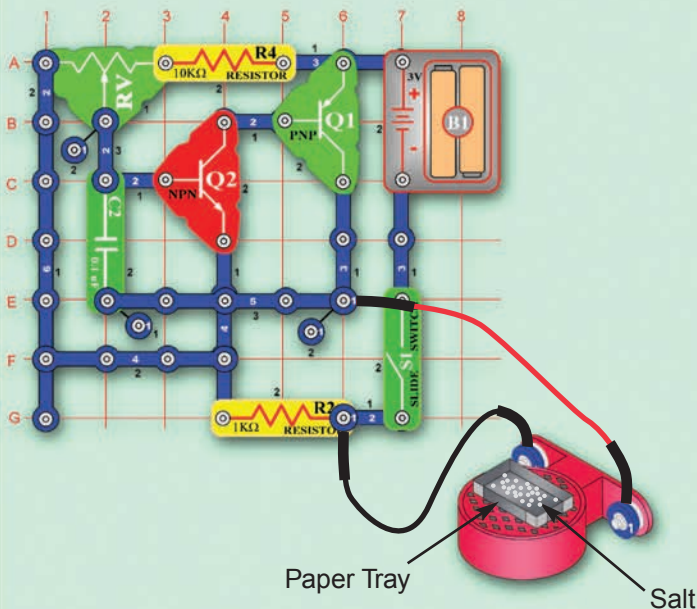

This circuit can be used to demonstrate how a speaker creates sound using mechanical vibrations. Connect the speaker using the jumper wires and lay on a table. Using paper, scissors, and tape, make a small tray and lay on the speaker, as shown. Here is a sample cutout pattern:

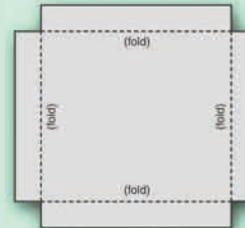

Sprinkle some table salt in the tray and turn on the switch. The speaker uses vibrations to create sound waves; those vibrations will also move the salt around in the tray. Adjust the adjustable resistor to change the pitch (frequency) of the sound, and see how the salt moves.

6-3 The Whistle Chip

The whistle chip is like the $0.02\mu\text{F}$ capacitor, except that it also can make sound like a speaker does.

It contains two thin plates separated by a dielectric material, similar to a capacitor. When a voltage is applied across them they will stretch slightly in an effort to separate (like two magnets opposing each other), when the signal is removed they come back together. If the voltage is changing quickly, then the plates will vibrate. These vibrations create variations in air pressure that your ears feel, just like sound from a speaker.

Introducing New Parts



Whistle Chip (WC)



Whistle Chip Symbol

Experiments

Consider this circuit (which is project 199), it uses the whistle chip to make sound:

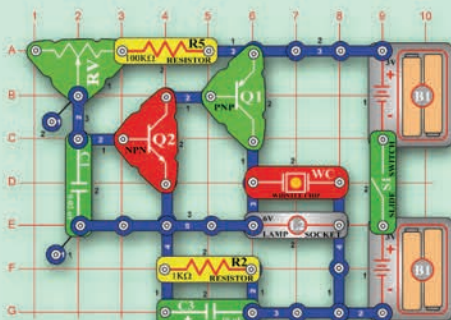

The frequency (pitch) of the sound is controlled by the resistors and capacitors in the circuit, increasing their values decrease the frequency. One way to change it is using the adjustable resistor. Another way is to place the $0.1\mu\text{F}$ capacitor on top of the $0.02\mu\text{F}$, increasing the capacitance (project 200). You could also replace the $100\text{k}\Omega$ resistor with the photoresistor to control the frequency using light.

6-4 Oscillator Circuits

Experiments

Consider this circuit (which is project 197):

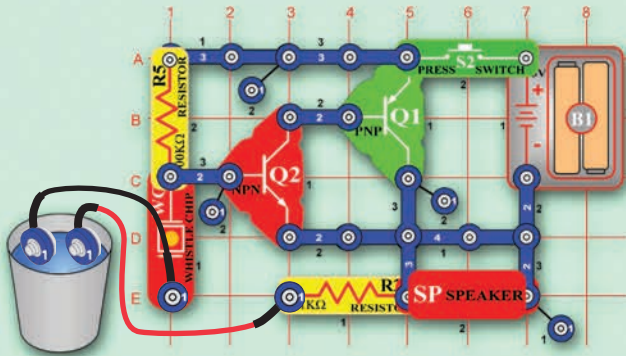

If the two loose jumpers are placed into a cup of water, an alarm sounds. You could put this circuit in your basement and use it to alarm you if the basement floods during a storm. If you slowly add salt to the water, you will hear the pitch slowly increase.

Oscillators are used in nearly all forms of radio communications, and are among the most important circuits in electronics. They can also be the most difficult circuits to design, due to the feedback involved. Selection of component values is very important for oscillation to occur. For example, the above circuit would not work if the $0.02\mu\text{F}$ capacitor were replaced with the $100\mu\text{F}$. Also, many Snap Circuits® oscillator circuits do not work at all settings of the adjustable resistor.

Capacitors are important in a oscillator and filtering circuit because of their ability to store electric charge. This allows their values to be selected so they **pass some frequencies while blocking other frequencies**. For example, **a capacitor has lower resistance at higher frequencies, but higher resistance at lower frequencies**.

The resistance of a capacitor may be calculated from the frequency and capacitor value:

$$R_{\text{capacitor}} = \frac{1}{6.28 \times \text{Frequency} \times \text{Capacitance}}$$

For example, a $10\mu\text{F}$ capacitor will have a resistance of 1592Ω at 10Hz , but only a resistance of 15.92Ω at 1000Hz .

Experiments

Modify the circuit by replacing the press switch with the slide switch. You need one more part, and you are going to draw it. Take a pencil (No. 2 lead is best), SHARPEN IT, and fill in a shape like this:



Place a hard, flat surface beneath the paper you draw on. Press HARD and fill in the shape several times to get a thick, even layer of pencil lead. Turn on the switch and press the loose ends of the jumpers to the drawing, move them around over it. The tone of the sound will have a higher pitch if the

ends are farther apart in the shape. If you don't hear any sound, add another layer of lead or put a drop of water on the jumper ends to get better contact.

You can draw your own shapes and see what kinds of sounds you can make. Wash your hands when finished.

Actually, pencils aren't made out of lead anymore (although they are still called "lead pencils"). The "lead" in pencils is really a form of carbon, the same material that resistors are made of. So the drawings you just made should act just like the resistors in Snap Circuits®.

Morse Code: The forerunner of today's telephone system was the telegraph, which was widely used in the latter half of the 19th century. It only had two states - on or off (that is, transmitting or not transmitting), and could not send the range of frequencies contained in human voices or music. A code was developed to send information over long distances using this system and a sequence of dots and dashes (short or long transmit bursts). It was named Morse Code after its inventor. It was also used extensively in the early days of radio communications, though it isn't in wide use today. It is sometimes referred to in Hollywood movies, especially Westerns.

MORSE CODE

A	· -	N	- ·	Period	· · · · ·
B	- · · ·	O	- - - -	Comma	- · · · -
C	- - · -	P	· - - ·	Question	· · · · ·
D	- · ·	Q	- - · -	1	· - - - -
E	·	R	· - ·	2	· · - - -
F	· · - ·	S	· · ·	3	· · · - -
G	- - ·	T	-	4	· · · · -
H	· · · ·	U	· · -	5	· · · · ·
I	· ·	V	· · · -	6	- · · · ·
J	· - - -	W	· - -	7	- - · · ·
K	- · ·	X	- · · -	8	- - - · ·
L	· · · ·	Y	- · - -	9	- - - - ·
M	- -	Z	- - · ·	0	- - - - -

Experiments

Consider this oscillator circuit (which is project 228):

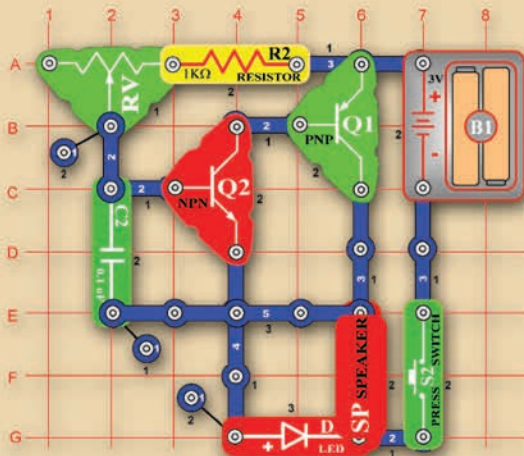

Press the switch in long and short bursts to make a sound pattern representing the dots and dashes shown in the table above. You can use Morse Code and this circuit to send secret messages to friends in hearing distance without others knowing what you're saying.

Replace the speaker with the 100Ω resistor to send Morse Code messages using flashes of light instead. During World War II Navy ships sometimes communicated by flashing Morse Code messages between ships using searchlights (because radio transmissions might reveal their presence or position to the enemy).

Experiments

Consider this circuit (which is projects 185-189):

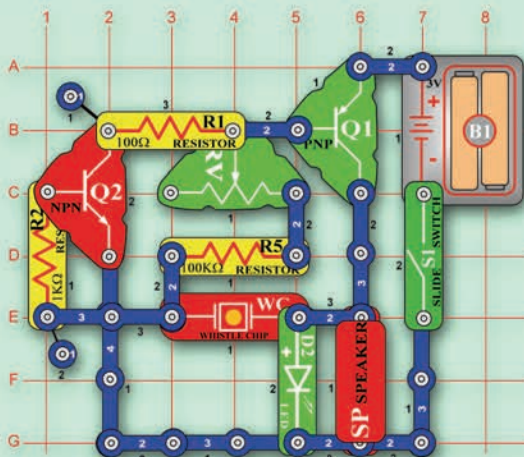

This is another adjustable oscillator circuit, which also includes an LED. Although the LED appears to be on, it is flashing at a very fast rate. The 0.02µF or 0.1µF capacitors can be placed on top of the whistle chip to lower the frequency. The 10µF may also be placed there, but then the frequency is so low that the LED is flashing and the series of clicks is heard. The speaker may be replaced by the 2.5V lamp.

Experiments

Consider this circuit (which is project 294):

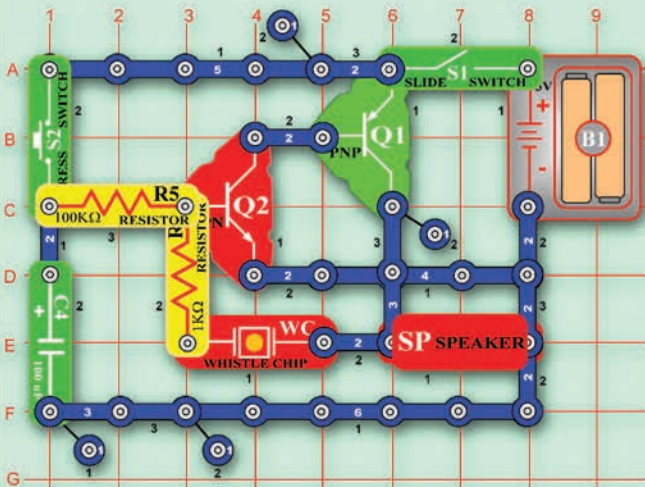

This circuit is an oscillator controlled by a discharging capacitor. Turn on the slide switch and press the press switch. The sound is loud but slowly goes away.

Other Snap Circuits® projects related to transistor oscillators: 110, 111, 112, 123, 134, 135, 136, 137, 138, 180, 181, 182, 183, 184, 190, 191, 192, 206, 207, 208, 209, 210, 211, 212, 230, 231, 232, 265, 266, 267, 284, and 285.

Summary

Summary of Chapter 6:

1. A speaker uses a changing electrical signal to make variations in air pressure.
2. All sounds are variations in air pressure that your ears feel.
3. Oscillators use feedback to set and control the frequency.
4. Frequency measures how fast something occurs, and is expressed in Hertz.
5. Audio refers to the range of frequencies that can be heard by human ears.
6. The whistle chip acts like a capacitor but can also make sound like a speaker does.
7. Capacitors have higher resistance at lower frequencies but lower resistance at higher frequencies.

Quiz

Chapter 6 Practice Problems

1. Which of the following has the highest frequency?
 - A. A stoplight repeating its green-yellow-red cycle.
 - B. The minutes hand on a clock passing twelve o'clock.
 - C. Your birthday.
 - D. The wipers sweeping across the windshield of a car while driving in the rain.
2. If you wanted to pass some frequencies of a signal while blocking other frequencies, which part would you need to use?
 - A. Capacitor
 - B. Resistor
 - C. Lamp
 - D. Switch
3. To lower the frequency in an oscillator circuit, you could . . .
 - A. increase the circuit resistance.
 - B. decrease the circuit capacitance.
 - C. add more batteries.
 - D. Both A and B.
4. Which of these parts has the lowest resistance at low frequencies?
 - A. Whistle Chip
 - B. Speaker
 - C. 1KΩ Resistor
 - D. 10µF Capacitor

Answers: 1. D, 2. A, 3. A, 4. B

CHAPTER 7: INTEGRATED CIRCUITS

Learn
By Doing®

A key advantage of semiconductors is that several transistors can be manufactured on a single piece of silicon. This led to the development of Integrated Circuit (IC) technology around 1960. In ICs, careful control of complex manufacturing processes has enabled entire circuits consisting of transistors, diodes, resistors, and capacitors to be constructed on a silicon base. IC manufacturing is so specialized that particles of dust can render parts useless.

Many thousands of parts now fit into an area smaller than your fingernail. In fact, some ICs used in computers now have more than a million transistors

on them, and a drawing of everything on them would be huge. Spectacular improvements in cost, size, and reliability have been achieved as a result.

Further research led to the development of microprocessor ICs, which can do many different tasks based on programming that can be easily changed. The leader of Intel Corporation once boasted that the speed of the newest microprocessors doubled every eighteen months. This came to be known as Moore's Law, and held true for more than a decade.

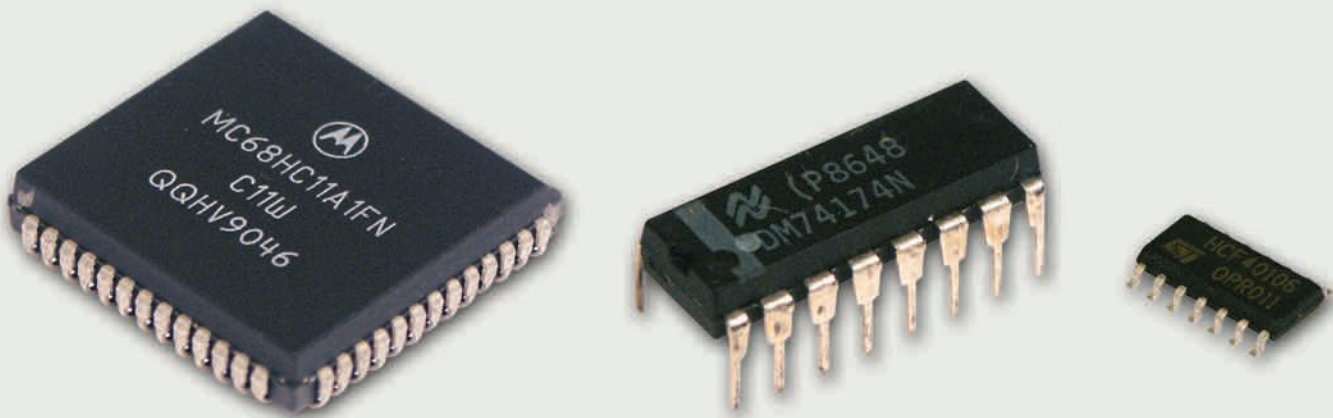

Integrated circuits are used in everything from simple electronic toys to the most advanced computers. Many technologies would not have been possible

without them. A cellular phone, for example, is an extremely complex device that has been so miniaturized with ICs that it fits in your hand.



In this chapter you will learn about the integrated circuit modules included in Snap Circuits®, and have the opportunity to make many types of circuits using them.

7-1 The ICs in Snap Circuits®

Although Snap Circuits® includes several parts that are called integrated circuits, they are actually modules containing a number of parts. The modules contain specialized sound-generation and amplifier ICs and other supporting components

(resistors, capacitors, and transistors) that are always needed with them. This was done to simplify the connections you need to make to use them.

Introducing New Parts

The **music IC** module contains sound-generation ICs and supporting components. It can play several musical tunes that are recorded in it. Its actual schematic is complex and looks like this:

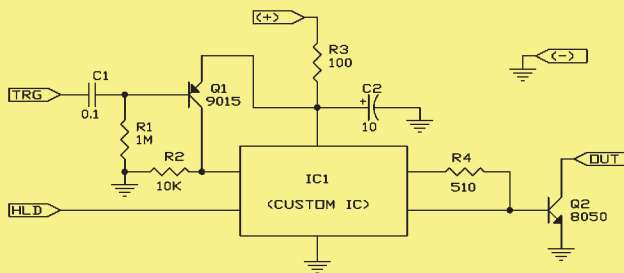

Its Snap Circuits® connections are like this:

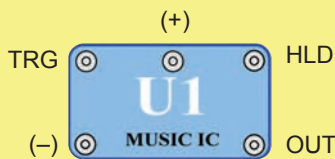

Music IC:

(+) - power from batteries HLD - hold control input
 (-) - power return to batteries TRG - trigger control input
 OUT - output connection

Music for ~20 sec on power-up, then hold HLD to (+) power or touch TRG to (+) power to resume music.

This module has two different control inputs. The OUT connection pulls current into the module (not out of it), usually from a speaker. This current is adjusted to make the music. Snap Circuits® projects 15 and 16 show how to connect this part and what it can do.

Introducing New Parts

The **alarm IC** module contains a sound-generation IC and supporting components. It can make several siren sounds. Its actual schematic looks like this:

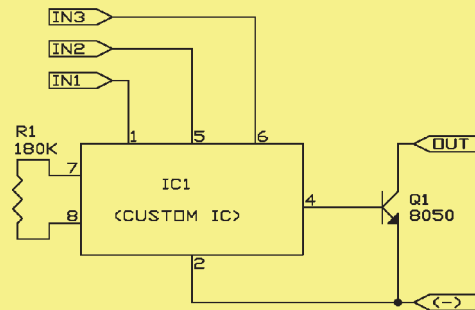

Its Snap Circuits® connections are like this:



Alarm IC:

IN1, IN2, IN3 - control inputs
 (-) - power return to batteries
 OUT - output connection

Connect control inputs to (+) power to make five alarm sounds.

This module has three control inputs, and can make five siren sounds. The OUT connection pulls current into the module (not out of it), usually from a speaker. This current is adjusted to make the siren sounds. Snap Circuits® project 17 shows a simple way to connect this part, and projects 113-117 show the connections needed to make the five possible sounds.

Quick Quiz

1. Select an electronic product in your home and guess how many ICs are inside it. Then (with the power disconnected from it) open it and look to see how many there are.

Introducing New Parts

The **space war IC** module contains sound-generation ICs and supporting components. It can make several siren sounds. Its actual schematic looks like this:

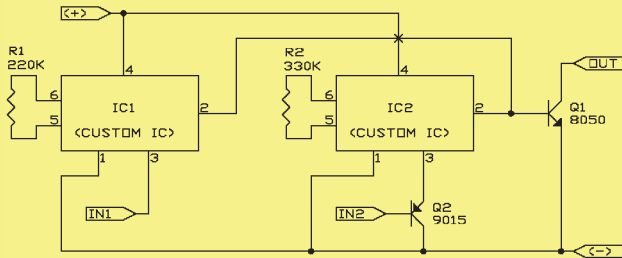

Its Snap Circuits® connections are like this:



Space War IC:

(+) - power from batteries OUT - output connection
 (-) - power return to batteries IN1, IN2 - control inputs

Connect each control input to (-) power to sequence through 8 sounds.

This module has two control inputs that can be stepped through 8 sounds. The OUT connection pulls current into the module (not out of it), usually from a speaker. This current is adjusted to make the space war sounds. Snap Circuits® project 19 shows how to connect this part and what it can do.

Introducing New Parts

The **power amplifier IC** module contains an LM386 audio amplifier IC and supporting components. Its actual schematic looks like this:

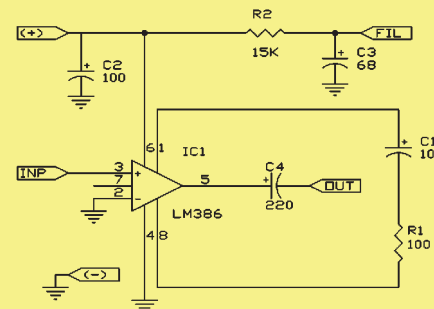

Its Snap Circuits® connections are like this:



Power Amplifier IC:

(+) - power from batteries INP - input connection
 (-) - power return to batteries OUT - output connection
 FIL - filtered power from batteries

This module amplifies a signal from its input. The OUT connection will usually be directly to a speaker. Amplifiers like this let a small amount of electricity control a much larger amount, such as using a tiny signal from a radio antenna to control a speaker playing music. Snap Circuits® projects 242 and 293 show how to connect this part and what it can do.

Introducing New Parts

The **high frequency IC** is an TA7642 (or other equivalent) AM radio IC. It is a specialized amplifier used only in high frequency radio circuits. The circuitry inside it looks like this:

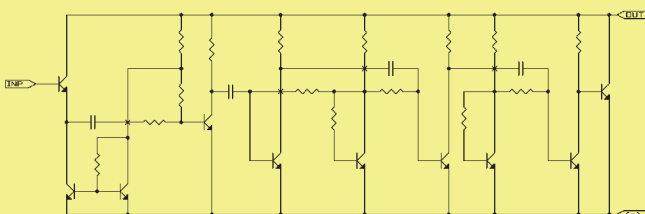

Its Snap Circuits® connections are like this:

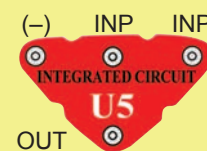

High Frequency IC:

INP - input connection (2 points are same)
 OUT - output connection
 (-) - power return to batteries

This module converts an AM radio signal at its input into an audio signal at its output. Snap Circuits® project 242 shows how to connect this part and what it can do.

7-2 Integrated Circuit Projects

Integrated circuits are used in most electronic products; there are probably more than a thousand throughout your home. The range and uses of ICs available is hard to imagine.

Although Snap Circuits® contains only five IC modules, more than half of the projects use at least one. There are many more examples of using the

parts described in the preceding chapters, such as the microphone and photoresistor. Here is a short description of each, the project manuals explain them in more detail:

Suggested Projects: 38, 51, 58, 61, 81, 83, 119, 158, 178, 202, 237, 238, 242, 245, 250, 255, 272, and 297.

Project 3: Uses the music IC with the whistle chip as a vibration sensor.

Project 4: Uses the music IC with the whistle chip as a vibration sensor.

Project 10: Combines the sound effects of the music and space war ICs.

Project 15: Uses the music IC as a doorbell.

Project 16: Uses the music IC as an alarm.

Project 17: Makes one of the alarm IC siren sounds.

Project 18: Makes one of the alarm IC siren sounds.

Project 19: This is the standard circuit using the space war IC.

Projects 20-21: This uses the photoresistor with the space war IC.

Projects 22-26: Uses the photoresistor and music IC to control the alarm IC siren sounds.

Projects 27-31: Uses the whistle chip and music IC to control the alarm IC siren sounds.

Projects 32-33: Uses the whistle chip and music IC to control the space war IC.

Projects 34-35: Uses the motor and music IC to control the space war IC.

Projects 36-37: Uses the motor and alarm IC to control the space war IC.

Projects 38-39: Uses the alarm IC to control the music IC. An example of a periodic (repeating) signal.

Projects 40-44: Uses the motor and music IC to control the alarm IC siren sounds.

Project 45: Uses the photoresistor, music IC, and alarm IC to control an LED.

Project 46: Makes one of the alarm IC siren sounds.

Project 51: The alarm IC uses the photoresistor to sense reflections from a lamp.

Project 52: The alarm IC uses the photoresistor to sense reflections from a lamp.

Project 53: Sound and light controlled by the alarm IC.

Project 54: Uses the alarm IC to control the space war IC.

Project 58: Uses the music IC to control the alarm IC, with additional control from the whistle chip and photoresistor. Also shows how some parts can be used as wires.

Project 60: Uses the alarm and space war ICs to control the motor.

Projects 61-65: The alarm IC makes sound with the whistle chip; loudness is controlled by the photoresistor.

Project 66: Uses the space war IC in a mind-reading game.

Project 67:	Uses the space war IC in a mind-reading game.
Project 68:	Combines the sound effects of the music and space war ICs.
Project 69:	Combines the sound effects of the alarm and space war ICs.
Project 70:	Uses the alarm IC as a water detector.
Projects 71-76:	Use either the photoresistor, whistle chip, or motor to control a light using the music IC.
Project 77:	Uses the alarm and space war ICs to control a light.
Project 78:	Makes an AND gate with the music IC.
Project 79:	Combines effects from the music and alarm ICs.
Projects 81-82:	Allows you to DRAW an activator for the alarm IC.
Project 83:	Effects from the music and alarm ICs are combined in several different ways.
Projects 84-85:	Sound effects from the music and alarm ICs are combined with the motor (in most manuals).
Project 86:	Effects from the music and alarm ICs are combined in several different ways.
Project 87:	Makes a fun sound with the space war IC.
Project 88:	Makes fun sounds by controlling the space war IC with the motor.
Projects 89-91:	The photoresistor and whistle chip are used to control the space war IC.
Projects 92-97:	Uses water to control the space war IC in various ways.

Projects 98-101:	Uses the alarm IC to make a water alarm in several ways.
Project 104:	Uses the space war IC to spin a fan.
Project 106:	Uses the photoresistor and NPN transistor with the alarm IC.
Projects 113-117:	The alarm IC makes sounds with the whistle chip.
Project 119:	Uses the motor as a generator. As you spin the motor, the power amplifier IC makes sounds like a typewriter.
Projects 120-121:	Use a transistor to amplify sounds from the space war IC.
Project 122:	Makes an AM radio transmitter using the space war IC. See chapter 8 for information about radio circuits.
Projects 139-144:	The microphone, photoresistor, and motor are used to control music and lights with the music IC.
Projects 145-150:	Makes an AM radio transmitter using the music IC, with several variations. See chapter 8 for information about radio circuits.
Project 151:	Uses the microphone and transistors to control the space war IC.
Projects 154-163:	The music, alarm, and space war ICs are used to control the speaker and lamp at the same time, sometimes with the fan running.
Projects 176-179:	Use the microphone and transistors to control the music IC.
Project 202:	Water and a transistor are used to control the alarm IC.

Projects 213-214: Make an AM radio transmitter using the music IC or the alarm IC. See chapter 8 for information about radio circuits.

Projects 217-219: Use the alarm IC with capacitors to make sirens that fade away.

Projects 220-221: The music, alarm, and space war ICs are used to control the speaker and lamp at the same time.

Projects 233-234: Uses the space war IC in a mind-reading game.

Project 237: Use the power amplifier IC to amplify sounds from the space war IC.

Projects 238-239: Use the power amplifier IC with feedback to make fun sounds.

Projects 240-241: Use the power amplifier IC with your finger to make fun sounds.

Project 242: Makes an AM radio receiver using the high frequency and power amplifier ICs. See chapter 8 for information about radio circuits.

Projects 243-244: The music, alarm, and space war ICs are used to control the speaker and lamp at the same time.

Project 245: Use the music and space war ICs with the whistle chip to make a vibration sensor with fun sounds.

Projects 248-249: Make fun sounds and lights with the space war IC.

Projects 250-251: Use the photoresistor and space war IC to control a fan and a lamp.

Project 255: Makes an alarm by using the music IC as an AM radio transmitter. See chapter 8 for information about radio circuits.

Projects 269-271: Makes an alarm by using the music and alarm ICs, controlled by the whistle chip, motor, or photoresistor.

Projects 274-275: Uses the power amplifier IC to amplify sounds from the microphone and whistle chip.

Project 277: Uses the music IC and photoresistor to control the space war IC (in most manuals).

Project 278: Combines the sound effects of the music and alarm ICs.

Project 279: Uses the alarm and music ICs to control fans, speakers, and LEDs.

Projects 286-287: Use the power amplifier IC with feedback to make an oscillator.

Project 288: Makes an AM radio receiver using the high frequency IC and transistors. See chapter 8 for information about radio circuits.

Project 289: Makes an AM radio receiver using the high frequency and power amplifier ICs. See chapter 8 for information about radio circuits.

Project 290: Use the power amplifier IC to amplify sounds from the music IC.

Project 293: Use the power amplifier IC to amplify sounds from the alarm IC.

Projects 297-298: Use the alarm IC with transistors and capacitors to make sirens that fade away.

Project 299: Use the microphone to control the space war IC.

Summary

Summary of Chapter 7:

1. Integrated Circuits are miniature circuits with many transistors, resistors, capacitors, and wires all made on a semiconductor base.
2. The ICs in Snap Circuits® are modules containing specialized integrated circuits and supporting parts that are always needed with them.

Quiz

Chapter 7 Practice Problems

1. The following parts can be built into an integrated circuit except:
 - A. Diodes
 - B. Switches
 - C. Resistors
 - D. Transistors
2. Which of these electrical products is least likely to have an integrated circuit in it?
 - A. Lamp
 - B. Garage door opener
 - C. Car
 - D. Radio
3. If you replace one component in this circuit with a 3-snap then it will make space war sounds, which component is it?
 - A. 100Ω Resistor
 - B. $0.02\mu\text{F}$ Capacitor
 - C. $10\text{K}\Omega$ Resistor
 - D. $100\text{K}\Omega$ Resistor
4. Which of the following are advantages of integrated circuits?
 - A. Size
 - B. Reliability
 - C. Cost
 - D. All of the above

Answers: 1. B, 2. A, 3. D, 4. D

CHAPTER 8: ELECTROMAGNETISM & RADIO

Learn
By Doing®

What would life be like without radio and television? Only a hundred years ago the fastest way to send a message between America and Europe or Asia was a fast ship. Now we get live television coverage of news and sports events from anywhere in the world.

While the telegraph and telephone allowed instant communication at great distances, these required wires. The development of radio made instant communication possible without wires. Initially the equipment required was expensive, so the first main use was in large ships at sea.

Today the air around us is full of radio transmissions for things such as music, television, cellular phones, aircraft navigation, communication with probes in outer space, radio-controlled toys, and thousands of other uses. The Federal Communications Commission (FCC) makes sure that all of these uses operate on different frequencies so that they don't interfere with each other.

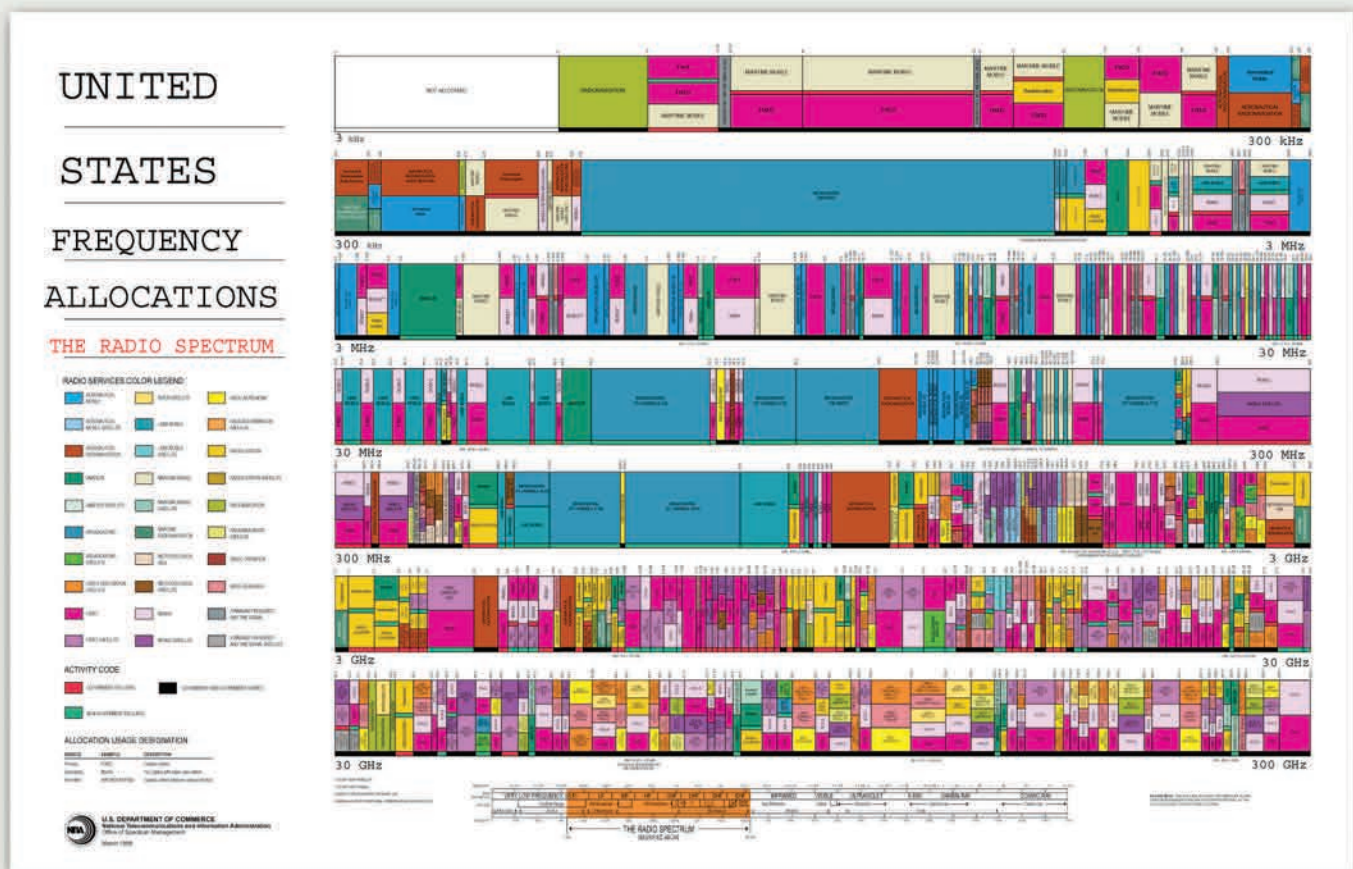

In this chapter you will learn how antennas are used to send radio signals through the air, how modulation is used to encode the information being sent, and

about transformers. You will also use Snap Circuits® to build radio circuits.

8-1 AC

The electricity supplied to your home and school by your local electric company is not a constant voltage like that from a battery. It averages about 120V but is constantly changing, due to the design of the generators that produce it. This is not a problem, since all equipment that uses it accounts for this change. Its frequency is 60 Hz.

An electrical signal that is changing is called an **alternating current**, or **AC**. Because of this, the power from the electric company is also called AC power. An electrical signal that is constant and unchanging is called a **direct current**, or **DC**. The power from a battery is also called DC power.

Experiments

For a demonstration of this, consider this simple circuit (which is projects 55-56):

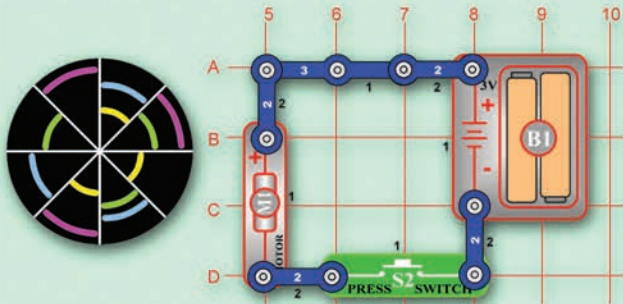

Make a paper disc with lines on it like the one shown here (a sample for cutout is on page 46 of project manual #1). Tape it to the fan blade and place it on the motor. Place this circuit under a white fluorescent light in your home or school (don't use an ordinary incandescent lamp). As the speed changes you will notice the white lines first seem to move in one direction then they start moving in another direction.

Do you know why it does this? The reason is because the lights are blinking 60 times a second and the changing speed of the motor is acting like a strobe light to catch the motion at certain speeds. To prove this, go into a dark room and try the same test with a flashlight. The light from a flashlight is constant, so you won't see this effect and will always see the lines move in the same direction.

The fluorescent lights are blinking because they use the AC power from the electric company. A flashlight uses DC power from batteries. Note: some new fluorescent lights use an electronic ballast and they also produce a constant light.

8-2 Transformers

In a motor, electricity can make mechanical motion: an electric current flowing through a coil of wire can make a magnet rotate on a shaft. But what if the small magnet was instead a large, heavy, iron bar and was held in position? The current in the wire magnetizes the ordinary iron bar, and it becomes an **electronic magnet**. The iron bar stores electrical energy as magnetic energy.

What if another coil of wire from a different circuit was also wrapped around the iron bar? The magnetization of the iron bar would create a current in it. This is a **transformer**, which allows one circuit to create a current in another circuit using magnetic fields.

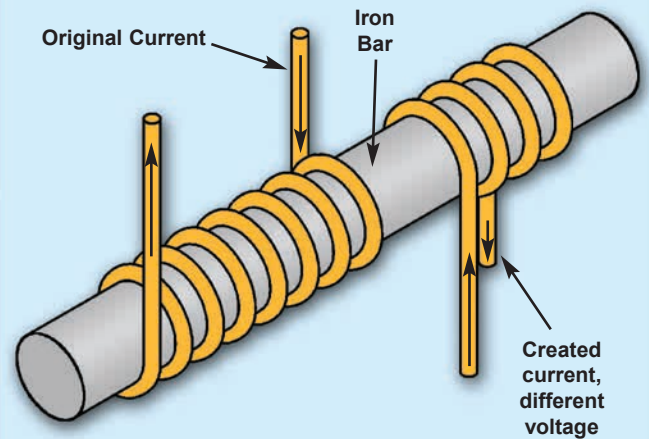

Important Note: Transformers only work with changing voltages (AC). Unchanging voltages (DC) have no magnetic properties and don't work with transformers. Many motors (like the one in Snap Circuits®) have a mechanical design that allows them to use the DC voltage from batteries.

Think of a transformer as a magnetic bridge in electronics, since we use magnetism to cross an air gap that electricity cannot cross by itself. Snap Circuits® does not include a transformer, but a typical one is shown here with its symbol:

