

User's Manual

300Mbps 802.11n Outdoor Wireless AP/CPE

▶ WAP-200N/WBS-200N



Copyright

Copyright © 2017 by PLANET Technology Corp. All rights reserved. No part of this publication may be reproduced, transmitted, transcribed, stored in a retrieval system, or translated into any language or computer language, in any form or by any means, electronic, mechanical, magnetic, optical, chemical, manual or otherwise, without the prior written permission of PLANET.

PLANET makes no representations or warranties, either expressed or implied, with respect to the contents hereof and specifically disclaims any warranties, merchantability or fitness for any particular purpose. Any software described in this manual is sold or licensed "as is". Should the programs prove defective following their purchase, the buyer (and not this company, its distributor, or its dealer) assumes the entire cost of all necessary servicing, repair, and any incidental or consequential damages resulting from any defect in the software. Further, this company reserves the right to revise this publication and to make changes from time to time in the contents hereof without obligation to notify any person of such revision or changes.

All brand and product names mentioned in this manual are trademarks and/or registered trademarks of their respective holders.

FCC Interference Statement

This equipment has been tested and found to comply with the limits for a Class B digital device,  pursuant to Part 15 of FCC Rules. These limits are designed to provide reasonable protection against harmful interference in a residential installation. This equipment generates, uses, and can radiate radio frequency energy and, if not installed and used in accordance with the instructions, may cause harmful interference to radio communications. However, there is no guarantee that interference will not occur in a particular installation. If this equipment does cause harmful interference to radio or television reception, which can be determined by turning the equipment off and on, the user is encouraged to try to correct the interference by one or more of the following measures:

- Reorient or relocate the receiving antenna.
- Increase the separation between the equipment and receiver.
- Connect the equipment into an outlet on a circuit different from that to which the receiver is connected.
- Consult the dealer or an experienced radio/TV technician for help.

FCC Caution:

Any changes or modifications not expressly approved by the party responsible for compliance could void the user's authority to operate the equipment. This transmitter must not be co-located or operating in conjunction with any other antenna or transmitter. To assure continued compliance, for example, use only shielded interface cables when connecting to computer or peripheral devices.

This device complies with Part 15 of the FCC Rules. Operation is subject to the following two conditions:

- (1) This device may not cause harmful interference
- (2) This device must accept any interference received, including interference that may cause undesired operation.

This transmitter must not be co-located or operating in conjunction with any other antenna or transmitter.

FCC Radiation Exposure Statement

This equipment complies with FCC radiation exposure limits set forth for an uncontrolled environment. This equipment should be installed and operated with a minimum distance of **21cm** between the radiator and your body.

CE Compliance Statement

This device meets the RED directive 2014/53/EU of EU requirements on the limitation of exposure of the general public to electromagnetic fields by way of health protection. The device complies with RF specifications in that the distance between the device and your body should not be less than 20 cm.

Safety

This equipment is designed with the utmost care for the safety of those who install and use it. However, special attention must be paid to the dangers of electric shock and static electricity when working with electrical equipment. All guidelines must be followed at all times to ensure the safe use of the equipment.

WEEE regulation

To avoid the potential effects on the environment and human health as a result of the presence of hazardous substances in electrical and electronic equipment, end users of electrical and electronic equipment should understand the meaning of the crossed-out wheeled bin symbol. Do not dispose of WEEE as unsorted municipal waste; WEEE should be collected separately.



Revision

User Manual of PLANET 2.4GHz 300Mbps 802.11n Outdoor Wireless AP/CPE

Model: WAP-200N/WBS-200N

Rev: 1.0 (August, 2017)

Part No. EM-WAP-200N_WBS-200N_v1.0

CONTENTS

Chapter 1.Product Introduction	7
1.1 Package Contents	7
1.2 Product Description	8
1.3 Product Features	10
1.4 Product Specifications	11
Chapter 2.Hardware Installation	14
2.1 Hardware Description	14
2.1.1 The Bottom Panel	16
Chapter 3.Connecting to the AP	18
3.1 Preparation before Installation	18
3.1.1 Professional Installation Required	18
3.1.2 Safety Precautions.....	18
3.2 Installation Precautions	18
3.3 Installing the AP	20
Chapter 4.Quick Installation Guide	22
4.1 Manual Network Setup -- TCP/IP Configuration	22
4.1.1 Configuring the IP Address Manually	22
4.2 Starting Setup in the Web UI	25
Chapter 5.Configuring the AP	27
5.1 Operation Mode	27
5.1.1 Access Point (AP).....	29
5.1.2 Client Bridge (CB).....	30
5.1.3 WDS Access Point (WDS AP)	31
5.1.4 WDS Station (WDS STA).....	32
5.1.5 WDS Bridge (WDS PtP/WDS PtMP)	33
5.1.6 Client Router (CR/WISP).....	39
5.1.7 Repeater	45
5.2 Status	49
5.2.1 Main	49
5.2.2 Save/Reload	51
5.2.3 Wireless Client List	52
5.2.4 WDS Link List	53
5.2.5 DHCP Client Table	53
5.2.6 Connection Status.....	54
5.2.7 System Log.....	55
5.3 System	56
5.3.1 IP Settings.....	56

5.3.2	Spanning Tree Settings (STP)	57
5.4	Router (WISP Mode Only).....	58
5.4.1	DHCP Server Settings	58
5.4.2	WAN Settings.....	59
5.4.2.1.	DHCP	60
5.4.2.2.	Static IP.....	61
5.4.2.3.	PPPoE	63
5.4.2.4.	PPTP	64
5.4.3	VPN Pass Through	65
5.4.4	Port Forwarding	66
5.4.5	DMZ Settings	67
5.5	Wireless.....	68
5.5.1	Wireless Network.....	68
5.5.2	WDS Link Settings.....	71
5.5.3	Security Settings.....	73
5.5.4	Wireless MAC Filter	83
5.5.5	Wireless Advanced Settings	84
5.6	Management	85
5.6.1	Administration (Password Settings).....	85
5.6.2	Management VLAN	86
5.6.3	SNMP Settings	87
5.6.4	Backup/Restore Settings	88
5.6.5	Auto Reboot Settings.....	89
5.6.6	Firmware Upgrade	89
5.6.7	Time Settings	91
5.6.8	Wi-Fi Schedule	92
5.6.9	CLI Settings	93
5.6.10	Log.....	93
5.6.11	Diagnostics	94
5.6.12	Logout.....	95
Appendix A:	Troubleshooting.....	96
Appendix B:	Use Planet Smart Discovery to find AP	98
Appendix C:	FAQ.....	99
Q1:	How to set up the AP Client Connection.....	99
Q2:	How to set up the WDS Connection	108

FIGURES

FIGURE 2-1 THREE-WAY VIEW (WAP-200N).....	14
FIGURE 2-2 THREE-WAY VIEW (WBS-200N).....	14
FIGURE 2-3 REAR PANEL (WAP-200N)	15
FIGURE 2-4 REAR PANEL (WBS-200N)	15
FIGURE 2-5 BOTTOM PANEL (WAP-200N/WBS-200N).....	17
FIGURE 2-6 PoE WARNING LABEL	17
FIGURE 3-1 PoE AND LAN PORT CONNECTION.....	20
FIGURE 3-2 FINISH INSTALLATION AND CONNECT TO ANTENNAS (WAP-200N ONLY)	20
FIGURE 3-3 POLE MOUNTING	21
FIGURE 3-4 WALL MOUNTING	21
FIGURE 4-1 TCP/IP SETTING	23
FIGURE 4-2 WINDOWS START MENU	24
FIGURE 4-3 SUCCESSFUL RESULT OF PING COMMAND	24
FIGURE 4-4 FAILED RESULT OF PING COMMAND	25
FIGURE 4-5 LOGIN BY DEFAULT IP ADDRESS	25
FIGURE 4-6 LOGIN WINDOW	25
FIGURE 4-7 WEB UI SCREENSHOT.....	26
FIGURE 5-1 OPERATION MODE – ALL	28
FIGURE 5-2 OPERATION MODE – AP.....	29
FIGURE 5-3 OPERATION MODE – CLIENT BRIDGE.....	30
FIGURE 5-4 OPERATION MODE – WDS AP	31
FIGURE 5-5 OPERATION MODE – WDS STATION.....	32
FIGURE 5-6 OPERATION MODE – WDS BRIDGE.....	33
FIGURE 5-7 OPERATION MODE – CLIENT ROUTER (WISP).....	39
FIGURE 5-8 OPERATION MODE – REPEATER	45
FIGURE 5-9 SYSTEM MENU - RESET	49
FIGURE 5-10 SYSTEM MENU – LANGUAGE OPTION	49
FIGURE 5-11 MAIN STATUS.....	50
FIGURE 5-12 SAVE/RELOAD	51
FIGURE 5-13 SAVE/RELOAD - DEFAULT	52
FIGURE 5-14 WIRELESS CLIENT LIST	52
FIGURE 5-15 KICK THE CLIENT.....	52
FIGURE 5-16 WDS LINK STATUS	53
FIGURE 5-17 DHCP CLIENT LIST	53
FIGURE 5-18 CONNECTION STATUS	54
FIGURE 5-19 SYSTEM LOG	55
FIGURE 5-20 LAN IP SETTINGS.....	56
FIGURE 5-21 SPANNING TREE SETTINGS.....	57
FIGURE 5-22 DHCP SERVER SETTINGS	58
FIGURE 5-23 WAN SETTINGS – ALL.....	59
FIGURE 5-24 WAN SETTINGS – DHCP.....	61
FIGURE 5-25 WAN SETTINGS – STATIC IP	62

FIGURE 5-26 WAN SETTINGS – PPPOE.....	63
FIGURE 5-27 WAN SETTINGS – PPTP	64
FIGURE 5-28 VPN PASS THROUGH	65
FIGURE 5-29 PORT FORWARDING.....	66
FIGURE 5-30 PORT FORWARDING.....	67
FIGURE 5-31 DMZ	68
FIGURE 5-32 WIRELESS NETWORK – AP/WDS AP MODE	69
FIGURE 5-33 WIRELESS NETWORK – SSID PROFILE.....	69
FIGURE 5-34 WIRELESS NETWORK – CB/WDS STA/CR/REPEATER MODE	71
FIGURE 5-35 WDS LINK SETTINGS – WDS BRIDGE MODE	72
FIGURE 5-36 SECURITY SETTINGS – AP/WDS AP MODE	73
FIGURE 5-37 SECURITY SETTINGS – CB/WDS STA/CR/REPEATER MODE.....	73
FIGURE 5-38 SECURITY SETTINGS – WDS BRIDGE MODE.....	74
FIGURE 5-39 SECURITY SETTINGS – WEP	75
FIGURE 5-40 SECURITY SETTINGS – WPA-PSK.....	76
FIGURE 5-41 SECURITY SETTINGS – WPA2-PSK.....	77
FIGURE 5-42 SECURITY SETTINGS – WPA-PSK MIXED.....	77
FIGURE 5-43 SECURITY SETTINGS – WPA (WPA ENTERPRISE).....	78
FIGURE 5-44 SECURITY SETTINGS – WPA2 (WPA2 ENTERPRISE)	79
FIGURE 5-45 SECURITY SETTINGS – WPA MIXED (WPA MIXED ENTERPRISE).....	81
FIGURE 5-46 WIRELESS MAC FILTER	83
FIGURE 5-47 WIRELESS ADVANCED SETTINGS	84
FIGURE 5-48 ADMINISTRATION (PASSWORD SETTINGS).....	86
FIGURE 5-49 MANAGEMENT VLAN.....	86
FIGURE 5-50 SNMP SETTINGS	87
FIGURE 5-51 BACKUP/RESTORE SETTINGS.....	88
FIGURE 5-52 AUTO REBOOT SETTINGS.....	89
FIGURE 5-53 FIRMWARE UPGRADE.....	89
FIGURE 5-54 TIME SETTINGS.....	91
FIGURE 5-55 WI-FI SCHEDULE	92
FIGURE 5-56 CLI SETTINGS.....	93
FIGURE 5-57 LOG	93
FIGURE 5-58 DIAGNOSTICS.....	94
FIGURE 5-59 LOGOUT.....	95

Chapter 1. Product Introduction

1.1 Package Contents

Thank you for choosing PLANET WAP-200N/WBS-200N series. Before installing the AP/CPE, please verify the contents inside the package box.

WBS-200N / WAP-200N

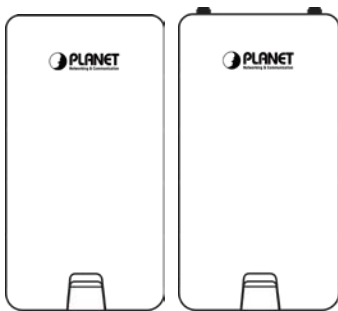

Quick Installation Guide

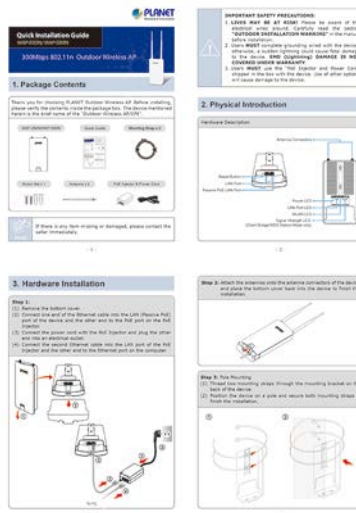

Mounting Strap x 2



Screw Set x 1

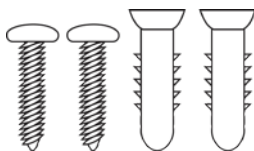

PoE Injector & Power Cord

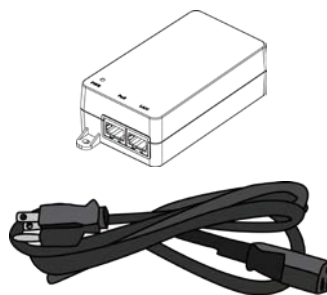

Antenna x 2 (WAP-200N only)



If there is any item missing or damaged, please contact the seller immediately.

1.2 Product Description

Cost-effective Wireless Solution with Superior Performance

PLANET WAP-200N/WBS-200N 300Mbps 802.11n Outdoor Wireless AP/CPE offers a better range and excellent throughput. Via the WAP-200N's RP-SMA antenna connectors and the WBS-200N's embedded 8dBi dual-polarity directional antenna, it is easy to build different point to multi-point applications with good diversity coverage and better noise immunity effect, thus heightening the performance and stability of a long-distance connectivity.



Designed for Various Requirements

The WAP-200N/WBS-200N is dedicatedly designed for WISP solution that provides CPE users with Internet access via the WISP provider in rural areas. Besides, it caters to various wireless communication connectivities (AP, Client, WDS, Repeater and WISP), thus meeting users' application requirements.



Multiple SSIDs with VLAN Tagging

Multiple SSIDs can broadcast up to four wireless networks with different names. For management purposes, the **IEEE 802.1Q VLAN** supported allows multiple VLAN tags to be mapped to multiple SSIDs to distinguish the wireless access. This makes it possible for the WAP-200N/WBS-200N to work with managed Ethernet switches to have VLANs assigned for a different access level and authority.

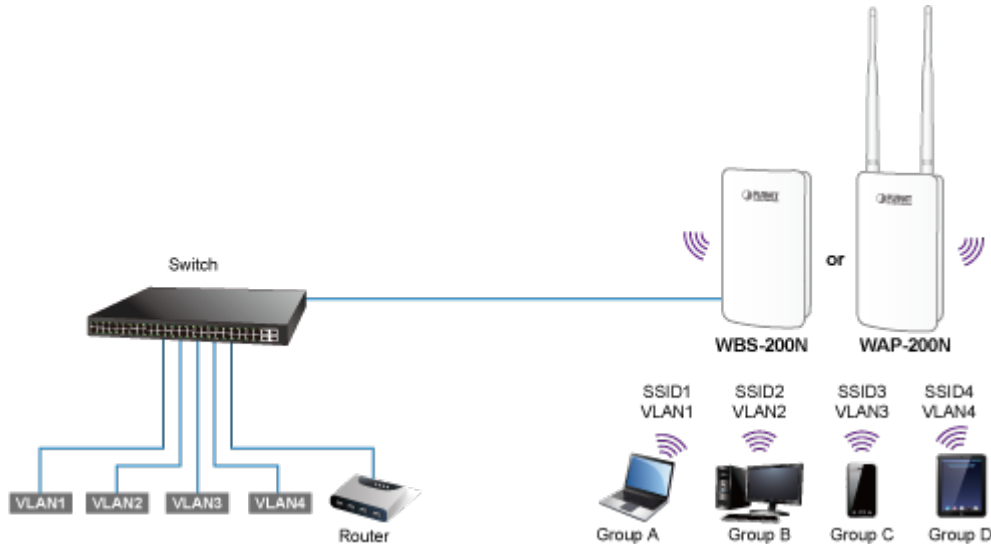

Flexible and Reliable Outdoor Characteristics

The WAP-200N/WBS-200N is definitely suitable for wireless IP surveillance to enable to have wide deployments between buildings and to act as the backbone of public service. Additionally, its self-healing capability keeps connection alive all the time. With the **IP55-rated** outdoor UV-resistant enclosure, the WAP-200N/WBS-200N can perform normally under rigorous weather conditions, meaning it can be installed in any harsh, outdoor environments. With the **proprietary Power over Ethernet (PoE)** design, the WAP-200N/WBS-200N can be easily installed in the areas where power outlets are not available.

Advanced Security and Rigorous Authentication

The WAP-200N/WBS-200N supports 152-bit WEP, WPA/WPA2, WPA-PSK and WPA2-PSK wireless encryptions, the advanced WPA2-AES mechanism and 802.1X RADIUS authentication, which can effectively prevent eavesdropping by unauthorized users or bandwidth occupied by unauthenticated wireless access. Furthermore, any users are granted or denied access to the wireless LAN network based on the ACL (Access Control List) that the administrator pre-established.

Easy Deployment and Management

With user-friendly Web UI and comprehensive management features including client limit control and **wireless traffic shaping**, the WAP-200N/WBS-200N is easy to limit the client access and inbound/outbound bandwidth control, even for users who have no experience in setting up a wireless network. Furthermore, with the **Planet Smart Discovery** Utility, **SNMP** and diagnostics tools, the WAP-200N/WBS-200N is convenient to be managed remotely.

1.3 Product Features

- **Industrial Compliant Wireless LAN**
 - Compliant with the IEEE 802.11b/g/n wireless technology
 - 2T2R architecture with data rate of up to 300Mbps
 - Equipped with two 10/100Mbps RJ45 ports, with auto MDI/MDI-X supported
- **Fixed Network Broadband Router**
 - Supported WAN connection types in WISP mode: DHCP, Static IP, PPPoE, PPTP
 - Supports Port Forwarding and DMZ for various networking applications
 - Supports DHCP server in WISP mode
- **RF Interface Characteristics**
 - Built-in 5dBi detachable antennas with RP-SMA connectors (WAP-200N)
 - Built-in 8dBi dual-polarization antenna (WBS-200N)
 - High output power with multiply-adjustable transmit power control
- **Outdoor Environmental Characteristics**
 - IP55 rating
 - Passive Power over Ethernet design
 - Operating temperature: -20~70°C
- **Multiple Operation Modes and Wireless Features**
 - Multiple operation modes: AP, Client Bridge, Client Router (WISP), WDS, Repeater
 - WMM (Wi-Fi multimedia) provides higher priority to multimedia transmitting over wireless
 - Wireless Traffic Shaping to control the upload/download bandwidth
 - Wi-Fi scheduler allows to be enabled or disabled based on predefined schedule
- **Secure Network Connection**
 - Full encryption supported: 64-/128-/152-bit WEP, WPA/WPA2, WPA-PSK/WPA2-PSK and 802.1X RADIUS authentication
 - Supports 802.1Q VLAN pass-through over WDS and SSID-to-VLAN mapping
 - Supports up to 50 entries of MAC address filtering
- **Easy Installation and Management**
 - IPv4/IPv6 dual-stack management networks
 - Multilingual Web User Interface: English, Spanish, French, German, Portuguese, Russian, and Simplified Chinese
 - CLI command and SNMP-based management interface
 - Self-healing mechanism through system auto reboot setting
 - System status monitoring through remote Syslog Server and Device Discovery
 - Diagnostic tools include Ping, Traceroute, Speed
 - Planet Smart Discovery Utility allows administrator to discover and locate each AP

1.4 Product Specifications

Product	WAP-200N	WBS-200N
		2.4GHz 300Mbps 802.11n Outdoor Wireless AP/CPE
Hardware Features		
Standard Support	IEEE802.11b/g/n IEEE 802.3 IEEE 802.3u IEEE 802.3x	
Memory	64 Mbytes DDR SDRAM 16 Mbytes Flash	
PoE	Passive PoE	
Interface	Wireless IEEE 802.11b/g/n, 2T2R PoE LAN (LAN 1): 1 x 10/100BASE-TX, auto-MDI/MDIX, 24V passive PoE In LAN 2: 1 x 10/100BASE-TX, auto-MDI/MDIX	
Button	Reset button	
LED	PWR, LAN, WLAN, Signal Strength	
Dimensions (W x D x H)	100 x 29 x 186mm (without antennas) 100 x 29 x 380mm (with antennas)	100 x 29 x 186mm
Weight	300g (without antennas) 332g (with antennas)	300g
Power Consumption	Maximum 7.2W	
Power Requirements	LAN1 <ul style="list-style-type: none"> ■ 24V DC, 0.6A (Passive PoE) ■ Pin 4, 5 V DC+ ■ Pin 7, 8 V DC- 	
Mounting Type	Mast, wall mount	
Wireless Interface Specifications		
Antenna	Built-in 5dBi detachable omnidirectional antennas with RP-SMA connectors HPBW Horizontal: 360 degrees HPBW Vertical: 30 degrees	Built-in 8dBi directional antenna with dual polarization [Port1] HPBW Horizontal: 78 degrees HPBW Vertical: 45 degrees [Port2] HPBW Horizontal: 54 degrees HPBW Vertical: 59 degrees
Data Rate	IEEE 802.11b: 1, 2, 5.5, 11Mbps IEEE 802.11g: up to 54Mbps IEEE 802.11n (20MHz): up to 150Mbps IEEE 802.11n (40MHz): up to 300Mbps	

Media Access Control	CSMA/CA
Modulation	Transmission/Emission type: OFDM Data Modulation type: OFDM with BPSK, QPSK, 16-QAM, 64-QAM
Frequency Band	2.412GHz ~ 2.472GHz
Operating Channel	United States -- FCC: 2.414~2.462GHz (11 channels) Europe -- ETSI: 2.412~2.472GHz (13 channels)
RF Output Power (dBm)	FCC: IEEE 802.11b/g/n: up to 26 ± 2dBm ETSI: IEEE 802.11b/g/n: < 20dBm (EIRP)
Receiver Sensitivity (dBm)	<p>IEEE 802.11b: -95/ -93dBm (1~2/ 5.5~11Mbps)</p> <p>IEEE 802.11g: -95/ -93/ -92/ -80/ -77/ -75dBm (6/ 9~18/ 24/ 36/ 48/ 54Mbps)</p> <p>IEEE 802.11n: MCS0/ MCS8: -95dBm MCS1/ MCS9: -93dBm MCS2/ MCS10: -92dBm MCS3/ MCS11: -90dBm MCS4/ MCS12: -86dBm MCS5/ MCS13: -83dBm MCS6/ MCS14: -76dBm MCS7/ MCS15: -73dBm</p>
Environment & Certification	
Operating Temperature	-20~70 degrees C
Operating Humidity	10~90% (non-condensing)
IP Level	IP55
Regulatory	CE, FCC, RoHS
Software Features	
LAN	<ul style="list-style-type: none"> ■ Static IP ■ Dynamic IP ■ DHCP server in WISP mode
	Supports 802.1d STP (Spanning Tree)
WAN Connection Type (WISP Mode only)	<ul style="list-style-type: none"> ■ Static IP ■ Dynamic IP ■ PPPoE ■ PPTP
Wireless Modes	<ul style="list-style-type: none"> ■ Access Point ■ Client Bridge ■ WDS (AP/Bridge/Station) ■ Client Router (WISP)/Client AP Router (WISP+AP) ■ Repeater

Firewall	Offers DoS protection to guard user's content network against DoS attacks
	Built-in DMZ and Port Forwarding
	VPN Pass-through: <ul style="list-style-type: none"> ■ PPTP Pass-through ■ L2TP Pass-through ■ IPSec Pass-through
Channel Width	20MHz/40MHz
Encryption Type	64-/128-/152-bit WEP, WPA, WPA-PSK, WPA2, WPA2-PSK, 802.1X
Wireless Security	Enable/Disable SSID Broadcast
	Wireless MAC address filtering up to 50 entries
	VAP Separation, Station Separation
Max. Wireless Clients	Max. 64 (Suggested 32, depending on usage)
Max. SSIDs	Up to 4
Max. WDS Peers	Up to 4
Wireless QoS	Supports Wi-Fi Multimedia (WMM)
	Supports Wireless Traffic Shaping per Radio
Wireless Advanced Control	Auto Channel Selection
	Auto Transmit Power by Regular Domains
	Client Limit Control
	Distance Control (Auto Ack Timeout)
	Wi-Fi Schedule
Status Monitoring	Connection Status
	Device Discovery, PLANET Smart Discovery
	Wireless Client List/WDS Link List
	DHCP Client Table
	System Log supports remote syslog server
	Signal Strength LEDs in Client Bridge and WDS Station modes
VLAN	VLAN pass-through over WDS
	SSID-to-VLAN mapping
	Management VLAN (VID: 1~4094)
Self-healing	Supports auto reboot settings
NTP	Network Time Management
Management	Web-based UI, CLI (Command Line Interface) supported
	Configuration backup and restore
	SNMP v1/v2c/v3 support, MIB I/II, Private MIB
Diagnostic Tools	Built-in Ping, Trace Route, Speed Test Tools

Chapter 2. Hardware Installation

2.1 Hardware Description

- Dimensions (W x D x H): 100 x 29 x 186mm (without antennas)/100 x 29 x 380mm (with 5dBi antennas)



Figure 2-1 Three-way View (WAP-200N)



Figure 2-2 Three-way View (WBS-200N)

Rear Panel – LED

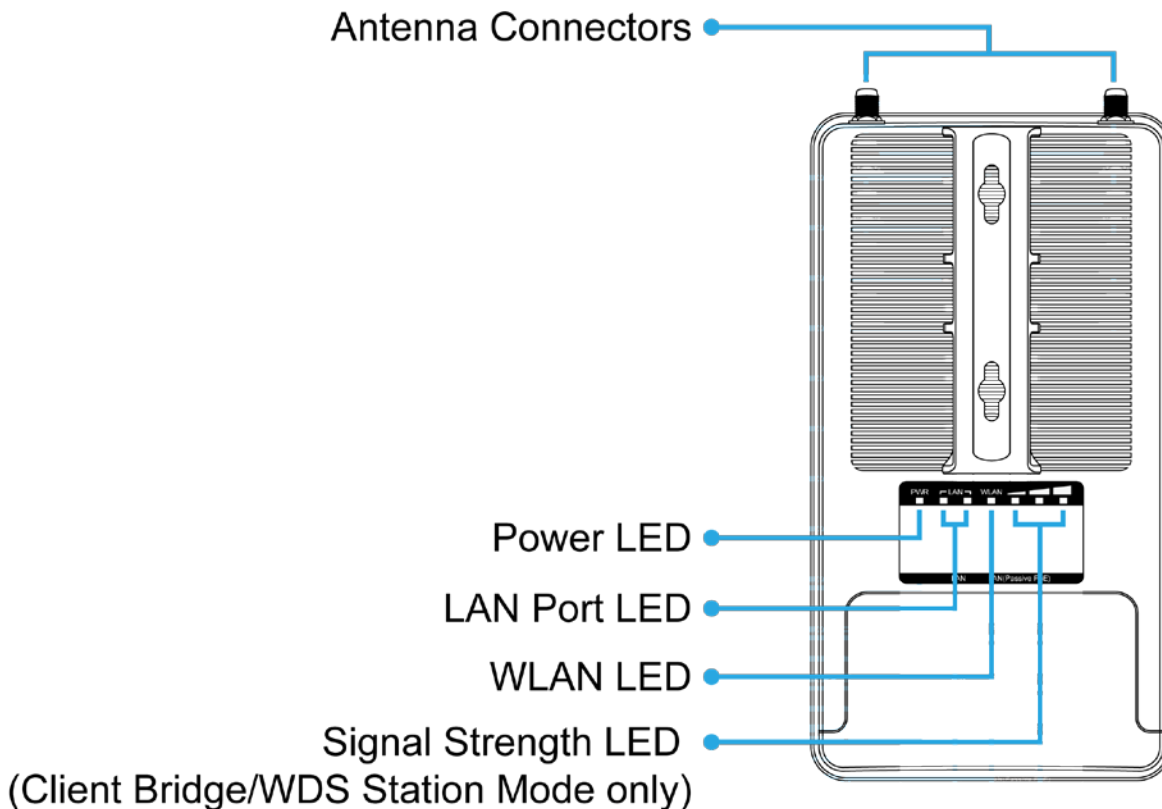

Figure 2-3 Rear Panel (WAP-200N)

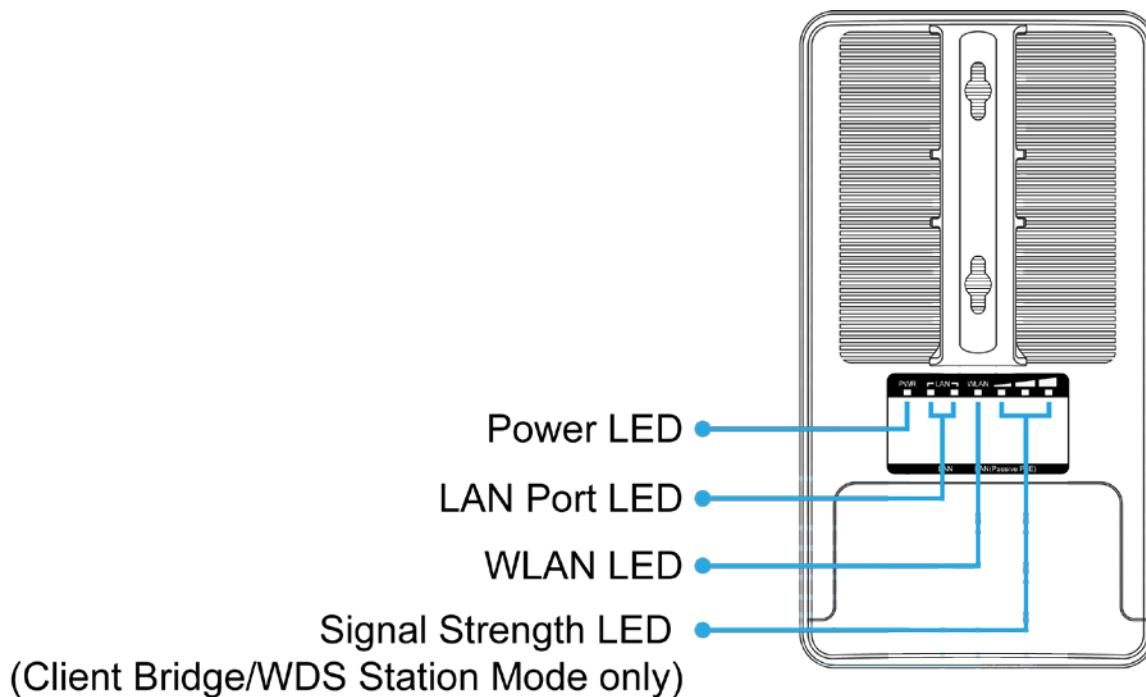

Figure 2-4 Rear Panel (WBS-200N)

LED Definition

LED	State	Meaning
Power	On	The device is powered on
	Off	The device is powered off
LAN Ports	On	Port linked
	Blinking	Data is transmitting or receiving data
	Off	No link
WLAN	On	The wireless radio is on
	Blinking	Data is transmitting or receiving over wireless
	Off	The wireless radio is off
Signal Strength (Client Bridge/WDS Station/Client Router mode only)	Green LED on	Signal is good
	Orange LED on	Signal is normal
	Red LED on	Signal is poor

Table 2-1 The LED indication

2.1.1 The Bottom Panel

The Bottom panel provides the physical connectors connected to the power adapter and any other network device. [Figure 2-5](#) shows the bottom panel of the WAP-200N/WBS-200N.

Bottom Panel

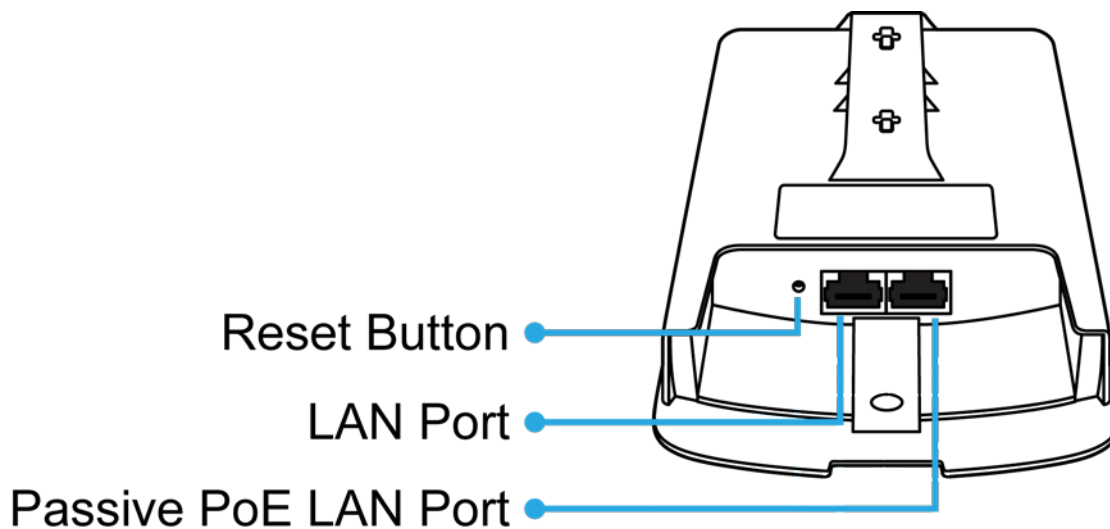

Figure 2-5 Bottom Panel (WAP-200N/WBS-200N)

PoE Warning Label

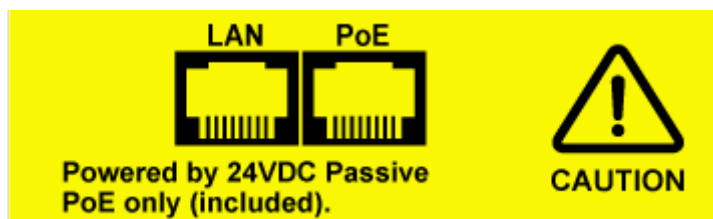

Figure 2-6 PoE Warning Label

Hardware Interface Definition

Object	Description
Antenna Connectors (WAP-200N only)	2 RP-SMA (Female) antenna connectors
Passive PoE LAN Port	10/100Mbps RJ45 port, auto MDI/MDI-X Passive PoE/PD supported, 24V DC In Pin assignment: Pins 4, 5 (+) Pins 7, 8 (-) NOTE: Please use the 24V DC Passive PoE only (included)
LAN Port	10/100Mbps RJ45 port, auto MDI/MDI-X
Reset Button	Press and hold the Reset button on the device for over 10 seconds to return to the factory default setting.

Table 2-2 Hardware Interface Definition

Chapter 3. Connecting to the AP

3.1 Preparation before Installation

3.1.1 Professional Installation Required

Please seek assistance from a professional installer who is well trained in the RF installation and knowledgeable in the local regulations.

3.1.2 Safety Precautions

1. To keep you safe and install the hardware properly, please read and follow these safety precautions.
2. If you are installing the WBS-200N or WAP-200N for the first time, for your safety as well as others', please seek assistance from a professional installer who has received safety training on the hazards involved.
3. Keep safety as well as performance in mind when selecting your installation site, especially where there are electric power and phone lines.
4. When installing the WBS-200N or WAP-200N, please note the following things:
 - ◆ Do not use a metal ladder;
 - ◆ Do not work on a wet or windy day;
 - ◆ Wear shoes with rubber soles and heels, rubber gloves, long sleeved shirt or jacket.
5. When the system is operational, avoid standing directly in front of it. Strong RF fields are present when the transmitter is on.

3.2 Installation Precautions

- Users **MUST** use a proper and well-installed surge arrestor and grounding kit with WBS-200N or WAP-200N; otherwise, a random lightning could easily cause fatal damage to the WBS-200N or WAP-200N. **EMD (Lightning) DAMAGE IS NOT COVERED UNDER WARRANTY.**
- Users **MUST** use the "Power Cord and PoE Injector" shipped in the box with the WBS-200N or WAP-200N. Use of other options will cause damage to the WBS-200N or WAP-200N.



OUTDOOR INSTALLATION WARNING

IMPORTANT SAFETY PRECAUTIONS:

LIVES MAY BE AT RISK! Carefully observe these instructions and any special instructions that are included with the equipment you are installing.

CONTACTING POWER LINES CAN BE LETHAL. Make sure no power lines are anywhere where possible contact can be made. Antennas, masts, towers, guy wires or cables may lean or fall and contact these lines. People may be injured or killed if they are touching or holding any part of equipment when it contacts electric lines. Make sure that equipment or personnel do not come in contact directly or indirectly with power lines.

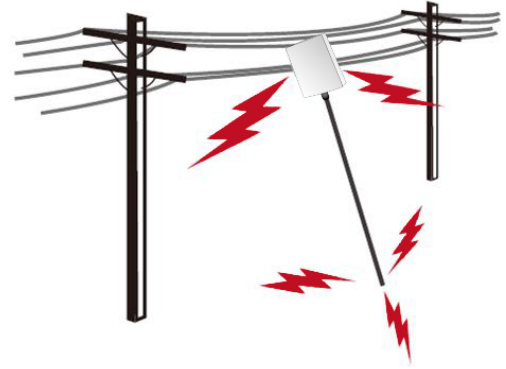

The horizontal distance from a tower, mast or antenna to the nearest power line should be at least twice the total length of the mast/antenna combination. This will ensure that the mast will not contact power if it falls either during installation or later.

TO AVOID FALLING, USE SAFE PROCEDURES WHEN WORKING AT HEIGHTS ABOVE GROUND.

- Select equipment locations that will allow safe, simple equipment installation.
- Don't work alone. A friend or co-worker can save your life if an accident happens.
- Use approved non-conducting ladders and other safety equipment. Make sure all equipment is in good repair.
- If a tower or mast begins falling, don't attempt to catch it. Stand back and let it fall.
- If anything such as a wire or mast does come in contact with a power line, **DON'T TOUCH IT OR ATTEMPT TO MOVE IT.** Instead, save your life by calling the power company.
- Don't attempt to erect antennas or towers on windy days.

MAKE SURE ALL TOWERS AND MASTS ARE SECURELY GROUNDED, AND ELECTRICAL CABLES CONNECTED TO ANTENNAS HAVE LIGHTNING ARRESTORS. This will help prevent fire damage or human injury in case of lightning, static build-up, or short circuit within equipment connected to the antenna.

- The base of the antenna mast or tower must be connected directly to the building protective ground or to one or more approved grounding rods, using 1 OAWG ground wire and corrosion-resistant connectors.
- Refer to the National Electrical Code for grounding details.

IF A PERSON COMES IN CONTACT WITH ELECTRICAL POWER, AND CANNOT MOVE:

- **DON'T TOUCH THAT PERSON, OR YOU MAY BE ELECTROCUTED.**
- Use a non-conductive dry board, stick or rope to push or drag them so they no longer are in contact with electrical power.

Once they are no longer contacting electrical power, administer CPR if you are certified, and make sure that emergency medical aid has been requested.

3.3 Installing the AP

Please install the AP according to the following steps. Don't forget to pull out the power plug and keep your hands dry.

Step 1. PoE and LAN port connection:

- (1) Remove the bottom cover.
- (2) Connect one end of the Ethernet cable into the LAN (Passive PoE) port of the device and the other end to the PoE port on the PoE Injector.
- (3) Connect the power cord with the PoE Injector and plug the other end into an electrical outlet.
- (4) Connect the second Ethernet cable into the LAN port of the PoE Injector and the other end to the Ethernet port on the computer.

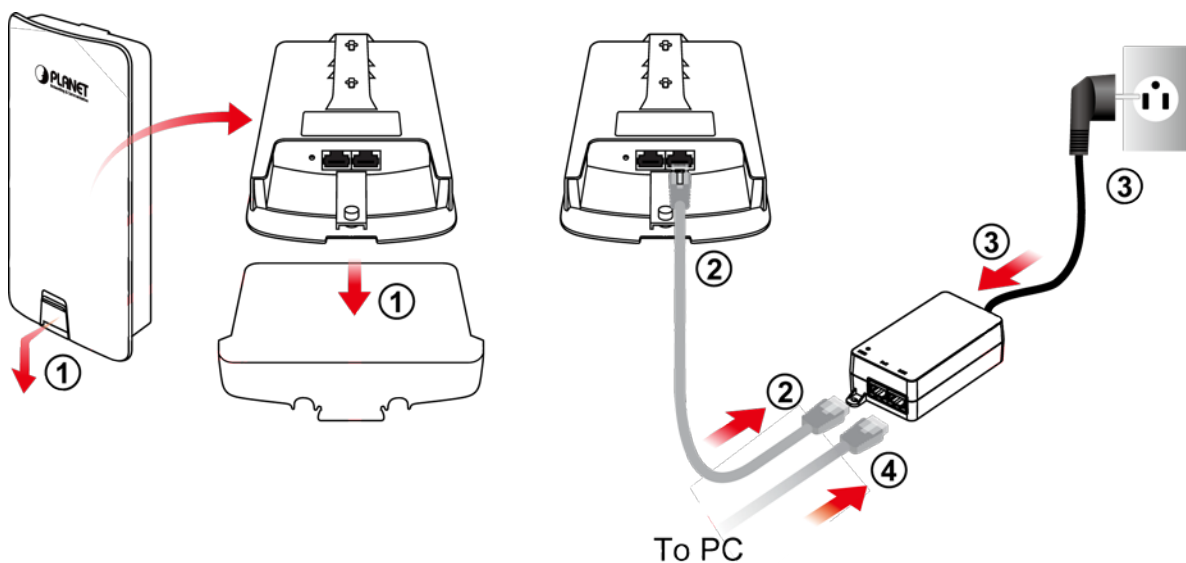

Figure 3-1 PoE and LAN port connection

Step 2. Attach the antennas onto the antenna connectors of the device and place the bottom cover back into the device to finish the installation.

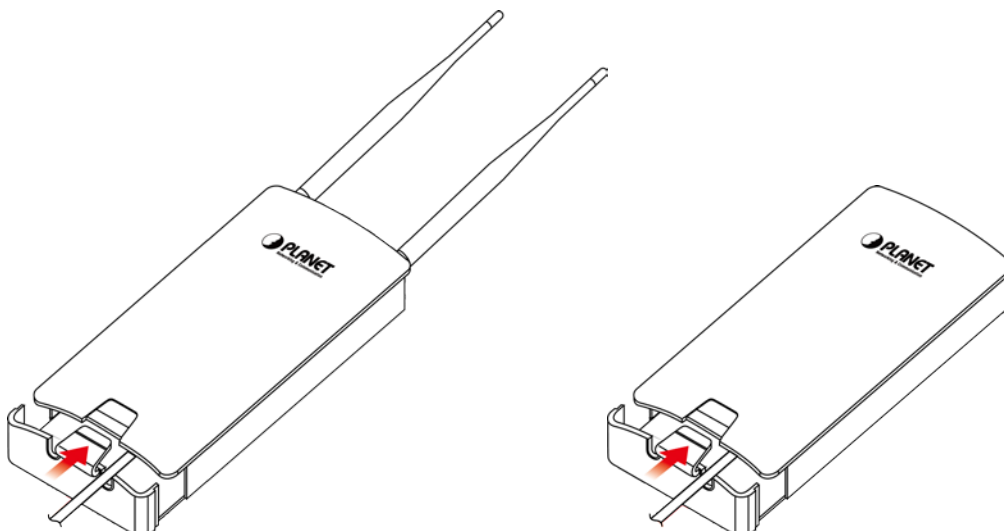

Figure 3-2 Finish installation and connect to antennas (WAP-200N only)

Step 3. Pole Mounting:

- (1) Thread two mounting straps through the mounting bracket on the back of the device.
- (2) Position the device on a pole and secure both mounting straps to finish the installation.

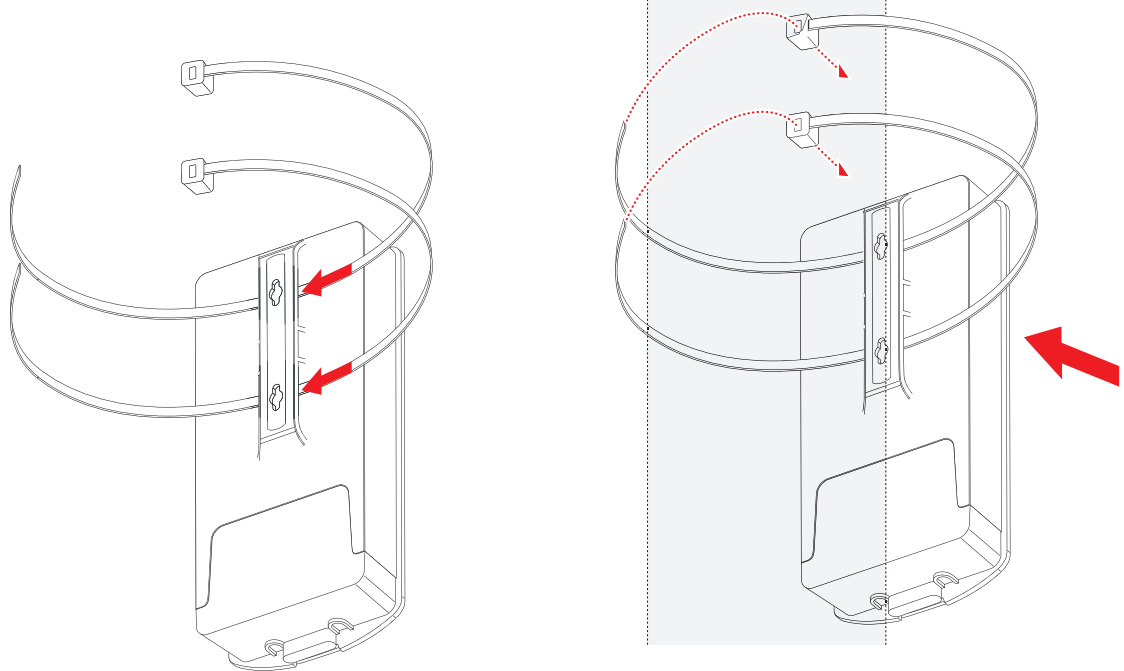

Figure 3-3 Pole Mounting

Step 4. Wall Mounting:

- (1) Secure the adhesive label to a position on the wall where you would like to install the device.
- (2) Follow the plotting sticker to drill two holes and secure the plastic anchors.
- (3) Align the screw holes on the mounting bracket with the screws and then install the device on the wall to finish the installation.

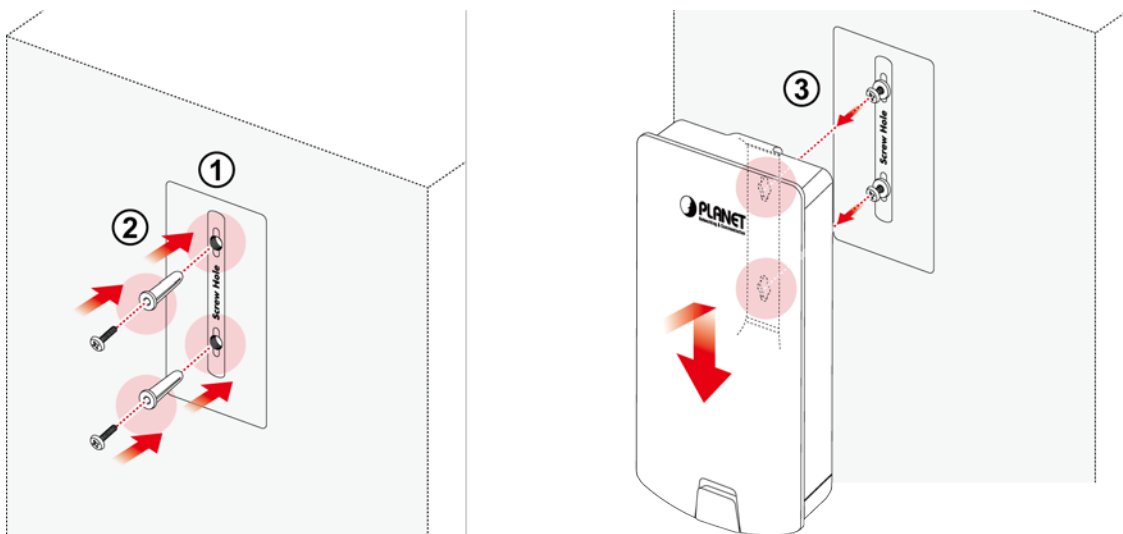

Figure 3-4 Wall Mounting

Chapter 4. Quick Installation Guide

This chapter will show you how to configure the basic functions of your AP within minutes.



A computer with wired Ethernet connection to the Wireless AP is required for the first-time configuration.

4.1 Manual Network Setup -- TCP/IP Configuration

The default IP address of the WBS-200N and WAP-200N is **192.168.1.253**. And the default Subnet Mask is 255.255.255.0. These values can be changed as you desire. In this guide, we use all the default values for description.

Connect the WBS-200N or WAP-200N with your PC via an Ethernet cable which is then plugged into a LAN port of the PoE injector with one end and into a LAN port of the PC with the other end. Then power on the WBS-200N and WAP-200N via PoE injector or PoE switch.

In the following sections, we'll introduce how to install and configure the TCP/IP correctly in **Windows 7**. And the procedures in other operating systems are similar. First, make sure your Ethernet adapter is working, and refer to the Ethernet adapter's manual if needed.

4.1.1 Configuring the IP Address Manually

Summary:

- Set up the TCP/IP Protocol for your PC.
- Configure the network parameters. The IP address is 192.168.1.xxx ("xxx" is any number from 2 to 252), Subnet Mask is 255.255.255.0.

- 1 Select **Use the following IP address** radio button.
- 2 If the AP's LAN IP address is 192.168.1.253, enter IP address 192.168.1.x (x is from 2 to 254 except 192.168.1.253), and **Subnet mask** is 255.255.255.0.
- 3 Select **Use the following DNS server addresses** radio button. In the **Preferred DNS Server** field, you can enter the DNS server IP address which has been provided by your ISP

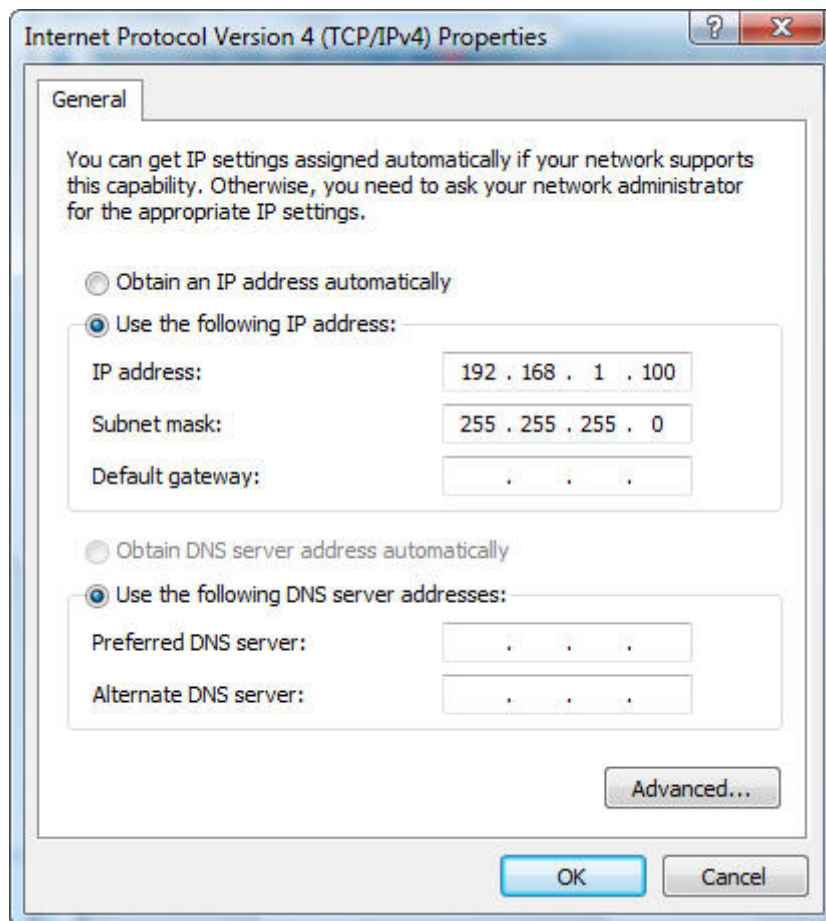

Figure 4-1 TCP/IP Setting

Now click **OK** to save your settings.

Now, you can run the ping command in the **command prompt** to verify the network connection between your PC and the AP. The following example is in **Windows 7 OS**. Please follow the Steps below:

1. Click on **Start > Run**.
2. Type "**cmd**" in the Search box.

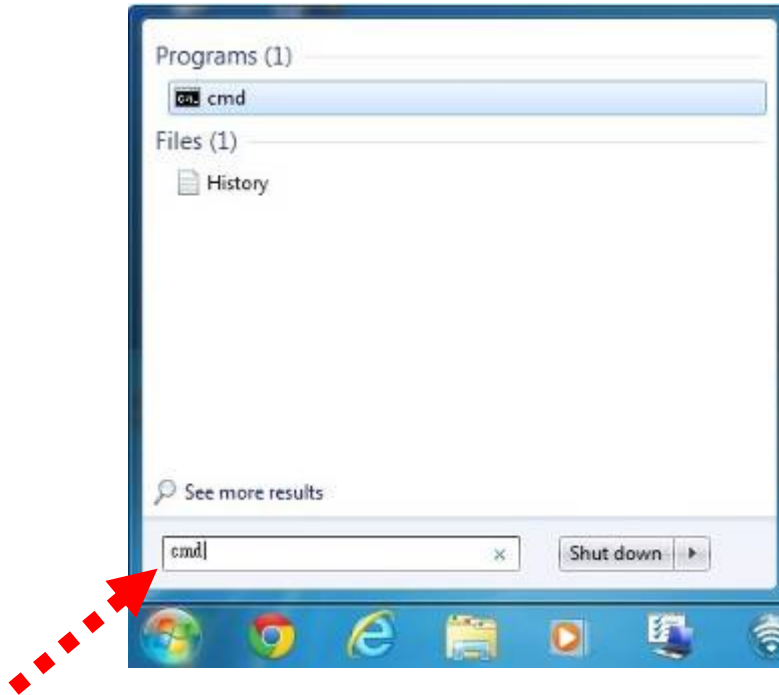

Figure 4-2 Windows Start Menu

3. Open a command prompt and type **ping 192.168.1.253**, and then press **Enter**.

If the result displayed is similar to [Figure 4-3](#), it means the connection between your PC and the AP has been established well.

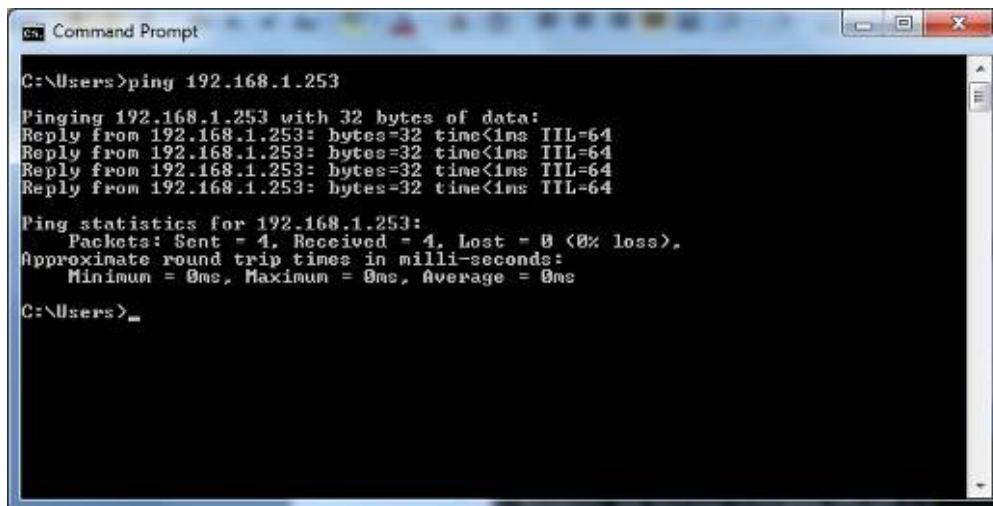

Figure 4-3 Successful result of Ping command

If the result displayed is similar to [Figure 4-4](#), it means the connection between your PC and the AP has failed.

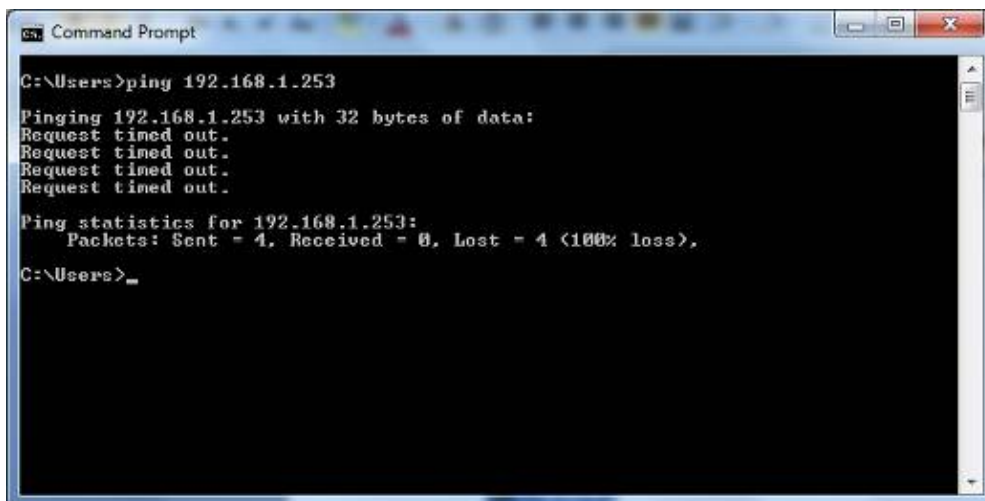

Figure 4-4 Failed result of Ping command

If the address is 0.0.0.0, check your adapter installation, security settings, and the settings on your AP. Some firewall software programs may block a DHCP request on newly installed adapters.

4.2 Starting Setup in the Web UI

It is easy to configure and manage the WBS-200N or WAP-200N with the web browser.

Step 1. To access the configuration page, open a web browser and enter the default IP address <http://192.168.1.253> in the web address field of the browser.

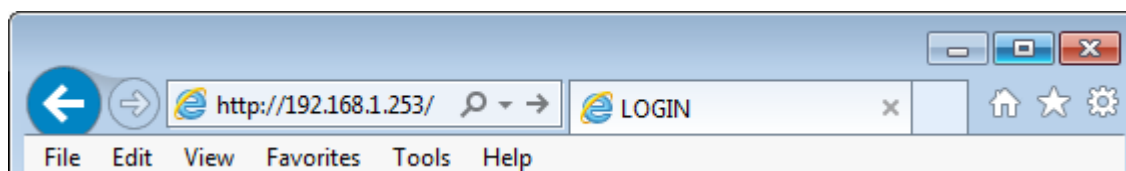

Figure 4-5 Login by default IP address

After a moment, a login window will appear. Enter **admin** for the User Name and Password, both in lower case letters. Then click the **OK** button or press the **Enter** key.

A screenshot of the Planet Networking & Communication login window. The window has a blue border and contains the Planet logo at the top. Below the logo, there are two input fields: "Username:" and "Password:". At the bottom, there are two buttons: "Login" and "Reset".

```
PLANET
Networking & Communication

Username: 
Password: 

Login Reset
```

Figure 4-6 Login Window

Default IP Address: **192.168.1.253**

Default User Name: **admin**

Default Password: **admin**



If the above screen does not pop up, it may mean that your web browser has been set to a proxy. Go to **Tools menu > Internet Options > Connections > LAN Settings** in the screen that appears, cancel the Using Proxy checkbox, and click OK to finish it.

After you enter into the Web User Interface, click **Operation Mode** at the left hand side of the screen to configure the wireless connection. Once the basic configuration of the device is done, go to the **Save/Reload** page to save and apply the changes.

Figure 4-7 Web UI Screenshot

You can choose an Operation Mode according to your application. Please refer to the instructions in the next chapter for configuring different Operation Modes.

Chapter 5. Configuring the AP

This chapter instructs you how to quickly configure the AP/CPE in different operation modes.

5.1 Operation Mode

On this page, you can select different operation modes of the AP depending on your application, including:

Operation Modes	Description
■ Access Point	Access Point mode is used to provide wireless connectivity to wireless clients. This mode is compatible with general wireless clients.
■ Client Bridge	Client Bridge mode allows the Access Point to become a wireless client to associate to another AP thus enabling the wireless capability of wired clients.
■ WDS Access Point	In WDS Access Point mode, the device functions as a WDS bridge with Access Point Mode. For WDS Access Point, it can be connected by same series of devices which using the WDS station mode. In this mode, the setting is same as Access Point Mode.
■ WDS Bridge	<p>In WDS Bridge mode, the device can bridge with remote LAN networks through MAC address. This application can create two individual networks for two groups of users sharing one Internet. The advantage of WDS is the Layer 2 transparent bridging and broadcasting across wireless connections so that all connected network devices form one common broadcast domain.</p> <p>NOTE: The WDS mode is a non-standard extension to the IEEE 802.11 standard, which implemented differently in wireless driver and firmware making them incompatible with each other. In order to use WDS, the same model of devices should be used.</p>
■ WDS Station	In WDS Station mode, the device functions as a wireless client which can bridge the remote WDS Access Point with SSID. In this mode, the setting is same as Client Bridge mode.
■ Client Router	<p>With Client Router (Wireless ISP) mode, the device can connect to a wireless network and share the Internet connection to the WISP subscribers.</p> <p>On the LAN side, the device acts like a wired router for IP sharing function. In this mode, the wireless interface acts as WAN side.</p>
■ Repeater	Repeater mode is used to extend the wireless coverage with same SSID and security.

Go to “**System → Operation Mode**” page to configure the device in the operation mode which is suitable for your application. Then go to “**Wireless → Wireless Network**” to configure the related wireless settings of each mode.

System Properties

Home
Reset

System Properties

Device Name	PLANET	(1 to 32 characters)	<input checked="" type="checkbox"/> Green
Country/Region	Please Select a Country Code ▾		
Operation Mode	<input type="radio"/> Access Point <input type="radio"/> Client Bridge <input checked="" type="radio"/> WDS <input checked="" type="radio"/> Access Point <input type="radio"/> Bridge <input type="radio"/> Station <input type="radio"/> Client Router <input type="radio"/> Repeater		

Save & Apply
Cancel

Figure 5-1 Operation Mode – All

The page includes the following settings:

Object	Description
• Device Name	Enter a name for the device (1-32 characters). The name you type appears in SNMP management. This name is not the SSID and is not broadcast to other devices.
• Green	Disable the green option to enable transmit power to be configured manually. Keep it as default setting to prevent violating regional regulation unless your configuration meets the regulation.
• Country/Region	Select a Country/Region to conform to local regulations.
• Operation Mode	Use the radio button to select an operation mode.
• Save & Apply	Click Save & Apply to save changes.
• Cancel	Click Cancel to cancel the unsaved changes and revert to the previous settings.

5.1.1 Access Point (AP)

This section allows you to configure the AP Bridge mode to provide wireless connectivity for wireless clients.

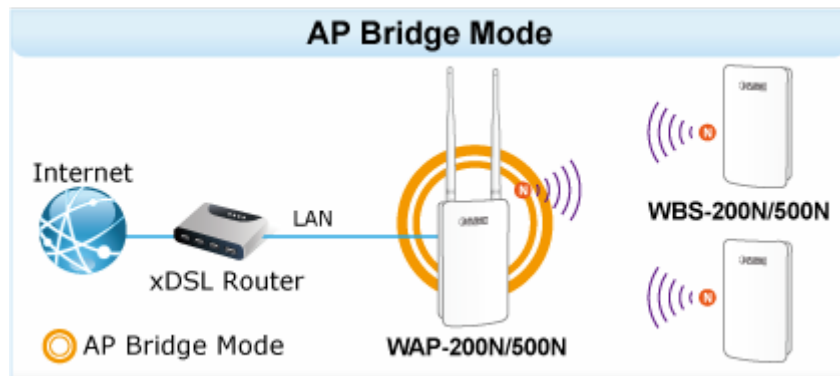

Go to the “**System → Operation Mode**” page to configure the device as “**Access Point**” and then go to “**Wireless → Wireless Network**” to configure the related wireless settings.

System Properties		Home	Reset
System Properties			
Device Name	<input type="text" value="PLANET"/> (1 to 32 characters)	<input checked="" type="checkbox"/> Green	
Country/Region	<input type="text" value="Please Select a Country Code"/>		
Operation Mode	<input checked="" type="radio"/> Access Point <input type="radio"/> Client Bridge <input type="radio"/> WDS <input type="radio"/> Client Router <input type="radio"/> Repeater		
<input type="button" value="Save & Apply"/>		<input type="button" value="Cancel"/>	

Figure 5-2 Operation Mode – AP

For the configuration example, please refer to the section “[Appendix C: FAQ, Q1](#)”.

5.1.2 Client Bridge (CB)

This section allows you to configure the Client Bridge mode. In this mode, the device enables the wired client to be connected to the central site through wireless interface.

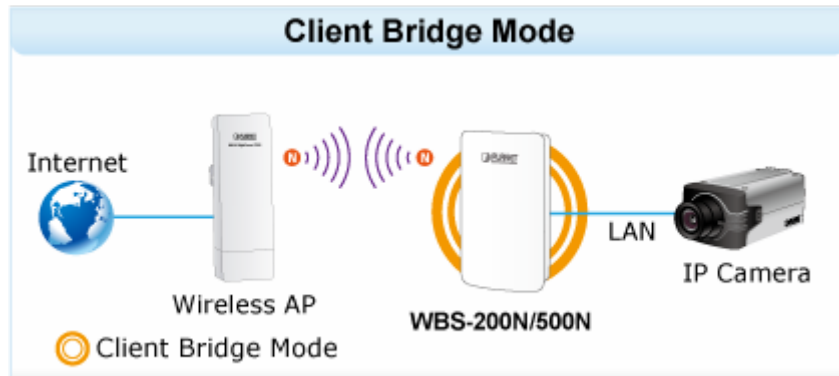

Go to the “**System → Operation Mode**” page to configure the device as “**Client Bridge**” and then go to “**Wireless → Wireless Network**” to configure the related wireless settings.

System Properties		Home	Reset
System Properties			
Device Name	PLANET (1 to 32 characters)	<input checked="" type="checkbox"/>	Green
Country/Region	Please Select a Country Code		
Operation Mode	<input type="radio"/> Access Point <input checked="" type="radio"/> Client Bridge <input type="radio"/> WDS <input type="radio"/> Client Router <input type="radio"/> Repeater		
Save & Apply		Cancel	

Figure 5-3 Operation Mode – Client Bridge

For the configuration example, please refer to the section “[Appendix C: FAQ, Q1](#)”.

5.1.3 WDS Access Point (WDS AP)

This section allows you to configure the WDS AP mode. In this mode, the device is acting as master AP in the WDS connection.

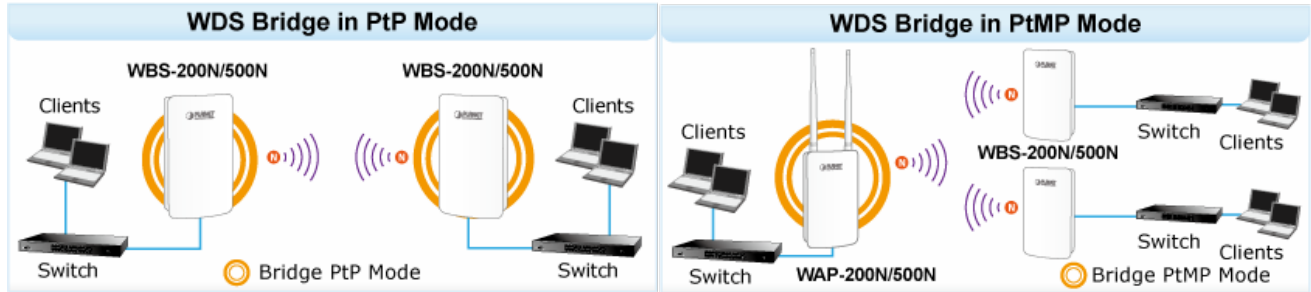

Go to the “**System → Operation Mode**” page to configure the device as “**WDS Access Point**” and then go to “**Wireless → Wireless Network**” to configure the related wireless settings.

System Properties

Home
Reset

System Properties

Device Name	PLANET	(1 to 32 characters)	<input checked="" type="checkbox"/> Green
Country/Region	Please Select a Country Code ▾		
Operation Mode	<input type="radio"/> Access Point <input type="radio"/> Client Bridge <input checked="" type="radio"/> WDS <input checked="" type="radio"/> Access Point <input type="radio"/> Bridge <input type="radio"/> Station <input type="radio"/> Client Router <input type="radio"/> Repeater		

Save & Apply
Cancel

Figure 5-4 Operation Mode – WDS AP

For the configuration example, please refer to the section “[Appendix C: FAQ, Q2](#)”.

5.1.4 WDS Station (WDS STA)

This section allows you to configure the WDS Station mode. In this mode, the device is acting as slave AP in the WDS connection.

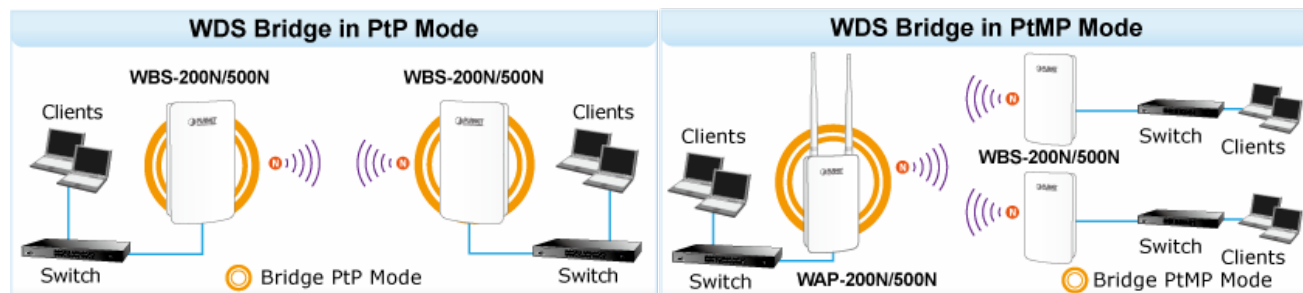

Go to the “**System → Operation Mode**” page to configure the device as “**WDS Station**” and then go to “**Wireless → Wireless Network**” to configure the related wireless settings.

System Properties		Home	Reset
System Properties			
Device Name	PLANET (1 to 32 characters)	<input checked="" type="checkbox"/>	Green
Country/Region	Please Select a Country Code ▾		
Operation Mode	<input type="radio"/> Access Point <input type="radio"/> Client Bridge <input checked="" type="radio"/> WDS <input type="radio"/> Access Point <input type="radio"/> Bridge <input checked="" type="radio"/> Station <input type="radio"/> Client Router <input type="radio"/> Repeater		
Save & Apply		Cancel	

Figure 5-5 Operation Mode – WDS Station

For the configuration example, please refer to the section “[Appendix C: FAQ, Q2](#)”.

5.1.5 WDS Bridge (WDS PtP/WDS PtMP)

This section allows you to configure the WDS Bridge mode. In this mode, the device is bridging to remote node through wireless MAC address. When suppressed **SSID broadcast** is checked, unknown wireless clients are not allowed to connect to the AP.

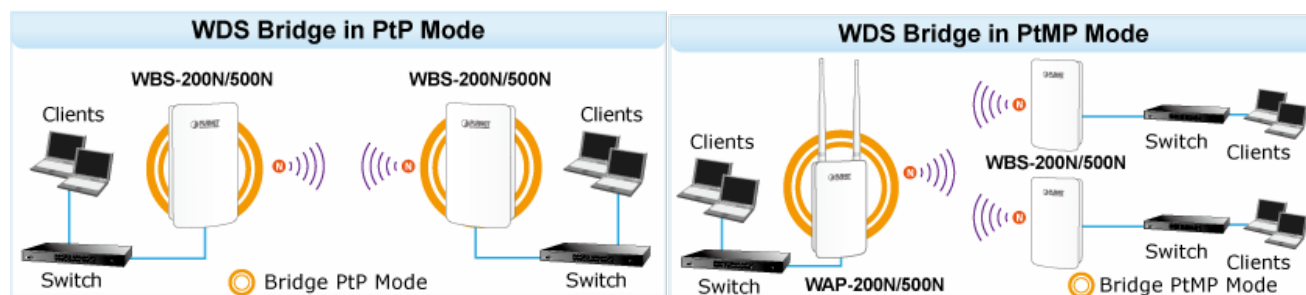

Go to the “**System → Operation Mode**” page to configure the device as “**WDS Bridge**” and then go to “**Wireless → WDS Link Settings**” to configure the WDS bridge mode in PtP (Point to Point) or PtMP (Point to Multiple Points) applications.

System Properties		Home	Reset
System Properties			
Device Name	PLANET (1 to 32 characters)	<input checked="" type="checkbox"/>	Green
Country/Region	Please Select a Country Code		
Operation Mode	<input type="radio"/> Access Point <input type="radio"/> Client Bridge <input checked="" type="radio"/> WDS <input type="radio"/> Access Point <input checked="" type="radio"/> Bridge <input type="radio"/> Station <input type="radio"/> Client Router <input type="radio"/> Repeater		
Save & Apply		Cancel	

Figure 5-6 Operation Mode – WDS Bridge

Configuration Example

The following procedure will guide you to how to establish WDS connection.

Step 1. Go to the “**Operation Mode**” page to configure the device as “**WDS Bridge**”.

System Properties		Home	Reset
System Properties			
Device Name	PLANET (1 to 32 characters)	<input checked="" type="checkbox"/>	Green
Country/Region	Please Select a Country Code ▾		
Operation Mode	<input type="radio"/> Access Point <input type="radio"/> Client Bridge <input checked="" type="radio"/> WDS <input type="radio"/> Access Point <input checked="" type="radio"/> Bridge <input type="radio"/> Station <input type="radio"/> Client Router <input type="radio"/> Repeater		
Save & Apply		Cancel	

Step 2. Go to the “**System → IP Settings**” page to configure LAN IP of central site and remote site. **The LAN IP must be different at both sites.** In this example, the master AP at the central site is configured to 192.168.1.252 and the slave AP at remote site is configured to 192.168.1.253.

IP Settings		Home	Reset
System Information			
IP Network Setting	<input type="radio"/> Obtain an IP address automatically (DHCP) <input checked="" type="radio"/> Specify an IP address		
IP Address	192 . 168 . 1 . 253		
IP Subnet Mask	255 . 255 . 255 . 0		
Default Gateway	192 . 168 . 1 . 253		
Primary DNS	0 . 0 . 0 . 0		
Secondary DNS	0 . 0 . 0 . 0		
Use Link-Local Address	<input checked="" type="checkbox"/>		
IPv6 IP Address			
IPv6 Subnet Prefix Length			
IPv6 Default Gateway			
IPv6 Primary DNS			
IPv6 Secondary DNS			
Accept		Cancel	

Step 3. Go to the “**Wireless → Wireless Network**” page to configure the wireless parameters of the WDS link. In this example, we set the channel to 6 and channel width to 40MHz.

- (1) Channel HT Mode: set to 40MHz for wider bandwidth to optimize performance
- (2) Channel/Frequency: set to a fixed channel. For the WDS link, the fixed channel must be used.

Wireless Network		Home	Reset
Wireless Mode	802.11 B/G/N Mixed ▾		
Channel HT Mode	40MHz ▾		
Extension Channel	Lower Channel ▾		
Channel / Frequency	Ch6-2.437GHz ▾		
<input type="button" value="Accept"/> <input type="button" value="Cancel"/>			

Step 4. Go to the “**Wireless → WDS Link Settings**” page to enter the wireless MAC of the remote node and add encryption to protect the WDS link. Click **Accept** to save the changes.

- (1) In PtMP of the master node: enter the wireless MAC of each remote slave node up to 4 entries.
- (2) In PtMP, the distance from each slave node must be configured to the actual distance from each slave node to the master node. As to the master node, it should be configured to the value of the farthest node. In PtMP application, the distance from each node to master node should not have too much deviation to ensure the connection stability.

WDS Link Settings

Home
Reset

Security	AES ▼
WEP Key	<input type="text"/> 40/64-bit(10 hex digits) ▼
AES Passphrase	12345678 (8-63 ASCII characters or 64 hexadecimal digits)

AES is strongly recommended

PtP application: enable ID1 and enter the wireless MAC of remote node

CAUTION: WDS was enabled, you need to assign Wifi Channel manually later.

ID	MAC Address	Mode
1	A8 : F7 : E0 : 58 : 1A : 94	Enable ▼
2	<input type="text"/> : <input type="text"/> : <input type="text"/> : <input type="text"/> : <input type="text"/> : <input type="text"/>	Disable ▼
3	<input type="text"/> : <input type="text"/> : <input type="text"/> : <input type="text"/> : <input type="text"/> : <input type="text"/>	Disable ▼
4	<input type="text"/> : <input type="text"/> : <input type="text"/> : <input type="text"/> : <input type="text"/> : <input type="text"/>	Disable ▼

PtMP application: up to 4 remote peers can be configured in the master AP

Accept
Cancel

Step 5. If the connection range exceeds 1km, go to the “**Wireless → Wireless Advanced Settings**” page to configure the distance parameter between two sites.

- (3) In PtP, the distance must be configured to the same at both sites.
- (4) In PtMP, the distance at each slave nodes must be configured to the actual distance from each slave node to the master node; as to the master node should be configured to the value of the farthest node. In PtMP application, the distance from each node to master node should not have too much deviation to ensure the connection stability.

Wireless Advanced Settings

Data Rate	Auto
Transmit Power	Auto
RTS/CTS Threshold (1 - 2346)	2346 Bytes
Distance (1-30km)	1 km (0.6 miles)
Aggregation:	<input checked="" type="radio"/> Enable <input type="radio"/> Disable 32 Frames 50000 Bytes(Max)

Wireless Traffic Shaping

Enable Traffic Shaping	<input type="radio"/> Enable <input checked="" type="radio"/> Disable
Upload Limit	1000 kbit/s (512-99999999)
Download Limit	180000 kbit/s (512-99999999)
Total Percentage	0 %
WDS1 : (OFF)	5 %
WDS2 : (OFF)	5 %
WDS3 : (OFF)	5 %
WDS4 : (OFF)	5 %

Step 6. Go to the “**Status -> Save/Reload**” page to save and apply settings.

WDS Bridge

Status

- . Save/Reload:5
- . Main
- . WDS Link List
- . System Log

System

- . Operation Mode
- . IP Settings
- . Spanning Tree Settings

Save/Reload

Unsaved changes list

```

wireless.cfg0b8c04.WLANWDSAESKey=12345678
-wireless.cfg0b8c04.WLANWDSWEPKey
wireless.cfg0b8c04.encryption=aes
wireless.cfg0b8c04.WLANEnable=1
wireless.cfg0b8c04.WLANWDSPeer=A8F7E0581A94v
            
```

Step 7. Repeat Steps1 to 6 for each node.

Step 8. Go to the “**Status -> WDS Link List**” page to check the connection status.

WDS Link Status				Home	Reset
WDS Link ID	MAC Address	Link Status	RSSI (dBm)		
1	a8:f7:e0:58:1a:94	UP	-35		

Refresh

5.1.6 Client Router (CR/WISP)

This section allows you to configure the Client Router (Wireless ISP) mode to enable clients to access Internet through remote wireless AP provided by ISP. In this mode, the DHCP server is enabled and able to assign IP address to local clients after the device is connected to remote wireless AP provided by ISP.

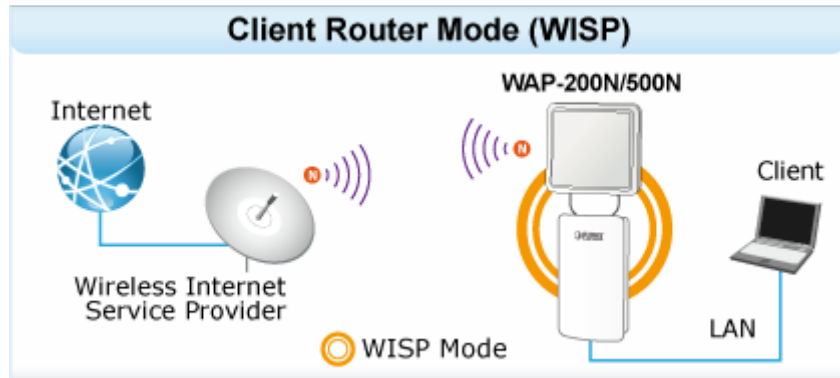

Go to the “**System → Operation Mode**” page to configure the device as “**Client Router**” and then go to “**Wireless → Wireless Network**” to configure the related wireless settings.

System Properties		Home	Reset
System Properties			
Device Name	PLANET	(1 to 32 characters)	<input checked="" type="checkbox"/> Green
Country/Region	Please Select a Country Code ▾		
Operation Mode	<input type="radio"/> Access Point <input type="radio"/> Client Bridge <input type="radio"/> WDS <input checked="" type="radio"/> Client Router <input type="radio"/> Repeater		
Save & Apply		Cancel	

Figure 5-7 Operation Mode – Client Router (WISP)

Configuration Example

The following procedure will guide you to how to establish WISP connection.

Step 1. Go to the “**Operation Mode**” page to configure the device as “**Client Router**”.

System Properties		Home	Reset
System Properties			
Device Name	PLANET (1 to 32 characters)	<input checked="" type="checkbox"/>	Green
Country/Region	Please Select a Country Code ▾		
Operation Mode	<input type="radio"/> Access Point <input type="radio"/> Client Bridge <input type="radio"/> WDS <input checked="" type="radio"/> Client Router <input type="radio"/> Repeater		
Save & Apply		Cancel	

Step 2. Go to the “Router → LAN Settings” page to configure LAN IP and enable the DHCP server. The LAN IP must be a different subnet from the remote wireless AP provided by ISP.

LAN Settings		Home	Reset
LAN IP Setup			
IP Address	192 . 168 . 1 . 251		
IP Subnet Mask	255 . 255 . 255 . 0		
<input checked="" type="checkbox"/> Use Router As DHCP Server			
Starting IP Address	192 . 168 . 1 . 100		
Ending IP Address	192 . 168 . 1 . 200		
WINS Server IP	0 . 0 . 0 . 0		
Accept		Cancel	

Step 3. Go to the “Wireless → Wireless Network” page to click the **Site Survey** button to discover the root AP.

Wireless Network		Home	Reset
Wireless Mode	802.11 B/G/N Mixed ▼		
SSID	Specify the static SSID :		
	<input type="text" value="AP SSID"/> (1 to 32 characters) Or press the button to search for any available WLAN Service.		
	<input type="button" value="Site Survey"/>		
Preferred BSSID	<input type="checkbox"/> <input type="text" value=""/> : <input type="text" value=""/> : <input type="text" value=""/> : <input type="text" value=""/> : <input type="text" value=""/> : <input type="text" value=""/>		
Wireless Security			
Changing the wireless security settings may cause this wireless client to associate with a different one. This may temporarily disrupt your configuration session.			
Security Mode	Disabled ▼		
<input type="button" value="Accept"/> <input type="button" value="Cancel"/>			

Step 4. Click the **root AP** as shown below and it will go back to the previous wireless network page.

Site Survey						
2.4GHz Site Survey						
BSSID	SSID	Channel	Signal Level	Type	Security	Mode
A8:F7:E0:42:12:83	PLANET1	1	-57 dBm	11g/n	WPA2-PSK	
00:30:4F:CE:94:63	CHT Wi-Fi Auto	5	-80 dBm	11g/n	WPA/WPA2	
C8:3A:35:24:65:7C	11F_Demo_Room	6	-83 dBm	11g/n	WPA2-PSK	

Step 5. Click the check box of the preferred BSSID and configure the encryption to be the same as the root AP. The Repeater SSID can be modified to an easily-recognized name for wireless clients. Then, click **“Accept”** to save the configurations.

Wireless Network		Home	Reset
Wireless Mode	802.11 B/G/N Mixed ▼		
SSID	Specify the static SSID : <input type="text" value="PLANET 1"/> (1 to 32 characters) Or press the button to search for any available WLAN Service. <input type="button" value="Site Survey"/>		
Preferred BSSID	<input checked="" type="checkbox"/> A8 : F7 : E0 : 42 : 12 : 83		
Wireless Security			
Changing the wireless security settings may cause this wireless client to associate with a different one. This may temporarily disrupt your configuration session.			
Security Mode	WPA2-PSK ▼		
Encryption	AES ▼		
Passphrase	<input type="text" value="12345678"/> (8 to 63 characters) or (64 Hexadecimal characters)		
<input type="button" value="Accept"/> <input type="button" value="Cancel"/>			

Step 6. Go to the “Router -> WAN Settings” page to configure WAN settings. The Internet connection type is provided by your ISP and should be configured properly. Disable “Discard Ping on WAN” and then you’ll be able to use ping test tool of Diagnostics page to ping DNS to ensure the WAN connection is established properly through WISP mode.

WAN Settings		Home	Reset
Internet Connection Type	DHCP ▼		
Options			
Account Name (if required)	<input type="text"/>		
Domain Name (if required)	<input type="text"/>		
MTU	Auto ▼	<input type="text" value="1500"/>	(576 - 1500)
Domain Name Server (DNS) Address			
<input checked="" type="radio"/> Get Automatically From ISP <input type="radio"/> Use These DNS Servers			
Primary DNS	<input type="text" value="0"/>	<input type="text" value="0"/>	<input type="text" value="0"/>
Secondary DNS	<input type="text" value="0"/>	<input type="text" value="0"/>	<input type="text" value="0"/>
WAN Ping			
Discard Ping on WAN	<input type="checkbox"/>		
<input type="button" value="Accept"/> <input type="button" value="Cancel"/>			

Step 7. Go to the “**Status -> Save/Reload**” page to save and apply settings.

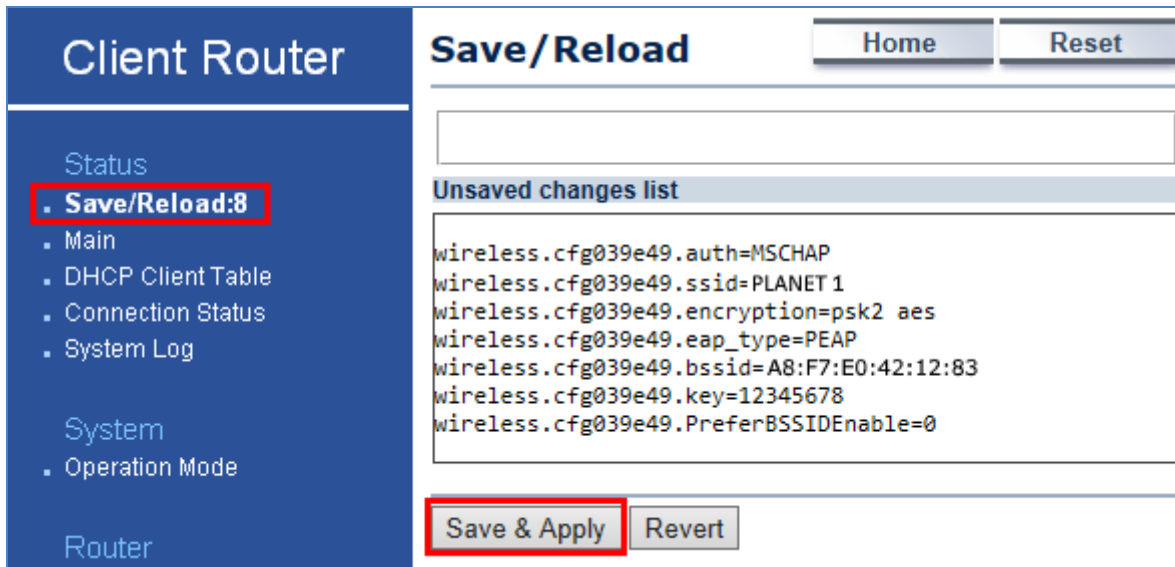

Step 8. Modify your PC/laptop connected to the LAN port of this client router to “**Obtain an IP address automatically**”.

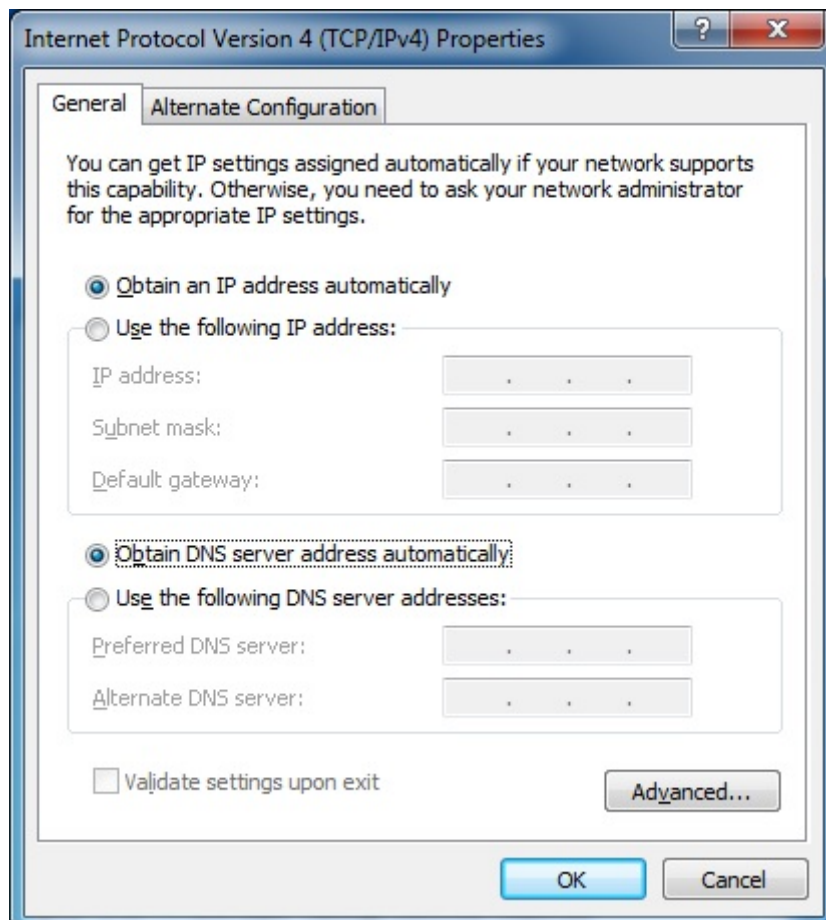

Step 9. Go to “**Status -> DHCP Client Table**” to ensure your PC/laptop receives the IP automatically.

DHCP Client List						Home	Reset
MAC Address	IP	Host Name	Expires	Revoke	Reserve		
00:16:d4:ff:d2:e3	192.168.1.107	ENM-2-PC	23h 53min 48s	Revoke	Reserve		
<input type="button" value="Refresh"/>							

Step 10. Go to “**Status -> Connection Status**” to check whether the connection is established successfully.

Connection Status		Home	Reset
Wireless			
Network Type	Client Router		
SSID	PLANET1		
BSSID	A8:F7:E0:42:12:83		
Connection Status	Associated		
Wireless Mode	IEEE 802.11B/G/N Mixed		
Current Channel	2.412 GHz(Channel 1)		
Security	WPA2-PSK AES		
Tx Data Rates(Mbps)	135 Mbps		
Current noise level	-95 dBm		
Signal strength	-40 dBm		
WAN			
MAC Address	A8:F7:E0:2F:83:57		
Connection Type	DHCP	<input type="button" value="Renew"/>	<input type="button" value="Release"/>
Connection Status	Up		
IP Address	192.168.100.131		
IP Subnet Mask	255.255.255.0		
Primary DNS	192.168.100.1		
Secondary DNS			
<input type="button" value="Refresh"/>			

5.1.7 Repeater

This section allows you to configure the Repeater mode to extend the root AP's signal coverage.

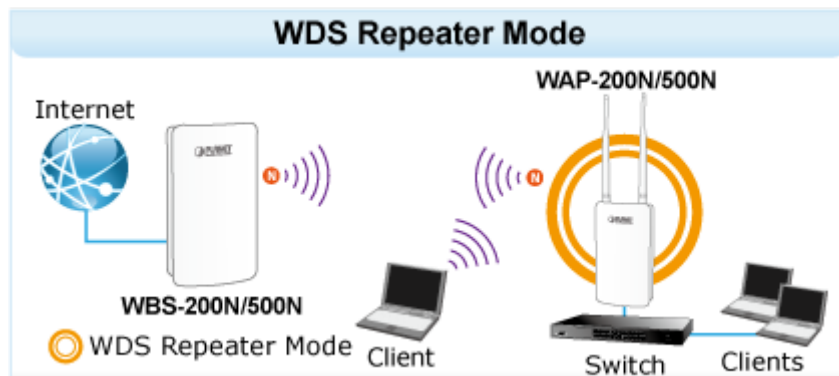

Go to the **“System → Operation Mode”** page to configure the device as **“Repeater”** and then go to **“Wireless → Wireless Network”** to configure the related wireless settings.

System Properties		Home	Reset
System Properties			
Device Name	PLANET (1 to 32 characters)	<input checked="" type="checkbox"/>	Green
Country/Region	Please Select a Country Code ▾		
Operation Mode	<input type="radio"/> Access Point <input type="radio"/> Client Bridge <input type="radio"/> WDS <input type="radio"/> Client Router <input checked="" type="radio"/> Repeater		
Save & Apply		Cancel	

Figure 5-8 Operation Mode – Repeater

Configuration Example

The following procedure will guide you to how to establish repeater connection.

Step 1. Go to **“Operation Mode”** page to configure the device as **“Repeater”**.

System Properties		Home	Reset
System Properties			
Device Name	<input type="text" value="PLANET"/> (1 to 32 characters)	<input checked="" type="checkbox"/>	Green
Country/Region	<input type="text" value="Please Select a Country Code"/>		
Operation Mode	<input type="radio"/> Access Point <input type="radio"/> Client Bridge <input type="radio"/> WDS <input type="radio"/> Client Router <input checked="" type="radio"/> Repeater		
<input type="button" value="Save & Apply"/> <input type="button" value="Cancel"/>			

Step 2. Go to the “Wireless → Wireless Network” page to click the **Site Survey** button to discover the root AP.

Wireless Network		Home	Reset
Wireless Mode	<input type="text" value="802.11 B/G/N Mixed"/>		
SSID	Specify the static SSID : <input type="text" value="AP SSID"/> (1 to 32 characters) Or press the button to search for any available WLAN Service. <input checked="" type="button" value="Site Survey"/>		
Repeater SSID	<input type="text" value="AP SSID"/> (1 to 32 characters)		
Preferred BSSID	<input type="checkbox"/> <input type="text" value=""/> : <input type="text" value=""/> : <input type="text" value=""/> : <input type="text" value=""/> : <input type="text" value=""/> : <input type="text" value=""/>		
Wireless Security			
Changing the wireless security settings may cause this wireless client to associate with a different one. This may temporarily disrupt your configuration session.			
Security Mode	<input type="text" value="Disabled"/>		
<input type="button" value="Accept"/> <input type="button" value="Cancel"/>			

Step 3. Click the **root AP** as shown below and it will go back to the previous wireless network page.

Site Survey

2.4GHz Site Survey

:Infrastructure :Ad_hoc

BSSID	SSID	Channel	Signal Level	Type	Security	Mode
A8:F7:E0:42:12:83	PLANET1	1	-57 dBm	11g/n	WPA2-PSK	
00:30:4F:CE:94:63	CHT Wi-Fi Auto	5	-80 dBm	11g/n	WPA/WPA2	
C8:3A:35:24:65:7C	11F_Demo_Room	6	-83 dBm	11g/n	WPA2-PSK	

Refresh

Step 4. Click the check box of the preferred BSSID and configure the encryption to be the same as the root AP. The Repeater SSID can be modified to an easily-recognized name for wireless clients. Then, click “Accept” to save the configurations.

Wireless Network

Home
Reset

Wireless Mode	802.11 B/G/N Mixed ▾
SSID	Specify the static SSID : <input style="width: 80%;" type="text" value="PLANET 1"/> (1 to 32 characters) Or press the button to search for any available WLAN Service. <div style="text-align: center; margin-top: 5px;"> Site Survey </div>
Repeater SSID	<input style="width: 80%;" type="text" value="Repeater"/> (1 to 32 characters)
Preferred BSSID	<input checked="" type="checkbox"/> A8 : F7 : E0 : 42 : 12 : 83

Wireless Security

Changing the wireless security settings may cause this wireless client to associate with a different one. This may temporarily disrupt your configuration session.

Security Mode	WPA2-PSK ▾
Encryption	AES ▾
Passphrase	<input style="width: 80%;" type="text" value="12345678"/> (8 to 63 characters) or (64 Hexadecimal characters)

Accept
Cancel

Step 5. Go to the “Status-> Save/Reload” page to save and apply settings.

Repeater

Status

- Save/Reload:11**
- Main
- Wireless Client List
- Connection Status
- System Log

System

- Operation Mode
- IP Settings
- Spanning Tree Settings

Save/Reload Home Reset

Unsaved changes list

```
wireless.cfg039e49.auth=MSCHAP
wireless.cfg039e49.ssid=PLANET 1
wireless.cfg039e49.encryption=psk2 aes
wireless.cfg039e49.eap_type=PEAP
wireless.cfg039e49.bssid=A8:F7:E0:42:12:83
wireless.cfg039e49.key=12345678
wireless.cfg039e49.PreferBSSIDEnable=0
```

Save & Apply Revert

Step 6. Use a wireless client to connect to the repeater AP and ensure it is able to receive IP address from the root AP's network.

Settings WLAN

WLAN

✓ Repeater

CHOOSE A NETWORK...

- 11111111
- 731U_2.4G
- 731U_5G
- ADN-4102
- JesusLovesU_password: 12...
- K1200AC
- vdsItesting
- WNRT-627

WLAN Repeater

Forget This Network

IP ADDRESS

DHCP BootP Static

IP Address 192.168.100.102

Subnet Mask 255.255.255.0

Router 192.168.100.1

DNS 192.168.100.1

Search Domains sitecom.router

Client ID

Renew Lease

5.2 Status

This section provides the current system summary, system log and connection status including Wireless Client List, WDS Link List, DHCP Client Table and Connection Status to assist the administrator in viewing the network status.

In the upper-right corner of each function page, you can click "**Home**" to go back to the **Main** page to view the current system status and click "**Reset**" to force the system to reboot or reset the device to factory defaults.



Figure 5-9 System Menu - Reset

In the upper-right corner of each function page, you can choose the **Language** supported in the system from the drop-down list for better user experience. Once the language is chosen, the whole web page will be translated in the language.



Figure 5-10 System Menu – Language option

5.2.1 Main

Click "**Status → Main**" to view the current system summary.

Main		Home	Reset
System Information			
Device Name	WBS-200N		
Ethernet Main MAC Address	A8:F7:E0:58:E9:73		
Ethernet Secondary MAC Address	A8:F7:E0:58:E9:73		
Wireless MAC Address	A8:F7:E0:58:E9:72		
Country	N/A		
Current Time	Wed Apr 26 18:09:46 UTC 2017		
Firmware Version	1.0.0		
LAN Settings			
IP Address	192.168.1.251		
Subnet Mask	255.255.255.0		
DHCP Server	Enabled		
RX(Packets)	184.158 KB (2072 PKts.)		
TX(Packets)	2.94403 MB (2918 PKts.)		
WAN Settings			
MAC Address	A8:F7:E0:58:E9:72		
Connection Type	DHCP		
Connection Status	Up		
IP Address	192.168.100.131		
IP Subnet Mask	255.255.255.0		
Primary DNS	192.168.100.1		
Secondary DNS			
RX(Packets)	9.13184 KB (54 PKts.)		
TX(Packets)	7.24023 KB (123 PKts.)		
Current Wireless Settings			
Operation Mode	Client Router		
Wireless Mode	IEEE 802.11B/G/N Mixed		
Channel Bandwidth	20/40 MHz		
Frequency/Channel	2.412 GHz (Channel 1)		
Wireless Network Name (SSID)	PLANET 1		
Security	WPA2-PSK AES		
Distance	1 km		
RX(Packets)	9.13184 KB (54 PKts.)		
TX(Packets)	7.24023 KB (123 PKts.)		
Refresh			

Figure 5-11 Main Status

The page includes the following settings:

Object	Description
<ul style="list-style-type: none"> • System Information 	Shows the general system information such as device name, MAC address, country, current time, and firmware version.
<ul style="list-style-type: none"> • LAN Settings 	Shows Local Area Network settings such as the LAN IP address, subnet mask, DHCP Server, and Rx/Tx packets.
<ul style="list-style-type: none"> • WAN Settings 	Shows Wide Area Network settings such as the MAC address, connection type, connection status, IP address, subnet mask, primary and secondary DNS, and Rx/Tx packets.
<ul style="list-style-type: none"> • Current Wireless Settings 	Shows wireless information such as operation mode, wireless mode, channel bandwidth, frequency, channel, information about each SSID, security settings, and Rx/Tx packets.

5.2.2 Save/Reload

Click "**Status** → **Save/Reload**" and the following page will be displayed.

The screenshot displays the 'Save/Reload' configuration page. The left sidebar is titled 'Access Point' and contains a 'Status' section with 'Save/Reload:16' highlighted. The main content area has a 'Save/Reload' header with 'Home' and 'Reset' buttons. Below the header is an 'Unsaved changes list' containing the following configuration parameters:

```
-network.1.ifname
-network.3.ifname
network.lan.ifname=eth0
-network.4.ifname
-network.2.ifname
network.sys.ManagementVLANID=4096
wireless.cfg039f7e.wps_configured=1
wireless.cfg039f7e.key=12345678
wireless.cfg039f7e.encryption=psk2 aes
wireless.cfg039f7e.WLANWpaRadiusAccSrvIP=...
wireless.cfg039f7e.hidden=0
wireless.cfg039f7e.server=...
wireless.wifi0.WLANHTMode=40
wireless.wifi0.WLANExtChannel=0
wireless.wifi0.channel=1
wireless.cfg09feac.WLANVLANEnable=0
```

At the bottom of the page, there are two buttons: 'Save & Apply' (highlighted in red) and 'Revert'.

Figure 5-12 Save/Reload

Click **Save & Apply** to save and apply all configurations.

Click **Revert** to cancel the unsaved changes and revert to the previous settings that have been saved.

It's not necessary to save and apply the settings if unsaved changes list is empty.

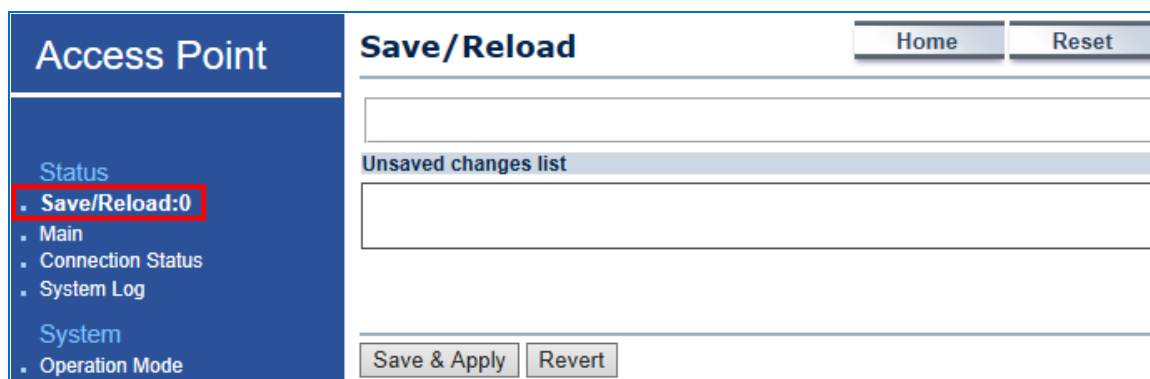

Figure 5-13 Save/Reload - Default

5.2.3 Wireless Client List

Click “**Status** → **Wireless Client List**” to view the current associated client.

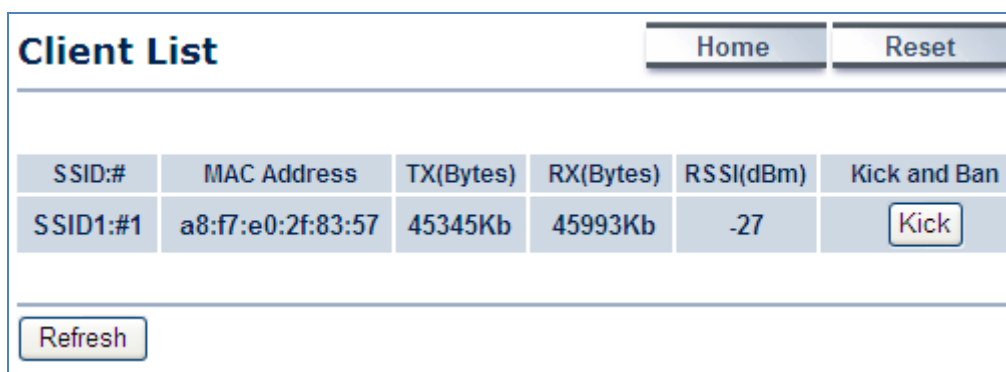

Figure 5-14 Wireless Client List

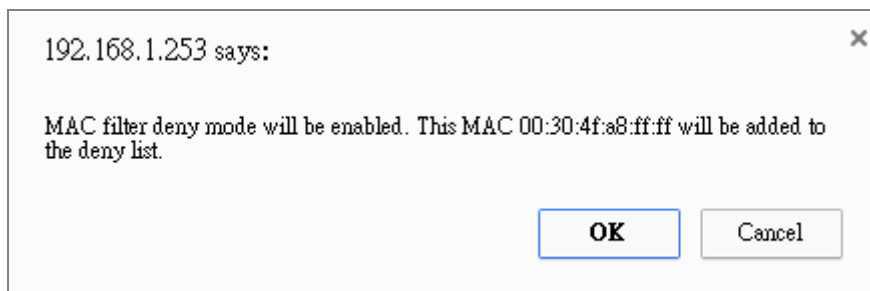

Figure 5-15 Kick the client

The page includes the following settings:

Object	Description
• SSID:#	The SSID number that the client associated to.
• MAC Address	The MAC Address of the associated client.
• TX (Bytes)	The current transmit packet of the associated client.
• RX (Bytes)	The current received packet of the associated client.
• RSSI (dBm)	The current signal strength of the associated client.
• Kick and Ban	Click Kick to add the client to the wireless mac filtering deny list.

5.2.4 WDS Link List

Click “**Status** → **WDS Link List**” to view the current WDS link client.

The **WDS Link List** is only available in WDS Bridge mode.

WDS Link Status				Home	Reset
WDS Link ID	MAC Address	Link Status	RSSI (dBm)		
1	a8:f7:e0:2f:83:57	UP	-35		
Refresh					

Figure 5-16 WDS Link Status

The page includes the following settings:

Object	Description
• WDS Link ID	The sequence number of the WDS link.
• MAC Address	The MAC Address of the associated remote node.
• Link Status	The current link status.
• RSSI (dBm)	The current signal strength of the associated remote node.
• Refresh	Click Refresh to update the current list.

5.2.5 DHCP Client Table

Click “**Status** → **DHCP Client Table**” to view the current DHCP client.

The **DHCP Client Table** is only available in Client Router (WISP) mode.

DHCP Client List						Home	Reset
MAC Address	IP	Host Name	Expires	Revoke	Reserve		
00:16:d4:ff:d2:e3	192.168.1.107	ENM-2-PC	23h 53min 48s	Revoke	Reserve		
Refresh							

Figure 5-17 DHCP Client List

The page includes the following settings:

Object	Description
• MAC Address	The MAC Address of the DHCP client.
• IP	The IP assigned to the DHCP client.
• Host Name	The Host Name of the DHCP client.
• Expires	The Expiry time of the DHCP client.

• Revoke	Click Revoke to revoke the DHCP lease of the client.
• Reserve	Click Reserve to reserve the IP to the client.
• Refresh	Click Refresh to update the client list.

5.2.6 Connection Status

Click “**Status → Connection Status**” to view the current DHCP client.

The **Connection Status** is only available in the following operation modes:

- (1) Client Bridge
- (2) Client Router
- (3) WDS Station
- (4) Repeater

Connection Status		Home	Reset
Network Type	Client Bridge		
SSID	PLANET1		
BSSID	A8:F7:E0:04:B4:C0		
Connection Status	Associated		
Wireless Mode	IEEE 802.11B/G/N Mixed		
Current Channel	2.412 GHz(Channel 1)		
Security	WPA2-PSK AES		
Tx Data Rates(Mbps)	300 Mbps		
Current noise level	-95 dBm		
Signal strength	-60 dBm		
Refresh			

Figure 5-18 Connection Status

The page includes the following settings:

Object	Description
• Network Type	The current operation mode of the device.
• SSID	The SSID of the connected AP.
• BSSID	The MAC Address of the connected AP.
• Connection Status	The status of the connection.
• Wireless Mode	The current wireless mode of the AP.
• Current Channel	The current channel used of this connection.
• Security	The encryption method of the AP.
• Tx Data Rates (Mbps)	The current data rates of the connection.

• Current noise level	The current noise level of the connection
• Signal Strength	The current signal strength of the connected AP.
• Refresh	Click Refresh to update the current data.

5.2.7 System Log

Click “**Status → System Log**” to view the system log.

The screenshot shows the 'System Log' interface. At the top right, there are 'Home' and 'Reset' buttons. Below the title, there is a 'Show log type' dropdown menu currently set to 'All'. The main area contains a scrollable list of log entries. Each entry includes a date and time (e.g., 'May 22 15:'), a log level (e.g., 'Debug', 'Warning'), and a message (e.g., 'ON user.notice root: starting ntpd'). At the bottom of the interface, there are three buttons: 'Save', 'Refresh', and 'Clear'.

Figure 5-19 System Log

The page includes the following settings:

Object	Description
• Show log type	Select log type to filter the records.
• Save	Click Save to save the records.
• Refresh	Click Refresh to update the current data.
• Clear	Click Clear to erase the records.

5.3 System

5.3.1 IP Settings

Click “**System → IP Settings**” to configure the LAN IP address.

IP Settings		Home	Reset
System Information			
IP Network Setting	<input type="radio"/> Obtain an IP address automatically (DHCP) <input checked="" type="radio"/> Specify an IP address		
IP Address	192	168	1 . 253
IP Subnet Mask	255	255	255 . 0
Default Gateway	192	168	1 . 253
Primary DNS	0	0	0 . 0
Secondary DNS	0	0	0 . 0
Use Link-Local Address	<input checked="" type="checkbox"/>		
IPv6 IP Address	<input type="text"/>		
IPv6 Subnet Prefix Length	<input type="text"/>		
IPv6 Default Gateway	<input type="text"/>		
IPv6 Primary DNS	<input type="text"/>		
IPv6 Secondary DNS	<input type="text"/>		
<input type="button" value="Accept"/> <input type="button" value="Cancel"/>			

Figure 5-20 LAN IP Settings

The page includes the following settings:

Object	Description
• IP Network Setting	Select Obtain an IP address automatically (DHCP) to receive the IP from DHCP server. Select Specify an IP address to configure the AP to use static IP.
• IP Address	The LAN IP of the AP. The default is 192.168.1.253 . You can change it according to your needs.
• IP Subnet Mask	The LAN subnet mask of the AP.
• Default Gateway	Enter the Gateway IP address of the AP.
• Primary DNS	Enter the primary DNS server of the AP.
• Secondary DNS	Enter the secondary DNS server of the AP.
• Use Link-Local Address	Click to enable a link-local address for the AP.

• IPv6 IP Address	Enter the IPv6 LAN IP of the AP.
• IPv6 Subnet Prefix Length	Enter the secondary DNS server of the AP.
• IPv6 Default Gateway	Enter the IPv6 Gateway IP address of the AP.
• IPv6 Primary DNS	Enter the IPv6 primary DNS server of the AP.
• IPv6 Secondary DNS	Enter the IPv6 secondary DNS server of the AP.
• Accept	Click Accept to apply the new settings.
• Cancel	Click Cancel to cancel the unsaved changes and revert to the previous settings.

5.3.2 Spanning Tree Settings (STP)

The Spanning Tree Settings (STP) protocol allows network to provide a redundant link in the event of a link failure. It is advised to turn on this option for multi-point bridge network to avoid network loop.

Click "**System → Spanning Tree Settings**" to enable/disable Spanning Tree Settings.

Spanning Tree Settings	
Spanning Tree Status	<input type="radio"/> ON <input checked="" type="radio"/> OFF
Bridge Hello Time	<input type="text" value="2"/> seconds (1-10)
Bridge Max Age	<input type="text" value="20"/> seconds (6-40)
Bridge Forward Delay	<input type="text" value="4"/> seconds (4-30)
Priority	<input type="text" value="32768"/> (0-65535)

Figure 5-21 Spanning Tree Settings

The page includes the following settings:

Object	Description
• Spanning Tree Status	Click ON to enable or click OFF to disable the option.
• Bridge Hello Time	Specify Bridge Hello Time, in seconds. This value determines how often the AP sends hello packets to communicate information about the topology throughout the entire Bridged Local Area Network.
• Bridge Max Age	Specify Bridge Max Age, in seconds. If another bridge in the spanning tree does not send a hello packet for a long period of time, it is assumed to be dead.
• Bridge Forward Delay	Specify Bridge Forward Delay, in seconds. Forwarding delay time is the time spent in each of the Listening and Learning states before the

	Forwarding state is entered. This delay is provided so that when a new bridge comes onto a busy network, it looks at some traffic before participating.
• Priority	Specify the Priority number. Smaller numbers have greater priority.
• Accept	Click Accept to apply the setting.
• Cancel	Click Cancel to cancel the setting.

5.4 Router (WISP Mode Only)

5.4.1 DHCP Server Settings

Go to the “**Operation Mode**” page to configure the device as “**Client Router**” and then go to “**Router → LAN Settings**” to configure the device’s LAN IP settings in client router mode.

On this page, enable the DHCP server to assign IP address to local wired/wireless clients after the device is connected to the remote AP supplied by wireless ISP.

LAN Settings Home Reset

LAN IP Setup

IP Address: 192 . 168 . 1 . 253

IP Subnet Mask: 255 . 255 . 255 . 0

Use Router As DHCP Server

Starting IP Address: 192 . 168 . 1 . 100

Ending IP Address: 192 . 168 . 1 . 200

WINS Server IP: 0 . 0 . 0 . 0

Accept Cancel

Figure 5-22 DHCP Server Settings

The page includes the following settings:

Object	Description
• IP Address	The LAN IP of the AP.
• IP Subnet Mask	The LAN subnet mask of the AP.
• Use Router As DHCP Server	Select it to enable DHCP server. In here the device is acting as a router.
• Starting IP Address	Specify the starting IP address for the DHCP range.

• Ending IP Address	Specify the ending IP address for the DHCP range.
• WINS Server IP	Enter the IP address of the WINS server.
• Accept	Click Accept to apply the setting.
• Cancel	Click Cancel to cancel the setting.

5.4.2 WAN Settings

Go to the “**Operation Mode**” page to configure the device as “**Client Router**” and then go to “**Router → WAN Settings**” to configure the device’s WAN settings in client router mode. The WAN settings should be provided by the ISP.

Figure 5-23 WAN Settings – All

The page includes the following common settings in each Internet Connection Type:

Object	Description
• Internet Connection Type	<ul style="list-style-type: none"> • DHCP: Dynamic IP addressing assigns a different IP address each time a device connects to an ISP service provider. • Static IP: Setting a static IP address allows an administrator to set a specific IP address for the router and guarantees that it cannot be

	<p>assigned a different address.</p> <ul style="list-style-type: none"> • PPPoE: Point-to-Point Protocol over Ethernet (PPPoE) is used mainly by ISPs that provide DSL modems to connect to the Internet. • PPTP: The point-to-point tunneling protocol (PPTP) is used in association with virtual private networks (VPNs).
--	---

Options: This section will not be the same depending on the Internet Connection Type. Refer to settings of each corresponding section from 5.4.2.1 to 5.4.2.4

Domain Name Server (DNS) Address

• Get Automatically From ISP	Select it to obtain the DNS automatically from the DHCP server.
• Use These DNS Servers	Select it to set up the Primary DNS and Secondary DNS servers manually.
• Primary DNS	Enter the primary DNS server address.
• Secondary DNS	Enter the secondary DNS server address.

WAN Ping

• Discard Ping on WAN	Check it to enable pings on the WAN interface or disable to block pings on the WAN interface.
• Accept	Click Accept to apply the setting.
• Cancel	Click Cancel to cancel the setting.

5.4.2.1. DHCP

Select **DHCP** and the device will automatically obtain IP addresses, subnet masks and gateway addresses from the ISP.

WAN Settings Home Reset

Internet Connection Type: DHCP

Options

Account Name (if required):

Domain Name (if required):

MTU: Auto 1500 (576 - 1500)

Domain Name Server (DNS) Address

Get Automatically From ISP

Use These DNS Servers

Primary DNS: 0 . 0 . 0 . 0

Secondary DNS: 0 . 0 . 0 . 0

WAN Ping

Discard Ping on WAN:

Accept Cancel

Figure 5-24 WAN Settings – DHCP

The page includes the following specific settings in DHCP type:

Object	Description
• Account Name (if required)	Enter the account name provided by your ISP.
• Domain Name (if required)	Enter the domain name provided by your ISP.
• MTU	The maximum transmission unit (MTU) specifies the largest packet size permitted for an internet transmission. The factory default MTU size for DHCP is 1500. The MTU size can be set between 576 and 1500.
• Accept	Click Accept to apply the setting.
• Cancel	Click Cancel to cancel the setting.

5.4.2.2. Static IP

If your ISP offers you static IP Internet connection type, select **Static IP** and then enter IP address, subnet mask, primary DNS and secondary DNS information provided by ISP in the corresponding fields.

WAN Settings Home Reset

Internet Connection Type Static IP ▼

Options

Account Name (if required)	<input type="text"/>		
Domain Name (if required)	<input type="text"/>		
MTU	Auto ▼	1500	(576 - 1500)

Internet IP Address

IP Address	192	.	168	.	10	.	1
IP Subnet Mask	255	.	255	.	255	.	0
Gateway IP Address	0	.	0	.	0	.	0

Domain Name Server (DNS) Address

Primary DNS	0	.	0	.	0	.	0
Secondary DNS	0	.	0	.	0	.	0

WAN Ping

Discard Ping on WAN

Accept Cancel

Figure 5-25 WAN Settings – Static IP

The page includes the following specific settings in Static IP type:

Object	Description
• Account Name (if required)	Enter the account name provided by your ISP.
• Domain Name (if required)	Enter the domain name provided by your ISP.
• MTU	The maximum transmission unit (MTU) specifies the largest packet size permitted for an internet transmission. The factory default MTU size for static IP is 1500. The MTU size can be set between 576 and 1500.
• IP Address	Enter the device's WAN IP address provided by ISP.
• IP Subnet Mask	Enter the device's WAN IP subnet mask provided by ISP.
• Gateway IP Address	Enter the device's WAN Gateway IP provided by ISP.
• Accept	Click Accept to apply the setting.
• Cancel	Click Cancel to cancel the setting.

5.4.2.3. PPPoE

Select **PPPOE** if ISP is using a PPPoE connection and provide you with PPPoE user name and password.

WAN Settings Home Reset

Internet Connection Type: PPPoE

Options

MTU: Auto 1492 (576 - 1492)

PPPoE Options

Login: admin

Password:

Service Name (if required):

Connect on Demand: Max idle Time 1 Minutes

Keep Alive: Redial Period 30 Seconds

Domain Name Server (DNS) Address

Get Automatically From ISP

Use These DNS Servers

Primary DNS: 0 . 0 . 0 . 0

Secondary DNS: 0 . 0 . 0 . 0

WAN Ping

Discard Ping on WAN:

Accept Cancel

Figure 5-26 WAN Settings – PPPOE

The page includes the following specific settings in PPPoE type:

Object	Description
• MTU	The maximum transmission unit (MTU) specifies the largest packet size permitted for an internet transmission. The factory default MTU size for PPPoE is 1492. The MTU size can be set between 576 and 1492.
• Login	Enter the username provided by ISP.
• Password	Enter the password provided by ISP.
• Service Name (if required)	Enter the service name of an ISP (optional).
• Connect on Demand	Select it to specify the maximum idle time. Internet connection will disconnect when it reaches the maximum idle time, but it will

	automatically connect when user tries to access the network.
<ul style="list-style-type: none"> • Keep Alive 	Select whether to keep the Internet connection always on, or enter a redial period once the internet loses connection.
<ul style="list-style-type: none"> • Accept 	Click Accept to apply the setting.
<ul style="list-style-type: none"> • Cancel 	Click Cancel to cancel the setting.

5.4.2.4. PPTP

Select **PPTP** if ISP is using a PPTP connection.

WAN Settings

Home
Reset

Internet Connection Type PPTP ▼

Options

MTU Auto ▼ 1400 (1200 - 1400)

PPTP Options

IP Address 192 . 168 . 10 . 1

Subnet Mask 255 . 255 . 255 . 0

Default Gateway 0 . 0 . 0 . 0

PPTP Server 0 . 0 . 0 . 0

Username admin

Password

Connect on Demand: Max idle Time 15 Minutes

Keep Alive: Redial Period 30 Seconds

Domain Name Server (DNS) Address

Get Automatically From ISP

Use These DNS Servers

Primary DNS 0 . 0 . 0 . 0

Secondary DNS 0 . 0 . 0 . 0

WAN Ping

Discard Ping on WAN

Accept
Cancel

Figure 5-27 WAN Settings – PPTP

The page includes the following specific settings in PPTP type:

Object	Description
• MTU	The maximum transmission unit (MTU) specifies the largest packet size permitted for an internet transmission. The factory default MTU size for PPTP is 1400. The MTU size can be set between 1200 and 1400.
• IP Address	Enter the device's WAN IP address provided by ISP.
• Subnet Mask	Enter the device's WAN IP subnet mask provided by ISP.
• Default Gateway	Enter the device's WAN Gateway IP provided by ISP.
• PPTP Server	Enter the IP address of the PPTP server.
• Username	Enter the username provided by ISP.
• Password	Enter the password provided by ISP.
• Connect on Demand	Select it to specify the maximum idle time. Internet connection will disconnect when it reaches the maximum idle time, but it will automatically connect when user tries to access the network.
• Keep Alive	Select whether to keep the Internet connection always on, or enter a redial period once the internet loses connection.
• Accept	Click Accept to apply the setting.
• Cancel	Click Cancel to cancel the setting.

5.4.3 VPN Pass Through

VPN Pass-through allows a secure virtual private network (VPN) connection between two sites. Enabling the options on this page opens a VPN port and enables connections to pass through the AP without interruption.

Go to the “**Operation Mode**” page to configure the device as “**Client Router**” and then go to “**Router → VPN Pass Through**” to enable VPN pass through you required in client router mode.

The screenshot shows a web interface for configuring VPN Pass Through. The title is "VPN Pass Through". There are two buttons at the top right: "Home" and "Reset". Below the title, there are three checked checkboxes: "PPTP Pass Through", "L2TP Pass Through", and "IPSec Pass Through". At the bottom of the form, there are two buttons: "Accept" and "Cancel".

Figure 5-28 VPN Pass Through

The page includes the following settings:

Object	Description
• PPTP Pass Through	Check this option to enable PPTP pass-through mode.
• L2TP Pass Through	Check this option to enable L2TP pass-through mode.
• IPSec Pass Through	Check this option to enable IPSec pass-through mode.
• Accept	Click Accept to apply the setting.
• Cancel	Click Cancel to cancel the setting.

5.4.4 Port Forwarding

Go to “**Operation Mode**” page to configure the device as “**Client Router**” and then go to “**Router → Port Forwarding**” to enable VPN pass through you required in client router mode.

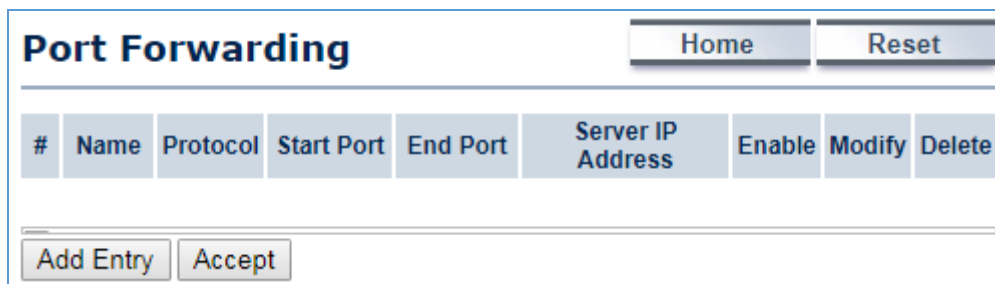

Figure 5-29 Port Forwarding

The page includes the following settings:

Object	Description
• #	Displays the sequence number of the forwarded port.
• Name	Displays the name of the forwarded port.
• Protocol	Displays the protocol to use for mapping from the following: TCP, UDP or Both.
• Start Port	Displays the LAN port number that WAN client packets will be forward to.
• End Port	Displays the port number that the WAN client packets are received.
• Server IP Address	Displays the IP address of the server for the forwarded port.
• Enable	Click to enable or disable the forwarded port profile.
• Modify	Click to modify the forwarded port profile.
• Delete	Click to delete the forwarded port profile.
• Add Entry	Click Add Entry to add the new forwarding rule.
• Accept	Click Accept to apply the setting.

When clicking **Add Entry**, the following window will pop up and fill in the fields required to add a new forwarding rule.

Figure 5-30 Port Forwarding

The page includes the following settings:

Object	Description
• Service Name	Enter a name for the port forwarding rule.
• Protocol	Select a protocol for the application: Choices are Both, TCP and UDP.
• Starting Port (1~65535)	Enter a starting port number.
• Ending Port (1~65535)	Enter an ending port number. All ports numbers between the starting and ending ports will forward users to the IP address specified in the IP Address field.
• IP Address	Enter the IP address of the server computer on the LAN network where users will be redirected.
• Save	Click Save to save the new forwarding rule.
• Cancel	Click Cancel to cancel the setting.

5.4.5 DMZ Settings

The DMZ function allows the device to redirect all packets going to the WAN port IP address to a particular IP address on the LAN. The difference between the virtual server and the DMZ function is that a virtual server redirects a particular service or Internet application, such as FTP, to a particular LAN client or server, whereas a DMZ redirects all packets, regardless of the service, going to the WAN IP address to a particular LAN client or server.

Go to the **“Operation Mode”** page to configure the device as **“Client Router”** and then go to **“Router → DMZ Settings”** to enable/configure DMZ in client router mode.

Figure 5-31 DMZ

The page includes the following settings:

Object	Description
• DMZ Hosting	Select Enable DMZ to activate DMZ functionality.
• DMZ Address	Enter an IP address of a device on the LAN.
• Accept	Click Accept to apply the setting.
• Cancel	Click Cancel to cancel the setting.

5.5 Wireless

This section provides wireless related settings in different operation modes.

5.5.1 Wireless Network

Click "**Wireless** → **Wireless Network**" to configure the wireless basic settings. The wireless settings on this page may vary according to the selected operation mode.

Wireless Network Home Reset

Wireless Mode	802.11 B/G/N Mixed ▼				
Channel HT Mode	20/40MHz ▼				
Extension Channel	Lower Channel ▼				
Channel / Frequency	Ch5-2.432GHz ▼	<input checked="" type="checkbox"/> Auto			
AP Detection	<input type="button" value="Scan"/>				

Current Profiles					
SSID	Security	Isolation	VID	Enable	Edit
PLANET1	None	<input type="checkbox"/>	1	<input checked="" type="checkbox"/>	<input type="button" value="Edit"/>
PLANET2	None	<input type="checkbox"/>	2	<input type="checkbox"/>	<input type="button" value="Edit"/>
PLANET3	None	<input type="checkbox"/>	3	<input type="checkbox"/>	<input type="button" value="Edit"/>
PLANET4	None	<input type="checkbox"/>	4	<input type="checkbox"/>	<input type="button" value="Edit"/>

Figure 5-32 Wireless Network – AP/WDS AP Mode

In the AP/WDS AP mode, click the **Edit** button on the “Wireless Network” page to enter the “SSID Profile” page to configure the SSID profile for the wireless network.

SSID Profile

Wireless Setting

SSID	PLANET1	(1 to 32 characters)
VLAN ID	1	(1~4094)
Suppressed SSID	<input type="checkbox"/>	
Station Separation ⓘ	<input type="radio"/> Enable <input checked="" type="radio"/> Disable	

Wireless Security

Security Mode	Disabled ▼
---------------	------------

Figure 5-33 Wireless Network – SSID Profile

The page includes the following settings:

Object	Description
<ul style="list-style-type: none"> • Wireless Mode 	Wireless mode supports 802.11b/g/n mixed modes.
<ul style="list-style-type: none"> • Channel HT Mode 	The default channel bandwidth is 20/40MHz. The larger the channel, the better the transmission quality and speed.
<ul style="list-style-type: none"> • Extension Channel 	Select upper or lower channel. Your selection may affect the Auto channel function.
<ul style="list-style-type: none"> • Channel / Frequency 	Select the channel and frequency appropriate you're your country's regulation.
<ul style="list-style-type: none"> • Auto 	Check this option to enable auto-channel selection.
<ul style="list-style-type: none"> • AP Detection 	AP Detection can select the best channel to use by scanning nearby areas for Access Points.
<ul style="list-style-type: none"> • Current Profile 	Configure up to four different SSIDs. If many client devices will be accessing the network, you can arrange the devices into SSID groups. Click Edit to configure the profile and check whether you want to enable extra SSIDs.
SSID Profile	
<ul style="list-style-type: none"> • SSID 	Specify the SSID for the current profile.
<ul style="list-style-type: none"> • VLAN ID 	Specify the VLAN tag for the current profile.
<ul style="list-style-type: none"> • Suppressed SSID 	Check this option to hide the SSID from clients. If checked, the SSID will not appear in the site survey.
<ul style="list-style-type: none"> • Station Separation 	Click the appropriate radio button to allow or prevent communication between client devices.
<ul style="list-style-type: none"> • Wireless Security 	Refer to section 5.5.3 Security Setting .
<ul style="list-style-type: none"> • Save 	Click Save to save changes.
<ul style="list-style-type: none"> • Cancel 	Click Cancel to cancel the unsaved changes and revert to the previous settings.

In the CB/WDS STA/CR/Repeater mode, select **Security Mode** on the “**Wireless Network**” page to configure the wireless security to be the same as the root AP's security settings.

Wireless Network		Home	Reset
Wireless Mode	802.11 B/G/N Mixed ▼		
SSID	Specify the static SSID : <input type="text" value="AP SSID"/> (1 to 32 characters) Or press the button to search for any available WLAN Service. <input type="button" value="Site Survey"/>		
Preferred BSSID	<input type="checkbox"/> <input type="text"/> : <input type="text"/> : <input type="text"/> : <input type="text"/> : <input type="text"/> : <input type="text"/>		
Wireless Security			
Changing the wireless security settings may cause this wireless client to associate with a different one. This may temporarily disrupt your configuration session.			
Security Mode	Disabled ▼		
<input type="button" value="Accept"/> <input type="button" value="Cancel"/>			

Figure 5-34 Wireless Network – CB/WDS STA/CR/Repeater Mode

The page includes the following settings:

Object	Description
• Wireless Mode	Wireless mode supports 802.11b/g/n mixed modes.
• SSID	Specify the SSID if known. This field is completed automatically if you select an Access Point in the Site Survey.
• Site Survey	Scans nearby locations for Access Points. You can select a discovered Access Point to establish a connection.
• Prefer BSSID	Enter the MAC address if known. If you select an Access Point in the Site Survey, this field is completed automatically.
• Wireless Security	Refer to section 5.5.3 Security Setting .
• Accept	Click Accept to apply the setting.
• Cancel	Click Cancel to cancel the unsaved changes and revert to the previous settings.

5.5.2 WDS Link Settings

Go to the “**Operation Mode**” page to configure the device as “**WDS Bridge**” and then go to “**Wireless → WDS Link Settings**” to configure the WDS link settings including PtP (Point to Point) or PtMP (Point to Multiple Points) applications.

WDS Link Settings Home Reset

Security	AES ▼				
WEP Key	<input type="text"/>				40/64-bit(10 hex digits) ▼
AES Passphrase	12345678 (8-63 ASCII characters or 64 hexadecimal digits)				

CAUTION: WDS was enabled, you need to assign Wifi Channel manually later.

ID	MAC Address	Mode
1	<input type="text" value="A8"/> : <input type="text" value="F7"/> : <input type="text" value="E0"/> : <input type="text" value="58"/> : <input type="text" value="1A"/> : <input type="text" value="94"/>	Enable ▼
2	<input type="text"/> : <input type="text"/> : <input type="text"/> : <input type="text"/> : <input type="text"/> : <input type="text"/>	Disable ▼
3	<input type="text"/> : <input type="text"/> : <input type="text"/> : <input type="text"/> : <input type="text"/> : <input type="text"/>	Disable ▼
4	<input type="text"/> : <input type="text"/> : <input type="text"/> : <input type="text"/> : <input type="text"/> : <input type="text"/>	Disable ▼

Figure 5-35 WDS Link Settings – WDS Bridge Mode

The page includes the following settings:

Object	Description
• Security	Select the type of WDS security: None, WEP, or AES.
• WEP Key	Enter the WEP key if select security as WEP.
• AES Passphrase	Enter the AES passphrase if select security as AES
• MAC Address	Enter the wireless MAC address of the AP to which you want to extend wireless connectivity.
• Mode	Select Disable or Enable to disable or enable WDS.
• Accept	Click Accept to save the settings.
• Cancel	Click Cancel to cancel the unsaved changes and revert to the previous settings.

NOTE:



1. The WDS link setting is only available in WDS Bridge mode and is communicating through wireless MAC address to each other by using non-standard protocol which may not be compatible with other brands/models of device. Using the same model for full compatibility is required.
2. The security setting in each site of WDS link must be the same.
3. The wireless channel must be fixed and must be the same in each site of WDS link.

5.5.3 Security Settings

Go to the “**Wireless → Wireless Network**” page to configure the security settings.

In the AP/WDS AP mode, click the **Edit** button on the “**Wireless Network**” page to enter the “**SSID Profile**” page and configure the wireless security for the wireless network.

SSID Profile	
Wireless Setting	
SSID	PLANET1 (1 to 32 characters)
VLAN ID	1 (1~4094)
Suppressed SSID	<input type="checkbox"/>
Station Separation	<input type="radio"/> Enable <input checked="" type="radio"/> Disable
Wireless Security	
Security Mode	Disabled ▼
<input type="button" value="Save"/> <input type="button" value="Cancel"/>	

Figure 5-36 Security Settings – AP/WDS AP Mode

In the CB/WDS STA/CR/Repeater mode, select **Security Mode** on the “**Wireless Network**” page to configure the wireless security to be the same as the root AP’s security settings.

Wireless Network		Home	Reset
Wireless Mode	802.11 B/G/N Mixed ▼		
SSID	Specify the static SSID : <input type="text" value="AP SSID"/> (1 to 32 characters) Or press the button to search for any available WLAN Service. <input type="button" value="Site Survey"/>		
Prefered BSSID	<input type="checkbox"/> <input type="text"/> : <input type="text"/> : <input type="text"/> : <input type="text"/> : <input type="text"/> : <input type="text"/>		
Wireless Security			
Changing the wireless security settings may cause this wireless client to associate with a different one. This may temporarily disrupt your configuration session.			
Security Mode	Disabled ▼		
<input type="button" value="Accept"/> <input type="button" value="Cancel"/>			

Figure 5-37 Security Settings – CB/WDS STA/CR/Repeater Mode

In the WDS Bridge mode, select **Security Mode** on the “**WDS Link Settings**” page to configure the wireless security settings. The security settings in each site of the WDS link must be configured to the same.

WDS Link Settings		Home	Reset
Security	AES		
WEP Key		40/64-bit(10 hex digits)	
AES Passphrase	12345678 (8-63 ASCII characters or 64 hexadecimal digits)		

Figure 5-38 Security Settings – WDS Bridge Mode

The option includes the following settings:

Object	Description
<ul style="list-style-type: none"> • Security Mode 	<p>Select the suitable security mode from the drop-down list to encrypt the wireless network. The options include Disabled, WEP, WPA-PSK, WPA2-PSK, WPA-PSK Mixed, WPA, WPA2, and WPA Mixed. The latest WPA2-PSK mode is strongly recommended to use.</p>

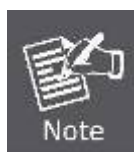

1. The WEP and WPA/WPA2 with TKIP didn't support in pure 802.11n mode and these options will not available in pure 802.11n mode.
2. In 802.11b/g/n mixed mode, if configured the security to WEP, WPA/WPA2 with TKIP, the connection mode/speed will be changed from 802.11n to 802.11g.

■ Disabled

Authentication is disabled and no password/key is required to connect to the access point.

■ WEP

WEP (Wired Equivalent Privacy) is a basic encryption. For a higher level of security, consider using the WPA encryption.

Wireless Security	
Security Mode	WEP ▼
Auth Type	Open System ▼
Input Type	Hex ▼
Key Length	40/64-bit (10 hex digits or 5 ASCII char) ▼ 40/64-bit (10 hex digits or 5 ASCII char) 104/128-bit (26 hex digits or 13 ASCII char) 128/152-bit (32 hex digits or 16 ASCII char)
Default Key	
Key1	
Key2	
Key3	
Key4	
<input type="button" value="Save"/> <input type="button" value="Cancel"/>	

Figure 5-39 Security Settings – WEP

The security mode includes the following settings:

Object	Description
<ul style="list-style-type: none"> • Security Mode 	Select WEP from the drop-down list to configure the wireless network using WEP encryption method.
<ul style="list-style-type: none"> • Auth Type 	Select Open System or Shared.
<ul style="list-style-type: none"> • Input Type 	Select an input type of Hex or ASCII.
<ul style="list-style-type: none"> • Key Length 	<p>Level of WEP encryption is applied to all WEP keys. Select a 64-/128-/152-bit password length.</p> <ul style="list-style-type: none"> ■ 40/64-bit: enter 10 hexadecimal digits (any combination of 0-9, a-f, A-F and null key is not permitted) or 5 ASCII characters. ■ 104/128-bit: enter 26 hexadecimal digits (any combination of 0-9, a-f, A-F and null key is not permitted) or 13 ASCII characters. ■ 128/152-bit: enter 32 hexadecimal digits (any combination of 0-9, a-f, A-F and null key is not permitted) or 16 ASCII characters.
<ul style="list-style-type: none"> • Default Key 	Select 1 – 4 to specify which of the four WEP keys the device uses as its default.
<ul style="list-style-type: none"> • Key1 – Key4 	Specify a password for the security key index. For security, each typed character is masked by a dot.
<ul style="list-style-type: none"> • Save 	Click Save to save the settings.
<ul style="list-style-type: none"> • Cancel 	Click Cancel to cancel the unsaved changes and revert to the previous settings.

■ WPA-PSK

Wireless Security	
Security Mode	WPA-PSK <input type="button" value="v"/>
Encryption	Both(TKIP+AES) <input type="button" value="v"/>
Passphrase	12345678 (8 to 63 characters) or (64 Hexadecimal characters)
Group Key Update Interval	3600 seconds(30~3600, 0: disabled)
<input type="button" value="Save"/> <input type="button" value="Cancel"/>	

Figure 5-40 Security Settings – WPA-PSK

The security mode includes the following settings:

Object	Description
• Security Mode	Select WPA-PSK from the drop-down list to configure the wireless network using WPA-PSK encryption method.
• Encryption	Select Both, TKIP, or AES as the encryption type. <ul style="list-style-type: none"> ■ Both: uses TKIP and AES. ■ TKIP: automatic encryption with WPA-PSK; requires passphrase. ■ AES: automatic encryption with WPA2-PSK; requires passphrase.
• Passphrase	Specify the security password. For security, each typed character is masked by a dot.
• Group Key Update Interval	Specify how often, in seconds, the group key changes.
• Save	Click Save to save the settings.
• Cancel	Click Cancel to cancel the unsaved changes and revert to the previous settings.

■ WPA2-PSK

The later WPA2 protocol features compliance with the full IEEE 802.11i standard and uses Advanced Encryption Standard (AES) in addition to TKIP encryption protocol to guarantee better security than that provided by WEP or WPA.

Wireless Security	
Security Mode	WPA2-PSK ▾
Encryption	Both(TKIP+AES) ▾
Passphrase	12345678 (8 to 63 characters) or (64 Hexadecimal characters)
Group Key Update Interval	3600 seconds(30~3600, 0: disabled)
<input type="button" value="Save"/> <input type="button" value="Cancel"/>	

Figure 5-41 Security Settings – WPA2-PSK

The security mode includes the following settings:

Object	Description
• Security Mode	Select WPA2-PSK from the drop-down list to configure the wireless network using WPA2-PSK encryption method.
• Encryption	Select Both, TKIP, or AES as the encryption type. <ul style="list-style-type: none"> ■ Both: uses TKIP and AES. ■ TKIP: automatic encryption with WPA-PSK; requires passphrase. ■ AES: automatic encryption with WPA2-PSK; requires passphrase.
• Passphrase	Specify the security password. For security, each typed character is masked by a dot.
• Group Key Update Interval	Specify how often, in seconds, the group key changes.
• Save	Click Save to save the settings.
• Cancel	Click Cancel to cancel the unsaved changes and revert to the previous settings.

■ WPA-PSK Mixed

Wireless Security	
Security Mode	WPA-PSK Mixed ▾
Encryption	Both(TKIP+AES) ▾
Passphrase	12345678 (8 to 63 characters) or (64 Hexadecimal characters)
Group Key Update Interval	3600 seconds(30~3600, 0: disabled)
<input type="button" value="Save"/> <input type="button" value="Cancel"/>	

Figure 5-42 Security Settings – WPA-PSK Mixed

The security mode includes the following settings:

Object	Description
--------	-------------

• Security Mode	Select WPA-PSK Mixed from the drop-down list to configure the wireless network using WPA-PSK Mixed encryption method.
• Encryption	Select Both, TKIP, or AES as the encryption type. <ul style="list-style-type: none"> ■ Both: uses TKIP and AES. ■ TKIP: automatic encryption with WPA-PSK; requires passphrase. ■ AES: automatic encryption with WPA2-PSK; requires passphrase.
• Passphrase	Specify the security password. For security, each typed character is masked by a dot.
• Group Key Update Interval	Specify how often, in seconds, the group key changes.
• Save	Click Save to save the settings.
• Cancel	Click Cancel to cancel the unsaved changes and revert to the previous settings.

■ **WPA (WPA Enterprise)**

Wireless Security

Security Mode	WPA ▼
Encryption	Both(TKIP+AES) ▼
Radius Server
Radius Port	1812
Radius Secret	
Group Key Update Interval	3600 seconds(30~3600, 0: disabled)
Radius Accounting	Enable ▼
Radius Accounting Server
Radius Accounting Port	1813
Radius Accounting Secret	
Interim Accounting Interval	600 Seconds(60~600)

Figure 5-43 Security Settings – WPA (WPA Enterprise)

The security mode includes the following settings:

Object	Description
• Security Mode	Select WPA from the drop-down list to configure the wireless network using WPA encryption method.
• Encryption	Select Both, TKIP, or AES as the encryption type. <ul style="list-style-type: none"> ■ Both: uses TKIP and AES. ■ TKIP: automatic encryption with WPA-PSK; requires passphrase. ■ AES: automatic encryption with WPA2-PSK; requires passphrase.

• Radius Server	Specify the IP address of the RADIUS server.
• Radius Port	Specify the port number that your RADIUS server uses for authentication. Default port is 1812.
• Radius Secret	Specify RADIUS secret furnished by the RADIUS server.
• Group Key Update Interval	Specify how often, in seconds, the group key changes.
• Radius Accounting	Select to enable or disable RADIUS accounting.
• Radius Accounting Server	Specify the IP address of the RADIUS accounting server.
• Radius Accounting Port	Specify the port number that your RADIUS accounting server uses for authentication. Default port is 1813.
• Radius Accounting Secret	Specify RADIUS accounting secret furnished by the RADIUS server.
• Interim Accounting Interval	Specify the interim accounting interval (60 - 600 seconds).
• Save	Click Save to save the settings.
• Cancel	Click Cancel to cancel the unsaved changes and revert to the previous settings.

■ WPA2 (WPA2 Enterprise)

Wireless Security

Security Mode	<input type="text" value="WPA2"/>		
Encryption	<input type="text" value="Both(TKIP+AES)"/>		
Radius Server	<input type="text"/>	<input type="text"/>	<input type="text"/>
Radius Port	<input type="text" value="1812"/>		
Radius Secret	<input type="text"/>		
Group Key Update Interval	<input type="text" value="3600"/>	seconds(30~3600, 0: disabled)	
Radius Accounting	<input type="text" value="Enable"/>		
Radius Accounting Server	<input type="text"/>	<input type="text"/>	<input type="text"/>
Radius Accounting Port	<input type="text" value="1813"/>		
Radius Accounting Secret	<input type="text"/>		
Interim Accounting Interval	<input type="text" value="600"/>	Seconds(60~600)	

Figure 5-44 Security Settings – WPA2 (WPA2 Enterprise)

The security mode includes the following settings:

Object	Description
<ul style="list-style-type: none"> • Security Mode 	Select WPA2 from the drop-down list to configure the wireless network using WPA2 encryption method.
<ul style="list-style-type: none"> • Encryption 	Select Both, TKIP, or AES as the encryption type. <ul style="list-style-type: none"> ■ Both: uses TKIP and AES. ■ TKIP: automatic encryption with WPA-PSK; requires passphrase. ■ AES: automatic encryption with WPA2-PSK; requires passphrase.
<ul style="list-style-type: none"> • Radius Server 	Specify the IP address of the RADIUS server.
<ul style="list-style-type: none"> • Radius Port 	Specify the port number that your RADIUS server uses for authentication. Default port is 1812.
<ul style="list-style-type: none"> • Radius Secret 	Specify RADIUS secret furnished by the RADIUS server.
<ul style="list-style-type: none"> • Group Key Update Interval 	Specify how often, in seconds, the group key changes.
<ul style="list-style-type: none"> • Radius Accounting 	Select to enable or disable RADIUS accounting.
<ul style="list-style-type: none"> • Radius Accounting Server 	Specify the IP address of the RADIUS accounting server.
<ul style="list-style-type: none"> • Radius Accounting Port 	Specify the port number that your RADIUS accounting server uses for authentication. Default port is 1813.
<ul style="list-style-type: none"> • Radius Accounting Secret 	Specify RADIUS accounting secret furnished by the RADIUS server.
<ul style="list-style-type: none"> • Interim Accounting Interval 	Specify the interim accounting interval (60 - 600 seconds).
<ul style="list-style-type: none"> • Save 	Click Save to save the settings.
<ul style="list-style-type: none"> • Cancel 	Click Cancel to cancel the unsaved changes and revert to the previous settings.

■ WPA Mixed (WPA Mixed Enterprise)

Wireless Security	
Security Mode	WPA Mixed
Encryption	Both(TKIP+AES)
Radius Server	<input type="text"/> . <input type="text"/> . <input type="text"/> . <input type="text"/>
Radius Port	1812
Radius Secret	<input type="text"/>
Group Key Update Interval	3600 seconds(30~3600, 0: disabled)
Radius Accounting	Enable
Radius Accounting Server	<input type="text"/> . <input type="text"/> . <input type="text"/> . <input type="text"/>
Radius Accounting Port	1813
Radius Accounting Secret	<input type="text"/>
Interim Accounting Interval	600 Seconds(60~600)
<input type="button" value="Save"/> <input type="button" value="Cancel"/>	

Figure 5-45 Security Settings – WPA Mixed (WPA Mixed Enterprise)

The security mode includes the following settings:

Object	Description
• Security Mode	Select WPA Mixed from the drop-down list to configure the wireless network using WPA Mixed encryption method.
• Encryption	Select Both, TKIP, or AES as the encryption type. <ul style="list-style-type: none"> ■ Both: uses TKIP and AES. ■ TKIP: automatic encryption with WPA-PSK; requires passphrase. ■ AES: automatic encryption with WPA2-PSK; requires passphrase.
• Radius Server	Specify the IP address of the RADIUS server.
• Radius Port	Specify the port number that your RADIUS server uses for authentication. Default port is 1812.
• Radius Secret	Specify RADIUS secret furnished by the RADIUS server.
• Group Key Update Interval	Specify how often, in seconds, the group key changes.
• Radius Accounting	Select to enable or disable RADIUS accounting.
• Radius Accounting Server	Specify the IP address of the RADIUS accounting server.
• Radius Accounting Port	Specify the port number that your RADIUS accounting server uses for authentication. Default port is 1813.
• Radius Accounting Secret	Specify RADIUS accounting secret furnished by the RADIUS server.

<ul style="list-style-type: none">• Interim Accounting Interval	Specify the interim accounting interval (60 - 600 seconds).
<ul style="list-style-type: none">• Save	Click Save to save the settings.
<ul style="list-style-type: none">• Cancel	Click Cancel to cancel the unsaved changes and revert to the previous settings.

5.5.4 Wireless MAC Filter

Wireless MAC Filters are used to allow or deny network access to wireless clients according to their MAC addresses. You can manually add a MAC address to restrict the permission to access the device or refer to [section 5.2.3](#) to kick the associated client from the wireless client list.

Click “**Wireless → Wireless MAC Filter**” to configure the wireless access control settings.

The screenshot shows the 'Wireless MAC Filter' configuration interface. At the top right are 'Home' and 'Reset' buttons. The 'ACL Mode' is a dropdown menu currently set to 'Deny MAC in the List'. Below this is a form to add a new MAC address, consisting of six input fields separated by colons, followed by an 'Add' button. A table below shows one entry with '# 1' and 'MAC Address 00:30:4F:A8:FF:FF', with a 'Delete' button next to it. At the bottom, there is an 'Accept' button.

Figure 5-46 Wireless MAC Filter

The page includes the following settings:

Object	Description
<ul style="list-style-type: none"> • ACL Mode 	Determines whether network access is granted or denied to clients whose MAC addresses appear in the MAC Address table on this page. The option includes Disable, Deny MAC in the list, or Allow MAC in the list.
<ul style="list-style-type: none"> • Add 	Enter the wireless MAC address of the client in front of the Add button and then click Add to add the new entry to the MAC filtering list.
<ul style="list-style-type: none"> • # 	Displays the sequence number of the entries.
<ul style="list-style-type: none"> • MAC Address 	Displays the MAC Address that will be denied/allowed to access this device.
<ul style="list-style-type: none"> • Delete 	Click Delete to remove the entry from the list.
<ul style="list-style-type: none"> • Accept 	Click Accept to apply the setting.

5.5.5 Wireless Advanced Settings

Click “Wireless → Wireless Advanced Settings” to configure the wireless advanced settings.

This section allows you to configure the wireless related settings to optimize the wireless network.

Wireless Advanced Settings		Home	Reset
Data Rate	Auto ▼		
Transmit Power	Auto ▼		
RTS/CTS Threshold (1 - 2346)	2346	Bytes	
Distance (1-30km)	1	km (0.6 miles)	
Aggregation:	<input checked="" type="radio"/> Enable <input type="radio"/> Disable 32 Frames 50000 Bytes(Max)		
Wireless Traffic Shaping			
Enable Traffic Shaping	<input type="radio"/> Enable <input checked="" type="radio"/> Disable		
Upload Limit	1000	kbit/s (512-9999999)	
Download Limit	180000	kbit/s (512-9999999)	
Client Limit			
	Frequency	Enable	Max Client
	2.4G	<input checked="" type="checkbox"/>	64
<input type="button" value="Accept"/> <input type="button" value="Cancel"/>			

Figure 5-47 Wireless Advanced Settings

The page includes the following settings:

Object	Description
<ul style="list-style-type: none"> Data Rate 	Select a data rate from the drop-down list. The data rate affects throughput. If you select a low data rate value, for example, the throughput is reduced but the transmission distance increases. The default is “Auto”.
<ul style="list-style-type: none"> Transmit Power 	<p>Configure the output transmission power of the device (Range: 11~29dBm). The PtP range less 1km should keep it as default and distance exceed 5km is suggested to highest value.</p> <p>The option is only allowed to be configured after disabled Green option of “Operation Mode” page. Keep it as default “Auto” setting to prevent violating regional regulation unless your configuration meets the</p>

	regulation.
<ul style="list-style-type: none"> • RTS/CTS Threshold 	When the length of a data packet exceeds this value, the device will send an RTS frame to the destination wireless node, and the latter will reply with a CTS frame, and thus they are ready to communicate. The default value is 2346. A small number causes RTS/CTS packets to be sent more often and consumes more bandwidth.
<ul style="list-style-type: none"> • Distance 	Specify the distance between the master AP and slave AP. Longer distances may drop high-speed connections.
<ul style="list-style-type: none"> • Aggregation 	A part of the 802.11n standard that allows sending multiple frames per single access to the medium by combining frames together into one larger frame. It creates the larger frame by combining smaller frames with the same physical source, destination end points, and traffic class (QoS) into one large frame with a common MAC header. This option reduces the number of packets, but increases packet sizes.
Wireless Traffic Shaping	
<ul style="list-style-type: none"> • Enable Traffic Shaping 	Enable or disable the regulation of packet flow leaving an interface for improved QoS.
<ul style="list-style-type: none"> • Incoming Traffic Limit 	Specify the wireless transmission speed used for downloading.
<ul style="list-style-type: none"> • Outgoing Traffic Limit 	Specify the wireless transmission speed used for uploading.
<ul style="list-style-type: none"> • Total Percentage 	Specify the total percentage of the wireless traffic that is shaped.
<ul style="list-style-type: none"> • SSID1 to SSID4 	Specify the percentage of the wireless traffic that is shaped for a specific SSID.
Client Limit: This option is only available in AP and WDS AP modes.	
<ul style="list-style-type: none"> • Frequency 	Display the frequency of the device's radio interface.
<ul style="list-style-type: none"> • Enable 	Click to enable the client limit function.
<ul style="list-style-type: none"> • Max Client 	Specify the max. client quantity that is allowed to connect to the radio interface.
<ul style="list-style-type: none"> • Accept 	Click Accept to apply all changes.
<ul style="list-style-type: none"> • Cancel 	Click Cancel to cancel the settings.

5.6 Management

On this page, you can configure the system settings for management purposes, including Management VLAN settings, Time settings, Password settings, SNMP settings, CLI settings, Wi-Fi schedule, Firmware upgrade, Configuration backup and restore, Factory default, and Auto reboot.

5.6.1 Administration (Password Settings)

Click "**Management → Administration**" to configure username and password of the login account.

Figure 5-48 Administration (Password Settings)

The page includes the following settings:

Object	Description
• New Name	Enter a new username for logging in to the Web page.
• New Password	Enter a new password for logging in to the Web page.
• Confirm Password	Re-enter the new password for confirmation.
• Save/Apply	Click Save/Apply to apply all changes.
• Cancel	Click Cancel to cancel the settings.

5.6.2 Management VLAN

Click “**Management → Management VLAN**” to configure the management VLAN settings.

Figure 5-49 Management VLAN

The page includes the following settings:

Object	Description
• Management VLAN ID	If your network includes VLANs and if tagged packets need to pass through the Access Point, enter the VLAN ID. Otherwise, select No VLAN tag .

• Accept	Click Accept to apply the changes.
• Cancel	Click Cancel to cancel the settings.

5.6.3 SNMP Settings

SNMP is used in network management systems to monitor network-attached devices for conditions that warrant administrative attention.

Click "**Management → SNMP Settings**" to configure SNMP settings.

SNMP Settings		Home	Reset
SNMP	<input checked="" type="radio"/> Enable <input type="radio"/> Disable		
Contact	<input type="text"/>		
Location	<input type="text"/>		
Community Name (Read Only)	public		
Community Name (Read Write)	private		
Trap Destination Address	<input type="text"/>		
Trap Destination Community Name	public		
SNMPv3	<input checked="" type="radio"/> v3Enable <input type="radio"/> v3Disable		
User Name (1-31 Characters)	admin		
Auth Protocol	MD5 ▼		
Auth Key (8-32 Characters)	12345678		
Priv Protocol	DES ▼		
Priv Key (8-32 Characters)	12345678		
Engine ID	<input type="text"/>		
<input type="button" value="Save/Apply"/> <input type="button" value="Cancel"/>			

Figure 5-50 SNMP Settings

The page includes the following settings:

Object	Description
• SNMP	Enable or disable the SNMP service.
• Contact	Enter the contact details of the device.
• Location	Enter the location of the device.
• Community Name (Read Only)	Enter the password for accessing the SNMP community for read-only access.

• Community Name (Read/Write)	Enter the password for accessing the SNMP community for read and write access.
• Trap Destination Address	Enter the IP address where SNMP traps are to be sent.
• Trap Destination Community Name	Enter the password of the SNMP trap community.
• SNMPv3	Enable or Disable the SNMPv3 feature.
• User Name	Specify the username for SNMPv3.
• Auth Protocol	Select the authentication protocol type: MD5 or SHA.
• Auth Key (8-32 Characters)	Specify the authentication key for authentication.
• Priv Protocol	Select the privacy protocol type: DES.
• Priv Key (8-32 Characters)	Specify the privacy key for privacy.
• Engine ID	Specify the engine ID for SNMPv3.
• Save/Apply	Click Save/Apply to apply all changes.
• Cancel	Click Cancel to cancel the settings.

5.6.4 Backup/Restore Settings

Click “**Management → Backup/Restore Settings**” and the following page will be displayed.

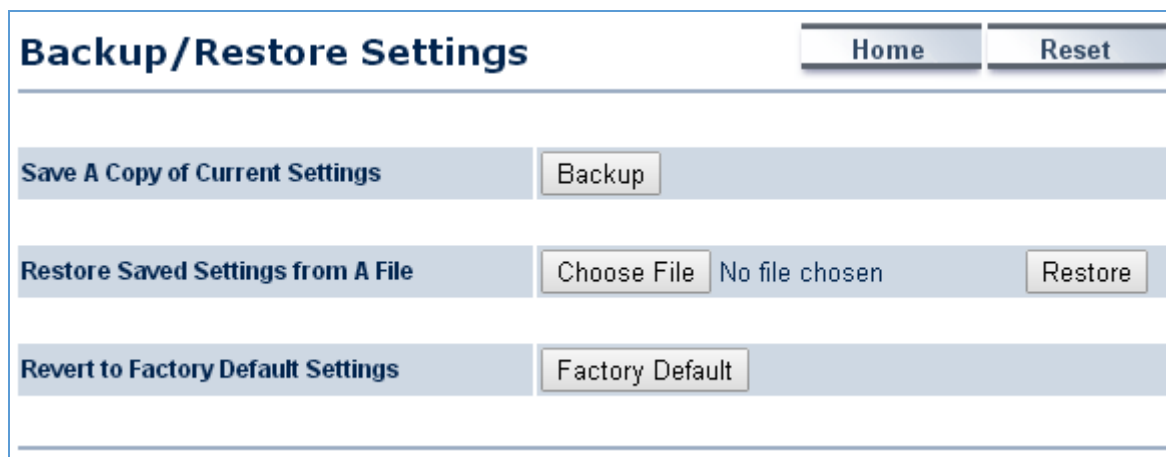

Figure 5-51 Backup/Restore Settings

The page includes the following settings:

Object	Description
• Save A Copy of Current Settings	Click Backup to save the current configured settings.
• Restore Saved Settings from A File	To restore settings that have been previously backed up, click Choose File to select the file, and click Restore .
• Revert to Factory Default Settings	Click Factory Default to restore the device to its factory default settings.

5.6.5 Auto Reboot Settings

Click “**Management → Auto Reboot Settings**” and the following page will be displayed.

This page allows you to enable and configure system auto reboot interval. The device can regularly reboot according to the frequency in different time formats of interval.

Figure 5-52 Auto Reboot Settings

The page includes the following settings:

Object	Description
<ul style="list-style-type: none"> • Auto Reboot Settings 	Select Enable from the drop-down menu to setup this function.
<ul style="list-style-type: none"> • Frequency of Auto Reboot 	Select the frequency interval using the drop-down menus. The interval supported in different time formats: <ul style="list-style-type: none"> • Min: 10/20/30/40/50/60 Mins • Hour: 1~24 hours • Day: 1~31 days • Week: 1~5 weeks
<ul style="list-style-type: none"> • Save/Apply 	Click Save/Apply to apply all changes.
<ul style="list-style-type: none"> • Cancel 	Click Cancel to cancel the settings.

5.6.6 Firmware Upgrade

Click “**Management → Firmware Upgrade**” to upgrade the device’s firmware.

Figure 5-53 Firmware Upgrade

The page includes the following settings:

Object	Description
<ul style="list-style-type: none"> • Current Firmware Version 	Click ON to enable or click OFF to disable the option.
<ul style="list-style-type: none"> • Choose File 	Click Choose File to locate and select the upgrade file from your local hard disk.
<ul style="list-style-type: none"> • Upload 	Click Upload to upgrade the firmware.

Firmware Upgrade Procedure

The following procedure will guide you to how to upgrade the firmware.

Step 1. Click the **Choose File** button to locate the firmware file path. Then, click the **Upload** button.

Step 2. The firmware checksum information appeared to help you confirm the file is correct. Once confirmed, click the **Upgrade** button to begin the upgrade process.

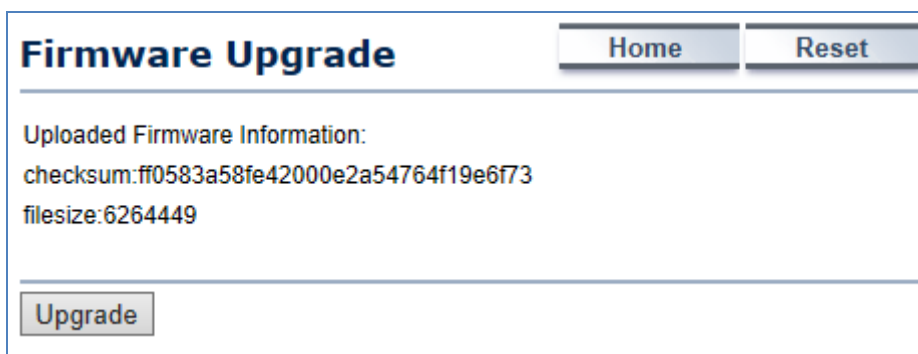

Step 3. Wait for the process to finish.

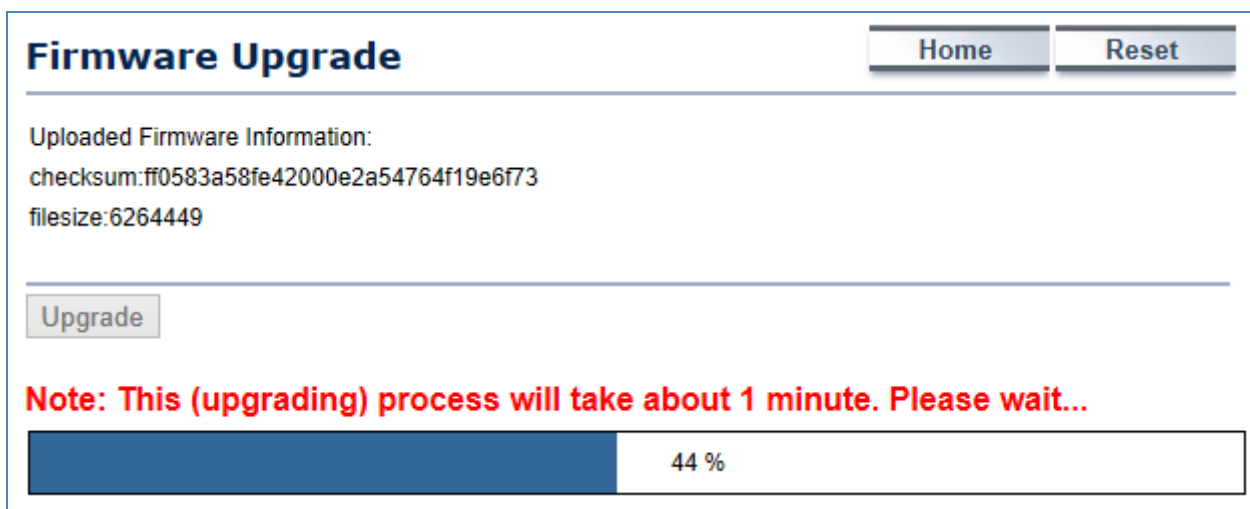

Step 4. When the upgrade is finished, the system will auto reboot and you can click the hyperlink “**Click here when AP is ready**” after the system restarts.

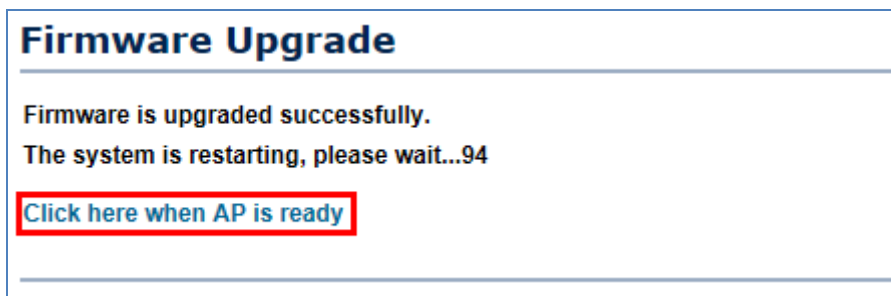

5.6.7 Time Settings

Click “**Management → Time Settings**” to configure time zone and NTP server settings to be in sync with the device’s time.

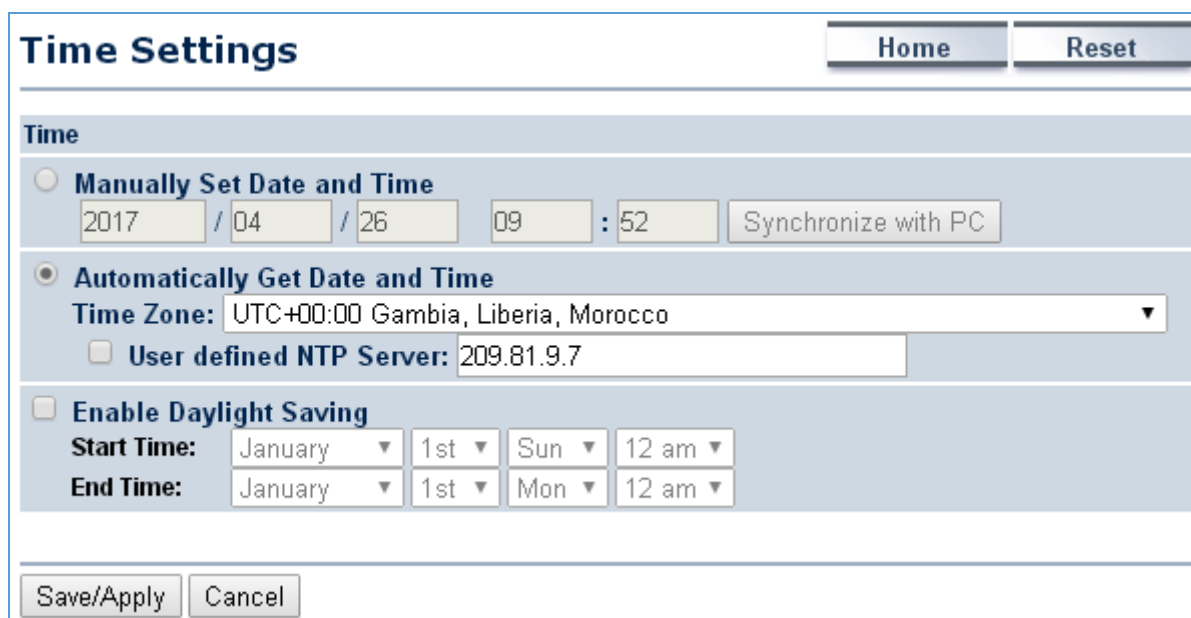

Figure 5-54 Time Settings

The page includes the following settings:

Object	Description
<ul style="list-style-type: none"> • Manually Set Date and Time 	Enter the date and time values in the date and time fields or click the Synchronize with PC to get the date and time values from the administrator’s PC.
<ul style="list-style-type: none"> • Automatically Get Date and Time 	Select a time zone from the drop-down list and check whether you want to enter the IP address of an NTP server or use the default NTP server.
<ul style="list-style-type: none"> • Enable Daylight Saving 	Click to enable or disable daylight savings time. Select the start and stop times from the Start Time and Stop Time dropdown lists.
<ul style="list-style-type: none"> • Save/Apply 	Click Save/Apply to apply all changes.
<ul style="list-style-type: none"> • Cancel 	Click Cancel to cancel the settings.

5.6.8 Wi-Fi Schedule

This page allows you to configure wireless schedule. The device can regularly enable/disable Wi-Fi function according to the pre-defined schedule rules.

Click “**Management → Auto Reboot Settings**” and the following page will be displayed.

Figure 5-55 Wi-Fi Schedule

The page includes the following settings:

Object	Description
• Schedule Name	Enter the description of the schedule service.
• Service	Select the type of schedule service, either Wireless Power ON or Wireless Power OFF.
• Day	Select the days of the week to enable the schedule service.
• Time of Day	Set the start time that the service is active.
• Add	Click Add to append the schedule service to the schedule service table
• Cancel	Click Cancel to discard changes.

5.6.9 CLI Settings

The command line interface (CLI) allows user to access the device through a command console, modem or Telnet connection for configuration.

Click "**Management** → **CLI Settings**" to enable/disable CLI (Command Line Interface).

Figure 5-56 CLI Settings

The page includes the following settings:

Object	Description
• CLI	Select ON/OFF to enable or disable the ability to modify the device via a command line interface (CLI).
• Save/Apply	Click Save/Apply to apply all changes.
• Cancel	Click Cancel to cancel the settings.

5.6.10 Log

Click "**Management** → **Log**" to enable/disable system log.

Figure 5-57 Log

The page includes the following settings:

Object	Description
• Syslog	Enable or disable the syslog function.
• Log Server IP Address	Enter the IP address of the log server.
• Local Log	Enable or disable the local log service.
• Save/Apply	Click Save/Apply to apply all changes.
• Cancel	Click Cancel to cancel the settings.

5.6.11 Diagnostics

Click "**Management → Diagnostics**" to test the connection and performance through the built-in diagnostics utilities.

Diagnostics

Home
Reset

Ping Test Parameters

Target IP / Domain Name	<input style="width: 90%;" type="text"/>
Ping Packet Size	<input style="width: 40px;" type="text" value="64"/> Bytes
Number of Pings	<input style="width: 40px;" type="text" value="4"/>

Start Ping

Traceroute Test Parameters i

Traceroute target	<input style="width: 90%;" type="text"/>
--------------------------	--

Start Traceroute

Speed Test

Target Address	<input style="width: 90%;" type="text"/>
Time Period	<input style="width: 40px;" type="text" value="20"/> Sec
Check Interval	<input style="width: 40px;" type="text" value="5"/> Sec
IPv4 Port	5001
IPv6 Port	5002

Start Speed Test

Figure 5-58 Diagnostics

The page includes the following settings:

Object	Description
• Target IP / Domain Name	Enter the IP address you would like to search.
• Ping Packet Size	Enter the packet size of each ping.
• Number of Pings	Enter the number of times you want to ping.
• Start Ping	Click Start Ping to begin pinging.
• Trace route target	Enter an IP address or domain name you want to trace.
• Start Traceroute	Click Start Traceroute to begin the traceroute operation.
• Target Address	Enter the IP address of the target PC.
• Time period	Enter time period for the speed test.
• Check Interval	Enter the interval for the speed test.
• Start Speed Test	Click Start Speed Test to begin the speed test operation.
• IPv4 Port	Displays the IPv4 port number of the device.
• IPv6 Port	Displays the IPv6 port number of the device.

5.6.12 Logout

Click "**Management** → **Logout**" to log out the system.

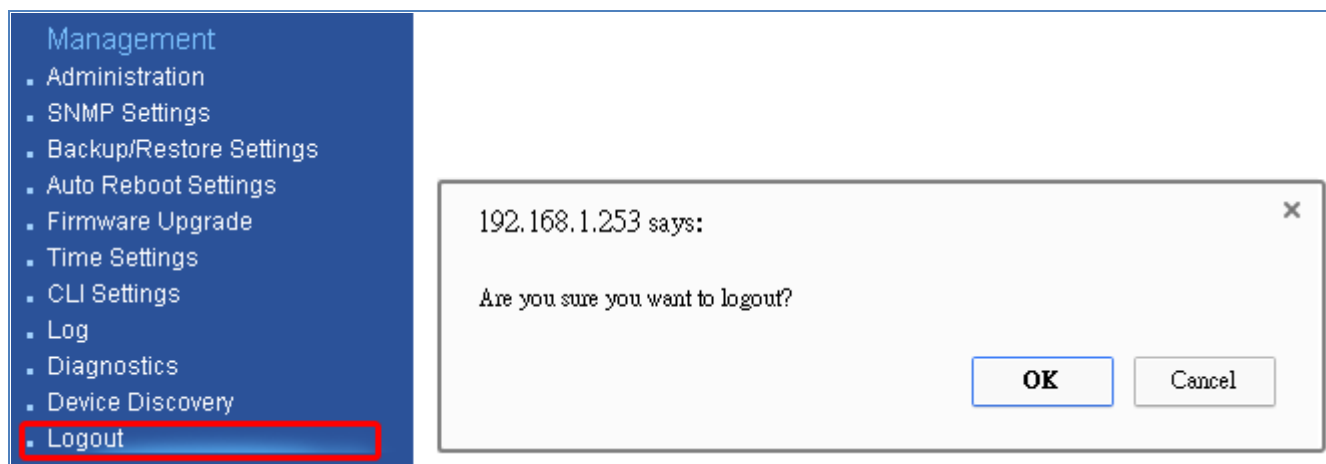

Figure 5-59 Logout

The page includes the following settings:

Object	Description
• OK	Click OK to log out the system.
• Cancel	Click Cancel to cancel the operation.

Appendix A: Troubleshooting

If you find the AP is working improperly or stop responding to you, please read this troubleshooting first before contacting the Planet Tech Support for help. Some problems can be solved by yourself within very short time.

Scenario	Solution
The AP is not responding to me when I want to access it by web browser.	<ol style="list-style-type: none"> Please check the connection of the power cord and the Ethernet cable of this AP. All cords and cables should be correctly and firmly inserted to the AP. If all LEDs on this AP are off, please check the status of power adapter, and make sure it is correctly powered. You must use the same IP address section that AP uses. Are you using MAC or IP address filter? Try to connect the AP by another computer and see if it works; if not, please reset the AP to the factory default settings (Press the 'reset' button for over 10 seconds). Set your computer to static IP address, and see if the Planet Smart Discovery can find the AP or not. If you did a firmware upgrade and this happens, contact the Planet Tech Support for help. If all the solutions above don't work, contact Planet Tech Support for help.
I can't get connected to the Internet.	<ol style="list-style-type: none"> Check the Internet connection status from the router that is connected with the AP. Please be patient. Sometimes Internet is just that slow. If you have connected a computer to Internet directly before, try to do that again, and check if you can get connected to Internet with your computer directly attached to the device provided by your Internet service provider. Check PPPoE / L2TP / PPTP user ID and password in your router again. Call your Internet service provider and check if there's something wrong with their service. If you just can't connect to one or more website, but you can still use other internet services, please check URL/Keyword filter. Try to reset the AP and try again later. Reset the device provided by your Internet service provider. Try to use IP address instead of hostname. If you can use IP address to communicate with a remote server, but can't use hostname, please check DNS setting.
I can't locate my AP by my wireless device.	<ol style="list-style-type: none"> 'Broadcast ESSID' set to off? The antenna is properly secured.

	<ul style="list-style-type: none"> c. Are you too far from your AP? Try to get closer. d. Please remember that you have to input ESSID on your wireless client manually, if ESSID broadcast is disabled.
<p>File downloading is very slow or breaks frequently.</p>	<ul style="list-style-type: none"> a. Are you using QoS function? Try to disable it and try again. b. Internet is slow sometimes; try to be patient. c. Try to reset the AP and see if it's better after that. d. Try to know what computers do on your local network. If someone's transferring big files, other people will think Internet is really slow. e. If this never happens before, call you Internet service provider to know if there is something wrong with their network.
<p>I can't log in to the web management interface; the password is wrong.</p>	<ul style="list-style-type: none"> a. Make sure you're connecting to the correct IP address of the AP. b. Password is case-sensitive. Make sure the 'Caps Lock' light is not illuminated. c. If you really forget the password, do a hard reset.
<p>The AP becomes hot</p>	<ul style="list-style-type: none"> a. This is not a malfunction, if you can keep your hand on the AP's case. b. If you smell something wrong or see the smoke coming out from AP or A/C power adapter, please disconnect the AP and A/C power adapter from utility power (make sure it's safe before doing this!), and call your dealer for help.

Appendix B: Use Planet Smart Discovery to find AP

To easily discover the WAP-200N/WBS-200N in your Ethernet environment, the Planet Smart Discovery Utility is an ideal solution. The utility is available at: http://www.planet.com.tw/en/product/images/48590/Planet_Utility.zip

The following instructions will guide you to how to use the Planet Smart Discovery Utility.

Step 1. Download the **Planet Smart Discovery Utility** in administrator PC.

Step 2. Execute this utility.



Step 3. Click the “**Refresh**” button as shown below to update the list of the currently connected devices.

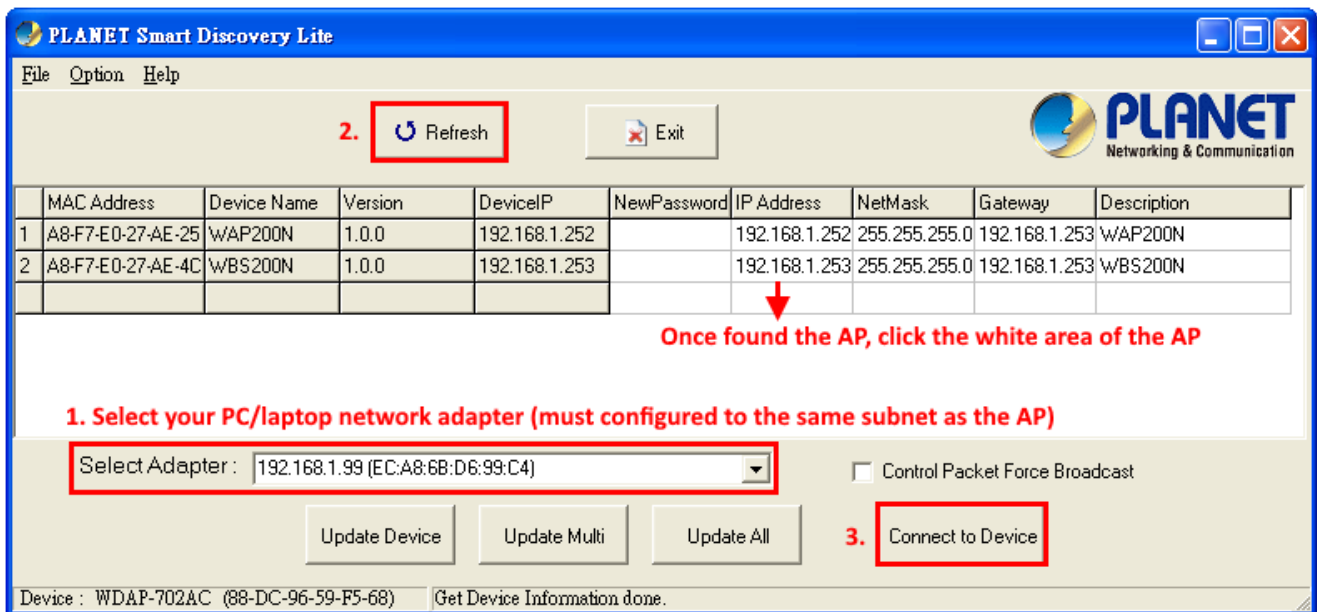

Figure B-1 PLANET Smart Discovery

Step 4. Select the AP from the list and then click the “**Connect to Device**” button to link to the Web Management Configuration page.



The fields in white background can be modified directly, and then you can apply the new setting by clicking the “**Update Device**” button.

Appendix C: FAQ

Q1: How to set up the AP Client Connection

Topology:

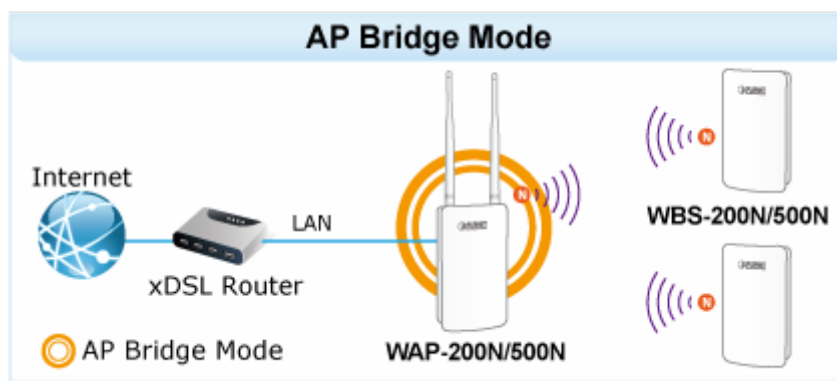

1. Use static IP in the PCs that are connected with AP-1 (Site-1) and AP-2 (Site-2). In this case, Site-1 is “192.168.1.100”, and Site-2 is “192.168.1.200”.

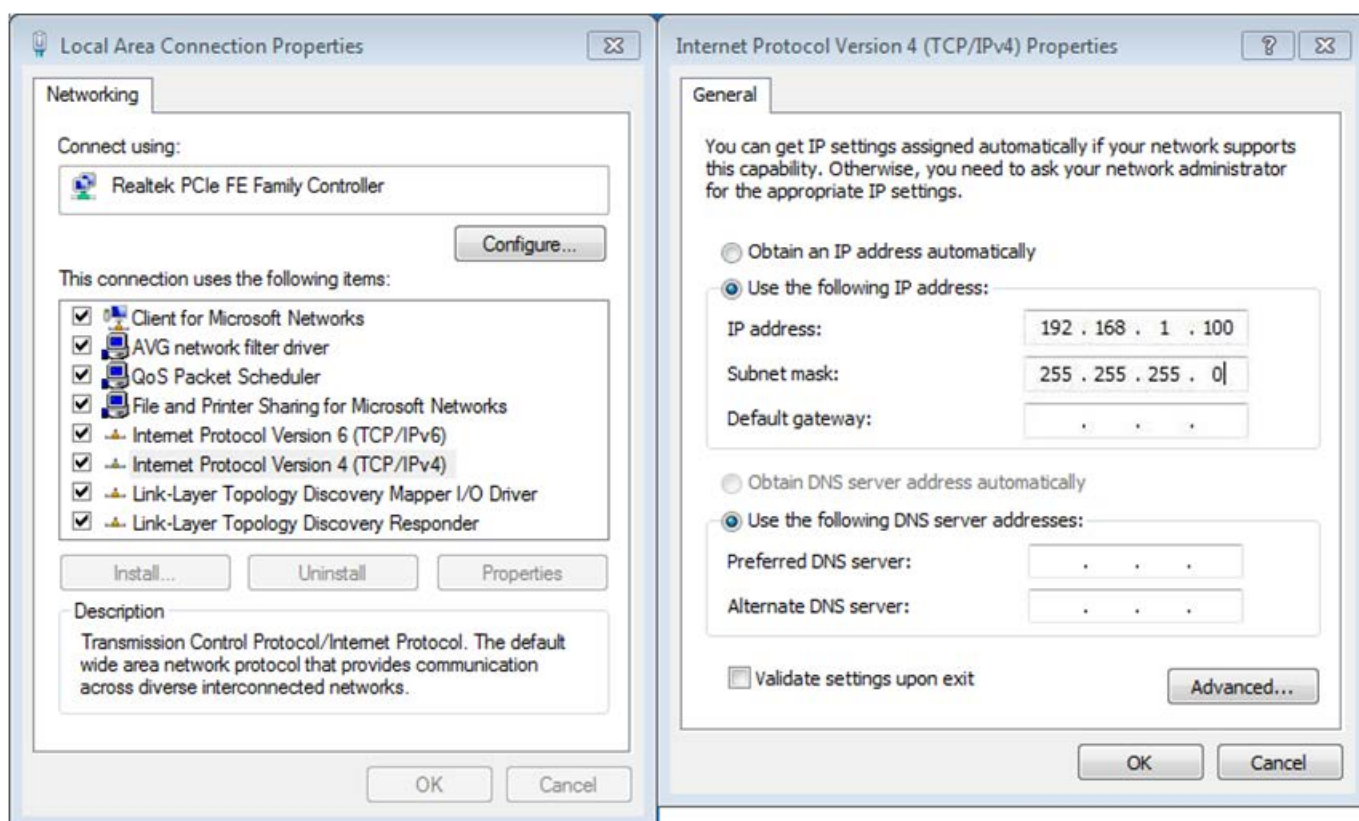

2. In the AP-1, go to “**System-> IP Settings**” to configure the IP address to static and different from the CPE.

IP Settings		Home	Reset
System Information			
IP Network Setting	<input type="radio"/> Obtain an IP address automatically (DHCP) <input checked="" type="radio"/> Specify an IP address		
IP Address	192	168	1 . 252
IP Subnet Mask	255	255	255 . 0
Default Gateway	192	168	1 . 253
Primary DNS	0	0	0 . 0
Secondary DNS	0	0	0 . 0
Use Link-Local Address	<input checked="" type="checkbox"/>		
IPv6 IP Address	<input type="text"/>		
IPv6 Subnet Prefix Length	<input type="text"/>		
IPv6 Default Gateway	<input type="text"/>		
IPv6 Primary DNS	<input type="text"/>		
IPv6 Secondary DNS	<input type="text"/>		
<input type="button" value="Accept"/> <input type="button" value="Cancel"/>			

3. In the AP-1, go to “**System-> Operation Mode**” and set it to use “**Access Point**” mode. Then, click “**Save & Apply**”.

System Properties		Home	Reset
System Properties			
Device Name	PLANET	(1 to 32 characters)	<input checked="" type="checkbox"/> Green
Country/Region	Please Select a Country Code <input type="text"/>		
Operation Mode	<input checked="" type="radio"/> Access Point <input type="radio"/> Client Bridge <input type="radio"/> WDS <input type="radio"/> Client Router <input type="radio"/> Repeater		
<input type="button" value="Save & Apply"/> <input type="button" value="Cancel"/>			

4. In the AP-1, go to “**Wireless-> Wireless Network**” to configure channel and click “**Edit**” for security setting.
- (1) Channel HT Mode: set to “**40MHz**” for wider bandwidth
 - (2) Channel/Frequency: uncheck “**Auto**” and set to a fixed channel

Wireless Network

Home
Reset

Wireless Mode	802.11 B/G/N Mixed ▾
Channel HT Mode	40MHz ▾
Extension Channel	Upper Channel ▾
Channel / Frequency	Ch1-2.412GHz ▾ <input type="checkbox"/> Auto
AP Detection	Scan

Current Profiles

SSID	Security	Isolation	VID	Enable	Edit
PLANET1	None	<input type="checkbox"/>	1	<input checked="" type="checkbox"/>	Edit
PLANET2	None	<input type="checkbox"/>	2	<input type="checkbox"/>	Edit
PLANET3	None	<input type="checkbox"/>	3	<input type="checkbox"/>	Edit
PLANET4	None	<input type="checkbox"/>	4	<input type="checkbox"/>	Edit

Accept
Cancel

5. In the SSID Profile, you can configure your own SSID and Passphrase. Then, click “**Save**” to go back to the main page.

SSID Profile

Wireless Setting

You can modify the SSID or keep it as default.

SSID	PLANET1 (1 to 32 characters)
VLAN ID	1 (1~4094)
Suppressed SSID	<input type="checkbox"/>
Station Separation i	<input type="radio"/> Enable <input checked="" type="radio"/> Disable

Wireless Security

Suggested configure the security to WPA2-PSK/AES

Security Mode	WPA2-PSK ▾
Encryption	AES ▾
Passphrase	12345678 (8 to 63 characters) or (64 Hexadecimal characters)
Group Key Update Interval	3600 seconds(30~3600, 0: disabled)

Save
Cancel

6. Click “**Accept**” to save the configurations.

Wireless Network

Home Reset

Wireless Mode	802.11 B/G/N Mixed ▼
Channel HT Mode	40MHz ▼
Extension Channel	Upper Channel ▼
Channel / Frequency	Ch1-2.412GHz ▼ <input type="checkbox"/> Auto
AP Detection	Scan

Current Profiles					
SSID	Security	Isolation	VID	Enable	Edit
PLANET1	WPA2-PSK AES	<input type="checkbox"/>	1	<input checked="" type="checkbox"/>	Edit
PLANET2	None	<input type="checkbox"/>	2	<input type="checkbox"/>	Edit
PLANET3	None	<input type="checkbox"/>	3	<input type="checkbox"/>	Edit
PLANET4	None	<input type="checkbox"/>	4	<input type="checkbox"/>	Edit

Accept
Cancel

7. Go to the “**Status-> Save/Reload**” page to click “**Save & Apply**” to force the AP to reboot so that it can apply all configurations and take effect.

Access Point

Home Reset

Status

- Save/Reload:16
- Main
- Wireless Client List
- System Log

System

- Operation Mode
- IP Settings
- Spanning Tree Settings

Wireless

- Wireless Network
- Wireless MAC Filter
- Wireless Advanced Settings

Management

- Administration

Save/Reload

Unsaved changes list

```

-network.1.ifname
-network.3.ifname
network.lan.ifname=eth0
-network.4.ifname
-network.2.ifname
network.sys.ManagementVLANID=4096
wireless.cfg039f7e.wps_configured=1
wireless.cfg039f7e.key=12345678
wireless.cfg039f7e.encryption=psk2 aes
wireless.cfg039f7e.WLANWpaRadiusAccSrvIP=...
wireless.cfg039f7e.hidden=0
wireless.cfg039f7e.server=...
wireless.wifi0.WLANHTMode=40
wireless.wifi0.WLANExtChannel=0
wireless.wifi0.channel=1
wireless.cfg09feac.WLANVLANEnable=0

```

Save & Apply
Revert

8. In the AP-2, go to “**System-> IP Settings**” to configure the IP address to static and different from the CPE.

IP Settings		Home	Reset
System Information			
IP Network Setting	<input type="radio"/> Obtain an IP address automatically (DHCP) <input checked="" type="radio"/> Specify an IP address		
IP Address	192	168	1 . 253
IP Subnet Mask	255	255	255 . 0
Default Gateway	192	168	1 . 253
Primary DNS	0	0	0 . 0
Secondary DNS	0	0	0 . 0
Use Link-Local Address	<input checked="" type="checkbox"/>		
IPv6 IP Address	<input type="text"/>		
IPv6 Subnet Prefix Length	<input type="text"/>		
IPv6 Default Gateway	<input type="text"/>		
IPv6 Primary DNS	<input type="text"/>		
IPv6 Secondary DNS	<input type="text"/>		
<input type="button" value="Accept"/> <input type="button" value="Cancel"/>			

9. In the AP-2, go to “**System-> Operation Mode**” and set it to use “**Client Bridge**” mode. Then, click “**Save & Apply**”.

System Properties		Home	Reset
System Properties			
Device Name	PLANET	(1 to 32 characters)	<input checked="" type="checkbox"/> Green
Country/Region	Please Select a Country Code <input type="text"/>		
Operation Mode	<input type="radio"/> Access Point <input checked="" type="radio"/> Client Bridge <input type="radio"/> WDS <input type="radio"/> Client Router <input type="radio"/> Repeater		
<input type="button" value="Save & Apply"/> <input type="button" value="Cancel"/>			

10. In the AP-2, go to “**Wireless-> Wireless Network**”. Click “Site Survey” to discover the AP-1.

Wireless Network

Home
Reset

Wireless Mode 802.11 B/G/N Mixed ▼

SSID Specify the static SSID :
 (1 to 32 characters)
 Or press the button to search for any available WLAN Service.
Site Survey

Preferred BSSID : : : : :

Wireless Security

Changing the wireless security settings may cause this wireless client to associate with a different one. This may temporarily disrupt your configuration session.

Security Mode Disabled ▼

Accept
Cancel

11. Click the AP-1 to let the AP-2 to connect it. Then, it will go back to the main page.

Site Survey

2.4GHz Site Survey

i:Infrastructure
i:Ad_hoc

BSSID	SSID	Channel	Signal Level	Type	Security	Mode
A8:F7:E0:42:12:83	PLANET1	1	-57 dBm	11g/n	WPA2-PSK	i
00:30:4F:CE:94:63	CHT Wi-Fi Auto	5	-80 dBm	11g/n	WPA/WPA2	i
C8:3A:35:24:65:7C	11F_Demo_Room	6	-83 dBm	11g/n	WPA2-PSK	i

Refresh

12. Click the check box of the preferred BSSID and configure the encryption to be the same as the AP-1. Then, click **“Accept”** to save the configurations.

Wireless Network		Home	Reset
Wireless Mode	802.11 B/G/N Mixed ▾		
SSID	Specify the static SSID : <input type="text" value="PLANET 1"/> (1 to 32 characters) Or press the button to search for any available WLAN Service. <input type="button" value="Site Survey"/>		
Preferred BSSID	<input checked="" type="checkbox"/> A8 : F7 : E0 : 42 : 12 : 83		
Wireless Security			
Changing the wireless security settings may cause this wireless client to associate with a different one. This may temporarily disrupt your configuration session.			
Security Mode	WPA2-PSK ▾		
Encryption	AES ▾		
Passphrase	<input type="text" value="12345678"/> × (8 to 63 characters) or (64 Hexadecimal characters)		
<input type="button" value="Accept"/> <input type="button" value="Cancel"/>			

- Go to the “**Status-> Save/Reload**” page to click “**Save & Apply**” to force the AP to reboot so that it can apply all configurations and take effect.

Client Bridge		Save/Reload		Home	Reset
<ul style="list-style-type: none"> Status Save/Reload:7 Main Connection Status System Log System Operation Mode IP Settings Spanning Tree Settings Wireless 		<div style="border: 1px solid gray; height: 20px; width: 100%;"></div> <p>Unsaved changes list</p> <pre>wireless.cfg039e49.auth=MSCHAP wireless.cfg039e49.ssid=PLANET 1 wireless.cfg039e49.encryption=psk2 aes wireless.cfg039e49.eap_type=PEAP wireless.cfg039e49.bssid=A8:F7:E0:42:12:83 wireless.cfg039e49.key=12345678 wireless.cfg039e49.PreferBSSIDEnable=0</pre>			
		<input type="button" value="Save & Apply"/> <input type="button" value="Revert"/>			

- In the AP-2, go to the “**Status-> Connection Status**” page to check whether the AP-2 is associated to the AP-1 successfully.

Connection Status		Home	Reset
Network Type	Client Bridge		
SSID	PLANET1		
BSSID	A8:F7:E0:42:12:83		
Connection Status	Associated		
Wireless Mode	IEEE 802.11B/G/N Mixed		
Current Channel	2.412 GHz(Channel 1)		
Security	WPA2-PSK AES		
Tx Data Rates(Mbps)	300 Mbps		
Current noise level	-95 dBm		
Signal strength	-60 dBm		

Refresh

15. In the AP-1, go to the “Status-> Wireless Client List” page to check the client’s signal strength.

Client List						Home	Reset
SSID:#	MAC Address	TX(Bytes)	RX(Bytes)	RSSI(dBm)	Kick and Ban		
SSID1:#1	a8:f7:e0:2f:83:57	45345Kb	45993Kb	-27	<input type="button" value="Kick"/>		

Refresh

16. Use command line tool to ping each other to ensure the link is successfully established.

For example, from Site-1, ping 192.168.1.200; and at Site-2, ping 192.168.1.100.

```

C:\WINDOWS\system32\CMD.exe - ping 192.168.1.100 -t
Destination host unreachable.
Destination host unreachable.
Destination host unreachable.
Destination host unreachable.
Destination host unreachable.
Ping statistics for 192.168.0.100:
    Packets: Sent = 25, Received = 0, Lost = 25 (100% loss),
Control-C
^C
C:\Documents and Settings\Administrator>ping 192.168.1.100 -t

Pinging 192.168.1.100 with 32 bytes of data:

Request timed out.
Reply from 192.168.1.100: bytes=32 time=7ms TTL=128
Reply from 192.168.1.100: bytes=32 time=1ms TTL=128
Reply from 192.168.1.100: bytes=32 time=2ms TTL=128
Reply from 192.168.1.100: bytes=32 time=1ms TTL=128
Reply from 192.168.1.100: bytes=32 time=2ms TTL=128
Reply from 192.168.1.100: bytes=32 time=2ms TTL=128
Reply from 192.168.1.100: bytes=32 time=1ms TTL=128
Reply from 192.168.1.100: bytes=32 time=1ms TTL=128
Reply from 192.168.1.100: bytes=32 time=1ms TTL=128

```



Attention should be paid to the following hints:

- 1) The encryption method must be the same at both sites if configured.
 - 2) Both sites should be Line-of-Sight.
 - 3) Included in the package are two 5dBi antennas for the WAP-200N only for long distance over 1km. Please connect to the 2.4GHz antennas with higher gain.
 - 4) For PtP connection over 1km, please adjust "**Distance**" setting to the actual distance between both sites on the 'both sites' setting page.
 - 5) To adjust "**Transmit Power**", please:
 - (a) Go to the "**Operation Mode**" page to disable the "**Green**" option.
 - (b) Go to "**Wireless Advanced Settings-> Transmit Power**" to manually adjust the transmit power.
-

Q2: How to set up the WDS Connection

Topology:

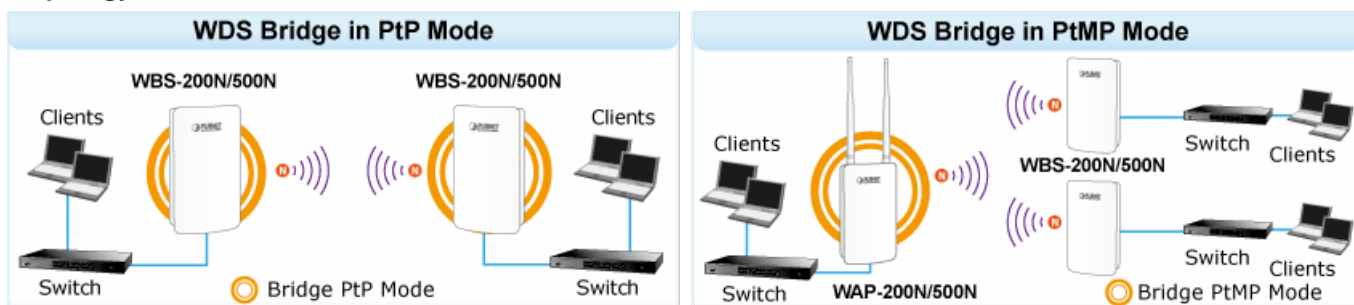

1. Use static IP in the PCs that are connected with WBS-200N-1 (Site-1) and WBS-200N-2 (Site-2). In this case, Site-1 is “192.168.1.100”, and Site-2 is “192.168.1.200”.

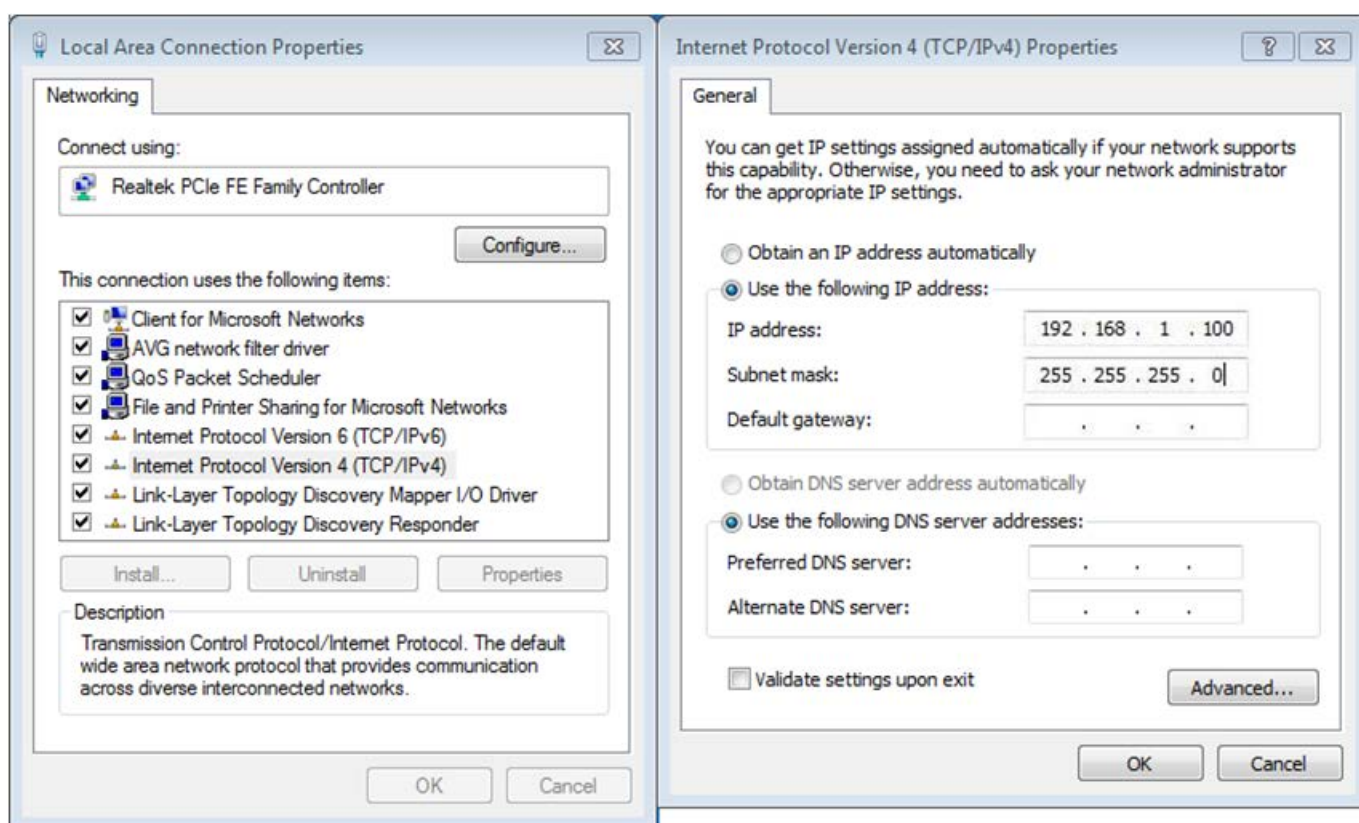

2. In the AP-1, go to “**System-> IP Settings**” to configure the IP address to static and different from the CPE.

IP Settings		Home	Reset
System Information			
IP Network Setting	<input type="radio"/> Obtain an IP address automatically (DHCP) <input checked="" type="radio"/> Specify an IP address		
IP Address	192	168	1 . 252
IP Subnet Mask	255	255	255 . 0
Default Gateway	192	168	1 . 253
Primary DNS	0	0	0 . 0
Secondary DNS	0	0	0 . 0
Use Link-Local Address	<input checked="" type="checkbox"/>		
IPv6 IP Address	<input type="text"/>		
IPv6 Subnet Prefix Length	<input type="text"/>		
IPv6 Default Gateway	<input type="text"/>		
IPv6 Primary DNS	<input type="text"/>		
IPv6 Secondary DNS	<input type="text"/>		
<input type="button" value="Accept"/> <input type="button" value="Cancel"/>			

3. In the AP-1, go to “**System-> Operation Mode**” and set it to use “**WDS Access Point**” mode. Then, click “**Save & Apply**”.

System Properties		Home	Reset
System Properties			
Device Name	PLANET	(1 to 32 characters)	<input checked="" type="checkbox"/> Green
Country/Region	Please Select a Country Code <input type="text"/>		
Operation Mode	<input type="radio"/> Access Point <input type="radio"/> Client Bridge <input checked="" type="radio"/> WDS <input checked="" type="radio"/> Access Point <input type="radio"/> Bridge <input type="radio"/> Station <input type="radio"/> Client Router <input type="radio"/> Repeater		
<input type="button" value="Save & Apply"/> <input type="button" value="Cancel"/>			

4. In the AP-1, go to “**Wireless-> Wireless Network**” to configure channel and click “**Edit**” for security setting.
- (1) Channel HT Mode: set to “**40MHz**” for wider bandwidth
 - (2) Channel/Frequency: uncheck “**Auto**” and set to a fixed channel

Wireless Network

Wireless Mode	802.11 B/G/N Mixed ▾
Channel HT Mode	40MHz ▾
Extension Channel	Upper Channel ▾
Channel / Frequency	Ch1-2.412GHz ▾ <input type="checkbox"/> Auto
AP Detection	<input type="button" value="Scan"/>

Current Profiles

SSID	Security	Isolation	VID	Enable	Edit
PLANET1	None	<input type="checkbox"/>	1	<input checked="" type="checkbox"/>	<input type="button" value="Edit"/>
PLANET2	None	<input type="checkbox"/>	2	<input type="checkbox"/>	<input type="button" value="Edit"/>
PLANET3	None	<input type="checkbox"/>	3	<input type="checkbox"/>	<input type="button" value="Edit"/>
PLANET4	None	<input type="checkbox"/>	4	<input type="checkbox"/>	<input type="button" value="Edit"/>

5. In the SSID Profile, you can configure your own SSID and Passphrase. Then, click “**Save**” to go back to the main page.

SSID Profile

Wireless Setting	You can modify the SSID or keep it as default.	
SSID	PLANET1	(1 to 32 characters)
VLAN ID	1	(1~4094)
Suppressed SSID	<input type="checkbox"/>	
Station Separation i	<input type="radio"/> Enable <input checked="" type="radio"/> Disable	
Wireless Security	Suggested configure the security to WPA2-PSK/AES	
Security Mode	WPA2-PSK ▾	
Encryption	AES ▾	
Passphrase	12345678	(8 to 63 characters) or (64 Hexadecimal characters)
Group Key Update Interval	3600	seconds(30~3600, 0: disabled)

6. Click “**Accept**” to save the configurations.

Wireless Network

Wireless Mode	802.11 B/G/N Mixed ▼
Channel HT Mode	40MHz ▼
Extension Channel	Upper Channel ▼
Channel / Frequency	Ch1-2.412GHz ▼ <input type="checkbox"/> Auto
AP Detection	<input type="button" value="Scan"/>

Current Profiles					
SSID	Security	Isolation	VID	Enable	Edit
PLANET1	WPA2-PSK AES	<input type="checkbox"/>	1	<input checked="" type="checkbox"/>	<input type="button" value="Edit"/>
PLANET2	None	<input type="checkbox"/>	2	<input type="checkbox"/>	<input type="button" value="Edit"/>
PLANET3	None	<input type="checkbox"/>	3	<input type="checkbox"/>	<input type="button" value="Edit"/>
PLANET4	None	<input type="checkbox"/>	4	<input type="checkbox"/>	<input type="button" value="Edit"/>

7. Go to the “**Status-> Save/Reload**” page to click “**Save & Apply**” to force the AP to reboot so that it can apply all configurations and take effect.

WDS Access Point

Status

- **Save/Reload:16**
- Main
- Wireless Client List
- System Log

System

- Operation Mode
- IP Settings
- Spanning Tree Settings

Wireless

- Wireless Network
- Wireless MAC Filter
- Wireless Advanced Settings

Management

- Administration

Save/Reload

Unsaved changes list

```

-network.1.ifname
-network.3.ifname
network.lan.ifname=eth0
-network.4.ifname
-network.2.ifname
network.sys.ManagementVLANID=4096
wireless.cfg039f7e.wps_configured=1
wireless.cfg039f7e.key=12345678
wireless.cfg039f7e.encryption=psk2 aes
wireless.cfg039f7e.WLANWpaRadiusAccSrvIP=...
wireless.cfg039f7e.hidden=0
wireless.cfg039f7e.server=...
wireless.wifi0.WLANHTMode=40
wireless.wifi0.WLANExtChannel=0
wireless.wifi0.channel=1
wireless.cfg09feac.WLANVLANEnable=0

```

8. In the AP-2, go to “**System-> IP Settings**” to configure the IP address to static and different from the CPE.

IP Settings		Home	Reset
System Information			
IP Network Setting	<input type="radio"/> Obtain an IP address automatically (DHCP) <input checked="" type="radio"/> Specify an IP address		
IP Address	192	168	1 . 253
IP Subnet Mask	255	255	255 . 0
Default Gateway	192	168	1 . 253
Primary DNS	0	0	0 . 0
Secondary DNS	0	0	0 . 0
Use Link-Local Address	<input checked="" type="checkbox"/>		
IPv6 IP Address	<input type="text"/>		
IPv6 Subnet Prefix Length	<input type="text"/>		
IPv6 Default Gateway	<input type="text"/>		
IPv6 Primary DNS	<input type="text"/>		
IPv6 Secondary DNS	<input type="text"/>		
<input type="button" value="Accept"/> <input type="button" value="Cancel"/>			

9. In the AP-2, go to “**System-> Operation Mode**” and set it to use “**WDS Station**” mode. Then, click “**Save & Apply**”.

System Properties		Home	Reset
System Properties			
Device Name	PLANET	(1 to 32 characters)	<input checked="" type="checkbox"/> Green
Country/Region	Please Select a Country Code <input type="text"/>		
Operation Mode	<input type="radio"/> Access Point <input type="radio"/> Client Bridge <input checked="" type="radio"/> WDS <input type="radio"/> Access Point <input type="radio"/> Bridge <input checked="" type="radio"/> Station <input type="radio"/> Client Router <input type="radio"/> Repeater		
<input type="button" value="Save & Apply"/> <input type="button" value="Cancel"/>			

10. In the AP-2, go to “**Wireless-> Wireless Network**”. Click “Site Survey” to discover the AP-1.

Wireless Network

Wireless Mode	802.11 B/G/N Mixed ▼
SSID	Specify the static SSID : <input style="width: 150px;" type="text" value="AP SSID"/> (1 to 32 characters) Or press the button to search for any available WLAN Service. <input type="button" value="Site Survey"/>
Preferred BSSID	<input type="checkbox"/> <input style="width: 30px;" type="text"/> : <input style="width: 30px;" type="text"/> : <input style="width: 30px;" type="text"/> : <input style="width: 30px;" type="text"/> : <input style="width: 30px;" type="text"/> : <input style="width: 30px;" type="text"/>

Wireless Security

Changing the wireless security settings may cause this wireless client to associate with a different one. This may temporarily disrupt your configuration session.

Security Mode	Disabled ▼
----------------------	------------

11. Click the AP-1 to let the AP-2 connect it. Then, it will go back to the main page.

Site Survey

2.4GHz Site Survey 📶:Infrastructure 📶:Ad_hoc

BSSID	SSID	Channel	Signal Level	Type	Security	Mode
A8:F7:E0:42:12:83	PLANET1	1	-57 dBm	11g/n	WPA2-PSK	📶
00:30:4F:CE:94:63	CHT Wi-Fi Auto	5	-80 dBm	11g/n	WPA/WPA2	📶
C8:3A:35:24:65:7C	11F_Demo_Room	6	-83 dBm	11g/n	WPA2-PSK	📶

12. Click the check box of the preferred BSSID and configure the encryption to be the same as the AP-1. Then, click **“Accept”** to save the configurations.

Wireless Network		Home	Reset
Wireless Mode	802.11 B/G/N Mixed ▾		
SSID	Specify the static SSID : <input type="text" value="PLANET 1"/> (1 to 32 characters) Or press the button to search for any available WLAN Service. <input type="button" value="Site Survey"/>		
Preferred BSSID	<input checked="" type="checkbox"/> A8 : F7 : E0 : 42 : 12 : 83		
Wireless Security			
Changing the wireless security settings may cause this wireless client to associate with a different one. This may temporarily disrupt your configuration session.			
Security Mode	WPA2-PSK ▾		
Encryption	AES ▾		
Passphrase	<input type="text" value="12345678"/> × (8 to 63 characters) or (64 Hexadecimal characters)		
<input type="button" value="Accept"/> <input type="button" value="Cancel"/>			

13. Go to the “**Status-> Save/Reload**” page to click “**Save & Apply**” to force the AP to reboot so that it can apply all configurations and take effect.

WDS Station		Save/Reload	Home	Reset
<ul style="list-style-type: none"> Status Save/Reload:7 Main Connection Status System Log System Operation Mode IP Settings Spanning Tree Settings Wireless 		<input type="text"/> Unsaved changes list <pre>wireless.cfg039e49.auth=MSCHAP wireless.cfg039e49.ssid=PLANET 1 wireless.cfg039e49.encryption=psk2 aes wireless.cfg039e49.eap_type=PEAP wireless.cfg039e49.bssid=A8:F7:E0:42:12:83 wireless.cfg039e49.key=12345678 wireless.cfg039e49.PreferBSSIDEnable=0</pre>		
		<input type="button" value="Save & Apply"/> <input type="button" value="Revert"/>		

14. In the AP-2, go to the “**Status-> Connection Status**” page to check whether the AP-2 is associated with the AP-1 successfully.

Connection Status		Home	Reset
Network Type	WDS Station		
SSID	PLANET1		
BSSID	A8:F7:E0:42:12:83		
Connection Status	Associated		
Wireless Mode	IEEE 802.11B/G/N Mixed		
Current Channel	2.412 GHz(Channel 1)		
Security	WPA2-PSK AES		
Tx Data Rates(Mbps)	300 Mbps		
Current noise level	-95 dBm		
Signal strength	-60 dBm		
Refresh			

15. In the AP-1, go to the “**Status-> Wireless Client List**” page to check the client’s signal strength.

Client List						Home	Reset
SSID:#	MAC Address	TX(Bytes)	RX(Bytes)	RSSI(dBm)	Kick and Ban		
SSID1:#1	a8:f7:e0:2f:83:57	45345Kb	45993Kb	-27	Kick		
Refresh							

16. Use command line tool to ping each other to ensure the link is successfully established.

For example, from Site-1, ping 192.168.1.200; and at Site-2, ping 192.168.1.100.

```

C:\WINDOWS\system32\CMD.exe - ping 192.168.1.100 -t
Destination host unreachable.
Destination host unreachable.
Destination host unreachable.
Destination host unreachable.
Destination host unreachable.
Ping statistics for 192.168.0.100:
    Packets: Sent = 25, Received = 0, Lost = 25 (100% loss),
Control-C
^C
C:\Documents and Settings\Administrator>ping 192.168.1.100 -t

Pinging 192.168.1.100 with 32 bytes of data:

Request timed out.
Reply from 192.168.1.100: bytes=32 time=7ms TTL=128
Reply from 192.168.1.100: bytes=32 time=1ms TTL=128
Reply from 192.168.1.100: bytes=32 time=2ms TTL=128
Reply from 192.168.1.100: bytes=32 time=1ms TTL=128
Reply from 192.168.1.100: bytes=32 time=2ms TTL=128
Reply from 192.168.1.100: bytes=32 time=2ms TTL=128
Reply from 192.168.1.100: bytes=32 time=1ms TTL=128
Reply from 192.168.1.100: bytes=32 time=1ms TTL=128
Reply from 192.168.1.100: bytes=32 time=1ms TTL=128

```

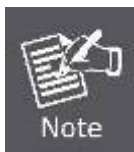

Attention should be paid to the following hints:

- 1) The encryption method must be the same at both sites if configured.
 - 2) Both sites should be Line-of-Sight.
 - 3) Included in the package are two 5dBi antennas for the WAP-200N only for long distance over 1km. Please connect to the 2.4GHz antennas with higher gain.
 - 4) For PtP connection over 1km, please adjust "**Distance**" setting to the actual distance between both sites on the 'both sites' setting page.
 - 5) To adjust "**Transmit Power**", please:
 - (a) Go to the "Operation Mode" page to disable the "Green" option.
 - (b) Go to the "Wireless Advanced Settings-> Transmit Power" to manually adjust the transmit power.
-

EC Declaration of Conformity

English	Hereby, PLANET Technology Corporation , declares that this 300Mbps 802.11n Wireless Outdoor AP/CPE is in compliance with the essential requirements and other relevant provisions of Directive 1999/5/EC.	Lietuviškai	Šiuo PLANET Technology Corporation ., skelbia, kad 300Mbps 802.11n Wireless Outdoor AP/CPE tenkina visus svarbiausius 1999/5/EC direktyvos reikalavimus ir kitas svarbias nuostatas.
Česky	Společnost PLANET Technology Corporation , tímto prohlašuje, že tato 300Mbps 802.11n Wireless Outdoor AP/CPE splňuje základní požadavky a další příslušná ustanovení směrnice 1999/5/EC.	Magyar	A gyártó PLANET Technology Corporation , kijelenti, hogy ez a 300Mbps 802.11n Wireless Outdoor AP/CPE megfelel az 1999/5/EK irányelv alapkövetelményeinek és a kapcsolódó rendelkezéseknek.
Dansk	PLANET Technology Corporation , erklærer herved, at følgende udstyr 300Mbps 802.11n Wireless Outdoor AP/CPE overholder de væsentlige krav og øvrige relevante krav i direktiv 1999/5/EF	Malti	Hawnhekk, PLANET Technology Corporation , jiddikjara li dan 300Mbps 802.11n Wireless Outdoor AP/CPE jikkonforma mal-ħtiġijiet essenzjali u ma provvedimenti oħrajn relevanti li hemm fid-Dirrettiva 1999/5/EC
Deutsch	Hiermit erklärt PLANET Technology Corporation , dass sich dieses Gerät 300Mbps 802.11n Wireless Outdoor AP/CPE in Übereinstimmung mit den grundlegenden Anforderungen und den anderen relevanten Vorschriften der Richtlinie 1999/5/EG befindet". (BMW)	Nederlands	Hierbij verklaart , PLANET Technology Corporation , dat 300Mbps 802.11n Wireless Outdoor AP/CPE in overeenstemming is met de essentiële eisen en de andere relevante bepalingen van richtlijn 1999/5/EG
Eesti keeles	Käesolevaga kinnitab PLANET Technology Corporation , et see 300Mbps 802.11n Wireless Outdoor AP/CPE vastab Euroopa Nõukogu direktiivi 1999/5/EC põhinõuetele ja muudele olulistele tingimustele.	Polski	Niniejszym firma PLANET Technology Corporation , oświadcza, że 300Mbps 802.11n Wireless Outdoor AP/CPE spełnia wszystkie istotne wymogi i klauzule zawarte w dokumencie „Directive 1999/5/EC”.
Ελληνικά	<i>ΜΕ ΤΗΝ ΠΑΡΟΥΣΑ</i> , PLANET Technology Corporation , <i>ΔΗΛΩΝΕΙ ΟΤΙ ΑΥΤΟ 300Mbps 802.11n Wireless Outdoor AP/CPE ΣΥΜΜΟΡΦΩΝΕΤΑΙ ΠΡΟΣ ΤΙΣ ΟΥΣΙΩΔΕΙΣ ΑΠΑΙΤΗΣΕΙΣ ΚΑΙ ΤΙΣ ΛΟΙΠΕΣ ΣΧΕΤΙΚΕΣ ΔΙΑΤΑΞΕΙΣ ΤΗΣ ΟΔΗΓΙΑΣ 1999/5/EK</i>	Português	PLANET Technology Corporation , declara que este 300Mbps 802.11n Wireless Outdoor AP/CPE está conforme com os requisitos essenciais e outras disposições da Directiva 1999/5/CE.
Español	Por medio de la presente, PLANET Technology Corporation , declara que 300Mbps 802.11n Wireless Outdoor AP/CPE cumple con los requisitos esenciales y cualesquiera otras disposiciones aplicables o exigibles de la Directiva 1999/5/CE	Slovensky	Výrobca PLANET Technology Corporation , týmto deklaruje, že táto 300Mbps 802.11n Wireless Outdoor AP/CPE je v súlade so základnými požiadavkami a ďalšími relevantnými predpismi smernice 1999/5/EC.
Français	Par la présente, PLANET Technology Corporation , déclare que les appareils du 300Mbps 802.11n Wireless Outdoor AP/CPE sont conformes aux exigences essentielles et aux autres dispositions pertinentes de la directive 1999/5/CE	Slovensko	PLANET Technology Corporation , s tem potrjuje, da je ta 300Mbps 802.11n Wireless Outdoor AP/CPE skladen/a z osnovnimi zahtevami in ustreznimi določili Direktive 1999/5/EC.
Italiano	Con la presente , PLANET Technology Corporation , dichiara che questo 300Mbps 802.11n Wireless Outdoor AP/CPE è conforme ai requisiti essenziali ed alle altre disposizioni pertinenti stabilite dalla direttiva 1999/5/CE.	Suomi	PLANET Technology Corporation , vakuuttaa täten että 300Mbps 802.11n Wireless Outdoor AP/CPE tyyppinen laite on direktiivin 1999/5/EY oleellisten vaatimusten ja sitä koskevien direktiivin muiden ehtojen mukainen.
Latviski	Ar šo PLANET Technology Corporation , apliecina, ka šī 300Mbps 802.11n Wireless Outdoor AP/CPE atbilst Direktīvas 1999/5/EK pamatprasībām un citiem atbilstošiem noteikumiem.	Svenska	Härmed intygar, PLANET Technology Corporation , att denna 300Mbps 802.11n Wireless Outdoor AP/CPE står i överensstämmelse med de väsentliga egenskapskrav och övriga relevanta bestämmelser som framgår av direktiv 1999/5/EG.

