

Register your product and get support at

www.magnavox.com/usasupport

19MF338B



EN USER MANUAL

EN: For further assistance, call the customer support service in your country.

- 1-800-705-2000

Enter below the Serial No. located on the rear of the cabinet.

ES: Para obtener más información, llame al servicio de soporte al cliente de su país.

- 1-800-705-2000

Escriba a continuación el N° de serie, el cual se encuentra en la parte posterior del gabinete.

- Model / Modelo • Serial / Serie:

MAGNAVOX

Return your Product Registration Card or register online at
www.magnavox.com/usasupport today to get the very most from your purchase.

Registering your model with MAGNAVOX makes you eligible for all of the valuable benefits listed below, so don't miss out. Complete and return your Product Registration Card at once, or register online at www.magnavox.com/usasupport to ensure:

*Proof of Purchase

Returning the enclosed card guarantees that your date of purchase will be on file, so no additional paperwork will be required from you to obtain warranty service.

*Product Safety Notification

By registering your product, you'll receive notification directly from the manufacturer - in the rare case of a product recall or safety defect.

*Additional Benefits

Registering your product guarantees that you'll receive all of the privileges to which you're entitled, including special money-saving offers.

MAGNAVOX

Congratulations on your purchase, and welcome to the "family!"

Dear MAGNAVOX product owner:

Thank you for your confidence in MAGNAVOX. You've selected one of the best-built, best-backed products available today. We'll do everything in our power to keep you happy with your purchase for many years to come.

As a member of the MAGNAVOX "family," you're entitled to protection by one of the most comprehensive warranties and outstanding service networks in the industry. What's more, your purchase guarantees you'll receive all the information and special offers for which you qualify, plus easy access to accessories from our convenient home shopping network.

Most importantly, you can count on our uncompromising commitment to your total satisfaction.

All of this is our way of saying welcome - and thanks for investing in a MAGNAVOX product.

P.S. To get the most from your MAGNAVOX purchase, be sure to complete and return your Product Registration Card at once or register online at:

www.magnavox.com/usasupport

Know these safety symbols



This "bolt of lightning" indicates uninsulated material within your unit may cause an electrical shock. For the safety of everyone in your household, please do not remove product covering.



The "exclamation point" calls attention to features for which you should read the enclosed literature closely to prevent operating and maintenance problems.

WARNING: To reduce the risk of fire or electric shock, this apparatus should not be exposed to rain or moisture and objects filled with liquids, such as vases, should not be placed on this apparatus.

CAUTION: To prevent electric shock, match wide blade of plug to wide slot, fully insert.

ATTENTION: Pour éviter les choc électriques, introduire la lame la plus large de la fiche dans la borne correspondante de la prise et pousser jusqu'au fond.

For Customer Use

Enter below the Serial No. which is located on the rear of the cabinet. Retain this information for future reference.

Model No. _____

Serial No. _____

MAGNAVOX

Visit our World Wide Web Site at <http://www.magnavox.com/usasupport>

1. Safety instructions

Read before operating equipment

1. Read and keep these instructions.
2. Heed all warnings.
3. Follow all instructions.
4. Do not insert any strange object into the ventilation slots. This might lead to damage of the TV.
5. Do not use this apparatus near water.
6. Clean only with a dry cloth.
7. Do not block any of the ventilation openings. Install in accordance with the manufacturer's instructions.
8. Do not install near any heat sources such as radiators, heat registers, stoves, or other apparatus (including amplifiers) that produce heat.
9. Do not defeat the safety purpose of the polarized or grounding-type plug. A polarized plug has two blades with one wider than the other. A grounding type plug has two blades and third grounding prong. The wide blade or third prong are provided for your safety. When the provided plug does not fit into your outlet, consult an electrician for replacement of the obsolete outlet.
10. Protect the power cord from being walked on or pinched particularly at plugs, convenience receptacles, and the point where they exit from the apparatus.
11. Only use attachments/accessories specified by the manufacturer.
12.  Use only with a cart, stand, tripod, bracket, or table specified by the manufacturer, or sold with the apparatus. When a cart is used, use caution when moving the cart/apparatus combination to avoid injury from tip-over.
13. Unplug this apparatus during lightning storms or when unused for long periods of time.
14. Refer all servicing to qualified service personnel. Servicing is required when the apparatus has been damaged in any way, such as power-supply cord or plug is damaged, liquid has been spilled or objects have fallen into apparatus, the apparatus has been exposed to rain or moisture, does not operate normally, or has been dropped.
15. This product may contain lead or mercury. Disposal of these materials may be regulated due to environmental considerations. For disposal or recycling information, please contact your local authorities or the Electronic Industries Alliance: www.eiae.org.
16. **Damage Requiring Service** - The appliance should be serviced by qualified service personnel when:
 - A. The power supply cord or the plug has been damaged;
 - B. Objects have fallen, or liquid has been spilled into the appliance;
 - C. The appliance has been exposed to rain
 - D. The appliance does not appear to operate normally or exhibits a marked change in performance;
 - E. The appliance has been dropped, or the enclosure damaged.
17. **Tilt/Stability** - All televisions must comply with recommended international global safety standards for tilt and stability properties of its cabinet design.
 - Do not compromise these design standards by applying excessive pull force to the front, or top, of the cabinet which could ultimately overturn the product.
 - Also, do not endanger yourself, or children, by placing electronic equipment/toys on the top of the cabinet. Such items could unsuspectingly fall from the top of the set and cause product damage and/or personal injury.
18. **Wall or Ceiling Mounting** - The appliance should be mounted to a wall or ceiling only as recommended by the manufacturer.
19. **Power Lines** - An outdoor antenna should be located away from power lines.
20. **Outdoor Antenna Grounding** - If an outside antenna is connected to the receiver, be sure the antenna system is grounded so as to provide some protection against voltage surges and built up static charges. Section 810 of the National Electric Code, ANSI/NFPA No. 70-1984, provides information with respect to proper grounding of the mast and supporting structure, grounding of the lead-in wire to an antenna discharge unit, size of grounding connectors, location of antenna-discharge unit, connection to grounding electrodes, and requirements for the grounding electrode. See Figure below.
21. **Object and Liquid Entry** - Care should be taken so that objects do not fall and liquids are not spilled into the enclosure through openings.
22. **Battery Usage CAUTION** - To prevent battery leakage that may result in bodily injury, property damage, or damage to the unit:
 - Install all batteries correctly, with + and - aligned as marked on the unit.
 - Do not mix batteries (old and new or carbon and alkaline, etc.).
 - Remove batteries when the unit is not used for a long time.

Example of Antenna Grounding as per NEC - National Electric Code

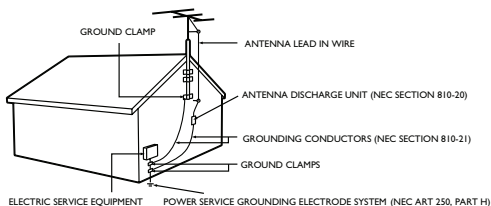

Note to the CATV system installer: This reminder is provided to call the CATV system installer's attention to Article 820-40 of the NEC that provides guidelines for proper grounding and, in particular, specifies that the cable ground shall be connected to the grounding system of the building, as close to the point of cable entry as practical.

2008 © Koninklijke Philips Electronics N.V. All rights reserved. Specifications are subject to change without notice. Trademarks are the property of Koninklijke Philips Electronics N.V. or their respective owners.

Philips reserves the right to change products at any time without being obliged to adjust earlier supplies accordingly.

The material in this manual is believed adequate for the intended use of the system. If the product, or its individual modules or procedures, are used for purposes other than those specified herein, confirmation of their validity and suitability must be obtained. Philips warrants that the material itself does not infringe any United States patents. No further warranty is expressed or implied.

Philips can't be held responsible neither for any errors in the content of this document nor for any problems as a result of the content in this document. Errors reported to Philips will be adapted and published on the Philips support website as soon as possible.

Warranty

No components are user-serviceable. Do not open or remove covers to the inside of the product. Repairs may only be done by Philips Service Centers and official repair shops. Failure to do so shall void any warranty, stated or implied. Any operation expressly prohibited in this manual, any adjustments, or assembly procedures not recommended or authorised in this manual shall void the warranty.

Pixel characteristics

This LCD product has a high number of color pixels. Although it has effective pixels of 99,999% or more, black dots or bright points of light (red, green or blue) may appear constantly on the screen. This is a structural property of the display (within common industry standards) and is not a malfunction.

Federal Communications Commission Notice

This equipment has been tested and found to comply with the limits for a Class B digital device, pursuant to part 15 of the FCC Rules. These limits are designed to provide reasonable protection against harmful interference in a residential installation. This equipment generates, uses, and can radiate radio frequency energy and, if not installed and used in accordance with the instructions, may cause harmful interference to radio communications. However, there is no guarantee that interference will not occur in a particular installation. If this equipment does cause harmful interference to radio or television

reception, which can be determined by turning the equipment off and on, the user is encouraged to try to correct the interference by one or more of the following measures:

1. Reorient or relocate the receiving antenna.
2. Increase the separation between the equipment and the receiver.
3. Connect the equipment into an outlet on a circuit different from that to which the receiver is connected.
4. Consult the dealer or an experienced radio or television technician for help.

Modifications

The FCC requires the user to be notified that any changes or modifications made to this device that are not expressly approved by Philips Consumer Lifestyle may void the user's authority to operate the equipment.

Cables

Connections to this device must be made with shielded cables with metallic RF/EMI connector hoods to maintain compliance with FCC Rules and Regulations.

Canadian notice

This Class B digital apparatus meets all requirements of the Canadian Interference-Causing Equipment Regulations.

Avis Canadien

Cet appareil numérique de la classe B respecte toutes les exigences du Règlement sur le matériel brouilleur du Canada.

Safety symbols

Know these safety symbols:



 This "bolt of lightning" indicates uninsulated material within your unit may cause an electrical shock. For the safety of everyone in your household, please do not remove product covering.

 The exclamation point calls attention to features for which you should read the enclosed literature closely to prevent operating and maintenance problems.

If the TV is mounted on a swivel base or swivel arm, ensure no strain is placed on the power cord when the TV is swivelled. Strain on the power cord can loosen connections. This may cause arcing and result in fire.

Copyright



ENERGY STAR

As an ENERGY STAR[®] Partner, Magnavox has determined this product meets the ENERGY STAR[®] guidelines for energy efficiency. ENERGY STAR[®] is a U.S. registered mark. Using products with ENERGY STAR[®] label can save energy. Saving energy reduces air pollution and lowers utility.



Manufactured under license from Dolby Laboratories. 'Dolby' and the double-D symbol are trademarks of Dolby Laboratories.

Table of Contents

1. Safety instructions	2	7. Change your TV installation	23
2. Important	5	7.1 Select your menu language	23
2.1 Product information	5	7.2 Autoprogramming	23
2.2 Screen care	5	7.3 Return your settings to default values	23
2.3 Environmental care	5	8. Connect devices	24
2.4 Regulatory notices	5	8.1 Connection overview	24
3. Your TV	6	8.2 Select connection quality	24
3.1 TV overview	6	8.3 Connect devices	26
3.2 Remote control	6	9. Glossary	28
4. Get started	7	10. Trouble shooting	29
4.1 Position the TV	7	11. Technical specifications	30
4.2 Wall mount the TV	7	12. Index	31
4.3 Install the remote control batteries	8	13. Warranty	33
4.4 Connect the antenna or cable	8		
4.5 Connect the AC power cord	10		
4.6 Manage cables	10		
4.7 Switch on the TV	10		
5. Use your TV	11		
5.1 Switch your TV on or to standby	11		
5.2 Watch TV	11		
5.3 Watch channels from a cable receiver box	12		
5.4 Watch a DVD	12		
6. Use more of your TV	13		
6.1 Remote control overview	13		
6.2 Change picture and sound settings	14		
6.3 Use Smart mode	16		
6.4 Create favorite channels list	17		
6.5 Set the clock	17		
6.6 Set the sleep timer	17		
6.7 Use parental control and rating locks	18		
6.8 Closed captions	21		
6.9 Use your TV as a PC monitor	22		
6.10 Select your TV in PC mode	22		

2. Important

Congratulations on your purchase and welcome to Magnavox!

To fully benefit from the support that Magnavox offers, register your product at www.magnavox.com/usasupport.

Registering your model with Magnavox makes you eligible for all of the valuable benefits listed below, so don't miss out.

Complete and return your Product Registration Card at once, or register online at www.magnavox.com/usasupport to ensure:

- **Proof of Purchase**
Returning the enclosed card guarantees that your date of purchase will be on file, so no additional paperwork will be required from you to obtain warranty service.
- **Product Safety Notification**
By registering your product you'll receive notification - directly from the manufacturer - in the rare case of a product recall or safety defect.
- **Additional Benefits of Product Ownership** Registering your product guarantees that you'll receive all of the privileges to which you're entitled, including special money-saving offers.

 **Note:** Specifications and information are subject to change without notice.

 For further assistance, call the customer support service in your country.

- **TO OBTAIN ASSISTANCE IN THE U.S.A., PUERTO RICO, OR U.S. VIRGIN ISLANDS.** Contact Magnavox Customer Care Center at: 1-800-705-2000
- **TO OBTAIN ASSISTANCE IN CANADA.** Contact Magnavox Customer Care Center at: 1-800-661-6162 (French Speaking) 1-800-705-2000 (English or Spanish Speaking)

2.1 Product information

The model and serial number are on the rear of the TV and on the packaging.

This TV consumes minimal energy in standby mode to minimise environmental impact. The active power consumption is given on the type plate at the rear of the TV.

2.2 Screen care

- Turn off and unplug the AC power cord before cleaning the screen.
- Clean the screen with a soft, dry cloth. Do not use substances such as household cleaning agents as these may damage the screen.

- To avoid deformations or color fading, wipe off water droplets as soon as possible.
- Do not touch, push, rub or strike the screen with hard objects as this may damage the screen permanently.
- Where possible, avoid stationary images that remain on-screen for extended periods of time. If you must use stationary images, reduce the screen contrast and brightness to avoid screen damage.

2.3 Environmental care



Recycling

The packaging of this product is intended to be recycled. Contact your local authorities for information about how to recycle the packaging.



End of life directives

Like all LCD products, this set contains a lamp with Mercury, please dispose of according to all Local, State and Federal laws.

Magnavox is paying a lot of attention to produce environmentally-friendly products in green focal areas. Your new TV contains materials which can be recycled and reused. At the end of its life, specialized companies can dismantle the discarded TV to concentrate the reusable materials and to minimize the amount of materials to be disposed off. Please ensure you dispose off your old TV according to local regulations.

Disposal of batteries

The batteries supplied do not contain the heavy metals mercury and cadmium. Nevertheless, in many areas batteries may not be disposed of with your household waste. Please ensure you dispose of batteries according to local regulations.

2.4 Regulatory notices

 **WARNING:** To reduce the risk of fire or electric shock, this apparatus should not be exposed to rain or moisture. Objects filled with liquids, such as vases, should not be placed on this apparatus.

3. Your TV

This section gives you an overview of commonly-used TV controls and functions.

3.1 TV overview

Top controls and indicators

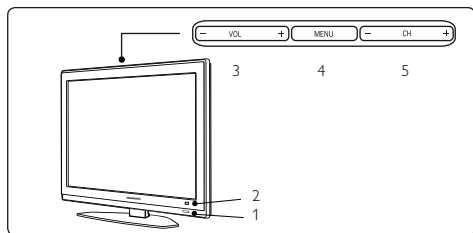

1. Power switch
2. Remote control sensor
3. Volume up/down
4. Menu
5. Channel up/down

Side connectors

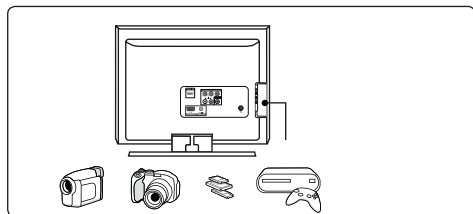

Use the TV side connectors to connect to mobile devices such as a camera or game console. You can also connect to the headphone.

Rear connectors

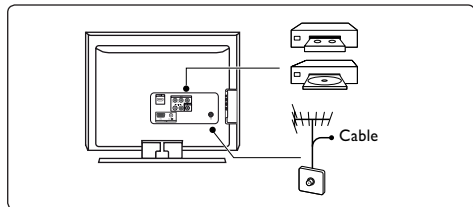

Use the TV rear connectors to connect to the antenna and permanent devices such as a high-definition disc player or DVD player.

Note

For more information about connections, see *Section 7 Connect devices.*

3.2 Remote control

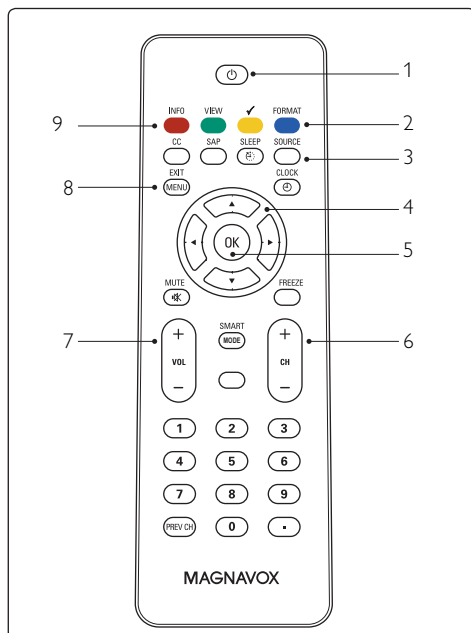

1. Standby / ON
2. Format
3. Source selection
4. Cursor buttons
5. OK button
6. Channel selection
7. Volume
8. Menu button
9. INFO button

For more information about the remote control, See *Remote control overview.* on page 13.

4. Get started

This section describes how to position and connect your TV, and how to perform your first-time installation.

4.1 Position the TV

WARNING

- Do not insert the power plug into the wall socket before all the connections are made.
- Large screen TVs are heavy. Two people are required to carry and handle the TV.

Wherever you decide to position your TV, ensure that you always have easy access to the AC power cord or plug to disconnect the TV from the power.

If the TV is mounted on a swivel base or swivel arm, ensure no strain is placed on the AC power cord when the TV is swivelled. Strain on the AC power cord can loosen connections. This may cause arcing and result in fire.

For ideal viewing conditions, position the TV where light does not fall directly on the screen.

The ideal viewing distance for watching TV is three times its screen size.

Kensington security slot

Your TV is equipped with a Kensington Security Slot at the back of the TV.

If you connect an anti-theft Kensington lock (not supplied), position the TV within reach of a permanent object that can be attached to the lock.

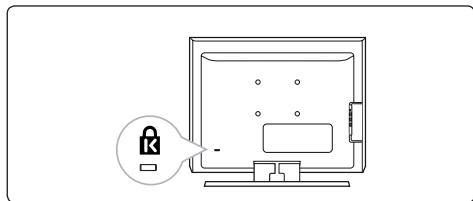

4.2 Wall mount the TV

WARNING

Wall mounting of the TV should only be performed by qualified installers. Koninklijke Philips Electronics N.V. Bears no responsibility for improper mounting that results in accident or injury.

Step 1 Purchase a VESA-compatible wall bracket

Depending on the size of your TV screen, purchase one of the following wall brackets:

TV screen size (inches)	VESA-compatible wall bracket type (millimeters)	Screw type
19MF338B	100 x 100 mm	Metric 4 x 10mm

Step 2 Remove the TV stand

Note

These instructions are only applicable to TV models with mounted stands. If your TV stand is not mounted, skip to *Step 3 Connect cables*.

1. Carefully place the TV face down on a flat, stable surface that is covered by soft cloth. The cloth should be thick enough to protect your screen.

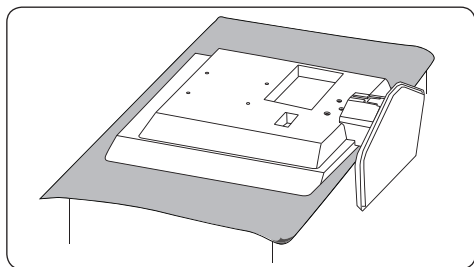

2. Using a cross-head screwdriver (not supplied), unscrew the three bolts that secure the stand to the TV.

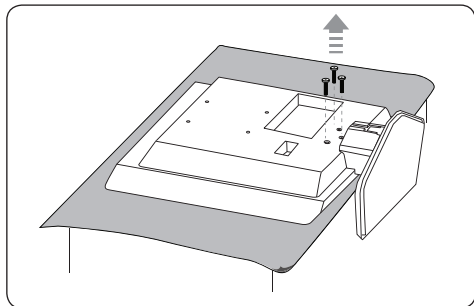

3. Firmly pull the stand from the bottom of the TV. Place both the stand and bolts in a secure location for future reinstallation.

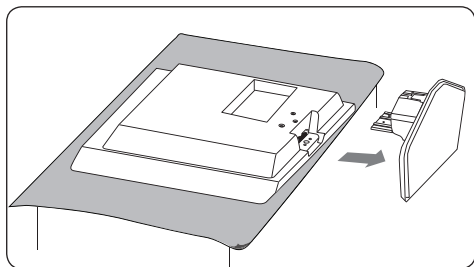

Step 3 Connect cables

Connect the antenna cable, AC power cord and all other devices to the back of the TV as described in the following sections and in *Section 7 Connect devices*.

Step 4 Secure the VESA-compatible wall bracket to the TV

⚠ WARNING
Only use the specified bolts (M4) to secure the VESA-compatible wall bracket to your TV. The specified bolts are designed to match the weight of your TV.

📌 Note
Depending on your VESA-compatible wall bracket, you may need to separate the mounting plate from the wall bracket for easier installation. Refer to your VESA-compatible wall bracket documentation for instructions.

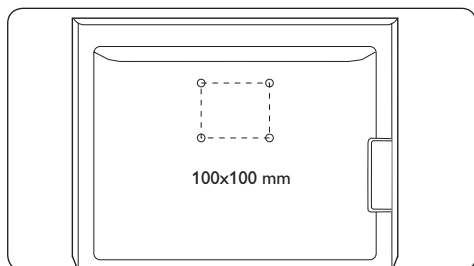

4.3 Install the remote control batteries

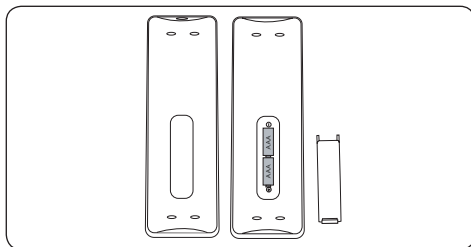

1. Open the battery cover on the back of the remote control.
2. Insert the 2 batteries supplied. Make sure the + and - ends of the batteries line up correctly. (inside of case is marked).
3. Close the cover.

4.4 Connect the antenna or cable

This section describes how to connect your TV to an antenna, cable, Direct Broadcast Satellite, and to a cable receiver box.

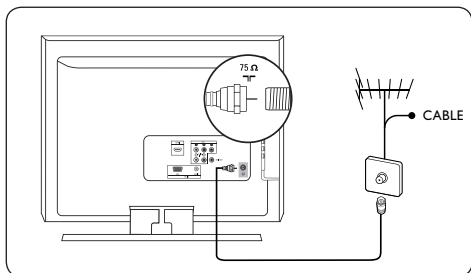

Connect to an antenna

Any DTV programs that are broadcast in your area can be received for free through an antenna connection.

Contact your local content provider or your local electronics retailer if you are unsure about what HDTV programs are available in your area.

Broadcasters are transitioning from analog to digital TV. This means that a given broadcaster can have channels available either in analog or in digital, or both analog and digital at the same time.

The TV has stereo sound if the broadcasting channel makes it available.

Connect to a cable

When your TV is connected to the cable socket, you may receive free digital and high definition programming (depending on your cable provider). Digital and high definition cable channels can be recognized by the format of the channel number. The channel number includes a dot "." For example, 11.1, 46.30, 108.201. Contact your cable provider for more information.

Connect to a Direct Broadcast Satellite (DBS)

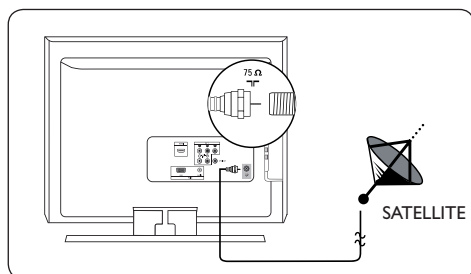

There are two main DBS systems: DirecTV and DishNetwork. These systems require a separate, proprietary set-top box to decode signals and send them to the TV. The set-top box contains a digital TV tuner for receiving off-air digital television broadcasts.

Contact your local DBS provider for more information about the connections and the TV channels.

Connect to a cable receiver box/satellite set-top box

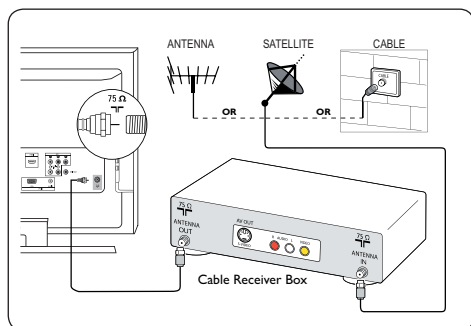

A cable receiver box or satellite set-top box can be connected to the TV through the following connections:

- ANTENNA (75ohm)

- A/V (Composite Video and Audio)
- S-Video and Audio
- YPbPr (Component Video Input)
- HDMI

Connect a cable receiver box/satellite set-top box through RF IN/OUT

If the TV is connected to a cable box or satellite set-top box via a coaxial connection, set the TV to channel 3 and 4, or the channel specified by the service provider.

Connect a cable receiver box/satellite set-top box through component video input or HDMI

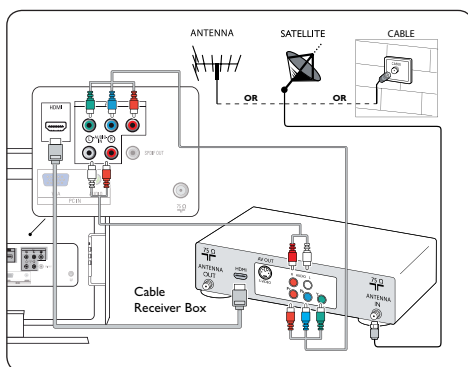

4.5 Connect the AC power cord

- ⚠ WARNING:**
Verify that your voltage corresponds with the voltage printed at the back of the TV. Do not insert the AC power cord if the voltage is different.

To connect the AC power cord

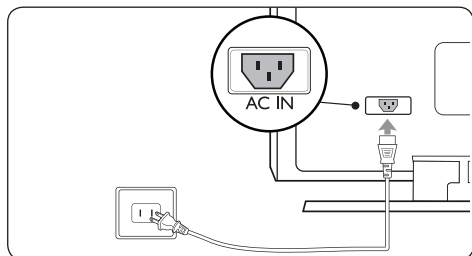

1. Locate the power connector at the back of the TV. The location of the power connector varies according to TV model.
2. Insert the AC power cord fully into the TV power connector.
3. Connect the AC power cord plug to the power outlet. Ensuring that the cord is tightly secured at both ends.

4.6 Manage cables

Route your AC power cord, antenna cable and all other device cables through the cable holder at the back of the TV. The holder helps keep your cables tidy and easily manageable.

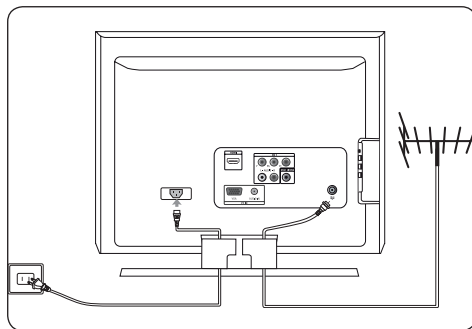

4.7 Switch on the TV

Before you switch on the TV, check that the mains cord is properly connected. Press **POWER** button at the front side of the TV, or press power the remote control. The TV normally takes 10-15 seconds to start up and the following screen appears the first time you turn on the TV.

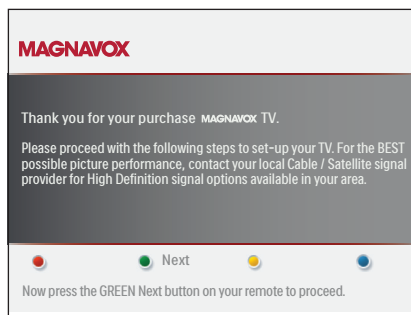

Follow the on-screen instructions to select your language and complete your TV setup. Installation takes approximately 10 minutes.

- ⓘ Note:** If you connect your TV to a cable receiver box or satellite set-top box, you do not need to install channels. Press the red button on the remote control to exit the channel installation stage of the setup.

5. Use your TV

This section helps you perform basic TV operations.

5.1 Switch your TV on or to standby

To Switch the TV on

Press **POWER** at the front of the TV.

- If the standby indicator is off, press **POWER** on the front of the TV.
- If the standby indicator is on, press **POWER** on the remote control.

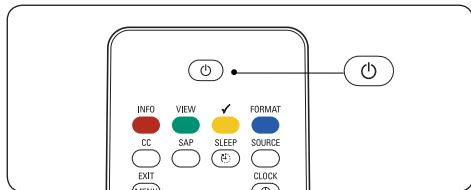
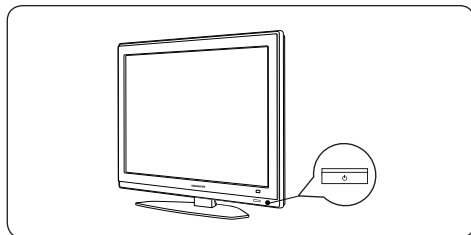

To Switch to standby

- Press **POWER** on the remote control.

To switch on from standby without the remote control.

- Press **POWER** at the front of the TV to switch the TV off.
- Press **POWER** again to switch the TV on.

Note

The TV is never powered off completely unless it is physically unplugged.

5.2 Watch TV

Switch channels

- Press a number (1 to 999) or press **CH +/-** on your remote control.
- Press **PREV CH** to return to the previously viewed TV channel.

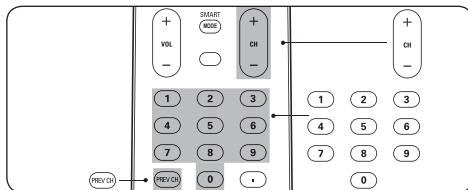

Note

You can also switch channels by pressing **CH +/-** on the top of the TV

Adjust volume

1. Press **VOL+** or **VOL-** on your remote control.
2. Press **MUTE** on your remote control to mute the sound. Press **MUTE** again or press **VOL -** or **+** to restore the sound.

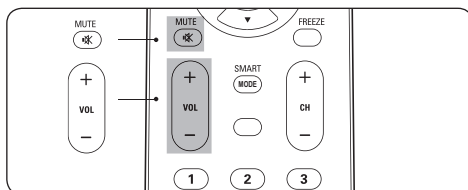

Note

You can also switch volume by pressing **VOL +/-** on the top of the TV

5.3 Watch channels from a cable receiver box

1. Switch on the cable receiver box.
The picture from your cable receiver box might appear automatically on your screen.
2. Use the remote control of your cable receiver box to select channels.

If the picture does not appear

1. Press **SOURCE** repeatedly to select the connected cable receiver box and wait a few seconds for the picture to appear.

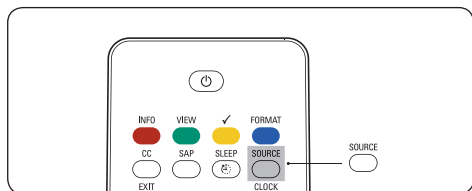

2. Press **OK**.
3. Use the remote control of your set-top box to select channels.

5.4 Watch a DVD

1. Insert a DVD disc in your player.
2. Press **Play >** on the remote control of your player.
The picture from the player might appear automatically on your screen.

If the picture does not appear

1. Press **SOURCE** repeatedly to select correct source and wait a few seconds for the picture to appear.
2. Press **OK**.

6. Use more of your TV

This section describes the advanced features of your TV.

6.1 Remote control overview

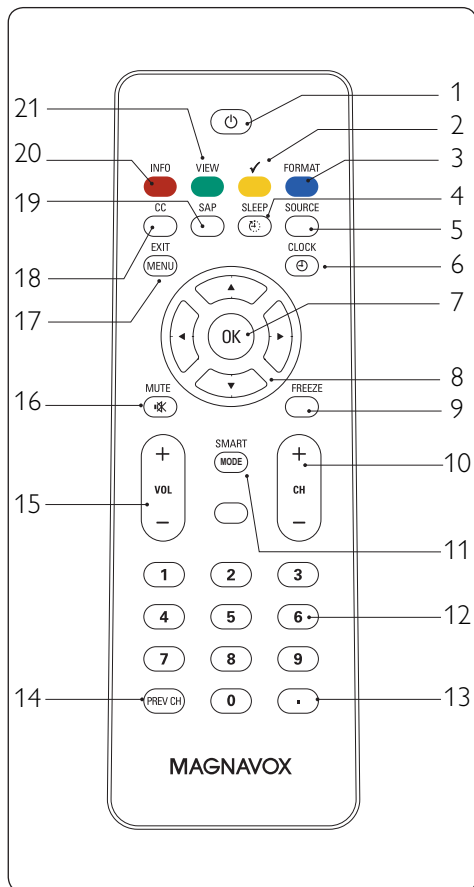

- 1. POWER**
Switches the TV on from standby or back to standby.
- √** To add or remove a channel in the favorite channels list of TV.
- FORMAT**
Selects a picture format. See *Change Picture format* on page 15.
- SLEEP**
Press to set the TV to turn itself off within a certain time.

- SOURCE**
Selects connected devices.
- CLOCK**
See page 17.
- OK**
- To activate a setting.
- To display the list of channels stored (according to the selection made in the Installation mode (Antenna or Cable))
- CURSOR BUTTONS** ▲ ▼ ◀ ▶
To navigate through the menus.
- FREEZE**
No function
- CH +/-**
Switches to the next or previous channel.
- SMART MODE**
Selects the among Personal, Sports, Standard, Movie, or Powers Saver settings.
- NUMBER BUTTONS**
Selects a channel, page or setting.
- DOT**
Uses the dot for digital channels.
- PREVIOUS CHANNEL**
Returns to the previously-viewed channel.
- VOLUME +/-**
Increases or decreases volume.
- MUTE**
Mutes or restores sound.
- MENU**
Toggles the menu on or off.
- CC (Closed Captions)**
To select CC on, Off or On during mute.
- SAP**
To select a Audio Program if available with the TV program: Main or SAP.

Note:
With Digital signal, you can choose different language.

- INFO**
Displays programme information, if available.
- VIEW**
To display a list of all channels marked as favorite (incl. subchannels).

6.2 Change picture and sound settings

Change picture settings

This section describes how to adjust your picture settings.

1. Press **MENU** on the remote control.

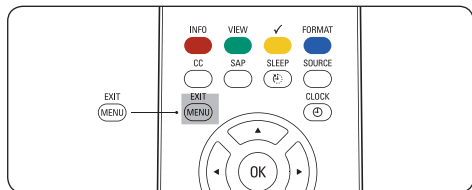

2. Press **▼** or **▶** to select the **Picture** menu.
3. Press **▲** or **▼** to select the one of the picture settings, and press **▶** to enter the setting.
4. Press **▲** or **▼** to adjust the setting, and press **OK** to confirm the change.
5. Press **Menu** to exit.

MAGNAVOX	
Settings	Picture
Picture	Contrast
Sound	Brightness
Features	Color
Parental control	Sharpness
Installation	Color temperature
	Tint
	Dynamic contrast
	Picture format

MAGNAVOX		
Settings	Picture	Contrast
Contrast	50	
Brightness	50	
Color	50	
Sharpness	1	
Color temperature		
Tint	3	
Dynamic contrast		
Picture format		

Summary of picture settings

The following picture settings can be configured. Depending on the format of the picture source, some picture settings might not be available.

- **Contrast** - Sets the level of white in the picture.
- **Brightness** - Sets the brightness of the picture.
- **Color** - Sets the level of saturation.
- **Tint** - Adjusts the color balance between red and green.
- **Sharpness** - Sets the sharpness of fine details.
- **Color temperature** - Sets the color temperature to normal, warm or cool.
- **Dynamic contrast** - Enhances contrast in the darker and the brighter picture areas as the image on the screen changes.
- **Picture format** - Changes the format of the picture.

Change picture format

1. Press **FORMAT** to enter the **Picture format** menu.

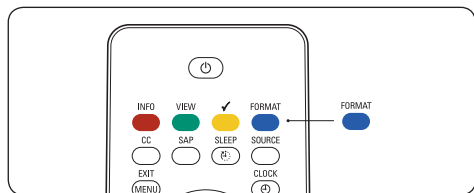

2. Press **▲** or **▼** to select a picture format.
3. **Automatic** (Not for HD and PC)
Enlarges the picture automatically to fill the screen. The subtitles remain visible.

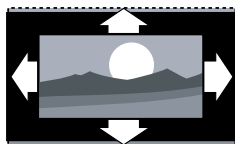

- **Super zoom** (Not for HD and PC)
Removes the black bars on the side of 4:3 broadcasts with minimal distortion.

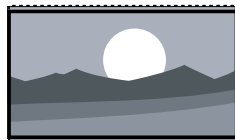

- **4:3** (Not for HD)
Displays the classic 4:3 format.

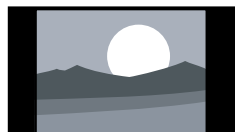

- **Movie expand 14:9** (Not for HD and PC)
Scales the classic 4:3 format to 14:9.

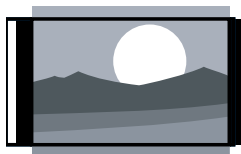

- **Movie expand 16:9** (Not for HD and PC)
Scales the classic 4:3 format to 16:9.

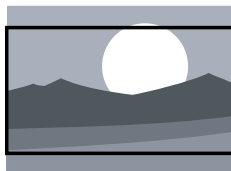

- **16:9 subtitle** (Not for PC)
Display 4:3 pictures using the full surface of the screen leaving the subtitles visible.

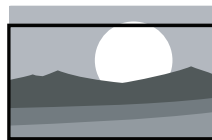

- **Wide screen**
Stretches the classic 4:3 format to 16:9.

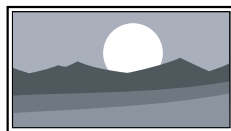

Adjust sound settings

This section describes how to adjust sound settings.

1. Press **MENU** on the remote control and press **▼** to select **Sound**.

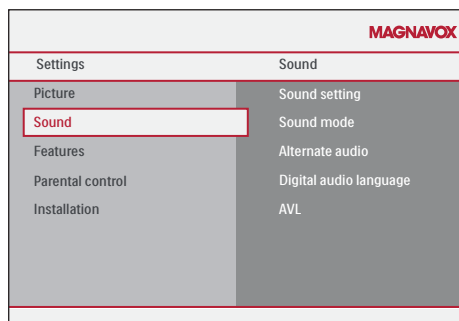

2. Press **▶** to enter the list.
3. Press **▲** or **▼** to select one of the following settings:
 - **Sound setting**
Changes the bass and treble of the sound. Select each bar to change a setting.
 - **Sound mode**
Mono, Stereo, Virtual surround
 - **Alternate audio**
This gives you the possibility to swap between Main and second audio program (SAP), when it is available in analog channel.
 - **Digital audio language**
This gives you the possibility to swap between main and alternative language, when it is available in digital channel.
 - **Automatic volume leveling**
Reduces sudden volume changes, for example, during commercials or when switching from one channel to another.
Select **On** or **Off**.

6.3 Use Smart mode

1. Press **SMART MODE** to set your TV to a predefined picture and sound setting.
2. Select one of the following settings:
 - **Personal**
The customized settings you defined by using the **Picture** menu.
 - **Sports**
Vivid picture settings and clear sound for high action.
 - **Standard**
For normal TV viewing.
 - **Movie**
Brilliant picture settings for a cinematic experience.
 - **Power saver**
Eco friendly settings for lower power consumption.

6.4 Create favorite channels list

This section describes how to use favorite channels list of your TV. Select channels from your list, and choose the channel which you want to add.

Create the list

1. Press the **Yellow** button on the remote control. To add a channel in the favorite channels list.
2. Press the **Green** button. The favorite channels list is shown.
3. Press the **Green** button again to exit.

 **Note:** To remove the channel, press the **Yellow** button on the remote control repeatedly.

Select a channel of favorite channels list

1. Press the green button on the remote control. to show all channels of your favorite list.
2. Press **▲** or **▼** to highlight a channel.
3. Press **OK** to confirm.

-  **Tip**
- Select channels that are not in a list by using the number buttons.

6.5 Set the clock

This section describes how set the time.

1. Press **MENU** on the remote control and select **Installation > Clock**

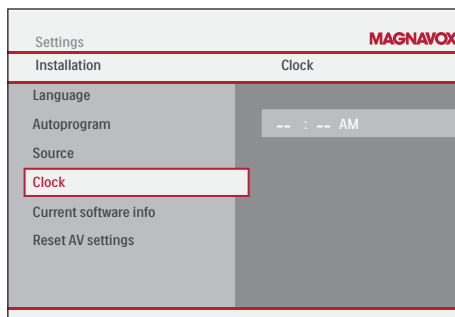

2. Press **▶** to enter the list.
3. Press **▲** or **▼** to set the time. (hour/minute/AM or PM)
4. Press **OK** to confirm.

6.6 Set the sleeptimer

Sleeptimer switches the TV to standby after a defined period of time.

1. Press **MENU** on the remote control and select **Features > Sleptimer**.

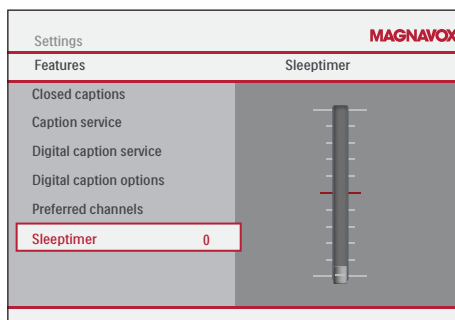

2. Press **▶** to enter the **Sleeptimer** bar.
3. Press **▲** or **▼** to set the sleep time from zero to 180 minutes. If set to zero minutes, the Sleptimer is switched off.
4. Press **OK** to activate the Sleptimer.

(or press SLEEP button on the remote control)

6.7 Use parental control and rating locks

Lock TV channels or connected devices with a four digit code to prevent children from watching unauthorised content.

Set or change your PIN

1. Press **MENU** on the remote control and select **Parental control > Change PIN**.

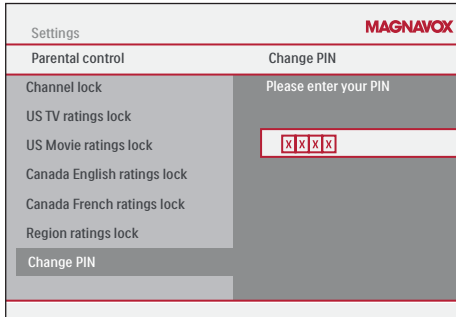

2. Enter a 4-digit PIN with the number buttons on the remote control.
 - If you have a PIN, enter your current PIN.
 - If you do not have a PIN, enter the default code **0000**.
 - If you have lost your PIN, enter master code **0711**.
3. Enter your new 4-digit PIN and then enter it again to confirm.

A message appears to confirm that your PIN has been changed.
4. Press **MENU** to exit.

To lock one or more channels and connected devices

1. In the **Parental control** menu, select **Channel lock**.
2. Enter your PIN.
3. Press **▲** or **▼** to select the channel or device you want to lock or unlock.
4. At each selection, press **OK** to lock or unlock the channel or device.
 - An box with **X** indicates that the channel is locked.

- An empty box indicates that the channel is not locked.

5. Press **MENU** to quit.

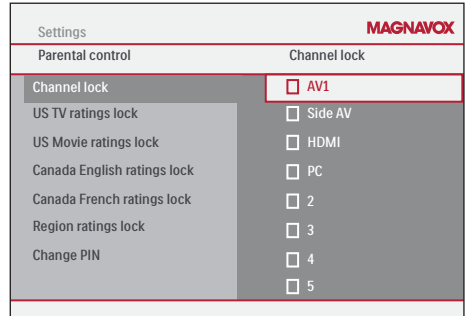

Use the TV ratings lock

Your TV is equipped with a V-chip that allows you to control access to individual programs based on their age rating and content rating. The program content advisory data are sent by the broadcaster or by the program provider.

If you are receiving channels through a set-top box or cable receiver box connected by HDMI, you cannot use the TV ratings lock. Your set-top box or cable receiver box must be connected through RF or AV connectors.

1. Press **MENU** on the remote control and select **Parental control > US TV ratings lock**.

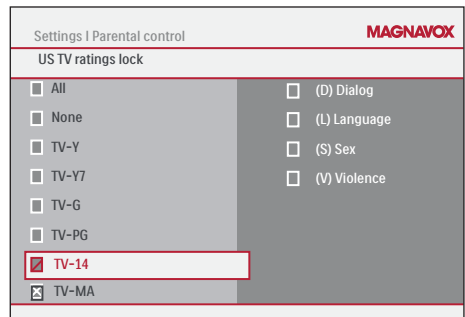

2. Enter your PIN.

If you do not have a PIN, set one as described in *Set or change you PIN* on the previous page.
3. Press **▲** or **▼** and then press **OK** to lock or unlock one or more ratings.

Each rating has a box-graphic in front of it to indicate whether programs carrying that rating are currently locked:

- A box with **X** indicates that all items in the content ratings list are locked.
 - An empty box indicates that the item is not selected.
 - A box with / indicates that some content ratings are deselected. For example, for rating TV-14, you can deselect one or more of the following content ratings: Dialog (D), Language (L), Sex (S), or Violence (V).
 - When you select **All**, all items in the ratings list are locked.
 - When you select **None**, programs with no rating and programs with a rating of **None** are locked.
 - When you lock a rating, all ratings in the younger age categories are automatically locked.
4. Press **MENU** to exit.

Summary of TV ratings

Age rating	Content rating
All	None
None	None
TV-Y Appropriate for children of all ages with themes and elements suitable for children aged 2-6.	None
TV-Y7 Programs designed for children age 7 and older.	Fantasy Violence (FV)
TV-G Programs suitable for all ages. These programs contain little or no violence, no strong language and little or no sexual dialog or situations.	None
TV-PG Programs contain elements that some parents may find unsuitable for younger children and which may need parental guidance. The program may contain moderate violence, sexual dialog and/or situations and some strong language.	Dialog (D) Language (L) Sex (S) Violence (V)
TV-14 Programs contain elements that may not be suitable for children under 14 years of age. These programs include one or more of the following: intense violence, intense sexual situations, suggestive dialog and strong language.	Dialog (D) Language (L) Sex (S) Violence (V)

Age rating	Content rating
TV-MA Programs are designed to be viewed by adults and may be unsuitable for children under the age of 17. These programs may contain graphical violence, explicit sexual activity and/or crude or indecent language.	Language (L) Sex (S) Violence (V)

Use the movie ratings lock

This section describes how to control viewing of movies based on their Motion Picture Association of America (MPAA) rating.

1. Press **MENU** on the remote control and select **Parental control**.
2. Select one of the menus for movie ratings lock.
 - In the USA, select **US Movie ratings lock**.
 - In Canada, select **Canada English ratings lock** or **Canada French ratings lock**.
3. Enter your PIN.

If you do not have a PIN, set one as described in *Set or change you PIN* on the page 18

The following screen shows the ratings in **US Movie ratings lock**.

Settings		MAGNAVOX
Parental control	US Movie ratings lock	
Channel lock	<input type="checkbox"/>	ALL
US TV ratings lock	<input type="checkbox"/>	NR
US Movie ratings lock	<input type="checkbox"/>	G
Canada English ratings lock	<input type="checkbox"/>	PG
Canada French ratings lock	<input type="checkbox"/>	PG-13
Region ratings lock	<input type="checkbox"/>	R
Change PIN	<input type="checkbox"/>	NC-17
	<input type="checkbox"/>	X

4. Press **▲** or **▼**, then press **OK** to lock or unlock one or more ratings.

Each rating has a box-graphic in front of it to indicate whether it is locked:

- A box with **X** indicates that the rating is locked
- An empty box indicates that the rating is not locked

When you lock a movie rating, all items for ages below that movie rating are automatically locked.

5. Press **MENU** to exit.

Summary of US movie ratings

Movie rating	Description
All	All items in the ratings list are locked.
NR	Not rated.
G	Movies with a mild content, suitable for all ages.
PG	Movies for which parental guidance is recommended. They may contain a few racy or violent scenes or maybe some bad language.
PG -13	Movies for which parental guidance may be recommended if under age 13.
R	Restricted. The movies usually contain offensive sex or bad language and may be unsuitable for children under the age of 17. Parental guidance or permission needed.
NC-17	Even with parental permission, forbidden under age 17. More offensive sex, violence or bad language.
X	Movies which generally focus on sex, violence and/or bad language. Also known as pornography.

Summary of Canadian movie ratings.

Movie rating	Description
C	Programming suitable for children under the age of 8 years. No profanity or sexual content of any level allowed. Minimal comedic violence.
C8+	Suitable for children ages 8 and over. Low intensity violence and fantasy horror allowed.
G	Movies with a mild content, suitable for all ages.
PG	Movies for which parental guidance is recommended. They may contain a few racy or violent scenes or maybe some bad language.
14+	Programming intended for children ages 14 and over. May contain intense scenes of violence, strong profanity, and depictions of sexual activity within the context of a story.
18+	Programming intended for viewers ages 18 and over. May contain strong violence, language, and sexual activity.

Summary of Canadian French movie ratings.

Movie rating	Description
G	Appropriate for all ages with little or no violence and little to no sexual content.
8 ans+	Appropriate for children 8 and up which may contain little violence, some foul language and/or little to no sexual content.
13 ans+	Appropriate for children 13 and up, with moderate violence, language, and some sexual situations. Persons under 13 should be accompanied by an adult.

Movie rating	Description
16 ans+	Appropriate for children 16 and up, with strong violence, strong language, and strong sexual content.
18 ans+	Only to be viewed by adults and contains extreme violence and graphic sexual content/pornography.

Use the region rating lock

This section describes how to control access to digital programs based on downloaded region ratings.

Before you download a ratings table, ensure that regional ratings are broadcast.

1. Press **MENU** on the remote control and select **Parental control > Region ratings lock**.

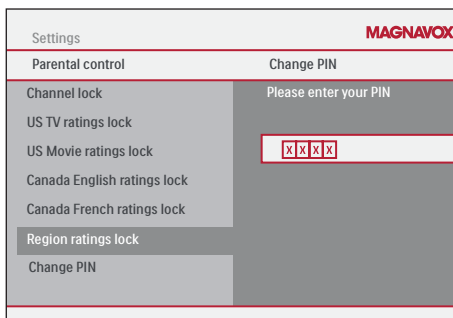

2. Enter your PIN.
3. If you do not have a PIN, set one as described in *Set or change your PIN* on page 18.
4. Press **▲** or **▼** and then press **OK** to lock or unlock one or more ratings.
5. Each rating has a box-graphic in front of it to indicate whether it is locked:
 - A box with **X** indicates that the rating is locked
 - An empty box indicates that the rating is not locked
6. Press **MENU** to exit.

6.8 Closed captions

The caption service displays transmitted CC-, T-, and CS- text. The caption text can be displayed permanently or only when the TV is muted. This section describes how to use the caption service.

Note

- This television provides a display of television closed captioning that conforms with the EIA-608 standard and in accordance with Sections 15.119 of the FCC rules.
- If you connect your cable receiver box via HDMI or component video input, you cannot select closed caption through the TV. You can select closed caption through the cable receiver box only.
- The captions do not always use correct spelling and grammar.
- Not all TV programs and product commercials include closed caption information. Refer to your area TV program listings for the TV channels and times of closed caption shows. The captioned programs are usually noted in the TV listings with service marks such as 'CC'.

Display captions

1. Press **MENU** on the remote control and select **Features > Closed captions**.
2. Press **▲** or **▼** to select **On, Off** or **On during mute**, and press **OK** to confirm your choice.
3. Press **MENU** to exit.

Select caption services

For information about the caption services see *Summary of caption service* on next page.

1. Turn captions on as described in *Display captions* on this page.
2. Select a caption service for analog channels:
 - Press **MENU** on the remote control and select **Features > Caption service**.
 - Press **▲** or **▼** to select one of the listed caption services and press **OK** to confirm your choice.
Not all caption services are necessarily being used by a TV channel during the transmission of a closed caption program.
3. Select a caption service for digital channels:

- Press **MENU** on the remote control and select **Features > Digital caption service**.
- Press **▲** or **▼** to select one of the listed caption services and press **OK** to confirm your choice.

4. Press **MENU** to exit.

Summary of caption services

- **CC-1, CC-2, CC-3, and CC-4**
Dialog and descriptions for the action on the captioned TV program show on screen. Usually **CC 1** is the most used. **CC 2** can be used for alternate languages if they are being transmitted.
- **T-1, T-2, T-3 and T-4**
Often used for channel guide, schedules, bulletin board information for Closed Captions programs, news, weather information, or stock market reports.
- **CS-1, CS-2, CS-3, CS-4, CS-5 and CS-6**
Service 1 is designated as the Primary Caption Service. This service contains verbatim, or near-verbatim captions for the primary language being spoken in the accompanying program audio.

Service 2 is designated as the Secondary Language Service. This service contains captions in a secondary language which are translations of the captions in the Primary Caption Service. The other service subchannels are not pre-assigned. It is up to the discretion of the individual caption provider to utilize the remaining service channels.

Choose how digital captions are displayed

You can define the size, font, color, background and other characteristics of the caption text.

1. Press **MENU** on the remote control and select **Features > Digital caption options**.
2. Press **▲** or **▼** to highlight an option for digital captions, and press **OK** to select the option.
3. Press **▲** or **▼** to highlight a setting for the option, and press **OK** to confirm your choice.
4. Press **MENU** to exit.

6.9 Use your TV as a PC monitor

Using a VGA cable connects a PC to your TV as a PC monitor.

Caution

Before you connect your PC, set the PC monitor refresh rate to 60Hz.

Supported screen resolutions

The following screen resolutions are supported in PC mode:

Resolution	Refresh rate
640 × 480	60Hz
800 × 600	60Hz
1024 × 768	60Hz
1280 × 768	60Hz
1440 × 900	60Hz

If necessary, you can adjust the picture position to the center of the screen with the cursor buttons.

6.10 Select your TV in PC mode

1. Press **MENU** on the remote control and select **Installation > Source**

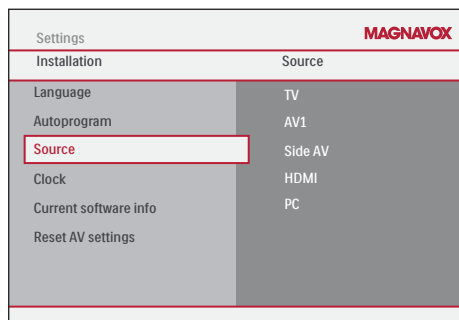

2. Select **PC** and press **OK** to confirm your choice.
3. If necessary, adjust the picture settings as described in *Change picture settings* on page 14.

 Tip: Set the picture format to 4:3 or Full screen in PC mode.

4. Press **MENU** to exit.

7. Change your TV installation

The first time you switch on your TV you select the language for the TV menus and make basic choices for picture and sound settings. Use this chapter to reinstall the TV, to set preferences in the TV menus, or to tune new TV channels.

7.1 Select your menu language

1. Press **MENU** on the remote control and select **Installation > Language**.

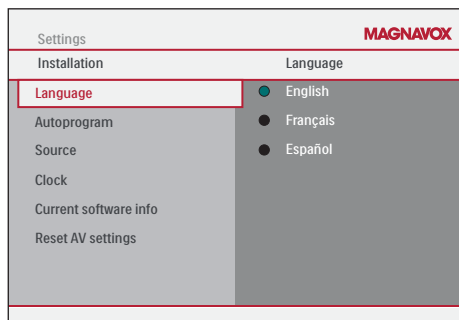

2. Select a language and press **OK** to confirm your choice.
3. Press **◀** to return to the **Installation** menu.

7.2 Autoprogramming

This section describes how to search for and store channels automatically. Before you tune channels, ensure that you are registered with your cable TV provider and that your equipment is correctly connected.

1. Press **MENU** on the remote control and select **Installation > Autoprogram > Start Now**.

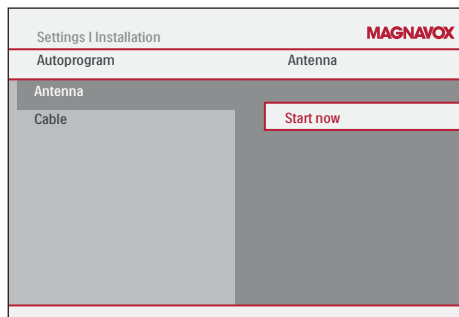

2. Select **Cable** or **Antenna** and press **▶**.
 - When **Antenna** is selected, the TV detects antenna signals. It searches for NTSC and ATSC channels available in your area.
 - When **Cable** is selected, the TV detects signals supplied by cable. It searches for NTSC, ATSC, and QAM modulated channels available in your area.
3. Press **OK** to start the installation.

If you run **Autoprogram** when you have locked channels, a message appears asking to enter your PIN code. Enter your PIN code in order to complete the installation.

If you have forgotten your PIN, reset it as described in *Set or change your PIN* on page 18.

When autoprogramming is complete, this message appears “**Channel search completed**”.

4. Follow the on-screen instructions to complete the installation.

7.3 Return your settings to default values

This section describes how to return picture and sound settings to their default values. The channel installation settings are not affected.

1. Press **MENU** on the remote control and select **Installation > Reset AV settings**.

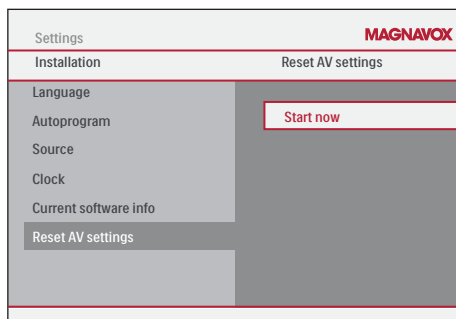

2. Press **▶** to highlight **Start now**, and press **OK** to reset the AV settings.
3. Press **Menu** to exit.

8. Connect devices

8.1 Connection overview

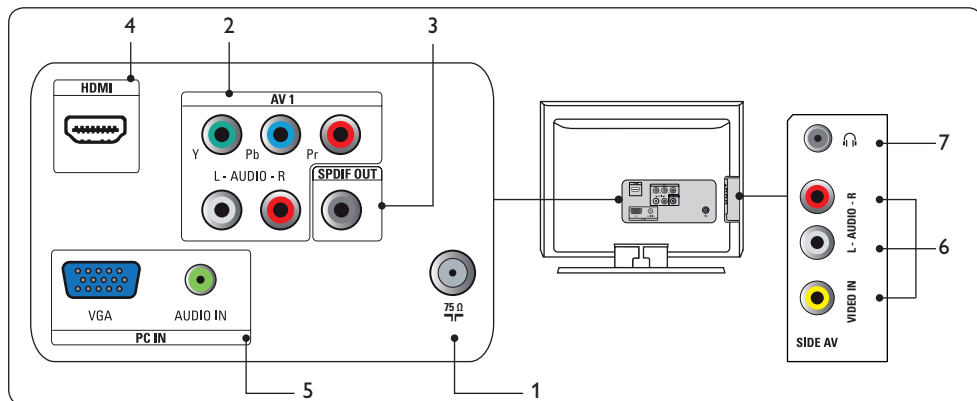

Rear connectors

- 1. Antenna input / 75 Ω**
- 2. AV1**
Component video input. Y Pb Pr and Audio L/R connectors for DVD, digital receiver or game console, etc.
- 3. SPDIF Out**
Digital audio out.
- 4. HDMI In**
HDMI in connector for Blu-ray Disc player, HD digital receiver or HD game console, etc.
- 5. PC In**
VGA, Audio connectors for PC.

Side connectors

- 6. Headphones**
Stereo Mini Jack.
- 7. Video (Side AV)**
Video input cinch connector to be used together with Audio L/R connectors for camcorder, game console, etc.

8.2 Select connection quality

This section describes how you can enhance your audio visual experience by connecting your devices with the best possible connectors.

HDMI - Highest quality

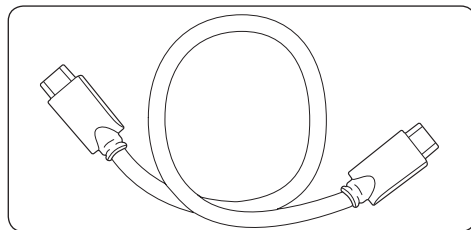

HDMI produces the best audio visual quality possible. Both audio and video signals are combined in one HDMI cable, providing an uncompressed, digital interface between your TV and HDMI devices. You must use HDMI to experience full high-definition video.

- * **Tip**
If the device only with a DVI connector, use a DVI-HDMI adaptor to connect your device to a HDMI connector at the back of the TV. You must connect a separate audio cable from the device to the AUDIO L/R at Side AV.

Component (Y Pb Pr) - Higher quality

Component (Y Pb Pr) video provides better picture quality than composite video connections. Though component video supports high-definition signals, picture quality is lower than HDMI and is analogue.

When connecting a component video cable, match the cable colours. Also connect a Audio L/R cable to the red and white Audio L/R input connectors at AV1.

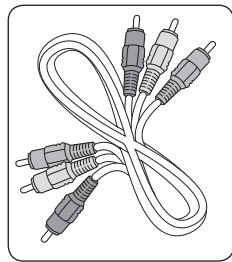

Component video cable
- Red, Green, Blue

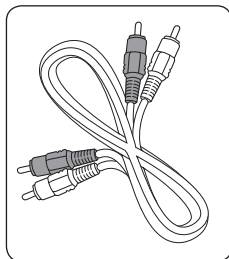

Audio L/R cable
- Red, White

Composite - Basic quality

Composite video provides basic analogue connectivity, usually combining a (yellow) video cinch cable with (red and white) Audio L/R cinch cable. Match the cable colours when connecting to the composite Video and Audio L/R input connectors on the side of the TV.

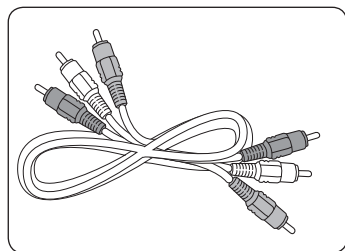

Composite audio/video cable - yellow, red and white

8.3 Connect devices

This section describes how to connect a selection of devices with different connectors. Note that different types of connectors may be used to connect a device to your TV. The following sections describe examples only, other configurations are possible.

When connecting composite or component cables, match the cable colors to the connectors on the TV.

Connect a cable receiver box and a DVD player/recorder via composite connectors

Warning

Do not place your recorder too close to the screen because some recorders can be susceptible to signals.

Connect a cable receiver box, DVD player/recorder and game console via HDMI

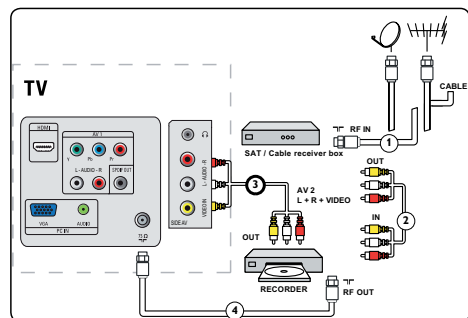
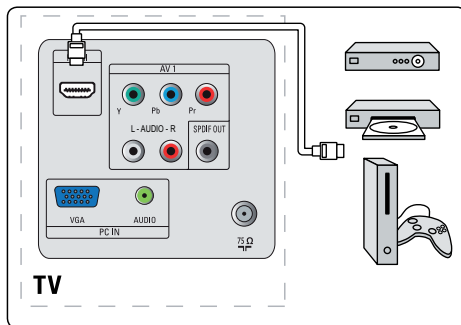

Connect a DVD recorder or VCR and a second A/V device via composite connectors.

Connect a DVD player/recorder via HDMI-DVI and DIGITAL AUDIO OUT connectors

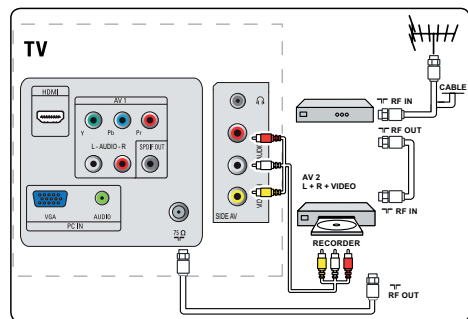
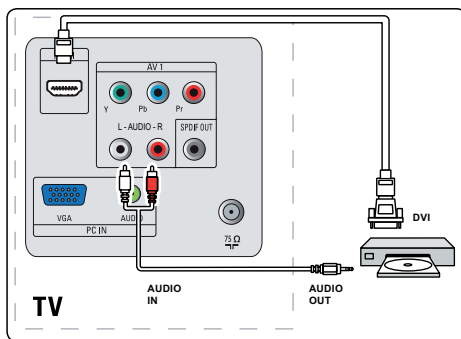

Connect a DVD player/recorder via component video output connectors (YPbPr) and analog audio

Selected TV models are capable of displaying 1080i, 720p and 480i/p DTV signals when connected to a DTV tuner cable receiver box. Select the output of the cable receiver box to either 1080i, 720p or 480i/p. A DTV signal must be available in your area.

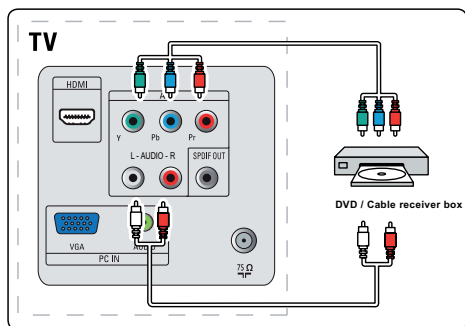

Connect a PC

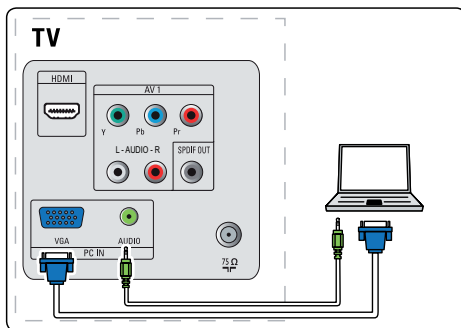

Connect a digital home theatre amplifier

⚠ Warning

Due to legal requirements, it is possible that with certain copy protected PCM audio qualities from an accessory device connected to the HDMI input, the digital audio signal is muted.

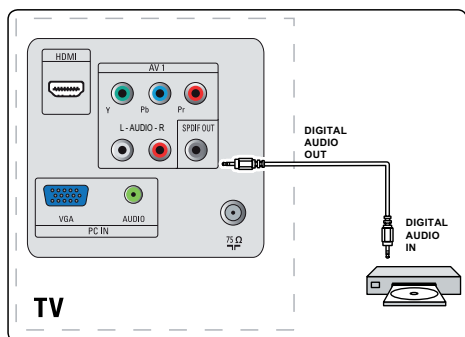

9. Glossary

Aspect Ratio	The ratio between the width and height of the TV picture on the screen. In a normal TV set the aspect ratio is 4 to 3 (4:3). The new aspect ratio in HDTV is 16:9 which resembles the aspect ratio in a movie theatre (Widescreen). New TV systems support both 4:3 and 16:9 aspect ratio and can automatically switch between them.
Audio Video (A/V)	A term often used when discussing a channel on a TV receiver or on video equipment, which has been especially designed to accept VCR audio-video signals. This channel automatically activates special circuitry within the TV set to prevent picture distortion and skewing. It is also used for audio-video processors, which handle both types of signals.
ATSC	ATSC: Advanced Television Systems Committee. Formed to establish technical standards for advanced television systems, including digital high definition television (HDTV).
CVBS	Composite Video Baseband Signal. In broadcast television this refers to the video signal, including the colour information and syncs.
Component Video Input (Y Pb Pr)	Component Video Input is a type of connection that uses a cinch-type connector to allow set top boxes or analog DVD players to connect a signal to the TV. By offering the cinch-type input (YPbPr) the primary colors, red, green and blue are connected from a set top box directly into the TV allowing for the signal to display on the screen.
DTV	Digital television. Generic term that refers to all digital television formats, including high-definition television (HDTV) and standard-definition television (SDTV).
DOLBY Digital	Dolby Digital - Six-channel digital audio standard that is part of the U.S. digital television standard; also called AC-3 or Digital 5.1. The channels consist of front left, front right, front center, surround or rear left, surround or rear right, and a separate subwoofer.
Digital Tuner	A digital tuner serves as the decoder required to receive and display digital broadcasts. It can be included inside TV sets or via a cable receiver box.
HDTV	The generally agreed upon definition of HDTV is approximately twice the vertical and horizontal picture resolution of today's NTSC TV, which essentially makes the picture twice as sharp. HDTV also has a screen ratio of 16:9 as compared with most of today's TV screens, which have a screen ratio of 4:3. HDTV offers reduced motion artifacts (i.e. ghosting, dot crawl), and offers 5.1 independent channels of CD-quality stereo surround sound, (also referred to as AC-3).
NTSC	National television system committee. The organization that developed the analog television standard currently in use in the U.S., Canada, and Japan. Now generally used to refer to that standard. The NTSC standard combines blue, red, and green signals modulated as an AM signal with an FM signal for audio.
Progressive Scan	In Progressive Scanning all the horizontal scan lines are scanned on to the screen at one time. The Digital TV and HDTV Standards accept both Interlaced Scan and Progressive Scan broadcast and display methods.
Resolution	Resolution: A measurement of the finest (smallest) detail that is visible in a video image. TV Resolutions may be expressed as number of pixels in an image; or more commonly, As Total Number of (horizontally scanned) Lines used to create the image. Standard Digital TV Resolutions: SDTV: 480i - The picture is 704x480 pixels, 480p - The picture is 704x480 pixels. HDTV: 720p - The picture is 1280x720 pixels, 1080i - The picture is 1920x1080 pixels, 1080p - The picture is 1920x1080 pixels.
SPDIF	SPDIF (Sony and Philips Digital Interconnect Format) is highly recommended for high quality digital sound output.

10. Trouble shooting

Symptoms	Possible cause	What should you do
No power or indicator light.	The TV is not connected to the power.	1. Press POWER at the front of the TV, or press ϕ on the remote control.
		2. Ensure the AC power cord is connected tightly to the TV power connector and to the power socket outlet.
		3. Remove the AC power cord from the power socket outlet, wait 60 seconds and reconnect the AC power cord.
		4. Connect the TV to a different power socket outlet.
Error message on the screen with HDMI connection.	HDCP authentication fail.	1. Ensure that your HDMI cable is certified.
		2. Press SOURCE on the remote control to switch to another source and then switch back to the HDMI source.
		3. Reset the accessory device and the TV. Turn on the TV Select the HDMI channel Turn on the accessory device
		4. While the TV and the accessory device are powered on, unplug either end of the HDMI cable and then reinsert the cable.
No sound is detected from the PC.	Audio cable is not connected.	1. Connect an audio cable to the PC AUDIO IN port on the TV.
		2. Press SOURCE on the remote control, and select the PC source.
TV does not respond to the remote control.	Batteries are installed incorrectly, or low battery power.	1. Ensure the indicator light on the TV blinks when the remote control buttons are pressed.
		2. Ensure that you are using the remote control supplied with the TV.
		3. Ensure that the batteries of the remote control are inserted according to the illustration on the remote control and that the batteries do not need to be replaced.
		4. Remove the AC power cord from the power socket outlet, wait 60 seconds and reconnect the AC power cord.
The picture is distorted. It is stretched out, has short, fat, black bars on the side or top.	Broadcast video format.	1. Press the FORMAT button on the remote control to select the best picture format.
		2. For some accessory devices, the picture format has to be set in the accessory device.
The picture is mostly red and green, or the picture is missing red when the TV is connected to an accessory device via component cables.	Insecure/incorrect connection.	1. Ensure all the connections are made according to the color code. 2. Push the component cables all the way into the YPbPr sockets on the TV.
No sound on the TV loudspeaker.	Volume level is set to zero.	1. Increase the volume.
	Sound is muted.	2. Press MUTE on the remote control.
	Headphones are connected.	3. Ensure the headphones are not plugged into the TV.
	Audio cable is not connected.	4. For AV connection, ensure that the Audio L/R cable is connected as described in <i>Connect devices</i> on page 26. If you are using a component cable, ensure that you have not crossed the red audio cable with the red video cable.
	Accessory device audio output setting is incorrect.	5. For HDMI connections, some accessory devices have an HDMI audio output setting that must be turned on for HDMI to HDMI connections.
Bad picture quality with a coaxial connection.	Standard definition channels are not as clear as high definition channels.	1. Connect the devices via component or HDMI cables.
No picture or sound.	Incorrect channel	1. Ensure you have selected the correct channel.
	Incomplete channel installation.	1. If the TV receives channels via an AV connection, set the TV to the correct source input.
		2. If the TV is connected directly to the wall via a coaxial connection, perform the auto-installation again.

11. Technical specifications

Model no.	19MF338B
PICTURE/DISPLAY	
Aspect Ratio	16:9
Resolution	1440x900p
Brightness	300 cd/m2 (typ.)
Response Time (on/off)	5ms (typ.)
Viewing Angles (V/H)	160 by 160 (typ.)
SOUND ENHANCEMENT	
Sound output (RMS Watts)	3 W x 2
Sound modes	Mono, Stereo, Virtual surround
EASE OF USE	
Video formats	Automatic, 4:3, Movie Expand 14:9, Movie Expand 16:9, Super Zoom, 16:9 subtitle, Wide Screen,
Smart modes	Personal, Sports, Standard, Movie, Power saver
CONNECTIONS	
Rear connectors	AV1: Component video input with Audio L/R (support 480i/p, 720p, 1080i)
	HDMI (Ver 1.3a HDMI support 480i/p, 720p, 1080i)
	SPDIF output (Digital audio out, support AC-3 & PCM)
	PC IN: VGA, PC Audio IN
Side connectors	Headphone x 1
	Composite video input with audio L/R (support 480i)
WEIGHT & DIMENSIONS	
Gross weight	13.4 lbs
Net weight	11.4 lbs
Box dimension (LxWxH)	20.3" x 17.3" x 6.1"
Product dimension (HxWxD)	15.1" x 18.3" x 6.6"
POWER	
Power consumption	50W
Standby power consumption	<1W
Mains Power	100-120 V/60HZ

12. Index

A

- AC power cord 10
 - Alternative 16
 - Antenna 6
 - Automatic format 15
-

B

- Back connectors 24
 - Batteries 8
 - Brightness 14
-

C

- Cable 8
 - Cable receiver box 9
 - Care
 - Environment 5
 - Screen 5
 - Channel
 - Install 10
 - Channel lock 18
 - Clock 17
 - Connect devices 26
-

D

- DBS 9
 - Dynamic contrast 14
-

F

- Favorite lists 17
-

H

- HDMI cable 24
-

I

- Installation 7
-

L

- Language 23
-

M

- Manage cables 10
 - Model number 1
 - Movie expand 15
 - Movie ratings 19
 - Mute 13
-

O

- Overview
 - Connection 24
 - TV 6
-

P

- Parental control 18
 - PC mode 22
 - Picture 14
 - PIN code 18
 - Position the TV 7
-

R

- Recycling 5
 - Registration Card 1
-

S

- Screen resolutions 22
 - Sharpness 14
 - Side connectors 24
 - Sleeptimer 17
 - Sound 14
 - Super zoom 15
 - Switch on the TV 10
-

T

- Technical specifications 30
 - Tint 14
-

Trouble shooting 29

V

V-chip 18

VESA wall bracket 7

Volume 13

W

Warranty 33

Y

Y Pb Pr 27

13. Warranty

LIMITED WARRANTY NINETY (90) DAY LABOR / ONE (1) YEAR PARTS

WARRANTY COVERAGE:

This warranty obligation is limited to the terms as set forth below.

WHO IS COVERED:

This product warranty is issued to the original purchaser or the person receiving the product as a gift against defects in materials and workmanship as based on the date of original purchase ("Warranty Period") from an Authorized Dealer. The original sales receipt showing the product name and the purchase date from an authorized retailer is considered such proof.

WHAT IS COVERED:

This warranty covers new products if a defect in material or workmanship occurs and a valid claim is received by within the Warranty Period. At its option, the company will either (1) repair the product at no charge, using new or refurbished replacement parts, or (2) exchange the product with a product that is new or which has been manufactured from new, or serviceable used parts and is at least functionally equivalent or most comparable to the original product in current inventory, or (3) refund the original purchase price of the product.

Replacement products or parts provided under this warranty are covered against defects in materials and workmanship from the date of the replacement or repair for ninety (90) days or for the remaining portion of the original product's warranty, whichever provides longer coverage for you. When a product or part is exchanged, any replacement item becomes your property and the replaced item becomes company property. When a refund is given, your product becomes company property.

Note: Any product sold and identified as refurbished or renewed carries a ninety (90) day limited warranty.

Replacement product can only be sent if all warranty requirements are met. Failure to follow all requirements can result in delay.

WHAT IS NOT COVERED - EXCLUSIONS AND LIMITATIONS:

This Limited Warranty applies only to new company manufactured products that can be identified by the trademark, trade name, or logo affixed to it. This Limited Warranty does not apply to any hardware product or any software, even if packaged or sold with the product, as manufacturers, suppliers, or publishers may provide a separate warranty for their own products packaged with the bundled product.

The company is not liable for any damage to or loss of any programs, data, or other information stored on any media contained within the product, or other additional product or part not covered by this warranty. Recovery or reinstallation of programs, data or other information is not covered under this Limited Warranty.

This warranty does not apply (a) to damage caused by accident, abuse, misuse, neglect, misapplication, or non-supplied product, (b) to damage caused by service performed by anyone other than company approved Authorized Service Location, (c) to a product

or a part that has been modified without written company permission, or (d) if any serial number has been removed or defaced, or (e) product, accessories or consumables sold "AS IS" without warranty of any kind by including refurbished product sold "AS IS" by some retailers.

This Limited Warranty does not cover:

- Shipping charges to return defective product.
- Labor charges for installation or setup of the product, adjustment of customer controls on the product, and installation or repair of antenna/signal source systems outside of the product.
- Product repair and/or part replacement because of improper installation or maintenance, connections to improper voltage supply, power line surge, lightning damage, retained images or screen markings resulting from viewing fixed stationary content for extended periods, product cosmetic appearance items due to normal wear and tear, unauthorized repair or other cause not within the control of the company.
- Damage or claims for products not being available for use, or for lost data or lost software.
- Damage from mishandled shipments or transit accidents when returning product.
- A product that requires modification or adaptation to enable it to operate in any country other than the country for which it was designed, manufactured, approved and/or authorized, or repair of products damaged by these modifications.
- A product used for commercial or institutional purposes (including but not limited to rental purposes).
- Product lost in shipment and no signature verification receipt can be provided.
- Failure to operate per Owner's Manual.

TO OBTAIN ASSISTANCE...

Contact the Customer Care Center at:
1-800-705-2000

REPAIR OR REPLACEMENT AS PROVIDED UNDER THIS WARRANTY IS THE EXCLUSIVE REMEDY FOR THE CONSUMER, WITH THE ISSUING COMPANY NOT LIABLE FOR ANY INCIDENTAL OR CONSEQUENTIAL DAMAGES FOR BREACH OF ANY EXPRESS OR IMPLIED WARRANTY ON THIS PRODUCT. EXCEPT TO THE EXTENT PROHIBITED BY APPLICABLE LAW, ANY IMPLIED WARRANTY OF MERCHANTABILITY OR FITNESS FOR A PARTICULAR PURPOSE ON THIS PRODUCT IS LIMITED IN DURATION TO THE DURATION OF THIS WARRANTY.

Some states do not allow the exclusions or limitation of incidental or consequential damages, or allow limitations on how long an implied warranty lasts, so the above limitations or exclusions may not apply to you.

This warranty gives you specific legal rights. You may have other rights which vary from state/province to state/province.

Funai Corporation Inc., Rutherford, NJ 07070

062408

