

# HDO Fixture User Manual

UPDATE: 14 Aug.2020

VERSION: V1.0.0

## TABLE OF CONTENTS

<b>1. LEGAL NOTICES</b> .....	<b>4</b>
<b>2. WARRANTY</b> .....	<b>5</b>
<b>3. SECURITY SUMMARY</b> .....	<b>6</b>
<b>4. REVISION HISTORY</b> .....	<b>8</b>
<b>5. INTRODUCTION</b> .....	<b>9</b>
5.1 FUNCTION .....	9
5.2 MAIN PURPOSE .....	9
5.3 FUNCTIONS & FEATURES .....	9
5.4 TECHNICAL SPECIFICATIONS .....	9
5.5 FIXTURE OVERVIEW .....	10
5.6 MAIN BOX.....	10
5.7 HDO (HEAT DISPLAY OPENER) .....	11
5.8 NORTH BAR MODULE .....	11
5.9 SUCTION CUP ASSEMBLY .....	12
5.10 HOT POCKET .....	12
5.11 TOGGLE CAM .....	13
5.12 HP POGO BLOCK MODULE.....	13
<b>6. ILLUSTRATION OF FIXTURE PARTS</b> .....	<b>14</b>
6.1 MAIN FIXTURE.....	14
6.2 FIXTURE KEY MODULES .....	14
6.3 HDO KEY MODULE .....	15
6.4 HOT POCKET .....	15
6.5 NORTH BAR MODULE .....	16
6.6 POGO PIN MODULE.....	16
6.7 MAIN BOX.....	17
6.8 MAIN BOX ILLUSTRATION .....	17
<b>7. SAFETY REGULATIONS</b> .....	<b>18</b>
7.1 WARNING SIGNS DESCRIPTION .....	19
7.2 SAFETY DEVICE .....	20
<b>8. FIXTURE OPERATING ENVIRONMENT REQUIREMENTS</b> .....	<b>21</b>
<b>9. OPERATION PROCEDURES</b> .....	<b>22</b>
<b>10. SOFTWARE INTERFACE AND ERROR CODES</b> .....	<b>26</b>

10.1 START-UP AND STANDBY INTERFACE .....	26
10.2 HEATING INTERFACE .....	26
10.3 KEEP WARM INTERFACE .....	27
10.4 COMPLETION INTERFACE.....	27
10.5 ERROR CODE AND TROUBLE SHOOTINGS.....	28
<b>11. MAINTENANCE .....</b>	<b>29</b>
<b>12. CONSUMABLE PART LIST .....</b>	<b>30</b>
<b>13. SPARE PART LIST .....</b>	<b>31</b>
<b>14. FIXTURES DISMANTLING AND SCRAPPING .....</b>	<b>31</b>

## 1. LEGAL NOTICES

The information in this document is subjected to change without notice.

Kunshan Myzy Fixture Technology Co., Ltd. makes no warranty for any kind with regard to this manual, including, but no limited to the implies of warranties of merchantability and fitness for a particular purpose.

Kunshan Myzy Fixture Technology Co., Ltd. shall not be held liable for errors contained herein or direct, indirect, special, incidental or consequential damages in connection with the furnishing, performance, or use of this material.

Kunshan Myzy Fixture Technology Co., Ltd.  
No. 2618 Huanqing Road, North of Kunshan City,  
Jiangsu Province, China 215300.  
TEL: +86 (512) 5717 8888  
Fax: +86 (512) 5717 8888

Copyright Notices, Copyright 2003 - 2009 Kunshan Myzy Fixture Technology Co., Ltd., all rights reserved.  
Reproduction, adaptation, or translation of this document without prior written permission is prohibited, except as allowed under the copyright laws.

## 2. WARRANTY

All Myzy fixtures are warranted against defects in material and workmanship for a period of one year after date of shipment. Myzy agrees to repair or replace any assembly or component found to be defective, under normal use during this period.

Myzy's obligation under this warranty is limited solely to repairing any such fixture, which in Myzy's sole opinion prove to be defective within the scope of the warranty when returned to the factory or to an authorized service center. Transportation to the factory or service center is to be prepaid by purchaser. Shipment should not be made without prior authorization by Myzy.

This warranty does not apply to any products repaired or altered by persons not authorized by Myzy, or not in accordance with instructions furnished by Myzy. If the fixture is defective as a result of misuse, improper repair, or abnormal conditions or operations, repairs will be billed at cost.

Myzy assumes no responsibility for its product being used in a hazardous or dangerous manner either alone or in conjunction with other equipment. High voltage used in some fixtures may be dangerous if misused. Special disclaimers apply to this fixture. Myzy assumes no liability for secondary charges or consequential damages and in any event, Myzy's liability for breach of warranty under any contract or otherwise, shall not exceed the purchase price of the specific fixture shipped and against which a claim is made.

Any recommendations made by Myzy for use of its products are based upon fixtures believed to be liable, but Myzy makes no warranty of the results to be obtained. This warranty is in lieu of all other warranties, expressed or implied, and no representative or person is authorized to represent or assume for Myzy any liability in connection with the sale of our products other than set forth herein.

### 3. SECURITY SUMMARY

The following general safety precautions must be observed at all stages of operation, service, and maintenance testing fixtures. Failure to comply with these precautions or the use of specific warnings given elsewhere in this manual will violate safety standards for the design, manufacture, and testing of fixtures. If the customer fails to comply with these requirements, Myzy will not be held responsible.



#### BEFORE APPLYING POWER

Verify that the power is set to match the rated input of this power supply.



#### PROTECTIVE GROUNDING

Make sure to connect the protective grounding to prevent an electric shock before turning on the power.



#### NECESSITY OF PROTECTIVE GROUNDING

Never cut off the internal or external protective grounding wire, or disconnect the wiring of protective grounding terminal. Doing so will cause a potential shock hazard that may bring injury to a person.



#### FUSES

Only fuses with the required rated current, voltage, and specified type (normal blow, time delay, etc.) should be used. Do not use repaired fuses or short-circuited fuse holders. To do so could cause a shock or fire hazard.



#### DO NOT OPERATE IN AN EXPLOSIVE ATMOSPHERE

Do not operate the instrument in the presence of flammable gases or fumes. The instrument should be used in an environment of good ventilation.



#### DO NOT REMOVE THE COVER OF THE INSTRUMENT

Operating personnel must not remove the cover of the instrument. Component replacement and internal adjustment can be done only by qualified service personnel.

## STORAGE

When the tester is no longer in use, please pack it properly and store it in a good environment.

1	Indoor Temperature 23°C±3 °C
2	Indoor Humidity 45%~60%
3	Places that do not receive direct sunlight
4	Keep away from water and oil stains
5	Keep away from areas containing volatile components or corrosive gases
6	Store in a dust-free place as much as possible.
7	Avoid subjecting the fixture to vibration shocks above 0.5G.
8	Avoid exposing the fixture to electromagnetic waves, ultraviolet light, and radiation.

## FREIGHT

Use the original packaging material when moving this test fixture over long distances. If there is a lack of packaging material, please use the equivalent cushioning material for packaging and mark it fragile and waterproof, etc., so as not to damage the test fixture during transportation.

The test fixture is a kind of precision equipment. please use qualified means of transportation as far as possible and avoid damage to the equipment such as external forces.

## MAINTENANCE

This is a manual for the average user that does not need to be maintained (in addition to the instructions in the manual). When the test fixture is abnormal by user judgment, please contact the after-sales maintenance department of the company. Do not maintain without permission, avoid unnecessary danger and serious damage to the test kit.

## CLEANING

Turn off the power before cleaning. Gently clean the dust with a brush.

For internal cleaning, please use a low-pressure vacuum cleaner to absorb the dust inside.

#### 4. REVISION HISTORY

Date	Version	Change Note
14.08.2020	v1.0.0	Complete this manual
20.08.2020	v1.0.1	Add NFC information into the Technical specification



## 5. INTRODUCTION

### 5.1 Function

This is a manual disassembling HDO Fixture, Model: MZ20-FT012-01. The fixture is mainly composed of HDO Main Fixture, Main Box and specific Hot Pockets. It is an automatic heating controlled and manual disassembly of the phone display for defective products, and achieve fast and high yield rate of product repair and dismantling.

### 5.2 Main Purpose

This fixture is automatically heat controlled universal display opener for iPhone.

### 5.3 Functions & Features

- Designed for D52, D53G/P, and D54 generation. applies controlled heat to display enclosure. Adaptable for future generations with new hot pockets.
- Main fixture with mechanical and electronics, removable product specific Hot Pockets.

### 5.4 Technical specifications

<b>Fixture Name</b>	HDO Fixture
<b>Fixture Model</b>	MZ20-FT012-01
<b>Fixture Size</b>	225*300*310mm
<b>Fixture Net Weight</b>	9.28kg
<b>Fixture Input Voltage</b>	100~240VAC
<b>Fixture Life Span</b>	3 years
<b>NFC Model</b>	FRM-006
<b>NFC Size</b>	20mm*15mm*2mm
<b>NFC Working Frequency</b>	13.56Mhz
<b>NFC Card Reading Distance</b>	0~8cm

## 5.5 Fixture Overview

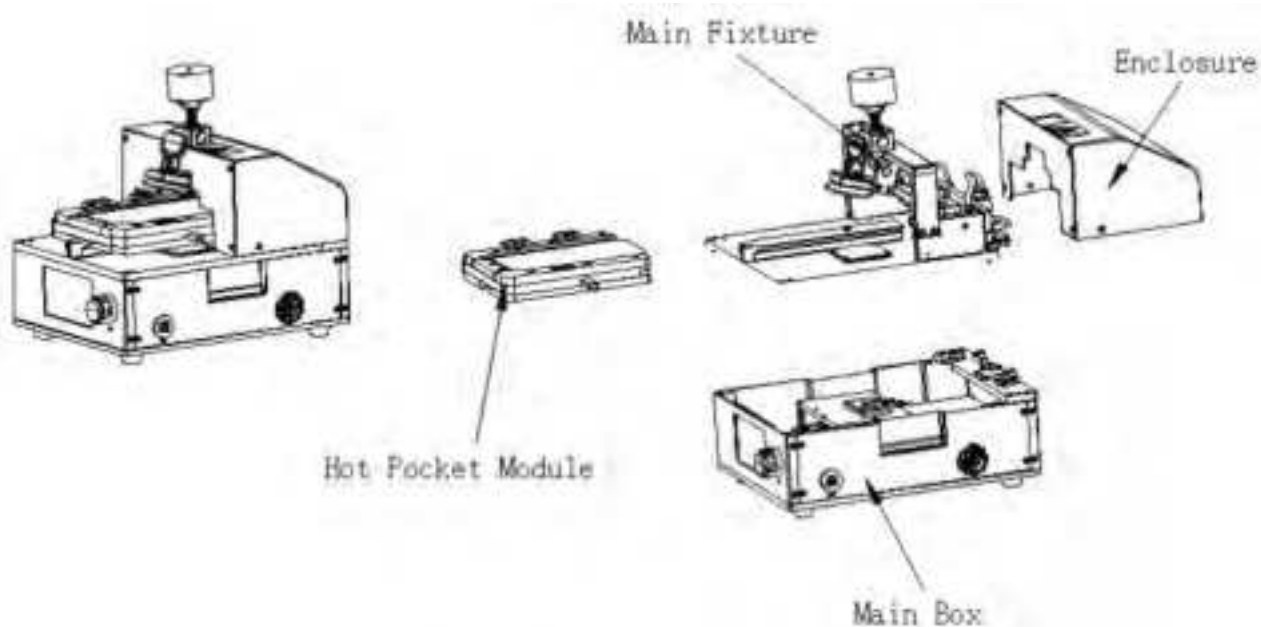

## 5.6 Main Box

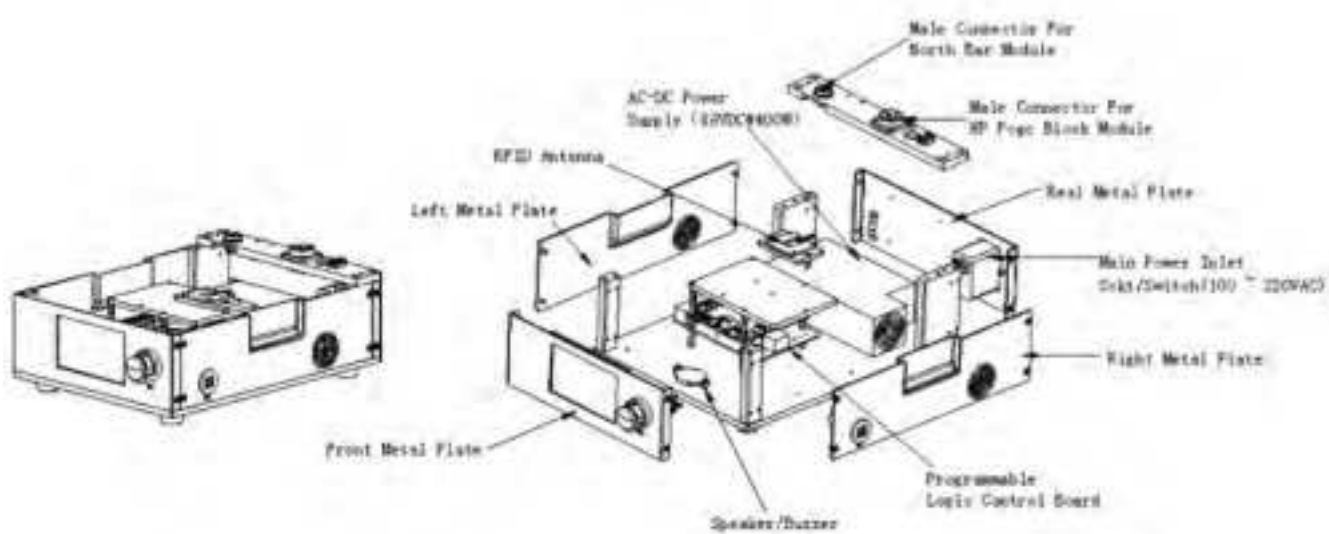



### 5.9 Suction Cup Assembly

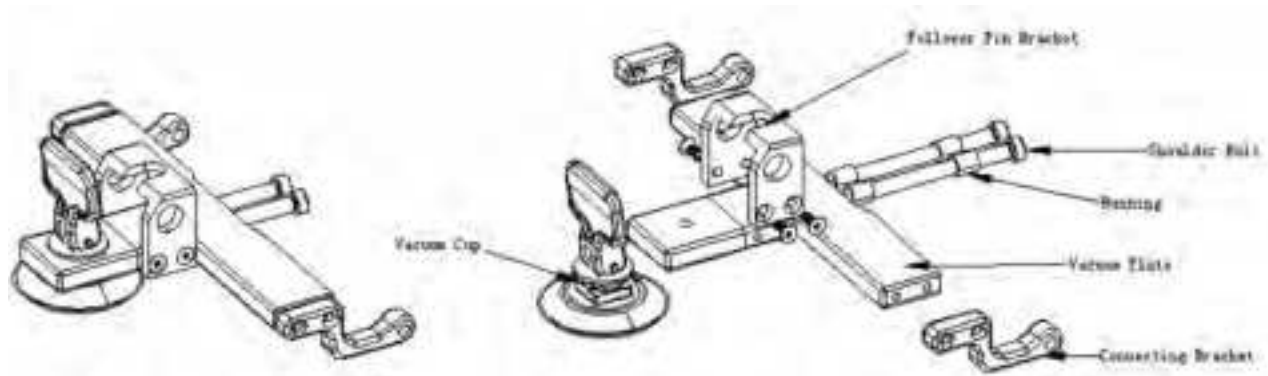

### 5.10 Hot Pocket

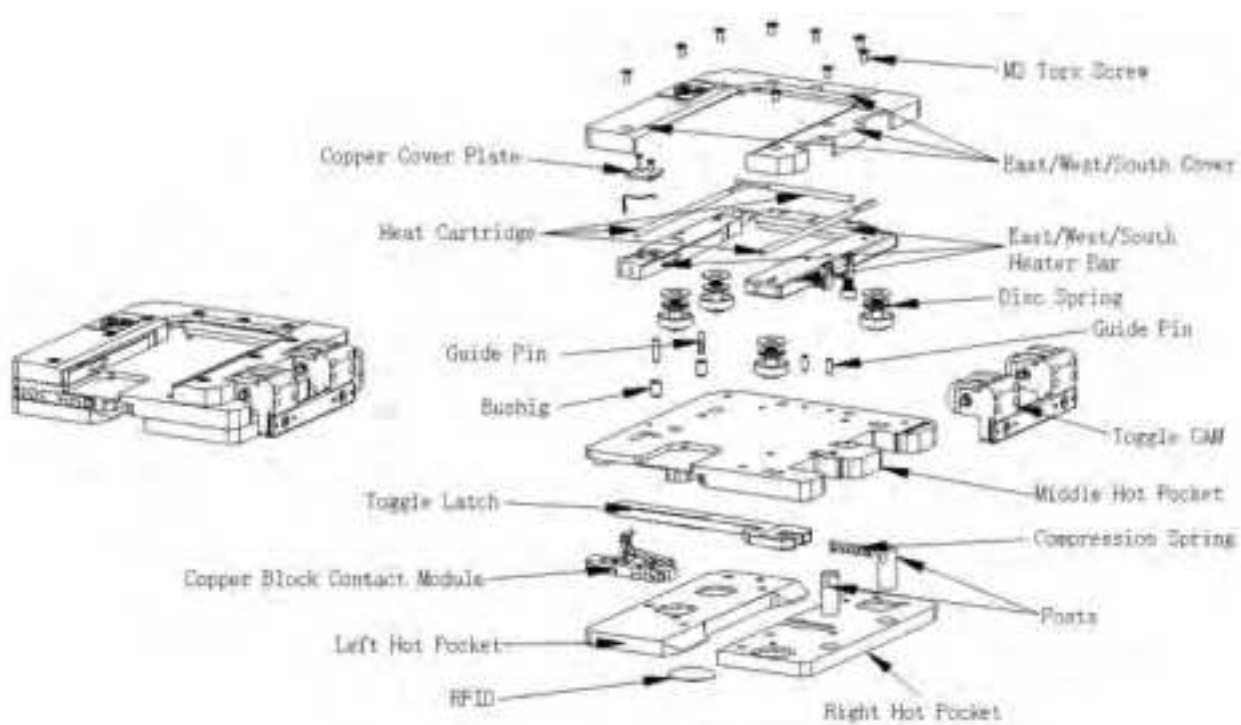

### 5.11 Toggle CAM

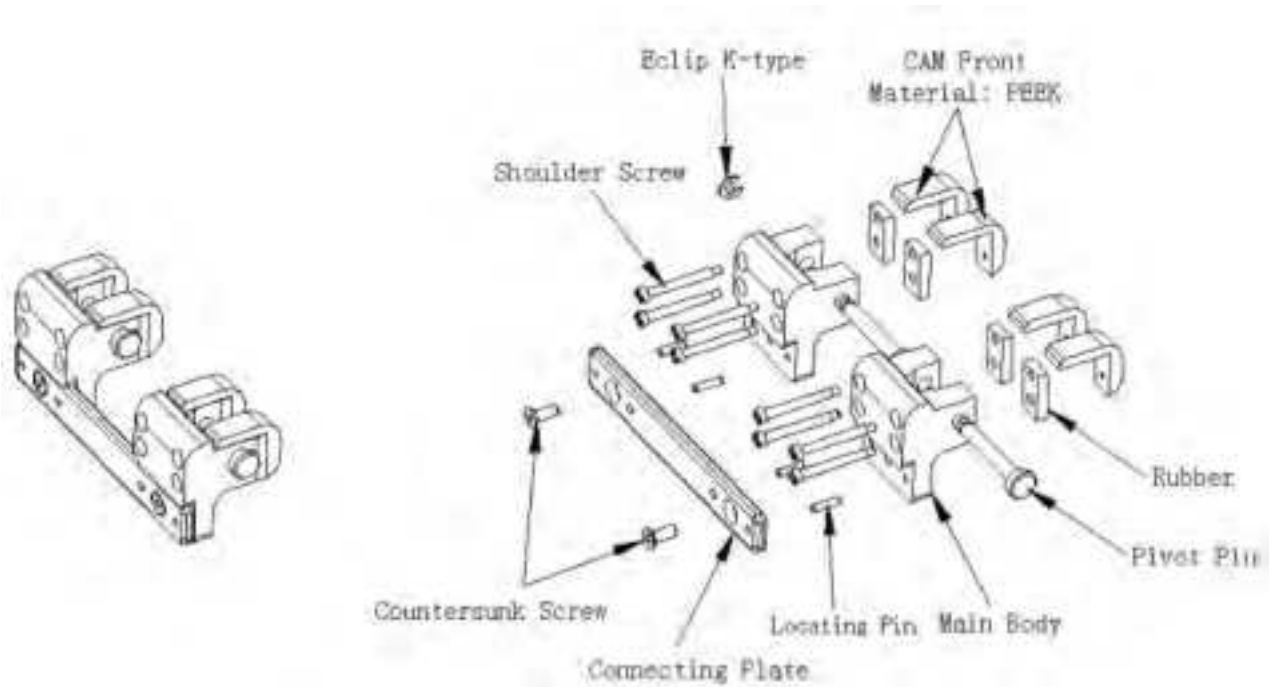

### 5.12 HP Pogo Block Module

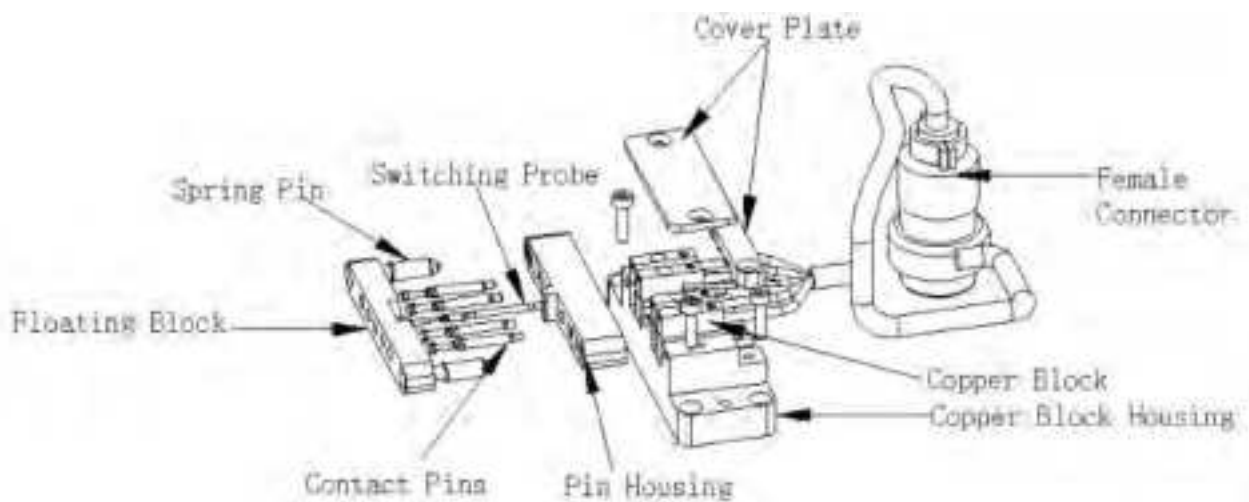

## 6. ILLUSTRATION OF FIXTURE PARTS

### 6.1 Main Fixture

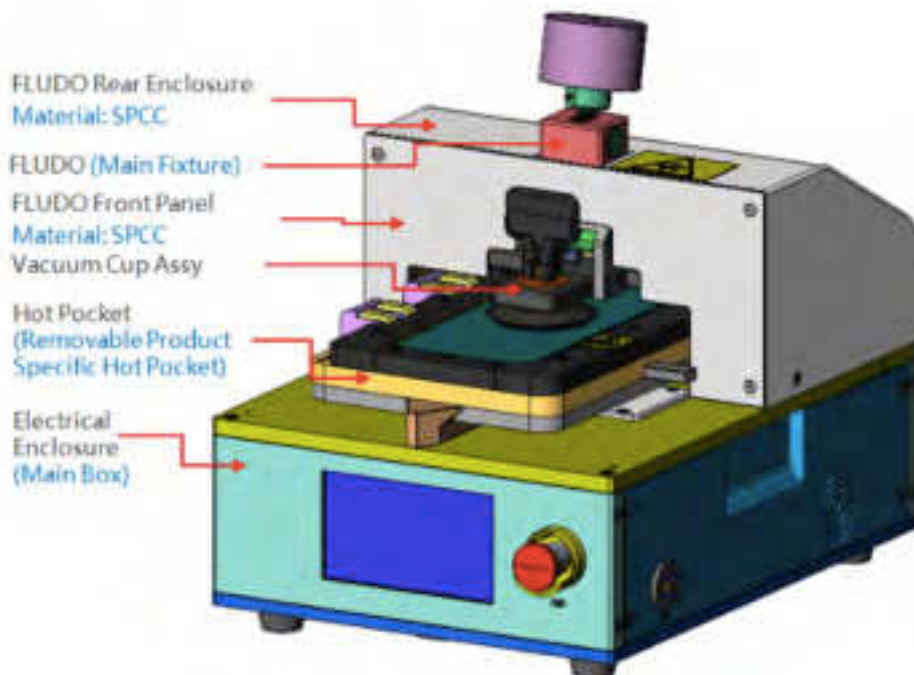

### 6.2 Fixture Key Modules

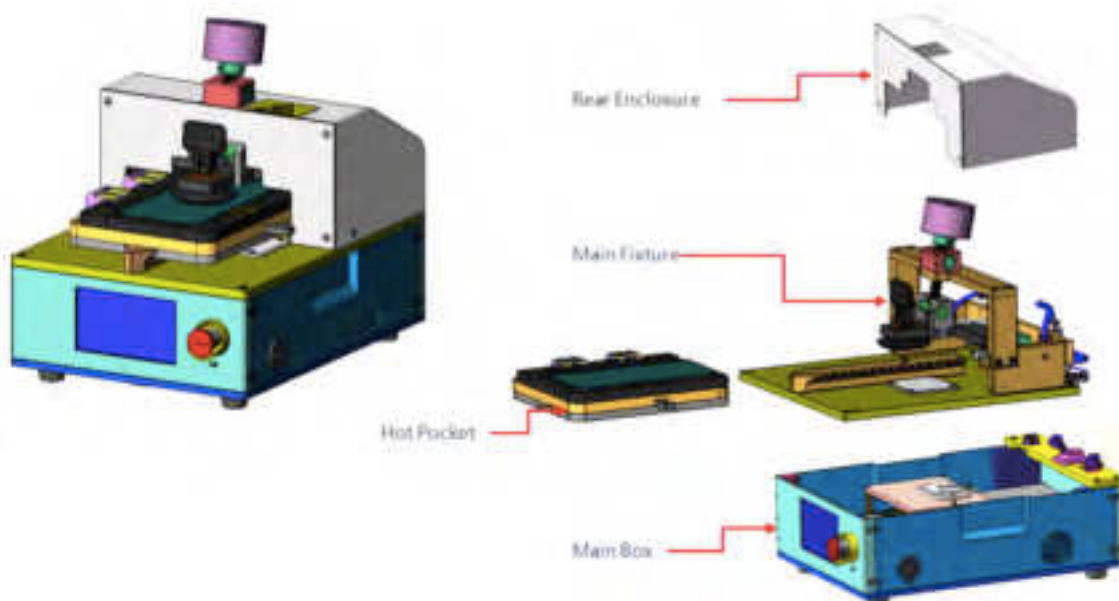



### 6.3 HDO Key Module

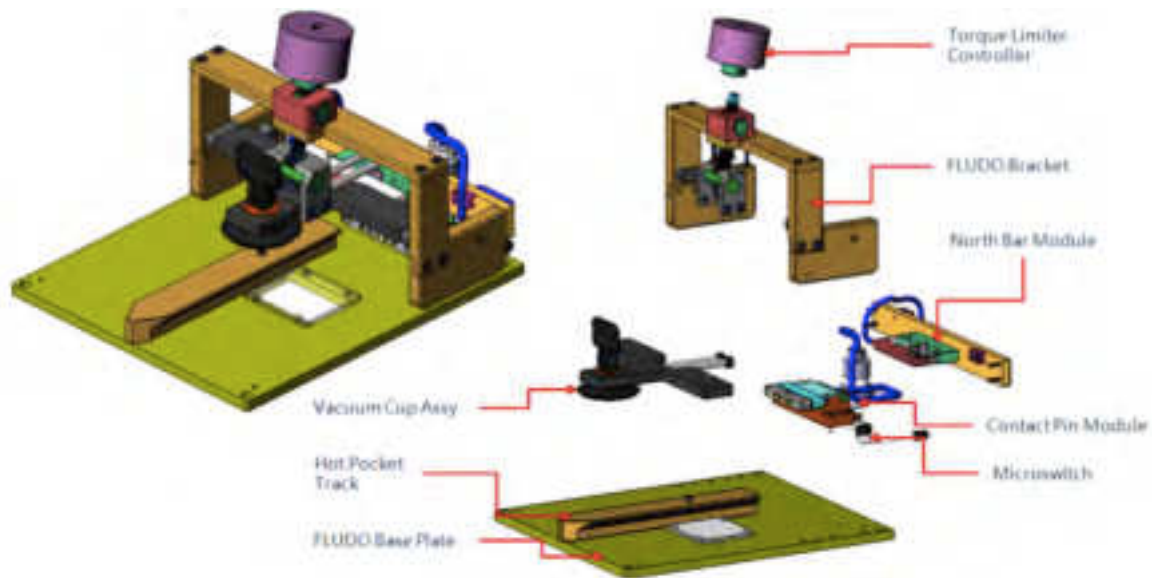

### 6.4 Hot Pocket

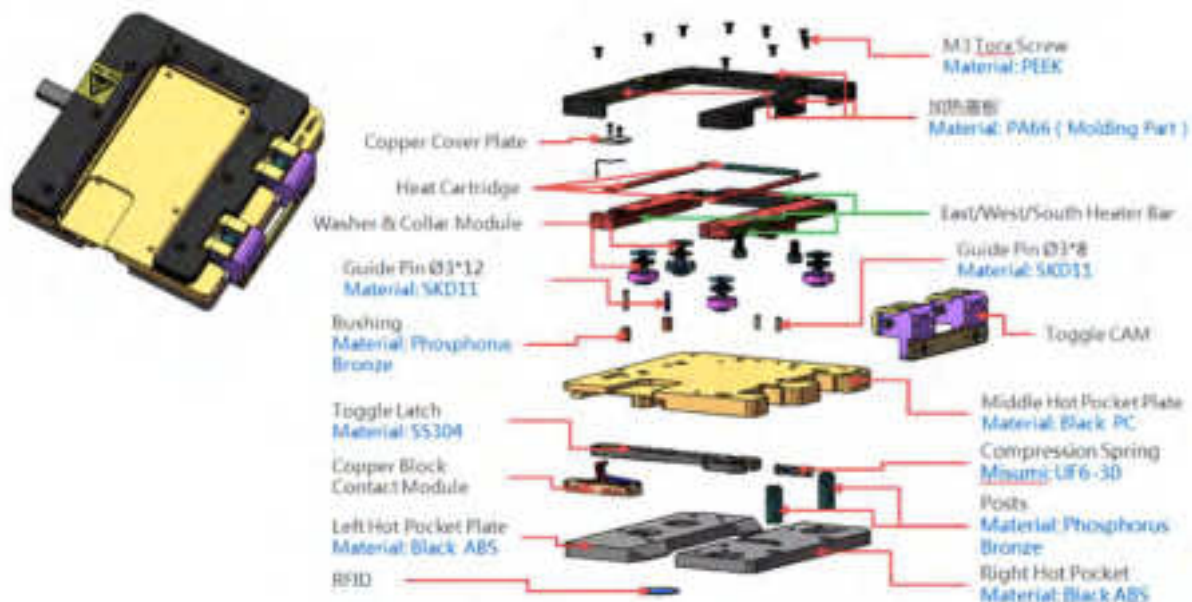

### 6.5 North Bar Module

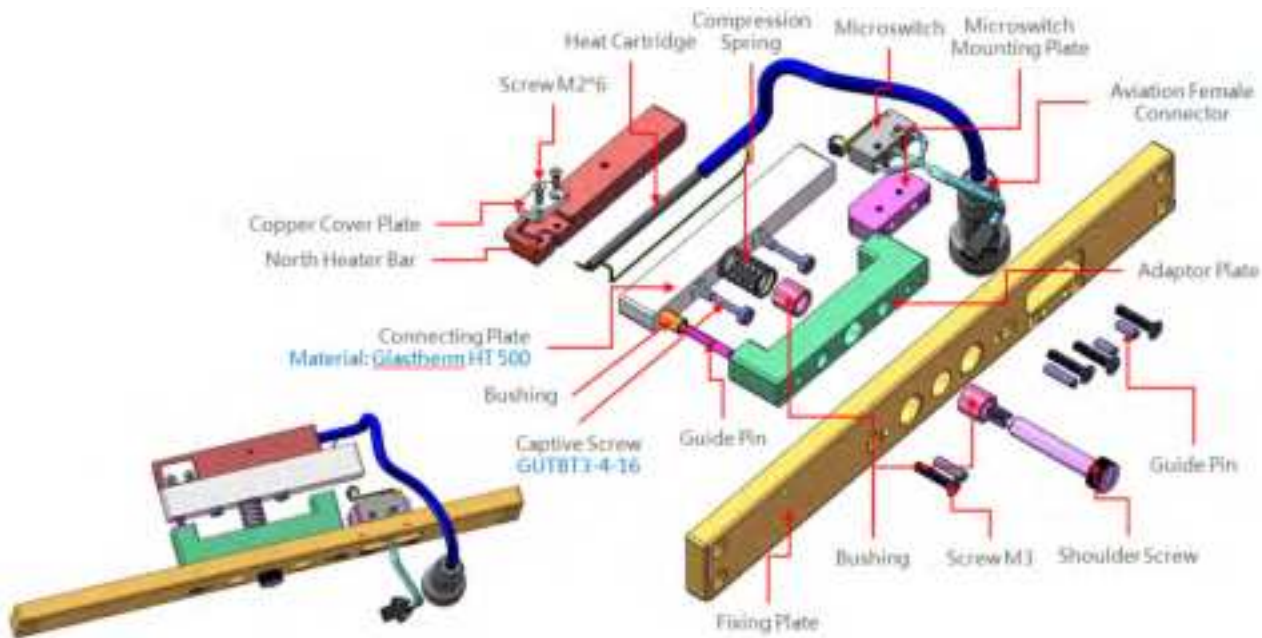

### 6.6 Pogo Pin Module

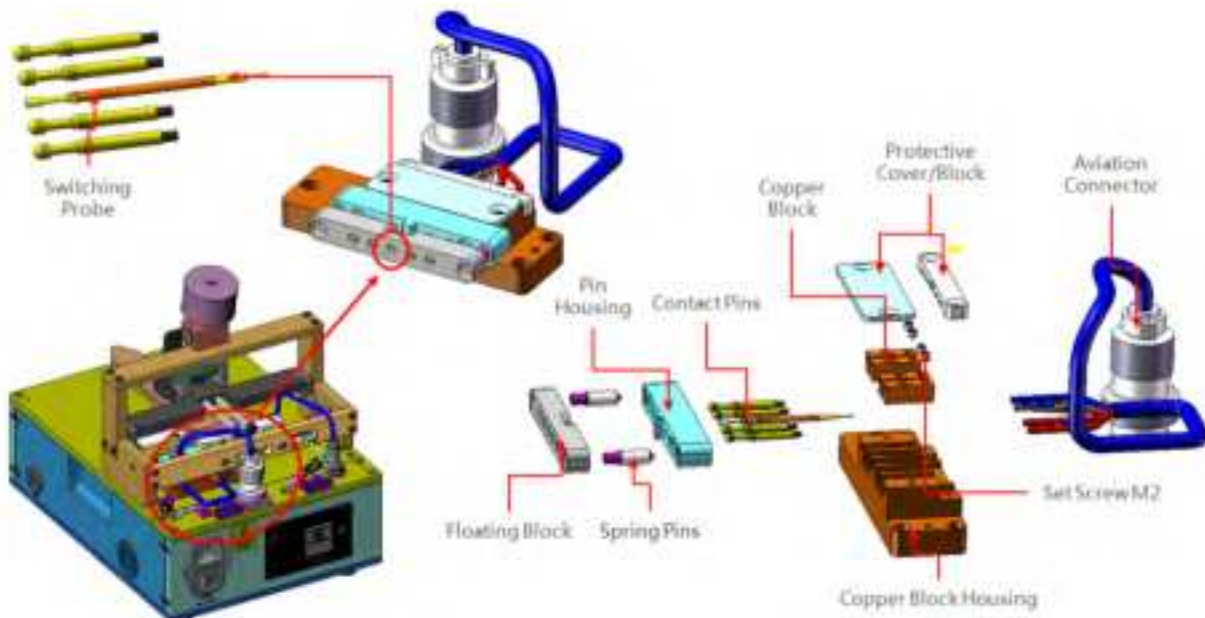



## 6.7 Main Box

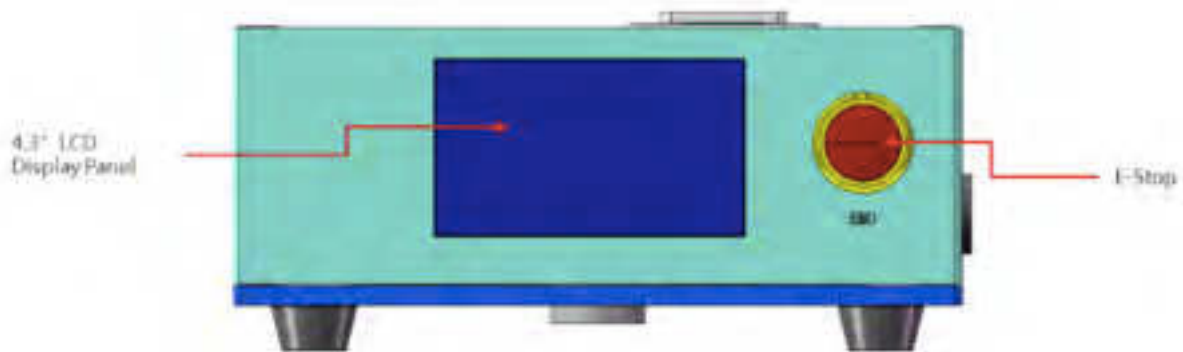

## 6.8 Main Box Illustration

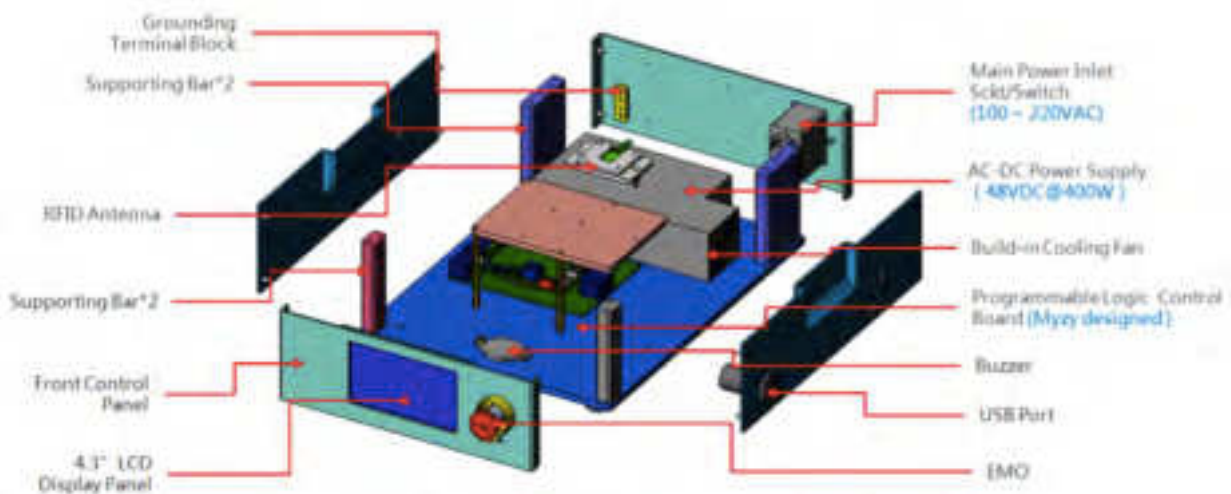

## 7. SAFETY REGULATIONS

- The fixture to be operate by one person, the operator and all users must be trained qualified to used the fixture.
- Before start up, please ensure all the power cables are proper connection.
- Operators cannot leave the workplace at will.
- During operation process, if encountered the fixture abnormality, please press the Emergency Stop Switch.
- Do not simply change the relevant parameters of the fixture.
- Fixture maintenance needs to perform by skilled technicians, make ensure main power-off and North Bar has cooled down before execute.
- Turn off the main power when not in use.  
The following general safety precautions must be observed at all stages of operation, service and maintenance of test fixtures. Failure to observe these precautions or the specific warnings given elsewhere in this manual will violate safety standards in the design, manufacture and testing of the fixtures for their intended use.  
Myzy assumes no responsibility for the Customer's failure to comply with these requirements.

### NOTES

Fixture is equipped with an alarm alert feature that displays an alarm message on the touch screen with a beep sound. Do not operate by unqualified or untrained personnel.

## 7.1 Warning Signs Description



Do not touch hazardous power sources.



Do not put your fingers into the HDO fixture while it is operating.



Beware with the hot copper bar.

## 7.2 Safety Device

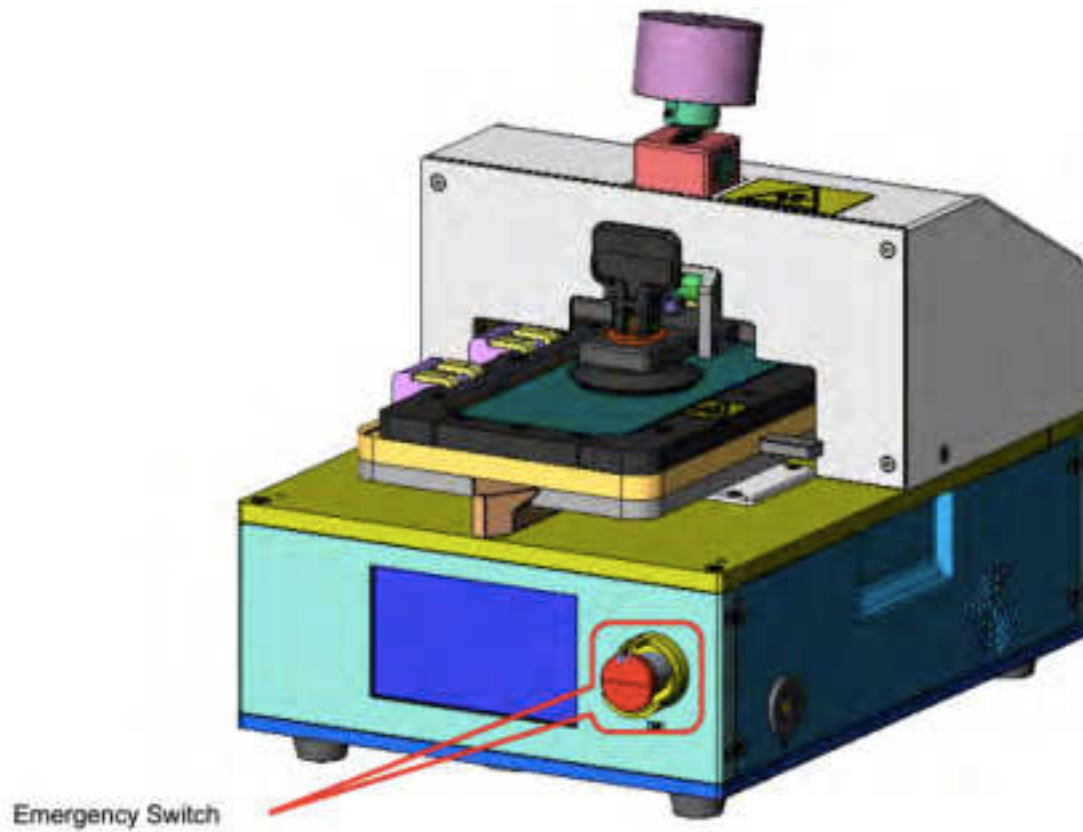

When the temperature is abnormal, you can press the emergency stop switch, the device will immediately cut off the entire fixture power.

## 8. FIXTURE OPERATING ENVIRONMENT REQUIREMENTS

Input power: 100VAC ~ 240VAC

Working Temperature: 23°C~26°C

Humidity: 45%~60%

## 9. OPERATION PROCEDURES

### STEP1. PRE-START PREPARATION (FIXTURE + HOT POCKETS + DUT)

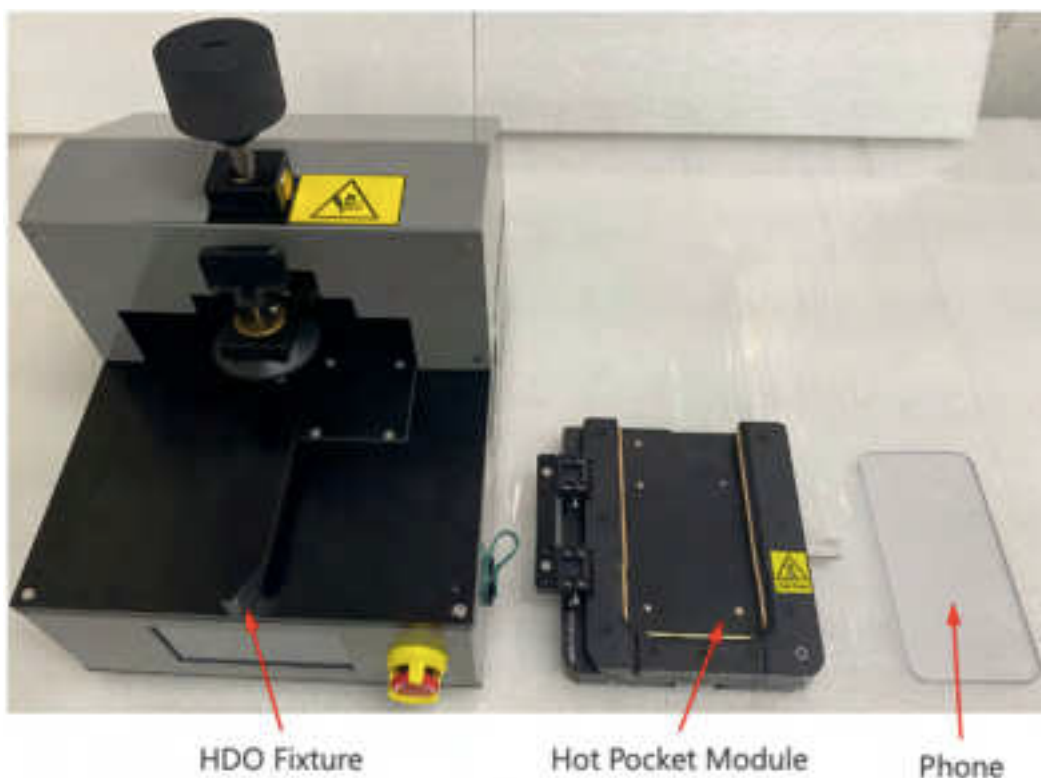

### STEP2. INSERT THE PHONE INTO A HOT POCKET



### STEP3. FIXING OF MOBILE PHONE



There is a gap between the West Bar and the phone when not clamped



Flip down Toggle CAM 90° to make the West Bar fully fit with the mobile phone to complete clamping

### STEP4. HOT POCKET INSERT



The fixture is powered on and running normally , Hot Pocket clamped phone is ready



The Hot Pocket slides in along the dovetail slide



Hot Pocket full insert  
RFID automatic identification model and power on. The Hot Pocket starts heating from room temperature to the specified temperature, and starts counting down 120s after reaching the specified temperature



### STEP5. SUCTION CUP PRESSES DOWN



Fixture will beep when the countdown ends.  
At this point, turn the knob clockwise until the suction cup presses down on the phone.



Turn the handle of the suction cup downward 90° to ensure that the suction cup is firmly attached to the surface of the phone.



The adsorbed state of suction cup

### STEP6. REMOVE THE PHONE'S SCREEN



After pressing the suction cup OK, the screen can begin to remove, and the display begins to count down for 15 minutes



Turn the knob counterclockwise until the screen is pulled up to remove the screen



### STEP7. TAKEOUT THE HOT POCKET



Get ready to exit the Hot Pocket



Press the Latch to the bottom

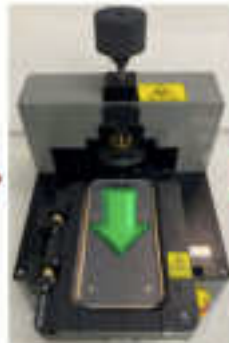

Hold down the Latch and slide the Hot Pocket out

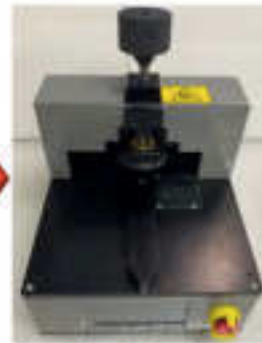

Take out the Hot Pocket  
The Hot Pocket needs to be taken out within the 15-minute countdown, otherwise the machine will alarm E02.

### STEP8. TAKEOUT THE PHONE



The phone is clamped



Flip the Toggle CAM up and release the phone



Pull the phone out



Take out the phone

## 10. SOFTWARE INTERFACE AND ERROR CODES

### 10.1 Start-up and Standby Interface

After powering on the unit, the unit self-tests with no abnormalities, then the North Bar begins to warm up to 50 degrees and the LCD displays as shown below.



### 10.2 Heating interface

Insert Hot Pocket module to HDO and read the RFID and identify the correct information on the hot pocket, North Bar and Hot Pocket will be heated to the preset temperature at the same time according to the software configuration, the interface will be displayed as follows ( Note: Do not turn the knob at this time, otherwise an E01 error will be reported )



### 10.3 Keep warm interface

When the North Bar and Hot Pocket heat up to a steady state, the timer starts counting down. ( Note: Do not turn the knob at this time, otherwise an E01 error will be reported )



### 10.4 Completion Interface

When the countdown is over the buzzer will be activated, indicating that the operator can release the knob to start the disassembly screen. The fixture will display a 15mins countdown to remind the operator to take out the hot pocket.( Note: If the operator has not removed the Hot Pocket within 15min, the interface will report an E02 error. )



## 10.5 ERROR CODE AND TROUBLE SHOOTINGS

<b>ERR.Code</b>	<b>Description</b>	<b>Solution</b>
E01	Turn the knob during the heating process	Restart the fixture and follow the procedure.
E02	Hot Pocket has not removed the within 15min.	Restart the fixture and follow the procedure.
E04	HP read failed	Restart the fixture and re-insert HP pocket
E05	There is no phone in the HP module	Pull-out HP pocket and place phone onto it
E51	Invalid HP module	Restart the fixture and replace HP pocket
E37	NB thermocouple anomaly	Restart the fixture, if cannot resolve the problem, replace new NB module.
E38	HP thermocouple anomaly	Restart the fixture and replace HP if needed
E57	NB Heater Open Circuit	Restart the fixture, if cannot resolve the problem, replace new NB module.
E58	HP Heater Open Circuit	Restart the fixture and replace HP if needed
E62	NB temperature 100 degrees over limit detected.	Replace new NB module.
E63	HP temperature 100 degrees over limit detected.	Replace new HP.
E67	NB Heater Short Circuit	Restart the fixture, if cannot resolve the problem, replace new NB module.
E68	HP Heater Short Circuit	Restart the fixture and replace HP if needed
E72	NB Thermocouple Attachment Anomaly	Replace new NB module.
E73	HP Thermocouple Attachment Anomaly	Restart the fixture and replace HP if needed
E76	NB temperature beyond the set range detected	Restart the fixture, if cannot recover the problem, replace new NB module.
E77	HP temperature beyond the set range detected	Restart the fixture, if cannot recover the problem, replace new HP.

## 11. MAINTENANCE

Note: Turn off the power before perform maintenance and do not operate until the heating bar temperature drops below 35°C.

### PURPOSE

The test fixture is performed by a precise mechanical movement, which must be regularly maintained in order to guarantee the normal use of the fixture.

Items	Method	Daily	Monthly
Clean the hot pocket and HP Track before power on.	Lint-free cloths	√	
Ensure the emergency stop switch is functioning well.	Press E-stop in the fixture running state to see if the motion components will stop.		√
Check whether the motion components are loose	Visual inspection and wrench		√
Check whether the NB/HP module cables are loose.	Visual inspection and wrench		√

## 12. CONSUMABLE PART LIST

No.	Part No.	Description	Brand	Safety inventory	Remark
1	0301-40-010851	Pogo block Module	Myzy	1set / Fixture	D5x FLUDO
2	0301-22-010852	North Bar Module	Myzy	1set / Fixture	
3	0301-20-010759	Torque Limiter Module	Myzy	1set / Fixture	
4	0106-28-033550	Suction Cup assembly	Myzy	1set / Fixture	
5	0105-12-015300	Emergency stop switch	Myzy	1set / Fixture	
6	0105-12-033540	Micro switch	Myzy	1set / Fixture	
7	0301-99-010954	D52 Hot Pocket	Myzy	1set / Fixture	Hot Pocket Module
8	0301-99-010955	D53 Hot Pocket	Myzy	1set / Fixture	
9	0301-99-010956	D53 Hot Pocket	Myzy	1set / Fixture	
10	0207-21-077781	CAM Front	Myzy	4pcs / Module	

### 13. SPARE PART LIST

No.	Part No.	Description	Brand	Safety inventory	Remark
1	0105-99-032995	RFID Antenna	Myzy	1pc / Site	N/A
2	0105-17-032956	Power supply	MeanWell	1pc / Site	
3	0305-14-010871	PCB Board	Myzy	1set / Site	
4	0105-07-032963	LCD Screen	TaoJingChi	1pc / Site	
5	0105-27-008856	Buzzer	Myzy	1pc / Site	

### 14. FIXTURES DISMANTLING AND SCRAPPING

If the fixture exceeds the service life, the main structure is obsolete, and the motion precision can not meet the use requirements, it is recommended to disassemble and scrap with the consent of the customer.

Note: Fixture dismantling and scrapping need professional technical personnel to complete.

This device complies with Part 15 of the FCC Rules. Operation is subject to the following two conditions: (1) this device may not cause harmful interference, and (2) this device must accept any interference received, including interference that may cause undesired operation

NOTE: This equipment has been tested and found to comply with the limits for a Class B digital device, pursuant to Part 15 of the FCC Rules. These limits are designed to provide reasonable protection against harmful interference in a residential installation. This equipment generates, uses and can radiate radio frequency energy and, if not installed and used in accordance with the instructions, may cause harmful interference to radio communications. However, there is no guarantee that interference will not occur in a particular installation. If this equipment does cause harmful interference to radio or television reception, which can be determined by turning the equipment off and on, the user is encouraged to try to correct the interference by one or more of the following measures:

- Reorient or relocate the receiving antenna.
- Increase the separation between the equipment and receiver.
- Connect the equipment into an outlet on a circuit different from that to which the receiver is connected.
- Consult the dealer or an experienced radio/TV technician for help.

Warning: changes or modifications not expressly approved by the party responsible for compliance could void the user's authority to operate the equipment