

EPSON Perfection 1240U
EPSON Perfection 1240U PHOTO

Scanner Basics

EPSON[®] COLOR SCANNER **PERFECTION**[®] **1240U**

Copyright Notice

All rights reserved. No part of this publication may be reproduced, stored in a retrieval system, or transmitted in any form or by any means, electronic, mechanical, photocopying, recording, or otherwise, without the prior written permission of SEIKO EPSON CORPORATION. The information contained herein is designed only for use with this EPSON scanner. EPSON is not responsible for any use of this information as applied to other scanners.

Neither SEIKO EPSON CORPORATION nor its affiliates shall be liable to the purchaser of this product or third parties for damages, losses, costs, or expenses incurred by purchaser or third parties as a result of: accident, misuse, or abuse of this product or unauthorized modifications, repairs, or alterations to this product, or (excluding the U.S.) failure to strictly comply with SEIKO EPSON CORPORATION's operating and maintenance instructions.

SEIKO EPSON CORPORATION shall not be liable for any damages or problems arising from the use of any options or any consumable products other than those designated as Original EPSON Products or EPSON Approved Products by SEIKO EPSON CORPORATION.

A Note Concerning Responsible Use of Copyrighted Materials

Digital cameras and scanners, like photocopiers and conventional cameras, can be misused by improper copying of copyrighted material. While some countries' laws permit limited copying of copyrighted material in certain circumstances, those circumstances may not be as broad as some people assume. EPSON encourages each user to be responsible and respectful of the copyright laws when using digital cameras and scanners.

Trademarks

EPSON and EPSON Stylus are registered trademarks and EPSON Smart Panel is a trademark of SEIKO EPSON CORPORATION.

ColorTrue and EPSON Perfection are registered trademarks, and EPSON Software, EPSON Store, and Micro Step Drive are trademarks of Epson America, Inc.

General Notice: Other product names used herein are for identification purposes only and may be trademarks of their respective owners. EPSON disclaims any and all rights in those marks.

The ENERGY STAR emblem does not represent EPA endorsement of any product or service.



Printed on recycled paper

Contents

| | |
|--|-----------|
| A Complete Scanning Solution | 1 |
| Getting More Information | 1 |
| Cautions, Notes, and Tips | 2 |
| Setting Up Your Scanner | 3 |
| Unpack Your Scanner | 3 |
| Choose a Good Place for Your Scanner | 4 |
| Unlock and Initialize the Scanner | 5 |
| Connect the Scanner to Your Computer | 6 |
| Install the EPSON TWAIN Driver | 7 |
| If You're Running Windows 98 . . . | 8 |
| If You're Running Windows Millennium Edition . . . | 11 |
| If You're Running Windows 2000 . . . | 13 |
| If You're Using a Macintosh . . . | 17 |
| Install the Scanner Software and Bonus Software | 19 |
| Install Adobe PhotoDeluxe | 22 |
| Viewing Your Electronic Manuals | 23 |
| Viewing Your HTML Reference Guide | 23 |
| Viewing Your EPSON Smart Panel PDF Manual | 25 |
| Scanning from Start to Finish | 27 |
| Placing Your Original Document | 27 |
| Using the Scanner Buttons | 28 |
| Using EPSON Smart Panel | 29 |

| | |
|--|-----------|
| Scanning Projects | 30 |
| Scanning and Converting a Text Document | 30 |
| Scanning a Document to E-mail | 34 |
| Scanning and Copying | 35 |
| Scanning for Creativity | 36 |
| Scanning with EPSON TWAIN | 37 |
| Selecting TWAIN from Your Application | 37 |
| Using EPSON TWAIN | 38 |
| Selecting TWAIN Settings | 41 |
| Tips for Getting the Best Scan | 42 |
| Recommended Settings | 42 |
| Selecting Resolution | 43 |
| Scanning Something That Doesn't Fit Under the Document Cover | 44 |
| Using the Transparency Unit | 45 |
| Installing the Transparency Unit | 45 |
| Loading Transparencies | 46 |
| Loading 35 mm Negative or Positive Film | 47 |
| Loading Slides and Film Directly on the Document Table | 49 |
| Selecting Settings | 51 |
| Scanning Reflective Documents or Photographs | 51 |
| Removing the Transparency Unit | 52 |
| Scanner Maintenance | 53 |
| Cleaning the Scanner | 53 |
| Transporting the Scanner | 54 |

| | |
|----------------------------------|-----------|
| Problem Solving | 55 |
| Scanner Light and Buttons | 55 |
| Problems and Solutions | 57 |
| Setup Problems | 57 |
| Scanner Problems | 57 |
| Software Problems | 59 |
| Scanning Problems | 61 |
| Where To Get Help | 67 |
| EPSON Technical Support | 67 |
| Bonus Software Technical Support | 68 |
| | |
| Requirements and Notices | 69 |
| System Requirements | 69 |
| Windows | 69 |
| Macintosh | 70 |
| Important Safety Instructions | 70 |
| ENERGY STAR Compliance | 72 |
| FCC Compliance Statement | 72 |
| Declaration of Conformity | 73 |
| Warranty | 73 |
| | |
| Index | 75 |

A Complete Scanning Solution

Your EPSON Perfection® 1240U scanner is a professional-quality, 42-bit scanner packed with easy-to-use scanning features for business, home, or school. The “plug & play” USB connection is fast and easy with no extra hardware to install. Using EPSON’s ColorTrue® II Imaging System, the scanner captures your images with amazing detail and accurate colors. Your scanner can achieve up to 1200 × 2400 dpi hardware resolution with EPSON’s proprietary Micro Step Drive™ technology, delivering crisp, precise images.

The EPSON Perfection 1240U PHOTO includes a transparency unit to make scanning slides, negatives, and positives simple.



References to the EPSON Perfection 1240U also apply to the EPSON Perfection 1240U PHOTO.

Getting More Information

There are several sources of information for your scanner, including printed materials, help utilities and electronic manuals. In addition to this *Scanner Basics* guide, here’s where to look for help:

- **Electronic EPSON Perfection 1240U *Reference Guide***
Check this HTML manual for detailed information about your scanner, including how to use EPSON TWAIN, assigning applications to your scanner buttons, troubleshooting, and technical specifications. See page 23 for instructions on accessing and viewing this manual.
- **On-screen Help**
Whenever you’re working with EPSON Smart Panel™ or any of the other software that came with your scanner, you can click the **Help** button or **Help** menu.

■ Other Electronic Documents

EPSON Smart Panel includes an electronic manual in the Adobe® Acrobat® PDF format. See page 25 for instructions on accessing and reading this manual. Your scanner or bonus software may also include electronic manuals or online help.

If you need more information or have questions not covered in these resources, please see “Where To Get Help” on page 67.

For a list of software included with your scanner, see the inside front cover of this manual.

Cautions, Notes, and Tips

Please follow these guidelines as you read your documentation:



Cautions must be observed to avoid damage to your equipment.



Notes contain important information about your scanner.



Tips contain additional information for better scanning.

Setting Up Your Scanner

Setting up your scanner is easy—just follow the simple steps in this book in the order listed below.

1. Unpack and choose a place for your scanner.
2. Unlock and initialize the scanner.
3. Connect the scanner to your computer.
4. Install the EPSON TWAIN driver.
5. Install the scanner and bonus software and view your electronic manuals.

If you purchased the EPSON Perfection 1240U PHOTO, which includes the transparency unit, or purchased the transparency unit as an option, see “Using the Transparency Unit” on page 45 for installation instructions.

Unpack Your Scanner

Remove the scanner from the box, then remove the packing material from your scanner. Save the packaging in case you need it later. Your EPSON Perfection 1240U comes with the items shown below.

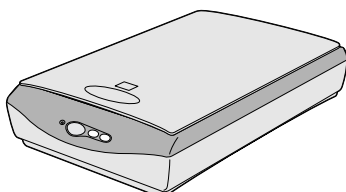

scanner



CD-ROM with driver, electronic manuals, and creative software



Adobe PhotoDeluxe CD-ROM

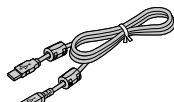

USB interface cable

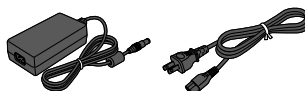

AC adapter and power cord

Your EPSON Perfection 1240U PHOTO also includes the items shown here. You can store the transparency unit in the packing materials when you are not scanning transparencies.

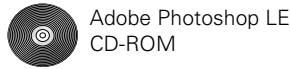
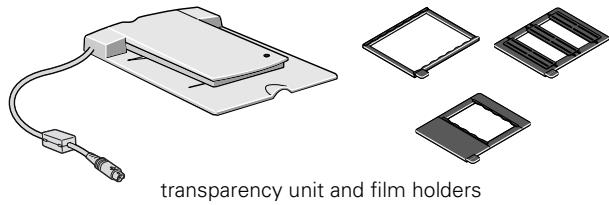

Choose a Good Place for Your Scanner

Here are some points to consider:

- Place the scanner on a flat, stable surface. If the scanner is tilted, it can't operate properly.
- Be sure to place the scanner and AC adapter where you can easily unplug the power cord, and where the USB cable can reach your computer.
- Keep the scanner away from direct sunlight and strong light sources.
- Avoid places subject to shocks and vibrations, or high or rapidly changing temperatures and humidity.
- Make sure there's enough room behind the scanner for the cables, and above the scanner so you can fully raise the document cover.



If you attach the transparency unit to your scanner, the dimensions will differ from the ones listed.

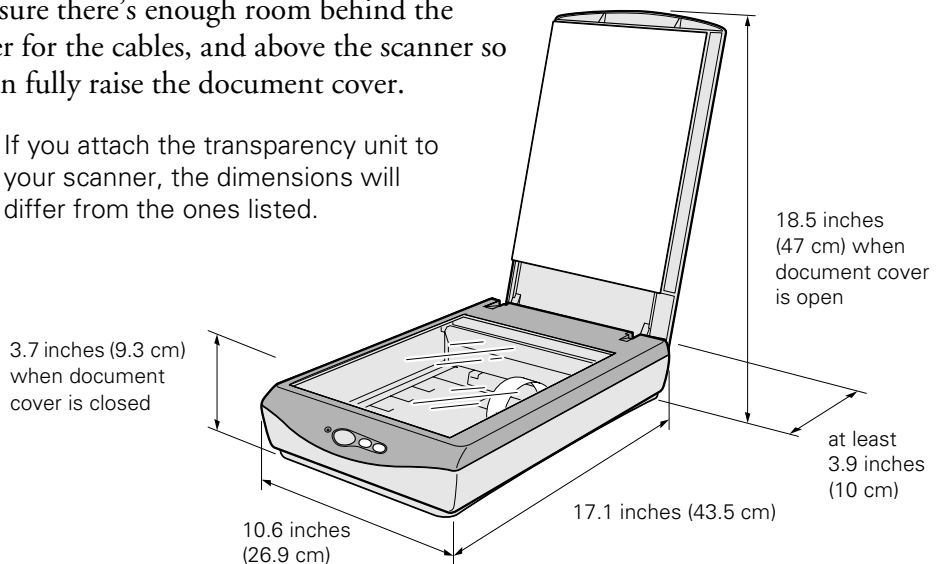

Unlock and Initialize the Scanner

Before connecting the scanner to a power source, you must release the transportation lock on the back of the scanner. Before connecting the scanner to your computer, follow the steps below to make sure the scanner is operating properly.

1. Slide the transportation lock to the right; this releases the scanner carriage.
2. Locate the AC adapter and power cord supplied with your scanner. Connect the power cord to the AC adapter. Then connect the AC adapter to the DC inlet on the back of the scanner.
3. Plug the other end of the power cord into an electrical outlet. The indicator light on the front of the scanner starts flashing.

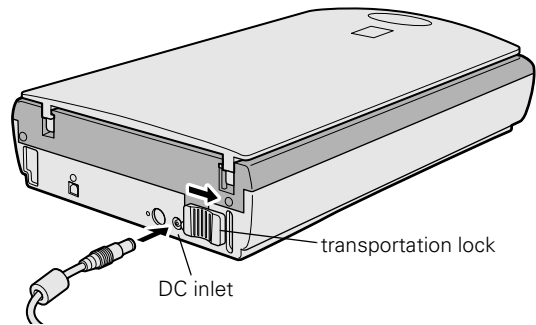

It is not possible to change the AC adapter's voltage. If the label on the AC adapter does not show the correct voltage for your country, contact your dealer. Do not plug in the power cord.

4. Open the document cover so you can see the operation of the scanner during initialization (startup).
5. Make sure the carriage moves slightly and the fluorescent lamp on the carriage comes on. When the indicator light stays green, the scanner has completed its initialization.

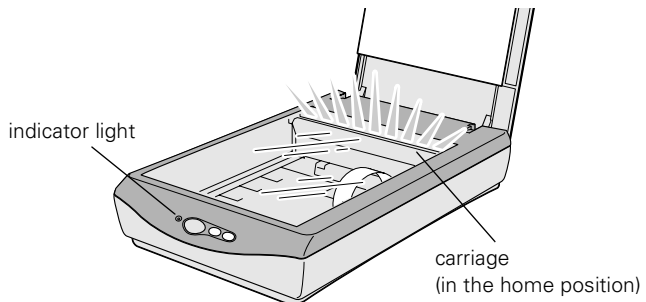

If the scanner does not work as described, make sure the power cord is firmly plugged in, and then try again.



The scanner lamp comes on when it is plugged in, but goes into sleep mode when it has not been used for 15 minutes. The lamp comes back on when you scan.

Unplug the scanner when you have finished using it.





If you need to plug the scanner back in after unplugging it, wait at least 10 seconds before plugging it back in. Rapidly plugging in and unplugging the scanner can damage it.

Always lock the scanner carriage with the transportation lock before moving it; otherwise, the scanner may be damaged. Make sure the scanner lamp is in the home position (toward the back of the scanner) before locking the carriage. See “Transporting the Scanner” on page 54.

Connect the Scanner to Your Computer

Make sure your computer meets the system requirements listed on page 69 or 70. If you are connecting to a PC, Windows® must be factory preinstalled on your system and a built-in USB port must be available.

1. Locate the USB cable that came with your scanner.
2. Plug the square connector  on the USB cable into the USB connector on the back of the scanner. Then plug the flat connector  into the USB port on your computer or USB hub.

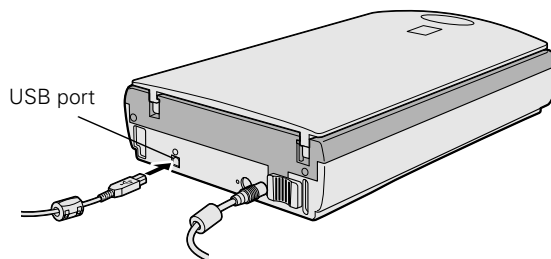



Your system may not work correctly if you use a USB cable other than the one supplied by EPSON or if you connect your scanner through more than one hub.

For Macintosh® users: If you connect the scanner before installing the software, a message appears telling you that the scanner driver needs to be installed (Mac OS® 8.X), or a message appears to prompt you to download the scanner driver from the Internet (Mac OS 9). When this happens, click OK (Mac OS 8.X) or Cancel (Mac OS 9) and insert the EPSON Scanner Software CD-ROM in the CD-ROM drive. Then follow the instructions in "If You're Using a Macintosh . . ." on page 17 to install the scanner software.

Install the EPSON TWAIN Driver

The scanner software CD-ROM that comes with your scanner includes your EPSON TWAIN driver, scanner software, bonus software, and electronic documentation. You also have an Adobe PhotoDeluxe® CD-ROM and, if you have the EPSON Perfection 1240U PHOTO, an Adobe Photoshop® LE CD-ROM. Use the scanner software CD-ROM to install EPSON TWAIN. Follow the instructions for your operating system:

- Windows 98 on page 8
- Windows Millennium Edition (Me) on page 11
- Windows 2000 on page 13
- Macintosh on page 17

If You're Running Windows 98 . . .

You may be asked to insert your Windows 98 operating system CD-ROM during the scanner installation. Please have this CD-ROM handy, in case it is needed. If you don't have your Windows CD-ROM, see page 57 in "Problem Solving."

1. Make sure your scanner is plugged into a power source and connected to your computer; then turn on your computer. The Add New Hardware Wizard screen appears.
2. Insert the scanner software CD-ROM in the CD-ROM or DVD drive, then click **Next**.
3. Select **Search for the best driver for your device**, then click **Next**.
4. Check only the **Specify a location** checkbox, then click **Browse**.



5. Browse to the \TWAIN 5\Win98 folder on the CD-ROM, then click OK.

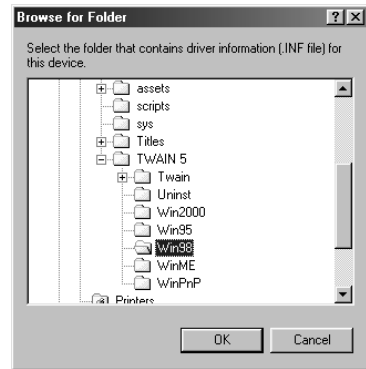

6. When you return to the Add New Hardware Wizard, click Next.



7. Windows finds the driver for your scanner and you see this screen:
Click Next.



8. Depending on your system, you may be asked to insert the Windows 98 CD-ROM. After inserting the CD-ROM, click OK.

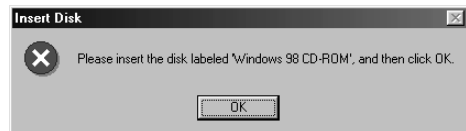

9. After the scanner software installation is complete, the Screen Calibration utility automatically starts. For the best results from an EPSON ink jet printer, leave the default setting of 1.8.

If you are using a different printer or your printouts don't match what you see on screen, you can change the setting. Move the slider to the right or left until the shades of the horizontal gray stripes appear similar. View the screen from a short distance. The gray stripes will not perfectly blend together; however, try to make the two tones match as closely as possible.

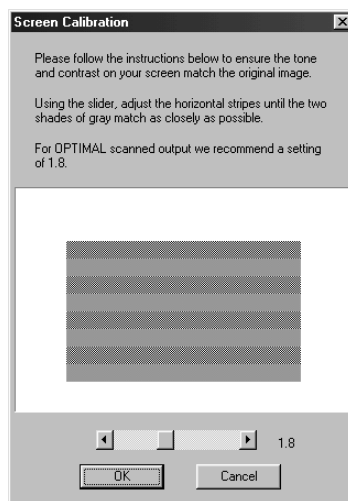

10. Click **OK** to register the calibration setting.



You will not need to change the screen calibration again as long as you continue to use the same monitor.

If you don't see the Screen Calibration utility, you can access the utility as follows: Double-click the Scanners and Cameras icon in the Control Panel. Click the Properties button. Click the Utility tab, then click the Screen Calibration utility icon. The Screen Calibration utility appears.

11. Click **Finish** to exit the Add New Hardware Wizard.
12. Now you can install the rest of your software (see page 19) and view your electronic manuals (see page 23).



If You're Running Windows Millennium Edition . . .

1. Make sure your scanner is plugged into a power source and connected to your computer; then turn on your computer. The Add New Hardware Wizard screen appears.
2. Insert the scanner software CD-ROM in the CD-ROM or DVD drive.
3. Select **Specify the location of the driver**, then click **Next**.
4. Select **Search for the best driver for your device** and **Specify a location**, then click **Browse**.
5. Select the **TWAIN 5\WinME** folder on the CD-ROM, then click **OK**.

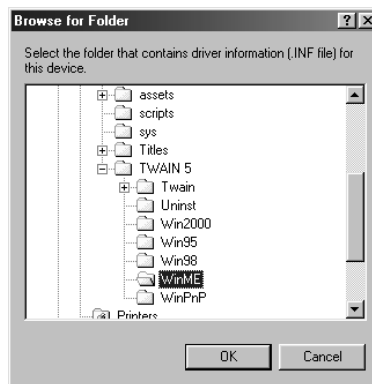

- When you return to the Add New Hardware Wizard, click **Next**.



- Windows finds the driver for your scanner and you see this screen:
Click **Next**.



- After the scanner software installation is complete, the Screen Calibration utility automatically starts. For the best results from an EPSON ink jet printer, leave the default setting of 1.8.

If you are using a different printer or your printouts don't match what you see on screen, you can change the setting. Move the slider to the right or left until the shades of the horizontal gray stripes appear similar. View the screen from a short distance. The gray stripes will not perfectly blend together; however, try to make the two tones match as closely as possible.

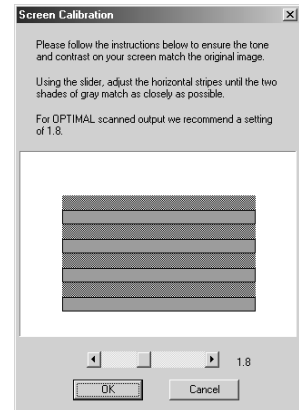

- Click **OK** to register the calibration setting.



You will not need to change the screen calibration again as long as you continue to use the same monitor. If you need to recalibrate your screen, see your electronic *Reference Guide* for instructions.

10. Click **Finish** to exit the Add New Hardware Wizard.
11. Now you can install the rest of your software (see page 19) and view your electronic manuals (see page 23).



If You're Running Windows 2000 . . .

1. Make sure your scanner is plugged into a power source and connected to your computer; then turn on your computer. The Found New Hardware Wizard screen appears.
2. Insert the scanner software CD-ROM in the CD-ROM or DVD drive, then click **Next**.
3. Select **Search for a suitable driver for my device**, then click **Next**.



- Uncheck the Floppy disk drives and CD-ROM drive options and check Specify a location. Then click Next.

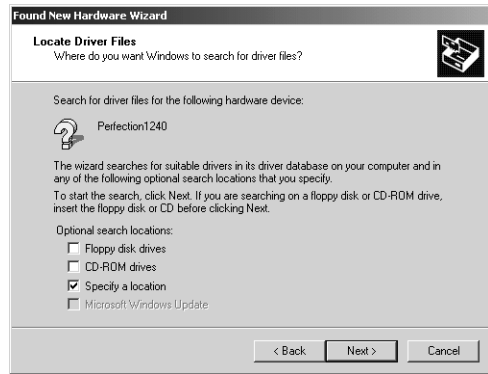

- Click Browse.



- Browse to the \TWAIN 5\WIN2000 folder on the CD-ROM drive; then click Open.

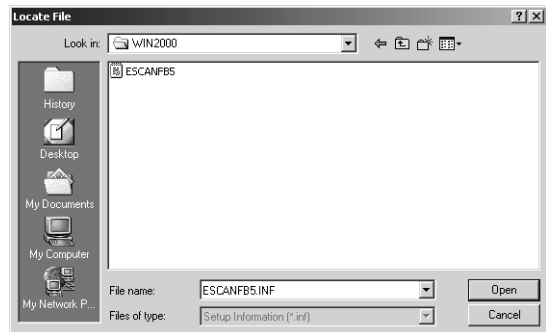

- Click OK to continue with the installation.



8. Then click Next.

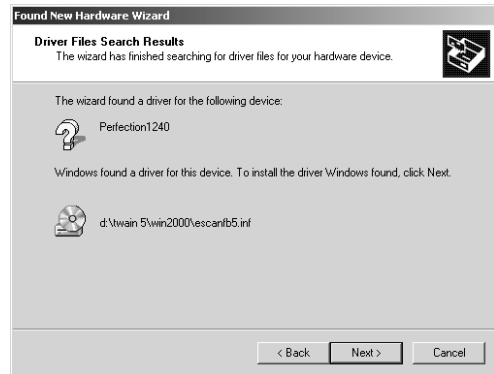

9. When this screen appears, click Yes.

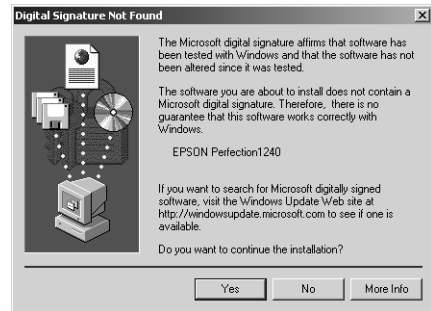

10. After the scanner software installation is complete, the Screen Calibration utility automatically starts. For the best results from an EPSON ink jet printer, leave the default setting of 1.8.

If you are using a different printer or your printouts don't match what you see on screen, you can change the setting. Move the slider to the right or left until the shades of the horizontal gray stripes appear similar. View the screen from a short distance. The gray stripes will not perfectly blend together; however, try to make the two tones match as closely as possible.

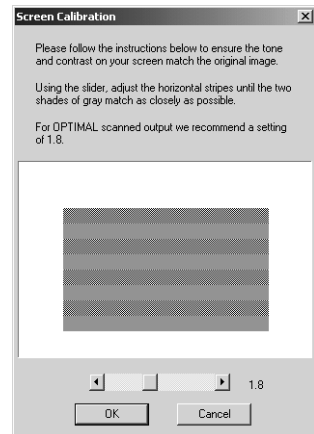

11. Click OK to register the calibration setting.



You will not need to change the screen calibration again as long as you continue to use the same monitor. If you need to recalibrate your screen, see your electronic *Reference Guide* for instructions.

12. Click **Finish** to exit the Found New Hardware Wizard.



13. If you see this screen, click **Yes** to restart your computer.

14. Now you can install the rest of your software (see page 19) and view your electronic manuals (see page 23).

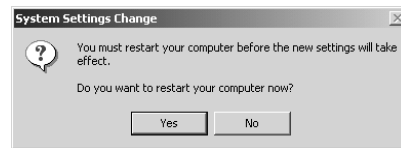

If You're Using a Macintosh . . .



Before installing any software, check the Apple® web site for any updates to your operating system.

1. Make sure your scanner is plugged into a power source and connected to the computer. Then turn on your Macintosh and turn off any virus protection programs.

If you see a message stating that you need to install the software for your scanner, click **Cancel** and continue with step 2 (if you are using OS 8.6, or earlier, click **OK**).

2. Insert the scanner software CD-ROM in the CD-ROM or DVD drive. (If necessary, double-click the EPSON CD-ROM icon to open it.)
3. Double-click the  EPSON icon.
4. The software License Agreement screen appears. After reading the license agreement, click **Agree** to continue with the installation.
5. When the Install TWAIN Driver screen appears, click **Install**.

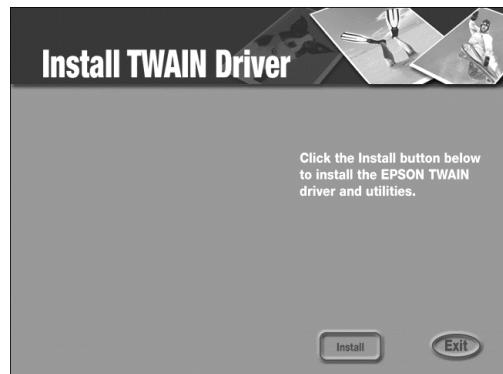

6. When the EPSON TWAIN 5 Installer screen appears, click **Install** for the default installation.



7. When the scanner software installation is complete, you see this screen:

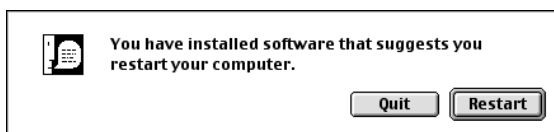

Click **Restart**. The Screen Calibration utility starts. (Your Macintosh will not restart until after you calibrate your screen.)

8. For the best results from an EPSON ink jet printer, leave the default setting of 1.8.

If you are using a different printer or your printouts don't match what you see on screen, you can change the setting. Move the slider to the right or left until the shades of the horizontal gray stripes appear similar. View the screen from a short distance. The gray stripes will not perfectly blend together; however, try to make the two tones match as closely as possible.

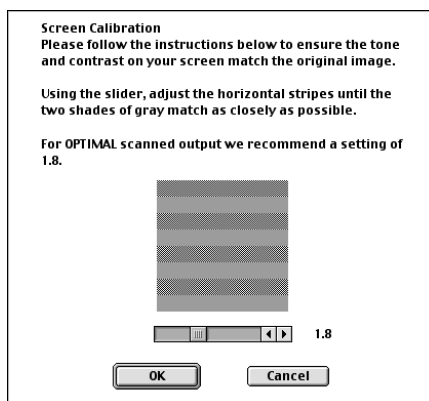

9. Click **OK** to register the calibration setting. Your Macintosh restarts.



The EPSON Screen Calibration utility will not appear if it is already on your system from a previous installation of the EPSON Perfection 1240U or other EPSON scanner.

You will not need to change the screen calibration again as long as you continue to use the same monitor. If you need to recalibrate your screen at a later time, select Screen Calibration in the EPSON Scanner folder.

10. Now you can install the rest of your software (see page 19) and view your electronic manuals (see page 23).



Install the Scanner Software and Bonus Software

Now that you've installed EPSON TWAIN, you're ready to install the rest of the software on the CD-ROM. Before you begin, make sure any virus protection programs are turned off.



Be sure to install EPSON Smart Panel, ScanSoft™ TextBridge® Pro, and Adobe PhotoDeluxe to take advantage of your scanner's one-touch scanning buttons. For instructions on installing Adobe PhotoDeluxe, see page 22.

Follow these steps:

1. Insert the scanner software CD-ROM in your CD-ROM or DVD drive.
2. **Windows:** Double-click  **My Computer**, then double-click the  CD-ROM icon. The CD-ROM window opens. Double-click  **EPSON**.

Macintosh: Double-click the EPSON CD-ROM icon to open it, if necessary, then double-click  **EPSON**.

3. If the software License Agreement screen appears, read the agreement and click **Agree** to continue with the installation. The Main Menu appears on your screen.



The licence agreement appears only the first time you use the CD-ROM.



4. Click **Scanner Software**. The Scanner Software screen appears.
5. Click **EPSON Smart Panel**.



6. Click the **Install** button and follow the instructions on the screen to install EPSON Smart Panel.
7. When the installation is complete, you return to the EPSON Smart Panel install screen. Click **Back**.



If the EPSON Smart Panel folder is open, close or minimize the folder so you can continue with the software installation.



8. From the Scanner Software screen, click **ScanSoft TextBridge Pro**.
9. Click the **Install** button and follow the instructions on the screen to install TextBridge Pro.
10. When the installation is complete, click **Restart** to restart your computer.
11. Return to the Main Menu (see step 2) so you can continue installing software.
12. Click **Bonus Software**.



- Click the application name for the program you want to install (the example shown is for EPSON Software™ Film Factory™).

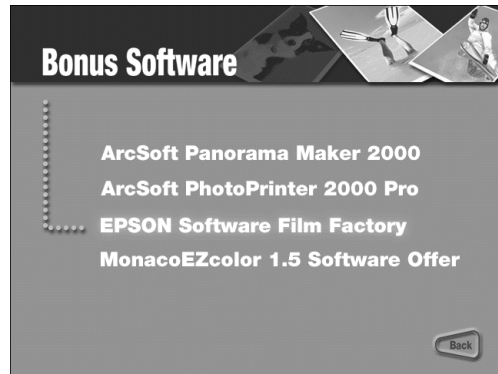

- The install screen appears for the application you selected.

Click the **Install** button to install the selected software. (You can skip the installation by clicking the **Back** button.)

- If the application requires a restart, go back to step 12 after restarting to install another application. If the application did not require a restart, you return to the application's install screen. Select another application to install or click **Back** to return to the Main Menu.





If any of the software you installed requires a restart and you did not restart when you installed the software, you should restart your computer now.

Install Adobe PhotoDeluxe

Adobe PhotoDeluxe is included on a separate CD-ROM. Follow these steps to install PhotoDeluxe.

Windows

1. Insert the PhotoDeluxe CD-ROM in your CD-ROM or DVD drive.
2. Double-click  My Computer, then double-click the  CD-ROM icon.
3. Open the English\Install folder and double-click Setup.exe.
4. Follow the instructions on the screen and then restart your computer.

Macintosh

1. Insert the PhotoDeluxe CD-ROM in your CD-ROM or DVD drive and double-click the CD-ROM icon, if necessary.
2. Double-click the English icon, then double-click the Adobe PhotoDeluxe Installer icon.
3. Follow the steps on the screen and then restart your computer.

Viewing Your Electronic Manuals



You always have easy access to your electronic manuals—just go to the Main Menu screen on your scanner software CD-ROM and click Electronic Documentation.



Viewing Your HTML Reference Guide

Your scanner software CD-ROM includes an electronic *Reference Guide* for your scanner. The manual is in HTML format, so you need a browser—such as Internet Explorer 3.0 or later or Netscape Navigator™ 3.0 or later—to view it. If you are using a different browser, the pages may not display correctly. (A browser is not included on the CD-ROM.)

You can view your electronic *Reference Guide* from the CD-ROM or copy it to your hard drive and view it from there. Follow these steps:

1. Insert your scanner software CD-ROM.
2. **Windows:** Double-click  My Computer, double-click your  EPSON CD-ROM icon, then double-click the  EPSON icon.
Macintosh: Double-click the EPSON CD-ROM icon, if necessary.

3. The Main Menu appears. Click Electronic Documentation.



4. At the next screen, click View Reference Guide.

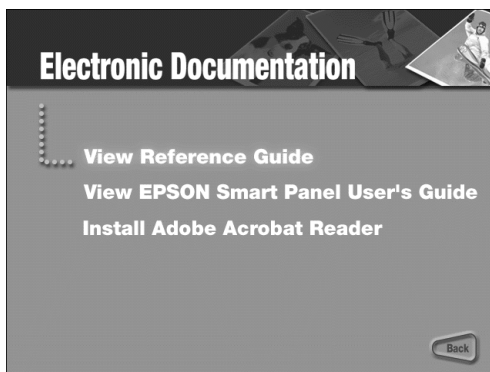

5. You see this screen:

You can either view the guide from the CD-ROM (View Reference Guide) or copy it to your hard drive (Install Reference Guide) and view it from there. For details on viewing the guide, see below.

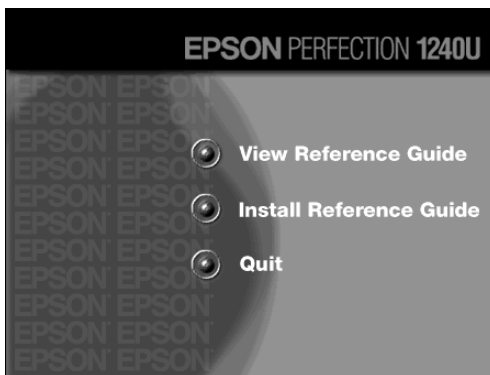

If you copied the manual to your hard drive, you can access it at any time, as follows:

Windows: Select Start, Programs, EPSON, and double-click PF1240U Guide.

Macintosh: Open the EPSON Perfection 1240U folder and double-click View Reference Guide.

When you first open the *Reference Guide*, you see this screen:

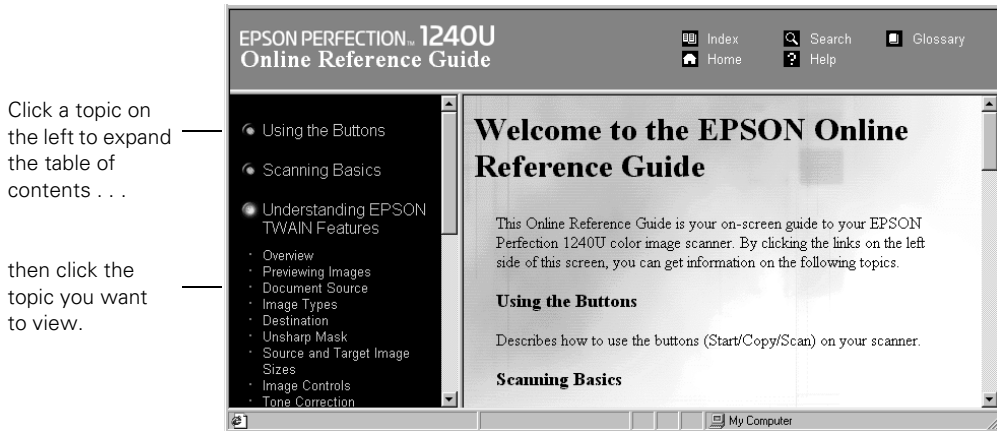

If you see an icon in place of a graphic when viewing your *Reference Guide* in Netscape Navigator, click the Reload button to load the graphic.

Viewing Your EPSON Smart Panel PDF Manual

You always have easy access to your EPSON Smart Panel electronic manual—it is automatically copied to your hard drive when you install the software.

In Windows, you can access the manual by clicking **Start, Programs, EPSON Smart Panel for Scanner**, then **EPSON Smart Panel for Scanner User's Manual**.

On a Macintosh, open the **EPSON Smart Panel for Scanner** folder and double-click **SMART PANEL for Scanner Manual**.

You can also view the EPSON Smart Panel *User's Guide* from the CD-ROM.

If you already have Adobe Acrobat Reader (version 3.0 or later) on your system, the manual opens in Acrobat Reader automatically. If you don't have Acrobat Reader, you can install it from the scanner software CD-ROM.

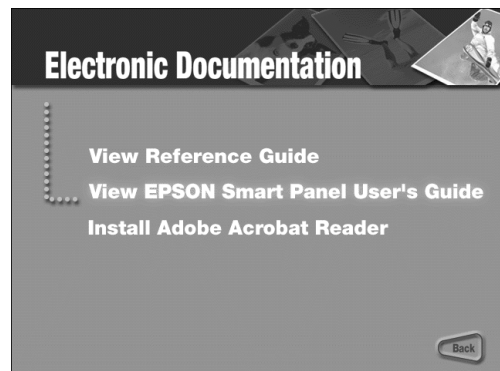

For guidelines on viewing your electronic manuals using Acrobat Reader, see “Navigating a PDF Manual” below.



Your Bonus software may also include electronic manuals in PDF format. After installing the software, check its program folder to see if an electronic manual is available.

Navigating a PDF Manual

When you open a PDF manual, you’ll see this toolbar at the top of the screen:

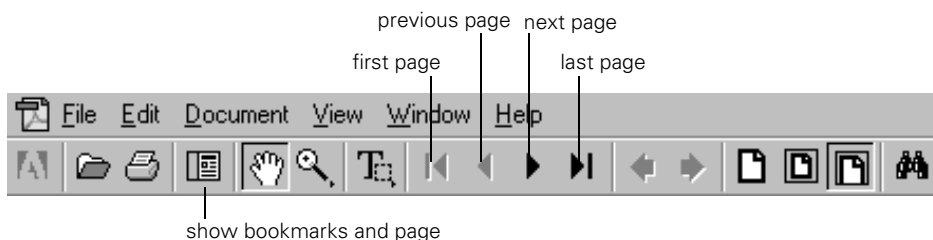



With Acrobat Reader, you have several ways to navigate through text:

- Click on hot topics, which are usually underlined or displayed in a different color. To find out if a topic is hot, move your cursor over it. If the cursor turns into a pointing hand, the topic is hot—you can jump to it by clicking once.
- Use the bookmark section on the left side of the screen to move quickly to the topic of your choice. Click the **Show Bookmarks** icon on the toolbar to see the bookmark section, if the manual has bookmarks. Some manuals only have a table of contents, but you can also use this to navigate the manual if the topics are hot.
- Use the arrow buttons in the toolbar or the vertical scroll bar on the right side of the document to move through a manual. (The box to the left of the scroll bar displays the current page number.)

For more information, see your Acrobat Reader online guide.

Scanning from Start to Finish

Scanning with the EPSON Perfection 1240U lets you turn pictures and text into digital files on your computer just by pressing the  Start,  Copy, or  Scan button on your scanner. You can use the buttons in conjunction with the EPSON Smart Panel, which has a convenient on-screen control panel. Then you can e-mail the files, display them on your web site, or use them to create projects that you can print out.

If you're experienced with scanning, you can use EPSON TWAIN to scan with applications like Adobe PhotoDeluxe or any other TWAIN-compliant program. See "Scanning with EPSON TWAIN" on page 37 for instructions.

Placing Your Original Document

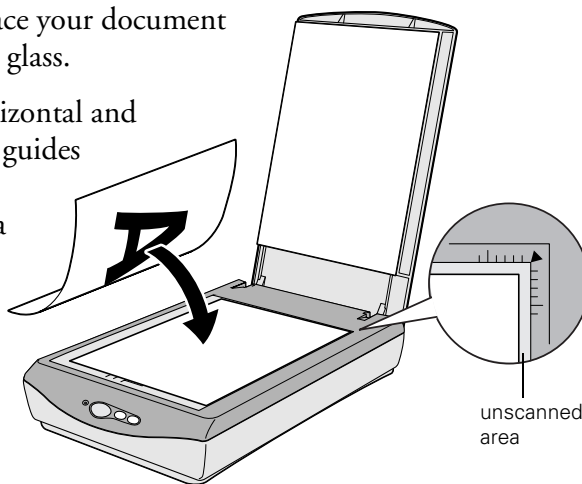

1. Raise the document cover and place your document face down on the document table glass.
2. Position the document so the horizontal and vertical edges are aligned with the guides on the top and right side of the document table. Be sure to leave a small gap because an area of 0.2 inch (5 mm) out from the guides is not scanned.
3. Close the document cover slowly. Be careful not to move the document.











If you place your document against the guides, the document edges next to the guides will not be scanned.

The self-adjusting cover allows you to place thick documents on the document table glass without removing it (see page 44).

Using the Scanner Buttons

The scanner's  Start,  Copy, and  Scan buttons let you perform one-touch scanning with EPSON Smart Panel and assigned applications. With one-touch scanning, you can load a document on the scanner, press a button, and watch as Smart Panel starts and then opens EPSON TWAIN and your assigned application automatically. Your document is automatically scanned into the assigned application. The buttons are described below:



| | |
|---|---|
|  Start | Pressing the  Start button on the scanner starts EPSON Smart Panel (default). You also can assign any of the EPSON Smart Panel applications to the  Start button; pressing the  Start button then starts the scanning process and sends data to the application. For instructions on scanning a text document to OCR (Optical Character Recognition), see page 30. |
|  Copy | If you have an EPSON ink jet printer connected to your computer, you can press the  Copy button to automatically scan and print a document. For more details, see page 35. |
|  Scan | Pressing the  Scan button automatically scans an image and then opens Adobe PhotoDeluxe, where you can edit your image with the easy-to-use tools. For more details, see page 36. |





For Windows users:
You can assign other applications that support “Scanner events” (for example, Microsoft® Imaging for Windows) to the scanner buttons. See your electronic *Reference Guide* for instructions.

Using EPSON Smart Panel

Follow these steps to use EPSON Smart Panel to scan your document or photo:

1. Place your original document face down on the document table, as described on page 27.
2. Do one of the following to open the EPSON Smart Panel:
 - Press the  Start button on your scanner.
 - In Windows, click the  Smart Panel icon on the Windows taskbar.
 - On a Macintosh, open the Apple menu and select **EPSON SMART PANEL**.



The  Start button is set to open the Smart Panel by default. However, you can assign the  Start button to automatically open any of the Smart Panel applications.

EPSON Smart Panel opens:

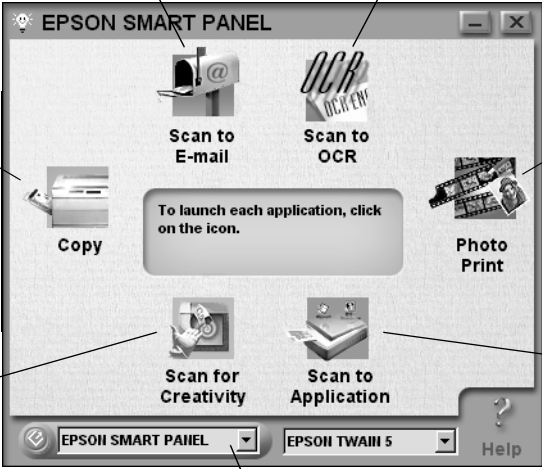

Optical Character Recognition (OCR) converts a scanned text image into text that you can edit in a word processing program

send photos or documents by e-mail (requires a modem and e-mail service)

make copies of printed pages and photos

reprint your photos in any size—create enlargements or combine several prints on one sheet

scans your image automatically and then opens it in Adobe PhotoDeluxe

automatically scans your image and then opens it in any supported application program on your computer

To launch each application, click on the icon.

select EPSON Smart Panel or a Smart Panel application to use with the  Start button

The screenshot shows the EPSON SMART PANEL window with the following icons and labels: Copy, Scan to E-mail, Scan to OCR, Photo Print, Scan for Creativity, and Scan to Application. The window title bar includes 'EPSON SMART PANEL', 'EPSON TWAIN 5', and a 'Help' button.

3. Click the icon for your desired scanning application. The window for that application appears and lets you adjust settings for your scan. Follow the on-screen steps for each application.





If you select Copy or Photo Print, make sure your printer is turned on and the correct paper type and size is loaded in your printer. You can use Photo Print only with an EPSON Stylus® Color or EPSON Stylus Photo printer.

For detailed instructions on using each of the Smart Panel applications, read your electronic manual for EPSON Smart Panel, as described on page 25.



Scanning Projects

This section gives examples for four of the Smart Panel scanning applications:

- Scan and convert a text document using **Scan to OCR** and the  Start button below
- Scan to E-mail on page 34
- Scan and Copy using the  Copy button on page 35
- Scan for Creativity using the  Scan button on page 36

The steps for the other Smart Panel applications are similar. For detailed instructions, see your electronic manual for EPSON Smart Panel.

Scanning and Converting a Text Document

This project begins by assigning Scan to OCR to the  Start button. After selecting your settings in Smart Panel and scanning one page, you can continue scanning with the same settings by placing additional pages on the document table and pressing the  Start button. Follow the steps below:

1. Place your document face down on the document table; then close the scanner cover.

2. Open EPSON Smart Panel, if it isn't already open.
3. From the pull-down menu in the bottom left, select Scan to OCR. The  Start button icon appears next to Scan to OCR.
4. Click the Scan to OCR icon. The Scan to OCR window opens.

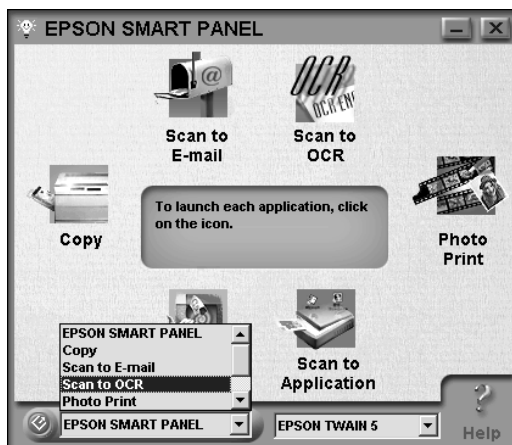

5. Click Preview. You see the OCR scan settings screen with a preview of your document:

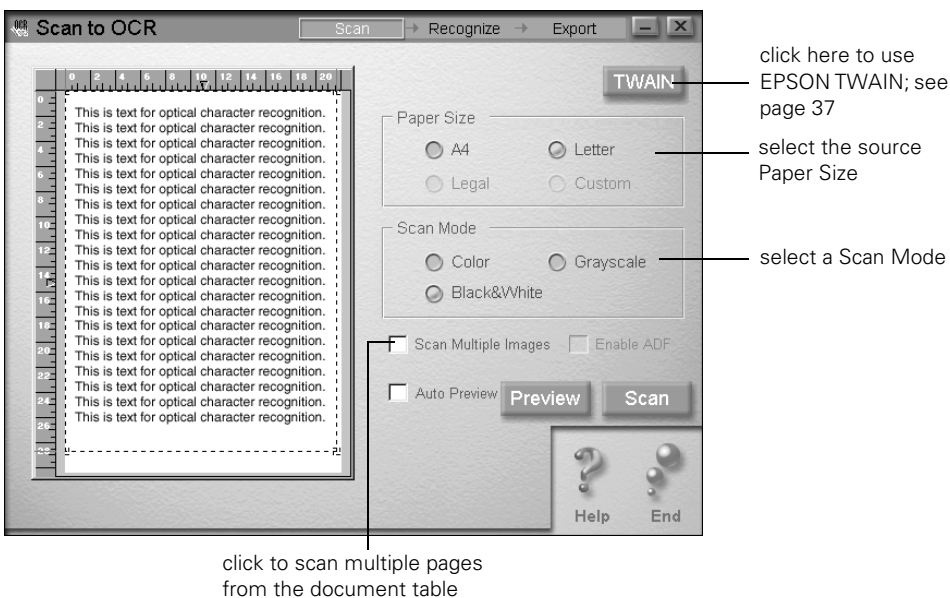

6. Select the settings for your scan:
 - Select the paper size for your document: you can choose Letter or A4.
 - Select a Scan Mode: Color, Grayscale, or Black&White (recommended).
 - Check Scan Multiple Images if you will be scanning more than one document.

7. Click **Scan**. The scanner scans your document and you see the **Recognize** screen.



- Select a language for the documents that you'll be scanning.
- Select the OCR engine that you want to use to recognize and convert the text. If you select **Presto! OCR**, you can click the **Options** button and set up additional options.



TextBridge Pro does not work with EPSON Smart Panel on Macintosh systems. Use TextBridge Pro by itself, or use the Smart Panel with Presto! OCR.

8. Click **Recognize**. The OCR engine recognizes the text. Then you see a screen that lets you choose how you want to save or open the text.

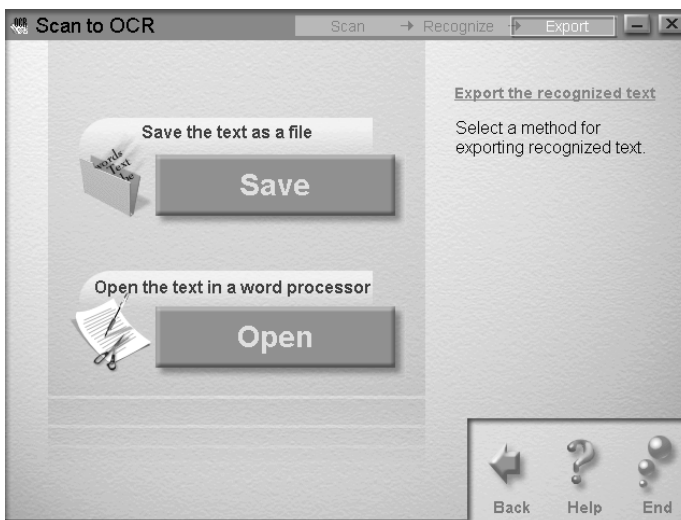

9. To save your documents without opening them, click **Save**. Enter a name and folder in the File Name and Path box, or leave the default name. For multiple documents, each file is assigned the file name you select with a new number. Select one of the available formats for saving your file: **TXT**, **RTF**, **HTML**, or **PDF**.

To open your files for editing, click **Open**. Select an application from the list. Click **Property** to change any settings for the way your documents will open. Click **OK** when you are done making changes to the Property settings, or click **Cancel** if you don't want to save your changes. Click **Open**.



The PDF format is available only if you have Adobe PDF Writer installed. (It is not included on the CD-ROM.)

When you scan to OCR using the  Start button, the pages are automatically opened as individual files in the last application that was selected in Smart Panel's OCR option.

The next time you scan using the  Start button, Smart Panel uses these same settings.

Scanning a Document to E-mail

You can scan photos or documents and then attach the resulting files to an e-mail message. Follow these steps to scan to e-mail:

1. Open the EPSON Smart Panel:

In Windows, click the  Smart Panel icon on the Windows taskbar.

On a Macintosh, click the Apple menu icon, then click **EPSON SMART PANEL**.

2. Click the **Scan to E-mail** icon.
3. Select the document settings for your scans:
 - Select the document type for your source image.
 - Select a destination setting.
4. Click **Scan**. The scanner scans your image(s).
5. Click **Specify Name and Format**. You see the following:
6. Choose a format for your file(s).



If you save your file in the JPEG format, you can select a compression application from the Options list. If you select RTF, your scan is saved as an image in an RTF file; it is not converted to editable text.

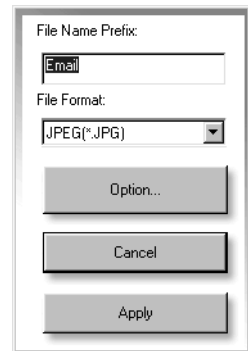

7. Click **Apply** and then click **Finish**. A screen appears showing any available e-mail programs on your system.



Your e-mail program must be MAPI-compliant, for example, Microsoft Exchange or Outlook. See your e-mail documentation for details. AOL® is not a MAPI-compliant e-mail application.

8. Select your e-mail program and click **Send E-mail**. Enter the e-mail address, type in a message and subject, then send your e-mail.

Scanning and Copying

This example explains how to scan and print a document using the  Copy button, EPSON Smart Panel's Copy utility, and an EPSON ink jet printer.

1. Make sure your printer is turned on and paper is loaded.
2. Place your document on the document table, as described on page 27.
3. If you want to change the default settings, open Smart Panel and the Copy utility, then change your settings. Otherwise, skip to step 4.



4. Press the  Copy button on your scanner. You see the Smart Panel Copy utility. Your document is automatically scanned and printed.

Scanning for Creativity

This example explains how to scan a photograph using the Scan button, EPSON Smart Panel's Scan for Creativity, and PhotoDeluxe. If you haven't already installed PhotoDeluxe, see page 22 for instructions.

1. Place your document on the document table, as described on page 27.
2. Press the  Scan button on your scanner. EPSON Smart Panel Scan for Creativity opens in the background. Your document is scanned and opens in Adobe PhotoDeluxe.

You can use all of the PhotoDeluxe features to edit and enhance your photo, add text and special effects, or create many types of projects. For more information, click **Help** or view the electronic manual for PhotoDeluxe.



If you want to scan with different settings, for example in Grayscale, open the Smart Panel Scan for Creativity window, change your settings, then scan from Smart Panel.

You cannot use the  Scan button when the Scan for Creativity window is open.

Scanning with EPSON TWAIN

Scans are performed from within a host application—the application into which you plan to import the scanned image or document, such as Adobe PhotoDeluxe or other TWAIN-compliant program. You have to start this application before you can access EPSON TWAIN, your scanner software.

Once you've started your application, you need to select the scanner “source” you want to scan with. Your EPSON Perfection 1240U scanner comes with the EPSON TWAIN 5 driver. You need to select this driver as the source in your application.

This section contains step-by-step instructions for doing this. Since Adobe PhotoDeluxe comes with your scanner, this section uses it as an example, but you can perform the same steps with most TWAIN-compliant graphics programs, such as Adobe Photoshop® or CorelDRAW®. The electronic *Reference Guide* on your CD-ROM has detailed instructions on how to use the EPSON TWAIN driver (see page 23). For instructions on using a creative software application, see its electronic manual or online help.

Selecting TWAIN from Your Application

Once the document is placed on the scanner and the scanner is turned on, you can start EPSON TWAIN to capture the image into your graphics application.

Follow these steps (the steps may vary, depending on your application):

1. Start your application.
2. Select the scanner source. Open the File menu and choose **Select Source**, **Import**, or **Acquire**, and then select either **Select TWAIN_32 Source** (Windows) or **TWAIN Select** (Macintosh).

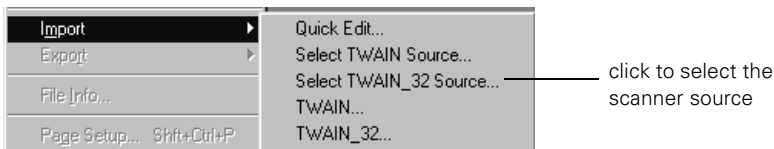

3. Make sure **EPSON TWAIN 5** is highlighted and click **Select** or **OK**.



You can also access EPSON TWAIN from EPSON Smart Panel; click the TWAIN button on the scan settings screen.

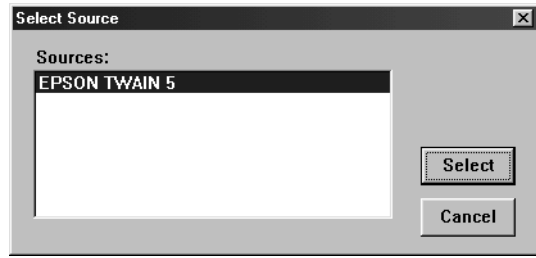

Using EPSON TWAIN

Once EPSON TWAIN 5 is selected, you can start scanning from your application. Follow these steps to make manual settings in EPSON TWAIN:

1. Start EPSON TWAIN for scanning. Open the File menu and choose **Import** or **Acquire** and if necessary, select either **TWAIN_32** (Windows) or **TWAIN Acquire** (Macintosh).

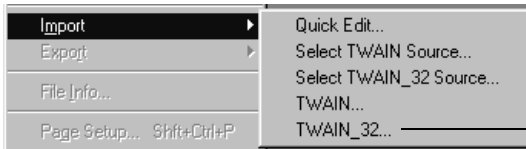

click to open
EPSON TWAIN



If your computer fails to recognize the scanner, you won't see the EPSON TWAIN driver when you try to select a scanner source from your host application. In addition, an error message may appear. If this happens, turn off your computer and scanner, and then turn the scanner back on. Then restart the computer.

2. You see the automatic scanning window.

If you want, you can let the TWAIN driver automatically scan your document. It detects what type of document you're scanning and automatically chooses the optimum settings for your scan.

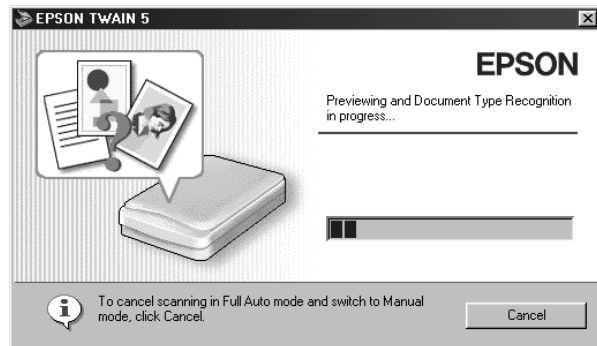

To scan in manual mode and adjust your scan settings, click **Cancel**.

You see the following window:

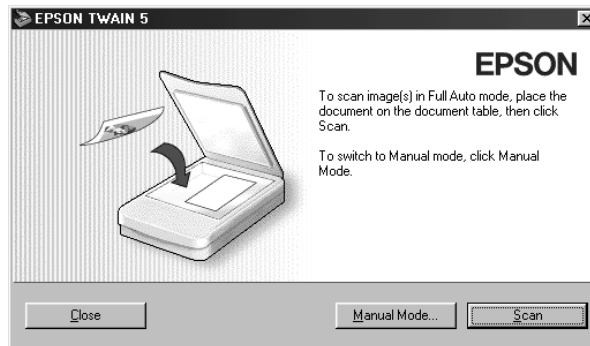

3. Click Manual Mode. The EPSON TWAIN 5 window opens:



4. Select the type of image (such as Color Photo or Line Art) and final output destination (such as Screen/Web or Laser Printer) from the Image Type and Destination menus.

5. Click the  Preview icon to preview your scan. You see a preview of your scan in the preview area on the right side of your screen.

6. Click the **Scan** button to scan your image.

The indicator light on the top of the scanner blinks for several seconds while it's scanning. In a few moments, the scanned image is imported into your application.

7. Click **Close** to close the EPSON TWAIN window.

See “Selecting TWAIN Settings” on page 41 for a summary of EPSON TWAIN settings, or your electronic *Reference Guide* for a complete description.

If the indicator light continues to blink, it may indicate an error condition. See “Scanner Light and Buttons” on page 55 for more information.



Don't leave documents, especially photographs, on the document table or in the transparency unit for long periods of time. They may stick to the glass or deteriorate from the warmth of the scanner.

Selecting TWAIN Settings

The illustration below shows the different settings you can adjust in the EPSON TWAIN window, and the preferred order you should adjust them in. Detailed descriptions are given in your electronic *Reference Guide*.

Manually adjust settings in the EPSON TWAIN window in the following order:

The screenshot shows the EPSON TWAIN 5 interface with the following callouts:

- 1** Select the basic settings: Document Source, Image Type, Destination
- 2** Preview your image
- 3** Automatically set the scan area for your image using Auto Locate
- 4** Size or scale the image (be sure to increase the Resolution if you increase the size or scale)
- 5** Customize your settings and configuration, and use color management
- 6** Scan the image into your application
- 7** Close the EPSON TWAIN window



The most important thing to remember when scanning is to select the correct image type and best resolution for your scan. For tips on selecting the best resolution, see “Selecting Resolution” on page 43. For more detailed information on making settings in your EPSON TWAIN driver, see your electronic *Reference Guide*, as described on page 23.

Tips for Getting the Best Scan

Getting the best scan possible depends on several factors, including the quality of your original and the resolution you select. The better your original is, the better your scan will be. While you can make some corrections in your scanning software, you'll need to do major photo retouching in a program such as Adobe PhotoDeluxe or Adobe Photoshop to correct or mask problems such as a coffee stain on the original image.

Recommended Settings

If you are manually adjusting the settings in the TWAIN window, you should consider using the following settings for optimal scans (a more detailed listing is available in your electronic *Reference Guide*):

| Image type | Recommended Image Type | Scanning resolution for printing^{1, 2} |
|--------------------------------------|-------------------------------|--|
| Photograph | Color Photo | 300 dpi |
| Small photograph to be enlarged | Color Photo | 300 dpi to 3200 dpi |
| Magazine | Color Photo | 300 dpi |
| Newspaper (text only) | Text (Background Removal) | 400 dpi |
| Text for OCR | Text (Background Removal) | 400 dpi |
| Text with images | Color Document | 400 dpi |
| Line art | Line Art | 300 to 3200 dpi |
| 35 mm film (negative) | TPU for neg.Film | 300 to 3200 dpi |
| 4 x 5 or Brownie film (negative) | TPU for neg.Film | 300 to 3200 dpi |
| 35 mm slide or 4 x 5 transparency | TPU for pos.Film | 300 to 3200 dpi |

¹ If your final file is for on-screen viewing (for example, on a web page or in an e-mail message), select 72 dpi for your resolution.

² If you are enlarging your image, you must manually increase the resolution (dpi) proportionally to maintain the resolution of your original.

Selecting Resolution

Resolution refers to how many dots per inch (dpi) or dots per centimeter (dpcm) your image contains. The best resolution for a scanned image depends on the type of image you're scanning and your final output device.

As a rule of thumb for most images except line art, use a scanning resolution that is approximately one third of your output resolution. For example, use a scanning resolution up to 100 dpi with a 300 dpi laser printer, and up to 200 dpi with a 600 dpi laser printer. For 1440 dpi ink jet printers, such as the EPSON Stylus® Color or Photo series, use a scanning resolution of approximately 300 dpi. Try a scanning resolution of 240 dpi for 720 dpi printing.

Keep the following in mind when you choose a resolution:

- Higher resolution settings result in larger file sizes. For example, an 8.5 × 11-inch original scanned at 300 dpi can produce a 26MB file. The same original scanned at 72 dpi creates only a 1.4MB file. Large files take longer to process and print, so consider the practical limitations of your computer system when selecting a resolution. To keep your file size manageable, select the lowest possible resolution that gives acceptable quality.
- If you need to scan at a higher resolution, you can reduce the size of the image file by scanning only part of the image. For information about selecting part of an image, see “Previewing Images” in your electronic *Reference Guide*.
- If you will be enlarging a file in your image editing software, scan at a higher resolution to maintain the image quality.
- If your final file is for on-screen viewing (for example, on a web page or in an e-mail message), select 72 dpi for your resolution.

Scanning Something That Doesn't Fit Under the Document Cover

The self-adjusting scanner cover allows you to place thick documents on the document table glass without removing the cover. If your document is too thick to fit under the cover—such as a photo in an album—you can remove the document cover. To do this, simply raise the document cover, then lift the back of the document cover straight up.

When scanning with the cover removed, make sure no area of the document table is exposed. This prevents interference from external light.

When reattaching the document cover, be sure to position the cover as shown. Then push straight down until the cover clicks into place.

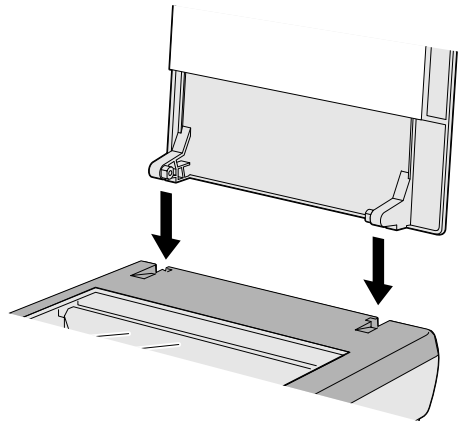
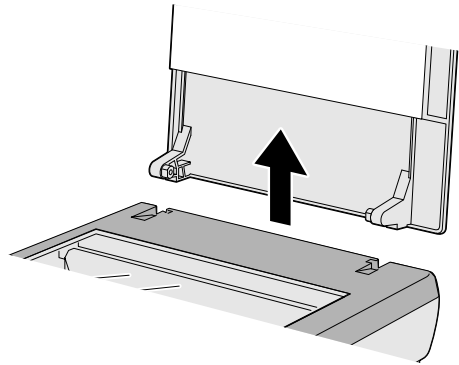

Using the Transparency Unit

This section includes basic information on installing and using the transparency unit (B813172) for the EPSON Perfection 1240U. The transparency unit, also referred to as the film adapter, lets you scan negative or positive film strips and slides on your scanner.

The transparency unit is included with the EPSON Perfection 1240U PHOTO scanner. If you have the EPSON Perfection 1240U, you can purchase the transparency unit from the EPSON Store™ at (800) 873-7766 or visit our web site at www.epsonstore.com (U.S. sales only). In Canada, please call (800) 873-7766 for dealer referral.

Installing the Transparency Unit

Follow the steps below to install the transparency unit on the scanner.

1. Make sure the scanner is not connected to a power source.
2. Remove the document cover from the scanner by opening it to an upright position and lifting it straight up.
3. Make sure the document table glass is clean and dust free.

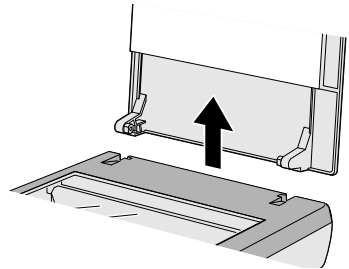

4. Place the transparency unit on the document table glass so that the hinges face the rear of the scanner and it fits on the document table glass.
5. Connect the transparency unit connector (the arrow on the connector faces up) to the scanner's option interface.
6. Turn on the transparency unit.

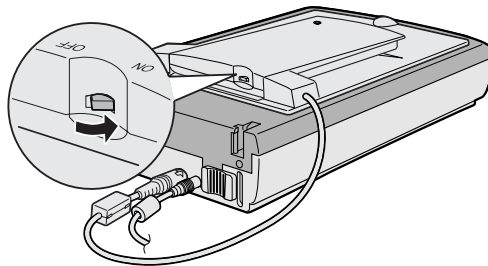
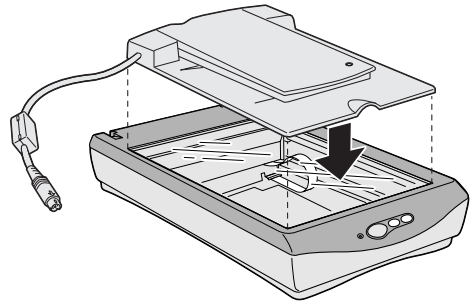

7. Connect the scanner to a power source.

For information on loading transparencies and selecting driver settings, see the following sections.

Loading Transparencies

Before scanning transparencies, wipe the lid of the transparency unit, the scanner's document table glass, and the narrow calibration window near the hinges; dust in the calibration window can cause a line in the scanned image. Keep the window uncovered when loading your transparencies. If your transparency obstructs the window, the colors in your scans will be affected.

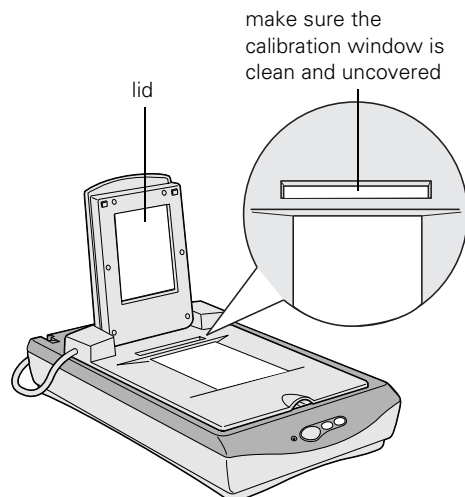

You can load transparencies in the film holders or you can place them directly on the document table, as described in the following sections.

Three film holders are included with the transparency unit. To place film in the holders, see the instructions for the type of film you're scanning. To remove a film holder from the document table, lift it out by its tab.



Hold the film by the edges or use gloves. Touching the film surface with bare hands can leave fingerprints or other marks on the film.

Film has two sides, a base side that is shiny and an emulsion side that is dull. The base side of the film has the film maker's name and film ID numbers printed on it. Whether you load film in a film holder or place it directly on the document table, always place the base side down.

Loading 35 mm Negative or Positive Film

Insert a strip of film in the 35 mm film holder, base side facing down.

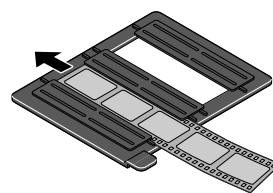
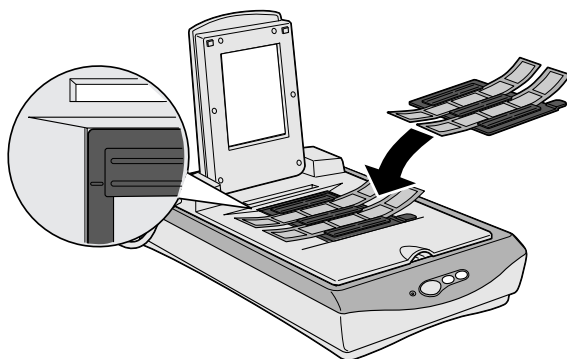

Then place the film holder on the document table. Align the upper left corner of the film holder with the upper left corner of the transparency unit. You can adjust the position of 35 mm film by sliding the strips in the film holder so the frames you want to scan are positioned in the window.

Loading Brownie Size Film

Brownie size film is 2.4×3.5 inches (6×9 cm). Insert the film in the Brownie size film holder, base side facing down.

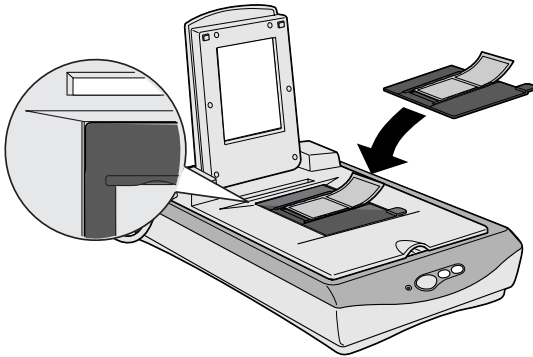
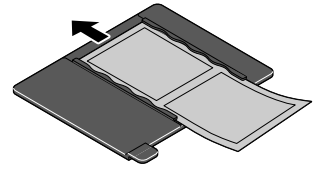

Then place the film holder on the document table. Align the upper left corner of the film holder with the upper left corner of the transparency unit.

Loading 4 x 5 inch Film

Insert film in the 4×5 inch film holder, base side facing down.

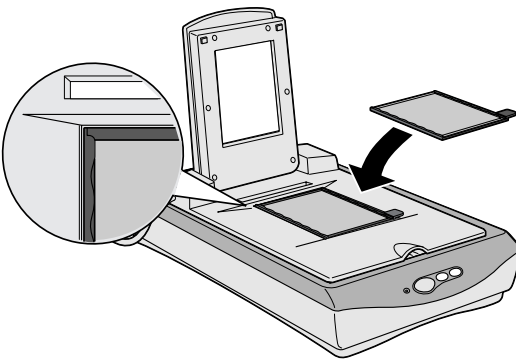
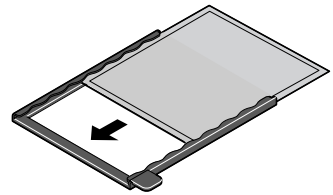

Then place the film holder on the document table. Align the upper left corner of the film holder with the upper left corner of the transparency unit.

Loading Slides and Film Directly on the Document Table



Hold the film by the edges or use gloves. Touching the film surface with bare hands can leave fingerprints or other marks on the film.

You can scan slides and film strips in the 4 × 5-inch (101.6 × 127 mm) scanning area of the transparency unit. You can use film holders (as described in the previous sections) or place them directly on the document table. Follow the steps on the next page.

TIP



If the film size is 4 × 5 inches, it may be easier to use the film holder. If you place the film directly on the document table, it may be difficult to pick up.

1. Open the top of the transparency unit while holding the base down.

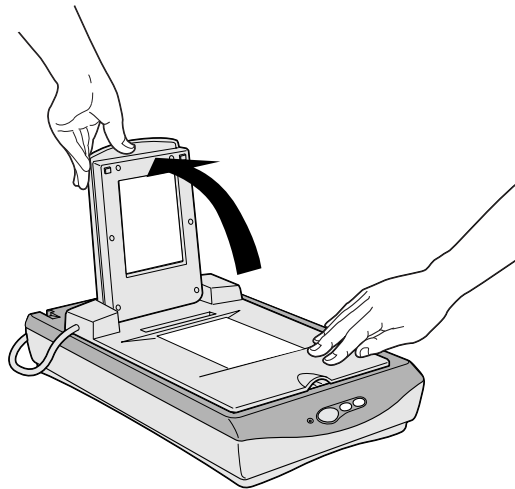

2. Load the slide or film with the base side down on the scanner's document table in the transparency unit window, as shown below.

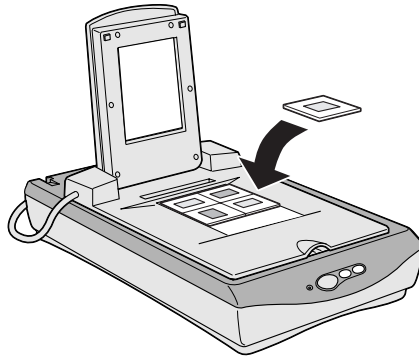

3. Close the transparency unit.

Leave the narrow calibration window uncovered, otherwise the colors in your scans will be affected.

Make sure the unit is completely closed, otherwise an option error results and you will not be able to scan the document or get correctly colored images.

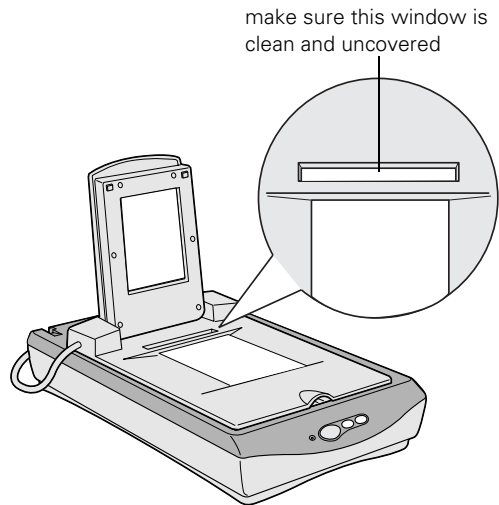

Selecting Settings

In EPSON TWAIN, select TPU - neg. Film or TPU - pos. Film as the Document Source setting, depending on the type of film (35 mm film strips or slides) you are scanning. When previewing images of negatives scanned using a film holder, the color may appear odd. To see the correct color, click and drag the mouse over the image area, then click the  Zoom Preview button. For details on scanner software settings, see your electronic *Reference Guide*.

Scanning Reflective Documents or Photographs

When you return to scanning normal reflective documents (non-transparent documents such as memos or photographs), you can turn off the transparency unit, then place documents between it and the document table. Remember to change the Document Source setting to **Flatbed** in EPSON TWAIN.

Be aware that the entire document table will be scanned so you will scan not only your document, but also the underside of the transparency unit. To prevent scanning the underside of the transparency unit, you can place a white piece of paper between your document and the transparency unit.

When scanning thin documents, you may see an impression of the underside of the transparency unit in your scans. If so, remove the transparency unit and re-install the document cover as described in the next section.

If you don't plan to scan transparencies for a while, you can remove the transparency unit and re-install the document cover as described in the next section.

Removing the Transparency Unit

Follow these steps to remove the transparency unit:

1. Turn off the transparency unit.
2. Remove any film holders or film from the document table.
3. Unplug the transparency unit connector from the scanner's option interface.
4. Store the transparency unit and film holders in their original packaging.
5. Reattach the document cover as described on page 44.

Scanner Maintenance

This section gives you basic maintenance instructions and tells you how to transport your scanner safely.

Cleaning the Scanner

To keep your scanner operating at its best, you should clean it periodically. Before cleaning, unplug the power cord.

Use a soft cloth to clean the outer case with mild detergent dissolved in water.

If the document table glass gets dirty, clean it with a soft, dry cloth that is free of lint. Paper towels are not recommended for cleaning the glass. If the glass is stained with grease or other hard-to-remove material, use a small amount of glass cleaner on a soft cloth to remove it. Wipe off any remaining liquid with a dry cloth.

Be sure there's no dust on your document table. Dust can cause white spots to appear in your scanned image.



Never use a harsh or abrasive brush or cleaning product to clean the document table. A damaged glass surface can decrease the scanning quality.

Never use alcohol, thinner, or corrosive solvent to clean the scanner. These chemicals can damage the scanner components as well as the case.

Be careful not to spill liquid into the scanner mechanism or electronic components. This could permanently damage them.

Never open the scanner case. Don't spray lubricants inside the scanner. If you think repairs or adjustments are necessary, consult your dealer or contact EPSON.

Transporting the Scanner

When you transport the scanner a long distance or store it for an extended time, follow the steps below to secure the carriage.

1. Remove any optional equipment and replace the document cover.
2. Plug in the scanner and AC adapter and wait until the carriage moves to the home position (toward the back of the scanner).

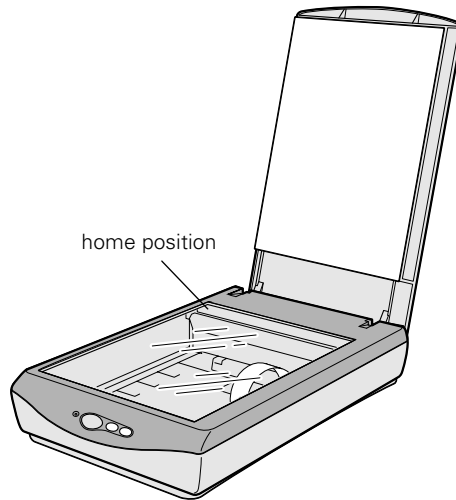

3. Disconnect the USB cable from the scanner.
4. Disconnect the AC adapter and then slide the transportation lock to the left.

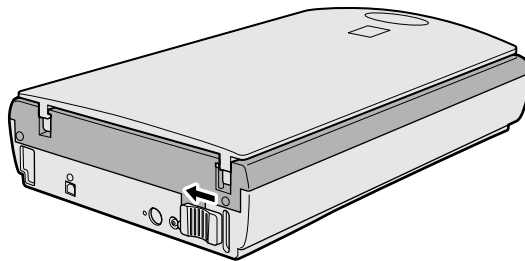

Problem Solving

This chapter gives you the basics for diagnosing and solving scanner problems. For illustrations identifying the scanner parts, see the inside back cover of this manual.

For more troubleshooting tips, see the “Troubleshooting” section of your electronic *Reference Guide*.

Scanner Light and Buttons

The scanner has one light and three buttons. The tables on the next page provide details about the light status and button functions.

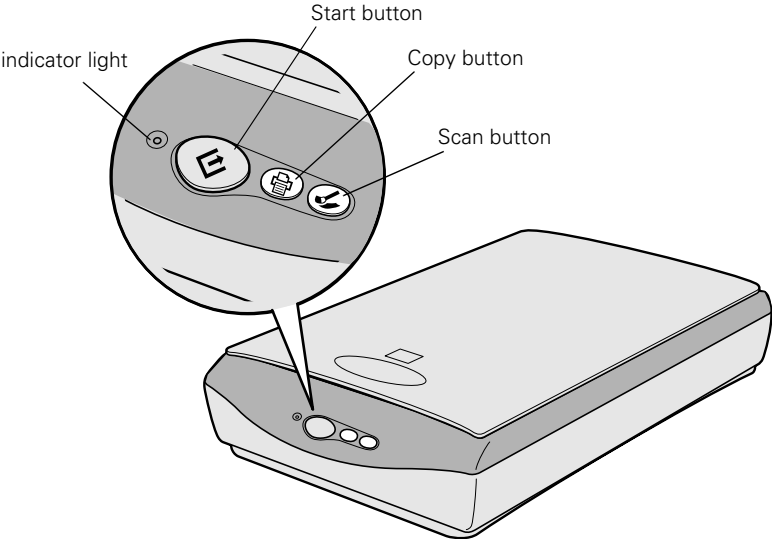



The light indicates the status of the scanner. If an error occurs, the scanner stops operating and the light shows the type of error.

Scanner light

| Light | Color | Status |
|-----------------|-------|---|
| Slowly flashing | Green | The scanner is initializing or is busy scanning. |
| On | Green | The scanner is ready to scan images. |
| On | Red | The scanner has received incorrect commands from your scanning software. When this error occurs, try to rescan the document. The scanner returns to normal when it receives correct commands. Normally you do not need to reset the scanner when this type of error occurs. |
| Flashing | Red | The scanner may not be properly connected to the computer. Unplug the scanner from its power source, remove the USB cable, and then plug them back in. If this does not eliminate the error, one of the following may be the problem: <ul style="list-style-type: none"> ■ The fluorescent lamp needs to be replaced. ■ The scanner is malfunctioning. Consult your dealer or EPSON. |
| Off | — | The scanner or AC adapter is unplugged. |

Scanner buttons

| Button | Function |
|---|--|
|  Start | Scan directly to EPSON Smart Panel or a Smart Panel application. See your <i>Reference Guide</i> for more information. |
|  Copy | Scan directly to the Copy utility in EPSON Smart Panel and print on your EPSON ink jet printer. |
|  Scan | Scan directly to Adobe PhotoDeluxe. |

Problems and Solutions

If you're having problems, this section answers some of the most common questions.

Setup Problems

Your system doesn't recognize the scanner.

- Make sure your scanner is plugged into a power source. If you opened your host application before you plugged in your scanner, close your application and reopen it.
- Check the cable connection or try using another USB cable.
- If you get the message, "No push button scanner found," unplug your scanner, shut down your computer, plug in your scanner, and then turn on your computer.

You are unable to install EPSON TWAIN in Windows.

- In Windows 2000, don't select Block under Control Panel, System, Hardware, Driver Signing; select Ignore or Warn instead.
- If you see an error message or the software doesn't install correctly on Windows 2000,

you may not have software installation privileges. See your system administrator.

- If you are installing EPSON TWAIN in Windows 98, you may be prompted for the Windows 98 CD-ROM. If you are prompted and don't have your Windows 98 CD-ROM, browse to the **Sys** folder on the scanner software CD-ROM to continue the installation.

Scanner Problems

The indicator light doesn't come on or blinks slowly.

Make sure the power cord is connected to the scanner and plugged into a power outlet. Also, check that the power outlet is working and provides sufficient power for the scanner.

The fluorescent lamp isn't on.

- Make sure the power cord is connected to the scanner and plugged into a power outlet.

- This may also be due to the power saving function (sleep mode); if the scanner doesn't receive any commands after ten minutes, it turns off the lamp. The lamp comes back on when you scan.

The scanner doesn't scan.

- Make sure you selected **EPSON TWAIN 5** as your scanner source.
- Wait until the fluorescent lamp stays on (ready for scanning). You may need to preview your scan to make the lamp come on.
- If you are using a USB hub, try connecting the scanner directly to the computer's USB port. Use only the USB cable that came with your scanner.
- If you see your scanner in the Windows Control Panel, but you can't scan, uninstall and reinstall your scanner as described on page 59.

You see the message "Scanner Not Ready" (Windows) or "Cannot find the scanner on the bus" (Macintosh).

- Make sure the scanner is plugged in. You may need to restart your computer after plugging in your scanner.
- Make sure your USB cable is securely connected. If you still see the message, unplug your scanner, then plug it in again, and restart your system.

The scanner lid seems "loose."

This is normal. Your scanner has a self-adjusting cover that allows you to place thick documents on the document table glass without removing the cover.

You're having trouble scanning while using the transparency unit.

- Make sure the transparency unit is correctly installed, connected to the scanner's option interface, and turned on.
- Make sure you select the correct Document Source setting for the option and your image: TPU for neg.Film, or TPU for pos.Film.
- Make sure the transparency lid is closed.

Software Problems

You can't open the EPSON TWAIN driver.

- Check the cable connection. Also, make sure the scanner's light is on. Try restarting your computer.
- Check that your system recognizes your scanner. Check System Device Manager in the Windows Control Panel.
- If you aren't using EPSON Smart Panel, check your scanner source setting in your application. Make sure you selected EPSON TWAIN 5.

The scanner software doesn't work properly.

- Make sure your computer meets the system requirements listed on page 69, and supports the software applications you're using.
- Check if your computer has enough memory for your software. If you're running other software at the same time, using RAM resident programs, or have many device drivers, the computer may not have enough memory. (See your software and computer manuals.) Try closing

any open applications, including screen savers and virus protection programs. If you are scanning a large image or scanning at a high resolution, your computer may not have enough memory to process the image.

- Check your software installation. Make sure that your software is correctly installed and set up. If all else fails, uninstall your software, then reinstall it, as described below.



You need to uninstall your scanner in Windows.

1. Make sure your scanner is connected to your computer.
2. Click **Start**, point to **Settings**, then click **Control Panel**. Double-click the **Scanners and Cameras** icon.
3. On the devices tab, select **EPSON Perfection 1240U**.
4. Click **Remove**. (In Windows Millennium, select **Delete** from the File menu.) Then click **OK** to close the window.

You need to reinstall EPSON TWAIN in Windows.



You must first uninstall your scanner as described above.

1. Insert your scanner CD-ROM in your CD-ROM drive.
2. Double-click  **My Computer**, then double-click the  CD-ROM icon. The CD-ROM window opens. Double-click  **EPSON**.
3. On the Main Menu, select **Reinstall TWAIN Driver**.
4. On the Re-install screen, click the **Reinstall** button.
5. At the restart message, click **Yes** or **OK**.
6. Restart your system if it doesn't automatically restart.
7. After you restart, follow the installation instructions for your operating system (see page 7).

You've uninstalled and reinstalled EPSON TWAIN in Windows, but you get error messages when you scan.

Be sure you uninstalled and reinstalled your scanner as described above. If you still get error messages, uninstall both your scanner and EPSON Smart Panel, and then reinstall them.

You need to reinstall your scanner software on a Macintosh.

1. Insert your scanner CD-ROM in your CD-ROM drive.
2. Double-click the  **EPSON** icon.
3. On the Main Menu, select **Reinstall Scanner Software**.
4. On the Reinstall window, click the **Reinstall** button.
5. Read the next message, then click **Yes**.
6. On the TWAIN Installer screen, make sure **Easy Install** is selected for the default installation, then click **Install**.
7. After the installation is complete, click **Restart**. If necessary, calibrate your screen. Then your Macintosh automatically restarts.

Scanning Problems



The file size is too big.

Adjust your scan settings. Try selecting a lower resolution (dpi), or scan only part of the image.



Your scanned image is faint or has gaps.

- Check the brightness setting. Decrease the software or driver's brightness setting.
- Try adjusting the Gamma setting.
- Check the condition of your original. If the document is damaged, dirty, or wrinkled, these imperfections will show up in your scan.
- Check that the document is placed flush against the document table.



Your scanned image is blurred or distorted.

- Check the position and condition of your document. Make sure the document is placed flat against the scanner's document table glass. If only part of the image is blurred, part of your document may be wrinkled or warped.
- Make sure the document table glass is clean.
- Make sure the scanner is not tilted or placed on an unstable or uneven surface.



Your image scans at an angle.

Check the position of your source document. It may be placed at an angle on the document table. Align it so the horizontal and vertical edges are carefully aligned with the guides on the top and side of the document table.



The edges of the document are not scanned.

- Check the position of your source document. Adjust your document's position so that the image is within the glass area.
- The document table has non-readable areas around the edges. If part of your document extends beyond the maximum limits marked on the document table edge guides, you may have to reposition your document so that the image you want to scan is within the readable area.
- Make sure the marquee (the frame showing the selected area) has selected the entire image.



Your image is too dark.

- Make sure your software settings are correct for your document type.
- Try adjusting the brightness with your application software. Also check the brightness and contrast values of your display screen.
- If you are using the transparency unit, make sure the rectangular window near the hinges on the base is uncovered, or make sure the top of the transparency unit is closed when scanning.

- The dark area around film, such as the frame of the film holder, is perceived as white—altering the exposure of the scanning area and causing your scans to appear darker. Set the correct color by adjusting the marquee or frame border and then adjusting the exposure. See your electronic *Reference Guide* for details.

The color is patchy or distorted at the edges of the image.

- Make sure your document is flat. If the document is thick or warped at the edges, the scan may appear discolored from too much outside light. Try covering the edges of the document with paper to block outside light.
- If your document is too large, part of the document extends beyond the document table, and that edge may not be in contact with the document table. Change the position of the document.

Color of negative film preview images looks odd.

- Check that your scanner software settings are correct. See your electronic *Reference Guide* for details.
- Make sure the narrow calibration window at the top of the transparency unit is not covered.
- Remember that the dark area around the film, such as the frame of the film holder, is perceived as white—altering the exposure of the scanning area and causing your scans to appear darker. Set the correct color by adjusting the marquee or frame border and then adjusting the exposure. See your electronic *Reference Guide* for details.

The image does not look the same as the original.

- Your software settings are not correct for your document type. Try different combinations of image settings using your scanner software.
- The colors displayed on your monitor don't match the original or printed colors. Try increasing your monitor's color palette to 16 bit or 24 bit.

- Because your monitor and printer use different technologies to represent colors, your printed colors cannot exactly match the colors you see on your monitor screen.

Your software may not have sufficient color matching and color management features, or these components of your software may not be correctly installed. (See your software, monitor, and computer manuals for information on color matching and calibration.)

- If you are importing an image file into your application software, make sure the file format is one your software can read. Also check that the image settings in your application are appropriate for the type of image you want to scan. (See your software manual.)
- Check the image settings in your scanner software, especially data format, gamma correction, and color correction. Try a different combination of these settings.

Straight lines in the image are jagged.

The document may have been placed at an angle on the document table. Align it so that the horizontal and vertical lines are carefully aligned with the scales on the top and side of the document table.

A line of dots is always missing in the scanned image.

- If you are printing, your printer may be running out of ink or toner and you need to replace the cartridge. For an EPSON ink jet printer, try cleaning the print head as described in your documentation.
- If this happens on both your screen and printout, the scanner's sensor may be malfunctioning. Consult your dealer.

A line of dots always appears in the scanned image.

If this happens on both your screen and printout, the document table glass may be dusty or scratched. Clean the document table glass as described on page 53.

Lines appear in the scanned image when using the transparency unit.

Dust in the transparency unit's calibration window will result in a vertical line in the scanned image.

Clean the scanner document glass, especially in the calibration window area on your scanner.

The printed image is larger or smaller than the original size.

You have changed the resolution or scaled your image. The image size settings in your software determine the size of the printed image. Do not use the size of the image on your monitor to judge the printed size.

You cannot print your image or the printout is garbled.

- Your image file size may be too large. Confirm that the computer has enough memory for your software. If your computer has many device drivers, or if you are running other software at the same time, or using RAM-resident programs, the computer may not have enough memory available. (See your software and computer documentation.)
- Check that the printer is properly connected to the computer and is correctly set up. (See your printer manual.)
- Check that your software is properly installed and set up for your printer. (See your software manual.)

Where To Get Help

EPSON Technical Support

EPSON provides technical assistance 24 hours a day through the electronic support services and automated telephone services listed in the following table:

| Service | Access |
|--------------------------------|--|
| World Wide Web | From the Internet, you can reach EPSON Support at http://support.epson.com . At this site, you can download drivers and other files, look at documentation such as product brochures and user manuals, and access troubleshooting information. |
| EPSON Internet FTP Site | If you have Internet FTP capability, use your Web browser (or other software for FTP downloading) to log onto ftp.epson.com with the user name anonymous and your e-mail address as the password. |
| EPSON E-mail Technical Support | To receive technical advice through e-mail, go to http://support.epson.com and complete the form under the troubleshooting tab, as requested. |
| Automated Telephone Services | A variety of automated help services are available 24 hours a day, seven days a week. To use these services, you must have a touch tone telephone and call (800) 922-8911 . |

To speak to a technical support representative, dial (562) 276-4382 (U.S.) or (905) 709-3839 (Canada), 6 AM to 6 PM, Pacific Time, Monday through Friday. Toll or long distance charges may apply.

Before you call, please have the following information ready:

- Product name (EPSON Perfection 1240U or EPSON Perfection 1240U PHOTO)
- Product serial number (located on the back of the scanner)
- Proof of purchase (such as a store receipt) and date of purchase
- Computer configuration
- Description of the problem

You can purchase genuine EPSON supplies and accessories from the EPSON Store at (800) 873-7766 or visit our web site at www.epsonstore.com (U.S. sales only). In Canada, please call (800) 873-7766 for dealer referral.



If you need help using another manufacturer's software with an EPSON product, see the documentation for that software for technical support information.

Bonus Software Technical Support

| Software | Telephone | Fax | Online and E-mail |
|--|--|---|--|
| EPSON TWAIN driver ScanSoft TextBridge Pro EPSON Software Film Factory | U.S. (562) 276-4382 Canada (905) 709-3839 | (800) 922-8911 fax-on-demand system | support.epson.com |
| EPSON Smart Panel | (510) 445-8616 | (510) 445-8601 | tech@newsoftinc.com |
| Adobe PhotoDeluxe Adobe Photoshop LE | (206) 675-6126 6:00 AM to 5:00 PM, PST, Monday through Friday (pay support) | (206) 675-6137 fax-on-demand system | www.adobe.com/support techdocs@adobe.com |
| ArcSoft PhotoPrinter 2000 Pro ArcSoft Panorama Maker 2000 | (510) 440-9901 8:30 AM to 5:30 PM, PST, Monday through Friday | (510) 440-1270 | www.arcsoft.com support@arcsoft.com |
| Monaco Systems MonacoEZcolor* | (978) 749-9944 9:00 AM to 5:00 PM, EST, Monday through Friday | — | www.ezcolor.com/faq.html support@monacosys.com |

* Software offer available at a discounted price for EPSON Perfection 1240U/1240U PHOTO owners, for a limited time. Call (978) 749-9944 to order from Monaco Systems. The color management package includes software, a target print, and a corresponding target file. You can install the software and target file from your scanner CD-ROM. However, you won't be able to use the software until you obtain the target print, available by mail when you purchase the color management package for \$149 (U.S.)—that's half off the retail price of \$299. The offer expires 12/31/01.

Requirements and Notices

This chapter includes system requirements, safety instructions, and other important information about your EPSON Perfection 1240U.

System Requirements

The minimum system requirements for Windows and Macintosh are listed below. For optimum performance, a faster processor and more memory are recommended. If you are scanning high-resolution images, you need more than the minimum available hard disk space and memory listed.

Windows

- An IBM-compatible PC with a Pentium® or faster processor
- Microsoft Windows 98, Windows Millennium Edition (Me), or Windows 2000, preinstalled
- 32MB RAM (64MB RAM recommended)
- 50MB available hard disk space
- CD-ROM or DVD drive
- Built-in USB port or self-powered hub connection
- Mouse or pointing device
- VGA color monitor with 640 × 480 or higher resolution (a color monitor with a resolution of 800 × 600 or higher recommended)
- 8-bit, 256-color display adapter card (24-bit display adapter card with millions of colors recommended).



On-screen color and tone reproduction are subject to the display capability of your computer system, including the video card, monitor, and software. See the documentation for these products for details.

Macintosh

You cannot use a serial interface to connect the scanner.

- Available USB port or self-powered hub connection
- Apple® Macintosh computer (G3, G4, or iMac™) with built-in USB port, running Mac® OS 8.5.1 or later



Check the Apple website for any updates to your operating system.

- 32MB RAM (64MB recommended)
- 50MB available hard disk space
- CD-ROM or DVD drive
- Built-in USB port or self-powered hub connection
- Mouse or pointing device
- VGA color monitor with 640 × 480 screen resolution (or higher recommended) and 256 colors (millions of colors recommended)



Color and tone reproduction are subject to the display capability of your computer system, including the video card, monitor, and software. See the documentation for these products for details.

EPSON TWAIN supports the Apple ColorSync™ 2.× color management system and QuickTime.™ These extensions are automatically installed during EPSON TWAIN installation.

Important Safety Instructions

Read all of these instructions and save them for later reference. Follow all warnings and instructions marked on the scanner.

- Use only the AC adapter that comes with your scanner. Using any other adapter could cause fire, electrical shock, or injury.
- The AC adapter is designed for use with the scanner with which it was included. Do not attempt to use it with other electronic devices unless specified.
- Do not use the scanner or AC adapter near water, outdoors, or handle either device with wet hands. Do not expose to excess humidity. Never insert or disconnect the power plug with wet hands.
- Use only the type of power source indicated on the AC adapter's label, and always supply power directly from a standard domestic electrical outlet.

- If you are not going to use the scanner, be sure to unplug the AC adapter from the electrical outlet.
- Be sure your AC power cord meets the relevant local safety standards.
- Power-supply cords should be protected from abrasion, cuts, crimping and kinking. Be sure to place your cords to avoid any damage. Do not place objects on top of the power cord and the AC adapter or allow the power cord to be stepped on or run over. You should take special care to try to keep the power cord straight at the ends and the points where it enters and leaves the transformer.
- Do not place multiple loads on the electrical outlet.
- Beware of electrical shock hazards.
- Keep out of reach of children.
- For US and Canadian users:

Use the included power cord or a 6 to 10 feet long UL-approved type NISPT-2, 2 x 18 AWG cord with a 125 V 10 A polarized plug and 125 V 7 A connector.

The AC adapter is equipped with a polarized alternating-current line plug (a plug having one blade wider than the other) and polarized power inlet. These plugs only fit into a power outlet and your equipment in one way. This is a safety feature. If you are unable to insert the plug properly, try reversing the plug. If the plug still fails to fit, contact an electrician to replace your outlet. Be sure to use only the polarized AC cord that comes with the scanner.

- Unplug the scanner and AC adapter before cleaning. Clean with a damp cloth only. Do not use liquid or aerosol cleaners.
- Do not place the scanner or AC adapter on an unstable surface, near a radiator, or near a heat source.
- Do not block or cover the openings in the scanner's cabinet. Do not insert objects into any openings as they may touch dangerous voltage points or short out parts.
- Connect all equipment to properly grounded power outlets. Avoid using outlets on the same circuit as photocopiers or air control systems that regularly switch on and off.
- Do not let the power cord become damaged or frayed.
- If you use an extension cord with the scanner, make sure the total ampere rating of the devices plugged into the extension cord does not exceed the cord's ampere rating. Also, make sure the total ampere rating of all devices plugged into the wall outlet does not exceed the wall outlet's ampere rating.
- Do not attempt to service the scanner and the power cord yourself.
- Never disassemble, modify, or attempt to repair the AC adapter.
- Never disassemble or attempt to repair the scanner or optional equipment.
- Unplug the scanner and refer servicing to qualified service personnel under the following conditions:

If the power cord or plug is damaged; if liquid has entered the scanner; if the scanner has been dropped or the case damaged; if the scanner does not operate normally or exhibits a distinct change in performance. (Do not adjust controls that are not covered by the operating instructions.)

ENERGY STAR Compliance

As an ENERGY STAR Partner, EPSON has determined that this product meets the ENERGY STAR guidelines for energy efficiency. The EPA ENERGY STAR office equipment program is a voluntary partnership with the computer and office equipment industry to promote the introduction of energy-efficient personal computers, monitors, printers, fax machines, and copiers in an effort to reduce air pollution caused by power generation.



FCC Compliance Statement

For United States Users

This equipment has been tested and found to comply with the limits for a Class B digital device, pursuant to Part 15 of the FCC Rules. These limits are designed to provide reasonable protection against harmful interference in a residential installation. This equipment generates, uses, and can radiate radio frequency energy and, if not installed and used in accordance with the instructions, may cause harmful interference to radio or television reception. However, there is no guarantee that interference will not occur in a particular installation. If this equipment does cause interference to radio and television reception, which can be determined by turning the equipment off and on, the user is encouraged to try to correct the interference by one or more of the following measures:

- Reorient or relocate the receiving antenna.
- Increase the separation between the equipment and receiver.
- Connect the equipment into an outlet on a circuit different from that to which the receiver is connected.
- Consult the dealer or an experienced radio/TV technician for help.

WARNING: The connection of a non-shielded equipment interface cable to this equipment will invalidate the FCC Certification of this device and may cause interference levels which exceed the limits established by the FCC for this equipment. It is the responsibility of the user to obtain and use a shielded equipment interface cable with this device. If this equipment has more than one interface connector, do not leave cables connected to unused interfaces. Changes or modifications not expressly approved by the manufacturer could void the user's authority to operate the equipment.

For Canadian Users

This Class B digital apparatus meets all requirements of the Canadian Interference-Causing Equipment Regulations.

Cet appareil numérique de la classe B respecte toutes les exigences du Règlement sur le matériel brouilleur du Canada.

Declaration of Conformity

According to 47CFR, Part 2 and 15 for Class B Personal Computers and Peripherals; and/or CPU Boards and Power Supplies used with Class B Personal Computers:

We: EPSON America, Inc.
Located at: MS 6-43
3840 Kilroy Airport Way
Long Beach, CA 90806-2469

Declare under sole responsibility that the product identified herein, complies with 47CFR Part 2 and 15 of the FCC rules as a Class B digital device. Each product marketed, is identical to the representative unit tested and found to be compliant with the standards. Records maintained continue to reflect the equipment being produced can be expected to be within the variation accepted, due to quantity production and testing on a statistical basis as required by 47CFR §2.909. Operation is subject to the following two conditions: (1) this device may not cause harmful interference, and (2) this device must accept any interference received, including interference that may cause undesired operation.

Trade Name: EPSON
Type of Product: Image Scanner
Model: G810A

Warranty

Epson America, Inc. Limited Warranty

What Is Covered: Epson America, Inc. (“EPSON”) warrants to the first end user customer of the EPSON product enclosed with this limited warranty statement, that the product if purchased and used in the United States or Canada, conforms to the manufacturer’s specifications and will be free from defects in workmanship and materials for a period of one year from the date of original purchase. EPSON warrants that the EPSON product is manufactured from new components and parts, or if you have purchased a refurbished product, like-new components and parts which perform like new and meet the EPSON standard of quality.

What EPSON Will Do To Correct Problems: Should your EPSON product prove defective during the warranty period, please bring the product securely packaged in its original container or an equivalent, along with proof of the date of original purchase, to your EPSON Dealer or EPSON Customer Care Center. You are responsible for all costs (shipping, insurance, travel time) in getting the product to the service location. EPSON will, at its option, repair or replace on an exchange basis the defective unit, without charge for parts or labor. When warranty service involves the exchange of the product or of a

part, the item replaced becomes EPSON property. The replacement unit may be new or refurbished to the Epson standard of quality, and at Epson's option, the replacement may be another model of like kind and quality. Epson's liability for replacement of the covered product will not exceed the original retail selling price of the covered product. Exchange or replacement products or parts assume the remaining warranty period of the product covered by this limited warranty.

What This Warranty Does Not Cover: This warranty covers only normal use in the United States and Canada. This warranty does not cover damage to the EPSON product caused by parts or supplies not manufactured, distributed or certified by EPSON. This warranty does not cover third party parts, components or peripheral devices added to the EPSON product after its shipment from EPSON, e.g., dealer-added boards, chips or drives. EPSON is not responsible for warranty service should the EPSON label or logo or the rating label or serial number be removed or should the product fail to be properly maintained or fail to function properly as a result of misuse, abuse, improper installation, neglect, improper shipping, damage caused by disasters such as fire, flood, and lightning, improper electrical current, software problems, interaction with non-EPSON products, or service other than by an EPSON Authorized Servicer. If a claimed defect cannot be identified or reproduced in service, you will be held responsible for costs incurred.

THE WARRANTY AND REMEDY PROVIDED ABOVE ARE EXCLUSIVE AND IN LIEU OF ALL OTHER EXPRESS OR IMPLIED WARRANTIES INCLUDING, BUT NOT LIMITED TO, THE IMPLIED WARRANTIES OF MERCHANTABILITY OR FITNESS FOR A PARTICULAR PURPOSE. SOME LAWS DO NOT ALLOW THE EXCLUSION OF IMPLIED WARRANTIES. IF THESE LAWS APPLY, THEN ALL EXPRESS AND IMPLIED WARRANTIES ARE LIMITED TO THE WARRANTY PERIOD IDENTIFIED ABOVE. UNLESS STATED HEREIN, ANY STATEMENTS OR REPRESENTATIONS MADE BY ANY OTHER PERSON OR FIRM ARE VOID. IN THE EVENT THE REMEDIES ABOVE FAIL, EPSON'S ENTIRE LIABILITY SHALL BE LIMITED TO A REFUND OF THE PRICE PAID FOR THE EPSON PRODUCT COVERED BY THIS LIMITED WARRANTY. EXCEPT AS PROVIDED IN THIS WRITTEN WARRANTY, NEITHER EPSON AMERICA, INC. NOR ITS AFFILIATES SHALL BE LIABLE FOR ANY LOSS, INCONVENIENCE, OR DAMAGE, INCLUDING DIRECT, SPECIAL, INCIDENTAL, OR CONSEQUENTIAL DAMAGES, RESULTING FROM THE USE OR INABILITY TO USE THE EPSON PRODUCT, WHETHER RESULTING FROM BREACH OF WARRANTY OR ANY OTHER LEGAL THEORY.

In Canada, warranties include both warranties and conditions.

Some jurisdictions do not allow limitations on how long an implied warranty lasts and some jurisdictions do not allow certain exclusions or limitations on damages, so the above limitations and exclusions may not apply to you. This warranty gives you specific legal rights, and you may also have other rights which vary from jurisdiction to jurisdiction.

To locate the EPSON Authorized Reseller or EPSON Customer Care Center nearest you call: (800) 922-8911 or write to: Epson America, Inc., P.O. Box 93008, Long Beach, CA 90809-9985.

Index

Numerics

35 mm film, loading, 47
4 × 5 inch film, loading, 48

A

Accessories, 45, 68
Adobe Acrobat Reader, 25 to 26
Adobe PhotoDeluxe, 36
Advanced settings, TWAIN, 38 to 41

B

Base side, film, 47
Blurred image, 62
Brightness problems, 63 to 64
Brownie size film, loading, 48
Browser, 23
Buttons, 55 to 56

C

Carriage, 5
Cleaning scanner, 53
Command error, 56
Connecting the scanner to computer, 6 to 7
Copy button, 55 to 56
Copy utility, 29
Copying, 35
Correcting color, 63 to 64

D

Dark images, 63 to 64
Document cover, removing, 44
Document position, 62, 63
Documentation, how to use, 1 to 2, 23 to 26

E

Electronic manuals, 23 to 26
E-mail, scanning to, 34
Emulsion side, film, 47
ENERGY STAR, 72
EPSON
 help, 67 to 68
 Store, 45, 68
Error, 56

F

File size, 61
Film holder
 35 mm film, 47
 4 × 5 inch film, 48
 Brownie size film, 48
 removing, 47
Fluorescent lamp, 6, 57

H

Help
 EPSON, 67 to 68
 software, 68

I

- Image quality problems, 61 to 66
- Incorrect colors, 63 to 65
- Initialization, 5
- Installing
 - scanner software, 7 to 18
 - scanner software and bonus software, 19 to 21
 - transparency unit, 45 to 46

L

- Lamp, fluorescent, 6, 57
- Lid, 58
- Light, scanner, 55 to 56, 57
- Lines in image, 66
- Loading slides and film
 - on document table, 49 to 50
 - using film holders, 47 to 48

M

- Macintosh
 - installing software, 17 to 21
 - reinstalling software, 60
 - screen calibration, 18
- Maintenance, 53
- Manual mode, TWAIN, 38 to 41
- Manuals, viewing electronic, 23 to 26
- Moving the scanner, 54

O

- OCR, scanning to, 30 to 33
- Optical character recognition (OCR), 28
- Option, transparency unit, 45 to 52, 58

P

- Photo Print, 29
- Photographs, scanning, 42
- Placement of scanner, 4
- Power on/off, 6

R

- Recommended settings, 42
- Reference Guide, 23 to 25
- Reflective documents, 51
- Removing document cover, 44
- Requirements, system, 69 to 70
- Resolution, choosing, 42 to 43

S

- Safety instructions, 4, 70 to 71
- Scan button, 55 to 56
- Scan for Creativity, 29
- Scan to Application, 29
- Scan to E-mail, 29
- Scan to OCR, 29
- Scanner
 - troubleshooting, 57 to 58
 - turning on/off, 6
- Scanning
 - advanced, 37 to 43
 - basic, 28 to 36
 - photos, 42
 - problems, 61 to 66
 - projects, 30 to 36
 - to e-mail, 34
 - to OCR, 30 to 33
 - TWAIN, 37 to 43
- Screen calibration
 - Macintosh, 18
 - Windows 98, 10, 12, 15

- Service, 67 to 68
- Setting tips, 42
- Settings, software, 39, 41, 42
- Setup problems, 57
- Slides, loading, 49 to 50
- Smart Panel
 - copying, 35
 - documentation, 25 to 26
 - electronic manual, 25 to 26
 - overview, 29 to 30
 - scanning for creativity, 36
 - scanning from, 29 to 30
 - scanning to e-mail, 34
 - scanning to OCR, 30 to 33
- Software
 - problems, 59 to 60
 - reinstalling, 60
- Software installation
 - Macintosh, 17 to 21
 - Windows, 7 to 16, 19 to 21, 57
- Software settings, 39, 41, 42
- Software, uninstalling, 59, 60
- Space requirements, 4
- Start button
 - scanner, 55 to 56
 - using, 30
- Support, 67 to 68
- System requirements, 69 to 70

T

- Technical support, 67 to 68
- Text, scanning, 42
- Thick documents, 44
- Transparency unit
 - installing, 45 to 46
 - removing, 52
 - troubleshooting, 58, 66
 - using, 46 to 51
- Transparency, scanning, 42, 46 to 51
- Transportation lock, 5
- Transporting the scanner, 54

- Troubleshooting
 - image quality, 61 to 66
 - scanner, 57 to 58
 - setup, 57
 - software, 59 to 60
 - transparency unit, 58, 66
- TWAIN
 - advanced scanning, 38 to 41
 - automatic scanning, 38
 - installing, 7
 - instructions, 37 to 43
 - manual scanning, 38 to 41
 - selecting in application, 37 to 38
- TWAIN installation
 - Macintosh, 17 to 18
 - Windows 2000, 13 to 16
 - Windows 98, 8 to 10
 - Windows Me, 11 to 13

U

- Unpacking the scanner, 3 to 4
- USB, 69, 70

V

- Viewing electronic manuals, 23 to 26

W

- Warranty, 73 to 74
- Windows
 - installing software, 7 to 16, 19 to 21, 57
 - reinstalling software, 59, 60
 - screen calibration, 10, 12, 15
 - troubleshooting, 57
 - uninstalling software, 59, 60
- World Wide Web, 67

