

F0-04DAH-2, 4-CHANNEL ANALOG VOLTAGE OUTPUT



In This Chapter...

Module Specifications	9-2
Connecting and Disconnecting the Field Wiring	9-4
Wiring Diagram	9-5
Module Operation	9-6
Special V-memory Locations	9-7
Using the Pointer in Your Control Program	9-9
Output Scale Conversion.....	9-11
Module Resolution.....	9-14

Module Specifications

The F0-04DAH-2 analog output module offers the following features:

- The DL05 and DL06 will update all four channels in one scan.
- The removable terminal block simplifies module replacement.
- Full 16-bit resolution.

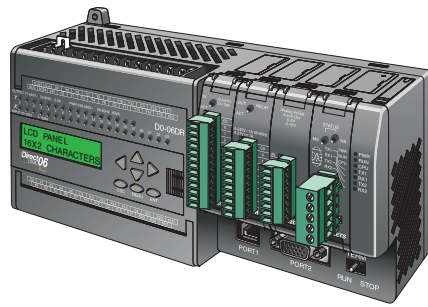

NOTE: The DL05 CPU's analog feature for this module requires **DirectSOFT32 Version 3.0c (or later)** and firmware version 5.20 (or later). The DL06 requires **DirectSOFT32 version V4.0, build 16 (or later)** and firmware version 2.30 (or later). See our website for more information: www.automationdirect.com.

The following tables provide the specifications for the F0-04DAH-2 Analog Output Module. Review these specifications to make sure the module meets your application requirements.

Output Specifications	
Outputs per module	4
Output Range	0–10 VDC
Resolution	16-bit, 152 μ V/bit
Output Type	Voltage sourcing/sinking at 5mA max.
PLC Data Format	16-bit, Unsigned Integer, 0–FFFF (binary) or 0–65535 (BCD)
Output value in program mode	0V (excluding PID, independent mode)
Output Impedance	0.5 Ohms typical
Load Impedance	>2000 Ohms
Maximum Capacitive Load	0.01 μ F maximum
Allowed load type	Grounded
Maximum Inaccuracy	0.2% of range (including temperature changes)
Maximum Full Scale Calibration Error (including offset error)	\pm 0.025% of range maximum
Maximum Offset Calibration Error	\pm 0.025% of range maximum
Accuracy vs. Temperature	\pm 50 ppm/ $^{\circ}$ C maximum full scale calibration change
Maximum Crosstalk	\pm 10 counts
Linearity Error (End to End)	\pm 16 count maximum (\pm 0.025% of full scale) Monotonic with no missing codes
Output Stability and Repeatability	\pm 10 counts after 10 min. warm-up typical
Output Ripple	0.05% of Full Scale
Output Settling Time	0.5 ms maximum, 5 μ s minimum (full scale change)
All Channel Update Rate	100 μ s
Maximum Continuous Overload	Outputs current limited to 40mA typical. A continuous short circuit will damage the output.
Type of Output Protection	24VDC Peak Output Voltage (capacitor transient voltage suppressor)
Output signal at power-up and power-down	0V
External 24VDC Power Required	24VDC \pm 10% @45mA
Base Power Required (5.0 V)	25mA

Each channel requires 2 words of V-memory irrespective of the format used.

General Specifications	
Operating Temperature	0 to 55 $^{\circ}$ C (32 to 131 $^{\circ}$ F)
Storage Temperature	-20 to 70 $^{\circ}$ C (-4 to 158 $^{\circ}$ F)
Humidity	5 to 95% (non-condensing)
Environmental air	No corrosive gases permitted (EN61131-2 pollution degree 1)
Vibration	MIL STD 810C 514.2
Shock	MIL STD 810C 516.2
Field to Logic side Isolation	1800VAC applied for 1 second (100% tested)
Insulation Resistance	>10M ohms @ 500VDC
Noise Immunity	NEMA ICS3-304; Impulse 1000V @ 1ms pulse; RFI, (145MHz, 440Mhz 5W @ 15cm); Worst case error during noise disturbance is 0.5% of full scale
Agency Approvals	UL508; UL60079-15 Zone 2
Module Location	Any slot in a DL05 or DL06 System
Field Wiring	Removable Terminal Block
Weight	49g (1.7 oz.)

Connecting and Disconnecting the Field Wiring



WARNING: Before removing the analog module or the terminal block on the face of the module, disconnect power to the PLC and all field devices. Failure to disconnect power can result in damage to the PLC and/or field devices.

Wiring Guidelines

Your company may have guidelines for wiring and cable installation. If so, you should check those before you begin the installation. Here are some general things to consider:

- Use the shortest wiring route whenever possible.
- Use shielded wiring and ground the shield at the transmitter source. *Do not* ground the shield at both the module and the source.
- Do not run the signal wiring next to large motors, high current switches, or transformers. This may cause noise problems.
- Route the wiring through an approved cable housing to minimize the risk of accidental damage. Check local and national codes to choose the correct method for your application.

The F0-04DAH-2 does not supply power to field devices. You will need to power transmitters separately from the PLC.

To remove the terminal block, disconnect power to the PLC and the field devices. Pull the terminal block firmly until the connector separates from the module.

You can remove the analog module from the PLC by folding out the retaining tabs at the top and bottom of the module. As the retaining tabs pivot upward and outward, the module's connector is lifted out of the PLC socket. Once the connector is free, you can lift the module out of its slot.

Terminal Block Specifications	
Number of Positions	13
Re-Order Number	D0-ACC-4
Pitch	0.2 inch (5.08 mm)
Wire Range	28-16 AWG Solid or Stranded Conductor; Wire strip length 5/16" (7-8 mm)
Screwdriver Size (Slotted)	0.4T x 2.5W mm (part number DN-SS1)
Screw Size	M2.5 size
Screw Torque	4.5 inch-pounds (0.52 N·m)

Wiring Diagram

Use the following diagram to connect the field wiring. If necessary, the F0-04DAH-2 terminal block can be removed to make removal of the module possible without disturbing field wiring.

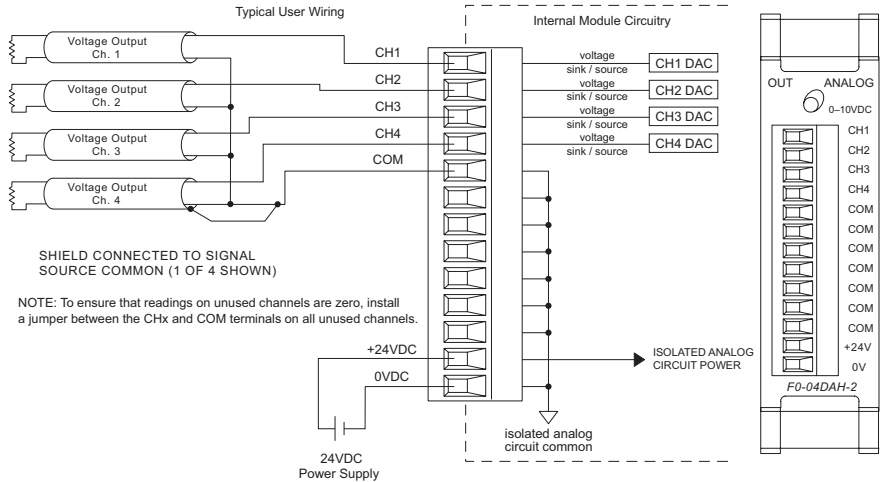

Module Operation

Channel Scanning Sequence

The DL05 and DL06 will read all four channels of output data during each scan. Each CPU supports special V-memory locations that are used to manage the data transfer. This is discussed in more detail beginning in the section on “Special V-memory Locations”.

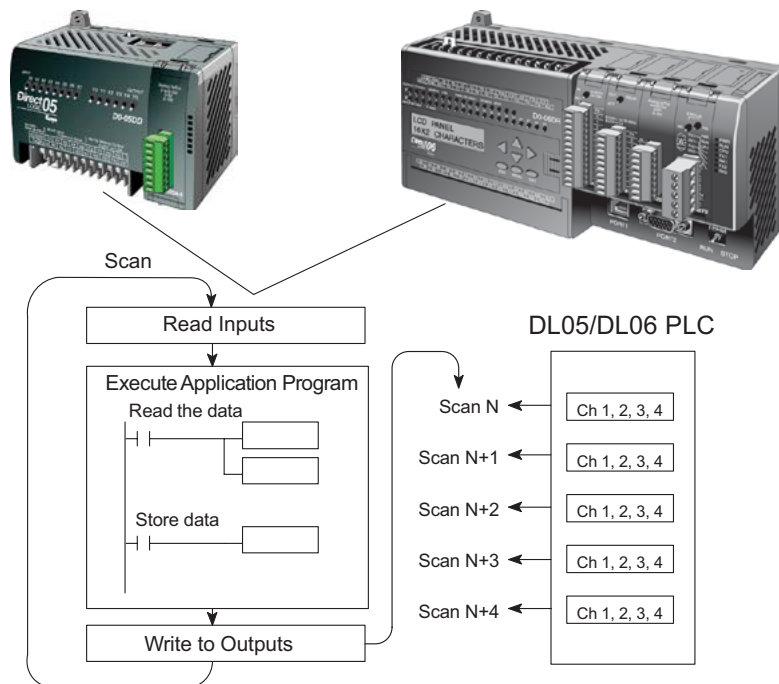

Special V-memory Locations

Formatting the Analog Module Data

The DL05 and DL06 PLCs have special V-memory locations assigned to their respective option slots. These V-memory locations allow you to:

- Specify the data format (binary or BCD)
- Specify the number of channels to scan (up to 4 channels for the F0-04DAH-2)
- Specify the V-memory locations where the user program will store the output data pending distribution to the output module

DL05 Data Formatting

The table below shows the special V-memory locations used by the DL05 PLC for the F0-04DAH-2.

Analog Output Module DL05 Special V-memory Locations	
Data Type and Number of Channels	V7700
Storage Pointer	V7702

Data Type and Number of Active Channels Setup

System memory location V7700 is used to set the data format either to BCD or binary and to set the number of channels that will be active.

For example, loading a constant of 0004 (BCD) into V7700 sets four channels active and causes the output data value to be read from pointer-designated V-memory as a BCD number.

Alternatively, loading a constant of 0084 (BCD) into V7700 sets four channels active and causes the output data value to be read from pointer-designated V-memory as a binary number.

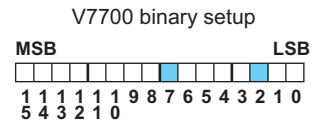
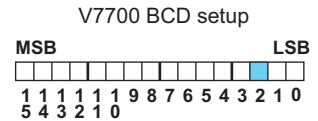

Storage Pointer Setup

System memory location V7702 is used as a pointer. It points to a user memory location where the analog output data is stored by the user program, pending distribution to the output module. An octal number is loaded to the pointer memory to identify the beginning of a block of user memory where output values are stored.

For example, loading O2100 into V7702 causes the CPU to look for Ch 1's output data value in V2100 – 2101, Ch 2's data value in V2102 – 2103, Ch 3's data value in V2104 – 2105, and Ch 4's data value in V2106 – 2107.

You will find an example program that loads appropriate values to V7700 and V7702 on page 9-9.

DL06 Data Formatting

Special V-memory locations are assigned to the four option slots of the DL06 PLC. The table below shows these V-memory locations which can be used to setup the F0-04DAH-2.

Analog Output Module DL06 Special V-memory Locations				
Slot No.	1	2	3	4
Data Type and Number of Channels	V700	V710	V720	V730
Output Pointer	V702	V712	V722	V732

Data Type and Number of Active Channels Setup

System memory locations V700, 710, 720, and 730 are used to set the data format either to BCD or binary and to set the number of channels that will be active.

For example, loading a constant of 0004 (BCD) into V700 sets four channels active and causes the output data value to be read from pointer-designated V-memory as a BCD number.

Alternatively, loading a constant of 0084 (BCD) into V700 sets four channels active and causes the output data value to be read from pointer-designated V-memory as a binary number.

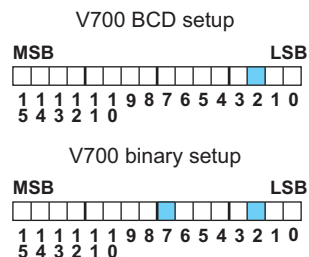

Storage Pointer Setup

System memory locations V702, 712, 722, and 732 are used as pointers. They point to user memory locations where the analog output data is stored by the user program, pending distribution to the output module. An octal number is loaded to the pointer memory to identify the beginning of a block of user memory where output values are stored.

For example, loading O2100 into V702 causes the CPU to look for Ch 1's output data value in V2100 – 2101, Ch 2's data value in V2102 – 2103, Ch 3's data value in V2104 – 2105, and Ch 4's data value in V2106 – 2107.

You will find an example program that loads appropriate values to V7700 and V7702 on page 9-10.

Using the Pointer in Your Control Program

DL05 Pointer Method Using Conventional Ladder Logic



NOTE: The proper use of the DL05 pointer requires that the V-memory address be written to the special memory location on the first scan only. Use the SP0 bit as a permissive contact when using the code shown below.

The example program below shows how to setup the special V-memory locations. This rung can be placed anywhere in the ladder program or in the initial stage if you are using stage programming instructions.

This is all that is required to read the analog output data from V-memory locations. In the example, V2100 is used, but you can use any user V-memory location.

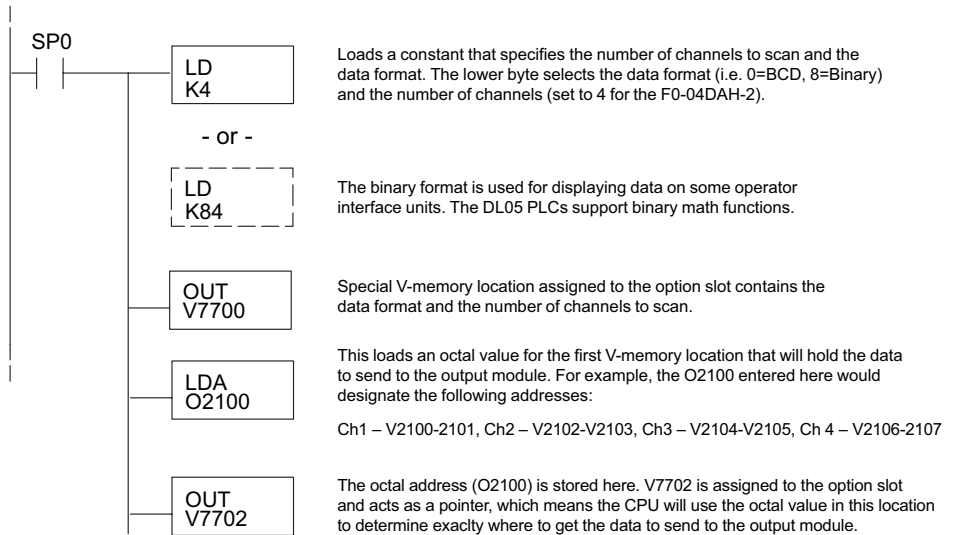

DL05 Pointer Method Using the IBox Instruction Available in DirectSOFT6

The following logic accomplishes the same thing as the previous ladder example, but it uses the IBox instruction ANLGOUT.

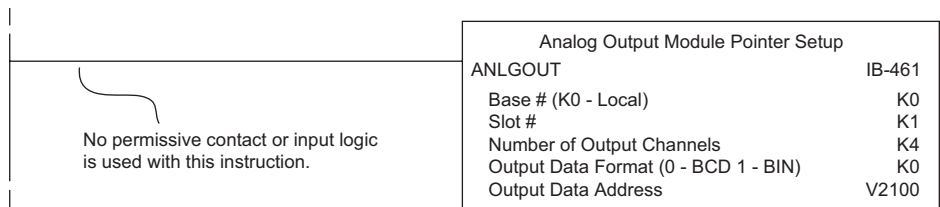

DL06 Pointer Method Using Conventional Ladder Logic



NOTE: The proper use of the DL06 pointer requires that the V-memory address be written to the special memory location on the first scan only. Use the SPO bit as a permissive contact when using the code shown below.

Use the special V-memory table below as a guide to setup the storage pointer in the following example for the DL06. Slot 1 is the left most option slot.

Analog Output Module DL06 Special V-memory Locations				
Slot No.	1	2	3	4
No. of Channels	V700	V710	V720	V730
Output Pointer	V702	V712	V722	V732

The F0-04DAH-2 can be installed in any available DL06 option slot. The ladder diagram below shows how to setup these locations with the module installed in slot 1 of the DL06. Use the above table to determine the pointer values if locating the module in any of the other slot locations. Place this rung anywhere in the ladder program or in the initial stage if you are using stage programming instructions.

This logic is all that is required to write the analog output data from V-memory locations. In the example, V2100 is used, but you can use any user V-memory location.

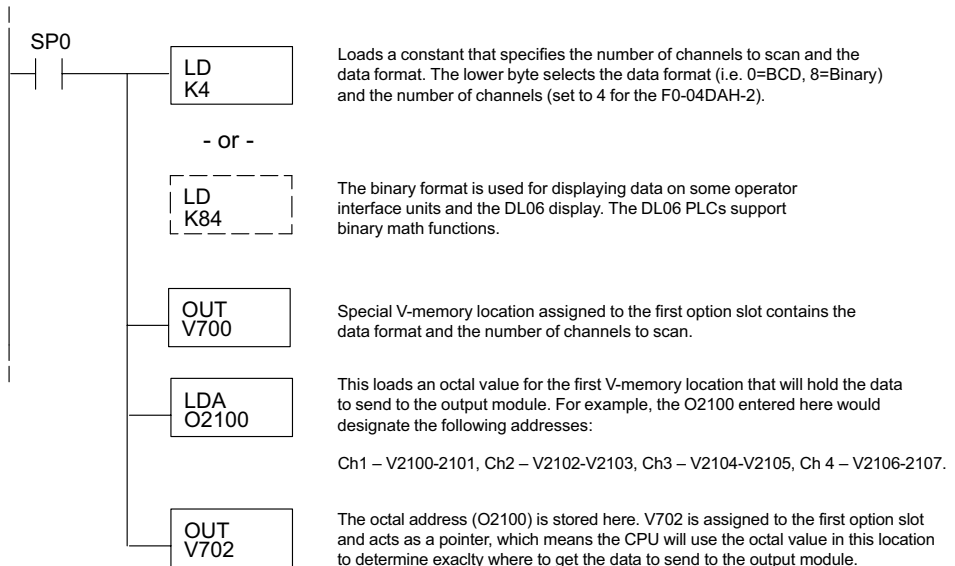

DL06 Pointer Method Using the IBox Instruction Available in DirectSOFT6

The following logic accomplishes the same thing as the previous ladder example, but it uses the IBox instruction ANLGOUT.

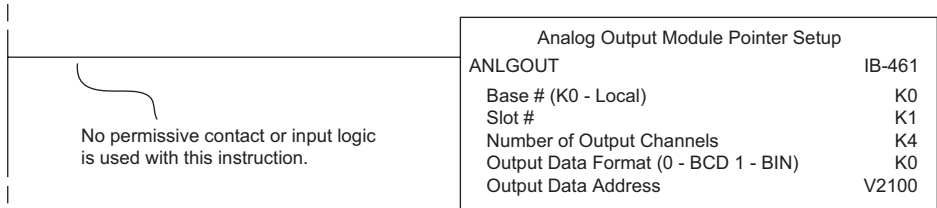

Output Scale Conversion

Calculating the Digital Output Value

Your program has to calculate the digital value to send to the analog output module. Most applications use measurements in engineering units, so it is usually necessary to convert from engineering units to a suitable output value. The conversion to an output value can be accomplished by using the conversion formula shown.

You will need to substitute the engineering units for your scale into the formula to the right.

For example, if you want to output pressure (PSI) between 0.0 and 100.0, you may multiply the pressure value by 10 to store in a V-memory location and eliminate the decimal point. Notice how the calculations differ when you use the multiplier.

The following example demonstrates how to output 49.4 PSI.

$$A = \frac{U - L}{H - L} \cdot 65535$$

U = Engineering units to output

H = High limit of the engineering unit range

L = Low limit of the engineering unit range

A = Analog value (0 – 65535)

Example without multiplier	Example with multiplier
$A = \frac{U - L}{H - L} \cdot 65535$	$A = \frac{U - L}{H - L} \cdot 65535$
$A = \frac{49 - 0}{100 - 0} \cdot 65535$	$A = \frac{494 - 0}{1000 - 0} \cdot 65535$
A = 32112	A = 32374

The Conversion Program in Standard Ladder Logic

The following example shows how you would write the program to perform the engineering unit conversion. This example assumes you have BCD data loaded into the appropriate V-memory locations using instructions that apply for the model of CPU you are using.

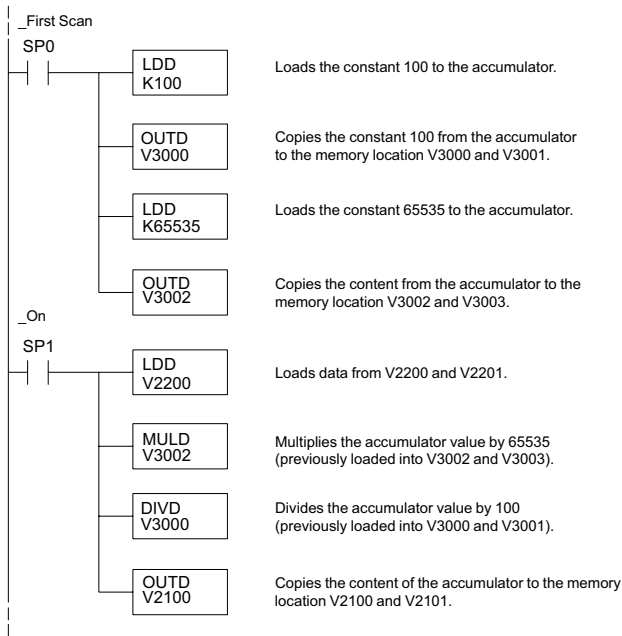

Analog and Digital Value Conversions

Sometimes it is useful to convert between the signal levels and the digital values. This is especially helpful during machine startup or troubleshooting. The following table provides formulas to make this conversion easier.

The formulas in the table show the relationship between A, the analog value, and D, the digital value.

Range	If you know the digital value	If you know the analog signal level
0 to 10VDC	$A = \frac{10}{65535} \cdot D$	$D = \frac{65535}{10} \cdot A$

For example, if you need a 6VDC signal to achieve the desired result, you can use the formula to determine the digital value that should be used.

$$D = \frac{65535}{10} \cdot A$$

$$D = \frac{65535}{10} \cdot 6V$$

$$D = 39321$$

Module Resolution

Analog Data Bits

Two 16-bit words are reserved for the analog data whether you are using BCD or binary data formatting. The 16 bits in the low word represent the analog data in binary format.

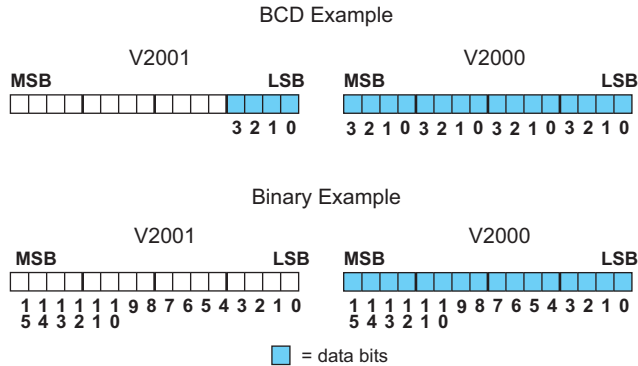

Resolution Details

Since the module has 16-bit resolution, the analog signal is converted into 65536 counts ranging from 0–65535 (2^{16}). A 0VDC signal would be 0 and a 10VDC signal would be 65535. This is equivalent to a binary value of 0000 0000 0000 0000 to 1111 1111 1111 1111, or 000 to FFFF hexadecimal.

Each count can also be expressed in terms of the signal level by using the following equation:

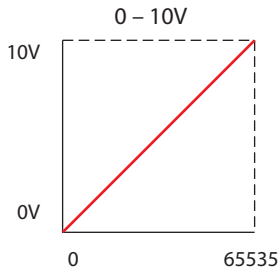

$$\text{Resolution} = \frac{H - L}{65535}$$

H = high limit of the signal range

L = low limit of the signal range

VDC Range	Signal Span (H - L)	Divide By	Smallest Detectable Change
0 to 10 VDC	10VDC	65535	153µV