

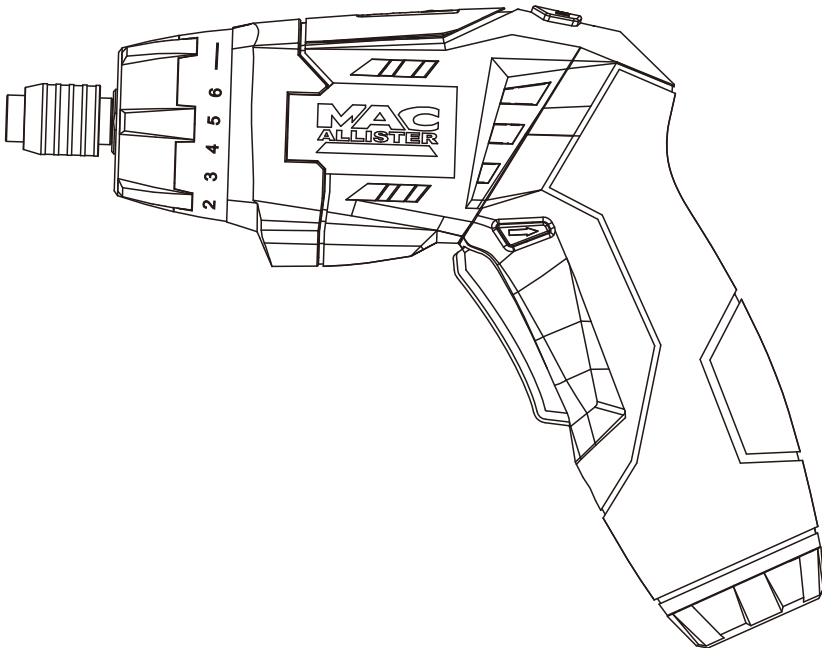

3.6V Cordless Screwdriver



MSSD36T-Li

Barcode: 3663602798897



WARNING: Read the instructions before using the product!

Let's get started...

These instructions are for your safety. Please read through them thoroughly before use and retain them for future reference.



Getting **started**... 02

- Safety** information 03
- Your** product 11
- Before** you **start** 13



In more **detail**... 16

- Product** functions 17
- Operation** 20
- Care** and **maintenance** 21
- Trouble** shooting 23
- Recycling** and **disposal** 24
- Guarantee** 24
- EC** declaration of **conformity** 26

Safety warnings

General power tool safety warnings



WARNING! Read all safety warnings, instructions, illustrations and specifications provided with this power tool. *Failure to follow all instructions listed below may result in electric shock, fire and/or serious injury. Save all warnings and instructions for future reference. The term “power tool” in the warnings refers to your mains-operated (corded) power tool or battery-operated (cordless) power tool.*

Work area safety

- > **Keep work area clean and well lit.** *Cluttered or dark areas invite accidents.*
- > **Do not operate power tools in explosive atmospheres, such as in the presence of flammable liquids, gases or dust.** *Power tools create sparks which may ignite the dust or fumes.*
- > **Keep children and bystanders away while operating a power tool.** *Distractions can cause you to lose control.*

Electrical safety

- > **Power tool plugs must match the outlet. Never modify the plug in any way. Do not use any adapter plugs with earthed (grounded) power tools.** *Unmodified plugs and matching outlets will reduce risk of electric shock.*
- > **Avoid body contact with earthed or grounded surfaces, such as pipes, radiators, ranges and refrigerators.** *There is an increased risk of electric shock if your body is earthed or grounded.*

Safety warnings

- > **Do not expose power tools to rain or wet conditions.** *Water entering a power tool will increase the risk of electric shock.*
- > **Do not abuse the cord. Never use the cord for carrying, pulling or unplugging the power tool. Keep cord away from heat, oil, sharp edges or moving parts.** *Damaged or entangled cords increase the risk of electric shock.*
- > **When operating a power tool outdoors, use an extension cord suitable for outdoor use.** *Use of a cord suitable for outdoor use reduces the risk of electric shock.*
- > **If operating a power tool in a damp location is unavoidable, use a residual current device (RCD) protected supply.** *Use of an RCD reduces the risk of electric shock.*

Personal safety

- > **Stay alert, watch what you are doing and use common sense when operating a power tool. Do not use a power tool while you are tired or under the influence of drugs, alcohol or medication.** *A moment of inattention while operating power tools may result in serious personal injury.*
- > **Use personal protective equipment. Always wear eye protection.** *Protective equipment such as a dust mask, non-skid safety shoes, hard hat, or hearing protection used for appropriate conditions will reduce personal injuries.*

- > **Prevent unintentional starting.** Ensure the switch is in the off-position before connecting to power source and/or battery pack, picking up or carrying the tool. *Carrying power tools with your finger on the switch or energising power tools that have the switch on invites accidents.*
- > **Remove any adjusting key or wrench before turning the power tool on.** *A wrench or a key left attached to a rotating part of the power tool may result in personal injury.*
- > **Do not overreach.** Keep proper footing and balance at all times. *This enables better control of the power tool in unexpected situations.*
- > **Dress properly.** Do not wear loose clothing or jewellery. Keep your hair, clothing away from moving parts. *Loose clothes, jewellery or long hair can be caught in moving parts.*
- > **If devices are provided for the connection of dust extraction and collection facilities, ensure these are connected and properly used.** *Use of dust collection can reduce dust-related hazards.*
- > **Do not let familiarity gained from frequent use of tools allow you to become complacent and ignore tool safety principles.** *A careless action can cause severe injury within a fraction of a second.*

Power tool use and care

- > **Do not force the power tool.** Use the correct power tool for your application. *The correct power tool will do the job better and safer at the rate for which it was designed.*
- > **Do not use the power tool if the switch does not turn it on and off.** *Any power tool that cannot be controlled with the switch is dangerous and must be repaired.*

Safety warnings

- > **Disconnect the plug from the power source and/or the battery pack, if detachable, from the power tool before making any adjustments, changing accessories, or storing power tools.** *Such preventive safety measures reduce the risk of starting the power tool accidentally.*
- > **Store idle power tools out of the reach of children and do not allow persons unfamiliar with the power tool or these instructions to operate the power tool.** *Power tools are dangerous in the hands of untrained users.*
- > **Maintain power tools and accessories. Check for misalignment or binding of moving parts, breakage of parts and any other condition that may affect the power tool's operation. If damaged, have the power tool repaired before use.** *Many accidents are caused by poorly maintained power tools.*
- > **Keep cutting tools sharp and clean.** *Properly maintained cutting tools with sharp cutting edges are less likely to bind and are easier to control.*
- > **Use the power tool, accessories and tool bits etc. in accordance with these instructions, taking into account the working conditions and the work to be performed.** *Use of the power tool for operations different from those intended could result in a hazardous situation.*
- > **Keep handles and grasping surfaces dry, clean and free from oil and grease.** *Slippery handles and grasping surfaces do not allow for safe handling and control of the tool in unexpected situations.*

Battery tool use and care

- > **Recharge only with the charger specified by the manufacturer.** *A charger that is suitable for one type of battery pack may create a risk of fire when used with*

another battery pack.

- > **Use power tools only with specifically designated battery pack.** *Use of any other battery packs may create a risk of injury and fire.*
- > **When battery pack is not in use, keep it away from other metal objects, like paper clips, coins, keys, nails, screws or other small metal objects that can make a connection from one terminal to another.** *Shorting the battery terminals together may cause burns or a fire.*
- > **Under abusive conditions, liquid may be ejected from the battery; avoid contact. If contact accidentally occurs, flush with water. If liquid contacts eyes, additionally seek medical help.** *Liquid ejected from the battery may cause irritation or burns.*
- > **Do not use a battery pack or tool that is damaged or modified.** *Damaged or modified batteries may exhibit unpredictable behaviour resulting in fire, explosion or risk of injury.*
- > **Do not expose a battery pack or tool to fire or excessive temperature.** *Exposure to fire or temperature above 130 °C may cause explosion.*
- > **Follow all charging instructions and do not charge the battery pack or tool outside the temperature range specified in the instructions.** *Charging improperly or at temperatures outside the specified range may damage the battery and increase the risk of fire.*

Service

- > **Have your power tools serviced by a qualified repair person using only identical replacement parts.** *This will ensure that safety of the power tool is maintained.*
- > **Never service damaged battery packs.** *Service of battery packs should only be performed by the manufacturer or authorized service providers.*

Safety warnings

Screwdriver safety warnings

> Hold power tool by insulated gripping surfaces, when performing an operation where the fastener may contact hidden wiring. *Fastener contacting a "live" wire may make exposed metal parts of the power tool "live" and could give the operator an electric shock.*

Additional safety warnings for charger

- > *This appliance can be used by children aged from 8 years and above and persons with reduced physical, sensory or mental capabilities or lack of experience and knowledge if they have been given supervision or instruction concerning use of the appliance in a safe way and understand the hazards involved.*
- > *Children shall not play with the appliance. Cleaning and user maintenance shall not be made by children without supervision.*
- > *The charger and the cordless screwdriver supplied with it are specifically designed to work together. Only use the charger with the cordless screwdriver.*
- > *Charge the product indoors only as the charger is designed for indoor use only.*
- > *Do not charge non-rechargeable batteries.*
- > *Protect the charger against moisture and wet conditions. There is a danger of electric shock.*

Additional safety warnings for built-in battery

- > *Charge/operate and store the product in an ambient temperature of 15-25°C to ensure the longest battery life and best performance. Do not charge/operate or store the battery in temperatures below 5°C and above 40°C.*

- >Never attempt to open the product housing for any reason. If the plastic housing of the product breaks open or cracks, immediately discontinue its use and do not recharge it.*
- >Do not pierce the product with nails, strike the battery with a hammer, step on the product or otherwise subject it to strong impacts or shocks.*
- >Protect the product against heat. Do not place the product in direct sunlight or use or store the product inside cars in hot weather. Doing so may cause the battery to generate heat, explode or ignite.*

Residual risks

Even if you are operating this product in accordance with all the safety requirements, potential risks of injury and damage remain. The following dangers can arise in connection with the structure and design of this product:

- >Health defects resulting from vibration emission if the product is being used over long periods of time or not adequately managed and properly maintained.*
- >Danger of injury and property damage caused by flying objects.*

Symbols



On the product, the rating label and within these instructions you will find among others the following symbols and abbreviations. Familiarize yourself with them to reduce hazards like personal injuries and damage to property.

 Lock / to tighten or secure.  Unlock / to loosen.

 Note / Remark.  Caution / Warning.

 Read the instruction manual.  Wear hearing protection.

 Wear eye protection.  Wear protective, slip-resistant footwear.

 Wear protective gloves.  Polarity

yyWxx Manufacturing date code; year of manufacturing (20yy) and week of manufacturing (Wxx)

 Switch the product off and disconnect from the power supply before assembly, cleaning, adjustments, maintenance, storage and transportation.

 This product is of protection class II. That means it is equipped with enhanced or double insulation.

 The product complies with the applicable European directives and an evaluation method of conformity for these directives was done.

 WEEE symbol. Waste electrical products should not be disposed of with household waste. Please recycle where facilities exist. Check with your Local Authority or local store for recycling advice.

 Indoor use only.

 Approx. 1h Charging time.
1h

Your product

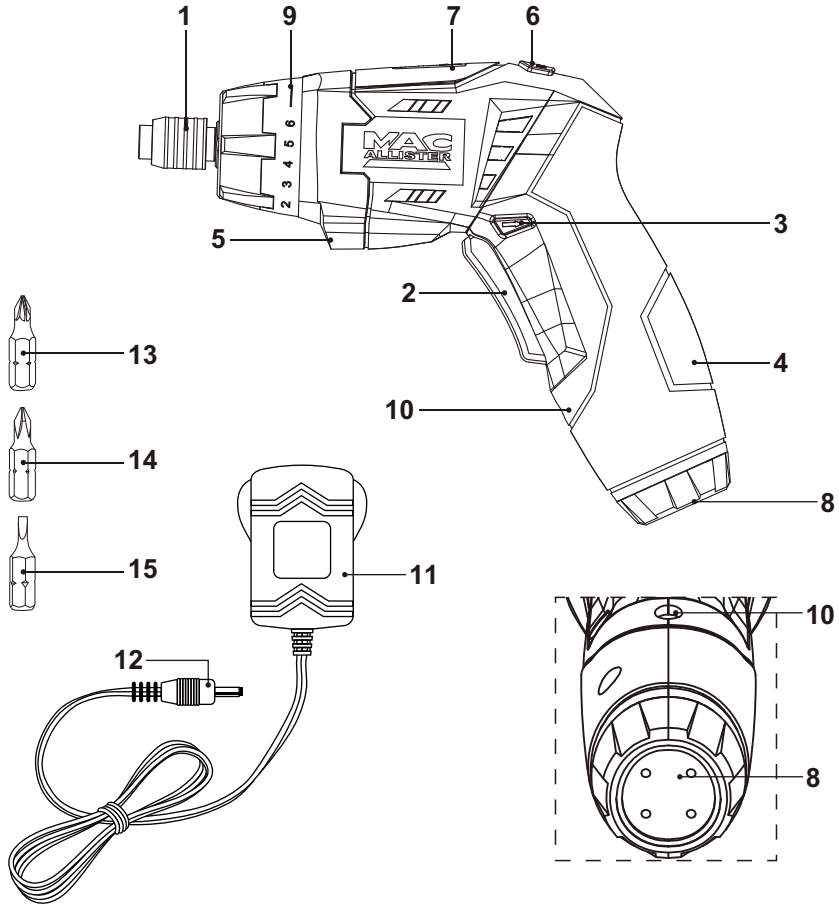

1. Tool socket with lock sleeve
2. On/off switch
3. Forward/Reverse rotation control
4. Handle
5. Work light
6. Unlock button
7. Indicator lights with switch
8. On/off switch button for Flash light

9. Torque setting
10. Charging socket
11. Charger
12. Charger jack
13. 25mm Driver bit PZ (x1)
14. 25mm Driver bit PH (x1)
15. 25mm Driver bit slotted (x1)

Technical specifications



Screwdriver

- > **Rated voltage** : 3.6V 
- > **Rated no load speed n_0** : 200 min⁻¹
- > **Tool socket** : Hex 6.35 mm
- > **Maximum torque** : 5 Nm
- > **Weight** : approx. 0.5 kg

Built-in battery

- > **Type** : Li-Ion
- > **Capacity** : 1300 mAh
- > **Voltage** : 3.6V 

Charger

- > **Model no.** : MC4BS-Li
- > **Rated input voltage** : 100-240V~, 50-60Hz
- > **Rated input power** : 15 W
- > **Rated output voltage** : 5 V 
- > **Rated output current** : 1650 mA
- > **Protection class** : II 
- > **Charging time** : approx. 1 h
- > **Weight** : approx. 0.08 kg

Sound values

- > **Sound pressure level L_{pA}** : 54 dB(A)
- > **Sound power level L_{WA}** : 65 dB(A)
- > **Uncertainty K_{pA} , K_{WA}** : 3 dB(A)

Hand arm vibration values

- > **Screwdriving a_h** : 0.3 m/s²
- > **Uncertainty K** : 1.5 m/s²

Rating Label Explanation

MSSD36T-Li

- : MS=MacAllister
- SD=Screwdriver
- 36=3.6Volts
- T=Torch
- Li=Lithium Ion

The sound intensity level for the operator may exceed 80 dB(A) and ear protection measures are necessary.

Technical specifications

The declared vibration total values and the declared noise emission values have been measured in accordance with a standard test method and may be used for comparing one tool with another; they may also be used in a preliminary assessment of exposure.



WARNING! The vibration and noise emissions during actual use of the power tool can differ from the declared values depending on the ways in which the tool is used especially what kind of workpiece is processed; and need to identify safety measures to protect the operator that are based on an estimation of exposure in the actual conditions of use (taking account of all parts of the operating cycle such as the times when the tool is switched off and when it is running idle in addition to the trigger time).

Unpacking

- > Unpack all parts and lay them on a flat, stable surface.
- > Remove all packing materials and shipping devices, if applicable.
- > Make sure the delivery contents are complete and free of any damage. If you find that parts are missing or show damage do not use the product but contact your dealer. Using an incomplete or damaged product represents a hazard to people and property.
- > Ensure that you have all the accessories and tools needed for assembly and operation. This also includes suitable personal protective equipment.



WARNING! The product and the packaging are not children's toys! Children must not play with plastic bags, sheets and small parts! There is a danger of choking and suffocation!

You will need

(items not supplied)

suitable personal protective equipment
suitable bit holder

(items supplied)

Charger (11)
25mm Driver bit PZ (x1) (13)
25mm Driver bit PH (x1) (14)
25mm Driver bit slotted (x1) (15)

Setup



WARNING! The product must be fully assembled before operation! Do not use a product that is only partly assembled or assembled with damaged parts!

Follow the assembly instructions step-by-step and use the pictures provided as a visual guide to easily assemble the product!

Do not connect the product to power supply before it is completely assembled!

Driver bits

Different driver bits can be used with this product depending on the screw heads being worked with. Use only Hex 6.35 mm bits which are 25 mm or 50 mm long.

- > Insert a suitable driver bit all the way to the stop into the tool socket (1).
- > Push backward and hold the tool socket lock sleeve(1), then remove the driver bit from the tool socket.

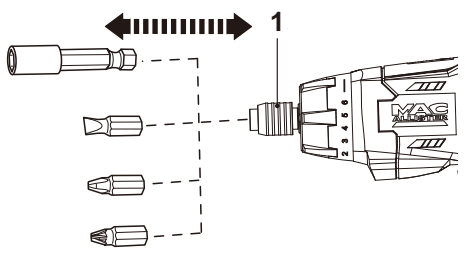

Fig. 1



NOTE: Use a suitable bit holder to access areas that are hard to reach. Insert the bit holder into the socket in the same way as the driver bits, then insert a driver bit into the bit holder.

Charge

The battery of this product is integrated in the handle and cannot be removed. The battery has been shipped in a low charge condition. Charge it fully before first use.



WARNING! The product cannot be operated while charging! Charge in a safe location away from moisture or heat sources!

Charge

- > Plug the charger jack (12) into the charging socket (10) on the handle (4) (Fig. 2).
- > Connect the charger (11) to the power supply.
- > The indicator light (7) shows the charging status.

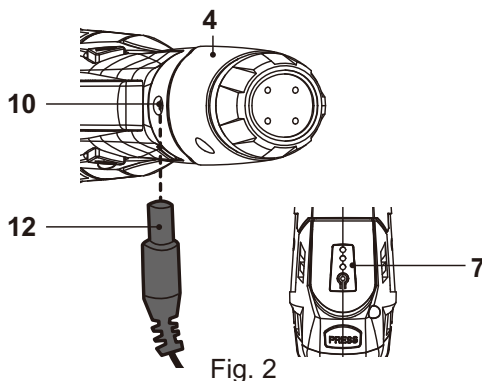

Fig. 2

RED - charging

GREEN - charging finished



WARNING! Check the voltage! The voltage must comply with the information on the rating label!



NOTE: It is normal for the battery pack and charger to become warm (but not hot) during the charging process. Depending on temperature and existing charge level, the actual charging time may change.

- > After charging finished (this normally takes about 1 hour), disconnect the charger from the power supply and then pull the charger jack (12) from the charger socket (10).



WARNING! Always charge the product before storage! It's important to disconnect the charger from the power supply after charging finished. Cool down a just-operated product for approximately 30 minutes before attempting to recharge.

Indicator lights

Switch on the indicator lights (7) by pressing the small button next to them, the lights show the battery status as below:

RED LED	YELLOW LED	GREEN LED	BATTERY STATUS
ON ●	ON ●	ON ●	Fully charged
ON ●	ON ●	OFF ○	Less than 70% charged
ON ●	OFF ○	OFF ○	Less than 45% charged and needs to be recharged.

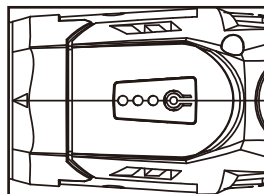
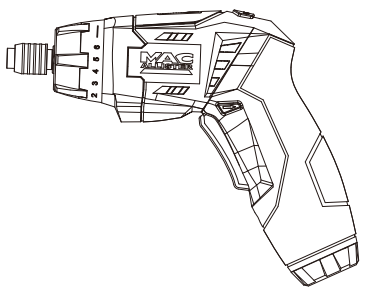

Fig. 3



In more detail...

Product functions	17
Operation	20
Care and maintenance	21
Trouble shooting	23
Recycling and disposal	24
Guarantee	24
EC declaration of conformity	26



Intended use

This product is intended for light fastening and removing screws with 25 mm or 50 mm driver bits. The product is not suitable for heavy duty screw driving work into hard wood or with large diameter screws. It must not be used for drilling and should not be used for working on materials that are dangerous to health. For safety reasons it is essential to read the entire instruction manual before first operation and to observe all the instructions therein.

On/off switch

- > Switch the product on by pressing the on / off trigger switch (2).
- > Switch the product off by releasing the trigger switch (2).

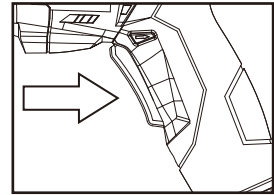

Fig. 4

Forward / reverse rotation control









Change the rotational direction from forward to reverse by pressing the forward / reverse rotation control (3).

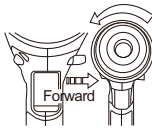

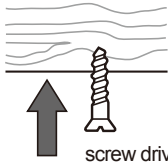
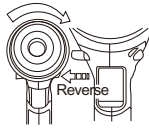
WARNING! Only change the rotational direction when the product is switched off and has come to a complete stop! Always ensure that the forward / reverse rotation control is adjusted to the correct position depending on the intended operation!

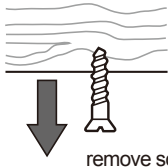
Always push the forward / reverse rotation control as far as it will go!
Do not use the product with the control switch in any other intermediate position!

1. Move the forward / reverse rotation control switch (3) to the left (as seen from the operators position) in order to use the product in a clockwise rotational mode (Fig. 5).
2. Move the forward / reverse rotation control switch (3) to the right (as seen from the operators position) in order to use the product in anticlockwise rotational mode (Fig. 6).
3. Move the forward / reverse rotation control switch (3) to the centre position to lock the on/off switch and avoid accidental starting (Fig. 7).

Position	Rotational direction	Application
 <p>Fig. 5</p>		 <p>screw driving</p>
 <p>Fig. 6</p>		 <p>remove screw</p>
 <p>Fig. 7</p>		 <p>lock the on/off switch and avoid accidental starting</p>



NOTE: If you are using the product for the first time after changing the rotational direction, a locking sound may be heard. This is normal and does not represent a defect.

Handle position

This product has two handle positions for optimum performance in different work location. The pistol position provides a firm grip for those jobs where more torque is required. The rod position suits narrow working areas.



WARNING! Only change the position when the product is switched off and has come to a complete stop!

Always rotate the handle as far as it will go! Do not use the product with the handle in any other intermediate position!

Make sure that the handle clicks in place. Never use the product if the handle has not been fully locked!

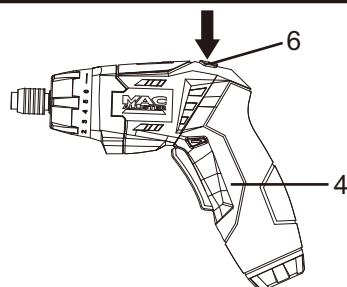

Fig. 8 pistol position

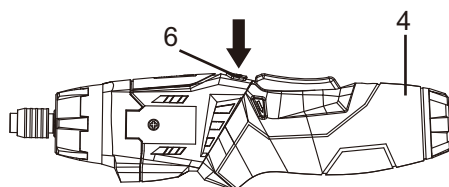

Fig. 9 rod position

To change to rod position, press and hold the unlock button (6) and rotate the handle (4) clockwise at the same time until it locks in place (Fig. 8).

To change to pistol position, press and hold the unlock button (6) and rotate the handle (4) anti-clockwise at the same time until it locks in place (Fig. 9).

Torque adjustment

By rotating the torque adjustment collar (9) behind the chuck, it is possible to adjust the output torque to each of seven settings. The range of seven torque settings allows better control when using as it prevents overtightening of the screws.

The numbers circling the collar are used to indicate the level of torque.

The higher number on the collar, the higher torque and the larger fastener can be driven. To select any of the numbers, rotate the collar (9) until the desired number aligns with the arrow head indicator on the housing.

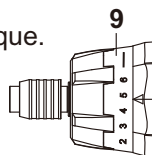

Fig. 10

Flash light

To turn the flash light on, depress the on/off switch button(8) and release.
To turn the flash light off, depress the on/off switch button(8) and release again.

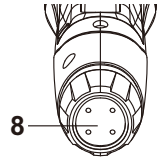

Fig. 11

Automatic work light

The work light (5) will automatically illuminate by pressing the on/off switch(2).

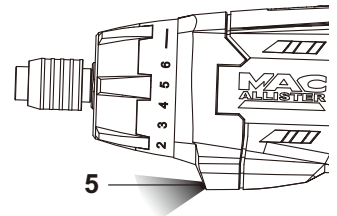

Fig. 12



WARNING! Do not look directly into the light flash light and work light.

General operation

- > Check the product and charger as well as accessories for damage before each use. Do not use the product if it is damaged or shows wear.
- > Double check that the accessories and attachments are properly fixed.
- > Always hold the product on its handle. Keep the handle dry to ensure safe support.
- > Switch the product off immediately if you are disturbed while working by other people entering the working area. Always let the product come to complete stop before putting it down.
- > Do not overwork yourself. Take regular breaks to ensure you can concentrate on the work and have full control over the product.
- > Where possible, secure smaller workpieces to prevent them from moving during operation.

In more detail...

General operation



WARNING! Keep in mind that there are buried objects hidden in every household! Ensure that there are no gas, water or power lines hidden in the working area that may be hit before operation – danger of electrical shock and serious damage to people and property! Use a suitable detector to trace such objects in advance!

Screw driving

- > Pre-drill the holes with a smaller diameter of the screw to be screwed.
- > Hold the product perpendicular to the screw to be screwed in/out. Holding it at an angle may cause slipping or jamming of the driver bit.
- > Place the tip of the driver bit directly on the screw first and then switch the product on.
- > Only apply as much pressure as necessary to keep the screw in place and the driver bit in contact with the screw head. Too much pressure will cause damage to the screw head and driver bit, too little pressure will cause the driver bit to slide away.
- > Remove blocked and stuck screws by changing the rotational direction.

After use

- > Switch the product off and let it cool down.
- > Check, clean and store the product as described below.

The golden rules for care



WARNING! Always switch the product off, disconnect the product from the power supply and let the product cool down before performing inspection, maintenance and cleaning work!



- > Keep the product clean. Remove debris from it after each use and before storage.
- > Regular and proper cleaning will help ensure safe use and prolong the life of the product.

- > Inspect the product before each use for worn and damaged parts. Do not operate it if you find broken and worn parts.



WARNING! Only perform repairs and maintenance work according to these instructions! All further works must be performed by a qualified specialist!

General cleaning

- > Clean the product with a dry cloth. Use a brush for areas that are hard to reach.
- > Remove stubborn dirt with high pressure air (max. 3 bar).



NOTE: Do not use chemical, alkaline, abrasive or other aggressive detergents or disinfectants to clean this product as they might be harmful to its surfaces.

- > Check for worn or damaged parts. Replace worn parts as necessary or contact an authorised service centre for repair before using the product again.

Maintenance

Before and after each use, check the product and accessories (or attachments) for wear and damage. If required, exchange them for new ones as described in this instruction manual. Observe the technical requirements.

Repair

This product does not contain any parts that can be repaired by the consumer. Contact an authorised service centre or a similarly qualified person to have it checked and repaired.

Storage

- > Switch the product off.
- > Clean the product as described above.
- > Store the product and its accessories in a dark, dry, frost-free, well-ventilated place.
- > Always store the product in a place that is inaccessible to children.
- > We recommend using the original package for storage or covering the product with a suitable cloth or enclosure to protect it against dust.

Transportation

- > Switch the product off.
- > Attach transportation guards, if applicable.
- > Always carry the product by its handle.
- > Protect the product from any heavy impact or strong vibrations which may occur during transportation in vehicles.
- > Secure the product to prevent it from slipping or falling over.

Troubleshooting

Suspected malfunctions are often due to causes that the users can fix themselves. Therefore check the product using this section. In most cases the problem can be solved quickly.



WARNING! Only perform the steps described within these instructions! All further inspection, maintenance and repair work must be performed by an authorised service centre or a similarly qualified specialist if you cannot solve the problem yourself!

Problem	Possible Cause	Solution
1. Product does not start	1.1 Battery discharged 1.2 Battery damaged 1.3 Other electrical defect to the product	1.1 Charge battery 1.2 Check by a specialist electrician 1.3 Check by a specialist electrician
2. Product does not reach full power	2.1 Battery capacity too low	2.1 Charge battery
3. Unsatisfactory result	3.1 Driver bit is worn 3.2 Driver bit not suitable for intended operation	3.1 Replace with a new one 3.2 Use suitable driver bit

Recycling and disposal



Waste electrical products should not be disposed of with household waste. Please recycle where facilities exist.

Check with your Local Authority or local store for recycling advice.

Disposal of an exhausted battery pack

The built-in battery is Li-Ion type. To preserve natural resources, please recycle or dispose of the battery properly.

Consult your local waste authority for information regarding available recycling and/ or disposal options.

Discharge your battery by operating your product before disposal.

To remove the built-in battery from the product, separate the handle shells from one another by removing the fixing screws for handle, disconnect the battery from the circuit with a suitable tool. Fully wrap it with tape to avoid exposing two conductive ends of the battery.

Guarantee

At MacAllister we take special care to select high quality materials and use manufacturing techniques that allow us to create ranges of products incorporating design and durability. That's why we offer a 2 year guarantee against manufacturing defects on our MacAllister power tool products.

This power tool is guaranteed for 2 years from the date of purchase, if bought in store, delivered or if bought online. You may only make a claim under this guarantee upon presentation of your sales receipt or purchase invoice. Please keep your proof of purchase in a safe place.

This guarantee covers product failures and malfunctions provided the MacAllister power tool was used for the purpose for which it is intended and subject to installation, cleaning, care and maintenance in accordance with standard practice and with the information contained above and in the user manual. This guarantee does not cover defects and damage caused by or resulting from:

- Normal wear and tear
- Overload, misuse or neglect
- Repairs attempted by anyone other than an authorised agent
- Cosmetic damage
- Damage caused by foreign objects, substances or accidents
- Accidental damage or modification
- Failure to follow manufacturer's guidelines
- Loss of use of the goods

This guarantee is limited to parts recognised as defective. It does not, in any case, cover ancillary costs (movement, labour) and direct and indirect damage.

If the MacAllister power tool is defective during the guarantee period, then we reserve the right, at our discretion, to replace the item with a product of equivalent quality and functionality or to provide a refund.

This guarantee only applies to the country of purchase or delivery and is not transferrable to any other countries. This guarantee is non-transferrable to any other person or product. Relevant local law will apply to this guarantee.

Guarantee related queries should be addressed to a store affiliated with the distributor from where you purchased the MacAllister power tool.

This guarantee is in addition to and does not affect your statutory rights relating to faulty goods as a consumer.

In more detail...

EC declaration of conformity

We
Kingfisher International Products Limited
3 Sheldon Square
London W2 6PX
United Kingdom

Declare that the product
MSSD36T-Li 3.6V Cordless screwdriver
Serial number: from 000001 to 999999

Complies with the essential health and safety requirements of the following directives:

The Low Voltage Directive 2014/35/EU

EN 60335-1:2012+A11:2014

EN 60335-2-29:2004+A2:2010

EN 62233:2008

The Machinery Directive 2006/42/EC

EN 62841-1:2015

EN 62841-2-2:2014

The EMC Directive 2014/30/EU

EN 55014-1: 2006 + A1: 2009 + A2: 2011

EN 55014-1:2017

EN 55014-2:2015

EN 61000-3-2:2014

EN 61000-3-3:2013

The Rohs Directive 2011/65/EU

WEEE WASTE ELECTRICAL AND ELECTRONIC EQUIPMENT DIRECTIVE 2012/19/EU
Regulation (EC) No 1907/2006, concerning the Registration, Evaluation, Authorization and
Restriction of Chemicals (REACH)

Authorized Signatory and technical file holder

Signed for and on behalf of:

Kingfisher International Products Limited

3 Sheldon Square

London W2 6PX

United Kingdom

Lisa Davis
Group Quality Director



on: 12/06/2018



**Manufacturer • Fabricant • Producent
Hersteller • Producator • Fabricante:**

Kingfisher International Products Limited
3 Sheldon Square
London
W2 6PX
United Kingdom
www.kingfisher.com/products



Distributor:

B&Q plc,
Chandlers Ford, Hants,
SO53 3LE United Kingdom
www.diy.com

Screwfix Direct Limited
Trade House, Mead Avenue
Yeovil
BA22 8RT, United Kingdom
www.screwfix.com

To view instruction manuals online
visit www.kingfisher.com/products
