

User's Reference Series

# DASHER™ Display Terminals Models D100 / D200



User's Reference Series

**DASHER™ Display Terminals**  
**Models D100 / D200**

## NOTICE

Data General Corporation (DGC) has prepared this manual for use by DGC personnel and customers. The information contained herein is the property of DGC and shall not be reproduced in whole or in part without DGC's prior written approval.

Users are cautioned that DGC reserves the right to make changes without notice in the specifications and materials contained herein and shall not be responsible for any damages (including consequential) caused by reliance on the materials presented, including, but not limited to typographical, arithmetic, or listing errors.

**NOVA**, **INFOS**, and **ECLIPSE** are registered trademarks of Data General Corporation, Westboro, Massachusetts. **DASHER** and **microNOVA** are trademarks of Data General Corporation, Westboro, Massachusetts.

## FIRST EDITION

*(First Printing October 1979)*

Ordering No. 014-000640  
©Data General Corporation, 1979  
All Rights Reserved  
Printed in the United States of America  
Rev. 00, October 1979

## PREFACE

The DASHER<sup>TM</sup> D100/D200 User's Manual provides a wide spectrum of product information. Each chapter is intended to support a specific user requirement.

- Chapter 1 provides the systems programmer or engineer with a description of the functional capabilities of the display terminals. (The technical specifications appear on the inside of the front cover).
- Chapter 2 explains to the programmer the codes required to drive and manipulate the display of information on the terminal's screen. This chapter also explains how a group of special codes that are totally user definable can be generated by the keyboards.
- Chapters 3 and 4 provide the systems engineer and installer with interfacing, cabling, installation and checkout information and instructions.
- Chapter 5 describes the basic components that comprise the display terminals and provides an overview of theory of operation for the systems engineer.

A companion book, the DASHER D100/D200 Operator's Manual (DGC No. 014-000641), tells how to operate the display terminals.



# CONTENTS

<b>CHAPTER 1</b>	<b>PRODUCT OVERVIEW</b>
1	DISPLAY
1	KEYBOARD
2	User Function Keys
2	DIAGNOSTICS
2	SPLIT-BAUD AND PRINTER OPTION
<b>CHAPTER 2</b>	<b>PROGRAMMING</b>
1	TRANSMISSION AND RECEPTION
1	ON-LINE/OFF-LINE MODE
1	KEYBOARD
1	User Function Codes
4	DISPLAY
4	Display Commands
<b>CHAPTER 3</b>	<b>INTERFACING AND CABLING</b>
1	COMMUNICATIONS INTERFACE
1	Cabling
6	OPTIONAL PRINTER INTERFACE
<b>CHAPTER 4</b>	<b>INSTALLATION</b>
1	CHOOSING A SITE
3	UNPACKING
4	COMMUNICATIONS INTERFACE TAILORING
5	PRINTER INTERFACE TAILORING
5	OPERATIONAL CHECK-OUT
5	Off-line Check-out
6	On-line Check-out
7	PROBLEM DIAGNOSIS

**CHAPTER 5**

**1**  
**1**  
**1**  
**4**  
**4**  
**4**  
**4**  
**4**  
**4**  
**6**  
**6**  
**6**  
**6**  
**6**

**APPENDIX A**

**APPENDIX B**

**APPENDIX C**

**APPENDIX D**

**GLOSSARY**

**ARCHITECTURE**

**PRINTED CIRCUIT BOARD**

**Control Logic**

**Display Logic**

**Interface Logic**

**Power Supply**

**CRT/YOKE ASSEMBLY**

**KEYBOARD**

**OPERATION**

**Powering Up**

**Scanning Keyboard**

**Communications Interface**

**Processing Codes**

**Displaying Characters**

**ASCII-128 CONTROL CODES**

**ASCII CODES DISPLAYED BY D100/D200  
TERMINALS**

**CODE SEQUENCES GENERATED BY  
D100/D200 TERMINALS**

**INTERNATIONAL CHARACTER FONTS**



Figure 1.1 DASHER D100 and D200 Display Terminals

# Chapter 1

## PRODUCT OVERVIEW

DASHER D100/D200 display terminals are ASCII-based, soft-copy devices that support the full upper/lower case, alphanumeric, printing character set. Both terminals are offered with the following choice of international character fonts: American, British, Danish/Norwegian, French, German, Spanish and Swedish/Finnish.

Designed for use in a wide range of interactive terminal applications, D100/D200 terminals communicate with a computer in full-duplex mode over either a 20mA current loop or EIA RS232-C communications line. Both models support a subset of standard EIA modem control functions that allows them to interface to Bell 103, 113 or 212 compatible modems.

D100/D200 terminals consist of two units: a CRT display (mounted on a swivel base) and a detached keyboard. A 3.95 foot (1.2 meter) external cable connects them. On line, the display and keyboard function as two independent I/O devices while sharing a common asynchronous interface located in the display unit to communicate with a computer.

The terminal's asynchronous interface transmits and receives serial data bursts at transmission rates ranging from 50 to 19200 bits per second. Additionally, D100/D200 terminals have a *split-baud and printer option*. When present, this option allows the transmit and receive transmission rates to be selected independently. While each serial data burst must contain 1 start bit and 7 data bits, the remaining code parameters (parity type and number of stop bits) as well as the data transmission rate(s) are switch-selectable.

### DISPLAY

The display unit of both terminals has a 1920-character, semiconductor memory and a non-interlaced video monitor with a 12 inch diagonal screen. The screen's active area is 8.5 inches by 5.5 inches, formatted as 24 lines, 80 characters per line.

All printing characters sent to the display are stored in memory and displayed on the screen as 7 by 11 dot matrices. The non-destructive cursor is displayed as a solid 7 by 11 white field; i.e., all dots in the 7 by 11 matrix are intensified.

The display interprets a subset of the ASCII-128 control characters as display commands. In general, D100/D200 display commands can be divided into three functional groups:

- Screen control and cursor commands
- Character attribute commands
- Terminal identification and remote diagnostic commands

The first command group controls screen erasing, blinking, and rolling as well as cursor positioning and sensing.

The second command group assigns one or more of the following attributes to displayable characters: *blink*, *dim*, *underscore* and/or *reverse video* (black character on a white field). Since attributes are added to characters as they are stored in the display's memory, they can be added or deleted on a character-by-character basis.

The third command group initiates the transmission of terminal identification information to the computer. It also places the terminal in diagnostic mode. In this mode, DASHER D100/D200 diagnostic programs can be remotely loaded from the computer and executed by the terminal's internal microprocessor.

### KEYBOARD

Figures 1.2 and 1.3 show the D100 and D200 keyboards, respectively. Both keyboards have typewriter-style main keypads and incorporate a *typematic* facility. *Typematic* allows the user to repeat a character (at a 10 character per second rate) by simply pressing a key for a period of one second or more.

In addition to the main keypad, the keyboards contain one or more supplementary keypads. D100 keyboards contain a single supplementary keypad that combines screen management functions with standard numeric keys. D200 keyboards contain two supplementary keypads — screen management and numeric — plus 15 user function keys.





PH0253.

Figure 1.2 DASHER D100 Keyboard



PH0255.

Figure 1.3 DASHER D200 Keyboard

## User Function Keys

While the D200 keyboard has 15 dedicated user function keys, D100 and D200 keyboards can generate 35 and 75 unique user function codes, respectively. These codes, consisting of two-code sequences, are user definable and thus expand the functional capability of the keyboards from an applications viewpoint.

## DIAGNOSTICS

On power-up, D100/D200 terminals execute a self-test that verifies the proper operation of the terminal's control logic and the presence of the keyboard. If the terminal fails its self-test, it generates a bell tone and displays a failure code on the screen.

On command, the terminals execute remotely loaded diagnostics.

## SPLIT-BAUD AND PRINTER OPTION

This option expands the capabilities of D100/D200 terminals in the following manner.

The *split-baud* portion of the option allows independent selection of transmit and receive transmission rates. When the option is selected, the terminal receives information at rates ranging from 50 to 19200 bits per second and transmits information at rates ranging from 110 to 4800 bits per second.

The *printer* portion of the option interfaces an ASCII-based, serial printer directly to the terminal, thus providing facilities for hardcopy output of information displayed on the screen.



PH0249.

Figure 1.4 DASHER D200 Display with DASHER TP2 Printer

# Chapter 2

## PROGRAMMING

From a programmer's point of view, the DASHER D100/D200 display terminal consists of two independent I/O devices — a keyboard input device and a display output device. Thus, on-line communication between them must be provided by the computer's software. This means that all displayable information entered at the keyboard must be *echoed* to the display by the executing program.

### TRANSMISSION AND RECEPTION

D100/D200 terminals transmit and receive information serially, one character at a time. The transmission rate and portions of the serial character format are defined by the setting of switches located in the display unit.

Data transmission rates range from 50 to 19,200 bits per second. The format of each serial character appears below.

- 1 start bit
- 7 data bits
- 1 or 0 parity bit — switch-selectable
- 1 or 2 stop bits — switch selectable

If selected, parity can be even, odd, or mark. The number of stop bits selected normally depends upon the data transmission rate. For more information, refer to Chapter 4, Installation.

Once the terminal's transmission rate and character code format are selected, all data transmitted by the terminal will conform to these conventions. Furthermore, all data received by the terminal must also conform to the selected conventions; otherwise, a transmission error will occur. The terminal indicates a transmission error by displaying a white field that is smaller than the cursor.

### ON-LINE/OFF-LINE MODE

On power-up, the terminal executes a self-test. At the conclusion of a successful self-test, it senses the communications interface connector. If the connector is properly inserted, the terminal enters on-line mode. After this occurs, the operating mode of the terminal, on- or off-line, can be selected by the operator at the keyboard.

### KEYBOARD

D100/D200 keyboards can transmit the 96 graphic characters of the ASCII-128 character set as well as 30 of the 32 ASCII control characters. These codes are listed in appendices A and B.

The keyboards cannot *independently* transmit the following ASCII control characters: Unit Separator ( $037_g$ ) and Record Separator ( $036_g$ ).

Unit Separator is the header code for a three-code sequence. The terminal transmits this code sequence in response to a display command requesting cursor position information. This is explained more fully under the Read Cursor Address command description later in this chapter.

### User Function Codes

Record Separator is the header code for all user function codes; i.e., the keyboard transmits this control code as the first code in each user-function, two-code sequence. The second code is one of the ASCII characters listed in Appendix C. D200 keyboards can transmit 75 unique, user function, two-code sequences while D100 keyboards can transmit 35 of them. Figures 2.1 and 2.2 define the location of the user function keys on the D100 and D200 keyboards, respectively.

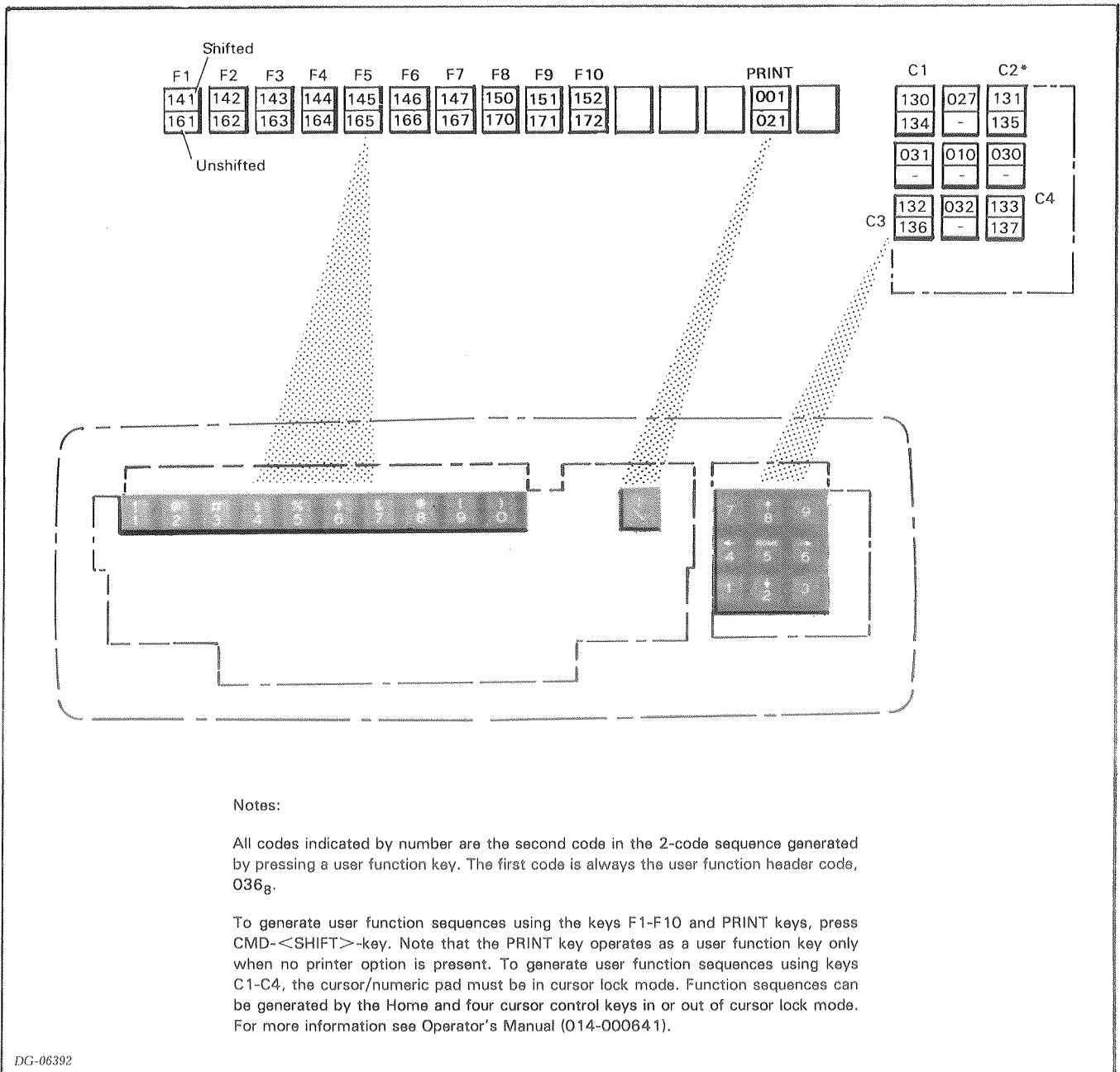

**Notes:**

All codes indicated by number are the second code in the 2-code sequence generated by pressing a user function key. The first code is always the user function header code, 036<sub>8</sub>.

To generate user function sequences using the keys F1-F10 and PRINT keys, press CMD-<SHIFT>-key. Note that the PRINT key operates as a user function key only when no printer option is present. To generate user function sequences using keys C1-C4, the cursor/numeric pad must be in cursor lock mode. Function sequences can be generated by the Home and four cursor control keys in or out of cursor lock mode. For more information see Operator's Manual (014-000641).

DG-06392

Figure 2.1 D100 User Function Keys



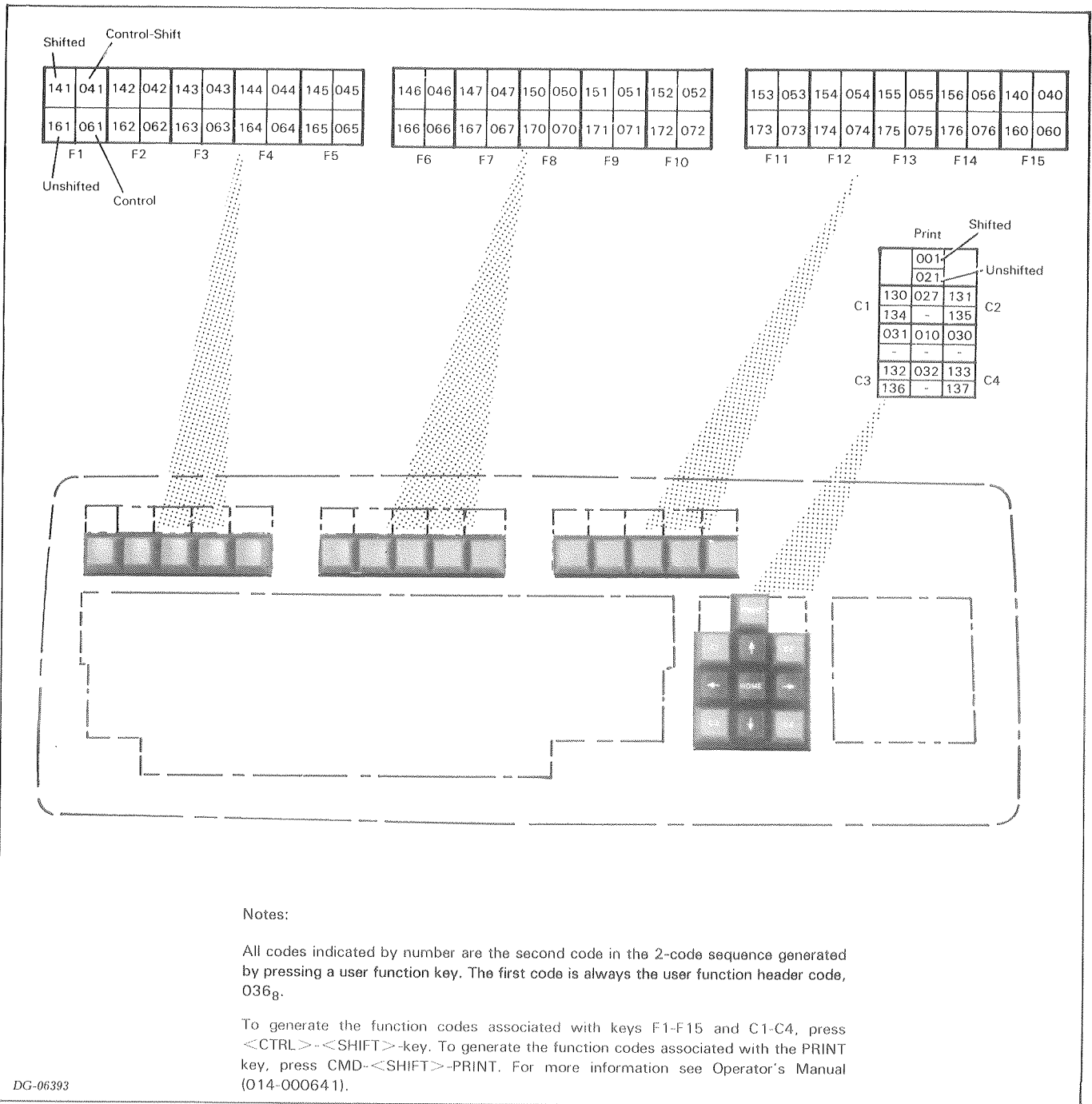

Figure 2.2 D200 User Function Keys

## DISPLAY

The display responds to ASCII characters in the following manner:

- It plots the 96 graphic characters as 7 by 11 dot matrices on its screen.
- It decodes control characters and performs specified functions when the decoded character is a display command. It ignores control characters that are not recognized as display commands.

The display plots graphic characters on its screen using a 24-line, 80-characters-per-line format. Within this format, a character's location on the screen is defined by the position of the cursor when the character is received. As the display plots each character, the cursor moves one character position to the right. To facilitate character positioning on the screen, a group of display commands is dedicated to manipulating the cursor's position.

### Display Commands

Display commands can be divided into four functional groups.

- Screen control commands
- Cursor position commands
- Character attribute commands
- Terminal identification and diagnostic commands

A fifth group, print commands, is available when the terminal includes the *split baud and printer option*.

In the discussions that follow, display commands are described using the format shown below.

**COMMAND NAME**     *octal command code*

*Function:* Functional description

*D100 Keyboard:*

Ways to generate the command code using the D100 keyboard.

*D200 Keyboard:*

Ways to generate the command code using the D200 keyboard.

### Screen Control Commands

Six commands enable or inhibit screen rolling and character blinking, and erase either a line of characters or the whole screen. These commands are described below.

**ROLL ENABLE**     *022<sub>g</sub>*

*Function:* Turns on roll mode. In this mode, each time a command is issued that would move the cursor beyond the bottom of the screen, the screen rolls up one line. The cursor then moves to the new (blank) bottom line and information previously displayed on the top line is lost. When the terminal is powered-up, this command is automatically executed.

*D100 Keyboard:*

CTRL-R or CTRL-SHIFT-R

*D200 Keyboard:*

Same as D100 Keyboard.

**ROLL DISABLE**     *023<sub>g</sub>*

*Function:* Turns off roll mode. In this mode, each time a command is issued that would move the cursor beyond the bottom of the screen, the cursor moves to the top line.

*D100 Keyboard:*

CTRL-S or CTRL-SHIFT-S

*D200 Keyboard:*

Same as D100 Keyboard.

**ERASE END-OF-LINE**     *013<sub>g</sub>*

*Function:* Erases displayed characters, beginning with the current position of the cursor to the end of that line.

*D100 Keyboard:*

CTRL-K or CTRL-SHIFT-K; CMD-``` or CMD-SHIFT-```

*D200 Keyboard:*

ERASE EOL, CTRL-ERASE EOL, SHIFT-ERASE EOL, or CTRL-SHIFT-ERASE EOL

**ERASE PAGE**     *014<sub>g</sub>*

*Function:* Erases all displayed characters and moves the cursor to the first (leftmost) position on the top line of the screen. Also, Erase Page forces the execution of the following commands: End Blink, End Underscore, End Dim, End Reverse Video and Enable Blink.

*D100 Keyboard:*

CTRL-L, CTRL-SHIFT-L, CMD-`=` or CMD-SHIFT-`=`

*D200 Keyboard:*

ERASE PAGE, CTRL-ERASE PAGE, SHIFT-ERASE PAGE or CTRL-SHIFT-ERASE PAGE

**ENABLE BLINK**     *003<sub>g</sub>*

*Function:* Allows the screen to blink any character whose blink attribute is turned on. (See the Start Blink command description.) When the terminal is powered-up or an Erase Page command is executed, Enable Blink is automatically executed.

*D100 Keyboard:*

CTRL-C or CTRL-SHIFT-C

*D200 Keyboard:*

Same as D100 Keyboard.

**DISABLE BLINK**     *004<sub>g</sub>*

*Function:* Disables character blinking regardless of the state of the blink attributes assigned to displayed characters.

*D100 Keyboard:*

CTRL-D or CTRL-SHIFT-D

*D200 Keyboard:*

Same as D100 Keyboard.

## Cursor Position Commands

Nine commands relate to the cursor's position. Eight of them move the cursor around the screen. The ninth command sends the cursor's column and row positions to the computer.

In addition to responding to these commands, the cursor automatically moves under the following conditions:

- It moves one character position to the right each time the display plots a new graphic character on its screen.
- It moves to the first (leftmost) character position on the next line each time the display plots a new graphic character in the last (rightmost) character position on the current line. When the next line exceeds the screen's capacity, the new location of the cursor depends upon the roll mode state of the display.

In cases where the cursor moves to a position already occupied by a graphic character, that character is displayed in reverse video form; i.e., a black character appears on a white field.

### CARRIAGE RETURN 015<sub>8</sub>

*Function:* Moves the cursor to the first character position on the current line.

*D100 Keyboard:*

CR, SHIFT-CR, CTRL-CR, CTRL-SHIFT-CR, CTRL-M or CTRL-SHIFT-M

*D200 Keyboard:*

Same as D100 Keyboard.

### NEW LINE 012<sub>8</sub>

*Function:* Moves the cursor to the first character position on the next line.

*D100 Keyboard:*

NEW LINE, SHIFT-NEW LINE, CTRL-NEW LINE, CTRL-SHIFT-NEW LINE, CTRL-J or CTRL-SHIFT-J

*D200 Keyboard:*

Same as D100 Keyboard.

### CURSOR UP 027<sub>8</sub>

*Function:* Moves the cursor up one line while remaining in the same column (character) position. If the cursor is on the top line, it moves to the bottom line of the screen.

*D100 Keyboard:*

CTRL-W, CTRL-SHIFT-W, or ↑

*D200 Keyboard:*

Same as D100 Keyboard.

### CURSOR RIGHT 030<sub>8</sub>

*Function:* Moves the cursor one column position to the right. If the cursor is at the end of a line, a New Line operation is performed.

*D100 Keyboard:*

CTRL-X, CTRL-SHIFT-X, or →

*D200 Keyboard:*

Same as D100 Keyboard.

### CURSOR LEFT 031<sub>8</sub>

*Function:* Moves the cursor one column position to the left. If the cursor is in the first column position of a line, it moves to the last column position and a Cursor Up operation is performed.

*D100 Keyboard:*

CTRL-Y, CTRL-SHIFT-Y or ←

*D200 Keyboard:*

Same as D100 Keyboard.

### CURSOR DOWN 032<sub>8</sub>

*Function:* Moves the cursor down one line while remaining in the same column position. If the cursor is on the bottom line, its new location depends upon the roll mode state of the display.

*D100 Keyboard:*

CTRL-Z, CTRL-SHIFT-Z, or ↓

*D200 Keyboard:*

Same as D100 Keyboard.

### HOME 010<sub>8</sub>

*Function:* Moves the cursor to the first column position on the top line. This command is automatically executed each time an Erase Page command is issued.

*D100 Keyboard:*

CTRL-H, CTRL-SHIFT-H, or HOME

*D200 Keyboard:*

Same as D100 Keyboard.

### WRITE CURSOR ADDRESS 020<sub>8</sub>

*Function:* Moves the cursor to the position defined by the next two codes received by the display. The first code is interpreted as the column position (numbered from left to right, 000 through 117<sub>8</sub>) and the second code is interpreted as the line position (numbered from top to bottom, 000 through 027<sub>8</sub>). If the column position code is greater than 117<sub>8</sub>, the cursor control logic wraps around; e.g., 121<sub>8</sub> equals 001<sub>8</sub>. The line position code is handled in a similar manner; e.g., 036<sub>8</sub> equals 006<sub>8</sub>.

*D100 Keyboard:*

CTRL-P or CTRL-SHIFT-P (column code, line code)

*D200 Keyboard:*

Same as D100 Keyboard.

### READ CURSOR ADDRESS 005<sub>8</sub>

*Function:* The terminal sends the following three-code sequence to the computer.

037<sub>8</sub>

Column position (000 through 117<sub>8</sub>)

Line position (000 through 027<sub>8</sub>)

See the Write Cursor Address command for information about the column and line position code meanings.

*D100 Keyboard:*

CTRL-E or CTRL-SHIFT-E

*D200 Keyboard:*

Same as D100 Keyboard.



## Character Attribute Commands

Eight commands allow characters to be dimmed, blinked, underscored and/or displayed in a reverse video block (black character on a white field). Since the commands turn blinking, dimming, underscoring and reverse video on and off independently, one character may be dimmed and underscored while another may be underscored in a blinking reverse video block.

**NOTE:** *Dimming a reverse video character is meaningless, since reverse video characters are always dimmed.*

### START BLINK 016<sub>8</sub>

*Function:* Turns on the blink attribute of each successive character received by the display. However, before any character will blink, the screen must be blink enabled. Refer to the screen control commands.

*D100 Keyboard:*  
CTRL-N or CTRL-SHIFT-N

*D200 Keyboard:*  
Same as D100 Keyboard.

### END BLINK 017<sub>8</sub>

*Function:* Turns off the blink attribute of each successive character received by the display. This command is automatically executed each time an Erase Page command is issued.

*D100 Keyboard:*  
CTRL-O or CTRL-SHIFT-O

*D200 Keyboard:*  
Same as D100 Keyboard.

### START DIM 034<sub>8</sub>

*Function:* Turns on the dim attribute of each successive character received by the display.

*D100 Keyboard:*  
CTRL-\

*D200 Keyboard:*  
Same as D100 Keyboard.

### END DIM 035<sub>8</sub>

*Function:* Turns off the dim attribute of each successive character received by the display. This command is automatically executed each time an Erase Page command is issued.

*D100 Keyboard:*  
CTRL-]

*D200 Keyboard:*  
Same as D100 Keyboard.

### START UNDERSCORE 024<sub>8</sub>

*Function:* Turns on the underscore attribute of each successive character received by the display.

*D100 Keyboard:*  
CTRL-T or CTRL-SHIFT-T

*D200 Keyboard:*  
Same as D100 Keyboard.

### END UNDERSCORE 025<sub>8</sub>

*Function:* Turns off the underscore attribute of each successive character received by the display. This command is automatically executed each time an Erase Page command is issued.

*D100 Keyboard:*  
CTRL-U or CTRL-SHIFT-U

*D200 Keyboard:*  
Same as D100 Keyboard.

### START REVERSE VIDEO 036<sub>8</sub>, 104<sub>8</sub>

*Function:* Turns on the reverse video attribute of each successive character received by the display.

This command, consisting of a two-code sequence, cannot be generated by the keyboard.

### END REVERSE VIDEO 036<sub>8</sub>, 105<sub>8</sub>

*Function:* Turns off the reverse video attribute of each successive character received by the display. This command is automatically executed each time an Erase Page command is issued.

This command, consisting of a two-code sequence, cannot be generated by the keyboard.

## Terminal Identification/Diagnostic Commands

Three commands allow a computer to identify and test the display terminals. A fourth command generates a bell tone that can be used to alert the operator to an impending event.

### MODEL REPORT REQUEST 036<sub>8</sub>, 103<sub>8</sub>

*Function:* The terminal sends the following six-code sequence to the computer:

036<sub>8</sub> — Header code  
157<sub>8</sub> — Header code  
043<sub>8</sub> — Indicates model report request data follow.  
041<sub>8</sub> — Indicates D100/D200 series terminal.  
XXX — Configuration code  
YYY — Firmware code

The meaning of the configuration code is shown in Table 2.1. In the table, bit 6 represents the most significant bit while bit 0 represents the least significant bit. Since bit 7 may or may not be transmitted, depending upon the parity selection of the terminal, this bit is ignored.



Bit Numbers	Meaning
6	Always 1.
5	1 indicates 50Hz operation is selected; 0 indicates 60Hz operation is selected.
4	1 indicates the <i>split baud and printer option</i> is not present; 0 indicates the option is present.
3	If bit 4 is 0, 0 indicates the printer is not ready; 1 indicates the printer is ready.
2	0 indicates the American character font is installed; 1 indicates one of the other character fonts is installed.
1, 0	01 indicates the D100 keyboard is present; 10 indicates the D200 keyboard is present; 00 indicates no keyboard is present.

Table 2.1 Configuration Code

This two-code command cannot be generated by the keyboard.

**ENTER REMOTE TEST** 036<sub>8</sub>, 101<sub>8</sub>

*Function:* Places the terminal in diagnostic mode, thus allowing it to receive programs that will be executed by the terminal's internal microprocessor. In this mode, the keyboard is effectively disabled. To exit diagnostic mode, either issue the Exit Remote Test command or power down the terminal.

This two-code command cannot be generated by the keyboard.

**EXIT REMOTE TEST** 036<sub>8</sub>, 102<sub>8</sub>

*Function:* Terminates diagnostic mode. After this command is issued, the terminal automatically executes its self-test, providing the terminal was in diagnostic mode. Otherwise, the command is ignored.

This two-code command cannot be generated by the keyboard.

**BELL** 007<sub>8</sub>

*Function:* The terminal sounds a bell tone.

*D100 Keyboard:*

CTRL-G or CTRL-SHIFT-G

*D200 Keyboard:*

Same as D100 Keyboard.

**Printer Commands**

Two commands initiate print operations when the D100/D200 terminal is interfaced to an ASCII-based, serial printer.

**PRINT** 021<sub>8</sub>

*Function:* Transmits the information appearing on the display screen to the printer, beginning with the line on which the cursor is located. During the print operation, the keyboard cannot transmit information to the computer; however, a print operation can be aborted from the keyboard by typing CMD-CR.

*D100 Keyboard:*

CTRL-Q, CTRL-SHIFT-Q, or CMD-\

*D200 Keyboard:*

CMD-PRINT

**PRINT FORM** 001<sub>8</sub>

*Function:* Transmits the information displayed at full intensity to the printer, beginning with the line on which the cursor is located. Dimmed characters are ignored. During the print operation, the keyboard cannot transmit information to the computer; however, a print form operation can be aborted from the keyboard by typing CMD-CR.

*D100 Keyboard:*

CTRL-A, CTRL-SHIFT-A, or CMD-SHIFT-\

*D200 Keyboard:*

CMD-SHIFT-PRINT

# Chapter 3

## INTERFACING AND CABLING

DASHER D100/D200 display terminals contain a serial asynchronous interface that supports full-duplex communication with a computer or communications system. The interface accommodates both 20mA current loop and EIA RS232-C connections and provides a subset of standard EIA modem control functions.

DASHER D100/D200 terminals equipped with the *split baud and printer option* contain a second serial asynchronous interface and support logic. The optional (printer) interface performs the following functions:

- It transmits serial data to an ASCII-based printer.
- It defines the transmission rate of data transmitted by the terminal, when selected.

Thus, the split baud portion of the option allows the terminal to support a communications line with two bandwidths, one high-speed and one low-speed.

### COMMUNICATIONS INTERFACE

The terminal's communications interface transmits and receives serial data bursts that consist of 1 start bit, 7 data bits, an optional parity bit and 1 or 2 stop bits.

Chapter 4, Installation, explains how to select the parity bit as well as the data transmission rate (baud). The number of stop bits normally depends upon the selected transmission rate. When operating at 110 baud and below, two stop bits are automatically selected; when operating at 134.5 to 19,200 baud, 1 stop bit is selected. However, if the split baud option is enabled, 1 stop bit is selected for all baud rates.

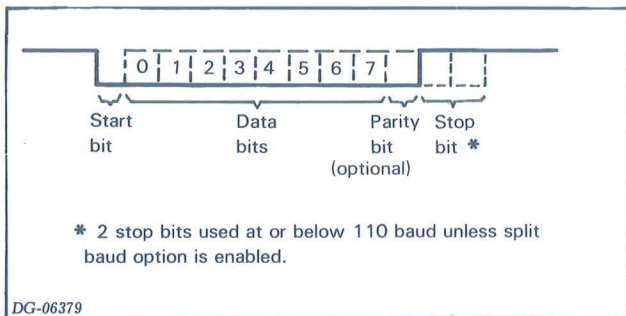

Figure 3.1 Communications Data Format

### Cabling

In general, the choice of communications line, 20mA current loop or EIA, depends upon the cable length required, the presence of a modem, and the configuration of the host system. When a long cable is required to connect the terminal directly to a system, the 20mA current loop connection can be used. It supports a 1500 foot (457.2 meters) cable at transmission rates up to 9600 baud and a 500 foot (152.4 meters) cable at 19,200 baud. When a short cable (50 feet/15.2 meters, maximum) is required or the terminal is interfaced to a Bell 103, 113 or 212 compatible modem, the EIA connection can be used.

### EIA Connection

Figure 3.2 shows the 25-pin Cannon connector (located at the back of the terminal) that joins the terminal's EIA interface to a computer or modem via an EIA cable. Figure 3.3 lists the EIA cables that are available from Data General and identifies the pin connections. When using a cable not shown in Figure 3.3, wire the terminal end as shown in Figure 3.4.

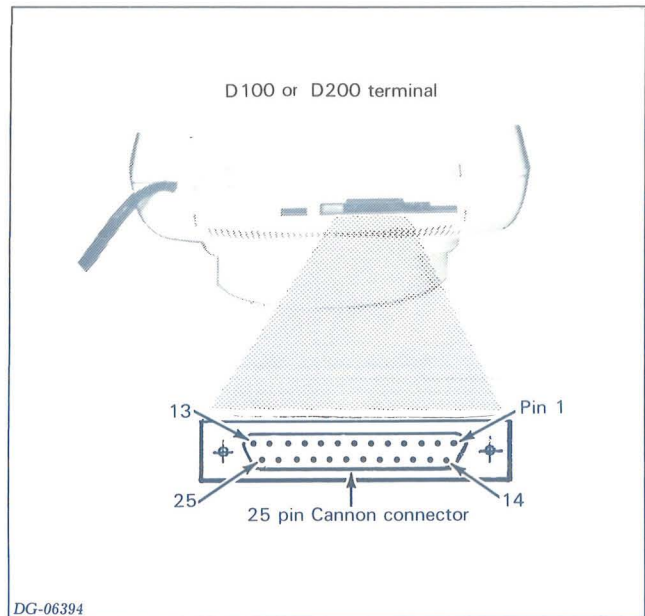
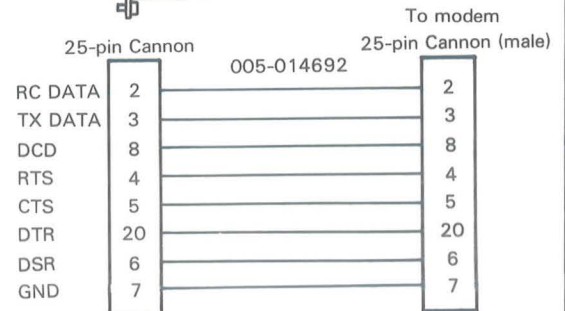
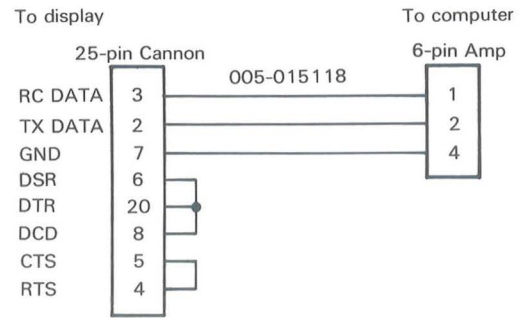
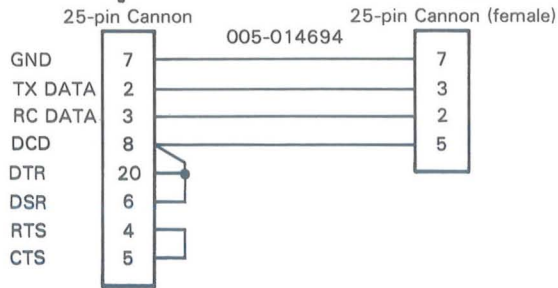
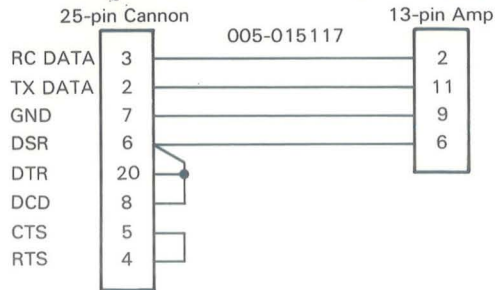
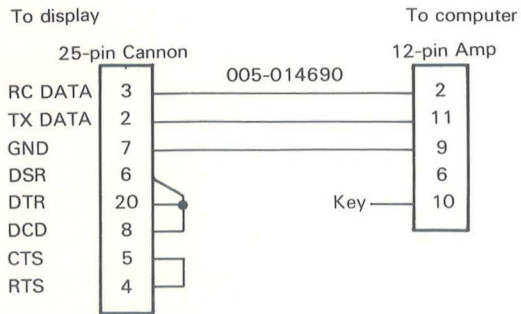

Figure 3.2 Communications Connector



Computer/controller	Cable Number
Primary terminal (all CPUs including microproducts) * ULM, 4010	005-014690
ECLIPSE M600, 350, 250, 150 primary terminal	005-014694
ALM-8 CS systems	005-015117
ALM-16	005-015118
Modem	005-014692

\* Except ECLIPSE M600, 350, 250, 150.

DG-06380

Figure 3.3 Data General Cables (EIA Interface)

Use the following configuration when interfacing with Data General EIA controllers:

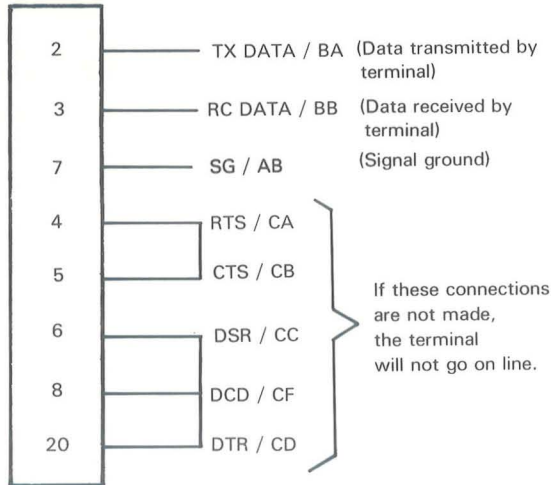

Use the following configuration when interfacing to a Bell 103, 113, or 212 compatible (full duplex) modem.

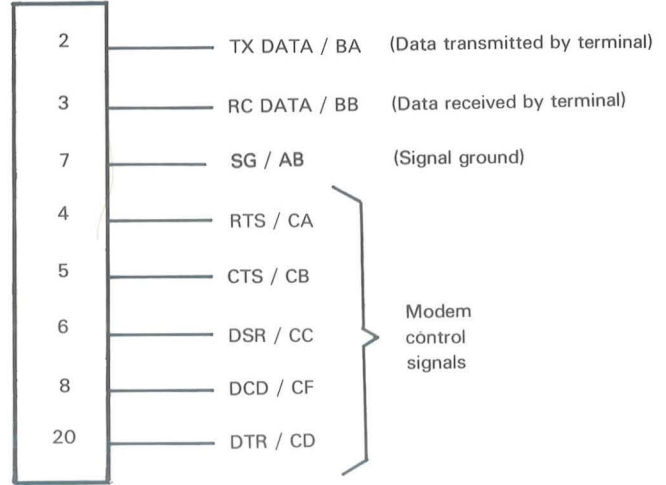

Signal	EIA Interface Function
TX DATA / BA (Transmitted Data)	Data transmitted by the terminal.
RC DATA / BB (Received Data)	Data received by the terminal.
DTR / CD (Data Terminal Ready)	This signal is asserted by the terminal when powered-up. It tells the modem that the terminal is ready.
DSR / CC (Data Set Ready)	This signal must be asserted for the terminal to go on line. If the controlling device negates DSR, the terminal goes off line.
DCD / CF (Data Carrier Detect)	This signal must be asserted for the terminal to receive data. If the controlling device negates DCD, the terminal will stay on line but will not receive data until DCD is asserted again.
RTS / CA (Request to Send)	This signal is asserted by the terminal to indicate it would like to transmit data. D100 and D200 terminals always assert this signal because they operate in full-duplex mode.
CTS / CB (Clear to Send)	This signal is asserted by the modem in response to RTS from the terminal. The terminal can transmit data only when CTS is asserted.
SG / AB (Signal Ground)	This signal provides a ground reference for EIA voltage levels.

DG-06381

Figure 3.4 External Cabling (EIA Interface)



### Current Loop Connection

The 20mA current loop interface can be either active or passive. In an active connection, the terminal supplies the energy to drive the terminal's interface; in a passive connection, the computer or communications system supplies the energy.

The same 25-pin Cannon connector used for EIA connections joins the terminal's current loop interface to a computer via a current loop cable. Refer to Figure 3.2. Figure 3.5 lists the current loop cables that are available from Data General and identifies the pin connections. When using a cable not shown in Figure 3.5, select a passive or active connection by wiring the terminal end of the cable as shown in Figure 3.6.

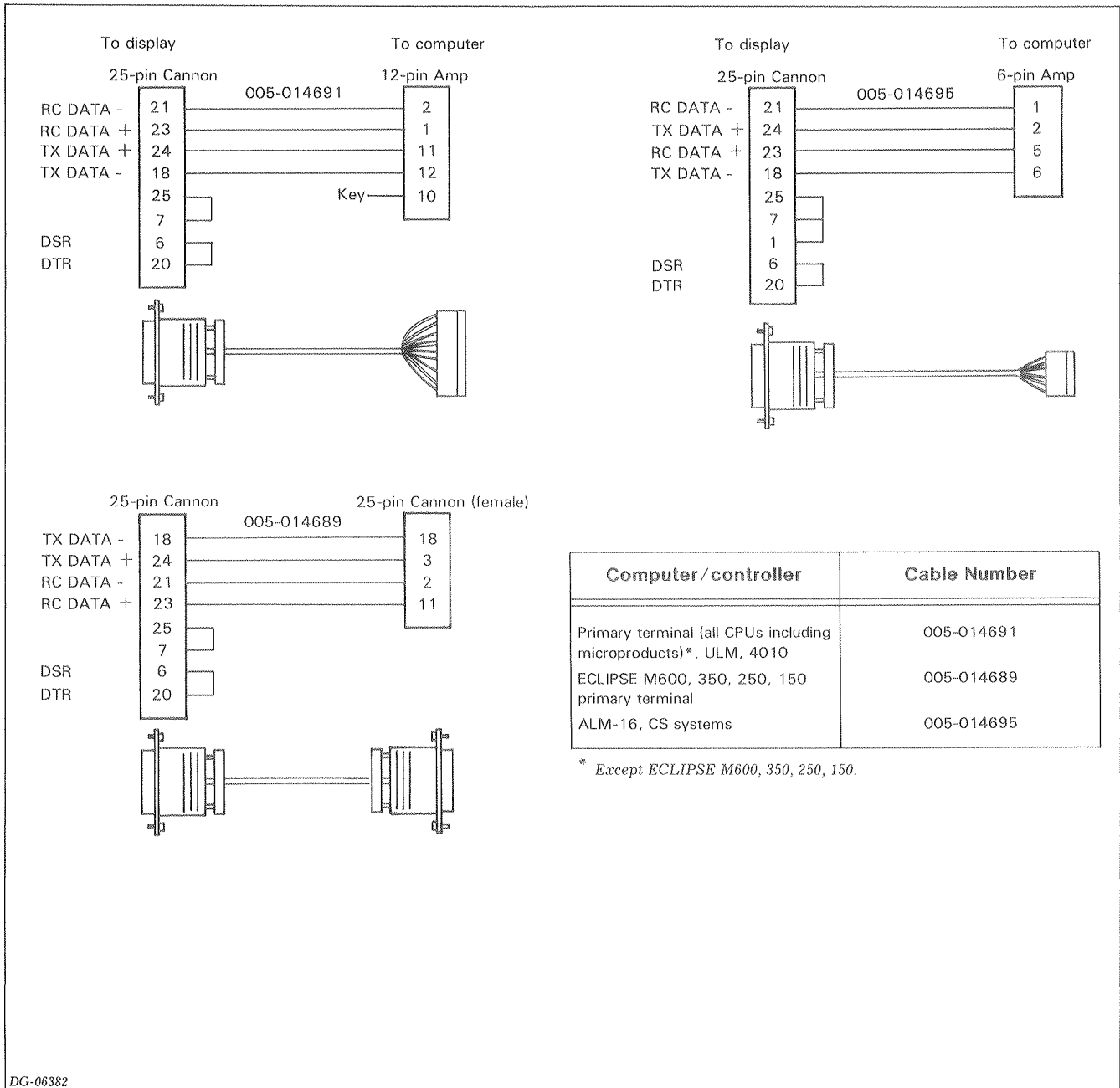

DG-06382

Figure 3.5 Data General Cables (20mA Current Loop Interface)

Use the following configuration to select a passive current loop connection. (All Data General current loop controllers use this type of connection).

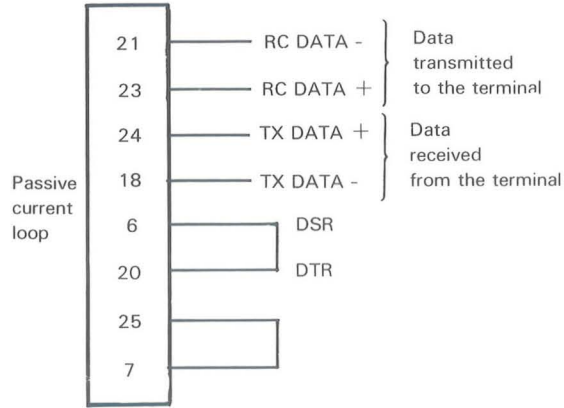

Use the following configuration to select an active current loop configuration.

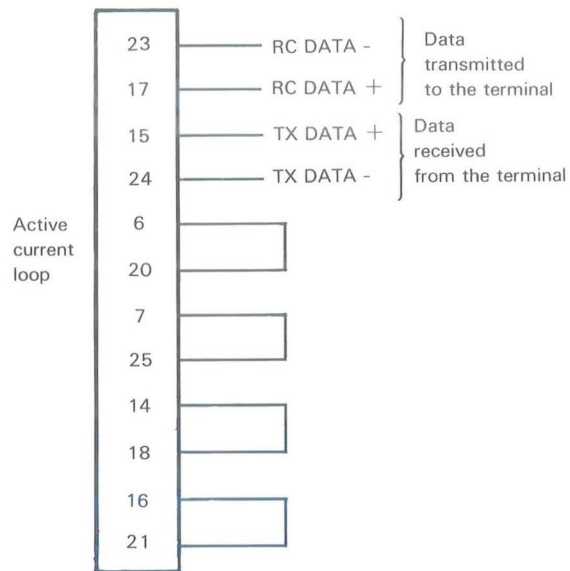

DG-06383

Figure 3.6 External Cabling (20mA Current Loop Interface)

# OPTIONAL PRINTER INTERFACE

Chapter 4, "Installation", explains how to tailor the split baud portion of this interface.

The printer portion of the interface transmits serial data to the printer that consists of 1 start bit, 7 data bits, an even parity bit and 1 or 2 stop bits.

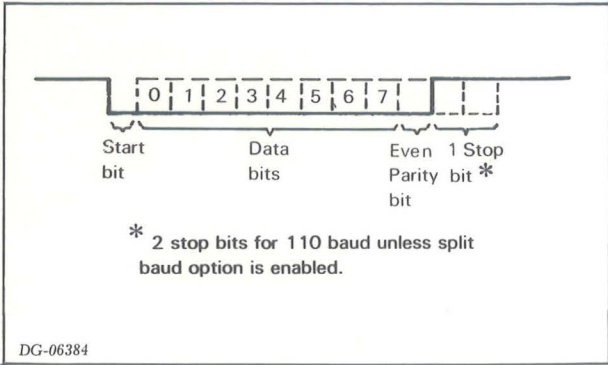

Figure 3.7 Printer Interface Data Format

The printer interface is joined to the printer via the 7-pin connector shown in Figure 3.8 and an EIA RS232-C cable. Figure 3.9 shows the Data General cable that connects a D100/D200 display terminal to a DASHER TP1 or TP2 printer. When using any other EIA cable, wire the terminal end as shown in Figure 3.8.

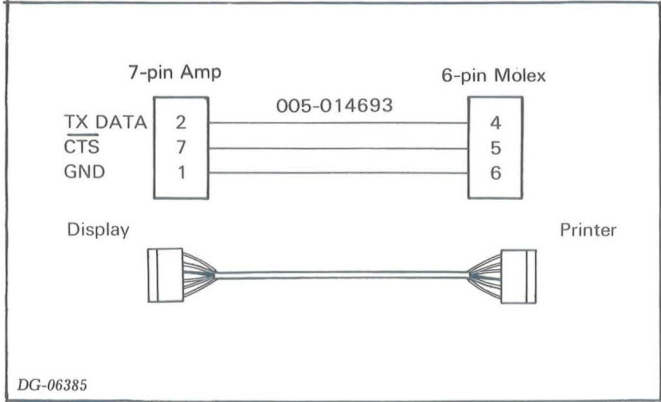

Figure 3.9 Data General Printer Option Cable

Signal Name	Function
Transmit Data (TX DATA)	Carries data from the terminal to a printer.
Request To Send (RTS)	Is asserted by the terminal when it is powered-up.
Clear To Send (CTS)	Is asserted by the printer in response to RTS allowing the terminal to transmit data. A buffered printer may use this signal to stop the terminal from transmitting data when the printer's buffer fills.

\* When connecting a printer without a CTS signal, tie RTS to CTS. However, make sure your printer can accept data at the selected baud rate. The printer can use CTS as a transmit enable signal if its receive baud rate is greater than its average print rate.

DG-06397

Figure 3.8 Printer Connector

# Chapter 4

## INSTALLATION

After selecting the appropriate cable connection(s), as described in Chapter 3, the D100/D200 terminal installer should:

- Choose a site for the terminal.
- Unpack the terminal.
- Tailor the communications interface.
- Tailor the optional printer interface, when present.
- Perform an operational check-out.

### CHOOSING A SITE

Choose a site for the DASHER D100/D200 terminal using the specifications shown in Figure 4.1 and Table 4.1.

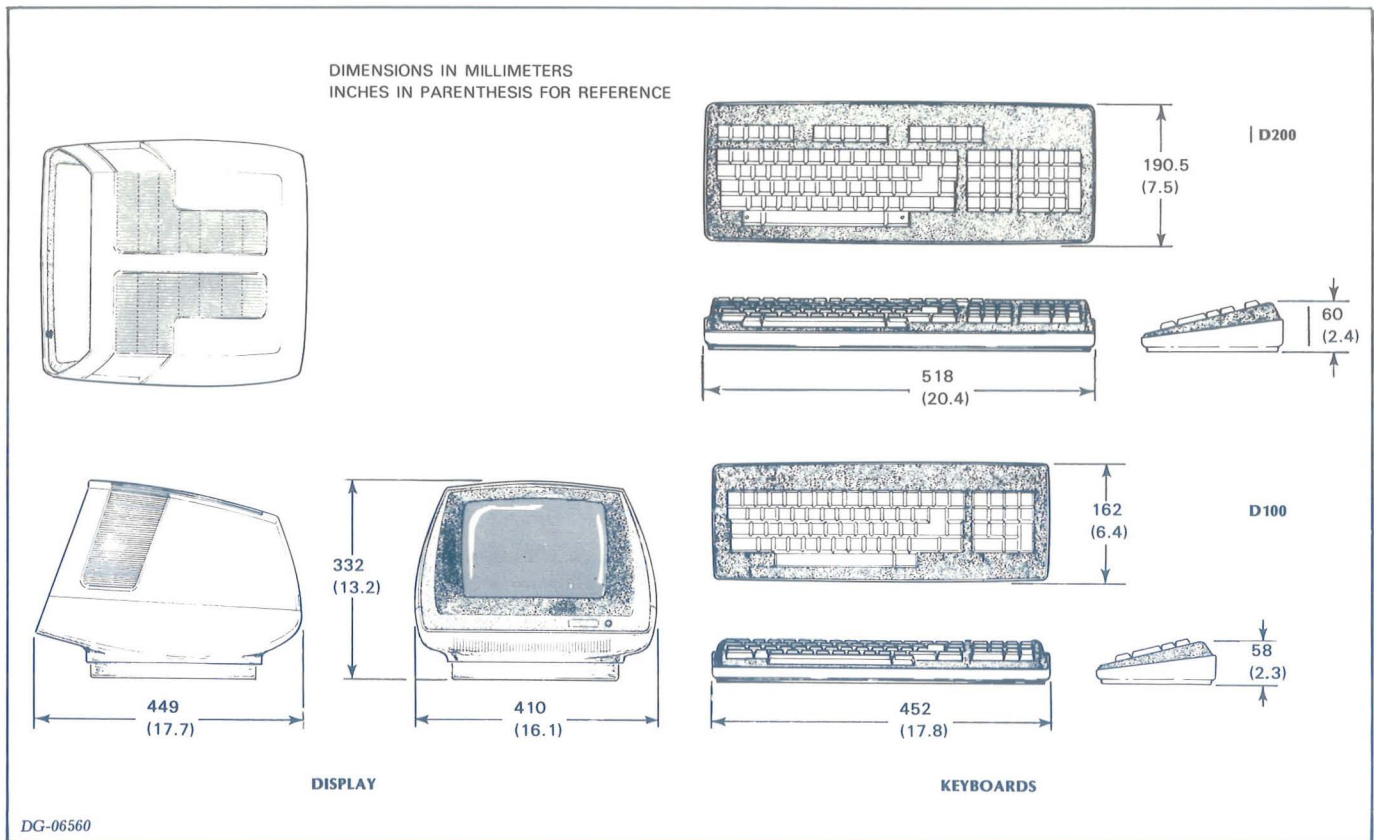

Figure 4.1 Terminal Dimensions



<b>DIMENSIONS:</b>				<b>POWER REQUIREMENTS:</b>			
<b>Display</b>				<b>(Domestic)</b>			
	<b>Width</b>	<b>Depth</b>	<b>Height</b>	<b>Voltage:</b>	85-132 VAC		
Millimeters	410	449	332	<b>Freq.:</b>	47-63 HZ		
Inches	16.1	17.7	13.2	<b>Current:</b>	1.5 Amps at 120 VAC, 60 Hz		
<b>D100 Keyboard:</b>				<b>(Export)</b>			
	<b>Width</b>	<b>Depth</b>	<b>Height</b>	<b>Voltage:</b>	187-264 VAC		
Millimeters	452	162	58	<b>Freq.:</b>	47-63 HZ		
Inches	17.8	6.4	2.3	<b>Current:</b>	0.75 Amps at 240 VAC, 50 Hz		
<b>D200 Keyboard:</b>				<b>Startup Surge:</b>	30 Amps at 240 VAC, 50 Hz for 2 cycles		
	<b>Width</b>	<b>Depth</b>	<b>Height</b>	<b>OPERATING ENVIRONMENT:</b>			
Millimeters	518	190.5	60	<b>Temperature (max)</b>	0°- 45°C 32°- 113°F		
Inches	20.4	7.5	2.4	<b>Humidity (max)</b>	10% - 90% non-condensing		
				<b>Altitude</b>	3048 m 10,000 ft		
<b>WEIGHT:</b>				<b>CABLES:</b>			
	<b>kg</b>	<b>lbs</b>		<b>Primary Power</b>	<b>Length</b>	<b>Conn</b>	<b>Mating Conn</b>
Display:	10	22		<b>Domestic 60Hz</b>	1.8m(6')	5-15P	5-15R
D100 keyboard:	1.1	2.4		<b>Export 50Hz</b>	1.8m(6')	—	—
D200 keyboard:	1.6	3.5					
<b>HEAT OUTPUT (Max.):</b>				<b>Watts</b>	<b>BTU/hr</b>		
				40	140		

DG-06573

Table 4.1 Terminal Specifications

## UNPACKING

Unpack the display and keyboard as shown in Figure 4.2. Then, plug the cable attached to the keyboard into the receptacle provided at the rear of the display unit. See Figure 4.3.

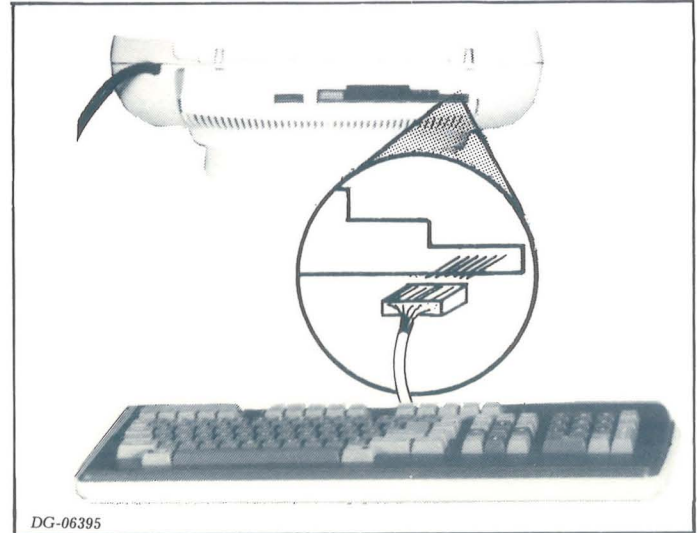

Figure 4.3 Plugging in the Keyboard

Information to be supplied

DG-06567

Figure 4.2 Unpacking the Terminal

# COMMUNICATIONS INTERFACE TAILORING

Tailoring the communications interface consists of selecting the parity and data transmission rate (baud) for the terminal. Figure 4.4 locates and identifies the switches that are used for this purpose.

If the split baud portion of the optional printer interface will be used, follow the directions set forth in Figure 4.4 for receive data; i.e., the data received by the terminal. Then, refer to Figure 4.5. This figure locates and identifies the switches that enable the split baud feature and select the data transmission rate for transmit data.

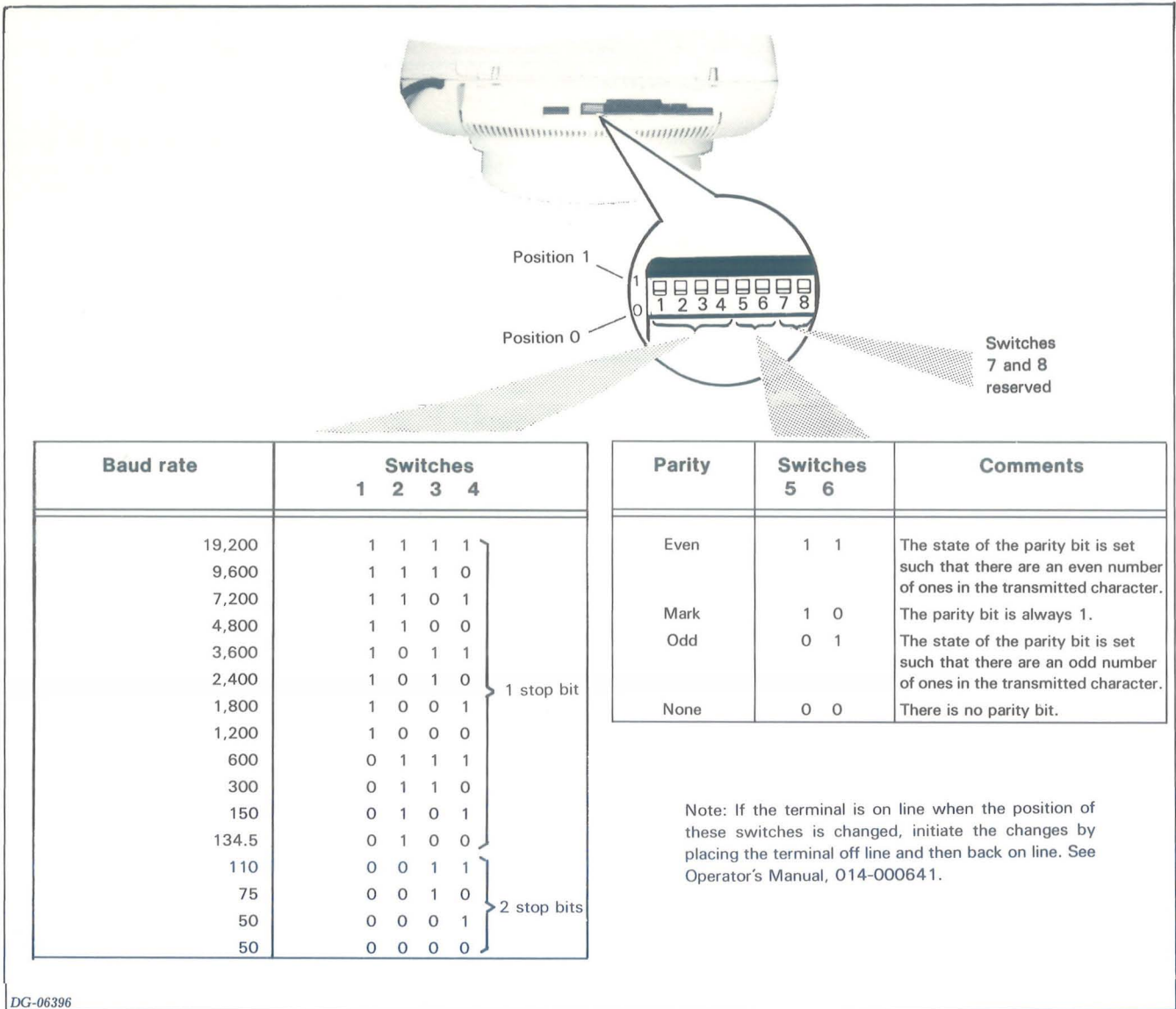

DG-06396

Figure 4.4 Baud and Parity Switches

**CAUTION** Hazardous voltages. Wait at least 5 minutes after power-down before opening case.

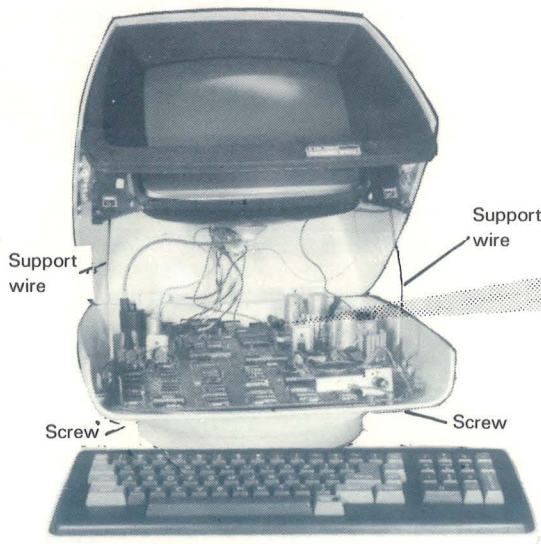

Split baud	Switch 1
Enable	
Disable	

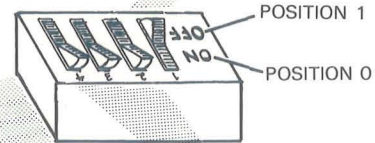

Printer Interface and/or Display Transmit Baud Rate (Split Baud)	Switches		
	2	3	4
4800	1	1	1
3600	1	1	0
2400	1	0	1
1800	1	0	0
1200	0	1	1
600	0	1	0
300	0	0	1
110	0	0	0

To open case:

1. Turn off terminal, unplug power cord, and wait at least five minutes.
2. Remove the power ON/OFF knob by pulling it straight out. Push switch in to the OFF position.
3. Loosen the two screws underneath the front of case.
4. While holding the bottom of the case, lift the top of the case up until the support wires lock in place.

To close case:

1. Unlock the support wires by pushing out on the top of each wire.
2. Lower the top of the case until it is in closed position.
3. Replace the power ON/OFF knob.
4. Tighten the two screws underneath the front of the case.
5. Plug in the power cord.

DG-06386

Figure 4.5 Option Baud Switches

## PRINTER INTERFACE TAILORING

Tailoring the printer interface consists of selecting the transmission rate for the printer as shown in Figure 4.5. Consult your printer manual to select the appropriate transmission rate. If the split baud feature is enabled, the option baud switches define both the display's transmit rate and the terminal-to-printer transmission rate.

## OPERATIONAL CHECK-OUT

The operational check-outs described below will ensure that your terminal is working properly. Before performing the check-outs, read the *DASHER D100/D200 Operator's Manual*, DG No. 014-000641.

## Off-line Check-out

After unpacking and tailoring your system as described above, perform the following steps:

- Make sure the power supplied by the selected wall outlet is compatible with the power requirements listed on the label at the rear of the display unit. Then, plug the power cord into the outlet.
- Disconnect your communications cable, if installed.
- Turn the power on and wait 10 seconds for the cursor to appear in the upper-left corner of the display screen. Adjust the display intensity, as desired.

**NOTE:** A character appearing at the top center of the display screen indicates that the power-up diagnostic detected a problem. If this occurs, read the *Problem Diagnosis* section appearing at the end of this chapter.



- Perform the procedures outlined in Table 4.2. Since many procedures specified in the table incorporate display commands, it may be helpful to reference the display commands described in Chapter 2, Programming .

Procedure	Expected Result
Check On Line light	On Line light is off
Press Alpha Lock key	Alpha Lock light goes on
Type in some text on keyboard	Text appears in upper case
Press Alpha Lock key	Alpha Lock light goes off
Type in more text	Text appears in lower case, unless SHIFT is used
Press CTRL-G	Terminal emits a beep
Press CTRL-T, and enter some text	Text appears underscored
Press CTRL-\, and enter some text	Text appears dimmed and underscored
Press CTRL-C, CTRL-N, and enter some text	Text blinks, and is dimmed and underscored
Press CTRL-U, and enter some text	Underscore does not appear under new text, but remains under old text
Press CTRL-], and enter some text	New text is brightly displayed, but old text remains dim
Press CTRL-O, and enter some text	New text does not blink, but old text continues blinking
Press CTRL-D	All text stops blinking
Press the cursor control keys that have arrows on them *	Cursor moves in direction of arrow on each keycap.
Press Home *	Cursor moves to upper-left corner of screen
Press CTRL-S, enter some text, and repeatedly press New-line	Cursor moves to bottom of screen, then jumps to top and continues moving downward; text is not affected
Press CTRL-R, and repeatedly hit New-line	Cursor moves to bottom of screen, then text moves up one line with each depression of New-line
Press CTRL-T, CTRL-\, CTRL-C, CTRL-N, and enter some text	Text is underscored, dimmed, and blinking
Press CTRL-L, and enter some text	Screen clears, and new text is not underscored, dimmed, or blinking
Move cursor to middle of previously entered line of text, and press Erase EOL	Characters from cursor position to end-of-line (inclusive) are erased

Table 4.2 Off-line Check-out Procedure

\*Activate the cursor controls on the D100 terminals by pressing the CMD key together with the desired cursor function key on the cursor/numeric keypad, or by first placing this keypad in cursor lock mode by pressing CMD-9. The CURSOR LOCK light goes on to indicate that the keypad is in cursor lock mode. Press CMD-7 to disable cursor lock mode.

- If the terminal contains the optional printer interface and the printer is present, plug the printer's EIA cable into the terminal's printer connector and power-up the printer. Then, refer to the printer display commands and transmit displayed information to the printer.

## On-line Check-out

After a successful off-line check-out, proceed as follows:

- Plug the communications cable into the terminal's 25-pin interface connector and configure your system, as required.
- Make sure that the host computer contains an appropriately coded echo program that will be called when the keyboard transmits data.
- Place the terminal on-line.
- Enter alphanumeric data on the keyboard and observe that the display is receiving the data from the system.

**NOTE:** *If a solid white block, smaller than the cursor, appears on the screen, a transmission error occurred. In most cases, this means that either the parity or transmission rate selected for the terminal is not compatible with the host system.*

- Refer to the display commands in Chapter 2 and enter these commands through the keyboard. Observe that the display is responding appropriately. If the terminal fails to respond as expected, read the Problem Diagnosis section on the next page.

## PROBLEM DIAGNOSIS

If your terminal does not respond properly, see table 4.3 below.

Symptom	Probable Cause
No cursor appears within 10 seconds of power-up.	Brightness control turned down. Display malfunction (power supply, microprocessor, or program ROM).
The screen is blank except for the cursor, and the ON LINE light is off.	Bad connection to the host computer (see Figure 3.2) or bad modem (if using one).
Display beeps and displays a character.	Letter 'A' displayed: Keyboard cable connector is improperly seated in the keyboard receptacle at the rear of the display (see Figure 4.3). Other letter displayed: Display and/or keyboard malfunction.
None of the above.	One of the following may be causing the problem: Bad connection to keyboard (see Figure 4.3) or host computer (see Figure 3.2). Improper ac voltage supplied to terminal power supply (see Technical Specification on the inside of the front cover). Incorrect switch settings for parity and transmission rate (see Figures 4.4 and 4.5). Bad modem (if using one). Configuration of host system does not support terminal properly.

Table 4.3 Troubleshooting

# Chapter 5

## ARCHITECTURE

D100/D200 terminals consist of two separate units — a display and a keyboard — that are connected by an external cable. The display houses a cathode ray tube (CRT) and yoke assembly and one printed circuit board. This modular design facilitates maintenance because malfunctions can be isolated to one of three main components: the circuit board, the CRT/yoke assembly, or the keyboard. Figure 5.1 locates these three components.

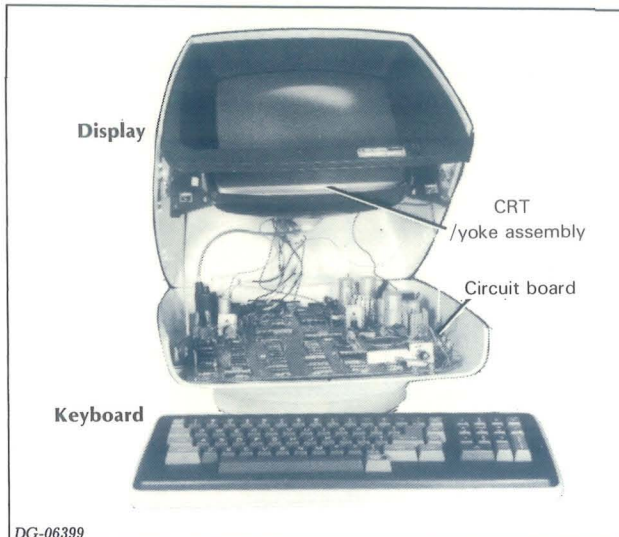

Figure 5.1 D100/D200 Components

### PRINTED CIRCUIT BOARD

The circuit board contains four major units: the control logic, the display logic, the interface logic, and the power supply. These units, except for the power supply, are connected by a bi-directional bus as shown in Figure 5.2.

### Control Logic

The control logic governs the terminal's response to ASCII codes from the computer and commands from the keyboard. Its main components are a microprocessor and a read-only-memory (the program ROM).

The microprocessor synchronizes the operations of the other units and coordinates the transfer of information between them. It also stores the current attributes that determine how characters will be displayed (e.g., blinking, underscored, etc.).

The program ROM stores the instructions (firmware) that the microprocessor executes to control the other units.

### Display Logic

The display logic controls cursor positioning, the displaying of characters, and screen rolling. Its main components are a display RAM, the CRT control logic, and a character generator ROM.

The display RAM stores the ASCII codes for the characters to be displayed on the screen as well as each character's attributes.

The CRT control logic controls display operations. It is programmed by the microprocessor to perform the following functions:

- Initiates screen refreshing by continually providing the CRT driver circuits with synchronizing signals and the contents of the display RAM.
- Maintains the cursor address and controls the positioning of the cursor accordingly.

The character generator ROM stores the bit patterns that determine how each displayable character appears on the screen. Different character generator ROMs are used for the different character fonts.

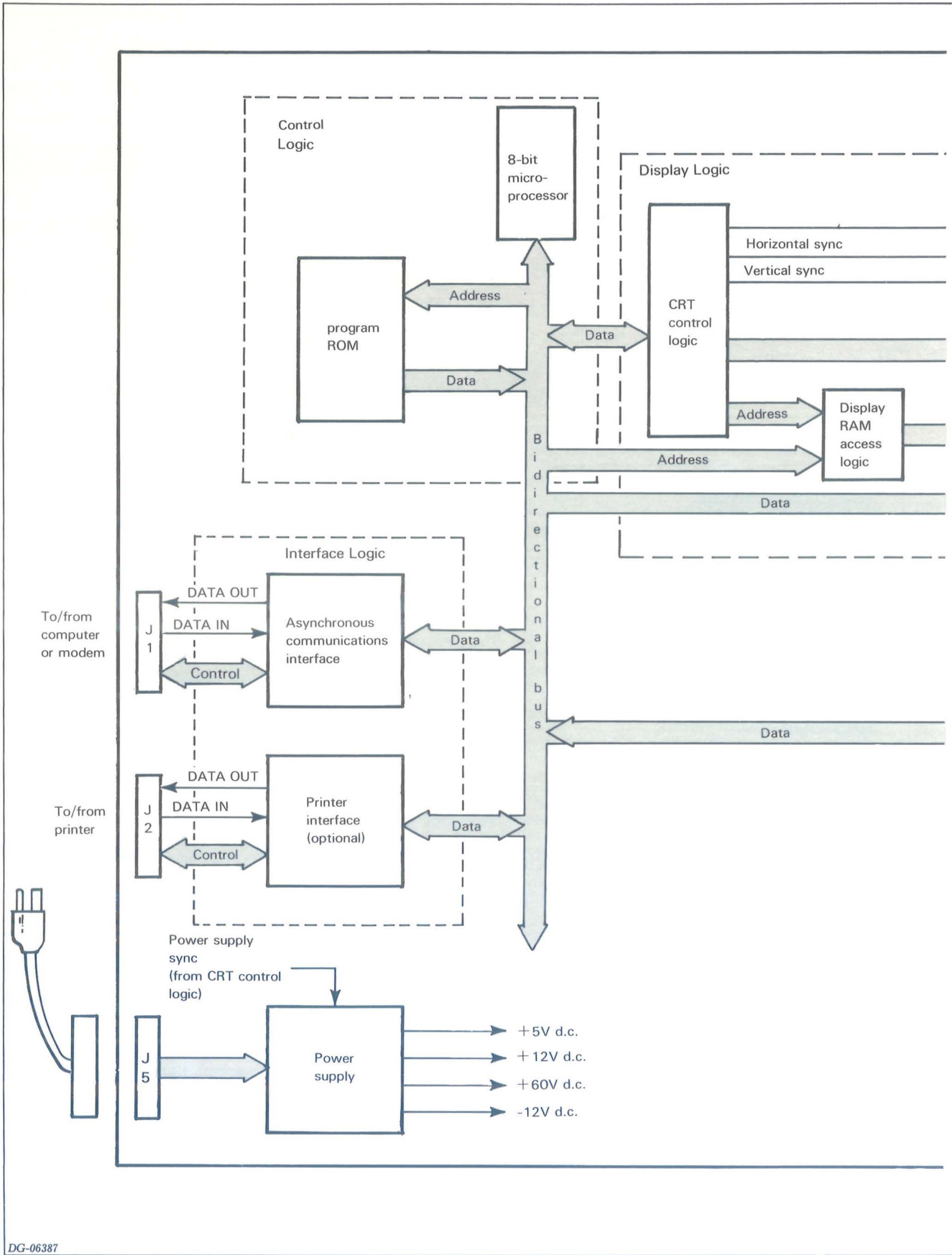

DG-06387

Figure 5.2 Terminal architecture



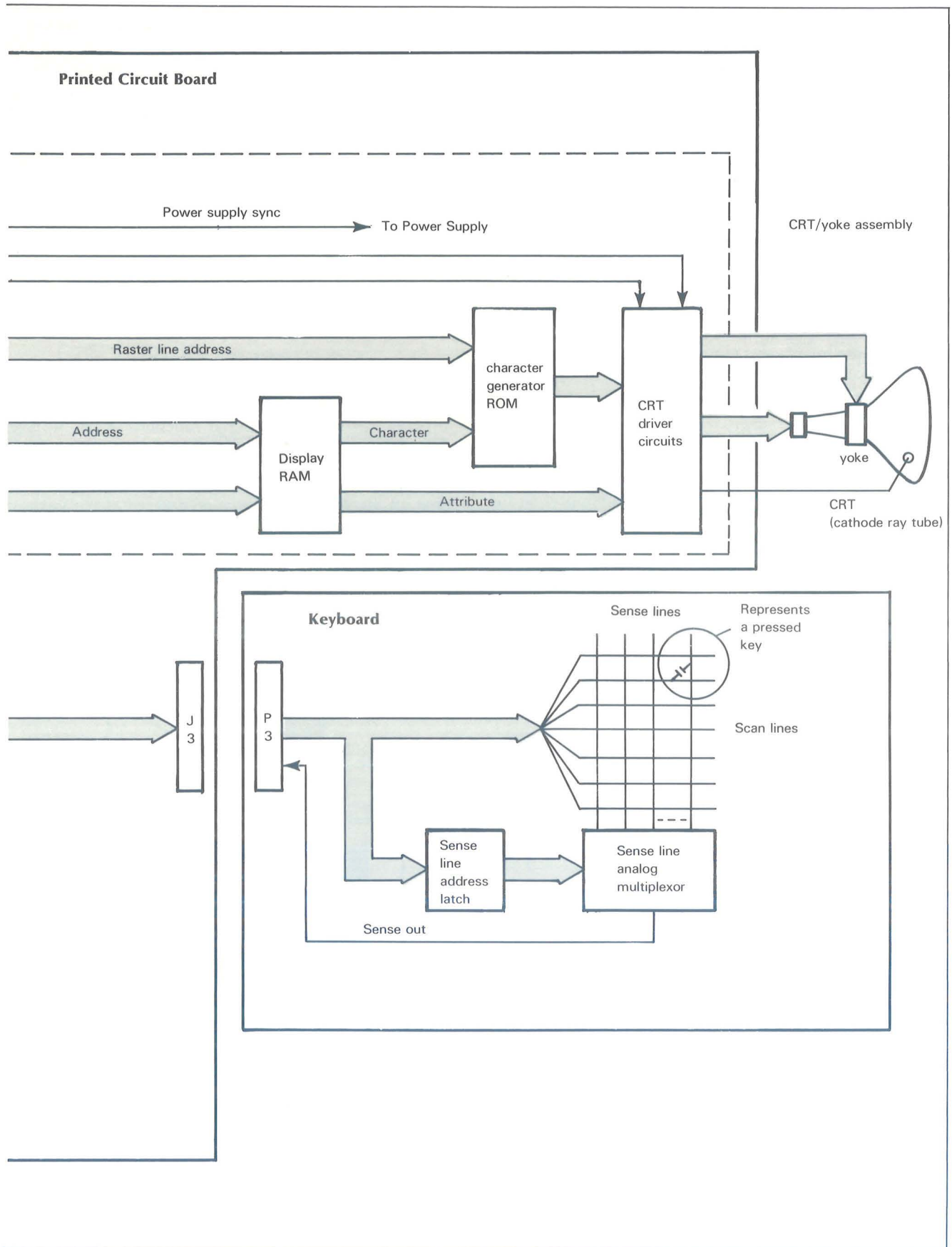

## Interface Logic

The interface logic provides a communications interface. This asynchronous serial interface allows communication in full-duplex mode between the microprocessor and a computer via a 20mA current loop or an EIA RS232-C communications line. When the split baud/printer option is present, an additional asynchronous serial interface (printer interface) allows communication between the microprocessor and a local printer via an EIA RS232-C communications line. Both interfaces use a universal asynchronous receiver/transmitter (UAR/T).

The line characteristics (e.g. baud rate, parity) for these interfaces are selected by on-board switches. When the terminal is powered-up or switched on-line, the microprocessor senses the setting of these switches and programs the interface(s) to function accordingly.

## Power Supply

The power supply provides the five d.c. supply voltages necessary to drive the various circuits within the terminal. The primary power input is either 85-132 V a.c. or 187-264 V a.c., 47-63 Hz, as selected by hardwired jumpers on the board.

The power supply uses a switching regulator to provide the output voltages. The incoming a.c. voltage is converted to a d.c. voltage and fed through a high frequency oscillator and into a transformer. The outputs of the transformer are rectified and filtered to provide the various output voltages. Constant power output is maintained by varying the duty cycle of the oscillator (pulse width modulation). Protection circuits prevent damage in the event of an over-current or over-voltage condition.

The switching of the supply is synchronized to occur when the display screen is retraced, i.e., when the electron beam in the CRT is shut off and the CRT is preparing for the next line scan. This prevents switching pulses from appearing on the screen.

## CRT/Yoke Assembly

The CRT (cathode ray tube) is a vacuum tube that projects a beam of electrons towards a fluorescent screen. When this beam hits the screen it forms a luminous dot. Signals generated by the CRT driver circuits control the position and intensity of this dot.

The yoke assembly is an electromagnetic deflection device that moves the electron beam in response to drive signals generated by the CRT control logic. These signals cause the beam to trace out a system of parallel horizontal scans on the screen. Eighty column positions are defined within each horizontal scan. Each column consists of seven dots which form part of a matrix. Eleven consecutive scans form a line of eighty 7 by 11 dot matrices. A character is displayed by controlling the intensity of the dots within a dot matrix as shown in Figure 5.3. Appendix D gives the 7 by 11 dot pattern for each character.

## KEYBOARD

The keyboard consists of keypads mounted on a printed circuit board and three (D100) or two (D200) LED indicator lights. The printed circuit board contains sense circuitry that allows the microprocessor to determine which keys are pressed when it scans the keyboard.

When a key is depressed, it moves an insulated foam-backed foil pad towards two contacts on the printed circuit board, thus increasing the capacitance between the foil and the contacts. When the microprocessor scans this key, it detects the increase in capacitance and identifies the location of the key.

## OPERATION

The terminal operates in two different modes: on-line and off-line. On-line the terminal functions as two different I/O devices — a keyboard input device and a display output device. Communication between these two devices must be provided by the computer's software. This means that all displayable information entered at the keyboard must be "echoed" to the display by the executing program. Off-line the terminal functions as one device. Figure 5.4 shows how the terminal functions in both of these modes.

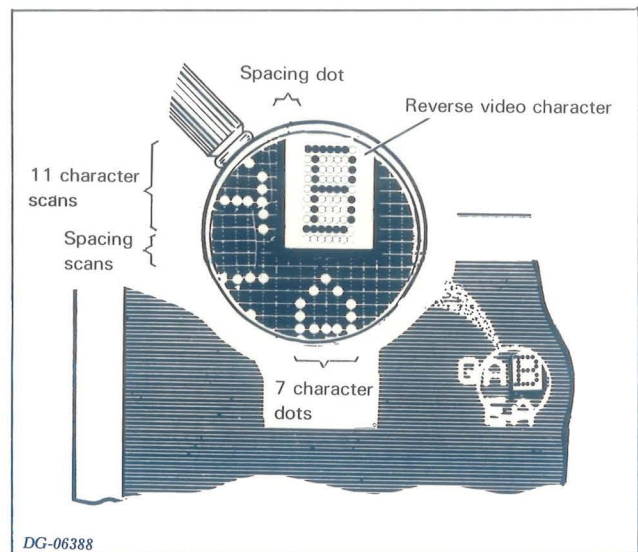
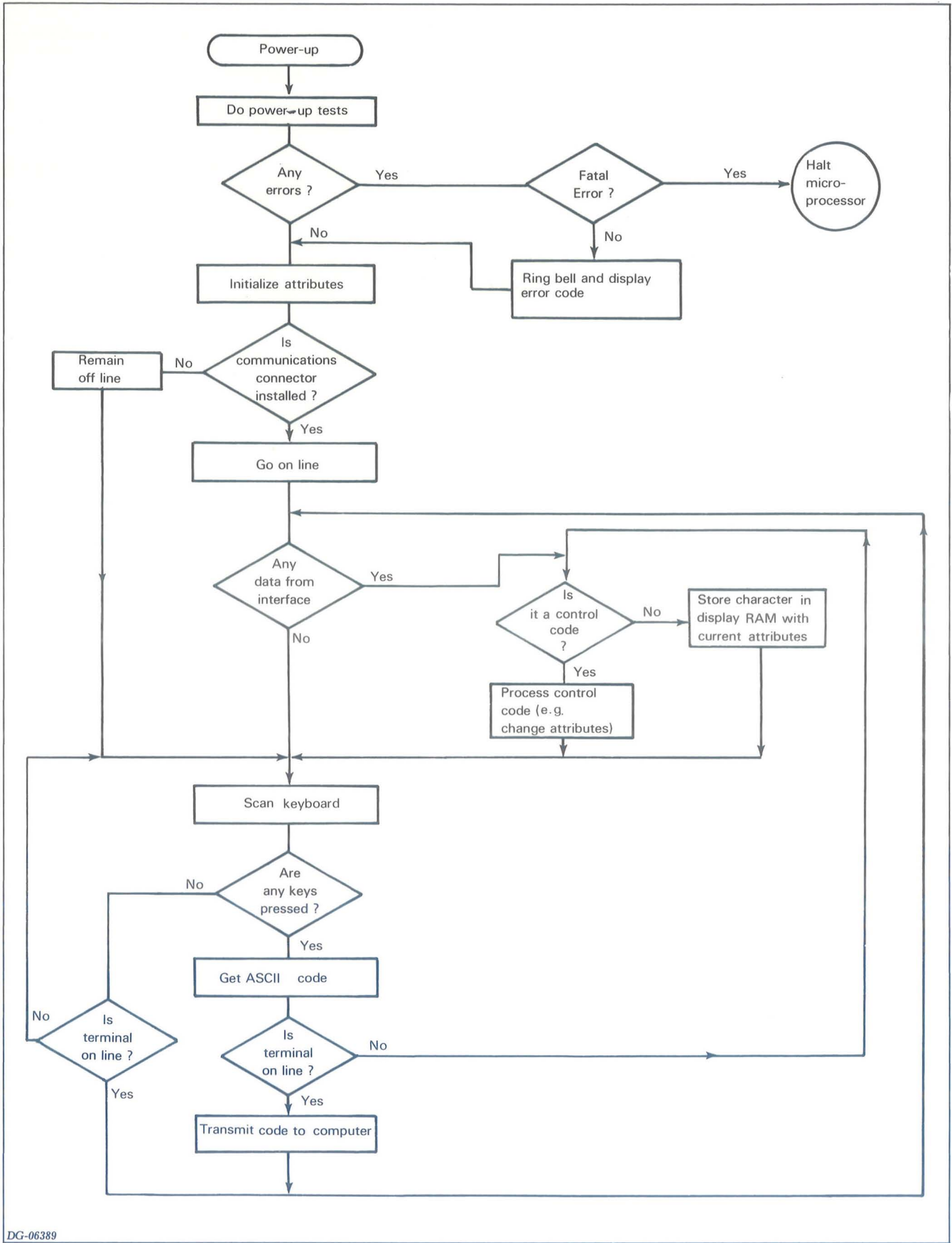

Figure 5.3 Dot Matrix on Display Screen



DG-06389

Figure 5.4 Functional Flow



## Powering Up

When the terminal is powered up, the microprocessor executes a series of diagnostic programs that test the operation of the control logic and the presence of the keyboard. As soon as it completes these tests, the microprocessor initializes the character attributes to a default state where rolling and blinking are enabled but no characters will be blinking, dimmed, underscored, or in reverse video until these attributes are specified.

Besides initializing the character attributes, the microprocessor turns off the alpha lock to place the terminal in lower-case mode. In a D100 terminal, it also places the keyboard in cursor lock mode to enable the cursor pad.

Next, the microprocessor places the terminal on-line if the communications connector is installed; otherwise, the terminal stays off-line. In on-line mode the microprocessor constantly scans the keyboard for pressed keys and checks the communications interface for ASCII codes received via the communications line. In off-line mode, it only scans the keyboard.

## Scanning Keyboard

The microprocessor scans the keyboard by addressing consecutive keys. If the addressed key is pressed, the sense circuitry on the keyboard sends a pulse to the microprocessor. If the same key (or combination of keys) is pressed for two consecutive scans of the keyboard, the microprocessor generates the ASCII code for the key (or combination) from its address. It then transfers this code to the communications interface for transmission (on line) or processes the code internally (off line) as if it was received from the communications interface.

## Communications Interface

The microprocessor sends ASCII codes to the communications interface (on line) where they are converted into serial format and transferred to the communications line.

When the terminal receives an ASCII code via the communications line, the communications interface assembles the data into an 8-bit buffer. As soon as the code is assembled, the interface notifies the microprocessor to retrieve the code.

## Processing Codes

When the microprocessor receives a code from the communications interface (on line) or senses a pressed key (off line), it first determines if the code is a control character or a printing character. If it is a control character (000<sub>8</sub> to 037<sub>8</sub>), the microprocessor performs the defined function. For example, a *Start Dim* command causes the microprocessor to change the current attribute settings so that subsequent printing characters are dimmed. If a printing character (040<sub>8</sub> to 176<sub>8</sub>) is received, the

microprocessor stores the character's ASCII code, along with a copy of the current attributes, in RAM.

## Displaying Characters

The CRT control logic continually addresses sequential locations in display RAM, accessing character codes and their attributes. In this way, the logic updates the screen as the microprocessor changes the contents of the display RAM.

The character codes, read from display RAM, address locations in the character generator ROM that contain bit patterns used to form each character. These bit patterns, along with the attribute information, enter the CRT driver circuits where they are converted into the voltage levels required by the CRT/yoke assembly. At the same time, the CRT control logic generates the cursor and provides the horizontal and vertical synchronizing signals required by the yoke to position the characters on the screen.



# **APPENDIX A**

## **ASCII-128 CONTROL CODES**

ASCII 128 CONTROL CODES

Code (octal)	D100 Keyboard	D200 Keyboard	Function
000	CTRL-SHIFT-2 (CTRL-@)	CTRL-SHIFT-2 (CTRL-@)	—
001	CTRL-A	CTRL-A	Print form
002	CTRL-SHIFT-A	CTRL-SHIFT-A	—
003	CTRL-B	CTRL-B	Enable blink
004	CTRL-SHIFT-B	CTRL-SHIFT-B	Disable blink
005	CTRL-C	CTRL-C	Read cursor address
006	CTRL-SHIFT-C	CTRL-SHIFT-C	—
007	CTRL-D	CTRL-D	Bell
010	CTRL-SHIFT-D	CTRL-SHIFT-D	Cursor home
011	CTRL-E	CTRL-E	—
012	CTRL-SHIFT-E	CTRL-SHIFT-E	New line
013	CTRL-F	CTRL-F	Erase to end-of-line
014	CTRL-SHIFT-F	CTRL-SHIFT-F	Erase page
015	CTRL-G	CTRL-G	Carriage return
016	CTRL-SHIFT-G	CTRL-SHIFT-G	Start blink
017	CTRL-H	CTRL-H	End blink
020	CTRL-SHIFT-H CMD-5, * 5 * CTRL-5	CTRL-SHIFT-H HOME, CTRL-HOME	Write cursor address
011	CTRL-I	CTRL-I	—
012	CTRL-SHIFT-I TAB	CTRL-SHIFT-I TAB	New line
013	CTRL-J	CTRL-J	Erase to end-of-line
014	CTRL-SHIFT-J NEW LINE CTRL-NEW LINE SHIFT-NEW LINE CTRL-SHIFT-NEW LINE	CTRL-SHIFT-J NEW LINE CTRL-NEW LINE SHIFT-NEW LINE CTRL-SHIFT-NEW LINE	Erase page
015	CTRL-K	CTRL-K	Carriage return
016	CTRL-SHIFT-K CMD-' CMD-SHIFT-'	CTRL-SHIFT-K ERASE EOL	Start blink
017	CTRL-L	CTRL-L	End blink
020	CTRL-SHIFT-L CMD-= CMD-SHIFT-=	CTRL-SHIFT-L ERASE PAGE	Write cursor address
015	CTRL-M	CTRL-M	Carriage return
016	CTRL-SHIFT-M RETURN CTRL-RETURN SHIFT-RETURN CTRL-SHIFT-RETURN	CTRL-SHIFT-M RETURN CTRL-RETURN SHIFT-RETURN CTRL-SHIFT-RETURN	Start blink
017	CTRL-N	CTRL-N	End blink
020	CTRL-SHIFT-N	CTRL-SHIFT-N	Write cursor address
017	CTRL-O	CTRL-O	—
020	CTRL-SHIFT-O	CTRL-SHIFT-O	—
020	CTRL-P	CTRL-P	—
020	CTRL-SHIFT-P	CTRL-SHIFT-P	—

ASCII -128 CONTROL CODES (CONTINUED)

Code (octal)	D 100 Keyboard	D200 Keyboard	Function
021	CTRL-Q CTRL-SHIFT-Q	CTRL-Q CTRL-SHIFT-Q	Print
022	CTRL-R CTRL-SHIFT-R	CTRL-R CTRL-SHIFT-R	Roll enable
023	CTRL-S CTRL-SHIFT-S	CTRL-S CTRL-SHIFT-S	Roll disable
024	CTRL-T CTRL-SHIFT-T	CTRL-T CTRL-SHIFT-T	Start underscore
025	CTRL-U CTRL-SHIFT-U	CTRL-U CTRL-SHIFT-U	End underscore
026	CTRL-V CTRL-SHIFT-V	CTRL-V CTRL-SHIFT-V	—
027	CTRL-W CTRL-SHIFT-W CMD-], * [ ] * CTRL-]	CTRL-W CTRL-SHIFT-W [, CTRL-]	Cursor up
030	CTRL-X CTRL-SHIFT-X CMD- →, * → * CTRL-→	CTRL-X CTRL-SHIFT-X →, CTRL-→	Cursor right
031	CTRL-Y CTRL-SHIFT-Y CMD- ←, * ← * CTRL-←	CTRL-Y CTRL-SHIFT-Y ←, CTRL-←	Cursor left
032	CTRL-Z CTRL-SHIFT-Z CMD ], * [ ] * CTRL-]	CTRL-Z CTRL-SHIFT-Z ], CTRL-]	Cursor down
033	ESC CTRL- [	ESC CTRL- [	—
034	CTRL- \	CTRL- \	Start dim
035	CTRL- ]	CTRL- ]	End dim
036	—	—	Function code prefix
037	—	—	Read cursor address code prefix

\*Denotes a key that is accessible only on the auxiliary keypad in cursor lock mode.

**NOTE:** The Enter remote test, Exit remote test, Model report request, Start reverse video, and End reverse video functions (code sequences  $036_8 - 101_8$ ,  $036_8 - 102_8$ ,  $036_8 - 103_8$ ,  $036_8 - 104_8$ , and  $036_8 - 105_8$ , respectively) cannot be generated from the keyboard.

**APPENDIX B**  
**ASCII CODES DISPLAYED BY D100/D200**  
**TERMINALS**



ASCII CODES DISPLAYED BY D100/D200 TERMINALS

NAME	SYMBOL DISPLAY	7 BIT OCTAL CODE	KEYPAD	
			MAIN KEYPAD	NUMERIC KEYPAD *
Space	Non-printing	040	Space Bar	-
Exclamation Mark	!	041	SH 1	-
Quotation Marks	"	042	SH '	-
Number Sign	#	043	SH 3	-
Dollar Sign	\$	044	SH 4	-
Percent	%	045	SH 5	-
Ampersand	&	046	SH 7	-
Apostrophe (Single Closing Quotation Mark)	'	047	'	-
Opening Parenthesis	(	050	SH 9	-
Closing Parenthesis	)	051	SH 0	-
Asterisk	*	052	SH 8	-
Plus	+	053	SH =	-
Comma	,	054	,	,
Hyphen (Minus)	-	055	-	-
Period (Decimal Point)	.	056	.	-
Slant	/	057	/	-
Zero	0	060	0	0
One	1	061	1	1
Two	2	062	2	2
Three	3	063	3	3
Four	4	064	4	4
Five	5	065	5	5
Six	6	066	6	6
Seven	7	067	7	7
Eight	8	070	8	8
Nine	9	071	9	9
Colon	:	072	SH ;	-
Semicolon	;	073	;	-
Less Than	<	074	SH ,	-
Equals	=	075	=	-
Greater Than	>	076	SH .	-
Question Mark	?	077	SH /	-
Commercial At	@	100	SH 2	-
A	A	101	SH A	-
B	B	102	SH B	-
C	C	103	SH C	-
D	D	104	SH D	-
E	E	105	SH E	-
F	F	106	SH F	-
G	G	107	SH G	-
H	H	110	SH H	-
I	I	111	SH I	-
J	J	112	SH J	-
K	K	113	SH K	-
L	L	114	SH L	-
M	M	115	SH M	-

\* The numeric/cursor control keypad on the D100 keyboard must be in cursor unlock mode to generate these codes.

ASCII CODES DISPLAYED BY D100/D200 TERMINALS (CONTINUED)

NAME	SYMBOL DISPLAY	7 BIT OCTAL CODE	KEYPAD	
			MAIN KEYPAD	NUMERIC KEYPAD
N	N	116	SH N	-
O	O	117	SH O	-
P	P	120	SH P	-
Q	Q	121	SH Q	-
R	R	122	SH R	-
S	S	123	SH S	-
T	T	124	SH T	-
U	U	125	SH U	-
V	V	126	SH V	-
W	W	127	SH W	-
X	X	130	SH X	-
Y	Y	131	SH Y	-
Z	Z	132	SH Z	-
Opening Bracket	[	133	[	-
Reverse Slant	\	134	\	-
Closing Bracket	]	135	]	-
Up Arrow	↑	136	SH 6	-
Underline	—	137	SH -	-
Single Opening Quotation Mark	`	140	`	-
a	a	141	A	-
b	b	142	B	-
c	c	143	C	-
d	d	144	D	-
e	e	145	E	-
f	f	146	F	-
g	g	147	G	-
h	h	150	H	-
i	i	151	I	-
j	j	152	J	-
k	k	153	K	-
l	l	154	L	-
m	m	155	M	-
n	n	156	N	-
o	o	157	O	-
p	p	160	P	-
q	q	161	Q	-
r	r	162	R	-
s	s	163	S	-
t	t	164	T	-
u	u	165	U	-
v	v	166	V	-
w	w	167	W	-

ASCII CODES DISPLAYED BY D100/D200 TERMINALS (CONTINUED)

NAME	SYMBOL DISPLAY	7 BIT OCTAL CODE	KEYPAD	
			MAIN KEYPAD	NUMERIC KEYPAD
x	x	170	X	-
y	y	171	Y	-
z	z	172	Z	-
Open Brace	{	173	SH [	-
Vertical Line		174	SH \	-
Closing Brace	}	175	SH ]	-
Tilde	~	176	SH `	-

ALTERNATE ASCII CODES DISPLAYED BY INTERNATIONAL D100/D200 DISPLAY TERMINALS

	NAME	SYMBOL DISPLAY	7 BIT OCTAL CODE	KEYPAD	
				MAIN KEYPAD	NUMERIC KEYPAD
<b>FRENCH</b>	Pound Sign	£	043	£	-
	a grave	à	100	à	-
	Degree	°	133	SH )	-
	C Cedille	ç	134	ç	-
	Paragraph Sign	¶	135	SH !	-
	e aigue	é	173	é	-
	u grave	ù	174	ù	-
	e grave	è	175	è	-
<b>GERMAN</b>	Paragraph Sign	¶	100	SH 3	-
	A umlaut	Ä	133	SH Ä	-
	O umlaut	Ö	134	SH Ö	-
	U umlaut	Ü	135	SH Ü	-
	a umlaut	ä	173	Ä	-
	o umlaut	ö	174	Ö	-
	u umlaut	ü	175	Ü	-
	Schaffe	ß	176	B	-
<b>SPANISH</b>	N tilde	Ñ	134	SH Ñ	-
	n tilde	ñ	174	Ñ	-
<b>SWEDISH/ FINNISH</b>	Crown	☉	044	SH 4	-
	E acute	É	100	SH É	-
	A umlaut	Ä	133	SH Ä	-
	O umlaut	Ö	134	SH Ö	-
	A dot	Å	135	SH Å	-
	U umlaut	Ü	136	SH Ü	-
	e acute	é	140	É	-
	a umlaut	ä	173	Ä	-
	o umlaut	ö	174	Ö	-
	a dot	å	175	Å	-
u umlaut	ü	176	Ü	-	
<b>BRITISH</b>	Pound Sign	£	043	SH 3	-
	Vertical Line		174	SH \	-
	Over Bar	—	176	SH `	-

DG-03824

DANISH/NORWEGIAN TO BE SUPPLIED.



**APPENDIX C**  
**CODE SEQUENCES GENERATED BY D100/D200**  
**TERMINALS**

CODE SEQUENCES GENERATED BY D100/D200 TERMINALS

CODE SEQUENCE (octal)	D 100 Keyboard	D200 Keyboard
036,001	CMD-SHIFT-\	CMD-SHIFT-PRINT
036,010	SHIFT-HOME *	SHIFT-MODE-HOME
036,021	CMD-\	CMD-PRINT
036,027	SHIFT-] *	SHIFT-]
036,030	SHIFT-→ *	SHIFT-→
036,031	SHIFT-← *	SHIFT-←
036,032	SHIFT-[ *	SHIFT-[
036,040	-	CTRL-SHIFT-F15
036,041	-	CTRL-SHIFT-F1
036,042	-	CTRL-SHIFT-F2
036,043	-	CTRL-SHIFT-F3
036,044	-	CTRL-SHIFT-F4
036,045	-	CTRL-SHIFT-F5
036,046	-	CTRL-SHIFT-F6
036,047	-	CTRL-SHIFT-F7
036,050	-	CTRL-SHIFT-F8
036,051	-	CTRL-SHIFT-F9
036,052	-	CTRL-SHIFT-F10
036,053	-	CTRL-SHIFT-F11
036,054	-	CTRL-SHIFT-F12
036,055	-	CTRL-SHIFT-F13
036,056	-	CTRL-SHIFT-F14
036,060	-	CTRL-F15
036,061	-	CTRL-F1
036,062	-	CTRL-F2
036,063	-	CTRL-F3
036,064	-	CTRL-F4
036,065	-	CTRL-F5
036,066	-	CTRL-F6
036,067	-	CTRL-F7
036,070	-	CTRL-F8
036,071	-	CTRL-F9
036,072	-	CTRL-F10
036,073	-	CTRL-F11
036,074	-	CTRL-F12

\*On cursor/numeric keypad; keypad must be in cursor lock mode. (See DASHER D100/D200 Operator's Manual. DGC 014-000641.) All other D100 code sequences are generated by the main keypad.

CODE SEQUENCE (octal)	D100 Keyboard	D200 Keyboard
036,075	-	CTRL-F13
036,076	-	CTRL-F14
036,130	SHIFT-7 *	SHIFT-C1
036,131	SHIFT-9 *	SHIFT-C2
036,132	SHIFT-1 *	SHIFT-C3
036,133	SHIFT-3 *	SHIFT-C4
036,134	7 *	C1
036,135	9 *	C2
036,136	1 *	C3
036,137	3 *	C4
036,140	-	SHIFT-F15
036,141	CMD-SHIFT-1	SHIFT-F1
036,142	CMD-SHIFT-2	SHIFT-F2
036,143	CMD-SHIFT-3	SHIFT-F3
036,144	CMD-SHIFT-4	SHIFT-F4
036,145	CMD-SHIFT-5	SHIFT-F5
036,146	CMD-SHIFT-6	SHIFT-F6
036,147	CMD-SHIFT-7	SHIFT-F7
036,150	CMD-SHIFT-8	SHIFT-F8
036,151	CMD-SHIFT-9	SHIFT-F9
036,152	CMD-SHIFT-0	SHIFT-F10
036,153	-	SHIFT-F11
036,154	-	SHIFT-F12
036,155	-	SHIFT-F13
036,156	-	SHIFT-F14
036,160	-	F15
036,161	CMD-1	F1
036,162	CMD-2	F2
036,163	CMD-3	F3
036,164	CMD-4	F4
036,165	CMD-5	F5
036,166	CMD-6	F6
036,167	CMD-7	F7
036,170	CMD-8	F8
036,171	CMD-9	F9
036,172	CMD-0	F10
036,173	-	F11
036,174	-	F12
036,175	-	F13
036,176	-	F14

# APPENDIX D

## INTERNATIONAL CHARACTER FONTS

There are seven 96-symbol character fonts available with DASHER D100 and D200 display terminals. They correspond to standard ASCII code specifications for the United States, the United Kingdom, France, Germany, Spain, and the Scandinavian countries.

Each character is defined by a 7-bit ASCII code. Control codes,  $000_8$  to  $037_8$  are not displayed. The codes from  $040_8$  to  $176_8$  define the 96-symbol character fonts. The dot matrix patterns that the display produces for each code are shown on the following pages. The American font is illustrated in its entirety. However, of the remaining six fonts, only those patterns which differ from the American font are shown.

# AMERICAN USAGE

040



041

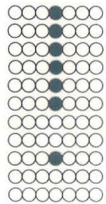

042



043



044

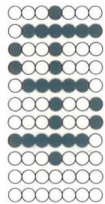

045



046



047

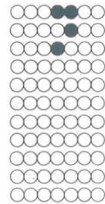

050

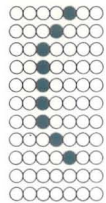

051

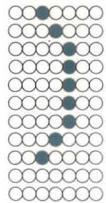

052

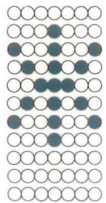

053

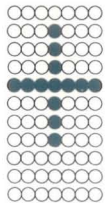

054

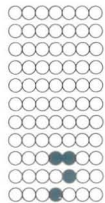

055

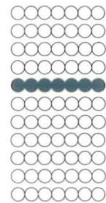

056

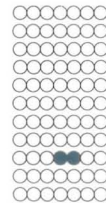

057



060



061

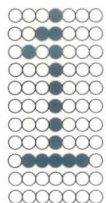

062

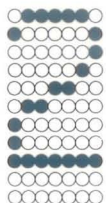

063

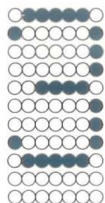

064

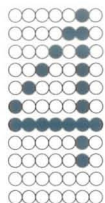

065



066



067



070

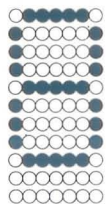

071

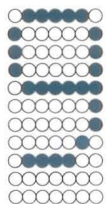

072

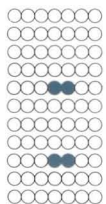

073

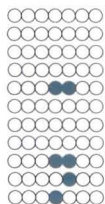

074

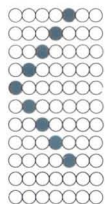

075



076



077



100

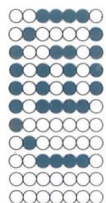

101

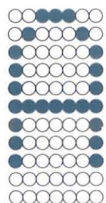

102

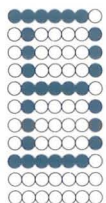

103



104

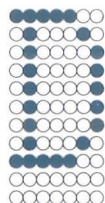

105



106



107





# AMERICAN USAGE

110

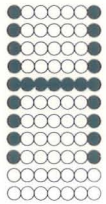

111



112



113



114

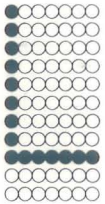

115



116



117

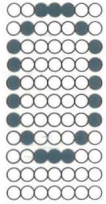

120

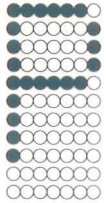

121

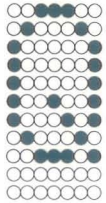

122

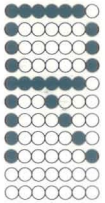

123

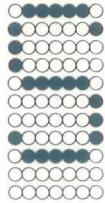

124

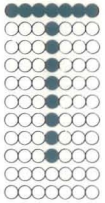

125

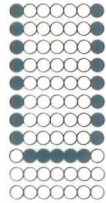

126



127

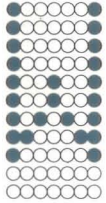

130

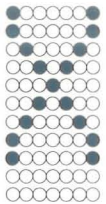

131

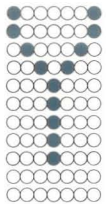

132

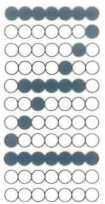

133



134

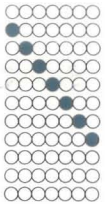

135

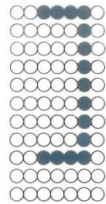

136

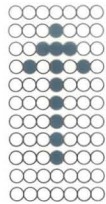

137

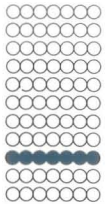

140

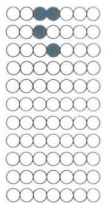

141

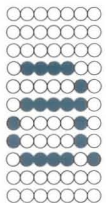

142

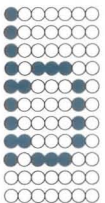

143



144

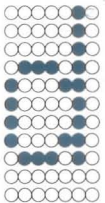

145



146



147

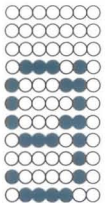

150

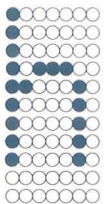

151

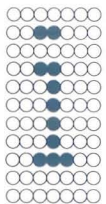

152

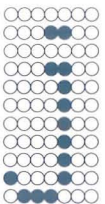

153



154

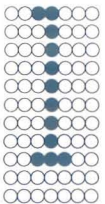

155

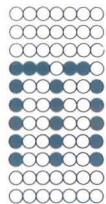

156

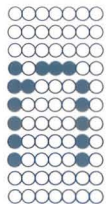

157

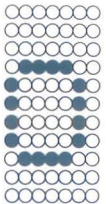

## AMERICAN USAGE

160

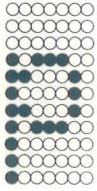

161



162



163



164



165



166



167



170



171



172



173



174



175



176



## BRITISH USAGE

043



174



176



## FRENCH USAGE

043

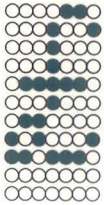

100

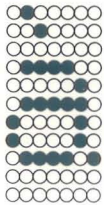

133



134

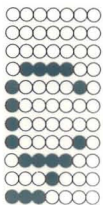

135

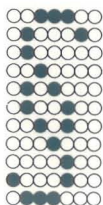

173



174



175



## GERMAN USAGE

100

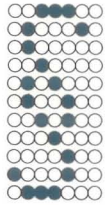

133

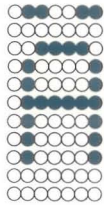

134



135



173



174



175



176

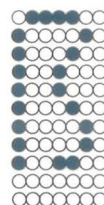

## SPANISH USAGE

134



174







# GLOSSARY

<b>ASCII</b>	American Standard Code for Information Interchange, one of the standards used to translate <b>Alphanumeric</b> and control characters into <b>Binary</b> numbers (the <i>language</i> of computers). The ASCII code assigns a unique binary number to each letter, digit, punctuation mark, or other symbol used.	<b>Bus</b>	A group of wires (often a multiple of 8) that move several <b>Bits</b> of information at a time from one electronic part or <b>Peripheral</b> to another.
<b>Address</b>	A number which indicates the <b>Location</b> of stored <b>Data</b> in <b>Memory</b> .	<b>Byte</b>	A group of 8 <b>Bits</b> .
<b>Alphanumeric</b>	Refers to a <b>Character set</b> containing alphabetic and numeric symbols as well as other symbols such as punctuation marks.	<b>Cathode ray tube (CRT)</b>	A television-type picture tube used in display terminals.
<b>Asynchronous Communication</b>	Refers to a method of <b>Serial communication</b> where <b>characters</b> are transmitted one at a time, with no restrictions on how often they are sent.	<b>Character</b>	A digit, letter, or other symbol.
<b>Baud</b>	The number of information <b>Bits</b> which can be transmitted serially each second over a communication line.	<b>Character code</b>	A combination of <b>Bits</b> which represents a particular <b>Character</b> in a <b>Character set</b> .
<b>Binary</b>	Referring to the system of numerical notation which has a <b>Radix 2</b> .	<b>Character generator</b>	An electronic component ( <b>ROM</b> ) that contains the <b>Bit</b> patterns necessary to print or display characters in a printer or terminal.
<b>Binary digit</b>	See <b>Bit</b> .	<b>Character set</b>	A collection of <b>Alphanumeric</b> and control symbols.
<b>Bit</b>	One of the two symbols (0 or 1) in the <b>Binary</b> numbering system. Since computers process all information by means of electronic signals (on/off, high/low), binary digits lend themselves ideally to representing this information. Sometimes called a <b>Binary digit</b> .	<b>Command</b>	See <b>Instruction</b> .
<b>Buffer</b>	A temporary storage area for <b>Data</b> in a <b>Device</b> .	<b>Computer</b>	The computer that a <b>Peripheral</b> is connected to.
		<b>Controller</b>	The equipment between a computer and a <b>Device</b> which interprets signals between them.
		<b>Data</b>	A general expression for the information that moves throughout a computer system and all its <b>Peripherals</b> .
		<b>Device</b>	A unit which provides the computer system with outside communication, service, or storage, e.g., card punch, disc drive, paper tape reader, video display, line printer, etc.
		<b>Dot matrix</b>	Refers to a method of forming characters using a rectangular block of dots. When individual dots within



	the block are printed or displayed in certain patterns, a character is formed.		
<b>Full-duplex</b>	Refers to a mode of serial data transmission which enables information to be received and transmitted at the same time.	<b>Radix</b>	Solve a specific problem. The <b>Radix</b> of a numbering system is the maximum number of different digits which can be used in the numbering system.
<b>Half-duplex</b>	Refers to a mode of serial data transmission which enables information to be received and transmitted but not at the same time.	<b>RAM</b>	See <b>Random access memory</b> .
<b>Hardware</b>	The physical <b>Devices</b> or electronic parts that which make up a computer system.	<b>Random access memory (RAM)</b>	A type of <b>Memory</b> that stores information until the power is turned off, or until new information is written over the old information.
<b>Instruction</b>	Part of a <b>Program</b> , consisting of a <b>Word</b> which defines the operation to be performed.	<b>Read only memory (ROM)</b>	A type of <b>Memory</b> that stores information which is permanent. Often used for storing a <b>Program</b> that must remain intact when the power is turned off.
<b>Location</b>	An area in <b>Memory</b> (designated by an <b>Address</b> ) which contains a <b>Word</b> .	<b>ROM</b>	See <b>Read only memory</b> .
<b>Memory</b>	The storage area of a computer.	<b>Routine</b>	A subdivision of a <b>Program</b> consisting of two or more <b>Instructions</b> .
<b>Microprocessor</b>	An electronic part that contains all the circuits necessary to fetch and execute <b>Instructions</b> that make up a <b>Program</b> .	<b>Serial communication</b>	Process of communication whereby <b>Bits</b> are transmitted one at a time. A <b>Character</b> is therefore not formed until all the bits comprising it are received.
<b>Off-line</b>	The state of a <b>Device</b> when it is not controlled by a computer system.	<b>Terminal</b>	A <b>Device</b> which has a printer or display and a keyboard for use by a human when entering <b>Data</b> or <b>Commands</b> manually.
<b>On-line</b>	The state of a <b>Device</b> when it is controlled by a computer system.	<b>UAR/T</b>	Universal Asynchronous Receiver/Transmitter. Used to transfer <b>Serial</b> data from one <b>Device</b> to another.
<b>Parity</b>	A method of error detection. An extra <b>Bit</b> (the parity bit) is added to the code for each unit of data. When using even parity, the sum of all the ones in the code is even; when using odd parity, the sum is odd. A computer can detect errors by checking for the correct parity in each unit of data received.	<b>Word</b>	A unit of <b>Data</b> consisting of a fixed number of <b>Bits</b> which can be stored in one <b>Memory</b> location.
<b>Peripheral</b>	Specifically, a system consisting of a <b>Device</b> , a <b>Controller</b> , and sometimes an adapter, but often used synonymously with <b>Device</b> .		
<b>Program</b>	The sequence of <b>Instructions</b> or <b>Routines</b> required to perform a specific action or		

# Data General Users group

## Installation Membership Form

Name \_\_\_\_\_ Position \_\_\_\_\_ Date \_\_\_\_\_  
 Company, Organization or School \_\_\_\_\_  
 Address \_\_\_\_\_ City \_\_\_\_\_ State \_\_\_\_\_ Zip \_\_\_\_\_  
 Telephone: Area Code \_\_\_\_\_ No. \_\_\_\_\_ Ext. \_\_\_\_\_

<b>1. Account Category</b> <input type="checkbox"/> OEM <input type="checkbox"/> End User <input type="checkbox"/> System House <input type="checkbox"/> Government	<b>5. Mode of Operation</b> <input type="checkbox"/> Batch (Central) <input type="checkbox"/> Batch (Via RJE) <input type="checkbox"/> On-Line Interactive																																							
<b>2. Hardware</b> <table border="1"> <thead> <tr> <th></th> <th>Qty. Installed</th> <th>Qty. On Order</th> </tr> </thead> <tbody> <tr><td>M/600</td><td>_____</td><td>_____</td></tr> <tr><td>C/350, C/330, C/300</td><td>_____</td><td>_____</td></tr> <tr><td>S/250, S/230, S/200</td><td>_____</td><td>_____</td></tr> <tr><td>S/130</td><td>_____</td><td>_____</td></tr> <tr><td>AP/130</td><td>_____</td><td>_____</td></tr> <tr><td>CS Series</td><td>_____</td><td>_____</td></tr> <tr><td>N3/D</td><td>_____</td><td>_____</td></tr> <tr><td>Other NOVA</td><td>_____</td><td>_____</td></tr> <tr><td>microNOVA</td><td>_____</td><td>_____</td></tr> <tr><td>Other _____</td><td>_____</td><td>_____</td></tr> <tr><td>(Specify) _____</td><td>_____</td><td>_____</td></tr> <tr><td>_____</td><td>_____</td><td>_____</td></tr> </tbody> </table>		Qty. Installed	Qty. On Order	M/600	_____	_____	C/350, C/330, C/300	_____	_____	S/250, S/230, S/200	_____	_____	S/130	_____	_____	AP/130	_____	_____	CS Series	_____	_____	N3/D	_____	_____	Other NOVA	_____	_____	microNOVA	_____	_____	Other _____	_____	_____	(Specify) _____	_____	_____	_____	_____	_____	<b>6. Communications</b> <input type="checkbox"/> RSTCP <input type="checkbox"/> CAM <input type="checkbox"/> HASP <input type="checkbox"/> 4025 <input type="checkbox"/> RJE80 <input type="checkbox"/> Other <input type="checkbox"/> SAM Specify _____ _____
	Qty. Installed	Qty. On Order																																						
M/600	_____	_____																																						
C/350, C/330, C/300	_____	_____																																						
S/250, S/230, S/200	_____	_____																																						
S/130	_____	_____																																						
AP/130	_____	_____																																						
CS Series	_____	_____																																						
N3/D	_____	_____																																						
Other NOVA	_____	_____																																						
microNOVA	_____	_____																																						
Other _____	_____	_____																																						
(Specify) _____	_____	_____																																						
_____	_____	_____																																						
<b>3. Software</b> <input type="checkbox"/> AOS <input type="checkbox"/> RDOS <input type="checkbox"/> DOS <input type="checkbox"/> RTOS <input type="checkbox"/> SOS <input type="checkbox"/> Other Specify _____ _____	<b>7. Application Description</b> ○ _____ _____ _____ _____ _____ _____																																							
<b>4. Languages</b> <input type="checkbox"/> Algol <input type="checkbox"/> Assembler <input type="checkbox"/> DG/L <input type="checkbox"/> Interactive <input type="checkbox"/> Cobol <input type="checkbox"/> Fortran <input type="checkbox"/> ECLIPSE Cobol <input type="checkbox"/> RPG II <input type="checkbox"/> Business BASIC <input type="checkbox"/> PL/1 <input type="checkbox"/> BASIC <input type="checkbox"/> Other Specify _____ _____	<b>8. Purchase</b> From whom was your machine(s) purchased? <input type="checkbox"/> Data General Corp. <input type="checkbox"/> Other Specify _____ _____																																							
<b>9. Users Group</b> Are you interested in joining a special interest or regional Data General Users Group? ○ _____ _____																																								

FOLD

FOLD

STAPLE

STAPLE

FOLD

FOLD

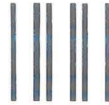

NO POSTAGE  
NECESSARY  
IF MAILED  
IN THE  
UNITED STATES

**BUSINESS REPLY MAIL**  
FIRST CLASS PERMIT NO. 26 SOUTHBORO, MA. 01772

Postage will be paid by addressee:



ATTN: Users Group Coordinator  
4400 Computer Drive  
Westboro, MA 01581

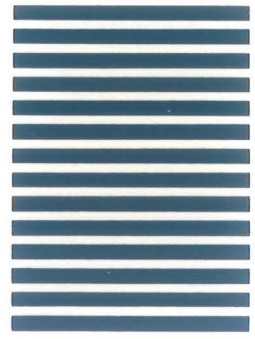



# Engineering Publications Comment Form

Please help us improve our future publications by answering the questions below. Use the space provided for your comments.

Title: \_\_\_\_\_

Document No. \_\_\_\_\_

Yes <input type="checkbox"/>	No <input type="checkbox"/>	Is this manual easy to read?	<input type="radio"/> You (can, cannot) find things easily. <input type="radio"/> Other: <input type="radio"/> Language (is, is not) appropriate. <input type="radio"/> Technical terms (are, are not) defined as needed.
		In what ways do you find this manual useful?	<input type="radio"/> Learning to use the equipment <input type="radio"/> To instruct a class. <input type="radio"/> As a reference <input type="radio"/> Other: <input type="radio"/> As an introduction to the product
<input type="checkbox"/>	<input type="checkbox"/>	Do the illustrations help you?	<input type="radio"/> Visuals (are, are not) well designed. <input type="radio"/> Labels and captions (are, are not) clear. <input type="radio"/> Other:
<input type="checkbox"/>	<input type="checkbox"/>	Does the manual tell you all you need to know? What additional information would you like?	
<input type="checkbox"/>	<input type="checkbox"/>	Is the information accurate? (If not please specify with page number and paragraph.)	

Name: \_\_\_\_\_ Title: \_\_\_\_\_

Company: \_\_\_\_\_ Division: \_\_\_\_\_

Address: \_\_\_\_\_ City: \_\_\_\_\_

State: \_\_\_\_\_ Zip: \_\_\_\_\_ Telephone: \_\_\_\_\_ Date: \_\_\_\_\_

FOLD

FOLD

STAPLE

STAPLE

FOLD

FOLD

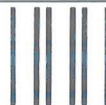

NO POSTAGE  
NECESSARY  
IF MAILED  
IN THE  
UNITED STATES

**BUSINESS REPLY MAIL**  
FIRST CLASS PERMIT NO. 26 SOUTHBORO, MA. 01772

Postage will be paid by addressee:

 **Data General**

ATTN: ENGINEERING PUBLICATIONS  
4400 Computer Drive  
Westboro, MA 01581

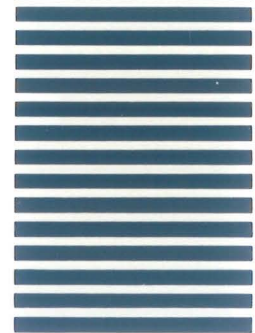



# Technical Specifications

## General

<b>Display</b>	Tabletop mounting. 12 in. diagonal screen; 24 lines by 80 characters/line in active area 8.5 in. by 5.5 in.
<b>Characters</b>	7 x 11 dot matrix characters
<b>Character Fonts</b>	American, British, Danish/Norwegian, French, German, Spanish, and Swedish/Finnish
<b>Keyboard</b>	Independent tabletop mounting; n-key roll over; typematic and manual repeat; user definable function keys
<b>Self Test</b>	Diagnostic routine checks terminal at power-up.
<b>Interface</b>	Asynchronous serial; full-duplex; EIA RS232-C and 20mA current loop. Compatible with Bell 103, 113, and 212 type modems.
<b>Baud Rates</b>	50, 75, 110, 134.5, 150, 300, 600, 1200, 1800, 2400, 3600, 4800, 7200, 9600, and 19200 bits per second.
<b>Data Format</b>	ASCII; 7 data bits; even, odd, mark, or no parity; one stop bit (two stop bits at or below 110 baud).
<b>Printer/Split Baud Option</b>	Second interface for serial ASCII-based printer; EIA RS232-C; 110, 300, 600, 1200, 1800, 2400, 3600, or 4800 baud; 7-data bits; even parity; one stop bit (two stop bits at or below 110 baud). Allows separate receive baud selection (50 - 19,200 baud) and transmit baud selection (110 - 4800 baud). In split baud mode, one stop bit is selected for all terminal communications (including printer).

## Electrical

<b>Power Requirements</b>	100 volts AC, 50 hz.; 120 volts AC, 60 hz.; 220/240 volts AC, 50hz.
<b>Power Consumption</b>	50 watts maximum (171 BTU per hour)
<b>Display Refresh Rate</b>	60 frames/second (domestic) 50 frames/second (foreign)
<b>Display Scan</b>	Noninterlaced raster
<b>Line Cord</b>	1.8 meters (6 feet)
<b>Keyboard Cable</b>	1.2 meters (3.95 feet)
<b>I/O Cable</b>	EIA interface -- 15.2 meters (50 feet) maximum. 20mA current loop interface at 9600 baud or below -- 457.2 meters (1500 feet) maximum. 20mA current loop interface at 19200 baud -- 152.4 meters (500 feet) maximum.

## Mechanical

<b>Display Dimensions</b>	Height: 33.2 cm (13.2 inches) Width: 41.0 cm (16.1 inches) Depth: 44.9 cm (17.7 inches)
<b>D100 Keyboard Dimensions</b>	Height: 5.8 cm (2.3 inches) Width: 45.2 cm (17.8 inches) Depth: 16.2 cm (6.4 inches)
<b>D200 Keyboard Dimensions</b>	Height: 6.0 cm (2.4 inches) Width: 51.8 cm (20.4 inches) Depth: 19.0 cm (7.5 inches)
<b>Weight</b>	Display -- 10 Kg (22 lbs) D100 Keyboard -- 1.1 Kg (2.4 lbs) D200 Keyboard -- 1.6 Kg (3.5 lbs)

## Environmental

<b>Temperature Ranges</b>	Operating : 0 to 45 degC (32 to 113 degF) Storage: -40 to +40 degC (-40 to 104 degF)
<b>Humidity</b>	Operating: 10% to 90% noncondensing Storage: 10% to 90% noncondensing
<b>Altitude</b>	3048 meters (10,000 feet)
<b>Radiation</b>	Below 0.5 milliroentgens per hour (complies with Underwriters Laboratories Standard 478)

## Models

<b>6106</b>	D100 Display Terminal
<b>6107</b>	D100 Display Terminal with split baud and printer option
<b>6108</b>	D200 Display Terminal
<b>6109</b>	D200 Display Terminal with split baud and printer option





Data General Corporation, Westboro, Massachusetts 01581

014-000640-00, Copyright © Data General Corporation 1979

S11387800F860A9790866B9791CE00014FA7000839  
S11387908C000A26F8868097009706BDEF8C860B1E  
S10987A097900E7EF31B0E  
S9038780F5

UNDERCURS

S11387800F860A9790860F9791CE00014FA7000895  
S11387908C000A26F8868097009706BDEF8C7EF33E  
S10487A01BB9  
S9038780F5

KILLCURS



THIS DRAWING AND SPECIFICATIONS, HEREIN, ARE THE PROPERTY OF DATA GENERAL CORPORATION AND SHALL NOT BE REPRODUCED OR COPIED OR USED IN WHOLE OR IN PART AS THE BASIS FOR MANUFACTURE OR SALE OF ITEMS WITHOUT WRITTEN PERMISSION.

REVISIONS				
REV	DESCRIPTION	DR-FC	APP BY	DATE
00	RELSD PER ECO E942			8-24-77
01	PER ECO E973			11-27-77
02	PER ECO E993A			1-13-78
03	PER ECO J758			1-19-78
04	PER ECO 10085			2-20-78
05	PER ECO 10313		B.V.	1-10-78
06	PER ECO 10385		B.V.	2-14-78
07	PER ECO 10725		B.V.	2-14-78
08	PER ECO 10331		B.V.	2-14-78
09	PER ECO 10225A	VM	B.V.	1-11-78
10	PER ECO 11407	VM	B.V.	1-11-78
11	PER ECO 11422	VM	B.V.	1-11-78
12	PER ECO 12080A	VM	B.V.	2-5-78
13	PER ECO 12104	VM	B.V.	2-5-78
14	PER ECO 12533	VM	B.V.	1-11-78
15	PER ECO 12125	VM	B.V.	1-11-78

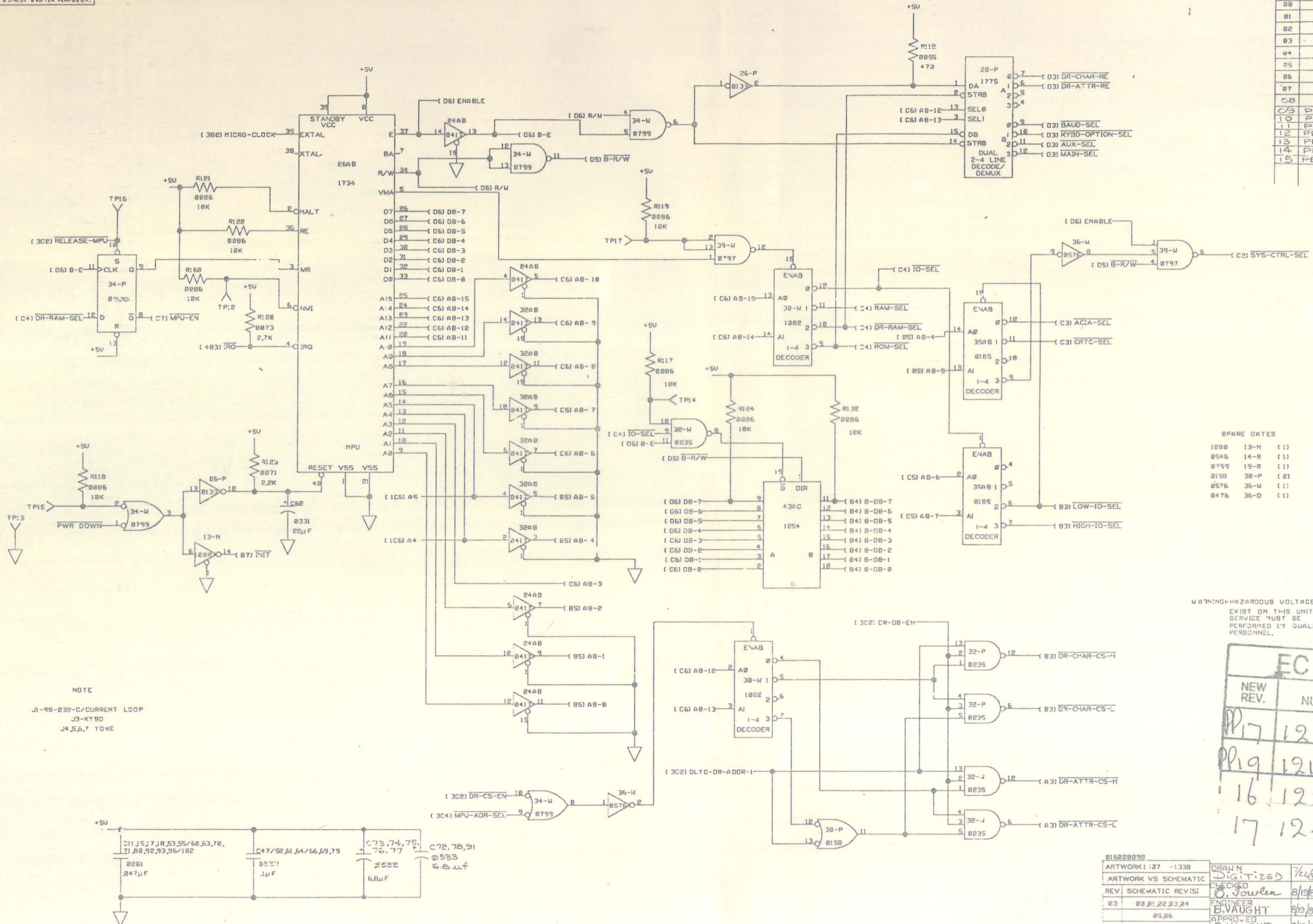

- SPARE GATES
- 1002 13-N (1)
  - 0546 14-R (1)
  - 0759 19-R (1)
  - 0158 30-P (2)
  - 0576 36-W (1)
  - 0476 36-D (1)

WARNING-HAZARDOUS VOLTAGES EXIST ON THIS UNIT SERVICE MUST BE PERFORMED BY QUALIFIED PERSONNEL.

EC OUTSTANDING			
NEW REV.	ECO NUMBER	NEW REV.	ECO NUMBER
P17	12117		
P19	12107		
16	12552		
17	12557		

NOTE  
J1-RS-232-C/CURRENT LOOP  
J3-KYBD  
J4,5,6,7 YOKE

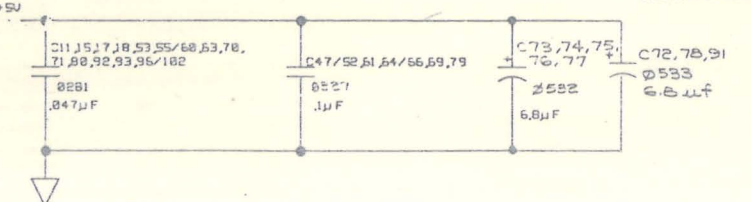

ARTWORK: 137-1338	DRAWN: Digitized 7/26/77	DATA GENERAL CORPORATION WESTBORO, MASSACHUSETTS 01581
ARTWORK VS SCHEMATIC: CHECKED	ENGINEER: B. VAUGHT 8/19/80	
REV: 03	SCHEMATIC REV: 03, 01, 02, 03, 04	TITLE CRT MAIN DASHER D100/0200
04	05, 06	
APPROVED: B. VAUGHT 8/19/80		SIZE: 001002691
FIRM: 005014529		
005014533		
005013685		
005014531		



THIS DRAWING AND SPECIFICATIONS, HEREIN, ARE THE PROPERTY OF DATA GENERAL CORPORATION AND SHALL NOT BE REPRODUCED OR COPIED OR USED IN WHOLE OR IN PART AS THE BASIS FOR MANUFACTURE OR SALE OF ITEMS WITHOUT WRITTEN PERMISSION.

REVISIONS			
REV	DESCRIPTION	DRFTS	APP BY

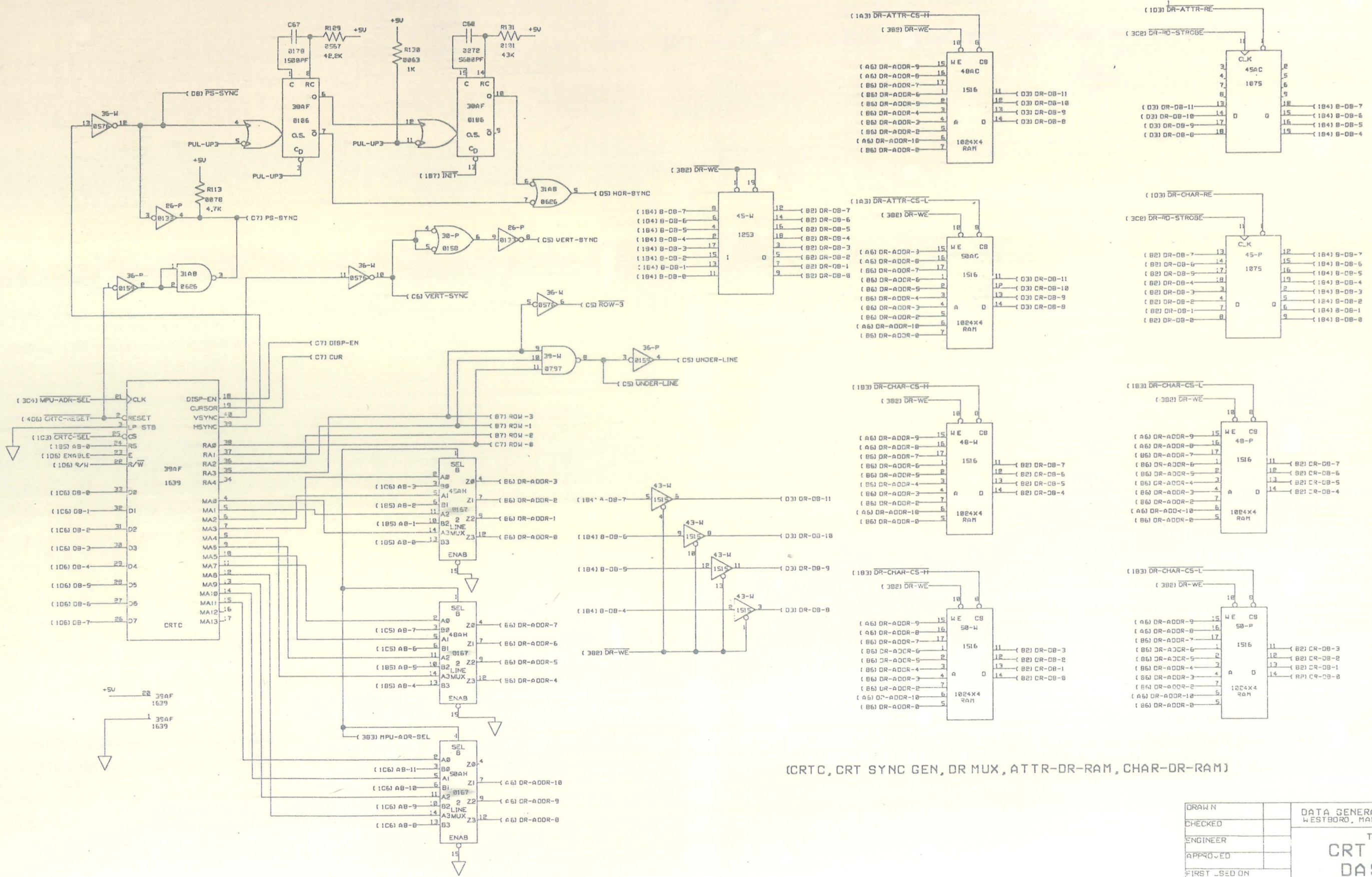

(CRTC, CRT SYNC GEN, DR MUX, ATTR-DR-RAM, CHAR-DR-RAM)

DRAWN	DATA GENERAL CORPORATION WESTBORO, MASSACHUSETTS 01581
CHECKED	TITLE <b>CRT MAIN DASHER</b>
ENGINEER	0100/0200
APPROVED	001002691
FIRST USED ON	REV



PROPERTY OF DATA GENERAL CORPORATION AND WILL NOT BE REPRODUCED OR COPIED OR USED IN WHOLE OR IN PART AS THE BASIS FOR MANUFACTURE OR SALE OF ITEMS WITHOUT WRITTEN PERMISSION.

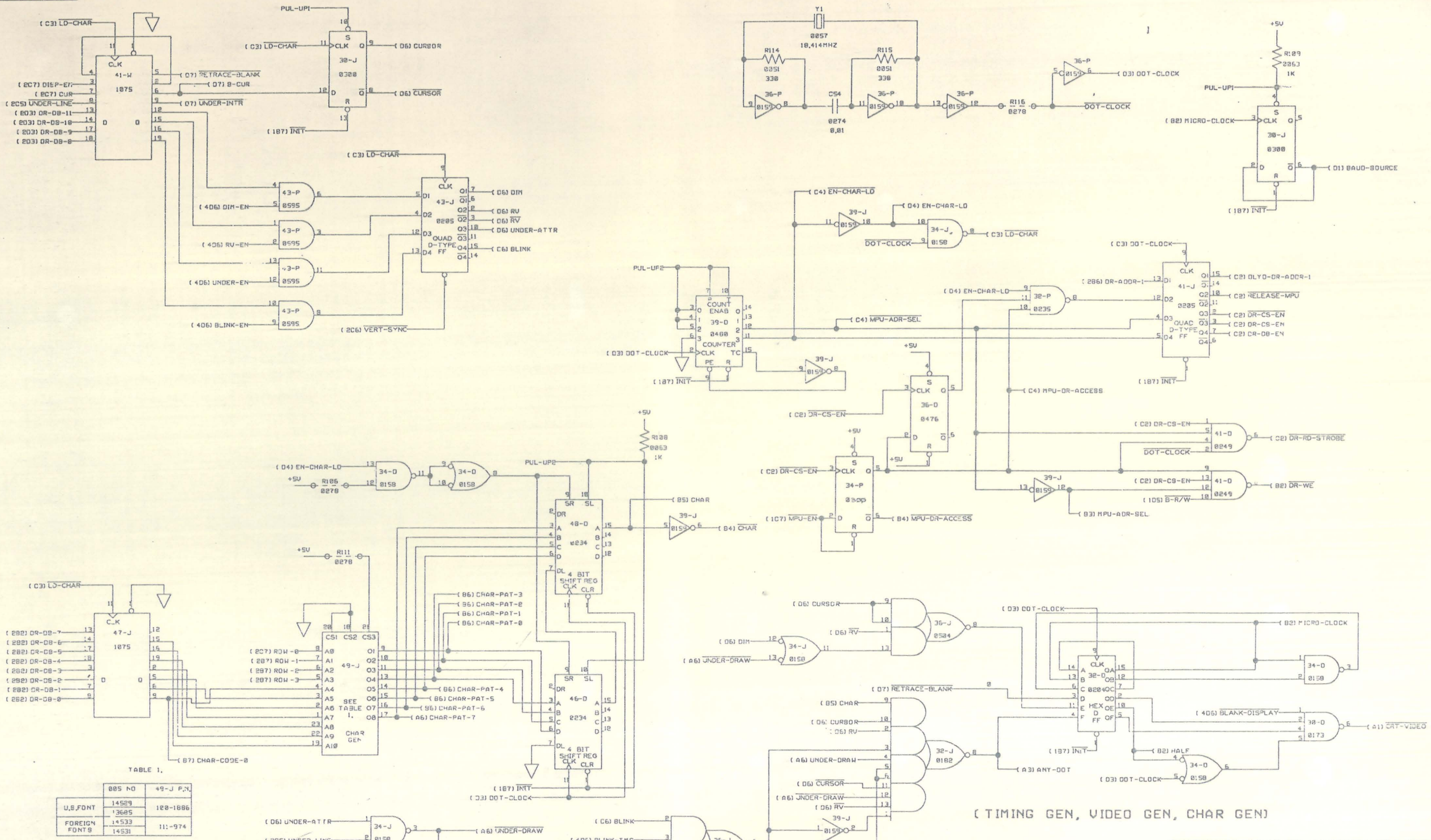

TABLE 1.

885 NO	49-J P.N.
U.S. FONT	14529 100-1886
FOREIGN FONTS	14533 111-974

NOTE: THESE MAIN PCB ASSYS. WITH TEST ARE BUILT PER TABLE 1.  
 WHEN THESE PCB ASSYS ARE USED WITH DIFFERENT TOP LEVEL ASSY NUMBERS, REFER TO PAGE 3 OF 85-496 FOR CONFIGURATION.

(TIMING GEN, VIDEO GEN, CHAR GEN)

DRAWN		DATA GENERAL CORPORATION WESTBORD, MASSACHUSETTS 01581  <b>TITLE</b> <b>CRT MAIN DASHER</b> <b>D100/D200</b> SIZE CODE DRAWING NUMBER REV <b>001002691</b>
CHECKED		
ENGINEER		
APPROVED		
FIRST USED ON		







THIS DRAWING AND SPECIFICATIONS, HEREIN, ARE THE PROPERTY OF DATA GENERAL CORPORATION AND SHALL NOT BE REPRODUCED OR COPIED OR USED IN WHOLE OR IN PART AS THE BASIS FOR MANUFACTURE OR SALE OF ITEMS WITHOUT WRITTEN PERMISSION.

REVISIONS				
REV	DESCRIPTION	DRFTG	APP BY	DATE

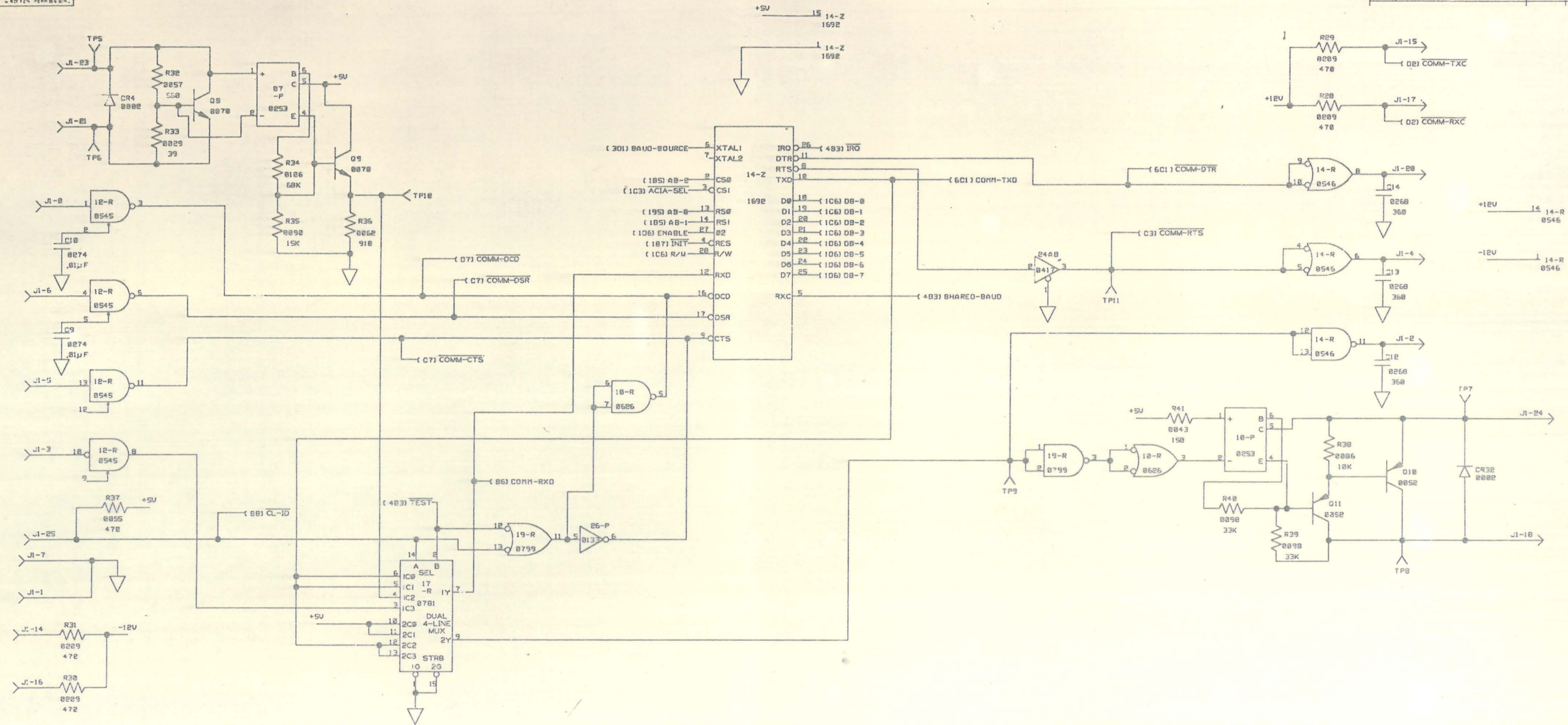

ASYNCHRONOUS  
INTERFACE

DRAWN	DATA GENERAL CORPORATION WESTBORO, MASSACHUSETTS 01581  TITLE <b>CRT MAIN DASHER</b> 0100/0200 DRAWING NUMBER <b>001002691</b>
CHECKED	
ENGINEER	
APPROVED	
FIRST USED ON	



THIS DRAWING AND SPECIFICATIONS, HEREIN, ARE THE PROPERTY OF DATA GENERAL CORPORATION AND SHALL NOT BE REPRODUCED OR COPIED OR USED IN WHOLE OR IN PART AS THE BASIS FOR MANUFACTURE OR SALE OF ITEMS WITHOUT WRITTEN PERMISSION.

REVISIONS				
REV	DESCRIPTION	CRFTG	APP BY	DATE

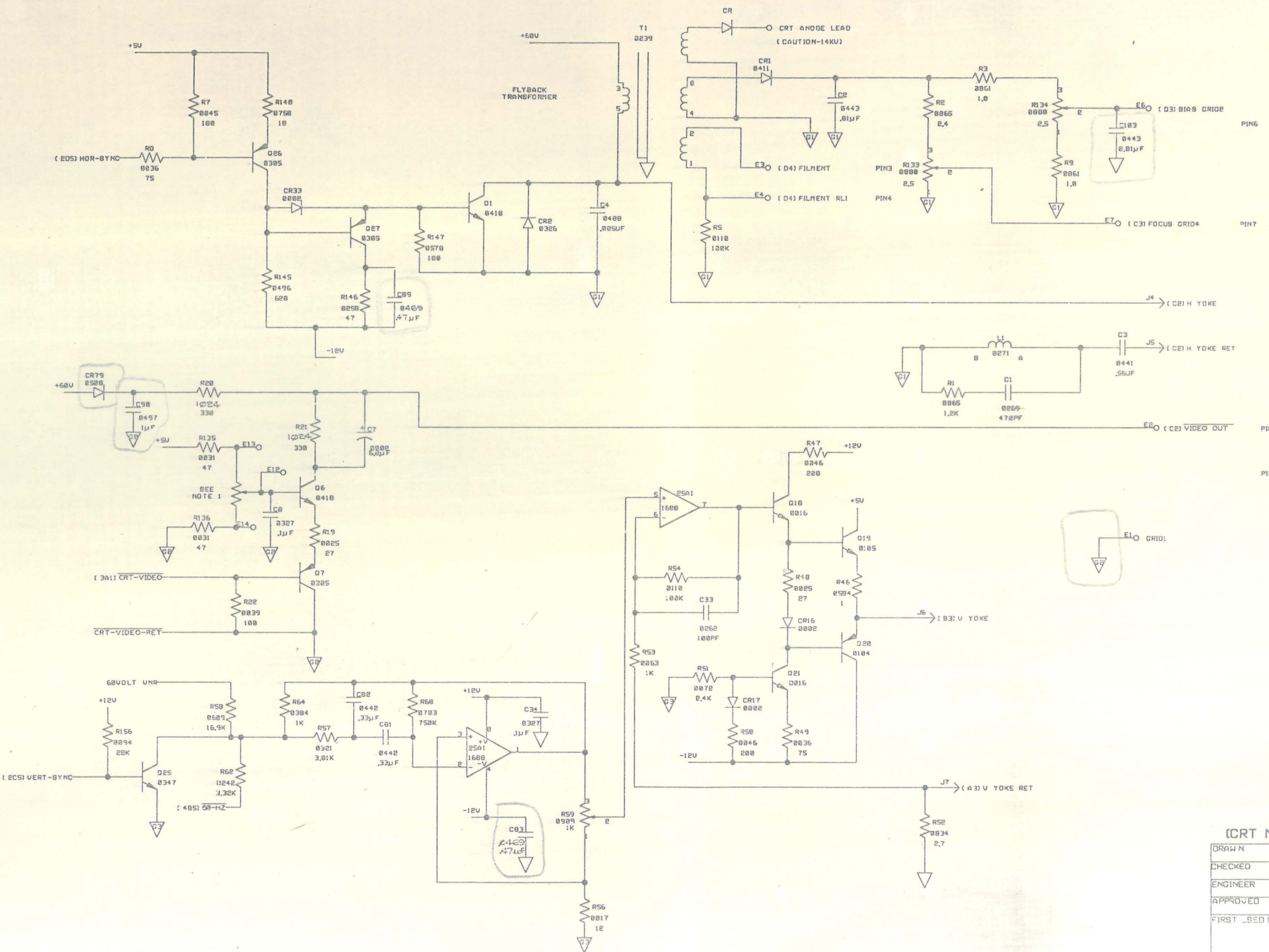

NOTE 1. 100 OHM POTENTIOMETER AND SWITCH NOT ON BOARD CONNECT TO E10 E11 E12 E13 E14

(CRT MONITOR CIRCUIT)

DRAWN		DATA GENERAL CORPORATION WESTBORO, MASSACHUSETTS 01581
CHECKED		
ENGINEER		
APPROVED		
FIRST USED ON		
TITLE <b>CRT MAIN DASHER</b> D100/D200		
SIZE	COLE	DRAWING NUMBER
0		001002691
		1 SHEET OF 5







THIS DRAWING AND SPECIFICATIONS, HEREIN, ARE THE PROPERTY OF DATA GENERAL CORPORATION AND SHALL NOT BE REPRODUCED OR COPIED OR USED IN WHOLE OR IN PART AS THE BASIS FOR MANUFACTURE OR SALE OF ITEMS WITHOUT WRITTEN PERMISSION.

REVISIONS			
REV	DESCRIPTION	DRFTG	APP BY

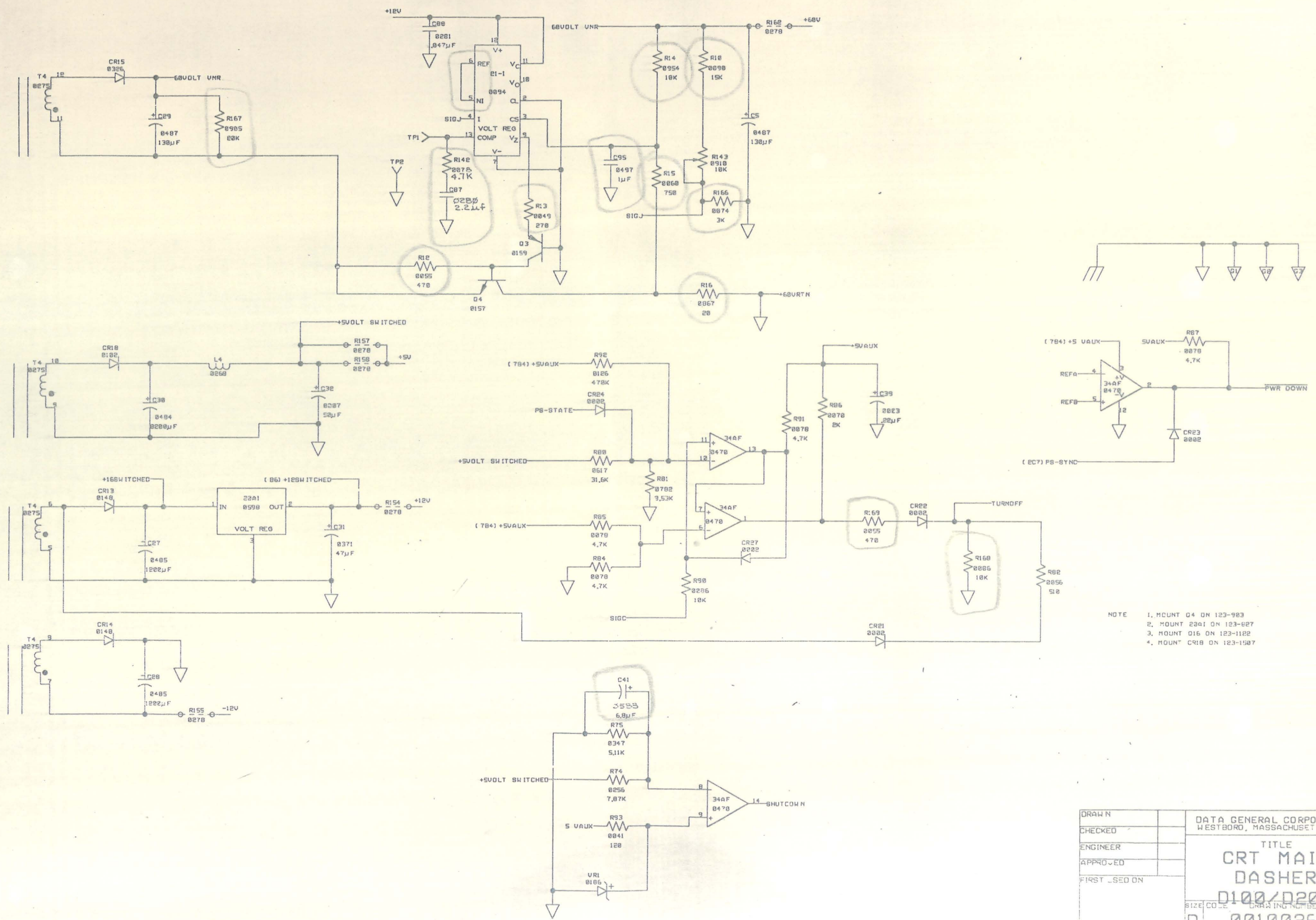

- NOTE
1. MOUNT Q4 ON 123-983
  2. MOUNT 23A1 ON 123-827
  3. MOUNT Q16 ON 123-1182
  4. MOUNT CR18 ON 123-1507

DRAWN		DATA GENERAL CORPORATION WESTBORO, MASSACHUSETTS 01581  <b>TITLE</b> <b>CRT MAIN</b> <b>DASHER</b> <b>D100/D200</b> SIZE COLE DRAWING NUMBER RE 0 001002691 1E
CHECKED		
ENGINEER		
APPROVED		
FIRST USED ON		



THIS DRAWING AND SPECIFICATIONS, HEREIN, ARE THE PROPERTY OF DATA GENERAL CORPORATION AND SHALL NOT BE REPRODUCED OR COPIED OR USED IN WHOLE OR IN PART AS THE BASIS FOR MANUFACTURE OR SALE OF ITEMS WITHOUT WRITTEN PERMISSION.

REVISIONS			
REV	DESCRIPTION	DRFTG	APP BY DATE

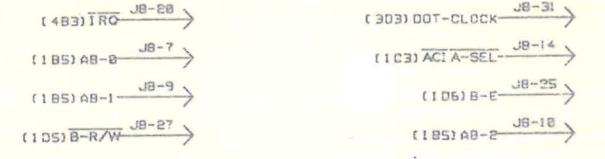
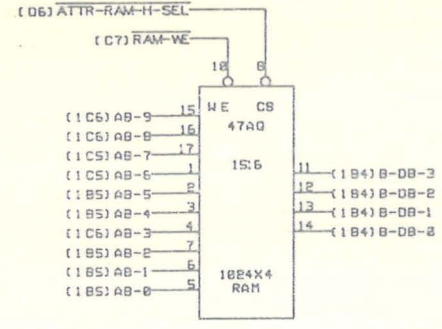
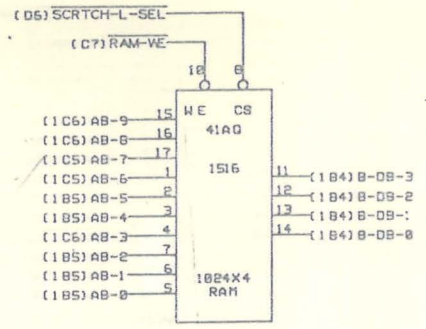
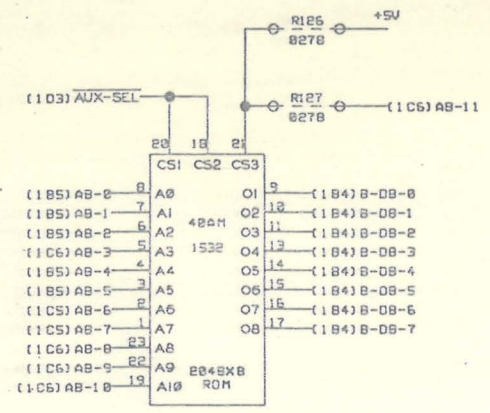
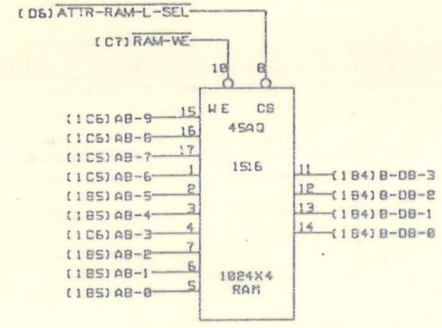
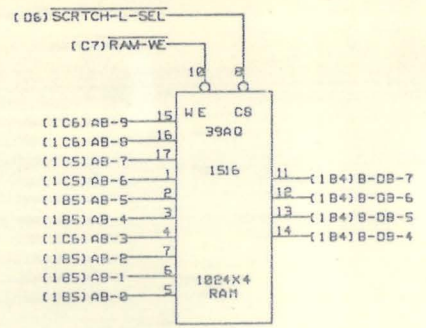
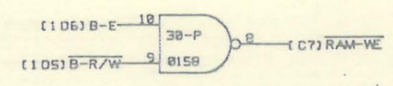
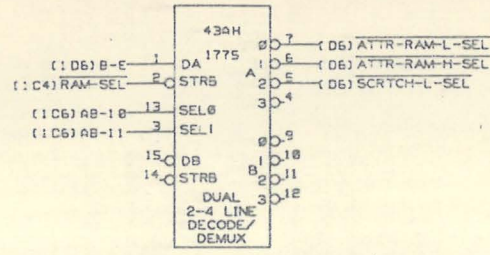

DRAWN	DATA GENERAL CORPORATION WESTBORO, MASSACHUSETTS 01581
CHECKED	
ENGINEER	
APPROVED	
FIRST USED ON	
TITLE	
VDT MAIN	
SIZE CODE	DRAWING NUMBER
0	00100157951



THIS DRAWING AND SPECIFICATIONS, HEREIN, ARE THE PROPERTY OF DATA GENERAL CORPORATION AND SHALL NOT BE REPRODUCED OR COPIED OR USED IN WHOLE OR IN PART AS THE BASIS FOR MANUFACTURE OR SALE OF ITEMS WITHOUT WRITTEN PERMISSION.

REVISIONS			
REV	DESCRIPTION	DR'G	APP BY

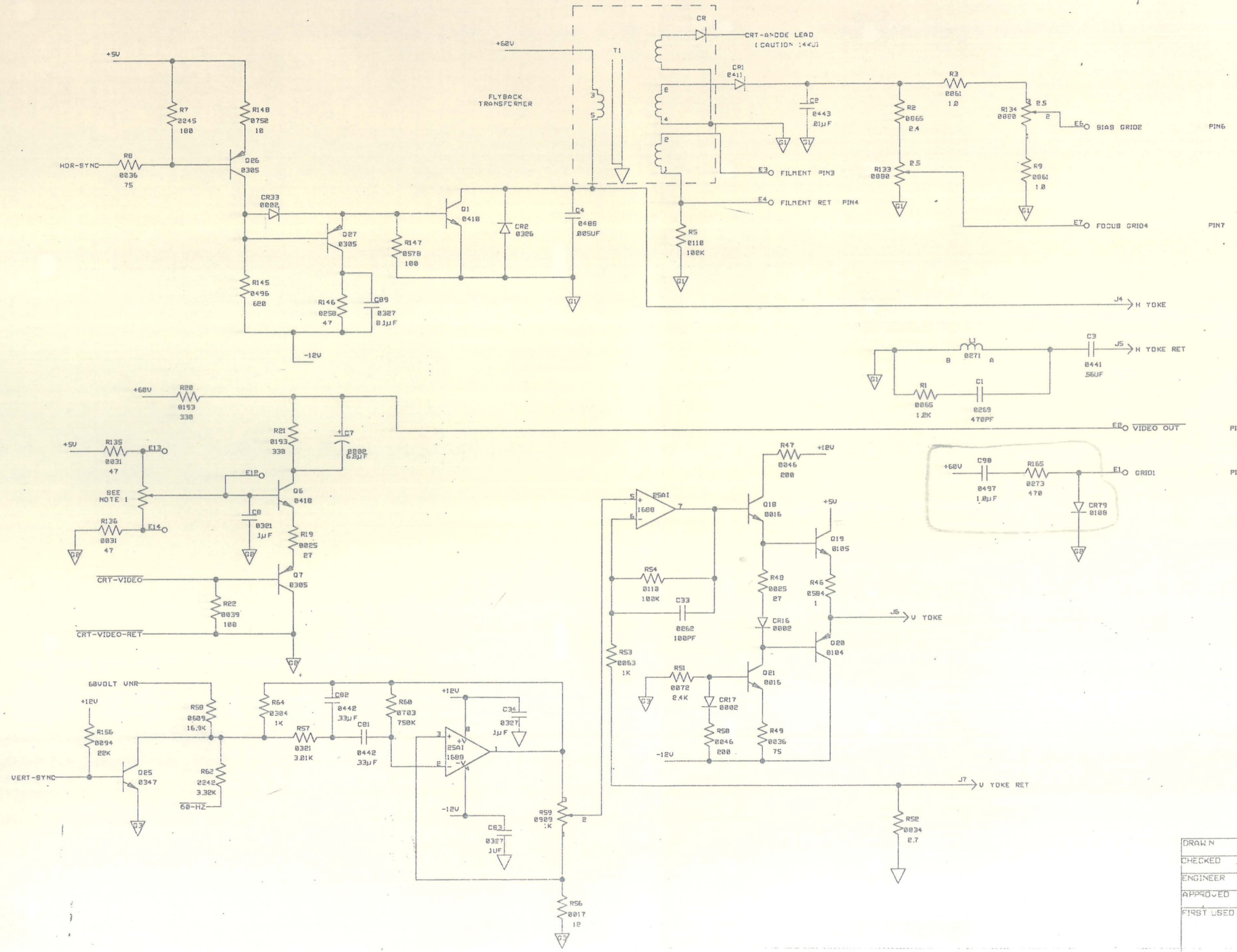

NOTE 1. 100 POTENTIOMETER AND SWITCH NOT ON BOARD CONNECT TO E10 E11 E12 E13 E14

( CRT MONITOR CIRCUIT )

DRAWN	DATA GENERAL CORPORATION
CHECKED	WESTBORO, MASSACHUSETTS 01581
ENGINEER	TITLE
APPROVED	VDT MAIN
FIRST USED ON	
SIZE CODE	DRAWING NUMBER
D	001001579



THIS DRAWING AND SPECIFICATIONS, HEREIN, ARE THE PROPERTY OF DATA GENERAL CORPORATION AND SHALL NOT BE REPRODUCED OR COPIED OR USED IN WHOLE OR IN PART AS THE BASIS FOR MANUFACTURE OR SALE OF ITEMS WITHOUT WRITTEN PERMISSION.

REVISIONS				
REV	DESCRIPTION	DRFTG	APP BY	DATE

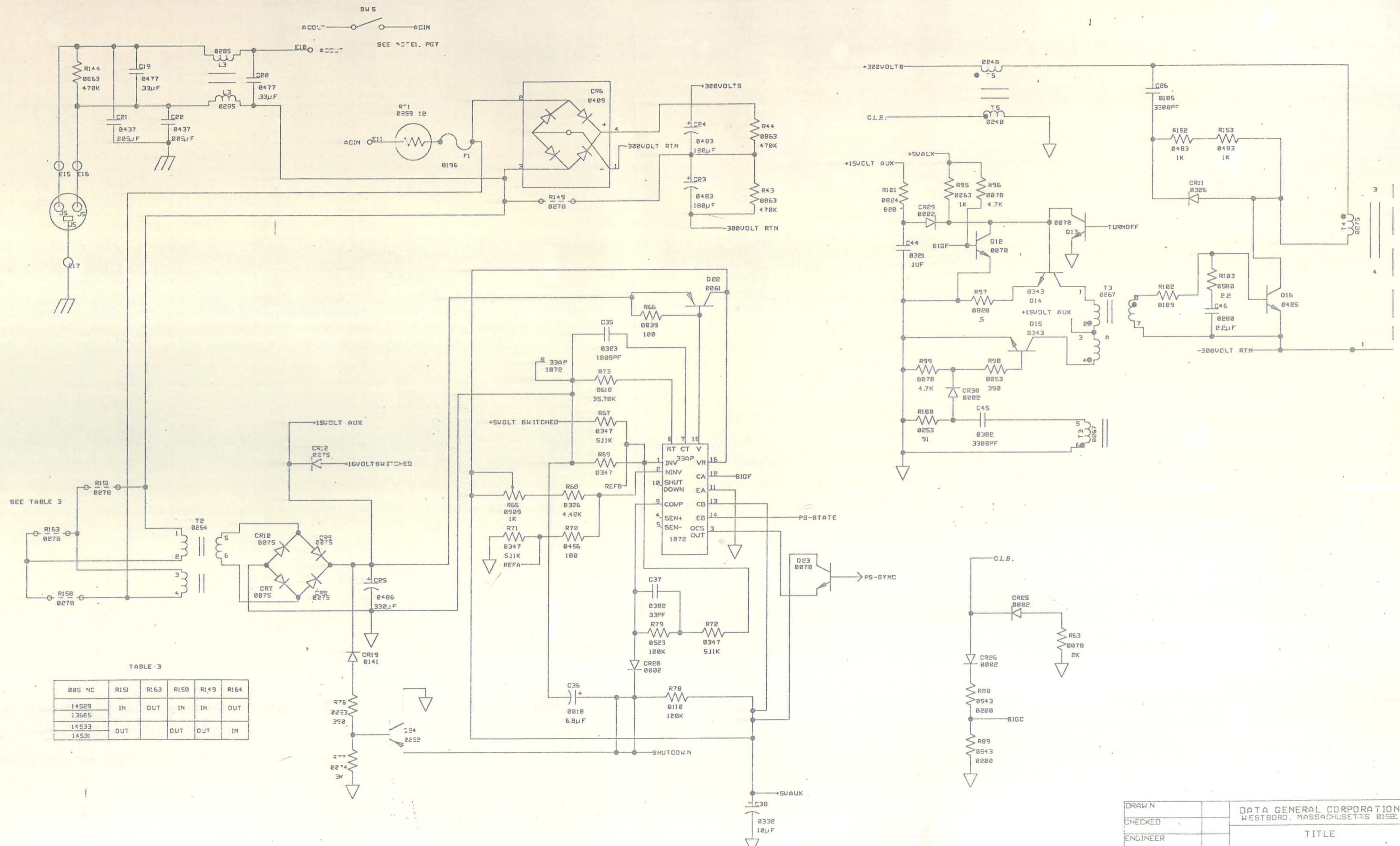

TABLE-3

005 NC	R151	R163	R150	R149	R164
14529	IN	OUT	IN	IN	OUT
13685					
14533	OUT		OUT	OUT	IN
14531					

DRAWN		DATA GENERAL CORPORATION WESTBORO, MASSACHUSETTS 01581
CHECKED		
ENGINEER		
APPROVED		
FIRST USED ON		
TITLE		
VDT MAIN		
SIZE CODE	DRAWING NUMBER	REV
D	001001579	5



THIS DRAWING AND SPECIFICATIONS, HEREIN, ARE THE PROPERTY OF DATA GENERAL CORPORATION AND SHALL NOT BE REPRODUCED OR COPIED OR USED IN WHOLE OR IN PART BY THE BIDDERS FOR MANUFACTURE OR SALE OF ITEMS WITHOUT WRITTEN PERMISSION.

REVISIONS			
REV	DESCRIPTION	DRG'G	APP BY

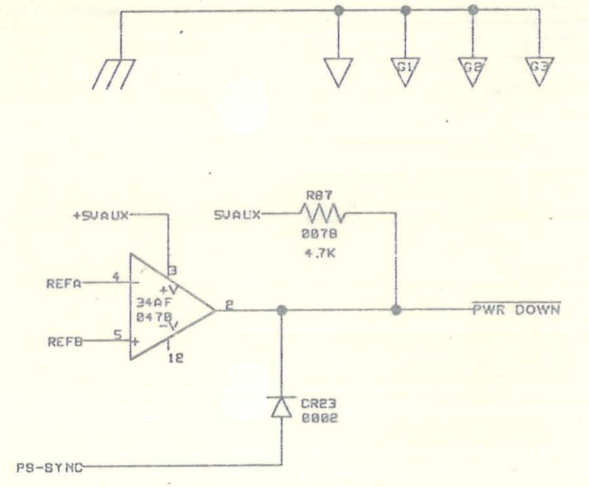
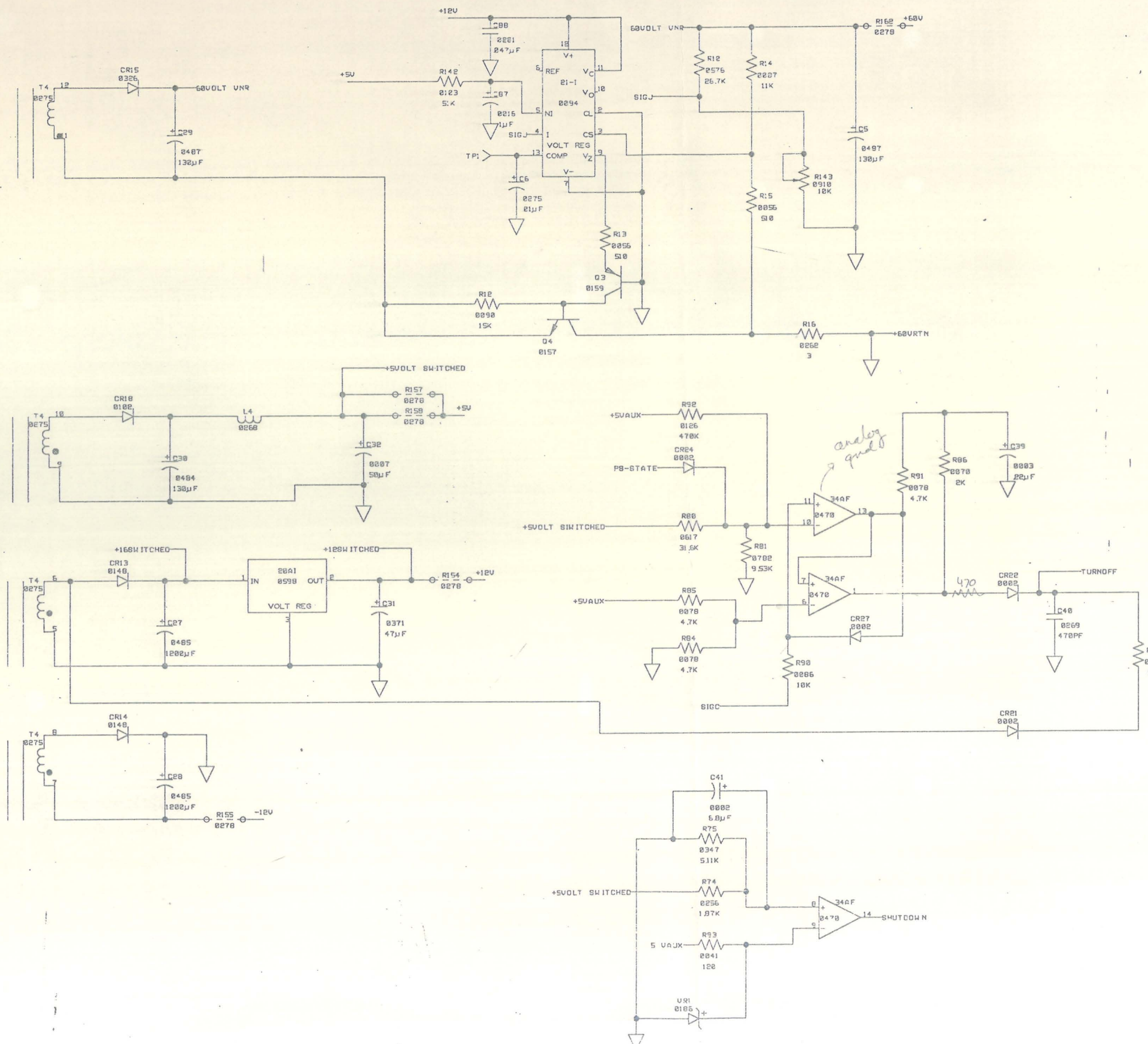

- NOTE
1. MOUNT 4 ON 123-903
  2. MOUNT 20A1 ON 128-027
  3. MOUNT 016 ON 128-1122
  4. MOUNT CR19 ON 123-1507

(MAIN PCB)

DRAWN		DATA GENERAL CORPORATION WESTBORO, MASSACHUSETTS 01581  TITLE  <b>VDT MAIN</b>  SIZE CODE    DRAWING NUMBER    REV
CHECKED		
ENGINEER		
APPROVED		
FIRST USED ON		