

Johnson Controls

Series 100 Single Package Units



70 THROUGH 105 TONS

ASHRAE
90.1
COMPLIANT



Table of Contents

NOMENCLATURE	2
INTRODUCTION.....	5
FEATURES AND BENEFITS.....	6
APPLICATION DATA.....	12
PHYSICAL DATA.....	17
WEIGHT DATA.....	20
COOLING PERFORMANCE DATA – 70 TON MODEL.....	23
COOLING PERFORMANCE DATA – 75 TON MODEL.....	27
COOLING PERFORMANCE DATA – 80 TON MODEL.....	31
COOLING PERFORMANCE DATA – 90 TON MODEL.....	35
COOLING PERFORMANCE DATA – 105 TON MODEL.....	39
HEATING PERFORMANCE DATA – GAS/ELECTRIC HEAT.....	43
SUPPLY FAN DATA.....	45
COMPONENT STATIC PRESSURE DROPS	46
GAS HEAT PRESSURE DROPS.....	48
ELECTRIC HEAT PRESSURE DROPS	49
EXHAUST FAN DATA.....	50
RETURN FAN DATA.....	51
ELECTRICAL DATA	52
CONTROLS	55
POWER WIRING: YPAL070-105.....	63
FIELD CONTROL WIRING	67
GENERAL ARRANGEMENT DRAWING – 70-80 TON MODELS	69
GENERAL ARRANGEMENT DRAWING – 90-105 TON MODELS	72
GENERAL ARRANGEMENT DRAWING – 70-80 TON MODELS	76
GENERAL ARRANGEMENT DRAWING – 90-105 TON MODELS	79
GENERAL ARRANGEMENT DRAWING	83
HOT WATER/STEAM COIL CONNECTION LOCATIONS.....	85
POWER/CONTROL ENTRY DRAWING – 70-105 TON MODELS.....	87
GUIDE SPECIFICATIONS	89

THIS PAGE INTENTIONALLY LEFT BLANK.

Introduction

**The Series 100 single package units –
Designed to meet the demands of
the market for today and tomorrow.**

Better Economy...

Lower total cost of ownership

- JOHNSON CONTROLS provides a standard product offering that meets the latest ASHRAE 90.1 energy efficiency requirements.
- Fully modulating gas heat and greater steps of capacity control offer superior off-design performance while maintaining optimum occupant comfort.
- Accurate ventilation control ensures that no more than the proper amount of ventilation air is utilized. This avoids the energy cost of conditioning excess outside air and simultaneously monitors all other unit functions for maximized energy efficiency.
- Flexible design configurations simplify the design process and allows the Series 100 to be applied to virtually any building application.
- Accessibility through double-wall access doors, spacious compartments and supportive floors improves serviceability.

Better Ecology...

Indoor air quality features for the indoor environment

- A double-sloped stainless steel drain pan with a single drain connection ensures that all condensate is voided from the drain pan. It is also visible and accessible for periodic inspection and cleaning required by the ASHRAE 62 IAQ standard.
- Double-wall construction of the roof, floor, doors, and walls prevents insulation fibers from entering the conditioned air. The inner liner also facilitates periodic cleaning of the unit to prevent harmful build-up of bacteria or contaminants.
- The single package unit control center uses microprocessor logic to analyze and optimize ventilation decisions and perform demand ventilation, airflow compensation, and airflow measurement to maintain the air quality at a healthy level.

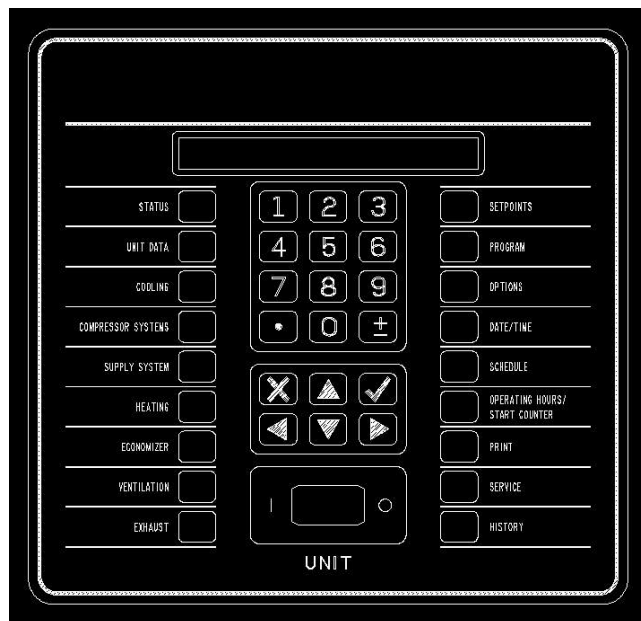

LD07431

The Single Package Unit Control Center uses microprocessor logic to optimize operation of the Series 100 single package unit.

Features and Benefits

AIRFLOW CONFIGURATIONS

Variable-Air-Volume – Series 100 units are available for single-zone variable-air-volume (VAV) applications. Control can be used with a zone sensor or building automation system. Supply fans are controlled to the supply duct static pressure setpoint, which can be reset via a BAS, or through a 0-5VDC analog input on the unit controller for optimized duct static pressure control. The static pressure transducer is provided in the single package unit, and 5/16" or 1/4" plastic tubing and static pressure sensor must be supplied by others and installed approximately 3/4 down the longest duct run.

FlexSys Underfloor Air VAV – Series 100 units are configurable for underfloor air variable-air-volume (VAV) applications. Control can be used with a zone sensor or building automation system. Supply fans are controlled to the supply duct static pressure setpoint, which can be reset via a BAS, or through a 0-5VDC analog input on the unit controller for optimized duct static pressure control. The static pressure transducer is provided in the single package unit, and 5/16" or 1/4" plastic tubing and static pressure sensor must be supplied by others and installed approximately 3/4 down the longest duct run. *Refer to 100.50-EG8 engineering guide for more detailed information on this application.*

Constant Volume – Series 100 units are available for single-zone constant volume applications. Control can be used with a zone sensor, thermostat, or building automation system.

COOLING AND HEATING CONFIGURATIONS

Cooling Only – For applications where no heat is required, or heating is provided elsewhere within the building HVAC system, cooling only units include an empty discharge plenum. Supply duct connections are configurable for bottom, left or right discharge. The supply air temperature sensor is included and factory-installed.

Staged Gas Heat – For applications requiring gas heat for morning warm-up, or other heating needs, a staged natural gas furnace is available. The furnace is located in the discharge plenum, downstream of the supply fan. The supply air temperature sensor is located across the face of the supply duct opening in the unit. Furnaces are designed in 375 mbh modules with two stages in each. For 70 through 105 ton units, optional Propane Conversion Kits contain the necessary orifices and gas valve/parts to convert staged heat only (Not modulating) from natural gas to propane. Ignition and safety controls are included and factory-wired. Units with staged gas heat are ETL listed.

Modulating Gas Heat – For applications requiring gas heat for morning warm-up, supply air tempering or other heating needs, a modulating natural gas furnace is available for finer temperature control. The furnace is located in the discharge plenum, downstream of the supply fan. The supply air temperature sensor is located across the face of the supply duct opening in the unit. Furnaces are designed in 375 mbh modules in 8:1 turndown increments. Three are available for the YPAL070-105 (8:1, 16:1 or 24:1 turndown). Ignition and safety controls are included and factory-wired. Units with modulating gas heat are ETL listed.

Electric Resistance Heat – For applications where electric heat is desired, a slip-in electric resistance heat element is available in sizes from 80-250 kW depending on the single package unit model size. The number of stages varies by size and voltage, but all have a minimum of two stages of capacity. Units with electric heat are ETL listed.

Hot Water Heat – For applications where hot water is available for heating, a hot water heating coil is available. A range of coil fin count selections are available to properly size the heating for the application. Units with hot water heat are ETL listed.

Steam Heat – For applications where steam is available for heating, a steam heating coil is available. A range of coil fin count selections are available to properly size the heating for the application. Units with steam heat are ETL listed.

POWER OPTIONS

Single-point supply with terminal block – This configuration is standard, and includes three terminals for the incoming 3-phase power and is the standard configuration for the Series 100 product. It includes the enclosure, terminal-block, and interconnecting wiring to the compressors, heater and furnace controls, all fans, etc. In this configuration, code requires that a means of disconnect (not provided) must be installed at the site within line-of-sight of the equipment.

Single-point supply with non-fused disconnect switch – This option is the same as the single-point with terminal block option except it includes a unit-mounted through-the-door manual non-fused disconnect switch with an external, lockable handle (in compliance with Article 440-14 of N.E.C.). This option provides a means to isolate the unit power voltage for servicing. Others must supply separate external fusing which must comply with the National Electric Code and/or local codes.

Dual-point supply with terminal block – This option includes enclosure, terminal blocks circuited to the supply and exhaust fans and control transformer and a second set of terminal blocks with interconnecting wiring to the compressors, heat (if applicable) and condenser.

Convenience Outlet – This options includes a powered 115V GFCI convenience outlet that can be used for powering tools or lights for servicing. A protective cover plate is included while not in use. The outlet is located on the bottom left hand corner of the power panel.

CONTROL FEATURES AND OPTIONS

Microprocessor-Based Single Package Unit Controller – All Series 100 units are equipped with a factory-installed, programmed and commissioned unit controller with all I/O capabilities and control sequences. The controls include all on-board diagnostic, safety and control features to operate the single package unit. A multimedia card interface is included for software upgrades and can be used for data logging to simplify equipment troubleshooting. Communication ports are included as standard with three alarm outputs, a shutdown contact, remote start/stop input, smoke ventilation controls, analog inputs for supply air temperature and duct static pressure rest, along with a variety of other capabilities.

Standard Ambient – YPAL070-105 models operate down to 45°F as standard.

Low Ambient – (YPAL070-105) This option includes low ambient control of the first refrigerant circuit down to 0°F through the use of suction and discharge pressure transducers on circuit one, and condenser fan speed using a variable-frequency drive on the first condenser fan of circuit one. Mechanical cooling with circuit two and three for YPAL070-105 is locked out below 45°F.

Low Ambient on Circuits One, Two and Three – (YPAL070-105) This option includes low ambient control of the first, second and third refrigerant circuits down to 0°F through the use of suction and discharge pressure transducers on both circuits.

Pressure Transducers with Readout Capability – This option includes suction and discharge pressure transducers on each circuit and provides pressure readout of all circuits at the unit control panel.

SENSOR AND THERMOSTAT AND SENSOR OPTIONS

Wall-Mount Zone Sensor – a 10 kOhm thermister type III NTC zone sensor for wall mounting. This zone sensor is for sensing temperature only, and does not include any setpoint adjustment features.



Zone Sensor

7-Wire Thermostat – This option is for a ship-loose thermostat to interface with the Series 100 unit. All models, YPAL070-105, include an interface for a 7-wire thermostat as standard.



Thermostat

COMMUNICATIONS

BACnet MSTP (RS-485) Communications – This communication option is standard on every Series 100 unit. Communications to the unit are through a twisted pair, and the wire terminations are on the primary unit control board. See supplemental information for the available control points and PICS/Bibbs statements of conformity.

Modbus RTU Communications – This communication option is standard on every Series 100 unit and can be used in lieu of the BACnet communications (only one can be used at a time). See supplemental information for the available control points.

FILTER OPTIONS

Filter Options – two-inch throwaway, cleanable, carbon coated MERV 8 or pleated MERV 8 filters in an angled rack are available. For higher filtration requirements, optional rigid filter racks are available with twelve-inch 65% (MERV 11) or 95% (MERV 14) efficient rigid filters. Two-inch MERV 8 pre-filters are included with rigid filter options. The rigid filter rack option is available without filter media where field-supplied filters are required.

Features and Benefits (Cont'd)

OUTSIDE AIR DAMPER OPTIONS

Manual Damper – This option includes a manually adjustable outside air damper. It is manually adjustable at the unit by setting a mechanical stop between 0-100 percent.

Two-Position – This outside air damper option is controlled to a two positions, opened and closed. Determination of the damper position is based on the occupancy schedule. In the occupied mode, the outside air damper is positioned to the manually configured point (set by mechanical stop). In the unoccupied mode, the damper is fully closed.

Modulating Economizer – This option includes modulating outdoor air and return air dampers that are software interlocked (YPAL070-105 software interlock) and positioned by fully modulating, solid state damper actuators. Control of the damper is via a standard ambient outdoor air dry bulb sensor, or optional single or comparative enthalpy controls.

Airflow Measurement – Optional outside airflow measurement is available on units equipped with a Modulating Economizer.

CO₂ Sensors – Optional carbon dioxide sensors for occupied space that operate demand ventilation control opening outside air dampers to ventilate building. The CO₂ sensors can operate in a single or comparative control scheme.

Rain Hoods on Outside Air Intakes – For all options with outside air intake openings, rain hoods are provided as standard to keep moisture from entering the equipment. The rain hoods are an integral part of the unit and are rotated into place at the jobsite.

RELIEF SYSTEM

Barometric Relief – This option does not include an exhaust or return fan, but rather uses barometric relief dampers to exhaust air from the building. The dampers will open relative to the building pressure. The opening pressure is adjustable via a spring tension adjustment.

On/Off Powered Exhaust – This option provides simple building pressure control. It can be controlled via a building pressure signal, or via outside air damper control. ***This option is not available for VAV units.***

Modulating Powered Exhaust with Damper Control – This option consists of a constant-speed exhaust fan with a discharge damper that is modulated to control the flow of exhaust air. The damper control logic is based on the building static pressure setpoint within the single package unit controller. The static pressure transducer is provided in the return plenum of the sin-

gle package unit, and 5/16" or 1/4" plastic tubing and static pressure sensor must be supplied by others and installed in a representative location in the building.

Modulating Powered Exhaust with a VFD – This option consists of a VFD to modulate the speed of the exhaust fan to control the flow of exhaust air. The VFD control logic is based on the building static pressure setpoint within the single package unit controller. The static pressure transducer is provided in the return plenum of the single package unit, and 5/16" or 1/4" plastic tubing and static pressure sensor must be supplied by others and installed in a representative location in the building.

Powered Return Fan with Exhaust – This option uses SWSI plenum fan(s) to control building pressure. The fan motors are driven by a VFD to maintain a constant return plenum pressure. An exhaust hood with a modulating control damper is used to maintain building pressure via the building static pressure. The static pressure transducer is provided in the return plenum of the single package unit, and 5/16" or 1/4" plastic tubing and static pressure sensor must be supplied by others and installed in a representative location in the building. The powered return fan is also available without the exhaust capabilities. For units with no exhaust capabilities, the HVAC system must provide alternate means of controlling building pressure.

SUPPLY FAN OPTIONS

DWDI Forward-Curved Supply Fan – The standard supply air blower in the YPAL070-80 models is a forward-curved supply fan. This fan is good for medium static pressures and high airflows.

DWDI Airfoil Supply Fan – The standard supply air blower in the YPAL090-105 is an airfoil blade supply fan. This fan is also available as an option on YPAL070-080 for higher static conditions. This fan offers higher efficiency and lower sound in certain applications.

Fan Skid Isolation – the entire supply fan assembly is isolated from the unit base with one- (standard) or two-inch deflection springs, or one (standard) or two-inch deflection springs with seismic restraints.

Supply and Exhaust Fan Motors – Premium efficiency ODP and premium efficiency TEFC motors are available all meeting the Energy Policy Act of 1992 (EPACT).

Supply Fan VFD and Manual Bypass – for VAV applications, VFD's are provided to modulate air flow. Optional manual bypass can also be provided to allow full airflow in the event of a VFD failure.

EVAPORATOR SECTION

Double Sloped Stainless Steel Drain Pan – The Series 100's stainless steel drain pan is factory-mounted and installed on every unit. A condensate drain trap is needed, and must be provided and installed in the field by others.

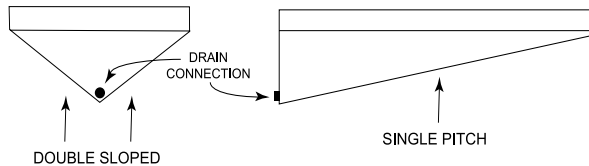

NOTE:

This is a visual reference only. Actual drain pan pitch will vary.

FIGURE 1 - DRAIN PAN DETAIL

Double Wall Construction – Double-wall construction is the standard construction of the Series 100 and incorporates powder coated outer panels and corner post for maximum exterior surface protection.

Factory Shrink-wrap – All Series 100 single package units are shipped from the factory with factory-fresh shrink-wrap packaging. No longer does the contractor need to worry about dirt and debris clogging up condenser coils or moisture leaking into the air handler on the units way to the job site or rigging yard.

Copper Fins – For more extreme climates that aggressively can attack aluminum, copper tube evaporator coils with copper fins are available. (This is not recommended for units in areas where they may be exposed to acid rain or environments where ammonia is present)

CONDENSER FEATURES AND OPTIONS

Scroll Compressors – Reliable, efficient, trouble-free operation is the true measure of a single package unit's value. That's why JOHNSON CONTROLS Series 100 Single package units use established scroll compressor technology to deliver dependable, economical performance in a wide range of applications. With the Series 100 Single package units, you get the latest generation of compressor enhancements added to the scroll's inherent strengths. The simplicity of a hermetic scroll compressor allows the use of fewer moving parts to minimize breakdown.

Multiple Compressor Staging – Through the use of the scroll compressor, the Series 100 has the ability to stage it's cooling by enabling and disabling multiple single stage compressors on multiple circuits.

Compressor Circuiting – the Series 100 is designed so that only 2 scroll compressors are in tandem within one refrigeration circuit. This means more reliable compressors, and less equipment down time. With multiple circuits, if a compressor should ever fail on one circuit, the other circuit/s will remain operational to maintain occupied loads. In sizes 70-105T, the Series 100 has three independent refrigeration circuits per unit.

Condenser Fan Motors – The condenser fan motors used on the Series 100 unit are Totally Enclosed Air Over (TEAO) to provide maximum durability through any season.

Hot Gas Bypass – This options permits continuous, stable operation at capacities below the minimum step of unloading by introducing an artificial load on the evaporator. For models YPAL070-105, it is used on the lead circuit.

Replaceable Core Suction Line Driers – suction line driers are standard on the Series 100 single package unit. An option is provided for replaceable core driers.

Post-Coated Fins – Optional coil-coating used on condenser coils for seashore and other corrosive applications (with the exception of strong alkalis, oxidizers, wet bromide, chlorine and fluorine in concentrations greater than 100ppm).

Compressor Sound Blankets – Optional compressor acoustic sound blankets are available for sound sensitive applications.

ROOF CURBS

Full perimeter roof curbs – This option includes a knock-down 14" high roof curb for use with wood nailer (by others). Roof curb supports the entire perimeter of the unit.

Partial perimeter roof curbs – This option includes a knock-down 14" high roof curb for use with wood nailer (by others). Roof curb supports the air handling section with a separate support under the condenser end.

Features and Benefits (Cont'd)

CABINET FEATURES AND OPTIONS

Double-Wall Access Doors - Full-sized access doors provide easy access into the unit for routine maintenance and inspection. Solid wall liners encase insulation and prevent damage and erosion into the airstream.

Diffuser Section – An optional diffuser section is available downstream of the supply fan in the extended discharge plenum cabinet option. The diffuser section distributes the airflow from the fan evenly across the downstream filter bank to optimize filter life and effectiveness. The diffuser design is optimized to provide uniform flow at minimal airside pressure loss.

Downstream Final Filter Rack – An optional 90-95% efficient MERV 14 12-inch rigid filter rack and filters is available downstream of the supply fan and diffuser segment for hospital applications (YPAL070-105 only). A magnahelic pressure gauge is included and visible from the outside of the unit for servicing and code compliance.

Blank Section – An optional blank section is available downstream of the supply fan and diffuser section.

ACCESSORIES

Filter Switch – An optional dirty filter alarm can be provided that will provide an alarm when the filters require cleaning.

Magnahelic Filter Pressure Gauge – On units equipped with downstream filtration, a magnahelic filter gauge is included and visible on the exterior of the unit. The filter gauge measures the air pressure drop for through the rigid filter bank to indicate when replacement is required.

YPAL070-105 MODEL

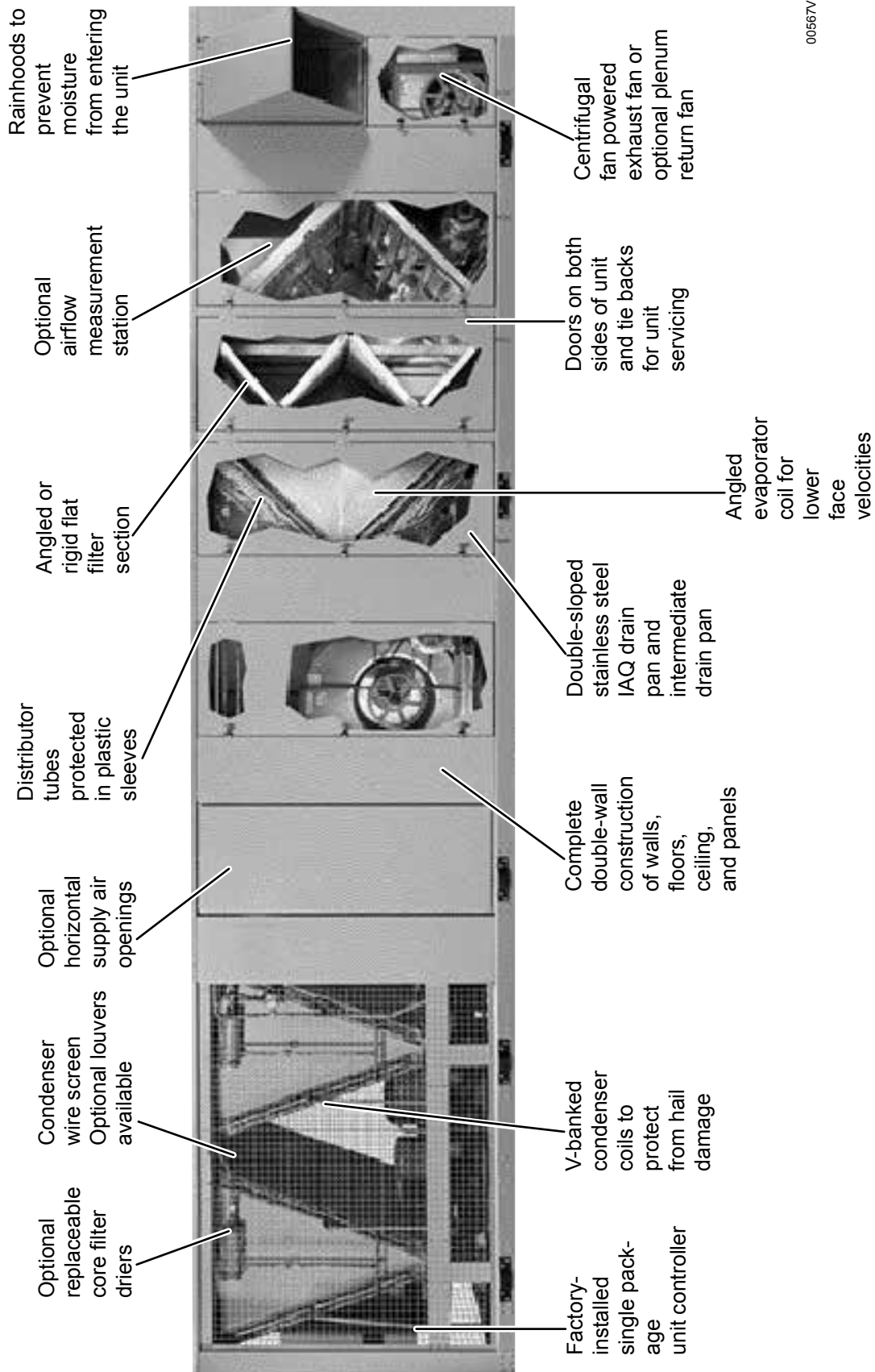

Application Data

GENERAL

The Series 100 Single Package units are designed for outdoor installation. When selecting a site for installation, be guided by the following conditions:

- Unit must be installed on a level surface.
- For the outdoor location of the unit, select a place having a minimum sun exposure and an adequate supply of fresh air for the condenser.
- Also avoid locations beneath windows or between structures.
- Optional condenser coil protection should be used for seashore locations or other harsh environments.
- The unit should be installed on a roof that is structurally strong enough to support the weight of the unit with a minimum of deflection. It is recommended that the unit(s) be installed not more than 15 feet from a main support beam to provide proper structural support and to minimize the transmission of sound and vibration. Ideally, the center of gravity should be located over a structural support or building column.
- Location of unit(s) should also be away from building flue stacks or exhaust ventilators to prevent possible reintroduction of contaminated air through the outside air intakes.
- Be sure the supporting structures will not obstruct the duct, gas or wiring connections.
- Proper service clearance space of 6-feet around the perimeter of the unit, 8-feet on one side for coil servicing, and 12-feet to any adjacent units is required to eliminate cross contamination of exhaust and outdoor air, and for maintenance tasks such as coil pull and cleaning. No obstructions should be above the condensing unit section.

LOCATION

Of the many factors that can effect the location of equipment, some of the most important to consider are Structural, Acoustical and Service clearances. Proper attention should be made at the design stage to ensure proper structural support. In cases where equipment is being replaced, be aware of building design to insure support is adequate for the application.

The next most important consideration in applying single package units equipment is that of sound from the equipment. Special care should be made to keep the single package unit away from sound sensitive areas

such as conference rooms, auditoriums and executive offices and any other room that may have potential for tenant occupancy. Possible locations could be above hallways, mechanical or utility rooms.

Finally, service clearances should be maintained in single package unit design to insure safe access to the unit. Unit clearances are designed so that technicians have enough space between units, building walls, and edges of building to gain access safely. In cases where space is limited, please call your local JOHNSON CONTROLS representative for additional information.

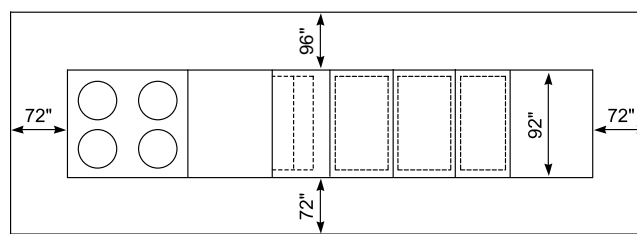

LD08044

NOTE:

1. Under certain conditions these clearances may be encroached upon.
2. This is a visual reference for all Series 100 units.

RIGGING

Proper rigging and handling of the equipment is mandatory during unloading and setting it into position to retain warranty status.

Spreader bars must be used by cranes to prevent damage to the unit casing. All lifting lugs must be used when lifting the single package unit. Fork lifts will damage the single package unit and are not recommended.

Care must be taken to keep the unit in the upright position during rigging and to prevent damage to the watertight seams in the unit casing. Avoid unnecessary jarring or rough handling.

UNIT PLACEMENT

- **Elevated** – Elevated roof curbs or dunnage steel can be used to support the unit in order to raise it to specific heights. When this type of placement is required, be sure to keep unit access in mind. Cat walks or other forms of unit access may be required to one or both sides of the unit, depending on your area of the country and the local codes that are enforced. Please check with local officials to ensure the application conforms to local codes and regulations.

- **Ground Level Locations** – It is important that the units be installed on a substantial base that will not settle, causing strain on the refrigerant lines and sheet metal and resulting in possible leaks. A one-piece concrete slab with footers extended below the frost line is highly recommended. Additionally, the slab should be isolated from the main building foundation to prevent noise and vibration transmission to the building structure.

For ground level installations, precautions should be taken to protect the unit from tampering by, or injury to, unauthorized persons. Erecting a fence around the unit is common practice.

- **Roof curb** – JOHNSON CONTROLS offers optional roof curbs designed specifically for the Series 100 footprint. These curbs come in full perimeter or open condenser models and are shipped disassembled and require field assembly and installation. For bottom supply and return openings, the curbs have matching connections to ease installation. A pipe chase that matches the single package unit pipe chase is also included in the curb footprint for through-the-curb utility connections.

The curb should be located according to the location recommendations above, and properly sealed to prevent moisture and air leakage into and out of the duct system. Flexible collars should be used when connecting the duct work to prevent unit noise transmission and vibration into the building.

Duct work should be supported independently of the unit.

TABLE 1 - SUPPLY AIR DUCT CONNECTION CONFIGURATIONS

UNIT CONFIGURATION	SUPPLY AIR			
	BOTTOM	LEFT	RIGHT	
YPAL 070-105	STANDARD CABINET			
	Cooling only	X	X	X
	Cool/gas heat	X	X	
	Cool/electric heat	X		
	Cool/hydrionic heat	X		
	EXTENDED CABINET			
	Cooling only	X	X	X
Cool/hydrionic heat	X	X	X	

TABLE 2 - RETURN AIR DUCT CONNECTION CONFIGURATIONS

UNIT CONFIGURATION	RETURN AIR				
	BOTTOM	LEFT	RIGHT	FRONT	
YPAL 070-105	No exhaust	X	X	X	X
	Barometric relief damper	X	X	X	
	Powered exhaust fan (all types)	X	X	X	
	Powered return fan	X			

UNIT ORIENTATION

For applications with multiple single package units located in close proximity on the roof, the orientation of the unit may be important to reduce the potential for re-entrainment of outside airflow. Regardless of the outside air and exhaust air openings on a unit, all single package unit applications can permit recirculation of exhaust air to the return, if applied improperly.

HORIZONTAL APPLICATIONS

The spectrum of applications for single package units in today’s market is continuing to grow wider by the day. Flexibility in unit design and construction is a must in today’s market in order to insure safe and sound applications of HVAC equipment. If the application calls for horizontal supply and return air, JOHNSON CONTROLS can ship it from the factory as a horizontal unit. This option eliminates the need for field modification of equipment saving time and money. The Series 100 can support a left discharge on all units and/or right discharge on all cooling only units and hydrionic heat units with an extended cabinet. Return air can be brought through the end or side return air inlet making the unit specific to building needs.

Application Data (Cont'd)

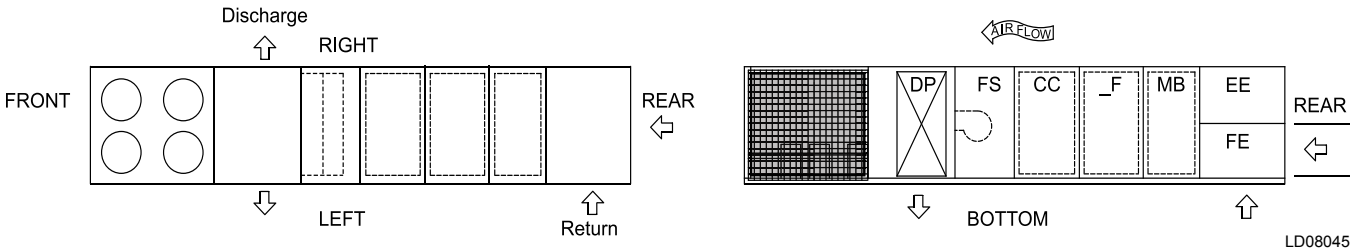

NOTE:

This diagram is provided as a visual reference of the Series 100 discharge & return air openings & locations for all sizes. Please refer to the dimensional data for exact size & location of panels and openings.

ECONOMIZER

The economizer section is used to maintain indoor air quality, and also to reduce energy consumption by using outdoor air cooling in lieu of mechanical cooling. If outdoor air is appropriate for cooling, but not sufficient for the cooling demand, mechanical cooling will stage on as necessary until the cooling load is met.

Dual (comparative or differential) enthalpy operation is the most accurate and efficient means of economizer operation. The IPU controller monitors the return and outside air energy content, and selects the lower of the two for operation.

VAV SUPPLY AIR PRESSURE CONTROL

Traditional packaged single package unit systems use inlet guide vanes (IGVs) for duct static pressure control. These control supply duct pressure by modulating dampers (introducing losses and inefficiencies) on the inlet of the fan, open and closed. JOHNSON CONTROLS variable frequency drives (VFDs) offer superior fan speed control and quieter, energy efficient operation.

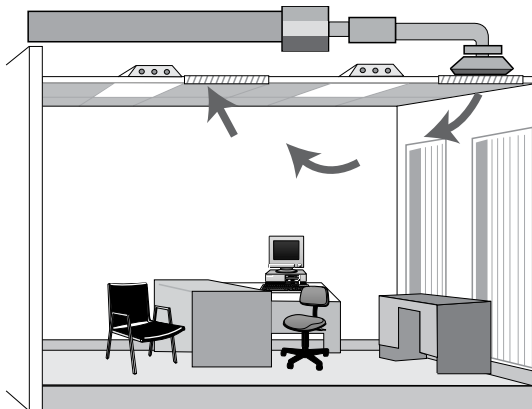

FIGURE 2 - TRADITIONAL OVERHEAD VAV AIR DELIVERY SYSTEM

For VAV applications, the JOHNSON CONTROLS Series 100 unit uses a VFD to modulate fan speed and

maintain a constant duct static pressure. VFDs offer superior control over the operation of the unit at part load, and offer the additional benefits of quieter and more efficient operation when compared to IGVs.

FLEXSYS

The traditional approach to HVAC design in commercial buildings has been to supply conditioned air through extensive overhead duct networks to an array of diffusers spaced evenly in the ceiling. In Figure 1, the conditioned air is both supplied and returned at ceiling level. Ceiling plenums must be designed large enough to accommodate the supply ducts that run through them. Return air is typically configured as ceiling plenum return without any ductwork. This type of air distribution, known as the “well-mixed” type, is the most common system in use. This conventional HVAC system is designed to promote complete mixing of supply air with room air, thereby maintaining the entire volume of all air in the space (from floor to ceiling) at the desired space setpoint temperature. In addition, to meet IAQ requirements, an adequate supply of fresh outside air must be introduced to this mix. A key disadvantage to this control strategy is that it has no provisions to accommodate different temperature preferences among the building occupants or to provide preferential ventilation in the occupied zone.

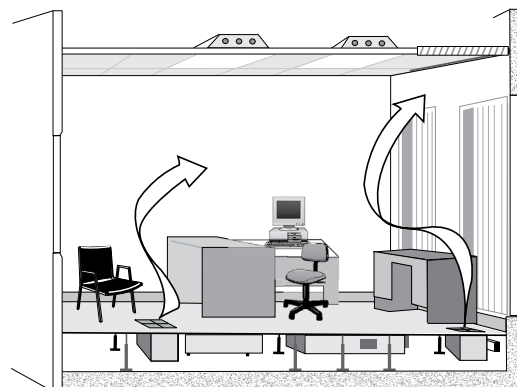

FIGURE 3 - JOHNSON CONTROLS FLEXSYS UNDERFLOOR AIR DELIVERY SYSTEM

With the JOHNSON CONTROLS FlexSys Underfloor Air System, conditioned air is ducted to the underfloor plenum. As shown in *Figure 3 on page 14*, this conditioned air flows freely throughout the plenum to individual supply discharge outlets. Unlike the larger single supply duct outlets typical of overhead systems, underfloor systems are configured to have a large number of smaller supply outlets, in close proximity to the building occupants. These adjustable outlets provide an opportunity for nearby occupants to have some amount of control over thermal comfort conditions in their local environment. Air is returned from the room at ceiling level (unducted plenum return is shown). The resulting overall floor-to-ceiling air flow pattern takes advantage of the natural buoyancy produced by heat sources in the space and more efficiently removes heat loads and contaminants from the space, particularly for cooling applications. In fact, some of the most important advantages of underfloor systems over ceiling-based systems occur during cooling conditions, which are required year-round in the vast majority of interior office space in many parts of the United States.

HARSH ENVIRONMENTS – CONDENSER AND EVAPORATOR COIL PROTECTION

For harsh environmental conditions such as sea-shore applications, JOHNSON CONTROLS offers two types of coil protection: copper fin evaporator coils and post coated condenser coils. JOHNSON CONTROLS recommends that for corrosive environments that copper fins be used to protect the evaporator coils. In areas where chemicals that can corrode copper are present, such as ammonia, JOHNSON CONTROLS recommends that post coated condenser coil be used for maximum protection.

BUILDING PRESSURE CONTROL SYSTEMS

Building pressure control systems are often necessary when economizers are used to bring in outdoor air. Without proper building exhaust, the building may become over pressurized. The pressure control system maintains the proper building pressure by expelling the appropriate amount of air from the building.

Return fans – For high return static applications, such as buildings with ducted return systems, a powered return fan may be necessary to maintain building pressure control. JOHNSON CONTROLS offers a powered return fan that is located in the return plenum. This fan operates coincidentally with the supply fan and draws return air back through the return ductwork and into a pressurized plenum. A control damper modulates to

exhaust air out of the building and maintain the building pressure. A second control damper modulates to provide return air from the ductwork to the unit air mixing section.

The return fan configuration is available in two forms: with and without an exhaust damper. The option with the exhaust damper provides a means of building exhaust at the unit. In some applications, the exhaust system is located elsewhere and the unit is not required to provide building exhaust. In these situations, the Series 100 can be offered without the exhaust damper to help reduce installed costs.

Exhaust/relief fans – In this application, a powered exhaust fan may be suitable, however careful consideration of the fan type is necessary. JOHNSON CONTROLS offers a centrifugal powered exhaust fan to perform this function. Some manufacturers use a propeller exhaust fan, which cannot handle the static pressure requirements.

For systems with moderate to low return static pressure, an exhaust fan is recommended. The benefit of the exhaust fan is that it does not run all of the time, and may facilitate compliance with the ASHRAE 90.1 fan motor horsepower requirement.

The exhaust fan operates in parallel with the supply fan. In this arrangement, the supply fan handles the full static pressure requirements of the system. For normal building pressure control, the exhaust fan operates to draw air from the return plenum and exhaust it out of the building.

The exhaust fan configuration is available in two forms, modulating and non-modulating. Modulating is the most common and recommended for the majority of applications, while non-modulating should be used only in certain circumstances.

In the modulating exhaust system, the volume of airflow exhausted from the building is proportional to the entering volume of outside air. Control is accomplished via either a discharge damper or a variable-frequency-drive (VFD). JOHNSON CONTROLS recommends the use of a VFD to reduce energy consumption, sound levels and improved reliability due to fewer moving parts.

In the non-modulating exhaust system, the exhaust airflow is constant whenever the exhaust fan is operating. This type of control should only be used to either assist a smoke purge system or when a system requires a constant volume of exhaust airflow.

Application Data (Cont'd)

ACOUSTICAL CONSIDERATIONS

The Series 100 unit is designed for lower sound levels than competitive units by using flexible fan connections, fan spring isolators, double-wall construction, multiple fan options, and lower speed and horsepower fans. For VAV applications, VFDs are used instead of inlet guide vanes. Additional sound attenuation can be obtained using compressor sound blankets when necessary.

Even with these equipment design features, the acoustical characteristics of the entire installation must never be overlooked. Additional steps for the acoustical characteristics of a single package unit installation should be addressed during the design phase of a project to avoid costly alterations after the installation of the equipment. During the design phase of a project, the designing engineer should consider, at a minimum, the impact of the equipment location, single package unit installation, building structure, and duct work. For sound sensitive projects, refer to the JOHNSON CONTROLS sound application guide, Form 100.00-AG1.

Physical Data

TABLE 3 - PHYSICAL DATA – MODELS 70-105

MODEL SIZE	70	75	80	90	105
COMPRESSOR DATA					
Quantity/Size (Nominal HP)	4x10, 2x11	4x11, 2x13	4x13, 2x11	4x15, 2x13	4x20, 2x15
Type	Scroll	Scroll	Scroll	Scroll	Scroll
Capacity Steps (Qty x %)	4x16, 2x18	4x16, 2x18	4x17, 2x15	4x18, 2x15	4x18, 2x14
SUPPLY FAN AND DRIVE					
Quantity	1	1	1	1/1	1/1
Type	FC	FC	FC	AF	AF
Size	28-25	28-25	28-25	32	32
Motor Size Range (min. to max. HP)	10-50	10-50	10-50	10-50	10-50
Air Flow Range (min. to max. cfm)	14000-32000	14000-32000	14000-32000	0-36000	0-36000
Static Pressure Range (min. to max. ESP)	0-4"	0-4"	0-4"	0-6"	0-6"
OPTIONAL AIRFOIL SUPPLY FAN					
Quantity	1/1	1/1	1/1	NA	NA
Type	AF	AF	AF	NA	NA
Size	32	32	32	NA	NA
Motor Size Range (min. to max. HP)	15-50	15-50	15-50	NA	NA
Air Flow Range (min. to max. cfm)	0-32000	0-32000	0-32000	NA	NA
Static Pressure Range (min. to max. ESP)	0-6"	0-6"	0-6"	NA	NA
EXHAUST FAN					
Quantity	2	2	2	2	2
Type	FC	FC	FC	FC	FC
Size	18-18	18-18	18-18	18-18	18-18
Motor Size Range (min. to max. HP)	10-20	10-20	10-20	10-20	10-20
Air Flow Range (min. to max. cfm)	0-20000	0-20000	0-20000	0-20000	0-20000
Static Pressure Range (min. to max. ESP)	0-2"	0-2"	0-2"	0-2"	0-2"
OPTIONAL EXHAUST FAN					
Quantity	2/1	2/1	2/1	2/1	2/1
Type	FC	FC	FC	FC	FC
Size	20-18	20-18	20-18	20-18	20-18
Motor Size Range (min. to max. HP)	5-30	5-30	5-30	5-30	5-30
Air Flow Range (min. to max. cfm)	0-32000	0-32000	0-32000	0-36000	0-36000
Static Pressure Range (min. to max. iwg)	0-1"	0-1"	0-1"	0-1"	0-1"
OPTIONAL RETURN FAN					
Quantity	2/2	2/2	2/2	2/2	2/2
Type	Plenum	Plenum	Plenum	Plenum	Plenum
Size	270	270	270	270	270
Motor Size Range (min. to max. HP)	5-30	5-30	5-30	5-40	5-40
Air Flow Range (min. to max. cfm)	0-32000	0-32000	0-32000	0-36000	0-36000
Static Pressure Range (min. to max. iwg)	0-3"	0-3"	0-3"	0-3"	0-3"
EVAPORATOR COIL					
Size (square feet)	56.9	56.9	56.9	56.9	56.9
Number of Rows/Fins per Inch	3/17	3/17	3/17	3/17	3/17
Tube Diameter/Surface	3/8"/enhanced	3/8"/enhanced	3/8"/enhanced	3/8"/enhanced	3/8"/enhanced
CONDENSER COIL (R410A)					
Size (square feet)	164	164	164	164	164
Number of Rows/Fins per Inch	1/21	1/21	1/21	1/21	1/21
Tube Diameter/Surface	1mm micro channel	1mm micro channel	1mm micro channel	1mm micro channel	1mm micro channel
CONDENSER FANS					
Quantity	6	6	6	6	6
Type	Prop.	Prop.	Prop.	Prop.	Prop.
Diameter (inches)	36	36	36	36	36
Power (HP each)	2	2	2	2	2

Physical Data (Cont'd)

TABLE 3 - PHYSICAL DATA – MODELS 70-105 (CONT'D)

MODEL SIZE	70	75	80	90	105
FILTERS - 2" THROWAWAY (PRE-FILTER POSITION)					
Quantity	10/15	10/15	10/15	12/18	12/18
Size (length x width) (in.)	25x16/25x20	25x16/25x20	25x16/25x20	25x16/25x20	25x16/25x20
Total Filter Face Area (square feet)	77.1	77.1	77.1	92.5	92.5
FILTERS - 2" CLEANABLE (PRE-FILTER POSITION)					
Quantity	10/15	10/15	10/15	12/18	12/18
Size (length x width) (in.)	25x16/25x20	25x16/25x20	25x16/25x20	25x16/25x20	25x16/25x20
Total Filter Face Area (square feet)	77.1	77.1	77.1	92.5	92.5
FILTERS - 2" PLEATED, 30% EFFICIENT (PRE-FILTER POSITION) (MERV 8)					
Quantity	10/15	10/15	10/15	12/18	12/18
Size (length x width) (in.)	25x16/25x20	25x16/25x20	25x16/25x20	25x16/25x20	25x16/25x20
Total Filter Face Area (square feet)	77.1	77.1	77.1	92.5	92.5
FILTERS - 12" RIGID 65%, 2" 30% PRE-FILTER (PRE-FILTER POSITION) (MERV 11)					
Quantity	2/8/9	2/8/9	2/8/9	8/12	8/12
Size (length x width) (in.)	16x20/25x16/ 25x20	16x20/25x16/ 25x20	16x20/25x16/ 25x20	25x16/25x20	25x16/25x20
Total Filter Face Area (square feet)	55.8	55.8	55.8	61.6	61.6
FILTERS - 12" RIGID 95%, 2" 30% PRE-FILTER (PRE-FILTER POSITION) (MERV 14)					
Quantity	2/8/9	2/8/9	2/8/9	8/12	8/12
Size (length x width) (in.)	16x20/25x16/ 25x20	16x20/25x16/ 25x20	16x20/25x16/ 25x20	25x16/25x20	25x16/25x20
Total Filter Face Area (square feet)	55.8	55.8	55.8	61.6	61.6
FILTERS - 2" CARBON (PRE-FILTER POSITION) (MERV8)					
Quantity	10/15	10/15	10/15	12/18	12/18
Size (length x width) (in.)	16x20/25x16/ 25x20	25x16/25x20	25x16/25x20	25x16/25x20	25x16/25x20
Total Filter Face Area (square feet)	77.1	77.1	77.1	92.5	92.5
FILTERS - 12" RIGID 95% IN POST-FILTER POSITION (MERV 14)					
Quantity	2/7/9	2/7/9	2/7/9	7/12	7/12
Size (length x width) (in.)	16x20/25x16/ 25x20	16x20/25x16/ 25x20	16x20/25x16/ 25x20	25x16/25x20	25x16/25x20
Total Filter Face Area (square feet)	55.1	55.1	55.1	61.1	61.1
GAS FURNACE					
Staged Furnace Sizes (input/output/stages)	375 mbh / 300 mbh / 2 stages				
	750 mbh / 600 mbh / 4 stages				
	1125 mbh / 900 mbh / 6 stages				
Gas Pressure Range (min. to max. iwg)	3-14" w.c.	3-14" w.c.	3-14" w.c.	3-14" w.c.	3-14" w.c.
Airflow Range (min. to max. cfm)	6,950-36,000	6,950-36,000	11,150-36,000	15,150-36,000	15,150-36,000
Modulating Furnace Sizes (input/output/stages)	375 mbh / 300 mbh / 8:1 turndown				
	750 mbh / 600 mbh / 16:1 turndown				
	1125 mbh / 900 mbh / 24:1 turndown				
Gas Pressure Range (min. to max. iwg)	3.5-14" w.c. ²	3.5-14" w.c. ²	3.5-14" w.c. ²	3.5-14" w.c. ²	3.5-14" w.c. ²
Airflow Range (min. to max. cfm)	8,250-36,000	8,250-36,000	11,150-36,000	15,150-36,000	15,150-36,000

NOTES

2. 3.5" is minimum gas pressure for full firing rate. 3.0" is acceptable at reduced firing rate.

TABLE 3 - PHYSICAL DATA – MODELS 70-105 (CONT'D)

MODEL SIZE	70	75	80	90	105
ELECTRIC HEATERS					
Size Range (min. to max. kW)	80-200	80-200	108-250	108-250	108-250
Heating Steps ¹	2-6	2-6	2-6	2-6	2-6
MINIMUM OA TEMP. FOR MECH. CIG.	45	45	45	45	45
LOW AMBIENT OPTION MIN. OA TEMP.	0	0	0	0	0

NOTES

1. Electric heat steps and airflow range depends on voltage and size. Consult *Table 13 on page 43* for minimum allowable airflow. Consult *Table 31 on page 53* for the number of steps for a given voltage and unit size.

Weights are for components only and need to be added to the extended cabinet weights. The diffuser is required in the extended cabinet for any unit with hot water or final filter option.

TABLE 4 - REFRIGERANT CHARGE DATA

	70	75	80	90	105
REFRIGERANT CHARGE (R410A STD CABINET)					
SYS 1 - LB	36	34.5	29.9	33.3	36.1
SYS 2 - LB	31	24.3	21.1	23.5	25.9
SYS 3 - LB	31	24.3	24.3	23.5	25.5
REFRIGERANT CHARGE (R410A EXTD CABINET)					
SYS 1 - LB	38.4	36.9	32.3	35.7	38.5
SYS 2 - LB	33.4	26.7	23.5	25.9	28.3
SYS 3 - LB	33.4	26.7	26.7	25.9	27.9

Weight Data

TABLE 5 - APPROXIMATE BASE OPERATING WEIGHTS (LBS)

MODEL SIZE	70	75	80	90	105
Approximate Unit Weight	10309	10433	10449	10799	11287

NOTES

- Unit base weights include the following features: sheet metal, control panels, refrigerant, compressors, condenser assemblies, minimum capacity supply fan, and 2" throwaway filter.
- Base weights shown represent approximate operating weights and have a $\pm 10\%$ accuracy. To calculate weight for a specific configuration, use YORKworks or contact a Johnson Controls sales representative.

TABLE 6 - COMPONENT WEIGHTS (LBS)

MODEL SIZE	70	75	80	90	105
CABINET					
Sheet Metal	6994	6994	6994	6913	6913
Control Panel	200	200	200	200	200
REFRIGERANT					
Refrigerant Charge (R410A)	75	75	75	75	75
COMPRESSORS					
Compressor 1	131	135	135	227	324
Compressor 2	131	135	135	227	324
Compressor 3	135	135	143	227	227
Compressor 4	135	135	143	227	227
Compressor 5	135	143	143	227	324
Compressor 6	135	143	143	227	324
CONDENSER ASSEMBLY					
Coils					
Condenser Coils ¹	616	616	616	616	616
Condenser Motors/Fans					
Condenser Motors, 2Hp 460/208—230	300	300	300	300	300
Condenser Fans	60	60	60	60	60
Condenser Fan Grilles	60	60	60	60	60
SUPPLY FAN					
Comefri 28-25 FC Class II	498	498	—	—	—
Comefri 32 AF Class I	649	649	649	649	649
Comefri 32 AF Class II	694	694	694	694	694
Isolators	20	20	20	20	20
SUPPLY FAN MOTOR					
5HP	87	87	87	87	87
7.5HP	120	120	120	120	120
10HP	144	144	144	144	144
15HP	217	217	217	217	217
20HP	237	237	237	237	237
25HP	330	330	330	330	330
30HP	372	372	372	372	372
40HP	474	474	474	474	474
50HP	472	472	472	472	472
60HP	556	556	556	556	556
SUPPLY FAN VFD					
5 — 10 HP	22	22	22	22	22
15—25 HP	51	51	51	51	51
30 — 40 HP	66	66	66	66	66
50 — 60 HP	106	106	106	106	106
SUPPLY MTR BASE, 364T FRAME					
Supply Motor and Fan Drive	20	20	20	20	20
Evaporator Coil Top and Btm	540	640	640	540	640

TABLE 6 – COMPONENT WEIGHTS (LBS) (CONT'D)

MODEL SIZE	70	75	80	90	105
FILTERS					
2" Throwaway	25	25	25	25	25
2" Cleanable	25	25	25	25	25
2" Pleated	25	25	25	25	25
2" Carbon	25	25	25	25	25
RF — Rack only	297	297	297	327	327
RF — 2" Throwaway	322	322	322	352	352
RF — 12" 60—65%	535	535	535	565	565
RF — 12" 90—95%	535	535	535	565	565
ECONOMIZER					
OA Damper (30 x 84)	110	110	110	120	120
RA Damper (30 x 84)	110	110	110	120	120
Right Side OA Hood	46	46	46	54	54
Left Side OA Hood	46	46	46	54	54
Rear OA Hood	82	82	82	82	82
Tray & Liner	181	181	181	198	198
OA Filters Back Top	8	8	8	8	8
OA Filters Back Btm	8	8	8	8	8
OA Filters Right Top	2	2	2	2	2
OA Filters Right Btm	2	2	2	2	2
OA Filters Left Top	2	2	2	2	2
OA Filters Left Btm	2	2	2	2	2
POWER EXHAUST					
Exhaust Mtr Base, 256 T Frame	30	30	30	30	30
Exhaust Fan					
Comefri 15—15 FC Class R	194	194	194	194	194
Comefri 15—15 FC Class II	280	280	280	280	280
Comefri 18—18 FC Class R	306	306	306	306	306
Comefri 18—18 FC Class II	396	396	396	396	396
Return Fan	490	490	490	490	490
EXHAUST FAN MOTOR					
5HP	87	87	87	87	87
7.5HP	120	120	120	120	120
10HP	144	144	144	144	144
15HP	217	217	217	217	217
20HP	237	237	237	237	237
25HP	330	330	330	330	330
30HP	372	372	372	372	372
RETURN FAN MOTOR					
5HP	87	87	87	87	87
7.5HP	120	120	120	120	120
10HP	144	144	144	144	144
15HP	217	217	217	217	217
20HP	237	237	237	237	237
25HP	330	330	330	330	330
30HP	372	372	372	372	372
40HP	474	474	474	474	474
EXHAUST FAN VFD					
5–10 HP	22	22	22	22	22
15–25 HP	51	51	51	51	51
30–40 HP	66	66	66	66	66

Weight Data (Cont'd)

TABLE 6 – COMPONENT WEIGHTS (LBS) (CONT'D)

MODEL SIZE	70	75	80	90	105
EXHAUST DAMPER					
Barometric, (24 x 76)	45	45	45	55	55
Modulating, (24 x 76)	75	75	75	90	90
Fan skid	46	46	46	49	49
Exhaust Hood	91	91	91	102	102
HEATING OPTIONS					
Electric Heat — 80kW (Max)	430	430	430	430	430
Electric Heat — 108kW (Max)	450	450	450	450	450
Electric Heat — 150kW (Max)	470	470	470	470	470
Electric Heat — 200kW (Max)	490	490	490	490	490
Electric Heat — 250kW (Max)	510	510	510	510	510
Gas Heat — 375 MBH (Max)	162	162	162	162	162
Gas Heat — 750 MBH (Max)	324	324	324	324	324
Gas Heat — 1125 MBH (Max)	486	486	486	486	486
Hot Water Coil	318	318	318	318	318
Steam Coil	236	236	236	236	236
MISC.					
Open Perimeter Curb	577	577	577	615	615
Enclosed Perimeter Curb	1020	1020	1020	1040	1040
Condenser Section Sheet Metal	2767	2767	2767	2767	2767
0—100% AMS ²	125	125	125	140	140
Condenser Section Wire Guards	102	102	102	102	102
Louvered Panel Guard	465	465	465	465	465

NOTES

1. The weight given is the total weight of all eight aluminum coils and all eight copper coils, respectively. Indicates that particular option is not available with that model size.
2. The 0—100% AMS option needs some predetermined minimum airflow rate to work.

Cooling Performance Data – 70 Ton Model

TABLE 7 - COOLING PERFORMANCE DATA* – 70 TON MODEL

85° OUTDOOR AMBIENT TEMPERATURE

CFM		ENTERING AIR DRY BULB																	
		90		86		83		80		77		74		71		68			
		EWB	TKW	TMBH	SMBH	TMBH	SMBH	TMBH	SMBH	TMBH	SMBH	TMBH	SMBH	TMBH	SMBH	TMBH	SMBH	TMBH	SMBH
16000	75	58.4	907.4	537.4	905.9	470.3	904.8	419.6	903.9	368.8	902.9	317.7							
	73	57.9	880.3	576.1	878.3	508.7	877.1	457.9	875.9	406.9	874.8	355.7	873.7	304.2					
	71	57.4	855.0	615.1	852.4	547.4	850.8	496.4	849.4	445.3	848.0	393.9	846.7	342.3	845.6	290.5			
	67	56.9	804.4	692.0	799.7	623.1	796.9	571.5	794.6	519.9	792.3	468.0	790.4	416.0	788.7	363.9	787.2	311.6	
	62	56.5	761.1	761.1	739.8	717.8	731.4	663.0	725.9	609.6	720.4	556.0	716.4	502.9	713.3	450.0	710.8	397.2	
17750	75	58.8	928.9	565.2	927.2	491.1	926.2	435.2	925.2	379.0	924.2	322.5							
	73	58.3	901.2	607.6	899.1	533.1	897.7	477.1	896.6	420.8	895.4	364.2	894.3	307.4					
	71	57.8	875.4	650.4	872.7	575.6	870.9	519.3	869.4	462.8	867.9	406.1	866.6	349.1	865.5	291.9			
	67	57.3	824.5	735.1	819.0	658.9	815.8	601.9	813.3	544.9	810.8	487.6	808.7	430.3	806.9	372.7	805.4	315.0	
	62	56.9	798.1	798.1	761.5	761.5	749.8	703.4	743.0	644.1	736.2	584.6	731.6	525.9	728.1	467.6	725.3	409.2	
19500	75	59.2	950.3	594.0	948.6	512.8	947.5	451.6	946.5	390.1	945.5	328.3							
	73	58.7	922.1	640.0	919.9	558.5	918.5	497.1	917.2	435.5	916.0	373.6	914.9	311.4					
	71	58.2	895.9	686.5	892.9	604.7	891.0	543.1	889.5	481.3	887.9	419.2	886.5	356.8	885.3	294.2			
	67	57.7	844.9	779.2	838.4	695.6	834.8	633.2	832.0	570.8	829.3	508.1	827.0	445.3	825.2	382.3	823.6	319.2	
	62	57.3	824.8	824.8	786.2	786.2	768.7	744.9	760.1	679.5	751.6	613.9	746.1	549.5	742.2	485.5	739.2	421.7	
21250	75	59.6	971.8	623.3	970.0	535.1	968.8	468.6	967.8	401.8	966.8	334.6							
	73	59.1	943.1	673.1	940.7	584.5	939.2	517.9	937.9	450.9	936.5	383.6	935.4	316.0					
	71	58.6	916.5	723.4	913.2	634.4	911.2	567.5	909.5	500.3	907.8	432.8	906.3	365.1	905.1	297.0			
	67	58.1	865.7	824.2	857.9	733.0	853.8	665.1	850.8	597.3	847.7	529.2	845.3	460.9	843.3	392.5	841.6	323.9	
	62	57.7	858.6	858.6	818.0	818.0	788.3	787.3	777.2	715.5	766.2	643.3	759.7	573.2	755.3	503.6	752.0	434.3	
23000	75	60.0	993.3	653.2	991.4	557.9	990.2	486.1	989.1	414.0	988.0	341.4							
	73	59.5	964.1	706.6	961.5	611.0	959.9	539.0	958.5	466.8	957.1	394.1	955.9	321.1					
	71	59.0	937.1	760.7	933.5	664.6	931.3	592.4	929.5	519.9	927.7	447.0	926.2	373.8	924.9	300.3			
	67	58.5	886.9	869.8	877.5	771.0	872.9	697.5	869.5	624.3	866.1	550.7	863.5	477.0	861.4	403.1	859.6	329.0	
	62	58.1	883.9	883.9	841.2	841.2	809.2	809.2	794.3	751.8	779.5	672.7	771.7	596.6	766.8	521.4	763.2	446.5	
24750	75	60.1	1003.6	679.4	1001.5	577.1	1000.3	500.0	999.2	422.6	998.1	344.7							
	73	59.6	974.6	736.7	971.8	634.0	970.1	556.7	968.7	479.1	967.2	401.1	966.0	322.7					
	71	59.1	947.6	794.5	943.6	691.3	941.2	613.7	939.3	535.9	937.4	457.6	935.9	379.1	934.5	300.2			
	67	58.5	899.8	899.8	887.8	805.3	882.4	726.3	878.7	647.6	875.0	568.6	872.2	489.4	869.9	410.1	868.1	330.6	
	62	58.1	903.4	903.4	858.8	858.8	825.4	825.4	802.8	784.5	780.1	696.6	770.3	614.2	764.5	533.4	760.6	453.0	
26500	75	60.1	1013.8	706.1	1011.7	596.8	1010.3	514.4	1009.2	431.6	1008.1	348.3							
	73	59.6	985.1	767.1	982.1	657.4	980.3	574.8	978.8	491.9	977.3	408.5	976.0	324.7					
	71	59.1	958.2	828.7	953.7	718.4	951.2	635.4	949.2	552.3	947.2	468.6	945.5	384.7	944.1	300.4			
	67	58.6	914.2	914.2	898.4	840.1	892.1	755.5	887.9	671.4	883.8	586.8	880.7	502.2	878.4	417.5	876.4	332.5	
	62	58.1	926.3	926.3	880.3	880.3	845.7	845.7	811.2	811.2	776.6	719.1	763.5	630.0	756.7	543.4	752.3	457.4	
28250	75	60.1	1024.1	733.1	1021.8	616.7	1020.4	529.0	1019.3	440.9	1018.1	352.3							
	73	59.6	995.7	797.9	992.4	681.2	990.5	593.2	989.0	504.9	987.4	416.2	986.1	327.0					
	71	59.1	968.9	863.3	963.9	745.8	961.2	657.5	959.0	569.0	956.9	480.0	955.2	390.6	953.7	300.9			
	67	58.6	931.3	931.3	909.3	875.4	901.8	785.0	897.1	695.4	892.5	605.3	889.2	515.3	886.7	425.1	884.7	334.7	
	62	58.2	935.9	935.9	889.4	889.4	854.5	854.5	819.6	819.6	784.7	747.1	767.5	651.0	759.7	558.6	755.0	467.1	
30000	75	60.1	1034.3	760.3	1032.0	636.9	1030.5	543.9	1029.3	450.4	1028.1	356.5							
	73	59.6	1006.3	829.0	1002.8	705.1	1000.7	611.9	999.1	518.3	997.5	424.1	996.1	329.6					
	71	59.1	979.8	898.2	974.1	773.5	971.1	679.8	968.9	585.9	966.6	491.5	964.8	396.8	963.3	301.6			
	67	58.6	954.3	954.3	920.6	911.1	911.5	814.9	906.3	719.7	901.1	624.1	897.6	528.6	894.9	433.0	892.8	337.0	
	62	58.2	945.5	945.5	898.5	898.5	863.3	863.3	828.0	828.0	792.7	775.4	768.5	670.9	759.5	572.6	754.4	475.5	

* Rated performance is at sea level. Cooling capacities are gross cooling capacity.

Cooling Performance Data – 70 Ton Model (Cont'd)

TABLE 7 –COOLING PERFORMANCE DATA* – 70 TON MODEL (CONT'D)

95° OUTDOOR AMBIENT TEMPERATURE

			ENTERING AIR DRY BULB															
			90		86		83		80		77		74		71		68	
CFM	EWB	TKW	TMBH	SMBH	TMBH	SMBH	TMBH	SMBH	TMBH	SMBH	TMBH	SMBH	TMBH	SMBH	TMBH	SMBH	TMBH	SMBH
16000	75	63.4	877.8	525.5	874.1	457.6	871.6	406.5	869.4	355.3	867.2	303.8						
	73	62.9	850.8	563.6	846.7	495.4	844.0	444.2	841.6	392.8	839.3	341.2	837.1	289.4				
	71	62.4	824.5	601.6	819.7	533.1	816.7	481.6	814.1	430.1	811.5	378.3	809.2	326.4	807.1	274.3		
	67	61.9	774.8	677.7	767.6	607.8	763.3	555.6	759.9	503.6	756.5	451.3	753.6	399.0	751.2	346.7	749.0	294.3
	62	61.4	743.4	743.4	712.3	703.1	701.3	647.2	694.5	593.3	687.7	539.2	682.9	485.8	679.2	432.9	676.3	380.0
17750	75	63.8	897.4	553.0	893.6	478.1	891.0	421.8	888.8	365.2	886.5	308.4						
	73	63.3	870.0	594.8	865.6	519.6	862.8	463.1	860.4	406.4	857.9	349.4	855.7	292.3				
	71	62.8	843.2	636.6	838.1	561.0	834.9	504.2	832.2	447.3	829.5	390.2	827.1	332.9	825.0	275.5		
	67	62.3	793.6	720.7	785.2	643.3	780.5	585.7	776.8	528.3	773.1	470.6	770.1	413.0	767.6	355.2	765.4	297.4
	62	61.9	774.3	774.3	734.0	734.0	718.3	687.4	709.9	627.5	701.6	567.4	696.1	508.4	692.1	449.9	689.0	391.6
19500	75	64.2	917.1	581.4	913.1	499.5	910.4	437.8	908.1	376.0	905.8	313.8						
	73	63.7	889.2	626.9	884.6	544.7	881.6	482.8	879.1	420.8	876.5	358.5	874.3	296.0				
	71	63.3	862.1	672.4	856.5	589.7	853.1	527.6	850.3	465.4	847.4	402.9	845.0	340.3	842.9	277.4		
	67	62.7	812.9	764.6	802.9	679.7	797.7	616.6	793.7	553.8	789.7	490.7	786.5	427.6	783.9	364.5	781.6	301.2
	62	62.3	802.8	802.8	761.6	761.6	736.0	728.6	725.4	662.4	714.8	596.0	708.5	531.4	704.1	467.3	700.8	403.5
21250	75	64.7	936.8	610.5	932.6	521.5	929.8	454.5	927.4	387.3	925.0	319.8						
	73	64.2	908.5	659.7	903.5	570.3	900.4	503.1	897.8	435.8	895.2	368.1	892.9	300.2				
	71	63.7	881.0	708.9	875.0	619.1	871.4	551.6	868.4	484.1	865.4	416.2	862.9	348.2	860.7	279.9		
	67	63.2	832.7	809.4	820.8	716.7	814.9	648.1	810.6	579.9	806.3	511.4	802.9	442.9	800.2	374.3	797.9	305.5
	62	62.7	828.4	828.4	786.4	786.4	754.8	754.8	740.8	697.9	726.8	624.6	719.3	554.2	714.5	484.6	711.0	415.2
23000	75	65.1	956.5	639.9	952.1	543.9	949.2	471.6	946.8	399.1	944.3	326.1						
	73	64.6	927.7	692.9	922.5	596.4	919.2	523.9	916.5	451.2	913.8	378.1	911.4	304.8				
	71	64.1	900.0	745.9	893.4	648.9	889.6	576.1	886.5	503.2	883.4	429.9	880.8	356.5	878.5	282.7		
	67	63.6	853.3	853.3	838.9	754.3	832.2	680.1	827.5	606.4	822.8	532.4	819.2	458.5	816.4	384.4	814.0	310.2
	62	63.1	851.2	851.2	808.3	808.3	776.1	776.1	756.3	733.8	736.4	652.6	727.4	576.1	722.0	500.9	718.2	426.1
24750	75	65.1	967.0	666.5	962.3	563.4	959.4	485.8	956.9	408.0	954.4	329.7						
	73	64.6	938.5	723.3	932.9	619.7	929.6	541.9	926.8	463.9	924.0	385.5	921.6	306.8				
	71	64.1	910.9	780.2	903.7	675.9	899.7	597.8	896.4	519.5	893.2	440.9	890.5	362.0	888.2	282.9		
	67	63.6	868.1	868.1	849.5	789.1	841.9	709.2	836.8	630.1	831.7	550.6	827.9	471.2	824.9	391.8	822.5	312.1
	62	63.1	873.3	873.3	829.9	829.9	797.3	797.3	764.7	764.7	732.2	674.7	720.2	591.6	713.9	510.7	709.9	430.4
26500	75	65.2	977.5	693.5	972.6	583.3	969.6	500.4	967.0	417.2	964.5	333.6						
	73	64.7	949.4	754.1	943.4	643.4	939.9	560.3	937.0	477.0	934.1	393.2	931.7	309.1				
	71	64.2	921.9	814.8	914.1	703.3	909.7	619.8	906.3	536.2	903.0	452.2	900.2	368.0	897.9	283.4		
	67	63.6	885.9	885.9	860.6	824.3	851.6	738.8	846.0	654.2	840.4	569.1	836.4	484.3	833.4	399.5	830.9	314.3
	62	63.2	882.9	882.9	839.0	839.0	806.1	806.1	773.2	773.2	740.3	702.7	724.5	612.7	717.3	526.0	712.9	440.2
28250	75	65.2	988.1	720.7	982.9	603.5	979.8	515.3	977.2	426.8	974.6	337.8						
	73	64.7	960.3	785.2	953.9	667.4	950.3	579.0	947.3	490.3	944.3	401.1	941.8	311.7				
	71	64.2	933.1	849.8	924.4	731.0	919.8	642.1	916.3	553.2	912.8	463.8	909.9	374.1	907.6	284.2		
	67	63.7	909.9	909.9	872.1	860.1	861.5	768.6	855.3	678.5	849.1	587.9	844.9	497.7	841.7	407.3	839.2	316.8
	62	63.2	892.6	892.6	848.2	848.2	814.9	814.9	781.7	781.7	748.4	731.0	726.0	632.8	717.5	540.2	712.7	448.8
30000	75	65.2	998.6	748.2	993.2	623.9	990.0	530.4	987.3	436.6	984.7	342.2						
	73	64.7	971.3	816.6	964.5	691.7	960.6	597.9	957.5	503.8	954.5	409.3	952.0	314.4				
	71	64.2	944.5	885.1	934.8	758.9	929.9	664.7	926.2	570.4	922.5	475.6	919.6	380.5	917.3	285.2		
	67	63.7	933.4	933.4	884.3	884.3	871.4	798.7	864.6	703.0	857.7	606.9	853.2	511.2	850.0	415.4	847.4	319.4
	62	63.2	902.3	902.3	857.4	857.4	823.8	823.8	790.1	790.1	756.5	756.5	722.8	651.1	712.4	552.4	707.1	455.4

* Rated performance is at sea level. Cooling capacities are gross cooling capacity.

TABLE 7 – COOLING PERFORMANCE DATA* – 70 TON MODEL (CONT'D)
105° OUTDOOR AMBIENT TEMPERATURE

CFM		ENTERING AIR DRY BULB																
		90		86		83		80		77		74		71		68		
		EWB	TKW	TMBH	SMBH	TMBH	SMBH	TMBH	SMBH	TMBH	SMBH	TMBH	SMBH	TMBH	SMBH	TMBH	SMBH	
16000	75	70.8	861.8	519.2	858.2	451.4	855.7	400.3	853.6	349.2	851.4	297.7						
	73	70.2	834.8	557.0	830.8	488.9	828.1	437.7	825.8	386.4	823.4	334.8	821.4	283.1				
	71	69.7	808.9	594.8	804.2	526.3	801.2	474.9	798.6	423.5	796.0	371.8	793.8	319.9	791.8	267.9		
	67	69.1	759.6	670.5	752.3	600.6	748.1	548.5	744.7	496.5	741.3	444.3	738.5	392.1	736.1	339.9	734.0	287.5
	62	68.7	733.9	733.9	697.8	695.5	686.2	639.4	679.2	585.5	672.3	531.3	667.4	478.1	663.8	425.2	660.9	372.4
17750	75	71.1	872.5	543.5	868.7	468.7	866.2	412.4	864.0	356.0	861.8	299.2						
	73	70.5	845.3	584.9	841.0	509.8	838.2	453.4	835.8	396.8	833.4	339.9	831.3	282.9				
	71	70.0	819.2	626.5	814.2	551.0	811.0	494.3	808.3	437.6	805.7	380.5	803.3	323.3	801.3	266.0		
	67	69.4	770.8	710.1	762.2	632.8	757.4	575.3	753.8	518.0	750.1	460.4	747.1	402.9	744.7	345.2	742.5	287.5
	62	69.0	753.6	753.6	714.6	714.6	696.3	676.3	687.5	616.3	678.7	556.1	673.1	497.2	669.1	438.8	666.1	380.6
19500	75	71.4	883.1	568.8	879.2	487.0	876.6	425.5	874.4	363.8	872.1	301.7						
	73	70.8	855.8	613.9	851.2	531.8	848.4	470.1	845.9	408.2	843.4	346.0	841.3	283.6				
	71	70.3	829.7	659.2	824.2	576.6	820.8	514.6	818.1	452.6	815.3	390.2	812.9	327.7	810.9	264.9		
	67	69.7	782.6	751.0	772.2	666.0	766.8	603.0	762.8	540.4	758.9	477.4	755.7	414.4	753.2	351.4	751.0	288.2
	62	69.3	776.8	776.8	737.3	737.3	707.7	707.7	695.8	648.1	683.9	581.2	677.3	516.6	672.9	452.7	669.6	389.0
21250	75	71.7	893.8	594.9	889.7	506.1	887.0	439.3	884.7	372.2	882.5	304.8						
	73	71.1	866.4	643.6	861.5	554.5	858.5	487.4	855.9	420.3	853.4	352.7	851.2	284.9				
	71	70.6	840.3	692.7	834.2	602.9	830.7	535.6	827.8	468.3	824.9	400.5	822.5	332.6	820.4	264.5		
	67	70.0	795.4	793.0	782.4	700.0	776.3	631.5	771.9	563.4	767.6	495.0	764.3	426.6	761.6	358.2	759.4	289.6
	62	69.6	791.6	791.6	751.6	751.6	721.7	721.7	704.1	680.5	686.5	605.8	678.3	535.2	673.4	465.7	669.9	396.5
23000	75	72.0	904.6	621.5	900.2	525.6	897.5	453.5	895.1	381.2	892.8	308.4						
	73	71.4	877.0	673.9	871.8	577.7	868.6	505.3	866.0	432.8	863.4	359.9	861.2	286.8				
	71	70.9	850.9	726.7	844.3	629.8	840.5	557.2	837.5	484.5	834.5	411.4	832.0	338.1	829.9	264.6		
	67	70.3	809.8	809.8	792.8	734.7	785.7	660.5	781.0	587.0	776.3	513.1	772.7	439.3	770.0	365.5	767.8	291.4
	62	69.9	813.5	813.5	773.1	773.1	742.7	742.7	712.4	712.4	682.0	627.7	671.0	550.5	665.2	475.4	661.4	400.7
24750	75	72.0	914.3	648.1	909.7	545.2	906.9	467.8	904.5	390.1	902.1	312.0						
	73	71.4	887.0	704.4	881.4	601.0	878.1	523.4	875.4	445.6	872.7	367.3	870.5	288.8				
	71	70.9	861.2	761.0	853.8	656.9	849.8	578.9	846.6	500.8	843.5	422.4	840.9	343.7	838.8	264.8		
	67	70.3	826.8	826.8	803.1	769.6	794.7	689.7	789.5	610.7	784.3	531.3	780.5	452.1	777.7	372.8	775.4	293.3
	62	69.9	822.4	822.4	781.5	781.5	750.8	750.8	720.1	720.1	689.5	655.4	674.6	571.3	667.8	490.3	663.7	410.2
26500	75	72.0	924.0	675.1	919.2	565.2	916.2	482.4	913.8	399.4	911.4	315.9						
	73	71.5	897.1	735.2	891.1	624.8	887.6	541.8	884.8	458.6	882.1	375.0	879.8	291.1				
	71	70.9	871.6	795.7	863.4	684.3	859.0	600.9	855.7	517.5	852.4	433.7	849.8	349.6	847.6	265.2		
	67	70.4	851.0	851.0	813.9	805.1	803.8	719.2	798.0	634.7	792.2	549.8	788.2	465.1	785.3	380.4	782.9	295.5
	62	69.9	831.2	831.2	789.9	789.9	758.9	758.9	727.9	727.9	696.9	683.5	674.8	590.9	666.7	504.0	662.2	418.2
28250	75	72.0	933.7	702.4	928.6	585.3	925.6	497.3	923.1	408.9	920.6	320.1						
	73	71.5	907.2	766.3	900.8	648.7	897.1	560.4	894.3	471.9	891.4	382.9	889.0	293.6				
	71	70.9	882.1	830.7	872.9	712.0	868.3	623.2	864.8	534.5	861.4	445.2	858.7	355.7	856.5	266.0		
	67	70.4	871.4	871.4	825.6	825.6	813.0	749.1	806.5	659.0	800.0	568.4	795.8	478.3	792.7	388.2	790.3	297.8
	62	70.0	840.1	840.1	798.3	798.3	767.0	767.0	735.6	735.6	704.3	704.3	673.0	609.9	662.8	516.8	657.8	425.4
30000	75	72.0	943.5	729.8	938.1	605.7	935.0	512.3	932.5	418.7	929.9	324.5						
	73	71.5	917.5	797.7	910.5	672.9	906.7	579.2	903.7	485.4	900.7	391.0	898.3	296.3				
	71	71.0	893.0	866.1	882.6	739.9	877.6	645.7	874.0	551.6	870.3	456.9	867.6	362.1	865.3	266.9		
	67	70.4	884.9	884.9	838.6	838.6	822.3	779.2	815.0	683.5	807.7	587.3	803.2	491.7	800.0	396.1	797.5	300.2
	62	70.0	848.9	848.9	806.7	806.7	775.0	775.0	743.4	743.4	711.7	711.7	680.1	632.9	667.5	533.4	662.0	436.4

* Rated performance is at sea level. Cooling capacities are gross cooling capacity.

Cooling Performance Data – 70 Ton Model (Cont'd)

TABLE 7 –COOLING PERFORMANCE DATA* – 70 TON MODEL (CONT'D)

115° OUTDOOR AMBIENT TEMPERATURE

			ENTERING AIR DRY BULB															
			90		86		83		80		77		74		71		68	
CFM	EWB	TKW	TMBH	SMBH	TMBH	SMBH	TMBH	SMBH	TMBH	SMBH	TMBH	SMBH	TMBH	SMBH	TMBH	SMBH	TMBH	SMBH
16000	75	78.1	845.8	512.9	842.2	445.2	839.9	394.2	837.7	343.1	835.6	291.7						
	73	77.6	818.9	550.3	814.8	482.4	812.2	431.2	809.9	380.0	807.6	328.5	805.6	276.8				
	71	77.0	793.3	588.0	788.6	519.7	785.6	468.3	783.1	417.0	780.6	365.3	778.4	313.5	776.4	261.6		
	67	76.4	744.5	663.3	737.1	593.4	732.9	541.4	729.5	489.5	726.1	437.4	723.3	385.3	720.9	333.1	718.9	280.8
	62	76.0	721.2	721.2	683.5	683.5	671.1	631.6	663.9	577.7	656.8	523.6	651.9	470.4	648.3	417.5	645.5	364.8
17750	75	78.3	847.5	534.0	843.8	459.4	841.3	403.2	839.2	346.8	837.0	290.2						
	73	77.7	820.6	575.1	816.4	500.1	813.7	443.8	811.3	387.3	809.0	330.6	806.9	273.6				
	71	77.1	795.2	616.4	790.2	541.1	787.1	484.5	784.5	427.9	781.8	370.9	779.6	313.9	777.6	256.6		
	67	76.5	748.0	699.7	739.1	622.4	734.4	564.9	730.7	507.7	727.1	450.3	724.2	392.8	721.7	335.3	719.7	277.6
	62	76.2	734.5	734.5	696.7	696.7	674.5	665.5	665.1	605.3	655.6	544.9	649.9	486.1	645.9	427.8	642.9	369.6
19500	75	78.5	849.2	556.4	845.3	474.7	842.8	413.3	840.6	351.7	838.5	289.7						
	73	77.9	822.4	601.0	817.9	519.1	815.1	457.5	812.7	395.7	810.3	333.7	808.3	271.4				
	71	77.3	797.3	646.1	791.8	563.7	788.5	501.8	785.8	439.9	783.1	377.6	780.8	315.2	778.8	252.6		
	67	76.7	752.6	737.7	741.4	652.5	736.0	589.6	732.0	527.1	728.0	464.2	724.9	401.4	722.5	338.5	720.4	275.5
	62	76.3	746.3	746.3	708.5	708.5	680.1	680.1	666.2	634.0	652.3	566.3	645.2	501.6	640.7	437.8	637.5	374.2
21250	75	78.6	850.9	579.5	846.8	490.9	844.3	424.2	842.1	357.3	839.9	290.1						
	73	78.1	824.3	627.8	819.5	538.9	816.6	472.0	814.1	405.0	811.7	337.6	809.6	269.9				
	71	77.5	799.6	676.6	793.5	587.1	790.0	519.9	787.2	452.7	784.3	385.1	782.0	317.4	780.0	249.4		
	67	76.9	759.0	759.0	744.0	683.7	737.6	615.1	733.2	547.2	728.9	478.9	725.6	410.7	723.1	342.4	721.0	273.9
	62	76.5	759.0	759.0	721.1	721.1	692.7	692.7	667.4	663.4	642.0	585.3	632.4	514.2	627.1	444.8	623.7	375.8
23000	75	78.8	852.6	603.3	848.4	507.7	845.7	435.8	843.5	363.6	841.3	291.0						
	73	78.2	826.3	655.3	821.1	559.3	818.0	487.1	815.5	414.8	813.0	342.0	810.9	269.0				
	71	77.6	802.0	707.9	795.2	611.1	791.4	538.6	788.5	466.1	785.6	393.2	783.2	320.0	781.2	246.7		
	67	77.0	769.1	769.1	747.1	715.6	739.4	641.3	734.5	567.9	729.6	494.1	726.2	420.4	723.5	346.8	721.4	272.9
	62	76.7	763.4	763.4	725.4	725.4	697.0	697.0	668.5	668.5	640.0	608.8	626.1	530.6	619.8	455.3	616.0	380.8
24750	75	78.8	861.5	630.0	857.0	527.3	854.3	450.1	852.0	372.6	849.7	294.6						
	73	78.2	835.5	685.8	829.9	582.7	826.7	505.2	824.1	427.5	821.5	349.4	819.3	271.0				
	71	77.7	811.6	742.3	803.9	638.2	799.9	560.4	796.8	482.5	793.7	404.2	791.3	325.6	789.2	246.9		
	67	77.1	793.1	793.1	757.2	750.7	747.7	670.5	742.2	591.6	736.8	512.2	733.1	433.2	730.3	354.1	728.2	274.8
	62	76.7	771.4	771.4	733.1	733.1	704.3	704.3	675.5	675.5	646.8	636.5	625.1	549.6	617.4	468.5	613.2	388.4
26500	75	78.8	870.4	657.0	865.7	547.3	862.9	464.7	860.5	381.8	858.2	298.5						
	73	78.3	844.8	716.7	838.7	606.4	835.4	523.5	832.7	440.5	830.0	357.0	827.8	273.3				
	71	77.7	821.4	777.0	812.7	665.6	808.3	582.4	805.1	499.1	801.9	415.4	799.3	331.5	797.3	247.3		
	67	77.1	810.9	810.9	768.3	768.3	756.1	700.1	750.0	615.6	743.8	530.6	739.9	446.1	737.0	361.6	734.8	276.8
	62	76.7	779.5	779.5	740.7	740.7	711.6	711.6	682.6	682.6	653.5	653.5	624.4	569.1	614.6	481.7	609.9	396.1
28250	75	78.9	879.4	684.3	874.4	567.4	871.4	479.5	869.1	391.3	866.7	302.6						
	73	78.3	854.2	747.8	847.6	630.3	844.0	542.1	841.3	453.7	838.5	364.9	836.3	275.7				
	71	77.7	831.5	812.1	821.5	693.3	816.8	604.6	813.4	516.0	810.0	426.9	807.4	337.6	805.3	248.0		
	67	77.1	824.1	824.1	781.1	781.1	764.7	729.9	757.7	639.8	750.7	549.2	746.4	459.2	743.4	369.2	741.1	279.0
	62	76.7	787.5	787.5	748.3	748.3	719.0	719.0	689.6	689.6	660.2	660.2	630.9	591.9	618.3	498.0	613.1	406.7
30000	75	78.9	888.4	711.7	883.1	587.7	880.0	494.5	877.6	401.0	875.2	306.9						
	73	78.3	863.7	779.1	856.5	654.4	852.7	560.9	849.8	467.1	847.0	372.9	844.7	278.4				
	71	77.7	842.1	842.1	830.4	721.1	825.3	627.0	821.7	533.0	818.1	438.5	815.5	343.8	813.3	248.8		
	67	77.1	840.9	840.9	797.5	797.5	773.5	760.0	765.4	664.1	757.3	567.8	752.7	472.3	749.6	376.9	747.3	281.2
	62	76.7	795.5	795.5	756.0	756.0	726.3	726.3	696.7	696.7	667.0	667.0	637.3	614.8	620.3	513.7	614.4	416.7

* Rated performance is at sea level. Cooling capacities are gross cooling capacity.

Cooling Performance Data – 75 Ton Model

TABLE 8 - COOLING PERFORMANCE DATA* – 75 TON MODEL

85° OUTDOOR AMBIENT TEMPERATURE

CFM		ENTERING AIR DRY BULB																
		90		86		83		80		77		74		71		68		
		EWB	TKW	TMBH	SMBH	TMBH	SMBH	TMBH	SMBH	TMBH	SMBH	TMBH	SMBH	TMBH	SMBH	TMBH	SMBH	
16000	75	58.9	964.4	560.9	962.9	493.5	961.9	442.7	961.0	391.7	960.1	340.4						
	73	58.3	935.3	599.8	933.4	532.2	932.2	481.3	931.1	430.1	930.0	378.7	929.1	327.1				
	71	57.7	906.4	638.4	904.1	570.5	902.6	519.4	901.2	468.1	899.9	416.6	898.7	364.8	897.6	312.9		
	67	57.1	849.3	714.3	845.1	645.3	842.6	593.7	840.5	541.9	838.4	490.0	836.6	437.9	835.0	385.7	833.7	333.3
	62	56.6	794.3	794.3	778.9	738.9	772.0	684.8	767.3	631.6	762.6	578.1	759.0	525.1	756.2	472.2	753.9	419.3
17750	75	59.5	989.3	589.2	987.8	514.8	986.8	458.8	985.8	402.5	984.9	345.8						
	73	58.9	959.5	631.9	957.6	557.2	956.3	501.0	955.2	444.6	954.0	387.8	953.0	330.8				
	71	58.3	930.0	674.2	927.5	599.3	925.9	542.9	924.5	486.3	923.1	429.4	921.9	372.3	920.7	314.9		
	67	57.7	872.1	757.9	867.3	681.7	864.5	624.7	862.2	567.6	859.9	510.3	858.0	452.8	856.3	395.1	854.9	337.3
	62	57.1	826.1	826.1	801.7	786.1	792.8	725.7	787.1	666.8	781.5	607.6	777.4	549.0	774.3	490.6	771.8	432.3
19500	75	60.0	1014.3	618.6	1012.7	537.2	1011.6	475.8	1010.7	414.2	1009.7	352.2						
	73	59.4	983.8	664.9	981.7	583.3	980.4	521.7	979.2	460.0	978.0	397.9	977.0	335.5				
	71	58.8	953.7	711.0	951.0	629.0	949.2	567.3	947.8	505.4	946.3	443.1	945.0	380.6	943.8	317.8		
	67	58.2	895.0	802.6	889.5	719.1	886.4	656.7	883.9	594.2	881.4	531.5	879.3	468.6	877.6	405.5	876.1	342.2
	62	57.7	862.0	862.0	826.0	826.0	813.8	767.7	806.9	702.9	800.1	637.9	795.4	573.7	792.0	509.8	789.2	445.9
21250	75	60.6	1039.3	648.7	1037.6	560.2	1036.4	493.6	1035.5	426.6	1034.5	359.3						
	73	60.0	1008.1	698.7	1005.9	610.0	1004.5	543.2	1003.3	476.1	1002.0	408.6	1000.9	340.8				
	71	59.4	977.4	748.6	974.4	659.5	972.6	592.5	971.0	525.2	969.5	457.6	968.1	389.7	966.9	321.4		
	67	58.8	918.3	848.1	911.8	757.3	908.3	689.4	905.6	621.5	902.9	553.3	900.7	485.0	898.8	416.5	897.2	347.7
	62	58.2	890.7	890.7	852.7	852.7	835.2	810.5	826.8	739.7	818.3	668.6	812.9	598.7	809.1	529.2	806.1	459.8
23000	75	61.2	1064.2	679.3	1062.5	583.8	1061.3	511.8	1060.3	439.5	1059.3	366.8						
	73	60.6	1032.5	733.0	1030.1	637.3	1028.6	565.1	1027.3	492.7	1026.0	419.9	1024.9	346.7				
	71	60.0	1001.2	786.7	997.9	690.5	996.0	618.1	994.3	545.5	992.6	472.5	991.2	399.2	990.0	325.5		
	67	59.4	941.8	894.2	934.2	795.9	930.3	722.6	927.3	649.3	924.3	575.7	922.0	501.9	920.0	428.0	918.4	353.7
	62	58.8	924.8	924.8	885.0	885.0	857.2	854.1	846.6	777.0	835.9	699.5	829.7	623.9	825.4	548.8	822.3	473.9
24750	75	61.2	1076.8	705.8	1074.9	603.3	1073.7	526.0	1072.7	448.4	1071.6	370.4						
	73	60.6	1045.3	763.4	1042.8	660.6	1041.2	583.2	1039.9	505.4	1038.5	427.2	1037.4	348.7				
	71	60.0	1013.9	820.8	1010.3	717.5	1008.2	639.8	1006.5	561.9	1004.7	483.5	1003.3	404.8	1002.0	325.8		
	67	59.4	955.5	936.4	946.4	830.6	941.9	751.8	938.7	673.1	935.4	594.0	932.9	514.8	930.8	435.4	929.1	355.7
	62	58.8	943.9	943.9	902.4	902.4	871.2	871.2	856.9	810.1	842.6	725.7	835.2	644.2	830.4	563.5	826.9	483.1
26500	75	61.3	1089.3	732.7	1087.3	623.2	1086.1	540.7	1085.0	457.8	1084.0	374.4						
	73	60.7	1058.2	794.3	1055.5	684.4	1053.8	601.7	1052.4	518.6	1051.1	435.0	1049.9	351.1				
	71	60.1	1026.6	855.4	1022.7	745.0	1020.5	662.0	1018.6	578.7	1016.8	495.0	1015.3	410.9	1014.0	326.4		
	67	59.5	970.0	970.0	958.7	865.7	953.6	781.4	950.0	697.3	946.4	612.7	943.7	528.1	941.5	443.3	939.7	358.2
	62	58.9	963.6	963.6	920.4	920.4	887.9	887.9	867.3	843.6	846.7	751.1	837.5	663.5	832.0	577.2	828.3	491.2
28250	75	61.4	1101.9	760.1	1099.8	643.6	1098.5	555.7	1097.4	467.4	1096.3	378.7						
	73	60.8	1071.1	825.5	1068.2	708.6	1066.5	620.5	1065.0	532.1	1063.6	443.2	1062.3	353.9				
	71	60.1	1039.5	890.4	1035.2	772.9	1032.8	684.5	1030.8	595.9	1028.9	506.8	1027.3	417.3	1025.9	327.4		
	67	59.5	985.6	985.6	971.2	901.3	965.3	811.4	961.4	721.8	957.4	631.8	954.5	541.8	952.2	451.5	950.3	360.9
	62	58.9	990.0	990.0	945.0	945.0	911.3	911.3	877.7	877.5	844.0	773.8	832.1	679.8	825.7	587.7	821.6	496.2
30000	75	61.4	1114.4	787.8	1112.2	664.2	1110.9	571.0	1109.8	477.4	1108.6	383.3						
	73	60.8	1084.1	857.0	1081.0	733.1	1079.1	639.7	1077.6	545.9	1076.1	451.7	1074.8	356.9				
	71	60.2	1052.4	925.7	1047.6	801.0	1045.0	707.3	1043.0	613.3	1040.9	518.8	1039.3	424.0	1037.9	328.7		
	67	59.6	1002.9	1002.9	983.9	937.2	977.1	841.7	972.7	746.7	968.3	651.2	965.2	555.7	962.8	459.9	960.8	363.9
	62	59.0	1001.9	1001.9	956.3	956.3	922.2	922.2	888.0	888.0	853.9	802.6	839.0	701.9	831.9	604.2	827.5	507.2

Cooling Performance Data – 75 Ton Model (Cont'd)

TABLE 8 – COOLING PERFORMANCE DATA* – 75 TON MODEL (CONT'D)

95° OUTDOOR AMBIENT TEMPERATURE

			ENTERING AIR DRY BULB															
			90		86		83		80		77		74		71		68	
CFM	EWB	TKW	TMBH	SMBH	TMBH	SMBH	TMBH	SMBH	TMBH	SMBH	TMBH	SMBH	TMBH	SMBH	TMBH	SMBH	TMBH	SMBH
16000	75	64.0	924.8	544.5	921.4	476.5	919.1	425.3	917.0	374.0	914.9	322.3						
	73	63.4	897.6	583.5	893.8	515.2	891.3	463.8	889.0	412.4	886.8	360.6	884.7	308.7				
	71	62.8	869.6	621.7	865.2	553.1	862.4	501.5	860.0	449.9	857.5	398.0	855.3	346.0	853.4	293.8		
	67	62.2	815.4	697.4	808.9	627.6	805.0	575.4	801.9	523.3	798.7	471.0	796.0	418.7	793.7	366.2	791.7	313.7
	62	61.6	767.5	767.5	745.4	720.8	736.5	665.7	730.6	612.1	724.7	558.2	720.4	504.9	717.0	451.9	714.3	399.0
17750	75	64.6	948.4	572.9	944.8	497.9	942.4	441.4	940.2	384.8	938.1	327.8						
	73	64.0	920.6	615.6	916.6	540.3	913.9	483.6	911.6	426.8	909.3	369.7	907.2	312.5				
	71	63.4	892.0	657.5	887.3	581.9	884.4	525.0	881.8	468.0	879.2	410.8	877.0	353.4	875.0	295.8		
	67	62.7	837.2	741.2	829.9	664.0	825.6	606.4	822.2	549.0	818.8	491.3	816.0	433.6	813.6	375.7	811.5	317.7
	62	62.2	806.4	806.4	768.0	768.0	756.1	706.7	749.1	647.3	742.1	587.6	737.3	528.8	733.6	470.3	730.8	411.9
19500	75	65.1	972.0	602.2	968.2	520.2	965.7	458.4	963.5	396.4	961.3	334.1						
	73	64.5	943.7	648.6	939.3	566.2	936.6	504.3	934.2	442.2	931.7	379.7	929.6	317.0				
	71	63.9	914.5	694.3	909.5	611.5	906.3	549.4	903.6	487.1	900.9	424.5	898.6	361.7	896.6	298.7		
	67	63.3	859.4	785.9	850.9	701.3	846.2	638.3	842.6	575.5	838.9	512.4	836.0	449.2	833.5	386.0	831.3	322.5
	62	62.7	832.4	832.4	793.0	793.0	776.2	748.6	767.7	683.2	759.2	617.6	753.7	553.2	749.7	489.2	746.7	425.3
21250	75	65.7	995.7	632.2	991.7	543.1	989.1	476.0	986.8	408.7	984.5	341.0						
	73	65.1	966.7	682.3	962.1	592.8	959.2	525.6	956.7	458.1	954.2	390.3	952.0	322.2				
	71	64.4	937.1	731.8	931.6	641.9	928.3	574.4	925.5	506.7	922.7	438.8	920.3	370.6	918.2	302.1		
	67	63.8	881.8	831.5	872.0	739.3	866.9	670.9	862.9	602.6	859.0	534.1	855.9	465.5	853.3	396.8	851.1	327.9
	62	63.2	863.7	863.7	823.4	823.4	796.8	791.4	786.2	719.8	775.7	647.9	769.4	577.8	765.1	508.2	761.9	438.9
23000	75	66.2	1019.3	662.7	1015.1	566.5	1012.4	494.1	1010.1	421.4	1007.7	348.4						
	73	65.6	989.8	716.5	984.9	619.9	981.9	547.3	979.3	474.5	976.7	401.3	974.5	327.9				
	71	65.0	959.6	769.8	953.8	672.7	950.2	599.9	947.3	526.9	944.4	453.5	941.9	379.9	939.7	306.0		
	67	64.3	904.8	877.7	893.3	777.9	887.5	703.9	883.3	630.2	879.1	556.2	875.8	482.2	873.1	408.0	870.8	333.7
	62	63.7	890.5	890.5	849.2	849.2	818.3	818.3	804.8	756.8	791.3	678.2	784.0	602.3	779.3	527.2	775.9	452.4
24750	75	66.3	1030.5	689.1	1026.2	585.9	1023.4	508.2	1021.0	430.2	1018.6	351.8						
	73	65.7	1001.3	746.7	996.2	643.1	993.0	565.2	990.4	487.1	987.7	408.5	985.4	329.7				
	71	65.0	971.2	803.8	964.8	699.6	961.1	621.4	958.0	543.0	955.0	464.3	952.4	385.3	950.3	306.1		
	67	64.4	918.3	918.3	904.3	812.4	897.9	732.9	893.3	653.8	888.7	574.3	885.3	494.9	882.5	415.3	880.2	335.5
	62	63.8	906.2	906.2	864.4	864.4	833.1	833.1	813.9	789.7	794.6	703.3	785.9	621.4	780.7	540.7	777.0	460.4
26500	75	66.3	1041.8	715.9	1037.3	605.6	1034.4	522.7	1032.0	439.4	1029.5	355.6						
	73	65.7	1012.9	777.4	1007.5	666.7	1004.2	583.5	1001.5	500.0	998.7	416.1	996.4	331.9				
	71	65.1	982.8	838.2	975.8	726.8	971.9	643.3	968.7	559.6	965.6	475.5	963.0	391.2	960.8	306.5		
	67	64.4	933.2	933.2	915.6	847.4	908.2	762.2	903.3	677.7	898.4	592.8	894.7	508.0	891.8	423.0	889.5	337.8
	62	63.8	928.5	928.5	886.3	886.3	854.6	854.6	823.0	823.0	791.3	725.7	780.2	637.5	774.2	551.1	770.3	465.3
28250	75	66.4	1053.1	743.1	1048.3	625.8	1045.4	537.5	1042.9	448.9	1040.4	359.8						
	73	65.7	1024.5	808.4	1018.8	690.6	1015.4	602.1	1012.6	513.3	1009.8	424.0	1007.4	334.5				
	71	65.1	994.5	873.0	986.9	754.5	982.7	665.6	979.5	576.6	976.2	487.1	973.5	397.3	971.3	307.3		
	67	64.4	950.2	950.2	927.1	882.8	918.7	792.0	913.3	702.0	907.9	611.6	904.1	521.3	901.1	430.9	898.7	340.2
	62	63.9	938.8	938.8	896.1	896.1	864.1	864.1	832.1	832.1	800.1	754.0	785.8	659.1	779.1	567.1	774.9	475.7
30000	75	66.4	1064.4	770.5	1059.4	646.2	1056.4	552.6	1053.8	458.6	1051.3	364.2						
	73	65.8	1036.2	839.7	1030.1	714.8	1026.5	621.0	1023.6	526.9	1020.8	432.2	1018.4	337.2				
	71	65.1	1006.3	908.2	998.0	782.4	993.6	688.1	990.2	593.8	986.8	498.9	984.1	403.8	981.8	308.3		
	67	64.5	971.6	971.6	939.0	918.7	929.1	822.0	923.3	726.6	917.5	630.6	913.4	534.9	910.3	439.1	907.9	342.9
	62	63.9	949.1	949.1	905.9	905.9	873.6	873.6	841.2	841.2	808.9	782.5	789.7	680.1	781.9	582.3	777.4	485.4

* Rated performance is at sea level. Cooling capacities are gross cooling capacity.

TABLE 8 – COOLING PERFORMANCE DATA* – 75 TON MODEL (CONT'D)
105° OUTDOOR AMBIENT TEMPERATURE

			ENTERING AIR DRY BULB															
			90		86		83		80		77		74		71		68	
CFM	EWB	TKW	TMBH	SMBH	TMBH	SMBH	TMBH	SMBH	TMBH	SMBH	TMBH	SMBH	TMBH	SMBH	TMBH	SMBH	TMBH	SMBH
16000	75	71.5	923.4	544.0	919.9	475.9	917.6	424.7	915.5	373.4	913.4	321.8						
	73	70.8	896.6	583.0	892.8	514.8	890.2	463.4	888.0	411.9	885.7	360.2	883.7	308.3				
	71	70.1	868.9	621.4	864.5	552.7	861.7	501.2	859.2	449.6	856.8	397.7	854.6	345.6	852.6	293.4		
	67	69.4	814.7	697.1	808.2	627.3	804.4	575.1	801.2	523.0	798.0	470.7	795.3	418.4	793.0	365.9	791.0	313.4
	62	69.0	765.2	765.2	742.8	719.4	733.8	664.3	727.9	610.7	722.0	556.8	717.7	503.6	714.3	450.6	711.6	397.7
17750	75	71.8	933.4	567.0	929.8	492.1	927.4	435.6	925.3	379.0	923.2	322.1						
	73	71.2	906.4	609.7	902.4	534.5	899.7	477.9	897.4	421.1	895.1	364.1	893.1	306.9				
	71	70.5	878.5	651.7	873.9	576.1	870.9	519.3	868.4	462.4	865.8	405.2	863.6	347.9	861.6	290.3		
	67	69.8	824.8	735.3	817.3	658.1	813.1	600.6	809.7	543.3	806.3	485.6	803.5	427.9	801.2	370.1	799.1	312.2
	62	69.3	793.2	793.2	755.4	755.4	742.9	699.9	735.7	640.4	728.5	580.8	723.7	522.0	720.0	463.6	717.2	405.3
19500	75	72.2	943.4	591.3	939.6	509.4	937.2	447.7	935.0	385.9	932.9	323.7						
	73	71.5	916.2	637.6	912.0	555.4	909.2	493.5	906.9	431.5	904.5	369.2	902.5	306.6				
	71	70.8	888.3	683.3	883.2	600.7	880.1	538.6	877.5	476.4	874.9	413.9	872.6	351.2	870.6	288.3		
	67	70.1	835.3	774.8	826.6	690.3	821.9	627.4	818.2	564.7	814.6	501.6	811.7	438.6	809.2	375.4	807.2	312.1
	62	69.6	810.6	810.6	772.4	772.4	752.5	736.8	743.5	671.3	734.4	605.5	728.8	541.1	724.9	477.2	721.9	413.5
21250	75	72.5	953.4	616.5	949.5	527.6	947.0	460.7	944.8	393.5	942.6	326.0						
	73	71.8	926.1	666.5	921.6	577.2	918.8	510.1	916.3	442.8	913.9	375.1	911.8	307.2				
	71	71.1	898.1	715.9	892.7	626.1	889.4	558.8	886.7	491.3	883.9	423.4	881.6	355.4	879.6	287.1		
	67	70.4	846.3	815.5	836.0	723.3	830.7	655.0	826.8	586.9	822.9	518.4	819.8	450.0	817.3	381.5	815.2	312.7
	62	69.9	830.7	830.7	792.2	792.2	763.3	763.3	751.3	702.9	739.2	630.5	732.6	560.4	728.3	491.0	725.1	421.8
23000	75	72.8	963.4	642.4	959.4	546.5	956.8	474.3	954.5	401.8	952.3	328.9						
	73	72.1	936.0	696.0	931.2	599.7	928.3	527.3	925.8	454.6	923.3	381.6	921.2	308.4				
	71	71.4	908.0	749.1	902.1	652.3	898.6	579.6	895.8	506.8	893.0	433.6	890.6	360.2	888.6	286.5		
	67	70.7	858.3	857.2	845.5	757.1	839.5	683.2	835.3	609.7	831.1	535.9	827.8	462.0	825.2	388.1	823.1	313.9
	62	70.2	844.7	844.7	805.8	805.8	776.6	776.6	759.0	735.1	741.5	655.0	733.5	578.9	728.6	503.9	725.2	429.2
24750	75	72.9	973.6	668.8	969.3	565.9	966.7	488.3	964.4	410.5	962.1	332.3						
	73	72.2	946.4	726.2	941.4	622.8	938.3	545.1	935.8	467.2	933.2	388.8	931.0	310.2				
	71	71.5	918.5	783.1	912.1	679.1	908.4	601.1	905.4	522.9	902.5	444.4	900.1	365.6	898.0	286.5		
	67	70.8	872.1	872.1	855.7	791.7	848.9	712.2	844.3	633.2	839.7	553.9	836.3	474.7	833.6	395.3	831.4	315.7
	62	70.3	865.6	865.6	826.2	826.2	796.7	796.7	767.2	767.2	737.7	677.2	727.2	594.7	721.6	514.1	717.9	433.9
26500	75	72.9	983.7	695.6	979.3	585.6	976.5	502.8	974.2	419.7	971.9	336.1						
	73	72.2	956.9	756.8	951.5	646.4	948.3	563.3	945.7	480.0	943.1	396.3	940.9	312.3				
	71	71.5	929.1	817.5	922.0	706.3	918.1	622.9	915.1	539.5	912.0	455.5	909.5	371.4	907.4	286.9		
	67	70.8	888.4	888.4	866.3	826.7	858.3	741.5	853.3	657.1	848.2	572.3	844.6	487.6	841.9	402.8	839.6	317.8
	62	70.3	874.8	874.8	835.0	835.0	805.2	805.2	775.4	775.4	745.5	705.1	731.8	615.9	725.4	529.6	721.5	443.9
28250	75	72.9	993.9	722.7	989.3	605.7	986.4	517.5	984.1	429.1	981.7	340.2						
	73	72.3	967.5	787.8	961.7	670.2	958.4	581.8	955.7	493.2	953.0	404.1	950.7	314.7				
	71	71.5	939.9	852.3	932.1	733.8	927.9	645.1	924.7	556.3	921.5	467.0	919.0	377.4	916.8	287.5		
	67	70.8	909.9	909.9	877.2	862.2	867.8	771.2	862.2	681.3	856.7	590.9	852.9	500.8	850.0	410.6	847.8	320.1
	62	70.3	884.0	884.0	843.8	843.8	813.7	813.7	783.5	783.5	753.4	733.2	734.1	636.3	726.6	544.2	722.4	452.9
30000	75	73.0	1004.1	750.1	999.2	625.9	996.3	532.5	993.9	438.7	991.5	344.4						
	73	72.3	978.1	819.0	971.9	694.3	968.4	600.6	965.6	506.6	962.8	412.2	960.6	317.4				
	71	71.6	950.8	887.4	942.1	761.6	937.7	667.5	934.3	573.3	931.0	478.6	928.4	383.7	926.2	288.4		
	67	70.9	933.5	933.5	888.8	888.8	877.4	801.1	871.2	705.7	865.1	609.8	861.1	514.2	858.1	418.6	855.8	322.6
	62	70.4	893.2	893.2	852.6	852.6	822.1	822.1	791.7	791.7	761.2	761.2	730.8	654.6	721.7	556.4	717.0	459.6

* Rated performance is at sea level. Cooling capacities are gross cooling capacity.

Cooling Performance Data – 75 Ton Model (Cont'd)

TABLE 8 – COOLING PERFORMANCE DATA* – 75 TON MODEL (CONT'D)

115° OUTDOOR AMBIENT TEMPERATURE

			ENTERING AIR DRY BULB															
			90		86		83		80		77		74		71		68	
CFM	EWB	TKW	TMBH	SMBH	TMBH	SMBH	TMBH	SMBH	TMBH	SMBH	TMBH	SMBH	TMBH	SMBH	TMBH	SMBH	TMBH	SMBH
16000	75	79.0	922.0	543.4	918.5	475.4	916.2	424.2	914.1	372.8	912.0	321.2						
	73	78.2	895.6	582.6	891.7	514.3	889.2	463.0	886.9	411.5	884.7	359.8	882.7	307.8				
	71	77.5	868.1	621.0	863.8	552.4	860.9	500.9	858.5	449.2	856.0	397.3	853.8	345.3	851.9	293.1		
	67	76.7	814.0	696.8	807.5	626.9	803.7	574.8	800.5	522.7	797.3	470.4	794.7	418.0	792.4	365.6	790.3	313.1
	62	76.3	763.0	763.0	740.3	718.0	731.2	662.9	725.3	609.3	719.4	555.4	715.0	502.2	711.7	449.2	709.0	396.3
17750	75	79.1	918.3	561.1	914.8	486.3	912.4	429.9	910.3	373.4	908.2	316.5						
	73	78.3	892.1	603.8	888.1	528.7	885.6	472.2	883.3	415.5	881.0	358.5	879.0	301.4				
	71	77.6	865.0	645.9	860.4	570.3	857.4	513.6	854.9	456.8	852.4	399.7	850.2	342.4	848.3	284.9		
	67	76.8	812.3	729.4	804.8	652.3	800.6	594.9	797.2	537.5	793.8	479.9	791.1	422.3	788.7	364.6	786.7	306.7
	62	76.4	780.1	780.1	743.0	743.0	729.6	693.1	722.3	633.7	714.9	574.0	710.0	515.3	706.4	456.9	703.6	398.7
19500	75	79.2	914.7	580.5	911.0	498.8	908.6	437.2	906.5	375.4	904.5	313.3						
	73	78.5	888.8	626.8	884.6	544.7	881.9	482.9	879.6	421.0	877.3	358.8	875.3	296.3				
	71	77.7	862.0	672.4	857.0	589.9	854.0	527.9	851.4	465.9	848.8	403.5	846.6	340.9	844.7	278.1		
	67	76.9	811.2	763.9	802.3	679.4	797.5	616.5	793.9	553.9	790.3	491.0	787.4	428.0	785.0	365.0	783.0	301.8
	62	76.5	790.9	790.9	754.0	754.0	729.0	725.2	719.3	659.5	709.5	593.5	703.8	529.1	699.8	465.3	696.9	401.7
21250	75	79.3	911.1	601.1	907.3	512.4	904.9	445.6	902.8	378.6	900.7	311.2						
	73	78.6	885.5	650.9	881.0	561.8	878.3	494.8	876.0	427.7	873.6	360.1	871.6	292.4				
	71	77.8	859.2	700.2	853.7	610.6	850.5	543.4	847.8	476.1	845.2	408.4	843.0	340.5	841.0	272.3		
	67	77.0	811.2	799.9	799.9	707.6	794.5	639.3	790.6	571.3	786.7	503.0	783.7	434.8	781.2	366.4	779.2	297.8
	62	76.6	795.1	795.1	758.4	758.4	730.8	730.8	716.3	686.3	701.7	612.9	694.6	542.7	690.2	473.4	687.1	404.3
23000	75	79.4	907.5	622.5	903.6	526.8	901.1	454.8	899.0	382.5	896.9	309.8						
	73	78.7	882.2	675.9	877.5	579.8	874.7	507.5	872.3	435.1	869.9	362.3	867.9	289.2				
	71	77.9	856.5	728.9	850.5	632.2	847.0	559.7	844.3	487.1	841.6	414.0	839.3	340.8	837.4	267.3		
	67	77.1	813.0	813.0	797.9	736.8	791.6	663.0	787.3	589.6	783.0	515.9	779.8	442.2	777.4	368.5	775.3	294.5
	62	76.8	804.8	804.8	768.2	768.2	740.7	740.7	713.3	713.3	685.9	629.4	676.1	552.8	670.9	477.9	667.5	403.4
24750	75	79.5	916.6	648.9	912.5	546.2	909.9	468.9	907.7	391.2	905.6	313.2						
	73	78.7	891.6	706.1	886.6	602.9	883.6	525.4	881.1	447.6	878.7	369.4	876.6	290.9				
	71	77.9	866.0	762.9	859.4	659.0	855.7	581.1	852.8	503.2	850.0	424.8	847.7	346.2	845.7	267.3		
	67	77.2	828.3	828.3	807.5	771.4	800.0	691.9	795.3	613.0	790.6	533.8	787.2	454.8	784.6	375.6	782.5	296.2
	62	76.8	812.9	812.9	775.9	775.9	748.2	748.2	720.5	720.5	692.8	656.9	679.7	573.5	673.7	492.9	670.0	412.9
26500	75	79.5	925.7	675.7	921.3	565.9	918.7	483.2	916.5	400.3	914.3	316.9						
	73	78.7	901.0	736.6	895.6	626.4	892.5	543.5	890.0	460.4	887.4	376.8	885.3	293.0				
	71	78.0	875.7	797.3	868.3	686.1	864.4	602.9	861.4	519.6	858.4	435.8	856.0	351.9	854.0	267.5		
	67	77.2	849.8	849.8	817.5	806.6	808.4	721.1	803.2	636.8	798.0	552.1	794.4	467.6	791.8	383.0	789.6	298.1
	62	76.8	821.0	821.0	783.7	783.7	755.7	755.7	727.7	727.7	699.7	684.7	680.4	593.3	673.3	506.8	669.2	421.3
28250	75	79.5	934.8	702.7	930.2	585.9	927.5	497.9	925.2	409.6	923.0	320.9						
	73	78.8	910.5	767.5	904.7	650.1	901.4	561.9	898.8	473.4	896.2	384.5	894.0	295.3				
	71	78.0	885.5	832.0	877.2	713.6	873.0	625.0	869.9	536.3	866.8	447.2	864.4	357.8	862.3	268.0		
	67	77.2	869.8	869.8	828.2	828.2	817.0	750.7	811.2	660.9	805.4	570.6	801.6	480.6	798.8	390.5	796.6	300.2
	62	76.8	829.2	829.2	791.5	791.5	763.2	763.2	735.0	735.0	706.7	706.7	678.4	612.2	669.5	519.6	665.1	428.5
30000	75	79.5	943.9	730.0	939.1	606.0	936.3	512.8	934.0	419.1	931.7	325.0						
	73	78.8	920.0	798.6	913.7	674.0	910.3	580.5	907.6	486.7	904.9	392.4	902.8	297.8				
	71	78.0	895.6	867.0	886.3	741.2	881.7	647.2	878.5	553.2	875.2	458.7	872.7	363.9	870.6	268.7		
	67	77.2	882.2	882.2	840.2	840.2	825.7	780.5	819.2	685.1	812.6	589.2	808.5	493.8	805.6	398.3	803.4	302.5
	62	76.9	837.3	837.3	799.3	799.3	770.7	770.7	742.2	742.2	713.6	713.6	685.1	635.0	674.1	536.2	669.2	439.5

* Rated performance is at sea level. Cooling capacities are gross cooling capacity.

Cooling Performance Data – 80 Ton Model

TABLE 9 - COOLING PERFORMANCE DATA* – 80 TON MODEL

85° OUTDOOR AMBIENT TEMPERATURE

		ENTERING AIR DRY BULB																
		90		86		83		80		77		74		71		68		
CFM	EWB	TKW	TMBH	SMBH	TMBH	SMBH	TMBH	SMBH	TMBH	SMBH	TMBH	SMBH	TMBH	SMBH	TMBH	SMBH	TMBH	SMBH
16000	75	68.7	1010.3	580.3	1008.7	512.7	1007.6	461.7	1006.6	410.5	1005.6	359.0						
	73	68.0	979.1	619.3	977.1	551.4	975.8	500.3	974.6	448.9	973.4	397.3	972.4	345.5				
	71	67.4	949.0	658.3	946.5	590.1	944.9	538.7	943.4	487.2	942.0	435.5	940.7	383.5	939.5	331.3		
	67	66.7	890.3	735.1	886.0	665.8	883.3	613.9	881.1	561.9	878.8	509.7	876.9	457.4	875.2	405.0	873.7	352.3
	62	66.0	832.1	832.1	818.2	760.7	811.5	706.4	806.7	652.9	801.9	599.2	798.2	545.9	795.2	492.7	792.7	439.6
18250	75	69.4	1041.3	615.6	1039.6	539.0	1038.5	481.2	1037.5	423.2	1036.5	364.9						
	73	68.8	1009.3	659.3	1007.1	582.4	1005.7	524.5	1004.5	466.4	1003.2	407.9	1002.1	349.2				
	71	68.1	978.4	703.1	975.7	625.9	973.9	567.7	972.4	509.4	970.8	450.8	969.5	392.0	968.2	332.9		
	67	67.4	918.7	790.0	913.6	711.5	910.6	652.7	908.1	593.8	905.6	534.7	903.5	475.5	901.7	416.1	900.1	356.5
	62	66.7	869.2	869.2	846.5	820.1	837.4	757.9	831.4	697.1	825.5	636.1	821.1	575.7	817.8	515.5	815.0	455.3
20500	75	70.2	1072.3	652.7	1070.6	567.0	1069.4	502.5	1068.3	437.6	1067.3	372.5						
	73	69.5	1039.5	701.1	1037.2	615.2	1035.7	550.5	1034.4	485.5	1033.1	420.2	1031.9	354.6				
	71	68.8	1007.9	749.7	1004.8	663.4	1002.9	598.5	1001.3	533.4	999.6	467.9	998.2	402.1	996.9	336.1		
	67	68.1	947.4	846.8	941.3	758.9	937.9	693.1	935.1	627.4	932.3	561.3	930.0	495.1	928.1	428.8	926.4	362.1
	62	67.5	916.8	916.8	876.7	876.7	863.7	811.2	856.2	742.9	848.7	674.4	843.5	606.7	839.7	539.4	836.7	472.2
22750	75	70.9	1103.4	690.9	1101.5	596.3	1100.3	524.9	1099.2	453.2	1098.1	381.2						
	73	70.2	1069.7	744.2	1067.2	649.2	1065.6	577.7	1064.2	505.9	1062.8	433.6	1061.6	361.1				
	71	69.5	1037.4	797.6	1034.0	702.2	1031.9	630.5	1030.2	558.4	1028.4	486.0	1026.9	413.3	1025.6	340.3		
	67	68.8	976.5	904.9	969.1	807.5	965.2	734.8	962.1	662.1	959.0	589.0	956.5	515.9	954.5	442.5	952.7	368.9
	62	68.2	953.5	953.5	910.8	910.8	890.5	865.9	880.9	789.8	871.2	713.4	865.1	638.5	860.8	564.0	857.5	489.6
25000	75	71.7	1134.5	730.1	1132.5	626.4	1131.2	548.2	1130.0	469.6	1128.9	390.6						
	73	71.0	1100.0	788.1	1097.3	684.1	1095.6	605.7	1094.1	527.0	1092.6	447.8	1091.4	368.3				
	71	70.3	1067.0	846.4	1063.2	741.9	1061.0	663.2	1059.1	584.3	1057.2	505.0	1055.6	425.3	1054.2	345.3		
	67	69.6	1006.0	964.0	997.1	857.0	992.5	777.2	989.1	697.6	985.7	617.5	983.0	537.3	980.7	457.0	978.9	376.3
	62	68.9	997.6	997.6	952.4	952.4	918.4	918.4	905.6	837.5	892.8	752.8	885.5	670.4	880.5	588.7	876.9	507.2
27250	75	71.8	1148.0	763.5	1145.9	650.7	1144.5	565.8	1143.3	480.4	1142.1	394.5						
	73	71.1	1113.9	826.4	1111.0	713.3	1109.2	628.2	1107.6	542.6	1106.1	456.6	1104.8	370.2				
	71	70.4	1080.8	889.5	1076.7	775.9	1074.2	690.4	1072.2	604.6	1070.2	518.4	1068.5	431.8	1067.1	344.9		
	67	69.6	1022.0	1017.8	1010.5	900.8	1005.2	814.0	1001.3	727.3	997.5	640.3	994.5	553.2	992.2	465.8	990.2	378.1
	62	69.0	1019.0	1019.0	971.5	971.5	935.8	935.8	916.8	879.2	897.8	784.9	888.5	694.9	882.8	606.0	878.7	517.4
29500	75	71.9	1161.6	797.6	1159.3	675.8	1157.9	584.0	1156.6	491.8	1155.4	399.1						
	73	71.1	1127.9	865.5	1124.7	743.3	1122.8	651.3	1121.2	558.9	1119.5	466.0	1118.2	372.7				
	71	70.4	1094.8	933.4	1090.1	810.6	1087.4	718.2	1085.3	625.6	1083.1	532.5	1081.4	439.0	1079.9	345.1		
	67	69.7	1039.5	1039.5	1024.3	945.4	1017.9	851.4	1013.6	757.8	1009.2	663.7	1006.0	569.6	1003.5	475.2	1001.4	380.5
	62	69.0	1047.9	1047.9	998.1	998.1	960.8	960.8	928.0	921.7	895.2	814.4	882.8	716.1	875.9	619.9	871.4	524.2
31750	75	71.9	1175.1	832.2	1172.7	701.4	1171.2	602.8	1170.0	503.7	1168.7	404.1						
	73	71.2	1141.9	905.1	1138.4	773.8	1136.4	675.0	1134.7	575.7	1133.0	475.9	1131.6	375.7				
	71	70.5	1108.9	977.8	1103.6	845.8	1100.7	746.6	1098.4	647.1	1096.1	547.0	1094.2	446.6	1092.7	345.7		
	67	69.8	1059.9	1059.9	1038.4	990.7	1030.7	889.4	1025.8	788.7	1020.9	687.6	1017.4	586.4	1014.7	485.1	1012.5	383.4
	62	69.1	1066.1	1066.1	1015.3	1015.3	977.3	977.3	939.2	939.2	901.1	848.3	884.3	741.3	876.3	637.6	871.4	534.8
34000	75	72.0	1188.7	867.3	1186.1	727.4	1184.6	622.0	1183.3	516.1	1182.0	409.5						
	73	71.3	1156.0	945.1	1152.2	804.7	1150.0	699.0	1148.2	592.9	1146.4	486.2	1145.0	379.0				
	71	70.6	1123.1	1022.8	1117.1	881.5	1113.9	775.4	1111.5	669.0	1109.0	562.0	1107.1	454.6	1105.5	346.8		
	67	69.9	1086.5	1086.5	1053.1	1036.6	1043.6	927.8	1038.0	820.1	1032.5	711.8	1028.6	603.6	1025.8	495.3	1023.5	386.5
	62	69.2	1078.8	1078.8	1027.4	1027.4	988.9	988.9	950.4	950.4	911.9	884.7	888.2	767.9	878.8	656.8	873.4	546.8

* Rated performance is at sea level. Cooling capacities are gross cooling capacity.

Cooling Performance Data – 80 Ton Model (Cont'd)

TABLE 9 – COOLING PERFORMANCE DATA* – 80 TON MODEL (CONT'D)

95° OUTDOOR AMBIENT TEMPERATURE

			ENTERING AIR DRY BULB															
			90		86		83		80		77		74		71		68	
CFM	EWB	TKW	TMBH	SMBH	TMBH	SMBH	TMBH	SMBH	TMBH	SMBH	TMBH	SMBH	TMBH	SMBH	TMBH	SMBH	TMBH	SMBH
16000	75	74.7	970.5	563.5	966.7	495.1	964.2	443.6	961.9	392.0	959.5	340.2						
	73	74.0	941.3	602.5	937.2	533.8	934.4	482.2	931.9	430.5	929.4	378.5	927.2	326.3				
	71	73.3	912.9	641.4	908.2	572.4	905.1	520.6	902.4	468.7	899.7	416.5	897.3	364.2	895.1	311.8		
	67	72.6	856.9	718.1	850.1	647.8	846.0	595.3	842.6	543.0	839.1	490.3	836.2	437.7	833.7	385.0	831.4	332.2
	62	71.9	805.0	805.0	786.0	742.8	777.3	687.6	771.3	633.7	765.2	579.5	760.7	525.9	757.0	472.6	754.1	419.4
18250	75	75.5	999.6	598.8	995.6	521.4	992.9	463.2	990.5	404.8	988.2	346.1						
	73	74.8	969.7	642.5	965.2	564.9	962.3	506.5	959.7	447.9	957.1	389.1	954.8	330.1				
	71	74.0	940.6	686.3	935.5	608.2	932.2	549.6	929.3	490.9	926.5	431.9	924.0	372.7	921.8	313.3		
	67	73.3	883.9	773.1	876.0	693.5	871.4	634.1	867.7	574.8	864.0	515.3	860.9	455.7	858.2	396.1	855.9	336.3
	62	72.6	847.1	847.1	813.5	802.5	801.6	739.1	794.3	677.8	786.9	616.3	781.7	555.6	777.7	495.2	774.5	435.0
20500	75	76.2	1028.7	635.7	1024.5	549.4	1021.7	484.3	1019.2	419.1	1016.8	353.5						
	73	75.5	998.1	684.3	993.3	597.6	990.2	532.3	987.5	467.0	984.8	401.2	982.4	335.3				
	71	74.8	968.4	732.9	962.8	645.7	959.3	580.2	956.3	514.6	953.3	448.7	950.7	382.7	948.4	316.4		
	67	74.1	911.4	829.9	902.1	740.7	896.9	674.4	892.8	608.2	888.8	541.7	885.5	475.2	882.7	408.6	880.3	341.8
	62	73.4	888.3	888.3	844.1	844.1	826.5	792.3	817.3	723.4	808.0	654.2	802.0	586.2	797.6	518.8	794.2	451.5
22750	75	77.0	1057.9	673.8	1053.4	578.4	1050.5	506.5	1047.9	434.4	1045.4	362.0						
	73	76.3	1026.5	727.1	1021.4	631.3	1018.1	559.3	1015.3	487.0	1012.5	414.4	1010.0	341.5				
	71	75.5	996.2	780.6	990.1	684.2	986.3	611.9	983.2	539.5	980.0	466.6	977.3	393.6	975.0	320.3		
	67	74.8	939.4	888.0	928.2	789.1	922.4	715.7	918.0	642.6	913.5	569.1	910.0	495.6	907.1	422.1	904.6	348.3
	62	74.1	927.9	927.9	882.4	882.4	852.2	846.9	840.3	769.9	828.3	692.6	821.2	617.4	816.4	542.8	812.7	468.5
25000	75	77.8	1087.0	712.7	1082.3	608.1	1079.3	529.5	1076.6	450.5	1074.0	371.1						
	73	77.0	1055.0	770.8	1049.5	665.8	1046.0	586.9	1043.1	507.8	1040.2	428.3	1037.6	348.5				
	71	76.3	1024.2	829.1	1017.4	723.5	1013.4	644.3	1010.1	565.0	1006.8	485.2	1004.0	405.3	1001.6	325.0		
	67	75.5	968.1	947.2	954.6	838.4	947.9	757.8	943.1	677.7	938.3	597.2	934.5	516.7	931.4	436.2	928.9	355.4
	62	74.8	961.2	961.2	914.5	914.5	879.5	879.5	863.3	817.2	847.0	731.1	838.5	648.3	833.1	566.6	829.2	485.2
27250	75	77.9	1100.8	746.6	1095.8	633.0	1092.7	547.5	1090.0	461.8	1087.3	375.5						
	73	77.1	1069.3	809.7	1063.3	695.6	1059.7	609.9	1056.7	523.9	1053.7	437.5	1051.1	350.8				
	71	76.4	1038.5	872.8	1031.1	758.1	1026.8	672.0	1023.3	585.8	1019.8	499.2	1017.0	412.3	1014.5	325.1		
	67	75.6	985.9	985.9	968.4	882.8	960.7	795.1	955.4	708.0	950.1	620.5	946.1	533.0	943.0	445.5	940.4	357.7
	62	74.9	983.4	983.4	936.1	936.1	900.6	900.6	874.6	859.4	848.5	762.1	837.7	671.5	831.4	582.6	827.2	494.1
29500	75	78.0	1114.6	781.1	1109.4	658.5	1106.1	566.2	1103.4	473.6	1100.6	380.4						
	73	77.2	1083.6	849.2	1077.3	726.0	1073.5	633.5	1070.4	540.7	1067.3	447.3	1064.6	353.7				
	71	76.5	1053.0	917.2	1044.7	793.2	1040.1	700.3	1036.5	607.2	1032.9	513.6	1029.9	419.8	1027.4	325.7		
	67	75.7	1006.4	1006.4	982.7	927.9	973.6	833.0	967.8	738.8	961.9	644.3	957.6	549.9	954.4	455.3	951.7	360.5
	62	75.0	1005.5	1005.5	957.7	957.7	921.7	921.7	885.8	885.8	849.9	793.9	835.2	694.7	827.9	598.5	823.3	502.9
31750	75	78.1	1128.5	816.2	1122.9	684.4	1119.6	585.3	1116.7	485.8	1113.9	385.8						
	73	77.3	1098.0	889.2	1091.2	756.9	1087.2	657.5	1084.0	557.8	1080.8	457.6	1078.1	357.0				
	71	76.6	1067.6	962.2	1058.4	828.8	1053.5	729.0	1049.7	629.0	1045.9	528.6	1042.9	427.8	1040.3	326.7		
	67	75.8	1032.9	1032.9	997.5	973.8	986.6	871.3	980.1	770.1	973.6	668.5	969.0	567.0	965.6	465.5	962.9	363.7
	62	75.1	1018.3	1018.3	969.9	969.9	933.5	933.5	897.1	897.1	860.8	830.3	840.0	721.7	831.4	618.0	826.4	515.3
34000	75	78.2	1142.3	851.6	1136.5	710.7	1133.0	604.8	1130.1	498.4	1127.2	391.5						
	73	77.4	1112.5	929.6	1105.1	788.1	1101.0	681.8	1097.6	575.3	1094.3	468.2	1091.6	360.7				
	71	76.7	1082.5	1007.6	1072.2	864.8	1066.9	758.1	1062.9	651.2	1058.9	543.8	1055.8	436.1	1053.2	328.0		
	67	75.9	1066.8	1066.8	1013.1	1013.1	999.7	910.1	992.4	801.8	985.1	692.9	980.3	584.5	976.7	476.0	973.9	367.2
	62	75.2	1031.2	1031.2	982.1	982.1	945.2	945.2	908.4	908.4	867.0	838.3	746.2	827.7	634.8	822.2	524.9	

* Rated performance is at sea level. Cooling capacities are gross cooling capacity.

TABLE 9 – COOLING PERFORMANCE DATA* – 80 TON MODEL (CONT'D)
105° OUTDOOR AMBIENT TEMPERATURE

		ENTERING AIR DRY BULB																
		90		86		83		80		77		74		71		68		
CFM	EWB	TKW	TMBH	SMBH	TMBH	SMBH	TMBH	SMBH	TMBH	SMBH	TMBH	SMBH	TMBH	SMBH	TMBH	SMBH	TMBH	SMBH
16000	75	82.7	935.4	548.9	931.7	480.7	929.2	429.4	927.0	378.0	924.8	326.3						
	73	81.9	908.1	588.0	904.0	519.5	901.3	468.1	898.9	416.5	896.5	364.7	894.3	312.6				
	71	81.1	879.5	626.2	874.9	557.4	871.9	505.7	869.2	453.9	866.6	402.0	864.3	349.8	862.2	297.5		
	67	80.3	830.2	704.8	823.4	634.7	819.4	582.3	816.0	530.1	812.6	477.6	809.7	425.1	807.3	372.6	805.1	319.9
	62	79.6	792.6	792.6	772.4	735.4	763.5	680.2	757.4	626.3	751.3	572.2	746.8	518.7	743.2	465.4	740.2	412.2
18250	75	83.4	958.1	582.4	954.2	505.2	951.7	447.2	949.4	389.0	947.1	330.4						
	73	82.6	930.3	626.2	925.9	548.8	923.1	490.5	920.6	432.1	918.1	373.5	915.9	314.6				
	71	81.8	901.2	669.2	896.2	591.3	893.0	532.9	890.2	474.3	887.5	415.5	885.1	356.5	882.9	297.3		
	67	80.9	851.9	757.8	843.9	678.3	839.3	619.1	835.6	560.0	832.0	500.6	828.9	441.2	826.4	381.7	824.1	322.1
	62	80.3	835.1	835.1	795.7	793.2	783.1	729.5	775.6	668.2	768.1	606.7	762.8	546.1	758.9	485.8	755.7	425.7
20500	75	84.1	980.9	617.5	976.8	531.4	974.1	466.6	971.7	401.5	969.4	336.1						
	73	83.3	952.5	666.1	947.8	579.6	944.8	514.6	942.3	449.4	939.7	383.8	937.4	318.0				
	71	82.4	923.0	713.9	917.5	626.9	914.1	561.6	911.2	496.3	908.3	430.5	905.8	364.6	903.6	298.5		
	67	81.6	874.2	812.8	864.5	723.7	859.3	657.4	855.3	591.4	851.3	525.1	848.0	458.8	845.4	392.3	843.1	325.7
	62	80.9	866.6	866.6	823.7	823.7	803.5	780.8	793.8	711.7	784.1	642.4	777.9	574.5	773.5	507.2	770.2	440.0
22750	75	84.7	1003.6	653.8	999.3	558.6	996.5	487.0	994.1	415.1	991.6	342.8						
	73	83.9	974.8	707.1	969.8	611.5	966.6	539.7	963.9	467.6	961.2	395.2	958.9	322.5				
	71	83.1	945.0	759.7	938.9	663.6	935.2	591.5	932.1	519.2	929.1	446.6	926.5	373.8	924.3	300.7		
	67	82.3	897.3	869.2	885.3	770.2	879.4	696.9	874.9	623.9	870.5	550.6	867.1	477.3	864.3	403.9	861.9	330.3
	62	81.6	901.9	901.9	858.0	858.0	825.1	825.1	811.9	756.2	798.8	678.5	791.4	603.3	786.5	528.8	782.9	454.6
25000	75	85.4	1026.5	690.8	1021.9	586.6	1018.9	508.1	1016.4	429.3	1013.9	350.2						
	73	84.6	997.2	748.9	991.7	644.2	988.4	565.5	985.6	486.6	982.8	407.2	980.4	327.6				
	71	83.8	967.0	806.4	960.3	701.1	956.3	622.0	953.1	542.9	949.9	463.4	947.2	383.6	944.9	303.6		
	67	82.9	921.6	921.6	906.4	817.5	899.5	737.1	894.6	657.1	889.7	576.8	886.1	496.5	883.1	416.1	880.7	335.5
	62	82.3	928.1	928.1	883.2	883.2	849.6	849.6	830.1	801.5	810.7	714.1	801.6	631.2	796.0	549.6	792.1	468.3
27250	75	85.5	1038.0	724.5	1033.1	611.2	1030.1	525.9	1027.5	440.3	1024.9	354.2						
	73	84.7	1009.1	787.4	1003.2	673.6	999.7	588.1	996.9	502.3	994.0	416.1	991.5	329.6				
	71	83.8	979.2	849.8	971.6	735.2	967.3	649.3	964.0	563.3	960.6	476.9	957.9	390.2	955.6	303.2		
	67	83.0	939.3	939.3	918.4	861.6	910.2	773.9	904.8	687.0	899.4	599.6	895.5	512.3	892.4	425.0	889.9	337.4
	62	82.3	953.0	953.0	907.6	907.6	873.6	873.6	839.6	839.6	805.5	742.5	793.0	651.4	786.5	562.5	782.2	474.1
29500	75	85.6	1049.5	758.7	1044.4	636.3	1041.2	544.2	1038.6	451.7	1036.0	358.8						
	73	84.8	1021.1	826.5	1014.8	703.6	1011.1	611.2	1008.1	518.6	1005.1	425.5	1002.6	332.0				
	71	83.9	991.5	893.8	983.0	769.9	978.4	677.2	974.9	584.3	971.3	490.9	968.5	397.3	966.2	303.4		
	67	83.1	962.9	962.9	931.1	906.5	921.0	811.3	915.0	717.3	909.0	622.9	904.8	528.6	901.6	434.3	899.1	339.7
	62	82.4	963.7	963.7	917.9	917.9	883.4	883.4	849.0	849.0	814.6	778.0	797.0	677.8	789.3	581.5	784.7	486.1
31750	75	85.7	1061.1	793.3	1055.6	661.8	1052.4	562.9	1049.7	463.6	1047.0	363.8						
	73	84.8	1033.2	866.1	1026.4	734.0	1022.5	634.8	1019.4	535.3	1016.3	435.3	1013.7	334.9				
	71	84.0	1004.1	938.4	994.4	805.1	989.5	705.4	985.8	605.7	982.1	505.4	979.1	404.8	976.7	303.9		
	67	83.1	994.7	994.7	944.7	944.7	932.0	849.2	925.2	748.1	918.4	646.5	913.9	545.2	910.6	443.9	908.0	342.3
	62	82.5	974.5	974.5	928.1	928.1	893.3	893.3	858.5	858.5	823.7	813.9	795.7	702.4	786.2	598.4	781.0	495.8
34000	75	85.7	1072.7	828.3	1066.9	687.7	1063.5	581.9	1060.8	475.8	1058.0	369.0						
	73	84.9	1045.5	906.0	1037.9	764.7	1033.8	658.6	1030.6	552.3	1027.4	445.3	1024.8	338.0				
	71	84.1	1017.1	983.4	1005.9	840.6	1000.5	734.0	996.6	627.3	992.7	520.1	989.7	412.6	987.3	304.7		
	67	83.2	1010.4	1010.4	959.8	959.8	943.2	887.5	935.4	779.2	927.7	670.4	922.8	562.1	919.3	453.8	916.7	345.2
	62	82.6	985.2	985.2	938.3	938.3	903.1	903.1	867.9	867.9	832.7	832.7	797.6	728.7	785.5	616.8	779.7	507.0

* Rated performance is at sea level. Cooling capacities are gross cooling capacity.

Cooling Performance Data – 80 Ton Model (Cont'd)

TABLE 9 – COOLING PERFORMANCE DATA* – 80 TON MODEL (CONT'D)
115° OUTDOOR AMBIENT TEMPERATURE

			ENTERING AIR DRY BULB															
			90		86		83		80		77		74		71		68	
CFM	EWB	TKW	TMBH	SMBH	TMBH	SMBH	TMBH	SMBH	TMBH	SMBH	TMBH	SMBH	TMBH	SMBH	TMBH	SMBH	TMBH	SMBH
16000	75	90.7	900.3	534.6	896.7	466.6	894.3	415.5	892.2	364.2	890.0	312.6						
	73	89.8	874.8	573.7	870.8	505.5	868.2	454.2	865.9	402.8	863.6	351.1	861.5	299.2				
	71	88.9	846.1	611.2	841.5	542.6	838.6	491.1	836.1	439.5	833.5	387.7	831.3	335.7	829.3	283.6		
	67	88.0	803.6	691.7	796.8	621.7	792.7	569.5	789.4	517.4	786.1	465.1	783.3	412.7	780.9	360.3	778.8	307.8
	62	87.4	780.4	780.4	758.8	728.0	749.7	672.7	743.6	618.9	737.4	564.9	732.9	511.4	729.3	458.2	726.4	405.2
18250	75	91.3	916.6	566.3	912.8	489.4	910.4	431.5	908.2	373.4	906.0	315.0						
	73	90.4	890.9	610.1	886.6	532.9	883.9	474.8	881.5	416.6	879.1	358.1	876.9	299.4				
	71	89.5	861.8	652.3	856.8	574.7	853.7	516.4	851.1	458.1	848.4	399.4	846.1	340.6	844.1	281.5		
	67	88.6	820.0	742.8	811.8	663.5	807.2	604.3	803.6	545.4	800.0	486.1	797.0	426.9	794.5	367.6	792.3	308.1
	62	88.0	819.1	819.1	778.2	778.2	764.7	720.0	756.9	658.7	749.2	597.2	743.9	536.6	740.0	476.5	736.9	416.4
20500	75	91.9	933.0	599.7	929.0	513.8	926.4	449.1	924.2	384.2	921.9	319.0						
	73	91.0	907.0	648.2	902.4	561.9	899.5	497.1	897.0	432.1	894.5	366.7	892.4	301.1				
	71	90.0	877.8	695.2	872.2	608.5	868.9	543.4	866.1	478.2	863.3	412.6	860.9	346.9	858.8	281.0		
	67	89.1	837.2	796.0	827.0	706.9	821.7	640.8	817.8	574.9	813.8	508.7	810.6	442.6	808.0	376.3	805.8	309.9
	62	88.5	846.3	846.3	804.7	804.7	780.6	769.4	770.3	700.2	759.9	630.7	753.6	562.8	749.3	495.6	746.0	428.6
22750	75	92.5	949.4	634.2	945.2	539.2	942.5	467.7	940.2	396.0	937.9	323.9						
	73	91.6	923.2	687.4	918.2	592.1	915.1	520.4	912.6	448.5	910.0	376.3	907.8	303.8				
	71	90.6	893.8	739.3	887.6	643.4	884.0	571.4	881.1	499.3	878.1	426.9	875.7	354.3	873.6	281.4		
	67	89.7	855.6	850.8	842.5	751.6	836.3	678.3	831.9	605.5	827.5	532.3	824.1	459.2	821.4	386.0	819.2	312.6
	62	89.1	872.7	872.7	830.3	830.3	798.6	798.6	783.6	742.7	768.7	664.3	760.9	589.0	756.0	514.6	752.4	440.5
25000	75	93.1	965.9	669.4	961.4	565.4	958.6	487.1	956.2	408.6	953.8	329.6						
	73	92.2	939.4	727.4	934.0	622.9	930.8	544.4	928.1	465.7	925.4	386.6	923.1	307.1				
	71	91.2	910.0	784.1	903.1	679.0	899.2	600.2	896.1	521.2	893.0	441.9	890.4	362.3	888.3	282.5		
	67	90.3	876.2	876.2	858.4	797.1	851.0	716.7	846.1	636.9	841.2	556.6	837.6	476.5	834.7	396.3	832.4	315.9
	62	89.7	897.5	897.5	854.4	854.4	822.1	822.1	797.0	786.0	771.8	696.2	761.7	613.0	755.9	531.4	752.1	450.3
27250	75	93.1	975.1	702.7	970.4	589.7	967.5	504.6	965.0	419.2	962.6	333.3						
	73	92.2	949.0	765.6	943.2	652.0	939.7	566.6	937.0	481.1	934.2	395.0	931.9	308.7				
	71	91.3	920.0	827.2	912.2	712.8	907.9	627.1	904.7	541.3	901.4	455.0	898.8	368.5	896.6	281.7		
	67	90.4	896.4	896.4	868.8	841.0	859.7	753.1	854.2	666.3	848.7	579.0	844.8	491.9	841.8	404.7	839.4	317.3
	62	89.7	913.3	913.3	869.8	869.8	837.2	837.2	804.6	804.6	772.0	727.4	757.5	635.5	750.6	546.6	746.3	458.4
29500	75	93.2	984.4	736.6	979.4	614.4	976.3	522.5	973.8	430.3	971.3	337.5						
	73	92.3	958.7	804.3	952.3	681.5	948.7	589.3	945.8	496.9	943.0	404.0	940.6	310.7				
	71	91.3	930.3	870.9	921.3	747.1	916.7	654.4	913.2	561.8	909.8	468.6	907.1	375.2	904.9	281.4		
	67	90.4	926.8	926.8	880.2	880.2	868.6	790.1	862.3	696.1	856.0	601.7	851.8	507.6	848.7	413.5	846.3	319.1
	62	89.8	922.0	922.0	878.1	878.1	845.1	845.1	812.2	812.2	779.3	762.4	756.6	660.1	748.2	563.7	743.5	468.3
31750	75	93.3	993.7	770.8	988.3	639.6	985.2	540.8	982.6	441.7	980.1	342.1						
	73	92.3	968.6	843.4	961.5	711.4	957.7	612.4	954.7	513.1	951.7	413.3	949.3	313.1				
	71	91.4	941.1	915.1	930.5	781.8	925.4	682.2	921.8	582.6	918.2	482.5	915.4	382.2	913.1	281.5		
	67	90.5	940.5	940.5	893.4	893.4	877.6	827.5	870.4	726.4	863.1	624.8	858.5	523.7	855.3	422.5	852.8	321.1
	62	89.9	930.6	930.6	886.3	886.3	853.1	853.1	819.8	819.8	786.6	786.6	753.4	684.1	742.4	579.7	737.1	477.2
34000	75	93.3	1003.1	805.3	997.3	665.0	994.1	559.4	991.5	453.4	988.8	346.9						
	73	92.4	978.6	882.8	970.8	741.7	966.7	635.7	963.6	529.6	960.5	422.8	958.0	315.7				
	71	91.5	952.4	952.4	939.8	816.8	934.2	710.3	930.4	603.8	926.5	496.8	923.6	389.5	921.3	281.8		
	67	90.5	958.1	958.1	910.6	910.6	887.0	865.4	878.5	757.0	869.9	648.0	865.0	539.8	861.6	431.7	859.0	323.3
	62	89.9	939.2	939.2	894.5	894.5	861.0	861.0	827.4	827.4	793.9	793.9	760.4	712.8	746.1	600.2	740.2	490.4

* Rated performance is at sea level. Cooling capacities are gross cooling capacity.

Cooling Performance Data – 90 Ton Model

TABLE 10 - COOLING PERFORMANCE DATA* – 90 TON MODEL

85° OUTDOOR AMBIENT TEMPERATURE

CFM		EWB		TKW		ENTERING AIR DRY BULB															
						90		86		83		80		77		74		71		68	
						TMBH	SMBH	TMBH	SMBH	TMBH	SMBH	TMBH	SMBH	TMBH	SMBH	TMBH	SMBH	TMBH	SMBH	TMBH	SMBH
20000	75	84.4	1170.1	686.5	1168.4	602.4	1167.2	539.0	1166.1	475.4	1165.0	411.4									
	73	83.4	1134.9	734.9	1132.7	650.6	1131.2	587.0	1129.9	523.2	1128.6	459.1	1127.4	394.7							
	71	82.4	1098.9	782.5	1096.0	697.8	1094.2	634.0	1092.6	570.1	1090.9	505.8	1089.5	441.2	1088.2	376.4					
	67	81.5	1033.4	878.8	1028.2	792.8	1025.1	728.3	1022.5	663.8	1019.9	599.0	1017.7	534.0	1015.8	468.9	1014.2	403.5			
	62	80.6	969.8	969.8	948.6	910.0	939.7	842.3	933.7	775.9	927.7	709.2	923.3	643.0	919.8	577.0	917.0	511.0			
22000	75	85.4	1199.2	719.5	1197.3	627.4	1196.1	558.0	1195.0	488.3	1193.8	418.2									
	73	84.4	1163.1	772.1	1160.7	679.8	1159.2	610.2	1157.8	540.4	1156.5	470.1	1155.2	399.6							
	71	83.4	1126.3	824.0	1123.3	731.3	1121.3	661.5	1119.6	591.4	1117.9	521.0	1116.4	450.3	1115.1	379.3					
	67	82.3	1060.0	929.3	1054.1	835.0	1050.6	764.4	1047.8	693.8	1045.0	622.8	1042.7	551.6	1040.7	480.3	1038.9	408.7			
	62	81.5	1009.4	1009.4	975.5	964.8	964.0	889.7	956.8	816.8	949.7	743.5	944.7	670.9	940.8	598.6	937.8	526.4			
24000	75	86.3	1228.2	753.5	1226.2	653.4	1225.0	578.0	1223.8	502.2	1222.7	425.9									
	73	85.3	1191.4	810.4	1188.8	710.0	1187.2	634.4	1185.8	558.4	1184.4	482.0	1183.1	405.3							
	71	84.3	1153.9	866.6	1150.5	765.8	1148.4	689.9	1146.6	613.7	1144.8	537.2	1143.3	460.3	1141.9	383.1					
	67	83.2	1086.8	980.8	1080.0	878.2	1076.1	801.4	1073.1	724.6	1070.1	647.4	1067.5	570.1	1065.4	492.5	1063.6	414.7			
	62	82.3	1047.9	1047.9	1004.2	1004.2	988.5	938.2	979.9	858.5	971.4	778.4	965.6	699.4	961.4	620.8	958.1	542.3			
26000	75	87.2	1257.2	788.2	1255.2	680.1	1253.8	598.6	1252.7	516.7	1251.5	434.3									
	73	86.2	1219.6	849.4	1216.9	740.9	1215.2	659.2	1213.7	577.1	1212.3	494.6	1210.9	411.8							
	71	85.2	1181.4	909.9	1177.8	800.9	1175.6	719.0	1173.7	636.7	1171.8	554.0	1170.1	471.0	1168.7	387.6					
	67	84.1	1113.9	1033.2	1106.0	922.1	1101.7	839.1	1098.4	756.2	1095.1	672.8	1092.4	589.2	1090.2	505.4	1088.3	421.3			
	62	83.2	1081.7	1081.7	1035.9	1035.9	1013.5	987.5	1003.0	900.8	992.6	813.8	986.0	728.4	981.3	643.4	977.7	558.5			
28000	75	88.1	1286.3	823.5	1284.1	707.3	1282.7	619.7	1281.5	531.7	1280.3	443.2									
	73	87.1	1247.9	888.9	1245.1	772.4	1243.3	684.6	1241.7	596.4	1240.1	507.8	1238.8	418.7							
	71	86.1	1209.0	953.7	1205.1	836.7	1202.7	748.6	1200.7	660.2	1198.7	571.4	1197.0	482.1	1195.5	392.5					
	67	85.0	1141.3	1086.2	1132.1	966.6	1127.3	877.4	1123.7	788.2	1120.1	698.6	1117.2	608.8	1114.9	518.8	1112.9	428.4			
	62	84.1	1122.1	1122.1	1074.1	1074.1	1039.1	1037.6	1026.1	943.7	1013.1	849.4	1005.6	757.4	1000.4	666.0	996.5	574.8			
30000	75	88.1	1296.0	852.2	1293.8	728.0	1292.4	634.4	1291.1	540.3	1289.9	445.7									
	73	87.0	1257.8	921.8	1254.8	797.3	1252.9	703.4	1251.3	609.2	1249.7	514.5	1248.3	419.3							
	71	86.0	1218.9	990.9	1214.6	865.8	1212.1	771.6	1210.0	677.2	1207.9	582.2	1206.1	486.8	1204.6	391.1					
	67	85.0	1152.8	1132.7	1141.7	1004.4	1136.3	908.9	1132.4	813.5	1128.4	717.7	1125.4	621.8	1122.9	525.6	1120.9	429.0			
	62	84.1	1138.9	1138.9	1089.0	1089.0	1051.6	1051.6	1034.1	979.7	1016.5	877.3	1007.5	778.6	1001.7	680.8	997.5	583.4			
32000	75	88.0	1305.8	881.4	1303.5	749.2	1302.0	649.6	1300.7	549.4	1299.4	448.8									
	73	87.0	1267.8	955.3	1264.5	822.7	1262.5	722.9	1260.9	622.6	1259.2	521.7	1257.8	420.4							
	71	86.0	1228.8	1028.6	1224.2	895.4	1221.4	795.2	1219.2	694.6	1217.0	593.6	1215.2	492.1	1213.6	390.1					
	67	84.9	1165.3	1165.3	1151.5	1042.7	1145.4	940.9	1141.1	839.4	1136.7	737.4	1133.5	635.2	1130.9	532.8	1128.7	430.0			
	62	84.0	1158.1	1158.1	1106.3	1106.3	1067.6	1067.6	1042.0	1016.2	1016.4	904.2	1005.3	798.5	998.7	694.3	994.2	590.5			
34000	75	88.0	1315.6	911.1	1313.2	770.9	1311.6	665.2	1310.3	559.0	1309.0	452.2									
	73	86.9	1277.7	989.3	1274.3	848.7	1272.2	742.7	1270.5	636.3	1268.7	529.4	1267.3	421.9							
	71	85.9	1238.9	1066.9	1233.7	925.5	1230.8	819.2	1228.5	712.6	1226.2	605.4	1224.3	497.7	1222.7	389.6					
	67	84.9	1179.2	1179.2	1161.6	1081.7	1154.5	973.5	1149.7	865.7	1145.0	757.4	1141.5	649.1	1138.8	540.5	1136.5	431.4			
	62	83.9	1183.5	1183.5	1130.1	1130.1	1090.0	1090.0	1049.9	1049.9	1009.8	928.6	995.4	815.4	987.7	704.7	982.8	594.6			
36000	75	87.9	1325.4	941.2	1322.9	793.0	1321.3	681.2	1319.9	568.9	1318.6	456.0									
	73	86.9	1287.8	1023.7	1284.0	875.0	1281.8	762.9	1280.1	650.5	1278.3	537.4	1276.8	423.8							
	71	85.8	1249.0	1105.6	1243.3	956.0	1240.2	843.6	1237.8	730.9	1235.4	617.5	1233.4	503.7	1231.7	389.4					
	67	84.8	1195.5	1195.5	1172.0	1121.1	1163.6	1006.4	1158.4	892.4	1153.2	777.8	1149.4	663.2	1146.6	548.4	1144.3	433.2			
	62	83.9	1192.4	1192.4	1138.6	1138.6	1098.2	1098.2	1057.8	1057.8	1017.5	959.9	999.3	839.0	990.8	721.7	985.5	605.3			

* Rated performance is at sea level. Cooling capacities are gross cooling capacity.

Cooling Performance Data – 90 Ton Model (Cont'd)

TABLE 10 – COOLING PERFORMANCE DATA* – 90 TON MODEL (CONT'D)

95° OUTDOOR AMBIENT TEMPERATURE

			ENTERING AIR DRY BULB															
			90		86		83		80		77		74		71		68	
CFM	EWB	TKW	TMBH	SMBH	TMBH	SMBH	TMBH	SMBH	TMBH	SMBH	TMBH	SMBH	TMBH	SMBH	TMBH	SMBH	TMBH	SMBH
20000	75	91.9	1135.4	672.3	1131.2	587.4	1128.3	523.5	1125.8	459.4	1123.2	394.9						
	73	91.0	1100.7	720.2	1096.0	635.0	1092.9	570.9	1090.2	506.7	1087.4	442.1	1085.0	377.3				
	71	90.0	1065.3	767.4	1059.9	681.8	1056.5	617.4	1053.5	553.0	1050.4	488.2	1047.8	423.3	1045.4	358.2		
	67	89.0	998.6	861.7	990.5	774.5	985.8	709.4	981.9	644.5	978.0	579.2	974.7	513.9	971.9	448.4	969.4	382.8
	62	88.1	945.7	945.7	916.0	892.5	904.6	823.6	897.2	756.7	889.8	689.4	884.4	623.0	880.3	556.8	876.9	490.7
22000	75	92.9	1160.9	704.4	1156.5	611.5	1153.6	541.5	1151.0	471.4	1148.4	400.9						
	73	91.9	1125.6	756.6	1120.6	663.3	1117.4	593.2	1114.5	522.9	1111.7	452.2	1109.2	381.3				
	71	90.9	1089.5	808.0	1083.8	714.3	1080.1	643.9	1077.0	573.4	1073.9	502.5	1071.2	431.5	1068.7	360.2		
	67	89.9	1022.3	911.3	1013.2	815.8	1008.0	744.5	1003.8	673.4	999.7	602.0	996.2	530.5	993.3	458.9	990.8	387.1
	62	89.0	987.8	987.8	941.1	941.1	926.0	870.1	917.2	796.5	908.5	722.6	902.5	649.8	898.1	577.4	894.5	505.0
24000	75	93.9	1186.5	737.5	1181.9	636.5	1178.8	560.5	1176.2	484.3	1173.5	407.6						
	73	92.9	1150.5	793.9	1145.2	692.6	1141.9	616.4	1138.9	540.0	1136.0	463.2	1133.4	386.1				
	71	91.9	1113.8	849.6	1107.7	747.8	1103.8	671.3	1100.6	594.7	1097.3	517.7	1094.5	440.5	1092.0	363.0		
	67	90.9	1046.4	962.1	1035.9	858.0	1030.2	780.6	1025.8	703.3	1021.3	625.7	1017.7	548.0	1014.7	470.2	1012.1	392.2
	62	89.9	1016.9	1016.9	969.2	969.2	947.8	917.7	937.3	837.2	926.8	756.4	920.0	677.1	915.2	598.4	911.5	519.9
26000	75	94.8	1212.0	771.2	1207.2	662.2	1204.1	580.2	1201.3	497.9	1198.6	415.1						
	73	93.8	1175.4	831.9	1169.8	722.5	1166.3	640.2	1163.3	557.7	1160.3	474.8	1157.7	391.6				
	71	92.8	1138.2	892.0	1131.6	782.0	1127.5	699.4	1124.1	616.7	1120.8	533.6	1117.9	450.2	1115.3	366.5		
	67	91.8	1070.8	1013.6	1058.8	901.0	1052.5	817.2	1047.7	733.8	1043.0	649.9	1039.2	566.1	1036.1	482.1	1033.4	397.8
	62	90.8	1052.6	1052.6	1003.9	1003.9	970.3	966.1	957.4	878.5	944.4	790.5	936.8	704.7	931.5	619.7	927.6	534.8
28000	75	95.8	1237.6	805.6	1232.6	688.5	1229.3	600.4	1226.5	511.9	1223.7	423.0						
	73	94.8	1200.3	870.5	1194.5	753.0	1190.8	664.6	1187.7	576.0	1184.6	486.9	1181.9	397.5				
	71	93.8	1162.6	934.9	1155.5	816.7	1151.2	728.1	1147.7	639.2	1144.2	549.9	1141.2	460.4	1138.6	370.5		
	67	92.8	1095.8	1065.9	1081.8	944.5	1074.8	854.5	1069.7	764.8	1064.6	674.7	1060.6	584.7	1057.4	494.4	1054.6	403.9
	62	91.8	1080.9	1080.9	1031.2	1031.2	993.9	993.9	977.4	920.3	961.0	824.6	952.2	732.2	946.5	640.8	942.4	549.7
30000	75	95.7	1247.3	834.6	1242.1	709.5	1238.7	615.3	1235.9	520.8	1233.0	425.8						
	73	94.7	1210.2	903.8	1204.0	778.2	1200.2	683.8	1197.0	589.1	1193.8	493.9	1191.1	398.4				
	71	93.7	1172.5	972.4	1164.8	846.2	1160.4	751.4	1156.7	656.5	1153.1	561.1	1150.0	465.4	1147.4	369.3		
	67	92.7	1108.4	1108.4	1091.4	982.6	1083.6	886.3	1078.1	790.5	1072.6	694.2	1068.4	597.9	1065.1	501.5	1062.4	404.9
	62	91.7	1096.2	1096.2	1046.1	1046.1	1008.5	1008.5	985.1	956.6	961.7	851.8	951.3	752.6	944.9	654.8	940.6	557.4
32000	75	95.6	1257.0	864.1	1251.5	731.0	1248.1	630.8	1245.2	530.2	1242.3	429.1						
	73	94.6	1220.1	937.6	1213.6	804.0	1209.6	703.5	1206.4	602.7	1203.1	501.4	1200.3	399.8				
	71	93.6	1182.5	1010.5	1174.2	876.1	1169.5	775.3	1165.7	674.3	1162.0	572.7	1158.9	470.9	1156.2	368.7		
	67	92.6	1122.6	1122.6	1101.3	1021.4	1092.4	918.6	1086.5	816.6	1080.6	714.1	1076.2	611.7	1072.8	509.1	1070.0	406.2
	62	91.6	1119.1	1119.1	1068.6	1068.6	1030.7	1030.7	992.8	992.8	954.9	876.0	941.5	769.5	934.3	665.3	929.6	561.7
34000	75	95.5	1266.7	894.1	1261.0	752.9	1257.5	646.6	1254.5	540.0	1251.6	432.8						
	73	94.5	1230.0	971.8	1223.1	830.1	1219.0	723.6	1215.7	616.7	1212.4	509.3	1209.5	401.5				
	71	93.5	1192.7	1049.1	1183.6	906.5	1178.7	799.5	1174.8	692.4	1170.9	584.7	1167.7	476.7	1165.0	368.4		
	67	92.5	1139.7	1139.7	1111.5	1060.7	1101.3	951.4	1094.9	843.2	1088.5	734.4	1083.9	625.7	1080.4	516.9	1077.5	407.8
	62	91.5	1127.8	1127.8	1076.8	1076.8	1038.7	1038.7	1000.5	1000.5	962.3	907.2	945.2	793.0	937.2	682.3	932.2	572.3
36000	75	95.4	1276.4	924.3	1270.5	775.1	1266.9	662.8	1263.9	550.1	1260.9	436.8						
	73	94.4	1240.0	1006.4	1232.7	856.6	1228.5	744.0	1225.0	631.0	1221.6	517.5	1218.7	403.5				
	71	93.4	1202.9	1088.1	1193.1	937.2	1187.8	824.1	1183.8	710.9	1179.7	597.1	1176.5	482.9	1173.8	368.3		
	67	92.4	1162.2	1162.2	1122.1	1100.5	1110.3	984.5	1103.3	870.0	1096.3	754.9	1091.5	640.1	1087.9	525.1	1085.0	409.8
	62	91.4	1136.4	1136.4	1085.1	1085.1	1046.6	1046.6	1008.2	1008.2	969.7	938.6	946.7	815.8	937.5	698.4	932.1	582.2

* Rated performance is at sea level. Cooling capacities are gross cooling capacity.

TABLE 10 – COOLING PERFORMANCE DATA* – 90 TON MODEL (CONT'D)

105° OUTDOOR AMBIENT TEMPERATURE

CFM		ENTERING AIR DRY BULB																
		90		86		83		80		77		74		71		68		
		EWB	TKW	TMBH	SMBH	TMBH	SMBH	TMBH	SMBH	TMBH	SMBH	TMBH	SMBH	TMBH	SMBH	TMBH	SMBH	
20000	75	101.2	1077.3	649.0	1073.2	564.4	1070.5	500.7	1068.1	436.9	1065.7	372.7						
	73	100.2	1045.1	696.8	1040.5	611.9	1037.5	548.1	1034.9	484.1	1032.3	419.7	1030.0	355.2				
	71	99.2	1011.6	743.7	1006.3	658.4	1002.9	594.3	1000.0	530.1	997.2	465.6	994.6	400.9	992.4	336.0		
	67	98.1	949.4	838.0	941.2	751.0	936.4	686.2	932.6	621.4	928.8	556.4	925.6	491.3	922.9	426.1	920.6	360.8
	62	97.2	913.0	913.0	872.4	869.5	859.4	800.1	851.7	733.2	843.9	666.0	838.5	599.7	834.4	533.8	831.2	468.0
22000	75	102.2	1101.6	681.3	1097.3	588.7	1094.5	519.0	1092.0	449.1	1089.5	378.8						
	73	101.1	1068.8	733.4	1063.9	640.5	1060.8	570.6	1058.1	500.5	1055.4	430.0	1053.0	359.3				
	71	100.1	1034.7	784.6	1029.0	691.2	1025.5	621.0	1022.5	550.8	1019.5	480.1	1016.8	409.3	1014.5	338.2		
	67	99.0	972.3	887.9	962.8	792.5	957.6	721.5	953.5	650.6	949.4	579.4	946.1	508.1	943.3	436.8	940.9	365.2
	62	98.1	942.9	942.9	898.6	898.6	880.2	846.9	870.8	773.2	861.3	699.2	855.2	626.5	850.8	554.3	847.4	482.2
24000	75	103.1	1125.9	714.5	1121.4	613.9	1118.5	538.1	1116.0	462.1	1113.4	385.7						
	73	102.1	1092.5	770.9	1087.4	669.8	1084.1	593.9	1081.3	517.7	1078.5	441.1	1076.1	364.2				
	71	101.0	1057.9	826.3	1051.8	724.8	1048.0	648.6	1044.9	572.2	1041.7	495.4	1039.0	418.4	1036.7	341.1		
	67	100.0	995.6	938.9	984.6	834.9	978.8	757.6	974.4	680.5	970.0	603.1	966.5	525.7	963.6	448.1	961.1	370.3
	62	99.0	976.3	976.3	931.0	931.0	901.6	894.7	889.9	813.9	878.1	732.7	871.1	653.6	866.3	575.0	862.7	496.7
26000	75	104.1	1150.2	748.4	1145.5	639.7	1142.5	557.8	1139.9	475.7	1137.3	393.2						
	73	103.0	1116.2	808.9	1110.8	699.8	1107.4	617.8	1104.5	535.5	1101.6	452.8	1099.1	369.7				
	71	102.0	1081.1	868.7	1074.5	759.0	1070.6	676.7	1067.3	594.2	1064.0	511.3	1061.2	428.1	1058.8	344.6		
	67	100.9	1019.5	990.7	1006.5	877.9	1000.0	794.3	995.3	711.0	990.6	627.4	986.9	543.7	983.8	460.0	981.3	375.9
	62	99.9	1005.1	1005.1	958.8	958.8	924.1	924.1	908.9	855.2	893.7	766.4	885.6	680.6	880.3	595.7	876.5	511.1
28000	75	105.0	1174.6	782.7	1169.7	665.9	1166.5	578.0	1163.8	489.7	1161.1	401.0						
	73	104.0	1140.0	847.5	1134.3	730.3	1130.7	642.1	1127.7	553.7	1124.7	464.8	1122.1	375.6				
	71	102.9	1104.4	911.6	1097.3	793.7	1093.1	705.2	1089.7	616.6	1086.3	527.5	1083.4	438.2	1081.0	348.5		
	67	101.8	1044.0	1043.2	1028.5	921.4	1021.3	831.5	1016.2	742.0	1011.1	652.1	1007.2	562.2	1004.0	472.2	1001.5	381.9
	62	100.9	1031.4	1031.4	984.2	984.2	948.7	948.7	928.0	896.8	907.3	799.5	897.7	706.9	891.9	615.7	887.8	524.8
30000	75	104.9	1182.8	811.6	1177.7	686.8	1174.5	592.9	1171.7	498.6	1169.0	403.8						
	73	103.9	1148.4	880.7	1142.3	755.4	1138.6	661.2	1135.6	566.7	1132.5	471.7	1129.9	376.4				
	71	102.8	1113.0	949.1	1105.3	823.0	1100.8	728.5	1097.3	633.8	1093.8	538.6	1090.8	443.1	1088.3	347.3		
	67	101.7	1056.8	1056.8	1037.1	959.5	1028.8	863.2	1023.3	767.5	1017.7	671.4	1013.6	575.3	1010.4	479.2	1007.8	382.7
	62	100.8	1052.3	1052.3	1004.7	1004.7	969.0	969.0	934.5	933.0	899.9	823.4	887.6	723.6	880.9	625.9	876.5	528.8
32000	75	104.8	1191.0	841.1	1185.7	708.2	1182.4	608.2	1179.6	507.9	1176.8	406.9						
	73	103.8	1156.9	914.4	1150.4	781.0	1146.6	680.7	1143.4	580.2	1140.3	479.1	1137.6	377.6				
	71	102.7	1121.7	987.1	1113.2	852.8	1108.6	752.2	1104.9	651.4	1101.2	550.1	1098.2	448.4	1095.7	346.4		
	67	101.6	1072.5	1072.5	1046.0	998.2	1036.4	895.4	1030.4	793.5	1024.3	691.1	1020.0	588.9	1016.7	486.5	1014.0	383.8
	62	100.7	1060.7	1060.7	1012.8	1012.8	976.9	976.9	941.0	941.0	905.0	853.5	888.9	746.0	881.3	641.8	876.6	538.4
34000	75	104.7	1199.3	870.9	1193.7	730.0	1190.3	623.9	1187.5	517.5	1184.6	410.4						
	73	103.7	1165.4	948.5	1158.5	807.0	1154.5	700.6	1151.3	594.0	1148.0	486.8	1145.4	379.2				
	71	102.6	1130.6	1025.6	1121.3	883.0	1116.3	776.2	1112.5	669.3	1108.7	561.9	1105.6	454.1	1103.1	345.9		
	67	101.5	1094.4	1094.4	1055.3	1037.5	1044.0	928.0	1037.4	819.8	1030.8	711.1	1026.3	602.7	1022.8	494.1	1020.1	385.2
	62	100.6	1068.0	1068.0	1019.7	1019.7	983.6	983.6	947.4	947.4	911.3	884.5	888.9	768.2	880.1	657.3	875.1	547.6
36000	75	104.6	1207.5	901.0	1201.7	752.0	1198.2	639.9	1195.4	527.4	1192.5	414.2						
	73	103.6	1174.0	982.9	1166.6	833.2	1162.4	720.8	1159.1	608.1	1155.8	494.7	1153.1	381.0				
	71	102.5	1139.7	1064.4	1129.3	913.5	1124.0	800.6	1120.1	687.6	1116.1	574.0	1113.0	460.0	1110.4	345.7		
	67	101.4	1118.6	1118.6	1065.5	1065.5	1051.8	960.9	1044.5	846.4	1037.2	731.4	1032.4	616.7	1028.9	501.9	1026.1	386.8
	62	100.5	1075.2	1075.2	1026.7	1026.7	990.3	990.3	953.9	953.9	917.5	915.6	882.5	787.9	871.8	670.1	866.3	554.0

* Rated performance is at sea level. Cooling capacities are gross cooling capacity.

Cooling Performance Data – 90 Ton Model (Cont'd)

TABLE 10 – COOLING PERFORMANCE DATA* – 90 TON MODEL (CONT'D)

115° OUTDOOR AMBIENT TEMPERATURE

			ENTERING AIR DRY BULB															
			90		86		83		80		77		74		71		68	
CFM	EWB	TKW	TMBH	SMBH	TMBH	SMBH	TMBH	SMBH	TMBH	SMBH	TMBH	SMBH	TMBH	SMBH	TMBH	SMBH	TMBH	SMBH
20000	75	110.5	1019.2	626.2	1015.3	542.0	1012.7	478.5	1010.4	414.9	1008.1	350.9						
	73	109.4	989.5	674.0	985.0	589.4	982.2	525.8	979.7	462.0	977.2	397.9	975.0	333.5				
	71	108.3	957.8	720.6	952.7	635.6	949.4	571.7	946.6	507.8	943.9	443.5	941.5	379.0	939.3	314.3		
	67	107.2	900.3	814.8	891.8	728.1	887.1	663.4	883.3	598.9	879.6	534.1	876.5	469.2	873.9	404.3	871.7	339.1
	62	106.3	871.1	871.1	830.0	830.0	814.5	777.1	806.2	710.2	797.9	642.9	792.4	576.8	788.3	511.1	785.2	445.5
22000	75	111.4	1042.2	658.8	1038.1	566.5	1035.4	497.0	1033.1	427.3	1030.7	357.2						
	73	110.4	1012.0	710.8	1007.3	618.1	1004.3	548.4	1001.7	478.6	999.1	408.3	996.8	337.8				
	71	109.2	979.9	761.7	974.3	668.5	970.8	598.6	967.9	528.6	965.0	458.1	962.5	387.5	960.3	316.7		
	67	108.1	922.5	865.1	912.5	769.8	907.2	698.9	903.2	628.2	899.1	557.2	895.9	486.2	893.2	415.0	890.9	343.7
	62	107.2	901.7	901.7	859.8	859.8	834.8	824.3	824.3	750.3	813.8	676.0	807.4	603.4	803.0	531.4	799.7	459.5
24000	75	112.4	1065.3	692.1	1061.0	591.8	1058.2	516.2	1055.8	440.4	1053.3	364.2						
	73	111.3	1034.5	748.3	1029.5	647.6	1026.4	571.8	1023.7	495.8	1021.0	419.5	1018.7	342.8				
	71	110.2	1002.0	803.5	995.9	702.2	992.2	626.2	989.2	550.0	986.1	473.5	983.6	396.7	981.3	319.6		
	67	109.0	945.2	916.3	933.3	812.2	927.4	735.0	923.0	658.2	918.6	581.0	915.2	503.7	912.4	426.4	910.1	348.8
	62	108.1	931.3	931.3	888.4	888.4	856.2	856.2	842.4	791.0	828.6	709.1	821.1	629.9	816.2	551.6	812.7	473.4
26000	75	113.3	1088.4	726.0	1083.8	617.5	1081.0	535.9	1078.4	454.0	1075.9	371.6						
	73	112.2	1057.1	786.4	1051.8	677.5	1048.5	595.7	1045.7	513.6	1042.9	431.1	1040.5	348.3				
	71	111.1	1024.1	845.9	1017.5	736.5	1013.6	654.3	1010.4	572.0	1007.3	489.3	1004.6	406.3	1002.3	323.1		
	67	110.0	968.7	968.4	954.3	855.2	947.6	771.7	942.9	688.7	938.1	605.2	934.5	521.7	931.6	438.2	929.2	354.3
	62	109.0	956.5	956.5	912.7	912.7	879.9	879.9	860.5	832.2	841.1	741.7	832.2	655.8	826.8	571.1	823.0	486.6
28000	75	114.3	1111.5	760.2	1106.7	643.7	1103.7	556.0	1101.1	467.9	1098.6	379.4						
	73	113.2	1079.7	824.9	1074.0	707.9	1070.6	620.0	1067.7	531.8	1064.8	443.1	1062.4	354.1				
	71	112.1	1046.4	888.8	1039.2	771.1	1035.0	682.8	1031.7	594.4	1028.4	505.5	1025.6	416.4	1023.3	326.9		
	67	110.9	993.4	993.4	975.5	898.7	967.9	808.8	962.7	719.5	957.5	629.8	953.7	540.1	950.7	450.3	948.2	360.2
	62	109.9	987.0	987.0	942.3	942.3	908.8	908.8	878.6	873.8	848.5	772.4	837.3	679.4	831.1	588.2	827.0	497.5
30000	75	114.2	1118.3	789.1	1113.3	664.5	1110.2	570.8	1107.6	476.7	1104.9	382.1						
	73	113.1	1086.7	858.0	1080.6	733.0	1077.0	638.9	1074.1	544.7	1071.1	449.9	1068.6	354.8				
	71	111.9	1053.7	926.2	1045.7	800.3	1041.3	705.9	1037.9	611.4	1034.4	516.4	1031.6	421.1	1029.3	325.5		
	67	110.8	1007.6	1007.6	983.0	936.9	974.1	840.5	968.5	744.9	962.8	648.9	958.7	553.1	955.6	457.1	953.1	360.8
	62	109.8	996.3	996.3	951.3	951.3	917.6	917.6	883.9	883.9	850.1	800.9	835.2	700.2	828.1	602.5	823.6	505.5
32000	75	114.1	1125.1	818.4	1119.8	685.8	1116.6	586.0	1114.0	485.8	1111.3	385.1						
	73	113.0	1093.7	891.6	1087.2	758.4	1083.5	658.3	1080.5	558.0	1077.4	457.1	1074.9	355.8				
	71	111.8	1061.1	964.1	1052.3	830.0	1047.6	729.5	1044.0	628.9	1040.4	527.7	1037.6	426.3	1035.2	324.5		
	67	110.7	1028.6	1028.6	991.1	975.6	980.4	872.5	974.2	770.7	968.0	668.4	963.7	566.3	960.5	464.2	957.9	361.7
	62	109.7	1002.2	1002.2	957.0	957.0	923.1	923.1	889.1	889.1	855.2	831.3	833.8	721.8	825.4	617.4	820.7	514.1
34000	75	114.0	1131.9	848.0	1126.4	707.4	1123.1	601.5	1120.4	495.3	1117.7	388.4						
	73	112.9	1100.8	925.5	1093.9	784.2	1089.9	678.0	1086.8	571.6	1083.7	464.5	1081.2	357.1				
	71	111.7	1068.8	1002.4	1058.9	860.0	1053.9	753.3	1050.2	646.6	1046.5	539.3	1043.5	431.7	1041.1	323.7		
	67	110.6	1049.9	1049.9	1000.1	1000.1	986.9	904.9	980.0	796.8	973.0	688.2	968.5	579.9	965.1	471.5	962.5	362.8
	62	109.6	1008.1	1008.1	962.6	962.6	928.5	928.5	894.4	894.4	860.2	860.2	826.1	740.9	815.8	629.7	810.5	520.0
36000	75	113.9	1138.7	878.0	1133.0	729.2	1129.6	617.3	1126.8	504.9	1124.1	392.0						
	73	112.8	1108.0	959.7	1100.5	810.2	1096.4	698.0	1093.2	585.4	1090.0	472.3	1087.4	358.7				
	71	111.6	1076.8	1041.2	1065.6	890.2	1060.2	777.5	1056.4	664.6	1052.5	551.2	1049.5	437.4	1047.0	323.3		
	67	110.5	1060.6	1060.6	1010.5	1010.5	993.5	937.7	985.7	823.2	977.9	708.1	973.1	593.6	969.6	479.0	967.0	364.1
	62	109.5	1014.1	1014.1	968.3	968.3	933.9	933.9	899.6	899.6	865.3	865.3	830.9	765.8	818.3	647.4	812.6	531.3

* Rated performance is at sea level. Cooling capacities are gross cooling capacity.

Cooling Performance Data – 105 Ton Model

TABLE 11 - COOLING PERFORMANCE DATA* – 105 TON MODEL

85° OUTDOOR AMBIENT TEMPERATURE

		ENTERING AIR DRY BULB																
		90		86		83		80		77		74		71		68		
CFM	EWB	TKW	TMBH	SMBH	TMBH	SMBH	TMBH	SMBH	TMBH	SMBH	TMBH	SMBH	TMBH	SMBH	TMBH	SMBH	TMBH	SMBH
20000	75	91.8	1291.5	737.8	1289.8	653.2	1288.6	589.4	1287.6	525.4	1286.5	461.0						
	73	90.5	1257.3	789.2	1255.2	704.4	1253.8	640.4	1252.5	576.2	1251.3	511.7	1250.1	446.9				
	71	89.2	1219.7	838.7	1217.1	753.5	1215.4	689.3	1213.8	624.9	1212.3	560.2	1210.9	495.3	1209.7	430.0		
	67	87.9	1146.9	936.5	1142.5	850.1	1139.7	785.4	1137.3	720.5	1134.9	655.3	1132.9	589.9	1131.1	524.3	1129.5	458.5
	62	86.6	1060.0	1056.0	1046.4	964.2	1039.6	897.1	1034.7	830.7	1029.8	764.0	1025.9	697.7	1022.8	631.4	1020.2	565.1
22000	75	93.1	1327.3	771.8	1325.5	679.2	1324.3	609.4	1323.2	539.3	1322.2	468.9						
	73	91.8	1292.2	827.5	1290.0	734.6	1288.5	664.7	1287.2	594.4	1285.9	523.8	1284.7	452.8				
	71	90.5	1253.7	881.2	1250.9	788.0	1249.1	717.8	1247.4	647.4	1245.8	576.6	1244.4	505.5	1243.1	434.1		
	67	89.2	1179.3	988.0	1174.4	893.5	1171.3	822.6	1168.8	751.6	1166.3	680.2	1164.1	608.7	1162.2	537.0	1160.6	465.0
	62	87.9	1095.3	1095.3	1077.1	1019.4	1069.0	945.6	1063.4	872.9	1057.7	799.8	1053.5	727.2	1050.1	654.6	1047.3	582.1
24000	75	94.5	1363.1	807.0	1361.2	706.4	1360.0	630.6	1358.9	554.4	1357.8	477.8						
	73	93.2	1327.1	867.0	1324.8	766.1	1323.3	690.0	1321.9	613.7	1320.6	536.9	1319.3	459.9				
	71	91.8	1287.7	925.0	1284.7	823.7	1282.7	747.5	1281.1	670.9	1279.4	594.0	1277.9	516.8	1276.6	439.2		
	67	90.5	1211.9	1040.7	1206.3	938.0	1203.0	860.9	1200.3	783.8	1197.6	706.3	1195.3	628.6	1193.3	550.7	1191.6	472.4
	62	89.2	1133.9	1133.9	1108.5	1076.0	1098.5	995.3	1092.0	916.1	1085.5	836.5	1080.8	757.6	1077.1	678.7	1074.2	599.9
26000	75	95.8	1398.9	843.0	1397.0	734.4	1395.7	652.5	1394.6	570.3	1393.4	487.6						
	73	94.5	1362.1	907.3	1359.6	798.4	1358.0	716.3	1356.6	633.8	1355.2	550.9	1353.9	467.7				
	71	93.1	1321.7	969.7	1318.5	860.4	1316.4	778.0	1314.7	695.4	1312.9	612.3	1311.4	528.9	1310.0	445.0		
	67	91.8	1244.5	1094.3	1238.3	983.3	1234.7	900.2	1231.8	816.9	1228.9	733.2	1226.5	649.3	1224.4	565.1	1222.6	480.6
	62	90.4	1178.9	1178.9	1140.6	1133.7	1128.2	1045.8	1120.7	960.1	1113.2	873.9	1107.9	788.6	1103.9	703.5	1100.7	618.3
28000	75	97.2	1434.7	879.8	1432.7	763.1	1431.4	675.2	1430.2	586.8	1429.1	497.9						
	73	95.9	1397.0	948.4	1394.4	831.3	1392.8	743.2	1391.3	654.6	1389.8	565.6	1388.5	476.1				
	71	94.5	1355.7	1015.1	1352.3	897.6	1350.2	809.2	1348.3	720.4	1346.4	631.2	1344.8	541.6	1343.4	451.5		
	67	93.1	1277.3	1148.7	1270.4	1029.4	1266.4	940.0	1263.3	850.6	1260.2	760.7	1257.6	670.6	1255.4	580.1	1253.5	489.4
	62	91.7	1218.9	1218.9	1173.9	1173.9	1158.1	1097.0	1149.3	1004.6	1140.6	911.8	1134.7	820.1	1130.4	728.6	1127.0	637.2
30000	75	97.4	1451.6	909.9	1449.6	785.2	1448.2	691.2	1447.0	596.8	1445.8	501.8						
	73	96.0	1414.4	982.9	1411.7	857.9	1409.9	763.6	1408.4	669.0	1406.9	573.9	1405.6	478.3				
	71	94.6	1372.8	1053.8	1369.1	928.3	1366.8	833.8	1364.9	739.0	1363.0	643.7	1361.3	547.9	1359.8	451.7		
	67	93.2	1294.5	1196.4	1286.5	1068.7	1282.2	973.2	1278.9	877.6	1275.5	781.5	1272.8	685.3	1270.5	588.7	1268.5	491.7
	62	91.9	1242.9	1242.9	1196.2	1196.2	1174.0	1141.7	1163.5	1042.5	1153.0	942.8	1146.3	844.6	1141.6	746.9	1138.0	649.1
32000	75	97.5	1468.6	940.6	1466.4	807.9	1465.0	707.9	1463.8	607.4	1462.6	506.3						
	73	96.2	1431.8	1018.1	1428.9	885.0	1427.1	784.8	1425.6	684.1	1424.0	582.8	1422.6	481.1				
	71	94.8	1389.9	1093.3	1385.9	959.7	1383.5	859.1	1381.5	758.2	1379.5	656.8	1377.8	554.9	1376.3	452.5		
	67	93.4	1311.9	1244.8	1302.8	1108.7	1298.0	1007.0	1294.4	905.3	1290.8	803.0	1287.9	700.6	1285.5	597.8	1283.5	494.6
	62	92.0	1273.4	1273.4	1224.9	1224.9	1190.6	1187.3	1177.6	1080.9	1164.7	974.1	1157.2	869.4	1152.0	765.3	1148.1	661.3
34000	75	97.7	1485.5	971.8	1483.3	831.2	1481.8	725.1	1480.6	618.5	1479.3	511.3						
	73	96.3	1449.2	1053.8	1446.2	912.7	1444.3	806.4	1442.7	699.6	1441.1	592.2	1439.7	484.4				
	71	95.0	1407.0	1133.3	1402.7	991.6	1400.2	885.0	1398.1	777.9	1396.0	670.3	1394.2	562.3	1392.7	453.7		
	67	93.6	1329.8	1294.0	1319.1	1149.3	1313.8	1041.3	1310.0	933.4	1306.1	825.0	1303.0	716.4	1300.5	607.4	1298.4	497.9
	62	92.2	1295.9	1295.9	1245.7	1245.7	1208.1	1208.1	1191.8	1119.8	1175.5	1005.4	1166.8	894.1	1161.1	783.6	1157.0	673.3
36000	75	97.9	1502.5	1003.5	1500.1	854.8	1498.6	742.7	1497.3	630.0	1496.1	516.7						
	73	96.5	1466.7	1090.0	1463.5	940.8	1461.5	828.4	1459.8	715.6	1458.1	602.1	1456.7	488.0				
	71	95.1	1424.1	1173.7	1419.6	1023.9	1416.9	911.2	1414.7	798.1	1412.5	684.3	1410.6	570.1	1409.1	455.4		
	67	93.7	1348.1	1343.8	1335.6	1190.3	1329.7	1076.1	1325.5	962.0	1321.3	847.4	1318.1	732.5	1315.5	617.3	1313.3	501.7
	62	92.4	1318.2	1318.2	1266.2	1266.2	1227.3	1227.3	1205.9	1159.1	1184.6	1036.3	1174.5	918.3	1168.2	801.4	1163.8	684.8

* Rated performance is at sea level. Cooling capacities are gross cooling capacity.

Cooling Performance Data – 105 Ton Model (Cont'd)

TABLE 11 – COOLING PERFORMANCE DATA* – 105 TON MODEL (CONT'D)

95° OUTDOOR AMBIENT TEMPERATURE

		ENTERING AIR DRY BULB																
		90		86		83		80		77		74		71		68		
CFM	EWB	TKW	TMBH	SMBH	TMBH	SMBH	TMBH	SMBH	TMBH	SMBH	TMBH	SMBH	TMBH	SMBH	TMBH	SMBH	TMBH	SMBH
20000	75	100.9	1231.3	712.0	1227.3	626.7	1224.6	562.5	1222.2	498.2	1219.7	433.4						
	73	99.5	1201.3	764.0	1196.9	678.4	1194.0	614.0	1191.4	549.5	1188.7	484.6	1186.4	419.5				
	71	98.0	1172.7	816.4	1167.7	730.4	1164.4	665.7	1161.6	600.9	1158.7	535.8	1156.1	470.5	1153.8	405.0		
	67	96.6	1103.4	914.0	1096.4	826.7	1092.1	761.3	1088.4	696.0	1084.8	630.4	1081.7	564.7	1079.0	498.9	1076.6	432.9
	62	94.9	1017.5	1017.5	998.6	937.4	989.8	869.4	983.5	802.6	977.3	735.5	972.6	669.0	968.8	602.6	965.7	536.2
22000	75	102.6	1264.4	745.8	1260.3	652.5	1257.5	582.3	1255.0	511.9	1252.5	441.1						
	73	101.1	1233.7	802.1	1229.1	708.5	1226.1	638.0	1223.4	567.4	1220.6	496.4	1218.2	425.1				
	71	99.6	1204.4	858.8	1199.1	764.7	1195.7	694.0	1192.8	623.1	1189.8	551.9	1187.1	480.5	1184.8	408.8		
	67	98.1	1133.9	965.3	1126.1	869.7	1121.5	798.2	1117.6	726.8	1113.8	655.0	1110.5	583.2	1107.7	511.2	1105.3	439.0
	62	96.4	1053.9	1053.9	1027.7	992.5	1017.0	917.6	1010.0	844.4	1002.9	770.9	997.7	698.0	993.7	625.4	990.4	552.8
24000	75	104.2	1297.6	780.7	1293.2	679.4	1290.4	603.1	1287.8	526.6	1285.2	449.7						
	73	102.7	1266.2	841.2	1261.3	739.5	1258.1	663.1	1255.3	586.3	1252.5	509.2	1250.0	431.8				
	71	101.2	1236.2	902.2	1230.6	800.0	1227.0	723.3	1223.9	646.3	1220.8	569.0	1218.1	491.4	1215.7	413.5		
	67	99.7	1164.5	1017.7	1156.0	913.8	1150.9	836.2	1146.9	758.6	1142.8	680.7	1139.4	602.7	1136.5	524.5	1133.9	446.1
	62	98.0	1097.5	1097.5	1057.7	1049.0	1044.4	966.9	1036.4	887.2	1028.3	807.1	1022.6	727.9	1018.3	649.0	1014.8	570.2
26000	75	105.9	1330.7	816.4	1326.2	707.0	1323.3	624.7	1320.6	542.0	1318.0	459.0						
	73	104.4	1298.6	881.2	1293.5	771.4	1290.2	688.8	1287.3	606.0	1284.4	522.8	1281.9	439.2				
	71	102.8	1268.1	946.5	1262.1	836.2	1258.3	753.3	1255.1	670.3	1251.9	586.8	1249.1	503.0	1246.6	418.9		
	67	101.3	1195.4	1071.0	1185.8	958.7	1180.4	874.9	1176.1	791.2	1171.8	707.1	1168.2	622.9	1165.2	538.5	1162.6	453.8
	62	99.5	1136.7	1136.7	1089.1	1089.1	1072.1	1017.0	1062.8	930.6	1053.4	843.9	1047.2	758.3	1042.6	673.1	1038.9	588.0
28000	75	107.5	1363.9	852.6	1359.2	735.2	1356.1	646.8	1353.4	558.0	1350.7	468.8						
	73	106.0	1331.1	921.7	1325.7	803.9	1322.3	715.2	1319.3	626.3	1316.3	536.9	1313.7	447.1				
	71	104.4	1299.9	991.4	1293.6	873.0	1289.6	784.0	1286.3	694.8	1283.0	605.1	1280.1	515.2	1277.5	424.9		
	67	102.9	1226.4	1125.0	1215.8	1004.3	1209.9	914.2	1205.3	824.3	1200.7	734.0	1197.0	643.6	1193.9	553.0	1191.2	462.1
	62	101.1	1171.5	1171.5	1122.7	1122.7	1100.1	1067.7	1089.2	974.6	1078.3	881.0	1071.4	789.0	1066.4	697.5	1062.6	606.1
30000	75	107.7	1375.9	881.5	1371.0	756.1	1367.9	661.6	1365.1	566.8	1362.4	471.5						
	73	106.2	1343.3	954.8	1337.7	829.0	1334.2	734.3	1331.1	639.3	1328.1	543.8	1325.4	447.9				
	71	104.6	1312.1	1028.7	1305.4	902.2	1301.3	807.2	1297.8	711.9	1294.4	616.2	1291.4	520.1	1288.9	423.7		
	67	103.0	1239.5	1171.3	1227.3	1042.1	1221.0	945.9	1216.1	849.8	1211.3	753.3	1207.4	656.8	1204.2	560.0	1201.5	462.9
	62	101.2	1197.7	1197.7	1148.5	1148.5	1112.3	1111.2	1098.9	1010.9	1085.6	910.1	1077.8	811.7	1072.5	713.9	1068.6	616.3
32000	75	107.9	1387.9	910.9	1382.9	777.5	1379.6	677.1	1376.8	576.2	1374.0	474.8						
	73	106.4	1355.6	988.6	1349.7	854.7	1346.1	754.0	1343.0	652.9	1339.8	551.3	1337.1	449.3				
	71	104.8	1324.4	1066.7	1317.2	932.1	1312.9	831.0	1309.4	729.6	1305.8	627.8	1302.8	525.6	1300.2	423.0		
	67	103.2	1253.1	1218.6	1239.0	1080.6	1232.0	978.1	1226.9	876.0	1221.8	773.3	1217.8	670.6	1214.5	567.6	1211.7	464.3
	62	101.4	1212.7	1212.7	1163.0	1163.0	1125.7	1125.7	1108.7	1047.7	1091.6	939.3	1082.8	834.3	1077.1	730.2	1072.9	626.3
34000	75	108.1	1399.9	940.9	1394.7	799.5	1391.4	693.0	1388.5	586.1	1385.7	478.6						
	73	106.5	1367.9	1022.9	1361.7	880.9	1358.0	774.1	1354.8	667.0	1351.6	559.3	1348.9	451.2				
	71	105.0	1336.7	1105.2	1329.0	962.5	1324.5	855.3	1320.9	747.9	1317.2	639.9	1314.2	531.6	1311.6	422.8		
	67	103.4	1267.4	1266.6	1250.9	1119.7	1243.2	1010.9	1237.7	902.6	1232.2	793.7	1228.1	684.8	1224.7	575.7	1221.9	466.2
	62	101.6	1229.2	1229.2	1179.1	1179.1	1141.5	1141.5	1118.5	1085.1	1095.4	967.9	1085.0	856.1	1078.8	745.7	1074.4	635.6
36000	75	108.3	1411.9	971.4	1406.5	821.9	1403.1	709.3	1400.3	596.3	1397.4	482.7						
	73	106.7	1380.2	1057.6	1373.8	907.6	1369.9	794.7	1366.6	681.5	1363.4	567.7	1360.6	453.4				
	71	105.2	1349.1	1144.2	1340.9	993.3	1336.2	880.0	1332.4	766.5	1328.7	652.4	1325.5	537.9	1322.9	423.0		
	67	103.6	1282.8	1282.8	1262.9	1159.2	1254.3	1044.1	1248.5	929.6	1242.7	814.5	1238.3	699.4	1234.9	584.1	1232.1	468.4
	62	101.8	1251.2	1251.2	1200.6	1200.6	1162.7	1162.7	1128.2	1122.8	1093.7	994.4	1081.1	875.6	1074.2	758.8	1069.6	642.4

* Rated performance is at sea level. Cooling capacities are gross cooling capacity.

TABLE 11 – COOLING PERFORMANCE DATA* – 105 TON MODEL (CONT'D)

105° OUTDOOR AMBIENT TEMPERATURE

		ENTERING AIR DRY BULB																
		90		86		83		80		77		74		71		68		
CFM	EWB	TKW	TMBH	SMBH	TMBH	SMBH	TMBH	SMBH	TMBH	SMBH	TMBH	SMBH	TMBH	SMBH	TMBH	SMBH	TMBH	SMBH
20000	75	110.3	1189.5	694.5	1185.7	609.5	1183.1	545.5	1180.7	481.3	1178.4	416.7						
	73	109.1	1152.3	742.5	1148.0	657.2	1145.2	593.0	1142.7	528.6	1140.1	464.0	1137.9	399.1				
	71	107.9	1117.7	791.0	1112.9	705.4	1109.7	641.0	1107.0	576.4	1104.2	511.6	1101.8	446.6	1099.6	381.3		
	67	106.8	1046.8	885.5	1039.8	798.5	1035.5	733.4	1032.0	668.4	1028.5	603.1	1025.5	537.7	1022.9	472.2	1020.6	406.5
	62	105.1	977.9	977.9	956.1	914.1	946.8	846.1	940.5	779.5	934.1	712.6	929.4	646.2	925.7	580.1	922.7	514.0
22000	75	111.9	1217.9	727.0	1213.9	634.0	1211.2	564.0	1208.8	493.7	1206.3	423.1						
	73	110.7	1179.9	779.2	1175.4	685.9	1172.4	615.7	1169.8	545.3	1167.2	474.5	1164.9	403.5				
	71	109.5	1144.6	832.1	1139.5	738.3	1136.2	667.9	1133.3	597.3	1130.4	526.3	1127.9	455.2	1125.7	383.8		
	67	108.3	1072.8	935.4	1064.9	840.2	1060.3	769.0	1056.6	697.9	1052.9	626.4	1049.7	554.9	1047.0	483.2	1044.7	411.3
	62	106.6	1015.3	1015.3	981.9	968.1	970.1	893.0	962.8	819.8	955.5	746.4	950.3	673.8	946.4	601.4	943.2	529.1
24000	75	113.5	1246.3	760.5	1242.0	659.5	1239.3	583.4	1236.8	507.1	1234.3	430.3						
	73	112.3	1207.5	817.0	1202.7	715.6	1199.7	639.3	1197.0	562.9	1194.3	486.0	1191.9	408.8				
	71	111.1	1171.6	874.1	1166.1	772.3	1162.6	695.8	1159.6	619.1	1156.7	542.1	1154.1	464.8	1151.8	387.2		
	67	109.9	1099.0	986.5	1090.1	882.9	1085.1	805.6	1081.2	728.3	1077.2	650.7	1073.9	573.0	1071.1	495.1	1068.7	416.9
	62	108.1	1053.3	1053.3	1009.2	1009.2	993.8	940.9	985.2	861.1	976.6	781.1	970.9	702.0	966.6	623.4	963.3	544.8
26000	75	115.1	1274.6	794.8	1270.2	685.7	1267.4	603.6	1264.8	521.2	1262.3	438.3						
	73	113.9	1235.1	855.5	1230.1	746.1	1226.9	663.8	1224.1	581.2	1221.4	498.2	1218.9	414.8				
	71	112.7	1198.6	917.0	1192.7	807.1	1189.1	724.5	1186.0	641.7	1182.9	558.5	1180.2	475.0	1177.9	391.2		
	67	111.4	1125.4	1038.5	1115.4	926.4	1110.0	842.9	1105.7	759.4	1101.5	675.6	1098.1	591.7	1095.2	507.6	1092.7	423.3
	62	109.6	1084.3	1084.3	1039.2	1039.2	1017.7	989.6	1007.6	903.1	997.4	816.2	990.9	730.8	986.4	645.8	982.8	561.0
28000	75	116.7	1303.0	829.7	1298.4	712.6	1295.5	624.4	1292.9	535.8	1290.2	446.8						
	73	115.5	1262.7	894.7	1257.5	777.2	1254.2	688.8	1251.3	600.1	1248.4	510.9	1245.9	421.4				
	71	114.2	1225.6	960.5	1219.3	842.5	1215.5	753.7	1212.3	664.8	1209.1	575.5	1206.3	485.8	1203.9	395.8		
	67	113.0	1152.2	1091.2	1140.8	970.5	1134.8	880.7	1130.3	791.1	1125.8	701.1	1122.2	611.0	1119.2	520.7	1116.7	430.1
	62	111.2	1121.0	1121.0	1074.9	1074.9	1042.2	1039.1	1029.9	945.5	1017.6	851.6	1010.4	759.7	1005.4	668.4	1001.7	577.3
30000	75	116.8	1317.0	859.8	1312.3	734.6	1309.2	640.4	1306.6	545.8	1303.9	450.7						
	73	115.6	1277.0	929.2	1271.5	803.6	1268.1	709.2	1265.2	614.4	1262.2	519.1	1259.7	423.5				
	71	114.4	1239.8	999.3	1233.0	873.1	1229.0	778.3	1225.7	683.3	1222.4	587.8	1219.6	492.0	1217.2	395.9		
	67	113.1	1167.5	1139.2	1154.2	1009.8	1147.6	913.8	1142.8	818.0	1138.0	721.8	1134.2	625.5	1131.2	529.0	1128.6	432.2
	62	111.3	1138.8	1138.8	1092.2	1092.2	1057.2	1057.2	1041.3	983.2	1025.5	881.5	1017.2	783.1	1011.8	685.5	1007.9	588.1
32000	75	117.0	1331.0	890.4	1326.1	757.2	1323.0	656.9	1320.3	556.3	1317.6	455.1						
	73	115.7	1291.4	964.2	1285.6	830.6	1282.0	730.1	1279.0	629.2	1276.0	527.8	1273.4	426.0				
	71	114.5	1254.0	1038.6	1246.8	904.2	1242.6	803.4	1239.1	702.3	1235.7	600.7	1232.8	498.7	1230.4	396.4		
	67	113.2	1183.6	1183.6	1167.7	1049.7	1160.4	947.3	1155.3	845.4	1150.1	743.0	1146.2	640.5	1143.1	537.8	1140.5	434.8
	62	111.4	1157.0	1157.0	1109.8	1109.8	1074.4	1074.4	1052.7	1021.3	1031.0	911.0	1021.3	805.8	1015.4	701.9	1011.3	598.2
34000	75	117.1	1345.1	921.5	1340.0	780.2	1336.7	673.9	1334.0	567.1	1331.3	459.8						
	73	115.9	1305.8	999.7	1299.7	858.0	1296.0	751.4	1292.9	644.4	1289.8	536.9	1287.2	429.0				
	71	114.6	1268.2	1078.3	1260.5	935.8	1256.1	828.9	1252.5	721.7	1249.0	613.9	1246.1	505.8	1243.6	397.3		
	67	113.4	1200.8	1200.8	1181.5	1090.0	1173.3	981.3	1167.8	873.2	1162.3	764.5	1158.2	655.9	1154.9	547.0	1152.3	437.8
	62	111.5	1180.6	1180.6	1132.9	1132.9	1097.1	1097.1	1064.1	1059.7	1031.1	938.3	1019.2	826.1	1012.7	715.8	1008.3	605.9
36000	75	117.2	1359.1	952.9	1353.8	803.6	1350.5	691.2	1347.7	578.3	1344.9	464.9						
	73	116.0	1320.2	1035.5	1313.7	885.7	1309.9	773.0	1306.8	660.0	1303.6	546.3	1300.9	432.3				
	71	114.7	1282.6	1118.4	1274.3	967.8	1269.6	854.7	1266.0	741.4	1262.3	627.5	1259.3	513.2	1256.8	398.5		
	67	113.5	1219.8	1219.8	1195.4	1130.8	1186.2	1015.7	1180.3	901.3	1174.3	786.4	1170.0	671.6	1166.7	556.5	1164.0	441.0
	62	111.7	1196.0	1196.0	1147.8	1147.8	1111.7	1111.7	1075.5	1075.5	1039.4	969.8	1024.7	850.3	1017.4	733.5	1012.8	617.3

* Rated performance is at sea level. Cooling capacities are gross cooling capacity.

Cooling Performance Data – 105 Ton Model (Cont'd)

TABLE 11 – COOLING PERFORMANCE DATA* – 105 TON MODEL (CONT'D)

115° OUTDOOR AMBIENT TEMPERATURE

			ENTERING AIR DRY BULB															
			90		86		83		80		77		74		71		68	
CFM	EWB	TKW	TMBH	SMBH	TMBH	SMBH	TMBH	SMBH	TMBH	SMBH	TMBH	SMBH	TMBH	SMBH	TMBH	SMBH	TMBH	SMBH
20000	75	119.6	1147.8	677.3	1144.1	592.6	1141.5	528.7	1139.3	464.7	1137.0	400.3						
	73	118.7	1103.3	721.3	1099.1	636.3	1096.4	572.4	1094.0	508.2	1091.5	443.8	1089.3	379.1				
	71	117.9	1062.8	766.3	1058.0	680.9	1055.0	616.8	1052.4	552.5	1049.7	487.9	1047.4	423.1	1045.3	358.1		
	67	117.0	990.3	857.7	983.2	771.0	979.0	706.2	975.6	641.5	972.2	576.5	969.3	511.4	966.8	446.1	964.7	380.7
	62	115.2	940.5	940.5	914.0	891.5	903.9	823.3	897.4	756.8	890.9	690.0	886.2	623.8	882.5	557.9	879.6	492.1
22000	75	121.2	1171.4	708.5	1167.5	615.7	1164.8	545.9	1162.5	475.8	1160.2	405.3						
	73	120.3	1126.0	756.7	1121.6	663.7	1118.8	593.8	1116.3	523.6	1113.8	453.0	1111.6	382.2				
	71	119.4	1084.8	806.0	1079.8	712.6	1076.6	642.4	1073.8	572.1	1071.1	501.4	1068.7	430.5	1066.6	359.3		
	67	118.5	1011.9	906.4	1003.8	811.4	999.2	740.5	995.5	669.6	991.9	598.5	988.9	527.2	986.3	455.8	984.1	384.2
	62	116.7	977.9	977.9	936.9	936.9	923.4	868.8	915.7	795.7	908.0	722.4	902.7	649.9	898.8	577.7	895.7	505.6
24000	75	122.7	1194.9	740.7	1190.9	639.9	1188.2	564.0	1185.8	487.9	1183.4	411.3						
	73	121.8	1148.8	793.2	1144.2	692.1	1141.2	616.1	1138.6	539.8	1136.1	463.2	1133.8	386.2				
	71	121.0	1107.0	846.7	1101.5	745.3	1098.2	669.0	1095.3	592.6	1092.5	515.8	1090.0	438.7	1087.8	361.4		
	67	120.0	1033.7	956.2	1024.4	852.8	1019.4	775.7	1015.5	698.7	1011.6	621.3	1008.4	543.9	1005.8	466.3	1003.5	388.5
	62	118.3	1004.5	1004.5	962.7	962.7	943.4	915.4	934.0	835.6	924.7	755.4	918.8	676.5	914.6	598.1	911.3	519.7
26000	75	124.3	1218.5	773.7	1214.3	664.8	1211.5	582.9	1209.0	500.7	1206.6	418.0						
	73	123.4	1171.6	830.4	1166.7	721.3	1163.6	639.2	1161.0	556.8	1158.3	474.0	1156.0	390.9				
	71	122.5	1129.2	888.2	1123.3	778.7	1119.8	696.3	1116.8	613.8	1113.8	530.8	1111.3	447.6	1109.1	364.1		
	67	121.6	1055.9	1006.9	1045.1	894.9	1039.6	811.5	1035.4	728.4	1031.2	644.8	1027.9	561.2	1025.1	477.4	1022.8	393.4
	62	119.8	1038.0	1038.0	995.3	995.3	963.9	963.0	952.4	876.0	940.8	788.8	934.0	703.4	929.5	618.7	926.0	534.1
28000	75	125.9	1242.1	807.2	1237.7	690.3	1234.8	602.3	1232.3	514.0	1229.8	425.2						
	73	124.9	1194.4	868.2	1189.3	751.0	1186.0	662.8	1183.3	574.4	1180.6	485.4	1178.2	396.2				
	71	124.0	1151.4	930.3	1145.1	812.6	1141.4	724.2	1138.3	635.5	1135.2	546.4	1132.6	457.0	1130.3	367.3		
	67	123.1	1078.7	1058.4	1066.0	937.6	1059.8	848.0	1055.3	758.6	1050.8	668.9	1047.3	579.0	1044.5	489.0	1042.1	398.7
	62	121.3	1061.7	1061.7	1018.2	1018.2	985.6	985.6	970.7	917.0	955.8	822.2	948.0	730.3	943.0	639.2	939.4	548.3
30000	75	125.9	1258.1	838.5	1253.5	713.6	1250.6	619.5	1248.0	525.1	1245.5	430.2						
	73	125.0	1210.8	904.0	1205.4	778.7	1202.0	684.5	1199.2	589.9	1196.4	494.9	1194.0	399.5				
	71	124.1	1167.5	970.4	1160.7	844.6	1156.8	750.0	1153.6	655.3	1150.4	560.1	1147.7	464.5	1145.4	368.6		
	67	123.2	1096.6	1096.6	1081.2	978.3	1074.3	882.4	1069.5	786.8	1064.6	690.8	1061.0	594.8	1058.1	498.6	1055.7	402.1
	62	121.3	1081.6	1081.6	1037.5	1037.5	1004.5	1004.5	983.7	955.9	963.0	852.4	953.8	753.7	948.3	656.3	944.4	559.2
32000	75	126.0	1274.2	870.2	1269.4	737.2	1266.3	637.1	1263.7	536.6	1261.1	435.6						
	73	125.1	1227.2	940.2	1221.5	806.9	1218.0	706.5	1215.1	605.9	1212.2	504.7	1209.7	403.1				
	71	124.2	1183.7	1011.0	1176.4	876.9	1172.2	776.3	1168.9	675.4	1165.6	574.1	1162.8	472.4	1160.5	370.3		
	67	123.3	1115.8	1115.8	1096.7	1019.5	1088.9	917.2	1083.7	815.4	1078.4	713.2	1074.6	611.0	1071.6	508.6	1069.1	405.8
	62	121.4	1107.4	1107.4	1062.7	1062.7	1029.2	1029.2	996.8	995.2	964.3	880.3	952.9	774.6	946.7	670.8	942.6	567.4
34000	75	126.1	1290.2	902.2	1285.2	761.2	1282.1	655.1	1279.4	548.5	1276.8	441.3						
	73	125.2	1243.6	976.8	1237.6	835.3	1234.0	728.9	1231.0	622.2	1228.0	514.9	1225.5	407.1				
	71	124.3	1199.9	1051.9	1192.0	909.6	1187.6	802.9	1184.2	695.9	1180.7	588.4	1177.9	480.5	1175.6	372.2		
	67	123.3	1137.2	1137.2	1112.4	1061.1	1103.5	952.3	1097.8	844.4	1092.2	735.9	1088.2	627.4	1085.0	518.8	1082.5	409.8
	62	121.5	1122.9	1122.9	1077.7	1077.7	1043.7	1043.7	1009.8	1009.8	975.9	913.3	961.7	800.3	954.8	690.0	950.4	580.3
36000	75	126.2	1306.3	934.6	1301.1	785.5	1297.9	673.3	1295.2	560.6	1292.5	447.3						
	73	125.2	1260.1	1013.7	1253.7	864.1	1250.0	751.6	1246.9	638.7	1243.8	525.3	1241.3	411.4				
	71	124.3	1216.3	1093.2	1207.7	942.6	1203.1	829.7	1199.5	716.7	1195.9	603.0	1193.0	488.9	1190.6	374.4		
	67	123.4	1162.3	1162.3	1128.4	1103.1	1118.1	987.7	1112.0	873.5	1105.9	758.7	1101.7	644.1	1098.4	529.3	1095.9	414.0
	62	121.6	1137.4	1137.4	1091.6	1091.6	1057.2	1057.2	1022.8	1022.8	988.5	947.0	970.3	826.2	962.6	709.4	957.9	593.3

* Rated performance is at sea level. Cooling capacities are gross cooling capacity.

Heating Performance Data – Gas/Electric Heat

GAS HEATING

TABLE 12 - GAS HEAT PERFORMANCE DATA

Unit	Gas Input Capacity (Btu/hr x 1000)	Maximum Output Capacity (Btu/hr x 1000)	Airflow Minimum	Temp. Rise (°F)
70-80	375	300	7,500	10-40
	750	600	11,150	20-50
	1125	900	15,150	25-55
90-105	375	300	6,950	10-40
	750	600	11,150	20-50
	1125	900	15,150	25-55

NOTE

Gas valve rated for .5 PSIG. If gas pressure greater than .5 PSIG then a gas pressure regulator is required.
Minimum gas pressure is 3.5 iwg.

ELECTRIC HEATING

TABLE 13 - ELECTRIC HEAT PERFORMANCE DATA

UNIT	SIZE (KW)	HEAT CAPACITY (MBH)	AIR FLOW MIN (CFM)	MAX TEMP RISE (°F)
70-80 TON	80	273	10,000	25
	108	369	12,000	28
	150	512	14,000	34
	200	683	15,000	42
90-105 TON	108	369	12,000	28
	150	512	14,000	34
	200	683	15,000	42
	250	854	16,000	49

THIS PAGE INTENTIONALLY LEFT BLANK.

Supply Fan Data

TABLE 14 - YPAL070-080: 28X25 FORWARD-CURVED FAN

TOTAL STATIC PRESSURE (INCHES OF WATER COLUMN)												
CFM STD. AIR	1.0		2.0		3.0		4.0		5.0		6.0	
	BHP	RPM	BHP	RPM	BHP	RPM	BHP	RPM	BHP	RPM	BHP	RPM
18000			10.0	513	13.9	616						
20000			11.7	520	15.9	619	20.8	717				
22000			13.6	527	18.3	629	22.9	712	28.9	808		
24000			15.8	537	20.9	637	25.9	720	31.1	795		
26000			18.3	549	23.6	643	29.1	729	34.5	801		
28000			21.2	562	26.6	651	32.6	736	38.5	810		
30000			24.2	574	30.1	662	36.3	742	42.8	819		
32000			27.4	585	34.0	674	40.3	750	47.2	825		
34000			30.9	597	38.2	686	44.8	760				

NOTE: For performance at operating points not included in these tables, consult your local JOHNSON CONTROLS representative.

TABLE 15 - YPAL070-105: 32" AIRFOIL FAN

TOTAL STATIC PRESSURE (INCHES OF WATER COLUMN)												
CFM STD. AIR	1.0		2.0		3.0		4.0		5.0		6.0	
	BHP	RPM	BHP	RPM	BHP	RPM	BHP	RPM	BHP	RPM	BHP	RPM
18000					11.6	923	15.5	1036	19.5	1145	23.8	1236
20000					13.0	954	17.2	1055	21.6	1157	26.0	1256
22000					14.7	991	18.9	1083	23.7	1176	28.5	1269
24000			12.4	936	16.5	1030	21.0	1119	25.7	1202	31.0	1287
26000			14.4	978	18.5	1074	23.3	1155	28.2	1235	33.4	1313
28000			16.6	1021	20.9	1117	25.7	1195	31.1	1272	36.3	1344
30000			18.9	1067	23.7	1159	28.5	1240	34.0	1310	39.7	1381
32000			21.3	1114	26.8	1201	31.6	1283	37.1	1352	43.2	1418
YPAL090-095 Only												
34000			23.8	1161	30.0	1245	35.2	1325	40.6	1396	46.7	1458
36000			26.6	1209	33.3	1289	39.2	1366	44.6	1438	50.6	1501

NOTE: For performance at operating points not included in these tables, consult your local JOHNSON CONTROLS representative.

Component Static Pressure Drops

TABLE 16 - COMPONENT STATIC PRESSURE DROPS (INCHES OF WATER COLUMN)

Size	Air Flow CFM Std. Air	Evaporator Coils		Return Air Opening			Filters				
		Wet	Dry	Bottom	Rear	Side	2" Throwaway	2" Cleanable	2" Pleated MERV 8	2" Carbon MERV 8	Rigid Filter Track w/ 2" Throwaway (only)
YPAL 70-80	14000	0.20	0.20	0.07	0.03	0.08	0.06	0.01	0.06	0.12	0.09
	16000	0.25	0.24	0.08	0.03	0.09	0.07	0.02	0.07	0.14	0.11
	18000	0.30	0.28	0.10	0.04	0.11	0.08	0.02	0.09	0.16	0.13
	20000	0.35	0.33	0.11	0.05	0.13	0.10	0.03	0.10	0.18	0.16
	22000	0.40	0.38	0.13	0.05	0.15	0.11	0.03	0.11	0.20	0.18
	24000	0.46	0.43	0.15	0.06	0.18	0.13	0.04	0.13	0.23	0.21
	26000	0.52	0.48	0.18	0.08	0.21	0.14	0.05	0.14	0.25	0.23
	28000	0.59	0.54	0.21	0.09	0.24	0.16	0.06	0.16	0.27	0.26
	30000	0.66	0.60	0.25	0.10	0.29	0.18	0.07	0.17	0.29	0.29
	32000	0.73	0.67	0.29	0.12	0.34	0.20	0.08	0.19	0.32	0.32
YPAL 90-105	18000	0.30	0.28	0.10	0.04	0.11	0.06	0.01	0.07	0.13	0.11
	20000	0.35	0.33	0.11	0.05	0.13	0.07	0.02	0.08	0.15	0.13
	22000	0.40	0.38	0.13	0.05	0.15	0.08	0.02	0.09	0.17	0.16
	24000	0.46	0.43	0.15	0.06	0.18	0.10	0.03	0.10	0.18	0.18
	26000	0.52	0.48	0.18	0.08	0.21	0.11	0.03	0.11	0.20	0.20
	28000	0.59	0.54	0.21	0.09	0.24	0.12	0.04	0.12	0.22	0.22
	30000	0.66	0.60	0.25	0.10	0.29	0.13	0.04	0.14	0.24	0.25
	32000	0.73	0.67	0.29	0.12	0.34	0.15	0.05	0.15	0.26	0.27
	34000	0.80	0.73	0.34	0.14	0.39	0.16	0.06	0.16	0.27	0.30
36000	0.88	0.80	0.40	0.17	0.46	0.18	0.07	0.17	0.29	0.33	

NOTES: *Includes 2" pleated filters. ** Power exhaust pressure drops are for sizing supply fan.

1. Return air opening pressure drop does not include an exhaust fan. Use the value in the Powered Exhaust column to determine return air pressure drop attributed to the exhaust fan assembly.
2. Front return is not available with barometric relief, exhaust fans or return fans.
3. Pressure drop for Rigid Filter Rack includes a 2-inch throwaway prefilter.

Filters			Air Dampers				Discharge Opening	
12" MERV 11* w/ 2" MERV 8 Prefilters	12" MERV 14* w/ 2" MERV 8 Prefilters	Final Filter 12" MERV 14*	Standard Outside Air Damper & Hoods w/ 1" Cleanable Filters	Low Leak Outside Air Damper & Hoods w/ 1" Cleanable Filters	Bottom & Rear Return	Powered Exhaust**	Side	Bottom
0.22	0.34	0.26	0.15	0.14	0.08	0.02	0.07	0.07
0.26	0.40	0.30	0.19	0.19	0.10	0.02	0.09	0.10
0.30	0.46	0.34	0.25	0.24	0.13	0.03	0.12	0.12
0.35	0.52	0.39	0.31	0.30	0.16	0.04	0.14	0.15
0.40	0.59	0.43	0.37	0.36	0.19	0.04	0.17	0.18
0.45	0.66	0.48	0.44	0.43	0.23	0.05	0.21	0.22
0.50	0.74	0.54	0.52	0.51	0.27	0.06	0.24	0.26
0.56	0.81	0.59	0.61	0.60	0.31	0.07	0.28	0.30
0.62	0.90	0.65	0.70	0.69	0.36	0.08	0.32	0.34
0.68	0.98	0.71	0.80	0.78	0.41	0.09	0.37	0.39
0.27	0.41	0.31	0.18	0.18	0.09	0.02	0.10	0.10
0.31	0.46	0.34	0.23	0.23	0.12	0.02	0.12	0.12
0.35	0.52	0.38	0.28	0.27	0.14	0.03	0.15	0.15
0.39	0.58	0.43	0.34	0.33	0.17	0.03	0.18	0.17
0.44	0.65	0.47	0.40	0.39	0.20	0.04	0.21	0.21
0.49	0.71	0.52	0.46	0.45	0.23	0.05	0.24	0.24
0.54	0.78	0.57	0.53	0.52	0.26	0.05	0.28	0.27
0.59	0.85	0.62	0.61	0.59	0.30	0.06	0.31	0.31
0.64	0.93	0.67	0.69	0.67	0.34	0.07	0.35	0.35
0.70	1.01	0.72	0.77	0.76	0.38	0.07	0.40	0.39

NOTES: *Includes 2" pleated filters. ** Power exhaust pressure drops are for sizing supply fan.

1. Return air opening pressure drop does not include an exhaust fan. Use the value in the Powered Exhaust column to determine return air pressure drop attributed to the exhaust fan assembly.
2. Front return is not available with barometric relief, exhaust fans or return fans.
3. Pressure drop for Rigid Filter Rack includes a 2-inch throwaway prefilter.

Gas Heat Pressure Drops

TABLE 17 - GAS HEAT AIR PRESSURE DROPS

Size	Air Flow CFM Std. Air	Size (mbh)		
		375	750	1125
70	14,000	0.05	0.08	0.09
	16,000	0.07	0.11	0.11
	18,000	0.09	0.14	0.14
	20,000	0.11	0.17	0.17
	22,000	0.14	0.20	0.21
	24,000	0.16	0.24	0.25
	26,000	0.19	0.28	0.29
	28,000	0.22	0.33	0.34
	30,000	0.25	0.38	0.39
	32,000	0.29	0.43	0.45
75	14,000	0.05	0.08	0.09
	16,000	0.07	0.11	0.11
	18,000	0.09	0.14	0.14
	20,000	0.11	0.17	0.17
	22,000	0.14	0.20	0.21
	24,000	0.16	0.24	0.25
	26,000	0.19	0.28	0.29
	28,000	0.22	0.33	0.34
	30,000	0.25	0.38	0.39
	32,000	0.29	0.43	0.45
80	14,000	0.05	0.08	0.09
	16,000	0.07	0.11	0.11
	18,000	0.09	0.14	0.14
	20,000	0.11	0.17	0.17
	22,000	0.14	0.20	0.21
	24,000	0.16	0.24	0.25
	26,000	0.19	0.28	0.29
	28,000	0.22	0.33	0.34
	30,000	0.25	0.38	0.39
	32,000	0.29	0.43	0.45
90	18,000	0.07	0.11	0.11
	20,000	0.09	0.13	0.14
	22,000	0.11	0.16	0.17
	24,000	0.13	0.19	0.20
	26,000	0.15	0.22	0.23
	28,000	0.17	0.26	0.27
	30,000	0.20	0.30	0.31
	32,000	0.23	0.34	0.35
	34,000	0.26	0.38	0.40
	36,000	0.29	0.43	0.45
105	18,000	0.07	0.11	0.11
	20,000	0.09	0.13	0.14
	22,000	0.11	0.16	0.17
	24,000	0.13	0.19	0.20
	26,000	0.15	0.22	0.23
	28,000	0.17	0.26	0.27
	30,000	0.20	0.30	0.31
	32,000	0.23	0.34	0.35
	34,000	0.26	0.38	0.40
	36,000	0.29	0.43	0.45

Electric Heat Pressure Drops

TABLE 18 - ELECTRIC HEAT AIR PRESSURE DROPS

Model	Air Flow CFM Std. Air	Electric Heater Air Pressure Drop (in w.c.)				
		80 kW	108 kW	150 kW	200 kW	250 kW
YPAL070-080	14,000	0.02	0.03	0.04	0.05	
	16,000	0.03	0.04	0.06	0.07	
	18,000	0.04	0.06	0.07	0.09	
	20,000	0.05	0.07	0.09	0.11	
	22,000	0.06	0.08	0.11	0.13	
	24,000	0.07	0.10	0.13	0.16	
	26,000	0.08	0.12	0.15	0.19	
	28,000	0.09	0.13	0.18	0.22	
	30,000	0.11	0.15	0.20	0.25	
	32,000	0.12	0.17	0.23	0.28	
YPAL090-105	18,000		0.06	0.07	0.09	0.12
	20,000		0.07	0.09	0.11	0.15
	22,000		0.08	0.11	0.13	0.19
	24,000		0.10	0.13	0.16	0.22
	26,000		0.12	0.15	0.19	0.26
	28,000		0.13	0.18	0.22	0.30
	30,000		0.15	0.20	0.25	0.35
	32,000		0.17	0.23	0.28	0.39
	34,000		0.20	0.26	0.32	0.44
	36,000		0.22	0.29	0.36	0.50

TABLE 19 - ELECTRIC HEATER SIZE AVAILABILITY BY UNIT SIZE

MODEL	80kW	108kW	150kW*	200kW*	250kW*
YPAL070-080	X	X	X	X	
YPAL090-105**		X	X	X	X

*150-250kW electric heat not available in 200-230V configurations.

**For 208V YPAL105, contact JOHNSON CONTROLS.

Exhaust Fan Data

EXHAUST FAN MOTOR SIZING INSTRUCTIONS

In order to determine the proper exhaust fan motor size, add the return duct static pressure to the appropriate damper pressure drop value in Table 23 to get the total static pressure applied to the exhaust fan.

Based on the exhaust fan air flow and total static pressure, determine the brake horsepower and RPM of the exhaust fan.

TABLE 20 - DUAL 18X18 FORWARD-CURVED FAN (SERIES 100, 70-105 TON)

TOTAL STATIC PRESSURE (INCHES OF WATER COLUMN)												
CFM STD. AIR	0.25		0.50		0.75		1.00		1.25		1.50	
	BHP	RPM	BHP	RPM	BHP	RPM	BHP	RPM	BHP	RPM	BHP	RPM
6000	0.4	291	0.7	398	1.1	501	1.6	596	2.1	683	2.7	763
8000	0.7	316	1.1	406	1.5	485	1.9	566	2.4	643	3.0	717
10000	1.2	349	1.6	429	2.1	499	2.5	562	3.0	627	3.6	691
12000	1.9	392	2.3	456	2.9	522	3.4	581	3.9	635	4.5	688
14000	2.8	435	3.3	491	3.9	549	4.5	605	5.1	656	5.7	704
16000	3.9	476	4.6	533	5.1	579	5.9	631	6.6	681	7.3	727
18000	5.2	517	6.2	577	6.7	619	7.4	661	8.3	707	9.1	752
20000	7.0	560	8.0	619	8.8	662	9.4	698	10.2	737	11.2	779
22000	9.1	604	10.1	660	11.3	706	12.0	740	12.7	773	13.6	809
24000	11.7	648	12.7	701	14.0	748						
26000	14.7	693										

NOTE: For performance at operating points not included in these tables, consult your local JOHNSON CONTROLS representative.

TABLE 21 - EXHAUST FAN PERFORMANCE

FAN TYPE	18X18	20X18
YPAL070-080	X	X
YPAL090-105	X	X

TABLE 22 - DUAL 20X18 FORWARD-CURVED FAN (SERIES 100, 70-105 TON)

TOTAL STATIC PRESSURE (INCHES OF WATER COLUMN)												
CFM STD. AIR	0.25		0.50		0.75		1.00		1.25		1.50	
	BHP	RPM	BHP	RPM	BHP	RPM	BHP	RPM	BHP	RPM	BHP	RPM
12000	1.3	295	1.9	373	2.5	445	3.2	514	3.9	577	4.6	635
14000	1.9	318	2.5	388	3.2	453	3.9	515	4.7	574	5.5	630
16000	2.6	344	3.3	407	4.1	466	4.9	522	5.7	576	6.6	629
18000	3.5	371	4.3	429	5.1	483	6.0	535	6.9	584	7.8	633
20000	4.6	399	5.4	453	6.4	503	7.3	551	8.3	597	9.3	642
22000	5.9	428	6.8	478	7.8	525	8.8	570	9.9	613	11.0	654
24000	7.5	458	8.5	505	9.5	549	10.6	591	11.7	631	12.9	670
26000	9.4	488	10.4	532	11.5	574	12.7	613	13.9	652	15.1	689
28000	11.5	519	12.6	560	13.8	600	15.0	637	16.3	673	17.6	709
30000	13.9	551	15.2	589	16.4	626	17.7	662	19.0	697	20.4	730
32000	16.7	583	18.1	618	19.4	654	20.7	688	22.1	721	23.6	753
34000	19.9	615	21.3	648	22.7	682	24.1	715	25.6	746		
36000	23.4	647	24.9	679	26.4	710	27.9	742				

NOTE: For performance at operating points not included in these tables, consult your local JOHNSON CONTROLS representative.

Return Fan Data

TABLE 23 - YPAL070-105: 270 SWSI AIRFOIL FAN

TOTAL STATIC PRESSURE (INCHES OF WATER COLUMN)										
CFM STD. AIR	1.0		1.5		2.0		2.5		3.0	
	BHP	RPM	BHP	RPM	BHP	RPM	BHP	RPM	BHP	RPM
16000	5.4	966	7.3	1056	9.2	1139	11.2	1217	13.3	1295
18000	6.6	1041	8.6	1126	8.6	1126	12.9	1277	16.1	1618
20000	7.9	1119	10.2	1198	12.5	1272	14.9	1342	18.8	1709
22000	9.6	1199	12.0	1273	14.5	1343	17.1	1410	21.7	1803
24000	11.5	1283	14.0	1351	16.8	1417	19.5	1481	24.9	1900
26000	13.7	1369	16.4	1430	19.3	1493	22.2	1554	25.1	1611
28000	16.2	1456	19.0	1512	22.0	1571	25.2	1629	28.4	1684
30000	19.0	1544	22.0	1597	25.1	1651	28.5	1705	31.9	1759
32000	22.2	1633	25.4	1683	28.6	1733	32.1	1784	35.7	1835
34000	25.7	1723	29.1	1770	32.5	1817	36.1	1864	39.8	1912
36000	29.7	1813	33.3	1859	36.9	1902				

NOTE: For performance at operating points not included in these tables, consult your local JOHNSON CONTROLS representative.

TABLE 24 - RETURN FAN PERFORMANCE

FAN TYPE	2X270
YPAL070-080	X
YPAL090-105	X

Electrical Data

ELECTRICAL SERVICE SIZING

In order to determine the electrical service required for the cooling only Series 100 single package unit, use the appropriate calculations listed below from U.L. 1995. Based on the configuration of the single package unit, the calculations will yield different MCA (minimum circuit ampacity), and MOP (maximum overcurrent protection).

Using the following load definitions and calculations, determine the correct electrical sizing for your unit. All concurrent load conditions must be considered in the calculations, and you must use the highest value for any combination of loads.

Load Definitions:

- **LOAD1** is the current of the largest motor – compressor or fan motor.
- **LOAD2** is the sum of the remaining motor currents that may run concurrently with LOAD1.
- **LOAD3** is the current of the electric heaters – zero for cooling only units.
- **LOAD4** is the sum of any remaining currents greater than or equal to 1.0 amp.

Use the following calculations to determine MCA and MOP for units supplied with a single-point power connection:

$$\text{MCA} = (1.25 \times \text{LOAD1}) + \text{LOAD2} + \text{LOAD3} + \text{LOAD4}$$

$$\text{MOP} = (2.25 \times \text{LOAD1}) + \text{LOAD2} + \text{LOAD3} + \text{LOAD4}$$

If the MOP does not equal a standard current rating of an overcurrent protective device, then the marked maximum rating is to be the next lower standard rating. However, if the device selected for MOP is less than the MCA, then select the lowest standard maximum fuse size greater than or equal to the MCA.

TABLE 25 - COMPRESSOR DATA — R410A

MODEL	COMPRESSOR		NOMINAL VOLTAGE					
	QTY	MODEL	208/230		460		575	
			RLA	LRA	RLA	LRA	RLA	LRA
YPAL 70 Ton	2	ZP137	53.6	245	20.7	125	16.4	100
	4	ZP120	37.1	239	20	125	14.3	80
YPAL 75 Ton	2	ZP154	57.1	300	25.7	150	22.1	109
	4	ZP137	53.6	245	20.7	125	16.4	100
YPAL 80 Ton	4	ZP154	57.1	300	25.7	150	22.1	109
	2	ZP137	53.6	245	20.7	125	16.4	100
YPAL 90 Ton	4	ZP182	62.1	340	30	173	26.4	132
	2	ZP154	57.1	300	26	150	22.1	109
YPAL 105 Ton	4	ZP235	82.4	505	33.9	225	27.4	180
	2	ZP182	62.1	340	30	173	26.4	132

NOTE: *RLA data is per compressor

TABLE 26 - SUPPLY, RETURN, AND EXHAUST FAN MOTOR DATA

MOTOR HP	PREMIUM EFFICIENCY - ODP			
	NOMINAL VOLTAGE			
	208/3/60	230/3/60	460/3/60	575/3/60
	FLA	FLA	FLA	FLA
5	14	12.7	6.33	5.06
7.5	20.5	18.5	9.25	7.4
10	27.4	24.8	12.4	9.92
15	41.1	37.2	18.6	14.9
20	55.3	50	25	20
25	66.1	59.8	29.9	23.9
30	78.3	70.8	35.4	28.3
40	107	96.4	48.2	38.6
50	132	120	59.9	47.9
60	155	140	69.9	55.9

MOTOR HP	PREMIUM EFFICIENCY - TEFC			
	NOMINAL VOLTAGE			
	208/3/60	230/3/60	460/3/60	575/3/60
	FLA	FLA	FLA	FLA
5	14.4	13	6.49	5.19
7.5	20.1	18.1	9.07	7.26
10	27	24.4	12.2	9.76
15	40.3	36.4	18.2	14.6
20	54.6	49.4	24.7	19.8
25	65.2	59	29.5	23.6
30	77.6	70.2	35.1	28.1
40	107	96.4	48.2	38.6
50	131	118	59.2	47.4
60	151	137	68.3	54.6

TABLE 27 - POWER SUPPLY VOLTAGE LIMITS

Nominal Voltage	Power Supply	Minimum Voltage	Maximum Voltage
208	200V/3Ph/60Hz	187	218
240	230V/3Ph/60Hz	216	252
480	460V/3Ph/60Hz	432	504
600	575V/3Ph/60Hz	540	630

TABLE 28 - CONDENSER FAN MOTOR RLA

RLA EACH MOTOR		208V/3PH/60HZ	230V/3PH/60HZ	460V/3PH/60HZ	575V/3PH/60HZ
		7.3	6.2	3.1	2.5
MODEL	QUANTITY OF FANS	208V/3PH/60HZ	230V/3PH/60HZ	460V/3PH/60HZ	575V/3PH/60HZ
YPAL070-130	6	43.8	37.2	18.6	15.0

TABLE 29 - MISCELLANEOUS ELECTRICAL DATA

DESCRIPTION	NOMINAL VOLTAGE				
	208V	230V	460V	575V	380V-60
	AMPS	AMPS	AMPS	AMPS	AMPS
Contrl X'fmr. 750 VA	3.6	3.3	1.6	1.3	2.0
Contrl X'fmr. 1.0 KVA	4.8	4.4	2.2	1.8	2.6
Convenience Outlet	9.6	8.7	4.4	3.5	N/A
Gas Heat	9.6	8.7	4.4	3.5	5.3

TABLE 30 - ELECTRIC HEAT AMP DRAW

KW*	200V/3Ph/60Hz	240V/3Ph/60Hz	480V/3Ph/60Hz	600V/3Ph/60Hz
	AMPS	AMPS	AMPS	AMPS
80	193	193	96	80
108	260	260	130	109
150			181	151
200			241	201
250			301	251

Notes:

Heaters will be sized as follows: 208V heaters rated at 208V, 230V heaters rated at 240V, 460V heaters rated at 480V, 575V heaters rated at 600V.

TABLE 31 - ELECTRICAL HEAT STAGES

		70-80 Tons			
		80 kW	108 kW	150 kW	200 kW
Available Voltages	200V/3/60Hz	5	6	NA	NA
	230V/3/60Hz	5	6	NA	NA
	460V/3/60Hz	3	3	4	6
	575V/3/60Hz	2	3	4	5
		90-105 tons			
		108 kW	150 kW	200 kW	250 kW
Available Voltages	200V/3/60Hz	6	NA	NA	NA
	230V/3/60Hz	6	NA	NA	NA
	460V/3/60Hz	3	4	6	6
	575V/3/60Hz	3	4	5	6

THIS PAGE INTENTIONALLY LEFT BLANK.

Controls

CONTROL SEQUENCES (CV and VAV)

GENERAL

The control system for the JOHNSON CONTROLS Series 100 single package unit is fully self-contained and based around a single package unit controller. To aid in unit setup, maintenance, and operation, the single package unit controller is equipped with a user interface that is based around a 4 line x 20 character backlit LCD display. The LCD displays plain language text in a menu-driven format to facilitate use.

Based on the unit type (constant volume or VAV), the Johnson Controls Series 100 Single Package units can be operated by a typical 7-wire thermostat (constant volume only), a space temperature sensor, or stand alone. A field wiring terminal block is provided to facilitate unit setup and installation.

In lieu of the hard-wired control options, the single package unit controller can be connected to and operated by a Building Automation System (BAS).

The IPU Controller uses the latest technology and provides complete control for the unit along with standard BACnet™ MS/TP and Modbus RTU communications. The IPU also has an SD card slot that can be used to capture historic data on unit operation.

If required, the unit can be equipped with an optional field installed gateway which allows N2 or Echelon® communications. The E-Link gateway device is field installed and purchased through the Advanced Order Management System (AOMS).

YK-ELNKE01-0 – E-Link for Echelon®

YK-ELNKE00-0 – E-Link for N2

UNOCCUPIED / OCCUPIED SWITCHING

Depending on application, the unit can be indexed between unoccupied and occupied modes of operation by one of three methods, hard-wired input, internal time clock, or BAS. A contact-closure input is provided for hard-wiring to an external indexing device such as a central time clock, thermostat with built in scheduling, or a manual switch. The unit controller is also equipped with a built in 7-day time clock which can be used, in lieu of the contact closure input, to switch the unit between Unoccupied and Occupied modes of operation.

The internal time clock is fully configurable via the user interface and includes Holiday scheduling. In addition to the hard-wired input or the internal time clock, the unit can also be indexed between unoccupied and occupied modes of operation via a BAS command.

GAS HEATING OPERATION

Units supplied with gas heat can be equipped with one, two, or three independently operated burner modules. Each module is a fully self-contained furnace with all necessary ignition controls, safeties, and gas valves. The IPU single package unit controller determines how the furnaces are started and stopped and prevents furnace operation if the Supply Fan airflow is not sufficient or if the Supply Air Temperature is excessively high. If a furnace module receives a signal to start from the IPU controller, the ignition control engages the furnace inducer (draft) fan for a 30-second pre-purge cycle. At the end of the 30-second pre-purge, the ignition control will stop the furnace and allows the inducer fan to operate for a 30-second post-purge. Each furnace contains a direct spark ignition system and included safeties for flame and inducer fan verification, high temperature and flame roll-out.

HYDRONIC HEAT

If the unit is configured with either of the wet heat options (steam or hot water) the single package unit controls will modulate the hydronic valve to maintain a supply air set point. In the event temperatures off the hydronic coil are below 34 degrees the fans will be shut down and the hydronic valve will open 100%. This function is an automatic reset so as the temperature rises above 36 degrees, the unit will automatically begin normal operation.

ELECTRIC HEATING OPERATION

For units equipped with electric heaters, the unit can control up to six stages of electric heat which are staged on based on heating demand calculates by the IPU controller.

MORNING WARM-UP

Morning Warm-Up can be initialized by BAS or by the IPU controller if the Internal Scheduling is used. If the Internal Scheduling is used, the Morning Warm-Up start time is calculated through an adaptive algorithm. When Morning Warm-Up is required, the IPU controller energizes the VAV heat relay, starts the Supply Fan and qualifies the Return Air Temperature for 5 minutes. The internal heat source (Gas, HW/Steam, or Electric) is controlled to maintain the Return Air Temperature to the Return Air Heating Setpoint, Morning Warm-Up ends when occupancy occurs (BAS, Internal Scheduling, or contact closure), or when the Maximum Morning Warm-Up Time has expired.

Controls (Cont'd)

ECONOMIZER OPERATION

The unit can be equipped with one of three types of optional economizers, dry bulb, single enthalpy, or comparative enthalpy. When the unit controller determines that Outside Air is suitable for economizing, the unit controller will control the outside air damper(s) open to provide economizer cooling. If economizer cooling alone is insufficient for the cooling load, the unit controller will stage up compressors, one at a time, to meet demand.

The control logic for the three types of economizers is as follows:

Dry Bulb Economizer

The dry bulb economizer is the default economizer control scheme. With the dry bulb economizer, the unit controller monitors the Outside Air temperature only and compares it to a reference temperature setting. Outside Air is deemed suitable for economizing when the Outside Air temperature is determined to be less than the reference temperature setting. This method of economizing is effective, but is prone to some change-over inefficiencies due to the fact that this method is based on sensible temperatures only and does not take Outside Air moisture content into consideration.

Single Enthalpy Economizer

With the optional single enthalpy economizer, the unit controller monitors the Outside Air enthalpy in addition to the Outside Air temperature and compares it to a reference enthalpy setting and a reference temperature setting. Outside Air is deemed suitable for economizing when the Outside Air enthalpy is determined to be less than the reference enthalpy setting and the Outside Air temperature is less than the reference temperature setting. This method of economizing allows the reference temperature setting to be set higher than the DB Economizer and is consequently a more efficient single package unit economizer.

Dual Enthalpy Economizer

With the optional dual enthalpy economizer, the unit controller monitors and compares the Outside Air and Return Air enthalpies in addition to comparing the Outside Air temperature to the reference temperature setting. Outside Air is deemed suitable for economizing when the Outside Air enthalpy is determined to be less than the Return Air enthalpy and the Outside Air temperature is less than the reference temperature setting. This method of economizing is the most accurate and provides the highest degree of energy efficiency for a packaged single package unit economizer.

VENTILATION CONTROL SEQUENCES

Minimum OA Damper Position (CV Units)

When the unit goes into the Occupied mode of operation, the unit controller will open the Outside Air Damper to a fixed minimum position. The damper will remain at this position as long as the unit is in the occupied mode, and the economizer is not suitable for cooling.

Minimum OA Damper Position (VAV Units)

With Variable Air Volume units, there are two Minimum OA Damper Positions, one when the unit is at full speed and the second when the unit is at approximately half speed. These two points allow the control to linearly reset the position of the OA damper in response to fan speed.

When the unit goes into the Occupied mode of operation, the unit controller will monitor the speed of the supply fan and open the Outside Air damper to a calculated minimum position based on the fan speed. This minimum position will vary as the speed of the fan changes. The damper will remain at this calculated position as long as the unit is in the occupied mode, and the economizer is not suitable for cooling.

Air Measurement Stations

When the unit is equipped with an air measurement station, the unit controller will control the Outside Air damper to a measured flow rate through the Air Measurement Station.

When the unit goes into the Occupied mode of operation, the unit controller will control the Outside Air damper to maintain the Minimum AirFlow Setpoint through the Air Measurement Station. The unit controller will control the Outside Air damper to this flow rate as long as the unit is in the Occupied mode, and the economizer is not suitable for cooling.

Demand Ventilation

If optional CO₂ sensors are connected to the unit, the unit controller can reset the minimum OA damper position(s) or minimum flow rate based on demand.

The unit controller will monitor the CO₂ level within the building. If the CO₂ level rises above the CO₂ setpoint, the controller will temporarily increase the Minimum OA Damper Position or Minimum OA flow rate to increase ventilation. If the CO₂ level drops below the CO₂ setpoint, the controller will decrease the Minimum OA Damper Position or Minimum OA flow rate to decrease ventilation. Demand Ventilation will remain active as long as the unit is in the Occupied mode of operation.

EXHAUST CONTROL SEQUENCES

Barometric

The optional barometric exhaust system consists of a lightweight barometric relief damper installed on the end of the unit in the Return Air section. As more outside air is introduced into the controlled zone due to Economizer and Ventilation control sequences, the pressure inside the building rises. As building static pressure increases to overcome any exhaust duct static pressure, air will be allowed to escape through the barometric relief damper. Because this type of exhaust is not powered, the amount of air exhausted will be limited to the static pressure that will need to be overcome.

Powered Variable Volume Exhaust-Discharge Damper Controlled

This optional variable volume powered exhaust system consists of a fixed speed fan configured with a proportionally controlled discharge damper. The single package unit controller monitors the pressure inside the building and controls the Exhaust Damper and the Exhaust Fan. If the Building Pressure rises, the Exhaust Damper is proportionally controlled open and the Exhaust Fan is controlled ON. If the Building Pressure falls, the Exhaust Damper is proportionally controlled closed and the Exhaust Fan is controlled OFF. The position of the Exhaust Damper in which the Exhaust Fan is controlled ON and OFF as well as the Building Pressure setpoint is user selectable from the single package unit User Interface.

Powered Variable Volume Exhaust-VFD Controlled

This optional variable volume powered exhaust system consist of an Exhaust Fan driven by a Variable Frequency Drive (VFD), which is controlled by the single package unit controller. The single package unit controller monitors the pressure within the building. As the pressure rises, the VFD is controlled to increase Exhaust Fan speed. As the pressure falls, the VFD is controlled to decrease Exhaust Fan speed. The Building Pressure Setpoint is user selectable from the single package unit User Interface. On/Off control is maintained the same as Exhaust-Discharge Damper control stated above.

Return Fan Controlled

This optional variable volume powered return fan system consists of two return fans controlled by one VFD that is controlled by the single package unit control center. The VFD is controlled to maintain a slightly positive pressure over the mixing box section to prevent reverse flow. As the return and/or exhaust air dampers open, the return plenum pressure drops, the fan will speed up to maintain pressure. When the return and/or exhaust air dampers close, the return plenum pressure increases causing the VFD to slow the fan speed down.

LOW AMBIENT/HEAD PRESSURE CONTROL OPERATION

The single package unit controller continuously monitors the outside air temperature to determine if mechanical cooling should be allowed. As a safety, if the Outside Air temperature falls to or below the Low Ambient Lockout temperature, mechanical cooling is prevented from operating. For units with economizers, the Low Ambient Lockout temperature is typically low enough that mechanical cooling will rarely be required. However, for some applications mechanical cooling is required when the Outside Air temperature is lower than the Low Ambient Lockout temperature.

For these applications, the unit must be equipped with optional Low Ambient controls. For optional Low Ambient operation, the single package unit controller monitors the refrigeration system discharge pressure and controls the speed of the condenser fans. If the discharge pressure falls, the speed of the first condenser fan on the refrigeration circuit is reduced to maintain acceptable condensing pressures in the refrigeration system. With the optional Low Ambient controls, mechanical cooling is allowed down to Outside Air temperatures of 0°F.

SMOKE PURGE SEQUENCES

General

The controls of the Series 100 are designed as standard with a Ventilation Override sequence to remove, exhaust or ventilate smoke, fumes or other air born contaminants from the occupied space. This feature offers 3 selectable operations, which include, Purge, Pressurization and Evacuation The sequence is activated via one of three binary inputs. Some typical contact closures are smoke detectors, fire alarms, manual switches, etc.

Note: All cooling and heating modes are disabled during Smoke purge.

Controls (Cont'd)

Purge

Purge – Purge shall be used to displace the air inside the space with fresh outside air. When this sequence is started, the following will occur:

Start the Supply Fan if not already on. (Note, with VAV and FlexSys units, the fan speed will be controlled to maintain the active Duct Pressure Set Point.) Start the Return Fan if not already on. Start the Exhaust Fan if not already ON and set the VFD to 100%. Set the OA damper position to 100%. Set the Exhaust damper to 100%.

Pressurization

Pressurization – Pressurization shall be used to pressurize the building or space in order to force the air inside the space through the walls to adjacent spaces or outside the building envelope. When this sequence is started, the following will occur:

Start the Supply Fan if not already on. (Note, with VAV and FlexSys units, the fan speed shall be controlled to maintain the active Duct Pressure Set Point.) Stop the Return Fan if on. Stop the Exhaust fan if on and set Exhaust/Return Fan VFD to 0%. Set the OA damper to 100%. Set the Exhaust damper to 0%.

Evacuation

Evacuation – Evacuation shall be used to evacuate (negatively pressurize) the building or space in order to draw air through the walls from adjacent spaces or outside the building envelope. When this sequence is started, the following shall occur:

Stop the Supply Fan if on. Start the Return Fan if not already on. Start the Exhaust fan if not already on and set the Exhaust/Return Fan VFD to 100%. Set the OA damper to 0%. Set the Exhaust damper to 100%

SPECIFIC SEQUENCES

(See IOM for further detail)

Variable Air Volume Mode

Occupied Cooling – In the OCCUPIED COOLING mode the Unit Controller monitors the “RETURN AIR TEMP” and compares it to the “RAT COOLING SETPOINT”. The “RAT COOLING SETPOINT” is entered into the Unit Controller through the SET POINT key COOLING subsection of the User Interface. If the “RE-

TURN AIR TEMP” is equal to or greater than the “RAT COOLING SETPOINT” plus 0.50 F the Unit Controller will place the unit in the OCCUPIED COOLING mode. The unit will remain in the OCCUPIED COOLING mode until the “RETURN AIR TEMP” is equal to or less than the “RAT COOLING SETPOINT” minus 0.5°F.

Occupied Heating – In the OCCUPIED HEATING mode the Unit Controller monitors the “RETURN AIR TEMP” and compares it to the “RAT HEATING SETPOINT”. The “RAT HEATING SETPOINT” is entered into the Unit Controller through the SET POINTS key HEATING subsection of the User Interface. If the “RETURN AIR TEMP” is equal to or LESS than the “RAT HEATING SETPOINT” minus 0.50 F the Unit Controller will place the unit in the OCCUPIED HEATING mode. The unit will remain in the OCCUPIED HEATING mode until the “RETURN AIR TEMP” is equal to or greater than the “RAT HEATING SETPOINT” plus 0.5°F.

Unoccupied Cooling – In the UNOCCUPIED COOLING mode the Unit Controller will monitor the “ZONE TEMP” and compare it to the “UNOCC ZONE COOLING SETPOINT”. The “UNOCC ZONE COOLING SETPOINT” is set through the SET POINTS key, COOLING subsection of the User Interface. If the “ZONE TEMP” is equal to or greater than the “UNOCC ZONE COOLING SETPOINT” temperature plus 0.50 F, the Unit Controller will place the unit in the UNOCCUPIED COOLING mode. The unit will remain in the UNOCCUPIED COOLING mode until the “ZONE TEMP” is equal to or less than the “UNOCC ZONE COOLING SETPOINT” minus 0.5°F.

Unoccupied Heating – In order for the UNOCCUPIED HEATING to function, the “NIGHT SET BACK” setting must be set to ENABLE. This can be done through the PROGRAM key, HEATING subsection of the User Interface. In the UNOCCUPIED HEATING mode the Unit Controller will monitor the “ZONE TEMP” and compare it to the “UNOCC ZONE HEATING SETPOINT”. The “UNOCC ZONE HEATING SETPOINT” is set through the SET POINTS key, HEATING subsection of the User Interface. If “ZONE TEMP” is equal to or less than the “UNOCC ZONE HEATING S” minus 0.50 F, the Unit Controller will place the unit in the UNOCCUPIED HEATING mode. The unit will remain in the UNOCCUPIED HEATING mode until the “ZONE TEMP” is equal to or greater than the “UNOCC ZONE HEATING SETPOINT” plus 0.5°F.

Constant Volume Mode

A “CONSTANT VOLUME” unit will be controlled by one of three “CONTROL METHOD”: • “STAGED” (Thermostat) • “WIRED ZONE TEMP” (Hardwired) • “COMM ZONE TEMP” (Communicated) The “CONTROL METHOD” is entered into the Unit Controller through the OPTION key, UNIT DATA subsection of the User Interface.

Staged Input – The unit compares the analog “WIRED ZONE TEMP” or “ COMM ZONE TEMP” input to the “OCC ZONE COOLING”, “OCC ZONE HEATING” ,”UNOCC ZONE COOLING”, or “UNOCC ZONE HEATING” set points to determine the sub-mode of operation.

This graphic shows what the UNIT MODE would be, based on the difference between the zone temperature and the zone temperature set points. The only difference between Hard Wired and Communicated is the method the Unit Controller uses to determine the “ZONE TEMP”. In the Hard Wired mode the input is an analog input to the control. In the Communicated mode the input is a serial input from a BAS control system.

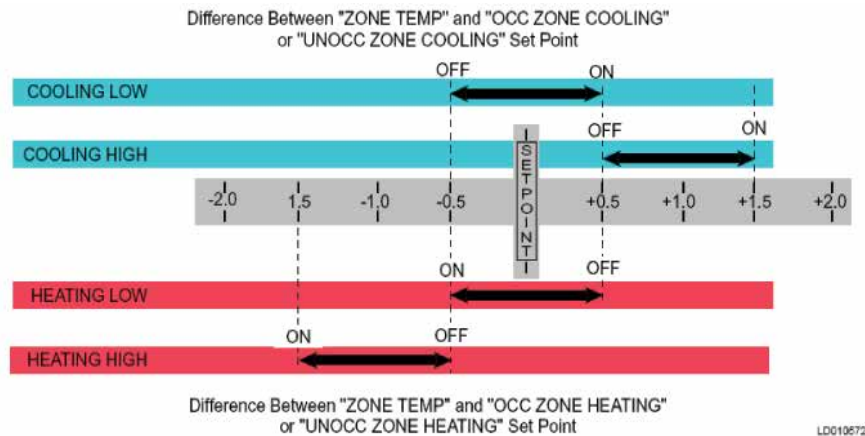

COOLING OPERATION

Thermostat Control

If a 7-wire thermostat (2 Cool/2 Heat) controls the unit, all zone temperature setpoint control is maintained at the thermostat. With this operation, the unit remains idle until it receives a stage call from the thermostat. If “G” is called from the thermostat, the Supply Fan will start. Ventilation functions (if equipped) will be permitted to run with an occupied signal. Economizer functions will operate with a “G” call and a call for cooling.

Stage 1 (“Y1”) Call

If Y1 is called and the unit is equipped with an economizer, the control will check to see if the Outside Air is suitable for economizing. If conditions are suitable for economizing, the control will control the economizer and stage up compressors, as required, to maintain the economizer first-stage setpoint. If conditions are not suitable for economizing or not equipped with an economizer, the control will stage up 50% of the compressors. This shall be maintained until Stage 1 is deactivated or Stage 2 is called.

Stage 2 (“Y2”) Call

If Y2 is called and the unit is equipped with an economizer, the control will check to see if the Outside Air is suitable for economizing. If conditions are suitable for economizing, the control will control the economizer and stage up compressors, as required, to maintain the economizer second-stage setpoint. If conditions are not suitable for economizing or not equipped with an economizer, the control will stage up 100% of the compressors. This shall be maintained until Stage 2 is deactivated.

Controls (Cont'd)

Zone Sensor Control

If a zone sensor controls the unit, the single package unit controller shall maintain the zone temperature setpoint. This setpoint is user selectable at the single packaged unit User Interface.

When a zone sensor is used for control, the single package unit controller will monitor the temperature within the space and control the unit accordingly. A closed-loop staging algorithm is used to stage compressors up and down as required to maintain the desired zone temperature setpoint. If the unit is equipped with an economizer, Outside Air conditions are continuously monitored by the control to determine if conditions are suitable for economizing. If conditions are suitable for economizing, the single package unit controller will modulate the Outside Air damper in addition to staging compressors up and down to maintain the zone temperature setpoint.

HEATING OPERATION

Thermostat Control

If a 7-wire thermostat (2 Cool/2 Heat) controls the unit, all zone temperature setpoint control is maintained at the thermostat. With this operation, the unit remains idle until it receives a stage call from the thermostat. If "G" is called from the thermostat, the Supply Fan will start.

Ventilation functions (if equipped) will be permitted to run with an occupied signal.

Stage 1 ("W1") Call

If W1 is called and the unit is equipped with an economizer, the economizer will go to minimum position with an occupied signal or close with an unoccupied signal and the control will stage up 50% of the heating steps. This shall remain active until Stage 1 call is deactivated or a Stage 2 call is activated.

Stage 2 ("W2") Call

If W2 is called and the unit is equipped with an economizer, the economizer will go to minimum position with an occupied signal or close with an unoccupied signal, and the control will stage up 100% of the heating steps. This shall remain active until Stage 2 call is deactivated.

Zone Sensor Control

If a zone sensor controls the unit, the single package unit controller shall maintain all zone temperature setpoints. These setpoints are user selectable at the single package unit User Interface.

When a zone sensor is used for control, the single package unit controller will monitor the temperature within the space and control the unit accordingly. A closed-loop staging algorithm is used to stage heating steps up and down as required to maintain the desired zone temperature setpoint. If the unit is equipped with an economizer, Outside Air conditions are continuously monitored by the control to determine if conditions are suitable for economizing. If conditions are suitable for economizing, the single package unit controller will modulate the Outside Air damper in addition to staging heating steps up and down to maintain the zone temperature setpoint.

TABLE 32 - THREE PHASE POWER SUPPLY CONDUCTOR SIZE RANGE**70-75 TON UNITS**

SUPPLY VOLTAGE	SINGLE POINT TB	SINGLE POINT DISCONNECT	DUAL POINT TB TB1	TB2
208V	(2") 250 kcmil-500 kcmil	(2") 2 AWG-500 kcmil	4 AWG-500 kcmil	6 AWG-350 kcmil
230V	(2") 250 kcmil-500 kcmil	(2") 2 AWG-500 kcmil	6 AWG-400 kcmil	6 AWG-350 kcmil
380V-60	(2") 3/0-250 kcmil	4 AWG-500 kcmil	6 AWG-400 kcmil	14 AWG-2/0
460V	(2") 3/0-250 kcmil	4 AWG-500 kcmil	14 AWG-2/0	14 AWG-2/0
575V	6 AWG-400 kcmil	6 AWG-350 kcmil	14 AWG-2/0	14 AWG-2/0

80 TON UNITS

SUPPLY VOLTAGE	SINGLE POINT TB	SINGLE POINT DISCONNECT	DUAL POINT TB TB1	TB2
208V	(2") 2/0-400 kcmil	(2") 2 AWG-500 kcmil	(2") 2 AWG-500 kcmil	6 AWG-350 kcmil
230V	(2") 250 kcmil-500 kcmil	(2") 2 AWG-500 kcmil	4 AWG-500 kcmil	6 AWG-350 kcmil
380V-60	(2") 3/0-250 kcmil	4 AWG-500 kcmil	6 AWG-400 kcmil	14 AWG-2/0
460V	(2") 3/0-250 kcmil	4 AWG-500 kcmil	6 AWG-400 kcmil	14 AWG-2/0
575V	(2") 3/0-250 kcmil	6 AWG-350 kcmil	14 AWG-2/0	14 AWG-2/0

90-105 TON UNITS

SUPPLY VOLTAGE	SINGLE POINT TB	SINGLE POINT DISCONNECT	DUAL POINT TB TB1	TB2
208V	(2") 2/0-400 kcmil	(2") 2 AWG-500 kcmil	(2") 2 AWG-500 kcmil	4 AWG-600 kcmil
230V	(2") 2/0-400 kcmil	(2") 2 AWG-500 kcmil	(2") 2 AWG-500 kcmil	4 AWG-600 kcmil
380V-60	(2") 3/0-250 kcmil	4 AWG-500 kcmil	4 AWG-500 kcmil	14 AWG-2/0
460V	(2") 3/0-250 kcmil	4 AWG-500 kcmil	6 AWG-400 kcmil	14 AWG-2/0
575V	(2") 3/0-250 kcmil	6 AWG-350 kcmil	14 AWG-2/0	14 AWG-2/0

THIS PAGE INTENTIONALLY LEFT BLANK.

Power Wiring: YPAL070-105

SINGLE-POINT POWER SUPPLY WIRING

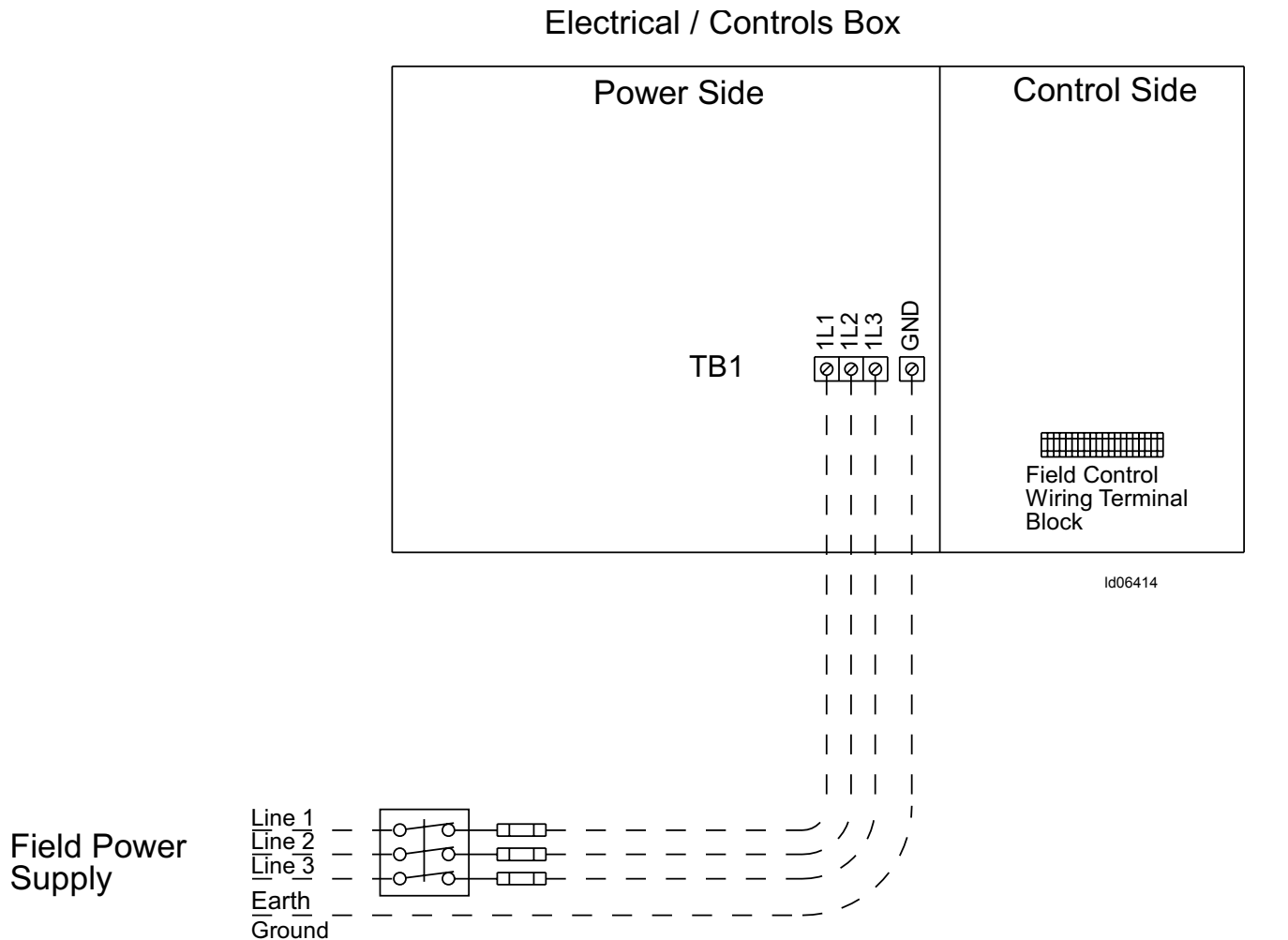

NOTES:

1. All field wiring must be provided through a field-supplied fused disconnect switch to the unit terminals (or optional molded disconnect switch).
2. All electrical wiring must be made in accordance with all N.E.C. and/or local code requirements.
3. Minimum Circuit Ampacity (MCA) is based on U.L. Standard 1995, Section 36.14 (N.E.C. Section 440.34).
4. Maximum Dual Element Fuse size is based on U.L. Standard 1995, Section 36.15 (N.E.C. Section 440.22)
5. Use copper conductors only.
6. On units with an optional disconnect switch, the supplied disconnect switch is a "Disconnecting Means" as defined in the N.E.C. Section 100, and is intended for isolating the unit from the available power supply to perform maintenance and troubleshooting. This disconnect switch is not intended to be a Load Break Device.

FIGURE 4 - SINGLE-POINT POWER SUPPLY WIRING

Power Wiring: YPAL070-105 (Cont'd)

SINGLE-POINT POWER SUPPLY WIRING WITH NON-FUSED DISCONNECT

Electrical / Controls Box

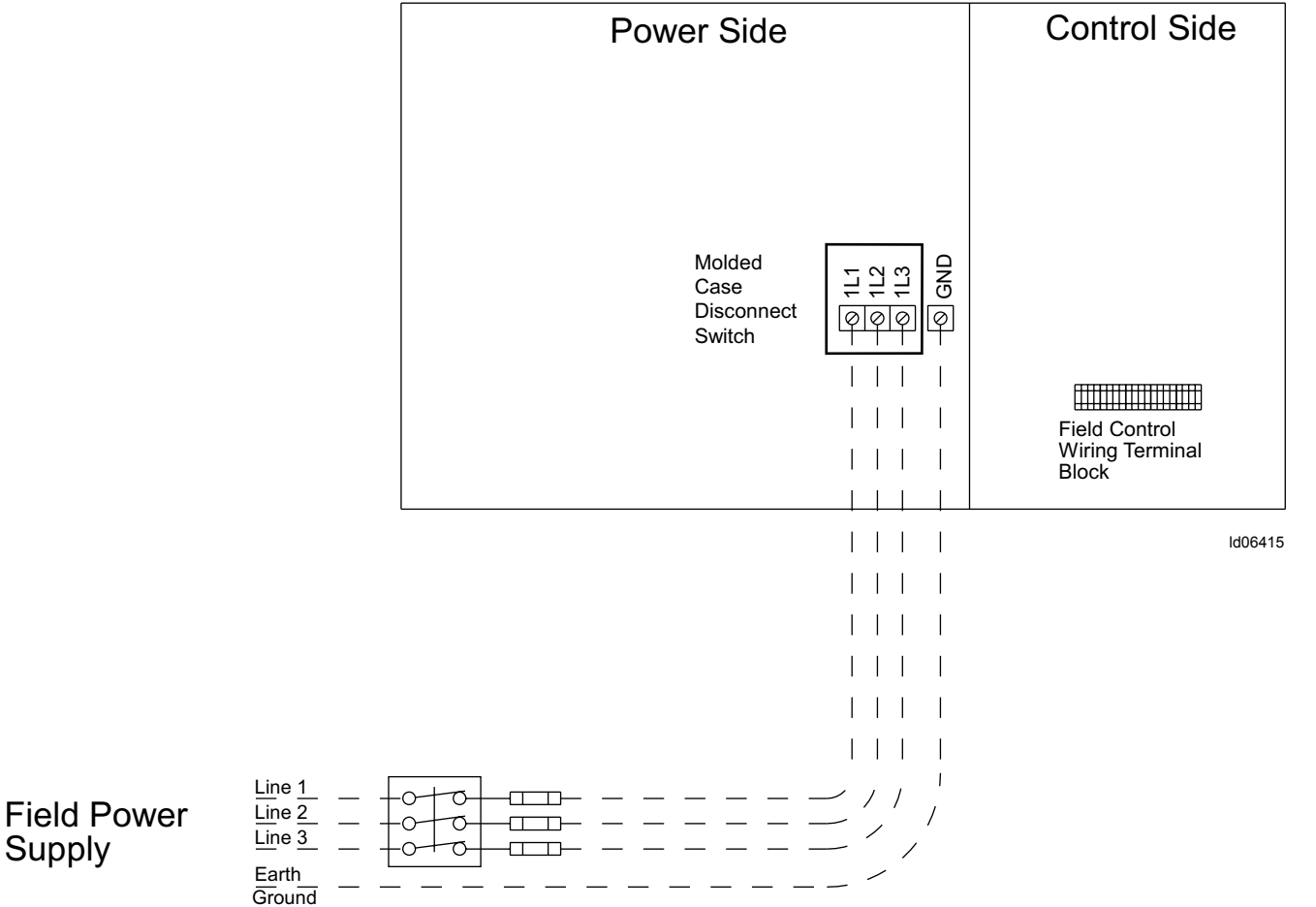

NOTES:

1. All field wiring must be provided through a field-supplied fused disconnect switch to the unit terminals (or optional molded disconnect switch).
2. All electrical wiring must be made in accordance with all N.E.C. and/or local code requirements.
3. Minimum Circuit Ampacity (MCA) is based on U.L. Standard 1995, Section 36.14 (N.E.C. Section 440.34).
4. Maximum Dual Element Fuse size is based on U.L. Standard 1995, Section 36.15 (N.E.C. Section 440.22)
5. Use copper conductors only.
6. On units with an optional disconnect switch, the supplied disconnect switch is a "Disconnecting Means" as defined in the N.E.C. Section 100, and is intended for isolating the unit from the available power supply to perform maintenance and troubleshooting. This disconnect switch is not intended to be a Load Break Device.

FIGURE 5 - SINGLE-POINT POWER SUPPLY WIRING WITH NON-FUSED DISCONNECT

DUAL-POINT POWER SUPPLY WIRING

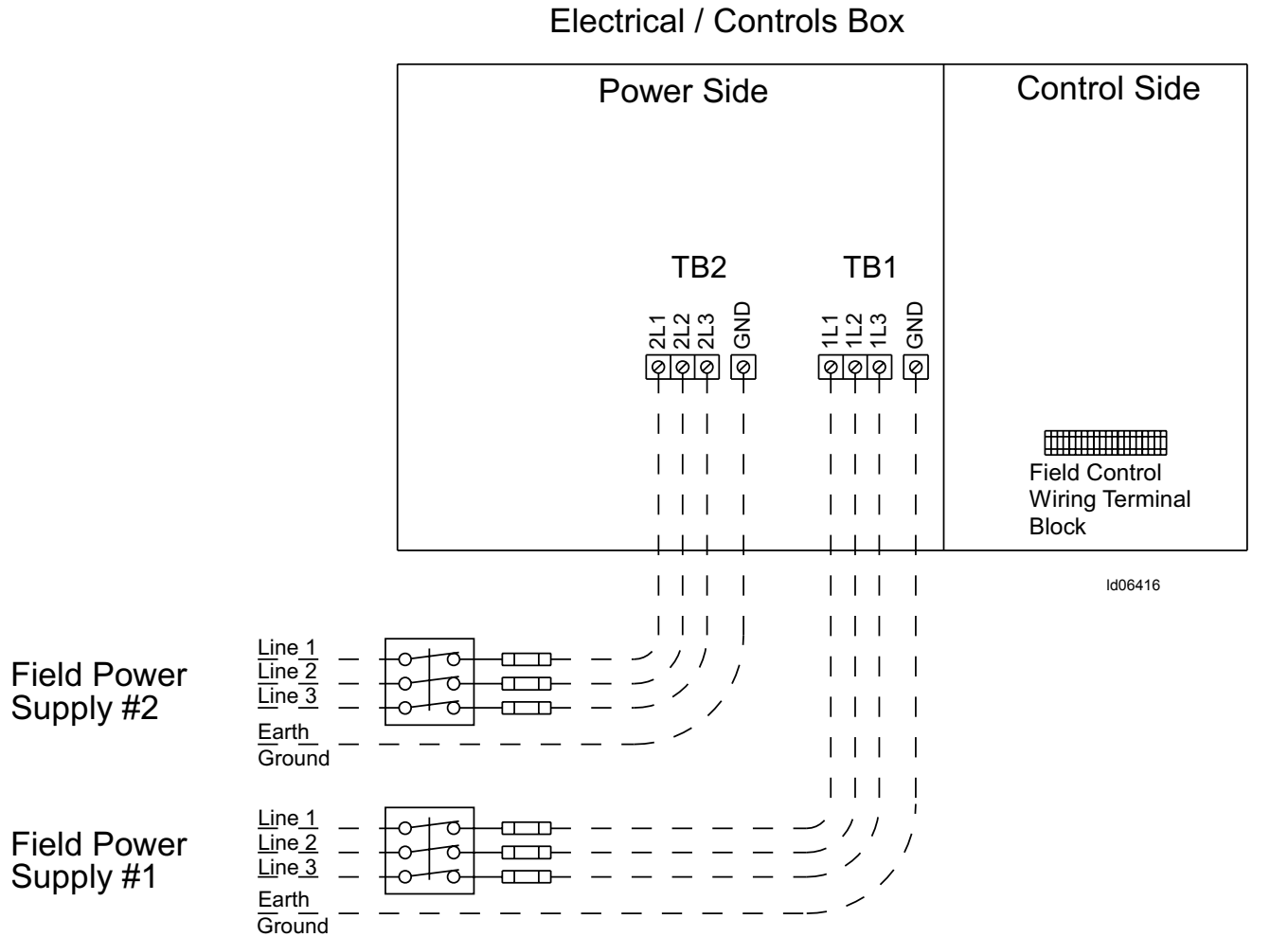

NOTES:

1. All field wiring must be provided through a field-supplied fused disconnect switch to the unit terminals (or optional molded disconnect switch).
2. All electrical wiring must be made in accordance with all N.E.C. and/or local code requirements.
3. Minimum Circuit Ampacity (MCA) is based on U.L. Standard 1995, Section 36.14 (N.E.C. Section 440.34).
4. Maximum Dual Element Fuse size is based on U.L. Standard 1995, Section 36.15 (N.E.C. Section 440.22)
5. Use copper conductors only.
6. On units with an optional disconnect switch, the supplied disconnect switch is a "Disconnecting Means" as defined in the N.E.C. Section 100, and is intended for isolating the unit from the available power supply to perform maintenance and troubleshooting. This disconnect switch is not intended to be a Load Break Device.

FIGURE 6 - DUAL-POINT POWER SUPPLY WIRING

THIS PAGE INTENTIONALLY LEFT BLANK.

Field Control Wiring

Wiring Notes:

1. Wiring shown indicates typical wiring. Refer to the I.O.M. manual for more detailed wiring methods and options.
2. All wiring is Class 2, low voltage.
3. Maximum power available from the 24 VAC terminal is 40 VA.
4. Use shielded wire where shown.
5. Potentiometer application shown. As an alternative, signal inputs can be driven from an analog output of a third party controller. Note: Input load resistance is 15K ohms.

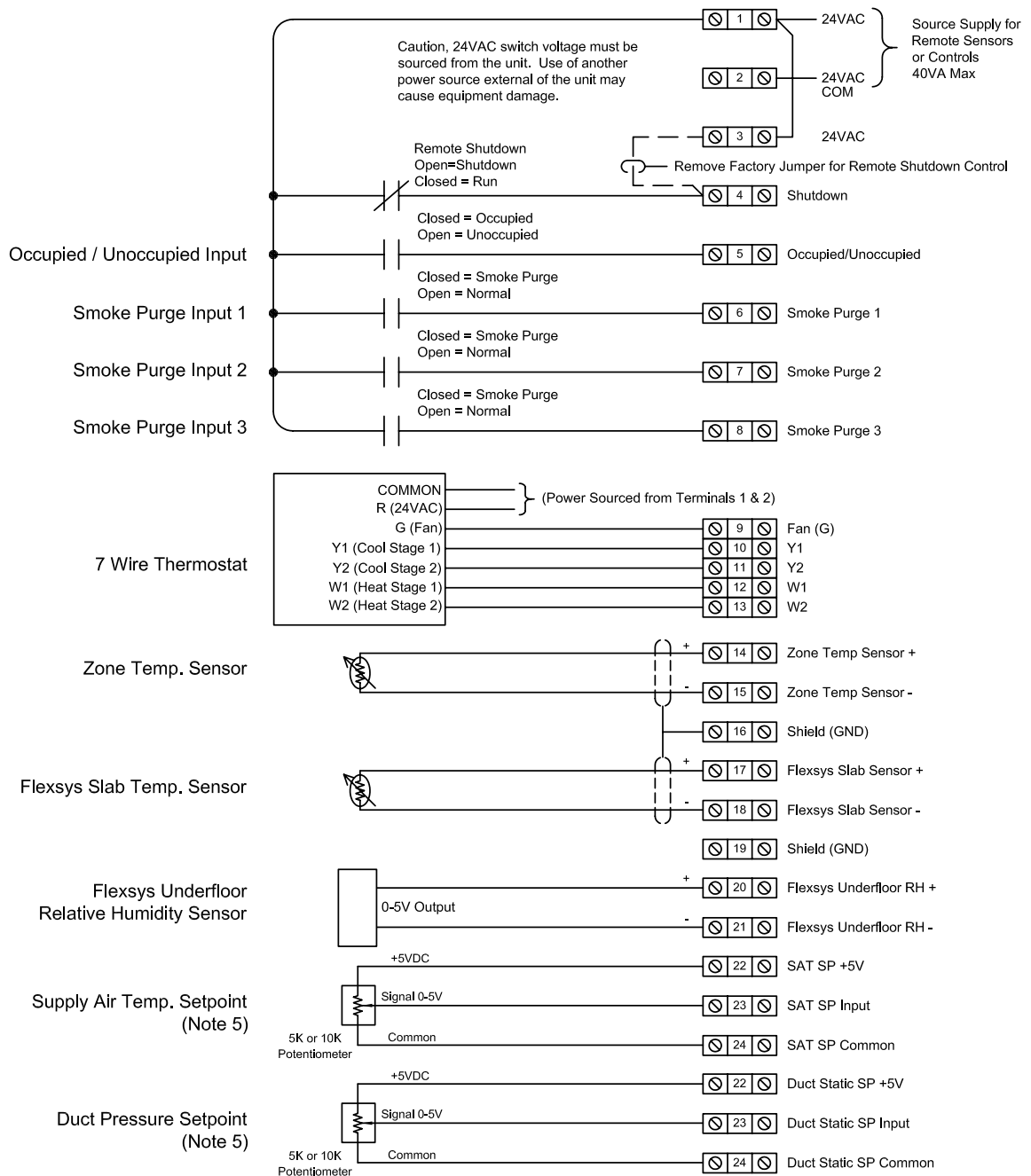

Id08184

FIGURE 7 - FIELD CONTROL WIRING

Field Control Wiring (Cont'd)

Wiring Notes:

1. Wiring shown indicates typical wiring. Refer to the I.O.M. manual for more detailed wiring methods and options.
2. All wiring is Class 2, low voltage.
3. Maximum power available from the 24 VAC terminal is 40 VA.
4. Use shielded wire where shown.
5. Relay contacts suitable for pilot duty to 1A from 24VAC to 120VAC

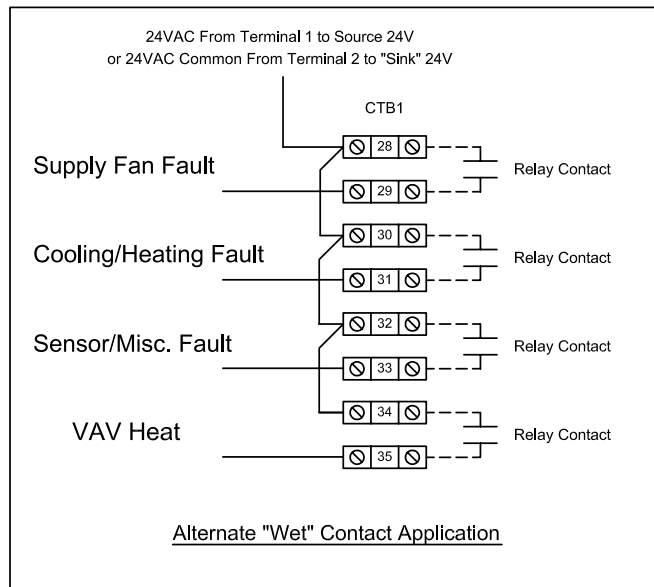
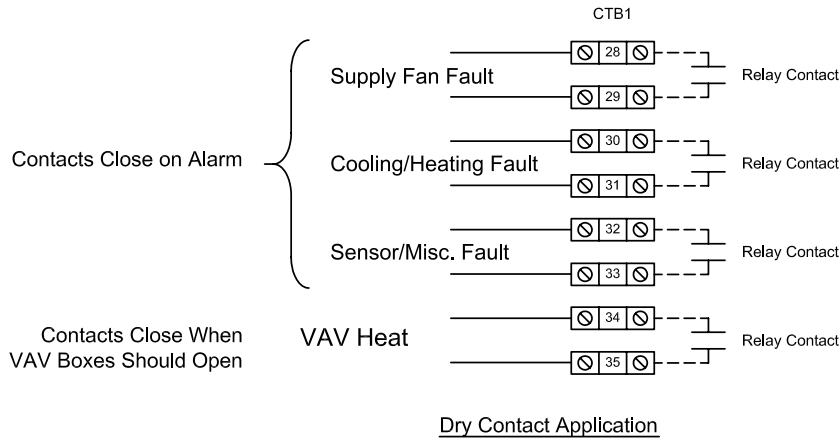

Id08186

FIGURE 8 - FIELD CONTROL WIRING

General Arrangement Drawing – 70-80 Ton Models

BOTTOM SUPPLY / BOTTOM RETURN

SECTION DESCRIPTIONS:

- EE = Economizer
- FE = Fan Exhaust
- MB = Mixing Box
- F = Filter Segments
- CC = Cooling Coils
- FS = Supply Fan
- DP = Discharge Plenum
- CO = Condenser Section
- CP = Control Panel

- ### NOTES:
1. 10' Clearance Minimal Over The Top of the Condensing Unit.
 2. Only One Adjacent Wall Can Exceed Unit Height.
 3. 12' Clearance Required to Adjacent Units
 4. 8' Service Access Recommended on One Side.
 5. Economizer and Exhaust Hoods, Where Applicable, are Folded Inside Unit for Shipment.

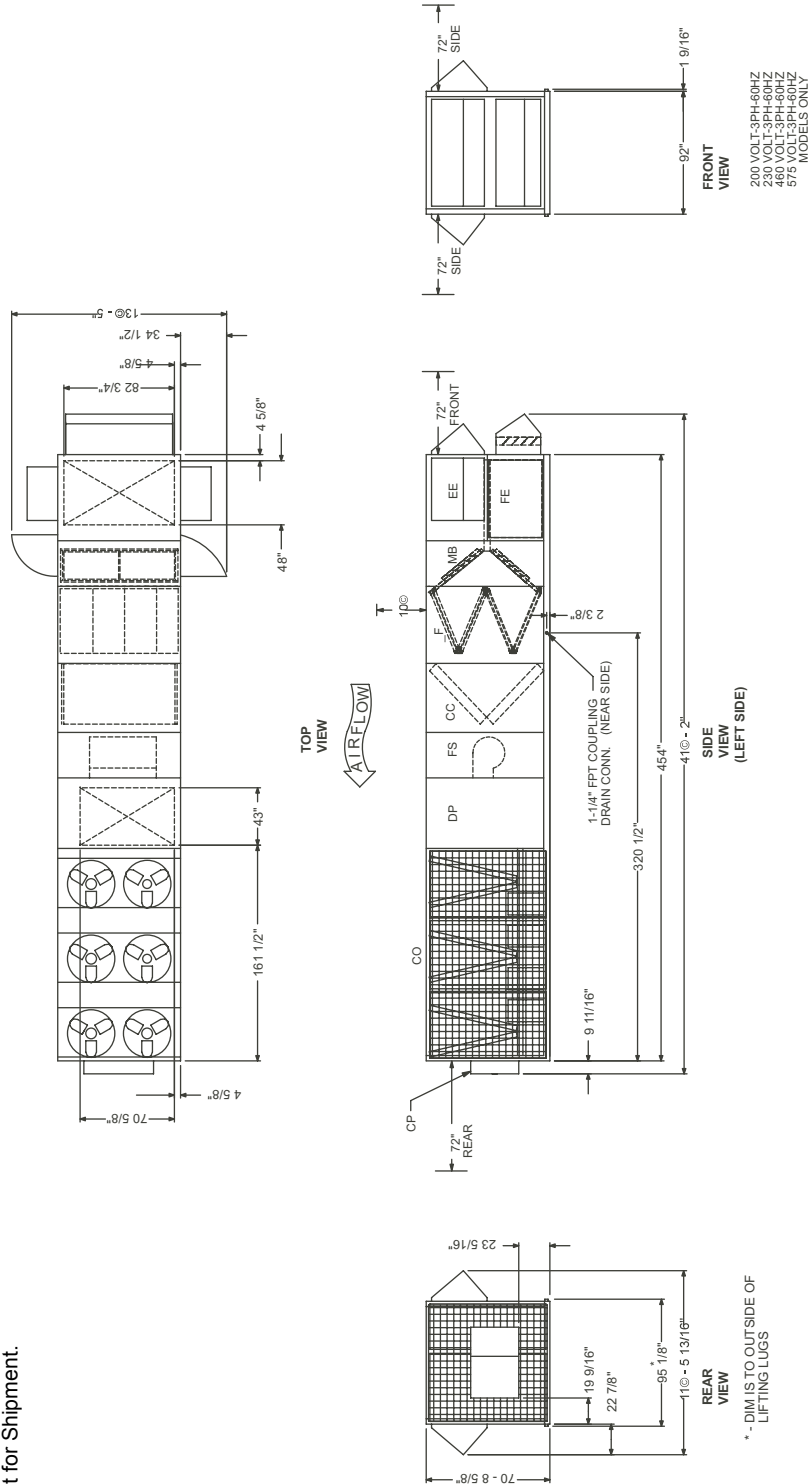

FIGURE 9 - GENERAL ARRANGEMENT DRAWING

General Arrangement Drawing – 70-80 Ton Models (Cont'd)

LEFT SUPPLY / LEFT RETURN

SECTION DESCRIPTIONS:

- EE = Economizer
- FE = Fan Exhaust
- MB = Mixing Box
- F = Filter Segments
- CC = Cooling Coils
- FS = Supply Fan
- DP = Discharge Plenum
- CO = Condenser Section
- CP = Control Panel

- ### NOTES:
1. 10' Clearance Minimal Over The Top of the Condensing Unit.
 2. Only One Adjacent Wall Can Exceed Unit Height.
 3. 12' Clearance Required to Adjacent Units
 4. 8' Service Access Recommended on One Side.
 5. Economizer and Exhaust Hoods, Where Applicable, are Folded Inside Unit for Shipment.

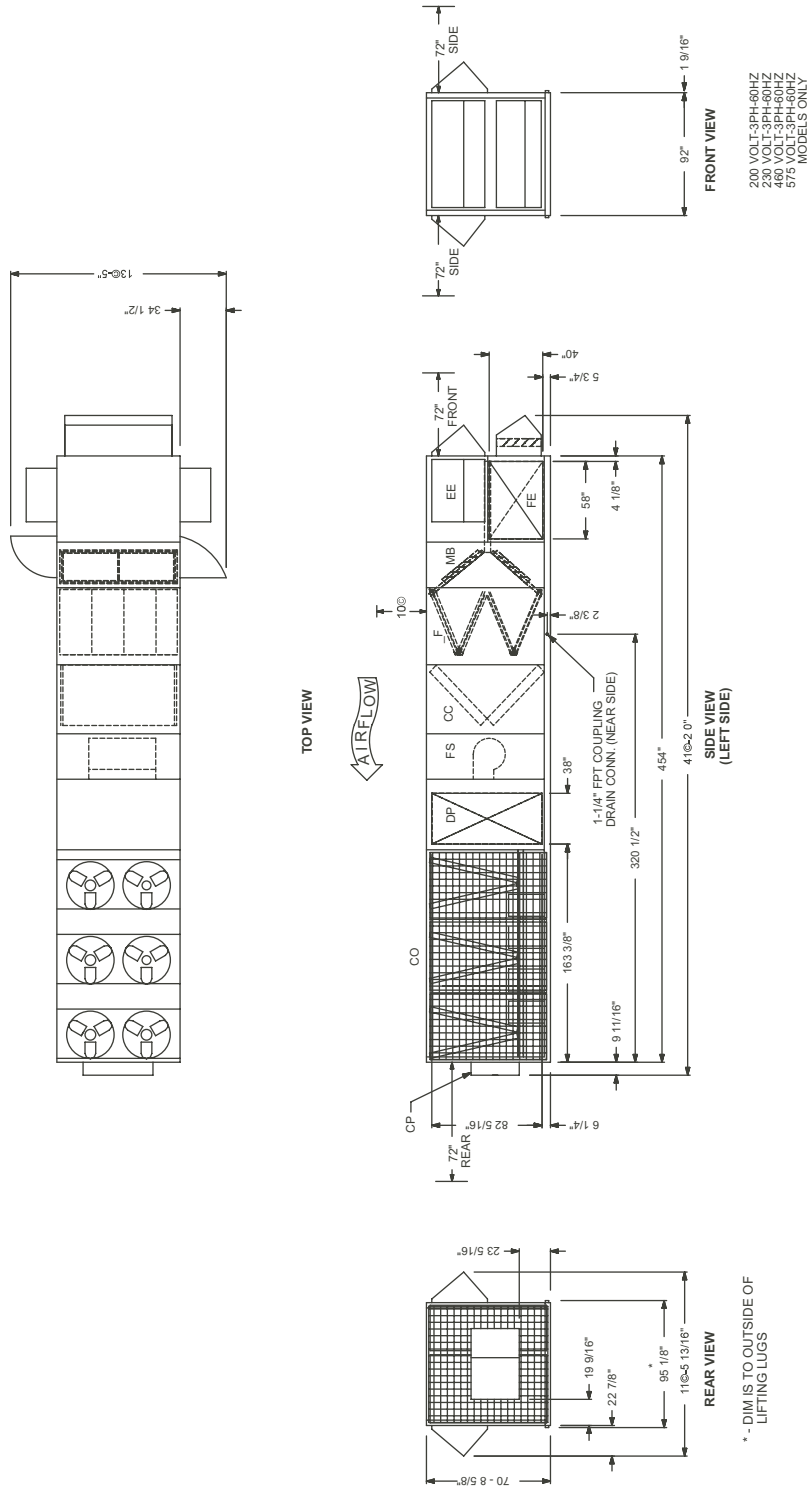

FIGURE 10 - GENERAL ARRANGEMENT DRAWING

LEFT SUPPLY / FRONT RETURN

SECTION DESCRIPTIONS:

- EE = Economizer
- FE = Fan Exhaust
- MB = Mixing Box
- F = Filter Segments
- CC = Cooling Coils
- FS = Supply Fan
- DP = Discharge Plenum
- CO = Condenser Section
- CP = Control Panel

- NOTES:
1. 10' Clearance Minimal Over The Top of the Condensing Unit.
 2. Only One Adjacent Wall Can Exceed Unit Height.
 3. 12' Clearance Required to Adjacent Units
 4. 8' Service Access Recommended on One Side.
 5. Economizer and Exhaust Hoods, Where Applicable, are Folded Inside Unit for Shipment.

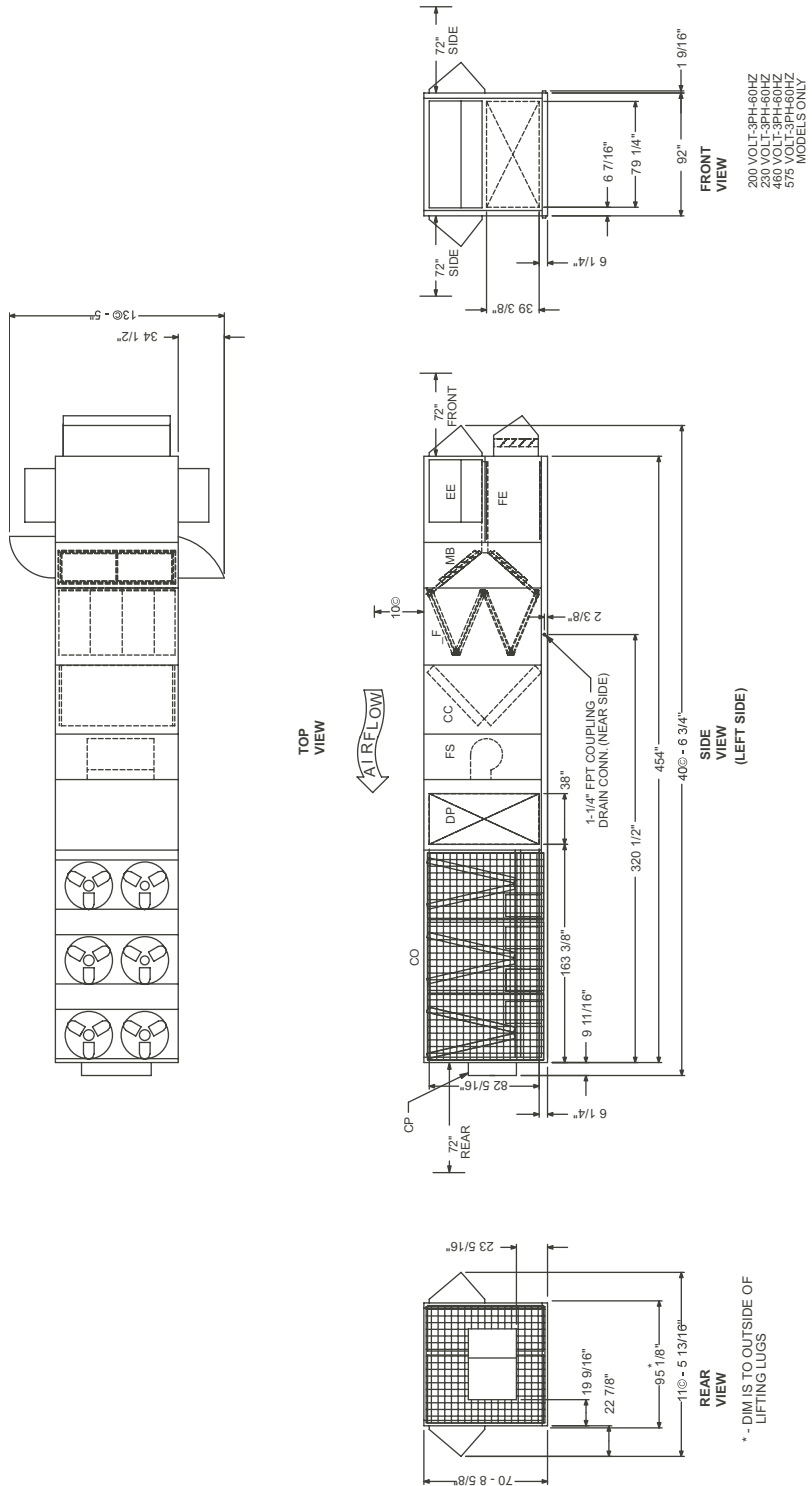

FIGURE 11 - GENERAL ARRANGEMENT DRAWING

General Arrangement Drawing – 90-105 Ton Models

BOTTOM SUPPLY / BOTTOM RETURN

SECTION DESCRIPTIONS:

- EE = Economizer
- FE = Fan Exhaust
- MB = Mixing Box
- F = Filter Segments
- CC = Cooling Coils
- FS = Supply Fan
- DP = Discharge Plenum
- CO = Condenser Section
- CP = Control Panel

- NOTES:**
1. 10' Clearance Minimal Over The Top of the Condensing Unit.
 2. Only One Adjacent Wall Can Exceed Unit Height.
 3. 12' Clearance Required to Adjacent Units
 4. 8' Service Access Recommended on One Side.
 5. Economizer and Exhaust Hoods, Where Applicable, are Folded Inside Unit for Shipment.

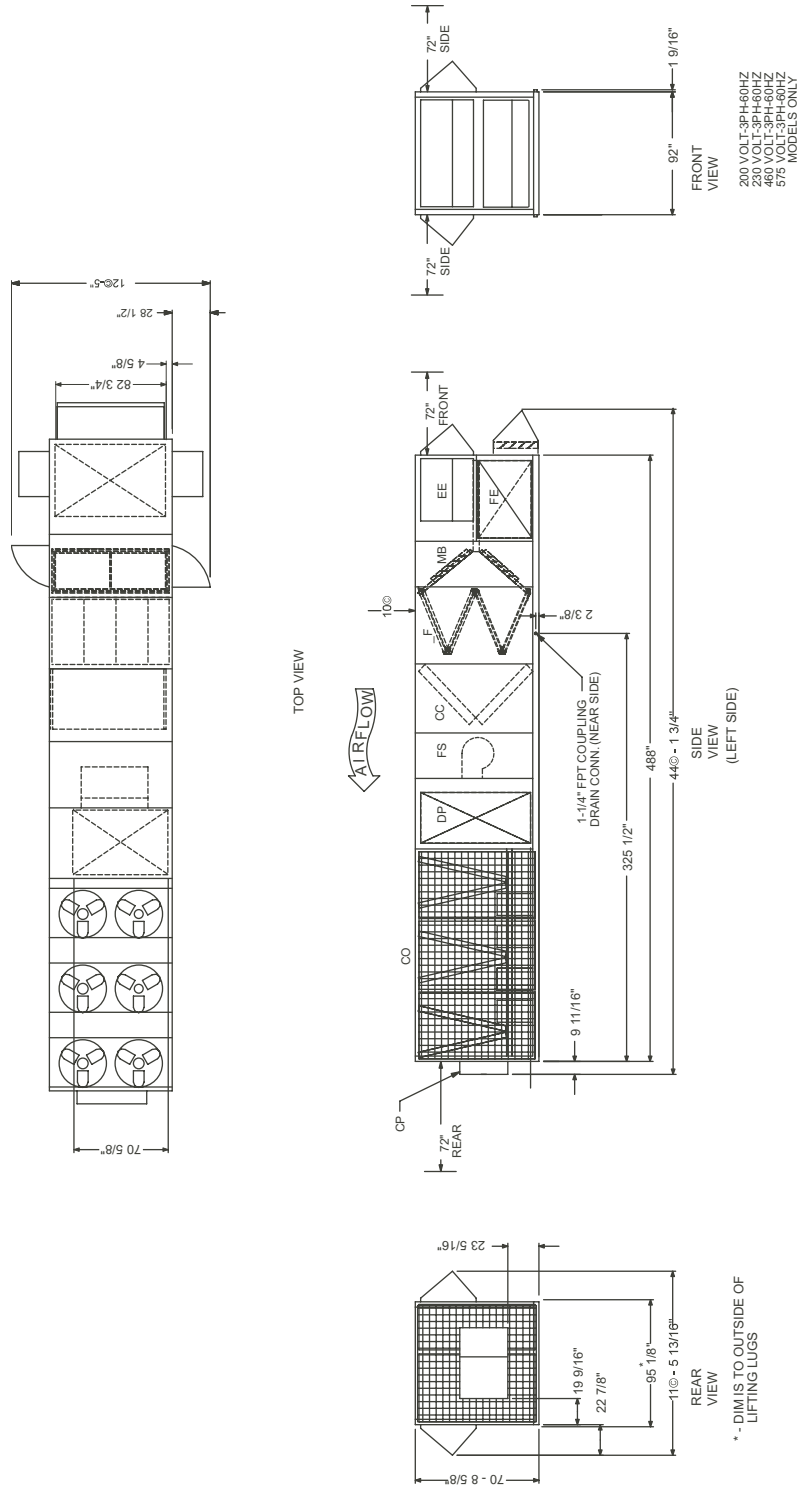

FIGURE 12 - GENERAL ARRANGEMENT DRAWING

Id08131

LEFT SUPPLY / LEFT RETURN

SECTION DESCRIPTIONS:

- EE = Economizer
- FE = Fan Exhaust
- MB = Mixing Box
- F = Filter Segments
- CC = Cooling Coils
- FS = Supply Fan
- DP = Discharge Plenum
- CO = Condenser Section
- CP = Control Panel

- NOTES:**
1. 10' Clearance Minimal Over The Top of the Condensing Unit.
 2. Only One Adjacent Wall Can Exceed Unit Height.
 3. 12' Clearance Required to Adjacent Units
 4. 8' Service Access Recommended on One Side.
 5. Economizer and Exhaust Hoods, Where Applicable, are Folded Inside Unit for Shipment.

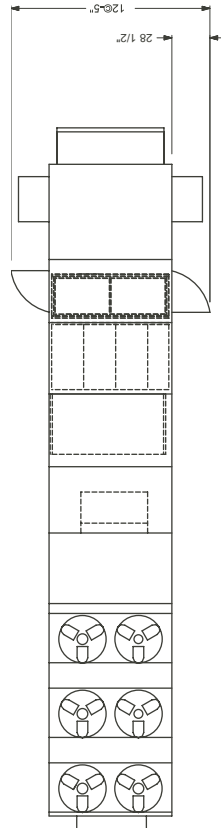

TOP VIEW

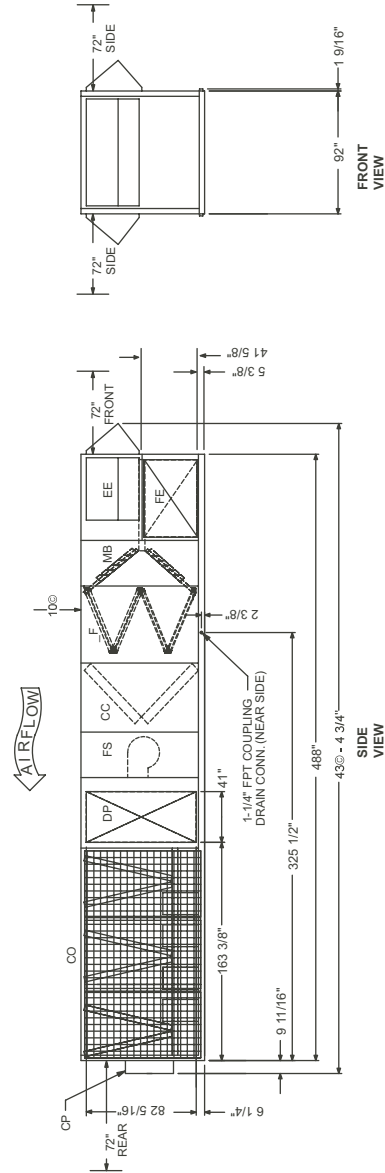

FRONT VIEW

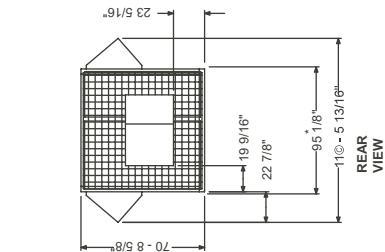

REAR VIEW

* - DIM IS TO OUTSIDE OF LIFTING LUGS

200 VOLT-3PH-60HZ
230 VOLT-3PH-60HZ
460 VOLT-3PH-60HZ
577 VOLT-3PH-60HZ
MODELS ONLY

FIGURE 13 - GENERAL ARRANGEMENT DRAWING

General Arrangement Drawing – 90-105 Ton Models (Cont'd)

LEFT SUPPLY / FRONT RETURN

SECTION DESCRIPTIONS:

- EE = Economizer
- FE = Fan Exhaust
- MB = Mixing Box
- F = Filter Segments
- CC = Cooling Coils
- FS = Supply Fan
- DP = Discharge Plenum
- CO = Condenser Section
- CP = Control Panel

- NOTES:**
1. 10' Clearance Minimal Over The Top of the Condensing Unit.
 2. Only One Adjacent Wall Can Exceed Unit Height.
 3. 12' Clearance Required to Adjacent Units
 4. 8' Service Access Recommended on One Side.
 5. Economizer and Exhaust Hoods, Where Applicable, are Folded Inside Unit for Shipment.

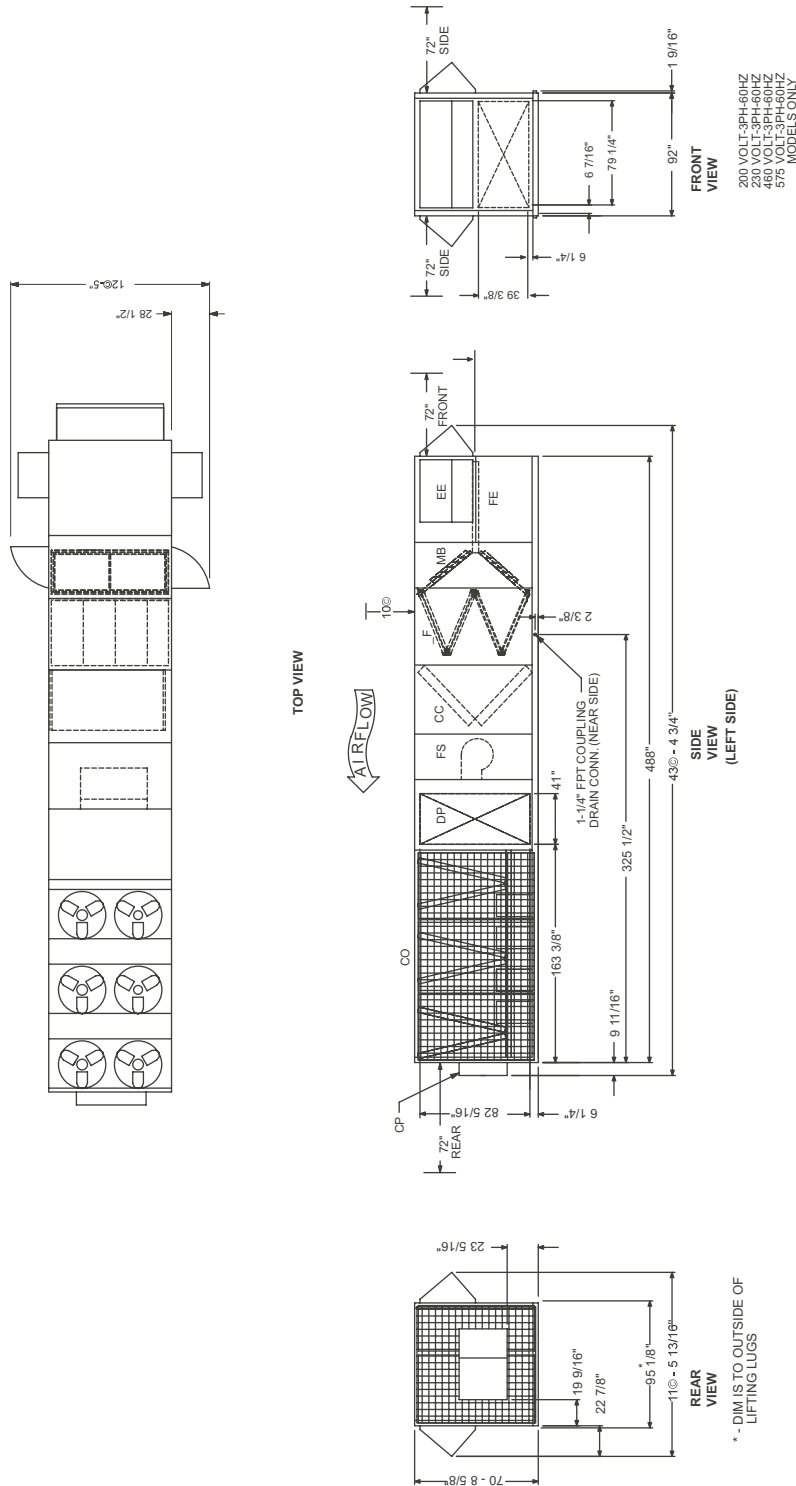

FIGURE 14 - GENERAL ARRANGEMENT DRAWING

ld08133

EXTENDED CABINET / BOTTOM SUPPLY / BOTTOM RETURN

SECTION DESCRIPTIONS:

- EE = Economizer
- FE = Fan Exhaust
- MB = Mixing Box
- F = Filter Segments
- CC = Cooling Coils
- FS = Supply Fan
- FF = Final Filter
- DP = Discharge Plenum
- CO = Condenser Section
- CP = Control Panel

- NOTES:**
1. 10' Clearance Minimal Over The Top of the Condensing Unit.
 2. Only One Adjacent Wall Can Exceed Unit Height.
 3. 12' Clearance Required to Adjacent Units
 4. 8' Service Access Recommended on One Side.
 5. Economizer and Exhaust Hoods, Where Applicable, are Folded Inside Unit for Shipment.
 6. Clearance Downstream of the Diffuser. If the Diffuser Factory Option is Not Installed, Clearance, Downstream of the Supply Fan Outlet is Required to Provide Adequate Air Flow and Reduce Air Pressure Drop.

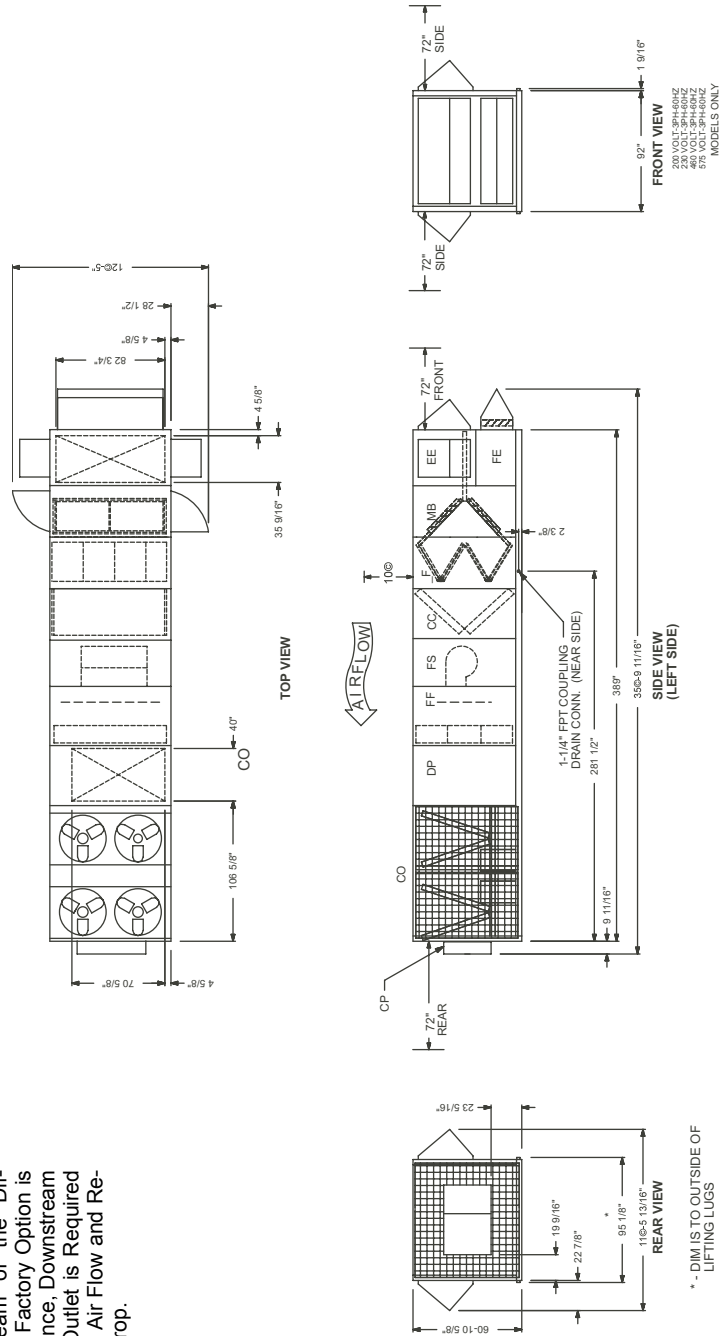

FIGURE 15 - GENERAL ARRANGEMENT DRAWING

General Arrangement Drawing – 70-80 Ton Models

EXTENDED CABINET / BOTTOM SUPPLY / BOTTOM RETURN

SECTION DESCRIPTIONS:

- EE = Economizer
- FE = Fan Exhaust
- MB = Mixing Box
- F = Filter Segments
- CC = Cooling Coils
- FS = Supply Fan
- DP = Discharge Plenum
- CO = Condenser Section
- CP = Control Panel

- NOTES:**
1. 10' Clearance Minimal Over The Top of the Condensing Unit.
 2. Only One Adjacent Wall Can Exceed Unit Height.
 3. 12' Clearance Required to Adjacent Units
 4. 8' Service Access Recommended on One Side.
 5. Economizer and Exhaust Hoods, Where Applicable, are Folded Inside Unit for Shipment.
 6. Clearance Downstream of the Diffuser. If the Diffuser Factory Option is Not Installed, Clearance, Downstream of the Supply Fan Outlet is Required to Provide Adequate Air Flow and Reduce Air Pressure Drop.

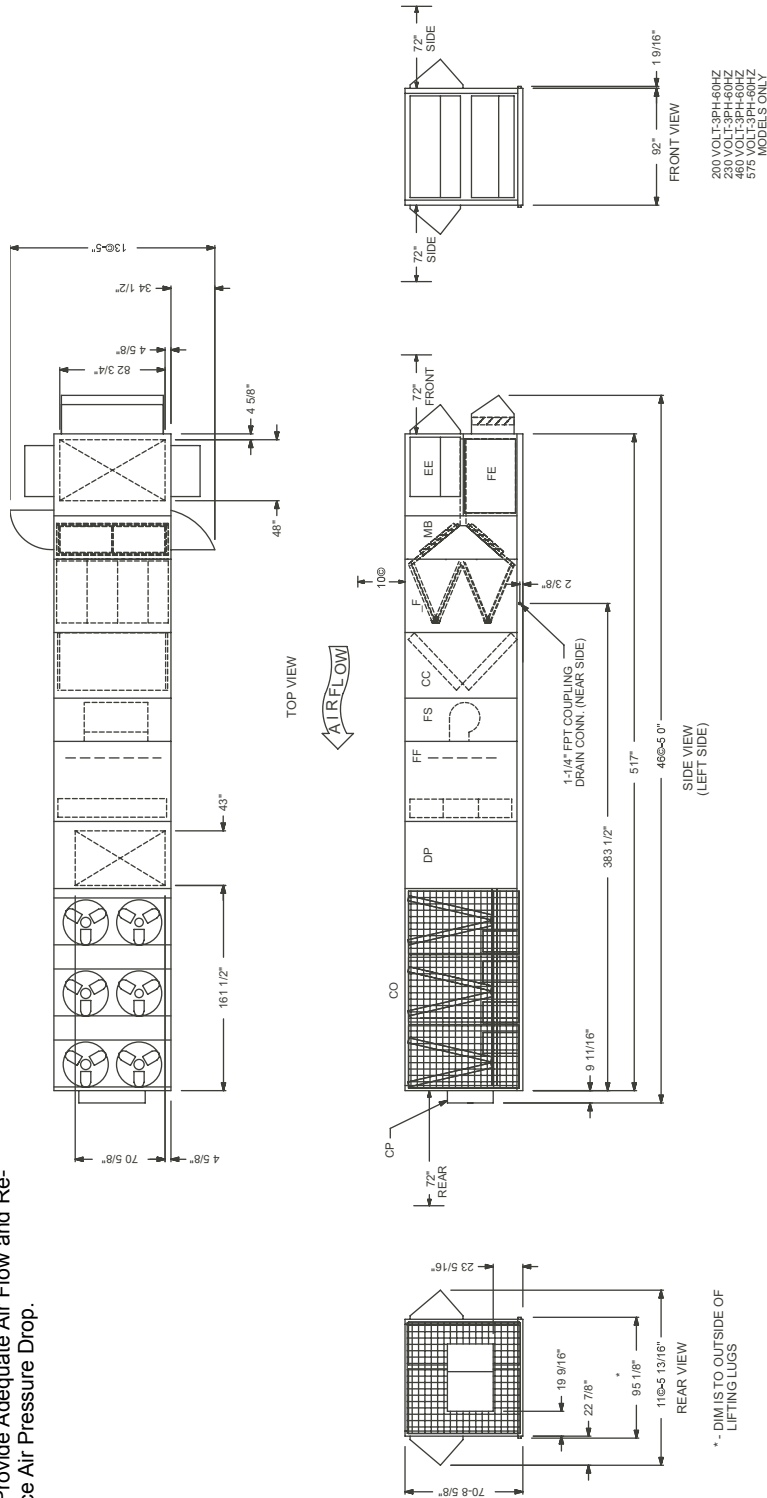

280 VOLT 3PH-60HZ
 230 VOLT 3PH-60HZ
 460 VOLT 3PH-60HZ
 575 VOLT 3PH-60HZ
 MODELS ONLY

FIGURE 16 - GENERAL ARRANGEMENT DRAWING

LD08138

EXTENDED CABINET / LEFT SUPPLY / LEFT RETURN

SECTION DESCRIPTIONS:

- EE = Economizer
- FE = Fan Exhaust
- MB = Mixing Box
- F = Filter Segments
- CC = Cooling Coils
- FS = Supply Fan
- FF = Final Filter
- DP = Discharge Plenum
- CO = Condenser Section
- CP = Control Panel

- NOTES:**
1. 10' Clearance Minimal Over The Top of the Condensing Unit.
 2. Only One Adjacent Wall Can Exceed Unit Height.
 3. 12' Clearance Required to Adjacent Units
 4. 8' Service Access Recommended on One Side.
 5. Economizer and Exhaust Hoods, Where Applicable, are Folded Inside Unit for Shipment.
 6. Clearance Downstream of the Diffuser. If the Diffuser Factory Option is Not Installed, Clearance, Downstream of the Supply Fan Outlet is Required to Provide Adequate Air Flow and Reduce Air Pressure Drop.

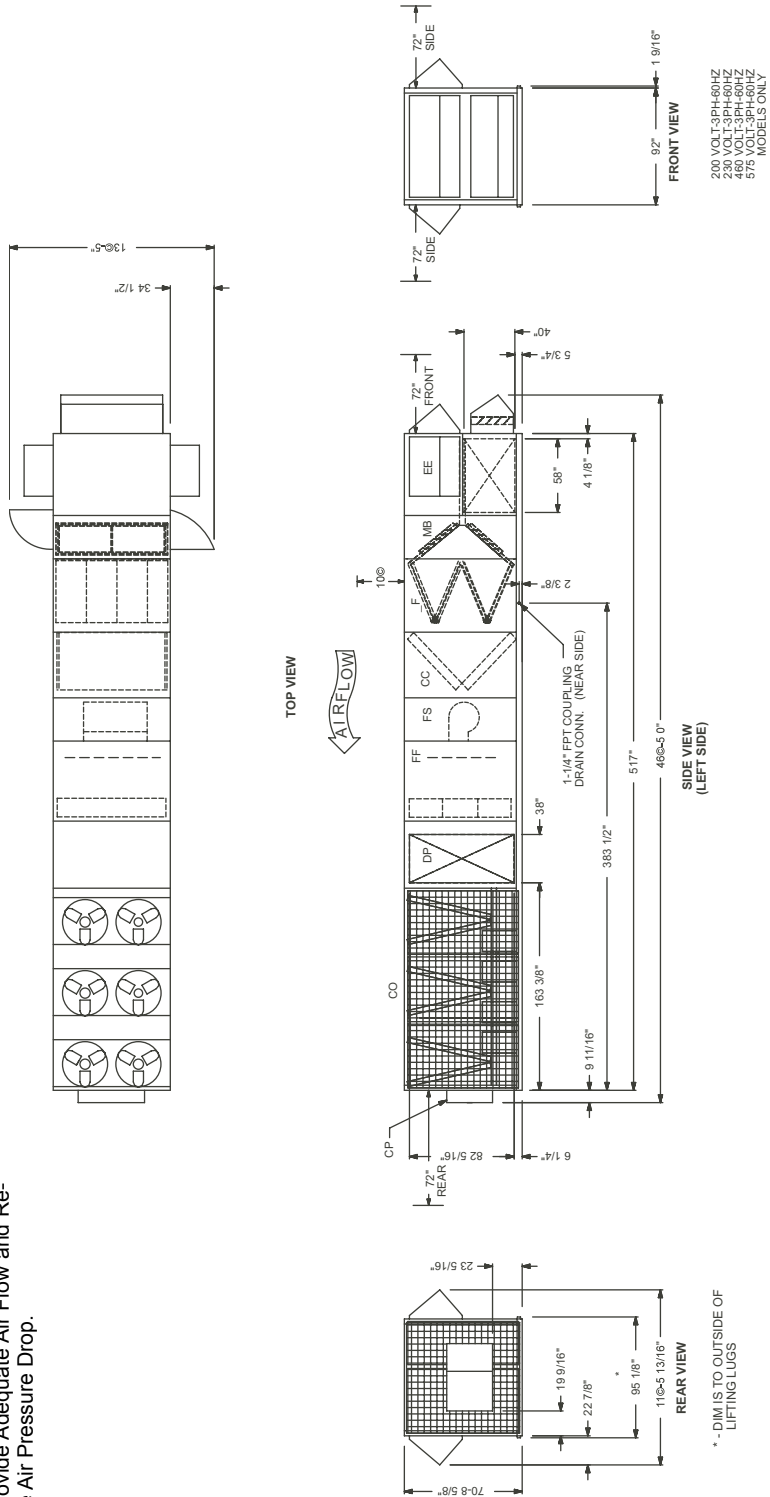

FIGURE 17 - GENERAL ARRANGEMENT DRAWING

General Arrangement Drawing – 70-80 Ton Models (Cont'd)

EXTENDED CABINET / LEFT SUPPLY / FRONT RETURN

SECTION DESCRIPTIONS:

- EE = Economizer
- FE = Fan Exhaust
- MB = Mixing Box
- F = Filter Segments
- CC = Cooling Coils
- FS = Supply Fan
- DP = Discharge Plenum
- CO = Condenser Section
- CP = Control Panel

- NOTES:**
1. 10' Clearance Minimal Over The Top of the Condensing Unit.
 2. Only One Adjacent Wall Can Exceed Unit Height.
 3. 12' Clearance Required to Adjacent Units
 4. 8' Service Access Recommended on One Side.
 5. Economizer and Exhaust Hoods, Where Applicable, are Folded Inside Unit for Shipment.
 6. Clearance Downstream of the Diffuser. If the Diffuser Factory Option is Not Installed, Clearance Downstream of the Supply Fan Outlet is Required to Provide Adequate Air Flow and Reduce Air Pressure Drop.

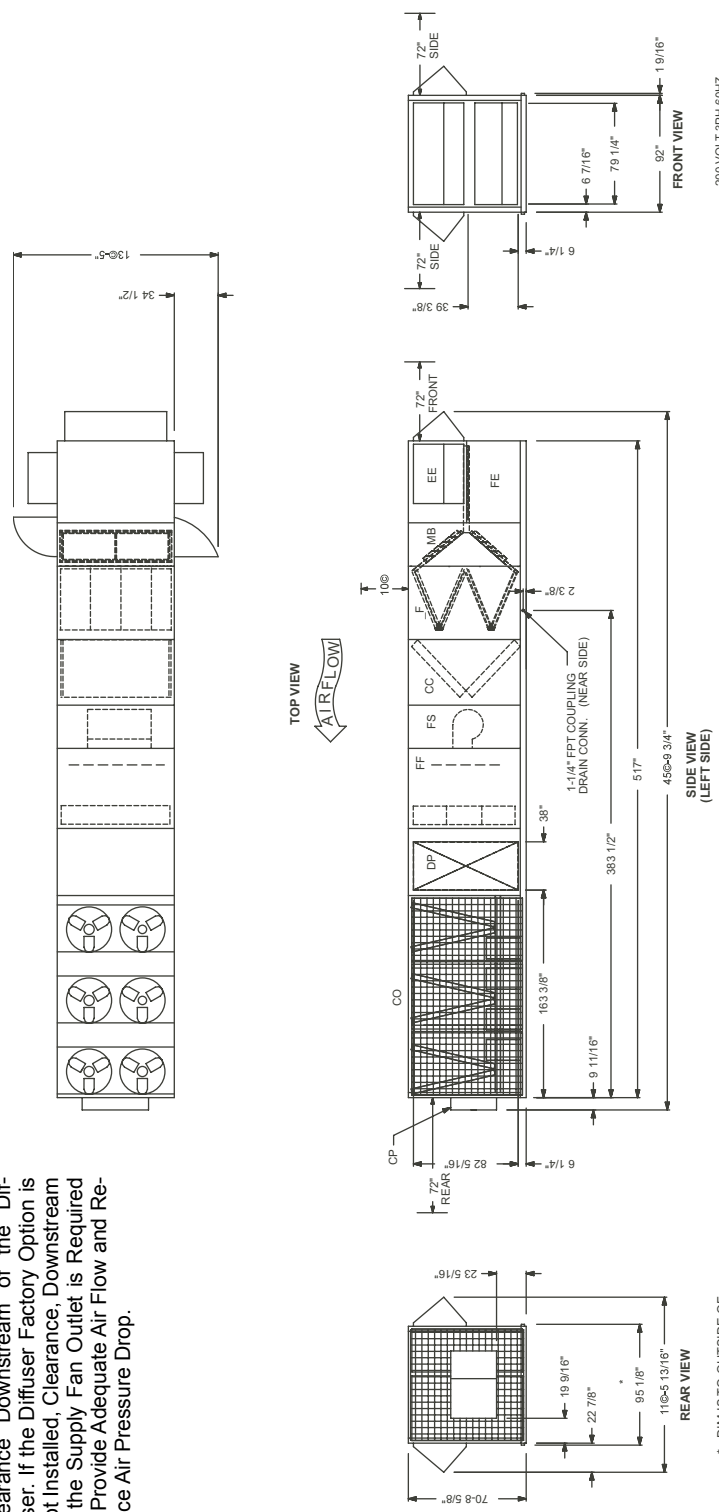

200 VOLT-3PH-60HZ
 400 VOLT-3PH-60HZ
 480 VOLT-3PH-60HZ
 575 VOLT-3PH-60HZ
 MODELS ONLY

* - DIM IS TO OUTSIDE OF LIFTING LUGS

FIGURE 18 - GENERAL ARRANGEMENT DRAWING

General Arrangement Drawing – 90-105 Ton Models

EXTENDED CABINET / BOTTOM SUPPLY / BOTTOM RETURN

SECTION DESCRIPTIONS:

- EE = Economizer
- FE = Fan Exhaust
- MB = Mixing Box
- F = Filter Segments
- CC = Cooling Coils
- FS = Supply Fan
- FF = Final Filter
- DP = Discharge Plenum
- CO = Condenser Section
- CP = Control Panel

- NOTES:**
1. 10' Clearance Minimal Over The Top of the Condensing Unit.
 2. Only One Adjacent Wall Can Exceed Unit Height.
 3. 12' Clearance Required to Adjacent Units
 4. 8' Service Access Recommended on One Side.
 5. Economizer and Exhaust Hoods, Where Applicable, are Folded Inside Unit for Shipment.
 6. Clearance Downstream of the Diffuser. If the Diffuser Factory Option is Not Installed, Clearance, Downstream of the Supply Fan Outlet is Required to Provide Adequate Air Flow and Reduce Air Pressure Drop.

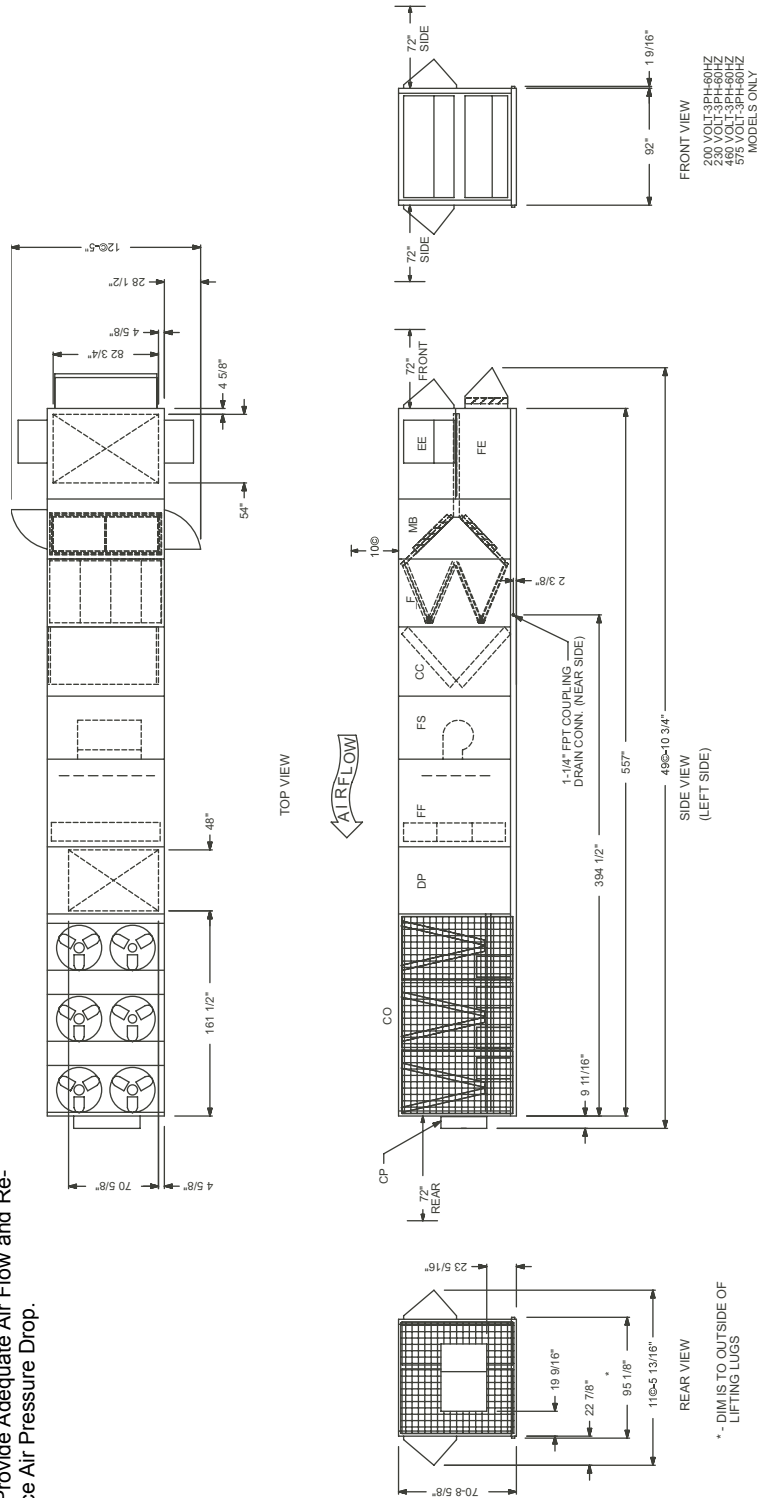

FIGURE 19 - GENERAL ARRANGEMENT DRAWING

General Arrangement Drawing – 90-105 Ton Models (Cont'd)

EXTENDED CABINET / LEFT SUPPLY / LEFT RETURN

NOTES:

1. 10' Clearance Minimal Over The Top of the Condensing Unit.
2. Only One Adjacent Wall Can Exceed Unit Height.
3. 12' Clearance Required to Adjacent Units
4. 8' Service Access Recommended on One Side.
5. Economizer and Exhaust Hoods, Where Applicable, are Folded Inside Unit for Shipment.
6. Clearance Downstream of the Diffuser. If the Diffuser Factory Option is Not Installed, Clearance, Downstream of the Supply Fan Outlet is Required to Provide Adequate Air Flow and Reduce Air Pressure Drop.

- ### SECTION DESCRIPTIONS:
- EE = Economizer
 - FE = Fan Exhaust
 - MB = Mixing Box
 - F = Filter Segments
 - CC = Cooling Coils
 - FS = Supply Fan
 - FF = Final Filter
 - DP = Discharge Plenum
 - CO = Condenser Section
 - CP = Control Panel

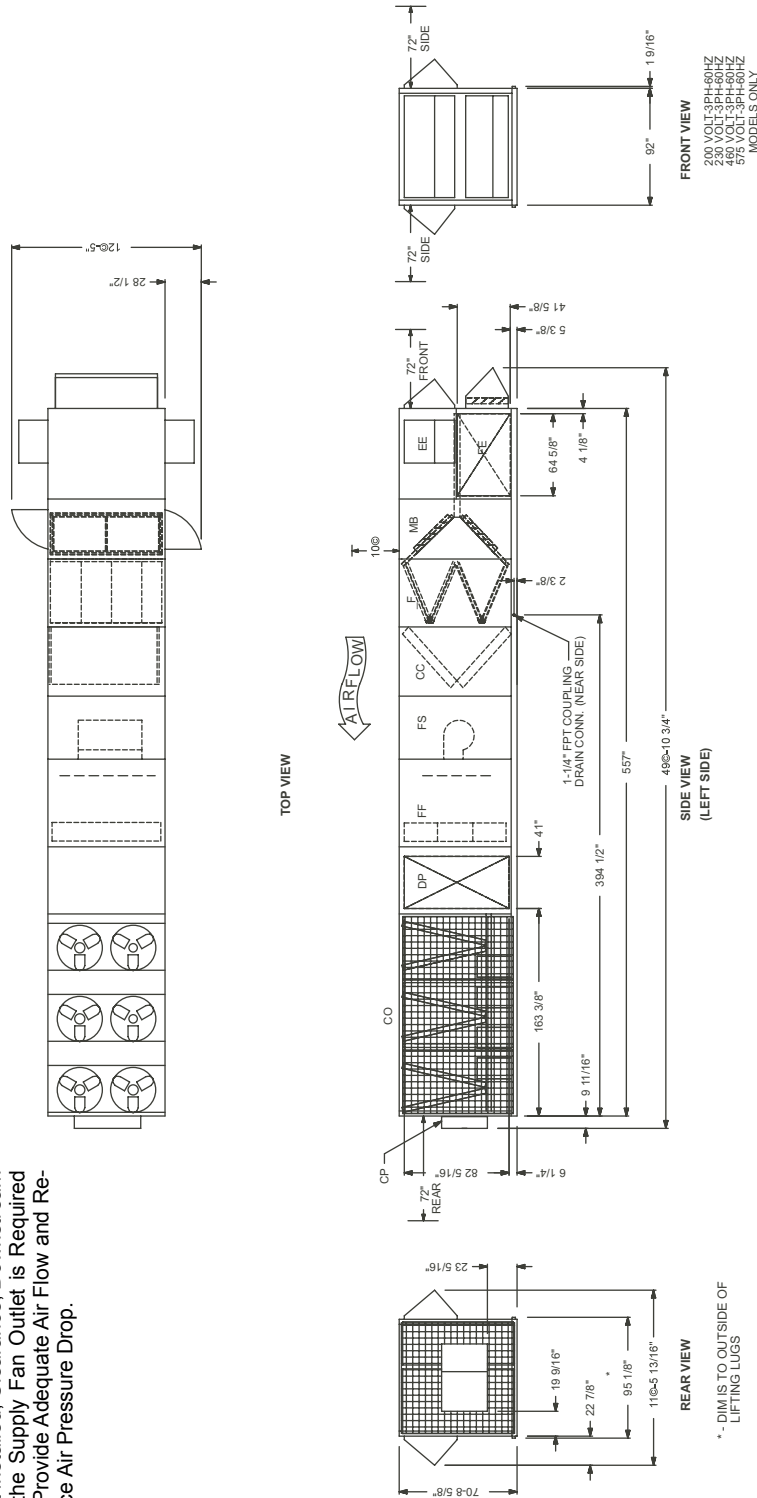

FIGURE 20 - GENERAL ARRANGEMENT DRAWING

Id08137

EXTENDED CABINET / LEFT SUPPLY / BOTTOM RETURN

SECTION DESCRIPTIONS:

- EE = Economizer
- FE = Fan Exhaust
- MB = Mixing Box
- _F = Filter Segments
- CC = Cooling Coils
- FS = Supply Fan
- FF = Final Filter
- DP = Discharge Plenum
- CO = Condenser Section
- CP = Control Panel

- NOTES:**
1. 10' Clearance Minimal Over The Top of the Condensing Unit.
 2. Only One Adjacent Wall Can Exceed Unit Height.
 3. 12' Clearance Required to Adjacent Units
 4. 8' Service Access Recommended on One Side.
 5. Economizer and Exhaust Hoods, Where Applicable, are Folded Inside Unit for Shipment.
 6. Clearance Downstream of the Diffuser. If the Diffuser Factory Option is Not Installed, Clearance, Downstream of the Supply Fan Outlet is Required to Provide Adequate Air Flow and Reduce Air Pressure Drop.

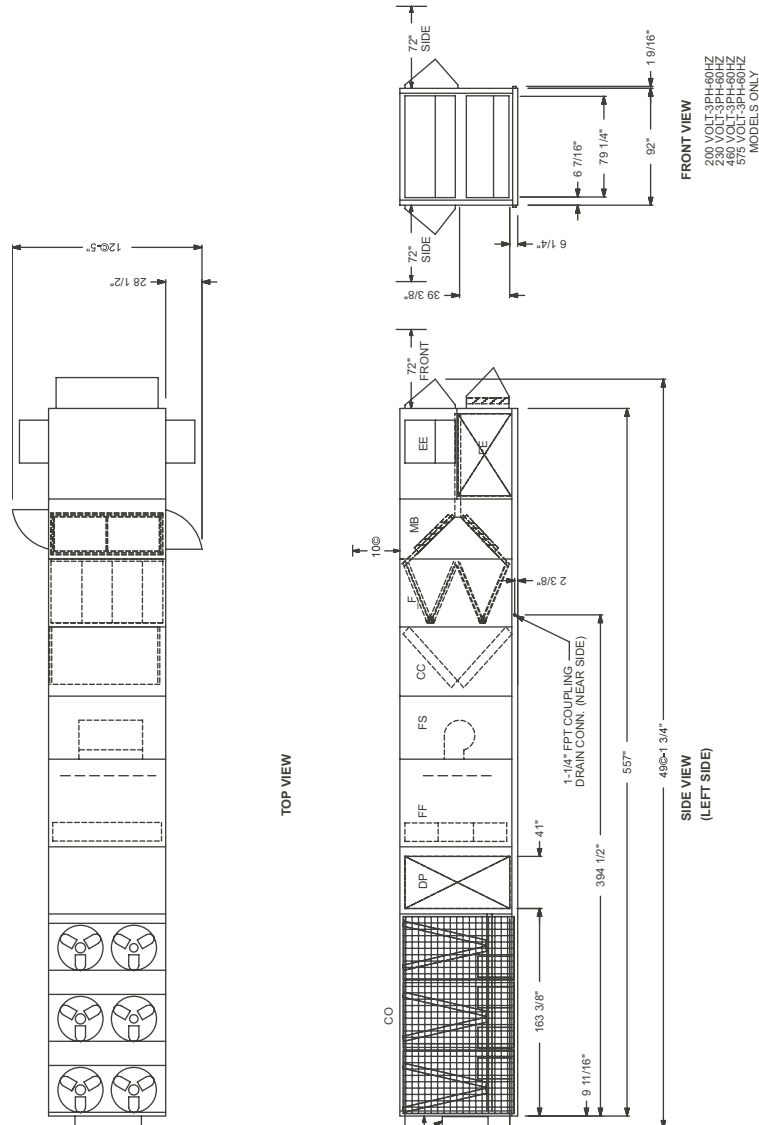
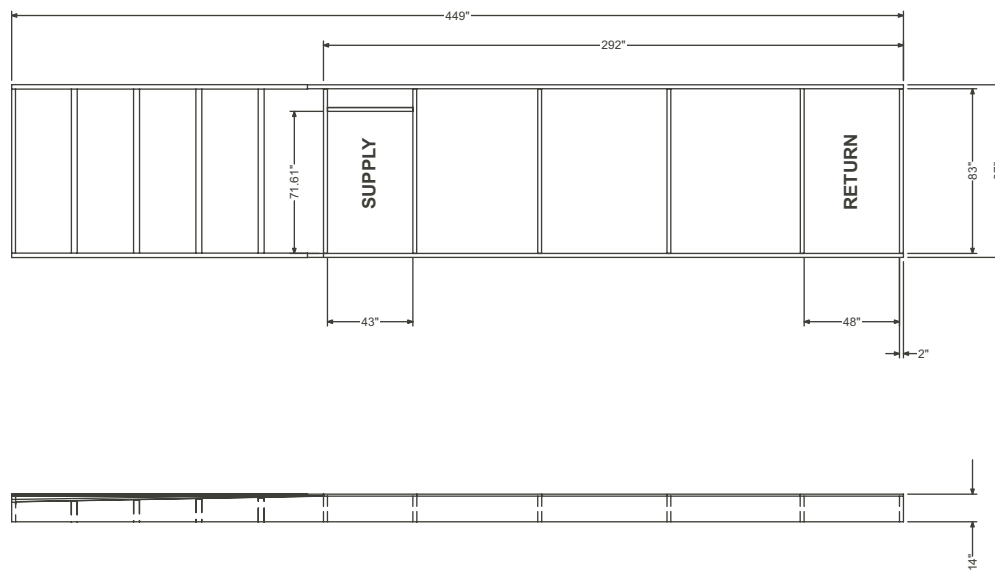

FIGURE 21 - GENERAL ARRANGEMENT DRAWING

THIS PAGE INTENTIONALLY LEFT BLANK.

General Arrangement Drawing

CURB LAYOUT DRAWING / 70-80 TON MODEL



CURB LAYOUT DRAWING / 90-105 TON MODEL

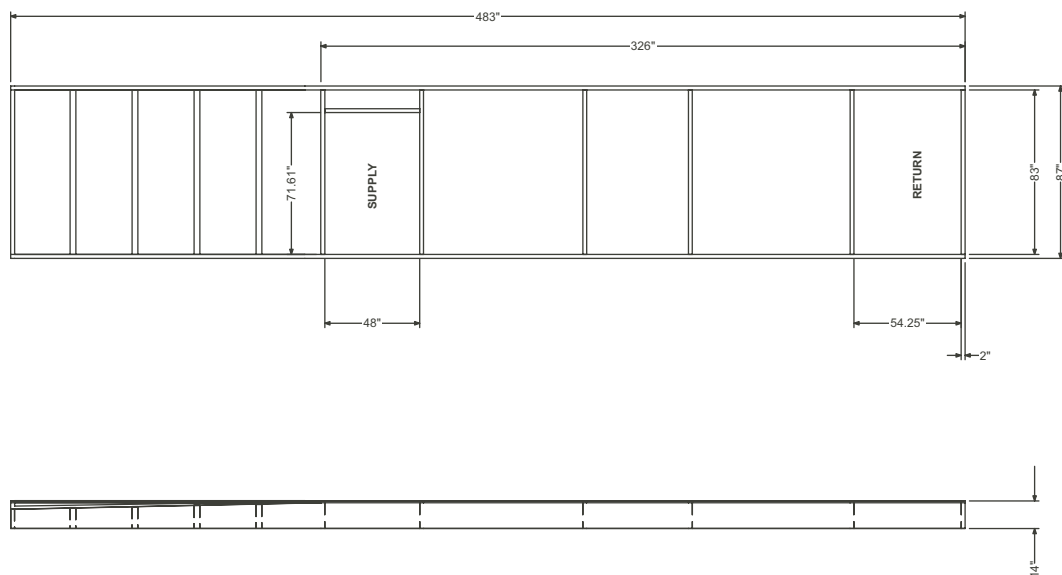

NOTES:

1. Unit must be installed square and level.
2. Curb configuration for "bottom" return and "bottom" supply.
3. These drawings are not intended as construction documents for the field fabricated roof curbs. JOHNSON CONTROLS will not be responsible for the unit fit up, leak integrity, or sound level for installation using field fabricated roof curbs.
4. The YPAL unit does not have a base pan under the condensing section of the unit. Field fabricated roof curbs must have a cap on the top of the condensing section of the curb to prevent moisture from entering the space. The cap design must be sloped away from the supply duct opening to the end of the unit for the drainage of the moisture off of the top of the cap.

FIGURE 22 - GENERAL ARRANGEMENT DRAWING

General Arrangement Drawing (Cont'd)

EXTENDED CURB LAYOUT DRAWING / 90-105 TON MODEL

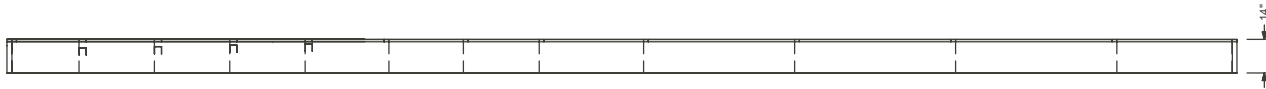
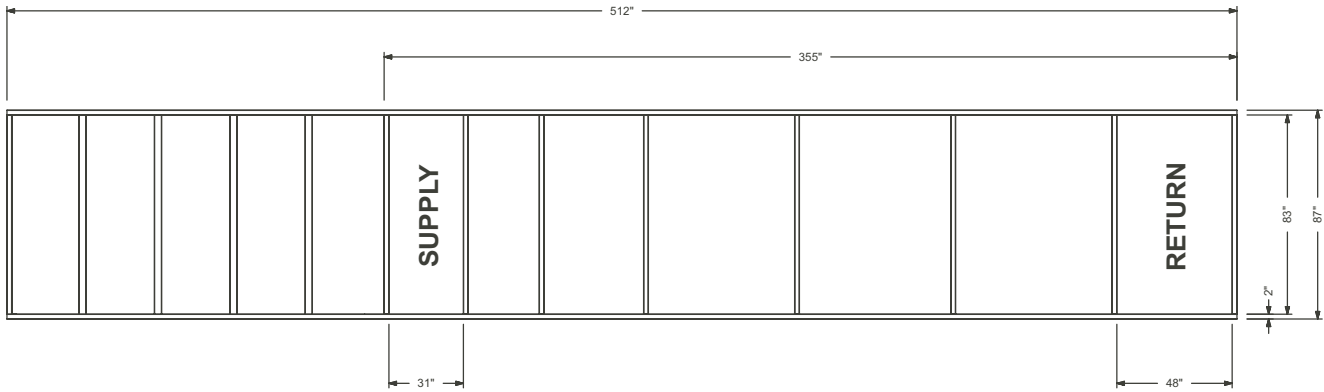

EXTENDED CURB LAYOUT DRAWING / 70-80 TON MODEL

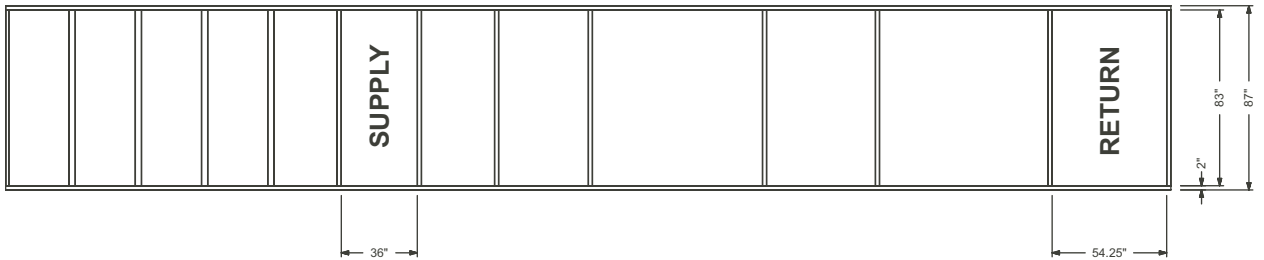

NOTES:

1. Unit must be installed square and level.
2. Curb configuration for "bottom" return and "bottom" supply.
3. These drawings are not intended as construction documents for the field fabricated roof curbs. JOHNSON CONTROLS will not be responsible for the unit fit up, leak integrity, or sound level for installation using field fabricated roof curbs.
4. The YPAL unit does not have a base pan under the condensing section of the unit. Field fabricated roof curbs must have a cap on the top of the condensing section of the curb to prevent moisture from entering the space. The cap design must be sloped away from the supply duct opening to the end of the unit for the drainage of the moisture off of the top of the cap.

FIGURE 23 - GENERAL ARRANGEMENT DRAWING

Hot Water/Steam Coil Connection Locations

HOT WATER & STEAM COIL CONNECTION LOCATIONS

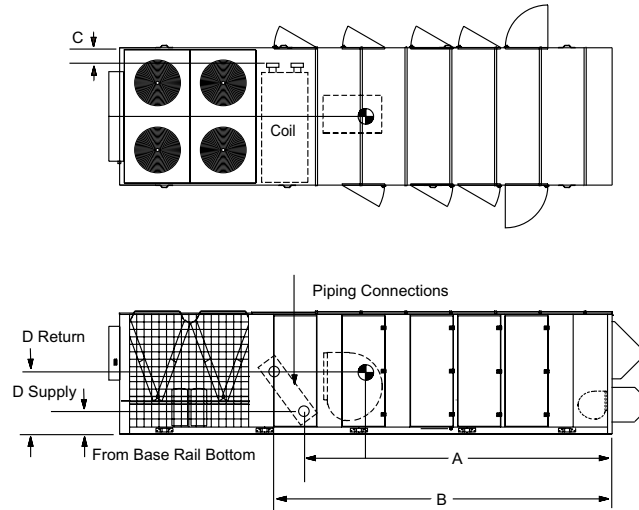

LD08119

TABLE 33 - FITTING LOCATION DIMENSIONS

UNIT SIZE	A	B	C	D _{SUPPLY}	D _{RETURN}	CONNECTION SIZES (INCHES)	
	Note 1	Note 2	Note 3	Note 4	Note 4	SUPPLY	RETURN
HOT WATER							
70-80	254.60	285.60	6.25	45.60	16.00	2" FPS	2" FPS
90-105	283.10	319.80	6.25	50.10	15.50	2" FPS	2" FPS
STEAM							
70-80	254.60	270.50	5.75	31.90	16.00	2" MPT	1.5" MPT
90-105	283.10	301.50	5.75	32.60	15.60	2" MPT	1.5" MPT

NOTES:

1. Location of return line connection, horizontal from economizer corner post, in direction of airflow
2. Location of supply line connection, horizontal from economizer corner post, in direction of airflow
3. Location of both supply and return lines, horizontal from outside casing of unit, across direction of airflow
4. Location of supply and return lines, vertical from bottom edge of base rail

MPT = Male Pipe Thread FPS = Female Pipe Sweat FPT = Female Pipe Thread

Hot Water Coil Connections w/ controls are valve connections facing bottom of the unit, at locations indicated.
 Steam and Hot Water connections w/o controls are fittings connections facing side of the unit, at locations indicated.

THIS PAGE INTENTIONALLY LEFT BLANK.

Power/Control Entry Drawing – 70-105 Ton Models

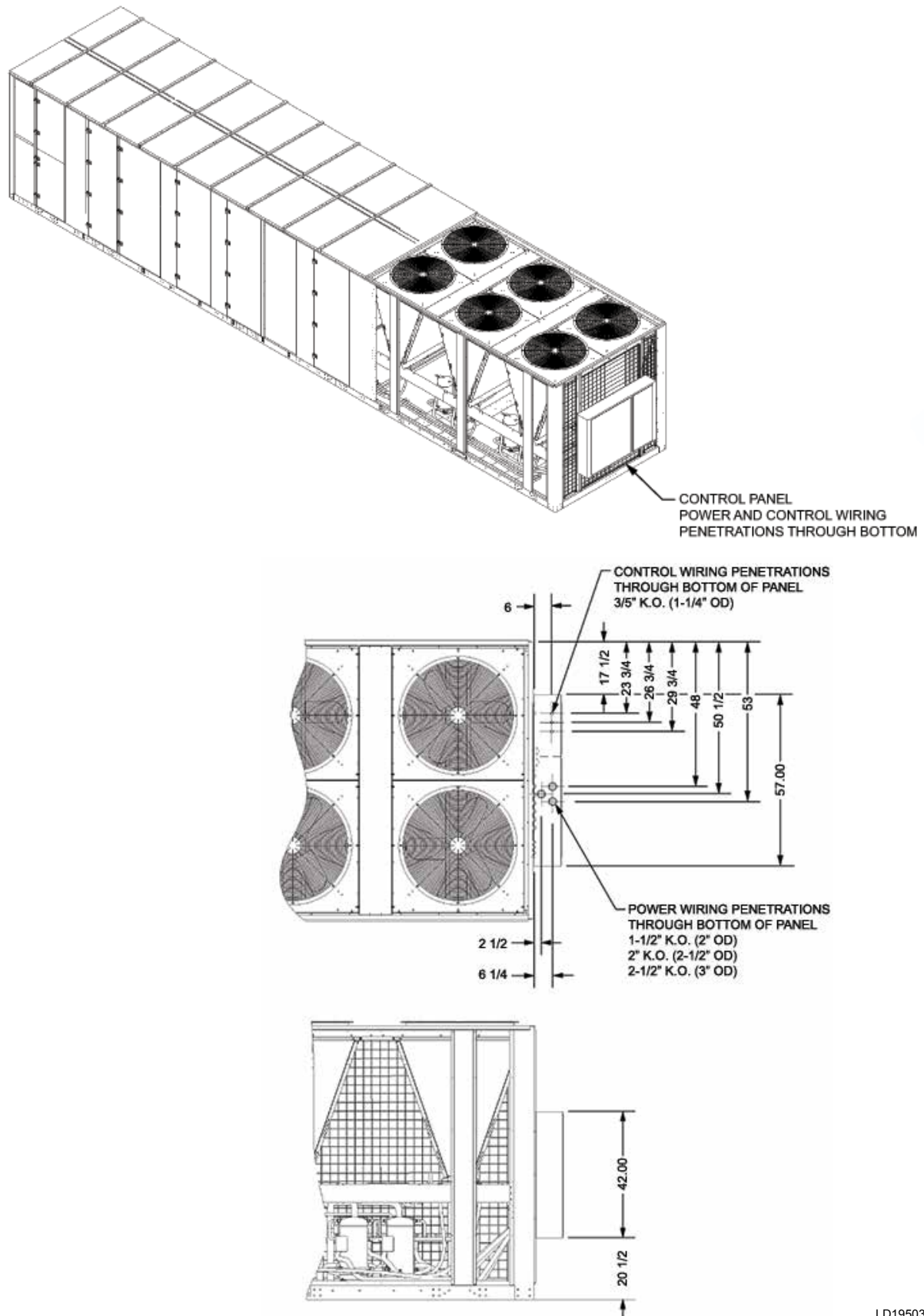

LD19503

FIGURE 24 - POWER/CONTROL ENTRY DRAWING – 70 - 105 TON MODELS

THIS PAGE INTENTIONALLY LEFT BLANK.

Guide Specifications

GENERAL

Scope

The requirements of the General Conditions, Supplementary Conditions, Division 1 and drawings apply to all work herein.

Provide Microprocessor-controlled, air-cooled, double-wall construction outdoor packaged single package unit air conditioning product of the scheduled capacities and performance as shown and indicated on the Drawings, including but not limited to:

1. Single-piece single package unit package
2. Charge of refrigerant and oil
3. Electrical power and control connections
4. Supply and return duct connections
5. Factory start-up

Quality Assurance

All units are tested, rated or certified, as applicable, in accordance with the following standards, guidelines and codes:

1. All units shall meet the latest ASHRAE 90.1 minimum energy-efficiency requirements (EER)
2. All units shall meet the latest ASHRAE 62 requirements for ventilation and indoor air quality.
3. All units shall be rated in accordance with the ARI Standard 340/360
4. All units shall be tested to ANSI/UL 1995 and CAN/CSA C22.2 No. 236 standards
5. Gas heating units shall be designed in conform to ANSI Z21.47-2006/CSA2.3-2006 standards and be carry the ETL listed.
6. Units shall be ETL and ETL Canada listed

Manufacturers: The design shown on the drawing is based upon products of the manufacturer scheduled. Alternate equipment manufacturers shall be acceptable if equipment meets the scheduled performance and complies with these specifications. If equipment manufactured by manufacturer other than that scheduled is utilized, then the Mechanical Contractor shall be responsible for coordinating with the General Contractor and all affected Subcontractors to insure proper provisions for installation of the furnished unit. This coordination shall include, but not be limited to, the following:

1. Structural supports for units.
2. Roof curb transition.
3. Piping size and connection/header locations.
4. Electrical power requirements and wire/conduit and overcurrent protection sizes.
5. All costs incurred to modify the building provisions to accept the furnished units.

Warranty: Manufacturer shall warrant all equipment and material of its manufacture against defects in workmanship and material for a period of eighteen (18) months from date of shipment.

1. The warranty shall include parts only during this period.
2. The warranty shall not include parts associated with routine maintenance, such as belts, air filters, etc.

Delivery and Handling

Unit shall be delivered to the job site fully assembled, wired, and charged with refrigerant and oil by the manufacturer.

Unit shall be stored and handled per Manufacturer's instructions.

All handling and storage procedures shall be per manufacturer's recommendations.

Submittals

Shop Drawings: Shop drawing submittals shall include, but not limited to, the following: drawings indicating components, dimensions, weights, required clearances, and location, type and size of field connections, and power and control wiring connections.

Product Data: Product data shall include dimensions, weights, capacities, ratings, fan performance, motor electrical characteristics, and gauges and finishes of materials.

Documentation:

1. Fan curves with specified operating point clearly plotted shall be provided.
2. Product data of filter media, filter performance data, filter assembly, and filter frames shall be provided.

Guide Specifications (Cont'd)

3. Electrical requirements for power supply wiring; including wiring diagrams for interlock and control wiring shall be supplied. Factory and field-installed wiring shall be clearly indicated.
4. Operation and maintenance documentation shall be supplied in accordance with Section 01830 – Operation and Maintenance, including but not limited to instructions for lubrication, filter replacement, compressor, motor and drive replacement, coil cleaning, filter maintenance, spare parts lists, and wiring diagrams.

Warranties

Equipment shall include the manufacturer's warranty not less than eighteen months from the date of shipment.

Extended parts warranty [optional] shall be included for an additional one [five] years

Extended parts and labor warranty [optional] shall be included for an additional one [five] years

EQUIPMENT

Product Specification

Summary: Completely factory assembled unitized construction packaged single package unit air conditioning unit including a factory-mounted and wired unit controller and sensors, single-point power connection 460V [208V/230V/575V] three-phase, 60Hz power supply, outdoor air handling section with return and supply openings, discharge plenum, direct-expansion refrigerant condensing section.

Factory Test: The refrigerant circuit shall be pressure-tested, evacuated and fully charged with refrigerant and oil. The completed refrigerant circuit shall undergo a factory helium leak test and undergo an automated operational run test and quality inspection prior to shipment. The unit controller shall be configured and run tested at the factory to minimize field setup time. If the unit is not configured and tested, then the manufacturer shall provide field start up and testing to ensure that the controller is functioning properly.

Unit Construction

Base Rail: The unit shall include an integral design base rail with lifting points clearly marked and visible on the base rail and a 1-1/4" FPT connection for condensate drainage. The unit base shall be designed with a recessed curb mounting location. The recessed curb-mounting surface shall provide a continuous surface for field application of curb gasketing to create a weather tight seal between the curb and unit.

Casing: Casing shall be complete post and panel construction with exterior skin. All panels, doors, walls, up-rights, floor panels and roofing shall be one-inch thick; 1-1/2 pound density insulation. Units are specifically designed for outdoor installation.

Roof: The unit roof shall be bowed with the peak in the middle of the unit and sloped to both sides of the unit for drainage. A drip lip shall run the length of the unit to prevent water drainage down the side of the unit. Roof and sidewall seams shall be continuously caulked and covered with formed galvanized seam caps. All panel fasteners shall be secured through standing seams to prevent fastener penetrations that are exposed to the air stream.

Paint: Exterior painted surfaces are designed to withstand a minimum of 500 salt spray hours when tested in accordance with ASTM B-117.

Markings and Diagrams: All necessary tags and decals to aid in the service and/or indicating caution areas shall be provided. Electrical wiring diagrams shall be attached to the control panel access door.

Documentation: Installation and maintenance manuals shall be supplied with each unit.

Access Doors: Double wall access doors shall be provided in the fan, coil, filter and inlet sections of the unit on both sides of the unit. Doors shall be double-wall construction with a solid liner and a minimum thickness of 1-inch. Doors shall be attached to the unit with piano-type stainless steel hinges. Latches shall be positive-action, creating an airtight seal between the door and unit. Panels and doors shall be completely gasketed with a closed-cell, neoprene gasket. Door tiebacks shall be provided for all doors to secure doors while servicing.

Economizer Type

Select None or One of the Following

1. **No Outside Air:** the unit has no provisions for outside ventilation air.
2. **Manual Outside Air Damper:** A manually adjustable outside air damper capable of admitting 0-25% outside air shall be provided.
3. **Two-Position Outside Air Damper:** A two position damper outside air damper capable of admitting 0-25% outside air shall be provided. The minimum position shall be manually adjustable from 0-25%. Control shall be based on the occupied mode of the unit. For occupied mode, the damper shall be open to the minimum position and for unoccupied, it shall be closed.

4. **Modulating Economizer:** The economizer segment shall be designed to use outside air for cooling and ventilation and provide a means of exhausting air from the air-handling unit. The segment shall consist of parallel acting low-leak dampers. The return air, outside air and exhaust air dampers shall be sized for 100% of nominal unit airflow. The exhaust air damper assembly shall have a factory-assembled rain hood. The rain hood shall have a drip-lip the full width of the hood to channel moisture away from the air being drawn into the unit.

Economizer Leakage

Select One of the Following

1. Damper assemblies are low-leak design. Damper blades are fabricated from a minimum of 16-gauge galvanized steel. Blade edges are covered with vinyl seals.
2. Damper assemblies have a maximum leakage rate of 10 CFM/Sq-ft at 1.0 in WC when tested in accordance with AMCA Standard 500, and have a longevity of 60,000 damper opening and closing cycles, complying with the requirements of California Title 24.

Select One of the Following Types of Building Pressure Control

1. **No Building Exhaust/Relief:** The unit has no provisions to exhaust building return air.
2. **Barometric Relief Damper:** Building air exhaust shall be accomplished through barometric relief dampers installed in the return air plenum. The dampers open relative to the building pressure. The opening pressure shall be adjustable.
3. **On/Off Fan Powered Exhaust:** A twin DWDI Class II forward-curved centrifugal exhaust fan shall be provided to exhaust building return air to relieve building static pressure. The fans shall be constant volume and operate based on either a building static pressure, or outside air damper position.
4. **Powered Exhaust with Modulating Discharge Damper:** A twin DWDI Class II forward-curved centrifugal exhaust fan shall be provided to exhaust building return air to relieve building static pressure. The fans shall operate at a constant volume and operate based on building static pressure. Exhaust airflow shall be modulated via a parallel-acting control damper. The exhaust air dampers shall be sized for 100% of the exhaust airflow.

5. **Powered Exhaust with Variable-Frequency-Drive:** A twin DWDI Class II forward-curved centrifugal exhaust fan shall be provided to exhaust building return air to relieve building static pressure. Exhaust airflow shall be modulated via a factory-installed and commissioned variable-frequency-drive with the same nameplate horsepower as the supply fan motor.
6. **Power Return Fan:** Two SWSI plenum fans shall be provided to draw return air from the building to the single package unit. An access door shall be provided on at least one side of the unit for fan/motor access. The return fan shall operate to maintain a constant pressure within the return plenum.
7. **Power Return Fan:** Two SWSI plenum fans shall be provided to draw return air from the building to the single package unit. An access door shall be provided on at least one side of the unit for fan/motor access. The return fan shall operate to maintain a constant pressure within the return plenum. A discharge damper shall be provided to modulate building exhaust. The damper shall be controlled via building pressure. The return damper shall linked with the outside air damper to modulate volumes of return and outside airflows.

For Powered Exhaust or Return Fan Options Above, Use The Following

1. **Fan Motor:** Fan motors shall be NEMA design ball-bearing types with electrical characteristics and horsepower as specified. Motors shall be 1750 RPM, open drip-proof type [TEFC]. [Optional shaft grounding rings on motors increase motor longevity when applied with a VFD.] The motor shall be located within the unit on an adjustable base.

Mountings: Fan and fan motor shall be internally mounted and isolated on a full width isolator support channel using 1-inch springs [**2-inch springs and seismic restraints**]. The fan discharge shall be connected to the fan cabinet using a flexible connection to insure vibration-free operation.

Bearings and Drives: Fan bearings shall be self-aligning, pillow block or flanged type regreaseable ball bearings and shall be designed for an average life (L50) of at least 200,000 hours. All bearings shall be factory lubricated and equipped with standard hydraulic grease fittings and lube lines extended to the motor side of the fan. Fan drives shall be selected for a 1.5 service factor and anti-static belts shall be furnished. All drives shall be

Guide Specifications (Cont'd)

fixed pitch. Fan shafts shall be selected to operate well below the first critical speed and each shaft shall be factory coated after assembly with an anti-corrosion coating.

Filter Section

Select a Filter Rack, Filter Media, and Switch if Desired

1. **Angled Filter Rack:** two-inch throwaway filters shall be provided in an angled filter rack.
2. **Angled Filter Rack:** two-inch cleanable filters shall be provided in an angled filter rack.
3. **Angled Filter Rack:** two-inch MERV 8 carbon media filters shall be provided in an angled filter rack.
4. **Angled Filter Rack:** two-inch high-efficiency (30%) MERV 8 pleated filters shall be provided in an angled filter rack.
5. **Flat Filter Rack:** 60-65% Efficient MERV 11 Rigid Filters with a two-inch high-efficiency MERV 8 pleated pre-filters shall be provided in a flat filter rack.
6. **Flat Filter Rack:** 90-95% Efficient MERV 14 Rigid Filters with a two-inch high-efficiency MERV 8 pleated pre-filters shall be provided in a flat filter rack.
7. **Dirty Filter Alarm:** A dirty filter switch shall be provided and wired to the single package unit control panel. Upon closure of the switch, the controller shall display a dirty filter fault. The setting of the switch can be changed manually to close at a specified pressure drop across the filters.

Evaporator Section

1. **Cooling Coil:** Evaporator coils shall be direct expansion type with intertwined circuiting to assure complete coil face activity during part load operation. Coil tubes shall be 3/8" OD copper, with internally enhanced tubes. Fins shall be enhanced mechanically expanded to bond with the copper tubes. Coil casing shall be fabricated from heavy gauge galvanized steel. All coils shall be pressure tested at a minimum of 450 PSIG.
2. **IAQ Drain Pan:** The main coil drain pan shall be double-sloped stainless steel with a condensate connection through the base rail of the unit. Clearance between the evaporator coil and the drain pan shall allow for easy access to the drain pan for cleaning, and shall be visible for inspection without the removal of components.

3. **Intermediate Drain Pan:** Coils with finned height greater than 48" shall have an intermediate drain pan extending the entire finned length of the coil. The intermediate pans shall have drop tubes to guide condensate to the main drain pan.

Supply Fan Section

1. **Fan:** The fan section shall be equipped with a single double width, double inlet (DWDI) forward-curved [airfoil optional on 70-85T but standard on 90-105T] centrifugal type wheels. An access door shall be provided on both sides of the unit for fan/motor access.
2. **Fan Motor:** Fan motors shall be NEMA design ball-bearing types with electrical characteristics and horsepower as specified. Motors shall be 1750 RPM, open drip-proof type [TEFC optional]. [Optional shaft grounding rings on motors increase motor longevity when applied with a VFD.] The motor shall be located within the unit on an adjustable base.

Mountings: Fan and fan motor shall be internally mounted and isolated on a full width isolator support channel using 1-inch [2-inch optional] springs [with optional seismic restraints]. The fan discharge shall be connected to the fan cabinet using a flexible connection to insure vibration-free operation.

Bearings and Drives: Fan bearings shall be self-aligning, pillow block or flanged type regreaseable ball bearings and shall be designed for an average life (L50) of at least 200,000 hours. All bearings shall be factory lubricated and equipped with standard hydraulic grease fittings and lube lines extended to the motor side of the fan. Fan drives shall be selected for a 1.5 service factor and anti-static belts shall be furnished. All drives shall be fixed pitch. Fan shafts shall be selected to operate well below the first critical speed and each shaft shall be factory coated after assembly with an anti-corrosion coating.

3. **VAV Fan Control:** VAV supply fan control shall be accomplished by using a variable-frequency-drive matched to the supply fan motor HP. The VFD shall include an integral DC line reactor to reduce harmonic distortion in the incoming and outgoing power feeds. If a DC line reactor is not provided, an AC line reactor must be provided. Inlet guide vanes shall not be acceptable. VFD control keypads shall be located in the control cabinet for accessibility and servicing while the unit is operating.

- Optional VFD manual bypass: a three contactor manual bypass shall be provided to permit replacement of the VFD in the event of a power failure.

Discharge Plenum

Select One of the Following Heat/No Heat Configurations:

- Cooling Only:** The discharge air temperature sensor shall be located in the discharge plenum and be located such that it accurately measures the supply air temperature. Walls shall be lined with a solid liner to prevent erosion of the insulation and separate insulation from the air stream.
- Staged Gas Heat:** The heating section shall include an induced draft furnace in two stages [four stages or six stages] of heating capacity.

Heat Exchanger: The heat exchanger shall be constructed of tubular aluminized steel [stainless steel], with stainless steel flue baffles and flue assembly.

Burner and Ignition Control: The burner shall include a direct-driven induced-draft combustion fan with energy efficient intermittent pilot spark ignition, redundant main gas valves with pressure regulator.

Combustion Air Fan: The inducer fan(s) shall maintain a positive flow of air through each tube, to expel the flue gas and to maintain a negative pressure within the heat exchanger relative to the conditioned space.

Safety Devices: A high limit controller with automatic reset to prevent the heat exchanger from operating at an excessive temperature shall be included. A centrifugal switch on the induced draft fan motor shaft shall prevent ignition until sufficient airflow is established through the heat exchanger. A rollout switch shall provide secondary airflow safety protection. The rollout switch shall discontinue furnace operation if the flue becomes restricted.

Flue: The furnace flue shall be shipped loose to protect it from damage during transit. The flue shall be field-mounted by the installing contractor. The flue outlet shall be located above the unit to help prevent recycling of combustion gases back through the heat exchanger. Agency Certification: Gas heating sections are ETL listed to both US and Canadian safety standards.

- Modulating Gas Heat:** The heating section shall include an induced draft furnace in 8:1 modulation [16:1, 24:1] of heating capacity.

Heat Exchanger(s): The heat exchanger(s) shall be constructed of tubular aluminized steel [stainless steel], with stainless steel flue baffles and flue assembly.

Burner(s) and Ignition Control: The burner(s) shall include a direct-driven induced-draft combustion fan with energy efficient intermittent pilot spark ignition, redundant main gas valves with pressure regulator.

Combustion Air Fan(s): The inducer fan(s) shall maintain a positive flow of air through each tube, to expel the flue gas and to maintain a negative pressure within the heat exchanger relative to the conditioned space.

Safety Devices: A high limit controller with automatic reset to prevent the heat exchanger from operating at an excessive temperature shall be included. A centrifugal switch on the induced draft fan motor shaft shall prevent ignition until sufficient airflow is established through the heat exchanger. A rollout switch shall provide secondary airflow safety protection. The rollout switch shall discontinue furnace operation if the flue becomes restricted.

Flue: The furnace flue shall be shipped loose to protect it from damage during transit. The flue shall be field-mounted by the installing contractor. The flue outlet shall be located above the unit to help prevent recycling of combustion gases back through the heat exchanger.

Agency Certification: Gas heating sections are ETL listed to both US and Canadian safety standards.

- Electric Heat:** An electric slip-in heater is installed within the single package unit discharge plenum to provide the heating requirements per the schedule shown on the plans. The electric heater is wired in such a manner as to provide a minimum of two steps of capacity.

Heat Exchanger: The furnace is an industrial grade design using an open coil made of the highest-grade resistance wire containing 80% nickel and 20% chromium. The resistance coils are adequately supported in the air stream using ceramic bushings in the supporting framework. Terminals of the coil are stainless steel with high temperature ceramic bushings.

Guide Specifications (Cont'd)

Safety Devices: The primary high temperature protection is a manual reset type thermal cut out. Secondary protection is a manual reset type thermal cut out. Secondary protection is a replaceable thermal link.

Agency Certification: The operation of the electric heater is an integral part of the single package units control system. Power connection to the heater is through the power panel for the unit. Electric heat is ETL certified to both US and Canadian safety standards.

5. **Hot Water Heating Coil:** A hot water coil shall be installed in the single package unit discharge plenum.

Construction: The hot water coil shall have eight [10, 12, 14] fins per inch, 2 tubes per circuit, and an 2" inlet and outlet connection. Primary surface shall be 1/2" OD copper tube, staggered in direction of airflow. Connections have 1/4" FPT drain plug on each connection. A structural galvanized steel casing shall protect the coil. An intermediate coil support shall be provided. The coil shall be circuited to provide free draining and venting, through one vent and drain. Freezestat shall be provided to prevent coil freeze up.

Testing: Completed coil, including headers, connections and return bends shall be tested with 325 pounds compressed air under water. Coils shall be designed for operation at 250 psig design working pressure.

6. **Steam Heating Coil:** A steam heating coil shall be installed in the single package unit discharge plenum.

Construction: The steam coil shall be constructed in the non-freeze style. The steam coil shall have six fins per inch, an 2" inlet, and 1 1/2" outlet connection. Tubes shall be 1" OD seamless copper tubing with a minimum wall thickness of 0.035" and expanded into the fin collars for maximum fin-tube bond. Inner distributing tubes shall be 5/8" OD seamless copper tubing with a minimum wall thickness of 1/4". All header connections shall be of red brass or steel, with male pipe threads and silver braze to headers. Casing shall be galvanized steel. The core shall be pitched in the direction of the condensate connection for proper drainage. Freezestat shall be provided to prevent coil freeze up.

Testing: The completed coil, including headers and connections, shall be tested underwater with 325 lbs. compressed air to ensure a leak free coil.

7. **Diffuser Section:** For applications with an extended discharge plenum with downstream filtration or heating, a diffuser section is provided. A diffuser shall be included to distribute the airflow from the fan evenly across the heating coil or filter bank to optimize coil/filter life and effectiveness. The diffuser shall be sized for 50% free area and provide adequate upstream and downstream clearance to minimize airside pressure drop.

For Extended Discharge Plenums, Select One of the Following:

1. **Downstream Final Filter Rack:** A 12-inch rigid filter rack and filters shall be provided downstream of the supply fan and diffuser segment for hospital applications. The filter shall be 90-95% efficient MERV 14. A magnahelic pressure gauge shall be included and visible from the outside of the unit for servicing and code compliance.
2. **Blank Section:** A blank section shall be provided downstream of the supply fan and diffuser section.

Condenser Section

1. **Condenser Fans:** Condenser fans shall be matched up with compressors to optimize system control. Condenser fans shall be propeller type, directly driven by permanently lubricated TEAO motor.
2. **Condenser Coil:** Microchannel condenser coils shall be constructed of parallel flow aluminum alloy tubes metallurgically brazed to enhanced aluminum alloy fins. Coils are configured in a V-bank configuration, with individual flat coils rotated from the vertical plane for protection from hail damage for each condensing circuit. Condensing coils shall have a subcooler for more efficient, stable operation.
3. **Compressors:** Units shall use industrial-duty hermetic scroll compressors, piped and charged with P.O.E. oil and R410A refrigerant. Compressors shall have an enlarged liquid carrying capacity to withstand rugged operating conditions. Compressor frame shall be cast iron, with cast iron fixed and orbiting scrolls. Each compressor shall feature a solid state protection module, designed to protect the compressor from over-temperature and over-current conditions. Compressors shall be vibration-isolated from the unit, and installed in an easily accessible area of the unit. All compressor-to-pipe connections shall

be brazed to minimize potential for leaks. Each compressor shall include a replaceable suction screen, discharge line check valve, and oil sight glass.

4. **Low Ambient:** Compressors shall operate down to 0°F [optional] by monitoring the refrigeration system discharge pressure and adjusting condenser airflow to maintain the proper head pressure to protect compressor operation. Refrigerant pressure transducers shall be included and provide the discharge pressure on the single package unit control display.
5. **In-Line Refrigerant Driers [replaceable core driers]:** Refrigerant piping includes check valves, thermal expansion valves with replaceable thermostatic elements, high and low pressure switches, anti-recycling timing device to prevent compressor restart for five minutes after shutdown.
6. **Condenser Wire Grill [optional louvered condenser enclosure or no enclosure]:** The condenser section shall be enclosed by a wire grill [louvered or none] condenser enclosure on the three exposed sides. Paint finish shall match the color and salt spray specifications of the unit exterior.
7. **Hot Gas Bypass [optional on constant volume units]:** Hot gas bypass piping shall be provided to enable compressor unloading to as low as 5% to better match cooling demand at low loads, prevent excessive cycling of the compressor, and reduce the risk of coil freeze-up.
8. **Compressor sound treatment [optional]:** Compressor sound blankets shall be provided to attenuate radiated sound from the compressors.
9. **Service Valves [optional]:** Liquid, suction and discharge service valves shall be included to provide a means of isolating the refrigerant charge in the system so that the refrigeration system may be serviced without removing the charge of the unit.

Controls

1. **Enclosure:** Unit shall be shipped complete with factory configured, installed, wired and tested single package unit controller housed in a rain and dust tight enclosure with hinged, latched, and gasket sealed door.

2. **Basic Controls:** Control shall include automatic start, stop, operating, and protection sequences across the range of scheduled conditions and transients. The single package unit controller shall provide automatic control of compressor start/stop, energy saver delay and anti-recycle timers, condenser fans, and unit alarms. Automatic reset to normal operation after power failure. Software stored in non-volatile memory, with programmed setpoints retained in lithium battery backed real time clock (RTC) memory for minimum 5 years. Eighty character liquid crystal display, descriptions and numeric data in English (or Metric) units. The sealed keypad shall include buttons for Setpoints, Display, Entry, Unit Options & clock, and an On/Off Switch.
3. **Diagnostics:** Upon startup, the controller shall run through a self-diagnostic check to verify proper operation and sequence loading. The single package unit controller shall continually monitor all input and output points on the controller to maintain proper operation. The unit shall continue to operate in a trouble mode or shut down as necessary to prevent an unsafe condition for the building occupants, or to prevent damage to the equipment. In the event of a unit shutdown or alarm, the operating conditions, date and time shall be stored in the shutdown history to facilitate service and troubleshooting.

4. Controls and BAS Communications

BACnet MSTP (RS-485) or Modbus: The unit shall include BACnet or Modbus communications directly from the unit controller. Equipment that is not native BACnet at the unit control board shall include any necessary interface or translator device factory-mounted and wired within the unit. If a field-installed gateway device is required by the manufacturer, the manufacturer shall include all necessary materials, equipment, service and commissioning of the gateway. A control points list, BIBBs and PICS statement shall be provided by the manufacturer to facilitate communications programming with the building automation system. Programming, establishing communications and commissioning shall be the responsibility of the installing controls contractor. Start-up assistance and support may be purchased from the manufacturer.

Analog inputs: 0-5VDC inputs shall be provided for remote reset of supply air temperature, and duct static pressure

Guide Specifications (Cont'd)

Binary inputs: Dry (or “wet”) contacts shall be provided for alarm outputs for supply fan fault, cooling/heating fault, or general/sensor faults. Contacts shall also be provided for occupied/unoccupied (start/stop) switching; shutdown, smoke purge, exhaust or pressurization operations; call for cooling or heating; and for morning warm-up.

EXECUTION

Installation

General: Installing contractor shall install single package unit(s), including components and controls required for operation, in accordance with single package unit manufacturer’s written instructions and recommendations. Single package units shall be installed as specified.

1. Unit(s) specified shall include a protective covering membrane for such equipment being shipped by truck, rail, or ship. The membrane is fully formed around the equipment exterior. The membrane covers the entire top, side and end panel surface as to protect the product effectively during shipping & storage including “Long Term Storage”. Storing on job-site shall no longer require the unit(s) to be covered with a tarp as long as the covering membrane has not been removed.

2. All size or shape equipment including electrical components, especially those not built with weatherproof enclosures, variable-frequency drives and end devices shall be effectively covered for protection against rain, snow, wind, dirt, sun fading, road salt/chemicals, rust, and corrosion during shipping cycle. Equipment shall remain clean and dry.

3. Manufacturers of units not having a protective membrane, fully formed around the equipment exterior, covering the entire top, side and end panel surface area shall be required to ship equipment covered with a tarp, in crating or in a closed truck as is necessary to ensure product protection from road salt/chemicals damage, moisture and dirt infiltration. Arrangements for long term storage at the job site shall be required.

Location: Locate the single package unit as indicated on drawings, including cleaning and service maintenance clearance per Manufacturer instructions. Adjust and level the single package unit on support structure.

INSPECTION AND START-UP SUPERVISION

A factory-trained service representative of the manufacturer shall supervise the unit startup and application specific calibration of control components.

Notes

Printed on recycled paper

Form: 100.50-EG7 (615) Supersedes: 100.50-EG7 (1214)
© 2015 Johnson Controls, Inc. P.O. Box 423, Milwaukee, WI 53201 Printed in USA
www.johnsoncontrols.com
Issued on 6/01/2015

