

Global Leader in Air Suspension



2021 PARTS CATALOG



OVER THREE DECADES OF AIR SUSPENSION EXCELLENCE

As the trusted leader in aftermarket air suspension parts and accessories for luxury cars, trucks and SUV's, Arnott has grown into a global brand with over 450 SKU's for more than 800 applications that are sold by leading distributors world-wide.

Founded by the Arnott family in Punta Gorda, Florida, Arnott has always focused on ensuring customer satisfaction by manufacturing high-quality, aftermarket products that offer OE form, fit and function at an affordable price.

For more than three decades, Arnott has demonstrated a commitment to developing exceptional air suspension technology and earning the trust of distributors, installers and end users. Arnott's long list of innovations and patents has cemented our position as a global leader in aftermarket air suspension replacement solutions.

THE BROADEST COVERAGE OF QUALITY AIR SUSPENSION PRODUCTS & OPTIONS

Arnott offers more than 450 quality aftermarket air suspension products covering over 800 applications including remanufactured OE air struts, Arnott-designed new air struts, magnetic shocks, innovative air springs, OES air suspension compressors, coil spring conversion kits, valve blocks and ride height sensors.

WARRANTY

Arnott's Warranty is the gold standard in the automotive aftermarket industry.

For our customers in the United States and Canada, Arnott offers a Limited Lifetime Warranty on all Arnott-branded air springs, new and remanufactured air strut and shock assemblies, coil spring conversion kits and air suspension compressors. Orders from outside the United States and Canada are backed by a Limited Two-Year Warranty.

Arnott's Warranty is non-transferable. Defective parts will be either replaced or repaired if the part is within the warranty period and proof of purchase is provided. Arnott offers a 30-Day Warranty for parts used in commercial vehicles. Improper use or installation is not a manufacturer's defect. Arnott does not warranty air suspension compressors that have burned out due to an air suspension leak, pumps and electrical plugs that were modified, those that have missing labels or that have water damage.

DOING BUSINESS WITH ARNOTT

Our global team works every day to build on the trust and quality the Arnott name has signified to our customers for 30 years. We forge meaningful relationships with every customer and strive to support their continued success. By offering a comprehensive product line at an exceptional value backed by best-in-class support and a trusted global distribution network, Arnott gives its distributors, resellers and installers the necessary tools to maximize their growth opportunities.

THE ARNOTT ADVANTAGE

Since 1989, Arnott Air Suspension has been the trusted industry leader in aftermarket air suspension parts and accessories for luxury cars, trucks and SUVs.

Arnott delivers exceptional innovation to the global aftermarket industry. Our state-of-the-art manufacturing and remanufacturing processes are driven by decades of extensive research and development, now housed in a 60,000-square-foot R&D facility. With a trusted global network of premier auto parts distributors, Arnott products have unparalleled availability in the marketplace. Our leadership in the industry is the result of unwavering dedication to:

- ▲ High quality aftermarket products that offer OE form, fit and function at an affordable price
- ▲ Professional, multi-lingual US-based customer service
- ▲ Demonstrated engineering, manufacturing & management expertise
- ▲ Superior Limited Lifetime Warranties

Table of Contents	
About Arnott	1
Why Choose Arnott	2
Product Features	85-90
Contact Arnott	Back Cover

Anatomy of Air Suspension	
Overview	16
Air Springs	32
New Air Struts	49
Compressors	71
Remanufactured Air Struts	84

Arnott Air Suspension Products for:			
Acura*	3	Lexus*	42-44
Audi*	3-10	Lincoln*	44-48
Bentley*	10-11	Maybach*	48
BMW*	11-14	Mercedes-Benz*	50-70
Buick*	15	Mercury*	70
Cadillac*	17-22	Nissan*	72
Chevrolet*	23-26	Oldsmobile*	73
Citroën*	26	Peugeot*	73
Ford*	27-28	Pontiac*	73-74
GMC*	29-31	Porsche*	74-77
Hummer*	33	Ram*	77-78
Infiniti*	33	Saab*	78
Iveco*	33	Tesla*	79
Jaguar*	34	Toyota*	80
Jeep*	35-36	Volkswagen*	81-82
Lamborghini*	36	Volvo*	83
Land Rover*	37-42		

WHY CHOOSE ARNOTT

INFORMATION WITHIN REACH:

Get the specs you need instantly with detailed product information on our website. Arnott products can also be found in standardized industry data feeds via ACES (Aftermarket Catalog Exchange Standard) and PIES (Product Information Exchange Standard). Need a custom ordering solution? Our catalog team can provide customized spreadsheets or feeds.

RELIABLE DISTRIBUTION:

Having multiple Arnott warehouses and partnerships with the industry's foremost distributors, we provide total coverage of North America. This extensive network means fast and dependable deliveries, centralized billing and discounted, tiered pricing.

SEAMLESS INSTALLATION:

We provide the know-how needed to remove faulty OE products and quickly install Arnott replacement products. Arnott's expert Technical Support is complemented by detailed installation manuals and professional installation videos, making installation easy for technicians of all skill levels.

ACURA					
Part #	Product Type	Position	Model Information	Vehicle Attributes	Product Attributes
YD2					
C-3020			2007-2013 MDX	3.7 AWD, w/EDC, w/Advance & Sports Packages, w/Active Suspension Dampers	

AUDI					
Part #	Product Type	Position	Model Information	Vehicle Attributes	Product Attributes
4G					
AS-3309			2013-2018 A7 2013-2018 S7	1.8 TFSI, 2.0 TFSI/TFSI quattro, 2.8 FSI/FSI quattro, 3.0 TDI/TDI quattro quattro	> New > Eibach Shock Absorber
P-3483			2012-2018 A7 2013-2018 S7	1.8 TFSI, 2.0 TFSI/TFSI quattro, 2.8 FSI/FSI quattro, 3.0 TDI/TDI quattro/TFSI quattro quattro	> WABCO OES > Includes Dryer









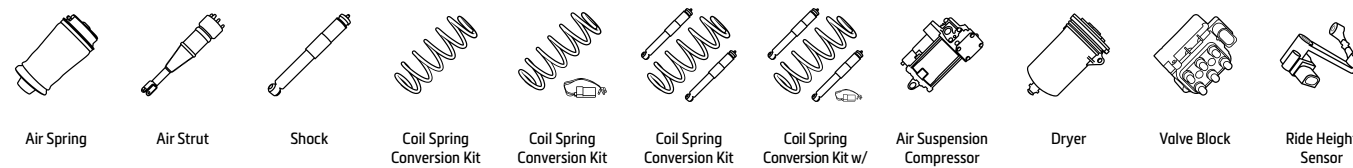

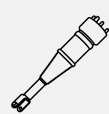

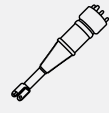



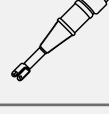

4L					
A-2523			2007-2015 Q7	3.0 TDI quattro/TFSI quattro, 3.6 FSI quattro, 4.2 FSI quattro/TDI quattro, 6.0 TDI quattro	
A-2571			2007-2015 Q7	3.0 TDI quattro/TFSI quattro, 3.6 FSI quattro, 4.2 FSI quattro/TDI quattro, 6.0 TDI quattro	
A-2572			2007-2015 Q7	3.0 TDI quattro/TFSI quattro, 3.6 FSI quattro, 4.2 FSI quattro/TDI quattro, 6.0 TDI quattro	
C-3419			2007-2015 Q7	3.0 TDI quattro/TFSI quattro, 3.6 FSI quattro, 4.2 FSI quattro/TDI quattro, 6.0 TDI quattro	
P-2496			2007-2015 Q7	3.0 TDI quattro/TFSI quattro, 3.6 FSI quattro, 4.2 FSI quattro/TDI quattro, 6.0 TDI quattro	> WABCO OES > Includes Dryer
VB-3470			2007-2015 Q7	3.0 TDI quattro/TFSI quattro, 3.6 FSI quattro, 4.2 FSI quattro/TDI quattro, 6.0 TDI quattro	

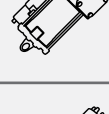
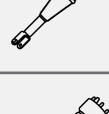

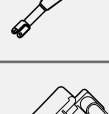

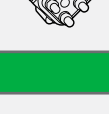
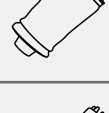





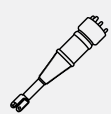

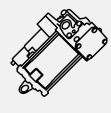

AUDI					
Part #	Product Type	Position	Model Information	Vehicle Attributes	Product Attributes
4M					
P-3473			2016-2021 Q7 2019-2021 Q8 2020-2021 SQ7 2020-2021 SQ8	2.0 TFSI quattro, 3.0 TDI e-tron quattro, TDI/TFSI quattro, 45/50 TDI Mild Hybrid quattro, 55 TFSI Mild Hybrid quattro, 55/60 TFSI e quattro, Van (3.0 45/50 TDI Mild Hybrid quattro, 3.0 TDI quattro) quattro/TDI quattro, Van 4.0 TDI quattro	> WABCO OES > Includes Dryer

8R					
RH-3459			2009-2017 Q5 2014-2017 SQ5	2.0 TDI, 2.0 TDI quattro, 2.0 TFSI hybrid quattro, 2.0 TFSI quattro, 3.0 TDI quattro, 3.0 TFSI quattro, 3.2 FSI quattro, 35 TDI quattro, 40 TDI quattro, 45 TDI quattro, 45 TFSI Mild Hybrid quattro, 50 TDI quattro, 55 TFSI e quattro, SQ5 TDI Mild Hybrid quattro, SQ5 TDI quattro, SQ5 TFSI quattro, 2.0 Hybrid quattro	
RH-3460			2009-2017 Q5 2014-2017 SQ5	2.0 TDI, 2.0 TDI quattro, 2.0 TFSI hybrid quattro, 2.0 TFSI quattro, 3.0 TDI quattro, 3.0 TFSI quattro, 3.2 FSI quattro, 35 TDI quattro, 40 TDI quattro, 45 TDI quattro, 45 TFSI Mild Hybrid quattro, 50 TDI quattro, 55 TFSI e quattro, SQ5 TDI Mild Hybrid quattro, SQ5 TDI quattro, SQ5 TFSI quattro, 2.0 Hybrid quattro	
RH-3589			2009-2018 Q5 2014-2017 SQ5	2.0 TDI, 2.0 TDI quattro, 2.0 TFSI hybrid quattro, 2.0 TFSI quattro, 3.0 TDI quattro, 3.0 TFSI quattro, 3.2 FSI quattro, 35 TDI quattro, 40 TDI quattro, 45 TDI quattro, 45 TFSI Mild Hybrid quattro, 50 TDI quattro, 55 TFSI e quattro, SQ5 TDI Mild Hybrid quattro, SQ5 TDI quattro, SQ5 TFSI quattro, 2.0 Hybrid quattro	
RH-3590			2009-2018 Q5 2014-2017 SQ5	2.0 TDI, 2.0 TDI quattro, 2.0 TFSI hybrid quattro, 2.0 TFSI quattro, 3.0 TDI quattro, 3.0 TFSI quattro, 3.2 FSI quattro, 35 TDI quattro, 40 TDI quattro, 45 TDI quattro, 45 TFSI Mild Hybrid quattro, 50 TDI quattro, 55 TFSI e quattro, SQ5 TDI Mild Hybrid quattro, SQ5 TDI quattro, SQ5 TFSI quattro, 2.0 Hybrid quattro	

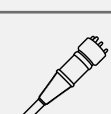

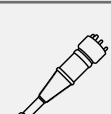

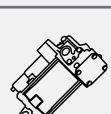



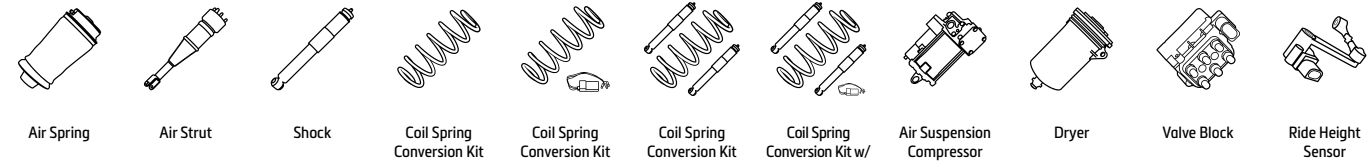

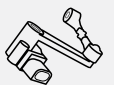

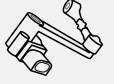

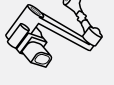

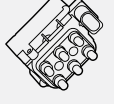
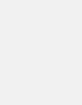
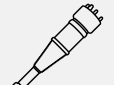

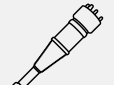
C5					
A-2133			2001-2005 Allroad Quattro	4B5, 4BH - 2.5 TDI quattro, 2.7 quattro/T quattro, 4.6 quattro/V8 quattro, S6 quattro	
A-2731			2001-2005 Allroad Quattro	4B5, 4BH - 2.5 TDI quattro, 2.7 quattro/T quattro, 4.6 quattro/V8 quattro, S6 quattro	> Generation II
A-2869			2001-2005 Allroad Quattro	4BH - 2.5 TDI quattro, 2.7 quattro/T quattro, 4.2 V8 quattro	
A-2885			2001-2005 Allroad Quattro	4BH - 2.5 TDI quattro, 2.7 quattro/T quattro, 4.2 V8 quattro	> Generation II

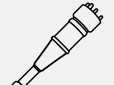









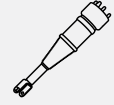

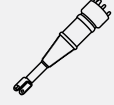

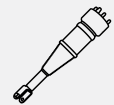

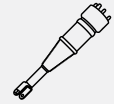

AUDI					
Part #	Product Type	Position	Model Information	Vehicle Attributes	Product Attributes
C5					
AS-3222			2001-2005 Allroad Quattro	4B2, 4B5, 4BH - 1.8, 1.8 T/T quattro, 1.9 TDI, 2.0, 2.4, 2.4 quattro, 2.5 TDI/TDI quattro, 2.7 quattro/T/T quattro, 2.8, 2.8 quattro, 3.0, 3.0 quattro, 3.6, 3.7 quattro, 4.2 quattro/V8 quattro, RS6 plus quattro/quattro, S6 quattro	> New
AS-3223			2001-2005 Allroad Quattro	4B2, 4B5, 4BH - 1.8, 1.8 T/T quattro, 1.9 TDI, 2.0, 2.4, 2.4 quattro, 2.5 TDI/TDI quattro, 2.7 quattro/T/T quattro, 2.8, 2.8 quattro, 3.0, 3.0 quattro, 3.6, 3.7 quattro, 4.2 quattro/V8 quattro, RS6 plus quattro/quattro, S6 quattro	> New
AS-3230			2001-2005 Allroad Quattro	4B2, 4B5, 4BH - 1.8, 1.8 T/T quattro, 1.9 TDI, 2.0, 2.4, 2.4 quattro, 2.5 TDI/TDI quattro, 2.7 quattro/T/T quattro, 2.8, 2.8 quattro, 3.0, 3.0 quattro, 3.6, 3.7 quattro, 4.2 quattro/V8 quattro, RS6 plus quattro/quattro, S6 quattro	> New > Generation II
AS-3231			2001-2005 Allroad Quattro	4B2, 4B5, 4BH - 1.8, 1.8 T/T quattro, 1.9 TDI, 2.0, 2.4, 2.4 quattro, 2.5 TDI/TDI quattro, 2.7 quattro/T/T quattro, 2.8, 2.8 quattro, 3.0, 3.0 quattro, 3.6, 3.7 quattro, 4.2 quattro/V8 quattro, RS6 plus quattro/quattro, S6 quattro	> New > Generation II
C-2718			2001-2005 Allroad Quattro	4BH - 2.5 TDI quattro, 2.7 quattro/T quattro, 4.2 V8 quattro	
P-2134			2001-2005 Allroad Quattro	4BH - 2.5 TDI quattro, 2.7 quattro/T quattro, 4.2 quattro/V8 quattro, S6 quattro	> WABCO OES > Includes Dryer
SK-2779			2001-2005 Allroad Quattro	4BH - 2.5 TDI quattro, 2.7 quattro/T quattro, 4.2 V8 quattro	> New > Shock Only
SK-2805			2001-2005 Allroad Quattro	4B5, 4BH - 1.8 T quattro, 2.4 quattro, 2.5 TDI quattro, 2.7 quattro/T quattro, 2.8 quattro, 3.0 quattro, 3.7 quattro, 4.2 quattro/V8 quattro, RS6 plus quattro/quattro, S6 quattro	> New > Shock Only
VB-3265			2001-2005 Allroad Quattro	4B2, 4B5, 4BH - 1.9 TDI, 2.0, 2.4, 2.4 quattro, 2.5 TDI/TDI quattro, 2.7 quattro/T/T quattro, 2.8, 2.8 quattro, 3.0, 3.0 quattro, 3.6, 3.7 quattro, RS6 quattro, S6 quattro	
C6					
A-2960			2005-2011 A6 2007-2011 S6	4F2, 4F5, 4FH - 2.0 TDI/TFSI, 2.4, 2.4 quattro, 2.7 TDI/TDI quattro, 2.8 FSI/FSI quattro, 3.0, 3.0 quattro/TDI/TDI quattro/TFSI quattro, 3.2 FSI/FSI quattro, 4.2 FSI quattro/quattro, RS6 quattro, S6 quattro	
AS-3363			2005-2011 A6 2007-2011 S6	4F2, 4F5, 4FH - 2.0 TDI/TFSI, 2.4, 2.4 quattro, 2.7 TDI/TDI quattro, 2.8 FSI/FSI quattro, 3.0, 3.0 quattro/TDI/TDI quattro/TFSI quattro, 3.2 FSI/FSI quattro, 4.2 FSI quattro/quattro, RS6 quattro, S6 quattro	> New

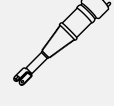

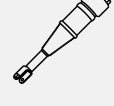



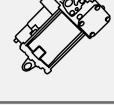
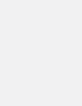
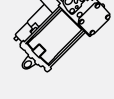
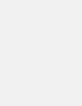

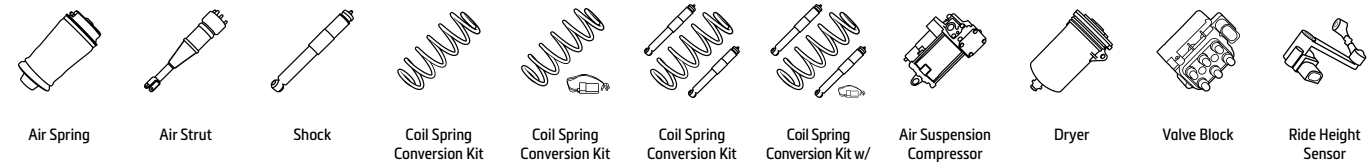

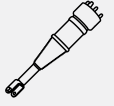

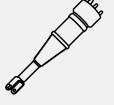

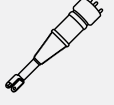

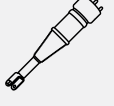
AUDI					
Part #	Product Type	Position	Model Information	Vehicle Attributes	Product Attributes
C6					
AS-3369			2005-2011 A6 2007-2011 S6	4F2, 4F5, 4FH - 2.0 TDI/TFSI, 2.4, 2.4 quattro, 2.7 TDI/TDI quattro, 2.8 FSI/FSI quattro, 3.0, 3.0 quattro/TDI/TDI quattro/TFSI quattro, 3.2 FSI/FSI quattro, 4.2 FSI quattro/quattro, RS6 quattro, S6 quattro	> New
P-2984			2005-2011 A6 2007-2011 S6	4F2, 4F5, 4FH - 2.0 TDI/TFSI, 2.4, 2.4 quattro, 2.7 TDI/TDI quattro, 2.8 FSI/FSI quattro, 3.0, 3.0 quattro/TDI/TDI quattro/TFSI quattro, 3.2 FSI/FSI quattro, 4.2 FSI quattro/quattro, RS6 quattro, S6 quattro	> WABCO OES > Includes Dryer
VB-3265			2005-2011 A6 2007-2011 S6	4F2, 4F5, 4FH - 2.0 TDI/TFSI, 2.4, 2.4 quattro, 2.7 TDI/TDI quattro, 2.8 FSI/FSI quattro, 3.0, 3.0 quattro/TDI/TDI quattro/TFSI quattro, 3.2 FSI/FSI quattro, 4.2 FSI quattro/quattro, RS6 quattro, S6 quattro	
C7					
A-3294			2012-2018 A6 2013-2018 S6 2013-2018 S7 2014-2018 RS7	4G2, 4G5, 4GA, 4GC, 4GD, 4GF - 1.8 TFSI, 2.0 TDI/TDI quattro/TFSI/TFSI hybrid/TFSI quattro, 2.8 FSI/FSI quattro, 3.0 TDI/TDI quattro/TFSI quattro, RS6/7 performance quattro/quattro, S6/7 quattro	
A-3295			2012-2018 A6 2013-2018 S6 2013-2018 S7 2014-2018 RS7	4G2, 4GC - 1.8 TFSI, 2.0 TDI/TDI quattro/TFSI/TFSI hybrid/TFSI quattro, 2.8 FSI/FSI quattro, 3.0 TDI/TDI quattro/TFSI quattro, RS7 performance quattro/quattro, S6/7 quattro	
AS-3309			2012-2018 A6 2013-2018 S6	4G2, 4G5, 4GC, 4GD - 1.8 TFSI, 2.0 TDI/TDI quattro/TFSI/TFSI quattro, 2.8 FSI/FSI quattro, 3.0 TDI/TDI quattro/TFSI quattro, RS6 quattro/performance quattro	> New > Eibach Shock Absorber
AS-3312			2012-2018 A6 2012-2018 A7 2013-2018 S6 2013-2018 S7	4G2, 4G5, 4GA, 4GC, 4GD, 4GF - 1.8 TFSI, 2.0 TDI/TDI quattro/TFSI/TFSI hybrid/TFSI quattro, 2.8 FSI/FSI quattro, 3.0 TDI/TDI quattro/TFSI quattro, RS6/7 performance quattro/quattro, S6/7 quattro	> Remanufactured
P-3483			2012-2018 A6 2013-2018 S6 2014-2018 RS7	1.8 TFSI, 2.0 TDI/TDI quattro/TFSI/TFSI hybrid/TFSI quattro, 2.8 FSI/FSI quattro, 3.0 TDI/TDI quattro/TFSI quattro quattro performance quattro	> WABCO OES > Includes Dryer
RH-3587			2012-2018 A6 2012-2018 A7 2013-2018 S6 2013-2018 S7 2014-2018 RS7	4G2, 4G5, 4GA, 4GC, 4GD, 4GF - 1.8 TFSI, 2.0 TDI/TDI quattro/TFSI/TFSI hybrid/TFSI quattro, 2.8 FSI/FSI quattro, 3.0 TDI/TDI quattro/TFSI quattro, RS6/7 performance quattro/quattro, S6/7 quattro	

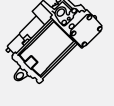
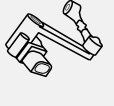

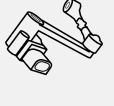

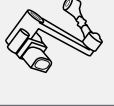

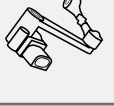



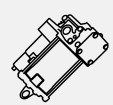

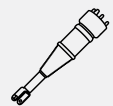

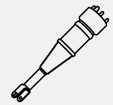

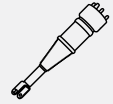

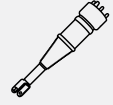
AUDI						
Part #	Product Type	Position	Model Information	Vehicle Attributes	Product Attributes	
C7						
RH-3588			2012-2018 A6	4G2, 4G5, 4GA, 4GC, 4GD, 4GF - 1.8 TFSI, 2.0 TDI/TDI quattro/TFSI/TFSI hybrid/TFSI quattro, 2.8 FSI/FSI quattro, 3.0 TDI/TDI quattro/TFSI quattro, RS6/7 performance quattro/quattro, S6/7 quattro		
			2012-2018 A7			
			2013-2018 S6			
			2013-2018 S7			
			2014-2018 RS7			
RH-3589			2012-2018 A6	4G2, 4G5, 4GA, 4GC, 4GD, 4GF - 1.8 TFSI, 2.0 TDI/TDI quattro/TFSI/TFSI hybrid/TFSI quattro, 2.8 FSI/FSI quattro, 3.0 TDI/TDI quattro/TFSI quattro, RS6/7 performance quattro/quattro, S6/7 quattro		
			2012-2018 A7			
			2013-2018 S6			
			2013-2018 S7			
			2014-2018 RS7			
RH-3590			2012-2018 A6	4G2, 4G5, 4GA, 4GC, 4GD, 4GF - 1.8 TFSI, 2.0 TDI/TDI quattro/TFSI/TFSI hybrid/TFSI quattro, 2.8 FSI/FSI quattro, 3.0 TDI/TDI quattro/TFSI quattro, RS6/7 performance quattro/quattro, S6/7 quattro		
			2012-2018 A7			
			2013-2018 S6			
			2013-2018 S7			
			2014-2018 RS7			
VB-3491			2012-2018 A6	4G2, 4GA, 4GC, 4GF - 1.8 TFSI, 2.0 TDI/TDI quattro/TFSI/TFSI hybrid/TFSI quattro, 2.8 FSI/FSI quattro, 3.0 TDI/TDI quattro/TFSI quattro, RS7 quattro/performance quattro		
			2013-2018 S6			
			2014-2018 RS7			
D3						
AS-2560			2004-2010 A8 Quattro	w/o Sport Suspension	4E2, 4E8 - 2.8 FSI, 3.0, 3.0 quattro/TDI quattro, 3.2 FSI/FSI quattro, 3.7 quattro, 4.0 TDI quattro, 4.2 FSI quattro/quattro/TDI quattro, 6.0 W12 quattro, S8 quattro	> Remanufactured
AS-2561			2004-2010 A8 Quattro	w/o Sport Suspension	4E2, 4E8 - 2.8 FSI, 3.0, 3.0 quattro/TDI quattro, 3.2 FSI/FSI quattro, 3.7 quattro, 4.0 TDI quattro, 4.2 FSI quattro/quattro/TDI quattro, 6.0 W12 quattro, S8 quattro	> Remanufactured
AS-2562			2004-2010 A8	w/Sport Suspension	4E2, 4E8 - 3.0, 3.0 quattro/TDI quattro, 3.2 FSI/FSI quattro, 3.7 quattro, 4.0 TDI quattro, 4.2 FSI quattro/quattro/TDI quattro, 6.0 W12 quattro, S8 quattro	> Remanufactured
			2007-2010 S8			
AS-2563			2004-2010 A8	w/Sport Suspension	4E2, 4E8 - 3.0, 3.0 quattro/TDI quattro, 3.2 FSI/FSI quattro, 3.7 quattro, 4.0 TDI quattro, 4.2 FSI quattro/quattro/TDI quattro, 6.0 W12 quattro, S8 quattro	> Remanufactured
			2007-2010 S8			
AS-2775			2004-2010 A8	w/o Sport Suspension	4E2, 4E8 - 2.8 FSI, 3.0, 3.0 quattro/TDI quattro, 3.2 FSI/FSI quattro, 3.7 quattro, 4.0 TDI quattro, 4.2 FSI quattro/quattro/TDI quattro, 6.0 W12 quattro, S8 quattro	> New
AS-2776			2004-2010 A8	w/o Sport Suspension	4E2, 4E8 - 2.8 FSI, 3.0, 3.0 quattro/TDI quattro, 3.2 FSI/FSI quattro, 3.7 quattro, 4.0 TDI quattro, 4.2 FSI quattro/quattro/TDI quattro, 6.0 W12 quattro, S8 quattro	> New

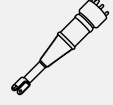
AUDI						
Part #	Product Type	Position	Model Information	Vehicle Attributes	Product Attributes	
D3						
AS-2777			2004-2010 A8	w/Sport Suspension	4E2, 4E8 - 3.0, 3.0 quattro/TDI quattro, 3.2 FSI/FSI quattro, 3.7 quattro, 4.0 TDI quattro, 4.2 FSI quattro/quattro/TDI quattro, 6.0 W12 quattro, S8 quattro	> New
			2007-2010 S8			
AS-2778			2004-2010 A8	w/Sport Suspension	4E2, 4E8 - 3.0, 3.0 quattro/TDI quattro, 3.2 FSI/FSI quattro, 3.7 quattro, 4.0 TDI quattro, 4.2 FSI quattro/quattro/TDI quattro, 6.0 W12 quattro, S8 quattro	> New
			2007-2010 S8			
AS-2958			2004-2010 A8	w/o Sport Suspension	4E2, 4E8, 4H2, 4H8, 4HC, 4HL - 2.8 FSI, 3.0, 3.0 quattro/TDI quattro, 3.2 FSI/FSI quattro, 3.7 quattro, 4.0 TDI quattro, 4.2 FSI quattro/quattro/TDI quattro, 6.0 W12 quattro, S8 quattro	> Remanufactured
AS-2959			2004-2010 A8	w/o Sport Suspension	4E2, 4E8, 4H2, 4H8, 4HC, 4HL - 2.8 FSI, 3.0, 3.0 quattro/TDI quattro, 3.2 FSI/FSI quattro, 3.7 quattro, 4.0 TDI quattro, 4.2 FSI quattro/quattro/TDI quattro, 6.0 W12 quattro, S8 quattro	> Remanufactured
AS-2965			2004-2010 A8	w/Sport Suspension	4E2, 4E8 - 3.0, 3.0 quattro/TDI quattro, 3.2 FSI/FSI quattro, 3.7 quattro, 4.0 TDI quattro, 4.2 FSI quattro/quattro/TDI quattro, 6.0 W12 quattro, S8 quattro	> Remanufactured
			2007-2010 S8			
AS-2966			2004-2010 A8	w/Sport Suspension	4E2, 4E8 - 3.0, 3.0 quattro/TDI quattro, 3.2 FSI/FSI quattro, 3.7 quattro, 4.0 TDI quattro, 4.2 FSI quattro/quattro/TDI quattro, 6.0 W12 quattro, S8 quattro	> Remanufactured
			2007-2010 S8			
AS-3030			2004-2010 A8	w/o Sport Suspension	2.8 FSI, 3.0, 3.0 quattro, 3.0 TDI quattro, 3.2 FSI, 3.2 FSI quattro, 3.7 quattro, 4.0 TDI quattro, 4.2 FSI quattro, 4.2 quattro, 4.2 TDI quattro, 6.0 W12 quattro	> New
AS-3031			2004-2010 A8	w/o Sport Suspension	2.8 FSI, 3.0, 3.0 quattro, 3.0 TDI quattro, 3.2 FSI, 3.2 FSI quattro, 3.7 quattro, 4.0 TDI quattro, 4.2 FSI quattro, 4.2 quattro, 4.2 TDI quattro, 6.0 W12 quattro	> New
P-2539			2004-2010 A8 Quattro	w/ & w/o Sport Suspension V8 Gas Engine Only	4E2, 4E8 - 2.8 FSI, 3.0, 3.0 quattro, 3.2 FSI/FSI quattro, 3.7 quattro, 4.2 FSI quattro/quattro, 6.0 W12 quattro, S8 quattro	> WABCO OES > Includes Dryer
			2007-2010 S8			
P-2599			2004-2010 A8 Quattro	w/ & w/o Sport Suspension Diesel Engine & W12 Gas Engine Only	3.0 TDI quattro, 4.0 TDI quattro, 4.2 TDI quattro	> WABCO OES > Includes Dryer

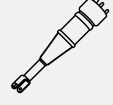



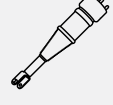



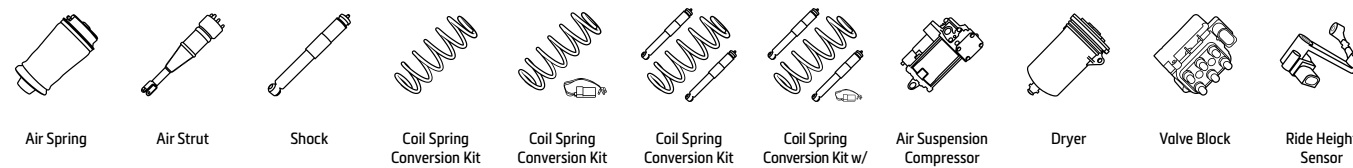

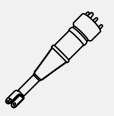

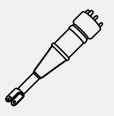

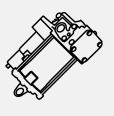
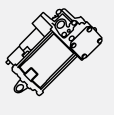

AUDI						
Part #	Product Type	Position	Model Information	Vehicle Attributes	Product Attributes	
D3						
VB-3265			2004-2010 A8	w/ & w/o Sport Suspension	4E2, 4E8 - 2.8 FSI, 3.0, 3.0 quattro/TDI quattro, 3.2 FSI/FSI quattro, 3.7 quattro, 4.0 TDI quattro, 4.2 FSI quattro/quattro/TDI quattro, 6.0 W12 quattro, S8 quattro	
			2007-2010 S8	w/Sport Suspension		
D4						
AS-2864			2011-2018 A8 Quattro	w/o Sport Suspension	4H - 2.0 TFSI hybrid, 2.5 TFSI, 3.0 TDI, 3.0 TDI quattro, 3.0 TFSI quattro, 4.0 TFSI quattro, 4.2 FSI quattro, 4.2 TDI quattro, 6.3 W12 quattro, S8 plus quattro, S8 quattro	> Remanufactured
AS-2865			2011-2018 A8 Quattro	w/Sport Suspension	4H - 2.0 TFSI hybrid, 2.5 TFSI, 3.0 TDI, 3.0 TDI quattro, 3.0 TFSI quattro, 4.0 TFSI quattro, 4.2 FSI quattro, 4.2 TDI quattro, 6.3 W12 quattro, S8 plus quattro, S8 quattro	> Remanufactured
			2013-2018 S8	w/Sport Suspension		
AS-3121			2011-2018 A8	w/o Sport Suspension	4H2, 4H8, 4HC, 4HL - 2.0 TFSI Hybrid, 2.5 TFSI, 3.0 TDI/TDI quattro/FSI quattro, 4.0 TFSI quattro, 4.2 TDI quattro, 6.3 W12 quattro	> New > Eibach Shock Absorber
AS-3123			2011-2018 A8	w/o Sport Suspension	4H2, 4H8, 4HC, 4HL - 2.0 TFSI Hybrid, 2.5 TFSI, 3.0 TDI/TDI quattro/FSI quattro, 4.0 TFSI quattro, 4.2 TDI quattro, 6.3 W12 quattro	> New > Eibach Shock Absorber
P-2986			2011-2018 A8 Quattro	w/ & w/o Sport Suspension	4H - 2.0 TFSI hybrid, 2.5 TFSI, 3.0 TDI, 3.0 TDI quattro, 3.0 TFSI quattro, 4.0 TFSI quattro, 4.2 FSI quattro, 4.2 TDI quattro, 6.3 W12 quattro, S8 plus quattro, S8 quattro	> WABCO OES > Includes Dryer
			2013-2018 S8 Quattro	w/Sport Suspension		
RH-3587			2011-2018 A8	w/ & w/o Sport Suspension	4H - 2.0 TFSI hybrid, 2.5 TFSI, 3.0 TDI, 3.0 TDI quattro, 3.0 TFSI quattro, 4.0 TFSI quattro, 4.2 FSI quattro, 4.2 TDI quattro, 6.3 W12 quattro, S8 plus quattro, S8 quattro	
			2013-2018 S8	w/Sport Suspension		
RH-3588			2011-2018 A8	w/ & w/o Sport Suspension	4H - 2.0 TFSI hybrid, 2.5 TFSI, 3.0 TDI, 3.0 TDI quattro, 3.0 TFSI quattro, 4.0 TFSI quattro, 4.2 FSI quattro, 4.2 TDI quattro, 6.3 W12 quattro, S8 plus quattro, S8 quattro	
			2013-2018 S8	w/Sport Suspension		
RH-3589			2011-2018 A8	w/ & w/o Sport Suspension	4H - 2.0 TFSI hybrid, 2.5 TFSI, 3.0 TDI, 3.0 TDI quattro, 3.0 TFSI quattro, 4.0 TFSI quattro, 4.2 FSI quattro, 4.2 TDI quattro, 6.3 W12 quattro, S8 plus quattro, S8 quattro	
			2013-2018 S8	w/Sport Suspension		
RH-3590			2011-2018 A8	w/ & w/o Sport Suspension	4H - 2.0 TFSI hybrid, 2.5 TFSI, 3.0 TDI, 3.0 TDI quattro, 3.0 TFSI quattro, 4.0 TFSI quattro, 4.2 FSI quattro, 4.2 TDI quattro, 6.3 W12 quattro, S8 plus quattro, S8 quattro	
			2013-2018 S8	w/Sport Suspension		
VB-3491			2011-2018 A8	w/ & w/o Sport Suspension	4H - 2.0 TFSI hybrid, 2.5 TFSI, 3.0 TDI, 3.0 TDI quattro, 3.0 TFSI quattro, 4.0 TFSI quattro, 4.2 FSI quattro, 4.2 TDI quattro, 6.3 W12 quattro, S8 plus quattro, S8 quattro	
			2013-2018 S8	w/Sport Suspension		



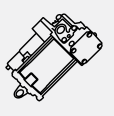







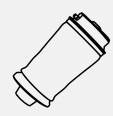

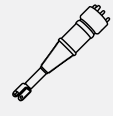

AUDI						
Part #	Product Type	Position	Model Information	Vehicle Attributes	Product Attributes	
FY						
P-3474			2018-2021 Q5	2.0 TDI/TDI quattro/TFSI quattro, 3.0 TDI quattro, 30/35 Mild Hybrid, 35 TDI quattro, 40 TDI quattro/Mild Hybrid quattro, 45 TDI quattro/TFSI Mild Hybrid quattro, 50 TDI quattro/TFSI e quattro, 55 TFSI e quattro	> WABCO OES > Includes Dryer	
			2018-2021 SQ5	TDI Mild Hybrid quattro, TFSI quattro		

BENTLEY						
Part #	Product Type	Position	Model Information	Vehicle Attributes	Product Attributes	
D1						
AS-2580			2003-2019 Continental GT	3W_ - 4.0, 4.0 Flex/Flex AWD, 6.0, 6.0 AWD/CSISR/Flex/Flex AWD	> Remanufactured	
			2006-2019 Continental Flying Spur	3W_ - 6.0, 6.0 Flex		
AS-2581			2003-2019 Continental GT	3W_ - 4.0, 4.0 Flex/Flex AWD, 6.0, 6.0 AWD/CSISR/Flex/Flex AWD	> Remanufactured	
			2006-2019 Continental Flying Spur	3W_ - 6.0, 6.0 Flex		
AS-2892			2003-2019 Continental GT	3W_ - 4.0, 4.0 Flex/Flex AWD, 6.0, 6.0 AWD/CSISR/Flex/Flex AWD	> New	
			2006-2019 Continental Flying Spur	3W_ - 6.0, 6.0 Flex		
AS-2893			2003-2019 Continental GT	3W_ - 4.0, 4.0 Flex/Flex AWD, 6.0, 6.0 AWD/CSISR/Flex/Flex AWD	> New	
			2006-2019 Continental Flying Spur	3W_ - 6.0, 6.0 Flex		
AS-2968			2003-2019 Continental GT	3W_ - 4.0, 4.0 Flex/Flex AWD, 6.0, 6.0 AWD/CSISR/Flex/Flex AWD	> Remanufactured	
			2006-2019 Continental Flying Spur	3W_ - 6.0, 6.0 Flex		
AS-2969			2003-2019 Continental GT	3W_ - 4.0, 4.0 Flex/Flex AWD, 6.0, 6.0 AWD/CSISR/Flex/Flex AWD	> Remanufactured	
			2006-2019 Continental Flying Spur	3W_ - 6.0, 6.0 Flex		
AS-3127			2003-2019 Continental GT	3W_ - 4.0, 4.0 Flex/GT, 6.0, 6.0 AWD/Flex/Supersports AWD	> New > Eibach Shock Absorber	
			2006-2019 Continental Flying Spur	3W_ - 6.0, 6.0 Flex		
AS-3128			2003-2019 Continental GT	3W_ - 4.0, 4.0 Flex/GT, 6.0, 6.0 AWD/Flex/Supersports AWD	> New > Eibach Shock Absorber	
			2006-2019 Continental Flying Spur	3W_ - 6.0, 6.0 Flex		

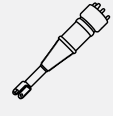

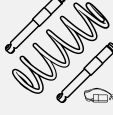

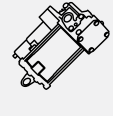
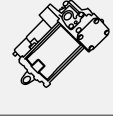

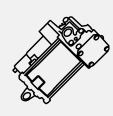

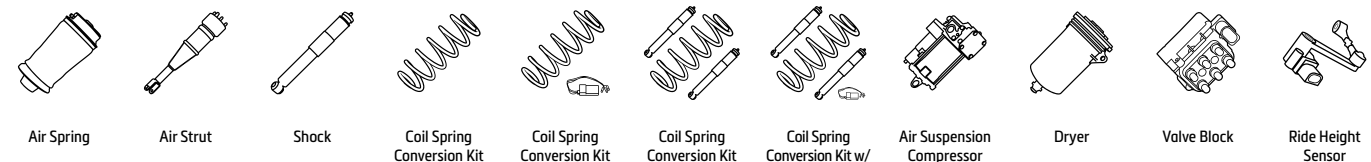

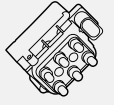
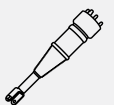

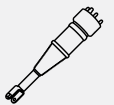

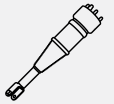

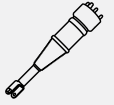

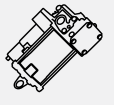

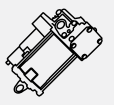

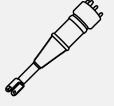
BENTLEY					
Part #	Product Type	Position	Model Information	Vehicle Attributes	Product Attributes
D1					
AS-3129			2003-2019 Continental GT	3W_ - 4.0, 4.0 Flex/GT, 6.0, 6.0 AWD/Flex/Supersports AWD	<ul style="list-style-type: none"> › New › Eibach Shock Absorber
			2006-2019 Continental Flying Spur	3W_ - 6.0, 6.0 Flex	
AS-3130			2003-2019 Continental GT	3W_ - 4.0, 4.0 Flex/GT, 6.0, 6.0 AWD/Flex/Supersports AWD	<ul style="list-style-type: none"> › New › Eibach Shock Absorber
			2006-2019 Continental Flying Spur	3W_ - 6.0, 6.0 Flex	
P-2740			2003-2019 Continental GT	3W_ - 4.0, 4.0 Flex/Flex AWD, 6.0, 6.0 AWD/CSISR/Flex/Flex AWD	<ul style="list-style-type: none"> › WABCO OES › Includes Dryer
			2006-2019 Continental Flying Spur	3W_ - 6.0, 6.0 Flex	
F4					
P-3473			2014-2021 Bentayga		<ul style="list-style-type: none"> › WABCO OES › Includes Dryer

BMW					
Part #	Product Type	Position	Model Information	Vehicle Attributes	Product Attributes
E39					
A-2737			1993-2003 5 Series	Wagon Only, w/Auto-Leveling 520 d/i, 523 i, 525 d/i/tds, 528 i, 530 d/i, 540 i	
A-2738			1993-2003 5 Series	Wagon Only, w/Auto-Leveling 520 d/i, 523 i, 525 d/i/tds, 528 i, 530 d/i, 540 i	
P-2469			1999-2003 5 Series	Wagon Only, w/Auto-Leveling, w/Rear Air Suspension Only 520 d/i, 523 i, 525 d/i/tds, 528 i, 530 d/i, 540 i	<ul style="list-style-type: none"> › WABCO OES › Includes Dryer
E53					
A-2501			2000-2006 X5	w/Auto-Leveling, w/o Sport Suspension 3.0 d, 4.4 i, 4.6 is, 4.8 is	
A-2502			2000-2006 X5	w/Auto-Leveling, w/o Sport Suspension 3.0 d, 4.4 i, 4.6 is, 4.8 is	
A-2503			2000-2006 X5	w/Auto-Leveling, w/Sport Suspension 3.0 d, 4.4 i, 4.6 is, 4.8 is	

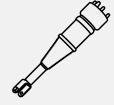

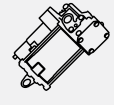
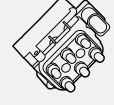

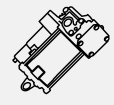
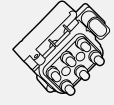

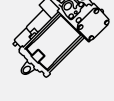

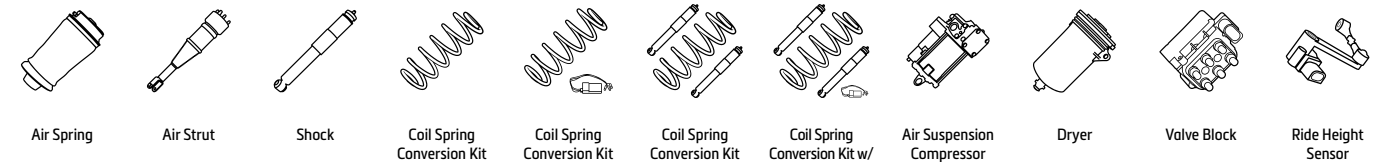







BMW					
Part #	Product Type	Position	Model Information	Vehicle Attributes	Product Attributes
E53					
A-2504			2000-2006 X5	w/Auto-Leveling, w/Sport Suspension 3.0 d, 4.4 i, 4.6 is, 4.8 is	
A-2861			2000-2006 X5	w/4-Corner Air Leveling, w/ & w/o Sport Suspension 3.0 d, 4.4 i, 4.6 is, 4.8 is	<ul style="list-style-type: none"> › New Air Spring Only, Reuse Factory Shock
A-2862			2000-2006 X5	w/4-Corner Air Leveling, w/ & w/o Sport Suspension 3.0 d, 4.4 i, 4.6 is, 4.8 is	<ul style="list-style-type: none"> › New Air Spring Only, Reuse Factory Shock
AS-2764			2000-2006 X5	w/4-Corner Air Leveling, w/ & w/o Sport Suspension 3.0 d, 4.4 i, 4.6 is, 4.8 is	<ul style="list-style-type: none"> › New
AS-2765			2000-2006 X5	w/4-Corner Air Leveling, w/ & w/o Sport Suspension 3.0 d, 4.4 i, 4.6 is, 4.8 is	<ul style="list-style-type: none"> › New
C-2664			2000-2006 X5	w/ & w/o Sport Suspension 3.0 d, 4.4 i, 4.6 is, 4.8 is	
P-2469			2000-2006 X5	w/Auto-Leveling, w/ & w/o Sport Suspension 3.0 d, 4.4 i, 4.6 is, 4.8 is	<ul style="list-style-type: none"> › WABCO OES › Includes Dryer
P-2494			2000-2006 X5	w/4-Corner Air Leveling, w/ & w/o Sport Suspension 3.0 d, 4.4 i, 4.6 is, 4.8 is	<ul style="list-style-type: none"> › WABCO OES › Includes Dryer
E61					
A-2755			2004-2010 5 Series	Wagon Only, w/Auto-Leveling 520 d/i, 523 i, 525 d/d xDrive/i/i xDrive/xd/xi, 530 d/d xDrive/i/i xDrive/xd/xi, 535 d, 545 i, 550 i	
P-3220			2004-2010 5 Series	Wagon Only, w/Auto-Leveling 520 d/i, 523 i, 525 d/d xDrive/i/i xDrive/xd/xi, 530 d/d xDrive/i/i xDrive/xd/xi, 535 d, 545 i, 550 i	<ul style="list-style-type: none"> › OES › Includes Dryer › Plug & Play Complete Assembly

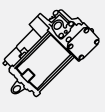
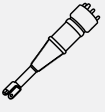

BMW					
Part #	Product Type	Position	Model Information	Vehicle Attributes	Product Attributes
E61					
VB-2897			2004-2010 5 Series	Wagon Only, w/Auto-Leveling	520 d/i, 523 i, 525 d/d xDrive/i/i xDrive/xd/xi, 530 d/d xDrive/i/i xDrive/xd/xi, 535 d, 545 i, 550 i
E65/66					
AS-2978			2002-2008 7 Series	w/EDC	730 d/i/Li/Ld, 735 i/Li, 740 d/i/Li, 745 d/i/Li, 750 i/Li, 760 i/Li > New
AS-2979			2002-2008 7 Series	w/EDC	730 d/i/Li/Ld, 735 i/Li, 740 d/i/Li, 745 d/i/Li, 750 i/Li, 760 i/Li > New
AS-2980			2002-2008 7 Series	w/o EDC	730 d/i/Li/Ld, 735 i/Li, 740 d/i/Li, 745 d/i/Li, 750 i/Li, 760 i/Li > New
AS-2981			2002-2008 7 Series	w/o EDC	730 d/i/Li/Ld, 735 i/Li, 740 d/i/Li, 745 d/i/Li, 750 i/Li, 760 i/Li > New
P-2469			2002-2008 7 Series	w/ & w/o EDC	730 d/i/Li/Ld, 735 i/Li, 740 d/i/Li, 745 d/i/Li, 750 i/Li, 760 i/Li > WABCO OES > Includes Dryer
E70/71					
A-2642			2007-2013 X5 2008-2014 X6	w/Adaptive Drive, Comfort or Sport Suspension w/Adaptive Drive, Comfort or Sport Suspension	3.0 d/sd/si, 4.8 i xDrive, M, M 50 d, xDrive (30 d/i, 35 d/i, 40 d/i, 48 i, 50 i) ActiveHybrid, Active Hybrid xDrive, M, M 50 d, xDrive (30 d, 35 d/i, 40 d, 50 i)
P-3221			2007-2013 X5 2008-2014 X6		3.0 d/sd/si, 4.8 i xDrive, M, M 50 d, xDrive (30 d/i, 35 d/i, 40 d/i, 48 i, 50 i) ActiveHybrid, Active Hybrid xDrive, M, M 50 d, xDrive (30 d, 35 d/i, 40 d, 50 i) > OES > Includes Dryer > Plug & Play Complete Assembly
VB-2898			2007-2013 X5 2008-2014 X6		3.0 d/sd/si, 4.8 i xDrive, M, M 50 d, xDrive (30 d/i, 35 d/i, 40 d, 48 i, 50 i) M, M 50 d, xDrive (30 d, 35 d/i, 40 d, 50 i)
F01/02/04					
AS-2823			2009-2015 7 Series		730 d/d xDrive/i/Li, 740 d/d xDrive/i/Li/Li xDrive, 750 d xDrive/i/i xDrive, 760 i, Active Hybrid > Remanufactured > w/FlexRay Technology

BMW					
Part #	Product Type	Position	Model Information	Vehicle Attributes	Product Attributes
F01/02/04					
AS-2824			2009-2015 7 Series		730 d/d xDrive/i/Li, 740 d/d xDrive/i/Li/Li xDrive, 750 d xDrive/i/i xDrive, 760 i, Active Hybrid > Remanufactured > w/FlexRay Technology
P-2985			2009-2015 7 Series		730 d/d xDrive/i/Li, 740 d/d xDrive/i/Li/Li xDrive, 750 d xDrive/i/i xDrive, 760 i, Active Hybrid > WABCO OES > Includes Dryer
VB-3502			2009-2015 7 Series		730 d/d xDrive/i/Li, 740 d/d xDrive/i/Li/Li xDrive, 750 d xDrive/i/i xDrive, 760 i, Active Hybrid
F07/11					
A-2780			2011-2017 5 Series GT 2011-2017 5 Series Wagon	w/Auto-Leveling, AWD & RWD	520 d, 528 i, 530 d/d xDrive, 535 d/d xDrive/i/i xDrive, 550 i/i xDrive
P-2985			2011-2017 5 Series GT 2011-2017 5 Series Wagon	w/Auto-Leveling, AWD & RWD	520 d, 528 i, 530 d/d xDrive, 535 d/d xDrive/i/i xDrive, 550 i/i xDrive > WABCO OES > Includes Dryer
VB-3502			2011-2017 5 Series GT	w/Auto-Leveling, AWD & RWD	520 d, 528 i, 530 d/d xDrive, 535 d/d xDrive/i/i xDrive, 550 i/i xDrive
F15/16					
A-2642			2014-2018 X5 2015-2019 X6	w/Adaptive Drive, Comfort or Sport Suspension w/Adaptive Drive, Comfort or Sport Suspension	M, M 50 d, sDrive 25 d, xDrive (25 d, 30 d, 35 i, 40 d/e, 50 i) M, M 50 d, xDrive (30 d, 35 i, 40 d, 50 i)
P-3279			2014-2018 X5 2015-2019 X6	w/Adaptive Drive, Comfort or Sport Suspension w/Adaptive Drive, Comfort or Sport Suspension	M, M 50 d, sDrive 25 d, xDrive (25 d, 30 d, 35 i, 40 d, 40e, 50 i) M, M 50 d, xDrive (30 d, 35 i, 40 d, 50 i) > WABCO OES > Includes Dryer



BUICK					
Part #	Product Type	Position	Model Information	Vehicle Attributes	Product Attributes
G Platform					
AS-2190			1995-1999 Riviera		<ul style="list-style-type: none"> › New › Sold in Pairs
			1997-2005 Park Avenue	3.8 Supercharged	
			2000-2005 LeSabre	3.8	
SK-2189			2000-2005 LeSabre	3.8	<ul style="list-style-type: none"> › New › Sold in Pairs
F55					
AS-2950			2006-2011 Lucerne	w/MagneRide, w/Sport Suspension	› New
MR-3447			2006-2011 Lucerne	w/MagneRide	<ul style="list-style-type: none"> › New › Magentic Shocks
MR-3448			2006-2011 Lucerne	w/MagneRide	<ul style="list-style-type: none"> › New › Magentic Shocks
P-2982			2006-2011 Lucerne		› Includes Dryer
SK-2952			2006-2011 Lucerne	w/MagneRide, w/Sport Suspension	› New
GMT360					
A-2610			2004-2007 Rainier		<ul style="list-style-type: none"> › Generation II › Crimped Assembly, Improved Design
C-2137			2004-2007 Rainier		

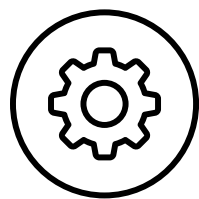

Innovative Engineering

Arnott's commitment to OE quality form, fit and function begins with exhaustive engineering. Arnott's advanced designs are not only more durable, but many are also easier to install than their OE counterparts.



Comprehensive Quality Assurance

Arnott's Quality Assurance Team is part of the process from development to production. At every step, they make sure that Arnott's high standards of quality, engineering and manufacturing are maintained.

AIR SUSPENSION BASICS





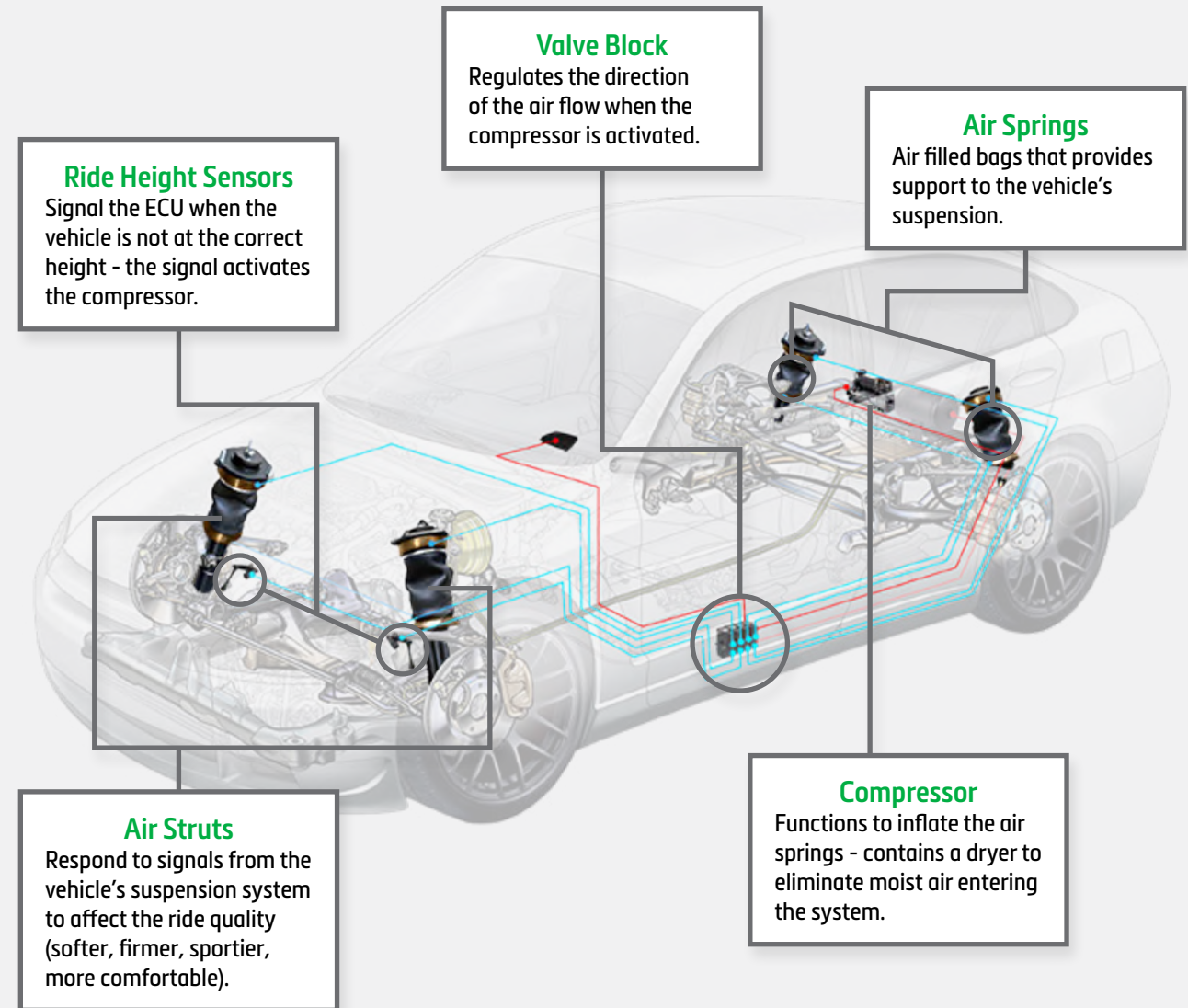













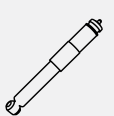

Air suspension systems use a compressor to inflate rubber air springs which may be separate from the shock absorber or combined with the damper as an air suspension strut. Height sensors give the ECU (Electronic Control Unit) a signal when the vehicle is not at a predetermined height and the compressor then pumps air into the air springs until the proper height is reached.





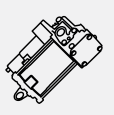
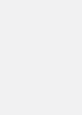





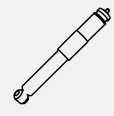

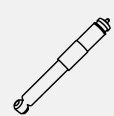



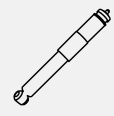

Like all rubber components, air springs and struts are wear and tear parts. Typically, the rubber will dry rot and small cracks form where the air bladder rolls upon itself. On average, an air suspension part will need to be replaced in six to ten years. Mileage, climate, driving conditions and off-road usage also influence the replacement rate.



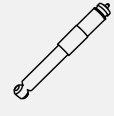







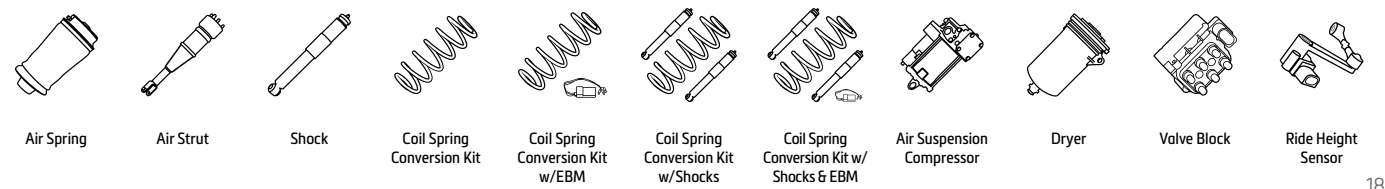

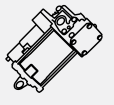



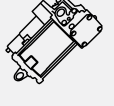
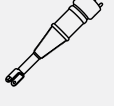

THE ARNOTT ADVANTAGE

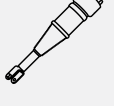

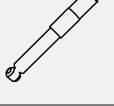

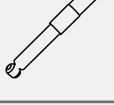













- ▶ **Trusted for more than 30 years**
- ▶ **Premium components**
- ▶ **OE fit**
- ▶ **Broadest aftermarket coverage**
- ▶ **Simplified diagnosis & installation**
- ▶ **Additional sales & profit**
- ▶ **Superior support**

CADILLAC						
Part #	Product Type	Position	Model Information	Vehicle Attributes	Product Attributes	
E-body, G-body, K-body						
AS-2121			1998-2001 Seville	SLS & STS	4.6 V8	<ul style="list-style-type: none"> > New > Sold in Pairs
			2000-2005 DeVille	DTS Only	4.6	
AS-2125			1993 Eldorado	All Models (Excl. ETC)	4.6	<ul style="list-style-type: none"> > New > Sold in Pairs
			1993 Seville	SLS	4.6 V8	
			1994-1995 DeVille	Base Model	4.6, 4.9	
AS-2163			1993-1995 Eldorado	ETC Model	4.6	<ul style="list-style-type: none"> > New > Sold in Pairs
			1993-1994 Seville	SLS & STS	4.6 V8	
			1994-1995 DeVille	Concours	4.6	
			1994-1996 Eldorado	Base Model	4.6	
			1995-1996 Seville	SLS	4.6 V8	
			1996 DeVille	Base Model	4.6	
AS-2177			1996-1999 DeVille	Concours	4.6	<ul style="list-style-type: none"> > New > Sold in Pairs
			1996-2002 Eldorado	ETC Model	4.6	
			1996 Seville	STS	4.6 V8	
			1997 Seville	SLS & STS	4.6 V8	
AS-2185			1997-1999 DeVille	Base Model	4.6, 4.9	<ul style="list-style-type: none"> > New > Sold in Pairs
			1997-2002 Eldorado	Base Model	4.6	
AS-2190			2000-2005 DeVille	All Models (Excl. DTS)	4.6	<ul style="list-style-type: none"> > New > Sold in Pairs
			2002-2003 Seville	SLS & STS	4.6 V8	
			2004 Seville	SLS	4.6 V8	
MR-3447			2006-2011 DTS	w/MagneRide		<ul style="list-style-type: none"> > New > Magentic Shocks
MR-3448			2006-2011 DTS	w/MagneRide		<ul style="list-style-type: none"> > New > Magentic Shocks
P-3021			1998-2004 Seville		4.6 V8	<ul style="list-style-type: none"> > WABCO OES > Includes Dryer
			2000-2005 DeVille		4.6, 4.9	
SK-2111			1993 Allante		4.6	<ul style="list-style-type: none"> > New > Sold in Pairs
SK-2118			1995 DeVille	Base Model	4.6, 4.9	<ul style="list-style-type: none"> > New > Sold in Pairs







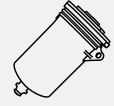

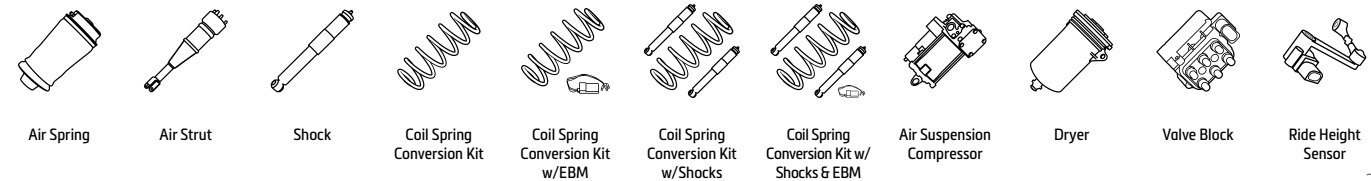

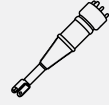



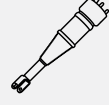

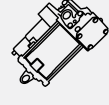



CADILLAC						
Part #	Product Type	Position	Model Information	Vehicle Attributes	Product Attributes	
E-body, G-body, K-body						
SK-2162			1993 Allante		4.6	<ul style="list-style-type: none"> > New > Sold in Pairs
			1993-1994 Eldorado	ETC Model	4.6	
			1993 Seville	STS	4.6 V8	
			1994 DeVille	Concours	4.6	
			1994 Eldorado	Base Model	4.6	
SK-2167			1994 Seville	SLS & STS	4.6 V8	<ul style="list-style-type: none"> > New > Sold in Pairs
			1995 DeVille	Concours	4.6	
			1995 Eldorado	Base & ETC Models	4.6	
			1996 Eldorado	Base Model	4.6	
			1995 Seville	SLS & STS	4.6 V8	
			1996 Seville	STS	4.6 V8	
SK-2176			1996 DeVille	Concours	4.6	<ul style="list-style-type: none"> > New > Sold in Pairs
			1996 Eldorado	Base Model	4.6	
			1996 Seville	STS	4.6 V8	
SK-2178			1997-1999 DeVille	Concours	4.6	<ul style="list-style-type: none"> > New > Sold in Pairs
			1997-2002 Eldorado	ETC Model	4.6	
			1997 Seville	SLS & STS	4.6 V8	
SK-2183			1997-1999 DeVille	Base Model	4.6, 4.9	<ul style="list-style-type: none"> > New > Sold in Pairs
			1997-2002 Eldorado	Base Model	4.6	
SK-2186			1998-2001 Seville	SLS & STS	4.6 V8	<ul style="list-style-type: none"> > New > Sold in Pairs
			2000-2001 DeVille	DTS Only	4.6	
SK-2189			2000-2005 DeVille	All Models (Excl. DTS)	4.6	<ul style="list-style-type: none"> > New > Sold in Pairs
			2002-2003 Seville	SLS & STS	4.6 V8	
			2004 Seville	SLS	4.6 V8	
SK-2264			1993 Seville	SLS	4.6 V8	<ul style="list-style-type: none"> > New > Sold in Pairs
			1994 DeVille	Base Model	4.6, 4.9	
Epsilon II						
A-3233			2013-2019 XTS	w/ & w/o AWD	3.6, 3.6 AWD	



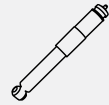



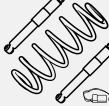



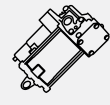

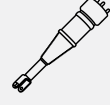

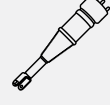



CADILLAC						
Part #	Product Type	Position	Model Information	Vehicle Attributes	Product Attributes	
Epsilon II						
P-3243			2013-2019 XTS	w/ & w/o AWD	3.6, 3.6 AWD	
SK-3357			2013-2019 XTS	w/ & w/o AWD	3.6, 3.6 AWD	> New
SK-3433			2013-2019 XTS	w/ & w/o AWD	3.6, 3.6 AWD	> New
F55						
AS-2950			2006-2011 DTS	w/MagneRide, w/Sport Suspension	4.6	> New
P-2982			2006-2011 DTS	4.6		> Includes Dryer
SK-2952			2006-2011 DTS	w/MagneRide, w/Sport Suspension	4.6	> New
GMT265						
MR-3441			2004-2009 SRX	w/MagneRide		> New > Magnetic Strut
MR-3442			2004-2009 SRX	w/MagneRide		> New > Magnetic Shock
GMT806, GMT820, GMT830, GMT926, GMT936, GMT946						
AS-2708			2002-2014 Escalade	Short Wheelbase & Long Wheelbase (ESV, EXT)	5.7 AWD, 6.0, 6.0 AWD, 6.2, 6.2 AWD/FLEXFUEL/FLEXFUEL AWD	> Remanufactured
AS-2715			2002-2014 Escalade	Short Wheelbase & Long Wheelbase (ESV, EXT)	5.7 AWD, 6.0, 6.0 AWD, 6.2, 6.2 AWD/FLEXFUEL/FLEXFUEL AWD	> New > Value

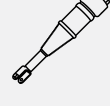







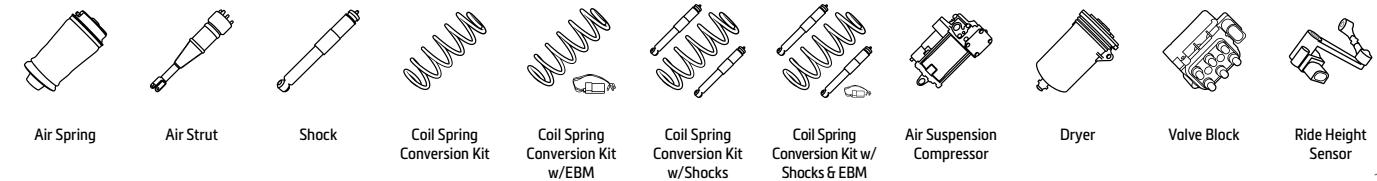





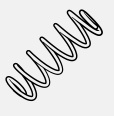

CADILLAC						
Part #	Product Type	Position	Model Information	Vehicle Attributes	Product Attributes	
GMT806, GMT820, GMT830, GMT926, GMT936, GMT946						
AS-3430			2002-2006 Escalade	Short Wheelbase & Long Wheelbase (ESV, EXT), w/Autoride Suspension	5.7 AWD, 6.0, 6.0 AWD, 6.2, 6.2 AWD/FLEXFUEL/FLEXFUEL AWD	> New
			2007-2014 Escalade	Short Wheelbase & Long Wheelbase (ESV, EXT), w/Autoride Suspension, w/MagneRide		
C-2666			2002-2006 Escalade	Short Wheelbase	5.7 AWD, 6.0, 6.0 AWD, 6.2, 6.2 AWD/FLEXFUEL/FLEXFUEL AWD	> Value
C-2667			2002-2006 Escalade	Long Wheelbase (ESV, EXT)	5.7 AWD, 6.0, 6.0 AWD, 6.2, 6.2 AWD/FLEXFUEL/FLEXFUEL AWD	> Value
C-2835			2007-2014 Escalade	Short Wheelbase	6.0 Hybrid/Hybrid AWD, 6.2, 6.2 AWD/FLEXFUEL/FLEXFUEL AWD/Flex/Flex AWD	> Value
C-2836			2007-2014 Escalade	Long Wheelbase (ESV, EXT)	6.0 Hybrid/Hybrid AWD, 6.2, 6.2 AWD/FLEXFUEL/FLEXFUEL AWD/Flex/Flex AWD	> Value
C-3182			2002-2006 Escalade	Short Wheelbase	5.7 AWD, 6.0, 6.0 AWD	> Eibach Shock Absorbers
C-3183			2002-2006 Escalade	Long Wheelbase (ESV, EXT)	5.7 AWD, 6.0, 6.0 AWD	> Eibach Shock Absorbers
C-3184			2007-2014 Escalade	Short Wheelbase	6.0 Hybrid/Hybrid AWD, 6.2, 6.2 AWD/FLEXFUEL/FLEXFUEL AWD/Flex/Flex AWD	> Eibach Shock Absorbers
C-3185			2007-2014 Escalade	Long Wheelbase (ESV, EXT)	6.0 Hybrid/Hybrid AWD, 6.2, 6.2 AWD/FLEXFUEL/FLEXFUEL AWD/Flex/Flex AWD	> Eibach Shock Absorbers
D-2803			2002-2014 Escalade	Short Wheelbase & Long Wheelbase (ESV, EXT)	5.7 AWD, 6.0, 6.0 AWD, 6.2, 6.2 AWD/FLEXFUEL/FLEXFUEL AWD	

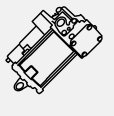















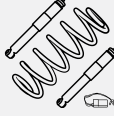

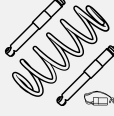

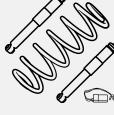
CADILLAC					
Part #	Product Type	Position	Model Information	Vehicle Attributes	Product Attributes
GMT806, GMT820, GMT830, GMT926, GMT936, GMT946					
MR-3435			2007-2014 Escalade	Short Wheelbase & Long Wheelbase (ESV, EXT) 5.7 AWD, 6.0, 6.0 AWD, 6.2, 6.2 AWD/FLEXFUEL/FLEXFUEL AWD	› New › Magnetic Strut
MR-3436			2007-2014 Escalade	Short Wheelbase & Long Wheelbase (ESV, EXT) 5.7 AWD, 6.0, 6.0 AWD, 6.2, 6.2 AWD/FLEXFUEL/FLEXFUEL AWD	› New › Magnetic Shock
MR-3568			2007-2014 Escalade	Short Wheelbase & Long Wheelbase (ESV, EXT) 5.7 AWD, 6.0, 6.0 AWD, 6.2, 6.2 AWD/FLEXFUEL/FLEXFUEL AWD	› New › Magnetic Strut › Coil-Over Strut
P-3242			2002-2014 Escalade	Short Wheelbase & Long Wheelbase (ESV, EXT)	› Includes Dryer › Plug & Play Complete Assembly
SK-2760			2002-2006 Escalade	Short Wheelbase & Long Wheelbase (ESV, EXT) 5.7 AWD, 6.0, 6.0 AWD, 6.2, 6.2 AWD/FLEXFUEL/FLEXFUEL AWD	› New › Value
SK-2806			2007-2014 Escalade	Short Wheelbase & Long Wheelbase (ESV, EXT) 6.0 Hybrid/Hybrid AWD, 6.2, 6.2 AWD/FLEXFUEL/FLEXFUEL AWD/Flex/Flex AWD	› New › Value
SK-2954			2007-2014 Escalade	Short Wheelbase & Long Wheelbase (ESV, EXT) (Excl. Hybrids) 5.7 AWD, 6.0, 6.0 AWD, 6.2, 6.2 AWD/FLEXFUEL/FLEXFUEL AWD	› New
SK-3062			2002-2006 Escalade	Short Wheelbase & Long Wheelbase (ESV, EXT)	› New › Eibach Shock Absorber
GMTK2XL					
AS-3066			2015-2020 Escalade	Incl. ESV	› New › Eibach Shock Absorber
C-3416			2015-2020 Escalade	Excl. ESV	› Eibach Shock Absorbers
C-3432			2015-2020 Escalade	ESV	› Eibach Shock Absorbers

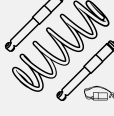

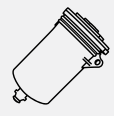
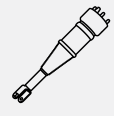

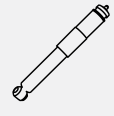



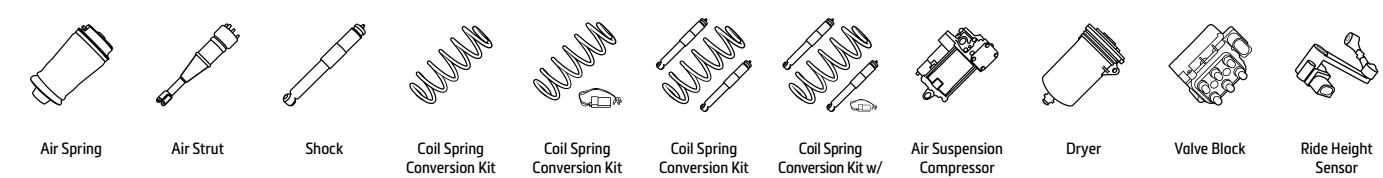

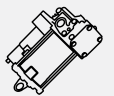
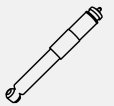

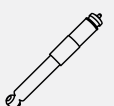

CADILLAC					
Part #	Product Type	Position	Model Information	Vehicle Attributes	Product Attributes
GMTK2XL					
P-3242			2015-2019 Escalade	Incl. ESV	› Includes Dryer › Plug & Play Complete Assembly
SK-3354			2015-2018 Escalade	ESV w/MagneRide	› New › Eibach Shock Absorber › Coil-Over Shock
GMX295					
MR-3437			2007-2010 STS	w/MagneRide, w/AWD	› New › Magnetic Strut
MR-3438			2007-2010 STS	w/MagneRide, w/RWD	› New › Magnetic Strut
MR-3439			2007-2010 STS	w/MagneRide, w/AWD or RWD	› New › Magnetic Shock
MR-3440			2007-2010 STS	w/MagneRide, w/AWD or RWD	› New › Magnetic Shock
GMX322					
MR-3443			2009-2015 CTS 2009-2015 CTS-V	w/MagneRide	› New › Magnetic Strut
MR-3444			2009-2015 CTS 2009-2015 CTS-V	w/MagneRide	› New › Magnetic Shock
MR-3445			2009-2015 CTS 2009-2015 CTS-V	w/MagneRide	› New › Magnetic Shock

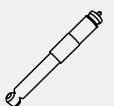





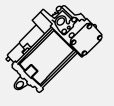

CHEVROLET					
Part #	Product Type	Position	Model Information	Vehicle Attributes	Product Attributes
GMT200					
AS-2235			1997-2005 Venture	w/Rear Air Assist	<ul style="list-style-type: none"> › New › Sold in Pairs
GMT360, GMT370					
A-2610			2002-2006 Trailblazer EXT	129" Wheelbase, 4.2 AWD	<ul style="list-style-type: none"> › Generation II › Crimped Assembly, Improved Design
			2002-2009 Trailblazer	113" Wheelbase, 4.2 AWD	
C-2137			2002-2009 Trailblazer	113" Wheelbase, 4.2 AWD	
C-2285			2002-2006 Trailblazer EXT	129" Wheelbase, 4.2 AWD	
P-2863			2002-2006 Trailblazer EXT	129" Wheelbase, 4.2 AWD	<ul style="list-style-type: none"> › WABCO OES › Remanufactured › Includes Dryer › Plug & Play Complete Assembly
GMT805, GMT820, GMT830, GMT921, GMT931, GMT941					
AS-2708			2000-2006 Tahoe 1500	4x2, 4x4 (w/Autoride Suspension)	<ul style="list-style-type: none"> › Remanufactured
			2000-2014 Suburban 1500	4.8 V8, 5.3, 5.3 AWD/V8 AWD, 6.0 V8	
			2002-2014 Avalanche 1500	4x2, 4x4 (w/Electronic Suspension)	
			2007-2014 Tahoe 1500	5.3 AWD/Flex-Fuel 4WD, 8.1 AWD	
AS-2715			2000-2006 Tahoe 1500	4x2, 4x4 (w/Autoride Suspension)	<ul style="list-style-type: none"> › New › Value
			2000-2014 Suburban 1500	4.8 V8, 5.3, 5.3 AWD/V8 AWD, 6.0 V8	
			2002-2014 Avalanche 1500	4x2, 4x4 (w/Electronic Suspension)	
			2007-2014 Tahoe 1500	5.3 AWD/Flex-Fuel 4WD, 8.1 AWD	
AS-3430			2000-2006 Suburban 1500	4x2, 4x4 (w/Autoride Suspension)	<ul style="list-style-type: none"> › New
			2000-2006 Tahoe 1500	4.8 V8, 5.3, 5.3 AWD/V8 AWD, 6.0 V8	
			2002-2006 Avalanche 1500	5.3 AWD, 8.1	
			2007-2013 Avalanche 1500	4x2, 4x4 (w/Autoride Suspension, w/MagneRide)	
			2007-2014 Suburban 1500	2.3 AWD/Flex-Fuel/Flex-Fuel AWD, 8.1	
			2007-2014 Tahoe 1500	5.3 AWD/Flex-Fuel 4WD, 8.1 AWD	
C-2666			2000-2006 Tahoe 1500	4x2, 4x4 (w/Autoride Suspension)	<ul style="list-style-type: none"> › Value



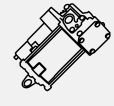

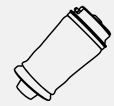

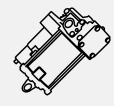
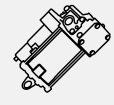

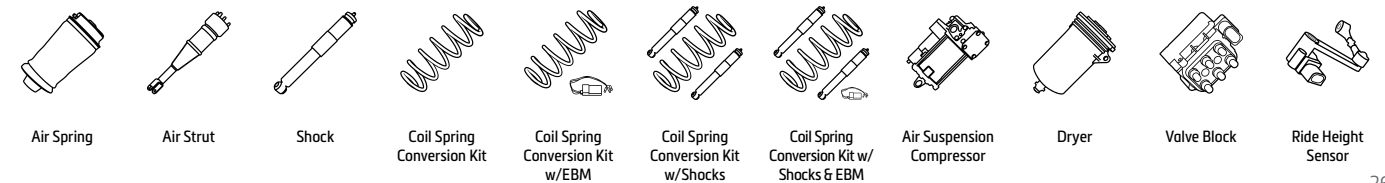







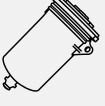
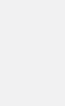
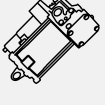
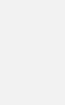

CHEVROLET					
Part #	Product Type	Position	Model Information	Vehicle Attributes	Product Attributes
GMT805, GMT820, GMT830, GMT921, GMT931, GMT941					
C-2667			2000-2006 Suburban 1500	4x2, 4x4 (w/Autoride Suspension)	<ul style="list-style-type: none"> › Value
			2002-2006 Avalanche 1500	4x2, 4x4 (w/Electronic Suspension)	
C-2835			2007-2014 Tahoe 1500	4x2, 4x4 (w/Electronic Suspension)	<ul style="list-style-type: none"> › Value
C-2836			2007-2014 Avalanche 1500	4x2, 4x4 (w/Electronic Suspension)	<ul style="list-style-type: none"> › Value
			2007-2014 Suburban 1500	4x2, 4x4 (w/Autoride Suspension)	
C-3182			2000-2006 Tahoe 1500	4x2, 4x4 (w/Autoride Suspension)	<ul style="list-style-type: none"> › Eibach Shock Absorbers
C-3183			2000-2006 Suburban 1500	4x2, 4x4 (w/Autoride Suspension)	<ul style="list-style-type: none"> › Eibach Shock Absorbers
			2002-2006 Avalanche 1500	4x2, 4x4 (w/Electronic Suspension)	
C-3184			2007-2014 Tahoe 1500	4x2, 4x4 (w/Electronic Suspension)	<ul style="list-style-type: none"> › Eibach Shock Absorbers
C-3185			2007-2014 Avalanche 1500	4x2, 4x4 (w/Electronic Suspension)	<ul style="list-style-type: none"> › Eibach Shock Absorbers
			2007-2014 Suburban 1500	4x2, 4x4 (w/Autoride Suspension)	
D-2803			2001-2006 Tahoe 1500	4x2, 4x4 (w/Autoride Suspension)	<ul style="list-style-type: none"> › Value
			2001-2014 Suburban 1500	4.8 V8, 5.3, 5.3 AWD/V8 AWD, 6.0 V8	
			2002-2014 Avalanche 1500	4x2, 4x4 (w/Electronic Suspension)	
			2007-2014 Tahoe 1500	5.3 AWD/Flex-Fuel/Flex-Fuel AWD, 8.1	
MR-3435			2007-2014 Suburban 1500	4x2, 4x4 (w/Autoride Suspension)	<ul style="list-style-type: none"> › Magnetic Strut
			2007-2014 Avalanche 1500	4x2, 4x4 (w/Electronic Suspension)	
			2007-2014 Tahoe 1500		
MR-3436			2007-2014 Suburban 1500	4x2, 4x4 (w/Autoride Suspension)	<ul style="list-style-type: none"> › Magnetic Shock
			2007-2014 Avalanche 1500	4x2, 4x4 (w/Electronic Suspension)	
			2007-2014 Tahoe 1500		











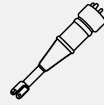

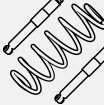

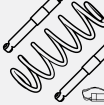

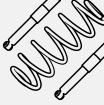
CHEVROLET					
Part #	Product Type	Position	Model Information	Vehicle Attributes	Product Attributes
GMT805, GMT820, GMT830, GMT921, GMT931, GMT941					
P-3242			2001-2006 Tahoe 1500	4x2, 4x4 (w/Autoride Suspension)	4.8 V8, 5.3, 5.3 AWD/V8 AWD, 6.0 V8
			2001-2014 Suburban 1500		5.3 AWD/Flex-Fuel 4WD
			2002-2014 Avalanche 1500	4x2, 4x4 (w/Electronic Suspension)	5.3 AWD/Flex-Fuel/Flex-Fuel AWD, 8.1
			2007-2014 Tahoe 1500		5.3
SK-2760			2000-2006 Suburban 1500	4x2, 4x4 (w/Autoride Suspension)	
			2000-2006 Tahoe 1500		4.8 V8, 5.3, 5.3 AWD/V8 AWD, 6.0 V8
			2002-2006 Avalanche 1500	4x2, 4x4 (w/Electronic Suspension)	5.3 AWD, 8.1
SK-2806			2007-2014 Avalanche 1500	4x2, 4x4 (w/Electronic Suspension)	5.3 Flex-Fuel/Flex-Fuel AWD
			2007-2014 Suburban 1500	4x2, 4x4 (w/Autoride Suspension)	
			2007-2014 Tahoe 1500	4x2, 4x4 (w/Electronic Suspension)	5.3, 6.0 Flex/Hybrid 4WD
SK-2954			2007-2014 Avalanche 1500	4x2, 4x4 (w/Electronic Suspension) (Excl. Hybrids)	5.3 Flex-Fuel, 5.3 Flex-Fuel AWD
			2007-2014 Suburban 1500	4x2, 4x4 (w/Autoride Suspension)	5.3 Flex-Fuel 4WD
			2007-2014 Tahoe 1500	4x2, 4x4 (w/Electronic Suspension)	5.3
SK-3062			2000-2006 Suburban 1500	4x2, 4x4 (w/Autoride Suspension)	
			2000-2006 Tahoe 1500		
			2002-2006 Avalanche 1500	4x2, 4x4 (w/Electronic Suspension)	
GMTK2UC, GMTK2YC					
AS-3066			2015-2020 Suburban 1500		<ul style="list-style-type: none"> > New > Eibach Shock Absorber
			2015-2020 Tahoe 1500		
C-3416			2015-2020 Tahoe 1500		<ul style="list-style-type: none"> > Eibach Shock Absorbers
C-3432			2015-2020 Suburban 1500		<ul style="list-style-type: none"> > Eibach Shock Absorbers
P-3242			2015-2019 Suburban 1500		<ul style="list-style-type: none"> > Includes Dryer > Plug & Play Complete Assembly
			2015-2019 Tahoe 1500		



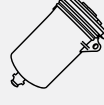
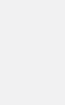
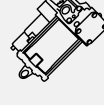
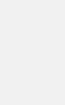
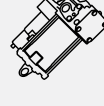
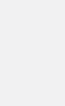





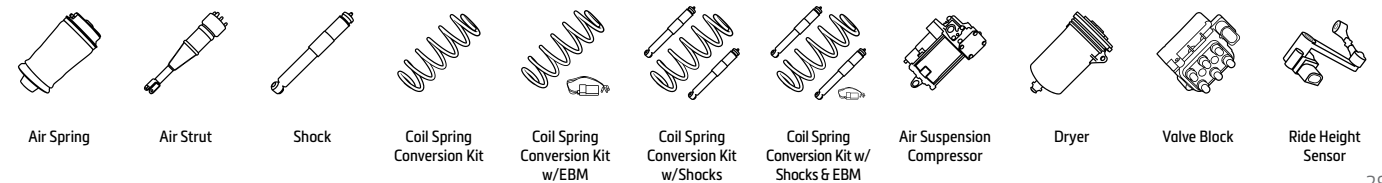



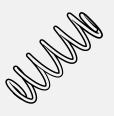

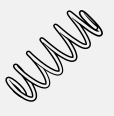

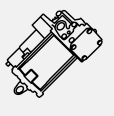
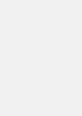

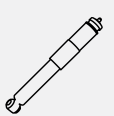

CHEVROLET					
Part #	Product Type	Position	Model Information	Vehicle Attributes	Product Attributes
GMTK2UC, GMTK2YC					
SK-3354			2015-2018 Suburban 1500	w/MagneRide	<ul style="list-style-type: none"> > New > Eibach Shock Absorber > Coil-Over Shock
			2015-2018 Tahoe 1500		
GMTK2HC					
P-3242			2015-2019 Silverado		<ul style="list-style-type: none"> > Includes Dryer > Plug & Play Complete Assembly
			2015-2019 Cheyenne		
SK-3354			2015-2018 Silverado	w/MagneRide	<ul style="list-style-type: none"> > New > Eibach Shock Absorber > Coil-Over Shock
CITROËN					
Part #	Product Type	Position	Model Information	Vehicle Attributes	Product Attributes
PF2					
A-2939			2006-2013 C4 Grand Picasso	1.2 THP 130, 1.6 16V/BlueHDi 100/BlueHDi 120/HDi/BlueHDi 115/HDi 110/HDi 90/THP 140/THP 150/THP 155/THP 165/VTi 120, 1.8 Bifuel/i 16V, 2.0 BlueHDi 135/BlueHDi 150/HDi 138/HDi 150/HDi 165/i 16V	
P-2854			2006-2013 C4 Grand Picasso	1.6 16V/HDi/HDi 110/THP 155/VTi 120, 1.8 i 16V, 2.0 HDi 138/HDi 150/HDi 165/i 16V	<ul style="list-style-type: none"> > WABCO OES > Includes Dryer
VF7					
P-2851			2007-2016 Jumpy	1.6 HDi 90 16V/8V, 2.0 HDi 120/HDi 125/HDi 140/HDi 165/HDi 95/i	<ul style="list-style-type: none"> > WABCO OES > Includes Dryer







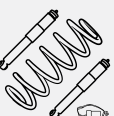







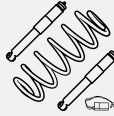

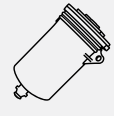
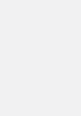
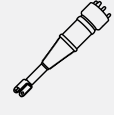

FORD					
Part #	Product Type	Position	Model Information	Vehicle Attributes	Product Attributes
Panther					
A-2105			1992-2011 Crown Victoria	4.6 Liter V8	
A-2220			1992-2011 Crown Victoria	4.6 Liter V8	> Heavy Duty for Limousine Use
C-2614			1992-2002 Crown Victoria	4.6 Liter V8	
C-2615			2003-2011 Crown Victoria	4.6 Liter V8	
D-2171			1992-2011 Crown Victoria	4.6 Liter V8	
P-2936			1992-2011 Crown Victoria	4.6 Liter V8	> Includes Dryer
U93, U222, U324					
A-2143			2003-2006 Expedition	2 Wheel Drive & 4 Wheel Drive	> New Air Spring Only, Reuse Factory Shock
A-2148			1997-2002 Expedition	2 Wheel Drive	
A-2153			1997-2002 Expedition	4 Wheel Drive	
A-2647			2007-2014 Expedition	2 Wheel Drive & 4 Wheel Drive	
A-2735			2003-2006 Expedition	2 Wheel Drive & 4 Wheel Drive	> New Air Spring Only, Reuse Factory Shock



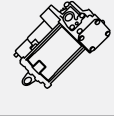
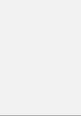
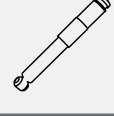





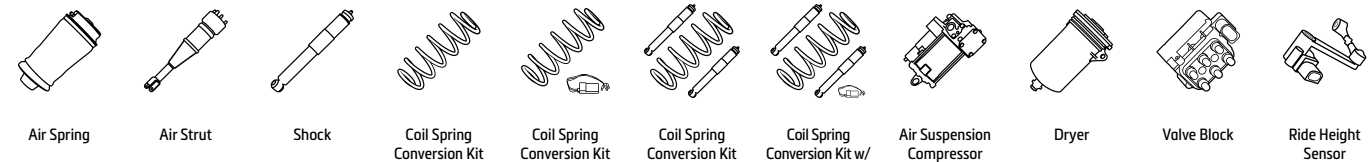





FORD					
Part #	Product Type	Position	Model Information	Vehicle Attributes	Product Attributes
U93, U222, U324					
AS-2139			2003-2006 Expedition	2 Wheel Drive & 4 Wheel Drive	> New > Strut, Air Spring & Upper Mount Assembly
C-2140			2003-2006 Expedition	2 Wheel Drive & 4 Wheel Drive	
C-2529			2007-2014 Expedition	2 Wheel Drive & 4 Wheel Drive (AWD/RWD)	
C-2607			1997-2002 Expedition	2 Wheel Drive (RWD)	
C-2608			1997-2002 Expedition	4 Wheel Drive (4WD)	
D-2155			1997-2006 Expedition	2 Wheel Drive & 4 Wheel Drive	
P-2932			1997-2006 Expedition	2 Wheel Drive & 4 Wheel Drive	> Includes Dryer
P-2937			2007-2017 Expedition	2 Wheel Drive & 4 Wheel Drive	> Includes Dryer
SK-2723			2003-2006 Expedition	2 Wheel Drive & 4 Wheel Drive	> New
WIN88, WIN126					
C-2175			1995-2003 Windstar	w/Load Leveling Rear Air Suspension	3.0 V6, 3.8, 3.8 V6

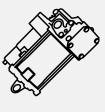

GMC						
Part #	Product Type	Position	Model Information	Vehicle Attributes	Product Attributes	
GMT305, GMT360, GMT370						
A-2610			2002-2006 Envoy XL	129" Wheelbase	<ul style="list-style-type: none"> › Generation II › Crimped Assembly, Improved Design 	
			2002-2006 Envoy XUV			
			2002-2009 Envoy	113" Wheelbase		
C-2137			2002-2009 Envoy	113" Wheelbase		
C-2285			2002-2006 Envoy XL	129" Wheelbase		
			2002-2006 Envoy XUV			
P-2863			2002-2006 Envoy XL	129" Wheelbase	<ul style="list-style-type: none"> › WABCO OES › Remanufactured › Includes Dryer › Plug & Play Complete Assembly 	
			2002-2006 Envoy XUV			
GMT820, GMT830, GMT922, GMT932						
AS-2708			2000-2013 Yukon 1500	All Models w/Autoride	6.2 4WD	› Remanufactured
			2000-2014 Yukon XL 1500			
AS-2715			2000-2013 Yukon 1500	All Models w/Autoride	6.2 4WD	<ul style="list-style-type: none"> › New › Value
			2000-2014 Yukon XL 1500			
AS-3430			2000-2006 Yukon 1500	All Models w/Autoride	6.2 4WD	› New
			2000-2006 Yukon XL 1500			
			2007-2013 Yukon 1500	All Models w/Autoride, w/MagneRide	5.3, 6.2, 6.2 4WD	
			2007-2014 Yukon XL 1500		6.0, 6.0 4WD	
C-2666			2000-2006 Yukon 1500	All Models w/Autoride		› Value
C-2667			2000-2006 Yukon XL 1500	All Models w/Autoride		› Value
C-2835			2007-2013 Yukon 1500	All Models w/Autoride	5.3, 6.2, 6.2 4WD	› Value
C-2836			2007-2014 Yukon XL 1500	All Models w/Autoride	6.0, 6.0 4WD	› Value

GMC						
Part #	Product Type	Position	Model Information	Vehicle Attributes	Product Attributes	
GMT820, GMT830, GMT922, GMT932						
C-3182			2000-2006 Yukon 1500	All Models w/Autoride		› Eibach Shock Absorbers
C-3183			2000-2006 Yukon XL 1500	All Models w/Autoride		› Eibach Shock Absorbers
C-3184			2007-2013 Yukon 1500	All Models w/Autoride	5.3, 6.2, 6.2 4WD	› Eibach Shock Absorbers
C-3185			2007-2014 Yukon XL 1500	All Models w/Autoride	6.0, 6.0 4WD	› Eibach Shock Absorbers
D-2803			2000-2013 Yukon 1500	All Models w/Autoride	6.2 4WD	
			2000-2014 Yukon XL 1500			
MR-3435			2007-2013 Yukon 1500	All Models w/Autoride		<ul style="list-style-type: none"> › New › Magnetic Strut
			2007-2014 Yukon XL 1500			
MR-3436			2007-2013 Yukon 1500	All Models w/Autoride		<ul style="list-style-type: none"> › New › Magnetic Shock
			2007-2014 Yukon XL 1500			
P-3242			2000-2014 Yukon 1500	All Models w/Autoride		<ul style="list-style-type: none"> › Includes Dryer › Plug & Play Complete Assembly
			2000-2014 Yukon XL 1500			
SK-2760			2000-2006 Yukon 1500	All Models w/Autoride		<ul style="list-style-type: none"> › New › Value
			2000-2006 Yukon XL 1500			
SK-2806			2007-2013 Yukon 1500	All Models w/Autoride		<ul style="list-style-type: none"> › New › Value
			2007-2014 Yukon XL 1500			

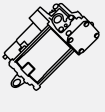

GMC						
Part #	Product Type	Position	Model Information	Vehicle Attributes	Product Attributes	
GMT820, GMT830, GMT922, GMT932						
SK-2954			2007-2013 Yukon 1500 2007-2014 Yukon XL 1500	All Models w/Autoride (Excl. Hybrids) 6.2 4WD		› New
SK-3062			2000-2006 Yukon 1500 2000-2006 Yukon XL 1500	All Models w/Autoride		› New › Eibach Shock Absorber
GMTK2UG, GMTK2YG						
AS-3066			2015-2019 Yukon 1500 2015-2019 Yukon XL 1500			› New › Eibach Shock Absorber
C-3416			2015-2020 Yukon 1500			› Eibach Shock Absorbers
C-3432			2015-2020 Yukon XL 1500			› Eibach Shock Absorbers
P-3242			2015-2019 Yukon 1500 2015-2019 Yukon XL 1500			› Includes Dryer › Plug & Play Complete Assembly
GMTK2UG, GMTK2YG						
SK-3354			2015-2018 Yukon 1500 2015-2018 Yukon XL 1500	w/MagneRide		› New › Eibach Shock Absorber › Coil-Over Shock
GMTK2HG						
P-3242			2015-2020 Sierra			› Includes Dryer › Plug & Play Complete Assembly
SK-3354			2015-2018 Sierra	w/MagneRide		› New › Eibach Shock Absorber › Coil-Over Shock

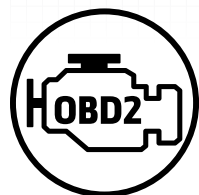

TECH TIP: WARNING LIGHTS

A dashboard warning light typically indicates an air suspension problem such as a failed compressor. Another common indicator for an air suspension problem is that the car is no longer leveled in the morning.

Air springs in a vehicle's suspension are durable rubber sleeves that are inflated and deflated through electronic inputs to create a smooth, controlled ride. An air spring can be connected to a vehicle's axle or integrated onto the suspension strut.

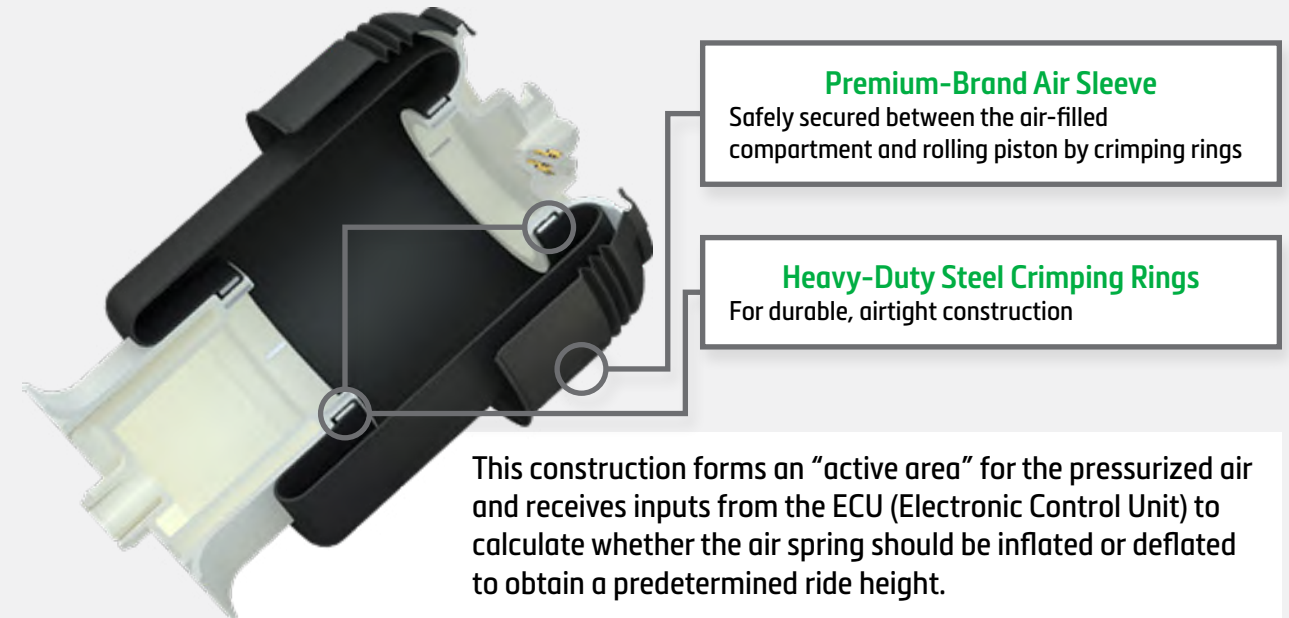

TECH TIP: LEAKS

Most air suspension problems occur because one or more of a vehicle's air springs have deteriorated and developed leaks. Thin rubber air sleeves and seals combined with weak crimping rings are common problems in many low-quality knock-offs and some stock air springs.



An air suspension leak is easy to find by spraying the air springs, struts and fittings with a soap and water solution. Bubbles will indicate where the leak or leaks are.

Arnott air springs feature multi-ply sleeves manufactured by industry-leading companies and are engineered to address the common problems many springs develop.

THE ARNOTT ADVANTAGE

- ▶ Long-lasting, premium-brand, multi-ply air sleeve manufactured by industry-leading companies
- ▶ Improved design installs up to 94% faster than OE
- ▶ Quick, economical repair option

ARNOTT OFFERS AIR SPRINGS FOR:

Audi • BMW • Buick • Cadillac • Chevrolet • Citroën • Ford • GMC • Iveco • Jeep • Land Rover • Lexus • Lincoln • Mercedes-Benz • Mercury • Oldsmobile • Porsche • Ram • Saab • Toyota • Volkswagen • Volvo









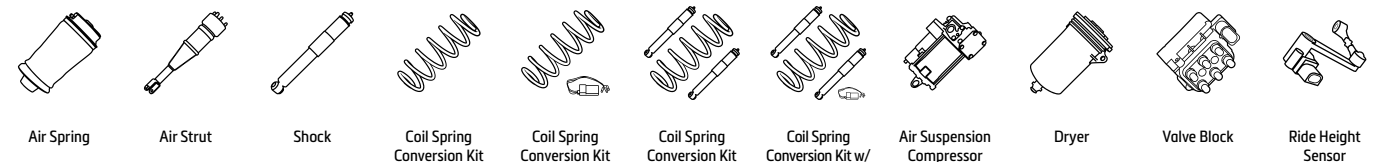



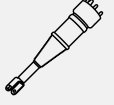

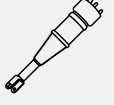

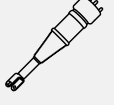

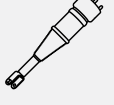

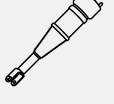
HUMMER						
Part #	Product Type	Position	Model Information	Vehicle Attributes		Product Attributes
GMT820						
C-2987			2003-2007 H2 Series	w/Rear Air Suspension	6.0/6.2 AWD	
C-2988			2008-2009 H2 Series	w/Rear Air Suspension	6.2 Flex AWD	

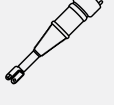
INFINITI						
Part #	Product Type	Position	Model Information	Vehicle Attributes		Product Attributes
JA60						
AS-3284			2004-2010 QX56	5.6 4WD		> New
C-3421			2004-2010 QX56	4 Wheel Drive (4WD)	5.6 4WD	
C-3434			2004-2010 QX56	Rear Wheel Drive (RWD)	5.6	
P-3277			2004-2010 QX56	5.6 4WD		

IVECO							
Part #	Product Type	Position	Model Information	Vehicle Attributes		Product Attributes	
A-3276			1999-2015 Daily 35/50, Daily III, IV, V, VI, EcoDaily	35 (C 14, C 15, C10 K, C12, C13K, C13DKP, C15, C15 V, C15 V/P, C18) 40 (C 10 (AEIB14A1), C 11, C 13, C 14, C 15, C10, C10 V, C11 V, C11, C11 D, C12, C12 V, C14 V/P, C13 V, C13 V/P, C13, C13/P, C14 G, C14 G/P, C14 GV, C14 GV/P, C14 K, C14 DK, C14 V, C14 V/P, C14, C14 /P, C15, C15 V, C15 V/P, C17 K, C17 DK, C17 V, C17 V/P, C17, C17/P, C18, C18 V, C18 V/P) 50 (C 11, C 11 Natural Power (CNG), C 13, C 14, C 15, C 17, C Electric, C14 G, C14 G/P, C14 GD, C14 GD/P, C14 GV, C14 GV/P, C14 K, C14 DK, C14 Natural Power, C14 V, C14 V/P, C14, C14/P, C15, C15 V, C15 V/P, C17 K, C17 DK, C17 V, C17 V/P, C17, C17/P, C18, C18 V, C18 V/P)			

JAGUAR						
Part #	Product Type	Position	Model Information	Vehicle Attributes		Product Attributes
X350, X358						
AS-2888			2004-2009 XJ Series	w/Comfort Suspension	3.0, 3.6, 4.2, D 2.7, R 4.2	> New
AS-2889			2004-2009 XJ Series	w/Comfort Suspension	3.0, 3.6, 4.2, D 2.7, R 4.2	> New
AS-2890			2004-2009 XJ Series	w/Sport Suspension	3.0, 3.6, 4.2, D 2.7, R 4.2	> New
AS-2891			2004-2009 XJ Series	w/Sport Suspension	3.0, 3.6, 4.2, D 2.7, R 4.2	> New
C-2745			2004-2009 XJ Series	3.0, 3.6, 4.2, D 2.7, R 4.2		> Eibach Shock Absorbers
C-3270			2004-2009 XJ Series	3.0, 3.6, 4.2, D 2.7, R 4.2		> Eibach Shock Absorbers
P-2291			2004-2009 XJ Series	3.0, 3.6, 4.2, D 2.7, R 4.2		> WABCO OES > Includes Dryer
X351						
AS-3234			2011-2019 XJ Series	w/AWD or RWD, Short Wheelbase & Long Wheelbase	2.0, 3.0, 3.0 AWD/D, 5.0, 5.0 R575/V8	> New > Eibach Shock Absorber
P-3244			2010-2019 XJ Series	w/AWD or RWD, Short Wheelbase & Long Wheelbase	2.0, 3.0, 3.0 AWD/D, 5.0, 5.0 R575/V8	> Includes Dryer > Plug & Play Complete Assembly

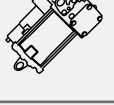

JEEP					
Part #	Product Type	Position	Model Information	Vehicle Attributes	Product Attributes
WK2					
A-3010			2011-2018 Grand Cherokee	3.0 4x4/CRD/CRD V6 4x4, 3.6 V6 4x4/V6 FlexFuel 4x4/VVT 4x4, 5.7 V8 4x4, 6.4 SRT8 4x4	
AS-3248			2016-2020 Grand Cherokee	w/Quadra-Lift, w/o Sport	3.6 VVT 4x4, 6.2 4x4, 6.2 i V8 4x4 > New
AS-3249			2016-2020 Grand Cherokee	w/Quadra-Lift, w/o Sport	3.6 VVT 4x4, 6.2 4x4, 6.2 i V8 4x4 > New
AS-3250			2016-2020 Grand Cherokee	w/Quadra-Lift, w/o Sport	3.6 VVT 4x4, 6.2 4x4, 6.2 i V8 4x4 > New > Eibach Shock Absorber
AS-3251			2016-2020 Grand Cherokee	w/Quadra-Lift, w/o Sport	3.6 VVT 4x4, 6.2 4x4, 6.2 i V8 4x4 > New > Eibach Shock Absorber
AS-3289			2011-2015 Grand Cherokee	w/Quadra-Lift, w/o Sport	3.0 4x4/CRD/CRD V6 4x4, 3.6 V6 4x4/V6 FlexFuel 4x4, 5.7 4x4/V8 4x4, 6.4 SRT8 4x4 > New
AS-3290			2011-2015 Grand Cherokee	w/Quadra-Lift, w/o Sport	3.0 4x4/CRD/CRD V6 4x4, 3.6 V6 4x4/V6 FlexFuel 4x4, 5.7 4x4/V8 4x4, 6.4 SRT8 4x4 > New
AS-3323			2011-2015 Grand Cherokee	w/Quadra-Lift, w/o Sport	3.0 4x4/CRD/CRD V6 4x4, 3.6 V6 4x4/V6 FlexFuel 4x4/VVT 4x4, 5.7 4x4/V8 4x4, 6.2 4x4/i V8 4x4 > New > Eibach Shock Absorber
AS-3324			2011-2015 Grand Cherokee	w/Quadra-Lift, w/o Sport	3.0 4x4/CRD/CRD V6 4x4, 3.6 V6 4x4/V6 FlexFuel 4x4/VVT 4x4, 5.7 4x4/V8 4x4, 6.2 4x4/i V8 4x4 > New > Eibach Shock Absorber
P-3245			2011-2020 Grand Cherokee		3.0 4x4/CRD/CRD V6 4x4/TD V6 4x4/V6 4x4, 3.6 V6/V6 4x4/V6 FlexFuel 4x4/VVT/VVT 4x4, 5.7 4x4/V8 4x4, 6.2 4x4/i V8 4x4, 6.4 SRT8 4x4 > OES > Includes Dryer
SK-3394			2011-2015 Grand Cherokee	w/Quadra-Lift	3.0 4x4/CRD/CRD V6 4x4, 3.6 V6 4x4/V6 FlexFuel 4x4/VVT 4x4, 5.7 4x4/V8 4x4, 6.2 4x4/i V8 4x4, 6.4 SRT8 4x4 > New > Eibach Shock Absorber

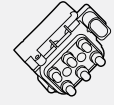
JEEP					
Part #	Product Type	Position	Model Information	Vehicle Attributes	Product Attributes
WK2					
VB-3266			2011-2020 Grand Cherokee	3.0 4x4/CRD/CRD V6 4x4, 3.6 V6 4x4/V6 FlexFuel 4x4/VVT 4x4, 5.7 V8 4x4, 6.4 SRT8 4x4	







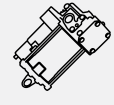

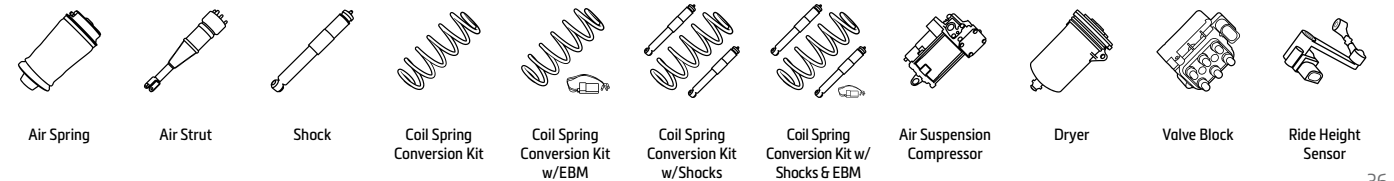

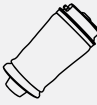



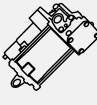
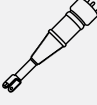

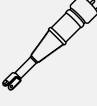
ARNOTT NEW AIR STRUTS

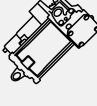
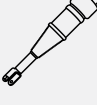









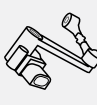

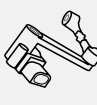





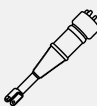

- Front air struts for 16-20 Jeep Grand Cherokee (WK2 Chassis)
- Continental ContiTech air sleeve
 - > Premium multi-ply, cross-corded construction
 - > Longer-lasting design using advanced materials
- New - not remanufactured, eliminates core handling
- Designed, assembled & tested in the USA
- AS-3248 (front right) & AS-3249 (front left)

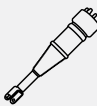

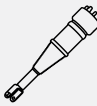

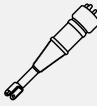

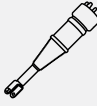



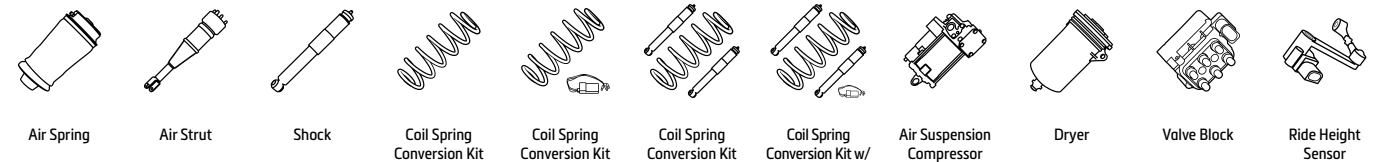

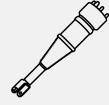

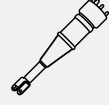

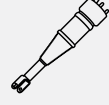



LAMBORGHINI					
Part #	Product Type	Position	Model Information	Vehicle Attributes	Product Attributes
P-3473			2018-2020 Urus		> WABCO OES > Includes Dryer



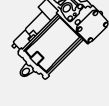
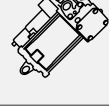
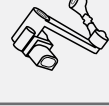

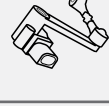





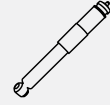

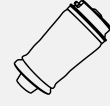

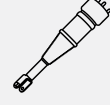

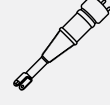

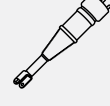

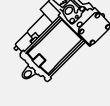
LAND ROVER						
Part #	Product Type	Position	Model Information	Vehicle Attributes	Product Attributes	
L318						
A-2202			1998-2004 Discovery II	2.5Td5, 4.0 V8		
C-2203			1998-2004 Discovery II	2.5Td5, 4.0 V8		
P-2495			1998-2004 Discovery II	2.5Td5, 4.0 V8	<ul style="list-style-type: none"> › WABCO OES › Includes Dryer 	
L319						
AS-2534			2005-2009 Discovery LR3	2.7TD, 4.0, 4.0 V6, 4.4	› New	
			2010-2016 Discovery LR4	2.7TD, 3.0, 3.0 TD, 4.0, 5.0 V8		
AS-2809			2005-2009 Discovery LR3	2.7TD, 4.0, 4.0 V6, 4.4	› New	
			2010-2016 Discovery LR4	2.7TD, 3.0, 3.0 TD, 4.0, 5.0 V8		
P-3431			2005-2009 Discovery LR3	2.7TD, 4.0, 4.0 V6, 4.4	› Includes Dryer	
			2010-2016 Discovery LR4	2.7TD, 3.0, 3.0 TD, 4.0, 5.0 V8		
L320						
AS-2534			2006-2013 Range Rover Sport	Incl. Supercharged	2.7 D, 3.0 D, 3.6 D, 4.2, 4.4, 5.0	› New
AS-2761			2010-2013 Range Rover Sport	w/VDS, Supercharged	3.0 D	› New
AS-2762			2010-2013 Range Rover Sport	w/VDS, Supercharged	3.0 D	› New
AS-2809			2006-2013 Range Rover Sport	Incl. Supercharged	2.7 D, 3.0 D, 3.6 D, 4.2, 4.4, 5.0	› New
P-3431			2006-2013 Range Rover Sport	Incl. Supercharged	2.7 D, 3.0 D, 3.6 D, 4.2, 4.4, 5.0	› Includes Dryer
			2010-2013 Range Rover Sport	w/VDS		

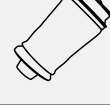



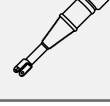



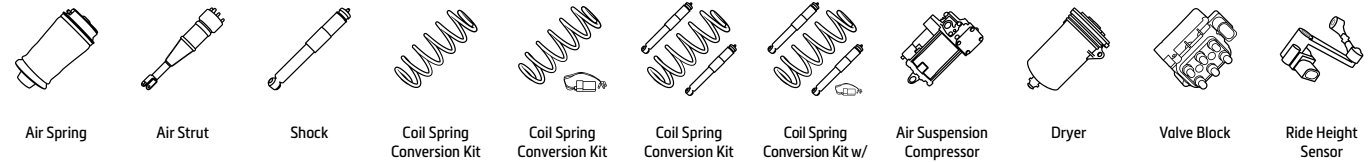

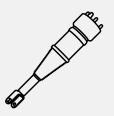

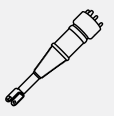

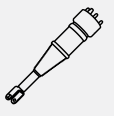

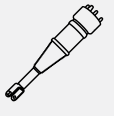

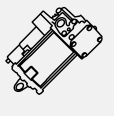

LAND ROVER						
Part #	Product Type	Position	Model Information	Vehicle Attributes	Product Attributes	
L320						
RH-3454			2010-2013 Range Rover Sport	w/VDS	2.7 D 4x4, 3.0 D 4x4, 3.6 D 4x4, 4.2 4x4, 4.4 4x4, 5.0 4x4	
RH-3455			2010-2013 Range Rover Sport	w/VDS	2.7 D 4x4, 3.0 D 4x4, 3.6 D 4x4, 4.2 4x4, 4.4 4x4, 5.0 4x4	
L322						
A-2831			2003-2005 Range Rover	w/o VDS	3.0 D, 3.6 D, 4.2, 4.4, 4.4 D, 5.0	
			2006-2012 Range Rover	w/o VDS, Incl. Supercharged		
			2010-2012 Range Rover	w/VDS, Incl. Supercharged		
A-2933			2003-2005 Range Rover	w/o VDS	3.0 D, 3.6 D, 4.2, 4.4, 4.4 D, 5.0	
			2006-2012 Range Rover	w/o VDS, Incl. Supercharged		
			2010-2012 Range Rover	w/VDS, Incl. Supercharged		
A-2934			2003-2005 Range Rover	w/o VDS	3.0 D, 3.6 D, 4.2, 4.4, 4.4 D, 5.0	
			2006-2012 Range Rover	w/o VDS, Incl. Supercharged		
			2010-2012 Range Rover	w/VDS, Incl. Supercharged		
AS-2757			2010-2012 Range Rover	w/VDS, Incl. Supercharged	3.0 D, 3.6 D, 4.2, 4.4, 4.4 D, 5.0	› Remanufactured
AS-2758			2010-2012 Range Rover	w/VDS, Incl. Supercharged	3.0 D, 3.6 D, 4.2, 4.4, 4.4 D, 5.0	› Remanufactured
AS-2795			2006-2012 Range Rover	w/o VDS, Supercharged	3.0 D, 3.6 D, 4.2, 4.4, 4.4 D, 5.0	› New
AS-2796			2006-2012 Range Rover	w/o VDS, Supercharged	3.0 D, 3.6 D, 4.2, 4.4, 4.4 D, 5.0	› New
AS-2797			2010-2012 Range Rover	w/VDS, Incl. Supercharged	3.0 D, 3.6 D, 4.2, 4.4, 4.4 D, 5.0	› New





LAND ROVER						
Part #	Product Type	Position	Model Information	Vehicle Attributes	Product Attributes	
L322						
AS-2798			2010-2012 Range Rover	w/VDS, Incl. Supercharged	3.0 D, 3.6 D, 4.2, 4.4, 4.4 D, 5.0	> New
AS-2961			2003-2005 Range Rover	w/o VDS	3.0 D, 3.6 D, 4.2, 4.4, 4.4 D, 5.0	> New
			2006-2012 Range Rover	w/o VDS, Incl. Supercharged		
AS-2962			2003-2005 Range Rover	w/o VDS	3.0 D, 3.6 D, 4.2, 4.4, 4.4 D, 5.0	> New
			2006-2012 Range Rover	w/o VDS, Incl. Supercharged		
C-2518			2003-2005 Range Rover	w/o VDS	3.0 D, 4.4	
C-2967			2010-2012 Range Rover	w/VDS, Incl. Supercharged	3.0 D, 3.6 D, 4.2, 4.4, 4.4 D, 5.0	
C-2989			2006-2012 Range Rover	w/o VDS, Incl. Supercharged	3.0 D, 3.6 D, 4.2, 4.4, 4.4 D, 5.0	
			2010-2012 Range Rover	w/VDS, Incl. Supercharged		
P-2462			2003-2005 Range Rover	w/o VDS	3.0 D, 4.2, 4.4	> WABCO OES > Includes Dryer
P-3232			2006-2012 Range Rover	w/o VDS, Incl. Supercharged	3.0 D 4x4, 3.6 D 4x4, 4.2 4x4, 4.4 4x4, 4.4 D 4x4, 5.0 4x4	> Includes Dryer
			2010-2012 Range Rover	w/VDS, Incl. Supercharged		
RH-3378			2010-2012 Range Rover	w/VDS, Incl. Supercharged	3.0 D 4x4, 3.6 D 4x4, 4.2 4x4, 4.4 4x4, 4.4 D 4x4, 5.0 4x4	
RH-3379			2010-2012 Range Rover	w/VDS, Incl. Supercharged	3.0 D 4x4, 3.6 D 4x4, 4.2 4x4, 4.4 4x4, 4.4 D 4x4, 5.0 4x4	
SK-3122			2003-2005 Range Rover	w/o VDS	3.0 D, 3.6 D, 4.2, 4.4, 4.4 D, 5.0	> New
			2006-2012 Range Rover	w/o VDS, Incl. Supercharged		

LAND ROVER						
Part #	Product Type	Position	Model Information	Vehicle Attributes	Product Attributes	
L322						
SK-3382			2010-2012 Range Rover	w/VDS		> New
L405						
A-3025			2013-2018 Range Rover	w/CVD	2.0 PHEV, 3.0, 3.0 D/D Hybrid/SD, 4.4 D, 5.0	
AS-3067			2013-2018 Range Rover	w/CVD	3.0, 3.0 D/D Hybrid, 4.4 D V8, 5.0	> Remanufactured
AS-3068			2013-2018 Range Rover	w/CVD	3.0, 3.0 D/D Hybrid, 4.4 D V8, 5.0	> Remanufactured
AS-3355			2013-2018 Range Rover	w/CVD	3.0, 3.0 D/D Hybrid, 4.4 D V8, 5.0	> New > Eibach Shock Absorber
P-3280			2013-2018 Range Rover	w/CVD	2.0 PHEV, 3.0, 3.0 D/D Hybrid/SD, 4.4 D, 5.0	> WABCO OES > Includes Dryer
SK-3384			2013-2019 Range Rover	w/CVD		> New > Eibach Shock Absorber
L494						
A-3027			2014-2020 Range Rover Sport	w/o CVD	2.0, 2.0 D/PHEV, 3.0, 3.0 D/D Hybrid, 4.4 D, 5.0	
AS-3069			2014-2020 Range Rover Sport	w/o CVD	2.0 D, 3.0, 3.0 D/D Hybrid, 4.4 D, 5.0	> Remanufactured
AS-3070			2014-2020 Range Rover Sport	w/o CVD	2.0 D, 3.0, 3.0 D/D Hybrid, 4.4 D, 5.0	> Remanufactured





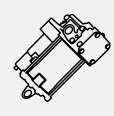

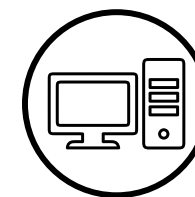
LAND ROVER					
Part #	Product Type	Position	Model Information	Vehicle Attributes	Product Attributes
L494					
AS-3204			2014-2018 Range Rover Sport	w/CVD 2.0 D, 3.0, 3.0 D/D Hybrid, 4.4 D, 5.0	› Remanufactured
AS-3205			2014-2018 Range Rover Sport	w/CVD 2.0 D, 3.0, 3.0 D/D Hybrid, 4.4 D, 5.0	› Remanufactured
AS-3362			2014-2018 Range Rover Sport	w/o VDS	› New › Eibach Shock Absorber
AS-3368			2014-2018 Range Rover Sport	w/VDS	› New › Eibach Shock Absorber
P-3280			2014-2018 Range Rover Sport	w/ & w/o CVD 2.0 P400e PHEV 4x4, 2.0 SD4 4x4, 2.0 Si4 4x4, 3.0 P400 MHEV 4x4, 3.0 SCV6 4x4, 3.0 SDV6 Hybrid 4x4, 3.0 TDV6 4x4, 4.4 SDV8 4x4, 5.0 SCV8 4x4	› WABCO OES › Includes Dryer
SK-3385			2014-2019 Range Rover Sport	w/o CVD	› New › Eibach Shock Absorber
SK-3386			2014-2019 Range Rover Sport	w/CVD	› New › Eibach Shock Absorber
P38A					
A-2611			1995-2002 Range Rover	2.5 D, 3.9, 4.0, 4.6	› Generation II › Extended Travel & Improved Design
A-2612			1995-2002 Range Rover	2.5 D, 3.9, 4.0, 4.6	› Generation II › Extended Travel & Improved Design
A-2691			1995-2002 Range Rover	2.5 D, 3.9, 4.0, 4.6	› Generation III
A-2692			1995-2002 Range Rover	2.5 D, 3.9, 4.0, 4.6	› Generation III

LAND ROVER					
Part #	Product Type	Position	Model Information	Vehicle Attributes	Product Attributes
P38A					
C-2227			1995-2002 Range Rover	2.5 D, 4.0, 4.6	
P-2514			1995-2002 Range Rover	2.5 D, 4.0, 4.6	

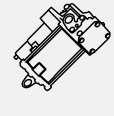

TECH TIP: SOFTWARE UPDATES

Arnott compressors for Land Rover LR3, LR4 and Range Rover Sport may need a software update after installation. Since Land Rover moved away from Hitachi to another compressor supplier, the software update is mandatory. Without this update, the compressor may not function well and this could void the warranty.

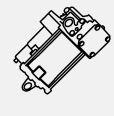
LEXUS					
Part #	Product Type	Position	Model Information	Vehicle Attributes	Product Attributes
AL10					
P-3194			2011-2015 RX 450H	450h (GYL10_)/AWD (GYL15_)	› Includes Dryer
J120					
A-2949			2003-2009 GX 470	w/ & w/o Kinetic Dynamic Suspension UZJ120	
C-2410			2003-2009 GX 470	UZJ120	
P-3192			2003-2009 GX 470	UZJ120	› OES › Includes Dryer



Air Spring



Air Strut



Shock



Coil Spring Conversion Kit



Coil Spring Conversion Kit w/EBM



Coil Spring Conversion Kit w/Shocks



Coil Spring Conversion Kit w/Shocks & EBMs



Air Suspension Compressor













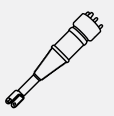





Dryer

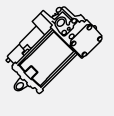
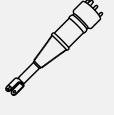



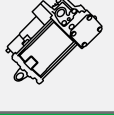
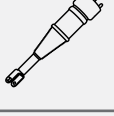

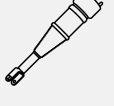



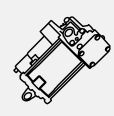



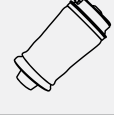

Valve Block

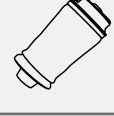







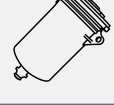

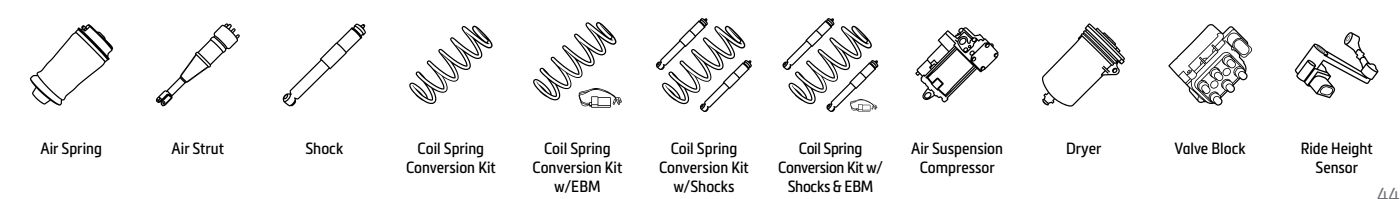

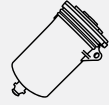
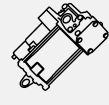
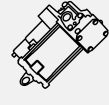
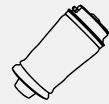

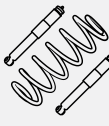
Ride Height Sensor

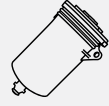
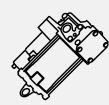
LEXUS					
Part #	Product Type	Position	Model Information	Vehicle Attributes	Product Attributes
J120					
SK-2812			2003-2009 GX 470	UZJ120	> New
SK-2813			2003-2009 GX 470	UZJ120	> New
J150					
A-3331			2010-2020 GX 460	w/ & w/o Kinetic Dynamic Suspension 4WD (URJ150)	
A-3332			2010-2020 GX 460	w/ & w/o Kinetic Dynamic Suspension 4WD (URJ150)	
P-3191			2010-2020 GX 460	4WD (URJ150)	> OES > Includes Dryer
UCF30					
AS-2894			2001-2006 LS 430	XF30	> New
AS-3073			2001-2006 LS 430	XF30	> New
AS-3074			2001-2006 LS 430	XF30	> New
P-3187			2001-2006 LS 430	XF30	> OES > Includes Dryer
USF40, USF41, USF45, USF46, UVF45, UVF46					
AS-2855			2007-2012 LS 460	w/RWD, Short Wheelbase & Long Wheelbase	> New
AS-2856			2007-2012 LS 460	w/AWD or RWD, Short Wheelbase & Long Wheelbase	> New
			2008-2012 LS 600	Short Wheelbase, Hybrid	
			2008-2012 LS 600h L	Long Wheelbase, Hybrid	

LEXUS					
Part #	Product Type	Position	Model Information	Vehicle Attributes	Product Attributes
USF40, USF41, USF45, USF46, UVF45, UVF46					
P-3188			2007-2017 LS 460	w/AWD or RWD, Short Wheelbase & Long Wheelbase	> OES > Includes Dryer
			2008-2016 LS 600	Short Wheelbase, Hybrid	
			2008-2016 LS 600h L	Long Wheelbase, Hybrid	









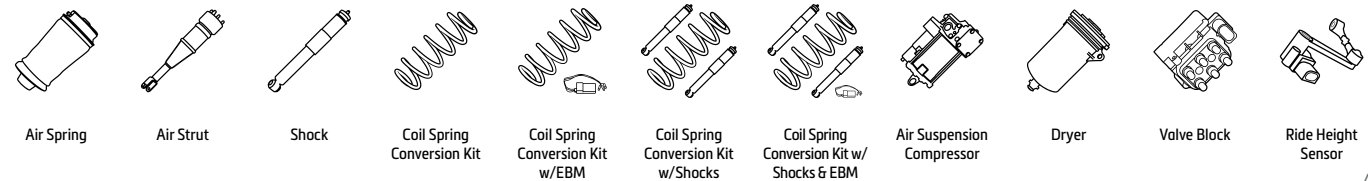





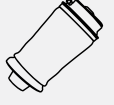



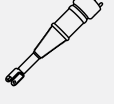

LINCOLN					
Part #	Product Type	Position	Model Information	Vehicle Attributes	Product Attributes
D186					
A-2106			1984-1987 Continental	5.0 Liter V8	
A-2107			1984-1987 Continental	5.0 Liter V8	
A-2173			1995-2002 Continental	4.6 Liter V8	
A-2174			1995-1996 Continental	4.6 Liter V8	> New Air Spring Only, Reuse Factory Shock
A-2212			1995-2002 Continental	4.6 Liter V8	
C-2180			1997-2002 Continental	4.6 Liter V8	
C-2224			1984-1987 Continental	5.0 Liter V8	
D-2155			1984-1987 Continental	5.0 Liter V8	









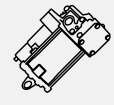
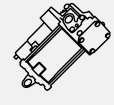

LINCOLN					
Part #	Product Type	Position	Model Information	Vehicle Attributes	Product Attributes
D186					
D-2171			1995-2002 Continental	4.6 Liter V8	
P-2211			1995-2002 Continental	4.6 Liter V8	> Includes Dryer
P-2231			1984-1987 Continental	5.0 Liter V8	> Includes Dryer
FN10					
A-2108			1993-1998 Mark VIII	4.6 Liter V8	
C-2236			1993-1998 Mark VIII	4.6 Liter V8	
D-2155			1993-1998 Mark VIII	4.6 Liter V8	
P-2210			1993-1998 Mark VIII	4.6 Liter V8	> Includes Dryer
SK-2225			1993-1998 Mark VIII	4.6 Liter V8	> New > Sold in Pairs
Fox					
A-2106			1984-1992 Mark VII	5.0 Liter V8	
A-2107			1984-1992 Mark VII	5.0 Liter V8	
C-2224			1984-1992 Mark VII	5.0 Liter V8	

LINCOLN					
Part #	Product Type	Position	Model Information	Vehicle Attributes	Product Attributes
Fox					
D-2155			1984-1992 Mark VII	5.0 Liter V8	
P-2231			1984-1992 Mark VII	5.0 Liter V8	> Includes Dryer
Panther					
A-2105			1990-1997 Town Car	4.6 Liter V8, 5.0 Liter V8	
			1998-2011 Town Car	4.6 Liter V8	
A-2220			1990-1997 Town Car	4.6 Liter V8, 5.0 Liter V8	> Heavy Duty for Limousine Use
			1998-2011 Town Car	4.6 Liter V8	
C-2614			1990-1997 Town Car	4.6 Liter V8, 5.0 Liter V8	
			1998-2002 Town Car	4.6 Liter V8	
C-2615			2003-2011 Town Car	4.6 Liter V8	
D-2155			1998-2002 Town Car	4.6 Liter V8	
D-2171			1990-1997 Town Car	4.6 Liter V8, 5.0 Liter V8	
			2003-2011 Town Car	4.6 Liter V8	
P-2935			1998-2002 Town Car	4.6 Liter V8	> Includes Dryer
P-2936			1990-1997 Town Car	4.6 Liter V8, 5.0 Liter V8	> Includes Dryer
			2003-2011 Town Car	4.6 Liter V8	

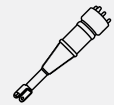

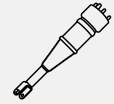
LINCOLN					
Part #	Product Type	Position	Model Information	Vehicle Attributes	Product Attributes
U173, U228, U326					
A-2143			2003-2006 Navigator	2 Wheel Drive & 4 Wheel Drive	> New Air Spring Only, Reuse Factory Shock
A-2148			1998-2002 Navigator	2 Wheel Drive	
A-2153			1998-2002 Navigator	4 Wheel Drive	
A-2647			2007-2014 Navigator	2 Wheel Drive & 4 Wheel Drive	
A-2735			2003-2006 Navigator	2 Wheel Drive & 4 Wheel Drive	> New Air Spring Only, Reuse Factory Shock
AS-2139			2003-2006 Navigator	2 Wheel Drive & 4 Wheel Drive	> New > Strut, Air Spring & Upper Mount Assembly
C-2140			2003-2006 Navigator	2 Wheel Drive & 4 Wheel Drive	
C-2529			2007-2014 Navigator	2 Wheel Drive & 4 Wheel Drive (AWD/RWD)	
C-2607			1998-2002 Navigator	2 Wheel Drive (RWD)	
C-2608			1998-2002 Navigator	4 Wheel Drive (4WD)	
D-2155			1998-2006 Navigator	2 Wheel Drive & 4 Wheel Drive	

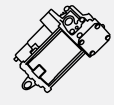
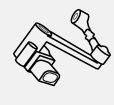
LINCOLN					
Part #	Product Type	Position	Model Information	Vehicle Attributes	Product Attributes
U173, U228, U326					
P-2932			1998-2006 Navigator	2 Wheel Drive & 4 Wheel Drive	> Includes Dryer
P-2937			2007-2017 Navigator	2 Wheel Drive & 4 Wheel Drive	> Includes Dryer
SK-2723			2003-2006 Navigator	2 Wheel Drive & 4 Wheel Drive	> New

MAYBACH					
Part #	Product Type	Position	Model Information	Vehicle Attributes	Product Attributes
W240					
AS-2746			2003-2012 57	Base & S Models	5.5 (240.078), 6.0, 6.0 (240.079), S 6.0 (240.079, 240.077)
			2003-2012 62		
AS-2747			2003-2012 57	Base & S Models	5.5 (240.078), 6.0, 6.0 (240.079), S 6.0 (240.079, 240.077)
			2003-2012 62		
P-2192			2003-2012 57	Base & S Models	5.5 (240.078), 6.0, 6.0 (240.079), S 6.0 (240.079, 240.077)
			2003-2012 62		
RH-3500			2003-2012 57	Base & S Models	5.5 (240.078), 6.0, 6.0 (240.079), S 6.0 (240.079, 240.077)
			2003-2012 62	Base & S Models	5.5 (240.178), 6.0 S (240.177), S 6.0 (240.179)

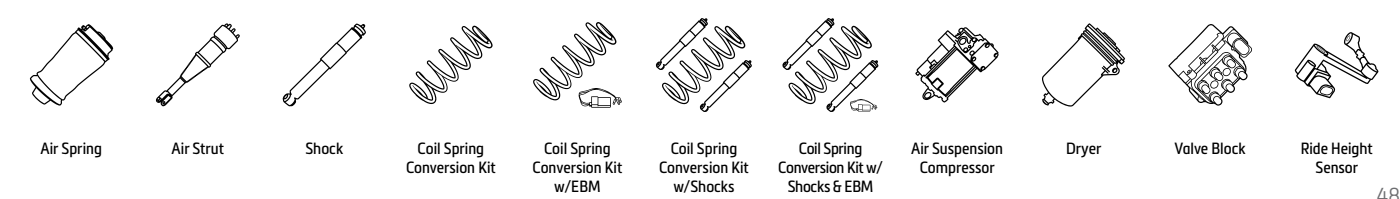

Arnott's engineers apply more than 30 years of remanufacturing experience and knowledge to every new strut they design and continually improve their ability to design new air struts that replicate the OE-like ride drivers expect.

Weaknesses in the OE design are improved and Arnott's new struts are built with Tier 1 components, including longer-lasting seals, new polyurethane bump stops, heavy-duty crimping rings and name-brand, dust baffles.



THE ARNOTT ADVANTAGE









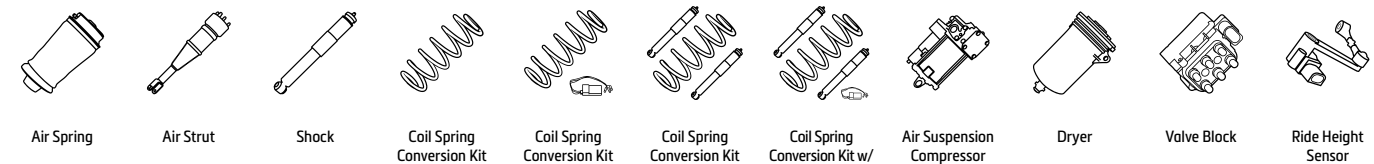

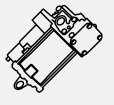
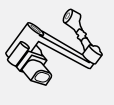

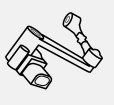

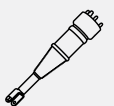

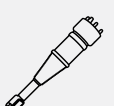

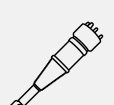

- ▶ Precision-tuned, Eibach monotube damper in many applications
- ▶ Premium brand air sleeves, bump stop & dust boot
- ▶ Works with vehicle's auto-leveling functionality
- ▶ Improved seals to prevent leaks
- ▶ Designed, assembled & tested in the USA





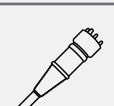

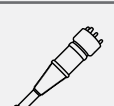



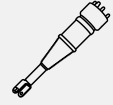

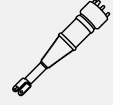

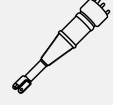

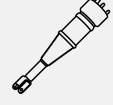

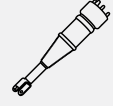
ARNOTT OFFERS NEW AIR STRUTS FOR:

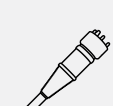
Audi • Bentley • BMW • Buick • Cadillac • Chevrolet • Ford • GMC • Jaguar • Jeep • Land Rover • Lexus • Lincoln • Maybach • Mercedes-Benz • Oldsmobile • Pontiac • Porsche • Ram • Tesla • Volkswagen • Volvo





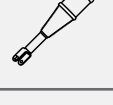



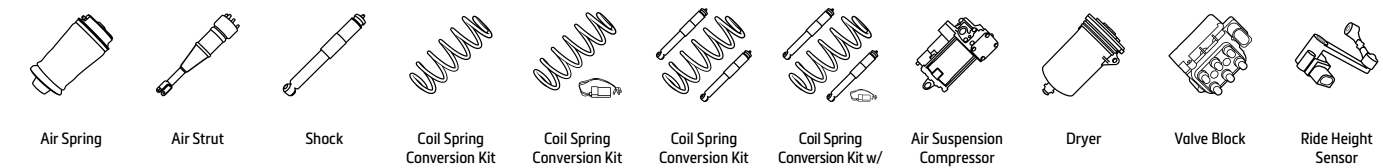

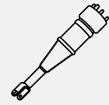

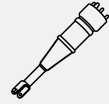

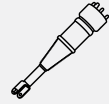

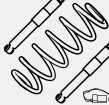
MERCEDES-BENZ						
Part #	Product Type	Position	Model Information	Vehicle Attributes	Product Attributes	
C/W208, C209						
RH-3501			1997-2010 CLK-Class	200/CGI/Kompressor, 220 CDI, 230 Kompressor, 240, 270 CDI, 280, 320/CDI, 350, 430, 500, 55 AMG, 63 AMG, DTM AMG	▶ For vehicles w/LED or Bi-Xenon Intelligent Lighting Systems	
C215, W220						
AS-2193			2000-2006 S-Class	w/AIRMATIC & ADS, w/o 4MATIC	S 280, S 320/CDI, S 350, S 400 CDI, S 430, S 500, S 600	▶ Remanufactured
AS-2194			2000-2002 S-Class	w/AIRMATIC & ADS, w/o 4MATIC	S 280, S 320/CDI, S 350/4-matic, S 400 CDI, S 430/4-matic, S 500/4-matic, S 600	▶ Remanufactured
			2003-2006 S-Class	w/AIRMATIC & ADS, w/ & w/o 4MATIC		
AS-2605			2000-2006 S-Class	w/AIRMATIC & ADS, w/o 4MATIC	S 280, S 320/CDI, S 350, S 400 CDI, S 430, S 500, S 600	▶ New
AS-2783			2003-2006 S-Class	w/AIRMATIC & ADS, w/4MATIC	S 350 4-matic, S 430 4-matic, S 500 4-matic	▶ New
AS-2784			2003-2006 S-Class	w/AIRMATIC & ADS, w/4MATIC	S 350 4-matic, S 430 4-matic, S 500 4-matic	▶ New
AS-2884			2000-2002 S-Class	w/AIRMATIC & ADS, w/o 4MATIC	S 280, S 320/CDI, S 350/4-matic, S 400 CDI, S 430/4-matic, S 500/4-matic, S 600	▶ New
			2003-2006 S-Class	w/AIRMATIC & ADS, w/ & w/o 4MATIC		
C-2242			2000-2006 S-Class	w/AIRMATIC & ADS, w/o 4MATIC	S 280, S 320/CDI, S 350, S 400 CDI, S 430, S 500, S 600	
C-2271			2003-2006 S-Class	w/AIRMATIC & ADS, w/4MATIC	S 350 4-matic, S 430 4-matic, S 500 4-matic	
C-3269			2000-2006 S-Class	w/AIRMATIC & ADS, w/o 4MATIC	S 280, S 320/CDI, S 350, S 400 CDI, S 430, S 500, S 600	▶ Eibach Shock Absorbers

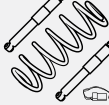

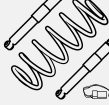

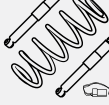

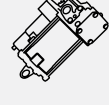
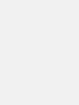
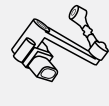



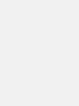
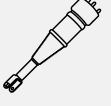

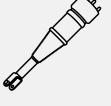

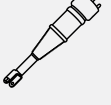

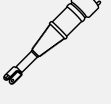

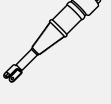
MERCEDES-BENZ					
Part #	Product Type	Position	Model Information	Vehicle Attributes	Product Attributes
C215, W220					
P-2192			2000-2002 S-Class	w/AIRMATIC & ADS, w/o 4MATIC	S 280, S 320/CDI, S 350/4-matic, S 400 CDI, S 430/4-matic, S 500/4-matic, S 600
			2003-2006 S-Class	w/AIRMATIC & ADS, w/ & w/o 4MATIC	
RH-3500			2000-2006 S-Class	w/AIRMATIC & ADS, w/o 4MATIC	S 280, S 320/DI, S 350, S 400 CDI, S 430, S 500, S 55 AMG/AMG Kompressor, S 600, S 63 AMG
			2003-2006 S-Class	w/AIRMATIC & ADS, w/4MATIC	
RH-3501			2000-2006 CL-Class	CL 500, CL 55 AMG/AMG Kompressor, CL 600, CL 63 AMG	
			2000-2002 S-Class	w/AIRMATIC & ADS, w/o 4MATIC	S 280, S 320/CDI, S 350/4-matic, S 400 CDI, S 430/4-matic, S 500/4-matic, S 600
			2003-2006 S-Class	w/AIRMATIC & ADS, w/ & w/o 4MATIC	
SK-2422			2003-2006 CL-Class	From VIN #032100 w/ABC Suspension, Non-AMG	CL 500, CL 55 AMG/AMG Kompressor, CL 600, CL 63 AMG
			2003-2006 S-Class	From VIN #290214 w/ABC Suspension, Non-AMG	S 400 CDI, S 430, S 500, S 600
SK-2423			2003-2006 CL-Class	From VIN #032100 w/ABC Suspension, Non-AMG	CL 500, CL 55 AMG/AMG Kompressor, CL 600, CL 63 AMG
			2003-2006 S-Class	From VIN #290214 w/ABC Suspension, Non-AMG	S 400 CDI, S 430, S 500, S 600
SK-2454			2000-2002 CL-Class	To VIN #032099 w/ABC Suspension, Incl. AMG	CL 500, CL 55 AMG/AMG Kompressor, CL 600, CL 63 AMG
			2000-2002 S-Class	To VIN #290213 w/ABC Suspension, Incl. AMG	S 55 AMG/AMG Kompressor
SK-2455			2000-2002 CL-Class	To VIN #032099 w/ABC Suspension, Incl. AMG	CL 500, CL 55 AMG/AMG Kompressor, CL 600, CL 63 AMG
			2000-2002 S-Class	To VIN #290213 w/ABC Suspension, Incl. AMG	S 55 AMG/AMG Kompressor
SK-2456			2000-2002 CL-Class	To VIN #032099 w/ABC Suspension, Incl. AMG	CL 500, CL 55 AMG/AMG Kompressor, CL 600, CL 63 AMG
			2000-2006 S-Class	From VIN #290214 w/ABC Suspension, Incl. AMG	S 400 CDI, S 430, S 500, S 55 AMG/AMG Kompressor, S 600
SK-2457			2000-2002 CL-Class	To VIN #032099 w/ABC Suspension, Incl. AMG	CL 500, CL 600
			2000-2006 S-Class	From VIN #290214 w/ABC Suspension, Incl. AMG	S 400 CDI, S 430, S 500, S 600
SK-2458			2003-2006 CL-Class	From VIN #032562 w/ABC Suspension, AMG	CL 500, CL 55 AMG/AMG Kompressor, CL 600, CL 63 AMG
			2003-2006 S-Class	From VIN #372602 w/ABC Suspension, AMG	S 55 AMG/AMG Kompressor, S 600, S 63 AMG, S 65 AMG
SK-2459			2003-2006 CL-Class	From VIN #032562 w/ABC Suspension, AMG	CL 500, CL 55 AMG/AMG Kompressor, CL 600, CL 63 AMG
			2003-2006 S-Class	From VIN #372602 w/ABC Suspension, AMG	S 55 AMG/AMG Kompressor, S 600, S 63 AMG, S 65 AMG









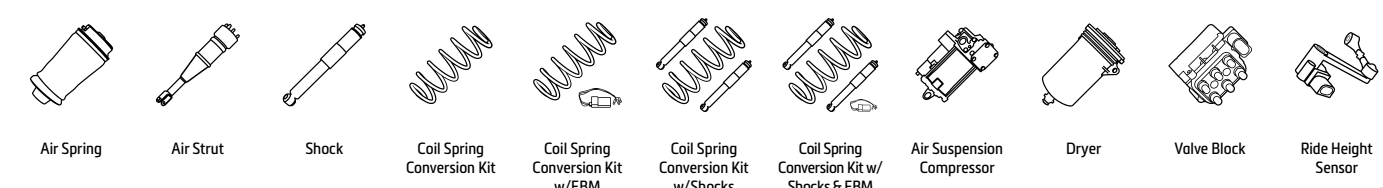

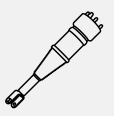

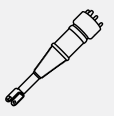

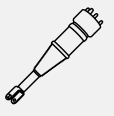

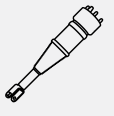

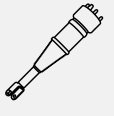
MERCEDES-BENZ					
Part #	Product Type	Position	Model Information	Vehicle Attributes	Product Attributes
C215, W220					
SK-2460			2003-2006 CL-Class	From VIN #032562 w/ABC Suspension, AMG	CL 500, CL 55 AMG/AMG Kompressor, CL 600, CL 63 AMG
			2003-2006 S-Class	From VIN #372602 w/ABC Suspension, AMG	S 55 AMG/AMG Kompressor, S 600, S 63 AMG, S 65 AMG
SK-2461			2003-2006 CL-Class	From VIN #032562 w/ABC Suspension, AMG	CL 500, CL 55 AMG/AMG Kompressor, CL 600, CL 63 AMG
			2003-2006 S-Class	From VIN #372602 w/ABC Suspension, AMG	S 55 AMG/AMG Kompressor, S 600, S 63 AMG, S 65 AMG
C216, W221					
AS-2540			2007-2013 S-Class	w/AIRMATIC & ADS, w/o 4MATIC	S 250 CDI, S 280, S 300, S 320 CDI, S 350/BlueTec/CGI, S 400 Hybrid, S 420 CDI, S 450, S 500/CGI, S 600
AS-2547			2007-2013 S-Class	w/AIRMATIC & ADS, w/4MATIC	S 320 CDI 4-matic, S 350 4-matic/BlueTEC 4-matic/CGI 4-matic, S 450 4-matic, S 500 4-matic/CGI 4-matic
			2007-2014 CL-Class		CL 500 4-matic
AS-2548			2007-2013 S-Class	w/AIRMATIC & ADS, w/4MATIC	S 320 CDI 4-matic, S 350 4-matic/BlueTEC 4-matic/CGI 4-matic, S 450 4-matic, S 500 4-matic/CGI 4-matic
			2007-2014 CL-Class		CL 500 4-matic
AS-2603			2007-2013 S-Class	w/AIRMATIC & ADS, w/ & w/o 4MATIC	S 250 CDI, S 280, S 300, S 320 CDI/CDI 4-matic, S 350/4-matic/BlueTec/BlueTEC 4-matic/CDI/CGI/CGI 4-matic, S 400 Hybrid, S 420 CDI, S 450/4-matic, S 500/4-matic/CGI/CGI 4-matic, S 600
			2007-2014 CL-Class		CL 500 4-matic
AS-2604			2007-2013 S-Class	w/AIRMATIC & ADS, w/ & w/o 4MATIC	S 250 CDI, S 280, S 300, S 320 CDI/CDI 4-matic, S 350/4-matic/BlueTec/BlueTEC 4-matic/CDI/CGI/CGI 4-matic, S 400 Hybrid, S 420 CDI, S 450/4-matic, S 500/4-matic/CGI/CGI 4-matic, S 600
			2007-2014 CL-Class		CL 500 4-matic
AS-2820			2007-2013 S-Class	w/AIRMATIC & ADS, w/o 4MATIC	S 250 CDI, S 280, S 300, S 320 CDI, S 350/BlueTec/CGI, S 400 Hybrid, S 420 CDI, S 450, S 500/CGI, S 600
AS-2821			2007-2013 S-Class	w/AIRMATIC & ADS, w/ & w/o 4MATIC	S 250 CDI, S 280, S 300, S 320 CDI/CDI 4-matic, S 350/4-matic/BlueTec/BlueTEC 4-matic/CDI/CGI/CGI 4-matic, S 400 Hybrid, S 420 CDI, S 450/4-matic, S 500/4-matic/CGI/CGI 4-matic, S 600
			2007-2014 CL-Class		CL 500 4-matic

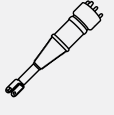

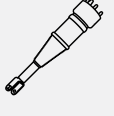



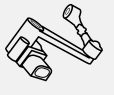







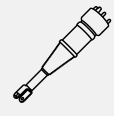

MERCEDES-BENZ					
Part #	Product Type	Position	Model Information	Vehicle Attributes	Product Attributes
C216, W221					
AS-2822			2007-2013 S-Class	w/AIRMATIC & ADS, w/ & w/o 4MATIC	S 250 CDI, S 280, S 300, S 320 CDI/CDI 4-matic, S 350/4-matic/BlueTec/BlueTEC 4-matic/CDI/CGI/CGI 4-matic, S 400 Hybrid, S 420 CDI, S 450/4-matic, S 500/4-matic/CGI/CGI 4-matic, S 600
			2007-2014 CL-Class	CL 500 4-matic	> New
AS-2852			2007-2013 S-Class	w/AIRMATIC & ADS, w/4MATIC	S 320 CDI 4-matic, S 350 4-matic/BlueTEC 4-matic/CGI 4-matic, S 450 4-matic, S 500 4-matic/CGI 4-matic
			2007-2014 CL-Class	CL 500 4-matic	> New
AS-2853			2007-2013 S-Class	w/AIRMATIC & ADS, w/4MATIC	S 320 CDI 4-matic, S 350 4-matic/BlueTEC 4-matic/CGI 4-matic, S 450 4-matic, S 500 4-matic/CGI 4-matic
			2007-2014 CL-Class	CL 500 4-matic	> New
C-2609			2007-2013 S-Class	w/AIRMATIC & ADS, w/o 4MATIC	S 250 CDI, S 280, S 300, S 320 CDI, S 350/BlueTec/CDI/CGI, S 400 Hybrid, S 420 CDI, S 450, S 500/CGI, S 600
C-2956			2007-2013 S-Class	w/AIRMATIC & ADS, w/4MATIC	S 320 CDI 4-matic, S 350 4-matic/BlueTEC 4-matic/CGI 4-matic, S 450 4-matic, S 500 4-matic/CGI 4-matic
C-3271			2007-2013 S-Class	w/AIRMATIC & ADS, w/o 4MATIC	S 250 CDI, S 280, S 300, S 320 CDI, S 350/BlueTec/CDI/CGI, S 400 Hybrid, S 420 CDI, S 450/CDI, S 500/CGI, S 600, S 63 AMG, S 65 AMG
C-3272			2007-2013 S-Class	w/AIRMATIC & ADS, w/4MATIC	S 320 CDI 4-matic, S 350 4-matic/BlueTEC 4-matic/CGI 4-matic, S 450 4-matic, S 500 4-matic/CGI 4-matic
P-3246			2007-2013 S-Class	w/AIRMATIC & ADS, w/ & w/o 4MATIC	S 250 CDI, S 280, S 300, S 320 CDI/CDI 4-matic, S 350/4-matic/BlueTec/BlueTEC 4-matic/CDI/CGI/CGI 4-matic, S 400 Hybrid, S 420 CDI, S 450/4-matic, S 500/4-matic/CGI/CGI 4-matic, S 600
			2007-2014 CL-Class	CL 500 4-matic	> Includes Dryer
RH-3501			2007-2013 S-Class	w/AIRMATIC & ADS, w/ & w/o 4MATIC	S 250 CDI, S 280, S 300, S 320 CDI/CDI 4-matic, S 350/4-matic/BlueTec/BlueTEC 4-matic/CDI/CGI/CGI 4-matic, S 400 Hybrid, S 420 CDI, S 450/4-matic, S 500/4-matic/CGI/CGI 4-matic, S 600
			2007-2014 CL-Class	CL 500/4-matic, CL 600, CL 63 AMG, CL 65 AMG	> For vehicles w/LED or Bi-Xenon Intelligent Lighting Systems

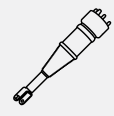

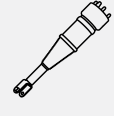

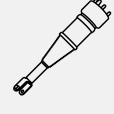



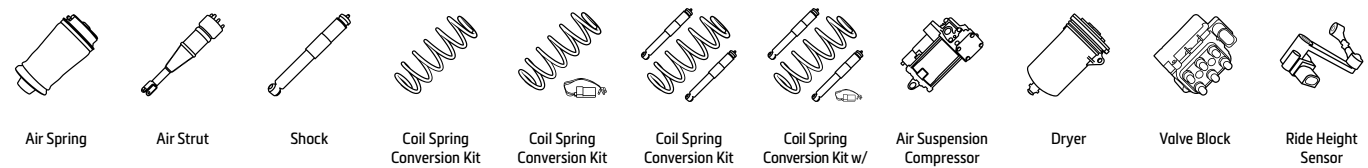

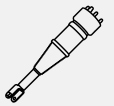

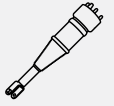
MERCEDES-BENZ					
Part #	Product Type	Position	Model Information	Vehicle Attributes	Product Attributes
C216, W221					
VB-3267			2007-2013 S-Class	w/AIRMATIC & ADS, w/ & w/o 4MATIC	S 250 CDI, S 280, S 300, S 320 CDI/CDI 4-matic, S 350/4-matic/BlueTec/BlueTEC 4-matic/CDI/CDI 4-matic/CGI/CGI 4-matic, S 400 Hybrid, S 420 CDI, S 450/4-matic/CDI, S 500/4-matic/CGI/CGI 4-matic, S 600, S 63 AMG, S 65 AMG
			2007-2014 CL-Class	w/AIRMATIC, w/ & w/o ADS, Incl. AMG	
R230					
SK-2412			2003-2006 SL-Class	w/ABC Suspension, Non-AMG	500 > Remanufactured
SK-2413			2003-2006 SL-Class	w/ABC Suspension, Non-AMG	500 > Remanufactured
SK-2414			2003-2006 SL-Class	w/ABC Suspension, Non-AMG	500 > Remanufactured
SK-2415			2003-2006 SL-Class	w/ABC Suspension, Non-AMG	500 > Remanufactured
SK-2417			2003-2006 SL-Class	w/ABC Suspension, SL55/66, AMG	55 AMG/AMG Kompressor, 65 AMG > Remanufactured
SK-2418			2003-2006 SL-Class	w/ABC Suspension, SL55/66, AMG	55 AMG/AMG Kompressor, 65 AMG > Remanufactured
SK-2419			2003-2006 SL-Class	w/ABC Suspension, SL55/66, AMG	55 AMG/AMG Kompressor, 65 AMG > Remanufactured
SK-2420			2003-2006 SL-Class	w/ABC Suspension, SL55/66, AMG	55 AMG/AMG Kompressor, 65 AMG > Remanufactured

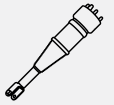

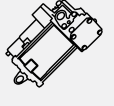
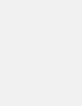
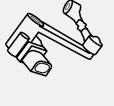







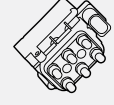
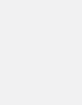
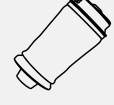

MERCEDES-BENZ						
Part #	Product Type	Position	Model Information	Vehicle Attributes	Product Attributes	
R230						
SK-2470			2007-2012 SL-Class	w/ABC Suspension, Non-AMG	600	› Remanufactured
SK-2471			2007-2012 SL-Class	w/ABC Suspension, Non-AMG	600	› Remanufactured
SK-2472			2007-2012 SL-Class	w/ABC Suspension, Non-AMG	600	› Remanufactured
SK-2473			2007-2012 SL-Class	w/ABC Suspension, Non-AMG	600	› Remanufactured
SK-2482			2007-2012 SL-Class	w/ABC Suspension, SL55/66, AMG	55 AMG/AMG Kompressor, 63 AMG, 65 AMG, 65 AMG Black Series	› Remanufactured
SK-2483			2007-2012 SL-Class	w/ABC Suspension, SL55/66, AMG	55 AMG/AMG Kompressor, 63 AMG, 65 AMG, 65 AMG Black Series	› Remanufactured
SK-2484			2007-2012 SL-Class	w/ABC Suspension, SL55/66, AMG	55 AMG/AMG Kompressor, 63 AMG, 65 AMG, 65 AMG Black Series	› Remanufactured
SK-2485			2007-2012 SL-Class	w/ABC Suspension, SL55/66, AMG	55 AMG/AMG Kompressor, 63 AMG, 65 AMG, 65 AMG Black Series	› Remanufactured
W163, W203						
RH-3501			2008-2014 C-Class	ML 230, ML 270 CDI, ML 320, ML 350, ML 400 CDI, ML 430, ML 500, ML 55 AMG		› For vehicles w/LED or Bi-Xenon Intelligent Lighting Systems

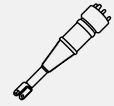

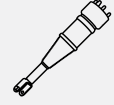

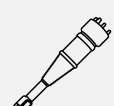



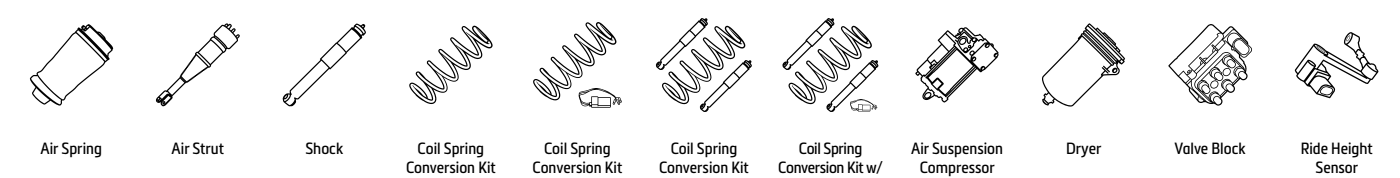

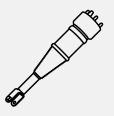

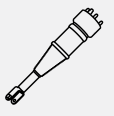

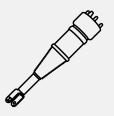

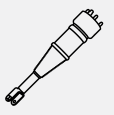

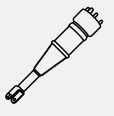
MERCEDES-BENZ						
Part #	Product Type	Position	Model Information	Vehicle Attributes	Product Attributes	
W164, X164						
A-2575			2006-2011 ML-Class	w/AIRMATIC, w/ & w/o ADS, Incl. AMG	ML 280 CDI 4-matic, ML 300 4-matic/CDI 4-matic, ML 320 CDI 4-matic, ML 350 4-matic/CDI 4-matic, ML 420 CDI 4-matic, ML 450 CDI 4-matic, ML 500 4-matic, ML 63 AMG 4-matic	› New Air Spring Only, Reuse Factory Shock
			2007-2012 GL-Class	w/AIRMATIC, w/ & w/o ADS	GL 320 CDI 4-matic/350 BlueTEC 4-matic, GL 350 CDI 4-matic, GL 420 CDI 4-matic, GL 450 4-matic/CDI 4-matic, GL 500 4-matic	
A-2596			2006-2011 ML-Class	w/AIRMATIC & ADS, AMG	ML 280 CDI 4-matic, ML 300 4-matic/CDI 4-matic, ML 320 CDI 4-matic, ML 350 4-matic/CDI 4-matic, ML 420 CDI 4-matic, ML 450 CDI 4-matic, ML 500 4-matic, ML 63 AMG 4-matic	› Remanufactured
			2007-2012 GL-Class	w/AIRMATIC, w/ & w/o ADS	GL 320 CDI 4-matic/350 BlueTEC 4-matic, GL 350 CDI 4-matic, GL 420 CDI 4-matic, GL 450 4-matic/CDI 4-matic, GL 500 4-matic	
AS-2450			2006-2011 ML-Class	w/AIRMATIC & ADS, Non-AMG	ML 280 CDI 4-matic, ML 300 CDI 4-matic, ML 320 CDI 4-matic, ML 350 4-matic/CDI 4-matic, ML 420 CDI 4-matic, ML 450 CDI 4-matic, ML 500 4-matic	› Remanufactured
			2007-2012 GL-Class	w/AIRMATIC & ADS	GL 320 CDI 4-matic/350 BlueTEC 4-matic, GL 350 CDI 4-matic, GL 420 CDI 4-matic, GL 450 4-matic/CDI 4-matic, GL 500 4-matic	
AS-2463			2006-2011 ML-Class	w/AIRMATIC & ADS, AMG	ML 63 AMG 4-matic	› Remanufactured
AS-2792			2006-2011 ML-Class	w/AIRMATIC & ADS, Non-AMG	ML 280 CDI 4-matic, ML 300 CDI 4-matic, ML 320 CDI 4-matic, ML 350 4-matic/CDI 4-matic, ML 420 CDI 4-matic, ML 450 CDI 4-matic, ML 500 4-matic	› New
			2007-2012 GL-Class	w/AIRMATIC & ADS	GL 320 CDI 4-matic/350 BlueTEC 4-matic, GL 350 CDI 4-matic, GL 420 CDI 4-matic, GL 450 4-matic/CDI 4-matic, GL 500 4-matic	
AS-2802			2006-2011 ML-Class	w/AIRMATIC & ADS, AMG	ML 63 AMG 4-matic	› New
AS-3005			2007-2012 GL-Class	w/AIRMATIC, w/o ADS	GL 320 CDI 4-matic/350 BlueTEC 4-matic, GL 350 CDI 4-matic, GL 420 CDI 4-matic, GL 450 4-matic/CDI 4-matic, GL 500 4-matic	› New

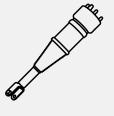

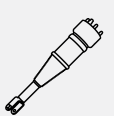

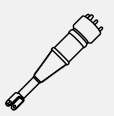

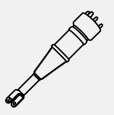



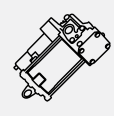

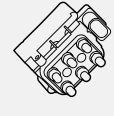
MERCEDES-BENZ						
Part #	Product Type	Position	Model Information	Vehicle Attributes	Product Attributes	
W164, X164						
AS-3058			2006-2011 ML-Class	w/AIRMATIC, w/o ADS, Non-AMG	ML 280 CDI 4-matic, ML 300 4-matic/CDI 4-matic, ML 320 CDI 4-matic, ML 350 4-matic/CDI 4-matic, ML 420 CDI 4-matic, ML 450 CDI 4-matic, ML 500 4-matic	<ul style="list-style-type: none"> › New › Eibach Shock Absorber
			2007-2012 GL-Class	w/AIRMATIC, w/o ADS	GL 320 CDI 4-matic/350 BlueTEC 4-matic, GL 350 CDI 4-matic, GL 420 CDI 4-matic, GL 450 4-matic/CDI 4-matic, GL 500 4-matic	
AS-3088			2006-2011 ML-Class	w/AIRMATIC & ADS, Non-AMG	ML 280 CDI 4-matic, ML 300 4-matic/CDI 4-matic, ML 320 CDI 4-matic, ML 350 4-matic/CDI 4-matic, ML 420 CDI 4-matic, ML 450 CDI 4-matic, ML 500 4-matic	<ul style="list-style-type: none"> › New › Eibach Shock Absorber
			2007-2012 GL-Class	w/AIRMATIC & ADS	GL 320 CDI 4-matic/350 BlueTEC 4-matic, GL 350 CDI 4-matic, GL 420 CDI 4-matic, GL 450 4-matic/CDI 4-matic, GL 500 4-matic	
AS-3089			2006-2011 ML-Class	w/AIRMATIC & ADS, AMG	ML 63 AMG 4-matic	<ul style="list-style-type: none"> › New › Eibach Shock Absorber
P-3214			2006-2011 ML-Class	w/AIRMATIC, w/ & w/o ADS, Incl. AMG	ML 280 CDI 4-matic, ML 300 CDI 4-matic, ML 320 CDI 4-matic, ML 350 4-matic/CDI 4-matic, ML 420 CDI 4-matic, ML 450 CDI 4-matic, ML 500 4-matic, ML 63 AMG 4-matic	<ul style="list-style-type: none"> › Includes Dryer
			2007-2012 GL-Class	w/AIRMATIC, w/ & w/o ADS	GL 320 CDI 4-matic/350 BlueTEC 4-matic, GL 350 CDI 4-matic, GL 420 CDI 4-matic, GL 450 4-matic/CDI 4-matic, GL 500 4-matic	
RH-3501			2006-2011 ML-Class	w/AIRMATIC, w/ & w/o ADS	ML 280 CDI 4-matic, ML 300 4-matic/CDI 4-matic, ML 320 CDI 4-matic, ML 350 4-matic/CDI 4-matic, ML 420 CDI 4-matic, ML 450 CDI 4-matic, ML 500 4-matic, ML 63 AMG 4-matic	<ul style="list-style-type: none"> › For vehicles w/LED or Bi-Xenon Intelligent Lighting Systems
			2007-2012 GL-Class	w/AIRMATIC, w/ & w/o ADS	GL 320 CDI 4-matic/350 BlueTEC 4-matic, GL 350 CDI 4-matic, GL 420 CDI 4-matic, GL 450 4-matic/CDI 4-matic, GL 500 4-matic	
SK-2867			2006-2011 ML-Class	w/AIRMATIC & ADS, Non-AMG	ML 280 CDI 4-matic, ML 300 CDI 4-matic, ML 320 CDI 4-matic, ML 350 4-matic/CDI 4-matic, ML 420 CDI 4-matic, ML 450 CDI 4-matic, ML 500 4-matic	<ul style="list-style-type: none"> › New
			2007-2012 GL-Class	w/AIRMATIC & ADS	GL 320 CDI 4-matic/350 BlueTEC 4-matic, GL 350 CDI 4-matic, GL 420 CDI 4-matic, GL 450 4-matic/CDI 4-matic, GL 500 4-matic	
SK-2868			2007-2012 GL-Class	w/AIRMATIC, w/o ADS	GL 320 CDI 4-matic/350 BlueTEC 4-matic, GL 350 CDI 4-matic, GL 420 CDI 4-matic, GL 450 4-matic/CDI 4-matic, GL 500 4-matic	<ul style="list-style-type: none"> › New



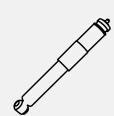





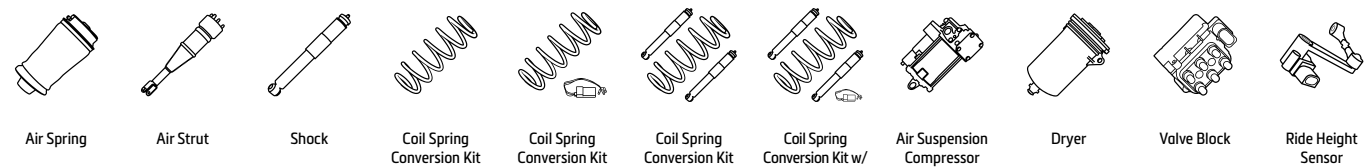

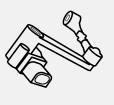

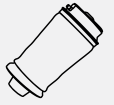



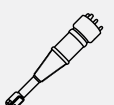

MERCEDES-BENZ						
Part #	Product Type	Position	Model Information	Vehicle Attributes	Product Attributes	
W164, X164						
SK-3029			2006-2011 ML-Class	w/AIRMATIC & ADS, Non-AMG	ML 280 CDI 4-matic, ML 300 CDI 4-matic, ML 320 CDI 4-matic, ML 350 4-matic/CDI 4-matic, ML 420 CDI 4-matic, ML 450 CDI 4-matic, ML 500 4-matic	<ul style="list-style-type: none"> › Remanufactured
			2007-2012 GL-Class	w/AIRMATIC & ADS	GL 320 CDI 4-matic/350 BlueTEC 4-matic, GL 350 CDI 4-matic, GL 420 CDI 4-matic, GL 450 4-matic/CDI 4-matic, GL 500 4-matic	
VB-3267			2006-2011 ML-Class	w/AIRMATIC & ADS, AMG	ML 280 CDI 4-matic, ML 300 4-matic/CDI 4-matic, ML 320 CDI 4-matic, ML 350 4-matic/CDI 4-matic, ML 420 CDI 4-matic, ML 450 CDI 4-matic, ML 500 4-matic, ML 63 AMG 4-matic	
			2007-2012 GL-Class	w/AIRMATIC, w/o ADS, Incl. AMG		
W166, X166						
A-2596			2012-2018 ML/GLE-Class	w/AIRMATIC & ADS, Incl. AMG		
			2013-2019 GL/GLS-Class	w/AIRMATIC, w/ & w/o ADS, Incl. AMG		
AS-3060			2012-2018 ML-Class	w/AIRMATIC & ADS, w/ & w/o 4MATIC, Non-AMG, Excl. ADS Plus	ML 250 CDI/BlueTEC 4-matic, ML 300 4-matic, ML 350 4-matic/350 BlueTEC 4-matic, ML 400 4-matic, ML 500 4-matic, ML 63 AMG 4-matic	<ul style="list-style-type: none"> › Remanufactured
			2013-2019 GL-Class		GL 350 CDI/BlueTEC 4-matic, GL 400 4-matic, GL 500 4-matic, GL 63 AMG 4-matic, 250 d/d 4-matic, 320 4-matic, 350 d 4-matic, 400 4-matic, 450 AMG 4-matic, 500 4-matic/e 4-matic, AMG 43 4-matic, AMG 63 4-matic/63 S 4-matic	
AS-3061			2012-2018 ML-Class	w/AIRMATIC & ADS, w/ & w/o 4MATIC, Non-AMG, Excl. ADS Plus	ML 250 CDI/BlueTEC 4-matic, ML 300 4-matic, ML 350 4-matic/350 BlueTEC 4-matic, ML 400 4-matic, ML 500 4-matic, ML 63 AMG 4-matic	<ul style="list-style-type: none"> › Remanufactured
			2013-2019 GL-Class		GL 350 CDI/BlueTEC 4-matic, GL 400 4-matic, GL 500 4-matic, GL 63 AMG 4-matic, 250 d/d 4-matic, 320 4-matic, 350 d 4-matic, 400 4-matic, 450 AMG 4-matic, 500 4-matic/e 4-matic, AMG 43 4-matic, AMG 63 4-matic/63 S 4-matic	
AS-3085			2013-2019 GL/GLS-Class	w/AIRMATIC, w/o ADS, Incl. AMG	GL 350 CDI/BlueTEC 4-matic, GL 400 4-matic, GL 500 4-matic, GL 63 AMG 4-matic, 250 d/d 4-matic, 320 4-matic, 350 d 4-matic, 400 4-matic, 450 AMG 4-matic, 500 4-matic/e 4-matic, AMG 43 4-matic, AMG 63 4-matic/63 S 4-matic	<ul style="list-style-type: none"> › Remanufactured

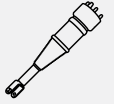

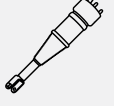

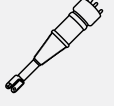

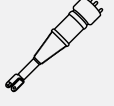



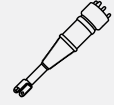

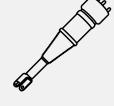

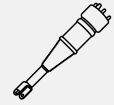

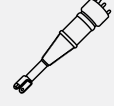
MERCEDES-BENZ						
Part #	Product Type	Position	Model Information	Vehicle Attributes	Product Attributes	
W166, X166						
AS-3086			2013-2019 GL/GLS-Class	w/AIRMATIC, w/o ADS, Incl. AMG	GL 350 CDI/BlueTec 4-matic, GL 400 4-matic, GL 500 4-matic, GL 63 AMG 4-matic, 250 d/d 4-matic, 320 4-matic, 350 d 4-matic, 400 4-matic, 450 AMG 4-matic, 500 4-matic/e 4-matic, AMG 43 4-matic, AMG 63 4-matic/63 S 4-matic	› Remanufactured
AS-3153			2012-2018 ML/GLE-Class	w/AIRMATIC & ADS, Non-AMG, Excl. GLE Coupe (292), Excl. ADS Plus	ML 250 CDI/BlueTEC 4-matic, ML 300 4-matic, ML 350 4-matic/BlueTEC 4-matic/350 CDI 4-matic, ML 400 4-matic, ML 500 4-matic	› New › Eibach Shock Absorber
			2013-2019 GL/GLS-Class	w/AIRMATIC & ADS, Non-AMG, Excl. ADS Plus	GL 350 CDI/BlueTec 4-matic, GL 400 4-matic, GL 500 4-matic, GL 63 AMG 4-matic, 250 d/d 4-matic, 320 4-matic, 350 d 4-matic, 400 4-matic, 500 4-matic/e 4-matic	
AS-3154			2012-2018 ML/GLE-Class	w/AIRMATIC & ADS, Non-AMG, Excl. GLE Coupe (292), Excl. ADS Plus	ML 250 CDI/BlueTEC 4-matic, ML 300 4-matic, ML 350 4-matic/BlueTEC 4-matic/350 CDI 4-matic, ML 400 4-matic, ML 500 4-matic	› New › Eibach Shock Absorber
			2013-2019 GL/GLS-Class	w/AIRMATIC & ADS, Non-AMG, Excl. ADS Plus	GL 350 CDI/BlueTec 4-matic, GL 400 4-matic, GL 500 4-matic, GL 63 AMG 4-matic, 250 d/d 4-matic, 320 4-matic, 350 d 4-matic, 400 4-matic, 500 4-matic/e 4-matic	
AS-3155			2013-2019 GL/GLS-Class	w/AIRMATIC, w/o ADS	GL 350 CDI/BlueTec 4-matic, GL 400 4-matic, GL 500 4-matic, GL 63 AMG 4-matic, 350 d 4-matic, 400 4-matic, 500 4-matic	› New › Eibach Shock Absorber
AS-3156			2013-2019 GL/GLS-Class	w/AIRMATIC, w/o ADS	GL 350 CDI/BlueTec 4-matic, GL 400 4-matic, GL 500 4-matic, GL 63 AMG 4-matic, 350 d 4-matic, 400 4-matic, 500 4-matic	› New › Eibach Shock Absorber
AS-3408			2012-2018 ML-Class	w/AIRMATIC & ADS, Incl. AMG	ML 250 CDI/BlueTec 4-matic, ML 300 4-matic, ML 350 4-matic, ML 400 4-matic, ML 500 4-matic, ML 63 AMG 4-matic	› New
			2013-2019 GL-Class	w/AIRMATIC, w/ & w/o ADS, Incl. AMG	GL 350 CDI/BlueTec 4-matic, GL 400 4-matic, GL 500, GL 63 AMG 4-matic	
AS-3409			2012-2018 ML-Class	w/AIRMATIC & ADS, Incl. AMG	ML 250 CDI/BlueTec 4-matic, ML 300 4-matic, ML 350 4-matic, ML 400 4-matic, ML 500 4-matic, ML 63 AMG 4-matic	› New
			2013-2019 GL-Class	w/AIRMATIC, w/ & w/o ADS, Incl. AMG	GL 350 CDI/BlueTec 4-matic, GL 400 4-matic, GL 500, GL 63 AMG 4-matic	
AS-3410			2013-2019 GL/GLS-Class	w/AIRMATIC, w/o ADS	GL 350 CDI/BlueTec 4-matic, GL 400 4-matic, GL 500 4-matic, GL 63 AMG 4-matic, 350 d 4-matic, 400 4-matic, 500 4-matic	› New
AS-3411			2013-2019 GL/GLS-Class	w/AIRMATIC, w/o ADS	GL 350 CDI/BlueTec 4-matic, GL 400 4-matic, GL 500 4-matic, GL 63 AMG 4-matic, 350 d 4-matic, 400 4-matic, 500 4-matic	› New

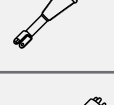
MERCEDES-BENZ						
Part #	Product Type	Position	Model Information	Vehicle Attributes	Product Attributes	
W166, X166						
P-3258			2012-2019 ML/GLE-Class	w/AIRMATIC & ADS, Incl. AMG	ML 250 CDI/BlueTec 4-matic, ML 300 4-matic, ML 350 4-matic, ML 400 4-matic, ML 500 4-matic, ML 63 AMG 4-matic	› Includes Dryer
			2013-2019 GL/GLS-Class	w/AIRMATIC, w/ & w/o ADS, Incl. AMG	GL 350 CDI/BlueTec 4-matic, GL 400 4-matic, GL 500, GL 63 AMG 4-matic	
SK-3268			2012-2018 ML-Class	w/AIRMATIC & ADS, Non-AMG	250 d/d 4-matic, 320 4-matic, 350 d 4-matic, 400 4-matic, 500 4-matic/e 4-matic, ML 250 CDI/BlueTec 4-matic, ML 300 4-matic, ML 350 4-matic/BlueTec 4-matic, ML 400 4-matic, ML 500 4-matic	› Remanufactured
			2013-2019 GL-Class		GL 400 4-matic, GL 500 4-matic	
VB-3267			2012-2019 ML-Class	w/AIRMATIC & ADS, Incl. AMG	250 d/d 4-matic, 320 4-matic, 350 d 4-matic, 400 4-matic, 450 AMG 4-matic, 500 4-matic/e 4-matic, AMG 43 4-matic/63 4-matic/63 S 4-matic	
			2013-2019 GL-Class	w/AIRMATIC, w/ & w/o ADS, Incl. AMG	GL 350 CDI/BlueTec 4-matic, GL 400 4-matic, GL 500, GL 63 AMG 4-matic	
W205						
A-3329			2015-2020 C-Class	w/ & w/o 4MATIC, Incl. AMG, Excl. C350e	AMG C 43 4-matic/63, C 160, C 180, C 180 BlueTec/d, C 200 4-matic/BlueTec/d/ EQ Boost/EQ Boost 4-matic, C 220 BlueTec/d/d 4-matic, C 250, C 250 BlueTec/d/d 4-matic, C 300, C 300 BlueTec Hybrid/h/d/d 4-matic, C 400 4-matic, C 450 AMG 4-matic	
A-3330			2015-2020 C-Class	w/ & w/o 4MATIC, Incl. AMG, Excl. C350e	AMG C 43 4-matic/63, C 160, C 180, C 180 BlueTec/d, C 200 4-matic/BlueTec/d/ EQ Boost/EQ Boost 4-matic, C 220 BlueTec/d/d 4-matic, C 250, C 250 BlueTec/d/d 4-matic, C 300, C 300 BlueTec Hybrid/h/d/d 4-matic, C 400 4-matic, C 450 AMG 4-matic	
SK-3389			2015-2018 C-Class	w/AIRMATIC, w/ & w/o 4MATIC, Incl. AMG, Excl. C350e	AMG C 43 4-matic/63, C 160, C 180, C 180 BlueTec/d, C 200 4-matic/BlueTec/d/ EQ Boost/EQ Boost 4-matic, C 220 BlueTec/d/d 4-matic, C 250, C 250 BlueTec/d/d 4-matic, C 300, C 300 BlueTec Hybrid/h/d/d 4-matic, C 400 4-matic, C 450 AMG 4-matic	› New › Eibach Shock Absorber
SK-3390			2015-2018 C-Class	w/AIRMATIC, w/ & w/o 4MATIC, Incl. AMG, Excl. C350e	AMG C 43 4-matic/63, C 160, C 180, C 180 BlueTec/d, C 200 4-matic/BlueTec/d/ EQ Boost/EQ Boost 4-matic, C 220 BlueTec/d/d 4-matic, C 250, C 250 BlueTec/d/d 4-matic, C 300, C 300 BlueTec Hybrid/h/d/d 4-matic, C 400 4-matic, C 450 AMG 4-matic	› New › Eibach Shock Absorber

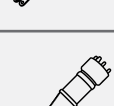

MERCEDES-BENZ					
Part #	Product Type	Position	Model Information	Vehicle Attributes	Product Attributes
W210					
RH-3501			1996-2002 E-Class	E 200/CDI/D/Kompressor, E 220 CDI/D, E 230, E 240, E 250 D/Turbo-D, E 270 CDI, E 280/4-matic, E 290 Turbo-D, E 300 D/Turbo-D, E 320/4-matic/CDI, E 36 AMG, E 420, E 430/4-matic, E 50 AMG/55 AMG	› For vehicles w/LED or Bi-Xenon Intelligent Lighting Systems
W211, W219					
A-2724			2003-2009 E-Class 2005-2011 CLS-Class	w/AIRMATIC & ADS, w/ & w/o 4MATIC, Non-AMG	› Must Be Replaced in Pairs
A-2725			2003-2009 E-Class 2005-2011 CLS-Class	w/AIRMATIC & ADS, AMG	› Must Be Replaced in Pairs
A-2726			2003-2009 E-Class	Wagon Only, w/AIRMATIC, w/o ADS, Incl. AMG	› Must Be Replaced in Pairs
AS-2245			2003-2009 E-Class 2005-2011 CLS-Class	w/AIRMATIC & ADS, w/o 4MATIC, Non-AMG	› Remanufactured
AS-2246			2003-2009 E-Class 2005-2011 CLS-Class	w/AIRMATIC & ADS, w/o 4MATIC, Non-AMG	› Remanufactured
AS-2294			2003-2009 E-Class	w/AIRMATIC & ADS, w/4MATIC, Non-AMG	› Remanufactured
AS-2295			2003-2009 E-Class	w/AIRMATIC & ADS, w/4MATIC, Non-AMG	› Remanufactured
AS-2300			2003-2009 E-Class 2005-2011 CLS-Class	w/AIRMATIC & ADS, AMG	› Remanufactured

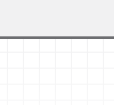
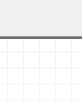
MERCEDES-BENZ					
Part #	Product Type	Position	Model Information	Vehicle Attributes	Product Attributes
W211, W219					
AS-2301			2003-2009 E-Class 2005-2011 CLS-Class	w/AIRMATIC & ADS, AMG	› Remanufactured
AS-2785			2003-2009 E-Class 2005-2011 CLS-Class	w/AIRMATIC & ADS, w/o 4MATIC, Non-AMG	› New
AS-2786			2003-2009 E-Class 2005-2011 CLS-Class	w/AIRMATIC & ADS, w/o 4MATIC, Non-AMG	› New
AS-2787			2003-2009 E-Class 2005-2011 CLS-Class	w/AIRMATIC & ADS, AMG	› New
AS-2788			2003-2009 E-Class 2005-2011 CLS-Class	w/AIRMATIC & ADS, AMG	› New
AS-3000			2003-2009 E-Class	w/AIRMATIC & ADS, w/4MATIC, Non-AMG	› New
AS-3001			2003-2009 E-Class	w/AIRMATIC & ADS, w/4MATIC, Non-AMG	› New
C-2278			2003-2009 E-Class 2005-2011 CLS-Class	Sedan Only, w/AIRMATIC & ADS, AMG	› New



Air Spring



Air Strut



Shock



Coil Spring Conversion Kit



Coil Spring Conversion Kit w/EBM



Coil Spring Conversion Kit w/Shocks



Coil Spring Conversion Kit w/Shocks & EBM



Air Suspension Compressor



Dryer



Valve Block









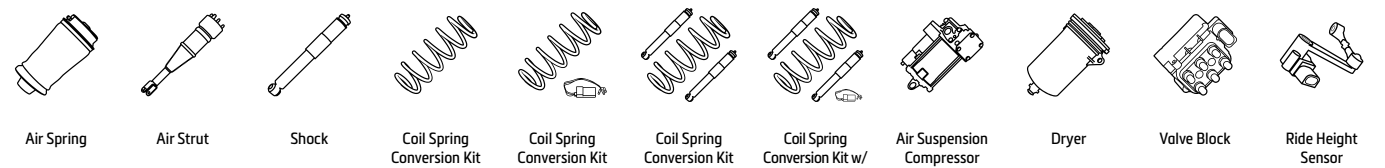



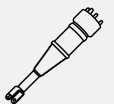



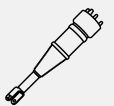

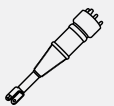

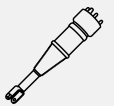

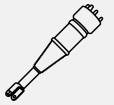

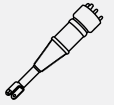

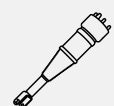

Ride Height Sensor

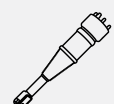
MERCEDES-BENZ					
Part #	Product Type	Position	Model Information	Vehicle Attributes	Product Attributes
W211, W219					
C-2663			2003-2009 E-Class	Wagon Only, w/AIRMATIC & ADS, w/4MATIC	E 200 CDI/Kompressor/NGT/T Kompressor, E 220 CDI/T CDI, E 230/T, E 240/4-matic/T/T 4-matic, E 270/T CDI, E 280/4-matic/CDI/CDI 4-matic/T/T 4-matic/T CDI/T CDI 4-matic, E 300 BlueTEC, E 320/4-matic/CDI/CDI 4-matic/T/T 4-matic/T CDI/T CDI 4-matic, E 350/4-matic/CGI/T/T 4-matic, E 400 CDI, E 420 CDI, E 500/4-matic/T/T 4-matic
C-2896			2003-2009 E-Class	Wagon Only, w/AIRMATIC, w/o ADS, Incl. AMG	350 CGI, E 200 CDI/Kompressor/T Kompressor, E 220 CDI/T CDI, E 230 T, E 240 T, E 270 T CDI, E 280 T/T 4-matic/T CDI/T CDI 4-matic, E 320 T/T 4-matic/T CDI/T CDI 4-matic, E 350 T, E 350 4-matic, E 500 T/T 4-matic
P-2192			2003-2009 E-Class	w/AIRMATIC & ADS, AMG	E 200 CDI/Kompressor/NGT/T Kompressor, E 220 CDI/T CDI, E 230/T, E 240/4-matic/T/T 4-matic, E 270 CDI/T CDI, E 280/4-matic/CDI/CDI 4-matic/T/T 4-matic/T CDI/T CDI 4-matic, E 300 BlueTEC, E 320/4-matic/CDI/CDI 4-matic/T/T 4-matic/T CDI/T CDI 4-matic, E 350/4-matic/CGI/T/T 4-matic, E 500 T/T 4-matic, E 400 CDI, E 420 CDI, E 500/4-matic, E 55 AMG Kompressor, E 63 AMG
				Wagon Only, w/AIRMATIC & ADS, w/o 4MATIC, Incl. AMG	
			2005-2011 CLS-Class	w/AIRMATIC & ADS, Incl. AMG	CLS 280, CLS 300, CLS 320 CDI, CLS 350/CDI, CLS 500, CLS 55 AMG, CLS 63 AMG
RH-3500			2003-2009 E-Class	w/AIRMATIC & ADS, AMG	E 200 CDI/Kompressor/NGT, E 220 CDI, E 230, E 240/4-matic, E 270 CDI, E 280/4-matic/CDI/CDI 4-matic, E 300 BlueTEC, E 320/4-matic/CDI/CDI 4-matic, E 350/4-matic/CGI, E 400 CDI, E 420 CDI, E 500/4-matic, E 55 AMG Kompressor, E 63 AMG
			2005-2011 CLS-Class	w/AIRMATIC & ADS, Incl. AMG	
RH-3501			2003-2009 E-Class	w/AIRMATIC & ADS, w/ & w/o 4MATIC, Non-AMG	E 200 CDI/Kompressor/NGT, E 220 CDI, E 230, E 240/4-matic, E 270 CDI, E 280/4-matic/CDI/CDI 4-matic, E 300 BlueTEC, E 320/4-matic/CDI/CDI 4-matic, E 350/4-matic/CGI, E 400 CDI, E 420 CDI, E 500/4-matic, E 55 AMG Kompressor, E 63 AMG
			2005-2011 CLS-Class	w/AIRMATIC & ADS, Incl. AMG	
SK-3012			2003-2009 E-Class	Sedan Only, w/AIRMATIC & ADS, AMG	E 200 CDI/Kompressor/NGT, E 220 CDI, E 230, E 240, E 270 CDI, E 280/CDI, E 300 BlueTEC, E 320/CDI, E 350/CGI, E 400 CDI, E 420 CDI, E 500, E 55 AMG Kompressor, E 63 AMG
			2005-2011 CLS-Class	w/AIRMATIC & ADS, Incl. AMG	
SK-3039			2003-2009 E-Class	w/o AIRMATIC, w/o ADS, w/ & w/o 4MATIC, Non-AMG	E 200 CDI/Kompressor/NGT/CDI, E 230, E 240/4-matic, E 270 CDI, E 280/4-matic/CDI/CDI 4-matic, E 300 BlueTEC, E 320/4-matic/CDI/CDI 4-matic, E 350/4-matic/CGI, E 400 CDI, E 420 CDI, E 500/500 4-matic
			2005-2011 CLS-Class	w/o AIRMATIC, w/o ADS, Non-AMG	

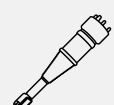
MERCEDES-BENZ					
Part #	Product Type	Position	Model Information	Vehicle Attributes	Product Attributes
W211, W219					
SK-3197			2003-2009 E-Class	Sedan Only, w/AIRMATIC & ADS, w/o 4MATIC, Incl. AMG	E 200 CDI/Kompressor/NGT, E 220 CDI/CDI, E 230, E 240, E 270 CDI, E 280/CDI, E 300 BlueTEC, E 320/CDI, E 350/CGI, E 400 CDI, E 420 CDI, E 500, E 55 AMG Kompressor, E 63 AMG
			2005-2011 CLS-Class	w/AIRMATIC & ADS, Incl. AMG	CLS 280, CLS 300, CLS 320 CDI, CLS 350/CDI, CLS 500, CLS 55 AMG, CLS 63 AMG
SK-3199			2003-2009 E-Class	w/AIRMATIC & ADS, AMG	E 55 AMG Kompressor, E 63 AMG
			2005-2011 CLS-Class		CLS 55 AMG, CLS 63 AMG
SK-3311			2003-2009 E-Class	w/o ADS	E 200 CDI/Kompressor/NGT/CDI, E 230, E 240/4-matic, E 270 CDI, E 280/4-matic/CDI/CDI 4-matic, E 300 BlueTEC, E 320/4-matic/CDI/CDI 4-matic, E 350/4-matic/CGI, E 400 CDI, E 420 CDI, E 500, E 500 4-matic, E 55 AMG Kompressor, E 63 AMG
			2005-2011 CLS-Class		CLS 280, CLS 300, CLS 320 CDI, CLS 350/CDI, CLS 500, CLS 55 AMG, CLS 63 AMG
W212, W218					
A-2790			2010-2016 E-Class	w/AIRMATIC & ADS, w/ & w/o 4MATIC	E 200, E 200 CDI/BlueTEC/CGI/NGT, E 220 BlueTEC/BlueTEC 4-matic/CDI, E 250, E 250 CDI/BlueTEC/BlueTEC 4-matic/CGI, E 300, E 300 4-matic/CDI/BlueTEC/Hybrid/BlueTEC Hybrid, E 350, E 350 4-matic/BlueTEC/BlueTEC 4-matic/CDI/CDI 4-matic/CGI, E 400, E 400 4-matic, E 500, E 500 4-matic, E 63 AMG, E 63 AMG 4-matic
				w/AIRMATIC, w/o ADS, w/4MATIC, Non-AMG	
			2012-2018 CLS-Class	w/AIRMATIC, w/ & w/o ADS, w/ & w/o 4MATIC, Incl. AMG	CLS 220 BlueTEC/d, CLS 250 BlueTEC 4-matic/d 4-matic/CDI/BlueTEC/d, CLS 350/BlueTEC/d/BlueTEC 4-matic/CDI/d/CDI 4-matic/d 4-matic, CLS 400/4-matic, CLS 500/4-matic, CLS 63 AMG/AMG 4-matic

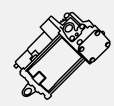
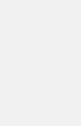

MERCEDES-BENZ					
Part #	Product Type	Position	Model Information	Vehicle Attributes	Product Attributes
W212, W218					
A-2791			2010-2016 E-Class	w/AIRMATIC & ADS, w/ & w/o 4MATIC	E 200, E 200 CDI/BlueTEC/CGI/NGT, E 220 BlueTEC/BlueTEC 4-matic/CDI, E 250, E 250 CDI/BlueTEC/BlueTEC 4-matic/CGI, E 300, E 300 4-matic/CDI/BlueTEC/Hybrid/BlueTEC Hybrid, E 350, E 350 4-matic/BlueTEC/BlueTEC 4-matic/CDI/CDI 4-matic/CGI, E 400, E 400 4-matic, E 500, E 500 4-matic, E 63 AMG, E 63 AMG 4-matic
			2012-2018 CLS-Class	w/AIRMATIC, w/ & w/o ADS, w/ & w/o 4MATIC, Incl. AMG	CLS 220 BlueTEC/d, CLS 250 BlueTEC 4-matic/d 4-matic/CDI/BlueTEC/d, CLS 350/BlueTEC/d/BlueTEC 4-matic/CDI/d/CDI 4-matic/d 4-matic, CLS 400 4-matic, CLS 500 4-matic, CLS 63 AMG/AMG 4-matic
AS-3237			2010-2016 E-Class	w/AIRMATIC & ADS, w/4MATIC	E 220 BlueTEC 4-matic, E 250 CDI/BlueTEC 4-matic, E 300 4-matic, E 350 BlueTEC 4-matic/CDI 4-matic, E 500 4-matic, E 63 AMG 4-matic
			2012-2018 CLS-Class	w/AIRMATIC & ADS, w/4MATIC, Incl. AMG	CLS 250 BlueTEC/d 4-matic, CLS 350 BlueTEC 4-matic/CDI/d 4-matic/d 4-matic, CLS 400 4-matic, CLS 500 4-matic, CLS 63 AMG 4-matic
AS-3238			2010-2016 E-Class	w/AIRMATIC & ADS, w/4MATIC	E 220 BlueTEC 4-matic, E 250 CDI/BlueTEC 4-matic, E 300 4-matic, E 350 BlueTEC 4-matic/CDI 4-matic, E 500 4-matic, E 63 AMG 4-matic
			2012-2018 CLS-Class	w/AIRMATIC & ADS, w/4MATIC, Incl. AMG	CLS 250 BlueTEC/d 4-matic, CLS 350 BlueTEC 4-matic/CDI/d 4-matic/d 4-matic, CLS 400 4-matic, CLS 500 4-matic, CLS 63 AMG 4-matic
AS-3239			2010-2016 E-Class	w/AIRMATIC & ADS, w/o 4MATIC, Non-AMG	E 180, E 200/CDI/BlueTEC/CGI/NGT, E 220 BlueTEC/CDI/BlueTEC, E 250/CDI/BlueTEC/CGI, E 300/CDI/BlueTEC/Hybrid/BlueTEC Hybrid, E 350/BlueTEC/CDI/CGI, E 400, E 500
AS-3240			2010-2016 E-Class	w/AIRMATIC & ADS, w/o 4MATIC, Non-AMG	E 180, E 200/CDI/BlueTEC/CGI/NGT, E 220 BlueTEC/CDI/BlueTEC, E 250/CDI/BlueTEC/CGI, E 300/CDI/BlueTEC/Hybrid/BlueTEC Hybrid, E 350/BlueTEC/CDI/CGI, E 400, E 500
AS-3414			2012-2017 CLS-Class	w/AIRMATIC, w/o ADS, w/o 4MATIC, Incl. AMG	CLS 220 BlueTEC/d, CLS 250 CDI/BlueTEC/d, CLS 350/BlueTEC/d/CDI, CLS 400, CLS 500, CLS 63 AMG
AS-3415			2012-2017 CLS-Class	w/AIRMATIC, w/o ADS, w/o 4MATIC, Incl. AMG	CLS 220 BlueTEC/d, CLS 250 CDI/BlueTEC/d, CLS 350/BlueTEC/d/CDI, CLS 400, CLS 500, CLS 63 AMG
AS-3422			2010-2016 E-Class	w/AIRMATIC & ADS, w/o 4MATIC, Incl. AMG	E 180, E 200/CDI/BlueTEC/CGI/NGT, E 220 BlueTEC/CDI/BlueTEC, E 250/CDI/BlueTEC/CGI, E 300/CDI/BlueTEC/Hybrid/BlueTEC Hybrid, E 350/BlueTEC/CDI/CGI, E 400, E 500, E 63 AMG

MERCEDES-BENZ					
Part #	Product Type	Position	Model Information	Vehicle Attributes	Product Attributes
W212, W218					
AS-3423			2010-2016 E-Class	w/AIRMATIC & ADS, w/o 4MATIC, Incl. AMG	E 180, E 200/CDI/BlueTEC/CGI/NGT, E 220 BlueTEC/CDI/BlueTEC, E 250/CDI/BlueTEC/CGI, E 300/CDI/BlueTEC/Hybrid/BlueTEC Hybrid, E 350/BlueTEC/CDI/CGI, E 400, E 500, E 63 AMG
AS-3424			2010-2016 E-Class	w/AIRMATIC & ADS, w/4MATIC	E 220 BlueTEC 4-matic, E 250 CDI/BlueTEC 4-matic, E 300 4-matic, E 350 4-matic/BlueTEC 4-matic/CDI 4-matic, E 400 4-matic, E 500 4-matic, E 63 AMG 4-matic
			2012-2018 CLS-Class	w/AIRMATIC & ADS, w/4MATIC, Incl. AMG	CLS 250 BlueTEC 4-matic/d 4-matic, CLS 350 BlueTEC 4-matic/d 4-matic/CDI 4-matic, CLS 400 4-matic, CLS 500 4-matic, CLS 63 AMG 4-matic
AS-3425			2010-2016 E-Class	w/AIRMATIC & ADS, w/4MATIC	E 220 BlueTEC 4-matic, E 250 CDI/BlueTEC 4-matic, E 300 4-matic, E 350 4-matic/BlueTEC 4-matic/CDI 4-matic, E 400 4-matic, E 500 4-matic, E 63 AMG 4-matic
			2012-2018 CLS-Class	w/AIRMATIC & ADS, w/4MATIC, Incl. AMG	CLS 250 BlueTEC 4-matic/d 4-matic, CLS 350 BlueTEC 4-matic/d 4-matic/CDI 4-matic, CLS 400 4-matic, CLS 500 4-matic, CLS 63 AMG 4-matic
P-2830			2010-2016 E-Class	w/AIRMATIC & ADS, w/ & w/o 4MATIC	E 200, E 200 CDI/BlueTEC/CGI/NGT, E 220 BlueTEC/BlueTEC 4-matic/CDI, E 250, E 250 CDI/BlueTEC/BlueTEC 4-matic/CGI, E 300, E 300 4-matic/CDI/BlueTEC/Hybrid/BlueTEC Hybrid, E 350, E 350 4-matic/BlueTEC/BlueTEC 4-matic/CDI/CDI 4-matic/CGI, E 400, E 400 4-matic, E 500, E 500 4-matic, E 63 AMG, E 63 AMG 4-matic
			2011-2018 CLS-Class	w/AIRMATIC, w/ & w/o ADS, w/ & w/o 4MATIC, Incl. AMG	CLS 220 BlueTEC/d, CLS 250 BlueTEC 4-matic/d 4-matic/CDI/BlueTEC/d, CLS 350/BlueTEC/d/BlueTEC 4-matic/CDI/d/CDI 4-matic/d 4-matic, CLS 400 4-matic, CLS 500 4-matic, CLS 63 AMG/AMG 4-matic
W213					
A-3313			2016-2020 E-Class	w/AIRMATIC, w/ & w/o 4MATIC, Incl. Hybrid, Incl. AMG	
A-3314			2016-2020 E-Class	w/AIRMATIC, w/ & w/o 4MATIC, Incl. Hybrid, Incl. AMG	



Air Spring



Air Strut



Shock



Coil Spring Conversion Kit



Coil Spring Conversion Kit w/EBM



Coil Spring Conversion Kit w/Shocks



Coil Spring Conversion Kit w/Shocks & EBM



Air Suspension Compressor













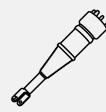

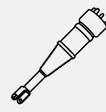

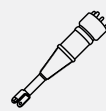

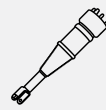

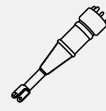
Dryer

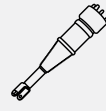

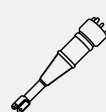

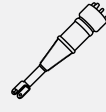

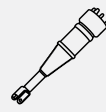



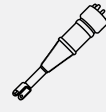

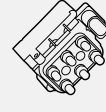
Valve Block



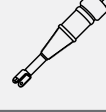



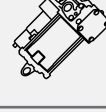
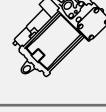
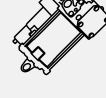

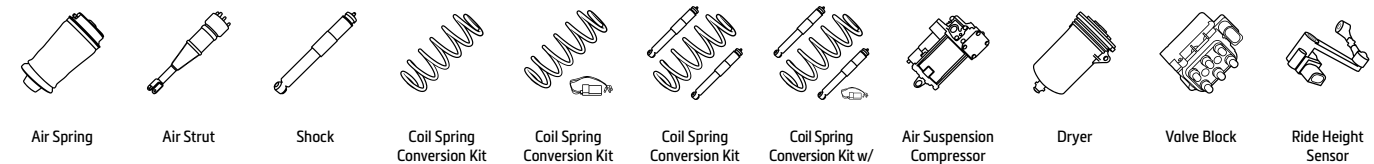







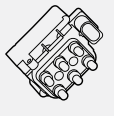
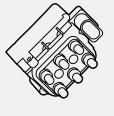



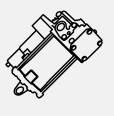



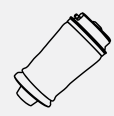

Ride Height Sensor

MERCEDES-BENZ					
Part #	Product Type	Position	Model Information	Vehicle Attributes	Product Attributes
W213					
AS-3577			2016-2018 E-Class	w/AIRMATIC, w/4MATIC, E43 AMG	> Remanufactured
AS-3578			2016-2018 E-Class	w/AIRMATIC, w/4MATIC, E43 AMG	> Remanufactured
W222					
AS-3160			2014-2020 S-Class 2014-2020 Maybach S 500	w/AIRMATIC, w/4MATIC, Non-AMG	> New > Eibach Shock Absorber
AS-3161			2014-2020 S-Class 2014-2020 Maybach S 500	w/AIRMATIC, w/4MATIC, Non-AMG	> New > Eibach Shock Absorber
AS-3162			2014-2020 S-Class 2014-2020 Maybach S 500	w/AIRMATIC, w/o 4MATIC, Incl. AMG	> New > Eibach Shock Absorber
AS-3163			2014-2020 S-Class 2014-2020 Maybach S 500	w/AIRMATIC, w/o 4MATIC, Incl. AMG	> New > Eibach Shock Absorber
AS-3360			2014-2020 S-Class 2014-2020 Maybach S 500	w/AIRMATIC, w/ & w/o 4MATIC, Non-AMG	> Remanufactured
AS-3361			2014-2020 S-Class 2014-2020 Maybach S 500	w/AIRMATIC, w/ & w/o 4MATIC, Non-AMG	> Remanufactured
AS-3364			2014-2020 S-Class 2014-2020 Maybach S 500	w/AIRMATIC, w/ & w/o 4MATIC, Incl. AMG	> New

MERCEDES-BENZ					
Part #	Product Type	Position	Model Information	Vehicle Attributes	Product Attributes
W222					
AS-3365			2014-2020 S-Class 2014-2020 Maybach S 500	w/AIRMATIC, w/ & w/o 4MATIC, Incl. AMG	> New
VB-3427			2014-2020 S-Class 2014-2020 Maybach S 500	w/ & w/o 4MATIC, Incl. AMG	AMG S 63, S 300 BlueTEC Hybrid/h, S 320, S 350 BlueTEC/d, S 400/d/ Hybrid/h, S 450/EQ Boost, S 500/EQ Boost/Hybrid/e/Maybach, S 560/e/Maybach, S 600/Maybach, S 63 AMG, S 65 AMG, S 650 Maybach
W251					
A-2587			2006-2013 R-Class	w/AIRMATIC & ADS, w/ & w/o 4MATIC, Incl. AMG	> New Air Spring Only, Reuse Factory Shock
A-2597			2006-2013 R-Class	w/AIRMATIC, w/ & w/o ADS, w/ & w/o 4MATIC, Incl. AMG	R 280/4-matic/CDI, R 300/CDI/CDI 4-matic, R 320 CDI 4-matic, R 350/4-matic/CDI 4-matic/CGI 4-matic, R 500 4-matic, R 63 AMG 4-matic
AS-2394			2006-2013 R-Class	w/AIRMATIC & ADS, w/ & w/o 4MATIC, Incl. AMG	> Remanufactured
AS-2833			2006-2013 R-Class	w/AIRMATIC & ADS, w/ & w/o 4MATIC, Incl. AMG	> New
P-2618			2006-2013 R-Class	w/AIRMATIC, w/o ADS, w/ & w/o 4MATIC, Incl. AMG	> AMK OES > Includes Dryer
P-3215			2006-2013 R-Class	w/AIRMATIC & ADS, w/ & w/o 4MATIC, Incl. AMG	> Includes Dryer
P-3281			2006-2013 R-Class	w/AIRMATIC, w/ & w/o ADS, w/ & w/o 4MATIC, Incl. AMG	> Includes Dryer

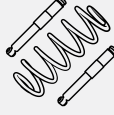

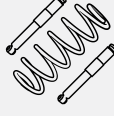
MERCEDES-BENZ						
Part #	Product Type	Position	Model Information	Vehicle Attributes	Product Attributes	
W251						
SK-3217			2006-2013 R-Class	w/AIRMATIC & ADS, w/ & w/o 4MATIC, Non-AMG	R 320 CDI 4-matic, R 350/4-matic/CDI 4-matic/CGI 4-matic, R 500 4-matic	› New
SK-3218			2006-2013 R-Class	w/o AIRMATIC, w/ & w/o 4MATIC, Incl. AMG	R 320 CDI 4-matic, R 350/4-matic/CDI 4-matic/CGI 4-matic, R 500 4-matic	› New
SK-3262			2006-2013 R-Class	w/AIRMATIC & ADS, w/4MATIC, Non-AMG	R 280/4-matic/CDI, R 300/CDI/CDI 4-matic, R 320 CDI 4-matic, R 350/4-matic/CDI 4-matic/CGI 4-matic, R 500 4-matic	› Remanufactured
VB-3267			2010-2012 R-Class	w/AIRMATIC, w/ & w/o ADS, w/ & w/o 4MATIC, Incl. AMG	R 350 CDI 4-matic	
VB-3499			2006-2012 R-Class	w/o AIRMATIC, w/ & w/o 4MATIC, Incl. AMG		
W257						
A-3313			2019-2020 CLS-Class	w/AIRMATIC, w/ & w/o 4MATIC, Incl. Hybrid, Incl. AMG		
A-3314			2019-2020 CLS-Class	w/AIRMATIC, w/ & w/o 4MATIC, Incl. Hybrid, Incl. AMG		
W638						
P-2219			1996-2003 V-Class	V 200, V 200 CDI, V 220 CDI, V 230, V 230 TD, V 280		› Includes Dryer
W639						
A-2801			2004-2014 V-Class	3.0, 3.2, 3.5, 3.7, CDI 2.0/4-matic, CDI 2.2/4-matic, CDI 3.0		

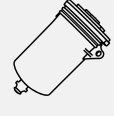
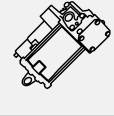
MERCEDES-BENZ						
Part #	Product Type	Position	Model Information	Vehicle Attributes	Product Attributes	
X253						
A-3313			2016-2020 GLC-Class	w/AIRMATIC, w/ & w/o 4MATIC, Incl. Hybrid, Incl. AMG		
A-3314			2016-2020 GLC-Class	w/AIRMATIC, w/ & w/o 4MATIC, Incl. Hybrid, Incl. AMG		
MERCURY						
Part #	Product Type	Position	Model Information	Vehicle Attributes	Product Attributes	
Panther						
A-2105			1992-2011 Grand Marquis	4.6 Liter V8		
A-2220			1992-2011 Grand Marquis	4.6 Liter V8		› Heavy Duty for Limousine Use
C-2614			1992-2002 Grand Marquis	4.6 Liter V8		
C-2615			2003-2011 Grand Marquis	4.6 Liter V8		
D-2171			1992-2011 Grand Marquis	4.6 Liter V8		
P-2936			1992-2011 Grand Marquis	4.6 Liter V8		› Includes Dryer



Air Spring



Air Strut



Shock



Coil Spring Conversion Kit



Coil Spring Conversion Kit w/EBM



Coil Spring Conversion Kit w/Shocks



Coil Spring Conversion Kit w/Shocks & EBM



Air Suspension Compressor



Dryer



Valve Block



Ride Height Sensor

Air suspension compressors inflate or deflate air spring bags to maintain a vehicle's factory designated height. Compressor burnout is one of the most frequent air suspension system problems and is often due to overuse caused by leaking air springs or air struts. When the vehicle is not at the correct height due to leaks in the system, the compressor repeatedly cycles to maintain pressure - ultimately leading to its failure.

Arnett's compressors are direct OE replacements and are vigorously tested to ensure a long life and reduced failure rates.

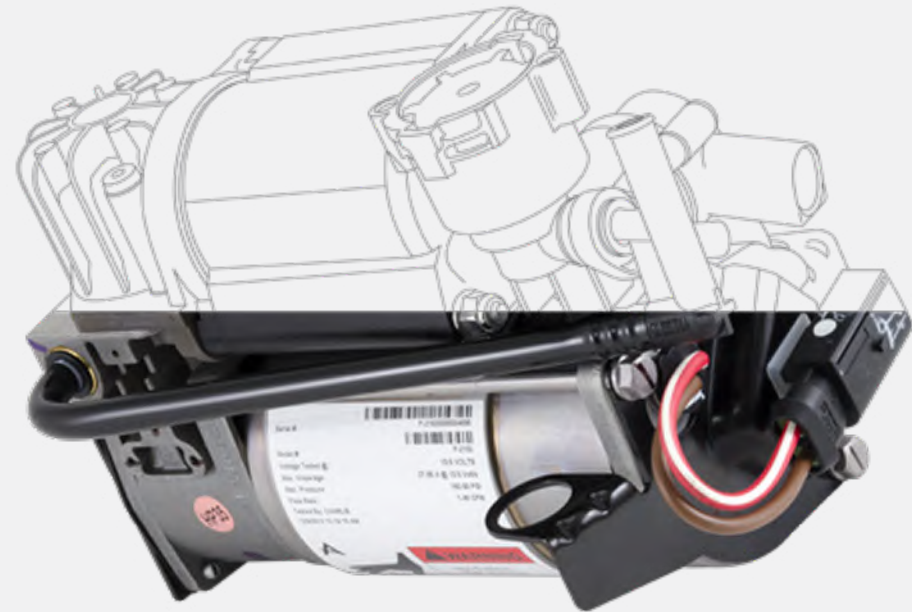

THE ARNOTT ADVANTAGE

- ▲ Meets OE specifications
- ▲ Electrocoated epoxy finish to prevent corrosion
- ▲ Maintenance-free integrated air dryers
- ▲ Most Arnett compressors are fully assembled, including application-specific air lines, wiring harness & brackets
- ▲ Assembled & tested in the USA
- ▲ Includes thermal overload protection
- ▲ Fast, flawless plug & play installation

ARNOTT OFFERS AIR SUSPENSION COMPRESSORS FOR:





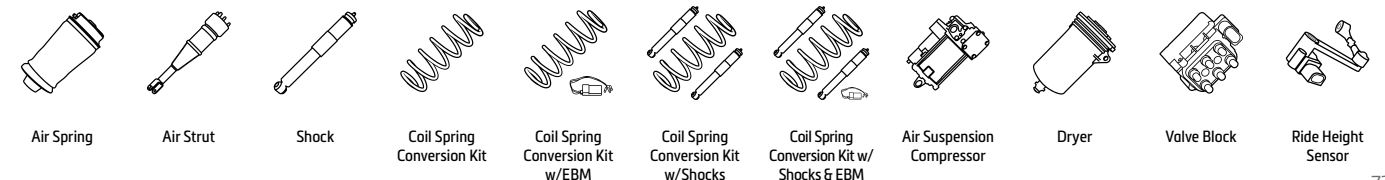

Audi • Bentley • BMW • Buick • Cadillac • Chevrolet • Citroën • Ford • GMC • Infiniti • Jaguar • Land Rover • Lexus • Lincoln • Maybach • Mercedes-Benz • Mercury • Nissan • Oldsmobile • Peugeot • Porsche • Toyota • Volkswagen • Volvo

NISSAN						
Part #	Product Type	Position	Model Information	Vehicle Attributes		Product Attributes
WA60						
AS-3284			2005-2015 Armada	4 Wheel Drive (4WD)	5.6 4x4	> New
C-3421			2005-2015 Armada	4 Wheel Drive (4WD)	5.6 4x4	
C-3434			2005-2015 Armada	Rear Wheel Drive (RWD)	5.6	
P-3277			2005-2015 Armada	4 Wheel Drive (4WD) & Rear Wheel Drive (RWD)	5.6, 5.6 4x4	





ARNOTT AIR SUSPENSION COMPRESSOR



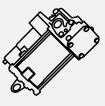

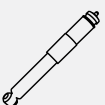
- New air suspension compressor for 04-10 Infiniti QX56 & 04-15 Nissan Armada (J/WA60)
- Quiet, maintenance-free design
- Includes thermal overload protection
- Pre-assembled with mounting brackets for fast installation
- Includes integrated air dryer & valve block
- P-3277











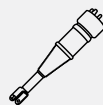

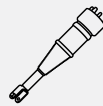

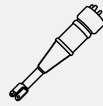
OLDSMOBILE					
Part #	Product Type	Position	Model Information	Vehicle Attributes	Product Attributes
G Platform					
AS-2190			1995-2003 Aurora		<ul style="list-style-type: none"> › New › Sold in Pairs
SK-2189			1998-2003 Aurora		<ul style="list-style-type: none"> › New › Sold in Pairs
GMT200					
AS-2235			1997-2005 Silhouette	w/Rear Air Assist	<ul style="list-style-type: none"> › New › Sold in Pairs
GMT360					
A-2610			2002-2004 Bravada		<ul style="list-style-type: none"> › Generation II › Crimped Assembly, Improved Design
C-2137			2002-2004 Bravada		

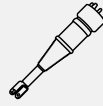

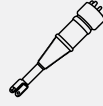



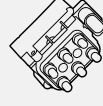

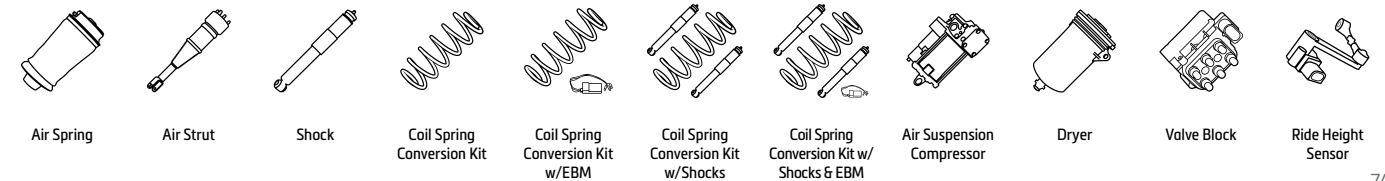





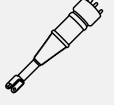

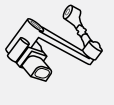

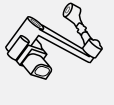

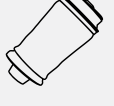

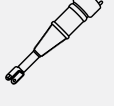
PEUGEOT					
Part #	Product Type	Position	Model Information	Vehicle Attributes	Product Attributes
VF3X_					
P-2851			2007-2011 Expert	1.6 HDi 90 16V/8V, 2.0 16V/HDi 120/HDi 120 4x4/HDi 140/HDi 165	<ul style="list-style-type: none"> › WABCO OES › Includes Dryer











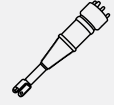

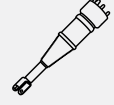

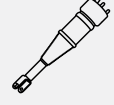

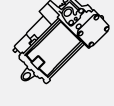
PONTIAC					
Part #	Product Type	Position	Model Information	Vehicle Attributes	Product Attributes
G Platform					
AS-2190			2000-2004 Bonneville		<ul style="list-style-type: none"> › New › Sold in Pairs
SK-2189			2000-2004 Bonneville		<ul style="list-style-type: none"> › New › Sold in Pairs

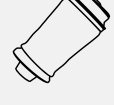
PONTIAC					
Part #	Product Type	Position	Model Information	Vehicle Attributes	Product Attributes
GMT250					
AS-2235			2001-2004 Aztek	w/Rear Air Assist	<ul style="list-style-type: none"> › New › Sold in Pairs
U Platform					
AS-2235			1999-2005 Montana	w/Rear Air Assist	<ul style="list-style-type: none"> › New › Sold in Pairs
			1997-1998 Trans Sport		

PORSCHE					
Part #	Product Type	Position	Model Information	Vehicle Attributes	Product Attributes
92A					
AS-3056			2011-2018 Cayenne	w/Auto Leveling	<ul style="list-style-type: none"> › Remanufactured
AS-3057			2011-2018 Cayenne	w/Auto Leveling	<ul style="list-style-type: none"> › Remanufactured
AS-3166			2011-2018 Cayenne	w/Auto Leveling	<ul style="list-style-type: none"> › New › Eibach Shock Absorber
AS-3167			2011-2018 Cayenne	w/Auto Leveling	<ul style="list-style-type: none"> › New › Eibach Shock Absorber
AS-3235			2011-2018 Cayenne	w/Auto Leveling	<ul style="list-style-type: none"> › New › Extended Travel & Improved Design
AS-3236			2011-2018 Cayenne	w/Auto Leveling	<ul style="list-style-type: none"> › New › Extended Travel & Improved Design
VB-3470			2011-2018 Cayenne	w/Auto Leveling	<ul style="list-style-type: none"> › Remanufactured

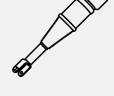

PORSCHE						
Part #	Product Type	Position	Model Information	Vehicle Attributes	Product Attributes	
95B						
A-3327			2015-2018 Macan	w/Auto Leveling	2.0, 3.0 GTS/S/S Diesel, 3.6 Turbo	
A-3328			2015-2018 Macan	w/Auto Leveling	2.0, 3.0 GTS/S/S Diesel, 3.6 Turbo	
AS-3351			2015-2018 Macan	w/Auto Leveling	2.0, 3.0 GTS/S/S Diesel, 3.6 Turbo	<ul style="list-style-type: none"> › New › Eibach Shock Absorber
RH-3459			2015-2020 Macan		2.0, 3.0 GTS/S/S Diesel, 3.6 Turbo	
RH-3460			2015-2020 Macan		2.0, 3.0 GTS/S/S Diesel, 3.6 Turbo	
970						
A-3306			2010-2016 Panamera		3.0 4S/D/S/S E-Hybrid, 3.6/4, 4.8 4S/GTS/S/Turbo/Turbo S	
AS-3035			2010-2013 Panamera		3.0 D/S E-Hybrid, 3.6, 3.6 4, 4.8 4S/GTS/S/Turbo/Turbo S	› Remanufactured
AS-3036			2010-2013 Panamera		3.0 D/S E-Hybrid, 3.6, 3.6 4, 4.8 4S/GTS/S/Turbo/Turbo S	› Remanufactured
AS-3037			2014-2016 Panamera		3.0 4S/D/S/S E-Hybrid, 3.6, 3.6 4, 4.8 GTS/Turbo/Turbo S	› Remanufactured
AS-3038			2014-2016 Panamera		3.0 4S/D/S/S E-Hybrid, 3.6, 3.6 4, 4.8 GTS/Turbo/Turbo S	› Remanufactured
AS-3345			2010-2013 Panamera	w/ & w/o AWD	3.0 D/S E-Hybrid, 3.6, 3.6 4, 4.8 4S/GTS/S/Turbo/Turbo S	<ul style="list-style-type: none"> › New › Eibach Shock Absorber

PORSCHE						
Part #	Product Type	Position	Model Information	Vehicle Attributes	Product Attributes	
970						
AS-3346			2010-2013 Panamera	w/ & w/o AWD	3.0 D/S E-Hybrid, 3.6, 3.6 4, 4.8 4S/GTS/S/Turbo/Turbo S	<ul style="list-style-type: none"> › New › Eibach Shock Absorber
AS-3376			2014-2016 Panamera		3.0 4S/D/S/S E-Hybrid, 3.6, 3.6 4, 4.8 GTS/Turbo/Turbo S	<ul style="list-style-type: none"> › New › Eibach Shock Absorber
AS-3377			2014-2016 Panamera		3.0 4S/D/S/S E-Hybrid, 3.6, 3.6 4, 4.8 GTS/Turbo/Turbo S	<ul style="list-style-type: none"> › New › Eibach Shock Absorber
VB-3489			2010-2016 Panamera		Excl. Hybrid	
971						
P-3477			2017-2021 Panamera		2.9 4 E-Hybrid/4S, 3.0, 3.0 4, 4.0 GTS/S 4 Diesel/Turbo/Turbo S E-Hybrid, Sport Turismo (3.0 4, 4.0 GTS/S 4 Diesel/Turbo/Turbo S E-Hybrid)	<ul style="list-style-type: none"> › WABCO OES › Includes Dryer
9PA						
A-2523			2003-2010 Cayenne		3.0 TDI, 3.2, 3.6, GTS 4.8, S 4.5/4.8, Turbo 4.5, Turbo S 4.5/4.8	
A-2571			2003-2010 Cayenne		3.0 TDI, 3.2, 3.6, GTS 4.8, S 4.5/4.8, Turbo 4.5, Turbo S 4.5/4.8	
A-2572			2003-2010 Cayenne		3.0 TDI, 3.2, 3.6, GTS 4.8, S 4.5/4.8, Turbo 4.5, Turbo S 4.5/4.8	
AS-3164			2003-2010 Cayenne		3.0 TDI, 3.2, 3.6, GTS 4.8, S 4.5/4.8, Turbo 4.5, Turbo S 4.5/4.8	› New
AS-3165			2003-2010 Cayenne		3.0 TDI, 3.2, 3.6, GTS 4.8, S 4.5/4.8, Turbo 4.5, Turbo S 4.5/4.8	› New

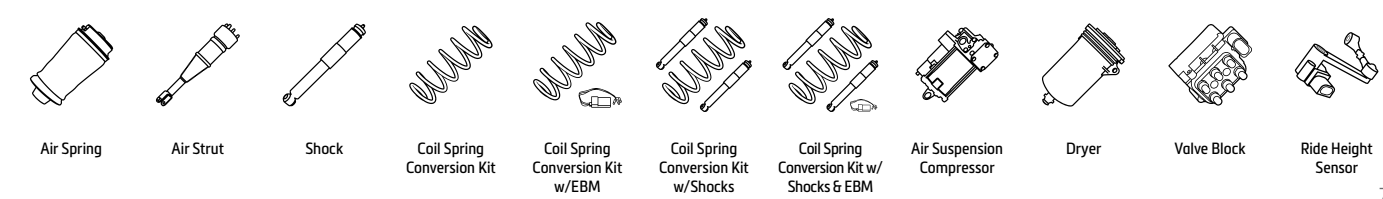

PORSCHE					
Part #	Product Type	Position	Model Information	Vehicle Attributes	Product Attributes
9PA					
C-2616			2003-2006 Cayenne	w/o PDCC 3.2, 3.6, GTS 4.8, S 4.5/4.8, Turbo 4.5, Turbo S 4.5/4.8	› Gas Engine Only
P-2496			2003-2010 Cayenne	3.0 TDI, 3.2, 3.6, GTS 4.8, S 4.5/4.8, Turbo 4.5, Turbo S 4.5/4.8	› WABCO OES › Includes Dryer › Gas Engine Only
VB-3470			2003-2010 Cayenne	3.0 TDI, 3.2, 3.6, GTS 4.8, S 4.5/4.8, Turbo 4.5, Turbo S 4.5/4.8	

RAM					
Part #	Product Type	Position	Model Information	Vehicle Attributes	Product Attributes
D2, DJ					
P-3241			2013-2018 1500	4.7/5.7 4x4	› OES › Includes Dryer
VB-3496			2013-2018 2500		
			2013-2018 3500		

DS					
Part #	Product Type	Position	Model Information	Vehicle Attributes	Product Attributes
A-3016			2013-2018 1500	Crew Cab Pickup	3.6 4WD, 5.7, 5.7 4WD
			2019-2020 1500 Classic		
AS-3017			2013-2018 1500	Crew Cab Pickup	3.6/5.7 4WD
				Extended Cab Pickup	3.0 TD 4WD, 5.7, 5.7 4WD
			2019-2020 1500 Classic	Standard Cab Pickup	3.6/5.7, 3.6/5.7 4WD
AS-3618			2015-2018 1500 Rebel	Crew Cab Pickup	3.0 TD 4WD, 3.6 4WD
				Extended Cab Pickup	3.0 TD 4WD
				Standard Cab Pickup	3.6, 3.6 4WD
P-3241			2013-2018 1500	Crew Cab Pickup	3.6/5.7 4WD
		Extended Cab Pickup		3.0 TD 4WD, 5.7, 5.7 4WD	
		Standard Cab Pickup		3.6/5.7, 3.6/5.7 4WD	
RH-3591			2013-2014 1500	Crew Cab Pickup	3.6/5.7 4WD
				Extended Cab Pickup	3.0 TD 4WD, 5.7, 5.7 4WD
				Standard Cab Pickup	3.0 TD 4WD, 3.6/5.7, 3.6/5.7 4WD

RAM					
Part #	Product Type	Position	Model Information	Vehicle Attributes	Product Attributes
DS					
RH-3592			2013-2014 1500	Crew Cab Pickup	3.6/5.7 4WD
				Extended Cab Pickup	3.0 TD 4WD, 5.7, 5.7 4WD
				Standard Cab Pickup	3.0 TD 4WD, 3.6/5.7, 3.6/5.7 4WD
SK-3556			2013-2018 1500	Crew Cab Pickup, 4WD	› New › Eibach Shock Absorber
				Extended Cab Pickup, 4WD	
			2019-2020 1500 Classic	Standard Cab Pickup, 4WD	
VB-3496			2013-2018 1500	4WD	







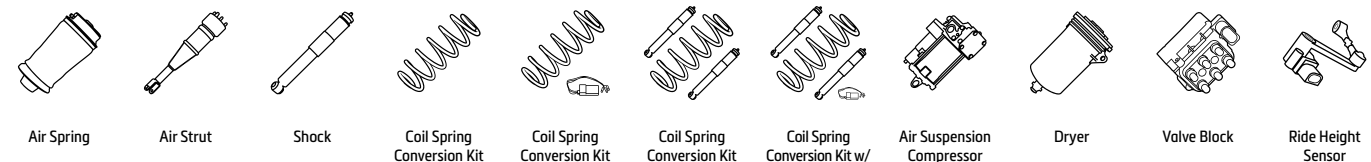

SAAB					
Part #	Product Type	Position	Model Information	Vehicle Attributes	Product Attributes
GMT360					
A-2610			2005-2009 9-7X	4.2/5.3 AWD	› Generation II › Crimped Assembly, Improved Design
GMT360					
C-2137			2005-2009 9-7X	4.2/5.3 AWD	

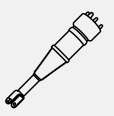

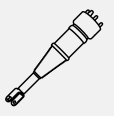

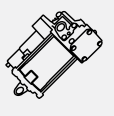
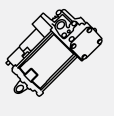
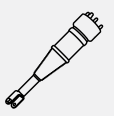

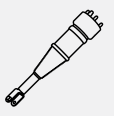

Quality Checked

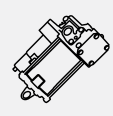
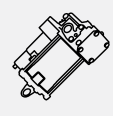
Arnott computer-tests remanufactured shocks and struts as well as compressors for durability and OE functionality.

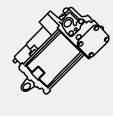
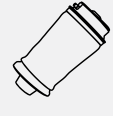

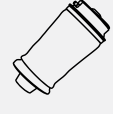







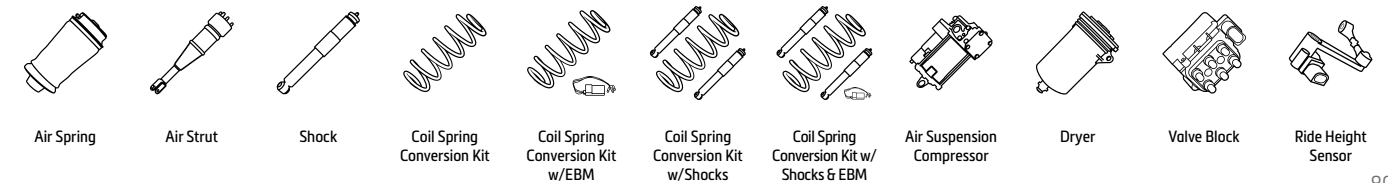

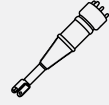

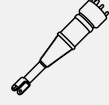

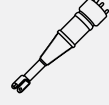

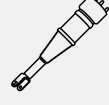

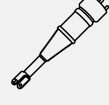

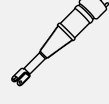
TESLA					
Part #	Product Type	Position	Model Information	Vehicle Attributes	Product Attributes
5YJS					
AS-3380			2016-2020 Model S	w/AWD 100D AWD, 60D AWD, 75D AWD, P100D AWD	<ul style="list-style-type: none"> › New › Eibach Shock Absorber
AS-3381			2016-2020 Model S	w/AWD 100D AWD, 60, 60D AWD, 75, 75D AWD, P100D AWD	<ul style="list-style-type: none"> › New › Eibach Shock Absorber
P-3283			2012-2016 Model S		<ul style="list-style-type: none"> › OES › Includes Dryer
P-3509			2016-2021 Model S	w/AWD 100D AWD, 60, 60D AWD, 70, 70D AWD, 75, 75D AWD, 85, 85D AWD, 90D AWD, P100D AWD, P85D AWD, P90 AWD	<ul style="list-style-type: none"> › WABCO OES › Includes Dryer
5YJX					
AS-3175			2016-2020 Model X	100D AWD, 60D AWD, 75D AWD, 90D AWD, P100D AWD, P90D AWD	<ul style="list-style-type: none"> › New › Firestone OES
AS-3176			2016-2020 Model X	100D AWD, 60D AWD, 75D AWD, 90D AWD, P100D AWD, P90D AWD	<ul style="list-style-type: none"> › New › Firestone OES

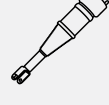





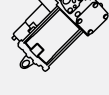

TOYOTA					
Part #	Product Type	Position	Model Information	Vehicle Attributes	Product Attributes
1st Generation					
P-3190			2005-2007 Sequoia	4.6/4.7/5.7, 4.7/5.7 4WD	<ul style="list-style-type: none"> › OES › Includes Dryer
2nd Generation					
P-3189			2008-2020 Sequoia	4.6, 4.7/4WD, 5.7/4WD/FLEX 4WD	<ul style="list-style-type: none"> › OES › Includes Dryer
N210					
A-2949			2003-2009 4Runner	3.0 D/D-4D, 4.0/ V6 VVT-i	
P-3192			2003-2009 4Runner	3.0 D/D-4D, 4.0/ V6 VVT-i	<ul style="list-style-type: none"> › OES › Includes Dryer
N280					
A-3331			2011-2018 4Runner	2.7, 2.8 D-4D, 3.0 D/D-4D/TDi, 3.5, 4.0 V6 Dual VVTi/V6 VVTi	
A-3332			2011-2018 4Runner	2.7, 2.8 D-4D, 3.0 D/D-4D/TDi, 3.5, 4.0 V6 Dual VVTi/V6 VVTi	

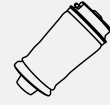
BENEFITS OF USING ARNOTT AIR SUSPENSION

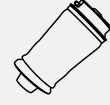
- ▶ Trusted for over three decades
- ▶ Highest quality with superior support
- ▶ Broadest aftermarket coverage
- ▶ Simplified diagnosis & installation
- ▶ Additional sales & profit
- ▶ Additional savings available for workshops

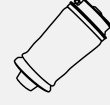

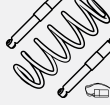
VOLKSWAGEN					
Part #	Product Type	Position	Model Information	Vehicle Attributes	Product Attributes
D1					
AS-2580			2003-2006 Phaeton	3D1, 3D2, 3D3, 3D4, 3D6, 3D7, 3D8, 3D9 - 3.0 V6 TDI 4motion, 3.2 V6/4motion, 4.2 V8 4motion, 5.0 V10 TDI 4motion, 6.0 W12 4motion	› Remanufactured
AS-2581			2003-2006 Phaeton	3D1, 3D2, 3D3, 3D4, 3D6, 3D7, 3D8, 3D9 - 3.0 V6 TDI 4motion, 3.2 V6/4motion, 4.2 V8 4motion, 5.0 V10 TDI 4motion, 6.0 W12 4motion	› Remanufactured
AS-2892			2003-2006 Phaeton	3D1, 3D2, 3D3, 3D4, 3D6, 3D7, 3D8, 3D9 - 3.0 V6 TDI 4motion, 3.2 V6/4motion, 4.2 V8 4motion, 5.0 V10 TDI 4motion, 6.0 W12 4motion	› New
AS-2893			2003-2006 Phaeton	3D1, 3D2, 3D3, 3D4, 3D6, 3D7, 3D8, 3D9 - 3.0 V6 TDI 4motion, 3.2 V6/4motion, 4.2 V8 4motion, 5.0 V10 TDI 4motion, 6.0 W12 4motion	› New
AS-2968			2003-2006 Phaeton	3D1, 3D2, 3D3, 3D4, 3D6, 3D7, 3D8, 3D9 - 3.0 V6 TDI 4motion, 3.2 V6/4motion, 4.2 V8 4motion, 5.0 V10 TDI 4motion, 6.0 W12 4motion	› Remanufactured
AS-2969			2003-2006 Phaeton	3D1, 3D2, 3D3, 3D4, 3D6, 3D7, 3D8, 3D9 - 3.0 V6 TDI 4motion, 3.2 V6/4motion, 4.2 V8 4motion, 5.0 V10 TDI 4motion, 6.0 W12 4motion	› Remanufactured
AS-3127			2003-2006 Phaeton	3D1, 3D2, 3D3, 3D4, 3D6, 3D7, 3D8, 3D9 - 3.2 V6/4motion, 4.2 V8 4motion, 5.0 V10 TDI 4motion, 6.0 W12 4motion	› New › Eibach Shock Absorber
AS-3128			2003-2006 Phaeton	3D1, 3D2, 3D3, 3D4, 3D6, 3D7, 3D8, 3D9 - 3.2 V6/4motion, 4.2 V8 4motion, 5.0 V10 TDI 4motion, 6.0 W12 4motion	› New › Eibach Shock Absorber
AS-3129			2003-2006 Phaeton	3D1, 3D2, 3D3, 3D4, 3D6, 3D7, 3D8, 3D9 - 3.0 V6 TDI 4motion, 3.2 V6/4motion, 4.2 V8 4motion, 5.0 V10 TDI 4motion, 6.0 W12 4motion	› New › Eibach Shock Absorber
AS-3130			2003-2006 Phaeton	3D1, 3D2, 3D3, 3D4, 3D6, 3D7, 3D8, 3D9 - 3.0 V6 TDI 4motion, 3.2 V6/4motion, 4.2 V8 4motion, 5.0 V10 TDI 4motion, 6.0 W12 4motion	› New › Eibach Shock Absorber
P-2740			2003-2006 Phaeton	3D1, 3D2, 3D3, 3D4, 3D6, 3D7, 3D8, 3D9 - 3.0 V6 TDI 4motion, 3.2 V6/4motion, 4.2 V8 4motion, 5.0 V10 TDI 4motion, 6.0 W12 4motion	› WABCO OES › Includes Dryer

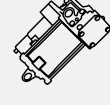
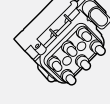

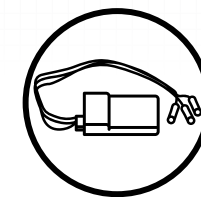



VOLKSWAGEN					
Part #	Product Type	Position	Model Information	Vehicle Attributes	Product Attributes
VW 7L					
A-2523			2004-2010 Touareg	7LA, 7L6, 7L7 - 2.5 R5 TDI, 3.0 TDI/V6 TDI, 3.2 V6, 3.6 V6 FSI, 4.2 V8/V8 FSI, 5.0 R50 TDI/V10 TDI, 6.0 W12	
A-2571			2004-2010 Touareg	7LA, 7L6, 7L7 - 2.5 R5 TDI, 3.0 TDI/V6 TDI, 3.2 V6, 3.6 V6 FSI, 4.2 V8/V8 FSI, 5.0 R50 TDI/V10 TDI, 6.0 W12	
A-2572			2004-2010 Touareg	7LA, 7L6, 7L7 - 2.5 R5 TDI, 3.0 TDI/V6 TDI, 3.2 V6, 3.6 V6 FSI, 4.2 V8/V8 FSI, 5.0 R50 TDI/V10 TDI, 6.0 W12	
C-3419			2004-2010 Touareg	7LA, 7L6, 7L7 - 2.5 R5 TDI, 3.0 TDI/V6 TDI, 3.2 V6, 3.6 V6 FSI, 4.2 V8/V8 FSI, 5.0 R50 TDI/V10 TDI, 6.0 W12	
P-2496			2004-2010 Touareg	7LA, 7L6, 7L7 - 2.5 R5 TDI, 3.0 TDI/V6 TDI, 3.2 V6, 3.6 V6 FSI, 4.2 V8/V8 FSI, 5.0 R50 TDI/V10 TDI, 6.0 W12	› WABCO OES › Includes Dryer
VB-3470			2004-2010 Touareg	7LA, 7L6, 7L7 - 2.5 R5 TDI, 3.0 TDI/V6 TDI, 3.2 V6, 3.6 V6 FSI, 4.2 V8/V8 FSI, 5.0 R50 TDI/V10 TDI, 6.0 W12	

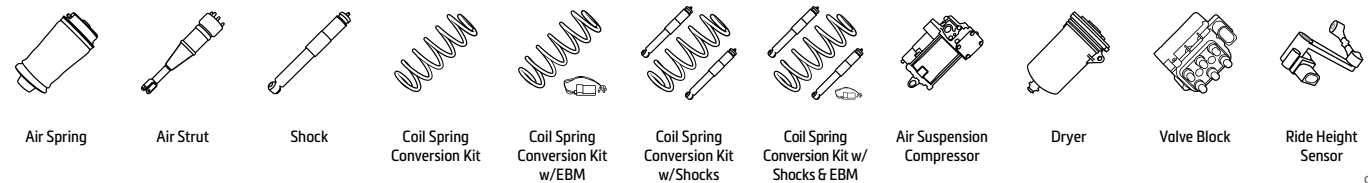

Warning Lights

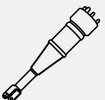
Arnott's patented Electronic Bypass Module is available for most kits and installs easily to turn off any dashboard warning lights once an Arnott Coil Spring Conversion Kit is installed.

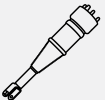

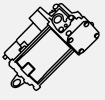
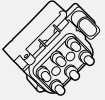
VOLVO						
Part #	Product Type	Position	Model Information	Vehicle Attributes	Product Attributes	
SPA Platform						
A-3307			2016-2020 XC90	w/Auto Leveling, Excl. Hybrid	2.0 T5 AWD/T6 AWD, D4/AWD, D5 AWD, T5 AWD, T6 AWD/Polestar AWD	
			2017-2020 V90 Cross Country		2.0 D3/2.0 D3 AWD/D4/D4 AWD/D5 AWD/Polestar AWD/T4/T5/T5 AWD/T6 AWD	
			2018-2020 XC60		2.0 D3/D4/D4 AWD/D4 Polestar AWD/D5 AWD/T4/T5/T5 AWD/T5 Polestar AWD/T6 AWD/T6 Polestar AWD	
AS-3343			2016-2019 XC90	w/Auto Leveling, Excl. Hybrid	2.0 D5 Polestar AWD/T5 AWD/T6 AWD, D4/AWD, D5 AWD, T5 AWD/Polestar AWD, T6 AWD/Polestar AWD, T8 Twin Engine AWD	<ul style="list-style-type: none"> › New › Eibach Shock Absorber
AS-3344			2016-2019 XC90	w/Auto Leveling, Excl. Hybrid	2.0 D5 Polestar AWD/T5 AWD/T6 AWD, D4/AWD, D5 AWD, T5 AWD/Polestar AWD, T6 AWD/Polestar AWD, T8 Twin Engine AWD	<ul style="list-style-type: none"> › New › Eibach Shock Absorber
P-3476			2016-2020 XC90	w/Auto Leveling, Excl. Hybrid	2.0 T5/6 AWD, D4, D4/5 AWD, T5/6 AWD	› Includes Dryer
			2017-2020 S90		2.0 (D3/4, 2.0 D4/5 AWD, D5 Polestar AWD, T4/5, T5 Drive-E Polestar, T6 AWD/Drive-E Polestar AWD), D4 Drive-E Polestar	
			2017-2020 V90 Cross Country		2.0 (D3/4, D3 AWD, D4/5 AWD, T4/5, T5 AWD/Polestar/Polestar AWD, T6 AWD/Polestar AWD)	
			2018-2020 XC60		2.0 (D3/4, D4/5 AWD, D5 Polestar AWD, T5, T5 AWD/Polestar AWD, T6 AWD/Polestar AWD), T5 Polestar, T5/6 Polestar AWD	
VB-3498			2016-2020 XC90	w/Auto Leveling, Excl. Hybrid	2.0 T5 AWD/T6 AWD, D4/AWD, D5 AWD, T5 AWD, T6 AWD/Polestar AWD	
			2018-2020 XC60		2.0 D3/D4/D4 AWD/D4 Polestar AWD/D5 AWD/T4/T5/T5 AWD/T5 Polestar AWD/T6 AWD/T6 Polestar AWD	

Arnott's multi-step remanufacturing process not only ensures that the remanufactured strut is made to our exacting standards, but includes multiple quality checks along the way.

1. Each strut is inspected, disassembled, steam cleaned and spin blasted to bare metal. Our proprietary process replaces old, used oil with new high-performance shock oil.
2. The worn internal components are replaced and the recharged shock is sealed with a new CNC-machined aluminum top.
3. Each shock is computer Dyno-tested to ensure OE durability and performance.
4. Arnott adds a protective, professional finish with corrosion-inhibiting paint and Arnott's skilled assemblers rebuild each strut by hand.
5. New, longer-lasting seals, a multi-ply name-brand air sleeve, heavy-duty crimping rings and other Tier 1 components round out the remanufacturing process.

Only the best are delivered to our customers.

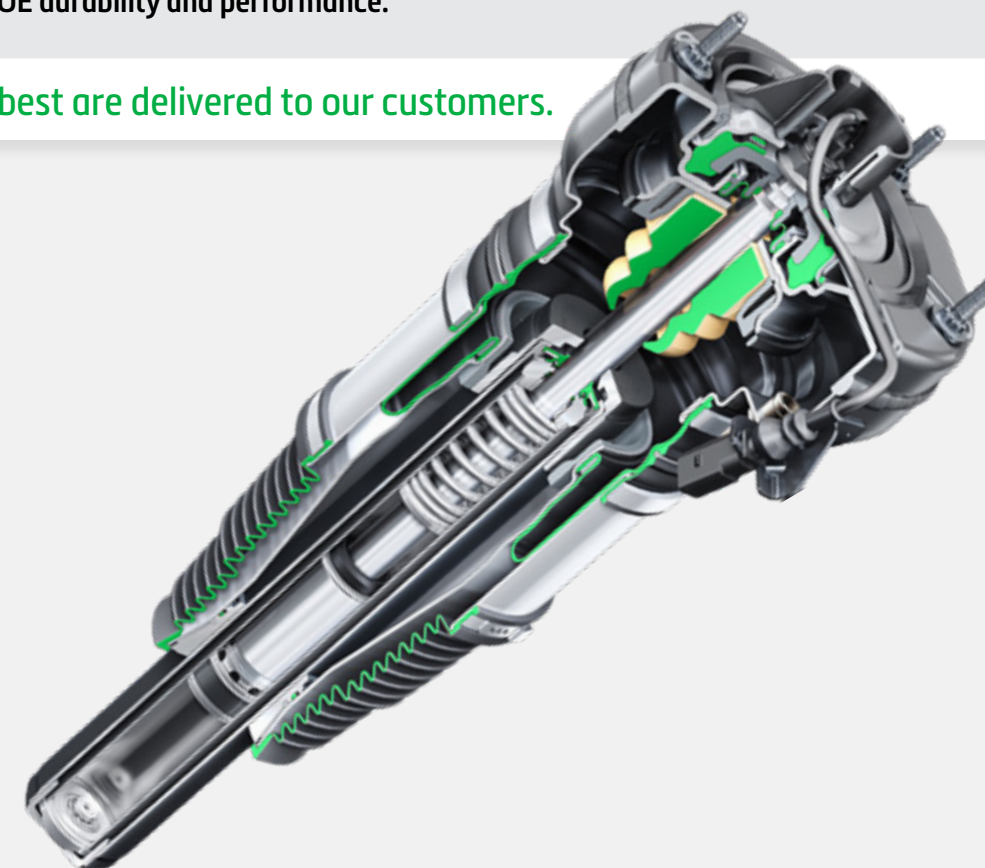

THE ARNOTT ADVANTAGE

- ✔ Works with vehicle's auto damping & leveling system
- ✔ Exact fit & functionality of OE
- ✔ Arnott-engineered to improve strut longevity
- ✔ Plug & play installation is identical to OE

ARNOTT OFFERS REMANUFACTURED AIR STRUTS FOR:

Audi • Bentley • BMW • Cadillac • Chevrolet • GMC • Land Rover • Maybach • Mercedes-Benz
Porsche • Volkswagen



ARNOTT-DESIGNED NEW AIR STRUTS

- Custom-valved shock adapts to driving style
- Premium brand air sleeve, bump stop & dust boot
- Works with vehicle's auto leveling functionality
- CNC-machined aluminum or stamped steel top
- Improved seals to prevent leaks
- Many connect to ADS system to eliminate warning lights
- Engineered & assembled in the USA
- Limited Lifetime Warranty on Arnott-branded products



Innovative
Engineering



Precision
Production



Extensive
Testing



Superior
Components



REMANUFACTURED AIR STRUTS

- Tested, cleaned & recharged OE shock
- New sealing cap & air line fitting
- Works with vehicle's auto damping & leveling system
- Premium air sleeve, bump stop, air fitting & dust boot
- OE top mount & sensor
- Remanufactured in the USA
- Limited Lifetime Warranty on Arnott-branded products



Comprehensive
Quality Assurance



MAGNETIC RIDE SHOCKS

Magnetic Ride Shocks are now offered in Arnott's aftermarket suspension product line. Designed as a direct replacement for GM SUVs with the magnetorheological damper system Z95 RPO, Arnott's OES magnetic shocks provide the same adaptive ride as the OE.



What are Magnetic Ride Shocks?

Magnetic Ride Shocks consist of a monotube damper filled with a combination of synthetic hydrocarbon oil and readily magnetized iron particles (the sum of which is known as magnetorheological fluid) as well as electromagnetic coils. Maintaining the system are a sensor set and an Electronic Control Unit (ECU).

How do Magnetic Ride Shocks work?

If the vehicle sensors detect a change in road conditions, a signal is sent to the ECU. The ECU then determines the electromagnetic current strength required for each shock. When activated, the electromagnetic coils create a magnetic field that instantly magnetizes the iron particles, increasing the viscosity of the magnetorheological fluid and suspension stiffness.

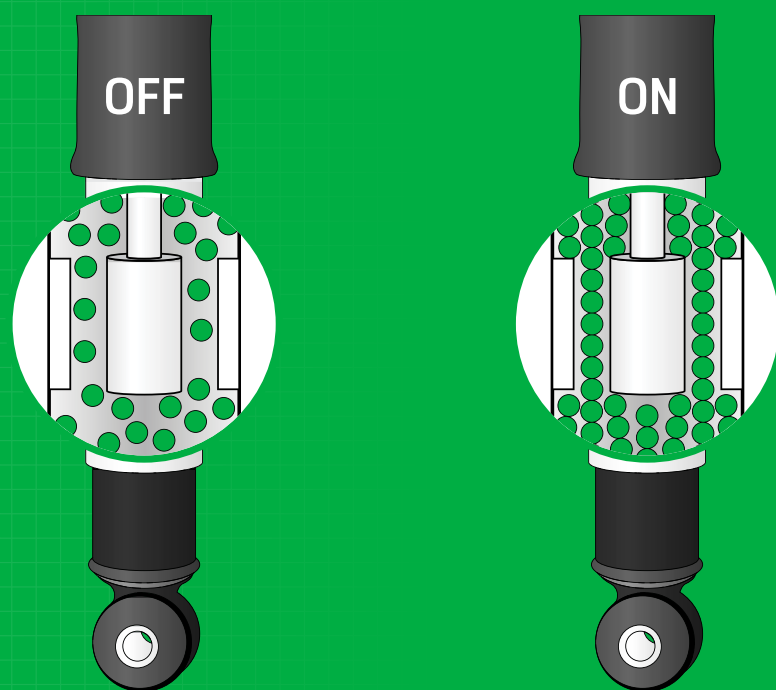

AIR SPRINGS

- Premium name-brand air sleeve
- Faster, easier installation
- Engineered & assembled in the USA
- Compatible with OE struts, air line & leveling system
- High-impact polyurethane or aircraft-quality aluminum tops



AIR SUSPENSION COMPRESSORS

- Compressors meet OE specifications
- Includes thermal overload protection
- Electrocoated epoxy finish to prevent corrosion
- Extensive life-cycle testing
- Most mate with OE lines & plugs for ease of installation
- Limited Lifetime Warranty on Arnott-branded products





COIL SPRING CONVERSION KITS

- Patented Electronic Bypass Module (EBM) eliminates fault codes
- Custom-valved shock absorbers
- Durable American-made, powder-coated coil springs
- Pre-assembled for easy & safe installation
- OE fit with no modifications needed

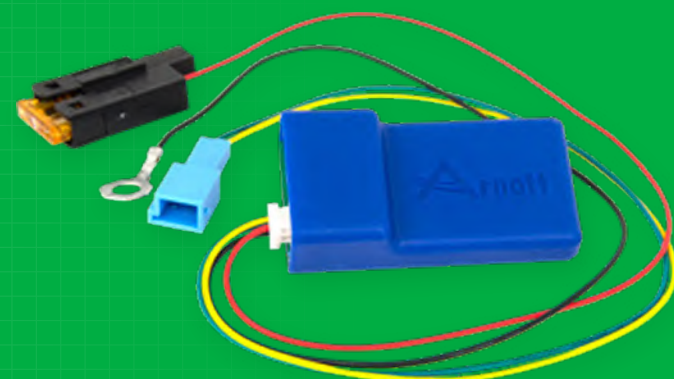

SOLENOID VALVE BLOCKS

- Distributes air pressure within the air suspension system
- Direct OE replacement
- Designed to meet or exceed OE
- Helps restore original air suspension system
- Growing product category

RIDE HEIGHT SENSORS

- Determines vehicle height
- Tested to 1 million cycles
- Road tested for function & fitment
- Direct fit for fast plug & play installation
- Quality components including hardware & mounting points for long service life





Our Customer Service team is readily available to assist you with choosing and ordering the right Arnett product for your needs. They can also provide updates on order status, product availability or help with any technical questions you might have regarding Arnett's air suspension products.

Contact Arnett US Business Office:

100 Sea Ray Drive
Merritt Island, FL 32953

Call: 800.251.8993
321.868.3016

Fax: 321.868.3703

Email: catalogfeedback@arnottinc.com

Contact Arnett Europe Business Office:

Docterskampstraat 1E/1F, 3
5222 AM 's-Hertogenbosch (NL)

NL Phone: +31 (0)73 7850 580

DE Phone: +49 (0)699 6759106

UK Phone: +44 (0)203 3186124

BE Phone: +32 (0)258 846 90

ES Phone: +34 91 901 10 56

FR Phone: +33 18 626 72 41

Email: info@arnotteurope.com

The air suspension experts at Arnett offer a comprehensive product line at an exceptional value backed by best-in-class support – from purchase to installation and beyond!

THE ARNOTT ADVANTAGE

- ▲ Expert technical support
- ▲ Se habla español
- ▲ Satisfaction guaranteed
- ▲ Over 30 years of customer satisfaction
- ▲ Better Business Bureau - A+ Rating
- ▲ Limited Lifetime Warranty on Arnett-branded products

Visit us online for the latest product releases, company news, demos & tutorials:

ARNOTTINC.COM



@ArnettInc



@ArnettAir



@Arnett Industries

