

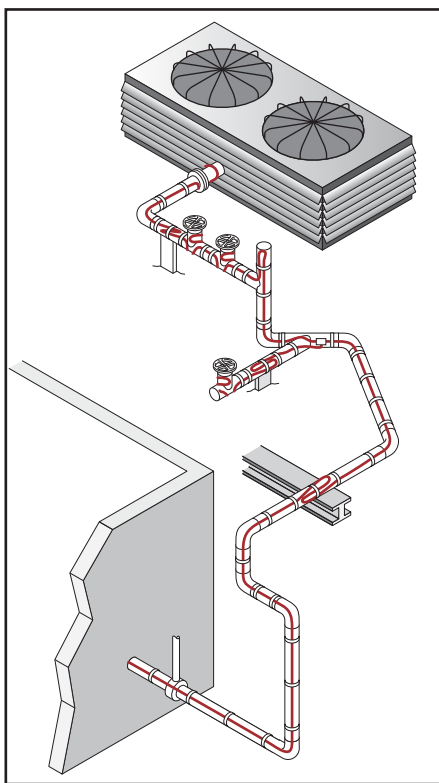

Raychem XL-Trace System

INSTALLATION AND OPERATION MANUAL FOR
PIPE FREEZE PROTECTION AND FLOW
MAINTENANCE



Important Safeguards and Warnings

WARNING: FIRE AND SHOCK HAZARD.

Raychem heat-tracing systems must be installed correctly to ensure proper operation and to prevent shock and fire. Read these important warnings and carefully follow all the installation instructions.

- To minimize the danger of fire from sustained electrical arcing if the heating cable is damaged or improperly installed, and to comply with Pentair Thermal Building Solutions requirements, agency certifications, and national electrical codes, ground-fault equipment protection must be used on each heating cable branch circuit. Arcing may not be stopped by conventional circuit breakers.
- Approvals and performance are based on the use of Pentair Thermal Building Solutions-specified parts only. Do not substitute parts or use vinyl electrical tape.
- Bus wires will short if they contact each other. Keep bus wires separated.
- Connection kits and cable ends must be kept dry before and during installation.
- The black heating cable core is conductive and can short. It must be properly insulated and kept dry.
- Damaged bus wires can overheat or short. Do not break bus wire strands when preparing the cable for connection.
- Damaged heating cable can cause electrical arcing or fire. Do not use metal attachments such as pipe straps or tie wire. Use only Pentair Thermal Building Solutions approved tapes and cable ties to secure the cable to the pipe.
- Do not attempt to repair or energize damaged heating cable. Remove damaged sections at once and replace them with a new length using the appropriate Raychem splice kit. Replace damaged connection kits.
- Use only fire-resistant insulation materials such as fiberglass wrap or flame-retardant foams.

Note: Pipes are shown without insulation for illustrative purposes only. All pipe installations must be fully covered with thermal insulation.

Table of Contents

1	General Information	1
	1.1 Use of the Manual	1
	1.2 XL-Trace Applications	2
	1.3 Safety Guidelines	2
	1.4 Approvals	3

2	Installation Guidelines	4
	2.1 Heating Cable Storage	4
	2.2 Pre-Installation Checks	4
	2.3 Heating Cable Installation	5
	2.4 Heating Cable Connections	17

3	Thermal Insulation	25
	3.1 Insulating the System	25
	3.2 Insulation Installation	25

4	Power Supply and Electrical Protection	28
	4.1 Voltage Rating	28
	4.2 Circuit Breaker Sizing	28
	4.3 Electrical Loading	28
	4.4 Ground-Fault Protection	28
	4.5 Important Power Supply Safeguards	29

5	Temperature Controls	30
	5.1 Ambient-Sensing Control	30
	5.2 Line-Sensing Control	30
	5.3 Wiring Schematic for Thermostat	32

6	Commissioning and Preventive Maintenance	36
	6.1 Tests	36

7	Test Procedures	38
	7.1 System Tests	38
	7.2 Fault Location Tests	43

8	Troubleshooting Guide	48
9	Appendix	50
10	Installation and Inspection Records	56

1

General Information

1.1 Use of the Manual

This manual covers the installation of Raychem XL-Trace self-regulating heating cables and connections for commercial construction pipe systems in ordinary (nonhazardous) areas. The manual covers general heating cable installation procedures and specific installation details and shows available connection kits for the different applications. The manual also discusses controls, testing, and periodic maintenance.

This manual assumes that the proper heat-tracing design has been completed according to the Pipe Freeze Protection and Flow Maintenance Design Guide (H55838). Only the applications described in Section 1.2 are approved by Pentair Thermal Building Solutions for XL-Trace systems when used with approved Raychem connection kits. The instructions in this manual and the installation instructions included with the connection kits, control systems, power distribution systems, and accessories must be followed for the Pentair warranty to apply. Contact your Pentair Thermal Building Solutions representative for other applications and products.

For additional information, contact:

Pentair Thermal Building Solutions

7433 Harwin Drive

Houston, TX 77036

USA

Tel: +1.800.545.6258

Tel: +1.650.216.1526

Fax: +1.800.527.5703

Fax: +1.650.474.7711

thermal.info@pentair.com

www.pentairthermal.com

1

General Information

1.2 XL-Trace Applications

XL-Trace heat-tracing systems are approved and qualified for the applications listed below.

Freeze protection

- **General water piping.** Freeze protection (40°F (4°C) maintain) of insulated metallic or plastic water piping.
- **Sprinkler piping systems.** Freeze protection (40°F (4°C) maintain) of insulated metallic standpipes and supply piping up to 20".

Flow maintenance



- **Greasy waste lines.** Flow maintenance (110°F (43°C) maintain) of insulated-grease disposal lines.
- **Fuel lines.** Flow maintenance (40°F (4°C) maintain) for insulated metallic piping containing #2 fuel oil.

For heating cable applications other than those listed above, please see your Pentair Thermal Building Solutions representative or call Pentair at (800) 545-6258.

1.3 Safety Guidelines

As with any electrical equipment, the safety and reliability of any system depends on the quality of the products selected and the manner in which they are installed and maintained. Incorrect design, handling, installation, or maintenance of any of the system connection kits could damage the system and may result in inadequate performance, overheating, electric shock, or fire. To minimize these risks and to ensure that the system performs reliably, read and carefully follow the information, warnings, and instructions in this guide.

Pay special attention to the following:

- Important instructions are marked  **Important**
- Warnings are marked  **WARNING**

1

General Information

1.4 Approvals

XL-Trace heat-tracing systems carry agency approvals for the different applications shown in Section 1.2. For detailed information on which approvals are carried for the specific application, refer to the Pipe Freeze Protection and Flow Maintenance design guide (H55838).

Warranty

Pentair Thermal Management standard limited warranty applies to all products.



An extension of the limited warranty period to ten (10) years from the date of installation is available if a properly completed online warranty form is submitted within thirty (30) days from the date of installation. You can access the complete warranty on our web site at www.pentairthermal.com.

2

Installation Guidelines

2.1 Heating Cable Storage

- Store the heating cable in a clean, dry location. Temperature range: 0°F (-18°C) to 140°F (60°C).
- Protect the heating cable from mechanical damage.

2.2 Pre-Installation Checks

Check materials received

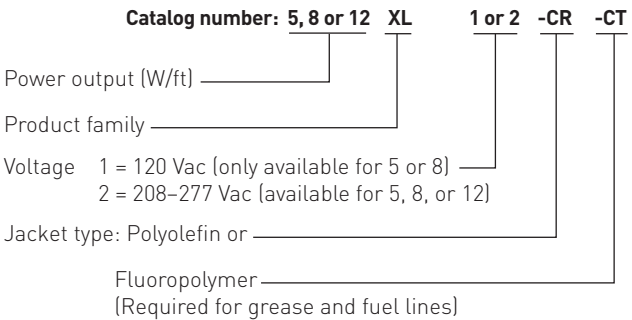

Figure 1: XL-Trace catalog number

- Review the heating cable design and compare the list of materials to the catalog numbers of the heating cables and connection kits received to confirm that the proper materials are on site. The heating cable type is printed on its jacket.
- Ensure that the service voltage available is correct for the XL-Trace heating cable selection.
- Inspect the heating cable and connection kits to ensure there is no in-transit damage.
- Verify the system design does not exceed the maximum exposure temperature of the heating cable 5XL/8XL: 150°F (65°C) 12XL: 185°F (85°C)
- Verify that the heating cable jackets are not damaged by conducting the insulation resistance test (refer to Section 7) on each reel of heating cable. Do not power the heating cable when it's on the reel.

2

Installation Guidelines

Check piping to be traced

- Make sure all mechanical pipe testing (i.e. hydrostatic testing/purging) is complete and the system has been cleared by the client for tracing.
- Walk the system and plan the routing of the heating cable on the pipe.
- Inspect the piping and remove any burrs, rough surfaces, or sharp edges.

2.3 Heating Cable Installation

Minimum installation temperature of: 0°F (-18°C).

Heating cable installation involves three basic steps:

1. Paying out the heating cable
2. Attaching the heating cable to the pipe
3. Wrapping heat sinks

Paying out the heating cable

Mount the reel on a holder and place it near either end of the pipe run to be traced. Use a reel holder that pays out smoothly with little tension as shown in Figure 2. Avoid jerking the heating cable while pulling.

Pay out the heating cable and loosely string it along the pipe, making sure the heating cable is always next to the pipe when crossing obstacles. If the heating cable is on the wrong side of a crossing pipe or I-beam, you will have to reinstall it or cut and splice it.

2

Installation Guidelines

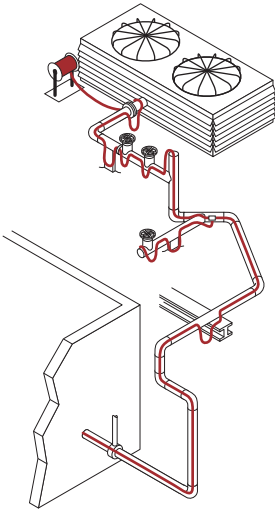

Figure 2: Paying out the heating cable

When paying out the heating cable, AVOID:

- Sharp edges
- Excessive pulling force or jerking
- Kinking or crushing
- Walking on or running over the heating cable with equipment

⚠ WARNING: Fire and shock hazard. Do not install damaged heating cable. Connection kits and heating cable ends must be kept dry before and during installation.

Attaching the heating cable

Once the heating cable has been run for the entire section, begin fastening it to the pipe. Start at the end and work toward the reel. The additional heating cable required for valves and other heat sinks is shown in Table 1 and Table 2. Refer to Table 3 for the additional heating cable required for connection kits. The heating cable may be installed in single or in multiple runs as required by the design.

2

Installation Guidelines

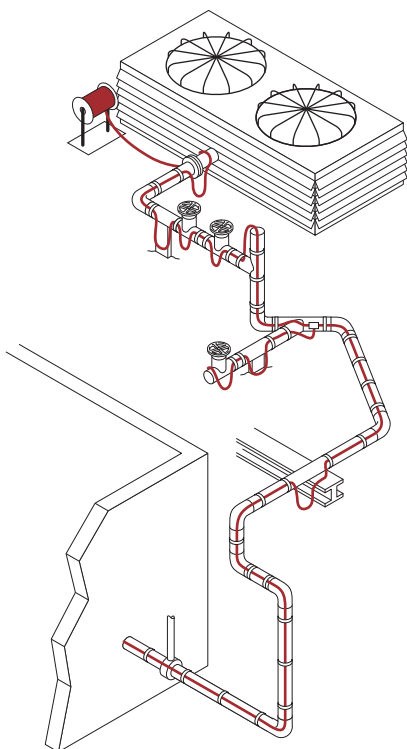

Figure 3: Attaching the heating cable

2

Installation Guidelines

TABLE 1: ADDITIONAL HEATING CABLE FOR VALVES

Pipe diameter (IPS)	Heating cable in feet (meters)	
1/2	0.8	(0.24)
3/4	1.3	(0.4)
1	2.0	(0.6)
1-1/4	3.3	(1.1)
1-1/2	4.3	(1.3)
2	4.3	(1.3)
3	4.3	(1.3)
4	4.3	(1.3)
6	5.0	(1.5)
8	5.0	(1.5)
10	5.6	(1.7)
12	5.9	(1.9)
14	7.3	(2.2)
18	9.4	(2.9)
20	10.5	(3.2)

TABLE 2: ADDITIONAL HEATING CABLE FOR PIPE SUPPORTS AND FLANGES

Support	Additional heating cable
Pipe hangers (insulated)	No additional heating cable
Pipe hangers noninsulated and U-bolt supports:	Add 2x pipe diameter
Welded support shoes	Add 3x the length of the shoe
Flanges	Add 2x pipe diameter

Note: For applications where more than one heating cable is required per foot of pipe, this correction factor applies for each heating cable run.

2

Installation Guidelines

- Run insulation through the pipe hanger ensuring that the pipe is not resting on the heater.

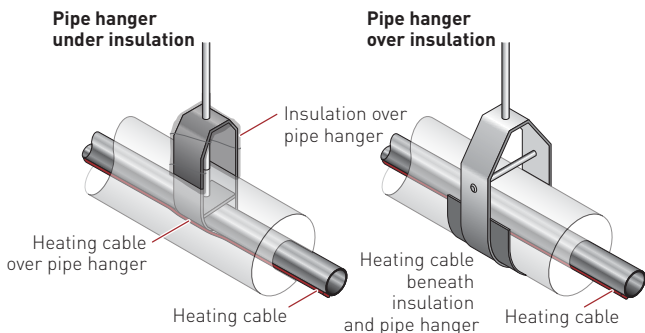

Figure 4: Pipe hanger with heating cable

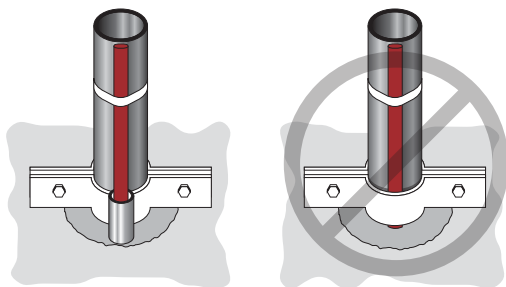

Figure 5: Single pipe floor penetration

- When making floor or wall penetrations, make sure the hole is large enough to accommodate the pipe and the thermal insulation. When sealing around pipes at floor penetrations, avoid damaging or cutting the heating cable, or pinching it between the pipe and the concrete.

2

Installation Guidelines

- The heating cable must not be embedded directly in the sealing material; the pipe should have thermal insulation over it (if allowed by local codes) or the heating cable should be run through the penetration in a tube or conduit. If the conduit must be sealed, use a pliable fire-resistant material (Dow Corning Fire Stop, 3M Fire Barrier, or T&B Flame-Safe) that can be removed if necessary.

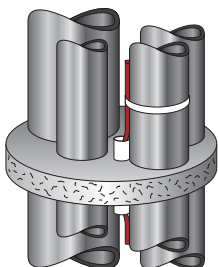

Figure 6: Multiple pipe floor penetration

- On vertical piping groups, run the heating cable along the inside of the pipe close to other pipes so it will not be damaged if the pipe hits the side of the floor penetration. Run the heating cable over the outside of the pipe support. Do not clamp the heating cable to the pipe with the pipe support.
- In high-rise construction it may be necessary to install the XL-Trace system 10 or 12 floors at a time to fit into the construction schedule. If so, the end of the heating cable should be sealed with a RayClic-E end seal and placed in an accessible location. This allows testing of one part of the heating cable at a time, and allows splicing it to another section when the system is complete.
- When XL-Trace is installed behind walls, the power connection kit must be accessible.

Whenever possible, position the heating cable on the lower section of the pipe as shown in Figure 7 to protect it from damage.

2

Installation Guidelines

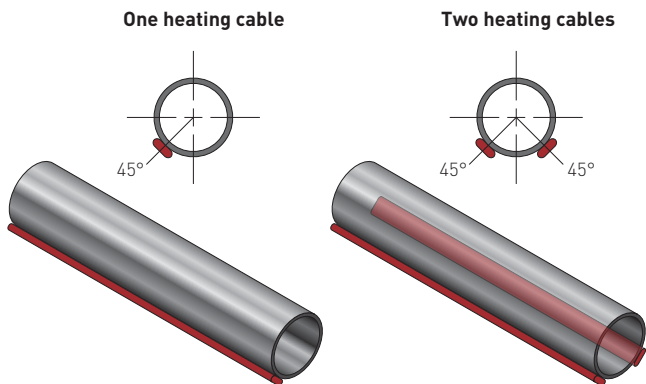

Figure 7: Positioning the heating cable

Securing the heating cable

⚠ WARNING: Damage to the heating cable can cause electrical arcing or fire. Do not use metal attachments such as pipe straps or tie wire. Use only Pentair Thermal Building Solutions-approved tapes or plastic cable ties.

🔧 Important: Before taping the heating cable to the pipe, make sure all heat-tracing allowances for flanges, valves, supports, and other connection kits have been verified.

Use one of the following attachment methods to secure the heating cable onto the pipe: GT-66 or GS-54 glass cloth tape, AT-180 aluminum tape, or plastic cable ties.

GLASS CLOTH ADHESIVE TAPE

- GT-66 (66-foot roll) general-purpose tape for installation at 40°F (4°C) and above. Apply at 1-foot intervals.
- GS-54 (54-foot roll) general-purpose tape for installation below 40°F (4°C). Apply at 1-foot intervals.

AT-180 ALUMINUM TAPE

- Required for plastic pipe applications to ensure proper power output of heating cable.

2

Installation Guidelines

- Tape lengthwise over the heating cable as required by the design drawing or specification (see Figure 8).
- Recommended for heat-tracing pump bodies or odd-shaped equipment, or as called out in the design drawing as a heat-transfer aid.
- Install at temperatures above 32°F (0°C).

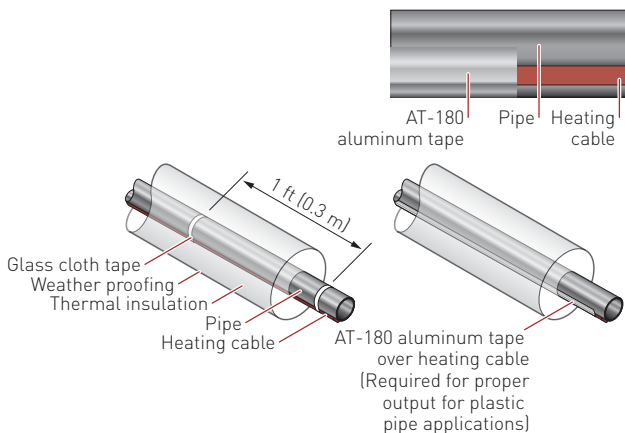

Figure 8: Attaching the heating cable

CABLE TIES

- Recommended in applications where the pipe surface prevents proper tape adhesion.
- Use plastic cable ties only.
- Cable ties must be hand-tightened only to prevent damage to heating cable!

Bending/Crossing/Cutting the Heating Cable

BENDING THE HEATING CABLE

When positioning the heating cable on the pipe, do not bend tighter than 1/2" radius. The heating cable does not bend easily in the flat plane. Do not force such a bend, as the heating cable will be damaged.

2

Installation Guidelines

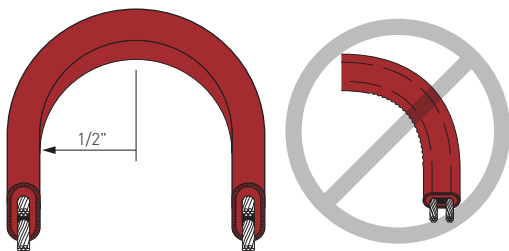

Figure 9: Bending technique

CROSSING THE HEATING CABLE

XL-Trace heating cables are self-regulating and may be overlapped whenever necessary without overheating or burning out.

CUTTING THE HEATING CABLE

Cut the heating cable to the desired length after it is attached to the pipe. XL-Trace can be cut to length without affecting the heat output per foot.

Wrapping the Heat Sinks

Once the straight sections are secured the heating cable can be secured to the heat sinks. Attach the heating cable to the heat sinks according to Figure 10 below. The length of heating cable installed is determined in the design.

2

Installation Guidelines

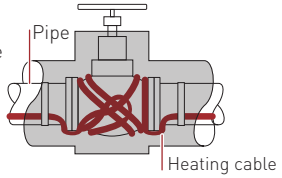
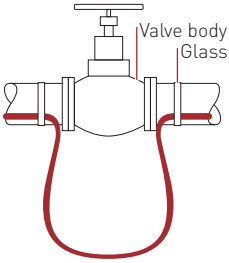

Multiple crossovers allowed for self-regulating cables

Note: Cable loop length varies depending on heat loss.

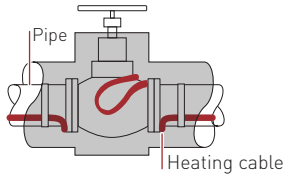

Single crossover only, allowed for power-limiting cables

Figure 10: Valve

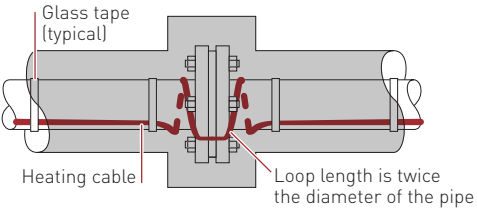

Figure 11: Flange

2

Installation Guidelines

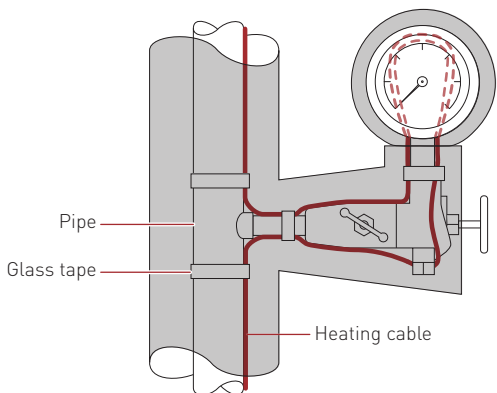

Figure 12: Pressure gauge

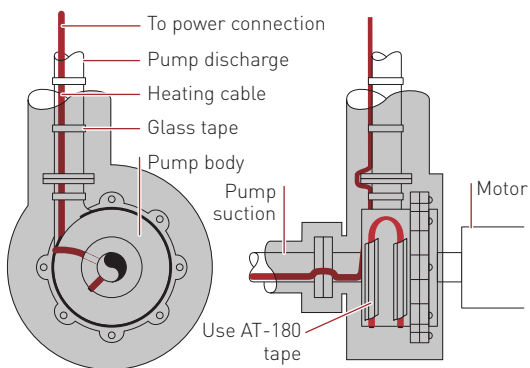

Figure 13: Split case centrifugal pump

2

Installation Guidelines

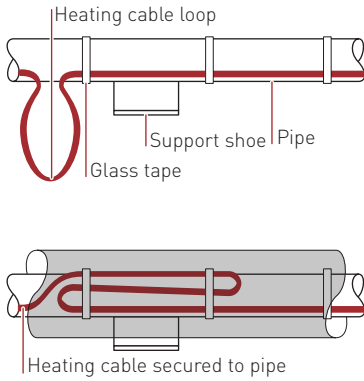

Figure 14: Pipe support shoe

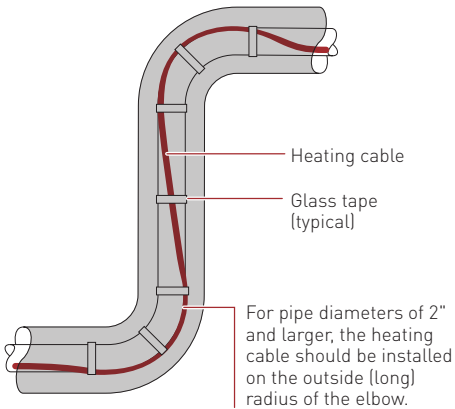

Figure 15: Elbow

2

Installation Guidelines

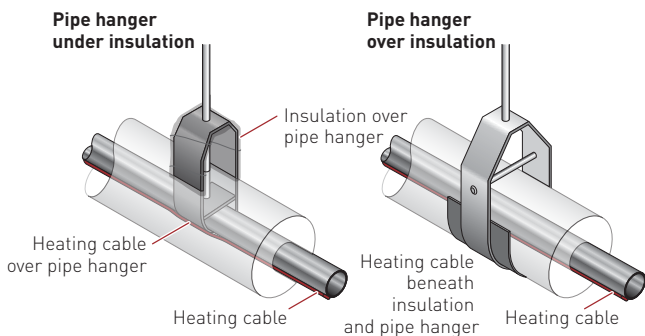

Figure 16: Pipe hanger

2.4 Heating Cable Connections

General Requirements

All XL-Trace systems require a power connection and end seal kit. Splice and tee kits are used as required. Use Table 3 (for aboveground applications) and Table 4 (for belowground applications) to select the appropriate connection kits.

When practical, mount connection kits on top of the pipe. Electrical conduit leading to power connection kits must have low-point drains installed to avoid condensation entry into the heating system. All heating cable connections must be mounted above grade level.

If your design has an exposure temperature $>150^{\circ}\text{F}$ (65°C) but $<185^{\circ}\text{F}$ (85°C), install all connections kits off the pipe.

⚠ WARNING: Connection kit approvals and performance are based on the use of specified parts only. Do not use substitute parts or vinyl electrical tape. Follow installation instructions provided with each kit.

2

Installation Guidelines

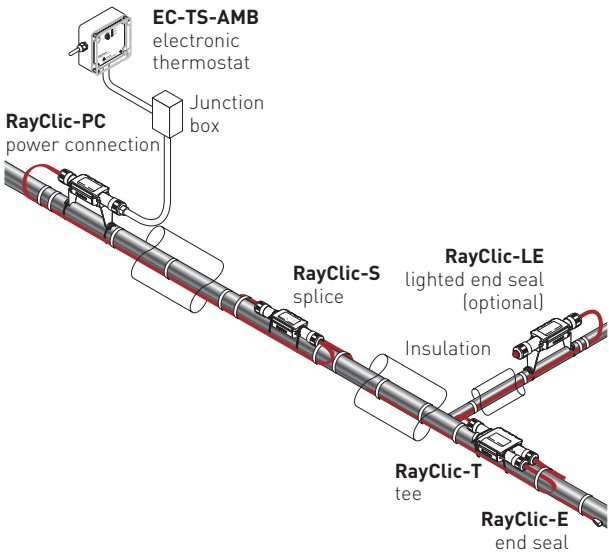

Figure 17: Aboveground XL-Trace System

Use Table 3 for general aboveground piping, sprinkler piping, and grease and fuel lines. Allow extra heating cable for ease of connection kit installation.

2

Installation Guidelines

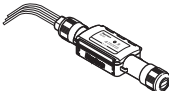
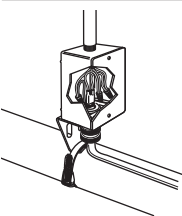
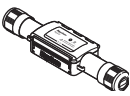
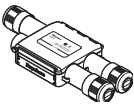
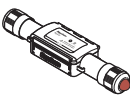
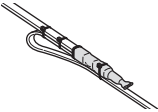

TABLE 3: CONNECTION KITS FOR GENERAL ABOVEGROUND PIPING

Catalog number	Description	Heating cable allowance ¹
 RayClic-PC ^{2,3}	Power connection and end seal kit; use 1 per circuit Standard pkg: 1	2 ft (0.6 m)
 FTC-P ^{4,5}	Power connection and end seal kit; use 1 per circuit Standard pkg: 1 Junction box not included	2 ft (0.6 m)
 RayClic-S ^{2,3,6}	Splice used to join two sections of heating cable Standard pkg: 1	2 ft (0.6 m)
 RayClic-T ^{2,6}	Tee kit with end seal; use as needed for pipe branches Standard pkg: 1	2 ft (0.6 m)
 RayClic-LE	Alternate lighted end seal Standard pkg: 1	2 ft (0.6 m)

2

Installation Guidelines

TABLE 3: CONNECTION KITS FOR GENERAL ABOVEGROUND PIPING





Catalog number	Description	Heating cable allowance ¹
Continued		
	Low-profile splice/tee; use as needed for pipe branches Standard pkg: 2	3 ft (0.9 m)
FTC-HST ⁴		
	Replacement end seal Standard pkg: 1	0.3 ft (0.1 m)
RayClic-E ³		

- ¹ For ease of component installation, allow extra heating cable.
- ² Powered splice, powered tee, and cross (tee with three legs) connections are also available.
- ³ For grease and fuel lines, install RayClic-LE or end seal off the pipe in junction box.
- ⁴ Not permitted with grease or fuel lines.
- ⁵ Use for circuits supplied with 40 A circuit breaker.
- ⁶ For grease and fuel lines, install tees and splices on pipe mounting bracket (RayClic-SB-04).

2

Installation Guidelines

TABLE 4: ACCESSORIES FOR GENERAL ABOVEGROUND PIPING

Catalog number	Description	Heating cable allowance
 ETL	“Electric Traced” label (use 1 label per 10 feet of pipe)	10 labels
 GT-66	Glass cloth adhesive tape for attaching heating cable to pipe at 40°F (4°C) or above. See Table 7.	66 ft
 GS-54	Glass cloth adhesive tape for attaching heating cable to pipe above -40°F (-40°C). See Table 7.	54 ft
 AT-180	Aluminum tape. Required for attaching heating cable to plastic pipe (use 1 foot of tape per foot of heating cable).	180 ft
 RayClic-SB-04	Pipe mounting bracket. Required for mounting the kits off the pipe for exposure temperatures greater than 150°F (65°C) and for grease and fuel line splices and tees.	1 ea

2

Installation Guidelines

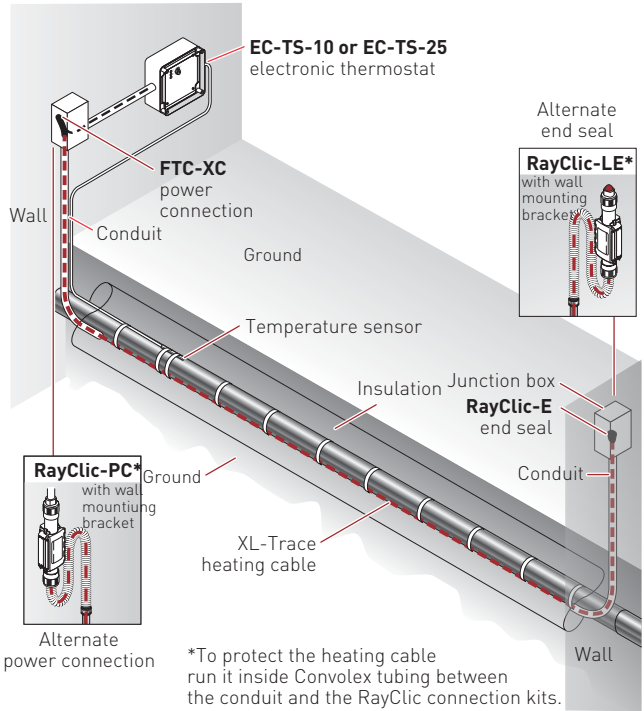
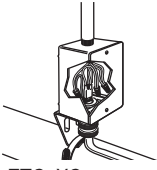
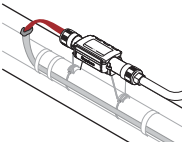

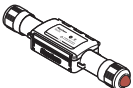

Figure 18: Buried pipe XL-Trace System

2

Installation Guidelines

TABLE 5: CONNECTION KITS FOR GENERAL BURIED PIPING

Catalog number	Description	Heating cable allowance*
 FTC-XC	<ul style="list-style-type: none">• Power connection and end seal• Junction box supplied by customer• Use 1 per circuit Standard pkg: 1	2 ft (0.6 m)
 RayClic-PC	Power connection and end seal kit Standard pkg: 1	
 RayClic-E	Replacement end seal. Standard pkg: 1	0.3 ft (0.1 m)
 RayClic-LE	Alternate lighted end seal Standard pkg: 1	2 ft (0.6 m)

* For ease of connection kit installation, allow extra heating cable.

2

Installation Guidelines

TABLE 6: ACCESSORIES FOR GENERAL BURIED PIPING

Catalog number	Description	Standard pkg
ETL	“Electric Traced” label (use 1 label per 10 feet of pipe)	10 labels
GT-66	Glass cloth adhesive tape for attaching heating cable to pipe at 40°F (4°C) or above. See Table 7.	66 ft
GS-54	Glass cloth adhesive tape for attaching heating cable to pipe above -40°F (-40°C). See Table 7.	54 ft
AT-180	Aluminum tape. Required for attaching heating cable to plastic pipe (use 1 foot of tape per foot of heating cable).	180 ft
RayClic-SB-02	Wall mounting bracket	1

TABLE 7: QUANTITY OF GLASS CLOTH ADHESIVE TAPE REQUIRED (ATTACH AT 1-FOOT INTERVALS)

Pipe size (in)	<2	3	4	6	8	10
Feet of pipe per GT-66 roll	60	50	40	25	20	15
Feet of pipe per GS-54 roll	49	41	33	20	16	12

3

Thermal Insulation

3.1 Insulating the System

Pipes must be insulated with the correct thermal insulation to maintain the desired pipe temperatures. Confirm that the insulation thickness agrees with the system design.

3.2 Insulation Installation

- Before insulating the pipe, visually inspect the heating cable and connection kits to ensure they are properly installed and there are no signs of damage. Damaged heating cable or connection kits must be replaced.
- Check that the insulation type and thickness is correct.
- Insulate the pipes immediately after the heating cable is installed and has passed all tests to minimize damage to the heating cable.
- Insulate the pipe at floor and wall penetrations. Failure to do so will cause cold spots in the water system and could lead to damage to the heating cable. If local codes do not allow this, the heating cable should be run through a conduit or channel before the firestop is installed. Use a fire-resistant sealing compound such as Dow Corning Fire Stop, 3M Fire Barrier, or T&B Flame-Safe.
- Do not use staples to seal insulation. Use tape or the adhesive-lined edge of the insulation to ensure that the seam remains sealed. Staples can damage the heating cable.

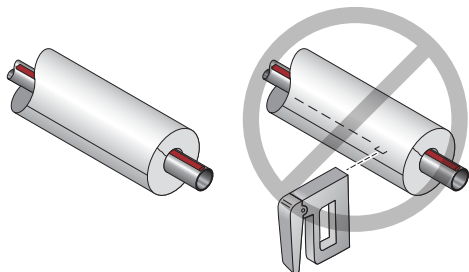

Figure 19: Sealing the insulation seam

3

Thermal Insulation

- All systems for outdoor, buried, or wet areas must use waterproof fire-resistant thermal insulation.
- Mark the location of splices, tees, and end seals on the outside of the insulation with labels provided in the kits, while installing the insulation. Use large diameter insulation or sheets to cover splices, tees, or service loops.

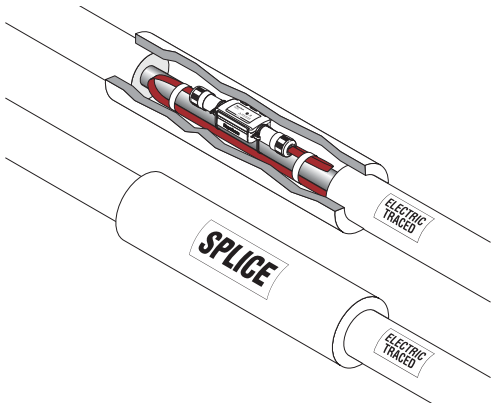

Figure 20: Installing connection kits below insulation

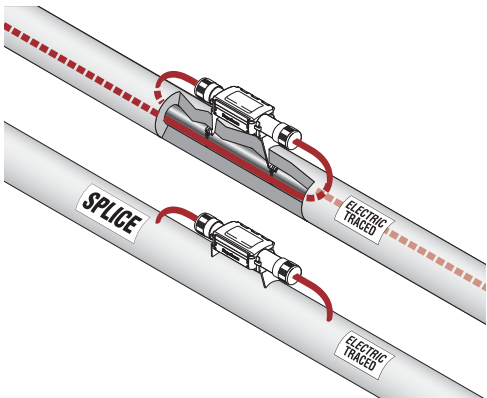

Figure 21: Installing connection kits above insulation

3

Thermal Insulation

- Make sure that all heat-traced piping, fittings, wall penetrations, and branch piping are insulated. Correctly designed systems require properly installed and dry thermal insulation. Uninsulated or wet sections of pipe can result in cold spots or frozen sections.
- After installing insulation, electrical codes require that you install “Electric Traced” labels along the piping at suitable intervals (10-foot intervals recommended) on alternate sides.

 **WARNING: Use only fire-resistant insulation materials such as fiberglass wrap or flame-retardant foams.**

4

Power Supply and Electrical Protection

4.1 Voltage Rating

Verify that the supply voltage is either 120 or 208–277 volts as specified by the XL-Trace system design and printed on the jacket of the heating cable.

4.2 Circuit Breaker Sizing

Circuit breakers must be sized using the heating cable lengths shown in the Appendix. Do not exceed the maximum circuit length shown for each breaker size. Use circuit breakers that incorporate 30-mA ground-fault circuit protection, or provide equivalent levels of ground-fault protection.

4.3 Electrical Loading

The maximum current draw for XL-Trace heating cables is shown in the Appendix. To size the transformer, multiply the total heating cable length (ft) by the appropriate current draw.

4.4 Ground-Fault Protection

If the heating cable is improperly installed or physically damaged to the point that water contacts the bus wires, sustained arcing or fire could result. If arcing does occur, the fault current may be too low to trip conventional circuit breakers. Pentair Thermal Building Solutions and national electrical codes require both ground-fault protection of equipment and a grounded metallic covering on all heating cables. Ground-fault protection must be provided by the installer.

 **WARNING:** To minimize the danger of fire from sustained electrical arcing if the heating cable is damaged or improperly installed, and to comply with Pentair Thermal Building Solutions requirements, agency certifications, and national electrical codes, ground-fault equipment protection must be used on each heating cable branch circuit. Arcing may not be stopped by conventional circuit breakers.

 **WARNING:** Disconnect all power before making connections to the heating cable.

4

Power Supply and Electrical Protection

4.5

Important Power Supply Safeguards

- Make sure that the heating cable load you are connecting is within the rating of the control system selected. Check the design drawings for the heating cable load.
- The electrical conduit that feeds wiring to the control device must have a low-point drain so condensation will not enter the thermostat enclosure.
- Make sure that the line voltage you are connecting to the control system is correct. For proper wiring, follow the installation instructions enclosed with the control device.

5

Temperature Controls

5.1 Ambient-Sensing Control

Ambient-sensing systems energize the circuit when the ambient temperature drops below the set point.

- Mount the device above grade level and out of sunlight.
- Mount the device where it will be exposed to the coldest temperature and the highest wind.

AMC-1A

ambient-sensing thermostat

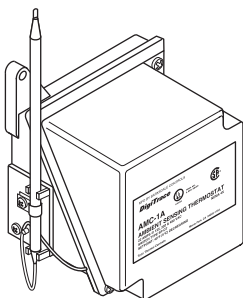

EC-TS-AMB

ambient-sensing thermostat

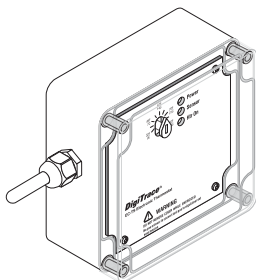

Figure 22: Ambient-sensing thermostats

5.2 Line-Sensing Control

Line-sensing systems sense the pipe temperature by means of a sensor attached to the pipe and connected to the device.

- Install the sensor on the pipe at 90 degrees from the heating cable so that the heating cable does not thermally interfere with the sensor. Be sure the sensor is firmly attached with aluminum tape to the pipe in order to get good thermal contact between the bulb and the pipe.
- Locate the sensor at least 3 feet (1 meter) from any heat sinks, such as valves, pipe supports, and pumps. Ideally, the sensor should be located at the end of the heating cable circuit.
- Be sure that you set the control to the proper temperature.
- Mount the device on a nearby wall or support, or install a mounting stanchion. Thermostats must

5

Temperature Controls

be mounted above grade level. In all cases, protect the sensor from physical damage. To prevent damage, mount the device where it will be away from foot and equipment traffic.

- To prevent water entry, seal the insulation where the capillary tube exits the insulation.

AMC-1B

line-sensing thermostat

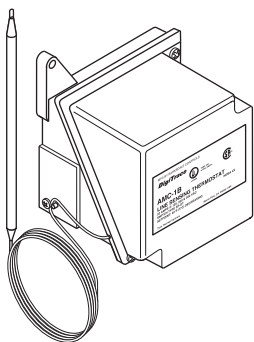

AMC-F5

ambient/line-sensing thermostat with a fixed setpoint at 40°F

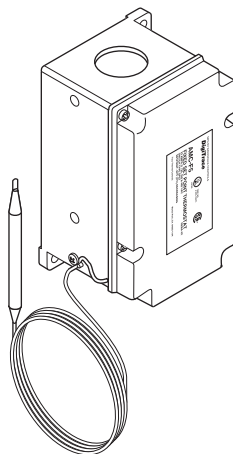

Figure 23: Mechanical thermostats

EC-TS-10/25

line-sensing electronic thermostat

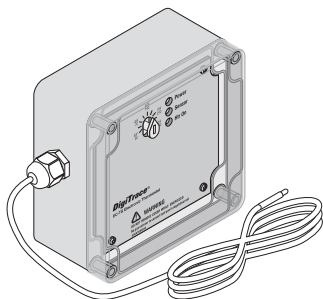
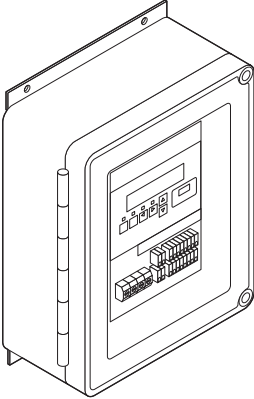

Figure 24: Electronic thermostat

5

Temperature Controls

Raychem 910
electronic controller



Raychem 920
electronic controller

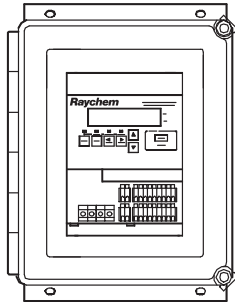

Figure 25: Electronic controllers

5.3 Wiring Schematic for Thermostat

The following is a typical wiring schematic for a thermostat.

Single circuit control

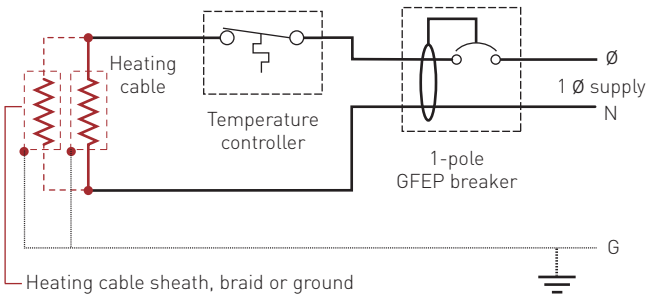

Figure 26: Single circuit control

5

Temperature Controls

Group control

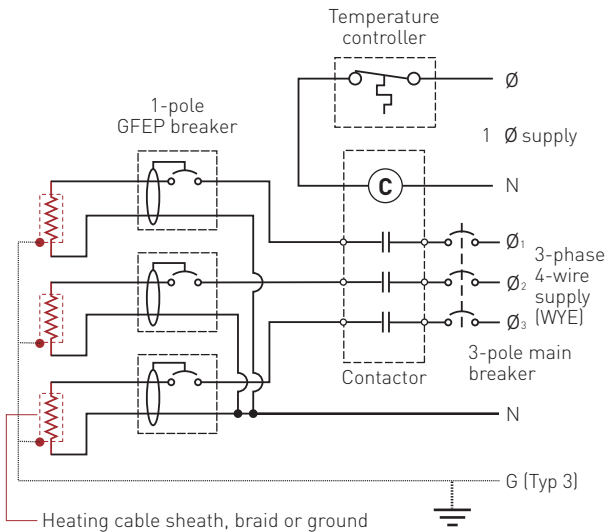

Figure 27: Group circuit control

5

Temperature Controls

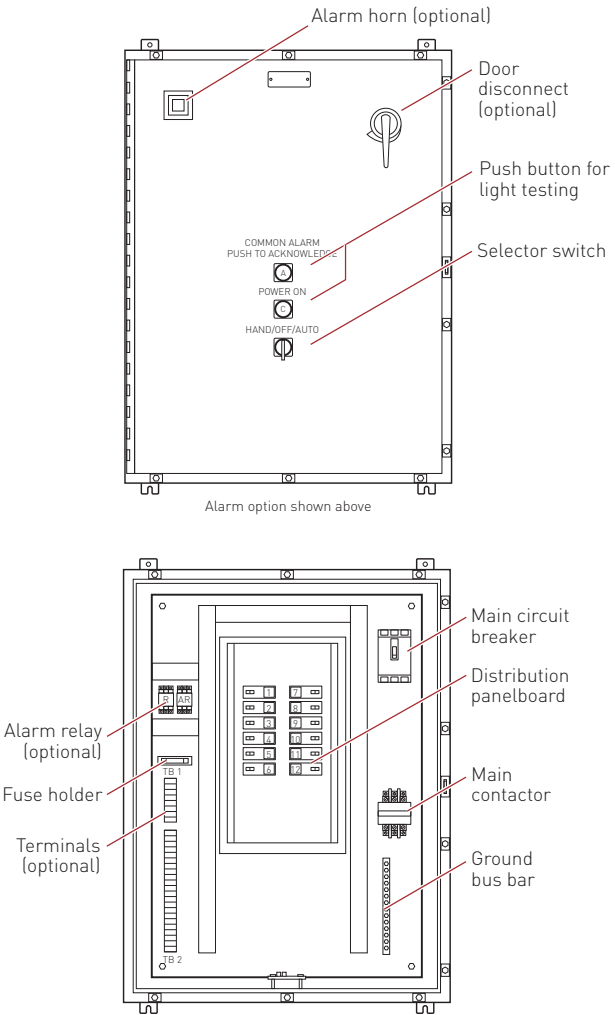

Figure 28: HTPG power distribution panel

5

Temperature Controls

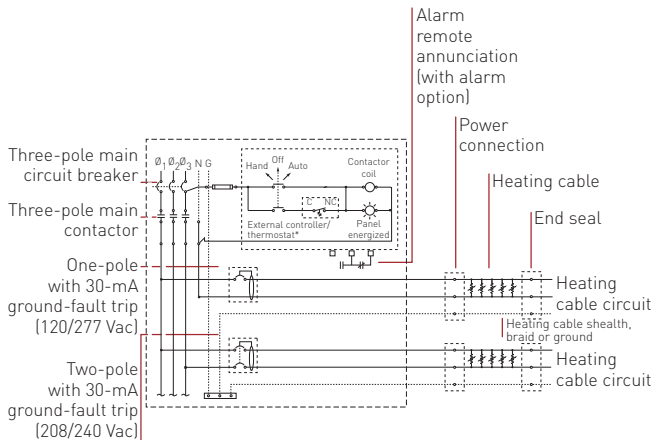

Figure 29: HTPG schematic

6

Commissioning and Preventive Maintenance

Pentair Thermal Building Solutions requires a series of commissioning tests be performed on the XL-Trace system. These tests are also recommended at regular intervals for preventive maintenance. Results must be recorded and maintained for the life of the system, utilizing the "Installation and Inspection Record" (refer to Section 9). Submit this manual with initial commissioning test results to the owner.

6.1 Tests

A brief description of each test is found below. Detailed test procedures are found in Section 7.

Visual Inspection

Visually inspect the pipe, insulation, and connections to the heating cable for physical damage. Check that no moisture is present, electrical connections are tight and grounded, insulation is dry and sealed, and control and monitoring systems are operational and properly set. Damaged heating cable must be replaced.

Insulation Resistance

Insulation Resistance (IR) testing is used to verify the integrity of the heating cable inner and outer jackets. IR testing is analogous to pressure testing a pipe and detects if a hole exists in the jacket.

Circuit Length Verification (Capacitance Test)

The installed circuit length is verified through a capacitance measurement of the XL-Trace heating cable. Compare the calculated installed length against the system design. If the calculated length is shorter than the system design, confirm all connections are secure and the grounding braid is continuous.

6

Commissioning and Preventive Maintenance

Power Check

The power check is used to verify that the system is generating the correct power output. This test can be used in commissioning to confirm that the circuit is functioning correctly. For ongoing maintenance, compare the power output to previous readings.

The heating cable power output per foot is calculated by dividing the total wattage by the total length of a circuit. The current, voltage, operation temperature, and length must be known. Circuit length can be determined from “as built” drawings, meter marks on the heating cable, or with the capacitance test. The watts per foot can be compared to the heating cable output in Figure 32 on page 43 for an indication of heating cable performance.

Ground-Fault Test

Test all ground-fault breakers per manufacturer’s instructions.

7

Test Procedures

7.1 System Tests

The following tests must be done after installing the connection kits, but before the thermal insulation is applied to the pipe:

1. Visual inspection
2. Insulation resistance test

After the thermal insulation has been installed on the pipe, the following tests must be performed:

1. Visual inspection
2. Insulation resistance test
3. Circuit length verification (Capacitance test)
4. Power test
5. Temperature test

All test procedures are described in this manual. It is the installer's responsibility to perform these tests or have an electrician perform them. Record the results in the Installation and Inspection Record in Section 10.

Visual Inspection Test

- Check inside all power, splice, and tee kits for proper installation, overheating, corrosion, moisture, or loose connections.
- Check the electrical connections to ensure that ground and bus wires are insulated over their full length.
- Check for damaged, missing, or wet thermal insulation.
- Check that end seals, splices, and tees are properly labeled on insulation cladding.
- Check the controller for proper setpoint and operation. Refer to its installation and operation manual for details.

Insulation Resistance Test

FREQUENCY

Insulation resistance testing is required during the installation process and as part of regularly scheduled maintenance, as follows:

- Before installing the heating cable

7

Test Procedures

- Before installing connection kits
- Before installing the thermal insulation
- After installing the thermal insulation
- Prior to initial start-up (commissioning)
- As part of the regular system inspection
- After any maintenance or repair work

PROCEDURE

Insulation resistance testing (using a megohmmeter) should be conducted at three voltages: 500, 1000, and **2500 Vdc**. Potential problems may not be detected if testing is done only at 500 and 1000 volts. First measure the resistance between the heating cable bus wires and the braid (Test A), then measure the insulation resistance between the braid and the metal pipe (Test B). Do not allow test leads to touch junction box, which can cause inaccurate readings.



Important: System tests and regular maintenance procedures require that insulation resistance testing be performed. Test directly from the controller or the junction box closest to the power connection.

INSULATION RESISTANCE CRITERIA

A clean, dry, properly installed circuit should measure thousands of megohms, regardless of the heating cable length or measuring voltage (500–2500 Vdc).

All insulation resistance values should be greater than 1000 megohms. If the reading is lower, consult Section 8, Troubleshooting Guide.



Important: Insulation resistance values for Test A and B for any particular circuit should not vary more than 25 percent as a function of measuring voltage. Greater variances may indicate a problem with your heat-tracing system; confirm proper installation and/or contact Pentair Thermal Building Solutions for assistance.

7

Test Procedures

Test A

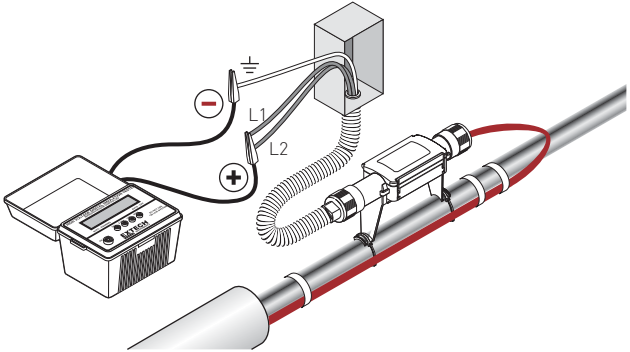

Test B

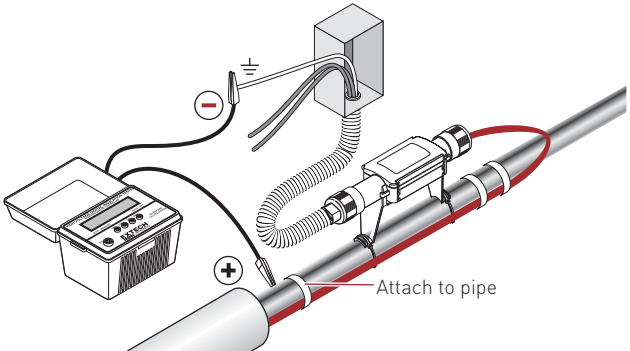

Figure 30: Insulation resistance test

7

Test Procedures

INSULATION RESISTANCE TEST PROCEDURE

1. De-energize the circuit.
2. Disconnect the controller if installed.
3. Disconnect bus wires from terminal block.
4. Set test voltage at 0 Vdc.
5. Connect the negative (-) lead to the heating cable metallic braid or RayClic green wire.
6. Connect the positive (+) lead to both heating cable bus wires or RayClic black wires.
7. Turn on the megohmmeter and set the voltage to 500 Vdc; apply the voltage for one minute. Meter needle should stop moving. Rapid deflection indicates a short. Record the insulation resistance value in the Inspection Record.
8. Repeat Steps 4–7 at 1000 and 2500 Vdc.
9. Turn off the megohmmeter.
10. If the megohmmeter does not self-discharge, discharge phase connection to ground with a suitable grounding rod. Disconnect the megohmmeter.
11. Repeat this test between braid and pipe.
12. Reconnect bus wires to terminal block.
13. Reconnect the temperature controller.

Circuit length verification (capacitance test)

Connect the capacitance meter negative lead to both bus wires and the positive lead to the braid wire. Set the meter to the 200 nF range. Multiply this reading by the capacitance factor for the correct heating cable shown below to determine the total circuit length.

Length (ft or m) = Capacitance (nF) x Capacitance factor (ft/nF or m/nF)

TABLE 8: CAPACITANCE FACTORS

Heating cable	Capacitance factor	
	ft/nF	(m/nF)
5XL and 8XL	5.0	(1.6)
12XL	5.8	(1.8)

Compare the calculated circuit length to the design drawings and circuit breaker sizing tables.

7

Test Procedures



Figure 31: Capacitance test

Power Check

The power output of self-regulating heating cable is temperature-sensitive and requires the following special procedure to determine its value:

1. Power the heating cable and allow it to stabilize for 2 hours, then measure current and voltage at the junction box. If a controller is used, refer to details below.
2. Check the pipe temperature under the thermal insulation at several locations.
3. Calculate the power of the heating cable by multiplying the current by the input voltage and dividing by the actual circuit length.

$$\text{Power (w/ft or m)} = \frac{\text{Volts (Vac)} \times \text{Current (Amps)}}{\text{Length (ft or m)}}$$

The power calculated should be similar to the value generated by:

$$\text{Rated Power (w/ft or m)} = \text{Volts (Vac)} \times \text{Rated Current}$$

7

Test Procedures

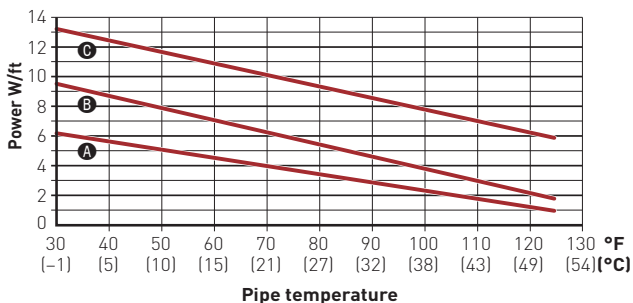

- A** 5XL1-CR and 5XL1-CT (120 V)
5XL2-CR and 5XL2-CT (208 V)
- B** 8XL1-CR and 8XL1-CT (120 V)
8XL2-CR and 8XL2-CT (208 V)
- C** 12XL2-CR and 12XL2-CT (208 V)

Figure 32: Power output

7.2 Fault Location Tests

There are three methods used for finding a fault within a section of heating cable.

1. Ratio method
2. Conductance method
3. Capacitance method

Ratio Method

The ratio method uses resistance measurements taken at each end of the heating cable to approximate the location of a bus wire short. A shorted heating cable could result in a tripped circuit breaker. If the resistance can be read on a standard ohm meter this method can also be used to find a fault from a bus wire to the ground braid. This type of short would trip a GFPD and show a failed insulation resistance reading. Measure the bus-to-bus heating cable resistance at each end (measurement A and measurement B) of the suspected section.

7

Test Procedures

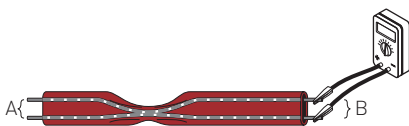

Figure 33: Heating cable resistance measurement test

The approximate location of the fault, expressed as a percentage of the heating cable length from the front end, is:

$$\text{Fault location: } D = \frac{A}{A + B} \times 100$$

Example: A = 1.2 ohms
B = 1.8 ohms

$$\text{Fault location: } D = \frac{1.2}{1.2 + 1.8} \times 100 = 40\%$$

To locate a low resistance ground fault, measure between bus and braid.



Figure 34: Low resistance ground-fault test

The approximate location of the fault, expressed as a percentage of the heating cable length from the front end, is:

$$\text{Fault location: } D = \frac{A}{A + B} \times 100$$

Example: A = 1.2 ohms
B = 1.8 ohms

$$\text{Fault location: } D = \frac{1.2}{1.2 + 1.8} \times 100 = 40\%$$

The fault is located 40% into the circuit as measured from the front end.

7

Test Procedures

Conductance Method

The conductance method uses the core resistance of the heating cable to approximate the location of a fault when the heating cable has been severed and the bus wires have not been shorted together. A severed heating cable may result in a cold section of pipe and may not trip the circuit breaker. Measure the bus-to-bus heating cable resistance at each end (measurement A and measurement B) of the suspect section. Since self-regulating heating cables are a parallel resistance, the ratio calculations must be made using the conductance of the heating cable.



Figure 35: Heating cable resistance measurement

The approximate location of the fault, expressed as a percentage of the heating cable length from the front end, is:

$$\text{Fault location: } D = \frac{1/A}{(1/A + 1/B)} \times 100$$

Example: A = 100 ohms
 B = 25 ohms

$$\begin{aligned} \text{Fault location: } D &= (1/100) / (1/100 + 1/25) \times 100 \\ &= 20\% \end{aligned}$$

The fault is located 20% from the front end of the circuit.

Capacitance Method

This method uses capacitance measurement (nF) as described on Figure 30, to approximate the location of a fault where the heating cable has been severed or a connection kit has not been connected.

Record the capacitance reading from one end of the heating cable. The capacitance reading should be measured between both bus wires twisted together

7

Test Procedures

(positive lead) and the braid (negative lead). Multiply the measured capacitance with the heating cable's capacitance factor as listed in the following example:

Example: 5XL2-CR = 16.2 nF

Capacitance factor = 5.0 ft/nF

Fault location = 42.2 nF x 5.0 ft/nF = 211 ft (64 m)

The ratio of one capacitance value taken from one end (A) divided by the sum of both A and B (A + B) and then multiplied by 100 yields the distance from the first end, expressed as a percentage of the total heating cable circuit length. See Table 8 on page 41 for capacitance factors.

Fault location: $C = \frac{A}{(A + B)} \times 100$

7

Test Procedures

8

Troubleshooting Guide

Symptom

Probable Causes

Circuit breaker trips

Circuit breaker is undersized

Connections and/or splices are shorting out.

Physical damage to heating cable is causing a direct short.

Bus wires are shorted at the end.

Circuit lengths too long.

Nick or cut exists in heating cable or power feed wire with moisture present or moisture in connections.

GFPD is undersized (5 mA used instead of 30 mA) or miswired.

Low or inconsistent insulation resistance

Nicks or cuts in the heating cable.

Short between the braid and heating cable core or the braid and pipe.

Arcing due to damaged heating-cable insulation.

Moisture present in the connection kits.

Test leads touching the junction box.

8

Troubleshooting Guide

Corrective Action

Recheck the design for startup temperature and current loads. Do not exceed the maximum circuit length for heating cable used. Replace the circuit breaker if defective or improperly sized.

Visually inspect the connection kits. Replace if necessary.

Check for damage around the valves and any area where there may have been maintenance work. Replace damaged sections of heating cable.

Check the end seal to ensure that bus wires are not shorted. If a dead short is found, the heating cable may have been permanently damaged by excessive current and may need to be replaced.

Separate the circuit into multiple circuits that do not exceed maximum circuit lengths.

Replace the heating cable, as necessary. Dry out and reseal the connection and splices. Using a megohmmeter, retest insulation resistance.

Replace undersized GFPD with 30-mA GFPD. Check the GFPD wiring instructions

If heating cable is not yet insulated, visually inspect the entire length for damage, especially at elbows in flanges and around valves. If the system is insulated, remove the connection kits one-by-one to isolate the damaged section.

Replace damaged heating-cable sections.

If moisture is present, dry out the connections and retest. Be sure all conduit entries are sealed, and that condensate in conduit cannot enter power connection boxes. If heating-cable core or bus wires are exposed to large quantities of water, replace the heating cable. (Drying the heating cable is not sufficient, as the power output of the heating cable can be significantly reduced.)

Clear the test leads from junction box and restart.

9

Appendix

TABLE A1 MAXIMUM CIRCUIT LENGTH IN FEET

Start-up temperature (°F)	CB size (A)	5XL1	8XL1	5XL2		
		120 V	120 V	208 V	240 V	277 V
-20°F	15	101	76	174	178	183
	20	134	101	232	237	245
	30	201	151	349	356	367
	40	270	201	465	474	478
0°F	15	115	86	199	203	209
	20	153	115	265	271	279
	30	230	172	398	406	419
	40	270	210	470	490	530
20°F	15	134	100	232	237	244
	20	178	133	309	315	325
	30	270	200	464	473	488
	40	270	210	470	490	530
40°F	15	160	119	278	283	292
	20	214	159	370	378	390
	30	270	210	470	490	530
	40	270	210	470	490	530
50°F (buried)	15	-	-	-	-	-
	20	-	-	-	-	-
	30	-	-	-	-	-
	40	-	-	-	-	-
65°F (indoors grease)	15	-	-	-	-	-
	20	-	-	-	-	-
	30	-	-	-	-	-
	40	-	-	-	-	-

* When circuit breaker sizing is listed in:

- black type, the value is for applications with a 40°F maintain
- **red** type, the value is for applications with a 110°F maintain

9

Appendix

Application 40°F/110°F Maintain*

Circuit breaker sizing (ft)

8XL2			12XL2		
208 V	240 V	277 V	208 V	240 V	277 V
131	138	146	111	114	117
175	184	194	148	151	156
262	276	291	223	227	234
349	368	388	297	303	312
149	157	166	120	122	126
199	209	221	160	163	138
298	314	331	239	244	252
370/399	390/420	420/443	319	326	336
173	182	192	126	129	133
231	243	257	169	172	177
346	365	385	253	258	266
370/462	390/486	420/513	340/349	344	355
206	217	229	142	145	150
275	290	306	190	194	200
370/416	390/438	420/462	285	291	300
370/554	390/584	420/616	349/398	360/406	380/419
228	240	254	152	155	160
304	320	338	203	207	213
457	481	507	304	310	320
609	641	676	405	414	427
272	286	302	169	172	178
362	381	402	225	230	237
543	572	603	338	345	356
610	660	720	430	460	490

9

Appendix

TABLE A2 MAXIMUM CIRCUIT LENGTH IN FEET

Start-up temperature (°C)	CB size (A)	5XL1		5XL2		
		120 V	120 V	208 V	240 V	277 V
-29°C	15	31	23	53	54	56
	20	41	101	71	72	75
	30	61	151	106	108	112
	40	82	201	142	145	149
-18°C	15	35	86	61	62	64
	20	47	115	81	83	85
	30	70	172	121	124	128
	40	82	210	143	149	162
-7°C	15	41	100	71	72	74
	20	54	133	94	96	99
	30	82	200	141	144	149
	40	82	210	143	149	162
40°C	15	49	119	85	86	89
	20	65	159	113	115	119
	30	82	210	143	149	162
	40	82	210	143	149	162
10°C (buried grease)	15	-	-	-	-	-
	20	-	-	-	-	-
	30	-	-	-	-	-
	40	-	-	-	-	-
18°C (indoors grease)	15	-	-	-	-	-
	20	-	-	-	-	-
	30	-	-	-	-	-
	40	-	-	-	-	-

* When circuit breaker sizing is listed in:

- black type, the value is for applications with a 4°C maintain
- **red** type, the value is for applications with a 43°C maintain

9

Appendix

Application 4°C/43°C Maintain*

Circuit breaker sizing (fm)

8XL2			12XL2		
208 V	240 V	277 V	208 V	240 V	277 V
40	42	44	34	35	36
53	56	59	45	46	48
80	84	89	68	69	71
106	112	118	90	92	95
45	48	51	36	37	38
61	64	67	49	50	51
91	96	101	73	74	77
113/122	119/128	128/135	97	99	102
53	56	59	39	39	41
70	74	78	51	52	54
106	111	117	77	79	81
113/141	119/148	128/156	104/106	105	108
63	66	70	43	44	46
84	88	93	58	59	61
113/127	119/134	128/141	87	89	91
113/169	119/178	128/188	104/121	110/124	116/128
70	73	77	46	47	49
93	98	103	62	63	65
139	147	155	93	95	98
186	195	206	124	126	130
83	87	92	52	53	54
110	116	123	69	70	72
166	174	184	103	105	108
186	201	220	131	140	149

9

Appendix

TABLE A3 TRANSFORMER SIZING (AMPERES/FOOT)

Minimum start-up temperature (°F)	5XL1	8XL1	5XL2		
	120 V	120 V	208 V	240 V	277 V
-20	0.119	0.159	0.069	0.067	0.065
0	0.105	0.139	0.060	0.059	0.057
20	0.090	0.120	0.052	0.051	0.049
40	0.075	0.101	0.043	0.042	0.041
50	-	-	-	-	-
65	-	-	-	-	-

TABLE A4 TRANSFORMER SIZING (AMPERES/METER)

Minimum start-up temperature (°C)	5XL1	8XL1	5XL2		
	120 V	120 V	208 V	240 V	277 V
-20	0.391	0.521	0.226	0.221	0.215
-18	0.343	0.457	0.198	0.194	0.188
-7	0.294	0.394	0.170	0.166	0.161
4	0.246	0.331	0.142	0.139	0.135
10	-	-	-	-	-
18	-	-	-	-	-

9

Appendix

8XL1			12XL2		
208 V	240 V	277 V	208 V	240 V	277 V
0.092	0.087	0.082	0.108	0.106	0.102
0.080	0.076	0.072	0.100	0.098	0.095
0.069	0.066	0.062	0.095	0.093	0.090
0.058	0.055	0.052	0.084	0.083	0.080
0.053	0.050	0.047	0.079	0.077	0.075
0.044	0.042	0.040	0.072	0.070	0.067

8XL1			12XL2		
208 V	240 V	277 V	208 V	240 V	277 V
0.301	0.286	0.270	0.354	0.347	0.336
0.264	0.251	0.238	0.329	0.322	0.312
0.227	0.216	0.205	0.311	0.305	0.296
0.191	0.181	0.172	0.276	0.271	0.263
0.172	0.164	0.155	0.259	0.254	0.246
0.145	0.138	0.130	0.233	0.228	0.221

10

Installation and Inspection Record

Installation and Inspection Record

Facility

Test Date:

Circuit number:

Heating cable type:

Controllers:

Temperature setting:

Circuit length:

Commission

Inspection date:

Visual inspection

Confirm 30-mA ground-fault device (proper rating/function)

Visual inspection inside connection boxes for overheating, corrosion, moisture, and other problems.

Proper electrical connection, ground, and bus wires insulated over full length

Damaged or missing thermal insulation; damaged, missing, cracked lagging or weatherproofing.

Covered end seals, splices, and tees properly labeled on insulation.

Check controllers for moisture, corrosion, setpoint, switch operation.

Insulation resistance test

M-Ohms

Bus to braid (Test A)

500 Vdc

1000 Vdc

2500 Vdc

Braid to pipe (Test B)

500 Vdc

1000 Vdc

2500 Vdc

Circuit length verification

Capacitance test: Circuit length (ft) = Capacitance (nF) x Capacitance factor (x 3.28 = m)

Power check

Circuit voltage

Panel

(Vac)

Circuit amps after 2 hours

(Amps)

Pipe temperature

(°F) (°C)

Power = (volts x amps after 2 hrs) / circuit length (watts/ft) (watts/m)



WWW.PENTAIRTHERMAL.COM

NORTH AMERICA

Tel: +1.800.545.6258
Fax: +1.800.527.5703
Tel: +1.650.216.1526
Fax: +1.650.474.7711
thermal.info@pentair.com

EUROPE, MIDDLE EAST, AFRICA

Tel: +32.16.213.511
Fax: +32.16.213.603
thermal.info@pentair.com

ASIA PACIFIC

Tel: +86.21.2412.1688
Fax: +86.21.5426.2917
cn.thermal.info@pentair.com

LATIN AMERICA

Tel: +1.713.868.4800
Fax: +1.713.868.2333
thermal.info@pentair.com

Pentair, RayClic, and XL-Trace are owned by Pentair or its global affiliates. All other trademarks are the property of their respective owners. Pentair reserves the right to change specifications without prior notice.

© 2008–2016 Pentair.