

Equipment for the Food Manufacturing Industry

HF1- Series

Fluid contact parts

- No grease or NSF H1 grade grease



HF2- Series

Fluid contact parts

- No grease or NSF H1 grade grease
- FDA compliant materials



HF1/HF2 Compatible Products

Available without prefix



Applicable for a diverse range of food manufacturing processes / Possible to blow directly onto food /
Designed for use in application to HACCP and other standards















HF **Series**







P-E20-17

HF1- Series/HF1 Compatible Products











Air Preparation Equipment/Pressure Control Equipment/Others

	Compressed Air Purity Class: ISO 8573 Line Filter HF1-AFF20/30/40-D		p. 5
	Compressed Air Purity Class: ISO 8573 Mist Separator HF1-AM20/30/40-D		p. 5
	Compressed Air Purity Class: ISO 8573 Micro Mist Separator HF1-AMD20/30/40-D		p. 5
	Activated Carbon Filter HF1-AMK20/30/40-D	HF1	p. 6
	Air Filter HF1-AF20/30/40/50/60-D		p. 7
	Mist Separator HF1-AFM20/30/40-D		p. 8
	Micro Mist Separator HF1-AFD20/30/40-D		p. 8
	Membrane Air Dryer IDG	HF1 compatible	p. 9
	Regulator HF1-AR(K)20/30/40/50/60-D		p. 11
	Filter Regulator HF1-AW(K)20/30/40/60-D	HF1	p. 13
	Precision Regulator HF1-IR1000/2000/3000-A		p. 15
	Clean Regulator SRH3000/4000	HF1 compatible	p. 16
	OSHA Standard Compliant/ Pressure Relief 3-Port Valve with Locking Holes HF1-VHS20/30/40/50-D	HF1	p. 17

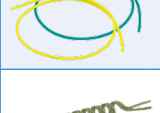

Fittings and Tubing

	Insert Fittings KF		p. 18
	Miniature Fittings M, MS		p. 18
	Self-align Fittings H/DL/L/LL	HF1 compatible	p. 19
	Stainless Steel 316 One-touch Fittings KQG2		p. 18





Fittings and Tubing

	Stainless Steel 316 Insert Fittings KFG2		p. 19
	Clean One-touch Fittings KPG		p. 19
	Clean One-touch Fittings KPQ		p. 19
	Nylon Tubing T/TIA		p. 20
	Soft Nylon Tubing TS/TISA		p. 20
	Polyurethane Tubing TU/TIUB	HF1 compatible	p. 21 p. 24
	Soft Polyurethane Tubing TUS		p. 27 p. 28
	Hard Polyurethane Tubing TUH		p. 29
	Wear Resistant Tubing TUZ/TIUBZ		p. 30
	Polyurethane Coil Tubing TCU		p. 31
	Polyurethane Flat Tubing TFU		p. 32

Flow Control Equipment





	Speed Controller with One-touch Fitting HF1-AS-F	HF1	p. 39
	Stainless Steel Speed Controller ASG	HF1 compatible	p. 42

Pressure Gauges



	Pressure Gauge for General Purposes G36/G46		p. 43 p. 44
	Pressure Gauge for General Purposes G36-X4/GA36-X4		p. 45
	Oil-free/External Parts Copper- free Pressure Gauge G46E	HF1 compatible	p. 46
	Pressure Gauge for Clean Regulator G46-SRA, B		p. 47





HF1- Series/HF1 Compatible Products

Switches/Sensors			
	3-Screen Display High-Precision Digital Pressure Switch ZSE20(F)/ISE20(X)-X2		p. 48
	3-Screen Display High-Precision Digital Pressure Switch ZSE20C(F)/ISE20C(H)	HF1 compatible	p. 50
	3-Screen Display High-Precision Digital Pressure Switch ISE70/71-X2		p. 51
	Digital Pressure Switch ISE35-X528		p. 52
	Pressure Switch/ Reed Switch Type HF1-IS10	HF1	p. 53
	2-Color Display Digital Flow Switch PF2M7		p. 54
	2-Color Display Digital Flow Switch PFMB7	HF1 compatible	p. 55
	Flow Sensor PFMV5		p. 56

Process Valves			
	2-Port Solenoid Valve HF1-JSX/JSXD	HF1	p. 57 p. 59
	Pulse Valve (Valve for Dust Collector) HF1-JSXFAE/F		p. 60
	High Speed 2-Port Valve SX10	HF1 compatible	p. 61
Directional Control Valves			
	3-Port Solenoid Valve HF1-VP300/500/700	HF1	p. 62
	Mechanical Valve HF1-VM		p. 65

HF2- Series/HF2 Compatible Products

Air Preparation Equipment			
	Bacteria Removal Filter/ Hollow Fiber Element SFDA	HF2 compatible	p. 4
Fittings and Tubing			
	EHEDG Compliant Fittings KFG2H(X)-E	HF2 compatible	p. 19
	Clean Design Fittings KFG2H(X)-C		p. 19
	FDA Compliant Fittings KQG2-F/KQB2-F/KFG2-F		p. 19
	FDA (U.S. Food and Drug Administration) and (EU) No 10/2011 Compliant Polyurethane Tubing TU-X214		p. 23
	Fluoropolymer Tubing TL/TIL		p. 33

Fittings and Tubing			
	Fluoropolymer Tubing (PFA) TLM/TILM	HF2 compatible	p. 34
	FEP Tubing (Fluoropolymer) TH/THI		p. 36
	Soft Fluoropolymer Tubing (Modified PTFE) TD/TID		p. 37
	Polyolefin Tubing TPH		p. 38
	Soft Polyolefin Tubing TPS		p. 38

Application Examples

Removal of particles on the container

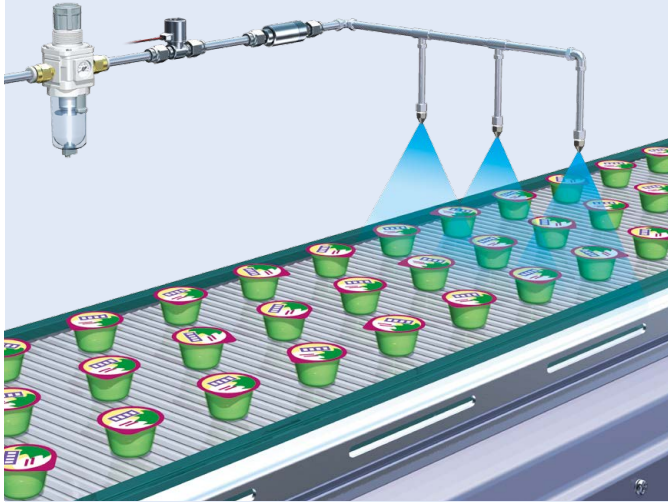

Air Preparation Equipment
HF1-AFF/AM□ Series

p. 5



Direct Operated 2-Port Solenoid Valve
HF1-JSX Series

p. 57



Bacteria Removal Filter
SFDA Series

p. 4



Blowing air onto breads

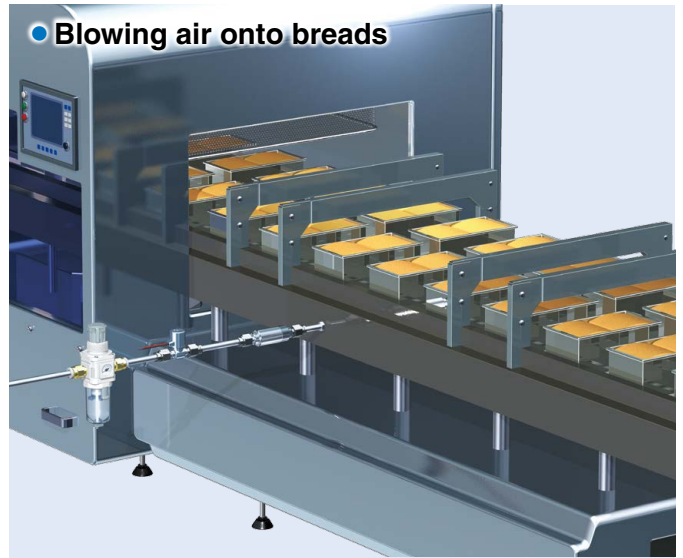

Air Preparation Equipment
HF1-AFF/AM□ Series

p. 5



Direct Operated 2-Port Solenoid Valve
HF1-JSX Series

p. 57



Bacteria Removal Filter
SFDA Series

p. 4



Nitrogen filling of packing machine



2-Color Display Digital Flow Switch
PF2M7 Series

p. 54



Direct Operated 2-Port Solenoid Valve
HF1-JSX Series

p. 57



Bacteria Removal Filter
SFDA Series

p. 4



Stirring



Restrictor In-line Type
HF1-AS-X214

p. 40



Direct Operated 2-Port Solenoid Valve
HF1-JSX Series

p. 57



Bacteria Removal Filter
SFDA Series

p. 4



Pneumatic equipment circuit of air blower for food application (example)

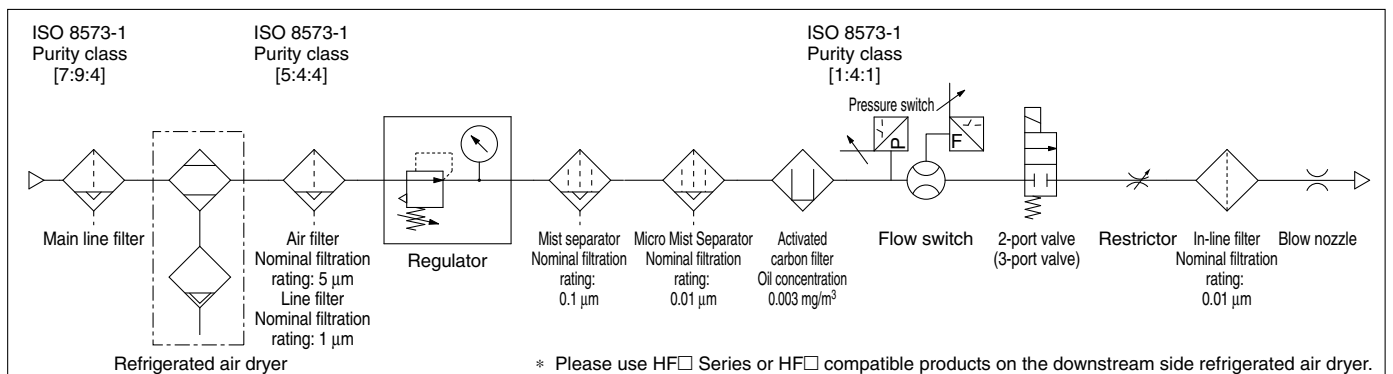

HF1

HF2

HF1 compatible

HF2 compatible

Bacteria Removal Filter Hollow Fiber Element

SFDA Series

RoHS



More for the specifications and dimensions

How to Order



SFDA 2 0 3 - [] 02

Bacteria Removal Filter
(Bacteria removal performance LRV ≥ 9)

Size

Symbol	Max. flow rate
2	500 L/min

Case material

Symbol	Case material
3	Stainless steel

Port size

Symbol	Size
02	1/4
03	3/8

* The bracket is equipped as standard.
(Single unit: SFD-BR200)

Thread type

Symbol	Type
Nil	Rc
F	G
N	NPT

Air Preparation Equipment
Pressure Control Equipment/Others

Fittings and Tubing

Flow Control
Equipment

Pressure Gauges

Switches/Sensors

Process Valves

Directional
Control Valves



Line Filter/Mist Separator/ Micro Mist Separator

HF1-AFF/AM/AMD Series



More for the specifications
and dimensions

How to Order

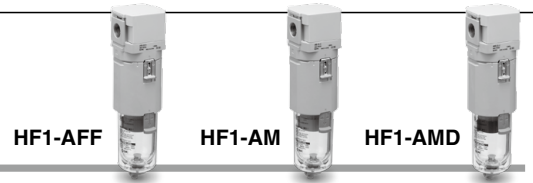

HF1 - **AFF** **30** - **03** **BD** - - **D**

① ② ③ ④ ⑤ ⑥

· Option/Semi-standard: Select one each for a to f.
· Option/Semi-standard symbol: When more than one specification is required, indicate in alphanumeric order.
Example) HF1-AM30-N03BD-6RZ-D

	Symbol	Description	② Body size				
			20	30	40		
① Filter type	AFF	Nominal filtration rating: 1 μm	●	●	●		
		Water droplet removal ratio: 99%					
	AM	Nominal filtration rating: 0.1 μm	●	●	●		
		Oil mist concentration on the outlet side: 1 mg/m ³					
AMD	Nominal filtration rating: 0.01 μm	●	●	●			
	Oil mist concentration on the outlet side: 0.1 mg/m ³						
③ Thread type	+						
	Nil	Rc	●	●	●		
	N* ¹	NPT	●	●	●		
④ Port size	+						
	F* ²	G	●	●	●		
	01	1/8	●	—	—		
	02	1/4	●	●	●		
⑤ Option	a	Mounting	03	3/8	—	●	●
			04	1/2	—	—	●
	b	Float type auto drain	Nil	Without mounting option	●	●	●
B* ³			With bracket	●	●	●	
+							
⑥ Semi-standard	c	Bowl* ⁶	Nil	Without auto drain	●	●	●
			2	Without auto drain	●	●	●
			6	N.C. (Normally closed) Drain port is closed when pressure is not applied.	●	●	●
d	Drain port* ⁹	D* ⁵	N.O. (Normally open) Drain port is open when pressure is not applied.	—	●	●	
			+				
			Nil	Polycarbonate bowl	●	●	●
e	Flow direction	2	Metal bowl	●	●	●	
		6	Nylon bowl	●	●	●	
		8	Metal bowl with level gauge	—	●	●	
f	Unit	C	With bowl guard	●	—* ⁷	—* ⁷	
		6C	With bowl guard/Nylon bowl	●	—* ⁸	—* ⁸	
		+					
⑥ Semi-standard	d	Drain port* ⁹	Nil	With drain cock	●	●	●
			J* ¹⁰	Drain guide 1/8	●	—	—
			W* ¹¹	Drain guide 1/4	—	●	●
e	Flow direction	W* ¹¹	Drain cock, Barb fitting (ø6)	—	●	●	
		+					
		Nil	Flow direction: Left to right	●	●	●	
f	Unit	R	Flow direction: Right to left	●	●	●	
		+					
		Nil	Name plate and caution plate for bowl in SI units: MPa, °C	●	●	●	
⑥ Semi-standard	f	Unit	Z* ¹²	Name plate and caution plate for bowl in imperial units: psi, °F	○* ¹³	○* ¹³	○* ¹³
			+				
			+				

*1 Drain guide is NPT1/8 (applicable to the HF1-AFF20, HF1-AM20, and HF1-AMD20) and NPT1/4 (applicable to the HF1-AFF30, HF1-AFF40, HF1-AM30, HF1-AM40, HF1-AMD30, and HF1-AMD40). The auto drain port comes with a ø3/8" One-touch fitting (applicable to the HF1-AFF30, HF1-AFF40, HF1-AM30, HF1-AM40, HF1-AMD30, and HF1-AMD40).
*2 Drain guide is G1/8 (applicable to the HF1-AFF20, HF1-AM20, and HF1-AMD20) and G1/4 (applicable to the HF1-AFF30, HF1-AFF40, HF1-AM30, HF1-AM40, HF1-AMD30, and HF1-AMD40).
*3 A bracket is not assembled and supplied loose at the time of shipment. Including 2 mounting screws
*4 When pressure is not applied, condensate which does not start the auto drain mechanism will be left in the bowl. Releasing the residual condensate before ending operations for the day is recommended.
*5 If the compressor is small (0.75 kW, discharge flow is less than 100 L/min

(ANR)), air leakage from the drain cock may occur during the start of operations. N.C. type is recommended.
*6 Refer to the chemical data in the **Web Catalog** for chemical resistance of the bowl.
*7 A bowl guard is provided as standard equipment (polycarbonate).
*8 A bowl guard is provided as standard equipment (nylon).
*9 The combination of float type auto drain C and D is not available.
*10 Without a valve function
The mounting screws are the same as the thread of ③.
*11 The combination of metal bowl 2 and 8 is not available.
*12 For pipe thread type: NPT
This product is for overseas use only according to the new Measurement Act. (The SI unit type is provided for use in Japan.)
*13 ○: For pipe thread type: NPT only



Activated Carbon Filter

HF1-AMK Series



More for the specifications and dimensions



How to Order

HF1-AMK

HF1 - AMK **30** - **F** **03** **B** - - D

1
 2
 3
 4
 5
 6

· Option/Semi-standard: Select one each for **a** to **d**.
 · Option/Semi-standard symbol: When more than one specification is required, indicate in alphanumeric order.
 Example) HF1-AMK30-N03B-6RZ-D

	Symbol	Description	② Body size			
			20	30	40	
① Filter type	AMK	Activated carbon filter	●	●	●	
+						
③ Thread type	Nil	Rc	●	●	●	
	N	NPT	●	●	●	
	F	G	●	●	●	
+						
④ Port size	01	1/8	●	—	—	
	02	1/4	●	●	●	
	03	3/8	—	●	●	
	04	1/2	—	—	●	
+						
⑤ Option	a Mounting	Nil	Without mounting option	●	●	●
		B*1	With bracket	●	●	●
+						
⑥ Semi-standard	b Bowl*2	Nil	Polycarbonate bowl	●	●	●
		2	Metal bowl	●	●	●
		6	Nylon bowl	●	●	●
		C	With bowl guard	●	—*3	—*3
		6C	With bowl guard/Nylon bowl	●	—*4	—*4
	+					
c Flow direction	Nil	Flow direction: Left to right	●	●	●	
	R	Flow direction: Right to left	●	●	●	
+						
d Pressure unit	Nil	Name plate and caution plate in SI units: MPa/°C	●	●	●	
	Z*5	Name plate and caution plate in imperial units: psi/°F	○*6	○*6	○*6	

- *1 A bracket is not assembled and supplied loose at the time of shipment. Including 2 mounting screws
- *2 Refer to the chemical data in the **Web Catalog** for chemical resistance of the bowl.
- *3 A bowl guard is provided as standard equipment (polycarbonate).
- *4 A bowl guard is provided as standard equipment (nylon).
- *5 For pipe thread type: NPT
This product is for overseas use only according to the new Measurement Act. (The SI unit type is provided for use in Japan.)
- *6 ○: For pipe thread type: NPT only

Air Preparation Equipment
Pressure Control Equipment/Others

Fittings and Tubing

Flow Control Equipment

Pressure Gauges

Switches/Sensors

Process Valves

Directional Control Valves



Air Filter

HF1-AF20-D to HF1-AF60-D



More for the specifications and dimensions

How to Order

HF1-AF30-D



HF1 - AF **30** - **03** **BD** - **03** - **D**

① ② ③ ④ ⑤

· Option/Semi-standard: Select one each for a to f.
 · Option/Semi-standard symbol:
 When more than one specification is required, indicate in alphanumeric order.
 Example) HF1-AF30-03BD-R-D

	Symbol	Description	① Body size						
			20	30	40	50	60		
② Pipe thread type	Nil	Rc	●	●	●	●	●		
	N	NPT	●	●	●	●	●		
	F	G	●	●	●	●	●		
+									
③ Port size	01	1/8	●	—	—	—	—		
	02	1/4	●	●	●	—	—		
	03	3/8	—	●	●	—	—		
	04	1/2	—	—	●	—	—		
	06	3/4	—	—	●	●	—		
	10	1	—	—	—	●	●		
+									
④ Option	a Mounting	Nil	Without mounting option		●	●	●	●	●
		B*1	With bracket		●	●	●	●	●
	+								
	b Float type auto drain*2	Nil	Without auto drain		●	●	●	●	●
C*3		N.C. (Normally closed) Drain port is closed when pressure is not applied.		●	●	●	●	●	
D*4		N.O. (Normally open) Drain port is open when pressure is not applied.		—	●	●	●	●	
+									
⑤ Semi-standard	c Bowl*5	Nil	Polycarbonate bowl		●	●	●	●	●
		2	Metal bowl		●	●	●	●	●
		6	Nylon bowl		●	●	●	●	●
		8	Metal bowl with level gauge		—	●	●	●	●
		C	With bowl guard		●	—*6	—*6	—*6	—*6
		6C	With bowl guard (Nylon bowl)		●	—*7	—*7	—*7	—*7
	+								
	d Drain port*8	Nil	With drain cock		●	●	●	●	●
		J*9	Drain guide 1/8		●	—	—	—	—
		W*10	Drain cock with barb fitting		—	●	●	●	●
	+								
e Flow direction	Nil	Flow direction: Left to right		●	●	●	●	●	
	R	Flow direction: Right to left		●	●	●	●	●	
+									
f Unit	Nil	Unit on product label: MPa, °C		●	●	●	●	●	
	Z*11	Unit on product label: psi, °F		○*12	○*12	○*12	○*12	○*12	

*1 Option B is included in the package with the product but does not come assembled. The assembly consists of 2 types of the bracket and 2 mounting screws.
 *2 The auto drain port is ø10 One-touch fitting (② Pipe thread type: Rc, G) or ø3/8" One-touch fitting (② Pipe thread type: NPT)
 *3 When pressure is not applied, condensate which does not start the auto drain mechanism will be left in the bowl. Releasing the residual condensate before ending operations for the day is recommended.
 *4 If the compressor is small (0.75 kW, discharge flow is less than 100 L/min (ANR)), air leakage from the drain cock may occur during the start of operations. N.C. type is recommended.
 *5 Refer to chemical data in the **Web Catalog** for chemical resistance of the bowl.
 *6 A bowl guard is provided as standard equipment (polycarbonate).
 *7 A bowl guard is provided as standard equipment (nylon).
 *8 The combination of float type auto drain C and D is not available.
 *9 Without a valve function. The mounting screws are the same as the thread of ②.
 *10 The combination of metal bowl 2 and 8 is not available.
 *11 For the pipe thread type: NPT. This product is for overseas use only according to the New Measurement Act. (The SI unit type is provided for use in Japan.)
 *12 ○: For the pipe thread type: NPT only



Mist Separator

HF1-AFM20-D to HF1-AFM40-D



Micro Mist Separator

HF1-AFD20-D to HF1-AFD40-D



More for the specifications and dimensions

How to Order

HF1-AFM30-D

HF1-AFD30-D

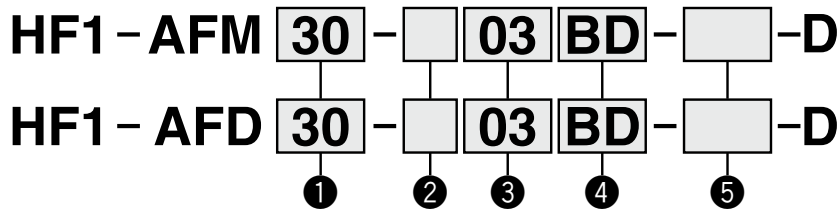

· Option/Semi-standard: Select one each for a to f.
 · Option/Semi-standard symbol:
 When more than one specification is required, indicate in alphanumeric order.
 Example) HF1-AFM30-03BD-R-D

		Symbol	Description	① Body size				
				20	30	40		
②	Pipe thread type	Nil	Rc	●	●	●		
		N	NPT	●	●	●		
		F	G	●	●	●		
		+						
③	Port size	01	1/8	●	—	—		
		02	1/4	●	●	●		
		03	3/8	—	●	●		
		04	1/2	—	—	●		
		06	3/4	—	—	●		
		+						
④	Option	a	Mounting	Nil	Without mounting option	●	●	●
				B*1	With bracket	●	●	●
		+						
④	Option	b	Float type auto drain*2	Nil	Without auto drain	●	●	●
				C*3	N.C. (Normally closed) Drain port is closed when pressure is not applied.	●	●	●
				D*4	N.O. (Normally open) Drain port is open when pressure is not applied.	—	●	●
		+						
⑤	Semi-standard	c	Bowl*5	Nil	Polycarbonate bowl	●	●	●
				2	Metal bowl	●	●	●
				6	Nylon bowl	●	●	●
				8	Metal bowl with level gauge	—	●	●
				C	With bowl guard	●	—*6	—*6
				6C	With bowl guard (Nylon bowl)	●	—*7	—*7
				+				
		d	Drain port*8	Nil	With drain cock	●	●	●
				J*9	Drain guide 1/8	●	—	—
					Drain guide 1/4	—	●	●
		W*10	Drain cock with barb fitting	—	●	●		
		+						
e	Flow direction	Nil	Flow direction: Left to right	●	●	●		
		R	Flow direction: Right to left	●	●	●		
		+						
f	Unit	Nil	Unit on product label: MPa, °C	●	●	●		
		Z*11	Unit on product label: psi, °F	○*12	○*12	○*12		

*1 Option B is included in the package with the product but does not come assembled. The assembly consists of 2 types of the bracket and 2 mounting screws.
 *2 The auto drain port is $\phi 10$ One-touch fitting (②) Pipe thread type: Rc, G) or $\phi 3/8"$ One-touch fitting (②) Pipe thread type: NPT)
 *3 When pressure is not applied, condensate which does not start the auto drain mechanism will be left in the bowl. Releasing the residual condensate before ending operations for the day is recommended.
 *4 If the compressor is small (0.75 kW, discharge flow is less than 100 L/min (ANR)), air leakage from the drain cock may occur during the start of operations. N.C. type is recommended.

*5 Refer to chemical data in the **Web Catalog** for chemical resistance of the bowl.
 *6 A bowl guard is provided as standard equipment (polycarbonate).
 *7 A bowl guard is provided as standard equipment (nylon).
 *8 The combination of float type auto drain C and D is not available.
 *9 Without a valve function. The mounting screws are the same as the thread of ②.
 *10 The combination of metal bowl 2 and 8 is not available.
 *11 For the pipe thread type: NPT. This product is for overseas use only according to the New Measurement Act. (The SI unit type is provided for use in Japan.)
 *12 ○: For the pipe thread type: NPT only

Air Preparation Equipment
Pressure Control Equipment/Others

Fittings and Tubing

Flow Control Equipment

Pressure Gauges

Switches/Sensors

Process Valves

Directional Control Valves

Membrane Air Dryer/Single Unit Type



IDG□A Series

HF1

HF2

HF1 compatible

HF2 compatible

Standard dew point -20°C , -15°C , -40°C , -60°C



More for the specifications and dimensions

How to Order



IDG **30** □ A - □ **03** □ - □

Size ●

30
50
60
75
100

Standard dew point temperature/Outlet air flow rate ●

Symbol	Standard dew point [°C]	Flow rate by size, Outlet air flow rate [L/min (ANR)]				
		30	50	60	75	100
Nil	-20	300	500	Select from IDG Series (Web Catalog)		
H	-15	300	500	Select from IDG Series (Web Catalog)		
L	-40	75	110	170	240	300
S	-60	—	—	50	100	150

Thread type ●

Symbol	Type
Nil	Rc
N	NPT
F	G

● Semi-standard

Symbol	Specifications
Nil	None (Standard)
R	Flow direction (Right → Left)

● Accessory

Symbol	Specifications
Nil	None (Standard)
B	With bracket

* When symbol: B is indicated, a bracket assembly with a part number shown to the left below is included as an accessory.

● Port size

Symbol	Port size	Size				
		30	50	60	75	100
02	1/4	●	●	—	—	—
03	3/8	●	●	●	●	●
04	1/2	—	—	●	●	●



Bracket Assembly (Accessory)/Part No.

Part no.	Applicable model
BM64	IDG30□A, IDG50□A
BM65	IDG60□A, IDG75□A, IDG100□A

* With hexagon socket head cap screws (2 pcs.) and spring washers (2 pcs.)



Membrane Air Dryer/Single Unit Type IDG Series

Standard dew point -20°C , -15°C



More for the specifications and dimensions

How to Order

IDG 10 - - 02 - -

Size

3
5
10
20
60
75
100

Standard dew point temperature/Outlet air flow rate

Symbol	Standard dew point [°C]	Flow rate by size, Outlet air flow rate [L/min (ANR)]						
		3	5	10	20	60	75	100
Nil	-20	25	50	100	200	600	750	1000
H	-15	25	50	100	200	600	750	1000
L	-40	—	—	—	—	Select from IDG□A Series (Web Catalog)		
S	-60	—	—	—	—			

Thread type/One-touch fitting

Symbol	Type
Nil	Rc
N	NPT
F	G

Accessory

Symbol	Specifications
Nil	None (Standard)
B	With bracket (Excludes the IDG1)

* When symbol: B is indicated, a bracket assembly with a part number shown to the left below is included as an accessory.

Port size/Applicable tubing O.D.

Symbol	Port size	Piping type	Size						
			3	5	10	20	60	75	100
01	1/8	Thread	●	●	—	—	—	—	—
02	1/4		●	●	●	●	—	—	—
03	3/8		—	—	●	●	●	—	—
04	1/2		—	—	—	—	●	●	●

Semi-standard

Symbol	Specifications	Size						
		3	5	10	20	60	75	100
Nil	None (Standard)	●	●	●	●	●	●	●
R	Flow direction (Right → Left)	●	●	●	●	●	●	●
S	With dew point indicator	●	●	Standard equipment				

* In the case of more than one symbol, indicate them alphabetically.

Bracket Assembly (Accessory)/Part No.

Part no.	Applicable model
BM59	IDG3, 5
BM61	IDG10
BM63	IDG20
BM65	IDG60, 75, 100

* With hexagon socket head cap screws (2 pcs.) and spring washers (2 pcs.)



Air Preparation Equipment
Pressure Control Equipment/Others

Fittings and Tubing

Flow Control Equipment

Pressure Gauges

Switches/Sensors

Process Valves

Directional Control Valves



Regulator

HF1-AR20-D to HF1-AR60-D



Regulator with Backflow Function

HF1-AR20K-D to HF1-AR60K-D



More for the specifications and dimensions

Models with the backflow function include a mechanism which allows for the air pressure in the outlet side to be released to the inlet side.

Example 1)
When the pressure in the rear and the front of the cylinder differs:

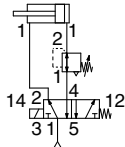

Example 2)
When the air supply is cut off and releasing the inlet pressure to the atmosphere, the residual pressure release of the outlet side can be ensured for a safety purpose.

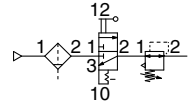

How to Order

HF1 - AR **30** - **03** **BE** - **D**

Option/Semi-standard: Select one each for a to g.
Option/Semi-standard symbol:
When more than one specification is required, indicate in alphanumeric order.
Example) HF1-AR30K-03BE-1NR-D

	Symbol	Description	① Body size						
			20	30	40	50	60		
② With backflow function	Nil	Without backflow function	●	●	●	●	●		
	K*1	With backflow function	●	●	●	●	●		
+									
③ Pipe thread type	Nil	Rc	●	●	●	●	●		
	N	NPT	●	●	●	●	●		
	F	G	●	●	●	●	●		
+									
④ Port size	01	1/8	●	—	—	—	—		
	02	1/4	●	●	●	—	—		
	03	3/8	—	●	●	—	—		
	04	1/2	—	—	●	—	—		
	06	3/4	—	—	●	●	—		
	10	1	—	—	—	●	●		
+									
⑤ Option*2	a Mounting	Nil	Without mounting option	●	●	●	●	●	
		B*3	With bracket	●	●	●	●	●	
		H	With set nut (for panel mount)	●	●	●	—	—	
	+								
	b Pressure gauge*4	Nil	Without pressure gauge	●	●	●	●	●	
		E	Square embedded type pressure gauge (with limit indicator)	●	●	●	●	●	
		G	Round type pressure gauge (with limit indicator)	●	●	●	●	●	
		M	Round type pressure gauge (with color zone)	●	●	●	●	●	
		Digital pressure switch*5	E1	Output: NPN output, Electrical entry: Wiring bottom entry	●	●	●	●	●
			E2	Output: NPN output, Electrical entry: Wiring top entry	●	●	●	●	●
E3			Output: PNP output, Electrical entry: Wiring bottom entry	●	●	●	●	●	
E4	Output: PNP output, Electrical entry: Wiring top entry		●	●	●	●	●		

Regulator **HF1-AR20-D to HF1-AR60-D Series**
 Regulator with Backflow Function **HF1-AR20K-D to HF1-AR60K-D Series**



HF1-AR30-D

⚠ Caution

Round type pressure gauge and square embedded type pressure gauge are standard. Refer to pages 43 and 44.
 Please refer to pages 45 to 47 for non-grease type.
 ISE35-X528 is used as the digital pressure switch. Refer to page 52.

	Symbol	Description	①					
			Body size					
			20	30	40	50	60	
⑥ Semi-standard	c	Set pressure*6	Nil	0.05 to 0.85 MPa setting				
			1	0.02 to 0.2 MPa setting				
	d	Exhaust mechanism	Nil	Relieving type				
			N	Non-relieving type				
	e	Flow direction	Nil	Flow direction: Left to right				
			R	Flow direction: Right to left				
	f	Knob	Nil	Downward				
			Y	Upward				
	g	Unit	Nil	Unit on product label: MPa, Pressure gauge in SI units: MPa				
			Z*7	Unit on product label: psi, Pressure gauge: MPa/psi dual scale				
			ZA*8	Digital pressure switch: With unit selection function				
				●	●	●	●	●
			○*9	○*9	○*9	○*9	○*9	
			△*10	△*10	△*10	△*10	△*10	

- *1 Set the inlet pressure to at least 0.05 MPa higher than the set pressure.
- *2 Options B, G, H, and M are not assembled and supplied loose at the time of shipment.
- *3 The assembly consists of a bracket and set nuts (applicable to the HF1-AR20(K)-D to HF1-AR40(K)-D).
 For the HF1-AR50(K)-D and HF1-AR60(K)-D, the assembly consists of 2 types of the bracket and 2 mounting screws.
- *4 When the pressure gauge is attached, a 1.0 MPa pressure gauge will be fitted for standard (0.85 MPa) type. 0.4 MPa pressure gauge for 0.2 MPa type.
- *5 When choosing with H (panel mount), the installation space for lead wires will not be secured. In this case, select "wiring top entry" for the electrical entry. (Select "wiring bottom entry" when the semi-standard Y is chosen simultaneously.)
- *6 Pressure can be set higher than the specification pressure in some cases, but use pressure within the specification range.
- *7 For the pipe thread type: NPT
 This product is for overseas use only according to the New Measurement Act. (The SI unit type is provided for use in Japan.) Cannot be used with M: Round type pressure gauge (with color zone). Available by request for special. The digital pressure switch will be equipped with the unit selection function, setting to psi initially.
- *8 For options: E1, E2, E3, E4
 This product is for overseas use only according to the New Measurement Act. (The SI unit type is provided for use in Japan.)
- *9 ○: For the pipe thread type: NPT only
- *10 △: Select with options: E1, E2, E3, E4.

Air Preparation Equipment
Pressure Control Equipment/Others

Fittings and Tubing

Flow Control Equipment

Pressure Gauges

Switches/Sensors

Process Valves

Directional Control Valves



Filter Regulator

HF1-AW20-D to HF1-AW60-D



Filter Regulator with Backflow Function

HF1-AW20K-D to HF1-AW60K-D



More for the specifications and dimensions

- Integrated filter and regulator units save space and require less piping.
- Models with the backflow function include a mechanism which allows for the air pressure in the outlet side to be released to the inlet side.

Example)

When the air supply is cut off and releasing the inlet pressure to the atmosphere, the residual pressure release of the outlet side can be ensured for a safety purpose.

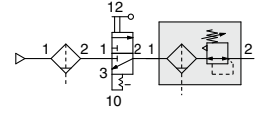

How to Order

HF1 - AW **30** **□** - **□** **03** **BE** - **□** - D

① ② ③ ④ ⑤ ⑥

- Option/Semi-standard: Select one each for a to i.
 - Option/Semi-standard symbol: When more than one specification is required, indicate in alphanumeric order.
- Example) HF1-AW30K-03BE-1NR-D

	Symbol	Description	① Body size					
			20	30	40	60		
② With backflow function	Nil	Without backflow function	●	●	●	●		
	K*1	With backflow function	●	●	●	●		
③ Pipe thread type	Nil	Rc	●	●	●	●		
	N	NPT	●	●	●	●		
	F	G	●	●	●	●		
④ Port size	01	1/8	●	—	—	—		
	02	1/4	●	●	●	—		
	03	3/8	—	●	●	—		
	04	1/2	—	—	●	—		
	06	3/4	—	—	●	●		
	10	1	—	—	—	●		
⑤ Option*2	a Mounting	Nil	Without mounting option	●	●	●	●	
		B*3	With bracket	●	●	●	●	
		H	With set nut (for panel mount)	●	●	●	—	
	b Float type auto drain*4	Nil	Without auto drain	●	●	●	●	
		C*5	N.C. (Normally closed) Drain port is closed when pressure is not applied.	●	●	●	●	
		D*6	N.O. (Normally open) Drain port is open when pressure is not applied.	—	●	●	●	
	c Pressure gauge*7	Nil	Without pressure gauge	●	●	●	●	
		E	Square embedded type pressure gauge (with limit indicator)	●	●	●	●	
		G	Round type pressure gauge (with limit indicator)	●	●	●	●	
		M	Round type pressure gauge (with color zone)	●	●	●	●	
		Digital pressure switch*8	E1	Output: NPN output, Electrical entry: Wiring bottom entry	●	●	●	●
			E2	Output: NPN output, Electrical entry: Wiring top entry	●	●	●	●
E3			Output: PNP output, Electrical entry: Wiring bottom entry	●	●	●	●	
E4	Output: PNP output, Electrical entry: Wiring top entry		●	●	●	●		
⑥ Semi-standard	d Set pressure*9	Nil	0.05 to 0.85 MPa setting	●	●	●	●	
		1	0.02 to 0.2 MPa setting	●	●	●	●	
	e Bowl*10	Nil	Polycarbonate bowl	●	●	●	●	
		2	Metal bowl	●	●	●	●	
		6	Nylon bowl	●	●	●	●	
		8	Metal bowl with level gauge	—	—	—	—	
C		With bowl guard	●	_*11	_*11	_*11		
6C		With bowl guard (Nylon bowl)	●	_*12	_*12	_*12		
f Drain port*13	Nil	With drain cock	●	●	●	●		
	J*14	Drain guide 1/8	●	—	—	—		
		Drain guide 1/4	—	●	●	●		
	W*15	Drain cock with barb fitting	—	●	●	●		

Filter Regulator **HF1-AW20-D to HF1-AW60-D Series**

Filter Regulator with Backflow Function **HF1-AW20K-D to HF1-AW60K-D Series**

⚠ Caution

Round type pressure gauge and square embedded type pressure gauge are standard. Refer to pages 43 and 44.

Please refer to pages 45 to 47 for non-grease type.

ISE35-X528 is used as the digital pressure switch. Refer to page 52.



HF1-AW30-D

		Symbol	Description	①					
				Body size					
				20	30	40	60		
⑥	Semi-standard	g	Exhaust mechanism	Nil	Relieving type	●	●	●	●
				N	Non-relieving type	●	●	●	●
			+						
	h	Flow direction	Nil	Flow direction: Left to right	●	●	●	●	
			R	Flow direction: Right to left	●	●	●	●	
		+							
	i	Unit	Nil	Unit on product label: MPa, °C, Pressure gauge in SI units: MPa	●	●	●	●	
			Z*16	Unit on product label: psi, °F, Pressure gauge: MPa/psi dual scale	○*18	○*18	○*18	○*18	
			ZA*17	Digital pressure switch: With unit selection function	△*19	△*19	△*19	△*19	

- *1 Set the inlet pressure to at least 0.05 MPa higher than the set pressure.
- *2 Options B, G, H, and M are not assembled and supplied loose at the time of shipment.
- *3 The assembly consists of a bracket and set nuts (applicable to the HF1-AW20(K)-D to HF1-AW40(K)-D).
For the HF1-AW60(K)-D, the assembly consists of 2 types of the bracket and 2 mounting screws.
- *4 The auto drain port is ø10 One-touch fitting (● Pipe thread type: Rc, G) or ø3/8" One-touch fitting (● Pipe thread type: NPT)
- *5 When pressure is not applied, condensate which does not start the auto drain mechanism will be left in the bowl. Releasing the residual condensate before ending operations for the day is recommended.
- *6 If the compressor is small (0.75 kW, discharge flow is less than 100 L/min (ANR)), air leakage from the drain cock may occur during the start of operations. N.C. type is recommended.
- *7 When the pressure gauge is attached, a 1.0 MPa pressure gauge will be fitted for standard (0.85 MPa) type. 0.4 MPa pressure gauge for 0.2 MPa type.
- *8 When choosing with H (panel mount), the installation space for lead wires will not be secured. In this case, select "wiring bottom entry" for the electrical entry.

- *9 Pressure can be set higher than the specification pressure in some cases, but use pressure within the specification range.
- *10 Refer to chemical data in the **Web Catalog** for chemical resistance of the bowl.
- *11 A bowl guard is provided as standard equipment (polycarbonate).
- *12 A bowl guard is provided as standard equipment (nylon).
- *13 The combination of float type auto drain C and D is not available.
- *14 Without a valve function. The mounting screws are the same as the thread of ●.
- *15 The combination of metal bowl 2 and 8 is not available.
- *16 For the pipe thread type: NPT. This product is for overseas use only according to the New Measurement Act. (The SI unit type is provided for use in Japan.)
Cannot be used with M: Round type pressure gauge (with color zone). Available by request for special. The digital pressure switch will be equipped with the unit selection function, setting to psi initially.
- *17 For options: E1, E2, E3, E4
This product is for overseas use only according to the New Measurement Act. (The SI unit type is provided for use in Japan.)
- *18 ○: For the pipe thread type: NPT only
- *19 △: Select with options: E1, E2, E3, E4.

Air Preparation Equipment
Pressure Control Equipment/Others

Fittings and Tubing

Flow Control
Equipment

Pressure Gauges

Switches/Sensors

Process Valves

Directional
Control Valves



Precision Regulator

HF1-IR1000-A/2000-A/3000-A



More for the specifications and dimensions

How to Order



HF1-IR **1** **0** **0** **0** - **01** **B** - - **A**

①
②
③
④
⑤
⑥
⑦

- Option/Semi-standard: Select one each for a to d.
- Option/Semi-standard symbol: When more than one specification is required, indicate in alphanumeric order.

		Symbol	Description	①				
				Body size				
				1	2	3		
②	Set pressure range	0	0.005 to 0.2 MPa	●	●	—		
			0.01 to 0.2 MPa	—	—	●		
		1	0.01 to 0.4 MPa	●	●	●		
			0.01 to 0.8 MPa	●	●	●		
③	Exhaust direction	+	0	Bottom exhaust	●	●	●	
			1	Front exhaust	—	—	●	
			2	Rear exhaust	—	—	●	
④	Pipe thread type	+	Nil	Rc	●	●	●	
			N	NPT	●	●	●	
			F	G	●	●	●	
⑤	Port size	+	01	1/8	●	—	—	
			02	1/4	—	●	●	
			03	3/8	—	—	●	
			04	1/2	—	—	●	
⑥	a	Mounting	Nil	Without mounting option	●	●	●	
			B*2	With bracket	●	●	●	
			H	With hexagon panel nut (for panel mount)	●	●	●	
	b	Pressure gauge	+	Nil	Without pressure gauge	●	●	●
				G	Round type pressure gauge	●	●	●
		With digital pressure switch	+	EA	NPN open collector 1 output	●	●	●
				EB	PNP open collector 1 output	●	●	●
				EC	NPN open collector 2 outputs + Analog voltage output	●	●	●
				ED	NPN open collector 2 outputs + Analog current output	●	●	●
⑦	c	Flow direction	Nil	Flow direction: Left to right	●	●	●	
			R	Flow direction: Right to left	●	●	●	
d	Knob	+	Nil	Upward	●	●	●	
			V	Downward	●	●	●	

*1 Options are not assembled and supplied loose at the time of shipment. B and H cannot be selected at the same time. The previous bracket cannot be used for this product.

*2 The assembly consists of a bracket and set nuts.



Clean Regulator

SRH Series



More for the specifications and dimensions

How to Order

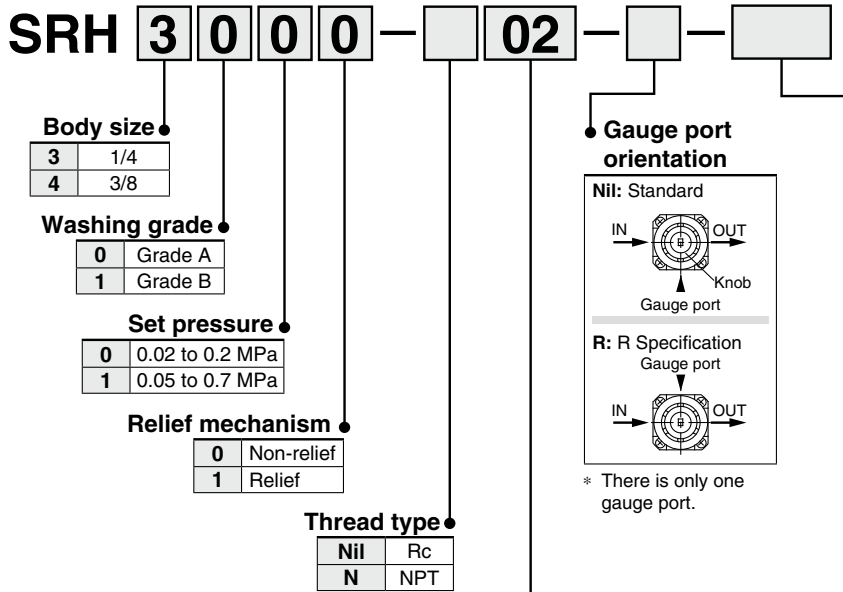

Gauge port orientation

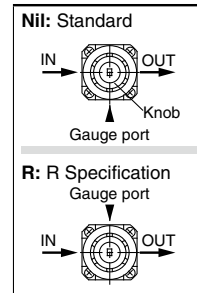

* There is only one gauge port.

Made to Order

Refer to the **Web Catalog** for details.

X210	EPDM seals
X211	With relief port fittings (Applicable tube O.D.: ø4)
X216	Machined relief port M5 thread
X233	Knob operation product with reduced torque
X234	Aluminum body

Symbol	Piping port size	SRH3000	SRH4000
01	1/8	●	—
02	1/4	●	●
03	3/8	—	●
04	1/2	—	●
A2	With metal gasket seal fitting	URJF 1/4	—
A3	With metal gasket seal fitting	—	URJF 3/8

* The pressure gauge is optional. Refer to the option specifications below. Note that the products used for the port size A2 or A3 are not available at SMC.

Options

Pressure Gauge

Specifications

Item	Model	G46-□-02-SRA	G46-□-02-SRB
Port size		R1/4	
Operating temperature range		0 to 60°C (No freezing)	
Accuracy		± 3%F.S.	
Scale range		270°	
Parts washing (fluid-contact parts)		Precision wash	General degrease
Assembly and adjustment environment		Clean room	General production line
Oil free/Water free		Non-lube / Non-wet	
Materials	Fluid-contact parts	Stainless steel 316	
	Case	Stainless steel 304 (Black melamine coating)	
	Clear cover	Polycarbonate (Hard coated)	Part No. G46-00-00-2
	Internal parts	Brass	
Weight		80 g	

Air Preparation Equipment
Pressure Control Equipment/Others

Fittings and Tubing

Flow Control Equipment

Pressure Gauges

Switches/Sensors

Process Valves

Directional Control Valves



Single Action

HF1-VHS20/30/40/50-D Series

Double Action

HF1-VHS20W/30W/40W/50W-D Series



More for the specifications and dimensions



HF1-VHS30-D

How to Order

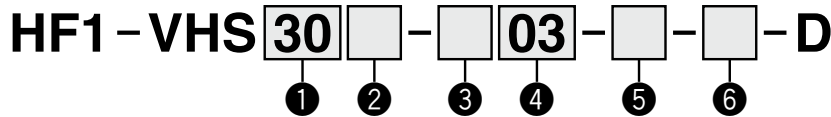

· Option/Semi-standard: Select one each for a to f.
 · Option/Semi-standard symbol:
 When more than one specification is required, indicate in alphanumeric order.
 Example) HF1-VHS30-N03-BS-RZ-D

		Symbol	Description	①				
				Body size				
				20	30	40	50	
②	Handle operation	Nil	Single action	●	●	●	●	
		W	Double action	●	●	●	●	
		+						
③	Pipe thread type	Nil	Rc*1	●	●	●	●	
		N	NPT	●	●	●	●	
		F	G	●	●	●	●	
		+						
④	Port size	01	1/8	●	—	—	—	
		02	1/4	●	●	●	—	
		03	3/8	—	●	●	—	
		04	1/2	—	—	●	—	
		06	3/4	—	—	●	●	
		10	1	—	—	—	●	
		+						
⑤	a	Mounting	Nil	Without mounting option	●	●	●	●
			B	With bracket	●	●	●	●
		+						
b	Silencer	Nil	Without silencer	●	●	●	●	
		S	With built-in silencer (for EXH port)	●	●	●	●	
		+						
⑥	c	Handle color	Nil	Red	●	●	●	●
			K	Black	●	●	●	●
			+					
	d	Handle material	Nil	Resin	●	●	●	●
			M	Metal	●	●	●	●
			+					
e	Flow direction	Nil	Flow direction: Left to right	●	●	●	●	
		R	Flow direction: Right to left	●	●	●	●	
		+						
f	Pressure unit	Nil	Product label in SI units: MPa	●	●	●	●	
		Z*2	Product label in imperial units: psi	○*3	○*3	○*3	○*3	

*1 The pipe thread type for the EXH port is G.
 *2 For the pipe thread type: NPT only. This product is for overseas use only according to the New Measurement Act. (The SI unit type is provided for use in Japan.)
 *3 ○: For the pipe thread type: NPT only

HF1

HF2

HF1 compatible

HF2 compatible

*1

Fittings

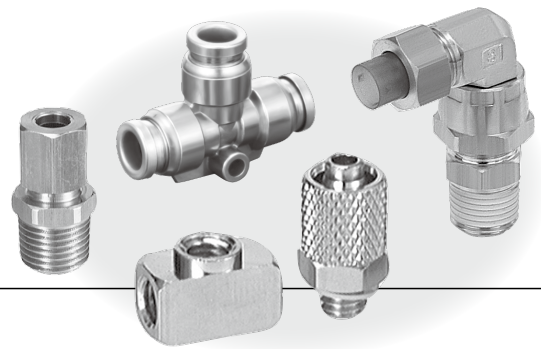

*1 Only EHEDG compliant/Clean design/FDA compliant fittings

Insert Fittings KF

RoHS

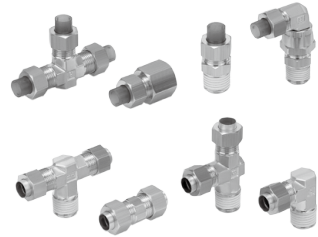

- -101.3 kPa applicable
- Piping can be done without removing the nut.
- Fluid temperature: -5 to 150°C (Brass sleeve)
-5 to 60°C (Resin sleeve)
- Steam can be used.
- Grease-free

Series	Applicable tubing O.D.	Connection thread
KF	ø4, ø6, ø8, ø10, ø12	1/8, 1/4, 3/8, 1/2

Miniature Fittings M

RoHS



- Compact and doesn't require tools for connection
- Compact piping space
- Hose nipple, Hose elbow, Barb

Series	Applicable tubing O.D.	Connection thread
M-□□-2	ø2	M3, M5
M	ø3.2, ø4, ø6	M3, M5, 1/8

Self-align Fittings H/DL/L/LL

RoHS

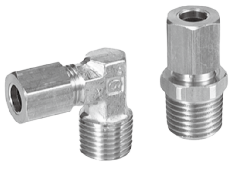

- Applicable for use on soft copper steel pipes
- Flared ridge metal ferrule

Series	Applicable tubing O.D.	Connection thread
H	ø4, ø6, ø8, ø10, ø12	1/8, 1/4, 3/8, 1/2
DL	ø4, ø6, ø8, ø10, ø12	1/8, 1/4, 3/8, 1/2
L	ø4, ø6, ø8, ø10, ø12	1/8, 1/4, 3/8, 1/2
LL	ø4, ø6, ø8, ø10, ø12	1/8, 1/4, 3/8, 1/2

Stainless Steel 316 One-touch Fittings KQG2

RoHS



- Compact and lightweight
 - Fluid temperature: -5 to 150°C
 - Materials: Metal parts stainless steel 316, seal parts special FKM
 - Grease-free/Can be used with steam
- Certified to meet current Food Sanitation Law standards

Series	Size	Applicable tubing O.D.	Connection thread
KQG2	Metric	ø3.2, ø4, ø6, ø8, ø10, ø12, ø16	M5 R, Rc 1/8, 1/4, 3/8, 1/2
KQG2	Inch	ø1/8", ø5/32", ø1/4", ø5/16", ø3/8", ø1/2"	UNF10-32 NPT1/8, 1/4, 3/8, 1/2

Air Preparation Equipment
Pressure Control Equipment/Others

Fittings and Tubing

Flow Control
Equipment

Pressure Gauges

Switches/Sensors

Process Valves

Directional
Control Valves

HF1

HF2

HF1 compatible

HF2 compatible

*1

Fittings

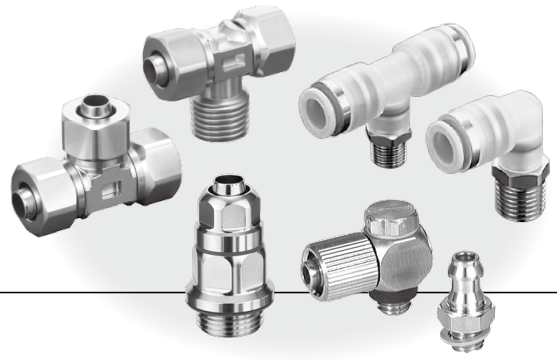

*1 Only EHEDG compliant/Clean design/FDA compliant fittings

Stainless Steel 316 Insert Fittings KFG2

RoHS



- Compact and lightweight
 - Fluid temperature: -65 to 260°C (Swivel elbow: -5 to 150°C)
 - Material: Stainless steel 316 Rubber materials are not used. (Excluding the swivel elbow)
 - Grease-free/Can be used with steam
- Certified to meet current Food Sanitation Law standards

Series	Size	Tubing O.D. x I.D.	Connection thread
KFG2	Metric	ø4 x ø2.5, ø4 x ø3, ø6 x ø4, ø8 x ø6, ø10 x ø7.5, ø10 x ø8, ø12 x ø9, ø12 x ø10, ø16 x ø13	R, Rc 1/8, 1/4, 3/8, 1/2
KFG2	Inch	ø1/8" x ø0.086", ø5/32" x 0.098", ø1/4" x ø5/32", ø5/16" x 0.236", ø3/8" x ø1/4", ø1/2" x ø3/8"	NPT1/8, 1/4, 3/8, 1/2

Miniature Fittings Stainless Steel 316 MS

RoHS



- Can be used in corrosive conditions
- Compact piping space
- Hose nipple, Hose elbow, Barb

Series	Applicable tubing O.D.	Connection thread
MS	ø3.2, ø4, ø6	M5

Clean One-touch Fittings for Driving Air Piping KPQ/KPG

RoHS



- One-touch fittings suitable for driveline air systems in clean room environments
- Resin parts: Polypropylene
- All metal portions: Brass (Electroless nickel-plated) KPQ
Stainless steel (Stainless steel 304) KPG

Series	Applicable tubing O.D.	Connection thread
KPQ	ø4, ø6, ø8, ø10, ø12	M5, 1/8, 1/4, 3/8, 1/2
KPG	ø4, ø6, ø8, ø10, ø12	M5, 1/8, 1/4, 3/8, 1/2

EHEDG Compliant/Clean Design/FDA Compliant Fittings KFG2H□-E/KFG2H□-C/KQ□2-F KFG2-F

RoHS



EHEDG compliant fittings Clean design fittings

- Hygienic design prevents liquid from accumulating after cleaning (EHEDG compliant, Clean design fittings)
- FDA compliant materials



FDA compliant fittings



Type	Series	Description	Thread type
EHEDG compliant	KFG2H□-E	Stainless steel 316 insert fittings	M, G thread
Clean design	KFG2H□-C	Stainless steel 316 insert fittings	M, G thread
FDA compliant	KQG2-F	Stainless steel 316 One-touch fittings	M, R, Rc, UNF, NPT, G
FDA compliant	KQB2-F	Metal One-touch fittings	M, R, Rc, UNF, NPT, G
FDA compliant	KFG2-F	Stainless steel 316 insert fittings	R, Rc, NPT, G



Nylon Tubing

T/TIA Series

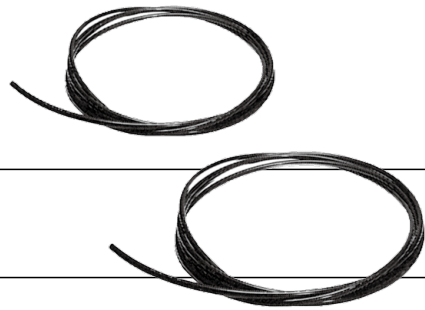

More for the specifications and dimensions

Model

● — 20 m roll □ — 100 m roll (T1613 is reel.)

Model	Tubing size												
	Metric size (T series)						Inch size (TIA series)						
	T0425	T0403	T0604	T0645	T0806	T1075	T1209	T1613	TIA01	TIA05	TIA07	TIA11	TIA13
Tubing O.D. [mm]	4	4	6	6	8	10	12	16	3.18	4.76	6.35	9.53	12.7
Tubing I.D. [mm]	2.5	3	4	4.5	6	7.5	9	13	2.18	3.48	4.57	6.99	9.56
Black (B)	●	●	●	●	●	●	●	●	●	●	●	●	●
White (W)	●	●	●	●	●	●	●	□	●	●	●	●	●
Red (R)	●	●	●	●	●	●	●	●	●	●	●	●	●
Blue (BU)	●	●	●	●	●	●	●	●	●	●	●	●	●
Yellow (Y)	●	●	●	●	●	●	●	●	●	●	●	●	●
Green (G)	●	●	●	●	●	●	●	●	●	●	●	●	●
	5/32"		5/16"			Nominal size (inch)							
						1/8" 3/16" 1/4" 3/8" 1/2"							
						Nominal size (mm)							
						3.2							

How to Order

T0425 **B** - **20**

Tubing model

Color

Symbol	Color
B	Black (Opaque)
W	White (Material color)
R	Red (Opaque)
BU	Blue (Opaque)
Y	Yellow (Opaque)
G	Green (Opaque)

Length per roll

Symbol	Length
20	20 m roll
100	100 m roll (Black and white only)

Air Preparation Equipment
Pressure Control Equipment/Others

Fittings and Tubing

Flow Control
Equipment



Soft Nylon Tubing

TS/TISA Series

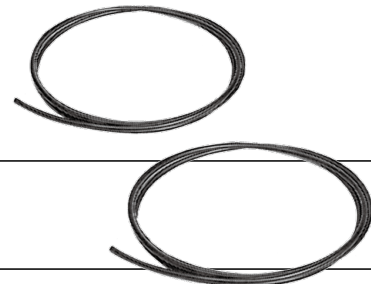

More for the specifications and dimensions

Model

● — 20 m roll □ — 100 m roll (TS1612 is reel.)

Model	Tubing size											
	Metric size (TS series)						Inch size (TISA series)					
	TS0425	TS0604	TS0806	TS1075	TS1209	TS1612	TISA01	TISA05	TISA07	TISA11	TISA13	
Tubing O.D. [mm]	4	6	8	10	12	16	3.18	4.76	6.35	9.53	12.7	
Tubing I.D. [mm]	2.5	4	6	7.5	9	12	2.18	3.48	4.57	6.99	9.56	
Black (B)	●	●	●	●	●	●	●	●	●	●	●	
White (W)	●	●	●	●	●	□	●	●	●	●	●	
Red (R)	●	●	●	●	●	●	●	●	●	●	●	
Blue (BU)	●	●	●	●	●	●	●	●	●	●	●	
Yellow (Y)	●	●	●	●	●	●	●	●	●	●	●	
Green (G)	●	●	●	●	●	●	●	●	●	●	●	
	5/32"		5/16"			Nominal size (inch)						
						1/8" 3/16" 1/4" 3/8" 1/2"						
						Nominal size (mm)						
						3.2						

How to Order

TS0604 **W** - **20**

Tubing model

Color

Symbol	Color
B	Black (Opaque)
W	White (Material color)
R	Red (Opaque)
BU	Blue (Opaque)
Y	Yellow (Opaque)
G	Green (Opaque)

Length per roll

Symbol	Length
20	20 m roll
100	100 m roll (Black and white only)

Pressure Gauges

Switches/Sensors

Process Valves

Directional
Control Valves

HF1

HF2

HF1 compatible

HF2 compatible

Polyurethane Tubing

TU/TIUB Series

RoHS



More for the specifications and dimensions

Model/Specifications

● — 20 m roll □ — 100 m roll (TU1610 is reel.) ◇ — 100 m roll, 200 m roll
 △ — Option ■ — Manufactured upon receipt of order (Please consult with SMC.)

Model	Tubing size											
	Metric size (TU series)						Inch size (TIUB series)					
	TU0212	TU0425	TU0604	TU0805	TU1065	TU1208	TU1610	TIUB01	TIUB05	TIUB07	TIUB11	TIUB13
Tubing O.D. [mm]	2	4	6	8	10	12	16	3.18	4.76	6.35	9.53	12.7
Tubing I.D. [mm]	1.2	2.5	4	5	6.5	8	10	2	3.18	4.23	6.35	8.46
Black (B)	●	◇	◇	●	●	●	●	●	●	●	●	●
White (W)	●	◇	◇	●	●	●	□	●	△	△	△	△
Red (R)	●	◇	◇	●	●	●	■	●	△	△	△	△
Blue (BU)	●	◇	◇	●	●	●	□	●	●	●	●	●
Yellow (Y)	●	◇	◇	●	●	●	■	●	△	△	△	△
Green (G)	●	◇	◇	●	●	●	■	●	△	△	△	△
Clear (C)	●	◇	◇	●	●	●	□	●	△	△	△	△
Orange (YR)	●	◇	◇	●	●	●	■	●	△	△	△	△
Solid blue (BU1)	■	●	●	●	●	●	■	●	■	■	■	■
Clear blue (BU2)	■	●	●	●	●	●	■	●	■	■	■	■
Medium blue (BU3)	■	●	●	●	●	●	■	●	■	■	■	■
Brown (BR1)	■	●	●	●	●	●	■	●	■	■	■	■
Solid green (G1)	■	●	●	●	●	●	■	●	■	■	■	■
Clear green (G2)	■	●	●	●	●	●	■	●	■	■	■	■
Neon green (G3)	■	●	●	●	●	●	■	●	■	■	■	■
Dark green (G4)	■	●	●	●	●	●	■	●	■	■	■	■
Gray (GR1)	■	●	●	●	●	●	■	●	■	■	■	■
Light gray (GR2)	■	●	●	●	●	●	■	●	■	■	■	■
Neon pink (P1)	■	●	●	●	●	●	■	●	■	■	■	■
Solid purple (PU1)	■	●	●	●	●	●	■	●	■	■	■	■
Clear purple (PU2)	■	●	●	●	●	●	■	●	■	■	■	■
Solid red (R1)	■	●	●	●	●	●	■	●	■	■	■	■
Clear red (R2)	■	●	●	●	●	●	■	●	■	■	■	■
Silver (S1)	■	●	●	●	●	●	■	●	■	■	■	■
Solid yellow (Y1)	■	●	●	●	●	●	■	●	■	■	■	■
Clear yellow (Y2)	■	●	●	●	●	●	■	●	■	■	■	■
Neon yellow (Y3)	■	●	●	●	●	●	■	●	■	■	■	■
Clear orange (YR1)	■	●	●	●	●	●	■	●	■	■	■	■
Neon orange (YR2)	■	●	●	●	●	●	■	●	■	■	■	■

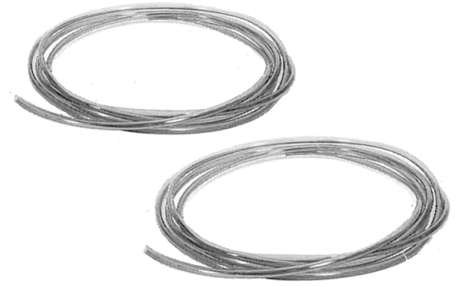

How to Order

TU0425 BU - 20

Tubing model

Length per roll

Symbol	Length
20	20 m roll
100	100 m roll
200	200 m roll

Color

Symbol	Color	Symbol	Color
B	Black (Opaque)	GR1	Gray (Opaque)
W	White (Opaque)	GR2	Light gray (Opaque)
R	Red (Translucent)	P1	Neon pink (Opaque)
BU	Blue (Translucent)	PU1	Solid purple (Opaque)
Y	Yellow (Opaque)	PU2	Clear purple (Translucent)
G	Green (Opaque)	R1	Solid red (Opaque)
C	Clear (Material color)	R2	Clear red (Translucent)
YR	Orange (Opaque)	S1	Silver (Opaque)
BU1	Solid blue (Opaque)	Y1	Solid yellow (Opaque)
BU2	Clear blue (Translucent)	Y2	Clear yellow (Translucent)
BU3	Medium blue (Opaque)	Y3	Neon yellow (Opaque)
BR1	Brown (Opaque)	YR1	Clear orange (Translucent)
G1	Solid green (Opaque)	YR2	Neon orange (Opaque)
G2	Clear green (Translucent)		
G3	Neon green (Opaque)		
G4	Dark green (Opaque)		

Made to Order

(Please contact SMC for detailed specifications, dimensions, delivery times, and specifications other than those mentioned above.)

Compatible with the Food Sanitation Law

Metric size: Suffix "-X217" to the end of part number. Ex.) TU0425BU-20-X217

FDA (U.S. Food and Drug Administration) In compliance with the EU No10/2011 dissolution test

Metric size: Suffix "-X214" to the end of part number. Ex.) TU0425BU-20-X214

Made to Order Availability

Part no.	Length	Model										Color
		TU0425	TU0604	TU0805	TU1065	TU1208	TIUB01	TIUB05	TIUB07	TIUB11	TIUB13	
X217*1	20 m roll	○	○	○	○	○						Black, White, Blue, Clear
X214*1	20 m roll	○	○	○	○	○						Black, White, Red, Blue, Yellow, Green, Clear, Orange

*1 Note that the model number is not printed on the tube body.

Air Preparation Equipment
Pressure Control Equipment/Others

Fittings and Tubing

Flow Control Equipment

Pressure Gauges

Switches/Sensors

Process Valves

Directional Control Valves



FDA (U.S. Food and Drug Administration) and (EU) No 10/2011 Compliant Polyurethane Tubing



More for the specifications and dimensions

In compliance with the FDA's (U.S. Food and Drug Administration) § 177.2600 dissolution test and the (EU) No 10/2011 dissolution test

Model

● - 20 m roll

Model	Tubing size (Metric size)				
	TU0425	TU0604	TU0805	TU1065	TU1208
O.D. [mm]	4	6	8	10	12
I.D. [mm]	2.5	4	5	6.5	8
Black (B)	●	●	●	●	●
White (W)	●	●	●	●	●
Red (R)	●	●	●	●	●
Blue (BU)	●	●	●	●	●
Yellow (Y)	●	●	●	●	●
Green (G)	●	●	●	●	●
Clear (C)	●	●	●	●	●
Orange (YR)	●	●	●	●	●



How to Order

TU0425 BU - 20 - X214

● Tubing model

Model	O.D. x I.D. [mm]
TU0425	4 x 2.5
TU0604	6 x 4
TU0805	8 x 5
TU1065	10 x 6.5
TU1208	12 x 8

● FDA (U.S. Food and Drug Administration) and (EU) No 10/2011 compliant

● 20 m roll

● Color

Symbol	Color	Symbol	Color
B	Black (Opaque)	Y	Yellow (Opaque)
W	White (Opaque)	G	Green (Opaque)
R	Red (Translucent)	C	Clear (Material color)
BU	Blue (Translucent)	YR	Orange (Opaque)

* Note that the model number is not printed on the tube body.

HF1

HF2

HF1
compatible

HF2
compatible

Polyurethane Flat Tubing Multi-core, Multi-color Specification

TU Series

RoHS



More for the specifications
and dimensions

Specifications

Model	TU0212	TU0425	TU0604	TU0805	TU1065	TU1208
Tubing O.D. [mm]	2	4	6	8	10	12
Tubing I.D. [mm]	1.2	2.5	4	5	6.5	8
Black (B)	●	●	●	●	●	●
White (W)	●	●	●	●	●	●
Red (R)	●	●	●	●	●	●
Blue (BU)	●	●	●	●	●	●
Yellow (Y)	●	●	●	●	●	●
Green (G)	●	●	●	●	●	●
Clear (C)	●	●	●	●	●	●
Orange (YR)	●	●	●	●	●	●
Number of cores	2 cores	X169 (Roll)/X200 (Reel)				
	3 cores	X170 (Roll)/X201 (Reel)				
	4 cores	X171 (Roll)/X202 (Reel)				
	5 cores	X172 (Roll)/X203 (Reel)				
	6 cores	X204 (Roll)/X207 (Reel)				



Air Preparation Equipment
Pressure Control Equipment/Others

Fittings and Tubing

Flow Control
Equipment

Pressure Gauges

Switches/Sensors

Process Valves

Directional
Control Valves

How to Order

Roll

Please contact SMC for delivery times.

Tube length per roll: **1, 2, 3, 4, 5, 10, 20** m

TU 0425 - 12345 A - X172

• Tubing model

• Tubing size

Symbol	O.D. x I.D.
0212	ø2 x ø1.2
0425	ø4 x ø2.5
0604	ø6 x ø4
0805	ø8 x ø5
1065	ø10 x ø6.5
1208	ø12 x ø8

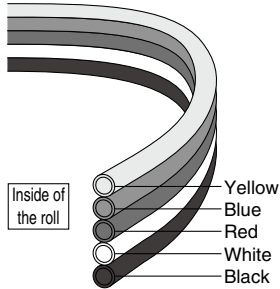

• Color*1

Symbol	Color	Symbol	Color
1	Black	5	Yellow
2	White	6	Green
3	Red	7	Clear
4	Blue	8	Orange*2

*1 Colors of the example (12345)
*2 Excludes the TU0212

• Multi-core, multi-color specification

Symbol	Number of cores
X169	2 cores
X170	3 cores
X171	4 cores
X172	5 cores
X204	6 cores

• Tube length per roll [m]

Symbol	Length	Symbol	Length
A	1	E	5
B	2	F	10
C	3	G	20
D	4		

Tube length per roll: **50** m

TU 0425 - 12345 H - X172

• Tubing model

• Tubing size

Symbol	O.D. x I.D.
0425	ø4 x ø2.5
0604	ø6 x ø4
0805	ø8 x ø5
1065	ø10 x ø6.5
1208	ø12 x ø8

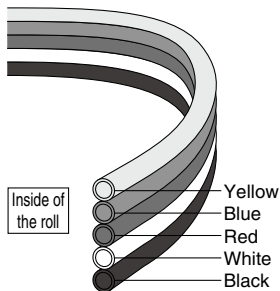

• Color*1

Symbol	Color	Symbol	Color
1	Black	5	Yellow
2	White	6	Green
3	Red	7	Clear
4	Blue	8	Orange

*1 Colors of the example (12345)

• Multi-core, multi-color specification

Symbol	Number of cores	Applicable tubing O.D.				
		ø4	ø6	ø8	ø10	ø12
X169	2 cores	●	●	●	●	●
X170	3 cores	●	●	●	●	●
X171	4 cores	●	●	●	●	●
X172	5 cores	●	●	●	●	●
X204	6 cores	●	●	●	●	●

• Tube length per roll [m]

Symbol	Length
H	50

Tube length per roll: **100** m

TU 0425 - 12345 J - X172

• Tubing model

• Tubing size

Symbol	O.D. x I.D.
0425	ø4 x ø2.5
0604	ø6 x ø4
0805	ø8 x ø5

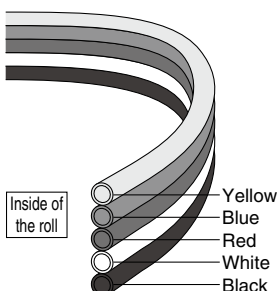

• Color*1

Symbol	Color	Symbol	Color
1	Black	5	Yellow
2	White	6	Green
3	Red	7	Clear
4	Blue	8	Orange

*1 Colors of the example (12345)

• Multi-core, multi-color specification

Symbol	Number of cores	Applicable tubing O.D.		
		ø4	ø6	ø8
X169	2 cores	●	●	●
X170	3 cores	●	●	●
X171	4 cores	●	●	●
X172	5 cores	●	●	●
X204	6 cores	●	●	●

• Tube length per roll [m]

Symbol	Length
J	100

How to Order

Please contact SMC for delivery times.

Reel

Tube length per roll: **10, 20** m

TU 0212 - 12345 F - X203

Tubing model

Tubing size

Symbol	O.D. x I.D.
0212	ø2 x ø1.2
0425	ø4 x ø2.5
0604	ø6 x ø4
0805	ø8 x ø5
1065	ø10 x ø6.5
1208	ø12 x ø8

Inside of the roll

Yellow
Blue
Red
White
Black

Color*1

Symbol	Color	Symbol	Color
1	Black	5	Yellow
2	White	6	Green
3	Red	7	Clear
4	Blue	8	Orange*2

*1 Colors of the example (12345)
*2 Excludes the TU0212

Multi-core, multi-color specification

Symbol	Number of cores	Applicable tubing O.D.					
		ø2	ø4	ø6	ø8	ø10	ø12
X200	2 cores	●	●	●	●	●	●
X201	3 cores	●	●	●	●	●	●
X202	4 cores	●	●	●	●	●	●
X203	5 cores	●	●	●	●	●	●
X207	6 cores	●	●	●	●	●	●

Tube length per roll [m]

Symbol	Length
F	10
G	20

Tube length per roll: **50** m

TU 0425 - 12345 H - X203

Tubing model

Tubing size

Symbol	O.D. x I.D.
0425	ø4 x ø2.5
0604	ø6 x ø4
0805	ø8 x ø5
1065	ø10 x ø6.5

Inside of the roll

Yellow
Blue
Red
White
Black

Color*1

Symbol	Color	Symbol	Color
1	Black	5	Yellow
2	White	6	Green
3	Red	7	Clear
4	Blue	8	Orange

*1 Colors of the example (12345)

Multi-core, multi-color specification

Symbol	Number of cores	Applicable tubing O.D.		
		ø4	ø6	ø8
X200	2 cores	●	●	●
X201	3 cores	●	●	●
X202	4 cores	●	●	●
X203	5 cores	●	●	●
X207	6 cores	●	●	●

Tube length per roll [m]

Symbol	Length
H	50

Tube length per roll: **100** m

TU 0425 - 12345 J - X203

Tubing model

Tubing size

Symbol	O.D. x I.D.
0425	ø4 x ø2.5
0604	ø6 x ø4
0805	ø8 x ø5

Inside of the roll

Yellow
Blue
Red
White
Black

Color*1

Symbol	Color	Symbol	Color
1	Black	5	Yellow
2	White	6	Green
3	Red	7	Clear
4	Blue	8	Orange

*1 Colors of the example (12345)

Multi-core, multi-color specification

Symbol	Number of cores	Applicable tubing O.D.		
		ø4	ø6	ø8
X200	2 cores	●	●	●
X201	3 cores	●	●	●
X202	4 cores	●	●	●
X203	5 cores	●	●	●
X207	6 cores	●	●	●

Tube length per roll [m]

Symbol	Length
J	100

Air Preparation Equipment
Pressure Control Equipment/Others

Fittings and Tubing

Flow Control Equipment

Pressure Gauges

Switches/Sensors

Process Valves

Directional Control Valves



Soft Polyurethane Tubing

TUS Series



More for the specifications and dimensions

Model/Specifications

● — 20 m roll □ — 100 m reel

Model	TUS0425	TUS0604	TUS0805	TUS1065	TUS1208
Tubing O.D. [mm]	4	6	8	10	12
Tubing I.D. [mm]	2.5	4	5	6.5	8
Black (B)	●	●	●	●	●
White (W)	●	●	●	●	●
Red (R)	●	●	●	●	●
Blue (BU)	●	●	●	●	●
Yellow (Y)	●	●	●	●	●
Green (G)	●	●	●	●	●
Translucent (N)	●	●	●	●	●
Yellow brown (YB)	●	●	●	●	●



How to Order

TUS1065 **B** - **100**

Tubing model

Length per roll

Symbol	Length
20	20 m roll
100	100 m reel

Color

Symbol	Color	Symbol	Color
B	Black (Opaque)	Y	Yellow (Opaque)
W	White (Opaque)	G	Green (Opaque)
R	Red (Opaque)	N	Translucent (Material color)
BU	Blue (Opaque)	YB	Yellow brown (Opaque)

Made to Order

Multi-core, Multi-color
Specification Flat Tubing

Refer to the **Web Catalog** for details.



Soft Polyurethane Flat Tubing Multi-core, Multi-color Specification

TUS Series



More for the specifications and dimensions

Specifications

Model	TUS0425	TUS0604	TUS0805	TUS1065	TUS1208
Tubing O.D. [mm]	4	6	8	10	12
Tubing I.D. [mm]	2.5	4	5	6.5	8
Black (B)	●	●	●	●	●
White (W)	●	●	●	●	●
Red (R)	●	●	●	●	●
Blue (BU)	●	●	●	●	●
Yellow (Y)	●	●	●	●	●
Green (G)	●	●	●	●	●
Translucent (N)	●	●	●	●	●
Yellow brown (YB)	●	●	●	●	●

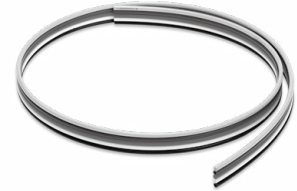

How to Order

Please contact SMC for delivery times.

TUS 0425 - 12345 A - X172

• Tubing model

• Tubing size

Symbol	O.D. x I.D.
0425	ø4 x ø2.5
0604	ø6 x ø4
0805	ø8 x ø5
1065	ø10 x ø6.5
1208	ø12 x ø8

• Multi-core, multi-color specification

Symbol	Number of cores
X169	2 cores
X170	3 cores
X171	4 cores
X172	5 cores

• Color*1

Symbol	Color	Symbol	Color
1	Black	5	Yellow
2	White	6	Green
3	Red	7	Translucent*2
4	Blue	8	Yellow brown

*1 Colors of the example (12345)

*2 Not clear, but translucent due to material.

• Tube length per roll [m]

Symbol	Length
A	1
B	2
C	3
D	4
E	5
F	10
G	20

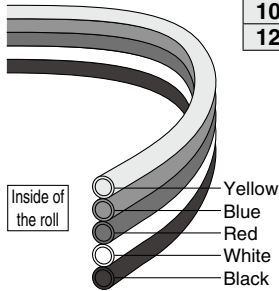

Air Preparation Equipment
Pressure Control Equipment/Others

Fittings and Tubing

Flow Control Equipment

Pressure Gauges

Switches/Sensors

Process Valves

Directional Control Valves



Hard Polyurethane Tubing/ Standard Type

TUH Series

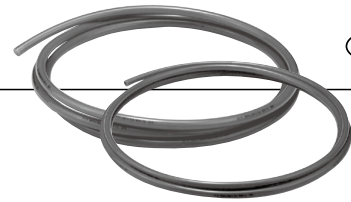

RoHS



More for the specifications
and dimensions

Model/Specifications

● — 20 m roll □ — 100 m roll

Model	TUH0428	TUH0644	TUH0858	TUH1073	TUH1288
O.D. [mm]	4	6	8	10	12
I.D. [mm]	2.8	4.4	5.8	7.3	8.8

	TUH0428	TUH0644	TUH0858	TUH1073	TUH1288
Black (B)	●	●	●	●	●
White (W)	□	□	□	□	□
Blue (BU)	●	●	●	●	●
Translucent (N)	●	●	●	●	●

How to Order

TUH0644 **B** - **20**

Tubing
model

Color

Symbol	Color
B	Black (Opaque)
W	White (Opaque)
BU	Blue (Translucent)
N	Translucent (Material color)

Length per roll

Symbol	Length
20	20 m roll
100	100 m roll



Hard Polyurethane Tubing/ High Pressure Type

TUH Series



RoHS



More for the specifications
and dimensions

Model/Specifications

● — 20 m roll □ — 100 m roll

Model	TUH0425	TUH0604	TUH0805	TUH1065	TUH1208
O.D. [mm]	4	6	8	10	12
I.D. [mm]	2.5	4	5	6.5	8

	TUH0425	TUH0604	TUH0805	TUH1065	TUH1208
Black (B)	●	●	●	●	●
White (W)	□	□	□	□	□
Blue (BU)	●	●	●	●	●
Translucent (N)	●	●	●	●	●

How to Order

TUH0604 **B** - **20**

Tubing
model

Color

Symbol	Color
B	Black (Opaque)
W	White (Opaque)
BU	Blue (Translucent)
N	Translucent (Material color)

Length per roll

Symbol	Length
20	20 m roll
100	100 m roll



Wear Resistant Tubing

TUZ/TIUZB Series



More for the specifications and dimensions

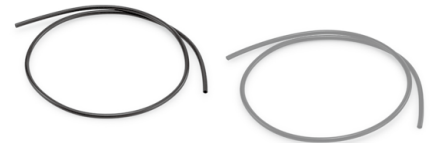

Model

● — 20 m roll □ — 100 m roll

Model	Tubing size										
	Metric size (TUZ series)							Inch size (TIUZB series)			
Model	TUZ0212	TUZ3220	TUZ0425	TUZ0604	TUZ0805	TUZ1065	TUZ1208	TUZ1610	TIUZB07	TIUZB11	TIUZB13
Tubing O.D. [mm]	2	3.2	4	6	8	10	12	16	6.35	9.53	12.7
Tubing I.D. [mm]	1.2	2	2.5	4	5	6.5	8	10	4.23	6.35	8.46
Black (B)	□	●	●	●	●	●	●	□	●	●	●
White (W)		●	●	●	●	●	●		●	●	●
Red (R)			●	●	●	●	●		●	●	●
Blue (BU)		●	●	●	●	●	●		●	●	●
Yellow (Y)			●	●	●	●	●		●	●	●
Green (G)			●	●	●	●	●		●	●	●

How to Order

TUZ0425 BU - 20

Tubing model ● Color ● Length per roll ●

Symbol	Color
B	Black
W	White
R	Red
BU	Blue
Y	Yellow
G	Green

Symbol	Length
20	20 m roll
100	100 m roll

* Not clear, but opaque due to material.

Made to Order

Multi-core, same color specification
TFU-X73

Flat type of the TUZ series

Number of cores: 2 to 12 cores

Specification: **Same color**

Multi-core, multi-color specification
TUZ-X169 to X172, -X204

Number of cores: 2 to 6 cores

Specification: **Multi-color**

Refer to the **Web Catalog** for details.

The identification line is not shown.

Please contact SMC for detailed specifications, dimensions, and delivery times.

How to Order

TFU0425 BU - 2 - 20 - X73

Color ● Special polyurethane (Multi-core, same color specification) ● Length per roll ● Number of cores 2 to 12 ● Tubing model ● 20 m

Symbol	Color
B	Black
W	White
R	Red
BU	Blue
Y	Yellow
G	Green

Symbol	Length
Nil	10 m
n	n m*1

Model	O.D. x I.D. [mm]
TFU0425	4 x 2.5
TFU0604	6 x 4
TFU0805	8 x 5
TFU1065	10 x 6.5
TFU1208	12 x 8

* Not clear, but opaque due to material.

*1 It is also available in lengths other than 10 m. Enter the length you need (1, 2, 3, 4, 5, 20).
Example) **TFU0425BU-2-20-X73**

Air Preparation Equipment
Pressure Control Equipment/Others

Fittings and Tubing

Flow Control Equipment

Pressure Gauges

Switches/Sensors

Process Valves

Directional Control Valves



Polyurethane Coil Tubing

TCU Series



More for the specifications and dimensions

Model/Specifications

Model	TCU 0425B-1	TCU 0425B-2	TCU 0425B-3	TCU 0604B-1	TCU 0604B-2	TCU 0604B-3	TCU 0805B-1
Number of cores	1 core	2 cores	3 cores	1 core	2 cores	3 cores	1 core
Tubing O.D. [mm]	4			6			8
Tubing I.D. [mm]	2.5			4			5
Color	Black (Opaque)						



Dimensions

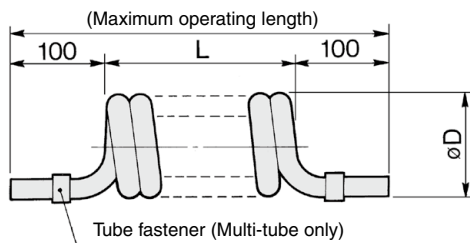

Model	Specifications		Tubing size [mm]		Coil [mm]		No. of cores	No. of coil windings per tube length	Max. operating length [m]	Standard unit of packing
	O.D.	I.D.	L	øD						
TCU0425B-1	4	2.5	210	18	1	52 ± 2	1.5	5 tubes/case		
TCU0425B-2			280	28	2	35 ± 1				
TCU0425B-3			265	28	3	22 ± 1				
TCU0604B-1	6	4	325	24	1	54 ± 2	2			
TCU0604B-2			37	2	27 ± 1	1.5				
TCU0604B-3			305	37	3	17 ± 1	1			
TCU0805B-1	8	5	330	31	1	41 ± 2	2			

* The number of coil windings per tube length and dimensions are changeable due to material.

Made to Order

Change of coil turns, Change of color

(Please contact SMC for detailed specifications, dimensions, and delivery times.)

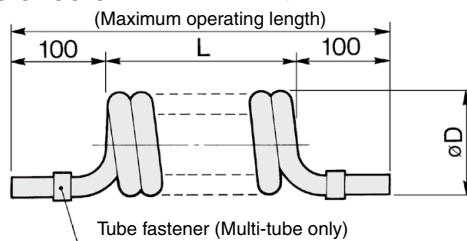

Model	Specifications		Tubing size [mm]		Coil [mm]		No. of cores	No. of coil windings per tube length (N)	Max. operating length [mm]
	O.D.	I.D.	L	øD					
TCU0425□-1-N-X6	4	2.5	N x 4	18	1	3 to 90	L x 5.9 + 200		
TCU0425□-2-N-X6			N x 8	28	2	3 to 90	L x 4.4 + 200		
TCU0425□-3-N-X6			N x 12	28	3	3 to 63	L x 2.9 + 200		
TCU0604□-1-N-X6	6	4	N x 6	24	1	3 to 90	L x 5.3 + 200		
TCU0604□-2-N-X6			N x 12	37	2	3 to 66	L x 3.8 + 200		
TCU0604□-3-N-X6			N x 18	37	3	3 to 44	L x 2.5 + 200		
TCU0805□-1-N-X6	8	5	N x 8	31	1	3 to 90	L x 5.2 + 200		
TCU0805□-2-N-X6			N x 16	42	2	3 to 40	L x 3 + 200		
TCU1065□-1-N-X6	10	6.5	N x 10	52	1	3 to 45	L x 5 + 200		
TCU1065□-2-N-X6			N x 20	52	2	3 to 35	L x 3 + 200		
TCU1208□-1-N-X6	12	8	N x 12	67	1	3 to 35	L x 5 + 200		
TCU1208□-2-N-X6			N x 24	67	2	3 to 30	L x 3 + 200		

* □: B (Black), W (White), R (Red), BU (Blue), Y (Yellow), G (Green), C (Clear), YR (Orange)

HF1

HF2

HF1 compatible

HF2 compatible

Polyurethane Flat Tubing

TFU Series

RoHS



More for the specifications and dimensions

Specifications

Model	TFU 0425B-2	TFU 0425B-3	TFU 0604B-2	TFU 0604B-3	TFU 0805B-2	TFU 0805B-3
No. of cores	2 cores	3 cores	2 cores	3 cores	2 cores	3 cores
Tubing O.D. [mm]	4		6		8	
Tubing I.D. [mm]	2.5		4		5	
Color	Black					



How to Order

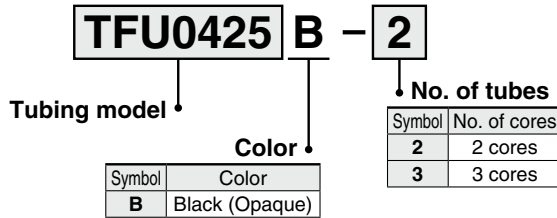

Air Preparation Equipment
Pressure Control Equipment/Others

Fittings and Tubing

Flow Control Equipment

Pressure Gauges

Switches/Sensors

Process Valves

Directional Control Valves



High Purity Fluoropolymer Tubing

TL/TIL Series



More for the specifications and dimensions

Material: Super PFA

Compatible with the Food Sanitation Law

• Compatible with the test conforming to the Food Sanitation Law based on the 370th notice given by the Ministry of Health and Welfare in 1959.

FDA (U.S. Food and Drug Administration) Compliant

• Complies with FDA (U.S. Food and Drug Administration) §177.1550 dissolution test.

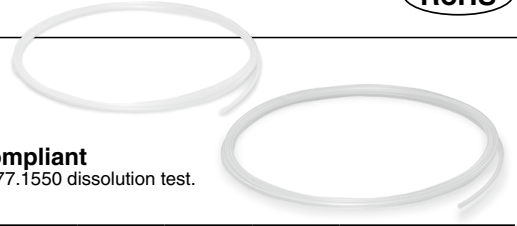

Series and Specifications

Tubing model	Metric sizes (TL series)						Inch sizes (TIL series)								
	TL0403	TL0604	TL0806	TL1008	TL1210	TL1916	TIL01	TILB01	TIL05	TIL07	TIL11	TIL13	TIL19	TIL25	
Nominal diameter	—	—	—	—	—	—	1/8"	1/8"	3/16"	1/4"	3/8"	1/2"	3/4"	1"	
Tubing size	ø4 x ø3	ø6 x ø4	ø8 x ø6	ø10 x ø8	ø12 x ø10	ø19 x ø16	1/8" x 0.086"	1/8" x 1/16"	3/16" x 1/8"	1/4" x 5/32"	3/8" x 1/4"	1/2" x 3/8"	3/4" x 5/8"	1" x 7/8"	
O.D. [mm]	Basic diameter	4	6	8	10	12	19	3.18	3.18	4.75	6.35	9.53	12.7	19.05	25.4
	Tolerance	±0.1			±0.1			±0.1			±0.1				
Thickness [mm]	Basic diameter	0.5	1				1.5	0.5	0.8	0.8	1.2	1.6			
	Tolerance	±0.05	±0.1				±0.15	±0.05	±0.08	±0.08	±0.12	±0.15			
Bundle	10 m	—	—	—	●	●	●	—	—	—	—	●	●	—	—
	20 m	●	●	●	●	●	●	●	—	●	●	●	●	●	●
	50 m	●	●	●	●	●	●	●	—	●	●	●	●	●	●
	100 m	●	●	●	●	●	●	●	—	●	●	●	●	●	—
	16 m (50 ft)	—	—	—	—	—	—	●	●	●	●	●	●	●	●
	33 m (100 ft)	—	—	—	—	—	—	●	●	●	●	●	●	●	●
Straight pipe	2 m	●	●	●	●	●	●	—	●	●	●	●	●	●	
Color	Translucent (color of material)														

How to Order

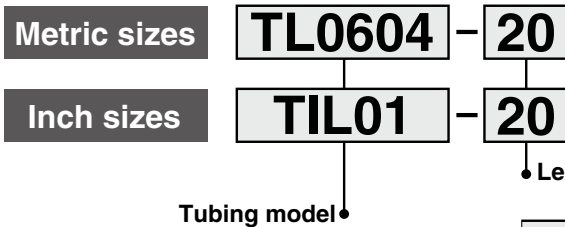

• Length Applicable to both metric and inch size

Symbol	Type	Length
10	Roll	10 m
20		20 m
50		50 m
100		100 m
2S	Straight	2 m

Length Applicable to inch size only

Symbol	Type	Length
16	Roll	16 m (50 ft)
33		33 m (100 ft)

Please refer to the "Series and Specifications" above, as the tubing length differs depending on each size.



Fluoropolymer Tubing (PFA) Metric Size

TLM Series

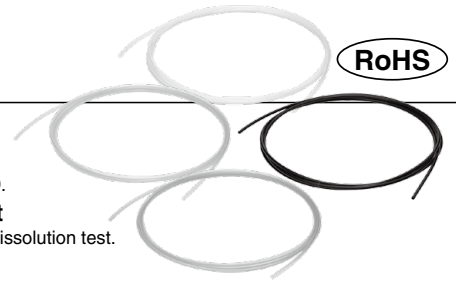

More for the specifications and dimensions

Compatible with the Food Sanitation Law

- Compatible with the test conforming to the Food Sanitation Law based on the 370th notice given by the Ministry of Health and Welfare in 1959.

FDA (U.S. Food and Drug Administration) Compliant

- Complies with FDA (U.S. Food and Drug Administration) §177.1550 dissolution test.

Series

Size	Metric size												
	TLM0201	TLM0302	TLM0425	TLM0403	TLM0604	TLM0806	TLM1075	TLM1008	TLM1209	TLM1210	TLM1613	TLM1916	TLM2522
Model	ø2 x ø1	ø3 x ø2	ø4 x ø2.5	ø4 x ø3	ø6 x ø4	ø8 x ø6	ø10 x ø7.5	ø10 x ø8	ø12 x ø9	ø12 x ø10	ø16 x ø13	ø19 x ø16	ø25 x ø22
Tubing size	ø2 x ø1	ø3 x ø2	ø4 x ø2.5	ø4 x ø3	ø6 x ø4	ø8 x ø6	ø10 x ø7.5	ø10 x ø8	ø12 x ø9	ø12 x ø10	ø16 x ø13	ø19 x ø16	ø25 x ø22
O.D. [mm]	2	3	4	4	6	8	10	10	12	12	16	19	25
I.D. [mm]	1	2	2.5	3	4	6	7.5	8	9	10	13	16	22

Length per roll	Color	Symbol	TLM0201	TLM0302	TLM0425	TLM0403	TLM0604	TLM0806	TLM1075	TLM1008	TLM1209	TLM1210	TLM1613	TLM1916	TLM2522	
Roll	10 m	Translucent	N						●	●	●	●	●	●	●	
		Translucent	N	●	●	●	●	●	●	●	●	●	●	●	●	●
	20 m	Red	R	●	●	●	●	●	●	●	●	●	●	●	●	●
		Blue	BU	●	●	●	●	●	●	●	●	●	●	●	●	●
		Black	B	●	●	●	●	●	●	●	●	●	●	●	●	●
	50 m	Translucent	N	●	●	●	●	●	●	●	●	●	●	●	●	●
	100 m	Translucent	N	●	●	●	●	●	●	●	●	●	●	●	●	●
	Straight	2 m	Translucent	N	●	●	●	●	●	●	●	●	●	●	●	●

Inch O.D. size
5/32"

Inch O.D. size
5/16"

O.D. 3.2 mm is available in ø1/8 inch (3.18 mm) tubing. For details, refer to the table "Series" in the Web Catalog.

How to Order

Metric size

TLM0425 N - 20

• Tubing designation

• Color indication

Symbol	Color
N	Translucent (Material color)
R	Red (Translucent)
BU	Blue (Translucent)
B	Black (Opaque)

• Length per roll

Symbol	Type	Length
10	Roll	10 m
20		20 m
50		50 m
100		100 m
2S	Straight	2 m

* Refer to the table "Series" above, as the tubing length differs depending on each size.

Air Preparation Equipment
Pressure Control Equipment/Others

Fittings and Tubing

Flow Control Equipment

Pressure Gauges

Switches/Sensors

Process Valves

Directional Control Valves



Fluoropolymer Tubing (PFA) Inch Size

TILM Series

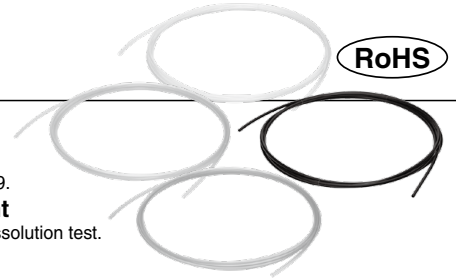

More for the specifications and dimensions

Compatible with the Food Sanitation Law

- Compatible with the test conforming to the Food Sanitation Law based on the 370th notice given by the Ministry of Health and Welfare in 1959.

FDA (U.S. Food and Drug Administration) Compliant

- Complies with FDA (U.S. Food and Drug Administration) §177.1550 dissolution test.

Series

Size			Inch size								
Model			TILM01	TILMB01	TILM05	TILM07	TILM11	TILM13	TILM19	TILM25	TILM32
Tubing size			1/8" x 0.086"	1/8" x 1/16"	3/16" x 1/8"	1/4" x 5/32"	3/8" x 1/4"	1/2" x 3/8"	3/4" x 5/8"	1" x 7/8"	1 1/4" x 1 1/10"
O.D.	inch		1/8"	1/8"	3/16"	1/4"	3/8"	1/2"	3/4"	1"	1 1/4"
	mm		3.18		4.75	6.35	9.53	12.7	19.05	25.4	31.75
I.D.	inch		0.086"	1/16"	1/8"	5/32"	1/4"	3/8"	5/8"	7/8"	1 1/10"
	mm		2.18	1.58	3.15	3.95	6.33	9.5	15.85	22.2	27.95
Length per roll	Color	Symbol									
Roll	10 m	Translucent	N					●	●		
		Translucent	N	●	●	●	●	●	●	●	●
	20 m	Red	R	●	●	●	●	●	●	●	●
		Blue	BU	●	●	●	●	●	●	●	●
		Black	B	●	●	●	●	●	●	●	●
	50 m	Translucent	N	●		●	●	●	●	●	●
	100 m	Translucent	N	●		●	●	●	●		
	16 m (50 ft)	Translucent	N	●	●	●	●	●	●	●	●
33 m (100 ft)	Translucent	N	●	●	●	●	●	●	●	●	
Straight	2 m	Translucent	N	●		●	●	●	●	●	●

Metric O.D. size
3.2

O.D. 5/32" is available in ø4 metric tubing, and O.D. 5/16" is available in ø8 metric tubing. For details, refer to the table "Series" in the Web Catalog.

How to Order

Inch size

TILM01 N - 20

Tubing designation

Color indication

Symbol	Color
N	Translucent (Material color)
R	Red (Translucent)
BU	Blue (Translucent)
B	Black (Opaque)

Length per roll

Symbol	Type	Length
10	Roll	10 m
20		20 m
50		50 m
100		100 m
16		16 m (50 ft)
33		33 m (100 ft)
2S	Straight	2 m

* Refer to the table "Series" above, as the tubing length differs depending on each size.



FEP Tubing (Fluoropolymer) Metric Size

TH Series

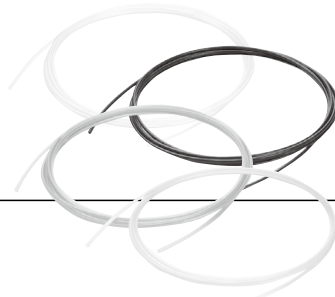

More for the specifications and dimensions

Compatible with the Food Sanitation Law

- Compatible with the test conforming to the Food Sanitation Law based on the 370th notice given by the Ministry of Health and Welfare in 1959.

FDA (U.S. Food and Drug Administration) Compliant

- Complies with FDA (U.S. Food and Drug Administration) §177.1550 dissolution test.

Series

● -20 m roll □ -100 m roll

		Metric size							
Model		TH0402	TH0425	TH0604	TH0806	TH1075	TH1008	TH1209	TH1210
Tubing O.D. [mm]		4	4	6	8	10	10	12	12
Tubing I.D. [mm]		2	2.5	4	6	7.5	8	9	10
Color	Symbol	● □		● □		● □		● □	
Translucent	N	●	□	●	□	●	□	●	□
Red	R	●	●	●	●	●	●	●	●
Blue	BU	●	●	●	●	●	●	●	●
Black	B	●	●	●	●	●	●	●	●
		Inch nominal size 5/32"				Inch nominal size 5/16"			

How to Order

Metric size

TH0604 N - 20

Indication of tubing model

Color indication

Symbol	Color
N	Translucent (Material color)
R	Red (Translucent)
BU	Blue (Translucent)
B	Black (Opaque)

Length per roll

Symbol	Roll size
20	20 m roll
100*1	100 m roll

*1 100 m roll is available with translucent (color indication: N) only.

Air Preparation Equipment
Pressure Control Equipment/Others

Fittings and Tubing

Flow Control Equipment



FEP Tubing (Fluoropolymer) Inch Size

TIH Series

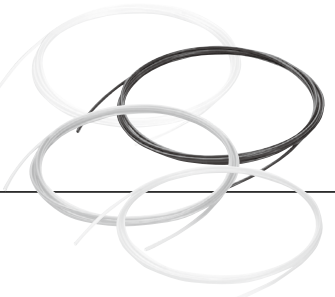

More for the specifications and dimensions

Compatible with the Food Sanitation Law

- Compatible with the test conforming to the Food Sanitation Law based on the 370th notice given by the Ministry of Health and Welfare in 1959.

FDA (U.S. Food and Drug Administration) Compliant

- Complies with FDA (U.S. Food and Drug Administration) §177.1550 dissolution test.

Series

● -16 m (50 ft) roll □ -33 m (100 ft) roll

		Inch size										
Model		TIHA01	TIHB01	TIHC01	TIHA05	TIHB05	TIHA07	TIHB07	TIHA11	TIHB11	TIH13	TIH19
Tubing O.D.	inch	1/8"		3/16"		1/4"		3/8"		1/2"	3/4"	
	mm	3.18		4.75		6.35		9.53		12.7	19.05	
Tubing I.D.	inch	0.093"	0.086"	0.065"	0.137"	0.124" (1/8")	0.18"	0.156" (5/32")	0.275"	0.25" (1/4")	0.374" (3/8")	0.624" (5/8")
	mm	2.36	2.18	1.65	3.48	3.15	4.57	3.95	6.99	6.33	9.5	15.85
Color	Symbol	● □		● □		● □		● □		● □		
Translucent	N	●	□	●	□	●	□	●	□	●	□	
Red	R	●	●	●	●	●	●	●	●	●	●	
Blue	BU	●	●	●	●	●	●	●	●	●	●	
Black	B	●	●	●	●	●	●	●	●	●	●	

How to Order

Inch size

TIHA01 N - 16

Indication of tubing model

Color indication

Symbol	Color
N	Translucent (Material color)
R	Red (Translucent)
BU	Blue (Translucent)
B	Black (Opaque)

Length per roll

Symbol	Roll size
16	16 m (50 ft) roll
33*1	33 m (100 ft) roll

*1 33 m (100 ft) roll is available with translucent (color indication: N) only.

Pressure Gauges

Switches/Sensors

Process Valves

Directional Control Valves



Soft Fluoropolymer Tubing Metric Size

TD Series

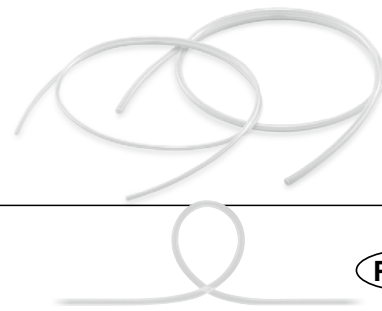

More for the specifications and dimensions

Compatible with the Food Sanitation Law

- Compatible with the test conforming to the Food Sanitation Law based on the 370th notice given by the Ministry of Health and Welfare in 1959.

FDA (U.S. Food and Drug Administration) Compliant

- Complies with FDA (U.S. Food and Drug Administration) §177.1550 dissolution test.

Model/Specifications

Size		Metric size				
Model		TD0425	TD0604	TD0806	TD1075	TD1209
Tubing O.D. [mm]		4	6	8	10	12
Tubing I.D. [mm]		2.5	4	6	7.5	9
Roll	10 m	●	●	●	●	●
	20 m	●	●	●	●	●
Color		Translucent (material color)				

How to Order

Metric size

TD0425 - **10**

Tubing model

Length per roll

Symbol	Length
10	10 m roll
20	20 m roll



Soft Fluoropolymer Tubing Inch Size

TID Series

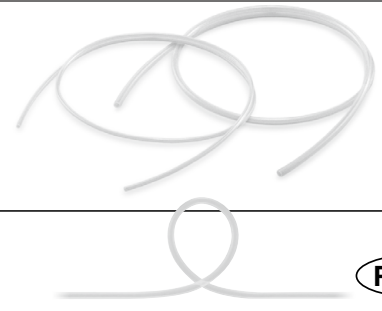

More for the specifications and dimensions

Compatible with the Food Sanitation Law

- Compatible with the test conforming to the Food Sanitation Law based on the 370th notice given by the Ministry of Health and Welfare in 1959.

FDA (U.S. Food and Drug Administration) Compliant

- Complies with FDA (U.S. Food and Drug Administration) §177.1550 dissolution test.

Model/Specifications

Size		Inch size				
Model		TID01	TID05	TID07	TID11	TID13
Tubing O.D.	inch	1/8"	3/16"	1/4"	3/8"	1/2"
	mm	3.18	4.75	6.35	9.53	12.7
Tubing I.D.	inch	0.086"	0.124" (1/8")	0.156" (5/32")	0.25" (1/4")	0.374" (3/8")
	mm	2.18	3.15	3.95	6.33	9.5
Roll	8 m (25 ft)	●	●	●	●	●
	16 m (50 ft)	●	●	●	●	●
Color		Translucent (material color)				

How to Order

Inch size

TID01 - **8**

Tubing model

Length per roll

Symbol	Length
8	8 m (25 ft) roll
16	16 m (50 ft) roll



Clean Tubing: Polyolefin Tubing

TPH Series



More for the specifications and dimensions

Model/Specifications

● — 20 m roll □ — 100 m roll

Model	TPH0425	TPH0604	TPH0806	TPH1075	TPH1209
O.D. [mm]	4	6	8	10	12
I.D. [mm]	2.5	4	6	7.5	9

White (W)	●	●	●	●	●
Blue (BU)	●	●	●	●	●
Yellow (Y)	●	●	●	●	●

Complies with FDA
(U.S. Food and Drug Administration)
§175.300 dissolution test

How to Order

TPH0604 W-20

Tubing model

Color

Symbol	Color
W	White (Material color)
BU	Blue (Opaque)
Y	Yellow (Opaque)

Length per roll

Symbol	Length
20	20 m roll
100	100 m roll

Air Preparation Equipment
Pressure Control Equipment/Others

Fittings and Tubing

Flow Control Equipment



Clean Tubing: Soft Polyolefin Tubing

TPS Series

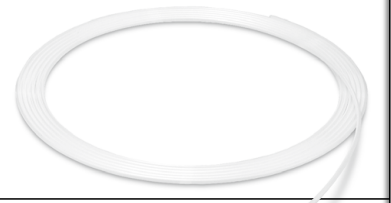

More for the specifications and dimensions

Model/Specifications

● — 20 m roll □ — 100 m roll

Model	TPS0425	TPS0604	TPS0805	TPS1065	TPS1208
O.D. [mm]	4	6	8	10	12
I.D. [mm]	2.5	4	5	6.5	8

White (W)	●	●	●	●	●
Blue (BU)	●	●	●	●	●
Yellow (Y)	●	●	●	●	●

Complies with FDA
(U.S. Food and Drug Administration)
§175.300 dissolution test

How to Order

TPS0604 W-20

Tubing model

Color

Symbol	Color
W	White (Material color)
BU	Blue (Opaque)
Y	Yellow (Opaque)

Length per roll

Symbol	Length
20	20 m roll
100	100 m roll

Pressure Gauges

Switches/Sensors

Process Valves

Directional Control Valves



Speed Controller with One-touch Fitting

Push-lock Type Lock Nut Type (Metal Knob)

Elbow Type/Universal Type

HF1-AS Series

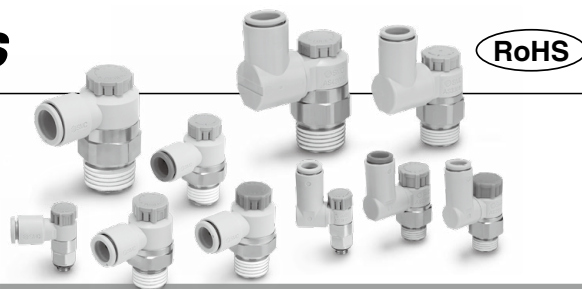

RoHS



More for the specifications and dimensions

Model

Model		Port size	Seal method	Applicable tubing O.D.														
Elbow type	Universal type			Metric size						Inch size								
				2*2	3.2	4	6	8	10	12	16	1/8"	5/32"	1/4"	5/16"	3/8"	1/2"	
HF1-AS12□1F-M5□	HF1-AS13□1F-M5□	M5 x 0.8	Gasket seal	●*3	●	●	●					●	●	●				
HF1-AS12□1F-U10/32□	HF1-AS13□1F-U10/32□	10-32UNF	Gasket seal	●*3	●	●	●					●	●	●				
HF1-AS22□1F-□01	HF1-AS23□1F-□01	R NPT	Sealant*1		●	●	●	●	●*3			●	●	●	●			
HF1-AS22□1F-□02	HF1-AS23□1F-□02			1/8		●	●	●	●	●			●*3	●	●	●	●	
HF1-AS32□1F-□02	HF1-AS33□1F-□02			1/4		●*3	●	●	●	●	●				●	●	●	●
HF1-AS32□1F-□03	HF1-AS33□1F-□03			3/8			●	●	●	●	●				●	●	●	●
HF1-AS42□1F-□04	HF1-AS43□1F-□04			1/2							●	●	●*3				●	●

*1 "Without sealant" type can be selected as a standard option. *2 Only polyurethane tubing is applicable for ø2. *3 Universal type is not available.

Flow Direction Symbols on Body

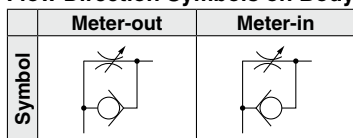

Caution

Be sure to read this before handling the products.
For safety instructions, flow control equipment precautions, and specific product precautions, refer to the Web Catalog.

How to Order

Width across flats (H)

E*2	8 mm
Nil	9 mm

*2 Push-lock type only

Body size

1	M5 x 0.8 10-32UNF
---	----------------------

Port size

M5	M5 x 0.8
U10/32	10-32UNF

Applicable tubing O.D.*3

Metric size	Inch size
02	ø2
23	ø3.2*4
04	ø4
06	ø6
01	ø1/8"
03	ø5/32"
07	ø1/4"

*3 For selecting applicable tubing O.D., refer to the "Model" shown above.
Metric size and inch size types can be visually identified by color of the release button.
Metric size: Light gray
Inch size: Orange
*4 Use ø1/8" tube.

Body size

2	1/8, 1/4
3	3/8
4	1/2

Thread type

Nil	R
N	NPT

Port size

01	1/8
02	1/4
03	3/8
04	1/2

Type

2	Elbow
3	Universal

Control type*1

0	Meter-out
1	Meter-in

*1 Meter-out and meter-in types can be visually identified by color of the knob.
Meter-out: Gray
Meter-in: Light blue

Applicable tubing O.D.*5

Metric size	Inch size
23	ø3.2*6
04	ø4
06	ø6
08	ø8
10	ø10
12	ø12
16	ø16
01	ø1/8"
03	ø5/32"
07	ø1/4"
09	ø5/16"
11	ø3/8"
13	ø1/2"

*5 For selecting applicable tubing O.D., refer to the "Model" shown above.
*6 Use ø1/8" tube.

Suffix

Nil	Speed controller
X214	Restrictor (Without check valve)

· Use the restrictor for air blow.
· Meter-out speed controller is applicable as a restrictor.

Knob locking method

A	Push-lock
Nil	Lock nut (Metal knob)

Seal method

Nil	Without sealant
S	With sealant

Model Examples:

HF1-AS 1 2 0 1 F - M5 E - 06 A - □

HF1-AS 2 2 0 1 F - □ 01 - 06 S A - □

Speed Controller with One-touch Fitting

Push-lock Type Lock Nut Type (Metal Knob)

In-line Type

HF1-AS Series

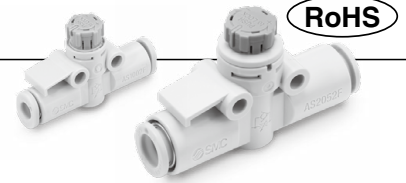

More for the specifications and dimensions

Model

Model	Applicable tubing O.D.											
	Metric size						Inch size					
	3.2	4	6	8	10	12	1/8"	5/32"	1/4"	5/16"	3/8"	1/2"
HF1-AS1002F	●	●	●				●	●	●			
HF1-AS2002F		●	●					●	●			
HF1-AS2052F			●	●					●	●		
HF1-AS3002F			●	●	●	●			●	●	●	
HF1-AS4002F					●	●					●	●

Flow Direction Symbol on Body

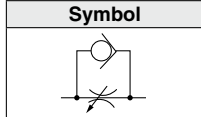

Caution

Be sure to read this before handling the products.
For safety instructions, flow control equipment precautions, and specific product precautions, refer to the Web Catalog.

How to Order

HF1-AS 200 2 F-06 A -

Body size

100	M5 standard
200	1/8 standard
205	1/4 standard
300	3/8 standard
400	1/2 standard

With One-touch fittings

Suffix

Nil	Speed controller
X214	Restrictor (Without check valve)

Use the restrictor for air blow.

Knob locking method

A	Push-lock
Nil	Lock nut (Metal knob)

Applicable tubing O.D.*1

Metric size		Inch size	
23	ø3.2*2	01	ø1/8"
04	ø4	03	ø5/32"
06	ø6	07	ø1/4"
08	ø8	09	ø5/16"
10	ø10	11	ø3/8"
12	ø12	13	ø1/2"

*1 For selecting applicable tubing O.D., refer to the "Model" shown above.

*2 Use ø1/8" tubing.

Air Preparation Equipment
Pressure Control Equipment/Others

Fittings and Tubing

Flow Control Equipment

Pressure Gauges

Switches/Sensors

Process Valves

Directional Control Valves

Speed Controller with One-touch Fitting

Push-lock Type Face Seal

Elbow Type/Universal Type

HF1-AS Series

RoHS

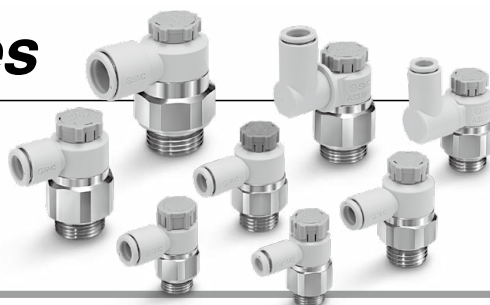

More for the specifications and dimensions

Model

Model		Port size	Seal method	Applicable tubing O.D.														
Elbow type	Universal type			Metric size						Inch size								
				3.2	4	6	8	10	12	16	1/8"	5/32"	1/4"	5/16"	3/8"	1/2"		
HF1-AS22□1F-G01	HF1-AS23□1F-G01	G	Face seal	●	●	●	●	●*1										
HF1-AS22□1F-G02	HF1-AS23□1F-G02			1/8	●*1	●	●	●	●									
HF1-AS32□1F-G02	HF1-AS33□1F-G02			1/4			●	●	●	●								
HF1-AS32□1F-G03	HF1-AS33□1F-G03			3/8			●	●	●	●								
HF1-AS42□1F-G04	HF1-AS43□1F-G04			1/2				●	●	●	●	●*1						
HF1-AS22□1F-01-□PA	—	R NPT	Face seal	1/8	●	●	●	●	●		●	●	●	●	●	●		
HF1-AS22□1F-02-□PA	—			1/4	●	●	●	●	●			●	●	●	●	●	●	
HF1-AS32□1F-03-□PA	—			3/8			●	●	●	●				●	●	●	●	
HF1-AS42□1F-04-□PA	—			1/2					●	●					●	●	●	

*1 Universal type is not available.

Flow Direction Symbols on Body

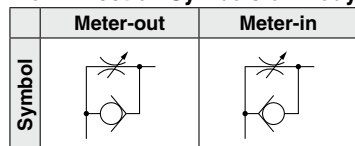

Caution

- Be sure to read this before handling the products.
- For safety instructions, flow control equipment precautions, and specific product precautions, refer to the Web Catalog.

How to Order

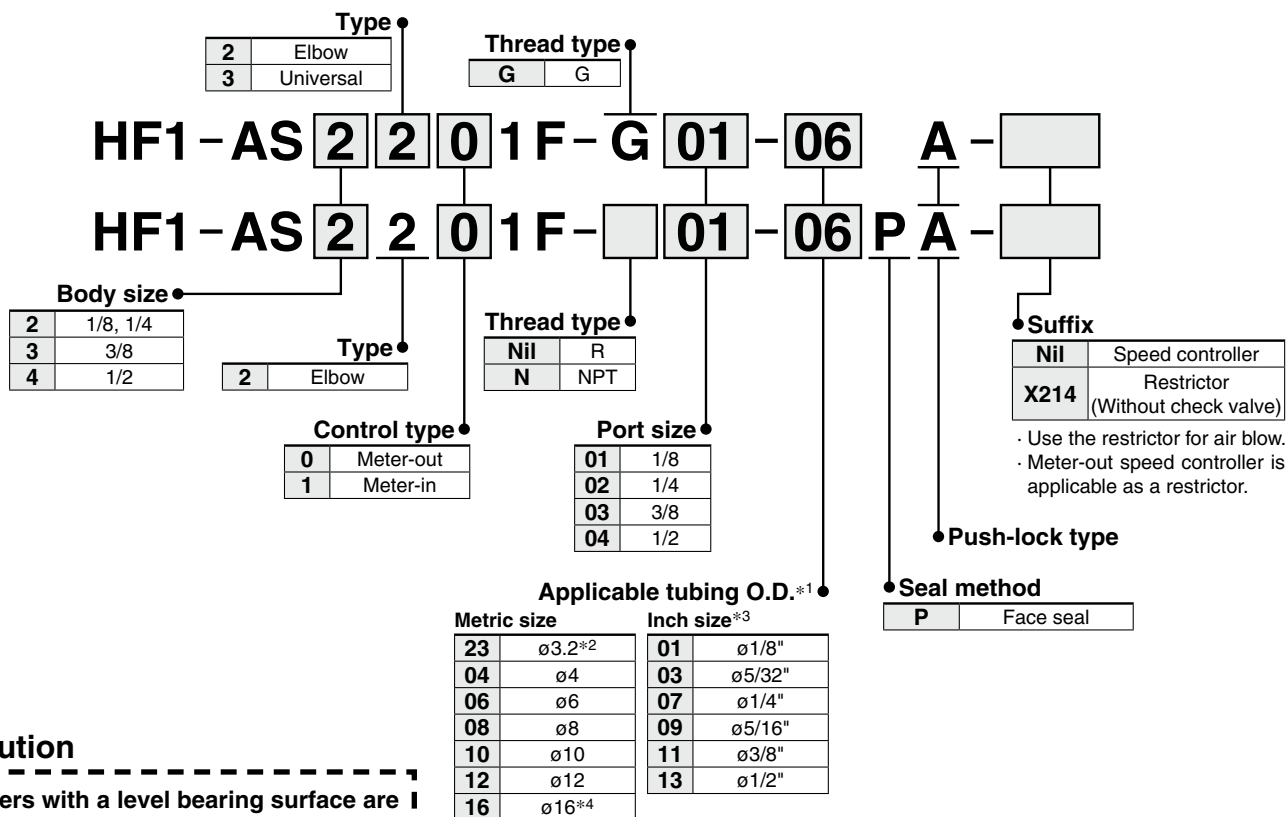

Caution

- Cylinders with a level bearing surface are suitable for the R thread or NPT thread face seal type.
- The R-shaped bearing surface of CG1 cylinders is not suitable.

*1 For selecting applicable tubing O.D., refer to the "Model" shown above.

*2 Use ø1/8" tubing.

*3 Only the metric size is available for the G thread type.

*4 Only G thread

HF1

HF2

HF1 compatible

HF2 compatible

Stainless Steel Speed Controller (Elbow Type)

ASG Series



More for the specifications and dimensions

<Food Sanitation Law compliant
(Component materials have met apparatus and container-package standards)>

Model

Elbow type	Port size	Applicable tubing O.D. [mm]				
		4	6	8	10	12
ASG2□F-M5	M5 x 0.8	●	●			
ASG3□F-01	R1/8	●	●	●		
ASG4□F-02	R1/4		●	●	●	
ASG5□F-03	R3/8			●	●	●
ASG6□F-04	R1/2					●

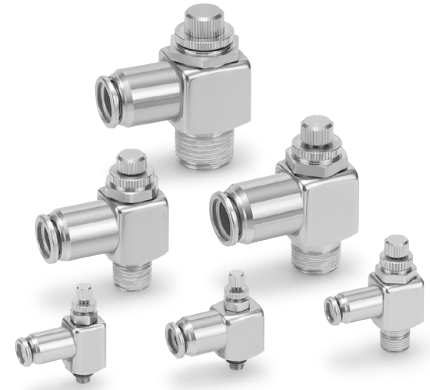

Symbol

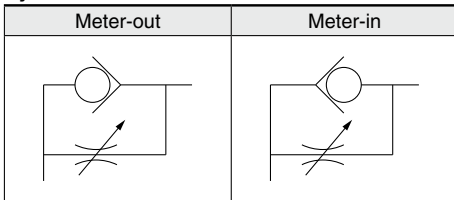

How to Order

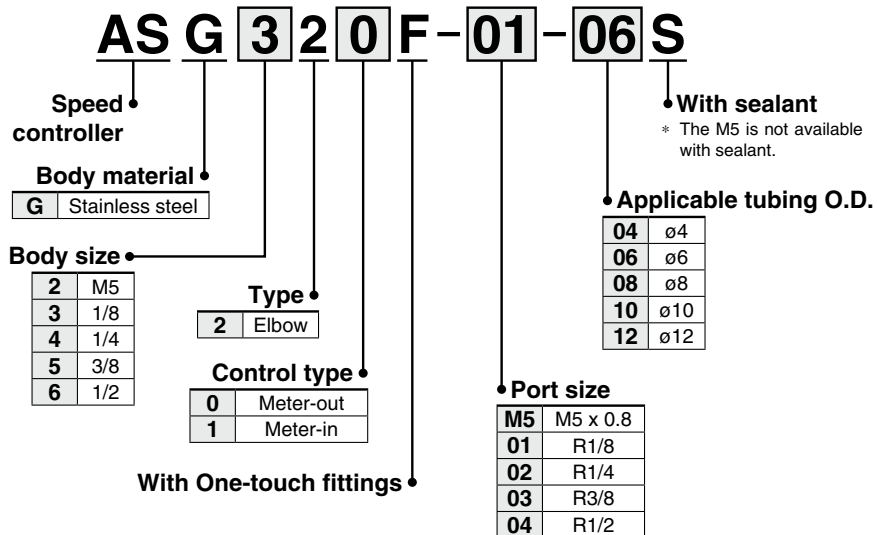

Air Preparation Equipment
Pressure Control Equipment/Others

Fittings and Tubing

Flow Control
Equipment

Pressure Gauges

Switches/Sensors

Process Valves

Directional
Control Valves



Pressure Gauge for General Purpose/ With Limit Indicator

G36



More for the specifications
and dimensions

How to Order

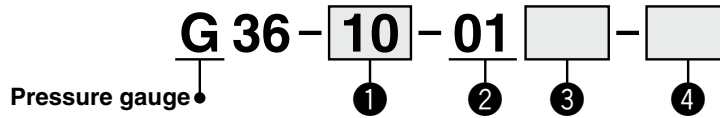

G36-10-01

· Please read the Caution of HF- Series (p. 69) before use.

	Symbol	Description	Type
			G36 Back side thread
+			
① Max. display pressure	2	0.2 MPa	●
	4	0.4 MPa	●
	7	0.7 MPa	●
	10	1.0 MPa	●
	15	1.5 MPa	●
	P2*1	0.2 MPa, 30 psi	○*2
	P4*1	0.4 MPa, 60 psi	○*2
	P7*1	0.7 MPa, 100 psi	○*2
	P10*1	1.0 MPa, 150 psi	○*2
	P15*1	1.5 MPa, 220 psi	○*2
+			
② Connection thread	01	R1/8	●
+			
③ Option	Nil	—	●
	M*3	With M5 (Female thread)	●
+			
④ Special specification*4	Nil	—	●
	X2	Stud parts nickel plated	—*5
	X30	Both MPa and psi	○*2

*1 This symbol must be used with Special specification "X30."

*2 Under the New Measurement Act, products for overseas use only (SI unit type for use in Japan)

*3 To use the pressure gauge with M5 (female thread), attach the joint when piping the tube. For combinations with the special specification products, please consult SMC separately.

*4 Wetted parts stainless steel specifications are not available.

*5 When necessary, please contact SMC.



Pressure Gauge for General Purpose/ With Limit Indicator

G46



More for the specifications
and dimensions

How to Order

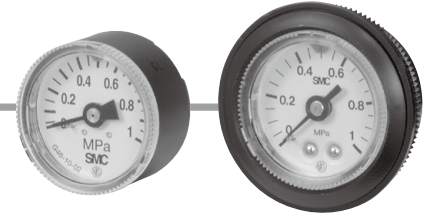
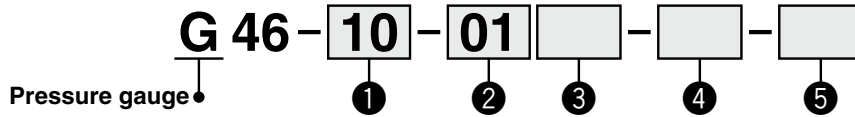

G46-10-02M-C

· Please read the Caution of HF- Series (p. 69)
before use.

		Symbol	Description	Type
				G46
				Back side thread
①	Max. display pressure	+		
		2	0.2 MPa	●
		4	0.4 MPa	●
		7	0.7 MPa	●
		10	1.0 MPa	●
		15	1.5 MPa	●
		P2*1	0.2 MPa, 30 psi	○*2
		P4*1	0.4 MPa, 60 psi	○*2
		P7*1	0.7 MPa, 100 psi	○*2
②	Connection thread	+		
		01	R1/8	●
③	Option	+		
		02	R1/4	●
④	Attachment	+		
		Nil	—	●
⑤	Special specification	+		
		M*3	With M5 (Female thread)	●
		Nil	Without cover ring assembly	●
④	Attachment	C	Clear cover has no protrusion. (Clear cover is irremovable.)	●
		C2	Clear cover has protrusion. (Clear cover is removable.) The wrench flats protrude.	●
⑤	Special specification	+		
		X2	Stud parts Nickel plated	—*4
		X30	Both MPa and psi	○*2

*1 This symbol must be used with Special specification "X30."
 *2 ○: Under the New Measurement Act, products for overseas use only (SI unit type for use in Japan).
 *3 To use the pressure gauge with M5 (female thread), attach the joint when piping the tube. For combinations with the special specification products, please consult SMC separately.
 *4 When necessary, please contact SMC.
 * When wetted parts with the stainless steel specifications are needed, use the G46-□-□-SRB.

Air Preparation Equipment
Pressure Control Equipment/Others

Fittings and Tubing

Flow Control
Equipment

Pressure Gauges

Switches/Sensors

Process Valves

Directional
Control Valves

HF1

HF2

HF1 compatible

HF2 compatible

Pressure Gauge for General Purpose/ With Limit Indicator

G36-X4/GA36-X4

RoHS



More for the specifications and dimensions

How to Order

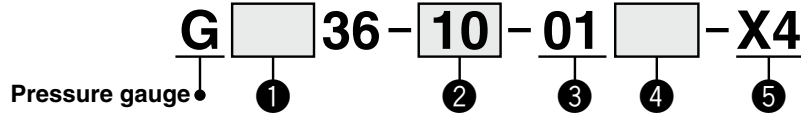

G36-10-01-X4

	Symbol	Description	①		
			Type		
			G36	GA36	
			Back side thread	Vertical side thread	
+					
②	Max. display pressure	2	0.2 MPa	●	●
		4	0.4 MPa	●	●
		7	0.7 MPa	●	●
		10	1.0 MPa	●	●
		15	1.5 MPa	●	●
+					
③	Connection thread	01	R1/8	●	●
+					
④	Option	Nil	—	●	●
		M*1	With M5 (Female thread)	●	—
+					
⑤	Special specification*2	X4	Oil-free (Wetted parts degrease washing)	●	●

Please read the Caution of HF- Series (p. 69) before use.

*1 To use the pressure gauge with M5 (female thread), attach the joint when piping the tube. For combinations with the special specification products, please consult SMC separately.

*2 Wetted parts stainless steel specifications are not available.



Oil-free/External Parts Copper-free Pressure Gauge/ With Limit Indicator

G46E



More for the specifications
and dimensions

How to Order

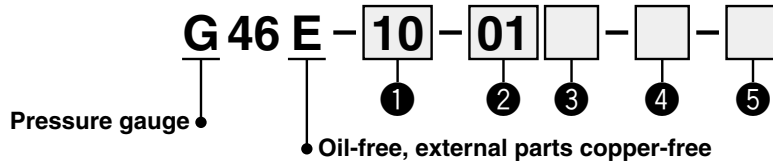

G46E-10-02M

G46E-10-02M-C

· Please read the Caution of HF- Series (p. 69)
before use.

	Symbol	Description	G46E
	+		
① Max. display pressure	2	0.2 MPa	●
	4	0.4 MPa	●
	7	0.7 MPa	●
	10	1.0 MPa	●
	15	1.5 MPa	●
	P2*1	0.2 MPa, 30 psi	○*2
	P7*1	0.7 MPa, 100 psi	○*2
	+		
② Connection thread	01	R1/8	●
	02	R1/4	●
	+		
③ Option	Nil	—	●
	M*3	With M5 (Female thread)	●
	+		
④ Attachment	Nil	Without cover ring assembly	●
	C	Clear cover has no protrusion. (Clear cover is irremovable.)	●
	C2	Clear cover has protrusion. (Clear cover is removable.) The wrench flats protrude.	●
	+		
⑤ Special specification	Nil	—	●
	X30	Both MPa and psi	○*2

*1 This symbol must be used with Special specification "X30."
 *2 Under the New Measurement Act, products for overseas use only (SI unit type for use in Japan)
 *3 To use the pressure gauge with M5 (female thread), attach the joint when piping the tube.

Air Preparation Equipment
Pressure Control Equipment/Others

Fittings and Tubing

Flow Control
Equipment

Pressure Gauges

Switches/Sensors

Process Valves

Directional
Control Valves



Pressure Gauge for Clean Regulator/ With Limit Indicator

G46-SRA/B



More for the specifications
and dimensions

How to Order

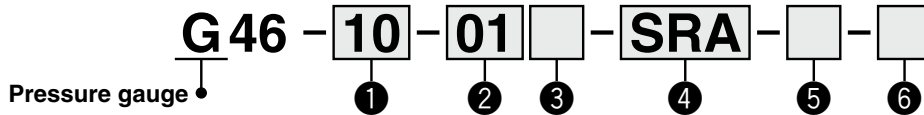

G46-10-02-SRA,B

• Please read the Caution of HF- Series (p. 69) before use.

		Symbol	Description	G46
		+		
①	Max. display pressure	2	0.2 MPa	●
		4	0.4 MPa	●
		7	0.7 MPa	●
		10	1.0 MPa	●
		P2 *1	0.2 MPa, 30 psi	○*2
		P10 *1	1.0 MPa, 150 psi	○*2
		+		
②	Connection thread	01	R1/8	●
		02	R1/4	●
		+		
③	Option	Nil	—	●
		M *3	With M5 (Female thread)	●
		+		
④	Grade	SRA	Component parts: Precision cleaning Assembly: Clean room M5.5 (Class 10000)	●
		SRB	Component parts: General degreasing Assembly: General production line	●
		+		
⑤	Attachment	Nil	Without cover ring assembly	●
		C	Clear cover has no protrusion. (Clear cover is irremovable.)	●
		C2	Clear cover has protrusion. (Clear cover is removable.) The wrench flats protrude.	●
		+		
⑥	Special specification	Nil	—	●
		X30	Both MPa and psi	○*2

*1 This symbol must be used with Special specification "X30."

*2 Under the New Measurement Act, products for overseas use only (SI unit type for use in Japan)

*3 To use the pressure gauge with M5 (female thread), attach the joint when piping the tube. For combinations with the special specification products, please consult SMC separately.



1 Output

3-Screen Display High-Precision Digital Pressure Switch

IP40

ZSE20(F)/ISE20-X2



More for the specifications and dimensions

How to Order

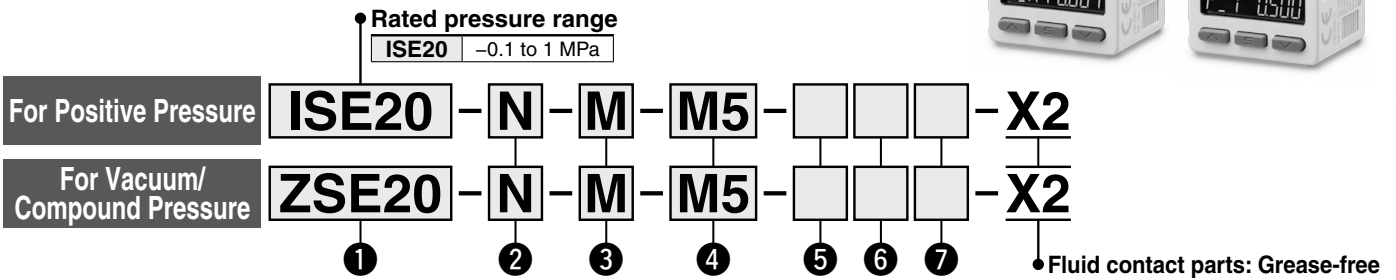

1 Rated pressure range

ZSE20	0 to -101 kPa
ZSE20F	-100 to 100 kPa

2 Output specification

Symbol	Description
N	NPN open collector 1 output
P	PNP open collector 1 output

3 Unit specification

Symbol	Description
Nil	Unit selection function*1
M	SI units only*2
P	Unit selection function (Initial value psi)*1

*1 Under the New Measurement Act, switches with the unit selection function are no longer allowed for use in Japan.

*2 Fixed units: kPa, MPa

4 Piping specification

Symbol	Description	Symbol	Description
M5	M5 female thread Piping port	C4H	One-touch fitting ø4 mm Straight type
		C6H	One-touch fitting ø6 mm
		N7H	One-touch fitting ø1/4 inch
O1	R1/8 R1/8 Piping adapter ZS-46-N1	C4L	One-touch fitting ø4 mm Elbow type
		C6L	One-touch fitting ø6 mm
		N7L	One-touch fitting ø1/4 inch
N01	NPT1/8 NPT1/8 Piping adapter ZS-46-N2	* One-touch fitting is shipped together with the product.	

5 Option 1

Symbol	Description
Nil	Without lead wire
L	Lead wire with connector (3-core, 2 m lead wire)

* For the lead wire with M12 connector, refer to the Web Catalog.

7 Option 3

Symbol	Operation manual*1	Calibration certificate*1
Nil	○	—
Y	—	○
K	○	○
T	—	○

*1 All texts are in both English and Japanese.

6 Option 2

Symbol	Description
Nil	None
A1	Bracket A (Vertical mounting) ZS-46-A1
A2	Bracket B (Horizontal mounting) ZS-46-A2
B	Panel mount adapter ZS-46-B
D	Panel mount adapter + Front protection cover ZS-46-D

Options/Part Nos.

When only optional parts are required, order with the part numbers listed below.

Description	Part no.	Note
Bracket A	ZS-46-A1	Tapping screw: Nominal size 3 x 8 L (2 pcs.)
Bracket B	ZS-46-A2	Tapping screw: Nominal size 3 x 8 L (2 pcs.)
Panel mount adapter	ZS-46-B	—
Panel mount adapter + Front protection cover	ZS-46-D	—
Lead wire with connector	ZS-46-3L	3-core, 2 m, Non-waterproof (Without waterproof cover)
Lead wire with M12 connector	ZS-46-5LM12	Made to order (Refer to the Web Catalog.)
Front protection cover	ZS-27-01	—
R1/8 Piping adapter	ZS-46-N1	R1/8
NPT1/8 Piping adapter	ZS-46-N2	NPT1/8

Air Preparation Equipment
Pressure Control Equipment/Others

Fittings and Tubing

Flow Control
Equipment

Pressure Gauges

Switches/Sensors

Process Valves

Directional
Control Valves



2 Outputs + Analog Output (Voltage/Current)

3-Screen Display High-Precision Digital Pressure Switch

IP40

ZSE20A(F)/ISE20A-X2



More for the specifications and dimensions



How to Order

For Positive Pressure **ISE20A** - **X** - **M** - **M5** - **X2**
 For Vacuum/Compound Pressure **ZSE20A** - **X** - **M** - **M5** - **X2**

1: Rated pressure range (ISE20A: -0.1 to 1 MPa)
 2: Output specification
 3: Unit specification
 4: Piping specification
 5: Option 1
 6: Option 2
 7: Option 3

Fluid contact parts: Grease-free

1 Rated pressure range

ZSE20A	0 to -101 kPa
ZSE20AF	-100 to 100 kPa

2 Output specification

Symbol	Description
R	NPN open collector 2 outputs + Analog voltage output *1
S	NPN open collector 2 outputs + Analog current output *1
T	PNP open collector 2 outputs + Analog voltage output *1
V	PNP open collector 2 outputs + Analog current output *1
X	NPN open collector 2 outputs + Copy function
Y	PNP open collector 2 outputs + Copy function

*1 Can be switched to auto-shift or copy function

3 Unit specification

Symbol	Description
Nil	Unit selection function *1
M	SI units only *2
P	Unit selection function (Initial value psi) *1

*1 Under the New Measurement Act, switches with the unit selection function are no longer allowed for use in Japan.
*2 Fixed units: kPa, MPa

4 Piping specification

Symbol	Description	Symbol	Description
M5	M5 female thread Piping port	C4H	One-touch fitting ø4 mm Straight type
		C6H	One-touch fitting ø6 mm
		N7H	One-touch fitting ø1/4 inch
01	R1/8 R1/8 Piping adapter ZS-46-N1	C4L	One-touch fitting ø4 mm Elbow type
		C6L	One-touch fitting ø6 mm
		N7L	One-touch fitting ø1/4 inch
N01	NPT1/8 NPT1/8 Piping adapter ZS-46-N2	* One-touch fitting is shipped together with the product.	

5 Option 1

Symbol	Description
Nil	Without lead wire
J	Lead wire with connector (5-core, 2 m lead wire)

* For the lead wire with M12 connector, refer to the Web Catalog.

7 Option 3

Symbol	Operation manual *1	Calibration certificate *1
Nil	○	—
Y	—	—
K	○	○
T	—	○

*1 All texts are in both English and Japanese.

6 Option 2

Symbol	Description
Nil	None
A1	Bracket A (Vertical mounting) ZS-46-A1
A2	Bracket B (Horizontal mounting) ZS-46-A2
B	Panel mount adapter ZS-46-B
D	Panel mount adapter + Front protection cover ZS-46-D

Options/Part Nos.

When only optional parts are required, order with the part numbers listed below.

Description	Part no.	Note
Bracket A	ZS-46-A1	Tapping screw: Nominal size 3 x 8 L (2 pcs.)
Bracket B	ZS-46-A2	Tapping screw: Nominal size 3 x 8 L (2 pcs.)
Panel mount adapter	ZS-46-B	—
Panel mount adapter + Front protection cover	ZS-46-D	—
Lead wire with connector	ZS-46-5L	5-core, 2 m, Non-waterproof (Without waterproof cover)
Lead wire with M12 connector	ZS-46-5LM12	Made to order (Refer to the Web Catalog.)
Front protection cover	ZS-27-01	—
R1/8 Piping adapter	ZS-46-N1	R1/8
NPT1/8 Piping adapter	ZS-46-N2	NPT1/8



2 Outputs + Analog Output (Voltage/Current)

3-Screen Display High-Precision Digital Pressure Switch for General Fluids IP65

ZSE20C(F)/ISE20C(H) Series



More for the specifications and dimensions

How to Order



Air Preparation Equipment
Pressure Control Equipment/Others

Fittings and Tubing

Flow Control Equipment

Pressure Gauges

Switches/Sensors

Process Valves

Directional Control Valves

Rated pressure range

ISE20C	-0.1 to 1 MPa
ISE20CH	-0.1 to 2 MPa

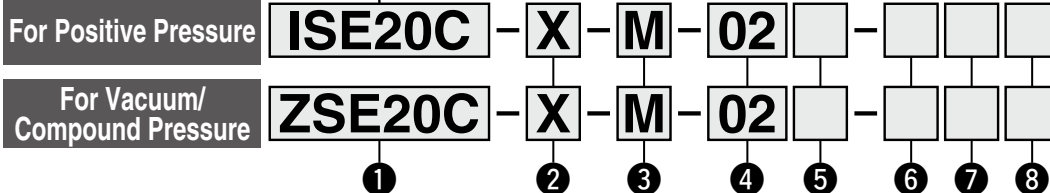

1 Rated pressure range

ZSE20C	0 to -101 kPa
ZSE20CF	-100 to 100 kPa

2 Output specification

Symbol	Description
R	NPN open collector 2 outputs + Analog voltage output*1
S	NPN open collector 2 outputs + Analog current output*1
T	PNP open collector 2 outputs + Analog voltage output*1
V	PNP open collector 2 outputs + Analog current output*1
X	NPN open collector 2 outputs + Copy function
Y	PNP open collector 2 outputs + Copy function

*1 Can be switched to auto-shift or copy function

3 Unit specification

Symbol	Description
Nil	Unit selection function*2
M	SI units only*3
P	Unit selection function (Initial value psi)*3

*2 Under the New Measurement Act, switches with the unit selection function are no longer allowed for use in Japan.

*3 Fixed units: kPa, MPa

4 Piping specification

Symbol	Description
02	R1/4 (M5 female threaded)
N02	NPT1/4 (M5 female threaded)
F02	G1/4 (M5 female threaded)
C01	Rc1/8
A2	URJ1/4 (Face seal fitting)
B2	TJSJ1/4 (Compression fitting)

7 Option 2

* Note that the optional parts that can be used vary depending on the piping direction.

Symbol	Description
Nil	None

Rear ported (5 Piping direction: Nil)

Symbol	Description	Symbol	Description
A1	Bracket A	B	Panel mount adapter
D	Panel mount adapter + Front protection cover	ZS-46-B	
		ZS-46-D	

Bottom ported (5 Piping direction: L)

Symbol	Description
A3	Bracket C
E	Panel mount adapter
F	Panel mount adapter + Front protection cover
	ZS-46-E
	ZS-35-B
	ZS-35-E

5 Piping direction

Nil	Rear ported
L	Bottom ported

6 Option 1

Symbol	Description
Nil	Without lead wire
W	Lead wire with connector, 5-core (2 m lead wire, With waterproof cover)

* For the lead wire with M12 connector, refer to the Web Catalog.

Options/Part Nos.

When only optional parts are required, order with the part numbers listed below.

Description	Part no.	Note
Bracket A	ZS-46-A1	For rear ported/Tapping screw: Nominal size 3 x 8 L (2 pcs.)
Bracket C	ZS-46-E	For bottom ported/Tapping screw: Nominal size 3 x 10 L (2 pcs.)
Panel mount adapter	ZS-46-B	Rear ported
	ZS-35-B	Bottom ported
Panel mount adapter + Front protection cover	ZS-46-D	Rear ported
	ZS-35-E	Bottom ported
Panel mount adapter (Compatible with the panel holes of the Z/ISE80)	ZS-46-F	Rear ported, Made to order (Refer to the Web Catalog.)
Panel mount adapter + Front protection cover (Compatible with the panel holes of the Z/ISE80)	ZS-46-G	Rear ported, Made to order (Refer to the Web Catalog.)
Lead wire with connector	ZS-46-5F	5-core, 2 m, Waterproof (With waterproof cover)
Lead wire with M12 connector	ZS-46-5FM12	Made to order (Refer to the Web Catalog.)
Front protection cover	ZS-27-01	Rear ported
	ZS-35-01	Bottom ported

8 Option 3

Symbol	Operation manual*4	Calibration certificate*4
Nil	○	—
Y	—	—
K	○	○
T	—	○

*4 All texts are in both English and Japanese.



3-Screen Display

High-Precision Digital Pressure Switch: For Air

ISE70/71-X2



More for the specifications and dimensions

How to Order



ISE70-02-L2-M **-X2**

Pressure range

Symbol	Description
ISE70	0 to 1 MPa
ISE71	0 to 1.6 MPa

Piping specification

Symbol	Description
02	Rc1/4
N02	NPT1/4
F02	G1/4*1

*1 ISO 1179-1 compliant

Output specification*1

Symbol	Description
L2	IO-Link: Switch output 1 + Switch output 2 (Switch output: NPN or PNP switching type)
AB	Switch output 1 + Switch output 2 (NPN or PNP switching type)

*1 Refer to the **Web Catalog** for details.

Unit specification

Symbol	Description
Nil	Unit selection function*1
M	SI unit only*2

*1 Under the New Measurement Act, switches with the unit selection function are not permitted for use in Japan.

*2 Fixed unit: MPa, kPa

• Fluid contact parts: Grease-free

Option 3

Symbol	Description
Nil	Operation manual
Y	None
K	Operation manual + Calibration certificate
T	Calibration certificate

Option 2



Symbol	Description
Nil	None
A	Bracket A (Interchangeable with ISE70)
B	Bracket B

Option 1

Symbol	Description
Nil	None
S	Lead wire with M12 connector (Straight, 5 m)
L	Lead wire with M12 connector (Right-angled, 5 m)

Options/Part Nos.

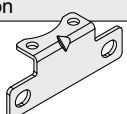
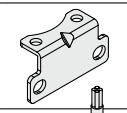
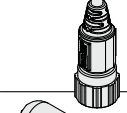
When only optional parts are required, order with the part numbers listed below.

Description	Part no.	Note
Bracket A 	ZS-50-A	Interchangeable with ISE70 With 2 mounting screws (M4 x 6L)
Bracket B 	ZS-50-B	With 2 mounting screws (M4 x 6L)
Lead wire with M12 connector: Straight 	ZS-31-B	Lead wire length: 5 m
Lead wire with M12 connector: Right-angled 	ZS-31-C	Lead wire length: 5 m



Digital Pressure Switch (Built-in Regulator Type)

ISE35-X528



More for the specifications and dimensions



How to Order

ISE35 - N - 25 - M L A - X528

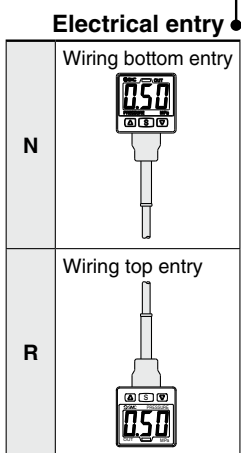

Output specifications

25	NPN output
65	PNP output

Unit specifications

Nil	With unit selection function*1
M	Fixed SI unit*2
P	Pressure unit: psi (Initial value), with unit selection function*1

*1 Under the New Measurement Act, sales of switches with the unit switching function have not been allowed for use in Japan.
*2 Fixed unit: MPa

Fluid contact parts: Grease-free (For AR/AW-D series)

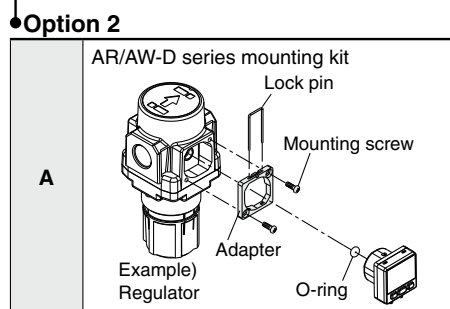

Option 1

Nil	None
L	Lead wire with connector (Length: 2 m)

Please read the Caution of HF- Series (p. 69) before use.

Option/Part No.

When optional parts are required separately, use the following part numbers to place an order.

Name	Part No.	Note
Lead wire with connector	ZS-32-A	Length: 2 m (With rubber cover)
Mounting kit	ZS-32-C-X527	For ISE35-□-A-X528 (AR/AW-D series) Mounting screw, adapter, lock pin, O-ring are attached

Applicable series

Product series that this product can be installed in.

Product series	Model
Regulator	AR20(K)-D/AR30(K)-D/AR40(K)-D/ AR50(K)-D/AR60(K)-D
Filter regulator	AW20(K)-D/AW30(K)-D/AW40(K)-D/ AW60(K)-D

Air Preparation Equipment
Pressure Control Equipment/Others

Fittings and Tubing

Flow Control Equipment

Pressure Gauges

Switches/Sensors

Process Valves

Directional Control Valves

HF1

HF2

HF1 compatible

HF2 compatible

Pressure Switch/Reed Switch Type

HF1-IS10



More for the specifications and dimensions

How to Order

HF1-IS10- 01 -
① ② ③



Semi-standard: Select one each for **a** to **c**.
When more than one specification is required, indicate in alphanumeric order.
Example) HF1-IS10-N01-6PZ

	Symbol	Description	
①	Thread type	Nil R	
		N NPT	
+			
②	Seal	Nil None	
		S With seal	
+			
③ Semi-standard	a	Set pressure range	Nil 0.1 to 0.4 MPa
			6*1 0.1 to 0.6 MPa
	+		
	b	Lead wire length	Nil 0.5 m
			L 3 m
			Z 5 m
+			
c	Scale plate pressure unit	Nil MPa	
		P*2 Both MPa and psi	

*1 Set pressure range of 6P(L, Z) is 0.2 to 0.6 MPa (30 to 90 psi).
*2 This product is for overseas use only according to the new Measurement Act. (The SI unit type is provided for use in Japan.)



2-Color Display Digital Flow Switch PF2M7 Series



More for the specifications and dimensions

How to Order

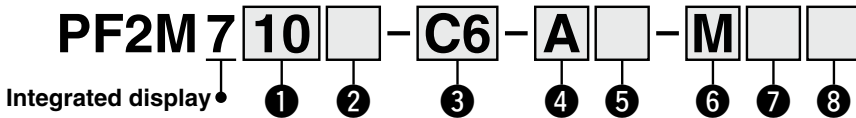

1 Rated flow range

01	0.01 to 1 L/min	25	0.2 to 25 L/min
02	0.02 to 2 L/min	50	0.5 to 50 L/min
05	0.05 to 5 L/min	11	1 to 100 L/min
10	0.1 to 10 L/min	21	2 to 200 L/min

2 Flow adjustment valve/Piping entry direction

Symbol	Flow adjustment valve	Piping entry direction	Rated flow range							
			1	2	5	10	25	50	100	200
Nil	None	Straight	●	●	●	●	●	●	●	●
S	Yes	Straight	—	—	●	●	●	●	●	●
L	None	Rear ported	●	●	●	●	●	●	●	●
W	Yes	Rear ported	—	—	●	●	●	●	●	●

* 1 and 2 L/min type products are not available with a flow adjustment valve.

3 Port size

Symbol	Port size	Rated flow range							
		1	2	5	10	25	50	100	200
01	Rc1/8	●	●	●	●	●	—	—	—
N1	NPT1/8	●	●	●	●	●	—	—	—
F1	G1/8	—	—	●	●	●	—	—	—
02	Rc1/4	—	—	—	—	—	—	—	●
N2	NPT1/4	—	—	—	—	—	—	—	●
F2	G1/4	—	—	—	—	—	—	—	●
C4 ^{*1}	ø4	●	●	●	—	—	—	—	—
C6	ø6	●	●	●	●	●	—	—	—
C8	ø8	—	—	—	—	—	—	—	●
N7	ø1/4"	—	—	—	—	—	●	●	●

*1 Made to order (Produced upon receipt of order)

Piping variations

With One-touch fitting		Female thread	
C4*2, C6, C8, N7		01, 02, N1, N2, F1, F2	
Straight		Straight	
Rear ported		Rear ported	

*2 Made to order (Produced upon receipt of order)

4 Output specification

Symbol	OUT1	OUT2
A	NPN	NPN
B	PNP	PNP
C	NPN	Analog 1 to 5 V ⇔ Analog 0 to 10 V*3
D	NPN	Analog 4 to 20 mA
E	PNP	Analog 1 to 5 V ⇔ Analog 0 to 10 V*3
F	PNP	Analog 4 to 20 mA

*3 1 to 5 V or 0 to 10 V can be selected by pressing the button. The default setting is 1 to 5 V.

7 Option 2

Nil	R	S
Without bracket	Bracket (For the type without a flow adjustment valve) ZS-33-M With 2 tapping screws	Bracket (For the type with a flow adjustment valve) ZS-33-MS With 3 tapping screws
	Panel mount adapter (For the type without a flow adjustment valve) ZS-33-2J Panel mount adapter Panel mount adapter B	Panel mount adapter (For the type with a flow adjustment valve) ZS-33-2JS Panel mount adapter S Panel mount adapter B

* Options are shipped together with the product but do not come assembled.

5 Option 1

Nil	W
Lead wire with connector (2 m) ZS-33-D	Lead wire with connector (2 m) + Connector cover (Silicone rubber) ZS-33-F ZS-33-D +
Without lead wire with connector	

6 Unit specification

M	SI unit only*4
Nil	Unit selection function*5

*4 Fixed unit: Instantaneous flow: L/min
Accumulated flow: L

*5 This product is for overseas use only. (The SI unit type is provided for use in Japan in accordance with the New Measurement Act.)
The unit can be changed.
Instantaneous flow: L/min ⇔ cfm
Accumulated flow: L ⇔ ft³

8 Calibration certificate*6

Nil	None
A	Yes

*6 Made to order
The certificate is in both English and Japanese.

DIN Rail Mounting Bracket (To Be Ordered Separately)

ZS-33-R 3

Stations	
1	1 station
2	2 stations
3	3 stations
4	4 stations
5	5 stations

DIN rail part number: **AXT100-DR-□**

* Refer to the Web Catalog for the DIN rail mounting dimensions.

Air Preparation Equipment
Pressure Control Equipment/Others

Fittings and Tubing

Flow Control Equipment

Pressure Gauges

Switches/Sensors

Process Valves

Directional Control Valves



2-Color Display

Digital Flow Switch

PFMB7 Series



More for the specifications and dimensions

How to Order



PFMB7 **501** - **04** - **A** - **M**

Rated flow range (Flow rate range)

501	5 to 500 L/min
102	10 to 1000 L/min
202	20 to 2000 L/min

Thread type

Nil	Rc
N	NPT
F	G *1

*1 ISO 228 compliant

Port size

Port size	Rated flow range		
	501	102	202
04	1/2	●	—
06	3/4	—	●

Output specification

	OUT1	OUT2	Applicable monitor unit model
A	NPN	NPN	—
B	PNP	PNP	—
C	NPN	Analog 1 to 5 V	PFG300 series
D	NPN	Analog 4 to 20 mA	PFG310 series
E *1	PNP	Analog 1 to 5 V	PFG300 series
F *1	PNP	Analog 4 to 20 mA	PFG310 series
G *1	NPN	External input *2	—
H *1	PNP	External input *2	—

*1 Made to order

*2 Accumulated flow value, peak/bottom flow value can be reset by external signal input.

Option 1

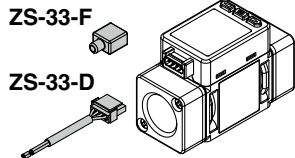
Nil	W
Lead wire with connector (2 m)	Lead wire with connector (2 m) + Rubber cover for connector (Silicone rubber)
	
N	
Without lead wire with connector	* When only optional parts are required, refer to Option 1/Part Nos. below.

Calibration certificate *1

Nil	None
A *2	With calibration certificate

*1 Certificate in both English and Japanese

*2 Made to order

Option 2

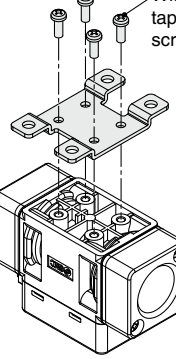
Nil	R
No bracket	With bracket 

* Options are shipped together with the product, but not assembled. When only optional parts are required, refer to Option 2/Part Nos. below.

Unit specification

M	SI unit only *1
Nil	Unit selection function *2

*1 Fixed unit: Instantaneous flow: L/min
Accumulated flow: L

*2 This product is for overseas use only according to the New Measurement Act. (The SI unit type is provided for use in Japan.)

Unit can be changed. Instantaneous flow: L/min ↔ cfm
Accumulated flow: L ↔ ft³

Option 1/Part Nos.

Option	Part no.	Qty.	Note
Lead wire with connector	ZS-33-D	1	Lead wire: 2 m
Rubber cover (Silicone rubber)	ZS-33-F	1	For connector

Option 2/Part Nos.

Option	Part no.	Qty.	Note
Bracket (for PFMB7201)	ZS-33-M	1	With 2 tapping screws (3 x 6)
Bracket (for PFMB7201S)	ZS-33-MS	1	With 3 tapping screws (3 x 6)
Panel mount adapter (for PFMB7201)	ZS-33-J	1	
Panel mount adapter (for PFMB7201S)	ZS-33-JS	1	
Bracket (for PFMB7501/7102)	ZS-42-C	1	With 4 tapping screws (3 x 6)
Bracket (for PFMB7202)	ZS-42-D	1	With 4 tapping screws (3 x 6)



Flow Sensor

PFMV5 Series



More for the specifications and dimensions

How to Order



PFMV5 05 - 1 - □ □

Measurement flow range

05	0.0 to 0.5 L/min
10	0.0 to 1.0 L/min
30	0.0 to 3.0 L/min
05F	-0.5 to 0.5 L/min
10F	-1.0 to 1.0 L/min
30F	-3.0 to 3.0 L/min

Output specifications

1	Analog output (1 to 5 V)
---	--------------------------

Option (shipped together)

Nil	None
A	With L-type bracket

* 2 L-type brackets (with 2 mounting screws) are included.

Operation manual

Nil	With operation manual (Japanese and English)
N	None

Option/Part No.

If a single option or manifold mounting are required, order sensors with the part numbers below separately.

Part no.	Stations	Note
ZS-36-A1	For 1 station (for single unit)	2 L-type brackets, 2 mounting screws M3 x 15L
ZS-36-A2	For 2 stations	2 L-type brackets, 2 mounting screws M3 x 25L
ZS-36-A3	For 3 stations	2 L-type brackets, 2 mounting screws M3 x 35L
ZS-36-A4	For 4 stations	2 L-type brackets, 2 mounting screws M3 x 45L
ZS-36-A5	For 5 stations	2 L-type brackets, 2 mounting screws M3 x 55L

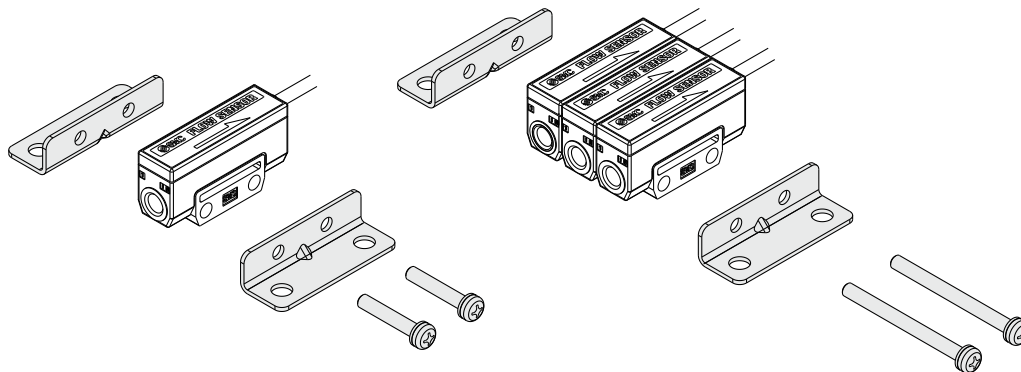

Air Preparation Equipment
Pressure Control Equipment/Others

Fittings and Tubing

Flow Control Equipment

Pressure Gauges

Switches/Sensors

Process Valves

Directional Control Valves



Direct Operated 2-Port Solenoid Valve

HF1-JSX Series

Body Material **Stainless Steel, Brass**



More for the specifications and dimensions

How to Order

Differs depending on the voltage and electrical entry. For details, refer to the **Web Catalog**.

HF1-JSX 2 1 - S N 302 R - 5 G - B



1 Size

Symbol	Size
1	10
2	20
3	30

2 Valve type

Symbol	Valve type
1	N.C. 2(OUT) 1(IN)

3 Body material

Symbol	Body material
S	Stainless steel
C	Brass

8 Electrical entry

Symbol	Electrical entry	Size			CE-compliant
		10	20	30	
G	Grommet*1	●	●	●	24 VDC
		—	—	—	12 VDC
GS	Grommet with PCB (With surge voltage suppressor)	●	●	●	100 VAC
		—	—	—	24 VDC
		—	—	—	12 VDC
		—	—	—	48 VAC
CS	Conduit (With surge voltage suppressor)	—	●	●	All voltages
		—	—	—	24 VAC
DS	DIN terminal (With surge voltage suppressor)	●	●	●	All voltages
		—	—	—	—
DZ	DIN terminal with light (With surge voltage suppressor)	●	●	●	All voltages
		—	—	—	—
DN	DIN terminal without connector (With surge voltage suppressor)	●	●	●	All voltages
		—	—	—	—
WN	M12 connector/Without connector cable (With surge voltage suppressor)*2	●	●	●	All voltages
		—	—	—	—

4 Seal material

Symbol	Seal material
N	NBR
F	FKM
E	EPDM

5 Orifice diameter and port size

Symbol	Orifice diameter [mmø]	Port size	Size		
			10	20	30
101	1.6	1/8	●	—	—
201	2.4	1/8	●	—	—
301	3.2	1/8	—	●	—
302		1/4	—	●	—
303	3/8	—	—	●	—
402	4	1/4	—	●	●
403		3/8	—	●	●
502	5.6	1/4	—	●	●
503		3/8	—	●	●
702	7.1	1/4	—	●	●
703		3/8	—	●	●

6 Thread type

Symbol	Thread type
R	Rc
N	NPT
F	G

7 Rated voltage

AC				DC	
Symbol	Rated voltage	Symbol	Rated voltage	Symbol	Rated voltage
1	100 VAC	7	240 VAC	5	24 VDC
2	200 VAC	8	48 VAC	6	12 VDC
3	120 (110) VAC	B	24 VAC		
4	220 VAC	J	230 VAC		

9 Option

Symbol	Option
Nil	None
B	With bracket*1 (Stainless steel)

*1 Refer to the **Web Catalog** for the bracket assembly part nos.

*1 DC voltage only

*2 A cable for the M12 connector is not included with the product. Refer to "Option" in the **Web Catalog** to order it separately.



Direct Operated 2-Port Solenoid Valve

HF1-JSX Series

Body Material **Aluminum**



More for the specifications and dimensions

How to Order



Differs depending on the voltage and electrical entry. For details, refer to the **Web Catalog**.

HF1-JSX 2 1 - A N 302 R - 5 G - B



1 Size

Symbol	Size
2	20
3	30

2 Valve type

Symbol	Valve type
1	N.C. 2(OUT) 1(IN)

3 Body material

Symbol	Body material
A	Aluminum

8 Electrical entry

Symbol	Electrical entry	Image	Size			CE-compliant
			10	20	30	
G	Grommet*1		●	●	●	24 VDC
			●	●	●	12 VDC
GS	Grommet with PCB (With surge voltage suppressor)		●	●	●	100 VAC
			●	●	●	24 VDC
			●	●	●	12 VDC
			●	●	●	48 VAC
CS	Conduit (With surge voltage suppressor)		—	●	●	24 VAC
			—	●	●	All voltages
DS	DIN terminal (With surge voltage suppressor)		●	●	●	All voltages
			●	●	●	All voltages
DZ	DIN terminal with light (With surge voltage suppressor)		●	●	●	All voltages
			●	●	●	All voltages
DN	DIN terminal without connector (With surge voltage suppressor)		●	●	●	All voltages
			●	●	●	All voltages
WN	M12 connector/Without connector cable (With surge voltage suppressor)*2		●	●	●	All voltages
			●	●	●	All voltages

4 Seal material

Symbol	Seal material
N	NBR
F	FKM

5 Orifice diameter and port size

Symbol	Orifice diameter [mmø]	Port size	Size	
			20	30
301	3	1/8	●	—
302		1/4	●	—
402	4	1/4	—	●
403		3/8	—	●
501	5	1/8	●	—
502		1/4	●	—
702	7	1/4	—	●
703		3/8	—	●

6 Thread type

Symbol	Thread type
R	Rc
N	NPT
F	G

7 Rated voltage

AC				DC	
Symbol	Rated voltage	Symbol	Rated voltage	Symbol	Rated voltage
1	100 VAC	7	240 VAC	5	24 VDC
2	200 VAC	8	48 VAC	6	12 VDC
3	120 (110) VAC	B	24 VAC		
4	220 VAC	J	230 VAC		

9 Option

Symbol	Option
Nil	None
B	With bracket*1

*1 Refer to the **Web Catalog** for the bracket assembly part nos.

*1 DC voltage only

*2 A cable for the M12 connector is not included with the product. Refer to "Option" in the **Web Catalog** to order it separately.

Air Preparation Equipment
Pressure Control Equipment/Others

Fittings and Tubing

Flow Control
Equipment

Pressure Gauges

Switches/Sensors

Process Valves

Directional
Control Valves



Pilot Operated 2-Port Solenoid Valve

HF1-JSXD Series



More for the specifications
and dimensions

How to Order

Differs depending on the voltage and electrical
entry. For details, refer to the **Web Catalog**.

HF1-JSXD **3** **1** - **C** **N** **02** **R** - **5** **G** - **B**

① ② ③ ④ ⑤ ⑥ ⑦ ⑧ ⑨

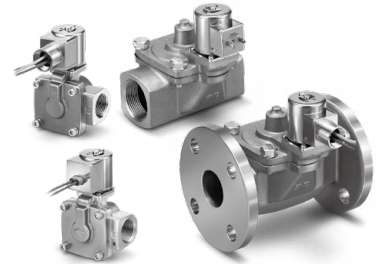

① Size

Symbol	Size
3	30
4	40
5	50
6	60
7	70
8	80
9	90

② Valve type

Symbol	Valve type
1	N.C.

③ Body material

Symbol	Body material	Size		
		30	40, 50, 60	70, 80, 90
C	Brass	●	●	—
S	Stainless steel	●	●	—
B	Bronze	—	—	●
A	Aluminum	●	—	—

④ Seal material

Symbol	Seal material
N	NBR
F	FKM
E*1	EPDM

*1 Cannot be used in combination with the aluminum body

⑤ Port size

Symbol	Connection	Port size	Size						
			30	40	50	60	70	80	90
02	Thread	1/4	●	—	—	—	—	—	—
03		3/8	●	●	—	—	—	—	—
04		1/2	●	●	—	—	—	—	—
06		3/4	—	—	●	—	—	—	—
10		1	—	—	—	●	—	—	—
12		1 1/4	—	—	—	—	●	—	—
14		1 1/2	—	—	—	—	—	●	—
20	2	—	—	—	—	—	—	●	
32	Flange	32A	—	—	—	—	●	—	
40		40A	—	—	—	—	●	—	
50		50A	—	—	—	—	—	●	

⑧ Electrical entry

Symbol	Electrical entry	CE-compliant
G	Grommet*1	12 VDC
		24 VDC
GS	Grommet with PCB (With surge voltage suppressor)	100 VAC
		24 VDC
		12 VDC
		48 VAC
CS	Conduit (With surge voltage suppressor)	24 VAC
		All voltages
DS	DIN terminal (With surge voltage suppressor)	All voltages
DZ	DIN terminal with light (With surge voltage suppressor)	All voltages
		All voltages
DN	DIN terminal without connector (With surge voltage suppressor)	All voltages
WN	M12 connector without connector cable (With surge voltage suppressor)*2	All voltages

⑥ Thread type*1

Symbol	Thread type
R	Rc
N	NPT
F	G

*1 Thread type cannot be selected for 70 to 90 size flange types.

⑦ Rated voltage

AC				DC	
Symbol	Rated voltage	Symbol	Rated voltage	Symbol	Rated voltage
1	100 VAC	7	240 VAC	5	24 VDC
2	200 VAC	8	48 VAC	6	12 VDC
3	120 (110) VAC	B	24 VAC		
4	220 VAC	J	230 VAC		

⑨ Bracket

Symbol	Bracket	Size		
		30 Aluminum, Brass, Stainless Steel	40, 50, 60	70, 80, 90
Nil	None	●	●	●
B	With bracket	●	●	—*1

*1 Sizes 70 to 90 are not available with a bracket.

*1 DC voltage only

*2 A cable for the M12 connector is not included with the product. Refer to "Option" in the **Web Catalog** to order it separately.



Pulse Valve **Valve for Dust Collector** HF1-JSXFAE/F Series

Compression Fitting Type/Direct Piping Type



More for the specifications and dimensions

How to Order

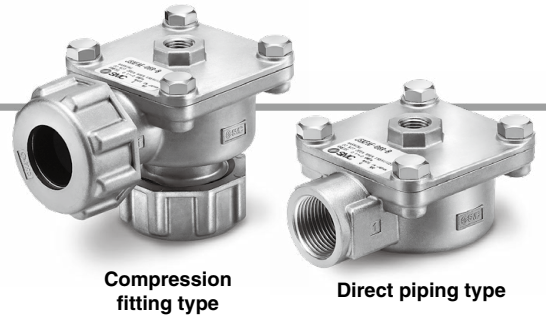
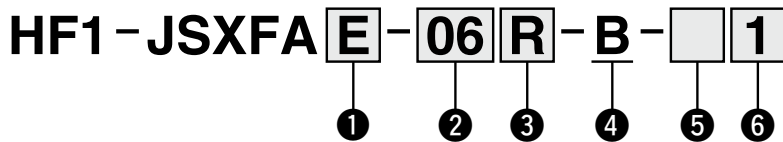

Compression fitting type

Direct piping type

① Piping

E	Compression fitting type*1
F	Direct piping type

*1 Seals and washers are included.

② IN/OUT port size

06	3/4 (20A)
10	1 (25A)
14	1 1/2 (40A)

③ Thread type

R	Rc
N	NPT
F	G

④ Fluid and ambient temperatures

B	-40 to 60°C
----------	-------------

⑤ With/without silencer

		Port size		
		06	10	14
Nil	Without	●	●	●
S	With	—	—	●

* Port size: 14 only
Select Nil for 06 and 10.

⑥ Pilot port size

Nil	1/4
1	1/8

Symbol

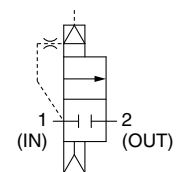

⚠ Caution

Selection of Pilot Valve

For the pilot valve orifice diameter, $\phi 5$ mm or larger is recommended.

When the pilot orifice diameter is $\phi 3$ mm or larger and less than $\phi 5$ mm, put "A" to the end of the product number for made-to-order. The product may not operate correctly if the pilot valve orifice diameter is inadequate. (port size: 3/4, 1) Depending on the pilot piping port size*1 or length, the valve may not operate correctly.

*1 The I.D. of the pilot piping must be larger than the pilot valve orifice diameter to use. The maximum pilot piping I.D. is 10 mm.

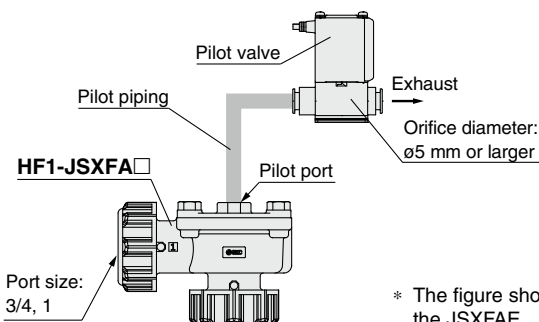

* The figure shows the JSXFAE.

Made to Order

Pilot valve orifice diameter: Special specification

A	For $\phi 3$ mm to $\phi 5$ mm	Port size: 06, 10
----------	--------------------------------	-------------------

HF1 - JSXFA **1** - **06** **R** - **B** - **1** **A**

Enter the standard product number.

Air Preparation Equipment
Pressure Control Equipment/Others

Fittings and Tubing

Flow Control Equipment

Pressure Gauges

Switches/Sensors

Process Valves

Directional Control Valves

HF1

HF2

HF1
compatible

HF2
compatible

High Speed 2-Port Valve

SX10 Series



More for the specifications and dimensions

How to Order



SX1 2 F - A G

Valve mounting

1	Screw mount type*1
2	Quick disconnect type

*1 Two mounting screws (M3 x 0.5) and a gasket are included. (packaged together)

Filter (IN port)

Nil	Without filter
F	With filter*2

*2 Flow reduction rate
 50 L/min: 5% or less
 100 L/min: 5 to 10%
 150 L/min: 10 to 15%

Flow rate/Operating frequency (at 24 VDC, 0.25 MPa)

Symbol	Flow rate [L/min]	Power consumption [W]	Max. operating frequency [Hz]
A	50	80	1200
B		40	1000
C		10	550
D		4	350
E	100	80	650
F		40	550
G		10	300
H		4	200
J	150	80	600
K		40	500
L		10	250
M		4	150

Lead wire (grommet) length

Symbol	Length
G	300 mm
H	500 mm
J	1000 mm



Rubber Seal 3-Port/Pilot Poppet Type Body Ported/Single Unit

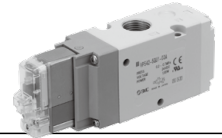

HF1-VP300/500/700 Series



More for the specifications and dimensions

How to Order



* Only DIN and conduit terminal types are available for AC mode. Refer to the electrical entry for details.

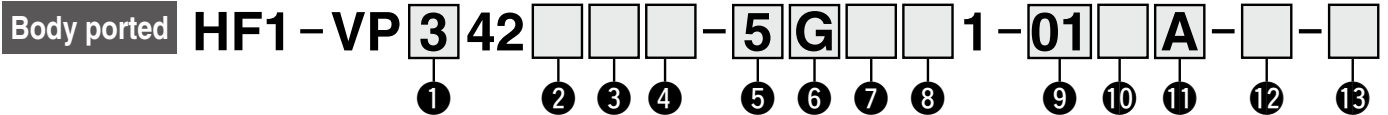

1 Series

3	VP300
5	VP500
7	VP700

2 Pilot type

Nil	Internal pilot
R	External pilot

* If the product is used for air blow, the use of external pilot valve is recommended to avoid operation failure due to pressure drop.

3 Pressure specification

Nil	Standard (0.7 MPa)
K	High-pressure type (1.0 MPa)

4 Coil specification

Nil	Standard
T	With power saving circuit (DC only)

* Be sure to select the power saving circuit type when it is continuously energized for a long time. (Refer to the **Web Catalog** for details.)
* T type is only available for DC mode. When T is selected, only Z type of light/surge voltage suppressor is available. (Note that when the electrical entry of DIN terminal type without connector is selected, only DOS and YOS are available.)

5 Rated voltage

DC	
5	24 VDC
6	12 VDC
AC (50/60 Hz)*1	
1	100 VAC
2	200 VAC
3	110 VAC [115 VAC]
4	220 VAC [230 VAC]
7	240 VAC
B	24 VAC

*1 For triac output, refer to the made-to-order specifications (X600).

7 Light/surge voltage suppressor

		DC	AC
Nil	Without light/surge voltage suppressor	○	○
S	With surge voltage suppressor	○	—*3
Z	With light/surge voltage suppressor	○	○
R	With surge voltage suppressor (Non-polar)	○	—
U	With light/surge voltage suppressor (Non-polar)	○	—

*3 There is no S option for AC mode, since a rectifier prevents surge voltage generation.

* In the DIN terminal type, since a light is installed in the connector, DOZ, DOU, YOZ, YOU are not available.

8 Manual override

Nil: Non-locking push type	D: Push-turn locking slotted type	E: Push-turn locking lever type

6 Electrical entry

Grommet	L-type plug connector	M-type plug connector	DIN terminal	DIN (EN175301-803) terminal	Conduit terminal
G: Lead wire length 300 mm H: Lead wire length 600 mm	L: With lead wire (length 300 mm)	M: With lead wire (length 300 mm)	D: With connector	Y: With connector	T: Conduit terminal
G: Lead wire length 300 mm H: Lead wire length 600 mm DC Without light/surge voltage suppressor	LN: Without lead wire	MN: Without lead wire	DO: Without connector	YO: Without connector	
CE-DC compliant AC ²	CE	CE	CE	CE	CE

*2 With the same specifications as the DC type, all lead wire entries for the 24 VAC type are CE marking compliant.

* LN and MN types are with 2 sockets.

* Refer to the **Web Catalog** when different length of lead wire for L/M-type plug connector is required.

* Refer to the **Web Catalog** for details on the DIN (EN175301-803) terminal.

9 Port size

Symbol	Port size	VP300	VP500	VP700
01	1/8	○	—	—
02	1/4	○	○	—
03	3/8	—	○	○
04	1/2	—	—	○

10 Thread type

Nil	Rc
F	G
N	NPT
T	NPTF

12 Bracket

Nil	Without bracket
F	With bracket

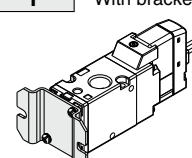

11 Type of actuation

A	N.C. (Normally closed)
B	N.O. (Normally open)

13 Made to Order

Nil	—
X500	Pilot exhaust port with piping thread (M3) specification (Refer to the Web Catalog).
X505	Interchangeable specification with the previous valve mounting hole pitch type (Refer to the Web Catalog).
X600	Triac output specification (Refer to the Web Catalog).

Caution

When using the surge voltage suppressor type, residual voltage will remain. Refer to the **Web Catalog** for details.



Rubber Seal 3-Port/Pilot Poppet Type Base Mounted/Single Unit

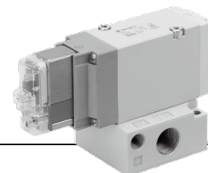

HF1-VP300/500/700 Series



More for the specifications and dimensions

How to Order



* Only DIN and conduit terminal types are available for AC mode. Refer to the electrical entry for details.

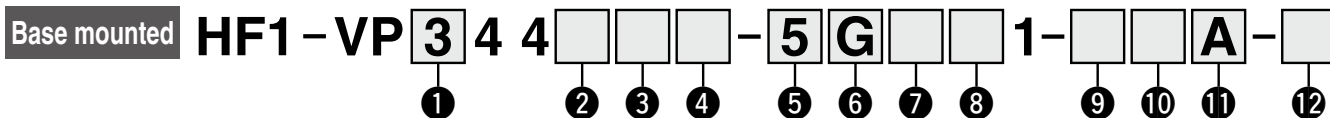

① Series

3	VP300
5	VP500
7	VP700

② Pilot type

Nil	Internal pilot
R	External pilot

* If the product is used for air blow, the use of external pilot valve is recommended to avoid operation failure due to pressure drop.

③ Pressure specification

Nil	Standard (0.7 MPa)
K	High-pressure type (1.0 MPa)

④ Coil specification

Nil	Standard
T	With power saving circuit (DC only)

* Be sure to select the power saving circuit type when it is continuously energized for a long time. (Refer to the **Web Catalog** for details.)

* T type is only available for DC mode. When T is selected, only Z type of light/surge voltage suppressor is available. (Note that when the electrical entry of DIN terminal type without connector is selected, only DOS and YOS are available.)

⑤ Rated voltage

DC	
5	24 VDC
6	12 VDC
AC (50/60 Hz)*1	
1	100 VAC
2	200 VAC
3	110 VAC [115 VAC]
4	220 VAC [230 VAC]
7	240 VAC
B	24 VAC

*1 For triac output, refer to the made-to-order specifications (X600).

⑦ Light/surge voltage suppressor

		DC	AC
Nil	Without light/surge voltage suppressor	○	○
S	With surge voltage suppressor	○	—*3
Z	With light/surge voltage suppressor	○	○
R	With surge voltage suppressor (Non-polar)	○	—
U	With light/surge voltage suppressor (Non-polar)	○	—

*3 There is no S option for AC mode, since a rectifier prevents surge voltage generation.

* In the DIN terminal type, since a light is installed in the connector, DOZ, DOU, YOZ, YOU are not available.

⑧ Manual override

Nil: Non-locking push type	D: Push-turn locking slotted type	E: Push-turn locking lever type

⑥ Electrical entry

Grommet	L-type plug connector	M-type plug connector	DIN terminal	DIN (EN175301-803) terminal	Conduit terminal
G: Lead wire length 300 mm H: Lead wire length 600 mm	L: With lead wire (length 300 mm)	M: With lead wire (length 300 mm)	D: With connector	Y: With connector	T: Conduit terminal
G: Lead wire length 300 mm H: Lead wire length 600 mm DC Without light/surge voltage suppressor	LN: Without lead wire	MN: Without lead wire	DO: Without connector	YO: Without connector	
CE-compliant	DC	CE	CE	CE	CE
	AC*2	—	CE	CE	CE

*2 With the same specifications as the DC type, all lead wire entries for the 24 VAC type are CE marking compliant.

* LN and MN types are with 2 sockets.

* Refer to the **Web Catalog** when different length of lead wire for L/M-type plug connector is required.

* Refer to the **Web Catalog** for details on the DIN (EN175301-803) terminal.

⑨ Port size (Sub-plate)

Symbol	Port size	VP300	VP500	VP700
Nil		Without sub-plate*4		
01	1/8	○	—	—
02	1/4	○	○	—
03	3/8	—	○	○
04	1/2	—	—	○

*4 With a gasket and two mounting bolts.

⑩ Thread type

Nil	Rc
F	G
N	NPT
T	NPTF

⑪ Type of actuation

A	N.C. (Normally closed)
B	N.O. (Normally open)

⑫ Made to Order

Nil	—
X500	Pilot exhaust port with piping thread (M3) specification (Refer to the Web Catalog).
X600	Triac output specification (Refer to the Web Catalog).

⚠ Caution

When using the surge voltage suppressor type, residual voltage will remain. Refer to the **Web Catalog** for details.



Low Wattage Specification

HF1-VP300/500 Series

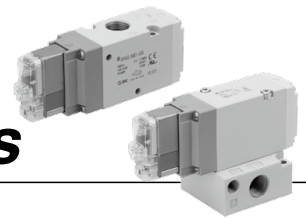

Body Ported **Base Mounted**



More for the specifications and dimensions

How to Order



* AC-type models that are CE-compliant have DIN terminals only. Refer to the electrical entry for details.

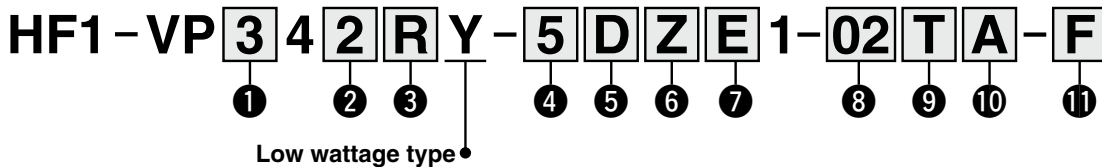

① Series

3	VP300
5	VP500

② Body type

		Mountable manifold	
		41	42
2	Body ported	—	—
4	Base mounted	●*1	●*1

*1 Refer to the **Web Catalog**.

③ Pilot type

Nil	Internal pilot
R	External pilot

* If the product is used for air blow, the use of external pilot valve is recommended to avoid operation failure due to pressure drop.

④ Rated voltage

1	100 VAC
2	200 VAC
3	110 VAC
4	220 VAC
5	24 VDC
6	12 VDC

⑤ Electrical entry

CE-compliant	24 VDC, 12 VDC/100 VAC, 110 VAC, 200 VAC, 220 VAC				24 VDC, 12 VDC/100 VAC, 110 VAC, 200 VAC, 220 VAC	
	Grommet	L-type plug connector	M-type plug connector	DIN terminal		
DC	●	●	●	●	●	●
AC	—	—	—	●	●	●

G: Lead wire length 300 mm
L: With lead wire (Length 300 mm)
M: With lead wire (Length 300 mm) **MN:** Without lead wire
H: Lead wire length 600 mm
LN: Without lead wire **LO:** Without connector **MO:** Without connector
DO: Without connector **YO:** Without connector

* LN and MN types are with 2 sockets.

* Y type DIN terminal complies with EN-175301-803C (former DIN 43650C). Refer to the **Web Catalog** for details.

⑥ Light/Surge voltage suppressor

Electrical entry for G, H, L, M

Nil	Without light/surge voltage suppressor
S	With surge voltage suppressor
Z	With light/surge voltage suppressor
R	With surge voltage suppressor (Non-polar type)
U	With light/surge voltage suppressor (Non-polar type)

* For AC voltage valves, there is no "S" option. It is already built into the rectifier circuit.
* For "R" and "U", DC voltage is only available.

Electrical entry for D, Y

Nil	Without light/surge voltage suppressor
S	With surge voltage suppressor (Non-polar type)
Z	With light/surge voltage suppressor (Non-polar type)

* DOZ and YOZ are not available.
* For AC voltage valves, there is no "S" option. It is already built into the rectifier circuit.

⑦ Manual override

Nil	Non-locking push type
D	Push-turn locking slotted type
E	Push-turn locking lever type

⑧ Port size

Body Ported

Symbol	Port size	VP300	VP500
01	1/8	○	—
02	1/4	○	○
03	3/8	—	○

Base Mounted

Symbol	Port size	VP300	VP500
Nil	Without sub-plate*2		
01	1/8	○	—
02	1/4	○	○
03	3/8	—	○

*2 With a gasket and two mounting bolts

⑨ Thread type

Nil	Rc, M5
F	G
N	NPT
T	NPTF

⑩ Type of actuation

A	N.C. (Normally closed)
B	N.O. (Normally open)

⑪ Bracket

Nil	Without bracket
F	With bracket*3

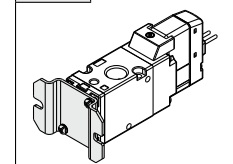

*3 Body ported only

Air Preparation Equipment
Pressure Control Equipment/Others

Fittings and Tubing

Flow Control
Equipment

Pressure Gauges

Switches/Sensors

Process Valves

Directional
Control Valves



Micro Mechanical Valve

HF1-VM1000 Series



More for the specifications and dimensions



Model

	Actuator	Piping	Number of ports	Applicable tubing		Note	Weight [g]
				T0425	TU0425/T0403		
Manual operation	Toggle lever	Side ported	3-port	HF1-VM1000-4N-08	HF1-VM1000-4NU-08	-	20
			2-port	HF1-VM1100-4N-08	HF1-VM1100-4NU-08	-	
		Bottom ported	3-port	HF1-VM1010-4N-08	HF1-VM1010-4NU-08	-	
			2-port	HF1-VM1110-4N-08	HF1-VM1110-4NU-08	-	
	Push button	Side ported	3-port	HF1-VM1000-4N-32R	HF1-VM1000-4NU-32R	Red	31
			2-port	HF1-VM1100-4N-32R	HF1-VM1100-4NU-32R	Red	
		Bottom ported	3-port	HF1-VM1010-4N-32R	HF1-VM1010-4NU-32R	Red	
			2-port	HF1-VM1110-4N-32R	HF1-VM1110-4NU-32R	Red	
		Side ported	3-port	HF1-VM1000-4N-32B	HF1-VM1000-4NU-32B	Black	
			2-port	HF1-VM1100-4N-32B	HF1-VM1100-4NU-32B	Black	
		Bottom ported	3-port	HF1-VM1010-4N-32B	HF1-VM1010-4NU-32B	Black	
			2-port	HF1-VM1110-4N-32B	HF1-VM1110-4NU-32B	Black	
		Side ported	3-port	HF1-VM1000-4N-32G	HF1-VM1000-4NU-32G	Green	
			2-port	HF1-VM1100-4N-32G	HF1-VM1100-4NU-32G	Green	
Bottom ported	3-port	HF1-VM1010-4N-32G	HF1-VM1010-4NU-32G	Green			
	2-port	HF1-VM1110-4N-32G	HF1-VM1110-4NU-32G	Green			

* To replace the push button and push button cover alone, refer to the **Web Catalog**. Other parts and actuator cannot be replaced.

How to Order

HF1-VM1 0 0 0 - 4N - 08

- Number of ports**

0	3-port
1	2-port
- Piping**

0	Side ported
1	Bottom ported
- Total travel/Basic (T.T.)**

0	4.8 mm
---	--------
- Color of push button**

R	Red
G	Green
B	Black
- Actuator type**

08	Toggle lever
32	Push button
- Applicable tubing (Material/Size)**

4N	Nylon ø4/2.5 (T0425)
	Nylon ø4/3 (T0403)
4NU	Soft nylon ø4/2.5 (TS0425)
	Polyurethane ø4/2.5 (TU0425)



2/3-Port Mechanical Valve

HF1-VM100 Series



More for the specifications and dimensions



Model

	Piping direction		Side ported				Bottom ported		Actuator	
	Body option		Standard		With bottom mounting thread		—		Actuator part number	Additional weight for actuator
	Number of ports		2-port	3-port	2-port	3-port	2-port	3-port		
Manual operation	Toggle lever		HF1-VM120-01-08A	HF1-VM130-01-08A	HF1-VM120U-01-08A	HF1-VM130U-01-08A	HF1-VM122-M5-08A	HF1-VM132-M5-08A	VM-08B	41 g
	Push button (Mushroom)	Red	HF1-VM120-01-30RA	HF1-VM130-01-30RA	HF1-VM120U-01-30RA	HF1-VM130U-01-30RA	HF1-VM122-M5-30RA	HF1-VM132-M5-30RA	VM-30AR	58 g
		Black	HF1-VM120-01-30BA	HF1-VM130-01-30BA	HF1-VM120U-01-30BA	HF1-VM130U-01-30BA	HF1-VM122-M5-30BA	HF1-VM132-M5-30BA	VM-30AB	
		Green	HF1-VM120-01-30GA	HF1-VM130-01-30GA	HF1-VM120U-01-30GA	HF1-VM130U-01-30GA	HF1-VM122-M5-30GA	HF1-VM132-M5-30GA	VM-30AG	
		Yellow	HF1-VM120-01-30YA	HF1-VM130-01-30YA	HF1-VM120U-01-30YA	HF1-VM130U-01-30YA	HF1-VM122-M5-30YA	HF1-VM132-M5-30YA	VM-30AY	
	Push button (Extended)	Red	HF1-VM120-01-32RA	HF1-VM130-01-32RA	HF1-VM120U-01-32RA	HF1-VM130U-01-32RA	HF1-VM122-M5-32RA	HF1-VM132-M5-32RA	VM-32AR	52 g
		Black	HF1-VM120-01-32BA	HF1-VM130-01-32BA	HF1-VM120U-01-32BA	HF1-VM130U-01-32BA	HF1-VM122-M5-32BA	HF1-VM132-M5-32BA	VM-32AB	
		Green	HF1-VM120-01-32GA	HF1-VM130-01-32GA	HF1-VM120U-01-32GA	HF1-VM130U-01-32GA	HF1-VM122-M5-32GA	HF1-VM132-M5-32GA	VM-32AG	
	Push button (Flush)	With a set of red, black, green, yellow	HF1-VM120-01-33A	HF1-VM130-01-33A	HF1-VM120U-01-33A	HF1-VM130U-01-33A	HF1-VM122-M5-33A	HF1-VM132-M5-33A	VM-33A	50 g
		Red	HF1-VM120-01-34RA	HF1-VM130-01-34RA	HF1-VM120U-01-34RA	HF1-VM130U-01-34RA	HF1-VM122-M5-34RA	HF1-VM132-M5-34RA	VM-34AR	56 g
		Black	HF1-VM120-01-34BA	HF1-VM130-01-34BA	HF1-VM120U-01-34BA	HF1-VM130U-01-34BA	HF1-VM122-M5-34BA	HF1-VM132-M5-34BA	VM-34AB	
	Green	HF1-VM120-01-34GA	HF1-VM130-01-34GA	HF1-VM120U-01-34GA	HF1-VM130U-01-34GA	HF1-VM122-M5-34GA	HF1-VM132-M5-34GA	VM-34AG		
	Twist selector (2-position)	Yellow	HF1-VM120-01-34YA	HF1-VM130-01-34YA	HF1-VM120U-01-34YA	HF1-VM130U-01-34YA	HF1-VM122-M5-34YA	HF1-VM132-M5-34YA	VM-34AY	
		Key selector (2-position)		HF1-VM120-01-36A	HF1-VM130-01-36A	HF1-VM120U-01-36A	HF1-VM130U-01-36A	HF1-VM122-M5-36A	HF1-VM132-M5-36A	VM-36A
	Twist selector (3-position)	3-port		3-port	5-port	3-port	5-port	3-port	5-port	—
Red		HF1-VM131-01-35RA	HF1-VM151-01-35RA	HF1-VM131U-01-35RA	HF1-VM151U-01-35RA	HF1-VM133-M5-35RA	HF1-VM153-M5-35RA			
Black		HF1-VM131-01-35BA	HF1-VM151-01-35BA	HF1-VM131U-01-35BA	HF1-VM151U-01-35BA	HF1-VM133-M5-35BA	HF1-VM153-M5-35BA			
Green		HF1-VM131-01-35GA	HF1-VM151-01-35GA	HF1-VM131U-01-35GA	HF1-VM151U-01-35GA	HF1-VM133-M5-35GA	HF1-VM153-M5-35GA			
	Yellow	HF1-VM131-01-35YA	HF1-VM151-01-35YA	HF1-VM131U-01-35YA	HF1-VM151U-01-35YA	HF1-VM133-M5-35YA	HF1-VM153-M5-35YA			

- * It is possible to change the actuator assembly when an actuator part number is specified in the column.
- * For push button (mushroom), push button (flush), push button (extended) and individual fastening ring, refer to the **Web Catalog**.
- * The handle of the selector (2-position and 3-position) cannot be removed or replaced alone.
- * Color of plunger: Gray (2-port), White (3-port)

How to Order

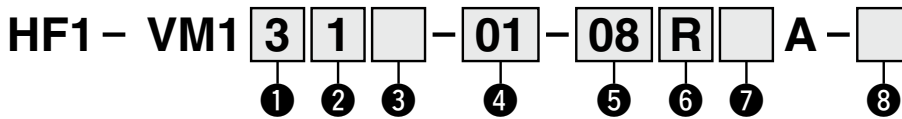

① Number of ports

2	2-port
3	3-port
5	5-port (Twist selector 3-position only)

② Piping direction and the height of plunger

0	Side ported	Long
1	Side ported	Short
2	Bottom ported	Long
3	Bottom ported	Short

③ Body option

Nil	Side mounting
U	With bottom mounting thread

* U: Applicable only to side ported type

④ Port size

01	Rc1/8	Side ported only
N01	NPT1/8	
F01	G1/8	Bottom ported only
M5	M5 x 0.8	

⑤ Actuator type

Actuator type	Height of plunger		Side ported		Bottom ported	
	Long	Short	Long	Short	Long	Short
08	Toggle lever	○	×	○	×	×
30	Push button (Mushroom)	○	×	○	×	×
32	Push button (Extended)	○	×	○	×	×
33	Push button (Flush)*1	○	×	○	×	×
34	Twist selector (2-position)	○	×	○	×	×
36	Key selector (2-position)	○	×	○	×	×
35	Twist selector (3-position)	×	○	×	○	○

Combination possible: ○
Combination impossible: ×

*1 When selecting the flush type, it is not necessary to select the suffix for the actuator.

⑥ Suffix for actuator

R	Red	Color of push button, selector
B	Black	
G	Green	
Y	Yellow	

⑦ Suffix for indicator

Nil	None
Z	With miniature indicator

* Applicable only to bottom ported type

⑧ Bracket option

Nil	None
B	With bracket

* Applicable only to side ported, side mounting type. However, not applicable to twist selector (3-position). Bracket is shipped together, but not assembled.

Air Preparation Equipment
Pressure Control Equipment/Others

Fittings and Tubing

Flow Control Equipment

Pressure Gauges

Switches/Sensors

Process Valves

Directional Control Valves



2/3-Port Mechanical Valve

HF1-VM200 Series



More for the specifications and dimensions



Model

	Piping direction	Side ported				Actuator		
		Standard		With bottom mounting thread		Actuator part number	Additional weight for actuator	
		2-port	3-port	2-port	3-port			
Manual operation	Toggle lever	HF1-VM220-02-08A	HF1-VM230-02-08A	HF1-VM220U-02-08A	HF1-VM230U-02-08A	VM-08A	110 g	
	Push button (Mushroom)	Red	HF1-VM220-02-30RA	HF1-VM230-02-30RA	HF1-VM220U-02-30RA	HF1-VM230U-02-30RA	VM-30AR	58 g
		Black	HF1-VM220-02-30BA	HF1-VM230-02-30BA	HF1-VM220U-02-30BA	HF1-VM230U-02-30BA	VM-30AB	
		Green	HF1-VM220-02-30GA	HF1-VM230-02-30GA	HF1-VM220U-02-30GA	HF1-VM230U-02-30GA	VM-30AG	
		Yellow	HF1-VM220-02-30YA	HF1-VM230-02-30YA	HF1-VM220U-02-30YA	HF1-VM230U-02-30YA	VM-30AY	
	Push button (Extended)	Red	HF1-VM220-02-32RA	HF1-VM230-02-32RA	HF1-VM220U-02-32RA	HF1-VM230U-02-32RA	VM-32AR	52 g
		Black	HF1-VM220-02-32BA	HF1-VM230-02-32BA	HF1-VM220U-02-32BA	HF1-VM230U-02-32BA	VM-32AB	
		Green	HF1-VM220-02-32GA	HF1-VM230-02-32GA	HF1-VM220U-02-32GA	HF1-VM230U-02-32GA	VM-32AG	
	Push button (Flush)	Yellow	HF1-VM220-02-32YA	HF1-VM230-02-32YA	HF1-VM220U-02-32YA	HF1-VM230U-02-32YA	VM-32AY	50 g
		With a set of red, black, green, yellow	HF1-VM220-02-33A	HF1-VM230-02-33A	HF1-VM220U-02-33A	HF1-VM230U-02-33A	VM-33A	
		Red	HF1-VM220-02-34RA	HF1-VM230-02-34RA	HF1-VM220U-02-34RA	HF1-VM230U-02-34RA	VM-34AR	
	Twist selector (2-position)	Black	HF1-VM220-02-34BA	HF1-VM230-02-34BA	HF1-VM220U-02-34BA	HF1-VM230U-02-34BA	VM-34AB	
		Green	HF1-VM220-02-34GA	HF1-VM230-02-34GA	HF1-VM220U-02-34GA	HF1-VM230U-02-34GA	VM-34AG	
		Yellow	HF1-VM220-02-34YA	HF1-VM230-02-34YA	HF1-VM220U-02-34YA	HF1-VM230U-02-34YA	VM-34AY	
	Key selector (2-position)	HF1-VM220-02-36A	HF1-VM230-02-36A	HF1-VM220U-02-36A	HF1-VM230U-02-36A	VM-36A	78 g	
	Twist selector (3-position)		3-port	5-port	3-port	5-port	—	230 g (Add to 2 basic units.)
		Red	HF1-VM230-02-35RA	HF1-VM250-02-35RA	HF1-VM230U-02-35RA	HF1-VM250U-02-35RA		
		Black	HF1-VM230-02-35BA	HF1-VM250-02-35BA	HF1-VM230U-02-35BA	HF1-VM250U-02-35BA		
Green		HF1-VM230-02-35GA	HF1-VM250-02-35GA	HF1-VM230U-02-35GA	HF1-VM250U-02-35GA			
Foot pedal	Yellow	HF1-VM230-02-35YA	HF1-VM250-02-35YA	HF1-VM230U-02-35YA	HF1-VM250U-02-35YA	—	340 g	
		2-port	3-port	—	—			
		HF1-VM220-02-40A	HF1-VM230-02-40A	—	—	—		

- * It is possible to change the actuator assembly when an actuator part number is specified in the column.
- * For push button (mushroom), push button (flush), push button (extended) and individual fastening ring, refer to the **Web Catalog**.
- * The handle of the selector (2-position and 3-position) cannot be removed or replaced alone.
- * Color of plunger: Gray (2-port), White (3-port)

How to Order

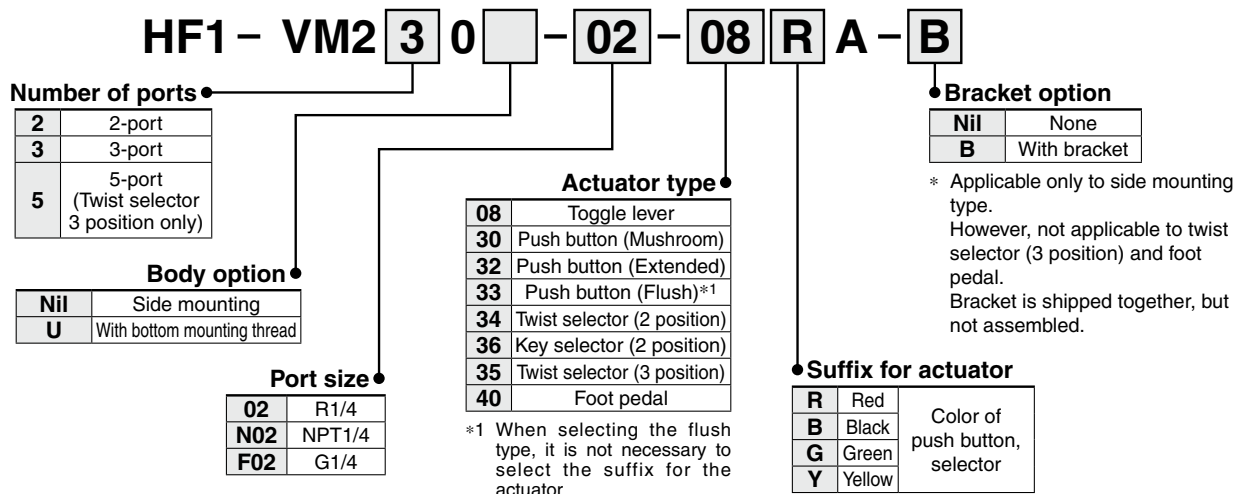

HF1

HF2

HF1 compatible

HF2 compatible

3-Port Mechanical Valve

HF1-VM400 Series

RoHS



More for the specifications and dimensions



Model

	Actuator	Model	Actuator part no.	Application	Weight [g]
Manual operation	Toggle lever	HF1-VM430-01-08	VM-08A	—	200
	Push button (Mushroom)	HF1-VM430-01-30R	VM-30AR	Red	168
		HF1-VM430-01-30B	VM-30AB	Black	
		HF1-VM430-01-30G	VM-30AG	Green	
		HF1-VM430-01-30Y	VM-30AY	Yellow	
	Push button (Extended)	HF1-VM430-01-32R	VM-32AR	Red	162
		HF1-VM430-01-32B	VM-32AB	Black	
		HF1-VM430-01-32G	VM-32AG	Green	
		HF1-VM430-01-32Y	VM-32AY	Yellow	
	Push button (Flush)	HF1-VM430-01-33	VM-33A	With a set of red, black, green, yellow	167
Twist selector (2 position)	HF1-VM430-01-34R	VM-34AR	Red	168	
	HF1-VM430-01-34B	VM-34AB	Black		
	HF1-VM430-01-34G	VM-34AG	Green		
	HF1-VM430-01-34Y	VM-34AY	Yellow		
Key selector (2 position)	HF1-VM430-01-36	VM-36A	—	188	

- * Actuator replacement is available for all types.
- * For push button (mushroom), push button (extended), push button (flush) and a single unit of fastening ring, refer to the **Web Catalog**. The other parts are not replaceable.
- * The handle of the selector (2 position) cannot be removed or replaced alone.

How to Order

HF1 - VM4 3 0 - 01 - 08 R

Number of ports

3	3-port
---	--------

Port size

01	Rc1/8
N01	NPT1/8
F01	G1/8

Actuator type

08	Toggle lever
30	Push button (Mushroom)
32	Push button (Extended)
33	Push button (Flush)*1
34	Twist selector (2 position)
36	Key selector (2 position)

Suffix for actuator

R	Red	Color of push button selector
B	Black	
G	Green	
Y	Yellow	

*1 When selecting the flush type, it is not necessary to select the suffix for the actuator.

Air Preparation Equipment
Pressure Control Equipment/Others

Fittings and Tubing

Flow Control Equipment

Pressure Gauges

Switches/Sensors

Process Valves

Directional Control Valves



HF□ Series Precautions

Be sure to read this before handling the products.

⚠ Safety Instructions Be sure to read the “Handling Precautions for SMC Products” (M-E03-3) and “Operation Manual” before use.

⚠ Caution

1. When selecting equipment, carefully consider the application, required specifications, and operating conditions (fluid, pressure, flow rate, filtration, and environment), making sure not to exceed the specification range.
2. This product is provided for normally typical forms of use in the manufacturing industry. As such, to use the product for applications that may affect the human body directly or indirectly, such as caisson shield, breathing, food, and the medical treatment, be sure to consult SMC in advance.
It is not necessary to consult SMC when the product is used as an air blower for food.
3. When the product is used as an air blower, install an appropriate filter to eliminate foreign matter in compressed air for air blowing. (Refer to the example of pneumatic circuit on page 3).
4. The solenoid valve generates particles from the wear of sliding parts inside. When the solenoid valve is used as an air blower, install an appropriate filter (filtration of 0.01 μm) on the outlet of the solenoid valve to prevent foreign matter from flowing to the downstream. Filters require regular inspection, replacement of the element, and maintenance referring to the operation manual for standard products.
5. Quality management relating to hygiene for food and medical treatment is not implemented for this product.
6. Compressed air hygiene should be managed in accordance with national and regional rules and regulations.
7. Grease
 - Fluid contact parts: NSF H1 grade grease
 - Part other than fluid contact parts:
NSF H1 grade grease or grease which is not NSF H1 grade

Pressure Gauge Specific Product Precautions

Selection

⚠ Caution

1. Make sure that no direct impact or vibrations are applied to the body.
2. If operating under pressure pulsations or in high frequency operations, please contact SMC.

Equipment for the Food Manufacturing Industry

HF1- Series

HF2- Series

HF1/HF2
Compatible Products



SMC Corporation

Akihabara UDX 15F,
4-14-1, Sotokanda, Chiyoda-ku, Tokyo 101-0021, JAPAN
Phone: 03-5207-8249 Fax: 03-5298-5362
<https://www.smcworld.com>
© 2021 SMC Corporation All Rights Reserved

Specifications are subject to change without prior notice
and any obligation on the part of the manufacturer.

D-G

Printing ZX 3600DN Printed in Japan.