



ST7500 Product Information Manual

MARCH 2021



Copyrights

The Motorola Solutions products described in this document may include copyrighted Motorola Solutions computer programs. Laws in the United States and other countries preserve for Motorola Solutions certain exclusive rights for copyrighted computer programs. Accordingly, any copyrighted Motorola Solutions computer programs contained in the Motorola Solutions products described in this document may not be copied or reproduced in any manner without the express written permission of Motorola Solutions.

© 2021 Motorola Solutions, Inc. All Rights Reserved

No part of this document may be reproduced, transmitted, stored in a retrieval system, or translated into any language or computer language, in any form or by any means, without the prior written permission of Motorola Solutions, Inc.

Furthermore, the purchase of Motorola Solutions products shall not be deemed to grant either directly or by implication, estoppel or otherwise, any license under the copyrights, patents or patent applications of Motorola Solutions, except for the normal non-exclusive, royalty-free license to use that arises by operation of law in the sale of a product.

Disclaimer

Please note that certain features, facilities, and capabilities described in this document may not be applicable to or licensed for use on a specific system, or may be dependent upon the characteristics of a specific mobile subscriber unit or configuration of certain parameters. Please refer to your Motorola Solutions contact for further information.

Trademarks

MOTOROLA, MOTO, MOTOROLA SOLUTIONS, and the Stylized M Logo are trademarks or registered trademarks of Motorola Trademark Holdings, LLC and are used under license. All other trademarks are the property of their respective owners.

Open Source Content

This product contains Open Source software used under license. Refer to the product installation media for full Open Source Legal Notices and Attribution content.

European Union (EU) Waste of Electrical and Electronic Equipment (WEEE) directive



■ The European Union's WEEE directive requires that products sold into EU countries must have the crossed out trash bin label on the product (or the package in some cases).

As defined by the WEEE directive, this cross-out trash bin label means that customers and end-users in EU countries should not dispose of electronic and electrical equipment or accessories in household waste.

Customers or end-users in EU countries should contact their local equipment supplier representative or service centre for information about the waste collection system in their country.

Contents

Copyrights.....	2
List of Figures.....	8
List of Tables.....	9
Icon Conventions.....	10
Chapter 1: Product Overview.....	11
1.1 ST7500 Overview.....	11
1.1.1 ST7500 Specifications.....	11
1.2 Ordering Options for Radios and Features.....	14
1.3 Radio Ordering.....	14
1.4 Customer Programming Software.....	14
Chapter 2: Services and Features.....	15
2.1 System Support.....	15
2.2 Trunked Mode Operation.....	15
2.3 Direct Mode Operation.....	16
2.4 DMO Gateway and Repeater Communication.....	16
2.4.1 Communication through Repeaters.....	17
2.4.2 Communication Through Gateways.....	18
2.4.3 Gateway and Repeater Synchronization.....	18
2.5 Numbering and Addressing.....	19
2.6 Dialing Methods.....	19
2.6.1 Individual Dialing.....	20
2.7 Unified Address Book.....	20
2.8 Call History.....	21
2.9 Group Call.....	21
2.9.1 Programmable Talkgroups.....	21
2.9.2 Talkgroup Folders.....	22
2.9.3 Talkgroup Selection.....	23
2.9.4 Favorite Folders.....	23
2.9.5 Receive-only Talkgroups.....	23
2.9.6 Non-Selectable Talkgroups.....	23
2.9.7 Transmission Timeout Timer.....	24
2.9.8 Group Call Reception.....	24
2.9.9 Talkgroup Scanning.....	24
2.9.10 Priority Monitor.....	25
2.9.11 Timed Talkgroup Change.....	25

2.9.12 Broadcast Call.....	26
2.9.13 D-PTT Tone.....	26
2.9.14 D-PTT Preempt Group Call.....	26
2.9.15 PTT Queue.....	27
2.9.16 Talking Party Identification.....	27
2.9.17 Call Ownership.....	27
2.9.18 Transmission During Group Call.....	27
2.9.19 Call Restoration.....	27
2.9.20 Temporary Group Address.....	27
2.9.21 Late Entry.....	28
2.9.22 User Initiated Group Attachment.....	28
2.10 Private Call.....	28
2.10.1 Transmission Timeout Timer.....	29
2.10.2 Call Restoration in Private Call.....	29
2.10.3 Call Modification.....	30
2.10.4 DMO Individual Call Presence Check.....	30
2.10.5 DMO Individual Only Talkgroups.....	31
2.10.6 Private Calls through DMO Gateway.....	31
2.11 Phone Call.....	31
2.11.1 Phone Call Initiation.....	31
2.11.2 Phone Call Reception.....	32
2.11.3 Call Restoration in Phone Call.....	32
2.12 Emergency Operations.....	32
2.12.1 Emergency Group Call.....	32
2.12.2 Non-Tactical Emergency.....	33
2.12.3 Emergency Individual Calls (Private or MSISDN).....	33
2.12.4 Emergency Alarm.....	34
2.12.5 Emergency SDS Status.....	34
2.12.6 Emergency Hot Microphone.....	34
2.12.7 Alternating Hot Microphone.....	34
2.12.8 Silent Emergency Mode.....	35
2.12.9 Invisible Emergency.....	35
2.12.10 Emergency Destination in Local Site Trunking.....	36
2.13 Short Data Services.....	36
2.13.1 Status Messages.....	37
2.13.2 Shadow Groups (Address Bundle).....	37
2.13.3 Text Messages.....	38
2.13.3.1 Buffer Full Overwrite Policy.....	39
2.13.3.2 SDS Messages Concatenation.....	39

2.13.4	Predefined Templates (ATS Entry Prompt).....	40
2.13.5	SDS Air Interface Aspects.....	40
2.13.6	SDS End-to-End Encryption.....	40
2.13.7	Store and Forward.....	42
2.13.8	SDS Receive Failure Notification.....	42
2.13.9	DMO SDS Transmit Traffic Stealing.....	42
2.14	Collaborative Messaging.....	42
2.15	Security Services.....	43
2.15.1	Terminal Equipment Identity.....	43
2.15.2	PIN/PUK User Authentication.....	43
2.15.3	Authentication.....	44
2.15.4	Air Interface Encryption.....	44
2.15.4.1	Clear Radios (Class 1).....	45
2.15.4.2	Static Cipher Key Encryption (Class 2).....	45
2.15.4.3	Derived Cipher Key and Common Cipher Keys Encryption (Class 3).....	45
2.15.4.4	Group Cipher Keys Encryption (Class 3G).....	46
2.15.4.5	Over-the-Air-Rekeying.....	46
2.15.4.6	Encryption Mobility.....	47
2.15.4.7	Encryption MMI.....	48
2.15.4.8	Air Interface Encryption Key Storage.....	48
2.15.5	Secure DMO.....	48
2.15.6	End-to-End Encryption.....	48
2.15.7	SIM Security.....	49
2.15.8	Radio Disable or Enable.....	50
2.15.9	Radio Permanent Disable.....	50
2.15.10	Radio Permanent Disable v2.....	51
2.15.11	High Assurance Boot.....	51
2.15.12	Covert Solution.....	52
2.15.12.1	Remote Control Unit.....	52
2.16	Packet Data.....	53
2.16.1	Voice and Data Support.....	54
2.16.2	Packet Data IP Addressing.....	54
2.16.3	Packet Data User Authentication.....	55
2.17	TETRA Network Protocol 1.....	55
2.17.1	TETRA Network Protocol 1 IP Addressing.....	56
2.18	Over The Air Programming.....	56
2.19	Mobility Services.....	57
2.19.1	Main Control Channel Frequencies.....	57
2.19.2	Channel Selection.....	57

2.19.3 Registration.....	58
2.19.4 Cell Roaming.....	58
2.19.5 Seamless Handover.....	59
2.19.6 Networks.....	59
2.19.6.1 Network Selection.....	60
2.19.7 Congested Cell Handling.....	60
2.19.8 Subscriber Class.....	61
2.19.9 Subscriber Class by Talkgroup.....	61
2.19.10 RF Power Class Toggle.....	61
2.19.11 Local Site Trunking.....	61
2.19.12 Cell Surveillance and Monitoring Threshold.....	62
2.20 Supplementary Services.....	62
2.20.1 Dynamic Group Number Assignment.....	62
2.20.2 Ambience Listening.....	64
2.20.3 Pseudo Power-Off.....	64
2.20.4 Auto Power-On.....	65
2.20.5 Preemptive Priority Call.....	65
2.20.6 Transmit Inhibit Mode.....	65
2.20.7 Calling Line Identification Presentation.....	66
2.20.8 Universal Time Display.....	66
2.21 Man Down.....	67
2.21.1 Man Down (Operation).....	67
2.22 Vibrate Mode.....	68
2.23 SDS Remote Control.....	68
2.24 Status Remote Control.....	69
2.25 Call-Out.....	69
2.25.1 Call-Out Interactions.....	71
2.25.2 Call-Out Templates.....	72
2.26 Global Navigation Satellite System (GNSS) Location Service.....	72
2.26.1 Global Navigation Satellite System (GNSS) over Packet Data.....	74
2.26.2 GNSS GPS Accuracy.....	75
2.26.3 Location Report Backlog.....	75
2.27 Bluetooth.....	76
2.27.1 Bluetooth Interactions.....	76
2.27.2 Bluetooth Restrictions.....	77
2.27.3 Bluetooth Sensor Data.....	77
2.27.4 Bluetooth Smart Proximity Pairing.....	78
2.27.5 Bluetooth Low Energy Indoor Location.....	78
Chapter 3: Man-Machine Interface.....	80

3.1 LED Indications.....	80
3.2 Battery Charging Indications.....	81
3.3 ST7500 Controls and Indicators.....	83
3.4 Keypad Lock.....	85
3.5 Automatic Keypad Lock.....	86
3.6 One-Touch Buttons.....	86
3.7 Display.....	90
3.7.1 Status Icons.....	91
3.7.2 Idle Display.....	94
3.7.3 Configurable Idle Screen.....	94
3.7.4 Languages Supported.....	95
3.8 Tones.....	96
3.9 Description of Tones.....	97
3.10 Dual Microphones.....	98
3.11 Audio Toggle.....	98
3.12 Volume Adjustment Mode.....	98
3.13 Accessory (Accry) Setup.....	98
3.14 Audio Features.....	99
3.14.1 Audio Profile.....	99
3.15 Test Page.....	99
3.16 Radio Info.....	101
3.17 Hardware Test.....	101
Appendix A: Maintenance.....	102
A.1 Preventive Maintenance.....	102
Appendix B: Service Information – EMEA.....	105
Appendix C: Service Information for APAC.....	107
Appendix D: Service Information – Americas.....	110
Glossary.....	112

List of Figures

Figure 1: ST7500	11
Figure 2: Trunked Mode Operation	16
Figure 3: Direct Mode Operation	16
Figure 4: Communication through Repeaters	17
Figure 5: Communication Through Gateways	18
Figure 6: Talkgroup Tree	22
Figure 7: SDS End-to-End Encryption	41
Figure 8: Voice and Data End to End Encryption	49
Figure 9: SDS Remote Control Overview	68
Figure 10: Charger Mode Screen	81
Figure 11: Charger Mode Screen	82
Figure 12: ST7500 Controls and Indicators	83
Figure 13: Default Home Screen with Icons	90
Figure 14: Areas to Keep Dry	103

List of Tables

Table 1: General Technical Specification	11
Table 2: RF Specification	12
Table 3: Environmental Specification	12
Table 4: Bluetooth Audio and Data Services	12
Table 5: Location Services	13
Table 6: Main Voice Services	13
Table 7: Call Answering Rules	29
Table 8: Maximum SDS Character with Encryptions	38
Table 9: Security Features Required Per Security Class	44
Table 10: Packet Data IP Addressing	54
Table 11: TETRA Network Protocol 1 (TNP1) IP Addressing	56
Table 12: GNSS Triggers	74
Table 13: LED Status Indications	80
Table 14: Battery Charging LED Indications	80
Table 15: Battery Icons	82
Table 16: Battery Icons	82
Table 17: ST7500 Controls and Indicators	83
Table 18: One-Touch Button Features	86
Table 19: Display	90
Table 20: Colors of the Soft Key Area	90
Table 21: Trunked Mode Operation (TMO) Icons	91
Table 22: Direct Mode Operation (DMO) Icons	91
Table 23: General Icons	92
Table 24: Languages Supported	95
Table 25: Radio Tones	96
Table 26: Tone Categories	97
Table 27: Areas to Keep Dry	103
Table 28: Service Information — Telephone Numbers to EIA Integrated Call Center	105
Table 29: Service Information – Telephone Numbers and Addresses of the Asia and Pacific Motorola Solutions Centers	107
Table 30: Service Information – Telephone Numbers and Addresses of Latin America Radio Support Centers	110
Table 31: Service Information – Telephone Numbers and Addresses of Latin America Motorola Solutions Centers	110

Icon Conventions

The documentation set is designed to give the reader more visual clues. The following graphic icons are used throughout the documentation set.



DANGER: The signal word DANGER with the associated safety icon implies information that, if disregarded, will result in death or serious injury.



WARNING: The signal word WARNING with the associated safety icon implies information that, if disregarded, could result in death or serious injury, or serious product damage.



CAUTION: The signal word CAUTION with the associated safety icon implies information that, if disregarded, may result in minor or moderate injury, or serious product damage.

CAUTION: The signal word CAUTION may be used without the safety icon to state potential damage or injury that is not related to the product.



IMPORTANT: IMPORTANT statements contain information that is crucial to the discussion at hand, but is not CAUTION or WARNING. There is no warning level associated with the IMPORTANT statement.



NOTICE: NOTICE contains information more important than the surrounding text, such as exceptions or preconditions. They also refer the reader elsewhere for additional information, remind the reader how to complete an action (when it is not part of the current procedure, for instance), or tell the reader where something is on the screen. There is no warning level associated with a notice.

Chapter 1

Product Overview

1.1

ST7500 Overview

The ST7500 is a compact and lightweight TETRA radio, designed specifically for public safety operations.

Figure 1: ST7500



The radio delivers premium performance, while combining high-quality audio and enhanced ergonomics with simplified user interface, allowing you to focus on the task at hand. The ST7500 radio is also certified to withstand dust, shock, and drops with IP65, IP67, and MIL-STD 810 D, E, F, G rating.

The integrated Bluetooth® 2.1 +EDR, Bluetooth 4.1 wireless technology and Bluetooth Smart (BTLE) allow you to add connected devices to the ST7500 radio. The ST7500 radio also provides uncompromising audio quality with low distortion, low audio power, and 1.8 W transmission power.

1.1.1

ST7500 Specifications

The following tables explain the specifications of the ST7500 radio.

Table 1: General Technical Specification

Parameter	Value
Dimensions H x W x D mm	112 x 63 x 22

Parameter	Value
	142 x 63 x 22 (radio with 28 mm antenna) 171 x 63 x 22 (radio with 57 mm antenna)
Weight g	199 (radio with battery and 28 mm antenna)
Battery	Removable 2300 mAh IMPRES™ 2 Li-Ion battery
Battery performance	5-5-90 > 22 hours 5-35-60 > 19 hours
Audio	Audio output power at Rated/Max: 1 W Audio distortion at Rated: < 1.0 %

Table 2: RF Specification

Parameter	Value
Frequency Bands MHz	380–430
Transmitter RF	Power Class 3L (1.8 W) & Class 4 (1 W)
Receiver Class	A and B
Receiver Static Sensitivity dBm	UHF: -116 (min); -118 (typical)
Receiver Dynamic Sensitivity dBm	UHF: -107 (min); -109 (typical)

Table 3: Environmental Specification

Parameter	Value
Operating Temperature °C	-30 to +60
Storage Temperature °C	-40 to +85
Humidity	ETS 300-019-1-7 Class 7.3E, MIL-STD 810 D, E, F, G
Dust and Water Ingress Protection	IP65, IP67 per IEC 60529
Shock, drop, and vibration	ETSI 300-019 1-7 Class 5M3; MIL-STD 810 D, E, F, G

Table 4: Bluetooth Audio and Data Services

Parameter	Value
Supported Versions	Bluetooth 2.1 +EDR, Bluetooth 4.1, and Bluetooth Smart (BTLE)
Security	Bluetooth 2.1 introduces mandatory encryption with Secure Simple Pairing (SSP), easier pairing and preventing sniffing/hacking.
Audio	HeadSet Profile, Fast PTT with Motorola Solutions accessories
Data Services	Serial Port Profile, Dial Up Networking Profile, Discovery Mode, Generic Access Profile, Generic Attributes Profile

Parameter	Value
	(GATT), Heart Rate Profile, Battery Service Profile, and Devices Info Profile.

Table 5: Location Services

Parameter	Value
Supported Constellations	GPS, BEIDOU, and GLONASS Integrated Internal Antenna
Simultaneous Satellites	12
Tracking Sensitivity dBm	-161 GPS -156 BEIDOU -155 GLONASS
Accuracy (measured at -130 dBm)	< 5 meter (50% probable)
Protocols	ETSI LIP and LRRP

Table 6: Main Voice Services

Services	Description
General	<p>Full Duplex TMO Private, PABX, PSTN, Emergency Inter-MNI, Gateway, Repeater Compatible</p> <p>Half Duplex TMO Private, Group, Emergency PTT Double Push</p> <p>Half Duplex DMO Private, Group, Emergency Adaptive Audio Gain Control (AGC)</p>
Emergency Call Management	<p>Tactical Emergency Group Call to ATTACHED talkgroup Emergency Status Msg sent to dispatch console</p> <p>Non-Tactical Emergency Group Call to DEDICATED talkgroup Preemptive Priority Calls</p> <p>HOT MIC Emergency - hands free in the Moments that Matter</p>
DMO Repeater and Gateway Services	Works with DMO Repeaters and Gateways ¹



NOTICE: This specification may be subject to change without further notice. All product features are subject to infrastructure support. Selected features are subject to optional software upgrade.

¹ Does not work as a DMO repeater.

1.2

Ordering Options for Radios and Features

TETRA terminals are sold directly to users by Motorola Solutions or are available through accredited channel partners.

Software options can be ordered and enabled in two ways:

- Enabled at the Distribution Center (DC).
- Enabled with a license in the Integrated Terminal Management (iTM) or Customer Programming Software (CPS).

1.3

Radio Ordering

Procedure:

- 1 Order the main radio model.
- 2 Order options from each of the following categories:
 - Software Selling Features
 - Customer Programming Software
 - Integrated Terminal Management
 - Accessories



NOTICE: Export controls apply when ordering encryption.

1.4

Customer Programming Software

For information about Customer Programming Software, see the *TETRA Terminals CPS Plus Start-up User Guide*.

Chapter 2

Services and Features

Motorola Solutions offers a wide range of services and features. With this range, you can meet the requirements of mission-critical communications.

2.1

System Support

The radio operates on the Dimetra IP 5.x, 6.x, 7.x and 8.x releases and Dimetra IP Compact. It also operates on previous versions of Dimetra; from Release 3.8 and on.

The radio is designed to operate optimally on the Dimetra IP system. The radio operates properly on all SwMIs that comply with the below list of IOP features defined by the TETRA And Critical Communications Association (TANDCCA). Official IOP certificates can be downloaded from the TANDCCA web page at <http://www.tandcca.com/interoperability/interoperability-certificates-and-test-reports/>.

TMO TIP:

- TIP Core TTR 001-01, TIP – Part 1: Core
- TIP DGNA TTR 001-03, TIP – Part 3: Dynamic Group Number Assignment
- TIP Auth TTR 001-04, TIP – Part 4: Authentication
- TIP PD TTR 001-05, TIP – Part 5: Packet Data
- TIP FSSN TTR 001-07, TIP – Part 7: Fleet Specific Short Number
- TIP SS-AL TTR 001-09 TIP – Part 9: Ambience Listening
- TIP E2EE TTR 001-10, TIP – Part 10: End to End Encryption (Selling option)
- TIP AIE TTR 001-11 TIP – Part 11: Air Interface Encryption
- TIP SI TTR 001-12, TIP – Part 12: Service Interaction
- TIP Enable/Disable TTR 001-13 TIP – Part 13: Enable or Disable
- TIP LIP TTR 001-19, TIP – Part 19: Location Information Protocol

DMO TIP:

- TIP DCore TTR 002-01, DMO TIP – Part 1: DMO Core
- TIP DGate TTR 002-02, DMO TIP – Part 2: DMO Gateway
- TIP DRep TTR 002-03, DMO TIP – Part 3: DMO Repeater Type 1
- TIP DE2EE TTR 002-04, DMO TIP – Part 4: DMO End to End Encryption
- TIP DAIE TTR 002-05, DMO TIP – Part 5: DMO Air Interface Encryption

2.2

Trunked Mode Operation

Trunked Mode Operation (TMO) requires the switching and management infrastructure.

TMO enables various voice and data communication types. Examples are group calls and short data service messages. TMO also enables access to features related to infrastructure such as packet data.

TMO enables various voice and data communication types such as group calls. TMO also enables access to features related to infrastructure such as packet data.

Figure 2: Trunked Mode Operation

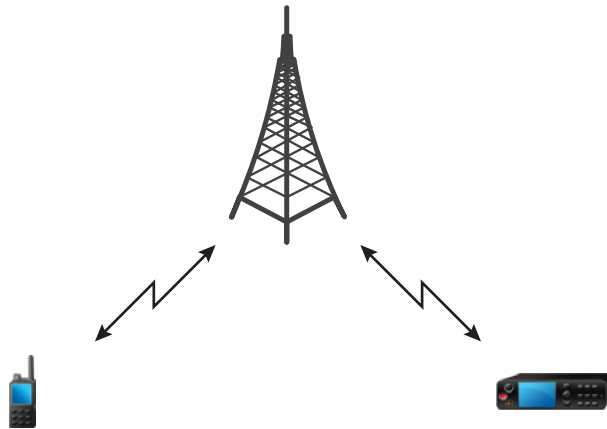

2.3

Direct Mode Operation

Direct Mode Operation (DMO) is a mode of simplex operation where radios communicate directly without the need of a network.



NOTICE: For those who use DMO mode, you are recommended to apply DMO SCK for data confidentiality.

Figure 3: Direct Mode Operation

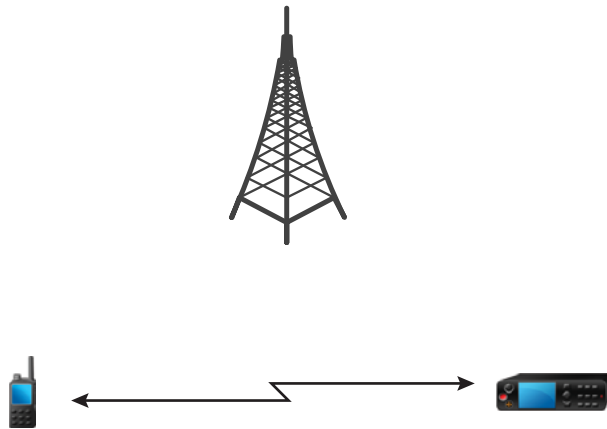

2.4

DMO Gateway and Repeater Communication

The radio allows communicating in Direct Mode Operation (DMO) with a Trunked Mode Operation (TMO) group. This communication occurs through Interoperability (IOP) certified gateways.

A DMO repeater retransmits information received from one DMO radio to other DMO radios. Retransmission occurs over the DMO air interface.

For each DMO talkgroup, the radio allows operating in one of the following modes:

Radio to radio only

The radio initiates communication only on a talkgroup directly and not through a gateway or repeater.

Auto gateway

The radio can initiate communication on the selected talkgroup directly with another radio. The radio can also initiate communication through any available gateway that is detected as present.

Repeater

The talkgroup links to a DMO repeater.

Specific gateway and repeater

The radio uses only the gateway with the specified gateway address for the talkgroup and/or a DMO repeater.

Automatic gateway and repeater

The radio uses the first available gateway for a talkgroup and/or a DMO repeater.

All outgoing communication is placed through the gateway if the following conditions occur:

- Either a specific gateway or auto gateway mode is chosen
- A suitable gateway is found

The radio attempts to set up communication directly if the following conditions occur:

- Communication setup through the gateway fails
- A suitable gateway is not found

When operating on a gateway and/or repeater, the radio indicates the communication mode.

2.4.1

Communication through Repeaters

Radios that are out of range and cannot communicate directly with each other in Direct Mode Operation (DMO) can do it through the repeater. The repeater is a radio that repeats all communication on a chosen channel, and as a result increases radios DMO range.

Figure 4: Communication through Repeaters

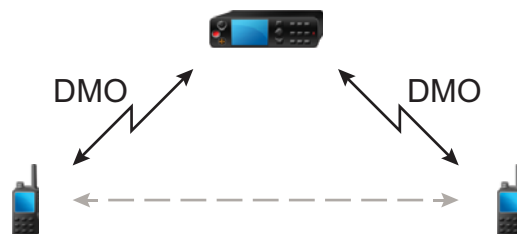

When the radio connects to a repeater, it plays a tone, displays the `Repeater available` message, and shows an appropriate icon. When the radio loses connection with the repeater, it plays a tone, displays the `Repeater not available` message, and the repeater icon is blinking.

2.4.2

Communication Through Gateways

Gateway provides connectivity between radios operating in Direct Mode Operation (DMO) and the TETRA network, so that the DMO radios can communicate with the Trunked Mode Operation (TMO) radios.

Figure 5: Communication Through Gateways

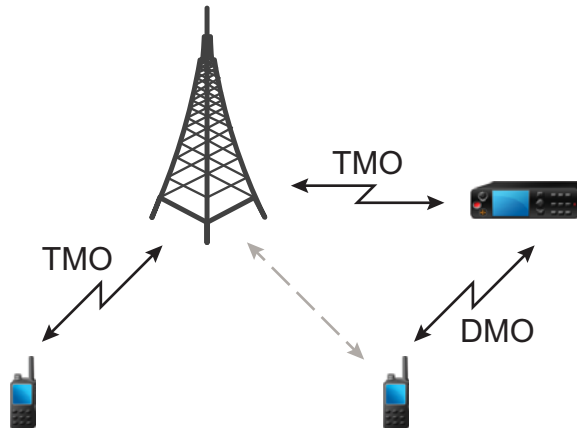

Radio behavior when radio connects to a gateway:

- A tone is sound.
- Gateway available message is displayed.
- An appropriate icon is shown.

Radio behavior when radio loses connection with the gateway:

- A tone is sound.
- Gateway not available message is displayed.
- The gateway icon is blinking.

2.4.3

Gateway and Repeater Synchronization

To communicate using gateways or repeaters, the radio requires synchronization with a gateway or a repeater.

A gateway or a repeater sends presence signals to radios. If a radio receives presence signals, it stays synchronized with the gateway or the repeater which sends the signals. If a radio fails to receive a presence signal it does not immediately lose synchronization. The radio waits for another successful presence for a time defined by your service provider. This function ensures that communications are not dropped due to temporary reception issues.

If a gateway or a repeater is unavailable or the radio is not synchronized with a gateway or a repeater, depending on the setup configured by your service provider, the following scenarios apply:

- The radio falls back to Direct Mode Operation (DMO).
- After pressing the **PTT** button, a prompt appears warning that the second press overrides the gateway or repeater operation mode.
- No direct DMO communications are permitted.

In the second scenario, while the radio receives individual calls and group calls, and replying to individual calls is possible, replying to group calls is not possible.

2.5

Numbering and Addressing

Each radio has an Individual TETRA Subscriber Identity (ITSI) used for addressing the radio over the air interface.

However, it is undesirable to require you to enter a long number to address another radio. To this end, a set of short number schemes can be used. Alternatively, the radio can be provisioned to treat a short number as a Short Subscriber Identity (SSI). This scheme can be refined to allow short dialing within a fleet by combining the ID entered with the radio own SSI.

If the radio is provisioned to treat a short number as a TETRA SSI, and the number entered is fewer than seven digits, the identity of the radio is combined with the number entered to produce the actual Individual Short Subscriber Identity (ISSI). Using this scheme, an ISSI can comprise of a fleet number part and a member part.

The ISSI of the radio is used to determine the leading digits for the digits omitted as in the following scenario:

- 1 The radio has the following ID: 1234567
- 2 You enter: 890
- 3 The SSI sent is: 1234890

The following services can use the short SSI for identification of both the called and the calling parties:

- Duplex private call
- Simplex private call
- Group call
- Mobile status
- Short data bearer service
- Text message service

If you are provisioned with the capability of entering a real TETRA ISSI and you enter an ID of seven digits, the number is interpreted as a real TETRA ISSI regardless of the short addressing scheme used.

2.6

Dialing Methods

The radio supports multiple methods of selecting a number for an outgoing call.

The radio supports the following dialing methods:

- Using predefined One-Touch Buttons
- Dialing from the favorite folders
- Dialing from the address book
- Dialing from the Recent Calls list
- Direct dialing

2.6.1

Individual Dialing

The Individual Call feature consists of the Telephone Interconnect feature and the Private Call feature.

The private ID number is a number of up to 16 digits. If you enter fewer than 16 digits, the Individual Short Subscriber Identity (ISSI) part is added to the full Individual TETRA Subscriber Identity (ITSI) with leading zeros. The private ID number consists of the following items with their respective dialing scheme:

- Mobile Country Code (MCC) 15–13
- Mobile Network Code (MNC) 12–9
- ISSI 8–1



NOTICE: For the MNC of a private ID (digits 12-9), values from 0000 through 9999 are accepted.

The Migration mode supports three types of relative dialing and whichever Mobile Network Identity (MNI) is assumed when the radio dials an ISSI:

- Relative to Switching and Management Infrastructure (SwMI) – the radio uses the MNI of the current SwMI.
- Relative to radio MNI – the radio uses its home MNI.
- Relative to current MNI – the radio uses its home MNI when it migrates to another network or the MNI of the SwMI when the radio has ITSI attached to another network.

Two dialing options are given to the user:

Fixed

Provides up to 16 digits which include the MCC, MNC, and ISSI numbers. If you enter fewer than 16 digits, then the rest is filled with the digits that are set in the codeplug.

Automatic

Provides up to eight digits. If you provide more, it switches to fixed mode. If you enter fewer than eight digits, the radio fills the rest of the number with its own ITSI.

If you enter more than 16 digits, you receive a prompt informing you of an incorrect input.

If the One-Touch Button is provisioned, you can call an individual by pressing and holding down one of the programmable buttons.

2.7

Unified Address Book

The radio offers an address book facility, where multiple numbers are associated with a single name tag. This facility presents an interface to the address book and provides a natural way to call an individual who can be contacted in different ways.

Each individual can have up to six associated numbers:

- Private (a TETRA ISSI or ITSI)
- Home (phone number)
- Mobile (phone number)
- Work (phone number)
- PABX (local short number)
- Other (phone number)

The Contact List has a maximum capacity of 2,000 Contacts, with up to 1,000 associated Private and up to 1,000 associated either Phone or PABX numbers distributed among the contacts.

The address book is also accessible through PEI. Using the PEI enables you to read, write, and modify contact list entries using AT commands.

2.8

Call History

A call history list consists of the following items:

- Last dialed numbers
- Missed call numbers
- Answered (Received) call numbers

Additionally, the time a call is established and all call durations are available. To view call history, press the down scroll key.

The Call History stack holds private TETRA IDs as well as phone and PABX numbers.

Numbers from the stack may be viewed, selected, and called. However, outgoing duplex calls from Recent Calls list display in DMO are not allowed. When you scroll through the lists, the entries appear in the opposite order (the most recent entry is shown first).

When a call is made to a number that exists in the last dialed list, this number is not duplicated in the list and is moved to the beginning of the list. However, a missed call and received entries are duplicated in the corresponding call list.

The call history lists are available after next power-up.

2.9

Group Call

The group call service enables the radio to communicate with a group of other TETRA radios using point to multi-point operation.

This service is available in both TMO and DMO. You can initiate a new group call to the selected talkgroup or talk back to the existing group call by pressing the PTT button.

2.9.1

Programmable Talkgroups

The radio offers a talkgroup list facility. Each talkgroup entry contains a TETRA group address and may be associated with a name tag. The talkgroups can be defined in the codeplug as per the radio capabilities.

Talkgroups are configured separately for TMO and DMO modes. To program a talkgroup in TMO define its name and Group Short Subscriber Identity (GSSI). To program a talkgroup in DMO define its name, Group TETRA Subscriber Identity (GTSI) and frequency. The radio operator can select a talkgroup which has an associated TMO or DMO frequency depending on the mode selected. When switching between the TMO and DMO modes the last active talkgroup is selected. However the required talkgroup can be mapped in CPS. In such a case a corresponding talkgroup is automatically selected during mode switching, regardless of the previously selected talkgroup.



NOTICE: Neither the group name nor the corresponding group address can be edited using the radio MMI.

A talkgroup linked to several networks produces as many new unique talkgroups as the networks it associates with. For example, if the talkgroup has the same GSSI and network in several talkgroup folders, one unique talkgroup is created. Alternatively, if the talkgroup has the same GSSI but with different networks in several talkgroup folders, several unique talkgroups are created for each network.

The GTSI indicates the talkgroup uniqueness. It is a combination of the GSSI and the network associated to the talkgroup in the given talkgroup folder. The talkgroup folders do not determine the uniqueness of the new talkgroups.

2.9.2

Talkgroup Folders

The talkgroups are organized in folders. You can select a talkgroup by first choosing a folder and then the talkgroup in the folder. The size of each folder is flexible and can be defined through provisioning.

The talkgroup folders are organized in a tree-structure:

Level 1 Folders

Can contain any number of level 2 folders.

Placed at the root of the folder structure.

Can contain both level 2 folders and talkgroups at the same time.

Level 2 Folders

Placed in level 1 folders.

Any given level 2 folder can only be sub-folder to one level 1 folder.



NOTICE: The radio supports up to four levels of folders.

Figure 6: Talkgroup Tree

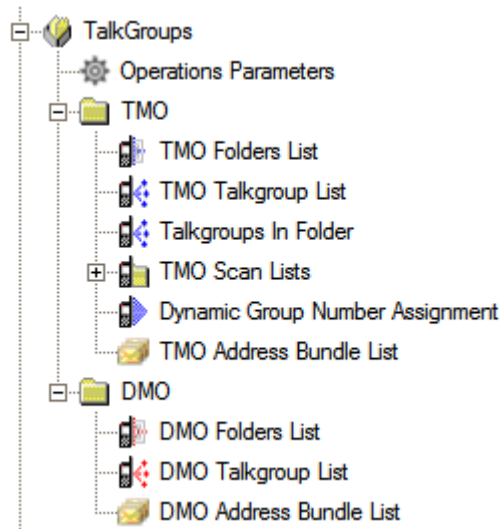

A maximum of 330 extended folders can be assigned for additional favorite talkgroups or covert talkgroups. Each folder contains up to 15 talkgroups that are pre-programmed through the Customer Programming Software (CPS).



NOTICE: The folder definitions cannot be changed using the radio MMI. Any talkgroup folder or sub-folder which is either empty or does not contain any programmed talkgroups is hidden in the MMI.

2.9.3

Talkgroup Selection

You can select a talkgroup when the display is turned off or turned on while in the idle screen using the **Talkgroup Selector** button.

Pressing the **Talkgroup Selector** button backward scrolls the talkgroup list vertically upward. On the contrary, pressing the button **Talkgroup Selector** button forward scrolls the talkgroup list vertically downward. The radio automatically attaches to the newly highlighted talkgroup after a timeout. The **Menu/OK** icon and the **Back** icon on the **Touch User Interface** are inactive during scrolling and talkgroup attachment. The icons revert to active once talkgroup attachment is successful.

You can select a covert talkgroup from the extended folders through the radio menu or Short Data Service (SDS) Remote Control.

2.9.4

Favorite Folders

The radio supports two favorite folders. The **Favorite TGs** folder contains TMO and DMO talkgroups whereas the **My Contacts** folder contains private and phone contacts. By default, these folders are already enabled in the radio.

The favorite folders are static links to talkgroups and contacts. Hence to populate the favorite folders, talkgroups and contacts must be pre-configured in the CPS. To access these folders, select either one of the folders from the radio menu. Selecting **Favorite TGs** enables scrolling within this folder. On the other hand, if **My Contacts** is selected, you can choose any contacts in the folder to initiate simplex or duplex calls for the contact. If a contact name has multiple contact numbers, then multiple entries must be configured in the contacts favorite with one entry per contact number type.

A favorite talkgroup range name replaces a talkgroup range name on the radio display whenever a favorite talkgroup is selected, or is in use for appropriate operation. The ranges of favorite talkgroups with their talkgroup assignments are kept through the radio power cycle.

2.9.5

Receive-only Talkgroups

Talkgroups can be provisioned as receive-only talkgroups. This setting depends on the settings of the folder the talkgroup is in. Any talkgroup from the receive-only folder can be selected. The radio allows you to receive calls, however, no call can be initiated to this talkgroup.

2.9.6

Non-Selectable Talkgroups

A talkgroup can be provisioned as a non-selectable talkgroup. Such talkgroups are not visible when scrolling through the talkgroup list, and thus cannot be selected.

The group name is displayed only upon receiving a call for the group, for instance, if it is an announcement talkgroup associated with the selected group, or if it is a scanned one. The radio user is not allowed to edit the scan list.

2.9.7

Transmission Timeout Timer

The radio limits the time you can continuously talk in a group call without interruption, according to a provisioned value. You are warned a short time before the talk time expires. The timer is provisioned per talkgroup folder.

2.9.8

Group Call Reception

In most situations, the radio receives group calls without any intervention. When the radio receives an incoming group call, you are alerted with a short alert tone. Depending on the configuration, the tone can be disabled. Then the speech follows.

To clear a call ended by the call owner, normally by the SwMI, you do not need to do anything. However, you can leave a group call. Then the call continues for other radios, even though your radio does not participate in the call anymore.

2.9.9

Talkgroup Scanning

Talkgroup scanning allows the radio to monitor signaling of a few talkgroups at the same time. In addition to monitoring signaling addressed to the selected talkgroup, the radio can monitor signaling addressed to multiple talkgroups.

To enable talkgroup scanning, select a pre-defined scan list. The available scan lists are configurable through the CPS only. This list holds up to 20 talkgroups, which you monitor in addition to the selected group.

You can choose only one user-activated scan list at a time. When this list is activated, the radio begins to monitor traffic for these groups in addition to the traffic for the selected group. Up to 40 scan lists can be defined.

The radio displays the scanned talkgroup ID when it receives a group call while talkgroup scanning is active. The display is turned off by default when the radio is transmitting. Pressing the **Power/Sleep/Wake** button turns on the display, showing the scanned talkgroup ID.

If the SwMI instructs a radio to detach one of the scanned groups, the radio stops monitoring the group, but the group remains in the scan list. Subsequent attachment of a group by the SwMI causes the radio to begin monitoring the group again.

The SwMI may also instruct a radio to attach groups from out of the scan list. If the group attachment is accepted, the radio monitors the group.

If talkgroups have been attached or are always attached, the radio may passively monitor the following talkgroups:

- Selected talkgroup.
- Announcement Talkgroup (ATG) associated with the selected talkgroup (if this talkgroup is not set as **Permanently detach**).
- Talkgroups associated with the selected ATG (if this talkgroup is not set as **Permanently detach**).
- Talkgroups in the user-activated scan list (if scanning is enabled and the SwMI-initiated detachment has not been performed on these groups).
- Talkgroups in the SwMI-controlled scan list (if scanning is enabled).
- Talkgroups with the class of usage set to **Always Scanned** (if supported).

2.9.10

Priority Monitor

While the radio is active in a group call, it may receive a group call setup for a different group. The radio decides whether to ignore the new call or accept it basing on the call priority. If the new call has the higher priority than the current one, the new call may be joined and the current call is dropped.

The following priority types are applicable to calls:

- Call priority indicated in the call setup signaling.
- Priority of the group indicated by the Class of Usage (CoU) negotiated upon attachment.

If the old call and new call have different call priorities, the radio follows the call with the higher call priority. If the calls have the same call priority, the CoU priority of the group decides.

If a radio is in a group call, but is not currently the talking party, and detects a call setup for a different group with the same priority, it joins the call if a CoU priority is higher.

The radio can be set up not to immediately join the new higher priority call but to present the new call to the user before joining it. If so provisioned, you are given a choice of following the new higher priority call or staying with the present call.

The radio can be set up to treat a selected group call as a higher priority than a scan group call. This behavior occurs regardless of the priority of the calls or the groups.

2.9.11

Timed Talkgroup Change

This feature allows switching between the original and the predefined Trunked Mode Operation (TMO) or Direct Mode Operation (DMO) talkgroup by using the One-Touch Button.

The radio attaches to the selected, predefined talkgroup only for a specified amount of time (**Functional Timer**). After the timer expires, the radio returns to the previously attached, original talkgroup. Returning to the original talkgroup can also be assigned to the second press action of the button.

Example: A campus university combines four buildings: A, B, C, and D. A security procedure is to raise an internal alarm for the building and then notify the entire campus. The staff in each campus building configures radios with three types of talkgroups.

- 1 Internal Communication Talkgroups – regular talkgroups for the entire campus and individual buildings to communicate between staff members.
- 2 Internal Alarm Talkgroups – emergency talkgroups, individual for each building.
- 3 External Alarm Talkgroup – an emergency talkgroup to alert the entire campus.

The staff in individual buildings uses the dedicated Internal Communication Talkgroups for daily routines and the Internal Alarm Talkgroup for safety procedures. The campus staff in every building also scans the External Alarm Talkgroup.

The campus IT administrator assigned in CPS the **Timed Talkgroup Change** function to a One-Touch Button to switch between the original Internal Communication Talkgroup, and the Internal Alarm Talkgroup. This way the radio users can immediately switch to the emergency talkgroup and start an internal emergency call.

One of the staff members in building A is in an emergency situation. The person presses the One-Touch Button to switch to the Internal Alarm Talkgroup and starts the emergency call. The other staff members in building A hear the voice communication on the Internal Alarm Talkgroup. It turns out that the emergency is serious and one of the building administrators starts the global alarm for all campus buildings.

2.9.12

Broadcast Call

Broadcast Call enables the dispatcher to transmit to all radios in the specific area. This call is only available on GMOI network.

The radio joins calls received with a communication type broadcast and displays a notification that this call is a broadcast call. Typically, this call type is addressed to the broadcast address (ISSI).

A broadcast call takes precedence over any other call that has the same or lower call priority.

2.9.13

D-PTT Tone

The PTT double push (D-PTT) feature enables the radio to generate a specific tone sent to other radios in the talkgroup.



NOTICE: Your radio can only support either D-PTT Tone feature or D-PTT Preempt Group Call feature at a time.

To send the tone, you can press the preconfigured One-Touch Button once or **PTT** twice in a period defined in CPS. The D-PTT is triggered only when the radio is in idle or group call mode. The D-PTT tone is not played on the sending radio.

After the D-PTT tone is played, you can press and hold the **PTT** once again to get the permission to talk. Otherwise if you press the **PTT** while the D-PTT tone is played, it is ignored. The D-PTT tone is not audible on the sending radio.

If you hold the **PTT** after the second press and the radio finishes sending the D-PTT tone, you can start a group call. You are notified of the behavior by the permission to talk tone after D-PTT tone ends. If **PTT** is released after the second press, only the D-PTT tone is sent.



NOTICE: The D-PTT tone is sent as voice, hence the receiving radio plays the sound no matter whether the feature is enabled on it.

You can adjust the D-PTT tone volume level in the speaker or earpiece of the sourcing radio. Disabling all the tones does not affect the sent tone volume. From the MMI, you can change the D-PTT tone to be single, double, or triple. The tone type can also be changed in the codeplug.

2.9.14

D-PTT Preempt Group Call



NOTICE: This is a Software Selling Feature.

The D-PTT Preempt Group Call allows superiors to take over and speak in an ongoing group call by making preemptive priority calls.



NOTICE: Your radio can only support either the D-PTT Tone feature or D-PTT Preempt Group Call feature at a time.

By pressing the PTT (Push-To-Talk) button twice, you make a preemptive request to temporarily interrupt an ongoing group call and gain permission to speak.

If your group call is preempted and you are still pressing the **PTT** button, your radio displays the **PTT Denied** prompt.

If your service provider enables the visual notification, your radio displays the **PTT Interrupted** prompt throughout the group call preemption, even if you no longer hold the **PTT** button.

If your service provider enables the audio notification, your radio plays the **PTT Denied** Tone until you no longer hold the **PTT** button.

2.9.15

PTT Queue

PTT Queue allows you to configure the response to releasing **PTT** of the call originating radio. This feature also determines how to cancel waiting for the call when the infrastructure is busy and your call is queued.

2.9.16

Talking Party Identification

Radios engaged in a group call receive an ID of the transmitting party. You can find the identification in the call setup message.

2.9.17

Call Ownership

The radio can be given the call ownership of a talkgroup call. When the radio is the call owner, it sends an appropriate TETRA signaling to end the call.



NOTICE: The SwMI decides the ownership of a call.

2.9.18

Transmission During Group Call

While receiving a group call, and the **PTT during received Group Call** is enabled, you may request to transmit by pressing and holding the **PTT**. The system registers this action and informs you that the request has been queued.

If you release the **PTT**, the radio sends a message to the system withdrawing the request.

2.9.19

Call Restoration

If the radio roams to a new cell during a call, it attempts to continue the call on the new cell. Cell reselection and call restoration procedures are employed for this attempt.

If the radio roams while being the transmitting party in the call, an announced cell reselection, if possible, is carried out in the new cell.

If the radio is not the transmitting party, it employs an unannounced cell reselection, followed by the call restoration procedures.

2.9.20

Temporary Group Address

The radio supports the temporary group address assigned by the SwMI. The address is valid only for the lifetime of the call.

The radio monitors signaling addressed to the temporary group, when the radio initiates a group call on the selected group, and the SwMI assigns the call to a temporary group.

The radio supports assignment of an incoming group call to a temporary group address.

2.9.21

Late Entry

A radio can join a group call even if it does not participate in it from the beginning.

For example, if you turn on your TETRA terminal and select a talkgroup with an ongoing group call, the radio automatically joins the call. Similarly, if the radio has been outside of the radio coverage, for example in a tunnel, the control channel continues to divert the terminal to a talkgroup call, assuming a call is already in progress.



NOTICE: For Trunked Mode Operation (TMO), this feature must be configured on SwMI. Acknowledged late entry and late entry paging are not supported.

2.9.22

User Initiated Group Attachment

A radio must attach itself to a talkgroup to participate in a group call.

The radio initiates a group attachment request to the SwMI during the following conditions:

- Radio powers up.
- Radio registers on a new site.
- User initiates a group change.
- User activates a scan list.

When a group change is requested, the radio initiates an attachment to the SwMI, detaching the old group and attaching to the new one.

All group attachments sent by the radio are sent with attachment mode of **Amendment** or **Detach all...** depending on which form causes sending fewer bits over the air interface.

When you turn on scanning and then select the scan list, the radio sends a group attachment request to attach the scan groups in addition to the selected group. Similarly, when you select an Announcement Talkgroup (ATG), the radio sends an attachment of the ATG as the selected group along with the attachment of the associated groups as scan groups. If a group associated with an ATG is selected, the radio sends an attachment of the ATG as the selected group and as a scan group.

The TETRA TIP provides a facility by which the radio can send a status message to the SwMI to turn scanning off and on to save air interface signaling.

If the radio is provisioned with this option, when you turn scanning off, the radio sends an appropriate TETRA signaling. In this state, the radio does not monitor any groups other than the selected group. If you then turn scanning on, the radio sends an appropriate TETRA signaling and begins monitoring all scanned groups again.

If the radio is not provisioned with this option, you can only deselect the active scan list. However, you cannot turn off the scanning. Deselection of the user scan list causes a group detachment of the scan list groups sent to the SwMI. However, the radio continues to scan all other groups, such as ATG associations.

2.10

Private Call

Private call, also called point-to-point call, enables communication between two individuals. No other radio can hear the conversation.

This call type can be carried out in two ways:

Duplex Call

This call type is only allowed in Trunked Mode Operation (TMO). During this call, both parties can speak at the same time.

Simplex Call

Available in TMO or Direct Mode Operation (DMO). Only one party can speak at a time.

In TMO, you can answer a private call in the following methods:

Hook (default)

When this method is selected, you must answer the call to begin transmission.

Direct

When this method is selected, the call is automatically answered without any keypress and transmission begins immediately. Therefore, ensure that the incoming call notification is configured properly to indicate the incoming call.

As Received

When this method is selected, the call is answered according to the call answering setup determined by the transmitting party.

Table 7: Call Answering Rules

The following table illustrates the dependencies between the call answering setup and the call receiving method. The setup on the receiving radio takes precedence over the setup of the transmitting radio.

Call Answering Setup		Call Answering Method
Transmitting Radio	Receiving Radio	
Hook	Hook	User answer
Hook	Direct	Auto answer
Hook	As Received	User answer
Direct	Hook	User answer
Direct	Direct	Auto answer
Direct	As Received	Auto answer



NOTICE: The Direct hook method for duplex calls is supported from Dimetra 9.0.2 onwards.

When a DMO private call takes place, the radios not involved in this call receive the channel busy indication. The radios are identified using their radio numbers.

2.10.1

Transmission Timeout Timer

In a simplex call, the radio limits the time you can continuously talk in a group call without interruption, according to a provisioned value. You are warned shortly before the talk time expires.

2.10.2

Call Restoration in Private Call

If the radio roams while you are the transmitting party in a private call, the announced cell reselection is employed (if possible). Call restoration procedures are performed in the new cell.

If you are not the transmitting party, the radio employs an unannounced cell reselection, followed by the call restoration procedures.

2.10.3

Call Modification

Call Modification is a feature that allows your service provider to modify the call to optimize it and adjust to a current situation.

Modification can cover:

Call priority

Modified during call setup.

Call type

Modified during call setup.

Call encryption

Modified during an ongoing call, but not in the transmission phase.

When the call is modified, your radio displays `Call Modified` message.

When a recently modified call requires the **PTT** button to transmit, your radio displays `Call Modified Use PTT`.

All modifications are made by your service provider and your radio only follows them. You have no influence on ongoing call modifications.

When call priority is changed to emergency:

- The display indicates that an Emergency Group Call has been received.
- Your radio plays a special audio alert.



NOTICE: If a Group Call is modified into an Emergency Group Call, no emergency-related features are triggered.

If your radio cannot follow a call modification requested by the service provider, due to its settings, your radio rejects it and displays `Service Not Available` message.

2.10.4

DMO Individual Call Presence Check

If the other party is listening, the Presence Check feature allows the user making a Direct Mode Operation (DMO) private call to have a confirmation. This confirmation is important in situations where it is crucial that the message gets through.

If the other party does not answer the call, a radio with Presence Check enabled displays the `Party not available` message. Both radios must support this feature to use it.

In addition, radios can be configured to Accept DMO Individual Calls with Presence Check. If enabled, the radio accepts incoming calls with or without the presence check. If disabled, the radio only accepts private calls without the presence check.

2.10.5

DMO Individual Only Talkgroups

It is possible to configure some or all Direct Mode Operation (DMO) talkgroups to allow only individual calls. This configuration optimizes the allocation of frequency in DMO.

2.10.6

Private Calls through DMO Gateway



NOTICE: This is a Software Selling Feature.

The DMO Gateway can relay clear and non-BSI encrypted private calls from a radio in Trunked Mode Operation (TMO) to another radio in DMO, and the other way around.

A DMO radio can directly establish a private call with another TMO radio through its Individual Short Subscriber Identity (ISSI).

A TMO radio initiating a private call with another DMO radio first establishes a private call with a DMO Gateway. Then the DMO Gateway establishes a private call with the target address of the DMO radio, which is already predefined in the Gateway. The DMO forwarding address is configurable using CPS, Integrated Terminal Management (iTM), Gateway MMI, or remotely using AT commands or TMO SDS Remote Control.

2.11

Phone Call

The phone call service enables a radio in Trunked Mode Operation (TMO) to communicate in a one-on-one simplex or duplex conversation with a phone (for example, a phone call-enabled TETRA radio or landline number) using a telephone switch. The radio supports individual call service to an external identity.

Two phone call types are available:

- a full phone number Public Switched Telephone Network (PSTN) call is addressed to the defined PSTN gateway address.
- an internal Private Automatic Branch Exchange (PABX) call is addressed to the defined PABX gateway address.



NOTICE: The PSTN phone call is supported when PSTN/PABX feature is enabled in the codeplug and the SwMI supports this functionality. The PSTN/PABX gateway must be configured properly.

Only one PSTN/PABX gateway ID and one PABX/PABX gateway ID are available in the radio.

2.11.1

Phone Call Initiation

The radio is able to initiate phone calls to a Public Switched Telephone Network (PSTN) or Private Automatic Branch Exchange (PABX) with duplex speech capability. This call type uses TETRA individual call signaling using single stage dialing and hook setup for outgoing calls.

Using the hook signaling for phone calls, implies that until a traffic channel is allocated, the radio generates all feedback tones internally. In addition, the radio accepts SwMI modification of the call setup to direct, enabling the infrastructure to generate the progress tones.

Phone calls can also be made between TETRA radios using the Mobile Station International Subscriber Directory Number (MSISDN) number as the called party number. MSISDN calls share the

same gateway as phone calls, that is, PSTN gateway configured in the codeplug. If an MSISDN call is placed, two radios can have a simplex or duplex call based on the assigned ISDN number.



NOTICE: The Dimetra Infrastructure does not support private calls and Short Data Service (SDS) through MSISDN.

2.11.2

Phone Call Reception

Incoming phone calls, from the land gateway to mobile, use on-off hook signaling. The radio extracts the gateway ID from the call setup signaling, to determine whether to start phone or Private Automatic Branch Exchange (PABX) call.

2.11.3

Call Restoration in Phone Call

If the radio roams while being in an active phone call, and the announced cell reselection is possible, then the announced cell reselection is employed. Also the call restoration procedures are performed.

2.12

Emergency Operations

Emergency Operations are used in critical situations.

Pressing the **Emergency** button and pressing the **Send** key, activates one or more services, depending on the service provider setting.



NOTICE: It is possible to power up the radio by pressing the Emergency Button. Depending on the service provider settings, the radio can start Emergency Operations automatically. If the radio is PIN-protected, except for SIM PIN, Emergency Operations bypass the PIN lock during the Emergency Operations.

During Emergency Operations, the radio automatically rejects phone, Private Automatic Branch Exchange (PABX), and private calls, and does not monitor the talkgroups in the selected scan list. However, if an Announcement Talkgroup (ATG) is the selected group, the radio monitors the sub-groups associated with the ATG.

When entering Emergency Operation, any ongoing voice call is aborted or cleared down. Any packet data transfer in progress is aborted. However, the session is kept open.

2.12.1

Emergency Group Call

The Emergency Group Call has the highest communication priority, which makes it a pre-emptive call. Emergency Group Call is available in both Trunked Mode Operation (TMO) and Direct Mode Operation (DMO) modes.

During Emergency Operations, Emergency Group Call can be started by pressing **PTT**. The radio may also support Hot Microphone operation, which allows the Emergency Call to be conducted without pressing **PTT**. If a radio receives an incoming group call with emergency priority, the display shows that an emergency call has been received, and a special audio alert is played.

The Emergency Group Call Termination feature allows the radio user to attempt terminating an Emergency Group Call by pressing the **Back** touch icon. The ownership status of the radio determines the following termination conditions:

Call Owner

The radio sends a disconnection PDU to the SwMI. The SwMI responds by sending a release PDU response with an indication that the call has been disconnected.

Non-Call Owner

If a radio is programmed to terminate a call, the termination procedure is the same as for the call owner in an Emergency Group Call. Otherwise, the radio leaves the group call without informing the SwMI.

The SwMI may reject the termination request, in which case the radio stays in the group call.

An emergency group call can be configured as non-tactical or tactical:

- A non-tactical call is initiated on a talkgroup designated by the codeplug setting. When in non-tactical emergency mode, you cannot switch talkgroups.
- A tactical call is initiated on the currently selected talkgroup.

In TMO, if the radio enters emergency operations while the emergency broadcast call is active the radio continues on the call without initiating any calls and sends an emergency alarm.

2.12.2

Non-Tactical Emergency

In Non-Tactical Emergency, the radio switches to a designated Emergency talkgroup when starting Emergency Operations. This talkgroup is used for the complete duration of the Emergency Operation. Changing talkgroups is not allowed at this point.

In Trunked Mode Operation (TMO), the radio can make Emergency Non-Tactical Group Calls without sending attachments. If configured, the radio assumes implicit attachments after receiving a temporary address.

In Direct Mode Operation (DMO), the Non-Tactical Emergency proceeds on the same frequency as the previously selected talkgroup. The service provider can designate any Individual TETRA Subscriber Identity (ITSI) address to be used for Emergency Operations. This ITSI can be an Open Group - broadcast address.

After exiting from Non-Tactical Emergency, the radio returns to the previously selected talkgroup.

2.12.3

Emergency Individual Calls (Private or MSISDN)

The Emergency Individual Calls are simplex or duplex calls with emergency priority.

On pressing the **Emergency** button, the radio initiates an individual call to a provisioned private or Mobile Station Integrated Services Digital Network (MSISDN) address.

This feature also supports the direct or hook dialing method on simplex and duplex calls. For full duplex Emergency Individual Calls initiated to an MSISDN address, the default dialing method is configured to hook. This default dialing method cannot be modified.

In Emergency Individual Calls, the radio rejects all incoming individual calls with nonemergency priority. These rejected calls are shown as missed calls after the Emergency Individual Calls have ended.

Emergency Full Duplex Private Calls (FDPC) supports high/low audio state. The audio state is configurable. You can select the audio state during incoming or outgoing emergency FDPC by toggling hi or low audio during active Emergency FDPC.

2.12.4

Emergency Alarm

The emergency alarm is a special status message sent to the infrastructure while starting the Emergency Operations. The radio may wait for infrastructure acknowledgment for this alarm and attempts retries.

Each time the radio enters the Emergency Operation, it sends an emergency alarm. When an emergency alarm is sent successfully, the respective audible tone sounds.

In addition, once the radio is in Emergency Operation and on pressing the **Emergency** button, an extra emergency alarm is sent. The only exception of this condition is during Hot Microphone transmission.

The message can be dispatched both in Trunked Mode Operation (TMO) and Direct Mode Operation (DMO).

2.12.5

Emergency SDS Status

Emergency Short Data Service (SDS) Status allows the radio to send a status message with a pre-programmed value to the destination address set up in the codeplug.

This feature is available in Trunked Mode Operation (TMO) only. If no status acknowledgment or negative acknowledgment is received, the radio retries sending the message. If Emergency Alarm or Hot Microphone is configured, status is not sent.

2.12.6

Emergency Hot Microphone

The Hot Microphone allows you to talk without pressing the **PTT** button during Emergency Operation. The transmission continues for a provisioned amount of time. Pressing the **PTT** button before the Hot Microphone time expires ends the Hot Microphone operation. Then normal PTT operation in Emergency group call takes over whereby the transmission is ongoing for the time the **PTT** button is held.

Subsequent **Emergency** button presses during the Emergency Operation restart the Hot Microphone transmission.

If a talk permit is granted to another member of the group, the Emergency Call received tone is played. If configured, the radio automatically attempts to get talk permit again.

Pressing **End** soft key or **End** key ends the Hot Microphone operation.

Pressing the **Back** touch icon ends the Hot Microphone operation.

2.12.7

Alternating Hot Microphone

The Alternating Hot Microphone is an enhancement of the Hot Microphone feature. It allows you to have the Hot Microphone switched on and off alternately.

If this feature is enabled, you can initiate the Alternating Hot Microphone by pressing the **Emergency** button.

The Alternating Hot Microphone terminates when one of the following conditions is met:

- The radio exits the Emergency Mode.
- The Alternating Hot Microphone timer expires.
- The **PTT** button is pressed.

- The **Back** touch icon is pressed (only during the transmission timeslot).



NOTICE:

When the radio goes out of the service, it enters the receiving mode and the Alternating Hot Microphone is on hold. When the radio is back to the service, the Hot Microphone transmission and the Alternating Hot Microphone resume.

When the radio is in the Emergency Mode, pressing the **Emergency** button restarts the Alternating Hot Microphone.

2.12.8

Silent Emergency Mode

The Silent Emergency Mode is a type of emergency services that provides no audible indications nor keypad tones at the entrance. All the display indications are as in the home mode. However, the radio cannot use any services except for:

- Receiving Ambience Listening
- Sending Silent Emergency Alarms
- Sending GPS location reports



NOTICE: The radio blocks any other feature that you try to activate.

If the Silent Emergency feature is enabled, the radio enters Silent Emergency Mode on pressing the **Emergency** button. After entering this Mode the radio stays in TMO or switches to it, depending on the actual state. Once in TMO, the radio sends Silent Emergency Alarm.



NOTICE: If the radio is in a private or group call, the radio waits until the call ends and then enters the Silent Emergency Mode.

The radio keeps re-sending the alarm until successful sending is confirmed. After the alarm is successfully delivered, the radio stays in Silent Emergency Mode and waits for the Ambience Listening.

Your radio exits the Silent Emergency Mode, under the following conditions:

- Press **Menu** and then **#** key within 3 seconds.
- Press **1** and **3** keys simultaneously.
- No success in sending the Silent Emergency Alarm and the maximum number of retries has been reached.
- The control room terminates the Silent Ambience Listening.
- The Ambience Listening is disconnected due to another reason.

If you turn off the radio in the Silent Emergency Mode, the radio switches to pseudo power off state. In this state, the radio appears to be turned off. However, the radio is still on and in the Silent Emergency Mode. On turning the radio on during the pseudo power off state, the radio acts as during turning on and still is in the Silent Emergency Mode.

2.12.9

Invisible Emergency

Your service provider can disable visual and audible indications on the radio in Emergency Operation. This feature is called Invisible Emergency. Invisible Emergency provides an extra layer of safety when

using Emergency Operation in critical situations. Critical situations are such as a direct attack on the user.

2.12.10

Emergency Destination in Local Site Trunking



NOTICE: This is a Software Selling Feature.

This feature allows the radio to send emergency requests to a different destination. This transmission occurs while in local site trunking mode.

The supported emergency services are:

- Emergency Alarm
- Emergency Call
- Emergency Short Data Service (SDS) Status
- Location Information Protocol reports

2.13

Short Data Services

The radio supports the following Short Data Service (SDS) message types:

- SDS Status.
- SDS User Defined Data Types 1, 2, 3.
- SDS User Defined Data Type 4 with or without SDS Transport Layer (SDS - TL).

The feature supports the following addressing modes:

- Radio to radio.
- Radio to talkgroup.
- Radio to external subscriber number (gateway address).



NOTICE: For SDS - TL, the message can be sent through the service center.

The radio provides a short data bearer service for both internal and external applications.

The radio supports SDS - TL services which provide end-to-end acknowledgments, delivery report requests, and message numbering for SDS user-defined data type 4 messages. The TL also provides SDS access for applications that do not request these transport layer services, however, use a Protocol Identifier (PI). The radio can send the delivery report by using an appropriate TETRA signaling, even if the originator requested a short report. The radio can support the old SDS - TL standard for operation on legacy systems, or for operation on other SwMIs.

An externally connected device may access the SDS services in the radio using AT commands and TNP1 protocol. An external application may use this service to send and receive SDS statuses, SDS user-defined data types 1, 2, 3, and 4.

Downlink SDS messages type 4 are presumed to contain a PI for identifying the target application. If an external application has registered with the radio for that PI, the radio delivers the message to the target application. The radio may receive downlink SDS messages that are successive retransmissions of a message already received and acknowledged by the radio. The radio does not display these messages, nor store in them in the inbox, nor send them to an external application.

2.13.1

Status Messages

You can select from a list of up to 4000 preprogrammed alphanumeric aliases each of which corresponds to a status value. The valid range of uplink status values is a set of provisioned parameters. If the radio is not enabled with targeted status, the status value is sent over the air interface to the address of the selected group. The radio recognizes the general status acknowledgment sent from the Switching and Management Infrastructure (SwMI) and the negative acknowledgment. In Trunked Mode Operation (TMO), if no status acknowledgment or negative acknowledgment is received, the radio retries sending the message. The number of retries and time to wait before retrying are provisioned parameters. You are notified of the delivery status. As there is no acknowledgment for Direct Mode Operation (DMO) status messages, you are notified only of sending the status message. The radio does not initiate sending of status messages on a traffic channel.

If the radio is provisioned with the targeted status, the status value is sent over the air interface by default to the last sent target. You have also an option to specify a different individual or group to send the message to. In other words, you can send a Short Data Service (SDS) status message to a directly entered ID (for example, ISSI, GSSI, MSISDN). If the radio is not provisioned with the targeted status and you want to send an SDS status message, the following possible actions apply:

- When the default address type of the targeted SDS status is set to **Private** or **Phone**, the default address is used as ISSI, ITSI, GSSI, or ISDN, depending on the configuration.
- When the default address type of the targeted SDS status is set to group, the selected talkgroup address is used.

The radio accepts status messages from addresses it is monitoring. The radio can be preprogrammed with an appropriate text associated with each status value. The radio notifies when a new status message has been received. Upon receiving an incoming status message, the stored text corresponding to the status value is extracted and placed in the text message buffer as a text message. Receiving a status causes the radio to display the message mail screen, which allows you quick access to read the message. A received status can be stored in the radio text message buffer.

The PEI provides access for external applications to send and receive status messages.



NOTICE: The Dimetra Infrastructure does not support the targeted status feature.

2.13.2

Shadow Groups (Address Bundle)



NOTICE: This is a Software Selling Feature.

Shadow Groups (Address Bundle) is not available on Gateway mode.

The Shadow Groups feature offers a way of sending statuses to multiple destinations or recipients simultaneously. Each radio can store up to 255 Address Bundles.

Four types of Address Bundles are supported:

- Status Addressing (including emergency alarm)
- GNSS/GPS LIP Addressing
- RMS/FMS Addressing
- Bluetooth Sensor Addressing

Shadow Groups in TMO

Each Address Bundle may contain up to four target addresses (ISSI or GSSI). Each talkgroup may be configured to send statuses, GNSS/GPS LIP reports or RMS/FMS messages to a specific Address Bundle.

Additional Address

The Additional Address feature allows the radio to send RMS messages, and Local Information Protocol (LIP) reports to additionally defined recipients.

Your service provider defines the default addresses where the radio sends RMS messages and LIP reports. If an Additional Address is selected and enabled, RMS messages and LIP reports are also sent to the recipient defined in the Additional Address.

Shadow Groups in DMO

In DMO the Address Bundle contains one target address (ISSI or GSSI). Each talk group may be configured to send statuses or GNSS/GPS LIP reports to a specific Address Bundle.

The Shadow Groups feature may affect Emergency Calls setup time to be slightly elongated.

2.13.3

Text Messages

The radio supports an internal text messaging application using the TETRA Short Data Service Transport Layer (SDS-TL).

The encoding schemes supported in text messages are:

ISO 8859-1 (Latin-1)

American Standard Code for Information Interchange (ASCII) encoding scheme which includes letters and special characters needed for Western European languages.

2-byte Universal Character Set (UCS-2)

Unicode standard which defines a consistent method of encoding and decoding multilingual text such as Chinese and Korean characters.

Table 8: Maximum SDS Character with Encryptions

Encoding Scheme	Without OPTA and E2EE	Without OPTA and with E2EE ²	With OPTA and without E2EE	With OPTA and E2EE ²
7-bit	160	124 (121)	136	100 (97)
8-bit	140	109 (106)	116	85 (82)
16-bit	70	54 (53)	46	30 (29)

Besides the 7-bit, 8-bit, and 16-bit encoding schemes, the radio also supports the Smart 8-16 and Smart 7-8-16 encoding schemes. These two encoding schemes are auto-selected if your text input has a combination of 7-, 8-, or 16-bit characters.



NOTICE: Usage of special characters or multilingual texts may reduce the maximum number of characters allowed.

The radio provides an edit facility for composing and editing a text message. The message can be sent to a target TETRA radio using Short Subscriber Identity (SSI) addressing, and is sent with a request for a received delivery report.

Incoming messages are stored in the **Inbox**, the following options are available:

Incoming text messages are stored in the **Inbox** whereas outgoing text messages are stored in **Outbox**, when the store and forward mechanism is not in place. When the store and forward feature is enabled and the messages go through the store and forward server, the short messages are stored

² In E2EE SDS, a timestamp reduces the maximum size of the user data. See values in parentheses.

regardless the delivery status. Whereas, long messages are stored only if delivered (even if only to the store and forward server).



NOTICE:

Message protection functionality is enabled in the **Inbox** folder. Users can only delete unprotected messages.

Delivery report is saved in the **Inbox** and in the associated message in **Outbox**. However, the report is deleted from the **Inbox** after viewing it.

Outbox and **Inbox** share memory area, hence their capacity depends on the combination of stored short and long messages in each of these folders. If **Inbox** is empty, **Outbox** may store up to 100 short messages or at least 20 full-size long messages. If **Outbox** is empty, **Inbox** may store up to 100 short messages or at least 10 full-size long messages. When you enter the **Messages** sub-menu, the number on the right side of **Inbox** and **Outbox** is indicating the number of the messages stored. If the **Outbox** is empty, then the radio displays **No Messages** notification.

2.13.3.1

Buffer Full Overwrite Policy

Upon receiving a text message, the radio places the text into a circular buffer. You are notified when a new text message is received and a quick access to read the message is provided. If a delivery report is requested, the radio sends it upon receipt of the message by SDSTL. If a consumed report is requested, the radio sends it when you read the message.



NOTICE: If you read the message when the radio is out of service, the report may not be sent.

You can save incoming or edited (outgoing) text messages. These messages can be edited and sent. You can also protect the message from being deleted or from the overwriting policy of the radio.

For each message, you can verify its timestamp. The timestamp displayed is extracted from the SDS TL PDU. The timestamp is generated and inserted to the message by the SwMI.

2.13.3.2

SDS Messages Concatenation

This feature allows sending long text messages up to 1000 characters. Messages that are longer than 140 characters are divided and sent separately one after another. When a recipient receives all the parts of the message, it displays as one on the screen.

When the radio receives an SDS message and the **Inbox/Outbox** is full, the radio acts according to the **Buffer Full, Overwrite Policy** codeplug field settings.

When the text or status message is received and accepted, the radio retrieves actual time information from its internal clock.

The radio can reconstruct a long text message consisting of up to ten short messages. The maximum length of the message is 141-1000, what can be defined in the codeplug. The radio recombines the text segments independently of the order they have been received to the correct order of the original message. The message can be combined only if all their message reference number are correct and the segmented receiver timer is still valid.

You can send long text messages to an individual destination. However, sending long text messages to groups is not possible:

- Receiving the message during a group or broadcast call – radio allows receipt of the text message during ongoing group call and broadcast call.
- Emergency Mode – you can receive SDS messages. To read the SDS messages the radio have to leave the emergency mode. Sending the SDS messages in the emergency mode is prohibited.

When sending long, segmented text messages, a timer is activated. If not all segments of the message are received before the timer expires, the whole sending process is considered as failed. The service provider sets the value of the timer.

2.13.4

Predefined Templates (ATS Entry Prompt)

This feature assists the radio in sending formatted messages with a predefined destination address (MSISDN, SSI, or TSI) for computer applications.

You can select a predefined entry prompt which defines a message format to help with the construction of a Short Data Service (SDS) message. The prompt definition is set in the codeplug. The definition sets areas that are read-only, areas that can be edited, and the type of characters that can be entered (numeric, alpha-numeric, or phone digits). Along with the message definition, the address to send the message is provided.

When you send the message, it is sent using SDS Transport Layer with the PI that is provisioned in the codeplug. A receipt report is requested.

The radio chains multiple predefined templates with the same Prompt ID into a single multifield template. The Predefined menu can store predefined and multifield templates. There is no indication to distinguish between the two, although an alternative solution is to define the template name which is displayed as the title of the template. However, this solution is subject to user configuration.

2.13.5

SDS Air Interface Aspects

The types of delivery reports available are standard report and short form report. The radio can be provisioned to send a short-form SDS - TL receive report when the originator of the message allows short-form report. The short form report uses a specially designated 16-bit SDS status value instead of SDS-REPORT. The radio can respond to a delivery response request automatically or manually although selection of report types through radio MMI is available only in manual response.

The radio supports SwMIs that employ store and forward service as indicated in the cell broadcast information. The radio supports use of a service center, which address is set in the radio. The store and forward operation is supported. However, the radio notifies you only on successful sending of the message. The radio does not wait for the report from the service center.

Downlink SDS messages types 1, 2, and 3 are always routed to the PEI when an AT application is registered. If no external application is registered, the message is discarded.



NOTICE: The DMO SDS does not support type 1, 2, and 3 user-defined short messages.

2.13.6

SDS End-to-End Encryption



NOTICE: This is a Software Selling Feature.

End-to-end Encryption (E2EE) provides customers with a higher degree of confidentiality than existing TETRA air interface data encryption.

The TETRA standard supports the air interface security that provides protection of the air interface. The information flow inside the infrastructure is not secured. When you require data protection for your data going through the infrastructure, you need your entire transport path to be encrypted.

This entire path encryption is called E2EE. The source and the destinations are supplied with the mechanism for encrypting and decrypting.

 **NOTICE:** The 260–275 MHz radios do not support the SDS end-to-end encryption.

In air interface encryption, the receiving Base Station decrypts data which travels clear within the system domain. For E2EE, the transmitting radio encrypts the data and the receiving radio or an E2E terminator located in the infrastructure decrypts the data.

E2EE protects the SDS/SDS-TL data services both in TMO and DMO. The following TETRA data types are protected.

- SDS type 4 with SDS - TL
- SDS type 4 without TL

For short data applications, the source data may come from an external application or from a task internal to the radio, such as text messages or GPS. The radio passes only the internal text messages and GPS data for encryption by its crypto-engine.

The encrypted short data service is established between two end points. One end point is terminated in the radio, and the other end point is terminated in a Short Data Encryption Gateway (SDEG) or another radio. The destination address specifies the encryption type, that is, whether the packets are transmitted as encrypted, clear, or dropped.

Figure 7: SDS End-to-End Encryption

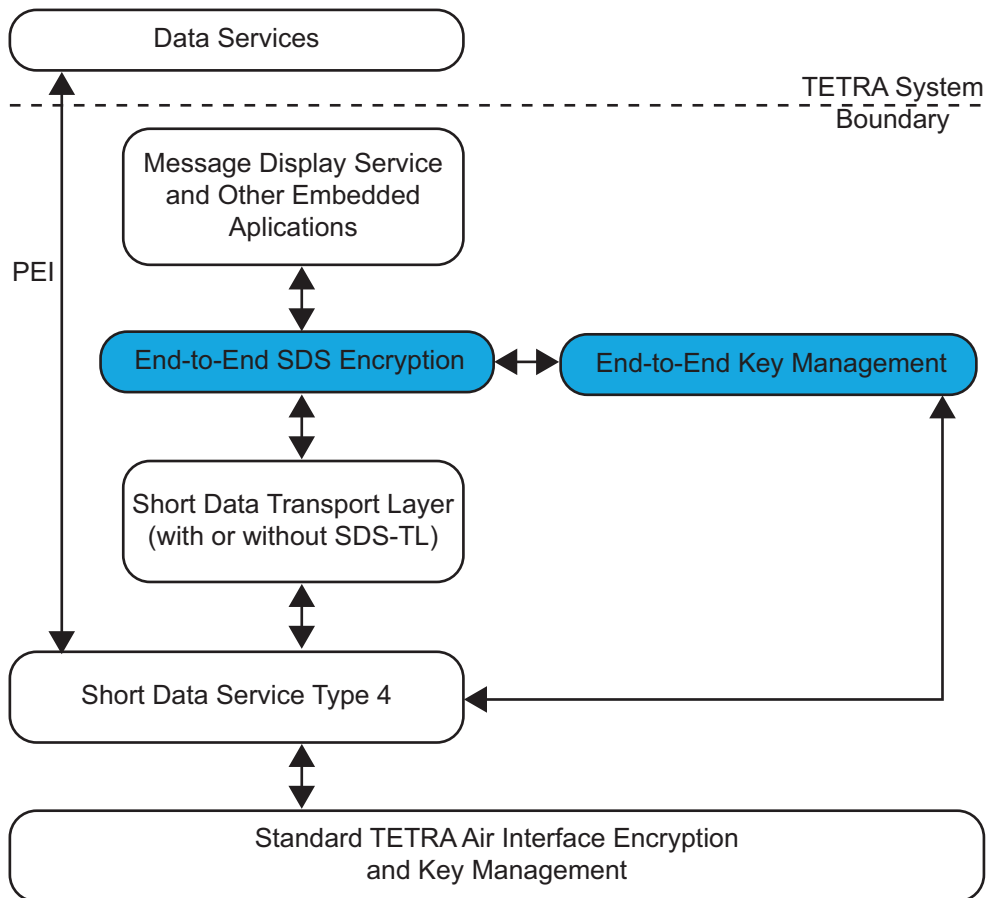

 **NOTICE:** Key Management Facility (KMF) can manage and support only one short data association and a key at the same time.

The radio selects the E2EE mode for the outgoing text message in accordance to the address association and requirements for the E2EE High Security Mode. Depending on codeplug settings, you can override the address association and select using the MMI menu whether an SDS is sent to clear or encrypted contact (Group or Private Number).

The radios support the high security mode configurable using the CPS. In this mode, the association that binds the address to a given cryptogroup is always mandatory.

If no cryptogroup associations exist, this condition means that the keys are not loaded. In such situation, the radio discards any outgoing or incoming message that is encrypted. You are alerted when this situation occurs.

This feature can only be disabled using the Key Variable Loader (KVL).

2.13.7

Store and Forward

This feature allows communicating with each other without being available at the same time. If the destination is not reachable, the message is stored in the system (if supported) until it is available or the expiration time is exceeded. The system is configured to delete the message after a preconfigured time and this time cannot be configured using the radio.

You can send the store and forward messages to an individual address or a group. Depending on the codeplug settings, if you choose to send it to the group, the message status is switched from **Store and Forward** to **Immediate**.

When the **Sending group message to Store and Forward Server** is enabled, an SDS message sent to a group is conveyed with assistance of the store and forward service. The radio sends Store and Forward SDS to group only with Delivery Report Request set to **None** by the service provider. For Store and Forward SDS to an individual address, the radio can send SDS with any Delivery Report Request (None, Received, Consumed, Received and Consumed) the user set (from the MMI or codeplug settings). The radio does not request a delivery report, thus you are not notified of the delivery status.



NOTICE: Verify whether the infrastructure system supports this functionality.

2.13.8

SDS Receive Failure Notification

When a radio fails to decrypt a received SDS message, it displays a notification including the ISSI of sender and reason for failure.

2.13.9

DMO SDS Transmit Traffic Stealing

DMO SDS Transmit Traffic Stealing enables your radio to send status or SDS during voice call transmission by replacing audio frame with the status or SDS payload.

This feature is only applicable in Direct Mode Operation (DMO).

2.14

Collaborative Messaging

This feature allows external device to send/receive message when the radio application is enabled. It is mutually exclusive with Secure SDS Storage feature and EtE High Security Mode Feature. The

external device can be connected to the radio using either Bluetooth connection or wired cable connection.

It includes the following functions:

- Inbox/Outbox synchronization.
- Notification on message status, or user action synchronization between the external device and the radio.



NOTICE: This feature does not support Call Out/RMS/Home Display.

2.15

Security Services

The radio provides TETRA security features as described in the TETRA Security ETS 300 392-7 standard, TTR 001-11 TIP, and TTR 001-13 TIP.

2.15.1

Terminal Equipment Identity

The Terminal Equipment Identity (TEI) is a unique identification number programmed in the radio at the factory. TEI cannot be later modified.

2.15.2

PIN/PUK User Authentication

In order to authenticate yourself, the radio supports a Personal Identification Number (PIN) and PIN Unblocking Key (PUK) mechanisms. These mechanisms prevent unauthorized access to the radio. The PIN/PUK operations are available from both MMI and PEI (using AT commands).

For the authentication purpose, the radio prompts you to enter a valid 4-digit PIN, before the radio allows you to access all the available services. The PIN is defined in the codeplug.

If the maximum number of consecutive failed attempts is reached, the radio is blocked and remains in this state until it is unblocked. The permissible number of consecutive failed attempts is defined in the codeplug. The blocked status is sustained regardless of turning off or battery removal.

When the radio is PIN locked, you have no or limited access to the radio services. The PIN is defined in the codeplug. The radio is unblocked either by entering the PUK or by using the CPS. The PUK can be entered through the MMI or through the PEI. The PUK is defined in the codeplug.

BSI PIN/PUK Authentication

When the radio has determined that BSI PIN/PUK is required, the radio prompts you to enter a valid BSI PIN before the radio allows you to access all the available services. The BSI PIN/PUK length is configurable by your service provider up to a maximum of 8-digit code.

The permissible number of consecutive failed attempts for BSI PIN is defined in by your service provider. When the radio is BSI PIN locked or BSI PUK blocked, you have no access to the radio services. As the BSI PIN and BSI PUK code is defined by your service provider, you are unable to change the BSI PIN/PUK code.



NOTICE: The radio is only able to support either PIN/PUK mechanism or BSI PIN/PUK mechanism at a time.

2.15.3

Authentication

Authentication establishes a level of a trust between a radio and SwMI. It is a challenge-response result protocol between two parties based on their common knowledge of a secret key (K) to verify the identity of each party.

The SwMI Authentication Centre (AuC) provides a single K for authentication, which is shared only with the radio. The SwMI always initiates Authentication. If set by the service provider, the radio can also authenticate the SwMI.

2.15.4

Air Interface Encryption



NOTICE: This is a Software Selling Feature.

Enhanced Security consists of Trunked Mode Operation (TMO) Air Interface Encryption class 3G and DMO class 2.

The radio supports TETRA Air Interface Encryption (AIE) using the standard TETRA public encryption algorithms, as defined in TETRA Security ETS 300 392-7, TEA1, TEA2, and TEA3. The focus of cryptography in TETRA is the encryption key. TETRA AIE provides 12 000⁸ key combinations.

TETRA TMO has three classes of encryption:

- Class 1 – clear (none)
- Class 2 – static key encryption (SCK)
- Class 3 – derived key encryption (DCK), sometimes called the dynamic key, the Common Cipher Key (CCK), and the Group Cipher Key (GCK)

TETRA Direct Mode Operation (DMO) has two classes of encryption: Class 1 and Class 2.

The security features supported in the radio depend on the security mode.

Table 9: Security Features Required Per Security Class

Security Feature	Mode			
	Security Class 1	Security Class 2	Security Class 3	Security Class 3G
Radio Initiated Authentication	Not Allowed	Not Allowed	Not Allowed	Not Allowed
SwMI Initiated Authentication	Optional	Optional	Mandatory	Mandatory
Mutual Authentication	Optional	Optional	Optional	Optional
Over-the-Air Rekeying (OTAR)	N/A	Optional	Mandatory	Mandatory
SCK AIE	N/A	Mandatory	N/A	N/A
DCK AIE	N/A	N/A	Mandatory	Mandatory

Security Feature	Mode			
	Security Class 1	Security Class 2	Security Class 3	Security Class 3G
GCK AIE	N/A	N/A	N/A	Mandatory



NOTICE:

In the current release, the radio does not support the following security features:

- Radio initiated authentication.
- Support for TEA4.
- Explicit authentication during Dynamic Group Number Assignment (DGNA).
- OTAR in foreign network.
- GCK AIE in foreign network.

2.15.4.1

Clear Radios (Class 1)

A radio can be configured as a clear radio. In such case, the radio identifies itself in registration as a Security Class 1 radio and does not support encryption. A Security Class 1 radio does not contain any encryption algorithms in its software.

2.15.4.2

Static Cipher Key Encryption (Class 2)

The radio supports static Air Interface Encryption (AIE) using a set of up to 32 Static Cipher Keys (SCK) shared by the Switching and Management Infrastructure (SwMI) and all authorized radios.

The radio then determines which static keys to use based on the SCK Number (SCKN) and SCK version number (SCK-VN) broadcast by the SwMI. A radio can be configured to support static key encryption. In such case, it identifies itself in registration as a Security Class 2 radio, and attempts to negotiate Security Class 2 encryption. Each radio then uses either the TEA1 or the TEA2 (TEA 3 for Asia and Pacific) Key Stream Generator (KSG) algorithm. Each radio contains only one of those algorithms in its software.

When Security Class 2 Encryption has been negotiated, encrypted PDUs are encrypted using SCK.

In Direct Mode Operation (DMO), the system manager may choose the SCK and the key may be distributed from the Trunked Mode Operation (TMO) SwMI using the Over-the-Air Rekeying (OTAR) mechanism or provided manually using Key Variable Loader (KVL).

2.15.4.3

Derived Cipher Key and Common Cipher Keys Encryption (Class 3)

Derived Cipher Key and Common Cipher Keys Encryption (DCK/CCK) are required to prevent over-exposure of key material. Existing encryption systems use Static Cipher Keys (SCK), where one key is used for all radios and all communications.

Key material is often exposed and SCK logistics of changing keys consist in programming all radios and Base Stations. DCK is used for individually addressed TM-SDU (Service Data Unit). DCK/CCK encryption provides Derived Cipher Key (DCK) for uplink (from the radio to the BTS) communication and Common Cipher Key (CCK) for downlink (from the BTS to the radios) group communication. The DCK is derived from either the one way or mutual authentication process and the CCK is received during registry.

The radios supporting the dynamic key encryption identify themselves to the system as Class 3 radios during registry and attempt to negotiate Class 3 encryption. A Class 3 radio supports group addressed

signaling and group communication traffic encryption using CCKs as well as encryption of uplink and down link individually addressed signaling messages and individual call traffic (private or phone) using its DCKs. The radios support Over the Air Re-keying (OTAR) of the CCK by the system.

A clear radio can transmit and receive from encrypted radios. The system informs the encrypted radios that the communication is with a clear radio and they switch to clear operation. Class 2 and 3 radios can only act as described if they are allowed to operate in a lower class.

2.15.4.4

Group Cipher Keys Encryption (Class 3G)

For the Security Class 3G the system allows grouping addressed signaling and dedicated group call traffic encryption using Group Cipher Keys (GCK) to cryptographically isolate talkgroups.

The downlink signaling is encrypted using Modified Group Cipher Key (MGCK) that is cryptographically derived from the Common Cipher Key (CCK) associated with the serving cell and the GCK associated with a given talkgroup. The Switching and Management Infrastructure (SwMI) does not change GCK and CCK simultaneously. Whenever a GCK change occurs, CCK changes are frozen for this time period.

The Derived Cipher Key (DCK) is derived from either the one way or mutual authentication process and the CCK is received during registry, whereas the GCK is received through Over-the-Air Rekeying (OTAR) mechanism only.

The radio supports over-the-air and manual provisioning of key associations that link a GCK to one or more Trunked Mode Operation (TMO) talkgroups, and manual provisionings of Key Association Group (KAG) to one or more Direct Mode Operation (DMO) talkgroups.

The system can provide the ability for the operator to group contiguous ranges of TMO Short Subscriber Identity (SSI). This case occurs where any talkgroup residing within the address range is assigned using the same GCK association. These ranges, referred to as Key Association Ranges (KAR), are used to convey the TMO talkgroup and GCK relationships to the relevant SwMI and radios responsible for GCK functions.

2.15.4.5

Over-the-Air-Rekeying

TETRA systems support GCK encryption for specific talkgroups:

- Group Over-the-Air-Rekeying (OTAR) of GCK.
- Group OTAR of fallback TM-SCK.
- Group OTAR of DM-SCK, including management of the cryptographic schedule of DM-SCKs.

The group OTAR mechanisms require a use of the group session key for OTAR (GSKO). The GSKO is delivered to the radio only by using individual OTAR and the session key for OTAR (KSO).

For the systems utilizing group OTAR, the fundamental system operation (regarding SCK/GCK OTAR) relies on the sites regular transmission. In other words, the sites are regularly broadcasting information regarding which security class and associated keys are in use. The sites transmit future versions of the respective keys to groups of radios belonging to the same cryptographic management group (CMG). The radios acquire the keys before the SwMI activates them. Then the air interface encryption service uses the keys. The sites also broadcast the current key that is in use which can be sent using OTAR mechanism to the radio on request.



NOTICE: When a radio has not received a new key before activation by the SwMI, the radio requests the missing keys.

Some systems adopt only individual OTAR methods for delivery of SCK and GCK to the radio. In such cases GSKO is not used. Some systems employ a mix of individual and group OTAR methods. The

radio supports the complement to functionality required for supporting the superset of different SwMI behaviors, for example:

- Individual OTAR (using KSO) of SCK and GCK.
- Group OTAR (using GSKO) of SCK and GCK.
- Individual OTAR (using KSO) of GSKO.
- Secure DMO Key Management (via SwMI).
- Crypto Management Group.
- Storage of 10 KAG (equivalent to 30 DM-SCK).
- Storage of 16 GCK (includes current/future versions).
- Storage of 2 TM-SCK.
- Storage of Group Association attribute per Talkgroup.
- GCK Air Interface Encryption.
- Seamless key changes of GCK.
- Seamless security class changes to SC3G.

The SwMI can support the group OTAR feature. Where supported, the SwMI groups radios that share the same set of cryptographic key material into a specific crypto management group (CMG). Any radio belonging to the same CMG is addressed using a CMG GTSI. The primary purpose of the addressing is to transmit group OTAR messages conveying TM-SCK, DM-SCK and/or GCK. Any radio that supports TM-SCK group OTAR, DM-SCK group OTAR, or GCK group OTAR is assigned to a specific CMG.

Each CMG has a designated specific GSKO. The system deploys over the air a CMG GSKO (and CMG GTSI) to each radio belonging to the CMG. The GSKO is used as the sealing key for TM-SCK, DM-SCK, and GCK, when sent across the air interface. The SwMI can perform scheduled transmissions of the future TM-SCK addressed to each CMG. The radio requesting a TM-SCK triggers the site to schedule additional transmissions of the requested TM-SCKs. These transmissions are addressed to either the CMG GTSI that the radio belongs to or its ITSI.

The SwMI can perform scheduled background transmissions of the future GCKs addressed to each CMG. The radio requesting for a given GCK triggers the site to schedule additional transmissions of the current and the future versions associated of the requested GCK. These transmissions are addressed to either the CMG GTSI that the radio belongs to or its ITSI.

The SwMI can perform scheduled background transmissions of the current and the future DM-SCK addressed to each CMG. The radio requesting for a DM-SCK triggers the site to schedule additional transmissions of the requested DM-SCK. These transmissions are addressed to either the CMG GTSI that the radio belongs to or its ITSI.

2.15.4.6

Encryption Mobility

A Class 2 or Class 3 radio can operate on a lower class Switching and Management Infrastructure (depending on configuration). A radio that is provisioned not to allow operation on a lower class SwMI, does not register on such a cell.

A Class 2 or Class 3 radio moves to a cell that supports an SCK/CCK/GCK that the radio possesses, applies Air Interface Encryption (AIE) to the registration Protocol Data Unit (PDU). If no acknowledgment is received, the radio sends the registration in clear.

2.15.4.7

Encryption MMI

A Class 2 or Class 3 radio that is involved in a clear communication provides visual and audible indications. If enabled by the service provider, these indications indicate that the communication is not encrypted.

2.15.4.8

Air Interface Encryption Key Storage

The radio stores all the keys, SCK/CCK/DCK/GCK, in a sealed manner in non-volatile memory of the radio. However, they are not stored in the codeplug.

The radio supports loading of the SCK keys manually using the Key Variable Loader (KVL). By using a special key combination, you can delete the cipher keys in the radio. Depending on configuration, you may erase either all keys or only the short-term keys.

2.15.5

Secure DMO

The Secure Direct Mode Operation (DMO) feature guarantees key ciphered transmission in the DMO.

When DM-SCKs are provided by OTAR, you are informed in case the radio does not contain the complete set of SDMO keys. Whenever the radio enters DMO and the radio does not possess past and present DM-SCKs for all provisioned KAG and/or it has not yet successfully received SCK Subset Grouping Type, SCK Subset Number and SCK-VN information from the SwMI, then the radio:

- plays a special reject tone.
- prompts a message indicating **OTAR incomplete**.

The radio provides SDMO status information to the user from the MMI **DMOSCK Validity** submenu inside the **Security** menu (present only when configured in the codeplug):

- **DMO SCK is Valid** if DMO SCK OTAR is disabled and all DM-SCKs are provided using the KVL.
- **DMO SCK is Valid** if DMO SCK OTAR is enabled and the radio knows the current SCK information and has all the corresponding past and present DM-SCKs.
- **DMO SCK is Invalid** in all other cases.

The radio supports system management of SDMO keys. The radio using system managed SDMO requires the structure of DM-SCKs used for SDMO, the current active SCK Subset Number, and Version Number information to coordinate key schedules. The radio considers the last received variant of this information PDU as the most accurate indication of SDMO key configuration.

DMO SCK can only be used if Enhanced Security feature is purchased.

2.15.6

End-to-End Encryption

The TETRA standard supports air encryption. The radio creates the PDU (Protocol Data Unit) and the PDU is encrypted before transmission. The Base Station receives this PDU and must decrypt it, to know what to do with it and where to send it. Thus, if a PDU contains voice information, the voice part of the message has been decrypted and is now unprotected, until it is transmitted out to the caller.

Figure 8: Voice and Data End to End Encryption

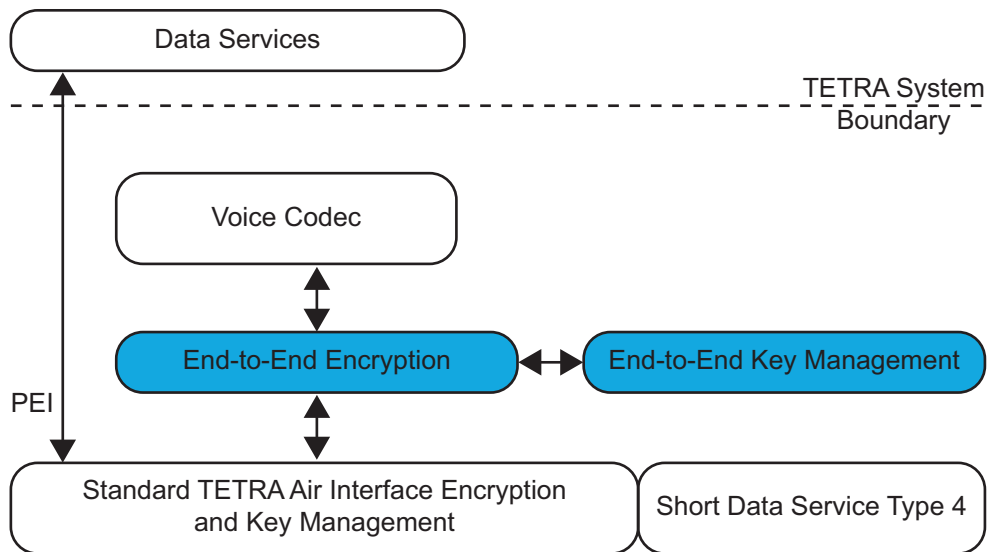

The End-to-End Encryption (E2EE) feature resolves this issue by encrypting the voice information before it is packed into the PDU. This message is also encrypted according to the over-the-air encryption of the TETRA standard. Thus, when the Base Station decrypts the PDU containing voice information, the voice part remains protected by encryption until the called radio receives the voice and decrypts it.

The Motorola Advanced Crypto Engine (MACE), located in the radio, carries out voice encryption. The crypto engine takes the voice stream and encrypts this stream using a set of keys. Likewise, the crypto engine takes encrypted voice stream and using the same keys decrypts back into clear voice.

The encryption of voice and data can be carried out using a dedicated SIM card reader.

In the end-to-end encryption feature, the radio notifies and informs whether the call, being made or received, is voice-encrypted. The radio also provides with means to select a different key, delete keys, request new keys and change the encryption mode of nondefined private calls.

The radio supports BSI encryption in full duplex calls.

This feature is relevant for group calls and private calls in TMO and DMO.

2.15.7

SIM Security

The SIM is an integrated circuit card that holds a filing system and an application. The SIM security feature is only available on the GMOI network.

The security of the SIM card is ensured by the means of the following security functionality groups:

- Voice End-to-End Encryption (E2EE) and related key management
- Network access parameters and authentication
- Key management for Air Interface Encryption (AIE)
- Operational Tactical Address (OPTA), modification, encryption, and transfer
- AES for E2EE of SIM Interface and SIM-Terminal Authentication

The application performs the following actions:

- Generation of Key Stream Segments (KSS)
- Synchronization for E2EE

- TETRA authentication algorithm based on K key on the SIM
- Key management for E2EE keys
- SIM interface encryption and authentication using the AES

The filing system holds the following items:

- Network access parameters as Individual Tetra Subscriber Identity (ITSI)
- Security class definition and authentication definition
- Integrated circuit card identifier
- SIM version number
- OPTA

The E2EE keys are also kept on the SIM. However, they are accessible for the SIM application only, thus E2EE key management is transparent to the radio.

The keys for AIE remain on the radio. The SIM application handles AIE key management.

2.15.8

Radio Disable or Enable

A dispatcher can disable or enable the radio remotely.

When disabled, the radio does not participate in any voice call or packet data activity and ignores all supplementary services sent on the down link. All visible and audible indications are disabled, and the radio appears to be turned off. All user inputs, such as key presses, are ignored, and the PEI interface is closed.

The radio continues to perform mobility management functions, such as roaming, to facilitate subsequent enabling or further disabling.

The radio stores the disabled or enabled state in the codeplug, so the unit remains in that state after turning on.

If the radio is in the disabled state, and receives an appropriate TETRA signaling for subscription enablement with the correct Short Subscriber Identity (SSI) and Mobile Network Identity (MNI), it restores to its normal operative state.

If the radio is in the equipment disabled state, and receives an appropriate TETRA signaling with the correct TEI, the radio restores to its normal operative state (if the subscription is also in the enabled state).

2.15.9

Radio Permanent Disable



NOTICE: This is a Software Selling Feature.

Radio Permanent Disable and Radio Permanent Disable v2 are features that are mutually exclusive.

Permanent disabling is intended to protect a network from attack from a compromised or faulty radio. It can be used when the radio has been compromised, or has been suspected of compromise for a long time. It is a one-way function and no equivalent enable is available. Then the radio should be recovered and reprogrammed before being used again by the service provider.

When the radio is permanently disabled, it becomes inoperable.

- All its MMI interfaces on the radio are disabled.
- All its security key material, that is GCK, GSKO, DMO SCKs, Ks, DCK, CCK, and TMO SCKs are deleted.

- All its codeplug is deleted.
- All its software is deleted.

The permanent disable should be invoked when it has been determined that a radio is unrecoverable. When a radio has been lost or stolen, the first step always is to stun the radio using temporary disable.

The permanent disable should be used with the deletion of the user radio record in the User Configuration Server and the deletion of the K-REF association of the disabled radio in the Provisioning Center and the Authentication Center. This deletion ensures that subscriber information is not downloaded into the Home Location Register if a restore of the UCS is performed.

The system operator has to also ensure that the radio K-REF association is also removed from the other Authentication Centers in the network, in cases where the K-REF pairs are duplicated across the network.

If this association is not removed, the radio could be assigned a new home zone that lies in a cluster where the K-REF association has not been deleted.

2.15.10

Radio Permanent Disable v2



NOTICE: This is a Software Selling Feature.

Radio Permanent Disable and Radio Permanent Disable v2 are features that are mutually exclusive.

When the radio is disabled using the permanent disable v2, it cannot be recovered over the air.

The radio appears to be inoperable if the following conditions are met:

- The radio accepts the permanent disable command.
- The permanent disable v2 flag is enabled in the codeplug.

Inoperable characteristics include the following items:

- All its MMI interfaces on the radio appear to be disabled.
- All its security key materials are deleted. The security key materials are GCK, GSKO, DMO SCKs, Ks, DCK, CCK, TMO SCKs, and End-to-End.
- The radio automatically enters programming mode upon powering attempts.
- The permanent disable flag is set in the codeplug.

Unlike in the permanent disable, a permanent disabled v2 radio can be re-enabled using the software selling dongle. If you have the software selling dongle, you can read the codeplug and clear the permanent disable flag.



NOTICE: To restore a radio that is disabled using the permanent disable v2, see *TETRA Terminals CPS Start-up User Guide* (Motorola Solutions Part Number: 6802974C10).

2.15.11

High Assurance Boot

The radio has a facility that ensures that the code and data flashed in the radio is authentic and has not been altered.

The hardware forces the High Assurance Boot (HAB) module to run at boot time. The module checks if all software comes from a trusted source. The radio is checking the signature of the code and data segments present in the radio using a public/private key mechanism.

If the HAB authentication of the flashed software fails, it does not allow the radio software to run.

2.15.12

Covert Solution



NOTICE: This is a Software Selling Feature.

Covert Solution enables you to completely shut down all visible and audible alerts and notifications, making the radio unnoticeable even in a silent and dark environment.

The Covert Solution is only available through One-touch button.

All audio activities are suppressed to the built-in speaker and microphone, and the audio is routed to and from the accessory only. If there is no accessory connected, the audio is routed to the small earpiece on the radio.

When the Covert Solution is turned on:

- The screen is disabled.
- All buttons are disabled except for the following buttons:
 - PTT
 - Emergency
 - Covert Solution One-touch button (to exit Covert Solution)
- The LED indicator is disabled.
- Change folder and talkgroup through MMI, over the air, and RCU.

When the Covert Solution is turned off, the following settings remain:

- Volume
- TXI
- Emergency

When paired with a Remote Control Unit (RCU), you are able to communicate using Mission Critical Communication Tones. The RCU is a third-party device that sends out tones as beeps in a group call. Pressing the button for tones on the RCU starts the group call and each press of the button produces beeps which are heard by all recipients and the initiator. To transmit a voice call in Covert Solution on the RCU, press the **PTT** button on the RCU. If an earpiece accessory is not connected to the radio, the voice call is routed to the low audio speaker of the radio.

2.15.12.1

Remote Control Unit

The Remote Control Unit (RCU) is a small third-party device attached to your covert radio over a wire.

The RCU communicates using Mission Critical Communication Tones which utilizes Morse code to transmit messages. The Mission Critical Communication Tones transmitted pulses are heard by all recipients and the initiator. The Mission Critical Communication Tones cannot activate when active voice transmission is being received or transmitted.

You can operate the RCU to perform the following functions on the radio discreetly:

- Change talkgroups
- Change folders
- Choose from any of the 15 changeable folders
- Increase and decrease volume
- Initiate calls by Push-To-Talk (PTT)
- Initiate emergency calls

- Enable or disable Transmit Inhibit (TXI) Mode

2.16

Packet Data

In Trunked Mode Operation (TMO), the radio provides a TETRA bearer service for applications that use the IP protocol. This service is available to external applications by connecting using the PEI.

The radio operates on the packet data channel with single-slot.

Packet data applications reside internally, over UDP. These applications can also reside in an external device that is connected using a USB cable port in the radio.

Communication to external radio is initialized using AT commands. When a connection is established, the external application requests and operates in Point-to-Point Protocol (PPP) mode. This operation occurs until data connection terminates.

The system provides Point-to-Point IP connectivity allowing the following datagram exchanges.

- Radio \longleftrightarrow External Equipment (Terminal Equipment) (for example PC).
- External Equipment (Terminal Equipment) \longleftrightarrow Network (through radio).

The radio supports only IP version 4 packets. The radio routes datagrams independently of the protocol sitting on top of IP.

The radio supports an MTU of 1500 bytes.

The radio provides a best effort delivery service. If the delivery fails due to the radio environment, the radio generates ICMP messages addressed to the Terminal Equipment. Delivery may fail due to the following reasons:

- no radio coverage.
- failed transmission.
- service interaction.

The packet data service Packet Data Channel (PDCH) access signaling has the same priority as a circuit mode setup-related signaling. The radio uses advanced link for packet data transmission and supports advanced link flow control. If the link does not disconnect between cells, advanced link roaming is supported.

The radio does not support data compression. Application attempts to negotiate data compression during context activation is rejected. If the SwMI sends a data compressed IP packet, it is silently discarded. The radio supports negotiations of IP header compression that is received from Terminal Equipment during Packet Data Protocol (PDP) context activation. The radio transparently transfers IP packets with the header compression between the Terminal Equipment and SwMI.

The packet data service employs the TETRA standard cell selection and reselection. The packet data service suspends while the reselection is occurring. When the cell reselection procedure completes, the packet data service resumes.



NOTICE: The cell reselection is undeclared in a strict TETRA case. However, the SNDCCP protocol defines a procedure for reconnecting the packet data service on the new cell. In this case, the cell reselection procedure resembles the unannounced cell reselection procedure.

2.16.1

Voice and Data Support

The radio can alternate voice and packet data service. However, voice and data running in parallel are not supported. This behavior corresponds to Packet Data Type B - IP dual mode.

If the SwMI rejects the context activation due to `PD MS type not supported`, the radio re-initiates context activation indicating that supports Type C. It is done to accommodate legacy SwMIs that uses an older definition of these types.

The radio can operate in one of the voice-data interaction modes.

Voice Only Mode

You can select **Voice Only mode**, in which PD service is disabled. If an external application attempts to start up in this mode, PD registration for a wide link is rejected. If the PD service is active when this mode is selected, the radio deactivates PD. The PEI operates in the local mode only (data transfer between TE and MT).

Data Only Mode

You can select **Data only mode**, in which normal voice calls are not permitted. Incoming non-emergency voice calls are rejected, and you cannot initiate non-emergency voice calls. Incoming and outgoing emergency calls are allowed.

Voice and Data Mode

In **Voice and Data mode** any voice call activity that occurs during a data session takes priority over the PD. Once a voice call has interrupted the data session, the PD session is suspended, until the voice activity has ended. Then the session is resumed. Voice priority mode is the default mode.

You can choose one of the interaction modes. The choice of interaction mode is stored in non-volatile memory and remembered at power-up.

In **Voice and Data mode**, if the radio moves to the traffic channel due to the voice service, the radio terminates any active packet data transmission or reception. The data service is suspended. The data service resumes when the voice service ends.

The radio accepts any downlink Short Data Service (SDS) message received on the Packet Data Control Channel (PDCH). The radio can send uplink SDS messages on the PDCH.

The radio allows PEI, GNSS/GPS, and packet data applications to activate and use the packet data context simultaneously. The first application initiates PD context activation. The next PD context activation from another PD application results in sending a reply indicating that the PD context is active. When GNSS/GPS and PEI PD applications are using the active PD context, the radio can filter the downlink IP packets based on their TCP/UDP port.

- UDP packets addressed to the GNSS/GPS port (configured in the codeplug) are routed to the GNSS/GPS internal application.



NOTICE: When activating another PD context on the radio, use the same settings in both PD contexts.

2.16.2

Packet Data IP Addressing

Table 10: Packet Data IP Addressing

Addressing Mode	Description
Wide IP Address	An IP address may be assigned to the terminal by the SwMI during the Packet Data (PD) context activation. When assigned, both Terminal Equipment and

Addressing Mode	Description
	Mobile Terminal applications use this address as the source address in IP packets delivered to the infrastructure.
Local IP Address	By default both Terminal Equipment and the radio have their own IP addresses. Terminal Equipment and Mobile Terminal use these addresses for local datagram transmissions between Terminal Equipment and Mobile Terminal only and are not passed to the SwMI.
Static or Dynamic IP Address Assignment	The terminals support static and dynamic IP address assignment. The dynamic support is requested in the following situations: <ul style="list-style-type: none"> • Request a Dynamic IP Address is set to Dynamic and the PD Application Type is the radio internal PD application. • Request a Dynamic IP Address is set to Dynamic and the PD Application Type is a PEI PD application requesting dynamic IP address.

2.16.3

Packet Data User Authentication

The Packet Data (PD) user authentication is a method of authenticating the Terminal Equipment user. Authentication is done before allowing activation of the packet data link.

A PD Authentication server connected to the SwMI authenticates the Terminal Equipment user. The terminal only sends the messages between the Terminal Equipment and the SwMI. In the wide mode, the terminal offers Point-to-Point Protocol (PPP) user authentication between Mobile Terminal and Terminal Equipment. The terminal uses Password Authentication Protocol (PAP) or Challenge Handshake Authentication Protocol (CHAP), before the IP link is established. The terminal always attempts to negotiate usage of the CHAP method. The radio agrees to use PAP when the Terminal Equipment application insists. If the terminal does not require PD user authentication, it operates without any user authentication. If the terminal requires the PD user authentication, it rejects the Packet Data Protocol (PDP) context activation.



NOTICE: If the SwMI does not agree for the authentication method, for example PAP, the SwMI can reject it.

2.17

TETRA Network Protocol 1

TETRA Network Protocol type 1 (TNP1) is a bridge protocol based on the TETRA layer 3 over the air protocol. The TNP1 supports all TETRA dispatch functionality.

In the Trunked Mode Operation (TMO), the TNP1 specifies a protocol for use over the PEI, that allows Terminal Equipment (TE) to have control over the TETRA services: mobility management, call control, short data service, and supplementary services: send GNSS/GPS reports, software information, and battery state information. In addition, commands to access the radio configuration and storage parameters are available.

The radio supports TETRA standard packet data using the IP network layer protocol.

The radio operates on the single slot packet data channel.

Packet data applications reside internally, for example: GNSS/GPS reports, WAP, or in an external device connected to the 8-wire RS232 data port on the radio. Communication to the external device is initialized using AT commands.

The system provides point-to-point IP connectivity allowing the following datagram exchanges:

- Radio ↔ External Equipment (TE) (for example PC).

- External Equipment (TE) ↔ Network (through radio).

The radio supports IP version 4 packet.

TNP1 services can use one of two Point-to-Point Protocol (PPP) methods to connect from the terminal equipment to the radio, local mode, and wide mode. The TNP1 should be used in wide-mode wherever possible, to allow the parallel operation of TNP1-SDS services and packet data services over a common PPP link.

If the transmit inhibit is entered, the radio drops the wide mode connection, thus the PEI goes back to AT mode. Then the TNP1 client detects this change and reinitiates the PPP session in local mode.

The radio disables the TNP1 session while being in the Direct Mode Operation (DMO).

AT commands are used to initiate the PPP service for TNP1 to operate. Once the PPP session is running all AT commands are blocked. When the PPP session is closed, AT commands are available.

2.17.1

TETRA Network Protocol 1 IP Addressing

Table 11: TETRA Network Protocol 1 (TNP1) IP Addressing

Addressing Mode	Description
Wide Mode	All TNP1 services are available including packet data transfer towards the SwMI. The address used is the dynamic address MS IP or configured statically.
Local Mode	All TNP1 services are available except packet data transfer. The addresses used are the two static addresses TE IP: 10.0.0.101 and MT IP: 10.0.0.100.
Port Addressing	The radio uses a fixed port address for reception and transmission of TNP1 packets. The port number is 4024.

2.18

Over The Air Programming



NOTICE: This is a Software Selling Feature.

Over The Air Programming (OTAP) enables remote radio reconfiguration over TETRA network.

OTAP mitigates grounding or sending your radio to the service center for updates. Radio OTAP tool enables operators to create and prepare an update package before sending it over to the destination radio. Upon receiving the package, the recipient radio prompts for accepting the configuration update. Accepting the prompt enables the radio to update with the new configuration through OTAP. During the configuration update progress, indication guidance and update status are provided.

In the event of update failure, radio self-recovery is available without user intervention. Contact your radio administrator or service provider for support if the new configuration is not working.



NOTICE: OTAP operates on Trunked Mode Operation (TMO) only.

2.19

Mobility Services

Terminal mobility is the ability of terminals to acquire, register, and operate on an appropriate TETRA network. If required, terminals can change cells with minimum interruption to services.

2.19.1

Main Control Channel Frequencies

The radio can find a wide range of main control channels. The radio maintains stored lists of carrier frequencies which are scanned in order.

- 1 A list of discrete entries of the last 32 control channels used by the radio.
- 2 A static list of up to 32 discrete frequencies specified by the operator that can be preprovisioned. The system operator can modify this list using the programming tool.
- 3 A frequency range specification, using a specific offset, that can be preprogrammed in the factory. The system operator can modify this range using the programming tool. Then the radio scans all frequencies in 25 kHz intervals in the specified range.
- 4 An extra frequency range specification. Having two separate range specifications allows for two non-contiguous blocks of frequencies or two different offsets.

The radio can use all four frequency lists to speed up registration process after a power cycle or loss of Trunked Mode Operation (TMO) coverage.

2.19.2

Channel Selection

Each TDMA frame on a given carrier comprises of four time slots, which any slot can be used as a physical channel.

The following types of physical channels are available:

- Traffic physical (TP) channel - used primarily for circuit call traffic.
- Control physical (CP) channel - dedicated only for signaling.
- Packed Data Control (PDCH) channel - dedicated for Packet Data traffic.
- Unallocated physical (UP) channel.

The following types of control channels are available:

- Main Control Channel (MCCH) - occupies the first slot of the main carrier.
- Secondary Control Channel (SCCH) - can be used to extend Control Channel capacity.



NOTICE: This is a Software Selling Feature.

The following types of SCCH are available:

- Common SCCH
- Assigned SCCH

In addition to the MCCH, a cell can have up to three common SCCHs, which could occupy slots 2, 3, and 4 in the main carrier. This solution allows the radio to distribute its population among up to four channels and so to increase Control Channel capacity at the expense of traffic channel capacity.

Until having received a specific parameter on a cell, the radio uses the MCCH. When the signal is received, each radio maps itself to a particular common SCCH, and that SCCH operates as the MCCH for the radio.

2.19.3

Registration

On camping on a cell, the radio sends a registration request PDU to the SwMI, which includes a request to attach to the selected talkgroup.

If the registration and attachment succeed, the radio begins normal operation on the cell. If the registration attempt times out, or the SwMI rejects the registration for a temporary reason, another registration attempt is made. If both attempts fail, the radio attempts to camp on a different cell.

If the SwMI denies the registration request due to the location area rejection, the radio does not attempt to register again at this cell until the next power-on. The radio supports the modification of its subscriber class on receipt of a new subscriber class from the SwMI in the registration acknowledgment PDU. This subscriber class is used until turning off the radio or next Individual TETRA Subscriber Identity (ITSI) attach.

The radio does not send registration signaling when one of the following occurs:

- Roaming and registration fail before the radio receives the random access acknowledgment and the radio goes back to the last serving cell.
- The radio discovers a link failure on the serving cell, the link failure is shorter than the predefined timer and the radio is not in the transmit inhibit mode.
- The radio discovers a link failure on the serving cell and is in the transmit inhibit mode. In this case, the radio always goes back to the serving cell without registration and stays in the transmit inhibit mode until the mode is turned off.



NOTICE: When two or more scenarios occur at the same time, the radio registers with signaling.

If the radio discovers a link failure on the serving cell, a specific timer starts counting. If the link failure remains after the timer expires, then the radio acts as during a normal link failure. If the link failure ends before timer expires, then the radio goes back to the serving cell without registration. This mechanism ensures that unnecessary registration is avoided.

When a radio is out of the serving cell range for a period shorter than configured in the codeplug, then the radio does not register to go back in the range.

2.19.4

Cell Roaming

The radio continually monitors neighbor cells and scans the highest ranked neighbor cell.

When the state of the highest ranked neighbor cell is sufficiently better than the serving cell, or when the radio has lost the serving cell, the radio employs cell reselection procedures using the following methods:

- If not in a call - undeclared cell reselection.
- If in a call and not transmitting or link failure occurs - unannounced cell reselection.
- If transmitting in a call, and a neighbor has been scanned, and the cells are synchronized - announced type-1 or type-2 cell reselection.
- If transmitting in a call and no neighbor has been scanned or the cells are not synchronized - announced type-3 cell reselection.

For compatibility with systems that do not support type-1 or type-2 cell reselection, the radio can be provisioned to never perform these types of reselections.

The radio decides on the need for cell reselection, based on comparison of the signal strength and the service level between the serving cell and neighbor cells. The service level criteria are based on the following criteria listed in priority order:

- 1 System Wide Services available (Local or Wide Trunking)
- 2 Valid or Invalid Subscriber Class
- 3 Relinquishing criteria
- 4 Preferred MNI criteria
- 5 Congestion level
- 6 Security Class
- 7 Subscriber Class
- 8 Quadrature Amplitude Modulation (QAM) availability
- 9 Home Location Area (Home Location area)
- 10 Location Area (LA) Boundary
- 11 Cell Load
- 12 Local Site Trunking (LST) Services

The radio prefers a cell that has a higher service level to one with a lower service level. If the radio is operating on a serving cell that has a lower service level than a neighbor cell, the radio roams to the neighbor, even during a call.

During network reconfiguration, a significant number of radios registered on one cell may roam. This roaming can cause major congestion on specific cells. To avoid the congestion on control channels for the specific cells, the specified radios roaming should be distributed in time.

As the operation cannot be performed immediately for all the radios, some of the radios must wait longer to roam. The time cannot be programmed not to cause any of the radios to have inferior roaming capabilities. Thus the roaming time for the radios is randomized.

The randomization means that after roaming scenario starts, a radio is not sending registration parameters to other cells at once but waits random time before sending registration PDUs to other cells. Link failures and other related scenarios are not randomized not to cause any unwanted delays in restoring the link.

2.19.5

Seamless Handover

Seamless handover eliminates voice interruption during calls by enabling the radio to roam faster between cells while transmitting.

Faster roaming is possible because the radio asks its serving cell to perform the reselection and the SwMI performs all the roaming signaling. The radio then moves straight to the traffic channel on the new cell and continues the call without call restoration.

2.19.6

Networks

The radio holds a list of 101 allowed network identities (including 1 home network and 100 foreign networks) with a combination of Mobile Country Code (MCC) and Mobile Network Code (MNC).

Each network can have an associated name that can indicate to the user which network it is. The radio can perform initial cell selection and registration on these networks. You can limit registration to the home network only, selected network only, or any network.

The radio selects the network registration method based on the following Customer Programming Software (CPS) configurations:

ITSI Attach

The radio registers to the network using regular Individual TETRA Subscriber Identity (ITSI) attachment.

The radio operates in all networks similar to its operation in the home network, with some behavior configurable using the CPS. All group calls are placed using Short Subscriber Identity (SSI) addresses. It is the responsibility of the Switching and Management Infrastructure (SwMI) to reject calls for groups that the local system cannot reach, or connect the calls to another foreign system. Individual calls are placed using SSI addresses for intra-network calls, or TETRA Subscriber Identity (TSI) for inter-network calls.

2.19.6.1

Network Selection

You can select one or multiple preprogrammed networks to register your radio to.

The following network options are only available when the radio is in Trunked Mode Operation (TMO) or Gateway mode:

Network Sel

In this option, you can select the network to which the radio is allowed to register.

Home Only

The radio registers only to its home network, even if it finds a foreign network that is in range first.

Select Net

This option allows you to manually select a preferred network from a list of configured networks. As a result, the radio registers only to this selected network, even if it finds another network that is in range first.

If the radio selects a network different from the current one, the radio may force initial cell selection to find a cell that belongs to the home or the selected network. In the selected network option, the radio displays a list of network names where each network name corresponds to one of the Mobile Network Identities (MNI) in the list. The network names are configured in the radio as part of the configuration of the MNI list.

2.19.7

Congested Cell Handling

This feature is used only during initial registration and when roaming between sites. It is not used when camped on a site that has become busy or congested due to no free traffic channel to make or receive calls.

When the cell that the terminal is trying to register is congested, a special level-based algorithm is in the place. Depending on the level of congestion, the terminal is waiting for the registration or is rejected on that cell.

The terminal recognizes whether the cell is congested (Control Channel Congestion). The terminal tries to roam to not congested cells first, ranking congested ones as secondary. The cell congestion is one of the service level criteria.

The following cells are never marked as congested.

- Last suitable cell - if there are no other suitable cells during roaming or initial cell selection.
- Serving cell.

The feature is configurable using the Customer Programming Software (CPS).

2.19.8

Subscriber Class

When the radio powers up, or whenever it performs registration or roaming, it always uses its provisioned Subscriber Class (SC).

When the radio registers on a cell that does not support any of its SCs, it is active only in services that have the emergency priority.

Whenever the radio SC does not match the cell SC (the feature is configurable using the CPS), it either uses normal ranking procedures (see [Cell Roaming on page 58](#)), or does not roam to the cell at all.

2.19.9

Subscriber Class by Talkgroup



NOTICE: This is a Software Selling Feature.

You can configure up to 16 Subscriber Class by Groups in the Customer Programming Software (CPS) by assigning talkgroups to Subscriber Classes. The talkgroups can be assigned to more than one Subscriber Class according to the Group Short Subscriber Identity (GSSI) or by the folder of the talkgroup, except for the Favorite folder. If a talkgroup is assigned to more than one Subscriber Class, the radio uses the first assigned Subscriber Class.

A radio Subscriber Class changes when the user changes to a talkgroup with a different Subscriber Class. A Subscriber Class received from the SwMI, over the air, has a higher priority than Subscriber Class by Groups. If the radio is not already using this Subscriber Class, it automatically changes to it.

The Subscriber Class by Talkgroup feature is useful in the following examples:

Preserving traffic channel capacity.

Two cells with the same coverage are placed together to multiply traffic capacity. Radios attached to Talkgroup 1 are registering on these two cells. As a result, traffic channel capacity is reduced as two channels are being used. The Subscriber Class by Talkgroup feature directs radios registered on the second cell to roam to the first cell, thus increasing traffic channel capacity.

Distributing radios across cells and prohibiting them from roaming to mismatched cells.

When there are many radios in a small area with multiple Base Transceiver Station (BTS), congestion occurs because of high roaming traffic. The Subscriber Class by Talkgroup feature directs radios attached to the same talkgroup to roam to a matching Subscriber Class cell. Also, it does not allow radios to roam to a mismatched Subscriber Class cell.

The Subscriber Class by Talkgroup feature does not apply to supergroups as they are regarded as scanned groups.

2.19.10

RF Power Class Toggle



NOTICE: This is a Software Selling Feature.

Changing RF power class is performed immediately. The change can be done, for example, during an active communication. Such action may result in dropping the communication, as the selected power class setting can be insufficient to sustain the transmission.

2.19.11

Local Site Trunking



NOTICE: This is a Software Selling Feature.

Local Site Trunking (LST) is a feature enabling a Base Station to operate stand-alone. The Base Station may enter the mode when the link from the local cell to the central switch has gone down. The radio limits functionality when the cell is in this mode.



NOTICE: Whether a radio can register on cells in LST depends on the codeplug settings.

If system broadcasts indicate that system-wide services are not available (LST) on a cell, the radio registers on this cell only if there are no system-wide cells available.

Depending on the infrastructure settings, when the radio is operating on an LST cell, the radio may prevent you from invoking the following services:

- Private call
- Phone call
- Private Automatic Branch Exchange (PABX) call
- Packet data

Depending on the codeplug configuration, the radio may indicate entering the LST with the following notifications:

- Visible and audible
- Visible
- Audible
- None

To avoid unnecessary roaming and reduce congestion, Local Site Trunking Ignoring feature can be enabled. When Local Site Trunking Ignoring feature is enabled, the radio temporarily ignores the LST/WST parameter when selecting a site. However, the radio still takes other parameters such as the Radio Signal Strength Indicator (RSSI) level of the cell into consideration when deciding on roaming.

2.19.12

Cell Surveillance and Monitoring Threshold

The radio constantly calculates a normalized value that represents the signal strength of a cell. This value is used by the radios to determine if the cell is usable and when to leave the cell.

In the default case, when the radio is camped on a cell, it initiates link failure procedures, such as leave the cell, if this normalized signal strength value falls below zero. However, it is possible to configure the radio to allow this normalized value to be processed below zero using the Customer Programming Software (CPS); value can be set in 1 db steps up to -5 db. Reducing this value below zero allows the radio to maintain service on a weak cell where the radio is unable to roam to a better cell.

2.20

Supplementary Services

Following is the description of the TETRA Supplementary Services (SS) that the radio supports in the Trunked Mode Operation (TMO).

2.20.1

Dynamic Group Number Assignment

The radio supports dynamic addition and removal of talkgroups in its talkgroup list through TETRA Dynamic Group Number Assignment (DGNA) and De-assignment signaling (SS-DGNA).

The radio responds to DGNA directed to it or to DGNA directed to a group the radio is attached to even if the talkgroup is not programmed in the codeplug.

When a DGNA request to add a talkgroup is received, the radio adds the group in the first available spot in the talkgroup list in the codeplug. Then you can scroll to the talkgroup to select the group. The codeplug determines which DGNA operations are allowed for a group.

Depending on the group type, the following is allowed:

- Static – only selection is allowed.
- Semi-Static – selection and reassignment are allowed.
- Dynamic – selection, de-assignment, and reassignment are allowed.

The groups can be assigned as not attached, attached as scanned or attached as selected.

Assignment of the group through DGNA with attached as selected makes it the selected group of the radio. If the group is assigned with attached as scanned, if it is not already in the currently active scan list, the radio adds this group to a SwMI Controlled scan list and begins monitoring downlink signaling addressed to this group. The SwMI controlled list holds up to ten groups, and the radio monitors these groups as well as groups in the user scan list.

If the talkgroup list is full when adding a group, the radio rejects the assignment operation. If the SwMI controlled list is full and the assignment is with attached as scanned, the attachment is rejected.

When a talkgroup de-assignment is received, depending on the codeplug settings (DGNA Operations field in the Talkgroup List) the radio behavior is as follows:

- If the DGNA Operations field is set to Static or Semi-Static, the radio;
 - leaves the talkgroup and the parameters assignments to folders unchanged.
 - sends an acknowledgment PDU with notification the group definition has been removed.
- If the DGNA Operations field is set to Dynamic or if the group is not in the talkgroup list, the radio;
 - removes the talkgroup from the talkgroup list, if the talkgroup is in the list.
 - removes all the occurrences of the talkgroup from the folder list.
 - sends an acknowledgment PDU with notification the group definition has been removed (also if the talkgroup has been deleted, or the talkgroup does not exist in the radio).

Even if the talkgroup is de-assigned, the radio can receive group calls or emergency group calls for any assigned scan list.

If the de-assignment is for a group in the scan list, the group remains in the list. However, it is not monitored.

If the de-assignment is for a group in the SwMI controlled list, the group is removed from the list.

If the de-assignment is for the selected group, depending on the service provider settings, the radio;

- notifies that there is no group attached, when in the group mode, and does not attach to another talkgroup automatically.
- attaches to the previously selected talkgroup, which is the talkgroup it was attached to before the DGNA being assigned. If the previous selected group is not present then the radio shows that there is no group attached and displays `No Group`.
- attaches to a default talkgroup configured by the service provider. If the default talkgroup is unavailable (it was deleted), the radio enters the `No Group` state.

At each talkgroup change, an appropriate notification is shown on the display.

If the de-assignment is for an announcement group, the talkgroup is removed from the talkgroup list. Also, all the groups that are associated with this announcement group do not have an associated announcement group. If the currently selected talkgroup is associated with this announcement group, the radio stops scanning the associated announcement group.

If DGNA user notification is provisioned, the user is notified once the DGNA operation is successful. For example, when a group is added or deleted. The notification is displayed until you confirm the operation. In case you receive a call, the message continues displaying until you confirm it.

The radio supports the reception of a DGNA Assignment that is addressed to its selected talkgroup as a supergroup of the selected group. All signaling addressed to the supergroup is monitored in addition to signaling addressed to the selected group, any announcement or associated groups, and groups in the active scan lists.

When the selected group is unselected, the radio ceases processing signaling to the supergroup that was associated with that selected group.

The radio receives the lifetime of the supergroup as part of the assignment signaling. If a subsequent assignment to the same group is not received within that lifetime, the radio ceases monitoring that supergroup.

The radio also supports supergroups of scanned groups, such that a group addressed DGNA assignment received on one of the user scan group addresses causes the radio to monitor all signaling addressed to that supergroup as long as the scan group is being monitored, and as long as the supergroup lifetime lasts.

The following DGNA functions are not supported:

- Call-related DGNA.
- Functionality of the authorized user.
- Network authentication before accepting DGNA.

2.20.2

Ambience Listening

The Ambience Listening (AL) feature allows a console operator or dispatcher to monitor audio activity near a specific radio without giving any indication to the affected radio.

When the radio receives a call setup message with an AL call, the radio accepts the call. Then the radio opens the microphone, and begins transmitting without showing any indication of the call. Call acceptance and rejection while active in another call follows the PPC rules.

The radio imposes no time limit on the transmission. The radio continues to transmit until the SwMI ends the call or when you perform an action that releases the call. If you attempt to start a service while the AL call is in progress, the radio disconnects the call and initiates the requested service. The radio allows performing actions that can be performed without releasing the AL call. These actions include access of most menu items, activating, deactivating scan lists, and changing talkgroups. When changing talkgroups, the radio appears as if it is performing an attachment. The attachment appears to be successful, but the actual attachment signaling is performed only after the AL call terminates. When performing the attachment after the call, no indication is shown to the user unless the attachment fails. If you attempt to power down the radio in the active AL call, the radio enters Pseudo Power-Off state.

2.20.3

Pseudo Power-Off

If you attempt to power down your radio in the active Ambience Listening (AL) call, your radio appears to turn off. However, it remains fully operational from Layer-3 and below.

Your radio has a blank screen, and all LEDs are turned off. When the AL call ends in this pseudo power-off state, your radio automatically turns off.

If you attempt to power up your radio from the pseudo power-off state, your radio acts as if it is really powering up.

2.20.4

Auto Power-On

The radio can be configured to turn on automatically after inserting the battery. This functionality is configurable using CPS.

If the emergency mode was active before removing the battery, the radio enters this mode when the power-off period is shorter than approximately 3 seconds. This behavior applies to normal and silent emergency modes. The three-second period is approximate and determined by the discharge rate of capacitors in the radio. The period may last from 3 up to 6 seconds.

2.20.5

Preemptive Priority Call

If during a call, a call setup is received for a call with higher priority than the present call, and the new call priority is Preemptive Priority 3 (value 14 in the codeplug) or Preemptive Priority 4 – Emergency (value 15 in the codeplug), the radio disconnects from the present call and joins the new high priority call.

If the call priority of the new call is Preemptive Priority 1 (12) or Preemptive Priority 2 (13), depending on configuration, the radio either accepts or rejects the new call.

When the new call is accepted, a special tone is played, and you are notified of the high priority call.

When you initiate a private call and you receive a rejection with the reason `Called party busy`, you have the option to interrupt the existing call or initiate a new call. However, this time the call is initiated with the preemptive priority.

2.20.6

Transmit Inhibit Mode

The Transmit Inhibit (TXI) Mode is a mode in which the radio sends no radio transmissions. Activate this mode in RF sensitive areas, for example hospitals, airplanes, where safety can be jeopardized due to transmission radiation.

To activate, select **Menu**→**Menu/OK**→**Networks**→**TXI Mode**→**Activate**.

In this mode, the radio does not transmit under any circumstances except for the Emergency Calls. All the functions and keys which cause transmission, for example registration to the network, changing talkgroup or folder, sending SDS messages, or pressing the **PTT** button are disabled. Any transmission trial causes the radio to display `Not Allowed In TXI Mode` notification and to play a tone.

In this mode, the radio does not transmit under any circumstances except for the Emergency Calls. All the functions and keys which cause transmission, for example registration to the network, changing talkgroup or folder, or pressing the **PTT** button are disabled. Any transmission trial causes the radio to display `Not Allowed In TXI Mode` notification and to play a tone. Your radio can still receive group calls.

Your radio can still receive:

- Group calls
- Messages - stored in the **Inbox**
- Private call attempts - stored in the **Missed Calls** list, without the option to respond

When no danger to safety exists anymore, for example, when you leave the RF sensitive area, you can deactivate the TXI Mode and the radio returns to standard operation.

You can deactivate the mode by selecting **Menu**→**Networks**→**TXI Mode**→**Deactivate**, pressing One-Touch Button, or implicitly when initiating an Emergency Call.

You can deactivate the mode by selecting **Menu/OK**→**Networks**→**TXI Mode**→**Deactivate**, or implicitly when initiating an Emergency Call.



NOTICE: RF Transmissions from the radio are prevented under the following conditions:

- TXI Mode is activated.
- Battery is removed.
- The radio is turned off.

On entering or exiting the TXI mode, when the radio is camped on a cell, it sends a specially designated Short Data Service (SDS) status message. This SDS message indicates to the SwMI that the radio is entering or exiting TXI mode.

Mobility procedures that do not require the radio to send an uplink transmission are performed except for cell reselection.

In TXI mode, the radio joins group calls for any group that the radio is monitoring, but the transmitting on that call is still prohibited.

The radio also displays any incoming SDS messages to the user. The missed call feature is active in the TXI mode and allows checking what calls were missed. However, the radio attempts to prevent call setup retransmission from being recorded as separate calls.

If you initiate an emergency call, the radio immediately leaves TXI mode and attempts to start the emergency call if the radio is in service.

If the radio is turned off in the TXI mode, on turning on, the radio asks whether to exit the TXI mode. If you choose **No**, the radio turns off.

If the radio is turned off in the transmit inhibit mode, on turning on the radio asks whether to exit the transmit inhibit mode. If you press the **Back** touch icon, the radio turns off.

2.20.7

Calling Line Identification Presentation

If the radio is provisioned with the Calling Line Identification Presentation (CLIP), the calling party number is transported as part of the incoming call setup signaling.

Also the calling party number is shown on the radio display. If the calling party ID is programmed in the radio with a corresponding name, the name is displayed in addition to the number.



NOTICE: The number sent by the SwMI is expected to be in a form that can be used to call back the calling party at any other time. Thus, for instance, the number can be stored in the address book.

If the calling party number is not present in the incoming call setup signaling, a blank line is displayed in its place.

2.20.8

Universal Time Display

The radio can present time information to the user. The time is derived from an internal clock. The radio maintains the clock both when the radio is powered on and powered off.



NOTICE: If the power is lost, for example due to the flat battery, the internal clock is not maintained.

To ensure the time displayed is accurate, the time is displayed only if within the last 48 hours either of the following events have occurred:

- The radio has received a network time update from the system.
- You have manually updated the time.

Also, as the internal clock is not maintained after a power loss event, the time is not displayed until either these events occur.

The feature is enabled or disabled and the default configuration can be set for the radio using the Customer Programming Software (CPS) or radio MMI.

The radio display supports the following:

- Twenty-four-hour and twelve-hour formats.
- DD/MM/YY, MM/DD/YY, DD-MON-YY, and YY/MM/DD date formats.

You can change the time, date, and offset information through the MMI, depending on the codeplug settings. Depending on configuration, system broadcast information can have higher priority than data entered manually. Thus time, date, and offset information entered from the MMI is overwritten, when data is received from the SwMI. The radio provides user indications upon crossing to another time zone, when a new Mobile Country Code (MCC) broadcast received.

2.21

Man Down



NOTICE: This is a Software Selling Feature.

Man Down alerts when no movement occurs for a set time or the radio stays at an angle of tilt below a defined value. The radio alerts you when:

- Its tilt exceeds a predefined angle value.
- No movement is detected in a predefined time interval.

In case any of the conditions are met, the radio alerts you with a Man Down pre-alert. If you do not disable the pre-alert condition, the radio switches to the Emergency Operation.

For easier localization of the radio, visual and audible indications are started until they are deactivated. If the Emergency Hot Microphone is on, the additional audio indication is not played.

To exit Man Down, exit the Emergency Mode by pressing and holding the **Exit Soft** key, or press the **PTT** button.

2.21.1

Man Down (Operation)

Man Down can be disabled or enabled from the menu or by OTB.

If the man down feature is deactivated with a One-Touch Button, the radio plays an audio tone once. If the feature is deactivated using the menu, the radio does not play the tone.

The man down feature is based on a sensor with low-power current consumption. When Man Down is enabled the sensor performs a self-test during powering on the radio. If the test fails, the radio notifies with a specific audio tone and status icon. The radio also notifies with the specific audio tone and status icon, when the man down device detects a failure during the activation of the feature.

If the feature is deactivated using radio MMI after the sensor failure is detected, the man down icon disappears and the tone is no longer played.

Depending on the CPS settings, extra audio and/or visual indications are available to help locate the radio. In such case, if the man down alarm is activated (emergency alarm started), the radio starts additional audio indication playing high and low frequency sounds continuously, with highest possible volume. The radio display and/or keypad may also start blinking.

If the emergency hot microphone is on, the additional audio indication is not played.

2.22

Vibrate Mode

The vibrate menu allows you to determine if the radio vibrates, rings, or vibrates, and then rings when receiving a call.

You can assign five vibration patterns using CPS, and apply the setting according to the user profile.

2.23

SDS Remote Control



NOTICE: This is a Software Selling Feature.

The Short Data Service (SDS) remote control feature enables controlling a radio through Air Interface using SDS - TL bearer service. A controlling terminal, for instance, a controlling radio or SwMI controlling terminal, sends the SDS remote control messages with AT commands to a radio for its execution.

Figure 9: SDS Remote Control Overview

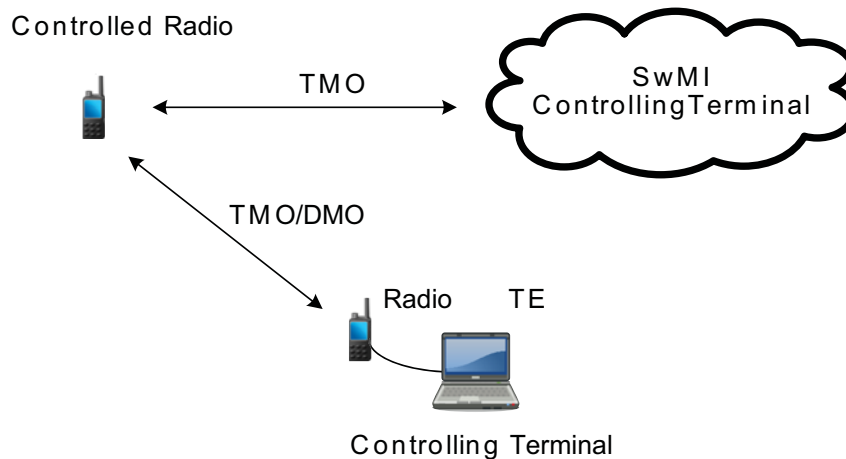

The SDS remote control functionality works in both Trunked Mode Operation (TMO) and Direct Mode Operation (DMO) and the remote control PDUs are sent using Terminal Equipment (TE).

You can use the feature only after a successful authorization, which requires entering a valid remote control PIN number.

The remote control messages can be sent to a group or individual radios.

A controlled radio receives over the air control information using SDS type 4 with Transport Layer (TL) on the specific PID number defined in the codeplug. If the received control message is originated from one of the Individual Short Subscriber Identities (ISSI) present on the radio authorized ISSI list, the radio executes received command and sends a response.

If configured by service provider upon the reception of SDS Remote Control Service (AT command) request, the radio gives an audio-visual notification.

The service provider has two options: **Limited SDS RC** and **Full SDS RC** modes.

The SDS remote control in the **Limited SDS RC** enables the following:

- Switching between TMO or DMO modes (read, change, notify) for individual radio and group using the **+CTOM** AT command.
- Selecting a talkgroup (read, change, notify) for individual radio and group using the **+CTGS** AT command.

- Reading and setting the scanning state using the **+CTSCAN** AT command.
- Collecting Network Information from individual radio - Network Registration Status and Cell Signal Quality using respectively the **+CREG** and **+CSQ** AT commands.
- Reading individual radio GPS position using the **+GPSPOS** AT command.
- Setting volume level for individual MT using the **+CLVL** AT command.
- Rebooting the radio using the **R** AT command.
- Terminating a call using the **H** AT command.

The SDS remote control in the **Full SDS RC** enables the radio to use most of the AT Commands. To see which AT Commands are not supported, refer to the *AT Commands Programmer's Guide*.

2.24

Status Remote Control

Status Remote Control is a feature that provides limited control of the radio, unlike Short Data Service (SDS) Remote Control.

Only one type of remote control can be active on a radio; either SDS or Status.

The following tasks can be assigned remotely to a radio:

Play loud tone until user interaction

The radio plays a loud tone as in the Man Down feature until you unlock the keypad (if needed) and press the appropriate soft key labeled **Exit**. The tone is played through the speaker even if an accessory is attached.

The tone is not emitted when the radio is in one of the following states:

- In a call
- Temporarily disabled
- Pseudo Off Mode
- Ambience Listening Mode
- Transmit Inhibit Mode (TXI)
- Emergency Mode
- Silent Emergency Mode
- Covert Mode
- Covert Solution

Send firmware version and TEI

The radio sends back an SDS message with its firmware version and TEI.



NOTICE: If the sending Individual Short Subscriber Identity (ISSI) is not on the Allowed ISSIs list, the receiving radio ignores the task.

2.25

Call-Out



NOTICE: This is a Software Selling Feature.

For those who use DMO mode, you are recommended to apply DMO SCK for data confidentiality.

A Call-Out is an alert sent to one or many recipients when an incident requires immediate attention. The Call-Out message can include an instruction to use a different talkgroup during the Call-Out or remain on the attached talkgroup. You can select from a list of up to 1120 preprogrammed alphanumeric aliases each of which corresponds to a status value.

The types of Call-Out alerts are:

Normal

An alert message sent by a dispatcher either to a single radio or to a group of radios.

Storm Plan

An alert message sent by a dispatcher to a group of radios. To raise its reliability, it is sent several times. You are not able to respond to the Call-Out alert and any key press takes you to the information phase.

Simple Call-Out

An alert with the functionality similar to full Call-Out but without the information phase. There are two types of Simple Call-Out:

With user receipt

The Call-Out mode is ended when the acknowledgment timer runs out, or when you select **Accept**, **Reject**, **Standby**, or reply with a text message.

Without user receipt

The Call-Out mode is ended when the acknowledgment timer runs out, or when you press **Menu/OK** to enter **CO Menu** and select **Exit**.

Fallback Mode

An alert message that is limited only to voice communication. To initiate this type of Call-Out, press a One-Touch Button predefined by your service provider. It can be cleared manually.



NOTICE: Fallback is only possible when the radio is in Local Site Trunking.

Test Call-Out

A special Call-Out alert sent by the dispatcher to test this feature. On receiving the Test Call-Out, the radio plays a tone and displays **Test Call-Out**. To respond and clear the alert, enter Call-Out menu and select **Test OK** or **Send Message**.

Only the emergency mode has higher priority than the Call-Out. However, if your service provider configures Emergency Calls to be ignored during Call-Out mode, the radio rejects them with no notification. When you receive the alert, the following responses are available.

- **Accept** – additional information from the dispatcher is displayed.
- **Reject** – display returns to the home display and the talkgroup is set to the one before the Call-Out.

You can address a Call-Out alert by:

- Individual Short Subscriber Identity (ISSI) – to an individual radio.
- Group short Subscriber Identity (GSSI) – to a group of recipients.

All incoming and outgoing Call-Out messages are stored in **CO Box** (Call-Out Box) and can be managed through the Man-Machine Interface (MMI). You can protect Call-Out messages from being deleted or from the overwriting policy of the radio. The overwrite policy deletes the oldest one upon receipt of a new Call-Out message. When a new Call-Out arrives, the new Call-Out overrides the old Call-Out, even if it has not been responded. An ongoing Call-Out overrides the old one in any phase of the Call-Out alert. Also, the overwrite policy deletes unprotected Call-Out messages first before deleting protected ones.

There is a two-level structure for the alerts. First level is the main alert list, and the second one are all the messages associated with the alerts. Both lists are displayed chronologically with the newest on top. The capacity of the **CO Box** is 100 Call-Out alerts and 100 messages (incoming/outgoing).

In normal mode, you can browse the **CO Box** and read all the Call-Out messages. In the Call-Out mode, you can only read the ongoing Call-Out messages.

The Call-Out service functions in two main phases:

Alert Phase

You receive the alert with the associated messages that you can respond to. These messages provide all the important information about an incident. A special tone is played when the alert is coming in. The tone volume range is configured in the codeplug and cannot be adjusted through the MMI. The conditions for stopping this tone are configured in the codeplug (for example, upon pressing any key). Also, an ongoing alert tone is paused on incoming Call-Out group call. This alert is resumed once the call ends (if not stopped before). The time-stamp on the Call-Out alert indicates the time and date when the Call-Out is received.

Information Phase

You are in the Call-Out mode and you may receive more messages about the incident with the text. You can also query for more information using the Call-Out text function which enables you to send a text message to the dispatcher host application. You are able to respond to a Call-Out by selecting a Call-Out template from a list of predefined replies. You may receive more info about the incident through subsequent text messages.

The voice message can be sent with the high priority as a group call. You can answer back to the group or to the dispatcher using the voice group call. You may receive more information about the incident either through subsequent text or voice messages.

Call-Out Authorized ISSI

This is a Software Selling Feature.

When you enable the Call-Out Authorized ISSI feature, your radio accepts Call-Out from authorized calling party and discards any unauthorized Call-Out. There is no indication displays if the radio discards unauthorized Call-Out. Your radio can accept up to 2000 Authorized ISSI list which includes Call-Out types such as Alert, Test, Information, Clear, and Availability Request. You may export and import the list in CPS.

2.25.1

Call-Out Interactions

Emergency Mode

When you receive a Call-Out alert while being in the emergency mode, the message is ignored.

Transmit Inhibit Mode

In the transmit inhibit mode, you can receive Call-Out messages. The Call-Out alert message is displayed on the screen. You have the option to exit TXI Mode or exit the Call-Out prompt. In exiting TXI mode, your radio prompts you to accept or reject the Call-Out message. To continue in TXI mode, exit the Call-Out prompt instead.

DMO

The Call-Out feature is supported in DMO.

Gateway

The Call-Out feature is supported in Gateway.

Fallback Mode

In the fallback mode (that is, when you are in the local site trunking) you can receive a Call-Out call. In such case, the receiving radio enters the Call-Out fallback mode, which only includes voice communication. You can only clear the fallback mode manually.

Call-Out Test

The dispatcher can test the feature by using the Call-Out test. The radio then displays `Call-Out Test` and generates the alert tone. Press **Menu/OK** to enter the Call-Out menu and select **Test OK** or **Exit** as a response. After responding to it, the display returns to the previous mode.

Storm plan alert is a special case of Call-Out. This alert is sent out to the larger group of people. You can respond to it with the **Menu/OK** button. After responding, you proceed to the information phase. The storm plan alert is sent several times to raise reliability.

You can configure the storm plan severity to either Severity 0 or Severity 15 using the CPS.

2.25.2

Call-Out Templates

The Call-Out template is a special type of the user-defined template. Call-Out templates enable responding to more Call-Out messages. These templates can be defined using the CPS. You cannot create or edit templates from the MMI level.

A target ISSI of a template cannot be selected, as the template is always sent to the Call-Out initiator.

2.26

Global Navigation Satellite System (GNSS) Location Service



NOTICE: This is a Software Selling Feature.

The GNSS Location Service feature uses information from satellites orbiting the Earth to determine the geographical location of your radio. GNSS uses satellites from the GPS, GLONASS, Galileo, and BeiDou systems.

The GNSS Location Service availability, accuracy, and the position calculation time vary depending on the environment in which you use the radio. The GNSS Location Service can assist your dispatcher or colleagues in many ways such as more efficient deployment of resources or locating your radio when you trigger your emergency service.

The radio supports the following system combinations depending on its hardware and configuration:

- Global Positioning System (GPS) including Satellite-Based Augmentation System (SBAS)
- Global Navigation Satellite System (GLONASS)
- GPS + GLONASS
- GPS + BeiDou

The radio can send the location information over-the-air to your dispatcher to display it in the control center. Check your radio configuration details with your service provider.



IMPORTANT: Where the signals from satellites are not available, the GNSS Location Service does not work. This situation usually happens when your radio cannot establish a view of a wide area of open sky, for example, when your GNSS antenna is covered or facing the ground. Such situations include being:

- In underground locations
- Inside buildings, trains, or other covered vehicles
- Under any other metal or concrete roof or structure
- Near a powerful radio or television tower
- In extreme temperature outside the operating limits of your radio

Even if your location information can be calculated in such situations, it may take longer to do so. Therefore, in any emergency situation, always report your location to your dispatcher.

Where adequate signals from multiple satellites are available, your GNSS Location Service feature provides a location, most probably near to your actual location.

The radio can be triggered to send Location Reports in various circumstances, for example:

- Upon a request
- Entering Emergency Mode
- At specified time intervals

- At specified distance intervals

The Location Reports can be sent in two ways using:

- Short Data Service (SDS)
- Packet Data - Trunked Mode Operation (TMO) only

Packet Data must be enabled on the network to send Location Reports using Packet Data. If the Location Reports are sent over the Packet Data, a **Packet Data** icon is displayed when the message is being sent.

If the Location Reports are sent using SDS with User-Defined Data Type-4 as a Transport Layer (SDS - TL), either the European Telecommunications Standards Institute (ETSI) Location Information Protocol (LIP) or Motorola Solutions Location Request/Response Protocol (LRRP) GPS Location Protocol is used. The LRRP GPS protocol either use SDS - TL (for added reliability) or Simple GPS with no SDS - TL (for saving air interface resources). GPS Protocol Identifiers are:

- LRRP SDS TL = 131
- LRRP Simple GPS = 3
- LIP GPS = 10

Location reports are sent in TMO. Your service provider can also provision location reports to be sent in Direct Mode Operation (DMO). If the radio is provisioned to provide user indications, the feature operational status is indicated on the radio display. Also, if configured by service provider, the radio gives an audio-visual notification upon reception of LIP command.

The GNSS Location Service feature can be enabled or disabled as a whole using the Customer Programming Software (CPS). It is possible to configure the feature parameters using the CPS, or over the air. The CPS configuration provides a default profile. The commands received over the air may overwrite the default profile configuration. The profile assigned to the radio determines when to send location data, what data to send with what accuracy and to what address. All data requests and configuration commands received over the air are checked to confirm that they have come from a trusted source. Location reports are accepted only from authorized Individual Short Subscriber Identities (ISSI) or IPs, depending on the configured transport layer of SDS or Packet Data.



NOTICE:

The Current GPS Cycle ends between 6th and 7th April 2019 at midnight Coordinated Universal Time (UTC). After this date, your service provider must reconfigure the Current GPS Cycle codeplug value to avoid malfunctions in GPS location reporting.

Ensure that the application receiving location messages uses valid addresses which are set up on radio as an authorized ISSI range. Otherwise the radio rejects all system position requests.

You can enable or disable the GNSS Location Service through the radio interface. If this feature is disabled, the Location Service Configuration can be programmed to the following parameters:

Receiver

GNSS Receiver is disabled. The radio responds to location requests by informing that location reporting is disabled.

Receiver and Location Protocol

GNSS Receiver and Location Protocol are disabled. The radio does not respond to any location requests.

Once the GNSS Location Service is re-enabled, the radio restores its location service.

The radio supports GNSS triggers functions, using LIP or LRRP, to report GNSS positions when the radio meets a set of criteria. Your service provider can set up the following triggers, together with their specific parameters:

Table 12: GNSS Triggers

Trigger Type	Trigger Event
Power-up	Radio powers up in TMO.
Power-down	Radio powers down in TMO.
Emergency condition	Radio enters emergency operations.
Periodic	Given time interval after the last location report expires.
Moved	Radio position has changed by at least the distance defined (the radio checks the movement from the last known position at an interval).
TMO ON	Successful registration on entering TMO from DMO.
DMO ON	Before TMO deregistration, and before entering DMO.
Transmit Inhibit Mode (TXI) ON	Radio is about to enter TXI.
Transmit Inhibit Mode (TXI) OFF	Radio has successfully registered after leaving TXI.
Low battery	Radio detects its battery level has reached or fallen below the level specified by service provider.
Loss of GNSS	Radio detects a loss of GNSS for a minimum duration defined by service provider.
Recovery of GNSS	Radio detects a recovery of GNSS signal for a minimum duration defined by service provider.
Status entered	Radio sends a status defined in the codeplug for location reporting by pre-programming.
GNSS ON	Positioning device has been switched ON.
GNSS OFF	Positioning device in the radio is switched OFF.
Emergency Periodic Profile (LRRP only)	Radio is in emergency operation and given time interval after the last location report expires.

2.26.1

Global Navigation Satellite System (GNSS) over Packet Data

This feature enables a radio to use the Global Navigation Satellite System (GNSS) Location Service over Packet Data instead of standard Short Data Services (SDS).

When the GNSS Location Service feature is enabled and the GNSS services have been turned on using the radio interface, the radio requests for Packet Data context activation.

With turning off the GNSS using the radio interface, Packet Data service deactivates. The ongoing Packet Data session deregisters. For the GNSS over Packet Data, triggers and location information are sent or received while Packet Data is activated. It is carried out similarly to the standard GNSS over SDS.

When the GNSS over Packet Data is enabled, sending or receiving triggers and location information during Direct Mode Operation (DMO) or Emergency Mode is not possible.

If a Packet Data connection cannot be established, the radio is not able to send or receive GNSS data.

2.26.2

GNSS GPS Accuracy

The GNSS GPS Location Service accuracy depends on the GNSS GPS coverage and the selected accuracy mode.

In good GNSSGPS coverage (at least -137 dBm or in open sky), the location accuracy presents as follows:

- In high accuracy mode, the accuracy is:
 - 5 m for 50% of location reports.
 - 10 m for 95% of location reports.
- In power optimized or normal mode, the accuracy is:
 - 20 m for 50% of location reports.
 - 50 m for 95% of location reports.



NOTICE:

The presented values depend on variety of factors, for example the view on the sky. To optimize the GNSSGPS performance the radio should have the clearest possible view of the open sky.

The use of the high capacity battery is recommended, especially when high accuracy mode is used.

2.26.3

Location Report Backlog

The radio can record location track when it is out of service, when in DMO, or when in TXI mode.

The location reports generated during this time is stored, and all location report backlog recordings are uploaded once the radio is back in service. Your radio can save up to maximum 180 location reports. The location report backlog function differently when in different mode:

Location Backlog Recording in Trunked Mode Operation (TMO)

The radio starts recording location reports when radio is out of service in TMO Mode.

The radio resumes latest location reporting when TMO coverage is regained.

Location Backlog Recording in Direct Mode Operation (DMO)

The radio starts recording location reports in DMO Mode.

The radio resumes latest location reporting when it switches back to TMO mode.



NOTICE: This feature is only available when enabled by your service provider.

Location Backlog Recording in Transmit Inhibit Mode (TXI)

When the radio is in TXI mode, location reports are generated and recorded but not sent out.

Once the radio exits TXI mode and is within TMO coverage, the location reports are uploaded to the server.

2.27

Bluetooth

Bluetooth is a wireless technology used to create personal networks operating in the 2.4 GHz unlicensed band with a range of up to 10 m.

The radio supports Bluetooth 2.1 + EDR, 4.1, and Bluetooth Smart (BTLE). The radio supports Bluetooth 2.1 and Bluetooth 4.1. The Secure Simple Pairing feature ensures a high level of security while pairing devices, thus protecting you against recording and passive eavesdropping.

One radio can be connected with up to seven devices at the same time.

The usable range may be reduced when you connect the radio with devices that support more limited ranges or if physical obstacles such as walls appear between devices. Five separate Bluetooth features available:

- Bluetooth Audio – includes Bluetooth Audio and Fast Push-to-Talk (PTT)
- Bluetooth Connectivity – includes Bluetooth Dial Up Networking (DUN) and Bluetooth Serial Port Profile (SPP)
- Bluetooth Connectivity – includes Bluetooth Serial Port Profile (SPP)
- Bluetooth Radio Control – includes Bluetooth Radio Control using AT commands and Bluetooth Generic Attribute Profiles (GATT) Sensors
- Bluetooth Smart Proximity Pairing
- Bluetooth Smart Ready includes:
 - Bluetooth Low Energy Indoor Location,
 - Bluetooth Low Energy Heart Rate Profile
 - Bluetooth Generic Attribute Profiles (GATT) Sensors



NOTICE: Bluetooth Audio, Bluetooth Connectivity, Bluetooth Radio Control, Bluetooth Smart Proximity Pairing, and Bluetooth Smart Ready are Software Selling Features.

You can use Bluetooth to:

- Connect the radio with wireless accessories, for example a headset, which gives you a greater freedom of movement and increases your work comfort. Also, wireless accessories allow performing the same activities in several ways. For example, you can change the volume level either in the headset or on the radio.
- Allow your radio to detect BTLE iBeacons.
- Allow radio collaboration with various Bluetooth sensors or data capture devices, for example biometric sensors, bar code scanners, or firearm devices.
- Allow radio collaboration with a body worn camera for photo and video capturing purposes.
- Increase connectivity with secure packet data services between the radio and a data device or a smartphone running appropriate applications.
- Enable radio control through a data device.

2.27.1

Bluetooth Interactions

The Bluetooth feature interacts differently with other features and situations of the radio.

The following features and situations limit the use of Bluetooth:

Car Kit

Car Kit affects Bluetooth headsets - when Car Kit is used, audio is routed only to/from accessories connected to the Car Kit. The audio is not routed to Bluetooth headsets.

Covert Mode

The radio cannot enter Discoverable Mode while in the Covert Mode as Covert Mode has a higher priority.

Covert Solution

The radio cannot enter Discoverable Mode while in the Covert Solution as Covert Solution has a higher priority.

Transmit Inhibit Mode (TXI)

Bluetooth does not work in the Transmit Inhibit Mode. When the radio enters the TXI while Bluetooth is enabled, all remote devices are disconnected and Bluetooth is disabled. After leaving the TXI, Bluetooth is enabled again (if it was previously turned on).

Transmit Inhibit Mode (TXI), Repeater Mode

Bluetooth does not work in the Transmit Inhibit Mode nor in the Repeater Mode. When the radio enters one of those modes while Bluetooth is enabled, all remote devices are disconnected and Bluetooth is disabled. After leaving the TXI or the Repeater Mode, Bluetooth is enabled again (if it was previously turned on).

Wired Audio Accessories

Wired audio accessories have a higher priority than Bluetooth audio accessories. If both types of devices are connected to the radio, it disconnects the Bluetooth audio device. When a wired audio device is already connected to the radio, scanning for Bluetooth audio devices is disabled.

2.27.2

Bluetooth Restrictions

TETRA Radios support simultaneous connection with up to seven remote devices.

The following restrictions on combinations of connected remote devices apply:

- It is only possible to connect one Motorola Solutions Push-to-Talk (PTT) device connected at a time.
- It is only possible to connect one Bluetooth (BT) audio device at a time.
- It is only possible to have one Object Push Profile (OPP) enabled device connected at a time.
- It is only possible to have one Bluetooth Dial Up Networking (DUN) enabled device connected at a time.
- It is possible to have up to seven Serial Port Profile (SPP) sensor devices connected at a time given that the total number of connected devices does not exceed seven.

In summary, it is possible to have one Motorola Solutions PTT device, one BT audio device, one OPP device, one DUN device, and three SPP devices connected at the same time.



NOTICE: The recommended size of the file to be sent is 2 GB.

2.27.3

Bluetooth Sensor Data

Your service provider can configure the details of the sensor information the radio displays.

Depending on the type of sensor connected to the radio and the setup configured by your service provider, various types of information are displayed. The following sections contain information on the most significant, pre-determined data the radio displays.

Sensor Battery Information

The radio displays the percentage of the remaining battery power of the connected sensors.

Heart Rate Sensor

If a heart rate sensor with the Energy Expended feature is paired and connected to the radio, two values are displayed:

- Heart Rate in bpm
- Energy Expended in kJ

Sensor Alarm

A radio paired with appropriate sensors increases the security of the radio user by making the user more aware of their surroundings. If the collected values exceed limits set by your service provider, the radio plays an alarm tone, light the LED, and display a warning message. The alarm concerns, for example, low battery, high toxicity, or low/high heart rate.

The alarm is active for a pre-defined time or until you discard it.

2.27.4

Bluetooth Smart Proximity Pairing

With the use of Proximity Pairing, you can instantly connect your radio with Bluetooth Low Energy (BTLE) devices.

BTLE devices are various types of sensors the radio can be paired with using Bluetooth, for example gas or heart rate sensors.

To pair the radio with a sensor, move the radio close to a sensor and press and hold the One-Touch Button. A tone indicates successful pairing and connection. After the connection, the radio collects information from the sensor.

2.27.5

Bluetooth Low Energy Indoor Location

The radio supports Indoor Location using Bluetooth Low Energy (BTLE) iBeacons. Indoor Location is used to track radio location while indoors. This feature is only supported on radio models with BTLE hardware. This feature is only available when enabled by your service provider.

The radio receives information from beacons that are within range. The radio then transmits the information in a Location Information Protocol message over the TETRA network. A mapping application decodes the information to calculate the radio location. This allows the supported console operator to know the location of the radio and ensure fast response when an incident occurs.

Indoor Location feature supports the following operation modes:

Enabled

Indoor Location is activated.

Disabled

Indoor Location is deactivated.

Suspended

Indoor Location is temporarily halted.

This feature is only supported in Trunked Mode Operation (TMO). Indoor Location is disabled automatically if the following conditions occur:

- Indoor Location is enabled.
- The radio enters Direct Mode Operation.

When the radio switches back to TMO, the Indoor Location remains disabled until it is manually enabled using either the menu or One-Touch Button.

Your radio also supports Outdoor Global Positioning System and Indoor Location concurrently, configurable through the CPS. This configuration allows you to move between indoors and outdoors without losing location data.



NOTICE: Indoor Location is suspended when you initiate Bluetooth Smart Proximity Pairing. When the pairing is completed, Indoor Location resumes.

Chapter 3

Man-Machine Interface

3.1

LED Indications



NOTICE: LED Coverage Indicator and LED Power Indicator are differentiated on the radio. See [ST7500 Controls and Indicators on page 83](#) for the positions of the two LED.

Table 13: LED Status Indications

Indication	Status
Solid green	<ul style="list-style-type: none">In useRepeating call
Blinking green	<ul style="list-style-type: none">In service or idleSwitching modes from TMO to DMO
Solid red	Out of service
Blinking red	<ul style="list-style-type: none">Connecting to the networkSwitching modes from DMO to TMO
Solid orange	<ul style="list-style-type: none">Radio is powering upTransmit inhibit in serviceChannel busy in DMORadio interference in DMOIncoming Short Data Service (SDS) that is unread.
Blinking orange	Incoming call
No indication	<ul style="list-style-type: none">Radio powered downRadio in Covert ModeRadio in Covert Solution

Table 14: Battery Charging LED Indications

Indication	Status
Solid green	Battery fully charged
Blinking green	Battery charged at 90%
Solid red	Rapid or trickle charge
Blinking red	Faulty or invalid battery

Indication	Status
Blinking orange	Battery is waiting to charge



NOTICE:

When you charge your radio in a multi-unit charger and the battery is at the 90–100% charge level, the LED indicators on the radio and on the multi-unit charger differs:

- LED on the radio – blinking green.
- LED on the multi-unit charger – solid green.

When you charge your radio in a multi-unit charger, the LED Power Indicator of the radio indicates the charge status of the battery.

If you insert a radio with a deeply discharged battery into the multi-unit charger, the LED on the radio shows blinking red, indicating a charging error. Resolve this error by reinserting the radio.

3.2

Battery Charging Indications

When the radio is charging, it displays the Charger Mode screen. The screen displays an appropriate Battery Charge Progress icon and charging progress expressed in percentage.



NOTICE:

To easily identify the charging status, check the Battery Charging LED Indicator. See [LED Indications on page 80](#).

When the radio is turned off while charging, it displays the Charger Mode screen. The screen displays the charging progress expressed in percentage.



NOTICE:

The Charger Mode screen does not remain on. The charging condition of a fully depleted battery only has its charging icon displayed after approximately 20–35 minutes. The red LED indicator serves as the primary indicator during the trickle charging state.

To identify the charging status, check the LED Power Indicator. See [LED Indications on page 80](#).

Figure 10: Charger Mode Screen

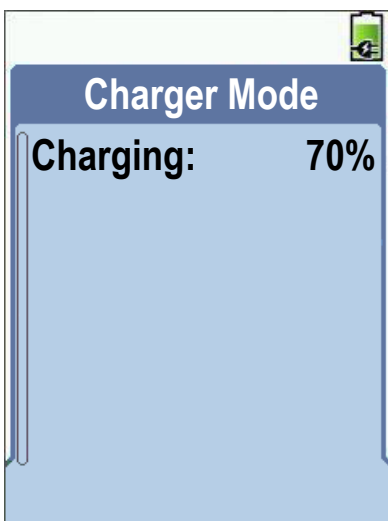

Figure 11: Charger Mode Screen



Table 15: Battery Icons

Battery Capacity						
0%–5%	5%–15%	15%–25%	25%–40%	40%–60%	60%–80%	80%–100%

Battery Charge Progress						
0%–5%	5%–15%	15%–25%	25%–40%	40%–60%	60%–80%	80%–100%

Table 16: Battery Icons

Battery Capacity						
0%–5%	5%–15%	15%–25%	25%–40%	40%–60%	60%–80%	80%–100%

Battery Charge Progress						
0%–5%	5%–15%	15%–25%	25%–40%	40%–60%	60%–80%	80%–100%

3.3

ST7500 Controls and Indicators

The simple-to-use controls and indicators of ST7500 allow you to quickly read and respond to alerts received on the radio.

Figure 12: ST7500 Controls and Indicators

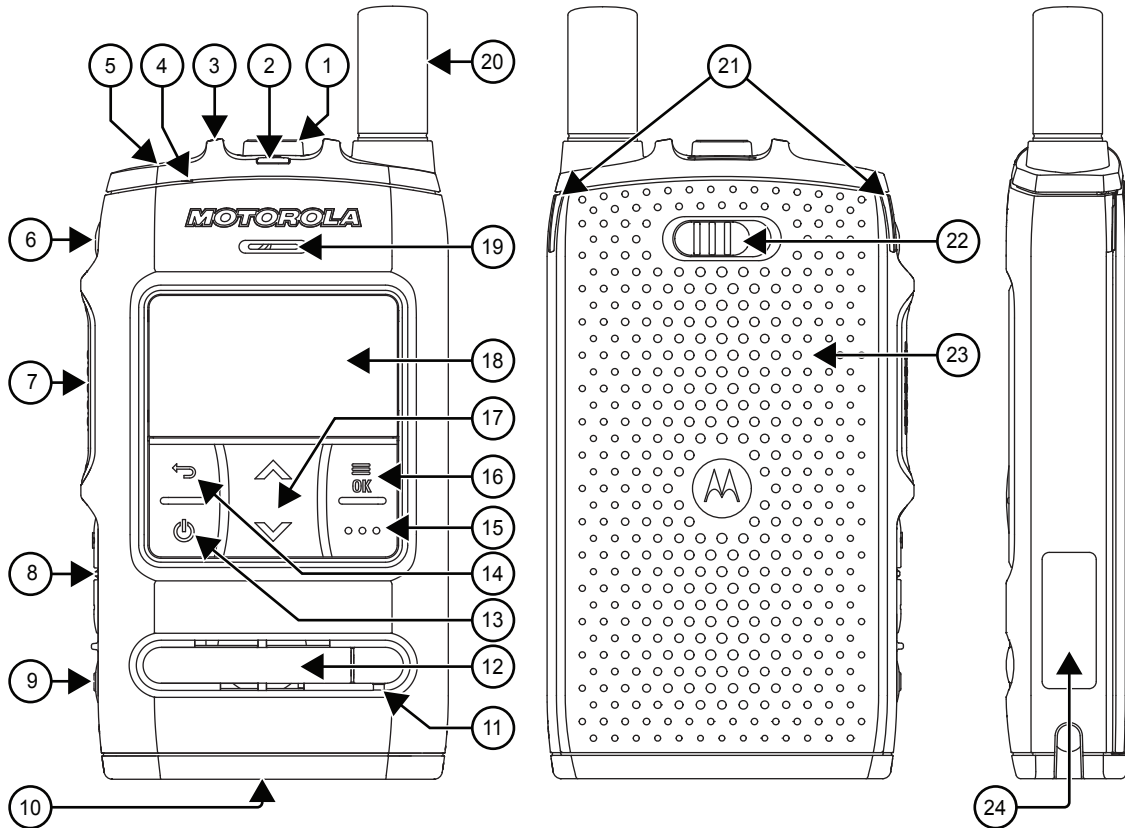



Table 17: ST7500 Controls and Indicators

Annotation	Description
1	<p>Talkgroup Selector</p> <p>The Talkgroup Selector has the following functions:</p> <ul style="list-style-type: none"> • Turns on the display when toggled once. Subsequent toggling allows you to scroll through the talkgroups of the current selected folder on the Idle screen. • Scrolls through text in the dialing and messaging editors.
2	<p>LED Coverage Indicator</p> <p>Shows the coverage status while the radio is transmitting and receiving over the network.</p>
3	<p>LED Power Indicator</p> <ul style="list-style-type: none"> • Shows the battery status when the radio is charging. • Indicates low battery level when it is blinking red.
4	<p>Top Microphone</p> <p>The top microphone is activated during high-audio simplex calls.</p>

Annotation	Description
5	Emergency Button Used to start the Emergency Operations, even when the radio is turned off.
6	P1 Programmable Button Supports the One-Touch Button feature.
7	Push-to-Talk (PTT) button Used to initiate a simplex call.  NOTICE: Pressing PTT activates the display for three seconds.
8	Volume button Increases or decreases the volume by pressing + or - .
9	P2 Programmable Button Supports the One-Touch Button feature. Changes the input characters to lower or upper case alphabets, numbers, or symbols in the messaging editor.
10	Bottom Connector Used for connecting accessories and programming the radio.
11	Bottom Microphone Activated during low-audio duplex calls.
12	Speaker Provides good quality high audio during simplex calls.
13	Power button <ul style="list-style-type: none">• Turns the display on or off.• Turns the radio on or off.
14	Back button The Back button has the following functions: <ul style="list-style-type: none">• Returns to the previous menu or deletes the last entered character in the dialing and messaging editors when pressed once.• In the dialing and messaging editors, pressing and holding the button clears the entire main text area.
15	P3 Programmable Button Supports the One-Touch Button feature.
16	Menu/OK button The Menu/OK button is used to: <ul style="list-style-type: none">• Select or enter context-sensitive menus.• Select the highlighted alphanumeric character in the dialing and messaging editors.• Show the dialing menu while in the dialing editor.
17	Navigation buttons The Up or Down button is used to navigate within the menu hierarchy or to edit alphanumeric text in the dialing and messaging editors.

Annotation	Description
18	PMOLED Display The 1.54-inch screen features a monochrome display with a resolution of 128 x 64 pixels. The screen consists of a two-line display area with the top line showing radio icons and the bottom line showing text.
19	Earpiece The Earpiece is active during low-audio simplex or duplex calls.
20	Hybrid Antenna
21	Battery Cover Finger Scoop
22	Battery Cover Latch Used to lock or unlock the battery cover.
23	Battery Cover
24	Seal Label  IMPORTANT: Do not remove the seal label to avoid compromising the ingress protection of IP67.

3.4

Keypad Lock

The keypad lock feature allows you to lock the keypad to avoid accidentally pressing a key.

By default, while the keypad is locked, all keys are inoperative except for the **Power** and **Emergency** buttons. When an incoming emergency call is received, the **PTT** button automatically unlocks for the call duration.

Your service provider can determine which of the following elements are also inoperative while the keypad is locked:

- PTT button (also on accessories)



NOTICE:

Your service provider can set the **PTT** button behavior in the codeplug to the following options:

- **Disable:** disables Lock PTT feature on all **PTT** buttons.
- **Enable - All:** locks all **PTTs**.
- **Enable - Radio with RSM:** locks radio **PTT** only, specifically when a Remote Speaker Microphone (RSM) is connected.
- **Enable - Accessories Only:** locks RSM **PTT** only.



NOTICE: Selecting **Enable - Accessories Only** does not lock or affect the Bluetooth **PTT**.

- Volume Control
- Side buttons
- Lock on Start-Up
- Accessory Dot Option buttons³

³ Accessory Dot Option buttons are programmable buttons available on your accessory. Note that only selected accessories have this function. Check with your service provider for more information.

3.5

Automatic Keypad Lock

The automatic keypad lock is a feature enabling the radio to lock its keypad automatically after a defined period. The radio allows activating or deactivating the feature using the MMI.

If the feature is enabled, after a defined time of inactivity the keypad locks automatically. Any user activity restarts the **Automatic Keypad Lock** timer.

3.6

One-Touch Buttons

The One-Touch Button (OTB) feature allows you to activate a feature by a long key press of the programmable button. Your service provider can also assign one-touch functions to the keypad keys.



NOTICE: You can also assign features to the option buttons of the RSM accessories. The One-Touch Button and One-Touch Dial are mutually exclusive features.

Table 18: One-Touch Button Features

Feature	Description
Activation of Covert Mode	Turns Covert Mode on or off.
Activation of Covert Solution	Turns Covert Solution on or off.
Add Bluetooth Device	Activates scanning for Bluetooth devices.
Any Network	Selects any network.
Any Talkgroup Network	Selects any talkgroup network.
Bluetooth Smart Proximity Pairing	Activates scanning for Bluetooth Smart Proximity Pairing.
Change Audio Profile	Changes to the specific audio profile.
Change Talkgroup	Changes the talkgroup to the one programmed by your service provider.
Change Talkgroup to the Previously Selected Talkgroup	Changes the talkgroup of the radio to the previously selected talkgroup (DMO or TMO).
Default Setting	Resets the radio to its default settings.
Direct Private Number Dialing	Displays the private dialing editor.
Disconnect All Connected Bluetooth Devices	Disconnects all Bluetooth devices connected to the radio.
Display Bluetooth Generic Attribute Profile (GATT) Sensors Battery Levels	Displays the battery levels of all paired Bluetooth GATT-based sensor devices.
Display GATT Service Data	Displays the GATT-based sensor data.
Display Heart Rate	Displays the heart rate value received from the connected GATT-based heart rate sensor.

Feature	Description
Display Operational-Tactical Address (OPTA)	Displays the OPTA.
Display Time	Displays universal time on the home screen.
DMO Pre-emptive Short Data Service (SDS)	Sends the next DMO SDS or status message with elevated priority.
Enable/Disable Howling Suppression	Enables or disables Howling Suppression.
Flip Display	Rotates the display by 180°. Flip Display is the default function for the upper Side button.
Hi/Low Audio	Toggles audio between the external earpiece and the main speaker.
Home Only	Selects only home network.
Home Talkgroup on Home Network	Selects only home network and home talkgroup network.
Inactive One Touch Key 0	The one-touch function assigned to the 0 key remains inactive until you long press the button twice.  NOTICE: A single long press on the 0 button calls out the + symbol.
Initiate Call-Out Fallback	Sends a Call-Out Fallback Alert.
Location Information Protocol (LIP) Report	Sends a message with the location of the radio to a dedicated address.
Lock to Current Network	Selects the current network only.
Phone and Private Automatic Branch Exchange (PABX) Call Setup	Initiates a PABX call to a predefined entry in the contact list.
Phone Call Setup	Initiates a phone call to a predefined entry in the contact list.
Prefer Talkgroup Network Shortcut	Displays the Prefer Talkgroup Network menu.
Private Call	Initiates a simplex or duplex private call to a predefined entry in the contact list or to the last group call originator.
Private Call Setup	Initiates a simplex or duplex private call to a predefined entry in the contact list or to the last group call originator.
Reset to Default	Resets the radio to its default settings.
Radio Messaging System (RMS) Man-Machine Interface (MMI) Menu	Opens the RMS menu without activating RMS mode.
RMS Mode Activation or Deactivation	Toggles the RMS feature on or off.
Radio User Identity (RUI) Logon or Logoff	Toggles the RUI feature of the radio.
Scan for Bluetooth Devices	Activates scanning for Bluetooth devices after the OTB assigned to the Add Bluetooth Device function is pressed.

Feature	Description
Select Talkgroup Network Shortcut	Displays the Select Talkgroup Network menu.
Selecting Audio Profiles	Changes the audio profile of the radio.
Send Double Push PTT Tone (D-PTT)	Sends the D-PTT tone to the currently used talkgroup.
Send Predefined Template (PDT)	Sends a predefined message to a dedicated address.
Send Status Message	Sends a dedicated status message to a dedicated address.
Sending Targeted Status	Sends a status message to a specific address.
Send User-Defined Template (UDT)	Sends a user-defined message to a dedicated address.
Speaker Enable or Disable per Call	Enables or disables the loudspeaker for a duration of the ongoing call.
Switch to Previously Selected Talkgroup	Changes the talkgroup of the radio to the previously selected talkgroup (DMO or TMO).
SIM Card End-to-End Encryption	Enables or disables End-to-End Encryption on the SIM card.
Timed Talkgroup Change	<p>Makes a predefined talkgroup the selected talkgroup for a specified amount of time. While you are using the predefined talkgroup, the second press of the One-Touch Button results in:</p> <ul style="list-style-type: none"> • the radio returning to the original talkgroup. • the radio restarting the timer before returning to the previously selected talkgroup. • no action on the radio, depending on the configuration. <p>After the timer expires, the radio returns to the previously selected talkgroup.</p>
TMO ↔ DMO Switch	Toggles between TMO and DMO modes.
TMO Talkgroup Scan	Turns the Talkgroup Scan feature in TMO Mode on or off.
Toggle Backlight	Toggles the backlight on or off.
Toggle Backlight Intensity	Regulates the backlight intensity.
Toggle Bluetooth Discoverable Mode	Turns Discoverable Mode on or off.
Toggle Bluetooth GATT Sensor MMI Alerts	Toggles Bluetooth GATT Sensor MMI Alerts on or off.
Toggle BSI Encryption Enabled or Disabled	Enables or disables BSI encryption.
Toggle Call Forwarding	Toggles Call Forwarding on or off.
Toggle Car Kit Speaker Permanent On or Off	Permanently turns the Car Kit speaker on or off.
Toggle DMO or TMO	Toggles between TMO and DMO modes.
Toggle Extra Zoom	Turns Extra Zoom on or off.

Feature	Description
Toggle Hi or Low Audio	<p>Toggles audio between the external earpiece and the main speaker. Hi or Low Audio is the default function for the lower Side button.</p> <p> NOTICE: This feature is supported in emergency Full Duplex Private Calls (FDPC) mode. Press the One-Touch Button to toggle high or low audio state during incoming or outgoing emergency FDPC.</p>
Toggle Horn and Lights	Toggles the horn and lights indication. Available only in Car Kit mode if the Horn and Light feature is enabled.
Toggle Howling Suppression	Enables or disables Howling Suppression.
Toggle Man Down On or Off	Turns the Man Down feature on or off.
Toggle RF Power Class	Toggles the RF Power Class between high and normal.
Toggle Remote Speaker Microphone (RSM) with Earpiece	Activates or deactivates the RSM earpiece.
Toggle Screen Saver	Activates or deactivates the Screen Saver feature.
Toggle Speaker During Call	Enables or disables the loudspeaker during a call. Available only in Car Kit mode.
Toggle Talkgroup Scan	Turns the Talkgroup Scan feature in TMO Mode on or off.
Toggle Transmit Inhibit Mode (TXI)	Turns TXI on or off.
Turn Bluetooth Indoor Location On or Off	Activates Bluetooth Indoor Location.
Turn Bluetooth On or Off	Turns Bluetooth on or off.
Turn On/Off Bluetooth	Turns Bluetooth on or off.
Turn Repeater Mode On or Off	Turns Repeater Mode on or off.
Unassigned	The radio displays <code>Unassigned Button</code> when no feature is assigned to this button.
Universal Time Display	Displays universal time on the home screen.
Volume Down	Decreases the volume by one level.
Volume Up	Increases the volume by one level.

3.7 Display

This section presents the default home screen elements of the radio.

Figure 13: Default Home Screen with Icons

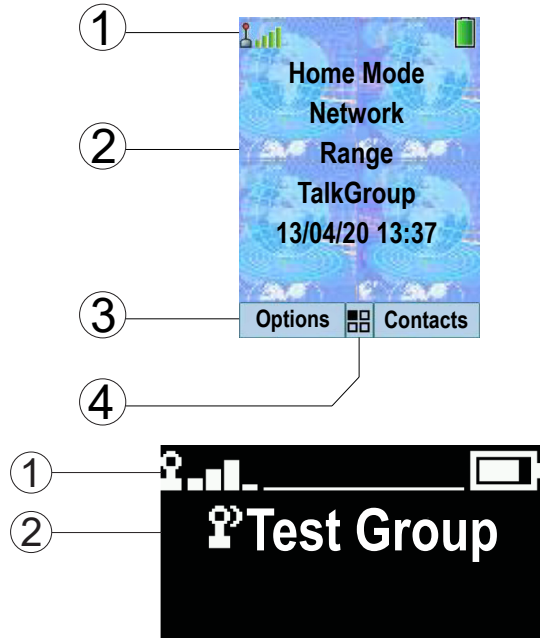

Table 19: Display

Annotation	Description
1	Status icon area
2	Text display area
3	Soft key area
4	Menu/Context sensitive icon

The color of the Soft key area changes according to the mode the radio is in.

Table 20: Colors of the Soft Key Area

Color	Mode or State
Light blue	Normal TMO and DMO Modes
Light red	Emergency Mode or Disaster Alert Call
Olive	Local Site Trunking Mode
Yellow	Call Out – Standby
Red	Call Out – Alert
Green	Call Out – Accepted
Blue	Radio Messaging Service (RMS)
Gray	Radio User Assignment (RUA) – Limited service

3.7.1

Status Icons

Status icons appear when your radio is engaged in certain activities or when you have activated certain features.

Table 21: Trunked Mode Operation (TMO) Icons





















Icon	Description
	In Service
	No Service
	Signal Strength The more bars, the stronger the signal.
	Migration Radio is registered to a foreign network.
	Scan Talkgroup scanning is activated in the radio.















Table 22: Direct Mode Operation (DMO) Icons





Icon	Description
	Direct Mode Call Radio is receiving a Direct Mode call. The more bars, the stronger the signal.
	Direct Mode Radio is in Direct Mode, radio-to-radio communication.
	DMO Gateway Communication Mode Indicates that the gateway is selected. This icon has the following states: Solid When the radio is synchronized with the gateway. Blinking When the radio is not synchronized or during attachment. No icon During a radio-to-radio and repeater call.
	DMO Repeater Communication Mode Indicates that the Repeater or GW + Rep option in DMO mode is selected. This icon has the following states: Solid When the radio has detected the repeater, for example, when the radio receives a presence signal. Blinking When the radio has not detected the repeater or during attachment.

Icon	Description
	No icon During a radio-to-radio and gateway call.

Table 23: General Icons

Icon	Description
	Low Audio Audio mode is changed to low.
	High Audio Audio mode is changed to high.
	Earpiece Connected Earpiece is connected to the radio.
	Battery Strength Indicates the charge of the battery.
	Battery Charging Indicates that the battery is charging.
	Emergency Radio is in Emergency Operation.
	Man Down Active Indicates that the Man Down feature is active.
	Man Down Alert Indicates that the Man Down feature is active. This icon has the following states: Blinking (Pre-Alert State) Triggered to inform and check on your status to avoid false Man Down trigger. To exit the pre-Alert state, change the conditions or press the PTT button. Solid (Emergency State) Your radio enters Alert mode once pre-alert state timed-out.
	Man Down Failure Indicates that the Man Down device failed.
	Bluetooth Connected Bluetooth is enabled and at least one device is connected.
	Bluetooth Disconnected This icon has the following states: Solid Bluetooth is enabled but no device is connected. Blinking Bluetooth is enabled and the radio is in Discoverable Mode or connection with a remote device is being established.
	Indoor Location Enabled Indicates that Indoor Location operation is enabled.

Icon	Description
	Indoor Location Suspended Indicates that Indoor Location operation is temporarily suspended.
	New Message Has Arrived Indicates that a new message has arrived.
	Normal Call-Out Alert Indicates Normal Call-Out alert.
	Normal Call-Out Alert Accepted Indicates that Normal Call-Out alert has been accepted.
	Normal Call-Out Alert on Standby Indicates that Normal Call-Out is on standby.
	Stormplan Call-Out Alert Indicates Stormplan Call-Out alert.
	Stormplan Call-Out Alert Accepted Indicates that Stormplan Call-Out alert has been accepted.
	Test Call-Out Alert Indicates Test Call-Out alert.
	Test Call-Out Alert Accepted Indicates that Test Call-Out alert has been accepted.
	Call-Out Fallback Alert Indicates Call-Out Fallback alert.
	Call-Out Alert Arrived Indicates a receipt of a new Call-Out message.
	Call-Out Alert Unread Indicates unread alert in the CO Box .
	End-to-End Encryption (E2EE) Solid, when E2EE is enabled: <ul style="list-style-type: none"> • For the selected talkgroup, • For the highlighted private number, • For the manually entered private number, • When transmitting voice in Group Calls, • When transmitting voice in Simplex Private Calls. Blinking, when E2EE is enabled: <ul style="list-style-type: none"> • When receiving voice in Group Calls, • When receiving voice in Simplex Private Calls, • During encrypted Duplex Private Calls.
	Encryption Off Blinking – Indicates that the SIM Card End-to-End Encryption is disabled in DMO and TMO Modes.
	SIM End-to-End Encryption (E2EE) Solid – Indicates that the SIM Card E2EE is enabled in TMO Mode.

Icon	Description
 or 	SIM End-to-End Encryption (E2EE) Solid – Indicates that the SIM Card E2EE is enabled in DMO Mode. Numbers 1 and 2 point to the type of DMO Encryption keys that has been selected.
 	Non-Secured Call – Air Encryption Unavailable Blinking – Indicates that Air Encryption is not available when the radio: <ul style="list-style-type: none">• Is in the Local Site Trunking Mode.• Attempts to connect to a gateway.
	Non-Secured Call – Air Encryption Unavailable Blinking – Indicates that Air Encryption is not available in DMO Mode. The icon appears after the PTT button is pressed.

3.7.2

Idle Display

The terminals provide access to all services from the main idle display.

Your service provider can configure the idle display. The idle display can show the following:

- Icons on the status area (top line):

- Status icons in Trunked Mode Operation (TMO) signal level icon.
- Battery level displayed at all times.



NOTICE: The terminal periodically repeats the audible and visible indication of low battery.

- Displays a single line of text which can comprise of multiple information. The content of this information depends on the Configurable Idle Screen settings.

- Selected Group.
- Current Scanlist.
- Time and Date.



NOTICE: If there is more than one line of text available on the idle screen, you can use the **Touch User Interface** to scroll through multiple text lines.

3.7.3

Configurable Idle Screen

Your service provider can configure the information that is displayed on the idle screen below the status icon area. The displayed information depends on the radio configuration and services supported.

- Audio Profile Name
- BSI Registration Status
- Home Mode
- Individual Short Subscriber Identity (ISSI)
- International Talkgroup Link Alias
- Network (No Service, or Mobile Country Code (MCC)/Mobile Network Code (MNC), or Networks Alias)

- Operational-Tactical Address (OPTA)
- Radio Status
- Range
- RMS/FMS
- Scan List Alias
- Secondary Talkgroup Alias
- Talkgroup Alias
- Time and Date
- Scan List Alias
- Talkgroup Alias



NOTICE: If the Favorite Talkgroup is selected, an icon preceding it denotes it as TMO or DMO.

- Time and Date

Order and visibility of these items are also subject of the Configurable Idle Screen settings.

3.7.4

Languages Supported

Table 24: Languages Supported

Language	ST7500
English	Yes
Arabic	Yes
Chinese (traditional)	Yes
Croatian	Yes
Danish	Yes
Dutch	Yes
Finnish	Yes
French	Yes
German	Yes
Hungarian	Yes
Icelandic	Yes
Italian	Yes
Japanese	Yes
Korean	Yes
Norwegian	Yes
Polish	Yes
Russian	Yes
European Portuguese	Yes
Latin American Portuguese	Yes

Language	ST7500
European Spanish	Yes
Latin American Spanish	Yes
Swedish	Yes

3.8

Tones









































NOTICE: The radio has two tone packs which are the default Classic Tones and New Tones. Your service provider decides which tone pack is enabled. To listen to the audio signal tones samples, click .

Table 25: Radio Tones

New Tone	Classic Tone	Tone Description
		Default Beep – Played when pressing a key.
		Invalid Action Examples: <ul style="list-style-type: none"> Pressing an invalid key. Dialing an invalid number. Talk prohibit.
		System Notification Examples: <ul style="list-style-type: none"> The radio changes its status from out-of-range to in service. The radio returns to the home network. Toggling between TMO and DMO modes.
		System Error Examples: <ul style="list-style-type: none"> The radio changes its status from in service to out-of-range. Call disconnected.
		General Notification Examples: <ul style="list-style-type: none"> Entering Local Site Trunking. Entering Transmit Inhibit Mode.
		Talk Permit – The radio user is allowed to transmit after pressing the PTT button.
		Emergency – Emergency Call received.
		Emergency 2 – Emergency Call received (optional tone).
		Low Battery – Battery charge level is low.

New Tone	Classic Tone	Tone Description
		Phone Busy – The called radio is busy.
		Phone Ring Back – Played on the initiating phone when Phone Call is being set up.
		Private Ring Back – Played on the initiating phone when Private Call is being set up.
		Ringtone 1
		Ringtone 2
		Ringtone 3
		Ringtone 4
		Ringtone 5
		Simplex Volume Set – Played when adjusting simplex volume.
		Duplex Volume Set – Played when adjusting duplex volume.

3.9

Description of Tones

Motorola Solutions TETRA terminal supports audible user notification, tones.

Tones for events are divided into five categories:

Table 26: Tone Categories

Category	Event
Keypad	For events triggered by key-press.
Alert	For events triggered by an application.
Ring	For events triggered by incoming/outgoing call.
Call-out	For events triggered by Call-Out alert.
Voice	For the event triggered by voice volume set.

A category may have many or few associated events.

The number of tones is limited; a specific tone may be used for indicating several different events. The generated tone may be mixed with the received speech signal, replace it, or be played while the radio is in idle (when there is no received or transmitted speech) dependent on its category and the features interaction.

The 'right' tone or event loudness is an objective matter. Motorola Solutions TETRA terminal tones architecture is highly flexible and allows you to adjust the level of every tone-event (such as valid key-press) individually and at the same time to adjust the level of all events associated with a tone-category.

Using the Customer Programming Software (CPS) tool, it is possible to set the level of each event compare with the nominal speech level (-20 dBm0); that means, for a given volume setting, a tone may

be louder, softer, or at speech level. This option is available both for in idle (when there is no received or transmitted speech) and in-call (during received or transmitted speech).

3.10

Dual Microphones

Each radio has two microphones. One at the top of the unit for dispatch (simplex) operation, and another at the bottom of the unit for duplex calls.

While the ambience listening is active or while being in the Covert Solution, you cannot switch to the high audio mode by pressing the speaker control key.

3.11

Audio Toggle

You can control audio routing between the speaker and earpiece for any private or group call through the dedicated **Speaker Control** key. You can also define through the menu to have all group calls in high audio or controlled by the **Speaker Control** key.

3.12

Volume Adjustment Mode

You can set the volume to Individual or Common. When set to Common, the audio has one setting for all items.

When set to Individual, the volume level for the following options can be set per user preferences.

- Voice
- Duplex
- Simple
- Keypad
- Tones
- Call-Out

The Volume Control Mode is configurable using the Customer Programming Software (CPS).



NOTICE: When a volume control capable Bluetooth device is connected, the radio always uses the Common setting.

You can configure the maximum volume offsets (dB) and the volume range (dB) through CPS. The field is **Audio Settings**→**User Profile**. The volume control in the radio is divided into 13 steps, from 0 to 14. If for example, the **vol. range** is set to 39, each step on the volume indication bar is 3 dB.

3.13

Accessory (Accry) Setup

You can connect IMPRES, CORE, Other, or Secondary accessories to the radio side connector. You can connect accessories to the audio connector at the bottom of the radio.

If you connect an IMPRES accessory, the radio detects and recognizes the accessory automatically. If you connect a CORE, Other (for example, a third-party accessory), or Secondary accessory (for example, an earpiece connected to an RSM), the radio may detect the connection but manual selection is required at the **Accry Setup** menu.

If you connect an accessory, the radio detects the connection and selects the IMPRES accessory automatically.

The **Accry Setup** menu contains the supported accessories, represented by their Model Number as defined by the related Audio Device Descriptor (ADD). ADD is a set of parameters in the radio that defines the audio settings, such as gains and filters settings, for each accessory.



IMPORTANT: Do not connect RSMs to both connectors at the same time. To ensure correct connection, do not press any RSM buttons when connecting the RSM to the radio.



NOTICE: To ensure proper connection of the audio accessory, fully insert the audio connector into the bottom connector of the radio. Ensure that the thumbscrews are fully fastened before powering on the radio. To resolve connection issues caused by partial insertion, remove and reinsert the audio connector.

3.14

Audio Features

Different audio quality and adaptive audio parameters can be configured according to the working environment.

The demand of audio quality changes according to the working environment. For example, an airport worker experiences different audio quality at various sites. Working in the field is noisier compared to inside the airport.

3.14.1

Audio Profile

The radio supports an audio profile which is configurable using the Customer Programming Software (CPS).

The following parameters can be configured for the audio profile:

- Mic Gain offsets.
- Howling Gains.
- AGC, Echo Canceller, and RX/TX Noise suppressor.
- Voice offsets and ranges for different audio devices.
- Tone offset and ranges.

3.15

Test Page

Only authorized persons can use the Test Page option and this option must be enabled in the codeplug.



NOTICE: If Test Page option is not enabled in the codeplug, you can only access the Key Variable Loader (KVL) mode option. When using a KVL device (a portable device used to load encryption keys to a secure entity), set the baud rate to 19200 bits/second.

Use the following key sequence to access the test page: **Menu/OK**→**Up**→**Down**→**Back**.

The following information is available in the test page:

- **Ver Info** – Version Information – displays software or hardware version information.
 - **Build Date** – software build (a compiled version of software).
 - **CP Ver** – Codeplug version.
 - **DSP Ver** – Signaling Processor Software version.
 - **Host Ver** – Application Software version.
 - **HardwareID** – hardware identification number.

- **EquipID** – TETRA Equipment Identity (TEI).
- **LLS version** – Local Language Package version.
- **Antenna Frequency Band**
- **Flashtrap Ver**
- **UCM Ver**
- **Addresses**
 - **Home MNI** – country identification code, network code.
 - **Group ID** – number of the currently selected talkgroup.
 - **Own ISSI** – Own Individual Short Subscriber Identity.
 - **ASSI** – Alias Short Subscriber Identity.
- **Err Logs** – Error Logs – displays information about software errors.
 - **ARM Resetlog** – Advanced Reduced Instruction Set Computing (RISC) Machine reset log.
 - **DSP Resetlog** – Digital Signal Processing reset log.
 - **UCM**
- **Cells Info** – Cell Information – displays information about the foreground and background cells (BTS sites). This menu displays the RSSI levels of the cells.
- **Cell Lists** – Displays frequency lists.
 - Frequency **List1** (32 variable frequencies)
 - Frequency **List2** (32 fixed frequencies)
 - Frequency **List3** (comprehensive hunt)
 - Frequency **List4** (comprehensive hunt)
- **Data Svc** – Data Services – allows access to the air tracer enable, the conformance tests, and the KVL mode.
 - **Air Tracer**
 - **Conf Test** – Conform test.
 - **KVL Mode**
 -  **NOTICE:** You can exit KVL Mode by power cycle.
- **E2E Key Del**
- **MS Logging**
- **CE Monitor** – Circulator Eliminator Monitor.
 - **CE Monitor Reading**
- **Key Info** – Key Information allows the radio to display security information for the following conditions:
 - For the serving cell:
 - + **Curr Cell SC** – Security class of the serving cell, that is Security Class 1, Security Class 2, Security Class 3, Security Class 3 with Group Cipher Key (GCK).
 - For the group OTAR:
 - + **CMG GSSI** – Crypto-Management Group (CMG) group of MSs with common key material
 - For SDMO and TM-SCK OTAR:
 - + **SCK SubsGrType** – SDMO SCK Subset Grouping Type.

- + **Curr Subs Info** – current SDMO SCK Subset Number and SCK-VN.
- + **Fallback TMSCK** – current Fallback TMO SCK, that is SCKN and SCK-VN attributes.
- + **SCK List** – list all SCKs stored in the radio, that is SCKN and SCK-VN attributes .



NOTICE: When checking for SDMO key information in the radio, the SDMO KAG range in the AuC is from 0 to 9 and the range in the radio is from 1 to 10.

- For the GCK:
 - + **Full GCK-VN** – current Full GCK-VN.
 - + **GCK List** – list all GCKs stored in the radio, that is GCKN and GCK-VN attributes.
- **E2E KVL Mode**

3.16

Radio Info

Depending on the codeplug configuration the manufacturer, type, and serial number information is available. The information is available through the service page accessible from the MMI.

The Radio Info provides the following data:

- Manufacturer
- Model Number



NOTICE: The manufacturer and model number information is displayed only on radios distributed under Motorola Solutions trademark.

- Release Name – the version of radio software.
- Individual Short Subscriber Identity (ISSI) – the ISSI that is in use.
- TETRA Equipment Identity (TEI) – the TEI is displayed as a hexadecimal number.
- Serial number – Motorola Solutions serial number is displayed only on radios distributed under Motorola Solutions trademark.

3.17

Hardware Test

This mode allows performing basic hardware tests and share the results immediately on the display.



NOTICE: The hardware test mode is only for use by authorized persons.

Use the following key combinations to access the hardware test: simultaneously press and hold the **P2 Programmable** button, **PTT** button, and the **Power/Sleep/Wake** button.

Appendix A

Maintenance



IMPORTANT: To avoid compromising the ingress protection of IP67, do not remove the seal label at the side of the radio. See [ST7500 Controls and Indicators on page 83](#).



NOTICE: To ensure optimum ingress protection of IP65 and IP67, you are recommended to change the battery cover after two years of usage.

The radio is submersible (compliant with the IP67 standard) – but only with the battery and the antenna attached.

To clean your radio and ensure that it is dust-free, use a moistened or antistatic/lint-free cloth to clean the battery cover seal and housing sealing surface.

A.1

Preventive Maintenance

Keeping Your Radio Dry

If your radio is submerged in water, shake off excess water and dry the radio with a towel. Take extra care when removing water trapped in the crevices and battery cover latch area of the radio, especially areas highlighted in [Figure 14: Areas to Keep Dry on page 103](#).



IMPORTANT: To avoid compromising the ingress protection of IP67, do not remove the seal label at the side of the radio. See [ST7500 Controls and Indicators on page 83](#).

Figure 14: Areas to Keep Dry

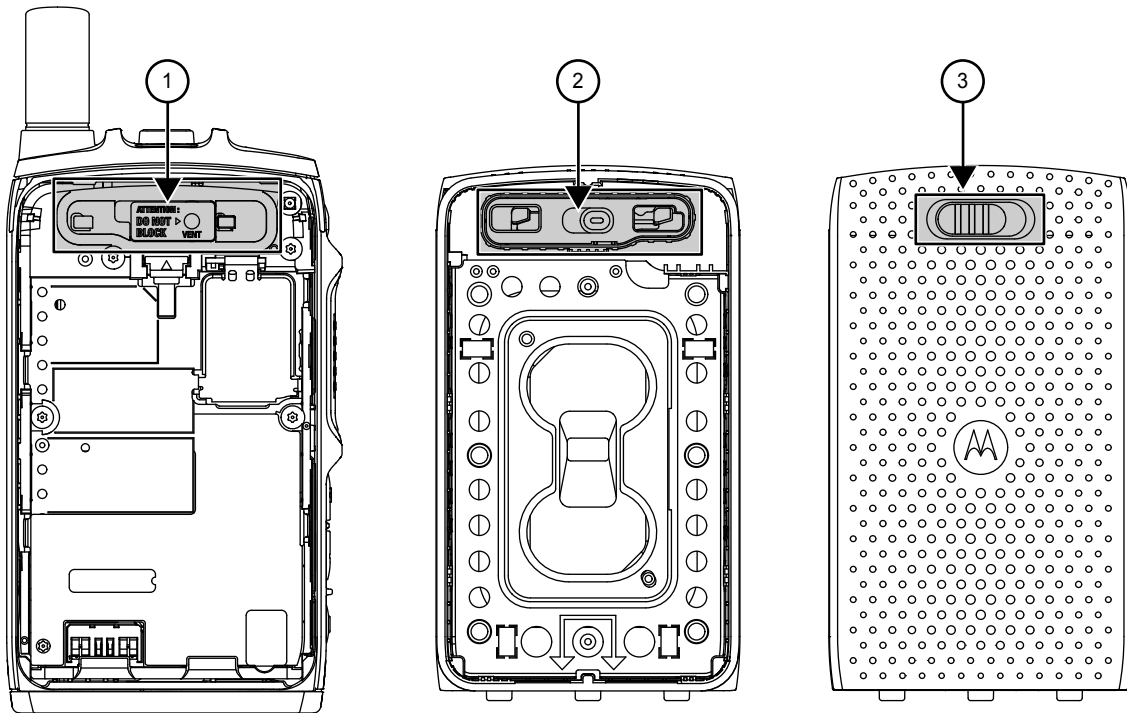

Table 27: Areas to Keep Dry

Annota- tion	Radio Section	Description
1	Radio Back View	Wipe dry after removing radio from water immersion.
2	Battery Cover Internal View	
3	Battery Cover External View	Wipe dry the Battery Cover Latch as water may penetrate into latch area.

Cleaning Bottom Connector Contacts



IMPORTANT: For reliable performance, it is important to ensure that the electrical contact interface remains clean and free of foreign material.

The contact material technologies used in the radio are engineered to provide a reliable interconnection.

To maintain optimal performance of the contact interface, Motorola Solutions recommends inspecting and cleaning the contacts every six months or before radio programming. Use a lint-free swab applied with isopropyl alcohol (100% by volume) to wipe or remove any dirt or foreign material from the contact pads.

You can also clean and protect the contacts with a CAIG DeoxIT® GOLD G100P Pen Applicator⁴. Motorola Solutions recommends the pen-based package for better cleaning action and access to contacts.

⁴ The CAIG DeoxIT GOLD G100P Pen Applicator is available at numerous electronics suppliers and directly from the manufacturer.

Before applying the lubricant/cleaner, wipe the contacts with lint-free swabs to remove any dirt or foreign material. Then, clean the bottom connector contact as per the instructions from the DeoxIT GOLD manufacturer.

Appendix B

Service Information – EMEA

Service orders are dealt with by two centres: European Radio Support Centre (ERSC) and European Systems and Components Centre (ESCC). This section contains contact details to service centers in Europe, Middle East, and Africa.

European Radio Support Centre (ERSC)

ERSC provides a remote Technical Support Service to help customers resolve technical issues and quickly restore their systems. The centre handles service orders for subscribers and accessories. This team of highly skilled professionals is available to the customers that have current ERSC service agreements in place. For further information and to verify whether your current service agreement entitles you to benefit from this service, contact your local customer support.

To contact ERSC, use the following EIA Integrated Call Center details:

E-mail: ersc@motorolasolutions.com.

Telephone: +49 (0)30 6686 1555

European Systems and Components Centre (ESCC)

ESCC provides a repair service for infrastructure equipment. Customers requiring a repair service should contact the Customer Information Desk and obtain a Return Material Authorization number. Unless advised otherwise, the equipment should then be shipped to the following address:

Motorola Solutions Systems Polska Sp.z o.o ul. Czerwone Maki 82, 30-392 Krakow, Poland.

E-mail: escc.admin@motorolasolutions.com.

Telephone: +49 (0)30 6686 1404

Monday to Friday, 08:00am–06:00pm (CET)

Table 28: Service Information — Telephone Numbers to EIA Integrated Call Center

Country	Telephone Number
Austria	1206091087
Denmark	43682114
France	157323434
Germany	6950070204
Italy	291483230
Lithuania	880030828
Netherlands	202061404
Norway	24159815
Portugal	800552277
Russia	810800228 41044 (Alternative 8108001201011)
South Africa	800981900
Spain	912754787

Country	Telephone Number
United Kingdom	2030277499
Other Countries	+42 0533336946

Parts Identification and Ordering

To get help in identification of non-referenced spare parts, contact your local Motorola Solutions Customer Care Organization.

To request replacement parts, kits and assemblies, place orders directly through your Motorola Solutions local distribution organization or through <http://emeaonline.motorolasolutions.com>.

EIA Test Equipment Support

For information related to support and service of Motorola Solutions Test Equipment, contact your local Motorola Solutions Customer Care Organization or see <http://emeaonline.motorolasolutions.com>.

For customers in Germany, contact the Equipment Service Group in Germany:

Telephone: +49 (0) 6128 702179

Fax: +49 (0) 6128 951046

Latest Versions of Manuals

To download the latest versions of technical manuals, see <http://emeaonline.motorolasolutions.com>.

Submit Your Comments

If you have any comments or would like to report a problem regarding Motorola Solutions publications, send an e-mail to: esc.admin@motorolasolutions.com.

Appendix C

Service Information for APAC

This topic contains contact details to service centers in Asia and Pacific region.

Technical Support

Technical support is available to assist the dealer/distributor in resolving any malfunction which may be encountered. Initial contact should be by telephone wherever possible. When contacting Motorola Solutions Technical Support, be prepared to provide the product model number and the serial number.

Further Assistance from Motorola Solutions

You can also contact the Customer Help Desk through the website: http://www.motorolasolutions.com/en_xp/products. If a unit requires further complete testing, knowledge and/or details of component level troubleshooting or service than is customarily performed at the basic level, send the radio to a Motorola Solutions Service Center as listed in the following table:

Table 29: Service Information – Telephone Numbers and Addresses of the Asia and Pacific Motorola Solutions Centers

Country	Telephone Number	Address
Singapore	+65-6352-6383	Motorola Solutions Singapore Pte. Ltd, c/o Azure Engineering, 49 Jalan Pemimpin, #03-11 APS Industrial Building, Singapore 577203 Contact: Alvin Tan E-mail: alvin.tan@motorolasolutions.com Contact: Gan Saw See E-mail: gan.sawsee@motorolasolutions.com
Malaysia	+603-7809-0000	Motorola Solutions Sdn. Bhd. Level 14, Persoft Tower, No. 68, Pesiaran Tropicana, 47410 Petaling Jaya, Selangor Darul Ehsan, Malaysia Contact: Koh Tiong Eng E-mail: A21001@motorolasolutions.com
Indonesia	+62-21-3043-5239	PT. Motorola Solutions Indonesia 30th Floor, Gedung BRI II, Suite 3001, Jl. Jend. Sudirman Kav. 44-46, Jakarta 10210, Indonesia Contact: Eko Haryanto E-mail: Eko.Haryanto@motorolasolutions.com
Thailand	Tel: +662-653-220	Motorola Solutions (Thailand) Ltd.

Country	Telephone Number	Address
	Fax: +668-254-5922	142 Two Pacific Place Suite 2201, 3220 Sukhumvit Road, Klongtoey, Bangkok 10110 Contact: Nitas Vatanasupapon E-mail: Nitas@motorolasolutions.com
India	+91-9844218850	Motorola Solutions India Pvt. Ltd. C/o Communication Test Design India Private Limited, #4, 5 Maruthi Industrial Estate, Rajapalya, Hoodi Village, Bangalore - 560048, India Contact: K. Umamaheswari E-mail: umamaheshwari@motorolasolutions.com
China	+86-10-8473-5128	Motorola Solutions (China) Co. Ltd. No. 1 Wang Jing East Road, Chao Yang District, Beijing, 100102, P.R. China Contact: Sophy Wang E-mail: C18170@motorolasolutions.com
Hong Kong	852-2966-4823	Motorola Solutions Asia Pacific Ltd. Unit 1807-1812, 18/F, Two Harbourfront, 22 Tak Fung Street, Hung Hom, Kowloon, Hong Kong Contact: Judy Leung E-mail: Judy.Leung@motorolasolutions.com
Philippines	Tel: +632 858-7500 Fax: +632 841-0681	Motorola Communications Philippines, Inc. Unit 2102, One Global Place Building, 5th Ave., Bonifacio Global City, Taguig, Philippines 1634. Contact: Arthur Nieves E-mail: Arthur.Nieves@motorolasolutions.com
Korea	+822-3497-3649	Motorola Solutions Korea, Inc. 9th Floor, Hibrand Building, 215, Yangjae-Dong, Seocho-Gu, Seoul, 137-924, Korea. Contact: KS Kwak E-mail: r45321@motorolasolutions.com
Taiwan	+886-2-8729 8000	Motorola Solutions Taiwan, Ltd. 8F, No. 9, Songgao Rd., Taipei 110,

Country	Telephone Number	Address
		Taiwan (R.O.C.) Contact: Michael Chou E-mail: ftpe239@motorolasolutions.com
Australia	+613-9847-7725	Motorola Solutions Australia Pty. Ltd. 10 Wesley Court, Tally Ho Business Park, East Burwood Victoria 3151, Australia. E-mail: servicecentre.au@motorolasolutions.com

Piece Parts

Some replacement parts, spare parts, and/or product information can be ordered directly. If a complete Motorola Solutions part number is assigned to the part, it is available from Motorola Solutions Service Organization. If no part number is assigned, the part is not normally available from Motorola Solutions. If a list of parts is not included, that means that no user-serviceable parts are available for that kit or assembly.

Customer Programming Software has no capability to tune the radio. Tuning the radio can only be performed at the factory or at the appropriate Motorola Solutions Repair Center. Component replacement can affect the radio tuning and must only be performed by the appropriate Motorola Solutions Repair Center.

All orders for parts/information should include the complete Motorola Solutions identification number. All part orders should be directed to your local Motorola Solutions Service Organization. See your latest price pages.

Expansion and Vocon board are working in pair for AVR version and NON-AVR version, whenever expansion board is replaced, Vocon board also have to be replaced and vice versa. PA000471A02 need to pair with PA000470A03 and PMLF4167D need to pair with PMLF4176C. There is not allowed to mix the Vocon-expansion pair as it can deeply affect the functionality of the radio.

Parts Identification and Ordering

Request for help in identification of non-referenced spare parts should be directed to the Customer Care Organization of Motorola Solutions local area representation. Orders for replacement parts, kits, and assemblies should be placed directly on a Motorola Solutions local distribution organization or from the Motorola Solutions Online (Extranet).

Appendix D

Service Information – Americas

This topic contains contact details to service centers in Latin America and Caribbean region.

Technical Support

To request technical support, go to <https://businessonline.motorolasolutions.com>, **Contact Us**.

Some replacement parts, spare parts, and/or product information can be ordered directly. If a complete Motorola Solutions part number is assigned to the part, it is available from Motorola Solutions. If no part number is assigned, the part is not normally available from Motorola Solutions. If the part number is appended with an asterisk, the part is serviceable by Motorola Solutions Depot only. If a list of parts is not included, that means that no user-serviceable parts are available for that kit or assembly.

Warranty and Repairs

Table 30: Service Information – Telephone Numbers and Addresses of Latin America Radio Support Centers

Country	Telephone Number	Address
Colombia	571- 376-6990	Motorola Solutions de Colombia Service Centre Torre Banco Ganadero Carrera 7 No. 71-52 Torre B piso 13 Oficina 1301 Bogota
Mexico	5252576700	Motorola Solutions de México Service Centre Bosques de Alisos #125 Col. Bosques de las Lomas CP 05120 Mexico DF

Piece Parts

To order parts in Latin America and the Caribbean contact your local Motorola Solutions CGISS representative.

Table 31: Service Information – Telephone Numbers and Addresses of Latin America Motorola Solutions Centers

Country	Telephone Number	Address
Argentina	5411-4317-5300	Motorola Solutions Argentina Ave. del Libertador 1855 B1638BGE, Vicente Lopez Buenos Aires
Brasil	5511-3847-668	Motorola Solutions Ltda Av. Chedid Jafet

Country	Telephone Number	Address
		222 Bloco D Conjuntos 11,12,21,22 E 41 Condominio Millennium Office Park 04551-065- Vila Olimpia, Sao Paulo
Chile	562-338-9000	Motorola Solutions Chile S.A. Av. Nueva Tajamar 481 Edif. World Trade Center Of. 1702, Torre Norte Las Condes Santiago
Colombia	571-376-6990	Motorola Solutions Colombia LTDA. Carrera 7 #71-52 Torre A, Oficina 1301 Bogotá
Costa Rica	506-201-1480	Motorola Solutions de Costa Rica Parque Empresarial Plaza Roble Edificio El Portico, 1er Piso Centro de Negocios Internacional Guachepelin, Escazu San Jose
Ecuador	5932-264-1627	Motorola Solutions del Ecuador Autopist Gral. Rumiñahui, Puente 2 Conjunto Puerta del Sol Este-Ciudad Jardin Pasa E, Casa 65 Quito
Mexico	52-555-257-6700	Motorola Solutions de México, S.A. Calle Bosques de Alisos #125 Col. Bosques de Las Lomas 05120 México D.F.
Peru	511-211-0700	Motorola Solutions del Peru Ave. República de Panama 3535 Piso 11, San Isidro Lima 27
USA	954-723-8959	Motorola Solutions, Inc. Latin American Countries Region 789 International Parkway Sunrise, FL 33325
Venezuela	58212-901-4600	Motorola Solutions de Los Andes C.A. Ave. Francisco de Miranda Centro Lido, Torre A Piso 15, El Rosal Caracas, 1060

Glossary

Air Interface (AI) The radio-based communication data transmitted over the air between the mobile and the active base station.

Air Interface Encryption (AIE) Provides confidentiality on the radio link over the air.

Alias Short Subscriber Identity (ASSI)

The Tetra address corresponds to the Individual Tetra Subscriber Identity (ITSI). It includes, in addition to the Mobile Country Code (MCC), the Mobile Network Code (MNC) nor the 7- or 8-digit subscriber short identifier, Short Subscriber Code (SSI), the allocation of mobile radio equipment to a private or public service produces.

| See also:

Announced Cell Reselection Cell reselection where radio Mobile Link Entity (MLE) informs the Switching and Management Infrastructure (SwMI) both in the serving cell and in the new cell that cell change is performed.

| See also:

Audio Device Descriptors (ADD) A structure which provides hardware information about a particular audio accessory (for both IMPRESS and core accessories). Files with ADD have an extension .add.

Base Station Term used to identify the installation including the Base Transceiver Station, antenna and ancillary equipment.

Base Transceiver Subsystem (BTS) A Base Station serving as the Radio Frequency (RF) interface between the radios and the system infrastructure.

| See also:

Cell A geographical area which is covered by a BTS site. Note that at the edge of the cell, the radio can begin to receive signals from adjacent cells and will use its stored reselection criteria to determine at what point it should return to a better signal.

Class Class.

| **Synonym:** Security Class
| **See also:**

Class 1 No encryption, may use authentication.

| **See also:**

Class 2 Static Cipher Key (SCK) encryption, Encrypted Short Identity (ESI) with SCK, may use authentication.

| **See also:**

Class 3 Derived Cipher Key (DCK) encryption, Encrypted Short Identity (ESI) with Common Cipher Key (CCK), authentication.

| **See also:**

Clear Not encrypted.

Common Cipher Key (CCK) Used to encrypt group and broadcast addressed downlink signaling (from infrastructure to a radio). Also used to protect Individual Short Subscriber Identities (ISSI).

| **See also:**

Control Channel (CCH) A dedicated channel at a site on which radios send and receive instructions for call processing.

Customer Programming Software (CPS) Computer-based software which allows the programming of the characteristics of the radio (for example, frequency, DPL codes, and alias).

Derived Cipher Key (DCK) Used to encrypt all uplink signaling (from radios to infrastructure) and individually addressed downlink signaling (from infrastructure to a radio).

| **See also:**

Direct Mode Operation (DMO) Direct communications between two or more radios without the use of any infrastructure.

Downlink The radio frequency communications path from the BTS to the radio. Also referred to as the BTS transmit path.

Dual-Tone Multi-Frequency (DTMF) Tone-based signaling scheme which combines two of a set of standard frequencies. The result is a third or beat frequency (signal) which is the desired or usable signal. DTMF signaling is used as tone-dialing in the common telephone.

Dynamic Group Number Assignment (DGNA) Dynamic Group Number Assignment is the possibility to provision talkgroups into the radio over the Air Interface.

| See also:

Encryption Secure communications systems are designed to provide coded (encrypted) signals between some or all links in the system. In order to do this, each device involved in secure communications is loaded with a multi-digit encryption variable (called a key). This key is used by an encryption algorithm built into the device to encrypt voice or data as needed. Only devices in the system with the same algorithm and encryption key can decode the encrypted signals.

European Telecommunications Standards Institute (ETSI) An independent, not-for-profit, standardization organization in the telecommunications industry (equipment makers and network operators) in Europe, with worldwide projection. European Telecommunications Standards Institute produces globally-applicable standards for Information and Communications Technologies (ICT), including fixed, mobile, radio, converged, broadcast, and internet technologies.

Firmware Computer instructions that reside as read-only software on the flash memory of a radio.

Flash A storage chip integrated in to radio hardware, that can be erased and reprogrammed.

Flashing Writing a software image file to a radio.

Group Call A call addressed to talkgroups or multigroups.

| See also:

Group Cipher Key (GCK) Predetermined cipher key used to provide confidentiality in Class 3 system with corresponding algorithm. Used to generate Modified Group Cipher Key (MGCK).

| See also:

Group Short Subscriber Identity (GSSI) TETRA term, in DIMETRA called Group ID or Talkgroup ID.

| See also:

Home Location Address Area within radio coverage of a base station or group of base stations within which a radio is allowed to operate.

| See also:

Individual Short Subscriber Identity (ISSI) A unique, individual ID that refers to a specific radio within a specific DIMETRA/TETRA system. Devices which are provisioned in different systems can have the same Individual Short Subscriber Identity. To provide a globally unique identifier for a DIMETRA/TETRA device, the Mobile Country Code (MCC) and Mobile Network Code (MNC) of the device's home system are used to create the device's Individual TETRA Subscriber Identifier (ITSI).

| See also:

Individual Tetra Subscriber Identity (ITSI) Consists of Individual Short Subscriber Identity (ISSI) plus Mobile Country Code (MCC) and Mobile Network Code (MNC) codes.

| See also:

Key A piece of data, which when used with a particular cryptographic algorithm, allows unencrypted information to be encrypted and encrypted information to be decrypted.

| See also:

Local Site Trunking (LST) When a system fails or many of the sites lose connection to the Central Network Equipment (CNE), the sites are designed to go into a fall back situation known as Local Site Trunking (LST). When the sites are forced to go into LST, the radios (users) are randomly distributed across all the sites and communication between radios is dependent on at which site they are registered. Only radios registered at a particular site can communicate to each other.

Location Request/Response Protocol (LRRP) This protocol allows for a single and efficient format of passing location information (requests and responses).

Main Control Channel (MCCH) The main control channel at a site. The channel is used by radios to register on the system and to request and setup speech calls with other radios.

| See also:

Man Machine Interface (MMI) Man Machine Interface commands are the input from a service computer entered to communicate with the Site Controller at the system level.

Mobile Country Code (MCC) The Mobile Country Code and Mobile Network Code together form a unique TETRA system identifier that is broadcast by a Dimetra system over the air interface.

| See also:

Mobile Link Entity (MLE) Responsible for the control of lower layer radio functions.

| See also:

Mobile Network Code (MNC) The Mobile Network Code should be allocated by the national authority that allocates frequency assignments in a country and should be requested from that authority at the same time as frequency allocations are requested. The Mobile Country Code and Mobile Network Code together form a unique TETRA system identifier that is broadcast by a Dimetra system over the air interface.

Modified Group Cipher Key (MGCK) Used to encrypt group addressed downlink signaling.

| See also:

Multigroup Two or more talkgroups that are combined into a permanent multigroup in trunked systems. Calls to the multigroup reach all members of the talkgroups that comprise the multigroup.

| See also:

Over-The-Air-Rekeying Protocol (OTAR) Used in connection with Air Interface Encryption.

| See also:

PABX Gateway A device that provides connectivity from a TETRA user to a PABX subscriber and the other way around.

| See also:

Permanent Disable Version 2 (PDV2) You can restore a disabled radio using CPS Plus.

Private Automatic Branch Exchange (PABX) A telephone switch that is operated privately within a confined setting, instead of publicly. Most large offices have a PBX to handle intraoffice calls and to connect calls to and from the Public Switched Telephone Network (PSTN).

| See also:

Private Call An individual call between two radios or between a radio and a console operator. Apart from the two interlocutors, no one else can participate or listen to the call.

Private Duplex Call A private call between two radios that resembles a telephone conversation. The two individuals can talk and listen at the same time without pressing PTT.

| See also:

Private Number Also called Private ID.

PSTN Gateway A device that provides connectivity from a TETRA user to a PSTN subscriber and the other way around. Additionally, for the duration of the call, the PSTN gateway allows TETRA signaling

information to be passed from TETRA Switching and Management Infrastructure (SwMI) to the external network user and from the external network user to the TETRA SwMI in accordance with the TETRA Call Control (CC) procedures.

| See also:

Public Switched Telephone Network (PSTN) The telephone network, traditionally the wired network, that requires the public user to address or dial the destination using a telephone number for a temporary connection.

Push-to-Talk (PTT) A method by which a radio user initiates or joins a call. When you press the PTT button (also known as keying up), the radio sends data to the network infrastructure to request call services.

Radio Frequency (RF) Part of the general frequency spectrum between the audio and infrared light regions (about 10 kHz to 10,000,000 MHz).

Radio Signal Strength Indicator (RSSI) Determines radiation patterns of transmitters antennas.

Radio User Assignment (RUA) Part of RUA/RUI feature.

| See also:

Radio User Assignment/Radio User Identity (RUA/RUI) This feature allows you to assign alphanumeric user names to radio users, and to authenticate the radio users in a log-on process.

| See also:

Radio User Identity (RUI) Part of RUA/RUI feature

| See also:

Radio A two-way communication device used for voice and data.

| **Synonym:**Subscriber

| See also:

Remote Control Unit (RCU) A small device attached to a covert radio over a thin wire, used for operating the radio.

Remote Flashing Programming the transceiver through the control head.

Semi-Duplex Private Call Also called Private Call or Express Connect Call. In this type of one-way call, the user presses and holds the PTT while talking, and releases the PTT while listening.

| See also:

Short Data Service (SDS) A flexible bearer service that transfers information from one interface to another.

Short Subscriber Identity (SSI) The network specific portion of a TETRA Subscriber Identity. An SSI is only unique within one TETRA subdomain (one TETRA network).

Software Image A collection of files distinguished by individual releases. It contains firmware, codeplug, and audio template files dedicated to specific radio models.

Static Cipher Key (SCK) Key used for encryption between radios and Base Transceiver Subsystem in Class 2 systems with corresponding algorithm.

| See also:

Status ID A feature that makes it possible for a subscriber to send status messages to other subscribers. The user can enter a status message for each ID in a Status ID list. When a subscriber sends a status message, the ID of the subscriber's unit is sent along with the status message.

Subscriber Identity Module (SIM) A smart card that holds subscriber information (including the authentication key) and is inserted into the radio to grant its personality.

Subscriber A user of telecommunications services who attaches to the network through a radio and receives the telecommunication service treatment specified for subscribers.

Switching and Management Infrastructure (SwMI) All the system

components excluding the mobile equipment that is the CNE and all the remote site equipment.

|Synonym:Fixed Network Equipment

Talkgroup A uniquely named group of radios that can share calls and messages. A talkgroup's normal communications do not require interfacing with other talkgroups. Typically, the majority of a radio user's communications are within their own talkgroup.

TETRA Equipment Identity (TEI) An electronic serial number that is permanently embedded in the TETRA equipment, like radios.

TETRA Acronym for TERrestrial Trunked RAdio. The digital trunked radio standard produced by European Telecommunications Standards Institute providing detailed telecommunications specifications to which Base Stations and radios should adhere.

|See also:

Trunked Mode Operation (TMO) A computer controlled communications system that allocates speech channels on demand selecting on a random basis from the group of channels available.

Upgrade To replace radio firmware with a newer version and preserve User and Sensitive Data.