

# review

02|2020 en

## Leveraging connectivity



- 
- 06–29 **Leveraging connectivity**
  - 30–45 **Connecting power**
  - 46–55 **Robots and handling**



Universal motor controller software

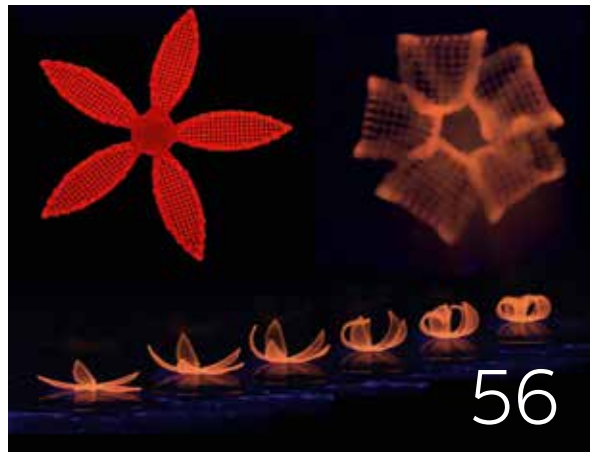

4D printing

Boosting buildings' energy efficiency





**PEGS tests  
power equipment**

---

05 **Editorial**

---

## **Leveraging connectivity**

- 08 **Intelligent Alarm Management**
- 14 **Boosting buildings' energy efficiency**
- 22 **Smart Sensor for hazardous areas**
- 28 **Network researcher gains award**

---

## **Connecting power**

- 32 **Zenith automatic transfer switch**
- 36 **Universal motor controller software**
- 40 **PEGS tests power equipment**

---

## **Robots and handling**

- 48 **Precise depalletization with machine learning**
- 52 **How to rev up your robots**

---

## **Buzzword Demystifier**

56 **4D printing**

---

63 **Imprint**

63 **Subscribe**

---

**The idea that the whole is greater than the sum of its parts can be traced back to ancient philosophy, but it is helping define and enable the next generation of technology tools, services, and solutions. This issue of ABB Review explores how that thinking is being put to work to make businesses more productive and profitable by connecting sensors, AI, and real-time oversight, thereby empowering use cases somewhere with insights from everywhere.**

---

EDITORIAL

# Leveraging connectivity



Dear Reader,

The previous issue of ABB Review looked at versatile and adaptive production, showing how factories are shifting from the mass-manufacture of identical products to flexibly producing a broader range. The present issue takes this one step further: A factory must be adaptive not only in its activities and output, but also in its equipment and configuration. During the lifetime of a plant, new tasks often require new functions and new devices, whose integration must be achieved with minimal downtime and configuration effort.

One enabler is wireless communication. As wireless is becoming more reliable and low latency, it is entering applications for which it was hitherto not suited.

Besides the breakthroughs in communications, this issue of ABB Review presents further tools and products providing greater functionality and easier configuration. These include a simulation tool, a motor starter, and a protection switch.

Enjoy your reading,

A red handwritten signature in cursive script, appearing to read 'Bazmi Husain'.

Bazmi Husain  
Chief Technology Officer

---

# Leveraging connectivity





The robust and secure innovation necessary to connect industrial and mission-critical functions is now coming online, both figuratively and literally; ABB is pioneering implementations in both operational and development environments, and has unveiled a next-gen smart sensor designed for extreme conditions. These stories reveal the details.

- 08 Intelligent Alarm Management directs plant operators to critical events
- 14 A network analyzer that's boosting buildings' energy efficiency
- 22 Smart Sensor for hazardous areas
- 28 Prestigious award for network researcher



## LEVERAGING CONNECTIVITY

# Intelligent Alarm Management directs operators to critical events

Relying on data mining techniques to extract data and create a sophisticated alarm model, ABB's IAM is the ultimate alarm management system for process industries.

—  
**Aldo Dagnino**  
 ABB Advanced Analytics  
 Cary, NC, United States

aldo.dagnino@  
 us.abb.com

**Carsten Beuthel**  
 S+ Operation  
 Mannheim, Germany

carsten.beuthel@  
 de.abb.com

**Thomas-Christian Skovholt**  
 Digital Delivery  
 Oslo, Norway

thomas.skovholt@  
 no.abb.com

**Martin Hollender  
 Marcel Dix**  
 ABB Corporate Research  
 Ladenburg, Germany

martin.hollender@  
 de.abb.com  
 marcel.dix@de.abb.com

Large processing plants such as petrochemical and power generation facilities rely on complex control systems to keep processes, equipment and operations on track to produce successful outputs. Originally, panel boards with control instruments connected to sensors yielded analog information on display to a well-trained expert who decided what needed to be done. Emergency systems were activated to stop a process in danger of surpassing safety, environmental or financially acceptable limits.

With the birth of distributed control systems (DCS), operators could control processes without understanding the equipment. Configuring and deploying alarms with ease, engineers set alarms throughout the system (typically, at 80 and 20 percent of equipment operating range). The consequence was a proliferation of alarms – every event set off an alarm. Suddenly process plants had to deal with too many alarms due to too much available data, yet insufficient germane information. Limited visual display space required operators to follow instruction manuals in case of an event – a laboriously slow process.

Even though the DCS is part of the Industrial Internet of Things (IIoT), the amount of big data, level of automation, availability of inexpensive

accurate sensors, unlimited data storage, and visualization display complexity necessitate a more straight-forward control system that focuses the operators' attention quickly on pertinent information – to as few and important

—  
 By relying on the actual plant operating conditions, the IAM permits operators to recognize and address significant alarms.

events/alarms as possible →01. But what if operators could predict critical events before they occur? They could prevent the loss of production and throughput; equipment breakdown and events that threaten both environmental and human safety. To accomplish this ultimate goal, ABB has focused on delivering its customers such a system: ABB's Intelligent Alarm Management (IAM).

## Intelligent Alarm System

Today, alarm management system design must incorporate ergonomics, instrumentation engineering, systems thinking, advanced analytics



— 01 Control room operators need to rapidly recognize critical events and take action to remedy any problems that arise; IAM relies on actual plant operating conditions and an array of analyses based on data mining techniques to identify data patterns and support operators.

and visualization to enhance the usability of the control system. Seizing on their expertise in the IIoT ecosystem and DCS experience, ABB's resultant IAM surpasses existing concepts to perfect analysis and usability. Not only is an extra analysis level added to reduce nuisance alarms (de-chattering), a further sophisticated three-layered second level of analysis has been engineered. The IAM consists of a data layer that extracts alarms and creates an alarm data model according to 25 attributes, an analytics layer with newly developed algorithms to precisely and repeatedly analyze alarm data, and the graphical user interface (GUI) visualization layer based on ABB's user-design concept for viewing the analytical results →02.

#### Alarms in control systems and their management

Fundamentally, alarms alert the operator to departures from normal operating conditions. To be effective, operators must quickly and accurately assess those alarms that need split-second attention and action. However, conventional systems are static; the alarms don't

respond to changes in mode of operation or conditions. When a large compressor shuts down in a petrochemicals plant, many resulting alarms are noncritical and secondary; superfluous and

— Relying on concepts like basketization, smart analysis was developed with historical data from oil and gas process plants.

annoying, these alarms require the operator to waste time searching and analyzing. ABB's IAM can remedy such problems. The dynamic system filters events and alarms based on the actual current plant operating conditions, thereby clearing the path for operators to swiftly recognize and address the significant alarms.

To accomplish this, the IAM conducts an array of five analyses: deep alarm de-chattering,

01



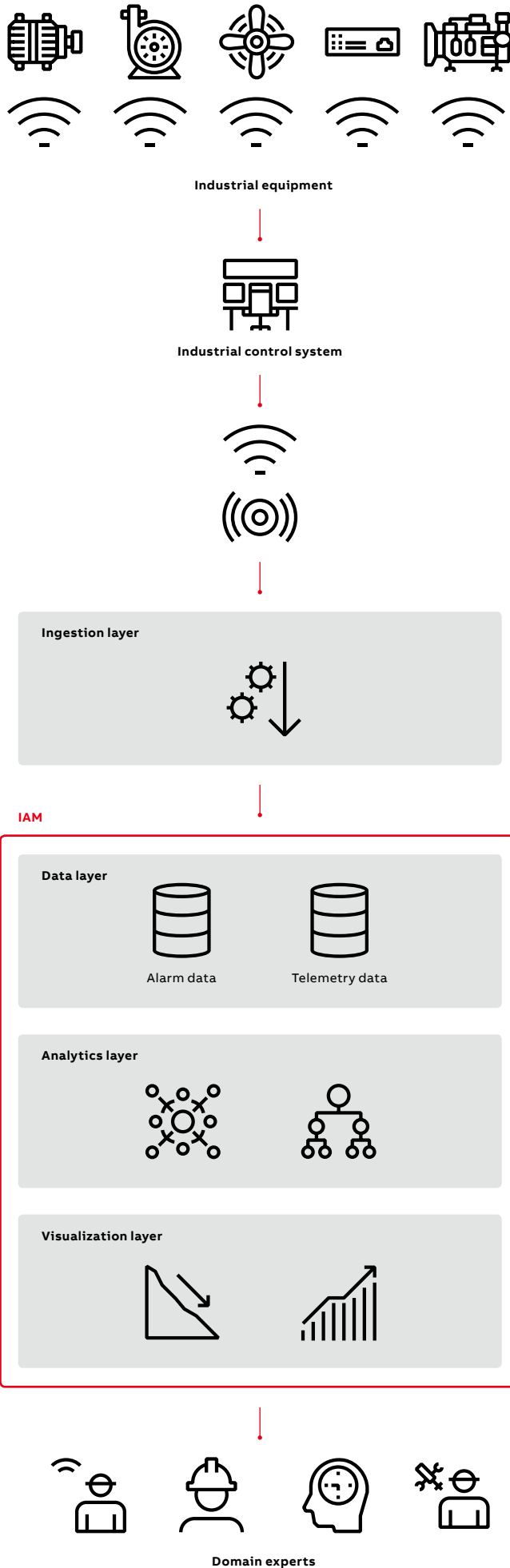

alarm sequence analysis, critical alarm analysis, masking rules, and alarm flood analysis. All of these methods rely on data mining techniques to identify data patterns.

**IAM development**

Developed with historical data from oil and gas process plants among others, analysis relies on concepts such as basketization, a process that slices data into appropriate time intervals; and metrics, which enables results to be prioritized.

Basketization is used either to store repeating or short duration alarms in the case of chattering alarms, to divide alarm sequences into equal time periods as with alarm sequence analysis, and to identify alarm sequences that occur before or after a specific event as in critical alarm analysis →03. Alarm lifetime – the time between the return to normal  $Rtn_t$  and the activation time of an alarm  $Act_t$  – and the time gaps between alarms (TG) – the time between the activation of one

Based on expertise and experience, ABB’s IAM surpasses existing concepts to perfect analysis and usability.

alarm and a second later occurring alarm ( $TG_{B-A} = Act_{tB} - Act_{tA}$ ) are determined by data attributes →04; these are used for the de-chattering analysis of alarm logs by applying two newly developed algorithms: one algorithm is for the life of an alarm and its frequency of repeatability; the other is for the repetitive alarms: those in which the time gap between activation and return to normal is short. The analyst performs the de-chattering analysis first and then can decide to remove these from the alarm log if appropriate.

**The sequence model analysis**

After de-chattering the alarm log, the IAM uses the activations times of historical alarm data to identify and characterize alarms that occur frequently together. Using two measures of significance: support and togetherness, alarm sequences can be ranked according to importance [1]. The algorithm creates four equal time baskets of a specific duration: each basket contains the alarms in the log – ordered according to activation time. The sequence mining

02 Industrial control systems monitor components that contain sensors. Sensors relay information to the ICS which filters some nuisance alarms. ABB's IAM adds a higher level of analysis with three more layers: the data layer to extract and create an alarm data model from current sensor data and historical data, an analytics layer that uses algorithms to analyze alarm data and a visualization layer for viewing.

03 Basketization (time baskets) is important for alarm sequence and critical alarm analyses. Different types of baskets are needed for each type of analysis.

03a An example of a critical alarm basket created around a specific critical alarm, C; this is used to identify alarm sequences that occur before and after this specific event. Here, four backward and forward baskets were created for the critical alarm C of length t.

03b An example of time slice basketization created with ABB's newly developed sequence mining algorithm is shown. The algorithm creates three equal time baskets and each basket contains the alarms that are recorded in the alarm log: These are ordered according to time stamps (the time when each alarm was activated).

algorithm identifies closed sequences of alarms with support – the proportion of observations in the data set that contain the specifically defined item set [1]. Togetherness is then used to rank the sets of closed sequences according to accepted procedures [1].

**Critical alarm analysis**

Every operator and manager in a process plant not only tries to solve critical events immediately, they try to avoid tripping events at all costs. The IAM facilitates this process by identifying those alarms that occur frequently, before or after a critical alarm (often listed for tracking purposes). Relying on alarm activation times in the historical alarm log, and forward and backward analysis over a specific timespan (usually 60 minutes), the model identifies sequences of alarms around critical alarms. Each event is associated with a level of severity that determines event criticality.

**More analysis, better functionality**

In addition to de-chattering, sequence, and critical alarm analytic models, ABB employed masking rules analysis and alarm flood analysis to provide operators with better functionality. The masking rules method is used to determine if the lifespan of an alarm is contained within that of another alarm; this suggests whether the contained alarm is redundant or not. As the name states, alarm flood analysis identifies waves of alarms that may occur following certain plant

operations: shut-down of equipment for preventive maintenance or cleaning purposes, etc. If no new alarms ensue, then these alarm floods might be “normal” and require no further action from an operator.

**Visualizing alarms to boost usability**

Following the extensive testing of the analytical models with data from the oil and gas industry, a major contributor to the development of alarm systems, ABB considered a variety of display visualizations concepts. After all, the operator should know what needs to be done and how much time is available to do it. Targeted visualizations

IAM uses an array of five analytical models to provide operators with better functionality.

reduce the operator load, enable better event predictions and improve alarm system configurations. [2]. Along the way, some well-known challenges surfaced: limited space and too much data on the screen; and color confusion. By developing concepts simultaneously to represent alarm analysis, allow for data filtering and grouping of visualizations: conventional list view →05a, sunburst diagrams →05b, and parallel

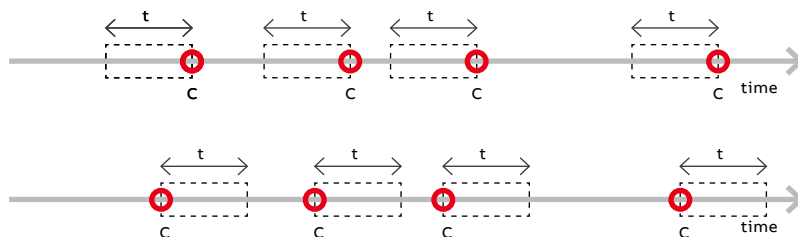

03a

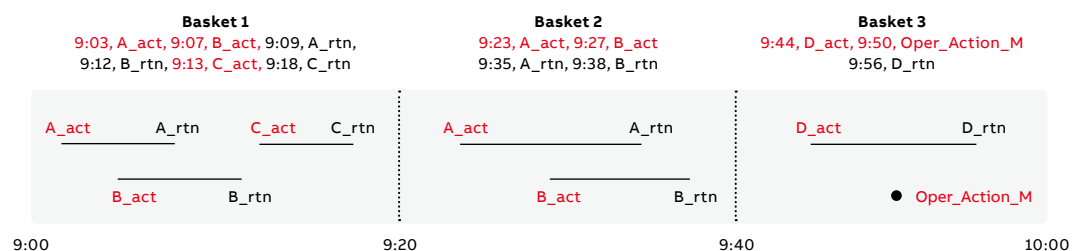

03b

Attribute No	Global module attribute (fixed)	Details with example
1	Timestamp	Timestamp when the event occurs. Can have various formats but most popular is: MM/DD/YYYY hh:mm:ss.msec AM/PM eg 7/19/2014 6:09:27.527 PM
2	Active timestamp	Timestamp linking the various alarm status such as RTN, inactive to its source when it is active
3	Priority	Priority of the alarm typically assigned by an ordinal value. Lower number reflects higher severe situation eg, 1. This attribute serves to identify if an alarm is critical.
4	Condition	An attribute indicating the associated condition of the alarm such as H, HH, L, LL etc. This attribute in conjunction with "Priority" helps to rank the severity of the alarm and also to identify the name of the alarm
5	Device	Plant device associated with alarm
6	Process area	Process area in the plant where the alarm originates
7	User	Operator viewing or operating on an alarm typically a descriptive variable indicating operator name or operator work station eg John or OL-PCD\erlst
8	Category	Event category ID, typically an ordinal value such as 666371

04

coordinates →05b; criteria such as practicality, readability, and grouping efficacy was evaluated and the best views for specific analysis types were developed [2].

**ABB’s alarm portfolio and vision**

The IAM system has been productized and is currently being incorporated into the ABB Ability™ Symphony® Plus software [3]. Basically, to perform alarm analysis, historical data is imported into the IAM as text files of various formats; data is transformed with the help of a mapping file, either created or imported, to a global alarm model (GLAM), which gives the least common multiple of historical alarm data and provides for storage →06. The software currently defines 10 different alarm aspects; however, up to 52 different individual aspects can be set depending on the needs of the customer.

The new system, ABB’s AlarmInsight® and Safety-insight™, has been designed to help achieve safe and reliable operations in the process automation industry throughout the lifecycle of a plant and covers the initial engineering phase and the subsequent operational phase.

The engineering phase relies on digitalized engineering data for tools to document hazards, define appropriate barriers, and design the “instrumented” safety and alarm system. The second, or operational phase, relies on contextualized operational data (IT/OT). This serves to

assist with monitoring alarm and safety system performance; transforming data into actionable insights to enable informed decision making.

The use of advanced alarm analysis takes the “guesswork” out of alarm rationalization. The deep-learning gained from analysis can be incorporated back into the engineering tools and used to optimize or maintain the automation and safety systems. ABB’s holistic process completes the alarm lifecycle management support.

ABB’s vision for alarm management is derived from the company’s extended involvement with, and demonstrated commitment to, standards like EEMUA 191 and ISA SP 18.2 that address the importance of a robust alarm management

—  
**ABB’s IAM approach provides process industries, like metals processing, with the potential to make predictions.**

capability in process plants, and their vast experience with power generation plants. Each alarm should alert, inform and guide; alarms should be presented at a rate that operators can deal with, detectable problems should be alarmed as early as possible, and the cost/benefit of alarm engineering should be reasonable. The Ability® Symphony™ Plus HMI, S+ Operations, implements ABB’s newest IAM technologies to make this vision a reality.

ABB’s intelligent alarm system consists of two critical yet distinguishable parts that cannot be separated: the technical optimization of the alarm system and the optimization of the human machine interface. This approach to alarm development not only leads operators to greater awareness, faster response times, and better decisions, it provides process industries with the potential for prediction. ABB’s Symphony Plus HMI, S+ Operations with IAM has abilities that are leaps-and-bounds beyond the descriptive capabilities of currently available alarm management systems. •

**Acknowledgements**

Special thanks are extended to the original IAM team members: Jinendra Gugaliya, Marcel Dix, Veronika Domova, and Mithun Acharya for their valuable contribution to the IAM project. Also, Roland Weiss and Alf Isaksson are thanked for their support as program research managers during the project.

—  
04 Table of eight critical attributes used to develop the alarm management system.

—  
05 The GUI views were chosen to enable maximal readability and usability.

05a A prototype of the UI: a list view for critical event analysis is shown on the right side while a parallel coordinates filter is displayed on the left side.

05b The sunburst visualization display includes the sunburst (right side) and the parallel coordinates filter (left side): the bigger the sunburst segment, the greater is the number of sequences that start with the alarm in question. The size of the circle segment represents the amount of alarms. The bigger the segment the more alarms of this name appear. Detailed information about the sequences that contain the hierarchy that has been selected is obtained by mouse-hovering.

—  
06 A workflow diagram for importing historical alarm data into the system for various analysis types: HRA – Hiding / Masking Rules Analysis, DC – De-Chat-tering, SF – Similar Alarm Floods, a type of sequence analysis, PCA – Parent-Child Analysis, SM – Sequence Model Analysis and CEA – Critical Alarm Analysis.



05a

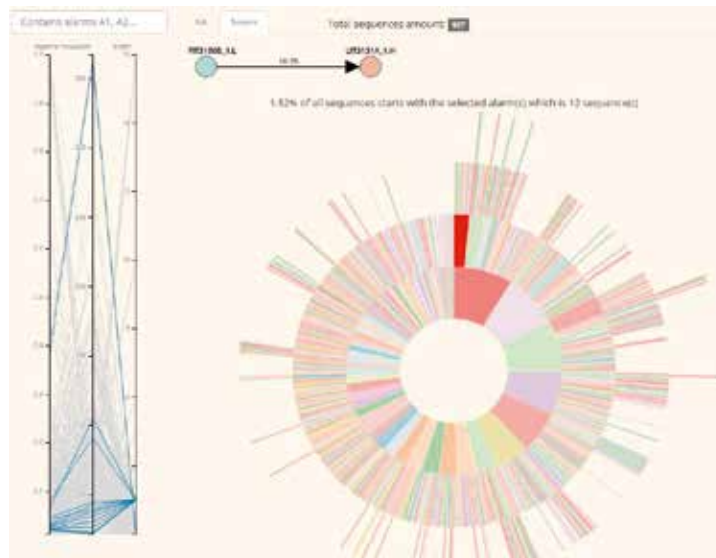

05b

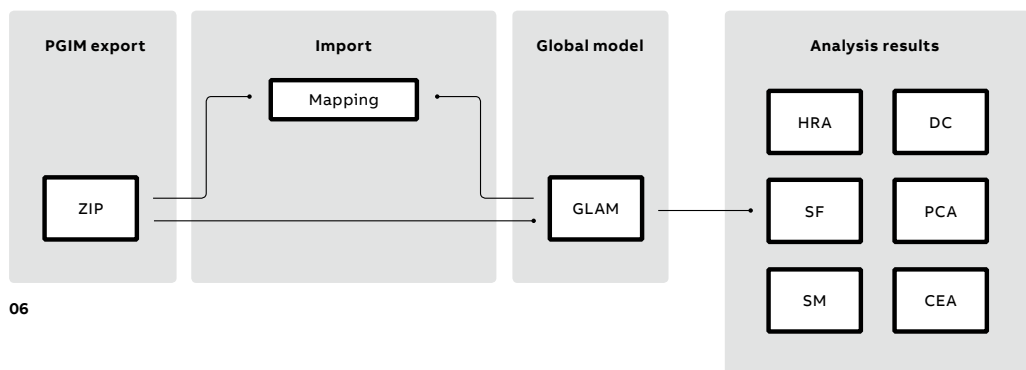

06

References

[1] A. Dagnino, "Data Mining Methods to Analyze Alarm Logs in IoT Processes", in IEEE 15th International Conference on Automation Science and Engineering, August 22-26, Vancouver, Canada, 2019, pp. 1-14.

[2] V. Domova, "Intelligent Alarms Management: Sequences analysis visualization: Guided report on implementation". ABB Internal Report, 2018, pp. 1-37.

[3] ABB Ability™ Symphony® Plus, "Intelligent Alarm Management Technical Preview 1: Release Notes in Power Generation & Water", ABB Internal Report, 2018, pp. 1-57.



---

LEVERAGING CONNECTIVITY

# A network analyzer that's boosting buildings' energy efficiency

Buildings account for 30 percent of global final energy use and 29 percent of the world's energy-related CO<sub>2</sub> emissions. But connected devices such as ABB's new M4M network analyzers are helping to reduce this impact by allowing accurate real-time energy data monitoring and enabling customers to improve building performance.



— Today's buildings are running smarter thanks to accurate, real-time energy data monitoring provided by devices such as ABB's new M4M network analyzers.

According to the UN's 2017 Environment Global Status Report, commercial and residential buildings account for 30 percent of global final energy use and 29 percent of the world's energy-related CO<sub>2</sub> emissions [1]. Daunting as these figures are, the report nevertheless notes that "building sector energy intensity (in terms of energy use per m<sup>2</sup>) continues to improve at an annual average rate of around 1.5 percent."

Indeed, today's smarter buildings, which interconnect digital energy monitoring and control devices, have attained levels of efficiency that

— **Connected devices, such as ABB's new M4M network analyzers, allow accurate real-time energy data monitoring.**

were impossible before the emergence of the Internet of Things (IoT) and scalable technology. For instance, connected devices, such as ABB's new M4M network analyzers, allow accurate

real-time energy data monitoring and enable customers to improve building performance while reducing impact on the environment.

#### **Robust real-time monitoring**

The first range of Bluetooth-equipped and ABB Ability™-native network analyzers from ABB, the M4M family, enables complete power-quality analysis and accurate energy-efficiency monitoring for commercial and industrial buildings, as well as data centers →01.

In commercial buildings, integration into ABB's scalable portfolio of energy and asset management digital solutions allows for efficient and rational use of real-time energy consumption and power monitoring, to avoid peak utility fees and penalties. In industrial buildings, M4M delivers easy monitoring and control of the power network to avoid outages, equipment damage and interruption of critical operations. User-defined alerts enhance reactivity to potential events in the electrical system, improving operations and allowing faster maintenance.

Also suitable for use in data centers, M4M network analyzers enable robust power chain and power quality monitoring, preventing damage

— **Jerzy Wąsacz**  
**Jakub Kozak**  
ABB Corporate  
Technology  
Krakow, Poland

jerzy.wasacz@pl.abb.com  
jakub.kozak@pl.abb.com

— **Alessandro Grieco**  
**Luciano Di Maio**  
**Tamara Duricic**  
ABB S.p.A.  
Vittuone, Italy

alessandro.grieco@  
it.abb.com  
luciano.di\_maio@  
it.abb.com  
tamara.duricic@  
it.abb.com



01

—

## M4M network analyzers cover everything from design and specifications to installation and commissioning.

to installed equipment and avoiding tripping or overloading, which can result in downtime. M4M network analyzers thus cover the complete customer experience, from design and specifications to installation and commissioning, as well as operations and maintenance →02.

### Family feeling

M4M analyzers are available in two versions →03, the M4M 20, which is equipped with a graphic color display and 5-button keyboard, and the M4M 30, which is outfitted with a touchscreen color display, thus easily presenting power-monitoring information from basic to complete power quality analysis as well as energy efficiency

evaluations. Thanks to the resulting family of characteristics, demands on customer learning are reduced.

These characteristics include a complete set of embedded communication protocol and I/O options for both versions in dedicated product codes, the same housing, the same installation and wiring process, and the same human machine interface (HMI), with product segmentation in terms of device access and measurement features. Both models' HMIs follow the ABB UX guidelines for intuitive interfaces, covering contents and the naming and order of menu items, thus making it easy to use any product type in the M4M range. The only difference is that the HMI is divided into 4 sections in the M4M 30, and 3 sections in the M4M 20.

### Scrolling through a world of data

Naturally, data reading is an essential part of the HMI in any measurement device because it allows users to instantaneously read out minimum, maximum and average values of



—  
 01 The M4M family enables complete power quality analysis and accurate energy efficiency monitoring of commercial and industrial buildings, as well as data centers.

—  
 02 M4M network analyzers cover the complete customer experience, from design and specifications to installation and commissioning, as well as operations and maintenance.

real-time parameters such as voltage, current, and power, as well as power quality KPIs such as total harmonic distortion (THD) and unbalances for voltage and current, all of which must comply with IEC standards.

The measurement data also includes energy values, which are either divided by tariffs for Time of Use (TOU) metering or are represented in 4 quadrants not only as energy consumption but also as local energy generation. Scrolling through and accessing needed information requires only

—  
 Thanks to a family of characteristics, including the same I/O options and HMI, demands on customer learning are reduced.

a few steps through the menu, which provides clear lists and sub-menus, with titles and subtitles →04.

The HMI's second section is called "Graphs." This enables visualization of bar graphs of the main real-time parameters and waveforms →05 by storing signal samples over 2-line cycles. Also, M4M network analyzers provide visualization of harmonics in order to identify eg if non-linear loads are affecting a power system. Voltage and current harmonics are displayed up to 15<sup>th</sup> on the HMI, while harmonics up to 40<sup>th</sup> are available via communication. Furthermore, the relationship between voltage and current is presented via phasor diagram and phasor data as numerical values →06.

The M4M 30 presents a historical view of key measurement data, which is supported by a 7 MB flash memory. This function makes it possible to





03

store average values of the main real-time measured quantities over a specific time interval, as well as three max and three min demand values, which are referred to as specific time intervals, for up to 25 user-defined channels of memory →07.

Energy snapshots and energy trends provide visualization of energy consumption curves for 20 energy parameters over a given period, respectively. Each graph contains the last 12 stored energy values.

Configuration of network analyzers is made easy and quick by a list of default values, an intuitive data entry process and by pop-ups that provide feedback to the user. Security is ensured by

—  
**Energy snapshots and trends provide visualization of consumption curves for 20 energy parameters over a given period.**

user-defined passwords designed to avoid any modification by unauthorized personnel →08. An audit log inside the meter stores the meter's configuration data and creates a timestamp every time a major modification is carried out.

Furthermore, a commissioning wizard is available to guide the user during the first basic settings

of the device such as when a network analyzer is first powered up or following a factory reset.

Notifications are available that can be divided into alarms, warnings and errors. Alarms represent threshold violations and can be stored in logs, as well as being linked to I/O. The M4M 30 can process complex alarms. This allows simple alarms to be combined into a single entity. Warnings are related to installation conditions, while errors are routed to device self-diagnostics.

#### **Data that's easy to see**

M4M HMI software uses advanced embedded graphic libraries outfitted with sophisticated graphical primitives that perfectly match the native 320 x 240 pixel (QVGA) 3.5-inch color display, thus supporting up to 65k colors. The result is excellent visibility of real time values, trends, icons and 2D graphs regardless of lighting conditions.

M4M display management is supported by an internal microcontroller unit (MCU) optimized for supporting Latin, European, Cyrillic and simplified UNICODE character sets. This gives the HMI's menus the flexibility to be displayed in local languages, including simplified Chinese characters.

#### **Fully connected power monitoring**

M4M analyzers are equipped with Modbus, BACnet/IP and Profibus DP-V0 state-of-the-art industrial protocols. These cover the main target applications for power quality analysis.

—  
03 The HMI on the M4M 20 is divided into 3 sections, whereas it is divided into 4 sections on the M4M 30.

—  
04 Accessing key data requires only a few steps.

—  
05 The HMI enables visualization of bar graphs of the main real-time parameters and waveforms.

—  
06 The relationship between voltage and current is presented via phasor diagram and phasor data as numerical values.

—  
07 The M4M 30 presents a historical view of key measurement data, which is supported by a 7MB flash memory.

—  
08 At first power-up or after a factory reset a “first commissioning wizard” is available, which guides the user through basic device settings. Security is ensured by user-defined passwords designed to avoid any modification by unauthorized personnel.

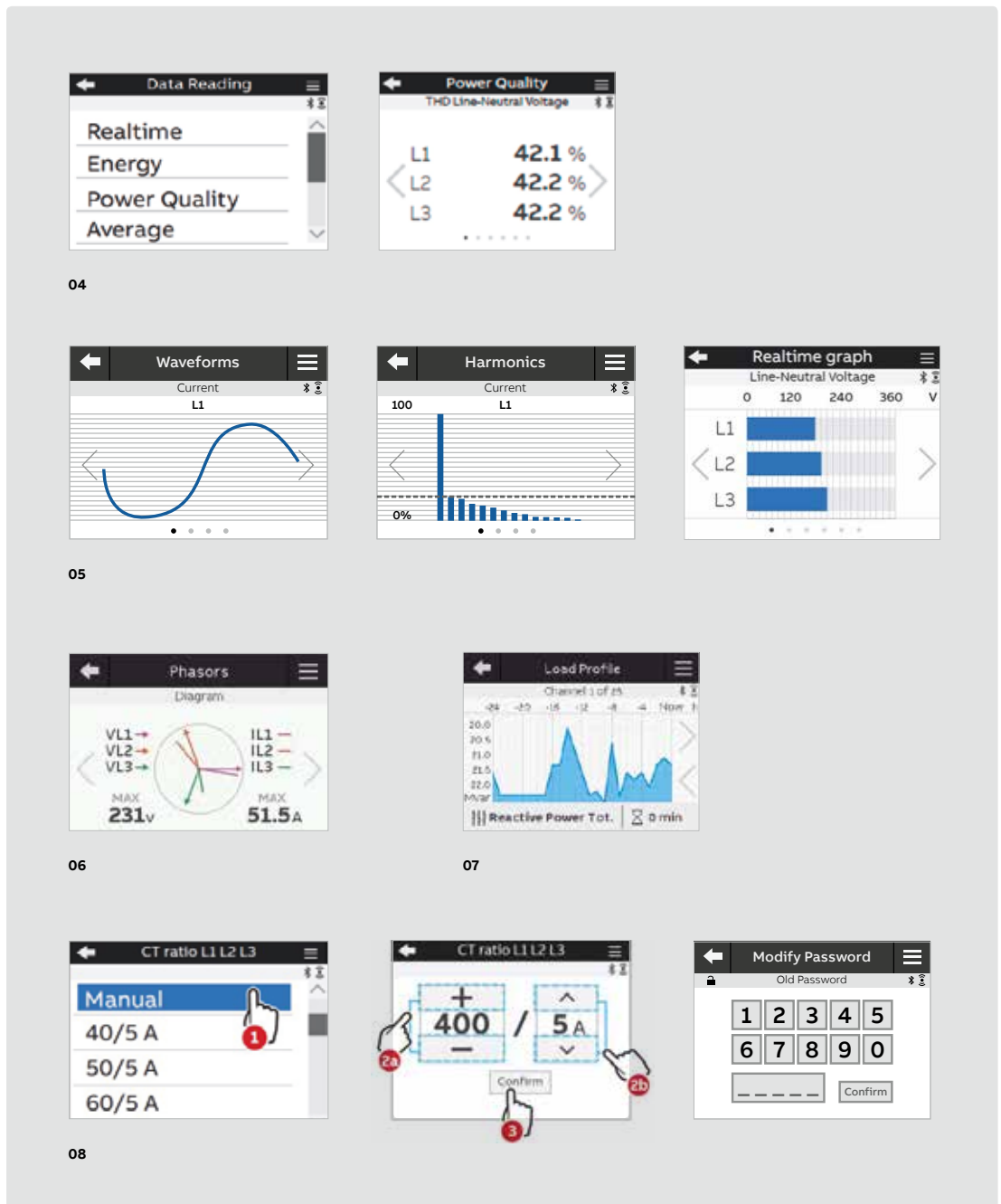

The devices' communication interface makes it possible to remotely access their data and thus integrate them into DMS, BMS, SCADA systems or cloud services.

A protocol specifically designed for building automation, BACnet guarantees the full interoperability of M4M analyzers with BACnet-compliant devices using clear and unambiguous rules to communicate among devices. This arrangement,

—  
An internal microcontroller unit (MCU) supports Latin, European, Cyrillic and simplified UNICODE character sets.

## M4M ANALYZERS IN A NUTSHELL

### Full connectivity

ABB Ability™-native and Bluetooth-equipped M4M analyzers benefit from the scalability of the ABB energy and asset management solution: from local HMI, EPiC mobile APP and Ekip Connect desktop software for stand-alone visualization and commissioning, to a complete electrical systems view via ABB Ability™ EDCS.

### Simple and intuitive

Compact dimensions, removable terminals and Rogowski coils make configuration simple and fast. Intuitive use and data access are ensured by a touchscreen color display, mobile APP and desktop software.

### Energy efficiency

M4M network analyzers ensure complete power quality analysis and highly-accurate energy efficiency monitoring of electrical parameters and advanced power quality KPIs, enabling easy data aggregation and straightforward benchmark analyses through the ABB Ability™ EDCS.

### Real-time supervision

M4M network analyzers make information accessible from any area of a system. They allow reactivity improvement in case of any event in an electrical system in order to avoid overloads, outages and uncoordinated maintenance, thanks to a comprehensive range of accurate data and interactive notifications.

which is in full compliance with BACnet Testing Laboratories (BTL), is designed to futureproof the customer's investment.

And when it comes to mastering industrial automation processes, M4M analyzers' Profibus interface is ideal, as it allows integration with multi-master real-time communication networks.

All M4M analyzers are equipped with Bluetooth Low Energy module version 4.2. Wireless communication connects M4M to the EPiC mobile app (available for IOS and Android systems). The EPiC app allows efficient commissioning of M4M when

—  
M4M analyzers' Profibus interface allows integration with multi-master real-time communication networks.

a large number of units are being installed. This allows quick configuration by replicating meter settings on multiple devices. Communication between M4M and EPiC mobile uses encryption algorithms to protect data as it is being transferred and to authenticate connected devices, while fulfilling stringent cybersecurity requirements to avoid man-in-the-middle attacks.

### Scalable services

ABB is focusing on providing complete solutions, from individual M4M analyzers all the way up to full integration in the ABB Ability™ Electrical Distribution Control System (EDCS) cloud-computing platform.

When M4M is authorized to automatically access ABB Ability™ EDCS, it recognizes installed product versions and reads out the required registers, resulting in a seamless integration process. With M4M connected to ABB Ability™ EDCS, customers are not only able to have a full view of their energy demand but can optimize it →09.

Customers have the option of remotely configuring their M4M analyzers using Ekip Connect desktop software. This makes it possible for them to update an analyzer's firmware by accessing ABB Library servers using encrypted images, which ensures that only ABB original firmware is being installed on a device.

### Hardware architecture

The M4M family of analyzers provides a range of peripherals. Different I/O options and

— 09 Key advantages of M4M analyzers.

— 10 Peripherals can be configured by using dedicated PCBAs, which enable input/output and communication functions.

communication alternatives, together with two display choices, add up to a total of 13 potential configurations – a level of flexibility that is supported by the analyzer's modular approach to hardware and software design.

Printed circuit board assemblies (PCBAs) are stacked together →10. Peripherals can be configured by using dedicated PCBAs, which enable input/output and communication functions. This

—  
**Customers are not only able to have a full view of their energy demand but can optimize it.**

makes it possible to swap digital I/O, analog out, serial communication, Ethernet communication, or Ethernet with a daisy chain.

The bottom board is responsible for power supply and measurements. It makes it possible for users to choose between regular and Rogowski coil support. The top board hosts the main microcontroller, Bluetooth, HMI support, memory, RTC, LED, and part of the analog circuit. Two variants of this PCBA make it possible to choose between a touch display and a push-button HMI.

The analyzer's main application runs on a microcontroller with ARM M4 Cortex core, which provides ideal support for its real-time operating system as it manages analogue signal processing, mathematical algorithms for power quality analysis, display and communication control.

Wireless communication is supported by a dedicated coprocessor in charge of RF communication to the host.

#### **M4M Production automation**

M4M analyzers are assembled and tested in a high-capacity automated production line that ensures seamless traceability of all components as well as of test results from the first assembly station all the way to final boxing and storage. Handling robots controlled by a central computer gently move the analyzers from one test station to another until all verifications are successfully passed.

A remarkably accurate current and voltage generator feeds the most important test stations with precise current and voltage signals, ensuring the highest signal quality during the calibration process on 100 percent of the analyzers produced. The narrow acceptance criteria ensure that only perfectly calibrated products reach ABB's customers. •

#### **References**

[1] See page 14 of: [https://www.worldgbc.org/sites/default/files/UNEP%20188\\_GABC\\_en%20%28web%29.pdf](https://www.worldgbc.org/sites/default/files/UNEP%20188_GABC_en%20%28web%29.pdf)

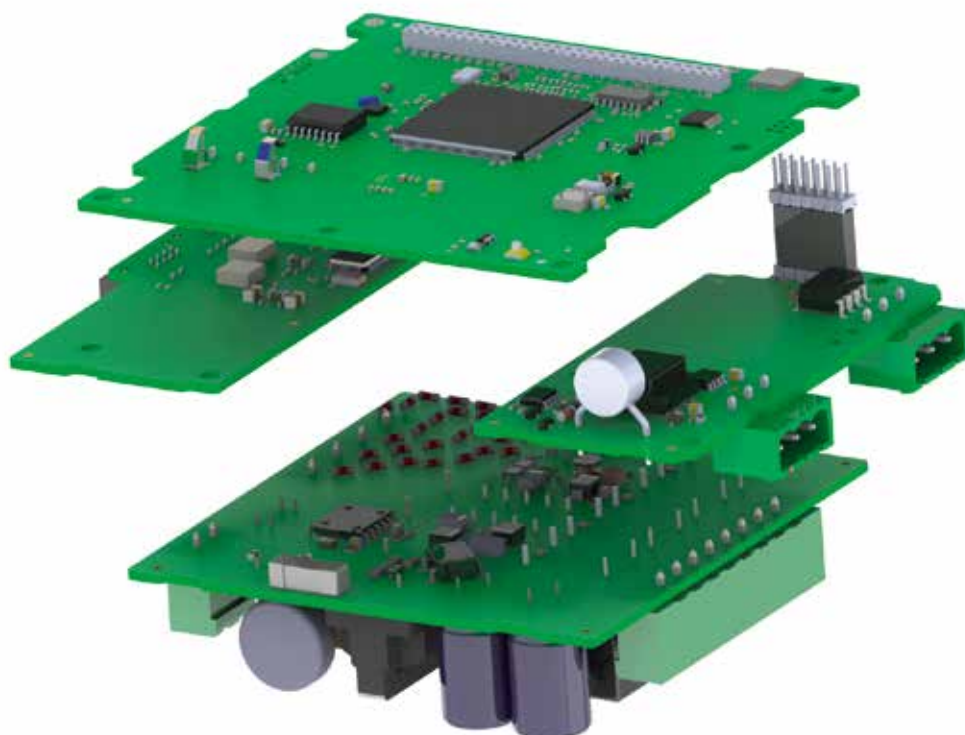



—  
01 The new ABB Ability Smart Sensor is specially designed for hazardous environments.

## LEVERAGING CONNECTIVITY

# Smart Sensor for hazardous areas

Launched in 2016, the ABB Ability™ Smart Sensor today operates in thousands of customer applications worldwide. ABB has now launched a new Smart Sensor that is suitable for hazardous environments.

—  
**Manuel Oriol**  
**Der-Yeuan Yu**  
ABB Motion, Motors and Generators  
Baden, Switzerland

manuel.oriol@ch.abb.com  
der-yeuan.yu@ch.abb.com

**Maciej Orman**  
ABB Business Services  
Sp. z o.o.  
Motion, Motors and Generators  
Krakow, Poland

maciej.orman@pl.abb.com

**Neethu Tp**  
ABB Global Industries and Services Private Limited  
Motion, Motors and Generators  
Bangalore, India

neethu.tp@in.abb.com

**Geir Svoen**  
ABB AS  
Industrial Automation, Energy Industries  
Oslo, Norway

geir.svoen@no.abb.com

**Philipp Sommer**  
**Gerd Schlottig**  
**Alexey Sokolov**  
**Ștefan Stănculescu**  
**Felix Sutton**  
ABB Corporate Research  
Baden-Dättwil, Switzerland

philipp.sommer@ch.abb.com  
gerd.schlottig@ch.abb.com  
alexey.sokolov@ch.abb.com  
stefan.stanculescu@ch.abb.com  
felix.sutton@ch.abb.com

Over the past ten years, ABB has released several integrated, intelligent sensors, such as WiMon100, the ABB Ability Smart Sensor for motors, the ABB Ability Smart Sensor for pumps and the ABB Ability Smart Sensor for mounted bearings and gearing.

Launched in 2016, the ABB Ability Smart Sensor family is now found in thousands of customer applications worldwide; however, a cost-efficient version of the product for rotating machines operating in hazardous areas was absent. To fill

survive in such environments – and be an improvement over existing ABB sensors – placed extreme design demands on the device, which would have to:

- Measure high-frequency vibrations.
- Demonstrate physical resilience against harsh and hazardous ambient conditions.
- Have a lifetime that matches that of most monitored equipment, with one – non-replaceable and non-rechargeable – battery.
- Use a flexible firmware architecture to accommodate different product needs in the future →01–02.

### Challenge 1: measuring vibration

Whereas most equivalent sensors on the market measure only vibrations and temperature, the ABB Ability Smart Sensor measures vibrations, magnetic field, temperature and acoustics. Consequently, the sensor can measure the speed of rotation of motors with a very high accuracy.

Vibration sensors are becoming commonplace in consumer electronics and industrial automation – but creating a high-quality vibration sensor is no easy task. For example, it is essential to stop

—  
ABB has designed a new generation of Smart Sensors for equipment operating in explosive atmospheres.

this gap, ABB has designed a new generation of ABB Ability Smart Sensors that can be used on equipment operating in explosive atmospheres. Ensuring the new sensor would comfortably



02

This first version of the metal plate delivered a poor performance with respect to self-resonance: Resonance forces from the body of the sensor propagated to the pressed metal base and were picked up by the vibration transducers. By using a fine-grained model of the sensor and metal

The metal plate sticks to the machine without propagating vibration from the body of the sensor to the vibration transducers.

resonances occurring anywhere in the sensor body from impacting the transducers that pick up vibrations from the machine being monitored. Many aspects make the problem more difficult to solve: positioning, mounting brackets, and method of attachment to cite a few. Doing so at the lowest possible cost is a complex tradeoff to solve.

ABB's first approach to the new sensor used a large pressed-steel plate at the bottom of the sensor to transmit the vibrations of the monitored asset in as direct a manner as possible. The sensor had two electronic boards: one glued to the metal plate (itself screwed to the asset) and another connected to the plate and that board using only a flexible cable →03.

plate, however, many alternatives were simulated, resulting in a metal plate that not only sticks completely to the machine without propagating vibration forces from the body of the sensor to the location of the vibration transducers, but also maintains cost targets →04.

**Challenge 2: building a sensor for hazardous areas**

Hazardous-area-certified sensors available on a global scale must comply with a large range of detailed requirements set out in several standards. Some essential conditions are:

- An internal short circuit in the battery shall not cause heating that can ignite gas.
- Internal hardware shall not cause heat or a spark that can ignite gas.

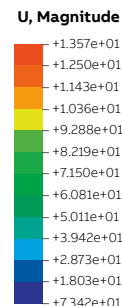
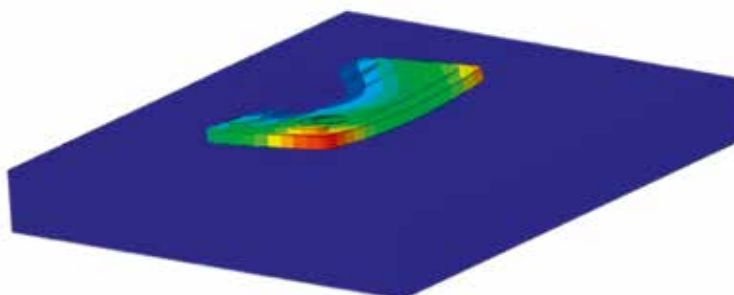

03



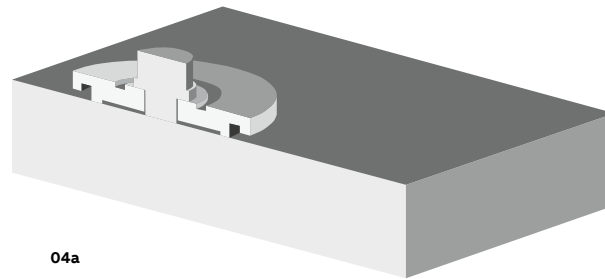

04a

—  
02 Resilience, long lifetime, a futureproof design, and an ability to cope with vibrations were some of the design demands placed on the new sensor.

—  
03 Early version of the metal plate model showing strong deformation at resonance frequency.

—  
04 3D model of the metal plate.

04a Sensor base and plate lug, oblique view.

04b Sensor base and plate lug, side view.

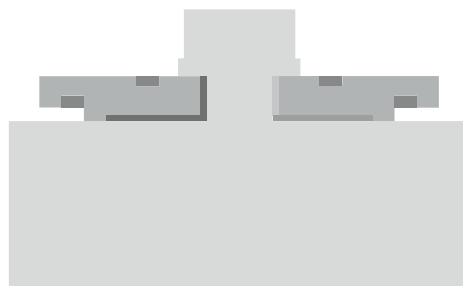

04b

- If the enclosure is compromised, and the sensor is filled with conductive material, no heating or sparks shall occur that may ignite gas.
- The sensor must sustain stresses arising from its environment.

The first condition is typically taken care of by checking the temperature that can be reached under the most extreme conditions. In the case of a battery-powered sensor, such conditions are checked by having the batteries short-circuited and the resulting temperatures remaining below the maximum limit defined by the standard,

—  
**The Smart Sensor has a battery life up to three times longer than most competing designs.**

135 °C (temperature class T4). In the design of the Smart Sensor for hazardous areas, this temperature criterion is met. Heat is also routed to the rest of the mechanical structure and absorbed by the plastics in the casing.

The last condition in the list above is to make sure that the sensor can survive even the most extreme environmental conditions. For the smart sensor, the target operating range was -40 to

+85 °C – typical for most industrial electronic components. Highly accelerated life tests (HALTs) were performed to test the sturdiness of the sensor outside of the nominal operational window – through cycles of high and low temperatures and through a combination of high vibrations and extreme temperatures. The results of the HALT tests showed that the sensor survives ranges of temperatures from -70 to 130 °C, which is well beyond the original target →05.

### Challenge 3: Building a battery-powered wireless sensor with a long lifetime

The ABB Ability Smart Sensor for hazardous areas has a battery life up to three times longer than most competing designs, and can match the lifetime of the monitored equipment. It also benefits from added range from the Bluetooth 5 protocol. The main battery cannot be replaced or recharged. Replaceable or rechargeable batteries are undesirable because:

- Replaceable batteries can increase the cost of the sensor to the point where it makes more sense to simply change the entire sensor – and get new electronic components with higher performance into the bargain.
- There is a risk that the user would compromise the hazardous area protection status by inserting the new batteries incorrectly.
- Ingress protection against dust and water could also be compromised if the batteries are not replaced correctly.



05a



05b

The combined goal of designing an embedded system with a design life of up to 15 years as well as providing a reliable indication of remaining battery life is difficult, for at least three reasons:

- To limit battery internal leakage current, the temperature experienced by the battery must be moderate.
- To prevent the soldered pads from breaking, vibration forces from the battery and the sensor must not propagate to the interface between the two.
- The sensor's power consumption must be kept low, even with a large battery installed.

In the new smart sensor, the battery and its soldered pads are enclosed in a battery holder that is separated from the primary heat sources by an air gap, which protects it from the heat coming from the monitored asset →06.

To evaluate the temperature-dependent leakage current of the battery, the sensor measures battery temperature during operation and estimates the corresponding leakage current based on a proven battery model.

In a further battery charge measurement tactic, the firmware uses a points system to calculate the charge consumed by normal sensor operations. Most of the time, the sensor is in a deep sleep and consumes very little power, but when the sensor wakes up, its power consumption

—  
The actual battery usage is captured rather than relying on a predefined battery lifetime and assumed power consumption.

ramps up. The sensor records how much time each battery-consuming operation takes – for example, the duration of a Bluetooth chip activity. From the durations and power curves of the operations, the consumed charge is calculated and subtracted from initial battery capacity. Based on a rolling average value of the consumption, remaining lifetime is estimated and published. This approach captures actual battery usage rather than relying on a predefined battery lifetime and assumed power consumption levels, which are often inaccurate.

—  
05 HALT testbed.

05a Temperature cycling.

05b Detail of the sensor under test mounted to its plate.

—  
06 Battery holder inside the sensor.

#### Challenge 4: Futureproof firmware and software

The new Smart Sensor firmware and software have two major goals: to support the creation of different types of sensors in the future and to allow a deployed sensor to be reconfigured for monitoring various asset types. As an example of the latter goal, a new sensor could be reconfigured on-the-fly to be used either as a motor sensor or a pump sensor – or for any other asset type, characterized by selecting predefined or custom-made machine profiles. The sensor's firmware can be adapted easily to new requirements due to a flexible software architecture that decouples individual components from the hardware/operating system platform. These components communicate using a publish-subscribe middleware. Overall, the firmware is organized as a software product line, making it futureproof and thus suitable for the creation of new sensor variants based on the same underlying platform.

Testing of these multiple configurations and advanced features requires automatic testing, which must be tracked and managed. For this purpose, ABB has commissioned a continuous integration testing suite that ensures data

gathering works as expected, any bugs introduced by reconfigurations or firmware changes are caught, algorithm upgrades are rigorously tested, and the firmware meets the requirements regarding low power consumption.

Based on increasing awareness of data protection, ABB has also been developing comprehensive cybersecurity features to satisfy customer requirements. These include secure key exchange for Bluetooth communication with out-of-band pairing, Bluetooth encryption, user authentication, role-based access control, and secure firmware update.

#### Smart for the future

The new smart sensor is a technological success that measures vibrations with an accuracy higher than that of all previous smart sensors. Hazardous-area certification (ATEX and IECEx: Zone 0, Zone 20, Class I Division I and Class 2 Division I) for this extremely sturdy sensor has been granted. Also, the sensor has benefitted from a

—  
The new smart sensor measures vibrations with an accuracy higher than that of all previous smart sensors.

design effort that introduces some features that significantly improve the operator's experience: easy-to-use sensor commissioning through NFC (near-field communication) activation, improved antenna design for optimal wireless communication, and extended battery lifetime.

In summary, the latest sensor offers comprehensive cybersecurity features, flexible firmware platform, optimized performance, and real-world control and evaluation of power consumption. These enhancements bring even more value to customers and make the new ABB Ability Smart Sensor for hazardous environments the de facto standard for condition monitoring of rotating equipment. •

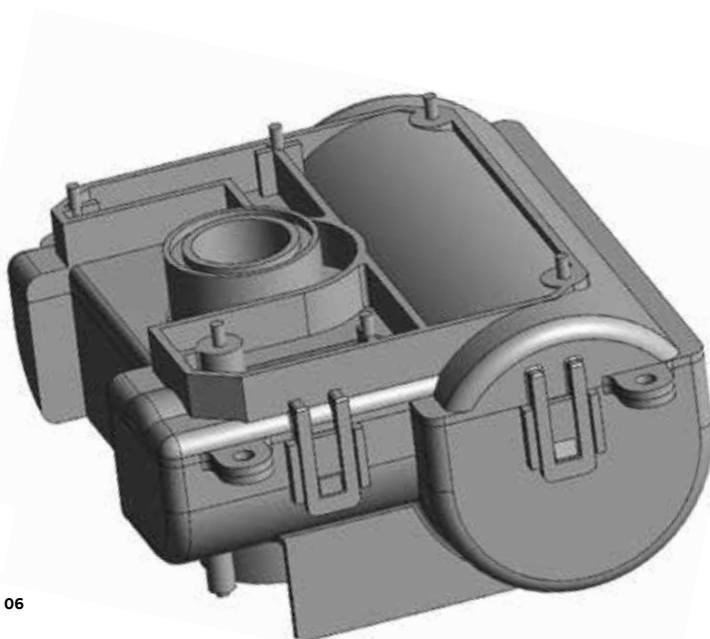

06

LEVERAGING CONNECTIVITY

# Prestigious award for network researcher



The prestigious ABB Research Award in Honor of Hubertus von Grünberg is bestowed only every third year and distinguishes external researchers. The latest laureate, Ambuj Varshney, is being recognized for ongoing research into making networked embedded systems more sustainable and data-gathering in industry easier.



**Reiner Schoenrock**  
ABB Corporate  
Communications  
Zürich, Switzerland

reiner.schoenrock@  
ch.abb.com

The ABB Research Award in Honor of Hubertus von Grünberg, named after the former Chairman of the Board of Directors of ABB, is selected by a prominent jury from among more than 60 submissions. Granting \$300,000 to support ongoing research over a three year period, the award is one of the world's highest endowed research prizes to be offered by a company.

The award has been bestowed on 33 year-old Ambuj Varshney. Varshney received his PhD in Computer Science in May 2018 from Uppsala University, Sweden. He was recognized at a ceremony in Dättwil, Switzerland, for his research on designing sustainable Networked Embedded Systems (NES).

—  
Varshney has demonstrated how to communicate over distances of up to a few kilometers while consuming only tens of microwatts.

The jury praised Varshney's innovative approach, identifying interconnected challenges that affect the sustainability of NES systems, such as co-existence on the shared wireless spectrum, energy consumption and the cost of the deployment and maintenance.



01

—  
01 Ambuj Varshney was awarded the prestigious ABB Research Award at a ceremony in ABB's research center at Dättwil, Switzerland.

In one of his major research projects, Varshney developed an ultra-low power and long-range communication system (LoRea) for battery-free sensors that harvest small amounts of energy from the ambient environment. He has demonstrated their ability to communicate over distances of up to a few kilometers while consuming only tens of microwatts. His research could lead to the deployment of battery-free and sustainable NES technology. He intends to further pursue this approach in his submitted – and now award-winning – postgraduate research project “Towards Future Factories: Enabling Sustainable Sensing”.

The past years have seen a rapid growth in NES applications. As the number of connected devices on the Internet of Things (IoT) grows relentlessly, sustaining their large-scale deployment is a critical challenge. In the jury's opinion, Varshney's approach is suitable for supporting NES in a sustainable manner for long periods without negatively impacting their physical or the radio environment. Varshney's research can lay the groundwork for collecting

large amounts of evaluable data in industries of all kinds paving the way for advanced data analytics.

#### The award

The ABB Research Award in Honor of Hubertus von Grünberg, which is presented every three years, honors the best PhD. dissertation leading to a research proposal in the fields of electrical, mechanical or software engineering, electronics, robotics, artificial intelligence, process automation, and any related technical discipline, as applied in utilities, industries, and transport and infrastructure<sup>1</sup>.

The jury paid special attention to specific real-world applications and potential for innovation in addition to the benefit of the research to society and the environment.

The research award is dedicated in honor of the achievements of Hubertus von Grünberg, who served as ABB Chairman from 2007 to April 2015. Von Grünberg, a theoretical physicist who wrote his doctoral dissertation in 1970 on Albert Einstein's

—  
**Varshney's research can pave the way for advanced data analytics in industries of all kinds.**

theory of relativity, was instrumental in setting ABB on a path to sustainable growth. It is his legacy that supporting research, both at universities and within the company, has become a strategic imperative for ABB. Investing some \$1.3 billion per year in R&D and operating numerous research centers around the world makes ABB one of the most innovative companies worldwide in driving the digital transformation of industries.

The prize decision was made by a renowned international jury consisting of Dr. Hubertus von Grünberg, Prof. Nina Thornhill (Imperial College London), Prof. M. Granger Morgan (Carnegie Mellon University Pittsburgh), Prof. Roland Siegwart (ETH Zurich), Prof. C.L. Philip Chen (University of Macau, Taipa, Macau) and Bazmi Husain, Chief Technology Officer of ABB. •

#### Footnote

1) Schoenrock R., “\$300,000 research award, ABB creates an award to honor and support outstanding postdoctoral research,” ABB Review 3/2015, pp. 60–61.



# Connecting power



**It is intriguing to equate units of energy to data that are collected, stored, distributed, and used in numerous ways. It unleashes flexibility and productivity within individual devices, between them, and across entire plants and grids – making them more successful and sustainable.**

- 32 Zenith automatic transfer switch
- 36 Universal motor controller software for fast and easy setup
- 40 ABB's ACS6000 Power Electronics Grid Simulator, PEGS, tests medium voltage equipment





---

CONNECTING POWER

# Zenith automatic transfer switch

The Zenith automatic transfer switch (ATS) combines the best of ATS technology from ABB and GE to deliver a device with all necessary sensors, controllers, switches and operator interfaces in a single, easy-to-use package that helps improve power protection capabilities.



**William T. Lindstrom**  
ABB Electrification,  
Smart Power  
Mephis, TN,  
United States  
william.t.lindstrom@  
us.abb.com

In mid 2018, ABB acquired GE Industrial Solutions, GE's global electrification solutions business. Since then, ABB has been busy integrating GE products into the ABB solution palette. One such integration combines GE's Zenith ZTX and ZTG ATS series with ABB's breakthrough TruONE™ technology to deliver an ATS that has improved system reliability, connectivity and ease of use. The new ATS series covers the ranges 30 to 1,200 A and 200 to 480 VAC.

#### **ABB's TruONE ATS technology**

When a backup generator is utilized as an alternate source in a critical application – such as a data center, a health facility or transport infrastructure – an ATS starts the generator and switches the load over upon mains failure (and back to the mains supply when it returns).

For panel builders, installing a traditional ATS can be a complex task involving various sensors, controllers, switches and operator interfaces that

all have to be configured and wired up. ABB's TruONE ATS technology removes all this complexity as it requires just a single wire to be connected and uses standard enclosures.

---

**ABB's TruONE ATS technology reduces complexity. It requires just a single wire to be connected and uses standard enclosures.**

TruONE is the first solution to package all the necessary sensors, controllers, switches and operator interfaces into a single, easy-to-install device that helps improve protection and makes installation simpler, more reliable and 80 percent faster →01–02. A modular design reduces downtime and service costs.



— Title picture: ABB is introducing the next ATS generation by leveraging the best of ABB and GE Industrial Solutions technologies to increase system reliability, connectivity and ease of use.

— 01 The ABB TruONE, the engine that now drives the Zenith ATS.

— 02 TruONE's architectural simplicity.

02a Traditional ATS installation approaches involve time-consuming and error-prone manual configuration.

02b TruONE has most of the ATS functionality needed in one package, this simplifying and speeding installation and increasing reliability.

**The Zenith ZTG and ZTX series**

The Zenith ZTG and ZTX ATSs combine ABB's TruONE with GE's time-tested Zenith ATS family, which is renowned for its reliability and performance. The Zenith ATS thus incorporates both

**The Zenith ATS incorporates both the switch and the controller in one seamless, self-contained unit.**

the switch and the controller in one seamless, self-contained unit within an enclosure →03–04. This reduces the number of wires and connections, provides up to 25 percent more space for wire bending in the enclosure and minimizes the potential for connection failures. The design also incorporates smart modular components that help reduce downtime and service costs by



01

allowing controller and operating mechanism replacement in under 10 minutes.

The Zenith devices set new industry safety standards as the detachable human-machine interface (HMI) is completely electrically isolated – so

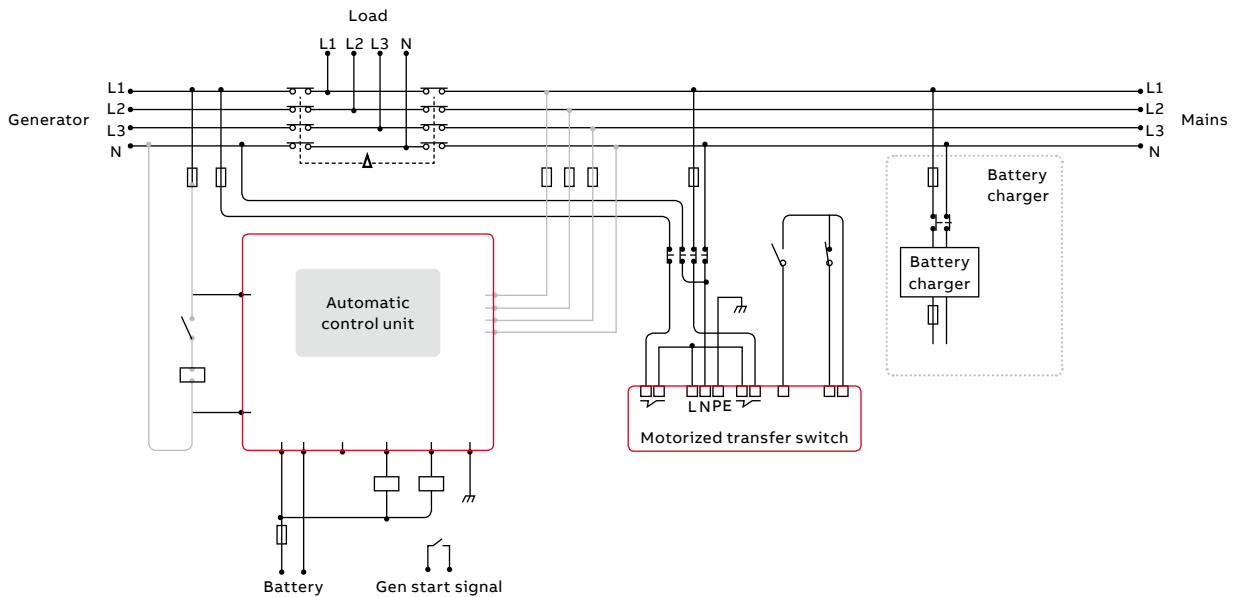

02a

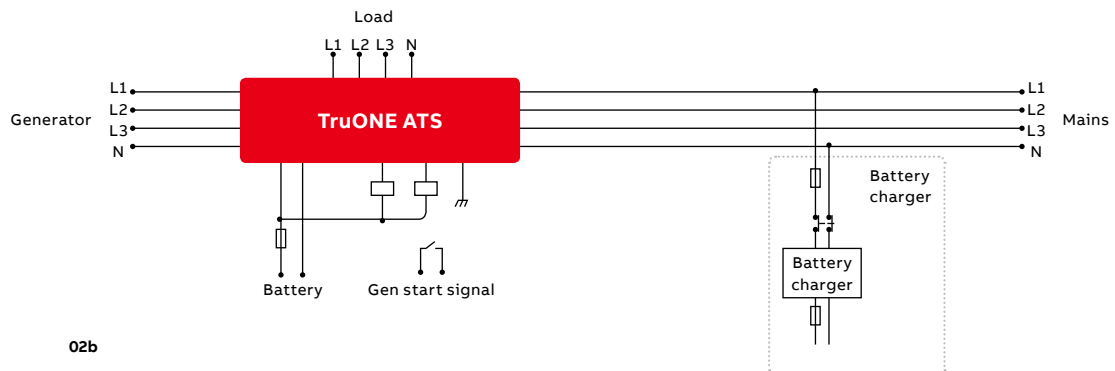

02b

potentially dangerous line voltages no longer need to be connected to the door →05. Further, IEC and UL test requirements are all met and/or surpassed by the Zenith.

The LCD HMI on the Zenith is password protected and allows access to features ranging from programmable set-points, time delays, digital I/O and access to switch status, event, and diagnostics information. For all models, ABB's

One of the key ATS inventions is the way it self-powers via the mains connections without the need for any external voltage transformers.

proprietary Ekip Connect computer software is an alternative to the HMI that enables remote as well as local programming. With this tool, ATS settings can be imported, exported, or modified via the USB port located on the HMI with no need to apply power to the unit. If multiple ATSs are on a network, Ekip Connect can be used to access all

of the controllers, making commissioning and data access easy.

One of the key inventions in the ATS design is the way it self-powers all the required functionalities via the mains connections (200 to 480 VAC, ±20 percent) without the need for any external voltage transformers.

Zenith ATS solutions are designed to last up to 6,000 cycles, which equates to 50 years of reliable operation, based on 10 transfers per month. All critical modules are customer-replaceable to simplify service and significantly reduce downtime and service costs.

The new device features a host of other design and engineering advances, including an ingenious contact construction that uses new materials and geometries to make load transfer more reliable.

**Snap-on accessories for flexibility**

Snap-on accessories – such as additional I/O, communication modules and terminal shrouds – can be added to the Zenith at any stage. These accessories lie within the device's footprint and, as the name suggests, require no mounting tools.

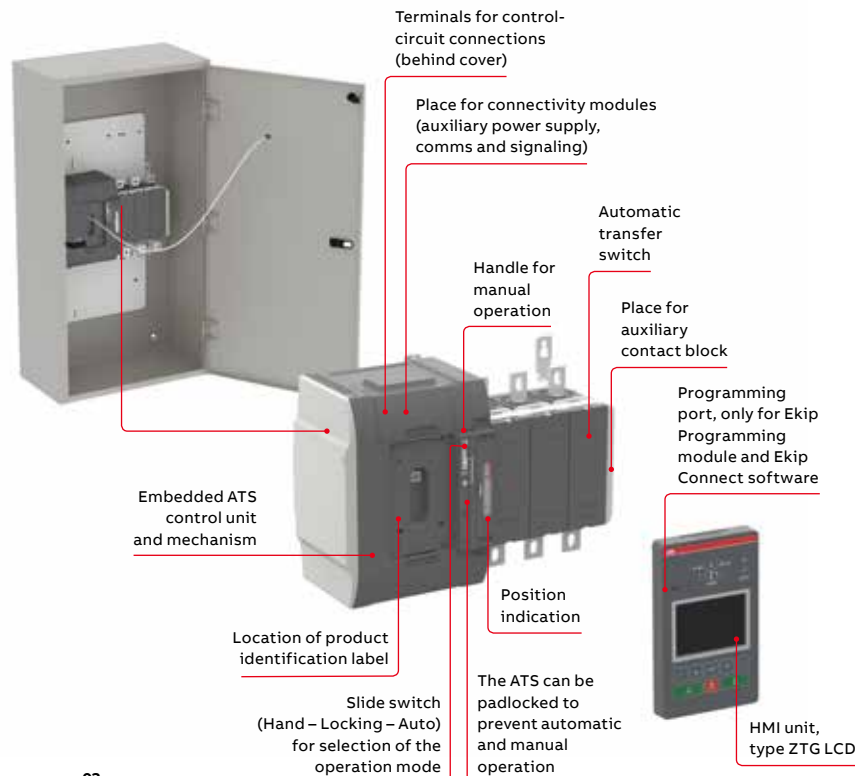



04

03 The Zenith ATS.

04 The ZTX and ZTG series ATS family. The Zenith ZTG series is intended for general-purpose commercial and industrial use, whereas the ZTX is aimed at residential and light commercial applications.

05 The Zenith HMI.

05a The HMI is plugged in via an Ethernet cable. This means the HMI is easy to replace, and in extreme circumstances, the ATS is fully capable of operating without an HMI.

05b The HMI is attached to the door exterior by two screws, with the HMI connector showing through and secured with a nut. An RJ45 cable connects the HMI to the TruONE unit.

Also, where auxiliary (position indication) mechanical contacts are needed in addition to the digital I/Os that are included as standard, they can also be simply snapped on without tools at any stage of the ATS solution creation. The same applies to the addition of different communication protocols (up to seven, see below), additional I/Os or a 24 V DC HMI auxiliary voltage supply.

#### Making the connection

An optimized interface makes advanced control, connectivity, and energy management much easier. With embedded connectivity, an auto-configure function and a range of programming options, setting-up with the Zenith ZTX and ZTG series takes a matter of minutes, as opposed to the potential hours of frustration that can occur with traditional ATSs. With no wiring, calibration, or troubleshooting work required, the new ZTX and ZTG are a big step forward in terms of expanding features and flexibility combined while improving ease of use.

With seven communications protocols providing all-round connectivity, the Zenith ATSs are part of the ABB Ability™ portfolio of solutions that boost customer productivity. Zenith has built-in condition monitoring and predictive maintenance functionality that ensures the device is available when it is needed.

To make system integration even easier, some Zenith models have the same user interface and software environment as the ABB Emax 2 smart air circuit breaker. Emax 2 enables a direct

communication to the ABB's energy management cloud-computing platform, ABB Ability Electrical Distribution Control System. Linking the Zenith ATS and ABB Ability Electrical Distribution Control

The Zenith is ideal for retrofitting old ATS equipment.

System makes the ATS compatible with other ABB devices. Using a laptop with Ekip Connect Software, the Zenith ZTG can even be configured onsite before installation – without the need for an external power supply.

The Zenith is ideal for retrofitting old ATS equipment. The compact, lightweight (some 30 percent lighter than equivalent ATSs), and self-contained design along with the need for a maximum of only one control wire connection – ie, the Ethernet cable from the switch to the HMI should door-mounting be needed – makes replacement simple and quick.

As the power landscape continues its rapid evolution, the requirement for, and demands on, ATS equipment will continue to increase. ABB's Zenith ZTX and ZTG will enable ATS operators to speed and simplify installation, improve reliability, lower costs, and improve power protection capabilities. •



05a



05b

#### References

[1] R. Peltari, "The power-of-one true ATS," ABB Review 2/2018, pp. 90–93.

CONNECTING POWER

# Universal motor controller software for fast and easy setup

Many industrial electric motors are managed by intelligent controllers – such as ABB’s UMC100.3 – that combine motor protection and control, communication, and fault diagnosis. ABB’s Field Device Integration-based universal motor controller software makes the configuration of the UMC100.3 fast and easy.



**Helmut Schönfelder**  
ABB Stotz-Kontakt  
Heidelberg, Germany

helmut.schoenfelder@  
de.abb.com

Electric motors and their associated loads are ubiquitous across industry and, as automation takes hold, their numbers are constantly increasing. Many of these motors drive critical processes where a shutdown simply cannot be tolerated – in oil and gas, mining, paper industry, for instance, where safety or reliable production may require a line restart. In other, less-critical applications, motor trouble is, at least, a major inconvenience that can cause lost production and incur costs.

## The Universal Motor Controller UMC100.3

To ensure the smooth running of industrial processes, it is recognized best practice to use a motor management system, such as ABB’s Universal Motor Controller UMC100.3 [1].



01

The UMC100.3 is an intelligent data hub that caters for all motor protection and control, communication, and fault diagnosis needs.

The UMC100.3 is an intelligent data hub that caters for all motor protection and control, communication, and fault diagnosis needs →01. The UMC100.3 is compatible with more communication protocols than other similar products: Fieldbus interfaces are available for Profibus DP, DeviceNet, and Modbus RTU; Ethernet interfaces are available for EtherNet/IP™, Modbus TCP, and Profinet IO.

ABB’s communication modules can be mounted either directly onto the UMC100.3 or separately in the cable compartment of a motor control center (MCC). This unique solution makes the communication wiring much simpler and robust against disturbances, specifically in MCCs with withdrawable modules. The solution significantly reduces complexity in Ethernet-based network wiring.

Further, the UMC100.3’s serial communication reduces wiring and installation effort and provides much more data than equivalent devices do.



02

— 01 ABB's Universal Motor Controller UMC100.3.

— 02 ABB's Universal Motor Controller UMC100.3 is used in a host of industries – such as the oil and gas application shown here – to provide motor protection and control, fieldbus and Ethernet communication, and fault diagnosis.

— 03 The UMC100.3's human-machine interface.

This enhanced access to data enables a sophisticated predictive maintenance approach that improves the reliability of the motor and, thus, process uptime →02.

To increase functionality, expansion modules can easily be added to the UMC100.3. These modules provide analog temperature inputs, additional digital I/O, and voltage modules for determining

— **Enhanced access to data enables a sophisticated predictive maintenance approach that improves motor reliability.**

phase voltages, power factor, active power, apparent power, energy, and total harmonic distortion →03–04.

ABB's new configuration software for the UMC100.3 now makes it even easier to set up and parametrize the device.

**ABB Ability™ FIM UMC Edition configuration software**

In process industry automation systems, field devices from many different vendors have to work together. Historically, combining these

different devices was troublesome, which led to an effort for open and standardized device integration. Over the past few years, the Field Device Integration (FDI) organization has specified a standard architecture for device integration that is based on IEC 61804, combining the advantages of EDDL, and FDT/DTM technology [2,3].

It is on FDI that the new ABB Ability FIM UMC Edition software is based. FIM UMC Edition software provides all the functionalities needed



03

for effective use of the UMC100.3. For instance, the FIM UMC Edition’s device parametrization, operating, and monitoring modes allow fast and easy configuration, testing, and online diagnosis →05a–d. All relevant UMC100.3 data – such as status, current, and voltage – can be monitored easily. Comprehensive diagnosis of faults and

warnings is included out of the box and this capability makes the UMC100.3/FIM UMC Edition combination an ideal platform for predictive applications, which can be implemented with the minimum of fuss. Further, project management features are included for the handling of larger

—  
Users have a unique solution that makes motor control flexible, easy, and quick to test, commission, and run.

and more complex installations. The localization feature allows for multilingual use (currently eight languages) and the software is easy to install, use, and maintain on Windows tablets, laptops, or PCs.

ABB’s UMC100.3 intelligent motor controller, when combined with the FIM UMC Edition configuration software, lets users configure, test, and run motors. Every relevant device parameter can be viewed.

**Configuring for maximum reliability**

As the tasks required of motors become more sophisticated and the number of motors in automation applications increases, more will be asked of the controllers that run them →06. When ABB’s UMC100.3 intelligent motor controller is combined with the FIM UMC Edition configuration software, users have a unique solution that makes motor control flexible, easy, and quick to test, commission, and run. Coupled with its advanced fault diagnosis, these characteristics of FIM UMC Edition will help customers ensure their process or production line works with maximum reliability. •

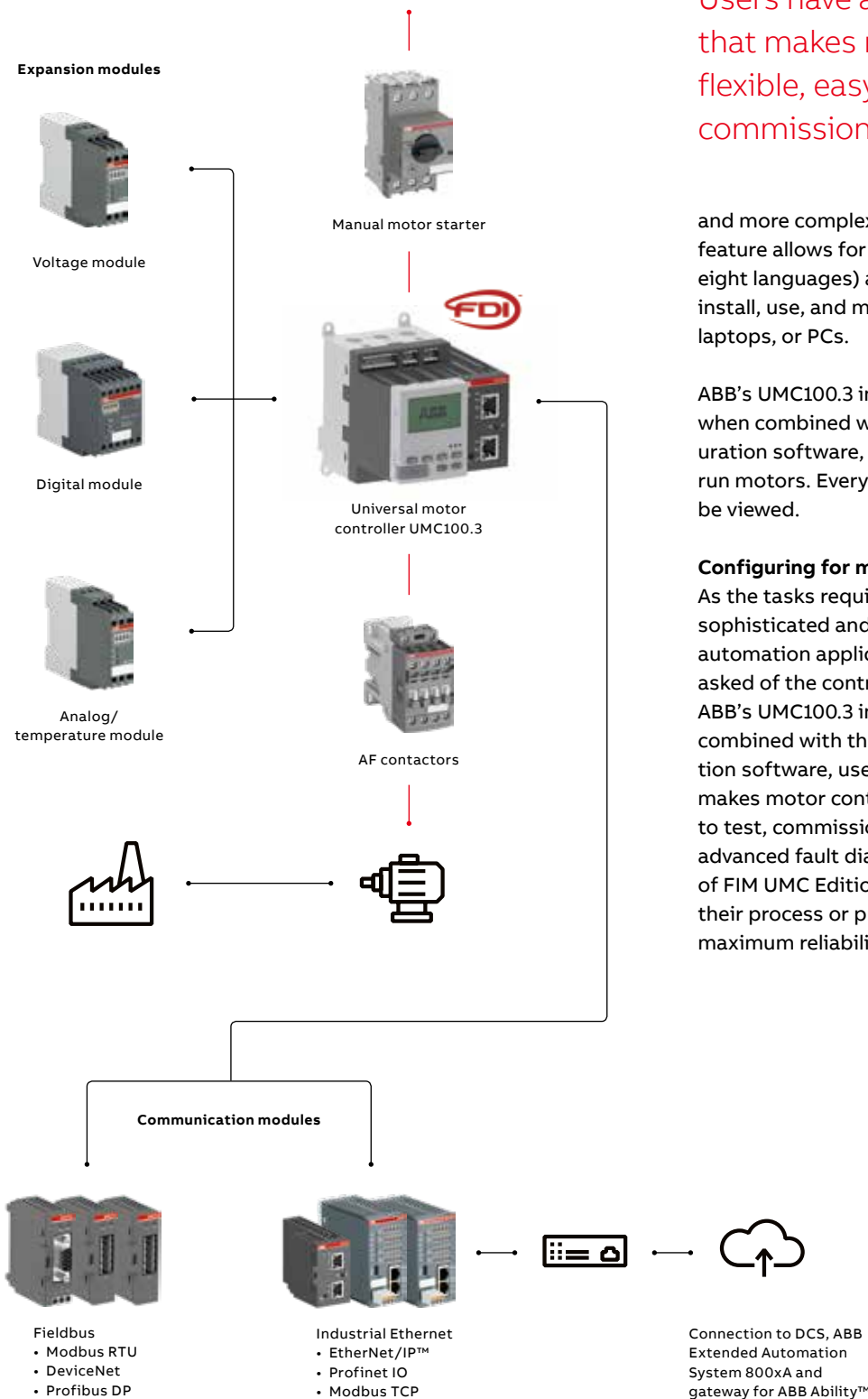

—  
04 Example setup of the ABB Universal Motor Controller UMC100.3 and some expansion modules.



05a

—  
05 The FIM UMC Edition's device parametrization, operating, and monitoring modes allow fast and easy configuration, testing, and online diagnosis.

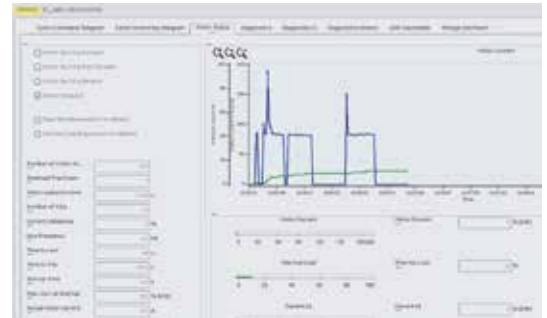

05b

05a Parametrize menu. A variety of menus to configure functions relevant to motor management, protection, etc., can be accessed.

05b Diagnostic menu. All relevant motor information is shown.

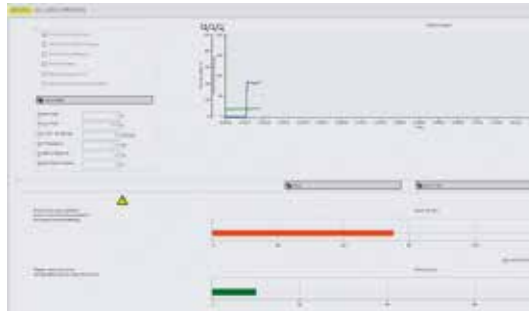

05c

05c Operate menu showing the most important motor data. Configurable motor start/stop and fault reset is possible from a PC for testing during commissioning.

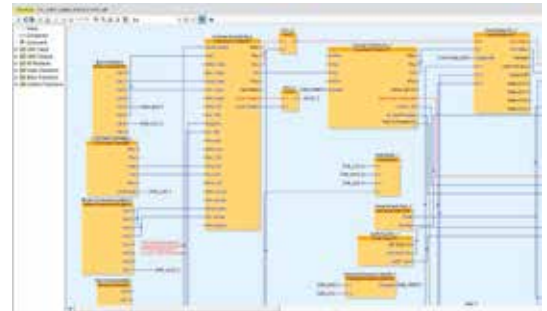

05d

05d In the Custom Application Editor of the FIM UMC Edition software, starter templates can be imported (here, a direct-on-line starter) and modified. The modified logic can be downloaded and tested in an online mode.

—  
06 ABB's UMC100.3 intelligent motor controller combined with the FIM UMC Edition UMC100.3 configuration software simplifies the task of setting up and running complex electric motor configurations. Enterprises like this copper mine at Collahuasi, Chile can employ large numbers of motors over a wide area and high motor reliability is essential if production is not to be interrupted.



06

## References

[1] P. Müller et al., "Intelligent motor control: The UMC100 is an excellent example of a flexible, modular and scalable motor controller," ABB Review 4/2010, pp. 27–31.

[2] International Electrotechnical Commission, "IEC 61804-2:2018 Function blocks (FB) for process control and electronic device description language (EDDL) – Part 2: Specification of FB concept."

[3] A. Gogolev "OPC UA and TSN: enabling Industry 4.0 for end devices," ABB Review, 1/2020, pp. 30–35.

## CONNECTING POWER

# ABB's ACS6000 Power Electronics Grid Simulator, PEGS, tests medium voltage equipment

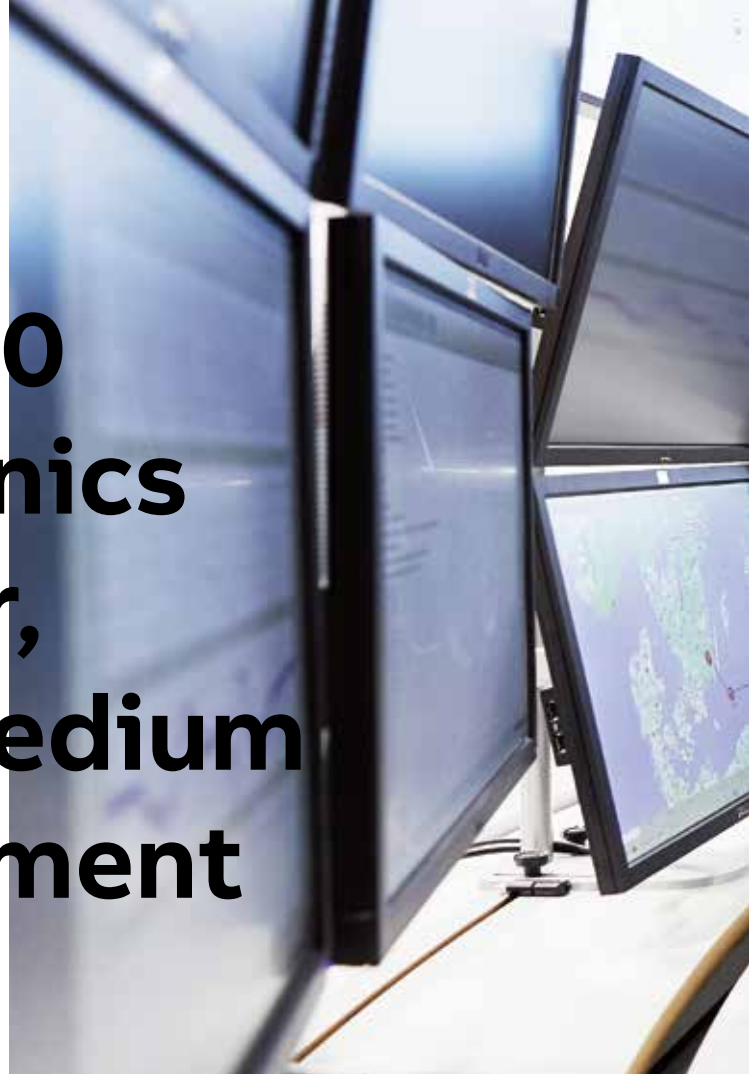

**Milosz Miskiewicz**  
**Glib Chekavskyy**  
**Piotr Sobanski**  
**Grzegorz Bujak**  
**Marcin Szlosek**  
ABB Corporate  
Research Center  
Kraków, Poland

milosz.miskiewicz@  
pl.abb.com  
glib.chekavskyy@  
pl.abb.com  
grzegorz.bujak@  
pl.abb.com  
piotr.sobanski@  
pl.abb.com  
marcin.szlosek@  
pl.abb.com

**Nikolaos Oikonomou**  
**Marc Halbeis**  
**Kai Pietilainen**  
**John Eckerle**  
**Jess Galang**  
**Wim van der Merwe**  
ABB System Drives  
Turgi, Switzerland

nikolaos.oikonomou@  
ch.abb.com  
marc.halbeis@  
ch.abb.com  
kai.pietilainen@  
ch.abb.com  
john.eckerle@  
ch.abb.com  
jess.galang@ch.abb.com  
wim.van-der-merwe@  
ch.abb.com

**Vahan Gevorgian**  
NREL  
Golden, CO,  
United States

**Torben Jersch**  
IWES  
Bremerhaven, Germany

Testing and research facilities can now depend on PEGS to emulate both healthy and faulty operating modes of medium voltage (MV) power grids; end-customers can with certainty test their devices for grid code compliance.

As the electric power sector transforms, an expanding wave of both variable and distributed energy resources are added to electric grids. Renewable energy resources are highly desirable as they reduce carbon emissions from the power source and yet the integration of these resources into the grid can be challenging for grid operators. To meet the swell of demands, today's electric grids are increasingly complex; they must accommodate the continuous growth in their power capacity and the ever-increasing variety of installed equipment while maintaining safe and reliable operation.

To ensure the reliable and stable operation of all grid components, governments have established well-defined regulations that are specified in grid codes. Regulatory compliance is not easy to

Penetration of renewable energy sources in the modern power grid necessitate new measures to assure total grid stability.

attain, however, as power generation and load must remain in balance without compromising power quality – an arduous task.

The penetration of new energy sources without mechanical-electrical inertia in the modern power grid necessitate new measures to assure total grid stability. This need has given rise to exacting directives that define the accepted behavior of





— 01 PEGS specification features. PowerLink is an ABB proprietary communication interface.

the power source under abnormal grid events, eg, changes in voltage, frequency variations, or fault conditions like short circuit events.

These grid code requirements must be fulfilled by every energy generation plant, including variable energy resources such as photovoltaic systems and Wind Power Plants (WPP), thereby adding complexity to compliance. Due to the existence of a variety of structures in the power network

— PEGS has been introduced to the power grid market for use at testing and research facilities to support certification.

and generation mix available, the applicable grid code varies significantly from country to country and can even vary from one utility to another. Before a renewable power source, eg, wind turbine, can be connected to the public power grid it must be certified by a specific applicable and possibly local grid code – a costly and protracted process

Parameter	Value
Nominal grid voltage	up to 46 kV ph2ph
Maximum continuous power	up to 20 MVA
Frequency of emulated grid	0 – 400 Hz
Voltage operational range	0 – 120 percent
Total control response time (w/o communication delay)	<250 $\mu$ s
Supported communication interfaces to overriding control (sampling time)	EtherCAT (mandatory) (1 ms) analogue (25 $\mu$ s), PowerLink (25 $\mu$ s)

01

that requires complex, exacting testing procedures to be performed. In light of this, ABB has introduced PEGS to the power grid market for use at testing and research facilities. This system emulates both healthy and faulty operating modes of MV power grids: end-customers can use PEGS at testing facilities to validate grid code compliance of their tested devices →01.

#### The need for power

In addition to fulfilling grid code compliance certification, tests need to be both repeatable

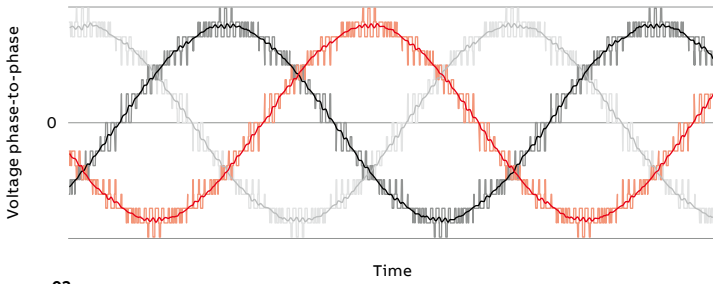

02

and granular and allow the equipment’s behavior to be investigated at operational boundaries.

Previously, different approaches were used to investigate operational boundaries, eg, short circuit events were simulated by switching

—  
**ABB’s new simulator, PEGS, emulates both healthy and faulty operating modes of MV power grids.**

reactors onto the network. There are drawbacks to this approach, in terms of repeatability and granularity, because of its reliance on the mechanical properties of the reactor and the opening and closing times of the electric switching equipment.

Building an artificial grid with power electronic converters is another approach gaining prevalence. The grid can then be controlled to simulate changes in frequency and voltage. With careful design of the converter and adjunct system even asymmetrical grid conditions can be emulated. This standard approach uses many smaller converters, with fast switching semi-conductors, connected in parallel. Hence, power can be adjusted to the required level to simulate an event.

Nevertheless, emulation of short circuit behavior requires considerable effort due to the large current requirements associated with critical events. At lower power levels, the power electronic converter for emulation can be oversized to handle the current without damaging the semi-conductors or converter system. Nowadays, however, the power levels of large wind turbines, especially for off-shore use, obviate the feasibility of creating an artificial grid that employs many LV converters running in parallel. The new generation of off-shore wind turbines, such as the Haliade-X, manufactured by General Electric, exemplifies this. With a rated power of 12 MW, it would be prohibitively challenging to emulate short circuit events with currents in the region of 2 per-unit.

**PEGS design and application**

Enter ABB’s ACS6000 grid simulator: PEGS. Based on tried-and-proven technology, PEGS is adapted to the high power levels necessary for today’s generation of power sources, like WPPs. The use of MV Integrated Gate-Commutated

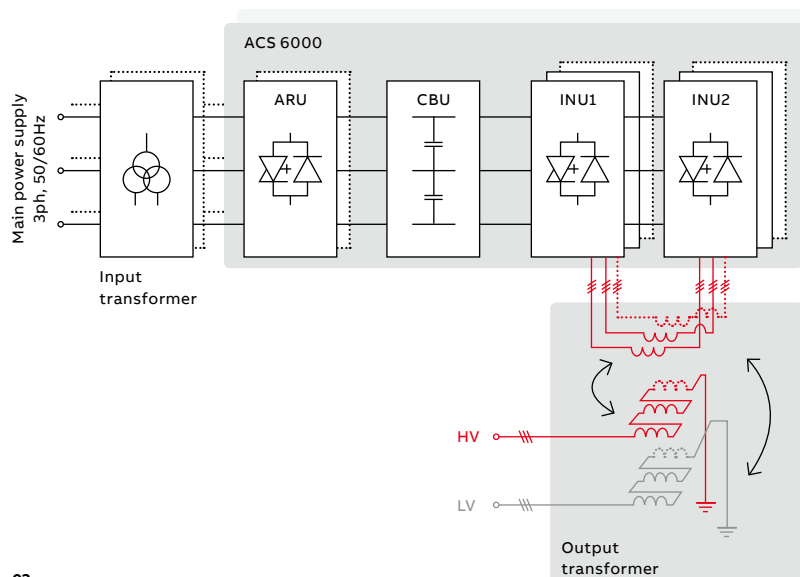

03

— 02 PEGS damps high order harmonics as shown in the shapes of filtered voltage.

— 03 Power electronics converter modular design is illustrated.

— 04 Rated parameters of existing installations.

— 05 PEGS enables crucial UVRT tests to be performed.

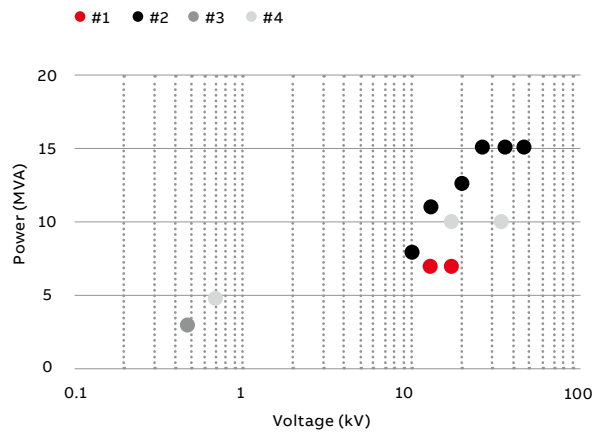

04

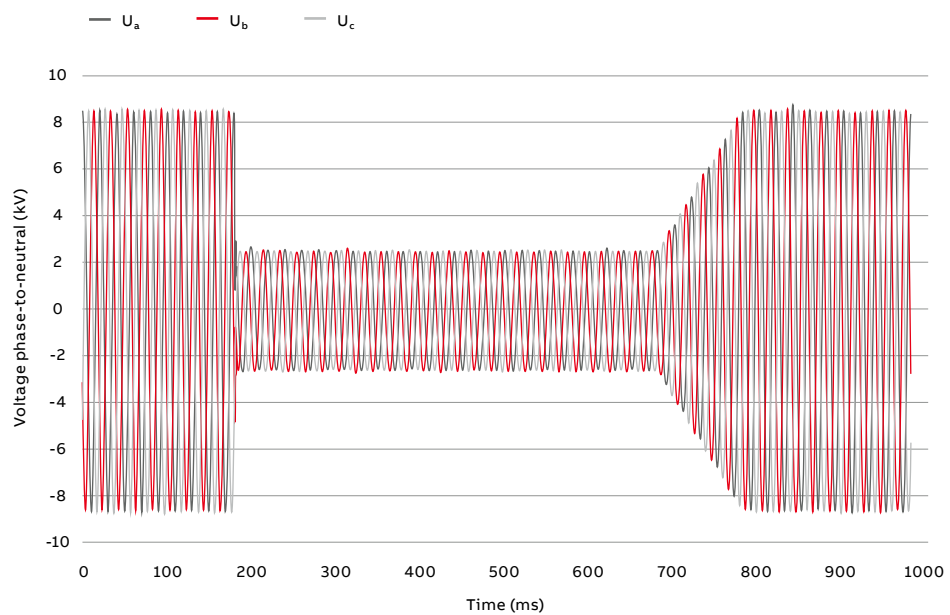

05

— ABB’s novel solution for modern wind turbines utilizes the flexible and modular structure of the ACS6000.

Thyristors, reduces the number of parallel connected semiconductors and converter systems necessary; this increases system reliability and reduces complexity.

At the power levels required by modern wind turbines, the available switching frequency of the semi-conductors is much lower than for lower voltage converters. ABB’s novel solution for testing modern wind turbines utilizes the flexible and modular structure of the ACS6000. The

power converter consists of the active rectifier, DC link, and three-phase multi-level NPC inverters with a special output transformer that makes an increase in the output voltage possible. ABB’s converter allows multiple inverter units to be connected to the same DC-link.

Additionally, PEGS is equipped with a passive filter that increases voltage quality to high levels →02. Not only does voltage modulation achieve high accuracy, Total Harmonic Distortion value (THDv), a measure of voltage quality, is exceedingly low. The converter can emulate a grid with short circuit power levels in excess of 40 MVA while keeping the THDv below one percent →02 – a significant feat.

Due to the power converter’s modular design, PEGS allows an almost unlimited configuration potential and flexible control →03.

ABB’s standard field-proven controller for MV applications, responsible for system initialization and protection, ensures the high reliability of PEGS operation. To further ensure the converter operates safely, PEGS-specific features are activated with a dedicated controller only after all protective conditions, ie, initialization procedures, have been fulfilled.

Newly created industrial protocols allow the operator to control PEGS output voltage according to the customer’s specific needs. Moreover, as part of a test laboratory, PEGS can operate in island mode as a controllable voltage source, or as part of Power Hardware In the Loop (PHIL) testing system with an interface between the physical and simulated systems.

**Reference installations**

Today, ABB’s ACS6000 MV converter, is found in many power-demanding industry segments, eg, mining, metals, and marine propulsion industries. With over 2000 units operating world-wide, this MV converter provides the broad range of power, voltages, and frequencies end-customers seek →03.

In addition to its practical testing application, PEGS can play an important role in research and

development: grid infrastructure, electricity and energy systems integration. Moreover, PEGS can be successfully utilized for special test benches, eg, cables, motors, or transformers.

In the industrial world, PEGS installations vary in terms of voltage levels, power, and customary functionalities →04. ABB has, to date, delivered PEGS applications to research and testing

—  
**ABB meets the challenge of new electric energy systems with customized products based on the PEGS platform.**

facilities such as the National Renewable Energy Laboratory (NREL) in Colorado, USA and to the Fraunhofer Institute for Wind Energy Systems (IWES) in Germany →04.

**Meeting the demanding requirements**

PEGS has been designed with performance in mind to fulfill both practical certification tests and research purposes:

- High-quality output voltage, characterized by low THDv50 (< one percent) values. A modulation error of the first harmonic is small for a wide range of operating voltages. Consequently, the testing devices can be supplied with an almost pure sinusoidal voltage waveform in which the root mean square (RMS) voltage value can be precisely controlled according to the customer’s needs.
- Capable of generating repetitive and uninterrupted voltage drops from a nominal value to zero voltage rapidly, ie, ≤ 1 ms →04. This feature enables Under Voltage Ride Through tests to be performed; this is critical for eg, wind turbines, as they must validate their ability to stay online continuously in order to prevent major blackouts that can occur under faulty grid operation conditions →05.
- Capable of providing Rate of Change of Frequency (RoCof) events of connected power equipment.
- The ability to test two devices simultaneously at different voltage levels; thereby allowing the PEGS testing facility operator to examine two end-customers contemporaneously.
- Harmonic Injection (HI), which can be used for the estimation of grid impedance in order to monitor the grid condition eg, to detect island conditions. This feature allows certification tests to be conducted under artificially distorted PEGS output voltages tailored to the customers’ requirements →06.

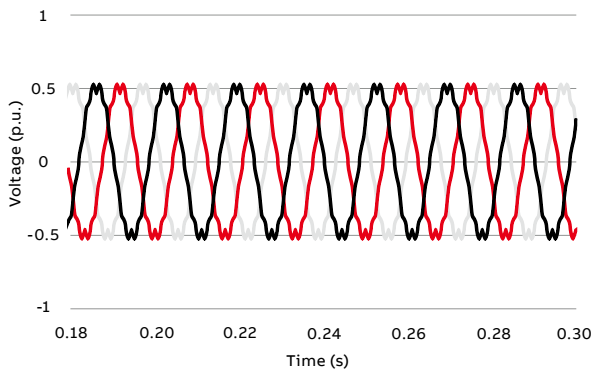

06a

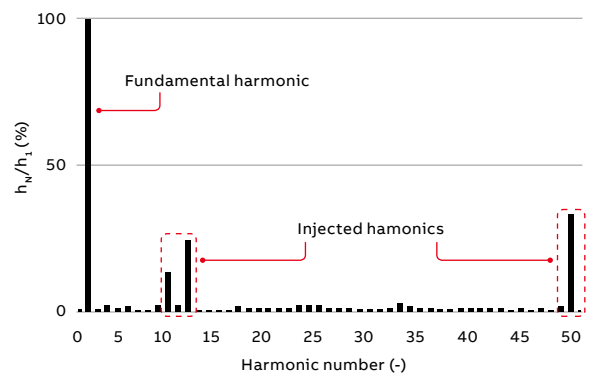

06b

06



07

—  
06 The system allows artificially distorted output voltages for testing.

06a Waveform.

06b Harmonics.

—  
07 The trend toward more diverse energy sources will continue and ABB will be there for those who require their power source devices tested and certified.

### Further proven benefits

Research and testing facilities such as the NREL have been able to showcase numerous benefits gained from operating ABB's PEGS system. PEGS creates the capability to test and validate advanced frequency response services by modern inverter-coupled generation for both high and low inertia grids. Advanced controls that can be tested by PEGS include: synthetic inertia, fast frequency response (FFR), primary frequency response, and power oscillations damping services.

Additionally, PEGS enables the capture of impedance characteristics of inverter-coupled generation in a wide range of frequencies (eg, 0–3 kHz for NREL controlled grid interface), crucial for an understanding of the nature and mitigation strategies for harmonic resonances, control interactions, and sub-synchronous oscillations. In addition, PEGS can integrate fast PHIL

—  
**Working closely with national research laboratories, ABB can predict the future needs of customers and end-customers alike.**

platforms for closed-loop testing of the impacts of variable power generation on power systems of different sizes (micro-grids, islands, larger power systems-coupled generation). Additionally,

because PEGS is a grid forming inverter, it allows facilities to replicate and test different grid forming methods, eg, f-P droop, virtual synchronous machine, and virtual oscillator; as well as black start strategies for inverter-coupled generation.

For inverters undergoing examination, PEGS permits the testing and validation of features on real scales, eg, advanced protection schemes, fault detection with the use of injections of negative and zero-sequence-currents.

PEGS can also be used to test an actual grid-forming inverter within a controlled environment for various “grid-of-the-future” scenarios, eg, fixed-frequency micro-grids, zero-inertia, and 100 percent inverter-based power systems, among others.

### Meeting the future energy needs

New electric energy systems bring new challenges →07. ABB not only provides customized products based on the PEGS platform to meet current demands, the company is also exploring PEGS functionalities and applications to meet future challenges. A new control concept will increase the power capacity of PEGS: the simultaneous operation of ACS6000 units. This will extend the power range of testing devices and make simulations of the behavior of micro-grid systems more possible. The integration of infrastructure and external control systems with a rapid PEGS response will allow operators to obtain the required reference voltage immediately, if external closed-loop control is needed. Consequently, PEGS can be used as part of a more complex application in accordance with the customer's need. ABB is also developing the concept of a Power Electronics Load Simulator so that customers can emulate testing devices such as wind turbines; or enable specialized certification tests to be conducted, eg, unintentional islanding. ABB is also investigating a design of PEGS for testing and integration studies of DC high-power applications, eg, traction or PV. Moreover, hardware designers and software developers are working together to create control structures to improve platform utilization and increase the power of PEGS applications.

By working closely with national research laboratories, ABB can aptly predict the future needs of customers and end-customers who require their power source devices tested. ABB's commitment to excellence, cross industry collaboration and the evolving renewable energy market drive their innovation and global offering. •



# Robots and handling





**ABB supplies robots that can respond to variable and sometimes unpredictable changes in work tasks by learning from their individual and collective experiences. This not only helps create an AI workforce that gets smarter over time, but also opens up opportunities for operations to be more flexible and even experimental in assembly and other functional workflows.**

- 48 Translating robotic vision into increasingly precise depalletization
- 52 How to rev up your robots



---

ROBOTS AND HANDLING

# Translating robotic vision into increasingly precise depalletization

Spurred by the introduction of new technologies throughout the worldwide supply chain, logistics operations are demanding faster, more highly automated and more precise depalletization technologies. With this in mind, ABB has introduced a game-changing element to solving the challenge: machine learning.





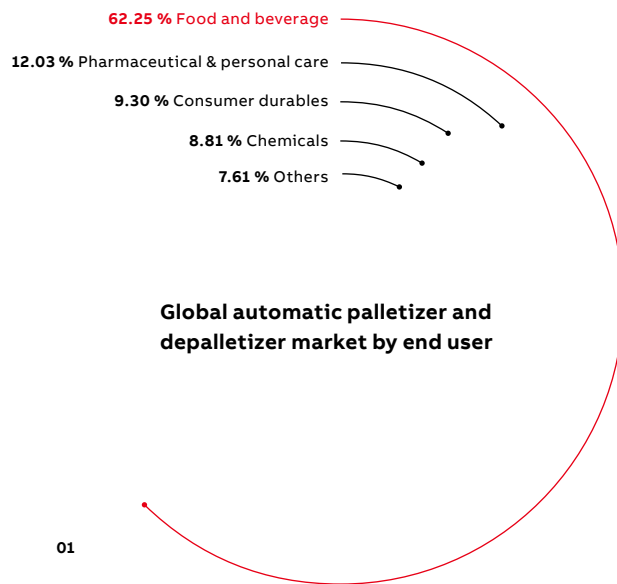

Title picture: Distribution and fulfillment centers are looking for new ways to make their infrastructure and people more productive.

01 According to Technavio, the global automatic palletizer and depalletizer market is expected to grow at a CAGR of close to 5 percent through 2021 [1].



**Toni Roda**  
Robotics and Discrete Automation  
Barcelona, Spain  
toni.roda@es.abb.com

The worldwide supply chain is being reshaped by Industry 4.0 technologies. AI, the Internet of Things, advanced sensing, and big data analytics are changing the way products are designed, tested, manufactured, and distributed. As this trend unfolds, logistics operations are responding not only to these forces, but also to the growth of e-commerce and the constraints imposed by a tight labor market. The result is that distribution and fulfillment centers must find new ways to make their infrastructure and people more productive. Clearly, automation of processes is a vital part of the solution.

One of the most common applications in distribution and fulfillment centers is depalletizing, which consists of picking boxes (technically referred to as “stock keeping units” or SKUs) from a pallet and placing them in an output system such as a conveyor. Essential for major industrial sectors such as the food and beverage industry, pharmaceuticals, consumer durables, and chemicals →01, this often strenuous work is now being targeted by automation companies to improve productivity in logistics. It’s also being introduced with a view to reducing physical fatigue and the incidence of repetitive strain injuries, which can result in reduced efficiency, medical leave, and increased insurance costs.

But although automated systems are already available that can perform limited depalletization, they suffer from high error rates and thus still require the support of manual labor. Typically, today’s distribution centers and warehouses

Depalletizing consists in picking boxes from a pallet and placing them in an output system such as a conveyor.

handle a mixture of stock keeping units that may vary in terms of materials, size, shape, and color. Depending on the type of boxes being processed, two cases can be differentiated:

- Single SKUs →02a, ie, pallets consisting of boxes of the same size on each layer.
- Multiple SKUs →02b, ie, boxes of different sizes randomly organized on a pallet.

#### The problem with traditional approaches

Most existing automation systems apply a three-part approach to depalletization:

- Data acquisition: A 3D-camera mounted above the depalletizing area takes images of the boxes in the picking environment.
- Image processing: The acquired images are processed to find the position and size of the boxes to pick.
- Picking: The system defines the most suitable grasping position and orientation to pick items without damaging or dropping boxes.

This traditional approach uses segmentation and classification algorithms to identify and isolate boxes from their background, as well as 2D filters and masks to detect box contours, position, and orientation. Once a box has been identified, the system calculates its position and orientation and sends the resulting data to a robot for picking.

But while mixed SKUs are relatively easy to differentiate from one another, single SKUs present a significant problem since all the boxes have the



02a

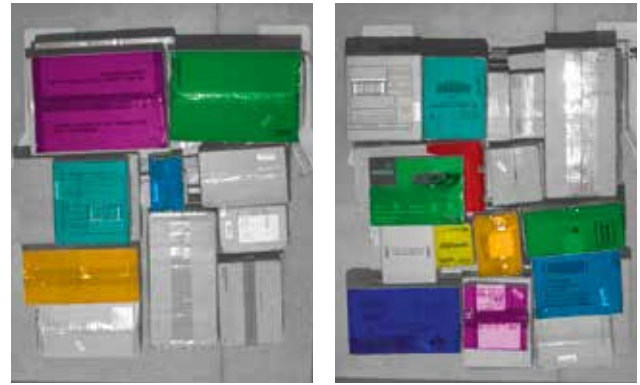

02b

same size and height, thus making it difficult to distinguish where one box ends and the next one begins – a task that can be difficult even for human eyes, especially if boxes are wrapped in plastic. Indeed, laboratory tests confirm that while geometrical algorithms result in segmentation errors only circa 2 percent of the time when handling mixed SKUs, they result in errors circa 33 percent of the time with single SKUs.

**How machine learning is changing the picture**  
While similar to traditional systems, ABB’s approach introduces a game-changing element

to solving depalletization: machine learning. The solution’s principle elements are a 3D vision sensor, which was developed and manufactured in-house, a control unit with machine learning-based vision software that’s applied to both single and mixed SKUs, and a robot equipped with a suitable gripper to pick boxes.

Machine learning makes it possible to build algorithms that rely on a collection of examples to improve the picking success rate. ABB’s example images are acquired with its own vision sensor and as the number of examples has grown, the system’s success rate has steadily improved. Known as supervised learning, which is a training function that maps an input to an output based on example input-output pairs, ABB produces models of single and mixed SKUs that take a

—  
The use of machine learning algorithms in combination with geometrical algorithms dramatically reduced the error rate.

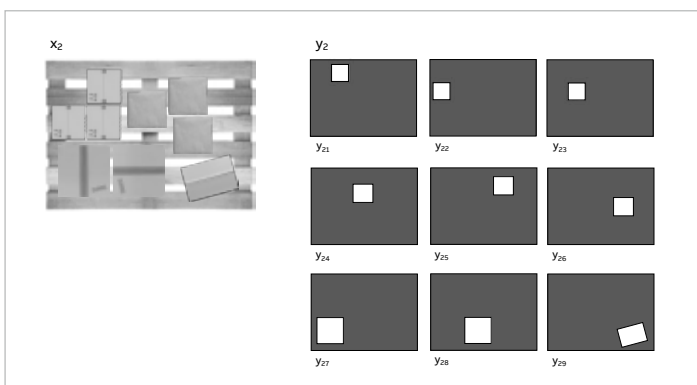
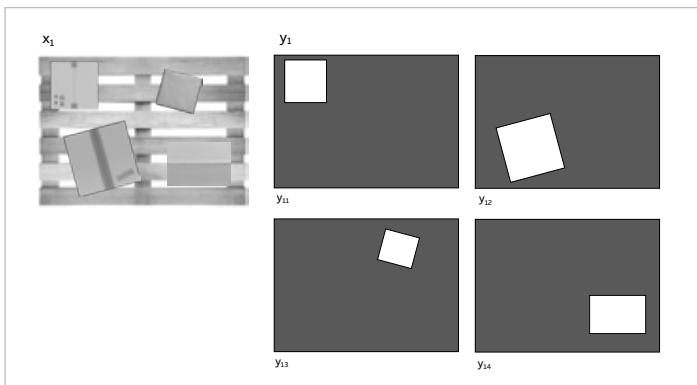

03

vector  $x$  as input and output a vector  $y$  with useful information to the user →03 top. In other words, in the case of depalletizing, the input is an image acquired by the vision sensor and the output is a list of binary images, where a box’s location in a 2D image is indicated by white pixels on a black background.

In supervised learning, the dataset is the collection of labeled examples  $\{(x_i, y_i)\}_{N_i=1}$  such that  $x$  represents images acquired by the vision sensor and  $y$  is a collection of masks for each box in an acquired image →03. The labeling process mainly consists of the identification of box contours from a collection of acquired images. If the

## AI AND ROBOTICS: A FORMULA FOR FLEXIBLE FACTORIES

The combination of artificial intelligence (AI) and robotics can substantially improve the flexibility of factory automation by replacing rigid applications with learning capabilities. This powerful mixture of technologies enables the expansion of robot functionalities, thus improving productivity, making work safer, and accelerating production.

ABB's range of applications in this area includes the use of AI and machine learning to enable robots to accurately depalletize boxes (adjoining article), sense and respond to their environment, inspect and analyze defects, and optimize processes autonomously.

AI also enables robots to inspect and analyze a wide range of objects, such as welding seams to detect defects and quality issues. AI has also made it possible for the first connected, sensor-equipped, robotic paint atomizer to allow for real-time smart diagnostics and paint quality optimization while reducing internal waste during color changes by 75 percent and cutting compressed air consumption by 20 percent.

In addition, ABB is applying AI algorithms to the analysis of presses and robot behavior in press and stamping lines to minimize equipment waiting times. •

02 Examples of single and multiple stock keeping units.

02a Single SKUs: pallets consisting of boxes of the same size on each layer.

02b Multiple SKUs: boxes of different sizes randomly organized on a pallet.

03 ABB's machine learning software produces models of single and mixed SKUs that take a vector  $x$  as input and output a vector  $y$  with useful information to the user.  $x$  represents images acquired by the vision sensor and  $y$  is a collection of masks for each box in an acquired image.

04 ABB uses AI to help robots detect and analyze defects.



04

machine learning model is well trained it should be able to predict the position and orientation of previously unseen examples from a new image acquired by the sensor, consequently allowing a robot to accurately pick boxes of previously unseen sizes and geometries →04.

In ABB's case study, the training dataset comprised many thousands of images taken by the vision sensor. Some of the images were taken during the first stage of training in the laboratory while the vast majority were taken in a real

production environment. After image processing with geometrical algorithms and filters, data analysts labelled the examples of the datasets and identified the contours of the boxes. The result was that segmentation errors in processing single SKUs dropped to below 0.25 percent while being reduced to below 0.02 percent in the case of mixed SKUs. All in all, ABB's case study demonstrated that the use of machine learning algorithms in combination with geometrical algorithms was able to dramatically reduce the error rate for picking boxes from pallets. •

### References

[1] <https://www.businesswire.com/news/home/20170606005883/en/Global-Automatic-Palletizer-Depalletizer-Market-Segmentation-Forecasts>.



01

## ROBOTS AND HANDLING

# How to rev up your robots

Designed for the digital transformation of industry, ABB's OmniCore™ controller provides the ultimate in flexibility, connectivity, and performance for motion control applications.



**Peter Fixell**  
ABB Robotics  
Vasteras, Sweden

[peter.fixell@se.abb.com](mailto:peter.fixell@se.abb.com)

You might call it a population explosion. In 2013 there were barely 1.3 million industrial robots worldwide. By 2022 there are expected to be nearly 4 million – a 13 percent annual growth rate, according to the International Federation of Robotics (IFR) →02. Although many trends are propelling this explosion in demand, probably the most comprehensive is the digitization of the consumer, computer, and communications sectors.

Early on, ABB identified this trend as a tremendous opportunity for flexible automation. In fact, it is expected to soon become the dominant driver for robot sales. Measured in terms of improvements in productivity and reduced costs, the impact of new digital technologies in terms of the markets ABB touches, could be on the order of \$4–11 trillion by 2025 →03.

The digitization of the consumer, computer, and communications sectors is set to become the key driver for robot sales.

The 12 industries shown in →03 share several common challenges and potential advantages:

- automation is changing faster than ever before;
- customers are increasingly in need of uniquely tailored solutions and greater integration flexibility;
- customers need to add new automation applications to existing lines, which are often

### Estimated worldwide operational stock of industrial robots 2013–2018 and forecast for 2019\*–2022\*

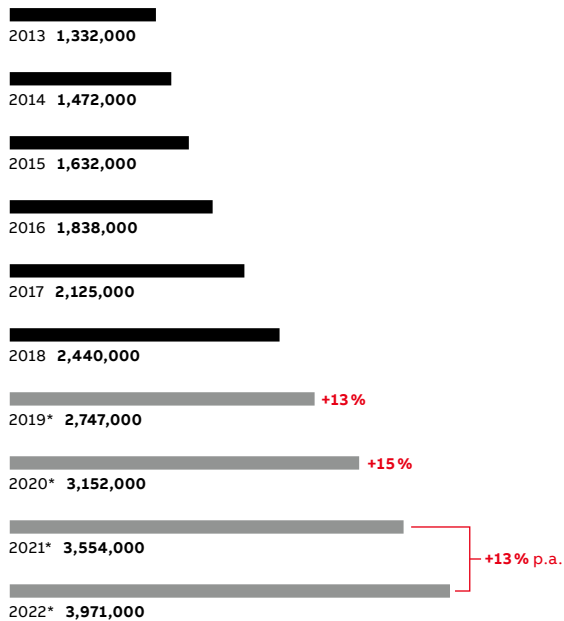

\* forecast

02

OmniCore™ was designed to meet the challenges faced by digital manufacturing environments (as outlined above), such as 24-hour production cycles, the growing need for predictive maintenance, and customer demand for robots designed to collaborate with humans (cobots). Essential to meeting such requirements is embedded ABB Ability™ – the company's

OmniCore™ is designed for easy connections to a variety of fieldbus protocols, force control and vision systems.

platform for advanced services for connected robots. This platform allows ABB to deliver best-in-class motion control and path accuracy in a 50 percent smaller package than its smallest previous controller, thus optimizing installation flexibility and floor space utilization. Moreover, the OmniCore™ controller family was built on a modular approach that allows the portfolio to be expanded to deliver tailored solutions as circumstances evolve.

#### A new era in digital robot control

The new controller was developed in response to customer demands for a more flexible solution for controlling diverse robots in unique applications. As a result, ABB decided to rethink its design approach to focus on configurable building blocks and common interfaces in order to provide a wider range of customizable offerings than ever before.

The result of these efforts represents a significant step toward a new era of digital robot control based on the broadest motion control options as well as tailored solutions for the connected factory of the future. Customers just need to “Power-on and Connect,” which provides access to the full scope of ABB Ability™ Connected Services and can reduce incidents by up to 25 percent while accelerating recovery by up to 60 percent.

Additionally, customers can seamlessly plug into ABB Ability™ Connected Services to turn data into actionable knowledge. For example, continuous supervision of gearbox vibrations using machine learning algorithms can be translated into preventive or corrective maintenance as needed. OmniCore™ is also designed for easy connections to a variety of fieldbus protocols, force control, and vision systems.

01 The OmniCore™ robot controller and portable Flexpendent programming device.

02 According to the International Federation of Robotics (IFR) there will soon be over 3.7 million industrial robots in operation worldwide [1].

in constrained spaces, where compactness and flexibility are critical;

- manufacturers are struggling to launch products with shorter cycles while maintaining high levels of productivity;
- markets are growing where automation is being adopted;
- markets and technologies are evolving rapidly where robots are being trained to perform new tasks and applications;
- optimized solutions are the key to enhanced competitiveness for manufacturers.

In view of these trends and their effects on the industrial environment, ABB decided to develop a new robot controller family called OmniCore™ →01. For robots, a controller is the equivalent of a brain. It's where motion control programs and learning capabilities are located, and it's what allows them to be connected to a factory's IT systems, production machines, and to each other.

**ABB is in the “eye of the storm” for massive value migration**  
(economic impact in trillions of US\$, annual)

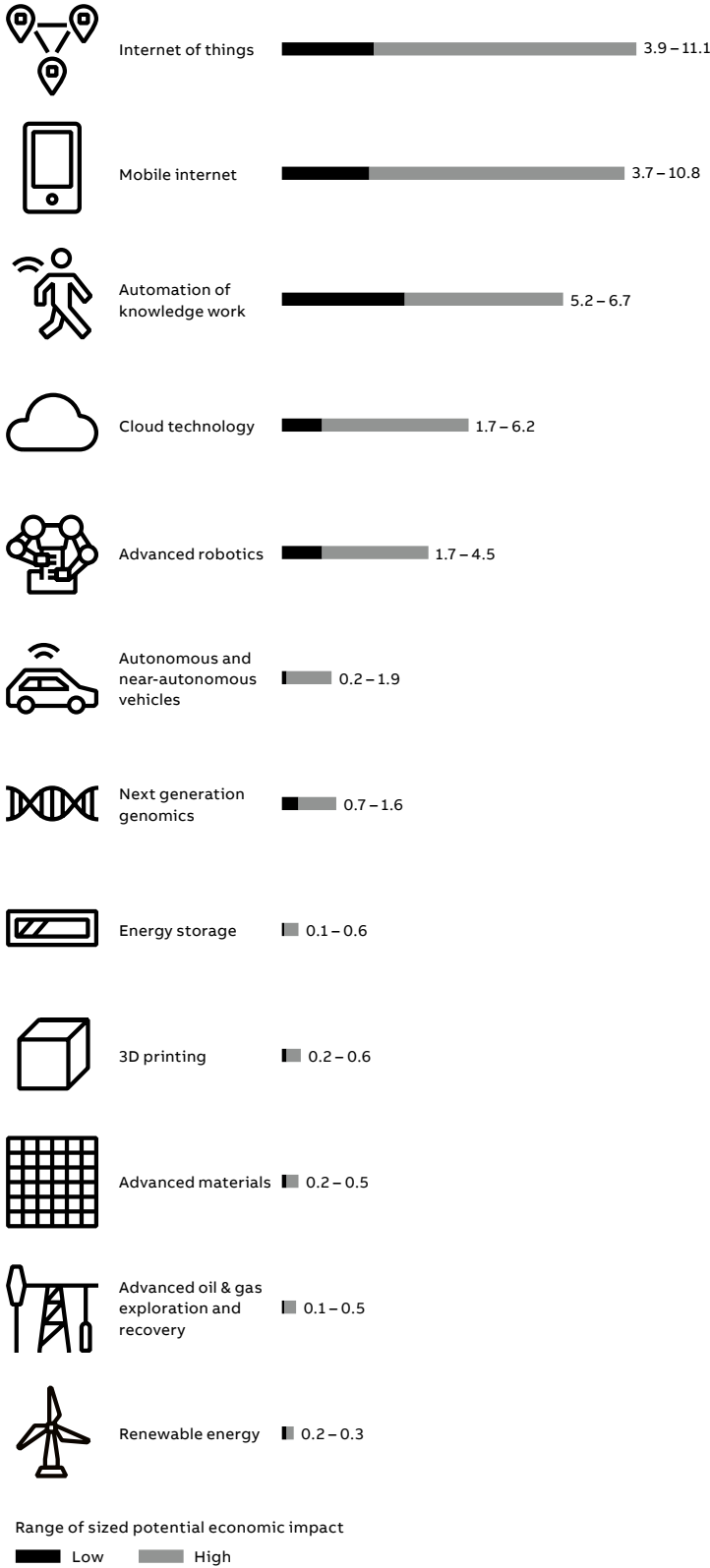

Moreover, OmniCore™ features cyber security elements designed to prevent data loss and production-line downtime, which could otherwise result in significant revenue loss. It also includes SafeMove2, an ABB software solution that transforms industrial robots into collaborative robots capable of safely working alongside humans while remaining productive.

The controller also comes with ABB’s powerful and intuitive FlexPendant for industrial robot programming →04. The FlexPendant is equipped with an ergonomic 3D joystick control and its

OmniCore™ includes SafeMove2, an ABB software solution that transforms industrial robots into collaborative robots.

8” multi-touch display supports standard gestures, such as pinch, swipe, and tap, to simplify robot programming. FlexPendant is hot-swappable, which means it can be unplugged when powered on and operational. This allows it to be shared between multiple robots, thereby accelerating robot deployment and minimizing costs.

**Future impact on industry**

ABB expects the trend toward ever-increasing levels of digitization to continue having a major impact on industry. Although digitization has been primarily a consumer-driven trend, enabled by mobile and broadband technologies, these days it is becoming well established in the industrial space as well. Customers increasingly realize that those who build robots can also help optimize operations from remote locations.

Digitization is therefore no longer a vision; it is reality. Indeed, ABB is experiencing its own digital transformation and the company has a profound understanding of what this means, what it entails, and the countless advantages it can deliver in terms of predictive maintenance, remote monitoring, optimization, reduced costs, improved efficiency, and heightened security. •



04

—  
03 The McKinsey Global Institute has identified 12 key technology areas of the near future. ABB sees a vast opportunity in terms of supplying these areas with digital production systems.

—  
04 FlexPendant's 8" multi-touch display supports standard gestures, such as pinch, swipe, and tap to simplify robot programming. FlexPendant can be shared between multiple robots, thereby accelerating robot deployment and minimizing costs.

#### — References

[1] See page 6 of the following: <https://ifr.org/downloads/press2018/IFR%20World%20Robotics%20Presentation%20-%2018%20Sept%202019.pdf>



01

---

## BUZZWORD DEMYSTIFIER

# 4D printing

By combining advances in 3D printing with new engineered smart materials, top universities and labs are creating analog autonomous objects that evolve over time without the need for computerized power at the device. The cross-industry potential is unprecedented.



**Chau Hon Ho**  
ABB Future Labs  
Baden-Dättwil,  
Switzerland

chau-hon.ho@  
ch.abb.com

What if non-living engineered complex-shaped objects could behave like living organisms; by sensing external stimuli and responding by adapting to their environment? And, what if they could revert back to their original condition once that stimulus is removed or another is activated? By changing a fundamental property such as shape, over time, without the need for electro-mechanical or computerized control systems in place, structures could self-assemble, self-adapt, and even self-repair. The implications for society and business would be revolutionary. This seemingly outlandish idea is no longer relegated to the realm of science fiction. Researchers in top institutions and laboratories worldwide are combining advances in 3D printing of complex structures with new smart responsive materials to create 4D printed structures that do just that.

With the Fourth Industrial Revolution well underway, industries that take advantage of its unprecedented possibilities will undoubtedly have an economic advantage. With this knowledge, institutions and corporations are investing in barrier-breaking technologies and 4D printing is one with radical potential.

By combining the 3D printing process, intelligent materials, mathematical modeling, and machine-learning algorithms, researchers are creating 3D objects that react to external stimuli by transforming over time, thereby adding a fourth dimension. The level of structural autonomy achieved is unprecedented.

---

4D technology could enable analog autonomous products to evolve without the need for computerized power at the device.

Such technology could enable analog autonomous products or agents to evolve without the need for computerized power at the device. 4D printed components that change shape or move without engines, wires or active power sources, would behave in much the same way that biological organisms behave, autonomously →01. The future applications of such



—  
01 4D printing of octagonal forms developed at MIT's self-assembly lab. Initially a 2D flat layer, the objects self-assemble into a 3D object.

—  
02 This 3D printed robot arm was printed in four days and weighed 50 percent less than the original.



02

structures in the building, transportation, textiles, health-care, defense, and aerospace industries are vast.

### 3D printing: the basics

Invented in the 1980s, additive manufacturing, or 3D printing, is unlike traditional manufacturing

—  
Most 4D printing research focuses on three functionalities: self-assembly, self-adaptability and self-repair.

techniques, in which parts are cast, molded, or milled; material is deposited in successive layers to build up the desired object. Although not yet

mainstream, 3D printing is widely used, eg, in robotics, biomedicine, and aerospace science, because it enables the fabrication of unique and customized 3D structures. Nowadays, mathematical modeling and machine learning algorithms are increasingly applied to boost design, material development, and to control printing. In 2019, a robot arm was 3D printed by MX3D, a Dutch company, to customize and optimize an arm of a robot supplied by ABB. A special 3D printing technique, Wire Arc Additive Manufacturing, allowed the complex organic geometries to be printed upright.

Intelligent algorithms determined the optimal printing strategy and toolpath direction for each geometric feature. Here, 3D printing applied to Generative Design Customization, saved time and cut costs by increasing productivity and reducing material waste – important for tailored robotic applications →02 [1].

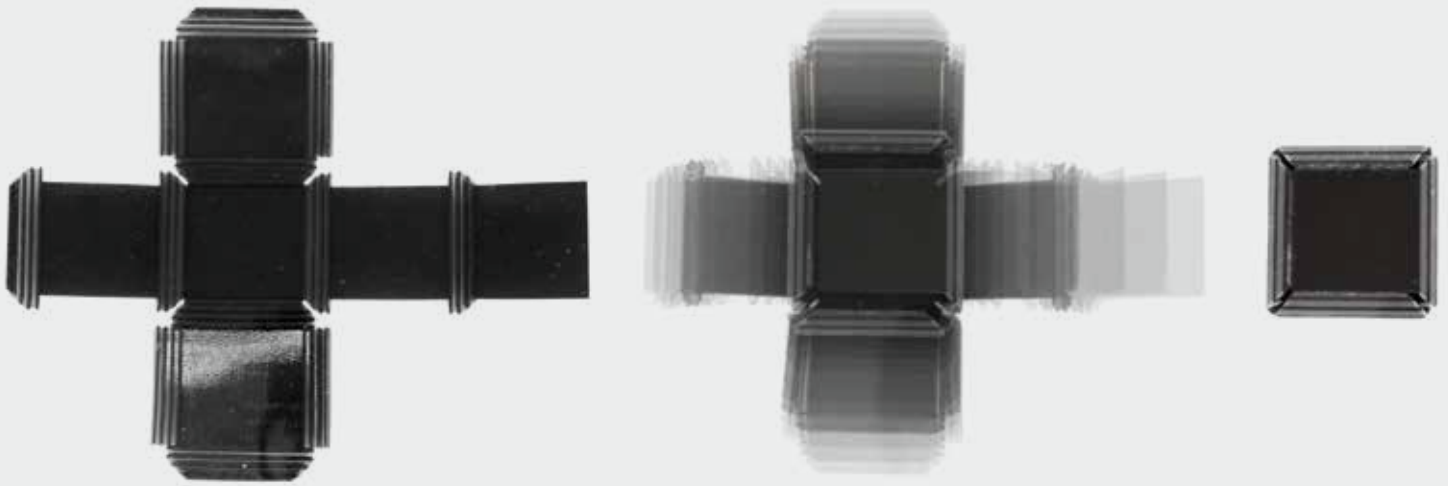

03a

### Paving the way for 4D printing

The development of smart materials – materials that contain functional or reactive components designed mathematically to respond to specific external environmental stimuli – and the availability of 3D printing set the stage for 4D printing.

Enter architect and computer scientist Skylar Tibbits who coined the term, 4D printing, in 2013. Although many labs were simultaneously exploring this combination, Tibbits and his group at

—  
Imagine leaking water pipes in a war zone that could self-heal without localization systems or human intervention.

Massachusetts Institute of Technology (MIT) founded the self-assembly lab in 2014. His ongoing vision focuses on three fundamental functionalities of 4D printed objects: self-assembly, self-adaptability and self-repair.

**Self-assembly:** If structures could autonomously assemble themselves at a specific time and place without intervention, from either human or electro-mechanical systems, then structures or even buildings could be constructed in difficult to reach or hazardous places. On a macro-scale, space antennae could self-construct in outer space; and on a nanoscale, minute objects

could be transported within the human body to a target location and self-assemble for medical purposes.

**Self-adaptability:** 4D printed structures can also combine sensing and actuation within the printed material, thereby making electro-mechanical systems superfluous. The resultant reduction in parts, assembly time, material, and energy use would translate to lower costs. Imagine building materials that adapt autonomously to weather conditions.

**Self-repair:** The ability to self-assemble necessitates the ability to disassemble. This opens the door to the concept of self-healing. Imagine leaking water pipes in a war zone that can self-repair without detection and localization systems or human intervention; or medically implanted smart tissues that can self-heal, thereby reducing the need for invasive procedures.

### Transformational intelligent structures

Successful 4D printing requires 3D printing, smart materials (those that react to an external environmental stimulus trigger), an external stimulus (eg, temperature, humidity, magnetic field etc.), a well-defined mechanism of interaction between the stimulus and material (eg, shape change due to water absorption), and the application of mathematical modeling to design material distribution and functionality and to predict and program movement at a later time. In this way, the desired change in shape, property, or function is achieved.

To shift shape, the smart materials must be able to bend, fold, twist, or curl, once printed, to achieve the desired structure. For instance, a 2D flat layer could become a 3D cubic form by self-folding →03a [2] or a flat 2D sheet could become a 3D flower form by self-bending or curling when submerged in water →03b [3] or a

1D wire strand could change to a 3D wire frame by self-folding →03c [4,5].

#### Changing shape: a two-way street

Nowadays, complex shape memory materials (SMM) are employed to “remember” a specific state: a shape memory effect (SME). This effect requires at least two programming steps: the stimulus is applied; the 3D printed object’s original shape is transformed to a temporary state where the object remains until a second stimulus is applied to change the object back to its original form. Once altered, the structure can, through programming or without programming, re-create the temporary state again, and again – a reversible process [6].

—  
If structures could self-assemble without intervention then structures could be constructed in hazardous places.

—  
03 Smart materials bend, fold, twist, or curl once printed to morph into the desired form in a specified time.

03a A 2D layer self-folds into a cube.

03b 4D Materials of varying compositions can achieve specific, measurable, organic-like forms like these printed hydrogel composites that shift shape when exposed to water.

03c 1D strand self-folds into a 3D wire-type cage. The strand, composed of engineered material, morphs when placed in water.

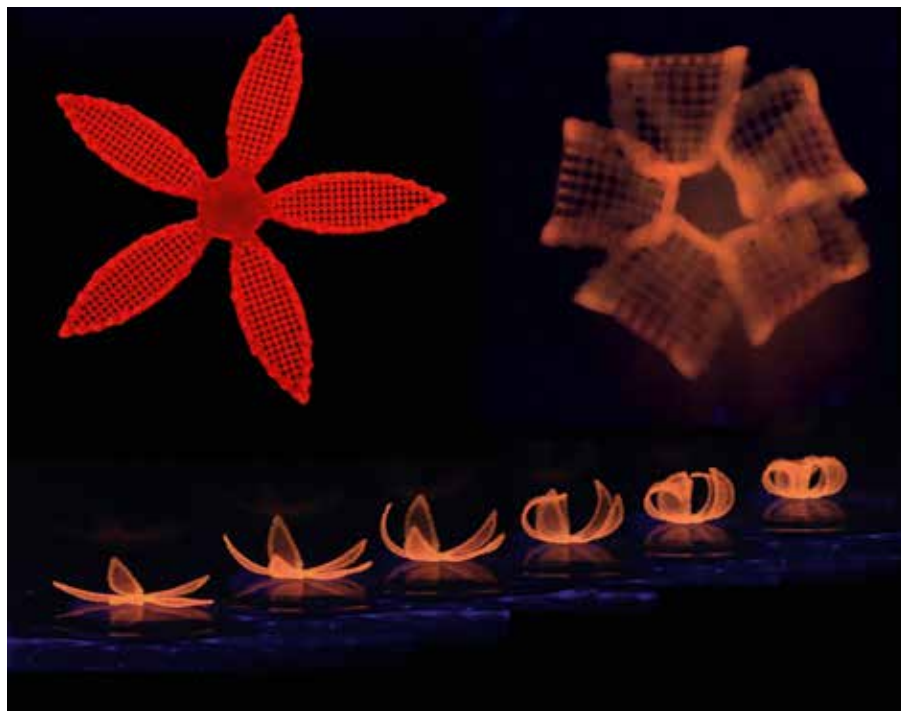

03b

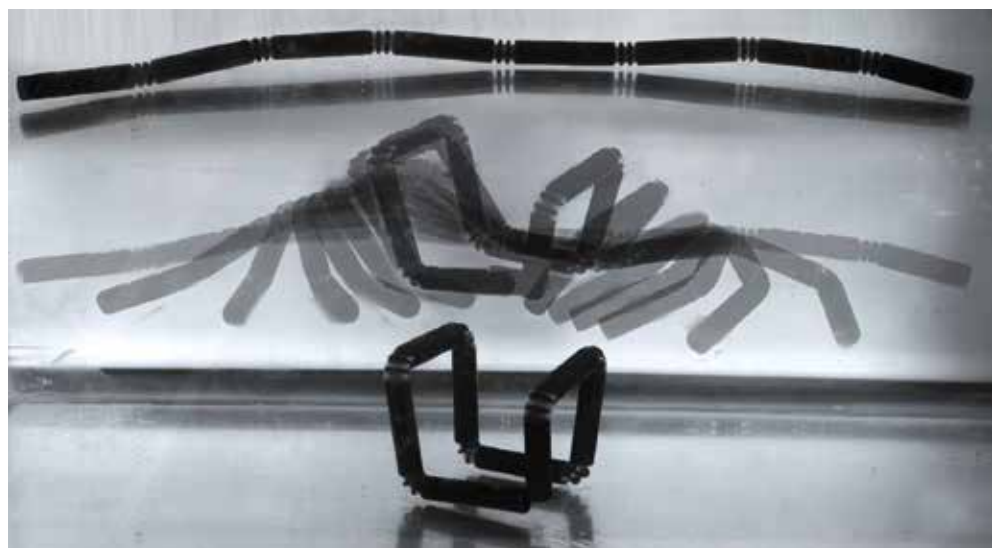

03c

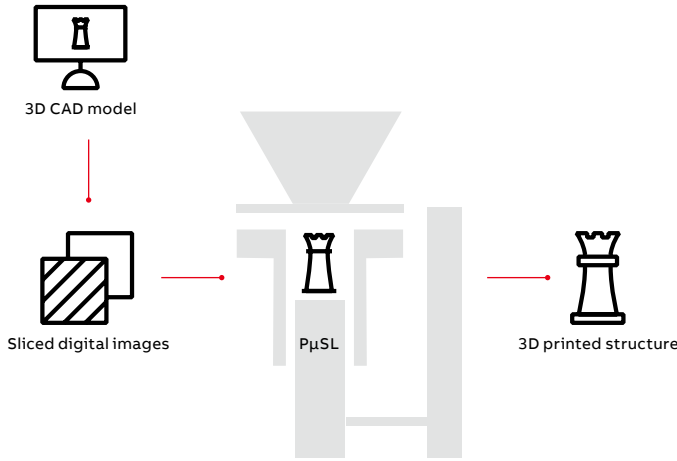

04a

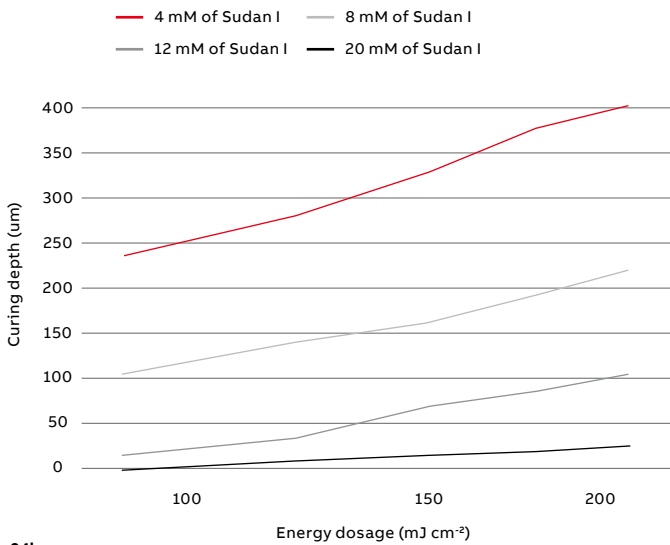

04b

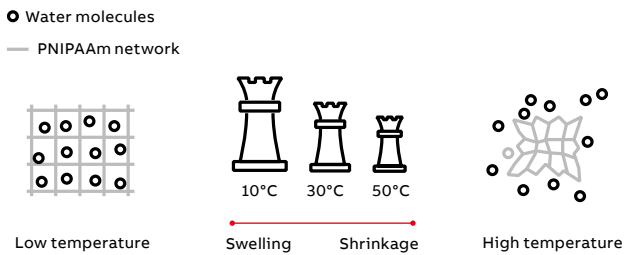

04c

The most common SMMs explored for 4D printing are based on hydrogels or liquid crystal elastomers, and various hybrids thereof. These hydrophilic polymeric substances can absorb vast amounts of water without dissolving: synthetic varieties are preferred due to their long life and gel strength [7]. Liquid crystal elastomers are polymer networks that can undergo a fully reversible large-amplitude shape change. They combine the elasticity of elastomers with the self-organization, and therefore programmable, property of liquid crystals. Due to their structures, this material shows promise in biomedicine, eg artificial muscle tissue and soft micro-robots.

**Research and development drive the expansion**

Currently, other top-notch research facilities such as the Wyss Research Institute for Biomedical Research at Harvard University, Rutgers University, the Swiss Federal Institute of Technology (ETH) in Zurich, and the California Institute of Technology (CIT) in addition to MIT, are making phenomenal advances in 4D printing.

The possibility of 4D printing to replicate biology is being studied by teams at the Wyss Institute at Harvard University, led by Jennifer Lewis. These researchers study how hydrogel changes shape

—  
 Nowadays, complex shape memory materials are used to “remember” a specific state – a reversible process.

and form in the presence of chemical stimuli, eg, water. Used as an ink, hydrogel enables the objects that it prints on to change shape to form different structures that are similar to those found in flowers. The tissue microstructures and compositions of different plants change depending on their environment. This research team replicated this organic process by mixing a

—  
04 The procedure for printing temperature-responsive hydrogel using a process developed at Rutgers University [8].

04a Schematic showing the PμSL printing process, which relies on UV light.

04b Curing depth study results are shown.

04c The temperature-dependent swelling of the printed hydrogel is shown.

4D-printed hydrogel with cellulose fibrils to create composites programmed to control swelling. The resultant 3D-printed flower forms change shape when exposed to water, thereby mimicking plant organs' responses to humidity, temperature, or other environmental stimuli →03b.

Other teams are printing hydrogels that respond to physical stimuli, eg, temperature. At Rutgers University, a lithography-based technique, projection micro-stereo-lithography (PμSL), printed temperature-dependent shape-shifting gels into 3D shapes. Such 4D printed structures could be used to develop attenuators in soft robotics or enable targeted drug delivery →04 [8].

At NASA's Jet Propulsion Laboratory at CIT, researchers are studying woven metal fabrics – so-called space chain mail. The fabrics have four essential functions: reflectivity, passive heat management, foldability and tensile strength. One side of the fabric reflects light, while the other absorbs it, thereby acting as a means of thermal control. The fabric can fold in many different ways and adapt to shapes without succumbing to negative force influences. The ability to program new functions into the material creates almost infinite possibilities. One day these materials could be used to construct large antennae in space, create protective suits for astronauts or act as meteorite shields [9].

Researchers, Kristina Shea and Tian Chen, at ETH Zurich, used a Stratasys Objet3 Connex500 printer to create objects made of shape memory polymers; a temperature-resistant rigid polymer; and an elastomer-like polymer. The objects were printed as flat 2D structures that unfolded into load-bearing 3D shapes when placed in warm water. The ability to alter load-bearing capabilities over time could be of particular interest in the fields of space exploration, architecture and construction and the automotive industry [10,11].

#### Challenges and limitations

Despite advances in 4D printing, challenges and limitations must be addressed before 4D printing

can leave the research labs; these include physical inertia, materials, durability, dependency factors, and cost. Currently, the transformation process takes from milliseconds to seconds to complete because large molecules must re-locate, moving over specific distances; this timing can be appropriate, too slow, or too rapid depending on the application, (eg, for building materials the process would be just right). Furthermore,

—  
The ability to program new functions into metal fabrics creates many possibilities, especially for use in space exploration.

stimuli-responsive materials are typically made of a limited range of polymers and thus restricted to specific environmental conditions, eg, heat, pressure, chemicals etc. To increase the reliability and durability of smart materials, composites that include metals and ceramics could also be used. And, because the structural transformation and its duration depend on multiple factors, different environmental conditions might cause different response times; this could be problematic. Moreover, 4D printing is currently rooted in well-funded niches, eg, medical, military, and luxury; but will scale to mainstream sectors in the future.

#### The future is 4D

Even though currently confined to research and development, the promise of benefits is expected to energize 4D printing over the next decade. The health-care, aerospace, defense, and automotive industries are beginning to seize on the possibilities.

Nevertheless, a range of product design possibilities and added functionality have yet to be adequately explored. For instance, design features with 4D printed connections, to allow

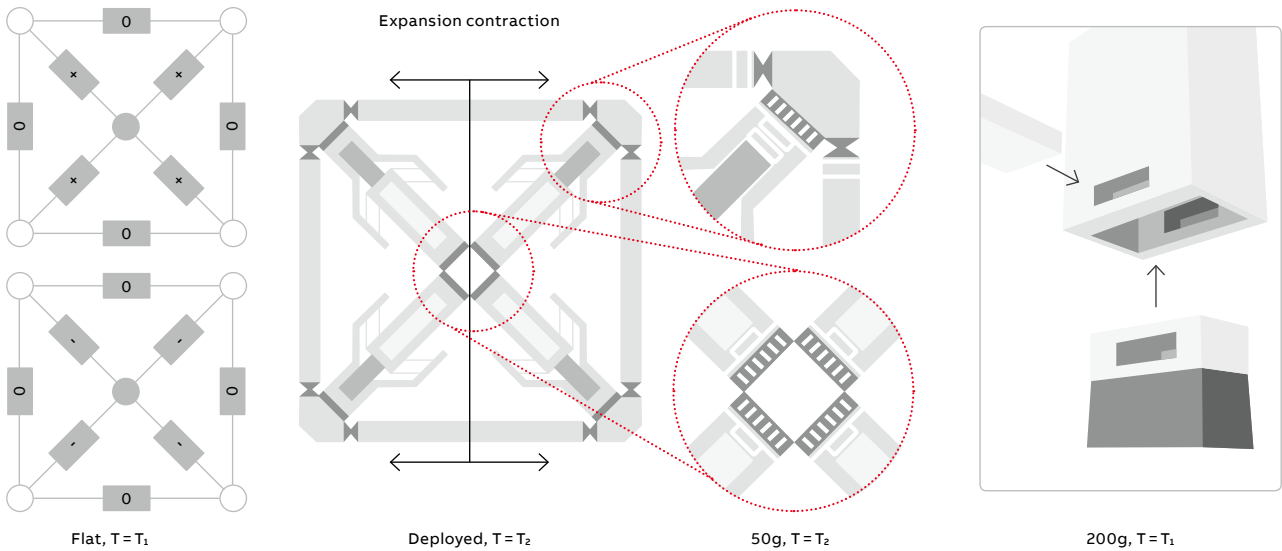

05

— 05 By combining specific types of functional polymers (FLX9895), a shape memory polymer; RGD525, a temperature-resistant rigid plastic; and Agilus30, an elastomer-like material, with a bi-stable mechanism, researchers achieved two distinct equilibrium states.

ease of product disassembly could be integrated, thereby fostering reuse (or recycling) of components. And, to meet broader environmental requirements, a wider range of suitable materials and composites are needed. Additionally, more effort should be made to control the 4D printed object's stability and optimize the 4D printing process. Nonetheless, businesses that desire to reap the rewards of digital innovation should contemplate the unprecedented potential of 4D printing, especially as an enabler for the creation of autonomous moving agents.

As the Fourth Industrial Revolution expands; and advances in smart material design, 4D printing technology, and robotics gain momentum, before

— In the future, 4D printing might enable robots to design, construct, and repair themselves anywhere at any time.

you know it, it might not only be possible to print customized robotic arms to support industrial processes, robots might be able to design, construct, and repair themselves, anywhere at any time. •

---

**References**

- [1] Altair, ABB, "MX3D Robot Arm", 2019, Online. Available: <https://mx3d.com/projects/robot-arm/>
- [2] S. Tibbets et al., "4D Printing: multi-material shape change" *Architect Design*, vol. 84, 2014, pp. 116–121.
- [3] Wyss Institute at Harvard, "Novel 4D printing method blossoms from botanical inspiration", 2016, Online. Available: <https://wyss.harvard.edu/news/novel-4d-printing-method/> Accessed on 9 Dec. 2019.
- [4] S. Tibbets et al., "4D printing and universal transformation", in *Material Agency*, 2014, pp. 539–548.
- [5] F. Momeni et al., "A review of 4D printing" in *Materials and Design*, 2017, pp. 42–79.
- [6] Zhou et al., "Reversible shape-shifting in polymeric materials", in *Journal of Polymer Science & Polymer Physics*, vol. 54, 2016, pp. 1365–1380.
- [7] "Hydrogel: Preparation, characterization, and applications: A review", in *Journal of Advanced Research*, vol. 6 issue 2, 2015, pp. 105–121. Online. Available: <https://www.sciencedirect.com/science/article/pii/S2090123213000969>
- [8] D. Han, Z. Lu, C. Shaun and H. Lee, "Micro 3D Printing of a Temperature-Responsive Hydrogel Using Projection Micro-Stereolithography", in *Sci. Reports*, no. 8, 31 Jan. 2018, Online. Available: <https://www.nature.com/articles/s41598-018-20385-2>
- [9] NASA Jet Propulsion Laboratory, "Space Fabric links Fashion and Engineering", April 18, 2017, Online. Available: <https://www.jpl.nasa.gov/news/news.php?feature=6816>
- [10] C. Scott, "ETH Zurich Researchers Develop 4D Printed Load-Bearing Polymer Structures", 2018, Online. Available: <https://3dprint.com/219758/eth-zurich-4d-printed-structures-2/>
- [11] Tian Chen and Kristina Shea, "An Autonomous Programmable Actuator and Shape Reconfigurable Structures Using Bistability and Shape Memory Polymers" in *3D Printing and Additive Manufacturing*, vol. 5, No 2, 1 June 2018 <https://doi.org/10.3929/ethz-b-000267291>

---

**Subscribe**

---

**How to subscribe**

For a subscription, please contact your nearest ABB representative or subscribe online at [www.abb.com/abbreview](http://www.abb.com/abbreview)

ABB Review is published four times a year in English, French, German, Spanish and Chinese. ABB Review is free of charge to those with an interest in ABB's technology and objectives.

---

**Stay informed...**

Have you ever missed a copy of ABB Review? Sign up for the e-mail alert at [abb.com/abbreview](http://abb.com/abbreview) and never miss another edition.



Please note that when you register for this alert, you will receive an e-mail with a confirmation link. Please ensure that you have confirmed your registration.

---

**Imprint**

---

**Editorial Board**

**Bazmi Husain**  
Chief Technology Officer  
Group R&D and Technology

**Adrienne Williams**  
Senior Sustainability  
Advisor

**Christoph Sieder**  
Head of Corporate  
Communications

**Reiner Schoenrock**  
Technology and Innovation

**Andreas Moglestue**  
Chief Editor, ABB Review  
[andreas.moglestue@ch.abb.com](mailto:andreas.moglestue@ch.abb.com)

---

**Publisher**  
ABB Review is published by ABB Group R&D and Technology.

ABB Switzerland Ltd.  
ABB Review  
Segelhofstrasse 1K  
CH-5405 Baden-Daettwil  
Switzerland  
[abb.review@ch.abb.com](mailto:abb.review@ch.abb.com)

Partial reprints or reproductions are permitted subject to full acknowledgement. Complete reprints require the publisher's written consent.

Publisher and copyright ©2020  
ABB Switzerland Ltd.  
Baden/Switzerland

---

**Printer**  
Vorarlberger  
Verlagsanstalt GmbH  
6850 Dornbirn/Austria

---

**Layout**

Publik. Agentur für  
Kommunikation GmbH  
Ludwigshafen/Germany

---

**Artwork**

Konica Minolta  
Marketing Services  
London,  
United Kingdom

---

**Disclaimer**

The information contained herein reflects the views of the authors and is for informational purposes only. Readers should not act upon the information contained herein without seeking professional advice. We make publications available with the understanding that the authors are not rendering technical or other professional advice or opinions on specific facts or matters and assume no liability whatsoever in connection with their use.

The companies of the ABB Group do not make any warranty or guarantee, or promise, expressed or implied, concerning the content or accuracy of the views expressed herein.

ISSN: 1013-3119

[abb.com/abbreview](http://abb.com/abbreview)

---

**Tablet version**

Production of the tablet version of ABB Review (for both iOS and Android) was discontinued at the end of 2018. Readers of the tablet versions are recommended to use the pdf or web versions instead.  
[abb.com/abbreview](http://abb.com/abbreview)



---

Next 03/2020  
**Data centers**

**Cloud computing that is always on depends on data centers that are never off. Minimizing energy demand while maximizing reliability and safety are mission-critical goals that help to realize the potential of big data and digitization. The next issue of ABB Review will explore examples of how the synergy of proven physical plant and cutting-edge information science enables businesses to keep their infrastructures connected to the sky.**