

Nikon

DIGITAL CAMERA

KeyMission 170

Quick Start Guide



For Smart Device Users	ii
Introduction	iv
Parts of the Camera	1
Getting Started	2
Using the Camera	12
Using the Menu	23
Technical Notes	24

En

- Read this manual thoroughly before using the camera.
- To ensure proper use of the camera, be sure to read “<Important> Notes About Shockproof, Waterproof, and Dustproof Performance and Condensation” (page ix), “Notes About Wireless Communication Functions” (page 26), and “For Your Safety” (separate document).
- After reading this manual, keep it in a readily accessible place for future reference.

SnapBridge

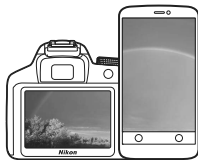

Your images. The world. Connected

Welcome to SnapBridge — Nikon's new family of services to enrich your image experience. SnapBridge connects your camera and compatible smart device, through a combination of *Bluetooth*® low energy (BLE) technology and a dedicated app. The stories you capture with your Nikon camera and lenses are automatically transferred to the device as they are taken. They can even be uploaded effortlessly to cloud storage services, inviting access across all your devices.

* Wireless communication is not available when the camera is underwater.

Download the SnapBridge 360/170 app to get started!

Take advantage of the wide-ranging convenience by downloading the "SnapBridge 360/170" app onto your smart device now. Through a few simple steps, this app connects your Nikon cameras with a compatible iPhone®, iPad® and/or iPod touch® or smart devices running on the Android™ operating system. The app is available free from the website (<http://snapbridge.nikon.com>), Apple App Store® and Google Play™.

For the latest information on SnapBridge, visit the Nikon website for your area (vii).



KeyMission 170 Model Name: N1531/ML-L6 Remote Control Model Name: N1544

The exciting image experience that SnapBridge offers...



Automatic picture transfer from camera to smart device thanks to the constant connection between the two devices — making online photo sharing easier than ever

* Movies cannot be transferred automatically.

NIKON IMAGE SPACE



Upload of photos and thumbnail images to the NIKON IMAGE SPACE cloud service

A range of services that enriches your imaging life, including:

- Camera remote control
- Imprinting up to two pieces of credit information (shooting info, shooting date and time, text, and logos) on pictures
- Automatic update of camera's date and time info and location info
- Receive camera's firmware updates



See from page 6 onwards for information on setting or using SnapBridge 360/170.

Introduction

Read This First

Thank you for purchasing the Nikon KeyMission 170 digital camera.

Downloading the “Reference Manual”

The Reference Manual (PDF format) provides details in various languages on how to use this product. Download the Reference Manual from our Download Center at the URL below and save it on your smart device or computer for reference.

- The Reference Manual can be viewed using Adobe Acrobat Reader (downloadable from the Adobe website) or iBooks (an iOS app).

Downloading Nikon Software

For Computer

Download the software from our Download Center at the URL below.

- KeyMission 360/170 Utility: This software enables you to transfer images and movies to your computer for viewing and editing.

For Smart Device

- SnapBridge 360/170: This app enables you to transfer images and movies to your smart device. See page ii for information on how to download it.

Visit Our Download Center

<http://downloadcenter.nikonimglib.com>

Visit our website to download manuals for Nikon imaging products, computer software, or firmware.



Nikon User Support

Should you need technical support, we offer a number of options.

Internet

For customers in the United States: **www.nikonusa.com**

For customers in Canada: **www.nikon.ca** (English), **fr.nikon.ca** (Français)

For customers in Mexico: **www.nikon.com.mx**

For customers in Brazil: **www.nikon.com.br**

Telephone

For customers in the United States: **1-800-NIKON-US (1-800-645-6687)**

For customers in Canada: **1-877-534-9910**

For customers in Mexico: **001-888-565-5452**

For customers in Brazil: **0800-886-4566 (0800-88 NIKON)**

Confirming the Package Contents

In the event that any items are missing, please contact the store where you purchased the camera.



KeyMission 170
Digital Camera



EN-EL12
Rechargeable
Li-ion Battery



EH-73P Charging
AC Adapter*



UC-E21 USB Cable



ML-L6 Remote
Control



Remote Control
Battery (3V CR2032
lithium battery)

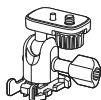

AA-1B Base
Adapter



AA-2 Base Mount
(Flat)



AA-3 Base Mount
(Curved)



AA-14B Lens
Protector



AA-15B Underwater
Lens Protector

Quick Start Guide
(this manual)

Warranty

* A plug adapter is included if the camera was purchased in a country or region that requires a plug adapter. The shape of the plug adapter varies with the country or region of purchase (📖4).

NOTE:

- A memory card is not included with the camera. In this manual, microSD, microSDHC, and microSDXC memory cards are referred to as “memory cards”.
- The lens protector is attached to the camera at the time of purchase.

Information and Precautions

Life-Long Learning

As part of Nikon's "Life-Long Learning" commitment to ongoing product support and education, continually updated information is available online at the following websites:

- For users in the U.S.A.: <http://www.nikonusa.com/>
- For users in Europe: <http://www.europe-nikon.com/support/>
- For users in Asia, Oceania, the Middle East, and Africa: <http://www.nikon-asia.com/>

Visit these websites to keep up-to-date with the latest product information, tips, answers to frequently asked questions (FAQs), and general advice on digital imaging and photography. Additional information may be available from the Nikon representative in your area. Visit the website below for contact information.

<http://imaging.nikon.com/>

Use Only Nikon Brand Electronic Accessories

Nikon cameras are designed to the highest standards and include complex electronic circuitry. Only Nikon brand electronic accessories (including battery chargers, batteries, AC adapters, and USB cables) certified by Nikon specifically for use with this Nikon digital camera are engineered and proven to operate within the operational and safety requirements of this electronic circuitry.

THE USE OF NON-NIKON ELECTRONIC ACCESSORIES COULD DAMAGE THE CAMERA AND MAY VOID YOUR NIKON WARRANTY.

The use of third-party rechargeable Li-ion batteries not bearing the Nikon holographic seal could interfere with normal operation of the camera or result in the batteries overheating, igniting, rupturing, or leaking.

Holographic seal: Identifies this device as an authentic Nikon product.



For more information about Nikon brand accessories, contact a local authorized Nikon dealer.

Before Taking Important Pictures

Before taking pictures on important occasions (such as at weddings or before taking the camera on a trip), take a test shot to ensure that the camera is functioning normally. Nikon will not be held liable for damages or lost profits that may result from product malfunction.

About the Manuals

- No part of the manuals included with this product may be reproduced, transmitted, transcribed, stored in a retrieval system, or translated into any language in any form, by any means, without Nikon's prior written permission.
- Illustrations and screen content shown in this manual may differ from the actual product.
- Nikon reserves the right to change the specifications of the hardware and software described in these manuals at any time and without prior notice.
- Nikon will not be held liable for any damages resulting from the use of this product.
- While every effort was made to ensure that the information in these manuals is accurate and complete, we would appreciate it were you to bring any errors or omissions to the attention of the Nikon representative in your area (address provided separately).

Comply with Copyright Notices

Under copyright law, photographs or recordings of copyrighted works made with the camera can not be used without the permission of the copyright holder. Exceptions apply to personal use, but note that even personal use may be restricted in the case of photographs or recordings of exhibits or live performances.

Disposing of Data Storage Devices

Please note that deleting images or formatting memory cards does not completely erase the original image data. Deleted files can sometimes be recovered from discarded memory cards using commercially available software, potentially resulting in the malicious use of personal image data. Ensuring the privacy of such data is the user's responsibility.

Before discarding a memory card or transferring ownership to another person, be sure to perform **Reset all** in **Camera settings** in the **Y** (setup) menu (📖23) to reset camera settings. After that, erase all data using commercial deletion software or perform **Format card** in **Camera settings** in the **Y** (setup) menu to format the memory card, then completely refill it with images containing no private information (for example, images of empty sky).

Care should be taken to avoid injury or damage to property when physically destroying memory cards.

Conformity Marking

Follow the procedure below to display some of the conformity markings that the camera complies with.

Enter shooting mode → **OK** button → **Y** (setup) icon → **OK** button → Camera settings → **OK** button → Conformity marking → **OK** button

<Important> Notes About Shockproof, Waterproof, and Dustproof Performance and Condensation

- The shockproof, waterproof, and dustproof performance described here do not guarantee that the camera will remain completely waterproof or free from damage and trouble under all conditions.
- Do not subject the camera to excessive shock, vibration or pressure by dropping it, hitting it, or placing a heavy object on it. Failure to observe this precaution could deform the camera, cause water to seep inside, or damage the airtight seals, resulting in camera malfunction.
- Your Nikon warranty may not cover troubles caused by water seeping inside the camera due to improper handling of the camera.

Notes About Shockproof Performance

This camera has passed Nikon's in-house test (drop test from a height of 200 cm (6 ft 6 in.) on a 5 cm (2 in.) thick plywood panel) compliant with the MIL-STD 810F Method 516.5-Shock¹ standard.²

Changes in appearance, such as paint peeling off and deformation of the camera, are not measured in Nikon's in-house test.

¹ U.S. Department of Defense test method standard.

This drop test drops 5 cameras in 26 directions (8 edges, 12 corners, and 6 faces) from a height of 122 cm (4 ft) to make sure that one to five cameras pass the test (if any defect is detected during the test, another five cameras are tested to make sure that the test criteria are satisfied for one to five cameras).

² When the lens protectors or underwater lens protectors are attached.

Notes About Waterproof and Dustproof Performance

The camera is rated equivalent to JIS/IEC waterproof class 8 (IPX8) and JIS/IEC dustproof class 6 (IP6X) and can shoot images underwater at a depth of 10 m (33 ft) for up to 60 minutes.*

* This rating indicates that the camera has been designed to withstand the specified water pressure for the specified period of time when the camera is used according to the methods defined by Nikon.

- The waterproof performance of this camera was tested in fresh water (swimming pools, rivers, and lakes) and salt water only.
- The inner portion of this camera is not waterproof. Water seeping inside the camera could cause the components to rust, resulting in high repair costs or irreparable damage.

Precautions When Cleaning

- Do not puncture the microphone or speaker openings with a sharp implement. If the inside of the camera is damaged, the waterproof performance will deteriorate.
- Do not use soap, neutral detergents, or chemicals such as benzene for cleaning.

Notes About Shockproof, Waterproof, and Dustproof Performance

- Do not drop the camera, strike it against a hard object such as a rock, or throw it against a water surface.
- Do not subject the camera to shock when using it underwater.
 - Do not subject the camera to water pressure by exposing it to rapids or waterfalls.
 - Do not expose to depths greater than 10 m (33 ft) underwater.
 - Make sure not to drop the camera underwater. This camera does not float in water.
- Do not continuously use the camera underwater for 60 minutes or more.
- Do not insert a wet memory card or battery in the camera.
 - Do not open the battery-chamber/memory card slot cover when the camera or your hands are wet. Doing so may cause water to seep inside the camera or result in camera malfunction.
- Do not open the battery-chamber/memory card slot cover underwater.
- If moisture such as water droplets adheres to the outside of the camera or inside of the battery-chamber/memory card slot cover, immediately wipe it off with a soft dry cloth.
 - If a foreign substance adheres to the outside of the camera or inside of the battery-chamber/memory card slot cover, immediately remove it with a blower or a soft cloth.
- Do not leave the camera in cold conditions or in hot conditions of 40°C (104°F) or more for a long period of time.
 - Doing so could cause deterioration of the waterproof performance.
 - When using the camera underwater, make sure the water temperature is from 0°C to 40°C (32°F to 104°F).
- Do not use the camera at hot springs.

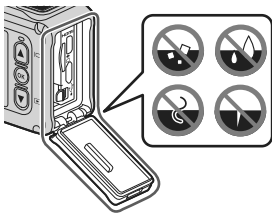

Before Using the Camera Underwater

Check the items below before using the camera underwater.

- Make sure that there are no foreign substances inside the battery-chamber/memory card slot cover.
- Make sure that the waterproofing packing of the battery-chamber/memory card slot cover is not cracked or deformed.
 - Make sure that the waterproofing packing is not detached from the camera.
- Make sure that the battery-chamber/memory card slot cover is firmly closed.
 - Make sure that the battery-chamber/memory card slot cover latch release is in the LOCK position (🔒).

Notes About Operating Temperature, Humidity, and Condensation

The operation of this camera has been tested at temperatures from -10°C to $+40^{\circ}\text{C}$ (14°F to 104°F).

When you use the camera in cold climate regions or at high altitudes, observe the following precautions.

- Battery performance deteriorates temporarily when cold. Keep the camera and batteries warm under your clothing before use.
- Camera performance may deteriorate temporarily if it is exposed to extreme cold for an extended period. For example, the monitor may appear darker than normal immediately after the camera is turned on, or residual images may be produced.

● Environmental conditions that are likely to cause condensation

Fogging (condensation) may occur on the inside of the monitor, lens, or underwater lens protector when there are sharp temperature changes or high humidity, such as in the environmental conditions described below. This is not a malfunction or defect.

- The camera is suddenly immersed in cold water after being in a hot place on land.
- The camera is brought to a warm place such as inside a building after being in the cold outdoors.
- The battery-chamber/memory card slot cover is opened or closed in a high-humidity environment.
- The camera or underwater lens protector is wet when the underwater lens protector is attached.

● Reducing condensation

- Open the battery-chamber/memory card slot cover, put the camera and a commercially-available desiccant in a container such as a plastic bag, and seal the container. Condensation is less likely to occur if the humidity inside the camera is reduced.
- Avoid storing the camera in places where the camera may become hot (such as places exposed to direct sunlight) before using it underwater. Taking the camera underwater while it is hot causes condensation due to sudden changes in temperature.

● Clearing the fogging

- Turn off the camera and open the battery-chamber/memory card slot cover while in a place where the ambient temperature is stable (avoid places with high temperature, high humidity, sand, or dust).
To clear the fogging from the lens or monitor, remove the battery and memory card, and leave the battery-chamber/memory card slot cover open to allow the camera to adjust to the ambient temperature. When the underwater lens protector is fogged, remove it.
- If the underwater lens protector is still fogged, try to clear the fogging by removing the underwater lens protector and using the camera for a while before attaching it again.

Notes About Waterproof Performance of the Remote Control

The remote control is rated equivalent to JIS/IEC waterproof class 7 (IPX7), and it is confirmed that water does not seep inside when soaked underwater at a depth of 1 m (3.2 ft) for up to 30 minutes.

- The remote control cannot be used underwater.

Notes About Condensation and Waterproof Performance of the Remote Control

- Do not drop the remote control, strike it against a hard object such as a rock, or throw it against a water surface.
- Do not take the remote control underwater.
 - If the remote control is dropped in water by accident, immediately pick it up and wipe it off with a soft dry cloth.
- Do not insert a wet battery in the remote control.
 - Do not open the battery-chamber cover when the remote control or your hands are wet. Doing so may cause water to seep inside the remote control and result in malfunction.
- If moisture such as water droplets or a foreign substance adheres to the outside of the remote control or the inside of the battery-chamber cover, immediately wipe it off with a soft dry cloth.
- Make sure that the battery-chamber cover is firmly closed.
 - Make sure that the battery-chamber cover is in the CLOSE position.
 - Make sure that no foreign substance such as lint is caught in the battery-chamber cover. Failure to observe this precaution could cause water to seep inside the remote control.
- Do not leave the remote control in cold conditions or in hot conditions of 40°C (104°F) or more for a long period of time.
 - Doing so could cause deterioration of the waterproof performance.
- Do not suddenly bring the remote control to high-humidity environment if it is exposed to extreme cold for an extended period.
 - Condensation may form inside the remote control.

Inspection and Repair

- If the camera is exposed to shock, it is recommended to consult your retailer or Nikon-authorized service representative to confirm the waterproof performance (charged service).
- If the waterproofing packing begins to deteriorate, consult your retailer or Nikon-authorized service representative. The waterproof performance of the waterproofing packing may start to deteriorate after one year.
- If water seeps inside the camera, immediately stop using it and take it to your Nikon-authorized service representative.

Parts of the Camera

The Camera Body

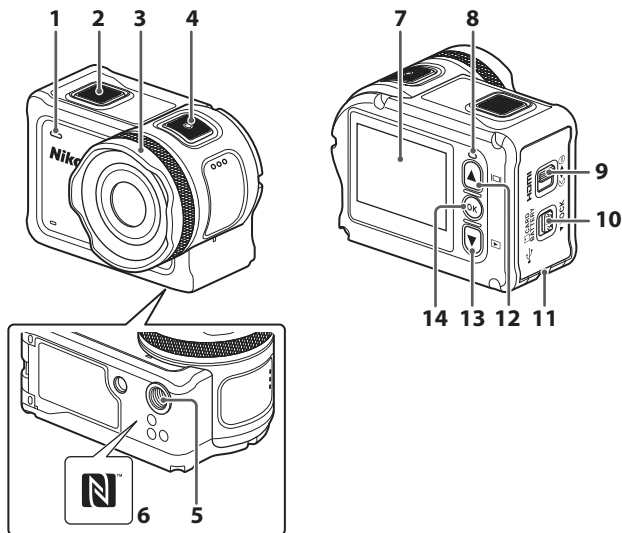

- 1** Status lamp
- 2** Photo button
- 3** Lens protector
- 4** Movie button
- 5** Tripod socket
- 6** N-Mark (NFC antenna)
- 7** Monitor
- 8** Status lamp

- 9** Battery-chamber/memory card slot cover latch
- 10** Battery-chamber/memory card slot cover latch release
- 11** Eyelet for fall prevention cord
- 12** ▲ (|□| monitor) button
- 13** ▼ (|▶| playback) button
- 14** Ⓞ (OK) (apply selection) button

Getting Started

Inserting the Battery and Memory Card

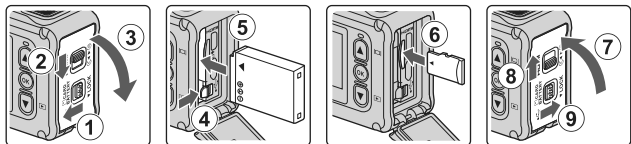

- Unlock the battery-chamber/memory card slot cover latch release (①), slide the battery-chamber/memory card slot cover latch to the ← position (②), and open the battery-chamber/memory card slot cover towards you (③).
- With the battery's positive and negative terminals oriented correctly, move the orange battery latch (④), and fully insert the battery (⑤).
- Slide the memory card in until it clicks into place (⑥).
- Be careful not to insert the battery or memory card upside-down or backward, as this could cause a malfunction or result in damage to the camera or memory card.
- After closing the cover (⑦), slide the battery-chamber/memory card slot cover latch to the → position (⑧), and return the battery-chamber/memory card slot cover latch release to the LOCK position (⑨). Make sure that the orange marks on both latches are not visible.

✓ Notes About Waterproof and Dustproof Performance

See "Notes About Shockproof, Waterproof, and Dustproof Performance" (📖) for more information.

✓ Formatting a Memory Card

The first time you insert a memory card that has been used in another device into this camera, make sure to format it with this camera.

- **Note that formatting a memory card permanently deletes all images and other data on the memory card.** Be sure to make copies of any images you wish to keep before formatting the memory card.
- Insert the memory card into the camera, and select **Format card** in **Camera settings** (📖23) in the **Y** (setup) menu.

Removing the Battery or Memory Card

Turn the camera off and make sure that the status lamps and screen have turned off, and then open the battery-chamber/memory card slot cover.

- Move the battery latch to eject the battery.
- Gently push the memory card into the camera to partially eject the memory card.
- Be careful when handling the camera, battery, and memory card immediately after using the camera, as they may be hot.

Memory Cards That Can Be Used

The camera supports microSD, microSDHC, and microSDXC memory cards.

- The camera also supports microSDHC and microSDXC cards compliant with UHS-I.
- Use microSDXC memory cards with an SD Speed Class rating of 6 or faster for recording movies.
 - Use memory cards with a UHS Speed Class rating of 3 or faster when the image size/frame rate is **2160/30p** (4K UHD) or **2160/25p** (4K UHD).
 - When using a memory card with a lower Speed Class rating, movie recording may stop unexpectedly.
- If you use a card reader, make sure that it is compatible with your memory card.
- Contact the manufacturer for information on features, operation, and limitations on use.

Charging the Battery

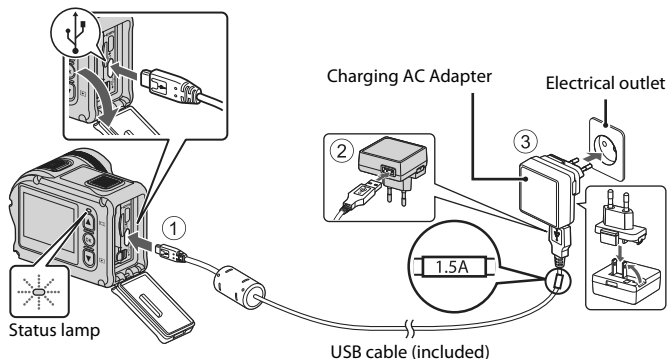

If a plug adapter* is included with your camera, securely connect it to the Charging AC Adapter. Once the two are connected, attempting to forcibly remove the plug adapter could damage the product.

- * The shape of the plug adapter varies according to the country or region in which the camera was purchased. This step can be omitted if the plug adapter comes permanently bonded to the Charging AC Adapter.
- Charging starts when the camera is connected to an electrical outlet while the battery is inserted, as shown in the illustration. The status lamps flash green slowly while the battery is charging.
- When charging is complete, the status lamps turn off. Unplug the Charging AC Adapter from the electrical outlet, and disconnect the USB cable. Charging time is about 3 hours for a fully exhausted battery.
- The battery cannot be charged when the status lamps are flashing green quickly, possibly due to one of the reasons described below.
 - The ambient temperature is not suited to charging.
 - The USB cable or Charging AC Adapter is not properly connected.
 - The battery is damaged.

✓ Notes About the USB Cable

- Check the shape and direction of the plugs and do not insert or remove the plugs at an angle.
- Do not use a USB cable other than the UC-E21. Using a USB cable other than the UC-E21 could result in overheating, fire or electric shock.

✓ Turning the Camera On While Charging

If you press the movie button or photo button while charging with the Charging AC Adapter, the camera turns on, enabling you to record movies, capture still images, play them back, and operate the setting menus (some menus cannot be operated).

Turning the Camera On or Off

Turning the Camera On

- Press the movie button or photo button to turn on the camera. When the camera turns on, the shooting screen is displayed.
- You can check the battery level on the monitor or on the SnapBridge 360/170 app screen.

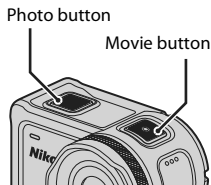

Turning the Camera Off

- You can turn off the camera by pressing and holding the movie button for at least 3 seconds while the camera is turned on.
- You can also turn off the camera using the following procedure. Enter shooting mode → OK button → Use ▲▼ to select Ⓛ (power off) → OK button
- The camera turns off automatically when no operations are performed for 30 seconds after shooting (default setting). You can configure settings in **Auto off** in **Camera settings** in the ⚙ (setup) menu (📖23).

📎 Setting the Auto Off Function

- If the camera is powered only by the battery and no operations are performed in the situations described below, the camera turns off regardless of the auto off function setting.
 - After the camera is turned on (before shooting starts): 1 minute
 - After operations are performed in menus or in playback mode: 3 minutes
 - When the camera is waiting to be paired with a smart device that supports NFC, after **Connect to device** is selected in the network menu: 30 minutes
 - When the camera is waiting to be paired with the remote control, after **Connection to remote** is selected in the network menu: 3 minutes
 - When an HDMI cable is connected (if there is no signal): 30 minutes
 - When a USB cable is connected (if there is no data transmitted or received): 30 minutes
- The auto off function is not activated in the following situations:
 - When the EH-62F AC Adapter is connected
 - When the camera is connected to a computer

✓ Notes About Turning Off the Camera During Remote Shooting

The camera buttons are disabled when using the SnapBridge 360/170 app to shoot remotely. Before turning off the camera, stop using the remote shooting function. For more information about remote shooting, see SnapBridge 360/170 app online help.

Camera Setup

Setup from a Smartphone or Tablet

Here, pairing refers to the setting used to connect the camera and smartphone or tablet (below, “smart device”) through Bluetooth.

Camera

- Insert a microSD memory card with sufficient free space into the camera.
- Check that the battery is sufficiently charged so that the camera does not turn off during the procedure.

Smart device

- Two apps are available: “SnapBridge” and “**SnapBridge 360/170**”. Use “**SnapBridge 360/170**” when pairing your device with this camera.
- **Do not pair from the Bluetooth setting screen of the smart device.**



1 Check that the camera is off (the screen is off).

- To turn off the camera, press and hold the movie button for at least three seconds. See “Turning the Camera On or Off” (📖5) for more information.

2 Enable Bluetooth and Wi-Fi on the smart device.

- If you are using NFC, enable the NFC setting on the smart device.

3 Install the SnapBridge 360/170 app.

- After installing the SnapBridge 360/170 app, close all apps that use NFC (including the SnapBridge 360/170 app). Pairing may fail if apps that use NFC are running.

4 Press the movie button or photo button to turn on the camera.

- A language selection dialog will be displayed. Press ▲ or ▼ on the back side of the camera to highlight a language and press Ⓞ to select.

Videos on How to Use the SnapBridge 360/170 App

Videos in the website below easily explain how to use the SnapBridge 360/170 app for pairing and basic operations.

http://imaging.nikon.com/lineup/action/keymission_170/index.htm#movie

5 Press ▼ to scroll through the screen, select **Options**, and press the **OK** button.

- If you do not wish to use a smart device to configure the camera, select **Later** (🗨9).

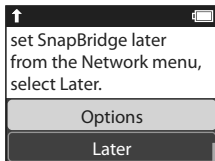

6 If you are not using NFC, press ▼ to scroll through the screen, select **Next**, and press the **OK** button.

- The screen shown on the right is displayed on the camera.
- The status lamps flash red and green alternately while the camera is waiting to be paired.
- **If You Are Using NFC**

Before selecting **Next** in step 6, touch the NFC antenna of the smart device to the **N** (N-Mark) on the camera (🗨1). The SnapBridge 360/170 app on the smart device launches, and when **Camera name acquired. Connect?** is displayed on the screen, select **OK**. Proceed to step 8.

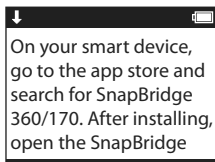

7 Launch the SnapBridge 360/170 app on the smart device.

- When the screen shown on the right is displayed on the smart device, tap the camera name.
- **For iOS Devices**

If the accessory selection screen is displayed after tapping the camera name, wait until the **B** Bluetooth icon in the top right corner of the smart device screen changes from white to gray, and then tap the camera name. It may take a while before the camera name is displayed.

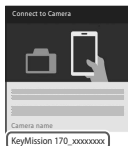

8 Check the authentication code.

- Confirm that the camera and smart device display the same authentication code.
- Perform the following operations on the camera and smart device at the same time.
 - On the camera, press ▼ to scroll through the screen, select **OK**, and press the **OK** button.
 - On the smart device, tap **Pairing** (the name of the button varies with the smart device).

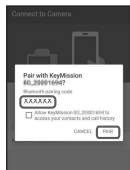
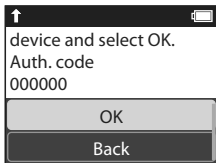

9 Follow the on-screen instructions to complete the pairing process.

- Camera: If pairing is successful, the screen shown on the right is displayed. Press ▼ to scroll through the screen, select **Next**, and press the **OK** button.
- Smart device: Follow the on-screen instructions.

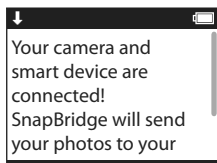

10 Follow the on-screen instructions to complete the setup process.

- To record location data with photographs, select **Yes** when prompted and enable the location data features both in the SnapBridge 360/170 app and on the smart device itself.
- You can also synchronize the camera clock to the time reported by the smart device by selecting **Yes** when prompted and enabling synchronization in the SnapBridge 360/170 app.
- Setup is complete when the camera returns to the shooting display.
- See page 10 for more information on using SnapBridge.

✓ Where the Use of Wireless Devices Is Prohibited

Where the use of wireless devices is prohibited, disable wireless features in the camera network menu by selecting **On** for **Airplane mode**. This will temporarily interrupt the constant connection with the smart device, but the connection is automatically re-established when airplane mode is turned off.

Setup from the Camera Menus

The camera clock can be set manually.

1 Press the movie button or photo button to turn on the camera (📖5).

- A language selection dialog will be displayed. Press ▲ or ▼ on the back side of the camera to highlight a language and press OK to select.
- The language can be changed at any time using the **Language** option in **Camera settings** in the ⚙ (setup) menu (📖23).

2 When the dialog at right is displayed, press ▲ or ▼ to select **Later**, and press OK.

- Press ▼ and scroll down to view the screen at right.
- Select **Yes** when prompted to set the camera clock.

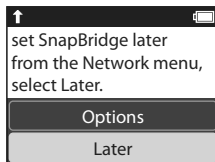

3 Press ▲ or ▼ to choose a date format and press OK.

4 Enter the current date and time and press OK.

- Press OK to highlight items and press ▲ or ▼ to change.
- When the item on the far right is highlighted, press OK to confirm the settings.

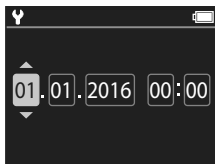

5 When prompted, press ▲ or ▼ to highlight **Yes** and press OK.

- The camera exits to the shooting display when setup is complete.

Resetting the Clock

The **Date and time** option in **Camera settings** (📖23) can be used to set the camera clock.

What SnapBridge Can Do for You

The SnapBridge 360/170 app can be used for a variety of tasks once the camera has been paired with your smart device.

See the online help for more information.

<http://nikonimglib.com/snbrkm/onlinehelp/en/index.html>

The online help can be displayed by tapping **Other** → **Info/settings** → **Instructions** in the SnapBridge 360/170 app.



Auto Upload

At default settings, pictures will automatically be uploaded to the smart device as they are taken.

- Place the smart device close to the camera and launch the SnapBridge 360/170 app.

Option	Description
Disabling auto upload	Auto upload can be disabled using the Send while shooting > Still images option in the network menu in Camera settings (📖23).
Upload options	Use the Send while shooting > Upload (photos) item in the network menu in Camera settings (📖23) to choose the types of pictures automatically uploaded.
Selecting pictures for upload	You can use  (upload) in the camera's playback menu (📖13) to upload pictures that were not automatically uploaded during shooting.
Resizing pictures for upload	Use the SnapBridge 360/170 app to choose the size at which pictures are copied to the smart device. The default size is 2 megapixels.

✓ Notes About Auto Upload

Movies cannot be uploaded using the **Send while shooting** or  (upload) options. To upload movies to a smart device, use the SnapBridge 360/170 app.

Wireless Networks

Option	Description
Pairing after camera setup	Select Connect to device in the camera network menu, and follow the instructions in “Setup from a Smartphone or Tablet” from Step 5 (📖7).
Unpairing	In the SnapBridge 360/170 app, tap ➡ in Connect , and then tap End pairing on the screen that is displayed.
Wi-Fi connection	A Wi-Fi connection is established when using Remote photography or Download selected pictures . For iOS devices, establish the Wi-Fi connection by selecting the SSID of the camera in Wi-Fi in Settings on the iOS device. Password and Auth./encrypt. can be checked in the Y (setup) menu of the camera, in Camera settings ➔ Network menu ➔ Wi-Fi ➔ Network settings . The default password is “NikonKeyMission”. Set a new password that is different from the default password.
Number of pairable smart devices	The camera can be paired with up to five smart devices. However, it can connect to only one device at a time.

Re-pairing

Re-pair when pairing again after unpairing.

Select **Connect to device** in the camera network menu, and then follow the instructions on the camera and smart device screen. When **Non-NFC enabled devices: select Next.** is displayed, select **Next** and press the **OK** button, and then launch the SnapBridge 360/170 app on the smart device. Tap ➡ in **Connect**, and then tap the product name of the camera you want to pair with on the screen that is displayed. When the authentication code is displayed on the camera screen, follow the instructions in “Setup from a Smartphone or Tablet” from Step 8 (📖8).

Other Options for the SnapBridge 360/170 App

Option	Description
Remote photography	Use the smart device to release the camera shutter.
Change settings remotely	Use the smart device to change settings such as the shooting settings.
Viewing the pictures on the camera	Use the smart device to view and download the pictures on the camera. This option is available even when the camera is off.

Using the Camera

Recording Movies and Shooting Still Images

1 Press the movie button or photo button.

- The camera turns on and the shooting screen is displayed.
- To shoot a series of images, select **Continuous** in the still images menu in the **Y** (setup) menu.

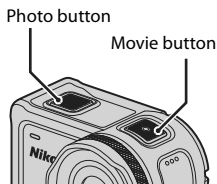

2 Press the movie button to record movies, and press the photo button to shoot still images.

- To stop recording a movie, press the movie button again. The recorded movies and captured still images are saved on the memory card.

✓ Notes About Using the Camera Underwater

- When using the camera underwater, attach the underwater lens protector (📖21). If it is not attached, the images you capture may be blurred.
- Set **Underwater** in **Shooting options** in the **Y** (setup) menu (📖23) to **On**.
- The angle of view (i.e., the area visible in the frame) becomes narrower when underwater.
- Wireless communication is not available when the camera is underwater. Also, the remote control cannot be used.

📎 Turning the Monitor On or Off

- You can turn the monitor on or off by pressing the **▲** (📺 monitor) button while the shooting screen is displayed.
- The monitor automatically turns off 30 seconds after you start recording a movie (default setting). The **▲** (📺 monitor) button cannot be used while recording a movie. You can change the amount of time that elapses before the monitor turns off in **LCD auto off** in **Movie recording** in **Camera settings** in the **Y** (setup) menu.

📎 Turning Off the Camera

At the default setting, the camera turns off automatically when no operations are performed for 30 seconds after shooting (📖5).



📎 Movies Over 4 GB in Size

When a movie with a file size of more than 4 GB is recorded, the movie is divided into files with a maximum size of 4 GB each.

Playing Back Movies and Still Images



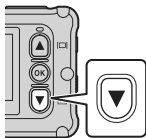

If fingerprints or other stains are on the underwater lens protector, they are captured in images. Use a soft dry cloth to clean the underwater lens protector before shooting.

1 Press the ▼ button.

- If the camera is turned off, turn it on by pressing the movie button or photo button before pressing the ▼ button.
- You can also play back movies and still images by selecting  (playback) on the  (HOME) screen (23).
- The most recently captured still image or the first frame of the most recently recorded movie is displayed on the screen.



2 Press ▲▼ to display the image that you want to play back.

- Press and hold  to scroll through the images quickly.
- To play back movies, press the  button and select  (playback).
- You can edit movies on the camera. For details on editing movies, see the Reference Manual. The Reference Manual can be downloaded from our Download Center (.

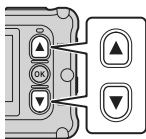

Transferring Images to a Smart Device

To transfer still images from the camera to a smart device, launch the SnapBridge 360/170 app on the smart device and perform the procedure below on the camera.

1 Press the ▼ button.

- If the camera is turned off, turn it on by pressing the movie button or photo button before pressing the ▼ button.
- The most recently captured still image or the first frame of the most recently recorded movie is displayed on the screen.

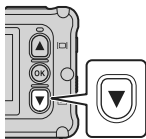

2 Press ▲▼ to display the image that you want to transfer.

- Press and hold ▲▼ to scroll through images quickly.
- Movies cannot be transferred by performing an operation on the camera. To transfer movies to a smart device, use the SnapBridge 360/170 app.

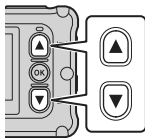

3 Press the OK button to display the playback menu.



4 Use ▲▼ to select  (upload), and press the OK button.

- You can select  (delete) in this step to delete the image.

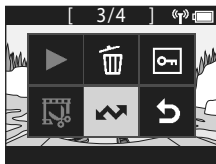

5 Select **Yes**, and press the OK button.

- The image is transferred to the smart device.

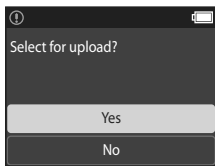

Using Accessories

This section describes the functions of the accessories included with the camera and how to use them.

Using the Remote Control

You can use the ML-L6 Remote Control to record movies, take pictures, and add highlight tags from a distance. You can also use it to turn on the camera.

Parts and Functions of the Remote Control

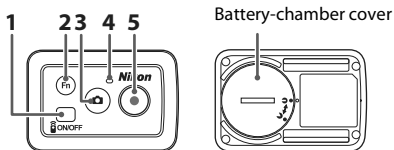

	Part	Function	
1	Power button	Turns on the remote control when pressed, and turns it off when pressed again. Also, turns off the camera.	-
2	Fn button	Performs one of the following operations when pressed while recording a movie: <ul style="list-style-type: none">• Adds a highlight tag (default setting)• Switches to high frame rate recording (while recording a movie in add slow motion mode) The operation that is performed when the Fn button is pressed can be specified in Camera settings in the Y (setup) menu (23).	-
		Switches the connection from the remote control to a paired smart device.	18
3	Photo button	Performs the same function as the photo button on the camera. Turns the camera on and captures a still image.	12
4	Status lamp	Displays the shooting status in conjunction with the status lamps on the camera.	-
5	Movie button	Turns the camera on and starts/stops movie recording.	12

Notes About Using the Remote Control

- The remote control cannot be used underwater.
- Make sure to read “Notes About Waterproof Performance of the Remote Control” (xii) and “Notes About Condensation and Waterproof Performance of the Remote Control” (xii).

Inserting the Battery in the Remote Control

Insert a 3V CR2032 lithium battery.

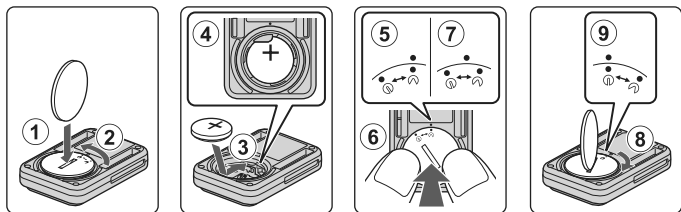

- Use a coin (1) to turn the battery-chamber cover counterclockwise (2) and open it.
- Insert the battery with the positive side face up (3). Make sure that the battery is firmly inserted at the center of the battery chamber (4).
- Align the ⤴• mark of the battery-chamber cover with the ● mark of the remote control (5), and press the battery-chamber cover with your thumbs (6). The battery-chamber cover rotates clockwise slightly and stops (7).
- Use a coin to turn the battery-chamber cover clockwise (8) to securely lock it. Make sure that the ⊖• mark of the battery-chamber cover is aligned with the ● mark of the remote control (9).
- Make sure that no foreign substance such as lint is caught in the battery-chamber cover. Failure to observe this precaution could impair the waterproof performance and cause water to seep inside the remote control.

Pairing the Camera and Remote Control

Before using the remote control for the first time, it must be paired with the camera. (The remote control included with the camera has already been paired. The settings described below are not necessary.)

* In this manual, "pairing" refers to the establishment of a Bluetooth connection between the camera and remote control.

- The camera can only be paired with one remote control at a time. When the camera is paired to a different remote control, only the most recent pairing information is saved.

1 Enable pairing on the camera.

- Enter shooting mode → **OK** button → **Y** (setup) icon → **OK** button → Camera settings → **OK** button → Network menu → **OK** button → Connection to remote → **OK** button

2 Press and hold (for at least 3 seconds) the power button on the remote control.

- Pairing starts for the camera and remote control. While the process is being performed, the status lamp on the remote control flashes.
- When pairing is complete, the remote control icon is displayed on the shooting screen.
- If a pairing failure message is displayed, perform the procedure again from step 1.



Status Lamps on the Camera

- The status lamps flash green and red alternately while the camera is waiting to be paired.
- When pairing is successful, the lamps flash green two times.
- When pairing fails, the lamps flash red six times.

Switching Between Smart Device and Remote Control

The camera cannot be operated by both the remote control and a smart device at the same time. Follow the procedure below to switch from one to the other.

Switching from Smart Device to Remote Control

Switch the connection from a smart device to a paired remote control.

1 Select **Camera & remote** in **Choose connection** in **Network menu**.

- The camera connects to the remote control.

2 Turn on the remote control.

- A connection is established between the camera and remote control. The  icon is displayed on the shooting screen.



Switching from Remote Control to Smart Device

Switch the connection from the remote control to a paired smart device.

1 Turn on the camera and remote control, then press and hold the **Fn** button on the remote control.

- The camera connects to the smart device.

2 Launch the SnapBridge 360/170 app on your smart device.

- A connection is established between the camera and smart device. The  icon is displayed on the shooting screen.

Using the Base Adapter and Base Mount

Attaching the base adapter to the camera allows you to use special accessories such as a base mount.

- To increase the adhesive strength, attach the base mount for 24 hours or longer before using the camera.

- 1** Align the camera screw with the tripod socket of the camera (①), and tighten the screw knob (②).

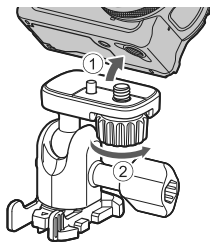

- 2** Attach the buckle of the base adapter to the base mount.

- While holding the two protrusions of the buckle at the same time, slide the buckle until it clicks into place.

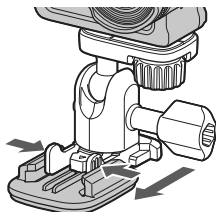

- When removing the buckle, hold the two protrusions at the same time, and slide them in the direction opposite of that for attachment.

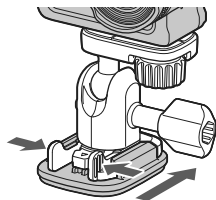

3 Adjust the camera angle.

- Loosen the plate lock (①), set the camera angle (②), and then tighten the lock (③).

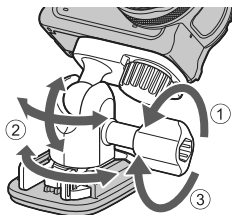

4 Make sure that there are no foreign substances on the surface to which the base mount will be attached.

- If there are foreign substances such as dust or water, remove them.

5 Peel off the release liner from the back of the base mount, and firmly press the base mount so that the entire surface is attached.

Base Mount

The base mount is an accessory that is used to easily attach and detach a base adapter mounted with the camera.

Attach the base mount to places where you want to mount the camera.

Use the flat or curved type depending on the surface to which the base mount will be attached.

The base mount is not designed for use on vehicles. Do not attach it on vehicles.

- Base mount (flat):**

Use to attach to flat surfaces.

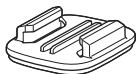

- Base mount (curved):**

Use to attach to curved surfaces such as helmets.

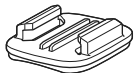

✓ Notes About Using the Base Adapter and Base Mount

- Do not use the base adapter and base mount so that they are subjected to sudden loads, such as directly attaching them to skis or snowboards. Subjecting them to sudden loads will damage the accessories or detach the base mount.
- You cannot reuse a base mount after it has been attached and then removed.
- The surface may be damaged or the paint may peel off depending on the material to which the base mount is attached. Care should be taken when attaching the base mount.
- The base mount is not suited for attachment to surfaces made of rough material such as wood or concrete.

Using the Lens Protector or Underwater Lens Protector

- **Lens protector***
Protects the lens from impact from the front.
 - **Underwater lens protector**
Protects the lens when using the camera underwater, or in situations where debris such as gravel may strike the lens.
- * The lens protector is attached to the camera at the time of purchase.

✓ Notes About Using the Camera Underwater

When using the camera underwater, attach the underwater lens protector. If it is not attached, the images you capture may be blurred.

Attaching the Lens Protector or Underwater Lens Protector

✓ Notes About Attaching the Underwater Lens Protector

Use a soft cloth or air duster to remove foreign substances such as water or dust from the camera or underwater lens protector. If the camera or underwater lens protector is still wet when the underwater lens protector is attached, this could cause condensation.

- 1 Align the mark on the lens protector with the one on the camera, and mount the lens protector on the camera.

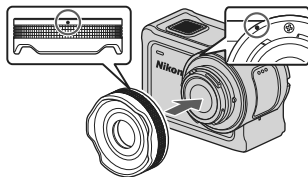

Lens protector

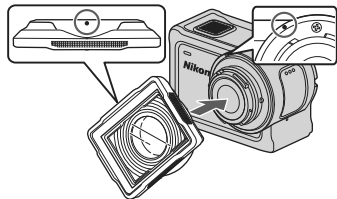

Underwater lens protector

2 Turn the lens protector clockwise to secure it.

- Turn the lens protector until it clicks into place and the mark on the lens protector is aligned with the mark on the top of the camera (○).
- To attach the underwater lens protector, press it against the camera while turning.

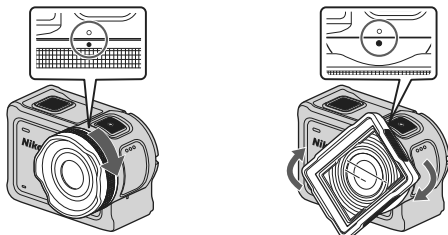

✓ Notes About Checking the Attached Lens Protector

Make sure that the lens protector is securely attached.

Removing the Lens Protector or Underwater Lens Protector

1 Turn the lens protector counterclockwise.

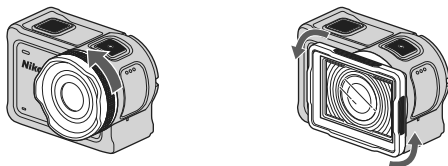

2 Pull the lens protector toward you to remove it.

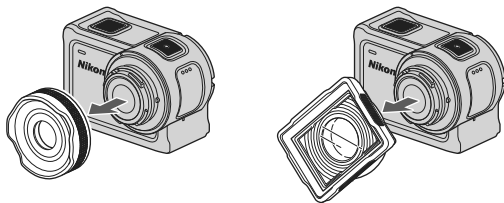

Using the Menu

Menu Operations

You can configure settings in the menus listed below.

- Movie menu^{1,2}
- Still images menu¹
- Shooting options menu¹
- Camera settings menu¹
- Playback menu³

¹ These menus appear on the **Y** (setup) menu screen.

² Menu icons and available setting options vary depending on the shooting mode.

³ This menu appears when the **OK** button is pressed while the playback screen is displayed.

Follow the procedure below to configure settings in the **Y** (setup) menu.

1 Press the **OK** button while the shooting screen is displayed.

- The **HOME** screen is displayed.
- To return to the shooting screen while configuring settings in the menus, press the movie button or photo button.

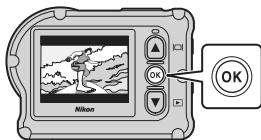

2 Use **▲▼** to select **Y** (setup), and press the **OK** button.

- The **Y** (setup) menu screen is displayed.

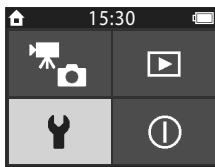

3 Use **▲▼** to select the menu item that you want to configure, and press the **OK** button.

- Use the same procedure in lower-level menus to select and configure items.
- To return to the previous screen, select **< Back** and press the **OK** button.

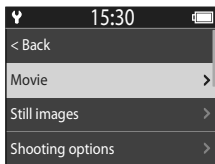

Technical Notes

Notices

Notices for Customers in the U.S.A.

IMPORTANT SAFETY INSTRUCTIONS - SAVE THESE INSTRUCTIONS.

DANGER - TO REDUCE THE RISK OF FIRE OR ELECTRIC SHOCK, CAREFULLY FOLLOW THESE INSTRUCTIONS

For connection to a supply not in the U.S.A., use an attachment plug adapter of the proper configuration for the power outlet if needed.

The power supply unit is intended to be correctly orientated in a vertical or floor mount position.

Federal Communications Commission (FCC) Radio Frequency Interference Statement

This equipment has been tested and found to comply with the limits for a Class B digital device, pursuant to Part 15 of the FCC rules. These limits are designed to provide reasonable protection against harmful

interference in a residential installation. This equipment generates, uses, and can radiate radio frequency energy and, if not installed and used in accordance with the instructions, may cause harmful interference to radio communications. However, there is no guarantee that interference will not occur in a particular installation. If this equipment does cause harmful interference to radio or television reception, which can be determined by turning the equipment off and on, the user is encouraged to try to correct the interference by one or more of the following measures:

- Reorient or relocate the receiving antenna.
- Increase the separation between the equipment and receiver.
- Connect the equipment into an outlet on a circuit different from that to which the receiver is connected.
- Consult the dealer or an experienced radio/television technician for help.

CAUTIONS

Modifications

The FCC requires the user to be notified that any changes or modifications made to this device that are not expressly approved by Nikon Corporation may void the user's authority to operate the equipment.

Interface Cables

Use the interface cables sold or provided by Nikon for your equipment. Using other interface cables may exceed the limits of Class B Part 15 of the FCC rules.



Notice for Customers in the State of California

WARNING

Handling the cord on this product will expose you to lead, a chemical known to the State of California to cause birth defects or other reproductive harm.

Wash hands after handling.

Nikon Inc.,

1300 Walt Whitman Road, Melville, New York 11747-3064, U.S.A.

Tel: 631-547-4200

Notice for Customers in Canada

CAN ICES-3 B / NMB-3 B

Notes About Wireless Communication Functions

Restrictions on Wireless Devices

The wireless transceiver included in this product conforms to wireless regulations in the country of sale and is not for use in other countries (products purchased in the EU or EFTA can be used anywhere within the EU and EFTA). Nikon does not accept liability for use in other countries. Users who are unsure as to the original country of sale should consult with their local Nikon service center or Nikon-authorized service representative. This restriction applies to wireless operation only and not to any other use of the product.

Security

Although one of the benefits of this product is that it allows others to freely connect for the wireless exchange of data anywhere within its range, the following may occur if security is not enabled:

- Data theft: Malicious third-parties may intercept wireless transmissions to steal user IDs, passwords, and other personal information.
- Unauthorized access: Unauthorized users may gain access to the network and alter data or perform other malicious actions. Note that due to the design of wireless networks, specialized attacks may allow unauthorized access even when security is enabled. Nikon is not responsible for data or information leaks that may occur during data transfer.
- Do not access networks that you are not permitted to use, even if they are displayed on your smartphone or tablet. Doing so may be regarded as unauthorized access. Only access networks that you are permitted to use.

Personal Information Management and Disclaimer

- User information registered and configured on the product, including wireless LAN connection settings and other personal information, is susceptible to alteration and loss resulting from operational error, static electricity, accident, malfunction, repair or other handling. Always keep separate copies of important information. Nikon is not responsible for any direct or indirect damages or lost profits resulting from alteration or loss of content that is not attributable to Nikon.
- Before discarding this product or transferring it to another owner, perform **Restore default settings** in **Network menu** in **Camera settings** in the **Y** (setup) menu (📖23) to delete all user information registered and configured with the product, including wireless LAN connection settings and other personal information.
- Nikon is not responsible for any damages resulting from unauthorized use of this product by third parties in the event that the product is stolen or lost.

Precautions when Exporting or Carrying This Product Abroad

This product is controlled by the United States Export Administration Regulations (EAR). The permission of the United States government is not required for export to countries other than the following, which as of this writing are subject to embargo or special controls: Cuba, Iran, North Korea, Sudan, and Syria (list subject to change).

Notice for Customers in the U.S.A. and Canada

Federal Communications Commission (FCC) and Industry of Canada (IC)

Declaration of Conformity

This device complies with Part 15 of FCC Rules and Industry Canada licence-exempt RSS standard(s). Operation is subject to the following two conditions: (1) this device may not cause interference, and (2) this device must accept any interference, including interference that may cause undesired operation of this device.

FCC/IC RF Exposure Statement

This transmitter must not be co-located or operated in conjunction with any other antenna or transmitter.

The available scientific evidence does not show that any health problems are associated with using low power wireless devices. There is no proof, however, that these low power wireless devices are absolutely safe. Low power wireless devices emit low levels of radio frequency energy (RF) in the microwave range while being used. Whereas high levels of RF can produce health effects (by heating tissue), exposure of low-level RF that does not produce heating effects causes no known adverse health effects. Many studies of low-level RF exposures have not found any biological effects. Some studies have suggested that some biological effects might occur, but such findings have not been confirmed by additional research.

KeyMission 170, which is equipped with a WM-BN-BM-26_A (FCC ID:2AAD3JA1D0J0 / IC ID:4634A-3152EC) Wireless LAN Module, and ML-L6 Remote Control (FCC ID:CGJ8152EB / IC ID:4634A-8152EB), have been tested and found to comply with FCC/IC radiation exposure limits set forth for an uncontrolled environment and meet the FCC radio frequency (RF) Exposure Guidelines in Supplement C to OET65 and RSS-102 of the IC radio frequency (RF) Exposure rules. Please refer to the SAR test report that was uploaded to FCC website.

Caring for the Product

Observe the precautions described below in addition to the warnings in “For Your Safety” (separate document) when using or storing the device.

The Camera

For information about the handling precautions for the camera, also read “<Important> Notes About Shockproof, Waterproof, and Dustproof Performance and Condensation” (ix).

Do Not Apply Strong Impact to the Camera

The product may malfunction if subjected to strong shock or vibration. In addition, do not touch or apply force to the lens or lens cover.

Avoid Sudden Changes in Temperature

Sudden changes in temperature, such as when entering or leaving a heated building on a cold day, can cause condensation to form inside the device. To prevent condensation, place the device in a carrying case or a plastic bag before exposing it to sudden changes in temperature.

Keep Away from Strong Magnetic Fields

Do not use or store this device in the vicinity of equipment that generates strong electromagnetic radiation or magnetic fields. Doing so could result in loss of data or camera malfunction.

Do Not Point the Lens at Strong Light Sources for Extended Periods

Avoid pointing the lens at the sun or other strong light sources for extended periods when using or storing the camera. Intense light may cause the image sensor to deteriorate or produce a white blur effect in photographs.

Turn the Product Off Before Removing or Disconnecting the Power Source or Memory Card

Do not remove the battery while the product is on, or while images are being saved or deleted. Forcibly cutting power in these circumstances could result in loss of data or in damage to the memory card or internal circuitry.

Notes About the Monitor

- Monitors (including electronic viewfinders) are constructed with extremely high precision; at least 99.99% of pixels are effective, with no more than 0.01% being missing or defective. Hence while these displays may contain pixels that are always lit (white, red, blue, or green) or always off (black), this is not a malfunction and has no effect on images recorded with the device.
- Images in the monitor may be difficult to see under bright lighting.
- Do not apply pressure to the monitor, as this could cause damage or malfunction. Should the monitor break, care should be taken to avoid injury caused by broken glass and to prevent the liquid crystal from the display touching the skin or entering the eyes or mouth.

The Battery

Precautions for Use

- Note that the battery may become hot after use.
- Do not use the battery at ambient temperatures below 0°C (32°F) or above 40°C (104°F) as this could cause damage or malfunction.
- If you notice any abnormalities such as excessive heat, smoke, or an unusual smell coming from the battery, immediately discontinue use and consult your retailer or Nikon-authorized service representative.
- After removing the battery from the camera or optional battery charger, put the battery in a plastic bag, etc. in order to insulate it.

Charging the Battery

Check the battery level before using the camera and replace or charge the battery if necessary.

- Charge the battery indoors with an ambient temperature of 5°C to 35°C (41°F to 95°F) before use.
- A high battery temperature may prevent the battery from charging properly or completely, and may reduce battery performance. Note that the battery may become hot after use; wait for the battery to cool before charging.
When charging the battery inserted into this camera using the Charging AC Adapter or a computer, the battery is not charged at battery temperatures below 0°C (32°F) or above 45°C (113°F).
- Do not continue charging once the battery is fully charged as this will result in reduced battery performance.
- The battery temperature may increase during charging. However, this is not a malfunction.

Carrying Spare Batteries

Whenever possible, carry fully charged spare batteries when taking pictures on important occasions.

Using the Battery When Cold

On cold days, the capacity of batteries tends to decrease. If an exhausted battery is used at a low temperature, the camera may not turn on. Keep spare batteries in a warm place and exchange as necessary. Once warmed, a cold battery may recover some of its charge.

Battery Terminals

Dirt on the battery terminals may prevent the camera from functioning. Should the battery terminals become dirty, wipe them off with a clean, dry cloth before use.

Charging an Exhausted Battery

Turning the camera on or off while an exhausted battery is inserted in the camera may result in reduced battery life. Charge the exhausted battery before use.

Storing the Battery

- Always remove the battery from the camera or optional battery charger when it is not being used. Minute amounts of current are drawn from the battery while it is in the camera, even when not in use. This may result in excessive battery drain and complete loss of function.
- Recharge the battery at least once every six months and completely exhaust it before returning it to storage.
- Put the battery in a plastic bag, etc. in order to insulate it and store it in a cool place. The battery should be stored in a dry location with an ambient temperature of 15°C to 25°C (59°F to 77°F). Do not store the battery in hot or extremely cold locations.

Battery Life

A marked drop in the time a fully charged battery retains its charge, when used at room temperature, indicates that the battery needs to be replaced. Purchase a new battery.

Recycling Used Batteries

Replace the battery when it no longer holds a charge. Used batteries are a valuable resource. Please recycle used batteries in accordance with local regulations.

The Charging AC Adapter

- The EH-73P Charging AC Adapter is for use only with compatible devices. Do not use with another make or model of device.
- Do not use any USB cable other than the UC-E21. Using a USB cable other than the UC-E21 could result in overheating, fire or electric shock.
- Do not, under any circumstances, use another make or model of AC adapter other than the EH-73P Charging AC Adapter or USB-AC adapter. Failure to observe this precaution could result in overheating or in damage to the camera.
- The EH-73P is compatible with AC 100–240 V, 50/60 Hz electrical outlets. When using in other countries, use a plug adapter (commercially available) as necessary. For more information about plug adapters, consult your travel agency.
- The symbols on this product represent the following:
~ AC, == DC,  Class II equipment (The construction of the product is double-insulated.)

Cleaning and Storage

Cleaning after Using the Camera Underwater

Follow the procedure below to rinse the camera with fresh water within 60 minutes after using it underwater or at the beach. The underwater lens protector is used here as an example.

1. Check that the battery-chamber/memory card slot cover is securely closed (locked).

- Check that the battery-chamber/memory card slot cover latch and battery-chamber/memory card slot cover latch release are positioned as shown in the figure on the right, and that their orange indicator marks are not visible.

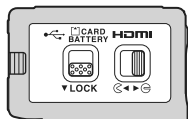

2. Wash with fresh water while the underwater lens protector is attached.

Immerse the camera in a shallow basin filled with fresh water for 10 minutes.

- Immerse the camera in fresh water and shake it sufficiently in the water to remove any foreign substances from the camera. If foreign substances still remain, remove them with a cotton swab, etc.
- When the camera is immersed in the water, a few air bubbles may come out from the water drain holes of the camera such as openings in the microphone or speakers. This is not a malfunction.



3. Wipe off water droplets with a soft dry cloth, and dry the camera in a well-ventilated and shady place.

- Place the camera on a dry cloth to dry it.
- Do not dry the camera with hot air from a hair dryer or clothes dryer.

4. Check that there are no water droplets, remove the underwater lens protector, and then remove any water droplets or sand remaining on the inner side of the underwater lens protector with a soft dry cloth.

- Attaching an underwater lens protector while the inner side is still wet could cause condensation or a malfunction.

5. After making sure that there are no water droplets on the camera, open the battery-chamber/memory card slot cover and use a soft dry cloth to gently wipe off any water or sand remaining on the waterproofing packing or inside the camera.

- If the cover is closed when the inside is wet, this could cause condensation or a malfunction.

Cleaning after Using the Camera in Conditions Other than Underwater

Use a blower or air duster to remove any dust or lint that adheres to the lens, lens protector, monitor, camera body, special accessories, etc. To remove fingerprints or other stains, gently wipe the parts with a soft dry cloth. If you wipe with too much pressure or with a rough cloth, it may damage the camera or cause a malfunction.

Storage

If you do not intend to use the camera for an extended period, remove the battery and avoid storing the camera in any of the following types of locations:

- Places that are poorly ventilated or subject to humidity of over 60%
- Places exposed to temperatures above 50°C (122°F) or below -10°C (14°F)
- Places next to equipment that produces strong electromagnetic fields, such as televisions or radios

To prevent mold or mildew, take the camera out of storage at least once a month, and turn it on and release the shutter a few times before putting it away again. Completely exhaust the battery before storing it, and recharge it at least once every six months. Also, place the battery in a container such as plastic bag in order to insulate it, and store it in a cool place.

Trademark Information

- Windows is either a registered trademark or trademark of Microsoft Corporation in the United States and/or other countries.
- The *Bluetooth*® word mark and logos are registered trademarks owned by Bluetooth SIG, Inc. and any use of such marks by Nikon Corporation is under license.
- Apple®, App Store®, the Apple logos, Mac, OS X, iPhone®, iPad®, iPod touch® and iBooks are trademarks or registered trademarks of Apple Inc., in the U.S. and other countries.
- Android and Google Play are trademarks or registered trademarks of Google Inc. The Android robot is reproduced or modified from work created and shared by Google and used according to terms described in the Creative Commons 3.0 Attribution License.
- iOS is a trademark or registered trademark of Cisco Systems, Inc., in the United States and/or other countries and is used under license.
- Adobe, the Adobe logo, and Reader are either trademarks or registered trademarks of Adobe Systems Incorporated in the United States and/or other countries.
- microSDXC, microSDHC, and microSD Logos are trademarks of SD-3C, LLC.



- HDMI, HDMI logo and High-Definition Multimedia Interface are trademarks or registered trademarks of HDMI Licensing LLC.

HDMI

- Wi-Fi and the Wi-Fi logo are trademarks or registered trademarks of the Wi-Fi Alliance.
- The N-Mark is a trademark or registered trademark of NFC Forum, Inc. in the United States and in other countries.
- All other trade names mentioned in this manual or the other documentation provided with your Nikon product are the trademarks or registered trademarks of their respective holders.

“Made for iPod,” “Made for iPhone,” and “Made for iPad” mean that an electronic accessory has been designed to connect specifically to iPod, iPhone, or iPad, respectively, and has been certified by the developer to meet Apple performance standards. Apple is not responsible for the operation of this device or its compliance with safety and regulatory standards. Please note that the use of this accessory with iPod, iPhone, or iPad may affect wireless performance.

AVC Patent Portfolio License

This product is licensed under the AVC Patent Portfolio License for the personal and non-commercial use of a consumer to (i) encode video in compliance with the AVC standard (“AVC video”) and/or (ii) decode AVC video that was encoded by a consumer engaged in a personal and non-commercial activity and/or was obtained from a video provider licensed to provide AVC video. No license is granted or shall be implied for any other use. Additional information may be obtained from MPEG LA, L.L.C.

See <http://www.mpegla.com>.

FreeType License (FreeType2)

- Portions of this software are copyright © 2012 The FreeType Project (<http://www.freetype.org>). All rights reserved.

MIT License (HarfBuzz)

- Portions of this software are copyright © 2016 The HarfBuzz Project (<http://www.freedesktop.org/wiki/Software/HarfBuzz>). All rights reserved.

No reproduction in any form of this manual, in whole or in part (except for brief quotation in critical articles or reviews), may be made without written authorization from NIKON CORPORATION.

NIKON CORPORATION

© 2016 Nikon Corporation



YP7D03(11)
6MQA1011-03