

SERVICE MANUAL

Combo Washer Dryer
Convertible Condensing / Venting Dryer

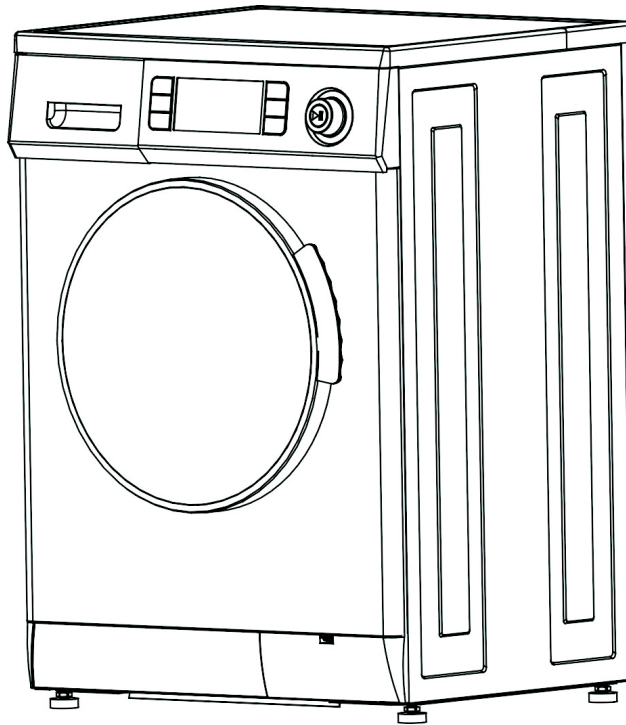

Factory Model – 4000 CV

Table of Contents

WARRANTY INFORMATION	3
SAFE SERVICING PRACTICES	4
IMPORTANT PRESERVICE INSTRUCTIONS.....	5
INSTALLATION (EZ 4000 CV)	6
DIAGNOSIS AND TROUBLE SHOOTING	7
WASH CYCLE	7
DRY CYCLE	15
APPENDIX	20
APPENDIX 1: TERMINAL SPECIFICATION ON ELECTRONIC MODULE	20
APPENDIX 2: OPTION BUTTONS AND GRAPHIC DISPLAY	21
APPENDIX 3 WIRING DIAGRAM	22
APPENDIX 4: WIRING LIST TABLE	23
QUICK CHECK.....	25

WARRANTY INFORMATION

Geographic Exception: If the product is installed at a location more than 50 miles from an urban area (minimum population 25,000), Equator Advanced Appliances may, at its option, offer a 2-year parts only Warranty, if a service agent cannot be found. Responsibility for labor, in such instances will be that of the consumer-owner. Equator Advanced Appliances will, however provide free technical assistance for repairs.

GENERAL

Since it is the responsibility of the consumer-owner to establish the warranty period by verifying the original purchase date, Equator Advanced Appliances recommends that a bill of sale, delivery slip or some other appropriate payment record be kept for that purpose. This warranty gives you specific legal rights, and you may also have other rights which vary from state to state.

EXCLUSIONS

In no event shall Equator Advanced Appliances be liable for incidental or consequential damages or for damages resulting from external causes such as abuse, misuse, incorrect voltage or acts of God.

This warranty does not cover service calls which do not involve defective workmanship or materials covered by this warranty. Accordingly, a diagnosis and repair cost for a service call which does not involve defective workmanship or materials will be the responsibility of the consumer-owner.

In addition, the following work is not covered under warranty and does not constitute warranty work:

- Installation - improper hook-up or leveling
- Maintenance - cleaning of air and/or water filter.
- Damage - replacing broken door handle Most work is covered. The defining factor is, has the machine malfunctioned (Equator is responsible) or has the customer omitted or done something to cause machine to malfunction (customer is responsible.)

Some states do not allow the exclusion or limitation of incidental or consequential damages, so the above limitation or exclusion may not apply to you.

Please Note : The warranty is provided by Appliance Desk hence for service on any of the units please contact Appliance Desk.

CONTACT INFORMATION

APPLIANCE DESK

10216 Georgibelle Dr, Suite 900D
Houston TX 77043
Phone: 800-490-8018
Fax : 832-201-0854

E-Mail





Service: service@appliancedesk.com

Parts: parts@appliancedesk.com

Tech : techsupport@appliancedesk.com

SAFE SERVICING PRACTICES

<p>To avoid the possibility of personal injury and/or property damage, it is important that safe servicing practices be observed. The following are examples, but without limitation, of such practices:</p> <ol style="list-style-type: none"> 1. Do not attempt a product repair if you have any doubts as to your ability to complete it in a safe and satisfactory manner. 2. Before servicing or moving an appliance: <ul style="list-style-type: none"> • remove fuse. • turn off gas supply. • turn off water supply. 3. Never interfere with the proper operation of any safety device. 4. USE ONLY REPLACEMENT PARTS CATALOGUE FOR THIS APPLIANCE. SUBSTITUTIONS MAY DEFEAT COMPLIANCE WITH SAFETY STANDARDS SET FOR HOME APPLIANCES. 5. GROUNDING: The standard color coding for safety ground wires is GREEN or GREEN with YELLOW STRIPES. Ground leads are not to be used as current carrying conductors. <p>IT IS EXTREMELY IMPORTANT THAT THE SERVICE TECHNICIAN RE-ESTABLISH ALL SAFETY GROUNDS PRIOR TO COMPLETION OF SERVICE. FAILURE TO DO SO WOULD CREATE A POTENTIAL HAZARD.</p>	<p>6. Prior to returning the product to service ensure that:</p> <ul style="list-style-type: none"> • all electric, gas, and water connections are correctly and securely connected. • all gas and water connections are tested for leaks. DO NOT TEST FOR GAS LEAKS WITH A FLAME. • all electrical leads are properly dressed and secured away from sharp edges, high-temperature components and moving parts. • all un insulated electrical terminals, connectors, heaters, etc. Have adequate spacing from all metal parts and panels. • all safety grounds (both internal and external to the product) are correctly and securely connected. • all panels are properly and securely reassembled. <p>CAUTION! When servicing a water - using appliance in a location where the water supply has not been in use for an extended time (such as vacation) open the hot water faucet at the sink and allow the water to run for several minutes allowing water and accumulated hydrogen gas to escape. Make sure there are no open flames (pilots) or cigarettes near the faucet.</p>
---	---

	CAUTION			<p>A lightning flash symbol, within a triangle. Is intended to alert the user to the presence of un insulated "dangerous voltage" within the product's enclosure that may be of sufficient magnitude to constitute a risk of electric shock to persons.</p>
<p>CAUTION: TO REDUCE THE RISK OF ELECTRIC SHOCK DO NOT REMOVE COVER OR BACK. DO NOT EXPOSE TO RAIN OR MOISTURE. NO USER SERVICABLE PARTS INSIDE. REFER SERVICING TO QUALIFIED SERVICE PERSONNEL.</p>				<p>An exclamation point within a triangle is intended to alert the user to the presence of important operating and maintenance (servicing) instructions in the literature accompanying the appliance.</p>
<p>WARNING: TO PREVENT FIRE OR SHOCK HAZARD, DO NOT EXPOSE THIS PRODUCT TO RAIN OR MOISTURE.</p>				

IMPORTANT PRESERVICE INSTRUCTIONS

► It is advisable for anyone to go through the following points before one actually works on the unit.

•**Shipping bolts:** The unit is shipped with 3 shipping bolts and spacers to avoid any damage to the unit during shipping. Make sure that all the shipping bolts and the spacers have been removed from the unit.

•**Height of drain hose:** The drain hose should be placed in such a way that the height of the drain hose does not exceed 36" and is not lower than 28" inches from the bottom of the unit.

•**Water inlets:** In this unit two water inlet valves are required to be connected for hot as well as for cold water (Note that Valves are Matrix Size & L Connector of the inlet hose supplied with the machine is also Matrix. The straight connector is US Thread). Make sure that water supply is provided to both the inlets. In case hot water supply is not available cold water supply should be connected to the hot water inlet valve.

•**Leveling:** The unit must be leveled properly for proper working of the unit. There are 4 Leveling feet which can be individually leveled.

•**Flooring:** The unit should be installed on strong and leveled floor, installation on carpet or wood increases vibrations. In case of wooden flooring, proper bracings should be made and the unit should be installed on a sheet of plywood.

***Please Note:** All the above instructions are mentioned in the Owner's Manual and if the unit is found to be malfunctioning due to any of the above points not been taken care of, the customer will be liable to pay for the complete service call along with the parts. If the customer is not willing to pay for the service we will be paying for the same but the customers warranty will be voided then.*

INSTALLATION (EZ 4000 CV)

Inlet Hoses

The inlet hoses must be fitted with the special rubber washers. These rubber washers ensure water tight seal between the hoses and the water inlet valves to prevent water leaks. Water should flow freely into the machine, be sure that the inlet hoses are not bent or kinked.

Please read the following steps carefully (Fig.1, Fig.2)

1. Connect the *straight* end of the hot-water hose to the hot-water faucet (Fig.1).
2. Connect the *straight* end of the cold-water hose to the cold-water faucet (Fig.1).
4. Connect the *L-shaped* end of hot-water hose to the inlet valve which has a red-colored filter. (Fig.2).
5. Connect the *L-shaped* end of cold-water hose to the inlet valve which has a white-colored filter. (Fig.2).

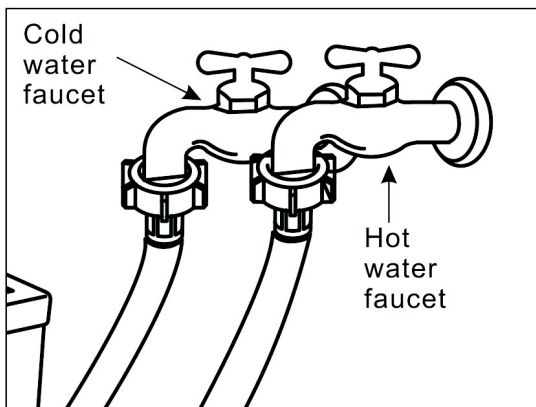

Fig.1

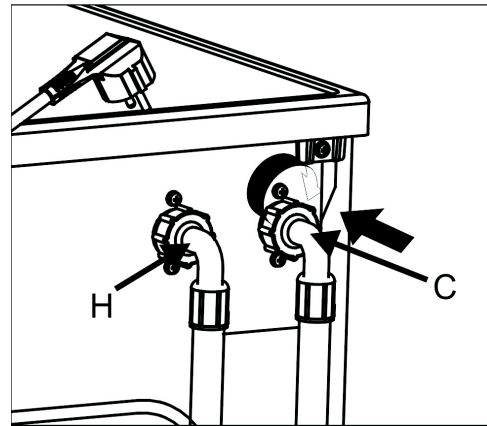

Fig.2

Drain Hose

Connect the drain hose to a drain duct (with internal diameter of at least 1.6 inches) or place it for drainage in to a sink or a tub, ensuring that there are no kinks or bends. The free end must be at a height of at least 24" from the floor (max 40"), the hose must be fixed in the appropriate hook on the upper part of the back panel (see figure below).

U-Connector

The end of the outlet hose must be passed through the U-Connector (included). This creates an upside-down U which is put into the drain pipe or over the edge of the sink. Failure to use the Connector may cause the drain hose to pop out during drainage of the water, which may cause water damage to the surrounding area.

DIAGNOSIS AND TROUBLE SHOOTING

WASH CYCLE

1. Unit won't power on

- 1.1 **No power input:** Check that the cord is plugged in, and circuit breaker or fuse is OK.
- 1.2 **Poor connection with the power terminals:** Check for the condition of terminal (JP) at the top right rear corner of the cabinet. Re-plug them and test it again.

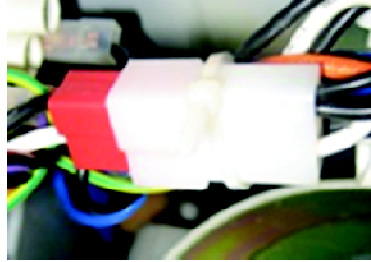

- 1.3 **No power on Electronic Module:** Check for the condition of plug housing JW1 on the electronic module. (EM located on bottom Left Corner of machine when looking from back. To remove EM, remove back panel & screws located on outside of cabinet.)



JW1

- 1.4 **No communication between two panels:** Check for the condition of the communication cable between two boards, or replace another one to test.

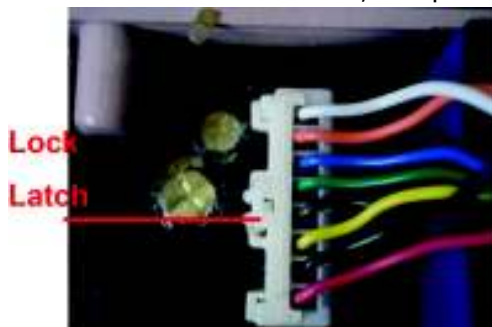

Cable Plug on EM



Cable Plug on DP

How to Replace A Communication Cable?

- Power off and unplug the unit.
- Remove two screws and washers on the rear side of work top. Lift the work top up a little by holding its rear side, and then push it towards the door to remove the work top.

- Remove the rear cover by unscrewing three screws, which fix the cover with the cabinet.
- Press the lock latch, and pull the plug housing from the cap housing on the PCB.
- Extract the communication cable from the harness.
- Replace a new one and then re-assemble the unit by following the reserve steps.

1.5 If you can't find the trouble shooting refer to the above mentioned, please replace a new electronic module. See ***How to Replace a New Electronic module.***

2. Door won't close

After all the options are ready, and press START button, but the door will not close, and the error code **E1** will be displayed on VFD.

- 2.1 **Door not closed well:** Close the door firmly, then E1 will be off, and the washer/combo will run your washing cycle.
- 2.2 **Poor wiring connection:** Disassemble the electronic module and check for the brown wire loose from the white plug housing JW2 on the electronic module. Or check for the white wire loose from the white plug housing J1 on the electronic module (See Appendix 1).
- 2.3 **Door lock is defective:** Disassemble the door lock and test it by following the next steps:
 - 2.3.1 Check for the resistance of terminals of 1&3, the reading should be about 1K Ω . (See figure below).
 - 2.3.2 In drying cycle, the terminals 6&7 (micro switch) should be closed after the door is closed firmly.
 - 2.3.3 In washing cycle, the terminals 6&7 should be closed after the door is closed firmly. And push the slide panel towards left, then the terminals 2&3 will be closed.
- 2.4 If not, the door lock is defective. Please replace a same new one.

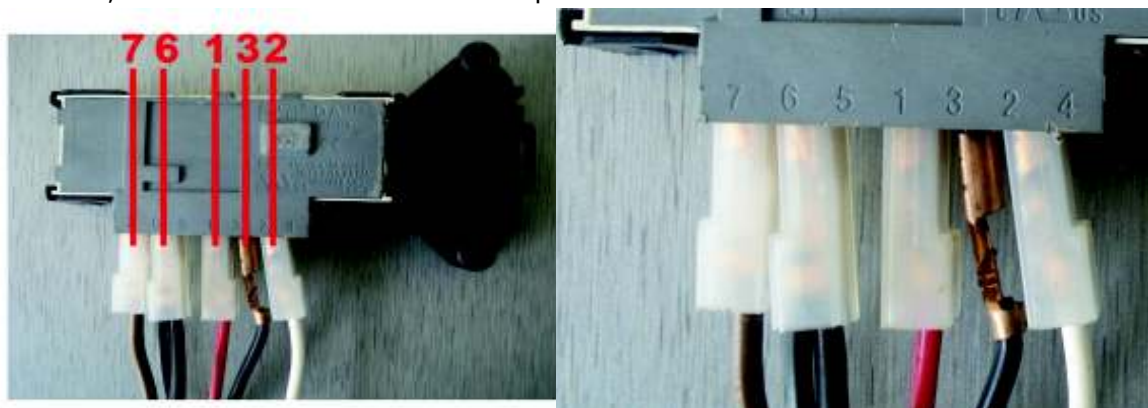

How To Replace A New Door Lock?

- Power off and unplug the unit.
- Open the door, and then disassemble the door gasket from the cabinet by removing the spring clamp.
- Disassemble the door lock by removing two screws and washers.
- Remove two screws and washers on the rear side of work top. Lift the work top up a little by holding its rear side, and then push it towards the door to remove the work top.
- Replace a new door lock, and wire it again.
- Re-assemble the door lock by following the reverse steps.

3. Unit won't drain

This machine drains the water out using 70W Drain pump however if the water doesn't drain out in the limited time, the error code of **E2** will be displayed on VFD.

- 3.1 **The filter of pump is block by foreign objects.**
 - 3.1.1 Lay the drain hose on the ground, and let the water flow out the unit.
 - 3.1.2 Open the coin trap cover to check for the filter or impeller of pump is blocked by some foreign objects, such as coins, pins or keys.
 - 3.1.3 Remove all the foreign objects, and then insert the filter into the drain pump, E2 will be off and the washing program will be continued from the interrupt point.
 - 3.1.4 Please advise the customer to look through the manual and clean the coin trap every some washing cycles.
- 3.2 **The pump or the drain hose is frozen:** During the winter, please check for the water in the pump and drain hose is frozen when you read E2 on the display. If it is, please advise the customer to winterize the washer/combo according to the instruction in manual.
- 3.3 **Poor wiring connection to the pump:** Disassemble the drain pump and check for the wiring to it as following.
 - 3.3.1 Check for the wire lost from the terminals DP-1 or DP-2 of the drain pump (see figure below).
 - 3.3.2 Check for the wire lost from the terminal housing JWL1-P1 (white wire), and/or P17 (black wire) (See Appendix 1).
- 3.4 **The drain pump is defective:** Check for the resistance of the drain pump, the reading should be 11.4Ω, if not, the pump is defective, please replace a new one.

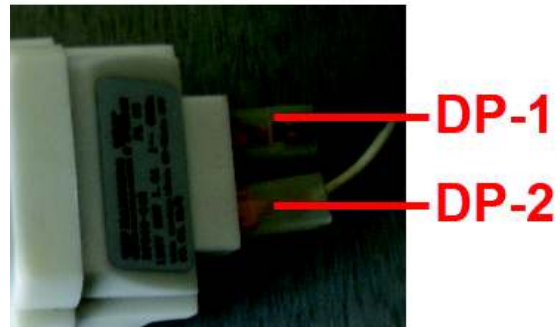

How To Replace A New Drain Pump?

- Power off and unplug the unit.
- Open the coin trap cover.
- Make sure there is no water in the unit.
- Disassemble the pump by unscrewing four screws and washer, which hold the pump on the cabinet.
- Disassemble the bottom panel by removing four adjustable legs.
- Disassemble the drain hose and tub-pump hose by removing two clamps, which hold the hose on the pump.
- Replace a new pump, and wire it again.
- Re-assemble the pump by following the reverse steps.

4. Unit won't fill

If the water can't reach the set level in the limited time, the error code of **E3** will be displayed on VFD. Please check it by following next steps:

- 4.1 **Drain outlet below 24"**: Make sure the drain hose is hanging up, and the free end of it must be at a height of 24" - 40" from the floor. Otherwise the filling water will flow out the machine, and the washer/combo will not work because the water can't reach the set level.
- 4.2 **The water faucet closed**: Turn on the water faucet.
- 4.3 **The water faucet is frozen**: Defrost the faucet in winter.
- 4.4 **No water pressure**: Check for all the hoses are connected and not kinked or trapped.
- 4.5 **Air leakage on hoses**: Check for any air leakage on the hoses to the pressure switch.



- 4.6 **The filter blocked**: The filter in the valve is blocked by the foreign substance in the water, if you can feel a light vibration when you touch the working valve. Please unscrew the inlet hose, and remove the filter, and clean it under the running water.

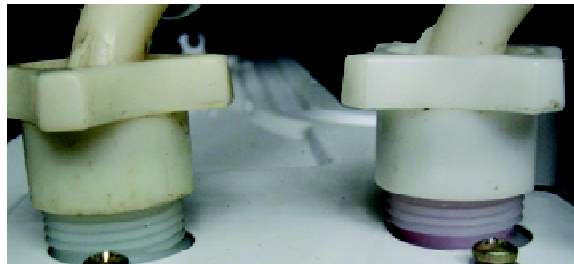

- 4.7 **Poor wiring connection to valves**: Disassemble the valve and check for the wire on the valve (see figure below). Or check the wire loose from the plug housing JWL1-P19 (black wire), P18 (red wire), or P20 (purple wire) on the electronic module. (See Appendix 1)
- 4.8 **The valve is defective**: Check for the resistance of the coil of the valve, the reading should be about 1K Ω , if not, the valve is defective, please replace a new one.

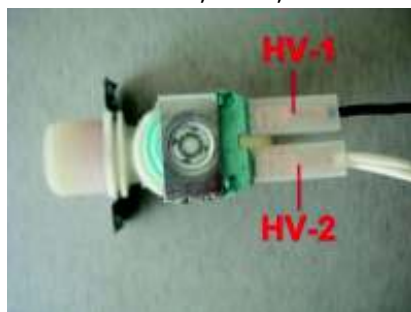

1-way valve for hot water

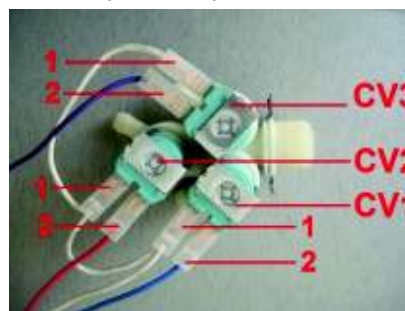

3-way valve for cold water

CV1: Condenser
CV2: Wash
CV3: Pre-wash
CV2+CV3: Softener

How To Replace A New Valve?

- Power off and unplug the unit.
- Unscrew the inlet hose on the bad valve.
- Remove two screws and washers on the rear side of work top. Lift the work top up a little by holding its rear side, and then push it towards the door to remove the work top.
- Disassemble all the rubber hoses by removing the clamps, which hold the hoses on the valves.
- Disassemble the bad valve by removing two screws and all the spacers.
- Replace a new same one, and then wire it again.
- Re-assemble the new valve by following the reverse steps.

- 4.9 ***The pressure switch is defective:*** Disassemble the pressure switch and check for the continuity between the terminals PS-1&PS-2(see figure below). If it is not, please check for there is any air leakage on the hose to this switch. Or replace a new pressure switch.

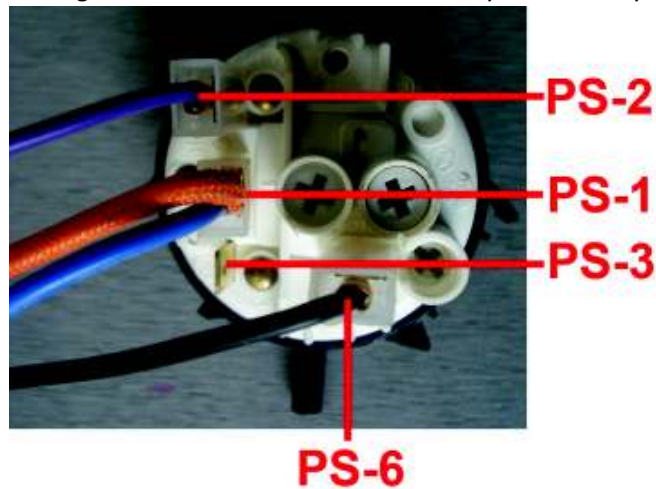

How To Replace A New pressure Switch?

- Power off and unplug the unit.
- Remove two screws and washers on the rear side of work top. Lift the work top up a little by holding its rear side, and then push it towards the door to remove the work top.
- Disassemble the metal bracket from the cabinet by unscrewing two screws and washers on the rear side of the unit.
- Disassemble the hose by removing the clamp.
- Replace a new pressure switch, and then wire it again.
- Re-assemble the new pressure switch by following the reverse steps.

5. Unit will overflow.

The washer/combo can't stop to fill after the water level reaches the set value, this unit will overflow. And the error code of ***E4*** will be displayed on VFD.

- 5.1 ***Air leakage on the hose:*** Check for the air leakage on the hoses to the pressure switch, and test it by re-filling water.
- 5.2 ***Inlet valve is defective:*** Please replace a new inlet valve, if water fills into the tub with the unit off.

- 5.3 **The electronic module is defective:** Please replace new electronic module if water fills into tub with the unit pausing.
- 5.4 **The pressure switch is defective:** Check for the continuity between the terminals of pressure switch as following.
- 5.4.1 When the drum is empty, the terminals PS-1& PS-2 should be closed. And when the water reaches to the set level, PS-1& PS-2 will be open, and PS-1& PS-3 will be closed. If not, please replace a new one.
- 5.4.2 If the terminals PS-1& PS-6 are closed with the tub empty, please replace a new pressure switch.

How To Replace A New Electronic module?

- Power off and unplug the unit.
- Remove the rear panel by unscrewing three screws.
- The electronic module is located at the bottom right corner of the unit.
- Disassemble the electronic module by removing three screws and washers on the rear side of the cabinet.
- Replace a new one and re-insert all the terminal blocks.
- Re-assemble the electronic module by following the reverse steps.

✘Please note: Pressing the lock latch, and pull the plug housing out from the cap housing on the PCB. Not to pull the plug housing by holding the wire or harness.

6. Malfunction with the universal motor

If the motor will not rotate, or agitate in high speed, the error code of **E5** will be displayed on VFD.

- 6.1 **Poor wire connection to the motor:** Disassemble the rear cover of cabinet and check for the wiring to motor (see figure below).
- 6.2 **Poor wire connection to the electronic module:** Check for the wiring to the electronic module (see appendix 1).
- 6.3 **The electronic module is defective:** If the drum will agitate in high speed, or the controller can't sense the feedback from motor, or the triac used to drive the motor was broken down. Replace a new electronic module.
- 6.4 **Water splashed on the electronic module:** Check for the water splashed on the electronic module, please dry it, and then test it again.
- 6.5 **The motor is defective:** Have a cold test on motor. Check for the resistance between the following terminals. If the readings match near about, the motor is good. Otherwise please replace a new one.



Sr. No.	Function	Terminals	Resistance
1	Tacho Generator	1-2	44Ω
2	Rotator	3-4	4.3Ω
3	Winding for Low Speed	5-6	1.8Ω
4	Winding for High Speed	5-10	0.8Ω
5	Thermal Protector	7-8	0.6Ω

How To Replace the Motor?

- Power off and unplug the unit.
- Make sure there is no water in the unit.
- Tilt the unit towards the door, and lay the unit down on a soft cushion.
- Remove the rear cover by unscrewing three screws, which fix the cover with the cabinet.
- Remove the belt.
- Disassemble the bottom panel by removing the four leveling legs.
- Disassemble the bad motor by removing two bolts, nuts and all the spacers.
- Replace a new motor, and re-assemble the unit by following the reserve steps.

※Please Note:

- 1. Adjust the belt tension after replacing the motor.**
- 2. Not to pull the plug housing by holing the wire or harness.**

7. Communication error between two boards.

If there is some problem with the communication between the display panel and electronic module, the error code of **E6** will be displayed on VFD.

- 7.1 **Poor connection to modules:** Disassemble the work top and check for the connection of the cable with two boards, pull out and then re-plug two plug housings again.
- 7.2 **The cable is defective:** Replace a new cable, and test it again.

8. Unit vibrates or vibrating noise.

The tub-drum unit of this washer/combo is a most optimized system, and the software features interval spin-cycle. It should have a low vibration during washing and spinning cycles, even it revolves in the highest spin speed. If this washer/combo vibrates very high, please work with it as following points.

- 8.1 **Shipping rods not removed:** There are 2 shipping rods which must be removed with all the spacers when the washer/combo was installed
- 8.2 **This washer/combo not level properly:** Re-level this unit by adjusting the feet, and then tighten the lock nuts against the unit housing.
- 8.3 **Unstable floor:** move this unit to, and re-install it on the stable floor.
- 8.4 **Poor condition of springs:** Check for three springs which hinge the tub on the unit housing.

- 8.5 **Poor connection between the absorbers and cabinet:** Check for two shock absorber units to support the tub unit to stand on the cabinet.

9. Suds coming out of the detergent dispenser

- 9.1 **Not appropriate detergent:** Use a detergent, which has low suds, and is suitable to the front loading washing machine.
- 9.2 **Too much detergent:** Pour right amount detergent according to the instruction of detergent manufacture, or the manual of this washer/combo.

10. Poor result with the softener

- 10.1 **Wrong chamber:** Pour the softener in the right chamber of detergent dispenser.
- 10.2 **Detergent drawer open:** Push back the detergent drawer.
- 10.3 **The siphon block:** Take out the siphon cap from the drawer, and clean the drawer recess by an old toothbrush, then wash it under the running water.

DRY CYCLE

11. Machine will not dry

If the laundry is cold and wet at the end of the dry cycle, please check for as following.

- 11.1 **Thermostats are open:** Disassemble the work top and check for the continuity between the terminals of TH2-3 & TH2-4 at room temperature (see figure below). If it is closed, then check for the dryer heaters. If it is opened, check for the turbo fan, and then push down the reset button.

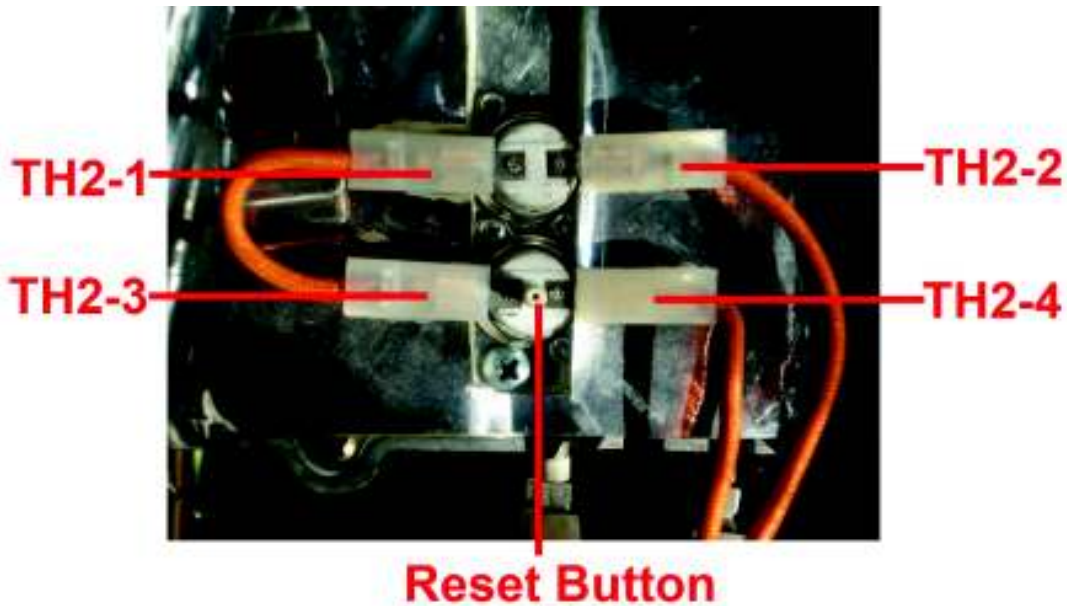

- 11.2 **Turbo fan not working**

- 11.2.1 **Thermostat open:** Check for the continuity between the terminals of TH1-1 & TH1-2 at room temperature (see figure below). It should be closed, if not, replace a new one.

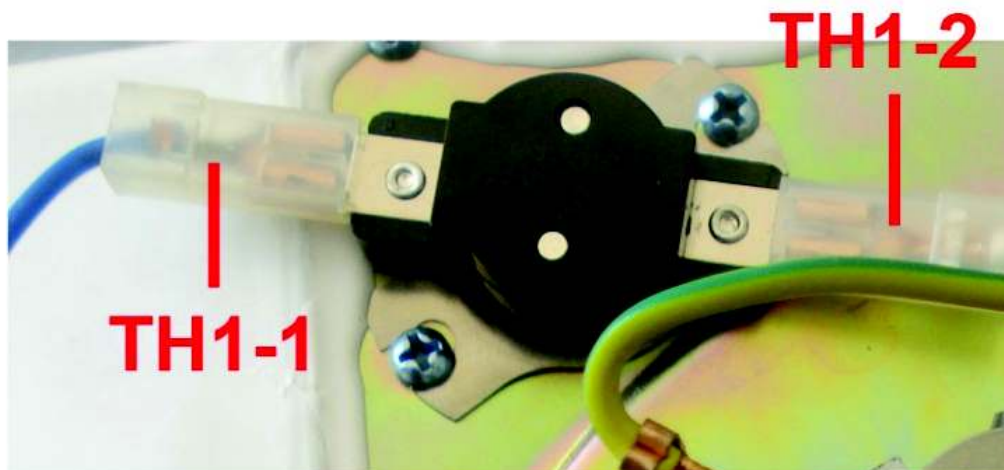

11.2.2 **Poor wire connection:** Check for the wiring to the turbo fan (see figure below).

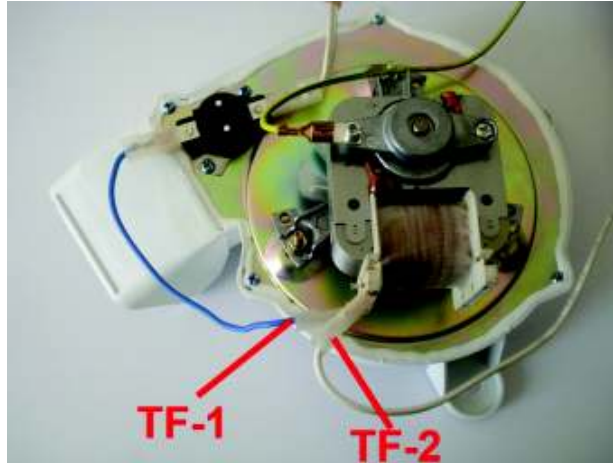

11.2.3 **The turbo fan is defective:** Check for the resistance between two terminals of TF-1 & TF-2, the reading should be about 33Ω .

11.2.4 **The impeller is blocked:** Disassemble the turbo fan unit from the blast chamber, and check for the deformation with the impeller and metal cover.

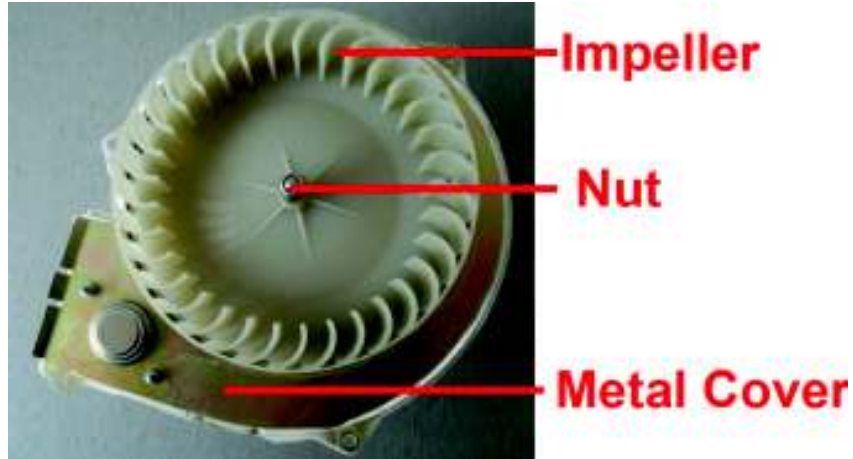

11.3 **The dryer heaters not work**

11.3.1 **Poor wire connection:** Check for the wiring to the heating elements (see figure below), and to the plug of JW2on the electronic module (see Appendix 1).

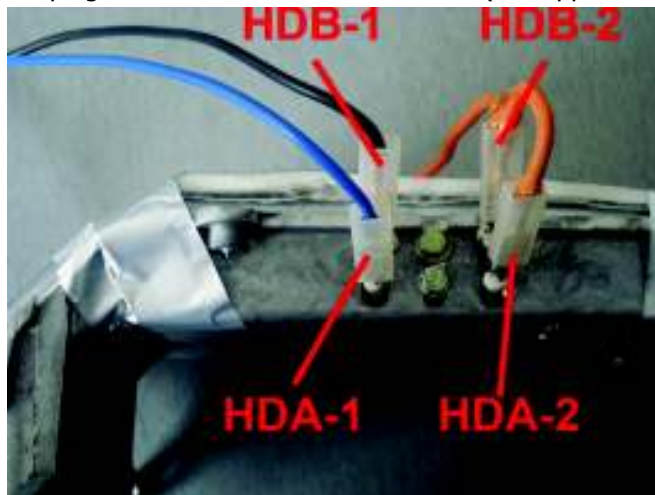

- 11.3.2 **The dryer heater is defective:** Check for the resistance between the terminals of HDA-1 &HAD-2, and HDB-1 & HDB-2 at room temperature, and the reading of A should be 17Ω, the reading of B should be 24Ω.If not, please replace the new heater(s).

How To Replace The Dryer Heater?

- Power off and unplug the unit.
- Remove two screws and washers on the rear side of work top. Lift the work top up a little by holding its rear side, and then push it towards the door to remove the work top.
- Disassemble the top cover of the chamber by removing five screws.
- Unscrew the screws and remove the metal bracket on the heaters.
- Disassemble the defective heater by removing the bolts.
- Replace a new heater and re-assemble the unit by following the reserve steps. Some silicon sealant should be painted on the mating faces of heater chamber

- 11.3.3 If you can't find the trouble shooting refer to the above mentioned, please replace a new electronic module.

12. Poor dry result

If the laundry is hot and damp at the end of the dry cycle, please check for:

- 12.1 **Wrong dry mode:** Make sure the dry mode is condensing or venting dry.
- 12.2 **The cold faucet is off:** Turn on the cold faucet in condensing dry operation.
- 12.3 **No condensing water intake:** Check for the inlet valve for cold water in condensing dry operation.
- 12.4 **Venting fan is covered:** Remove the metal cover on the venting fan, and connect the exhaust duct in venting dry operation.

13. Venting fan will not rotate

In the venting dry cycle, if the venting fan will not rotate, please check for it as following:

- 13.1 **Fan's impeller blocked:** Turn the impeller of the venting fan by hand, when the unit is power off, to check the impeller is blocked by some foreign objects. Clean it, and test it again.



- 13.2 **Poor wire connection to fan:** Check for the wiring between the following two mating terminals.

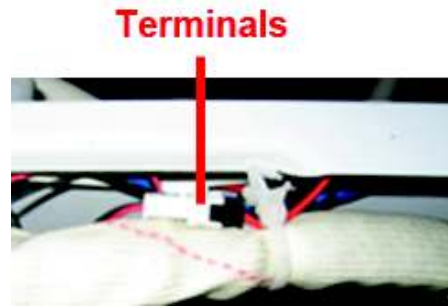

- 13.3 **The venting fan is defective:** Check for the resistance of this fan, the readings should be about 1.2M Ω (forward resistance) or 144M Ω (backward resistance). If not, please replace a new venting fan.

How To Replace A New Venting Fan?

- Power off and unplug the unit.
- Remove two screws and washers on the rear side of work top. Lift the work top up a little by holding its rear side, and then push it towards the door to remove the work top.
- Remove the exhaust duct from the connector, and disconnect the terminals.
- Disassemble the venting fan and its holder by removing four bolts, which fix them on the cabinet.
- Replace a new one and re-assemble the venting fan and its holder carefully, and then connect its terminals.

14. Condensing moisture on VFD/Lens.

- 14.1 **Ambient humidity too high:** Re-install the unit in a dry and ventilated place.
- 14.2 **Hot air escapes from the heater chamber:** Disassemble the top section of heater chamber by unscrewing five screws, and then re-assemble them with painting some silicon sealant on the mating surfaces.

15. Unreadable display on VFD

- 15.1 **Bad connection with the communication cable:** Check for this cable, and re-insert the terminals on the display board and electronic module.
- 15.2 **The display board is affected with damp:** Dry the display board, and test it again.
- 15.3 If not, replace a new display board.

How To Replace A New Display Panel?

- Power off and unplug the unit.
- Remove two screws and washers on the rear side of work top. Lift the work top up a little by holding its rear side, and then push it towards the door to remove the work top.
- Disassemble the front panel group by removing two screws and washers which assemble the front panel on the cabinet, and two screws and washers which assemble the detergent box.
- Unplug the communication cable.
- Disassemble the display panel by removing five screws and washers.
- Replace a new display panel, and then re-assemble it by following the reverse steps.

16. Some notes or warnings with operation

- 16.1 To this washer/combo, the free end of drain hose must be higher than the water surface in the sink, if it is not; the water in the sink will be siphoned in to the washer/combo after the pump stops to work.
- 16.2 In dry cycle, please close the loading door firmly if the remaining time is not reduced, and the washer/combo is not running.
- 16.3 If you have much condensing moisture in drum or have a poor dry result, please check the cold water faucet is on.
- 16.4 If you have a poor spin result, it is because of heavy unbalance caused by over load or too less laundry in drum.
- 16.5 In venting operation, there will be 5 minutes before the venting fan working, in order to increasing the temperature quickly.
- 16.6 To get a good dry result, the combo would run a spinning cycle. The time of this spinning cycle depends on the dry time the customer set (see the table below). If the customer pause the running dry cycle and reprogram it by pressing the buttons of "Time +" / "Time -", the new cycle will be started from the beginning.

Dry time (T)	Spinning time (t)
$T \geq 90 \text{ min}$	$t = 10 \text{ min}$
$90 \text{ min} > T \geq 60 \text{ min}$	$t = 5 \text{ min}$
$T < 60 \text{ min}$	$t = 0$

APPENDIX

Appendix 1: Terminal Specification on Electronic module

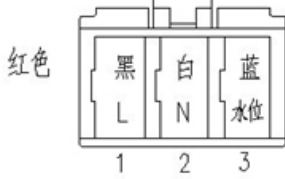
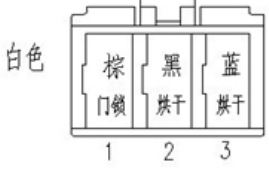
Code	JW1	JW2
Picture		
Color Of Housing	Red	White
Wiring	1 (Black): JP-L(Power) 2 (White): JP-N(Power) 3 (Blue): Water Level	1 (Brown): Door Lock 2 (Black): Heater for Drying 3 (Blue): Heater for Drying

Wiring On JWL1																
1	2	3	4	5	6	7	8	9	10							
白 排水泵	紫 水位	红 电机					红 电机	黑 排气扇								
白 烘干单温	红 排气扇		蓝 进水阀	红 门锁	白 鼓风机	黑 排水泵	红 进水阀	黑 进水阀	紫 进水阀							
11	12	13	14			17	18	19	20							
1(White): Drain Pump	2(Purple): Water Level	3(Red): Motor	4/5/6/7: N/C	8(Red): Motor	9(Black): Venting Fan -	10: N/C	11(White): Single-Contract Thermostat.	12(Red): Venting Fan +	13: N/C	14(Blue): Valve	15(Red): Door Lock	16(White): Turbo Fan	17(Black): Drain Pump	18(Red): Valve	19(Black): Valve	20(Purple): Valve

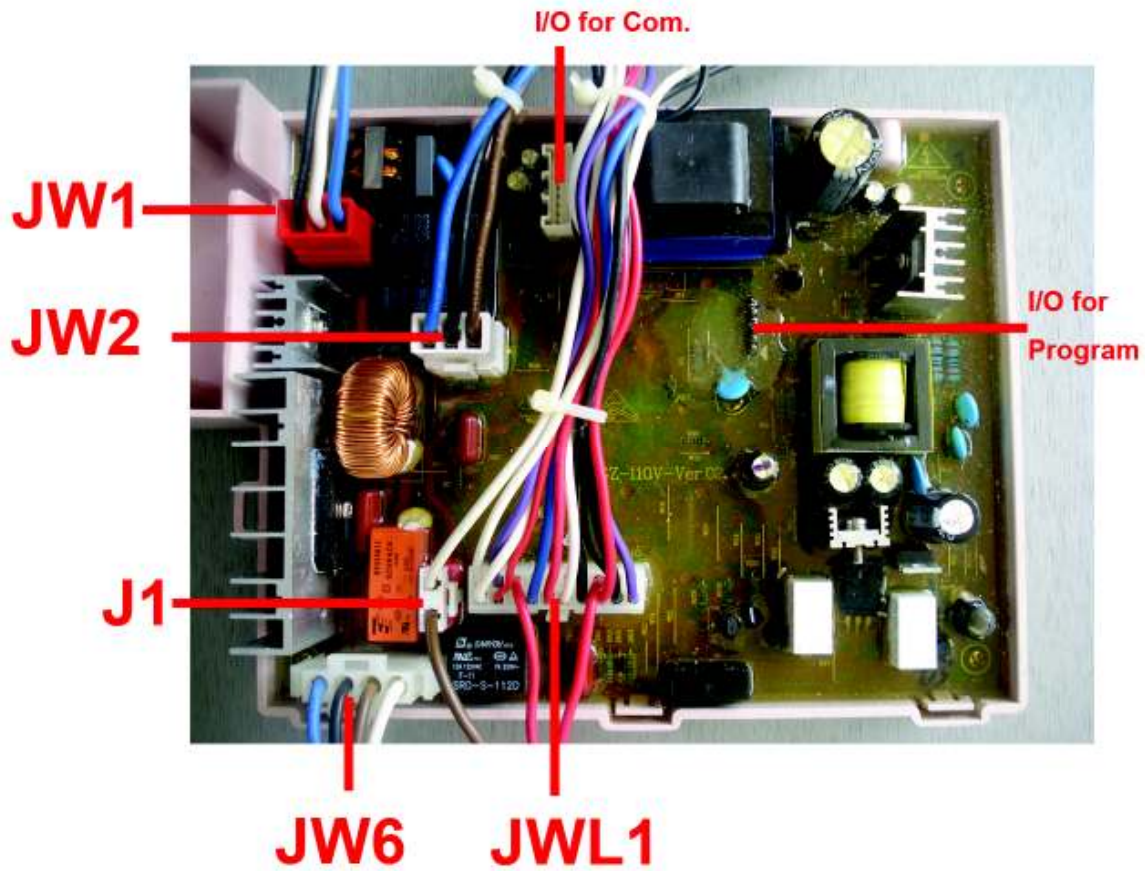

Appendix 2: Option Buttons and Graphic Display

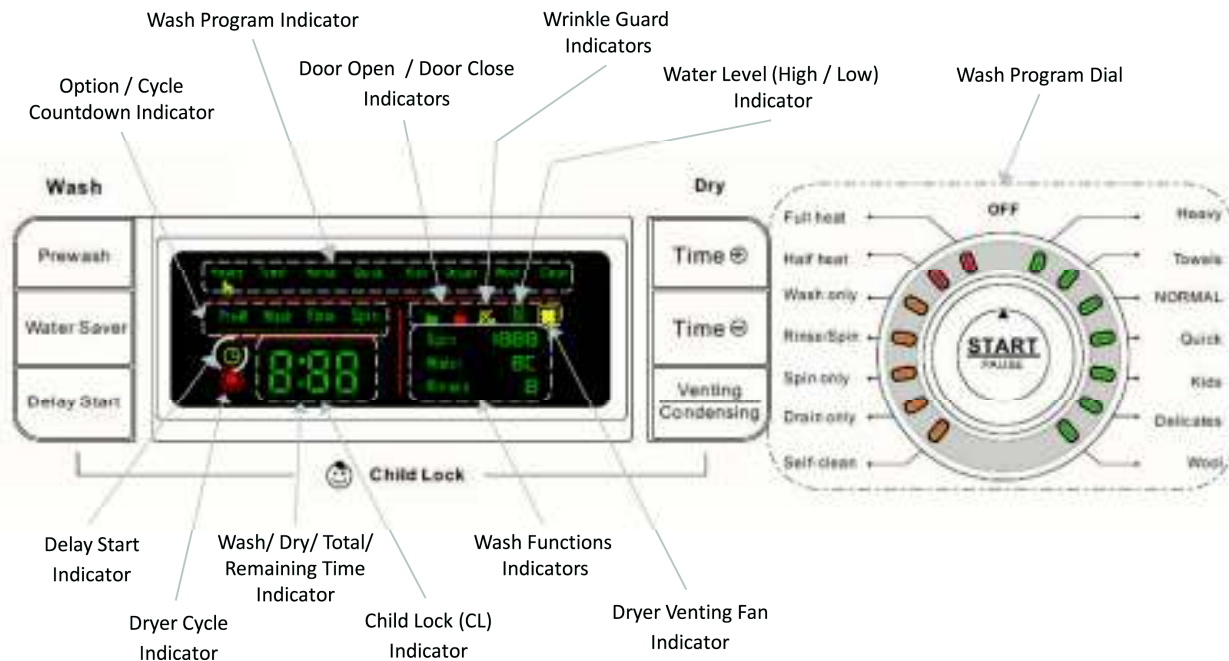

Appendix 3 Wiring Diagram

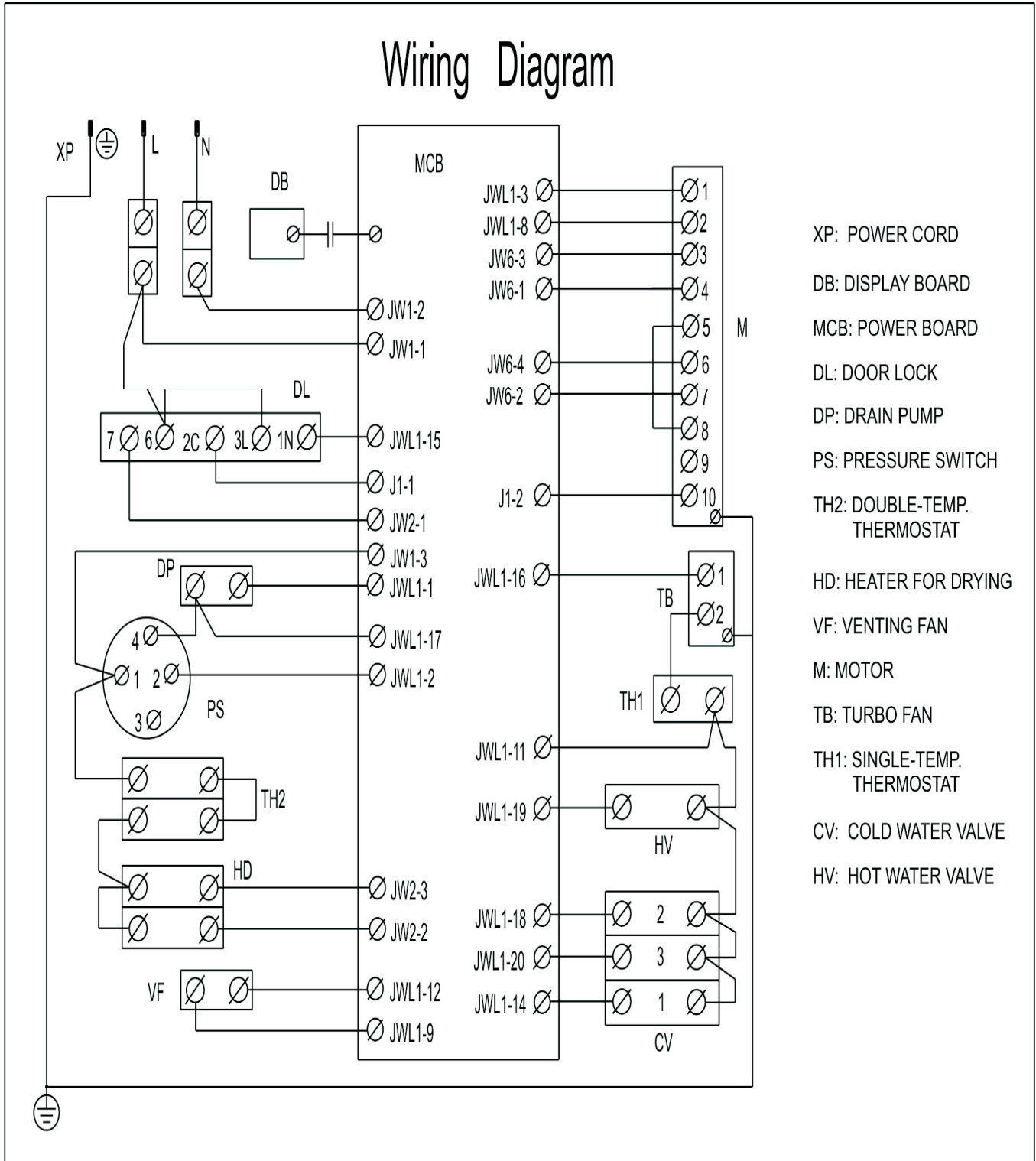

Error Code list:

E1	Door not closed
E2	Malfunction with draining
E3	Malfunction with water inlets
E4	Overfill
E5	Malfunction with the motor
E6	Communication error between 2 boards

Appendix 4: Wiring List Table

Sr. No.	Color	Length	Terminal 1	Terminal 2	Note
1	Black	08	Door Lock-3	Door Lock-6	
2	Black	087	Door Lock-6	JP-L	
3	Black	088	JP-L	JW1-1	
4	Red	1630	JWL1-15	Door Lock-1	
5	White	1630	J1-1	Door Lock-2	
6	Black	1440	JWL1-19	Hot water ValveHV-1	
7	White	1160	JWL1-11	Single-temp. ThermostatTH1-1	
8	White	085	Single-temp. ThermostatTH1-1	Hot ValveHV-2	
9	White	200	Hot ValveHV-2	Cold ValveCV1-1	
10	White	08	Cold ValveCV1-1	Cold ValveCV3-1	
11	White	140	Cold ValveCV3-1	Cold ValveCV2-1	
12	White	088	JW1-2	JP-N	
13	Blue	078	JW1-3	Pressure SwitchPS-1	
14	Orange	480	Pressure Switch PS-1	Double-temp. ThermostatTH2-2	
15	Purple	910	JWL1-2	Pressure SwitchPS-2	
16	Black	350	JWL1-17	Drain pumpDP-1	
17	Black	1160	Drain PumpDP-1	Pressure SwitchPS-6	
18	Purple	1560	JWL1-20	Cold ValveCV2-2	
19	Red	1510	JWL1-18	Cold ValveCV3-2	
20	Blue	1490	JWL1-14	Cold ValveCV1-2	
21	Black	1120	JWL1-9	Venting Fan(-)	
22	Red	1120	JWL1-12	Venting Fan(+)	
23	Brown	390	J1-2	Motor-10	
24	Red	400	JWL1-3	Motor-1	
25	Red	400	JWL1-8	Motor-2	
26	Black	09	Motor-5	Motor-8	
27	Blue	390	JW6-1	Motor-4	

Sr. No.	Color	Length	Terminal 1	Terminal 2	Note
28	Black	390	JW6-2	Motor-7	
29	Brown	390	JW6-3	Motor-3	
30	White	390	JW6-4	Motor-6	
31	Blue	1180	JW2-3	Heater for Drying HDA-1	
32	Black	1180	JW2-2	Heater for Drying HDB-1	
33	Brown	1590	JW2-1	Door Lock-7	
34	White	1250	JWL1-16	Turbo FanTF-1	
35	White	350	JWL1-1	Drain PumpDP-2	
36	Yellow/Green	260	Turbo Fan-GND	Pressure Switch Holder -GND	
37	Yellow/Green	1020	Pressure Switch Holder -GND	Tub-GND	
38	Orange	8	Heater for Drying HDB-2	Heater for Drying HDA-2	
39	Orange	170	Heater for Drying HDA-2	Double-temp. Thermostat TH2-4	
40	Orange	8	Double-temp. Thermostat TH2-1	Double-temp. Thermostat TH2-3	
41	Blue	140	Single-temp. Thermostat TH1-2	Turbo FanTF-2	
42	Yellow/Green	200	Motor-GND	Tub-GND	

QUICK CHECK

After replacing any components, you should have a quick check without laundry in the unit, in order to make sure the unit will work normally by following the next steps.

Checking the Wash Cycle: Turn the program dial to Towels position, and then press the START/PAUSE button. The unit will start to filling in with the water from both inlet valves. After some minutes, it will stop to fill when the water level reaches to the set value, and the drum will start to agitate. Then press the START/PAUSE button again, turn the program dial to the Spin only position and press the START/PAUSE button, the unit will pump the water out and begin to spin simultaneously.

Checking the Dry Cycle: Select the venting dry function by pressing the Venting/Condensing button. Turn the program dial to Full Heat position, and press the Time- button to reduce the dry time until it is less than 60 minutes, and then press the START/PAUSE button. The unit will start to heat up and you can sense the hot air nearby the venting fan.

※Please Note: In this unit the door can't be opened in washing cycle unless and until the unit is power off and in 2 minutes. However the door can be opened at any time after the lock-opening symbol displayed on the VFD in the drying cycle.