



ToyotaOwnersOnline.com

CUSTOMER EXPERIENCE CENTER

1-800-331-4331

AVALON

2 0 1 0

QUICK REFERENCE GUIDE



Mixed Sources

Product group from well-managed
forests, controlled sources and
recycled wood or fiber
www.fsc.org Cert no. SGS-COC-005612
© 1996 Forest Stewardship Council



2010 Avalon

This *Quick Reference Guide* is a summary of basic vehicle operations. It contains brief descriptions of fundamental operations so you can locate and use the vehicle's main equipment quickly and easily.

The *Quick Reference Guide* is not intended as a substitute for the *Owner's Manual* located in your vehicle's glove box. We strongly encourage you to review the *Owner's Manual* and supplementary manuals so you will have a better understanding of your vehicle's capabilities and limitations.

Your dealership and the entire staff of Toyota Motor Sales, U.S.A., Inc. wish you many years of satisfied driving in your new Avalon.

! A word about safe vehicle operations

This *Quick Reference Guide* is not a full description of Avalon operations. Every Avalon owner should review the *Owner's Manual* that accompanies this vehicle.

Pay special attention to the boxed information highlighted in color throughout the *Owner's Manual*. Each box contains safe operating instructions to help you avoid injury or equipment malfunction.

All information in this *Quick Reference Guide* is current at the time of printing. Toyota reserves the right to make changes at any time without notice.

Trunk-Internal release

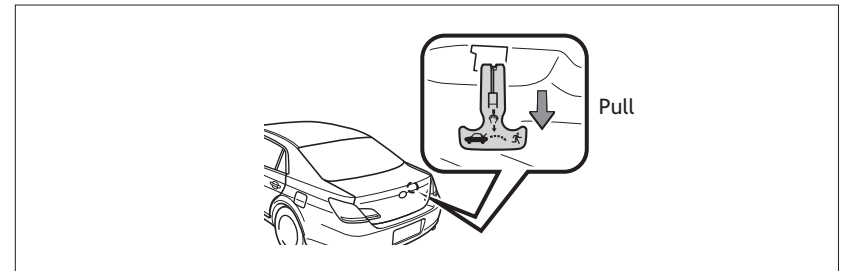

Spare tire & tools

Tool location

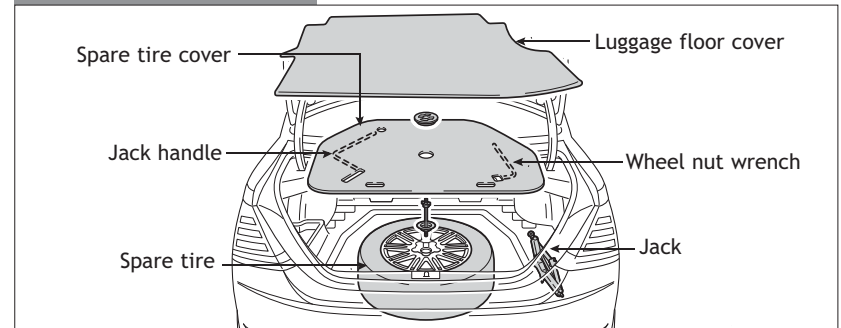

Removing the spare tire

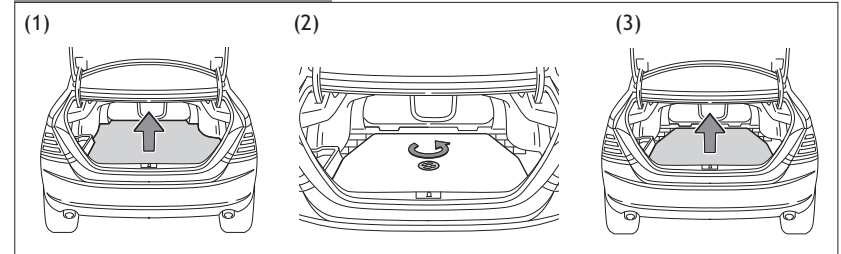

- (1) Remove the luggage cover.
- (2) Loosen and remove the center fastener.
- (3) Remove the spare tire cover.

Refer to the *Owner's Manual* for tire changing and jack positioning procedures.

INDEX

OVERVIEW

Engine maintenance	9
Fuel tank door release and cap	8
Hood release	9
Indicator symbols	4-5
Instrument cluster	4
Instrument panel	2-3
Keyless entry¹	6
Light control-Instrument panel	8
Smart Key system²	7
Trunk release	8

FEATURES/OPERATIONS

Air Conditioning/Heating	20
Audio	18
Auto lock functions²	10
Automatic Transmission	10
Center display	19
Clock	22
Cruise control	16
Cup holders	22
Door locks	21
Dynamic Laser Cruise Control	17
Garage door opener (HomeLink [®]) ³	16
Lights¹ & turn signals	13
Moonroof	14
Parking brake	11
Power outlets	22
Seat adjustments-Front	12
Seat adjustments-Rear	12
Seat ventilators/Heaters	21
Seats-Head restraints	11
Steering lock release	10
Steering wheel switches	19
Sunshade-Rear¹	14
Telephone controls (Bluetooth [®])	15
Tilt and telescopic steering wheel	11
Windows-Power	14
Windshield wipers & washers¹	12

SAFETY AND EMERGENCY FEATURES

Doors-Child safety locks	23
Seatbelt comfort guide	24
Seatbelts	23
Seatbelts-Shoulder belt anchor	23
Spare tire & tools	25
Tire Pressure Monitoring (warning) System	24
Trunk-Internal release	25

¹ Visit your Toyota dealer for information on customizing this feature.

² Programmable by customer. Refer to the Owner's Manual for instructions and more information.

³ HomeLink[®] is a registered trademark of Johnson Controls, Inc.

OVERVIEW

Instrument panel

Steering wheel controls

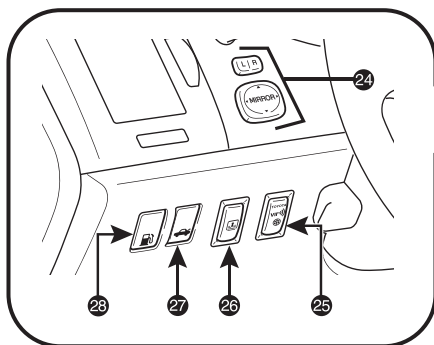
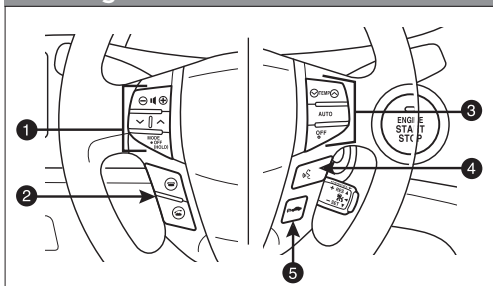

- 1 Steering wheel audio controls
- 2 Telephone controls¹
- 3 Steering wheel climate controls
- 4 Voice command button^{1,2}
- 5 Distance button¹
- 6 Driving position memory switches¹
- 7 Headlight, turn signal and front fog light¹ controls
- 8 Ignition switch (standard key)¹
- 9 Wiper and washer controls
- 10 "ENGINE START STOP" button (Smart Key)¹
- 11 Clock
- 12 Center display¹/Navigation system^{1,2}
- 13 Emergency flasher button
- 14 "AIR BAG ON" and "AIR BAG OFF" indicator and front passenger seatbelt reminder lights
- 15 Air Conditioning controls

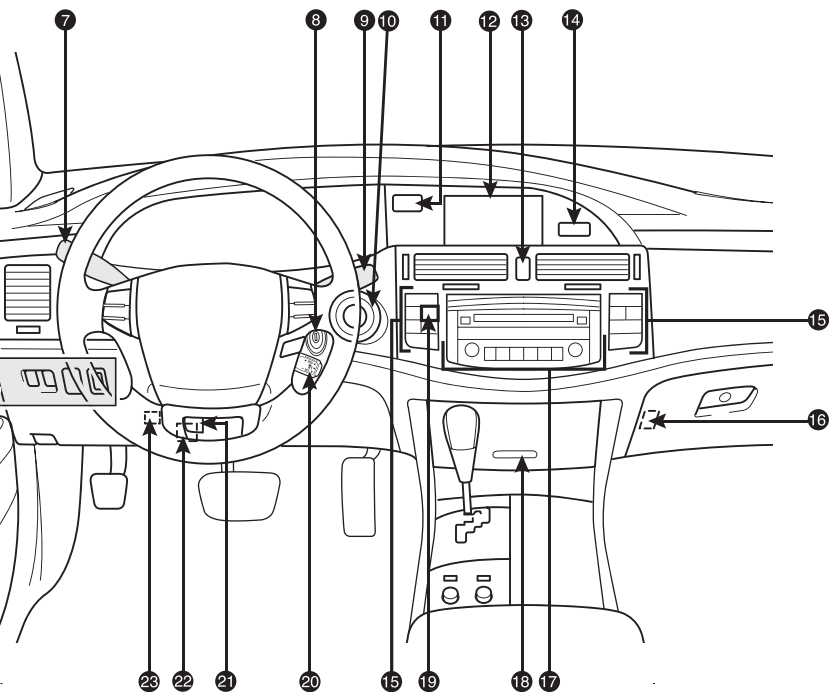

- 16 Trunk opener main switch
- 17 Audio system
- 18 Storage compartment¹/Navigation system switches^{1,2}
- 19 Outside rearview mirror¹/Rear window defogger button
- 20 Cruise control
- 21 Tilt lock release lever
- 22 Tire Pressure Monitoring (warning) System reset
- 23 Telescopic lock release
- 24 Power rearview mirror control
- 25 Glass breakage sensor¹
- 26 Rear sunshade switch¹
- 27 Trunk opener
- 28 Fuel filler door opener

¹ If equipped

² For vehicles with a navigation system, refer to the "Navigation System Owner's Manual."



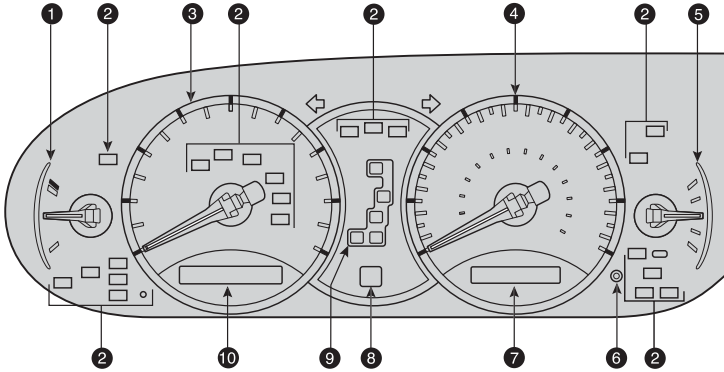

Instrument cluster





















- 1 Engine coolant temperature
- 2 Service indicator and reminder
- 3 Tachometer
- 4 Speedometer
- 5 Fuel gauge
- 6 Odometer/Trip meter and trip meter reset button
- 7 Odometer/Trip meter display
- 8 Automatic Transmission shift range display
- 9 Automatic Transmission shift position indicator
- 10 Dynamic laser cruise control display

Indicator symbols

For details, refer to "Indicators and warning lights," Section 2-2, 2010 *Owner's Manual*.

BRAKE	Brake system warning ¹
	Driver seatbelt reminder (alarm will sound if speed is over 9 mph)
PASSENGER 	Front passenger seatbelt reminder (alarm will sound if speed is over 9 mph)
	Charging system warning ¹
PASSENGER AIR BAG OFF 	Front passenger occupant classification indicator/ Front passenger airbag ON/OFF indicator ¹
	Low engine oil pressure warning ¹

¹ If indicator does not turn off within a few seconds of starting engine, there may be a malfunction. Have vehicle inspected by your Toyota dealer.

	Malfunction/Check Engine indicator ¹
	Engine oil replacement reminder ¹
	Low fuel level warning
	Open door warning
	Airbag SRS warning ¹
	Tire Pressure Warning ¹
	Low windshield washer fluid level warning ¹
	Security indicator
	Headlight low/high beam indicator
	Turn signal indicator
	Automatic headlight leveling system warning ¹
	Slip indicator
	Vehicle Stability Control system warning ¹
	Cruise control indicator ²
	Ready mode indicator ¹
	Conventional cruise
	Dynamic Laser Cruise Control master warning light ¹
	Anti-lock Brake System warning ¹
	Smart Key system warning ¹

² If this light flashes, refer to "Cruise control," Section 2-4, 2010 Owner's Manual.

Keyless entry

Locking operation

Without Smart Key system

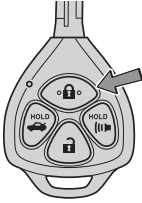

With Smart Key system



Unlocking operation

Without Smart Key system



With Smart Key system



Push ONCE: Driver door
TWICE: All doors



NOTE: If a door is not opened within 60 seconds of unlocking, all doors will relock for safety.

Trunk lid operation

Without Smart Key system

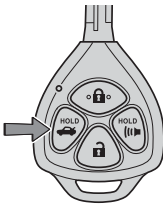

With Smart Key system

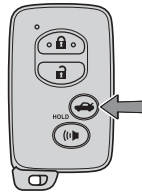

Panic button



Smart Key system (if equipped)

Start function

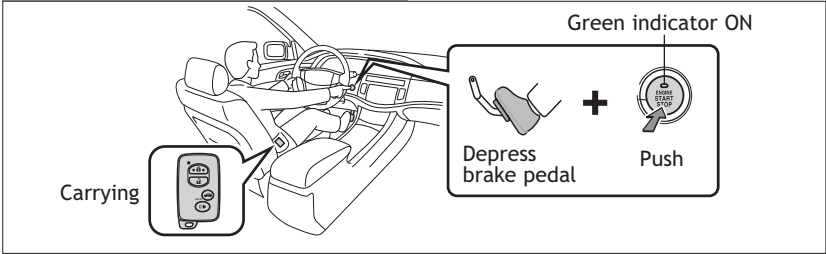

NOTE: Gear shift lever must be in Park and brake pedal depressed.

Power (without starting engine)

Without depressing the brake pedal, pressing the "ENGINE START STOP" switch will change the operation mode in succession from:

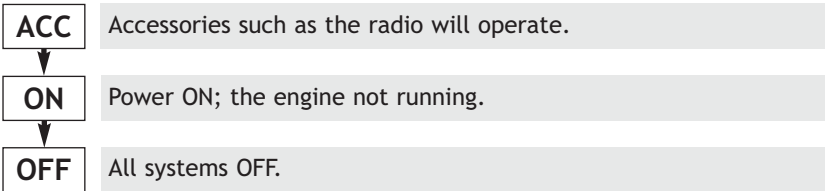

Locking operation

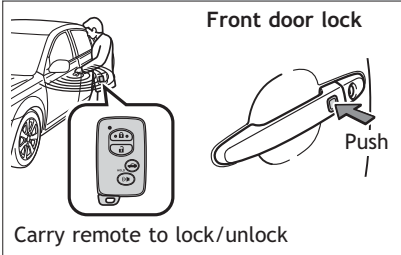

Unlocking operation

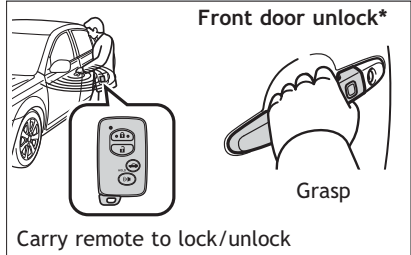

Trunk access

Opening trunk

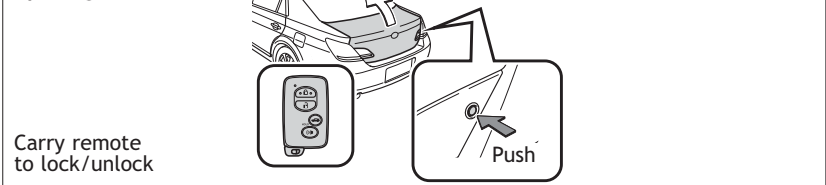

* Driver door unlocking function can be programmed to unlock driver door only, or all doors. Grasping passenger door handle will unlock all doors.

NOTE: Doors may also be locked/unlocked using remote.

Fuel tank door release and cap

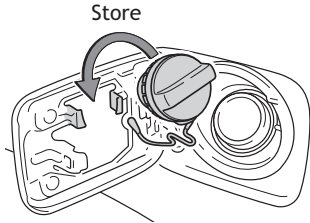
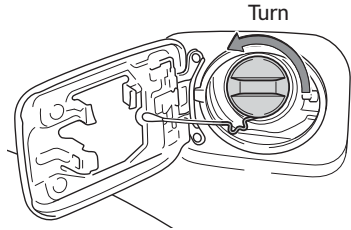
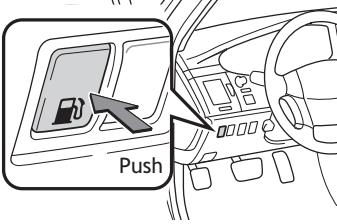

NOTE: Tighten until one click is heard. If the cap is not tightened enough, Check Engine “” indicator may illuminate.

Light control-Instrument panel

Brightness control

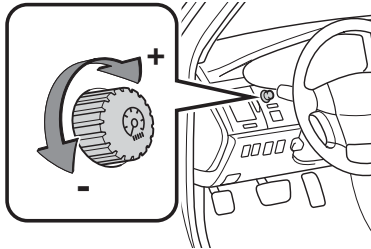

Trunk release

Trunk opener

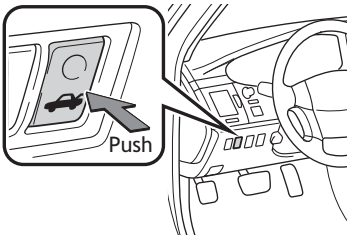

Main switch

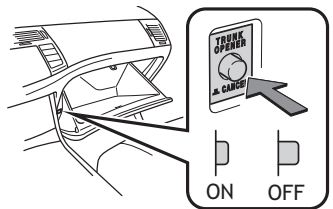

Hood release

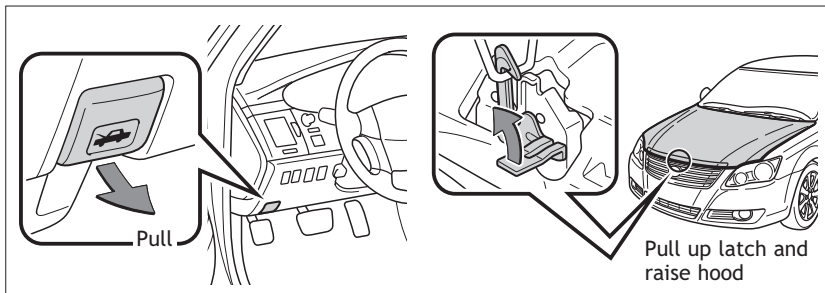

Engine maintenance

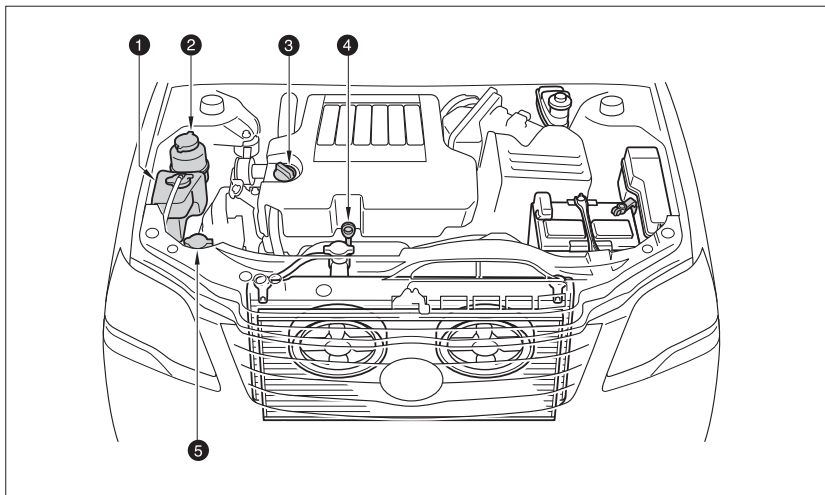

- ① Engine coolant reservoir
- ② Power steering fluid reservoir
- ③ Engine oil filler cap
- ④ Engine oil level dipstick
- ⑤ Windshield washer fluid tank

NOTE: Regularly scheduled maintenance, including oil changes, will help extend the life of your vehicle and maintain performance. Please refer to the "Warranty Maintenance Guide."

FEATURES/OPERATIONS

Auto lock functions

Automatic door locks can be programmed to operate in two different modes, or turned OFF.

1. Doors lock: when shifting from Park.
Doors unlock: when shifting into Park.
2. Doors lock: when the vehicle speed goes above 12 mph.
Doors unlock: when the driver's door is opened within 10 seconds after turning the "ENGINE START STOP" switch or the engine switch OFF.

Refer to the *Owner's Manual* for more details.

Automatic Transmission

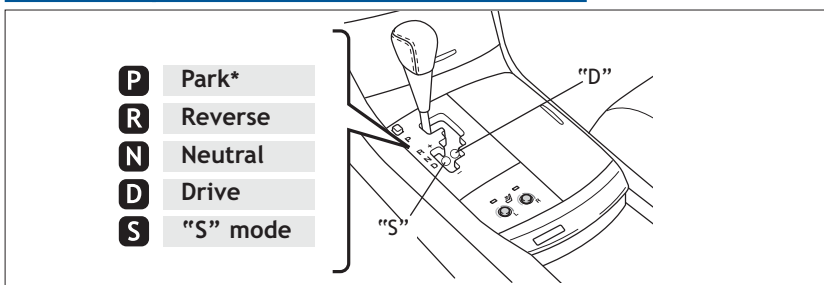

* The "ENGINE START STOP" switch/engine must be "ON" and the brake pedal depressed to shift from Park.

"S" (Sequential) mode

Shift the shift lever to "S" position from "D" position.

Floor shift type:

- + : Upshift (push and release)
- : Downshift (pull and release)

Downshifting increases power going uphill, or provides engine braking downhill. For best fuel economy during normal driving conditions, always drive with the shift lever in the "D" position.

Steering lock release

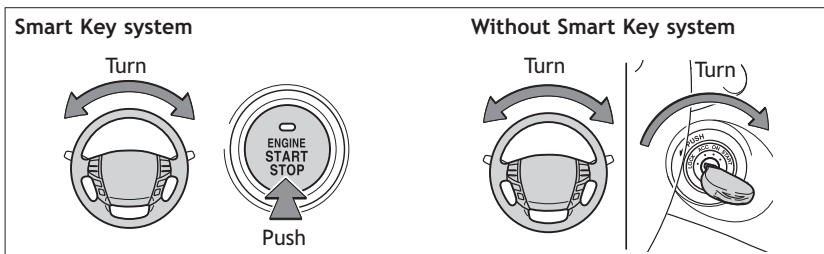

Tilt and telescopic steering wheel

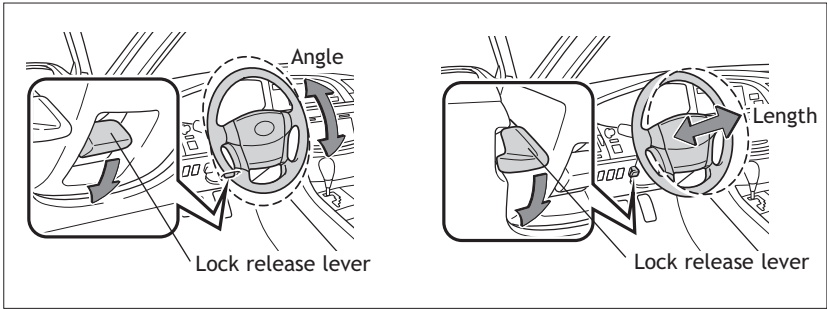

Hold wheel, push lever down, set angle and length, and return lever.

NOTE: Do not attempt to adjust while the vehicle is in motion.

Parking brake

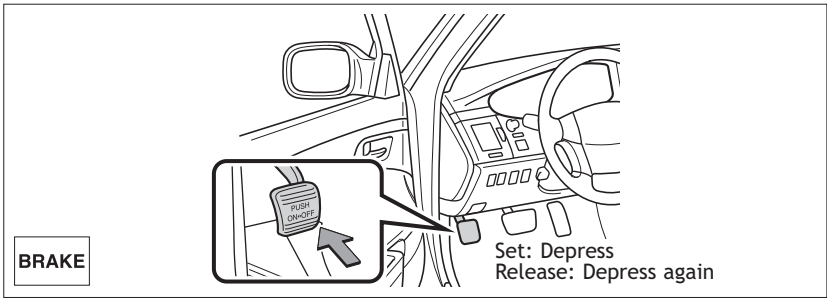

Set: Depress
Release: Depress again

Seats-Head restraints

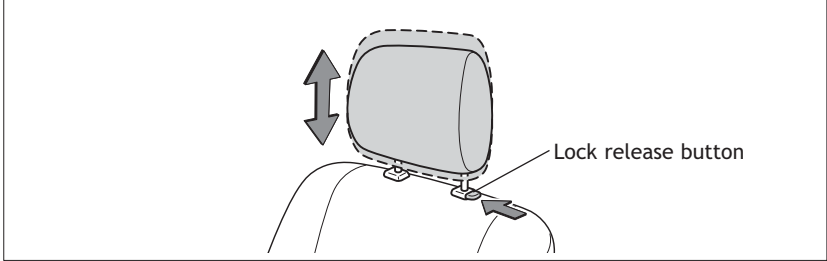

Seat adjustments-Front

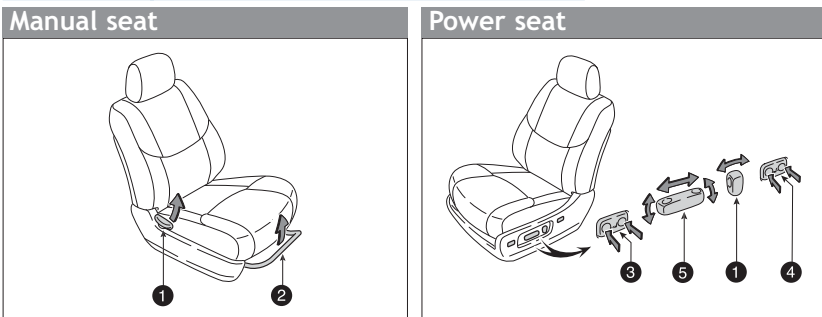

- ① Seatback angle
- ② Seat position (forward/backward)
- ③ Leg support (if equipped)
- ④ Lumbar support (if equipped)
- ⑤ Position, cushion angle (if equipped) and height (if equipped)

Seat adjustments-Rear

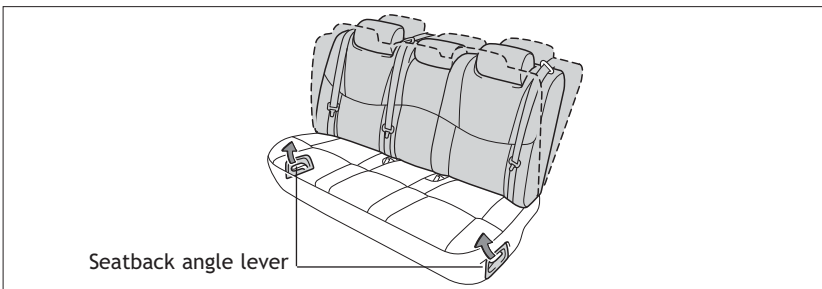

Refer to the *Owner's Manual* for more details.

Windshield wipers & washers

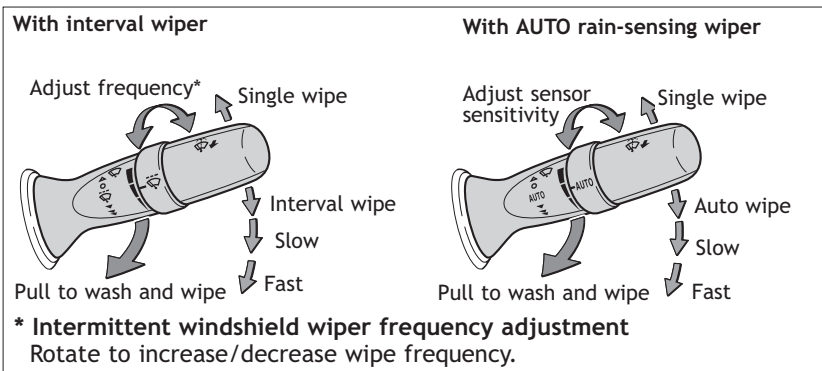

Lights & turn signals

Headlights

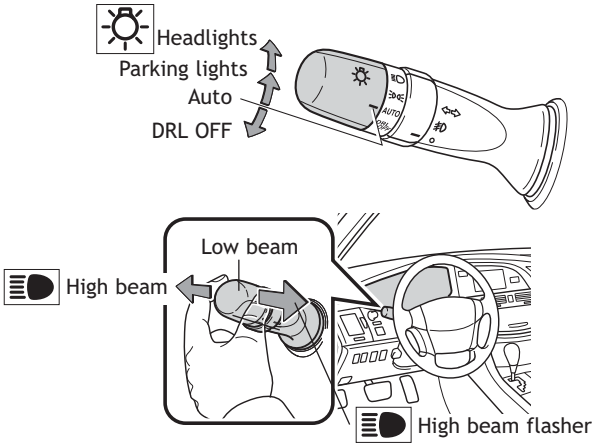

- Daytime Running Light system (DRL) Automatically turns on the headlights at a reduced intensity.
- Automatic light cut off system Automatically turns lights off after a delay of 30 seconds, or the lock switch on remote may be pushed after locking.

Front fog lights (if equipped)

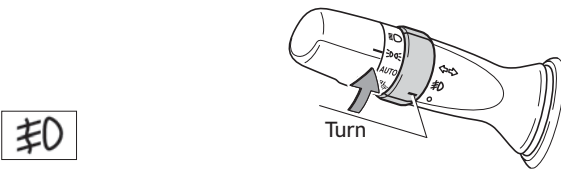

Front fog lights come on only when the headlights are on low beam.

Turn signals

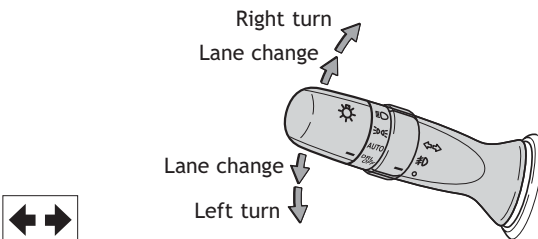

Windows-Power

Driver side

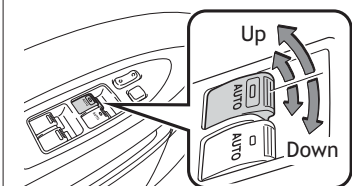

Automatic operation Push the switch completely down or pull it completely up and release to fully open or close. To stop window midway, lightly push the switch in the opposite direction.

Window lock switch Deactivates all passenger windows. Driver's window remains operable.

NOTE: If battery is disconnected, the window needs to be reinitialized. Refer to the *Owner's Manual* for more details.

Moonroof (if equipped)

Sliding operation

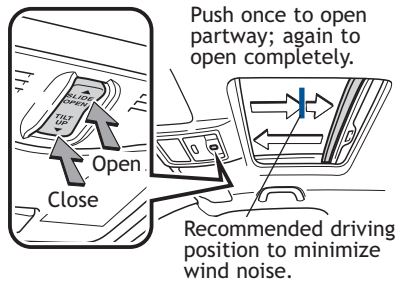

Tilting operation

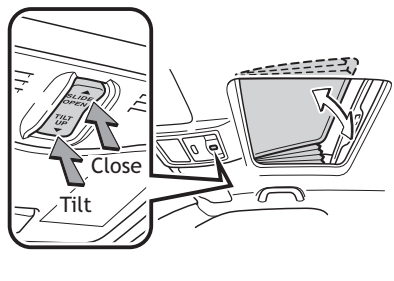

NOTE: If battery is disconnected, the moonroof needs to be reinitialized. Refer to the *Owner's Manual* for more details.

Sunshade-Rear (if equipped)

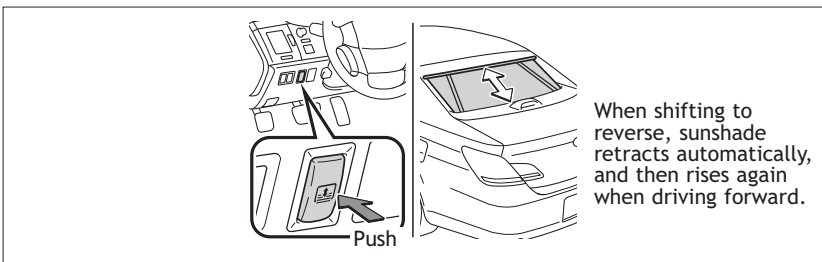

Telephone controls (Bluetooth®) (if equipped)

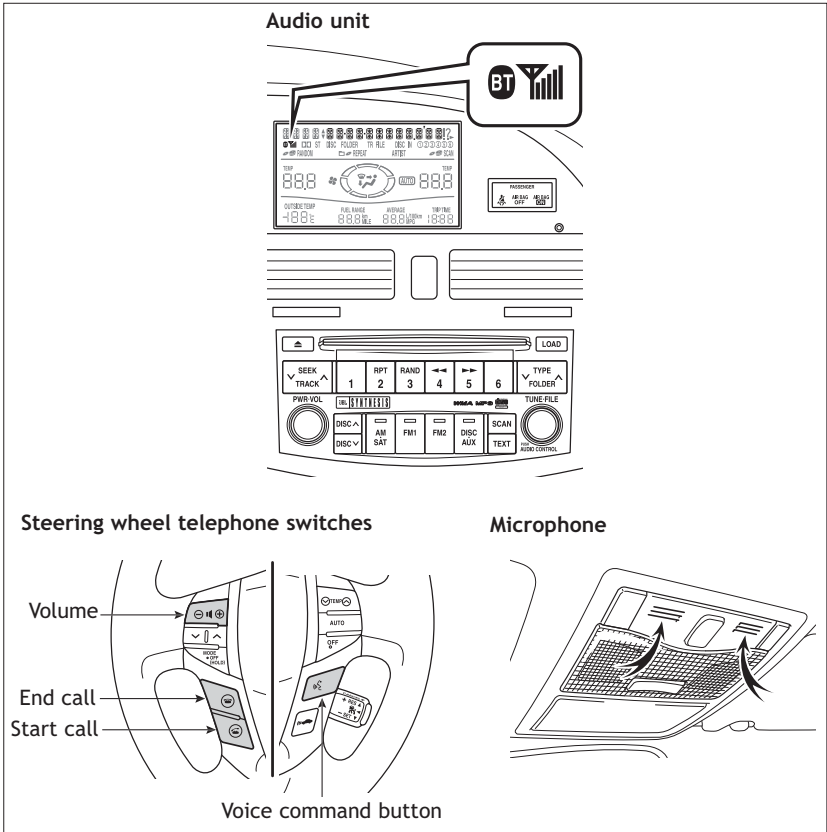

Bluetooth® technology allows dialing or receipt of calls without taking hands from the steering wheel or using a cable to connect the compatible telephone and the system.

Refer to "Hands-free system (for cellular phone)," Section 3-3 in the *Owner's Manual* for more details, or go to Toyota.com and enter "Bluetooth" in the keyword search.

Garage door opener (HomeLink®)* (if equipped)

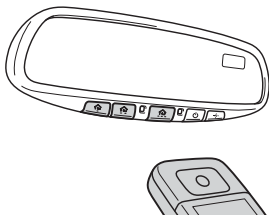

Garage door openers manufactured under license from HomeLink®* can be programmed to operate garage doors, estate gates, security lighting, etc.

Refer to "Garage door opener," Section 3-6 in the *Owner's Manual* for more details.

For programming assistance, contact HomeLink® at 1-800-355-3515, or visit <http://www.homelink.com>.

* HomeLink® is a registered trademark of Johnson Controls, Inc.

Cruise control

Turning system ON/OFF

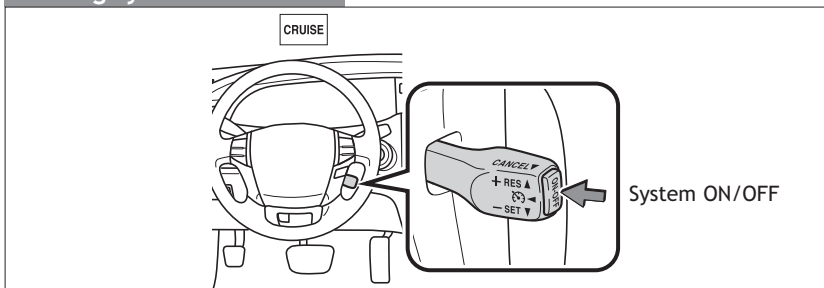

Functions

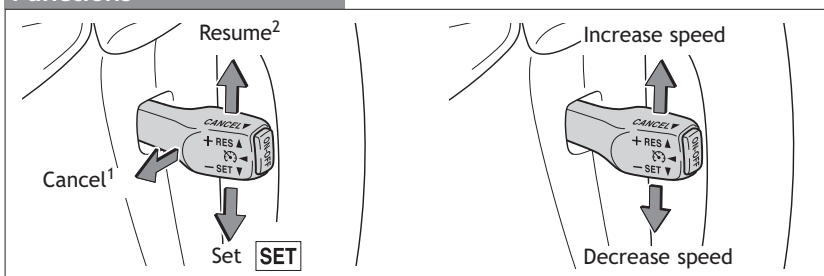

¹ The set speed may also be cancelled by depressing the brake pedal.

² The set speed may be resumed once vehicle speed exceeds 25 mph.

Dynamic Laser Cruise Control (if equipped)

Refer to the *Owner's Manual* for more details and complete safety precautions before attempting to use "Dynamic Laser Cruise Control."

Fixed speed mode

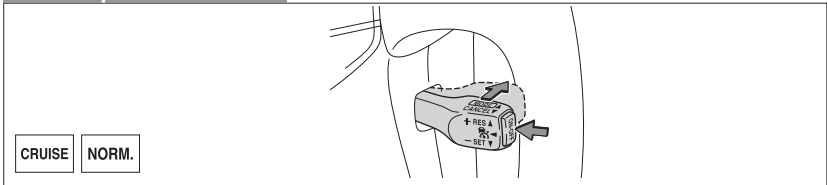

- (1) **To select conventional/fixed speed control** Push the ON-OFF button. Push the lever forward and hold until the "NORM." indicator appears.
- (2) **To set, cancel and resume a speed** Refer to instructions for *Cruise Control* on the previous page.

Distance control mode

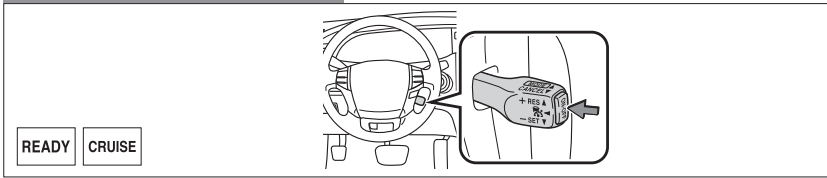

Distance control mode will cruise at a set speed, decelerate to maintain selected distance from a slower vehicle traveling in front of you, and accelerate back up to the selected speed if the vehicle in front of you changes lanes or speeds up.

- (1) **To select distance control mode** Push the ON-OFF button. The "READY" and "CRUISE" indicator will come on.
- (2) **To set, cancel and resume a speed** Refer to instructions for *Cruise Control* on the previous page.

NOTE: Once vehicle speed is set, pushing lever up toward "+ RES" will increase speed to the nearest 5 mph, and then in 5 mph increments. Pushing lever down toward "- SET" will reduce speed in the same way.

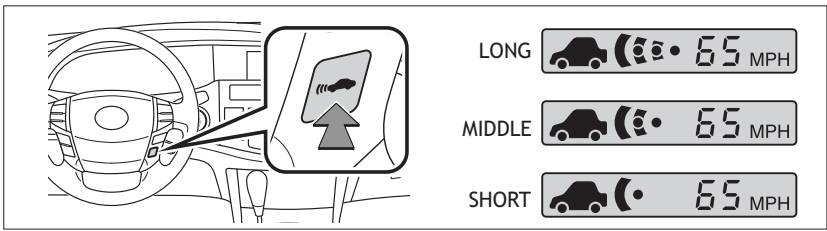

- (3) **To change the vehicle-to-vehicle distance** Push the distance button to cycle through the settings, which will change progressively from LONG to MIDDLE to SHORT.

Audio

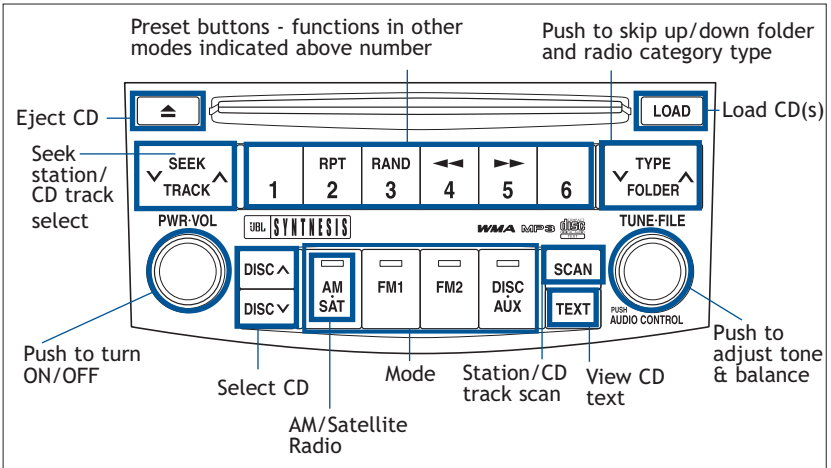

CD PLAYER

To scan tracks on a disc Push "SCAN." Push again to hold selection.

CD changer

- To load one disc Push "LOAD" and insert one disc.
- To load multiple discs Push and hold "LOAD" until you hear a beep. Insert one disc. Shutter will close and then re-open for next disc.

To select a CD Push "DISC ^" or "DISC v."

To select a file (MP3/WMA only) Turn "TUNE-FILE."

To select a folder (MP3/WMA only) Push either side of "FOLDER."

RADIO

To preset stations Tune in the desired station and hold down a preset button (1-6) until you hear a beep. Push desired preset button (1-6) to select.

To scan stations Push and hold "SCAN" to scan preset stations. Push again to hold selection.

AUX audio jack

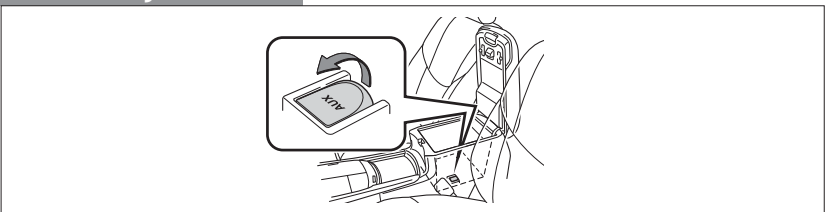

By inserting a mini plug into the AUX audio jack, you can listen to music from a portable audio device through the vehicle's speaker system while in AUX mode.

Steering wheel switches

Audio control

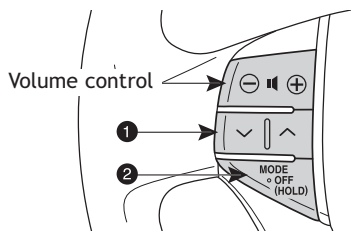

Climate control

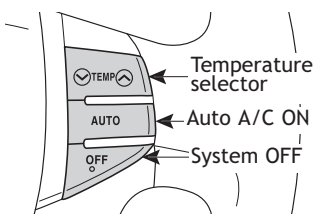

1 "V A"

Use to search within the selected audio medium (radio, CD, iPod, etc.).

2 "MODE"

Push to turn audio ON and select an audio mode. Push and hold to turn audio system OFF.

Center display

Without navigation system

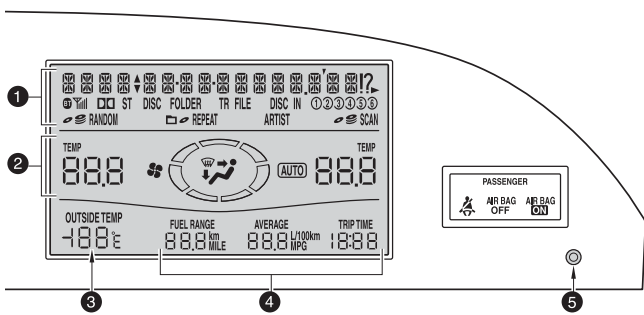

1 Audio display

2 Air Conditioning display

3 Outside temperature

4 Trip information display

5 Pattern selector knob

Display item can be switched by pushing the knob: (1) Entire display (2) Audio display and Air Conditioning display (3) OFF

With navigation system Refer to the "Navigation System Owner's Manual."

Air Conditioning/Heating

Display

Without navigation system

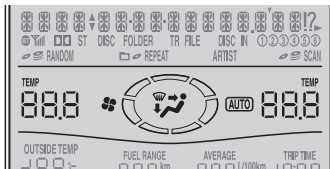

With navigation system

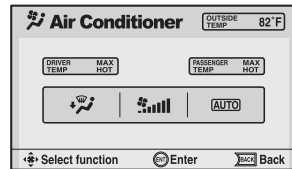

Control

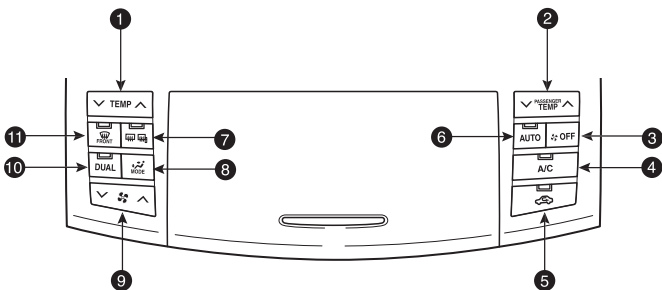

- 1 Temperature selector (driver side)
 - 2 Temperature selector (passenger side)
 - 3 Climate control OFF
 - 4 Air Conditioning ON/OFF
 - 5 Fresh or recirculated cabin air
 - 6 Automatic climate control ON
 - 7 Outside rearview mirror*/Rear defogger
 - 8 Airflow vent
In " " mode, use fresh air (" indicator OFF) to reduce window fogging.
 - 9 Fan speed
 - 10 "DUAL" button
Indicator ON: Separate temperature settings for driver and passenger.
Indicator OFF: Synchronize temperature settings for driver and passenger.
 - 11 Windshield defogger
- * If equipped

Seat ventilators/Heaters (if equipped)

With ventilator

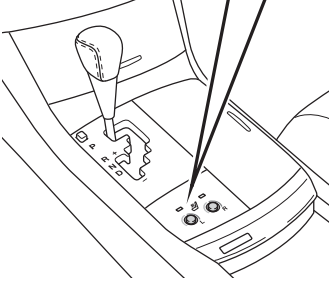
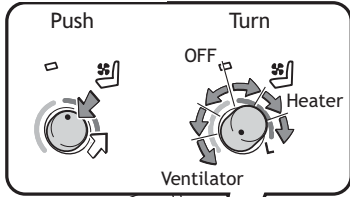

Heater only

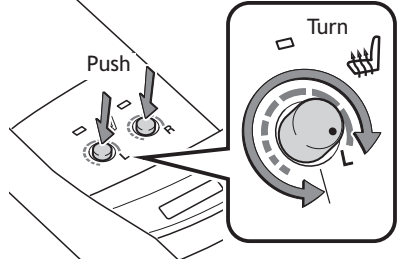

Push knob to pop the controller out. Turn clockwise for heater, counter-clockwise for ventilator.

Door locks

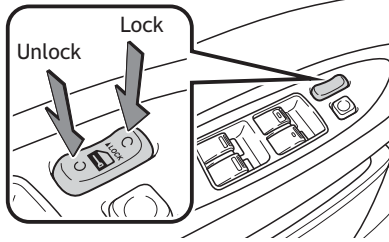

Power outlets

Auxiliary box

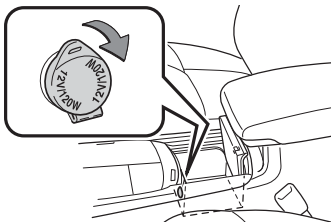

Console box

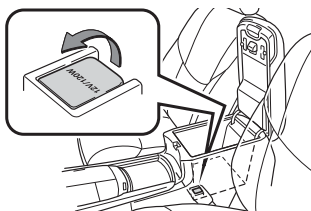

The "ENGINE START STOP" switch/engine switch must be in the "ACC" or "ON" position to be used.

Cup holders

Front

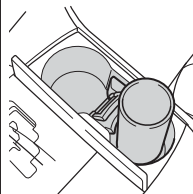
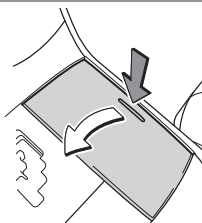

Rear (type A)

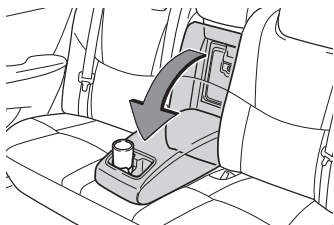

Rear (type B)



Clock

Without navigation system

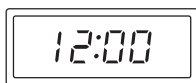

○ H ○ M ○ :88

H-Hour set
M-Minute set
:00-Round off minutes

With navigation system Refer to the "Navigation System Owner's Manual."

SAFETY AND EMERGENCY FEATURES

Doors-Child safety locks

Rear door

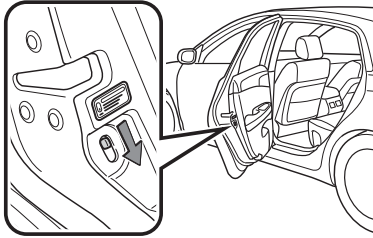

Moving the lever to "LOCK" will allow the door to be opened only from the outside.

Seatbelts

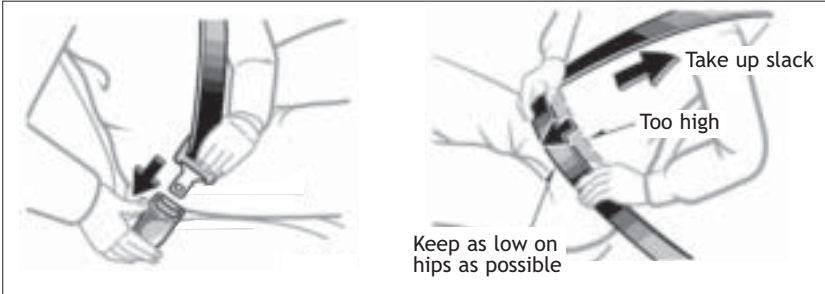

If belt is fully extended, then retracted even slightly, it cannot be re-extended beyond that point, unless fully retracted again. This feature is used to help hold child restraint systems securely.

To find more information about seatbelts, and how to install a child restraint system, refer to the *Owner's Manual*.

Seatbelts-Shoulder belt anchor

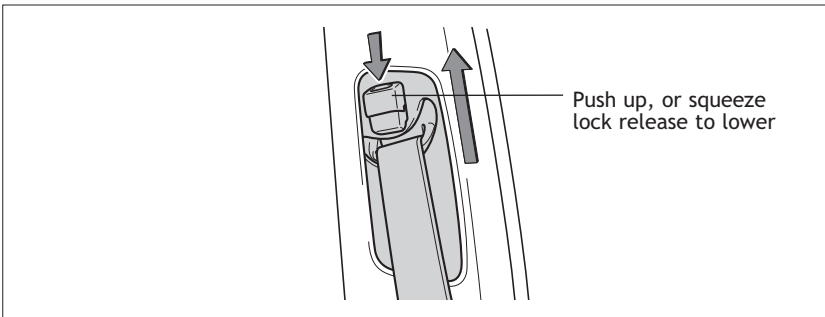

Seatbelt comfort guide

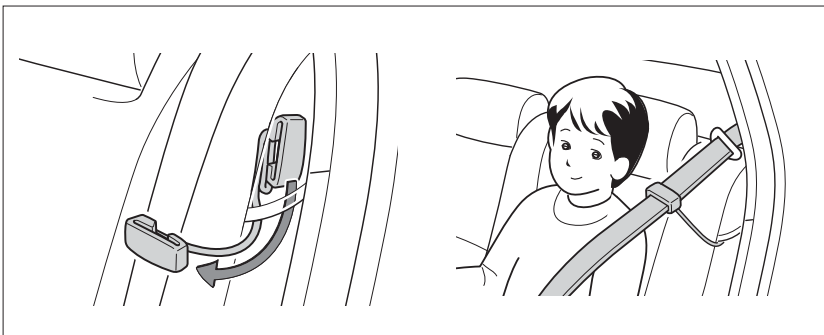

Rear seat outside position guides provide added comfort for children who have outgrown child restraints.

Tire Pressure Monitoring (warning) System

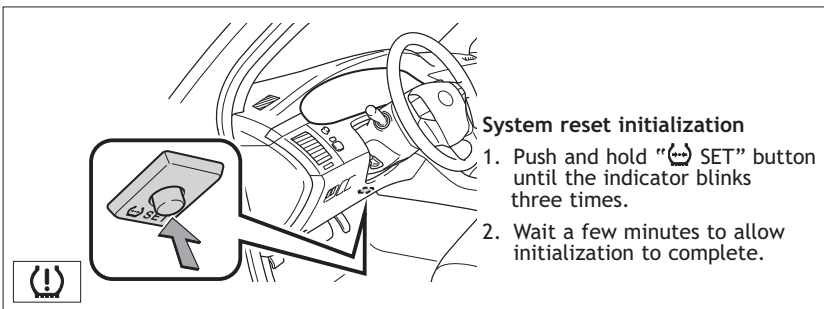

After adjusting tire pressures, or after tires have been rotated or replaced, turn the ignition switch to "ON" and press and hold the "SET" button until indicator blinks three times. Let the vehicle sit for a few minutes to allow initialization to complete.

Refer to the load label on the door jamb or the *Owner's Manual* for tire inflation specifications.

If the tire pressure indicator flashes for more than 60 seconds and then remains on, take the vehicle to your local Toyota dealer.

NOTE: The warning light may come on due to temperature changes or changes in tire pressure from natural air leakage. If the system has not been initialized recently, setting the tire pressures to factory specifications should turn off the light.

1 Before driving

1-1. Key information
 Keys 22

1-2. Opening, closing and locking the doors and trunk
 Smart key system..... 24
 Wireless remote control 36
 Doors..... 40
 Trunk 46

1-3. Adjustable components (seats, steering wheel, mirrors)
 Front seats 50
 Rear seats..... 53
 Driving position memory system..... 55
 Head restraints..... 59
 Seat belts 61
 Steering wheel 68
 Inside rear view mirror..... 70
 Outside rear view mirrors 72

1-4. Opening and closing the windows and moon roof
 Power windows 74
 Moon roof..... 77

1-5. Refueling
 Opening the fuel tank cap 80

1-6. Theft deterrent system
 Engine immobilizer system 83
 Alarm 85
 Theft prevention labels (U.S.A.)..... 87

1-7. Safety information
 Correct driving posture 88
 SRS airbags 90
 Front passenger occupant classification system..... 103
 Child restraint systems 109
 Installing child restraints 113

2 When driving

2-1. Driving procedures
 Driving the vehicle 124
 Engine (ignition) switch (with smart key system) 133
 Engine (ignition) switch (without smart key system) 137
 Automatic transmission 140
 Turn signal lever 145
 Parking brake 146
 Horn 147

2-2. Instrument cluster
 Gauges and meters 148
 Indicators and warning lights 151
 Center display..... 154

2-3. Operating the lights and windshield wipers	
Headlight switch.....	156
Fog light switch	159
Windshield wipers and washer	160
2-4. Using other driving systems	
Cruise control.....	165
Dynamic laser cruise control	168
Driving assist systems	181
2-5. Driving information	
Cargo and luggage	184
Vehicle load limits	188
Winter driving tips	189
Trailer towing	194
Dinghy towing	195

3 Interior features

3-1. Using the air conditioning system and defogger	
Automatic air conditioning system	198
Using the steering wheel climate control switches	206
Rear window and outside rear view mirror defoggers.....	208

3-2. Using the audio system	
Audio system type.....	210
Audio cover	212
Using the radio	213
Using the CD player	220
Playing MP3 and WMA discs	228
Optimal use of the audio system.....	236
Using the AUX adapter.....	238
Using the steering wheel audio switches.....	239
3-3. Using the hands-free system (for cellular phone)	
Hands-free system (for cellular phone)	242
Using the hands-free system.....	246
Making a phone call	254
Setting a cellular phone.....	259
Security and system setup	264
Using the phone book	267

3-4. Using the interior lights	
Interior lights list	275
3-5. Using the storage features	
List of storage features.....	278

3-6. Other interior features

Sun visors 286
 Vanity mirrors 287
 Clock 288
 Outside temperature display 289
 Ashtrays 290
 Power outlets 291
 Seat heaters/ventilators 293
 Armrest..... 295
 Rear sunshade 296
 Floor mats 298
 Trunk features 299
 Garage door opener 301
 Compass 306

4 Maintenance and care

4-1. Maintenance and care

Cleaning and protecting the vehicle exterior 312
 Cleaning and protecting the vehicle interior 315

4-2. Maintenance

Maintenance requirements 318
 General maintenance 320
 Emission inspection and maintenance (I/M) programs 323

4-3. Do-it-yourself maintenance

Do-it-yourself service precautions 324
 Hood 327
 Positioning a floor jack 328
 Engine compartment 330
 Tires 345
 Tire inflation pressure 354
 Wheels 358
 Air conditioning filter 360
 Key battery 363
 Checking and replacing fuses 367
 Headlight aim (with discharge headlights) 376
 Light bulbs 378

5 When trouble arises

5-1. Essential information

Emergency flashers 384
 If your vehicle needs to be towed 385
 If you think something is wrong 389
 Fuel pump shut off system 390
 Event data recorder 391

5-2. Steps to take in an emergency

If a warning light turns on or a warning buzzer sounds... 393
If you have a flat tire..... 405
If the engine will not start..... 414
If the shift lever cannot be shifted from P..... 416
If you lose your keys 417
If the electronic key does not operate properly (with smart key system)..... 418
If the vehicle battery is discharged 420
If your vehicle overheats..... 424
If the vehicle becomes stuck 427

6 Vehicle specifications

6-1. Specifications

Maintenance data (fuel, oil level, etc.)..... 430
Fuel information 439
Tire information 442

6-2. Customization

Customizable features 454

6-3. Initialization

Items to initialize 458

7 For owners

Reporting safety defects for U.S. owners 460 1
Seat belt instructions for Canadian owners (in French)..... 461

Index

Abbreviation list 466 3

Alphabetical index..... 467

What to do if..... 474 4



For your information

Main Owner's Manual

Please note that this manual applies to all models and explains all equipment, including options. Therefore, you may find some explanations for equipment not installed on your vehicle.

All specifications provided in this manual are current at the time of printing. However, because of the Toyota policy of continual product improvement, we reserve the right to make changes at any time without notice.

Depending on specifications, the vehicle shown in the illustration may differ from your vehicle in terms of equipment.

Noise from under vehicle after turning off the engine

Approximately five hours after the engine is turned off, you may hear sound coming from under the vehicle for several minutes. This is the sound of a fuel evaporation leakage check and, it does not indicate a malfunction.

Accessories, spare parts and modification of your Toyota

A wide variety of non-genuine spare parts and accessories for Toyota vehicles are currently available in the market. You should know that Toyota does not warrant these products and is not responsible for their performance, repair, or replacement, or for any damage they may cause to, or adverse effect they may have on, your Toyota vehicle.

This vehicle should not be modified with non-genuine Toyota products. Modification with non-genuine Toyota products could affect its performance, safety or durability, and may even violate governmental regulations. In addition, damage or performance problems resulting from the modification may not be covered under warranty.

Installation of a mobile two-way radio system

As the installation of a mobile two-way radio system in your vehicle could affect electronic systems such as the multiport fuel injection system/sequential multiport fuel injection system, electronic throttle control system, cruise control system, dynamic laser cruise control system, vehicle stability control system, SRS airbag system and seat belt pretensioner system, be sure to check with your Toyota dealer for precautionary measures or special instructions regarding installation.

Scrapping of your Toyota

The SRS airbag and seat belt pretensioner devices in your Toyota contain explosive chemicals. If the vehicle is scrapped with the airbags and seat belt pretensioners left as they are, this may cause an accident such as fire. Be sure to have the systems of the SRS airbag and seat belt pretensioner removed and disposed of by a qualified service shop or by your Toyota dealer before you scrap your vehicle.

Perchlorate Material

Special handling may apply,
See www.dtsc.ca.gov/hazardouswaste/perchlorate.
Your vehicle has components that may contain perchlorate. These components may include airbag, seat belt pretensioners, and wireless remote control batteries.

 CAUTION

■ **General precautions while driving**

Driving under the influence: Never drive your vehicle when under the influence of alcohol or drugs that have impaired your ability to operate your vehicle. Alcohol and certain drugs delay reaction time, impair judgment and reduce coordination, which could lead to an accident that will hurt or kill you, your occupants or others.

Defensive driving: Always drive defensively. Anticipate mistakes that other drivers or pedestrians might make and be ready to avoid accidents.

Driver distraction: Always give your full attention to driving. Anything that distracts the driver, such as adjusting controls, talking on a cellular phone or reading can result in a collision with resulting death or serious injury to you, your occupants or others.

■ **General precautions regarding children's safety**

Never leave children unattended in the vehicle, and never allow children to have or use the key.

Children may be able to start the vehicle or shift the vehicle into neutral. There is also a danger that children may injure themselves by playing with the cigarette lighter, the windows, the moon roof, or other features of the vehicle. In addition, heat build-up or extremely cold temperatures inside the vehicle can be fatal to children.

Symbols used throughout this manual

Cautions & Notices

CAUTION

This is a warning against anything which may cause injury to people if the warning is ignored. You are informed about what you must or must not do in order to reduce the risk of injury to yourself and others.

NOTICE

This is a warning against anything which may cause damage to the vehicle or its equipment if the warning is ignored. You are informed about what you must or must not do in order to avoid or reduce the risk of damage to your Toyota and its equipment.

Symbols used in illustrations



Safety symbol

The symbol of a circle with a slash through it means “Do not”, “Do not do this”, or “Do not let this happen”.

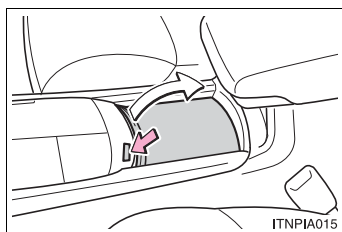

Arrows indicating operations



-  Indicates the action (pushing, turning, etc.) used to operate switches and other devices.
-  Indicates the outcome of an operation (e.g. a lid opens).

TABLE OF CONTENTS

1	Before driving	Adjusting and operating features such as door locks, mirrors, and steering column.
2	When driving	Driving, stopping and safe-driving information.
3	Interior features	Air conditioning and audio systems, as well as other interior features for a comfortable driving experience.
4	Maintenance and care	Cleaning and protecting your vehicle, performing do-it-yourself maintenance, and maintenance information.
5	When trouble arises	What to do if the vehicle needs to be towed, gets a flat tire, or is involved in an accident.
6	Vehicle specifications	Detailed vehicle information.
7	For owners	Reporting safety defects for U.S. owners and seat belt instructions for Canadian owners.
	Index	Alphabetical listing of information contained in this manual.



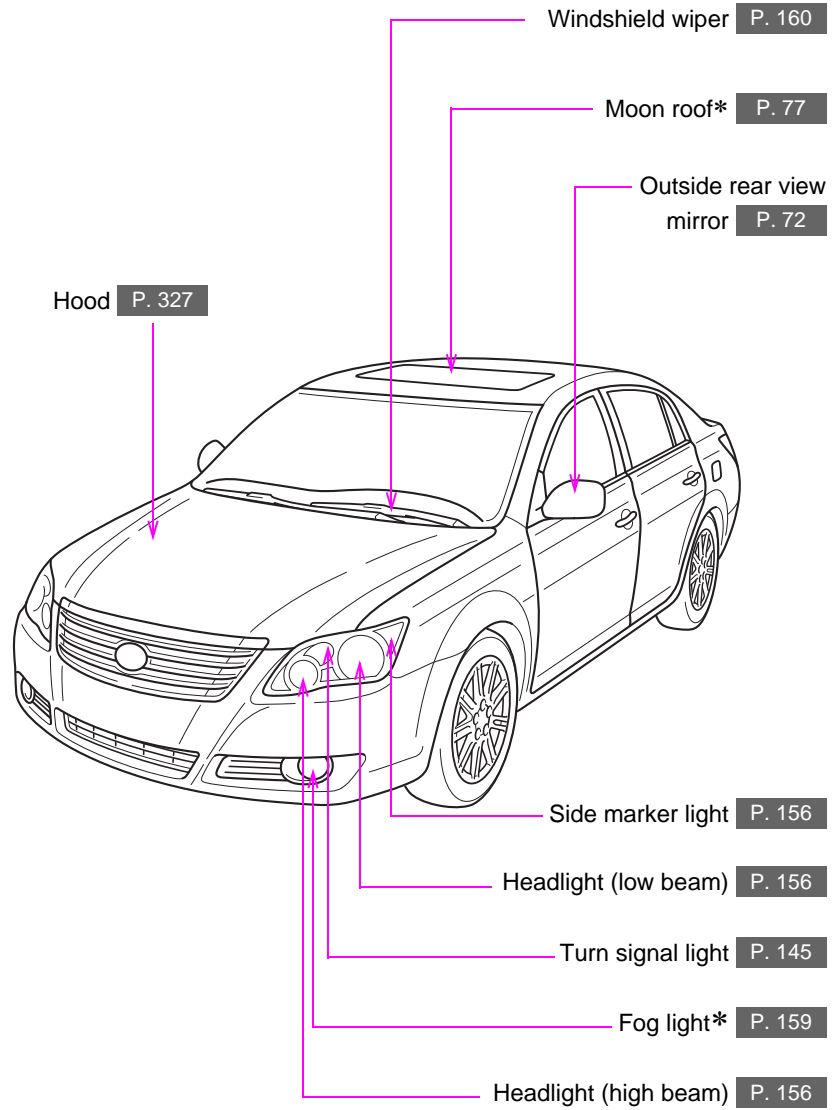
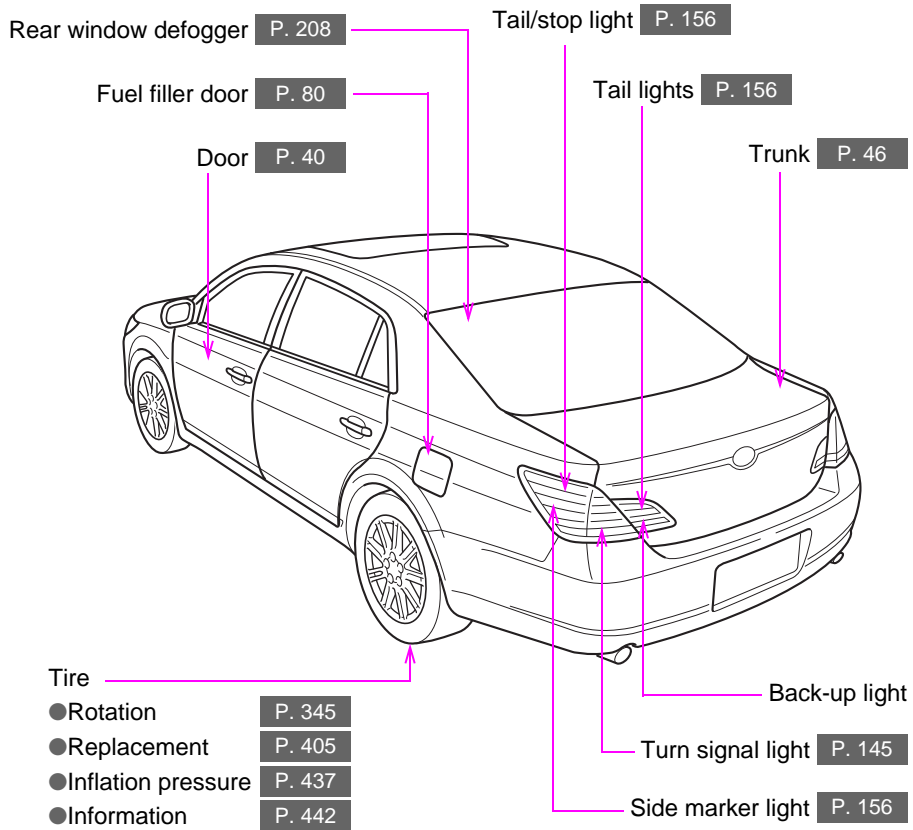

*: If equipped

Pictorial index

Interior

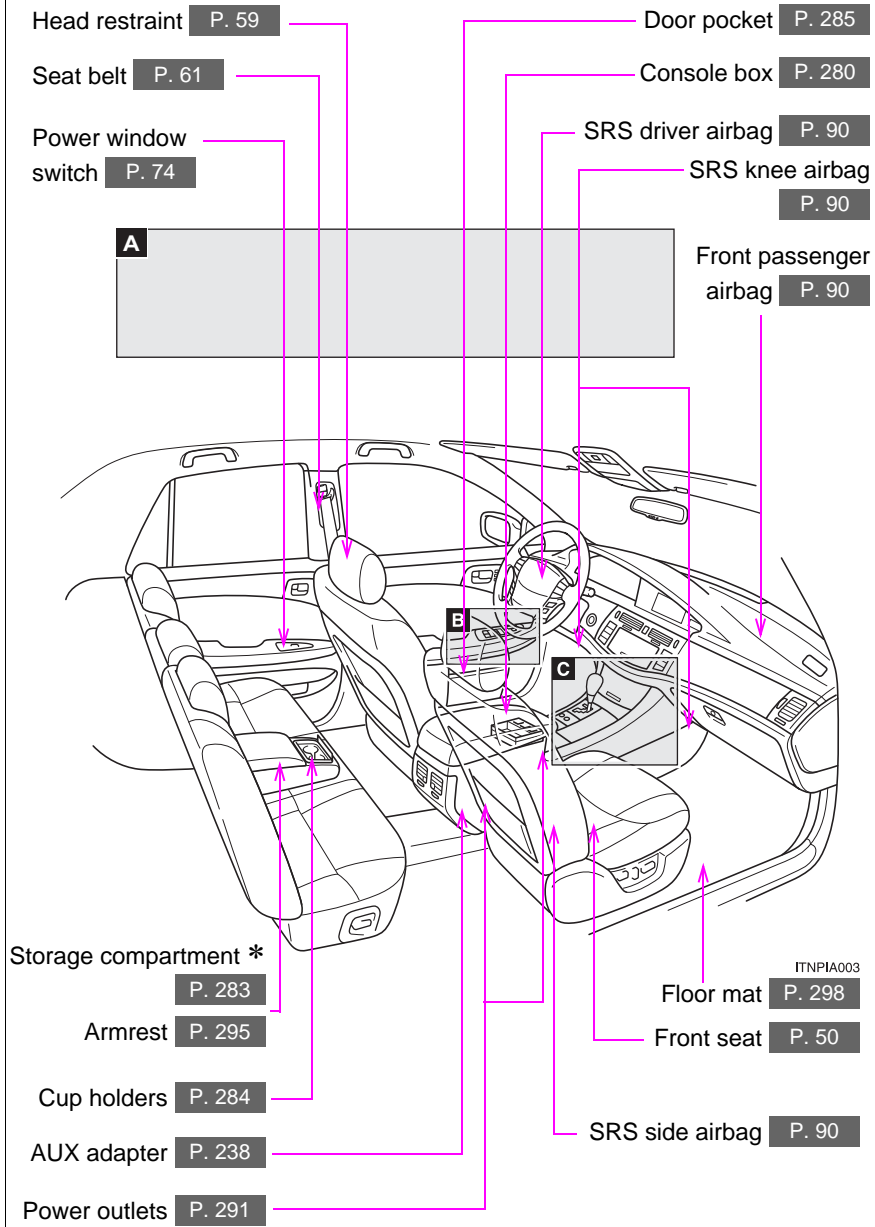

A

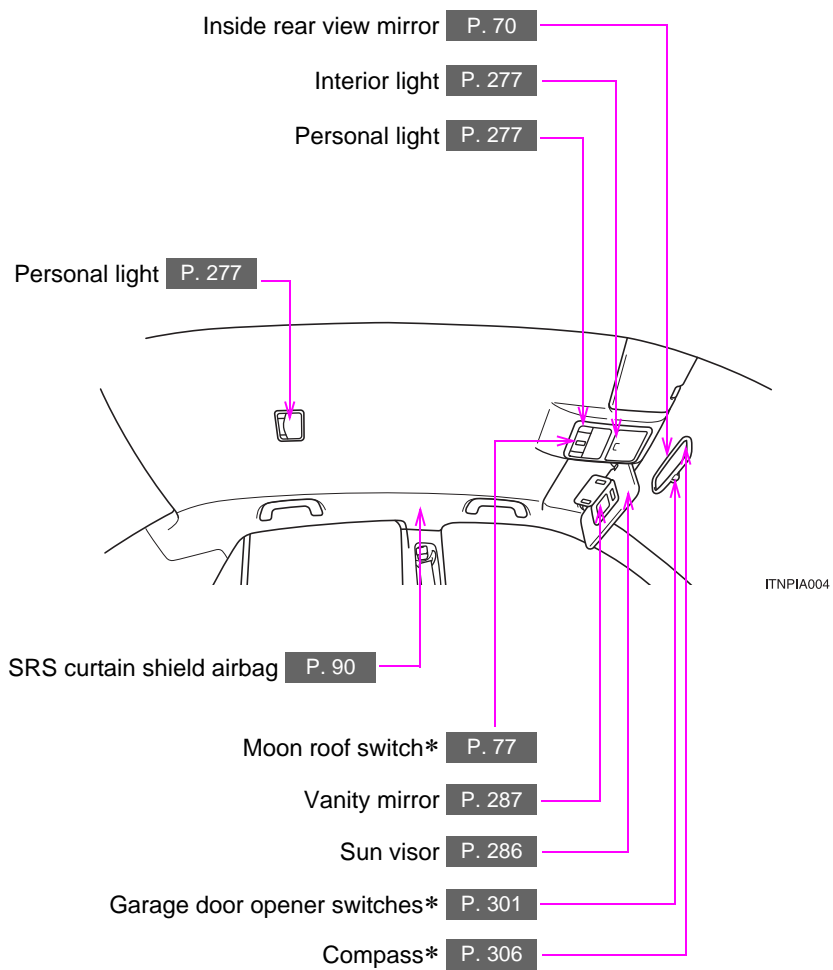

*: If equipped

B

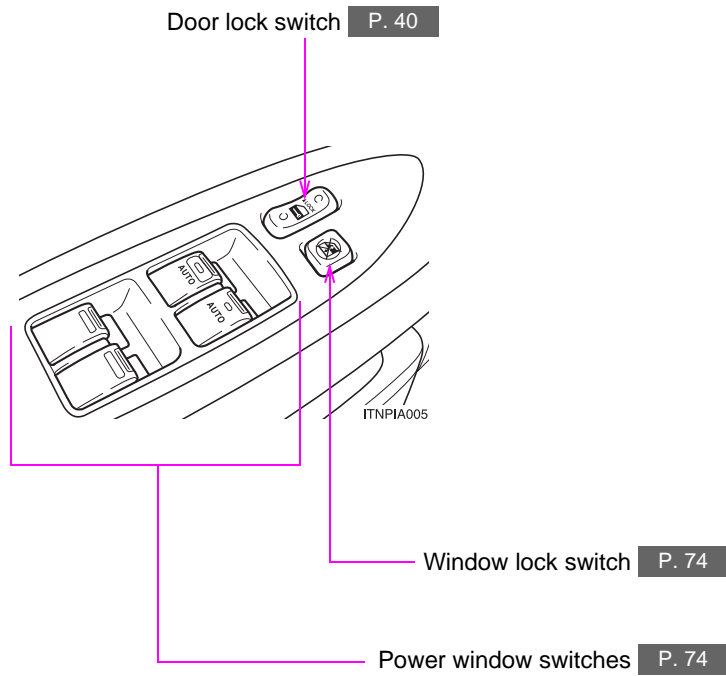

C

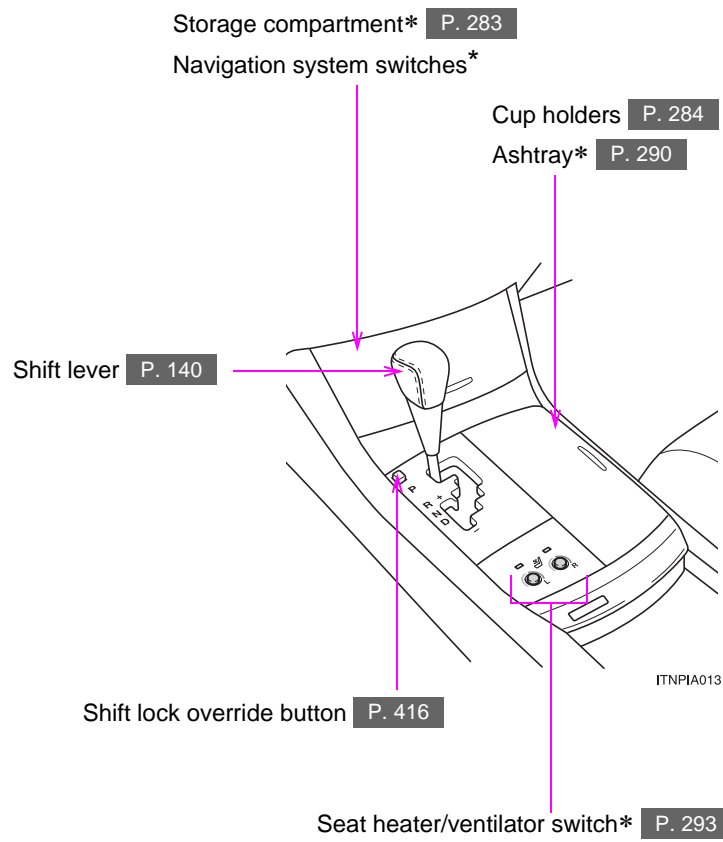

*: If equipped

*: Refer to "Navigation System Owner's Manual".

Pictorial index

Instrument panel

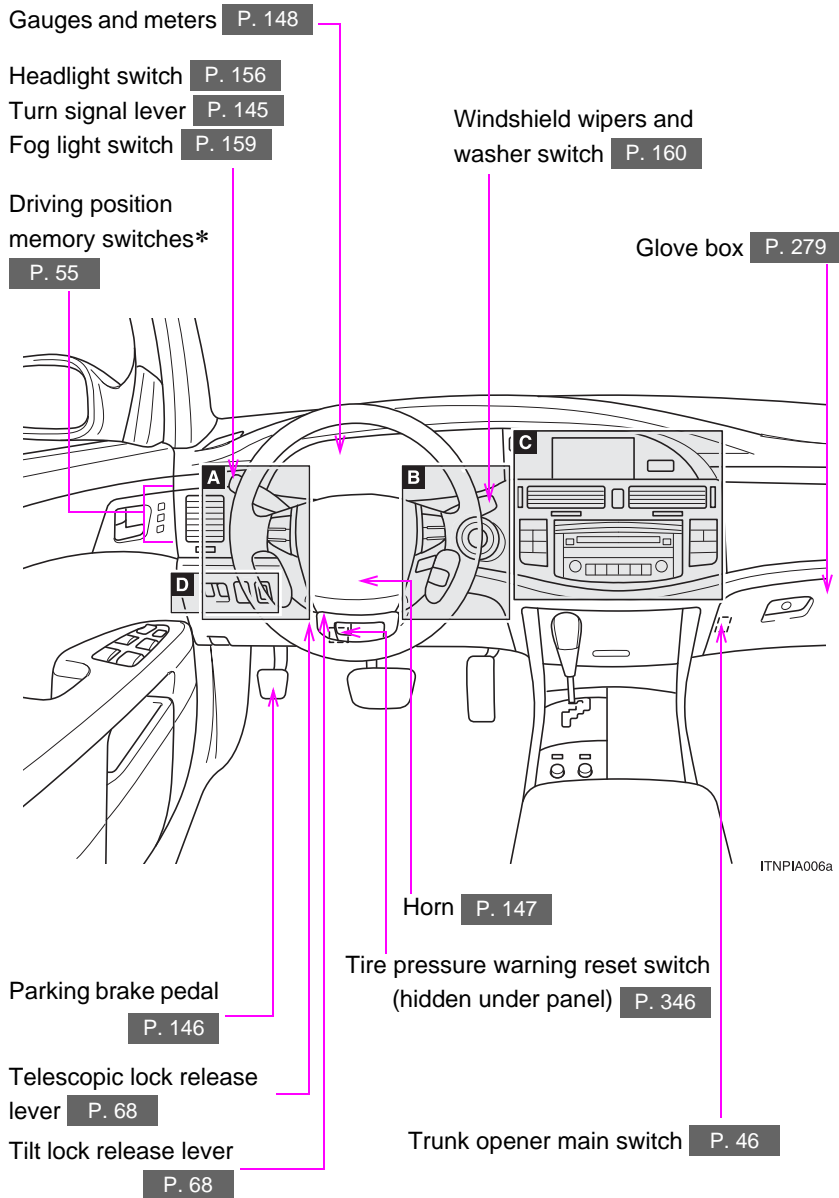

A

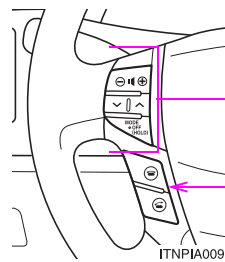

Audio remote control switches P. 239

Telephone switch* P. 247

B

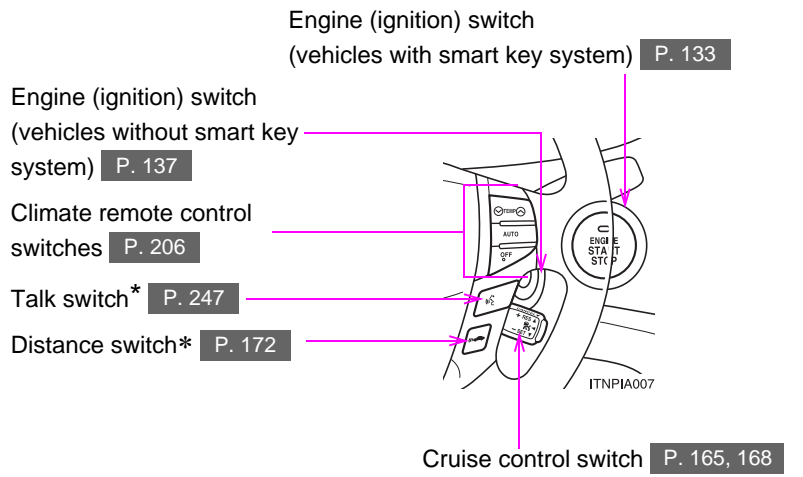

*: If equipped
*: Refer to "Navigation System Owner's Manual".

C

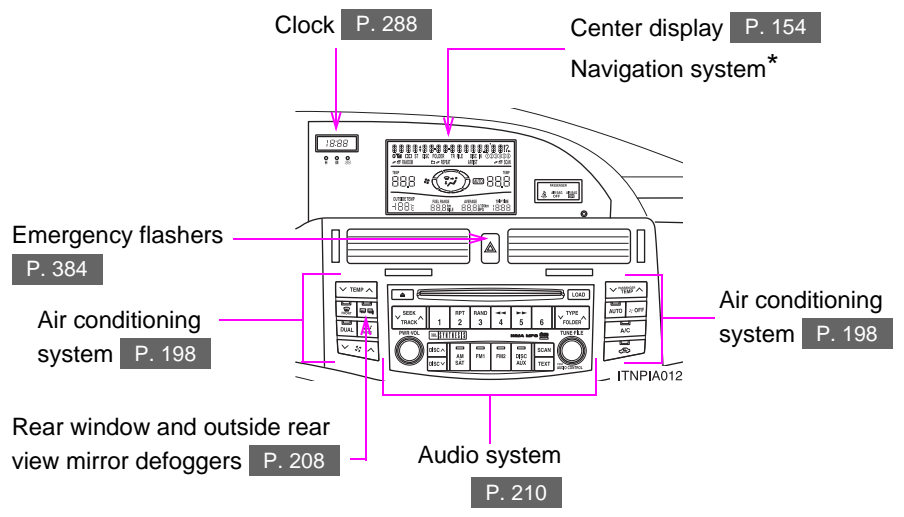

D

Outside rear view mirror switches P. 72

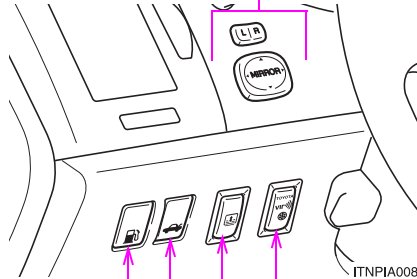

Fuel filler door opener P. 80

Trunk opener P. 46

Rear sunshade switch* P. 296

Glass breakage sensor* P. 85

*: If equipped

*: Refer to "Navigation System Owner's Manual".

1-1. Key information Keys

The following keys are provided with the vehicle.

► Vehicles with smart key system

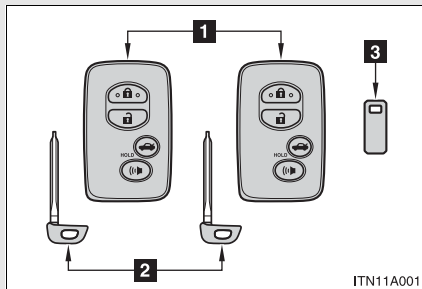

1 Electronic keys

- Operating the smart key system (→P. 24)
- Operating the wireless remote control function (→P. 36)

2 Mechanical keys

3 Key number plate

► Vehicles without smart key system

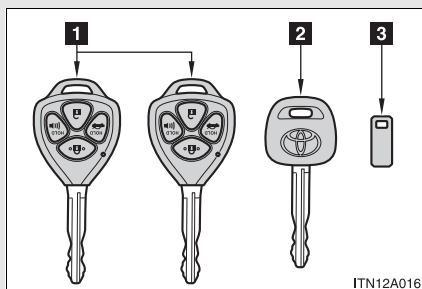

1 Master keys

Operating the wireless remote control function (→P. 36)

2 Valet key

3 Key number plate

Using the mechanical key (vehicles with smart key system)

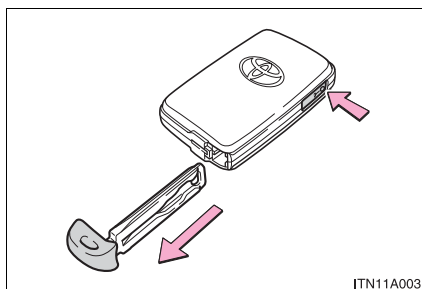

Take out the mechanical key.

After using the mechanical key, store it in the electronic key. Carry the mechanical key together with the electronic key. If the electronic key battery is depleted or the smart key system does not operate properly, you will need the mechanical key.

■ When required to leave a key to the vehicle with a parking attendant

Turn the trunk opener main switch OFF, lock the glove box and trunk storage extension door as circumstances demand. (→P. 46, 300)

- Vehicles with smart key system: Remove the mechanical key for your own use and provide the attendant with the electronic key only.
- Vehicles without smart key system: Provide the attendant with the valet key.

■ Key number plate

Keep the plate in a safe place such as your wallet, not in the vehicle. In the event that a key is lost, a new key can be made at your Toyota dealer using the key number plate. (→P. 417)

■ When riding in an aircraft

When bringing a key onto an aircraft, make sure you do not press any buttons on the key while inside the aircraft cabin. If you are carrying a key in your bag etc., ensure that the buttons are not likely to be pressed accidentally. Pressing a button may cause the key to emit radio waves that could interfere with the operation of the aircraft.

 NOTICE**■ To prevent key damage**

- Do not disassemble the key.
- Do not subject the keys to strong shocks, expose them to high temperatures by placing them in direct sunlight, or get them wet.
- Do not expose the keys to electromagnetic materials or attach any material that blocks electromagnetic waves to the key surface.

1-2. Opening, closing and locking the doors and trunk Smart key system*

The following operations can be performed simply by carrying the electronic key on your person, for example in your pocket.
(The driver should always carry the electronic key.)

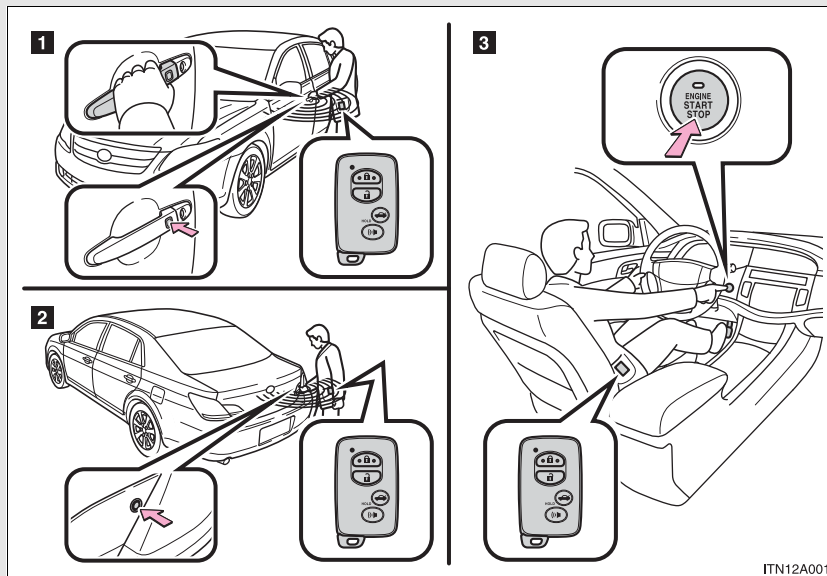

- 1** Locks and unlocks the doors (→P. 25)
- 2** Unlocks the trunk (→P. 25)
- 3** Starts and stops the engine (→P. 133)

ITN12A001

*: If equipped

1-2. Opening, closing and locking the doors and trunk

Unlocking and locking the doors

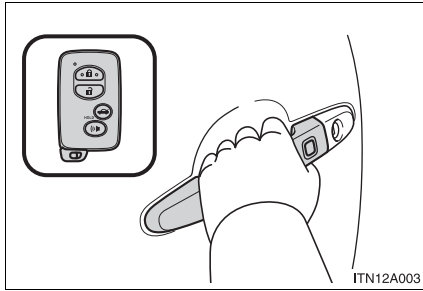

Grip the handle to unlock the door.

Make sure to touch the sensor on the back of the handle.

The door cannot be unlocked for 3 seconds after the door is locked.

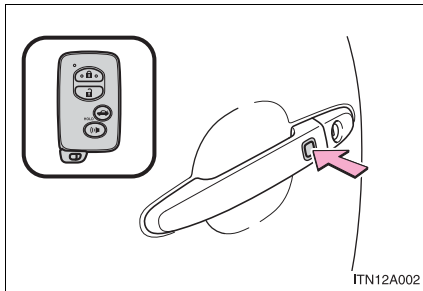

Press the lock button to lock the door.

1
Before driving

Unlocking the trunk

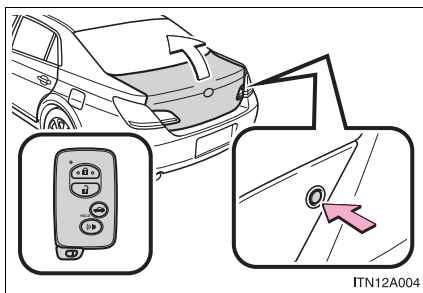

Press the button to unlock the trunk.

Antenna location and effective range

■ Antenna location

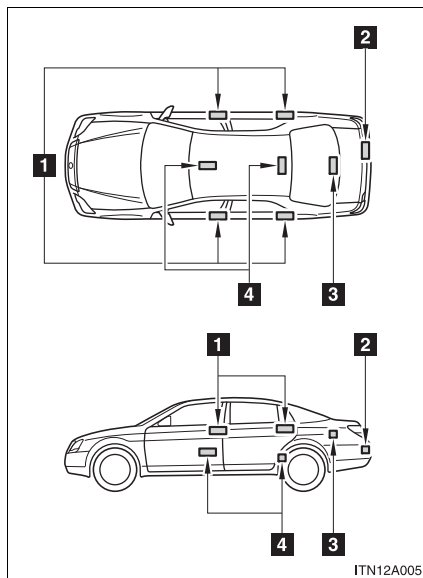

- 1 Antennas outside cabin
- 2 Antenna outside trunk
- 3 Antenna inside trunk
- 4 Antennas inside cabin

■ **Effective range (areas within which the electronic key is detected)**

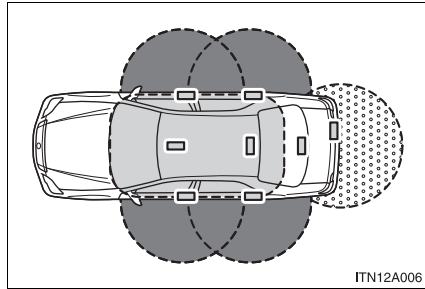

● When locking or unlocking the doors

The system can be operated when the electronic key is within about 3 ft. (1 m) of an outside door handles. (Only the doors detecting the key can be operated.)

● When starting the engine or changing “ENGINE START STOP” switch modes

The system can be operated when the electronic key is inside the vehicle.

● When unlocking the trunk

The system can be operated when the electronic key is within about 3 ft. (1 m) of the trunk release button.

1

Before driving

■ **Operation signals**

A buzzer sounds and the emergency flashers flash to indicate that the doors have been locked/unlocked. (Locked: Once; Unlocked: Twice)

■ **Conditions affecting operation**

The smart key system uses weak radio waves. In the following situations, the communication between the electronic key and the vehicle may be affected, preventing the smart key system and wireless remote control from operating properly. (Way of coping: →P. 418)





- When the electronic key battery is depleted
- Near a TV tower, electric power plant, gas station, radio station, large display, airport or other facility that generates strong radio waves or electrical noise
- When carrying a portable radio, cellular phone, cordless phone or other wireless communication devices
- When the electronic key has come into contact with, or is covered by a metallic object
- When multiple electronic keys are in the vicinity
- When carrying or using the electronic key together with the following devices that emit radio waves
 - Another vehicle's electronic key
 - A wireless key that emits radio waves
 - Personal computer
- If window tint with a metallic content or metallic objects are attached to the rear window

1-2. Opening, closing and locking the doors and trunk



■ Switching the door unlock function

It is possible to set which doors the entry function unlocks.

STEP 1 Turn the “ENGINE START STOP” switch off.

STEP 2 When the indicator on the key surface is turned off, push and hold  ,  , or  for approximately 5 seconds while pushing the  button on the key.

The setting changes each time an operation is performed, as shown below. (Wait for at least 5 seconds after each operation to continue an operation.)

Relevant doors	Unlocking doors	Beep
	Hold the driver's door handle to unlock only the driver's door	Beeps twice
	Hold a passenger's door handle to unlock all the doors	
	Hold a door handle to unlock all doors	Beeps twice

STEP 3 Unlock the doors using the wireless remote control and open one of the doors.

If a door is not opened within 60 second after  is pressed, the doors will be locked again and the alarm will automatically be set.

In case that the alarm is triggered, immediately stop the alarm.

(→P. 85)

1

Before driving

1-2. Opening, closing and locking the doors and trunk

■ Battery-saving function

In the following circumstances, the entry function is disabled in order to prevent the vehicle and electronic key batteries from discharging.

- When the entry function has not been used for 2 weeks or more
- When the electronic key has been left within approximately 3 ft. (1 m) of the vehicle for 10 minutes or more

The system will resume operation when...

- The vehicle is locked using the door handle lock switch
- The vehicle is locked/unlocked using the wireless remote control function (→P. 36) or the mechanical key (→P. 418)

■ Electronic key battery depletion

- The standard battery life is 1 to 2 years. (The battery becomes depleted even if the electronic key is not used.) If the smart key system or the wireless remote control function does not operate, or the detection area becomes smaller, the battery may be depleted. Replace the battery when necessary. (→ P. 363)
- To avoid serious deterioration, do not leave the electronic key within 3 ft. (1 m) of the following electrical appliances that produce a magnetic field.
 - TVs
 - Personal computers
 - Recharging cellular phones or cordless phones
 - Table lamps

■ To operate the system properly

Make sure to carry the electronic key when operating the system. Do not get the electronic key too close to the vehicle when operating the system from the outside of the vehicle.

Depending on the position and holding condition of the electronic key, the key may not be detected correctly and the system may not operate properly. (The alarm may go off accidentally, or the door lock prevention may not function.)

■ **Note for the smart key system**

- Even when the electronic key is within the effective range (detection areas), the system may not operate properly in the following cases.
 - The electronic key is too close to the window or outside door handle, near the ground, or in a high place when the doors are locked or unlocked.
 - The electronic key is near the ground or in a high place, or too close to the rear bumper center when the trunk is unlocked.
 - The electronic key is on the instrument panel, rear package tray or floor, or in the glove box when the engine is started or “ENGINE START STOP” switch modes are changed.
- As long as the electronic key is within the effective range, the doors may be locked or unlocked by anyone.
- Even if the electronic key is not inside the vehicle, it may be possible to start the engine if the electronic key is near the window.
- The doors may unlock if a large amount of water splashes on the door handle, such as in the rain or in a car wash when the electronic key is within the effective range. (The doors will automatically be locked after approximately 60 seconds if the doors are not opened and closed.)
- Gripping the door handle when wearing a glove may not unlock the door.
- If the wireless remote control is used to lock the doors when the electronic key is near the vehicle, there is a possibility that the door may not be unlocked by the entry function. (Use the wireless remote control to unlock the doors.)
- A sudden approach to the effective range or door handle operation may prevent the doors from being unlocked. In this case, return the door handle to the original position and check that the doors unlock before pulling the door handle again.

■ **When the vehicle is not driven for extended periods**

To prevent theft of the vehicle, do not leave the electronic key within 6 ft. (2 m) of the vehicle.

■ **Security feature**

If a door is not opened within approximately 60 seconds after the vehicle is unlocked, the theft deterrent system automatically locks the vehicle again.

1-2. Opening, closing and locking the doors and trunk

■ Alarms and warning indicators

A combination of exterior and interior alarms are used to prevent theft of the vehicle and unforeseeable accidents resulting from erroneous operation. Take appropriate measures according to which warning light comes on. (→P. 393)

The following table describes circumstances and correction procedures when only alarms are sounded.

Alarm	Situation	Correction procedure
Exterior alarm sounds once for 2 seconds	Tried to lock the doors using the entry function while the electronic key is still inside the passenger compartment	Retrieve the electronic key from the passenger compartment and lock the doors again.
	Tried to exit the vehicle with the electronic key and lock the doors without first turning the "ENGINE START STOP" switch OFF	Turn the "ENGINE START STOP" switch OFF and lock the doors again.
	Closed the trunk while the electronic key is still inside and all doors are locked	Retrieve the electronic key from the trunk and close the trunk lid.
Exterior alarm sounds once for 10 seconds	Tried to lock the vehicle using the entry function while a door is open	Close all of the doors and lock the doors again.
Interior alarm sounds once	The electronic key battery is low.	Replace the battery. (→P. 363)
Interior alarm sounds continuously	Tried to open the door and exit the vehicle without shifting the shift lever to "P"	Shift the shift lever to "P".

1-2. Opening, closing and locking the doors and trunk

Alarm	Situation	Correction procedure
Interior alarm rings continuously	Turned the "ENGINE START STOP" switch to ACCESSORY mode while the driver's door is open (Opened the driver's door when the "ENGINE START STOP" switch is in ACCESSORY mode.)	Turn the "ENGINE START STOP" switch OFF and close the driver's door.
	Turned the "ENGINE START STOP" switch OFF while the driver's door is open	Close the driver's door.

1

Before driving

■ **If the smart key system does not operate properly**

- Locking and unlocking the doors: Use the mechanical key. (→P. 418)
- Starting the engine: →P. 418

■ **When the electronic key battery is fully depleted**

→P. 363

■ **Customization that can be configured at Toyota dealer**

Settings (e.g. smart key system) can be changed.
(Customizable features →P. 454)

1-2. Opening, closing and locking the doors and trunk

■ Certification for the smart key system

► For vehicles sold in the U.S.A.

FCC ID: HYQ14AAB

FCC ID: HYQ13BZH

FCC ID: HYQ14ABK

FCC ID: HYQ13BZW

NOTE:

This device complies with part 15 of the FCC Rules. Operation is subject to the following two conditions: (1) This device may not cause harmful interference, and (2) this device must accept any interference received, including interference that may cause undesired operation.

FCC WARNING:

Changes or modifications not expressly approved by the party responsible for compliance could void the user's authority to operate the equipment.

FCC ID: NI4TMLF-1

NOTE:

This device complies with Part 15 of the FCC Rules. Operation is subject to the following two conditions: (1) this device may not cause harmful interference, and (2) this device must accept any interference received, including interference that may cause undesired operation.

FCC WARNING:

Changes or modifications not expressly approved by the party responsible for compliance could void the user's authority to operate the equipment.

 CAUTION

■ **Caution regarding interference with electronic devices**

- People with implanted pacemakers or cardiac defibrillators should keep away from the smart key system antennas. (→P. 26)
The radio waves may affect the operation of such devices. If necessary, the entry function can be disabled. Ask your Toyota dealer for details, such as the frequency of radio waves and timing of emitting the radio waves. Then, consult your doctor to see if you should disable the entry function.
- Users of any electrical medical device other than implanted pacemakers and implanted cardiac defibrillators should consult the manufacturer of the device for information about its operation under the influence of radio waves. Radio waves could have unexpected effects on the operation of such medical devices.

Ask your Toyota dealer for details for disabling the entry function.

1

Before driving

1-2. Opening, closing and locking the doors and trunk Wireless remote control

The wireless remote control can be used to lock and unlock the vehicle and the trunk from outside the vehicle.

► Vehicles with smart key system

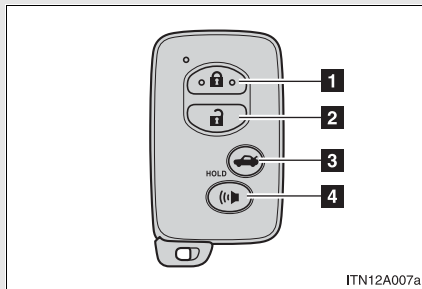

1 Locks all doors

2 Unlocks all doors

Pressing the button unlocks the driver's door. Pressing the button again within 3 seconds unlocks the other doors.

3 Unlocks the trunk
(push and hold)

4 Sounds alarm
(push and hold) (→P. 86)

► Vehicles without smart key system

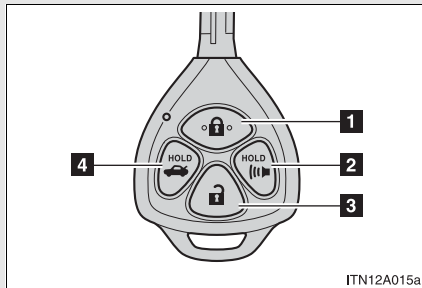

1 Locks all doors

2 Sounds alarm
(push and hold) (→P. 86)

3 Unlocks all doors

Pressing the button unlocks the driver's door. Pressing the button again within 3 seconds unlocks the other doors.

4 Unlocks the trunk
(push and hold)

■ **Operation indicator**

Doors: A buzzer sounds and the emergency flashers flash to indicate that the doors have been locked/unlocked. (Locked: Once; Unlocked: Twice)

Trunk: A buzzer sounds to indicate that the trunk has been unlocked.

■ **Door lock buzzer (vehicles with smart key system)**

If a door is not fully closed, a buzzer sounds continuously for 10 seconds if an attempt to lock the door is made. Fully close the door to stop the buzzer, and lock the vehicle once more.

■ **Security feature**

→P. 31

■ **When the key battery is fully depleted**

→P. 363

■ **Conditions affecting operation**

▶ Vehicles with smart key system

→P. 28

▶ Vehicles without smart key system

The wireless remote control function may not operate normally in the following situations.

- Near a TV tower, radio station, electric power plant, airport or other facility that generates strong radio waves
- When carrying a portable radio, cellular phone or other wireless communication device
- When multiple wireless keys are in the vicinity
- When the wireless key has come into contact with, or is covered by a metallic object
- When a wireless key (that emits radio waves) is being used nearby
- When the wireless key has been left near an electrical appliance such as a personal computer

1-2. Opening, closing and locking the doors and trunk

■ Customization that can be configured at Toyota dealer

Settings (e.g. 2-step unlocking function, trunk unlocking function) can be changed.

(Customizable features →P. 454)

■ Certification for wireless remote control

► For vehicles sold in the U.S.A.

FCC ID: HYQ14AAB

FCC ID: HYQ13BZH

FCC ID: HYQ14ABK

FCC ID: HYQ13BZW

NOTE:

This device complies with part 15 of the FCC Rules. Operation is subject to the following two conditions: (1) This device may not cause harmful interference, and (2) this device must accept any interference received, including interference that may cause undesired operation.

FCC WARNING:

Changes or modifications not expressly approved by the party responsible for compliance could void the user's authority to operate the equipment.

► For vehicles sold in Jordan.

Type Approval Number: TRC/LPD/2009/4

NOTE:

This device complies with the specifications mentioned in test reports No. (20071409200), (20071409300), and (20071409500) issued by Telefication B.V./The Netherlands.

TRC WARNING:

This Certificate does not apply to any modified or changed product nor does it authorize its holder to enter the subject equipment into Jordan without having a special permissions.

If this occurs Jordan TRC has the right to impose any penalties stipulated in Jordan's Telecommunications Law No. 13 of 1995 and its amendments and regulations of the Telecommunication Regulatory Commission.

1-2. Opening, closing and locking the doors and trunk

- ▶ For vehicles sold in the U.S.A.

NOTE:

This device complies with Part 15 of the FCC Rules. Operation is subject to the following two conditions: (1) this device may not cause harmful interference, and (2) this device must accept any interference received, including interference that may cause undesired operation.

NOTICE:

This equipment has been tested and found to comply with the limits for a Class B digital device, pursuant to Part 15 of the FCC Rules. These limits are designed to provide reasonable protection against harmful interference in a residential installation. This equipment generates, uses and can radiate radio frequency energy and, if not installed and used in accordance with the instructions, may cause harmful interference to radio communications. However, there is no guarantee that interference will not occur in a particular installation. If this equipment does cause harmful interference to radio or television reception, which can be determined by turning the equipment off and on, the user is encouraged to try to correct the interference by one or more of the following measures:

- Reorient or relocate the receiving antenna.
- Increase the separation between the equipment and receiver.
- Connect the equipment into an outlet on a circuit different from that to which the receiver is connected.
- Consult the dealer or an experienced radio/TV technician for help.

FCC WARNING:

Changes or modifications not expressly approved by the party responsible for compliance could void the user's authority to operate the equipment.

- ▶ For vehicles sold in Canada

NOTE:

Operation is subject to the following two conditions: (1) this device may not cause interference, and (2) this device must accept any interference, including interference that may cause undesired operation of the device.

1-2. Opening, closing and locking the doors and trunk Doors

The vehicle can be locked and unlocked using the entry function, wireless remote control or door lock switch.

■ Entry system (vehicles with smart key system)

→P. 25

■ Wireless remote control

→P. 36

■ Key

▶ Vehicles with smart key system

The doors can also be locked and unlocked with the mechanical key. (→P. 418)

▶ Vehicles without smart key system

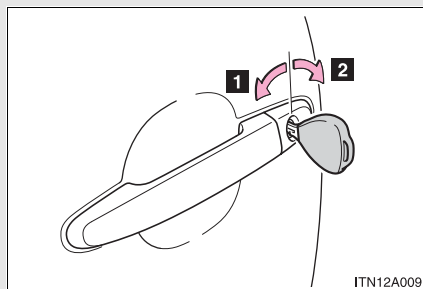

1 Locks all doors

2 Unlocks all doors

Turning the key unlocks the driver's door. Turning the key again unlocks the other doors.

■ Door lock switch

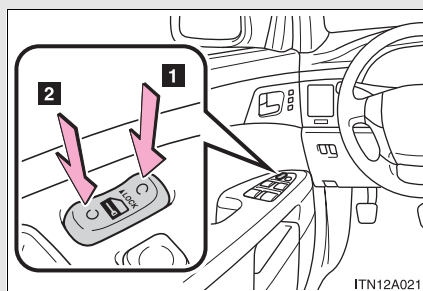

1 Locks all doors

2 Unlocks all doors

■ Inside lock button

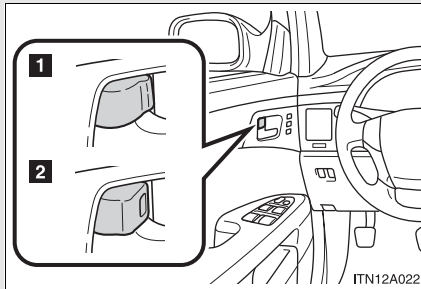

- 1 Locks the door
- 2 Unlocks the door

The front doors can be opened by pulling the inside handles even if the lock buttons are in the lock position.

1

Before driving

Locking the front doors from the outside without a key

STEP 1 Move the inside lock button to the lock position.

STEP 2 Close the door.

► Vehicles with smart key system

The door cannot be locked if the “ENGINE START STOP” switch is in the ACCESSORY or IGNITION ON mode, or the electronic key is left inside the vehicle.

The key may not be detected correctly and the door may be locked.

► Vehicles without smart key system

The door cannot be locked if either front door is open and the key is in the engine switch.

1-2. Opening, closing and locking the doors and trunk

Rear door child-protector lock

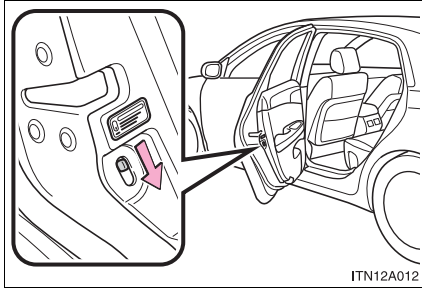

The door cannot be opened from inside the vehicle when the locks are set.

These locks can be set to prevent children from opening the rear doors. Push down rear door switches to lock the rear doors.

Automatic door locking and unlocking systems

The following functions can be set or canceled:

Function	Operation
Shift position linked door locking function	Shifting the shift lever out of "P" locks all doors.
Shift position linked door unlocking function	Shifting the shift lever to "P" unlocks all doors.
Speed linked door locking function	All doors are locked when the vehicle speed is approximately 12 mph (20 km/h) or higher.

1-2. Opening, closing and locking the doors and trunk

Function	Operation
Driver's door linked door unlocking function	<p>▶ Vehicles with smart key system All doors are unlocked when the driver's door is opened within 10 seconds after turning the "ENGINE START STOP" switch OFF.</p> <p>▶ Vehicles without smart key system All doors are unlocked when the driver's door is opened within 10 seconds after turning the engine switch to the "LOCK" position.</p>

1

Before driving

■ **Setting and canceling the functions**

To switch between setting and canceling, follow the procedure below:

STEP 1 Vehicles with smart key system: Close all the doors and turn the "ENGINE START STOP" switch to IGNITION ON mode. (Perform **STEP 2** within 10 seconds.)

Vehicles without smart key system: Close all the doors and turn the engine switch to the "ON" position. (Perform **STEP 2** within 10 seconds.)

1-2. Opening, closing and locking the doors and trunk

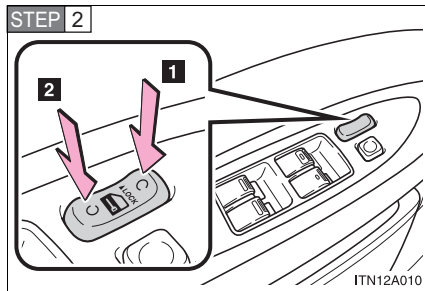

Shift the shift lever to “P” or “N”, press and hold the driver’s door lock switch (**1** or **2**) for about 5 seconds then release.

The shift lever and switch positions corresponding to the desired function to be set are shown as follows.

Use the same procedure to cancel the function.

Function	Shift lever position	Switch position
Shift position linked door locking function	“P”	1
Shift position linked door unlocking function		2
Speed linked door locking function	“N”	1
Driver’s door linked door unlocking function		2

When the setting or canceling operation is complete, all doors are locked and then unlocked.

■ **Customization that can be configured at Toyota dealer**

Settings (e.g. unlocking function using a key) can be changed.
(Customizable features →P. 454)

 **CAUTION**

■ **To prevent an accident**

Observe the following precautions while driving the vehicle.
Failing to do so may result in a door opening and an occupant falling out,
resulting in death or serious injury.

- Always use a seat belt.
- Always lock all doors.
- Ensure that all doors are properly closed.
- Do not pull the inside handle of the doors while driving.
- Set the rear door child-protector when children are seated in the rear seat.

1

Before driving

1-2. Opening, closing and locking the doors and trunk Trunk

The trunk can be opened using the trunk opener, smart key system or wireless remote control.

■ Opening the trunk from inside the vehicle

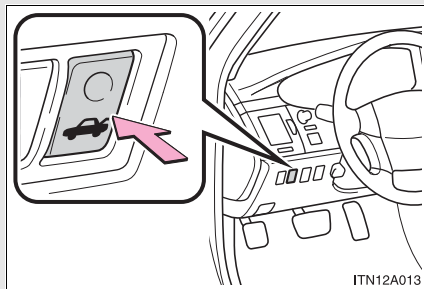

Push the opener switch.

■ Opening the trunk from outside the vehicle

- ▶ Entry system (vehicles with smart key system)
→P. 25
- ▶ Wireless remote control
→P. 36

Canceling the trunk opener feature

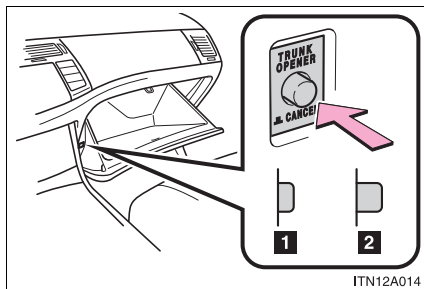

Turn the main switch in the glove box OFF to disable the trunk opener.

- 1 ON
- 2 OFF

The trunk lid cannot be opened even with the wireless remote control or the smart key system.

■ **Internal trunk release lever**

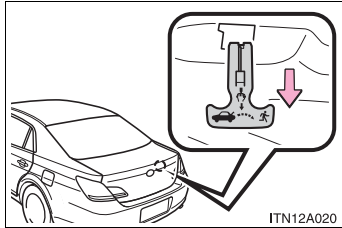

The trunk lid can be opened by pulling down on the glow-in-the-dark lever located on the inside of trunk lid.

The lever will continue to glow for some time after the trunk lid is closed.

■ **When keeping items in the trunk**

Turn off the main switch and lock the glove box and trunk storage extension door.

The trunk lid can be opened using a loop of wire near the trunk storage extension door even with the main switch in the glove box turned off.

1

Before driving

CAUTION

■ **Caution while driving**

- Keep the trunk lid closed while driving.
If the trunk lid is left open, it may hit near-by objects while driving or luggage in the trunk may be unexpectedly thrown out, causing an accident. In addition, exhaust gases may enter the vehicle, causing death or a serious health hazard. Make sure to close the trunk lid before driving.
- Before driving the vehicle, make sure that the trunk lid is fully closed. If the trunk lid is not fully closed, it may open unexpectedly while driving, causing an accident.
- Never let anyone sit in the trunk. In the event of sudden braking or a collision, they are susceptible to death or serious injury.

 CAUTION

■ **When children are in the vehicle**

Observe the following precautions.

Failure to do so may result in death or serious injury.

- Do not allow children to enter the trunk.
If a child is accidentally locked in the trunk, they could overheat or suffocate.
- Do not allow a child to open or close the trunk lid.
Doing so may cause the trunk lid operate unexpectedly, or cause the child's hands, head, or neck to be caught by the closing trunk lid.

■ **Using the trunk**

Observe the following precautions.

Failure to do so may cause parts of the body to be caught, resulting in serious injury.

- Remove any heavy loads, such as snow and ice, from the trunk lid before opening it. Failure to do so may cause the trunk lid to fall closed again after it is opened.
- When opening or closing the trunk lid, thoroughly check to make sure the surrounding area is safe.
- If anyone is in the vicinity, make sure they are safe and let them know that the trunk is about to open or close.
- Use caution when opening or closing the trunk lid in windy weather as it may move abruptly in strong wind.

1-2. Opening, closing and locking the doors and trunk

CAUTION

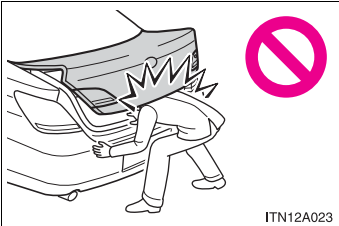

ITN12A023

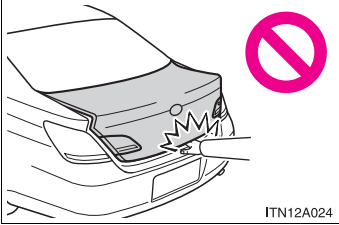

ITN12A024

- The trunk lid may fall if it is not opened fully. It is more difficult to open or close the trunk lid on an incline than on a level surface, so beware of the trunk lid unexpectedly opening or closing by itself. Make sure that the trunk lid is fully open and secure before using the trunk.
- When closing the trunk lid, take extra care to prevent your fingers etc. from being caught.
- When closing the trunk lid, make sure to press it lightly on its outer surface. If the trunk handle is used to fully close the trunk lid, it may result in hands or arms being caught.

● Do not attach any accessories other than genuine Toyota parts to the trunk lid. Such additional weight on the trunk lid may cause the lid to fall closed again after it is opened.

1

Before driving

1-3. Adjustable components (seats, steering wheel, mirrors)
Front seats

► Manual seat

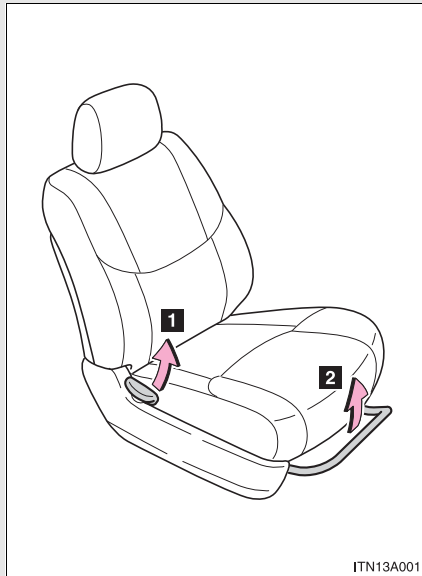

- 1** Seatback angle lever
- 2** Seat position lever

ITN13A001

1-3. Adjustable components (seats, steering wheel, mirrors)

► Power seat

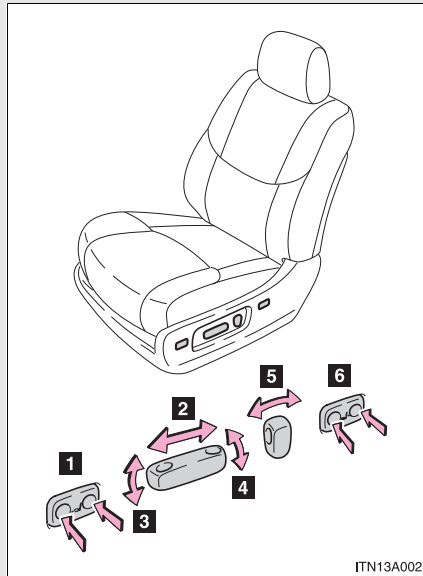

ITN13A002

- 1** Seat leg support switch*
 - 2** Seat position fore/aft switch
 - 3** Seat cushion (front) angle switch*
 - 4** Vertical height switch*
 - 5** Seatback angle switch
 - 6** Lumbar support switch*
- *: if equipped

1
Before driving

Active head restraint

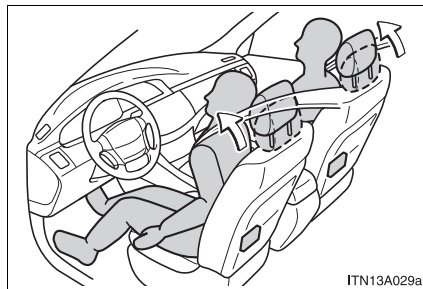

ITN13A029a

When a front seatback receives a strong impact during a rear-end collision, the head restraint moves slightly forward and upward to provide support for the occupants head.

■ **Active head restraint**

Even small forces applied to the seatback may cause the head restraint to move. Pushing up a locked head restraint forcibly may cause the head restraint inner structure to appear. This does not indicate a problem.

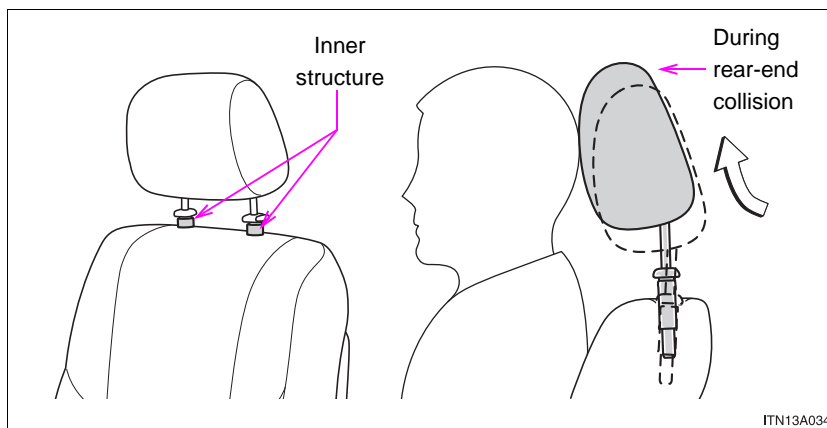

⚠ CAUTION

■ **Reclining adjustment**

Do not recline the seat more than necessary when the vehicle is in motion, to reduce the risk of sliding under the lap belt.

If the seat is too reclined, during an accident the lap belt may slide past the hips and apply restraint forces directly to the abdomen or your neck may contact the shoulder belt, increasing the risk of death or serious injury.

1-3. Adjustable components (seats, steering wheel, mirrors) Rear seats

To adjust the seat back angle, pull the lock release lever.

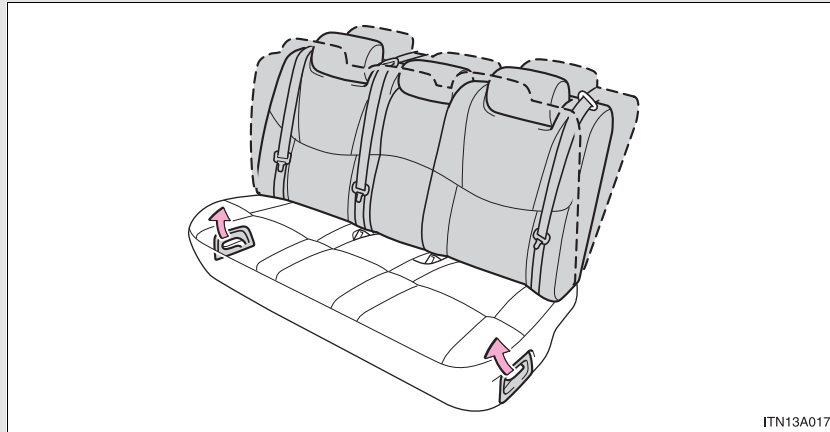

1

Before driving

■ Keep the flap area clear

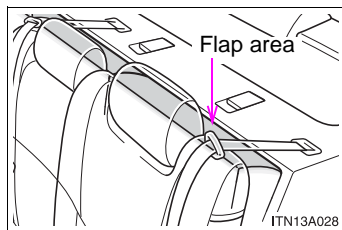

Do not place objects on the flap area. If objects are left in the gap, the reclining seatback will not lock properly, and may move unexpectedly.

1-3. Adjustable components (seats, steering wheel, mirrors)

CAUTION

■ Reclining adjustment

Do not recline the seat more than necessary when the vehicle is in motion, to reduce the risk of sliding under the lap belt.

If the seat is too reclined, during an accident the lap belt may slide past the hips and apply restraint forces directly to the abdomen or your neck may contact the shoulder belt, increasing the risk of death or serious injury.

1-3. Adjustable components (seats, steering wheel, mirrors) Driving position memory system*

Your preferred driving position (the position of the driver's seat and outside rear view mirrors) can be entered into the computer's memory and recalled with the touch of a button. It is also possible to set this function to activate automatically when the doors are unlocked. Two different driving positions can be entered into memory.

■ Entering a position to memory

STEP 1 Vehicles with smart key system: Turn the "ENGINE START STOP" switch to IGNITION ON mode.

Vehicles without smart key system: Turn the engine switch to the "ON" position.

STEP 2 Adjust the driver's seat and outside rear view mirrors to the desired positions.

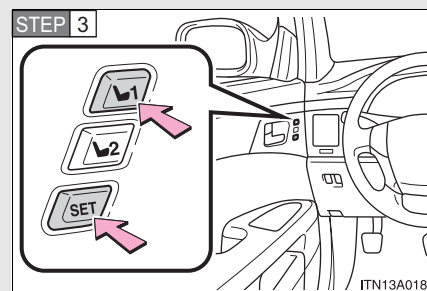

Push the "SET" button, then within 3 seconds, push button "1" or "2" until the signal beeps.

If the selected button has already been preset, the previously recorded position will be overwritten.

1

Before driving

*: If equipped

1-3. Adjustable components (seats, steering wheel, mirrors)

■ Recalling the memorized position

STEP 1 Vehicles with smart key system: Turn the “ENGINE START STOP” switch to IGNITION ON mode.

Vehicles without smart key system: Turn the engine switch to the “ON” position.

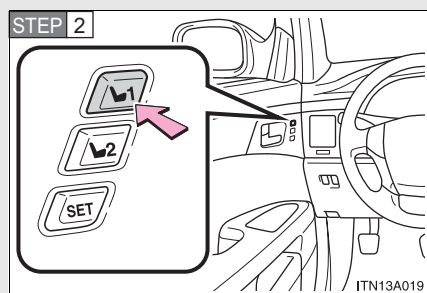

Push button “1” or “2” to recall the memorized position.

Linking driving position memory with door unlock operation (vehicles with smart key system)

Memorized driving positions can be recalled when you unlock the driver’s door using the entry function or wireless remote control and open the driver’s door.

■ Setting the linked door unlock operation

STEP 1 Set the driving positions into the memory system using the “1” or “2” buttons. (→P. 55)

STEP 2 Turn the “ENGINE START STOP” switch OFF, then close the driver’s door.

1-3. Adjustable components (seats, steering wheel, mirrors)

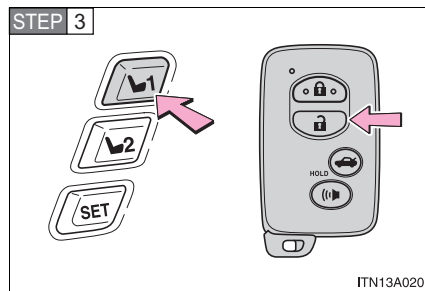

Push the “1” or “2” button on the driver’s side and the  button on the wireless remote control at the same time for about 1 second until you hear a beep.

1
Before driving

STEP 4 Open one of the doors.

If a door is not opened within 60 seconds after  is pressed, the doors will be locked again and the alarm will automatically be set. In case that the alarm is triggered, immediately stop the alarm. (→P. 85)

■ Canceling the linked door unlock operation

STEP 1 Close the driver’s door with the “ENGINE START STOP” switch OFF.

STEP 2 Push the “SET” button and the  button on the wireless remote control at the same time for about 1 second until you hear 2 beeps.

■ Retained accessory power

Memorized positions can be activated up to 180 seconds after the driver’s door is opened and another 60 seconds after it is closed again, even if the “ENGINE START STOP” switch or the engine switch is OFF.

■ If any position memory button is pushed while the adjustments are being made

The operation will stop. To reactivate the system, push the desired button (“1” or “2”) again.

■ If the battery is disconnected

The memorized positions must be reset because the computer’s memory is erased when the battery is disconnected.

1-3. Adjustable components (seats, steering wheel, mirrors)

 CAUTION

■ **Seat adjustment caution**

Take care during seat adjustment that the seat does not strike the rear passenger.

If this happens, you can stop the movement by pressing another seat position memory button.

1-3. Adjustable components (seats, steering wheel, mirrors) Head restraints

Head restraints are provided for all seats.

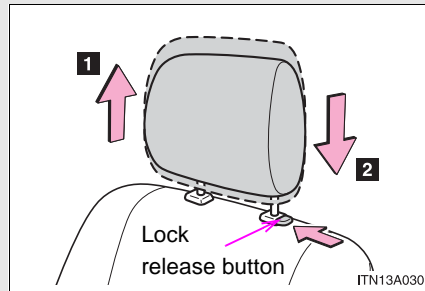

1 Up

2 Down

Push and hold the lock release button when lowering the head restraint.

1

Before driving

■ Removing the head restraints

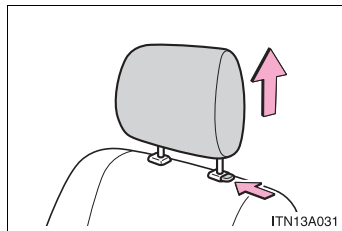

Pull the head restraint up while pushing the lock release button.

■ Installing the head restraints

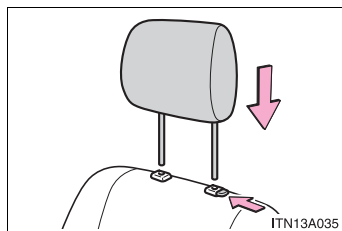

Align the head restraint with the installation holes and push it down to the lock position.

Press and hold the lock release button when lowering the head restraint.

1-3. Adjustable components (seats, steering wheel, mirrors)

■ Adjusting the height of the head restraints

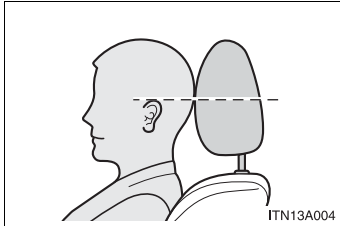

Make sure that the head restraints are adjusted so that the center of the head restraint is closest to the top of your ears.

■ Adjusting the center rear seat head restraint

Always raise the head restraint one level from the stowed position when using.

⚠ CAUTION

■ Head restraint precautions

Observe the following precautions regarding the head restraints. Failure to do so may result in death or serious injury.

- Use the head restraints designed for each respective seat.
- Adjust the head restraints to the correct position at all times.
- Do not drive with the head restraints removed.

1-3. Adjustable components (seats, steering wheel, mirrors) Seat belts

Make sure that all occupants are wearing their seat belts before driving the vehicle.

■ Correct use of the seat belts

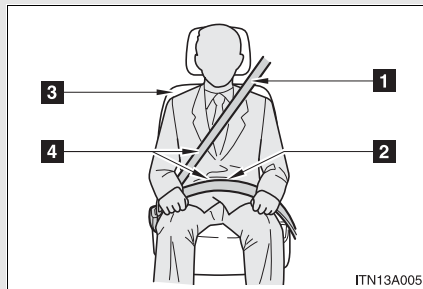

- 1** Extend the shoulder belt so that it comes fully over the shoulder, but does not come into contact with the neck or slide off the shoulder.
- 2** Position the lap belt as low as possible over the hips.
- 3** Adjust the position of the seatback. Sit up straight and well back in the seat.
- 4** Do not twist the seat belt.

■ Fastening and releasing the seat belt

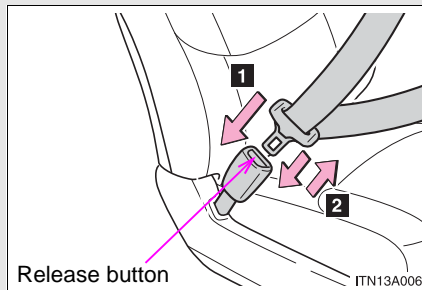

- 1** Fastening the belt
Push the tab into the buckle until a clicking sound is heard.
- 2** Releasing the belt
Press the release button.

1

Before driving

1-3. Adjustable components (seats, steering wheel, mirrors)

■ Adjusting the height of the belt (front seats)

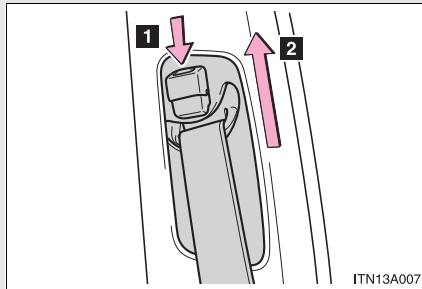

1 Down

2 Up

Move the height adjuster up and down as needed until you hear a click.

Seat belt comfort guide (outside rear seats)

If the shoulder belt sits close to a person's neck, use the seat belt comfort guide.

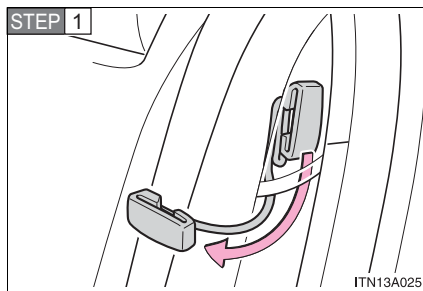

Pull the comfort guide from the pocket.

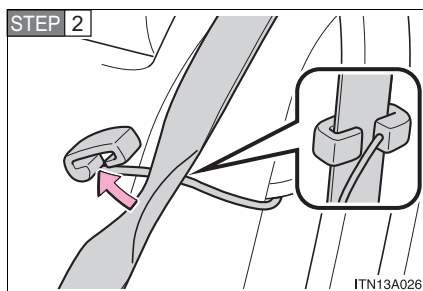

Slide the belt past the slot of the guide.

The elastic must be behind the seat belt.

1-3. Adjustable components (seats, steering wheel, mirrors)

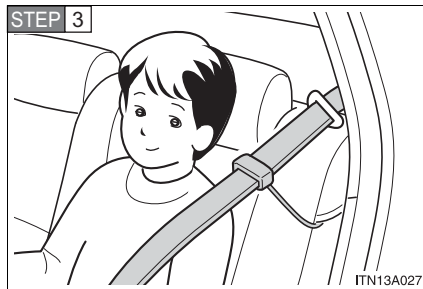

Buckle, position and release the seat belt.

1

Before driving

Seat belt pretensioners (front seats)

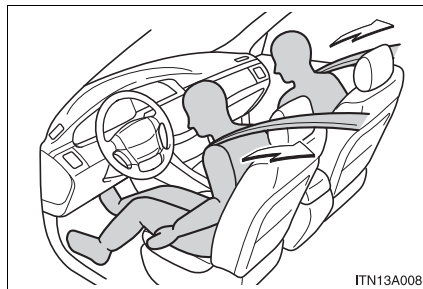

The pretensioner helps the seat belt to quickly restrain the occupant by retracting the seat belt when the vehicle is subjected to certain types of severe frontal collision.

The pretensioner may not activate in the event of a minor frontal impact, a side impact or a rear impact.

■ Emergency locking retractor (ELR)

The retractor will lock the belt during a sudden stop or on impact. It may also lock if you lean forward too quickly. A slow, easy motion will allow the belt to extend, and you can move around fully.

■ Automatic locking retractor (ALR)

When a passenger's shoulder belt is completely extended and then retracted even slightly, the belt is locked in that position and cannot be extended. This feature is used to hold the child restraint system (CRS) firmly. To free the belt again, fully retract the belt and then pull the belt out once more. (→P. 116)

■ Pregnant women

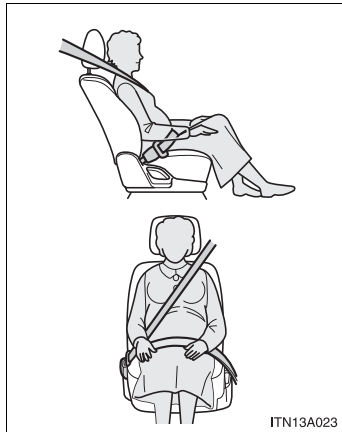

Obtain medical advice and wear the seat belt in the proper way. (→P. 61)

Women who are pregnant should position the lap belt as low as possible over the hips in the same manner as other occupants. Extend the shoulder belt completely over the shoulder and position the belt across the chest. Avoid belt contact over the rounding of the abdominal area.

If the seat belt is not worn properly, not only a pregnant woman, but also the fetus could suffer death or serious injury as a result of sudden braking or a collision.

■ People suffering illness

Obtain medical advice and wear the seat belt in the proper way. (→P. 61)

■ Child seat belt usage

The seat belts of your vehicle were principally designed for persons of adult size.

- Use a child restraint system appropriately for the child, until the child becomes large enough to properly wear the vehicle's seat belt. (→P. 109)
- When the child becomes large enough to properly wear the vehicle's seat belt, follow the instructions on P. 61 regarding seat belt usage.

■ Replacing the belt after the pretensioner has been activated

If the vehicle is involved in multiple collisions, the pretensioner will activate for the first collision, but will not activate for the second or subsequent collisions.

■ **Seat belt extender**

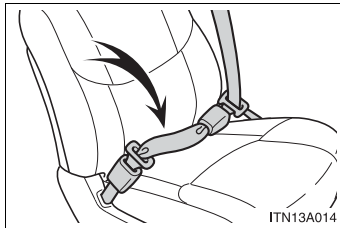

If your seat belts cannot be fastened securely because they are not long enough, a personalized seat belt extender is available from your Toyota dealer free of charge.

1

Before driving

⚠ CAUTION

Observe the following precautions to reduce the risk of injury in the event of sudden braking, sudden swerving or an accident. Failing to do so may cause death or serious injury.

■ **Wearing a seat belt**

- Ensure that all passengers wear a seat belt.
- Always wear a seat belt properly.
- Each seat belt should be used by one person only. Do not use a seat belt for more than one person at the same time, including children.
- Toyota recommends that children should be seated in the rear seat and always use a seat belt and/or an appropriate child restraint system.
- Do not recline the seat any more than necessary to achieve a proper seating position. The seat belt is most effective when the occupants are sitting up straight and well back in the seats.
- Do not wear the shoulder belt under your arm.
- Always wear your seat belt low and snug across your hips.

■ **Adjustable shoulder anchor**

Always make sure the shoulder belt is positioned across the center of your shoulder. The belt should be kept away from your neck, but not falling off your shoulder. Failure to do so could reduce the amount of protection in an accident and cause death or serious injuries in the event of a sudden stop, sudden swerve or accident. (→P. 62)

 CAUTION

■ **Seat belt pretensioners**

- Do not place anything, such as a cushion, on the front passenger's seat. Doing so will disperse the passenger's weight, which prevents the sensor from detecting the passenger's weight properly. As a result, the seat belt pretensioner for the front passenger's seat may not activate in the event of a collision.
- If the pretensioner has activated, the SRS warning light will come on. In that case, the seat belt cannot be used again and must be replaced at your Toyota dealer.

■ **Child restraint lock function belt**

Do not allow children to play with the child restraint lock function belt.

■ **Seat belt damage and wear**

- Do not damage the seat belts by allowing the belt, plate or buckle to be jammed in the door.
- Inspect the seat belt system periodically. Check for cuts, fraying, and loose parts. Do not use a damaged seat belt until it is replaced. Damaged seat belts cannot protect an occupant from injury.
- Ensure that the belt and tab are locked and the belt is not twisted. If the seat belt does not function correctly, immediately contact your Toyota dealer.
- Replace the seat assembly, including the belts, if your vehicle has been involved in a serious accident, even if there is no obvious damage.
- Do not attempt to install, remove, modify, disassemble or dispose of a seat belt. Have any necessary repairs carried out by your Toyota dealer. Inappropriate handling of the pretensioner may cause it to activate or operate improperly and may cause death or serious injury.

 CAUTION

■ **Using a seat belt comfort guide**

- Make sure the belt is not twisted and that it lies flat. The elastic cord must be behind the belt and the guide must be on the front.
- To reduce the chance of injury in case of a sudden stop, sudden swerve or accident while driving, remove and store the comfort guide in its pocket when it is not in use.
- Always make sure the shoulder belt is positioned across the center of the shoulder. The belt should be kept away from the neck, and should not fall off the shoulder.
Failure to observe these precautions could reduce the effectiveness of the seat belt in an accident, causing death or serious injury.

■ **Using a seat belt extender**

- Do not wear the seat belt extender, if you can fasten the seat belt without the extender.
- Do not use the seat belt extender when installing a child restraint system, because the belt will not securely hold the child restraint system, increasing the risk of death or injury in the event of a collision.
- The personalized extender may not be safe on another vehicle, when used by another person, or at a different seating position other than the one originally intended.

 NOTICE

■ **When using a seat belt extender**

When releasing the seat belt, press on the buckle release button on the extender, not on the seat belt.
This helps prevent damage to the vehicle interior and the extender itself.

1-3. Adjustable components (seats, steering wheel, mirrors) Steering wheel

The steering wheel can be adjusted to a comfortable position.

■ To change the angle

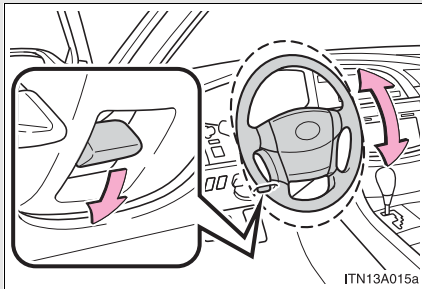

Hold the steering wheel, press the tilt lock release lever, and adjust to the ideal position by moving the steering wheel vertically.

When the steering wheel is in a low position, it will spring up as you release the lock release lever.

■ To change the column length

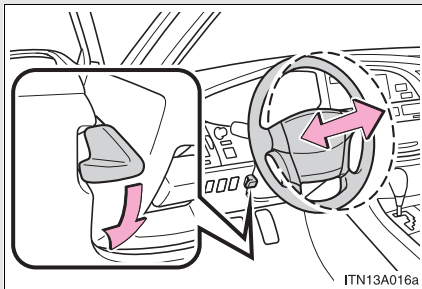

Hold the steering wheel and press the telescopic lock release lever, and adjust to the ideal position by moving the steering wheel horizontally.

After adjustment, pull the lever up to secure the steering wheel.

1-3. Adjustable components (seats, steering wheel, mirrors)

CAUTION

■ **After adjusting the steering wheel**

Make sure that the steering wheel is locked.
Otherwise, the steering wheel may move suddenly, possibly causing an accident and resulting in death or serious injury.

■ **While driving**

Do not adjust the steering wheel.
Doing so may cause the driver to mishandle the vehicle and an accident, resulting in death or serious injury.

1

Before driving

1-3. Adjustable components (seats, steering wheel, mirrors) Inside rear view mirror

Glare from the headlights of vehicles behind can be reduced by using the following functions.

► **Manual anti-glare inside rear view mirror**

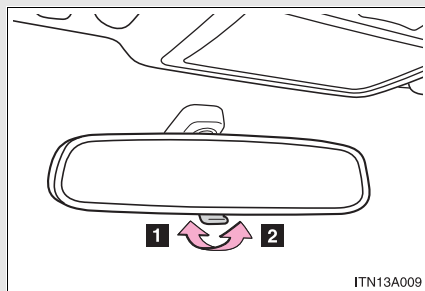

- 1** Normal position
- 2** Anti-glare position

► **Auto anti-glare inside rear view mirror**

In auto mode, sensors are used to detect the headlights of vehicles behind and automatically reduces the reflected light.

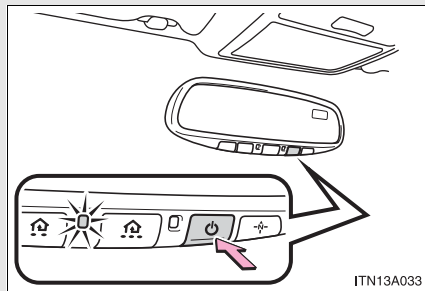

Press the button for longer than 3 seconds to turn auto mode on/off.

The indicator comes on when auto mode is turned on.

Vehicles with smart key system: The anti-glare mirror is automatically set to auto whenever the "ENGINE START STOP" switch is turned to IGNITION ON mode.

Vehicles without smart key system: The anti-glare mirror is automatically set to auto whenever the engine switch is turned to the "ON" position.

■ **To prevent sensor error (vehicles with auto anti-glare inside rear view mirror)**

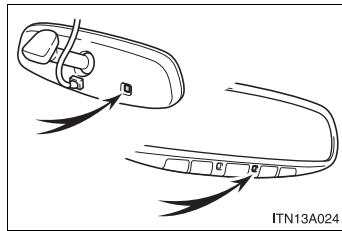

To ensure correct functioning of the sensors, do not touch or cover the sensors.

1

Before driving

⚠ CAUTION

■ **While driving**

Do not adjust the position of the mirror.
Doing so may lead to mishandling of the vehicle and an accident, or resulting in death or serious injury.

1-3. Adjustable components (seats, steering wheel, mirrors) Outside rear view mirrors

Mirror angle can be be adjusted using the switch.

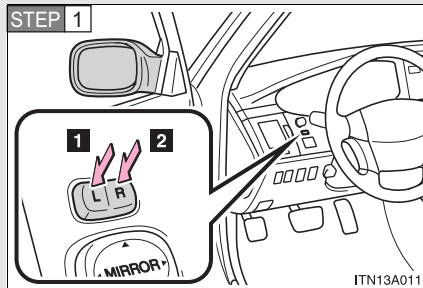

Select a mirror to adjust.

- 1** Left
- 2** Right

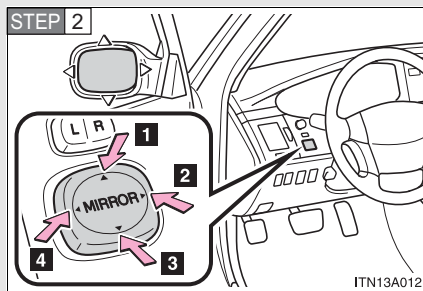

Adjust the mirror.

- 1** Up
- 2** Right
- 3** Down
- 4** Left

■ The outside rear view mirrors can be operated when

- ▶ Vehicles with smart key system

The “ENGINE START STOP” switch is in the ACCESSORY or IGNITION ON mode.

- ▶ Vehicles without smart key system

The engine switch is in the “ACC” or “ON” position.

■ When the mirrors are fogged up (vehicles with outside rear view mirror defoggers)

Turn on the mirror heaters to defog the mirrors. (→P. 208)

■ **Auto anti-glare function (vehicles with auto anti-glare inside rear view mirror)**

When the anti-glare inside rear view mirror is set to auto mode, the outside rear view mirrors will activate in conjunction with the anti-glare inside rear view mirror to reduce reflected light. (→P. 70)

■ **One touch power adjustment**

You can store and recall power adjustments such as the driver's seat and the outside rear view mirrors. (→P. 55)

1

Before driving

 **CAUTION**

■ **While driving**

Observe the following precautions.

Failing to do so may result in losing control of the vehicle and cause an accident, resulting in death or serious injury.

- Do not adjust the mirrors.
- Before driving, be sure to make an adjustment of the driver and passenger side mirrors properly.
- Do not drive with the mirrors folded.

■ **When the mirror heaters are operating (if equipped)**

Do not touch the mirror surface as the mirror surface becomes hot.

 **NOTICE**

■ **If ice should jam the mirror**

Do not operate the control or scrape the mirror face. Use a spray de-icer to free the mirror.

1-4. Opening and closing the windows and moon roof Power windows

The power windows can be opened and closed using the following switches.

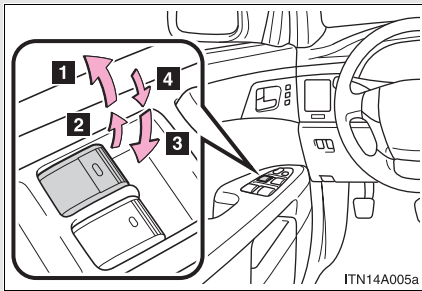

- 1 One-touch closing*
- 2 Closing
- 3 One-touch opening*
- 4 Opening

*: Pressing the switch in the opposite direction will stop window travel partway.

Lock switch

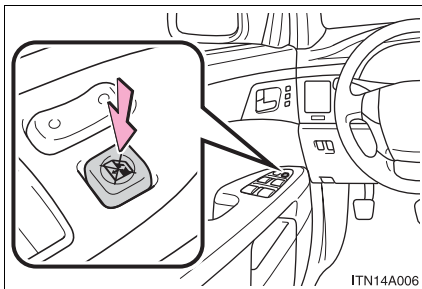

Press the switch down to lock passenger window switches.

Use this switch to prevent children from accidentally opening or closing a passenger window.

■ **The power windows can be operated when**

- ▶ Vehicles with smart key system

The “ENGINE START STOP” switch is in IGNITION ON mode.

- ▶ Vehicles without smart key system

The engine switch is in the “ON” position.

■ **Operating the power windows after turning the engine off**

- ▶ Vehicles with smart key system

The power windows can be operated for approximately 45 seconds even after the “ENGINE START STOP” switch is turned to ACCESSORY mode or turned OFF. They cannot, however, be operated once the driver’s or front passenger’s door is opened.

- ▶ Vehicles without smart key system

The power windows can be operated for approximately 45 seconds even after the engine switch is turned to the “ACC” or “LOCK” position. They cannot, however, be operated once the driver’s or front passenger’s door is opened.

■ **Jam protection function**

If an object becomes caught between the window and the window frame, window travel is stopped and the window is opened slightly.

■ **When the battery is disconnected**

The power windows must be initialized in order to ensure proper operation. (Perform for each window with the switch for each seat.)

STEP 1 Open the window halfway.

STEP 2 Fully close the window by pulling the switch up and continue holding the switch for 1 second.

The indicator on the switch changes from a flashing pattern to being on when initial settings are complete.

1-4. Opening and closing the windows and moon roof

CAUTION

■ **When closing the windows**

Observe the following precautions.

Failing to do so may result in death or serious injury.

- Check to make sure that all passengers do not have any part of their body in a position where it could be caught when a window is being operated.
- Do not allow children to operate the power windows.
Closing a power window on someone can cause death or serious injury.

■ **Jam protection function**

- Never try jamming any part of your body to activate the jam protection function intentionally.
- The jam protection function may not work if something gets caught just before the window fully closes.

1-4. Opening and closing the windows and moon roof Moon roof*

Use the overhead switches to open, close, and tilt the moon roof up and down.

■ Opening and closing

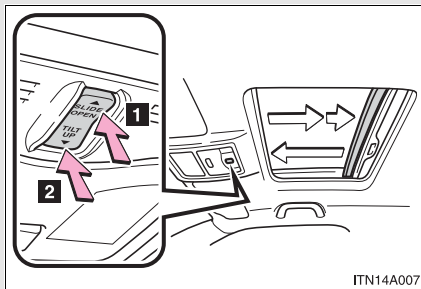

ITN14A007

1 Open

Stops just before it is opened fully. Press the switch again to fully open.

2 Close

To stop partway, press the switch lightly.

■ Tilt up and down

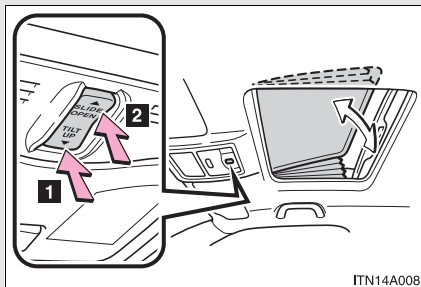

ITN14A008

1 Tilt up

2 Tilt down

To stop partway, press the switch lightly.

1

Before driving

*: If equipped

■ **The moon roof can be operated when**

- ▶ Vehicles with smart key system

The “ENGINE START STOP” switch is in IGNITION ON mode.

- ▶ Vehicles without smart key system

The engine switch is in the “ON” position.

■ **Operating the moon roof after turning the engine off**

- ▶ Vehicles with smart key system

The moon roof can be operated for approximately 45 seconds even after the “ENGINE START STOP” switch is turned to ACCESSORY mode or turned OFF. It cannot, however, be operated once the driver’s door is opened.

- ▶ Vehicles without smart key system

The moon roof can be operated for approximately 45 seconds even after the engine switch is turned to the “ACC” or “LOCK” position. It cannot, however, be operated once the driver’s door is opened.

■ **Jam protection function**

If an object is detected between the moon roof and the frame while closing or tilting down, travel is stopped and the moon roof opens slightly.

■ **If the moon roof cannot be closed automatically**

Keep the switch depressed.

■ **To reduce moon roof wind noise**

Drive with the moon roof opened automatically (just before fully opened position).

■ **Sunshade**

The sunshade can be opened and closed manually. However, the sunshade will open automatically when the moon roof is opened.

■ **When the battery is disconnected**

The moon roof must be initialized in order to ensure proper operation.

STEP 1 Open the window halfway.

STEP 2 Hold down “TILT UP” switch during the following moon roof sequence:

Tilt up → Tilt down → Slide open (fully open) → Slide close (fully close)

STEP 3 To ensure the initialization is complete, make sure automatic opening and closing functions work properly.

1

Before driving

 **CAUTION**

■ **When opening the moon roof**

Observe the following precautions.
Failing to do so may cause death or serious injury.

- Do not allow any passengers to put their hands or heads outside the vehicle while it is moving.
- Do not sit on top of the moon roof.

■ **When closing the moon roof**

Observe the following precautions.
Failing to do so may result in death or serious injury.

- Check to make sure that all passengers do not have any part of their bodies in a position where they could be caught when the moon roof is being operated.
- Do not allow children to operate the moon roof.
Closing the moon roof on someone can cause death or serious injury.

■ **Jam protection function**

- Never try jamming any part of your body to activate the jam protection function intentionally.
- The jam protection function may not work if something gets caught just before the moon roof fully closes.

1-5. Refueling

Opening the fuel tank cap

Perform the following steps to open the fuel tank cap.

■ Before refueling the vehicle

Turn the “ENGINE START STOP” switch or the engine switch OFF and ensure that all the doors and windows are closed.

■ Opening the fuel tank cap

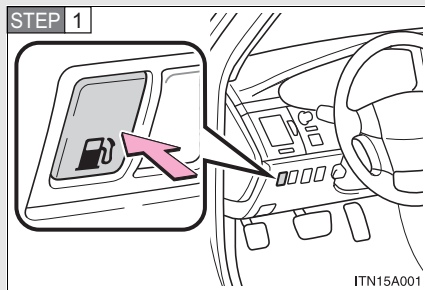

Press the fuel filler door opener switch.

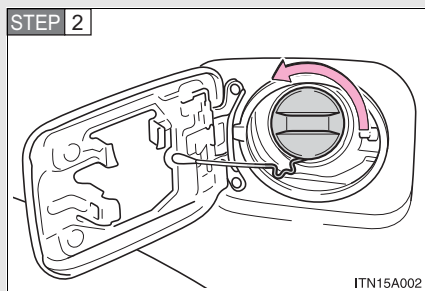

Turn the fuel tank cap slowly to open.

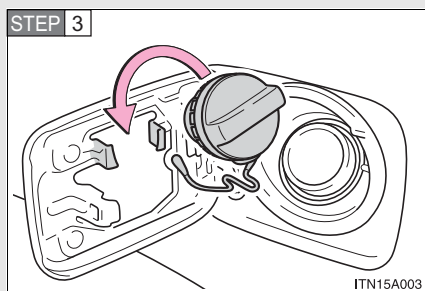

Hang the fuel tank cap on the back of the fuel filler door.

Closing the fuel tank cap

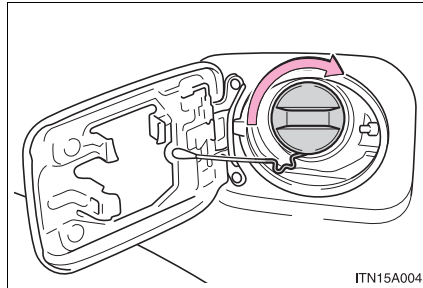

After refueling, turn the fuel tank cap clockwise until you hear a click. The cap will revolve slightly in the opposite direction once released.

1

Before driving

■ Fuel types

Use unleaded gasoline. (Octane Rating 87 [Research Octane Number 91] or higher)

■ Fuel tank capacity

Approximately 18.5 gal. (70 L, 15.4 Imp. gal.)

■ When the fuel filler door opener switch is inoperable

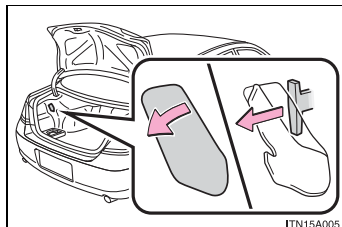

The lever can be used to open the fuel filler door if the fuel filler door cannot be opened using the inside switch because the battery discharged or for any other reason.

 CAUTION

■ **When refueling the vehicle**

Observe the following precautions while refueling the vehicle. Failure to do so, may result in death or serious injury.

- Before opening the fuel door, touch the vehicle or some other metal surface to discharge any static electricity.
It is important to discharge static electricity because sparks resulting from static electricity may cause the fuel vapors to ignite.
- Always hold the grips on the fuel tank cap and turn it slowly to remove it.
A whooshing sound may be heard when the fuel tank cap is loosened. Wait until the sound cannot be heard before fully removing the cap. In hot weather, pressurized fuel may spray out of the filler neck and cause injury.
- Do not allow anyone that has not discharged static electricity from their bodies to come close to an open fuel tank.
- Do not inhale vaporized fuel.
Fuel contains substances that are harmful if inhaled.
- Do not smoke while refueling the vehicle.
Doing so may cause the fuel to ignite and cause a fire.
- Do not return to the vehicle or touch any person or object that is statically charged.
This may cause static electricity to build up, resulting in a possible ignition hazard.

■ **When replacing the fuel tank cap**

Do not use anything but a genuine Toyota fuel tank cap designed for your vehicle. Failure to do so may cause a fire or other incident which may result in death or serious injury.

 NOTICE

■ **Refueling**

Do not spill fuel during refueling.
Failing to do so may damage the vehicle, such as causing the exhaust systems to operate abnormally or damaging fuel system components or the vehicle's painted surface.

1-6. Theft deterrent system Engine immobilizer system

The vehicle's keys have built-in transponder chips that prevent the engine from starting if the key has not been previously registered in the vehicle's on-board computer.

Never leave the keys inside the vehicle when you leave the vehicle.

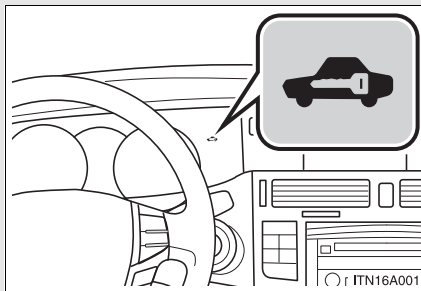

Vehicles with a smart key system

The indicator light flashes after the "ENGINE START STOP" switch has been turned off to indicate that the system is operating.

Vehicles without a smart key system

The indicator light flashes after the key has been removed from the engine switch to indicate that the system is operating.

1

Before driving

■ System maintenance

The vehicle has a maintenance-free type of engine immobilizer system.

■ Conditions that may cause the system to malfunction

- If the grip portion of the key is in contact with a metallic object.
- If the key is in close proximity to or touching a key to the security system (key with a built-in transponder chip) of another vehicle.

1-6. Theft deterrent system

■ Certifications for the engine immobilizer system

- ▶ For vehicles sold in the U.S.A.

FCC ID: MOZRI-21BTY

FCC ID: NI4TMIMB-1

This device complies with Part 15 of the FCC Rules. Operation is subject to the following two conditions: (1) this device may not cause harmful interference, and (2) this device must accept any interference received, including interference that may cause undesired operation.

- ▶ For vehicles sold in Canada

Operation is subject to the following two conditions: (1) this device may not cause interference, and (2) this device must accept any interference, including interference that may cause undesired operation of the device.

CAUTION

■ Certifications for the engine immobilizer system

Changes or modifications not expressly approved by the party responsible for compliance could void the user's authority to operate the equipment.

NOTICE

■ For proper system operation

Do not modify, remove or disable the engine immobilizer system. If any unauthorized changes or modifications are made, the proper operation of the system cannot be guaranteed.

1-6. Theft deterrent system Alarm*

The system sounds the alarm and flashes lights when forcible entry is detected.

■ Triggering the alarm

The alarm is triggered in the following situations.

- A locked door or trunk is unlocked or opened in any way other than using the entry function, wireless remote door lock function or using the mechanical key. (The doors will lock again automatically.)
- The hood is opened while the vehicle is locked.
- Vehicles with the glass breakage sensor: The side windows are tapped or broken.

■ Setting the alarm system

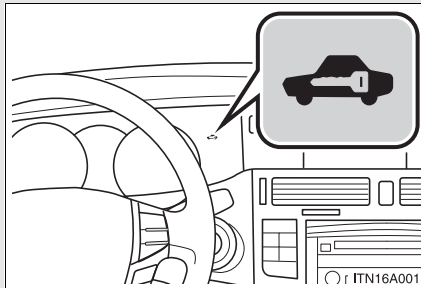

Close the doors, trunk and hood, and lock all doors. The system will be set automatically after 30 seconds.

The indicator light changes from being on to flashing when the system is set.

■ Deactivating or stopping the alarm

Do one of the following to deactivate or stop the alarm.

- Unlock the doors or trunk.
- Start the engine. (The alarm will be deactivated or stopped after a few seconds.)

1

Before driving

*: If equipped

1-6. Theft deterrent system

■ Items to check before locking the vehicle

To prevent unexpected triggering of the alarm and vehicle theft, make sure of the following:

- Nobody is in the vehicle.
- The windows and moon roof are closed before the alarm is set.
- No valuables or other personal items are left in the vehicle.

■ Triggering of the alarm

The alarm may be triggered in the following situations.

(Stopping the alarm deactivates the alarm system.)

- A person inside the vehicle opens a door, the trunk or hood.
- The battery is recharged or replaced when the vehicle is locked.

■ Panic mode

- ▶ Vehicles with smart key system

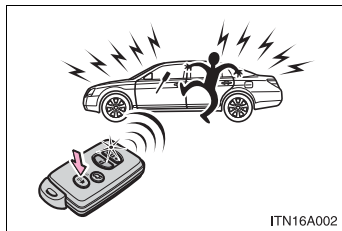

When  is pushed for longer than about one second, an alarm will sound for about 60 seconds and the vehicle lights will flash to deter any person from trying to break into or damage your vehicle.

To stop the alarm, push any button on the wireless remote control.

- ▶ Vehicles without smart key system

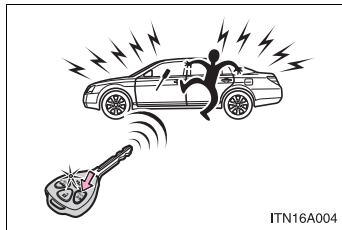

1-6. Theft deterrent system
Theft prevention labels (U.S.A.)

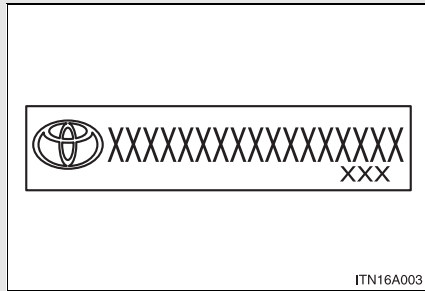

These labels are attached to the vehicle to reduce vehicle theft by facilitating the tracing and recovery of parts from stolen vehicles. Do not remove under penalty of law.

1

Before driving

1-7. Safety information

Correct driving posture

Drive with a good posture as follows:

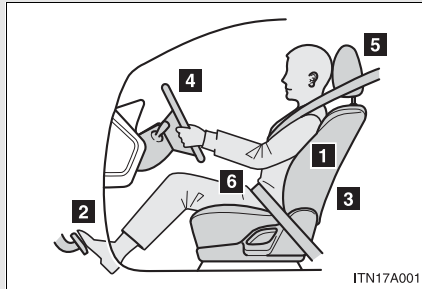

- 1** Sit upright and well back in the seat.
- 2** Adjust the position of the seat forward or backward to ensure the pedals can be reached and easily depressed to the extent required. (→P. 50)
- 3** Adjust the seatback so that the controls are easily operable.
- 4** Adjust the tilt and telescopic positions of the steering wheel downward so the air-bag is facing your chest. (→P. 68)
- 5** Lock the head restraint in place with the center of the head restraint closest to the top of your ears. (→P. 59)
- 6** Wear the seat belt correctly. (→P. 61)

⚠ CAUTION**■ While driving**

- Do not adjust the position of the driver's seat.
Doing so could cause the driver to lose control of the vehicle.
- Do not place a cushion between the driver or passenger and the seatback.
A cushion may prevent correct posture from being achieved, and reduce the effectiveness of the seat belt and head restraint, increasing the risk of death or serious injury to the driver or passenger.
- Do not place anything under the front seats.
Objects placed under the front seats may become jammed in the seat tracks and stop the seat from locking in place. This may lead to an accident. The adjustment mechanism may also be damaged.

■ Adjusting the seat position

- Take care when adjusting the seat position to ensure that other passengers are not injured by the moving seat.
- Do not put your hands under the seat or near the moving parts to avoid injury.
Fingers or hands may become jammed in the seat mechanism.

1

Before driving

1-7. Safety information

SRS airbags

The SRS airbags inflate when the vehicle is subjected to certain types of severe impacts that may cause significant injury to the occupants. They work together with the seat belts to help reduce the risk of death or serious injury.

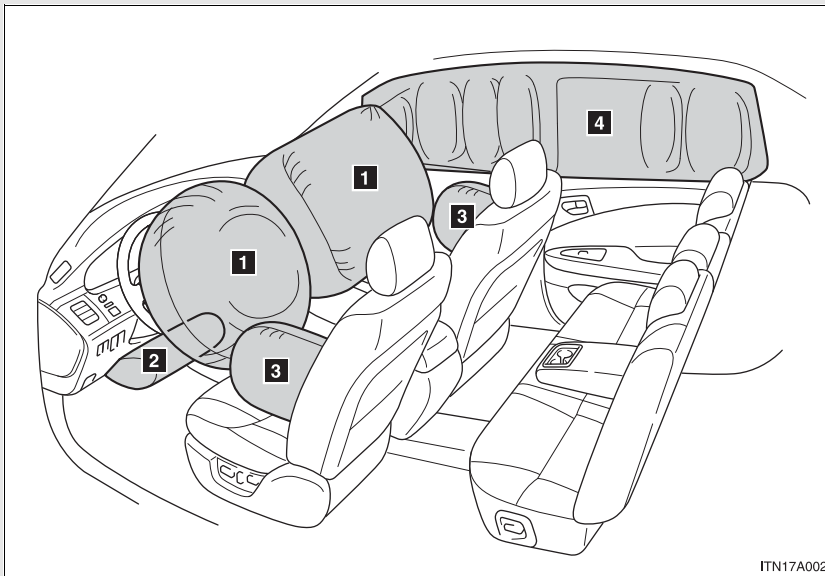

► Front airbags

1 Driver airbag/front passenger airbag

Can help protect the head and chest of the driver and front passenger from impact with interior components.

2 Knee airbag

Can help provide driver protection.

► Side and curtain shield airbags

3 Side airbag

Can help protect the torso of the front occupants.

4 Curtain shield airbag

Can help protect primarily the head of front occupants and rear outboard occupants.

Airbag system components

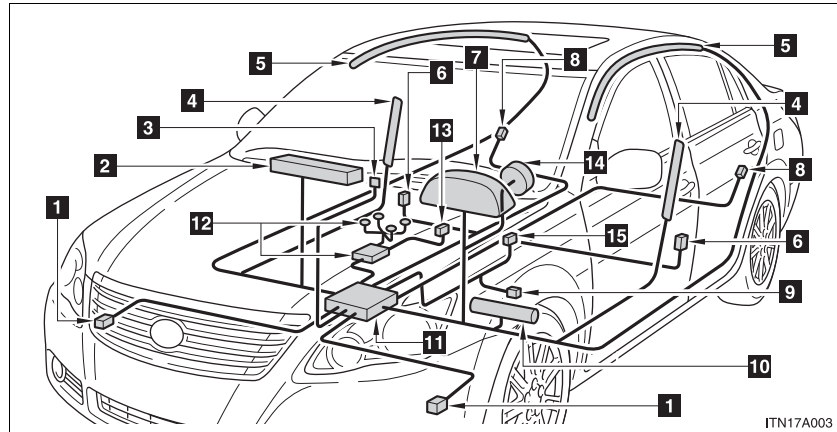

- | | |
|--|---|
| 1 Front airbag sensor | 9 Driver's seat position sensor |
| 2 Front passenger airbag | 10 Knee airbag |
| 3 "AIR BAG ON" and "AIR BAG OFF" indicator lights | 11 Airbag sensor assembly |
| 4 Side airbag | 12 Occupant detection system (ECU and sensors) |
| 5 Curtain shield airbag | 13 Front passenger's seat belt buckle switch |
| 6 Side and curtain shield airbag sensor | 14 Driver airbag |
| 7 SRS warning light | 15 Driver's seat belt buckle switch |
| 8 Curtain shield airbag sensor | |

1
Before driving

1-7. Safety information

Your vehicle is equipped with “ADVANCED AIRBAGS” designed based on US motor vehicle safety standards (FMVSS208). The airbag system controls airbag deployment power for the driver and front passenger. The driver airbag system consists of the driver seat’s position sensor etc. The front passenger’s airbag system consists of the front passenger occupant classification sensor etc.

In certain types of severe frontal or side impacts, the SRS airbag system triggers the airbag inflators. A chemical reaction in the inflators quickly fills the airbags with non-toxic gas to help restrain the motion of the occupants.

■ If the SRS airbags deploy (inflate)

- Bruising and slight abrasions may result from contact with a deploying (inflating) SRS airbag.
- A loud noise and white powder will be emitted.
- Parts of the airbag module (steering wheel hub, airbag cover and inflator) as well as the seats, and parts of the front and rear pillars, and roof side rail, may be hot for several minutes. The airbag itself may also be hot.
- The windshield may crack.

■ Operating conditions (front airbags)

- The SRS front airbags will deploy in the event of an impact that exceeds the set threshold level (the level of force corresponding to a 12-19 mph (20-30 km/h) frontal collision with a fixed wall that does not move or deform).

However, this threshold velocity will be considerably higher if the vehicle strikes an object, such as a parked vehicle or sign pole, which can move or deform on impact, or if the vehicle is involved in an underride collision (e.g. a collision in which the front of the vehicle “underrides”, or goes under, the bed of a truck, etc.).

- It is possible that in some collisions where the forward deceleration of the vehicle is very close to the designed threshold level, the SRS front airbags and the seat belt pretensioners may not activate together.
- The SRS front passenger airbags will not activate, if there is no passenger sitting in the front passenger seat. However, the front passenger airbag may deploy, if heavy luggage is put, even if the seat is unoccupied. (→P. 103)

■ Operating conditions (side and curtain shield airbags)

- The SRS side airbags and curtain shield airbags will deploy in the event of an impact that exceeds the set threshold level (the level of force corresponding to the impact force produced by a 3300 lb. (1500 kg) vehicle colliding with the vehicle cabin from a direction perpendicular to the vehicle orientation at a speed of 12-19 mph (20-30 km/h)).
- The SRS side airbags and curtain shield airbags are designed to inflate when the passenger compartment is subjected to a severe impact the side.
- The SRS side airbag on the passenger seat will not activate, if there is no passenger sitting in the front passenger seat. However, the side airbag on the passenger seat may deploy, if heavy luggage is put, even if the seat is unoccupied. (→P. 103)

1-7. Safety information

■ Conditions under which the SRS airbags may deploy (inflate), other than a collision

The SRS front airbags may also deploy if a serious impact occurs to the underside of your vehicle. Some examples are shown in the illustration.

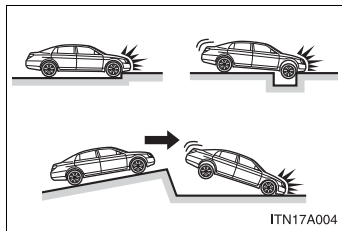

- Hitting a curb, edge of pavement or hard surface
- Falling into or jumping over a deep hole
- Landing hard or vehicle falling

■ Types of collisions that may not deploy the SRS airbag (front airbags)

The SRS front airbags are generally not designed to inflate if the vehicle is involved in a side or rear collision, if it rolls over, or if it is involved in a low-speed frontal collision. But, whenever a collision of any type causes sufficient forward deceleration of the vehicle, deployment of the SRS front airbags may occur.

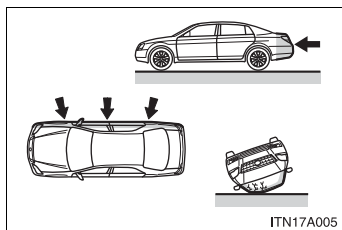

- Collision from the side
- Collision from the rear
- Vehicle rollover

■ **Types of collisions that may not deploy the SRS airbag (side and curtain shield airbags)**

The SRS side airbag and curtain shield airbag system may not activate if the vehicle is subjected to a collision from the side at certain angles, or a collision to the side of the vehicle body other than the passenger compartment.

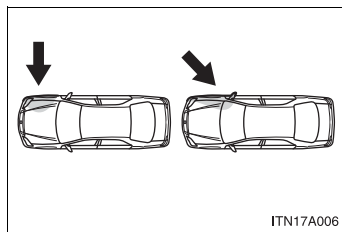

- Collision from the side to the vehicle body other than the passenger compartment
- Collision from the side at an angle

The SRS side airbags and curtain shield airbags are generally not designed to inflate if the vehicle is involved in a frontal or rear collision, if it rolls over, or if it is involved in a low-speed side collision.

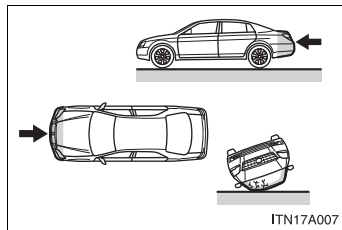

- Collision from the front
- Collision from the rear
- Vehicle rollover

1

Before driving

1-7. Safety information

■ When to contact your Toyota dealer

In the following cases, contact your Toyota dealer as soon as possible. Do not disconnect the battery cables before contacting your Toyota dealer.

- Any of the SRS airbags have been inflated.

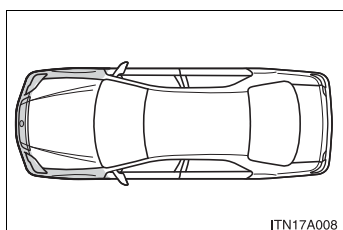

- The front of the vehicle is damaged or deformed, or was involved in an accident that was not severe enough to cause the SRS airbags to inflate.

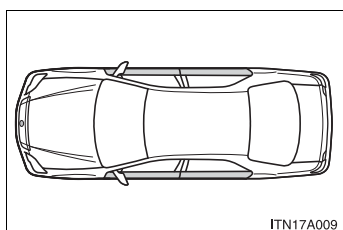

- A portion of the doors is damaged or deformed, or the vehicle was involved in an accident that was not severe enough to cause the SRS side airbags and curtain shield airbags to inflate.

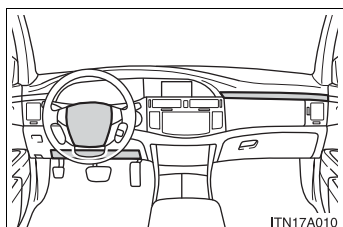

- The pad section of the steering wheel, front passenger airbag cover or lower portion of the instrument panel is scratched, cracked, or otherwise damaged.

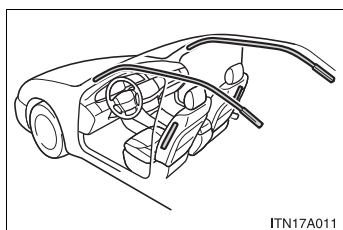

- The surface of the seats with the side airbag is scratched, cracked, or otherwise damaged.
- The portion of the front pillars, rear pillars or roof side rail garnishes (padding) containing the curtain shield airbags is scratched, cracked, or otherwise damaged.

⚠ CAUTION**■ SRS airbag precautions**

Observe the following precautions regarding the airbags. Failure to do so may cause death or serious injury.

- The driver and all passengers in the vehicle must wear their seat belts properly.

The SRS airbags are supplemental devices to be used with the seat belts.

- The SRS driver airbag deploys with considerable force, and can cause death or serious injury especially if the driver is very close to the airbag. The National Highway Traffic Safety Administration (“NHTSA”) advises:

Since the risk zone for driver airbag is the first 2 - 3 in. (50 - 75 mm) of inflation, placing yourself 10 in. (250 mm) from your driver airbag provides you with a clear margin of safety. This distance is measured from the center of the steering wheel to your breastbone. If you sit less than 10 in. (250 mm) away now, you can change your driving position in several ways:

- Move your seat to the rear as far as you can while still reaching the pedals comfortably.
- Slightly recline the back of the seat. Although vehicle designs vary, many drivers can achieve the 10 in. (250 mm) distance, even with the driver seat all the way forward, simply by reclining the back of the seat somewhat. If reclining the back of your seat makes it hard to see the road, raise yourself by using a firm, non-slippery cushion, or raise the seat if your vehicle has that feature.
- If your steering wheel is adjustable, tilt it downward. This points the airbag toward your chest instead of your head and neck.

The seat should be adjusted as recommended by NHTSA above, while still maintaining control of the foot pedals, steering wheel, and your view of the instrument panel controls.

1

Before driving

! CAUTION

■ SRS airbag precautions

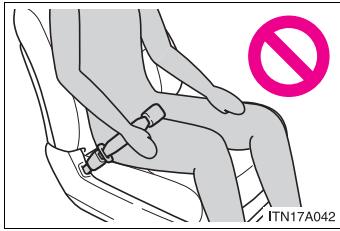

- If the seat belt extender has been connected to the driver's seat belt buckle but the seat belt extender has not also been fastened to the latch plate of the driver's seat belt, the SRS driver's airbag system will judge that the driver is wearing the seat belt even though the seat belt has not been connected. In this case, the driver's airbag may not activate correctly in a collision, resulting in death or serious injury in the event of collision. Be sure to wear the seat belt with the seat belt extender.
- The SRS front passenger airbag also deploys with considerable force, and can cause death or serious injury especially if the front passenger is very close to the airbag. The front passenger seat should be as far from the airbag as possible with the seatback adjusted, so the front passenger sits upright.
- Improperly seated and/or restrained infants and children can be killed or seriously injured by a deploying airbag. An infant or child who is too small to use a seat belt should be properly secured using a child restraint system. Toyota strongly recommends that all infants and children be placed in the rear seats of the vehicle and properly restrained. The rear seats are the safest for infants and children. (→P. 109)

⚠ CAUTION

■ SRS airbag precautions

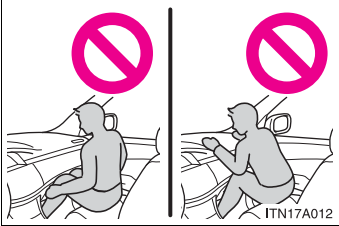

ITN17A012

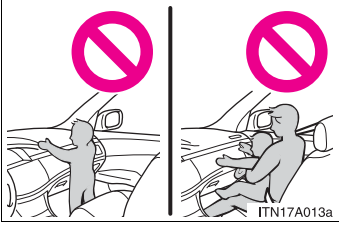

ITN17A013a

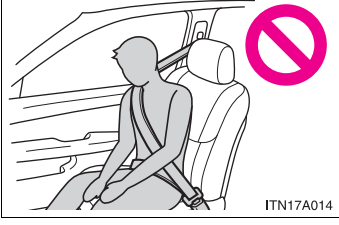

ITN17A014

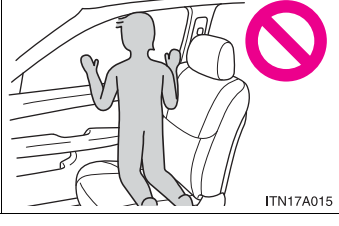

ITN17A015

- Do not sit on the edge of the seat or lean against the dashboard.
- Do not allow a child to stand in front of the SRS front passenger airbag unit or sit on the knees of a front passenger.
- Do not drive the vehicle while the driver or passenger have items resting on their knees.
- Do not lean against the door, the roof side rail or the front, side and rear pillars.
- Do not allow anyone to kneel on the passenger seat toward the door or put their head or hands outside the vehicle.

1

Before driving

CAUTION

SRS airbag precautions

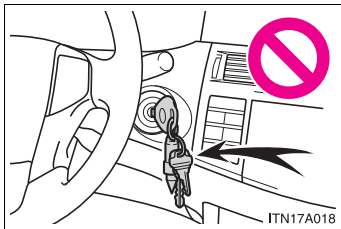
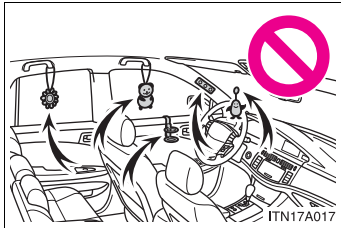
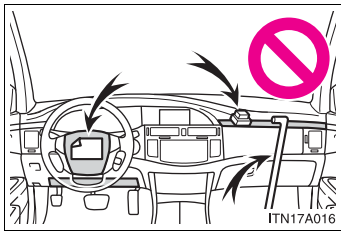

- Do not attach anything to or lean anything against areas such as the dashboard, steering wheel pad or lower portion of the instrument panel. These items can become projectiles when SRS driver, front passenger and knee airbags deploy.
- Do not attach anything to areas such as the door, windshield glass, side door glass, front and rear pillars, roof side rail or assist grip.
- Do not hang coat hangers or other hard objects on the coat hooks. All of these items could become projectiles and seriously injure or kill you, should the SRS curtain shield airbag deploy.
- Vehicles without smart key system: Do not attach any heavy, sharp or hard objects such as keys or accessories to the key. The objects may restrict the SRS knee airbag inflation or be thrust into the driver's seat area by the force of the deploying airbag, thus causing a danger.

⚠ CAUTION

- If the vinyl cover is put on the area where the SRS knee airbag will deploy, be sure to remove it.
- Do not use seat accessories which cover the parts where the SRS side airbags inflate as they may interfere with inflation of the airbags.
- Do not strike or apply significant levels of force to the area of the SRS airbag components shown on P. 91. Doing so can cause the SRS airbags to malfunction.
- Do not touch any of the component parts immediately after the SRS airbags have deployed (inflated) as they may be hot.
- If breathing becomes difficult after the SRS airbag has deployed, open a door or window to allow fresh air in, or leave the vehicle if it is safe to do so. Wash off any residue as soon as possible to prevent skin irritation.
- If the areas where the SRS airbags are stored, such as the steering wheel pad and front and rear pillar garnish, are damaged or cracked, have them replaced by your Toyota dealer.
- Do not place anything, such as a cushion, on the front passenger's seat. Doing so will disperse the passenger's weight, which prevents the sensor from detecting the passenger's weight properly. As a result, the SRS front passenger airbag may not deploy in the event of a collision.

1

Before driving

 CAUTION

■ **Modification and disposal of SRS airbag system components**

Do not dispose of your vehicle or perform any of the following modifications without consulting your Toyota dealer. The SRS airbag may malfunction or deploy (inflate) accidentally, causing death or serious injury.

- Installation, removal, disassembly and repair of the SRS airbags
- Repairs, modifications, removal or replacement of the steering wheel, instrument panel, dashboard, seats or seat upholstery, front, side and rear pillars or roof side rail
- Repairs or modifications of the front fender, front bumper, or side of the occupant compartment
- Installation of snow plows, winches, etc. to the front grille (bull bars, kangaroo bar etc.)
- Modifications to the vehicle's suspension system
- Installation of electronic devices such as mobile two-way radios or CD players
- Modifications to your vehicle for a person with a physical disability

1-7. Safety information

Front passenger occupant classification system

Your vehicle is equipped with a front passenger occupant classification system. This system detects the conditions of the front passenger seat and activates or deactivates the devices for front passenger.

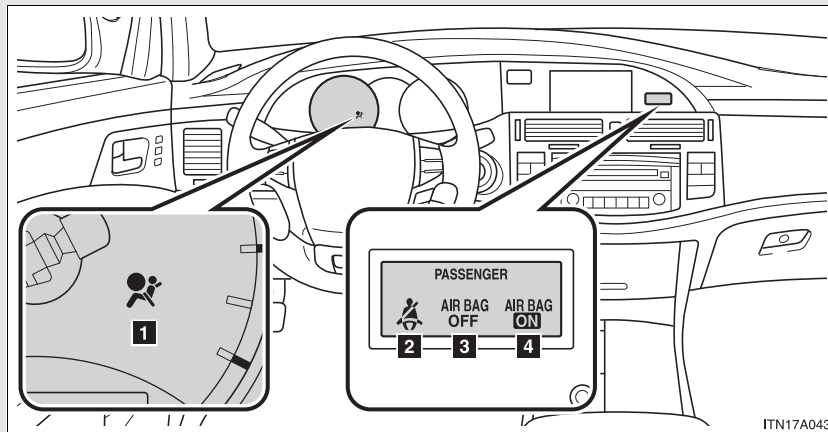

- 1** SRS warning light
- 2** Front passenger's seat belt reminder light
- 3** "AIR BAG OFF" indicator light
- 4** "AIR BAG ON" indicator light

1

Before driving

Condition and operation in the front passenger occupant classification system

■ **Adult*1**

Indicator/ warning light	“AIR BAG ON” and “AIR BAG OFF” indicator lights	“AIR BAG ON”
	SRS warning light	Off
	Front passenger’s seat belt reminder light	Flashing*2
Devices	Front passenger airbag	Activated
	Side airbag on the front passenger seat	
	Curtain shield airbag in the front passenger side	
	Front passenger’s seat belt pretensioner	

■ **Child*3 or child restraint system*4**

Indicator/ warning light	“AIR BAG ON” and “AIR BAG OFF” indicator lights	“AIR BAG OFF”*5
	SRS warning light	Off
	Front passenger’s seat belt reminder light	Flashing*2
Devices	Front passenger airbag	Deactivated
	Side airbag on the front passenger seat	
	Curtain shield airbag in the front passenger side	Activated
	Front passenger’s seat belt pretensioner	Activated

■ Unoccupied

Indicator/ warning light	"AIR BAG ON" and "AIR BAG OFF" indicator lights	Not illuminated
	SRS warning light	Off
	Front passenger's seat belt reminder light	
Devices	Front passenger airbag	Deactivated
	Side airbag on the front passenger seat	
	Curtain shield airbag in the front passenger side	Activated
	Front passenger's seat belt pretensioner	Deactivated

1

Before driving

■ System malfunction

Indicator/ warning light	"AIR BAG ON" and "AIR BAG OFF" indicator lights	"AIR BAG OFF"
	SRS warning light	On
	Front passenger's seat belt reminder light	Off
Devices	Front passenger airbag	Deactivated
	Side airbag on the front passenger seat	
	Curtain shield airbag in the front passenger side	Activated
	Front passenger's seat belt pretensioner	Activated

1-7. Safety information

- *1: The system judges a person of adult size as an adult. When a smaller adult sits in the front passenger seat, the system may recognize him/her as a child depending on his/her physique and posture.
- *2: In the event the front passenger does not wear a seat belt.
- *3: When a large child who has outgrown a child restraint system sits in the front passenger seat, the system may recognize him/her as an adult depending on his/her physique or posture.
- *4: Never install a rear-facing child restraint system on the front passenger seat. A forward-facing child restraint system should only be installed on the front passenger seat when it is unavoidable. (→P. 109)
- *5: In case the indicator is not illuminated, consult this manual as for installing the child restraint system properly. (→P. 113)

⚠ CAUTION**■ Front passenger occupant classification system precautions**

Observe the following precautions regarding front passenger occupant classification system.

Failure to do so may cause death or serious injury.

- Wear the seat belt properly.
- Make sure the front passenger's seat belt tab has not been left inserted into the buckle before someone sits in the front passenger seat.
- Make sure the "AIR BAG OFF" indicator light is not illuminated when using the seat belt extender for the front passenger seat. If the "AIR BAG OFF" indicator light is illuminated, disconnect the extender tongue from the seat belt buckle, then reconnect the seat belt. Reconnect the seat belt extender after making sure the "AIR BAG ON" indicator light is illuminated. If you use the seat belt extender while the "AIR BAG OFF" indicator light is illuminated, the front passenger airbag, side airbag on the front passenger side may not activate correctly, which could cause death or serious injury in the event of collision.
- Do not put weight on the front passenger seat by putting your hands or feet on the front passenger seatback from the rear passenger seat.
- Do not let a rear passenger lift the front passenger seat with their feet or press on the seatback with their legs.
- Do not put objects under the front passenger seat.
- Do not recline the front passenger seatback so far that it touches a rear seat. This may cause the "AIR BAG OFF" indicator light to be illuminated, which indicates that the passenger's airbags will not deploy in the event of a severe accident. If the seatback touches the rear seat, return the seatback to a position where it does not touch the rear seat. Keep the front passenger seatback as upright as possible when the vehicle is moving. Reclining the seatback excessively may lessen the effectiveness of the seat belt system.
- If an adult sits in the front passenger seat, the "AIR BAG ON" indicator light is illuminated, If the "AIR BAG OFF" indicator is illuminated, ask the passenger to sit up straight, well back in the seat, feet on the floor, and with the seat belt worn correctly. If the "AIR BAG OFF" indicator still remain illuminated, either ask the passenger to move to the rear seat, or if that is not possible, move the front passenger seat fully rearward.

1

Before driving

 CAUTION

■ **Front passenger occupant classification system precautions**

- When it is unavoidable to install the forward-facing child restraint system on the front passenger seat, install the child restraint system on the front passenger seat in the proper order. (→P. 113)
- Do not modify or remove the front seats.
- Do not kick the front passenger seat or subject it to severe impact. Otherwise, the SRS warning light may come on to indicate a malfunction on the detection system. In this case, contact your Toyota dealer immediately.
- Child restraint systems installed on the rear seat should not contact the front seatbacks.
- Do not use a seat accessory, such as a cushion or seat cover, that covers the seat cushion surface.

1-7. Safety information

Child restraint systems

A child restraint system for a small child or baby must itself be properly restrained on the seat with the lap portion of the lap/shoulder belt.

The laws of all 50 states of the U.S.A. and Canada now require the use of child restraint systems.

1

Before driving

Points to remember

Studies have shown that installing a child restraint on a rear seat is much safer than installing one to the front passenger seat.

- Choose a child restraint system that suits your vehicle and is appropriate to the age and size of the child.
- For installation details, follow the instructions provided with the child restraint system.
General installation instructions are provided in this manual.
(→P. 113)

Types of child restraints

Child restraint systems are classified into the following 3 types according to the age and size of the child.

- ▶ Rear-facing — Infant seat/convertible seat

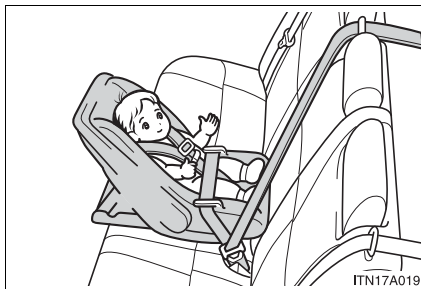

1-7. Safety information

▶ Forward-facing — Convertible seat

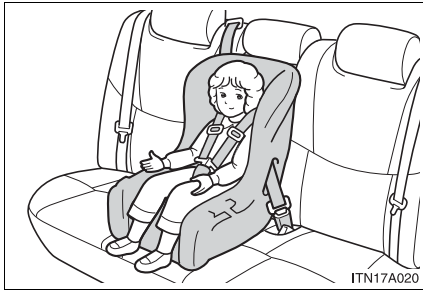

▶ Booster seat

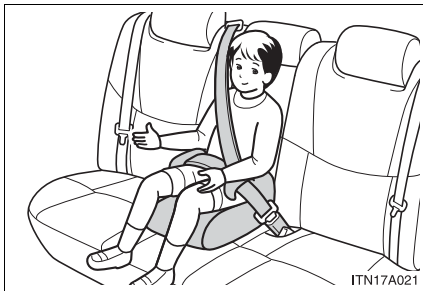

■ Selecting an appropriate child restraint system

- Use a child restraint system appropriate for the child until the child becomes large enough to properly wear the vehicle's seat belt.
- If a child is too large for a child restraint system, sit the child on a rear seat and use the vehicle's seat belt. (→P. 61)

⚠ CAUTION**■ Child restraint precautions**

- For effective protection in automobile accidents and sudden stops, a child must be properly restrained, using a seat belt or child restraint system depending on the age and size of the child. Holding a child in your arms is not a substitute for a child restraint system. In an accident, the child can be crushed against the windshield, or between you and the vehicle's interior.
- Toyota strongly urges the use of a proper child restraint system that conforms to the size of the child, installed on the rear seat. According to accident statistics, the child is safer when properly restrained in the rear seat than in the front seat.
- Never install a rear-facing child restraint system on the front passenger seat even if "AIR BAG OFF" indicator light is illuminated. In the event of an accident, the force of the rapid inflation of the front passenger airbag can cause death or serious injury to the child if the rear-facing child restraint system is installed on the front passenger seat.
- A forward-facing child restraint system may be installed on the front passenger seat only when it is unavoidable. A child restraint system that requires a top tether strap should not be used in the front passenger seat since there is no top tether strap anchor for the front passenger seat. Adjust the seatback as upright as possible and always move the seat as far back as possible even if "AIR BAG OFF" indicator light is illuminated, because the front passenger airbag could inflate with considerable speed and force. Otherwise, the child may be killed or seriously injured.
- Do not use the seat belt extender when installing a child restraint system on the front or rear passenger seat. If installing a child restraint system with the seat belt extender connected to the seat belt, the seat belt will not securely hold the child restraint system, which could cause death or serious injury to the child or other passengers in the event of a sudden stop, sudden swerve or accident.

1

Before driving

 CAUTION

■ **Child restraint precautions**

- Do not allow the child to lean his/her head or any part of his/her body against the door or the area of the seat, front pillar or roof side rail from which the side airbags or curtain shield airbags deploy even if the child is seated in the child restraint system. It is dangerous if the side airbags and curtain shield airbags inflate, and the impact could cause death or serious injury to the child.
- Make sure you have complied with all installation instructions provided by the child restraint manufacturer and that the system is properly secured. If it is not secured properly, it may cause death or serious injury to the child in the event of a sudden stop, sudden swerve or accident.

■ **Child restraint lock function belt precaution**

Do not allow children to play with the child restraint lock function belt. If the belt becomes twisted around a child's neck, it will not be possible to pull the belt out leading to choking or other serious injuries that result in death. If this occurs and the buckle cannot be unfastened, scissors should be used to cut the belt.

■ **When the child restraint system is not in use**

- Keep the child restraint system properly secured on the seat even if it is not in use. Do not store the restraint unsecured in the passenger compartment.
- If it is necessary to detach the child restraint system, remove it from the vehicle or store it securely in the trunk. This will prevent it from injuring passengers in the event of a sudden stop, sudden swerve or accident.

1-7. Safety information Installing child restraints

Follow the child restraint system manufacturer's instructions. Firmly secure child restraints to the outboard rear seats using the LATCH anchors or a seat belt. Attach the top tether strap when installing a child restraint.

The lap/shoulder belt can be used if your child restraint system is not compatible with the LATCH (Lower Anchors and Tethers for Children) system.

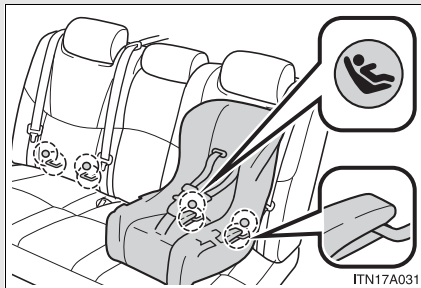

Child restraint LATCH anchors

LATCH anchors are provided for the outboard rear seats. (Buttons displaying the location of the anchors are attached to the seats.)

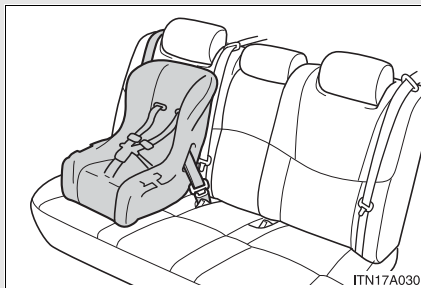

Seat belts equipped with a child restraint locking mechanism (ALR/ELR belts except driver's seat belt) (→P. 63)



Anchor bracket (for top tether strap)

Anchor brackets are provided for all rear seats.

1

Before driving

Installation with LATCH system

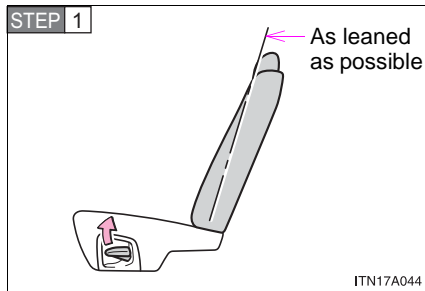

Adjust the seatback as leaned as possible.

STEP 2 Widen the gap between the seat cushion and seatback slightly.

► Type A

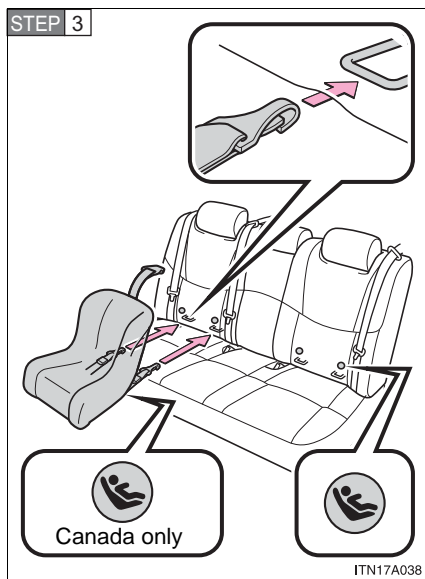

Latch the hooks of the lower straps onto the LATCH anchors.

STEP 4 If the child restraint has a top tether strap, the top tether strap should be latched onto the top tether anchors.

For owners in Canada:

The symbol on a child restraint system indicates the presence of a lower connector system.

► Type B

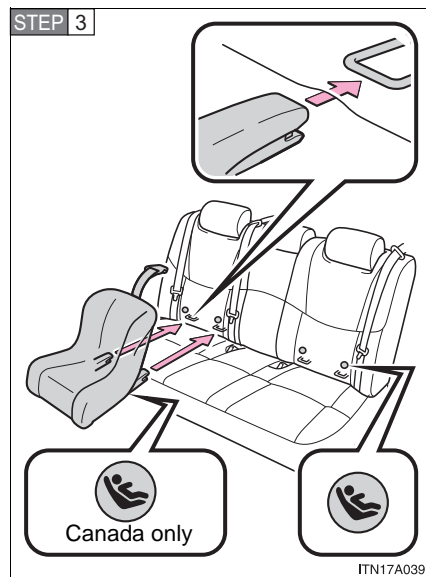

Latch the buckles onto the LATCH anchors.

1

Before driving

STEP 4 If the child restraint has a top tether strap, the top tether strap should be latched onto the top tether anchors.

For owners in Canada:

The symbol on a child restraint system indicates the presence of a lower connector system.

Installing child restraints using a seat belt (child restraint lock function belt)

■ **Rear-facing — Infant seat/convertible seat**

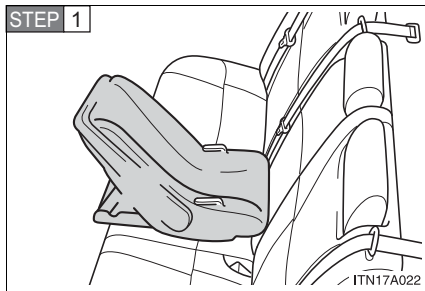

Place the child restraint system on the rear seat facing the rear of the vehicle.

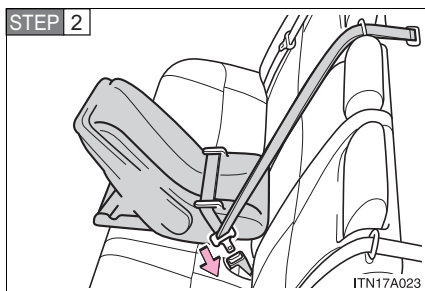

Run the seat belt through the child restraint system and insert the plate into the buckle. Make sure that the belt is not twisted.

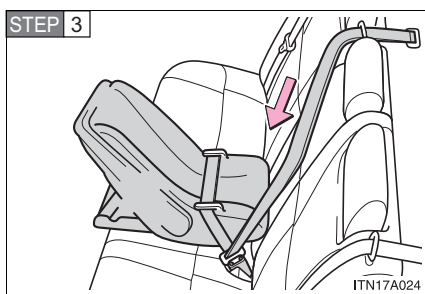

Fully extend the shoulder belt and then allow it to retract slightly in order to activate the ALR lock mode.

Lock mode allows the seat belt to retract only.

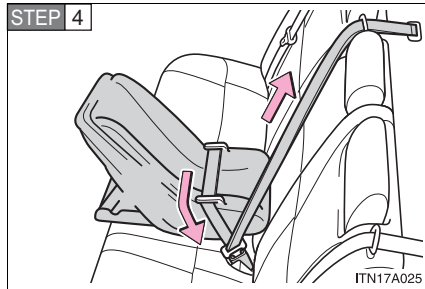

While pushing the child restraint system down into the rear seat, allow the shoulder belt to retract until the child seat is securely in place.

After the shoulder belt has retracted to a point where there is no slack in the belt, pull the belt to check that it cannot be extended.

1

Before driving

■ **Forward-facing — Convertible seat**

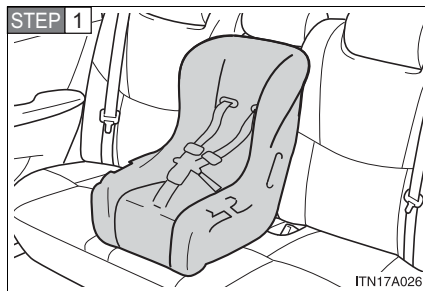

Place the child restraint system on the seat facing the front of the vehicle.

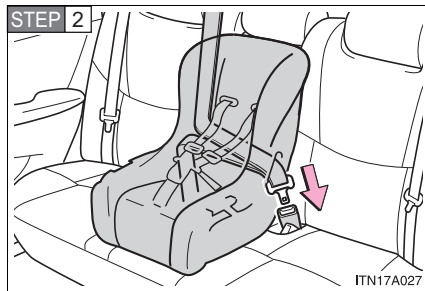

Run the seat belt through the child restraint system and insert the plate into the buckle. Make sure that the belt is not twisted.

1-7. Safety information

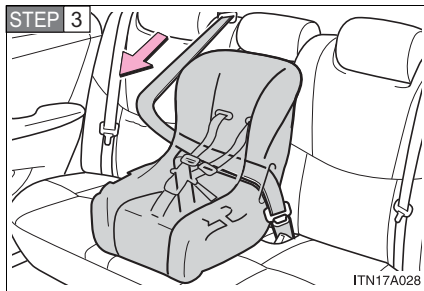

Fully extend the shoulder strap and then allow it to retract slightly into the ALR lock mode.

Lock mode allows the seat belt to retract only.

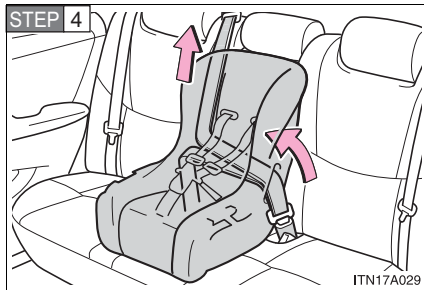

While pushing the child restraint system into the rear seat, allow the shoulder belt to retract until the child restraint system is securely in place.

After the shoulder belt has retracted to a point where there is no slack in the belt, pull the belt to check that it cannot be extended.

STEP 5 If the child restraint has a top tether strap, the top tether strap should be latched onto the top tether strap anchors. (→P. 120)

■ **Booster seat**

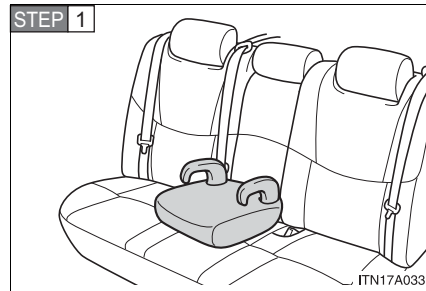

Place the booster seat on the seat facing the front of the vehicle.

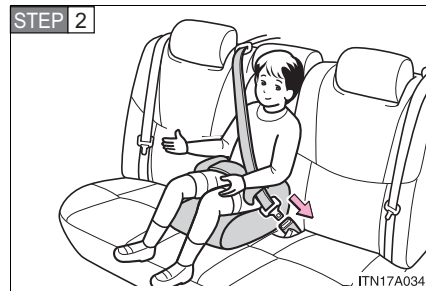

Sit the child in the booster seat. Fit the seat belt to the booster seat according to the manufacturer's instructions and insert the plate into the buckle. Make sure that the belt is not twisted.

Check that the shoulder belt is correctly positioned over the child's shoulder, and that the lap belt is as low as possible.
(→P. 61)

1

Before driving

Removing a child restraint installed with a seat belt

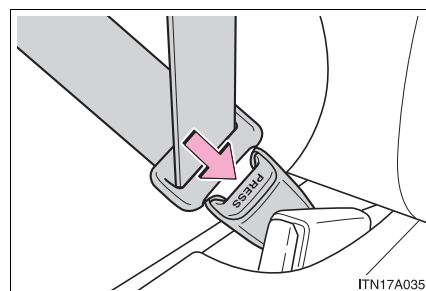

Push the buckle release button and fully retract the seat belt.

Child restraint systems with a top tether strap

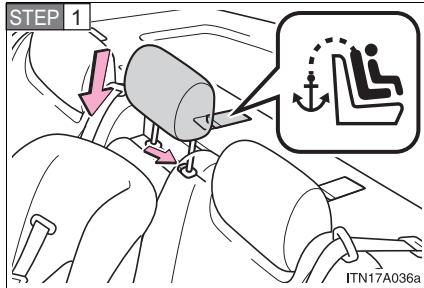

Secure the child restraint using a seat belt or LATCH anchors, and lock the head restraint in place at the lowest position.

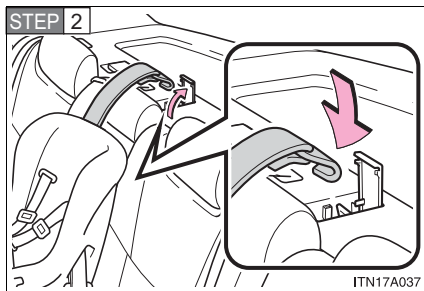

Open the anchor bracket cover, latch the hook onto the anchor bracket and tighten the top tether strap.

Make sure the top tether strap is securely latched.

■ Laws and regulations pertaining to anchorages

The LATCH system conforms to FMVSS225 or CMVSS210.2.

Child restraint systems conforming to FMVSS213 or CMVSS213 specifications can be used.

This vehicle is designed to conform to the SAE J1819.

⚠ CAUTION

■ When installing a booster seat

Do not fully extend the shoulder belt to prevent the belt from going to ALR lock mode: (→P. 63)

ALR mode causes the belt to tighten only which could cause injury or discomfort to the child.

⚠ CAUTION**■ When installing a child restraint system**

Follow the directions given in the child restraint system installation manual and fix the child restraint system securely in place.

If the child restraint system is not correctly fixed in place, the child or other passengers may be injured or even killed in the event of sudden braking, sudden swerving or an accident.

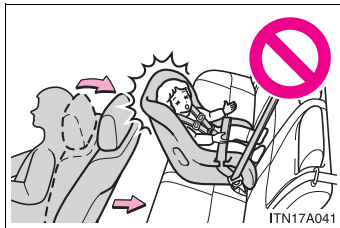

- If the driver's seat interferes with the child restraint system and prevents it from being attached correctly, attach the child restraint system to the right-hand rear seat.

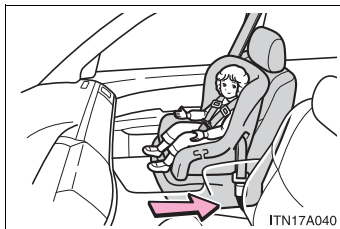

- Only put a forward-facing child seat on the front seat when unavoidable. When installing a forward-facing child restraint on the front passenger seat, move the seat as far back as possible even if "AIR BAG OFF" indicator light is illuminated. Failing to do so may result in death or serious injury if the airbags deploy (inflate).

- When a booster seat is installed, always ensure that the shoulder belt is positioned across the center of the child's shoulder. The belt should be kept away from the child's neck, but not so that it could fall off the child's shoulder. Failing to do so may result in death or serious injury in the event of sudden braking, sudden swerving or an accident.
- Ensure that the belt and tab are securely locked and the seat belt is not twisted.

1

Before driving

 CAUTION

■ **When installing a child restraint system**

- Push and pull the child restraint system from side to side and forward to be sure it is secure.
- After securing a child restraint system, never adjust the seat.
- Follow all installation instructions provided by the child restraint system manufacturer.

■ **Do not use a seat belt extender**

If a seat belt extender is used when installing a child restraint system, the seat belt will not securely hold the child restraint system, which could cause death or serious injury to the child or other passengers in the event of sudden braking, sudden swerving or an accident.

■ **To correctly attach a child restraint system to the anchors**

When using the LATCH anchors, be sure that there are no foreign objects around the anchors and that the seat belt is not caught behind the child seat. Make sure the child restraint system is securely attached, or it may cause death or serious injury to the child or other passengers in the event of a sudden stop, sudden swerve or accident.

2-1. Driving procedures

Driving the vehicle

The following procedures should be observed to ensure safe driving.

■ Starting the engine

→P. 133, 137

■ Driving

STEP 1 With the brake pedal depressed, shift the shift lever to "D".
(→P. 140)

STEP 2 Release the parking brake.
(→P. 146)

STEP 3 Gradually release the brake pedal and gently push the accelerator pedal to accelerate the vehicle.

■ Stopping

STEP 1 With the shift lever in "D", push the brake pedal.

STEP 2 If necessary, set the parking brake.

When the vehicle is stopped for an extended period of time, shift the shift lever to "P".
(→P. 140)

■ Parking the vehicle

STEP 1 With the shift lever in "D", push the brake pedal.

STEP 2 Set the parking brake.
(→P. 146)

STEP 3 Shift the shift lever to "P".
(→P. 140)

STEP 4 Stop the engine.

STEP 5 Lock the door, making sure that you have the key on your person.

Starting on a steep incline

- STEP 1** Firmly set the parking brake and shift the shift lever to “D”.
- STEP 2** Gently depress the accelerator pedal.
- STEP 3** Release the parking brake.

■ Driving in the rain

- Drive carefully when it is raining, because visibility will be reduced, the windows may become fogged-up, and the road will be slippery.
- Drive carefully when it starts to rain, because the road surface will be especially slippery.
- Refrain from high speeds when driving on an expressway in the rain, because there may be a layer of water between the tires and the road surface, preventing the steering and brakes from operating properly.

■ Breaking in your new Toyota

To extend the life of the vehicle, the following precautions are recommended to observe:

- For the first 200 miles (300 km):
 - Avoid sudden stops.
- For the first 1000 miles (1600 km):
 - Do not drive at extremely high speeds.
 - Avoid sudden acceleration.
 - Do not drive continuously in the low gears.
 - Do not drive at a constant speed for extended periods.

■ Operating your vehicle in a foreign country

Comply with the relevant vehicle registration laws and confirm the availability of the correct fuel. (→P. 432)

 CAUTION

■ **When starting the vehicle**

Always keep your foot on the brake pedal while stopped with the engine running. This prevents the vehicle from creeping.

■ **When driving the vehicle**

- Do not drive if you are unfamiliar with the location of the brake and accelerator pedals to avoid depressing the wrong pedal.
 - Accidentally depressing the accelerator pedal instead of the brake pedal will result in sudden acceleration that may lead to an accident that could result in death or serious injury.
 - When backing up, you may twist your body around, leading to a difficulty in operating the pedals. Make sure to operate the pedals properly.
 - Make sure to keep a correct driving posture even when moving the vehicle only slightly, allowing you to depress the brake and accelerator pedals properly.
 - Depress the brake pedal using your right foot. Depressing the brake pedal using your left foot may delay response in an emergency, resulting in an accident.
- Do not drive the vehicle over or stop the vehicle near flammable materials. The exhaust system and exhaust gases can be extremely hot. This may cause a fire if there is any flammable material nearby.
- Do not let the vehicle roll backwards while the shift lever is in a driving position, or roll forward while the shift lever is in "R". Doing so may cause the engine not to operate or lead to poor brake and steering performance, resulting in an accident or damage to the vehicle.
- If the smell of exhaust is noticed inside the vehicle, open the windows and check that the trunk is closed.

Large amounts of exhaust in the vehicle can cause driver drowsiness and an accident, resulting in death or a serious health hazard. Have the cause of the problem inspected immediately.

⚠ CAUTION**■ When driving the vehicle**

- Do not shift the shift lever to "P" while the vehicle is moving.
Doing so can damage the transmission and may result in a loss of vehicle control.
- Do not shift the shift lever to "R" while the vehicle is moving forward.
Doing so can damage the transmission and may result in a loss of vehicle control.
- Do not shift the shift lever to "D" while the vehicle is moving backward.
Doing so can damage the transmission and may result in a loss of vehicle control.
- Moving the shift lever to "N" while the vehicle is moving will disengage the engine from the transmission. Engine braking is not available when "N" is selected.
- During normal driving, do not turn off the engine. Turning the engine off while driving will not cause loss of steering or braking control, but the power assist to these systems will be lost. This will make it more difficult to steer and brake, so you should pull over and stop the vehicle as soon as it is safe to do so.
However, in the event of an emergency, such as if it becomes impossible to stop the vehicle in the normal way: →P. 393
- Use engine braking (downshift) to maintain a safe speed when driving down a steep hill.
Using the brakes continuously may cause the brakes to overheat and lose effectiveness. (→P. 142)
- Be careful when driving on slippery surfaces, as the vehicle may spin or skid when downshifting, rapidly accelerating, braking or turning.
- Do not adjust the position of the steering wheel, the seat, or the inside or outside rear view mirrors while driving.
Doing so may result in a loss of vehicle control that can cause accidents that may result in death or serious injury.
- Always check that all passengers' arms, heads or other parts of their bodies are not outside the vehicle, as this may result in death or serious injury.

 CAUTION

- Do not drive in excess of the speed limit. Even if the legal speed limit permits it, do not drive over 85 mph (140 km/h) unless your vehicle has high speed capability tires. Driving over 85 mph (140 km/h) may result in tire failure, loss of control and possible injury. Be sure to consult a tire dealer to determine whether the tires on your vehicle are high-speed capability tires or not before driving at such speeds.

■ **When driving on slippery road surfaces**

- Sudden braking, acceleration and steering may cause tire slippage and reduce your ability to control the vehicle, resulting in an accident.
- Sudden changes in engine speed, such as engine braking caused by up-shifting or down-shifting, may cause the vehicle to skid, resulting in an accident.
- After driving through a puddle, lightly depress the brake pedal to make sure that the brakes are functioning properly. Wet brake pads may prevent the brakes from functioning properly. If the brakes on only one side are wet and not functioning properly, steering control may be affected, resulting in an accident.

■ **When shifting the shift lever**

Be careful not to shift the shift lever with the accelerator pedal depressed. This may lead to unexpected rapid acceleration of the vehicle that may cause an accident and result in death or serious injury.

■ **When the vehicle is stopped**

- Do not race the engine.
If the vehicle is in any gear other than "P" or "N" the vehicle may accelerate suddenly and unexpectedly, and may cause an accident.
- Do not leave the vehicle with the engine on for a long time.
If such a situation cannot be avoided, park the vehicle in an open space and check that exhaust fumes do not enter the vehicle interior.
- Always keep a foot on the brake pedal while the engine is running to prevent an accident caused by the vehicle moving.

⚠ CAUTION**■ When the vehicle is parked**

- Do not leave glasses, cigarette lighters, spray cans, or soft drink cans in the vehicle when it is in the sun.
Failure to do so may result in the following:
 - Gas may leak from a cigarette lighter or spray can, and may lead to a fire.
 - The temperature inside the vehicle may cause the plastic lenses and plastic material of eye glasses to deform or crack.
 - Soft drink cans may fracture, causing the contents to spray over the interior of the vehicle, and may also cause a short circuit in the vehicle's electrical components.
- Always apply the parking brake, shift the shift lever to "P", stop the engine and lock the vehicle.
Do not leave the vehicle unattended while the engine is running.
- Do not touch the exhaust pipe while the engine is running or immediately after turning the engine off.
Doing so may cause burns.
- Do not leave the engine running in an area with snow build up, or where it is snowing, or snow is expected to fall.
Exhaust gases may collect and enter the vehicle, leading to death or a serious health hazard.

■ Exhaust gases

Exhaust gases include harmful carbon monoxide (CO) that is colorless and odorless. Inhaling exhaust gases may lead to death or a serious health hazard.

- If the vehicle is in a poorly ventilated area, stop the engine. In a closed area, such as a garage, exhaust gases may collect and enter the vehicle. This may lead to death or a serious health hazard.
- The exhaust should be checked occasionally. If there is a hole or crack caused by corrosion, damage to a joint or abnormal exhaust noise, be sure to have the vehicle inspected and repaired by your Toyota dealer. Failure to do so may allow exhaust gases to enter the vehicle, resulting in death or a serious health hazard.

 CAUTION

■ **When taking a nap in the vehicle**

Always turn the engine off.

Otherwise, you may accidentally move the shift lever or press the accelerator pedal, which could cause an accident or fire due to abnormal engine overheating. Additionally, if the vehicle is parked in a poorly ventilated area, exhaust gases may collect and enter the vehicle, leading to death or a serious health hazard.

■ **When braking the vehicle**

- When the brakes are wet, drive more cautiously.

Braking distance increases when the brakes are wet, and may cause one side of the vehicle to brake differently than the other side. Also the parking brake may not securely hold the vehicle.

- If the power brake assist function does not operate, do not follow other vehicles closely and avoid downhill or sharp turns that require making. In this case, braking is still possible, but it will require more force on the pedal than usual. Braking distance may also increase.

- Do not pump the brake pedal if the engine stalls. Each push on the pedal uses up the reserve for the power-assisted brakes.

- The brake system consists of 2 individual hydraulic systems: if one of the systems fails, the other will still operate. In this case, the brake pedal should be depressed more firmly than usual and braking distance becomes longer. Do not drive your vehicle with only a single brake system. Have your brakes fixed immediately.

 NOTICE

■ **While driving the vehicle**

Do not use the accelerator pedal or depress accelerator and brake pedals together to hold the vehicle on a hill.

■ **When parking the vehicle**

Always put the shift lever in "P". Failure to do so may cause the vehicle to move or the vehicle may accelerate suddenly if the accelerator pedal is accidentally depressed.

■ **Avoiding damage to vehicle parts**

- Do not turn the steering wheel fully in either direction and hold it there for a long time.
Doing so may damage the power steering pump.
- When driving over bumps in the road, drive as slowly as possible to avoid damaging the wheels, underside of the vehicle, etc.

■ **If you hear a squealing or scraping noise (brake pad wear limit indicators)**

Have your Toyota dealer check and replace the brake pads as soon as possible.
The rotor damage can result if the pads are not replaced when needed.

■ **If you get a flat tire while driving**

A flat or damaged tire may cause the following situations. Hold the steering wheel firmly and gradually press the brake pedal to slow down the vehicle.

- It may be difficult to control your vehicle.
- The vehicle will make abnormal sounds.
- The vehicle will behave abnormally.

Replace a flat tire with a new one. (→P. 408)

■ **If the vehicle becomes stuck or bogged**

Do not spin the wheels recklessly when any of the tires is up in the air, or stuck in sand or mud, etc. This may damage the drive system components or propel the vehicle forward (or in another direction) and cause an accident.

 NOTICE

■ **When encountering flooded roads**

Do not drive on a road that has flooded after heavy rain etc. Doing so may cause the following serious damage to the vehicle.

- Engine stalling
- Short in electrical components
- Engine damage caused by water immersion

In the event that you drive on a flooded road and the vehicle is flooded, be sure to have your Toyota dealer check the following.

- Brake function
- Changes in quantity and quality of oil and fluid used for the engine, transmission, differentials, etc.
- Lubricant condition for the bearings and suspension joints (where possible) and the function of all joints, bearings, etc.

2-1. Driving procedures

Engine (ignition) switch (with smart key system)

Performing the following operations when carrying the electronic key on your person starts the engine or changes “ENGINE START STOP” switch modes.

■ Starting the engine

STEP 1 Check that the parking brake is set.

STEP 2 Check that the shift lever is set in “P”.

STEP 3 Sit in the driver’s seat and firmly depress the brake pedal.

The “ENGINE START STOP” switch indicator turns green.

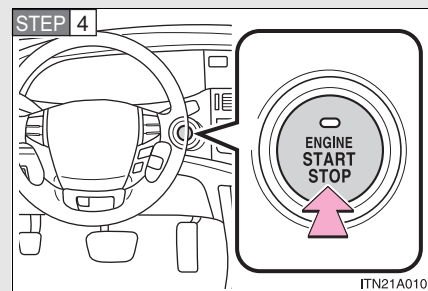

Press the “ENGINE START STOP” switch.

The engine can be started from any mode.

2

When driving

■ Changing engine (ignition) switch mode

Modes can be changed by pressing the “ENGINE START STOP” switch with the brake pedal released. (The mode changes each time the switch is pressed.)

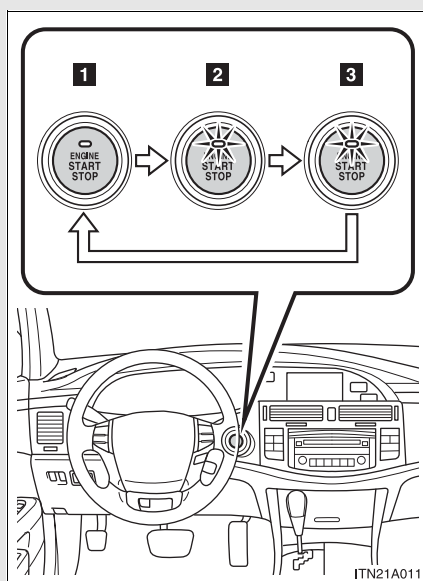

1 OFF*

Emergency flashers can be used.

2 ACCESSORY mode

Some electrical components such as the audio system can be used.

The “ENGINE START STOP” switch indicator turns amber.

3 IGNITION ON mode

All electrical components can be used.

The “ENGINE START STOP” switch indicator turns amber.

*: If the shift lever is in a position other than “P” when turning off the engine, the “ENGINE START STOP” switch will be turned to ACCESSORY mode, not to OFF.

■ **When the steering lock cannot be released**

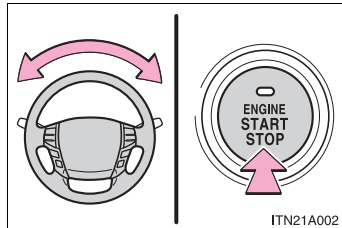

The green indicator light on the “ENGINE START STOP” switch will flash. Press the “ENGINE START STOP” switch again while turning the steering wheel slightly in either direction.

■ **If the engine does not start**

The engine immobilizer system may not have been deactivated. (→P. 83)

■ **When the “ENGINE START STOP” switch indicator flashes in amber**

The system may be malfunctioning. Have the vehicle inspected by your Toyota dealer immediately.

■ **Auto power OFF function**

The “ENGINE START STOP” switch will automatically turn OFF when left in ACCESSORY mode for 1 hour or more.

■ **Electronic key battery depletion**

→P. 30

■ **When the electronic key battery is discharged**

→P. 363

■ **Conditions affecting operation**

→P. 28

 CAUTION

■ **When starting the engine**

Always start the engine while sitting in the driver's seat. Do not press the accelerator pedal while starting the engine under any circumstances. Doing so may cause an accident resulting in death or serious injury.

■ **Stopping the engine in an emergency**

If you want to stop the engine in an emergency while driving the vehicle, push and hold the "ENGINE START STOP" switch for more than 3 seconds. However, do not touch the "ENGINE START STOP" switch while driving except in an emergency. Turning the engine off while driving will not cause loss of steering or braking control, but the power assist to these systems will be lost. This will make it more difficult to steer and brake, so you should pull over and stop the vehicle as soon as it is safe to do so.

 NOTICE

■ **To prevent battery discharge**

Do not leave the "ENGINE START STOP" switch in ACCESSORY or IGNITION ON mode for long periods if the engine is not running.

■ **When starting the engine**

- Do not race the engine.
- If the engine becomes difficult to start or stalls frequently, have the engine checked immediately.

2-1. Driving procedures

Engine (ignition) switch (without smart key system)

■ Starting the engine

- STEP 1** Check that the parking brake is set.
- STEP 2** Check that the shift lever is set in "P".
- STEP 3** Sit in the driver's seat and firmly depress the brake pedal.
- STEP 4** Turn the engine switch to the "START" position and start the engine.

■ Engine (ignition) switch

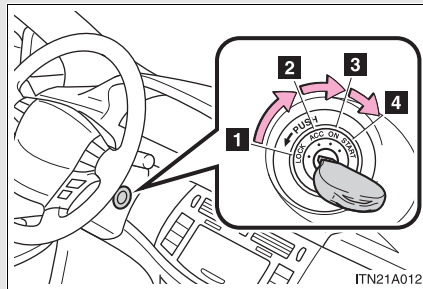

1 "LOCK"

The steering wheel is locked and the key can be removed. (The key can be removed only when the shift lever is in "P".)

2 "ACC"

Some electrical components such as the audio system can be used.

3 "ON"

All electrical components can be used.

4 "START"

For starting the engine.

2

When driving

■ Turning the key from "ACC" to "LOCK"

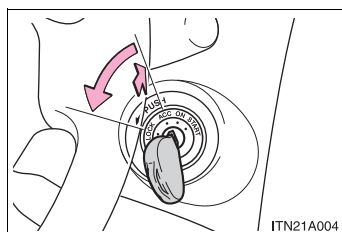

STEP 1 Shift the shift lever to "P".

STEP 2 Push in the key and turn to the "LOCK" position.

■ **When the steering lock cannot be released**

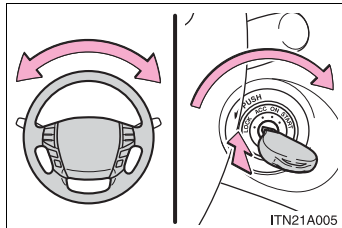

When starting the engine, the engine switch may seem stuck in the “LOCK” position. To free it, turn the key while turning the steering wheel slightly in either direction.

■ **If the engine does not start**

The engine immobilizer system may not have been deactivated. (→P. 83)

■ **Key reminder function**

A buzzer sounds if the driver’s door is opened, while the engine switch is in the “ACC” or “LOCK” position to remind you to remove the key.

⚠ CAUTION

■ **When starting the engine**

Always start the engine while sitting in the driver’s seat. Do not press the accelerator pedal while starting the engine under any circumstances. Doing so may cause an accident resulting in death or serious injury.

■ **While driving**

Do not turn the engine switch to the “LOCK” position. If in an emergency, you must turn the engine off while the vehicle is moving, turn the key only to the “ACC” position.

 NOTICE

■ **To prevent battery discharge**

Do not leave the key in the “ACC” or “ON” position for long periods without the engine running.

■ **When starting the engine**

- Do not crank for more than 30 seconds at a time. This may overheat the starter and wiring systems.
- Do not race the cold engine.
- If the engine becomes difficult to start or stalls frequently, have the engine checked immediately.

2-1. Driving procedures Automatic transmission

Select a shift position appropriate for the driving conditions.

■ Shifting the shift lever

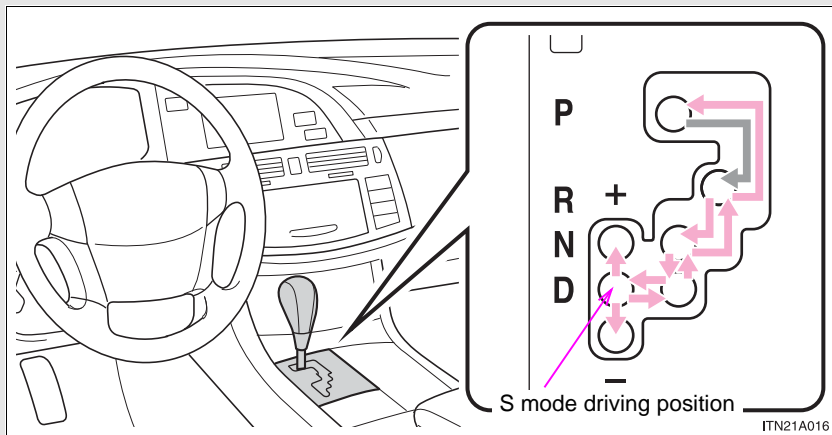

Vehicles with smart key system:

While the “ENGINE START STOP” switch is in IGNITION ON mode, depress the brake pedal and move the shift lever.

Vehicles without smart key system:

While the engine switch is in the “ON” position, depress the brake pedal and move the shift lever.

■ Shift position uses

Shift position	Function
P	Parking the vehicle or starting the engine
R	Reversing
N	Neutral
D	Normal driving ^{*1}
	S mode driving ^{*2}

^{*1}: Shifting to the D position allows the system to select a gear suitable for the driving conditions.

Setting the shift lever to the D position is recommended for normal driving.

^{*2}: Selecting shift ranges using S mode restricts the upper limit of the possible gear ranges, controls engine braking force, and prevents unnecessary upshifting.

2

When driving

Changing shift ranges in S mode

Shift the shift lever to the S mode driving position and operate the shift lever.

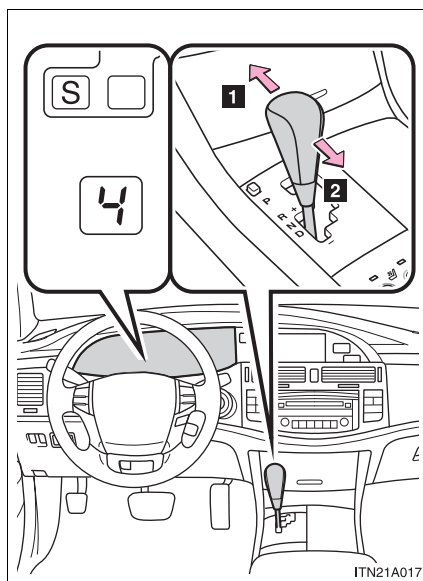

- 1 Upshifting
- 2 Downshifting

The initial shift range in S mode is automatically set to “5” or “4” according to vehicle speed. However, the initial shift range may be set to “3” if AI-SHIFT has operated while the shift lever was in the D position. (→P. 144)

■ **Shift ranges and their functions**

- You can choose from 6 levels of engine braking force.
- A lower shift range will provide greater engine braking force than a higher shift range, and the engine speed will also increase.

■ **S mode**

- When the shift range is “5” or lower, holding the shift lever toward “+” sets the shift range to “6”.
- To prevent excessive engine speed, a function was adopted that automatically selects a higher shift range before engine speed becomes too high.
- To protect the automatic transmission, a function is adopted that automatically selects a higher shift range when the fluid temperature is high.

■ **Down shifting restrictions warning buzzer (in the S mode)**

To help ensure safety and driving performance, downshifting operation may sometimes be restricted. In some circumstances, downshifting may not be possible even when the shift lever is operated. (The warning buzzer will sound twice.)

2-1. Driving procedures

■ When driving with the cruise control system or dynamic laser cruise control system

Engine braking will not occur in S mode, even when downshifting to “5” or “4”. (→P. 165, 168)

■ If the shift lever cannot be shifted from P

→P. 416

■ If the “S” indicator does not come on even after shifting the shift lever to S mode driving position

This may indicate a malfunction in the automatic transmission system. Have the vehicle inspected by your Toyota dealer immediately.

(In this situation, the transmission will operate in the same manner as when the shift lever is in D.)

■ AI-SHIFT

AI-SHIFT automatically selects the suitable gear according to driver performance and driving conditions.

AI-SHIFT automatically operates when the shift lever is in the D position. (Shifting the shift lever to the S mode driving position cancels the function.)

2-1. Driving procedures

Turn signal lever

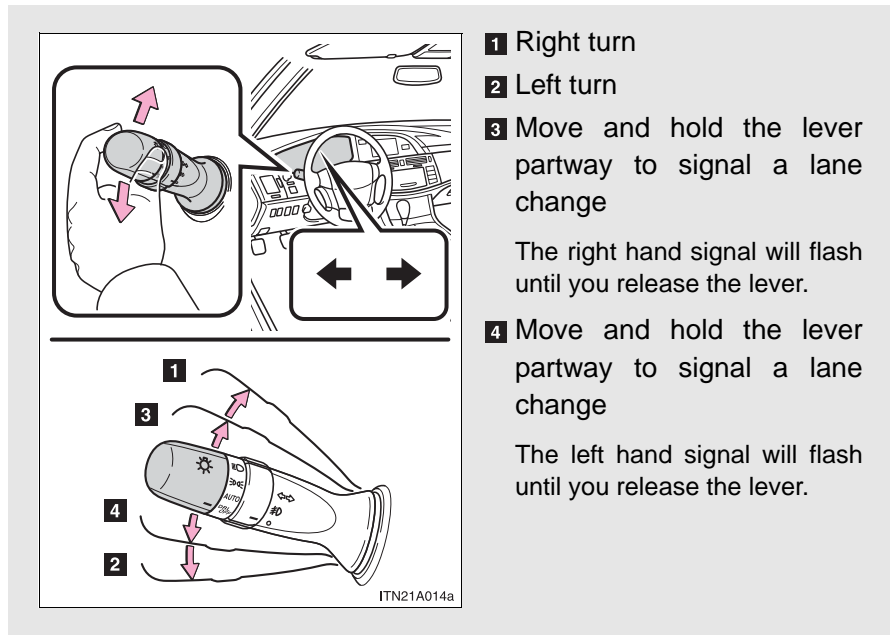

2

When driving

■ Turn signals can be operated when

- ▶ Vehicles with smart key system

The "ENGINE START STOP" switch is in IGNITION ON mode.

- ▶ Vehicles without smart key system

The engine switch is in the "ON" position.

■ If the indicators flash faster than usual

Check that a light bulb in the front or rear turn signal lights has not burned out.

2-1. Driving procedures

Parking brake

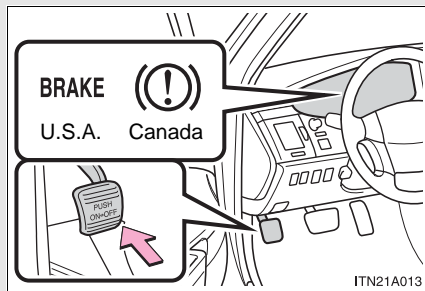

Sets the parking brake*
(Depressing the pedal again releases the parking brake.)

*: Fully depress the parking brake pedal with your left foot while depressing the brake pedal with your right foot.

NOTICE

■ Before driving

Fully release the parking brake.

Driving the vehicle with the parking brake set will lead to brake components overheating, which may affect braking performance and increase brake wear.

2-1. Driving procedures

Horn

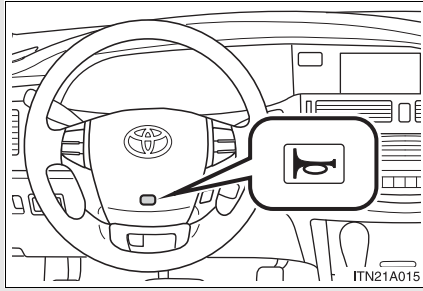

To sound the horn, press on or close to the  mark.

2

When driving

2-2. Instrument cluster Gauges and meters

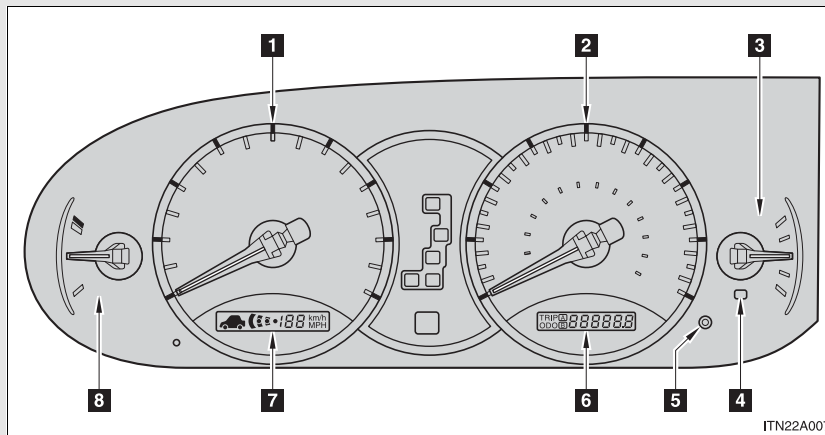

The units used on the speedometer may differ depending on the target region.

- 1** Tachometer
Displays the engine speed in revolutions per minute.
- 2** Speedometer
Displays the vehicle speed.
- 3** Fuel gauge
Displays the quantity of fuel remaining in the tank.
- 4** Low fuel level warning light
→P. 395
- 5** Odometer/trip meter and trip meter reset button
→P. 149

6 Odometer/Trip meter display

▶ Odometer

Displays the total distance the vehicle has been driven.

▶ Trip meter

Displays the distance the vehicle has been driven since the meter was last reset. Trip meters A and B can be used to record and display different distances independently.

7 Dynamic laser cruise control display

→P. 168

8 Engine coolant temperature gauge

Displays the engine coolant temperature.

2

When driving

Odometer and trip meter display button

▶ Vehicles with smart key system

Pressing this button switches among odometer and trip meter when the “ENGINE START STOP” switch is IGNITION ON mode.

▶ Vehicles without smart key system

Pressing this button switches among odometer and trip meter when the engine switch is in the “ON” position.

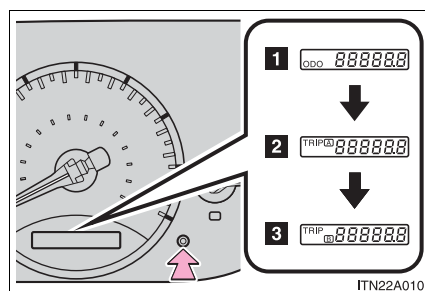
**1 Odometer****2 Trip meter A****3 Trip meter B**

Pushing and holding the button will reset the trip meter.

Instrument panel light control

The brightness of the instrument panel lights can be adjusted.

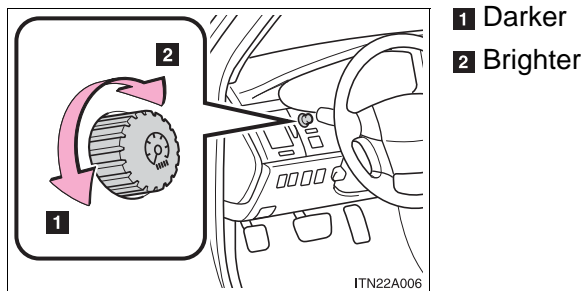

NOTICE

■ To prevent damage to the engine and its components

- Do not let the indicator needle of the tachometer enter the red zone, which indicates the maximum engine speed.
- The engine may be overheating if the temperature gauge is in the red zone ("H"). In this case, immediately stop the vehicle in a safe place. Check the engine after it has cooled completely. (→P. 424)

2-2. Instrument cluster Indicators and warning lights

The indicator and warning lights on the instrument cluster and center panel inform the driver of the status of the vehicle's various systems.

► Instrument cluster

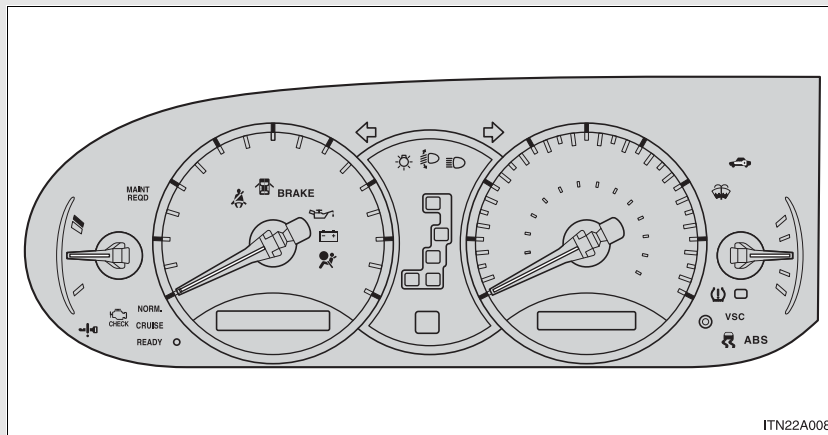

The units used on the speedometer and some indicators may differ depending on the target region.

► Center display

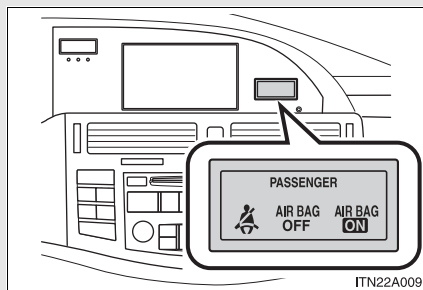

2

When driving

2-2. Instrument cluster

■ Indicators

The indicators inform the driver of the operating state of the vehicle's various systems.



Turn signal indicator
(→P. 145)



Headlight high beam indicator (→P. 157)



Headlight indicator
(→P. 156)



Tail light indicator
(→P. 156)



Security indicator
(→P. 83, 85)

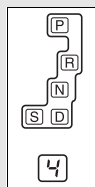

Shift position and shift range indicators
(→P. 140)



Cruise control indicator
(→P. 165)



Cruise control indicator
(→P. 165, 168)



Ready mode indicator
(→P. 168)



Conventional cruise indicator (→P. 168)



Slip indicator (→P. 181)



SRS airbag on-off indicator (→P. 103)

■ Warning lights

Warning lights inform the driver of malfunctions in the indicated vehicle's systems. (→P. 393)

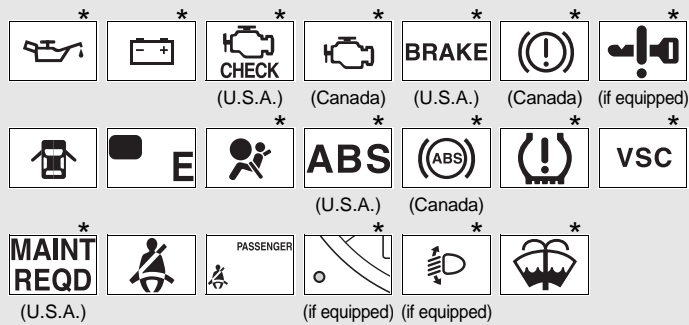

*: These lights turn on when the “ENGINE START STOP” switch is turned to IGNITION ON mode (vehicles with smart key system) or the engine switch is turned to the “ON” position (vehicles without smart key system) to indicate that a system check is being performed. They will turn off after the engine is started, or after a few seconds. There may be a malfunction in a system if the lights do not come on, or turn off. Have the vehicle inspected by your Toyota dealer.

⚠ CAUTION

■ If a safety system warning light does not come on

Should a safety system light such as ABS and the SRS airbag warning light not come on when you start the engine, this could mean that these systems are not available to help protect you in an accident, which could result in death or serious injury. Have the vehicle inspected by your Toyota dealer immediately if this occurs.

2-2. Instrument cluster Center display

The center display provides information including your vehicle's driving condition, outside temperature.

- ▶ Vehicles with navigation system
Refer to "Navigation System Owner's Manual".
- ▶ Vehicles without navigation system

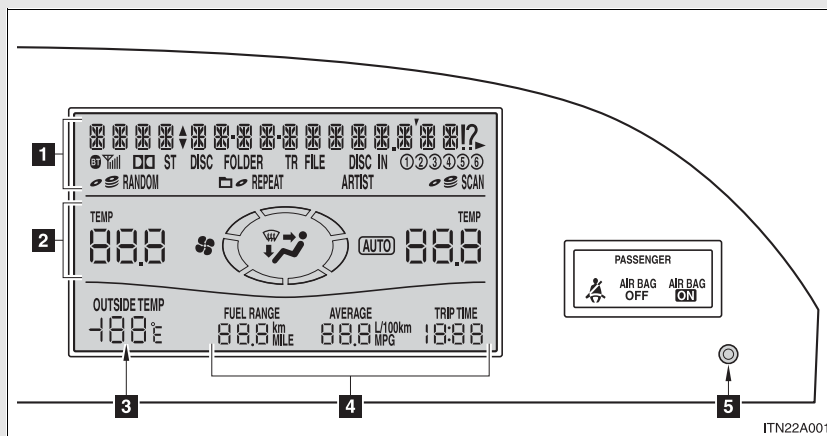

- 1** Audio display (→P. 210)
- 2** Air conditioning display (→P. 198)
- 3** Outside temperature display (→P. 289)
- 4** Trip information display
Displays driving range, fuel consumption and other cruising related information.
- 5** Pattern selector knob
Display items can be switched by pushing the knob.
All the display → Audio display and air conditioning display → off

Trip information

■ Driving range



Displays the estimated maximum distance that can be driven with the quantity of fuel remaining.

- This distance is computed based on your average fuel consumption. As a result, the actual distance that can be driven may differ from that displayed.
- When only a small amount of fuel is added to the tank, the display may not be updated.

■ Average fuel consumption after refueling

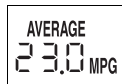

Displays the average fuel consumption since the vehicle was last refueled.

■ Elapsed time



Displays the elapsed time since the engine was started or since the function was reset.

The function can be reset when the "ENGINE START STOP" switch or the engine switch is turned off.

2

When driving

⚠ CAUTION

■ The center display at low temperatures

Allow the interior of the vehicle to warm up before using the liquid crystal information display. At extremely low temperatures, the information display monitor may respond slowly, and display changes may be delayed.

2-3. Operating the lights and windshield wipers

Headlight switch

The headlights can be operated manually or automatically.

► U.S.A.

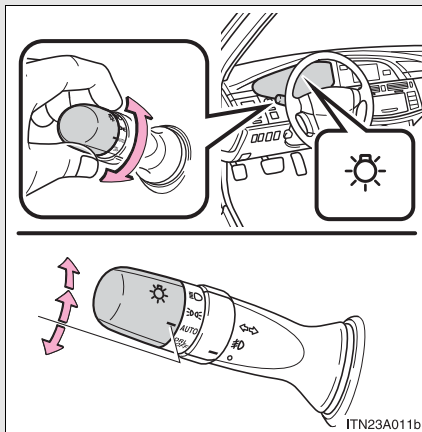

The side marker, parking, tail, license plate and instrument panel lights turn on.



The headlights and all lights listed above turn on.

AUTO

The headlights and all the lights listed above turn on and off automatically. (When the "ENGINE START STOP" switch is in IGNITION ON mode [vehicles with smart key system] or the engine switch is in the "ON" position [vehicles without smart key system].)

DRL OFF

(if equipped)

Turn off the daytime running light system.

► Canada

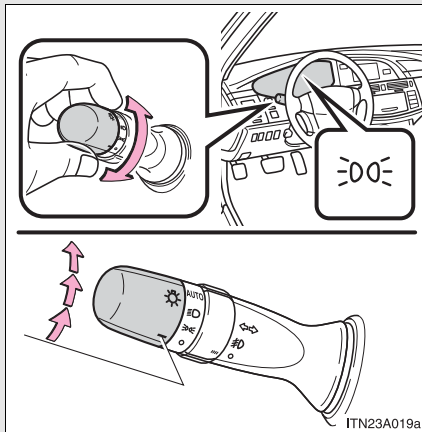

Turning on the high beam headlights

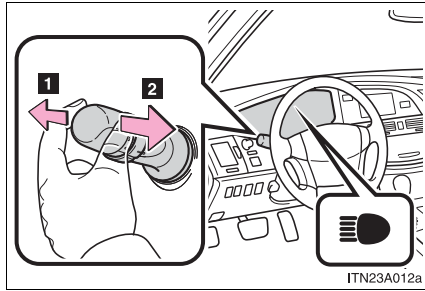

1 With the headlights on, push the lever forward to turn on the high beams.

Pull the lever back to the center position to turn the high beams off.

2 Pull the lever toward you to turn on the high beams.

Release to turn them off. You can flash the high beams with the headlights on or off.

2

When driving

■ Daytime running light system (if equipped)

To make your vehicle more visible to other drivers, the headlights turn on automatically (at a reduced intensity) whenever the engine is started and the parking brake is released. Daytime running lights are not designed for use at night.

■ Headlight control sensor

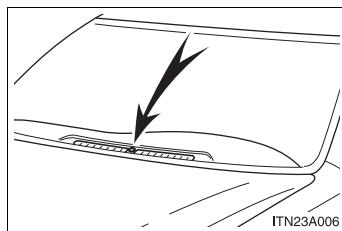



The sensor may not function properly if an object is placed on the sensor, or anything that blocks the sensor is affixed to the windshield.

Doing so interferes with the sensor detecting the level of ambient light and may cause the automatic headlight control system to malfunction.

■ **Automatic light off system**



▶ Vehicles with smart key system

The headlights and tail lights turn off 30 seconds after a door is opened or closed if the “ENGINE START STOP” switch has been turned to ACCESSORY or turned OFF while the headlights are turned on. (The lights turn off immediately if the  button on the key is pressed after all doors are locked.)

To turn the lights on again, turn the “ENGINE START STOP” switch to IGNITION ON mode, or turn the light switch OFF once and then back to the  or  position.

▶ Vehicles without smart key system

The headlights and tail lights turn off 30 seconds after a door is opened or closed if the engine switch has been turned to the “ACC” or “LOCK” position while the headlights are turned on. (The lights turn off immediately if the  button on the key is pressed after all doors are locked.)

To turn the lights on again, turn the engine switch to the “ON” position, or turn the light switch OFF once and then back to the  or  position.

■ **Customization that can be configured at Toyota dealer**

Settings (e.g. light sensor sensitivity) can be changed.
(Customizable features →P. 454)

 NOTICE

■ **To prevent battery discharge**

Do not leave the lights on longer than necessary if the engine is not running.

2-3. Operating the lights and windshield wipers Fog light switch*

The fog lights improve visibility in difficult driving conditions, such as in rain or fog. They can be turned on only when the headlights are on low beam.

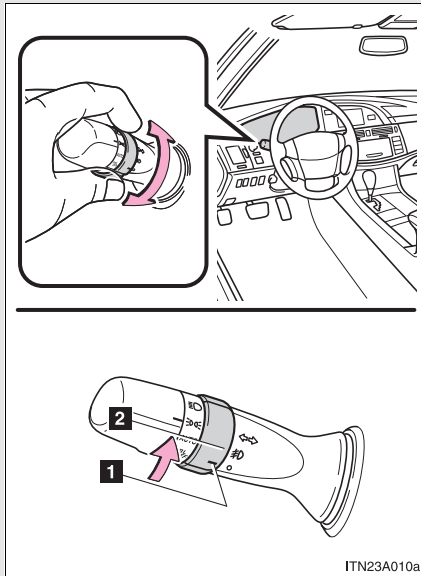

- 1** OFF
- 2** ON

2

When driving

*: If equipped

2-3. Operating the lights and windshield wipers Windshield wipers and washer

■ Intermittent wiper with interval adjuster (if equipped)

Wiper intervals can be adjusted for intermittent operation (when  is selected).

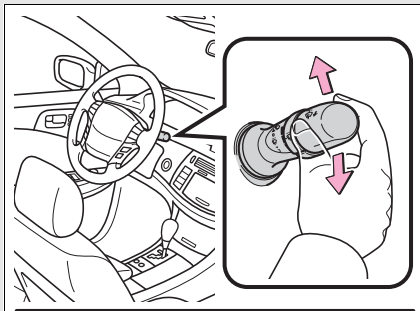

- 1** Intermittent wiper operation
- 2** Low speed wiper operation
- 3** High speed wiper operation
- 4** Temporary operation

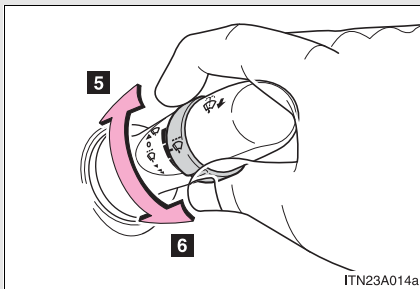
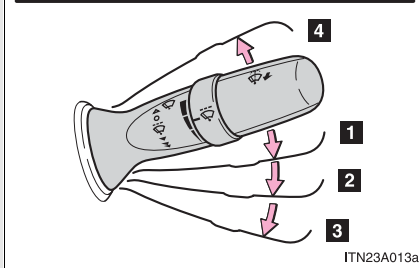

- 5** Increases the intermittent windshield wiper frequency
- 6** Decreases the intermittent windshield wiper frequency

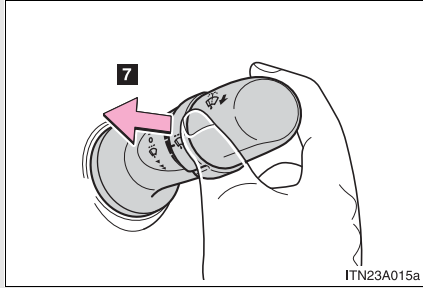

7 Wash/wipe operation

Wipers will automatically operate a couple of times after the washer squirts.

■ Raindrop detection windshield wipers (if equipped)

With “AUTO” selected, the wipers will operate automatically when the sensor detects falling rain. The system automatically adjusts wiper timing in accordance with rain volume and vehicle speed.

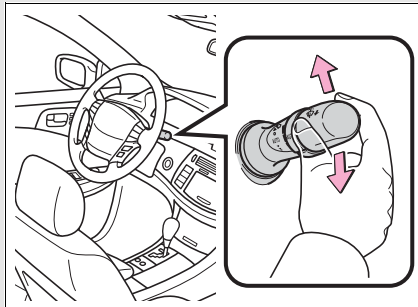

1 Raindrop detection wiper operation

2 Low speed wiper operation

3 High speed wiper operation

4 Temporary operation

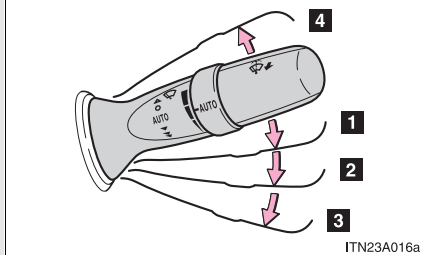

2-3. Operating the lights and windshield wipers

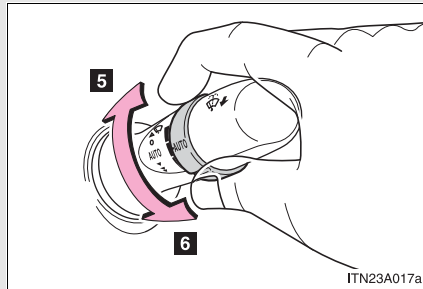

5 Sensor sensitivity (high)

6 Sensor sensitivity (low)

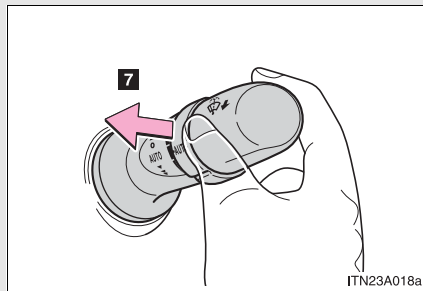

7 Wash/wipe operation

Wipers will automatically operate a couple of times after the washer squirts.

■ **The windshield wiper and washer can be operated when**

- ▶ Vehicles with smart key system

The "ENGINE START STOP" switch is in IGNITION ON mode.

- ▶ Vehicles without smart key system

The engine switch is in the "ON" position.

■ **Dripping prevention wiper sweep**

After washing and wiping operation several times, the wipers operate one more time after a short delay to prevent dripping.

However, the last sweep will not happen if the vehicle is traveling above 106 mph (170 km/h).

■ **Effects of vehicle speed on wiper operation**

Vehicle speed affects the following even when the wipers are not in "AUTO" mode.

- Intermittent wiper interval ( mode)
- Wiper operation when the washer is being used (delay until drip prevention wiper sweep occurs)

With low speed mode, wiper operation will be switched from low speed to intermittent wiper operation only when the vehicle is stationary.

■ **Rain drop sensor (vehicles equipped with the raindrop detection windshield wipers)**

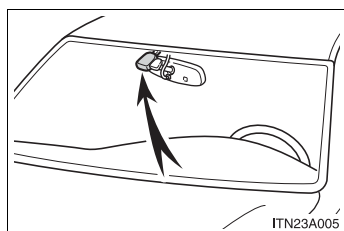

The sensor judges the amount of raindrops.

2-3. Operating the lights and windshield wipers

■ If no windshield washer fluid sprays

Check that the washer nozzles are not blocked if there is washer fluid in the windshield washer fluid reservoir.

■ In extremely hot or cold weather (vehicles equipped with the raindrop detection windshield wipers)

Even if the wiper lever is in "AUTO" mode, the system will switch to intermittent operations when the system malfunctions.

However, when the windshield gets extremely hot (at more than 194°F [90°C]) or extremely cold (at less than 14°F [-10°C]), the wipers do not operate even if the wiper lever is in "AUTO" mode.

■ Customization that can be configured at Toyota dealer

Settings (e.g. drip prevention function) can be changed.
(Customizable features →P. 457)

CAUTION

■ Caution regarding the use of windshield wipers in "AUTO" mode

The windshield wipers may operate unexpectedly if the sensor is touched or the windshield is subject to vibration in "AUTO" mode. Take care that your fingers or anything else do not become caught in the windshield wipers.

NOTICE

■ When the windshield is dry

Do not use the wipers, as they may damage the windshield.

■ When there is no washer fluid spray from the nozzle

Damage to the washer fluid pump may be caused if the lever is pulled toward you and held continually.

2-4. Using other driving systems Cruise control

Use the cruise control to maintain a set speed without using the accelerator.

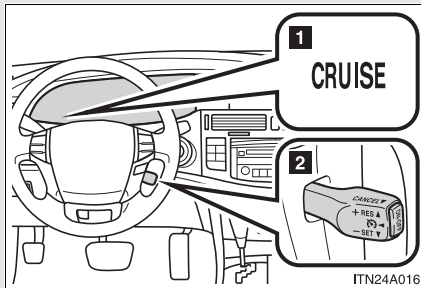

- 1 Indicator
- 2 Cruise control switch

■ Set the vehicle speed

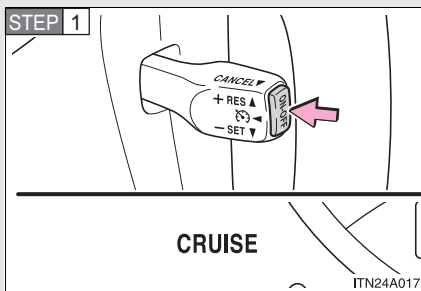

Press the "ON-OFF" button to operate the cruise control.

Push the button once more to deactivate the cruise control.

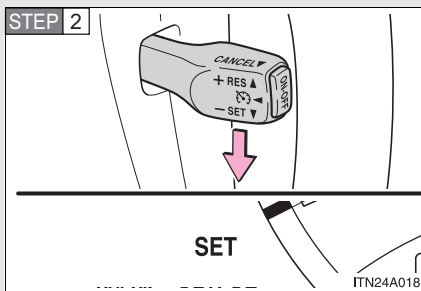

Accelerate or decelerate to the desired speed and press the lever down to set the cruise control speed.

■ Adjusting the speed setting

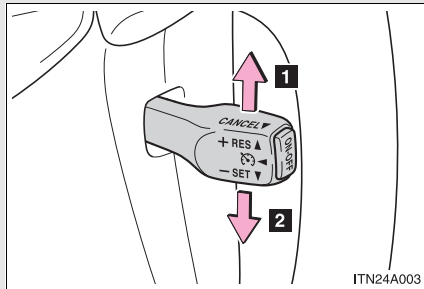

- 1 Increase speed
- 2 Decrease speed

Hold the lever until the desired speed setting is obtained.

Fine adjustment of the set speed (approximately 1.0 mph [1.6 km/h]) can be made by lightly pressing the lever up or down and releasing it.

■ Canceling and resuming regular acceleration

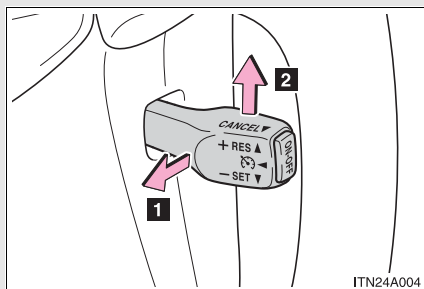

- 1 Cancel

Pull the lever towards you to cancel cruise control.

The setting is also canceled when the brake pedal is depressed.

- 2 Resume

To resume cruise control and return to the set speed, push the lever up.

■ Cruise control can be set when

- The shift lever is in the "D" or "4", "5", or "6" range of "S" mode.
- Vehicle speed is between approximately 25 mph (40 km/h) and 125 mph (200 km/h).

■ Accelerating

The vehicle can be accelerated normally. After acceleration, the set speed resumes.

■ **Automatic cruise control cancelation**

The set speed is automatically canceled in any of the following situations.

- Actual vehicle speed falls more than 10 mph (16 km/h) below the preset vehicle speed
At this time, the memorized set speed is not retained.
- Actual vehicle speed is below 25 mph (40 km/h)
- VSC is activated

■ **If the cruise control indicator light flashes**

Turn the "ON-OFF" button off once, and then reactivate the system.

If the cruise control speed cannot be set or if the cruise control cancels immediately after being activated, there may be a malfunction in the cruise control system. Have the vehicle inspected by your Toyota dealer.

2

When driving

 **CAUTION**

■ **To avoid operating the cruise control by mistake**

Keep the "ON-OFF" button off when not in use.

■ **Situations unsuitable for cruise control**

Do not use cruise control in any of the following situations. Doing so may result in control of the vehicle being lost and could cause serious or fatal accident.

- In heavy traffic
- On roads with sharp bends
- On slippery roads, such as those covered with rain, ice or snow
- On steep hills
Vehicle speed may exceed the set speed when driving down a steep hill.
- On winding roads

2-4. Using other driving systems Dynamic laser cruise control*

Dynamic laser cruise control supplements conventional cruise control with a vehicle-to-vehicle distance control. In the vehicle-to-vehicle distance control mode, the vehicle automatically accelerates or decelerates in order to maintain a set following distance from vehicles ahead.

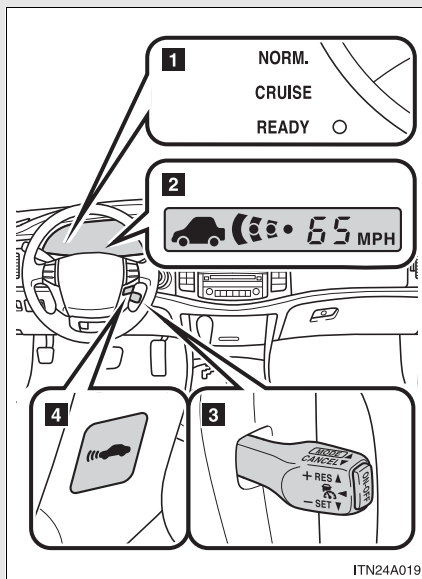

- 1 Indicator
- 2 Display
- 3 Cruise control switch
- 4 Distance switch

*: If equipped

■ Set the vehicle speed

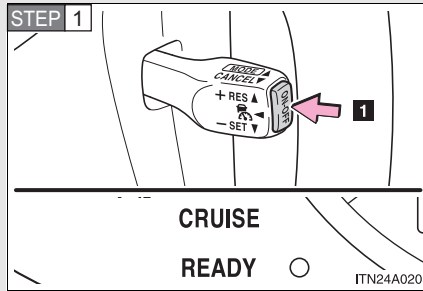

Press the "ON-OFF" button to operate the cruise control.

Push the button once more to deactivate.

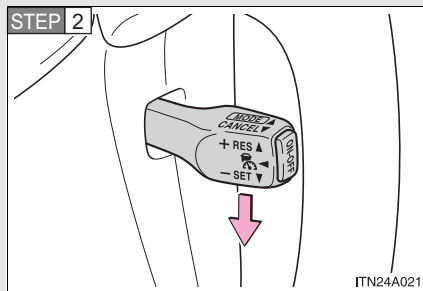

Accelerate or decelerate to the desired speed and press the lever down to set.

2

When driving

2-4. Using other driving systems

■ Selecting conventional constant speed control mode

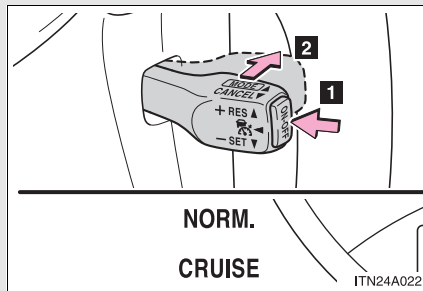

1 Press the “ON-OFF” button to operate the cruise control.

2 Switch to constant speed control mode.
(Push and hold for approximately 1 second.)

Push the button once more to deactivate.

Vehicles with smart key system: Vehicle-to-vehicle distance control mode is always reset when the “ENGINE START STOP” switch is turned to IGNITION ON mode.

Vehicles without smart key system: Vehicle-to-vehicle distance control mode is always reset when the engine switch is turned to the “ON” position.

■ **Adjusting the speed setting**

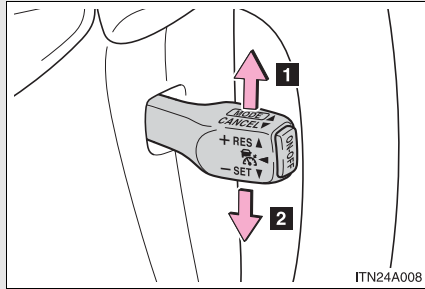

- 1** Increase speed
- 2** Decrease speed

Hold the lever until the desired speed setting is displayed.

In the constant speed control mode, fine adjustment of the set speed (approximately 1.0 mph [1.6 km/h]) can be made by lightly pressing the lever up or down and releasing it.

■ **Canceling and resuming the speed setting**

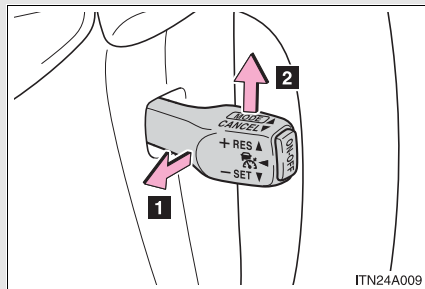

- 1** Cancel

Pull the lever towards you to cancel cruise control.

The setting is also canceled when the brake pedal is depressed.

- 2** Resume

To resume cruise control and return to the set speed, push the lever up.

■ Changing the vehicle-to-vehicle distance

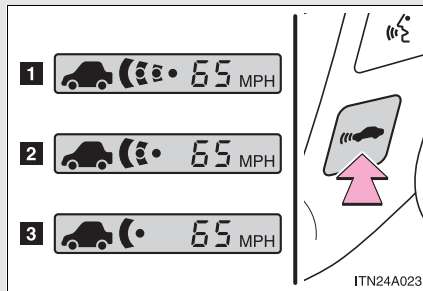

Each push of the switch changes the vehicle-to-vehicle distance

- 1** Long
- 2** Medium
- 3** Short

Vehicles with smart key system: The vehicle-to-vehicle distance is automatically set to the long mode when the "ENGINE START STOP" switch is turned to IGNITION ON mode.

Vehicles without smart key system: The vehicle-to-vehicle distance is automatically set to the long mode when the engine switch is turned to the "ON" position.

A vehicle mark is displayed ahead if one is detected.

Cruising in vehicle-to-vehicle distance control mode

This mode employs a laser radar sensor to detect the presence of vehicles within 400 ft. (120 m) ahead and to judge the distance between your vehicle and those vehicles.

Note that vehicle-to-vehicle distance will close when traveling on long downhill slopes.

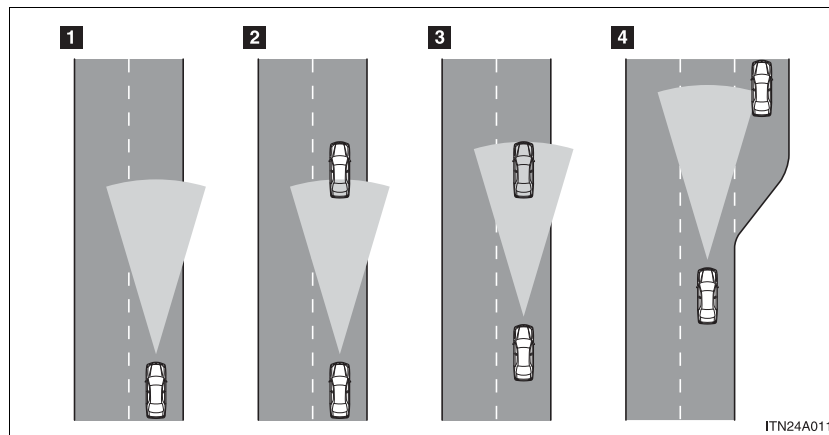

1 Example of constant speed cruising

When there are no vehicles ahead

The vehicle travels at the speed set by the driver. The desired vehicle-to-vehicle distance can also be set by operating the vehicle-to-vehicle distance switch.

2 Example of deceleration cruising

When the vehicle ahead is driving slower than the set speed

When a vehicle is detected running ahead of you, in the same lane, the system automatically decelerates your vehicle. When a greater reduction in vehicle speed is necessary, the system applies the brakes. A warning tone warns you when the system cannot decelerate sufficiently to prevent your vehicle from closing on the vehicle ahead.

2

When driving

2-4. Using other driving systems

3 Example of follow-up cruising

When following a vehicle driving slower than the set speed

The system continues follow-up cruising while adjusting for changes in the speed of the vehicle ahead in order to maintain the vehicle-to-vehicle distance set by the driver.

4 Example of acceleration

When there are no longer vehicles driving slower than the set speed in the lane ahead

When the vehicle ahead of you executes a lane change, the system slowly accelerates until the set vehicle speed is reached. The system then returns to fixed speed cruising.

Approach warning

When your vehicle is too close to a vehicle ahead, and sufficient automatic deceleration via the cruise control is not possible, the display will flash and buzzer will sound to alert the driver. An example of this would be if another driver cuts in front of you while you are following a vehicle. Apply the brake to ensure an appropriate vehicle-to-vehicle distance.

■ **Dynamic laser cruise control warning lights, display and buzzers**

Warning lights, display and buzzers are used to indicate a system malfunction or to alert you to the need for caution while driving.

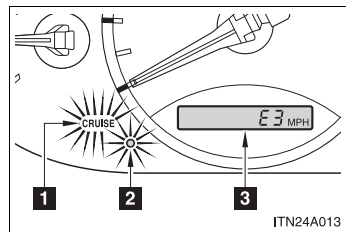

- 1 "CRUISE" indicator light
- 2 Master warning light
- 3 Warning code

2

When driving

The warning codes indicate the following.

Warning code	Details	Correction procedures
C1	Indicates that the laser radar sensor is dirty or covered with ice.	Clean the sensor.
C2	Indicates that the system is unable to judge the vehicle-to-vehicle distance.	<ul style="list-style-type: none"> • Stop the wiper or switch the wiper to variable intermittent operation. • Avoid direct sunlight. • Wait until the weather becomes clear.
E3 CRUISE (Flashing)	Indicates that a system malfunction has been detected.	Turn off and restart the "ENGINE START STOP" switch or the engine switch.

If the same code appears again after implementing the correction procedure, or if the cruise control cannot be set, contact your Toyota dealer.

■ **Switching modes**

The mode cannot be switched to constant speed control mode if vehicle-to-vehicle distance control mode has been used. The mode also cannot be switched from constant speed control to vehicle-to-vehicle control mode. Turn the system off by pressing the “ON-OFF” button, and turn it on again.

■ **The dynamic laser cruise can be set when**

- The shift lever is in “D” or the “4”, “5” or “6” range of “S” mode.
- Vehicle speed is between approximately 28 mph (45 km/h) and 85 mph (135 km/h).

■ **Accelerating**

The vehicle can be accelerated normally.

■ **Automatically canceling vehicle-to-vehicle distance control**

Vehicle-to-vehicle distance control driving is automatically canceled in the following situations.

- Vehicle speed falls below 25 mph (40 km/h)
- VSC is activated
- The sensor cannot operate correctly because it is covered in some way

Vehicle-to-vehicle distance control driving must be reset by turning the “ON-OFF” button on again.

If vehicle-to-vehicle distance control driving is automatically canceled for any other reason, there may be a malfunction in the system. Contact your Toyota dealer.

■ **Automatically canceling constant speed control**

The set speed is automatically canceled in the following situations.

- Actual vehicle speed is more than 10 mph (16 km/h) below the preset vehicle speed
At this time, the memorized set speed is not retained.
- Vehicle speed falls below 25 mph (40 km/h)
- VSC is activated

■ **Vehicle-to-vehicle distance settings**

Select a distance from the table below. Note that the distances shown correspond to a vehicle speed of 55 mph (90 km/h). Vehicle-to-vehicle distance increases/decreases in accordance with vehicle speed.

Distance options	Vehicle-to-vehicle distance
Long	Approximately 245 ft. (75 m)
Medium	Approximately 165 ft. (50 m)
Short	Approximately 100 ft. (30 m)

■ **Laser radar sensor**

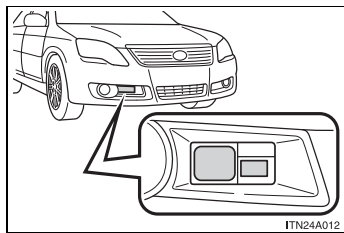

Always keep the sensor clean to ensure that the vehicle-to-vehicle distance control operates properly. (Some obstructions, such as snow, ice or plastic objects, cannot be detected by the obstruction sensor.)

Dynamic laser cruise control is canceled if an obstruction is detected.

■ **Approach warning**

In the following instances, there is a possibility that the warning will not occur.

- When the speed of the vehicle ahead matches or exceeds your vehicle's speed
- When the vehicle ahead is traveling at an extremely slow speed
- Immediately after the cruise control speed has been set
- At the instant the accelerator is applied

■ **Certification**

This product is a class I laser product complied with 21 C.F.R part 1040.10 and 1040.11.

 CAUTION

■ **Before using dynamic laser cruise control**

Do not overly rely on vehicle-to-vehicle distance control. Be aware of the set vehicle speed. If automatic deceleration/acceleration is not appropriate, adjust the vehicle speed, as well as the distance between your vehicle and vehicles ahead by applying the brakes, etc.

■ **To avoid operating the dynamic laser cruise control by mistake**

Keep the "ON-OFF" button off when not in use.

■ **Situations unsuitable for dynamic laser cruise control**

Do not use dynamic laser cruise control in any of the following situations. Doing so may result in inappropriate control of speed and could cause serious or fatal accident.

- In heavy traffic
- On roads with sharp bends
- On winding roads
- On slippery roads, such as those covered with rain, ice or snow
- Where there are sudden changes between sharp up and down gradients
- At entrances to expressways
- When weather conditions are bad enough that they may prevent the sensors from functioning correctly (fog, snow, sandstorm, heavy rain, etc.)
- When the approach warning buzzer can be heard often

⚠ CAUTION**■ When the laser radar sensor may not be correctly detecting the vehicle ahead**

Apply the brakes as necessary when any of the following types of vehicles are in front of you.

As the sensor may not be able to correctly detect these types of vehicles, the proximity alarm (→P. 175) will not be activated, and an accident may result.

- Vehicles that cut in suddenly
- Vehicles traveling at low speeds
- Vehicles that are not moving
- Vehicles with small rear ends (trailers with no load on board etc.)
- Motorcycles traveling in the same lane

■ Conditions under which the vehicle-to-vehicle distance control may not function correctly

Apply the brakes as necessary in the following conditions as the laser radar sensor may not be able to correctly detect vehicles ahead, and an accident may result.

- When water or snow thrown up by the surrounding vehicles hinders the functioning of the sensor
- When your vehicle is pointing upwards (caused by a heavy load in the trunk etc.)
- When the road curves or when the lanes are narrow
- When steering wheel operation or your position in the lane is unstable
- When the vehicle ahead of you decelerates suddenly.

 NOTICE

■ **To ensure the laser radar sensor functions correctly**

Do not do the following to the sensor or grille cover as doing so may cause the sensor not to function correctly and could result in an accident.

- Stick or attach anything to them
- Leave them dirty
- Disassemble or subject them to strong shocks
- Modify or paint them
- Replace them with non-genuine parts

■ **Handling the laser radar sensor**

Observe the following to ensure the cruise control system can function effectively.

- Keep the sensor clean at all times.
Clean the sensor with a soft cloth so you do not mark or damage them.
- Do not subject the sensor or surrounding area to a strong impact.
If the sensor moves even slightly off position, the system may malfunction.
If the sensor or surrounding area is subject to a strong impact, always have the area inspected and adjusted by a Toyota dealer.
- Do not disassemble the sensor.
- Do not attach accessories or stickers to the sensor, surrounding area.
- Do not modify or paint the sensor.

2-4. Using other driving systems Driving assist systems

To help enhance driving safety and performance, the following systems operate automatically in response to various driving situations. Be aware, however, that these systems are supplementary and should not be relied upon too heavily when operating the vehicle.

■ ABS (Anti-lock Brake System)

Helps to prevent wheel lock when the brakes are applied suddenly, or if the brakes are applied while driving on a slippery road surface.

■ Brake assist

Generates an increased level of braking force after the brake pedal is depressed, when the system detects a panic stop situation.

■ VSC (Vehicle Stability Control)

Helps the driver to control skidding when swerving suddenly or turning on slippery road surfaces.

■ TRAC (Traction Control)

Maintains drive power and prevents the front wheels from spinning when starting the vehicle or accelerating on slippery roads.

2

When driving

When the VSC/TRAC are operating

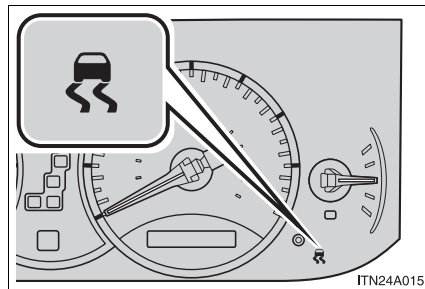

If the vehicle is in danger of slipping, or if the front wheels spin, the slip indicator light flashes to indicate that the VSC/TRAC have been engaged.

A buzzer (intermittent) sounds to indicate that VSC is operating.

■ **Sounds and vibrations caused by the ABS, brake assist, VSC and TRAC**

- A sound may be heard from the engine compartment when the engine is started or just after the vehicle begins to move. This sound does not indicate that a malfunction has occurred in any of these systems.
- Any of the following conditions may occur when the above systems are operating. None of these indicates that a malfunction has occurred.
 - Vibrations may be felt through the vehicle body and steering.
 - A motor sound may be heard after the vehicle comes to a stop.
 - The brake pedal may pulsate slightly after the ABS is activated.
 - The brake pedal may move down slightly after the ABS is activated.

 **CAUTION**

■ **The ABS does not operate effectively when**

- The limits of tire gripping performance have been exceeded.
- The vehicle hydroplanes while driving at high speed on the wet or slick road.

■ **Stopping distance when the ABS is operating on the wet or slick roads**

The ABS is not designed to shorten the vehicle's stopping distance. Always maintain a sufficient distance from the vehicle in front of you in the following situations.

- When driving on dirt, gravel or snow-covered roads
- When driving with tire chains
- When driving over bumps in the road
- When driving over roads with potholes or roads with uneven pavement

 CAUTION

■ **TRAC may not operate effectively when**

Directional control and power may not be achievable while driving on slippery road surfaces, even if the TRAC is operating.
Do not drive the vehicle in conditions where stability and power may be lost.

■ **When the VSC is activated**

The slip indicator light flashes and a warning buzzer sounds. Always drive carefully.
Reckless driving may cause an accident. Exercise particular care when the indicator light flashes and a buzzer sounds.

■ **Replacing tires**

Make sure that all tires are of the same size, brand, tread pattern and total load capacity. In addition, make sure that the tires are inflated to the recommended tire pressure level.
The ABS and VSC systems will not function correctly if different tires are fitted on the vehicle.
Contact your Toyota dealer for further information when replacing tires or wheels.

■ **Handling of tires and suspension**

Using tires with any kind of problem or modifying the suspension will affect the driving assist systems, and may cause the system to malfunction.

2-5. Driving information

Cargo and luggage

Take notice of the following information about storage precautions, cargo capacity and load.

- Stow cargo and luggage in the trunk whenever possible. Be sure all items are secured in place.
- Be careful to keep the vehicle level. Placing the weight as far forward as possible helps maintain vehicle balance.
- For better fuel economy, do not carry unnecessary weight.

Capacity and distribution

Cargo capacity depends on the total weight of the occupants.

(Cargo capacity) = (Total load capacity) – (Total weight of occupants)

Steps for Determining Correct Load Limit—

- (1) Locate the statement “The combined weight of occupants and cargo should never exceed XXX kg or XXX lbs.” on your vehicle’s placard.
- (2) Determine the combined weight of the driver and passengers that will be riding in your vehicle.
- (3) Subtract the combined weight of the driver and passengers from XXX kg or XXX lbs.
- (4) The resulting figure equals the available amount of cargo and luggage load capacity.

For example, if the “XXX” amount equals 1400 lbs. and there will be five 150 lb passengers in your vehicle, the amount of available cargo and luggage load capacity is 650 lbs. (1400 – 750 (5 × 150) = 650 lbs.)

- (5) Determine the combined weight of luggage and cargo being loaded on the vehicle.

That weight may not safely exceed the available cargo and luggage load capacity calculated in Step 4.

- (6) If your vehicle will be towing a trailer, load from your trailer will be transferred to your vehicle. Consult this manual to determine how this reduces the available cargo and luggage load capacity of your vehicle. (→P. 188)

Toyota does not recommend towing a trailer with your vehicle. Your vehicle is not designed for trailer towing.

2

When driving

Example on your vehicle

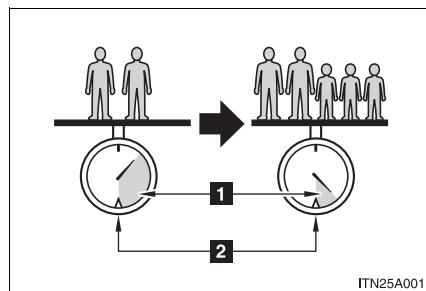

1 Cargo capacity

2 Total load capacity

When 2 people with the combined weight of 366 lb. (166 kg) are riding in your vehicle, which has a total load capacity of 870 lb. (395 kg), the available amount of cargo and luggage load capacity will be as follows:

$$870 \text{ lb.} - 366 \text{ lb.} = 504 \text{ lb.} \quad (395 \text{ kg} - 166 \text{ kg} = 229 \text{ kg})$$

In this condition, if 3 more passengers with the combined weight of 388 lb. (176 kg) get on, the available cargo and luggage load will be reduced as follows:

$$504 \text{ lb.} - 388 \text{ lb.} = 116 \text{ lb.} \quad (229 \text{ kg} - 176 \text{ kg} = 53 \text{ kg})$$

As shown in the above example, if the number of occupants increases, the cargo and luggage load equaling the combined weight of the occupants who got on later, by an amount. In other words, if an increase in the number of occupants causes an excess of the total load capacity (combined weight of occupants plus cargo and luggage load), you must reduce the cargo and luggage on your vehicle.

 CAUTION

■ **Things that must not be carried in the trunk**

The following things may cause a fire if loaded in the trunk.

- Receptacles containing gasoline
- Aerosol cans

■ **Storage precautions**

Observe the following precautions.

Failing to do so may result in death or serious injury.

- Do not place cargo or luggage in or on the following locations as the item may get under the brake or accelerator pedal and prevent the pedals from being depressed properly, block the driver's vision, or hit the driver or passengers, causing an accident.
 - Driver's feet
 - Front passenger or rear seats (when stacking items)
 - Instrument panel
 - Dashboard
- Secure all items in the occupant compartment, as they may shift and injure someone during an accident or sudden braking.
- Never allow anyone to ride in the trunk. It is not designed for passengers. They should ride in their seats with their seat belts properly fastened. Otherwise, they are much more likely to suffer death or serious injury, in the event of sudden braking, sudden swerving or an accident.

 CAUTION

■ **Weight of the load**

- Do not exceed the maximum axle weight rating or the total vehicle weight rating.
- Even if the total load of occupant's weight and the cargo load is less than the total load capacity, do not apply the load unevenly. Improper loading may cause deterioration of steering or braking control which may cause death or serious injury.

2

When driving

2-5. Driving information

Vehicle load limits

Vehicle load limits include total load capacity, seating capacity, towing capacity and cargo capacity.

■ **Total load capacity: 870 lb. (395 kg)**

Total load capacity means the combined weight of occupants, cargo and luggage.

■ **Seating capacity: 5 occupants (Front 2, Rear 3)**

Seating capacity means the maximum number of occupants whose estimated average weight is 150 lb. (68 kg) per person.

Even if the number of occupants are within the seating capacity, do not exceed the total load capacity.

■ **Towing capacity**

Toyota does not recommend towing a trailer with your vehicle.

■ **Cargo capacity**

Cargo capacity may increase or decrease depending on the weight and the number of occupants.

■ **Total load capacity and seating capacity**

These details are also described on the tire and loading information label. (→P. 354)

 **CAUTION**

■ **Overloading the vehicle**

Do not overload the vehicle.

It may not only cause damage to the tires, but also degrade steering and braking ability, resulting in an accident.

2-5. Driving information

Winter driving tips

Carry out the necessary preparations and inspections before driving the vehicle in winter. Always drive the vehicle in a manner appropriate to the prevailing weather conditions.

■ Pre-winter preparations

- Use fluids that are appropriate to the prevailing outside temperatures.
 - Engine oil
 - Engine coolant
 - Washer fluid
- Have a service technician inspect the level and specific gravity of battery electrolyte.
- Have the vehicle fitted with four snow tires or purchase a set of tire chains for the front tires.

Ensure that all tires are the same size and brand, and that chains match the size of the tires.

2-5. Driving information

■ Before driving the vehicle

Perform the following according to the driving conditions.

- Do not try to forcibly open a window or move a wiper that is frozen. Pour warm water over the frozen area to melt the ice. Wipe away the water immediately to prevent it from freezing.
- To ensure proper operation of the climate control system fan, remove any snow that has accumulated on the air inlet vents in front of the windshield.
- Remove any ice that has accumulated on the vehicle chassis.
- Periodically check for and remove any excess ice or snow that may have accumulated in the wheel well or on the brakes.

■ When driving the vehicle

Accelerate the vehicle slowly and drive at a reduced speed suitable to road conditions.

■ When parking the vehicle

Park the vehicle and move the shift lever to "P" without setting the parking brake. The parking brake may freeze up, preventing it from being released.

Selecting snow chains

Use the correct snow chain size when mounting the snow chains. Chain size is regulated for each tire size.

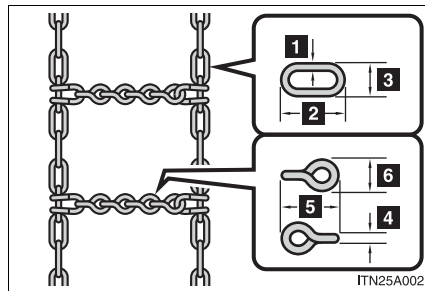

Side chain:

- 1 0.12 in. (3.0 mm)
- 2 1.18 in. (30.0 mm)
- 3 0.39 in. (10.0 mm)

Cross chain:

- 4 0.16 in. (4.0 mm)
- 5 0.98 in. (25.0 mm)
- 6 0.55 in. (14.0 mm)

2

When driving

Regulations on the use of snow chains

- Regulations regarding the use of tire chains vary according to location and type of road. Always check local regulations before installing chains.
- Install the chains on the front tires.
- Retighten the chains after driving 1/4 - 1/2 mile (0.5 - 1.0 km).

■ Snow chain installation

Observe the following precautions when installing and removing chains.

- Install and remove tire chains in a safe location.
- Install tire chains on the front tires only.
- Install tire chains following the instructions provided in the accompanying instructions.

 CAUTION

■ **Driving with snow tires**

Observe the following precautions to reduce the risk of accidents. Failing to do so may result in a loss of vehicle control and cause death or serious injury.

- Use tires of the size specified for your vehicle.
- Maintain the specified level of tire inflation pressure.
- Do not drive in excess of 75 mph (120 km/h), regardless of the type of snow tires being used.
- Snow tires should be installed on all wheels.

 CAUTION

■ **Driving with snow chains**

Observe the following precautions to reduce the risk of accidents. Failing to do so may result in the vehicle being unable to be driven safely, and may cause death or serious injury.

- Do not drive in excess of the speed limit specified for the tire chains being used, or 30 mph (50 km/h), whichever is lower.
- Avoid driving on bumpy road surfaces or over potholes.
- Avoid sudden turns and braking, as use of chains may adversely affect vehicle handling.
- Slow down sufficiently before entering a curve to ensure that vehicle control is maintained.

 NOTICE

■ **Repairing or replacing snow tires**

Request repairs of and obtain replacement snow tires from Toyota dealers. This is because the removal and attachment of snow tires affects the operation of the tire pressure warning valves and transmitters.

■ **Fitting tire chains**

The tire pressure warning valves and transmitters may not function correctly when tire chains are fitted.

2-5. Driving information

Trailer towing

Toyota does not recommend towing a trailer with your vehicle. Toyota also does not recommend the installation of a tow hitch or the use of a tow hitch carrier for a wheelchair, scooter, bicycle, etc. Your Toyota is not designed for trailer towing or for the use of tow hitch mounted carriers.

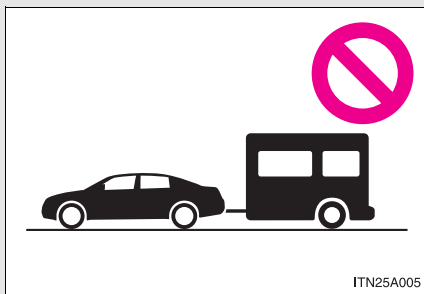

2-5. Driving information

Dinghy towing

Your vehicle is not designed to be dinghy towed (with 4 wheels on the ground) behind a motor home.

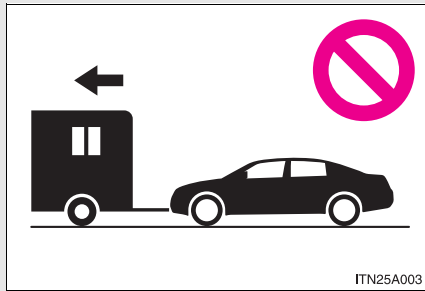

NOTICE

■ To avoid serious damage to your vehicle

Do not tow your vehicle with four wheels on the ground.

2

When driving

2-5. Driving information

3-1. Using the air conditioning system and defogger Automatic air conditioning system

Airflow and outlets are automatically adjusted according to the temperature setting.

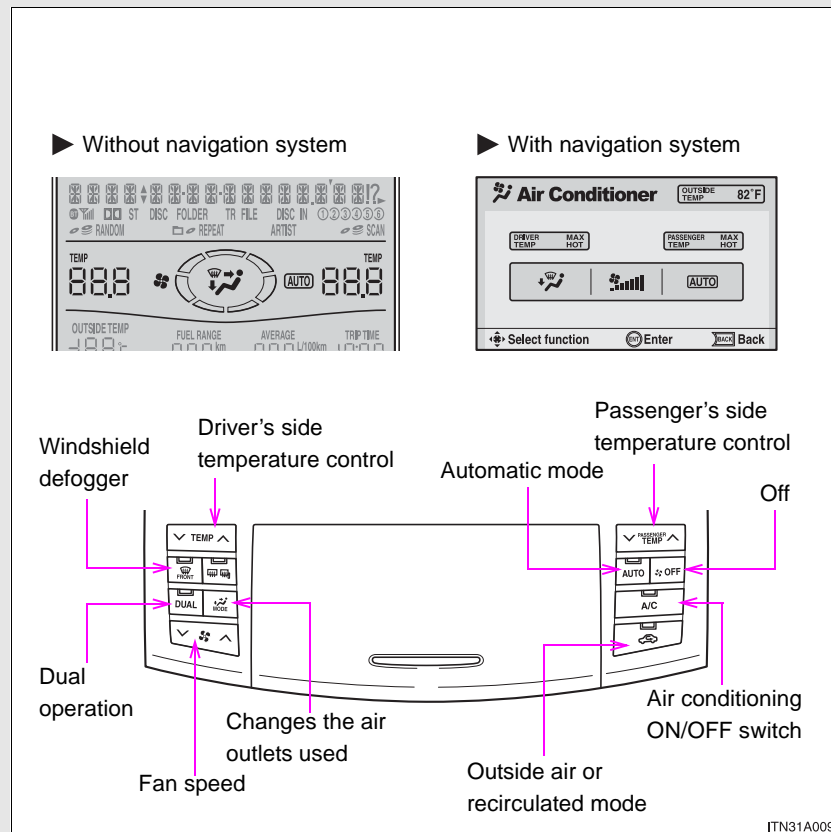

This illustration is a vehicle equipped with the outside rear view mirror defoggers.

Using the automatic mode

STEP 1 Press  .

The air conditioning system will begin to operate. Air outlets and fan speed are automatically adjusted according to the temperature setting.



STEP 2 Press “^” to increase the temperature and “v” to decrease the temperature on  .

The temperature for the driver and passenger seats can be set separately.

Adjusting the settings

■ Adjusting the temperature setting

Press “^” to increase the temperature and “v” to decrease the temperature on  .

Press “^” (increase) or “v” (decrease) on  to separately adjust the temperature for the passenger and driver sides (dual mode). Press  to return the driver and passenger side temperatures to the same setting (simultaneous mode).

The air conditioning system switches between dual and simultaneous modes each time  is pressed.

■ Adjusting the fan speed

Press “^” (increase) or “v” (decrease) on the  switch.

Press  to turn the fan off.

3-1. Using the air conditioning system and defogger

■ Changing the air outlets

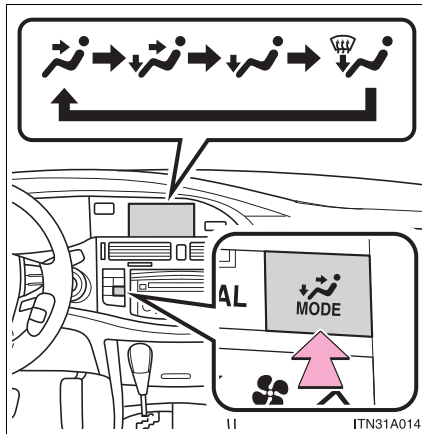

Press  .

The air outlets switch each time the button is pressed. The air flow shown on the display indicate the following.

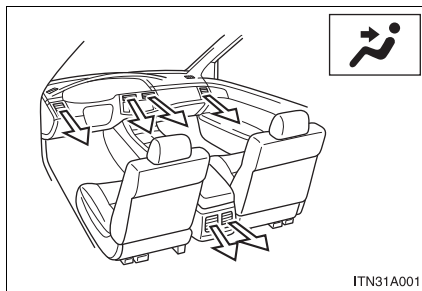

Air flows to the upper body.

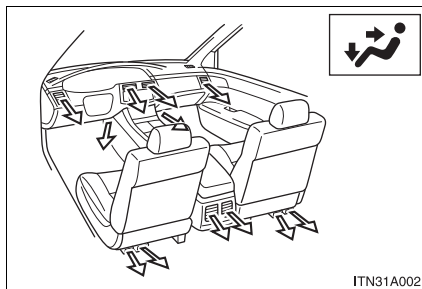

Air flows to the upper body and feet.

3-1. Using the air conditioning system and defogger

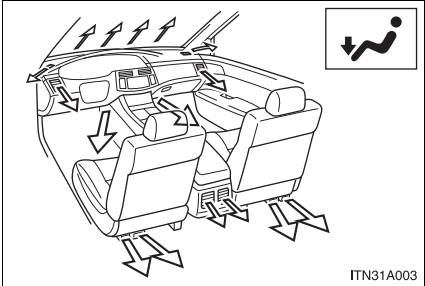

Air flows to the feet.

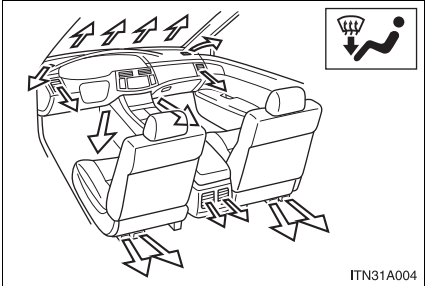

Air flows to the feet and the windshield defogger operates.

■ Switching between outside air and recirculated air modes

Press  .

The mode switches between outside air mode (indicator off) and recirculated air mode (indicator on) modes each time the button is pressed.

3-1. Using the air conditioning system and defogger

Defogging the windshield

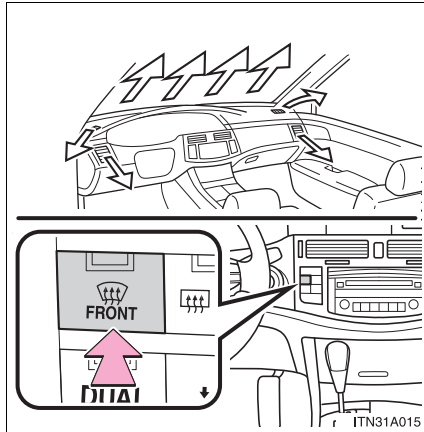

Press  .

The air conditioning system control operates automatically.

Adjusting the position of and opening and closing the air outlets

► Center outlets

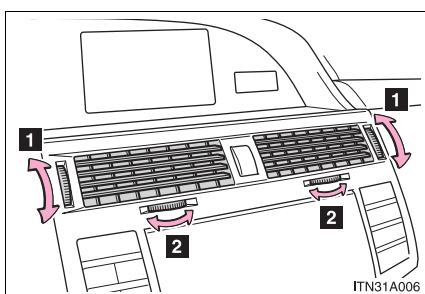

- 1 Turn the knob to open or close the vent
- 2 Direct air flow to the left or right

► Side outlets

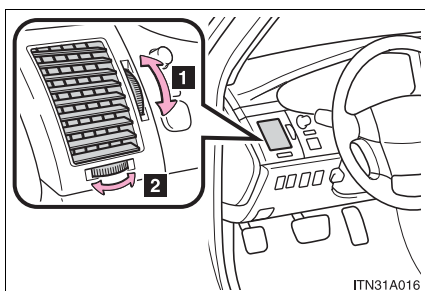

- 1 Turn the knob to open or close the vent
- 2 Direct air flow to the left or right

► Rear seat outlets

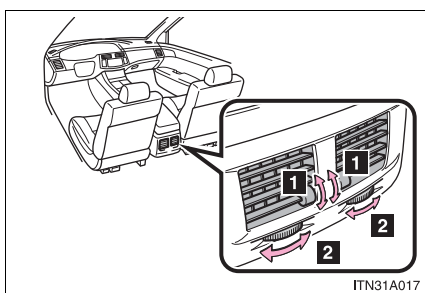

- 1 Turn the knob to open or close the vent
- 2 Direct air flow to the left or right

3-1. Using the air conditioning system and defogger

■ Using the automatic mode

Fan speed is adjusted automatically in accordance with the temperature setting and ambient conditions. As a result, the following may occur.

- Immediately after the switch is pressed, the fan may stop for a while until warm or cool air is ready to flow.
- Cool air may flow to the area around the upper body when the heater is on.

■ Using the system in recirculated air mode

The windows will fog up more easily if the recirculated air mode is used for an extended period.

■ Switching between outside air and recirculated air modes

Recirculated air mode or outside air mode may be automatically switched to in accordance with the temperature setting and the inside temperature.

■ Window defogger feature

Recirculated air mode may automatically switch to outside air mode in situations where the windows need to be defogged.

■ Outside temperature approaches 32°F (0°C)

The air conditioning system may not operate even when  is pressed.

■ When the indicator light on flashes

Press  and turn off the air conditioning system before turning it on once more. There may be a problem in the air conditioning system if the indicator light continues to flash. Turn the air conditioning system off and have it inspected by your Toyota dealer.

■ Air conditioning odors

- During use, various odors from inside and outside the vehicle may enter into and accumulate in the air conditioning system. This may then cause odor to be emitted from the vents.
- To reduce potential odors from occurring:
 - It is recommended that the air conditioning system be set to outside air mode prior to turning the vehicle off.
 - The start timing of the blower may be delayed for a short period of time immediately after the air conditioning system is started in automatic mode.

3-1. Using the air conditioning system and defogger

CAUTION

■ To prevent the windshield from fogging up

Do not use  during cool air operation in extremely humid weather. The difference between the temperature of the outside air and that of the windshield can cause the outer surface of the windshield to fog up, blocking your vision.

NOTICE

■ To prevent battery discharge

Do not leave the automatic air conditioning system on longer than necessary when the engine is not running.

3

Interior features

3-1. Using the air conditioning system and defogger Using the steering wheel climate control switches

Some air conditioning feature can be controlled using the switches on the steering wheel.

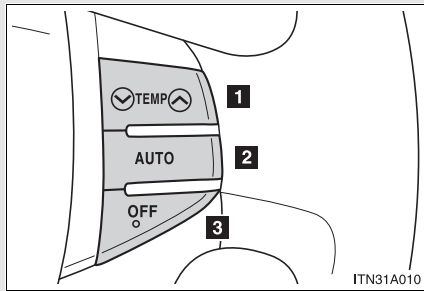

- 1** Temperature control
- 2** Automatic mode
- 3** Off

Using the automatic mode

STEP 1 Press  .



The air conditioning system will begin to operate. Air outlets and fan speed are automatically adjusted according to the temperature setting.

STEP 2 Press “^” to increase the temperature and “v” to decrease the temperature on  .

The temperature for the driver and passenger seats can be set separately.

Adjust the temperature settings

Press “^” to increase the temperature and “v” to decrease the temperature on .

Press “^” (increase) or “v” (decrease) on  to separately adjust the temperature for the passenger and driver sides (dual mode). Press  to turn off the dual mode and to return the driver and passenger side temperatures to the same setting (simultaneous mode).

This function will be canceled when  on the instrument panel is pushed.

Turning off the fan

Press .

3-1. Using the air conditioning system and defogger Rear window and outside rear view mirror defoggers

These features are used to defog the rear window, and to remove raindrops, dew and frost from the outside rear view mirrors.

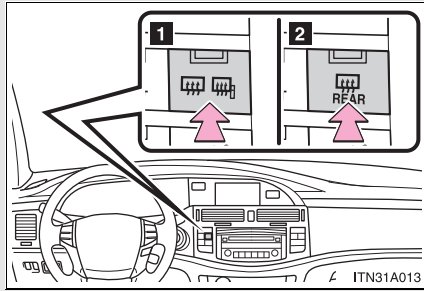

1 With outside rear view mirror defoggers

2 Without outside rear view mirror defoggers

Press the button to turn on the rear window (and outside rear view mirror) defoggers. The defoggers will automatically turn off after approximately 15 minutes. Pressing the button again also turns the defoggers off.

The operation time changes according to the ambient temperature and vehicle speed.

■ Operating conditions

▶ Vehicles with smart key system

The “ENGINE START STOP” switch must be in IGNITION ON mode.

▶ Vehicles without smart key system

The engine switch must be in the “ON” position.

3-1. Using the air conditioning system and defogger

CAUTION

■ **When the outside rear view mirror defoggers are on (if equipped)**

Do not touch the rear view mirror surfaces, as they can become very hot and burn you.

NOTICE

■ **To prevent battery discharge**

Turn the defoggers off when the engine is not running.

3-2. Using the audio system

Audio system type

CD player with changer and AM/FM radio

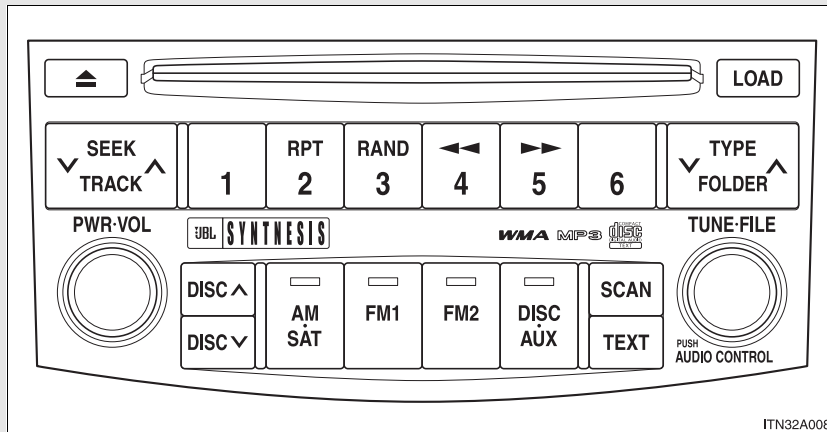

The audio system appearance may differ slightly for vehicles not equipped with JBL brand audio system.

Title	Page
Using the radio	P. 213
Using the CD player	P. 220
Playing MP3 and WMA discs	P. 228
Optimal use of the audio system	P. 236
Using the AUX adapter	P. 238
Using the steering wheel audio switches	P. 239

■ Using cellular phones

Interference may be heard through the audio system's speakers if a cellular phone is being used inside or close to the vehicle while the audio system is operating.

⚠ CAUTION**■ For vehicles sold in the U.S.A. and Canada****● Part 15 of the FCC Rules**

FCC Warning:

Any unauthorized changes or modifications to this equipment will void the user's authority to operate this device.

● Laser products

- Do not take this unit apart or attempt to make any changes yourself. This is an intricate unit that uses a laser pickup to retrieve information from the surface of compact discs. The laser is carefully shielded so that its rays remain inside the cabinet. Therefore, never try to disassemble the player or alter any of its parts since you may be exposed to laser rays and dangerous voltages.
- This product utilizes a laser. Use of controls or adjustments or performance of procedures other than those specified herein may result in hazardous radiation exposure.

⚠ NOTICE**■ To prevent battery discharge**

Do not leave the audio system on longer than necessary with the engine off.

■ To avoid damaging the audio system

Take care not to spill drinks or other fluids over the audio system.

3-2. Using the audio system

Audio cover

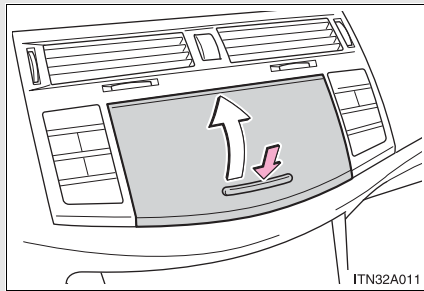

Press to open.

CAUTION

■ When opening or closing the audio cover

Do not jam your hands in the cover.

NOTICE

■ To avoid damaging the audio cover or CD

- Do not hold the cover while it is opening.
- Do not close the audio cover before removing an ejected CD.

3-2. Using the audio system Using the radio

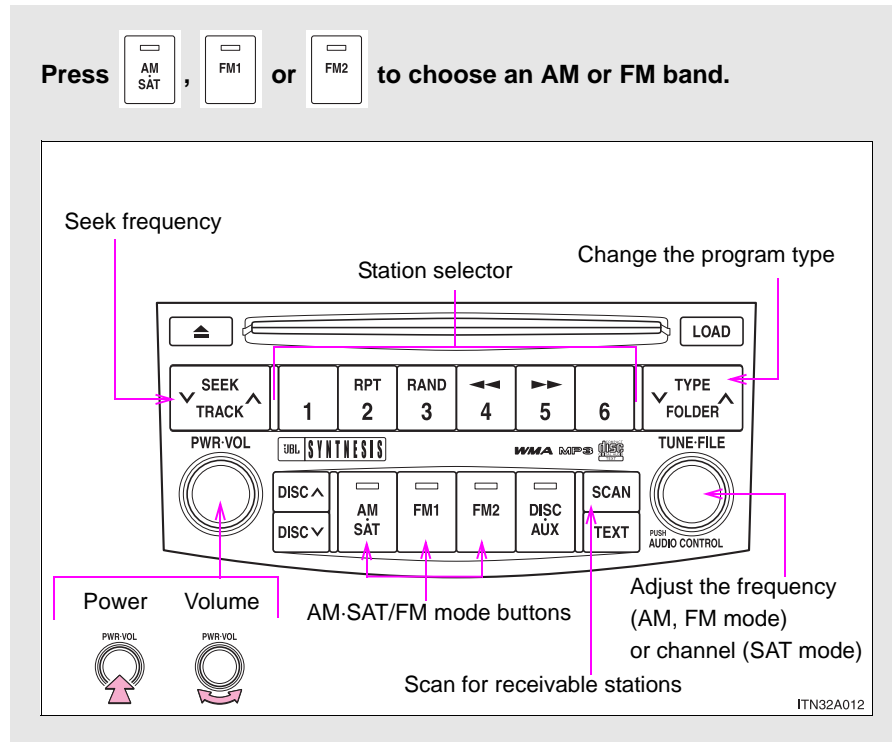

3

Interior features

Setting station presets (excluding XM[®] Satellite Radio)

STEP 1 Search for desired stations by turning  or pressing “^”

or “v” on .

STEP 2 Press and hold one of the preset stations (1 - 6) until you hear a beep.

Scanning radio stations (excluding XM[®] Satellite Radio)

■ Scanning the preset radio stations

STEP 1 Press and hold  until you hear a beep.

Preset stations will be played for 5 seconds each.

STEP 2 When the desired station is reached, press the button again.

■ Scanning all radio stations within range

STEP 1 Press  .

All stations with reception will be played for 5 seconds each.

STEP 2 When the desired station is reached, press the button again.

XM[®] Satellite Radio (if equipped)

■ Receiving XM[®] Satellite Radio

STEP 1 Press  until "SAT" shows in the display.

The display changes as follows each time the button is pressed.

"AM" → "SAT1" → "SAT2" → "SAT3"

STEP 2 Turn  to select a desired channel from all the categories

or press " \wedge " or " \vee " on  to select a desired channel in the current category.

3-2. Using the audio system

■ Presetting XM[®] Satellite Radio channels

Select the desired channel. Press and hold the button (1 - 6) until you hear a beep.

■ Changing the channel category

Press “^” or “v” on  .

■ Scanning XM[®] Satellite Radio channels

● Scanning channels in the current category

STEP 1 Press  .

STEP 2 When the desired channel is reached, press the button again.

● Scanning preset channels

STEP 1 Press and hold  until you hear a beep.

STEP 2 When the desired channel is reached, press the button again.

■ Displaying text information

Press  .

The display will show up to 12 characters.

The display changes as follows each time the button is pressed.

- CH NAME
- TITLE (SONG/PROGRAM TITLE)
- NAME (ARTIST NAME/FEATURE)
- CH NUMBER

■ When the battery is disconnected

All preset stations are erased.

■ Reception sensitivity

- Maintaining perfect radio reception at all times is difficult due to the continually changing position of the antenna, differences in signal strength and surrounding objects, such as trains, transmitters, etc.
- The radio antenna is mounted inside the rear window. To maintain clear radio reception, do not attach metallic window tinting or other metallic objects to the antenna wire mounted inside the rear window.

■ Receiving XM[®] Satellite Radio

An XM[®] Satellite Radio is a tuner designed exclusively to receive broadcasts provided under a separate subscription. Availability is limited to the 48 contiguous states and 10 Canadian provinces.

● XM[®] subscriptions

For detailed information about XM[®] Satellite Radio or to subscribe:

U.S.A–

Visit on the web at www.xmradio.com or call 1-800-967-2346.

Canada–

Visit on the web at www.xmradio.ca or call 1-877-438-9677.

● Radio ID

You will need the radio ID when activating XM[®] service or reporting a problem. Select “CH000” using , and the receiver's 8-character ID number will appear.

● Satellite tuner

The tuner supports only Audio Services (Music and Talk) and the accompanying Text Information of XM[®] Satellite Radio.

3-2. Using the audio system

■ If the satellite radio does not operate normally

If a problem occurs with the XM[®] tuner, a message will appear on the display. Refer to the table below to identify the problem, and take the suggested corrective action.

ANTENNA	The XM [®] antenna is not connected. Check whether the XM [®] antenna cable is attached securely.
	There is a short-circuit in the antenna or the surrounding antenna cable. See a Toyota certified dealer.
UPDATING	You have not subscribed to XM [®] Satellite Radio. The radio is being updated with the latest encryption code. Contact XM [®] Satellite Radio for subscription information. When a contract is canceled, you can choose "CH000" and all free-to-air channels.
	The premium channel you selected is not authorized. Wait for about 2 seconds until the radio returns to the previous channel or "CH001". If it does not change automatically, select another channel. If you want to listen to the premium channel, contact XM [®] Satellite Radio.
NO SIGNAL	The XM [®] signal is too weak at the current location. Wait until your vehicle reaches a location with a stronger signal.
LOADING	The unit is acquiring audio or program information. Wait until the unit has received the information.
OFF AIR	The channel you selected is not broadcasting any programming. Select another channel.
-----	There is no song/program title or artist name/feature associated with the channel at that time. No action needed.

---	The channel you selected is no longer available. Wait for about 2 seconds until the radio returns to the previous channel or "CH001". If it does not change automatically, select another channel.
-----	--

Contact the XM[®] Listener Care Center at 1-800-967-2346 (U.S.A.) or 1-877-438-9677 (Canada).

■ Certifications for the radio tuner

This equipment has been tested and found to comply with the limits for a class B digital device, pursuant to Part 15 of the FCC Rules. These limits are designed to provide reasonable protection against harmful interference in a residential installation. This equipment generates, uses and can radiate radio frequency energy and, if not installed and used in accordance with the instructions, may cause harmful interference to radio communications. However, there is no guarantee that interference will not occur in a particular installation.

If this equipment does cause harmful interference to radio or television reception, which can be determined by turning the equipment off and on, the user is encouraged to try to correct the interference by trying one or more of the following:

- Reorienting or relocating the receiving antenna.
- Increasing the separation between the equipment and receiver.
- Connecting the equipment into an outlet on a circuit different from that to which the receiver is connected.
- Consulting the dealer or an experienced radio/TV technician for help.

3-2. Using the audio system Using the CD player

Insert a CD or press  with a CD inserted.

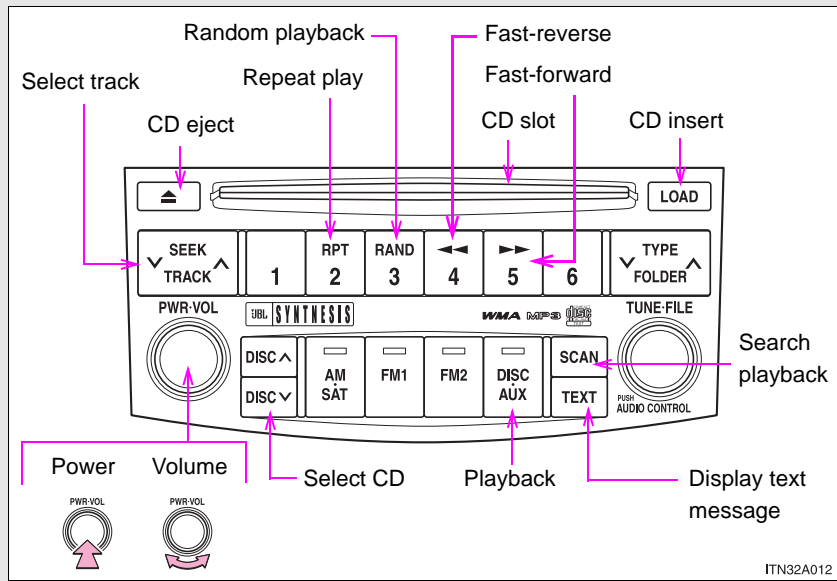

Loading a CD

■ Loading a CD

STEP 1 Press **LOAD**.

STEP 2 Insert a CD when the indicator on the slot turns from amber to green.

■ Loading multiple CDs

STEP 1 Press and hold **LOAD** until you hear a beep.

STEP 2 Insert a CD when the indicator on the slot turns from amber to green.

STEP 3 Insert the next CD when the indicator on the slot turns from amber to green.

Repeat steps 2 and 3 until you have inserted all CDs.

To cancel the operation, press **LOAD**. If you do not insert a CD within 15 seconds, loading will be canceled automatically.

Ejecting CDs

■ Ejecting a CD

STEP 1 To select the CD to be ejected, press “^” or “v” on **DISC^** or **DISCv**.

STEP 2 Press **DISC^** and remove the CD.

■ Ejecting all CDs

Press and hold **DISC^** until you hear a beep, then remove the CDs.

3-2. Using the audio system

Selecting a track

Press “^” to move up and “v” to move down using  until the desired track number is displayed.

Fast-forwarding and reversing tracks

To fast-reverse, press and hold  .

To fast-forward, press and hold  .

Scanning tracks

STEP 1 Press  .

The first 10 seconds of each track will be played.

STEP 2 Press the button again when the desired track is reached.

Selecting a CD

■ To select a CD to play

To select the desired CD, press “^” or “v” on  .

■ To scan loaded CDs

STEP 1 Press and hold  until you hear a beep.

The first 10 seconds of the first track on each CD will be played.

STEP 2 Press the button again when the desired CD is reached.

Random playback

■ Current CD

Press  .

Tracks are played in random order until the button is pressed again.

■ All CDs

Press and hold  until you hear a beep.

Tracks on all loaded CDs are played in random order until the button is pressed again.

Repeat play

■ To repeat a track

Press  .

■ To repeat all of the tracks on a CD

Press and hold  until you hear a beep.



Switching the display

Press  .

Each time the button is pressed, the display changes in the order of “Track no./Elapsed time” → “CD title” → “Track name”.

3-2. Using the audio system

■ Canceling random, repeat and scan playback

Press ,  or  again.

■ Display

Up to 12 characters can be displayed at a time.

If there are 13 characters or more, pressing and holding  for 1 second or more will display the remaining characters.

A maximum of 24 characters can be displayed.

Depending on the contents recorded, the characters may not be displayed properly or may not be displayed at all.

■ Error messages

Refer to the following table and take the appropriate measures. If the problem is not rectified, take the vehicle to your Toyota dealer.

Message	Cause	Correction Procedures
WAIT	Operation is stopped due to high temperature inside the player	Eject the disc and allow the player to cool down
ERROR 1	<ul style="list-style-type: none">• The disc is dirty or damaged• The disc is inserted upside down	<ul style="list-style-type: none">• Clean the disc• Insert the disc correctly
NO DISC	There is no disc	Insert a disc
ERROR 3	There is a malfunction within the system	Eject the disc
ERROR 4	Over current	Ask your Toyota dealer
NO MUSIC	This indicates that no playable data is included in the disc	Eject the disc

■ **Discs that can be used**

Discs with the marks shown below can be used.
Playback may be possible depending on recording format or disc features,
or due to scratches, dirt or deterioration.



CDs with copy-protect features may not be used.

■ **CD player protection feature**

To protect the internal components, playback is automatically stopped when
a problem is detected.

■ **If CDs are left inside the CD player or in the ejected position for
extended periods**

CDs may be damaged and may not play properly.

■ **Lens cleaners**

Do not use lens cleaners. Doing so may damage the CD player.

3-2. Using the audio system

NOTICE

■ Discs and adapters that cannot be used

Do not use the following types of discs, 3 in. (8 cm) disc adapters or Dual Disc.

Doing so may damage the player and render the disc insert/eject function unusable.

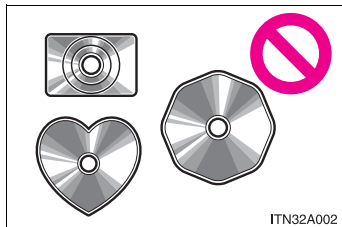

- Discs that have a diameter that is not 4.7 in. (12 cm).

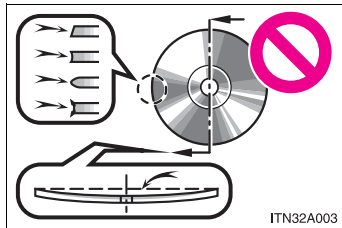

- Low-quality and deformed discs.

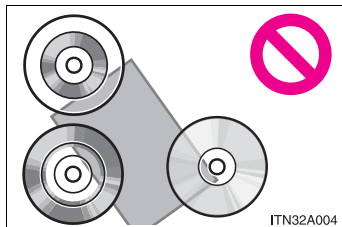

- Discs with a transparent or translucent recording area.

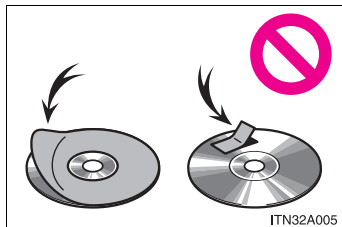

- Discs that have tape, stickers or CD-R labels attached to them, or that have the label peeled off.

 NOTICE

■ **Player precautions**

Failure to follow the precautions below may result in damage to the discs or the player itself.

- Do not insert anything other than discs into the disc slot.
- Do not apply oil to the player.
- Store discs away from direct sunlight.
- Never try to disassemble any part of the player.

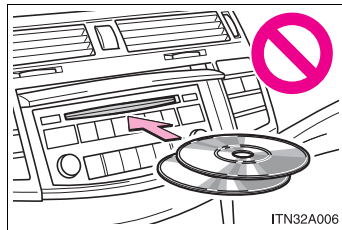

- Do not insert more than one disc at a time.

3-2. Using the audio system Playing MP3 and WMA discs

Insert an MP3 or WMA disc or press  with a disc inserted.

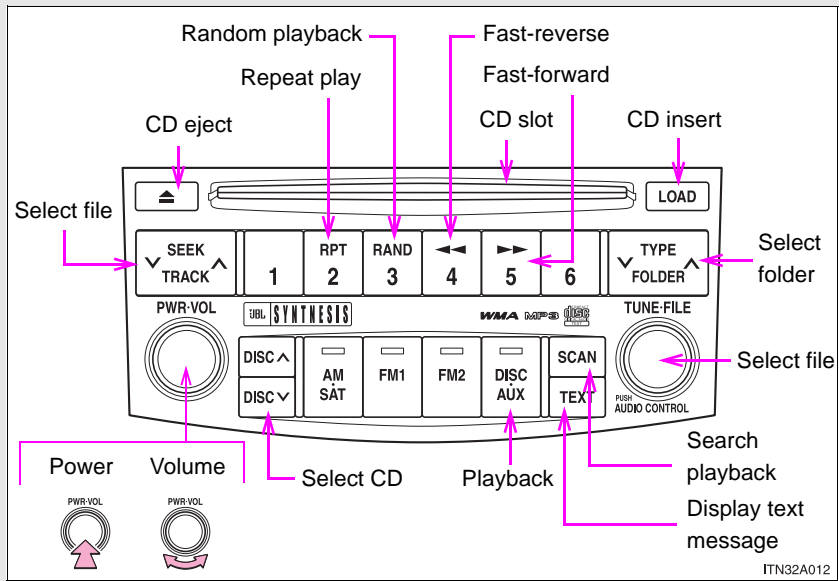

Loading, ejecting and selecting MP3 and WMA discs

Refer to the section titled "Using the CD player" for details. (→P. 220)

Selecting a folder■ **Selecting a folder**

Press "▲" or "▼" on  .



■ **Selecting the desired folder by cueing the first file of each folder**

Press and hold  until you hear a beep. When the desired folder is reached, press the button again.

Returning to the first folder

Press and hold "▼" on  until you hear a beep.

Selecting and scanning files■ **Selecting one file at a time**

Turn  or press "▲" or "▼" on  to select the desired file.

■ **Selecting a desired file by cueing the files in the folder**

Press  .
When the desired file is reached, press the button again.

Fast-forwarding and reversing files

To fast-reverse, press and hold  .

To fast-forward, press and hold  .

Random playback

- To play files from a particular folder in random order

Press  .

- To play all the files on a disc in random order

Press and hold  until you hear a beep.

Repeat play

- To repeat a file

Press  .

- To repeat all of the files on a folder

Press and hold  until you hear a beep.

Switching the display

Press  .

Each time the button is pressed, the display changes in the order of “Folder no./File no./Elapsed time” → “Folder name” → “File name” → “Album title” (MP3 only) → “Track title” → “Artist name”.

■ **Canceling random, repeat and scan playback**

Press ,  or  again.

■ **Display**

→P. 224

■ **Error messages**

→P. 224

■ **CD player protection feature**

To protect the internal components, playback is automatically stopped when a problem is detected while the CD player is being used.

■ **If CDs are left inside the CD player or in the ejected position for extended periods**

CDs may be damaged and may not play properly.

■ **Lens cleaners**

Do not use lens cleaners. Doing so may damage the CD player.

■ MP3 and WMA files

MP3 (MPEG Audio LAYER 3) is a standard audio compression format.

Files can be compressed to approximately 1/10 of their original size by using MP3 compression.

WMA (Windows Media TMAudio) is a Microsoft audio compression format.

This format compresses audio data to a size smaller than that of the MP3 format.

There is a limit to the MP3 and WMA file standards and to the media/formats recorded by them that can be used.

● MP3 file compatibility

- Compatible standards
MP3 (MPEG1 LAYER3, MPEG2 LSF LAYER3)
- Compatible sampling frequencies
MPEG1 LAYER3: 32, 44.1, 48 (kHz)
MPEG2 LSF LAYER3: 16, 22.05, 24 (kHz)
- Compatible bit rates
MPEG1 LAYER3: 64, 80, 96, 112, 128, 160, 192, 224, 256, 320 (kbps)
- MPEG2 LSF LAYER3: 64, 80, 96, 112, 128, 144, 160 (kbps)
*: Compatible with VBR
- Compatible channel modes: stereo, joint stereo, dual channel and monaural

● WMA file compatibility

- Compatible standards
WMA Ver. 7, 8, 9
- Compatible sampling frequencies
32, 44.1, 48 (kHz)
- Compatible bit rates
Ver. 7, 8: CBR 48, 64, 80, 96, 128, 160, 192 (kbps)
Ver. 9: CBR 48, 64, 80, 96, 128, 160, 192, 256, 320 (kbps)
*: Only compatible with 2-channel playback

● Compatible media

Media that can be used for MP3 and WMA playback are CD-Rs and CD-RWs.

Playback in some instances may not be possible, depending on the status of the CD-R or CD-RW. Playback may not be possible or the audio may jump if the disc is scratched or marked with fingerprints.

● Compatible disc formats

The following disc formats can be used.

- Disc formats: CD-ROM Mode 1 and Mode 2
CD-ROM XA Mode 2, Form 1 and Form 2
- File formats: ISO9660 level 1, level 2, (Romeo, Joliet)
MP3 and WMA files written in any format other than those listed above may not play correctly, and their file names and folder names may not be displayed correctly.

Items related to standards and limitations are as follows:

- Maximum directory hierarchy: 8 levels
- Maximum length of folder names/file names: 32 characters
- Maximum number of folders: 192 (including the root)
- Maximum number of files per disc: 255

● File names

The only files that can be recognized as MP3/WMA and played are those with the extension .mp3 or .wma.

● Multi-sessions

As the audio system is compatible with multi-sessions, it is possible to play discs that contain MP3 and WMA files. However, only the first session can be played.

● ID3 and WMA tags

ID3 tags can be added to MP3 files, making it possible to record the track title and artist name, etc.

The system is compatible with ID3 Ver. 1.0, 1.1, and Ver. 2.2, 2.3 ID3 tags. (The number of characters is based on ID3 Ver. 1.0 and 1.1.)

WMA tags can be added to WMA files, making it possible to record the track title and artist name in the same way as with ID3 tags.

3-2. Using the audio system

● MP3 and WMA playback

When a disc containing MP3 or WMA files is inserted, all files on the disc are first checked. Once the file check is finished, the first MP3 or WMA file is played. To make the file check finish more quickly, we recommend you do not write in any files other than MP3 or WMA files or create any unnecessary folders.

Discs that contain a mixture of music data and MP3 or WMA format data cannot be played.

● Extensions

If the file extensions .mp3 and .wma are used for files other than MP3 and WMA files, they will be mistakenly recognized and played as MP3 and WMA files. This may result in large amounts of interference and damage to the speakers.

● Playback

- To play MP3 files with steady sound quality, we recommend a fixed bit rate of 128 kbps and a sampling frequency of 44.1 kHz.
- CD-R or CD-RW playback may not be possible in some instances, depending on the characteristics of the disc.
- There is a wide variety of freeware and other encoding software for MP3 and WMA files on the market, and depending on the status of the encoding and the file format, poor sound quality or noise at the start of playback may result. In some cases, playback may not be possible at all.
- When files other than MP3 or WMA files are recorded on a disc, it may take more time to recognize the disc and in some cases, playback may not be possible at all.
- Microsoft, Windows, and Windows Media are the registered trademarks of Microsoft Corporation in the U.S. and other countries.

■ **CD-R and CD-RW discs**

- CD-R/CD-RW discs that have not been subject to the “finalizing process” (a process that allows discs to be played on a conventional CD player) cannot be played.
- It may not be possible to play CD-R/CD-RW discs recorded on a music CD recorder or a personal computer because of disc characteristics, scratches or dirt on the disc, or dirt, condensation, etc. on the lens of the unit.
- It may not be possible to play discs recorded on a personal computer depending on the application settings and the environment. Record with the correct format. (For details, contact the appropriate application manufacturers of the applications.)
- CD-R/CD-RW discs may be damaged by direct exposure to sunlight, high temperatures or other storage conditions. The unit may be unable to play damaged discs.
- If you insert a CD-RW disc into the MP3/WMA player, playback will begin more slowly than with a conventional CD or CD-R disc.
- Recordings on CD-R/CD-RW cannot be played using the DDCD (Double Density CD) system.

■ **Unsuitable discs, and player precautions**

→P. 226

3-2. Using the audio system Optimal use of the audio system

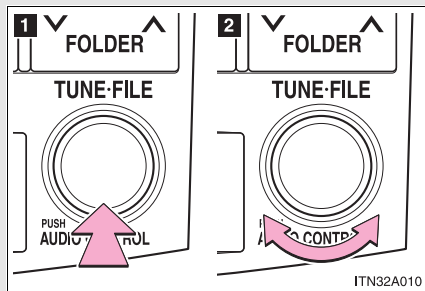

- 1 Displays the current mode
 - 2 Changes the following setting
 - Sound quality and volume balance (→P. 237)
- The sound quality and balance setting can be changed to produce the best sound.
- Automatic Sound Levelizer ON/OFF (→P. 237)

Using the AUDIO CONTROL function

■ Changing sound quality modes

Pressing  selects the mode to be change in the following order.

“BAS” → “MID”^{*} → “TRE” → “FAD” → “BAL” → “SURROUND”^{*} → “ASL”

^{*}: If equipped

■ Adjusting sound quality

Turning  adjust the level.

Mode displayed	Sound quality mode	Level	Turn to the left	Turn to the right
"BAS"	Bass*	-5 to 5	Low	High
"MID" (if equipped)	Mid-range*	-5 to 5		
"TRE"	Treble*	-5 to 5		
"FAD"	Front/rear volume balance	F7 to R7	Shifts to rear	Shifts to front
"BAL"	Left/right volume balance	L7 to R7	Shifts to left	Shifts to right
"SUR-ROUND" (if equipped)	Surround	ON/OFF	OFF	ON

*: The sound quality level is adjusted individually in each radio mode or CD mode.

■ Adjusting the Automatic Sound Levelizer (ASL)

When ASL is selected, turning  to the right turns on the ASL,

and turning  to the left turns off the ASL.

ASL automatically the volume and tone quality according to the vehicle speed.

3-2. Using the audio system Using the AUX adapter

This adapter can be used to connect a portable audio device and listen to it using the vehicle's speakers.

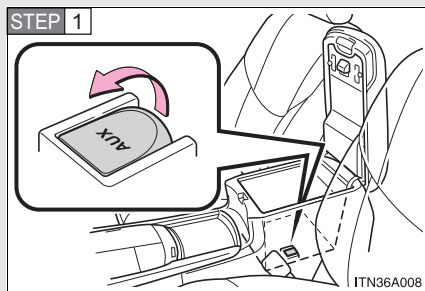

Connect the portable audio device.



■ Operating portable audio devices connected to the audio system

The volume can be adjusted using the vehicle's audio controls. All other adjustments must be made on the portable audio device itself.

3-2. Using the audio system Using the steering wheel audio switches

Some audio features can be controlled using the switches on the steering wheel.

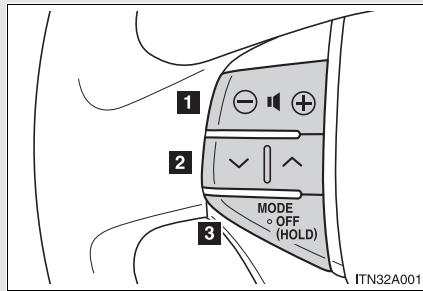

- 1** Volume
- 2** Radio: Select radio stations
CD: Select tracks, files (MP3 and WMA) and discs
- 3** Power on, select audio source

Turning on the power

Press  when the audio system is turned off.

The audio system can be turned off by holding the switch down for 1 second or more.

Changing the audio source

Press  when the audio system is turned on. The audio source changes as follows each time the button is pressed. If a CD is not inserted, that mode will be skipped.

“FM1” → “FM2” → “CD player” → “AUX” → “AM” → “SAT1” → “SAT2” → “SAT3”

3

Interior features

3-2. Using the audio system

Adjusting the volume

Press “+” on  to increase the volume and “-” to decrease the volume.

Press and hold the button to continue increasing or decreasing the volume.

Selecting a radio station

STEP 1 Press  to select the radio mode.

STEP 2 Press “^” or “v” on  to select a radio station.

To scan for receivable stations, press and hold the button until you hear a beep.

Selecting a track/file

STEP 1 Press  to select the CD mode.

STEP 2 Press “^” or “v” on  to select the desired track/file.

Selecting a disc in the CD player

STEP 1 Press  to select the CD mode.

STEP 2 Press and hold “^” or “v” on  until you hear a beep.

■ **Canceling automatic selection of a radio station**

Push the same switch.

 **CAUTION**

■ **To reduce the risk of an accident**

Exercise care when operating the audio switches on the steering wheel.

3-3. Using the hands-free system (for cellular phone) Hands-free system (for cellular phone)*

This system supports Bluetooth®, which allows you to make or receive calls without using cables to connect a cellular phone and the system, and without operating the cellular phone.

Title	Page
Using the hands-free system	P. 246
Making a phone call	P. 254
Setting a cellular phone	P. 259
Security and system setup	P. 264
Using the phone book	P. 267

■ Hands-free System Additional Information

For additional information pairing and connecting cellular phone or for phone compatibility with vehicle's Bluetooth® system, please visit the following website: <http://www.toyota.letstalk.com>

■ Conditions under which the system will not operate

- If using a cellular phone that does not support Bluetooth®.
- If the cellular phone is switched off.
- If you are outside service range.
- If the cellular phone is not connected.
- If the cellular phone's battery is low.

■ When transferring ownership of the vehicle

Be sure to initialize the system to prevent the personal data from being improperly accessed.

*: If equipped

3-3. Using the hands-free system (for cellular phone)

■ About Bluetooth®



Bluetooth is a registered trademark of Bluetooth SIG, Inc.

■ Compatible models

Compatible with HFP (Hands Free Profile) Ver. 1.0 and OPP (Object Push Profile) Ver. 1.1.

If your cellular phone does not support HFP, you cannot enter the Bluetooth® phone, and take OPP service individually.

■ Certification for the hands-free system

FCC ID: HYQBTAU01A

IC ID: 1551A-BTAU01A

MADE IN JAPAN

NOTE:

This device complies with Part 15 of the FCC Rules and RSS-210. Operation is subject to the following two conditions: (1) This device may not cause harmful interference, and (2) This device must accept any interference received, including interference that may cause undesired operation.

3-3. Using the hands-free system (for cellular phone)

NOTICE:

This equipment has been tested and found to comply with the limits for a Class B digital device, pursuant to Part 15 of the FCC Rules. These limits are designed to provide reasonable protection against harmful interference in a residential installation. This equipment generates, uses and can radiate radio frequency energy and, if not installed and used in accordance with the instructions, may cause harmful interference to radio communications. However, there is no guarantee that interference will not occur in a particular installation. If this equipment does cause harmful interference to radio or television reception, which can be determined by turning the equipment off and on, the user is encouraged to try to correct the interference by one or more of the following measures:

- Reorient or relocate the receiving antenna.
- Increase the separation between the equipment and receiver.
- Connect the equipment into an outlet on a circuit different from that to which the receiver is connected.
- Consult the dealer or an experienced radio/TV technician for help.

FCC WARNING:

Changes or modifications not expressly approved by the party responsible for compliance could void the user's authority to operate the equipment.

3-3. Using the hands-free system (for cellular phone)

CAUTION:

Radio Frequency Radiation Exposure

This equipment complies with FCC radiation exposure limits set forth, for uncontrolled equipment and meets the FCC radio frequency (RF) Exposure Guidelines in Supplement C to OET65. This equipment has very low levels of RF energy that it deemed to comply without maximum permissive exposure evaluation (MPE). But it is desirable that it should be installed and operated with at least 20 cm and more between the radiator and person's body (excluding extremities: hands, wrists, feet and legs).

Co-location:

This transmitter must not be co-located or operated in conjunction with any other antenna or transmitter.

 **CAUTION**

■ **While driving**

Do not use a cellular phone, or connect the Bluetooth® phone.

 **NOTICE**

■ **To prevent damage to a cellular phone**

Do not leave a cellular phone in the vehicle. The temperature inside may become high resulting in damage to the phone.

3-3. Using the hands-free system (for cellular phone)

Using the hands-free system

■ Audio unit

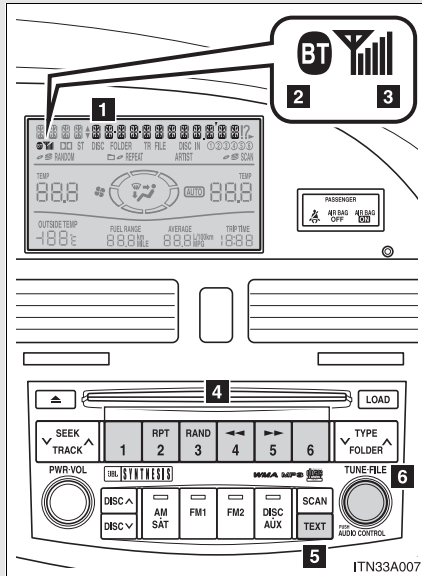

- 1 Displays such items as message, name, and phone number

Lower-case characters and special characters, such as an umlaut, cannot be displayed.

- 2 Displays Bluetooth® connection condition

If "BT" is not displayed, the hands-free system cannot be used.

- 3 Displays the reception level

- 4 Selects speed dials

- 5 Push and hold: Displays information that is too long to be displayed at one time on the display

- 6 Selects items such as menu or number

Turn: Selects an item

Press: Inputs the selected item

3-3. Using the hands-free system (for cellular phone)

■ Steering wheel

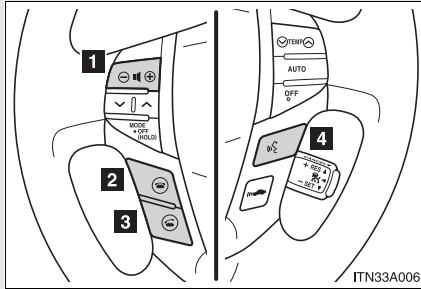

- 1** Volume
- 2** End call
- 3** Sending/Receiving
- 4** Press: Voice command system on
Press and hold: Voice command system off

■ Microphone

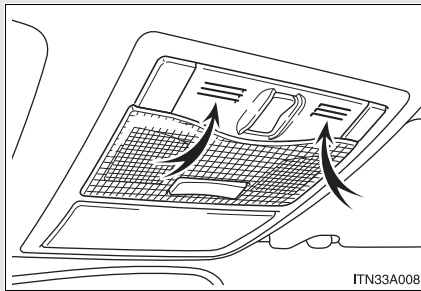

3

Interior features

3-3. Using the hands-free system (for cellular phone)

Operating the system by using a voice command

By following voice guidance instructions output from the speaker, voice commands can be given to allow for operation of the hands-free system without checking the display or operating  .

■ Operation procedure

Press  and say a command for a desired function.
(→P. 250)

■ Auxiliary commands

The following auxiliary commands can be used:

Cancel: Exits the hands-free system

Go back: Returns to the previous procedure



Using the hands-free system for the first time

Before using the hands-free system, it is necessary to register a cellular phone in the system. The phone registration mode will be entered automatically when starting the system with no cellular phone registered. Follow the procedure below to register a cellular phone:

STEP 1 Press  or .

The introductory guidance and phone name registration instructions are heard.

STEP 2 Register a phone name by either of the following methods.

- a. Select "Record Name" by using , and say a name to be registered.
- b. Press  and say a name to be registered.

Voice guidance instruction to confirm the input is heard.

STEP 3 Press  and say "Confirm", or select "Confirm" by using



A passkey is displayed and heard, and voice guidance instruction for inputting the passkey into the cellular phone is heard.

STEP 4 Input the passkey into the cellular phone.

Refer to the manual that comes with the cellular phone for the operation of the phone.

Guidance for registration completion is heard.

3-3. Using the hands-free system (for cellular phone)

Menu list of the hands-free system

■ Normal operation

First menu	Second menu	Third menu	Operation detail
Callback	—	—	Dialing a number stored in the incoming history memory
Redial	—	—	Dialing a number stored in the outgoing history memory
Dial by number	—	—	Dialing by inputting a number
Dial by name	—	—	Dialing by inputting a name registered in the phone book
Phone-book	Add Entry	—	Adding a new number
	Change Name	—	Changing a name in the phone book
	Delete Entry	—	Deleting the phone book data
	Delete Speed Dial (Delete Spd Dial)	—	Deleting a registered speed dial
	List Names	—	List the phone book data
	Set Speed Dial (Set Spd Dial)	—	Registering speed dial

3-3. Using the hands-free system (for cellular phone)

First menu	Second menu	Third menu	Operation detail
Setup	Security	Set PIN	Setting a PIN code
		Phonebook Lock	Locking the phone book
		Phonebook Unlock	Unlocking the phone book
	Phone Setup	Pair Phone	Registering a cellular phone to be used
		Change Name	Changing a registered name of a cellular phone
		Delete	Deleting a registered cellular phone
		List phones	Listing the registered cellular phones
		Select phone	Selecting a cellular phone to be used
		Set Passkey	Changing the passkey
	System Setup	Guidance Volume (Guidance Vol)	Setting voice guidance volume
		Initialize	Initialization

3

Interior features

3-3. Using the hands-free system (for cellular phone)

■ Using a short cut key

First menu	Second menu	Operation detail
Dial "XXX (name)"	—	Dialing a number registered in the phone book
Phone book add entry	—	Adding a new number
Phone book change name	—	Changing a name of a phone number in the phone book
Phone book delete entry	—	Deleting phone book data
Phone book set speed dial	—	Registering speed dial
Phone book delete speed dial	—	Deleting speed dial
Phonebook	Phonebook Unlock	Unlocking the phone book
	Phonebook Lock	Locking the phone book

3-3. Using the hands-free system (for cellular phone)

■ Automatic adjustment of volume

When vehicle speed is 50 mph (80 km/h) or more, the volume automatically increases. The volume returns to the previous volume setting when vehicle speed drops to 43 mph (70 km/h) or less.

■ When using a voice command

- For numbers, say a combination of single digits from zero to nine, # (pound), * (star), and + (plus).
- Say a command correctly and clearly.

■ The system may not recognize your voice in the following situations:

- When driving on unsealed roads
- When driving at high speeds
- If the window is open
- If the air conditioning is blowing directly on the microphone
- If the air conditioning is set too high

■ The following cannot be performed while driving:

- Operating the system with 
- Registering a cellular phone to the system

■ Changing the passkey

→P. 263

3-3. Using the hands-free system (for cellular phone)

Making a phone call

■ Making a phone call

- Dialing by inputting a number
 1. "Dial by number"
- Dialing by inputting a name
 1. "Dial by name"
- Speed dialing
- Dialing a number stored in the outgoing history memory
 1. "Redial"
- Dialing a number stored in the incoming history memory
 1. "Call back"

■ Receiving a phone call

- Answering the phone
- Refusing the call

■ Transferring a call

■ Using a call history memory

- Dialing
- Storing data in the phone book
- Deleting



Dialing by inputting a number

STEP 1 Press  and say "Dial by number".

STEP 2 Press  and say the phone number.

3-3. Using the hands-free system (for cellular phone)



STEP 3 Dial by one of the following methods:

- a. Press  .
- b. Press  and say “Dial”.
- c. Select “Dial” by using  .



Dialing by inputting a name

STEP 1 Press  and say “Dial by name”.

STEP 2 Select a registered name to be input by either of the following methods:

- a. Press  and say a registered name.
- b. Press  and say “List names”. Press  while the desired name is being read aloud.

STEP 3 Dial by one of the following methods:

- a. Press  .
- b. Press  and say “Dial”.
- c. Select “Dial” by using  .

3-3. Using the hands-free system (for cellular phone)

Speed dialing

STEP 1 Press  .

STEP 2 Press the preset button in which the desired number is registered.

STEP 3 Press  .

When receiving a phone call

■ Answering the phone

Press  .

■ Refusing the call

Press  .

Transferring a call

A call can be transferred between the cellular phone and system while dialing, receiving a call, or during a call. Use one of the following methods:

- a. Operate the cellular phone.

Refer to the manual that comes with the cellular phone for the operation of the phone.

- b. Press  *1.

- c. Press  and say "Call Transfer" *2.

*1: This operation can be performed only when transferring a call from the cellular phone to the system during a call.

*2: While the vehicle is in motion, a call cannot be transferred from the system to the cellular phone.

Using a call history memory

Follow the procedure below to use number stored in call history memory:

STEP 1 Press  and say "Redial" (when using a number stored in the outgoing history memory) or "Callback" (when using a number stored in the incoming history memory).

STEP 2 Select the number by either of the following methods:

- a. Say "Previous" or "Go back" until the desired number is displayed.

- b. Select the desired number by using  .

3-3. Using the hands-free system (for cellular phone)

The following operations can be performed:

Dialing: Press  or select “Dial” by using a voice command

or  .

Storing the number in the phone book: Select “Store” by using a

voice command or  .

Deleting: Select “Delete” by using a voice command or  .

■ Call history

Up to 5 numbers can be stored in each of the outgoing and incoming history memories.

■ When talking on the phone

- Do not talk simultaneously with the other party.
- Keep the volume of the receiving voice down. Otherwise, voice echo will increase.

3-3. Using the hands-free system (for cellular phone) Setting a cellular phone

Registering a cellular phone in the hands-free system allows the system to function. The following function can be used for registered cellular phones:

■ Functions and operation procedures

To enter menu for each function, follow the steps below by using a voice command or .

- Registering a cellular phone
 1. "Setup" → 2. "Phone Setup" → 3. "Pair Phone"
- Selecting a cellular phone to be used
 1. "Setup" → 2. "Phone Setup" → 3. "Select Phone"
- Changing a registered name
 1. "Setup" → 2. "Phone Setup" → 3. "Change Name"
- Listing the registered cellular phones
 1. "Setup" → 2. "Phone Setup" → 3. "List Phones"
- Deleting a cellular phone
 1. "Setup" → 2. "Phone Setup" → 3. "Delete"
- Changing the passkey
 1. "Setup" → 2. "Phone Setup" → 3. "Set Passkey"

Registering a cellular phone

Select "Pair Phone" by using a voice command or , and do the procedure for registering a cellular phone. (→P. 249)

3-3. Using the hands-free system (for cellular phone)

Selecting a cellular phone to be used

STEP 1 Select “Select Phone” by using a voice command or  .

► Pattern A

STEP 2 Select a cellular phone to be used by either of the following methods, and select “Confirm” by using a voice command or



a. Press  and say the desired phone name.

b. Press  and say “List phones”. While the name of the

desired cellular phone is being read aloud, press  .

► Pattern B

STEP 2 Select a cellular phone to be used by using  .

3-3. Using the hands-free system (for cellular phone)



Changing a registered name

STEP 1 Select “Change Name” by using a voice command or  .



STEP 2 Select a name of cellular phone to be changed by either of the following methods:

a. Press  and say the desired phone name, and select

“Confirm” by using a voice command or  .

b. Press  and say “List phones”. While the desired phone name is being read aloud, press  .

c. Select the desired phone name by using  .

STEP 3 Press  or select “Record Name” by using  , and say a new name.

STEP 4 Select “Confirm” by using a voice command or  .

Listing the registered cellular phones

Selecting “List Phones” by using a voice command or  begins reading aloud the list of the registered cellular phones. When listing is complete, the system returns to “Phone Setup”.

3-3. Using the hands-free system (for cellular phone)

Pressing  while a name of cellular phone is being read selects the cellular phone, and the following functions will be available:

- Selecting a cellular phone: “Select Phone”
- Changing a registered name: “Change Name”
- Deleting a cellular phone: “Delete”



Deleting a cellular phone

STEP 1 Select “Delete” by using a voice command or  .

► Pattern A

STEP 2 Select a cellular phone to be deleted by either of the following methods and select “Confirm” by using a voice command or



- Press  and say the name of the desired cellular phone.
- Press  and say “List phones”. While the name of the desired cellular phone is being read aloud, press  .

► Pattern B

STEP 2 Select a desired cellular phone to be deleted by using  .

3-3. Using the hands-free system (for cellular phone)

Changing the passkey

STEP 1 Select “Set Passkey” by using a voice command or  .

▶ Pattern A

STEP 2 Press  , say a four to eight-digit number, and select

“Confirm” by using a voice command or  .

▶ Pattern B

STEP 2 Select a four to eight-digit number by using  .

The number should be input one digit at a time.

STEP 3 When the entire number to be registered as a passkey has

been input, press  again.

■ The number of cellular phone that can be registered

Up to 6 cellular phones can be registered in the system.

3-3. Using the hands-free system (for cellular phone) Security and system setup

To enter the menu of each setting, follow the steps below:

■ Security setting items and operation procedure

- Setting or changing the PIN (Personal Identification Number)
1. "Setup" → 2. "Security" → 3. "Set PIN"
- Locking the phone book
1. "Setup" → 2. "Security" → 3. "Phonebook Lock"
- Unlocking the phone book
1. "Setup" → 2. "Security" → 3. "Phonebook Unlock"

■ System setup items and operation procedure

- Setting voice guidance volume
1. "Setup" → 2. "System Setup" → 3. "Guidance Vol"
- Initialization
1. "Setup" → 2. "System Setup" → 3. "Initialize"





can only be used for system setup operation.

Setting or changing the PIN

■ Setting a PIN

STEP 1 Select "Set PIN" by using a voice command or  .

STEP 2 Enter a PIN by using a voice command or  .

When using  , input the code one digit at a time.

3-3. Using the hands-free system (for cellular phone)

■ Changing the PIN

STEP 1 Select “Set PIN” by using a voice command or  .

STEP 2 Enter the registered PIN by using a voice command or  .

STEP 3 Enter a new PIN by using a voice command or  .

When using  , input the code one digit at a time.

Locking or unlocking the phone book

STEP 1 Select “Phonebook Lock (Phbk Lock)” or “Phonebook Unlock (Phbk Unlock)” by using a voice command or  .

STEP 2 Input the PIN by either of the following methods and select “Confirm” by using a voice command or  :

a. Press  and say the registered PIN.

b. Input a new PIN by using  .

3

Interior features

3-3. Using the hands-free system (for cellular phone)

Setting voice guidance volume

STEP 1 Select “Guidance Vol” by using .

STEP 2 Change the voice guidance volume.

To decrease the volume: Turn  counterclockwise.

To increase the volume: Turn  clockwise.

Initialization

STEP 1 Select “Initialize” and then “Confirm” by using .

STEP 2 Select “Confirm” by using a voice command or  again.

Initialization

- The following data in the system can be initialized:
 - Phone book
 - Outgoing and incoming history
 - Speed dial
 - Registered cellular phone data
 - Security code
- Once the initialization has been completed, the data cannot be restored to its original state.

When the phone book is locked

The following functions cannot be used:

- Dialing by inputting a name
- Speed dialing
- Dialing a number stored in the call history memory
- Using the phone book

3-3. Using the hands-free system (for cellular phone) Using the phone book

To enter the menu of each setting, follow the steps below:

- Adding a new phone number
1. "Phonebook" → 2. "Add Entry"
- Setting speed dial
1. "Phonebook" → 2. "Set Speed Dial (Speed Dial)"
- Changing a registered name
1. "Phonebook" → 2. "Change Name"
- Deleting registered data
1. "Phonebook" → 2. "Delete Entry"
- Deleting speed dial
1. "Phonebook" → 2. "Delete Speed Dial (Delete Spd Dial)"
- Listing the registered data
1. "Phonebook" → 2. "List Names"

3

Interior features

Adding a new phone number

The following methods can be used to add a new phone number:

- Inputting a phone number by using a voice command
- Transferring data from the cellular phone
- Inputting a phone number by using 
- Selecting a phone number from outgoing or incoming history

3-3. Using the hands-free system (for cellular phone)

■ Adding procedure

STEP 1 Select “Add Entry” by using a voice command or  .

STEP 2 Use one of the following methods to input a telephone number:

▶ Inputting a telephone number by using a voice command

STEP2-1 Select “By Voice” by using a voice command or



STEP2-2 Press  , say the desired number, and select “Confirm” by using a voice command.

▶ Transferring data from the cellular phone

STEP2-1 Select “By Phone” and then “Confirm” by using a voice command or  .

STEP2-2 Transfer the data from the cellular phone.
Refer to the manual that comes with the cellular phone for the details of transferring data.

STEP2-3 Select the data to be registered by either of the following methods:

a. Say “Previous” or “Next” until the desired data is displayed, and select “Confirm” by using a voice

command or  .

b. Select the desired data by using  .

3-3. Using the hands-free system (for cellular phone)

► Inputting a phone number by using 

STEP2-1 Select “Manual Input” by using  .

STEP2-2 Input a phone number by using  , and press

 again.

Input the phone number one digit at a time.

► Selecting a phone number from outgoing or incoming history

STEP2-1 Select “Call History” by using a voice command or





STEP2-2 Select “Outgoing” or “Incoming” by using a voice

command or  .

STEP2-3 Select the data to be registered by either of the following methods:

a. Say “Previous” or “Go back” until the desired data is displayed, and select “Confirm” by using

a voice command or  .

b. Select the desired data by using  .

3-3. Using the hands-free system (for cellular phone)

STEP 3 Select the name to be registered by either of the following methods, and select “Confirm” by using a voice command or



a. Press  and say the desired name.

b. Select “Record Name” by using , and say the desired name.

STEP 4 Select “Confirm” by using a voice command or  again.

In **STEP 3**, selecting “Set Speed Dial (Speed Dial)” instead of “Confirm” registers the newly added phone number as speed dial.

3-3. Using the hands-free system (for cellular phone)

Setting speed dial



STEP 1 Select “Set Speed Dial (Speed Dial)” by using a voice command or

mand or .

STEP 2 Select the data to be registered as speed dial by either of the following methods:

a. Press , say desired number, and select “Confirm” by

using a voice command or .

b. Press , and say “List names”. While the desired name is being read aloud, press , and select “Con-

firm” by using a voice command or .

c. Select the desired data by using .

STEP 3 Select the desired preset button, and register the data into speed dial by either of the following methods:

a. Press the desired preset button, and select “Confirm” by using a voice command or .



b. Press and hold the desired preset button.



3-3. Using the hands-free system (for cellular phone)

Changing a registered name

STEP 1 Select “Change Name” by using a voice command or  .

STEP 2 Select a name to be changed by either of the following methods.

a. Press  , say desired name, and select “Confirm” by using a voice command or  .

b. Press  , and say “List names”. During the desired name is read aloud, press  .

c. Select the desired name by using  .

STEP 3 Select “Record Name” by using a voice command or  .

STEP 4 Say a new name, and select “Confirm” by using a voice command or  .

3-3. Using the hands-free system (for cellular phone)

Deleting registered data



STEP 1 Select “Delete Entry” by using a voice command or  .

▶ Pattern A

STEP 2 Select data to be deleted by either of the following methods,

and select “Confirm” by using a voice command or  :

a. Press  , and say the name of the desired phone number to be deleted.

b. Press  , say “List phones”. While the name of the desired phone number is being read aloud, press  .

▶ Pattern B

STEP 2 Select data to be deleted by using  .

Deleting speed dial

STEP 1 Select “Delete Speed Dial (Delete Spd Dial)” by using a voice command or  .

STEP 2 Press the preset button in which the desired speed dial is registered, and select “Confirm” by using a voice command or



3-3. Using the hands-free system (for cellular phone)

Listing the registered data

Selecting “List names” by using a voice command begins reading the list of the registered data.

When listing is complete, the system returns to “Phonebook”.

Pressing  while a data is being read aloud selects the data, and the following function will be available.

- Dialing: “Dial”
- Changing a registered name: “Change Name”
- Deleting an entry: “Delete Entry”
- Setting speed dial: “Set Speed Dial (Speed Dial)”

■ Limitation of number of digits

A phone number that exceeds 24 digits cannot be registered.

3-4. Using the interior lights Interior lights list

Illuminated entry system: The various lights automatically turn on/off according to the presence of the key, whether the doors are locked/unlocked, whether the doors are open/closed, and the “ENGINE START STOP” switch mode (vehicles with smart key system) or the engine switch position (vehicles without smart key system).

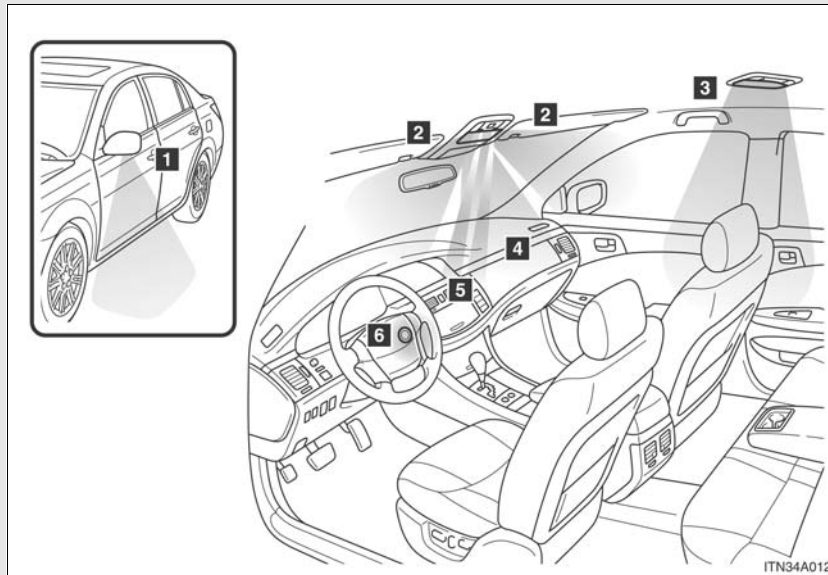

- 1** Outer foot light
- 2** Front personal lights (→P. 277)
- 3** Rear personal light (→P. 277)
- 4** Interior light (→P. 277)
- 5** Center console light
- 6** Engine switch light (if equipped)

3-4. Using the interior lights

■ To prevent battery discharge

If the interior lights, personal lights and engine switch light (if equipped) remain on when the door is not fully closed or the interior light switch in "DOOR" position, the lights will go off automatically after 20 minutes.

■ Customization that can be configured at Toyota dealer

Setting (e.g. The time elapsed before lights turn off) can be changed.
(Customizable features →P. 457)

Interior lights

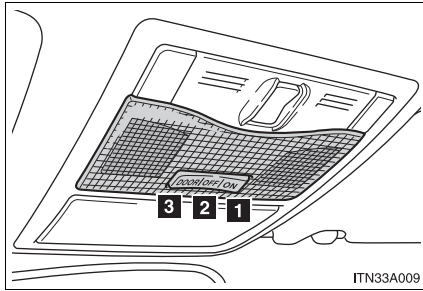

- 1 "ON"
- 2 "OFF"
- 3 "DOOR"

The interior lights are turned on/off by the illuminated entry system.

Personal lights

► Front

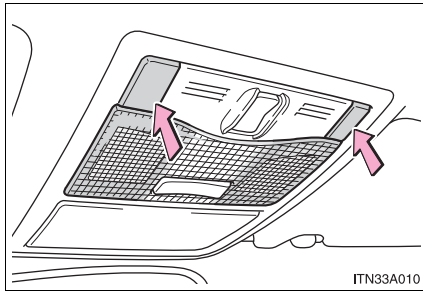

ON/OFF

► Rear

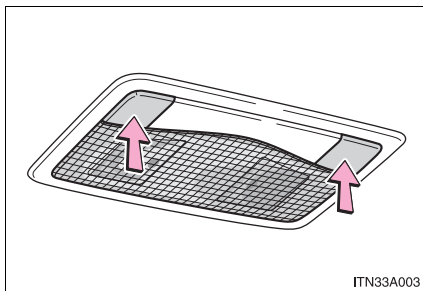

ON/OFF

3-5. Using the storage features

List of storage features

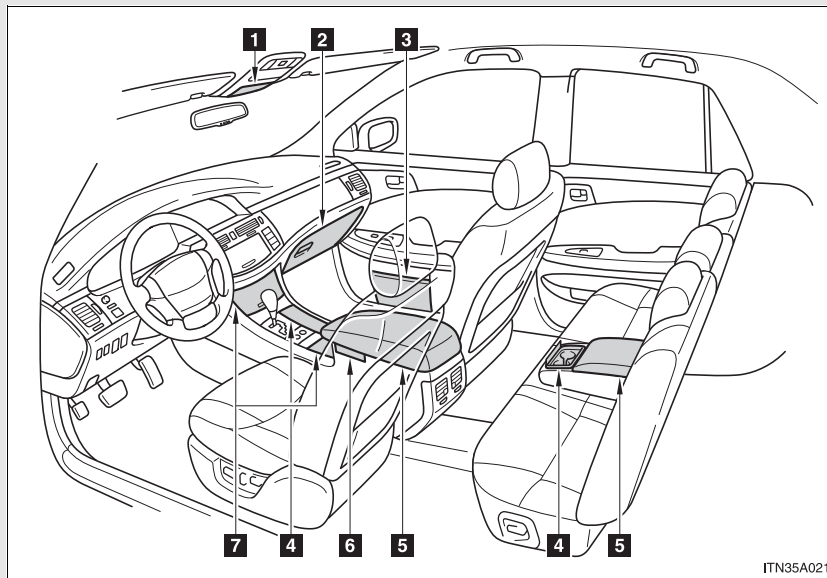

- 1** Overhead console
- 2** Glove box
- 3** Door pocket
- 4** Cup holders
- 5** Console boxes
- 6** Coin tray
- 7** Storage compartment

Glove box

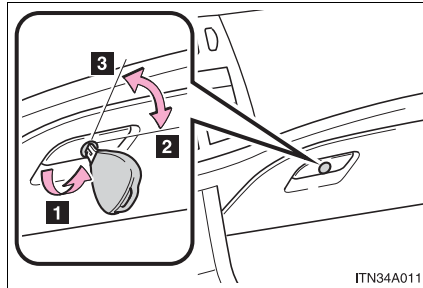

- 1** Open
- 2** Lock with the mechanical key or the master key
- 3** Unlock with the mechanical key or the master key

■ Glove box light

The glove box light turns on when the instrument panel light switch is on.

■ Trunk opener main switch

The trunk opener main switch is located in the glove box. (→ P. 46)

⚠ CAUTION

■ While driving

Keep the glove box closed.
Injuries may result in the event of an accident or sudden braking.

3-5. Using the storage features

Console boxes

► Front

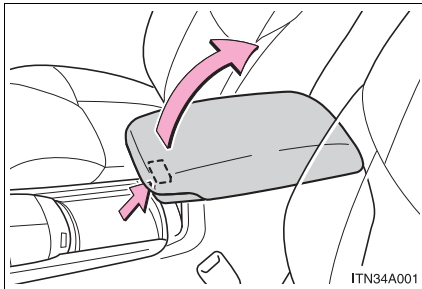

Lift the lid while pulling the lever.

► Rear

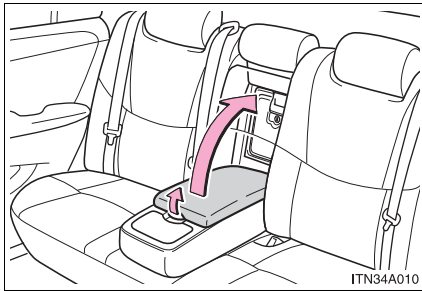

Lift the lid while pulling the lever.

■ When using the front console box lid as an armrest

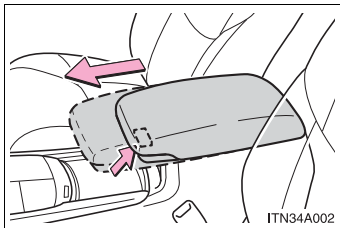

If necessary, the console box lid can slide forward. Pull the lid forward by grasping the front of the lid.

■ **Tray in the front console box**

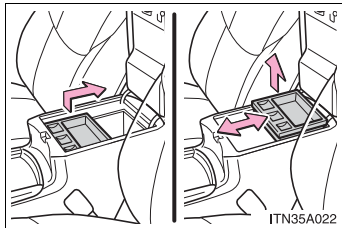

The tray slides forward/backward and can be removed.

⚠ CAUTION

■ **While driving**

Keep the console box closed.
Injuries may result in the event of an accident or sudden braking.

Overhead console

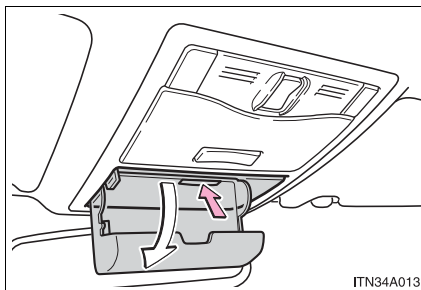

The overhead console is useful for temporarily storing sunglasses and similar small items.

3-5. Using the storage features

CAUTION

■ **Items that should not be left in the overhead console**

Do not leave glasses or lighters in the console.

If the interior of the vehicle becomes hot, lighters may explode and glasses may warp or become cracked.

■ **While driving**

Do not leave the overhead console open. Items may fall out and cause injury.

Storage compartment

- ▶ Front console (if equipped)

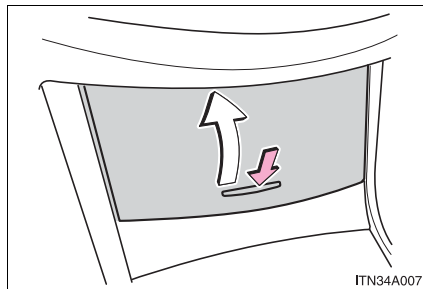

- ▶ Center console

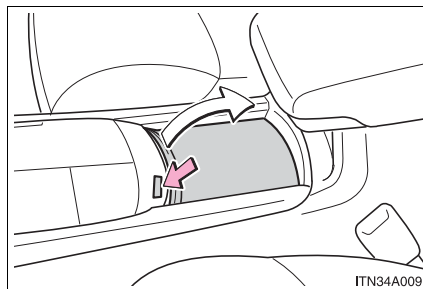

⚠ CAUTION

■ While driving

Do not leave the storage compartment open.

The opened compartment may hit your body or items may be thrown out of the compartment in the event of an accident or sudden braking and cause injury.

3-5. Using the storage features

Cup holders

► Front

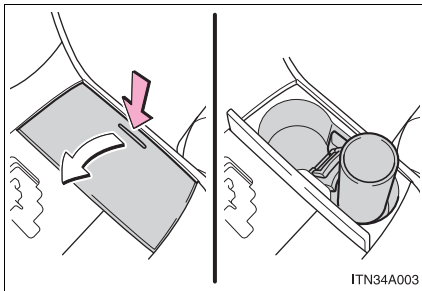

To open, press down and release the cup holder lid.

► Rear (type A)

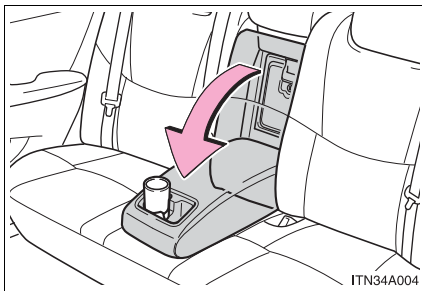

Pull down the armrest.

► Rear (type B)

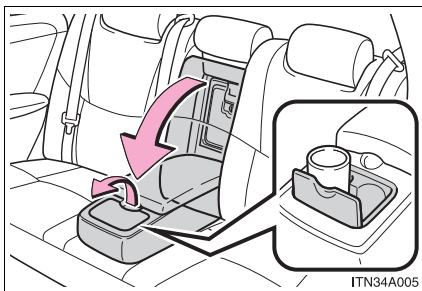

Pull down the armrest and open the lid.

⚠ CAUTION

■ **Items unsuitable for the cup holder**

Do not place anything other than cups or aluminum cans in the cup holders. Other items may be thrown out of the holders in the event of an accident or sudden braking and cause injury. If possible, cover hot drinks to prevent burns.

■ **When not in use**

Keep the cup holders closed. Injuries may result in the event of an accident or sudden braking.

Door pockets

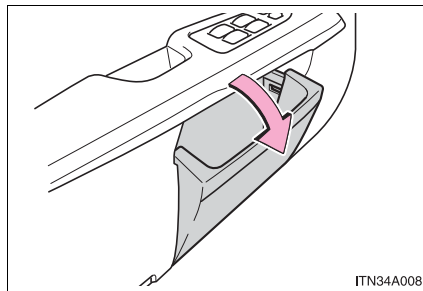

The front door pocket can be opened and closed.

⚠ CAUTION

■ **While driving**

Keep the door pockets closed. Injuries may result in the event of an accident or sudden braking.

3-6. Other interior features

Sun visors

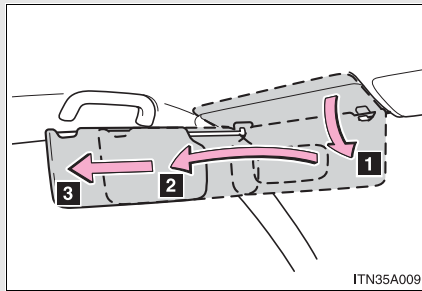

- 1** Forward position: Flip down.
- 2** Side position: Flip down, unhook, and swing to the side.
- 3** Side extender: Place in side position, then slide backwards.

3-6. Other interior features

Vanity mirrors

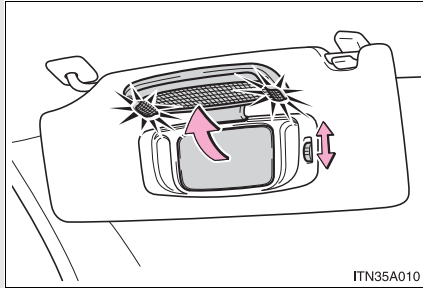

The light turns on when the cover is opened.
To adjust the brightness of the lights, slide the switch.

3-6. Other interior features

Clock

▶ Without navigation system

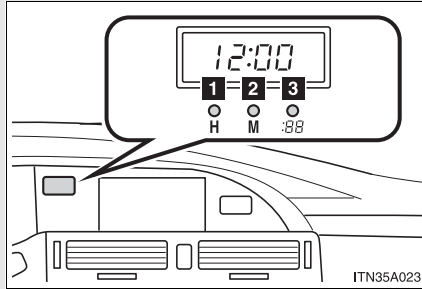

- 1** Adjust the hour
- 2** Adjust the minutes
- 3** Rounds to the nearest hour

▶ With navigation system

Refer to "Navigation System Owner's Manual".

■ The clock is displayed when

▶ Vehicles with smart key system

The "ENGINE START STOP" switch is in ACCESSORY or IGNITION ON mode.

▶ Vehicles without smart key system

The engine switch is in the "ACC" or "ON" position.

■ When the battery is disconnected

The time display will automatically be set to 1:00.

3-6. Other interior features

Outside temperature display

The displayed temperature ranges from -22°F (-30°C) up to 122°F (50°C).

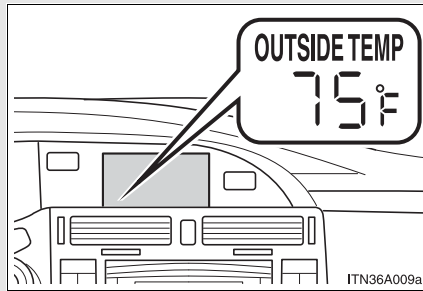

■ Operating conditions

- ▶ Vehicles with smart key system

The "ENGINE START STOP" switch is in IGNITION ON mode.

- ▶ Vehicles without smart key system

The engine switch is in the "ON" position.

■ When "--", "F" or "E" is displayed

The system may be malfunctioning. Take your vehicle to your Toyota dealer.

■ Display

In the following situations, the correct outside temperature may not be displayed, or the display may take longer than normal to change.

- When stopped, or driving at low speeds (less than 12 mph [20 km/h])
- When the outside temperature has changed suddenly (at the entrance/exit of a garage, tunnel, etc.)

3-6. Other interior features

Ashtrays*

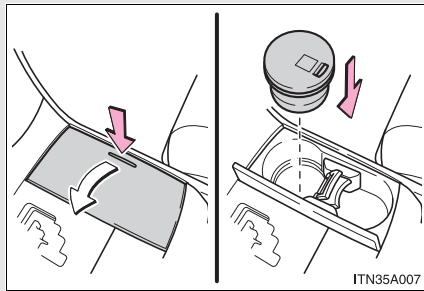

CAUTION

■ When not in use

Keep the ashtray closed. Injuries may result in the event of sudden braking, sudden swerving or an accident.

■ To prevent fire

- Fully extinguish matches and cigarettes before putting them in the ashtray, then make sure the ashtray is fully closed.
- Do not place paper or any other type of flammable object in the ashtray.

*: If equipped

3-6. Other interior features

Power outlets

The power outlets can be used for 12V accessories that run on less than 10A.

► Front console box

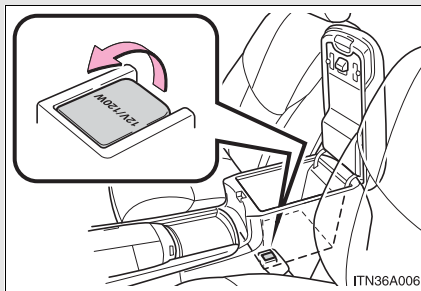

► Center console box

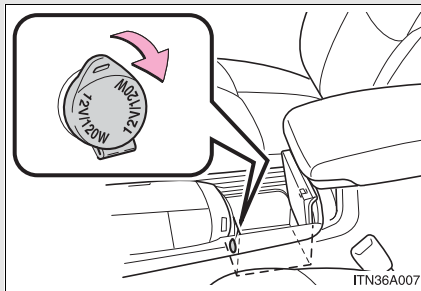

■ The power outlets can be used when

► Vehicles with smart key system

The “ENGINE START STOP” switch is in ACCESSORY or IGNITION ON mode.

► Vehicles without smart key system

The engine switch is in the “ACC” or “ON” position.

3-6. Other interior features

 NOTICE

■ **To avoid damaging the power outlets**

Close the power outlets lid when not in use.
Foreign objects or liquids that enter the power outlets may cause a short circuit.

■ **To prevent the fuse from being blown**

Do not use an accessory that uses more than 12V/10A.

■ **To prevent battery discharge**

Do not use the power outlets longer than necessary when the engine is not running.

3-6. Other interior features Seat heaters/ventilators*

The seat heaters and ventilators heat the seats and maintain good airflow by blowing air from the seats.

► Vehicles with ventilator

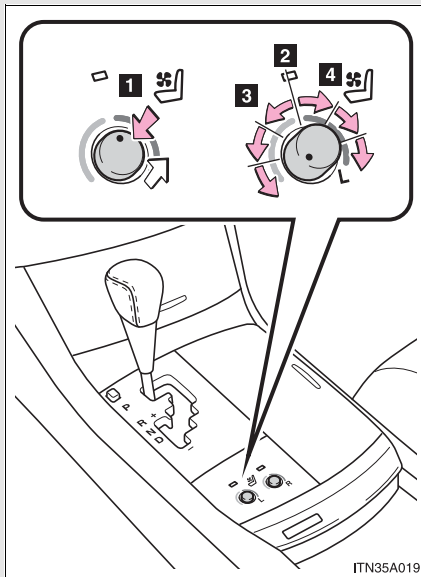

1 Press the knob to release it, and turn the knob to the desired temperature setting.

2 OFF

Press the knob to lock it when not in use.

3 Ventilation

4 Warm air

► Vehicles without ventilator

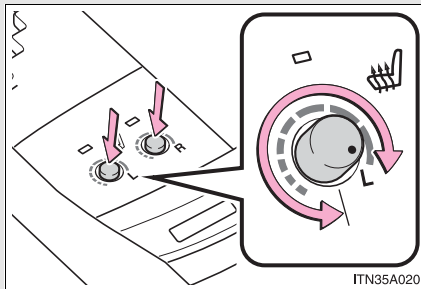

Press the knob to turn the system on, and turn the knob to the desired temperature setting.

The further you turn the knob clockwise, the warmer the seat temperature becomes. Press the knob again to turn the system off.

*: If equipped

■ **The seat heaters and ventilators can be used when**

- ▶ Vehicles with smart key system

The “ENGINE START STOP” switch is in IGNITION ON mode.

- ▶ Vehicles without smart key system

The engine switch is in the “ON” position.

 **CAUTION**

■ **Burns**

- Use caution when seating the following persons in a seat with the seat heater on to avoid the possibility of burns:

- Babies, small children, the elderly, the sick and the disabled
- Persons with sensitive skin
- Persons who are fatigued
- Persons who have taken alcohol or drugs that induce sleep (sleeping drugs, cold remedies, etc.)

- Do not cover the seat with anything when using the seat heater. Using the seat heater with a blanket or cushion increases the temperature of the seat and may lead to overheating.

 **NOTICE**

■ **To prevent seat heater/ventilator damage**

Do not put heavy objects on the seat and do not stick sharp objects (needles, nails, etc.) into the seat.

■ **To prevent battery discharge**

Turn the switches off when the engine is not running.

3-6. Other interior features

Armrest

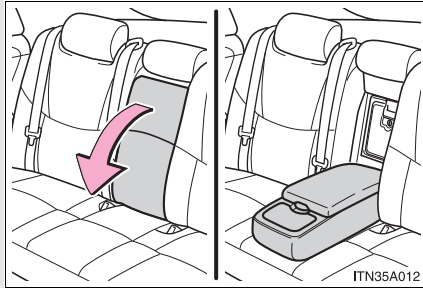

Pull the armrest down for use.

 **NOTICE**

■ To prevent damage to the armrest

Do not place too much strain on the armrest.

3

Interior features

3-6. Other interior features

Rear sunshade*

The rear sunshade can be raised and lowered by pressing the switch shown below.

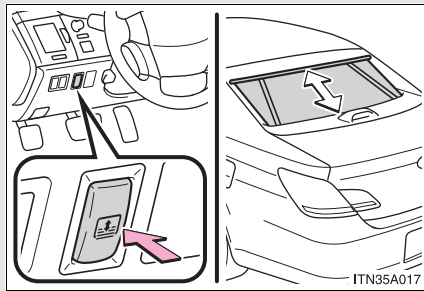

Raise/lower

■ The rear sunshade can be used when

- ▶ Vehicles with smart key system

The "ENGINE START STOP" switch is in IGNITION ON mode.

- ▶ Vehicles without smart key system

The engine switch is in the "ON" position.

■ Reverse operation feature

To ensure adequate rear visibility, the sunshade automatically lowers when the shift lever is shifted to "R".

However, the rear sunshade is raised again if any of the following occurs:

- Shift the shift lever into "P".
- The switch is pressed again.
- The shift lever is shifted out of "R", and the vehicle reaches a speed of 9 mph (15 km/h).

If the engine is turned off when the rear sunshade has been lowered due to the reverse operation feature, it will not be raised even when the engine is turned on again and the vehicle reaches a speed of 9 mph (15 km/h). To raise the sunshade again, press the switch.

*: If equipped

■ **Operating the rear sunshade after turning the “ENGINE START STOP” switch or the engine switch off**

The rear sunshade can be raised and lowered for approximately 1 minute.

■ **Customization that can be configured at Toyota dealer**

Contact your Toyota dealer for further details.

 **CAUTION**

■ **When the rear sunshade is being raised or lowered**

Do not place fingers or other objects in the fastener section or in the opening. They may get caught, causing injury.

 **NOTICE**

■ **To prevent battery discharge**

Do not operate the rear sunshade when the engine is not running.

■ **To ensure normal operation of the sunshade**

Observe the following precautions.

- Do not place excessive load on the motor or other components.
- Do not place objects where they may hinder opening and closing operations.
- Do not attach items to the rear sunshade.
- Keep the opening clean and clear of obstructions.
- Do not operate the rear sunshade continuously over long periods of time.

3-6. Other interior features

Floor mats

Securely place a mat that matches the size of the space on the carpet.

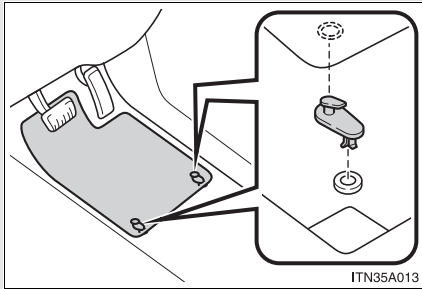

Secure the floor mat using the hooks provided.

⚠ CAUTION

■ When inserting the floor mat

Observe the following precautions.

Failure to do so may result in the floor mat slipping and interfering with the movement of the pedals during driving, resulting in an accident.

- Make sure the floor mat is properly placed on the vehicle carpet and the correct side face upward.
- Do not place floor mats on top of existing mats.

3-6. Other interior features

Trunk features

■ Cargo net

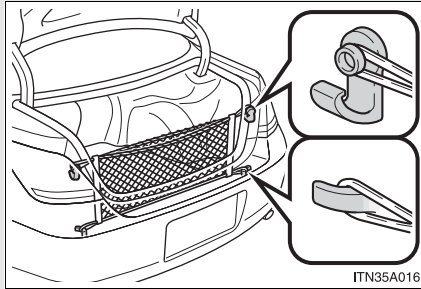

The cargo net is provided for securing loose items.

■ Shopping bag hooks

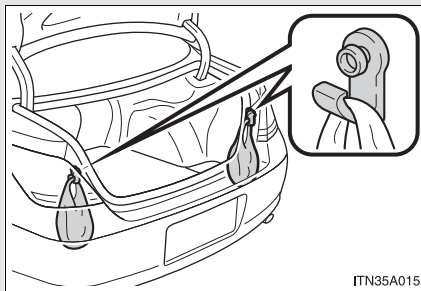

■ Storage box

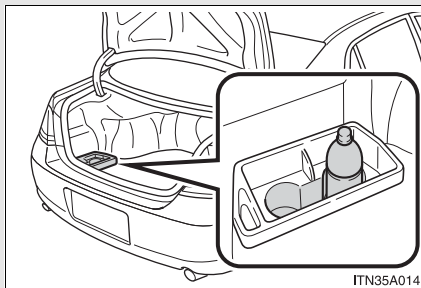

Trunk storage extension

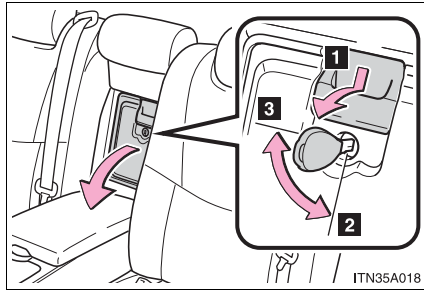

Pull down the rear seat center armrest.

- 1** Open (push down the handle)
- 2** Lock with the mechanical key or the master key
- 3** Unlock with the mechanical key or the master key

CAUTION

■ While driving

- To avoid injury, always return the cargo hooks to their positions when they are not in use.
- Always keep the trunk storage extension doors closed to reduce the chance of injury in case of accident or sudden stop.

NOTICE

■ When closing the trunk

Do not leave the luggage mat lever hooked on the edge of the trunk. The luggage mat may get damaged.

3-6. Other interior features Garage door opener*

The garage door opener can be programmed to operate garage doors, gates, entry doors, door locks, home lighting systems, and security systems, and other devices.

The garage door opener (HomeLink® Universal Transceiver) is manufactured under license from HomeLink®.

Programming the HomeLink® (for U.S.A. owners)

The HomeLink® compatible transceiver in your vehicle has 3 buttons which can be programmed to operate 3 different devices. Refer to the programming method below appropriate for the device.

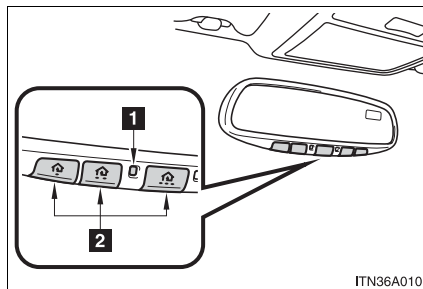

- 1 Indicator
- 2 Buttons

Programming the HomeLink®

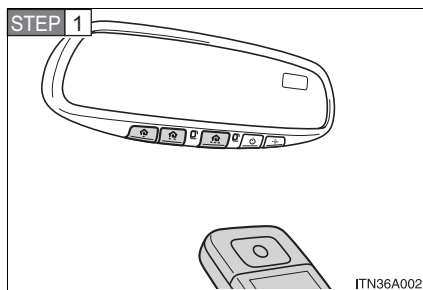

Point the remote control for the device 1 to 3 in. (25 to 75 mm) from the HomeLink® control buttons as shown in the illustration.

Keep the indicator light on the HomeLink® in view while programming.

*: If equipped

3-6. Other interior features

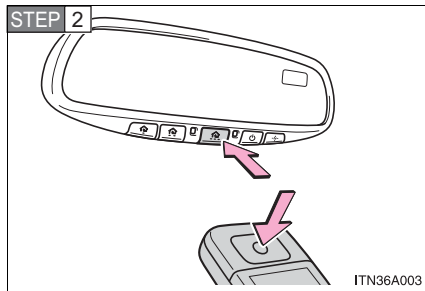

Press and hold down one of the buttons on the HomeLink[®] and the button on the transmitter. Continue holding down both buttons until the HomeLink[®] indicator light changes from a slow blink to a rapid flash. This will take approximately 30 seconds.

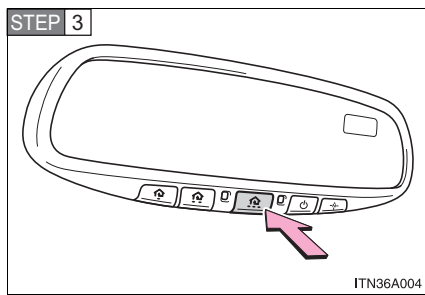

Test the HomeLink[®] operation by pressing and holding the newly programmed button for 2 seconds. If programming was successful, the garage door will open and close.

If the garage door does not operate, press and hold the programmed button for at least 3 seconds. If the indicator light flashes rapidly then remains solid, your garage door opener is Rolling Code type.

Skip STEP 4 and proceed to the section "Programming a Rolling Code system".

STEP 4 Repeat the steps above to program another device for each of the remaining HomeLink[®] buttons.

■ Programming a Rolling Code system (for U.S.A. owners)

If your device is Rolling Code equipped, follow the steps under the heading “Programming the HomeLink®” before proceeding with the steps listed below.

STEP 1 Locate the learn button on the ceiling mounted garage door opener motor. The exact location and color of the button may vary by brand of garage door opener.

Refer to the operation manual supplied with the garage door opener for the location of the learn button.

STEP 2 Press and release the learn button.

STEP 3 Press and hold the vehicle’s programmed HomeLink® button for 2 seconds and release it. Repeat this step once again. The garage door may open.

If the garage door opens, the programming process is complete. If the door does not open, press and release the button a third time. This third press and release will complete the programming process by opening the garage door.

The ceiling mounted garage door opener motor should now recognize the HomeLink® transceiver and operate the garage door.

STEP 4 Repeat the steps above to program another rolling code system for any of the remaining HomeLink® buttons.

■ Programming an entry gate (for U.S.A. owners)/Programming all devices in the Canadian market

STEP 1 Place your transmitter 1 to 3 in. (25 to 75 mm) away from the surface of the HomeLink®.

Keep the indicator light on the HomeLink® in view while programming.

STEP 2 Press and hold the selected HomeLink® button.

STEP 3 Repeatedly press and release (cycle) the device’s remote control button for two seconds each until step 4 is completed.

STEP 4 When the indicator light on the HomeLink® compatible transceiver starts to flash rapidly, release the buttons.

3-6. Other interior features

STEP 5 Test the operation of the HomeLink[®] by pressing the newly programmed button. Check to see if the gate/device operates correctly.

STEP 6 Repeat the steps above to program another device for each of the remaining HomeLink[®] buttons.

■ Programming other devices

To program other devices such as home security systems, home door locks or lighting, contact your authorized Toyota dealer for assistance.

■ Reprogramming a button

The individual HomeLink[®] buttons cannot be erased but can be reprogrammed. To reprogram a button, follow the “Basic programming” instructions.

Operating the HomeLink[®]

Press the appropriate HomeLink[®] button. The HomeLink[®] indicator light on the HomeLink[®] transceiver should turn on.

The HomeLink[®] continues to send a signal for up to 20 seconds as long as the button is pressed.

Erasing the entire HomeLink[®] memory (all three programs)

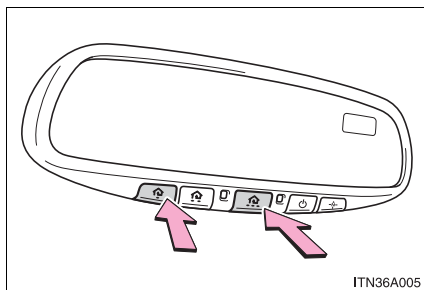

Press and hold down the 2 outside buttons for 20 seconds until the indicator light flashes.

If you sell your vehicle, be sure to erase the programs stored in the HomeLink[®] memory.

■ **Before programming**

- Install a new battery in the transmitter.
- The battery side of the transmitter must be pointed away from the HomeLink®.

■ **Certification for the garage door opener**

This device complies with Part 15 of the FCC Rules and with RSS-210 of the IC Rules.

Operation is subject to the following two conditions: (1) this device may not cause harmful interference, and (2) this device must accept any interference received, including interference that may cause undesired operation.

WARNING: This transmitter has been tested and complies with FCC and IC rules. Changes or modifications not expressly approved by the party responsible for compliance could void the user's authority to operate the device.

 **CAUTION**

■ **When programming a garage door or other remote control device**

The garage door may operate, so ensure people and objects are out of danger to prevent potential harm.

■ **Conforming to federal safety standards**

Do not use the HomeLink® Compatible Transceiver with any garage door opener or device that lacks safety stop and reverse features as required by federal safety standards.

This includes any garage door that cannot detect an obstruction object. A door or device without these features increases the risk of death or serious injury.

3-6. Other interior features

Compass*

The compass on the inside rear view mirror indicates the direction in which the vehicle is heading.

■ Operation

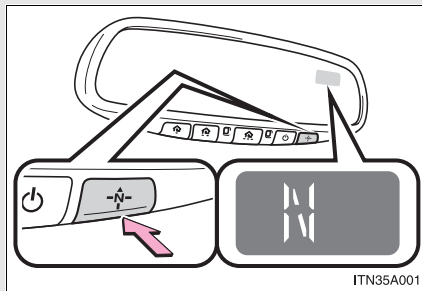

To turn the compass on or off, press the switch.

■ Displays and directions

Display	Direction
N	North
NE	Northeast
E	East
SE	Southeast
S	South
SW	Southwest
W	West
NW	Northwest

*: If equipped

Calibrating the compass

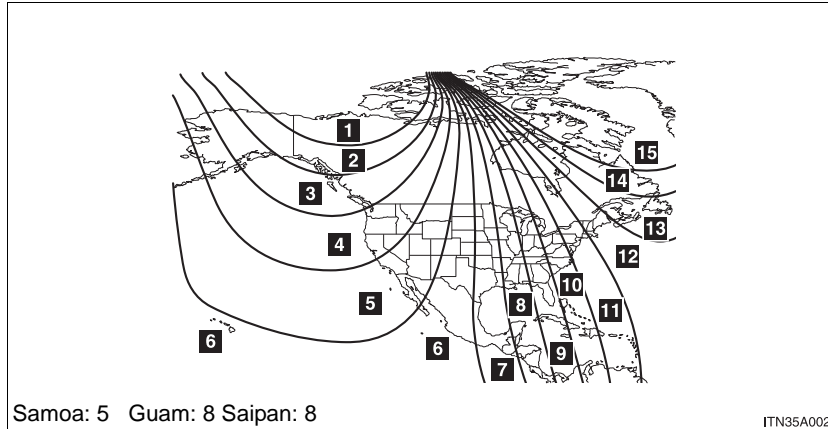

The direction display deviates from the true direction determined by the earth's magnetic field. The amount of deviation varies according to the geographic position of the vehicle.

If you cross over a map boundary shown in illustration, the compass will deviate.

To obtain higher precision or perfect calibration, refer to the following.

■ Deviation calibration

STEP 1 Stop the vehicle where it is safe to drive in a circle.

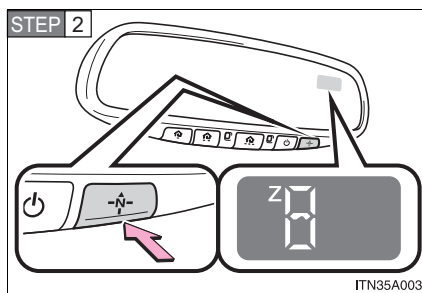

Press the switch until a number (1 to 15) appears on the compass display.

STEP 3 Press the switch, and referring to the map above, select the number of the zone where you are.

3-6. Other interior features

- STEP 4** Wait a few seconds until the compass direction is displayed.
The calibration is complete.

■ Circling calibration

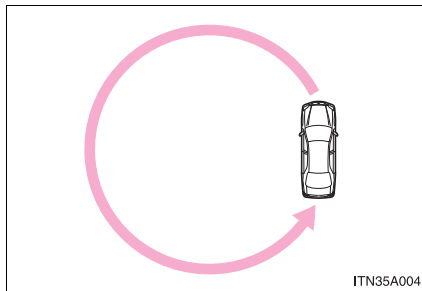

If “CAL” appears on the display, drive the vehicle at 5 mph (8 km/h) or less in a circle until a direction is displayed.

If there is not enough space to drive in a circle, drive around the block until the direction is displayed.

■ Conditions unfavorable to correct operation

The compass may not show the correct direction in the following conditions:

- The vehicle is stopped immediately after turning.
- The vehicle is on an inclined surface.
- The vehicle is in a place where the earth’s magnetic field is subject to interference by artificial magnetic fields (underground car park/parking lot, under a steel tower, between buildings, roof car park/parking lot, near an intersection, near a large vehicle, etc.).
- The vehicle has become magnetized.
(There is a magnet or metal object near the inside rear view mirror.)
- The battery has been disconnected.
- A door is open.

 CAUTION

■ **While driving**

Do not adjust the display.
Be sure to adjust the display only when the vehicle is stopped.

■ **When doing the circling calibration**

Be sure to secure a wide space, and watch out for people and vehicles in the neighborhood. Do not violate any local traffic rules while performing circling calibration.

 NOTICE

■ **To avoid the compass malfunctions**

Do not place magnets or any metal objects near the inside rear view mirror.
Doing this may cause a malfunction of the compass sensor.

■ **To ensure normal operation of the compass**

- Do not perform circling calibration of the compass in a place where the earth's magnetic field is subject to interference by artificial magnetic fields.
- During calibration, do not operate electric systems (moon roof, power windows, etc.) as they may interfere with the calibration.

3-6. Other interior features

4-1. Maintenance and care

Cleaning and protecting the vehicle exterior

Perform the following to protect the vehicle and maintain it in prime condition.

- Working from top to bottom, liberally apply water to the vehicle body, wheel wells and underside of the vehicle to remove any dirt and dust.

Wash the vehicle body using a sponge or soft cloth, such as a chambray.

- For hard-to-remove marks, use car wash soap and rinse thoroughly with water.
- Wipe away any water.
- Wax the vehicle when the waterproof coating deteriorates.

If water does not bead on a clean surface, apply wax when the vehicle body is cool.

■ **Automatic car washes**

- Fold the mirrors back before washing the vehicle.
- Brushes used in automatic car washes may scratch the vehicle surface and harm your vehicle's paint.

■ **High pressure car washes**

Do not allow the nozzles of the car wash to come within close proximity of the windows. Before car wash, check that the fuel filler door is closed.

■ **Aluminum wheels**

Remove any dirt immediately by using a neutral detergent. Do not use hard brushes or abrasive cleaners. Do not use strong or harsh chemical cleaners. Use the same mild detergent and wax as used on the paint.

■ **Bumpers and side moldings**

Do not scrub with abrasive cleaners.

■ **To prevent paint deterioration and corrosion on the body**

- Wash the vehicle immediately in the following cases:
 - After driving near the sea coast
 - After driving on salted roads
 - If you see coal tar or tree sap on the paint surface
 - If you see dead insects, insect droppings or bird droppings on the paint
 - After driving in an area contaminated with soot, oily smoke, mine dust, iron powder or chemical substances
 - If the vehicle becomes heavily soiled in dust or mud
 - If liquids such as benzine and gasoline are spilled on the paint surface
- If the paint is chipped or scratched, have it repaired immediately.

⚠ CAUTION

■ Caution about the exhaust pipe

Exhaust gasses cause the exhaust pipe to become quite hot. When washing the vehicle, be careful not to touch the pipe until it has cooled sufficiently, as touching a hot exhaust pipe can cause burns.

⚠ NOTICE

■ To protect your vehicle's painted surfaces

Do not use organic cleaners such as benzine or gasoline.

■ Cleaning the exterior lights

- Wash carefully. Do not use organic substances or scrub with a hard brush. This may damage the surfaces of the lights.
- Do not apply wax on the surface of the lights. Wax may cause damage to the lenses.

**■ When using an automatic car wash
(vehicles equipped with the raindrop detection windshield wipers)**

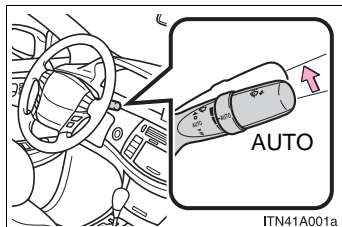

Turn off the wiper switch.

If the wiper switch is in "AUTO", the wipers may operate and the wiper blades may be damaged.

Cleaning and protecting the vehicle interior

The following procedures will help protect your vehicle's interior and keep it in top condition:

■ **Protecting the vehicle interior**

Remove dirt and dust using a vacuum cleaner. Wipe dirty surfaces with a cloth dampened with lukewarm water.

■ **Cleaning the leather areas**

- Remove dirt and dust using a vacuum cleaner.
- Wipe any excess dirt and dust with a soft cloth dampened with diluted detergent.

Use a diluted water solution of approximately 5% neutral wool detergent.

- Wring out any excess water from the cloth and thoroughly wipe off all remaining traces of detergent.
- Wipe the surface with a dry, soft cloth to remove any remaining moisture. Allow the leather to dry in a shaded and ventilated area.

■ **Synthetic leather areas**

- Remove loose dirt using a vacuum cleaner.
- Apply a mild soap solution to the synthetic leather using a sponge or soft cloth.
- Allow the solution to soak in for a few minutes. Remove the dirt and wipe off the solution with a clean, damp cloth.

■ **Caring for leather areas**

Toyota recommends cleaning the interior of the vehicle at least twice a year to maintain the quality of the vehicle's interior.

■ **Shampooing the carpets**

There are several commercial foaming-type cleaners available. Use a sponge or brush to apply the foam. Rub in overlapping circles. Do not apply water. The excellent results are obtained by keeping the carpet as dry as possible.

■ **Seat belts**

Clean with mild soap and lukewarm water using a cloth or sponge. Also check the belts periodically for excessive wear, fraying or cuts.

 **CAUTION**

■ **Water in the vehicle**

- Do not splash or spill liquid in the vehicle. Doing so may cause electrical components to malfunction or catch fire.
- Do not get any of the SRS components or wiring in the vehicle interior wet. (→P. 91)
Electrical malfunction may cause the airbags to deploy or not function properly, resulting in death or serious injury.

 NOTICE

■ **Cleaning detergents**

Do not use the following types of detergent, as they may discolor the vehicle interior or cause streaks or damage to painted surfaces.

- Non-seat portions: Organic substances such as benzene or gasoline, alkaline or acidic solutions, dye, or bleach.
- Seats: Acidic solutions, such as thinner, benzene, or alcohol.

■ **Preventing damage to leather surfaces**

Observe the following precautions to avoid damage to and deterioration of leather surfaces.

- Remove any dust or dirt on leather surfaces immediately.
- Do not expose the vehicle to direct sunlight for extended periods of time. Park the vehicle in the shade, especially during summer.
- Do not place items made of vinyl, plastic, or that contain wax on the upholstery, as they may stick to the leather surface if the vehicle interior heats up significantly.

■ **Water on the floor**

Do not wash the vehicle floor with water.

Vehicle systems such as the audio system may be damaged if water comes into contact with electrical components under the floor of the vehicle, and may also cause the body to rust.

■ **Cleaning the inside of the rear window**

- Do not use glass cleaner to clean the rear window, as this may cause damage to the rear window defogger heater wires. Use a cloth dampened with lukewarm water to gently wipe the window clean. Wipe the window in strokes running parallel to the heater wires.
- Be careful not to scratch or damage the heater wires or antenna.

4-2. Maintenance

Maintenance requirements

To ensure safe and economical driving, day-to-day care and regular maintenance is essential. It is the owner's responsibility to perform regular checks. Toyota recommends the following maintenance.

■ **General maintenance**

Should be performed on a daily basis. This can be done by yourself or by a Toyota dealer.

■ **Scheduled maintenance**

Should be performed at specified intervals according to the maintenance schedule.

For details about maintenance items and schedules, refer to the "Scheduled Maintenance Guide" or "Owner's Manual Supplement".

■ **Do-it-yourself maintenance**

You can perform some maintenance procedures yourself. Please be aware that do-it-yourself maintenance may affect warranty coverage.

The use of Toyota Repair Manuals are recommended.

For details about warranty coverage, see the separate "Owner's Warranty Information Booklet" or "Owner's Manual Supplement".

■ **Repair and replacement**

It is recommended that genuine Toyota parts be used for repair to ensure performance of each system. If non-Toyota parts are used in replacement or if a repair shop other than a Toyota dealer performs repairs, confirm the warranty coverage.

■ **Allow inspection and repairs to be performed by a Toyota dealer**

- Toyota technicians are well-trained specialists and are kept up to date with the latest service information. They are well informed about the operations of all systems on your vehicle.
- Keep a copy of the repair order. It proves that the maintenance that has been performed is under warranty coverage. If any problem should arise while your vehicle is under warranty, your Toyota dealer will promptly take care of it.

 **CAUTION**

■ **If your vehicle is not properly maintained**

It could result in serious damage to the vehicle and possible serious injury or death.

■ **Hazardous materials**

- Engine exhaust, some of its constituents, and a wide variety of automobile components contain or emit chemicals known to the State of California to cause cancer and birth defects and other reproductive harm. Work in a well ventilated area.
- Oils, fuels and fluids contained in vehicles as well as waste produced by component wear contain or emit chemicals known to the State of California to cause cancer and birth defects or other reproductive harm. Avoid exposure and wash any affected area immediately.
- Battery posts, terminals and related accessories contain lead and lead compounds which are known to cause brain damage. Wash your hands after handling. (→P. 341)
- Used engine oil contains chemicals that have been shown to cause cancer in laboratory animals. Avoid prolonged and repeated contact. Always protect your skin by washing thoroughly with soap and water.

4-2. Maintenance

General maintenance

Listed below are the general maintenance items that should be performed at the intervals specified in the “Scheduled Maintenance Guide” or “Owner’s” Manual Supplement”. It is recommended that any problem you notice should be brought to the attention of your Toyota dealer or qualified service shop for advice.

Engine compartment

Items	Check points
Battery	• Maintenance-free (→P. 341)
Brake fluid	• At the correct level? (→P. 338)
Engine coolant	• At the correct level? (→P. 336)
Engine oil	• At the correct level? (→P. 332)
Exhaust system	• No fumes or strange sounds?
Power steering fluid	• At the correct level? (→P. 339)
Radiator/condenser/hoses	• Not blocked with foreign matter? (→P. 337)
Washer fluid	• At the correct level? (→P. 344)

Vehicle interior

Items	Check points
Accelerator pedal	<ul style="list-style-type: none"> • Moves smoothly (without uneven pedal effort or catching)?
Automatic transmission "Park" mechanism	<ul style="list-style-type: none"> • Can the vehicle be hold securely on an incline with the shift lever in "P"?
Brake pedal	<ul style="list-style-type: none"> • Moves smoothly? • Does it have appropriate clearance and correct amount of free play?
Brakes	<ul style="list-style-type: none"> • Pulls to one side when applied? • Loss of brake effectiveness? • Spongy feeling brake pedal? • Pedal almost touches floor?
Head restraints	<ul style="list-style-type: none"> • Move smoothly and lock securely?
Indicators/buzzers	<ul style="list-style-type: none"> • Function properly?
Lights	<ul style="list-style-type: none"> • Do all the lights come on? • Headlights aimed correctly? (→P. 376)
Parking brake	<ul style="list-style-type: none"> • Moves smoothly? • Can hold the vehicle securely on an incline?
Seat belts	<ul style="list-style-type: none"> • Does the seat belt system operate smoothly? • Are the belts undamaged?
Seats	<ul style="list-style-type: none"> • Do the seat controls operate properly?
Steering wheel	<ul style="list-style-type: none"> • Moves smoothly? • Has correct free play? • No strange noises?

Vehicle exterior

Items	Check points
Doors/trunk	<ul style="list-style-type: none"> • Operate smoothly?
Engine hood	<ul style="list-style-type: none"> • The lock system works properly?
Fluid leaks	<ul style="list-style-type: none"> • Is there any leakage after parking?
Tire	<ul style="list-style-type: none"> • Inflation pressure is correct? • Tire surfaces not worn or damaged? • Tires rotated according to the maintenance schedule? • Wheel nuts are not loose?

⚠ CAUTION

■ If the engine is running

Turn off the engine and ensure that there is adequate ventilation before performing maintenance checks.

Some states have vehicle emission inspection programs which include OBD (On Board Diagnostics) checks. The OBD system monitors the operation of the emission control system.

■ **If the malfunction indicator lamp comes on**

The OBD system determines that a problem exists somewhere in the emission control system. Your vehicle may not pass the I/M test and may need to be repaired. Contact your Toyota dealer to service the vehicle.

■ **Your vehicle may not pass the I/M test:**

- When the battery is disconnected or discharged

Readiness codes that are set during ordinary driving are erased.

Also, depending on your driving habits, the readiness codes may not be completely set.

- When the fuel tank cap is loose

The malfunction indicator lamp comes on as a temporary malfunction and your vehicle may not pass the I/M test.

■ **When the malfunction indicator lamp goes off after several driving trips**

The error code in the OBD system will not be cleared unless the vehicle is driven 40 or more times.

■ **If your vehicle does not pass the I/M test**

Contact your Toyota dealer to prepare the vehicle for re-testing.

4-3. Do-it-yourself maintenance

Do-it-yourself service precautions

If you perform maintenance yourself, be sure to follow the correct procedure given in these sections.

Items	Parts and tools
Battery condition (→P. 341)	<ul style="list-style-type: none"> • Warm water • Baking soda • Grease • Conventional wrench (for terminal clamp bolts)
Brake fluid level (→P. 338)	<ul style="list-style-type: none"> • FMVSS No.116 DOT 3 or SAE J1703 brake fluid • Rag or paper towel • Funnel (used only for adding brake fluid)
Engine coolant level (→P. 336)	<ul style="list-style-type: none"> • “Toyota Super Long Life Coolant” or similar high quality ethylene glycol based non-silicate, non-amine, non-nitrite and non-borate coolant with long-life hybrid organic acid technology. For the U.S.A.: “Toyota Super Long Life Coolant” is pre-mixed with 50% coolant and 50% deionized water. For Canada: “Toyota Super Long Life Coolant” is pre-mixed with 55% coolant and 45% deionized water. • Funnel (used only for adding coolant)
Engine oil level (→P. 332)	<ul style="list-style-type: none"> • “Toyota Genuine Motor Oil” or equivalent • Rag or paper towel, funnel (used only for adding engine oil)

Items	Parts and tools
Fuses (→P. 367)	• Fuse with same amperage rating as original
Headlight aim (→P. 376)	• Phillips-head screwdriver
Power steering fluid level (→P. 339)	• Automatic transmission fluid DEXRON® II or III • Rag or paper towel • Clean funnel
Radiator and condenser (→P. 337)	—
Tire inflation pressure (→P. 354)	• Tire pressure gauge • Compressed air source
Washer fluid (→P. 344)	• Water washer fluid containing anti-freeze (for winter use) • Funnel

⚠ CAUTION

The engine compartment contains many mechanisms and fluids that may move suddenly, become hot, or become electrically energized. To avoid death or serious injury, observe the following precautions.

■ **When working on the engine compartment**

- Keep hands, clothing, and tools away from the moving fan and engine drive belt.
- Be careful not to touch the engine, radiator, exhaust manifold, etc. right after driving as they may be hot. Oil and other fluids may also be hot.
- Do not leave anything that may burn easily, such as paper or rags, in the engine compartment.
- Do not smoke, cause sparks or expose an open flame to fuel or the battery. Fuel and battery fumes are flammable.
- Be extremely cautious when working on the battery. It contains poisonous and corrosive sulfuric acid.

 CAUTION

■ **When working near the electric cooling fan or radiator grille**

▶ Vehicles with smart key system

Be sure the “ENGINE START STOP” switch is turned OFF. With the “ENGINE START STOP” switch in IGNITION ON mode, the electric cooling fan may automatically start to run if the air conditioning is on and/or the coolant temperature is high. (→P. 337)

▶ Vehicles without smart key system

Be sure the engine switch is OFF. With the engine switch in the “ON” position, the electric cooling fan may automatically start to run if the air conditioning is on and/or the coolant temperature is high. (→P. 337)

■ **Safety glasses**

Wear safety glasses to prevent flying or falling material, fluid spray, etc. from getting in the eyes.

 NOTICE

■ **If you remove the air cleaner filter**

Driving with the air cleaner filter removed may cause excessive engine wear due to dirt in the air. Also a backfire could cause a fire in the engine compartment.

4-3. Do-it-yourself maintenance Hood

Release the lock from the inside of the vehicle to open the hood.

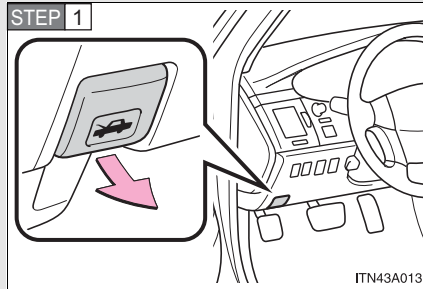

Pull the hood lock release lever.

The hood will pop up slightly.

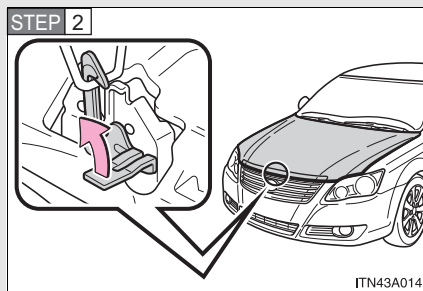

Lift the hood catch and lift the hood.

⚠ CAUTION

■ Pre-driving check

Check that the hood is fully closed and locked.
If the hood is not locked properly it may open while the vehicle is in motion and cause an accident, which may result in death or serious injury.

4-3. Do-it-yourself maintenance Positioning a floor jack

When raising your vehicle with a floor jack, position the jack correctly. Improper placement may damage your vehicle or cause injury.

► Front

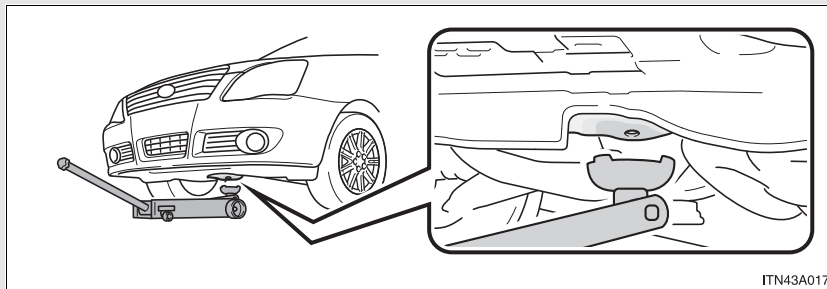

► Rear

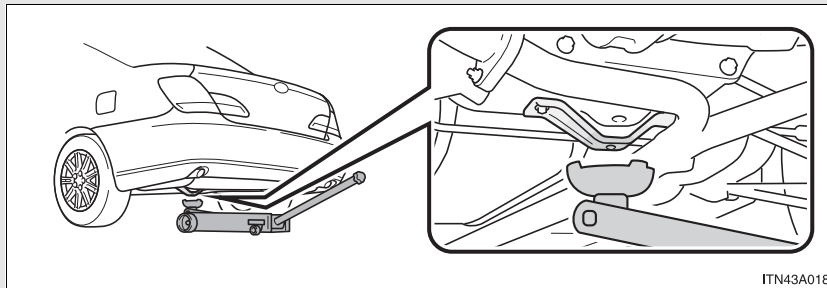

⚠ CAUTION**■ When raising your vehicle**

Make sure to observe the following to reduce the possibility of death or serious injury.

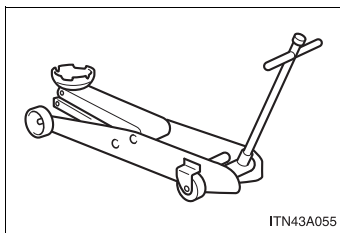

- Lift up the vehicle using a floor jack such as the one shown in the illustration.

- Do not use the jack that was supplied with your vehicle.
- Do not put any part of your body or get underneath the vehicle supported only by the jack.
Always use automotive jack stands or a solid, level surface.
- Do not start the engine while the vehicle is supported by the floor jack.
- Stop the vehicle on level firm ground, firmly set the parking brake and put the shift lever in "P".
- Make sure to set the floor jack properly at the jack point.
Raising the vehicle with an improperly positioned floor jack will damage the vehicle and may cause the vehicle to fall off the floor jack.
- Do not raise the vehicle while someone is in the vehicle.
- When raising the vehicle, do not place any objects on top of or underneath the floor jack.

4-3. Do-it-yourself maintenance Engine compartment

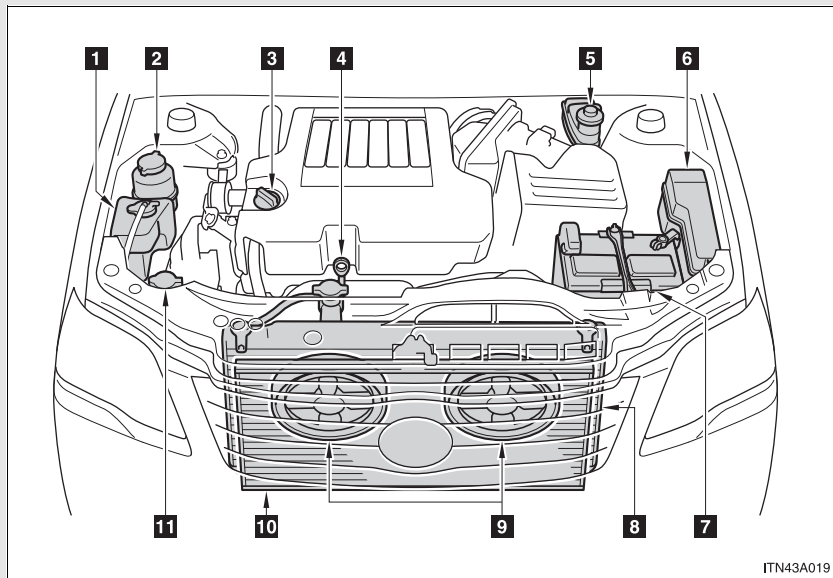

ITN43A019

- | | |
|--|--|
| 1 Engine coolant reservoir
(→P. 336) | 6 Fuse box
(→P. 367) |
| 2 Power steering fluid
reservoir (→P. 339) | 7 Battery
(→P. 341) |
| 3 Engine oil filler cap
(→P. 333) | 8 Radiator
(→P. 337) |
| 4 Engine oil level dipstick
(→P. 332) | 9 Electric cooling fans |
| 5 Brake fluid reservoir
(→P. 338) | 10 Condenser
(→P. 337) |
| | 11 Washer fluid tank
(→P. 344) |

Engine compartment cover

■ Removing the cover

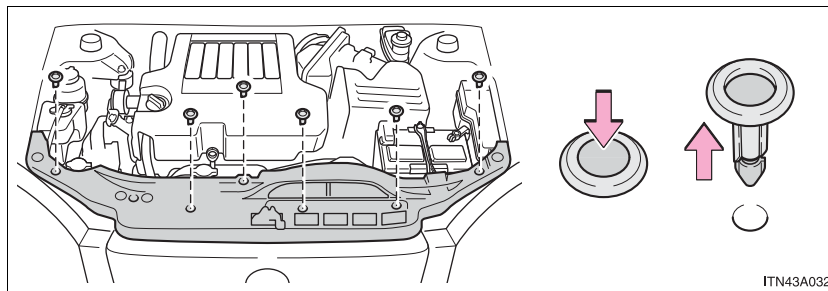

■ Installing the clips

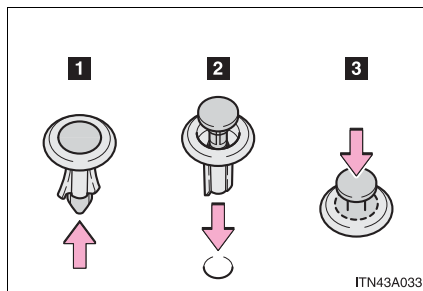

- 1** Open
- 2** Insert
- 3** Press

Engine oil

With the engine at operating temperature and turned off, check the oil level on the dipstick.

■ Checking the engine oil

STEP 1 Park the vehicle on level ground. After turning off the engine, wait more than five minutes for the oil to drain back into the bottom of the engine.

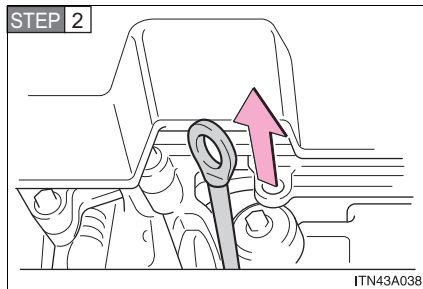

Hold a rag under the end and pull the dipstick out.

STEP 3 Wipe the dipstick clean.

STEP 4 Reinsert the dipstick fully.

STEP 5 Holding a rag under the end, pull the dipstick out and check the oil level.

STEP 6 Wipe the dipstick and reinsert it fully.

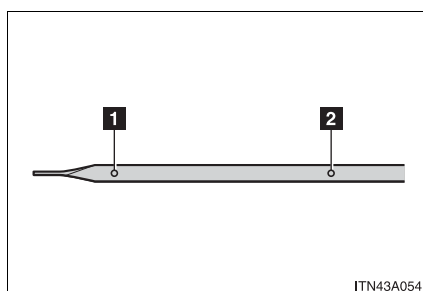

1 Low

2 Full

■ Adding engine oil

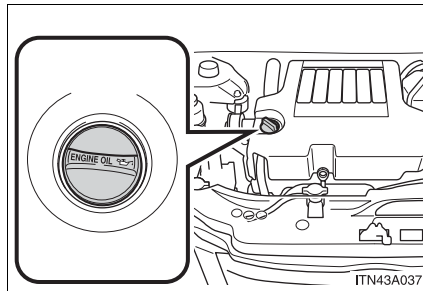

If the oil level is below or near the low level mark, add engine oil of the same type as already in the engine.

Make sure to check the oil type and prepare the items needed before adding oil.

Engine oil selection	→P. 433
Oil quantity (Low → Full)	1.6 qt. (1.5 L, 1.3 Imp. qt.)
Items	Clean funnel

- STEP 1** Remove the oil filler cap.
- STEP 2** Add engine oil slowly, checking the dipstick.
- STEP 3** Install the filler cap, turning it clockwise.

■ **Engine oil consumption**

- The amount of engine oil consumed depends on the oil viscosity, the quality of the oil and the way the vehicle is driven.
- More oil is consumed under driving conditions such as high speeds, frequent acceleration and deceleration.
- A new engine consumes more oil.
- When judging the amount of oil consumption, keep in mind that the oil may have become diluted, making it difficult to judge the true level accurately.
- Oil consumption: Max. 1.1 qt./600 miles, 0.9 Imp.qt./600 miles (1.0 L per 1000 km). If the vehicle consumes more than this amount, contact your Toyota dealer.

■ **After changing the engine oil (U.S.A.only)**

The oil change system should be reset. Perform the following procedures:

STEP 1 Switch the display to the odometer. (→P. 149)

STEP 2 Turn the “ENGINE START STOP” switch or the engine switch OFF.

STEP 3 Vehicles with smart key system: While pressing the trip meter reset button, turn the “ENGINE START STOP” switch to IGNITION ON mode. Continue to press and hold the button until the trip meter displays 000000.

Vehicles without smart key system: While pressing the trip meter reset button, turn the engine switch to the “ON” position. Continue to press and hold the button until the trip meter displays 000000.

 CAUTION

■ **Used engine oil**

- Used engine oil contains potentially harmful contaminants which may cause skin disorders such as inflammation or skin cancer, so care should be taken to avoid prolonged and repeated contact. To remove used engine oil from your skin, wash thoroughly with soap and water.
- Dispose of used oil and filters only in a safe and acceptable manner. Do not dispose of used oil and filters in household trash, in sewers or onto the ground.
Call your Toyota dealer, service station or auto parts store for information concerning recycling or disposal.
- Do not leave used engine oil within the reach of children.

 NOTICE

■ **To prevent serious engine damage**

Check the oil level on regular basis.

■ **When replacing the engine oil**

- Be careful not to spill engine oil on the vehicle components.
- Avoid overfilling, or the engine could be damaged.
- Check the oil level on the dipstick every time you refill the vehicle.
- Be sure the engine oil filler cap is properly tightened.

Engine coolant

The coolant level is satisfactory if it is between the “F” and “L” lines on the reservoir when the engine is cold.

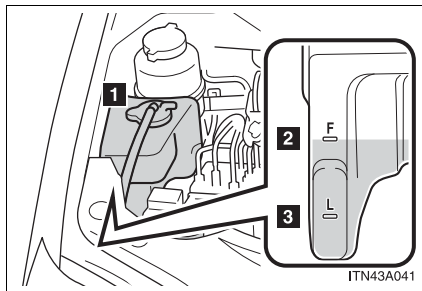

- 1** Reservoir cap
- 2** Full
- 3** Low

If the level is on or below the “L” line, add coolant up to the “F” line.

■ If the coolant level drops within a short time after replenishing

Visually check the radiator, hoses, coolant reservoir cap, radiator cap, drain cock and water pump.

If you cannot find a leak, have your Toyota dealer pressure test the cap and check for leaks in the cooling system.

■ Coolant selection

Only use “Toyota Super Long Life Coolant” or similar high quality ethylene glycol based non-silicate, non-amine, non-nitrite, and non-borate coolant with long-life hybrid organic acid technology.

U.S.A.: “Toyota Super Long Life Coolant” is a mixture of 50% coolant and 50% deionized water. (Enabled: -31°F [-35°C])

Canada: “Toyota Super Long Life Coolant” is a mixture of 55% coolant and 45% deionized water. (Enabled: -44°F [-42°C])

For more details about coolant, contact your Toyota dealer.

 CAUTION

■ **When the engine is hot**

Do not remove the radiator cap.
The cooling system may be under pressure and may spray hot coolant if the cap is removed, causing burns or other injuries.

 NOTICE

■ **When adding the coolant**

Coolant is neither plain water nor straight antifreeze. The correct mixture of water and anti freeze must be used to provide proper lubrication, corrosion protection and cooling. Be sure to read the antifreeze or coolant label.

■ **If you spill coolant**

Be sure to wash it off with water to prevent it from damaging to parts or paint.

Radiator and condenser

Check the radiator and condenser and clear any foreign objects.
If either of the above parts are extremely dirty or you are not sure of their condition, have your vehicle checked by your Toyota dealer.

 CAUTION

■ **When the engine is hot**

Do not touch the radiator or condenser, as they may be hot and you may be burned.

Brake fluid

■ Checking fluid level

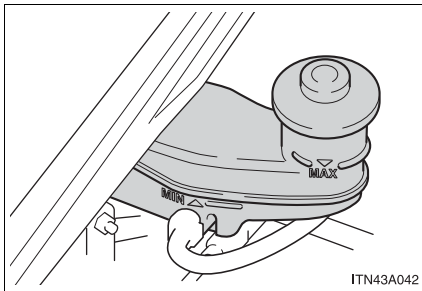

The brake fluid level should be between the “MAX” and “MIN” lines on the tank.

Make sure to check the fluid type and prepare the necessary items.

■ Adding fluid

Fluid type	FMVSS No.116 DOT 3 or SAE J1703 brake fluid
Items	Clean funnel

■ Brake fluid can absorb moisture from the air

Excess moisture in the fluid can cause a dangerous loss of braking efficiency. Use only newly opened brake fluid.

⚠ CAUTION

■ When filling the reservoir

Take care because brake fluid can harm your hands or eyes and damage painted surfaces.

If fluid gets in your eyes, flush your eyes with clean water immediately.

If you still experience discomfort, see a doctor.

 NOTICE

■ If the fluid level is low or high

It is normal for the brake fluid level to go down slightly as the brake pads wear or when the fluid level in the accumulator is high. If the reservoir needs frequent refilling, it may indicate a serious problem.

Power steering fluid

■ Fluid level

The fluid level should be within the appropriate range.

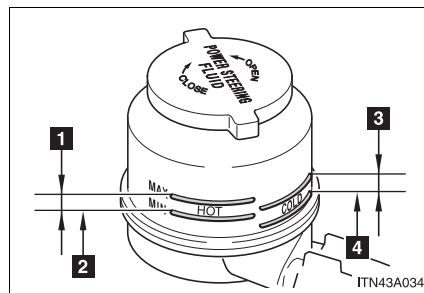

- 1 Full (when hot)
- 2 Add fluid (when hot)
- 3 Full (when cold)
- 4 Add fluid (when cold)

Hot: The vehicle has been driven around 50 mph (80 km/h) for 20 minutes, or slightly longer in frigid temperatures. (Fluid temperature, 140°F - 175°F [60°C - 80°C]).

Cold: The engine has not been run for about 5 hours. (Room temperature, 50°F - 85°F [10°C - 30°C]).

4-3. Do-it-yourself maintenance

■ Checking the fluid level

Make sure to check the fluid type and prepare the necessary items.

Fluid type	Automatic transmission fluid DEXRON® II or III
Items	Rag or paper, clean funnel (only for adding fluid)

STEP 1 Clean all dirt off the reservoir.

STEP 2 Remove the cap by turning it counterclockwise.

STEP 3 Wipe the dipstick clean.

STEP 4 Reinstall and remove the reservoir cap again.

STEP 5 Check the fluid level.

CAUTION

■ When checking the reservoir

Take care, as the reservoir may be hot.

NOTICE

■ When adding fluid

Avoid overfilling, or the power steering may be damaged.

■ After replacing the reservoir cap

Check the steering box case, vane pump and hose connections for leaks or damage.

Battery

Check the battery as follows.

■ Battery exterior

Make sure that the battery terminals are not corroded and that there are no loose connections, cracks, or loose clamps.

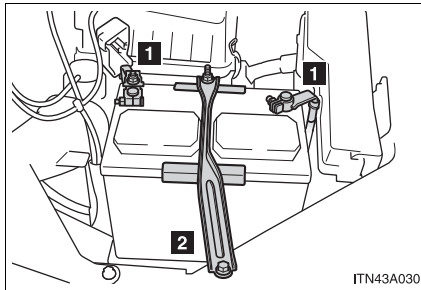

- 1** Terminals
- 2** Hold-down clamp

■ Checking battery condition

Check the battery condition by the indicator color.

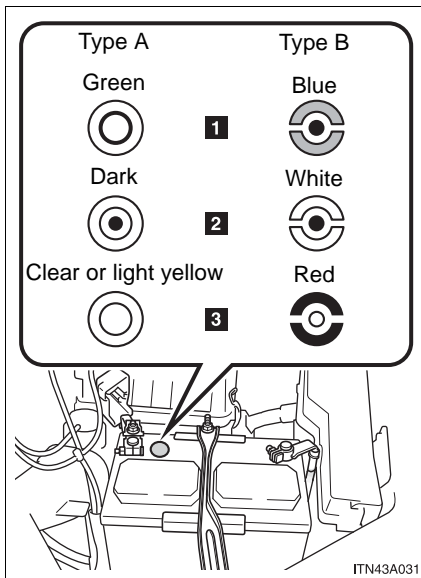

- 1** Good condition
- 2** Charging necessary.
Have the battery checked by your Toyota dealer.
- 3** Not working properly, have the battery checked by your Toyota dealer.

■ **Before recharging**

When recharging, the battery produces hydrogen gas which is flammable and explosive. Therefore, before recharging:

- If recharging with the battery installed on the vehicle, be sure to disconnect the ground cable.
- Make sure the power switch on the charger is off when connecting and disconnecting the charger cables to the battery.

⚠ CAUTION**■ Chemicals in the battery**

A battery contains poisonous and corrosive sulfuric acid and may produce hydrogen gas which is flammable and explosive. To reduce the risk of death or serious injury, take the following precautions while working on or near battery:

- Do not cause sparks by touching the battery terminals with tools.
- Do not smoke or light a match near the battery.
- Avoid contact with eyes, skin and clothes.
- Never inhale or swallow electrolyte.
- Wear protective safety glasses when working near the battery.
- Keep children away from the battery.

■ Where to safely charge the battery

Always charge the battery in an open area. Do not charge the battery in a garage or closed room where there is not sufficient ventilation.

■ How to recharge the battery

Only perform a slow charge (5A or less). The battery may explode if charged at a quicker rate.

■ Emergency measures regarding electrolyte

- If electrolyte gets in your eyes
Flush your eyes with clean water for at least 15 minutes and get immediate medical attention. If possible, continue to apply water with a sponge or cloth while traveling to the nearest medical facility.
- If electrolyte gets on your skin
Wash the affected area thoroughly. If you feel pain or a burning sensation, seek medical attention immediately.
- If electrolyte gets on your clothes
It can soak through clothing on to your skin. Immediately take off the clothing and follow the procedure above if necessary.
- If you accidentally swallow electrolyte
Drink a large quantity of water or milk. Get emergency medical attention immediately.

4-3. Do-it-yourself maintenance

NOTICE

■ When recharging the battery

Never recharge the battery while the engine is running. Also, be sure all accessories are turned off.

Washer fluid

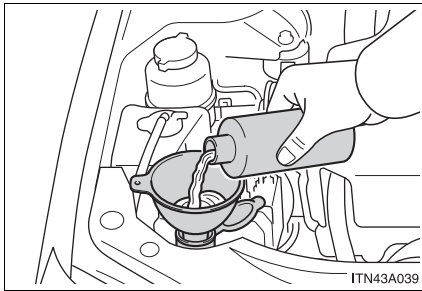

If any washer does not work or the low washer fluid warning light comes on, the washer tank may be empty. Add washer fluid.

CAUTION

■ When refilling the washer fluid

Do not refill the washer fluid when the engine is hot or running, as the washer fluid contains alcohol and may catch fire if spilled on the engine etc.

NOTICE

■ Do not use any fluid other than washer fluid

Do not use soapy water or engine antifreeze instead of washer fluid. Doing so may cause streaking on the vehicle's painted surfaces.

■ Diluting washer fluid

Dilute washer fluid with water as necessary. Refer to the freezing temperatures listed on the washer fluid tank.

4-3. Do-it-yourself maintenance Tires

Replace or rotate tires in accordance with maintenance schedules and treadwear.

■ Checking tires

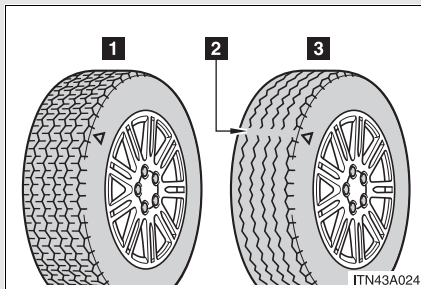

- 1 New tread
- 2 Treadwear indicator
- 3 Worn tread

The location of treadwear indicators is shown by the “TWI” or “Δ” marks, etc., molded on the sidewall of each tire.

Check spare tire condition and inflation pressure if not rotated.

■ Tire rotation

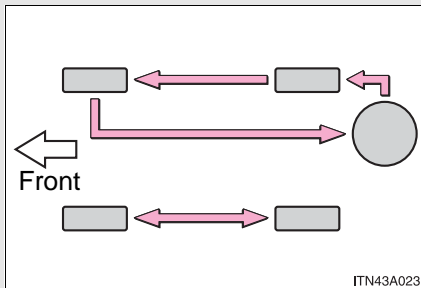

Rotate the tires in the order shown.

To equalize tire wear and extend tire life, Toyota recommends that tire rotation is carried out at the same interval as tire inspection.

Do not fail to initialize the tire pressure warning system after tire rotation.

■ The tire pressure warning system

Your Toyota is equipped with a tire pressure warning system that uses tire pressure warning valves and transmitters to detect low tire inflation pressure before serious problems arise. (→P. 396)

Installing tire pressure warning valves and transmitters

When replacing tires or wheels, tire pressure warning valves and transmitters must also be installed.

When new tire pressure warning valves and transmitters are installed, new tire pressure warning valve and transmitter ID codes must be registered in the tire pressure warning computer and tire pressure warning system must be initialized. Have tire pressure warning valve and transmitter ID codes registered by your Toyota dealer.

Initializing the tire pressure warning system

■ The tire pressure warning system must be initialized in the following circumstances:

- When rotating the tires on vehicles differing with front and rear tire inflation pressures.
- When changing the tire inflation pressure by changing traveling speed or load weight, etc.
- When changing the tire size.

When the tire pressure warning system is initialized, the current tire inflation pressure is set as the pressure benchmark.

■ How to initialize the tire pressure warning system

STEP 1 Park the vehicle in safe place and turn the “ENGINE START STOP” switch or the engine switch OFF.

While the vehicle is moving, initialization is not performed.

STEP 2 Adjust the tire inflation pressure to the specified cold tire inflation pressure level. (→P. 437)

Make sure to adjust the tire pressure to the specified cold tire inflation pressure level. The tire pressure warning system will operate based on this pressure level.

STEP 3 Turn the “ENGINE START STOP” switch to IGNITION ON mode (vehicles with smart key system) or the engine switch to the “ON” position (vehicles without smart key system).

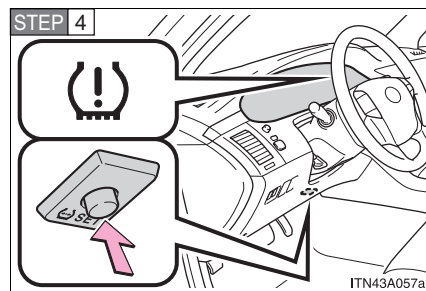

Push and hold the tire pressure warning reset switch until the tire pressure warning light blinks slowly 3 times.

STEP 5 Vehicles with smart key system: Wait for a few minutes with the “ENGINE START STOP” switch in IGNITION ON mode, and then turn the “ENGINE START STOP” switch OFF.

Vehicles without smart key system: Wait for a few minutes with the engine switch in the “ON” position, and then turn the engine switch to the “LOCK” position.

Registering ID codes

The tire pressure warning valve and transmitter is equipped with a unique ID code.

When replacing a tire pressure warning valve and transmitter, it is necessary to register the ID code of tire pressure warning valve and transmitter. Have the ID code registered by your Toyota dealer.

■ When to replace your vehicle's tires

Tires should be replaced if:

- You have tire damage such as cuts, splits, cracks deep enough to expose the fabric or bulges indicating internal damage
- A tire goes flat repeatedly or cannot be properly repaired due to the size or location of a cut or other damage

If you are not sure, consult with your Toyota dealer.

■ Replacing tires and wheels

If the ID code of the tire pressure warning valve and transmitter is not registered, the tire pressure warning system will not work properly. After about 20 minutes, the tire pressure warning light comes on after blinking for 1 minute to indicate a system malfunction.

■ Tire life

Any tire over 6 years old must be checked by a qualified technician even if they have seldom or never been used or damage is not obvious.

■ If the tread wears down below 0.16 in. (4 mm) on snow tires

The effectiveness of snow tires is lost.

■ Maximum load of tire

Check that the maximum load of the replacement tire is greater than 1/2 of the Gross Axle Weight Ratings (GAWR) of either the front axle or the rear axle, whichever is greater.

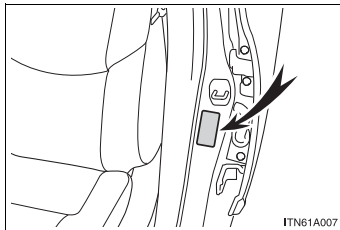

For the GAWR, see the Certification Label. For the maximum load of the tire, see the load limit at maximum cold tire inflation pressure mentioned on the sidewall of the tire. (→P. 442)

■ Tire types

1 Summer tires

Summer tires are high-speed performance tires best suited to highway driving under dry conditions. Since summer tires do not have the same traction performance as snow tires, summer tires are inadequate for driving on snow-covered or icy roads. For driving on snow-covered roads or icy roads, the use of snow tires is recommended. When installing snow tires, be sure to replace all four tires.

2 All season tires

All season tires are designed to provide better traction in snow and to be adequate for driving in most winter conditions, as well as for use year round. All season tires, however, do not have adequate traction performance compared with snow tires in heavy or loose snow. Also, all season tires fall short in acceleration and handling performance compared with summer tires in highway driving.

3 Snow tires

For driving on snow-covered roads or icy roads, we recommend using snow tires. If you need snow tires, select tires of the same size, construction and load capacity as the originally installed tires. Since your vehicle has radial tires as original equipment, make sure your snow tires also have radial construction. Do not install studded tires without first checking local regulations for possible restriction. Snow tires should be installed on all wheels. (→P. 189)

■ **Initializing the tire pressure warning system**

Initialize the tires with the tire inflation pressure adjusted to the specified level.

■ **If you push the tire pressure warning reset switch accidentally**

If initialization is performed, adjust the tire inflation pressure to the specified level and initialize the tire pressure warning system again.

■ **When the initialization of the tire pressure warning system has failed**

Initialization can be completed in a few minutes. However, in the following cases, the settings have not been recorded and the system will not operate properly. If repeated attempts to record tire inflation pressure settings are unsuccessful, have the vehicle inspected by your Toyota dealer.

- When operating the tire pressure warning reset switch, the tire pressure warning light does not flash 3 times.
- After carrying out the initialization procedure, the tire pressure warning light blinks for 1 minute then stays on after driving for about 20 minutes.

■ **Routine tire inflation pressure checks**

The tire pressure warning system does not replace routine tire inflation pressure checks. Make sure to check tire inflation pressure as part of your routine of daily vehicle checks.

■ **Tire pressure warning system certification**

FCC ID: PAXPMV107J

FCC ID: HYQ13BCX

IC ID: 3729A-PMV107J

IC ID: 1551A-13BCX

▶ For vehicles sold in the U.S.A.

This device complies with Part 15 of the FCC Rules. Operation is subject to the following two conditions: (1) this device may not cause harmful interference, and (2) this device must accept any interference received, including interference that may cause undesired operation.

FCC WARNING:

Changes or modifications not expressly approved by the party responsible for compliance could void the user's authority to operate the equipment.

▶ For vehicles sold in Canada

Operation is subject to the following two conditions: (1) this device may not cause interference, and (2) this device must accept any interference, including interference that may cause undesired operation of the device.

 CAUTION

■ **When inspecting or replacing tires**

Observe the following precautions to prevent accidents. Failure to do so may cause damage to parts of the drive train, as well as dangerous handling characteristics, which may lead to fatal injury or accidents.

- Do not mix tires of different makes, models or tread patterns.
Also, do not mix tires of remarkably different treadwear.
- Do not use tire sizes other than those recommended by Toyota.
- Do not mix differently constructed tires (radial, bias-belted or bias-ply tires).
- Do not mix summer, all season and winter tires.
- Do not use tires that have been used on another vehicle.
Do not use tires if you do not know how they were used previously.

■ **When initializing the tire pressure warning system**

Do not push the tire pressure warning reset switch without first adjusting the tire inflation pressure to the specified level. Otherwise, the tire pressure warning light may not come on even if the tire inflation pressure is low, or it may come on when the tire inflation pressure is actually normal.

 NOTICE

■ **Repairing or replacing tires, wheels and tire pressure warning valves and transmitters**

When removing or fitting the wheels, tires or the tire pressure warning valve and transmitter, contact your Toyota dealer as the tire pressure warning valve and transmitter may be damaged if not handled correctly.

■ **To avoid damaging the tire pressure warning valves and transmitters**

Do not use liquid sealants on flat tire.

 NOTICE

■ **Driving on rough roads**

Take particular care when driving on roads with loose surfaces or pot-holes.

These conditions may cause losses in tire inflation pressure, reducing the cushioning ability of the tires. In addition driving on rough roads may cause damage to the tires themselves, as well as the vehicle's wheels and body.

■ **If tire inflation pressures become low while driving**

Do not continue driving, or your tires and/or wheels may be ruined.

4-3. Do-it-yourself maintenance

Tire inflation pressure

■ Tire inflation pressure

The recommended cold tire inflation pressure and tire size is displayed on the tire and loading information label. (→P. 437)

► Type A

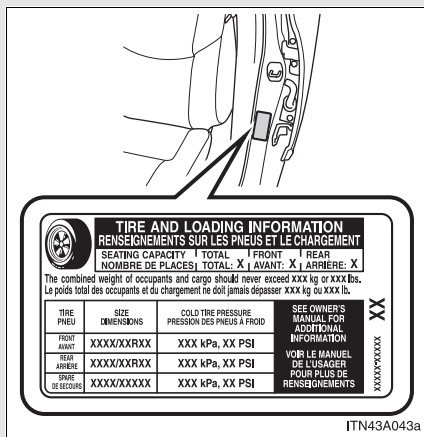

► Type B

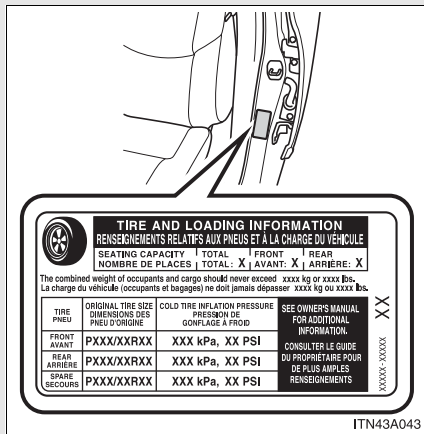

■ Inspection and adjustment procedure

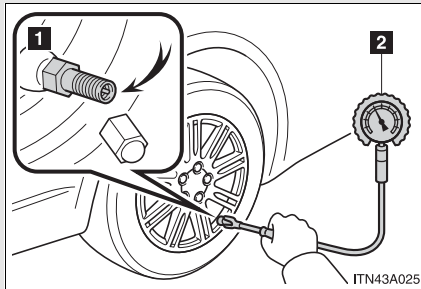

- 1 Tire valve
- 2 Tire pressure gauge

- STEP 1** Remove the tire valve cap.
- STEP 2** Press the tip of the tire pressure gauge onto the tire valve.
- STEP 3** Read the pressure using the graduations of the gauge.
- STEP 4** If the tire inflation pressure is not within the recommended levels, adjust tire pressure.
If you add too much air, press the center of the valve to lower.
- STEP 5** After completing the tire inflation pressure measurement and adjustment, apply soapy water to the valve and check for leakage.
- STEP 6** Reinstall the tire valve cap.

■ Tire inflation pressure check interval

You should check tire inflation pressure every two weeks, or at least once a month.
Do not forget to check the spare.

■ **Effects of incorrect tire inflation pressure**

Driving with incorrect tire inflation pressure may result in the following:

- Reduced fuel efficiency
- Reduced driving comfort and tire life
- Reduced safety
- Damage to the drive train

If a tire needs frequent refilling, have it checked by your Toyota dealer.

■ **Instructions for checking tire inflation pressure**

When checking tire inflation pressure, observe the following:

- Check only when the tires are cold.
If your vehicle has been parked for at least 3 hours and has not been driven for more than 1 mile or 1.5 km, you will get an accurate cold tire inflation pressure reading.
- Always use a tire pressure gauge.
The appearance of the tire can be misleading. In addition, tire inflation pressures that are even just a few pounds off can degrade ride and handling.
- Do not bleed or reduce tire inflation pressure after driving. It is normal for the tire inflation pressure to be higher after driving.
- Never exceed the vehicle capacity weight.
Passengers and luggage weight should be placed so that the vehicle is balanced.

 CAUTION

■ **Proper inflation is critical to save tire performance**

Keep your tires properly inflated. Otherwise, the following conditions may occur and result in an accident causing death or serious injury.

- Excessive wear
- Uneven wear
- Poor handling
- Possibility of blowouts resulting from overheated tires
- Poor sealing of the tire bead
- Wheel deformation and/or tire separation
- A greater possibility of tire damage from road hazards

 NOTICE

■ **When inspecting and adjusting tire inflation pressure**

Be sure to reinstall the tire valve caps.

Without the valve caps, dirt or moisture could get into the valve and cause air leakage, which could result in an accident. If the caps have been lost, replace them as soon as possible.

Wheels

If a wheel is bent, cracked or heavily corroded, it should be replaced.

Otherwise, the tire may separate from the wheel or cause loss of handling control.

■ Wheel selection

When replacing wheels, care should be taken to ensure that they are equivalent to those removed in load capacity, diameter, rim width, and offset.

Replacement wheels are available at your Toyota dealer.

Toyota does not recommend using:

- Wheels of different sizes or types
- Used wheels
- Bent wheels that have been straightened

■ Aluminum wheel precautions

- Use only Toyota wheel nuts and wrenches designed for use with your aluminum wheels.
- When rotating, repairing or changing your tires, check that the wheel nuts are still tight after driving 1000 miles (1600 km).
- Be careful not to damage the aluminum wheels when using tire chains.
- Use only Toyota genuine balance weights or equivalent and a plastic or rubber hammer when balancing your wheels.

■ When replacing wheels

The wheels of your Toyota are equipped with tire pressure warning valves and transmitters that allow the tire pressure warning system to provide advanced warning in the event of a loss in tire inflation pressure. Whenever wheels are replaced, the tire pressure warning valves and transmitters must be installed. (→P. 346)

CAUTION

■ When replacing wheels

- Do not use wheels that are a different size from those recommended in the Owner's Manual, as this may result in loss of handling control.
- Never use an inner tube in a leaking wheel which is designed for a tubeless tire. Doing so may result in an accident, causing death or serious injury.

NOTICE

■ Replacing tire pressure warning valves and transmitters

- Because tire repair or replacement may affect the tire pressure warning valves and transmitters, make sure to have tires serviced by your Toyota dealer or other qualified service shop. In addition, make sure to purchase your tire pressure warning valves and transmitters at your Toyota dealer.
- Ensure that only genuine Toyota wheels are used on your vehicle. Tire pressure warning valves and transmitters may not work properly with non-genuine wheels.

4-3. Do-it-yourself maintenance Air conditioning filter

The air conditioning filter must be cleaned or changed regularly to maintain air conditioning efficiency.

■ Removal method

STEP 1 Set the air conditioning system to recirculated mode.

The air conditioning filter case cannot be removed with the system in the outside air mode.

STEP 2 Turn the “ENGINE START STOP” switch or the engine switch OFF.

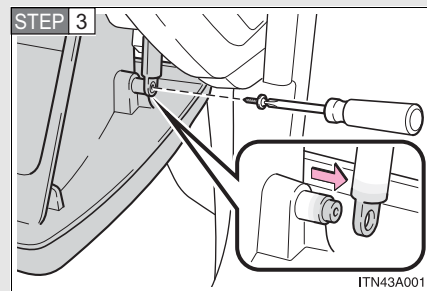

Open the glove box. Remove the screw with a Phillips-head screwdriver and slide off the damper.

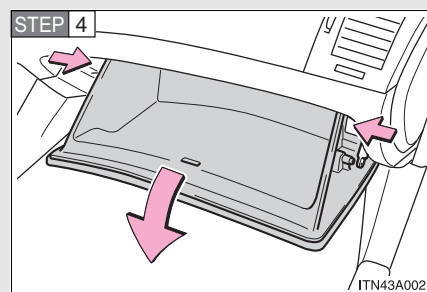

Push in each side of the glove box to disconnect the claws.

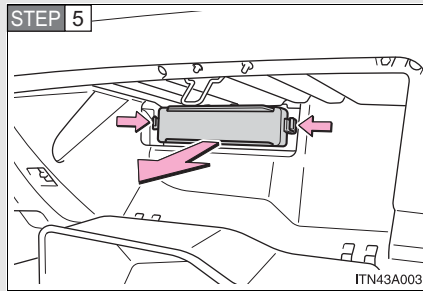

Remove the filter cover while pushing in both ends of the cover.

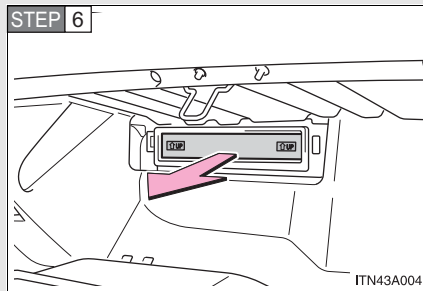

Pull the filter out of the filter outlet.

■ Cleaning method

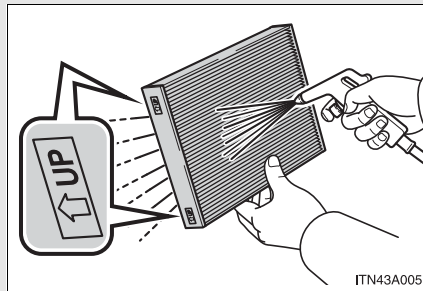

If the filter is dirty, clean by blowing compressed air through the filter from the downward side.

Hold the air gun 2 in. (5cm) from the filter and blow for approximately 2 minutes at 72 psi (500 kPa, 5.0 kgf/cm² or bar).

If it is not available, have the filter cleaned by your Toyota dealer.

4-3. Do-it-yourself maintenance

■ Replacement method

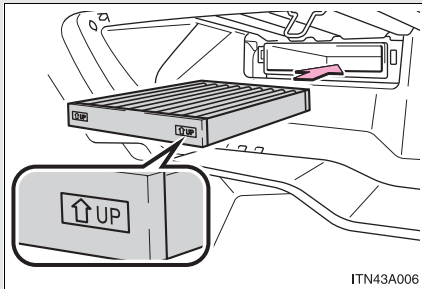

Remove the air conditioning filter from the filter case and replace it with a new one.

The “↑UP” marks shown on the filter and the filter case should be pointing up.

■ Checking interval

Inspect and replace the air conditioning filter according to the maintenance schedule. In dusty areas or areas with heavy traffic flow, early replacement may be required. (For scheduled maintenance information, refer to the “Scheduled Maintenance Guide” or “Owner’s Manual Supplement”.)

■ If air flow from the vents decreases dramatically

The filter may be clogged. Check the filter and replace if necessary.

⚠ NOTICE

■ To prevent damage to the system

- When using the air conditioning system, make sure that a filter is always installed.
- When cleaning the filter, do not clean the with water.

4-3. Do-it-yourself maintenance

Key battery

Replace the battery with a new one if it is discharged.

■ **You will need the following items:**

- Flathead screwdriver (To prevent damage to the key, cover the tip of the screwdriver with rag.)
- Small Phillips-head screwdriver
- Lithium battery CR1632 (vehicles with smart key system), CR2016 (vehicles without smart key system)

■ **Replacing the battery (vehicles with smart key system)**

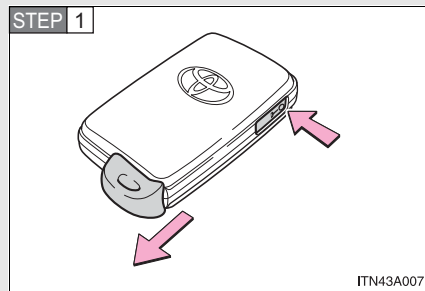

Take out the mechanical key.

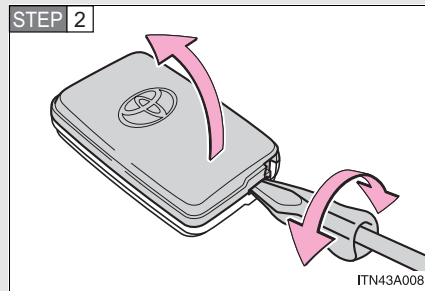

Remove the cover.

4-3. Do-it-yourself maintenance

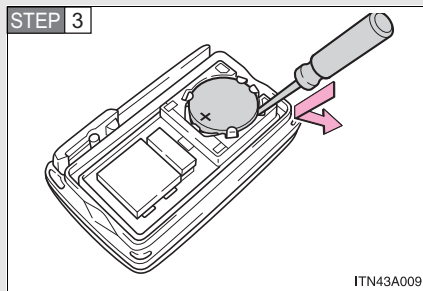

Remove the depleted battery.

Insert a new battery with the
“+” terminal facing up.

■ Replacing the battery (vehicles without smart key system)

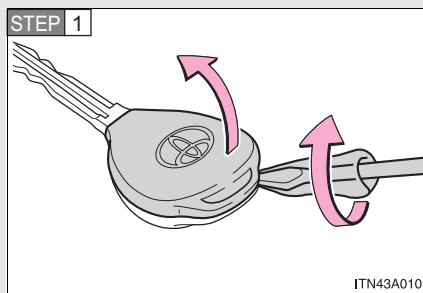

Remove the cover.

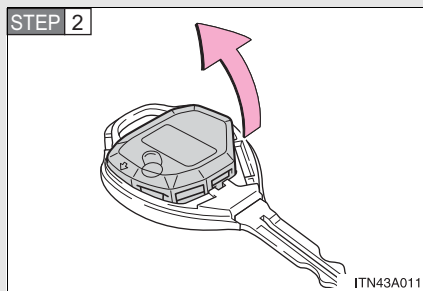

Remove the module.

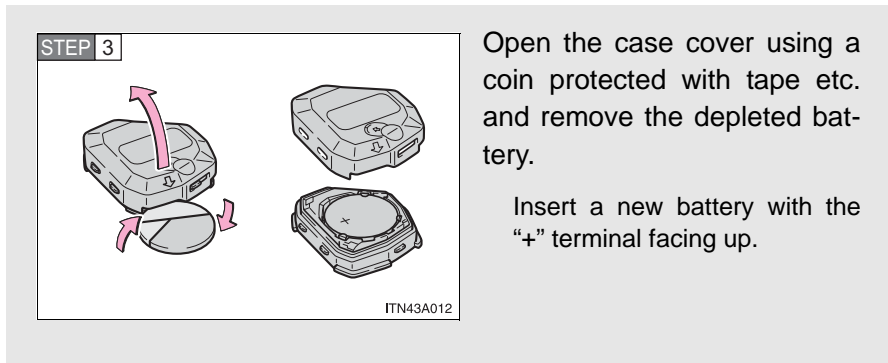

■ **If the key battery is discharged**

The following symptoms may occur.

- The smart key system and wireless remote control will not function properly.
- The operational range is reduced.

■ **Use a CR1632 (vehicles with smart key system), or CR2016 (vehicles without smart key system) lithium battery**

- Batteries can be purchased at your Toyota dealer, jewelers, or camera stores.
- Replace only with the same or equivalent type recommended by a Toyota dealer.
- Dispose of used batteries according to the local laws.

⚠ CAUTION

■ **Removed battery and other parts**

Keep away from children.
These parts are small and if swallowed by a child they can cause choking.

4-3. Do-it-yourself maintenance

 NOTICE

■ **For normal operation after replacing the battery**

Observe the following precautions to prevent accidents.

- Always work with dry hands.
Moisture may cause the battery to rust.
- Do not touch or move any other components inside the remote control.
- Do not bend the battery terminals.

4-3. Do-it-yourself maintenance Checking and replacing fuses

If any of the electrical components do not operate, a fuse may have blown. If this happens, check and replace the fuses as necessary.

STEP 1 Turn the “ENGINE START STOP” switch or the engine switch OFF.

STEP 2 Open the fuse box cover.

▶ Engine compartment

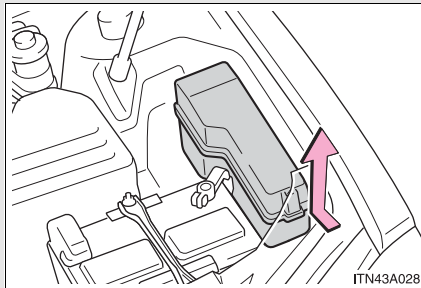

Push the tab in and lift the lid off.

▶ Driver's side instrument panel

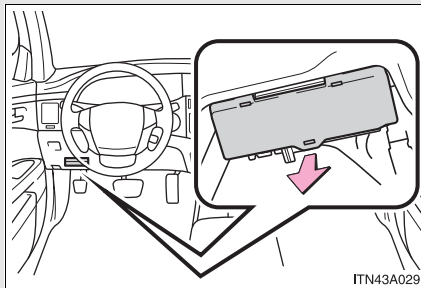

Remove the lid.

STEP 3 After a system failure, see “Fuse layout and amperage ratings” (→P. 369) for details about which fuse to check.

4-3. Do-it-yourself maintenance

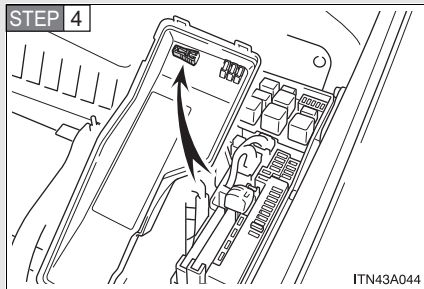

Remove the fuse with the pull-out tool.

STEP 5 Check if the fuse has blown.

► Type A

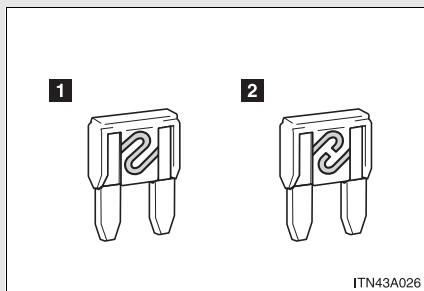

1 Normal fuse

2 Blown fuse

Replace it with one of an appropriate amperage rating. The amperage rating can be found on the fuse box lid.

► Type B

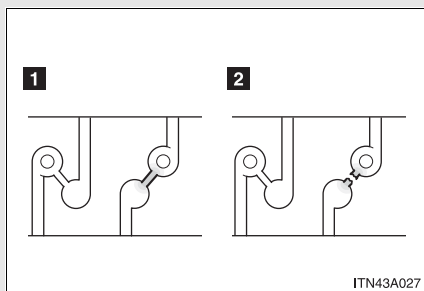

1 Normal fuse

2 Blown fuse

Replace it with one of an appropriate amperage rating. The amperage rating can be found on the fuse box lid.

Fuse layout and amperage ratings

■ **Engine compartment**

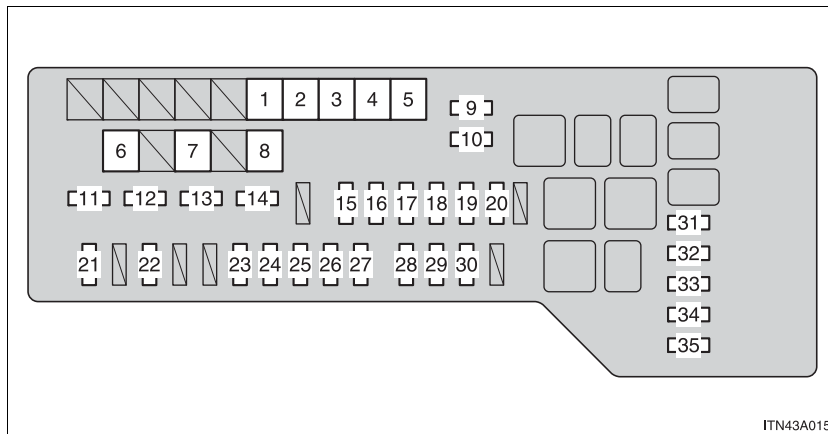

	Fuse	Ampere	Circuit
1	RR DEF	50 A	Rear window defogger, outside rear view mirror defogger
2	ABS/VSC No.2	30 A	Anti-lock brake system, vehicle stability control system
3	RDI FAN	50 A	Electric cooling fan
4	ABS/VSC No.1	50 A	Anti-lock brake system, vehicle stability control system
5	HEATER	50 A	Air conditioning system
6	ST/AM2	30 A	Starter system
7	MAIN	40 A	Headlights

4-3. Do-it-yourself maintenance

	Fuse	Ampere	Circuit
8	ALT	140 A (Limited grade) 120 A (XL, XLS grade)	Charging system, RR DEF, ABS/VSC No.2, HEATER, ABS/VSC No.1, RDI FAN, WASHER, S-HORN
9	STOP No.3	7.5 A	Electronic controlled transmission system, multiport fuel injection system/sequential multiport fuel injection system
10	INJ	15 A	Multiport fuel injection system/sequential multiport fuel injection system
11	AM2	7.5 A	Starter system
12	DOOR No.1	25 A	Multiplex communication system
13	ALT-S	7.5 A	Charging system
14	ETCS	10 A	Multiport fuel injection system/sequential multiport fuel injection system
15	IG2	25 A	Multiport fuel injection system/sequential multiport fuel injection system, electronic controlled transmission system
16	TURN/HAZ	15 A	Turn signal lights
17	AMP	30 A	Audio system
18	EFI No.3	7.5 A	Smart key system, electronic controlled transmission system

	Fuse	Ampere	Circuit
19	STR LOCK	25 A	Steering lock system
20	STOP No.1	15 A	Multiplex communication system
21	EFI No.1	25 A	Multiport fuel injection system/ sequential multiport fuel injection system, fuel pump
22	HORN	10 A	Horn
23	HEAD LH UPR	15 A	Left-hand headlight (high beam)
24	HEAD RH UPR	15 A	Right-hand headlight (high beam)
25	A/F	25 A	Air fuel ratio sensor
26	WASHER	20 A	Windshield washer
27	S-HORN	7.5 A	Horn
28	DOME	7.5 A	Gauges and meters, clock, front personal lights, door courtesy lights, garage door opener, rear personal lights, trunk light
29	ECU-B	10 A	Center display, multiplex communication system
30	RAD No.1	15 A	Audio system, center display, navigation system
31	EFI No.2	10 A	Multiport fuel injection system/ sequential multiport fuel injection system
32	STOP No.2	7.5 A	Stop lights, high mounted stoplight, vehicle stability control system, anti-lock brake system
33	RADAR CC	7.5 A	Vehicle stability control system
34	HEAD RH LWR	15 A	Right-hand headlight (low beam)
35	HEAD LH LWR	15 A	Left-hand headlight (low beam)

4-3. Do-it-yourself maintenance

■ Driver's side instrument panel

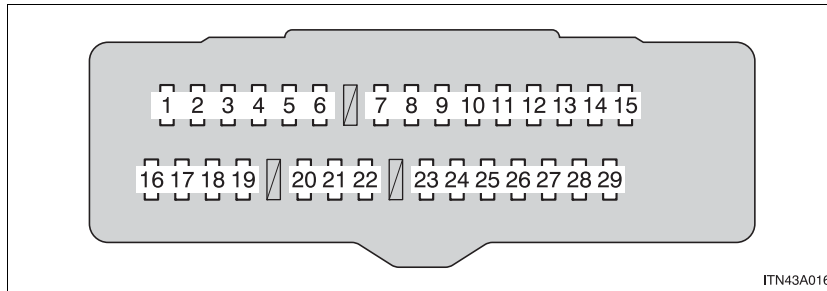

Fuse		Ampere	Circuit
1	RR DOOR	20 A	Power window
2	RL DOOR	20 A	Power window
3	FR DOOR	20 A	Power window, driving position memory system
4	FOG	15 A	Front fog lights
5	OBD	7.5 A	On-board diagnosis system
6	MPX-B	7.5 A	Multiplex communication system
7	FL DOOR	20 A	Power window, driving position memory system
8	FUEL OPN	7.5 A	Fuel filler door opener
9	AM1	7.5 A	Multiport fuel injection system/ sequential multiport fuel injection system, starting system, ignition system
10	A/C	7.5 A	Air conditioning system

	Fuse	Ampere	Circuit
11	S-HTR	20 A	Air conditioning system
12	DOOR No.2	25 A	Multiplex communication system
13	S/ROOF	30 A	Moon roof
14	TAIL	10 A	Parking lights, license plate lights, tail lights, front and rear side marker lights
15	PANEL	7.5 A	Seat heaters, navigation system, emergency flashers, electronically controlled automatic transmission system, glove box light, instrument panel lights, power outlets
16	ECU IG No.1	10 A	Center display, shift lock control system, moon roof, multiplex communication system, tire pressure monitoring (warning) system
17	ECU IG No.2	10 A	Anti-lock brake system, dynamic laser cruise control system, automatic headlight leveling system, vehicle stability control system, multiplex communication system
18	HTR	7.5 A	Air conditioning system, instrument panel lights, electric cooling fan
19	A/C COMP	7.5 A	Air conditioning system
20	GAUGE No.1	10 A	Back-up lights, navigation system, emergency flashers
21	WIP	30 A	Windshield wipers
22	RR S/SHADE	10 A	Rear sunshade

4-3. Do-it-yourself maintenance

	Fuse	Ampere	Circuit
23	IGN	10 A	Multiport fuel injection system/ sequential multiport fuel injection system, SRS airbag system, front passenger occupant classification system, smart key system, starting system, electronic controlled transmission system
24	GAUGE No.2	7.5 A	Gauges and meters, center display
25	ECU-ACC	7.5 A	Power rear view mirrors, center display, shift lock system, multiplex communication system
26	CIG	15 A	—
27	PWR OUTLET	15 A	Power outlets
28	RADIO No.2	7.5 A	Audio system, navigation system
29	MIR HTR	10 A	Outside rear view mirror defoggers

■ **After a fuse is replaced**

- If the lights do not turn on even after the fuse has been replaced, a bulb may need replacement. (→P. 378)
- If the replaced fuse blows again, have the vehicle inspected by your Toyota dealer.

■ **If there is an overload in the circuits**

The fuses are designed to blow before the entire wiring harness is damaged.

 **CAUTION**

■ **To prevent system breakdowns and vehicle fire**

Observe the following precautions.

Failing to do so may cause damage, and possibly a fire or injury.

- Never use a fuse of a higher amperage rating than indicated, or use any other object in place of a fuse.
- Always use a genuine Toyota fuse or equivalent.
Never replace a fuse with a wire, even as a temporary fix.
This can cause extensive damage or even fire.
- Do not modify fuses or the fuse box.

 **NOTICE**

■ **Before replacing fuses**

Have the cause of electrical overload determined and repaired by your Toyota dealer.

4-3. Do-it-yourself maintenance Headlight aim (with discharge headlights)

■ Vertical movement bolts

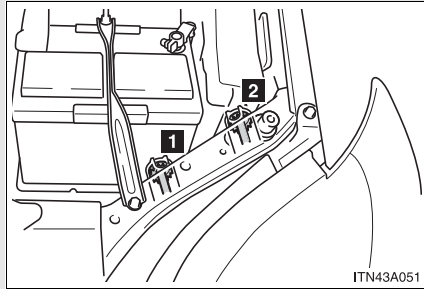

1 Adjustment bolt A

2 Adjustment bolt B

■ Before checking the headlight aim

STEP 1 Make sure the vehicle has a full tank of gas and the area around the headlight is not deformed.

STEP 2 Park the vehicle on level ground.

STEP 3 Sit in the driver's seat.

STEP 4 Bounce the vehicle several times.

■ Adjusting the headlight aim

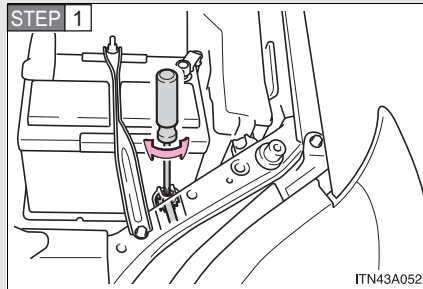

Turn bolt A in either direction using a Phillips-head screwdriver.

Remember the turning direction and the number of turns.

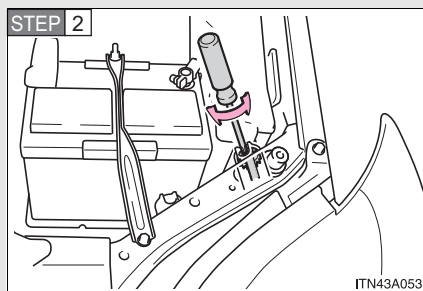

Turn bolt B the same number of turns and in the same direction as step 1 using a Phillips-head screwdriver.

If you feel that there is a large deviation, have the headlight aim adjusted at a Toyota dealer.

4-3. Do-it-yourself maintenance Light bulbs

You may replace the following bulbs yourself. For more information about replacing other light bulbs, contact your Toyota dealer.

■ **Prepare a replacement light bulb.**

Check the wattage of the light bulb being replaced. (→P. 438)

■ **Bulb locations**

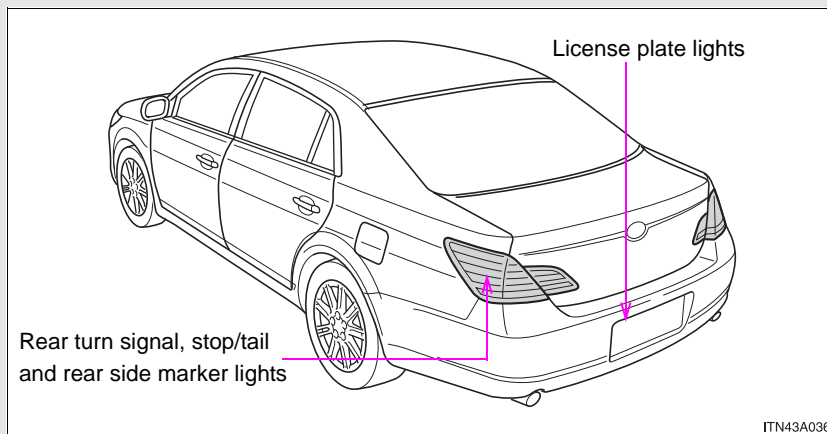

Replacing light bulbs

■ Rear turn signal lights, stop/tail and rear side marker lights

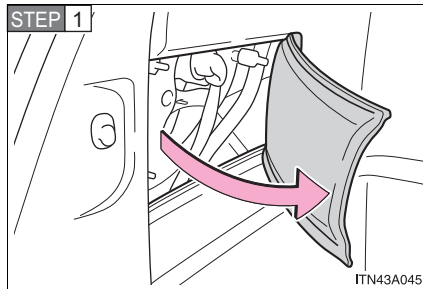

Open the trunk, remove the cover as follows.

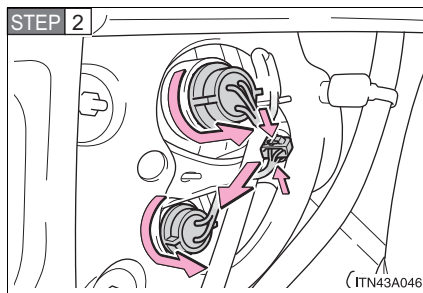

Turn the bulb bases counter-clockwise and remove (upper and lower), or squeeze bulb base and remove (center).

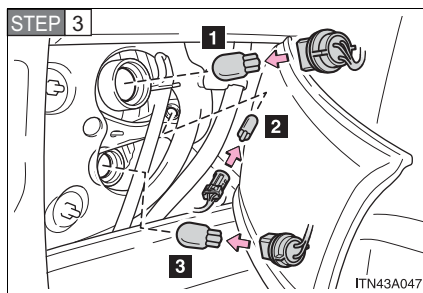

Remove the light bulb.

- 1** Stop/tail light
- 2** Rear side marker light
- 3** Rear turn signal light

4-3. Do-it-yourself maintenance

■ License plate lights

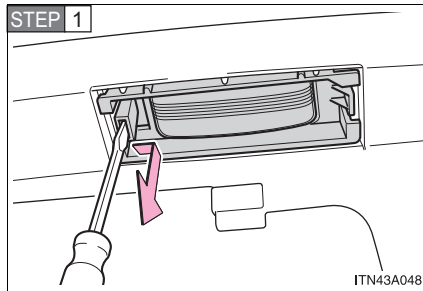

Use a flathead screwdriver to disengage the side of the lamp.

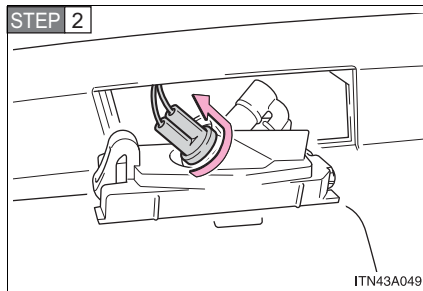

Turn the bulb base counterclockwise.

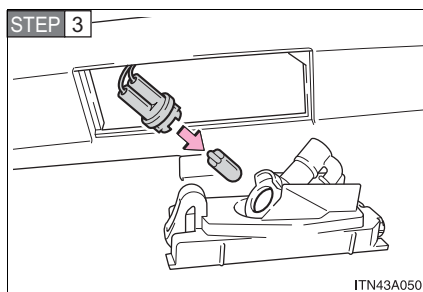

Remove the light bulb.

■ Bulbs other than the above

If any of the bulbs listed below has burnt out, have your Toyota dealer replace it.

- Headlights
- Fog lights
- Front turn signal/parking lights
- Front side marker lights
- Tail lights
- Back-up lights
- High mounted stoplight

■ Condensation build-up on the inside of the lens

Contact your Toyota dealer for more information in the following situations. Temporary condensation build-up on the inside of the headlight lens does not indicate a malfunction.

- Large drops of water are built up on the inside of the lens.
- Water has built up inside the headlight.

■ LED light bulbs

The high mounted stoplights consist of a number of LEDs. If any of the LEDs burn out, take your vehicle to your Toyota dealer to have the light replaced.

If two or more LEDs in a stoplight burn out, your vehicle may not conform to local laws (SAE).

■ High-intensity discharge (HID) headlights (if equipped)

If voltage to the high-intensity discharge bulbs is insufficient, the light may not come on, or may go out temporarily. The high-intensity discharge bulbs will come on when normal power is restored.

 CAUTION

■ **Replacing light bulbs**

- Turn off the headlights. Do not attempt to replace the bulb immediately after turning off the headlights.
The bulbs become very hot and may cause burns.
- Do not touch the glass portion of the light bulb with bare hands. Hold the bulb by the plastic or metal portion.
If the bulb is scratched or dropped it may blow out or crack.
- Fully install light bulbs and any parts used to secure them. Failing to do so may result in heat damage, fire, or water entering the headlight unit. This may damage the headlights or cause condensation to build up on the lens.
- Do not take apart or repair the low beam discharge headlight bulbs, connectors, power supply circuits, or related components.
Doing so could result in electric shock and death or serious injury.

■ **High-intensity discharge (HID) headlights (if equipped)**

- Contact your Toyota dealer before replacing high-intensity discharge headlights (including light bulbs).
- Do not touch the high-intensity discharge headlight's high voltage socket when the headlights are turned on. An extremely high voltage of 20000V will be discharged and could result in serious injury or death by electric shock.

■ **To prevent damage or fire**

Make sure bulbs are fully seated and locked.

5-1. Essential information

Emergency flashers

Use the emergency flashers if the vehicle malfunctions or is involved in an accident.

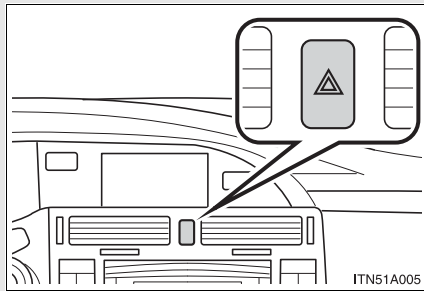

Press the switch to flash all the turn signal lights. To turn them off, press the switch once again.

NOTICE

■ To prevent battery discharge

Do not leave the emergency flashers on longer than necessary when the engine is not running.

5-1. Essential information

If your vehicle needs to be towed

If towing is necessary, we recommend having your vehicle towed by your Toyota dealer or a commercial towing service, using a lift-type truck or a flat bed truck.

Use a safety chain system for all towing, and abide by all state/provincial and local laws.

If towing from the front, the vehicle's rear wheel and axles must be in good condition. (→P. 387)

If they are damaged, use a towing dolly or flat bed truck.

Before towing

The following may indicate a problem with your transmission. Contact your Toyota dealer before towing.

- The engine is running, but the vehicle will not move.
- The vehicle makes an abnormal sound.

5-1. Essential information

Towing with a sling-type truck

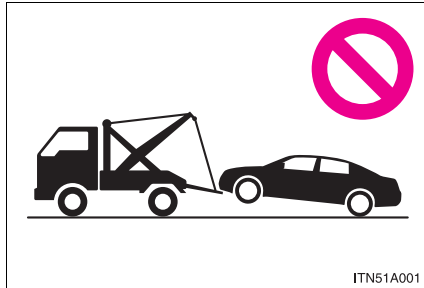

 **NOTICE**

■ To prevent body damage

Do not tow with a sling-type truck, either from the front or rear.

Towing with a wheel lift-type truck

► From front

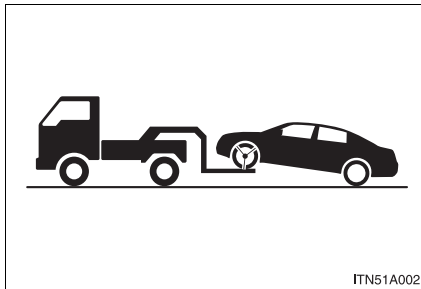

Release the parking brake.

► From rear

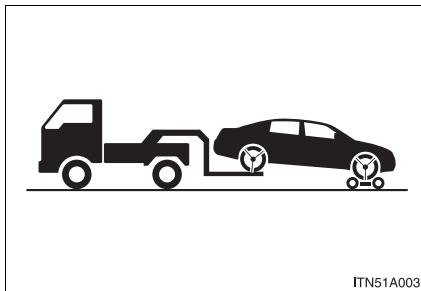

Use a towing dolly under the front wheel.

 NOTICE

■ **To prevent causing damage to the transmission**

Never tow this vehicle from the rear with the front wheel on the ground.

■ **To prevent damaging the vehicle**

When raising the vehicle, ensure adequate ground clearance for towing at the opposite end of the raised vehicle. Without adequate clearance, the vehicle could be damaged while being towed.

5-1. Essential information

Using a flat bed truck

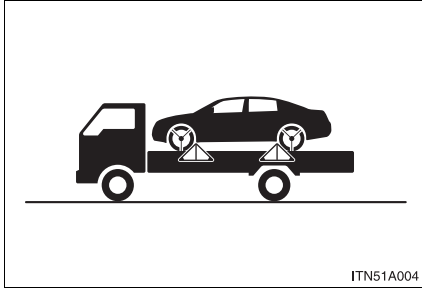

If you use chains or cables to tie down your vehicle, the angles shaded in black must be 45°.

Do not overly tighten the tie downs or the vehicle may be damaged.

5-1. Essential information

If you think something is wrong

If you notice any of the following symptoms, your vehicle probably needs adjustment or repair. Contact your Toyota dealer as soon as possible.

■ Visible symptoms

- Fluid leaks under the vehicle
(Water dripping from the air conditioning after use is normal.)
- Flat-looking tires or uneven tire wear
- Engine coolant temperature gauge needle continually points higher than normal

■ Audible symptoms

- Changes in exhaust sound
- Excessive tire squeal when cornering
- Strange noises related to the suspension system
- Pinging or other noises related to the engine

■ Operational symptoms

- Engine missing, stumbling or running rough
- Appreciable loss of power
- Vehicle pulls heavily to one side when braking
- Vehicle pulls heavily to one side when driving on a level road
- Loss of brake effectiveness, spongy feeling, pedal almost touches the floor

5-1. Essential information

Fuel pump shut off system

To minimize the risk of fuel leakage when the engine stalls or an air-bag inflates upon collision, the fuel pump shut off system stops supplying fuel to the engine.

Follow the procedure below to restart the engine after the system is activated.

STEP 1 Vehicles with smart key system: Turn the “ENGINE START STOP” switch OFF.

Vehicles without smart key system: Turn the engine switch to the “ACC” or “LOCK” position.

STEP 2 Restart the engine.

NOTICE

■ Before starting the engine

Inspect the ground under the vehicle.

If you find that fuel has leaked on to the ground, the fuel system has been damaged and is in need of repair. Do not restart the engine.

5-1. Essential information Event data recorder

Your vehicle has computers that monitor and control certain aspects of your vehicle. These computers assist in driving and maintaining optimal vehicle performance.

Besides storing data useful for troubleshooting, there is a system to record data in a crash or a near car crash event. This is called an Event Data Recorder (EDR).

In a crash or a near car crash event

The SRS airbag sensor assembly contains the EDR. In a crash or a near car crash event, this device may record some or all of the following information:

- Engine speed
- Whether the brake pedal was applied or not
- Vehicle speed
- To what extent the accelerator pedal was depressed
- Position of the transmission shift lever
- Whether the driver and front passenger wore seat belts or not
- Driver's seat position
- Front passenger's occupant classification
- SRS airbag deployment data
- SRS airbag system diagnostic data

The information above is intended to be used for the purpose of improving vehicle safety performance. Unlike general data recorders, the EDR does not record sound data such as conversation between passengers.

Disclosure of the data

Toyota will not disclose the data recorded in an EDR to a third party except when:

- An agreement from the vehicle's owner (or the leasing company for a leased vehicle) is obtained
- Officially requested by the police or other authorities
- Used as a defense for Toyota in a law suit
- Ordered by a court

However, if necessary Toyota will:

- Use the data for research on Toyota vehicle safety performance
- Disclose the data to a third party for research purposes without disclosing details of the vehicle owner, and only when it is deemed necessary
- Disclose summarized data cleared of vehicle identification information to a non-Toyota organization for research purposes



5-2. Steps to take in an emergency

If a warning light turns on or a warning buzzer sounds...

Calmly perform the following actions if any of the warning lights turn on or flash. If a light turns on or flashes, but then turns off, this does not necessarily indicate a malfunction in the system.

Stop the vehicle immediately. Continuing to drive the vehicle may be dangerous.

The following warning indicates a possible problem in the brake system. Immediately stop the vehicle in a safe place and contact your Toyota dealer.

Warning light	Warning light/Details
 (U.S.A.)	Brake system warning light (warning buzzer)* <ul style="list-style-type: none">• Low brake fluid• Malfunction in the brake system This light also comes on when the parking brake is not released. If the light turns off after the parking brake is fully released, the system is operating normally.
 (Canada)	



*: Parking brake engaged warning buzzer:

A buzzer will sound if the vehicle is driven at a speed of approximately 3 mph (5 km/h) or more.

5-2. Steps to take in an emergency



Stop the vehicle immediately.





The following warning indicates the possibility of damage to the vehicle that may lead to an accident. Immediately stop the vehicle in a safe place and contact your Toyota dealer.

Warning light	Warning light/Details
	Charging system warning light Malfunction in the vehicle's charging system.
	Low engine oil pressure warning light Abnormal level of engine oil pressure. This warning light may turn on if the level of engine oil declines. The light should turn off after checking the oil and adding oil if necessary.

Have the vehicle inspected immediately.



Failing to investigate the cause of the following warnings may lead to the system operating abnormally and possibly cause an accident. Have the vehicle inspected by your Toyota dealer immediately.

Warning light	Warning light/Details
 (U.S.A.)  (Canada)	Malfunction indicator lamp Malfunction in: <ul style="list-style-type: none"> • The electronic engine control system; • The electronic throttle control system; or • The transmission control system.
	SRS warning light Malfunction in: <ul style="list-style-type: none"> • The SRS airbag system; • Front passenger occupant classification system; or • The seat belt pretensioner system.





Warning light	Warning light/Details
 (U.S.A.)  (Canada)	ABS warning light Malfunction in: <ul style="list-style-type: none"> • The ABS; or • The brake assist system.
 (if equipped)	Automatic headlight leveling system warning light Malfunction in the automatic headlight leveling system.
	Vehicle stability control system warning light Malfunction in the VSC system or TRAC system.



Have the malfunction repaired immediately.

After taking the specified steps to correct the suspected problem, check that the warning light turns off.

Warning light	Warning light/Details	Correction procedure
	Open door warning light (warning buzzer)*¹ A door or a trunk is not fully closed.	Check that all doors and the trunk are closed.
	Low fuel level warning light Remaining fuel (Approximately 2.6 gal. [10 L, 2.2 Imp.gal.] or less)	Refuel the vehicle.

5-2. Steps to take in an emergency

Warning light	Warning light/Details	Correction procedure
	Driver's seat belt reminder light (warning buzzer) *2 Warns the driver to fasten his/her seat belt.	Fasten the seat belt.
	Front passenger's seat belt reminder light (warning buzzer) *2 Warns the front passenger to fasten his/her seat belt.	Fasten the seat belt.
	Tire pressure warning light	
	When the light comes on: Low tire inflation pressure.	Adjust the tire inflation pressure.
	When the light stays on after blinking for 1 minute: Malfunction in the tire pressure warning system.	Have the system checked by your Toyota dealer.
	Low washer fluid warning light Low level of washer fluid	Fill the tank.

Warning light	Warning light/Details	Correction procedure
	Engine oil replacement reminder light Illuminates for about 3 seconds and then flashes for about 15 seconds: Engine oil is scheduled to be changed.	Check and the engine oil, and change if necessary.
	Comes on and remains: Engine oil should be changed.	Check and change the engine oil.
 (if equipped)	Dynamic laser cruise control master warning light Malfunction in the dynamic laser cruise control system. When the light comes on, the alarm sounds and the warning code will appear on the display.	→P. 175

*1: Open door warning buzzer:

A buzzer will sound if the vehicle is driven at a speed of approximately 3 mph (5 km/h) or more with any door open.



*2: Driver's and front passenger's seat belt reminder buzzer:

The driver's and front passenger's seat belts reminder sounds to alert the driver and front passenger that his or her seat belt is not fastened. The buzzer sounds intermittently for 10 seconds after the vehicle has reached a speed of at least 9 mph (15 km/h). Then, if the seat belt is still unfastened, the buzzer will continue to sound.



5-2. Steps to take in an emergency

Have the malfunction repaired immediately. (vehicles with smart key system)

After taking the specified steps to correct the suspected problem, check that the warning light turn off.

Interior buzzer	Exterior buzzer	Warning light	Details	Correction procedure
Once	—	 (Flashing)	The electronic key is not detected when attempting to start the engine.	<ul style="list-style-type: none"> • Confirm the location of the electronic key. • The electronic key battery maybe discharged. (→P. 363)
Once	3 times	 (Flashing)	An open door other than the driver's door is closed while the electronic key is outside the detection range and the "ENGINE START STOP" switch is in ACCESSORY or IGNITION ON mode.	Confirm the location of the electronic key.

5-2. Steps to take in an emergency

Interior buzzer	Exterior buzzer	Warning light	Details	Correction procedure
Once	3 times	 (Flashing)	An open door other than the driver's door is closed while the electronic key is outside the detection range and the "ENGINE START STOP" switch is in ACCESSORY or IGNITION ON mode with the shift lever in "P".	Turn the "ENGINE START STOP" switch OFF or confirm the location of the electronic key.
Continuous	Continuous	 (Flashing)	An open door other than the driver's door is closed while the electronic key is outside the detection range and the "ENGINE START STOP" switch is in ACCESSORY or IGNITION ON mode with the shift lever not in "P".	Shift the shift lever to "P". Confirm the location of the electronic key.

5

When trouble arises

■ **If the malfunction indicator lamp comes on while driving**

First check the following:

- Is your vehicle low on gas?
If it is, refuel the vehicle immediately.
- Is the fuel tank cap loose?
If it is, tighten it securely.

The light will go off after taking several driving trips.

If the light does not go off even after several trips, contact your Toyota dealer as soon as possible.

■ **SRS warning light**

This warning light system monitors the following:

- The airbag sensor assembly
- Front airbag sensors
- The curtain shield airbag sensors
- The side and curtain shield airbag sensor assemblies
- The driver's seat position sensor
- Driver's seat belt buckle switch
- The front passenger occupant classification ECU
- The pressure sensor
- The belt tension sensor
- "AIR BAG ON" and "AIR BAG OFF" indicator lights
- Front passenger's seat belt buckle switch
- The inflators
- The warning light
- The interconnecting wiring and power sources

■ **Front passenger detection sensor and passenger seat belt reminder**

If luggage is placed on the front passenger seat, the front passenger detection sensor may cause the warning light to flash, even if a passenger is not sitting in the seat.

■ **If the tire pressure warning system is inoperative**

The tire pressure warning system will be disabled in the following conditions:

(When the condition becomes normal, the system will work properly.)

- If tires not equipped with tire pressure warning valves and transmitters are used.
- If the ID code on the tire pressure warning valves and transmitters is not registered in the tire pressure warning computer.
- If the tire inflation pressure is 73 psi (500 kPa, 5.1 kgf/cm² or bar) or higher.

The tire pressure warning system may be disabled in the following conditions:

(When the condition becomes normal, the system will work properly.)

- If electronic devices or facilities using similar radio wave frequencies are nearby.
- If a radio set at similar frequencies is in use in the vehicle.
- If a window tint that affects the radio wave signals is installed.
- If there is a lot of snow or ice on the vehicle, in particular around the wheels or wheel housings.
- If non-genuine Toyota wheels are used. (Even if you use Toyota wheels, the tire pressure warning system may not work properly with some types of tires.)
- If tire chains are used.
- If the spare tire is in a location subject to poor radio wave signal reception.
- If a large metallic object which can interfere with signal reception is put in the trunk.

5-2. Steps to take in an emergency

■ If the tire pressure warning light continues to come on after blinking for 1 minute frequently

▶ Vehicles with smart key system

If the tire pressure warning light comes on after blinking for 1 minute when the "ENGINE START STOP" switch is turned to IGNITION ON mode, have it checked by your Toyota dealer.

▶ Vehicles without smart key system

If the tire pressure warning light comes on after blinking for 1 minute when the engine switch is turned to the "ON" position, have it checked by your Toyota dealer.

■ When the tire pressure warning light comes on

Check the tire inflation pressure and adjust to the appropriate level. Pushing the tire pressure warning reset switch does not turn off the tire pressure warning light.

■ The tire pressure warning light may turn on due to natural causes

The tire pressure warning light may turn on due to natural causes such as natural air leaks or tire inflation pressure changes caused by temperature. In this case, adjusting the tire inflation pressure will turn off the light (after a few minutes).

■ When a tire is replaced with a spare tire

The spare tire is also equipped with the tire pressure warning valve and transmitter. The tire pressure warning light will turn on if the tire inflation pressure of the spare tire is low. If a tire goes flat, even though the flat tire is replaced with the spare tire, the tire pressure warning light does not turn off. Replace the spare tire with the repaired tire and adjust the proper tire inflation pressure. The tire pressure warning light will turn off after a few minutes.

⚠ CAUTION**■ If the tire pressure warning light comes on**

Be sure to observe the following precautions. Failure to do so could cause loss of vehicle control and result in death or serious injury.

- Stop your vehicle in a safe place as soon as possible. Adjust the tire inflation pressure immediately.
- If the tire pressure warning light comes on even after tire inflation pressure adjustment, it is probable that you have a flat tire. Check the tires. If the tire is flat, change to the spare tire and have the flat tire repaired by the nearest Toyota dealer.
- Avoid abrupt maneuvering and braking. If the vehicle tires deteriorate, you could lose control of the steering wheel or the brakes.

■ If a blowout or sudden air leakage should occur

The tire pressure warning system may not activate immediately.

■ Maintenance of the tires

Each tire, including the spare (if provided), should be checked monthly when cold and inflated to the inflation pressure recommended by the vehicle manufacturer on the vehicle placard or tire inflation pressure label (tire and load information label). (If your vehicle has tires of a different size than the size indicated on the vehicle placard or tire inflation pressure label [tire and load information label], you should determine the proper tire inflation pressure for those tires.)

As an added safety feature, your vehicle has been equipped with a tire pressure monitoring system (TPMS-tire pressure warning system) that illuminates a low tire pressure telltale (tire pressure warning light) when one or more of your tires is significantly under-inflated. Accordingly, when the low tire pressure telltale (tire pressure warning light) illuminates, you should stop and check your tires as soon as possible, and inflate them to the proper pressure. Driving on a significantly under-inflated tire causes the tire to overheat and can lead to tire failure. Under-inflation also reduces fuel efficiency and tire tread life, and may affect the vehicle's handling and stopping ability.

5-2. Steps to take in an emergency

CAUTION

Please note that the TPMS (tire pressure warning system) is not a substitute for proper tire maintenance, and it is the driver's responsibility to maintain correct tire pressure, even if under-inflation has not reached the level to trigger illumination of the TPMS low tire pressure telltale (tire pressure warning light).

Your vehicle has also been equipped with a TPMS (tire pressure warning system) malfunction indicator to indicate when the system is not operating properly. The TPMS (tire pressure warning system) malfunction indicator is combined with the low tire pressure telltale (tire pressure warning light). When the system detects a malfunction, the telltale will flash for approximately one minute and then remain continuously illuminated. This sequence will continue upon subsequent vehicle start-ups as long as the malfunction exists. When the malfunction indicator is illuminated, the system may not be able to detect or signal low tire pressure as intended.

TPMS (tire pressure warning system) malfunctions may occur for a variety of reasons, including the installation of replacement or alternate tires or wheels on the vehicle that prevent the TPMS (tire pressure warning system) from functioning properly. Always check the TPMS (tire pressure warning system) malfunction telltale after replacing one or more tires or wheels on your vehicle to ensure that the replacement or alternate tires and wheels allow the TPMS (tire pressure warning system) to continue to function properly.

NOTICE

■ **Precaution when installing a different tire**

When a tire of a different specification or maker is installed, the tire pressure warning system may not operate properly.

5-2. Steps to take in an emergency If you have a flat tire

Remove the flat tire and replace it with the spare provided.

■ **Before jacking up the vehicle**

- Stop the vehicle on a hard, flat surface.
- Set the parking brake.
- Shift the shift lever to "P".
- Stop the engine.
- Turn on the emergency flashers.

■ **Location of the spare tire, jack and tools**

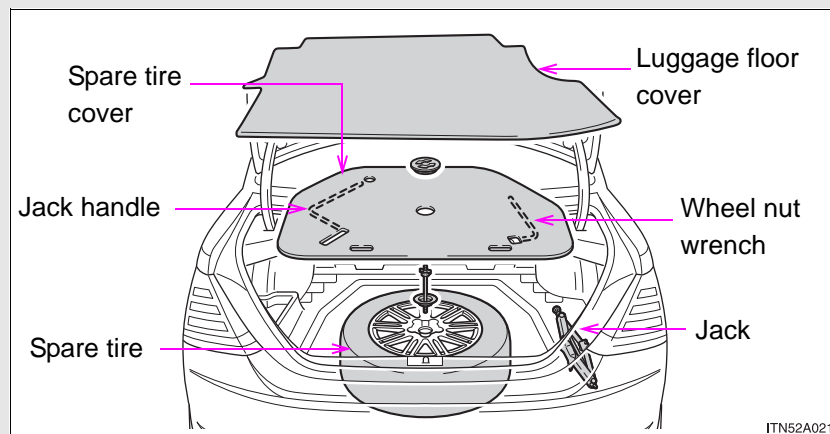

5

When trouble arises

5-2. Steps to take in an emergency

Take out the jack

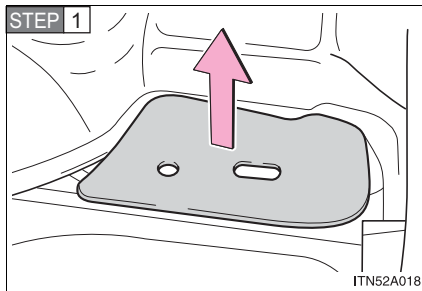

Remove the cover.

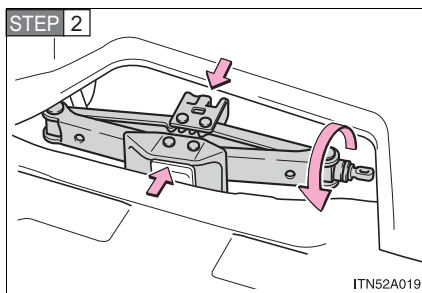

To remove the jack, turn the jack joint by hand until the jack becomes free.

Taking out the spare tire

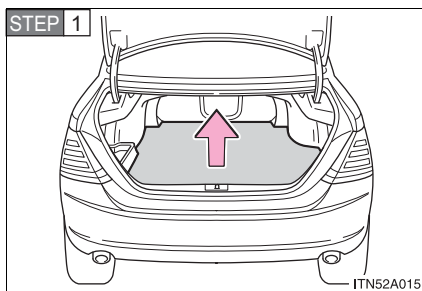

Remove the luggage floor cover.

5-2. Steps to take in an emergency

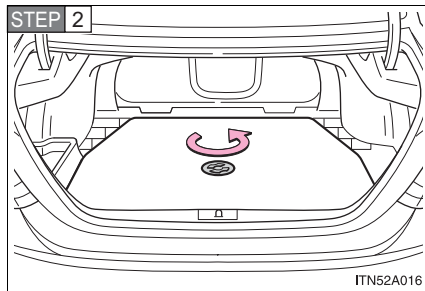

Loosen the center fastener that secures the spare tire.

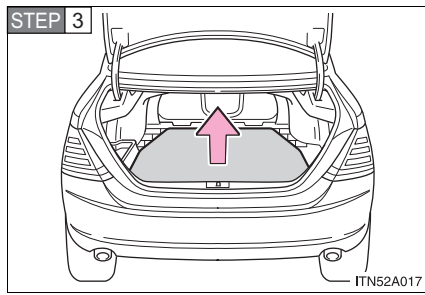

Remove the spare tire cover.

5-2. Steps to take in an emergency

Replacing a flat tire

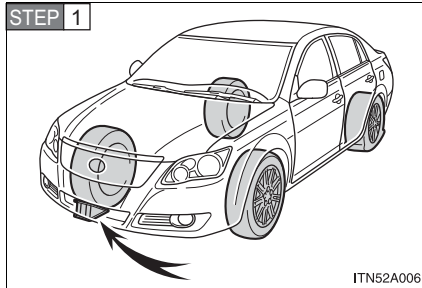

Chock the tires.

	Flat tire	Wheel chock positions
Front	Left-hand side	Behind the rear right-hand side tire
	Right-hand side	Behind the rear left-hand side tire
Rear	Left-hand side	In front of the front right-hand side tire
	Right-hand side	In front of the front left-hand side tire

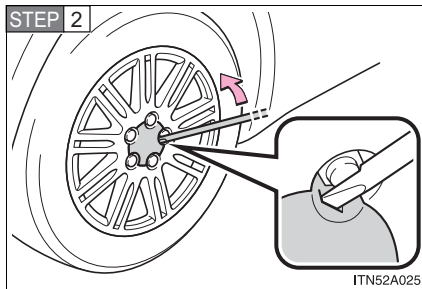

Type A: Remove the wheel ornament using the wheel nut wrench.

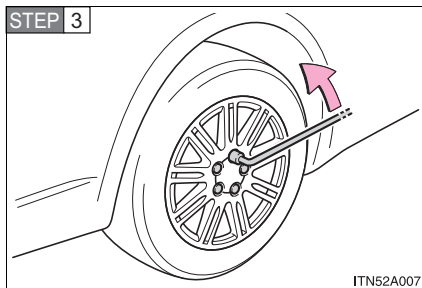

Slightly loosen the wheel nuts (one turn).

5-2. Steps to take in an emergency

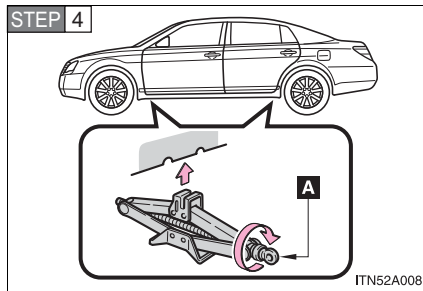

Turn the tire jack portion "A" by hand until the notch of the jack is in contact with the jack point.

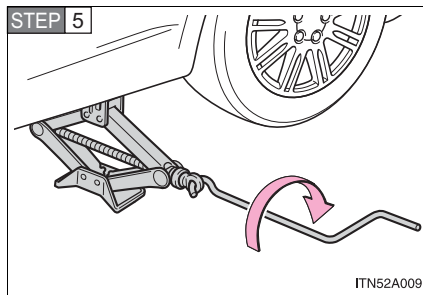

Raise the vehicle until the tire is slightly raised off the ground.

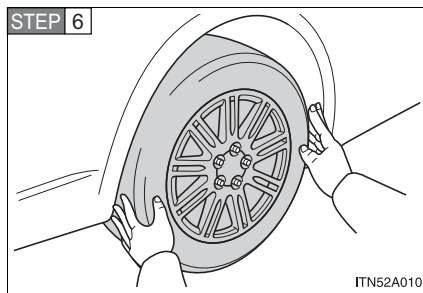

Remove all the wheel nuts and the tire.

When resting the tire on the ground, place the tire so that the wheel design faces up to avoid scratching the wheel surface.

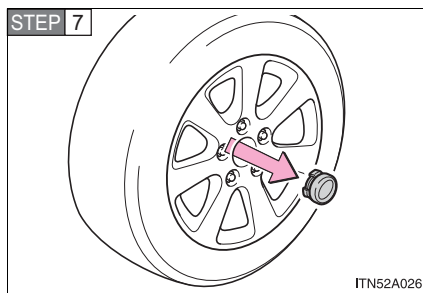

Type B: Remove the wheel ornament by pushing from the reverse side.

5

When trouble arises

5-2. Steps to take in an emergency

Installing the spare tire

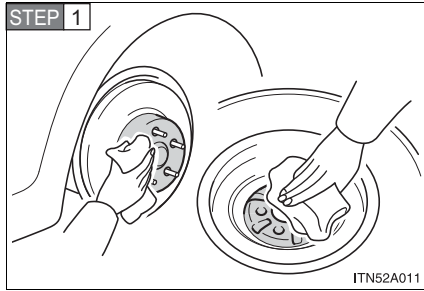

Remove any dirt or foreign matter from the wheel contact surface.

If foreign matter is on the wheel contact surface, the wheel nuts may loosen while the vehicle is in motion, and the tire may come off the vehicle.

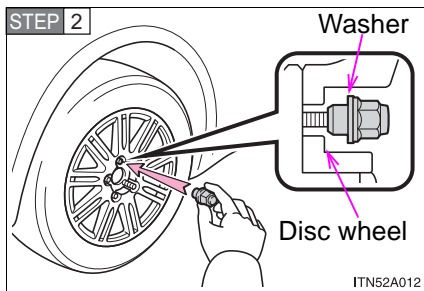

Install the spare tire and loosely tighten each wheel nut by hand to approximately the same amount.

Turn the nut washers until they come into contact with the disc wheel.

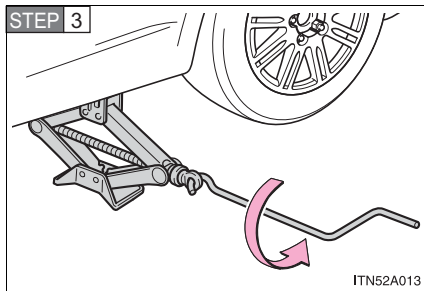

Lower the vehicle.

5-2. Steps to take in an emergency

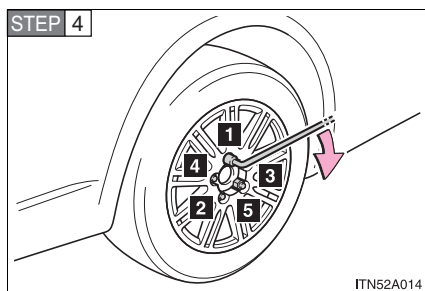

Firmly tighten each nut two or three times in the order shown in the illustration.

Tightening torque:
76 ft•lbf (103 N•m, 10.5 kgf•m)

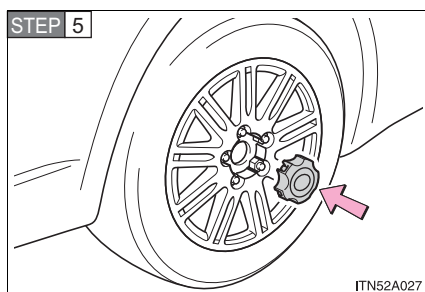

Reinstall the wheel ornament.

STEP 6 Stow the flat tire, tire jack and all tools.

■ To store the jack

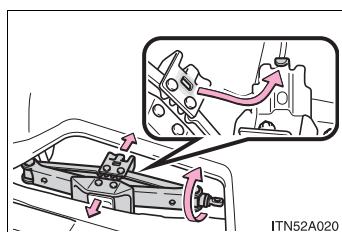

To store the jack, align the hole of the jack head with the vehicle hook. Turn the jack joint until the jack base fits securely with the vehicle body. This prevents the jack from flying forward during a collision or sudden stop.

■ After completing the tire change

The tire pressure warning system must be reset. (→P. 346)

5

When trouble arises

 CAUTION

■ **Using the tire jack**

Improper use of the tire jack may lead to death or injuries due to the vehicle suddenly falling off the jack.

- Do not use the tire jack for any purpose other than replacing tires or installing and removing tire chains.
- Only use the tire jack that comes with this vehicle for replacing a flat tire.
Do not use it on other vehicles, and do not use other tire jacks for replacing tires on this vehicle.
- Always check that the tire jack is securely set to the jack point.
- Do not raise the vehicle while someone is in it.
- When raising the vehicle, do not put an object on or under the jack.
- Do not raise the vehicle to a height greater than that required to replace the tire.
- Use a jack stand if it is necessary to get under the vehicle.
- Do not put any part of your body under the vehicle supported by a jack.
- Do not start or run the engine while your vehicle is supported by the jack.

Take particular care when lowering the vehicle to ensure that no one working on or near the vehicle may be injured.

■ **Replacing a flat tire**

Observe the following precautions to reduce the risk of death or serious injury.

- Never use oil or grease on the wheel bolts or wheel nuts.
Oil and grease may cause the wheel nuts to be excessively tightened, leading to bolt or disc wheel damage. In addition, the oil or grease can cause the wheel nuts to loosen and the wheel may fall off, causing a serious accident. Remove any oil or grease from the wheel bolts or wheel nuts.

 CAUTION

■ **Replacing a flat tire**

- Have the wheel nuts tightened with a torque wrench to 76 ft•lb (103 N•m, 10.5 kgf•m) as soon as possible after changing wheels. Failure to follow these precautions could cause the nuts to loosen and the wheels may fall off, which could lead to an accident causing death or serious injury.

 NOTICE

■ **Do not drive the vehicle with a flat tire**

Do not continue driving with a flat tire. Driving even a short distance with a flat tire can damage the tire and the wheel beyond repair.

■ **When replacing the tires**

When removing or fitting the wheels, tires or the tire pressure warning valve and transmitter, contact your Toyota dealer as the tire pressure warning valve and transmitter may be damaged if not handled correctly.

■ **To avoid damaging the tire pressure warning valves and transmitters**

Do not use liquid sealants on flat tires.

5-2. Steps to take in an emergency If the engine will not start

If the engine will not start even though correct starting procedures are being followed (→P. 133, P. 137), consider each of the following points.

■ The engine will not start even when the starter motor operates normally

One of the following may be the cause of the problem.

- There may not be sufficient fuel in the vehicle's tank.
Add fuel to the vehicle.
- The engine may be flooded.
Try to restart the engine once more following correct starting procedures. (→P. 133)
- There may be a malfunction in the engine immobilizer system.
(→P. 83)

■ The starter motor turns over slowly, the interior lights and headlights are dim, or the horn does not sound or sounds at a low volume

One of the following may be the cause of the problem.

- The battery may be discharged. (→P. 420)
- The battery terminal connections may be loose or corroded.

■ The starter motor does not turn over (vehicles with smart key system).

The engine starting system may be malfunctioning due to an electrical problem such as an open circuit or a blown fuse. However, an interim measure is available to start the engine.
(→P. 133)

■ **The starter motor does not turn over, the interior lights and headlights do not turn on, or the horn does not sound**

One of the following may be the cause of the problem.

- One or both of the battery terminals may be disconnected.
- The battery may be discharged. (→P. 420)
- There may be a malfunction in the steering lock system (vehicles with smart key system).

Contact your Toyota dealer if the problem cannot be repaired, or if repair procedures are unknown.

Emergency start function (vehicles with smart key system)

When the engine does not start, the following steps can be used as an interim measure to start the engine if the “ENGINE START STOP” switch is functioning normally.

STEP 1 Set the parking brake.

STEP 2 Shift the shift lever to “P”.

STEP 3 Set the “ENGINE START STOP” switch to the ACC mode.

STEP 4 Push and hold the “ENGINE START STOP” switch about 15 seconds while depressing the brake pedal firmly.

Even if the engine can be started using the above steps, the system may be malfunctioning. Have the vehicle checked by your Toyota dealer.

5-2. Steps to take in an emergency

If the shift lever cannot be shifted from P

If the shift lever cannot be shifted with your foot on the brake, there may be a problem with the shift lock system (a system to prevent accidental operation of the shift lever). Have the vehicle inspected by your Toyota dealer immediately.

The following steps may be used as an emergency measure to ensure that the shift lever can be shifted.

STEP 1 Set the parking brake.

STEP 2 Vehicles with smart key system: Turn the “ENGINE START STOP” switch to ACCESSORY mode.

Vehicles without smart key system: Turn the engine switch to the “ACC” position.

STEP 3 Depress the brake pedal.

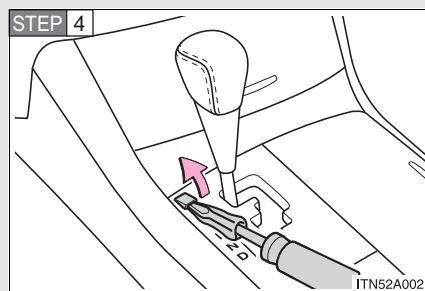

Pry the cover up with a flat-head screwdriver or equivalent.

To prevent damage to the cover, cover the tip of the screwdriver with a rag.

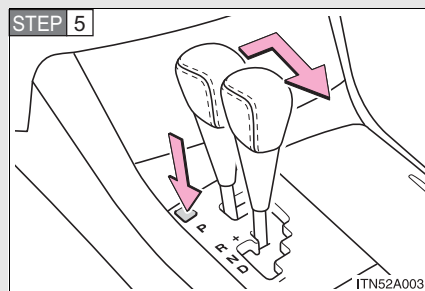

Press the shift lock override button.

The shift lever can be shifted while the button is pressed.

5-2. Steps to take in an emergency If you lose your keys

New genuine Toyota keys can be made by your Toyota dealer using one of the other master keys and the key number stamped on your key number plate.

5-2. Steps to take in an emergency

If the electronic key does not operate properly (with smart key system)

If communication between the electronic key and vehicle is interrupted (→P. 28) or the electronic key cannot be used because the battery is depleted, the smart key system and wireless remote control cannot be used. In such cases, the doors can be opened or the engine can be started by following the procedure below.

Locking and unlocking the doors key linked functions

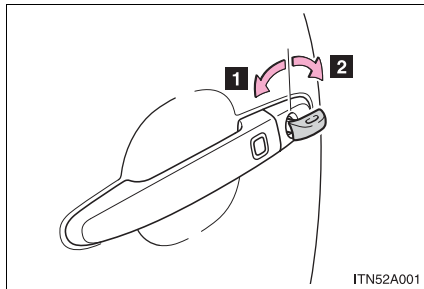

Using the mechanical key (→P. 22) in order to perform the following operations:

- 1 Locks all doors
- 2 Unlocks the door

Turning the key rearward unlocks the driver's door. Turning the key once again unlocks the other doors.

Changing "ENGINE START STOP" switch modes and starting the engine

STEP 1 Put the shift lever in "P" and apply the brakes.

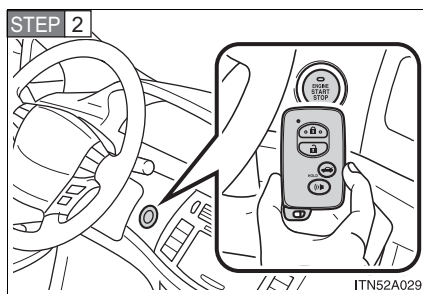

Touch the Toyota emblem side of the electronic key to the "ENGINE START STOP" switch.

An alarm will sound to indicate that the start function cannot detect the electronic key that is touched to the "ENGINE START STOP" switch if any of the doors is opened and closed while the key is touched to the switch.

STEP 3 To change the “ENGINE START STOP” switch modes: Within 5 seconds of the buzzer sounding, release the brake pedal and press the “ENGINE START STOP” switch. Modes can be changed each time the switch is pressed. (→P. 133)

To start the engine: Press the “ENGINE START STOP” switch within 5 seconds after the buzzer sounds, keeping the brake pedal depressed.

If the “ENGINE START STOP” switch still cannot be operated, contact your Toyota dealer.

■ **Stopping the engine**

Shift the shift lever to “P” and press the “ENGINE START STOP” switch as you normally do when stopping the engine.

■ **Replacing the key battery**

As the above procedure is the temporary measure, it is recommended that the electronic key battery be replaced immediately when the battery depletes. (→P. 363)

5-2. Steps to take in an emergency If the vehicle battery is discharged

The following procedures may be used to start the engine if the vehicle's battery is discharged.

You can call your Toyota dealer or qualified repair shop.

If you have a set of jumper (or booster) cables and a second vehicle with a 12 volt battery, you can jump start your Toyota following the steps below.

STEP 1 Connecting the jumper cables.

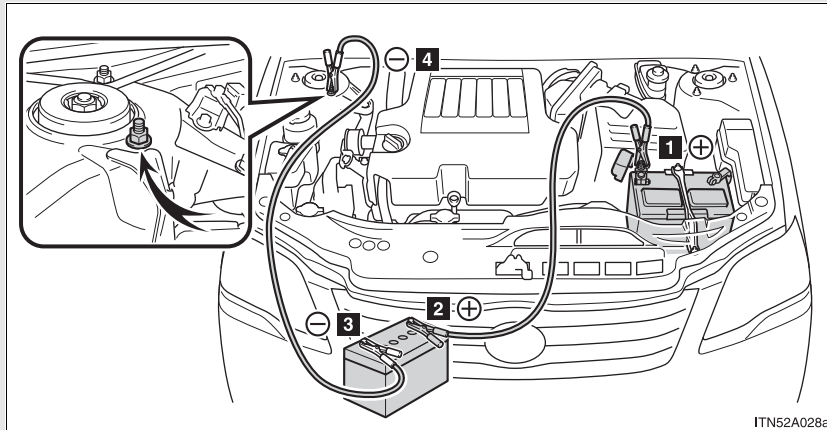

- 1** Positive (+) battery terminal on your vehicle.
- 2** Positive (+) battery terminal on the second vehicle.
- 3** Negative (-) battery terminal on the second vehicle.
- 4** Connect the jumper cable to ground on your vehicle as shown in the illustration.

STEP 2 Start the engine of the second vehicle. Increase the engine speed slightly and maintain at that level for approximately five minutes to recharge the battery of your vehicle.

STEP 3 Vehicles with smart key system — Open and close any of the doors with the “ENGINE START STOP” switch OFF.

STEP 4 Vehicles with smart key system: Maintain the engine speed on the second vehicle and turn the “ENGINE START STOP” switch to IGNITION ON mode, then start the vehicle’s engine.

Vehicles without smart key system: Maintain the engine speed on the second vehicle and turn the engine switch to the “ON” position, then start the vehicle’s engine.

STEP 5 Once the vehicle’s engine has started, remove the jumper cables in the exact reverse order in which they were connected.

Once the engine starts, have the vehicle checked at your Toyota dealer as soon as possible.

■ **Starting the engine when the battery is discharged**

The engine cannot be started by push-starting.

■ **To prevent battery discharge**

- Turn off the headlights and the audio system while the “ENGINE START STOP” switch or the engine is turned off.
- Turn off any unnecessary electrical components when the vehicle is running at a low speed for an extended period, such as in heavy traffic, etc.

5-2. Steps to take in an emergency

■ When the battery is removed or discharged

The following systems must be initialized.

- Power windows (→P. 74)
- Moon roof (→P. 79)

CAUTION

■ Avoiding battery fires or explosions

Observe the following precautions to prevent accidentally igniting the flammable gas that may be emitted from the battery.

- Make sure the jumper cable is connected to the correct terminal and that it is not unintentionally in contact with any part other than the intended terminal.
- Do not allow the jumper cables to come into contact with the “+” and “-” terminals.
- Do not allow open flame or use matches, cigarette lighters or smoke near the battery.

 CAUTION

■ **Battery precautions**

The battery contains poisonous and corrosive acidic electrolyte, while related parts contain lead and lead compounds. Observe the following precautions when handling the battery:

- When working with the battery, always wear safety glasses and take care not to allow any battery fluids (acid) to come into contact with skin, clothing or the vehicle body.
- Do not lean over the battery.
- In the event that battery fluid comes into contact with the skin or eyes, immediately wash the affected area with water and seek medical attention. Place a wet sponge or cloth over the affected area until medical attention can be received.
- Always wash your hands after handling the battery support, terminals, and other battery-related parts.
- Do not allow children near the battery.

 NOTICE

■ **When handling jumper cables**

Be careful that the jumper cables do not become tangled in the cooling fan or any of the belts when connecting or disconnecting them.

5-2. Steps to take in an emergency If your vehicle overheats

If your engine overheats:

STEP 1 Stop the vehicle in a safe place and turn off the air conditioning system.

STEP 2 Check to see if steam is coming out from under the hood.

If you see steam:

Stop the engine. Carefully lift the hood after the steam subsides and then restart the engine.

If you do not see steam:

Leave the engine running and carefully lift the hood.

STEP 3 Remove the engine compartment cover. (→P. 331)

STEP 4 Check to see if the cooling fan is operating.

If the fan is operating:

Wait until the engine coolant temperature gauge begins to fall and then stop the engine.

If the fan is not operating:

Stop the engine immediately and call your local Toyota dealer.

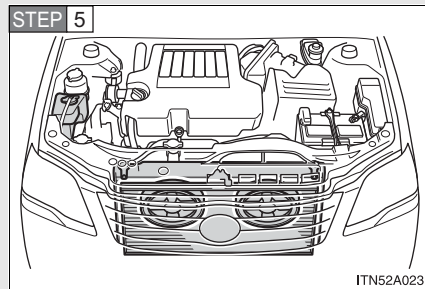

After the engine has cooled down sufficiently, check the coolant level and inspect the radiator core (radiator) for any leaks.

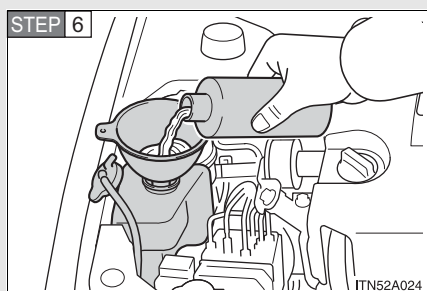

Add coolant if required.

Water can be used in an emergency measure if coolant is unavailable. (→P. 435)

Have the vehicle checked at your nearest Toyota dealer as soon as possible.

■ Overheating

In the following situations, your vehicle may be overheating.

- The engine coolant temperature gauge enters the red zone or a loss of power is experienced.
- Steam is coming from under the hood.

⚠ CAUTION

■ To prevent an accident or injury when inspecting under the hood of your vehicle

- If steam is seen coming from under the hood, do not open the hood until the steam has subsided. The engine compartment may be very hot, causing serious injury such as burns.
- Keep hands and clothing away from the fan and engine drive belt while the engine is running.
- Do not loosen the radiator cap while the engine and radiator are hot. Serious injury, such as burns, may result from hot coolant and steam released under pressure.

5-2. Steps to take in an emergency

NOTICE

■ **When adding engine coolant**

Wait until the engine has cooled down before adding engine coolant.
When adding coolant, do so slowly. Adding cool coolant to a hot engine too quickly can cause damage to the engine.

5-2. Steps to take in an emergency If the vehicle becomes stuck

Carry out the following procedures if the tires spin or the vehicle becomes stuck in mud, dirt, or snow.

- STEP 1** Stop the engine. Set the parking brake and shift the shift lever in “P”.
- STEP 2** Remove the mud, snow, or sand from around the stuck tire.
- STEP 3** Place wood, stones or some other material to help provide traction under the tires.
- STEP 4** Restart the engine.
- STEP 5** Shift the shift lever to the “D” or “R” position and carefully apply the accelerator to free the vehicle.

CAUTION

■ When attempting to free a stuck vehicle

If you choose to rock the vehicle back and forth to free it, make sure the surrounding area is clear, to avoid striking other vehicles, objects or persons. The vehicle may also lunge forward or lunge back suddenly as it becomes free. Use extreme caution.

■ When shifting the shift lever

Be careful not to shift the shift lever with the accelerator pedal depressed. This may lead to unexpected rapid acceleration of the vehicle that may cause an accident and result in death or serious injury.

NOTICE

■ To avoid damaging the transmission and other components

- Avoid spinning the wheels and do not rev the engine.
- If the vehicle remains stuck after trying these procedures, the vehicle may require towing to be freed.

5

When trouble arises

5-2. Steps to take in an emergency

428

6-1. Specifications

Maintenance data (fuel, oil level, etc.)

Dimensions and weight

Overall length	197.6 in. (5020 mm)	
Overall width	72.8 in. (1850 mm)	
Overall height *	58.5 in. (1485 mm)	
Wheelbase	111.0 in. (2820 mm)	
Tread	Front	62.2 in. (1580 mm)
	Rear	61.6 in. (1565 mm)
Vehicle capacity weight (occupants + luggage)	870 lb. (395 kg)	

*: Unladen vehicle

Vehicle identification

The vehicle identification number (VIN) is the legal identifier for your vehicle. This is the primary identification number for your Toyota. It is used in registering the ownership of your vehicle.

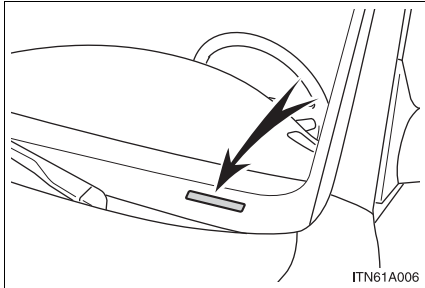

This number is stamped on the top left of the instrument panel.

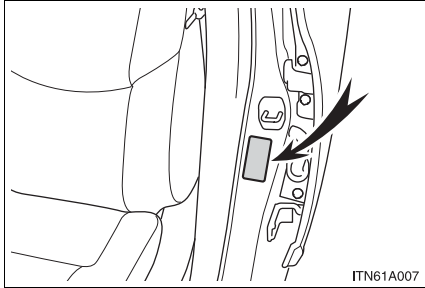

This number is also on the Certification Label.

■ Engine number

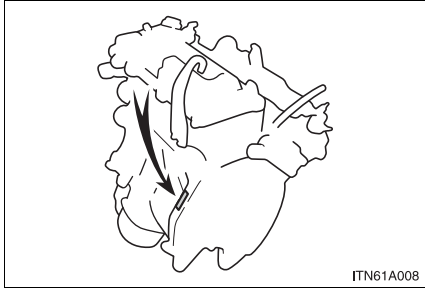

The engine number is stamped on the engine block as shown.

6-1. Specifications

Engine

Model	2GR-FE
Type	6-cylinder V type, 4-cycle, gasoline
Bore and stroke	3.70 × 3.27 in. (94.0 × 83.0 mm)
Displacement	210.9 cu.in. (3456 cm ³)
Drive belt tension	Automatic adjustment

Fuel

Fuel type	Unleaded gasoline only
Octane Rating	87 (Research Octane Number 91) or higher
Fuel tank capacity	18.5 gal. (70 L, 15.4 Imp.gal)

Lubrication system

Oil capacity	
Drain and refill (reference)	
with filter	6.4 qt. (6.1 L, 5.4 Imp.qt.)
without filter	6.0 qt. (5.7 L, 5.0 Imp.qt.)

■ Engine oil selection

“Toyota Genuine Motor Oil” is used in your Toyota vehicle. Use Toyota approved “Toyota Genuine Motor Oil” or equivalent to satisfy the following grade and viscosity.

Oil grade: ILSAC multigrade engine oil

Recommended viscosity: SAE 5W-30

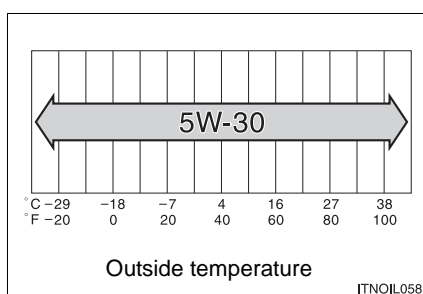

SAE 5W-30 is the best choice for good fuel economy and good starting in cold weather.

If SAE 5W-30 is not available, SAE 10W-30 oil may be used. However, it should be replaced with SAE 5W-30 at the next oil change.

The 5W portion of the oil viscosity rating indicates the characteristic of the oil which allows cold startability. Oils with a lower value before the W allow for easier starting of the engine in cold weather.

The 30 in 5W-30 indicates the oil viscosity when the oil is at its operating temperature. An oil with a higher viscosity may be better suited if the vehicle is operated at high speeds, or under extreme load conditions.

6-1. Specifications

How to read oil container label:

The ILSAC (International Lubricant Standardization and Approval Committee) Certification Mark is added to some oil containers to help you select the oil you should use.



Cooling system

Capacity	8.8 qt. (8.3 L, 7.3 Imp.qt.)
Coolant type	Use either of the following: <ul style="list-style-type: none"> • “Toyota Super Long Life Coolant” • Similar high-quality ethylene glycol-based non-silicate, non-amine, non-nitrite, and non-borate coolant with long-life hybrid organic acid technology Do not use plain water alone.

Ignition system

Spark plug Make	DENSO	FK20HR11
Gap	0.043 in. (1.1 mm)	

 NOTICE**■ Iridium-tipped spark plugs**

Use only iridium-tipped spark plugs. Do not adjust gap when tuning engine.

Electrical system

Battery Open voltage at 68°F (20°C):	12.6 — 12.8 V Fully charged 12.2 — 12.4 V Half charged 11.8 — 12.0 V Discharged (Voltage is checked 20 minutes after the engine and all lights are turned off.)
Charging rates	5A max.

6-1. Specifications

Automatic transaxle

Fluid capacity*	6.9 qt. (6.5 L, 5.7 Imp.qt.)
Fluid type	Toyota Genuine ATF WS

*: The fluid capacity is the quantity of reference. If replacement is necessary, contact your Toyota dealer.

NOTICE

■ Automatic transmission fluid type

Using automatic transmission fluid other than “Toyota Genuine ATF WS” may cause deterioration in shift quality, locking up of your transmission accompanied by vibration, and ultimately damage the automatic transmission of your vehicle.

Brakes

Pedal clearance *1	2.4 in. (61 mm) Min.
Pedal free play	Less than 0.04 — 0.24 in. (1.0 — 6.0 mm)
Brake pad wear limit	0.04 in. (1.0 mm)
Parking brake pedal travel *2	9 — 11 clicks
Parking brake lining wear limit	0.04 in. (1.0 mm)
Fluid type	SAE J1703 or FMVSS No. 116 DOT 3

*1: Minimum pedal clearance when depressed with a force of 110 lbf (490 N, 50 kgf) while the engine is running.

*2: Parking brake pedal travel when depressed with a force of 66 lbf (294 N, 30 kgf).

Steering

Free play	Less than 1.2 in. (30 mm)
-----------	---------------------------

Tires and wheels

► Type A

Tire size	P215/55R17 93V	
Front and rear tire inflation pressure (Recommended cold tire inflation pressure)	Vehicle speed	psi (kPa, kgf/cm ² or bar)
	More than 99 mph (160 km/h)	38 (260, 2.6)
	99 mph (160 km/h) or less	32 (220, 2.2)
Wheel size	17 × 7JJ, 17 × 7J	
Wheel nut torque	76 ft•lbf (103 N•m, 10.5 kgf•m)	

► Type B

Tire size	P215/60R16 94V	
Front and rear tire inflation pressure (Recommended cold tire inflation pressure)	Vehicle speed	psi (kPa, kgf/cm ² or bar)
	More than 99 mph (160 km/h)	35 (240, 2.4)
	99 mph (160 km/h) or less	29 (200, 2.0)
Wheel size	16 × 6 1/2JJ	
Wheel nut torque	76 ft•lbf (103 N•m, 10.5 kgf•m)	

6-1. Specifications

Light bulbs

	Light Bulbs	Bulb No.	W	Type
Exterior	Headlights Low beam (discharge bulbs)	D4R	35	A
	Low beam (halogen bulbs)	H11	55	B
	High beam	HIR1	65	C
	Fog lights	H11	55	B
	Front turn signal/parking lights	3457A	28/8	D
	Front side marker lights	W5W	5	E
	Rear turn signal lights	7440A	21	D
	Stop/tail lights	7443	21/5	E
	Rear side marker lights	194	3.8	E
	Tail lights	194	3.8	E
	Back-up lights	921	18	E
License plate lights	194	3.8	E	
Interior	Interior light	W5W	5	E
	Personal lights	W5W	5	E
	Vanity lights	7065	1.4	F
	Glove box light	74	1.2	E
	Door courtesy lights	168	5	E
	Trunk light	2825	4.8	E

- A: D4R discharge bulbs
- B: H11 halogen bulbs
- C: HIR1 halogen bulbs
- D: Wedge base bulbs (amber)
- E: Wedge base bulbs (clear)
- F: Double end bulbs

6-1. Specifications

Fuel information

Your vehicle must use only unleaded gasoline.

Select octane rating 87 (Research Octane Number 91) or higher. Use of unleaded gasoline with an octane rating lower than 87 may result in engine knocking. Persistent knocking can lead to engine damage.

At minimum, the gasoline you use should meet the specifications of ASTM D4814 in the U.S.A. and CGSB3.5-M93 in Canada.

■ Fuel tank opening for unleaded gasoline

To help prevent incorrect fueling, your Toyota has a fuel tank opening that only accommodates the special nozzle on unleaded fuel pumps.

■ If your engine knocks

- Consult your Toyota dealer.
- You may occasionally notice light knocking for a short time while accelerating or driving uphill. This is normal and there is no need for concern.

■ Gasoline quality

In very few cases, driveability problems may be caused by the brand of gasoline you are using. If driveability problems persist, try changing the brand of gasoline. If this does not correct the problem, consult your Toyota dealer.

■ Gasoline quality standards

- Automotive manufacturers in the US, Europe and Japan have developed a specification for fuel quality called World-Wide Fuel Charter (WWFC) that is expected to be applied worldwide.
- The WWFC consists of four categories that are based on required emission levels. In the US, category 4 has been adopted.
- The WWFC improves air quality by lowering emissions in vehicle fleets, and customer satisfaction through better performance.

6-1. Specifications

■ **Toyota recommends the use of gasoline containing detergent additives**

- Toyota recommends the use of gasoline that contains detergent additives to avoid build-up of engine deposits.
- All gasoline sold in the US contains detergent additives to clean and/or keep clean intake systems.

■ **Toyota recommends the use of cleaner burning gasoline**

Cleaner burning gasoline, including reformulated gasoline that contains oxygenates such as ethanol or MTBE (Methyl Tertiary Butyl Ether) is available in many areas.

Toyota recommends the use of cleaner burning gasoline and appropriately blended reformulated gasoline. These types of gasoline provide excellent vehicle performance, reduce vehicle emissions and improve air quality.

■ **Toyota does not recommend blended gasoline**

- Toyota allows the use of oxygenate blended gasoline where the oxygenate content is up to 10% ethanol or 15% MTBE.
- If you use gasohol in your Toyota, be sure that it has an octane rating no lower than 87.
- Toyota DOES NOT recommend the use of gasoline containing methanol.

■ **Toyota does not recommend gasoline containing MMT**

Some gasoline contains octane enhancing additive called MMT (Methylcyclopentadienyl Manganese Tricarbonyl).

Toyota DOES NOT recommend the use of gasoline that contains MMT. If fuel containing MMT is used, your emission control system may be adversely affected.

The malfunction indicator lamp on the instrument cluster may come on. If this happens, contact your Toyota dealer for service.

 NOTICE**■ Notice on fuel quality**

- Do not use improper fuels. If improper fuels are used the engine will be damaged.
- Do not use leaded gasoline.
Leaded gasoline can cause damage to your vehicle's three-way catalytic converters causing the emission control system to malfunction.
- Do not use gasohol other than that stated here.
Other gasohol may cause fuel system damage or vehicle performance problems.
- Using unleaded gasoline with an octane number or rating lower than that stated here will cause persistent heavy knocking.
At worst, this will lead to engine damage.

■ Fuel-related poor driveability

If after using a different type of fuel, poor driveability is encountered (poor hot starting, vaporization, engine knocking, etc.), discontinue the use of that type of fuel.

■ When refueling with gasohole

Take care not to spill gasohol. It can damage your vehicle's paint.

6-1. Specifications

Tire information

Typical tire symbols

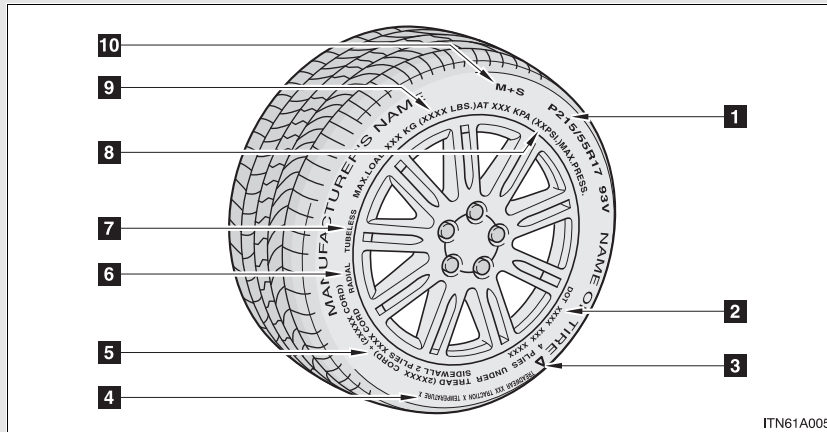

- 1** Tire size (→P. 444)
- 2** DOT and Tire Identification Number (TIN) (→P. 443)
- 3** Location of treadwear indicators (→P. 345)

4 Uniform tire quality grading

For details, see “Uniform Tire Quality Grading” that follows.

5 Tire ply composition and materials

Plies are layers of rubber-coated parallel cords. Cords are the strands which form the plies in a tire.

6 Radial tires or bias-ply tires

A radial tire has RADIAL on the sidewall. A tire not marked RADIAL is a bias-ply tire.

7 TUBELESS or TUBE TYPE

A tubeless tire does not have a tube and air is directly filled in the tire. A tube type tire has a tube inside the tire and the tube maintains the air pressure.

- 8** Maximum cold tire inflation pressure (→P. 447)
This means the pressure to which a tire may be inflated.
- 9** Load limit at maximum cold tire inflation pressure (→P. 447)
- 10** Summer tire or all season tire (→P. 349)
An all season tire has "M+S" on the sidewall. A tire not marked "M+S" is a summer tire.

Typical DOT and tire identification number (TIN)

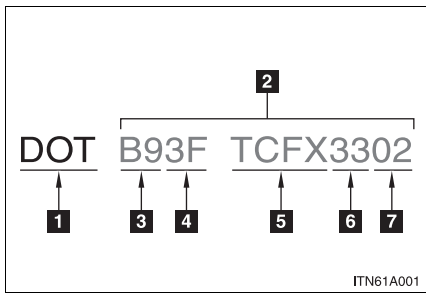

- 1** DOT symbol*
- 2** Tire Identification Number (TIN)
- 3** Tire manufacturer's identification mark
- 4** Tire size code
- 5** Manufacturer's optional tire type code (3 or 4 letters)
- 6** Manufacturing week
- 7** Manufacturing year

*: The DOT symbol certifies that the tire conforms to applicable Federal Motor Vehicle Safety Standards.

Tire size

■ Typical tire size information

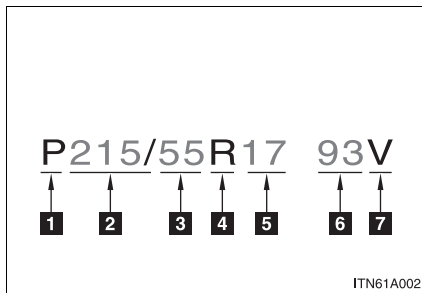

The illustration indicates typical tire size.

- 1** Tire use
(P = Passenger car,
T = Temporary use)
- 2** Section width (millimeters)
- 3** Aspect ratio
(tire height to section width)
- 4** Tire construction code
(R = Radial, D = Diagonal)
- 5** Wheel diameter (inches)
- 6** Load index (2 or 3 digits)
- 7** Speed symbol
(alphabet with one letter)

■ Tire dimensions

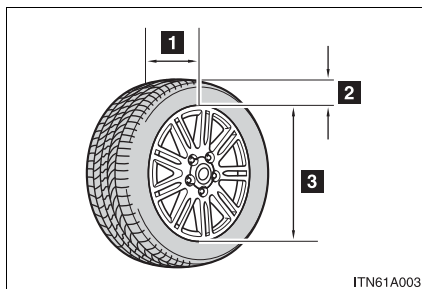

- 1** Section width
- 2** Tire height
- 3** Wheel diameter

Tire section names

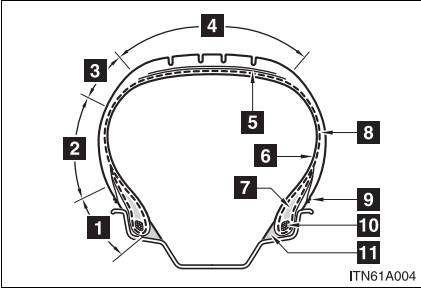

- 1 Bead
- 2 Sidewall
- 3 Shoulder
- 4 Tread
- 5 Belt
- 6 Inner liner
- 7 Reinforcing rubber
- 8 Carcass
- 9 Rim lines
- 10 Bead wires
- 11 Chafer

Uniform Tire Quality Grading

This information has been prepared in accordance with regulations issued by the National Highway Traffic Safety Administration of the U.S. Department of Transportation. It provides the purchasers and/or prospective purchasers of Toyota vehicles with information on uniform tire quality grading.

Your Toyota dealer will help answer any questions you may have as you read this information.

■ **DOT quality grades**

All passenger vehicle tires must conform to Federal Safety Requirements in addition to these grades. Quality grades can be found where applicable on the tire sidewall between tread shoulder and maximum section width.

For example: Treadwear 200 Traction AA Temperature A

6

Vehicle specifications

■ **Treadwear**

The treadwear grade is a comparative rating based on the wear rate of the tire when tested under controlled conditions on a specified government test course.

For example, a tire graded 150 would wear one and a half (1 - 1/2) times as well on the government course as a tire graded 100.

The relative performance of tires depends upon the actual conditions of their use, however, and may depart significantly from the norm due to variations in driving habits, service practices and differences in road characteristics and climate.

■ **Traction AA, A, B, C**

The traction grades, from highest to lowest, are AA, A, B and C, and they represent the tire's ability to stop on wet pavement as measured under controlled conditions on specified government test surfaces of asphalt and concrete.

A tire marked C may have poor traction performance.

Warning: The traction grade assigned to this tire is based on braking (straight ahead) traction tests and does not include cornering (turning) traction.

■ **Temperature A, B, C**

The temperature grades are A (the highest), B, and C, representing the tire's resistance to the generation of heat and its ability to dissipate heat when tested under controlled conditions on a specified indoor laboratory test wheel.

Sustained high temperature can cause the material of the tire to degenerate and reduce tire life, and excessive temperature can lead to sudden tire failure.

The grade C corresponds to a level of performance which all passenger car tires must meet under the Federal Motor Vehicle Safety Standard No. 109.

Grades B and A represent higher levels of performance on the laboratory test wheel than the minimum required by law.

Warning: The temperature grades for this tire are established for a tire that is properly inflated and not overloaded.

Excessive speed, underinflation, or excessive loading, either separately or in combination, can cause heat buildup and possible tire failure.

Glossary of tire terminology

Tire related term	Meaning
Cold tire inflation pressure	Tire pressure when the vehicle has been parked for three hours or more, or has not been driven more than 1 mile or 1.5 km under that condition
Maximum inflation pressure	The maximum cold inflated pressure to which a tire may be inflated, shown on the sidewall of the tire
Recommended inflation pressure	Cold tire inflation pressure recommended by a manufacturer.
Accessory weight	The combined weight (in excess of those standard items which may be replaced) of transmission, power steering, power brakes, power windows, power seats, radio and heater, to the extent that these items are available as factory-installed equipment (whether installed or not)
Curb weight	The weight of a motor vehicle with standard equipment, including the maximum capacity of fuel, oil and coolant, and if so equipped, air conditioning and additional weight optional engine
Maximum loaded vehicle weight	The sum of: (a) Curb weight (b) Accessory weight (c) Vehicle capacity weight (d) Production options weight

6-1. Specifications

Tire related term	Meaning
Normal occupant weight	150 lb. (68 kg) times the number of occupants specified in the second column of Table 1* that follows
Occupant distribution	Distribution of occupants in a vehicle as specified in the third column of Table 1* below
Production options weight	The combined weight of installed regular production options weighing over 5 lb. (2.3 kg) in excess of the standard items which they replace, not previously considered in curb weight or accessory weight, including heavy duty brakes, ride levelers, roof rack, heavy duty battery, and special trim
Rim	A metal support for a tire or a tire and tube assembly upon which the tire beads are seated
Rim diameter (Wheel diameter)	Nominal diameter of the bead seat
Rim size designation	Rim diameter and width
Rim type designation	The industry manufacturer's designation for a rim by style or code
Rim width	Nominal distance between rim flanges
Vehicle capacity weight (Total load capacity)	The rated cargo and luggage load plus 150 lb. (68 kg) times the vehicle's designated seating capacity
Vehicle maximum load on the tire	The load on an individual tire that is determined by distributing to each axle its share of the maximum loaded vehicle weight, and dividing by two

Tire related term	Meaning
Vehicle normal load on the tire	The load on an individual tire that is determined by distributing to each axle its share of curb weight, accessory weight, and normal occupant weight (distributed in accordance with Table 1* below), and dividing it by two
Weather side	The surface area of the rim not covered by the inflated tire
Bead	The part of the tire that is made of steel wires, wrapped or reinforced by ply cords and that is shaped to fit the rim
Bead separation	A breakdown of the bond between components in the bead
Bias ply tire	A pneumatic tire in which the ply cords that extend to the beads are laid at alternate angles substantially less than 90 degrees to the centerline of the tread
Carcass	The tire structure, except tread and sidewall rubber which, when inflated, bears the load
Chunking	The breaking away of pieces of the tread or sidewall
Cord	The strands forming the plies in the tire
Cord separation	The parting of cords from adjacent rubber compounds
Cracking	Any parting within the tread, sidewall, or inner-liner of the tire extending to cord material
CT	A pneumatic tire with an inverted flange tire and rim system in which the rim is designed with rim flanges pointed radially inward and the tire is designed to fit on the underside of the rim in a manner that encloses the rim flanges inside the air cavity of the tire

6-1. Specifications

Tire related term	Meaning
Extra load tire	A tire designed to operate at higher loads and at higher inflation pressures than the corresponding standard tire
Groove	The space between two adjacent tread ribs
Innerliner	The layer(s) forming the inside surface of a tubeless tire that contains the inflating medium within the tire
Innerliner separation	The parting of the innerliner from cord material in the carcass
Intended outboard sidewall	(a)The sidewall that contains a whitewall, bears white lettering, or bears manufacturer, brand, and/or model name molding that is higher or deeper than the same molding on the other sidewall of the tire, or (b)The outward facing sidewall of asymmetrical tire that has a particular side that must always face outward when mounted on a vehicle
Light truck (LT) tire	A tire designated by its manufacturer as primarily intended for use on lightweight trucks or multipurpose passenger vehicles
Load rating	The maximum load that a tire is rated to carry for a given inflation pressure
Maximum load rating	The load rating for a tire at the maximum permissible inflation pressure for that tire
Maximum permissible inflation pressure	The maximum cold inflation pressure to which a tire may be inflated
Measuring rim	The rim on which a tire is fitted for physical dimension requirements
Open splice	Any parting at any junction of tread, sidewall, or innerliner that extends to cord material

Tire related term	Meaning
Outer diameter	The overall diameter of an inflated new tire
Overall width	The linear distance between the exteriors of the sidewalls of an inflated tire, including elevations due to labeling, decorations, or protective bands or ribs
Passenger car tire	A tire intended for use on passenger cars, multipurpose passenger vehicles, and trucks, that have a gross vehicle weight rating (GVWR) of 10,000 lb. or less
Ply	A layer of rubber-coated parallel cords
Ply separation	A parting of rubber compound between adjacent plies
Pneumatic tire	A mechanical device made of rubber, chemicals, fabric and steel or other materials, that, when mounted on an automotive wheel, provides the traction and contains the gas or fluid that sustains the load
Radial ply tire	A pneumatic tire in which the ply cords that extend to the beads are laid at substantially 90 degrees to the centerline of the tread
Reinforced tire	A tire designed to operate at higher loads and at higher inflation pressures than the corresponding standard tire
Section width	The linear distance between the exteriors of the sidewalls of an inflated tire, excluding elevations due to labeling, decoration, or protective bands

6-1. Specifications

Tire related term	Meaning
Sidewall	That portion of a tire between the tread and bead
Sidewall separation	The parting of the rubber compound from the cord material in the sidewall
Snow tire	A tire that attains a traction index equal to or greater than 110, compared to the ASTM E-1136 Standard Reference Test Tire, when using the snow traction test as described in ASTM F-1805-00, Standard Test Method for Single Wheel Driving Traction in a Straight Line on Snow-and Ice-Covered Surfaces, and which is marked with an Alpine Symbol () on at least one sidewall
Test rim	The rim on which a tire is fitted for testing, and may be any rim listed as appropriate for use with that tire
Tread	That portion of a tire that comes into contact with the road
Tread rib	A tread section running circumferentially around a tire
Tread separation	Pulling away of the tread from the tire carcass
Treadwear indicators (TWI)	The projections within the principal grooves designed to give a visual indication of the degrees of wear of the tread
Wheel-holding fixture	The fixture used to hold the wheel and tire assembly securely during testing

*: Table 1 — Occupant loading and distribution for vehicle normal load for various designated seating capacities

Designated seating capacity, Number of occupants	Vehicle normal load, Number of occupants	Occupant distribution in a normally loaded vehicle
2 through 4	2	2 in front
5 through 10	3	2 in front, 1 in second seat
11 through 15	5	2 in front, 1 in second seat, 1 in third seat, 1 in fourth seat
16 through 20	7	2 in front, 2 in second seat, 2 in third seat, 1 in fourth seat

6-2. Customization

Customizable features

Your vehicle includes a variety of electronic features that can be personalized to your preferences. Programming these preferences requires specialized equipment and may be performed by your Toyota dealer.

Some function settings are changed simultaneously with other functions being customized. Contact your Toyota dealer for further details.

Item	Function	Default setting	Customized setting
Smart key system (→P. 24)	Smart key system	ON	OFF
	Operation signal (Emergency flashers)	ON	OFF
	Operation signal (Buzzer)	ON	OFF
Wireless remote control (→P. 36)	Unlocking operation	Driver's door unlocked in 1-step, all doors unlocked in 2-step	All doors unlocked in 1-step
		60 seconds	Time elapsed before automatic door lock function is activated if door is not opened after being unlocked
	30 seconds		
	120 seconds		

Item	Function	Default setting	Customized setting
Wireless remote control (→P. 36)	Operation indicator (Emergency flashers)	ON	OFF
	Operation indicator (Buzzer)	ON	OFF
	Trunk unlocking function	ON	OFF
	Trunk unlocking operation	Push and hold	Push twice
			One short push
	Panic function	ON	OFF
Buzzer sounds when pushing  with any door not closed	ON	OFF	

6-2. Customization

Item	Function	Default setting	Customized setting
Door lock (→P. 40)	Unlocking using a key	Driver's door unlocked in 1-step, all doors unlocked in 2-step	All doors unlocked in 1-step
	Speed-detecting automatic door lock function	OFF	ON
	Opening driver's door unlocks all doors	OFF	ON
	Shift the shift lever to "P" unlocks all doors	ON	OFF
	Shift the shift lever to position other than "P" locks all doors	ON	OFF
Automatic light control system (→P. 156)	Light sensor sensitivity	Level 3	Levels 1 to 5
	Time elapsed before headlights automatically turn off after doors are closed	60 seconds	0 seconds
			30 seconds
			90 seconds
Daytime running light	ON	OFF*	

*: Vehicles sold outside Canada

Item	Function	Default setting	Customized setting
Windshield wipers and washer (→P. 160)	Switching operation when the vehicle is stationary	ON	OFF
	Drip prevention function	ON	OFF
	Time elapsed before the drip prevention function operates	Variable depending on the vehicle speed	3 seconds
Illumination (→P. 275)	Time elapsed before lights turn off	15 seconds	7.5 seconds 30 seconds
	Operation when the doors are unlocked	ON	OFF
	Operation after the "ENGINE START STOP" switch or the engine switch turned OFF	ON	OFF
	Front/rear personal lights turned on when a door is opened	Corresponding light only	All lights
			OFF
	Outer foot lights	ON	OFF
Rear sunshade (→P. 296)	Time elapsed before the reverse operation feature activates	0.7 seconds	0 seconds
			0.9 seconds
			1.2 seconds

6-3. Initialization Items to initialize

After reconnecting or performing maintenance on the battery, the following items must be initialized for normal system operation.

Item	When to initialize	Reference
Power window	<ul style="list-style-type: none">• After reconnecting or changing the battery• After changing a fuse	P. 75
Moon roof		P. 79
Engine oil maintenance data	<ul style="list-style-type: none">• After changing engine oil	P. 334
Tire pressure warning system	<ul style="list-style-type: none">• When rotating the tires on vehicles differing with front and rear tire inflation pressures.• When changing the tire inflation pressure by changing traveling speed or load weight, etc.• When changing the tire size.	P. 347

Reporting safety defects for U.S. owners

If you believe that your vehicle has a defect which could cause a crash or could cause injury or death, you should immediately inform the National Highway Traffic Safety Administration (NHTSA) in addition to notifying Toyota Motor Sales, U.S.A., Inc. (Toll-free: 1-800-331-4331).

If NHTSA receives similar complaints, it may open an investigation, and if it finds that a safety defect exists in a group of vehicles, it may order a recall and remedy campaign. However, NHTSA cannot become involved in individual problems between you, your dealer, or Toyota Motor Sales, U.S.A., Inc.

To contact NHTSA, you may call the Vehicle Safety Hotline toll-free at 1-888-327-4236 (TTY: 1-800-424-9153); go to <http://www.safercar.gov>; or write to: Administrator, NHTSA, 1200 New Jersey Ave, S.E., Washington, DC 20590. You can also obtain other information about motor vehicle safety from <http://www.safercar.gov>.

Seat belt instructions for Canadian owners (in French)

The following is a French explanation of seat belt instructions extracted from the seat belt section in this manual.

See the seat belt section for more detailed seat belt instructions in English.

Utilisation adéquate des ceintures de sécurité

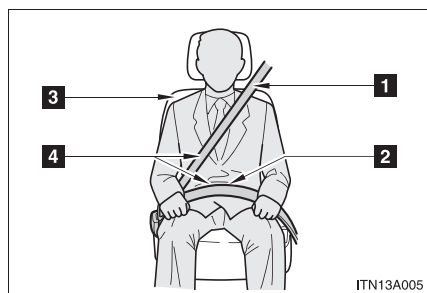

- 1** Tirez sur la ceinture épaulière jusqu'à ce qu'elle recouvre entièrement l'épaule; elle ne doit cependant pas toucher le cou ni glisser de l'épaule.
- 2** Placez la ceinture abdominale le plus bas possible sur les hanches.
- 3** Réglez la position du dossier du siège. Tenez-vous assis dans le fond du siège, le dos droit.
- 4** Ne tournez pas la ceinture de sécurité.

Guide des ceintures de sécurité (sièges latéraux arrière)

Si la ceinture épaulière est trop près du cou d'une personne, utilisez le guide de la ceinture de sécurité.

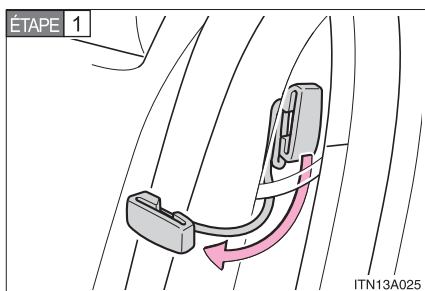

Retirez le guide de la poche.

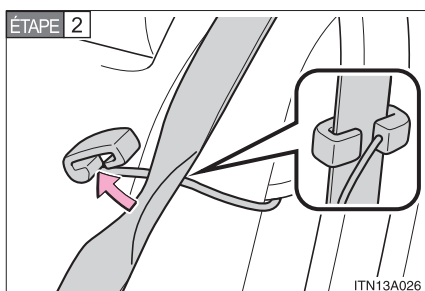

Faites glisser la ceinture au-delà de la fente du guide.

L'élastique doit être placé derrière la ceinture.

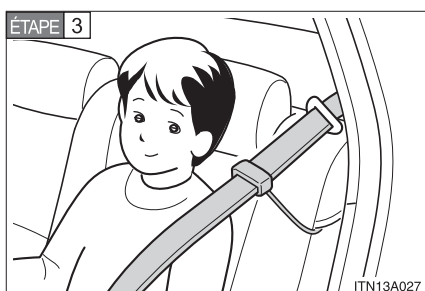

Bouclez, placez, puis relâchez la ceinture.

Entretien et soin

■ Ceintures de sécurité

Avec un tissu ou une éponge, nettoyez à l'aide d'un savon doux et de l'eau tiède. Vérifiez aussi les ceintures régulièrement pour vous assurer qu'elles ne présentent pas d'usure excessive, d'effilochage ou de coupures.

⚠ ATTENTION

■ Dommages et usure de la ceinture de sécurité

Vérifiez périodiquement le système de ceintures de sécurité. Assurez-vous qu'il n'y a pas de coupures, d'effilochures ni de pièces desserrées. N'utilisez pas une ceinture de sécurité endommagée avant qu'elle soit remplacée. Les ceintures de sécurité endommagées ne peuvent pas protéger les occupants contre les blessures.



Abbreviation list

Abbreviation/Acronym list

ABBREVIATIONS	MEANING
A/C	Air Conditioning
ABS	Anti-lock Brake System
ACC	Accessory
ALR	Automatic Locking Retractor
CRS	Child Restraint System
ECU	Electronic Control Unit
EDR	Event Data Recorder
ELR	Emergency Locking Retractor
GAWR	Gross Axle Weight Ratings
I/M	Emission inspection and maintenance
LATCH	Lower Anchors and Tethers for Children
LED	Light Emitting Diode
MMT	Methylcy clopentadienyl Manganese Tricarbonyl
M + S	Mud and Snow
MTBE	Methyl Tertiary Butyl Ether
OBD	On Board Diagnostics
SRS	Supplemental Restraint System
TIN	Tire Identification Number
TPMS	Tire Pressure Monitoring (Warning) System
TRAC	Traction Control
VIN	Vehicle Identification Number
VSC	Vehicle Stability Control

Alphabetical index

Alphabetical index

A	A/C	198
	ABS	181
	Air conditioning system	
	Air conditioning filter.....	360
	Automatic air conditioning system.....	198
	Steering switches.....	206
	Airbags	
	Airbag operating conditions....	93
	Airbag precautions for your child.....	97
	Airbag warning light.....	394
	Curtain shield airbag precautions.....	100
	Front passenger occupant classification system.....	103
	General airbag precautions....	97
	Locations of airbags.....	90
	Modification and disposal of airbags.....	102
	Side airbag precautions.....	97
	Side and curtain shield airbags operating conditions.....	93
	SRS airbags.....	90
	Alarm	85
	Antenna	217
	Anti-lock brake system	181
	Armrest	295
	Ashtrays	290
	Audio input	238
	Audio system	
	Antenna.....	217
	Audio input.....	238
	AUX adapter.....	238
	CD player/changer.....	220
	MP3/WMA disc.....	228
	Optimal use.....	236
	Portable music player.....	238
	Radio.....	213
	Steering switches.....	239
	Automatic headlight leveling system	156

	Automatic light control system	156
	Automatic transmission	
	Automatic transmission.....	140
	If the shift lever cannot be shifted from P.....	416
	S mode.....	142
	AUX adapter	238
B	Back-up lights	
	Wattage.....	438
	Battery	
	Checking.....	341
	If the vehicle battery is discharged.....	420
	Preparing and checking before winter.....	189
	Bluetooth®	243
	Brake	
	Fluid.....	338
	Parking brake.....	146
	Brake assist	181
	Break-in tips	125
C	Care	
	Exterior.....	312
	Interior.....	315
	Seat belts.....	316
	Cargo capacity	184
	CD player/changer	220
	Center display	154
	Chains	191
	Child-protectors	42
	Child restraint system	
	Definition.....	109
	Installation.....	113
	Installing CRS with lower anchorages.....	114
	Installing CRS with seat belts.....	116
	Installing CRS with top straps.....	120

Alphabetical index

Child safety

Airbag precautions	97
Child-protectors.....	42
Child restraint system.....	109
How your child should wear the seatbelt	64
Installing child restraints.....	113
Moon roof.....	79
Power window lock switch.....	74
Power window precautions	76
Removed key battery precautions	365
Seat belt comfort guide	62
Seat belt precautions	65
Seat heater precautions	294
Trunk.....	48

Cleaning

Exterior.....	312
Interior.....	315
Seat belts	316

Climate control seat.....293

Clock.....288

Compass.....306

Condenser.....337

Console box.....280

Cooling system

Engine overheating	424
--------------------------	-----

Cruise control

Cruise control.....	165
Dynamic laser cruise control.....	168

Cup holders.....284

Curtain shield airbags.....90

Customizable features.....454

D Daytime running light

system	157
--------------	-----

Defogger

Rear window	208
Side mirror.....	208

Dimension.....430

Dinghy towing.....195

Display

Trip information	155
------------------------	-----

Do-it-yourself maintenance324

Door pocket.....285

Doors

Door lock.....	24, 36
Rear door child-protector	42

Driver's seat belt reminder

light.....	396
------------	-----

Driving

Break-in tips	125
Correct posture	88
Procedures.....	124
Winter driving tips	189

E Electronic key

If the electronic key does not operate properly	418
--	-----

Emergency flashers

Switch	384
--------------	-----

Emergency, in case of

If a warning light turns on.....	393
If the electronic key does not operate properly	418
If the engine will not start	414
If the shift lever cannot be shifted from P	416
If the battery is discharged ...	420
If the warning buzzer sounds	393
If the warning light turns on.....	393
If you have a flat tire	405
If you lose your keys	417
If you think something is wrong.....	389
If your vehicle becomes stuck	427
If your vehicle needs to be towed.....	385
If your vehicle overheats	424

Engine	
Compartment.....	330
Engine switch	133, 137
Hood.....	327
How to start the engine	133, 137
Identification number.....	431
If the engine will not start.....	414
Ignition switch.....	133, 137
Overheating.....	424
Engine compartment cover.....	331
Engine coolant	
Capacity	435
Checking	336
Preparing and checking before winter	189
Engine coolant temperature gauge	148
Engine immobilizer system.....	83
Engine oil	
Capacity	433
Checking	332
Preparing and checking before winter	189
Event data recorder	391
F	
Floor mats.....	298
Fluid	
Brake.....	338
Washer.....	344
Fog lights	
Switch.....	159
Wattage.....	438
Foot light.....	275
Front passenger occupant classification system.....	103
Front passenger's seat belt reminder light.....	396
Front seats	
Adjustment	50
Driving position memory.....	55
Front turn signal lights	
Wattage.....	438

Fuel	
Capacity	432
Fuel gauge	148
Fuel pump shut off system.....	390
Gas station information	476
Information	439
Refueling	80
Fuel door.....	80
Fuel filler door	80
Fuel pump shut off system	390
Fuses.....	367
G	
Garage door opener.....	301
Gas station information.....	476
Gauges.....	148
Glove box.....	279
H	
Hands-free system (for cellular phone).....	242
Hazard lights	
Switch.....	384
Head restraints.....	59
Headlight aim	376
Headlights	
Discharge headlights precautions	382
Switch.....	156
Wattage.....	438
Heaters	
Seat heaters.....	293
Side mirror.....	208
Hood.....	327
Hooks	
Cargo	299
Shopping bag.....	299
Horn.....	147

I	I/M test	323
	Ignition switch	133, 137
	Identification	
	Engine	431
	Vehicle	431
	Illuminated entry system	275
	Indicator lights	151
	Initialization	
	Items to initialize.....	458
	Inside rear view mirror	70
	Instrument panel light	
	control	150
	Interior lights	
	Interior lights.....	275
	Switch.....	277
	Wattage.....	438
J	Jack	
	Positioning a floor jack	328
	Vehicle-equipped jack	405
	Jack handle	405
K	Keyless entry	36
	Keys	
	Electronic key	22
	Engine switch	133, 137
	If the electronic key does not properly	418
	If you lose your keys	417
	Key number plate	23
	Keyless entry.....	36
	Keys	22
	Mechanical key	22
	Wireless remote control key	36
L	Laser cruise control	168
	Licence plate lights	
	Replacing light bulbs	378
	Wattage.....	438
	Light bulbs	
	Replacing	378
	Wattage.....	438

Lights	
Emergency flasher switch	384
Fog light switch	159
Hazard light switch	384
Headlights switch	156
Interior lights list	275
Outer foot light	275
Personal light switch	277
Replacing light bulbs.....	378
Turn signal lever	145
Vanity lights.....	287
Wattage.....	438
Load capacity	188
Lock steering column	135, 138

M	Maintenance	
	Do-it-yourself maintenance ...	324
	General maintenance.....	320
	Maintenance data	430
	Maintenance requirements ...	318
	Meter	
	Instrument panel light	
	control.....	150
	Meters	148
	Mirrors	
	Inside rear view mirror	70
	Side mirror heater	208
	Side mirrors.....	72
	Vanity mirrors.....	287
	Moon roof	77
	MP3 disc	228
O	Odometer	148
	Oil	
	Engine oil	332
	Opener	
	Fuel filler door	80
	Hood	327
	Trunk.....	46
	Outside rear view mirrors	
	Adjustment	72
	Driving position memory	55

Outside temperature display 289
Overhead console 281
Overheating, Engine 424

P

Parking brake 146
Parking lights
 Replacing light bulbs 378
 Switch 156
 Wattage 438
Personal light
 Switch 277
 Wattage 438
Power outlets 291
Power windows 74

R

Radiator 337
Radio 213
Rear seat
 Adjustment 53
Rear sunshade 296
Rear turn signal lights
 Replacing light bulbs 378
 Wattage 438
Rear window defogger 208
Replacing
 Fuses 367
 Key battery 363
 Light bulbs 378
 Tires 405
Reporting safety defects for U.S. owners 460

S

Seat belts
 Adjusting the seat belt 62
 Automatic locking retractor 63
 Child restraint system installation 113
 Cleaning and maintaining the seat belts 316
 Emergency locking retractor 63
 How to wear your seat belt 61
 How your child should wear the seat belt 64
 Pregnant women, proper seat belt use 64
 Reminder light 396
 Seat belt extenders 65
 Seat belt pretensioners 63
Seat heaters 293
Seating capacity 188
Seats
 Adjustment 50, 53
 Adjustment precaution 52, 54
 Child seats/child restraint system installation 113
 Cleaning 315
 Climate control 293
 Climate control seat 293
 Driver's seat position memory 55
 Head restraint 59
 Properly sitting in the seat 88
 Seat heaters 293
Service reminder indicators 152
Shift lever
 Automatic transmission 140
 If the shift lever cannot be shifted from P 416

Shift lock system416

Shopping bag hooks299

Side airbags.....90

Side marker lights

 Switch..... 156

Side mirror

 Adjustment72

 Mirror position memory55

Smart key system

 Antenna location26

 Entry function24

 Starting the engine 133

Spare tire

 Inflation pressure.....437

 Storage location405

Spark plug435

Specifications.....430

Speedometer 148

Steering wheel

 Adjustment68

 Audio switches 239

 Climate switches206

 Steering wheel memory55

Storage compartment.....283

Storage feature.....278

Stuck

 If your vehicle becomes stuck427

Sun visors.....286

Switch

 Emergency flasher switch384

 Engine switch 133, 137

 Fog light switch 159

 Hazard light switch384

 Ignition switch..... 133, 137

 Light switches..... 156

 Power door lock switch40

 Power window switch74

 Window lock switch74

 Wipers and washer switch 160

T

Tail lights

 Replacing light bulbs379

 Switch 156

 Wattage.....438

Theft deterrent system

 Alarm.....85

 Engine immobilizer system83

Theft prevention labels87

Tire inflation pressure437

Tire information

 Glossary447

 Size444

 Tire identification number.....443

 Uniform Tire Quality Grading.....445

Tires

 Chains 191

 Checking345

 If you have a flat tire.....405

 Inflation pressure437

 Information442

 Replacing405

 Rotating tires.....345

 Size437

 Snow tires 192

 Tire pressure warning system 346, 396

Tools405

Total load capacity 188

Towing

 Dinghy towing 195

 Trailer towing 194

TRAC..... 181

Trip information 155

Trunk

 Extending a space300

 Opener46

 Wattage.....438

Turn signal lights

 Replacing light bulbs378

 Switch 145

 Wattage.....438

V	Valet key	22
	Vanity lights	
	Vanity lights.....	287
	Wattage.....	438
	Vanity mirrors	287
	Vehicle identification	
	number	431
	Vehicle load limits	188
	VSC	181
W	Warning buzzers	
	Brake system.....	393
	Downshifting.....	143
	Open door	395
	Seat belt reminder	396
	Warning lights	
	Anti-lock brake system	395
	Automatic heading light	
	leveling system	395
	Brake system.....	393
	Charging system	394
	Dynamic laser cruise control	
	master warning light.....	397
	Low fuel level.....	395
	Malfunction indicator lamp....	394
	Open door	395
	Seat belt reminder light	396
	SRS airbags	394
	Tire pressure warning	
	light	396
	Vehicle stability control.....	395
	Washer	
	Checking	344
	Preparing and checking	
	before winter	189
	Switch.....	160
	Washing and waxing	312
	Weight	
	Cargo capacity	184
	Load limits	188
	Weight	430

Wheels	358
Window glasses	74
Window lock switch	74
Windows	
Power windows	74
Rear window defogger	208
Washer.....	160
Windshield wipers	160
Winter driving tips	189
Wireless remote control key	
Locking/Unlocking	36
Replacing the battery	363
WMA disc	228

What to do if...
What to do if...







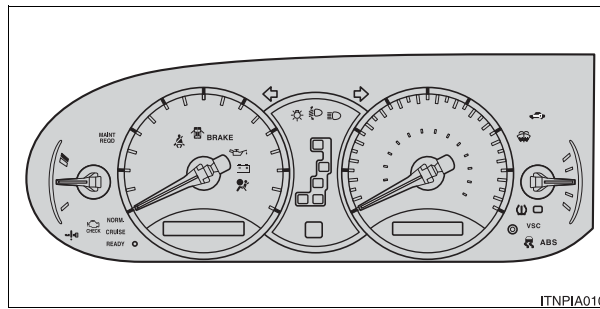







A tire punctures	P. 405	If you have a flat tire
The engine does not start	P. 83	Engine immobilizer system
	P. 414	If the engine will not start
	P. 420	If the battery is discharged
The shift lever cannot be moved out	P. 416	If the shift lever cannot be shifted from "P"
The engine coolant temperature gauge enters the red zone	P. 424	If your vehicle overheats
Steam can be seen coming from under the hood		
The key is lost	P. 417	If you lose your keys
The battery runs out	P. 420	If the battery is discharged
The doors cannot be locked	P. 40	Doors
The horn begins to sound	P. 85	Alarm
The vehicle is stuck in mud or sand	P. 427	If the vehicle becomes stuck

The warning light or indicator light comes on

P. 393 If the warning light turns on



■ Warning lights

BRAKE Brake system warning light or 	 Malfunction indicator lamp or 
ABS ABS warning light or 	 Driver's seat belt reminder light or 
 Low fuel level warning light	 Tire pressure warning light
 SRS warning light	 Automatic headlight leveling system warning light
 Open door warning light	 Low engine oil pressure warning light
 Charging system warning light	MAINT REQD Engine oil replacement reminder light
VSC VSC warning light Dynamic laser cruise control master warning	 Low washer fluid warning light

GAS STATION INFORMATION

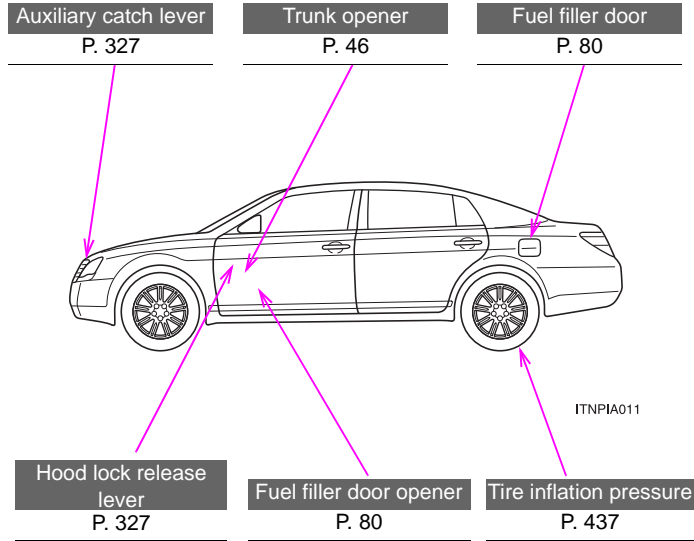

Fuel tank capacity	18.5 gal. (70 L, 15.4 Imp.gal.)	
Fuel type	Unleaded gasoline only	P. 80, 432
Cold tire inflation pressure		P. 437
Engine oil capacity (Drain and refill)	With filter Without filter	qt. (L, Imp.qt.) 6.4 (6.1, 5.4) 6.0 (5.7, 5.0)
Engine oil type	"Toyota Genuine Motor Oil" or equivalent Oil grade: ILSAC multigrade engine oil P. 433	