

2022



# Bolt EV Owner's Manual



## Contents

Introduction .....	1
Keys, Doors, and Windows .....	6
Seats and Restraints .....	24
Storage .....	68
Instruments and Controls .....	71
Lighting .....	105
Infotainment System .....	111
Climate Controls .....	147
Driving and Operating .....	154
Vehicle Care .....	215
Service and Maintenance .....	274
Technical Data .....	283
Customer Information .....	286
Reporting Safety Defects .....	294
OnStar .....	297
Connected Services .....	302
Index .....	305

Litho in U.S.A.  
Part No. 84814981 A First Printing

## Introduction



The names, logos, emblems, slogans, vehicle model names, and vehicle body designs appearing in this manual including, but not limited to, GM, the GM logo, CHEVROLET, the CHEVROLET Emblem, and BOLT are trademarks and/or service marks of General Motors LLC, its subsidiaries, affiliates, or licensors.

For vehicles first sold in Canada, substitute the name "General Motors of Canada Company" for Chevrolet Motor Division wherever it appears in this manual.

This manual describes features that may or may not be on the vehicle because of optional equipment that was not purchased on the vehicle, model variants, country specifications, features/applications that may

not be available in your region, or changes subsequent to the printing of this owner's manual.

Refer to the purchase documentation relating to your specific vehicle to confirm the features.

Keep this manual in the vehicle for quick reference.

### Canadian Vehicle Owners

A French language manual can be obtained from your dealer, at [www.helminc.com](http://www.helminc.com), or from:

#### Propriétaires Canadiens

On peut obtenir un exemplaire de ce guide en français auprès du concessionnaire ou à l'adresse suivante:

Helm, Incorporated  
Attention: Customer Service  
47911 Halyard Drive  
Plymouth, MI 48170  
USA

### Using this Manual

To quickly locate information about the vehicle, use the Index in the back of the manual. It is an alphabetical list of what is in the manual and the page number where it can be found.

### Danger, Warning, and Caution

Warning messages found on vehicle labels and in this manual describe hazards and what to do to avoid or reduce them.

#### **Danger**

Danger indicates a hazard with a high level of risk which will result in serious injury or death.

#### **Warning**

Warning indicates a hazard that could result in injury or death.

#### **Caution**

Caution indicates a hazard that could result in property or vehicle damage.





A circle with a slash through it is a safety symbol which means “Do not,” “Do not do this,” or “Do not let this happen.”

### Symbols

The vehicle has components and labels that use symbols instead of text. Symbols are shown along with the text describing the operation or information relating to a specific component, control, message, gauge, or indicator.

 : Shown when the owner’s manual has additional instructions or information.

 : Shown when the service manual has additional instructions or information.

 : Shown when there is more information on another page — “see page.”

### Vehicle Symbol Chart

Here are some additional symbols that may be found on the vehicle and what they mean. See the features in this manual for information.

 : Air Conditioning System

 : Air Conditioning Refrigerant Oil

 : Airbag Readiness Light

 : Antilock Brake System (ABS)

 : Brake System Warning Light

 : Dispose of Used Components Properly

 : Do Not Apply High Pressure Water

 : Energy Usage and Charge Mode Selection

 : Flame/Fire Prohibited

 : Flammable

 : First Responder

 : Forward Collision Alert

 : Fuse Block Cover Lock Location

 : Fuses

 : High Voltage

 : ISOFIX/LATCH System Child Restraints

 : Keep Fuse Block Covers Properly Installed

 : Lane Change Alert

 : Lane Departure Warning

 : Lane Keep Assist

 : Park Assist

 : Pedestrian Ahead Indicator

 : Power

 : Rear Cross Traffic Alert

 : Registered Technician

 : Remote Vehicle Start

 : Risk of Electrical Fire

 : Seat Belt Reminders

 : Service Vehicle Soon

 : Side Blind Zone Alert

 : Tire Pressure Monitor

 : Traction Control/StabiliTrak/Electronic Stability Control (ESC)

 : Under Pressure

 : Vehicle Ahead Indicator

 : Vehicle Ready

## Instrument Panel Overview

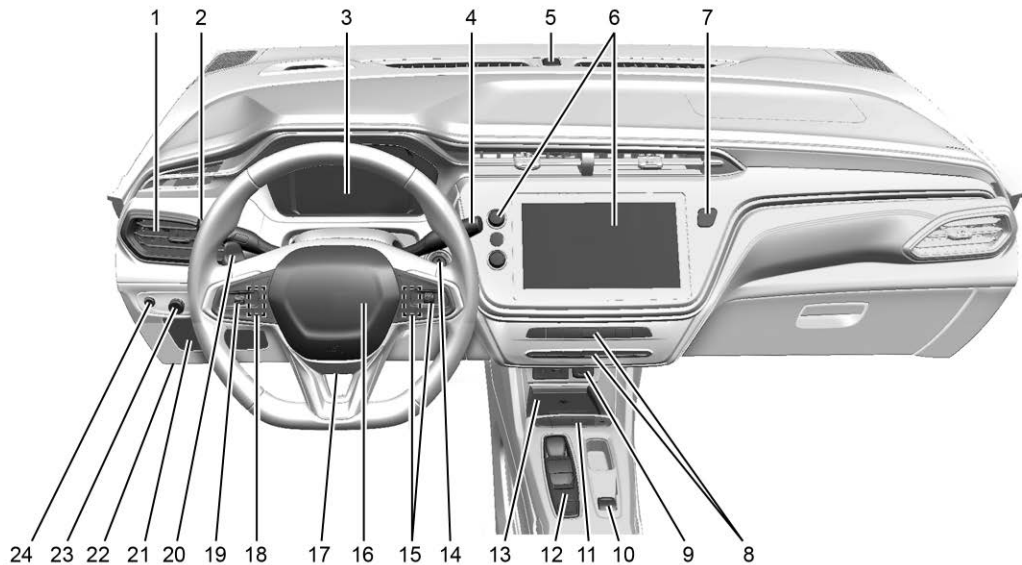

1. *Air Vents* ⇨ 151.
2. *Turn and Lane-Change Signals* ⇨ 108.  
IntelliBeam System Button (If Equipped).  
See *Exterior Lamp Controls* ⇨ 105.
3. *Instrument Cluster* ⇨ 78.  
*Driver Information Center (DIC)* ⇨ 98.
4. *Windshield Wiper/Washer* ⇨ 73.
5. *Charging Status Feedback* ⇨ 203.  
*Automatic Headlamp System* ⇨ 107.  
Indicator Light and Solar Sensor (ILSS).  
See "Sensors" under *Automatic Climate Control System* ⇨ 147.
6. *Infotainment System*. See *AM-FM Radio* ⇨ 116.
7. *Hazard Warning Flashers* ⇨ 108
8. *Automatic Climate Control System* ⇨ 147.  
*Heated Front Seats* ⇨ 28 (If Equipped).  
*Heated Steering Wheel* ⇨ 72 (If Equipped).
9. *Power Outlets* ⇨ 75.
10. *Electric Parking Brake* ⇨ 171.
11. *Driver Selected Operating Modes* ⇨ 167.  
*Traction Control/Electronic Stability Control* ⇨ 174  
*Lane Keep Assist (LKA)* ⇨ 197 (If Equipped).
12. *Shift Switches*. See *Electric Drive Unit* ⇨ 168.
13. *Wireless Charging* ⇨ 75.
14. *Power Button* ⇨ 164.
15. *Steering Wheel Controls* ⇨ 72  
Volume Switches. See *Steering Wheel Controls* ⇨ 72 (Out of View).
16. *Horn* ⇨ 72.
17. *Steering Wheel Adjustment* ⇨ 72 (Out of View).
18. *Favorite Switches*. See *Steering Wheel Controls* ⇨ 72 (Out of View).
19. *Cruise Control* ⇨ 175.  
*Adaptive Cruise Control (Camera)* ⇨ 177 (If Equipped).
20. *Regen on Demand*. See *Regenerative Braking* ⇨ 173.
21. *Instrument Panel Fuse Block* ⇨ 235.
22. *Data Link Connector (DLC) (Out of View)*.  
See *Service Vehicle Soon Light* ⇨ 84.
23. *Exterior Lamp Controls* ⇨ 105.
24. *Instrument Panel Illumination Control* ⇨ 108.

## Keys, Doors, and Windows

### Keys and Locks

Keys .....	6
Remote Keyless Entry (RKE) System .....	7
Remote Keyless Entry (RKE) System Operation .....	7
Remote Start .....	13
Door Locks .....	14
Power Door Locks .....	16
Delayed Locking .....	16
Automatic Door Locks .....	17
Lockout Protection .....	17
Safety Locks .....	17

### Doors

Liftgate .....	18
----------------	----

### Vehicle Security

Vehicle Security .....	18
Vehicle Alarm System .....	18
Immobilizer .....	19
Immobilizer Operation .....	20

### Exterior Mirrors

Convex Mirrors .....	20
Power Mirrors .....	21
Folding Mirrors .....	21
Heated Mirrors .....	21

### Interior Mirrors

Interior Rearview Mirrors .....	21
Manual Rearview Mirror .....	21
Automatic Dimming Rearview Mirror ...	21

### Windows

Windows .....	22
Power Windows .....	22
Sun Visors .....	23

## Keys and Locks

### Keys



#### Warning

Leaving children in a vehicle with a Remote Keyless Entry (RKE) transmitter is dangerous and children or others could be seriously injured or killed. They could operate the power windows or other controls or make the vehicle move. The windows will function with the RKE transmitter in the vehicle, and children or others could be caught in the path of a closing window. Do not leave children in a vehicle with an RKE transmitter.



The key that is part of the Remote Keyless Entry (RKE) transmitter can be used for all locks.



To remove the key, press the button near the bottom of the transmitter, and pull the key out. Never pull the key out without pressing the button.

If it becomes difficult to turn the key, inspect the key blade for debris. Periodically, clean the key with a brush or a pick.

See your dealer if a new key is needed.

If locked out of the vehicle, see *Roadside Assistance Program* ⇨ 288.

With an active OnStar or connected service plan, an OnStar Advisor may remotely unlock the vehicle. See *OnStar Overview* ⇨ 296.

## Remote Keyless Entry (RKE) System

See *Radio Frequency Statement* ⇨ 293.

If there is a decrease in the Remote Keyless Entry (RKE) operating range:

- Check the distance. The transmitter may be too far from the vehicle.
- Check the location. Other vehicles or objects may be blocking the signal.
- Check the transmitter's battery. See "Battery Replacement" later in this section.

- If the transmitter is still not working correctly, see your dealer or a qualified technician for service.

## Remote Keyless Entry (RKE) System Operation

The Keyless Access system allows for vehicle entry when the Remote Keyless Entry (RKE) transmitter is within 1 m (3 ft). See "Keyless Access Operation" following.

The transmitter functions may work up to 60 m (197 ft) away from the vehicle.

Other conditions can impact the performance of the transmitter. See *Remote Keyless Entry (RKE) System* ⇨ 7.







## 8 Keys, Doors, and Windows

 : Press to lock all doors.

The turn signal indicators may flash and/or the horn may sound on the second press to indicate locking. See *Vehicle Personalization* ⇨ 101.

If the driver door is open when  is pressed, all doors will lock and the driver door will immediately unlock, if enabled. See *Vehicle Personalization* ⇨ 101.

If the passenger door is open when  is pressed, all doors lock.



Pressing  may also arm the alarm system. See *Vehicle Alarm System* ⇨ 18.



 : Press to unlock the driver door. Press unlock again within five seconds to unlock all doors. The RKE transmitter can be programmed to unlock all doors on the first button press. See *Vehicle Personalization* ⇨ 101.

The turn signal indicators may flash to indicate unlocking. See *Vehicle Personalization* ⇨ 101.

Pressing  will disarm the alarm system. See *Vehicle Alarm System* ⇨ 18.

 : Press and release one time to initiate vehicle locator. The exterior lamps flash and the horn chirps three times.

Press and hold  for at least three seconds to sound the panic alarm. The horn sounds and the turn signals flash for about 30 seconds or until  is pressed again or the vehicle is started.

 : Press and release  and then immediately press and hold  for at least four seconds to start the vehicle's heating or air conditioning systems and rear window defogger from outside the vehicle using the RKE transmitter. See *Remote Start* ⇨ 13.

### Keyless Access Operation

The Keyless Access system allows the doors and liftgate to be locked and unlocked without pressing the RKE transmitter button. The RKE transmitter must be within 1 m (3 ft) of the liftgate or door being opened. If the vehicle has this feature, there will be a button on both outside front door handles.

Keyless Access can be programmed to unlock all doors on the first unlock/lock button press from the driver door. See *Vehicle Personalization* ⇨ 101.

### Keyless Unlocking/Locking from the Driver Door

When the doors are locked and the RKE transmitter is within 1 m (3 ft) of the driver door handle, pressing the lock/unlock button on the driver door handle will unlock the driver door. If the lock/unlock button is pressed again within five seconds, all passenger doors will unlock. Pull the door handle to unlatch the door.

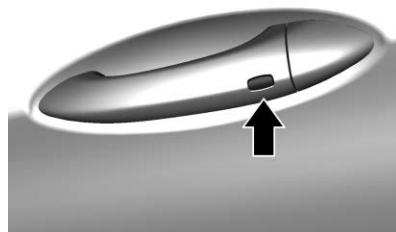

Pressing the lock/unlock button will cause all doors to lock if any of the following occur:

- It has been more than five seconds since the first lock/unlock button press.

- Two lock/unlock button presses were used to unlock all doors.
- Any vehicle door has opened and all doors are now closed.

See *Vehicle Personalization* ⇨ 101.

### Keyless Unlocking/Locking from Passenger Doors

When the doors are locked and the RKE transmitter is within 1 m (3 ft) of the door handle, pressing the lock/unlock button on that door handle will unlock all doors.



Pressing the lock/unlock button will cause all doors to lock if any of the following occur:

- The lock/unlock button was used to unlock all doors.
- Any vehicle door has opened and all doors are now closed.



### Disable/Enable Keyless Unlocking of Exterior Door Handles and Liftgate

If equipped, keyless unlocking of the exterior door handles and liftgate can be disabled and enabled.

### Disabling Keyless Unlocking:

With the vehicle off, press and hold  and  on the RKE transmitter at the same time for approximately three seconds. The turn signal lamps will flash four times quickly to indicate access is disabled. Using any exterior handle to unlock the doors or open the liftgate will cause the turn signal lamps to flash four times quickly, indicating access is disabled. If disabled, disarm the alarm system before starting the vehicle.

### Enabling Keyless Unlocking:

With the vehicle off, press and hold  and  on the RKE transmitter at the same time for approximately three seconds. The turn signal lamps will flash twice quickly to indicate access is enabled.

For an alternate way to disable/enable keyless unlocking, see *Vehicle Personalization* ⇨ 101.

### Passive Locking



The Keyless Access system will lock the vehicle several seconds after all doors are closed, if the vehicle is off and at least one RKE transmitter has been removed from the interior or none remain in the interior.

If other electronic devices interfere with the RKE transmitter signal, the vehicle may not detect the RKE transmitter inside the vehicle.

If passive locking is enabled, the doors may lock with the RKE transmitter inside the vehicle. Do not leave the RKE transmitter in an unattended vehicle.

To customize doors to automatically lock when exiting the vehicle, see *Vehicle Personalization* ⇨ 101.

### Temporary Disable of Passive Locking

Temporarily disable passive locking by pressing and holding  on the interior door switch with a door open for at least four seconds, or until three chimes are heard. Passive locking will then remain disabled until  on the interior door is pressed, or until the vehicle is started.

### Remote Left In Vehicle Alert

When the vehicle is turned off and an RKE transmitter is left in the vehicle, the horn will chirp three times after all doors are closed.

To turn on or off see *Vehicle Personalization* ⇨ 101.

### Remote No Longer In Vehicle Alert

If the vehicle is on with a door open, and then all doors are closed, the vehicle will check for RKE transmitters inside. If an RKE transmitter is not detected, the Driver Information Center (DIC) will display NO REMOTE DETECTED and the horn will chirp three times.

This occurs only once each time the vehicle is driven.

See *Vehicle Personalization* ⇨ 101.

### Keyless Liftgate Opening

Press the touch pad on the underside of the liftgate glass and lift up to open if the RKE transmitter is within 1 m (3 ft) and the doors are locked. If the doors are unlocked, the transmitter is not required to open the liftgate. See *Liftgate* ⇨ 18.

### Key Access

To access a vehicle with a weak transmitter battery, see *Door Locks* ⇨ 14.

### Programming Transmitters to the Vehicle

Only RKE transmitters programmed to the vehicle will work. If a transmitter is lost or stolen, a replacement can be purchased and programmed through your dealer. The

vehicle can be reprogrammed so that lost or stolen transmitters no longer work. Any remaining transmitters will need to be reprogrammed. Each vehicle can have up to eight transmitters matched to it.

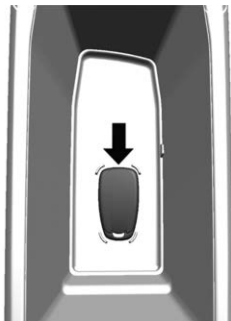

### Programming with Two Recognized Transmitters

A new transmitter can be programmed to the vehicle when there are two recognized transmitters. To program, the vehicle must be off and all of the transmitters, both currently recognized and new, must be with you.



1. Open the center console and take out the small tray, if equipped. Place the two recognized transmitters in the backup location with the buttons facing down.
2. Remove the key lock cylinder cover on the driver door handle. See *Door Locks* ⇨ 14. Insert the vehicle key of the new transmitter into the key lock cylinder on the driver door handle and turn the key to the unlock position five times within 10 seconds.

The DIC displays READY FOR REMOTE # 3, 4, 5, 6, 7, or 8.

3. Place the transmitter to be programmed in the backup location with the buttons facing down.
4. Press POWER ⏻ to start the vehicle. When the transmitter is learned, the DIC will show that it is ready to program the next transmitter.
5. Remove the transmitter from the backup location and press  or .

To program additional transmitters, repeat Steps 3–5.

When all additional transmitters are programmed, press and hold POWER ⏻ for 12 seconds to exit programming mode.

6. Put the key back into the RKE transmitter.
7. Replace the key lock cylinder cap. See *Door Locks* ⇨ 14.

### Programming without Two Recognized Transmitters

If two currently recognized transmitters are not available, follow this procedure to program up to eight transmitters. This feature is not available in Canada. This procedure will take approximately 30 minutes to complete. The vehicle must be off and all of the transmitters to be programmed must be with you.

1. Remove the key lock cylinder cover on the driver door handle. See *Door Locks* ⇨ 14. Insert the vehicle key of the transmitter into the key lock cylinder on the driver door handle and turn the key to the unlock position five times within 10 seconds.

The DIC displays REMOTE LEARN PENDING, PLEASE WAIT.

2. Wait for 10 minutes until the DIC displays PRESS ENGINE START BUTTON TO LEARN and then press POWER ⏻.

The DIC will again show REMOTE LEARN PENDING, PLEASE WAIT.

3. Repeat Step 2 two additional times. After the third time, all previously known transmitters will no longer work with the vehicle. Remaining transmitters can be relearned during the next steps.

The DIC should now show READY FOR REMOTE # 1.

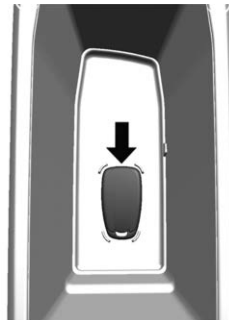

4. Open the center console and take out the small tray, if equipped. Place the transmitter in the backup location with the buttons facing down.
5. Press POWER ⏻ to start the vehicle. When the transmitter is learned, the DIC will show that it is ready to program the next transmitter.

6. Remove the transmitter from the backup location and press  or .

To program additional transmitters, repeat Steps 4–6.

When all additional transmitters are programmed, press and hold POWER ⏻ for 12 seconds to exit programming mode.

7. Put the key back into the RKE transmitter.
8. Replace the key lock cylinder cap. See *Door Locks* ⇨ 14.

### Starting the Vehicle with a Low Transmitter Battery

While trying to start the vehicle, if the transmitter battery is weak or if there is interference with the signal, the DIC may display NO REMOTE DETECTED or USE TRANSMITTER POCKET TO START. The DIC may also display REPLACE BATTERY IN REMOTE KEY.

For improved vehicle security, the transmitter is equipped with a motion sensor. When starting the vehicle, if the transmitter has been idle for a while, move the transmitter slightly and then try to start the vehicle.

## 12 Keys, Doors, and Windows

To start the vehicle:

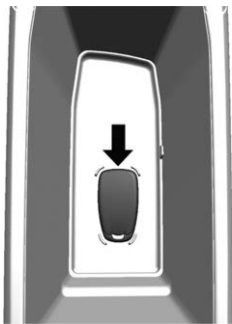

1. Open the center console and take out the small tray, if equipped. Place the transmitter in the backup location with the buttons facing down.
2. With the vehicle in P (Park) or N (Neutral), press the brake pedal and press POWER . Replace the transmitter battery as soon as possible.

### Battery Replacement

#### Warning

Never allow children to play with the RKE transmitter. The transmitter contains a small battery, which can be a choking hazard. If swallowed, internal burns can occur, resulting in severe injury or death. Seek medical attention immediately if a battery is swallowed.

#### Warning

To avoid personal injury, do not touch metal surfaces on the RKE transmitter when it has been exposed to extreme heat. These surfaces can be hot to the touch at temperatures above 59 °C (138 °F).

#### Caution

When replacing the battery, do not touch any of the circuitry on the transmitter. Static from your body could damage the transmitter.

#### Caution

Always replace the battery with the correct type. Replacing the battery with an incorrect type could potentially create a risk of battery explosion. Dispose of used batteries according to instructions and local laws. Do not attempt to burn, crush, or cut the used battery, and avoid exposing the battery to environments with extremely low air pressures or high temperatures.

Replace the battery if the DIC displays  
REPLACE BATTERY IN REMOTE KEY.

The battery is not rechargeable. To replace the battery:



1. Press the button on the side of the transmitter near the bottom and pull the key out. Never pull the key out without pressing the button.

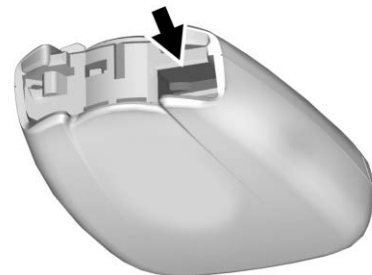

2. Separate the two halves of the transmitter using a flat tool inserted into the area near the key slot.



3. Remove the battery by pushing on the battery and sliding it toward the bottom of the transmitter.
4. Insert the new battery, positive side facing the back cover. Push the battery down until it is held in place. Replace with a CR2032 or equivalent battery.
5. Snap the battery cover back on to the transmitter.
6. Reinsert key into the transmitter.

### Remote Start

This feature starts the heating or air conditioning systems and the rear window defogger from outside the vehicle.

Use remote start to heat or cool the interior when the vehicle is plugged in to maximize electric range by utilizing electricity from the electrical outlet. Normal operation of the system will return after the vehicle has been turned on.

 : This button is on the RKE transmitter.

The climate control system will use the previous settings during a remote start. The rear defog may come on during remote start based on cold ambient conditions. The rear defog indicator light does not come on during a remote start.

## 14 Keys, Doors, and Windows

Laws in some local communities may restrict the use of remote starters. For example, some laws require a person using remote start to have the vehicle in view. Check local regulations for any requirements.



If the vehicle is low on energy, do not use the remote start feature. The vehicle may run out of energy.

The RKE transmitter range may be less while the vehicle is running.

Other conditions can affect the performance of the transmitter. See *Remote Keyless Entry (RKE) System* ⇨ 7.

### Remote Starting the Vehicle

To remote start the vehicle:

1. Press and release  on the RKE transmitter.
2. Immediately press and hold  for at least four seconds or until the turn signal lamps flash.
3. After entering the vehicle during a remote start, press POWER  with the brake pedal applied to start the vehicle and operate as normal.

Remote start will automatically shut off after 20 minutes unless a time extension is done.

When the vehicle starts, the parking lamps will turn on. Remote start run time can be extended.

### Extending Vehicle Run Time

The vehicle run time can also be extended by another 20 minutes, if after 30 seconds and during the first 20 minutes Steps 1 and 2 are repeated while the vehicle is running. This provides a total of 40 minutes.

The remote start can only be extended once.



A maximum of two remote starts, or a single start with an extension, are allowed between ignition cycles using POWER .

For additional remote starts, turn the vehicle on with the transmitter in the vehicle.

### Canceling Remote Start

To cancel a remote start, do any of the following:

- Press and hold  until the parking lamps turn off.
- Turn on the hazard warning flashers.

- Press POWER  with the brake pedal applied, then press POWER  again to turn the vehicle off.

### Conditions in Which Remote Start Will Not Work

The remote vehicle start feature will not operate if:

- The RKE transmitter is in the vehicle.
- The ignition is on.
- The hood is not closed.
- The hazard warning flashers are on.
- The electric drive unit coolant temperature is too high.
- Two remote vehicle starts, or a single remote start with an extension, have already been used.
- The vehicle is not in P (Park).

### Door Locks

#### Warning

Unlocked doors can be dangerous.

- Passengers, especially children, can easily open the doors and fall out of a moving vehicle. The doors can be

(Continued)



**Warning (Continued)**

unlocked and opened while the vehicle is moving. The chance of being thrown out of the vehicle in a crash is increased if the doors are not locked. So, all passengers should wear seat belts properly and the doors should be locked whenever the vehicle is driven.

- Young children who get into unlocked vehicles may be unable to get out. A child can be overcome by extreme heat and can suffer permanent injuries or even death from heat stroke. Always lock the vehicle whenever leaving it.
- Outsiders can easily enter through an unlocked door when you slow down or stop the vehicle. Locking the doors can help prevent this from happening.



To lock or unlock the doors from outside the vehicle:

- Use the key in the driver door to lock and unlock the door without the Remote Keyless Entry (RKE) transmitter. The key cylinder is covered with a cap. See “Driver Door Key Lock Cylinder Access (In Case of Dead Battery)” later in this section.

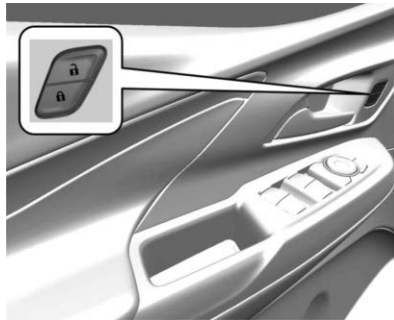
- Press  or  on the RKE transmitter to lock and unlock the doors.



To lock or unlock the doors from inside the vehicle:

- Press  or  on the power door lock switch.
- Pull the door handle. Pulling an interior door handle will unlock the door. Pulling the door handle again unlatches it.

**Keyless Access**

The RKE transmitter must be within 1 m (3 ft) of the liftgate or door being opened. Press the button on the door handle to

open. See “Keyless Access Operation” under *Remote Keyless Entry (RKE) System Operation* ⇨ 7.

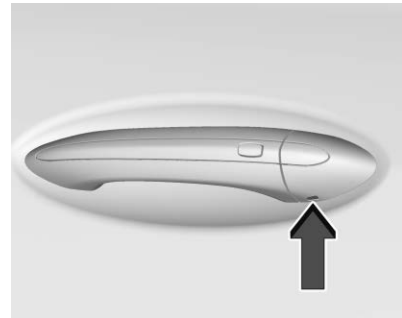
**Driver Door Key Lock Cylinder Access (In Case of Dead Battery)**

To access the driver door key lock cylinder:

1. Insert the key into the slot on the bottom of the cap.
2. Lift the key upward to remove the cap.
3. Insert the key into the cylinder and turn to unlock.



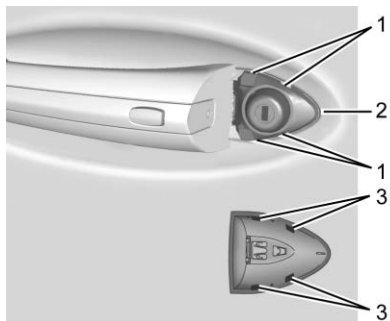

To replace the cap:

1. Position the bottom edge of the cap under the lower edge of the metal piece (2). The tabs (3) attach to the metal piece (2) at the positions (1).

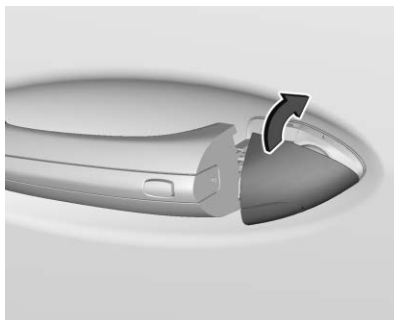

2. Rotate the cap upward and install into place.
3. Check that the cap is secure.

### Free-Turning Locks

The door key lock cylinder turns freely when either the wrong key is used, or the correct key is not fully inserted. The free-turning door lock feature prevents the lock from being forced open. To reset the lock, turn it to the vertical position with the correct key fully inserted. Remove the key and insert it again. If this does not reset the lock, turn the key halfway around in the cylinder and repeat the reset procedure.

### Power Door Locks

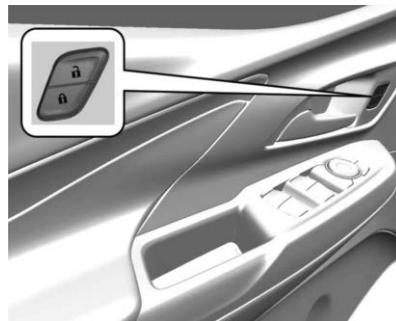

 : Press to unlock the doors.

 : Press to lock the doors.

Locking and unlocking the doors will also unlock the liftgate. See *Liftgate* ⇨ 18.



### Delayed Locking

This feature delays the actual locking of the doors until five seconds after all doors are closed.

Delayed locking can only be turned on when the Unlocked Door Anti Lockout feature has been turned off.

Press  on the power door lock switch with the door open.

The doors will then lock automatically five seconds after all doors are closed. If a door is reopened before five seconds have elapsed, the five-second timer will reset once all the doors are closed again.

Press  on the door lock switch again or press  on the RKE transmitter to override this feature and lock the doors immediately.

Delayed locking can be programmed. See *Vehicle Personalization* ⇨ 101.

## Automatic Door Locks

The doors will lock automatically when all doors are closed, the vehicle is on, and the shift switch is out of P (Park).

If a vehicle door is unlocked and then opened and closed, the doors will lock either when your foot is removed from the brake or the vehicle speed becomes faster than 13 km/h (8 mph).

To unlock the doors:

- Press  on a door.
- Shift the vehicle into P (Park).

Automatic door unlocking can be programmed. See *Vehicle Personalization* ⇨ 101.

## Lockout Protection

If the vehicle is on or in Service Mode and the power door lock switch is pressed with the driver door open, all the doors will lock and only the driver door will unlock.

If the vehicle is off and locking is requested while a door is open, when all doors are closed the vehicle will check for RKE transmitters inside. If an RKE transmitter is detected and the number of RKE transmitters inside has not reduced, the driver door will unlock and the horn will chirp three times.

Lockout Protection can be manually overridden with the driver door open by pressing and holding  on the power door lock switch.

If Unlocked Door Anti Lockout is turned on and the vehicle is off, the driver door is open, and locking is requested, all the doors will lock and only the driver door will unlock. The Unlocked Door Anti Lockout feature can be turned on or off. See *Vehicle Personalization* ⇨ 101.

## Safety Locks



If equipped, the safety lock is on the inside edge of the rear doors. To use the safety lock:

1. Move the lever forward to the lock position.
2. Close the door.
3. Do the same for the other rear door.

To open a rear door when the safety lock is on:

1. Unlock the door by using the inside handle, the power door lock switch, or the Remote Keyless Entry (RKE) transmitter.
2. Open the door from the outside.

## 18 Keys, Doors, and Windows

When the safety lock is enabled, adults and older children will not be able to open the rear door from the inside. Cancel the safety locks to enable the doors to open from the inside.

To cancel the safety lock:



1. Unlock the door and open it from the outside.
2. Move the lever rearward to unlock. Do the same for the other door.

## Doors



### Liftgate

#### Caution

To avoid damage to the liftgate or liftgate glass, make sure the area above and behind the liftgate is clear before opening it.

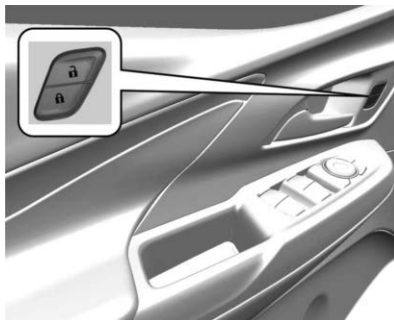
To lock or unlock the liftgate from the outside, press  or  on the RKE transmitter.



To lock or unlock the liftgate from the inside, press  or .

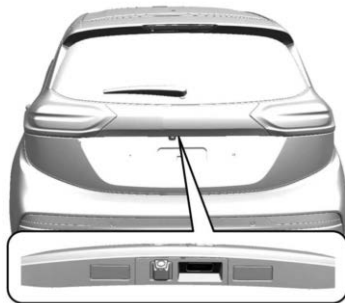

To open the liftgate, press the touch pad and lift up.

When closing the liftgate, use the pull cup.

### Keyless Liftgate Opening

Press the touch pad on the underside of the liftgate glass and lift up to open if the RKE transmitter is within 1 m (3 ft) and the doors are locked. If the doors are unlocked, the transmitter is not required to open the liftgate.

## Vehicle Security

This vehicle has theft-deterrent features; however, they do not make the vehicle impossible to steal.

### Vehicle Alarm System

This vehicle has an anti-theft alarm system.

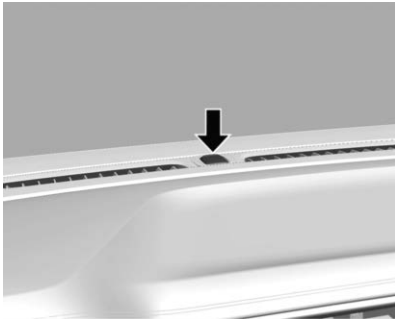

The red indicator light, on the instrument panel near the windshield, indicates the status of the system:

**Off** : Alarm system is disarmed



**On Solid** : Vehicle is secured during the delay to arm the system.

**Fast Flash** : Vehicle is unsecured. A door, the hood, or the liftgate is open.

**Slow Flash** : Alarm system is armed.

### Arming the Alarm System

1. Close the liftgate, then turn off the vehicle.

2. Lock the vehicle in one of three ways:
  - Use the RKE transmitter.
  - Use the Keyless Access system.
  - With a door open, press the inside .
3. After 30 seconds the alarm system will arm. Pressing  on the RKE transmitter a second time will bypass the 30-second delay and immediately arm the alarm system.

The vehicle alarm system will not arm if the doors are locked with the key.

If the driver door is opened without first unlocking with the RKE transmitter, the horn will chirp and the lights will flash to indicate pre-alarm. If the vehicle is not started, or the door is not unlocked by pressing  on the RKE transmitter during the 10-second pre-alarm, the alarm will be activated.

If a door or the liftgate is opened without first disarming the system, the turn signals will flash and the horn will sound for about 30 seconds. The alarm system will then re-arm to monitor for the next unauthorized event.

### Disarming the System

Do one of the following to disarm the alarm system or turn off the alarm if it has been activated:

- Press  on the RKE transmitter.
- Unlock the vehicle using the Keyless Access system.
- Start the vehicle.

To avoid setting off the alarm by accident:

- Lock the vehicle after all occupants have left the vehicle.
- Always unlock a door with the RKE transmitter.

Unlocking the driver door with the key will not disarm the system or turn off the alarm.

### How to Detect a Tamper Condition

If  is pressed on the RKE transmitter and the horn chirps and the lights flash three times, an alarm occurred previously while the alarm system was armed.

If the alarm has been activated, a message will appear on the DIC.

### Immobilizer

See *Radio Frequency Statement* ⇨ 293.

## Immobilizer Operation

This vehicle has a passive theft-deterrent system.

The system does not have to be manually armed or disarmed.

The vehicle is automatically immobilized when the transmitter leaves the vehicle.

The immobilization system is disarmed when POWER  is pressed and a valid transmitter is found in the vehicle.



The security light on the instrument cluster comes on when there is a problem with arming or disarming the theft-deterrent system.

The system has one or more transmitters matched to an immobilizer control unit in the vehicle. Only a correctly matched transmitter will start the vehicle. If the transmitter is damaged, you may not be able to start the vehicle.

When trying to start the vehicle, the security light comes on briefly when the vehicle is turned on.

If the vehicle does not start and the security light stays on, there is a problem with the system. Turn the vehicle off and try again.

If the RKE transmitter appears to be undamaged, try another transmitter, or place the transmitter in the transmitter pocket.

See “Starting the Vehicle with a Low Transmitter Battery” under *Remote Keyless Entry (RKE) System Operation* ⇨ 7.

If the vehicle does not start with the other transmitter or with the transmitter placed in the transmitter pocket, the vehicle needs service.

See your dealer who can service the theft-deterrent system and have a new transmitter programmed to the vehicle.

Do not leave the transmitter or device that disarms or deactivates the theft-deterrent system in the vehicle.

## Exterior Mirrors

### Convex Mirrors







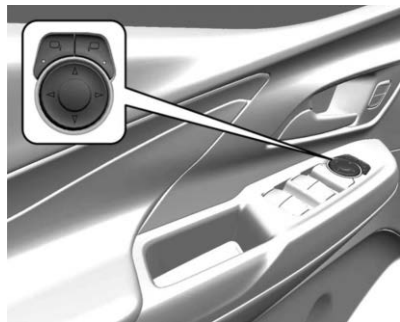

A convex mirror can make things, like other vehicles, look farther away than they really are. If you cut too sharply into the right lane, you could hit a vehicle on the right. Check the inside mirror or glance over your shoulder before changing lanes.

The passenger side mirror is convex shaped. A convex mirror's surface is curved so more can be seen from the driver seat.

## Power Mirrors



To adjust the mirrors:

1. Press  or  to choose the driver or passenger mirror.
2. Press one of the four arrows on the control pad while the indicator light on the  or  button is illuminated to move the mirror to the desired location.
3. Adjust each outside mirror so that a little of the vehicle and the area behind it can be seen.
4. Press  or  again to deselect the mirror, the mirror adjustment will turn off after about one minute.

## Folding Mirrors

### Manual Folding Mirrors

The mirrors can be folded inward by hand to prevent damage when going through tight maneuvers, such as an automatic car wash. To fold, pull the mirror toward the vehicle. Push the mirror outward to return it to the original position.

### Lane Change Alert (LCA)

The vehicle may have LCA. See *Lane Change Alert (LCA)* ⇨ 196.

### Side Blind Zone Alert

The vehicle may have Side Blind Zone Alert. See *Side Blind Zone Alert (SBZA)* ⇨ 196.

## Heated Mirrors

The rear window defogger also heats the outside mirrors, if equipped.



 : Press to heat the outside rearview mirrors. See “Rear Window Defogger” under *Automatic Climate Control System* ⇨ 147.

## Interior Mirrors

### Interior Rearview Mirrors

Adjust the rearview mirror for a clear view of the area behind your vehicle.

Do not spray glass cleaner directly on the mirror. Use a soft towel dampened with water.

### Manual Rearview Mirror

Push the tab forward for daytime use and pull it rearward for nighttime use to avoid glare of the headlamps from behind.

### Automatic Dimming Rearview Mirror

If equipped, automatic dimming reduces the glare of headlamps from behind. The dimming feature comes on when the vehicle is started.

## Windows

### Warning

Never leave a child, a helpless adult, or a pet alone in a vehicle, especially with the windows closed in warm or hot weather.

They can be overcome by the extreme heat and suffer permanent injuries or even death from heat stroke.



The vehicle aerodynamics are designed to improve electric range performance. This may result in a pulsing sound when either rear window is down and the front windows are up. To reduce the sound, open a front window.

## Power Windows

### Warning

Leaving children in a vehicle with the RKE transmitter is dangerous for many reasons; children or others could be badly injured or even killed. They could operate the power windows or other controls or even make the vehicle move. The windows will function with the RKE transmitter in the vehicle and they could be seriously injured or killed if caught in the path of a closing window. Do not leave the RKE transmitter in a vehicle with children.

When there are children in the rear seat, use the window lockout switch to prevent unintentional operation of the windows.

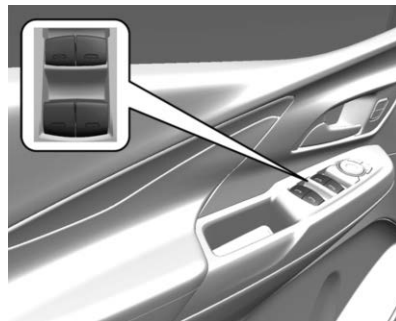

Press the switch to open the window. Pull the front of the switch up to close it.

The window switches on the driver door control all windows.

The power windows only operate with the vehicle on or in Service Mode, or when Retained Accessory Power (RAP) is active.

### Express Window Operation

The driver window has an express feature which allows the window to be lowered or raised without holding the switch. To automatically raise or lower the window, pull the driver window switch up or press it down all the way and release. Stop the window by pressing or pulling the switch in the same direction a second time, or by

briefly operating the switch to the first position in either direction. The front and rear passenger windows have express open only.

### Safety Function

This is for vehicles with the express-up feature. If any object is in the path of the window when the express-up feature is active, the window will stop and auto-reverse to a preset position. Weather conditions may cause the window to auto-reverse. The window switch may be held up to the second position to close the window. The window will return to normal operation once the obstruction or condition is removed.

### Safety Function Override

This is for vehicles with the express-up feature. If the battery on the vehicle has been recharged or disconnected, or is not working, the windows will need to be reprogrammed for the express-up feature to work. Before reprogramming, replace or recharge the vehicle's battery.

To program the driver window:

1. Close all doors with the vehicle on or in Service Mode.

2. Press and hold the power window switch until the window is fully open.
3. Pull the power window switch up until the window is fully closed.
4. Continue holding the switch up for approximately two seconds after the window is completely closed.

### Window Lockout

This feature prevents the rear passenger windows from operating, except from the driver position.

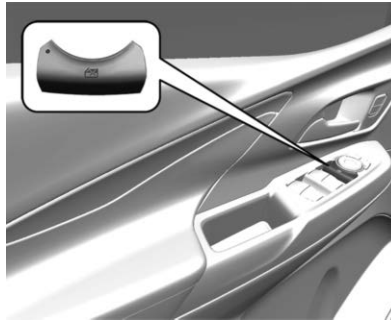

Press  on the driver door to activate the window lockout. The indicator light in the switch will illuminate when activated.

Press  again to deactivate the window lockout.

### Sun Visors

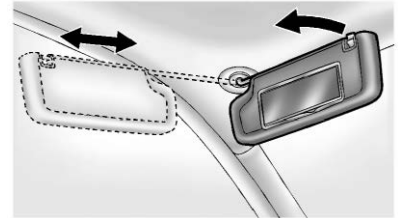

Pull the sun visor down to block glare. Detach the sun visor from the center mount to pivot to the side window or, if equipped, extend along the rod.

### Visor Vanity Mirror

The vehicle may have vanity mirrors and card holders on the back of the sun visors. Swing down the sun visor to expose the vanity mirror.



## Seats and Restraints

### Head Restraints

Head Restraints .....	24
-----------------------	----

### Front Seats

Seat Adjustment .....	26
Power Seat Adjustment .....	27
Reclining Seatbacks .....	27
Lumbar Adjustment .....	28
Heated Front Seats .....	28

### Rear Seats

Rear Seats .....	30
Rear Seat Armrest .....	31

### Seat Belts

Seat Belts .....	31
How to Wear Seat Belts Properly .....	32
Lap-Shoulder Belt .....	34
Seat Belt Use During Pregnancy .....	36
Seat Belt Extender .....	36
Safety System Check .....	37
Seat Belt Care .....	37
Replacing Seat Belt System Parts after a Crash .....	37

### Airbag System

Airbag System .....	37
Where Are the Airbags? .....	39
When Should an Airbag Inflate? .....	40

What Makes an Airbag Inflate? .....	41
How Does an Airbag Restrain? .....	41
What Will You See after an Airbag Inflates? .....	41
Passenger Sensing System .....	43
Servicing the Airbag-Equipped Vehicle .....	46
Adding Equipment to the Airbag-Equipped Vehicle .....	46
Airbag System Check .....	47
Replacing Airbag System Parts after a Crash .....	47

### Child Restraints

Older Children .....	48
Infants and Young Children .....	49
Child Restraint Systems .....	51
Where to Put the Restraint .....	53
Lower Anchors and Tethers for Children (LATCH System) .....	54
Replacing LATCH System Parts After a Crash .....	62
Securing Child Restraints (With the Seat Belt in the Rear Seat) .....	63
Securing Child Restraints (With the Seat Belt in the Front Seat) .....	65

## Head Restraints

The vehicle's front and rear seats have adjustable head restraints in the outboard seating positions.

### Warning

With head restraints that are not installed and adjusted properly, there is a greater chance that occupants will suffer a neck/spinal injury in a crash. Do not drive until the head restraints for all occupants are installed and adjusted properly.



Adjust the head restraint so that the top of the restraint is at the same height as the top of the occupant's head. This position reduces the chance of a neck injury in a crash.

### Front Seats

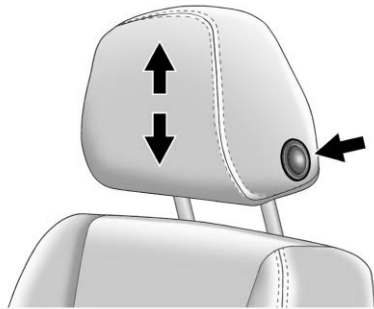

The height of the head restraint can be adjusted. To raise or lower the head restraint, press the button located on the side of the head restraint, and pull up or push the head restraint down, and release the button. Pull and push on the head restraint after the button is released to make sure that it is locked in place.

The front seat outboard head restraints are not removable.

### Rear Seats

The vehicle's rear seats have adjustable head restraints in the outboard seating positions.

The height of the head restraint can be adjusted.

Pull the head restraint up to raise it. Try to move the head restraint to make sure it is locked in place.

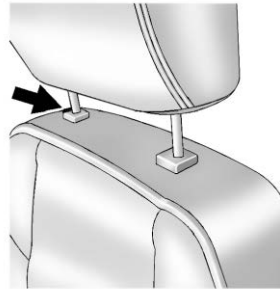

To lower the head restraint, press the button on the top of the seatback and push the head restraint down. Try to move the head restraint after the button is released to make sure it is locked in place.

If installing a child restraint in the rear seat, see "Securing a Child Restraint Designed for the LATCH System" under *Lower Anchors and Tethers for Children (LATCH System)* ⇨ 54.

### Folding the Rear Head Restraint

The head restraint can be folded rearward to allow for better visibility when the rear seat is unoccupied.



To fold the head restraint, press the button on the side of the head restraint.

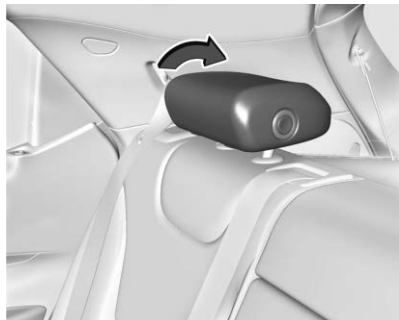

The head restraint will fold rearward automatically.

When an occupant or child restraint is in the seat, always return the head restraint to the full upright position. Pull the head restraint up and forward until it locks into place. Push and pull on the head restraint to make sure that it is locked.

Always adjust the head restraint so that the top of the restraint is at the same height as the top of the occupant's head.

## Front Seats

### Seat Adjustment

#### Manual Seats

#### Warning

You can lose control of the vehicle if you try to adjust a driver seat while the vehicle is moving. Adjust the driver seat only when the vehicle is not moving.

#### Seat Position



To adjust the seat:

1. Pull the handle at the front of the seat.

2. Slide the seat to the desired position and release the handle.
3. Try to move the seat back and forth to be sure it is locked in place.

#### Seat Height Adjuster



Move the lever on the outboard side of the seat up or down to manually adjust the seat height.

## Power Seat Adjustment

### Warning

The power seats will work with the ignition off. Children could operate the power seats and be injured. Never leave children alone in the vehicle.



To adjust the power driver seat, if available:

- Move the seat forward or rearward by sliding the control forward or rearward.
- Raise or lower the front part of the seat cushion by moving the front of the control up or down.
- Raise or lower the entire seat by moving the rear of the control up or down.

To adjust the seatback, see *Reclining Seatbacks* ⇨ 27.

To adjust the lumbar support, see *Lumbar Adjustment* ⇨ 28.

## Reclining Seatbacks

### Warning

Sitting in a reclined position when the vehicle is in motion can be dangerous. Even when buckled up, the seat belts cannot do their job.

The shoulder belt will not be against your body. Instead, it will be in front of you. In a crash, you could go into it, receiving neck or other injuries.

The lap belt could go up over your abdomen. The belt forces would be there, not at your pelvic bones. This could cause serious internal injuries.

For proper protection when the vehicle is in motion, have the seatback upright. Then sit well back in the seat and wear the seat belt properly.



Do not have a seatback reclined if the vehicle is moving.

## Manual Reclining Seatbacks

### Warning

If either seatback is not locked, it could move forward in a sudden stop or crash. That could cause injury to the person sitting there. Always push and pull on the seatbacks to be sure they are locked.



To recline a manual seatback:

1. Lift the lever.
2. Move the seatback to the desired position, and then release the lever to lock the seatback in place.
3. Push and pull on the seatback to make sure it is locked.

To return the seatback to the upright position:

1. Lift the lever fully without applying pressure to the seatback, and the seatback will return to the upright position.
2. Push and pull on the seatback to make sure it is locked.

### Power Reclining Seatbacks



To adjust a power seatback, if available:

- Tilt the top of the control rearward to recline.
- Tilt the top of the control forward to raise.

### Lumbar Adjustment



If available, press the front or rear of the switch to increase or decrease lumbar support. Release the switch when the desired level of support is reached.

### Heated Front Seats

#### Warning

If temperature change or pain to the skin cannot be felt, the seat heater may cause burns. To reduce the risk of burns, use care when using the seat heater, especially for long periods of time. Do not place anything on the seat that



(Continued)

**Warning (Continued)**

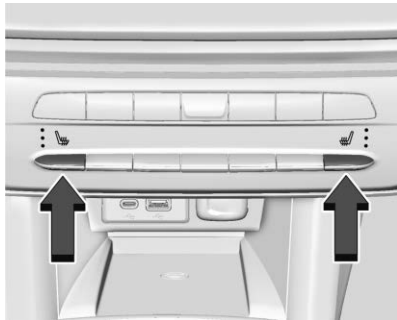
insulates against heat, such as a blanket, cushion, cover, or similar item. This may cause the seat heater to overheat. An overheated seat heater may cause a burn or may damage the seat.



If equipped, the heated seat controls are on the center stack. To operate, the vehicle must be on.



Lift  or  to heat the driver or passenger seat cushion. Indicator lights on the center stack show the current setting with three level indicators for high, medium, or low.

Press the button once for the highest setting. With each press of the button, the heated seat will change to the next lower setting, and then to the off setting. The lights indicate three for the highest setting and one for the lowest.

The passenger seat may take longer to heat up.

**Auto Heated Seats**

When the vehicle is on, this feature will automatically activate the heated seats at the level required by the vehicle's interior temperature. In auto mode, the indicators automatically show the level setting required.

Use the manual heated seat buttons to turn auto heated seats off. Once this feature is turned off, the auto heated seats will be activated the next time the vehicle is started. In manual mode, the controls can be accessed while the vehicle is on by lifting  or .

If the passenger seat is unoccupied, the auto heated seats feature will not activate that seat.

The auto heated seats feature can be programmed to always be enabled when the vehicle is on. See *Vehicle Personalization* ⇨ 101.

**Remote Start Heated Seats**

When it is cold outside, the heated seats can be turned on automatically during a remote vehicle start.

The heated seats will be canceled when the vehicle is started. If the auto heated seats are enabled in vehicle personalization, the seat heating level will automatically change to the level required by the vehicle's interior temperature when the vehicle is on.

The temperature performance of an unoccupied seat may be reduced. This is normal.

The heated seats will not turn on during a remote start unless the heated seat feature is enabled. See *Vehicle Personalization* ⇨ 101.

## Rear Seats

### Rear Seat Reminder

If equipped, the message REAR SEAT REMINDER LOOK IN REAR SEAT displays under certain conditions indicating there may be an item or passenger in the rear seat. Check before exiting the vehicle.

This feature will activate when a second row door is opened while the vehicle is on or up to 10 minutes before the vehicle is turned on. There will be an alert when the vehicle is turned off. The alert does not directly detect objects in the rear seat; instead, under certain conditions, it detects when a rear door is opened and closed, indicating that there may be something in the rear seat.

The feature is active only once each time the vehicle is turned on and off, and will require reactivation by opening and closing the second row doors. There may be an alert even when there is nothing in the rear seat; for example, if a child entered the vehicle through the rear door and left the vehicle without the vehicle being shut off.

The feature can be turned on or off. See *Vehicle Personalization* ⇨ 101.

### Folding the Seatback

Either side of the seatback can be folded down for more cargo space. Fold a seatback only when the vehicle is not moving.

#### Caution

Folding a rear seat with the seat belts still fastened may cause damage to the seat or the seat belts. Always unbuckle the seat belts and return them to their normal stowed position before folding a rear seat.

To fold the seatback down:



1. Make sure the seat belt is in the retainer hook.



2. Pull the lever on top of the seatback to unlock the seatback.

A red indicator near the seatback lever is exposed when the seatback is unlocked.

3. Fold the seatback down.

Repeat Steps 1–3 for the other seatback, if desired.

### Raising the Seatback

#### Warning

If either seatback is not locked, it could move forward in a sudden stop or crash. That could cause injury to the person sitting there. Always push and pull on the seatbacks to be sure they are locked.

**⚠ Warning**

A seat belt that is improperly routed, not properly attached, or twisted will not provide the protection needed in a crash. The person wearing the belt could be seriously injured. After raising the rear seatback, always check to be sure that the seat belts are properly routed and attached, and are not twisted.

To raise a seatback:

1. Lift the seatback up and push it rearward to lock it in place. Make sure the seat belt is in the retainer hook and is not twisted or caught in the seatback. A tab near the seatback lever retracts when the seatback is locked in place. The center rear seat belt may lock when you raise the seatback. If this happens, let the belt go back all the way and start again.
2. Push and pull the top of the seatback to be sure it is locked into position.
3. Repeat Steps 1 and 2 for the other seatback, if necessary.

When the seat is not in use, it should be kept in the upright, locked position.

**Rear Seat Armrest**

The rear seat has an armrest in the center of the seatback. Lower the armrest to access the two cupholders.

To fold, lift the armrest up and push it rearward until it is flush with the seatback.

**Seat Belts**

This section describes how to use seat belts properly, and some things not to do.

**⚠ Warning**

Do not let anyone ride where a seat belt cannot be worn properly. In a crash, if you or your passenger(s) are not wearing seat belts, injuries can be much worse than if you are wearing seat belts. You can be seriously injured or killed by hitting things inside the vehicle harder or by being ejected from the vehicle. In addition, anyone who is not buckled up can strike other passengers in the vehicle.

It is extremely dangerous to ride in a cargo area, inside or outside of a vehicle. In a collision, passengers riding in these areas are more likely to be seriously injured or killed. Do not allow passengers to ride in any area of the vehicle that is not equipped with seats and seat belts.

Always wear a seat belt, and check that all passenger(s) are restrained properly too.

This vehicle has indicators as a reminder to buckle the seat belts. See *Seat Belt Reminders* ⇨ 82.



## Why Seat Belts Work

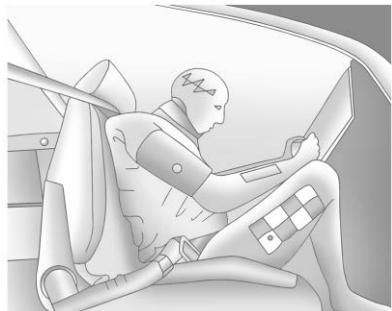

When riding in a vehicle, you travel as fast as the vehicle does. If the vehicle stops suddenly, you keep going until something stops you. It could be the windshield, the instrument panel, or the seat belts!

When you wear a seat belt, you and the vehicle slow down together. There is more time to stop because you stop over a longer distance and, when worn properly, your strongest bones take the forces from the seat belts. That is why wearing seat belts makes such good sense.

## Questions and Answers About Seat Belts

**Q:** Will I be trapped in the vehicle after a crash if I am wearing a seat belt?

**A:** You *could* be — whether you are wearing a seat belt or not. Your chance of being conscious during and after a crash, so you *can* unbuckle and get out, is *much* greater if you are belted.

**Q:** If my vehicle has airbags, why should I have to wear seat belts?

**A:** Airbags are supplemental systems only. They work *with* seat belts — not instead of them. Whether or not an airbag is provided, all occupants still have to buckle up to get the most protection.

Also, in nearly all states and in all Canadian provinces, the law requires wearing seat belts.

## How to Wear Seat Belts Properly

Follow these rules for everyone's protection.

There are additional things to know about seat belts and children, including smaller children and infants. If a child will be riding in the vehicle, see *Older Children* ⇨ 48 or *Infants and Young Children* ⇨ 49. Review and follow the rules for children in addition to the following rules.

It is very important for all occupants to buckle up. Statistics show that unbelted people are hurt more often in crashes than those who are wearing seat belts.

There are important things to know about wearing a seat belt properly.

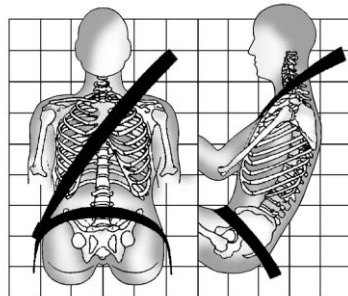

- Sit up straight and always keep your feet on the floor in front of you (if possible).
- Wear the lap part of the belt low and snug on the hips, just touching the thighs. In a crash, this applies force to the strong pelvic bones and you would be less likely to slide under the lap belt. If you slid under it, the belt would apply force on your abdomen. This could cause serious or even fatal injuries.
- Wear the shoulder belt over the shoulder and across the chest. These parts of the body are best able to take belt restraining forces. The shoulder belt locks if there is a sudden stop or crash.

**Warning**

You can be seriously injured, or even killed, by not wearing your seat belt properly.

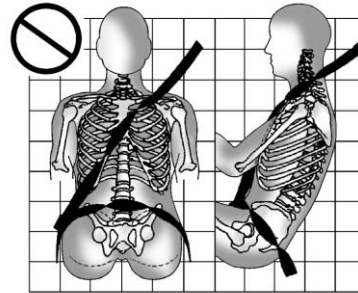
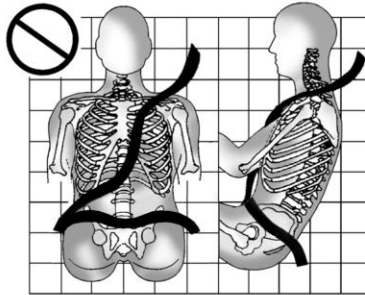

Never allow the lap or shoulder belt to become loose or twisted.

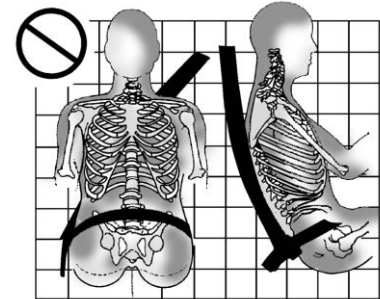
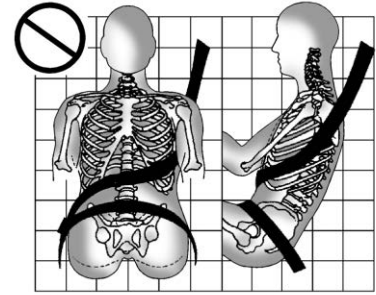

Never wear the shoulder belt under both arms or behind your back.

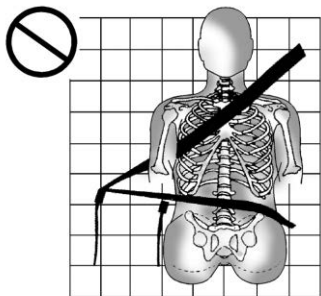

Always use the correct buckle for your seating position.

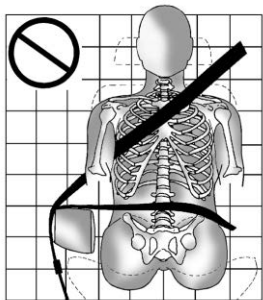

Never route the lap or shoulder belt over an armrest.

### Warning

The seat belt can be pinched if it is routed under plastic trim on the seat, such as trim around the rear seatback folding handle or side airbag. In a crash, pinched seat belts might not provide adequate protection. Never allow seat belts to be routed under plastic trim pieces.

### Warning

You can be seriously injured or killed if the shoulder belt is worn behind your back, under your legs, or wrapped around your neck. The shoulder belt can tighten but cannot be loosened if it is locked. The shoulder belt locks when it is pulled all the way out of the retractor. It unlocks when the shoulder belt is allowed to go all the way back into the retractor, but it cannot do this if it is wrapped around you. You may have to cut the seat belt if it is locked and tightened around you.

## Lap-Shoulder Belt

All seating positions in the vehicle have a lap-shoulder belt.

The following instructions explain how to wear a lap-shoulder belt properly.

1. Adjust the seat, if the seat is adjustable, so you can sit up straight. To see how, see "Seats" in the Index.

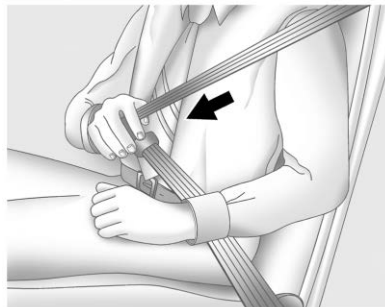

2. Pick up the latch plate and pull the belt across you. Do not let it get twisted.

The lap-shoulder belt may lock if you pull the belt across you very quickly. If this happens, let the belt go back slightly to unlock it. Then pull the belt across you more slowly.

If the shoulder portion of a passenger belt is pulled out all the way, the child restraint locking feature may be engaged. See *Child Restraint Systems* ⇨ 51. If this occurs, let the belt go back all the way and start again. If the locking feature stays engaged after letting the belt go back to stowed position on the seat, move the seat rearward or recline the seat until the shoulder belt retractor lock releases.

Engaging the child restraint locking feature in the front outboard seating position may affect the passenger sensing system. See *Passenger Sensing System* ⇨ 43.

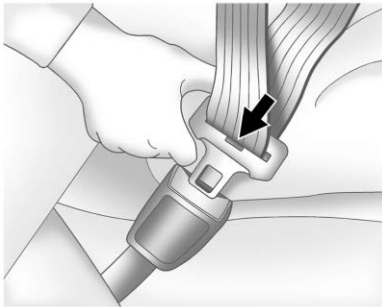

3. Push the latch plate into the buckle until it clicks.

Pull up on the latch plate to make sure it is secure. If the belt is not long enough, see *Seat Belt Extender* ⇨ 36.

Position the release button on the buckle so that the seat belt could be quickly unbuckled if necessary.

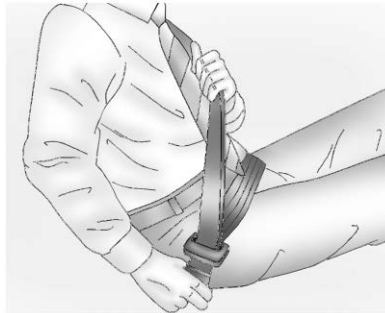

4. To make the lap part tight, pull up on the shoulder belt.



To unlatch the belt, push the button on the buckle. The belt should return to its stowed position.

Always stow the seat belt slowly. If the seat belt webbing returns quickly to the stowed position, the retractor may lock and cannot be pulled out. If this happens, pull the seat belt straight out firmly to unlock the webbing, and then release it. If the webbing is still locked in the retractor, see your dealer.

Before a door is closed, be sure the belt is out of the way. If a door is slammed against a seat belt, damage can occur to both the seat belt and the vehicle.

### Seat Belt Pretensioners

This vehicle has seat belt pretensioners for the front outboard occupants. Although the seat belt pretensioners cannot be seen, they are part of the seat belt assembly. They can help tighten the seat belts during the early stages of a moderate to severe frontal, near frontal, or rear crash if the threshold conditions for pretensioner activation are met. Seat belt pretensioners can also help tighten the seat belts in a side crash or a rollover event.

Pretensioners work only once. If the pretensioners activate in a crash, the pretensioners and probably other parts of the vehicle's seat belt system will need to be replaced. See *Replacing Seat Belt System Parts after a Crash* ⇨ 37.

Do not sit on the outboard seat belt while entering or exiting the vehicle or at any time while sitting in the seat. Sitting on the seat belt can damage the webbing and hardware.

### Rear Seat Belt Comfort Guides

Rear seat belt comfort guides may provide added seat belt comfort for older children who have outgrown booster seats and for

some adults. When installed on a shoulder belt, the comfort guide positions the shoulder belt away from the neck and head.

Comfort guides are available through your dealer for the rear outboard seating positions. Instructions are included with the guides.

### Seat Belt Use During Pregnancy

Seat belts work for everyone, including pregnant women. Like all occupants, they are more likely to be seriously injured if they do not wear seat belts.



A pregnant woman should wear a lap-shoulder belt, and the lap portion should be worn as low as possible, below the rounding, throughout the pregnancy.

The best way to protect the fetus is to protect the mother. When a seat belt is worn properly, it is more likely that the fetus will not be hurt in a crash. For pregnant women, as for anyone, the key to making seat belts effective is wearing them properly.

### Seat Belt Extender

If the vehicle's seat belt will fasten around you, you should use it.

But if a seat belt is not long enough, your dealer will order you an extender. Only a GM dealer issued extender should be used. When you go in to order it, take the heaviest coat you will wear, so the extender will be long enough for you. To help avoid personal injury, do not let someone else use it, and use it only for the seat it is made to fit. The extender has been designed for adults. Never use it for securing child restraints. For more information on the proper use and fit of seat belt extenders see the instruction sheet that comes with the extender.

## Safety System Check

Periodically check the seat belt reminder, seat belts, buckles, latch plates, retractors, shoulder belt height adjusters (if equipped), and seat belt anchorages to make sure they are all in working order. Look for any other loose or damaged seat belt system parts that might keep a seat belt system from performing properly. See your dealer to have it repaired. Torn, frayed, or twisted seat belts may not protect you in a crash. Torn or frayed seat belts can rip apart under impact forces. If a belt is torn or frayed, have it replaced immediately. If a belt is twisted, it may be possible to untwist by reversing the latch plate on the webbing. If the twist cannot be corrected, ask your dealer to fix it.

Make sure the seat belt reminder light is working. See *Seat Belt Reminders* ⇨ 82.

Keep seat belts clean and dry. See *Seat Belt Care* ⇨ 37.

## Seat Belt Care

Keep belts clean and dry.

Seat belts should be properly cared for and maintained.

Seat belt hardware should be kept dry and free of dust or debris. As necessary, exterior hard surfaces and seat belt webbing may be lightly cleaned with mild soap and water. Ensure there is not excessive dust or debris in the mechanism. If dust or debris exists in the system please see the dealer. Parts may need to be replaced to ensure proper functionality of the system.

### Warning

Do not bleach or dye seat belt webbing. It may severely weaken the webbing. In a crash, they might not be able to provide adequate protection. Clean and rinse seat belt webbing only with mild soap and lukewarm water. Allow the webbing to dry.

## Replacing Seat Belt System Parts after a Crash

### Warning

A crash can damage the seat belt system in the vehicle. A damaged seat belt system may not properly protect the person using it, resulting in serious injury  
(Continued)

### Warning (Continued)

or even death in a crash. To help make sure the seat belt systems are working properly after a crash, have them inspected and any necessary replacements made as soon as possible.

After a minor crash, replacement of seat belts may not be necessary. But the seat belt assemblies that were used during any crash may have been stressed or damaged. See your dealer to have the seat belt assemblies inspected or replaced.

New parts and repairs may be necessary even if the seat belt system was not being used at the time of the crash.

Have the seat belt pretensioners checked if the vehicle has been in a crash, or if the airbag readiness light stays on after you start the vehicle or while you are driving. See *Airbag Readiness Light* ⇨ 82.

## Airbag System

The vehicle has the following airbags:

- A frontal airbag for the driver
- A frontal airbag for the front outboard passenger

- A knee airbag for the driver
- A knee airbag for the front outboard passenger
- A seat-mounted side impact airbag for the driver
- A seat-mounted side impact airbag for the front outboard passenger
- A roof-rail airbag for the driver and the area directly behind the driver
- A roof-rail airbag for the front outboard passenger and the area directly behind the front outboard passenger

Sedan models may have the following airbags:

- Seat-mounted side impact airbags for the second row outboard passengers

All vehicle airbags have the word AIRBAG on the trim or on a label near the deployment opening.

For frontal airbags, the word AIRBAG is on the center of the steering wheel for the driver and on the instrument panel for the front outboard passenger.

For knee airbags, the word AIRBAG is on the lower part of the instrument panel.

For seat-mounted side impact airbags, the word AIRBAG is on the side of the seatback or side of the seat closest to the door.

For roof-rail airbags, the word AIRBAG is on the ceiling or trim.

Airbags are designed to supplement the protection provided by seat belts. Even though today's airbags are also designed to help reduce the risk of injury from the force of an inflating bag, all airbags must inflate very quickly to do their job.

Here are the most important things to know about the airbag system:

### **Warning**

You can be severely injured or killed in a crash if you are not wearing your seat belt, even with airbags. Airbags are designed to work with seat belts, not replace them. Also, airbags are not designed to inflate in every crash. In some crashes seat belts are the only restraint. See *When Should an Airbag Inflate?* ⇨ 40.

(Continued)

### **Warning (Continued)**

Wearing your seat belt during a crash helps reduce your chance of hitting things inside the vehicle or being ejected from it. Airbags are “supplemental restraints” to the seat belts. Everyone in the vehicle should wear a seat belt properly, whether or not there is an airbag for that person.

### **Warning**

Because airbags inflate with great force and faster than the blink of an eye, anyone who is up against, or very close to, any airbag when it inflates can be seriously injured or killed. Do not sit unnecessarily close to any airbag, as you would be if sitting on the edge of the seat or leaning forward. Seat belts help keep you in position before and during a crash. Always wear a seat belt, even with airbags. The driver should sit as far back as possible while still maintaining control of the vehicle. The seat belts and the front outboard passenger airbags are

(Continued)

**Warning (Continued)**

most effective when you are sitting well back and upright in the seat with both feet on the floor.

Occupants should not lean on or sleep against the door or side windows in seating positions with seat-mounted side impact airbags and/or roof-rail airbags.

**⚠ Warning**

Children who are up against, or very close to, any airbag when it inflates can be seriously injured or killed. Always secure children properly in the vehicle. To read how, see *Older Children* ⇨ 48 or *Infants and Young Children* ⇨ 49.



There is an airbag readiness light on the instrument cluster, which shows the airbag symbol. The system checks the airbag

electrical system for malfunctions. The light tells you if there is an electrical problem. See *Airbag Readiness Light* ⇨ 82 for more information.

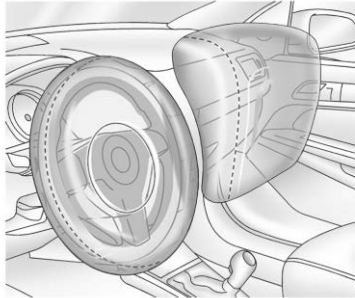
**Where Are the Airbags?**

The driver frontal airbag is in the center of the steering wheel.

The front outboard passenger frontal airbag is in the passenger side instrument panel.

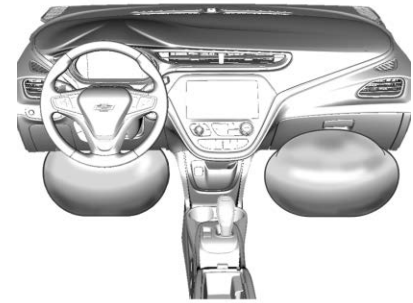

The driver knee airbag is below the steering column. The front outboard passenger knee airbag is below the glove box.

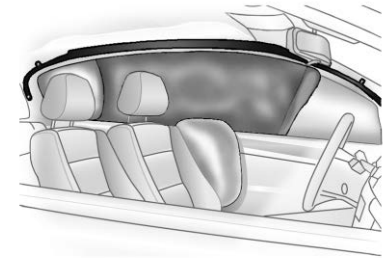

**Driver Side Shown, Passenger Side Similar**



The driver and front outboard passenger seat-mounted side impact airbags are in the side of the seatbacks closest to the door.

The roof-rail airbags for the driver, front outboard passenger, and second row outboard passengers are in the ceiling above the side windows.

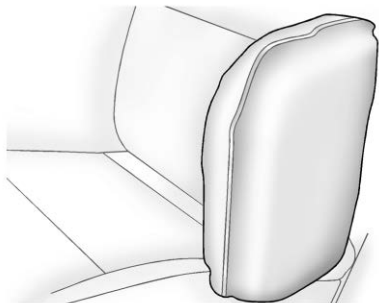

Rear Seat Driver Side Shown, Passenger Side Similar

On vehicles with second row seat-mounted side impact airbags, they are in the sides of the seatback closest to the door.

**Warning**

If something is between an occupant and an airbag, the airbag might not inflate properly or it might force the object into that person causing severe injury or even death. The path of an inflating airbag must be kept clear. Do not put anything between an occupant and an airbag, and do not attach or put anything on the steering wheel hub or on or near any other airbag covering.

Do not use seat accessories that block the inflation path of a seat-mounted side impact airbag.

Never secure anything to the roof of a vehicle with roof-rail airbags by routing a rope or tie-down through any door or window opening. If you do, the path of an inflating roof-rail airbag will be blocked.

**When Should an Airbag Inflate?**

This vehicle is equipped with airbags. Airbags are designed to inflate if the impact exceeds the specific airbag system's deployment threshold. Deployment

thresholds are used to predict how severe a crash is likely to be in time for the airbags to inflate and help restrain the occupants. The vehicle has electronic sensors that help the airbag system determine the severity of the impact. Deployment thresholds can vary with specific vehicle design.

Frontal airbags are designed to inflate in moderate to severe frontal or near frontal crashes to help reduce the potential for severe injuries, mainly to the driver's or front outboard passenger's head and chest.

Whether the frontal airbags will or should inflate is not based primarily on how fast the vehicle is traveling. It depends on what is hit, the direction of the impact, and how quickly the vehicle slows down.

Frontal airbags may inflate at different crash speeds depending on whether the vehicle hits an object straight on or at an angle, and whether the object is fixed or moving, rigid or deformable, narrow or wide.

Frontal airbags are not intended to inflate during vehicle rollovers, rear impacts, or in many side impacts.

In addition, the vehicle has advanced technology frontal airbags. Advanced technology frontal airbags adjust the restraint according to crash severity.

Knee airbags are designed to inflate in moderate to severe frontal or near frontal impacts. Knee airbags are not designed to inflate during vehicle rollovers, in rear impacts, or in many side impacts.

Seat-mounted side impact airbags are designed to inflate in moderate to severe side crashes, depending on the location of the impact. These airbags are also designed to inflate in some moderate to severe frontal or near-frontal impacts that could result in the occupant moving toward the side of the vehicle. Seat-mounted side impact airbags are not designed to inflate in rollovers, or rear impacts. A seat-mounted side impact airbag is designed to inflate on the side of the vehicle that is struck.

Roof-rail airbags are designed to inflate in moderate to severe side crashes depending on the location of the impact. In addition, these roof-rail airbags are designed to inflate during a rollover or in a severe frontal impact. Roof-rail airbags are not designed to inflate in rear impacts. Both roof-rail airbags will inflate when either side of the vehicle is

struck or if the sensing system predicts that the vehicle is about to roll over on its side, or in a severe frontal impact.

In any particular crash, no one can say whether an airbag should have inflated simply because of the vehicle damage or repair costs.

### What Makes an Airbag Inflate?

In a deployment event, the sensing system sends an electrical signal triggering a release of gas from the inflator. Gas from the inflator fills the airbag causing the bag to break out of the cover. The inflator, the airbag, and related hardware are all part of the airbag module.

For airbag locations, see *Where Are the Airbags?* ⇨ 39.

### How Does an Airbag Restrain?

In moderate to severe frontal or near frontal collisions, even belted occupants can contact the steering wheel or the instrument panel. In moderate to severe side collisions, even belted occupants can contact the inside of the vehicle.

Airbags supplement the protection provided by seat belts by distributing the force of the impact more evenly over the occupant's body.

Rollover capable roof-rail airbags are designed to help contain the head and chest of occupants in the outboard seating positions in the first and second rows. The rollover capable roof-rail airbags are designed to help reduce the risk of full or partial ejection in rollover events, although no system can prevent all such ejections.

But airbags would not help in many types of collisions, primarily because the occupant's motion is not toward those airbags. See *When Should an Airbag Inflate?* ⇨ 40.

Airbags should never be regarded as anything more than a supplement to seat belts.

### What Will You See after an Airbag Inflates?

After the frontal, knee, and seat-mounted side impact airbags inflate, they quickly deflate, so quickly that some people may not even realize the airbags inflated. Roof-rail airbags may still be at least

partially inflated for some time after they inflate. Some components of the airbag module may be hot for several minutes. For location of the airbags, see *Where Are the Airbags?* ⇨ 39.

The parts of the airbag that come into contact with you may be warm, but not too hot to touch. There may be some smoke and dust coming from the vents in the deflated airbags. Airbag inflation does not prevent the driver from seeing out of the windshield or being able to steer the vehicle, nor does it prevent people from leaving the vehicle.

### Warning

When an airbag inflates, there may be dust in the air. This dust could cause breathing problems for people with a history of asthma or other breathing trouble. To avoid this, everyone in the vehicle should get out as soon as it is safe to do so. If you have breathing problems but cannot get out of the vehicle after an airbag inflates, then get fresh air by opening a window or a door.

(Continued)

### Warning (Continued)

If you experience breathing problems following an airbag deployment, you should seek medical attention.

The vehicle has a feature that may automatically unlock the doors, turn on the interior lamps and hazard warning flashers after the airbags inflate. The feature may also activate, without airbag inflation, after an event that exceeds a predetermined threshold. After turning the ignition off and then on again, the doors can be locked, the interior lamps can be turned off, and the hazard warning flashers can be turned off using the controls for those features. If any of these systems are damaged in the crash they may not operate as normal.

### Warning

A crash severe enough to inflate the airbags may have also damaged important functions in the vehicle, such as the brake and steering systems, etc. Even if the vehicle appears to be drivable

(Continued)

### Warning (Continued)

after a moderate crash, there may be concealed damage that could make it difficult to safely operate the vehicle.

Use caution if attempting to restart the vehicle after a crash has occurred.

If an airbag inflates or the vehicle has been in a crash, the sensing system may shut down the high voltage system. When this occurs, the high voltage battery is disconnected and the vehicle will not start. Before the vehicle can be operated again, it must be serviced at your dealer.

In many crashes severe enough to inflate the airbag, windshields are broken by vehicle deformation. Additional windshield breakage may also occur from the front outboard passenger airbag.

- Airbags are designed to inflate only once. After an airbag inflates, you will need some new parts for the airbag system. If you do not get them, the airbag system will not be there to help protect you in another crash. A new system will include airbag modules and possibly other parts. The service manual for the vehicle covers the need to replace other parts.

- The vehicle has a crash sensing and diagnostic module which records information after a crash. See *Vehicle Data Recording and Privacy* ⇨ 294 and *Event Data Recorders* ⇨ 295.
- Let only qualified technicians work on the airbag systems. Improper service can mean that an airbag system will not work properly. See your dealer for service.

### Passenger Sensing System

The vehicle has a passenger sensing system for the front outboard passenger position. The passenger airbag status indicator will light on the overhead console when the vehicle is started.

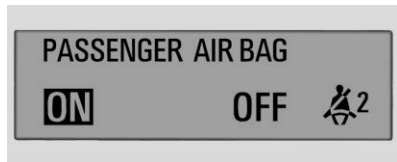

United States



Canada

The words ON and OFF, or the symbols for on and off, will be visible during the system check. When the system check is complete, either the word ON or OFF, or the symbol for on or off, will be visible. See *Passenger Airbag Status Indicator* ⇨ 83.

The passenger sensing system turns off the front outboard passenger frontal airbag and knee airbag under certain conditions. No other airbag is affected by the passenger sensing system.

The passenger sensing system works with sensors that are part of the front outboard passenger seat and seat belt. The sensors are designed to detect the presence of a properly seated occupant and determine if the front outboard passenger frontal airbag and knee airbag should be allowed to inflate or not.

According to accident statistics, children are safer when properly secured in a rear seat in the correct child restraint for their weight and size.

Whenever possible, children aged 12 and under should be secured in a rear seating position.

Never put a rear-facing child seat in the front. This is because the risk to the rear-facing child is so great, if the airbag inflates.

#### Warning

A child in a rear-facing child restraint can be seriously injured or killed if the passenger frontal airbag inflates. This is because the back of the rear-facing child restraint would be very close to the inflating airbag. A child in a forward-facing child restraint can be seriously injured or killed if the passenger frontal airbag inflates and the passenger seat is in a forward position.

Even if the passenger sensing system has turned off the front outboard passenger airbag(s), no system is fail-safe. No one

(Continued)

**Warning (Continued)**

can guarantee that an airbag will not deploy under some unusual circumstance, even though the airbag(s) are off.

Never put a rear-facing child restraint in the front seat, even if the airbag is off. If securing a forward-facing child restraint in the front outboard passenger seat, always move the seat as far back as it will go. It is better to secure child restraints in the rear seat. Consider using another vehicle to transport the child when a rear seat is not available.

If the vehicle does not have a rear seat that will accommodate a rear-facing child restraint, a rear-facing child restraint should not be installed in the vehicle, even if the airbag is off.

The passenger sensing system is designed to turn off the front outboard passenger frontal airbag and knee airbag if:

- The front outboard passenger seat is unoccupied.
- The system determines an infant is present in a child restraint.

- A front outboard passenger takes his/her weight off of the seat for a period of time.
- There is a critical problem with the airbag system or the passenger sensing system.

When the passenger sensing system has turned off the front outboard passenger frontal airbag and knee airbag, the OFF indicator will light and stay lit as a reminder that the airbags are off. See *Passenger Airbag Status Indicator* ⇨ 83.

The passenger sensing system is designed to turn on the front outboard passenger frontal airbag and knee airbag anytime the system senses that a person of adult size is sitting properly in the front outboard passenger seat. When the passenger sensing system has allowed the airbags to be enabled, the ON indicator will light and stay lit as a reminder that the airbags are active.

For some children, including children in child restraints, and for very small adults, the passenger sensing system may or may not turn off the front outboard passenger frontal airbag and knee airbag, depending upon the person's seating posture and body build. Everyone in the vehicle who has

outgrown child restraints should wear a seat belt properly — whether or not there is an airbag for that person.

**Warning**

If the airbag readiness light ever comes on and stays on, it means that something may be wrong with the airbag system. To help avoid injury to yourself or others, have the vehicle serviced right away. See *Airbag Readiness Light* ⇨ 82 for more information, including important safety information.

**If the On Indicator Is Lit for a Child Restraint**

The passenger sensing system is designed to turn off the front outboard passenger frontal airbag and knee airbag if the system determines that an infant is present in a child restraint. If a child restraint has been installed and the ON indicator is lit:

1. Turn the vehicle off.
2. Remove the child restraint from the vehicle.
3. Remove any additional items from the seat such as blankets, cushions, seat covers, seat heaters, or seat massagers.

4. Reinstall the child restraint following the directions provided by the child restraint manufacturer and refer to *Securing Child Restraints (With the Seat Belt in the Rear Seat)* ⇨ 63 or *Securing Child Restraints (With the Seat Belt in the Front Seat)* ⇨ 65.

Make sure the seat belt retractor is locked by pulling the shoulder belt all the way out of the retractor when installing the child restraint, even if the child restraint is equipped with a seat belt lock off. When the retractor lock is set, the belt can be tightened but not pulled out of the retractor.

5. If, after reinstalling the child restraint and restarting the vehicle, the ON indicator is still lit, turn the vehicle off. Then slightly recline the vehicle seatback and adjust the seat cushion, if adjustable, to make sure that the vehicle seatback is not pushing the child restraint into the seat cushion. Also make sure the child restraint is not trapped under the vehicle head restraint. If this happens, adjust the head restraint. See *Head Restraints* ⇨ 24.
6. Restart the vehicle.

The passenger sensing system may or may not turn off the airbags for a child in a child restraint depending upon the child's size. It is better to secure the child restraint in a rear seat. Consider using another vehicle to transport the child when a rear seat is not available. Never put a rear-facing child restraint in the front seat, even if the ON indicator is not lit.

### If the Off Indicator Is Lit for an Adult-Sized Occupant



If a person of adult size is sitting in the front outboard passenger seat, but the OFF indicator is lit, it could be because that person is not sitting properly in the seat or that the child restraint locking feature is

engaged. Use the following steps to allow the system to detect that person and enable the front outboard passenger frontal airbag and knee airbag:

1. Turn the vehicle off.
2. Remove any additional material from the seat, such as blankets, cushions, seat covers, seat heaters, or seat massagers.
3. Place the seatback in the fully upright position.
4. Have the person sit upright in the seat, centered on the seat cushion, with legs comfortably extended.
5. If the shoulder portion of the belt is pulled out all the way, the child restraint locking feature will be engaged. This may unintentionally cause the passenger sensing system to turn the airbag off for some adult-sized occupants. If this happens, unbuckle the belt and let the belt go back all the way, and then buckle the belt again without pulling the belt out all the way.
6. Restart the vehicle and have the person remain in this position for two to three minutes after the ON indicator is lit.

 **Warning**

If the front outboard passenger airbag is turned off for an adult-sized occupant, the airbag will not be able to inflate and help protect that person in a crash, resulting in an increased risk of serious injury or even death. An adult-sized occupant should not ride in the front outboard passenger seat, if the passenger airbag OFF indicator is lit.

**Additional Factors Affecting System Operation**

Seat belts help keep the passenger in position on the seat during vehicle maneuvers and braking, which helps the passenger sensing system maintain the passenger airbag status. See “Seat Belts” and “Child Restraints” in the Index for additional information about the importance of proper restraint use.

A thick layer of additional material, such as a blanket or cushion, or aftermarket equipment such as seat covers, seat heaters, and seat massagers can affect how well the passenger sensing system operates. We recommend that you not use seat covers or other aftermarket equipment except when

approved by GM for your specific vehicle. See *Adding Equipment to the Airbag-Equipped Vehicle* ⇨ 46 for more information about modifications that can affect how the system operates.

The ON indicator may be lit if an object, such as a briefcase, handbag, grocery bag, laptop, or other electronic device is put on an unoccupied seat. If this is not desired, remove the object from the seat.

 **Warning**

Stowing articles under the passenger seat or between the passenger seat cushion and seatback may interfere with the proper operation of the passenger sensing system.

**Servicing the Airbag-Equipped Vehicle**

Airbags affect how the vehicle should be serviced. There are parts of the airbag system in several places around the vehicle. Your dealer and the service manual have information about servicing the vehicle and the airbag system. To purchase a service manual, see *Publication Ordering Information* ⇨ 292.

 **Warning**

For up to 10 seconds after the vehicle is turned off and the 12-volt battery is disconnected, an airbag can still inflate during improper service. You can be injured if you are close to an airbag when it inflates. Avoid yellow connectors. They are probably part of the airbag system. Be sure to follow proper service procedures, and make sure the person performing work for you is qualified to do so.

**Adding Equipment to the Airbag-Equipped Vehicle**

Adding accessories that change the vehicle's frame, bumper system, height, front end, or side sheet metal may keep the airbag system from working properly.

The operation of the airbag system can also be affected by changing, including improperly repairing or replacing, any parts of the following:

- Airbag system, including airbag modules, front or side impact sensors, sensing and diagnostic module, or airbag wiring

- Front seats, including stitching, seams or zippers
- Seat belts
- Steering wheel, instrument panel, overhead console, ceiling trim, or pillar garnish trim
- Inner door seals, including speakers

Your dealer and the service manual have information about the location of the airbag modules and sensors, sensing and diagnostic module, and airbag wiring along with the proper replacement procedures.

In addition, the vehicle has a passenger sensing system for the front outboard passenger position, which includes sensors that are part of the passenger seat. The passenger sensing system may not operate properly if the original seat trim is replaced with non-GM covers, upholstery, or trim; or with GM covers, upholstery, or trim designed for a different vehicle. Any object, such as an aftermarket seat heater or a comfort-enhancing pad or device, installed under or on top of the seat fabric, could also interfere with the operation of the passenger sensing system. This could either prevent proper deployment of the passenger airbag(s) or prevent the passenger sensing

system from properly turning off the passenger airbag(s). See *Passenger Sensing System* ⇨ 43.

If the vehicle has rollover roof-rail airbags, see *Different Size Tires and Wheels* ⇨ 250 for additional important information.

If the vehicle must be modified because you have a disability and have questions about whether the modifications will affect the vehicle's airbag system, or if you have questions about whether the airbag system will be affected if the vehicle is modified for any other reason, call Customer Assistance. See *Customer Assistance Offices* ⇨ 286.

### Airbag System Check

The airbag system does not need regularly scheduled maintenance or replacement. Make sure the airbag readiness light is working. See *Airbag Readiness Light* ⇨ 82.

#### Caution

If an airbag covering is damaged, opened, or broken, the airbag may not work properly. Do not open or break the airbag coverings. If there are any opened or broken airbag coverings, have the airbag  
(Continued)

#### Caution (Continued)

covering and/or airbag module replaced. For the location of the airbags, see *Where Are the Airbags?* ⇨ 39. See your dealer for service.

### Replacing Airbag System Parts after a Crash

#### Warning

A crash can damage the airbag systems in the vehicle. A damaged airbag system may not properly protect you and your passenger(s) in a crash, resulting in serious injury or even death. To help make sure the airbag systems are working properly after a crash, have them inspected and any necessary replacements made as soon as possible.

If an airbag inflates, you will need to replace airbag system parts. See your dealer for service.



If the airbag readiness light stays on after the vehicle is started or comes on when you are driving, the airbag system may not work properly. Have the vehicle serviced right away. See *Airbag Readiness Light* ⇨ 82.

## Child Restraints

### Older Children

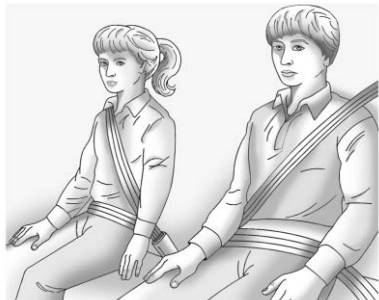

Older children who have outgrown booster seats should wear the vehicle's seat belts.

The manufacturer instructions that come with the booster seat state the weight and height limitations for that booster. Use a booster seat with a lap-shoulder belt until the child passes the fit test below:

- Sit all the way back on the seat. Do the knees bend at the seat edge? If yes, continue. If no, return to the booster seat.
- Buckle the lap-shoulder belt. Does the shoulder belt rest on the shoulder? If yes, continue. If no, try using the rear seat belt comfort guide, if available. See “Rear Seat Belt Comfort Guides” under *Lap-Shoulder Belt* ⇨ 34. If a comfort guide is not available, or if the shoulder belt still does not rest on the shoulder, then return to the booster seat.
- Does the lap belt fit low and snug on the hips, touching the thighs? If yes, continue. If no, return to the booster seat.
- Can proper seat belt fit be maintained for the length of the trip? If yes, continue. If no, return to the booster seat.

**Q: What is the proper way to wear seat belts?**

**A:** An older child should wear a lap-shoulder belt and get the additional restraint a shoulder belt can provide. The shoulder belt should not cross the face or neck. The lap belt should fit snugly below the hips, just touching the top of the thighs. This applies belt force to the child's pelvic bones in a crash. It should never be worn over the abdomen, which could cause severe or even fatal internal injuries in a crash.

Also see “Rear Seat Belt Comfort Guides” under *Lap-Shoulder Belt* ⇨ 34.

According to accident statistics, children are safer when properly restrained in a rear seating position.

In a crash, children who are not buckled up can strike other people who are buckled up, or can be thrown out of the vehicle. Older children need to use seat belts properly.

#### Warning

Never allow more than one child to wear the same seat belt. The seat belt cannot properly spread the impact forces. In a  
(Continued)

**Warning (Continued)**

crash, they can be crushed together and seriously injured. A seat belt must be used by only one person at a time.

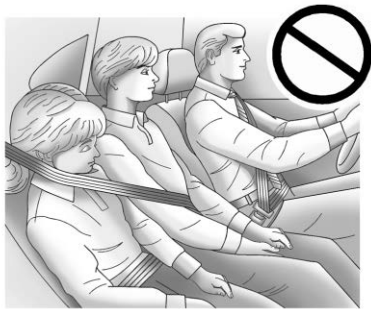

**Warning**

Never allow a child to wear the seat belt shoulder belt under both arms or behind their back. A child can be seriously injured by not wearing the lap-shoulder belt properly. In a crash, the child would not be restrained by the shoulder belt. The child could move too far forward increasing the chance of head and neck  
(Continued)

**Warning (Continued)**

injury. The child might also slide under the lap belt. The belt force would then be applied right on the abdomen. That could cause serious or fatal injuries. The shoulder belt should go over the shoulder and across the chest.



**Infants and Young Children**

Everyone in a vehicle needs protection! This includes infants and all other children. Neither the distance traveled nor the age and size of the traveler changes the need, for everyone, to use safety restraints. In fact, the law in every state in the United

States and in every Canadian province says children up to some age must be restrained while in a vehicle.

**Warning**

Children can be seriously injured or killed if the shoulder belt is worn behind their back, under their legs, or wrapped around their neck. The shoulder belt can tighten but cannot be loosened if it is locked. The shoulder belt locks when it is pulled all the way out of the retractor. It unlocks when the shoulder belt is allowed to go all the way back into the retractor, but it cannot do this if it is wrapped around the child. Never leave children unattended in a vehicle and never allow children to improperly wear, or play with, the seat belts.

Every time infants and young children ride in vehicles, they should have the protection provided by appropriate child restraints. Neither the vehicle's seat belt system nor its airbag system is designed for them.

Children who are not restrained properly can strike other people, or can be thrown out of the vehicle.

**⚠ Warning**

Never hold an infant or a child while riding in a vehicle. Due to crash forces, an infant or a child will become so heavy it is not possible to hold it during a crash. For example, in a crash at only 40 km/h (25 mph), a 5.5 kg (12 lb) infant will suddenly become a 110 kg (240 lb) force on a person's arms. An infant or child should be secured in an appropriate child restraint.

**⚠ Warning**

Children who are up against, or very close to, any airbag when it inflates can be seriously injured or killed. Never put a rear-facing child restraint in the front outboard seat. Secure a rear-facing child restraint in a rear seat. It is also better to secure a forward-facing child restraint in a rear seat. If you must secure a forward-facing child restraint in the front outboard seat, always move the front passenger seat as far back as it will go.



Child restraints are devices used to restrain, seat, or position children in the vehicle and are sometimes called child seats or car seats.

There are three basic types of child restraints:

- Forward-facing child restraints
- Rear-facing child restraints
- Belt-positioning booster seats

The proper child restraint for your child depends on their size, weight, and age, and also on whether the child restraint is compatible with the vehicle in which it will be used.

For each type of child restraints, there are many different models available. When purchasing a child restraint, be sure it is designed to be used in a motor vehicle and is certified to comply with US Federal or Canadian Motor Vehicle Safety Standards. If it is, the child restraint will have a label saying that it meets federal motor vehicle safety standards. The NHTSA website includes a list of registered car seat manufacturers (<https://www.nhtsa.gov>) and links to their registration pages for consumers. Registration helps manufacturers identify purchasers for recall notices.

The instruction manual that is provided with the child restraint states the weight and height limitations for that particular child

restraint. In addition, there are many kinds of child restraints available for children with special needs.

### Warning

To reduce the risk of neck and head injury in a crash, infants and toddlers should be secured in a rear-facing child restraint until age two, or until they reach the maximum height and weight limits of their child restraint.

### Warning

A young child's hip bones are still so small that the vehicle seat belt may not remain low on the hip bones, as it should. Instead, it may settle up around the child's abdomen. In a crash, the belt would apply force on a body area that is unprotected by any bony structure. This alone could cause serious or fatal injuries. To reduce the risk of serious or fatal injuries during a crash, young children should always be secured in an appropriate child restraint.

## Child Restraint Systems



### Rear-Facing Infant Restraint

A rear-facing child restraint provides restraint with the seating surface against the back of the infant.

The harness system holds the infant in place and, in a crash, acts to keep the infant positioned in the restraint.



### Forward-Facing Child Restraint

A forward-facing child restraint provides restraint for the child's body with the harness.

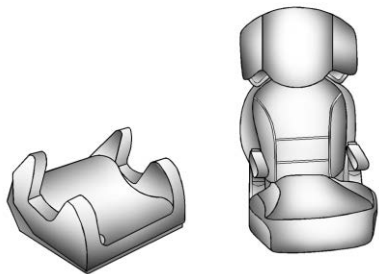

**Booster Seats**

A belt-positioning booster seat is used for children who have outgrown their forward-facing child restraint. Boosters are designed to improve the fit of the vehicle's seat belt system until the child is large enough for the vehicle seat belts to fit properly without a booster seat. See the seat belt fit test in *Older Children* ⇨ 48.

### Securing an Add-On Child Restraint in the Vehicle

#### **Warning**

A child can be seriously injured or killed in a crash if the child restraint is not properly secured in the vehicle. Secure the child restraint properly in the vehicle using the vehicle seat belt or LATCH system, following the instructions that came with that child restraint and the instructions in this manual.

To help reduce the chance of injury, the child restraint must be secured in the vehicle. Child restraints must be secured in vehicle seats by lap belts or the lap belt portion of a lap-shoulder belt, or by the LATCH system. See *Lower Anchors and Tethers for Children (LATCH System)* ⇨ 54 for more information. Never use a seat belt extender when installing a child restraint. Use only seats and related equipment that are certified to comply with US Federal or Canadian Motor Vehicle Safety Standards to secure a child restraint. Children can be endangered in a crash if the child restraint is not properly secured in the vehicle.

When securing an add-on child restraint, refer to the following:

1. Instruction labels provided on the child restraint
2. Instruction manual provided with the child restraint
3. This vehicle owner's manual

The child restraint instructions are important, so if they are not available, obtain a replacement copy from the manufacturer.

Keep in mind that an unsecured child restraint can move around in a collision or sudden stop and injure people in the vehicle. Be sure to properly secure any child restraint in the vehicle — even when no child is in it.

In some areas Certified Child Passenger Safety Technicians (CPSTs) are available to inspect and demonstrate how to correctly use and install child restraints. In the U.S., refer to the National Highway Traffic Safety Administration (NHTSA) website to locate the nearest child safety seat inspection station. For CPST availability in Canada, check with Transport Canada or the Provincial Ministry of Transportation office.

## Securing the Child Within the Child Restraint

### Warning

A child can be seriously injured or killed in a crash if the child is not properly secured in the child restraint. Secure the child properly following the instructions that came with that child restraint.

## Where to Put the Restraint

According to accident statistics, children and infants are safer when properly restrained in an appropriate child restraint secured in a rear seating position.

Whenever possible, children aged 12 and under should be secured in a rear seating position.

Never put a rear-facing child restraint in the front. This is because the risk to the rear-facing child is so great if the airbag deploys.

### Warning

A child in a rear-facing child restraint can be seriously injured or killed if the front passenger airbag inflates. This is because the back of the rear-facing child restraint would be very close to the inflating airbag. A child in a forward-facing child restraint can be seriously injured or killed if the front passenger airbag inflates and the passenger seat is in a forward position.

Even if the passenger sensing system has turned off the front passenger frontal airbag, no system is fail-safe. No one can guarantee that an airbag will not deploy under some unusual circumstance, even though it is turned off.

Secure rear-facing child restraints in a rear seat, even if the airbag is off. If you secure a forward-facing child restraint in the front seat, always move the front passenger seat as far back as it will go. It is better to secure the child restraint in a rear seat.

See *Passenger Sensing System* ⇨ 43 for additional information.

If the vehicle does not have a rear seat that will accommodate a rear-facing child restraint, a rear-facing child restraint should not be installed in the vehicle, even if the airbag is off.

When securing a child restraint with the seat belts in a rear seat position, study the instructions that came with the child restraint to make sure it is compatible with this vehicle.

Child restraints and booster seats vary considerably in size, and some may fit in certain seating positions better than others. Do not install a child restraint in any rear seating position where it cannot be installed securely.

Depending on where you place the child restraint and the size of the child restraint, you may not be able to access adjacent seat belts or LATCH anchors for additional passengers or child restraints. Adjacent seating positions should not be used if the child restraint prevents access to or interferes with the routing of the seat belt.

The seat in front of an installed child restraint should be adjusted to ensure proper installation according to the child restraint manual.

Wherever a child restraint is installed, be sure to follow the instructions that came with the child restraint and secure the child restraint properly.

Keep in mind that an unsecured child restraint can move around in a collision or sudden stop and injure people in the vehicle. Be sure to properly secure any child restraint in the vehicle — even when no child is in it.

### **Lower Anchors and Tethers for Children (LATCH System)**

The LATCH system secures a child restraint during driving or in a crash. LATCH attachments on the child restraint are used to attach the child restraint to the anchors in the vehicle. The LATCH system is designed to make installation of a child restraint easier.

In order to use the LATCH system in your vehicle, you need a child restraint that has LATCH attachments. LATCH-compatible rear-facing and forward-facing child seats can be properly installed using either the LATCH anchors or the vehicle's seat belts. Do not use both the seat belts and the LATCH anchorage system to secure a rear-facing or forward-facing child seat.

Booster seats use the vehicle's seat belts to secure the child and the booster seat. If the manufacturer recommends that the booster seat be secured with the LATCH system, this can be done as long as the booster seat can be positioned properly and there is no interference with the proper positioning of the lap-shoulder belt on the child.

Make sure to follow the instructions that came with the child restraint, and also the instructions in this manual.

When installing a child restraint with a top tether, you must also use either the lower anchors or the seat belts to properly secure the child restraint. A child restraint must never be installed using only the top tether and anchor.

For a forward-facing 5-pt harness child restraint where the combined weight of the child and restraint are up to 29.5 kg (65 lb), use either the lower LATCH anchorages with the top tether anchorage, or the seat belt with the top tether anchorage. Where the combined weight of the child and restraint are greater than 29.5 kg (65 lb), use the seat belt with the top tether anchorage only.

**Recommended Methods for Attaching Child Restraints**

Restraint Type	Combined Weight of the Child + Child Restraint	Use Only Approved Attachment Methods Shown with an X			
		LATCH – Lower Anchors Only	Seat Belt Only	LATCH – Lower Anchors and Top Tether Anchor	Seat Belt and Top Tether Anchor
Rear-Facing Child Restraint	Up to 29.5 kg (65 lb)	X	X		
Rear-Facing Child Restraint	Greater than 29.5 kg (65 lb)		X		
Forward-Facing Child Restraint	Up to 29.5 kg (65 lb)			X	X
Forward-Facing Child Restraint	Greater than 29.5 kg (65 lb)				X

See *Securing Child Restraints (With the Seat Belt in the Rear Seat)* ⇨ 63 or *Securing Child Restraints (With the Seat Belt in the Front Seat)* ⇨ 65.

Child restraints built after March 2014 will be labeled with the specific child weight up to which the LATCH system can be used to install the restraint.

The following explains how to attach a child restraint with these attachments in the vehicle.

Not all vehicle seating positions have lower anchors. In this case, the seat belt must be used (with top tether where available) to secure the child restraint. See *Securing Child Restraints (With the Seat Belt in the Rear Seat)* ⇨ 63 or *Securing Child Restraints (With the Seat Belt in the Front Seat)* ⇨ 65.



## Lower Anchors

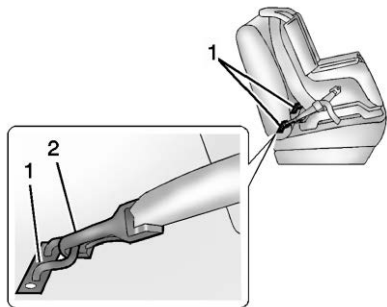

Lower anchors (1) are metal bars built into the vehicle. There are two lower anchors for each LATCH seating position that will accommodate a child restraint with lower attachments (2).

## Top Tether Anchor

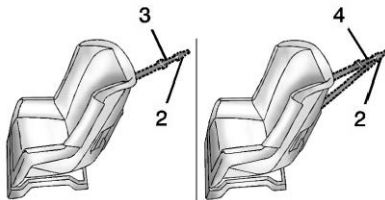

A top tether (3, 4) is used to secure the top of the child restraint to the vehicle. A top tether anchor is built into the vehicle. The top tether attachment hook (2) on the child restraint connects to the top tether anchor in the vehicle in order to reduce the forward movement and rotation of the child restraint during driving or in a crash.

The child restraint may have a single tether (3) or a dual tether (4). Either will have a single attachment hook (2) to secure the top tether to the anchor.

Some child restraints with top tether are designed for use with or without the top tether being attached. Others require the top tether always to be attached. In Canada, the law requires that forward-facing child restraints have a top tether, and that the tether be attached. Be sure to read and follow the instructions for your child restraint.

## Lower Anchor and Top Tether Anchor Locations

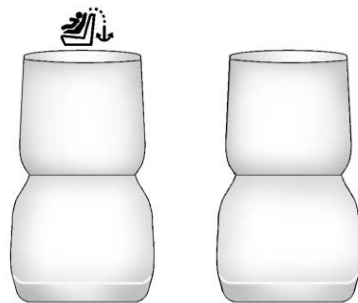

Rear Seat Delete Model

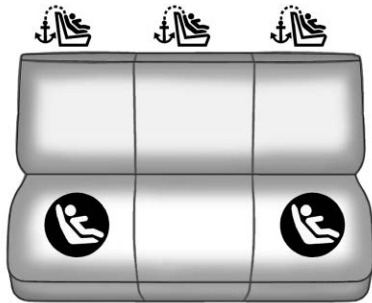

Sedan Models

 : Seating positions with top tether anchors.

 : Seating positions with two lower anchors.



To assist in locating the lower anchors, each seating position with lower anchors has two labels, near the crease between the seatback and the seat cushion.



The outboard lower anchors are behind the vertical openings in the rear seat trim.



To assist in locating the top tether anchors on sedan models, the top tether anchor symbol is on the trim near the anchor.

For sedan models, the top tether anchors are behind the rear seats.

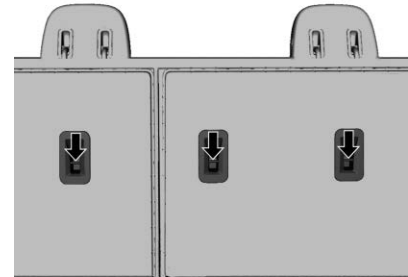

Sedan Model

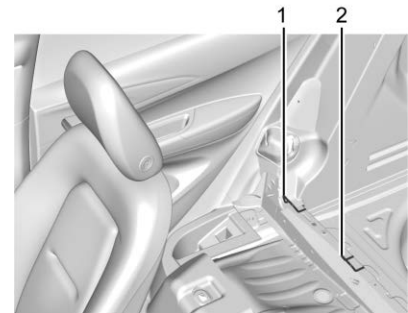

Rear Seat Delete Model

For rear seat delete models, the top tether anchors (1, 2) are located on the rear floor behind the passenger seat.



To assist in locating the top tether anchors on rear seat delete models, the top tether anchor symbol is near the anchor. The top tether anchors may be covered. If the top tether anchors are covered, the top tether anchor symbol is on the cover.



Do not attach the top tether to this location. Use only the approved top tether anchors identified previously in this section.

Be sure to use an anchor located directly behind the seating position where the child restraint will be placed.

Do not secure a child restraint in a position without a top tether anchor if a national or local law requires that the top tether be attached, or if the instructions that come with the child restraint say that the top tether must be attached.

According to accident statistics, children and infants are safer when properly restrained in a child restraint system or infant restraint system secured in a rear seating position. See *Where to Put the Restraint* ⇨ 53 for additional information.

### Securing a Child Restraint Designed for the LATCH System

#### Warning

A child could be seriously injured or killed in a crash if the child restraint is not properly attached to the vehicle using either the LATCH anchors or the vehicle

(Continued)

#### Warning (Continued)

seat belt. Follow the instructions that came with the child restraint and the instructions in this manual.

#### Warning

To reduce the risk of serious or fatal injuries during a crash, do not attach more than one child restraint to a single anchor. Attaching more than one child restraint to a single anchor could cause the anchor or attachment to come loose or even break during a crash. A child or others could be injured.

#### Warning

Children can be seriously injured or strangled if a shoulder belt is wrapped around their neck. The shoulder belt can tighten but cannot be loosened if it is locked. The shoulder belt locks when it is pulled all the way out of the retractor. It unlocks when the shoulder belt is allowed to go all the way back into the

(Continued)

**Warning (Continued)**

retractor, but it cannot do this if it is wrapped around a child's neck. If the shoulder belt is locked and tightened around a child's neck, the only way to loosen the belt is to cut it.

Buckle any unused seat belts behind the child restraint so children cannot reach them. Pull the shoulder belt all the way out of the retractor to set the lock, and tighten the belt behind the child restraint after the child restraint has been installed.

**Caution**

Do not let the LATCH attachments rub against the vehicle's seat belts. This may damage these parts. If necessary, move buckled seat belts to avoid rubbing the LATCH attachments.

Do not fold the rear seatback when the seat is occupied. Do not fold the empty rear seat with a seat belt buckled. This  
(Continued)

**Caution (Continued)**

could damage the seat belt or the seat. Unbuckle and return the seat belt to its stowed position, before folding the seat.

If you need to secure more than one child restraint in the rear seat, see *Where to Put the Restraint* ⇨ 53 for additional information.

**Rear Seat Delete Model**

1. For models without a rear seat, forward-facing child restraints should only be installed in the right front seating position with the seat belt and a top tether. See *Securing Child Restraints (With the Seat Belt in the Rear Seat)* ⇨ 63 or *Securing Child Restraints (With the Seat Belt in the Front Seat)* ⇨ 65.

If the child restraint manufacturer recommends that the top tether be attached, attach and tighten the top tether to the top tether anchor, if your vehicle has one. Refer to the child restraint instructions and the following steps:

- 1.1. Find the top tether anchor.

- 1.2. Route, attach, and tighten the top tether according to your child restraint instructions and the following instructions:

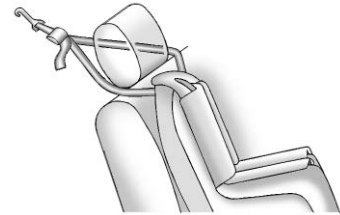

If the position you are using has an adjustable head restraint and you are using a dual tether, route the tether around the head restraint.

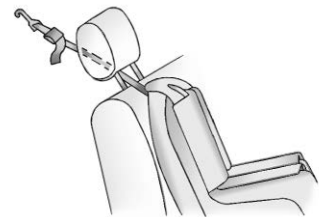

If the position you are using has an adjustable head restraint and you are using a single tether, raise the

head restraint and route the tether under the head restraint and in between the head restraint posts.

2. Secure the child restraint in the right front seating position with the vehicle belts. See *Securing Child Restraints (With the Seat Belt in the Rear Seat)* ⇨ 63 or *Securing Child Restraints (With the Seat Belt in the Front Seat)* ⇨ 65.
3. Before placing a child in the child restraint, make sure it is securely held in place. To check, grasp the child restraint at the belt path and attempt to move it side to side and back and forth. There should be no more than 2.5 cm (1 in) of movement for proper installation.

#### Sedan Models

1. Attach and tighten the lower attachments to the lower anchors. If the child restraint does not have lower attachments or the desired seating position does not have lower anchors, secure the child restraint with the top tether and the seat belt. Refer to the child restraint manufacturer instructions and the instructions in this manual.
  - 1.1. Find the lower anchors for the desired seating position.

- 1.2. Put the child restraint on the seat. For rear outboard seating positions, if the head restraint interferes with the proper installation of the child restraint, the head restraint may be removed. See “Head Restraint Removal and Reinstallation” at the end of this section.

When installing a rear-facing child restraint, it may be necessary to move the front seat forward to properly install the child restraint per the child restraint manufacturer instructions.

- 1.3. Attach and tighten the lower attachments on the child restraint to the lower anchors.
2. If the child restraint manufacturer recommends that the top tether be attached, attach and tighten the top tether to the top tether anchor, if equipped. Refer to the child restraint instructions and the following steps:
  - 2.1. Find the top tether anchor.
  - 2.2. Remove the cargo cover before installing the top tether. Place the cargo cover in its original location after installing your child restraint when the head restraint is removed.

- 2.3. Route, attach, and tighten the top tether according to your child restraint instructions and the following instructions:

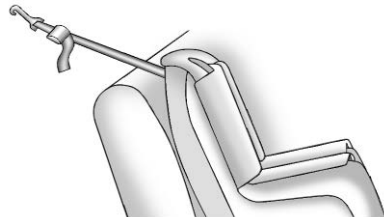

If the position you are using does not have a headrest or head restraint and you are using a single tether, route the tether over the seatback.

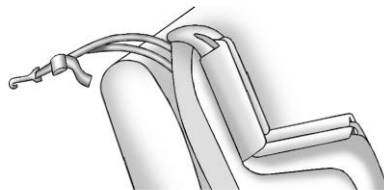

If the position you are using does not have a headrest or head restraint and you are using a dual tether, route the tether over the seatback.

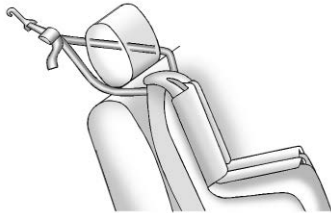

If the position you are using has an adjustable headrest or head restraint and you are using a dual tether, raise the headrest or head restraint and route the tether under the headrest or head restraint and around the headrest or head restraint posts.

If the child restraint is installed next to a center seat, make sure the top tether does not interfere with the center seating position shoulder belt/retractor. If it does, find another suitable seating position to install the child restraint.

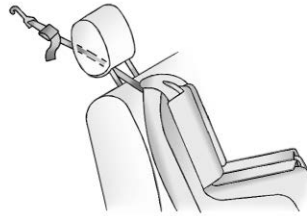

If the position you are using has an adjustable headrest or head restraint and you are using a single tether, raise the headrest or head restraint and route the tether under the headrest or head restraint and in between the headrest or head restraint posts.

3. Before placing a child in the child restraint, make sure it is securely held in place. To check, grasp the child restraint at the LATCH path and attempt to move it side to side and back and forth. There should be no more than 2.5 cm (1 in) of movement for proper installation.

## Head Restraint Removal and Reinstallation

The rear outboard head restraints can be removed if they interfere with the proper installation of the child restraint.

To remove the head restraint:

1. Partially fold the seatback forward. See *Rear Seats* ⇨ 30 for additional information.

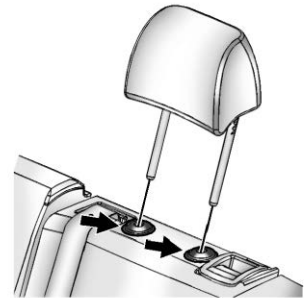

2. Press both buttons on the head restraint posts at the same time, and pull up on the head restraint.
3. Store the head restraint in a secure place.

- When the child restraint is removed, reinstall the head restraint before the seating position is used.

**Warning**

With head restraints that are not installed and adjusted properly, there is a greater chance that occupants will suffer a neck/spinal injury in a crash. Do not drive until the head restraints for all occupants are installed and adjusted properly.

To reinstall the head restraint:

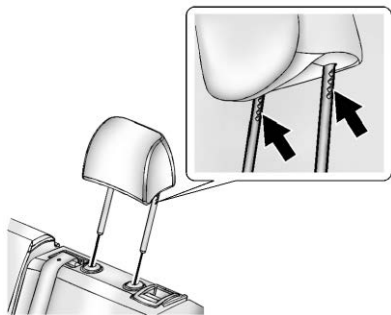

- Partially fold the seatback forward. See *Rear Seats* ⇨ 30.

- Insert the head restraint posts into the holes in the top of the seatback. The notches on the posts must face the driver side of the vehicle.
- Push the head restraint down. If necessary, press the height adjustment release button to further lower the head restraint. See *Head Restraints* ⇨ 24.



- Return the head restraint to the full upright position if folded. Pull the head restraint up and forward until it locks into place.
- Try to move the head restraint in all directions to make sure that it is locked in place.

Always adjust the head restraint so that the top of the restraint is at the same height as the top of the occupant's head. See *Head Restraints* ⇨ 24.

## Replacing LATCH System Parts After a Crash

**Warning**

A crash can damage the LATCH system in the vehicle. A damaged LATCH system may not properly secure the child restraint, resulting in serious injury or even death in a crash. To help make sure the LATCH system is working properly after a crash, see your dealer to have the system inspected and any necessary replacements made as soon as possible.

If the vehicle has the LATCH system and it was being used during a crash, new LATCH system parts may be needed.

New parts and repairs may be necessary even if the LATCH system was not being used at the time of the crash.

## Securing Child Restraints (With the Seat Belt in the Rear Seat)

When securing a child restraint in a rear seating position, study the instructions that came with the child restraint to make sure it is compatible with this vehicle.

If the child restraint has the LATCH system, see *Lower Anchors and Tethers for Children (LATCH System)* ⇨ 54 for how and where to install the child restraint using LATCH. If a child restraint is secured in the vehicle using a seat belt and it uses a top tether, see *Lower Anchors and Tethers for Children (LATCH System)* ⇨ 54 for top tether anchor locations.

Do not secure a child restraint in a position without a top tether anchor if a national or local law requires that the top tether be anchored, or if the instructions that come with the child restraint say that the top tether must be anchored.

In Canada, the law requires that forward-facing child restraints have a top tether, and that the tether be attached.

If the child restraint or vehicle seat position does not have the LATCH system, you will be using the seat belt to secure the child restraint. Be sure to follow the instructions that came with the child restraint.

If more than one child restraint needs to be installed in the rear seat, be sure to read *Where to Put the Restraint* ⇨ 53.

1. Put the child restraint on the seat.

If the head restraint interferes with the proper installation of the child restraint, the head restraint may be removed. See “Head Restraint Removal and Reinstallation” under *Lower Anchors and Tethers for Children (LATCH System)* ⇨ 54.

2. Pick up the latch plate, and run the lap and shoulder portions of the vehicle seat belt through or around the restraint. The child restraint instructions will show you how.

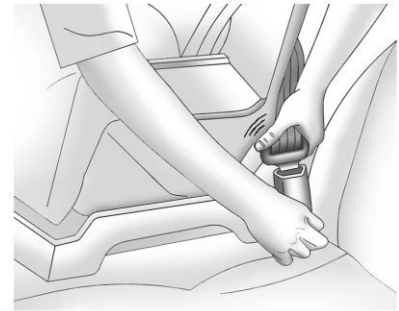

3. Push the latch plate into the buckle until it clicks.

Position the release button on the buckle, away from the child restraint, so that the seat belt could be quickly unbuckled if necessary.

The push button used to release the latch plate must be visible and not obscured by the child restraint. There must not be direct contact of the child restraint to the push button.





4. Pull the shoulder belt all the way out of the retractor to set the lock. When the retractor lock is set, the belt can be tightened but not pulled out of the retractor.

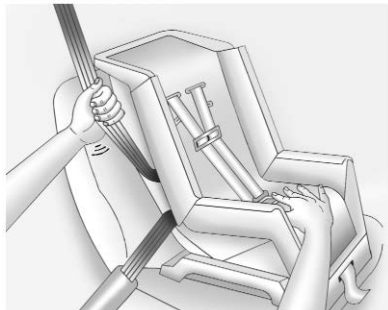

5. To tighten the belt, push down on the child restraint, pull the shoulder portion of the belt to tighten the lap portion of the belt, and feed the shoulder belt back into the retractor. When installing a forward-facing child restraint, it may be helpful to use your knee to push down on the child restraint as you tighten the belt.

Try to pull the belt out of the retractor to make sure the retractor is locked. If the retractor is not locked, repeat Steps 4 and 5.

6. If the child restraint has a top tether, follow the child restraint manufacturer's instructions regarding the use of the top tether. See *Lower Anchors and Tethers for Children (LATCH System)* ⇨ 54.
7. Before placing a child in the child restraint, make sure it is securely held in place. To check, grasp the child restraint at the seat belt path and attempt to move it side to side and back and forth. When the child restraint is properly installed, there should be no more than 2.5 cm (1 in) of movement.

To remove the child restraint, unbuckle the vehicle seat belt and let it return to the stowed position. If the top tether is attached to a top tether anchor, disconnect it. If the head restraint was removed, reinstall it before the seating position is used. See "Head Restraint Removal and Reinstallation" under *Lower Anchors and Tethers for Children (LATCH System)* ⇨ 54 for additional information on installing the head restraint properly.

## Securing Child Restraints (With the Seat Belt in the Front Seat)

This vehicle has airbags. A rear seat is a safer place to secure a forward-facing child restraint. See *Where to Put the Restraint* ⇨ 53.

In addition, the vehicle has a passenger sensing system which is designed to turn off the front outboard passenger frontal airbag and knee airbag under certain conditions. See *Passenger Sensing System* ⇨ 43 and *Passenger Airbag Status Indicator* ⇨ 83 for more information, including important safety information.

Never put a rear-facing child seat in the front. This is because the risk to the rear-facing child is so great if the airbag deploys.

### Warning

A child in a rear-facing child restraint can be seriously injured or killed if the front outboard passenger frontal airbag inflates. This is because the back of the rear-facing child restraint would be very close to the inflating airbag. A child in a  
(Continued)

### Warning (Continued)

forward-facing child restraint can be seriously injured or killed if the front outboard passenger frontal airbag inflates and the passenger seat is in a forward position.

Even if the passenger sensing system has turned off the front outboard passenger airbag(s), no system is fail-safe. No one can guarantee that an airbag will not deploy under some unusual circumstance, even though the airbag(s) are off.

Secure rear-facing child restraints in a rear seat, even if the airbag(s) are off. If you secure a forward-facing child restraint in the front outboard passenger seat, always move the seat as far back as it will go. It is better to secure the child restraint in a rear seat.

See *Passenger Sensing System* ⇨ 43 for additional information.

If the vehicle does not have a rear seat that will accommodate a rear-facing child restraint, a rear-facing child restraint should not be installed in the vehicle, even if the airbag is off.

If the child restraint uses a top tether, see *Lower Anchors and Tethers for Children (LATCH System)* ⇨ 54 for top tether anchor locations.

Do not secure a child restraint in a position without a top tether anchor if a national or local law requires that the top tether be anchored, or if the instructions that come with the child restraint say that the top tether must be anchored.

In Canada, the law requires that forward-facing child restraints have a top tether, and that the tether be attached.

When using the lap-shoulder belt to secure the child restraint in this position, follow the instructions that came with the child restraint and the following instructions:

1. Move the seat as far back as it will go before securing the forward-facing child restraint. Move the seat upward or the seatback to an upright position, if needed, to get a tight installation of the child restraint.

The push button used to release the latch plate must be visible and not obscured by the child restraint. There must not be direct contact of the child restraint to the push button.

When the passenger sensing system has turned off the front outboard passenger frontal airbag and knee airbag, the OFF indicator on the passenger airbag status indicator should light and stay lit when you start the vehicle. See *Passenger Airbag Status Indicator* ⇨ 83.

2. Put the child restraint on the seat.
3. Pick up the latch plate, and run the lap and shoulder portions of the vehicle seat belt through or around the restraint. The child restraint instructions will show you how.

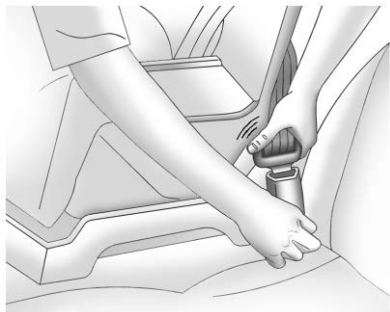

4. Push the latch plate into the buckle until it clicks.

Position the release button on the buckle, away from the child restraint, so that the seat belt could be quickly unbuckled if necessary.



5. Pull the shoulder belt all the way out of the retractor to set the lock. When the retractor lock is set, the belt can be tightened but not pulled out of the retractor.

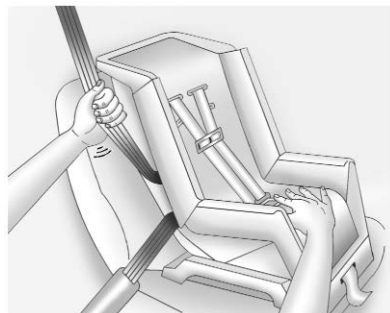

6. To tighten the belt, push down on the child restraint, pull the shoulder portion of the belt to tighten the lap portion of the belt, and feed the shoulder belt back into the retractor. When installing a forward-facing child restraint, it may be helpful to use your knee to push down on the child restraint as you tighten the belt.

Try to pull the belt out of the retractor to make sure the retractor is locked. If the retractor is not locked, repeat Steps 5 and 6.

7. If the vehicle does not have a rear seat and the child restraint manufacturer recommends using a top tether anchor, attach the top tether to the top tether anchor. Refer to the instructions that came with the child restraint and to *Lower Anchors and Tethers for Children (LATCH System)* ⇨ 54.
8. Before placing a child in the child restraint, make sure it is securely held in place. To check, grasp the child restraint at the seat belt path and attempt to move it side to side and back and forth. When the child restraint is properly installed, there should be no more than 2.5 cm (1 in) of movement.

If the airbags are off, the OFF indicator in the passenger airbag status indicator will come on and stay on when the vehicle is started.

If a child restraint has been installed and the ON indicator is lit, see “If the On Indicator Is Lit for a Child Restraint” under *Passenger Sensing System* ⇨ 43.

To remove the child restraint, unbuckle the vehicle seat belt and let it return to the stowed position. If the top tether is attached to a top tether anchor, disconnect it.

## Storage

### Storage Compartments

Storage Compartments .....	68
Glove Box .....	68
Cupholders .....	68
Center Console Storage .....	69

### Additional Storage Features

Cargo Cover .....	70
Cargo Management System .....	70

## Storage Compartments

### Warning

Do not store heavy or sharp objects in storage compartments. In a crash, these objects may cause the cover to open and could result in injury.

### Glove Box

Pull the handle up to open.

## Cupholders

The front cupholders are near the shift switch.



If equipped, lower the armrest to access the rear cupholders. The liner is removable for cleaning.

## Center Console Storage



There is storage in the center console. Pull up the latch and lift to open.

## Additional Storage Areas



There is a storage area under the center console.



There is a storage area in the center console under the climate controls.

## Additional Storage Features

### Cargo Cover

#### Warning

An unsecured cargo cover could strike people in a sudden stop or turn, or in a crash. Store the cargo cover securely or remove it from the vehicle.

If equipped, the cargo cover can be used to cover items in the rear of the vehicle.

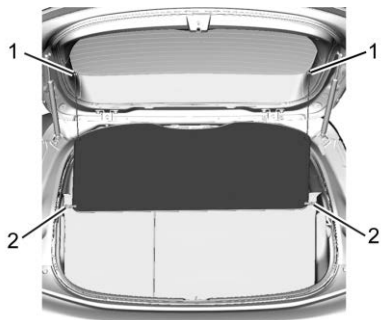

To remove the cargo cover:

1. Remove the cords from the hooks at the top of the liftgate (1).
2. Disconnect the loops from the hooks on the trim panel (2).

To install the cargo cover:

1. Attach the loops to the hooks on the trim panel (2).
2. Reconnect both of the cords to the hooks at the top of the liftgate (1).

### Cargo Management System

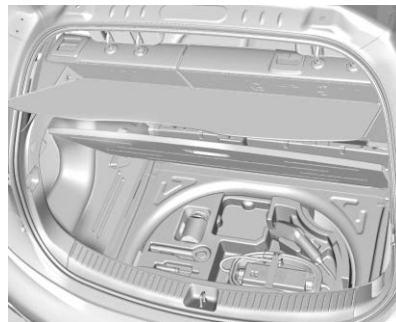

Pull up on the load floor cover to access the cargo management system, if equipped. There is a carpeted open storage area. Remove the carpet and the cover to access additional storage.

To close, lift the load floor cover and place it on the retainers. Push down on the load floor to secure it.

## Instruments and Controls

### Controls

Steering Wheel Adjustment .....	72
Steering Wheel Controls .....	72
Heated Steering Wheel .....	72
Horn .....	72
Pedestrian Safety Signal .....	72
Windshield Wiper/Washer .....	73
Rear Window Wiper/Washer .....	74
Compass .....	74
Clock .....	75
Power Outlets .....	75
Wireless Charging .....	75

### Warning Lights, Gauges, and Indicators

Warning Lights, Gauges, and Indicators .....	78
Instrument Cluster .....	78
Speedometer .....	80
Odometer .....	80
Trip Odometer .....	80
Battery Gauge (High Voltage) .....	80
Driver Efficiency Gauge .....	81
Power Indicator Gauge .....	81
Seat Belt Reminders .....	82
Airbag Readiness Light .....	82
Passenger Airbag Status Indicator .....	83
Charging System Light (12-Volt Battery) .....	83

Service Vehicle Soon Light .....	84
Brake System Warning Light .....	84
Electric Parking Brake Light .....	84
Service Electric Parking Brake Light .....	84
Antilock Brake System (ABS) Warning Light .....	85
Sport Mode Light .....	85
Lane Keep Assist (LKA) Light .....	85
Vehicle Ahead Indicator .....	86
Pedestrian Ahead Indicator .....	86
Traction Off Light .....	86
StabiliTrak OFF Light .....	86
Traction Control System (TCS)/StabiliTrak Light .....	87
Tire Pressure Light .....	87
Security Light .....	87
Vehicle Ready Light .....	87
One-Pedal Driving Light .....	88
High-Beam On Light .....	88
Lamps On Reminder .....	88
Cruise Control Light .....	88
Door Ajar Light .....	89

### Information Displays

Power Flows .....	89
Programmable Charging .....	89
Energy Information .....	97
Charging Options .....	98
Driver Information Center (DIC) .....	98

### Vehicle Messages

Vehicle Messages .....	100
Propulsion Power Messages .....	100
Vehicle Speed Messages .....	101

### Vehicle Personalization

Vehicle Personalization .....	101
-------------------------------	-----



## Controls

### Steering Wheel Adjustment



To adjust the steering wheel:

1. Pull the lever down.
2. Move the steering wheel up or down.
3. Pull or push the steering wheel closer or away from you.
4. Pull the lever up to lock the steering wheel in place.

Do not adjust the steering wheel while driving.

### Steering Wheel Controls

The infotainment system can be operated by using the steering wheel controls. See *Steering Wheel Controls* ⇨ 113.

### Heated Steering Wheel

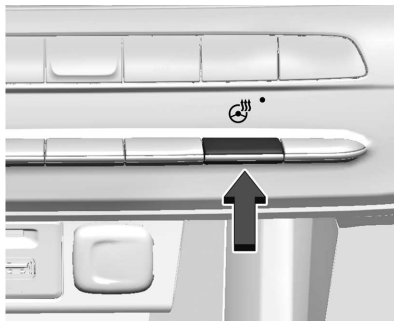

 : If equipped, press to turn on or off. An indicator light on the button displays when the feature is turned on.

The steering wheel takes about three minutes to start heating.

If equipped with a remote start heated steering wheel, the heated steering wheel will turn on automatically in remote start along with the heated seats when it is cold

outside. The heated steering wheel indicator light may not come on. See *Heated Front Seats* ⇨ 28.

### Horn

Press  on the steering wheel pad to sound the horn.

### Pedestrian Safety Signal

The vehicle is equipped with automatic sound generation.

The automatic sound is generated to indicate the vehicle presence to pedestrians.

#### United States

The sound changes if the vehicle is speeding up or slowing down. It is activated when the vehicle is shifted into a forward gear or R (Reverse), up to 33 km/h (20 mph).

#### Canada

The sound changes if the vehicle is speeding up or slowing down. It is activated when the vehicle is shifted into a forward gear or R (Reverse), up to 23 km/h (14 mph).

## Windshield Wiper/Washer

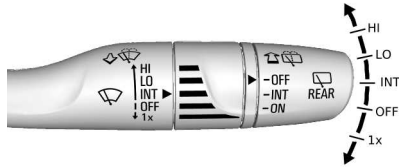

The windshield wiper/washer lever is on the side of the steering column. With the vehicle on or in Service Mode, move the windshield wiper lever to select the wiper speed.

**HI** : Use for fast wipes.

**LO** : Use for slow wipes.

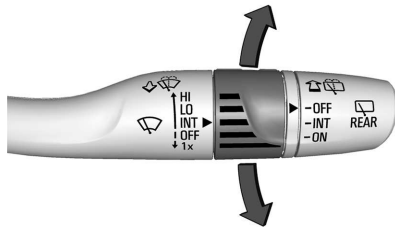

**INT** : If equipped with intermittent wipes, move the windshield wiper lever to INT. Turn the band up for more frequent wipes or down for less frequent wipes.

**OFF** : Use to turn the wipers off.

**1X** : For a single wipe, briefly move the lever down. For multiple wipes, hold the lever down.

Clear snow and ice from the wiper blades and windshield before using them. If frozen to the windshield, carefully loosen or thaw them. Damaged blades should be replaced. See *Wiper Blade Replacement* ⇨ 225.

Heavy snow or ice can overload the wiper motor. If the wiper motor overheats, the windshield wipers will stop until the motor cools and the wiper control is turned off. See *Electrical System Overload* ⇨ 230.

### Warning

In freezing weather, do not use the washer until the windshield is warmed. Otherwise the washer fluid can form ice on the windshield, blocking your vision.

### Warning

Before driving the vehicle, always clear snow and ice from the hood, windshield, washer nozzles, roof, and rear of the vehicle, including all lamps and windows. Reduced visibility from snow and ice buildup could lead to a crash.

### Wiper Parking

If the vehicle is turned off while the wipers are on LO, HI, or INT, they will immediately stop. If the windshield wiper lever is then moved to OFF before the driver door is opened or within 10 minutes, the wipers will restart and move to the base of the windshield. If the vehicle is turned off while the wipers are performing wipes due to windshield washing, the wipers continue to run until they reach the base of the windshield.

 : Pull the windshield wiper lever toward you to spray windshield washer fluid and activate the wipers.

The wipers will continue until the lever is released or the maximum wash time is reached. When the lever is released, additional wipes may occur depending on

how long the windshield washer had been activated. See *Washer Fluid* ⇨ 221 for information on filling the windshield washer fluid reservoir.

## Rear Window Wiper/Washer



The controls are on the end of the windshield wiper lever.

Move the control to:

**ON** : To turn on.

**OFF** : To turn off.

**INT** : To turn on intermittent rear wiper.



 : Push the windshield wiper lever forward to spray washer fluid on the rear window.

### Warning

In freezing weather, do not use the washer until the windshield is warmed. Otherwise the washer fluid can form ice on the windshield, blocking your vision.

### Auto Wipe in Reverse Gear

If the rear wiper control is off, the rear wiper will automatically operate continuously when the vehicle is in R (Reverse), and the front windshield wiper

is performing low or high speed wipes. If the rear wiper control is off, the vehicle is in R (Reverse), and the front windshield wiper is performing intermittent wipes, then the rear wiper automatically performs intermittent wipes.

This feature can be turned on or off. See *Vehicle Personalization* ⇨ 101.

The windshield washer reservoir is used for the windshield and the rear window. Check the fluid level in the reservoir if either washer is not working.

### Rear Wiper Arm Assembly Protection

Wiper operation returns to normal when the shift switch is no longer in N (Neutral) or the vehicle speed increases. The rear wiper will also stop when the liftgate is open.

When using an automatic car wash, move the rear wiper control to OFF to disable the rear wiper. If the shift switch is in N (Neutral) and the vehicle speed is very slow, the rear wiper will automatically stop at the base of the rear window.

## Compass

The vehicle has a compass display in the instrument cluster above the speedometer. The compass receives its heading and other

information from the Global Positioning System (GPS) antenna and vehicle speed information.

The compass system has automatic calibration and zone adjustment features.

Avoid covering the GPS antenna for long periods of time with objects that may interfere with the antenna's ability to receive a satellite signal. The compass system is designed to operate for a certain number of miles or degrees of turn before needing a signal from the GPS satellites. The compass system will automatically determine when a GPS signal is restored and provide a heading.

## Clock

Set the time and date using the infotainment system. See "Time / Date" under *Settings* ⇨ 132.

## Power Outlets

The accessory power outlet can be used to plug in electrical equipment, such as a mobile phone or MP3 player. The accessory power outlet only works with the vehicle turned on.

The vehicle has an accessory power outlet on the lower center stack below the climate control.

Open the cover to access and replace when not in use.

### Caution

Leaving electrical equipment plugged in for an extended period of time while the vehicle is off will drain the battery. Always unplug electrical equipment when not in use and do not plug in equipment that exceeds the maximum 20 amp rating.

Certain accessory power plugs may not be compatible with the accessory power outlet and could overload vehicle or adapter fuses. If a problem is experienced, see your dealer.

When adding electrical equipment, be sure to follow the proper installation instructions included with the equipment. See *Add-On Electrical Equipment* ⇨ 214.

### Caution

Hanging heavy equipment from the power outlet can cause damage not covered by the vehicle warranty. The power outlets are designed for accessory power plugs only, such as cell phone charge cords.

## Wireless Charging

If equipped, the vehicle has wireless charging in the bin below the climate control system. The system operates at 145 kHz and wirelessly charges one Qi compatible smartphone. The power output of the system is capable of charging at a rate up to 3 amp (15 W), as requested by the compatible smartphone. See *Radio Frequency Statement* ⇨ 293.

### Warning

Wireless charging may affect the operation of an implanted pacemaker or other medical devices. If you have one, it is recommended to consult with your doctor before using the wireless charging system.

The vehicle must be on, in Service Mode, or Retained Accessory Power (RAP) must be active. The wireless charging feature may not correctly indicate charging when the vehicle is in RAP, during a Bluetooth phone call, or when phone projection (e.g. Apple CarPlay / Android Auto) is active. See *Retained Accessory Power (RAP)* ⇨ 166.

The operating temperature is  $-40^{\circ}\text{C}$  ( $-40^{\circ}\text{F}$ ) to  $85^{\circ}\text{C}$  ( $185^{\circ}\text{F}$ ) for the charging system and  $0^{\circ}\text{C}$  ( $32^{\circ}\text{F}$ ) to  $35^{\circ}\text{C}$  ( $95^{\circ}\text{F}$ ) for the phone.

### Warning

Remove all objects from the charger before charging your compatible smartphone. Objects, such as coins, keys, rings, paper clips, or cards, between the smartphone and charger may become very hot.

On the rare occasion that the charging system does not detect an object, and the object gets wedged between the smartphone and charger, remove the smartphone and allow the object to cool before removing it from the charger, to prevent burns.

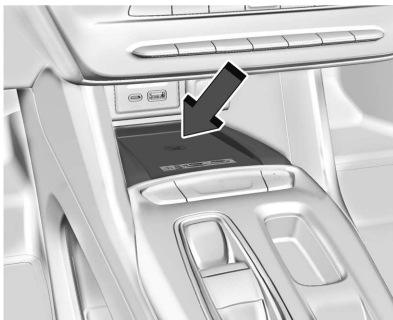



To charge a compatible smartphone:

1. Confirm the smartphone is capable of wireless charging.
2. Remove all objects from the charging pad. The system may not charge if there are any objects between the smartphone and charger.
3. Place the smartphone face up against the rear of the charger.

To maximize the charge rate, ensure the smartphone is fully seated and centered in the holder with nothing under it.

A thick smartphone case may prevent the charger from working, or reduce the charging performance. See your dealer for additional information.

4. A green  will appear on the infotainment display, next to the phone icon. This indicates that the smartphone is detected.
5. If a smartphone is placed on the charger and  turns off or turns yellow, remove the smartphone and any objects from the pad. Turn the smartphone 180 degrees and wait a few seconds before placing/aligning it on the pad again.
6. If a smartphone is placed on the charger and  turns red, the charger and/or the smartphone is overheated. Remove the smartphone and any objects from the charger in order to cool the system.

The smartphone may become warm during charging. This is normal. In warmer temperatures, the speed of charging may be reduced.

For vehicles with wireless phone projection, the smartphone may overheat during wireless charging. The smartphone may slow down, stop charging, or shut down to protect the battery. The phone may need to be removed from its case to prevent overheating. The  may flash while the phone is cooling down enough for wireless

charging to automatically resume. This is normal. Individual phone performance may vary.

### Software Acknowledgements

Certain Wireless Charging Module product from LG Electronics, Inc. ("LGE") contains the open source software detailed below. Refer to the indicated open source licenses (as are included following this notice) for the terms and conditions of their use.

### OSS Notice Information

To obtain the source code that is contained in this product, please visit <http://opensource.lge.com>. In addition to the source code, all referred license terms, warranty disclaimers and copyright notices are available for download. LG Electronics will also provide open source code to you on CD-ROM for a charge covering the cost of performing such distribution (such as the cost of media, shipping, and handling) upon email request to [opensource@lge.com](mailto:opensource@lge.com). This offer is valid for three (3) years from the date on which you purchased the product.

### Freescale-WCT library

Copyright (c) 2012-2014 Freescale Semiconductor, Inc.. All rights reserved.

Redistribution and use in source and binary forms, with or without modification, are permitted provided that the following conditions are met:

1. Redistributions of source code must retain the above copyright notice, this list of conditions and the following disclaimer.
2. Redistributions in binary form must reproduce the above copyright notice, this list of conditions and the following disclaimer in the documentation and/or other materials provided with the distribution.
3. Neither the name of the copyright holder nor the names of its contributors may be used to endorse or promote products derived from this software without specific prior written permission.

THIS SOFTWARE IS PROVIDED BY THE COPYRIGHT HOLDERS AND CONTRIBUTORS "AS IS" AND ANY EXPRESS OR IMPLIED WARRANTIES, INCLUDING, BUT NOT LIMITED TO, THE IMPLIED WARRANTIES OF MERCHANTABILITY AND FITNESS FOR A PARTICULAR PURPOSE ARE DISCLAIMED. IN NO EVENT SHALL THE COPYRIGHT HOLDER OR CONTRIBUTORS BE LIABLE FOR ANY DIRECT, INDIRECT, INCIDENTAL, SPECIAL, EXEMPLARY, OR CONSEQUENTIAL DAMAGES (INCLUDING, BUT NOT LIMITED TO, PROCUREMENT OF SUBSTITUTE GOODS OR SERVICES; LOSS OF USE, DATA, OR PROFITS; OR BUSINESS INTERRUPTION) HOWEVER CAUSED AND ON ANY THEORY OF LIABILITY, WHETHER IN CONTRACT, STRICT LIABILITY, OR TORT (INCLUDING NEGLIGENCE OR OTHERWISE) ARISING IN ANY WAY OUT OF THE USE OF THIS SOFTWARE, EVEN IF ADVISED OF THE POSSIBILITY OF SUCH DAMAGE.

## Warning Lights, Gauges, and Indicators

Warning lights and gauges can signal that something is wrong before it becomes serious enough to cause an expensive repair or replacement. Paying attention to the warning lights and gauges could prevent injury.

Some warning lights come on briefly when the propulsion system is started to indicate they are working. When one of the warning lights comes on and stays on while driving, or when one of the gauges shows there may be a problem, check the section that explains what to do. Waiting to do repairs can be costly and even dangerous.

## Instrument Cluster

The instrument cluster displays a preview of information that includes electric range, charging, odometer, and battery status. This happens upon entry when the driver door is opened, before starting the vehicle. This preview will dismiss after starting the vehicle or soon after closing the driver door.

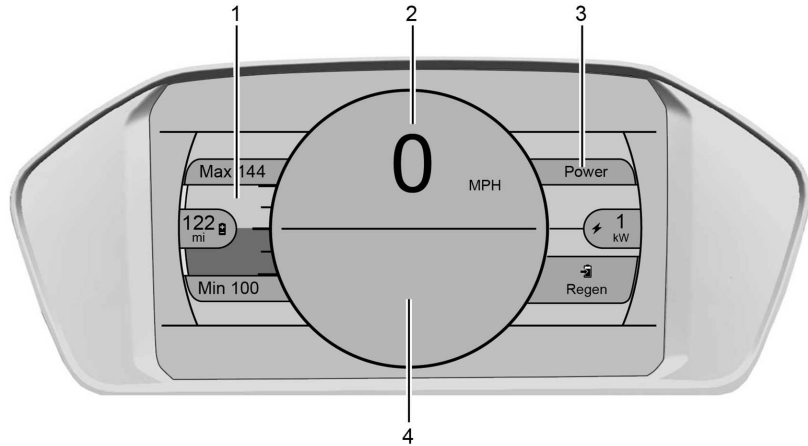

Enhanced English Cluster Shown, Others and Metric Similar

- |   |  |
|---|--|
| <ol style="list-style-type: none"> <li>1. <i>Battery Gauge (High Voltage)</i> ⇨ 80</li> <li>2. <i>Speedometer</i> ⇨ 80</li> </ol> | <ol style="list-style-type: none"> <li>3. <i>Driver Efficiency Gauge</i> ⇨ 81<br/><i>Power Indicator Gauge</i> ⇨ 81</li> <li>4. <i>Driver Information Center (DIC)</i> ⇨ 98</li> </ol> |
|---|--|

## Reconfigurable Instrument Cluster

The cluster layout can be changed. There are two display configurations to choose from: Modern, and Enhanced. Use the steering wheel control to move between the different display zones and scroll through the different displays. See “Layout” under “Cluster Menu” following.

- Modern configuration displays the speedometer with a battery gauge and efficiency gauge.
- Enhanced configuration displays the speedometer with battery gauge, efficiency ring, and power gauge.

## Cluster Menu

There is an interactive display area in the center of the instrument cluster.

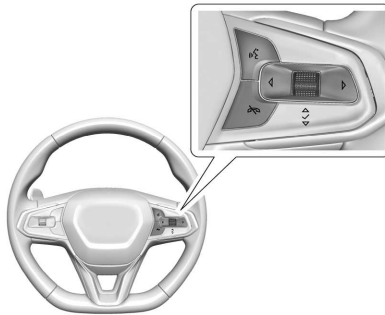

Use the right steering wheel control to open and scroll through the different items and displays.

Press  to access the cluster applications. Move the thumbwheel up or down to scroll through the list of available applications.

Not all applications will be available on all vehicles.

### Cluster Menu Applications

- Vehicle info. This is where the Driver Information Center (DIC) displays can be viewed. See *Driver Information Center (DIC)* ⇨ 98.

- Audio
- Navigation
- Phone
- Layout
- Options

## Audio

In the main view of the Audio application, move the thumbwheel up or down to scroll through radio stations or move to the next/previous track of a USB/Bluetooth device that is connected to the vehicle. Press the thumbwheel to select the Audio app, then press  to enter the Audio menu. In the Audio menu browse for music, select from the favorites, or change the audio source.

## Navigation

In the Navigation menu, if there is no active route, press the thumbwheel to access Recents or Favorites. If there is an active route, press the thumbwheel to cancel or resume route guidance, mute or unmute voice guidance, or access Recents or Favorites.



## Phone

In the Phone menu, if there is no active phone call, view recent calls, scroll through contacts, or select from the favorites.

If there is an active call, mute or unmute the phone or switch to handset or handsfree operation.

## Layout

Choose Modern, or Enhanced layout by pressing the thumbwheel while the desired item is highlighted. Exit the Layout menu by pressing ◀.

## Options

Press the thumbwheel to select the Options app.

Move the thumbwheel up or down to scroll through the items in the Options menu. Exit the Options menu by pressing ◀.

**Speed Warning** : The speed warning display allows the driver to set a speed that they do not want to exceed. To set the speed warning, press the thumbwheel when Speed Warning is displayed. Move the thumbwheel up or down to adjust the value. Press the thumbwheel to set the speed. Once set, this feature can be turned off by pressing the

thumbwheel while viewing this page. If the selected speed limit is exceeded, a pop-up warning is displayed and a chime may sound.

**Tutorial** : Press the thumbwheel to view tutorials for the Modern and Enhanced layout.

**Open Source Software** : Press the thumbwheel while Open Source Software is highlighted to display open source software information.

## Speedometer

The speedometer shows the vehicle's speed in either kilometers per hour (km/h) or miles per hour (mph).

## Odometer

The odometer shows how far the vehicle has been driven, in either kilometers or miles.

## Trip Odometer

The trip odometer shows how far the vehicle has been driven since the trip odometer was last reset.

The trip odometer is accessed and reset through the Driver Information Center (DIC). See *Driver Information Center (DIC)* ⇨ 98.

## Battery Gauge (High Voltage)

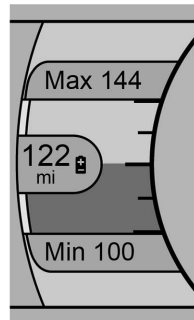

Enhanced Battery Gauge Shown

This displays the high voltage battery state of charge and the vehicle range prediction. The value in the center is an estimate of how far the vehicle can be driven on the remaining charge based on driving habits and conditions learned.

The range estimate and Max and Min numbers may be affected by climate settings, current vehicle conditions, and ambient conditions. Estimated range may increase and decrease based on climate control energy consumption.

A trend bar on the far left estimates how recent driving habits, conditions, and climate settings are affecting the range prediction.

When the high voltage battery state of charge is very low, the estimated range value in the center will change to Low. Max and Min ranges will no longer be displayed. Additional alerts may display and a sound may also be heard at low state of charge.

### Driver Efficiency Gauge

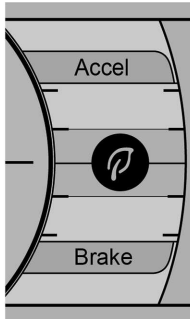

Modern Efficiency Gauge Shown

This gauge is a guide to driving in an efficient manner.

### Efficient Driving

- Modern layout: Keep the ball green and in the center of the gauge.
- Enhanced layout: Keep the outer ring of the speedometer green.

### Inefficient Driving/Aggressive Braking

- Modern layout: When driving inefficiently, the ball turns yellow and moves above the center of the gauge. When braking aggressively, the ball turns yellow and moves below the center of the gauge.
- Enhanced layout: The outer ring of the speedometer turns yellow.

### Power Indicator Gauge

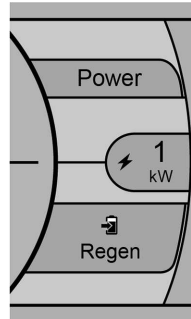

The power indicator gauge is on the right side of the display in the Enhanced layout.

This gauge displays the instantaneous charge and discharge power flowing either into or out of the high voltage battery. Maximum discharge power is available when the high voltage battery is fully charged. During normal operation, a slight reduction in discharge power may occur as the high voltage battery state of charge decreases. The power indicator gauge value shows the instantaneous power used by the battery.

### Regenerative Braking

When regenerative braking is active, the regen battery icon with arrows appears green. The power indicator gauge value shows the amount of instantaneous power being regenerated.

### Regenerative Power Limited

Regenerative power may be limited when the high voltage battery is near full charge or cold. The regen battery icon will appear gray when limited, and a horizontal bar may display on the gauge, at the level of the vehicle's maximum regenerative braking power.

## Seat Belt Reminders

### Driver Seat Belt Reminder Light

There is a driver seat belt reminder light on the instrument cluster.



When the vehicle is started, this light flashes and a chime may come on to remind the driver to fasten their seat belt.

Then the light stays on solid until the belt is buckled. This cycle may continue several times if the driver remains or becomes unbuckled while the vehicle is moving.

If the driver seat belt is buckled, neither the light nor the chime comes on.

### Front Passenger Seat Belt Reminder Light

The vehicle may have a front passenger seat belt reminder light near the passenger airbag status indicator. See *Passenger Sensing System* ⇨ 43.



When the vehicle is started, this light flashes and a chime may come on to remind passengers to fasten their seat belt.

Then the light stays on solid until the belt is buckled. This cycle continues several times if the front passenger remains or becomes unbuckled while the vehicle is moving.

If the front passenger seat belt is buckled, neither the chime nor the light comes on.

The front passenger seat belt reminder light and chime may come on if an object is put on the seat such as a briefcase, handbag, grocery bag, laptop, or other electronic device. To turn off the reminder light and/or chime, remove the object from the seat or buckle the seat belt.

### Airbag Readiness Light

This light shows if there is an electrical problem with the airbag system. It is located in the instrument cluster. The system check includes the airbag sensor(s),

passenger sensing system, the pretensioners (if equipped), the airbag modules, the wiring, and the crash sensing and diagnostic module. For more information on the airbag system, see *Airbag System* ⇨ 37.



The airbag readiness light comes on for several seconds when the vehicle is started. If the light does not come on then, have it fixed immediately.

### Warning

If the airbag readiness light stays on after the vehicle is started or comes on while driving, it means the airbag system might not be working properly. The airbags in the vehicle might not inflate in a crash, or they could even inflate without a crash. To help avoid injury, have the vehicle serviced right away.

If there is a problem with the airbag system, a Driver Information Center (DIC) message may also come on.

## Passenger Airbag Status Indicator

The vehicle has a passenger sensing system. See *Passenger Sensing System* ⇨ 43 for important safety information. The overhead console has a passenger airbag status indicator.

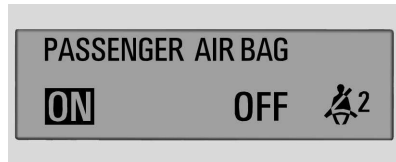

United States



Canada

When the vehicle is started, the passenger airbag status indicator will light ON and OFF, or the symbol for on and off, for several

seconds as a system check. Then, after several seconds, the status indicator will light either ON or OFF, or the on or off symbol to let you know the status of the front outboard passenger frontal airbag and knee airbag.

If the word ON or the on symbol is lit on the passenger airbag status indicator, it means that the front outboard passenger frontal airbag and knee airbag are allowed to inflate.

If the word OFF or the off symbol is lit on the passenger airbag status indicator, it means that the passenger sensing system has turned off the front outboard passenger frontal airbag and knee airbag.

If, after several seconds, both status indicator lights remain on, or if there are no lights at all, there may be a problem with the lights or the passenger sensing system. See your dealer for service.

### Warning

If the airbag readiness light ever comes on and stays on, it means that something may be wrong with the airbag system. To help avoid injury to yourself  
(Continued)

### Warning (Continued)

or others, have the vehicle serviced right away. See *Airbag Readiness Light* ⇨ 82 for more information, including important safety information.

## Charging System Light (12-Volt Battery)

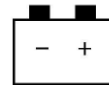

The charging system light comes on briefly when the vehicle is started, as a check to show the light is working.

If the light stays on, or comes on while driving, there could be a problem with the electrical charging system. Have it checked by your dealer. Driving while this light is on could drain the 12-volt battery.

If a short distance must be driven with the light on, be sure to turn off all accessories, such as the radio. Find a safe place to stop the vehicle.

## Service Vehicle Soon Light



This light comes on if a condition exists that may require the vehicle to be taken in for service.

If the light comes on, take the vehicle to your dealer for service as soon as possible.

## Brake System Warning Light



**BRAKE**

Metric

English

This light should come on briefly when the vehicle is turned on. If it does not come on then, have it fixed so it will be ready to warn you if there is a problem.

If the light comes on and stays on at start up, there is a brake problem. Have the brake system inspected right away.

If the light comes on while driving, pull off the road and stop carefully. The brake pedal might be harder to push, or the brake pedal may go closer to the floor. It could take longer to stop. If the light is still on, have the vehicle towed for service. See *Towing the Vehicle* ⇨ 262.

### Warning

The brake system might not be working properly if the brake system warning light is on. Driving with the brake system warning light on can lead to a crash. If the light is still on after the vehicle has been pulled off the road and carefully stopped, have the vehicle towed for service.

## Electric Parking Brake Light



**PARK**

Metric

English

This light comes on when the parking brake is applied. If the light continues flashing after the parking brake is released, or while driving, there is a problem with the Electric Parking Brake system. A message may also display in the Driver Information Center (DIC).

If the light does not come on, or remains flashing, see your dealer.

## Service Electric Parking Brake Light



This light should come on briefly when the vehicle is turned on. If it does not come on, have it fixed so it will be ready to warn if there is a problem.

If this light stays on or comes on while driving, there is a problem with the Electric Parking Brake (EPB). Take the vehicle to a dealer as soon as possible. In addition to the parking brake, other safety functions that utilize the EPB may also be degraded. A message may also display in the Driver Information Center (DIC). See *Electric Parking Brake* ⇨ 171.

## Antilock Brake System (ABS) Warning Light



This warning light should come on briefly when the vehicle is turned on. If the light does not come on, have it fixed so it will be ready to warn if there is a problem.

If the light comes on while driving, safely stop as soon as it is possible and turn off the vehicle. Then turn on the vehicle again to reset the system.

If the ABS warning light stays on, or comes on again while driving, the vehicle needs service. A chime may also sound when the light stays on.

If the ABS warning light is the only light on, the vehicle has regular brakes, but ABS is not functioning.

If both the ABS warning light and the brake system warning light are on, ABS is not functioning and there is a problem with the regular brakes. See your dealer for service.

See *Brake System Warning Light* ⇨ 84.

## Sport Mode Light



This light comes on when Sport Mode is selected.

## Lane Keep Assist (LKA) Light



If equipped, this light is white if LKA is turned on, but not ready to assist. This light is green if LKA is turned on and is ready to assist.

LKA may assist by gently turning the steering wheel if the vehicle approaches a detected lane marking. The LKA light is amber when assisting.

This light flashes amber as a Lane Departure Warning (LDW) alert, to indicate that the lane marking has been unintentionally crossed. If the system detects that the vehicle has been steered intentionally across a lane marker, the LDW may not be given. Do not expect the LDW to occur when intentionally crossing the lane marker.

LKA will not assist or alert if the turn signal is active in the direction of lane departure, or if LKA detects that you are accelerating, braking, or actively steering.

See *Lane Keep Assist (LKA)* ⇨ 197.

## Vehicle Ahead Indicator



If equipped, this indicator will display green when a vehicle is detected ahead and amber when you are following a vehicle ahead much too closely.

See *Forward Collision Alert (FCA) System* ⇨ 191.

## Pedestrian Ahead Indicator



If equipped, this indicator will display amber when a nearby pedestrian is detected in front of the vehicle.

See *Front Pedestrian Braking (FPB) System* ⇨ 194.

## Traction Off Light



This light comes on briefly when the vehicle is turned on. If it does not, have the vehicle serviced by your dealer. If the system is working normally, the indicator light then turns off.

The traction off light comes on when the Traction Control System (TCS) has been turned off. If StabiliTrak/Electronic Stability Control (ESC) is turned off, TCS is also turned off. To turn TCS and ESC off and on, see *Traction Control/Electronic Stability Control* ⇨ 174.

If TCS is off, wheel spin is not limited unless necessary to help protect the driveline from damage. Adjust driving accordingly.

## StabiliTrak OFF Light



This light comes on briefly when the vehicle is turned on. If the light does not come on, have the vehicle serviced by your dealer. If the system is working normally, the indicator light then turns off.

This light comes on when the StabiliTrak/Electronic Stability Control (ESC) system is turned off. If StabiliTrak/ESC is off, the Traction Control System (TCS) is also off. To turn ESC off and on, see *Traction Control/Electronic Stability Control* ⇨ 174.

If ESC and TCS are off, the systems do not assist in controlling the vehicle. Adjust driving accordingly.

## Traction Control System (TCS)/ StabiliTrak Light



This light comes on briefly when the vehicle is turned on.

If the light does not come on, have the vehicle serviced by your dealer. If the system is working normally, the indicator light turns off.

If the light is on and not flashing, the TCS and potentially the StabiliTrak/ESC system are not fully operational and may not assist in maintaining control. Adjust driving accordingly. If the condition persists, see your dealer as soon as possible. A Driver Information Center (DIC) message may display.

The light flashes when the TCS and/or the StabiliTrak/ESC system is actively working.

See *Traction Control/Electronic Stability Control* ⇨ 174.

## Tire Pressure Light



For vehicles with the Tire Pressure Monitor System (TPMS), this light comes on briefly when the vehicle is started. It provides information about tire pressures and the TPMS.

### When the Light Is On Steady

This indicates that one or more of the tires are significantly underinflated.

A Driver Information Center (DIC) tire pressure message may also display. Stop as soon as possible, and inflate the tires to the pressure value shown on the Tire and Loading Information label. See *Tire Pressure* ⇨ 243.

### When the Light Flashes First and Then Is On Steady

If the light flashes for about a minute and then stays on, there may be a problem with the TPMS. If the problem is not corrected,

the light will come on at every ignition cycle. See *Tire Pressure Monitor Operation* ⇨ 244.

## Security Light



The security light should come on briefly as the vehicle is started. If it does not come on, have the vehicle serviced by your dealer. If the system is working normally, the indicator light turns off.

If the light stays on and the vehicle does not start, there could be a problem with the theft-deterrent system.

## Vehicle Ready Light





The vehicle ready light comes on whenever the vehicle is ready to be driven.

### One-Pedal Driving Light



This light comes on when One-Pedal Driving is active. See *One-Pedal Driving* ⇨ 170.

### High-Beam On Light



This light comes on when the high-beam headlamps are in use. See *Headlamp High/Low-Beam Changer* ⇨ 106.

### IntelliBeam Light



This light comes on when the IntelliBeam system, if equipped, is enabled. See *Exterior Lamp Controls* ⇨ 105.

### Lamps On Reminder



This light comes on when the exterior lamps are in use, except when only the Daytime Running Lamps (DRL) are active. See *Exterior Lamp Controls* ⇨ 105.

### Cruise Control Light



The cruise control light is white when the cruise control is on and ready, and turns green when the cruise control is set and active.

See *Cruise Control* ⇨ 175.

### Adaptive Cruise Control Light



This light is white when the Adaptive Cruise Control (ACC, if equipped) is on and ready, and turns green when the ACC is set and active.

See *Adaptive Cruise Control (Camera)* ⇨ 177.

## Door Ajar Light



This light comes on when a door is open or not securely latched. Before driving, check that all doors are properly closed.

## Information Displays

### Power Flows

To view the Power Flow screen on the infotainment display from the home screen, touch Energy, touch the Energy tab, and then touch Flow.

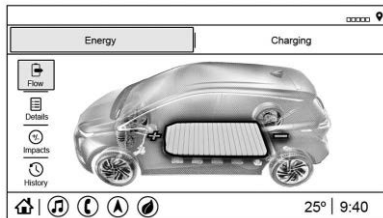

The Power Flow screen indicates the current operating condition. The screen shows energy flow to and from the high voltage battery while the vehicle is being driven. These components will be highlighted when they are active.

### Programmable Charging

#### Important Information about Portable Electric Vehicle Charging

- Charging an electric vehicle can stress a building's electrical system more than a typical household appliance.
- Before plugging into any electrical outlet, have a qualified electrician inspect and verify the electrical system (electrical outlet, wiring, junctions, and protection devices) for heavy-duty service at a 12 amp continuous load.
- Electrical outlets may wear out with normal usage or may be damaged over time, making them unsuitable for electric vehicle charging.
- Check the electrical outlet/plug while charging and discontinue use if the electrical outlet/plug is hot, then have the electrical outlet serviced by a qualified electrician.

- When outdoors, plug into an electrical outlet that is weatherproof while in use.
- Mount the charging cord to reduce strain on the electrical outlet/plug.
- Do not place the charge cord in a position where it is expected to be submerged in water.

#### Danger

Improper use of portable electric vehicle charge cords may cause a fire, electrical shock, or burns, and may result in damage to property, serious injury, or death.

- Do not use extension cords, multi-outlet power strips, splitters, grounding adaptors, surge protectors, or similar devices.
- Do not use an electrical outlet that is worn or damaged, or will not hold the plug firmly in place.
- Do not use an electrical outlet that is not properly grounded.
- Do not use an electrical outlet that is on a circuit with other electrical loads.

## Charging Status

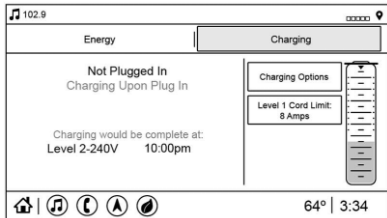

**Charging Status Screen with Quick Access Turned On**

To view the current charging status in the infotainment display, touch Energy in the infotainment display and then touch Charging at the top of the display.

Level 1-120V Cord Limit and Charge Overrides displays may not be displayed if quick access to these options is not turned on. To turn quick access for these options on or off, go to the Charging Options button and press on Level 1-120V Cord Limit or Delayed Charging (then Charge Overrides) and select Quick Access.

The charge start and charge complete time estimates are also displayed. These estimates are most accurate when the vehicle is plugged in and in moderate temperature conditions.

### Charging Options

To view or change charging options, touch Energy from the Infotainment home screen, touch the Charging tab, and then touch Charging Options on the Charging Status screen.

### Level 1-120V Cord Limit

The Level 1-120V Cord Limit setting allows the vehicle's charge level to be selected so it matches the capability of the charging location. If the vehicle consistently stops charging after plugging in, or if a circuit breaker continues to trip, reducing the Level 1-120V Cord Limit may resolve the issue.

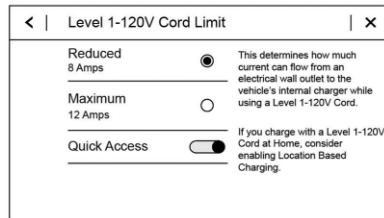

The Level 1-120V Cord Limit should be configured to match the electrical current rating for the electrical outlet that the charge cord is connected to. The Level 1-120V Cord Limit settings are:

- Reduced: Limits AC current to 8 amps
- Maximum: Limits AC current to 12 amps
- Quick Access: When this is on, the setting is shown on the Charging Status screen and Level 1-120V Cord Limit can be accessed from the Charging Status screen.

Exact current levels may vary from the values shown in this manual. Check the vehicle for the current available levels.

The Level 1-120V Cord Limit setting resets to the Reduced 8 amp setting each time the vehicle is driven. Location Based Charging can be enabled to maintain the Maximum

12 amp setting at a specified Home location. See “Location Based Charging” later in this section.

The Level 1-120V Cord Limit setting can be changed at any time while the infotainment display is operable.

### Warning

Using a charge level that exceeds the electrical circuit or electrical outlet capacity may start a fire or damage the electrical circuit. Use the lowest charge level until a qualified electrician inspects the electrical circuit capacity. Use the lowest charge level if the electrical circuit or electrical outlet capacity is not known.

### Target Charge Level

This mode allows the charging range for the vehicle to be set based on what is needed. When at a public pay station and a full charge is not needed, the target charge level can be set to only get as much range as needed.

If driving on a hill, the target charge level can be set to stop the charge before the battery is full to allow space for energy from regenerative braking when going down a hill.

There is a minimum target charge level. Once this level is reached, the – will not allow the target charge level bar move down further.

Target Charge Level can also be set separately for Location-Based Home and Away locations. If available, the Home and Away buttons will appear on the screen. When Location Based Charging is active, the Target Charge Level on the Charging Status screen will automatically update to the Home or Away setting based on the current location.

For quick access to the Target Charge Level, go to the Charging Status screen and the Target Charge level displays on the right side of the screen. The dark horizontal white line can be dragged up and down to the desired Target Charge Level. Tapping once on the Target Charge Level indication or attempting to change the setting will pop out a window that shows your current and projected range.

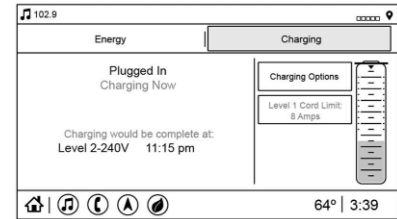

The main Target Charge Level screen can be found by pressing Target Charge Level in the Charging Options.

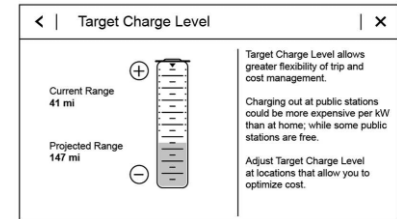

Touch + or – to increase or decrease the charge level, or drag the dark horizontal white line up and down on the graphic to the desired level.

A reminder will display on the instrument cluster to show Target Charge Level set.

If the Target Charge Level is higher than 80%, fast charging on the instrument cluster will show an 80% point, a shaded line up to the Target Charge Level, a solid line for current charge level, and the time to complete 80%.

If the Target Charge Level is less than 80%, fast charging on the instrument cluster will show a shaded line up to the Target Charge Level and the time to complete.

Target Charge Level defaults to 100% if the 12 volt battery becomes discharged.

### Displayed Charge Times

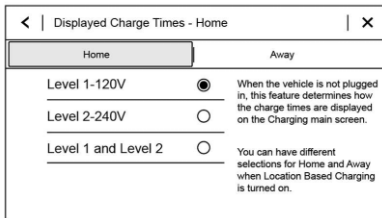

This feature determines how the charge times are displayed on the Charging Status screen. The selections for Home and Away can be different when location based charging is turned on.

### Location Based Charging

This feature allows charging settings to be customized when the vehicle is at home or away from home. The charge mode and charge level preference will update based on vehicle location. See “Level 1-120V Cord Limit” earlier in this section. The charging customization settings will be the saved home profile settings at home and will charge upon plug in when away from home.

Dashes display on the screen when GPS is unavailable.

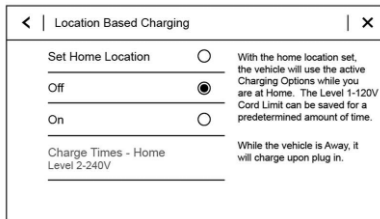

To use location based charging, a home location must first be stored. To store a home location:

1. From the infotainment home screen, touch Energy.
2. Touch Charging.
3. Touch Charging Options.

4. Touch Location Based Charging.
5. Set Home Location.
6. A pop-up will confirm the setting. In addition, Set Home Location will change to Update Home Location.

To turn location based charging on or off:

1. Follow Steps 1–4 under “Location Based Charging” to get to the Location Based Charging screen.
2. Touch On or Off.

To update the home location:

1. Follow Steps 1–4 under “Location Based Charging” to get to the Location Based Charging screen.
2. Select Update Home Location.
3. Select one of the following:

**Update** : Use when the vehicle is parked in a new location.

**Cancel** : Use to cancel this operation and make no changes.

**Remove** : Use to remove the stored home location from the vehicle. This will turn the feature off because there will be no home location stored.

The charge level preference at the home location is stored for up to 90 days. After 90 days, a notification will display on the screen and the charge level preference will need to be reset for the next 90 days.

To change how the charge times are displayed, press the Charge Times – Home button in the Location Based Charging screen and it will go to the Displayed Charge Times menu for changes to be made.

## Delayed Charging

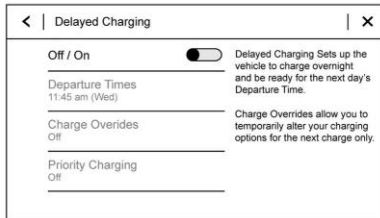

## Departure Times

To edit the departure time:

1. Make sure Delayed Charging is set to On.
2. Touch Departure Times.

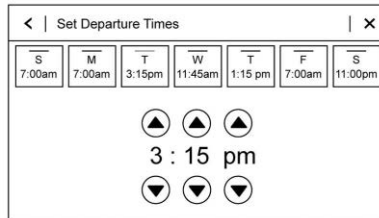

3. Touch the day to change.
4. Touch  $\wedge$  or  $\vee$  to change the hours and minutes.
5. Touch  $\wedge$  or  $\vee$  to change am or pm.
6. Touch  $\leftarrow$  to store changes and return to the previous screen.

## Charge Overrides

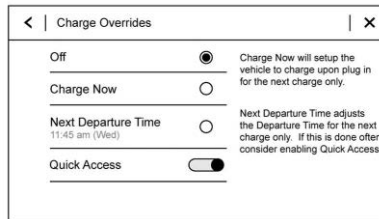

Delayed Charging can be temporarily overridden to an immediate charge for one charge cycle. Also, the next planned departure time can be temporarily overridden for one charge cycle. In addition to the in-vehicle overrides via the infotainment display, there are other ways to temporarily override a delayed charge mode. See *Plug-In Charging* ⇨ 199.

To temporarily override a delayed charge mode to Charge Now:

1. Touch Charging Options on the Charging Status screen.
2. Touch Delayed Charging.
3. Touch Charge Overrides.
4. Touch Charge Now.

The Charging Status screen will automatically display the revised charge complete time.

The vehicle starts charging as soon as it is connected to an electrical outlet. See *Plug-In Charging* ⇨ 199.

If quick access for Charge Overrides is on and vehicle is plugged in, the Charge Overrides button will be shown on the Charging Status screen and can also be used to access the Charge Overrides. If Charge

Overrides is off and the vehicle is plugged in, then Charging Now will be shown on the Charging Status screen.

To cancel the temporary override, select Off on the Charge Overrides screen.

To temporarily override the next planned departure time:

1. Touch Charging Options on the main charging screen.
2. Touch Delayed Charging.
3. Touch Charge Overrides.
4. Touch Next Departure Time.
5. Touch  $\wedge$  or  $\vee$  to change the Next Departure Time.
6. Touch Save to confirm a temporary override of the Next Departure Time.

The main charging screen will automatically display the revised departure time and charge complete time.

The temporary departure time override can only be updated for the day of the Next Planned Departure Time. The vehicle will not accept a temporary departure time that is before the present time of day.

To cancel the temporary override of the Next Departure Time, select Off on the Charge Overrides screen.

### Utility Rate Charging

The vehicle estimates the charging start time based on the utility rate schedule, utility rate preference, and programmed departure time for the current day of the week. The vehicle will charge during the least expensive rate periods to achieve a full battery charge by the departure time. Utility rate information from the utility company for the charging location is required for this mode.

Select one of the following:

### Charge Rate Preference

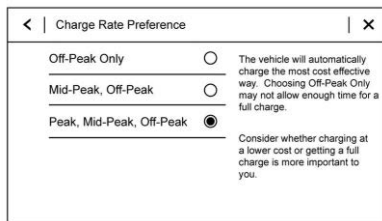

Charge Rate Preference

Off-Peak Only

Mid-Peak, Off-Peak

Peak, Mid-Peak, Off-Peak

The vehicle will automatically charge the most cost effective way. Choosing Off-Peak Only may not allow enough time for a full charge.

Consider whether charging at a lower cost or getting a full charge is more important to you.

Touch one of the following options to select the Charge Rate Preference:

- Off-Peak Only: The vehicle will only charge during Off-Peak rate periods.
- Mid-Peak, Off-Peak: The vehicle will charge during Off-Peak and/or Mid-Peak rate periods only and will select when to charge to minimize the total cost of the charge.
- Peak, Mid-Peak, Off-Peak: The vehicle can charge during any rate period to satisfy the next planned departure time. However, it will select when to charge to minimize the total cost of the charge.

Charging begins at the start time and is complete by the departure time only if sufficient time is allowed after the charge cord is plugged in. For example, if the vehicle is plugged in for only one hour prior to the departure time, and the battery is completely discharged, the vehicle will not be fully charged by the departure time regardless of the rate selection.

Also, if the selected utility rate settings result in a very long charge completion time, the vehicle will start charging immediately upon plug-in. For example, if the utility rate table is set up with all Peak rates and the rate preference is to

charge during Off-Peak rates only, then the vehicle will start charging immediately upon plug-in.

### Charge Completion

Charge Completion

Earliest Possible  Earliest Possible will begin charging upon plug in while it's Off-Peak. This is especially handy while running errands on weekends when Off-Peak rates are more common.

Latest Possible  Latest Possible sets up charging to finish right before your next Departure Time.

When the cost would be the same, based on utility rates, the earliest or latest possible time for a charge to complete can be selected. For example, if Off-Peak charge time is 12 am to 6 am and only three hours of charge are needed, Earliest Possible would start charging at 12 am and Latest Possible would start charging at 3 am. Use the Earliest Possible setting to charge as soon as possible. Use the Latest Possible setting to optimize energy usage.

To edit the Charge Completion:

1. From the Utility Rate Charging screen, touch Charge Completion.
2. Select Earliest Possible or Latest Possible.

### Rate Schedule Type

Utility rates, or cost per unit, may vary based on time, weekday/weekend, and season. During the day when the demand for electricity is high, the rates are usually higher and are called Peak rates. At night when the demand for electricity is low, the rates are usually lower and are called Off-Peak rates. In some areas, a Mid-Peak rate is offered.

Contact the utility company to obtain the rate schedule for your area. The summer and winter start dates must be established to use a summer/winter schedule.

To edit the Rate Schedule Type:

1. From the Charging Status screen, touch Charging Options.
2. Select Rate Schedule Type from the Utility Rate Charging screen.

Rate Schedule Type

Yearly  Some utility companies have different electric rate schedules depending on the season. If you enable Summer / Winter, you set the Utility Season Dates and additional weekday and weekend rate schedules from Utility Rate Charging.

Summer/Winter

To edit the Yearly schedule type:

1. Select Yearly.
2. Touch < to return to the Utility Rate Charging screen.
3. Scroll down to the bottom of the menu and under Yearly, select Weekday Schedule or Weekend Schedule. See “Weekday or Weekend Schedule Editing” section below for additional steps to set the Yearly schedule.

To edit the Summer/Winter Schedule type:

1. Select Summer/Winter.
2. Touch < to return to the Utility Rate Charging screen.
3. Scroll down to the bottom of the menu and under Summer or Winter, as desired, select the Weekday Schedule or Weekend Schedule that needs to be



changed. See “Weekday or Weekend Schedule Editing” section below for additional steps to set the Summer/Winter schedule.

### Weekday or Weekend Schedule Editing

To edit the weekday or weekend schedule:

1. From the Utility Rate Charging screen, touch Weekday Schedule or Weekend Schedule.
2. Touch Add A Rate Period or Subtract A Rate Period.
  - Weekdays are Monday through Friday and use the same rate schedule.
  - Weekends are Saturday and Sunday and use the same rate schedule.

Both weekday and weekend schedules must be set. The rate schedule only applies for a 24-hour period, starting at 12:00 am and ending at 12:00 am. There can be five rate changes for each day; not all must be used.

The finish times must be consecutive. If a finish time does not follow a start time, this error message displays: “An invalid entry was found in the data entered. Please re-enter data.”

### Energy Summary Pop-Up

When this function is turned on, the Energy Summary Pop-Up will provide a summary of energy usage when the vehicle is turned off.

Select On or Off.

### Charge Status Feedback

When this function is turned on, the vehicle will provide audible feedback of the charge status.

- 1 beep** : Immediate charging
- 2 beeps** : Delayed charging
- 3 beeps** : Charge port door is open
- 4 beeps** : Desired time cannot be met

Select On or Off.

### Charge Cord Theft Alert

When this function is turned on and the vehicle is off and locked, the horn will sound if the charge cord is removed.

Select On or Off.

### Charge Power Loss Alert

When this function is turned on and the vehicle is charging, the horn will sound if power is lost.

Select On or Off.

### Charging Interrupted or Overridden Pop-Up

The Charging Interrupted or Overridden message will appear if there was an unintended loss of AC power during the plug in charge event. For example, there was a power outage or the charge cord was unplugged from the wall.

See *Instrument Cluster* ⇨ 78.

### Programmable Charging Disabled

When the Programmable Charging system is disabled, the main charging screen will display “- :- -” for the Charge Complete Time. The Programmable Charging system will be disabled if the Charge Complete Time cannot be confidently estimated. If the Programmable Charging system is consistently disabled, see your dealer.

A message displays if the vehicle is not able to charge.

### Energy Information

To view Energy Detail, Range Impacts, and Efficiency History, touch Energy on the infotainment display, and then the desired screen button on the left side of the screen.

### Energy Detail

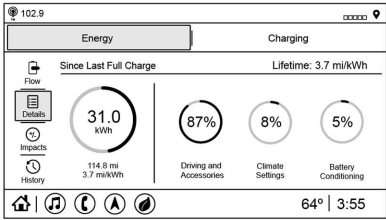

This screen displays how energy is being used since the last time the high voltage battery was fully charged. It includes Driving and Accessories, Climate Settings, and Battery Conditioning. The circle graph displays these percentages. Energy used, distance traveled, efficiency since last full charge, and lifetime efficiency are also displayed.

### Range Impacts

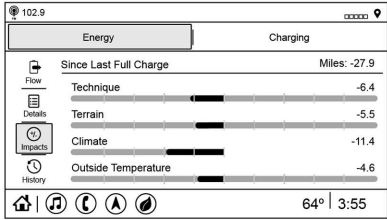

This screen provides an estimate of the factors that influence energy usage since the last full charge of the high voltage battery. Each factor is evaluated for energy gains or losses, and the total equivalent distance is indicated by the value on the upper right side of the screen. All values are reset after a complete charge.

- **Technique** includes speed, acceleration, and braking. Lower speeds will increase electric vehicle technique miles, while higher speeds will reduce them.
- **Terrain** includes road conditions, such as hills, rain, and snow. External factors like wind will also positively or negatively impact Terrain. Low tire pressure will worsen Terrain performance.

- **Climate Settings** includes how the heating and air conditioning are used. Using Fan Only settings will help reduce climate setting losses. See “Climate Controls.”
- **Outside Temperature** includes the effect that hot or cold ambient temperature has on the battery performance and propulsion system efficiency.

The individual factors provide an understanding of how energy usage is different from day to day, even when traveling the same route.

### Efficiency History

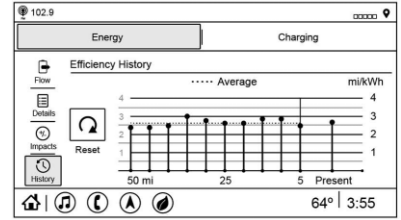

This screen displays a graph showing the energy efficiency that has been used over the last 50 km (50 mi). The Present point provides the average energy efficiency for the current 5 km (5 mi).

Touch Reset to clear the history data.

## Charging Options

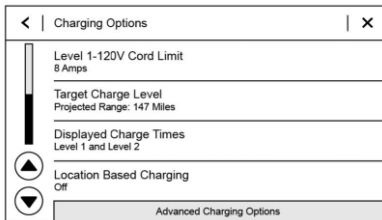

To view and change the Charging Options, touch Energy from the infotainment home screen, touch the Charging tab, and then touch Charging Options on the Charging Status screen. Use the arrows to scroll through the list, or hold and drag the list.

The following list of menu items may be available:

- **Level 1-120V Limit:** Allows the vehicle's charge current to be selected so it matches the capability of the charging location when using the Level 1-120V. See "Level 1-120V Cord Limit" in *Programmable Charging* ⇨ 89.

- **Target Charge Level:** Allows a charge level to be set, to provide greater flexibility for trip and cost management. This allows a lower target charge level (less than 100%) to be set, if desired, to reduce charging cost but still provide the estimated range needed to get to the destination.
- **Displayed Charge Times:** Determines which charge times are displayed on the Charging Status screen when the vehicle is unplugged. Select Level 1-120V, Level 2-240V, or Cord and Station based on user preference.
- **Location Based Charging:** Allows charging to be based on a home or away location.
- **Delayed Charging:** Allows delayed charging to match a scheduled departure time. See "Delayed Charging" in *Programmable Charging* ⇨ 89.
- **Utility Rate Charging:** Allows charging during the least expensive rate periods to achieve a full battery charge by the departure time. The vehicle estimates the charging start time based on the utility rate schedule, utility rate preference, and programmed departure time for the current day of the week. See "Utility Rate Charging" in *Programmable Charging* ⇨ 89.
- **Energy Summary Pop-Up :** Allows the feature to be set to On or Off.
- **Charge Status Feedback :** Allows the feature to be set to Horn Chirps or Off.
- **Charge Cord Theft Alert :** Allows the feature to be set to On or Off.
- **Charge Power Loss Alert :** Allows an alert to sound when the vehicle is charging and loses power at the electrical outlet. Set the feature to On or Off.

### Low Power Mode

To enter Low Power Mode manually:

1. Press and hold . The screen will turn off and display the time and outside temperature.
2. Press again to turn the radio on.

### Driver Information Center (DIC)

The DIC is displayed in the instrument cluster. It shows the status of many vehicle systems. The controls for the DIC are on the right steering wheel control. See *Instrument Cluster* ⇨ 78.

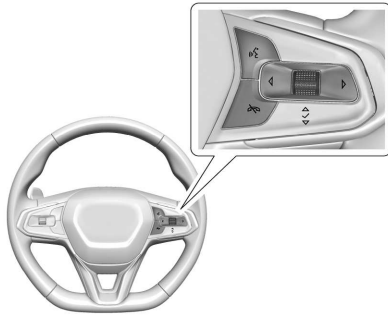

△ or ▽ : Press the thumbwheel up or down in a list.

◀ or ▶ : Press to move between the interactive display zones in the cluster.

**Thumbwheel** : Press to open a menu or select a menu item. Press and hold to reset values on certain screens.

### DIC Info Page Options

The info pages on the DIC can be turned on or off through the Options menu.

1. Press ◀ to access the cluster applications.
2. Move the thumbwheel up or down through the list of available applications.

3. Press the thumbwheel to select the application, then press ▶ to enter the application menu.
4. Move the thumbwheel △ or ▽ to move through the list of possible information displays.
5. Press the thumbwheel while an item is highlighted to select or deselect that item. When an item is selected, a check mark will appear next to it.

### DIC Info Pages

The following is the list of all possible DIC info page displays. Some may not be available for your particular vehicle. Some items may not be turned on by default but can be turned on through the Options app. See “DIC Info Page Options” earlier in this section.

#### Trip and Average Electrical Energy

**Economy** : The Trip display shows the current distance traveled, in either kilometers (km) or miles (mi), since the trip odometer was last reset. The trip odometer can be reset by pressing and holding the thumbwheel while this display is active.

The Average Electrical Energy Economy display shows the approximate average kilometers per kWh (km/kWh) or miles per kWh(mi/kWh). This number is calculated based on the number of km/kWh recorded since the last time this menu item was reset. This number reflects only the approximate average electrical energy economy that the vehicle has right now, and will change as driving conditions change. The Average Electrical Energy Economy can be reset along with the trip odometer by pressing and holding the thumbwheel while this display is active.

**Average Speed** : Shows the average speed of the vehicle in kilometers per hour (km/h) or miles per hour (mph). This average is calculated based on the various vehicle speeds recorded since the last reset of this value. The average speed can be reset by pressing and holding the thumbwheel while this display is active.

**Tire Pressure** : Shows the approximate pressures of all four tires. Tire pressure is displayed in either kilopascal (kPa) or in pounds per square inch (psi). If the pressure is low, the value for that tire is shown in amber.

**Timer** : This display can be used as a timer. To start the timer, press the thumbwheel while this display is active. The display will show the amount of time that has passed since the timer was last reset. To stop the timer, press the thumbwheel briefly while this display is active and the timer is running. To reset the timer to zero, press and hold the thumbwheel while this display is active.

**Driver Assistance** : If equipped, shows information for ACC, Follow Distance, Lane Keep Assist (LKA) and Forward Collision Alert (FCA).

**Blank Page** : The Blank Page display allows for no information to be displayed in the cluster info display areas.

## Vehicle Messages

Messages displayed on the DIC indicate the status of the vehicle or some action that may be needed to correct a condition. Multiple messages may appear one after another.

The messages that do not require immediate action can be acknowledged and cleared by pressing the thumbwheel. The

messages that require immediate action cannot be cleared until that action is performed.

All messages should be taken seriously; clearing the message does not correct the problem.

If a SERVICE message appears, see your dealer.

Follow the instructions given in the messages. The system displays messages regarding the following topics:

- Service Messages
- Fluid Levels
- Vehicle Security
- Brakes
- Ride Control Systems
- Driver Assistance Systems
- Cruise Control
- Lighting and Bulb Replacement
- Wiper/Washer Systems
- Doors and Windows
- Seat Belts
- Airbag Systems
- Propulsion and Transmission
- Tire Pressure
- Battery

## Propulsion Power Messages

### PROPULSION POWER IS REDUCED

This message displays when the vehicle's propulsion power is reduced. A reduction in propulsion power can affect the vehicle's ability to accelerate. If this message is on, but there is no observed reduction in performance, proceed to your destination. Under certain conditions the performance may be reduced the next time the vehicle is driven. The vehicle may be driven while this message is on, but maximum acceleration and speed may be reduced. Anytime this message stays on, or displays repeatedly, the vehicle should be taken to your dealer for service as soon as possible.

Under certain operating conditions propulsion will be disabled. Try restarting after the ignition has been off for 30 seconds.

### PROPULSION POWER REDUCED DUE TO TEMPERATURE

This message is most commonly displayed when the high voltage battery charge level is low. The vehicle is limiting power to maximize range. This message can display when the vehicle is parked during extreme

cold conditions without being plugged in. While driving the vehicle with this message displayed, the vehicle speed may be reduced until the high voltage battery is conditioned.

## Vehicle Speed Messages

### SPEED LIMITED TO XXX KM/H (MPH)

This message shows that the vehicle speed has been limited to the speed displayed. The limited speed is a protection for various propulsion and vehicle systems, such as lubrication, thermal, brakes, suspension, Teen Driver if equipped, or tires.

## Vehicle Personalization

The following are all possible vehicle personalization features. Depending on the vehicle, some may not be available.

For System, Apps, and Personal features and functions, see *Settings* ⇨ 132.

To access the vehicle personalization menu:

1. Touch the Settings icon on the Home Page of the infotainment display.
2. Touch Vehicle to display a list of available options.
3. Touch to select the desired feature setting.

4. Touch ○ or | to turn a feature off or on.
5. Touch ✕ to go to the top level of the Settings menu.

The menu may contain the following:

### Rear Seat Reminder

This allows for a chime and a message when the rear door has been opened before or during operation of the vehicle.

Touch Off or On.

### Climate and Air Quality

Touch and the following may display:

- Auto Fan Speed
- Auto Heated Seats
- Auto Defog
- Auto Rear Defog

### Auto Fan Speed

This setting specifies the amount of airflow when the climate control fan setting is Auto Fan.

Touch Low, Medium, or High.

### Auto Heated Seats

When enabled, this feature will automatically activate the heated seats at the level required by the interior

temperature. The auto heated seats can be turned off by using the heated seat buttons on the center console. See *Heated Front Seats* ⇨ 28.

Touch Off or On.

### Auto Defog

This setting automatically turns the front defogger on when the engine is started.

Touch Off or On.

### Auto Rear Defog

This setting automatically turns the rear defogger on based on temperature and humidity conditions.

Touch Off or On.

## Collision/Detection Systems

Touch and the following may display:

- Forward Collision System
- Front Pedestrian Detection
- Adaptive Cruise Go Notifier
- Lane Change Alert
- Park Assist
- Rear Cross Traffic Alert

### Forward Collision System

This setting can alert of a potential crash with a detected vehicle ahead and can apply brakes to help reduce a collision's severity.

Touch Off, Alert, or Alert and Brake.

### Front Pedestrian Detection

This feature may help avoid or reduce the harm caused by front-end crashes with nearby pedestrians.

See *Front Pedestrian Braking (FPB) System* ⇨ 194.

Select Off, Alert, or Alert and Brake.

### Adaptive Cruise Go Notifier

This setting determines if an alert will appear when Adaptive Cruise Control brings the vehicle to a complete stop and the vehicle ahead of you starts moving again. See *Adaptive Cruise Control (Camera)* ⇨ 177.

Touch Off or On.

### Lane Change Alert

The LCA system is a lane-changing aid that assists drivers with avoiding lane change crashes. See *Lane Change Alert (LCA)* ⇨ 196.

When Lane Change Alert is disabled, Side Blind Zone Alert is also disabled.

Touch Off or On.

### Park Assist

If equipped, this allows the feature to be turned on or off. See *Assistance Systems for Parking or Backing* ⇨ 187.

Touch Off or On.

### Rear Cross Traffic Alert

This allows the Rear Cross Traffic Alert feature to be turned on or off. See *Assistance Systems for Parking or Backing* ⇨ 187.

Touch Off or On.

### Comfort and Convenience

Touch and the following may display:

- Chime Volume
- Auto Wipe in Reverse Gear

### Chime Volume

This determines the chime volume level.

Touch the controls on the infotainment display to adjust the volume.

### Auto Wipe in Reverse Gear

When on and the front wiper is on, the rear wiper will automatically activate when the vehicle is shifted to R (Reverse).

Touch Off or On.

### Lighting

Touch and the following may display:

- Vehicle Locator Lights
- Exit Lighting

### Vehicle Locator Lights

This feature will flash the exterior lamps and allows some of the exterior lamps and most of the interior lamps to turn on briefly when  on the Remote Keyless Entry (RKE) transmitter is pressed to locate the vehicle.

Touch Off or On.

### Exit Lighting

This allows the selection of how long the exterior lamps stay on when leaving the vehicle when it is dark outside.

Touch Off, 30 Seconds, 60 Seconds, or 120 Seconds.

### Power Door Locks

Touch and the following may display:

- Open Door Anti Lockout
- Auto Door Unlock
- Delayed Door Lock

**Open Door Anti Lock Out**

When on, this feature will keep the driver door from locking when the door is open. If Off is selected, the Delayed Door Lock menu will be available.

Touch Off or On.

**Auto Door Unlock**

This allows selection of which of the doors will automatically unlock when the vehicle is shifted into P (Park).

Touch Off, All Doors, or Driver Door.

**Delayed Door Lock**

When on, this feature will delay the locking of the doors. To override the delay, press the power door lock switch on the door.

Touch Off or On.

**Remote Lock, Unlock, and Start**

Touch and the following may display:

- Remote Unlock Light Feedback
- Remote Lock Feedback
- Remote Door Unlock

- Remote Start Auto Heat Seats
- Passive Door Unlock
- Passive Door Lock
- Remote Left in Vehicle Alert

**Remote Unlock Light Feedback**

When on, the exterior lamps will flash when unlocking the vehicle with the RKE transmitter.

Touch Off or Flash Lights.

**Remote Lock Feedback**

This allows selection of what type of feedback is given when locking the vehicle with the RKE transmitter.

Touch Off, Lights and Horn, Lights Only, or Horn Only.

**Remote Door Unlock**

This allows selection of which doors will unlock when pressing  on the RKE transmitter.

Touch All Doors or Driver Door.

**Remote Start Auto Heat Seats**

If equipped and turned on, this feature will turn on the heated seats when using remote start on cold days. See *Heated Front Seats* ⇨ 28 and *Remote Start* ⇨ 13.

Touch Off or On.

**Passive Door Unlock**

This allows the selection of what doors will unlock when using the button on the driver door to unlock the vehicle.

Touch All Doors or Driver Door Only.

**Passive Door Lock**

This allows passive locking to be turned on or off and selects feedback. See *Remote Keyless Entry (RKE) System Operation* ⇨ 7.

Touch Off, On with Horn Chirp, or On.

**Remote Left in Vehicle Alert**

This feature sounds an alert when the RKE transmitter is left in the vehicle. This menu also enables the Remote No Longer In Vehicle Alert.

Touch Off or On.



### Teen Driver

See *Teen Driver* ⇨ 139.

### Valet Mode

This will lock the infotainment system and steering wheel controls. It may also limit access to vehicle storage locations, if equipped.

To enable valet mode:

1. Enter a four-digit code on the keypad.
2. Select Enter to go to the confirmation screen.
3. Re-enter the four-digit code.

Touch Lock or Unlock to lock or unlock the system. Touch Back to go back to the previous menu.

## Lighting

### Exterior Lighting

Exterior Lamp Controls .....	105
Exterior Lamps Off Reminder .....	106
Headlamp High/Low-Beam Changer ...	106
Flash-to-Pass .....	107
Daytime Running Lamps (DRL) .....	107
Automatic Headlamp System .....	107
Hazard Warning Flashers .....	108
Turn and Lane-Change Signals .....	108

### Interior Lighting

Instrument Panel Illumination Control .....	108
Courtesy Lamps .....	109
Dome Lamps .....	109
Reading Lamps .....	109

### Lighting Features



Entry Lighting .....	109
Exit Lighting .....	110
Battery Power Protection .....	110
Exterior Lighting Battery Saver .....	110

## Exterior Lighting

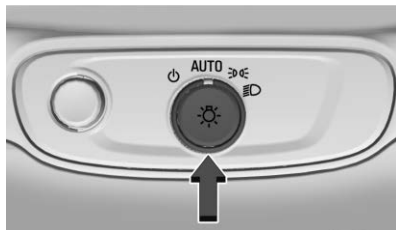
### Exterior Lamp Controls





The exterior lamp control is on the instrument panel to the left of the steering column.

 : Turns the exterior lamps off and deactivates the AUTO mode. Turn to  again to reactivate the AUTO mode.

In Canada, the headlamps will automatically reactivate when the vehicle is shifted out of P (Park).

**AUTO** : Turns the exterior lamps on and off automatically depending on outside lighting.

 : Turns on the parking lamps including all lamps, except the headlamps. The instrument panel lights also turn on.

 : Turns on the headlamps together with the parking lamps and instrument panel lights.

### IntelliBeam System

If equipped, this system turns the vehicle's high-beam headlamps on and off according to surrounding traffic conditions.



The system turns the high-beam headlamps on when it is dark enough and there is no other traffic present.

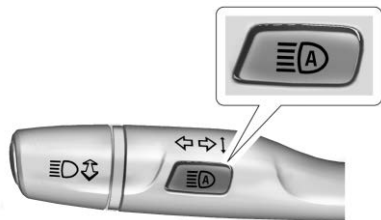

This light comes on in the instrument cluster when the IntelliBeam system is enabled.

## Turning On and Enabling IntelliBeam



To enable the IntelliBeam system, press  on the turn signal lever when the exterior lamp control is in the AUTO or  position.

## Driving with IntelliBeam



The system only activates the high beams when driving over 40 km/h (25 mph).

The blue high-beam on light appears on the instrument cluster when the high beams are on.

There is a sensor near the top center of the windshield that automatically controls the system.

Keep this area of the windshield clear of debris to allow for best system performance.

The high-beam headlamps remain on, under the automatic control, until one of the following situations occurs:

- The system detects an approaching vehicle's headlamps.
- The system detects a preceding vehicle's taillamps.
- The outside light is bright enough that high-beam headlamps are not required.
- The vehicle's speed drops below 20 km/h (12 mph).
- The IntelliBeam system is disabled by the button on the turn signal lever. If this happens, press  on the turn signal lever when the exterior lamp control is in the AUTO or  position.

The instrument cluster light will come on to indicate the IntelliBeam system is reactivated.

The high beams may not turn off automatically if the system cannot detect another vehicle's lamps because of any of the following:

- The other vehicle's lamps are missing, damaged, obstructed from view, or otherwise undetected.
- The other vehicle's lamps are covered with dirt, snow, and/or road spray.

- The other vehicle's lamps cannot be detected due to dense exhaust, smoke, fog, snow, road spray, mist, or other airborne obstructions.
- The vehicle's windshield is dirty, cracked, or obstructed by something that blocks the view of the light sensor.
- The vehicle is loaded such that the front end points upward, causing the light sensor to aim high and not detect headlamps and taillamps.
- Driving on winding or hilly roads.

The IntelliBeam system may need to be disabled if any of the above conditions exist.

## Exterior Lamps Off Reminder

A warning chime sounds if the driver door is opened while the vehicle is off and the exterior lamps are on.

## Headlamp High/Low-Beam Changer

Push the turn signal lever away from you and release, to turn the high beams on. To return to low beams, push the lever again or pull it toward you and release.



This indicator light turns on in the instrument cluster when the high-beam headlamps are on.

### Flash-to-Pass

To flash the high beams, pull the turn signal lever toward you, and release.

### Daytime Running Lamps (DRL)

DRL can make it easier for others to see the front of your vehicle during the day. Fully functional DRL are required on all vehicles first sold in Canada.

The DRL system comes on in daylight when the following conditions are met:

- The power button is on.
- The exterior lamp control is in AUTO.
- The light sensor determines it is daytime.
- The vehicle is not in P (Park).

When the DRL are on, the taillamps, sidemarker lamps, instrument panel lights, and other lamps will not be on.

The DRL turn off when the headlamps are turned to  or the vehicle is off.

For vehicles first sold in Canada, the DRL can only be turned off when the vehicle is parked.

### Automatic Headlamp System

The headlamps come on automatically when the exterior lamp control is set to AUTO and it is dark enough outside.

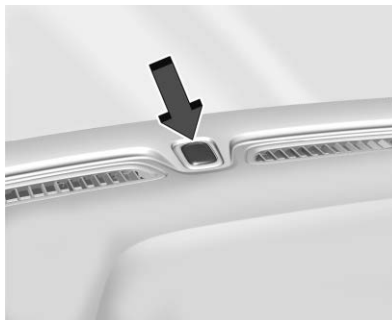



There is a light sensor on top of the instrument panel. Do not cover the sensor, otherwise the headlamps will come on when they are not needed.

The system may also turn on the headlamps when driving through a parking garage or tunnel.

When it is bright enough outside, the headlamps will turn off or may change to Daytime Running Lamps (DRL).

The automatic headlamp system turns off when the exterior lamp control is turned to  or the vehicle is off.

### Lights On with Wipers

If the windshield wipers are activated in daylight with the vehicle on, and the exterior lamp control is in AUTO, the headlamps, parking lamps, and other exterior lamps come on. The transition time for the lamps coming on varies based on wiper speed. When the wipers are not operating, these lamps turn off. Move the exterior lamp control to  or  to disable this feature.

## Hazard Warning Flashers



The hazard warning flasher button is on the center stack.

**▲** : Press to make the front and rear turn signal lamps flash on and off. This warns others that you are having trouble. Press the button again to turn the flashers off.

When the hazard warning flashers are on, the turn signals will not work.

## Turn and Lane-Change Signals

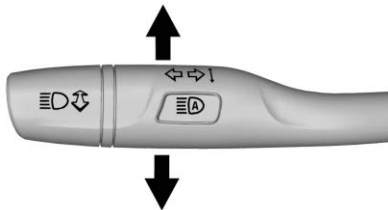

Move the lever all the way up or down to signal a turn.

An arrow on the instrument cluster flashes in the direction of the turn or lane change.

Raise or lower the lever until the arrow starts to flash to signal a lane change. Hold it there until the lane change is completed.

If the lever is briefly pressed and released, the turn signal flashes three times.

The turn and lane-change signal can be turned off manually by moving the lever back to its original position.

If after signaling a turn or lane change, the arrow flashes rapidly or does not come on, a signal bulb may be burned out.

Replace any burned out bulbs. If a bulb is not burned out, check the fuse. See *Underhood Compartment Fuse Block* ⇨ 232.

## Interior Lighting

### Instrument Panel Illumination Control

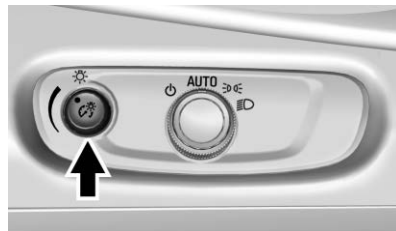

This feature adjusts the brightness of all illuminated controls. The instrument panel illumination control is next to the exterior lamp control.

Push the knob in all the way until it extends out and then turn the knob clockwise or counterclockwise to brighten or dim the lights. Push the knob back in when finished.

The knob is functional at night, or when the headlamps or parking lamps are ON.



## Courtesy Lamps



The courtesy lamps come on when any door is opened,  on the RKE transmitter is pressed, or when the vehicle is powered off. See *Dome Lamps* ⇨ 109.

## Dome Lamps



The dome lamp controls are in the headliner above the front seats.

 **OFF** : Press to turn the lamps off, even when any door is opened,  on the RKE transmitter is pressed, or when the vehicle is powered off.

 : When the button is returned to the middle position, the lamps turn on automatically when any door is opened,  on the RKE transmitter is pressed, or when the vehicle is powered off.

 **ON** : Press to turn on the dome lamps.

## Reading Lamps

There are front and rear reading lamps.





The front reading lamps are in the overhead console.

Press the lamp lenses to turn the reading lamps on or off.





The rear reading lamps are in the headliner.

 **OFF** : Press to turn the lamp off.

 **ON** : Press to turn the lamp on.

## Lighting Features

### Entry Lighting

Some exterior lamps and the interior lamps turn on briefly at night, or in areas with limited lighting, when  is pressed on the Remote Keyless Entry (RKE) transmitter. When a door is opened, the interior lamps come on if the dome lamp control is in the DOOR position. After about 30 seconds the exterior lamps turn off. Entry lighting can be disabled manually by powering on the vehicle, or by pressing the RKE transmitter  button.

This feature can be changed. See “Vehicle Locator Lights” under *Vehicle Personalization* ⇨ 101.

## Exit Lighting

Some exterior lamps and interior lamps turn on when the vehicle is powered off.

The exterior and interior lamps remain on for a set amount of time, then automatically turn off. If equipped with Keyless Access, the exterior lamps automatically turn on when the driver door is opened after the vehicle is powered off.

The interior lights turn on when the vehicle is powered off.

The exterior lamps turn off immediately by turning the exterior lamp control off.

This feature can be changed. See *Vehicle Personalization* ⇨ 101.

## Battery Power Protection

This feature helps prevent the battery from being drained if the interior courtesy lamps or reading lamps are accidentally left on.

If any of these lamps are left on, they automatically turn off after 10 minutes if the ignition is off. The lamps will not come back on again until one of the following occurs:

- The vehicle is powered on.
- The doors are closed and then re-opened.

### Battery Saver

The vehicle is equipped with electrical power management (EPM). EPM monitors and controls the charging system. The message BATTERY SAVER ACTIVE displays on the Driver Information Center (DIC) when the EPM detects the battery may be draining too quickly, the charge state needs to be reset, or the Auxiliary Power Module failed.

If safe to do so, when BATTERY SAVER ACTIVE displays, manually shut off windshield wipers, communications equipment, climate controls, etc. to slow the battery from draining. See *Automatic Climate Control System* ⇨ 147.

If the message still displays, fully charge the vehicle. Once fully charged, unplug the vehicle and let the vehicle sit an additional 8.5 hours or greater without being interrupted to allow the Body Control Module (BCM) to reset the battery to the required state of charge.

The following may interrupt the vehicle:



- Charging the vehicle
- Battery Maintenance Mode

- Approach Detection is activated
- The Key Fob is left in the car or left in close proximity of the vehicle
- Pressing buttons on the Remote Keyless Entry (RKE) transmitter
- Opening the doors or tailgate

To reduce the occurrence of this alert, GM recommends letting the vehicle sit uninterrupted for 8.5 hours or greater on a weekly basis.

If after completing this process the BATTERY SAVER ACTIVE message remains, see your dealer for service.

## Exterior Lighting Battery Saver

The exterior lamps turn off about 10 minutes after the ignition is turned off, if the parking lamps or headlamps have been manually left on. This protects against draining the battery. To restart the 10-minute timer, turn the exterior lamp control to the  position and then back to the  or  position.

To keep the lamps on for more than 10 minutes, the vehicle must be powered on or in ACC/ACCESSORY.

# Infotainment System

## Introduction

Introduction .....	111
Overview .....	112
Steering Wheel Controls .....	113
Using the System .....	113
Software Updates .....	116

## Radio

AM-FM Radio .....	116
Radio Data System (RDS) .....	118
Satellite Radio .....	118
Radio Reception .....	118
Multi-Band Antenna .....	119

## Audio Players

Avoiding Untrusted Media Devices .....	119
USB Port .....	119
Bluetooth Audio .....	122

## Voice Recognition

Voice Recognition .....	122
-------------------------	-----

## Phone

Bluetooth (Overview) .....	127
Bluetooth (Pairing and Using a Phone) .....	127
Apple CarPlay and Android Auto .....	131

## Settings

Settings .....	132
Teen Driver .....	139

## Trademarks and License Agreements

Trademarks and License Agreements ...	141
---------------------------------------	-----

# Introduction

Read the following pages to become familiar with the features.

## Warning

Taking your eyes off the road for too long or too often while using any infotainment feature can cause a crash. You or others could be injured or killed. Do not give extended attention to infotainment tasks while driving. Limit your glances at the vehicle displays and focus your attention on driving. Use voice commands whenever possible.

The infotainment system has built-in features intended to help avoid distraction by disabling some features when driving. These features may gray out when they are unavailable. Many infotainment features are also available through the instrument cluster and steering wheel controls.

Before driving:

- Become familiar with the operation, center stack controls, steering wheel controls, and infotainment display.



- Set up the audio by presetting favorite stations, setting the tone, and adjusting the speakers.
- Set up phone numbers in advance so they can be called easily by pressing a single control or by using a single voice command.





See *Distracted Driving* ⇨ 156.

### Overview

#### Infotainment System

The infotainment system is controlled by using the infotainment display, controls on the center stack, steering wheel controls, and voice recognition.



1.  (Power)
  - Press to turn the power on.
  - Press and hold to turn the power off.
  - Press to mute/unmute the system when on.
  - When the power is on and the system is not muted, a quick status pane will display when  is pressed. Pressing  will mute the system and trigger this pane to show a long press is required to actually power down the system.
  - Turn to decrease or increase the volume.
2. 
  - Press to go to the Home Page. See “Home Page” later in this section.
  - Press to exit Android Auto or Apple CarPlay. To enter back into Android Auto or Apple CarPlay, press and hold. See *Apple CarPlay and Android Auto* ⇨ 131.
3. 
  - Where applicable, turn to highlight a feature. Press to activate the highlighted feature.

#### Home Page

The Home Page is where vehicle application icons are accessed. Some applications are disabled when the vehicle is moving.

Swipe left or right across the display to access the pages of icons.

#### Managing Home Page Icons

1. Touch and hold any of the Home Page icons to enter edit mode.
2. Continue holding the icon and drag it to the desired position.
3. Release your finger to drop the icon in the desired position.
4. To move an application to another page, drag the icon to the edge of the display toward the desired page.
5. Continue dragging and dropping application icons as desired.

## Steering Wheel Controls

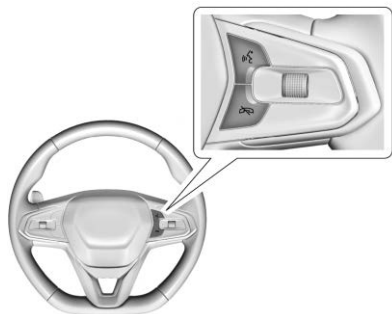

If equipped, some audio controls can be adjusted at the steering wheel.

 : Press to answer an incoming call or start voice recognition. See *Bluetooth (Overview)* ⇨ 127 or *Bluetooth (Pairing and Using a Phone)* ⇨ 127.

 : Press to decline an incoming call or end a current call. Press to mute or unmute the infotainment system when not on a call.

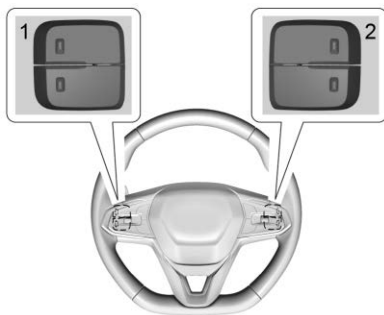

The favorites and volume switches are on the back of the steering wheel.

1. Favorite: When on a radio source, press to select the next or previous audio broadcast favorite. When listening to a media device, press to select the next or previous track.
2. Volume: Press to increase or decrease the volume.

## Using the System

### Audio

Touch the Audio icon to display the active audio source page. Examples of available sources may include AM, FM, SXM (if equipped), USB, and Bluetooth.

### Phone

Touch the Phone icon to display the Phone main page. See *Bluetooth (Overview)* ⇨ 127 or *Bluetooth (Pairing and Using a Phone)* ⇨ 127.

### Climate

If equipped, touch the Climate icon to display the Climate main page. See *Automatic Climate Control System* ⇨ 147.

### Wi-Fi Hotspot

Touch the Wi-Fi Hotspot icon to display the Wi-Fi Hotspot information. See *Settings* ⇨ 132.

### Users

If equipped, touch the Users icon to sign in or create a new user profile, and follow the on-screen instructions.

Only four user profiles can be active at one time in the vehicle. It may be necessary to remove a profile from the menu before creating or signing into an existing profile. The removed profile can be logged into at a later time.

## Settings

Touch the Settings icon to display the Settings menu. See *Settings* ⇨ 132.

## Apple CarPlay

Touch the Apple CarPlay icon to activate Apple CarPlay after a supported device is connected. See *Apple CarPlay and Android Auto* ⇨ 131.

## Android Auto

Touch the Android Auto icon to activate Android Auto after a supported device is connected. See *Apple CarPlay and Android Auto* ⇨ 131.

## Apps

If equipped, in-vehicle apps are available for download. Touch the Apps icon on the Home Page to begin.

Downloading and using in-vehicle apps requires Internet connectivity which can be accessed with a data plan through the vehicle's built-in 4G LTE Wi-Fi hotspot, if equipped, or a compatible mobile device hotspot. On most mobile devices, activation of the Wi-Fi hotspot is in the device's

Settings menu under Mobile Network Sharing, Personal Hotspot, Mobile Hotspot, or similar.

Availability of apps and connectivity varies by vehicle, conditions, and location. Data plan rates apply. Features are subject to change. For more information, see [www.my.chevrolet.com/learn](http://www.my.chevrolet.com/learn).

## OnStar Services

If equipped, touch the OnStar Services icon to display the OnStar Services and Account pages. See *OnStar Overview* ⇨ 296.

## Camera

If equipped, touch the Camera icon to access the camera application. See *Assistance Systems for Parking or Backing* ⇨ 187.

## Shortcut Tray

The shortcut tray is near the bottom of the display. It shows up to four applications.

## Infotainment Display Features

Infotainment display features show on the display when available. When a feature is unavailable, it may gray out. When a feature is touched, it may highlight.

## Haptic Feedback

If equipped, haptic feedback is a pulse that occurs when an icon or option is touched on the display or when controls on the center stack are pressed.

## Infotainment Gestures

Use the following finger gestures to control the infotainment system.

### Touch/Tap

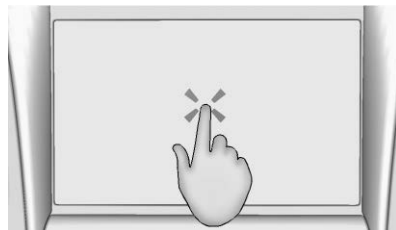

Touch/tap is used to select an icon or option, activate an application, or change the location inside a map.

**Touch and Hold**

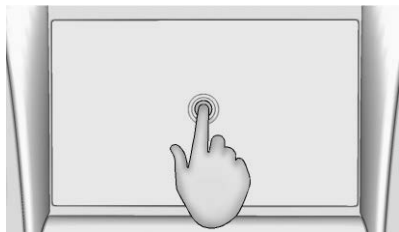

Touch and hold can be used to start another gesture, or to move or delete an application.

**Drag**

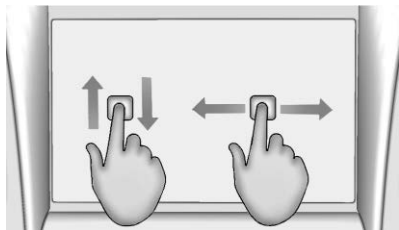

Drag is used to move applications on the Home Page, or to pan the map. To drag the item, it must be held and moved along the display to the new location. This can be

done up, down, right, or left. This feature is only available when vehicle is parked and not in motion.

**Nudge**

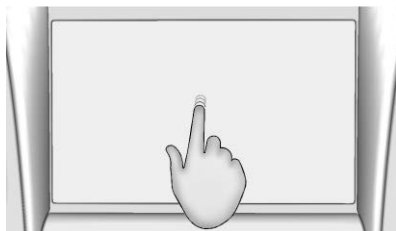

Nudge is used to move items a short distance on a list or a map. To nudge, hold and move the selected item up or down to a new location.

**Fling or Swipe**

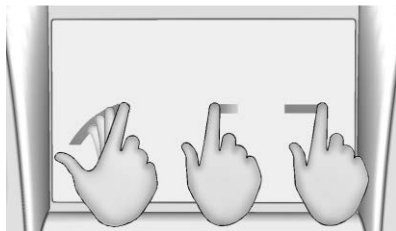

Fling or swipe is used to scroll through a list, pan the map, or change page views. Do this by placing a finger on the display then moving it rapidly up and down or right and left.

**Spread**

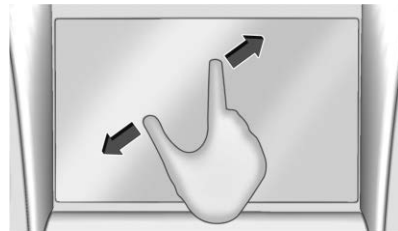

Spread is used to zoom in on a map, certain images, or a web page. Place finger and thumb together on the display, then move them apart.

## Pinch

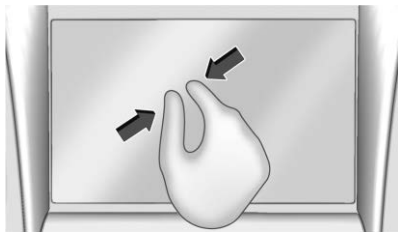

Pinch is used to zoom out on a map, certain images, or a web page. Place finger and thumb apart on the display, then move them together.

### Cleaning High Gloss Surfaces and Vehicle Information and Radio Displays

For vehicles with high gloss surfaces or vehicle displays, use a microfiber cloth to wipe surfaces. Before wiping the surface with the microfiber cloth, use a soft bristle brush to remove dirt that could scratch the surface. Then use the microfiber cloth by gently rubbing to clean. Never use window cleaners or solvents. Periodically hand wash the microfiber cloth separately, using mild soap. Do not use bleach or fabric softener. Rinse thoroughly and air dry before next use.

## Software Updates

### Over-the-Air Software Updates

If equipped, see “Updates” under *Settings* ⇨ 132 for details on software updates.

## Radio

### AM-FM Radio

#### Playing the Radio

From the Home Page, touch the Audio icon to display the active audio source page. Choose from the three most recently used sources listed at the left side of the display or touch the More option to display a list of available sources. Examples of available sources may include AM, FM, SXM (if equipped), MyMedia, USB, and Bluetooth.

#### Infotainment System Sound Menu

From any of the audio source main pages, touch Sound to display the following:

**Equalizer** : Touch to adjust Bass, Midrange, Treble, and Surround (if equipped) using the options on the infotainment display.

**Fade/Balance** : Touch to adjust by using the controls on the infotainment display or by tapping/dragging the crosshair.

### Finding a Station

#### Seeking a Station

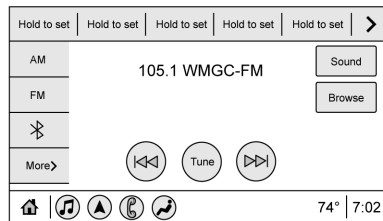

From the AM, FM, or SXM (if equipped) option, press or on the center stack to search for the previous or next strong station or channel.

#### Browsing Stations

Touch the Browse option to list all available stations or channels. Navigate up and down through all stations by scrolling the list. Touch the station or channel you want to listen to. Touch to save the station or channel as a favorite.

If equipped, touch Update Station List to update the active stations in your area.

## Direct Tune

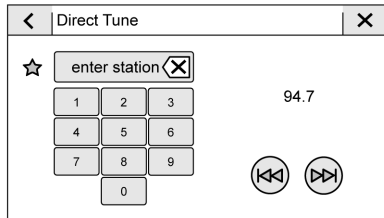

Access Direct Tune by touching the Tune icon on the infotainment display to bring up the keypad. Navigate through all frequencies using the arrows on the right side of the Direct Tune display. Directly enter a station or channel using the keypad. When a new station or channel is entered, the information about that station or channel displays on the right side. This information will update with each new valid frequency. Touch ☆ to save the station or channel as a favorite.

The keypad will gray out entries that do not contribute to a valid frequency and will automatically place a decimal point within the frequency number.

Touch (X) to delete one number at a time. Touch and hold (X) to delete all numbers.

A valid AM or FM station will automatically tune to the new frequency but not close the Direct Tune display. When listening to SXM (if equipped), touch Go after entering the channel. Touch the Back icon on the infotainment display or touch X to exit out of Direct Tune.

The tune arrows on the right side of the Direct Tune display will tune through the complete station or channel list one station step at a time per touch. A touch and hold advances through stations or channels quickly.

## FM and SXM Categories

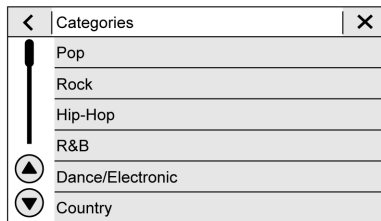

From the FM or SXM (if equipped) display, touch Categories at the top of the Browse menu to access the categories list. The list contains names associated with the FM stations or SXM channels. Touch a category

name to display a list of stations or channels for that category. Touching a station or channel from the list will tune the radio to that station or channel.

## Storing Radio Station Presets

Favorites show in the area at the top of the display.

**AM, FM or SXM (if equipped)** : Press and hold a preset to store the current station or channel as a favorite. Touch a saved favorite to recall a favorite station or channel.

Favorites can also be stored by touching ☆ in a station or channel list. This will highlight indicating that it is now saved as a favorite.

The number of favorites displayed is automatically adjusted by default, but can be manually adjusted in Settings in the System tab under Favorites and then Set Number of Audio Favorites. It can also be adjusted in Settings in the Apps tab under Audio and then Set Number of Audio Favorites.

## Radio Data System (RDS)

If equipped, RDS features are available for use only on FM stations that broadcast RDS information. With RDS, the radio can:

- Group stations by Category (i.e., Program Type) such as Rock, Jazz, Classical, etc.
- Display messages from radio stations.

This system relies on receiving specific information from these stations and only works when the information is available. It is possible that a radio station could broadcast incorrect information that causes the radio features to work improperly. If this happens, contact the radio station.

When information is broadcast from a RDS station, the station name or call letters display on the audio screen. Radio text supporting the currently playing broadcast may also appear.

## Satellite Radio

### SiriusXM Radio Service

If equipped, vehicles with a valid SiriusXM radio subscription can receive SiriusXM programming.

SiriusXM radio has a wide variety of programming and commercial-free music, coast to coast, in digital-quality sound. In the U.S., see [www.siriusxm.com](http://www.siriusxm.com) or call 1-888-601-6296. In Canada, see [www.siriusxm.ca](http://www.siriusxm.ca) or call 1-877-438-9677.

When SiriusXM is active, the channel name, number, song title, and artist appear on the display.

### SiriusXM with 360L

SiriusXM with 360L interface has enhanced in-vehicle listening experience for subscribers. The experience now offers more categories and system learned recommendations toward discovering more personalized content.

To use the full SiriusXM 360L program, including streaming content and listening recommendations, OnStar Connected Access is required. Connected vehicle services vary by model and require a complete working electrical system, cell reception, and GPS signal. An active connected plan is required.

Reference the SiriusXM user guide for use and subscription information.

## Radio Reception

Unplug electronic devices from the accessory power outlets if there is interference or static in the radio.

### FM

FM signals only reach about 16 to 65 km (10 to 40 mi). Although the radio has a built-in electronic circuit that automatically works to reduce interference, some static can occur, especially around tall buildings or hills, causing the sound to fade in and out.

### AM

The range for most AM stations is greater than for FM, especially at night. The longer range can cause station frequencies to interfere with each other. Static can also occur when things like storms and power lines interfere with radio reception. When this happens, try reducing the treble on the radio.

### SiriusXM Satellite Radio Service

If equipped, SiriusXM Satellite Radio Service provides digital radio reception. Tall buildings or hills can interfere with satellite radio signals, causing the sound to fade in and out. In addition, traveling or standing

under heavy foliage, bridges, garages, or tunnels may cause loss of the SiriusXM signal for a period of time. Some cellular services may interfere with SXM reception causing loss of signal.

### Mobile Device Usage

Mobile device usage, such as making or receiving calls, charging, or just having the mobile device on may cause static interference in the radio. Unplug the mobile device or turn it off if this happens.

### Multi-Band Antenna

The roof antenna is for AM, FM, SiriusXM Satellite Radio, OnStar, and GPS (Global Positioning System). Keep clear of obstructions for clear reception. If the vehicle has a sunroof, and it is open, reception can also be affected.

## Audio Players

### Avoiding Untrusted Media Devices

When using media devices such as SD cards, USB devices, and mobile devices, consider the source. Untrusted media devices could

contain files that affect system operation or performance. Avoid use if the content or origin cannot be trusted.

### USB Port

Audio stored on a USB device may be listened to.

The vehicle may be equipped with two USB ports on the center stack. These ports are for data and charging. There may also be two USB ports for charging only at the rear of the center console.

Caution
To avoid vehicle damage, unplug all accessories and disconnect all accessory cables from the vehicle when not in use. Accessory cables left plugged into the vehicle, unconnected to a device, could be damaged or cause an electrical short if the unconnected end comes in contact with liquids or another power source such as the accessory power outlet.

### Playing from a USB

A USB mass storage device can be connected to the USB port.

Audio extensions supported by the USB may include:

- MP3
- AAC
- OGG
- 3GP

### Gracenote

When plugging in a USB device, Gracenote service builds voice tags for music. Voice tags allow artists, albums with hard to pronounce names, and nicknames to be used to play music through voice recognition, if equipped.

While indexing, infotainment features may be available.

### My Media Library

MyMedia is only available when more than one indexed device is connected. It allows access to content from all indexed media sources. MyMedia will show as an available source in the Source page.

### USB MP3 Player and USB Devices

The USB MP3 players and USB devices connected must comply with the USB Mass Storage Class specification (USB MSC).



To play a USB device:

1. Connect the USB.
2. Touch Audio from the Home Page.
3. Touch the More option and then touch the USB device.

Use the following when playing an active USB source:

 : Touch to play the current media source.

 : Touch to pause playback of the current media source.

 :

- Touch to seek the beginning of the current or previous track.
- Touch and hold to reverse quickly through playback. Release to return to playing speed. Elapsed time displays.

 :

- Touch to seek the next track.
- Touch and hold to advance quickly through playback. Release to return to playing speed. Elapsed time displays.

**Shuffle** : Touch the shuffle icon to play music in random order.

### USB Sound Menu

See “Infotainment System Sound Menu” under *AM-FM Radio* ⇨ 116.

### USB Browse Menu

When a list of songs, albums, artists, or other types of media displays, the up and down arrows and A-Z appear on the left side. Select A-Z to view a display that will show all letters of the alphabet and select the letter to go to.

Touch the up and down arrows to move the list up and down.

Touch Browse and the following may display:

#### Playlists:

1. Touch to view the playlists stored on the USB.
2. Touch a playlist to view the list of all songs in that playlist.
3. Touch a song from the list to begin playback.

Supported playlist extensions are m3u and pls.

#### Artists:

1. Touch to view the list of artists stored on the USB.

2. Touch an artist name to view a list of all albums by the artist.
3. To select a song, touch All Songs or touch an album and then touch a song from the list.

#### Songs:

1. Touch to display a list of all songs on the USB.
2. To begin playback, touch a song from the list.

#### Albums:

1. Touch to view the albums on the USB.
2. Touch the album to view a list of all songs on the album.
3. Touch a song from the list to begin playback.

#### Genres:

1. Touch to view the genres on the USB.
2. Touch a genre to view a list of artists.
3. Touch an artist to view albums by that artist.
4. Touch an album to view songs on the album.
5. Touch a song to start playback.

**Composers:**

1. Touch to view the composers on the USB.
2. Touch a Composer to view a list of albums by that composer.
3. Touch an album or All Songs to view a list of songs.
4. Touch a song from the list to begin playback.

**Folders:**

1. Touch to view the directories on the USB.
2. Touch a folder to view a list of all files.
3. Touch a file from the list to begin playback.

**Podcasts :** Touch to view the podcasts on the connected Apple device and get a list of podcast episodes.

**Audiobooks:**

1. Touch to view the audiobooks stored on the Apple device.
2. Touch an audiobook to get a list of chapters.
3. Touch the chapter from the list to begin playback.

**File System and Naming**

File systems supported by the USB may include:

- FAT32
- NTFS
- HFS+

The songs, artists, albums, and genres are taken from the file's song information and are only displayed if present. The radio displays the file name as the track name if the song information is not available.

**Supported Apple Devices**

To view supported devices, see [my.chevrolet.com/learn](http://my.chevrolet.com/learn).

**Storing and Recalling Media Favorites**

To store media favorites, touch Browse to display a list of media types.

Touch one of the following Browse options to save a favorite:

**Playlists :** Touch ☆ next to any playlist to store the playlist as a favorite. Touch a saved favorite to recall a favorite playlist. The first song in the playlist begins to play.

**Artists :** Touch ☆ next to any artist to store the artist as a favorite. Touch a saved favorite to recall a favorite artist. The first song in the artist list begins to play.

**Songs :** Touch ☆ next to any song to store the song as a favorite. Touch a saved favorite to recall a favorite song.

**Albums :** Touch ☆ next to any album to store the album as a favorite. Touch a saved favorite to recall a favorite album. The first song in the album list begins to play.

**Genres :** Touch ☆ next to any genre to store the genre as a favorite. Touch a saved favorite to recall a favorite genre. The first song of the genre begins to play.

**Podcasts :** Touch ☆ next to any podcast to store the podcast as a favorite. Touch a saved favorite to recall a favorite podcast. The podcast begins to play.

**Audiobooks :** Touch ☆ next to any audiobook to store the audiobook as a favorite. Touch a saved favorite to recall a favorite audiobook. The first chapter in the audiobook begins to play.

## Media Playback and Mute

USB playback will be paused if the system is muted. If the steering wheel mute control is pressed again, playback will resume.

If the source is changed while in mute, playback resumes and audio will unmute.

## Bluetooth Audio

Music may be played from a paired Bluetooth device. See *Bluetooth (Overview)*

⇨ 127 or

*Bluetooth (Pairing and Using a Phone)* ⇨ 127 for help pairing a device.

Volume and song selection may be controlled by using the infotainment controls or the mobile device. If Bluetooth is selected and no volume is present, check the volume setting on the infotainment system.

Music can be launched by touching Bluetooth from the recent sources list on the left of the display or by touching the More option and then touching the Bluetooth device.

To play music via Bluetooth:

1. Power on the device, and pair to connect the device.

2. Once paired, touch Audio from the Home Page, then touch Bluetooth from the recent sources list on the left of the display.

### Bluetooth Sound Menu

See “Infotainment System Sound Menu” under *AM-FM Radio* ⇨ 116.

### Manage Bluetooth Devices

From the Home Page:

1. Touch Audio.
2. Touch More.
3. Touch Bluetooth.
4. Touch Devices to add or delete devices.



When touching Bluetooth, the radio may not be able to launch the audio player on the connected device to start playing. When the vehicle is not moving, use the mobile device to begin playback.

All devices launch audio differently. When selecting Bluetooth as a source, the radio may show as paused on the display. Press play on the device or touch  on the display to begin playback.

Browse functionality will be provided where supported by the Bluetooth device. This media content will not be part of the MyMedia source mode.

Some smartphones support sending Bluetooth music information to display on the radio. When the radio receives this information, it will check to see if any is available and display it. For more information about supported Bluetooth features, see [my.chevrolet.com/learn](http://my.chevrolet.com/learn).

## Voice Recognition

If equipped, voice recognition allows for hands-free operation within the audio, phone, and weather applications. This feature can be started by pressing  on the steering wheel or touching  on the infotainment display.

However, not all features within these areas are supported by voice commands. Generally, only complex tasks that require multiple manual interactions to complete are supported by voice commands.

For example, tasks that take more than one or two touches, such as a song or artist to play from a media device, would be supported by voice commands. Other tasks,

like adjusting the volume or seeking up or down, are audio features that are easily performed by touching one or two options, and are not supported by voice commands.

In general there are flexible ways to speak commands for completing the tasks.

### Hybrid Speech Recognition

If equipped, this feature helps distinguish words by using Internet-based information along with the system's voice recognition database. This allows you to speak more naturally when using voice recognition.

### Using Voice Recognition

Voice recognition becomes available once the system has been initialized. This begins when the ignition is turned on. Initialization may take a few moments.

1. Press  on the steering wheel controls to activate voice recognition.
2. The audio system mutes and the system plays a prompt.
3. Clearly speak one of the commands described in this section.

A voice recognition system prompt can be interrupted while it is playing by pressing  again.

Once voice recognition is started, both the infotainment display and instrument cluster show the selections and visual dialog content. These displays can be turned on or off in the Tutorial Mode under *Settings* ⇨ 132.

There are three voice prompt modes supported:

- **Informative verbal prompts:** This type of prompt will provide more information regarding the supported actions.
- **Short prompts:** This type of prompt will provide simple instructions about what can be stated.
- **Auto informative prompts:** This type of prompt plays during the first few speech sessions, then automatically switches to the short prompt after some experience has been gained through using the system.

If a command is not spoken, the voice recognition system says a help prompt.

### Prompts and Infotainment Displays

While a voice recognition session is active, there may be corresponding options showing on the displays. A selection can be made by manually touching the option, or by speaking the number for the option to

select. Manual interaction in the voice recognition session is permitted. Interaction during a voice session may be completed entirely using voice commands while some manual commands may expedite a task. If a selection is made using a manual control, the voice recognition dialog will progress in the same way as if the selection were made using a voice command. Once the system completes the task, or the session is terminated, the voice recognition dialog stops.

An example of this type of manual intervention is touching an entry of a displayed number list instead of speaking the number associated with the entry desired.

### Canceling Voice Recognition

- Touch or say “Cancel” or “Exit” to terminate the voice recognition session and show the display where voice recognition was initiated.
- Press  on the steering wheel controls to terminate the voice recognition session and show the display where voice recognition was initiated.

### Natural Language Commands

Most languages do not support natural language commands in sentence form. For those languages, use direct commands like the examples shown on the display.

### Helpful Hints for Speaking Commands

Voice recognition can understand commands that are naturally stated in sentence form or direct commands that state the application and the task.

For best results:

- Listen for the prompt before saying a command or reply.
- Speak the command naturally, not too fast, not too slow.
- Use direct commands without a lot of extra words. For example, “Call <name> at work,” “Play” followed by the artist or song name, or “Tune” followed by the radio station number.

Direct commands might be more clearly understood by the system. An example of a direct command would be “Call <number>.” Examples of these direct commands are displayed on most of the screens while a voice session is active. If “Phone” or “Phone Commands,” is spoken, the system

understands that a phone call is requested and will respond with questions until enough details are gathered to make a call.

If a cell phone number has been saved with a name and a place, the direct command should include both, for example “Call <name> at work.”

### Using Voice Recognition for List Options

When a list is displayed, a voice prompt will ask to confirm or select an option from that list.

When a display contains a list, there may be options that are available but not displayed. The list on a voice recognition screen functions the same as a list on other displays. Scrolling or flinging can be used to help display other entries from the list.

Manually scrolling or paging the list on a display during a voice recognition session suspends the current voice recognition event and plays the prompt “Please select manually or touch the Back icon on the infotainment display to try again.”

If manual selection takes more than 15 seconds, the session terminates and prompts that it has timed out. The display returns to the display where voice recognition was initiated.

### The Back Command

Say “Back” or touch the Back icon on the infotainment display to go to the previous menu.

If in voice recognition, and “Back” is spoken all the way back to the starting display, and then “Back” is spoken one more time, the voice recognition session will cancel.

### Help

Say “Help” on any voice recognition display and the help prompt for the display is played.

### Voice Recognition for the Radio

If browsing the audio sources when voice is touched, the voice recognition commands for AM, FM, and SiriusXM (if equipped) are available.

“**Switch to AM**” : Switch bands to AM and tune to the last AM radio station.

“**Switch to FM**” : Switch bands to FM and tune to the last FM radio station.

**“Switch to SXM”** : Switch bands to SiriusXM and tune to the last SiriusXM channel.

**“Tune to <AM frequency> AM”** : Tune to the radio station whose frequency is identified in the command (like “nine fifty”).

**“Tune to <FM frequency> FM”** : Tune to the radio station whose frequency is identified in the command (like “one oh one point one”).

**“Tune to SXM <SXM channel number>”** : Tune to the SiriusXM radio station whose channel number is identified in the command.

**“Tune to SXM <SXM channel name>”** : Tune to the SiriusXM radio station whose channel name is identified in the command.

### Voice Recognition for Audio MyMedia

The available voice recognition commands for [browsing] MyMedia are:

**“Play Artist”** : Begin a dialog to enter a specific artist name.

**“Play Artist <artist name>”** : Begin playback of a specific artist.

**“Play Album”** : Begin a dialog to enter a specific album name.

**“Play Album <album name>”** : Begin playback of a specific album.

**“Play Song”** : Begin a dialog to enter a specific song name.

**“Play Song <song name>”** : Begin playback of a specific song, if available.

**“Play Genre”** : Begin a dialog to enter a specific genre.

**“Play Genre <genre name>”** : Begin playback of a specific genre.

**“Play Playlist”** : Begin a dialog to enter a specific playlist name.

**“Play Playlist <playlist name>”** : Begin playback of a specific playlist.

**“Play <device name>”** : Play music from a specific device identified by name. The device name is the name displayed on the display when the device is first selected as an audio source.

**“Play Chapter”** : Begin a dialog to enter a specific name.

**“Play Chapter <chapter name>”** : Begin playback of a specific chapter.

**“Play Audiobook”** : Begin a dialog to enter a specific audiobook.

**“Play Audiobook <audiobook name>”** : Begin playback of a specific audiobook.

**“Play Episode”** : Begin a dialog to enter a specific name.

**“Play Episode <episode name>”** : Begin playback of a specific episode.

**“Play Podcast”** : Begin a dialog to enter a specific podcast.

**“Play Podcast <podcast name>”** : Begin playback of a specific podcast.

**“My Media”** : Begin a dialog to enter the desired media content.

### Handling Large Amounts of Media Content

It is expected that large amounts of media content will be brought into the vehicle. It may be necessary to handle large amounts of media content in a different way than smaller amounts of media. The system may limit the options of voice recognition by not allowing selection of files by voice at the highest level if the number of files exceeds the maximum limit.

Changes to voice commands due to media content limits are:

- Files including other individual files of all media types such as songs, audiobook chapters, podcast episodes, and videos.

- Album type folders including types such as albums and audiobooks.

There are no restrictions if the number of files and albums is fewer than 12,000. When the number of files connected to the system is between 12,000 and 24,000, the content cannot be accessed directly with one command like “Play <song name>.”

The restriction is that the command “Play Song” must be spoken first; the system will then ask for the song name. The reply command would be to say the name of the song to play.

Similar limits exist for album content.

If there are more than 12,000 albums, but fewer than 24,000, the content cannot be accessed directly with one command like, “Play <album name>.” The command “Play Album” must first be spoken; the system will then ask for the album name. The reply would be to say the name of the album to play.

Once the number of files has exceeded approximately 24,000, there is no support for accessing the songs directly through voice commands. There will still be access to the media content by using commands for playlists, artists, and genres.

The access commands for playlists, artists, and genres are prohibited after the number of this type of media exceeds 12,000.

The system will provide feedback the first time voice recognition is initiated if it has become apparent that any of these limits are reached during a device initializing process.

Voice recognition performance will degrade to some extent based on many factors when adding large amounts of data to recognize. If this is the case, perhaps accessing songs through playlists or artist name would work better.

### Voice Recognition for the Phone

“**Call <contact name>**” : Initiate a call to a stored contact. The command may include location if the contact has location numbers stored.

“**Call <contact> At Home,**” “**At Work,**” “**On Mobile,**” or “**On Other**” : Initiate a call to a stored contact and location at home, at work, on mobile device, or on another phone.

“**Call <cell phone number>**” : Initiate a call to a cell phone number of seven digits, 10 digits, or three digit emergency numbers.

“**Pair Phone**” : Begin the Bluetooth pairing process. Follow the instructions on the infotainment display.

“**Redial**” : Initiate a call to the last dialed number.

“**Switch Phone**” : Select a different connected cell phone for outgoing calls.

“**Voice Keypad**” : Begin a dialog to enter special numbers like international numbers. The numbers can be entered in groups of digits with each group of digits being repeated back by the system. If the group of digits is not correct, the command “Delete” will remove the last group of digits and allow them to be re-entered. Once the entire number has been entered, the command “Call” will start dialing the number.

### Phone Assistant Voice Recognition

Press and hold  on the steering wheel controls to pass through and launch Google phone assistant or Siri.

For the low radio, whether connected by Bluetooth or phone projection, the only available voice recognition is either Siri (iPhone) or the Google Assistant (Android).

## Phone

### Bluetooth (Overview)

The Bluetooth-capable system can interact with many mobile devices, allowing:

- Placement and receipt of calls in a hands-free mode.
- Sharing of the device's address book or contact list with the vehicle.

To minimize driver distraction, before driving, and with the vehicle parked:

- Become familiar with the features of the mobile device. Organize the phone book and contact lists clearly and delete duplicate or rarely used entries. If possible, program speed dial or other shortcuts.
- Review the controls and operation of the infotainment system.
- Pair mobile device(s) to the vehicle. The system may not work with all mobile devices. See "Pairing" later in this section.

Vehicles with a Bluetooth system can use a Bluetooth-capable mobile device with a Hands-Free Profile to make and receive phone calls. The infotainment system and voice recognition are used to control the system. The system can be used while the

ignition is on or in ACC/ACCESSORY. The range of the Bluetooth system can be up to 9.1 m (30 ft). Not all mobile devices support all functions and not all mobile devices work with the Bluetooth system. See [my.chevrolet.com](http://my.chevrolet.com) for more information about compatible mobile devices.

### Controls

Use the controls on the center stack and the steering wheel to operate the Bluetooth system.

### Steering Wheel Controls

 : Press to answer incoming calls and start voice recognition on your connected Bluetooth mobile device.

 : Press to end a call, decline a call, or cancel an operation. Press to mute or unmute the infotainment system when not on a call.

### Infotainment System Controls

For information about how to navigate the menu system using the infotainment controls, see *Using the System* ⇨ 113.

## Audio System

When using the Bluetooth mobile device system, sound comes through the vehicle's front audio system speakers and overrides the audio system. The volume level while on a mobile device call can be adjusted by pressing the steering wheel controls or the volume control on the center stack. The adjusted volume level remains in memory for later calls. The volume cannot be lowered beyond a certain level.

## Bluetooth (Pairing and Using a Phone)

### Pairing

A Bluetooth-enabled mobile device must be paired to the Bluetooth system and then connected to the vehicle before it can be used. See the mobile device manufacturer's user guide for Bluetooth functions before pairing the device.

### Pairing Information

- If no mobile device has been connected, the Phone main page on the infotainment display will show the Connect Phone option. Touch this option to connect.



Another way to connect is to touch the Phones tab at the top right of the display and then touch Add Phone.

- A Bluetooth smartphone with music capability can be paired to the vehicle as a smartphone and a music player at the same time.
- Up to 10 devices can be paired to the Bluetooth system.
- The pairing process is disabled when the vehicle is moving.
- Pairing only needs to be completed once, unless the pairing information on the cell phone changes or the cell phone is deleted from the system.
- If multiple paired cell phones are within range of the system, the system connects to the paired cell phone that is set to First to Connect. If there is no cell phone set to First to Connect, it will link to the cell phone which was used last. To link to a different paired cell phone, see “Linking to a Different Phone” later in this section.

### **Pairing a Phone**

1. Make sure Bluetooth has been enabled on the cell phone before the pairing process is started.

2. Touch the Phone icon on the Home Page or the phone icon on the shortcut tray near the bottom of the display.
3. Touch Phones at the top of the infotainment display. There is also a Connect Phones option in the middle of the Phone display which will shortcut to the Phone List menu.
4. Touch Add Phone.
5. Select the vehicle name shown on the infotainment display from your cell phone’s Bluetooth Settings list.
6. Follow the instructions on the cell phone to confirm the six-digit code showing on the infotainment display and touch Pair. The code on the cell phone and infotainment display will need to be acknowledged for a successful pair.
7. Start the pairing process on the cell phone to be paired to the vehicle. See the cell phone manufacturer’s user guide for information on this process. Once the cell phone is paired, it will show under Connected.

8. If the vehicle name does not appear on your cell phone, there are a few ways to start the pairing process over:

- Turn the cell phone off and then back on.
- Go back to the beginning of the Phone menus on the infotainment display and restart the pairing process.
- Reset the cell phone, but this step should be done as a last effort.

9. If the cell phone prompts to accept connection or allow phone book download, touch Always Accept and Allow. The phone book may not be available if not accepted.
10. Repeat Steps 1–8 to pair additional cell phones.

### **First to Connect Paired Phones**

If multiple paired cell phones are within range of the system, the system connects to the paired cell phone that is set as First to Connect. To enable a paired cell phone as the First to Connect phone:

1. Make sure the cell phone is turned on.
2. Touch Settings, then touch System.

3. Touch Phones to access all paired and all connected cell phones and mobile devices.
4. Touch the information icon to the right of the cell phone to open the cell phone's settings menu.
5. Touch the First to Connect option, to enable the setting for that device.

Cell phones and mobile devices can be added, removed, connected, and disconnected. A sub-menu will display whenever a request is made to add or manage cell phones and mobile devices.

### Secondary Phone

A cell phone can be enabled as a Secondary Phone by touching the information icon to the right of the paired cell phone name to open the phone settings menu. If a cell phone is enabled as a Secondary Phone, it can connect simultaneously alongside another Bluetooth mobile device. In doing so, the Secondary Phone will be labeled as Incoming Calls. This means the mobile device can only receive calls. The Address Book of a Secondary Phone will not be available and hands-free outgoing calls cannot be placed using this cell phone.

If needed, touch the Secondary Phone while in the Phones list to swap it into the Outgoing and Incoming role. This role makes it possible to place outgoing calls from the Contacts and Recents list.

### Listing All Paired and Connected Phones

1. Touch the Phone icon on the Home Page or the phone icon on the shortcut tray near the bottom of the display.
2. Touch Phones.

### Disconnecting a Connected Phone

1. Touch the Phone icon on the Home Page.
2. Touch Phones.
3. Touch the information icon next to the connected cell phone or mobile device to show the cell phone's or mobile device's information display.
4. Touch Disconnect.

### Deleting a Paired Phone

1. Touch the Phone icon on the Home Page or the phone icon on the shortcut tray near the bottom of the display.
2. Touch Phones.

3. Touch the information icon next to the connected cell phone to display the cell phone's or mobile device's information display.
4. Touch Forget Device.

### Linking to a Different Phone

To link to a different cell phone, the new cell phone must be in the vehicle and paired to the Bluetooth system.

1. Touch the Phone icon on the Home Page or the phone icon on the shortcut tray near the bottom of the display.
2. Touch Phones.
3. Touch the new cell phone to link to from the not connected phone list. See "First to Connect Paired Phones" and "Secondary Phone" previously in this section.

### Switching to Handset or Handsfree Mode

To switch between handset or handsfree mode:

- While the active call is hands-free, touch the Handset option to switch to the handset mode.

The mute icon will not be available or functional while Handset mode is active.

- While the active call is on the handset, touch the Handset option to switch to the hands-free mode.

### **Making a Call Using Contacts and Recent Calls**

Calls can be made through the Bluetooth system using personal cell phone contact information for all cell phones that support the Phone Book feature. Become familiar with the cell phone settings and operation. Verify the cell phone supports this feature.

The Contacts menu accesses the phone book stored in the cell phone.

The Recents menu accesses the recents call list from your cell phone.

To make a call using the Contacts menu:

1. Touch the Phone icon on the Home Page.
2. Touch Contacts.
3. The Contacts list can be searched by using the first character. Touch A-Z on the infotainment display to scroll through the list of names.  
Touch the name to call.
4. Touch the desired contact number to call.

To make a call using the Recents menu:

1. Touch Phone on the Home Page.
2. Touch Recents.
3. Touch the name or number to call.

### **Making a Call Using the Keypad**

To make a call by dialing the numbers:

1. Touch the Phone icon on the Home Page.
2. Touch Keypad and enter a phone number.
3. Touch  on the infotainment display to start dialing the number.

### **Searching Contacts Using the Keypad**

To search for contacts using the keypad:

1. Touch the Phone icon on the Home Page.
2. Touch Keypad and enter partial phone numbers or contact names using the digits on the keypad to search.

Results will show on the right side of the display. Touch one to place a call.

### **Accepting or Declining a Call**

When an incoming call is received, the infotainment system mutes and a ring tone is heard in the vehicle.

### **Accepting a Call**

There are two ways to accept a call:

- Press  on the steering wheel controls.
- Touch Answer on the infotainment display.

### **Declining a Call**

There are two ways to decline a call:

- Press  on the steering wheel controls.
- Touch Ignore on the infotainment display.

### **Call Waiting**

Call waiting must be supported on the Bluetooth cell phone and enabled by the wireless service carrier to work.

### **Accepting a Call**

Press  to answer, then touch Switch on the infotainment display.

### **Declining a Call**

Press  to decline, then touch Ignore on the infotainment display.

### Switching Between Calls (Call Waiting Calls Only)

To switch between calls, touch Phone on the Home Page to display Call View. While in Call View, touch the call information of the call on hold to change calls.



### Three-Way Calling

Three-way calling must be supported on the Bluetooth cell phone and enabled by the wireless service carrier to work.

To start a three-way call while in a current call:

1. In the Call View, touch Add Call to add another call.
2. Initiate the second call by selecting from Recents, Contacts, or Keypad.
3. When the second call is active, touch the merge icon to conference the three-way call together.

### Ending a Call

- Press  on the steering wheel controls.
- Touch  on the infotainment display, next to a call, to end only that call.

### Dual Tone Multi-Frequency (DTMF) Tones

The in-vehicle Bluetooth system can send numbers during a call. This is used when calling a menu-driven phone system. Use the Keypad to enter the number.

### Apple CarPlay and Android Auto

If equipped, Android Auto and/or Apple CarPlay capability may be available through a compatible smartphone. If available, the Android Auto and Apple CarPlay icons will change from gray to color on the Home Page of the infotainment display.

To use Android Auto and/or Apple CarPlay:

#### For Wired Phone Projection

1. Download the Android Auto app to your smartphone from the Google Play store. There is no app required for Apple CarPlay.
2. Connect your Android phone or Apple iPhone by using the factory-provided phone USB cable and plugging into a USB data port. For best performance, it is highly recommended to use the device's factory-provided USB cable, which should be replaced after significant wear to maintain connection quality. Aftermarket or third-party cables may not work.

3. When the phone is first connected to activate Apple CarPlay or Android Auto, accept the terms and conditions on both the infotainment system and the phone.
4. Follow the instructions on the phone.

The Android Auto and Apple CarPlay icons on the Home Page will illuminate depending on the smartphone. Android Auto and/or Apple CarPlay may automatically launch upon USB connection. If not, touch the Android Auto or Apple CarPlay icon on the Home Page to launch.

Press  on the center stack to return to the Home Page.

#### For Wireless Phone Projection

Verify your phone is wireless compatible by visiting the Google Android Auto or Apple CarPlay support page.

1. Download the Android Auto app to your smartphone from the Google Play store. There is no app required for Apple CarPlay.
2. For first time connection, there are two ways to set up wireless projection:
  - Connect your Android phone or Apple iPhone by using the factory-provided phone USB cable and plugging into a

USB data port. For best performance, it is highly recommended to use the device's factory-provided USB cable, which should be replaced after significant wear to maintain connection quality. Aftermarket or third-party cables may not work.

- Connecting the phone over Bluetooth. See *Bluetooth (Overview)* ⇨ 127 or *Bluetooth (Pairing and Using a Phone)* ⇨ 127.
3. Make sure wireless is turned on the phone for wireless projection to work.
  4. When the phone is first connected to activate Apple CarPlay or Android Auto, agree to the terms and conditions on both the infotainment system and the phone.
  5. Follow the instructions on the phone.

The Android Auto and Apple CarPlay icons on the Home Page will illuminate depending on the smartphone. Android Auto and/or Apple CarPlay may automatically launch upon wireless connection. If not, touch the Android Auto or Apple CarPlay icon on the Home Page to launch.

Wireless Carplay and/or Wireless Android Auto may experience occasional service disruption due to outside Wi-Fi interference.

To disconnect the phones wireless projection:



1. Select Settings from the Home Page.
2. Select Phones
3. Touch  next to the phone to be disconnected.
4. Turn off Apple CarPlay or Android Auto.

Press  on the center stack to return to the Home Page.

Features are subject to change. For further information on how to set up Android Auto and Apple CarPlay in the vehicle, see [my.chevrolet.com](http://my.chevrolet.com).

Android Auto is provided by Google and is subject to Google's terms and privacy policy. Apple CarPlay is provided by Apple and is subject to Apple's terms and privacy policy. Data plan rates apply. For Android Auto support and to see if your phone is compatible, see <https://support.google.com/androidauto>. For Apple CarPlay support and to see if your phone is compatible, see [www.apple.com/ios/carplay/](http://www.apple.com/ios/carplay/). Apple or Google may change or suspend availability

at any time. Android Auto, Android, Google, Google Play, and other marks are trademarks of Google Inc.; Apple CarPlay is a trademark of Apple Inc.

Press  on the center stack to exit Android Auto or Apple CarPlay. To enter back into Android Auto or Apple CarPlay, press and hold  on the center stack.

Apple CarPlay and Android Auto can be disabled from the infotainment system. To do this, touch Home, Settings, and then touch the Apps tab along the top of the display. Use the On/Off toggled to turn off Apple CarPlay or Android Auto.

## Settings

Certain settings can be managed in the Owner Center sites when an account is established, and may be modified if other users have accessed the vehicle or created accounts. This may result in changes to the security or functionality of the infotainment system. Some settings may also be transferred to a new vehicle, if equipped. For instructions, in the U.S. see [my.chevrolet.com](http://my.chevrolet.com) or in Canada see [mychevrolet.ca](http://mychevrolet.ca) or [monchevrolet.ca](http://monchevrolet.ca).

Refer to the User Terms and Privacy Statement for important details. To view, touch the Settings icon on the Home Page of the infotainment display.

The settings menu may be organized into four categories. Select the desired category by touching System, Apps, Vehicle, or Personal.

To access the personalization menus:

1. Touch Settings on the Home Page on the infotainment display.
2. Touch the desired category to display a list of available options.
3. Touch to select the desired feature setting.
4. Touch the options on the infotainment display to disable or enable a feature.
5. Touch **X** to go to the top level of the Settings menu.

## System

The menu may contain the following:

### Time / Date

Use the following features to set the clock:

- Automatic Time and Date: Touch Off or On to enable or disable automatic update of the time and date. When this feature is on, the time and date cannot be manually set.
- Set Time: Touch to manually set the time using the controls on the infotainment display.
- Set Date: Touch to manually set the date using the controls on the infotainment display.
- Automatic Time Zone (If Equipped): Touch Off or On to disable or enable automatic update of the time zone based on vehicle location. When this feature is on, the time zone cannot be manually set.
- Select Time Zone: Touch to manually set the time zone. Touch a time zone from the list.
- Use 24-hour Format: Touch to specify the clock format shown.  
Touch Off or On to disable or enable.

## Language

This will set the display language used on the infotainment display. It may also use the selected language for voice recognition and audio feedback. Touch Language and touch the appropriate language.

### Phones

Touch to connect to a different cell phone or mobile device source, disconnect a cell phone or media device, or delete a cell phone or media device.

### Wi-Fi Networks

This will show connected and available Wi-Fi networks.

If a 4G LTE data package is not active on the vehicle, the infotainment system can be connected to an external protected Wi-Fi network, such as a mobile device or home hotspot, to utilize connected services.

### Wi-Fi Hotspot

Touch and the following may display:

- Wi-Fi Services: This allows devices to use the vehicle hotspot.  
Touch the controls on the infotainment display to disable or enable.

- **Wi-Fi Name:** Touch to change the vehicle Wi-Fi name.
- **Wi-Fi Password:** Touch to change the vehicle Wi-Fi password.
- **Connected Devices:** Touch to show connected devices.
- **Share Hotspot Data:** Touch On to allow devices to use the vehicle hotspot and its data, or touch Off to allow devices to only use the vehicle hotspot but not its data.

### Privacy

Touch and the following may display:

- **Location Services:** This setting enables or disables sharing of vehicle location outside the vehicle. Emergency services will not be affected when Off is selected.
- **Data Services:** If equipped, this setting determines if data sharing can be used by features including Wi-Fi, Hotspot, and applications. Touch Off to disable data services. Emergency services and phone calls, such as calls with OnStar Advisors or others, will not be affected when Off is selected.
- **Voice Recognition Sharing:** This setting determines if voice commands can be shared with a cloud-based voice

recognition system. Touch Off to prevent the sharing and possible recording of your voice commands with this system. This may limit the system's ability to understand your voice commands and may disable some features.

- **Types:** This setting lists all Android-defined as dangerous permissions currently used by the infotainment system, the number of applications that have requested this permission, and the number of applications that are allowed to use this permission.
- **Used By Applications:** This setting lists all applications that are requested or are using Android-defined as dangerous permissions. Only requested and active permissions are shown.

### Display

Touch and the following may display:

- **Mode:** This adjusts the appearance of the navigation map view and any downloaded apps optimized for day or night time conditions. Set to Auto for the display to automatically adjust based on bright/dark conditions.  
Touch Auto, Day, or Night to adjust the display.

- **Turn Display Off:** Touch to turn the display off. Touch anywhere on the infotainment display or press any infotainment control on the center stack again to turn the display on.

### Sounds

Touch and the following may display:

- **Maximum Startup Volume:** This feature adjusts the maximum volume of the infotainment system when you start your vehicle. To set the maximum startup volume, touch the controls on the infotainment display to increase or decrease.
- **Startup/Shutdown Sounds:** This feature determines if sounds play when the infotainment system starts up and shuts down. This feature can be turned off or on.
- **Startup/Shutdown Audio Volume:** This setting controls the volume of the infotainment system played on startup and shut down. Touch the controls on the infotainment display to increase or decrease.

- **Audible Touch Feedback:** This setting determines if a sound plays when touching the infotainment display or radio controls. This feature can be turned off or on.

### Voice

Touch and the following may display:

- **Confirm More/Less:** This setting specifies how often the voice recognition system confirms commands. Touch Confirm More to have the system check with you more often before acting on your commands.
- **Prompt Length:** This setting specifies the amount of detail the voice recognition system provides when giving you feedback. Touch Auto to have the system automatically adjust to your speech habits. Touch Informative, Short, or Auto.
- **Audio Feedback Speed:** Touch Slow, Medium, or Fast to adjust how quickly the voice recognition system speaks.
- **Allow Prompt Interruptions:** This setting controls whether voice commands can be spoken before voice prompts finish. Turn this on to speak commands without hearing the full prompt. Speaking while the prompt is still playing will immediately stop playing the current

prompt and recognize your command. Background noise may cause accidental interruptions. Touch Off or On.

- **Friendly Prompts:** This setting adjusts the formality of voice prompts. Touch Off for shorter prompts. Touch On to hear prompts with more personality. Touch Auto to have the prompt match your command style.
- **Tutorial Mode:** Touch Off or On to provide tutorial feedback on the display.

### Favorites

Touch and the following may display:

- **Manage Favorites:** Touch to display a list of Audio, Phone, and Navigation favorites. Favorites can be moved, renamed, or deleted.  
To move, touch and hold the favorite, and then drag up or down to rearrange the position.
- **Set Number of Audio Favorites:** Touch to select how many favorites pages can be viewed from the audio application. The Auto setting will automatically adjust this number based on the number of favorites you have saved. Touch Auto, 5, 10, 15, 20, 25, 30, 35, or 40.

### Updates

If equipped, the vehicle can download and install select software updates over a wireless connection. The system will prompt for certain updates to be downloaded and installed. There is also an option to check for updates manually.

To manually check for updates, touch Settings on the Home Page and select the System tab. Go to the Vehicle Software section and touch Updates. Follow the on-screen prompts. The steps to check for, download, and install updates may vary by vehicle.

The vehicle can be used normally or can be charging during the software download. Once the download is complete, there may be a prompt to accept the installation of the update upon the next ignition cycle or the next time the vehicle is shifted into P (Park). For most updates, the vehicle will be disabled and cannot be driven during the installation. The system will deliver messages indicating success or error during and after the download and installation processes.



Downloading Over-the-Air vehicle software updates requires Internet connectivity, which can be accessed through the vehicle's built-in 4G LTE connection, if equipped and active. If required, data plans are provided by a third party. Optionally, a secure Wi-Fi hotspot such as a compatible mobile device hotspot, home hotspot, or public hotspot can be used. Applicable data rates may apply.

To connect the infotainment system to a secured mobile device hotspot, home hotspot, or public hotspot, touch Settings on the Home Page, select the System tab, followed by Wi-Fi Networks. Select the appropriate Wi-Fi network, and follow the on-screen prompts. Download speeds may vary.

On most compatible mobile devices, activation of the Wi-Fi hotspot is in the Settings menu under Mobile Network Sharing, Personal Hotspot, Mobile Hotspot, or similar.

Availability of Over-the-Air software updates varies by vehicle and country. Features are subject to change. For more information on this feature, see [my.chevrolet.com/learn](http://my.chevrolet.com/learn).

### Preferences

Touch the controls on the infotainment display to disable or enable the download of new updates in the background.

### About

Touch to view the infotainment system software information.

### Running Applications

Touch to see a complete list of applications that are currently running on the infotainment system.

### Return to Factory Settings

Touch and the following may display:

- **Reset Vehicle Settings:** Resets all vehicle settings for the current user.  
Touch Reset or Cancel.

- **Erase Settings and Personal Data:** Erases app data settings, user profiles, and personal data including navigation and mobile device data.  
Touch Erase or Cancel.

- **Clear Default Applications:** Resets preferred applications that have been set to open when selecting a function. No application data will be lost.  
Touch Clear or Cancel.

### Apps

The menu may contain the following:

#### Android Auto

This feature allows you to interact directly with your mobile device on the infotainment display. See *Apple CarPlay and Android Auto* ⇨ 131.

Touch the controls on the infotainment display to disable or enable.

#### Apple CarPlay

This feature allows you to interact directly with your mobile device on the infotainment display. See *Apple CarPlay and Android Auto* ⇨ 131.

Touch the controls on the infotainment display to disable or enable.

### Apps

Touch and the following may display:

- **Update Apps Automatically:** This allows downloaded applications to be updated automatically.  
Touch the controls on the infotainment display to disable or enable.
- **About Apps:** Touch to view the versions of the shop software.

**Audio**

Depending on the current audio source, different options will be available.

Touch and the following may display:

- **Tone Settings:** Touch to adjust Equalizer, Fade/Balance, or Sound Mode. See “Infotainment System Sound Menu” in *AM-FM Radio* ⇨ 116.
- **Adaptive Volume:** This feature adjusts the volume based on the vehicle speed.  
Touch Off, Low, Medium-Low, Medium, Medium-High, or High.
- **Bose AudioPilot Noise Compensation Technology (If Equipped):** This feature adjusts the volume based on the noise in the vehicle and the speed.  
Touch Off or On.
- **Manage Favorites:** Touch to display a list of Audio, Mobile Devices, and Navigation favorites.  
Favorites can be moved, renamed, or deleted.  
To move, touch and hold the favorite, and then drag up or down to rearrange the position.

- **Set Number of Audio Favorites:** Touch to select how many favorites pages can be viewed from the audio application. The Auto setting will automatically adjust this number based on the number of favorites you have saved. Touch Auto, 5, 10, 15, 20, 25, 30, 35, or 40.
- **RDS:** This allows the Radio Data System (RDS) to be turned on or off.  
Touch the controls on the infotainment display to disable or enable.
- **Explicit Content Filter:** This setting allows access to explicit content SiriusXM channels.  
Touch Off or On.
- **Manage Devices:** Select to connect to a different phone source, disconnect a phone, or delete a phone.
- **Reset Music Index:** This allows the music index to be reset if you are having difficulty accessing all of the media content on your device.  
Touch Yes or No.

**Climate**

Touch and the following may display:

- **Auto Fan Speed:** This setting specifies the amount of airflow when the climate control fan setting is Auto Fan.

- Touch Low, Medium, or High.
- **Air Quality Sensor:** This setting switches the system into Recirculation Mode based on the quality of the outside air.  
Touch Off, Low Sensitivity, or High Sensitivity.
- **Auto Cooled Seats:** This setting automatically turns on and regulates the ventilated seats when the cabin temperature is warm.  
Touch the controls on the infotainment display to disable or enable.
- **Auto Heated Seats:** This setting automatically turns on and regulates the heated seats when the cabin temperature is cool. The auto heated seats can be turned off by using the heated seat controls on the center stack.  
Touch the controls on the infotainment display to disable or enable.
- **Auto Defog:** This setting automatically turns the front defogger on when the vehicle is started.  
Touch the controls on the infotainment display to disable or enable.
- **Auto Rear Defog:** This setting automatically turns the rear window defogger on when the vehicle is started.

Touch the controls on the infotainment display to disable or enable.

**Phone**

Touch and the following may display:

- **My Number:** Displays the cell phone number of the Bluetooth connected device.
- **Active Call View:** Shows active call display when answering a call.

Touch the controls on the infotainment display to disable or enable.

- **Privacy:** Only show call alerts in the instrument cluster.

Touch Off or On.

- **Sort Contacts:** Touch to sort by first or last name.
- **Re-sync Device Contacts:**  
This allows the device contacts to re-sync if you are having difficulty accessing all of the contacts on your cell phone.
- **Delete All Vehicle Contacts:** Touch to delete all vehicle stored contacts.
- **OnStar Phone TTY Mode:** This enables OnStar cell phone TTY mode.

Touch Disable or Enable.

**SiriusXM**

Touch and the following may display:

- **Account Information:** Displays the account information and subscription information.
- **Listener Options:** Based on the current vehicle profile selected. Touch and the following may display:
  - **SiriusXM Favorites:** Favorites shown can be moved or deleted.
  - **Listener Settings:** Selections include hide explicit language, channels and content, reset listening history, and start songs at the beginning when tuning to a music channel.
- **System Settings:** Enable or disable SiriusXM location services. Also shows radio ID.
- **Contact SiriusXM:** Displays radio ID and phone number to call SiriusXM Customer Care.
- **SiriusXM Policies:** Shows information on the Customer Agreement and Privacy Policy.

**Vehicle**

This menu allows adjustment of different vehicle features. See *Vehicle Personalization* ⇨ 101.

**Personal**

If equipped, this menu allows adjustment of different user profile settings. See “Users” in *Using the System* ⇨ 113 for information on setting up user profiles.

The menu may contain the following:

**Name**

Touch to edit your user name that will be displayed in the vehicle.

**Vehicle Account Information**

Touch to view the vehicle account information and to change the account password.

An “unverified user account” pop-up will display until the account information verification process has been completed on the Internet. Check your registered e-mail account for an activation e-mail to complete the verification process.

**Profile Picture**

Touch to choose or change your profile picture.

**Profile Identifiers**

Touch to have the vehicle recognize the identifier you choose.

Touch Vehicle Key 1 and/or Vehicle Key 2.

If the Remote Keyless Entry (RKE) transmitter is lost or stolen, see your dealer.

### Security

Touch to have your profile secured with a Personal Identification Number (PIN).

Touch No or Yes.

### Vehicle Name

Touch to edit your vehicle name.

### Vehicle Account

Touch to view the vehicle account information and to change the account password.

### Delete Profile

Touch to remove the profile from the vehicle.

Touch Remove or Cancel.

## Teen Driver

If equipped, this allows multiple keys to be registered for beginner drivers to encourage safe driving habits. When the vehicle is started with a Teen Driver key, it will automatically activate certain safety systems, allow setting of some features, and

limit the use of others. The Report Card will record vehicle data about driving behavior that can be viewed later. When the vehicle is started with a registered key, the Driver Information Center (DIC) displays a message that Teen Driver is active.

### To access:

1. Touch Settings on the Home Page, then touch Vehicle, and then Teen Driver.
2. Create a Personal Identification Number (PIN) by choosing a four-digit PIN. Re-enter the PIN to confirm. To change the PIN, touch Change PIN.

### The PIN is required to:

- Register or unregister keys.
- Change Teen Driver settings.
- Change or clear the Teen Driver PIN.
- Access or delete Report Card data.

### Register keys to activate Teen Driver and assign restrictions to the key:

Any vehicle key can be registered, up to a maximum of eight keys. Label the key to tell it apart from the other keys.

### For a pushbutton start system:

1. Start the vehicle.
2. The vehicle must be in P (Park).

3. From the Settings menu, touch Vehicle and then Teen Driver.
4. Enter the PIN.
5. Place the Remote Keyless Entry (RKE) transmitter key you wish to register in the transmitter pocket. The key does not need to be the one that started the vehicle. See *Remote Keyless Entry (RKE) System Operation* ⇨ 7 for transmitter pocket location.
6. From the Teen Driver menu, touch Setup Keys.
  - If the transmitter key has not previously been registered, the option to add the key displays. Touch Setup and a confirmation message displays. Teen Driver restrictions will be applied whenever this key is used to operate the vehicle.
  - If the transmitter key has already been registered, the option to remove the key displays. If Remove is touched, the transmitter key is no longer registered. A confirmation message displays, and Teen Driver restrictions will not be applied if this transmitter key is used to operate the vehicle.

If a Teen Driver and a non-Teen Driver key are both present at start up, the vehicle will recognize the non-Teen Driver key to start the vehicle. The Teen Driver settings will not be active.

### Manage Settings

**Audio Volume Limit** : Allows the audio volume limit to be turned on or off. Touch Set Audio Volume Limit to choose the maximum allowable audio volume level.

**Set Audio Volume Limit** : Allows a maximum radio volume to be set. Use the arrows to choose the maximum allowable level for the audio volume.

**Teen Driver Speed Limiter** : Limits the maximum speed of the vehicle. When the speed limiter is turned on and the vehicle is started with a Teen Driver key, the DIC displays a message that the top speed is limited.

On certain vehicles, when the Speed Limiter is turned ON, the vehicle's maximum acceleration will be limited. The DIC will display a message that the acceleration is limited.

**Teen Driver Speed Warning** : Allows the speed warning to be turned on or off. Touch Set Teen Driver Speed Warning to set the warning speed.

**Set Teen Driver Speed Warning** : Displays a warning in the DIC when exceeding a selectable speed. Choose the desired speed warning level. The speed warning does not limit the speed of the vehicle.

**SiriusXM Explicit Content Filter (if equipped)** : Allows the SiriusXM Explicit Content Filter to be turned ON or OFF. When ON, the teen driver will not be able to listen to SiriusXM stations that contain explicit content, and the Explicit Content Filter selection in the Audio Settings will be unavailable for change.

### When Teen Driver is Active:

- If equipped with Buckle to Drive, shifting out of P (Park) will be prevented if the driver seat belt, and in some vehicles the front passenger seat belt, is not buckled.
- The radio will mute when the driver seat belt, and in some vehicles the front passenger seat belt, is not buckled. The audio from any device paired to the vehicle will also be muted.

- If an object, such as a briefcase, handbag, grocery bag, laptop, or other electronic device, is on the front passenger seat, it could cause the radio to mute. If this happens, remove the object from the seat. See *Passenger Sensing System* ⇨ 43.
- Some safety systems, such as Forward Collision Alert, if equipped, cannot be turned off.
- The gap setting for the Forward Collision Alert and Adaptive Cruise Control, if equipped, cannot be changed.
- When trying to change a safety feature that is not configurable in Teen Driver, the DIC displays a message indicating that Teen Driver is active and the action is not available.
- Super Cruise, if equipped, is not available.
- Do not tow a trailer.

### Report Card

The vehicle owner must secure the driver's consent to record certain vehicle data when the vehicle is driven with a registered Teen Driver key. There is one Report Card per vehicle. Data is only recorded when a registered Teen Driver key is used to operate the vehicle.

The Report Card data is collected from the time Teen Driver is activated or the last time the Report Card was reset. The following items may be recorded:

- Distance Driven – the total distance driven.
- Maximum Speed – the maximum vehicle speed detected.
- Overspeed Warnings – the number of times the speed warning setting was exceeded.
- Wide Open Throttle – the number of times the accelerator pedal was pressed nearly all the way down.
- Forward Collision Alerts – the number of times the driver was notified when approaching a vehicle ahead too quickly and at potential risk for a crash.
- Forward Automatic Braking, also called Automatic Emergency Braking – the number of times the vehicle detected that a forward collision was imminent and applied the brakes.
- Traction Control – the number of times the Traction Control System activated to reduce wheel spin or loss of traction.
- Stability Control – the number of events which required the use of electronic stability control.

- Antilock Braking System Active – The number of Antilock Brake System activations.
- Tailgating Alerts – the number of times the driver was alerted for following a vehicle ahead too closely.

### Report Card Data

Cumulative Data is saved for all trips until the Report Card is reset or until the maximum count is exceeded. If the maximum count is exceeded for a Report Card line item, that item will no longer be updated in the Report Card until it is reset. Each item will report a maximum of 1,000 counts. The distance driven will report a maximum of 64 374 km (40,000 mi).

To delete Report Card data, do one of the following:

- From the Report Card display, touch Reset.
- Touch Clear All Teen Keys and PIN from the Teen Driver menu. This will also unregister any Teen Driver keys and delete the PIN.

### Forgotten PIN

See your dealer to reset the PIN.

## Trademarks and License Agreements

### FCC Information

See *Radio Frequency Statement* ⇨ 293.



"Made for iPod," and "Made for iPhone," mean that an electronic accessory has been designed to connect specifically to iPod or iPhone, respectively, and has been certified by the developer to meet Apple performance standards. Apple is not responsible for the operation of this device or its compliance with safety and regulatory standards. Please note that the use of this accessory with iPod or iPhone may affect wireless performance. iPhone, iPod, iPod classic, iPod nano, iPod shuffle, and iPod touch are trademarks of Apple Inc., registered in the U.S. and other countries.



If you decide to continue service after your trial, your selected subscription plan will automatically renew thereafter. You will be charged at then-current rates. Fees and taxes apply. Please see the SiriusXM Customer Agreement at [siriusxm.com](http://siriusxm.com) for complete terms and how to cancel, which includes calling SiriusXM at 1-866-635-2349. All fees and programming are subject to change.

Fees and Taxes: Subscription fee, taxes, one time activation fee, and other fees may apply. Subscription fee is consumer only. All fees and programming subject to change. Subscriptions subject to Customer Agreement available at [www.siriusxm.com](http://www.siriusxm.com). SiriusXM service is only available in the 48 contiguous United States and Canada.

In Canada: Some deterioration of service may occur in extreme northern latitudes. This is beyond the control of SiriusXM Satellite Radio.

Explicit Language Notice: Channels with frequent explicit language are indicated with an "XL" preceding the channel name. Channel blocking is available for SiriusXM Satellite Radio receivers by notifying SiriusXM:

- USA Customers — See [www.siriusxm.com](http://www.siriusxm.com) or call 1-888-601-6296.
- Canada Customers — See [www.siriusxm.ca](http://www.siriusxm.ca) or call 1-877-438-9677.

It is prohibited to copy, decompile, disassemble, reverse engineer, hack, manipulate, or otherwise make available any technology or software incorporated in receivers compatible with the SiriusXM Satellite Radio System or that support the SiriusXM website, the Online Service or any of its content. Furthermore, the AMBER voice compression software included in this product is protected by intellectual property rights including patent rights, copyrights, and trade secrets of Digital Voice Systems, Inc.

General Requirements:

1. A License Agreement from SiriusXM is required for any product that incorporates SiriusXM Technology and/or for use of any of the SiriusXM marks to

be manufactured, distributed, or marketed in the SiriusXM Service Area.

2. For products to be distributed, marketed, and/or sold in Canada, a separate agreement is required with Canadian Satellite Radio Inc. (operating as SiriusXM Canada).



immersion®

TouchSense Technology and TouchSense System 1000 Series Licensed from Immersion Corporation. TouchSense System 1000 protected under one or more of the U.S. Patents at the following address [www.immersion.com/patent-marking.html](http://www.immersion.com/patent-marking.html) and other patents pending.

#### Bose

Bose AudioPilot and Bose Centerpoint surround are registered trademarks of Bose Corporation in the U.S. and other countries.

**Bluetooth**

The Bluetooth word mark and logos are owned by the Bluetooth SIG, Inc. and any use of such marks by General Motors is under license. Other trademarks and trade names are those of their respective owners.

**Java**

Java is a registered trademark of Oracle and/or its affiliates.

**Schedule I: Gracenote EULA**

Music recognition technology and related data are provided by Gracenote. Gracenote is the industry standard in music recognition technology and related content delivery. For more information see [www.gracenote.com](http://www.gracenote.com).

Music-related data from Gracenote, Inc., copyright © 2000 to present Gracenote. Gracenote Software, copyright © 2000 to present Gracenote. One or more patents owned by Gracenote may apply to this product and service. See the Gracenote

website for a non-exhaustive list of applicable Gracenote patents. Gracenote, CDDB, MusicID, MediaVOCS, the Gracenote logo and logotype, and the "Powered by Gracenote" logo are either registered trademarks or trademarks of Gracenote in the United States and/or other countries.

**Gracenote Terms of Use**

This application or device contains software from Gracenote, Inc. of Emeryville, California ("Gracenote"). The software from Gracenote (the "Gracenote Software") enables this application to do disc or file identification and obtain music-related information, including name, artist, track, and title information ("Gracenote Data") from online servers or embedded databases (collectively, "Gracenote Servers") and to perform other functions. You may use Gracenote Data only by means of the intended End-User functions of this application or device.

This application or device may contain content belonging to Gracenote's providers. If so, all of the restrictions set forth herein with respect to Gracenote Data shall also apply to such content and such content providers shall be entitled to all of the benefits and protections set forth herein that are available to Gracenote.

You agree that you will use Gracenote Data, the Gracenote Software, and Gracenote Servers for your own personal non-commercial use only. You agree not to assign, copy, transfer or transmit the Gracenote Software or any Gracenote Data to any third party. YOU AGREE NOT TO USE OR EXPLOIT GRACENOTE DATA, THE GRACENOTE SOFTWARE, OR GRACENOTE SERVERS, EXCEPT AS EXPRESSLY PERMITTED HEREIN.

You agree that your non-exclusive license to use the Gracenote Data, the Gracenote Software, and Gracenote Servers will terminate if you violate these restrictions. If your license terminates, you agree to cease any and all use of the Gracenote Data, the Gracenote Software, and Gracenote Servers. Gracenote reserves all rights in Gracenote Data, the Gracenote Software, and the Gracenote Servers, including all ownership rights. Under no circumstances will Gracenote become liable for any payment to you for any information that you provide. You agree that Gracenote may enforce its rights under this Agreement against you directly in its own name.



The Gracernote service uses a unique identifier to track queries for statistical purposes. The purpose of a randomly assigned numeric identifier is to allow the Gracernote service to count queries without knowing anything about who you are. For more information, see the web page for the Gracernote Privacy Policy for the Gracernote service.

The Gracernote Software and each item of Gracernote Data are licensed to you "AS IS." Gracernote makes no representations or warranties, express or implied, regarding the accuracy of any Gracernote Data. Gracernote reserves the right to delete data from the Gracernote Servers or to change data categories for any cause that Gracernote deems sufficient. No warranty is made that the Gracernote Software or Gracernote Servers are error-free or that functioning of Gracernote Software or Gracernote Servers will be uninterrupted. Gracernote is not obligated to provide you with new enhanced or additional data types or categories that Gracernote may provide in the future and is free to discontinue its services at any time.

GRACENOTE DISCLAIMS ALL WARRANTIES EXPRESS OR IMPLIED, INCLUDING, BUT NOT LIMITED TO, IMPLIED WARRANTIES OF

MERCHANTABILITY, FITNESS FOR A PARTICULAR PURPOSE, TITLE, AND NON-INFRINGEMENT. GRACENOTE DOES NOT WARRANT THE RESULTS THAT WILL BE OBTAINED BY YOUR USE OF THE GRACENOTE SOFTWARE OR ANY GRACENOTE SERVER. IN NO CASE WILL GRACENOTE BE LIABLE FOR ANY CONSEQUENTIAL OR INCIDENTAL DAMAGES OR FOR ANY LOST PROFITS OR LOST REVENUES.

© 2014. Gracernote, Inc. All Rights Reserved.

#### **MPEG4-AVC (H.264)**

THIS PRODUCT IS LICENSED UNDER THE AVC PATENT PORTFOLIO LICENSE FOR THE PERSONAL AND NON-COMMERCIAL USE OF A CONSUMER TO (i) ENCODE VIDEO IN COMPLIANCE WITH THE AVC STANDARD ("AVC VIDEO") AND/OR (ii) DECODE AVC VIDEO THAT WAS ENCODED BY A CONSUMER ENGAGED IN A PERSONAL AND NON-COMMERCIAL ACTIVITY AND/OR WAS OBTAINED FROM A VIDEO PROVIDER LICENSED TO PROVIDE AVC VIDEO. NO LICENSE IS GRANTED OR SHALL BE IMPLIED FOR ANY OTHER USE. ADDITIONAL INFORMATION MAY BE OBTAINED FROM MPEG LA, LLC. SEE [HTTP://WWW.MPEGLA.COM](http://www.mpegla.com).

#### **VC-1**

THIS PRODUCT IS LICENSED UNDER THE VC-1 PATENT PORTFOLIO LICENSE FOR THE PERSONAL AND NON-COMMERCIAL USE OF A CONSUMER TO (i) ENCODE VIDEO IN COMPLIANCE WITH THE VC-1 STANDARD ("VC-1 VIDEO") AND/OR (ii) DECODE VC-1 VIDEO THAT WAS ENCODED BY A CONSUMER ENGAGED IN A PERSONAL AND NON-COMMERCIAL ACTIVITY AND/OR WAS OBTAINED FROM A VIDEO PROVIDER LICENSED TO PROVIDE VC-1 VIDEO. NO LICENSE IS GRANTED OR SHALL BE IMPLIED FOR ANY OTHER USE. ADDITIONAL INFORMATION MAY BE OBTAINED FROM MPEG LA, LLC. SEE [HTTP://WWW.MPEGLA.COM](http://www.mpegla.com).

#### **MPEG4-Visual**

USE OF THIS PRODUCT IN ANY MANNER THAT COMPLIES WITH THE MPEG-4 VISUAL STANDARD IS PROHIBITED, EXCEPT FOR USE BY A CONSUMER ENGAGING IN PERSONAL AND NON-COMMERCIAL ACTIVITIES.

#### **MP3**

MPEG Layer-3 audio coding technology licensed from Fraunhofer IIS and Thomson.

**WMV/WMA**

This product includes technology owned by Microsoft Corporation and under a license from Microsoft Licensing, GP. Use or distribution of such technology outside of this product is prohibited without a license from Microsoft Corporation and/or Microsoft Licensing, GP as applicable.

**Unicode**

Copyright © 1991-2010 Unicode, Inc. All rights reserved. Distributed under the Terms of Use in <http://www.unicode.org/copyright.html>.

**Free Type Project**

Portions of this software are copyright © 2010 The FreeType Project (<http://www.freetype.org>). All rights reserved.

**Open Source SW**

Further information concerning the OSS licenses is shown in the infotainment display.

**QNX**

Portions of this software are copyright © 2008-2011, QNX Software Systems. All rights reserved.

**Part C – EULA**

Copyright © 2011, Software Systems GmbH & Co. KG. All Rights Reserved.

The product you have purchased ("Product") contains Software (Runtime Configuration No. 505962; "Software") which is distributed by or on behalf of the Product manufacturer ("Manufacturer") under license from Software Systems Co. ("QSSC"). You may only use the Software in the Product and in compliance with the license terms below.

Subject to the terms and conditions of this License, QSSC hereby grants you a limited, non-exclusive, non-transferable license to use the Software in the Product for the purpose intended by the Manufacturer. If permitted by the Manufacturer, or by applicable law, you may make one backup copy of the Software as part of the Product software. QSSC and its licensors reserve all license+C31 rights not expressly granted herein, and retain all right, title and interest in and to all copies of the Software, including all intellectual property rights therein. Unless required by applicable law you may not reproduce, distribute or transfer, or de-compile, disassemble or otherwise attempt to unbundle, reverse engineer, modify or create derivative works of, the

Software. You agree: (1) not to remove, cover or alter any proprietary notices, labels or marks in or on the Software, and to ensure that all copies bear any notice contained on the original; and (2) not to export the Product or the Software in contravention of applicable export control laws.

EXCEPT TO THE EXTENT OTHERWISE REQUIRED BY APPLICABLE LAW, QSSC AND ITS LICENSORS PROVIDE THE SOFTWARE ON AN "AS IS" BASIS, WITHOUT WARRANTIES OR CONDITIONS OF ANY KIND, EITHER EXPRESS OR IMPLIED INCLUDING, WITHOUT LIMITATION, ANY WARRANTIES OR CONDITIONS OF TITLE, NON-INFRINGEMENT, MERCHANTABILITY OR FITNESS FOR A PARTICULAR PURPOSE. ANY WARRANTIES OR OTHER PROVISIONS OFFERED BY THE MANUFACTURER OR ITS DISTRIBUTOR(S) THAT DIFFER FROM THIS LICENSE ARE OFFERED BY THE MANUFACTURER OR ITS DISTRIBUTOR(S) ALONE AND NOT BY QSSC, ITS AFFILIATES OR THEIR LICENSORS. YOU ASSUME ANY RISKS ASSOCIATED WITH YOUR USE OF THE SOFTWARE UNDER THIS LICENSE.

EXCEPT TO THE EXTENT OTHERWISE REQUIRED BY APPLICABLE LAW (SUCH AS IN THE CASE OF DELIBERATE OR GROSSLY

NEGLIGENT ACTS), IN NO EVENT SHALL QSSC, ITS AFFILIATES OR THEIR LICENSORS BE LIABLE TO YOU UNDER ANY LEGAL THEORY, WHETHER IN TORT (INCLUDING NEGLIGENCE), CONTRACT OR OTHERWISE, FOR DAMAGES, INCLUDING ANY DIRECT, INDIRECT, SPECIAL, INCIDENTAL, OR CONSEQUENTIAL DAMAGES OF ANY CHARACTER ARISING AS A RESULT OF THIS LICENSE OR OUT OF THE USE OR INABILITY TO USE THE PRODUCT (INCLUDING BUT NOT LIMITED TO DAMAGES FOR LOSS OF GOODWILL, WORK STOPPAGE, PRODUCT FAILURE OR MALFUNCTION, OR ANY AND ALL OTHER COMMERCIAL DAMAGES OR LOSSES), EVEN IF QSSC, ITS AFFILIATES OR THEIR LICENSORS HAVE BEEN ADVISED OF THE POSSIBILITY OF SUCH DAMAGES.

**WMA**

This product is protected by certain intellectual property rights of Microsoft. Use or distribution of such technology outside of this product is prohibited without a license from Microsoft.

For more information on the Software, including any open source software license terms (and available source code) as well as copyright attributions applicable to the Runtime Configuration indicated above, please contact the Manufacturer or contact QSSC at 175 Terence Matthews Crescent, Kanata, Ontario, Canada K2M 1W8 (licensing@qnx.com).

**Linotype**

Helvetica is a trademark of Linotype Corp. registered in the U.S. Patent and Trademark Office and may be registered in certain other jurisdictions in the name of Linotype Corp. or its licensee Linotype GmbH.

Usage in text form of each of the Licensed Trademarks is:

The trademark attribution requirements for the Licensed Trademarks may be viewed at <http://www.linotype.com/2061-19414/trademarks.html>.

**END USER NOTICE**

The marks of companies displayed by this product to indicate business locations are the marks of their respective owners. The use of such marks in this product does not imply any sponsorship, approval, or endorsement by such companies of this product.

## Climate Controls

### Climate Control Systems

Automatic Climate Control System .... 147

### Air Vents

Air Vents ..... 151

### Maintenance

Air Intake ..... 151

Passenger Compartment Air Filter .... 152

Air Conditioning Regular Operation .... 152

Service ..... 153

## Climate Control Systems

### Automatic Climate Control System

The climate control buttons on the center stack and on the climate control display are used to adjust the heating, cooling, and ventilation.

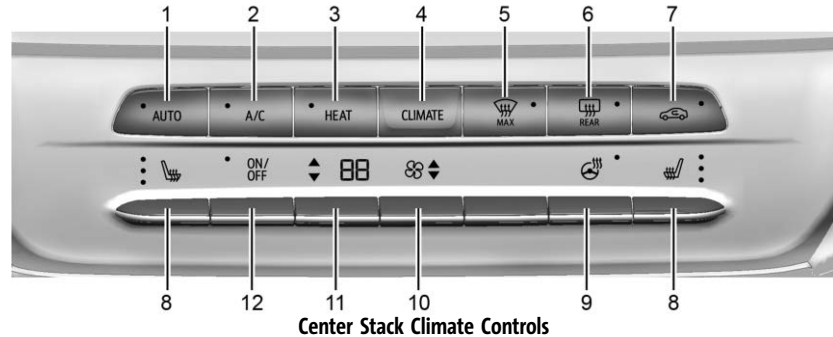

- |                                      |                               |
|--------------------------------------|-------------------------------|
| 1. AUTO (Automatic Operation)        | 7. Recirculation              |
| 2. A/C (Air Conditioning)            | 8. Heated Seats (If Equipped) |
| 3. Heater                            | 9. Heated Steering Wheel      |
| 4. Climate (Climate Control Display) | 10. Fan Control               |
| 5. Max Defrost                       | 11. Temperature Control       |
| 6. Rear Window Defogger              | 12. On/Off                    |

## Climate Control Display

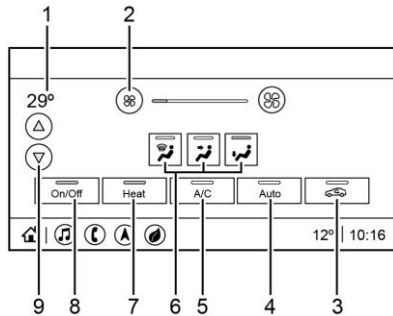

1. Temperature Display
2. Fan Control
3. Recirculation
4. Auto (Automatic Operation)
5. A/C (Air Conditioning)
6. Air Delivery Mode Controls
7. Heater
8. On/Off
9. Temperature Controls

The fan, air delivery mode, air conditioning and temperatures settings can be controlled by touching CLIMATE on the infotainment Home Page or the climate button in the

climate control display application tray. A selection can then be made on the front climate control page displayed.

## Climate Control Status Display

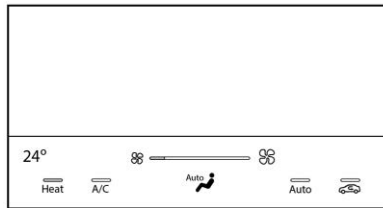

The climate control status display appears briefly when the climate control buttons on the center stack are adjusted. The air delivery mode can be adjusted on the climate control status display.

## Automatic Operation

The system automatically controls the fan speed, air delivery, air conditioning, electric heating, and recirculation to heat or cool the vehicle to the selected temperature.

When AUTO is lit, all five functions operate automatically. Each function can also be manually set and the selected setting is displayed or the indicator is lit. Functions not manually set will continue to be automatically controlled, even if the AUTO indicator is not lit.

For automatic operation:

1. Press AUTO.
2. Set the temperature. An initial setting of 22 °C (72 °F) is recommended. Allow the system time to stabilize. Adjust the temperature as needed.

## Manual Operation

**ON/OFF** : Press to turn the climate control system on and off.

The climate control system will turn on when any climate control button is pressed on the center stack or touched on the climate control display. To turn the system off, press the button again.

**▲** **☼** **▼** : Press the buttons to increase or decrease the fan speed. The fan speed setting appears on the climate control display. Manually adjusting the fan speed cancels automatic fan control. Press **AUTO** to

return to automatic operation. Press **ON/OFF** to turn off the fan and the climate control system.

**▲/▼** : Press to increase or decrease the temperature. Press and hold to rapidly increase or decrease the temperature.

The temperatures can also be adjusted by touching the buttons on the climate control display.

**Air Delivery Mode Control** : When the climate information is displayed, touch the desired air delivery mode on the climate control display to change the direction of the airflow. The selected air delivery mode button is lit. Touching any of the air delivery buttons cancels automatic air delivery control and the direction of the airflow can be controlled manually. Press **AUTO** to return to automatic operation.

To change the current mode, select one of the following:

 : Air is directed to the instrument panel outlets.

 : Air is divided between the instrument panel outlets and the floor outlets.

 : Air is directed to the floor outlets.

 : Clears the windows of fog or moisture. Air is directed to the windshield and floor outlets.

 **MAX** : Air is directed to the windshield and the fan runs at a higher speed. Fog or frost is cleared from the windshield more quickly. When the button is pressed again, the system returns to the previous mode setting. For best results, clear all snow and ice from the windshield before defrosting.

**A/C** : Press A/C Mode on the climate control display to turn the automatic air conditioning on or off. If the fan is turned off or the outside temperature falls below freezing, the air conditioner will not run.

Press **AUTO** to return to automatic operation and the air conditioner runs as needed.

**Automatic Air Recirculation** : When the **AUTO** indicator light is on, the air is automatically recirculated as needed to help quickly cool the inside of the vehicle.

 : Press to turn on recirculation. Using air conditioning and recirculation together for long periods of time may cause the air inside the vehicle to become too dry. To prevent this from happening, after the air in the vehicle has cooled, turn the recirculation mode off.

Pressing this button cancels automatic recirculation. Press **AUTO** to return to automatic operation; recirculation runs automatically as needed. Manual recirculation mode is not recommended when in Defrost or Defog modes.

**HEAT** : Press to turn the heater on when the fan is on.

**A/C** : Press to turn the air conditioning on when the fan is on.

**Auto Defog** : The system will monitor high humidity inside the vehicle. When high humidity is detected, the climate control system may adjust to outside air supply and turn on the air conditioner or the heater. The fan speed may slightly increase to help prevent fogging. When high humidity is no longer detected, the system will return to its prior operation. To turn Auto Defog off or on, see “Climate and Air Quality” under *Vehicle Personalization* ⇨ 101.

### Rear Window Defogger



 **REAR** : Press to turn the rear window defogger on or off. An indicator light on the button comes on to show that the rear window defogger is on.

The defogger only works when the vehicle is on. The defogger will turn off if the vehicle is turned off.

### Caution

Do not try to clear frost or other material from the inside of the front windshield and rear window with a razor blade or anything else that is sharp. This may damage the rear window defogger grid and affect the radio's ability to pick up stations clearly. The repairs would not be covered by the vehicle warranty.

### Heated Seats (If Equipped)

Lift  or  to heat the driver or passenger seat cushion. See *Heated Front Seats* ⇨ 28.

### Auto Heated Seats

When the vehicle is on, this feature will automatically activate the heated seats at the level required by the vehicle's interior temperature. The active high, medium, low, or off heated seat level will be indicated by the manual heated seat buttons on the center stack. Use the manual heated seat buttons on the center stack to turn auto heated seats off. If the passenger seat is

unoccupied, the auto heated seats feature will not activate that seat. The auto heated seats feature can be programmed to always be enabled when the vehicle is on. See *Heated Front Seats* ⇨ 28 and *Vehicle Personalization* ⇨ 101.

### Remote Start Climate Control Operation

If equipped with the remote start feature, the climate control system may run when the vehicle is started remotely. The system uses the driver's previous settings to heat or cool the inside of the vehicle. The rear defog may come on during remote start based on cold ambient conditions. The rear defog indicator light does not come on during a remote start.

If equipped, the heated seats will turn on if it is cold outside. The heated seat indicator lights may not come on during a remote start. See *Heated Front Seats* ⇨ 28 and *Vehicle Personalization* ⇨ 101.

**Remote Start** : The climate control system may be started by using the Remote Keyless Entry (RKE) transmitter. The climate control system will default to an appropriate heating or cooling mode. See *Remote Start* ⇨ 13.

The rear window defogger turns on if it is cold outside.

### Sensors

#### Indicator Light and Solar Sensor (ILSS)

The ILSS is on top of the instrument panel, near the windshield, where it monitors solar intensity.

The climate control system uses the sensor information to adjust the temperature, fan speed, recirculation, and air delivery mode for best comfort.

Do not cover the sensor; otherwise the automatic climate control system may not work properly.

#### Humidity Sensor

The humidity sensor is near the base of the inside rearview mirror. The climate control system uses the sensor information to adjust the temperature and recirculation for best comfort.

#### Outside Air Temperature Sensor

The outside air temperature sensor is behind the front grille of the vehicle. The vehicle uses the sensor information to display

outside air temperature. The climate control system uses the information to adjust the climate system operation.

### Afterblow Feature

If equipped, under certain conditions, the fan may stay on or may turn on and off several times after you turn off and lock the vehicle. This is normal.

## Air Vents

Adjustable air vents are in the center and on the side of the instrument panel.

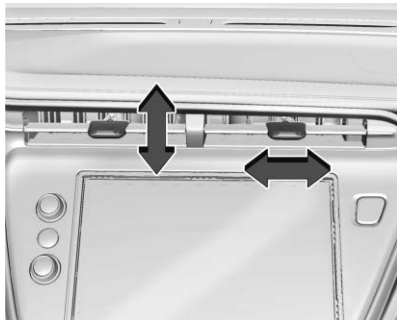

Move the slats to change the direction of the airflow.

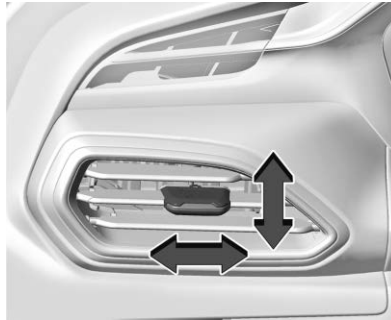

Move the slats to change the direction of the airflow.

Additional air vents are located beneath the windshield and the driver and passenger side door windows, and in the footwells. These are fixed and cannot be adjusted.

### Operation Tips

- Keep all outlets open whenever possible for best system performance.
- Clear snow off the hood to improve visibility and help decrease moisture drawn into the vehicle.
- Keep the path under all seats clear of objects to help circulate the air inside the vehicle more effectively.

- Use of non-GM approved hood deflectors can adversely affect the performance of the system.
- Do not attach any devices to the air vent slats. This restricts airflow and may cause damage to the air vents.

## Maintenance

### Air Intake

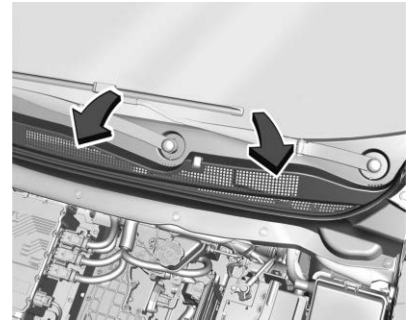

The air intake at the base of the windshield under the hood must be kept clear to allow the flow of air into the vehicle. Clear away any ice, snow, or leaves.



## Passenger Compartment Air Filter

The filter reduces the dust, pollen, and other airborne irritants from outside air that is pulled into the vehicle.

Replace the filter as part of routine scheduled maintenance.



1. Open the glove box.

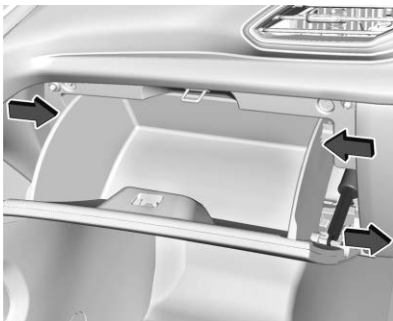

2. Pull the damper and push the side wall to unlock the stopper.
3. Lower the glove box completely.



4. Hold the right side of the filter cover, and then pull and remove it.
5. Install the new air filter.
6. Reinstall the filter cover.
7. Reconnect the glove box damper.
8. Reinstall the glove box.

See your dealer if additional assistance is needed.

## Air Conditioning Regular Operation

To ensure continuous efficient performance, operate the air conditioning for a few minutes once a month. The air conditioning will not operate if the outside temperature is too low.

### Caution

Damage caused by improper refrigerant usage could lead to costly repairs and may not be covered by the vehicle warranty. Refrigerant systems should only be serviced by qualified personnel. Always use the correct refrigerant.

 **Warning**

Performing service work to the climate control system could cause personal injury or damage to the vehicle. Climate control systems are serviced by qualified personnel only.

## Service

All vehicles have a label underhood that identifies the refrigerant used in the vehicle. The refrigerant system should only be serviced by trained and certified technicians. The air conditioning evaporator should never be repaired or replaced by one from a salvage vehicle. It should only be replaced by a new evaporator to ensure proper and safe operation.

During service, all refrigerants should be reclaimed with proper equipment. Venting refrigerants directly to the atmosphere is harmful to the environment and may also create unsafe conditions based on inhalation, combustion, frostbite, or other health-based concerns.

The air conditioning system requires periodic maintenance. See *Maintenance Schedule* ⇨ 275.

## Driving and Operating

### Driving Information

Driving for Better Energy Efficiency	155
Distracted Driving	156
Defensive Driving	156
Impaired Driving	157
Control of a Vehicle	157
Braking	157
Steering	157
Off-Road Recovery	158
Loss of Control	158
Driving on Wet Roads	159
Hill and Mountain Roads	159
Winter Driving	160
If the Vehicle Is Stuck	160
Vehicle Load Limits	161

### Starting and Operating

New Vehicle Break-In	164
Power Button	164
Starting and Stopping the Vehicle	165
Retained Accessory Power (RAP)	166
Shifting Into Park	166
Shifting out of Park	167
Extended Parking	167

### Electric Vehicle Operating Modes

Driver Selected Operating Modes	167
---------------------------------	-----

### Electric Drive Unit

Electric Drive Unit	168
One-Pedal Driving	170

### Brakes

Antilock Brake System (ABS)	171
Electric Parking Brake	171
Brake Assist	172
Hill Start Assist (HSA)	173
Regenerative Braking	173

### Ride Control Systems

Traction Control/Electronic Stability Control	174
---	-----

### Cruise Control

Cruise Control	175
Adaptive Cruise Control (Camera)	177

### Driver Assistance Systems

Driver Assistance Systems	186
Assistance Systems for Parking or Backing	187
Rear Vision Camera (RVC)	187
Surround Vision System	188
Park Assist	190
Rear Cross Traffic Alert (RCTA) System	191
Assistance Systems for Driving	191
Forward Collision Alert (FCA) System	191

Automatic Emergency Braking (AEB)	193
Front Pedestrian Braking (FPB) System	194
Side Blind Zone Alert (SBZA)	196
Lane Change Alert (LCA)	196
Lane Keep Assist (LKA)	197

### Charging

When to Charge	199
Plug-In Charging	199
Delayed Charging Override	203
Charging Status Feedback	203
Charge Cord	207
Utility Interruption of Charging	213
Electrical Requirements for Battery Charging	213

### Trailer Towing

General Towing Information	213
----------------------------	-----

### Conversions and Add-Ons

Add-On Electrical Equipment	214
-----------------------------	-----

## Driving Information

### Driving for Better Energy Efficiency

Use the following tips to help maximize energy efficiency and range.

In colder temperatures, while these efficiency tips will help, the electric vehicle driving range will be lower due to higher energy usage including energy spent heating the cabin.

The Range Impacts screen estimates the influence of the main factors impacting vehicle range. After charging is complete, this information is reset. See “Range Impacts” under. See *Energy Information* ⇨ 97.

### Acceleration/Braking/Coasting

Avoid rapid accelerations and decelerations.

Electric range is maximized at 89 km/h (55 mph) and less.

Use cruise control when appropriate.

Plan ahead for decelerations and coast whenever possible. Do not rush to traffic signals, and do not shift to N (Neutral) to coast.

The vehicle recovers more energy while coasting and braking in One-Pedal mode than in D (Drive) mode. See *One-Pedal Driving* ⇨ 170.

Using the steering wheel paddle during deceleration recovers more energy. See *Regenerative Braking* ⇨ 173.

### Terrain and Vehicle Speed

Higher speeds and grade changes use more energy and can significantly reduce electric range.

### Climate Setting

Using the heat and air conditioning systems decreases the energy available for electric driving.

Optimal energy efficiency is achieved when the heat, air conditioning, and fan are turned off.

Use the heated seat features (if equipped) instead of climate control system. Heating the seat uses less energy than heating and cooling the interior.

Use remote start to heat or cool the interior when the vehicle is plugged in to maximize the electric range by utilizing electricity from the electrical outlet.

In hot weather, avoid parking in direct sunlight or use sunshades inside the vehicle.

Keep the inside of the windows clean to reduce fogging, and turn off the front defroster and rear defogger when they are not needed.

Avoid driving with the windows open at highway speeds.

Use the Enhanced Battery Gauge on the Instrument Cluster to view the effect of climate control settings on your estimated range. See *Battery Gauge (High Voltage)* ⇨ 80.

### Outside Temperature

On colder days, it is best to plug in the vehicle overnight, and then remote start the vehicle.

Allow the vehicle to warm up for 20 minutes before driving.

If possible, use a level 2 (240 volt) high power charge station for best results. This allows the interior of the vehicle and high voltage battery to warm to optimal temperature.

**Vehicle Charging/Maintenance****Charging**

Keep the vehicle plugged in, even when fully charged, to keep the battery temperature ready for the next drive. This is important when outside temperatures are extremely hot or cold.

**Maintenance**

Always keep the tires properly inflated and the vehicle properly aligned.

The weight of excess cargo in the vehicle affects efficiency and range. Avoid carrying more than is needed.

Avoid unnecessary use of electrical accessories. Power used for functions other than propelling the vehicle will reduce EV range.

Using a rooftop carrier will reduce efficiency due to additional weight and drag.

**Distracted Driving**

Distraction comes in many forms and can take your focus from the task of driving. Exercise good judgment and do not let other activities divert your attention away from the road. Many local governments have

enacted laws regarding driver distraction. Become familiar with the local laws in your area.

To avoid distracted driving, keep your eyes on the road, keep your hands on the steering wheel, and focus your attention on driving.

- Do not use a mobile phone in demanding driving situations. Use a hands-free method to place or receive necessary phone calls.
- Watch the road. Do not read, take notes, or look up information on mobile phones or other electronic devices.
- Designate a front seat passenger to handle potential distractions.
- Become familiar with vehicle features before driving, such as programming favorite radio stations and adjusting climate control and seat settings. Program all trip information into any navigation device prior to driving.
- Wait until the vehicle is parked to retrieve items that have fallen to the floor.
- Stop or park the vehicle to tend to children.

- Keep pets in an appropriate carrier or restraint.
- Avoid stressful conversations while driving, whether with a passenger or on a mobile phone.

 **Warning**

Taking your eyes off the road too long or too often could cause a crash resulting in injury or death. Focus your attention on driving.

Refer to the Infotainment section for more information on using that system, including pairing and using a mobile phone.

**Defensive Driving**

Defensive driving means “always expect the unexpected.” The first step in driving defensively is to wear the seat belt.

- Assume that other road users (pedestrians, bicyclists, and other drivers) are going to be careless and make mistakes. Anticipate what they might do and be ready.
- Allow enough following distance between you and the driver in front of you.
- Focus on the task of driving.

## Impaired Driving

Death and injury associated with impaired driving is a global tragedy.

### Warning

Drinking alcohol or taking drugs and then driving is very dangerous. Your reflexes, perceptions, attentiveness, and judgment can be affected by even a small amount of alcohol or drugs. You can have a serious — or even fatal — collision if you drive after drinking or taking drugs.

Do not drive while under the influence of alcohol or drugs, or ride with a driver who has been drinking or is impaired by drugs. Find alternate transportation home; or if you are with a group, designate a driver who will remain sober.

## Control of a Vehicle

Braking, steering, and accelerating are important factors in helping to control a vehicle while driving.

## Braking

Braking action involves perception time and reaction time. Deciding to push the brake pedal is perception time. Actually doing it is reaction time.

Average driver reaction time is about three-quarters of a second. In that time, a vehicle moving at 100 km/h (60 mph) travels 20 m (66 ft), which could be a lot of distance in an emergency.

Helpful braking tips to keep in mind include:

- Keep enough distance between you and the vehicle in front of you.
- Avoid needless heavy braking.
- Keep pace with traffic.

## Steering

### Caution

To avoid damage to the steering system, do not drive over curbs, parking barriers, or similar objects at speeds greater than 3 km/h (1 mph). Use care when driving over other objects such as lane dividers and speed bumps. Damage caused by misuse of the vehicle is not covered by the vehicle warranty.

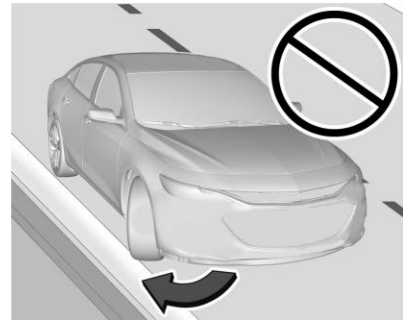

## Variable Effort Steering

The vehicle has a steering system that varies the amount of effort required to steer the vehicle in relation to the speed of the vehicle.

The amount of steering effort required is less at slower speeds to make the vehicle more maneuverable and easier to park. At faster speeds, the steering effort increases to provide a sport-like feel to the steering. This provides maximum control and stability.

## Electric Power Steering

The vehicle has electric power steering. It does not have power steering fluid. Regular maintenance is not required.

If power steering assist is lost due to a system malfunction, the vehicle can be steered, but may require increased effort.

If the steering wheel is turned until it reaches the end of its travel and is held against that position for an extended period of time, power steering assist may be reduced.

If the steering assist is used for an extended period of time while the vehicle is not moving, power assist may be reduced.

Normal use of the power steering assist should return when the system cools down.

See your dealer if there is a problem.

### Curve Tips

- Take curves at a reasonable speed.
- Reduce speed before entering a curve.
- Maintain a reasonable steady speed through the curve.
- Wait until the vehicle is out of the curve before accelerating gently into the straightaway.

### Steering in Emergencies

- There are some situations when steering around a problem may be more effective than braking.

- Holding both sides of the steering wheel allows you to turn 180 degrees without removing a hand.
- Antilock Brake System (ABS) allows steering while braking.

### Off-Road Recovery

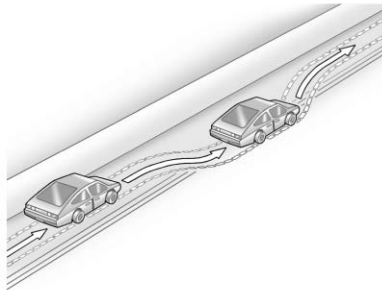

The vehicle's right wheels can drop off the edge of a road onto the shoulder while driving. Follow these tips:

1. Ease off the accelerator and then, if there is nothing in the way, steer the vehicle so that it straddles the edge of the pavement.

2. Turn the steering wheel about one-eighth of a turn, until the right front tire contacts the pavement edge.
3. Turn the steering wheel to go straight down the roadway.

### Loss of Control

#### Skidding

There are three types of skids that correspond to the vehicle's three control systems:

- Braking Skid — wheels are not rolling.
- Steering or Cornering Skid — too much speed or steering in a curve causes tires to slip and lose cornering force.
- Acceleration Skid — too much throttle causes the driving wheels to spin.

Defensive drivers avoid most skids by taking reasonable care suited to existing conditions, and by not overdriving those conditions. But skids are always possible.

If the vehicle starts to slide, follow these suggestions:

- Ease your foot off the accelerator pedal and steer the way you want the vehicle to go. The vehicle may straighten out. Be ready for a second skid if it occurs.

- Slow down and adjust your driving according to weather conditions. Stopping distance can be longer and vehicle control can be affected when traction is reduced by water, snow, ice, gravel, or other material on the road. Learn to recognize warning clues — such as enough water, ice, or packed snow on the road to make a mirrored surface — and slow down when you have any doubt.
- Try to avoid sudden steering, acceleration, or braking, including reducing vehicle speed by shifting to a lower gear. Any sudden changes could cause the tires to slide.

Remember: Antilock brakes help avoid only the braking skid.

## Driving on Wet Roads

Rain and wet roads can reduce vehicle traction and affect your ability to stop and accelerate. Always drive slower in these types of driving conditions and avoid driving through large puddles and deep-standing or flowing water.

### Warning

Wet brakes can cause crashes. They might not work as well in a quick stop and could cause pulling to one side. You could lose control of the vehicle.

After driving through a large puddle of water or a car/vehicle wash, lightly apply the brake pedal until the brakes work normally.

Flowing or rushing water creates strong forces. Driving through flowing water could cause the vehicle to be carried away. If this happens, you and other vehicle occupants could drown. Do not ignore police warnings and be very cautious about trying to drive through flowing water.

## Hydroplaning

Hydroplaning is dangerous. Water can build up under the vehicle's tires so they actually ride on the water. This can happen if the road is wet enough and you are going fast enough. When the vehicle is hydroplaning, it has little or no contact with the road.

There is no hard and fast rule about hydroplaning. The best advice is to slow down when the road is wet.

## Other Rainy Weather Tips

Besides slowing down, other wet weather driving tips include:

- Allow extra following distance.
- Pass with caution.
- Keep windshield wiping equipment in good shape.
- Keep the windshield washer fluid reservoir filled.
- Have good tires with proper tread depth.
- Turn off cruise control.

## Hill and Mountain Roads

Driving on steep hills or through mountains is different than driving on flat or rolling terrain.

- Keep the vehicle serviced and in good shape.
- Check all fluid levels and brakes, tires, cooling system, and electric drive unit.
- Keep the vehicle in gear when going down steep or long hills.



 **Warning**

Coasting downhill in N (Neutral) or with the vehicle turned off is dangerous. The brakes will have to do all the work of slowing down the vehicle and could become too hot. Hot brakes may not be able to slow the vehicle enough to maintain speed and control. You could crash. Always have the vehicle running and in gear when going downhill. This will allow the electric drive unit to assist in slowing and maintaining speed.

- Drive at speeds to keep the vehicle in its own lane. Do not swing wide or cross the center line.
- Be alert on top of hills. Something could be in your lane (e.g., stalled car, crash).
- Pay attention to special road signs (e.g., falling rocks area, winding roads, long grades, passing or no-passing zones) and take appropriate action.

**Winter Driving****Driving on Snow or Ice**

Snow or ice between the tires and the road creates less traction or grip, so drive carefully. Wet ice can occur at about 0 °C (32 °F) when freezing rain begins to fall. Avoid driving on wet ice or in freezing rain until roads can be treated.

**For Slippery Road Driving:**

- Turn off One-Pedal Driving.
- Accelerate gently. Accelerating too quickly causes the wheels to spin and makes the surface under the tires slick.
- Turn on the Traction Control System (TCS).
- The Antilock Brake System (ABS) improves vehicle stability during hard stops, but the brakes should be applied sooner than when on dry pavement.
- Allow greater following distance and watch for slippery spots. Icy patches can occur on otherwise clear roads in shaded areas. The surface of a curve or an overpass can remain icy when the surrounding roads are clear. Avoid sudden steering maneuvers and braking while on ice.

- Turn off cruise control.
- Avoid using Regen on Demand paddle.

**Blizzard Conditions**

Being stuck in snow can be a serious situation. Stay with the vehicle unless there is help nearby. If possible, use Roadside Assistance. See *Roadside Assistance Program* ⇨ 289. To get help and keep everyone in the vehicle safe:

- Turn on the hazard warning flashers.
- Tie a red cloth to an outside mirror.

To save energy, run the vehicle for only short periods as needed to warm the vehicle and then shut the vehicle off and partially close the window. Moving about to keep warm also helps.

**If the Vehicle Is Stuck**

Slowly and cautiously spin the wheels to free the vehicle when stuck in sand, mud, ice, or snow.

The Traction Control System (TCS) must be turned off by pressing the TCS/ESC button. Traction control is not completely off, but will only engage if the maneuver can cause damage to the electric drive unit.

**Warning**

If the vehicle's tires spin at high speed, they can explode, and you or others could be injured. The vehicle can overheat, causing an underhood compartment fire or other damage. Spin the wheels as little as possible and avoid going above 56 km/h (35 mph).

**Rocking the Vehicle to Get it Out**

Turn the steering wheel left and right to clear the area around the front wheels. Turn off TCS. Shift back and forth between R (Reverse) and a low forward gear, spinning the wheels as little as possible. To prevent electric drive unit wear, wait until the wheels stop spinning before shifting gears. Release the accelerator pedal while shifting, and press lightly on the accelerator pedal when the electric drive unit is in gear. Slowly spinning the wheels in the forward and reverse directions causes a rocking motion that could free the vehicle. If that does not get the vehicle out after a few tries, it might need to be towed out. See *Towing the Vehicle* ⇨ 262.

**Vehicle Load Limits**

It is very important to know how much weight the vehicle can carry. This weight is called the vehicle capacity weight and includes the weight of all occupants, cargo, and all nonfactory-installed options. Two labels on the vehicle may show how much weight it may properly carry: the Tire and Loading Information label and the Certification label.

**Warning**

Do not load the vehicle any heavier than the Gross Vehicle Weight Rating (GVWR), or either the maximum front or rear Gross Axle Weight Rating (GAWR). This can cause systems to break and change the way the vehicle handles. This could cause loss of control and a crash. Overloading can also reduce stopping performance, damage the tires, and shorten the life of the vehicle.

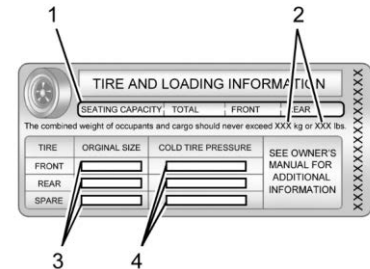
**Tire and Loading Information Label****Label Example**

A vehicle-specific Tire and Loading Information label is attached to the vehicle's center pillar (B-pillar). The Tire and Loading Information label shows the number of occupant seating positions (1), and the maximum vehicle capacity weight (2) in kilograms and pounds.

The Tire and Loading Information label also shows the tire size of the original equipment tires (3) and the recommended cold tire inflation

pressures (4). For more information on tires and inflation see *Tires* ⇨ 237 and *Tire Pressure* ⇨ 243.

There is also important loading information on the Certification label. It may show the Gross Vehicle Weight Rating (GVWR) and the Gross Axle Weight Rating (GAWR) for the front and rear axle. See “Certification Label” later in this section.

**“Steps for Determining Correct Load Limit–**

1. Locate the statement "The combined weight of occupants and cargo should never exceed XXX kg or XXX lbs." on your vehicle’s placard.
2. Determine the combined weight of the driver and passengers that will be riding in your vehicle.
3. Subtract the combined weight of the driver and passengers from XXX kg or XXX lbs.

4. The resulting figure equals the available amount of cargo and luggage load capacity. For example, if the "XXX" amount equals 1400 lbs. and there will be five 150 lb passengers in your vehicle, the amount of available cargo and luggage load capacity is 650 lbs. (1400-750 (5 x 150) = 650 lbs.)

5. Determine the combined weight of luggage and cargo being loaded on the vehicle. That weight may not safely exceed the available cargo and luggage load capacity calculated in Step 4.

6. If your vehicle will be towing a trailer, load from your trailer will be transferred to your vehicle. Consult this manual to determine how this reduces the available cargo and luggage load capacity of your vehicle.”

This vehicle is neither designed nor intended to tow a trailer.

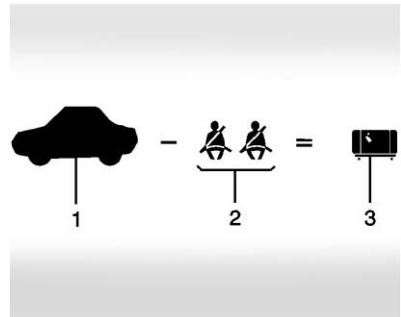

**Example 1**

1. Vehicle Capacity Weight for Example 1 = 453 kg (1,000 lbs).
2. Subtract Occupant Weight @ 68 kg (150 lbs) × 2 = 136 kg (300 lbs).
3. Available Occupant and Cargo Weight = 317 kg (700 lbs).

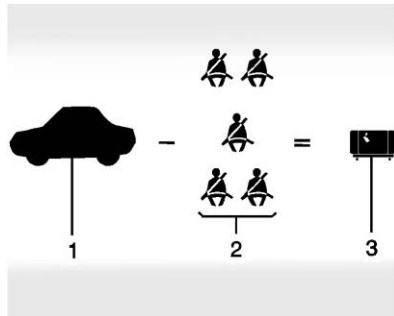

Example 2

1. Vehicle Capacity Weight for Example 2 = 453 kg (1,000 lbs).
2. Subtract Occupant Weight @ 68 kg (150 lbs) × 5 = 340 kg (750 lbs).
3. Available Cargo Weight = 113 kg (250 lbs).

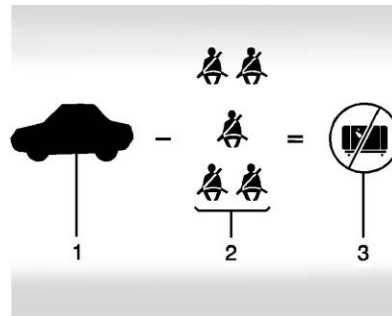

Example 3

1. Vehicle Capacity Weight for Example 3 = 453 kg (1,000 lbs).
2. Subtract Occupant Weight @ 91 kg (200 lbs) × 5 = 453 kg (1,000 lbs).
3. Available Cargo Weight = 0 kg (0 lbs).

Refer to the vehicle's Tire and Loading Information label for specific information about the vehicle's capacity weight and seating positions. The combined weight of the driver, passengers, and cargo should never exceed the vehicle's capacity weight.

### Certification Label

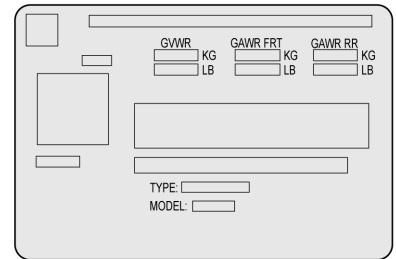

### Label Example

A vehicle-specific Certification label is attached to the vehicle's center pillar (B-pillar). The label may show the gross weight capacity of the vehicle, called the Gross Vehicle Weight Rating (GVWR). The GVWR includes the weight of the vehicle, all occupants, fuel, and cargo.

**Warning**

Things inside the vehicle can strike and injure people in a sudden stop or turn, or in a crash.

- Put things in the cargo area of the vehicle. In the cargo area, put them as far forward as possible. Try to spread the weight evenly.
- Never stack heavier things, like suitcases, inside the vehicle so that some of them are above the tops of the seats.
- Do not leave an unsecured child restraint in the vehicle.
- Secure loose items in the vehicle.
- Do not leave a seat folded down unless needed.

**Starting and Operating****New Vehicle Break-In****Caution**

Avoid making hard stops for the first 322 km (200 mi). During this time the new brake linings are not yet broken in. Hard stops with new linings can mean premature wear and earlier replacement. Follow this breaking-in guideline every time you get new brake linings. Following break-in, vehicle speed and load can be gradually increased.

**Power Button**

The vehicle has an electronic pushbutton start.

The Remote Keyless Entry (RKE) transmitter must be in the vehicle for the system to operate. If the vehicle will not start, place the RKE transmitter in the transmitter pocket, inside the center console.

**STOPPING THE VEHICLE/OFF :** To turn the vehicle off, apply the brakes, press the P (Park) switch on the center console and press POWER .

Alternatively, apply the brakes and press POWER . The electric drive unit will shift to P (Park) then shut off automatically.

Retained Accessory Power (RAP) will remain active until the driver door is opened.

If the vehicle must be shut off in an emergency:

1. Brake using a firm and steady pressure. Do not pump the brakes repeatedly. This may deplete power assist, requiring increased brake pedal force.
2. Shift the vehicle to N (Neutral). This can be done while the vehicle is moving. After shifting to N (Neutral), firmly apply the brakes and steer the vehicle to a safe location.
3. Come to a complete stop, shift to P (Park), and turn the vehicle off by pressing POWER .
4. Set the parking brake.



### Warning

Turning off the vehicle while moving may disable the airbags. While driving, only shut the propulsion system off in an emergency.

If the vehicle cannot be pulled over, and must be shut off while driving, press and hold POWER  for longer than two seconds, or press twice in five seconds.

**ON/RUN** : This position is for starting and driving. With the vehicle off, and the brake pedal applied, pressing POWER  once will place the vehicle in ON/RUN. When the vehicle ready light is on in the instrument cluster, the vehicle is ready to be driven. This could take up to 15 seconds at extremely cold temperatures.

### Service Mode

This power mode is available for service and diagnostics, and to verify the proper operation of the service vehicle soon light as may be required for emission inspection purposes. With the vehicle off, and the brake pedal not applied, pressing and holding POWER  for more than five seconds will place the vehicle in Service Mode. The instruments and audio systems will operate as they do in ON/RUN, but the vehicle will not be able to be driven. The propulsion system will not start in Service Mode. Press POWER  again to turn the vehicle off.

### Caution

Placing the vehicle in Service Mode will use the 12-volt battery. Do not use Service Mode for an extended period, or the vehicle may not start.

## Starting and Stopping the Vehicle

### Starting Procedure

Shift the vehicle to P (Park) or N (Neutral). The propulsion system will not start in any other position.

### Caution

Do not try to shift to P (Park) if the vehicle is moving or the electric drive unit could be damaged. Shift to P (Park) only when the vehicle is stopped.

### Caution

If you add electrical parts or accessories, you could change the way the vehicle operates. Any resulting damage would not be covered by the vehicle warranty.

The Remote Keyless Entry (RKE) transmitter must be in the vehicle. Press the brake pedal, then press and release POWER .

If the RKE transmitter is not in the vehicle or something is interfering with the transmitter, a message displays in the Driver Information Center (DIC).

If the vehicle will not start due to a low RKE transmitter battery, the vehicle can still be driven. See *Remote Keyless Entry (RKE) System Operation* ⇨ 7.



A vehicle ready light displays in the lower right corner of the instrument cluster when the vehicle is ready to be driven.

The instrument cluster also displays an active battery gauge when the vehicle is ready to be driven.

### Restarting Procedure

If the vehicle must be restarted while it is still moving, press the N (Neutral) switch and press POWER  twice without pressing the brake pedal. The propulsion system will not restart in any other position.

A chime will sound if the driver door is opened while the vehicle is on. Always press POWER  to turn the vehicle off before exiting.

### Stopping Procedure

For information on how to turn the vehicle off, see *Power Button* ⇨ 164.

### Retained Accessory Power (RAP)

The following features will operate for up to 10 minutes or until the driver door is opened:

- Audio System
- Accessory Power Outlets
- Power Windows

### Shifting Into Park

To shift into P (Park):

1. Hold the brake pedal down and set the parking brake. See “Electric Parking Brake.”
2. Press the P (Park) switch on the center console.
3. Turn the vehicle off.

If the vehicle is shifted into P (Park) on a hill, the electric parking brake (EPB) may apply automatically. The driver may not be able to release the EPB using the EPB switch. It should automatically release when the vehicle is shifted out of P (Park).

### Leaving the Vehicle with the Propulsion System On

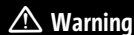

#### Warning

It is dangerous to get out of the vehicle if the P (Park) button is not pressed with the parking brake set. The vehicle can roll.

Do not leave the vehicle when the propulsion system is running. If you have left the propulsion system running, the

(Continued)

**Warning (Continued)**

vehicle can move suddenly. You or others could be injured. To be sure the vehicle will not move, even when you are on fairly level ground, always set the parking brake and press the P (Park) button.

If you have to leave the vehicle with the propulsion system running, the vehicle must be in P (Park) with the parking brake set before leaving the vehicle. After pressing the P (Park) button, hold down the regular brake pedal. If you cannot see the P (Park) indicator in the instrument cluster, the vehicle has not shifted into P (Park).

**Shifting out of Park**

This vehicle is equipped with an electric drive unit. To shift out of P (Park), the vehicle must be on, the brake pedal must be applied, and the charge cord must be unplugged.

Parking the vehicle in extreme cold for several days without the charge cord connected may cause the vehicle not to

start. The vehicle will need to be plugged in to allow the high voltage battery to be warmed sufficiently.

To shift out of P (Park):

1. Apply the brake pedal.
2. Press POWER  to start the vehicle.
3. Verify that the vehicle is unplugged and the vehicle ready light is on.
4. Press or pull the desired shift switch on the center console. For N (Neutral) press and hold the N (Neutral) switch until the N indicator illuminates red.

The P indicator will turn white and the gear indicator on the selected shift switch will turn red when the vehicle is no longer in P (Park).

If the vehicle cannot shift from P (Park), a Driver Information Center (DIC) message may be displayed. Check that the vehicle is on, the vehicle ready light is on, and the brake pedal is applied when you are attempting to shift out of P (Park). If all of these are met but the vehicle will not shift out of P (Park), see your dealer for service.

**Extended Parking**

It is best not to park with the vehicle running. If the vehicle is left running, be sure it will not move and there is adequate ventilation.

See *Shifting Into Park* ⇨ 166.

If the vehicle is left parked and running with the RKE transmitter outside the vehicle, it will continue to run for up to an hour.

If the vehicle is left parked and running with the RKE transmitter inside the vehicle, it will continue to run for up to two hours.

The timer will reset if the vehicle is taken out of P (Park) while it is running.

**Electric Vehicle Operating Modes****Driver Selected Operating Modes****Sport Mode**

Sport Mode provides more responsive acceleration than Normal Mode, but can reduce efficiency. When the SPORT indicator is not on, the vehicle is in Normal Mode.





Press SPORT to select Sport Mode.

Press SPORT again to return to Normal Mode.

An indicator will display in the instrument cluster.

Each time the vehicle is started, it will return to Normal Mode.

Sport Mode may be unavailable if the battery charge is too low.

## Electric Drive Unit



The shift switches are on the center console. The selected gear position will illuminate red on the shift switch, while all others will be displayed in white. If the shift is not immediate, as in very cold conditions, the indicator on the shift switch may flash until it is fully engaged.

If the vehicle is in ACC/ACCESSORY, the vehicle can be shifted into P (Park).

If POWER  is pressed twice while at a relatively high speed, the vehicle will turn off and automatically shift to N (Neutral). Once the vehicle is stopped, P (Park) can be selected.

**P** : This position locks the drive wheels. Use P (Park) when starting the vehicle to prevent the vehicle from moving easily.

### Warning

It is dangerous to get out of the vehicle if the P (Park) switch is not pressed with the parking brake set. The vehicle can roll.

Do not leave the vehicle when the propulsion system is running. If you have left the propulsion system running, the vehicle can move suddenly. You or others could be injured. To be sure the vehicle will not move, even when you are on fairly level ground, always set the parking brake and press the P (Park) switch.

The R (Reverse) and D (Drive) shift switches are designed to prevent inadvertent shifting out of P (Park) unless the propulsion system is on and the brake pedal is applied.

When the vehicle is stopped, press POWER  to turn off the vehicle. The vehicle will shift into P (Park) automatically.

The vehicle will not shift into P (Park) if it is moving too fast. Stop the vehicle and shift into P (Park).

To shift in and out of P (Park), see *Shifting Into Park* ⇨ 166 and *Shifting out of Park* ⇨ 167.

**R** : Use this gear to back up.

If the vehicle is shifted from either R (Reverse) to D (Drive), or D (Drive) to R (Reverse) while the speed is too high, the vehicle may shift to N (Neutral). Reduce the vehicle speed and try the shift again.

To shift into R (Reverse):

1. Bring the vehicle to a complete stop.
2. Pull the R (Reverse) switch on the center console.

To shift out of R (Reverse):

1. Bring the vehicle to a complete stop.
2. Shift to the desired gear.

At low vehicle speeds, R (Reverse) can be used to rock the vehicle back and forth to get out of snow, ice, or sand without damaging the electric drive unit. See “If the Vehicle is Stuck.”

**N** : In this position, the propulsion system is inactive. If the vehicle is moving and turned off, restart the propulsion system in N (Neutral) only.

### Caution

The vehicle is not designed to stay in N (Neutral) for extended periods of time. It will automatically shift into P (Park).

To shift into N (Neutral), press the N (Neutral) switch until the N indicator is red. See *Shifting out of Park* ⇨ 167 for shifting from P (Park) to N (Neutral).

To shift out of N (Neutral):

1. Bring the vehicle to a complete stop.
2. Apply the brake pedal.
3. Shift into the desired gear.

If the brake pedal is not applied, the vehicle may remain in N (Neutral).

### Car Wash Mode

This vehicle includes a Car Wash Mode that allows the vehicle to remain in N (Neutral) for use in automatic car washes.

Car Wash Mode is not to be used for vehicle towing. If the vehicle needs to be towed, see “Towing the Vehicle.”

### Caution

The vehicle is not designed to stay in N (Neutral) for extended periods of time. It will automatically shift into P (Park).

### Car Wash Mode (Driver in Vehicle)

To place the vehicle in N (Neutral) with the vehicle on and the vehicle occupied:

1. Drive to the entrance of the car wash.
2. Apply the brake pedal.
3. Shift into N (Neutral).
4. If desired, press POWER ⏻ to turn off the vehicle.
5. Release the brake pedal. The vehicle is now ready for the car wash.

### Car Wash Mode (Driver out of Vehicle)

To place the vehicle in N (Neutral) with the vehicle on and the vehicle unoccupied:

1. Drive to the entrance of the car wash.
2. Apply the brake pedal.
3. Open the door.
4. Shift into N (Neutral), then release the brake pedal.
5. The indicator should continue to show N. If it does not, repeat Steps 2–4.

6. If desired, press POWER  to turn off the vehicle.
7. Exit the vehicle and close the door. The vehicle is now ready for the car wash.
8. If left on, the vehicle may automatically shift into P (Park) upon re-entry.

**D** : This position is for normal driving. If more power is needed for passing, press the accelerator pedal down.

To shift into D (Drive):

1. Bring the vehicle to a complete stop.
2. Pull the D (Drive) switch on the center console.

To shift out of D (Drive):

1. Bring the vehicle to a complete stop.
2. Shift to the desired gear.

**Caution**

Spinning the tires excessively may damage the electric drive unit. The repair will not be covered by the vehicle warranty. If you are stuck, do not spin the tires.

Apply the brakes when stopping or shifting to P (Park) on a hill to prevent the vehicle from rolling.

**One-Pedal Driving**

With One-Pedal Driving, the accelerator pedal is used to control the deceleration of the vehicle to a complete stop.

Completely lifting off the accelerator pedal results in aggressive deceleration. Partially lifting off the accelerator pedal allows the deceleration of the vehicle to be adjusted as desired.

The amount of deceleration may vary under Regenerative Power Limited condition. See *Power Indicator Gauge* ⇨ 81.

Use the brake pedal if emergency braking is required.



To use One-Pedal Driving, press the One-Pedal Driving button on the Electric Drive Unit shift switch control. An indicator displays in the instrument cluster. When enabled, this feature applies in both D (Drive) and R (Reverse). This feature remains enabled until manually disabled by the driver. Press the accelerator pedal to the desired speed. The deceleration provided by One-Pedal Driving provides full regenerative braking and helps increase energy efficiency. The brake lamps may come on when the accelerator pedal is released or during substantial deceleration from regenerative braking.

Press the One-Pedal Driving button again to turn off One-Pedal Driving. If stopped, the vehicle stays stopped when One-Pedal Driving is turned off. Press the brake pedal or accelerator pedal to return to two-pedal driving.

While operating in One-Pedal Driving, the electric parking brake may apply in some circumstances. This can occur when:

- Driving on slopes.
- The driver's door is open.
- The vehicle remains stationary for five minutes.

- There is a problem with the propulsion system.

To drive, press the accelerator pedal again and the electric parking brake will automatically disengage.

One-Pedal Driving may shift the car into P (Park) if the vehicle is pushed once it has been stopped or if a problem with the propulsion system develops.

## Brakes

### Antilock Brake System (ABS)

The Antilock Brake System (ABS) helps prevent a braking skid and maintain steering while braking hard.

ABS performs a system check when the vehicle is first driven. A momentary motor or clicking noise may be heard while this test is going on, and the brake pedal may move slightly. This is normal.



If there is a problem with ABS, this warning light stays on. See *Antilock Brake System (ABS) Warning Light* ⇨ 85.

ABS does not change the time needed to get a foot on the brake pedal and does not always decrease stopping distance. If you get too close to the vehicle ahead, there will not be enough time to apply the brakes if that vehicle suddenly slows or stops. Always leave enough room ahead to stop, even with ABS.

#### Using ABS

Do not pump the brakes. Just hold the brake pedal down firmly. Hearing or feeling ABS operate is normal.

#### Braking in Emergencies

ABS allows steering and braking at the same time. In many emergencies, steering can help even more than braking.

### Electric Parking Brake

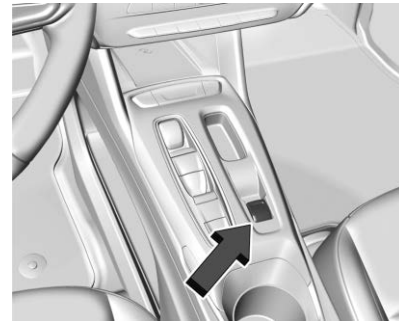

The Electric Parking Brake (EPB) can always be applied, even if the vehicle is off. In case of insufficient electrical power, the EPB cannot be applied or released. To prevent draining the battery, avoid unnecessary repeated cycles of the EPB.

The system has a red parking brake status light and an amber service parking brake warning light. See *Electric Parking Brake Light* ⇨ 84 and *Service Electric Parking Brake Light* ⇨ 84. There are also parking brake-related Driver Information Center (DIC) messages.

Before leaving the vehicle, check the red parking brake status light to ensure that the parking brake is applied.

### **EPB Apply**

To apply the EPB:

1. Be sure the vehicle is at a complete stop.
2. Pull the EPB switch momentarily.

The red parking brake status light will flash and then stay on once the EPB is fully applied. If the red parking brake status light flashes continuously, the EPB is only partially applied or there is a problem with the EPB. A DIC message will display. Release the EPB and try to apply it again. If the light does not come on, or keeps flashing, have the vehicle serviced. Do not drive the vehicle if the red parking brake status light is flashing. See your dealer.

If the amber service parking brake warning light is on, pull the EPB switch. Continue to hold the switch until the red parking brake status light remains on. If the amber service parking brake warning light is on, see your dealer.

If the EPB is applied while the vehicle is moving, the vehicle will decelerate as long as the switch is pulled. If the switch is pulled until the vehicle comes to a stop, the EPB will remain applied.

The vehicle may automatically apply the EPB in some situations when the vehicle is not moving. This is normal, and is done to periodically check the correct operation of the EPB system, or at the request of other safety functions that utilize the EPB.

If the EPB fails to apply, block the rear wheels to prevent vehicle movement.

### **EPB Release**

To release the EPB:

1. Turn the ignition on.
2. Apply and hold the brake pedal.
3. Press the EPB switch momentarily.

The EPB is released when the red parking brake status light is off.

If the amber service parking brake warning light is on, release the EPB by pressing and holding the EPB switch. Continue to hold the switch until the red parking brake status light is off. If either light stays on after release is attempted, see your dealer.

<b>Caution</b>
Driving with the parking brake on can overheat the brake system and cause premature wear or damage to brake system parts. Make sure that the parking brake is fully released and the brake warning light is off before driving.

### **Automatic EPB Release**

The EPB will automatically release if the vehicle is running, placed into gear, and an attempt is made to drive away. Avoid rapid acceleration when the EPB is applied, to preserve parking brake lining life.

### **Brake Assist**

Brake Assist detects rapid brake pedal applications due to emergency braking situations and provides additional braking to activate the Antilock Brake System (ABS) if the brake pedal is not pushed hard enough to activate ABS normally. Minor noise, brake pedal pulsation, and/or pedal movement during this time may occur. Continue to apply the brake pedal as the driving situation dictates. Brake Assist disengages when the brake pedal is released.

## Hill Start Assist (HSA)

### Warning

Do not rely on the HSA feature. HSA does not replace the need to pay attention and drive safely. You may not hear or feel alerts or warnings provided by this system. Failure to use proper care when driving may result in injury, death, or vehicle damage. See *Defensive Driving* ⇨ 156.

When the vehicle is stopped on a grade, Hill Start Assist (HSA) prevents the vehicle from rolling in an unintended direction during the transition from brake pedal release to accelerator pedal apply. The brakes release when the accelerator pedal is applied. If the accelerator pedal is not applied within a few minutes, the Electric Parking Brake will apply. The brakes may also release under other conditions. Do not rely on HSA to hold the vehicle.

HSA is available when the vehicle is facing uphill in a forward gear, or when facing downhill in R (Reverse). The vehicle must come to a complete stop on a grade for HSA to activate.

## Regenerative Braking

Regenerative braking takes some of the energy from the moving vehicle and turns it back into electrical energy. This energy is then stored back into the high voltage battery system, contributing to increased energy efficiency.

The brake system uses regenerative braking, conventional hydraulic braking, or a combination of both as appropriate.

The brake controller applies the hydraulic brakes using a pump. The pump may be heard during some braking, such as rapid applies. This is normal.

### Regen on Demand

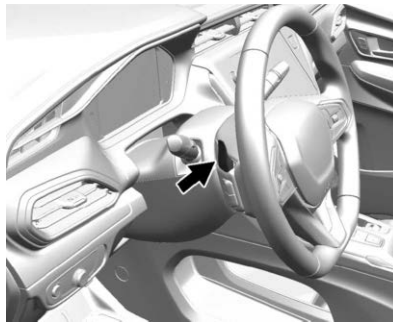

Regen on Demand allows increased deceleration by pressing and holding the steering wheel paddle. It works in D (Drive). Regen on Demand can add additional regenerative braking when One-Pedal Drive mode is enabled. The accelerator pedal can be used to manage deceleration while using Regen on Demand. See “One-Pedal Driving” under *Electric Drive Unit* ⇨ 168.

If the vehicle is brought to a complete stop while the Regen on Demand paddle is held, the vehicle will not creep forward when the paddle is released. The accelerator pedal must be pressed to move the vehicle forward.

If the vehicle is on a steep grade, the brake pedal must be used to hold the vehicle.

Regenerative power may be limited when the battery is near full charge or cold.

Cruise control will turn off and the brake lamps may come on when this feature is activated.

## Ride Control Systems

### Traction Control/Electronic Stability Control

#### System Operation

The vehicle has a Traction Control System (TCS) and StabiliTrak/Electronic Stability Control (ESC), an electronic stability control system. These systems help limit wheel slip and assist the driver in maintaining control, especially on slippery road conditions.

TCS activates if it senses that any of the drive wheels are spinning or beginning to lose traction. When this happens, TCS applies the brakes to the spinning wheels and reduces propulsion system power to limit wheel spin.

StabiliTrak/ESC activates when the vehicle senses a difference between the intended path and the direction the vehicle is actually traveling. StabiliTrak/ESC selectively applies braking pressure to any one of the vehicle wheel brakes to assist the driver in keeping the vehicle on the intended path.

If cruise control or adaptive cruise control is being used and TCS or StabiliTrak/ESC begins to limit wheel spin, cruise control or

adaptive cruise control will disengage. Cruise control or adaptive cruise control may be turned back on when road conditions allow.

Both systems come on automatically when the vehicle is started and begins to move. The systems may be heard or felt while they are operating or while performing diagnostic checks. This is normal and does not mean there is a problem with the vehicle.

It is recommended to leave both systems on for normal driving conditions, but it may be necessary to turn TCS off if the vehicle gets stuck in sand, mud, ice, or snow. See “Turning the Systems Off and On” later in this section.



The indicator light for both systems is in the instrument cluster. This light will:

- Flash when TCS is limiting wheel spin.
- Flash when StabiliTrak/ESC is activated.
- Turn on and stay on when either system is not working.

If either system fails to turn on or to activate, a message displays in the Driver Information Center (DIC), and  comes on and stays on to indicate that the system is inactive and is not assisting the driver in maintaining control. The vehicle is safe to drive, but driving should be adjusted accordingly.

If  comes on and stays on:

1. Stop the vehicle.
2. Turn the vehicle off and wait 15 seconds.
3. Start the vehicle.



Drive the vehicle. If  comes on and stays on, the vehicle may need more time to diagnose the problem. If the condition persists, see your dealer.



## Turning the Systems Off and On







### Caution



Do not repeatedly brake or accelerate heavily when TCS is off. The vehicle driveline could be damaged.

To turn off only TCS, press and release . The traction off light  displays in the instrument cluster.

To turn TCS on again, press and release . The traction off light  displayed in the instrument cluster will turn off.

If TCS is limiting wheel spin when  is pressed, the system will not turn off until the wheels stop spinning.

To turn off both TCS and StabiliTrak/ESC, press and hold  until the traction off light  and StabiliTrak/ESC OFF light  come on and stay on in the instrument cluster. StabiliTrak can only be disabled below 56 km/h (35 mph).

To turn TCS and StabiliTrak/ESC on again, press and release . The traction off light  and StabiliTrak/ESC OFF light  in the instrument cluster turn off.

Adding accessories can affect the vehicle performance. See *Accessories and Modifications* ⇨ 216.

## Cruise Control

The cruise control lets the vehicle maintain a speed of about 40 km/h (25 mph) or more without keeping your foot on the accelerator. Cruise control does not work at speeds below 40 km/h (25 mph).

### Warning

Cruise control can be dangerous where you cannot drive safely at a steady speed. Do not use cruise control on winding roads or in heavy traffic.

Cruise control can be dangerous on slippery roads. On such roads, fast changes in tire traction can cause excessive wheel slip, and you could lose control. Do not use cruise control on slippery roads.

With the Traction Control System (TCS) or StabiliTrak/Electronic Stability Control (ESC), the system may begin to limit wheel spin while you are using cruise control. If this happens, the cruise control will automatically disengage. See *Traction Control/Electronic Stability Control* ⇨ 174. If a collision alert occurs when cruise control is activated, cruise control is disengaged. See *Forward Collision Alert (FCA) System* ⇨ 191. When road conditions allow you to safely use it again, cruise control can be turned back on.

If the brakes or the Regen on Demand paddle are applied, cruise control disengages.



Cruise control will disengage if either TCS or StabiliTrak/ESC is turned off.

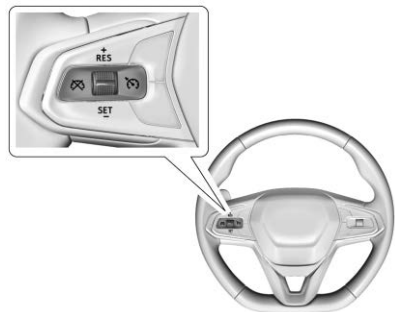



 : Press to turn the cruise control system on and off. A white indicator comes on in the instrument cluster when cruise is turned on.

 : Press to disengage cruise control without erasing the set speed from memory.

**+RES** : If there is a set speed in memory, press briefly to resume that speed or press and hold to accelerate. If cruise control is already active, use to increase vehicle speed.

**-SET** : Press briefly to set the speed and activate cruise control. If cruise control is already active, use to decrease vehicle speed.

### Setting Cruise Control

If  is on when not in use, -SET or +RES could get bumped and go into cruise when not desired. Keep  off when cruise is not being used.

To set a speed:

1. Press  to turn the cruise system on.
2. Get up to the desired speed.
3. Press and release -SET. The desired set speed briefly appears in the instrument cluster.
4. Remove foot from the accelerator pedal.

The cruise control indicator on the instrument cluster turns green after cruise control has been set to the desired speed. See *Instrument Cluster* ⇨ 78.

### Resuming a Set Speed

If the cruise control is set at a desired speed and then the brakes are applied or  is pressed, the cruise control is disengaged without erasing the set speed from memory.

Once the vehicle speed reaches about 40 km/h (25 mph) or more, briefly press +RES. The vehicle returns to the previous set speed.

### Increasing Speed While Using Cruise Control

If the cruise control system is already activated:

- Press and hold +RES until the vehicle accelerates to the desired speed, then release it.
- To increase the speed in small increments, briefly press +RES. For each press, the vehicle goes about 1 km/h (1 mph) faster.

The speedometer reading can be displayed in either English or metric units. See *Instrument Cluster* ⇨ 78. The increment value used depends on the units displayed.

### Reducing Speed While Using Cruise Control

If the cruise control system is already activated:

- Press and hold -SET until the desired lower speed is reached, then release it.
- To slow down in small increments, briefly press -SET. For each press, the vehicle goes about 1 km/h (1 mph) slower.

The speedometer reading can be displayed in either English or metric units. See *Instrument Cluster* ⇨ 78. The increment value used depends on the units displayed.

### Passing Another Vehicle While Using Cruise Control

Use the accelerator pedal to increase the vehicle speed. When you take your foot off the pedal, the vehicle will slow down to the previous set cruise speed. While pressing the accelerator pedal or shortly following the release to override cruise control, briefly pressing -SET will result in cruise control set to the current vehicle speed.



### Using Cruise Control on Hills

How well the cruise control works on hills depends upon the vehicle speed, load, and the steepness of the hills. When going up steep hills, you might have to step on the accelerator pedal to maintain the vehicle speed. When going downhill, you might have to brake or shift to a lower gear to keep your speed down. If the brake pedal is applied, cruise control will disengage.

### Ending Cruise Control

There are five ways to end cruise control:

- Step lightly on the brake pedal.

- Press .
- Shift the electric drive unit to N (Neutral).
- Press  to turn the cruise control system off completely.
- Activate Regen on Demand. See “Regen on Demand” under *Regenerative Braking* ⇨ 173.

### Erasing Speed Memory

The cruise control set speed is erased from memory if  is pressed or if the vehicle is turned off.

### Adaptive Cruise Control (Camera)

If equipped, Adaptive Cruise Control (ACC) allows the cruise control set speed and following gap to be selected. Read this entire section before using this system. The following gap is the following time between your vehicle and a vehicle detected directly ahead in your path, moving in the same direction. If no vehicle is detected in your path, ACC works like regular cruise control. ACC uses a windshield mounted front camera sensor.

If a vehicle is detected in your path, ACC can apply acceleration or limited, moderate braking to maintain the selected following gap. To disengage ACC, apply the brake.

If ACC is controlling the vehicle speed when the Traction Control System (TCS) or StabiliTrak/Electronic Stability Control (ESC) system activates, ACC may automatically disengage. See *Traction Control/Electronic Stability Control* ⇨ 174. When road conditions allow ACC to be safely used, ACC can be turned back on.

Disabling the TCS or StabiliTrak/ESC system will disengage and prevent engagement of ACC.

ACC can reduce the need for you to frequently brake and accelerate, especially when used on expressways, freeways, and interstate highways. When used on other roads, you may need to take over the control of braking or acceleration more often.

ACC automatically slows the vehicle down while navigating the curve and may increase speed out of the curve, but will not exceed the set speed.

### Warning

ACC has limited braking ability and may not have time to slow the vehicle down enough to avoid a collision with another  
(Continued)

**Warning (Continued)**

vehicle you are following. This can occur when vehicles suddenly slow or stop ahead, or enter your lane. Also see “Alerting the Driver” later in this section. Complete attention is always required while driving and you should be ready to take action and apply the brakes. See *Defensive Driving* ⇨ 156.

**Warning**

ACC will not detect or brake for children, pedestrians, animals, or other objects.

Do not use ACC when:

- On winding and hilly roads or when the camera sensor is blocked by snow, ice, or dirt. The system may not detect a vehicle ahead. Keep the windshield and headlamps clean.
- When visibility is poor due to rain, snow, fog, dirt, insect residue, or dust; when other foreign objects obscure the camera’s view; or when the vehicle in front or oncoming traffic causes additional environmental

(Continued)

**Warning (Continued)**

obstructions, such as road spray. ACC performance is limited under these conditions.

- On slippery roads where fast changes in tire traction can cause excessive wheel slip
- With extremely heavy cargo loaded in the cargo area or rear seat
- When towing a trailer

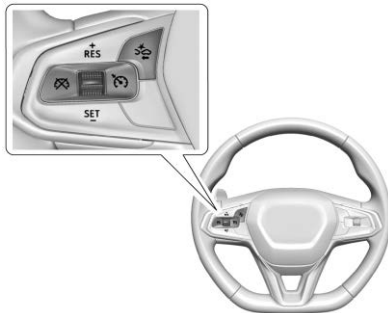

 : Press to turn the system on or off. The indicator turns white on the instrument cluster when ACC is turned on.

**RES+** : Press briefly to resume the previous set speed or to increase vehicle speed if ACC is already activated. To increase speed by about 1 km/h (1 mph), press RES+ briefly. To increase speed to the next 5 km/h (5 mph) mark on the speedometer, hold RES+.

**SET-** : Press briefly to set the speed and activate ACC or to decrease vehicle speed if ACC is already activated. To decrease speed by about 1 km/h (1 mph), press SET- briefly. To decrease speed to the next 5 km/h (5 mph) mark on the speedometer, hold SET-.

 : Press to disengage ACC without erasing the selected set speed.

 : Press to select a following gap setting for ACC of Far, Medium, or Near.

The speedometer reading can be displayed in either English or metric units. See *Instrument Cluster* ⇨ 78. The increment value used depends on the units displayed.

**Switching Between ACC and Regular Cruise Control**



To switch between ACC and regular cruise control, press and hold . A Driver Information Display (DIC) message displays. See *Vehicle Messages* ⇨ 100.

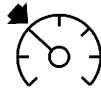

ACC Indicator



Regular Cruise Control Indicator

When ACC is engaged, a green  indicator will be lit on the instrument cluster and the following gap will be displayed. When the regular cruise control is engaged, a green  indicator will be lit on the instrument cluster; the following gap will not display.

When the vehicle is turned on, the cruise control mode will be set to the last mode used before the vehicle was turned off.

### Warning



Always check the cruise control indicator on the instrument cluster to determine which mode cruise control is in before using the feature. If ACC is not active, the vehicle will not automatically brake for other vehicles, which could cause a crash

(Continued)

### Warning (Continued)

if the brakes are not applied manually. You and others could be seriously injured or killed.

### Setting Adaptive Cruise Control

If  is on when not in use, it could get pressed and go into ACC when not desired. Keep  off when cruise is not being used.

Select the set speed desired for ACC. This is the vehicle speed when no vehicle is detected in your path.

While the vehicle is moving, ACC will not set at a speed less than 5 km/h (3 mph), although it can be resumed. The minimum allowable set speed is 25 km/h (15 mph).

To set ACC while moving:

1. Press .
2. Get up to the desired speed.
3. Press and release SET-.
4. Remove your foot from the accelerator pedal.

After ACC is set, it may immediately apply the brakes if a vehicle ahead is detected closer than the selected following gap.

ACC can also be set while the vehicle is stopped if ACC is on and the brake pedal is applied.



The ACC indicator displays on the instrument cluster. When ACC is turned on, the indicator will be lit white. When ACC is active, the indicator will turn green.

Be mindful of speed limits, surrounding traffic speeds, and weather conditions when selecting the set speed.

### Resuming a Set Speed

If the ACC is set at a desired speed and then the brakes are applied, ACC is disengaged without erasing the set speed from memory.

To begin using ACC again, press RES+ up briefly.

- If the vehicle is moving more than 5 km/h (3 mph), it returns to the previous set speed.

- If the vehicle is stopped with the brake pedal applied, press RES+ and release the brake pedal. ACC will hold the vehicle until RES+ or the accelerator pedal is pressed.

A green ACC indicator and the set speed display on the instrument cluster. The vehicle ahead indicator may be flashing if a vehicle ahead was present and moved. See “Approaching and Following a Vehicle” later in this section.

Once ACC has resumed, the vehicle speed will increase to the set speed under the following conditions:

- There is no vehicle ahead.
- The vehicle ahead is beyond the selected following gap.
- The vehicle speed is not being limited because of a sharp turn.

### **Increasing Speed While ACC Is at a Set Speed**

If ACC is already activated, do one of the following:

- Use the accelerator to get to the higher speed. Briefly press and release SET- and release the accelerator pedal. The vehicle will now cruise at the higher speed. When the accelerator pedal is pressed, ACC will not brake because it is

overridden. While overridden, the ACC indicator will turn blue on the instrument cluster.

- Press and hold RES+ until the desired set speed is displayed, then release it.
- To increase vehicle speed in smaller increments, press RES+ briefly. For each press, the vehicle goes about 1 km/h (1 mph) faster.
- To increase vehicle speed in larger increments, hold RES+. While holding RES+, the vehicle speed increases to the next 5 km/h (5 mph) step, then continues to increase by 5 km/h (5 mph) at a time.

The set speed can also be increased while the vehicle is stopped.

- If stopped with the brake applied, press RES+ until the desired set speed is displayed.
- If ACC is holding the vehicle at a stop and there is another vehicle directly ahead, pressing RES+ will increase the set speed.
- Pressing RES+ when there is no longer a vehicle ahead or the vehicle ahead is pulling away and the brake is not applied will cause the ACC to resume.

When it is determined that there is no vehicle ahead or the vehicle ahead is beyond the selected following gap, then the vehicle speed will increase to the set speed.

### **Reducing Speed While ACC Is at a Set Speed**

If ACC is already activated, do one of the following:

- Use the brake to get to the desired lower speed. Release the brake and press SET-. The vehicle will now cruise at the lower speed.
- Press and hold SET- until the desired lower speed is reached, then release it.
- To decrease the vehicle speed in smaller increments, press SET- briefly. For each press, the vehicle goes about 1 km/h (1 mph) slower.
- To decrease the vehicle speed in larger increments, hold SET-. While holding SET-, the vehicle speed decreases to the next 5 km/h (5 mph) step, then continues to decrease by 5 km/h (5 mph) at a time.

The set speed can also be decreased while the vehicle is stopped.

- If stopped with the brake applied, press or hold SET- until the desired set speed is displayed.

### Selecting the Follow Distance Gap

When a slower moving vehicle is detected ahead within the selected following gap, ACC will adjust the vehicle's speed and attempt to maintain the follow distance gap selected.

Press  on the steering wheel to adjust the following gap. Each press cycles the gap button through three settings: Far, Medium, or Near.

When pressed, the current gap setting displays briefly on the instrument cluster. The gap setting will be maintained until it is changed.

Since each gap setting corresponds to a following time (Far, Medium, or Near), the following distance will vary based on vehicle speed. The faster the vehicle speed, the further back your vehicle will follow a vehicle detected ahead. Consider traffic and weather conditions when selecting the following gap. The range of selectable gaps may not be appropriate for all drivers and driving conditions.

The gap setting used by ACC is independent to the alert timing sensitivity (Far, Medium, or Near) used by the Forward Collision Alert (FCA) feature. Pressing  while ACC is

active will only modify the gap setting used by ACC without changing the alert timing sensitivity used by FCA. Pressing  while ACC is not active will only modify the alert timing sensitivity used by FCA without modifying the gap setting used by ACC. See *Forward Collision Alert (FCA) System* ⇨ 191.

### Alerting the Driver

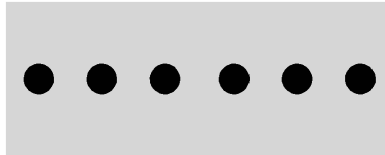

If ACC is engaged, driver action may be required when ACC cannot apply sufficient braking because of approaching a vehicle too rapidly.

When this condition occurs, the collision alert symbol will flash on the windshield and eight beeps will sound from the front. See “Collision/Detection Systems” under *Vehicle Personalization* ⇨ 101.

See *Defensive Driving* ⇨ 156.

### Approaching and Following a Vehicle



The vehicle ahead indicator is in the instrument cluster. It only displays when a vehicle is detected in your vehicle's path moving in the same direction. If this symbol is not displaying, ACC will not respond to or brake for vehicles ahead.

ACC automatically slows the vehicle down and adjusts vehicle speed to follow a detected vehicle ahead at the selected following gap. The vehicle speed increases or decreases to follow a detected vehicle in front of your vehicle when that vehicle is traveling slower than your vehicle set speed. It may apply limited braking, if necessary. When braking is active, the brake lamps will come on. The automatic braking may feel or sound different than if the brakes were applied manually. This is normal.

**Passing a Vehicle While Using ACC**

If the set speed is high enough, and the left turn signal is used to pass a vehicle ahead in the selected following gap, ACC may assist by gradually accelerating the vehicle prior to the lane change.

**Warning**

When using ACC to pass a vehicle or perform a lane change, the following distance to the vehicle being passed may be reduced. ACC may not apply sufficient acceleration or braking when passing a vehicle or performing a lane change. Always be ready to manually accelerate or brake to complete the pass or lane change.

**Stationary or Very Slow-Moving Objects**

**Warning**

ACC may not detect and react to stopped or slow-moving vehicles ahead of you. For example, the system may not brake for a vehicle it has never detected moving. This can occur in stop-and-go traffic or when a vehicle suddenly appears due to a vehicle  
(Continued)

**Warning (Continued)**

ahead changing lanes. Your vehicle may not stop and could cause a crash. Use caution when using ACC. Your complete attention is always required while driving and you should be ready to take action and apply the brakes.

**Irregular Objects Affecting ACC**

ACC may have difficulty detecting the following objects:

- Vehicles with cargo extending from the back end.
- Non-standard shaped vehicles, such as vehicle transport, vehicles with a side car fitted, or horse carriages.
- Objects that are close to the front of your vehicle.
- Vehicles in front of your vehicle that have a rear aspect that is low, small, or irregular.
- An empty truck or trailer that has no cargo in the cargo bed
- Vehicles that are low to the road surface
- Vehicles on which extremely heavy cargo is loaded in the cargo area or rear seat

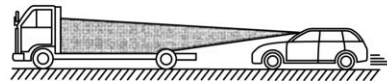

**ACC Automatically Disengages**

ACC may automatically disengage and the driver will need to manually apply the brakes to slow the vehicle if:

- The front camera is blocked or visibility is reduced.
- The Traction Control System (TCS) or StabiliTrak/ESC system has activated or been disabled.
- There is a fault in the system.
- A DIC message displays to indicate that ACC is temporarily unavailable.

The ACC indicator will turn white when ACC is no longer active.

In some cases, when ACC is temporarily unavailable, regular cruise control may be used. See "Switching Between ACC and

Regular Cruise Control” in this section. Always consider driving conditions before using either cruise control system.

#### Notification to Resume ACC

ACC will maintain a follow gap behind a detected vehicle and slow your vehicle to a stop behind that vehicle.

If the stopped vehicle ahead has driven away and ACC has not resumed, the vehicle ahead indicator will flash as a reminder to check traffic ahead before proceeding.

When the vehicle ahead drives away, ACC resumes automatically if the stop was brief. If necessary, press RES+ or the accelerator pedal to resume ACC. If stopped for more than two minutes or if the driver door is opened and the driver seat belt is unbuckled, the ACC automatically applies the Electric Parking Brake (EPB) to hold the vehicle. The EPB status light will turn on. See *Electric Parking Brake* ⇨ 171. To release the EPB, press the accelerator pedal.

A DIC warning message may display indicating to shift to P (Park) before exiting the vehicle. See *Vehicle Messages* ⇨ 100.

#### Warning

If ACC has stopped the vehicle, and if ACC is disengaged, turned off, or canceled, the vehicle will no longer be held at a stop. The vehicle can move. When ACC is holding the vehicle at a stop, always be prepared to manually apply the brakes.

#### Warning

Leaving the vehicle without placing it in P (Park) can be dangerous. Do not leave the vehicle while it is being held at a stop by ACC. Always place the vehicle in P (Park) and turn off the ignition before leaving the vehicle.

#### ACC Override

If using the accelerator pedal while ACC is active, the ACC indicator turns blue on the instrument cluster indicating ACC braking will not occur. ACC will resume operation when the accelerator pedal is not being pressed.

#### Warning

The ACC will not automatically apply the brakes if your foot is resting on the accelerator pedal. You could crash into a vehicle ahead of you.

#### Curves in the Road

#### Warning

On curves, ACC may not detect a vehicle ahead in your lane. You could be startled if the vehicle accelerates up to the set speed, especially when following a vehicle exiting or entering exit ramps. You could lose control of the vehicle or crash. Do not use ACC while driving on an entrance or exit ramp. Always be ready to use the brakes if necessary.

#### Warning

On curves, ACC may respond to a vehicle in another lane, or may not have time to react to a vehicle in your lane. You could crash into a vehicle ahead of you, or lose control of your vehicle. Give extra

(Continued)



**Warning (Continued)**

attention in curves and be ready to use the brakes if necessary. Select an appropriate speed while driving in curves.

ACC may operate differently in a sharp curve. It may reduce the vehicle speed if the curve is too sharp.

ACC automatically slows the vehicle down while navigating the curve and may increase speed out of the curve, but will not exceed the set speed.

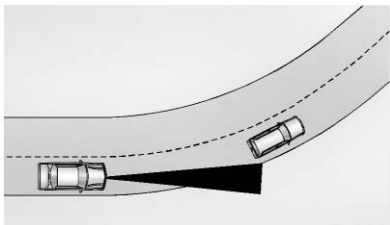

When following a vehicle and entering a curve, ACC may not detect the vehicle ahead and accelerate to the set speed. When this happens, the vehicle ahead indicator will not appear.

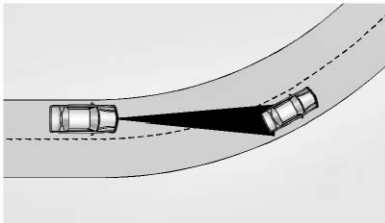

ACC may detect a vehicle that is not in your lane and apply the brakes.

ACC may occasionally provide an alert and/or braking that is considered unnecessary. It could respond to vehicles in different lanes or stationary objects when entering or exiting a curve. This is normal operation. The vehicle does not need service.

**Other Vehicle Lane Changes**

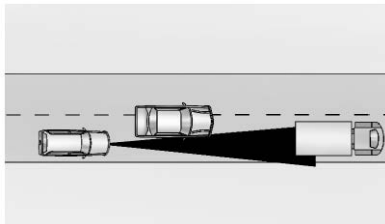

ACC will not detect a vehicle ahead until it is completely in the lane. The brakes may need to be manually applied.

**Objects Not Directly in Front of Your Vehicle**

The detection of objects in front of the vehicle may not be possible if:

- The vehicle or object ahead is not within your lane.
- The vehicle ahead is shifted, not centered, or is shifted to one side of the lane.

**Driving in Narrow Lanes**

Vehicles in adjacent traffic lanes or roadside objects may be incorrectly detected when located along the roadway.

**Do Not Use ACC on Hills**

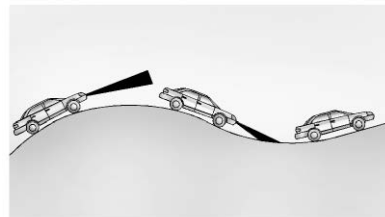



Do not use ACC when driving on steep hills as ACC may not detect a vehicle ahead.

**Do Not Use ACC When Towing a Trailer**

ACC should not be used when towing a trailer.

**Disengaging ACC**

There are four ways to disengage ACC:

- Step lightly on the brake pedal.
- Press .
- Press .
- Press the Regen on Demand paddle.

**Erasing Speed Memory**

The ACC set speed is erased from memory if  is pressed or if the ignition is turned off.

**Weather Conditions Affecting ACC**

If the interior temperature is extremely high, the instrument cluster may indicate that ACC is temporarily unavailable. This can be caused by extreme hot weather conditions with direct sunlight on the front camera. ACC will return to normal operation once the cabin temperature is lower.

Conditions that are associated with low visibility, such as fog, rain, snow, or road spray, may limit ACC performance. Water

droplets from rain or snow that remain on the windshield may also limit ACC's ability to detect objects.

** Warning**

Camera visibility may be limited and the ACC system may not work properly if the windshield is not clear. Do not use ACC if moisture is present on the inside of the windshield or the windshield washer is used in cold weather. Turn on the front defroster and make sure the windshield is clear before using ACC. Before driving, check that the windshield wipers are in good condition and replace them if worn.

**Lighting Conditions Affecting ACC**

The ACC front camera can be affected by poor lighting conditions, and ACC may have limited performance when:

- There are changes in brightness, such as entering and exiting tunnels, bridges, and overpasses.
- Low sun angles cause the camera to not detect objects, or it is more difficult to detect objects in the same traffic lane.
- Lighting is poor in the evening or early morning

- There are multiple changes in brightness or shadows along the vehicle roadway.
- In a tunnel without the headlamps on, or in a tunnel when there is a vehicle in front that does not have its taillamps on.
- Subjected to strong light from opposing lane traffic in the front of the vehicle, such as high-beam headlamps from oncoming traffic.

**Accessory Installations and Vehicle Modifications**

Do not install or place any object around the front camera windshield area that would obstruct the front camera view.

Do not install objects on top of the vehicle that overhang and obstruct the front camera, such as a canoe, kayak, or other items.

Do not modify the hood, headlamps, or fog lamps, as this may limit the camera's ability to detect an object.

**Cleaning the Sensing System**

The camera sensor on the windshield behind the rearview mirror can become blocked by snow, ice, dirt, mud, or debris. This area needs to be cleaned for ACC to operate properly.

The vehicle headlamps may need to be cleaned due to dirt, snow, or ice. Objects that are not illuminated correctly may be difficult to detect.

If ACC will not operate, regular cruise control may be available. See “Switching Between ACC and Regular Cruise Control” in this section. Always consider driving conditions before using either cruise control system.

For cleaning instructions, see “Washing the Vehicle” under *Exterior Care* ⇨ 265.

## Driver Assistance Systems

This vehicle may have features that work together to help avoid crashes or reduce crash damage while driving, backing, and parking. Read this entire section before using these systems.

### **Warning**

Do not rely on the Driver Assistance Systems. These systems do not replace the need for paying attention and driving safely. You may not hear or see alerts or warnings provided by these systems.

(Continued)

### **Warning (Continued)**

Failure to use proper care when driving may result in injury, death, or vehicle damage. See *Defensive Driving* ⇨ 156.

Under many conditions, these systems will not:

- Detect children, pedestrians, bicyclists, or animals.
- Detect vehicles or objects outside the area monitored by the system.
- Work at all driving speeds.
- Warn you or provide you with enough time to avoid a crash.
- Work under poor visibility or bad weather conditions.
- Work if the detection sensor is not cleaned or is covered by ice, snow, mud, or dirt.
- Work if the detection sensor is covered up, such as with a sticker, magnet, or metal plate.
- Work if the area surrounding the detection sensor is damaged or not properly repaired.

(Continued)

### **Warning (Continued)**

Complete attention is always required while driving, and you should be ready to take action and apply the brakes and/or steer the vehicle to avoid crashes.

### **Audible Alert**

Some driver assistance features alert the driver of obstacles by beeping. To change the volume of the warning chime, see “Comfort and Convenience” under *Vehicle Personalization* ⇨ 101.

### **Cleaning**

Depending on vehicle options, keep these areas of the vehicle clean to ensure the best driver assistance feature performance. Driver Information Center (DIC) messages may display when the systems are unavailable or blocked.



- Front and rear bumpers and the area below the bumpers
- Front grille and headlamps
- Front camera lens in the front grille or near the front emblem

- Front side and rear side panels
- Outside of the windshield in front of the rearview mirror
- Side camera lens on the bottom of the outside mirrors
- Rear side corner bumpers
- Rear Vision Camera above the license plate

### Radio Frequency

This vehicle may be equipped with driver assistance systems that operate using radio frequency. See *Radio Frequency Statement* ⇨ 294.

### Assistance Systems for Parking or Backing

If equipped, the Rear Vision Camera (RVC), Surround Vision, Rear Park Assist (RPA), and Rear Cross Traffic Alert (RCTA) may help the driver park or avoid objects. Always check around the vehicle when parking or backing.

### Rear Vision Camera (RVC)

When the vehicle is shifted into R (Reverse), the Rear Vision Camera (RVC) displays an image of the area behind the vehicle in the infotainment display. The previous screen displays when the vehicle is shifted out of

R (Reverse) after a short delay. To return to the previous screen sooner, press Home or Back on the infotainment system, shift into P (Park), or reach a vehicle speed of approximately 12 km/h (8 mph) while in D (Drive).

Turn  to adjust the display brightness while viewing the infotainment display.

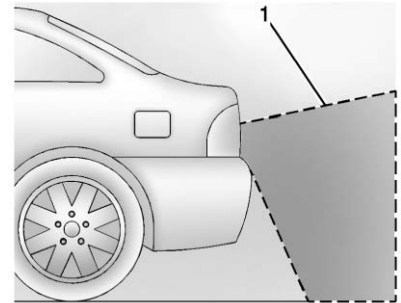

1. View Displayed by the Camera

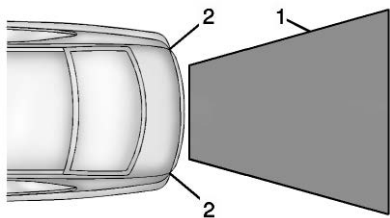

1. View Displayed by the Camera
2. Corners of the Rear Bumper

Displayed images may be farther or closer than they appear. The area displayed is limited and objects that are close to either corner of the bumper or under the bumper do not display.

A warning triangle may appear on the infotainment display to show that Rear Park Assist (RPA) or Rear Cross Traffic Alert (RCTA) has detected an object. This triangle changes from amber to red and increases in size the closer the object.

If  or a service message appears on the infotainment display, there may be a camera malfunction. See your dealer.

### Warning

The camera(s) do not display children, pedestrians, bicyclists, crossing traffic, animals, or any other object outside of the cameras' field of view, below the bumper, or under the vehicle. Shown distances may be different from actual distances. Do not drive or park the vehicle using only these camera(s). Always check behind and around the vehicle before driving. Failure to use proper care may result in injury, death, or vehicle damage.

### Surround Vision System

If equipped, Surround Vision displays an image of the area surrounding the vehicle, along with the front or rear camera views on the infotainment display. The front camera is in the grille or near the front emblem, the side cameras are on the bottom of the outside mirrors, and the rear camera is above the license plate.

The Surround Vision system can be accessed by selecting CAMERA in the infotainment display or when the vehicle is shifted into R (Reverse). To return to the previous screen

sooner, when not in R (Reverse) press Home or Back on the infotainment system, shift into P (Park), or reach a vehicle speed of approximately 12 km/h (8 mph) while in D (Drive).

### Warning

The Surround Vision Cameras have blind spots and will not display all objects near the corners of the vehicle. Folding side mirrors that are out of position will not display surround view correctly. Always check around the vehicle when parking or backing.



1. Views Displayed by the Surround Vision Cameras
2. Area Not Shown

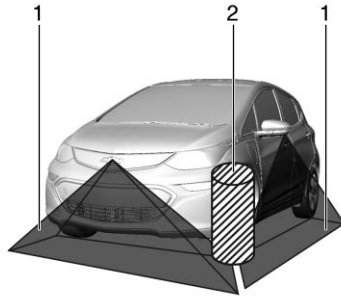

1. Views Displayed by the Surround Vision Cameras
2. Area Not Shown

**Warning**

The camera(s) do not display children, pedestrians, bicyclists, crossing traffic, animals, or any other object outside of the cameras' field of view, below the bumper, or under the vehicle. Shown distances may be different from actual distances. Do not drive or park the

(Continued)

**Warning (Continued)**

vehicle using only these camera(s). Always check behind and around the vehicle before driving. Failure to use proper care may result in injury, death, or vehicle damage.

**Camera Views**

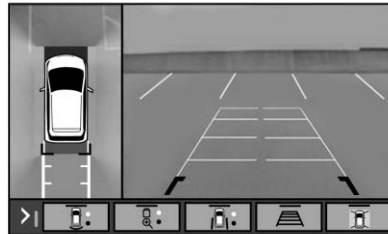

Touch the camera view buttons along the bottom of the infotainment display.

**Front/Rear Standard View** : Displays an image of the area in front or behind the vehicle. Touch Front/Rear Standard View on the infotainment display when a camera

view is active. Touching the button multiple times will toggle between front and rear camera views.

If equipped, the front view camera also displays when the Park Assist system detects an object within 30 cm (12 in).

**Front/Rear Overhead View** : Displays a front or rear overhead view of the vehicle. Touching the button will toggle between the two views.

**Side Forward/Rearward View** : Displays a view that shows objects next to the front or rear sides of the vehicle. Touch Side Forward/Rearward View on the infotainment display when a camera view is active. Touching the button multiple times will toggle between forward and rearward views. Park Assist and RCTA overlays are not available when Side Forward/Rearward view is active.

**Guidance Lines** : Displays available guidelines. a grayed-out button indicates that guidelines are not available. When enabled, the guidelines will display when the vehicle is shifted in R (Reverse).

**Top Down View** : Displays an image of the area surrounding the vehicle, along with the rear camera view in the infotainment

display. The rear camera view will be replaced by the front camera view after shifting from R (Reverse) to a forward gear, or when the vehicle is moving forward slower than approximately 12 km/h (8 mph).

## Park Assist

The vehicle may be equipped with Rear Park Assist (RPA). Under certain conditions, the Park Assist system can assist the driver during backing and reverse parking maneuvers when the vehicle is driven at no more than 9 km/h (6 mph).

Sensors located in the bumpers measure the distance between the vehicle and objects using sonar technology. These sensors are designed to detect certain objects up to 2.5 m (8 ft) behind your vehicle that are taller than 25 cm (10 in).

Different environmental conditions may affect whether and how far the Park Assist system can detect objects. Keep the sensors clean of mud, dirt, snow, ice, and slush; and clean sensors after a car wash in freezing temperatures. Sensors that are not clean may not detect objects or may cause the system to alert when not required.

### **Warning**

The Park Assist System is no substitute for careful and attentive driving. The Park Assist system does not detect children, pedestrians, bicyclists, animals, or objects located below the bumper or that are too close or too far from the vehicle. It is not available at speeds greater than 9 km/h (6 mph). To prevent injury, death, or vehicle damage, even with Park Assist, always check the area around the vehicle and check all mirrors before moving forward or backing.

### How the System Works

The vehicle may have a Park Assist amphitheatre-like display on the cluster with bars that represent the estimated location of a detected object and the vehicle's distance from the object. As a detected object becomes closer, more bars light up and change color from yellow to amber to red.

When an object is first detected in the rear, one beep will be heard from the rear, or the driver's seat will pulse two times, if equipped with Safety Alert Seat. When an

object is very close, five beeps will sound from the rear, or the driver's seat will pulse five times.

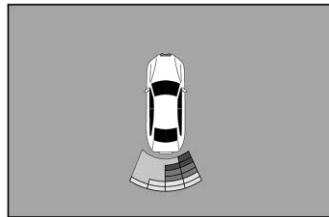

### Turning the System On and Off

The Park Assist System can be turned on or off using the infotainment system. See *Vehicle Personalization* ⇨ 101.

Turn off Park Assist when towing a trailer to prevent unwanted beeps and when a bike rack is attached to ensure proper operation.

### When the System Does Not Seem to Work Properly

If a service message displays, check the following conditions:

- The sensors may not be clean. Keep the vehicle's front and rear bumpers free of mud, dirt, snow, ice, and slush. For cleaning instructions, see *Exterior Care* ⇨ 265.

- The Park Assist sensors may be covered by frost or ice. Frost or ice can form around and behind the sensors and may not always be seen; this can occur after washing the vehicle in cold weather. The message may not clear until the frost or ice has melted.

If a service message displays and the above conditions do not exist, take the vehicle to your dealer for repairs.

If the Park Assist System does not activate due to a temporary condition, a system off message is shown on the display. This can occur under the following conditions:

- The driver has disabled the system.
- An object is currently blocking the rear sensors (for example, bike rack, tailgate, trailer hitch, etc.). Once the object is removed, Park Assist will return to normal operation.
- The bumper is damaged. Take the vehicle to your dealer for repairs.
- Other conditions, such as vibrations from a jackhammer or the compression of air brakes on a very large truck, are affecting system performance.

## Rear Cross Traffic Alert (RCTA) System

If equipped, Rear Cross Traffic Alert (RCTA) displays a red warning triangle with a left or right pointing arrow on the infotainment display to warn of traffic coming from the left or right. This system detects objects coming from up to 20 m (65 ft) from the left or right side of the vehicle. When an object is detected, three beeps sound from the left or right, depending on the direction of the detected vehicle.

Use caution while backing up when towing a trailer, as the RCTA detection zones that extend out from the back of the vehicle do not move farther back when a trailer is attached to the vehicle.

### Turning the Features On or Off

Rear Park Assist (RPA) can be turned on and off using the infotainment system. See *Vehicle Personalization* ⇨ 101.

Turn off Park Assist and RCTA when towing a trailer.

RCTA can be turned on or off using the infotainment system. See “Collision/Detection Systems” under *Vehicle Personalization* ⇨ 101.

## Assistance Systems for Driving

If equipped, when driving the vehicle in a forward gear, Forward Collision Alert (FCA), Lane Departure Warning (LDW), Lane Keep Assist (LKA), Side Blind Zone Alert (SBZA), Lane Change Alert (LCA), Automatic Emergency Braking (AEB), and/or the Front Pedestrian Braking (FPB) System can help to avoid a crash or reduce crash damage.

## Forward Collision Alert (FCA) System

If equipped, the FCA system may help to avoid or reduce the harm caused by front-end crashes. When approaching a vehicle ahead too quickly, FCA provides a red flashing alert on the windshield and rapidly beeps. FCA also lights an amber visual alert if following another vehicle much too closely. FCA detects vehicles within a distance of approximately 60 m (197 ft) and operates at speeds above 8 km/h (5 mph).



**⚠ Warning**

FCA is a warning system and does not apply the brakes. When approaching a slower-moving or stopped vehicle ahead too rapidly, or when following a vehicle too closely, FCA may not provide a warning with enough time to help avoid a crash. It also may not provide any warning at all. FCA does not warn of pedestrians, animals, signs, guardrails, bridges, construction barrels, or other objects. Be ready to take action and apply the brakes.

**Detecting the Vehicle Ahead**

FCA warnings will not occur unless the FCA system detects a vehicle ahead. When a vehicle is detected, the vehicle ahead indicator will display green. Vehicles may not be detected on curves, highway exit ramps, or hills, due to poor visibility; or if a

vehicle ahead is partially blocked by pedestrians or other objects. FCA will not detect another vehicle ahead until it is completely in the driving lane.

**⚠ Warning**

FCA does not provide a warning to help avoid a crash, unless it detects a vehicle. FCA may not detect a vehicle ahead if the FCA sensor is blocked by dirt, snow, or ice, or if the windshield is damaged. It may also not detect a vehicle on winding or hilly roads, or in conditions that can limit visibility such as fog, rain, or snow, or if the headlamps or windshield are not cleaned or in proper condition. Keep the windshield, headlamps, and FCA sensors clean and in good repair.

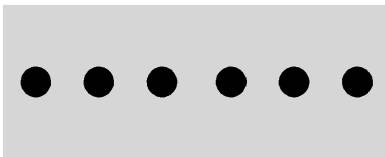
**Collision Alert**

When your vehicle approaches another detected vehicle too rapidly, the red FCA display will flash on the windshield. Also, eight rapid high-pitched beeps will sound from the front. When this Collision Alert occurs, the brake system may prepare for driver braking to occur more rapidly which can cause a brief, mild deceleration. Continue to apply the brake pedal as the driving situation dictates. Cruise control may be disengaged when the Collision Alert occurs.

**Tailgating Alert**

The vehicle ahead indicator will display amber when you are following a detected vehicle ahead much too closely.

**Selecting the Alert Timing**

The Collision Alert control is on the steering wheel. Press  to set the FCA timing to far, medium, or near. The first button press shows the current control setting on the DIC. Additional button presses will change this setting. The chosen setting will remain until it is changed and will affect the timing of both the Collision Alert and the Tailgating Alert features. The timing of both alerts will vary based on vehicle speed. The faster the vehicle speed, the farther away the alert will

occur. Consider traffic and weather conditions when selecting the alert timing. The range of selectable alert timing may not be appropriate for all drivers and driving conditions.

### Following Distance Indication

The following distance to a moving vehicle you are following is indicated in following time in seconds on the Driver Information Center (DIC).

The minimum following time is 0.5 seconds away. If there is no vehicle detected ahead, or the vehicle ahead is out of sensor range, dashes will be displayed.

### Unnecessary Alerts

FCA may provide unnecessary alerts to turning vehicles, vehicles in other lanes, objects that are not vehicles, or shadows. These alerts are normal operation and the vehicle does not need service.

### Cleaning the System

If the FCA system does not seem to operate properly, this may correct the issue:

- Clean the outside of the windshield in front of the rearview mirror.

- Clean the entire front of the vehicle.
- Clean the headlamps.

## Automatic Emergency Braking (AEB)

If the vehicle has Forward Collision Alert (FCA), it also has AEB, which includes Intelligent Brake Assist (IBA). When the system detects a vehicle ahead in your path that is traveling in the same direction that you may be about to crash into, it can provide a boost to braking or automatically brake the vehicle. This can help avoid or lessen the severity of crashes when driving in a forward gear. Depending on the situation, the vehicle may automatically brake moderately or hard. This automatic emergency braking can only occur if a vehicle is detected. This is shown by the FCA vehicle ahead indicator being lit. See *Forward Collision Alert (FCA) System* ⇨ 191.

The system works when driving in a forward gear between 8 km/h (5 mph) and 80 km/h (50 mph). It can detect vehicles up to approximately 60 m (197 ft).

### Warning

AEB is an emergency crash preparation feature and is not designed to avoid crashes. Do not rely on AEB to brake the vehicle. AEB will not brake outside of its operating speed range and only responds to detected vehicles.

AEB may not:

- Detect a vehicle ahead on winding or hilly roads.
- Detect all vehicles, especially vehicles with a trailer, tractors, muddy vehicles, etc.
- Detect a vehicle when weather limits visibility, such as in fog, rain, or snow.
- Detect a vehicle ahead if it is partially blocked by pedestrians or other objects.

Complete attention is always required while driving, and you should be ready to take action and apply the brakes and/or steer the vehicle to avoid crashes.

AEB may slow the vehicle to a complete stop to try to avoid a potential crash. If this happens, AEB may engage the Electric

Parking Brake (EPB) to hold the vehicle at a stop. Release the EPB or firmly press the accelerator pedal.

### Warning

AEB may automatically brake the vehicle suddenly in situations where it is unexpected and undesired. It could respond to a turning vehicle ahead, guardrails, signs, and other non-moving objects. To override AEB, firmly press the accelerator pedal, if it is safe to do so.

### Intelligent Brake Assist (IBA)

IBA may activate when the brake pedal is applied quickly by providing a boost to braking based on the speed of approach and distance to a vehicle ahead.

Minor brake pedal pulsations or pedal movement during this time is normal and the brake pedal should continue to be applied as needed. IBA will automatically disengage only when the brake pedal is released.

### Warning

IBA may increase vehicle braking in situations when it may not be necessary. You could block the flow of traffic. If this occurs, take your foot off the brake pedal and then apply the brakes as needed.

AEB and IBA can be disabled through vehicle personalization. See “Collision/Detection Systems” under *Vehicle Personalization* ⇨ 107.

A system unavailable message may display if:

- The front of the vehicle or windshield is not clean.
- Heavy rain or snow is interfering with object detection.
- There is a problem with the StabiliTrak system.

The AEB system does not need service.

### Front Pedestrian Braking (FPB) System

If equipped, the FPB system may help avoid or reduce the harm caused by front-end crashes with nearby pedestrians when driving in a forward gear. FPB displays an amber indicator, , when a pedestrian is detected ahead. When approaching a detected pedestrian too quickly, FPB provides a red flashing alert on the windshield and rapidly beeps. FPB can provide a boost to braking or automatically brake the vehicle. This system includes Intelligent Brake Assist (IBA), and the Automatic Emergency Braking (AEB) System may also respond to pedestrians. See *Automatic Emergency Braking (AEB)* ⇨ 193.

The FPB system can detect and alert to pedestrians in a forward gear at speeds between 8 km/h (5 mph) and 80 km/h (50 mph). During daytime driving, the system detects pedestrians up to a distance of approximately 40 m (131 ft). During nighttime driving, system performance is very limited.

**Warning**

FPB does not provide an alert or automatically brake the vehicle, unless it detects a pedestrian. FPB may not detect pedestrians, including children:

- When the pedestrian is not directly ahead, fully visible, or standing upright, or when part of a group.
- Due to poor visibility, including nighttime conditions, fog, rain, or snow.
- If the FPB sensor is blocked by dirt, snow, or ice.
- If the headlamps or windshield are not cleaned or in proper condition.

Be ready to take action and apply the brakes. For more information, see *Defensive Driving* ⇨ 156. Keep the windshield, headlamps, and FPB sensor clean and in good repair.

FPB can be set to Off, Alert, or Alert and Brake through vehicle personalization. See “Collision/Detection Systems” under *Vehicle Personalization* ⇨ 101.

**Detecting the Pedestrian Ahead**

FPB alerts and automatic braking will not occur unless the FPB system detects a pedestrian. When a nearby pedestrian is detected in front of the vehicle, the pedestrian ahead indicator will display amber.

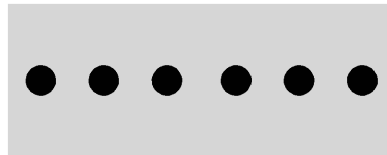
**Front Pedestrian Alert**

When the vehicle approaches a pedestrian ahead too rapidly, the red FPB alert display will flash on the windshield. Eight rapid high-pitched beeps will sound from the front. When this Pedestrian Alert occurs, the brake system may prepare for driver braking to occur more rapidly which can cause a

brief, mild deceleration. Continue to apply the brake pedal as needed. Cruise control may be disengaged when the Front Pedestrian Alert occurs.

**Automatic Braking**

If FPB detects it is about to crash into a pedestrian directly ahead, and the brakes have not been applied, FPB may automatically brake moderately or brake hard. This can help to avoid some very low speed pedestrian crashes or reduce pedestrian injury. FPB can automatically brake to detected pedestrians between 8 km/h (5 mph) and 80 km/h (50 mph). Automatic braking levels may be reduced under certain conditions, such as higher speeds.

If this happens, Automatic Braking may engage the Electric Parking Brake (EPB) to hold the vehicle at a stop. Release the EPB. A firm press of the accelerator pedal will also release Automatic Braking and the EPB.

**Warning**

FPB may alert or automatically brake the vehicle suddenly in situations where it is unexpected and undesired. It could falsely  
(Continued)

**Warning (Continued)**

alert or brake for objects similar in shape or size to pedestrians, including shadows. This is normal operation and the vehicle does not need service. To override Automatic Braking, firmly press the accelerator pedal, if it is safe to do so.

Automatic Braking can be disabled through vehicle personalization. See “Front Pedestrian Detection” in “Collision/Detection Systems” under *Vehicle Personalization* ⇨ 101.

**Cleaning the System**

If FPB does not seem to operate properly, cleaning the outside of the windshield in front of the rearview mirror may correct the issue.

**Side Blind Zone Alert (SBZA)**

If equipped, the SBZA system is a lane-changing aid that assists drivers with avoiding crashes that occur with moving vehicles in the side blind zone (or spot) areas. When the vehicle is in a forward gear, the left or right side mirror display will light up if a moving vehicle is detected in that blind zone. If the turn signal is activated and

a vehicle is also detected on the same side, the display will flash as an extra warning not to change lanes. Since this system is part of the Lane Change Alert (LCA) system, read the entire LCA section before using this feature.

**Lane Change Alert (LCA)**

If equipped, the LCA system is a lane-changing aid that assists drivers with avoiding lane change crashes that occur with moving vehicles in the side blind zone (or spot) areas or with vehicles rapidly approaching these areas from behind. The LCA warning display will light up in the corresponding outside mirror and will flash if the turn signal is on.

**Warning**

LCA does not alert the driver to vehicles outside of the system detection zones, pedestrians, bicyclists, or animals. It may not provide alerts when changing lanes under all driving conditions. Failure to use proper care when changing lanes may result in injury, death, or vehicle damage.

(Continued)

**Warning (Continued)**

Before making a lane change, always check mirrors, glance over your shoulder, and use the turn signals.

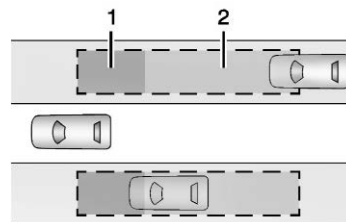
**LCA Detection Zones**

1. SBZA Detection Zone
2. LCA Detection Zone

The LCA sensor covers a zone of approximately one lane over from both sides of the vehicle, or 3.5 m (11 ft). The height of the zone is approximately between 0.5 m (1.5 ft) and 2 m (6 ft) off the ground. The Side Blind Zone Alert (SBZA) warning area starts at approximately the middle of the vehicle and goes back 5 m (16 ft). Drivers

are also warned of vehicles rapidly approaching from up to 70 m (230 ft) behind the vehicle.

### How the System Works

The LCA symbol lights up in the side mirrors when the system detects a moving vehicle in the next lane over that is in the side blind zone or rapidly approaching that zone from behind. A lit LCA symbol indicates it may be unsafe to change lanes. Before making a lane change, check the LCA display, check mirrors, glance over your shoulder, and use the turn signals.



Left Side Mirror  
Display



Right Side Mirror  
Display

When the vehicle is started, both outside mirror LCA displays will briefly come on to indicate the system is operating. When the vehicle is in a forward gear, the left or right side mirror display will light up if a moving vehicle is detected in the next lane over in that blind zone or rapidly approaching that

zone. If the turn signal is activated in the same direction as a detected vehicle, this display will flash as an extra warning not to change lanes.

LCA can be disabled through vehicle personalization. See "Collision/Detection Systems" under *Vehicle Personalization* ⇨ 101. If LCA is disabled by the driver, the LCA mirror displays will not light up.

### When the System Does Not Seem to Work Properly

The LCA system requires some driving for the system to calibrate to maximum performance. This calibration may occur more quickly if the vehicle is driven on a straight highway road with traffic and roadside objects (e.g., guardrails, barriers).

LCA displays may not come on when passing a vehicle quickly or for a stopped vehicle. LCA may alert to objects attached to the vehicle, such as a bicycle, or object extending out to either side of the vehicle. Attached objects may also interfere with the detection of vehicles. This is normal system operation; the vehicle does not need service.

LCA may not always alert the driver to vehicles in the next lane over, especially in wet conditions or when driving on sharp

curves. The system does not need to be serviced. The system may light up due to guardrails, signs, trees, shrubs, and other non-moving objects. This is normal system operation; the vehicle does not need service.

LCA may not operate when the LCA sensors in the left or right corners of the rear bumper are covered with mud, dirt, snow, ice, or slush, or in heavy rainstorms. For cleaning instructions, see "Washing the Vehicle" under *Exterior Care* ⇨ 265. If the DIC still displays the system unavailable message after cleaning both sides of the vehicle toward the rear corners of the vehicle, see your dealer.

If the LCA displays do not light up when moving vehicles are in the side blind zone or rapidly approaching this zone and the system is clean, the system may need service. Take the vehicle to your dealer.

### Lane Keep Assist (LKA)

If equipped, LKA may help avoid crashes due to unintentional lane departures. This system uses a camera to detect lane markings between 60 km/h (37 mph) and 180 km/h (112 mph). It may assist by gently turning the steering wheel if the vehicle approaches a detected lane marking. It may

also provide a Lane Departure Warning (LDW) alert if the vehicle crosses a detected lane marking. LKA can be overridden by turning the steering wheel. This system is not intended to keep the vehicle centered in the lane. LKA will not assist and alert if the turn signal is active in the direction of lane departure, or if it detects that you are accelerating, braking or actively steering.

### **Warning**

The LKA system does not continuously steer the vehicle. It may not keep the vehicle in the lane or give a Lane Departure Warning (LDW) alert, even if a lane marking is detected.

The LKA and LDW systems may not:

- Provide an alert or enough steering assist to avoid a lane departure or crash.
- Detect lane markings under poor weather or visibility conditions. This can occur if the windshield or headlamps are blocked by dirt, snow, or ice; if they are not in proper condition; or if the sun shines directly into the camera.

(Continued)

### **Warning (Continued)**

- Detect road edges.
- Detect lanes on winding or hilly roads.

If LKA only detects lane markings on one side of the road, it will only assist or provide an LDW alert when approaching the lane on the side where it has detected a lane marking. Even with LKA and LDW, you must steer the vehicle. Always keep your attention on the road and maintain proper vehicle position within the lane, or vehicle damage, injury, or death could occur. Always keep the windshield, headlamps, and camera sensors clean and in good repair. Do not use LKA in bad weather conditions or on roads with unclear lane markings, such as construction zones.





### **Warning**

Using LKA while towing a trailer or on slippery roads could cause loss of control of the vehicle and a crash. Turn the system off.

### **How the System Works**

LKA uses a camera sensor installed on the windshield ahead of the rearview mirror to detect lane markings. It may provide brief steering assist if it detects an unintended lane departure. It may further provide an audible alert or the driver seat may pulse indicating that a lane marking has been crossed.

To turn LKA on and off, press  on the center console. If equipped, the indicator light on the button comes on when LKA is on and turns off when LKA is disabled.

When on,  is white, if equipped, indicating that the system is not ready to assist.  is green if LKA is ready to assist. LKA may assist by gently turning the steering wheel if the vehicle approaches a detected lane marking.  is amber when assisting. It may also provide a Lane Departure Warning (LDW) alert by flashing  amber if the vehicle crosses a detected lane marking. Additionally, there may be three beeps, or the driver seat may pulse three times, on the right or left, depending on the lane departure direction.

### Take Steering

The LKA system does not continuously steer the vehicle. If LKA does not detect active driver steering, an alert and chime may be provided. Steer the vehicle to dismiss. LKA may become temporarily unavailable after repeated take steering alerts.

### When the System Does Not Seem to Work Properly

The system performance may be affected by:

- Close vehicles ahead.
- Sudden lighting changes, such as when driving through tunnels.
- Banked roads.
- Roads with poor lane markings, such as two-lane roads.

If the LKA system is not functioning properly when lane markings are clearly visible, cleaning the windshield may help.

A camera blocked message may display if the camera is blocked. Some driver assistance systems may have reduced performance or not work at all. An LKA or LDW unavailable message may display if the systems are temporarily unavailable. This message could be due to a blocked camera.

The LKA system does not need service. Clean the outside of the windshield behind the rearview mirror.

LKA assistance and/or LDW alerts may occur due to tar marks, shadows, cracks in the road, temporary or construction lane markings, or other road imperfections. This is normal system operation; the vehicle does not need service. Turn LKA off if these conditions continue.

## Charging

### When to Charge

When the high voltage battery is getting low, charging messages may display.

The CHARGE VEHICLE SOON message indicates that the driving range is low and the vehicle needs to be charged soon. As the charge level drops, the PROPULSION POWER IS REDUCED message is displayed and the accelerator pedal response is reduced. In addition, the remaining range value will change to LOW indicating the vehicle should be charged immediately.

When the energy is fully depleted, the OUT OF ENERGY, CHARGE VEHICLE NOW message displays and the vehicle slows to a stop. Brake and steering assist will still operate. Once the vehicle has stopped, turn the vehicle off. See *Propulsion Power Messages* ⇨ 100.

### Plug-In Charging

This section explains the process for charging the high voltage battery. Do not allow the vehicle to remain in temperature extremes for long periods without being driven or plugged in. Plug the vehicle in when temperatures are below 0 °C (32 °F) and above 32 °C (90 °F) to maximize high voltage battery life.

Charge times will vary based on battery condition, charge level, and outside temperature. See *Programmable Charging* ⇨ 89 for charge mode selection.

If equipped, the vehicle can be charged using DC charging equipment typically found at service stations and other public locations.

The following table shows the amount of range added and time to full charge based on how the vehicle is being charged:



	Level 1 (120 Volt)		Level 2 (240 Volt)		DC Fast Charging
	8 Amps	12 Amps	32 Amps*	48 Amps	
Range Added	About 4.5 km (2.8 mi) per hour of charge	About 6.4 km (4 mi) per hour of charge	About 42 km (26 mi) per hour of charge	About 63 km (39 mi) per hour of charge	Up to 161 km (100 mi) in about 30 minutes**
Time to Full Charge	About 79 hours	About 55 hours	About 10 hours	About 7 hours	—

\*Dual Level Charge Cord maximum.

\*\*Charger must be capable of 150 amps and assumes the charge starts from a depleted battery.

These time estimates are applicable to nominal temperature ranges. In extreme hot or cold conditions, this time may be lengthened. A full charge will take additional time.

The charging system may run fans and pumps that result in sounds from the vehicle while it is turned off. Additionally, clicking sounds may be caused by the electrical devices used while charging.

The vehicle does not require indoor charging area ventilation before, during, or after charging.

The vehicle cannot be driven while the charge cord is plugged into the vehicle.

Caution
To avoid damage to the vehicle, make sure the charging cord plug is in good condition, is not worn or damaged, and is connected securely to the vehicle's charging port. If vehicle charging is intermittent, disconnect the cord and inspect for damage. An excessively worn or damaged AC or DC charging cord plug (Continued)

Caution (Continued)
may result in an intermittent connection and potential damage to the vehicle's charging port.

### Charging Override

A CHARGING OVERRIDE/INTERRUPTION OCCURRED message may display to indicate that a charging override or interruption has occurred due to one or more of the following events:

- Override of the charge settings by the owner.
- Unintended interruption of AC power at the vehicle's charge port.
- Interruption of charging by the utility company.

There are several screens that will display depending on the current charging status. See *Programmable Charging* ⇨ 89.

A loss of AC power alert may sound for a short time if AC power is lost for over one minute. This sound alert can be turned off. See *Vehicle Personalization* ⇨ 101.

## AC Charging

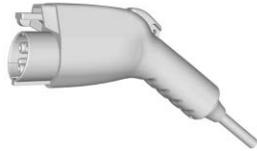

AC Charge Cord Vehicle Plug

### Start Charge

1. Make sure the vehicle is parked.



2. Push the rearward edge of the charge port door and release to open the door.

In cold weather conditions, ice may form around the charge port door. Remove ice from the area before attempting to open or close the charge port door.



3. Open the liftgate, lift the load floor cover, and remove the charge cord.
4. Plug the charge cord into the electrical outlet. Verify the charge cord status and select the appropriate charge level. See *Electrical Requirements for Battery Charging* ⇨ 213. See *Charge Cord* ⇨ 207. See *Programmable Charging* ⇨ 89.
5. Plug in the AC vehicle plug of the charge cord into the charge port on the vehicle. Make sure the AC vehicle plug is fully

connected to the AC charge port. If it is not properly seated, the charge may not occur.

6. Verify that the Charging Status Indicator illuminates on top of the instrument panel and an audible chirp occurs. See *Charging Status Feedback* ⇨ 203.
7. To arm the charge cord theft alert, lock the vehicle twice with the RKE transmitter. To disarm this feature, see *Charging Options* ⇨ 98.

### End Charge

1. Unlock the vehicle with the RKE transmitter to disarm the charge cord theft alert.
2. Unplug the vehicle plug of the charge cord from the vehicle. Unlock the vehicle plug of the charge cord from the vehicle by pressing the button on the top of the charge cord plug.
3. Close the charge port door by pressing firmly in the center until it latches.
4. Unplug the charge cord from the electrical outlet.
5. Place the charge cord into the storage compartment.

### DC Charging (If Equipped)

#### DC Charging Station Hardware

Check the charge station DC vehicle plug for compatibility with the DC charge port on this vehicle. When recharging at a DC charge station, the charging cable connected to the vehicle must be less than 10 m (33 ft) in length; this length restriction ensures regulatory compliance of less than 30 m (100 ft).

Follow the steps listed on the charging station to perform a DC vehicle charge.

If for any reason DC charging does not begin or is interrupted, check the DC charge station display for messages. Unplug to restart the DC charge process.

#### Start Charge

1. Make sure the vehicle is parked.
2. Push the rearward edge of the charge port door and release to open the door. In cold weather conditions, ice may form around the charge port door. The charge port door may not open on the first attempt. Remove ice from the area and repeat attempting to open the charge port door.

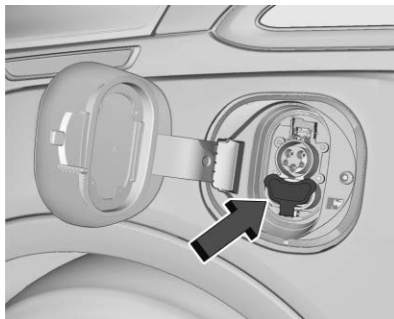

3. Unlatch the DC charging dust cover and lower it fully.
4. Plug in the DC vehicle plug into the DC charge port on the vehicle. Make sure that the DC vehicle plug is fully connected to the DC charge port. If it is not properly seated then the charge may not occur. Proper plug connection can be checked by information on the DIC.
5. Follow the steps listed on the charging station to start charging.
6. Once charging, the DC vehicle plug will be locked to the DC charge port and cannot be disconnected while charging is active.

7. Verify that the Charging Status Indicator illuminates on top of the instrument panel and an audible chirp occurs. See *Charging Status Feedback* ⇨ 203.

#### Caution

Do not attempt to disconnect the DC vehicle plug while charging is active. This action may damage the vehicle or charging station hardware.

#### Stop Charge

Controls on the charging station can be used to stop the charge process at any time.

To stop the charge when inside the vehicle, use the Stop button on the Charging screen, or press the button on top of the AC vehicle cord handle.

#### Stop Charge — Automatic

When the vehicle no longer needs to use power from the charging station, it will stop charging and the DC vehicle plug will be unlocked from the DC charge port.

Energy can still be consumed from the charging station when the vehicle's displays and indicators show that the battery is fully charged. This is to ensure the battery is in optimal temperature operating range to maximize vehicle range. See *Programmable Charging* ⇨ 89.

### End Charge

1. Wait until the charging process has been fully stopped, the vehicle plug is unlocked, and the Charging Status Indicator is solid green or off.  
If the vehicle plug does not unlock from the vehicle charge port after a charge, contact Roadside Assistance for assistance. See *Roadside Assistance Program* ⇨ 289.
2. Unplug the DC vehicle plug from the DC charge port on the vehicle and close the dust cover.
3. Close the charge port door by pressing firmly in the center until it latches.

4. The Electric Parking Brake should be manually disengaged before driving the vehicle.
5. To start another DC charge, remove the DC vehicle plug and reconnect.

### Delayed Charging Override

To temporarily override a delayed charge event, unplug the charge cord from the charge port and then plug it back in within five seconds. A single audible chirp will sound and charging will begin immediately.

To cancel a temporary override, unplug the charge cord, wait for 10 seconds, and then plug the charge cord back in. A double audible chirp will sound and charging will be delayed.

See *Programmable Charging* ⇨ 89 for advanced charge scheduling options.

### Charging Status Feedback

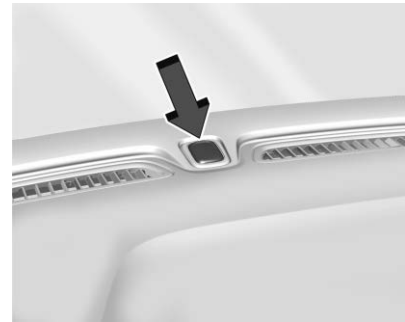

The vehicle has a Charging Status Indicator (CSI) at the center of the instrument panel near the windshield. When the vehicle is plugged in and vehicle power is off, the CSI indicates the following:

- Short Flashing Green – Vehicle is plugged in. Battery is not fully charged. Flash rate increases from one to four flashes as battery charges.
  - One Flash: 0–25% Charge
  - Two Flashes: 26–50% Charge
  - Three Flashes: 51–75% Charge
  - Four Flashes: 76–100% Charge

- Long Flashing Green – Vehicle is plugged in. Battery is not fully charged. Battery charging is delayed.
- Solid Green – Vehicle is plugged in. Battery is fully charged.
- Solid Yellow – Vehicle is plugged in. It is normal for the CSI to turn yellow for a few seconds after plugging in a compatible charge cord. The CSI may stay solid yellow longer depending on the vehicle and if there is a total utility interruption. See *Utility Interruption of Charging* ⇨ 213. This may also indicate that the charging system has detected a fault and will not charge the battery. See “Charge Cord Status Indicators” under *Charge Cord* ⇨ 207.



If the vehicle is plugged in and vehicle power is on, the CSI will flash or will be solid green, depending on the charge level.

If the vehicle is plugged in and the CSI is off, a total utility interruption or a charging fault has been detected. See *Utility Interruption of Charging* ⇨ 213 or “Charge Cord Status Indicators” under *Charge Cord* ⇨ 207.

A message displays if the vehicle is not able to charge.

Following is the vehicle feedback when the charge cord is plugged in.

Charging Status Indicator	Sound	Action/Reason
Short Flashing Green (flash rate increases from one to four as the battery charges)	One audible chirp	Vehicle is charging.
Long Flashing Green	Two audible chirps	Charging is delayed by Programmable Charging or by a total utility interruption, if equipped. Charging will begin later. See <i>Utility Interruption of Charging</i> ⇨ 213.
Short Flashing Green (one to four flashes depending on charge level)	Two audible chirps	Vehicle is charging but will be delayed by Programmable Charging at least once before the charge is complete.
Solid Green	None	Charging is complete.
Yellow (upon plug-in)	None	Charge cord is OK and the vehicle is preparing to charge.
Yellow (for extended time period after plug-in)	None	Charge cord is OK, but the vehicle is not charging. This may be due to a total utility interruption, and charging will begin later. This may also occur if the vehicle has detected a high voltage charging system fault. See <i>Utility Interruption of Charging</i> ⇨ 213 or <i>Service Vehicle Soon Light</i> ⇨ 84.
Short Flashing Green (from one to four flashes depending on charge level) or Long Flashing Green	Four audible chirps	Insufficient time to fully charge by departure time due to the selected rate preference. To increase the battery state of charge at the departure time, perform a delayed charging override. See <i>Delayed Charging Override</i> ⇨ 203.

Charging Status Indicator	Sound	Action/Reason
None (upon plug-in)	None	Check charge cord connection.
None (after Green or Yellow CSI observed)	None	Check charge cord connection. If connection is good, this may be due to a power failure or a total utility interruption, and charging will begin later. This may also occur if the vehicle has detected a high voltage charging system fault. See <i>Utility Interruption of Charging</i> ⇨ 213 or <i>Service Vehicle Soon Light</i> ⇨ 84.
None	<p>Repeated audible chirps</p> <p>To disable this feature, see “Charge Power Loss Alert” under <i>Vehicle Personalization</i> ⇨ 101.</p> <p>To stop this alert, do one of the following:</p> <ul style="list-style-type: none"> <li>• Unplug the charge cord.</li> <li>• Press  on the RKE transmitter.</li> <li>• Press and hold  on the RKE transmitter, then press again to stop the panic alarm.</li> <li>• Press the horn pad.</li> </ul>	Electricity was interrupted before charging was complete. Repeated chirps will stop if power is restored within 90 seconds.
None	Three audible chirps	Charge port door is open.

## Charge Cord

### IMPORTANT SAFETY INSTRUCTIONS



This symbol indicates risk of electrical shock if misused.

See *Radio Frequency Statement* ⇨ 294.

The vehicle will come equipped with either a single level or dual level portable charge cord used to charge the vehicle high voltage battery. The charge cord is stored under the load floor in the rear cargo area.

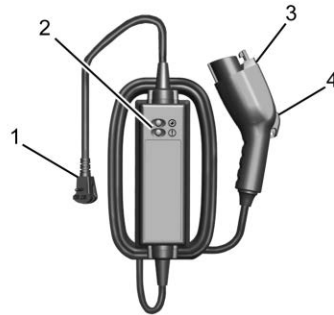

**Single Level Charge Cord**

1. Wall Plug
2. Status Indicators
3. Vehicle Connector Latch
4. Release Button

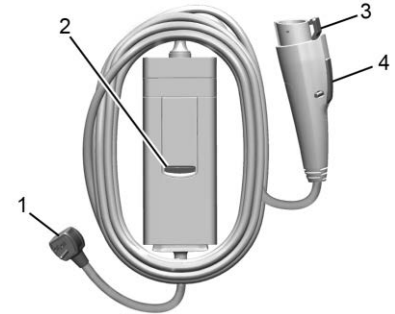

**Dual Level Charge Cord**

1. 120 Volt Wall Plug (240 Volt Wall Plug Similar)
2. Charge Cord Status Indicator
3. Vehicle Connector Latch
4. Release Button

### **Important Safety Instructions about Portable Electric Vehicle Charging**

- Charging an electric vehicle can stress a building's electrical system more than a typical household appliance.
- Before plugging into any electrical outlet, have a qualified electrician inspect and verify the electrical system (electrical outlet, wiring, junctions, and protection



devices) for heavy-duty service at a 12 amp continuous load for 120 volts charge and 32 amp for 240 volt charge.

- Electrical outlets may wear out with normal usage or may be damaged over time, making them unsuitable for electric vehicle charging.
- Check the electrical outlet/plug while charging and discontinue use if the electrical outlet/plug is hot, then have the electrical outlet serviced by a qualified electrician.
- When outdoors, plug into an electrical outlet that is weatherproof while in use.
- Mount the charge cord to reduce strain on the electrical outlet/plug.
- Do not place the charge cord in a position where it is expected to be submerged in water.

 **Danger**

Improper use of portable electric vehicle charge cords may cause a fire, electrical shock, or burns, and may result in damage to property, serious injury, or death.

(Continued)

**Danger (Continued)**

- Do not use extension cords, multi-outlet power strips, splitters, grounding adaptors, surge protectors, or similar devices.
- Do not use an electrical outlet that is worn or damaged, or will not hold the plug firmly in place.
- Do not use an electrical outlet that is not properly grounded.
- Do not use an electrical outlet that is on a circuit with other electrical loads.

 **Warning**

When using electric products, basic precautions should always be followed, including the following:

- Read all the safety warnings and instructions before using this product. Failure to follow the warnings and the instructions may result in electric shock, fire, and/or serious injury.

(Continued)

**Warning (Continued)**

- Never leave children unattended near the vehicle while the vehicle is charging and never allow children to play with the charge cord.
- If the plug provided does not fit the electrical outlet, do not modify the plug. Arrange for a qualified electrician to inspect the electrical outlet.
- Do not put fingers into the electric vehicle connector.

 **Warning**

- To reduce the risk of fire, installations shall comply with the requirements of National Electric Code, ANSI/NFPA 70 (USA), Canadian Electrical Code CSA 22.1 and IEC 60364 – Electrical installations in buildings, depending on the region in which the unit is being installed. The installer shall comply with any additional local requirements mandated by the country and/or municipality.

(Continued)



**Warning (Continued)**



- Do not use this product if the flexible power cord or the electric vehicle cable is frayed, has broken insulation, or shows any other signs of damage.
- For Canada only: Not for use in commercial garages.
- Do not use this product if the enclosure or the vehicle plug is broken, cracked, open, or shows any other indication of damage.
- The plug must be plugged into an appropriate electrical outlet that is properly installed in accordance with all local codes and ordinances. Do not modify the plug provided with the product. If the plug does not fit the electrical outlet, have a proper electrical outlet installed by a qualified electrician. If ground is missing, the charge cord indicators will indicate an electrical system fault and the vehicle may not charge.





**Charge Cord Status Indicators (Single Level Charge Cord)**

After plugging in the charge cord, it will perform a quick self test.

Verify the charge cord status. When the  indicator is lit solid green, the charge cord is ready to charge the vehicle.

The charge cord utilizes a combination of the  and  indicators to display the status of the charge cord per the following table.

⊙	①	Symbol	Fault/Condition/Event
● Solid Green	○ Off (No Light)	✓	No Faults: The charge cord is receiving power from the electrical outlet and is ready to supply it to the vehicle.
⊙ Flashing Green	● Solid Red	X  ⚡	Electrical Outlet/Plug Fault: The charge cord has detected that the electrical outlet/plug overheated. Electrical outlets may wear out with normal usage or may be damaged over time, making them unsuitable for electric vehicle charging. Do not use an electrical outlet that is worn, damaged, or one that will not hold the plug firmly in place. Use another electrical outlet or have the electrical outlet serviced by a qualified electrician. Reset the charge cord by unplugging the charge cord from the electrical outlet and re-plugging it.
○ Off (No Light)	● Solid Red	X 	Electrical System Fault: The charge cord has detected a missing or improper ground within the building's electrical system. Do not use an electrical outlet that is not properly grounded. Use another electrical outlet or have a qualified electrician inspect and verify the building's electrical system.
○ Off (No Light)	⊙ Flashing Red	X 	Vehicle Fault: The charge cord ground-fault circuit interrupter (GFCI) has tripped. Ensure that there is no physical damage to the charge cord, and that the vehicle plug is seated completely and making a good connection. Reset the charge cord by unplugging it from the electrical outlet and re-plugging it. If the fault remains, see an authorized dealer for service.

		Symbol	Fault/Condition/Event
● Solid Green	 Flashing Red	X 	Charge Cord Fault: The charge cord has detected a potential problem with the charge cord. Reset the charge cord by unplugging it from the electrical outlet and re-plugging it. If the fault remains, see an authorized dealer for service.

If no status indicators are lit, ensure the electrical outlet is powered.

### Charge Cord Status Indicators (Dual Level Charge Cord)

Refer to the instructions that come with the dual level charge cord. Do not lose these instructions.

### Charge Level Selection

Charge level selection can be made using the Charge Mode tab on the Charging screen on the infotainment display. See “Level 1–120V Cord Limit” under *Programmable Charging* ⇨ 89.

### Warning

Using a charge level that exceeds the electrical circuit or electrical outlet capacity may start a fire or damage the electrical circuit. Use the lowest charge level until a qualified electrician inspects the electrical circuit capacity. Use the lowest charge level if the electrical circuit or electrical outlet capacity is not known.

### Grounding Instructions

The portable charge cord must be grounded. If this charge cord should malfunction or break down, grounding provides a path of least resistance for electric current to reduce the risk of electric shock. This product is equipped with a cord that has an equipment grounding conductor and a grounding plug.

The plug must be plugged into an appropriate outlet that is properly installed and grounded in accordance with all local codes and ordinances.

### Warning

Improper connection of the charge cord ground may cause electrical shock. Check with a qualified electrician if there is doubt as to whether the charge circuit is properly grounded. Do not modify the plug provided with the product. If it will not fit the electrical outlet, have a proper electrical outlet installed by a qualified electrician.

### Mounting Instructions (Single Level Charge Cord Only)

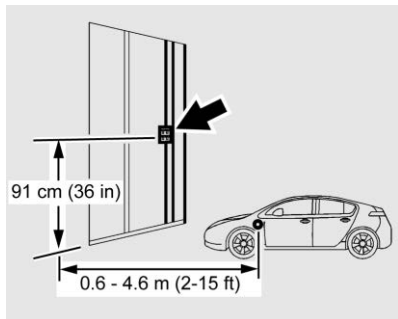

1. Identify an appropriate location for the charge cord.
2. Locate a mounting support, such as a wall stud.

The appropriate height for mounting the charge cord is 91 cm (36 in) from the floor.

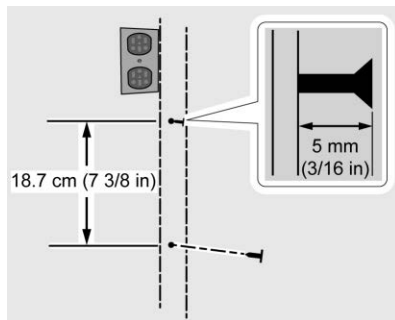

3. Mark and drill the mounting holes in a wall stud or suitable structure. Stay away from any power source. Space the holes 18.7 cm (7 3/8 in) apart.
4. Install the mounting screws in the wall surface leaving the head of the screws 5 mm (3/16 in) from the surface.

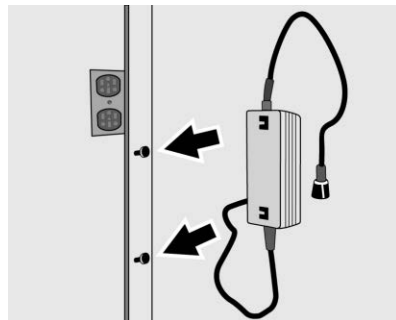

5. Securely mount the charge cord on to the screws.
6. Connect the wall plug to the electrical outlet.
7. Connect the vehicle plug to the charge port.

## Lock Feature (Single Level Charge Cord)

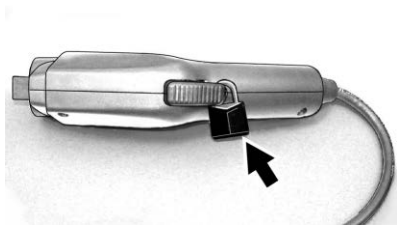

A lock can be added to the vehicle plug for additional security.

### FCC Information

See *Radio Frequency Statement* ⇨ 294.

## Utility Interruption of Charging

This vehicle will respond to requests through the utility company to limit or completely block electrical power grid usage. This feature is inactive during DC charging. A utility interruption of charging will lengthen the vehicle charge time.

When electrical grid power is completely blocked, the vehicle will delay charging until the utility interruption has expired. The vehicle should be left plugged in so that the vehicle can automatically begin charging.

Changing the charge mode to Immediate or performing a delayed charging override will not disable a utility interruption. Unplugging and plugging the car back in will also not disable a utility interruption.

A pop-up will appear in the infotainment display while starting the vehicle following any utility interruption. See “Charging Interrupted or Overridden Pop-Up” under *Programmable Charging* ⇨ 89.

A message will display on the instrument cluster indicating that a utility interruption has occurred.

## Electrical Requirements for Battery Charging

This vehicle is capable of being charged with most standard vehicle charging equipment complying with one or more of the following:

- SAE J1772
- SAE J2847-2
- IEC 61851-1
- IEC 61851-22
- IEC 61851-23
- IEC 61851-24
- IEC 62196-1

- IEC 62196-2
- IEC 62196-3

The charge cord requires a minimum circuit capacity as follows:

- 120 volt system — 15 amps
- 240 volt system — 60 amps (if equipped with dual level charge cord)

### Caution

Do not use portable or stationary backup generating equipment to charge the vehicle. This may cause damage to the vehicle's charging system. Only charge the vehicle from utility supplied power.

## Trailer Towing

### General Towing Information

#### Warning

Never tow a trailer with your vehicle. It was not designed or intended to tow a trailer.

## Conversions and Add-Ons

### Add-On Electrical Equipment

#### Warning

The Data Link Connector (DLC) is used for vehicle service and Emission Inspection/Maintenance testing. See *Service Vehicle Soon Light* ⇨ 84. A device connected to the DLC — such as an aftermarket fleet or driver-behavior tracking device — may interfere with vehicle systems. This could affect vehicle operation and cause a crash. Such devices may also access information stored in the vehicle's systems.

#### Caution

Some electrical equipment can damage the vehicle or cause components to not work and would not be covered by the vehicle warranty. Always check with your dealer before adding electrical equipment.

Add-on equipment can drain the vehicle's 12-volt battery, even if the vehicle is not operating.

When adding electrical equipment, it should only be connected using the accessory power outlets. The maximum power that can be supplied by one accessory power outlet or spread across all three is 200 watts or 15 amps. Exceeding 200 watts or 15 amps may cause erratic vehicle operation.

The vehicle has an airbag system. Before attempting to add anything electrical to the vehicle, see *Servicing the Airbag-Equipped Vehicle* ⇨ 46 and *Adding Equipment to the Airbag-Equipped Vehicle* ⇨ 46.

## Vehicle Care

### General Information

General Information .....	216
California Perchlorate Materials Requirements .....	216
Accessories and Modifications .....	216

### Vehicle Checks

Doing Your Own Service Work .....	217
Hood .....	217
Underhood Compartment Overview ...	219
Cooling System .....	220
Washer Fluid .....	221
Brakes .....	221
Brake Fluid .....	222
Battery - North America .....	223
Park Brake and P (Park) Mechanism Check .....	224
Wiper Blade Replacement .....	225
Windshield Replacement .....	226
Gas Strut(s) .....	226

### Headlamp Aiming

Front Headlamp Aiming .....	227
-----------------------------	-----

### Bulb Replacement

Bulb Replacement .....	227
Halogen Bulbs .....	228
LED Lighting .....	228
Back-Up Lamps .....	228
License Plate Lamp .....	229

### Electrical System

High Voltage Devices and Wiring .....	229
Electrical System Overload .....	230
Fuses and Circuit Breakers .....	231
Underhood Compartment Fuse Block .....	232
Instrument Panel Fuse Block .....	235

### Wheels and Tires

Tires .....	237
All-Season Tires .....	238
Winter Tires .....	238
Self-Sealing Tires .....	238
Summer Tires .....	239
Tire Sidewall Labeling .....	239
Tire Designations .....	240
Tire Terminology and Definitions ....	240
Tire Pressure .....	243

Tire Pressure Monitor System .....	243
Tire Pressure Monitor Operation .....	244
Tire Inspection .....	247
Tire Rotation .....	248
When It Is Time for New Tires .....	249
Buying New Tires .....	249
Different Size Tires and Wheels .....	250
Uniform Tire Quality Grading .....	251
Wheel Alignment and Tire Balance ....	252
Wheel Replacement .....	252
Tire Chains .....	253
If a Tire Goes Flat .....	253
Tire Sealant and Compressor Kit .....	254
Storing the Tire Sealant and Compressor Kit .....	259

### Jump Starting

Jump Starting - North America .....	259
-------------------------------------	-----

### Towing the Vehicle

Towing the Vehicle .....	262
Recreational Vehicle Towing .....	264

### Appearance Care

Exterior Care .....	265
Interior Care .....	269
Floor Mats .....	272



## General Information

For service and parts needs, visit your dealer. You will receive genuine GM parts and GM-trained and supported service people.

Genuine GM parts have one of these marks:



## California Perchlorate Materials Requirements

Certain types of automotive applications, such as airbag initiators, seat belt pretensioners, and lithium batteries contained in electronic keys, may contain perchlorate materials. Perchlorate Material – special handling may apply. See [www.dtsc.ca.gov/hazardouswaste/perchlorate](http://www.dtsc.ca.gov/hazardouswaste/perchlorate).

## Accessories and Modifications

Adding non-dealer accessories or making modifications to the vehicle can affect vehicle performance and safety, including such things as airbags, braking, stability, ride and handling, emissions systems, aerodynamics, durability, and electronic systems like antilock brakes, traction control, and stability control. These accessories or modifications could even cause malfunction or damage not covered by the vehicle warranty.

Damage to suspension components caused by modifying vehicle height outside of factory settings will not be covered by the vehicle warranty.

Damage to vehicle components resulting from modifications or the installation or use of non-GM certified parts, including control module or software modifications, is not covered under the terms of the vehicle warranty and may affect remaining warranty coverage for affected parts.

GM Accessories are designed to complement and function with other systems on the vehicle. See your dealer to accessorize the vehicle using genuine GM Accessories installed by a dealer technician.

Also, see *Adding Equipment to the Airbag-Equipped Vehicle* ⇨ 46.

## Vehicle Checks

### Doing Your Own Service Work

#### Warning

Never try to do your own service on high voltage battery components. You can be injured and the vehicle can be damaged if you try to do your own service work.

Service and repair of these high voltage battery components should only be performed by a trained dealer technician with the proper knowledge and tools.

Exposure to high voltage can cause shock, burns, and even death. The high voltage components in the vehicle can only be serviced by technicians with special training.

High voltage components are identified by labels. Do not remove, open, take apart, or modify these components. High voltage cable or wiring has orange covering. Do not probe, tamper with, cut, or modify high voltage cable or wiring.

#### Warning

It can be dangerous to work on your vehicle if you do not have the proper knowledge, service manual, tools, or parts. Always follow owner's manual procedures and consult the service manual for your vehicle before doing any service work.

If doing some of your own service work, use the proper service manual. It tells you much more about how to service the vehicle than this manual can. To order the proper service manual, see *Publication Ordering Information* ⇨ 293.

This vehicle has an airbag system. Before attempting to do your own service work, see *Servicing the Airbag-Equipped Vehicle* ⇨ 46.

Keep a record with all parts receipts and list the mileage and the date of any service work performed. See *Maintenance Records* ⇨ 282.

## Hood

#### Warning

Components under the hood can get hot from running the engine. To help avoid the risk of burning unprotected skin, never touch these components until they have cooled, and always use a glove or towel to avoid direct skin contact.

Clear any snow from the hood before opening.

#### To open the hood:

1. Pull the hood release lever with the  symbol. It is on the lower left side of the instrument panel.

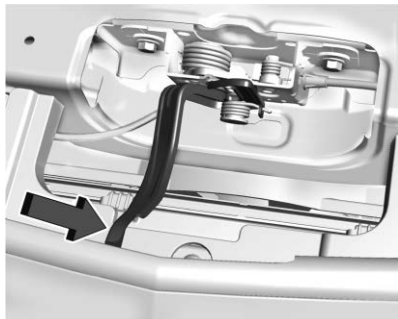

2. Go to the front of the vehicle and locate the secondary release lever under the front center of the hood. Push the secondary hood release lever to the right to release.

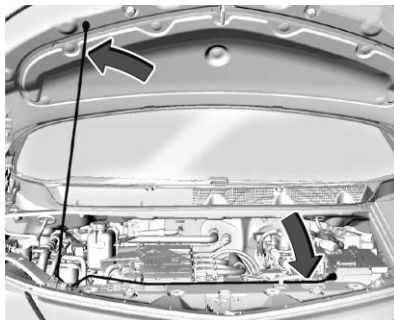

3. Lift the hood and release the hood prop rod from its retainer, in the front of the engine compartment. Securely insert the rod end into the slot marked with an arrow, on the underside of the hood.

#### To close the hood:

1. Before closing the hood, be sure all filler caps are on properly, and all tools are removed.
2. Lift the hood and remove the hood prop rod from the underside of the hood. Return the prop rod to its retainer. The prop rod must click into place when returning it to the retainer to prevent hood damage.
3. Lower the hood 20 cm (8 in) above the vehicle and release it. Check to make sure the hood is latched completely. Repeat this process with additional force if necessary.

#### Warning

Do not drive the vehicle if the hood is not latched completely. The hood could open fully, block your vision, and cause a crash. You or others could be injured. Always close the hood completely before driving.

## Underhood Compartment Overview

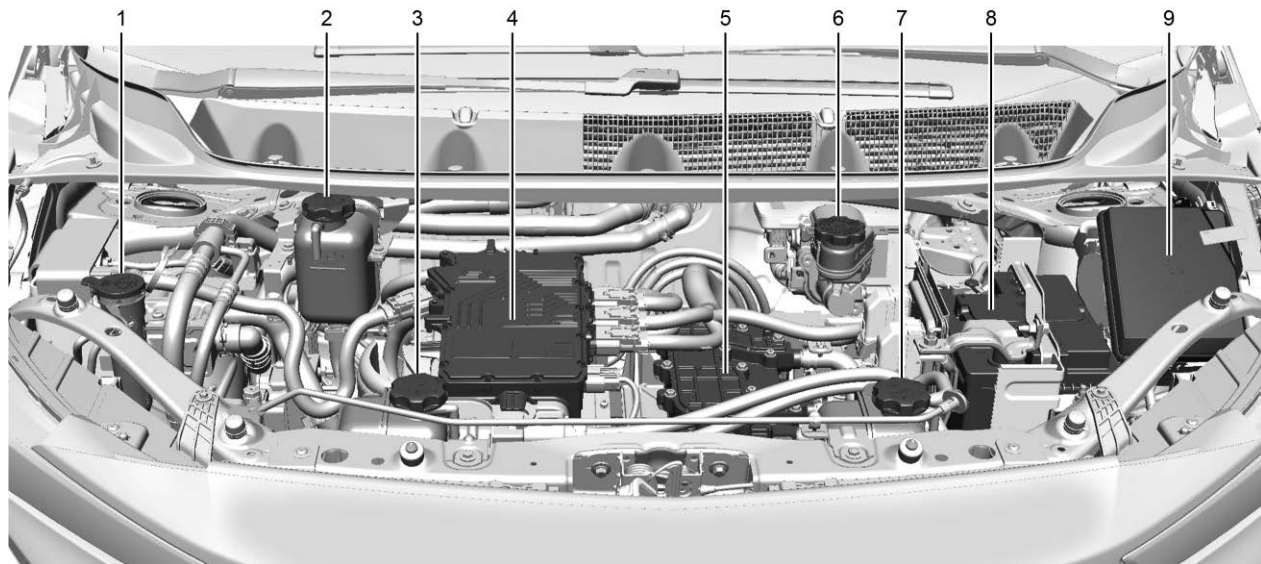

1. Windshield Washer Fluid Reservoir. See *Washer Fluid* ⇨ 221.
2. Cabin Heating Coolant Reservoir. See *Cooling System* ⇨ 220.
3. High Voltage Battery Coolant Reservoir. See *Cooling System* ⇨ 220.
4. HPDM (High Power Distribution Module).
5. APM (Accessory Power Module), OBCM (On-Board Charging Module).
6. Brake Fluid Reservoir. See *Brake Fluid* ⇨ 222.
7. SPIM, APM, and Charger Module Coolant Reservoir. See *Cooling System* ⇨ 220.
8. Battery. See *Battery - North America* ⇨ 223.
9. Underhood Compartment Fuse Block. *Underhood Compartment Fuse Block* ⇨ 232.

## Cooling System

It is not necessary to regularly check coolant unless a leak is suspected or an unusual noise is heard. A coolant loss could indicate a problem. Have it inspected and repaired by your dealer.

The following explains the cooling systems and how to check coolant levels.

- High Voltage Battery
- Single Power Inverter Module (SPIM), Accessory Power Module (APM), and Charger Module
- Cabin Heating

### High Voltage Battery

During vehicle operation and also during charging, the high voltage battery cells in the vehicle are kept within a normal operating temperature range. If the temperature rises above this temperature, the battery cooling system turns on the air conditioning compressor and cools the coolant until the correct temperature is reached. If the temperature falls below this temperature, a high voltage heater, located outside the battery on a cradle, heats the coolant until the correct temperature is reached.

### Single Power Inverter Module (SPIM), Accessory Power Module (APM), and Charger Module

The SPIM, APM, and charger module are cooled using a separate coolant loop. These modules are kept below a maximum temperature. If the temperature rises above this temperature, the electric cooling fan will turn on to cool the coolant.

### Cabin Heating

Cabin heating is maintained by coolant heated by the Coolant Heater Control Module (CHCM), separate from the power electronics and battery coolant loops. This module heats the coolant based on temperature inputs from the cabin climate control systems.

### Hybrid Cooling System Pressure Caps

The hybrid cooling system reservoirs have tamper resistant pressure caps. The coolant should only be serviced by a qualified technician.

### Checking Coolant

The coolant needs to be replaced at the appropriate interval. See *Maintenance Schedule* ⇨ 275.

The coolant reservoirs are in the underhood compartment. See *Underhood Compartment Overview* ⇨ 219.

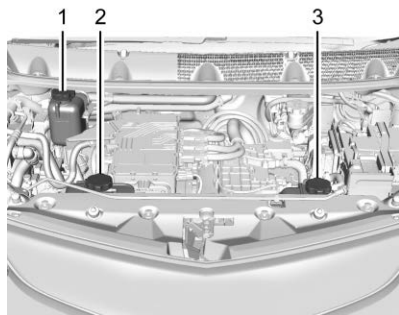

1. Cabin Heating Coolant Reservoir
2. High Voltage Battery Coolant Reservoir
3. SPIM, APM, and Charger Module Coolant Reservoir

1. Park on a level surface and turn the vehicle off.
2. After the system has completely cooled, check that the coolant level is at the cold fill mark on the reservoirs.
3. If the coolant level is not visible or needs to be adjusted within the reservoirs, contact your dealer.

## Washer Fluid

### What to Use

When windshield washer fluid is needed, be sure to read the manufacturer's instructions before use. If operating the vehicle in an area where the temperature may fall below freezing, use a fluid that has sufficient protection against freezing.

### Adding Washer Fluid

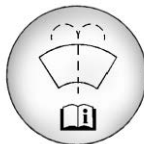

Open the cap with the washer symbol on it. Add washer fluid until the tank is full. See *Underhood Compartment Overview* ⇨ 219 for reservoir location.

### Caution

- Do not use washer fluid that contains any type of water repellent coating. This can cause the wiper blades to chatter or skip, and may also clog the washer nozzle.

(Continued)

### Caution (Continued)

- Do not use engine coolant (antifreeze) in the windshield washer. It can damage the windshield washer system and paint.
- Do not mix water with ready-to-use washer fluid. Water can cause the solution to freeze and damage the washer fluid tank and other parts of the washer system.
- When using concentrated washer fluid, follow the manufacturer instructions for adding water.
- Fill the washer fluid tank only three-quarters full when it is very cold. This allows for fluid expansion if freezing occurs, which could damage the tank if it is completely full.

## Brakes

Disc brake linings have built-in wear indicators that make a high-pitched warning sound when the brake linings are worn and new linings are needed. The sound can come and go or can be heard all the time when the vehicle is moving, except when applying the brake pedal firmly.

**Warning**

The brake wear warning sound means that soon the brakes will not work well. That could lead to a crash. When the brake wear warning sound is heard, have the vehicle serviced.

**Caution**

Continuing to drive with worn-out brake linings could result in costly brake repairs.

Some driving conditions or climates can cause a brake squeal when the brakes are first applied, clearing up following several applications. This does not mean something is wrong with the brakes.

Properly torqued wheel nuts are necessary to help prevent brake pulsation. When tires are rotated, inspect brake linings for wear and evenly tighten wheel nuts in the proper sequence to torque specifications. See *Capacities and Specifications* ⇨ 284.

Brake pads should be replaced as complete axle sets.

**Brake Pedal Travel**

See your dealer if the brake pedal does not return to normal height, or if there is a rapid increase in pedal travel. This could be a sign that brake service may be required.

**Replacing Brake System Parts**

Always replace brake system parts with new, approved replacement parts. If this is not done, the brakes may not work properly. The braking performance can change in many ways if the wrong brake parts are installed or if parts are improperly installed.

**Brake Fluid**

The brake master cylinder reservoir is filled with GM approved DOT 4 brake fluid as indicated on the reservoir cap. See *Underhood Compartment Overview* ⇨ 219 for the location of the reservoir.

**Checking Brake Fluid**

With the vehicle in P (Park) on a level surface, the brake fluid level should be between the minimum and maximum marks on the brake fluid reservoir.

There are only two reasons why the brake fluid level in the reservoir may go down:

- Normal brake lining wear. When new linings are installed, the fluid level goes back up.
- A fluid leak in the brake hydraulic system. Have the brake hydraulic system fixed. With a leak, the brakes will not work well.

Always clean the brake fluid reservoir cap and the area around the cap before removing it.

Do not top off the brake fluid. Adding fluid does not correct a leak. If fluid is added when the linings are worn, there will be too much fluid when new brake linings are installed. Add or remove fluid, as necessary, only when work is done on the brake hydraulic system.

When the brake fluid falls to a low level, the brake warning light comes on. See *Brake System Warning Light* ⇨ 84.

Brake fluid absorbs water over time which degrades the effectiveness of the brake fluid. Replace brake fluid at the specified intervals to prevent increased stopping distance. See *Maintenance Schedule* ⇨ 275.

#### What to Add

Use only GM approved DOT 4 brake fluid from a clean, sealed container. See *Recommended Fluids and Lubricants* ⇨ 280.

#### Warning

The wrong or contaminated brake fluid could result in damage to the brake system. This could result in the loss of braking leading to a possible injury. Always use the proper GM approved brake fluid.

#### Caution

If brake fluid is spilled on the vehicle's painted surfaces, the paint finish can be damaged. Immediately wash off any painted surface.

## Battery - North America

The original equipment battery is maintenance free. Do not remove the cap and do not add fluid.

This vehicle has a high voltage battery and a standard 12-volt battery.

#### Warning

Damage to the high voltage battery or high voltage system can create a risk of electric shock, overheating, or fire.

If the vehicle is damaged from a moderate to severe crash, flood, fire, or other event, the vehicle should be inspected as soon as possible. Until the vehicle has been inspected, store it outside at least 15 m (50 ft) from any structure or anything that can burn. Ventilate the vehicle by opening a window or a door.

Contact Customer Assistance as soon as possible to determine whether an inspection is needed. See *Customer Assistance Offices* ⇨ 287.

If the vehicle is in a crash, the sensing system may shut down the high voltage system. When this occurs, the high voltage battery is disconnected and the vehicle will not start. The SERVICE VEHICLE SOON message in the Driver Information Center (DIC) will be displayed. Before the vehicle can be operated again, it must be serviced at your dealer.

See "If a Crash Occurs" under *Collision Damage Repair* ⇨ 291 for additional information. If an airbag has inflated, see *What Will You See after an Airbag Inflates?* ⇨ 41.

Only a trained service technician with the proper knowledge and tools should inspect, test, or replace the high voltage battery. See your dealer if either the 12-volt or high voltage battery needs service. The dealer has information on how to recycle the high voltage battery. There is also information available at <http://www.recyclemymybattery.com>.

Keep the vehicle plugged in, even when fully charged, to keep the high voltage battery temperature ready for the next drive. This is important when outside temperatures are extremely hot or cold.



Propulsion power may be reduced in extremely cold temperatures, or if the high voltage battery is too cold. BATTERY TOO COLD, PLUG IN TO WARM will display.

A vehicle cover, which can reduce sun loading on the vehicle and improve high voltage battery life, is available from your dealer.

Refer to the replacement number shown on the original battery label when a new 12-volt battery is needed. The vehicle has an Absorbed Glass Mat (AGM) 12-volt battery. Installation of a standard 12-volt battery will result in reduced 12-volt battery life.

When using a 12-volt battery charger on the 12-volt AGM battery, some chargers have an AGM battery setting on the charger. If available, use the AGM setting on the charger, to limit charge voltage to 14.8 volts.

### Warning

**WARNING:** Battery posts, terminals and related accessories can expose you to chemicals including lead and lead compounds, which are known to the State of California to cause cancer and birth defects or other reproductive harm.

(Continued)

### Warning (Continued)

Wash hands after handling. For more information go to [www.P65Warnings.ca.gov](http://www.P65Warnings.ca.gov).

See the warning on the back cover.

### Vehicle Storage

#### Warning

Batteries have acid that can burn you and gas that can explode. You can be badly hurt if you are not careful. See *Jump Starting - North America* ⇨ 259 for tips on working around a battery without getting hurt.

#### Up to a Month

- Plug in the charge cord.

#### Planned Storage for more than a Month

- Do not plug in the charge cord.
- Remove the black negative (-) cable from the 12-volt battery and attach a trickle charger to the battery terminals or keep the 12-volt battery cables connected and trickle charge from the underhood remote

positive (+) and negative (-) terminals. See *Jump Starting - North America* ⇨ 259 for the location of these terminals.

### Caution

The vehicle is equipped with an AGM/VRLA 12-volt battery, which can be damaged by using the incorrect type of trickle charger. An AGM/VRLA-compatible charger must be used, with the appropriate setting selected. Follow the trickle charger manufacturer instructions.

After the battery cable is reconnected, it is possible that the vehicle may not operate. If this happens, the high voltage battery may need to be charged.

### Park Brake and P (Park) Mechanism Check

#### Warning

When you are doing this check, the vehicle could begin to move. You or others could be injured and property could be damaged. Make sure there is room in front of the vehicle in case it

(Continued)

**Warning (Continued)**

begins to roll. Be ready to apply the regular brake at once should the vehicle begin to move.

Park on a fairly steep hill, with the vehicle facing downhill. Keeping your foot on the regular brake, set the Electric Parking Brake (EPB).

- To check the EPB's holding ability: With the propulsion system active and the electric drive unit in N (Neutral), slowly remove foot pressure from the regular brake pedal. Do this until the vehicle is held by the EPB only.
- To check the P (Park) mechanism's holding ability: With the propulsion system active, shift to P (Park). Then release the EPB and slowly remove foot pressure from the regular brake pedal.

Contact your dealer if service is required.

**Wiper Blade Replacement****Front Wiper Blade Replacement**

Windshield wiper blades should be replaced periodically. See the *Maintenance Schedule* ⇨ 275.

Replacement blades come in different types and are removed in different ways. For proper type and length, see *Maintenance Replacement Parts* ⇨ 281.

**Caution**

Allowing the wiper arm to touch the windshield when no wiper blade is installed could damage the windshield. Any damage that occurs would not be covered by the vehicle warranty. Do not allow the wiper arm to touch the windshield.

To replace the windshield wiper blade:

1. Pull the windshield wiper assembly away from the windshield.

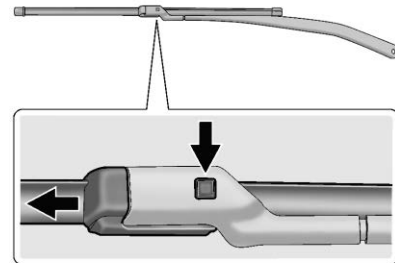

2. Press the button in the middle of the wiper arm connector, and pull the wiper blade away from the arm connector.
3. Remove the wiper blade.
4. Reverse Steps 1–3 for wiper blade replacement.

**Rear Wiper Blade Replacement**

The rear wiper blade and wiper arm have a cover for protection. The cover must be removed before the wiper blade can be replaced.

To remove the cover:



1. Slide a plastic tool under the cover and push upward to unsnap.
2. Slide the cover toward the wiper blade tip to unhook it from the blade assembly.
3. Remove the cover.
4. After wiper blade replacement, ensure that the cover hook slides into the slot in the blade assembly.
5. Snap the cover down to secure.

To replace the wiper blade:

1. Lift the wiper arm away from the windshield.

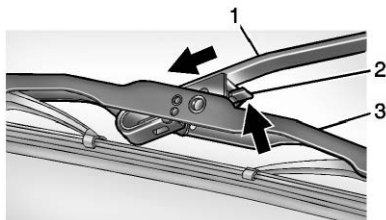

2. Push the release lever (2) to disengage the hook and push the wiper arm (1) out of the blade assembly (3).
3. Push the new blade assembly securely on the wiper arm until the release lever clicks into place.
4. Replace the wiper cover.

## Windshield Replacement

### Driver Assistance Systems

If the windshield needs to be replaced and the vehicle is equipped with a front camera sensor for the Driver Assistance Systems, a GM replacement windshield is recommended. The replacement windshield must be installed according to GM specifications for proper alignment. If it is not, these systems may not work properly,

they may display messages, or they may not work at all. See your dealer for proper windshield replacement.

## Gas Strut(s)

This vehicle is equipped with gas strut(s) to provide assistance in lifting and holding open the hood/trunk/liftgate system in full open position.

### Warning

If the gas struts that hold open the hood, trunk, and/or liftgate fail, you or others could be seriously injured. Take the vehicle to your dealer for service immediately. Visually inspect the gas struts for signs of wear, cracks, or other damage periodically. Check to make sure the hood/trunk/liftgate is held open with enough force. If struts are failing to hold the hood/trunk/liftgate, do not operate. Have the vehicle serviced.

**Caution**

Do not apply tape or hang any objects from gas struts. Also do not push down or pull on gas struts. This may cause damage to the vehicle.

See *Maintenance Schedule* ⇨ 275.



Hood

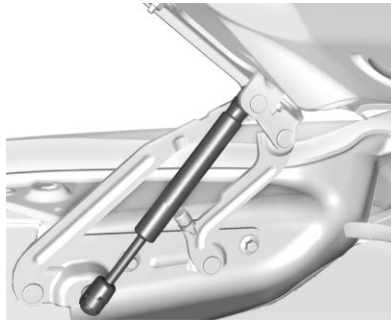

Trunk



Liftgate

**Headlamp Aiming****Front Headlamp Aiming**

Headlamp aim has been preset and should need no further adjustment.

If the vehicle is damaged in a crash, the headlamp aim may be affected.

If adjustment to the headlamps is necessary, see your dealer.

**Bulb Replacement**

For the proper type of replacement bulbs, or any bulb changing procedure not listed in this section, contact your dealer.

**Caution**

Do not replace incandescent bulbs with aftermarket LED replacement bulbs. This can cause damage to the vehicle electrical system.

## Halogen Bulbs

### Warning

Halogen bulbs have pressurized gas inside and can burst if you drop or scratch the bulb. You or others could be injured. Be sure to read and follow the instructions on the bulb package.

## LED Lighting

This vehicle has several LED lamps.

For replacement of any LED lighting assembly, contact your dealer.

## Back-Up Lamps



To access the bulbs, reach up behind the rear bumper. To replace one of these bulbs:



1. Turn the screws counterclockwise and remove the access cover under the rear bumper.



2. Turn the bulb socket counterclockwise and pull the bulb straight out of the socket.
3. Replace the bulb and reverse Steps 1–2 to reinstall.

## License Plate Lamp

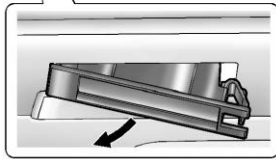
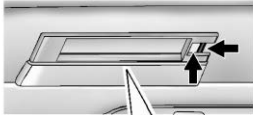

1. Press the spring clip on the right end of the lamp assembly to the left to unlock the lamp assembly.
2. Pull down on the lamp assembly to remove it from the fascia.

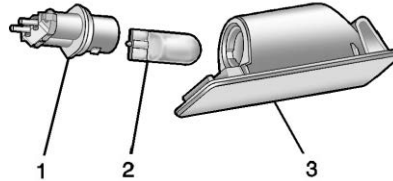

4. Turn the bulb socket (1) counterclockwise to remove it from the lamp assembly (3).
5. Pull the bulb (2) straight out of the bulb socket (1).
6. Push the replacement bulb straight into the bulb socket (1) and turn the bulb socket (1) clockwise to install it into the lamp assembly (3).
7. Reinstall the lamp assembly (3) into the fascia by inserting the left side first.
8. Push the spring clip into place.

## Electrical System

### High Voltage Devices and Wiring

#### Warning

Exposure to high voltage can cause shock, burns, and even death. The high voltage components in the vehicle can only be serviced by technicians with special training.

High voltage components are identified by labels. Do not remove, open, take apart, or modify these components. High voltage cable or wiring has orange covering or labels. Do not probe, tamper with, cut, or modify high voltage cable or wiring.

## Electrical System Overload

The vehicle has fuses and circuit breakers to protect against an electrical system overload.

When the current electrical load is too heavy, the circuit breaker opens and closes, protecting the circuit until the current load returns to normal or the problem is fixed. This greatly reduces the chance of circuit overload and fire caused by electrical problems.

Fuses and circuit breakers protect power devices in the vehicle.

If there is a problem on the road and a fuse needs to be replaced, the same amperage fuse can be borrowed. Choose some feature of the vehicle that is not needed to use and replace it as soon as possible.

To check a fuse, look at the band inside the fuse. If the band is broken or melted, replace the fuse. Be sure to replace a bad fuse with a fuse of the identical size and rating.

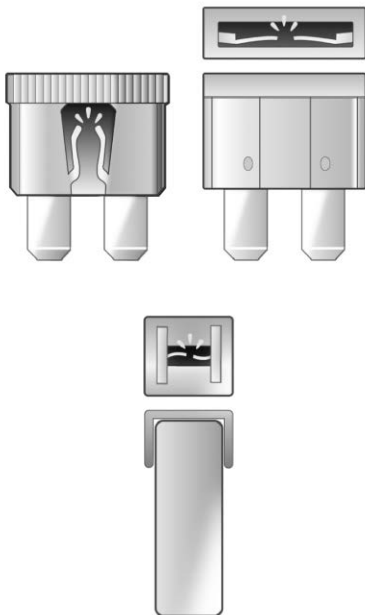

## Replacing a Blown Fuse

1. Power off the vehicle.
2. Locate the fuse puller in the underhood compartment fuse block.

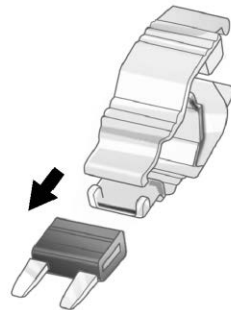

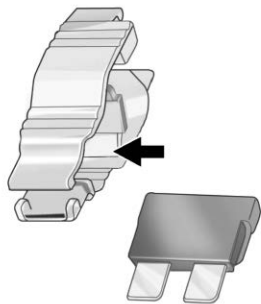

3. Use the fuse puller to remove the fuse from the top or side, as shown above.
4. If the fuse must be replaced immediately, borrow a replacement fuse with the same amperage from the fuse block. Choose a vehicle feature that is not needed to safely operate the vehicle. Repeat Steps 2-3.
5. Insert the replacement fuse into the empty slot of the blown fuse.

At the next opportunity, see your dealer to replace the blown fuse.

### Headlamp Wiring

An electrical overload may cause the lamps to go on and off, or in some cases to remain off. Have the headlamp wiring checked right away if the lamps go on and off or remain off.

### Windshield Wipers

If the wiper motor overheats due to heavy snow or ice, the windshield wipers will stop until the motor cools and the wiper control is turned off. After removal of the blockage, the wiper motor will restart when the control is then moved to the desired operating position.

Although the circuit is protected from electrical overload, overload due to heavy snow or ice, may cause wiper damage. Always clear ice and heavy snow from the windshield before using the windshield wipers.

If the overload is caused by an electrical problem and not snow or ice, be sure to get it fixed.

### Fuses and Circuit Breakers

The wiring circuits in the vehicle are protected from short circuits by a combination of fuses and circuit breakers. This greatly reduces the chance of damage caused by electrical problems.

#### Danger

Fuses and circuit breakers are marked with their ampere rating. Do not exceed the specified amperage rating when replacing fuses and circuit breakers. Use of an oversized fuse or circuit breaker can result in a vehicle fire. You and others could be seriously injured or killed.





**Warning**

Installation or use of fuses that do not meet GM's original fuse specifications is dangerous. The fuses could fail, and result in a fire. You or others could be injured or killed, and the vehicle could be damaged.

See *Accessories and Modifications* ⇨ 216 and *General Information* ⇨ 216.

To check or replace a blown fuse, see *Electrical System Overload* ⇨ 230.

## Underhood Compartment Fuse Block

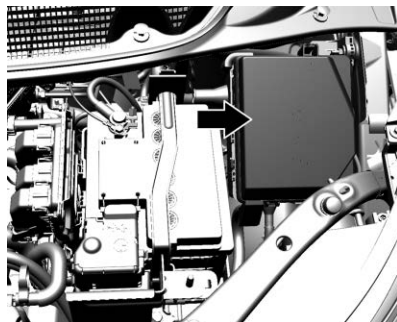

To open the fuse block cover, press the clips at the side and back and pull the cover up.

**Caution**

Spilling liquid on any electrical component on the vehicle may damage it. Always keep the covers on any electrical component.

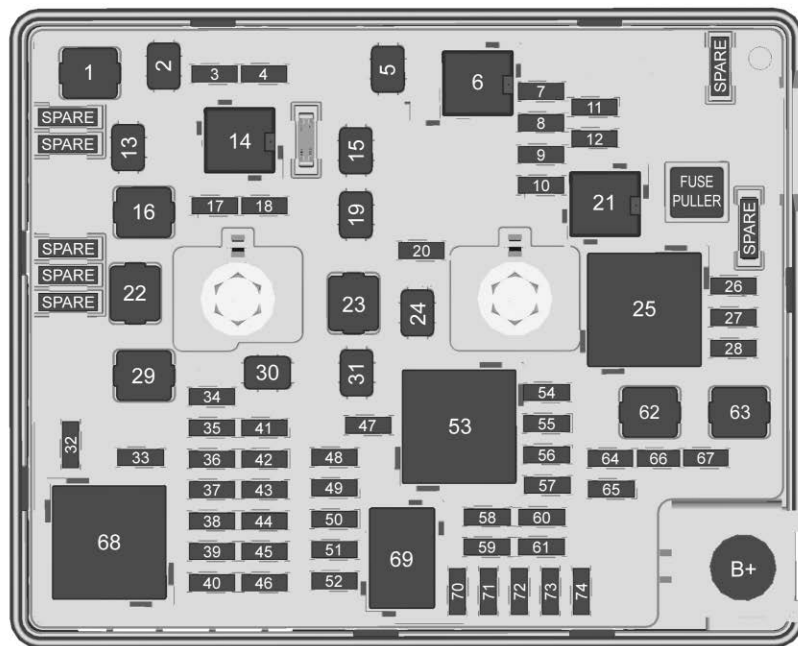

## 234 Vehicle Care

A fuse puller is in the underhood compartment fuse block.

The vehicle may not be equipped with all of the fuses, relays, and features shown.

Fuses	Usage
1	–
2	Power Window Rear
3	Cargo Lamp
4	Rechargeable Energy Storage System 1
5	Power Seat Driver
7	–
8	–
9	–
10	–
11	Horn
12	–
13	Front Wiper Motor Driver
15	Front Wiper Motor Co-driver
16	Electronic Brake Control Module Supply Electronics
17	Rear Wiper

Fuses	Usage
18	Liftgate
19	Seat Module Front
20	Washer
22	Linear Power Module
23	Electronic Brake Control Module Supply Motor
24	Power Seat Lumbar
26	Transmission Range Control Module
27	Aeroshutter
28	Auxiliary Oil Pump
29	Electric Brake Boost Motor Source
30	Front Power Windows
31	In-panel Bussed Electrical Center
32	Rear Window Defogger
33	Heated Exterior Rearview Mirror
34	Pedestrian Friendly Alert Function
35	–

Fuses	Usage
36	–
37	Current Sensor
38	–/Humidity Sensor
39	–
40	Electric Brake Boost (ECU)
41	Power Line Communication Module
42	Infant Only Suppression
43	Window Switch
44	Rechargeable Energy Storage System
45	Vehicle Integration Control Module
46	Shifter Interface Board
47	Humidity Sensor
48	Shifter Interface Board
49	Interior Rearview Mirror
50	–
51	Electric Brake Boost
52	–
54	A/C Control Module

Fuses	Usage
55	Rechargeable Energy Storage System Coolant Pump
56	–
57	Power Electronics Coolant Pump
58	Engine Control Module
59	–
60	HVAC Electric Heater
61	On-board Charging Module
62	Transmission Range Control Module 1
63	Electric Cooling Fan
64	Engine Control Module
65	Auxiliary Heater Pump
66	Powertrain
67	Drive Unit Controller
70	A/C Control Module
71	–
72	Transmission Range Control Module

Fuses	Usage
73	Single Power Inverter Module
74	–
Relays	Usage
6	Pedestrian Friendly Alert Function
14	Liftgate
21	–
25	Powertrain
53	Run/Crank
68	Rear Window Defogger
69	Second Run/Crank

### Instrument Panel Fuse Block

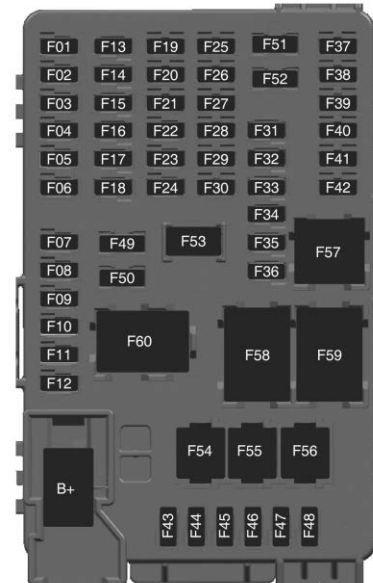

The instrument panel fuse block is on the left side of the instrument panel. To access the fuses, open the fuse panel door by pulling out.

To reinstall the door, insert the top tab first, then push the door back into its original location.

<b>Fuses</b>	<b>Usage</b>
F01	Video Processing Module
F02	Indicator Light Solar Sensor
F03	Side Blind Zone Alert
F04	Passive Entry, Passive Start
F05	CGM – Central Gateway Module
F06	Body Control Module 4
F07	Body Control Module 3
F08	Body Control Module 2
F09	Body control module 1
F10	Police SSV
F11	Amplifier
F12	Body Control Module 8
F13	Data Link Connector
F14	Parking Assist

<b>Fuses</b>	<b>Usage</b>
F15	Headlamp LH
F16	Single Power Inverter Module 1
F17	Body Control Module 6
F18	Body Control Module 5
F19	–
F20	–
F21	–
F22	–
F23	USB
F24	Wireless Charging Module
F25	Reflected LED Alert Display
F26	Heated Steering Wheel
F27	CGM – Central Gateway Module 2
F28	Instrument Cluster 2
F29	–
F30	–
F31	TCP – Telematics Control Platform (OnStar)
F32	–

<b>Fuses</b>	<b>Usage</b>
F33	Heating, Ventilation, and Air Conditioning Module
F34	Heating, Ventilation and Air Conditioning Display/Integrated Center Stack
F35	Instrument Cluster 1
F36	Center Stack Module
F37	–
F38	–
F39	–
F40	–
F41	–
F42	–
F43	Body Control Module 7
F44	Sensing and Diagnostic Module
F45	Front Camera Module
F46	Vehicle Integration Control Module
F47	Single Power Inverter Module 2
F48	Headlamp RH

Fuses	Usage
F49	Auxiliary Jack
F50	Steering Wheel Controls
F51	–
F52	–
F53	Auxiliary Power Outlet
F54	–
F55	Logistic
F56	Police SSV

Relays	Usage
F57	Police SSV
F58	Logistics Relay
F59	–
F60	Accessory/Retained Accessory Power Relay

## Wheels and Tires

### Tires

Every new GM vehicle has high-quality tires made by a leading tire manufacturer. See the warranty manual for information regarding the tire warranty and where to get service. For additional information refer to the tire manufacturer.

#### Warning

- Poorly maintained and improperly used tires are dangerous.
  - Overloading the tires can cause overheating as a result of too much flexing. There could be a blowout and a serious crash. See *Vehicle Load Limits* ⇨ 161.
  - Underinflated tires pose the same danger as overloaded tires. The resulting crash could cause serious injury. Check all tires frequently to
- (Continued)

#### Warning (Continued)

maintain the recommended pressure. Tire pressure should be checked when the tires are cold.

- Overinflated tires are more likely to be cut, punctured, or broken by a sudden impact — such as when hitting a pothole. Keep tires at the recommended pressure.
- Worn or old tires can cause a crash. If the tread is badly worn, replace them.
- Replace any tires that have been damaged by impacts with potholes, curbs, etc.
- Improperly repaired tires can cause a crash. Only your dealer or an authorized tire service center should repair, replace, dismount, and mount the tires.

(Continued)

**Warning (Continued)**

- Do not spin the tires in excess of 56 km/h (35 mph) on slippery surfaces such as snow, mud, ice, etc. Excessive spinning may cause the tires to explode.

**All-Season Tires**

This vehicle may come with all-season tires. These tires are designed to provide good overall performance on most road surfaces and weather conditions. Original equipment tires designed to GM's specific tire performance criteria have a TPC specification code molded onto the sidewall. Original equipment all-season tires can be identified by the last two characters of this TPC code, which will be "MS."

Consider installing winter tires on the vehicle if frequent driving on snow or ice-covered roads is expected. All-season tires provide adequate performance for most winter driving conditions, but they may not offer the same level of traction or performance as winter tires on snow or ice-covered roads. See *Winter Tires* ⇨ 238.

**Winter Tires**

This vehicle was not originally equipped with winter tires. Winter tires are designed for increased traction on snow and ice-covered roads. Consider installing winter tires on the vehicle if frequent driving on ice or snow covered roads is expected. See your dealer for details regarding winter tire availability and proper tire selection. Also, see *Buying New Tires* ⇨ 249.

With winter tires, there may be decreased dry road traction, increased road noise, and shorter tread life. After changing to winter tires, be alert for changes in vehicle handling and braking.

If using winter tires:

- Use tires of the same brand and tread type on all four wheel positions.
- Use only radial ply tires of the same size, load range, and speed rating as the original equipment tires.

Winter tires with the same speed rating as the original equipment tires may not be available for H, V, W, Y, and ZR speed rated tires. If winter tires with a lower speed rating are chosen, never exceed the tire's maximum speed capability.

**Self-Sealing Tires**

This vehicle may have self-sealing tires. These tires have a material inside that can seal punctures from common road hazards, such as nails and screws, in the tread area. The tire may lose air pressure if the sidewall is damaged or the tread puncture is too large. If the Tire Pressure Monitor System indicates the tire pressure is low, inspect the tire for damage and inflate it to the recommended pressure. If the tire is unable to maintain the recommended pressure, contact the nearest authorized GM servicing facility immediately for inspection and repair or replacement. To locate the nearest GM servicing facility, call GM Customer Assistance.

**Caution**

Do not drive on a deflated self-sealing tire as this could damage the tire. Make sure the tire is inflated to the recommended pressure or have it immediately repaired or replaced.

When tire replacement is needed replace with a self-sealing tire, because the vehicle does not come with a spare tire or tire changing equipment.

## Summer Tires

### High Performance Summer Tires

This vehicle may come with 215/50R17 high performance summer tires. These tires have a special tread and compound that are optimized for maximum dry and wet road performance. This special tread and compound will have decreased performance in cold climates, and on ice and snow. It is recommended that winter tires be installed on the vehicle if frequent driving at temperatures below approximately 5 °C (40 °F) or on ice or snow covered roads is expected. See *Winter Tires* ⇨ 238.

#### Caution

High performance summer tires have rubber compounds that lose flexibility and may develop surface cracks in the tread area at temperatures below -7 °C (20 °F). Always store high performance summer tires indoors and at temperatures above -7 °C (20 °F) when not in use. If the tires have been subjected to -7 °C (20 °F) or less, let them warm up in a heated space to at least 5 °C (40 °F) for 24 hours or more before

(Continued)

#### Caution (Continued)

being installed or driving a vehicle on which they are installed. Do not apply heat or blow heated air directly on the tires. Always inspect tires before use. See *Tire Inspection* ⇨ 247.

### Tire Sidewall Labeling

Useful information about a tire is molded into its sidewall. The example shows a typical passenger tire sidewall.

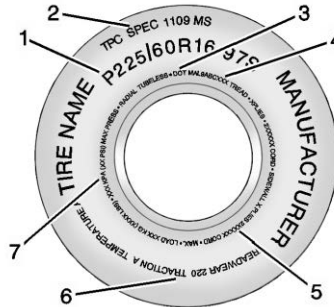

Passenger (P-Metric) Tire Example

**(1) Tire Size :** The tire size is a combination of letters and numbers used to define a particular tire's width, height, aspect ratio, construction type, and service description. See the "Tire Size" illustration later in this section.

**(2) TPC Spec (Tire Performance Criteria Specification) :** Original equipment tires designed to GM's specific tire performance criteria have a TPC specification code molded onto the sidewall. GM's TPC specifications meet or exceed all federal safety guidelines.

**(3) DOT (Department of Transportation) :** The Department of Transportation (DOT) code indicates that the tire is in compliance with the U.S. Department of Transportation Motor Vehicle Safety Standards.

**DOT Tire Date of Manufacture :** The last four digits of the TIN indicate the tire manufactured date. The first two digits represent the week and the last two digits, the year. For example, the third week of the year 2020 would have a



4-digit DOT date of 0320. Week 01 is the first full week (Sunday through Saturday) of each year.

**(4) Tire Identification Number (TIN) :** The letters and numbers following the DOT code are the Tire Identification Number (TIN). The TIN shows the manufacturer and plant code, tire size, and date the tire was manufactured. The TIN is molded onto both sides of the tire, although only one side may have the date of manufacture.

**(5) Tire Ply Material :** The type of cord and number of plies in the sidewall and under the tread.

**(6) Uniform Tire Quality Grading (UTQG) :** Tire manufacturers are required to grade tires based on three performance factors: treadwear, traction, and temperature resistance. For more information see *Uniform Tire Quality Grading* ⇨ 251.

**(7) Maximum Cold Inflation Load Limit :** Maximum load that can be carried and the maximum pressure needed to support that load.

## Tire Designations

### Tire Size

The example shows a typical passenger vehicle tire size.

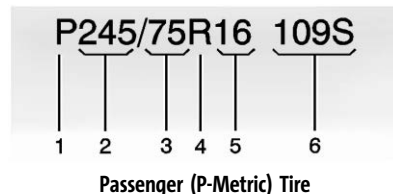

**(1) Passenger (P-Metric) Tire :** The United States version of a metric tire sizing system. The letter "P" as the first character in the tire size means a passenger vehicle tire engineered to standards set by the U.S. Tire and Rim Association.

**(2) Tire Width :** The 3-digit number indicates the tire section width in millimeters from sidewall to sidewall.

**(3) Aspect Ratio :** A 2-digit number that indicates the tire height-to-width measurements. For example, if the tire size aspect ratio is 75, as shown in

item (3) of the illustration, it would mean that the tire's sidewall is 75 percent as high as it is wide.

**(4) Construction Code :** A letter code is used to indicate the type of ply construction in the tire. The letter "R" means radial ply construction; the letter "D" means diagonal or bias ply construction.

**(5) Rim Diameter :** Diameter of the wheel in inches.

**(6) Service Description :** These characters represent the load index and speed rating of the tire. The load index represents the load carrying capacity a tire is certified to carry. The speed rating is the maximum speed a tire is certified to carry a load.

## Tire Terminology and Definitions

**Air Pressure :** The amount of air inside the tire pressing outward on each square inch of the tire. Air pressure is expressed in kPa (kilopascal) or psi (pounds per square inch).

**Accessory Weight** : The combined weight of optional accessories. Some examples of optional accessories are, electric drive unit, power windows, power seats, and air conditioning.

**Aspect Ratio** : The relationship of a tire's height to its width.

**Belt** : A rubber coated layer of cords that is located between the plies and the tread. Cords may be made from steel or other reinforcing materials.

**Bead** : The tire bead contains steel wires wrapped by steel cords that hold the tire onto the rim.

**Bias Ply Tire** : A pneumatic tire in which the plies are laid at alternate angles less than 90 degrees to the centerline of the tread.

**Cold Tire Pressure** : The amount of air pressure in a tire, measured in kPa (kilopascal) or psi (pounds per square inch) before a tire has built up heat from driving. See *Tire Pressure* ⇨ 243.

**Curb Weight** : The weight of a motor vehicle with standard and optional equipment including the maximum capacity of fuel, oil, and coolant, but without passengers and cargo.

**DOT Markings** : A code molded into the sidewall of a tire signifying that the tire is in compliance with the U.S. Department of Transportation (DOT) Motor Vehicle Safety Standards. The DOT code includes the Tire Identification Number (TIN), an alphanumeric designator which can also identify the tire manufacturer, production plant, brand, and date of production.

**GAWR FRT** : Gross Axle Weight Rating for the front axle. See *Vehicle Load Limits* ⇨ 161.

**GAWR RR** : Gross Axle Weight Rating for the rear axle. See *Vehicle Load Limits* ⇨ 161.

**GVWR** : Gross Vehicle Weight Rating. See *Vehicle Load Limits* ⇨ 161.

**Intended Outboard Sidewall** : The side of an asymmetrical tire, that must always face outward when mounted on a vehicle.

**Kilopascal (kPa)** : The metric unit for air pressure.

**Light Truck (LT-Metric) Tire** : A tire used on light duty trucks and some multipurpose passenger vehicles.

**Load Index** : An assigned number ranging from 1 to 279 that corresponds to the load carrying capacity of a tire.

**Maximum Inflation Pressure** : The maximum air pressure to which a cold tire can be inflated. The maximum air pressure is molded onto the sidewall.

**Maximum Load Rating** : The load rating for a tire at the maximum permissible inflation pressure for that tire.

**Maximum Loaded Vehicle Weight** : The sum of curb weight, accessory weight, vehicle capacity weight, and production options weight.

**Normal Occupant Weight** : The number of occupants a vehicle is designed to seat multiplied by 68 kg (150 lbs). See *Vehicle Load Limits* ⇨ 161.

**Occupant Distribution** : Designated seating positions.

**Outward Facing Sidewall** : The side of an asymmetrical tire that has a particular side that faces outward when mounted on a vehicle. The side of the tire that contains a whitewall, bears white lettering, or bears manufacturer, brand, and/or model name molding that is higher or deeper than the same moldings on the other sidewall of the tire.

**Passenger (P-Metric) Tire** : A tire used on passenger cars and some light duty trucks and multipurpose vehicles.

**Recommended Inflation Pressure** : Vehicle manufacturer's recommended tire inflation pressure as shown on the tire placard. See *Tire Pressure* ⇨ 243 and *Vehicle Load Limits* ⇨ 161.

**Radial Ply Tire** : A pneumatic tire in which the ply cords that extend to the beads are laid at 90 degrees to the centerline of the tread.

**Rim** : A metal support for a tire and upon which the tire beads are seated.

**Sidewall** : The portion of a tire between the tread and the bead.

**Speed Rating** : An alphanumeric code assigned to a tire indicating the maximum speed at which a tire can operate.

**Traction** : The friction between the tire and the road surface. The amount of grip provided.

**Tread** : The portion of a tire that comes into contact with the road.

**Treadwear Indicators** : Narrow bands, sometimes called wear bars, that show across the tread of a tire when only 1.6 mm (1/16 in) of tread remains. See *When It Is Time for New Tires* ⇨ 249.

**UTQGS (Uniform Tire Quality Grading Standards)** : A tire information system that provides consumers with ratings for a tire's traction, temperature, and treadwear. Ratings are determined by tire manufacturers using government testing procedures. The ratings are molded into the sidewall of the tire. See *Uniform Tire Quality Grading* ⇨ 251.

**Vehicle Capacity Weight** : The number of designated seating positions multiplied by 68 kg (150 lbs) plus the rated cargo load. See *Vehicle Load Limits* ⇨ 161.

**Vehicle Maximum Load on the Tire** : Load on an individual tire due to curb weight, accessory weight, occupant weight, and cargo weight.

**Vehicle Placard** : A label permanently attached to a vehicle showing the vehicle's capacity weight and the original equipment tire size and recommended inflation pressure. See "Tire and Loading Information Label" under *Vehicle Load Limits* ⇨ 161.

## Tire Pressure

Tires need the correct amount of air pressure to operate effectively.

### Warning

Neither tire underinflation nor overinflation is good. Underinflated tires, or tires that do not have enough air, can result in:

- Tire overloading and overheating which could lead to a blowout.
- Premature or irregular wear.
- Poor handling.
- Reduced battery-electric range.

Overinflated tires, or tires that have too much air, can result in:

- Unusual wear.
- Poor handling.
- Rough ride.
- Needless damage from road hazards.

The Tire and Loading Information label on the vehicle indicates the original equipment tires and the correct cold tire inflation pressures. The recommended pressure is the minimum air pressure needed to support the vehicle's maximum load carrying capacity. See *Vehicle Load Limits* ⇨ 161.

How the vehicle is loaded affects vehicle handling and ride comfort. Never load the vehicle with more weight than it was designed to carry.

### When to Check

Check the pressure of the tires once a month or more.

### How to Check

Use a good quality pocket-type gauge to check the tire pressure. Proper tire inflation cannot be determined by looking at the tire. Check the tire inflation pressure when the tires are cold, meaning the vehicle has not been driven for at least three hours or no more than 1.6 km (1 mi).

Remove the valve cap from the tire valve stem. Press the tire gauge firmly onto the valve to get the pressure measurement. If the cold tire inflation pressure matches the recommended pressure on the Tire and Loading Information label, no further adjustment is necessary.

If the inflation pressure is low, add air until the recommended pressure is reached. If the inflation pressure is high, press on the metal stem in the center of the tire valve to release air. Re-check the tire pressure with the tire gauge.

Put the valve caps back on the valve stems to keep out dirt and moisture. Use only valve caps designed for the vehicle by GM. TPMS sensors could be damaged and would not be covered by the vehicle warranty.

### Tire Pressure Monitor System

The Tire Pressure Monitor System (TPMS) uses radio and sensor technology to check tire pressure levels. The TPMS sensors

monitor the air pressure in your tires and transmit tire pressure readings to a receiver located in the vehicle.

Each tire, including the spare (if provided), should be checked monthly when cold and inflated to the inflation pressure recommended by the vehicle manufacturer on the vehicle placard or tire inflation pressure label. (If your vehicle has tires of a different size than the size indicated on the vehicle placard or tire inflation pressure label, you should determine the proper tire inflation pressure for those tires.)

As an added safety feature, your vehicle has been equipped with a tire pressure monitoring system (TPMS) that illuminates a low tire pressure telltale when one or more of your tires is significantly under-inflated.

Accordingly, when the low tire pressure telltale illuminates, you should stop and check your tires as soon as possible, and inflate them to the proper pressure. Driving on a significantly under-inflated tire causes the tire to overheat and can lead to tire failure. Under-inflation also reduces fuel efficiency and tire tread life, and may affect the vehicle's handling and stopping ability.

Please note that the TPMS is not a substitute for proper tire maintenance, and it is the driver's responsibility to maintain correct tire pressure, even if under-inflation has not reached the level to trigger illumination of the TPMS low tire pressure telltale.

Your vehicle has also been equipped with a TPMS malfunction indicator to indicate when the system is not operating properly. The TPMS malfunction indicator is combined with the low tire pressure telltale. When the system detects a malfunction, the telltale will flash for approximately one minute and then remain continuously illuminated. This sequence will continue upon subsequent vehicle start-ups as long as the malfunction exists.

When the malfunction indicator is illuminated, the system may not be able to detect or signal low tire pressure as intended. TPMS malfunctions may occur for a variety of reasons, including the installation of replacement or alternate tires or wheels on the vehicle that prevent the TPMS from functioning properly. Always check the TPMS malfunction telltale after replacing one or more tires or wheels on

your vehicle to ensure that the replacement or alternate tires and wheels allow the TPMS to continue to function properly.

See *Tire Pressure Monitor Operation* ⇨ 244.

See *Radio Frequency Statement* ⇨ 294.

## **Tire Pressure Monitor Operation**

This vehicle may have a Tire Pressure Monitor System (TPMS). The TPMS is designed to warn the driver when a low tire pressure condition exists. TPMS sensors are mounted onto each tire and wheel assembly, excluding the spare tire and wheel assembly. The TPMS sensors monitor the air pressure in the tires and transmits the tire pressure readings to a receiver located in the vehicle.



When a low tire pressure condition is detected, the TPMS illuminates the low tire pressure warning light located on the instrument cluster. If the warning light comes on, stop as soon as possible and

inflate the tires to the recommended pressure shown on the Tire and Loading Information label. See *Vehicle Load Limits* ⇨ 161.

A message to check the pressure in a specific tire displays in the Driver Information Center (DIC). The low tire pressure warning light and the DIC warning message come on at each ignition cycle using POWER ⏻ until the tires are inflated to the correct inflation pressure. Using the DIC, tire pressure levels can be viewed. For additional information and details about the DIC operation and displays see *Driver Information Center (DIC)* ⇨ 98.

The low tire pressure warning light may come on in cool weather when the vehicle is first started, and then turn off as the vehicle is driven. This could be an early indicator that the air pressure is getting low and needs to be inflated to the proper pressure.

A Tire and Loading Information label, attached to your vehicle, shows the size of the original equipment tires and the correct inflation pressure for the tires when they are cold. See *Vehicle Load Limits* ⇨ 161, for an example of the Tire and Loading Information label and its location. Also see *Tire Pressure* ⇨ 243.

The TPMS can warn about a low tire pressure condition but it does not replace normal tire maintenance. See *Tire Inspection* ⇨ 247, *Tire Rotation* ⇨ 248 and *Tires* ⇨ 237.

### Caution

Tire sealant materials are not all the same. A non-approved tire sealant could damage the TPMS sensors. TPMS sensor damage caused by using an incorrect tire sealant is not covered by the vehicle warranty. Always use only the GM approved tire sealant available through your dealer or included in the vehicle.

Factory-installed Tire Inflator Kits use a GM-approved liquid tire sealant. Using non-approved tire sealants could damage the TPMS sensors. See *Tire Sealant and Compressor Kit* ⇨ 254 for information regarding the inflator kit materials and instructions.

### TPMS Malfunction Light and Message

The TPMS will not function properly if one or more of the TPMS sensors are missing or inoperable. When the system detects a malfunction, the low tire warning light flashes for about one minute and then stays

on for the remainder of the ignition cycle using POWER ⏻. A DIC warning message also displays. The malfunction light and DIC warning message come on at each ignition cycle using POWER ⏻ until the problem is corrected. Some of the conditions that can cause these to come on are:

- One of the road tires has been replaced with the spare tire. The spare tire does not have a TPMS sensor. The malfunction light and DIC message should go off after the road tire is replaced and the sensor matching process is performed successfully. See "TPMS Sensor Matching Process" later in this section.
- The TPMS sensor matching process was not done or not completed successfully after rotating the tires. The malfunction light and the DIC message should go off after successfully completing the sensor matching process. See "TPMS Sensor Matching Process" later in this section.
- One or more TPMS sensors are missing or damaged. The malfunction light and the DIC message should go off when the TPMS sensors are installed and the sensor matching process is performed successfully. See your dealer for service.

- Replacement tires or wheels do not match the original equipment tires or wheels. Tires and wheels other than those recommended could prevent the TPMS from functioning properly. See *Buying New Tires* ⇨ 249.
- Operating electronic devices or being near facilities using radio wave frequencies similar to the TPMS could cause the TPMS sensors to malfunction.

If the TPMS is not functioning properly it cannot detect or signal a low tire condition. See your dealer for service if the TPMS malfunction light and DIC message come on and stay on.

### Tire Fill Alert (If Equipped)

This feature provides visual and audible alerts outside the vehicle to help when inflating an underinflated tire to the recommended cold tire pressure.

When the low tire pressure warning light comes on:

1. Park the vehicle in a safe, level place.
2. Set the parking brake firmly.
3. Place the vehicle in P (Park).
4. Add air to the tire that is underinflated. The turn signal lamp will flash.

When the recommended pressure is reached, the horn sounds once and the turn signal lamp will stop flashing and briefly turn solid.

Repeat these steps for all underinflated tires that have illuminated the low tire pressure warning light.

#### Warning

Overinflating a tire could cause the tire to rupture and you or others could be injured. Do not exceed the maximum pressure listed on the tire sidewall. See *Tire Sidewall Labeling* ⇨ 239 and *Vehicle Load Limits* ⇨ 161.

If the tire is overinflated by more than 35 kPa (5 psi), the horn will sound multiple times and the turn signal lamp will continue to flash for several seconds after filling stops. To release and correct the pressure, while the turn signal lamp is still flashing, briefly press the center of the valve stem. When the recommended pressure is reached, the horn sounds once.

If the turn signal lamp does not flash within 15 seconds after starting to inflate the tire, the tire fill alert has not been activated or is not working.

If the hazard warning flashers are on, the tire fill alert visual feedback will not work properly.

The TPMS will not activate the tire fill alert properly under the following conditions:

- There is interference from an external device or transmitter.
- The air pressure from the inflation device is not sufficient to inflate the tire.
- There is a malfunction in the TPMS.
- There is a malfunction in the horn or turn signal lamps.
- The identification code of the TPMS sensor is not registered to the system.
- The battery of the TPMS sensor is low.

If the tire fill alert does not operate due to TPMS interference, move the vehicle about 1 m (3 ft) back or forward and try again. If the tire fill alert feature is not working, use a tire pressure gauge.

### TPMS Sensor Matching Process

Each TPMS sensor has a unique identification code. The identification code needs to be matched to a new tire/wheel position after rotating the vehicle's tires or replacing one or more of the TPMS sensors. The TPMS sensor matching process should

also be performed after replacing a spare tire with a road tire containing the TPMS sensor. The malfunction light and the DIC message should go off at the next ignition cycle using POWER . The sensors are matched to the tire/wheel positions, using a TPMS relearn tool, in the following order: driver side front tire, passenger side front tire, passenger side rear tire, and driver side rear. See your dealer for service or to purchase a relearn tool. A TPMS relearn tool can also be purchased. See Tire Pressure Monitor Sensor Activation Tool at [www.gmtoolsandequipment.com](http://www.gmtoolsandequipment.com) or call 1-800-GM TOOLS (1-800-468-6657).

There are two minutes to match the first tire/wheel position, and five minutes overall to match all four tire/wheel positions. If it takes longer, the matching process stops and must be restarted.

The TPMS sensor matching process is:

1. Set the parking brake.
2. Press POWER  to start the vehicle. See *Power Button* ⇨ 164.

3. Make sure the Tire Pressure info page option is turned on. The info pages on the DIC can be turned on and off through the Options menu. See *Driver Information Center (DIC)* ⇨ 98.
4. Use the DIC controls on the right side of the steering wheel to scroll to the Tire Pressure screen under the DIC info page.
5. Press and hold the thumbwheel in the center of the DIC controls.

A message requesting acceptance of the process may display.

The horn sounds twice to signal the receiver is in relearn mode and the TIRE LEARNING ACTIVE message displays on the DIC screen.

6. Start with the driver side front tire.
7. Place the relearn tool against the tire sidewall, near the valve stem. Then press the button to activate the TPMS sensor. A horn chirp confirms that the sensor identification code has been matched to this tire and wheel position.
8. Proceed to the passenger side front tire, and repeat the procedure in Step 7.
9. Proceed to the passenger side rear tire, and repeat the procedure in Step 7.

10. Proceed to the driver side rear tire, and repeat the procedure in Step 7. The horn sounds two times to indicate the sensor identification code has been matched to the driver side rear tire, and the TPMS sensor matching process is no longer active. The TIRE LEARNING ACTIVE message on the DIC display screen goes off.
11. Turn the vehicle off.
12. Set all four tires to the recommended air pressure level as indicated on the Tire and Loading Information label.

## Tire Inspection

We recommend that the tires, including the spare tire, if the vehicle has one, be inspected for signs of wear or damage at least once a month.

Replace the tire if:

- The indicators at three or more places around the tire can be seen.
- There is cord or fabric showing through the tire's rubber.
- The tread or sidewall is cracked, cut, or snagged deep enough to show cord or fabric.



- The tire has a bump, bulge, or split.
- The tire has a puncture, cut, or other damage that cannot be repaired well because of the size or location of the damage.

## Tire Rotation

Tires should be rotated every 12 000 km (7,500 mi). See *Maintenance Schedule* ⇨ 275.

Tires are rotated to achieve a more uniform wear for all tires. The first rotation is the most important.

Anytime unusual wear is noticed, rotate the tires as soon as possible, check for proper tire inflation pressure, and check for damaged tires or wheels. If the unusual wear continues after the rotation, check the wheel alignment.

See *When It Is Time for New Tires*

⇨ 249 and

*Wheel Replacement* ⇨ 252.

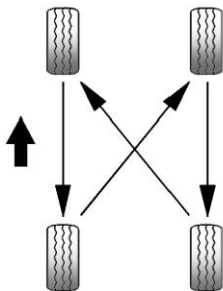

Use this rotation pattern when rotating the tires.

Adjust the front and rear tires to the recommended inflation pressure on the Tire and Loading Information label after the tires have been rotated. See *Tire Pressure* ⇨ 243 and *Vehicle Load Limits* ⇨ 161.

Reset the Tire Pressure Monitor System. See *Tire Pressure Monitor Operation* ⇨ 244.

Check that all wheel nuts are properly tightened. See “Wheel Nut Torque” under *Capacities and Specifications* ⇨ 284.

### Warning

Rust or dirt on a wheel, or on the parts to which it is fastened, can cause wheel nuts to become loose over time. The wheel could come off and cause a crash. When changing a wheel, remove any rust or dirt from places where the wheel attaches to the vehicle. In an emergency, a cloth or paper towel can be used; however, use a scraper or wire brush later to remove all rust or dirt.

Lightly coat the inner diameter of the wheel hub opening with wheel bearing grease after a wheel change or tire rotation to prevent corrosion or rust buildup.

### Warning

Do not apply grease to the wheel mounting surface, wheel conical seats, or the wheel nuts or bolts. Grease applied to these areas could cause a wheel to become loose or come off, resulting in a crash.

## When It Is Time for New Tires

Factors, such as maintenance, temperatures, driving speeds, vehicle loading, and road conditions affect the wear rate of the tires.

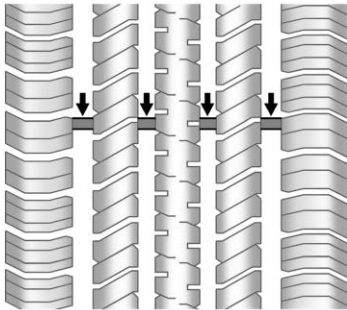

Treadwear indicators are one way to tell when it is time for new tires. Treadwear indicators appear when the tires have only 1.6 mm (1/16 in) or less of tread remaining. See *Tire Inspection* ⇨ 247 and *Tire Rotation* ⇨ 248 for additional information.

The rubber in tires ages over time. This also applies to the spare tire, if the vehicle has one, even if it is never used. Multiple factors including temperatures, loading conditions, and inflation pressure maintenance affect

how fast aging takes place. GM recommends that tires, including the spare if equipped, be replaced after six years, regardless of tread wear. To identify the age of a tire, use the tire manufacture date, which is the last four digits of the DOT Tire Identification Number (TIN) molded into one side of the tire sidewall. The last four digits of the TIN indicate the tire manufactured date. The first two digits represent the week and the last two digits, the year. For example, the third week of the year 2020 would have a 4-digit DOT date of 0320. Week 01 is the first full week (Sunday through Saturday) of each year.

### Vehicle Storage

Tires age when stored normally mounted on a parked vehicle. Park a vehicle that will be stored for at least a month in a cool, dry, clean area away from direct sunlight to slow aging. This area should be free of grease, gasoline, or other substances that can deteriorate rubber.

Parking for an extended period can cause flat spots on the tires that may result in vibrations while driving. When storing a vehicle for at least a month, remove the tires or raise the vehicle to reduce the weight from the tires.

## Buying New Tires

GM has developed and matched specific tires for the vehicle. The original equipment tires installed were designed to meet General Motors Tire Performance Criteria Specification (TPC Spec) system rating. When replacement tires are needed, GM strongly recommends buying tires with the same TPC Spec rating.

GM's exclusive TPC Spec system considers over a dozen critical specifications that impact the overall performance of the vehicle, including brake system performance, ride and handling, traction control, and tire pressure monitoring performance. GM's TPC Spec number is molded onto the tire's sidewall near the tire size. If the tires have an all-season tread design, the TPC Spec number will be followed by MS for mud and snow. See *Tire Sidewall Labeling* ⇨ 239 for additional information.

GM recommends replacing worn tires in complete sets of four. Uniform tread depth on all tires will help to maintain the performance of the vehicle. Braking and handling performance may be adversely affected if all the tires are not replaced at the same time. If proper rotation and maintenance have been done, all four tires should wear out at about the same time. However, if it is necessary to replace only one axle set of worn tires, place the new tires on the rear axle. See *Tire Rotation* ⇨ 248.

### Warning

Tires could explode during improper service. Attempting to mount or dismount a tire could cause injury or death. Only your dealer or authorized tire service center should mount or dismount the tires.

### Warning

Mixing tires of different sizes (other than those originally installed on the vehicle), brands, tread patterns, or types may cause loss of vehicle control, resulting in a crash or other vehicle damage. Use the correct size, brand, and type of tire on all wheels.

### Warning

Using bias-ply tires on the vehicle may cause the wheel rim flanges to develop cracks after many miles of driving. A tire and/or wheel could fail suddenly and cause a crash. Use only radial-ply tires with the wheels on the vehicle.

Winter tires with the same speed rating as the original equipment tires may not be available for H, V, W, Y and ZR speed rated tires. Never exceed the winter tires' maximum speed capability when using winter tires with a lower speed rating.

If the vehicle tires must be replaced with a tire that does not have a TPC Spec number, make sure they are the same size, load range, speed rating, and construction (radial) as the original tires.

The Tire and Loading Information label indicates the original equipment tires on the vehicle. See *Vehicle Load Limits* ⇨ 161.

## Different Size Tires and Wheels

If wheels or tires are installed that are a different size than the original equipment wheels and tires, vehicle performance, including its braking, ride and handling characteristics, stability, and resistance to rollover may be affected. If the vehicle has electronic systems such as antilock brakes, rollover airbags, traction control, electronic stability control, or All-Wheel Drive, the performance of these systems can also be affected.

**⚠ Warning**

If different sized wheels are used, there may not be an acceptable level of performance and safety if tires not recommended for those wheels are selected. This increases the chance of a crash and serious injury. Only use GM specific wheel and tire systems developed for the vehicle, and have them properly installed by a GM certified technician.

See *Buying New Tires* ⇨ 249 and *Accessories and Modifications* ⇨ 216.

**Uniform Tire Quality Grading**

The following information relates to the system developed by the United States National Highway Traffic Safety Administration (NHTSA), which grades tires by treadwear, traction, and temperature performance. This applies only to vehicles sold in the United States. The grades are molded on the sidewalls of most passenger car tires. The Uniform Tire Quality Grading (UTQG) system does not apply to deep tread, winter tires, compact spare tires,

tires with nominal rim diameters of 10 to 12 inches (25 to 30 cm), or to some limited-production tires.

While the tires available on General Motors passenger cars and light trucks may vary with respect to these grades, they must also conform to federal safety requirements and additional General Motors Tire Performance Criteria (TPC) standards.

Quality grades can be found where applicable on the tire sidewall between tread shoulder and maximum section width. For example:

**Treadwear 200 Traction AA Temperature A**

All Passenger Car Tires Must Conform to Federal Safety Requirements In Addition To These Grades.

**Treadwear**

The treadwear grade is a comparative rating based on the wear rate of the tire when tested under controlled conditions on a specified government test course. For example, a tire graded 150 would wear one and one-half (1½)

times as well on the government course as a tire graded 100. The relative performance of tires depends upon the actual conditions of their use, however, and may depart significantly from the norm due to variations in driving habits, service practices and differences in road characteristics and climate.

**Traction**

The traction grades, from highest to lowest, are AA, A, B, and C. Those grades represent the tire's ability to stop on wet pavement as measured under controlled conditions on specified government test surfaces of asphalt and concrete. A tire marked C may have poor traction performance. **Warning:** The traction grade assigned to this tire is based on straight-ahead braking traction tests, and does not include acceleration, cornering, hydroplaning, or peak traction characteristics.

## Temperature

The temperature grades are A (the highest), B, and C, representing the tire's resistance to the generation of heat and its ability to dissipate heat when tested under controlled conditions on a specified indoor laboratory test wheel. Sustained high temperature can cause the material of the tire to degenerate and reduce tire life, and excessive temperature can lead to sudden tire failure. The grade C corresponds to a level of performance which all passenger car tires must meet under the Federal Motor Safety Standard No. 109. Grades B and A represent higher levels of performance on the laboratory test wheel than the minimum required by law. **Warning:** The temperature grade for this tire is established for a tire that is properly inflated and not overloaded. Excessive speed, underinflation, or excessive loading, either separately or in combination, can cause heat buildup and possible tire failure.

## Wheel Alignment and Tire Balance

The tires and wheels were aligned and balanced at the factory to provide the longest tire life and best overall performance. Adjustments to wheel alignment and tire balancing are not necessary on a regular basis. Consider an alignment check if there is unusual tire wear or the vehicle is significantly pulling to one side or the other. Some slight pull to the left or right, depending on the crown of the road and/or other road surface variations such as troughs or ruts, is normal. If the vehicle is vibrating when driving on a smooth road, the tires and wheels may need to be rebalanced. See your dealer for proper diagnosis.

## Wheel Replacement

Replace any wheel that is bent, cracked, or badly rusted or corroded. If wheel nuts keep coming loose, the wheel, wheel bolts, and wheel nuts should be replaced. If the wheel leaks air, replace it. Some aluminum wheels can be repaired. See your dealer if any of these conditions exist.

Your dealer will know the kind of wheel that is needed.

Each new wheel should have the same load-carrying capacity, diameter, width, offset, and be mounted the same way as the one it replaces.

Replace wheels, wheel bolts, wheel nuts, or Tire Pressure Monitor System (TPMS) sensors with new GM original equipment parts.

### Warning

Using the wrong replacement wheels, wheel bolts, or wheel nuts can be dangerous. It could affect the braking and handling of the vehicle. Tires can lose air, and cause loss of control, causing a crash. Always use the correct wheel, wheel bolts, and wheel nuts for replacement.

### Caution

The wrong wheel can also cause problems with bearing life, brake cooling, speedometer or odometer calibration, headlamp aim, bumper height, vehicle ground clearance, and tire or tire chain clearance to the body and chassis.

## Used Replacement Wheels

### Warning

Replacing a wheel with a used one is dangerous. How it has been used or how far it has been driven may be unknown. It could fail suddenly and cause a crash. When replacing wheels, use a new GM original equipment wheel.

## Tire Chains

### Warning

Do not use tire chains. There is not enough clearance. Tire chains used on a vehicle without the proper amount of clearance can cause damage to the brakes, suspension, or other vehicle parts. The area damaged by the tire chains could cause loss of control and a crash.

Use another type of traction device only if its manufacturer recommends it for the vehicle's tire size combination and road conditions. Follow that manufacturer's instructions. To avoid vehicle damage, drive slow and readjust or remove the

(Continued)

### Warning (Continued)

traction device if it contacts the vehicle. Do not spin the wheels. If traction devices are used, install them on the front tires.

## If a Tire Goes Flat

The vehicle has no spare tire, no tire changing equipment, and no place to store a tire.

If the vehicle has self-sealing tires, see *Self-Sealing Tires* ⇨ 238. Tread punctures typically will not cause tires to lose air. However, if the vehicle does get a flat tire, there is no spare tire, tire changing equipment, or place to store a tire. Contact Roadside Assistance for help.

It is unusual for a tire to blow out while driving, especially if the tires are maintained properly. See *Tires* ⇨ 237. If air goes out of a tire, it is much more likely to leak out slowly. But if there is ever a blowout, here are a few tips about what to expect and what to do.

If a front tire fails, the flat tire creates a drag that pulls the vehicle toward that side. Take your foot off the accelerator pedal and

grip the steering wheel firmly. Steer to maintain lane position, and then gently brake to a stop, well off the road, if possible.

A rear blowout, particularly on a curve, acts much like a skid and may require the same correction as used in a skid. Stop pressing the accelerator pedal and steer to straighten the vehicle. It may be very bumpy and noisy. Gently brake to a stop, well off the road, if possible.

### Warning

Driving on a flat tire will cause permanent damage to the tire. Re-inflating a tire after it has been driven on while severely underinflated or flat may cause a blowout and a serious crash. Never attempt to re-inflate a tire that has been driven on while severely underinflated or flat. Have your dealer or an authorized tire service center repair or replace the flat tire as soon as possible.

If a tire goes flat, avoid further tire and wheel damage by driving slowly to a level place, well off the road, if possible. Turn on the hazard warning flashers. See *Hazard Warning Flashers* ⇨ 108.

This vehicle may come with a tire sealant and compressor kit. To use the tire sealant and compressor kit, see *Tire Sealant and Compressor Kit* ⇨ 254.

## Tire Sealant and Compressor Kit

### Warning

Overinflating a tire could cause the tire to rupture and you or others could be injured. Be sure to read and follow the tire sealant and compressor kit instructions and inflate the tire to its recommended pressure. Do not exceed the recommended pressure.

### Warning

Storing the tire sealant and compressor kit or other equipment in the passenger compartment of the vehicle could cause injury. In a sudden stop or collision, loose equipment could strike someone. Store the tire sealant and compressor kit in its original location.

If this vehicle has a tire sealant and compressor kit, there may not be a spare tire or tire changing equipment, and on some vehicles there may not be a place to store a tire.

The tire sealant and compressor can be used to temporarily seal punctures up to 6 mm (0.25 in) in the tread area of the tire. It can also be used to inflate an underinflated tire.

If the tire has been separated from the wheel, has damaged sidewalls, or has a large puncture, the tire is too severely damaged for the tire sealant and compressor kit to be effective. See *Roadside Assistance Program* ⇨ 289.

Read and follow all of the tire sealant and compressor kit instructions.

The kit includes:

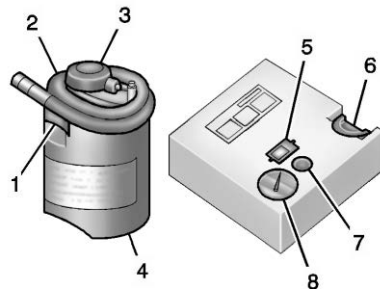

1. Sealant Canister Inlet Valve
2. Sealant/Air Hose
3. Base of Sealant Canister
4. Tire Sealant Canister
5. On/Off Button
6. Slot on Top of Compressor
7. Pressure Deflation Button
8. Pressure Gauge

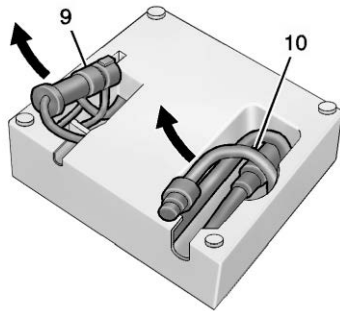

- 9. Power Plug
- 10. Air Only Hose

### Tire Sealant

Read and follow the safe handling instructions on the label adhered to the tire sealant canister (4).

Check the tire sealant expiration date on the tire sealant canister. The tire sealant canister (4) should be replaced before its expiration date. Replacement tire sealant canisters are available at your local dealer.

There is only enough sealant to seal one tire. After usage, the tire sealant canister must be replaced.

### Using the Tire Sealant and Compressor Kit to Temporarily Seal and Inflate a Punctured Tire

When using the tire sealant and compressor kit during cold temperatures, warm the kit in a heated environment for five minutes. This will help to inflate the tire faster.

If a tire goes flat, avoid further tire and wheel damage by driving slowly to a level place. Turn on the hazard warning flashers. See *Hazard Warning Flashers* ⇨ 108.

See *If a Tire Goes Flat* ⇨ 253 for other important safety warnings.

Do not remove any objects that have penetrated the tire.

1. Remove the tire sealant canister (4) and compressor from its storage location. See *Storing the Tire Sealant and Compressor Kit* ⇨ 259.
2. Remove the air only hose (10) and the power plug (9) from the bottom of the compressor.
3. Place the compressor on the ground near the flat tire.

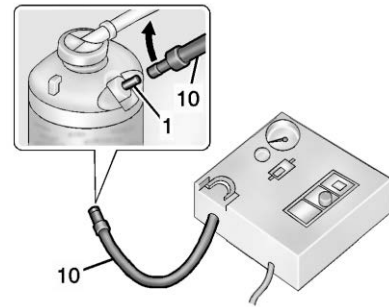

4. Attach the air only hose (10) to the sealant canister inlet valve (1) by turning it clockwise until tight.

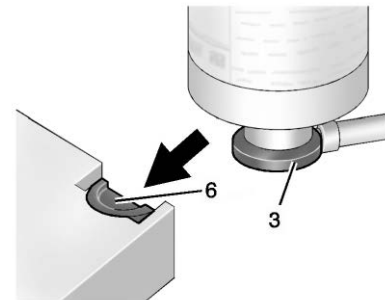



5. Slide the base of the tire sealant canister (3) into the slot on the top of the compressor (6) to hold it upright. Make sure the tire valve stem is positioned close to the ground so the hose will reach it.
6. Remove the valve stem cap from the flat tire by turning it counterclockwise.

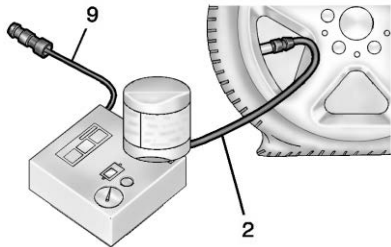

7. Attach the sealant/air hose (2) to the tire valve stem by turning it clockwise until tight.
8. Plug the power plug (9) into the accessory power outlet in the vehicle. Unplug all items from other accessory power outlets. See *Power Outlets* ⇨ 75.

If the vehicle has an accessory power outlet, do not use the cigarette lighter. If the vehicle only has a cigarette lighter, use the cigarette lighter.

Do not pinch the power plug cord in the door or window.

9. Start the vehicle. The vehicle must be running while using the air compressor.
10. Press the on/off button (5) to turn the tire sealant and compressor kit on. The compressor will inject sealant and air into the tire.

The pressure gauge (8) will initially show a high pressure while the compressor pushes the sealant into the tire. Once the sealant is completely dispersed into the tire, the pressure will quickly drop and start to rise again as the tire inflates with air only.

11. Inflate the tire to the recommended inflation pressure using the pressure gauge (8). The recommended inflation pressure can be found on the Tire and Loading Information label. See *Tire Pressure* ⇨ 243.

The pressure gauge (8) may read higher than the actual tire pressure while the compressor is on. Turn the compressor

off to get an accurate pressure reading. The compressor may be turned on/off until the correct pressure is reached.

### Caution

If the recommended pressure cannot be reached after approximately 25 minutes, the vehicle should not be driven farther. The tire is too severely damaged and the tire sealant and compressor kit cannot inflate the tire. Remove the power plug from the accessory power outlet and unscrew the inflating hose from the tire valve. See *Roadside Assistance Program* ⇨ 289.

12. Press the on/off button (5) to turn the tire sealant and compressor kit off. The tire is not sealed and will continue to leak air until the vehicle is driven and the sealant is distributed in the tire. Therefore, Steps 13–21 must be done immediately after Step 12. Be careful while handling the tire sealant and compressor kit as it could be warm after usage.
13. Unplug the power plug (9) from the accessory power outlet in the vehicle.

14. Turn the sealant/air hose (2) counterclockwise to remove it from the tire valve stem.
15. Replace the tire valve stem cap.
16. Remove the tire sealant canister (4) from the slot on top of the compressor (6).
17. Turn the air only hose (10) counterclockwise to remove it from the tire sealant canister inlet valve (1).
18. Turn the sealant/air hose (2) clockwise onto the sealant canister inlet valve (1) to prevent sealant leakage.
19. Return the air only hose (10) and power plug (9) back to their original storage location.



20. If the flat tire was able to inflate to the recommended inflation pressure, remove the maximum speed label from the sealant canister and place it in a highly visible location.

21. Return the equipment to its original storage location in the vehicle.
22. Immediately drive the vehicle 8 km (5 mi) to distribute the sealant in the tire.
23. Stop at a safe location and check the tire pressure. Refer to Steps 1–10 under “Using the Tire Sealant and Compressor Kit without Sealant to Inflate a Tire (Not Punctured).”

If the tire pressure has fallen more than 68 kPa (10 psi) below the recommended inflation pressure, stop driving the vehicle. The tire is too severely damaged and the tire sealant cannot seal the tire. See *Roadside Assistance Program* ⇨ 289.

If the tire pressure has not dropped more than 68 kPa (10 psi) from the recommended inflation pressure, inflate the tire to the recommended inflation pressure.

24. Wipe off any sealant from the wheel, tire, or vehicle.

25. Dispose of the used tire sealant canister (4) at a local dealer or in accordance with local state codes and practices.
26. Replace it with a new canister available from your dealer.
27. After temporarily sealing a tire using the tire sealant and compressor kit, take the vehicle to an authorized dealer within 161 km (100 mi) of driving to have the tire repaired or replaced.

### Using the Tire Sealant and Compressor Kit without Sealant to Inflate a Tire (Not Punctured)

The kit includes:

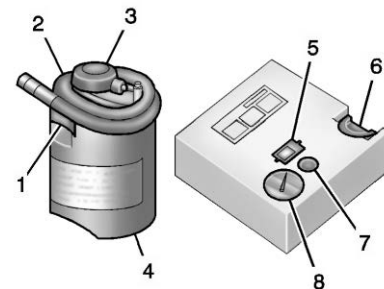

1. Sealant Canister Inlet Valve
2. Sealant/Air Hose
3. Base of Sealant Canister
4. Tire Sealant Canister
5. On/Off Button
6. Slot on Top of Compressor
7. Pressure Deflation Button
8. Pressure Gauge

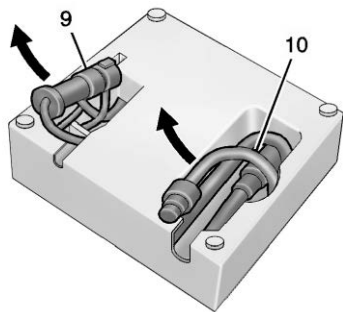

9. Power Plug
10. Air Only Hose

If a tire goes flat, avoid further tire and wheel damage by driving slowly to a level place. Turn on the hazard warning flashers. See *Hazard Warning Flashers* ⇨ 108.

See *If a Tire Goes Flat* ⇨ 253 for other important safety warnings.

1. Remove the compressor from its storage location. See *Storing the Tire Sealant and Compressor Kit* ⇨ 259.
2. Remove the air only hose (10) and the power plug (9) from the bottom of the compressor.
3. Place the compressor on the ground near the flat tire.

Make sure the tire valve stem is positioned close to the ground so the hose will reach it.

4. Remove the valve stem cap from the flat tire by turning it counterclockwise.
5. Attach the air only hose (10) to the tire valve stem by turning it clockwise until tight.
6. Plug the power plug (9) into the accessory power outlet in the vehicle. Unplug all items from other accessory power outlets. See *Power Outlets* ⇨ 75.

If the vehicle has an accessory power outlet, do not use the cigarette lighter.

If the vehicle only has a cigarette lighter, use the cigarette lighter.

Do not pinch the power plug cord in the door or window.

7. Start the vehicle. The vehicle must be running while using the air compressor.
8. Press the on/off button (5) to turn the tire sealant and compressor kit on.  
The compressor will inflate the tire with air only.
9. Inflate the tire to the recommended inflation pressure using the pressure gauge (8). The recommended inflation pressure can be found on the Tire and Loading Information label. See *Tire Pressure* ⇨ 243.

The pressure gauge (8) may read higher than the actual tire pressure while the compressor is on. Turn the compressor off to get an accurate pressure reading. The compressor may be turned on/off until the correct pressure is reached.

### Caution

If the recommended pressure cannot be reached after approximately 25 minutes, the vehicle should not be driven farther. The tire is too severely damaged and the tire sealant and compressor kit cannot inflate the tire. Remove the power plug from the accessory power outlet and

(Continued)

**Caution (Continued)**

unscrew the inflating hose from the tire valve. See *Roadside Assistance Program* ⇨ 289.

10. Press the on/off button (5) to turn the tire sealant and compressor kit off.  
Be careful while handling the compressor as it could be warm after usage.
11. Unplug the power plug (9) from the accessory power outlet in the vehicle.
12. Turn the air only hose (10) counterclockwise to remove it from the tire valve stem.
13. Replace the tire valve stem cap.
14. Return the air only hose (10) and power plug (9) back to their original storage location.
15. Return the equipment to its original storage location in the vehicle.

The tire sealant and compressor kit has accessory adapters located in a compartment on the bottom of its housing that can be used to inflate air mattresses, balls, etc.

**Storing the Tire Sealant and Compressor Kit**

To access the tire sealant and compressor kit:

1. Open the liftgate. See *Liftgate* ⇨ 18.
2. Remove the load floor.

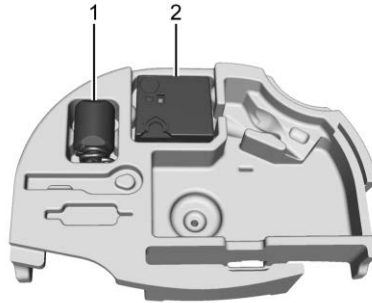

3. Remove the tire sealant canister (1) and the compressor (2).

To store the tire sealant canister and the compressor, reverse the steps.

**Jump Starting****Jump Starting - North America**

For more information about the vehicle battery, see *Battery - North America* ⇨ 223.

If the 12-volt battery has run down, try to use another vehicle and some jumper cables to start your vehicle. Be sure to use the following steps to do it safely.

**⚠ Warning**

The high voltage battery cannot be jump started either with another vehicle or battery charger. Personal injury, death, or damage to the vehicle could result.

**⚠ Warning**

**WARNING:** Battery posts, terminals and related accessories can expose you to chemicals including lead and lead compounds, which are known to the State of California to cause cancer and birth defects or other reproductive harm. Wash hands after handling. For more information go to [www.P65Warnings.ca.gov](http://www.P65Warnings.ca.gov).

See the warning on the back cover.

**Warning**

Batteries can hurt you. They can be dangerous because:

- They contain acid that can burn you.
- They contain gas that can explode or ignite.
- They contain enough electricity to burn you.

If you do not follow these steps exactly, some or all of these things can hurt you.

**Caution**

Ignoring these steps could result in costly damage to the vehicle that would not be covered by the vehicle warranty. Trying to start the vehicle by pushing or pulling it will not work, and it could damage the vehicle.

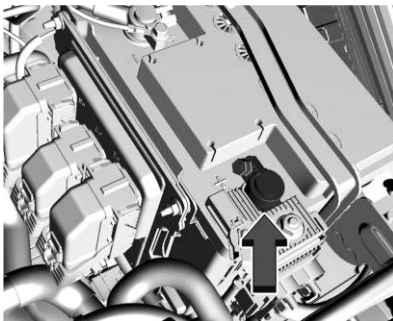

**Discharged Battery Positive (+) Terminal**

The discharged battery positive (+) terminal is on the driver side of the vehicle.

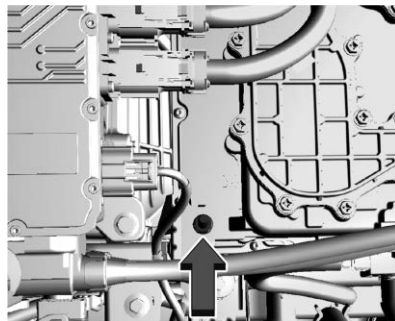

**Discharged Battery Negative (-) Grounding Point**

The discharged battery negative (-) grounding point is a stud on a bracket located near the Accessory Power Module (APM).

The good battery positive (+) terminal and the good battery negative (-) terminal are on the battery of the vehicle providing the jump start.

The discharged battery positive (+) terminal is under a trim cover. Open the cover to expose the terminal.

1. Check the other vehicle. It must have a 12-volt battery with a negative ground system.

**Caution**

If the other vehicle does not have a 12-volt system with a negative ground, both vehicles can be damaged. Only use a vehicle that has a 12-volt system with a negative ground for jump starting.

2. Position the two vehicles so that they are not touching.
3. Set the parking brake and shift into P (Park). See *Shifting Into Park* ⇨ 166.

**Caution**

If any accessories are left on or plugged in during the jump starting procedure, they could be damaged. The repairs would not be covered by the vehicle warranty. Whenever possible, turn off or unplug all accessories on either vehicle when jump starting.

4. Turn the vehicle off. Turn off all lights and accessories in both vehicles, except the hazard warning flashers if needed.

 **Warning**

An electric fan can start up even when the propulsion system is not operating and can injure you. Keep hands, clothing and tools away from any underhood electric fan.

 **Warning**

Using a match near a battery can cause battery gas to explode. People have been hurt doing this, and some have been blinded. Use a flashlight if you need more light.

Battery fluid contains acid that can burn you. Do not get it on you. If you accidentally get it in your eyes or on your skin, flush the place with water and get medical help immediately.

 **Warning**

Fans or other moving propulsion system parts can injure you badly. Keep your hands away from moving parts once the propulsion system is operating.

5. Connect one end of the red positive (+) cable to the discharged battery positive (+) terminal.
6. Connect the other end of the red positive (+) cable to the good battery positive (+) terminal.
7. Connect one end of the black negative (-) cable to the good battery negative (-) terminal.
8. Connect the other end of the black negative (-) cable to the discharged battery negative (-) grounding point.
9. Start the vehicle with the good battery.
10. Try to start the vehicle with the discharged battery. If it will not start after a few tries, it probably needs service.

**Caution**

If the jumper cables are connected or removed in the wrong order, electrical shorting may occur and damage the vehicle. The repairs would not be covered by the vehicle warranty. Always connect and remove the jumper cables in the correct order, making sure that the cables do not touch each other or other metal.

**Jumper Cable Removal**

Reverse the sequence exactly when removing the jumper cables.

**Towing the Vehicle****Caution**

Incorrectly transporting a disabled vehicle may cause damage to the vehicle. Use proper tire straps and do not strap or hook to any frame, underbody, or suspension component not specified below. Do not move vehicles with drive axle tires on the ground. Damage is not covered by the vehicle warranty.

**Caution**

The vehicle may be equipped with an Electric Parking Brake and/or an Electronic Transmission Range Select (ETRS) shifter. In the event of a loss of 12 v battery power, the electric parking brake cannot be released, and the vehicle cannot be shifted to N (Neutral). Tire skates or dollies must be used under the non-rolling tires to prevent damage while  
(Continued)

**Caution (Continued)**

loading/unloading the vehicle. Dragging the vehicle will cause damage not covered by the vehicle warranty.

**Caution**

The vehicle may be equipped with a tow eye. Improper use of the tow eye may cause damage to the vehicle and is not covered by the vehicle warranty. If equipped, use the tow eye to load the vehicle onto a flatbed tow truck from a flat road surface, or to move the vehicle a very short distance at a walking pace. The tow eye is not designed for off-road recovery. The vehicle must be in N (Neutral) with the Electric Parking Brake released when using the tow eye.

Contact a professional towing service if the disabled vehicle must be transported. GM recommends a flatbed tow truck to transport a disabled vehicle. Use ramps to help reduce approach angles, if necessary.

If equipped, a tow eye may be located near the spare tire or emergency jack. Do not use the tow eye to pull the vehicle from the snow, mud, sand, or ditch. Tow eye threads may have right or left-hand threads. Use Caution when installing or removing the tow eye.

The vehicle must be in Neutral and the Electric Parking Brake must be released when loading the vehicle onto a flatbed tow truck. If the vehicle is equipped with car-wash mode and has 12 v power available, the following procedure can be used to place the vehicle in Neutral.

1. Refer to “car wash mode” under *Electric Drive Unit* ⇨ 168.

If the 12 v battery is dead, the vehicle will not go into Vehicle Ready Mode. Try to jump start the vehicle with a known good 12 v battery and retry car wash mode from above. Refer to *Jump Starting - North America* ⇨ 259. If unsuccessful, the vehicle will not move. Tire skates or dollies must be used under the non-rolling tires to prevent vehicle damage.

### Front Tow Eye Attachment Point

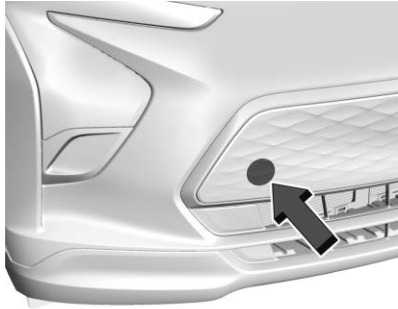

Carefully open the cover in the fascia by using the small notch that conceals the tow eye socket.



Install the tow eye into the socket and turn it until it is fully tightened. When the tow eye is removed, reinstall the cover with the notch in the original position.

### Rear Tow Eye Attachment Point

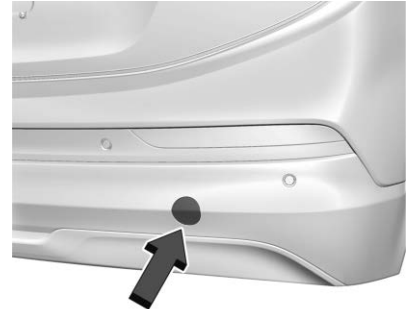

Carefully open the cover in the fascia by using the small notch that conceals the tow eye socket.





Install the tow eye into the socket and turn it until it is fully tightened. When the tow eye is removed, reinstall the cover with the notch in the original position.

## Recreational Vehicle Towing

Recreational vehicle towing means towing the vehicle behind another vehicle, such as behind a motor home. The two most common types of recreational vehicle towing are known as dinghy towing and dolly towing. Dinghy towing is towing the vehicle with all four wheels on the ground. Dolly towing is towing the vehicle with two wheels on the ground and two wheels up on a device known as a dolly.

Here are some important things to consider before recreational vehicle towing:

- Before towing the vehicle, become familiar with the local laws that apply to recreational vehicle towing. These laws may vary by region.
- What is the towing capacity of the towing vehicle? Be sure to read the tow vehicle manufacturer's recommendations.
- How far will the vehicle be towed? Some vehicles have restrictions on how far and how long they can tow.
- Does the vehicle have the proper towing equipment? See your dealer or trailering professional for additional advice and equipment recommendations.
- Is the vehicle ready to be towed? Just as preparing the vehicle for a long trip, make sure the vehicle is prepared to be towed.

### Caution

Use of a shield mounted in front of the vehicle grille could restrict airflow and cause damage to the electric drive unit. The repairs would not be covered by the

(Continued)

### Caution (Continued)

vehicle warranty. If using a shield, only use one that attaches to the towing vehicle.

## Dinghy Towing

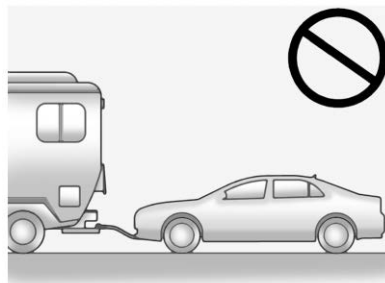

### Caution

If the vehicle is towed with all four wheels on the ground, the drivetrain components could be damaged. The repairs would not be covered by the vehicle warranty. Do not tow the vehicle with all four wheels on the ground.

The vehicle was not designed to be towed with all four wheels on the ground. If the vehicle must be towed, a dolly should be used. See “Dolly Towing” following.

### Dolly Towing

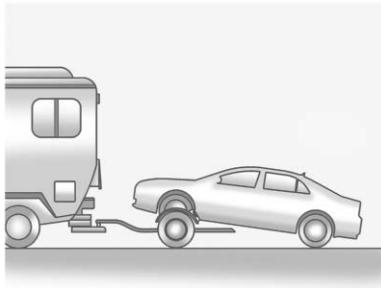

Tow the vehicle with the two rear wheels on the ground and the front wheels on a dolly.

To tow the vehicle from the front with the rear wheels on the ground:

1. Put the front wheels on the dolly.
2. Shift the vehicle into P (Park). See *Shifting Into Park* ⇨ 166.
3. Set the parking brake.
4. Secure the vehicle to the dolly.

5. Follow the dolly manufacturer's instructions for preparing the vehicle and dolly for towing.
6. Release the parking brake.
7. Turn the vehicle off.
8. Open the hood.
9. Wait two minutes.
10. Disconnect the negative (-) terminal connector from the 12-volt battery.
11. Close and latch the hood.

### Towing the Vehicle from the Rear

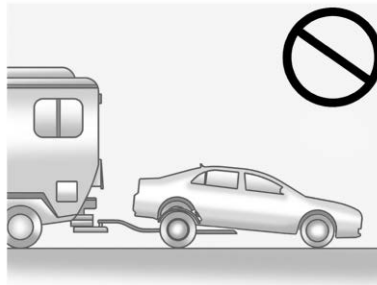

<b>Caution</b>
Towing the vehicle from the rear could damage it. Also, repairs would not be covered by the vehicle warranty. Never have the vehicle towed from the rear.

## Appearance Care

### Exterior Care

#### Locks

Locks are lubricated at the factory. Use a de-icing agent only when absolutely necessary, and have the locks greased after using.

#### Washing the Vehicle

To preserve the vehicle's finish, wash it often and out of direct sunlight.

<b>Caution</b>
Do not use petroleum-based, acidic, or abrasive cleaning agents as they can damage the vehicle's paint, metal, or plastic parts. If damage occurs, it would not be covered by the vehicle warranty. Approved cleaning products can
<i>(Continued)</i>

**Caution (Continued)**

be obtained from your dealer. Follow all manufacturer directions regarding correct product usage, necessary safety precautions, and appropriate disposal of any vehicle care product.

**Caution**

Avoid using high-pressure washes closer than 30 cm (12 in) to the surface of the vehicle. Use of power washers exceeding 8 274 kPa (1,200 psi) can result in damage or removal of paint and decals.

If using an automatic car wash, follow the car wash instructions. The windshield wiper and rear window wiper, if equipped, must be off. Remove any accessories that may be damaged or interfere with the car wash equipment.

Rinse the vehicle well, before washing and after, to remove all cleaning agents completely. If they are allowed to dry on the surface, they could stain.

Dry the finish with a soft, clean chamois or an all-cotton towel to avoid surface scratches and water spotting.

**Cleaning Underhood Components****Caution**

Do not power wash any component under the hood that has this  symbol.

This could cause damage that would not be covered by the vehicle warranty.

Solvents or aggressive cleaners may harm underhood components. The usages of these chemicals should be avoided.

Recommend water only.

A pressure washer may be used, but care must be utilized. The following criteria must be followed:

- Water pressure must be kept below 14 000 KPa (2,000 PSI).
- Water temperature must be below 80 °C (180 °F).
- Spray nozzle with a 40 degree wide angle spray pattern or wider must be used.
- Nozzle must be kept at least 30 cm (1ft) away from all surfaces.

**Finish Care**

Application of aftermarket clearcoat sealant/wax materials is not recommended. If painted surfaces are damaged, see your dealer to have the damage assessed and repaired. Foreign materials such as calcium chloride and other salts, ice melting agents, road oil and tar, tree sap, bird droppings, chemicals from industrial chimneys, etc., can damage the vehicle's finish if they remain on painted surfaces. Wash the vehicle as soon as possible. If necessary, use non-abrasive cleaners that are marked safe for painted surfaces to remove foreign matter.

Occasional hand waxing or mild polishing should be done to remove residue from the paint finish. See your dealer for approved cleaning products.

Do not apply waxes or polishes to uncoated plastic, vinyl, rubber, decals, simulated wood, or flat paint as damage can occur.

**Caution**

Machine compounding or aggressive polishing on a basecoat/clearcoat paint finish may damage it. Use only

(Continued)

**Caution (Continued)**

non-abrasive waxes and polishes that are made for a basecoat/clearcoat paint finish on the vehicle.

To keep the paint finish looking new, keep the vehicle garaged or covered whenever possible.

**Protecting Exterior Bright Metal Moldings**

**Caution**

Failure to clean and protect the bright metal moldings can result in a hazy white finish or pitting. This damage would not be covered by the vehicle warranty.

The bright metal moldings on the vehicle are aluminum or stainless steel. To prevent damage always follow these cleaning instructions:

- Be sure the molding is cool to the touch before applying any cleaning solution.
- Use a cleaning solution approved for aluminum or stainless steel. Some cleaners are highly acidic or contain alkaline substances and can damage the moldings.

- Always dilute a concentrated cleaner according to the manufacturer's instructions.
- Do not use chrome cleaners.
- Do not use cleaners that are not intended for automotive use.
- Use a nonabrasive wax on the vehicle after washing to protect and extend the molding finish.

**Cleaning Exterior Lamps/Lenses, Emblems, Decals, and Stripes**

Use only lukewarm or cold water, a soft cloth, and a car washing soap to clean exterior lamps, lenses, emblems, decals and stripes. Follow instructions under "Washing the Vehicle" previously in this section.

Lamp covers are made of plastic, and some have a UV protective coating. Do not clean or wipe them while they are dry.

Do not use any of the following on lamp covers:

- Abrasive or caustic agents.
- Washer fluids and other cleaning agents in higher concentrations than suggested by the manufacturer.
- Solvents, alcohols, fuels, or other harsh cleaners.

- Ice scrapers or other hard items.
- Aftermarket appearance caps or covers while the lamps are illuminated, due to excessive heat generated.

**Caution**

Failure to clean lamps properly can cause damage to the lamp cover that would not be covered by the vehicle warranty.

**Caution**

Using wax on low gloss black finish stripes can increase the gloss level and create a non-uniform finish. Clean low gloss stripes with soap and water only.

**Air Intakes**

Clear debris from the air intakes, between the hood and windshield, when washing the vehicle.

**Windshield and Wiper Blades**

Clean the outside of the windshield with glass cleaner.

Clean rubber blades using a lint-free cloth or paper towel soaked with windshield washer fluid or a mild detergent. Wash the

windshield thoroughly when cleaning the blades. Bugs, road grime, sap, and a buildup of vehicle wash/wax treatments may cause wiper streaking.

Replace the wiper blades if they are worn or damaged. Damage can be caused by extreme dusty conditions, sand, salt, heat, sun, snow, and ice.

### Weatherstrips

Apply weatherstrip lubricant on weatherstrips to make them last longer, seal better, and not stick or squeak. Lubricate weatherstrips at least once a year. Hot, dry climates may require more frequent application. Black marks from rubber material on painted surfaces can be removed by rubbing with a clean cloth.

### Tires

Use a stiff brush with tire cleaner to clean the tires.

#### Caution

Using petroleum-based tire dressing products on the vehicle may damage the paint finish and/or tires. When applying a  
(Continued)

#### Caution (Continued)

tire dressing, always wipe off any overspray from all painted surfaces on the vehicle.

### Wheels and Wheel Trim

Use a soft, clean cloth with mild soap and water to clean the wheels. After rinsing thoroughly with clean water, dry with a soft, clean towel. A wax may then be applied.

#### Caution

Chrome wheels and chrome wheel trim may be damaged if the vehicle is not washed after driving on roads that have been sprayed with magnesium chloride or calcium chloride. These are used on roads for conditions such as dust and ice. Always wash the chrome with soap and water after exposure.

#### Caution

To avoid surface damage on wheels and wheel trim, do not use strong soaps, chemicals, abrasive polishes, cleaners,  
(Continued)

#### Caution (Continued)

or brushes. Use only GM approved cleaners. Do not drive the vehicle through an automatic car wash that uses silicon carbide tire/wheel cleaning brushes. Damage could occur and the repairs would not be covered by the vehicle warranty.

### Brake System

Visually inspect brake lines and hoses for proper hook-up, binding, leaks, cracks, chafing, etc. Inspect disc brake pads for wear and rotors for surface condition. Inspect drum brake linings/shoes for wear or cracks. Inspect all other brake parts.

### Steering, Suspension, and Chassis Components

Visually inspect steering, suspension, and chassis components for damaged, loose, or missing parts or signs of wear at least once a year.

Inspect power steering for proper attachment, connections, binding, leaks, cracks, chafing, etc.

Visually check constant velocity joint boots and axle seals for leaks.

### Body Component Lubrication

Lubricate all key lock cylinders, hood hinges, liftgate hinges, steel charge port door, and power assist step hinges, unless the components are plastic. Applying silicone grease on weatherstrips with a clean cloth will make them last longer, seal better, and not stick or squeak.

### Underbody Maintenance

At least twice a year, spring and fall, use plain water to flush any corrosive materials from the underbody. Take care to thoroughly clean any areas where mud and other debris can collect.

### Sheet Metal Damage

If the vehicle is damaged and requires sheet metal repair or replacement, make sure the body repair shop applies anti-corrosion material to parts repaired or replaced to restore corrosion protection.

Original manufacturer replacement parts will provide the corrosion protection while maintaining the vehicle warranty.

### Finish Damage

Quickly repair minor chips and scratches with touch-up materials available from your dealer to avoid corrosion. Larger areas of finish damage can be corrected in your dealer's body and paint shop.

### Chemical Paint Spotting

Airborne pollutants can fall upon and attack painted vehicle surfaces causing blotchy, ring-shaped discolorations, and small, irregular dark spots etched into the paint surface. See "Finish Care" previously in this section.

### Interior Care

To prevent dirt particle abrasions, regularly clean the vehicle's interior. Before using cleaners, read and follow all safety instructions on the label. While cleaning the interior, open the doors and windows to get proper ventilation. Newspapers or dark garments can transfer color to the vehicle's interior.

#### Caution

Immediately remove cleaners, hand lotions, sunscreen, and insect repellent from all interior surfaces or permanent damage may result.

#### Caution

Use cleaners specifically designed for the surfaces being cleaned to prevent permanent damage to the vehicle. Apply all cleaners directly to a cleaning cloth. Do not spray cleaners on any switches or controls.

When using liquid soap cleaners, follow the directions on the specific cleaner or soap solution for dilution instructions.

#### Caution

To prevent damage:

- Never use a razor or any other sharp object to remove soil from any interior surface
- Never use a brush with stiff bristles.

(Continued)

**Caution (Continued)**

- Never rub any surface aggressively or with too much pressure.
- Do not get any exposed electrical components wet.
- Do not use laundry detergents or dishwashing soaps with degreasers. Do not use solutions that contain strong or caustic soap.
- Do not heavily saturate the upholstery when cleaning.
- Do not use solvents or cleaners containing solvents.
- Do not use disinfecting wipes that are scented or contain bleach. Do not use wipes or cleaners that show a color transfer to the wipe or change the appearance of the interior surface when used.
- Do not use scented or gel-type hand sanitizers. If hand sanitizer comes in contact with interior surfaces of the vehicle, blot immediately and clean with a soft cloth dampened with a mild soap and water solution.

**Interior Glass**

To clean, use a microfiber cloth fabric dampened with water. Wipe droplets left behind with a clean dry cloth. If necessary, use a commercial glass cleaner after cleaning with plain water.

**Caution**

To prevent scratching, never use abrasive cleaners on automotive glass. Abrasive cleaners or aggressive cleaning may damage the rear window defogger.

Cleaning the windshield with water during the first three to six months of ownership will reduce tendency to fog.

**Speaker Covers**

Vacuum around a speaker cover gently, so that the speaker will not be damaged. Clean spots with water and mild soap.

**Coated Moldings**

Coated moldings should be cleaned.

- When lightly soiled, wipe with a sponge or soft, lint-free cloth dampened with water.
- When heavily soiled, use warm soapy water.

**Vinyl/Rubber**

If equipped with vinyl floor and rubber floor mats, use a soft cloth and/or brush dampened with water to remove dust and loose dirt. For more thorough cleaning, use a mild soap and water solution.

** Warning**

Do not use cleaners that contain silicone, wax-based products, or cleaners that increase gloss on vinyl/rubber floor and mats. These cleaners can permanently change the appearance and feel of the vinyl/rubber and can make the floor slippery. Your foot could slip while operating the vehicle, and you could lose control, resulting in a crash. You or others could be injured.

**Fabric/Carpet/Suede**

Start by vacuuming the surface using a soft brush attachment. If a rotating vacuum brush attachment is being used, only use it on the floor carpet. Before cleaning, gently remove as much of the soil as possible:

- Gently blot liquids with a paper towel. Continue blotting until no more soil can be removed.

- For solid soils, remove as much as possible prior to vacuuming.

To clean:

1. Saturate a clean, lint-free colorfast cloth with water. Microfiber cloth is recommended to prevent lint transfer to the fabric or carpet.
2. Remove excess moisture by gently wringing until water does not drip from the cleaning cloth.
3. Start on the outside edge of the soil and gently rub toward the center. Fold the cleaning cloth to a clean area frequently to prevent forcing the soil into the fabric.
4. Continue gently rubbing the soiled area until there is no longer any color transfer from the soil to the cleaning cloth.
5. If the soil is not completely removed, use a mild soap solution followed only by plain water.

If the soil is not completely removed, it may be necessary to use a commercial upholstery cleaner or spot lifter. Test a small hidden area for colorfastness before using a

commercial upholstery cleaner or spot lifter. If ring formation occurs, clean the entire fabric or carpet.

After cleaning, use a paper towel to blot excess moisture.

### **Cleaning High Gloss Surfaces and Vehicle Information and Radio Displays**

Use a microfiber cloth on high gloss surfaces or vehicle displays. First, use a soft bristle brush to remove dirt that can scratch the surface. Then gently clean by rubbing with a microfiber cloth. Never use window cleaners or solvents. Periodically hand wash the microfiber cloth separately, using mild soap. Do not use bleach or fabric softener. Rinse thoroughly and air dry before next use.

#### **Caution**

Do not attach a device with a suction cup to the display. This may cause damage and would not be covered by the vehicle warranty.

### **Instrument Panel, Leather, Vinyl, Other Plastic Surfaces, Low Gloss Paint Surfaces, and Natural Open Pore Wood Surfaces**

Use a soft bristle brush to remove dust from knobs and crevices on the instrument cluster. Use a soft microfiber cloth dampened with water to remove dust and loose dirt. For a more thorough cleaning, use a soft microfiber cloth dampened with a mild soap and water solution.

#### **Caution**

Soaking or saturating leather, especially perforated leather, as well as other interior surfaces, may cause permanent damage. Wipe excess moisture from these surfaces after cleaning and allow them to dry naturally. Never use heat, steam, or spot removers. Do not use liquids that contain alcohol or solvents on leather seats. Do not use cleaners that contain silicone or wax-based products. Cleaners containing these solvents can permanently change the appearance and feel of leather or soft trim, and are not recommended.



Do not use cleaners that increase gloss, especially on the instrument panel. Reflected glare can decrease visibility through the windshield under certain conditions.

### Caution

Use of air fresheners may cause permanent damage to plastics and painted surfaces. If an air freshener comes in contact with any plastic or painted surface in the vehicle, blot immediately and clean with a soft cloth dampened with a mild soap solution. Damage caused by air fresheners would not be covered by the vehicle warranty.

### Cargo Cover and Convenience Net

If equipped, wash with warm water and mild detergent. Do not use chlorine bleach. Rinse with cold water, and then dry completely.

### Care of Seat Belts

Keep belts clean and dry.

### Warning

Do not bleach or dye seat belt webbing. It may severely weaken the webbing. In a crash, they might not be able to provide adequate protection. Clean and rinse seat belt webbing only with mild soap and lukewarm water. Allow the webbing to dry.

### Floor Mats

### Warning

If a floor mat is the wrong size or is not properly installed, it can interfere with the pedals. Interference with the pedals can cause unintended acceleration and/or increased stopping distance which can cause a crash and injury. Make sure the floor mat does not interfere with the pedals.

Use the following guidelines for proper floor mat use.

- The original equipment floor mats are designed for your vehicle. If the floor mats need to be replaced, it is recommended that GM-certified floor mats are purchased. Non-GM floor mats may not fit properly and may interfere with the pedals. Always check that the floor mats do not interfere with the pedals.
- Do not use a floor mat if the vehicle is not equipped with a floor mat retainer on the driver side floor.
- Use the floor mat with the correct side up. Do not turn it over.
- Do not place anything on top of the driver side floor mat.
- Use only a single floor mat on the driver side.
- Do not place one floor mat on top of another.

### Removing and Replacing the Floor Mats

Pull up on the rear of the floor mat to unlock each retainer and remove.

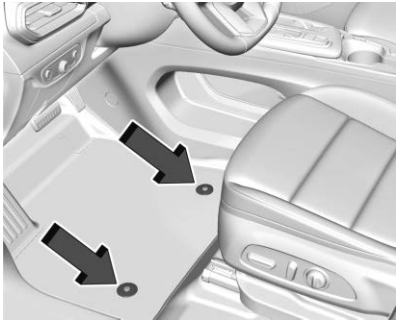

Reinstall by lining up the floor mat retainer openings over the carpet retainers and snap into position.

Make sure the floor mat is properly secured in place.

Verify the floor mat does not interfere with the pedals.

### **Cleaning Rubber Floor Mats (All-Weather Mats and Floor Liners)**

See “Vinyl/Rubber” under *Interior Care*  
⇒ 269 for important cleaning information.

## Service and Maintenance

### General Information

General Information ..... 274

### Maintenance Schedule

Maintenance Schedule ..... 275

### Owner Checks and Services

Owner Checks and Services ..... 277

### Additional Maintenance and Care

Additional Maintenance and Care ..... 277

### Recommended Fluids, Lubricants, and Parts

Recommended Fluids and  
Lubricants ..... 280  
Maintenance Replacement Parts ..... 281

### Maintenance Records

Maintenance Records ..... 282

## General Information

Your vehicle is an important investment. This section describes the required maintenance for the vehicle. Follow this schedule to help protect against major repair expenses resulting from neglect or inadequate maintenance. It may also help to maintain the value of the vehicle if it is sold. It is the responsibility of the owner to have all required maintenance performed.

Your dealer has trained technicians who can perform required maintenance using genuine replacement parts. They have up-to-date tools and equipment for fast and accurate diagnostics. Many dealers have extended evening and Saturday hours, courtesy transportation, and online scheduling to assist with service needs.

Your dealer recognizes the importance of providing competitively priced maintenance and repair services. With trained technicians, the dealer is the place for routine maintenance such as tire rotations and additional maintenance items like tires, brakes, batteries, and wiper blades.

### Caution

Damage caused by improper maintenance can lead to costly repairs and may not be covered by the vehicle warranty. Maintenance intervals, checks, inspections, recommended fluids, and lubricants are important to keep the vehicle in good working condition.

Do not have chemical flushes that are not approved by GM performed on the vehicle. The use of flushes, solvents, cleaners, or lubricants that are not approved by GM could damage the vehicle, requiring expensive repairs that are not covered by the vehicle warranty.

The Tire Rotation and Required Services are the responsibility of the vehicle owner. It is recommended to have your dealer perform these services every 12 000 km/7,500 mi. Proper vehicle maintenance helps to keep the vehicle in good working condition.

The Additional Required Services are for vehicles that:

- Carry passengers and cargo within recommended limits on the Tire and Loading Information label. See *Vehicle Load Limits* ⇨ 161.
- Are driven on reasonable road surfaces within legal driving limits.

Refer to the information in the Maintenance Schedule Additional Required Services chart.

### Warning

Performing maintenance work can be dangerous and can cause serious injury. Perform maintenance work only if the required information, proper tools, and equipment are available. If they are not, see your dealer to have a trained technician do the work. See *Doing Your Own Service Work* ⇨ 217.

## Maintenance Schedule

### Owner Checks and Services

#### Once a Month

- Check the tire inflation pressures. See *Tire Pressure* ⇨ 243.
- Inspect the tires for wear. See *Tire Inspection* ⇨ 247.
- Check the windshield washer fluid level. See *Washer Fluid* ⇨ 221.

### Air Conditioning Desiccant (Replace Every Seven Years)

The air conditioning system requires maintenance every seven years. This service requires replacement of the desiccant to help the longevity and efficient operation of the air conditioning system. This service can be complex. See your dealer.

### Tire Rotation and Required Services Every 12 000 km/7,500 mi

Rotate the tires, if recommended for the vehicle, and perform the following services. See *Tire Rotation* ⇨ 248.

- Check coolant level. See *Cooling System* ⇨ 220.
- Check windshield washer fluid level. See *Washer Fluid* ⇨ 221.
- Check tire inflation pressures. See *Tire Pressure* ⇨ 243.
- Inspect tire wear. See *Tire Inspection* ⇨ 247.
- Visually check for fluid leaks.
- Inspect brake system. See *Exterior Care* ⇨ 265.
- Visually inspect steering, suspension, and chassis components for damage, including cracks or tears in the rubber boots, loose or missing parts, or signs of wear at least once a year. See *Exterior Care* ⇨ 265.

- Inspect power steering for proper attachment, connections, binding, leaks, cracks, chafing, etc.
- Visually inspect halfshafts and drive shafts for excessive wear, lubricant leaks, and/or damage including: tube dents or cracks, constant velocity joint or universal joint looseness, cracked or missing boots, loose or missing boot clamps, center bearing excessive looseness, loose or missing fasteners, and axle seal leaks.
- Check restraint system components. See *Safety System Check* ⇨ 37.
- Lubricate body components. See *Exterior Care* ⇨ 265.
- Check accelerator pedal for damage, high effort, or binding. Replace if needed.
- Visually inspect gas strut for signs of wear, cracks, or other damage. Check the hold open ability of the strut. If the hold open ability is low, service the gas strut. See *Gas Strut(s)* ⇨ 226.
- Check tire sealant expiration date, if equipped. See *Tire Sealant and Compressor Kit* ⇨ 254.

Maintenance Schedule Additional Required Services	12 000 km/7,500 mi	24 000 km/15,000 mi	36 000 km/22,500 mi	48 000 km/30,000 mi	60 000 km/37,500 mi	72 000 km/45,000 mi	84 000 km/52,500 mi	96 000 km/60,000 mi	108 000 km/67,500 mi	120 000 km/75,000 mi	132 000 km/82,500 mi	144 000 km/90,000 mi	156 000 km/97,500 mi	168 000 km/105,000 mi	180 000 km/112,500 mi	192 000 km/120,000 mi	204 000 km/127,500 mi	216 000 km/135,000 mi	228 000 km/142,500 mi	240 000 km/150,000 mi
Rotate tires and perform Required Services.	✓	✓	✓	✓	✓	✓	✓	✓	✓	✓	✓	✓	✓	✓	✓	✓	✓	✓	✓	✓
Replace passenger compartment air filter. (1)			✓			✓			✓			✓			✓			✓		
Drain and fill vehicle coolant circuits. (2)																				✓
Replace brake fluid. (3)																				
Replace front and rear wiper blades. (4)		✓		✓		✓		✓		✓		✓		✓		✓		✓		✓
Replace hood and/or body lift support gas struts. (5)									✓											✓
Replace air conditioning desiccant. (6)																				

**Footnotes — Maintenance Schedule Additional Required Services**

(1) Or every two years, whichever comes first. More frequent passenger compartment air filter replacement may be needed if driving in areas with heavy traffic, poor air quality, high dust levels, or environmental allergens. Passenger compartment air filter replacement may also be needed if there is reduced airflow, window fogging, or odors. Your GM dealer can help determine when to replace the filter.

(2) Or every five years, whichever comes first. See *Cooling System* ⇨ 220.

(3) Replace brake fluid every five years. See *Brake Fluid* ⇨ 222.

(4) Or every 12 months, whichever comes first. See *Wiper Blade Replacement* ⇨ 225.

(5) Or every 10 years, whichever comes first. See *Gas Strut(s)* ⇨ 226.

(6) Replace air conditioning desiccant every seven years.

**Owner Checks and Services**

- At least twice a year, have underbody flushing service performed. See "Underbody Maintenance" in *Exterior Care* ⇨ 265.

**Additional Maintenance and Care**

Your vehicle is an important investment and caring for it properly may help to avoid future costly repairs. To maintain vehicle performance, additional maintenance

services may be required. It is recommended that your dealer perform these services — their trained dealer technicians know your vehicle best. Your dealer can also perform a thorough assessment with a multi-point inspection to recommend when your vehicle may need attention. The following list is intended to explain the services and conditions to look for that may indicate services are required.

### **Battery**

The battery supplies power to operate any additional electrical accessories.

- To avoid break-down or failure, maintain a battery with full power.
- Trained dealer technicians have the diagnostic equipment to test the battery and ensure that the connections and cables are corrosion-free.

### **Brakes**

Brakes stop the vehicle and are crucial to safe driving.

- Signs of brake wear may include chirping, grinding, or squealing noises, or difficulty stopping.

- Trained dealer technicians have access to tools and equipment to inspect the brakes and recommend quality parts engineered for the vehicle.

### **Fluids**

Proper fluid levels and approved fluids protect the vehicle's systems and components. See *Recommended Fluids and Lubricants* ⇨ 280 for GM approved fluids.

- Keep the windshield washer fluid reservoir filled.
- Instrument cluster lights may come on to indicate that fluids may be low and need to be filled.

### **Hoses**

Hoses transport fluids and should be regularly inspected to ensure that there are no cracks or leaks. With a multi-point inspection, your dealer can inspect the hoses and advise if replacement is needed.

### **Lamps**

Properly working headlamps, taillamps, and brake lamps are important to see and be seen on the road.

- Signs that the headlamps need attention include dimming, failure to light, cracking, or damage. The brake lamps need to be checked periodically to ensure that they light when braking.
- With a multi-point inspection, your dealer can check the lamps and note any concerns.

### **Shocks and Struts**

Shocks and struts help aid in control for a smoother ride.

- Signs of wear may include steering wheel vibration, bounce/sway while braking, longer stopping distance, or uneven tire wear.
- As part of the multi-point inspection, trained dealer technicians can visually inspect the shocks and struts for signs of leaking, blown seals, or damage, and can advise when service is needed.

### **Tires**

Tires need to be properly inflated, rotated, and balanced. Maintaining the tires can save money and reduce the risk of tire failure.

- Signs that the tires need to be replaced include three or more visible treadwear indicators; cord or fabric showing through the rubber; cracks or cuts in the tread or sidewall; or a bulge or split in the tire.
- Trained dealer technicians can inspect and recommend the right tires. Your dealer can also provide tire/wheel balancing services to ensure smooth vehicle operation at all speeds. Your dealer sells and services name brand tires.

### Vehicle Care

To help keep the vehicle looking like new, vehicle care products are available from your dealer. For information on how to clean and protect the vehicle's interior and exterior, see *Interior Care* ⇨ 269 and *Exterior Care* ⇨ 265.

### Wheel Alignment

Wheel alignment is critical for ensuring that the tires deliver optimal wear and performance.

- Signs that the alignment may need to be adjusted include pulling, improper vehicle handling, or unusual tire wear.
- Your dealer has the required equipment to ensure proper wheel alignment.

### Windshield

For safety, appearance, and the best viewing, keep the windshield clean and clear.

- Signs of damage include scratches, cracks, and chips.
- Trained dealer technicians can inspect the windshield and recommend proper replacement if needed.

### Wiper Blades

Wiper blades need to be cleaned and kept in good condition to provide a clear view.

- Signs of wear include streaking, skipping across the windshield, and worn or split rubber.
- Trained dealer technicians can check the wiper blades and replace them when needed.



## Recommended Fluids, Lubricants, and Parts

### Recommended Fluids and Lubricants

Fluids and lubricants identified below by name or specification, including fluids or lubricants not listed here, can be obtained from your dealer.

Usage	Fluid/Lubricant
Electric Drive Unit	See your dealer.
Hydraulic Brake System	GM approved DOT 4 Hydraulic Brake Fluid.
Key Lock Cylinders, Hood and Liftgate Hinges	Multi-Purpose Lubricant, Superlube. See your dealer.
Vehicle Coolant Circuits	Use only ACDelco Premix (50/50 mixture of de-ionized water and DEX-COOL Coolant). See your dealer.
Windshield Washer	Automotive windshield washer fluid that meets regional freeze protection requirements.

## Maintenance Replacement Parts

Replacement parts identified below by name, part number, or specification can be obtained from your dealer.

Part	GM Part Number	ACDelco Part Number
Passenger Compartment Air Filter	13508023	CF185
Wiper Blades		
Driver Side – 68 cm (26.8 in)	42341754	—
Passenger Side – 68 cm (26.8 in)	42341756	—
Rear – 30 cm (11.8 in)	84215609	—



## Technical Data

### Vehicle Identification

Vehicle Identification Number (VIN) ... 283  
 Service Parts Identification ..... 283

### Vehicle Data

Capacities and Specifications ..... 284

## Vehicle Identification

### Vehicle Identification Number (VIN)



This legal identifier is in the front corner of the instrument panel, on the driver side of the vehicle. It can be seen through the windshield from outside. The Vehicle Identification Number (VIN) also appears on the Vehicle Certification label and certificates of title and registration.

### Engine Identification

The eighth character in the VIN is the engine code. This code identifies the vehicle's engine, specifications, and replacement parts. See “Engine Specifications” under *Capacities and Specifications* ⇨ 284 for the vehicle's engine code.

### Service Parts Identification

There may be a large barcode on the certification label on the center pillar that you can scan for the following information:

- Vehicle Identification Number (VIN)
- Model designation
- Paint information
- Production options

If there is not a large barcode on this label, then you will find this same information on a label inside of the trunk.

## Vehicle Data

### Capacities and Specifications

The following approximate capacities are given in metric and English conversions.

Refer to *Recommended Fluids and Lubricants* ⇨ 280 for more information.

Application	Capacities	
	Metric	English
Air Conditioning Refrigerant	For the air conditioning system refrigerant charge type and amount, see the refrigerant label under the hood. See your dealer for more information.	
Cooling Systems*		
High Voltage Battery	7.0 L	7.4 qt
Power Electronics	3.8 L	4.0 qt
Heater	2.0 L	2.1 qt

Application	Capacities	
	Metric	English
Wheel Nut Torque	140 N•m	100 lb ft
All capacities are approximate. When adding, be sure to fill to the approximate level, as recommended in this manual. Recheck fluid level after filling.		
*Cooling systems capacity values are based on the individual cooling system and its components.		

## Customer Information

### Customer Information

Customer Satisfaction Procedure . . . . .	286
Customer Assistance Offices . . . . .	287
Customer Assistance for Text Telephone (TTY) Users . . . . .	288
Online Owner Center . . . . .	288
GM Mobility Reimbursement Program . . . . .	288
Roadside Assistance Program . . . . .	289
Scheduling Service Appointments . . . . .	290
Courtesy Transportation Program . . . . .	290
Collision Damage Repair . . . . .	291
Publication Ordering Information . . . . .	293
Radio Frequency Statement . . . . .	294

### Reporting Safety Defects

Reporting Safety Defects to the United States Government . . . . .	294
Reporting Safety Defects to the Canadian Government . . . . .	294
Reporting Safety Defects to General Motors . . . . .	295

### Vehicle Data Recording and Privacy

Vehicle Data Recording and Privacy . . . . .	295
Cybersecurity . . . . .	295
Event Data Recorders . . . . .	296
OnStar . . . . .	296

## Customer Information

### Customer Satisfaction Procedure

Your satisfaction and goodwill are important to your dealer and to Chevrolet. Normally, any concerns with the sales transaction or the operation of the vehicle will be resolved by your dealer's sales or service departments. Sometimes, however, despite the best intentions of all concerned, misunderstandings can occur. If your concern has not been resolved to your satisfaction, the following steps should be taken:

**STEP ONE** : Discuss your concern with a member of dealership management. Normally, concerns can be quickly resolved at that level. If the matter has already been reviewed with the sales, service, or parts manager, contact the owner of your dealership or the general manager.

**STEP TWO** : If after contacting a member of dealership management, it appears your concern cannot be resolved by your dealership without further help, in the U.S., call the Chevrolet Customer Assistance Center at 1-800-222-1020. In Canada, call General Motors of Canada Customer Care Centre at 1-800-263-3777 (English), or 1-800-263-7854 (French).

We encourage you to call the toll-free number in order to give your inquiry prompt attention. Have the following information available to give the Customer Assistance representative:

- Vehicle Identification Number (VIN). This is available from the vehicle registration or title, or the plate at the top left of the instrument panel and visible through the windshield.
- Dealership name and location.
- Vehicle delivery date and present mileage.

When contacting Chevrolet, remember that your concern will likely be resolved at a dealer's facility. That is why we suggest following Step One first.

**STEP THREE — U.S. Owners** : Both General Motors and your dealer are committed to making sure you are completely satisfied with your new vehicle. However, if you continue to remain unsatisfied after following the procedure outlined in Steps One and Two, you can file with the Better Business Bureau (BBB) AUTO LINE Program to enforce your rights.

The BBB AUTO LINE Program is an out-of-court program administered by BBB National Programs, Inc. to settle automotive

disputes regarding vehicle repairs or the interpretation of the New Vehicle Limited Warranty. Although you may be required to resort to this informal dispute resolution program prior to filing a court action, use of the program is free of charge and your case will generally be heard within 40 days. If you do not agree with the decision given in your case, you may reject it and proceed with any other venue for relief available to you.

You may contact the BBB AUTO LINE Program using the toll-free telephone number or write them at the following address:

BBB AUTO LINE a Division of  
BBB National Programs, Inc.  
1676 International Drive  
Suite 550  
McLean, VA 22102

Telephone: 1-800-955-5100  
<http://www.bbb.org/council/programs-services/dispute-handling-and-resolution/bbb-auto-line>

This program is available in all 50 states and the District of Columbia. Eligibility is limited by vehicle age, mileage, and other factors.

General Motors reserves the right to change eligibility limitations and/or discontinue its participation in this program.

**STEP THREE — Canadian Owners :** In the event that you do not feel your concerns have been addressed after following the procedure outlined in Steps One and Two, General Motors of Canada Company wants you to be aware of its participation in a no-charge Mediation/Arbitration Program. General Motors of Canada Company has committed to binding arbitration of owner disputes involving factory-related vehicle service claims. The program provides for the review of the facts involved by an impartial third party arbiter, and may include an informal hearing before the arbiter. The program is designed so that the entire dispute settlement process, from the time you file your complaint to the final decision, should be completed in about 70 days. We believe our impartial program offers advantages over courts in most jurisdictions because it is informal, quick, and free of charge.

For further information concerning eligibility in the Canadian Motor Vehicle Arbitration Plan (CAMVAP), call toll-free 1-800-207-0685,

or call the General Motors Customer Care Centre, 1-800-263-3777 (English), 1-800-263-7854 (French), or write to:

The Mediation/Arbitration Program  
c/o Customer Care Centre  
General Motors of Canada Company  
Mail Code: CA1-163-005  
1908 Colonel Sam Drive  
Oshawa, Ontario L1H 8P7

Your inquiry should be accompanied by the Vehicle Identification Number (VIN).

## Customer Assistance Offices

Chevrolet encourages customers to call the toll-free number for assistance. However, if a customer wishes to write or e-mail Chevrolet, the letter should be addressed to:

### United States and Puerto Rico

Chevrolet Motor Division  
Chevrolet Customer Assistance Center  
P.O. Box 33170  
Detroit, MI 48232-5170  
[www.Chevrolet.com](http://www.Chevrolet.com)

1-800-222-1020  
1-800-833-2438 (For Text Telephone Devices (TTYs))  
Roadside Assistance: 1-800-243-8872



From U.S. Virgin Islands:

1-800-496-9994

### Canada

General Motors of Canada Company  
Customer Care Centre, Mail Code:

CA1-163-005

1908 Colonel Sam Drive  
Oshawa, Ontario L1H 8P7  
[www.gm.ca](http://www.gm.ca)

1-800-263-3777 (English)

1-800-263-7854 (French)

1-800-263-3830 (For Text Telephone devices  
(TTYs))

Roadside Assistance: 1-800-268-6800

### Overseas

Please contact the local General Motors  
Business Unit.

### Customer Assistance for Text Telephone (TTY) Users

To assist customers who are deaf, hard of  
hearing, or speech-impaired and who use  
Text Telephones (TTYs), Chevrolet has TTY  
equipment available at its Customer  
Assistance Center. Any TTY user in the U.S.

can communicate with Chevrolet by dialing:  
1-800-833-2438. TTY users in Canada can dial  
1-800-263-3830.

### Online Owner Center

#### The Chevrolet Owner Center (U.S.) [my.chevrolet.com](http://my.chevrolet.com)

Learn more about your vehicle features,  
shop for and manage your connected  
services and OnStar plans, and access  
diagnostic information specific to your  
vehicle.

#### Membership Benefits

 : Download owner's manuals and view  
vehicle-specific how-to videos.

 : View maintenance schedules, alerts, and  
Vehicle Diagnostic Information. Schedule  
service appointments.

 : View service records from your  
dealership and add your own.

 : Select a preferred dealer and view  
locations, maps, phone numbers, and hours.

 : Track your vehicle's warranty  
information.

 : View active recalls by Vehicle  
Identification Number (VIN). See *Vehicle  
Identification Number (VIN)* ⇨ 283.

 : Manage your profile and payment  
information. View your GM Rewards Card  
earnings and My Chevrolet Rewards points.

 : Chat with online help representatives.

Visit [my.chevrolet.com](http://my.chevrolet.com) and create an  
account today.

#### Chevrolet Owner Centre (Canada) [mychevrolet.ca](http://mychevrolet.ca)

Visit the Chevrolet Owner Centre at  
[mychevrolet.ca](http://mychevrolet.ca) (English) or [my.chevrolet.ca](http://my.chevrolet.ca)  
(French) to access similar benefits to the  
U.S. site.

### GM Mobility Reimbursement Program

GENERAL MOTORS MOBILITY



This program is available to qualified applicants for cost reimbursement, up to certain limits, of eligible aftermarket adaptive equipment required for the vehicle, such as hand controls or a wheelchair/scooter lift for the vehicle.

To learn about the GM Mobility program, see [www.gmmobility.com](http://www.gmmobility.com) or call the GM Mobility Assistance Center at 1-800-323-9935. Text Telephone (TTY) users, call 1-800-833-9935.

General Motors of Canada also has a Mobility program. See [www.gm.ca](http://www.gm.ca), or call 1-800-GM-DRIVE (800-463-7483) for details. TTY users call 1-800-263-3830.

## Roadside Assistance Program

From the U.S., call 1-888-811-1926; Text Telephone (TTY): 1-888-889-2438.

From Canada, call 1-800-268-6800.

Service is available 24 hours a day, 365 days a year.

### Calling for Assistance

When calling Roadside Assistance, have the following information ready:

- Your name, home address, and home telephone number.

- Telephone number of your location.
- Location of the vehicle.
- Model, year, color, and license plate number of the vehicle.
- Odometer reading, Vehicle Identification Number (VIN), and delivery date of the vehicle.
- Description of the problem.

### Coverage

Services are provided for the duration of the vehicle's powertrain warranty.

In the U.S., anyone driving the vehicle is covered. In Canada, a person driving the vehicle without permission from the owner is not covered.

Roadside Assistance is not a part of the New Vehicle Limited Warranty. General Motors North America and Chevrolet reserve the right to make any changes or discontinue the Roadside Assistance program at any time without notification.

General Motors North America and Chevrolet reserve the right to limit services or payment to an owner or driver if they decide the claims are made too often, or the same type of claim is made many times.

### Services Provided

- **Lock-Out Service:** Service to unlock the vehicle if you are locked out. A remote unlock may be available if you have OnStar. For security reasons, the driver must present identification before this service is given.
- **Emergency Tow from a Public Road or Highway:** Tow to the nearest certified Bolt EV dealer for warranty service, or if the vehicle was in a crash and cannot be driven. Assistance is not given when the vehicle is stuck in the sand, mud, or snow.  
Emergency towing may be covered during the Extended Vehicle (EV) warranty.
- **Flat Tire Change:** If the tire has been separated from the wheel, has damaged sidewalls, or has a large puncture, the tire is too severely damaged for the self sealing tire to be effective and the vehicle will have to be towed. It is the owner's responsibility for the repair or replacement of the tire if it is not covered by the warranty.
- **Battery Jump Start:** Service to jump start a dead battery.

- **Trip Interruption Benefits and Assistance:** If your trip is interrupted due to a warranty event, incidental expenses may be reimbursed within the Powertrain warranty period. Items considered are reasonable and customary hotel, meals, rental car, or a vehicle being delivered back to the customer, up to 500 miles.

### Services Not Included in Roadside Assistance

- Impound towing caused by violation of any laws.
- Legal fines.
- Mounting, dismounting, or changing of snow tires, chains, or other traction devices.

Service is not provided if a vehicle is in an area that is not accessible to the service vehicle or is not a regularly traveled or maintained public road, which includes ice and winter roads. Off-road use is not covered.

### Services Specific to Canadian Vehicles

- **Lock-Out Service:** Vehicle registration is required.

- **Trip Interruption Benefits and Assistance:** Must be over 150 km (93 mi) from where the trip was started to qualify. Pre-authorization, original detailed receipts, and a copy of the repair orders are required. Once authorization has been received, the Roadside Assistance advisor will help to make arrangements and explain how to receive payment.
- **Alternative Service:** If assistance cannot be provided right away, the Roadside Assistance advisor may give permission to get local emergency road service. You will receive payment, up to \$100, after sending the original receipt to Roadside Assistance. Mechanical failures may be covered, however any cost for parts and labor for repairs not covered by the warranty are the owner's responsibility.

### Scheduling Service Appointments

When the vehicle requires warranty service, contact your dealer and request an appointment. By scheduling a service appointment and advising the service consultant of your transportation needs, your dealer can help minimize your inconvenience.

If the vehicle cannot be scheduled into the service department immediately, keep driving it until it can be scheduled for service, unless, of course, the problem is safety related. If it is, please call your dealership, let them know this, and ask for instructions.

If your dealer requests you to bring the vehicle for service, you are urged to do so as early in the work day as possible to allow for same-day repair.

### Courtesy Transportation Program

To enhance your ownership experience, we and our participating dealers are proud to offer Courtesy Transportation, a customer support program for vehicles with the Bumper-to-Bumper (Base Warranty Coverage period in Canada), Federal Emission, Extended Powertrain or Electric specific warranties in both the U.S. and Canada.

Several Courtesy Transportation options are available to assist in reducing inconvenience when warranty repairs are required.

Courtesy Transportation is not a part of the New Vehicle Limited Warranty. A separate manual entitled "Limited Warranty and Owner Assistance Information" furnished with each new vehicle provides detailed warranty coverage information.

### **Transportation Options**

Warranty service can generally be completed while you wait. However, if you are unable to do so, your dealer may offer the following transportation options:

#### **Shuttle Service**

This includes one-way or round-trip shuttle service within reasonable time and distance parameters of your dealer's area.

#### **Public Transportation or Fuel Reimbursement**

If overnight warranty repairs are needed, and public transportation is used, the expense must be supported by original receipts and within the maximum amount allowed by GM. If U.S. customers arrange their own transportation, limited reimbursement for reasonable fuel expenses may be available. Claim amounts should reflect actual costs and be supported by original receipts. See your dealer for information.

### **Courtesy Rental Vehicle**

For an overnight warranty repair, the dealer may provide an available courtesy rental vehicle or provide for reimbursement of a rental vehicle. Reimbursement is limited and must be supported by original receipts as well as a signed and completed rental agreement and meet state/provincial, local, and rental vehicle provider requirements. Requirements vary and may include minimum age requirements, insurance coverage, credit card, etc. Additional fees such as fuel, rental vehicle insurance, taxes, levies, usage fees, excessive mileage, or rental usage beyond the completion of the repair are also your responsibility.

It may not be possible to provide a like vehicle as a courtesy rental.

### **Additional Program Information**

All program options, such as shuttle service, may not be available at every dealer. Contact your dealer for specific availability.

General Motors reserves the right to unilaterally modify, change, or discontinue Courtesy Transportation at any time and to resolve all questions of claim eligibility pursuant to the terms and conditions described herein at its sole discretion.

### **Collision Damage Repair**

If the vehicle is involved in a collision and it is damaged, have the damage repaired by a qualified technician using the proper equipment and quality replacement parts. Poorly performed collision repairs diminish the vehicle resale value, and safety performance can be compromised in subsequent collisions.

### **Collision Parts**

Genuine GM Collision parts are new parts made with the same materials and construction methods as the parts with which the vehicle was originally built. Genuine GM Collision parts are the best choice to ensure that the vehicle's designed appearance, durability, and safety are preserved. The use of Genuine GM parts can help maintain the GM New Vehicle Limited Warranty.

Recycled original equipment parts may also be used for repair. These parts are typically removed from vehicles that were total losses in prior crashes. In most cases, the parts being recycled are from undamaged sections of the vehicle. A recycled original equipment GM part may be an acceptable choice to maintain the vehicle's originally designed

appearance and safety performance; however, the history of these parts is not known. Such parts are not covered by the GM New Vehicle Limited Warranty, and any related failures are not covered by that warranty.

Aftermarket collision parts are also available. These are made by companies other than GM and may not have been tested for the vehicle. As a result, these parts may fit poorly, exhibit premature durability/corrosion problems, and may not perform properly in subsequent collisions. Aftermarket parts are not covered by the GM New Vehicle Limited Warranty, and any vehicle failure related to such parts is not covered by that warranty.

### **Repair Facility**

GM also recommends that you choose a collision repair facility that meets your needs before you ever need collision repairs. Your dealer may have a collision repair center with GM-trained technicians and state-of-the-art equipment, or be able to recommend a collision repair center that has GM-trained technicians and comparable equipment.

### **Insuring the Vehicle**

Protect your investment in the GM vehicle with comprehensive and collision insurance coverage. There are significant differences in the quality of coverage afforded by various insurance policy terms. Many insurance policies provide reduced protection to the GM vehicle by limiting compensation for damage repairs by using aftermarket collision parts. Some insurance companies will not specify aftermarket collision parts. When purchasing insurance, we recommend that you ensure that the vehicle will be repaired with GM original equipment collision parts. If such insurance coverage is not available from your current insurance carrier, consider switching to another insurance carrier.

If the vehicle is leased, the leasing company may require you to have insurance that ensures repairs with Genuine GM Original Equipment Manufacturer (OEM) parts or Genuine Manufacturer replacement parts. Read the lease carefully, as you may be charged at the end of the lease for poor quality repairs.

### **If a Crash Occurs**

If there has been an injury, call emergency services for help. Do not leave the scene of a crash until all matters have been taken care of. Move the vehicle only if its position puts you in danger, or you are instructed to move it by a police officer.

Give only the necessary information to police and other parties involved in the crash.

For emergency towing see *Roadside Assistance Program* ⇨ 289.

Gather the following information:

- Driver name, address, and telephone number
- Driver license number
- Owner name, address, and telephone number
- Vehicle license plate number
- Vehicle make, model, and model year
- Vehicle Identification Number (VIN)
- Insurance company and policy number
- General description of the damage to the other vehicle

Choose a reputable repair facility that uses quality replacement parts. See “Collision Parts” earlier in this section.

In a crash, the sensing system may shut down the high voltage system. See *Battery - North America* ⇨ 223 for important safety information. If an airbag has inflated, see *What Will You See after an Airbag Inflates?* ⇨ 41.

If the vehicle is damaged from a crash, flood, fire, or other event it may be necessary to have the vehicle inspected. See *Battery - North America* ⇨ 223 for important safety information.

### Managing the Vehicle Damage Repair Process

In the event that the vehicle requires damage repairs, GM recommends that you take an active role in its repair. If you have a pre-determined repair facility of choice, take the vehicle there, or have it towed there. Specify to the facility that any required replacement collision parts be original equipment parts, either new Genuine GM parts or recycled original GM parts. Remember, recycled parts will not be covered by the GM vehicle warranty.

Insurance pays the bill for the repair, but you must live with the repair. Depending on your policy limits, your insurance company may initially value the repair using aftermarket parts. Discuss this with the repair professional, and insist on Genuine GM parts. Remember, if the vehicle is leased, you may be obligated to have the vehicle repaired with Genuine GM parts, even if your insurance coverage does not pay the full cost.

If another party's insurance company is paying for the repairs, you are not obligated to accept a repair valuation based on that insurance company's collision policy repair limits, as you have no contractual limits with that company. In such cases, you can have control of the repair and parts choices as long as the cost stays within reasonable limits.

## Publication Ordering Information

### Service Manuals

Service manuals have the diagnosis and repair information on the engine, transmission, axle, suspension, brakes, electrical system, steering system, body, etc.

## Customer Literature

Owner's manuals are written specifically for owners and are intended to provide basic operational information about the vehicle. The owner's manual includes the Maintenance Schedule for all models.

Customer literature publications available for purchase include owner's manuals, warranty manuals, and portfolios. Portfolios include an owner's manual, warranty manual, if applicable, and zip lock bag or pouch.

### Current and Past Models

Service manuals and customer literature are available for many current and past model year GM vehicles.

To order, call 1-800-551-4123 Monday–Friday, 8:00 a.m.–6:00 p.m. eastern time

For credit card orders only (VISA, MasterCard, or Discover), see Helm, Inc. at: [www.helminc.com](http://www.helminc.com).

To order by mail, write to:

Helm, Incorporated  
Attention: Customer Service  
47911 Halyard Drive  
Plymouth, MI 48170

Make checks payable in U.S. funds.

## Radio Frequency Statement

This vehicle uses license-exempt transmitters / receivers / systems that operate on a radio frequency that complies with Part 15/Part 18 of the Federal Communications Commission (FCC) rules and with Innovation, Science and Economic Development (ISED) Canada's license-exempt RSS(s) / RSP-100 / ICES-GEN.

Operation is subject to the following two conditions:

1. The device may not cause harmful interference.
2. The device must accept any interference received, including interference that may cause undesired operation of the device.

Changes or modifications to any of these systems by other than an authorized service facility could void authorization to use this equipment.

## Reporting Safety Defects

### Reporting Safety Defects to the United States Government

If you believe that your vehicle has a defect which could cause a crash or could cause injury or death, you should immediately inform the National Highway Traffic Safety Administration (NHTSA) in addition to notifying General Motors.

If NHTSA receives similar complaints, it may open an investigation, and if it finds that a safety defect exists in a group of vehicles, it may order a recall and remedy campaign. However, NHTSA cannot become involved in individual problems between you, your dealer, or General Motors.

To contact NHTSA, you may call the Vehicle Safety Hotline toll-free at 1-888-327-4236 (TTY: 1-800-424-9153); go to <http://www.safercar.gov>; or write to:

Administrator, NHTSA  
1200 New Jersey Avenue, S.E.  
Washington, D.C. 20590

You can also obtain other information about motor vehicle safety from <http://www.safercar.gov>.

### Reporting Safety Defects to the Canadian Government

If you live in Canada, and you believe that the vehicle has a safety defect, notify Transport Canada immediately, and notify General Motors of Canada Company. Call Transport Canada at 1-800-333-0510; go to:

[www.tc.gc.ca/recalls](http://www.tc.gc.ca/recalls) (English)

[www.tc.gc.ca/rappels](http://www.tc.gc.ca/rappels) (French)

or write to:

Transport Canada  
Motor Vehicle Safety Directorate  
Defect Investigations and Recalls  
Division  
80 Noel Street  
Gatineau, QC J8Z 0A1

## Reporting Safety Defects to General Motors

In addition to notifying NHTSA (or Transport Canada) in a situation like this, notify General Motors.

In the U.S., call 1-800-222-1020, or write:

Chevrolet Motor Division  
Chevrolet Customer Assistance Center  
P.O. Box 33170  
Detroit, MI 48232-5170

In Canada, call 1-800-263-3777 (English) or 1-800-263-7854 (French), or write:

General Motors of Canada Company  
Customer Care Centre, Mail Code:  
CA1-163-005  
1908 Colonel Sam Drive  
Oshawa, Ontario L1H 8P7

In Mexico, call 800-466-0811 or 800-508-0000.

In other Central America and Caribbean Countries, call 52-555-901-2369.

## Vehicle Data Recording and Privacy

The vehicle has a number of computers that record information about the vehicle's performance and how it is driven or used. For example, the vehicle uses computer modules to monitor and control electric drive unit performance, to monitor the conditions for airbag deployment and to deploy them in a crash, and, if equipped, to provide antilock braking to help the driver control the vehicle. These modules may store data to help the dealer technician service the vehicle or to help GM improve safety or features. Some modules may also store data about how the vehicle is operated, such as rate of energy consumption or average speed. These modules may retain personal preferences, such as radio presets, seat positions, and temperature settings.

## Cybersecurity

GM collects information about the use of your vehicle including operational and safety related information. We collect this information to provide, evaluate, improve, and troubleshoot our products and services and to develop new products and services. The protection of vehicle electronics systems and customer data from unauthorized outside electronic access or control is important to GM. GM maintains appropriate security standards, practices, guidelines and controls aimed at defending the vehicle and the vehicle service ecosystem against unauthorized electronic access, detecting possible malicious activity in related networks, and responding to suspected cybersecurity incidents in a timely, coordinated and effective manner. Security incidents could impact your safety or compromise your private data. To minimize security risks, please do not connect your vehicle electronic systems to unauthorized devices or connect your vehicle to any unknown or untrusted networks (such as Bluetooth, WIFI or similar technology). In the event you suspect any security incident impacting your data or the safe operation of your vehicle, please stop operating your vehicle and contact your dealer.



## Event Data Recorders

This vehicle is equipped with an event data recorder (EDR). The main purpose of an EDR is to record, in certain crash or near crash-like situations, such as an air bag deployment or hitting a road obstacle, data that will assist in understanding how a vehicle's systems performed. The EDR is designed to record data related to vehicle dynamics and safety systems for a short period of time, typically 30 seconds or less. The EDR in this vehicle is designed to record such data as:

- How various systems in your vehicle were operating;
- Whether or not the driver and passenger safety belts were buckled/fastened;
- How far (if at all) the driver was depressing the accelerator and/or brake pedal; and,
- How fast the vehicle was traveling.

These data can help provide a better understanding of the circumstances in which crashes and injuries occur.

### Note

EDR data are recorded by your vehicle only if a non-trivial crash situation occurs; no data are recorded by the EDR under normal

driving conditions and no personal data (e.g., name, gender, age, and crash location) are recorded. However, other parties, such as law enforcement, could combine the EDR data with the type of personally identifying data routinely acquired during a crash investigation.

To read data recorded by an EDR, special equipment is required, and access to the vehicle or the EDR is needed. In addition to the vehicle manufacturer, other parties, such as law enforcement, that have the special equipment, can read the information if they have access to the vehicle or the EDR.

GM will not access these data or share it with others except: with the consent of the vehicle owner or, if the vehicle is leased, with the consent of the lessee; in response to an official request by police or similar government office; as part of GM's defense of litigation through the discovery process; or, as permitted by law. Data that GM collects or receives may also be used for GM research needs or may be made available to others for research purposes, where a need is shown and the data is not tied to a specific vehicle or vehicle owner.

## OnStar

If the vehicle is equipped with OnStar and has an active service plan, additional data may be collected and transmitted through the OnStar system. This includes information about the vehicle's operation; collisions involving the vehicle; the use of the vehicle and its features, including infotainment; and the location and approximate GPS speed of the vehicle. Refer to the OnStar Terms and Conditions and Privacy Statement on the OnStar website.

See *OnStar Additional Information* ⇨ 298.

## OnStar

### OnStar Overview

OnStar Overview ..... 297

### OnStar Services

Emergency ..... 298

Security ..... 298

### OnStar Additional Information

OnStar Additional Information ..... 299

## OnStar Overview



 Voice Command Button



 Blue OnStar Button



 Red Emergency Button

This vehicle may be equipped with a comprehensive, in-vehicle system that can connect to an OnStar Advisor for Emergency, Security, Navigation, Connections, and Diagnostics Services. OnStar services may require a paid service plan and data plan. OnStar requires the vehicle battery and electrical system, cellular service, and GPS satellite signals to be available and operating. OnStar acts as a link to existing emergency service providers. OnStar may collect information about you and your vehicle, including location information. See OnStar User Terms, Privacy Statement, and Software Terms for more details including system limitations at [www.onstar.com](http://www.onstar.com) (U.S.) or [www.onstar.ca](http://www.onstar.ca) (Canada).

The OnStar system status light is next to the OnStar buttons. If the status light is:

- Solid Green: System is ready.
- Flashing Green: On a call.
- Red: Indicates a problem.
- Off: System is off. Press  twice to speak with an OnStar Advisor.

Press  or call 1-888-4ONSTAR (1-888-466-7827) to speak to an Advisor.

Functionality of the Voice Command button may vary by vehicle and region.

Press  to:

- Open the OnStar app on the infotainment display. If equipped, the infotainment system has OnStar controls in the embedded OnStar app on the Home Page. Most OnStar functions that can be performed with the buttons can be done using the app. To open the app, touch the OnStar icon on the Home Page. App updates require a corresponding service plan. Features vary by region and model. Features are subject to change. For more information, see [my.chevrolet.com/learn](http://my.chevrolet.com/learn) or press .

Or

- Give OnStar Turn-by-Turn Navigation voice commands.
- Obtain and customize the Wi-Fi hotspot name or SSID and password, if equipped.

Press **On** to connect to an Advisor to:

- Verify account information or update contact information.
- Get driving directions.
- Receive a Diagnostic check of the vehicle's key operating systems.
- Receive Roadside Assistance.
- Manage Wi-Fi Settings, if equipped.

Press **SOS** to get a priority connection to an OnStar Advisor available 24/7 to:

- Get help for an emergency.
- Be a Good Samaritan or respond to an AMBER Alert.
- Get assistance in severe weather or other crisis situations and find evacuation routes.

## OnStar Services

### Emergency

Emergency Services require an active safety and security plan. With Automatic Crash Response, built-in sensors can automatically alert a specially trained OnStar Advisor who is immediately connected in to the vehicle to help.

Press **SOS** for a priority connection to an OnStar Advisor who can contact emergency service providers, direct them to your exact location, and relay important information.

With OnStar Crisis Assist, specially trained Advisors are available 24 hours a day, 7 days a week, to provide a central point of contact, assistance, and information during a crisis.

With Roadside Assistance, Advisors can locate a nearby service provider to help with a flat tire, a battery jump, or an empty gas tank.

### Security

If equipped, OnStar provides these services:

- With Stolen Vehicle Assistance, OnStar Advisors can use GPS to pinpoint the vehicle and help authorities quickly recover it.
- With Remote Ignition Block, if equipped, OnStar can block the vehicle from being restarted.
- With Stolen Vehicle Slowdown, if equipped, OnStar can work with law enforcement to gradually slow the vehicle down.

### Theft Alarm Notification

If equipped, if the doors are locked and the vehicle alarm sounds, a notification by text, e-mail, or phone call will be sent. If the vehicle is stolen, an OnStar Advisor can work with authorities to recover the vehicle.

## OnStar Additional Information

### In-Vehicle Audio Messages

Audio messages may play important information at the following times:

- Prior to vehicle purchase. Press **On** to set up an account.
- After change in ownership and at 90 days.

### Transferring Service

Press **On** to request account transfer eligibility information. The Advisor can cancel or change account information.

### Selling/Transferring the Vehicle

Call 1-888-4ONSTAR (1-888-466-7827) immediately to terminate your OnStar or connected services if the vehicle is disposed of, sold, transferred, or if the lease ends.

### Reactivation for Subsequent Owners

Press **On** and follow the prompts to speak to an Advisor as soon as possible. The Advisor will update vehicle records and explain OnStar or connected service options.

### How OnStar Service Works

Automatic Crash Response, Emergency Services, Crisis Assist, Stolen Vehicle Assistance, Remote Services, and Roadside Assistance are available on most vehicles. Not all OnStar services are available everywhere or on all vehicles. For more information, a full description of OnStar services, system limitations, and OnStar User Terms, Privacy Statement, and Software Terms:

- Call 1-888-4ONSTAR (1-888-466-7827).
- See [www.onstar.com](http://www.onstar.com) (U.S.).
- See [www.onstar.ca](http://www.onstar.ca) (Canada).
- Call TTY 1-877-248-2080.
- Press **On** to speak with an Advisor.

OnStar or connected services cannot work unless the vehicle is in a place where OnStar has an agreement with a wireless service provider for service in that area. The wireless service provider must also have coverage, network capacity, reception, and technology compatible with OnStar or connected services. Service involving location information about the vehicle cannot work unless GPS signals are available, unobstructed, and compatible with the OnStar hardware. OnStar or connected

services may not work if the OnStar equipment is not properly installed or it has not been properly maintained. If equipment or software is added, connected, or modified, OnStar or connected services may not work. Other problems beyond the control of OnStar — such as hills, tall buildings, tunnels, weather, electrical system design and architecture of the vehicle, damage to the vehicle in a crash, or wireless phone network congestion or jamming — may prevent service.

See *Radio Frequency Statement* ⇨ 294.

### Services for People with Disabilities

Advisors provide services to help with physical disabilities and medical conditions.

Press **On** to help:

- Find a hotel, restaurant, etc., that meets accessibility needs.
- Provide directions to the closest hospital or pharmacy in urgent situations.

### TTY Users

OnStar has the ability to communicate to deaf, hard-of-hearing, or speech-impaired customers while in the vehicle. The available

TTY system can provide in-vehicle access to all OnStar services, except Virtual Advisor and OnStar Turn-by-Turn Navigation.

If equipped, TTY mode can be turned on or off by touching Settings, then Apps, and then Phone. When TTY mode is on, phone calls can be made or received with OnStar using the infotainment display.

### OnStar Personal Identification Number (PIN)

A PIN is needed to access some OnStar services. The PIN will need to be changed the first time when speaking with an Advisor. To change the OnStar PIN, contact an OnStar Advisor by pressing  or calling 1-888-4ONSTAR.

### Warranty

OnStar equipment may be warranted as part of the vehicle warranty.

### Languages

The vehicle can be programmed to respond in multiple languages. Press  and ask for an Advisor. Advisors are available in English, Spanish, and French. Available languages may vary by country.

### Potential Issues

OnStar cannot perform Remote Door Unlock or Stolen Vehicle Assistance after the vehicle has been off continuously for an extended period of time without an ignition cycle. To find out the duration of time that applies for the vehicle, contact an OnStar Advisor by pressing  or calling 1-888-4ONSTAR. If the vehicle has not been started for an extended period of time, OnStar can contact Roadside Assistance or a locksmith to help gain access to the vehicle.

### Global Positioning System (GPS)

- Obstruction of the GPS can occur in a large city with tall buildings; in parking garages; around airports; in tunnels and underpasses; or in an area with very dense trees. If GPS signals are not available, the OnStar system should still operate to call OnStar. However, OnStar could have difficulty identifying the exact location.
- In emergency situations, OnStar can use the last stored GPS location to send to emergency responders.

A temporary loss of GPS can cause loss of the ability to send a Turn-by-Turn Navigation route. The Advisor may give a verbal route or may ask for a call back after the vehicle is driven into an open area.

### Cellular and GPS Antennas

Cellular reception is required for OnStar to send remote signals to the vehicle. Do not place items over or near the antenna to prevent blocking cellular and GPS signal reception.

### Unable to Connect to OnStar Message

If there is limited cellular coverage or the cellular network has reached maximum capacity, this message may come on. Press  to try the call again or try again after driving a few miles into another cellular area.

### Vehicle and Power Issues

OnStar services require a vehicle electrical system, wireless service, and GPS satellite technologies to be available and operating for features to function properly. These systems may not operate if the battery is discharged or disconnected.

### Add-on Electrical Equipment

The OnStar system is integrated into the electrical architecture of the vehicle. Do not add any electrical equipment. See *Add-On Electrical Equipment* ⇨ 214. Added electrical equipment may interfere with the operation of the OnStar system and cause it to not operate.

### Vehicle Software Updates

OnStar or GM may remotely deliver software updates or changes to the vehicle without further notice or consent. These updates or changes may enhance or maintain safety, security, or the operation of the vehicle or the vehicle systems. Software updates or changes may affect or erase data or settings that are stored in the vehicle, such as saved navigation destinations or pre-set radio stations. Neither OnStar nor GM is responsible for any affected or erased data or settings.

These updates or changes may also collect personal information. Such collection is described in the OnStar privacy statement or separately disclosed at the time of installation. These updates or changes may also cause a system to automatically communicate with GM servers to collect information about vehicle system status, identify whether updates or changes are available, or deliver updates or changes. An active OnStar agreement constitutes consent to these software updates or changes and agreement that either OnStar or GM may remotely deliver them to the vehicle.

### Privacy

The complete OnStar Privacy Statement may be found at [www.onstar.com](http://www.onstar.com) (U.S.), or [www.onstar.ca](http://www.onstar.ca) (Canada). We recommend that you review it. If you have any questions, call 1-888-4ONSTAR (1-888-466-7827) or press  to speak with an Advisor. Users of wireless communications are cautioned that the privacy of any information sent via wireless cellular communications cannot be assured.

Third parties may unlawfully intercept or access transmissions and private communications without consent.

### OnStar - Software Acknowledgements

To obtain the source code under GPL, LGPL, MPL, and other open source licenses, that is contained in this product, please visit <http://opensource.lge.com>. In addition to the source code, all referred license terms, warranty disclaimers, and copyright notices are available for download. This offer is valid for a period of three years after our last shipment of this product. This offer is valid to anyone in receipt of this information.

\*Provided through LG Electronics Inc., who is solely responsible for provisions of related OSS compliance.

## Connected Services

### Connected Services

Navigation .....	302
Connections .....	302
Diagnostics .....	304

## Connected Services

### Navigation

Navigation requires a specific OnStar or connected service plan.

Press  to receive Turn-by-Turn directions or have them sent to the vehicle's navigation screen, if equipped. Select Turn-by-Turn Directions from the Services tab of the OnStar app to call an Advisor or select a recent or favorite destination. Touch the navigation icons to select home, address, or place. A destination transfer from OnStar will show the detail view of the destination when it is transferred from OnStar to the Navigation application. See [www.onstar.com](http://www.onstar.com) for a coverage map. Services vary by model. Map coverage is available in the United States and Canada.

### Turn-by-Turn Navigation

1. Press  to connect to an Advisor.
2. Request directions to be downloaded to the vehicle.
3. Follow the voice-guided commands.

### Using Voice Commands During a Planned Route

Functionality of the Voice Command button, if equipped, may vary by vehicle and region. For some vehicles, press  to open the OnStar app on the infotainment display.

### Send Destination to Vehicle

Directions can be sent to the vehicle's navigation screen, if equipped.

Press , then ask the Advisor to download directions to the vehicle's navigation system, if equipped. After the call ends, the navigation screen will provide prompts to begin driving directions. Routes that are sent to the navigation screen can only be canceled through the navigation system.

See [www.onstar.com](http://www.onstar.com) (U.S.) or [www.onstar.ca](http://www.onstar.ca) (Canada).

### Connections

The following services help with staying connected.

For coverage maps, see [www.onstar.com](http://www.onstar.com) (U.S.) or [www.onstar.ca](http://www.onstar.ca) (Canada).

**Ensuring Security**

- Change the default passwords for the Wi-Fi hotspot and myChevrolet mobile application. Make these passwords different from each other and use a combination of letters and numbers to increase the security.
- Change the default name of the SSID (Service Set Identifier). This is your network’s name that is visible to other wireless devices. Choose a unique name and avoid family names or vehicle descriptions.

**Wi-Fi Hotspot (If Equipped)**

The vehicle may have a built-in Wi-Fi hotspot that provides access to the Internet and web content at 4G LTE speed. Up to seven mobile devices can be connected. A data plan is required. Use the in-vehicle controls only when it is safe to do so.

1. To retrieve Wi-Fi hotspot information, press  to open the OnStar app on the infotainment display, then select Wi-Fi Hotspot. On some vehicles, touch Wi-Fi or Wi-Fi Settings on the screen.
2. The Wi-Fi settings will display the Wi-Fi hotspot name (SSID), password, and on some vehicles, the connection type (no

Internet connection, 3G, 4G, 4G LTE), and signal quality (poor, good, excellent). The LTE icon shows connection to Wi-Fi. It is possible that the icon may not illuminate even though the vehicle has an active connection.

3. To change the SSID or password, press  or call 1-888-4ONSTAR to connect with an Advisor. On some vehicles, the SSID and password can be changed in the Wi-Fi Hotspot menu.

After initial set-up, your vehicle’s Wi-Fi hotspot will connect automatically to your mobile devices. Manage data usage by turning Wi-Fi on or off on your mobile device, using the myChevrolet mobile app, or by contacting an OnStar Advisor. On some vehicles, Wi-Fi can also be managed from the Wi-Fi Hotspot menu.

**MyChevrolet Mobile App (If Available)**

Download the myChevrolet mobile app to compatible Apple and Android smartphones. Chevrolet users can access the following services from a smartphone:

- Remotely start/stop the vehicle, if factory-equipped.
- Lock/unlock doors, if equipped with automatic locks.

- Activate the horn and lamps.
- Check the vehicle’s energy level, range or tire pressure, if factory-equipped with the Tire Pressure Monitor System.
- Send destinations to the vehicle.
- Locate the vehicle on a map (U.S. market only).
- Turn the vehicle's Wi-Fi hotspot on/off, manage settings, and monitor data consumption, if equipped.
- Locate a dealer and schedule service.
- Request Roadside Assistance.
- Set a parking reminder with pin drop, take a photo, make a note, and set a timer.
- Connect with Chevrolet on social media.

Features are subject to change. For myChevrolet mobile app information and compatibility, see [my.chevrolet.com](http://my.chevrolet.com).

An active OnStar or connected service plan may be required. A compatible device, factory-installed remote start, and power locks are required. Data rates apply. See [www.onstar.com](http://www.onstar.com) for details and system limitations.



### **Remote Services**

Contact an OnStar Advisor to unlock the doors or sound the horn and flash the lamps.

### **Marketplace**

OnStar Advisors can provide offers from restaurants and retailers on your route, help locate hotels, or book a room. These services vary by market.

### **Diagnostics**

By monitoring and reporting on the vehicle's key systems, OnStar Advanced Diagnostics, if equipped, provides a way to keep up on maintenance. Capabilities vary by model. See [www.onstar.com](http://www.onstar.com) for details and system limitations. Features are subject to change. For updates on feature capabilities, see [my.chevrolet.com](http://my.chevrolet.com). Message and data rates may apply.

## Index

<b>A</b>	
Accessories and Modifications .....	216
Accessory Power .....	166
Adaptive Cruise Control .....	177
Add-On Electrical Equipment .....	214
Additional Information	
OnStar .....	299
Additional Maintenance and Care .....	277
Adjustments	
Lumbar, Front Seats .....	28
Agreements	
Trademarks and License .....	141
Air Conditioning .....	147
Air Conditioning Regular Operation .....	152
Air Filter, Passenger Compartment .....	152
Air Intake .....	151
Air Vents .....	151
Airbag System	
Check .....	47
How Does an Airbag Restrain? .....	41
Passenger Sensing System .....	43
What Makes an Airbag Inflate? .....	41
What Will You See after an Airbag Inflates? .....	41
When Should an Airbag Inflate? .....	40
Where Are the Airbags? .....	39
Airbags	
Adding Equipment to the Vehicle .....	46
Passenger Status Indicator .....	83
Readiness Light .....	82
Servicing Airbag-Equipped Vehicles .....	46
System Check .....	37
Alarm	
Vehicle Security .....	18
Alert	
Lane Change .....	196
Rear Cross Traffic .....	191
Side Blind Zone (SBZA) .....	196
All-Season Tires .....	238
AM-FM Radio .....	116
Antenna	
Multi-band .....	119
Antilock Brake System (ABS) .....	171
Warning Light .....	85
Appearance Care	
Exterior .....	265
Interior .....	269
Apple CarPlay and Android Auto .....	131
Armrest	
Rear Seat .....	31
Assistance Program, Roadside .....	289
Assistance Systems for Driving .....	191
Assistance Systems for Parking and Backing .....	187

- Audio  
 Bluetooth ..... 122
- Automatic  
 Climate Control System ..... 147  
 Door Locks ..... 17  
 Emergency Braking (AEB) ..... 193  
 Headlamp System ..... 107
- Avoiding Untrusted Media Devices ..... 119
- B**
- Battery ..... 80  
 Exterior Lighting Battery Saver ..... 110  
 Power Protection ..... 110
- Battery - North America ..... 223, 259
- Battery Gauge  
 High Voltage ..... 80
- Blade Replacement, Wiper ..... 225
- Bluetooth  
 Overview ..... 127
- Bluetooth Audio ..... 122
- Brake  
 Parking, Electric ..... 171  
 System Warning Light ..... 84
- Brakes ..... 221  
 Antilock ..... 171  
 Assist ..... 172  
 Fluid ..... 222  
 Regenerative Braking ..... 173
- Braking ..... 157  
 Automatic Emergency (AEB) ..... 193
- Braking System  
 Front Pedestrian (FPB) ..... 194
- Break-In, New Vehicle ..... 164
- Bulb Replacement  
 Back-up Lamps ..... 228  
 Halogen Bulbs ..... 228  
 Headlamp Aiming ..... 227  
 Headlamps ..... 227  
 License Plate Lamps ..... 229
- Buying New Tires ..... 249
- C**
- Calibration ..... 74
- California  
 Perchlorate Materials Requirements ... 216
- California Proposition  
 65 Warning ..... 223, 259,  
 Back Cover
- Camera  
 Rear Vision (RVC) ..... 187
- Canadian Vehicle Owners ..... 1
- Capacities and Specifications ..... 284
- Car Wash Mode ..... 168
- Carbon Monoxide  
 Liftgate ..... 18  
 Winter Driving ..... 160
- Cargo  
 Cover ..... 70  
 Management System ..... 70
- Caution, Danger, and Warning ..... 2
- Center Console Storage ..... 69
- Chains, Tire ..... 253
- Charge Cord ..... 207
- Charging  
 Delay Override ..... 203  
 Electrical Requirements ..... 213  
 Plug-In ..... 199  
 Programmable ..... 89  
 Utility Interruption ..... 213  
 Wireless ..... 75
- Charging Options ..... 98
- Charging Status Screens ..... 203
- Charging System Light ..... 83
- Child Restraints  
 Infants and Young Children ..... 49  
 Lower Anchors and Tethers for  
 Children ..... 54  
 Older Children ..... 48  
 Securing ..... 63, 65  
 Systems ..... 51
- Circuit Breakers ..... 231
- Cleaning  
 Exterior Care ..... 265  
 Interior Care ..... 269

Climate Control Systems	
Automatic .....	147
Clock .....	75
Cluster, Instrument .....	78
Collision Damage Repair .....	291
Compartment	
Underhood .....	219
Compartments	
Storage .....	68
Compass .....	74
Compressor Kit, Tire Sealant .....	254
Connected Services	
Connections .....	302
Diagnostics .....	304
Navigation .....	302
Connections	
Connected Services .....	302
Control	
Traction and Electronic Stability .....	174
Control of a Vehicle .....	157
Controls	
Steering Wheel .....	113
Convex Mirrors .....	20
Cooling .....	147
Cooling System .....	220
Courtesy Lamps .....	109
Courtesy Transportation Program .....	290

Cover	
Cargo .....	70
Cruise Control .....	175
Light .....	88
Cruise Control, Adaptive .....	177
Cupholders .....	68
Customer Assistance .....	288
Offices .....	287
Text Telephone (TTY) Users .....	288
Customer Information	
Publications Ordering Information .....	293
Customer Satisfaction Procedure .....	286
Cybersecurity .....	295

**D**

Damage Repair, Collision .....	291
Danger, Warning, and Caution .....	2
Data Collection	
OnStar .....	296
Data Recorders, Event .....	296
Daytime Running Lamps (DRL) .....	107
Defensive Driving .....	156
Delayed Charging Override .....	203
Delayed Locking .....	16
Diagnostics	
Connected Services .....	304
Distracted Driving .....	156
Dome Lamps .....	109

Door	
Ajari Light .....	89
Delayed Locking .....	16
Locks .....	14
Power Locks .....	16
Drive Unit	
Electric .....	168
Driver	
Teen .....	139
Driver Assistance Systems .....	186
Driver Efficiency Gauge .....	81
Driver Information Center (DIC) .....	98
Driver Selected Operating Modes .....	167
Driving	
Assistance Systems .....	191
Defensive .....	156
Hill and Mountain Roads .....	159
If the Vehicle is Stuck .....	160
Impaired .....	157
Loss of Control .....	158
Off-Road Recovery .....	158
One-Pedal .....	170
Vehicle Load Limits .....	161
Wet Roads .....	159
Winter .....	160
Driving for Better Energy Efficiency .....	155

**E**

Electric Drive Unit .....	168
Electric Parking Brake .....	171
Electric Parking Brake Light .....	84
Electrical Equipment, Add-On .....	214
Electrical Requirements for Battery	
Charging .....	213
Electrical System	
Fuses and Circuit Breakers .....	231
Instrument Panel Fuse Block .....	235
Overload .....	230
Emergency	
OnStar .....	298
Energy Efficiency	
Driving .....	155
Energy Information .....	97
Engine	
Cooling System .....	220
Entry Lighting .....	109
Event Data Recorders .....	296
Exit Lighting .....	110
Extended Parking .....	167
Extender, Seat Belt .....	36
Exterior Lamp Controls .....	105
Exterior Lamps Off Reminder .....	106
Exterior Lighting Battery Saver .....	110

**F**

Flash-to-Pass .....	107
Flashers, Hazard Warning .....	108
Flat Tire .....	253
Floor Mats .....	272
Fluid	
Brakes .....	222
Washer .....	221
Folding Mirrors .....	21
Forward Collision Alert (FCA) System .....	191
Frequency Statement	
Radio .....	294
Front Pedestrian Braking (FPB)	
System .....	194
Front Seats	
Adjustment .....	26
Heated .....	28
Fuses	
Fuses and Circuit Breakers .....	231
Instrument Panel Fuse Block .....	235
Underhood Compartment .....	232

**G**

Gas Strut(s) .....	226
Gauges	
Battery .....	80
Driver Efficiency .....	81
Odometer .....	80

**Gauges (cont'd)**

Power Indicator .....	81
Speedometer .....	80
Trip Odometer .....	80
Warning Lights and Indicators .....	78
General Information	
Service and Maintenance .....	274
Towing .....	213
Vehicle Care .....	216
Glove Box .....	68
GM Mobility Reimbursement	
Program .....	288

**H**

Halogen Bulbs .....	228
Hazard Warning Flashers .....	108
Head Restraints .....	24
Headlamps	
Aiming .....	227
Automatic .....	107
Bulb Replacement .....	227
Daytime Running Lamps (DRL) .....	107
Flash-to-Pass .....	107
High-Beam On Light .....	88
High/Low Beam Changer .....	106
Lamps On Reminder .....	88
Heated	
Steering Wheel .....	72

Heated Front Seats .....	28
Heated Mirrors .....	21
Heating .....	147
High Voltage Battery Gauge .....	80
High Voltage Devices and Wiring .....	229
High-Beam On Light .....	88
Hill and Mountain Roads .....	159
Hill Start Assist (HSA) .....	173
Hood .....	217
Horn .....	72
How to Wear Seat Belts Properly .....	32
HVAC .....	147
<b>I</b>	
Immobilizer .....	19
Indicator	
Pedestrian Ahead .....	86
Vehicle Ahead .....	86
Infants and Young Children, Restraints ....	49
Information	
Energy .....	97
Publication Ordering .....	293
Instrument Cluster .....	78
Instrument Panel Overview .....	4
Interior Rearview Mirrors .....	21
Introduction .....	1, 111

<b>J</b>	
Jump Starting - North America .....	259
<b>K</b>	
Keyless Entry	
Remote (RKE) System .....	7
Keys .....	6
<b>L</b>	
Labeling, Tire Sidewall .....	239
Lamps	
Courtesy .....	109
Daytime Running (DRL) .....	107
Dome .....	109
Exterior Controls .....	105
Exterior Lamps Off Reminder .....	106
Exterior Lighting Battery Saver .....	110
License Plate .....	229
On Reminder .....	88
Reading .....	109
Lane Change Alert (LCA) .....	196
Lane Keep Assist (LKA) .....	197
Lane Keep Assist Light .....	85
Lap-Shoulder Belt .....	34
LATCH System	
Replacing Parts after a Crash .....	62
LATCH, Lower Anchors and Tethers for Children .....	54

LED Lighting .....	228
Liftgate .....	18
Lighting	
Entry .....	109
Exit .....	110
Illumination Control .....	108
LED .....	228
Lights	
Airbag Readiness .....	82
Antilock Brake System (ABS)	
Warning .....	85
Brake System Warning .....	84
Charging System .....	83
Cruise Control .....	88
Door Ajar .....	89
Electric Parking Brake .....	84
Flash-to-Pass .....	107
High-Beam On .....	88
High/Low Beam Changer .....	106
Lane Keep Assist .....	85
One-Pedal Driving .....	88
Seat Belt Reminders .....	82
Security .....	87
Service Electric Parking Brake .....	84
Service Vehicle Soon .....	84
Sport Mode .....	85
StabiliTrak OFF .....	86
Tire Pressure .....	87

Lights (cont'd)			
Traction Control System (TCS)/StabiliTrak .....	87		
Traction Off .....	86		
Vehicle Ready .....	87		
Locks			
Automatic Door .....	17		
Delayed Locking .....	16		
Door .....	14		
Lockout Protection .....	17		
Power Door .....	16		
Safety .....	17		
Loss of Control .....	158		
Lower Anchors and Tethers for Children (LATCH System) .....	54		
Lumbar Adjustment .....	28		
Front Seats .....	28		
<b>M</b>			
Maintenance			
Air Conditioning Regular Operation ....	152		
Records .....	282		
Maintenance and Care			
Additional .....	277		
Maintenance Schedule .....	275		
Recommended Fluids and Lubricants .....	280		
Media			
Avoiding Untrusted Devices .....	119		
Messages			
Propulsion Power .....	100		
Vehicle .....	100		
Vehicle Speed .....	101		
Mirrors			
Automatic Dimming Rearview .....	21		
Convex .....	20		
Folding .....	21		
Heated .....	21		
Manual Rearview .....	21		
Power .....	21		
Mirrors, Interior Rearview .....	21		
Mode			
Car Wash .....	168		
Modes			
Driver Selected .....	167		
Monitor System, Tire Pressure .....	243		
Multi-band Antenna .....	119		
<b>N</b>			
Navigation			
Connected Services .....	302		
New Vehicle Break-In .....	164		
<b>O</b>			
Odometer .....	80		
Trip .....	80		
Off-Road			
Recovery .....	158		
Older Children, Restraints .....	48		
One-Pedal Driving .....	170		
One-Pedal Driving Light .....	88		
Online Owner Center .....	288		
OnStar .....	296		
OnStar Additional Information .....	299		
OnStar Emergency .....	298		
OnStar Overview .....	297		
OnStar Security .....	298		
Options			
Charging .....	98		
Outlets			
Power .....	75		
Overview .....	112		
Instrument Panel .....	4		
Underhood Compartment .....	219		
Owner Checks and Services .....	277		

<b>P</b>			
Park			
Shifting Into .....	166		
Shifting Out of .....	167		
Park Assist .....	187, 190		
Parking			
Brake and P (Park) Mechanism			
Check .....	224		
Extended .....	167		
Parking or Backing			
Assistance Systems .....	187		
Passenger Airbag Status Indicator .....	83		
Passenger Compartment Air Filter .....	152		
Passenger Sensing System .....	43		
Pedestrian Ahead Indicator .....	86		
Pedestrian Safety Signal .....	72		
Perchlorate Materials Requirements,			
California .....	216		
Personalization			
Vehicle .....	101		
Phone			
Apple CarPlay and Android Auto .....	131		
Bluetooth .....	127		
Plug-In Charging .....	199		
Port			
USB .....	119		
Power			
Button .....	164		
		Power (cont'd)	
		Door Locks .....	16
		Flows .....	89
		Indicator Gauge .....	81
		Mirrors .....	21
		Outlets .....	75
		Protection, Battery .....	110
		Retained Accessory (RAP) .....	166
		Seat Adjustment .....	27
		Windows .....	22
		Pregnancy, Using Seat Belts .....	36
		Privacy	
		Vehicle Data Recording .....	295
		Program	
		Courtesy Transportation .....	290
		Programmable Charging .....	89
		Proposition 65 Warning,	
		California .....	223, 259,
			Back Cover
		Propulsion Power Messages .....	100
		Publication Ordering Information .....	293
		<b>R</b>	
		Radio Data System (RDS) .....	118
		Radio Frequency Statement .....	294
		Radio Reception .....	118
		Radios	
		AM-FM Radio .....	116
		Satellite .....	118
		Reading Lamps .....	109
		Ready Indicator .....	87
		Rear Cross Traffic Alert System .....	191
		Rear Seat Armrest .....	31
		Rear Seats .....	30
		Rear Vision Camera (RVC) .....	187
		Rear Window Washer/Wiper .....	74
		Rearview Mirrors .....	21
		Automatic Dimming .....	21
		Reclining Seatbacks .....	27
		Recognition	
		Voice .....	122
		Recommended Fluids and Lubricants .....	280
		Records	
		Maintenance .....	282
		Recreational Vehicle Towing .....	264
		Regenerative Braking .....	173
		Reimbursement Program, GM	
		Mobility .....	288
		Remote Keyless Entry (RKE) System .....	7
		Remote Start .....	13
		Replacement Parts	
		Airbags .....	47
		Maintenance .....	281



Replacing Airbag System .....	47	Satellite Radio .....	118	Service (cont'd)	
Replacing LATCH System Parts after a Crash .....	62	Scheduling Appointments .....	290	Doing Your Own Work .....	217
Replacing Seat Belt System Parts after a Crash .....	37	Sealant Kit, Tire .....	254	Maintenance Records .....	282
Reporting Safety Defects		Seat Belts .....	31	Maintenance, General Information .....	274
Canadian Government .....	294	Care .....	37	Parts Identification .....	283
General Motors .....	295	Extender .....	36	Scheduling Appointments .....	290
U.S. Government .....	294	How to Wear Seat Belts Properly .....	32	Vehicle Soon Light .....	84
Requirements		Lap-Shoulder Belt .....	34	Service Electric Parking Brake Light .....	84
Electrical Battery Charging .....	213	Reminders .....	82	Servicing the Airbag .....	46
Restraints		Replacing after a Crash .....	37	Settings .....	132
Where to Put .....	53	Use During Pregnancy .....	36	Shifting	
Retained Accessory Power (RAP) .....	166	Seats		Into Park .....	166
Roads		Adjustment, Front .....	26	Out of Park .....	167
Driving, Wet .....	159	Head Restraints .....	24	Side Blind Zone Alert (SBZA) .....	196
Roadside Assistance Program .....	289	Heated Front .....	28	Signals, Turn and Lane-Change .....	108
Rotation, Tires .....	248	Lumbar Adjustment, Front .....	28	Software Updates .....	116
<b>S</b>		Power Adjustment, Front .....	27	Specifications and Capacities .....	284
Safety Defects Reporting		Rear .....	30	Speedometer .....	80
Canadian Government .....	294	Reclining Seatbacks .....	27	Sport Mode Light .....	85
General Motors .....	295	Securing Child Restraints .....	63, 65	StabiliTrak	
U.S. Government .....	294	Security		OFF Light .....	86
Safety Locks .....	17	Light .....	87	Start	
Safety Signal		OnStar .....	298	Remote .....	13
Pedestrian .....	72	Vehicle .....	18	Start Assist, Hill .....	173
Safety System Check .....	37	Vehicle Alarm .....	18	Starting and Stopping the Vehicle .....	165
		Self-Sealing Tires .....	238	Status Screens	
		Service .....	153	Charging .....	203
		Accessories and Modifications .....	216	Steering .....	157

Steering (cont'd)			
Heated Wheel .....	72		
Wheel Adjustment .....	72		
Wheel Controls .....	72		
Steering Wheel Controls .....	113		
Storage Areas			
Cargo Cover .....	70		
Cargo Management System .....	70		
Center Console .....	69		
Glove Box .....	68		
Storage Compartments .....	68		
Storing the Tire Sealant and Compressor Kit .....	259		
Struts			
Gas .....	226		
Stuck Vehicle .....	160		
Summer Tires .....	239		
Sun Visors .....	23		
Surround Vision System .....	188		
Symbols .....	2		
System			
Forward Collision Alert (FCA) .....	191		
Rear Cross Traffic Alert .....	191		
Surround Vision .....	188		
Systems			
Driver Assistance .....	186		
<b>T</b>			
Teen Driver .....	139		
Text Telephone (TTY) Users .....	288		
Theft-Deterrent Systems .....	20		
Immobilizer .....	19		
Time .....	75		
Tires .....	237		
All-Season .....	238		
Buying New Tires .....	249		
Chains .....	253		
Designations .....	240		
Different Size .....	250		
If a Tire Goes Flat .....	253		
Inspection .....	247		
Pressure .....	243		
Pressure Light .....	87		
Pressure Monitor Operation .....	244		
Pressure Monitor System .....	243		
Rotation .....	248		
Sealant and Compressor Kit .....	254		
Sealant and Compressor Kit, Storing .....	259		
Self-Sealing .....	238		
Sidewall Labeling .....	239		
Terminology and Definitions .....	240		
Uniform Tire Quality Grading .....	251		
Wheel Alignment and Tire Balance .....	252		
Wheel Replacement .....	252		
Tires (cont'd)			
When It Is Time for New Tires .....	249		
Winter .....	238		
Towing			
General Information .....	213		
Recreational Vehicle .....	264		
Vehicle .....	262		
Traction			
Control System (TCS)/StabiliTrak Light .....	87		
Off Light .....	86		
Traction Control/Electronic Stability Control .....	174		
Trademarks and License Agreements .....	141		
Transportation Program, Courtesy .....	290		
Trip Odometer .....	80		
Turn and Lane-Change Signals .....	108		
<b>U</b>			
Underhood Compartment Fuse Block .....	232		
Underhood Compartment Overview .....	219		
Uniform Tire Quality Grading .....	251		
Updates			
Software .....	116		
USB Port .....	119		
Using the System .....	113		
Using This Manual .....	2		
Utility Interruption of Charging .....	213		

**V**

Vehicle	
Alarm System .....	18
Canadian Owners .....	1
Control .....	157
Identification Number (VIN) .....	283
Load Limits .....	161
Messages .....	100
Personalization .....	101
Security .....	18
Service Soon Light .....	84
Speed Messages .....	101
Starting and Stopping .....	165
Towing .....	262
Vehicle Ahead Indicator .....	86
Vehicle Care	
Storing the Tire Sealant and Compressor Kit .....	259
Tire Pressure .....	243
Vehicle Data Recording and Privacy .....	295
Vehicle Ready Light .....	87
Ventilation, Air .....	151
Visors .....	23
Voice Recognition .....	122
Voltage Devices and Wiring .....	229

**W**

Warning	
Brake System Light .....	84
Caution and Danger .....	2
Warning Lights, Gauges, and Indicators .....	78
Warnings	
Hazard Flashers .....	108
Washer Fluid .....	221
Wheels	
Alignment and Tire Balance .....	252
Different Size .....	250
Replacement .....	252
When It Is Time for New Tires .....	249
When to Charge .....	199
Where to Put the Restraint .....	53
Windows .....	22
Power .....	22
Windshield	
Replacement .....	226
Wiper/Washer .....	73
Winter	
Driving .....	160
Winter Tires .....	238

Wiper Blade Replacement .....	225
Wipers	
Rear Washer .....	74
Wireless Charging .....	75
Wiring, High Voltage Devices .....	229



# WARNING

Operating, servicing and maintaining a passenger vehicle or off-highway motor vehicle can expose you to chemicals including engine exhaust, carbon monoxide, phthalates, and lead, which are known to the State of California to cause cancer and birth defects or other reproductive harm. To minimize exposure, avoid breathing exhaust, do not idle engine except as necessary, service your vehicle in a well-ventilated area and wear gloves or wash your hands frequently when servicing your vehicle. For more information go to [www.P65Warnings.ca.gov/passenger-vehicle](http://www.P65Warnings.ca.gov/passenger-vehicle).



84814981 A

## Scan to Access

US



Canada



- Owner and Warranty Manuals
- Connected Services
- myChevrolet Mobile App
- How To Videos
- Vehicle Diagnostics
- Schedule Maintenance
- Vehicle Features
- Many Additional Resources

**United States**  
**Customer Assistance**

1-800-222-1020

**Roadside Assistance**

1-800-243-8872

**Canada**  
**Customer Assistance**

1-800-263-3777

**Roadside Assistance**

1-800-268-6800

**United States and Canada**

**Connected Services**

1-888-4-DNSTAR