



CONFIGURATION GUIDE

PMP/PTP 450 Series

System Release 16.2/16.2.1/16.2.2

Covers:

PMP 450 AP / PMP 450 SM / PTP 450 / PMP 450d

PMP 450i / PTP 450i

PMP 450b / PTP 450b

PMP 450m



Accuracy

While reasonable efforts have been made to assure the accuracy of this document, Cambium Networks assumes no liability resulting from any inaccuracies or omissions in this document, or from use of the information obtained herein. Cambium reserves the right to make changes to any products described herein to improve reliability, function, or design, and reserves the right to revise this document and to make changes from time to time in content hereof with no obligation to notify any person of revisions or changes. Cambium does not assume any liability arising out of the application or use of any product, software, or circuit described herein; neither does it convey license under its patent rights or the rights of others. It is possible that this publication may contain references to, or information about Cambium products (machines and programs), programming, or services that are not announced in your country. Such references or information must not be construed to mean that Cambium intends to announce such Cambium products, programming, or services in your country.

Copyrights

This document, Cambium products, and 3rd Party software products described in this document may include or describe copyrighted Cambium and other 3rd Party supplied computer programs stored in semiconductor memories or other media. Laws in the United States and other countries preserve for Cambium, its licensors, and other 3rd Party supplied software certain exclusive rights for copyrighted material, including the exclusive right to copy, reproduce in any form, distribute and make derivative works of the copyrighted material. Accordingly, any copyrighted material of Cambium, its licensors, or the 3rd Party software supplied material contained in the Cambium products described in this document may not be copied, reproduced, reverse engineered, distributed, merged or modified in any manner without the express written permission of Cambium. Furthermore, the purchase of Cambium products shall not be deemed to grant either directly or by implication, estoppel, or otherwise, any license under the copyrights, patents or patent applications of Cambium or other 3rd Party supplied software, except for the normal non-exclusive, royalty free license to use that arises by operation of law in the sale of a product.

Restrictions

Software and documentation are copyrighted materials. Making unauthorized copies is prohibited by law. No part of the software or documentation may be reproduced, transmitted, transcribed, stored in a retrieval system, or translated into any language or computer language, in any form or by any means, without prior written permission of Cambium.

License Agreements

The software described in this document is the property of Cambium and its licensors. It is furnished by express license agreement only and may be used only in accordance with the terms of such an agreement.

High Risk Materials

Cambium and its supplier(s) specifically disclaim any express or implied warranty of fitness for any high-risk activities or uses of its products including, but not limited to, the operation of nuclear facilities, aircraft navigation or aircraft communication systems, air traffic control, life support, or weapons systems ("High Risk Use").

This product is not restricted in the EU. Any High Risk is unauthorized, is made at your own risk and you shall be responsible for any and all losses, damage or claims arising out of any High-Risk Use.

Contents

Contents	3
About This User Guide	13
Contacting Cambium Networks	13
Purpose	13
Product notation conventions in document	13
Cross references	15
Feedback	15
Important regulatory information	15
Application software	15
USA specific information	16
Canada specific information	17
Renseignements spécifiques au Canada	17
EU Declaration of Conformity	18
Specific expertise and training for professional installers	18
Ethernet networking skills	18
Lightning protection	18
Training	19
Problems and warranty	19
Reporting problems	19
Repair and service	19
Hardware warranty	19
Security advice	20
Warnings, cautions, and notes	20
Warnings	20
Cautions	20
Notes	20
Caring for the environment	20
In EU countries	21
In non-EU countries	21

Chapter 1: Configuration	22
Preparing for configuration	22
Safety precautions	23
Regulatory compliance	23
Connecting to the unit	23
Configuring the management PC	23
Connecting to the PC and powering up	24
Using the web interface	25
Logging into the web interface	25
Web GUI	26
Using the menu options	26
Quick link setup	30
Initiating Quick Start Wizard	30
Configuring time settings	35
Viewing the Session Status of the AP/BHM to determine test registration	37
Configuring IP and Ethernet interfaces	40
Configuring the IPv4 interface	40
Auxiliary port	51
NAT, DHCP Server, DHCP Client and DMZ	52
DHCP	53
Reconnecting to the management PC	68
VLAN configuration for PMP	68
VLAN configuration for PTP	78
PPPoE page of SM	81
IP4 and IPv6	83
Upgrading the software version and using CNUT	87
Checking the installed software version	87
Upgrading to a new software version	88
General configuration	91
PMP 450m and PMP/PTP 450i Series	91

PMP/PTP 450b Series	106
PMP/PTP 450 Series	115
Configuring Unit Settings page	125
Unit Settings page of 450 Platform Family - AP/BHM	126
Unit Settings page of PMP/PTP 450i SM/BHS	128
Setting up time and date	129
Time page of 450 Platform Family - AP/BHM	129
Configuring synchronization	130
Sync Input	130
Free Run Before GPS Sync	132
Device Type	133
Verify GPS Message Checksum	133
Sync Aux Port Config	133
Aux Port Power to UGPS	134
Configuring security	134
Managing module access by password	134
Isolating from the internet - APs/BHMs	138
Encrypting radio transmissions	138
Requiring SM Authentication	138
Filtering protocols and ports	139
Encrypting downlink broadcasts	143
Isolating SMs	143
Filtering management through Ethernet	143
Allowing management only from specified IP addresses	143
Restricting radio Telnet access over the RF interface	144
Configuring SNMP Access	146
Configuring Security	149
Configuring 802.1X authentication	166
802.1X authentication page of AP	167
802.1x authentication page of SM	167

Configuring radio parameters	168
PMP 450m Series - configuring radio	169
PMP/PTP 450i Series - configuring radio	176
PMP/PTP 450b Series - configuring radio	200
PMP/PTP 450 Series - configuring radio	213
Custom Frequencies page	234
DFS for 5 GHz Radios	238
Contention slots	238
MIMO-A mode of operation	244
Improved PPS performance of 450 Platform Family	246
Setting up SNMP agent	246
Configuring SM/BHS's IP over-the-air access	246
Configuring SNMP	247
Configuring syslog	253
Syslog event logging	253
Configuring system logging	254
Syslog page of AP/BHM	254
Syslog page of SM	255
Syslog page of BHS	256
Configuring remote access	257
Accessing SM/BHS over-the-air by Web Proxy	257
Monitoring the Link	258
Link monitoring procedure	258
Exporting Session Status page of AP/BHM	260
Configuring quality of service	260
Maximum Information Rate (MIR) Parameters	260
Token Bucket Algorithm	261
MIR Data Entry Checking	261
Committed Information Rate (CIR)	262
Bandwidth from the SM Perspective	263

Interaction of Burst Allocation and Sustained Data Rate Settings	263
SM Prioritization	263
Weighted Fair Queuing (WFQ)	264
Proportional Scheduler	267
High-priority Bandwidth Traffic	268
Traffic Scheduling	269
Setting the Configuration Source	270
Configuring Quality of Service (QoS)	272
Installation Color Code	282
Zero Touch Configuration Using DHCP Option 66	282
Configuration Steps	283
Troubleshooting	286
Configuring Radio via config file	287
Import and Export of config file	288
Configuring cnMaestro™ Connectivity	289
Onboarding	289
Prerequisites for onboarding to cnMaestro™	290
Knowledge Based articles for onboarding	292
Order of Device Onboarding	292
Device Agent Logs	292
Monitoring Tools for PMP Devices on cnMaestro™	293
Zero Touch on boarding of the PMP SMs when the corresponding AP is on boarded	293
Configuring a RADIUS server	294
Understanding RADIUS for PMP 450 Platform Family	294
Choosing Authentication Mode and Configuring for Authentication Servers - AP	295
SM Authentication Mode - Require RADIUS or Follow AP	300
Handling Certificates	305
Configuring RADIUS servers for SM authentication	306
Assigning SM management IP addressing via RADIUS	307
Configuring RADIUS server for SM configuration	307

Configuring RADIUS server for SM configuration using Zero Touch feature	311
Using RADIUS for centralized AP and SM user name and password management	311
RADIUS Device Data Accounting	317
RADIUS Device Re-authentication	319
RADIUS Change of Authorization and Disconnect Message	320
Microsoft RADIUS support	321
Cisco ACS RADIUS Server Support	325
Monitoring Logs	328
Configuring Ping Watchdog	332
Chapter 2: Tools	333
Using Spectrum Analyzer tool	333
Mapping RF Neighbor Frequencies	334
Spectrum Analyzer tool	334
Remote Spectrum Analyzer tool	342
Using the Alignment Tool	345
Aiming page and Diagnostic LED – SM/BHS	346
Alignment Tone	349
Using the Link Capacity Test tool	349
Performing Link Test	350
Performing Extrapolated Link Test	353
Link Capacity Test page of AP	354
Link Capacity Test page of BHM/BHS/SM	356
Using AP Evaluation tool	357
AP Evaluation page	357
Using BHM Evaluation tool	361
BHM Evaluation page of BHS	361
Using the OFDM Frame Calculator tool	364
Using the Subscriber Configuration tool	368
Using the Link Status tool	369
Link Status – AP/BHM	370

Link Status - SM/BHS	372
Using BER Results tool	375
Using the Sessions tool	376
Using the Ping Test tool	376
Chapter 3: Operation	378
System information	379
Viewing General Status	379
Viewing Session Status	400
Viewing Remote Subscribers	408
Interpreting messages in the Event Log	409
Viewing the Network Interface	411
Viewing the Layer 2 Neighbors	412
System statistics	412
Viewing the Scheduler statistics	412
Viewing list of Registration Failures statistics	414
Interpreting Bridging Table statistics	415
Interpreting Translation Table statistics	416
Interpreting Ethernet statistics	417
Interpreting RF Control Block statistics	419
Interpreting Sounding statistics for AP	420
Interpreting VLAN statistics	421
Interpreting Data Channels statistics	422
Interpreting Proportional Scheduler	425
Interpreting MIR/Burst statistics	426
Interpreting Throughput statistics	428
Interpreting Overload statistics	431
Interpreting DHCP Relay statistics	433
Interpreting Filter statistics	434
Viewing ARP statistics	435
Viewing NAT statistics	435

Viewing NAT DHCP Statistics	436
Interpreting Sync Status statistics	438
Interpreting PPPoE Statistics for Customer Activities	438
Interpreting Bridge Control Block statistics	440
Interpreting Pass Through Statistics	442
Interpreting SNMPv3 Statistics	443
Interpreting syslog statistics	445
Interpreting Frame Utilization statistics	446
Interpreting Spatial Utilization statistics	451
Radio Recovery	455
Radio Recovery Console- PMP/PTP 450i/450b and PMP 450m	455
Using the Default/Override Plug	457
Chapter 4: Reference information	459
Equipment specifications	459
Specifications for 5 GHz PMP 450m Series - AP	459
Specifications for 3 GHz PMP 450m Series - AP	463
Specifications for PMP 450i Series - AP	466
Specifications for PMP 450 MicroPoP - AP	471
Specifications for PMP 450i Series - SM	476
Specifications for PTP 450i Series - BH	481
Specifications for PMP 450b 5 GHz Mid-Gain Series - SM	486
Specifications for PMP 450b 5 GHz High Gain Series - SM	489
Specifications for PMP/PTP 450b 3 GHz High Gain Series - SM/BHS	493
Specifications for PMP 450 Series - AP	495
Specifications for PMP 450 Series - SM	500
Specifications for PTP 450 Series - BH	505
PSU specifications	509
Data network specifications	511
Ethernet interface	511
Wireless specifications	512

General wireless specifications	512
Link Range and Throughput	512
Country specific radio regulations	513
Type approvals	513
DFS for 2.4 and 5 GHz Radios	514
Equipment Disposal	516
Waste (Disposal) of Electronic and Electric Equipment	516
Country specific band range maximum transmit power	516
Maximum transmit power 900 MHz band	516
Maximum transmit power 2.4 GHz band	517
Maximum transmit power 3 GHz band	518
Maximum transmit power 4.9 GHz band	520
Maximum transmit power 5.1 GHz band	522
Maximum transmit power 5.2 GHz band	525
Maximum transmit power 5.4 GHz band	528
Maximum transmit power 5.8 GHz band	533
Country specific frequency range	538
Frequency range 900 MHz band	538
Frequency range 2.4 GHz band	539
Frequency range 3.5 GHz band	539
Frequency range 3.65 GHz band	539
Frequency range 4.9 GHz band	540
Frequency range 5.1 GHz band	542
Frequency range 5.2 GHz band	545
Frequency range 5.4 GHz band	547
Frequency range 5.8 GHz band	553
FCC specific information	559
FCC compliance testing	559
FCC IDs	559
FCC approved antenna list	571

Innovation Science and Economic Development Canada (ISED) specific information	573
900 MHz ISED notification	573
4.9 GHz ISED notification	573
Utilisation de la bande 4.9 GHz FCC et ISED	573
5.2 GHz and 5.4 GHz ISED notification	573
Utilisation de la bande 5.2 and 5.4 GHz ISED	574
ISED notification 5.8 GHz	574
Utilisation de la bande 5.8 GHz ISED	574
ISED certification numbers	574
Canada approved antenna list	577
Chapter 5: Troubleshooting	580
General troubleshooting procedure	580
General planning for troubleshooting	580
General fault isolation process	581
Secondary Steps	582
Troubleshooting procedures	582
Module has lost or does not establish connectivity	583
NAT/DHCP-configured SM has lost or does not establish connectivity	584
SM Does Not Register to an AP	585
Module has lost or does not gain sync	586
Module does not establish Ethernet connectivity	586
CMM4 does not pass proper GPS sync to connected modules	587
Module Software Cannot be Upgraded	587
Module Functions Properly, Except Web Interface Became Inaccessible	588
Power-up troubleshooting	589
Registration and connectivity troubleshooting	590
Logs	590
Persistent Logging	590
450m Reference information	591
Quality of Service (QoS) Glossary	593

About This User Guide

This guide describes configuration and operation of the Cambium point-to-point and point-to-multipoint wireless Ethernet bridges. It covers PMP/PTP 450, 450i, 450b, 450d and PMP 450m platform Series. It is intended for use by the system designer, system installer and system administrator.

For system configuration, tools and troubleshooting, refer to the following chapters:

- Chapter 1: Configuration
- Chapter 2: Tools
- Chapter 3: Operation
- Chapter 4: Reference information
- Chapter 5: Troubleshooting

Contacting Cambium Networks

Main website:	http://www.cambiumnetworks.com
Sales enquiries:	solutions@cambiumnetworks.com
Support/Repair enquiries:	https://support.cambiumnetworks.com
Telephone number list:	http://www.cambiumnetworks.com/contact
Address:	Cambium Networks Limited, Linhay Business Park, Eastern Road, Ashburton, Devon, TQ13 7UP United Kingdom

Purpose

Cambium Networks Point-to-Multi-Point (PMP)/Point-To-Point (PTP) 450 documents are intended to instruct and assist personnel in the operation, installation and maintenance of the Cambium PMP/PTP equipment and ancillary devices of 450 Platform Family. It is recommended that all personnel engaged in such activities be properly trained.

Cambium disclaims all liability whatsoever, implied or express, for any risk of damage, loss or reduction in system performance arising directly or indirectly out of the failure of the customer, or anyone acting on the customer's behalf, to abide by the instructions, system parameters, or recommendations made in this document.

Product notation conventions in document

This document covers Cambium 450 Series, 450b series, 450i Series and 450m Series products. The following notation conventions are followed while referring to product series and product family:

Product notation	Description
450 Platform Family	Refers to the complete 450 Series family, which includes 450 Series, 450i Series, 450b Series, 450m Series, 450 MicroPoP Series
450 Series	<p>Refers to 450 Series devices in the following configurations:</p> <ul style="list-style-type: none"> • PMP 450 • AP [2.4, 3.5, 3.65, 5 GHz] <ul style="list-style-type: none"> ■ Connectorized/Integrated • SM [900 MHz and 2.4, 3.5, 3.65, 5 GHz] <ul style="list-style-type: none"> ■ Connectorized/Integrated • PTP 450 BHM/ BHS [900 MHz and 3.5, 3.65, 5 GHz] <ul style="list-style-type: none"> • Connectorized/Integrated • PMP 450d SM [5 GHz]
450i Series	<p>Refers to 450i Series devices in the following configurations:</p> <ul style="list-style-type: none"> • PMP 450i • AP [900 MHz and 3, 5 GHz] <ul style="list-style-type: none"> • Connectorized/Integrated • SM [3 GHz and 5 GHz] <ul style="list-style-type: none"> • Connectorized/Integrated • PTP 450i BHM/ BHS [3 GHz and 5 GHz] <ul style="list-style-type: none"> • Connectorized/Integrated
450b Series	<p>Refers to 450b Series devices in the following configurations:</p> <ul style="list-style-type: none"> • PMP 450b Mid-Gain • SM [5 GHz] <ul style="list-style-type: none"> • Integrated • PMP 450b High Gain • SM [3 GHz and 5 GHz] - Dish • PTP 450b Mid-Gain • BHM/BHS [5 GHz] <ul style="list-style-type: none"> • Integrated

Product notation	Description
	<ul style="list-style-type: none"> • PTP 450b High Gain • BHM/BHS [3 GHz and 5 GHz] - Dish
450m Series	Refers to 450m Series device configuration: <ul style="list-style-type: none"> • PMP 450m AP (5 GHz) • Integrated • PMP 450m AP (3 GHz) • Integrated
450 MicroPoP AP Series	Refers to 450 MicroPoP Series device configuration: <ul style="list-style-type: none"> • PMP 450 MicroPoP Omni 5 GHz Integrated • PMP 450 MicroPoP Sector 5 GHz Integrated

Cross references

References to external publications are shown in italics. Other cross references, emphasized in blue text in electronic versions, are active links to the references.

This document is divided into numbered chapters that are divided into sections. Sections are not numbered but are individually named at the top of each page, and are listed in the table of contents.

Feedback

We appreciate feedback from the users of our documents. This includes feedback on the structure, content, accuracy, or completeness of our documents. To provide feedback, visit our support website: <https://support.cambiumnetworks.com>.



Caution

This device complies with Part 15 of the FCC Rules. Operation is subject to the following two conditions:

- This device may not cause harmful interference, and
- This device must accept any interference received, including interference that may cause undesired operation

Important regulatory information

The 450 Platform Family products are certified as an unlicensed device in frequency bands where it is not allowed to cause interference to licensed services (called primary users of the bands).

Application software

Download the latest 450 Platform Family software and install it in the Outdoor Units (ODUs) before deploying the equipment. Instructions for installing software are provided in Upgrading the software

version and using CNU T on page 1.

USA specific information

The USA Federal Communications Commission (FCC) requires manufacturers to implement special features to prevent interference to weather radar systems that operate in the band 5600 MHz to 5650 MHz. These features must be implemented in all products able to operate outdoors in the band 5470 MHz to 5725 MHz.

Manufacturers must ensure that such radio products cannot be configured to operate outside of FCC rules; specifically, it must not be possible to disable or modify the radar protection functions that have been demonstrated to the FCC.

Cambium supplies variants of the 5 GHz 450, 450i, 450b, and 450m Series specifically for operation in the USA to comply with FCC requirements (KDB 905462 D02 UNII DFS Compliance Procedures New Rules v02). These variants are only allowed to operate with license keys that comply with FCC rules.

To ensure compliance when using PMP 450 Series and PTP 450 Series, follow the recommendation in Avoidance of weather radars (USA only).

External antennas

When using a connectorized version of the product, the conducted transmit power may need to be reduced to ensure the regulatory limit on transmitter EIRP is not exceeded. The installer must have an understanding of how to compute the effective antenna gain from the actual antenna gain and the feeder cable losses.

The range of permissible values for maximum antenna gain and feeder cable losses are included in this user guide together with a sample calculation. The product GUI automatically applies the correct conducted power limit to ensure that it is not possible for the installation to exceed the EIRP limit, when the appropriate values for antenna gain and feeder cable losses are entered into the GUI.

Avoidance of weather radars (USA only)

To comply with FCC rules (KDB 443999: Interim Plans to Approve UNII Devices Operating in the 5470 - 5725 MHz Band with Radar Detection and DFS Capabilities), units which are installed within 35 km (22 miles) of a Terminal Doppler Weather Radar (TDWR) system (or have a line of sight propagation path to such a system) must be configured to avoid any frequency within +30 MHz or -30 MHz of the frequency of the TDWR device. This requirement applies even if the master is outside the 35 km (22 miles) radius but communicates with outdoor clients which may be within the 35 km (22 miles) radius of the TDWRs. If interference is not eliminated, a distance limitation based on line-of-sight from TDWR will need to be used. Devices with bandwidths greater than 20 MHz may require greater frequency separation.

When planning a link in the USA, visit <http://spectrumbridge.com/udia/home.aspx>, enter the location of the planned link and search for TDWR radars. If a TDWR system is located within 35 km (22 miles) or has line of sight propagation to the PTP device, perform the following tasks:

- Register the installation on <http://spectrumbridge.com/udia/home.aspx>.
- Make a list of channel center frequencies that must be barred, that is, those falling within +30 MHz or -30 MHz of the frequency of the TDWR radars.

The 450 Platform Family AP must be configured to not operate on the affected channels.

Canada specific information



Caution

This device complies with ISEDC 's license-exempt RSSs. Operation is subject to the following two conditions:

- (1) This device may not cause interference; and
- (2) This device must accept any interference, including interference that may cause undesired operation of the device.

ISEDC requires manufacturers to implement special features to prevent interference to weather radar systems that operate in the band 5600 MHz to 5650 MHz. These features must be implemented in all products able to operate outdoors in the band 5470 MHz to 5725 MHz.

Manufacturers must ensure that such radio products cannot be configured to operate outside of ISEDC rules; specifically it must not be possible to disable or modify the radar protection functions that have been demonstrated to ISEDC .

In order to comply with these ISEDC requirements, Cambium supplies variants of the 450 Platform Family for operation in Canada. These variants are only allowed to operate with license keys that comply with ISEDC rules. In particular, operation of radio channels overlapping the band 5600 MHz to 5650 MHz is not allowed and these channels are permanently barred.

In addition, other channels may also need to be barred when operating close to weather radar installations.

Other variants of the 450 Platform Family are available for use in the rest of the world, but these variants are not supplied to Canada except under strict controls, when they are needed for export and deployment outside Canada.

Renseignements spécifiques au Canada



Attention

Le présent appareil est conforme aux CNR d'Industrie Canada applicables aux appareils radio exempts de licence. L'exploitation est autorisée aux deux conditions suivantes :

- (1) l'appareil ne doit pas produire de brouillage, et
- (2) l'utilisateur de l'appareil doit accepter tout brouillage radioélectrique subi, même si le brouillage est susceptible d'en compromettre le fonctionnement.

ISEDC a demandé aux fabricants de mettre en œuvre des mécanismes spécifiques pour éviter d'interférer avec des systèmes radar fonctionnant dans la bande 5600 MHz à 5650 MHz. Ces mécanismes doivent être mis en œuvre dans tous les produits capables de fonctionner à l'extérieur dans la bande 5470 MHz à 5725 MHz.

Les fabricants doivent s'assurer que les produits de radiocommunications ne peuvent pas être configurés pour fonctionner en dehors des règles ISEDC, en particulier, il ne doit pas être possible de désactiver ou modifier les fonctions de protection des radars qui ont été démontrés à ISEDC.

Afin de se conformer à ces exigences de ISEDC, Cambium fournit des variantes du 450 Platform Family exclusivement pour le Canada. Ces variantes ne permettent pas à l'équipement de fonctionner en dehors des règles de ISEDC. En particulier, le fonctionnement des canaux de radio qui chevauchent la bande 5600-5650 MHz est interdite et ces canaux sont définitivement exclus.

ISED DC approved antennas

The list of antennas used to obtain ISED DC approvals is provided in section Country specific radio regulations, Innovation Science and Economic Development Canada (ISED DC) specific information, Table 233 Canada approved dedicated external antenna list 4.9 and 5.8 GHz.

Antennas externes

Lorsque vous utilisez une version du produit sans antenne intégrée, il peut être nécessaire de réduire la puissance d'émission pour garantir que la limite réglementaire de puissance isotrope rayonnée équivalente (PIRE) n'est pas dépassée. L'installateur doit avoir une bonne compréhension de la façon de calculer le gain de l'antenne réelle et les pertes dans les câbles de connections.

La plage de valeurs admissibles pour un gain maximal de l'antenne et des pertes de câbles de connections sont inclus dans ce guide d'utilisation avec un exemple de calcul. L'interface utilisateur du produit applique automatiquement la limite de puissance menée correct afin de s'assurer qu'il ne soit pas possible pour l'installation de dépasser la limite PIRE, lorsque les valeurs appropriées pour le gain d'antenne et les pertes de câbles d'alimentation sont entrées dans l'interface utilisateur.

Antennes approuvées par ISED DC

La liste des antennes approuvées pour l'opération au Canada est fournie dans le chapitre Country specific radio regulations, Innovation Science and Economic Development Canada (ISED DC) specific information tableaux Table 233 Canada approved dedicated external antenna list 4.9 and 5.8 GHz.

EU Declaration of Conformity

Hereby, Cambium Networks declares that the Cambium 450 Series, 450b Series, 450i Series and 450m Series Wireless Ethernet Bridge complies with the essential requirements and other relevant provisions of Radio Equipment Directive 2014/53/EU. The declaration of conformity may be consulted at:

https://www.cambiumnetworks.com/eu_dofc

Specific expertise and training for professional installers

To ensure that the 450 Platform Family products – PMP/PTP 450 Series, PMP/PTP 450i Series, PMP 450m Series are installed and configured in compliance with the requirements of ISED DC and the FCC, installers must have the radio engineering skills and training described in this section.

The Cambium Networks technical training program details can be accessed from below link:

<https://www.cambiumnetworks.com/training/>

Ethernet networking skills

The installer must have the ability to configure IP addressing on a PC and to set up and control products using a web browser interface.

Lightning protection

To protect outdoor radio installations from the impact of lightning strikes, the installer must be familiar with the normal procedures for site selection, bonding and grounding. Installation guidelines for the 450 Platform Family can be found in Chapter 2: System hardware and Chapter 3: System planning of 450 Platform Planning and Installation Guide.

Training

The installer needs to have basic competence in radio and IP network installation. The specific requirements applicable to the 450 Platform should be gained by reading:

- Chapter 4: Preparing for installation and Chapter 5: Installation of 450 Platform Planning and Installation Guide,
- Chapter 1: Configuration, Chapter 2: :Tools, and Chapter 3: Operation of 450 Platform Configuration Guide (this document),
- And by performing sample set ups at base workshop before live deployments.

The Cambium Networks technical training program details can be accessed from below link:

<https://www.cambiumnetworks.com/training/>

Problems and warranty

Reporting problems

If any problems are encountered when installing or operating this equipment, follow this procedure to investigate and report:

1. Search this document and the software release notes of supported releases.
2. Visit the support website.
3. Ask for assistance from the Cambium product supplier.
4. Gather information from affected units, such as any available diagnostic downloads.
5. Escalate the problem by emailing or telephoning support.

Repair and service

If unit failure is suspected, obtain details of the Return Material Authorization (RMA) process from the support website (<http://www.cambiumnetworks.com/support>).

Hardware warranty

Cambium's standard hardware warranty is for one (1) year from date of shipment from Cambium Networks or a Cambium distributor. Cambium Networks warrants that hardware will conform to the relevant published specifications and will be free from material defects in material and workmanship under normal use and service. Cambium shall within this time, at its own option, either repair or replace the defective product within thirty (30) days of receipt of the defective product. Repaired or replaced product will be subject to the original warranty period but not less than thirty (30) days.

To register PMP and PTP products or activate warranties, visit the support website. For warranty assistance, contact the reseller or distributor. The removal of the tamper-evident seal will void the warranty.



Caution

Using non-Cambium parts for repair could damage the equipment or void warranty. Contact Cambium for service and repair instructions.

Portions of Cambium equipment may be damaged from exposure to electrostatic discharge. Use precautions to prevent damage.

Security advice

Cambium Networks systems and equipment provide security parameters that can be configured by the operator based on their particular operating environment. Cambium recommends setting and using these parameters following industry recognized security practices. Security aspects to be considered are protecting the confidentiality, integrity, and availability of information and assets. Assets include the ability to communicate, information about the nature of the communications, and information about the parties involved.

In certain instances Cambium makes specific recommendations regarding security practices, however the implementation of these recommendations and final responsibility for the security of the system lies with the operator of the system.

Warnings, cautions, and notes

The following describes how warnings and cautions are used in this document and in all documents of the Cambium Networks document set.

Warnings

Warnings precede instructions that contain potentially hazardous situations. Warnings are used to alert the reader to possible hazards that could cause loss of life or physical injury. A warning has the following format:



Warning

Warning text and consequence for not following the instructions in the warning.

Cautions

Cautions precede instructions and are used when there is a possibility of damage to systems, software, or individual items of equipment within a system. However, this damage presents no danger to personnel. A caution has the following format:



Caution

Caution text and consequence for not following the instructions in the caution.

Notes

A note means that there is a possibility of an undesirable situation or provides additional information to help the reader understand a topic or concept. A note has the following format:



Note

Note text.

Caring for the environment

The following information describes national or regional requirements for the disposal of Cambium Networks supplied equipment and for the approved disposal of surplus packaging.

In EU countries

The following information is provided to enable regulatory compliance with the European Union (EU) directives identified and any amendments made to these directives when using Cambium equipment in EU countries.



Disposal of Cambium equipment

European Union (EU) Directive 2012/19/EU Waste Electrical and Electronic Equipment (WEEE)

Do not dispose of Cambium equipment in landfill sites. For disposal instructions, refer to

<https://www.cambiumnetworks.com/support/compliance/>

Disposal of surplus packaging

Do not dispose of surplus packaging in landfill sites. In the EU, it is the individual recipient's responsibility to ensure that packaging materials are collected and recycled according to the requirements of EU environmental law.

In non-EU countries

In non-EU countries, dispose of Cambium equipment and all surplus packaging in accordance with national and regional regulations.

Chapter 1: Configuration

This chapter describes how to use the web interface to configure the 450 Platform link. This chapter contains the following topics:

- Preparing for configuration
- Connecting to the unit
- Using the web interface
- Quick link setup
- Configuring IP and Ethernet interfaces
- Upgrading the software version and using CNUT
- General configuration
- Configuring Unit Settings page
- Setting up time and date
- Configuring synchronization
- Configuring security
- Configuring 802.1X authentication
- Configuring radio parameters
- Setting up SNMP agent
- Configuring syslog
- Configuring remote access
- Monitoring the Link
- Configuring quality of service
- Installation Color Code
- Zero Touch Configuration Using DHCP Option 66
- Configuring Radio via config file
- Configuring a RADIUS server

Preparing for configuration

This section describes the checks to be performed before proceeding with unit configuration and antenna alignment.

Safety precautions

All national and local safety standards must be followed while configuring the units and aligning the antennas.



Warning

Ensure that personnel are not exposed to unsafe levels of RF energy. The units start to radiate RF energy as soon as they are powered up. Respect the safety standards defined in Legal and Open Sources Guide, in particular the minimum separation distances.

Observe the following guidelines:

Never work in front of the antenna when the ODU is powered.

Always power down the PSU before connecting or disconnecting the drop cable from the PSU, ODU or LPU.

Regulatory compliance

All applicable radio regulations must be followed while configuring the units and aligning the antennas. For more information, refer to chapter Compliance with radio regulations in Legal and Open Sources Guide.

Connecting to the unit

This section describes how to connect the unit to a management PC and power it up.

Configuring the management PC

Use this procedure to configure the local management PC to communicate with the 450 Platform ODU.

Procedure 1 Configuring the management PC

1	Select Properties for the Ethernet port. In Windows 7 this is found in Control Panel > Network and Internet > Network Connections > Local Area Connection.
2	Select Internet Protocol (TCP/IP):

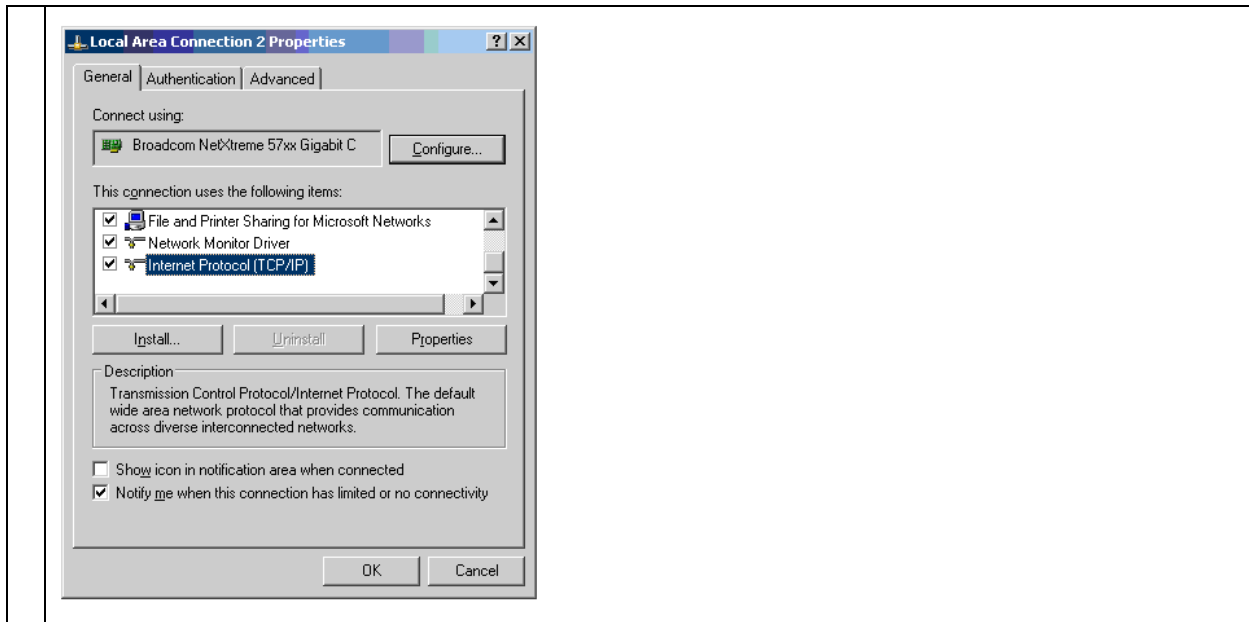

3 Click Properties.

4 Enter an IP address that is valid for the 169.254.X.X network, avoiding 169.254.0.0 and 169.254.1.1. A good example is 169.254.1.3:

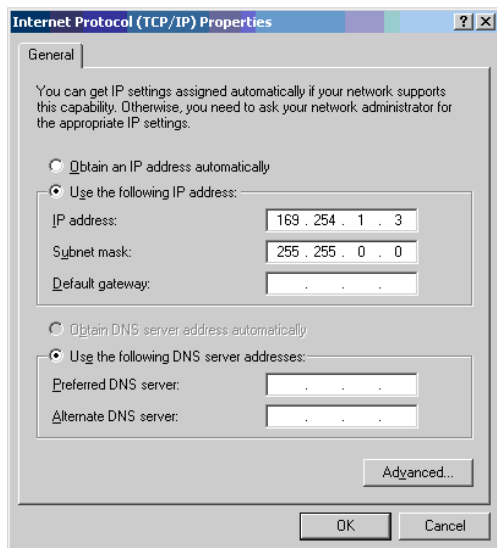

5 Enter a subnet mask of 255.255.0.0. Leave the default gateway blank.

Connecting to the PC and powering up

Use this procedure to connect a management PC and power up the 450 platform ODU.

Procedure 2 Connecting to the PC and powering up

1 Check that the ODU and PSU are correctly connected.

2	Connect the PC Ethernet port to the LAN port of the PSU using a standard (not crossed) Ethernet cable.
3	Apply mains or battery power to the PSU. The green Power LED should illuminate continuously.
4	After about several seconds, check that the orange Ethernet LED starts with 10 slow flashes.
5	Check that the Ethernet LED then illuminates continuously.

Using the web interface

This section describes how to log into the 450 Platform Family web interface and use its menus.

Logging into the web interface

Use this procedure to log into the web interface as a system administrator.

Procedure 3 Logging into the web interface

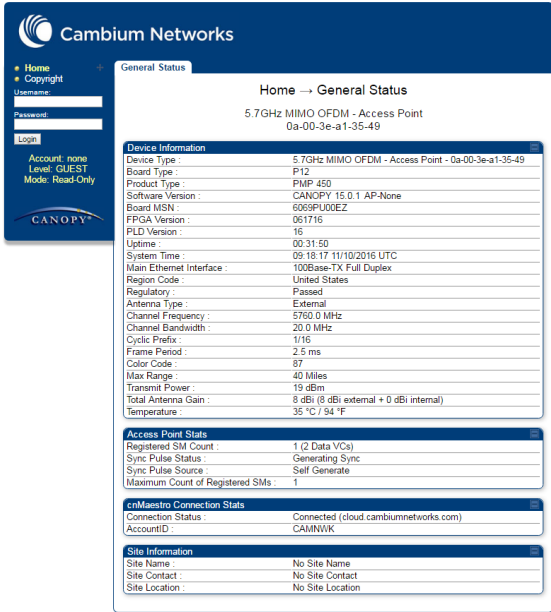
1	Start the web browser from the management PC.
2	Type the IP address of the unit into the address bar. The factory default IP address is 169.254.1.1. Press ENTER. The web interface menu and System Summary page are displayed:
	 <p>The screenshot shows the Cambium Networks web interface. On the left is a navigation menu with 'Home' selected. The main content area is titled 'General Status' and shows 'Home -> General Status' for a '5.7GHz MIMO OFDM - Access Point' with ID '0a-00-3e-a1-35-49'. Below this are several sections: 'Device Information' (listing device type, board type, software version, etc.), 'Access Point Stats' (showing 1 registered SM), 'eMissions Connection Stats' (showing connection to cambiumnetworks.com), and 'Site Information' (showing no site name or contact).</p>
3	On left hand side of home page, the login information is displayed:

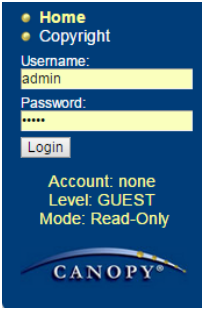
	
4	Enter Username (factory default username is admin) and Password (factory default password is admin) and click Login.

Web GUI

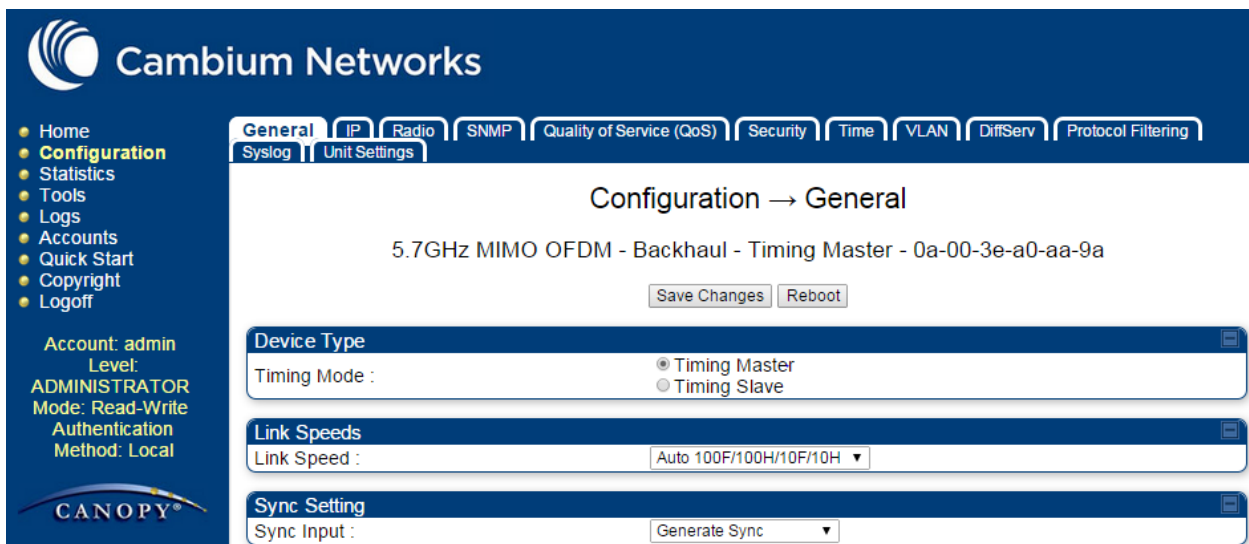

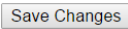
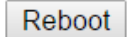
Field Name	Description
Main Menu	Click an option in side navigation bar (area marked as “1”). Multiple options in sub-navigation bars appear
Menu Options	Click top sub-navigation bar to choose one configuration page (area marked as “2”)
Parameters	To configure the parameters (e.g. area marked as “3”)
	Press “Save Changes” to confirm and save the changes
	To reboot the ODU

Using the menu options

Use the menu navigation bar in the left panel to navigate to each web page. Some of the menu options are only displayed for specific system configurations. Use below table to locate information about using each



web page.

Table 1 :Menu options and web pages

Main menu	Menu options	Applicable module	Description
● Home			
	General Status	All	Viewing General Status
	Session Status	AP, BHM	Viewing Session Status
	Event Log	All	Interpreting messages in the Event Log
	Network Interface	All	Viewing the Network Interface
	Layer 2 Neighbors	All	Viewing the Layer 2 Neighbors
● Configuration			
	General	All	General configuration
	IP	All	Configuring IP and Ethernet interfaces
	Radio	All	Configuring radio parameters
	SNMP	All	Setting up SNMP agent
	cnMaestro	All	Configuring cnMaestro™ Connectivity
	Quality of Service (QoS)	All	Configuring quality of service
	Security	All	Configuring security
	Time	AP, BHM	Setting up time and date
	VLAN	All	VLAN configuration for PMP VLAN configuration for PTP
	DiffServ	All	IPv4 and IPv6 Prioritization
	Protocol Filtering	All	Filtering protocols and ports
	Syslog	All	Configuring syslog
	Ping Watchdog	All	Configuring Ping Watchdog
	Unit Setting	All	Configuring Unit Settings page
● Statistics			
	Scheduler	All	Viewing the Scheduler statistics

Main menu	Menu options	Applicable module	Description
	Registration Failures	AP, BHM	Viewing list of Registration Failures statistics
	Bridge Control Block	All	Interpreting Bridge Control Block statistics
	Bridging Table	All	Interpreting Bridging Table statistics
	Ethernet	All	Interpreting Ethernet statistics
	Radio	All	Interpreting RF Control Block statistics
	VLAN	All	Interpreting VLAN statistics
	Data Channels	All	Interpreting Data Channels statistics
	MIR/Burst	AP, SM	Interpreting MIR/Burst statistics
	Throughput	AP, BHM	Interpreting Throughput statistics
	Filter	All	Interpreting Filter statistics
	ARP	All	Viewing ARP statistics
	Overload	All	Interpreting Overload statistics
	Syslog Statistics	All	Interpreting syslog statistics
	Translation Table	SM	Interpreting Translation Table statistics
	DHCP Relay	AP	Interpreting DHCP Relay statistics on page 1
	NAT Stats	SM	Viewing NAT statistics
	NAT DHCP	SM	Viewing NAT DHCP Statistics
	Pass Through Statistics	AP	Interpreting Pass Through Statistics
	Sync Status	AP	Interpreting Sync Status statistics
	PPPoE	SM	Interpreting PPPoE Statistics for Customer Activities
	SNMPv3 Statistics	All	Interpreting SNMPv3 Statistics
	Frame Utilization	AP, BH	Interpreting Frame Utilization statistics
			
	Link Capacity Test	All	Using the Link Capacity Test tool

Main menu	Menu options	Applicable module	Description
	Spectrum Analyzer	All	Spectrum Analyzer tool
	Remote Spectrum Analyzer	All	Remote Spectrum Analyzer tool
	AP/BHM Evaluation	SM, BHS	Using AP Evaluation tool Using BHM Evaluation tool
	Subscriber Configuration	AP	Using the Subscriber Configuration tool
	OFDM Frame Calculator	All	Using the OFDM Frame Calculator tool
	BER results	SM, BHS	Using BER Results tool
	Alignment Tool	SM, BHS	Using the Alignment Tool
	Link Status	All	Using the Link Status tool
	Sessions	AP, BHM	Using the Sessions tool
	Ping Test	All	Using the Ping Test tool
	 Logs		
	 Accounts		
	Change User Setting	All	Changing a User Setting
	Add user	All	Adding a User for Access to a module
	Delete User	All	Deleting a User from Access to a module
	User	All	Users account
	 Quick Start		
	Quick Start	AP, BHM	Quick link setup
	 Region Settings	AP, BHM	Quick link setup
	Radio Carrier Frequency	AP, BHM	Quick link setup
	Synchronization	AP, BHM	Quick link setup
	LAN IP Address	AP, BHM	Quick link setup

Main menu	Menu options	Applicable module	Description
	Review and Save Configuration	AP, BHM	Quick link setup
			
	Quick Status	SM	The PDA web-page includes 320 x 240 pixel formatted displays of information important to installation and alignment for installers using legacy PDA devices. All device web pages are compatible with touch devices such as smart phones and tablets.
	Spectrum Results (PDA)	SM	
	Information	SM	
	BHM Evaluation	SM	
	AIM	SM	
			
	Copyright Notices	All	The Copyright web- page displays pertinent device copyright information.
		All	

Quick link setup

This section describes how to use the Quick Start Wizard to complete the essential system configuration tasks that must be performed on a PMP/PTP configuration.

Initiating Quick Start Wizard

Applicable products PMP: p AP PTP: p BHM

To start with Quick Start Wizard: after logging into the web management interface click the Quick Start button on the left side of main menu bar. The AP/BHM responds by opening the Quick Start page.

Figure 1: Disarm Installation page (top and bottom of page shown)

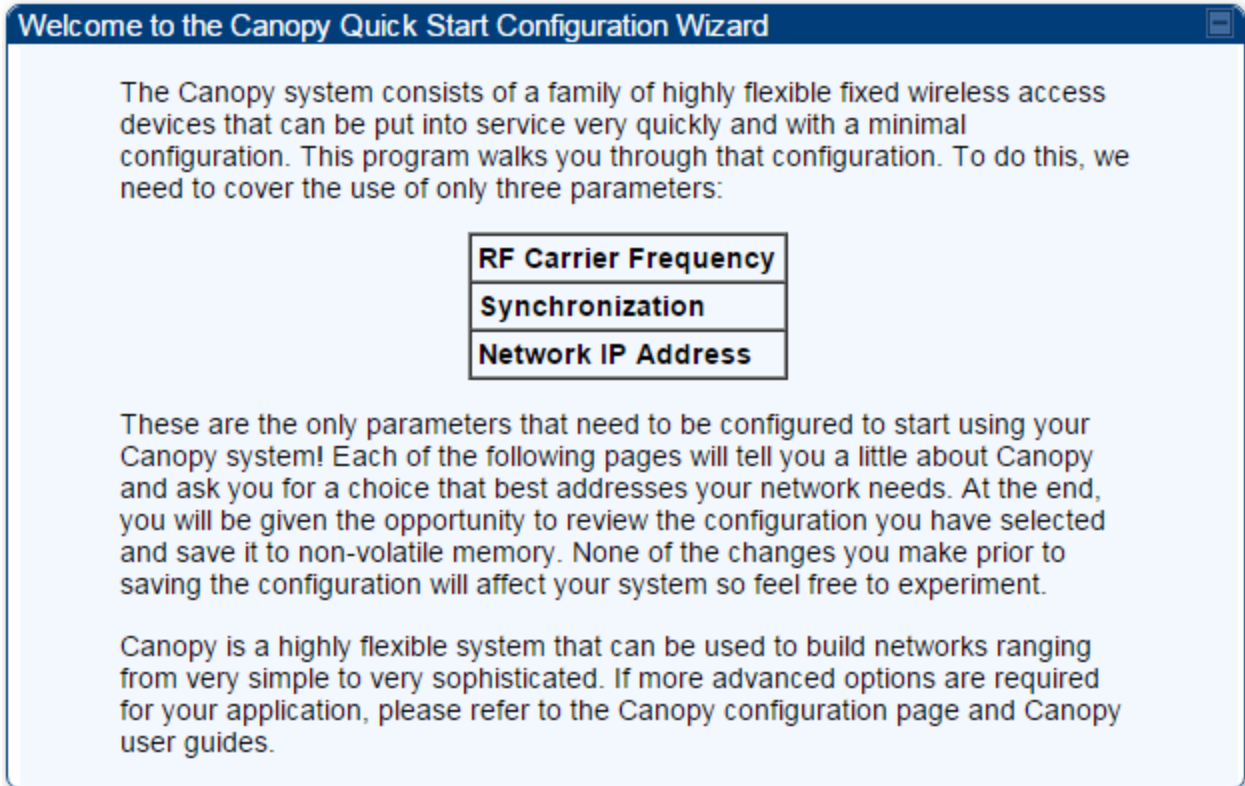

Quick Start is a wizard that helps you to perform a basic configuration that places an AP/BHM into service. Only the following parameters must be configured:

- Region Code
- RF Carrier Frequency
- Synchronization
- LAN (Network) IP Address

In each Quick Start page, you can

- specify the settings to satisfy the requirements of the network.
- review the configuration selected.
- save the configuration to non-volatile memory.

Procedure 4 Quick start wizard

1	At the bottom of the Quick Start tab, click Go To Next Page .
2	From the pull-down menu, select the region in which the AP will operate. <i>Figure 2 : Regional Settings tab of AP/BHM</i>

Region Settings Descriptions

To comply with various international regulations, a region setting is required. This unit will NOT transmit unless a valid region code is set. Please select your region code from the drop down menu. If your region does not appear, then select "Other".

Region Settings

Region : Other - Regulatory ▾
 Country : Other - FCC ▾

<=>Go To Previous Page | Go To Next Page=>

3 Click the Go To Next Page button.

4 From the pull-down menu, select a frequency for the test.

Figure 3: Radio Carrier Frequency tab of AP/BHM

Radio Carrier Frequency

To communicate, each Access Point (AP) and Backhaul (BH) timing master must be assigned a specific carrier frequency. By default, this frequency is not set at the factory to ensure that new units do not accidentally transmit on an unintended frequency. For our purposes, frequency selection for OFDM platforms has two basic rules:

- Two radios located at a single location (such as an AP cluster) and on the same frequency should not have an overlapping pattern.
- Generally for PMP 450, no guard band is needed. With the exception of 3.5/3.65 GHz platform, which can also operate with no guard band if "Adjacent Channel Support" is enabled. Otherwise 3.5/3.65 will need a guard band of 5/3/2 MHz for 20/10/5 MHz channel bandwidths. For PMP 430 and PTP 230, 5/5/2.5 MHz guard band is required for 20/10/5 MHz channels bandwidths.

We recommend multipoint AP clusters use frequencies separated by 15 MHz where convenient. For a 360 degree multipoint AP, each frequency is used twice with the back-to-back units sharing the same frequency.

Please see the Canopy User's Guide online for the latest information.

Direction of Access Point Radio	Frequency	Sector ID	Symbol
Northeast	5495 MHz	1	A
Southeast	5545 MHz	2	B
Southwest	5495 MHz	1	A
Northwest	5545 MHz	2	B



AP Carrier Frequency Parameter

Please select Carrier Frequency from the list : 5490.0 ▾

<=>Go To Previous Page | Go To Next Page=>

5 Click the Go To Next Page button.

6 At the bottom of this tab, select Generate Sync Signal.

Figure 4: Synchronization tab of AP/BHM

	<div data-bbox="282 205 1045 1003"> <p>Synchronization</p> <p>When any radio transmits, it radiates energy. If a nearby radio is trying to receive at the same time another is transmitting, interference can result. One of the mechanisms used by Canopy to avoid this issue is to synchronize all transmissions. This approach ensures that all Canopy units will transmit and receive during the same time interval.</p> <p>To accomplish this, Canopy Cluster Management Module's (CMM) each contain a GPS receiver. This receiver is used to create a precision timing signal which is then used by the attached APs/BHs (Backhauls). For systems that have only one AP/BH, this signal can be generated by selecting "Generate Sync" which causes AP/BH to use a simulated synchronization. For systems that have multiple APs/BHs, GPS synchronization should be used.</p> <p>Each AP or BH timing master (BHM) must be programmed to either generate its own synchronization pulse (for single AP/BHM use only) or to use an external pulse. If you are using a CMM or other source of synchronization timing, you should select "AutoSync"; if not, you should select "Generate Sync". There are three methods on the AP/BHM from which the synchronization is received:</p> <ol style="list-style-type: none"> 1)Power Port (Not applicable for PTP450) 2)Timing Port 3)On-board GPS (PMP 450 AP only) <p>If the power port is being used, only one cable is necessary to obtain power and the synchronization pulse. If the timing port is used, two cables will be necessary, one to obtain power and the other for the synchronization pulse.</p> <p>Selecting "AutoSync + Free Run" will allow the AP/BHM to continue to transmit even after the sync pulse is lost. Otherwise if "AutoSync" is selected and synchronization pulse is lost, the AP/BHM will immediately stop transmitting. This is done to prevent interference with other Canopy systems.</p> <p>Please be aware that operating multiple APs/BHs without an external GPS timing source may lead to degraded system operation.</p> <p>Also, use the Frame Calculator tool for complete transmit and receive synchronization across different Canopy products.</p> </div> <div data-bbox="282 1024 1045 1121"> <p>Synchronization Parameters</p> <p>Synchronization : <input type="text" value="Generate Sync"/></p> <p><input type="button" value="<=Go To Previous Page"/> <input type="button" value="Go To Next Page=>"/></p> </div>
7	Click the Go To Next Page button.
8	<p>At the bottom of the IP address configuration tab, either</p> <ul style="list-style-type: none"> • specify an IP Address, a Subnet Mask, and a Gateway IP Address for management of the AP and leave the DHCP state set to Disabled. • set the DHCP state to Enabled to have the IP address, subnet mask, and gateway IP address automatically configured by a domain name server (DNS). <p><i>Figure 5 : LAN IP Address tab of the AP/BHM</i></p>

	<div data-bbox="284 205 1291 598"> <h3>LAN IP Address</h3> <p>The IP address of the Canopy AP/BH timing master is used to talk to the unit in order to monitor, update, and manage the Canopy system. If you are viewing this page (which you appear to be doing now), your browser is communicating with the Canopy AP/BH using this IP address.</p> <p>Each network has its own collection of IP addresses that are used to route traffic between network elements such as APs, BHs, Routers, and Computers. You need to select the IP address, Default Gateway, and Network Mask which you intend to use to communicate with the AP/BH timing master in the space below.</p> <p>If you don't know what these are, please consult your local network specialist.</p> </div> <div data-bbox="284 619 1291 961"> <h3>LAN1 Network Interface Configuration</h3> <table border="1"> <tr> <td>IP Address :</td> <td><input type="text" value="10.110.65.90"/></td> </tr> <tr> <td>Subnet Mask :</td> <td><input type="text" value="255.255.255.0"/></td> </tr> <tr> <td>Gateway IP Address :</td> <td><input type="text" value="10.110.65.254"/></td> </tr> <tr> <td>DHCP state :</td> <td> <input type="radio"/> Enabled <input checked="" type="radio"/> Disabled </td> </tr> <tr> <td>DHCP DNS IP Address :</td> <td> <input checked="" type="radio"/> Obtain Automatically <input type="radio"/> Set Manually </td> </tr> <tr> <td>Preferred DNS Server :</td> <td><input type="text" value="10.110.12.31"/></td> </tr> <tr> <td>Alternate DNS Server :</td> <td><input type="text" value="10.110.12.30"/></td> </tr> <tr> <td>Domain Name :</td> <td><input type="text" value="pool.ntp.org"/></td> </tr> </table> <p style="text-align: center;"> <input type="button" value="<=Go To Previous Page"/> <input type="button" value="Go To Next Page=>"/> </p> </div> <div data-bbox="284 1050 1344 1197">  <p>Note</p> <p>Cambium encourages you to experiment with the interface. Unless you save a configuration and reboot the AP after you save the configuration, none of the changes are affected.</p> </div>	IP Address :	<input type="text" value="10.110.65.90"/>	Subnet Mask :	<input type="text" value="255.255.255.0"/>	Gateway IP Address :	<input type="text" value="10.110.65.254"/>	DHCP state :	<input type="radio"/> Enabled <input checked="" type="radio"/> Disabled	DHCP DNS IP Address :	<input checked="" type="radio"/> Obtain Automatically <input type="radio"/> Set Manually	Preferred DNS Server :	<input type="text" value="10.110.12.31"/>	Alternate DNS Server :	<input type="text" value="10.110.12.30"/>	Domain Name :	<input type="text" value="pool.ntp.org"/>
IP Address :	<input type="text" value="10.110.65.90"/>																
Subnet Mask :	<input type="text" value="255.255.255.0"/>																
Gateway IP Address :	<input type="text" value="10.110.65.254"/>																
DHCP state :	<input type="radio"/> Enabled <input checked="" type="radio"/> Disabled																
DHCP DNS IP Address :	<input checked="" type="radio"/> Obtain Automatically <input type="radio"/> Set Manually																
Preferred DNS Server :	<input type="text" value="10.110.12.31"/>																
Alternate DNS Server :	<input type="text" value="10.110.12.30"/>																
Domain Name :	<input type="text" value="pool.ntp.org"/>																
9	Click the Go To Next Page button.																
10	Ensure that the initial parameters for the AP are set as you intended. <i>Figure 6 : Review and Save Configuration tab of the AP/BHM</i>																

11	Click Save Changes button.
12	Click the Reboot button. RESULT: The AP responds with the message Reboot Has Been Initiated...
13	Wait until the indicator LEDs are not red.
14	Trigger your browser to refresh the page until the AP redisplay the General Status tab.
15	Wait until the red indicator LEDs are not lit.

Configuring time settings

Applicable products PMP: p AP PTP: p BHM

To proceed with the test setup, click the Configuration link on the left side of the General Status page. When the AP responds by opening the Configuration page to the General page, click the Time tab.

Figure 7 : Time tab of the AP/BHM

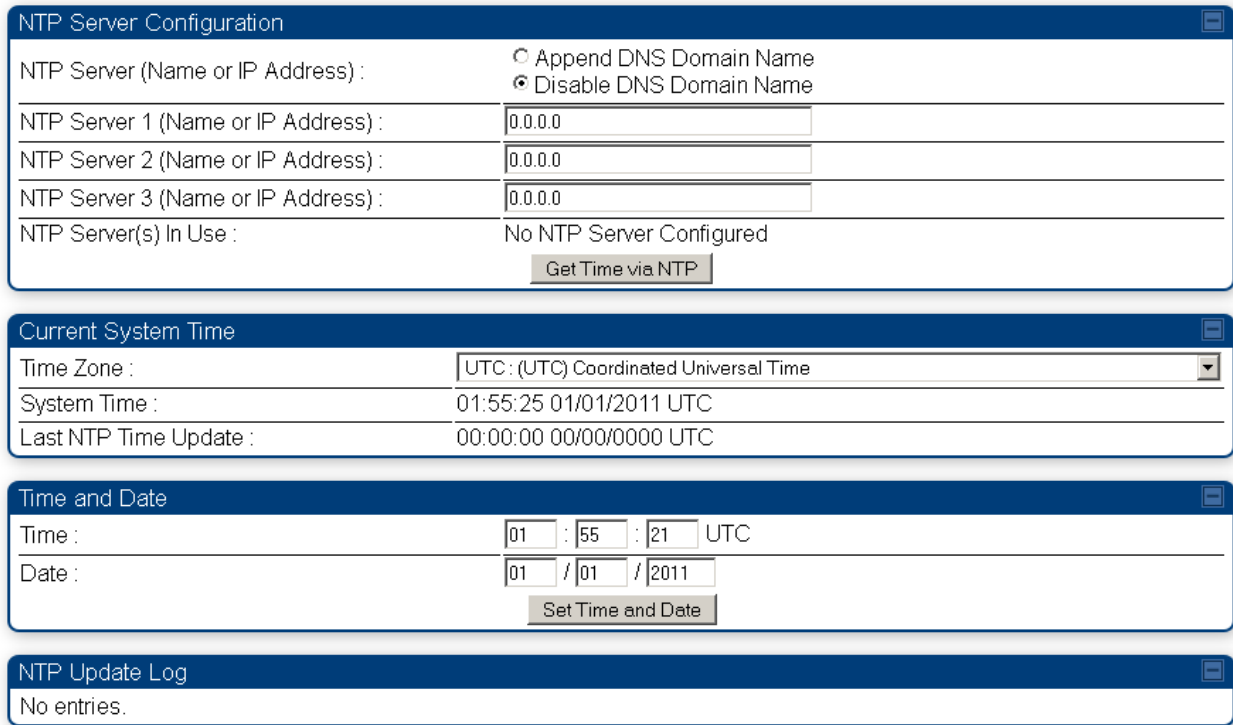

To have each log in the AP/BHM correlated to a meaningful time and date, either a reliable network element must pass time and date to the AP/BHM or you must set the time and date whenever a power cycle of the AP/BHM has occurred. A network element passes time and date in any of the following scenarios:

- A connected CMM4 passes time and date (GPS time and date, if received).
- A separate NTP server is addressable from the AP/BHM.

If the AP/BHM should obtain time and date from a CMM4, or a separate NTP server, enter the IP address of the CMM4 or NTP server on this tab. To force the AP/BHM to obtain time and date before the first (or next) 15-minute interval query of the NTP server, click Get Time through NTP.

If you enter a time and date, the format for entry is

Figure 8 : *Time and date entry formats*

Time:	hh	/	mm	/	ss
Date:	MM	/	dd	/	yyyy

where

hh	represents the two-digit hour in the range 00 to 24
mm	represents the two-digit minute

ss	represents the two-digit second
MM	represents the two-digit month
dd	represents the two-digit day
yyyy	represents the four-digit year

Proceed with the time setup as follows.

Procedure 5 Entering AP/BHM time setup information

1. Enter the appropriate information in the format shown above.
2. Then click the Set Time and Date button.



Note

The time displayed at the top of this page is static unless your device is set to automatically refresh

Powering the SM/BHS for test

Procedure 6 Powering the SM/BHS for test

1	In one hand, securely hold the top (larger shell) of the SM/BHS. With the other hand, depress the lever in the back of the base cover (smaller shell). Remove the base cover.
2	Plug one end of a CAT5 Ethernet cable into the SM PSU port
3	Plug the other end of the Ethernet cable into the jack in the pig tail that hangs from the power supply
4	Roughly aim the SM/BHS toward the AP/BHM
5	Plug the power supply into an electrical outlet
	 <div style="background-color: #f8d7da; padding: 5px;"> <p>Warning</p> <p>From this point until you remove power from the AP/BHM, stay at least as far from the AP/BHM as the minimum separation distance specified in Calculated distances and power compliance margins in chapter 11.</p> </div>
6	Repeat the foregoing steps for each SM/BHS that you wish to include in the test.

Viewing the Session Status of the AP/ BHM to determine test registration

Once the SMs/BHS under test are powered on, return to the computing device to determine if the SM/BHS units have registered to the AP/BHM.



Note

In order for accurate power level readings to be displayed, traffic must be present on the radio link.

The Session Status tab provides information about each SM/BHS that has registered to the AP/BHM. This information is useful for managing and troubleshooting a system. All information that you have entered in the Site Name field of the SM/BHS displays in the Session Status tab of the linked AP/BHM.

The Session Status tab also includes the current active values on each SM(or BHS) (LUID) for MIR, and VLAN, as well as the source of these values (representing the SM/BHS itself, Authentication Server, or the AP/BHM and cap, if any—for example, APCAP as shown above).. As an SM/BHS registers to the AP/BHM, the configuration source that this page displays for the associated LUID may change. After registration, however, the displayed source is stable and can be trusted.

Idle subscribers may be included or removed from the session status display by enabling or disabling, respectively, the Show Idle Sessions parameter. Enabling or disabling this parameter only affects the GUI display of subscribers, not the registration status.

The SessionStatus.xml hyperlink allows user to export session status page from web management interface of AP/BHM. The session status page will be exported in xml file.

Procedure 7 Viewing the AP Session Status page

1 On the AP web management GUI, navigate to Home, Session Status:

Figure 9 : Session Status tab of AP

Note
Session status page for BHM is same as AP.

2 Verify that for each SM (or BHS) MAC address (printed on the SM/BHS housing) the AP/BHM has established a registered session by verifying the “State” status of each entry.

The Session Status page of the AP/BHM is explained in Session Status Attributes – AP.

Table 2 :Session Status Attributes – AP

SM Prioritization Status

SM Prioritization Low Group Count : 0 (0%) **(Note: SM Prioritization is disabled)**

SM Prioritization High Group Count : 0 (0%)

Session Status Configuration

Show Idle Sessions : Enabled
 Disabled

Link Quality Update Interval : 1 minute ▼

Link Quality Metric : Rate ▼

Session List Tools

Last Session Counter Reset : None

Last Time Idle SMs Removed : None

Reference EVM setting option : Set Reference EVM only if it is not already set
 Always override

Session Status List

Data : [SessionStatus.xml](#)

Encryption Information : Encryption is disabled on this radio

Subscriber	LUID	Hardware	Software Version	FPGA Version	State
LUID: 002 - [0a-00-3e-70-2a-95]	002	NA			IDLE

Attribute	Meaning
Show Idle Sessions	Idle subscribers may be included or removed from the session status display by enabling or disabling, respectively, the Show Idle Sessions parameter. Enabling or disabling this parameter only affects the GUI display of subscribers, not the registration status.
Last Session Counter Reset	This field displays date and time stamp of last session counter reset.
Reference EVM setting option	Option to configure reference EVM for all connected SMs.
Last Time Idle SMs Removed	This field displays date and time stamp of last Idle SMs Removed. On click of "Remove Idle SMs" button, all the SMs which are in Idle state are flushed out.
Data	See Exporting Session Status page of AP/BHM
Device tab	See Device tab
Session tab	See Session tab
Power tab	See Power tab
Configuration tab	See Configuration tab
Link Quality	See Link Quality tab

Configuring IP and Ethernet interfaces

This task consists of the following sections:

- Configuring the IPv4 interface
- NAT, DHCP Server, DHCP Client and DMZ
- IP interface with NAT disabled - SM
- IP interface with NAT enabled - SM
- NAT tab with NAT disabled - SM
- NAT tab with NAT enabled - SM
- NAT DNS Considerations - SM
- DHCP - BHS
- VLAN configuration for PMP
- VLAN page of AP
- VLAN page of SM
- VLAN Membership tab of SM
- VLAN configuration for PTP
- NAT Port Forwarding tab - SM

Configuring the IPv4 interface

The IPv4 interface allows users to connect to the 450 Platform Family web interface, either from a locally connected computer or from a management network.

Applicable products PMP: AP SM PTP: BHM BMS

To configure the IP interface, follow these instructions:

Procedure 8 Configuring the AP/BHM IPv4 interface

1	Select menu option Configuration > IP. The LAN configuration page is displayed:
---	---

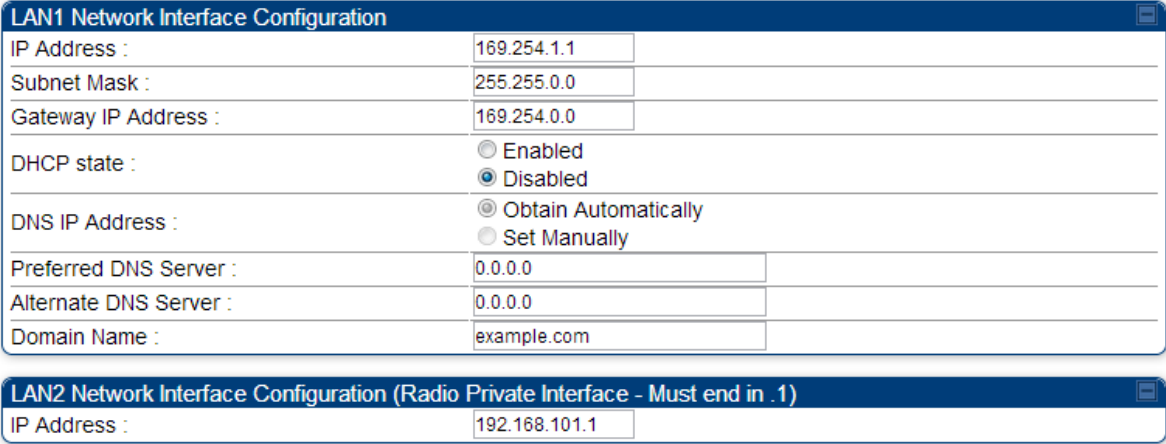
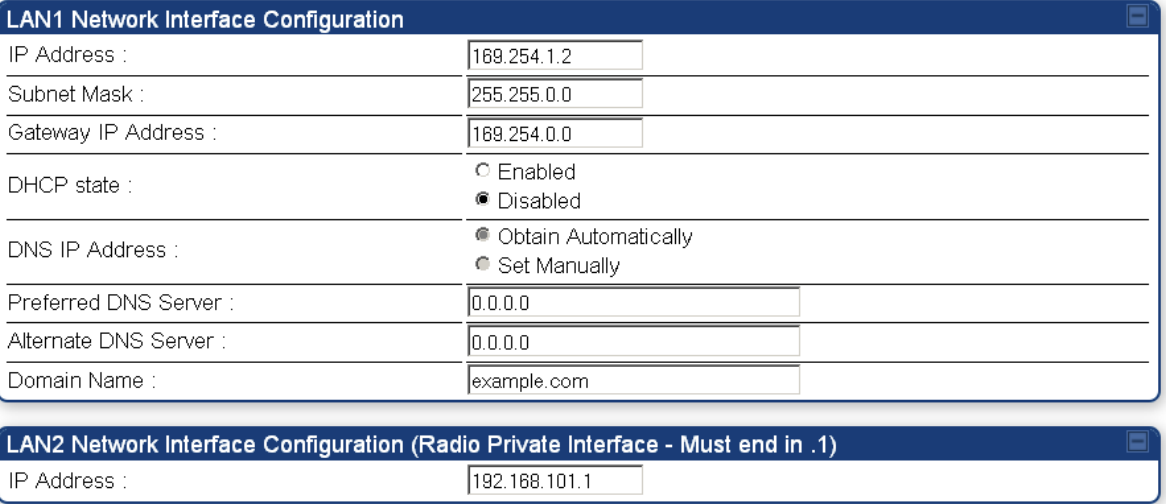
	
2	Update IPv4 Address, Subnet Mask and Gateway IP Address to meet network requirements (as specified by the network administrator).
3	Review the other IP interface attributes and update them, if necessary (see).
4	Click Save. “Reboot Required” message is displayed: 
5	Click Reboot button.

The IP page of AP/SM/BHM/BHS is explained in below table.

LAN1 Network Interface Configuration	
IP Address :	10.110.245.135
Subnet Mask :	255.255.255.0
Gateway IP Address :	10.110.245.254
DHCP state :	<input type="radio"/> Enabled <input checked="" type="radio"/> Disabled
DHCP DNS IP Address :	<input checked="" type="radio"/> Obtain Automatically <input type="radio"/> Set Manually
Preferred DNS Server :	10.110.12.30
Alternate DNS Server :	10.110.12.31
Domain Name :	example.com

Advanced LAN1 IP Configuration	
Default alternative LAN1 IP address :	<input type="radio"/> Enabled <input checked="" type="radio"/> Disabled

Aux Ethernet Port	
AUX Ethernet Port :	<input type="radio"/> Enabled <input checked="" type="radio"/> Disabled
AUX Ethernet Port PoE :	<input type="radio"/> Enabled <input checked="" type="radio"/> Disabled <input type="button" value="Reset AUX PoE"/>

LAN2 Network Interface Configuration (Radio Private Interface - Must end in .1)	
IP Address :	192.168.101.1

Table 3 :IPv4 interface attributes

Attribute	Meaning
IP Address	Internet Protocol (IP) address. This address is used by family of Internet protocols to uniquely identify this unit on a network.
Subnet Mask	Defines the address range of the connected IP network.
Gateway IP Address	The IP address of a computer on the current network that acts as a gateway. A gateway acts as an entrance and exit to packets from and to other networks.
DHCP state	If Enabled is selected, the DHCP server automatically assigns the IP configuration (IP address, subnet mask, and gateway IP address) and the values of those individual parameters (above) are not used. The setting of this DHCP state parameter is also viewable (read only), in the Network Interface tab of the Home page.
DNS IP Address	Canopy devices allow for configuration of a preferred and alternate DNS server IP address either automatically or manually. Devices must set DNS server IP address

Attribute	Meaning									
	manually when DHCP is disabled for the management interface of the device. DNS servers may be configured automatically from the DHCP response when DHCP is enabled for the management interface of the device. Optionally devices may be configured to set the DNS server IP address manually when DHCP is enabled for the management interface. The default DNS IP addresses are 0.0.0.0 when configured manually.									
Preferred DNS Server	The first address used for DNS resolution.									
Alternate DNS Server	If the Preferred DNS server cannot be reached, the Alternate DNS Server is used.									
Domain Name	The operator's management domain name may be configured for DNS. The domain name configuration can be used for configuration of the servers in the operator's network. The default domain name is example.com, and is only used if configured as such.									
Advanced LAN1 IP Configuration - Default alternate LAN1 IP address	Hardcoded default alternate IP address (169.254.1.1) that is available only when connected to the Ethernet port. When enabled, user can configure a second IP address for the bridge which is other than the hardcoded IP address (169.254.1.1).									
AUX Ethernet Port - AUX Ethernet Port	Enabled: Data is enabled for Auxiliary port Disabled: Data is disabled for Auxiliary port									
AUX Ethernet Port - AUX Ethernet Port PoE	Enabled: PoE out is enable for Auxiliary port Disabled: PoE out is disabled for Auxiliary port									
LAN2 Network Interface Configuration (Radio Private Interface) - IP Address	<p>It is recommended not to change this parameter from the default AP/BHM private IP address of 192.168.101.1. A /24 CIDR subnet is used to communicate with each of the SMs/BHS that are registered. The AP/BHM uses a combination of the private IP and the LUID (logical unit ID) of the SM/BHS.</p> <p>It is only displayed for AP and BHM.</p> <p>Table 4 :SM/BHS private IP and LUID</p> <table border="1"> <thead> <tr> <th>SM/BHS</th> <th>LUID</th> <th>Private IP</th> </tr> </thead> <tbody> <tr> <td>First SM/BHS registered</td> <td>2</td> <td>192.168.101.2</td> </tr> <tr> <td>Second SM registered</td> <td>3</td> <td>192.168.101.3</td> </tr> </tbody> </table>	SM/BHS	LUID	Private IP	First SM/BHS registered	2	192.168.101.2	Second SM registered	3	192.168.101.3
SM/BHS	LUID	Private IP								
First SM/BHS registered	2	192.168.101.2								
Second SM registered	3	192.168.101.3								

Configuring the IPv6 interface

The IPv6 interface allows users to connect to the 450 Platform Family web interface, either from a locally connected computer or from a management network.

To configure the IPv6 interface, follow these instructions:

Configuring the AP/BHM IPv6 interface

To enable this feature,

1. Go to Configuration > IP > LAN1 IPv6 Network Interface Configuration.
2. Set the IPv6 parameter as Enabled.

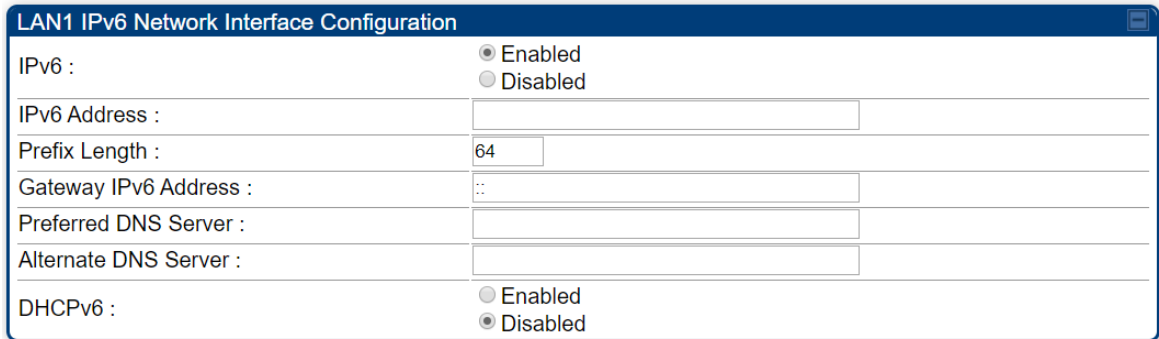

The screenshot shows the 'LAN1 IPv6 Network Interface Configuration' window. It contains the following fields and options:

IPv6 :	<input checked="" type="radio"/> Enabled <input type="radio"/> Disabled
IPv6 Address :	<input type="text"/>
Prefix Length :	<input type="text" value="64"/>
Gateway IPv6 Address :	<input type="text" value="::"/>
Preferred DNS Server :	<input type="text"/>
Alternate DNS Server :	<input type="text"/>
DHCPv6 :	<input type="radio"/> Enabled <input checked="" type="radio"/> Disabled

3. Once IPv6 is enabled and reboot, the device generates a link-local IPv6 address using the EUI-64 format.

When the IPv6 feature is enabled, the IPv6 LAN interface addresses are displayed on General > Network Interface page of the radio GUI.

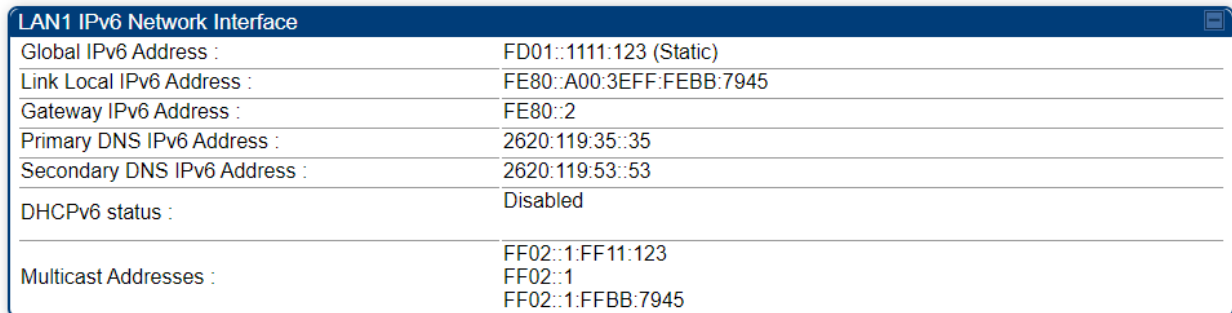

The screenshot shows the 'LAN1 IPv6 Network Interface' window with the following information:

Global IPv6 Address :	FD01::1111:123 (Static)
Link Local IPv6 Address :	FE80::A00:3EFF:FE8B:7945
Gateway IPv6 Address :	FE80::2
Primary DNS IPv6 Address :	2620:119:35::35
Secondary DNS IPv6 Address :	2620:119:53::53
DHCPv6 status :	Disabled
Multicast Addresses :	FF02::1:FF11:123 FF02::1 FF02::1:FFBB:7945

Once the Stateless Auto Address Configuration (SLAAC) IP is received, Network Interface page is updated with most recent SLAAC IP address and gateway information as follows:

LAN1 IPv6 Network Interface	
Global IPv6 Address :	FD01::A00:3EFF:FE8B:7945 (SLAAC)
Link Local IPv6 Address :	FE80::A00:3EFF:FE8B:7945
Gateway IPv6 Address :	FE80::2
Primary DNS IPv6 Address :	::
Secondary DNS IPv6 Address :	::
DHCPv6 status :	Disabled
Multicast Addresses :	FF02::1 FF02::1:FF8B:7945

IPv6 Trap Addresses

Go to Configuration > SNMP > IPv6 Trap Addresses of radio to configure a maximum of five IPv6 trap addresses. Any changes made to the IPv6 Trap Addresses requires a reboot.

IPv6 Trap Addresses	
Trap Address 1 :	<input type="text" value="FD01::ABCD:1"/>
Trap Address 2 :	<input type="text" value="::"/>
Trap Address 3 :	<input type="text" value="::"/>
Trap Address 4 :	<input type="text" value="::"/>
Trap Address 5 :	<input type="text" value="::"/>

IPv6 Statistics

Go to Statistics > IPv6 MIB Statistics of radio to view the IPv6 and ICMPv6 MIB statistics.

IPv6 MIB Statistics	
Forwarding:	2
DefaultHopLimit:	0
Interfaces:	0
IfTableLastChange:	0
RouteNumber:	0
DiscardedRoutes:	0
ip6InPkts:	849
ip6InErrs:	18
ip6InDrops:	0
ip6InUnknown:	0
ip6OutPkts:	1093
ip6OutErrs:	0

```

ICMPv6 MIB Statistics
ICMPv6 stats for iface et0
InMsgs:17
InErrors:0
InDestUnreachs:0
InAdminProhibs:0
InTimeExcds:0
InParmProblems:0
InPktTooBigs:0
InEchos:0
InEchoReplies:0
InRouterSolicits:0
InRouterAdvertisements:5
InNeighborSolicits:5
InNeighborAdvertisements:7
InRedirects:0
InGroupMembQueries:0
InGroupMembResponses:0
InGroupMembReductions:0
OutMsgs:19
OutErrors:0
OutDestUnreachs:0
OutAdminProhibs:0
OutTimeExcds:0
OutParmProblems:0
OutPktTooBigs:0
OutEchos:0
OutEchoReplies:0
OutRouterSolicits:2
OutRouterAdvertisements:0
OutNeighborSolicits:12
OutNeighborAdvertisements:5
OutRedirects:0
OutGroupMembQueries:0
OutGroupMembResponses:0
OutGroupMembReduction:0

```

IPv6 Neighbor Discovery Cache

Go to Statistics > IPv6 Neighbor Discover Cache of the AP/SM GUI to view Neighbor Discovery Cache.

Interface	Pending	IPv6 Address	State	Timeout	MAC Address
et0	n	2620:119:35::35	NDS_STALE	4294967273	38-0e-4d-8b-08-b2
et0	n	FE80::2	NDS_STALE	174268	38-0e-4d-8b-08-b2
et0	n	FE80::C476:56E9:3E9D:DCF7	NDS_REACHABLE	4294967003	8c-ec-4b-ec-50-a4



Note

The IPv6 feature is supported with HTTP, HTTPS, SSH, Telnet, SNMPv2c, and SNMPv3 application protocols.

Ping Test

To perform IPv6 ping test,

1. Go to Tools > Ping Test > Ping IPv6 Test Settings of the radio.
2. Configure the IPv6 Address parameter

- Configure the Count parameter with any value from 3 to 64.
- Click Perform Ping v6 Test. The IPv6 ping test results are displayed under Ping IPv6 Test Results.

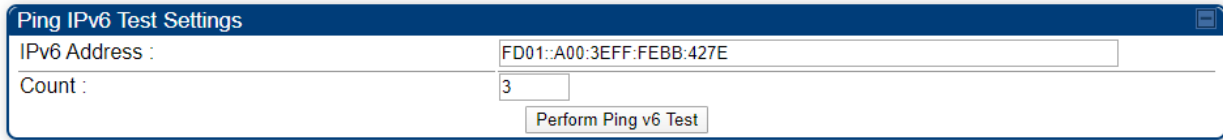

Ping IPv6 Test Settings

IPv6 Address :

Count :

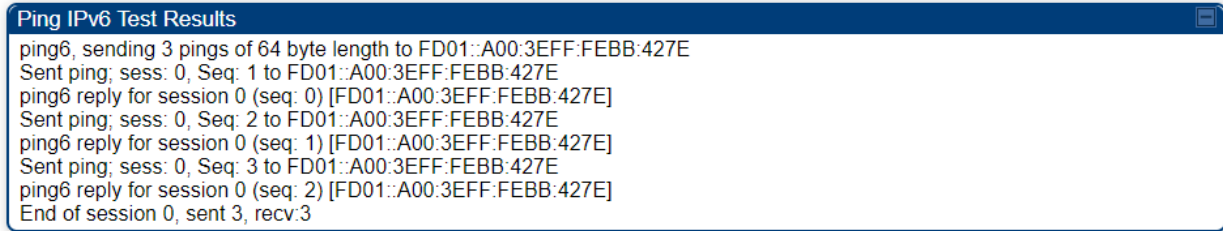

Ping IPv6 Test Results

```
ping6, sending 3 pings of 64 byte length to FD01::A00:3EFF:FE8B:427E
Sent ping; sess: 0, Seq: 1 to FD01::A00:3EFF:FE8B:427E
ping6 reply for session 0 (seq: 0) [FD01::A00:3EFF:FE8B:427E]
Sent ping; sess: 0, Seq: 2 to FD01::A00:3EFF:FE8B:427E
ping6 reply for session 0 (seq: 1) [FD01::A00:3EFF:FE8B:427E]
Sent ping; sess: 0, Seq: 3 to FD01::A00:3EFF:FE8B:427E
ping6 reply for session 0 (seq: 2) [FD01::A00:3EFF:FE8B:427E]
End of session 0, sent 3, rcv:3
```

DHCPv6

DHCPv6 can either be enabled explicitly or can be enabled when radio receives Managed bit set in Router Advertisement (RA).

DHCPv6 Status can be: Disabled/Enabled (explicitly enabled) or Managed (DHCPv6 enabled due to M-bit been set in RA).

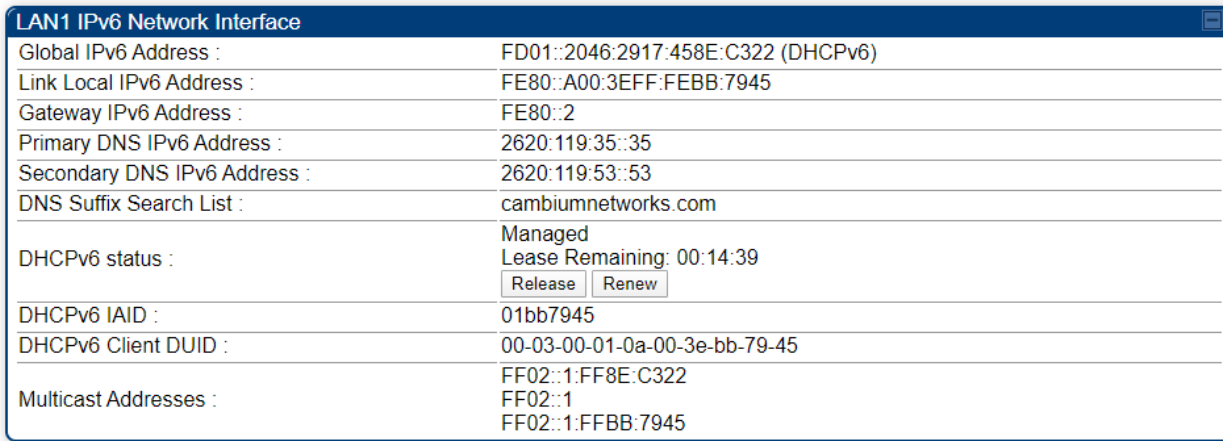

LAN1 IPv6 Network Interface	
Global IPv6 Address :	FD01::2046:2917:458E:C322 (DHCPv6)
Link Local IPv6 Address :	FE80::A00:3EFF:FE8B:7945
Gateway IPv6 Address :	FE80::2
Primary DNS IPv6 Address :	2620:119:35::35
Secondary DNS IPv6 Address :	2620:119:53::53
DNS Suffix Search List :	cambiumnetworks.com
DHCPv6 status :	Managed Lease Remaining: 00:14:39 <input type="button" value="Release"/> <input type="button" value="Renew"/>
DHCPv6 IAID :	01bb7945
DHCPv6 Client DUID :	00-03-00-01-0a-00-3e-bb-79-45
Multicast Addresses :	FF02::1:FF8E:C322 FF02::1 FF02::1:FFBB:7945

AP Statistics:

When this feature is enabled a new statistics page is available on the AP GUI. To access this page,

- Go to **Statistics > DHCPv6 Statistics**.

```

DHCPv6 Statistics
DHCPv6 stats for iface et0
Solicit: 2
Advertise: 2
Request: 2
Confirm: 0
Renew: 4
Rebind: 0
Reply: 7
Release: 1
Decline: 0
Reconfigure: 0
Information Request: 0
Relay Forward: 0
Relay Reply: 0

```

DNSv6

DNS information can be obtained 3 different ways in IPv6:

1. Router Advertisement support DNS information as mentioned by [RFC 8106](#). If the router sends DNSv6 information, radio will display on Network Interface page.
2. Stateless DHCPv6: In this scenario Router Advertisement won't send any DNS information but will set O-bit. Radio will initiate a DHCPv6 Information Request transaction ([RFC 8415](#)) and fetch the DNS information from server.
3. Stateful DHCPv6: Router Advertisement will be sent with M-bit set, Radio will initiate a complete DHCPv6 transaction to obtain IPv6 address and DNSv6 information.

LAN1 IPv6 Network Interface	
Global IPv6 Address :	FD01::2046:2917:458E:C322 (DHCPv6)
Link Local IPv6 Address :	FE80::A00:3EFF:FE8B:7945
Gateway IPv6 Address :	FE80::2
Primary DNS IPv6 Address :	2620:119:35::35
Secondary DNS IPv6 Address :	2620:119:53::53
DNS Suffix Search List :	cambiumnetworks.com

Maximum two DNS IPv6 server are supported. If there is a static entry configured, it will be overridden with received value.



Note

Currently we only support vendor options DNS Recursive Name Server & DNS Suffix Search List.

DNS IPv6 Resolution

DNS test tool can be used to resolve IPv6 address for Fully Qualified Domain Name (FQDN) using DNS IPv6 Lookup.

DNS Test Settings

Fully Qualified Domain Name :

DNS Test Results

www.google.com resolves to: 2404:6800:4009:800::2004

The IPv6 page of AP/SM/BHM/BHS is explained in below table.

Table 5 :IPv6 interface attributes

LAN1 Network Interface Configuration	
IP Address :	10.110.215.234
Subnet Mask :	255.255.255.0
Gateway IP Address :	10.110.215.254
DHCP state :	<input type="radio"/> Enabled <input checked="" type="radio"/> Disabled
DHCP DNS IP Address :	<input type="radio"/> Obtain Automatically <input checked="" type="radio"/> Set Manually
Preferred DNS Server :	0.0.0.0
Alternate DNS Server :	0.0.0.0
Domain Name :	example.com

LAN1 IPv6 Network Interface Configuration	
IPv6 :	<input checked="" type="radio"/> Enabled <input type="radio"/> Disabled
IPv6 Address :	FD01::234
Prefix Length :	64
Gateway IPv6 Address :	::
Preferred DNS Server :	FD01::35
Alternate DNS Server :	FD01::36
DHCPv6 :	<input checked="" type="radio"/> Enabled <input type="radio"/> Disabled

Advanced LAN1 IP Configuration	
Default alternative LAN1 IP address :	<input checked="" type="radio"/> Enabled <input type="radio"/> Disabled

LAN1 IPv6 Network Interface Configuration	
IPv6 :	<input checked="" type="radio"/> Enabled <input type="radio"/> Disabled
IPv6 Address :	
Prefix Length :	64
Gateway IPv6 Address :	::
Preferred DNS Server :	
Alternate DNS Server :	
DHCPv6 :	<input type="radio"/> Enabled <input checked="" type="radio"/> Disabled

Advanced LAN1 IP Configuration

Default alternative LAN1 IP address : Enabled
 Disabled

Aux Ethernet Port

AUX Ethernet Port : Enabled
 Disabled
Please Note:
Enabling the Aux Ethernet port will disrupt the Aux Power to UGPS

AUX Ethernet Port PoE : Enabled
 Disabled

LAN2 Network Interface Configuration (Radio Private Interface - Must end in .1)

IP Address :

Attribute	Meaning
IP Address	Internet Protocol (IP) address. This address is used by family of Internet protocols to uniquely identify this unit on a network.
Subnet Mask	Defines the address range of the connected IP network.
Gateway IP Address	The IP address of a computer on the current network that acts as a gateway. A gateway acts as an entrance and exit to packets from and to other networks.
DHCP state	If Enabled is selected, the DHCP server automatically assigns the IP configuration (IP address, subnet mask, and gateway IP address) and the values of those individual parameters (above) are not used. The setting of this DHCP state parameter is also viewable (read only), in the Network Interface tab of the Home page.
DHCP DNS IP Address	Canopy devices allow for configuration of a preferred and alternate DNS server IP address either automatically or manually. Devices must set DNS server IP address manually when DHCP is disabled for the management interface of the device. DNS servers may be configured automatically from the DHCP response when DHCP is enabled for the management interface of the device. Optionally devices may be configured to set the DNS server IP address manually when DHCP is enabled for the management interface. The default DNS IP addresses are 0.0.0.0 when configured manually.
Preferred DNS Server	The first address used for DNS resolution.
Alternate DNS Server	If the Preferred DNS server cannot be reached, the Alternate DNS Server is used.
Domain Name	The operator's management domain name may be configured for DNS. The domain name configuration can be used for configuration of the servers in the operator's network. The default domain name is example.com, and is only used if configured as such.
IPv6	Provision to Enable/Disable IPv6 option.
IPv6 Address	Internet Protocol version 6 (IPv6) address. This address is used by family of Internet protocols to uniquely identify this unit on a network.

Attribute	Meaning									
Prefix Length	Displays the number of leading bits in the prefix that are valid (from 0 to 128 bits).									
Gateway IPv6 Address	This field displays the gateway IPv6 address for the device.									
Preferred DNS Server	The first address used for DNS resolution.									
Alternate DNS Server	If the Preferred DNS server cannot be reached, the Alternate DNS Server is used.									
DHCPv6	If Enabled is selected, the DHCP server automatically assigns the IP configuration (IP address, subnet mask, and gateway IP address) and the values of those individual parameters (above) are not used. The setting of this DHCP state parameter is also viewable (read only), in the Network Interface tab of the Home page.									
Advanced LAN1 IP Configuration - Default alternate LAN1 IP address	Hardcoded default alternate IP address (169.254.1.1) that is available only when connected to the Ethernet port. When enabled, user can configure a second IP address for the bridge which is other than the hardcoded IP address (169.254.1.1).									
AUX Ethernet Port - AUX Ethernet Port	Enabled: Data is enabled for Auxiliary port Disabled: Data is disabled for Auxiliary port									
AUX Ethernet Port - AUX Ethernet Port PoE	Enabled: PoE out is enable for Auxiliary port Disabled: PoE out is disabled for Auxiliary port									
LAN2 Network Interface Configuration (Radio Private Interface) - IP Address	<p>It is recommended not to change this parameter from the default AP/BHM private IP address of 192.168.101.1. A /24 CIDR subnet is used to communicate with each of the SMs/BHS that are registered. The AP/BHM uses a combination of the private IP and the LUID (logical unit ID) of the SM/BHS.</p> <p>It is only displayed for AP and BHM.</p> <p>Table 6 :SM/BHS private IP and LUID</p> <table border="1"> <thead> <tr> <th>SM/BHS</th> <th>LUID</th> <th>Private IP</th> </tr> </thead> <tbody> <tr> <td>First SM/BHS registered</td> <td>2</td> <td>192.168.101.2</td> </tr> <tr> <td>Second SM registered</td> <td>3</td> <td>192.168.101.3</td> </tr> </tbody> </table>	SM/BHS	LUID	Private IP	First SM/BHS registered	2	192.168.101.2	Second SM registered	3	192.168.101.3
SM/BHS	LUID	Private IP								
First SM/BHS registered	2	192.168.101.2								
Second SM registered	3	192.168.101.3								

Auxiliary port

An additional Ethernet port labeled “Aux” for Auxiliary port is implemented for downstream traffic. This feature is supported only for PTP/PMP 450i ODU.

To enable the Aux port, follow these instructions:

Procedure 9 Enabling Aux port interface

1	Select menu option Configuration > IP > Aux Network Interface tab.: 
2	Click Enable button of Aux Ethernet Port parameter to enable Aux Ethernet port
3	Click Enable button of Aux Ethernet Port PoE parameter to enable Aux port PoE out.
4	Click Save. "Reboot Required" message is displayed.
5	Click Reboot.

Table 7 :Aux port attributes



Attribute	Meaning
Aux Ethernet Port	Enabled: Data is enabled for Auxiliary port Disabled: Data is disabled for Auxiliary port
Aux Ethernet Port PoE	Enabled: PoE out is enable for Auxiliary port Disabled: PoE out is disabled for Auxiliary port

By disabling this feature, the data at the Auxiliary port will be disabled.

NAT, DHCP Server, DHCP Client and DMZ

Applicable products PMP: b SM

The system provides NAT (Network Address Translation) for SMs in the following combinations of NAT and DHCP (Dynamic Host Configuration Protocol):

- NAT Disabled
- NAT with DHCP Client (DHCP selected as the Connection Type of the WAN interface) and DHCP Server
- NAT with DHCP Client (DHCP selected as the Connection Type of the WAN interface)
- NAT with DHCP Server
- NAT without DHCP

NAT

NAT isolates devices connected to the Ethernet or wired side of a SM from being seen directly from the wireless side of the SM. With NAT enabled, the SM has an IP address for transport traffic (separate from its address for management), terminates transport traffic and allows you to assign a range of IP addresses to devices that are connected to the Ethernet or wired side of the SM.

In the Cambium system, NAT supports many protocols, including HTTP, ICMP (Internet Control Message Protocols), and FTP (File Transfer Protocol). For virtual private network (VPN) implementation, L2TP over IPSec (Level 2 Tunneling Protocol over IP Security) and PPTP (Point to Point Tunneling Protocol) are supported.



Note

When NAT is enabled, a reduction in throughput is introduced in the system (due to processing overhead).

DHCP

DHCP enables a device to be assigned a new IP address and TCP/IP parameters, including a default gateway, whenever the device reboots. Thus, DHCP reduces configuration time, conserves IP addresses, and allows modules to be moved to a different network within the Cambium system.

In conjunction with the NAT features, each SM provides the following:

- A DHCP server that assigns IP addresses to computers connected to the SM by Ethernet protocol.
- A DHCP client that receives an IP address for the SM from a network DHCP server.

DMZ

In conjunction with the NAT features, a DMZ (Demilitarized Zone) allows the allotment of one IP address behind the SM for a device to logically exist outside the firewall and receive network traffic. The first three octets of this IP address must be identical to the first three octets of the NAT private IP address.

- A DHCP server that assigns IP addresses to computers connected to the SM by Ethernet protocol.
- A DHCP client that receives an IP address for the SM from a network DHCP server.

NAT Disabled

The NAT Disabled implementation is illustrated in below figure.

Figure 10 : NAT disabled implementation

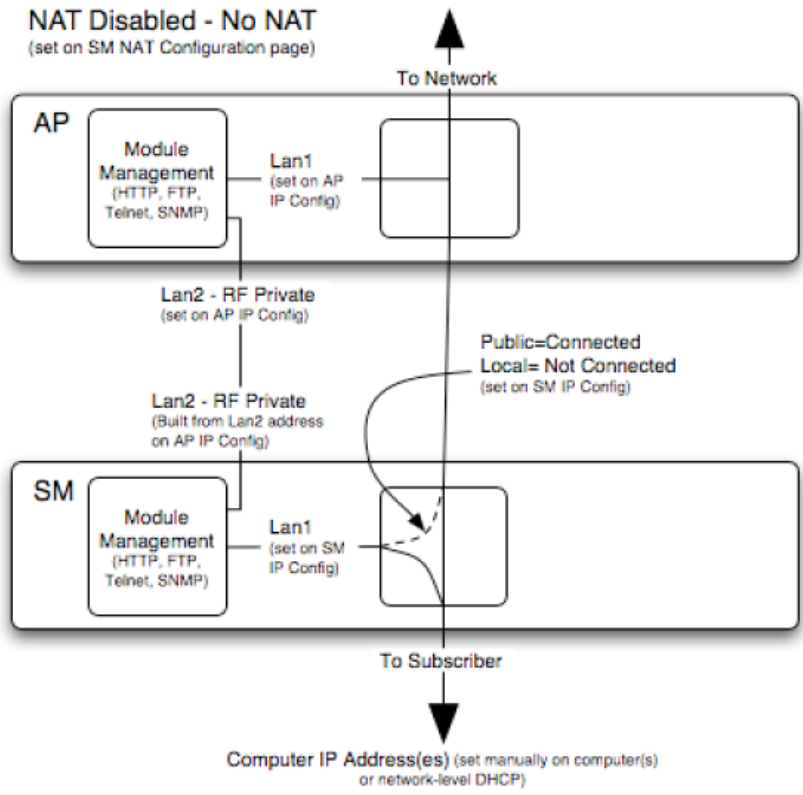

NAT with DHCP Client and DHCP Server

The NAT with DHCP Client and DHCP server is illustrated in below figure.

Figure 11 : NAT with DHCP client and DHCP server implementation

NAT with DHCP Client and DHCP Server

(set on SM NAT Configuration page)

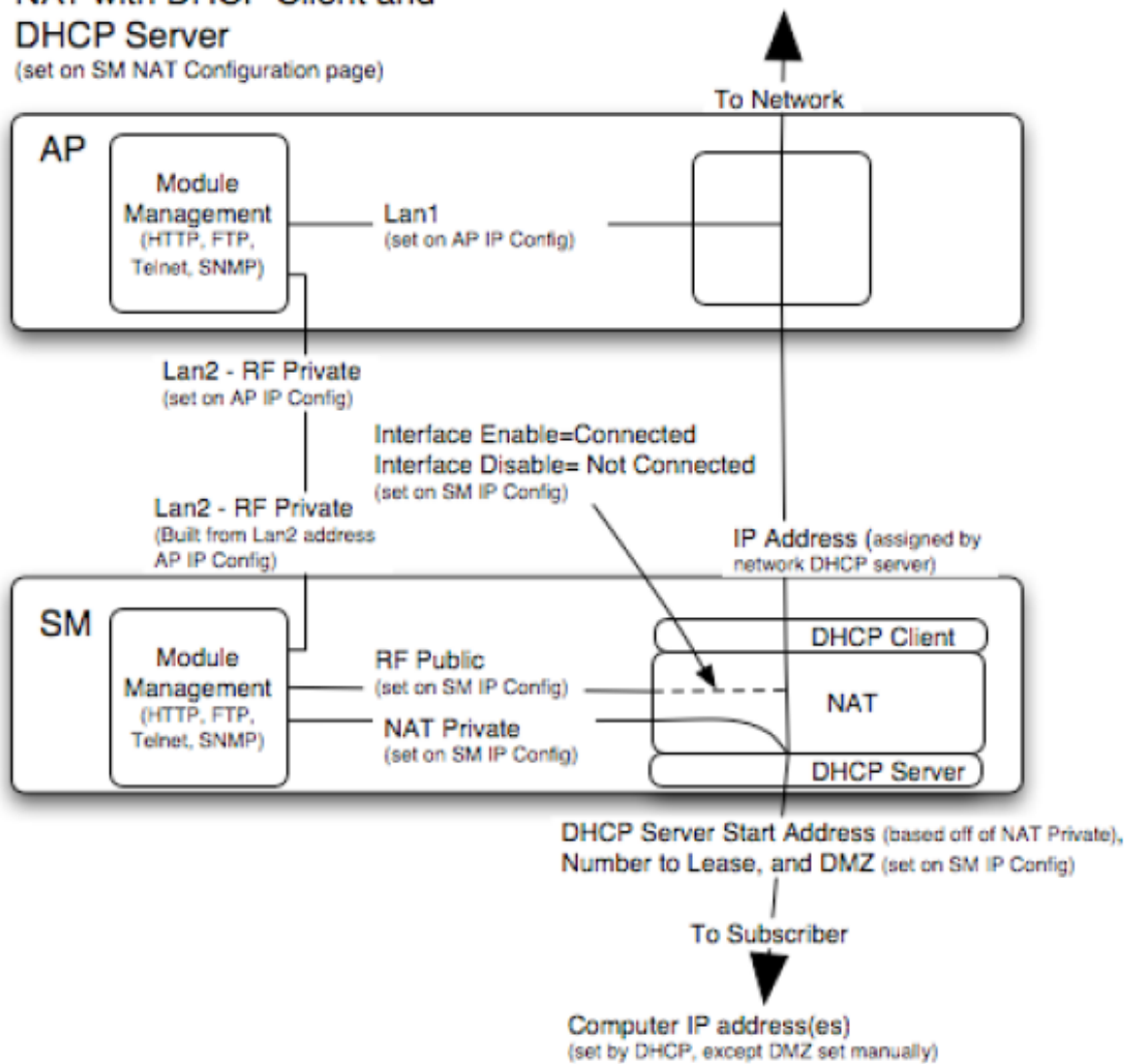

NAT with DHCP Client

Figure 12 : NAT with DHCP client implementation

NAT with DHCP Client

(set on SM NAT Configuration page)

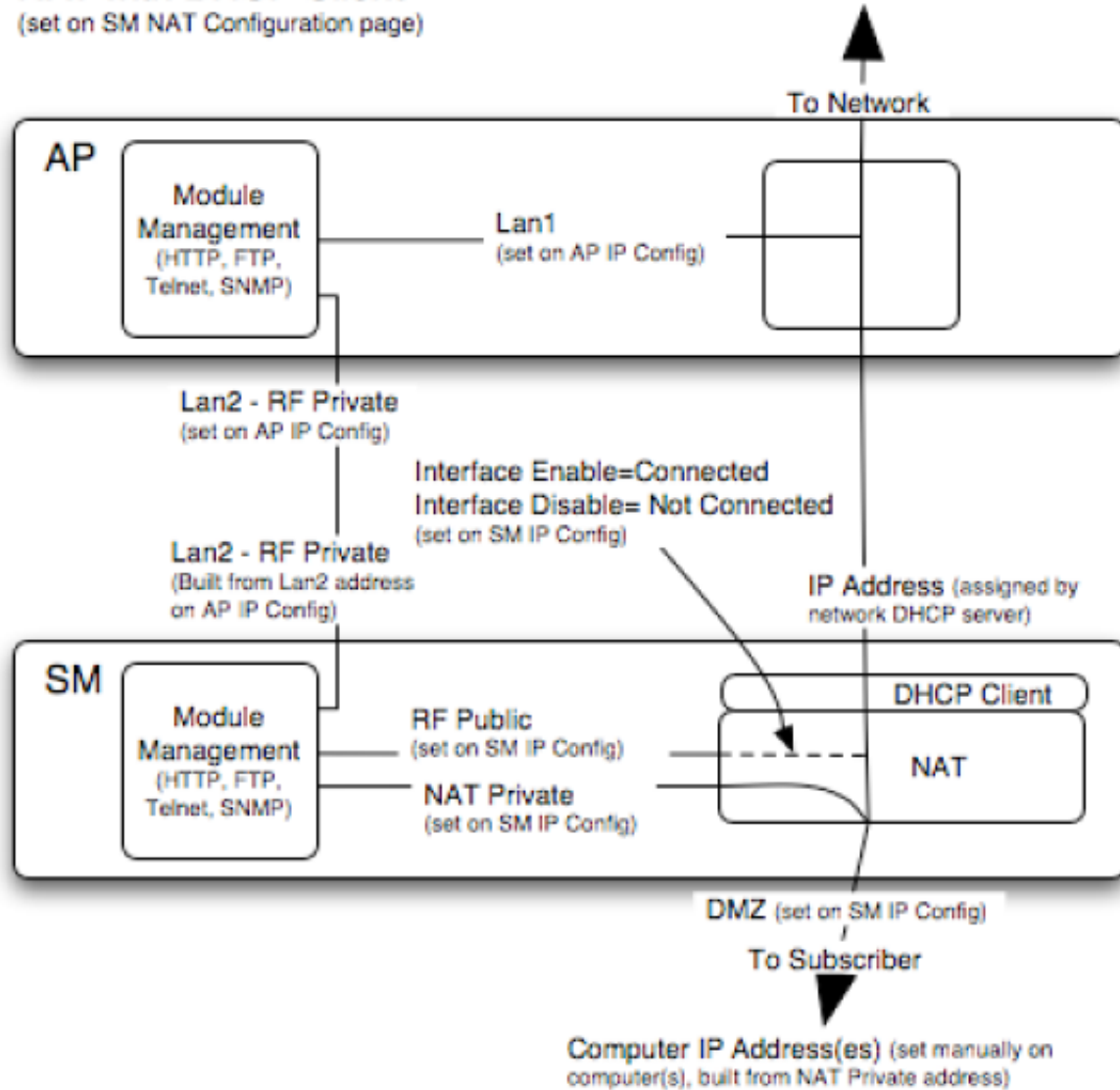

NAT with DHCP Server

Figure 13 : NAT with DHCP server implementation

NAT with DHCP Server

(set on SM NAT Configuration page)

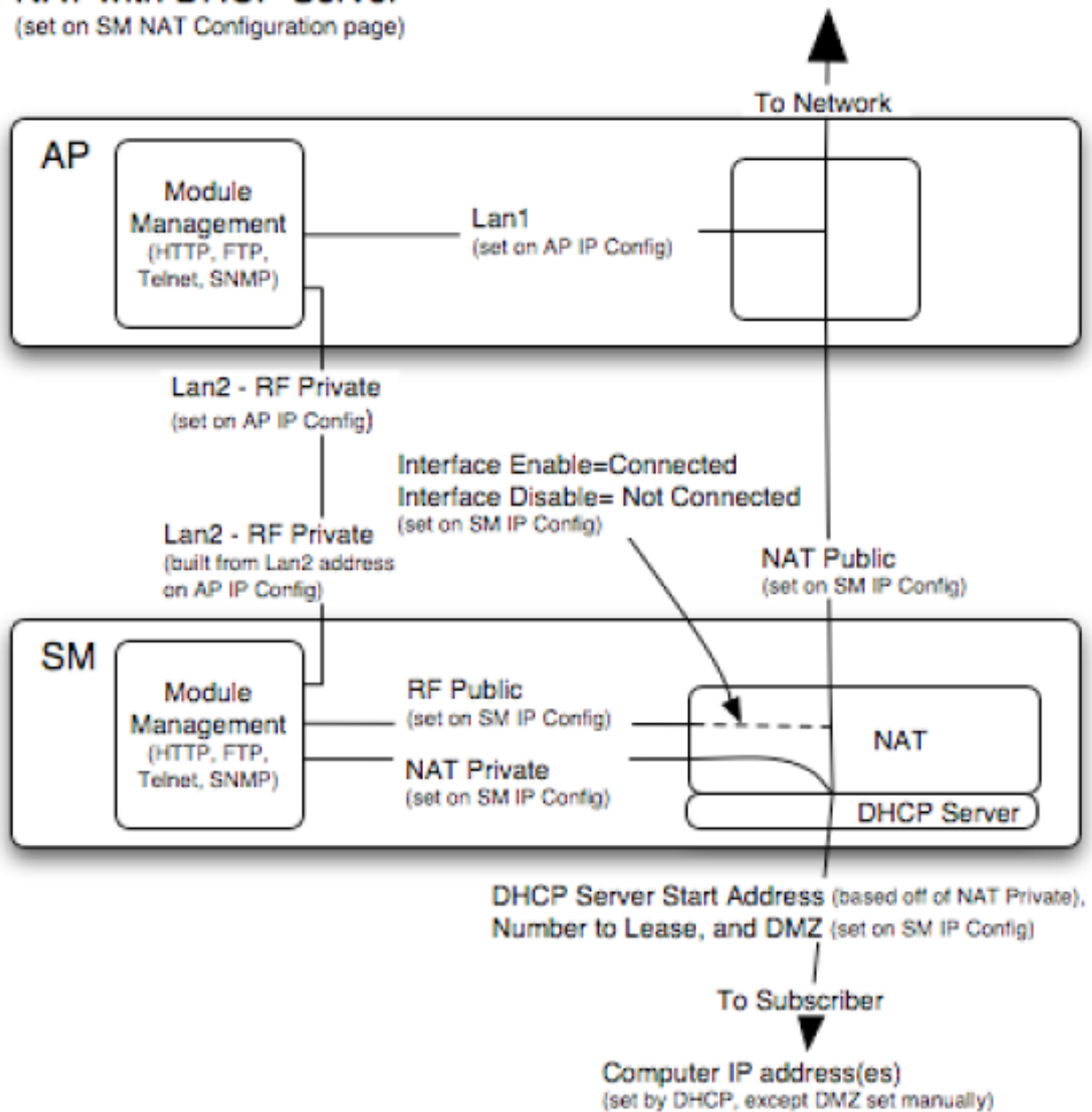

NAT without DHCP

Figure 14 : NAT without DHCP implementation

NAT with no DHCP
(set on SM NAT Configuration page)

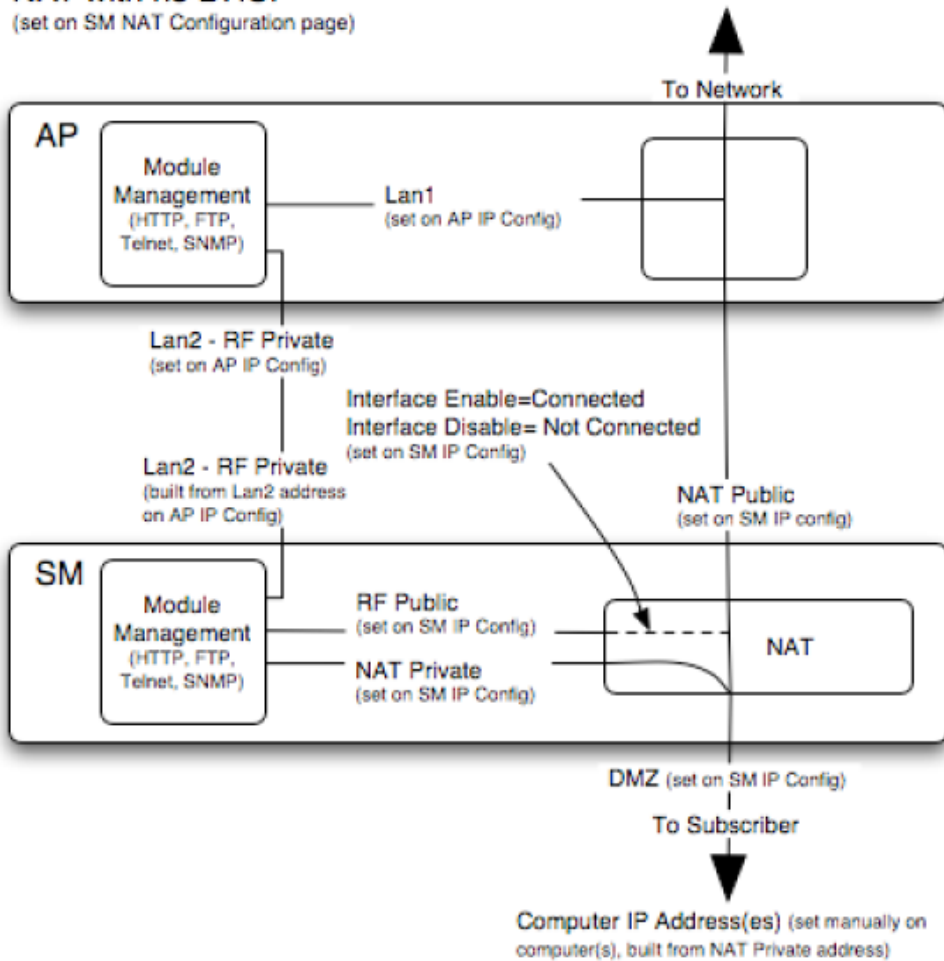

NAT and VPNs

VPN technology provides the benefits of a private network during communication over a public network. One typical use of a VPN is to connect employees remotely (who are at home or in a different city), with their corporate network through a public Internet. Any of several VPN implementation schemes is possible. By design, NAT translates or changes addresses, and thus interferes with a VPN that is not specifically supported by a given NAT implementation.

With NAT enabled, SM supports L2TP over IPSec (Level 2 Tunneling Protocol over IP Security) VPNs and PPTP (Point to Point Tunneling Protocol) VPNs. With NAT disabled, SM supports all types of VPNs.

IP interface with NAT disabled - SM

The IP page of SM with NAT disabled is explained in below table.

Table 8 :IP attributes - SM with NAT disabled

LAN1 Network Interface Configuration	
IP Address :	10.120.216.15
Network Accessibility :	<input checked="" type="radio"/> Public <input type="radio"/> Local
Subnet Mask :	255.255.255.0
Gateway IP Address :	10.120.216.254
DHCP state :	<input type="radio"/> Enabled <input checked="" type="radio"/> Disabled
DHCP DNS IP Address :	<input type="radio"/> Obtain Automatically <input type="radio"/> Set Manually
Preferred DNS Server :	0.0.0.0
Alternate DNS Server :	0.0.0.0
Domain Name :	example.com

Attribute	Meaning
IP Address	<p>Enter the non-routable IP address to associate with the Ethernet connection on this SM. (The default IP address from the factory is 169.254.1.1.) If you forget this parameter, you must both:</p> <ul style="list-style-type: none"> physically access the module. use recovery mode to access the module configuration parameters at 169.254.1.1. <div style="border: 1px solid black; padding: 5px; margin-top: 10px;"> <p> Note Note or print the IP settings from this page. Ensure that you can readily associate these IP settings both with the module and with the other data that you store about the module.</p> </div>
Network Accessibility	Specify whether the IP address of the SM must be visible to only a device connected to the SM by Ethernet (Local) or be visible to the AP/BHM as well (Public).
Subnet Mask	Enter an appropriate subnet mask for the SM to communicate on the network. The default subnet mask is 255.255.0.0.
Gateway IP Address	Enter the appropriate gateway for the SM to communicate with the network. The default gateway is 169.254.0.0.
DHCP state	<p>If you select Enabled, the DHCP server automatically assigns the IP configuration (IP address, subnet mask, and gateway IP address) and the values of those individual parameters (above) are not used. The setting of this DHCP state parameter is also viewable, but not settable, in the Network Interface tab of the Home page.</p> <p>In this tab, DHCP State is settable only if the Network Accessibility parameter in the IP tab is set to Public. This parameter is also settable in the NAT tab of the Configuration web page, but only when NAT is enabled.</p> <p>If the DHCP state parameter is set to Enabled in the Configuration > IP sub-menu of the SM/BHS, do not check the BootpClient option for Packet Filter Types in its Protocol Filtering tab, because doing so can block the DHCP request. (Filters apply to all packets that leave the SM via its RF interface, including those that the SM itself generates.) If you want to keep DHCP enabled and avoid the blocking scenario, select the Bootp Server</p>

Attribute	Meaning
	option instead. This will result in responses being appropriately filtered and discarded.
DHCP DNS IP Address	Canopy devices allow for configuration of a preferred and alternate DNS server IP address either automatically or manually. Devices must set DNS server IP address manually when DHCP is disabled for the management interface of the device. DNS servers may be configured automatically from the DHCP response when DHCP is enabled for the management interface of the device. Optionally devices may be configured to set the DNS server IP address manually when DHCP is enabled for the management interface. The default DNS IP addresses are 0.0.0.0 when configured manually.
Preferred DNS Server	The first DNS server used for DNS resolution.
Alternate DNS Server	The second DNS server used for DNS resolution.
Domain Name	The operator's management domain name may be configured for DNS. The domain name configuration can be used for configuration of the servers in the operator's network. The default domain name is example.com, and is only used if configured as such.

IP interface with NAT enabled - SM

The IP page of SM with NAT enabled is explained in below table.

Table 9 :IP attributes - SM with NAT enabled

The screenshot shows a window titled "NAT Network Interface Configuration". It contains two input fields: "IP Address" with the value "169.254.1.1" and "Subnet Mask" with the value "255.255.255.0".

Attribute	Meaning
IP Address	Assign an IP address for SM/BHS management through Ethernet access to the SM/BHS. Set only the first three bytes. The last byte is permanently set to 1. This address becomes the base for the range of DHCP-assigned addresses.
Subnet Mask	Assign a subnet mask of 255.255.255.0 or a more restrictive subnet mask. Set only the last byte of this subnet mask. Each of the first three bytes is permanently set to 255.

NAT tab with NAT disabled - SM

The NAT tab of SM with NAT disabled is explained in below table.

Table 10 :NAT attributes - SM with NAT disabled



NAT Enable

NAT Enable/Disable : Enabled
 Disabled

Save Changes

WAN Interface

Connection Type : DHCP

IP Address : 0.0.0.0

Subnet Mask : 255.255.255.0

Gateway IP Address : 0.0.0.0

Reply to Ping on WAN Interface : Enabled
 Disabled

LAN Interface

IP Address : 10.120.216.19

Subnet Mask : 255.255.255.xxx

DMZ Enable : Enabled
 Disabled

DMZ IP Address : xxx.xxx.xxx.52

LAN DHCP Server

DHCP Server Enable/Disable : Enabled
 Disabled

DHCP Server Lease Timeout : 30 Days (Range : 1 — 30)

DHCP Start IP : xxx.xxx.xxx.2

Number of IP's to Lease : 50

DNS Server Proxy : Enabled
 Disabled

DNS IP Address : Obtain Automatically (From WAN DHCP or PPPoE)
 Set Manually

Preferred DNS IP Address : 0.0.0.0

Alternate DNS IP Address : 0.0.0.0

Remote Configuration Interface

Remote Management Interface : Disable

Connection Type : DHCP
 Static IP

IP Address : 0.0.0.0

Subnet Mask : 255.255.255.0

Gateway IP Address : 0.0.0.0

DHCP DNS IP Address : Obtain Automatically
 Set Manually

Preferred DNS Server : 0.0.0.0

Alternate DNS Server : 0.0.0.0

Domain Name : example.com

NAT Protocol Parameters

ARP Cache Timeout : 20 Minutes (Range : 1 — 30)

TCP Session Garbage Timeout : 120 Minutes (Range : 4 — 1440)

UDP Session Garbage Timeout : 4 Minutes (Range : 1 — 1440)

Translation Table Size : 2048 Translations (Range : 1024 — 8192)

Attribute	Meaning
NAT Enable/Disable	This parameter enables or disables the Network Address Translation (NAT) feature for the SM. NAT isolates devices connected to the Ethernet or wired side of a SM from being seen directly from the wireless side of the SM. With NAT enabled, the SM has an IP address for transport traffic separate from its address for management, terminates transport traffic, and allows you to assign a range of IP addresses to devices that are

Attribute	Meaning
	connected to the Ethernet or wired side of the SM. When NAT is enabled, VLANs are not supported on the wired side of that SM. You can enable NAT in SMs within a sector where VLAN is enabled in the AP/BHM, but this may constrain network design.
IP Address	This field displays the IP address for the SM. DHCP Server will not automatically assign this address when NAT is disabled.
Subnet Mask	This field displays the subnet mask for the SM. DHCP Server will not automatically assign this address when NAT is disabled.
Gateway IP Address	This field displays the gateway IP address for the SM. DHCP Server will not automatically assign this address when NAT is disabled.
ARP Cache Timeout	If a router upstream has an ARP cache of longer duration (as some use 30 minutes), enter a value of longer duration than the router ARP cache. The default value of this field is 20 minutes.
TCP Session Garbage Timeout	Where a large network exists behind the SM, you can set this parameter to lower than the default value of 120 minutes. This action makes additional resources available for greater traffic than the default value accommodates.
UDP Session Garbage Timeout	You may adjust this parameter in the range of 1 to 1440 minutes, based on network performance. The default value of this parameter is 4 minutes.
Translation Table Size	Total number of minutes that have elapsed since the last packet transfer between the connected device and the SM/BHS.



Note

When NAT is disabled, the following parameters are not required to be configurable:

WAN Interface > Connection Type, IP Address, Subnet Mask, Gateway IP address

LAN Interface > IP Address

LAN DHCP Server > DHCP Server Enable/Disable, DHCP Server Lease Timeout, Number of IP's to Lease, DNS Server Proxy, DNS IP Address, Preferred DNS IP address, Alternate DNS IP address

Remote Management Interface > Remote Management Interface, IP address, Subnet Mask, DHCP DNS IP Address, Preferred DNS Server, Alternate DNS Server, Domain Name

NAT Protocol Parameters > ARP Cache Timeout, TCP Session Garbage Timeout, UDP Session Garbage Timeout, Translation Table Size

NAT tab with NAT enabled - SM

The NAT tab of SM with NAT enabled is explained in below table.

Table 11: NAT attributes - SM with NAT enabled

NAT Enable

NAT Enable/Disable : Enabled
 Disabled

Save Changes

WAN Interface

Connection Type : DHCP

IP Address : 0.0.0.0

Subnet Mask : 255.255.255.0

Gateway IP Address : 0.0.0.0

Reply to Ping on WAN Interface : Enabled
 Disabled

LAN Interface

IP Address : 169.254.1.1

Subnet Mask : 255.255.255.0

DMZ Enable : Enabled
 Disabled

DMZ IP Address : 169.254.1.52

LAN DHCP Server

DHCP Server Enable/Disable : Enabled
 Disabled

DHCP Server Lease Timeout : 30 Days (Range : 1 — 30)

DHCP Start IP : 169.254.1.2

Number of IP's to Lease : 50

DNS Server Proxy : Enabled
 Disabled

DNS IP Address : Obtain Automatically (From WAN DHCP or PPPoE)
 Set Manually

Preferred DNS IP Address : 0.0.0.0

Alternate DNS IP Address : 0.0.0.0

Remote Configuration Interface

Remote Management Interface : Enable (Standalone Config)

Connection Type : DHCP
 Static IP

IP Address : 169.254.1.2

Subnet Mask : 255.255.0.0

Gateway IP Address : 169.254.0.0

DHCP DNS IP Address : Obtain Automatically
 Set Manually

Preferred DNS Server : 0.0.0.0

Alternate DNS Server : 0.0.0.0

Domain Name : example.com

NAT Protocol Parameters

ARP Cache Timeout : 20 Minutes (Range : 1 — 30)

TCP Session Garbage Timeout : 120 Minutes (Range : 4 — 1440)

UDP Session Garbage Timeout : 4 Minutes (Range : 1 — 1440)

Attribute	Meaning
NAT	See description in NAT attributes - SM with NAT disabled.

Attribute	Meaning
Enable/Disable	
WAN Interface	The WAN interface is the RF-side address for transport traffic.
Connection Type	This parameter may be set to Static IP—when this is the selection, all three parameters (IP Address, Subnet Mask, and Gateway IP Address) must be properly populated. DHCP—when this is the selection, the information from the DHCP server configures the interface. PPPoE—when this is the selection, the information from the PPPoE server configures the interface.
Subnet Mask	If Static IP is set as the Connection Type of the WAN interface, then this parameter configures the subnet mask of the SM for RF transport traffic.
Gateway IP Address	If Static IP is set as the Connection Type of the WAN interface, then this parameter configures the gateway IP address for the SM for RF transport traffic.
Reply to Ping on WAN Interface	By default, the radio interface does not respond to pings. If you use a management system (such as WM) that will occasionally ping the SM, set this parameter to Enabled.
LAN Interface	The LAN interface is both the management access through the Ethernet port and the Ethernet-side address for transport traffic. When NAT is enabled, this interface is redundantly shown as the NAT Network Interface Configuration on the IP tab of the Configuration web page in the SM.
IP Address	Assign an IP address for SM/BHS management through Ethernet access to the SM. This address becomes the base for the range of DHCP-assigned addresses.
Subnet Mask	Assign a subnet mask of 255.255.255.0 or a more restrictive subnet mask. Set only the last byte of this subnet mask. Each of the first three bytes is permanently set to 255.
DMZ Enable	Either enable or disable DMZ for this SM/BHS.
DMZ IP Address	If you enable DMZ in the parameter above, set the last byte of the DMZ host IP address to use for this SM when DMZ is enabled. Only one such address is allowed. The first three bytes are identical to those of the NAT private IP address. Ensure that the device that receives network traffic behind this SM is assigned this address. The system provides a warning if you enter an address within the range that DHCP can assign.
DHCP Server	This is the server (in the SM) that provides an IP address to the device connected to the Ethernet port of the SM.
DHCP Server Enable/Disable	Select either Enabled or Disabled. Enable to: <ul style="list-style-type: none"> • Allow this SM to assign IP addresses, subnet masks, and gateway IP addresses to attached devices. • Assign a start address for DHCP. • Designate how many IP addresses may be temporarily used (leased).

Attribute	Meaning
	Disable to: <ul style="list-style-type: none"> Restrict SM/BHS from assigning addresses to attached devices.
DHCP Server Lease Timeout	Based on network performance, enter the number of days between when the DHCP server assigns an IP address and when that address expires. The range of values for this parameter is 1 to 30 days. The default value is 30 days.
DHCP Start IP	If you enable DHCP Server below, set the last byte of the starting IP address that the DHCP server assigns. The first three bytes are identical to those of the NAT private IP address.
Number of IPs to Lease	Enter how many IP addresses the DHCP server is allowed to assign. The default value is 50 addresses.
DNS Server Proxy	This parameter enables or disables advertisement of the SM/BHS as the DNS server. On initial boot up of a SM with the NAT WAN interface configured as DHCP or PPPoE, the SM module will not have DNS information immediately. With DNS Server Proxy disabled, the clients will renew their lease about every minute until the SM has the DNS information to give out. At this point the SM will go to the full configured lease time period which is 30 days by default. With DNS Server Proxy enabled, the SM will give out full term leases with its NAT LAN IP as the DNS server.
DNS IP Address	Select either: Obtain Automatically to allow the system to set the IP address of the DNS server or Set Manually to enable yourself to set both a preferred and an alternate DNS IP address.
Preferred DNS IP Address	Enter the preferred DNS IP address to use when the DNS IP Address parameter is set to Set Manually.
Alternate DNS IP Address	Enter the DNS IP address to use when the DNS IP Address parameter is set to Set Manually and no response is received from the preferred DNS IP address.
Remote Management Interface	<p>To offer greater flexibility in IP address management, the NAT-enabled SM's configured WAN Interface IP address may be used as the device Remote Management Interface (unless the SM's PPPoE client is set to Enabled)</p> <p>Disable: When this interface is set to "Disable", the SM is not directly accessible by IP address. Management access is only possible through either the LAN (Ethernet) interface or a link from an AP web page into the WAN (RF-side) interface.</p> <p>Enable (Standalone Config): When this interface is set to "Enable (Standalone Config)", to manage the SM/BHS the device must be accessed by the IP addressing information provided in the Remote Configuration Interface section.</p> <div data-bbox="412 1667 480 1745" style="float: left; margin-right: 10px;"> </div> <div data-bbox="548 1667 1424 1808" style="border: 1px solid black; background-color: #e6f2ff; padding: 5px;"> <p>Note</p> <p>When configuring PPPoE over the link, use this configuration option (PPPoE traffic is routed via the IP addressing specified in section Remote Configuration Interface).</p> </div>

Attribute	Meaning
	<p>Enable (Use WAN Interface): When this interface is set to “Enable (Use WAN Interface)”, the Remote Configuration Interface information is greyed out, and the SM is managed via the IP addressing specified in section WAN Interface).</p> <div style="display: flex; align-items: center;">  <div style="border: 1px solid black; background-color: #e6f2ff; padding: 5px;"> <p>Note</p> <p>When using this configuration, the ports defined in section Configuration, Port Configuration are consumed by the device. For example, if FTP Port is configured as 21 by the SM, an FTP server situated below the SM must use a port other than 21. This also applies to DMZ devices; any ports specified in section Configuration, Port Configuration will not be translated through the NAT, they are consumed by the device’s network stack for management.</p> </div> </div>
Connection Type	<p>This parameter can be set to:</p> <p>Static IP: when this is the selection, all three parameters (IP Address, Subnet Mask, and Gateway IP Address) must be properly populated.</p> <p>DHCP: when this is the selection, the information from the DHCP server configures the interface.</p>
IP Address	<p>If Static IP is set as the Connection Type of the WAN interface, then this parameter configures the IP address of the SM for RF management traffic.</p>
Subnet Mask	<p>If Static IP is set as the Connection Type of the WAN interface, then this parameter configures the subnet mask of the SM for RF management traffic.</p>
Gateway IP Address	<p>If Static IP is set as the Connection Type of the WAN interface, then this parameter configures the gateway IP address for the SM for RF management traffic.</p> <p>Note or print the IP settings from this page. Ensure that you can readily associate these IP settings both with the module and with the other data that you store about the module.</p>
DHCP DNS IP Address	<p>Select either:</p> <p>Obtain Automatically to allow the system to set the IP address of the DNS server.</p> <p>or</p> <p>Set Manually to enable yourself to set both a preferred and an alternate DNS IP address.</p>
Preferred DNS Server	<p>Enter the preferred DNS IP address to use when the DNS IP Address parameter is set to Set Manually.</p>
Alternate DNS Server	<p>Enter the DNS IP address to use when the DNS IP Address parameter is set to Set Manually and no response is received from the preferred DNS IP address.</p>
Domain Name	<p>Domain Name to use for management DNS configuration. This domain name may be concatenated to DNS names used configured for the remote configuration interface.</p>
ARP Cache Timeout	<p>If a router upstream has an ARP cache of longer duration (as some use 30 minutes), enter a value of longer duration than the router ARP cache. The default value of this</p>

Attribute	Meaning
	field is 20 (minutes).
TCP Session Garbage Timeout	Where a large network exists behind the SM, you can set this parameter to lower than the default value of 120 (minutes). This action makes additional resources available for greater traffic than the default value accommodates.
UDP Session Garbage Timeout	You may adjust this parameter in the range of 1 to 1440 minutes, based on network performance. The default value of this parameter is 4 (minutes).

NAT DNS Considerations - SM

SM DNS behavior is different depending on the accessibility of the SM. When NAT is enabled the DNS configuration that is discussed in this document is tied to the RF Remote Configuration Interface, which must be enabled to utilize DNS Client functionality. Note that the WAN DNS settings when NAT is enabled are unchanged with the addition of the management DNS feature discussed in this document.

Table 12 :SM DNS Options with NAT Enabled

NAT Configuration	Management Accessibility	Interface	DHCP Status	DNS Status
NAT Enabled	RF Remote Management Interface Disabled		N/A	DNS Disabled
	RF Remote Management Interface Enabled		DHCP Disabled	DNS Static Configuration
			DHCP Enabled	DNS from DHCP or DNS Static Configuration

NAT Port Forwarding tab – SM

NAT Port Forwarding allows customers to define an external port as well as an internal port, which could be the same or different. The limitation of 10 entries also has been removed. If there are any NAT Port Forwarding rules that have mismatching internal and external ports, they will be removed upon downgrade to any release before 16.1.1 and these rules will be lost. Any NAT Port Forwarding rules with matching internal and external ports will be preserved upon downgrading to releases prior to 16.1.1 as well as imported upon upgrading from releases older than 16.1.1.

After upgrading to 16.1.1, NAT Port Mapping rules will be automatically applied to NAT Port Forwarding with same external and internal port mapping.

The NAT Port Forwarding tab of the SM is explained in below table.

Table 13 : NAT Port Forwarding attributes - SM

Port Forwarding Configuration

Internal IP :

Internal Port : (0—65535)

External Port : (0—65535)

Protocol :

Port Forwarding Mapping Table

Internal IP	Internal Port	External Port	Protocol
10.110.215.78	80	8080	ALL
10.110.215.80	443	443	ALL

Attribute	Meaning
Internal IP	Enter Internal IP address to access the port.
Internal Port	Enter Internal Port to access the port.
External Port	Enter External Port to access the port.
Protocol	Select protocol for traffic through the port.

DHCP – BHS

Applicable products

PTP: BHM

DHCP enables a device to be assigned a new IP address and TCP/IP parameters, including a default gateway, whenever the device reboots. Thus, DHCP reduces configuration time, conserves IP addresses, and allows modules to be moved to a different network within the Cambium system.

In conjunction with the NAT features, each BHS provides:

- A DHCP server that assigns IP addresses to computers connected to the BHS by Ethernet protocol.
- A DHCP client that receives an IP address for the BHS from a network DHCP server.

Reconnecting to the management PC

If the IP Address, Subnet Mask and Gateway IP Address of the unit have been updated to meet network requirements, then reconfigure the local management PC to use an IP address that is valid for the network. See Configuring the management PC

Once the unit reboots, log in using the new IP address. See Logging into the web interface

VLAN configuration for PMP

Applicable products

PMP: AP SM

VLAN Remarking

VLAN Remarking feature allows the user to change the VLAN ID and priority of both upstream and downstream packets at the Ethernet Interface. The remarking configuration is available for:

1. VLAN ID re-marking
2. 802.1p priority re-marking



Note

For Q-in-Q VLAN tagged frame, re-marking is performed on the outer tag.

VLAN ID Remarking

SM supports the ability to re-mark the VLAN ID on both upstream and downstream VLAN frames at the Ethernet interface. For instance, a configuration can be added to re-mark VLAN ID 'x' to VLAN ID 'y' as shown in below table. AP does not support VLAN ID remarking.

Table 14 :VLAN Remarking Example

VLAN frame direction	Remarking
Upstream	SM receives VLAN ID 'x' frame at the Ethernet interface, checks the configuration and re-marks to VLAN ID 'y'. So VLAN ID 'y' frame comes out of AP's Ethernet interface. When SM re-marks, a dynamic entry in VLAN membership table for 'y' is added to allow reception of VLAN ID 'y' downstream packet.
Downstream	AP receives VLAN ID 'y' frame at the Ethernet interface and sends to SM. SM accepts the frame as it has an entry in the membership table and re-marks to VLAN ID 'x'. This reverse re-marking is necessary because the downstream devices do not know of re-marking and are expecting VLAN 'x' frames. This remarking is done just before sending the packet out on Ethernet interface.

802.1P Remarking

AP/BHM and SM/BHS allow re-marking of 802.1p priority bits for the frames received at the Ethernet interface. Priority bits are not re-marked for the packets sent out of Ethernet interface (reverse direction).

Configuration must be added at SM/BHS for upstream frames and at AP/BHM for downstream frames.

VLAN Priority Bits configuration

VLAN Priority Bits Configuration feature allows the user to configure the three 802.1p bits upon assigning VLAN to an ingress packet. The priority bits configuration is available for:

- Default Port VID
- Provider VIDs
- MAC Address mapped Port VID
- Management VID

Default Port VID

This VID is used for untagged frames and will correspond to the Q-Tag for 802.1Q frames (if VLAN Port Type is Q), or the C-Tag for 802.1ad frames (if the VLAN Port Type is QinQ).

The priority bits used in the Q-tag/C-tag are configurable.

The configuration can be:

- Promote IPv4/IPv6 priority – The priority in the IP header is copied to the Q-tag/C-tag.
- Define priority – Specify the priority in the range of 0 to 7. This value is used as priority in the Q-tag/C-tag.

MAC Address Mapped VID

If a packet arrives at the SM/BHS that is sourced from a device whose MAC address is in the table, then the corresponding VID is used for that frame's Q-tag (Q port) or C-tag (QinQ port). The priority bits used in the Q-tag/C-tag are configurable similar to default port VID.

Provider VID

The provider VID is used for the S-tag. The priority bits used in the S-tag are configurable similar to default port VID. Provider VID has an extra priority configuration:

Copy inner tag 802.1p priority – The priority in the C-tag is copied to the S-tag.

Management VID

This VID is used to communicate with AP/BHM and SM/BHS for management purposes. The priority bits used in the Q-tag are configurable similar to default port VID.

Use AP's Management VID for ICC connected SM

This feature allows the SM to use the AP's management VLAN ID when the SM is registered to the AP via ICC. This feature is useful for the customer who uses a different management VID for the SM and AP and Zero Touch feature is enabled for configuration. This parameter may be accessed via the Configuration > VLAN page on the AP's web management interface.

VLAN page of AP

The VLAN tab of the AP/BHM is explained in below table.

Table 15 :AP/BHM VLAN tab attributes

VLAN Configuration	
VLAN :	<input type="radio"/> Enabled <input checked="" type="radio"/> Disabled
Always use Local VLAN Config :	<input type="radio"/> Enabled <input checked="" type="radio"/> Disabled (NOTE: If you want to run spectrum analysis on this AP, enable this option to keep VLAN settings intact when booting as an SM.)
Allow Frame Types :	All Frames ▾
Dynamic Learning :	<input checked="" type="radio"/> Enabled <input type="radio"/> Disabled
VLAN Aging Timeout :	25 Minutes (Range : 5 — 1440 Minutes)
Management VID (Range : 1 — 4094) :	1
QinQ EtherType :	0x88a8 ▾
Use AP's Management VID for ICC connected SM :	<input type="radio"/> Enabled <input checked="" type="radio"/> Disabled

Active Configuration	
VLAN Not Active	

VLAN Membership Configuration	
VLAN Membership Table Configuration :	1 (Range : 1 — 4094)
<input type="button" value="Add Member"/> <input type="button" value="Remove Member"/>	

VLAN Membership Table	
Empty Set	

VLAN 802.1p Remarking	
Source VLAN :	1 (Range : 1 — 4094)
Remark Priority :	0 (Range : 0 — 7)
<input type="button" value="Add/Modify 802.1p Remarking"/> <input type="button" value="Remove 802.1p Remarking"/>	

VLAN Remarking Table	
Empty Set	

Attribute	Meaning
VLAN	Specify whether VLAN functionality for the AP and all linked SMs must (Enabled) or may not (Disabled) be allowed. The default value is Disabled.
Always use Local VLAN Config	Enable this option before you reboot this AP as a SM to use it to perform spectrum analysis. Once the spectrum analysis completes, disable this option before you reboot the module as an AP.
Allow Frame Types	Select the type of arriving frames that the AP must tag, using the VID that is stored in the Untagged Ingress VID parameter. The default value is All Frames.
Dynamic Learning	Specify whether the AP must (Enabled) or not (Disabled) add the VLAN IDs (VIDs) of upstream frames to the VID table. (The AP passes frames with VIDs that are stored in the table both upstream and downstream.). The default value is Enabled.
VLAN Aging Timeout	Specify how long the AP must keep dynamically learned VIDs. The range of values is 5 to 1440 (minutes). The default value is 25 (minutes).

Attribute	Meaning							
	 <div style="border: 1px solid black; background-color: #e6f2ff; padding: 5px; margin-top: 5px;"> <p>Note</p> <p>VIDs that you enter for the Management VID and VLAN Membership parameters do not time out.</p> </div>							
Management VID	Enter the VID that the operator wishes to use to communicate with the module manager. The range of values is 1 to 4095. The default value is 1.							
QinQ EtherType	<p>Modules can be configured with 802.1ad Q-in-Q DVLAN (Double-VLAN) tagging which is a way for an operator to put an 802.1Q VLAN inside of an 802.1ad VLAN. A nested VLAN, which is the original 802.1Q tag and a new second 802.1ad tag, allows for bridging of VLAN traffic across a network and segregates the broadcast domains of 802.1Q VLANs. Q-in-Q can be used with PPPoE and/or NAT.</p> <p>The 802.1ad standard defines the S-VLAN as the Service Provider VLAN and the C-VLAN as the customer VLAN. The radio software does 2 layer Q-in-Q whereby the C-VLAN is the 802.1Q tag and the S-VLAN is the second layer Q tag as shown below:</p> <p>Q-in-Q Ethernet frame</p> <table border="1" data-bbox="386 831 1419 915" style="width: 100%; border-collapse: collapse;"> <tr> <td style="width: 25%;">Ethernet Header</td> <td style="width: 25%;">S- VLAN 0x88a8</td> <td style="width: 25%;">EthType</td> <td style="width: 25%;">C- VLAN 0x8100</td> <td style="width: 25%;">EthType</td> <td style="width: 25%;">IP Data 0x0800</td> <td style="width: 25%;">EthType</td> </tr> </table> <p>The 802.1ad S-VLAN is the outer VLAN that is configurable on the Configuration > VLAN web page of the AP. The Q-in-Q EtherType parameter is configured with a default EtherType of 0x88a8 in addition to four alternate EtherTypes that can be configured to aid in interoperability with existing networks that use a different EtherType than the default.</p> <p>The C-VLAN is the inner VLAN tag, which is the same as 802.1Q. As a top-level concept, this operates on the outermost tag at any given time, either “pushing” a tag on or “popping” a tag off. This means packets will at most transition from an 802.1Q frame to an 801.ad frame (with a tag “pushed” on) or an untagged 802.1 frame (with the tag “popped” off). Similarly, for an 802.1ad frame, this can only transition from an 802.1ad frame to an 802.1Q frame (with the tag “popped” off) since the radio software only supports 2 levels of tags.</p>	Ethernet Header	S- VLAN 0x88a8	EthType	C- VLAN 0x8100	EthType	IP Data 0x0800	EthType
Ethernet Header	S- VLAN 0x88a8	EthType	C- VLAN 0x8100	EthType	IP Data 0x0800	EthType		
Use AP’s Management VID for ICC connected SM	This field allows the SM to use the AP’s management VLAN ID when the SM is registered to the AP via ICC.							
VLAN Not Active	When VLAN is enabled in the AP, the Active Configuration block provides the following details as read-only information in this tab. In the Cambium fixed wireless broadband IP network, each device of any type is automatically a permanent member of VID 1. This facilitates deployment of devices that have VLAN enabled with those that do not.							
VLAN Membership Table Configuration	For each VLAN in which you want the AP to be a member, enter the VLAN ID and then click the Add Member button. Similarly, for any VLAN in which you want the AP to no longer be a member, enter the VLAN ID and then click the Remove Member button.							

Attribute	Meaning
VLAN Membership table	This field lists the VLANs that an AP is a member of. As the user adds a number between 1 and 4094, this number is populated here.
Source VLAN (Range: 1-4094)	Enter the VID for which the operator wishes to remark the 802.1p priority for the downstream packets. The range of values is 1 to 4094. The default value is 1.
Remark Priority (Range 0-7)	This is the priority you can assign to the VLAN Tagged packet. Priority of 0 is the highest.
VLAN Remarking table	As the user enters a VLAN and a Remarking priority, this information is added in this table.

VLAN page of SM

The VLAN tab of SM/BHS is explained in below table.

Table 16 :SM VLAN attributes

VLAN Configuration

VLAN Port Type :

Accept QinQ Frames : Enabled Disabled

Allow Frame Types :

Dynamic Learning : Enabled Disabled

VLAN Aging Timeout : Minutes (Range : 5 — 1440 Minutes)

Management VID (Range : 1 — 4094) : Priority (0 — 7)

SM Management VID Pass-through : Disable Enable
 (NOTE: If disabled, MVID traffic will not be allowed to or from the SM wired interface. Also, if Management VID is the same as a Port VID (Default or MAC-based), then this setting will be ignored and assumed to be Enabled.)

Default Port VID (Range : 1 — 4094) : Priority (0 — 7)

Port VID MAC Address Mapping
 MAC address of 0's indicates an unused entry
 VID Range: 1 — 4094
 Priority Range: 0 — 7 :

00-00-00-00-00-00	VID	<input type="text" value="1"/>	Priority	<input type="text" value="0"/>	<input type="text" value="Promote IPv4/IPv6 priority"/>
00-00-00-00-00-00	VID	<input type="text" value="1"/>	Priority	<input type="text" value="0"/>	<input type="text" value="Promote IPv4/IPv6 priority"/>
00-00-00-00-00-00	VID	<input type="text" value="1"/>	Priority	<input type="text" value="0"/>	<input type="text" value="Promote IPv4/IPv6 priority"/>
00-00-00-00-00-00	VID	<input type="text" value="1"/>	Priority	<input type="text" value="0"/>	<input type="text" value="Promote IPv4/IPv6 priority"/>
00-00-00-00-00-00	VID	<input type="text" value="1"/>	Priority	<input type="text" value="0"/>	<input type="text" value="Promote IPv4/IPv6 priority"/>
00-00-00-00-00-00	VID	<input type="text" value="1"/>	Priority	<input type="text" value="0"/>	<input type="text" value="Promote IPv4/IPv6 priority"/>
00-00-00-00-00-00	VID	<input type="text" value="1"/>	Priority	<input type="text" value="0"/>	<input type="text" value="Promote IPv4/IPv6 priority"/>
00-00-00-00-00-00	VID	<input type="text" value="1"/>	Priority	<input type="text" value="0"/>	<input type="text" value="Promote IPv4/IPv6 priority"/>
00-00-00-00-00-00	VID	<input type="text" value="1"/>	Priority	<input type="text" value="0"/>	<input type="text" value="Promote IPv4/IPv6 priority"/>
00-00-00-00-00-00	VID	<input type="text" value="1"/>	Priority	<input type="text" value="0"/>	<input type="text" value="Promote IPv4/IPv6 priority"/>

Provider VID (Range : 1 — 4094) : Priority (0 — 7)

Support 802.1p Frames (VID 0) : Enabled Disabled

Active Configuration

Default Port VID : 1
 MAC Address VID Map:
 Management VID : 1
 SM Management VID Passthrough : Enabled
 Dynamic Ageing Timeout : 25
 Allow Learning : Yes
 Allow Frame Type : All Frame Types
 QinQ : Disabled
 QinQ EthType : 0x88a8
 Allow QinQ Tagged Frames : No

Current VID Member Set:
 VID Number Type Age

VID Number	Type	Age
1	Permanent	0

Active Configuration
 VLAN Not Active

VLAN Membership Configuration

VLAN Membership Table Configuration : (Range : 1 — 4094)

VLAN Membership Table
 Empty Set

VLAN VID Remarking

Source VLAN : (Range : 1 — 4094)
 Remark to VLAN : (Range : 1 — 4094)

VLAN 802.1p Remarking

Source VLAN : (Range : 1 — 4094)
 Remark Priority : (Range : 0 — 7)

VLAN Remarking Table
 Empty Set

L3 Port VID Map

L3 Port VID Map look-up key : Use Source IP Use Destination IP

IP Address / Subnet Mask : /

VID :

Priority Mode :

Priority :

L3 Port VID Map

Map Key	IP Address/NetMask	VID	Priority Mode	Priority	Hash Key
Dst Ip	192.168.1.20/ 32	20	Define Priority	3	7d
Src Ip	10.10.10.1/ 32	100	Promote IPv4/IPv6 priority	0	b
Dst Ip	10.20.30.1/ 24	200	Promote IPv4/IPv6 priority	0	0

Attribute	Meaning
VLAN Port Type	By default, this is Q, indicating that it is to operate in the existing manner. The other option is Q-in-Q, which indicates that it must be adding and removing the S-Tag, and adding a C-Tag if necessary for untagged packets. The VLAN Port type corresponds to the Ethernet port of the SM/BHS. Currently, the internal management interfaces will always operate as Q ports.

Attribute	Meaning
Accept QinQ Frames	This option is valid for the Q-in-Q port so that the user may force blocking of existing 802.1ad Q-in-Q frames. This way, only untagged or single tagged packets will come in and out of the Ethernet interface. If a Q-in-Q frame is about ingress or egress the Ethernet interface and this is disabled, it is dropped and a filter entry will show up on the VLAN Statistics page as DVLAN Egress or DVLAN Ingress.
Allow Frame Types	<p>Select the type of arriving frames that the SM must tag, using the VID that is stored in the Untagged Ingress VID parameter. The default value is All Frames.</p> <p>Tagged Frames Only: The SM only tags incoming VLAN-tagged frames</p> <p>Untagged Frames Only: The SM will only tag incoming untagged frames</p>
Dynamic Learning	Specify whether the SM must (Enable) or not (Disable) add the VIDs of upstream frames (that enter the SM through the wired Ethernet interface) to the VID table. The default value is Enable.
VLAN Aging Timeout	<p>Specify how long the SM/BHS must keep dynamically learned VIDs. The range of values is 5 to 1440 (minutes). The default value is 25 (minutes).</p> <div data-bbox="402 825 467 898" style="display: inline-block; vertical-align: middle;"> </div> <div data-bbox="532 814 1421 930" style="border: 1px solid black; background-color: #e6f2ff; padding: 5px; margin-left: 20px;"> <p>Note</p> <p>VIDs that you enter for the Untagged Ingress VID and Management VID parameters do not time out.</p> </div>
Management VID	Enter the VID that the SM/BHS must share with the AP/BHM. The range of values is 1 to 4095. The default value is 1.
SM Management VID Pass-through	<p>Specify whether to allow the SM/BHS (Enabled) or the AP/RADIUS (Disabled) to control the VLAN settings of this SM. The default value is Enabled.</p> <p>When VLAN is enabled in the AP to whom this SM is registered, the Active Configuration block provides the following details as read-only information in this tab. In the Cambium fixed wireless broadband IP network, each device of any type is automatically a permanent member of VID 1. This facilitates deployment of devices that have VLAN enabled with those that do not.</p> <p>If disabled, MVID traffic is not allowed to or from the SM wired interface. Also, if Management VID is the same as a Port VID (Default or MAC-based), then this setting is ignored and assumed to be Enabled.</p>
Default Port VID	This is the VID that is used for untagged frames and will correspond to the Q-Tag for 802.1Q frames (if VLAN Port Type is Q), or the C-Tag for 802.1ad frames (if the VLAN Port Type is Q-in- Q).
Port VID MAC Address Mapping	These parameters allow operators to place specific devices onto different VLANs (802.1Q tag or 802.1ad C-tag) based on the source MAC address of the packet. If the MAC address entry is 00-00-00-00-00-00 then that entry is not used. If a packet arrives at the SM that is sourced from a device whose MAC address is in the table, then the corresponding VID is used for that frame's Q-tag (Q port) or C-tag (Q-in-Q port). If there is no match, then the Default Port VID is used. This table is also used in the downstream direction for removal of the tag based on the destination MAC address so that an untagged (for Q port) or Q-Tagged (for Q-in-Q port) frame is delivered to the end device. You may use wildcards for the non-OUI (Organizationally Unique Identifier)

Attribute	Meaning
	<p>portion of the MAC address, which is the last 3 bytes. MAC addresses contain 6 bytes, the first 3 of which are the OUI of the vendor that manufactured the device and the last 3 are unique to that vendor OUI. If you want to cover all devices from a known vendor's OUI, you have to specify 0xFF for the remaining 3 bytes. So, for example, if you wanted all devices from a specific vendor with an OUI of 00-95-5b (which is a Netgear OUI) to be on the same VID of 800, you have to specify an entry with MAC address 00-95-5b-ff-ff-ff. Then, any device underneath of the SM with MAC addresses starting with 00-95-5b is put on VLAN 800.</p>
Provider VID	<p>The provider VID is used for the S-tag. It is only used if the Port Type is Q-in-Q and will always be used for the S-tag. If an existing 802.1Q frame arrives, the Provider VID is what is used for adding and removing of the outer S-tag. If an untagged frame arrives to a Q-in-Q port, then the Provider VID is the S-tag and the Default Port VID (or Port VID MAC Address Mapping, if valid) is used for the C-tag.</p>
Support 802.1p Frames	<p>This parameter allows the operator to enable or disable 802.1p frames. When 802.1p feature is enabled on SM, the packets are added with VID=0 and priority bits are set.</p>
Active Configuration, Default Port VID	<p>This is the value of the parameter of the same name, configured above.</p>
Active Configuration, MAC Address VID Map	<p>This is the listing of the MAC address VIDs configured in Port VID MAC Address Mapping.</p>
Active Configuration, Management VID	<p>This is the value of the parameter of the same name, configured above.</p>
Active Configuration, SM Management VID Pass-Through	<p>This is the value of the parameter of the same name, configured above.</p>
Active Configuration, Dynamic Aging Timeout	<p>This is the value of the VLAN Aging Timeout parameter configured above.</p>
Active Configuration, Allow Learning	<p>Yes is displayed if the value of the Dynamic Learning parameter above is Enabled. No is displayed if the value of Dynamic Learning is Disabled.</p>

Attribute	Meaning
Active Configuration, Allow Frame Type	This displays the selection that was made from the drop-down list at the Allow Frame Types parameter above.
Active Configuration, QinQ	This is set to Enabled if VLAN Port Type is set to QinQ, and is set to Disabled if VLAN Port Type is set to Q.
Active Configuration, QinQ EthType	This is the value of the QinQ EtherType configured in the AP.
Active Configuration, Allow QinQ Tagged Frames	This is the value of Accept QinQ Frames, configured above.
Active Configuration, Current VID Member Set, VID Number	This column lists the ID numbers of the VLANs in which this module is a member, whether through assignment or through dynamic learning.
Active Configuration, Current VID Member Set, Type	<p>For each VID number in the first column, the entry in this column correlates the way in which the module became and continues to be a member:</p> <p>Permanent—This indicates that the module was assigned the VID number through direct configuration by the operator.</p> <p>Dynamic—This indicates that the module adopted the VID number through enabled dynamic learning, when a tagged packet from a SM behind it in the network or from a customer equipment that is behind the SM in this case, was read.</p>
Active Configuration, Current VID Member Set, Age	<p>For each VID number in the first column of the table, the entry in this column reflects whether or when the VID number will time out:</p> <p>Permanent type - Number never times out and this is indicated by the digit 0.</p> <p>Dynamic type - Age reflects what is configured in the VLAN Aging Timeout parameter in the Configuration => VLAN tab of the AP or reflects a fewer number of minutes that represents the difference between what was configured and what has elapsed since the VID was learned. Each minute, the Age decreases by one until, at zero, the AP deletes the learned VID, but can it again from packets sent by elements that are beneath it in the network.</p> <div data-bbox="402 1612 467 1696" style="display: inline-block; vertical-align: middle;"> </div> <div data-bbox="532 1612 1424 1814" style="border: 1px solid black; background-color: #e6f2ff; padding: 5px; margin-top: 10px;"> <p>Note</p> <p>Values in this Active Configuration block can differ from attempted values in configurations:</p> <p>The AP can override the value that the SM has configured for SM Management VID Pass-Through.</p> </div>

Attribute	Meaning
IP Lookup Direction	This parameter supports following options. <ul style="list-style-type: none"> • Use Source IP: Mapping is done based on the source IP of the incoming packet. • Use Destination IP: Mapping is done based on the Destination IP of the incoming packet.
IP Address / Subnet Mask	This parameter specifies the IP Address and the Subnet Mask which needs to be matched.
VID	This parameter specifies the VLAN which is tagged to the packet.
Priority Mode	This parameter specifies the priority precedence to decide if 802.1p or DSCP Priority bits need to be used when making priority decisions.
Priority	This parameter specifies the 802.1p Priority bits in the VLAN tag.
L3 Port VID Map	This field displays the Map key, IP address/subnet mask, VID, Priority mode, Priority, and Hash key information of the tagged packets.

VLAN Membership tab of SM

The Configuration > VLAN > VLAN Membership tab is explained in below table.

Table 17 : SM VLAN Membership attributes

Attribute	Meaning
VLAN Membership Table Configuration	For each VLAN in which you want the AP to be a member, enter the VLAN ID and then click the Add Member button. Similarly, for any VLAN in which you want the AP to no longer be a member, enter the VLAN ID and then click the Remove Member button.

VLAN configuration for PTP

Applicable products

PTP: BHM BMS

VLAN page of BHM

The VLAN tab of BHS is explained in below table.

Table 18 : BHM VLAN page attributes

VLAN Configuration

VLAN : Enabled
 Disabled

VLAN Port Type :

Accept QinQ Frames : Enabled
 Disabled

Management VID (Range : 1 — 4094) : Priority (0 — 7)

Default Port VID (Range : 1 — 4094) : Priority (0 — 7)

QinQ EtherType :

Active Configuration

Default Port VID : 1 Priority : Promote IPv4/IPv6 priority
Management VID : 1 Priority : Promote IPv4/IPv6 priority
QinQ : Disabled
QinQ EthType : 0x88a8
Allow QinQ Tagged Frames : No
Current VID Member Set:

VID Number	Type	Age
1	Permanent	0

Attribute	Meaning
VLAN	Specify whether VLAN functionality for the BHM and all linked BHS must be (Enabled) or may not (Disabled) be allowed. The default value is Disabled.
VLAN Port Type	By default, this is Q, indicating that it is to operate in the existing manner. The other option is Q-in-Q, which indicates that it must be adding and removing the S-Tag, and adding a C-Tag if necessary for untagged packets. The VLAN Port type corresponds to the Ethernet port of the BHS. Currently, the internal management interfaces will always operate as Q ports.
Accept QinQ Frames	This option is valid for the Q-in-Q port so that the user may force blocking of existing 802.1ad Q-in-Q frames. This way, only untagged or single tagged packets will come in and out of the Ethernet interface. If a Q-in-Q frame is about ingress or egress the Ethernet interface and this is disabled, it is dropped and a filter entry will show up on the VLAN Statistics page as DVLAN Egress or DVLAN Ingress.
Management VID (Range 1-4094)	Enter the VID that the BHS must share with the BHM. The range of values is 1 to 4095. The default value is 1.
Default Port VID (Range 1-4094)	This is the VID that is used for untagged frames and corresponds to the Q-Tag for 802.1Q frames (if VLAN Port Type is Q), or the C-Tag for 802.1ad frames (if the VLAN Port Type is Q-in-Q).
QinQ Ether Type	Modules can be configured with 802.1ad Q-in-Q DVLAN (Double-VLAN) tagging which is a way for an operator to put an 802.1Q VLAN inside of an 802.1ad VLAN. A nested VLAN, which is the original 802.1Q tag and a new second 802.1ad tag, allows for bridging of VLAN traffic across a network and segregates the broadcast domains of 802.1Q VLANs. Q-in-Q can be used with PPPoE and/or NAT. The 802.1ad standard defines the S-VLAN as the Service Provider VLAN and the C-VLAN as the customer VLAN. The radio software does 2-layer Q-in-Q whereby the C-VLAN is the 802.1Q tag and the S-VLAN is the second layer Q tag as shown below:

Attribute	Meaning							
	<table border="1"> <tr> <td>Ethernet Header</td> <td>S- VLAN 0x88a8</td> <td>EthType</td> <td>C- VLAN 0x8100</td> <td>EthType</td> <td>IP Data 0x0800</td> <td>EthType</td> </tr> </table> <p>The 802.1ad S-VLAN is the outer VLAN that is configurable on the Configuration > VLAN web page of the BHM. The Q-in-Q EtherType parameter is configured with a default EtherType of 0x88a8 in addition to four alternate EtherTypes that can be configured to aid in interoperability with existing networks that use a different EtherType than the default.</p> <p>The C-VLAN is the inner VLAN tag, which is the same as 802.1Q. As a top-level concept, this operates on the outermost tag at any given time, either “pushing” a tag on or “popping” a tag off. This means packets will at most transition from an 802.1Q frame to an 801.ad frame (with a tag “pushed” on) or an untagged 802.1 frame (with the tag “popped” off). Similarly, for an 802.1ad frame, this can only transition from an 802.1ad frame to an 802.1Q frame (with the tag “popped” off) since the radio software only supports 2 levels of tags.</p>	Ethernet Header	S- VLAN 0x88a8	EthType	C- VLAN 0x8100	EthType	IP Data 0x0800	EthType
Ethernet Header	S- VLAN 0x88a8	EthType	C- VLAN 0x8100	EthType	IP Data 0x0800	EthType		
VLAN Not Active	When VLAN is enabled in the BHM, the Active Configuration block provides the following details as read-only information in this tab. In the Cambium fixed wireless broadband IP network, each device of any type is automatically a permanent member of VID 1. This facilitates deployment of devices that have VLAN enabled with those that do not.							

VLAN page of BHS

The VLAN tab of BHS is explained in below table.

Table 19 :Table 20 BHS VLAN page attributes

VLAN Configuration

VLAN : Enabled Disabled

VLAN Port Type : ▼

Accept QinQ Frames : Enabled Disabled

Management VID (Range : 1 — 4094) : Priority (0 — 7) ▼

Default Port VID (Range : 1 — 4094) : Priority (0 — 7) ▼

Active Configuration

VLAN Not Active

Attribute	Meaning
VLAN	Specify whether VLAN functionality for the BHM and all linked BHS must be (Enabled) or may not (Disabled) be allowed. The default value is Disabled.
VLAN Port Type	By default, this is Q, indicating that it is to operate in the existing manner. The other option is Q-in-Q, which indicates that it must be adding and removing the S-Tag, and adding a C-Tag if necessary for untagged packets. The VLAN Port type corresponds to the Ethernet port of the BHS. Currently, the internal management interfaces will always operate as Q ports.

Attribute	Meaning
Accept QinQ Frames	This option is valid for the Q-in-Q port so that the user may force blocking of existing 802.1ad Q-in-Q frames. This way, only untagged or single tagged packets will come in and out of the Ethernet interface. If a Q-in-Q frame is about ingress or egress the Ethernet interface and this is disabled, it is dropped and a filter entry will show up on the VLAN Statistics page as DVLAN Egress or DVLAN Ingress.
Management VID (Range 1-4094)	Enter the VID that the BHS must share with the BHM. The range of values is 1 to 4095. The default value is 1.
Default Port VID (Range 1-4094)	This is the VID that is used for untagged frames and corresponds to the Q-Tag for 802.1Q frames (if VLAN Port Type is Q), or the C-Tag for 802.1ad frames (if the VLAN Port Type is Q-in- Q).
VLAN Not Active	When VLAN is enabled in the BHM, the Active Configuration block provides the following details as read-only information in this tab. In the Cambium fixed wireless broadband IP network, each device of any type is automatically a permanent member of VID 1. This facilitates deployment of devices that have VLAN enabled with those that do not.

PPPoE page of SM

Applicable products PMP: b SM

Point-to-Point Protocol over Ethernet (PPPoE) is a protocol that encapsulates PPP frames inside Ethernet frames (at Ethernet speeds). Benefits to the network operator may include

- Access control
- Service monitoring
- Generation of statistics about activities of the customer
- Re-use of infrastructure and operational practices by operators who already use PPP for other networks

PPPoE options are configurable for the SM only, and the AP indicates whether or not PPPoE is enabled for a specific subscriber.

When PPPoE is enabled, once the RF session comes up between the SM and the AP, the SM will immediately attempt to connect to the PPPoE Server. You can monitor the status of this by viewing the PPPoE Session Log in the Logs section (Administrator only). Every time the RF session comes up, the SM will check the status of the link and if it is down, the SM will attempt to redial the link if necessary depending on the Timer Type. Also, on the Configuration page, the user may 'Connect' or 'Disconnect' the session manually. This can be used to override the session to force a manual disconnect and/or reconnect if there is a problem with the session.

In order to enable PPPoE, NAT MUST be enabled on the SM and Translation Bridging MUST be disabled on the AP. These items are strictly enforced for you when you are trying to enable PPPoE. A message will indicate any prerequisites not being met. Also, the NAT Public IP DHCP client cannot be enabled, because the NAT Public IP is received through the IPCP process of the PPPoE discovery stages.

The pre-requisites are:

- NAT MUST be enabled on the SM:
- NAT DHCP Client is disabled automatically. The NAT public IP is received from the PPPoE Server.
- NAT Public Network Interface Configuration will not be used and must be left to defaults. Also NAT Public IP DHCP is disabled if it is enabled.

Translation Bridging MUST be DISABLED on the AP

- This will only be determined if the SM is in session since the SM won't know the AP configuration otherwise. If the SM is not in session, PPPoE can be enabled but if the SM goes into session to a Translation Bridge-enabled AP, then PPPoE will not be enabled.

The PPPoE configuration parameters are explained in below table.

Table 20 :SM PPPoE attributes

The screenshot shows a 'PPPoE Configuration' window with the following settings:

- PPPoE: Enabled, Disabled
- NAT DHCP Client will be disabled.**
- Access Concentrator: [Empty text box]
- Service Name: [Empty text box]
- Authentication Type: [None (dropdown)]
- User Name: [admin]
- Password: [Masked with dots]
- MTU: Use MTU Received from PPPoE Server, Use User Defined MTU (1492)
- Timer Type: [Keep Alive (dropdown)]
- Timer Period: [30] seconds (20s Minimum)
- TCP MSS Clamping: Enabled, Disabled

Attribute	Meaning
Access Concentrator	An optional entry to set a specific access concentrator to connect to for the PPPoE session. If this is blank, the SM will accept the first access concentrator which matches the service name (if specified). This is limited to 32 characters.
Service Name	An optional entry to set a specific service name to connect to for the PPPoE session. If this is left blank the SM will accept the first service option that comes back from the access concentrator specified above, if any. This is limited to 32 characters.
Authentication Type	None means that no PPPoE authentication is implemented CHAP/PAP means that CHAP authentication is attempted first, then PAP authentication. The same password is used for both types.
User Name	This is the CHAP/PAP user name that is used if CHAP/PAP authentication is selected. If None is selected for authentication, then this field is unused. This is limited to 32 characters.

Attribute	Meaning
Password	This is the CHAP/PAP password that is used if PAP authentication is selected. If None is selected for authentication, then this field is unused. This is limited to 32 characters.
MTU	<p>Use MTU Received from PPPoE Server causes the SM to use the MRU of the PPPoE server received in LCP as the MTU for the PPPoE link.</p> <p>Use User Defined MTU allows the operator to specify an MTU value to use to override any MTU that may be determined in the LCP phase of PPPoE session setup. If this is selected, the user is able to enter an MTU value up to 1492. However, if the MTU determined in LCP negotiations is less than this user-specified value, the SM will use the smaller value as its MTU for the PPPoE link.</p>
Timer Type	<p>Keep Alive is the default timer type. This timer will enable a keepalive that will check the status of the link periodically. The user can set a keepalive period. If no data is seen from the PPPoE server for that period, the link is taken down and a reconnection attempt is started. For marginal links, the keep alive timer can be useful so that the session will stay alive over periodic dropouts. The keepalive timer must be set such that the session can outlast any session drop. Some PPPoE servers will have a session check timer of their own so that the timeouts of the server and the SM are in sync, to ensure one side does not drop the session prematurely.</p> <p>Idle Timeout enables an idle timer that checks the usage of the link from the customer side. If there is no data seen from the customer for the idle timeout period, the PPPoE session is dropped. Once data starts flowing from the customer again, the session is started up again. This timer is useful for users who may not be using the connection frequently. If the session is idle for long periods of time, this timer will allow the resources used by the session to be returned to the server. Once the connection is used again by the customer, the link is reestablished automatically.</p>
Timer Period	The length in seconds of the PPPoE keepalive timer.
TCP MSS Clamping	If this is enabled, then the SM will alter TCP SYN and SYN-ACK packets by changing the Maximum Segment Size to be compatible with the current MTU of the PPPoE link. This way, the user does not have to worry about MTU on the client side for TCP packets. The MSS is set to the current MTU - 40 (20 bytes for IP headers and 20 bytes for TCP headers). This will cause the application on the client side to not send any TCP packets larger than the MTU. If the network is exhibiting large packet loss, try enabling this option. This may not be an option on the PPPoE server itself. The SM will NOT reassemble IP fragments, so if the MTUs are incorrect on the end stations, then MSS clamping will solve the problem for TCP connections.

IP4 and IPv6

Applicable products PMP: AP SM PTP: BHM BMS

IPv4 and IPv6 Prioritization

450 Platform Family provides operators the ability to prioritize IPv6 traffic in addition to IPv4 traffic. IPv6/IPv4 prioritization can be configured by selecting a CodePoint and the corresponding priority from the GUI of the AP/BHM and the IPv6/IPv4 packet is set up accordingly. There is no GUI option for selecting IPv6 or IPv4 priority. Once the priority is set, it is set for IPv4 and IPv6 packets.

Configuring IPv4 and IPv6 Priority

IPv4 and IPv6 prioritization is set using the DiffServ tab on the AP/BHM and SM/BHS (located at Configuration > DiffServ). A priority set to a specific CodePoint will apply to both IPv4 and IPv6 traffic.

Table 21: DiffServ attributes – AP/BHM

DiffServ Configuration							
CodePoints (00) — (07):							
CP00 : 0	CP01 : 1	CP02 : 1	CP03 : 1	CP04 : 1	CP05 : 1	CP06 : 1	CP07 : 1
CodePoints (08) — (15):							
CP08 : 1	CP09 : 1	CP10 : 1	CP11 : 1	CP12 : 1	CP13 : 1	CP14 : 1	CP15 : 1
CodePoints (16) — (23):							
CP16 : 2	CP17 : 1	CP18 : 2	CP19 : 1	CP20 : 2	CP21 : 1	CP22 : 2	CP23 : 1
CodePoints (24) — (31):							
CP24 : 3	CP25 : 1	CP26 : 3	CP27 : 1	CP28 : 3	CP29 : 1	CP30 : 3	CP31 : 1
CodePoints (32) — (39):							
CP32 : 4	CP33 : 1	CP34 : 4	CP35 : 1	CP36 : 4	CP37 : 1	CP38 : 4	CP39 : 1
CodePoints (40) — (47):							
CP40 : 5	CP41 : 1	CP42 : 1	CP43 : 1	CP44 : 1	CP45 : 1	CP46 : 5	CP47 : 1
CodePoints (48) — (55):							
CP48 : 6	CP49 : 1	CP50 : 1	CP51 : 1	CP52 : 1	CP53 : 1	CP54 : 1	CP55 : 1
CodePoints (56) — (63):							
CP56 : 7	CP57 : 1	CP58 : 1	CP59 : 1	CP60 : 1	CP61 : 1	CP62 : 1	CP63 : 1
CodePoint Select :	1 ▼						
Priority Select :	0 ▼						
Priority Precedence :	DiffServ Then 802.1p ▼						
PPPoE Control Message Priority :	<input type="radio"/> High <input checked="" type="radio"/> Normal						

MPLS Configuration	
MPLS Traffic Class (TC) 0 :	0 ▼
MPLS Traffic Class (TC) 1 :	1 ▼
MPLS Traffic Class (TC) 2 :	2 ▼
MPLS Traffic Class (TC) 3 :	3 ▼
MPLS Traffic Class (TC) 4 :	4 ▼
MPLS Traffic Class (TC) 5 :	5 ▼
MPLS Traffic Class (TC) 6 :	6 ▼
MPLS Traffic Class (TC) 7 :	7 ▼

Attribute	Meaning
Codepoints 1 through 63	The PMP family of APs support four levels of QoS. The mapping of these eight priority values to data channels is determined by the number of data channels configured per SM as shown in the table below:

Attribute	Meaning																									
	<table border="1"> <thead> <tr> <th>Number of QoS levels →</th> <th>1</th> <th>2</th> <th>3</th> <th>4</th> </tr> </thead> <tbody> <tr> <td>Level 1</td> <td>0-7</td> <td>0-3</td> <td>0-1</td> <td>0-1</td> </tr> <tr> <td>Level 2</td> <td>-</td> <td>4-7</td> <td>2-3</td> <td>2-3</td> </tr> <tr> <td>Level 3</td> <td>-</td> <td>-</td> <td>4-7</td> <td>4-5</td> </tr> <tr> <td>Level 4</td> <td>-</td> <td>-</td> <td>-</td> <td>6-7</td> </tr> </tbody> </table> <p>For example, for an AP that uses the default table shown above has configured 3 QoS levels per SM, would see codepoints 0 through 15 mapped to the Low Priority data channels, codepoint 16 would be mapped to the Medium Priority data channels, and so on.</p> <p>Note that CodePoints 0, 8, 16, 24, 32, 48, and 56 are predefined to the fixed values shown in DiffServ attributes - AP/BHM above and are not user configurable. Operator cannot change any of these three fixed priority values. Among the configurable parameters, the priority values (and therefore the handling of packets in the high or low priority channel) are set in the AP/BHM for all downlinks within the sector and in the SM/BHS for each uplink.</p>	Number of QoS levels →	1	2	3	4	Level 1	0-7	0-3	0-1	0-1	Level 2	-	4-7	2-3	2-3	Level 3	-	-	4-7	4-5	Level 4	-	-	-	6-7
Number of QoS levels →	1	2	3	4																						
Level 1	0-7	0-3	0-1	0-1																						
Level 2	-	4-7	2-3	2-3																						
Level 3	-	-	4-7	4-5																						
Level 4	-	-	-	6-7																						
CodePoint Select	This represents the CodePoint Selection to be modified via Priority Select.																									
Priority Select	The priority setting input for the CodePoint selected in CodePoint Select.																									
Priority Precedence	Allows operator to decide if 802.1p or DiffServ priority bits must be used first when making priority decisions.																									
PPPoE Control Message Priority	Operators may configure the AP/BHM to utilize the high priority channel for PPPoE control messages. Configuring the AP/BHM in this fashion can benefit the continuity of PPPoE connections when there are issues with PPPoE sessions being dropped in the network. This prioritization may be configured in the DiffServ tab in the Configuration menu of the AP/BHM.																									
MPLS Traffic Class (TC) 0 through MPLS Traffic Class (TC) 7	<p>The Multi-Protocol Label Switching (MPLS) protocol is used to route traffic based on the priority setting configured each MPLS Traffic Class.</p> <p>MPLS Traffic Class (TC) 0 through MPLS Traffic Class (TC) 7 can be configured with 0 through 7 priority settings.</p>																									

IPv4 and IPv6 Filtering

The operator can filter (block) specified IPv6 protocols including IPv4 and ports from leaving the AP/BHM and SM/BHS and entering the network. This protects the network from both intended and inadvertent

packet loading or probing by network users. By keeping the specified protocols or ports off the network, this feature also provides a level of protection to users from each other.

Configuring IPv4 and IPv6 Filtering

IPv6 filters are set using the Protocol Filtering tab on the AP/BHM and SM/BHS (at Configuration > Protocol Filtering). Once a filter is set for a packet type, those packets will not be sent over the RF interface depending on “Filter Direction” setting.

Table 22 :Packet Filter Configuration attributes

Packet Filter Configuration	
Packet Filter Types :	<input checked="" type="checkbox"/> PPPoE <input type="checkbox"/> All IPv4 <input type="checkbox"/> SMB (Network Neighborhood) <input type="checkbox"/> SNMP <input type="checkbox"/> Bootp Client <input type="checkbox"/> Bootp Server <input type="checkbox"/> IPv4 Multicast <input type="checkbox"/> User Defined Port 1 (See Below) <input type="checkbox"/> User Defined Port 2 (See Below) <input type="checkbox"/> User Defined Port 3 (See Below) <input type="checkbox"/> All other IPv4 <input type="checkbox"/> All IPv6 <input type="checkbox"/> SMB (Network Neighborhood) <input type="checkbox"/> SNMP <input type="checkbox"/> Bootp Client <input type="checkbox"/> Bootp Server <input type="checkbox"/> IPv6 Multicast <input type="checkbox"/> All other IPv6 <input type="checkbox"/> ARP <input type="checkbox"/> All others
Filter Direction :	<input checked="" type="checkbox"/> Upstream <input checked="" type="checkbox"/> Downstream

User Defined Port Filtering Configuration	
Port #1 :	<input type="text" value="0"/> (Decimal Value)
TCP :	<input type="radio"/> Enabled <input checked="" type="radio"/> Disabled
UDP :	<input type="radio"/> Enabled <input checked="" type="radio"/> Disabled
Port #2 :	<input type="text" value="0"/> (Decimal Value)
TCP :	<input type="radio"/> Enabled <input checked="" type="radio"/> Disabled
UDP :	<input type="radio"/> Enabled <input checked="" type="radio"/> Disabled
Port #3 :	<input type="text" value="0"/> (Decimal Value)
TCP :	<input type="radio"/> Enabled <input checked="" type="radio"/> Disabled
UDP :	<input type="radio"/> Enabled <input checked="" type="radio"/> Disabled

AP Specialty Filters	
RF Telnet Access :	<input type="radio"/> Enabled <input checked="" type="radio"/> Disabled
PPPoE PADI Downlink Forwarding :	<input checked="" type="radio"/> Enabled <input type="radio"/> Disabled

Attribute	Meaning
Packet Filter Types	<p>For any box selected, the Protocol and Port Filtering feature blocks the associated protocol type.</p> <p>To filter packets in any of the user-defined ports, you must do all of the following:</p> <ul style="list-style-type: none"> • Check the box for User Defined Port n (See Below) in the Packet Filter Types section of this tab. • Provide a port number at Port #n. in the User Defined Port Filtering Configuration section of this tab • Enable TCP and/or UDP by clicking the associated radio button
Filter Direction	Operators may choose to filter upstream (uplink) RF packets or downstream (downlink) RF packets.
User Defined Port Filtering Configuration	You can specify ports for which to block subscriber access, regardless of whether NAT is enabled.

Upgrading the software version and using CNUT

This section consists of the following procedures:

- Upgrading to a new software version
- Checking the installed software version



Caution

If the link is operational, ensure that the remote end of the link is upgraded first using the wireless connection, and then the local end can be upgraded. Otherwise, the remote end may not be accessible.

Use CNUT 4.11.2 or later version and always refer to the software release notes before upgrading system software. The release notes are available at:

<https://support.cambiumnetworks.com/files/pmp450>

<https://support.cambiumnetworks.com/files/ptp450>

Checking the installed software version

To check the installed software version, follow these instructions:

Procedure 10 Checking the installed software version:

1. Click on General tab under Home menu.
2. Note the installed Software Version (under Device Information):

PMP/PTP 450/450i/450m

Software Version :	CANOPY 15.0.1 AP-None
--------------------	-----------------------

3. Go to the support website (see Contacting Cambium Networks) and find Point-to-Multipoint software updates. Check that the latest 450 Platform Family software version is the same as the

installed Software Version.

4. To upgrade software to the latest version, see [Upgrading to a new software version](#)

Upgrading to a new software version

All 450 platform modules are upgraded using the Canopy Network Updater Tool. The Canopy Network Updater Tool (CNUT) manages and automates the software upgrade process for a Canopy radio, or CMM4 (but not its 14-port switch) across the network. This eliminates the need for an administrator to visit each radio in the network (or each AP/BHM while using the Auto update feature) to upgrade the modules.



Note

Please ensure that you have the most up-to-date version of CNUT by browsing to the Customer Support Web Page located:

<https://www.cambiumnetworks.com/products/software-tools/cambium-network-updater-tool/>

This section includes an example of updating a single unit before deployment. System-wide upgrading procedures may be found in the CNUT Online Help manual, which can be found on the Cambium support website (see [Contacting Cambium Networks](#)).

CNUT functions

The Canopy Network Updater tool has the following functions:

- Automatically discovers all network elements
- Executes a UDP command that initiates and terminates the Auto-update mode within APs/BHMs. This command is both secure and convenient:
 - For security, the AP/BHM accepts this command from only the IP address that you specify in the Configuration page of the AP/BHM.
 - For convenience, Network Updater automatically sets this Configuration parameter in the APs/BHMs to the IP address of the Network Updater server when the server performs any of the update commands.
- CNUT supports HTTP and HTTPS
- Allows you to choose the following among updating:
 - Your entire network.
 - Only elements that you select.
 - Only network branches that you select.
- Provides a Script Engine that you can use with any script that:
 - You define.
 - Cambium supplies.
- Configurability of any of the following to be the file server for image files:

- The AP/BHM, for traditional file serving via UDP commands and monitoring via UDP messaging
- CNUT HTTP/HTTPS Server, for upgrading via SNMP commands and monitoring via SNMP messaging. This also supports an option to either set the image order specifically for this file server or to allow the AP to determine the order.
- Local TFTP Server, for traditional file serving via UDP commands and monitoring via UDP messaging. This supports setting the number of simultaneous image transfers per AP/BHM
- The capability to launch a test of connectivity and operational status of the local HTTP, HTTPS and TFTP file servers
- An interface that supports efficient specification of the proper IP address for the local file server(s) where Network Updater resides on a multi-homed computer
- An md5 checksum calculator utility for identifying corruption of downloaded image files before Network Updater is set to apply them.

Network element groups

With the Canopy Network Updater Tool, you can identify element groups composed of network elements that you select. Identifying these element groups does the following:

- Organizes the display of elements (for example, by region or by AP/BHM cluster).
- Allows to:
 - Perform an operation on all elements in the group simultaneously.
 - Set group-level defaults for ftp password access and SNMP Community String (defaults that can be overridden in an individual element when necessary).

Network layers

A typical network contains multiple layers of elements, with each layer farther from the Point of Presence. For example, SMs (or BHS) are behind an AP/BHM and thus, in this context, at a lower layer than the AP/BHM. Correctly portraying these layers in Network Updater is essential so that Network Updater can perform radio and AP/BHM cluster upgrades in an appropriate order.

Script engine

Script Engine is the capability in Network Updater that executes any user-defined script against any network element or element group. This capability is useful for network management, especially for scripts that you repetitively execute across your network.

The Autodiscovery capability in Network Updater finds all of your network elements. This comprehensive discovery:

- Ensures that, when you intend to execute a script against all elements, the script is indeed executed against all elements.
- Maintains master lists of elements (element groups) against which you selectively execute scripts.

The following scripts are included with CNUT:

- Gather Customer Support Information
- Set Access Point Authentication Mode
- Set Autoupdate Address on APs/BHMs
- Set SNMP Accessibility
- Reset Unit

Software dependencies for CNUT

CNUT functionality requires:

- one of the following operating systems:
 - Windows®2000
 - Windows Server 2003
 - Windows 7 and Windows 8
 - Windows XP or XP Professional
 - Red Hat Enterprise Linux (32-bit) Version 4 or 5
- Java™ Runtime Version 2.0 or later (installed by the CNUT installation tool)

CNUT download

CNUT can be downloaded together with each system release that supports CNUT. Software for these system releases is available from <https://www.cambiumnetworks.com/products/software-tools/cambium-network-updater-tool/>, as either:

- A .zip file for use without the CNUT application.
- A .pkg file that the CNUT application can open.

Upgrading a module prior to deployment

To upgrade to a new software version, follow this:

Procedure 11 Upgrading a module prior to deployment

1. Go to the support website (see Contacting Cambium Networks) and find Point-to-Multipoint software updates. Download and save the required software image.
2. Start CNUT
3. If you don't start up with a blank new network file in CNUT, then open a new network file with the New Network Archive operation (located at File >New Network).
4. Enter a new network element to the empty network tree using the Add Elements to Network Root operation (located at Edit >Add Elements to Network Root).
5. In the Add Elements dialogue, select a type of Access Point or Subscriber Module and enter the IP address of 169.254.1.1.
6. Make sure that the proper Installation Package is active with the Package Manager dialogue (located at Update > Manage Packages).

7. To verify connectivity with the radio, perform a Refresh, Discover Entire Network operation (located at View >Refresh/Discover Entire Network). You must see the details columns for the new element filled in with ESN and software version information.
8. Initiate the upgrade of the radio using Update Entire Network Root operation (located at Update >Update Entire Network Root). When this operation finishes, the radio is done being upgraded.

General configuration

The Configuration > General page of the AP/BMH or BHM/BHS contains many of the configurable parameters that define how the radios operate in sector or backhaul.

Applicable products PMP: AP SM PTP: BHM BMS

PMP 450 m and PMP/ PTP 450 i Series

General page - PMP 450 i AP

The General page of AP is explained in below table.

Table 23 :General page attributes – PMP/PTP 450i AP

Link Speeds	
Link Speed :	Auto 1000F/100F/100H/10F/10H ▼
Ethernet Link :	<input checked="" type="radio"/> Enabled <input type="radio"/> Disabled
Ethernet Bounce Timeout :	0 Minutes (Range : 0–60 Minutes, 0 = Disable)
PoE	
802.3at Type 2 PoE Status :	Not Present (Ignored)
PoE Classification :	<input type="radio"/> Enabled <input checked="" type="radio"/> Disabled
Bandwidth Configuration Source	
Configuration Source :	SM ▼
Sync Setting	
Sync Input :	Generate Sync ▼
Free Run Before GPS Sync :	<input type="radio"/> Enabled <input checked="" type="radio"/> Disabled
Region Settings	
Region :	Other - Regulatory ▼
Country :	Other ▼
Web Page Configuration	
Webpage Auto Update :	0 Seconds (0 = Disable Auto Update)
Bridge Configuration	
Bridge Entry Timeout :	25 Minutes (Range : 25–1440 Minutes)
Translation Bridging :	<input type="radio"/> Enabled <input checked="" type="radio"/> Disabled
Send Untranslated ARP :	<input type="radio"/> Enabled <input checked="" type="radio"/> Disabled
SM Isolation :	Disable SM Isolation ▼
Forward Unknown Unicast Packets :	<input type="radio"/> Enabled - If destination address is not known, forward packet to all SMs. <input checked="" type="radio"/> Disabled - If destination address is not known, drop packet.
Update Application Information	
Update Application Address :	0.0.0.0

TCP Settings	
Prioritize TCP ACK :	<input checked="" type="radio"/> Enabled <input type="radio"/> Disabled

Layer 2 Discovery Destination Address	
Multicast Destination Address :	<input type="radio"/> Broadcast <input checked="" type="radio"/> LLDP Multicast

DHCP Relay Agent	
DHCP Relay Agent :	Disable
DHCP Server (Name or IP Address) :	<input type="radio"/> Append DNS Domain Name <input checked="" type="radio"/> Disable DNS Domain Name 255.255.255.255
Option 82 Circuit ID :	\$apmacbi\$
Option 82 Remote ID :	\$smmacbi\$
Option 82 Vendor Specific ID :	\$smvidbi\$

Coordinates		
Latitude :	+0.000000	Decimal Degree
Longitude :	+0.000000	Decimal Degree
Height :	0	Meters

Attribute	Meaning
Link Speed	<p>From the drop-down list of options, select the type of link speed for the Ethernet connection. The Auto settings allow the two ends of the link to automatically negotiate with each other the best possible speed, and check whether the Ethernet traffic is full duplex or half duplex.</p> <p>However, some Ethernet links work best when either:</p> <ul style="list-style-type: none"> • both ends are set to the same forced selection • both ends are set to auto-negotiate and both have capability in least one common speed and traffic type combination.
Ethernet Link	This parameter allows the operator to enable or disable Ethernet Link.
Ethernet Bounce Timeout	This parameter allows the operator to configure Ethernet bounce timeout ranging from 0 to 60 minutes. Value 0 disables Ethernet bounce timeout.
802.3at Type 2 PoE Status and PoE Classification (PMP 450i Series only)	<p>When the PoE Classification functionality is enabled and if Type 2 power is not present, the PAs do not power up and draw too much power.</p> <p>By default, the PoE Classification feature is disabled and the PAs will power up regardless of the classification presented by the power source.</p> <p>This is supported only on 450i series devices.</p> <p>PoE Classification configuration status also can be check under home > General > Device Information tab:</p> <hr/> <p>802.3at Type 2 PoE Status : Not Present (Ignored)</p>
Configuration Source	See Setting the Configuration Source

Attribute	Meaning
Sync Input	See Configuring synchronization
Free Run Before GPS Sync	See Free Run Before GPS Sync
Region	From the drop-down list, select the region in which the radio is operating.
Country	<p>From the drop-down list, select the country in which the radio is operating.</p> <p>Unlike selections in other parameters, your Country selection requires a Save Changes and a Reboot cycle before it will force the context-sensitive GUI to display related options (for example, Alternate Frequency Carrier 1 and 2 in the Configuration > Radio tab).</p> <p>PMP 450i Series ODUs shipped to the United States is locked to a Region Code setting of "United States". Units shipped to regions other than the United States must be configured with the corresponding Region Code to comply with local regulatory requirements.</p> <p>Country Code settings affect the radios in the following ways:</p> <ul style="list-style-type: none"> • Maximum transmit power limiting (based on radio transmitter power plus configured antenna gain) • DFS operation is enabled based on the configured region code, if applicable <p>For more information on how transmit power limiting and DFS is implemented for each country, see the PMP 450 Planning Guide.</p>
Webpage Auto Update	Enter the frequency (in seconds) for the web browser to automatically refresh the web-based interface. The default setting is 0. The 0 setting causes the web-based interface to never be automatically refreshed.
Bridge Entry Timeout	<p>Specify the appropriate bridge timeout for correct network operation with the existing network infrastructure. The Bridge Entry Timeout must be a longer period than the ARP (Address Resolution Protocol) cache timeout of the router that feeds the network.</p> <div style="border: 1px solid black; background-color: #f4a460; padding: 5px; margin-top: 10px;">  <p>Caution</p> <p>An inappropriately low Bridge Entry Timeout setting may lead to temporary loss of communication with some end users.</p> </div>
Translation Bridging	<p>Optionally, you can configure the AP to change the source MAC address in every packet it receives from its SMs to the MAC address of the SM that bridged the packet, before forwarding the packet toward the public network. If you do, then:</p> <p>Not more than 128 IP devices at any time are valid to send data to the AP from behind the SM.</p> <p>SM populates the Translation Table tab of its Statistics web page, displaying the MAC address and IP address of all the valid connected devices.</p> <p>Each entry in the Translation Table is associated with the number of minutes that have elapsed since the last packet transfer between the connected device and the SM.</p> <p>If 128 are connected and another attempts to connect:</p>

Attribute	Meaning
	<p>If no Translation Table entry is older than 255 minutes, the attempt is ignored.</p> <p>If an entry is older than 255 minutes, the oldest entry is removed and the attempt is successful.</p> <p>The Send Untranslated ARP parameter in the General tab of the Configuration page can be:</p> <p>Disabled, so that the AP overwrites the MAC address in Address Resolution Protocol (ARP) packets before forwarding them.</p> <p>Enabled, so that the AP forwards ARP packets regardless of whether it has overwritten the MAC address.</p> <p>When this feature is disabled, the setting of the Send Untranslated ARP parameter has no effect, because all packets are forwarded untranslated (with the source MAC address intact).</p>
Send Untranslated ARP	<p>If the Translation Bridging parameter is set to Enabled, then the Send Untranslated ARP parameter can be:</p> <p>Disabled - so that the AP will overwrite the MAC address in Address Resolution Protocol (ARP) packets before forwarding them.</p> <p>Enabled - so that the AP will forward ARP packets regardless of whether it has overwritten the MAC address.</p> <p>If the Translation Bridging parameter is set to Disabled, then the Send Untranslated ARP parameter has no effect.</p>
SM Isolation	<p>Prevent or allow SM-to-SM communication by selecting from the following drop-down menu items:</p> <p>Disable SM Isolation (the default selection). This allows full communication between SMs.</p> <p>Block SM Packets from being forwarded - This prevents both multicast/broadcast and unicast SM-to-SM communication.</p> <p>Block and Forward SM Packets to Backbone - This not only prevents multicast/broadcast and unicast SM-to-SM communication but also sends the packets, which otherwise are handled SM to SM, through the Ethernet port of the AP.</p>
Forward Unknown Unicast Packets	<p>Enabled: All unknown Unicast packets (no entry in the AP's bridge table) received via the AP's Ethernet LAN interface are forwarded to registered SMs. If the target device is situated beneath a particular SM, when the device responds the SM and AP will learn and add the device to their bridge tables so that subsequent packets to that device is bridged to the proper SM.</p> <p>Disabled: All unknown Unicast packets (no entry in the AP's bridge table) received via the AP's Ethernet LAN interface are discarded at the AP.</p>
Update Application Address	<p>Enter the address of the server to access for software updates on this AP and registered SMs.</p>
Prioritize	<p>To reduce the likelihood of TCP acknowledgement packets being dropped, set this</p>

Attribute	Meaning
TCP ACK	parameter to Enabled. This can improve throughput that the end user perceives during transient periods of congestion on the link that is carrying acknowledgements. This parameter, when enabled, can be particularly useful when running bi-direction FTP sessions over the link. If a link is primarily used for video surveillance, it is recommended to set this parameter to Disable.
Multicast Destination Address	Using Link Layer Discovery Protocol (LLDP), a module exchanges multicast addresses with the device to which it is wired on the Ethernet interface. Although some switches (CMM4, for example) do not pass LLDP addresses upward in the network, a radio can pass it as the value of the Multicast Destination Address parameter value in the connected device that has it populated.
DHCP Relay Agent	<p>The AP may act as a DHCP relay for SMs and CPEs underneath it. The AP will make use of the DHCP Option 82 (DHCP Relay Agent Information) from RFC 3046 when performing relay functions. The AP offers two types of DHCP relay functionality:</p> <p>Full Relay Information - Configuring the DHCP Full Relay Operation will take broadcast DHCP packets and send them to a Unicast server in unicast mode. This way the DHCP requests and replies can be routed like any other UDP packet.</p> <p>Only Insert Option 82 - This option leaves the DHCP request on its broadcast domain as opposed to DHCP Full Relay Operation which will turn it into a unicast packet.</p> <p>In order to accommodate setting up pools or classes for different VLANs, the Option 82 field will include information to tell the server what VLAN the client is on.</p>
DHCP Server (Name or IP Address)	The DHCP relay server may be either a DNS name or a static IP address in dotted decimal notation. Additionally, the management DNS domain name may be toggled such that the name of the DHCP relay server only needs to be specified and the DNS domain name is automatically appended to that name. The default DHCP relay server addresses are 255.255.255.255 with the appending of the DNS domain name disabled.
Option 82 Circuit ID	<p>This parameter specifies the Circuit ID for DHCP Relay Option 82 data. Following wildcards are supported:</p> <ul style="list-style-type: none"> • \$apmac\$ - AP MAC address in ascii format, no delimiters • \$apmacbi\$ - AP MAC address in hex format (6 bytes) • \$smmac\$ - SM MAC address in ascii format, no delimiters • \$smmacbi\$ - SM MAC address in hex format (6 bytes) • \$apsn\$ - AP Site Name (may be truncated to 32 chars) • \$smsn\$ - SM Site Name (may be truncated to 32 chars) • \$smvid\$ - SM Port VID in ascii format, leading 0 included, 4 chars long • \$smvidbi\$ - SM Port VID in hex format (2 bytes) • \$smfluid\$ - SM LUID <p>Default value is \$apmacbi\$</p>

Attribute	Meaning
	Note: Overall expanded Option 82 data is limited to 255 bytes.
Option 82 Remote ID	<p>This parameter specifies the Remote ID for DHCP Relay Option 82 data. Following wildcards are supported:</p> <ul style="list-style-type: none"> • \$apmac\$ - AP MAC address in ascii format, no delimiters • \$apmacbi\$ - AP MAC address in hex format (6 bytes) • \$smmac\$ - SM MAC address in ascii format, no delimiters • \$smmacbi\$ - SM MAC address in hex format (6 bytes) • \$apsn\$ - AP Site Name (may be truncated to 32 chars) • \$smsn\$ - SM Site Name (may be truncated to 32 chars) • \$smvid\$ - SM Port VID in ascii format, leading 0 included, 4 chars long • \$smvidbi\$ - SM Port VID in hex format (2 bytes) • \$smfluid\$ - SM LUID <p>Default value is \$smmacbi\$</p> <p>Note: Overall expanded Option 82 data is limited to 255 bytes.</p>
Option 82 Vendor Specific ID	<p>This parameter specifies the Vendor Specific ID for DHCP Relay Option 82 data. Following wildcards are supported:</p> <ul style="list-style-type: none"> • \$apmac\$ - AP MAC address in ascii format, no delimiters • \$apmacbi\$ - AP MAC address in hex format (6 bytes) • \$smmac\$ - SM MAC address in ascii format, no delimiters • \$smmacbi\$ - SM MAC address in hex format (6 bytes) • \$apsn\$ - AP Site Name (may be truncated to 32 chars) • \$smsn\$ - SM Site Name (may be truncated to 32 chars) • \$smvid\$ - SM Port VID in ascii format, leading 0 included, 4 chars long • \$smvidbi\$ - SM Port VID in hex format (2 bytes) • \$smfluid\$ - SM LUID <p>Default value is \$smvidbi\$</p> <p>Note: Overall expanded Option 82 data is limited to 255 bytes.</p>
Latitude Longitude Height	<p>Physical radio location data may be configured via the Latitude, Longitude and Height fields. Latitude and Longitude is measured in Decimal Degree while the Height is calculated in Meters.</p>

General page - PMP 450 m AP

The General page of AP is explained in below table.

Table 24 :General page attributes –PMP 450m AP

MU-MIMO		
Trial Mode :	<input type="radio"/> Enabled <input checked="" type="radio"/> Disabled	
Link Speeds		
Ethernet Port Selection :	Main Port ▾	
Link Speed :	Auto 1000F/100F/100H/10F/10H ▾	
SFP Link Speed :	Auto 1000FX ▾	
Ethernet Link :	<input checked="" type="radio"/> Enabled <input type="radio"/> Disabled	
Ethernet Bounce Timeout :	0 Minutes (Range : 0—60 Minutes, 0 = Disable)	
Bandwidth Configuration Source		
Configuration Source :	SM ▾	
Sync Setting		
Sync Input :	Generate Sync ▾	
Free Run Before GPS Sync :	<input type="radio"/> Enabled <input checked="" type="radio"/> Disabled	
Region Settings		
Region :	Other - Regulatory ▾	
Country :	Other ▾	
Web Page Configuration		
Webpage Auto Update :	0 Seconds (0 = Disable Auto Update)	
Bridge Configuration		
Bridge Entry Timeout :	25 Minutes (Range : 25—1440 Minutes)	
Translation Bridging :	<input type="radio"/> Enabled <input checked="" type="radio"/> Disabled	
Send Untranslated ARP :	<input type="radio"/> Enabled <input checked="" type="radio"/> Disabled	
SM Isolation :	Disable SM Isolation ▾	
Forward Unknown Unicast Packets :	<input type="radio"/> Enabled - If destination address is not known, forward packet to all SMs. <input checked="" type="radio"/> Disabled - If destination address is not known, drop packet.	
Update Application Information		
Update Application Address :	0.0.0.0	
TCP Settings		
Prioritize TCP ACK :	<input checked="" type="radio"/> Enabled <input type="radio"/> Disabled	
Layer 2 Discovery Destination Address		
Multicast Destination Address :	<input type="radio"/> Broadcast <input checked="" type="radio"/> LLDP Multicast	
DHCP Relay Agent		
DHCP Relay Agent :	Disable ▾	
DHCP Server (Name or IP Address) :	<input type="radio"/> Append DNS Domain Name <input checked="" type="radio"/> Disable DNS Domain Name 255.255.255.255	
Option 82 Circuit ID :	\$apmacb1\$	
Option 82 Remote ID :	\$smmacb1\$	
Option 82 Vendor Specific ID :	\$smvidb1\$	
Coordinates		
Latitude :	+0.000000	Decimal Degree
Longitude :	+0.000000	Decimal Degree
Height :	0	Meters

Attribute	Meaning
Trial Mode	This parameter allows to enable or disable Trial mode for radios with a Limited key. Once the trial key is applied, the 30-day trial can be enabled or disabled at any time.
Ethernet Port Selection	<p data-bbox="475 369 1424 432">Ethernet Port selection is applicable to the 450m platform only with two choices in the drop-down list:</p> <ul data-bbox="526 457 1424 638" style="list-style-type: none"> <li data-bbox="526 457 1424 548">• Main: A selection of main indicates that link connectivity and power to the 450m is provided through the RF45 connection on the Main port of the AP <li data-bbox="526 573 1424 638">• SFP: A selection of SFP indicates that link connectivity will be provided through the SFP port on the 450m <p data-bbox="475 663 1424 726">Power continues to be provided via the RJ45 Main port (5 GHz 450m only; the 3 GHz 450m utilizes a separate DC connector).</p>
For information about remaining attributes, refer General page attributes – PMP/PTP 450i AP .	

General page - PMP 450i SM

The General page of PMP 450i SM is explained in below table. The General page of PMP 450 SM looks the same as PMP 450i SM.

Table 25 :General page attributes – PMP 450i SM

Link Speeds	
Link Speed :	Auto 1000F/100F/100H/10F/10H ▾
Ethernet Link :	<input checked="" type="radio"/> Enabled <input type="radio"/> Disabled <input type="button" value="Bounce Main Ethernet Port"/>
Ethernet Bounce Timeout :	0 Minutes (Range : 0—60 Minutes, 0 = Disable)
PoE	
802.3at Type 2 PoE Status :	Not Present (Ignored)
PoE Classification :	<input type="radio"/> Enabled <input checked="" type="radio"/> Disabled
Sync Setting	
Remote Device Type :	<input type="radio"/> PMP/PTP 100 <input checked="" type="radio"/> Other
Region Settings	
Region :	Other - Regulatory ▾
Country :	Other ▾
Web Page Configuration	
Webpage Auto Update :	0 Seconds (0 = Disable Auto Update)
Bridge Configuration	
Bridge Entry Timeout :	25 Minutes (Range : 25—1440 Minutes)
Bridge Table Size :	4096 (Range : 4—4096) (Note: 2 entries in the bridge table are used for internal purpose)
Bridge Table Restriction :	<input type="radio"/> Drop packets if MAC address is not in bridge table <input checked="" type="radio"/> Forward packets even if MAC address is not in bridge table
Frame Timing	
Frame Timing Pulse Gated :	<input checked="" type="radio"/> Enable (If SM out of sync then do not propagate the frame timing pulse) <input type="radio"/> Disable (Always propagate the frame timing pulse)
Layer 2 Discovery Destination Address	
Multicast Destination Address :	<input type="radio"/> Broadcast <input checked="" type="radio"/> LLDP Multicast
Coordinates	
Latitude :	+0.000000 Decimal Degree
Longitude :	+0.000000 Decimal Degree
Height :	0 Meters

Attribute	Meaning
Link Speed	From the drop-down list of options, select the type of link speed for the Ethernet connection. The default for this parameter is that all speeds are selected. The recommended setting is a single speed selection for all APs and SMs in the operator network.
Ethernet Link	See General page attributes - PMP/PTP 450i AP
Ethernet Bounce Timeout	
802.3at Type 2 PoE Status and PoE Classification	<p>When the PoE Classification functionality is enabled and if Type 2 power is not present, the PAs do not power up and draw too much power.</p> <p>By default, the PoE Classification feature is disabled, and the PAs will power up regardless of the classification presented by the power source.</p>

Attribute	Meaning
	<p>This is supported only on 450i series ODUs.</p> <p>PoE Classification configuration status also can be check under home > General > Device Information tab:</p> <hr/> <p>802.3at Type 2 PoE Status : Not Present (Ignored)</p> <hr/>
Remote Device Type	See General page attributes – PMP 450b SM.
Region	<p>This parameter allows you to set the region in which the radio will operate.</p> <p>The SM radio automatically inherits the Region type of the master. This behavior ignores the value of the Region parameter in the SM, even when the value is None. Nevertheless, since future system software releases may read the value in order to configure some other region-sensitive feature(s), this parameter must be always set to the value that corresponds to the local region.</p>
Country	<p>This parameter allows you to set the country in which the radio will operate.</p> <p>The SM radio automatically inherits the Country Code type of the master. This behavior ignores the value of the Country parameter in the SM, even when the value is None. Nevertheless, since future system software releases may read the value in order to configure some other region-sensitive feature(s), this parameter must be always set to the value that corresponds to the local region.</p> <p>PMP/PTP 450i Series ODU shipped to the United States is locked to a Region Code setting of “United States”. Units shipped to regions other than the United States must be configured with the corresponding Region Code to comply with local regulatory requirements.</p>
Webpage Auto Update	See General page attributes – PMP/PTP 450i AP
Bridge Entry Timeout	<p>Specify the appropriate bridge timeout for correct network operation with the existing network infrastructure. Timeout occurs when the AP encounters no activity with the SM (whose MAC address is the bridge entry) within the interval that this parameter specifies. The Bridge Entry Timeout must be a longer period than the ARP (Address Resolution Protocol) cache timeout of the router that feeds the network.</p> <div style="border: 1px solid black; padding: 5px; margin-top: 10px;">  <p style="margin: 0;">Caution</p> <p style="margin: 0;">This parameter governs the timeout interval, even if a router in the system has a longer timeout interval. The default value of this field is 25 (minutes). An inappropriately low Bridge Entry Timeout setting may lead to temporary loss of communication with some end users.</p> </div>
Bridge Table Size	This parameter allows to restrict devices to connect to the SM. It is configurable from 4 to 4096.

Attribute	Meaning
	 <div style="border: 1px solid black; background-color: #e6f2ff; padding: 5px; margin-top: 5px;"> <p>Note</p> <p>Configure Bridge Table Restriction parameter to Drop packets if MAC address is not in bridge table option to restrict the number of devices configured from connecting to SM.</p> </div>
Bridge Table Restriction	<p>This parameter allows to either allow or restrict devices to connect to SM using the following options:</p> <ul style="list-style-type: none"> • Drop packets if MAC address is not in bridge table: Select this option to restrict communication from devices not listed in bridge table. • Forward packets even if MAC address is not in bridge table: Select this option to allow communication from any device.
Frame Timing Pulse Gated	<p>If this SM extends the sync pulse to a BH master or an AP, select either</p> <p>Enable: If this SM loses sync from the AP, then do not propagate a sync pulse to the BH timing master or another AP. This setting prevents interference in the event that the SM loses sync.</p> <p>Disable: If this SM loses sync from the AP, then propagate the sync pulse to the BH timing master or another AP.</p>
Multicast Destination Address	<p>Using Link Layer Discovery Protocol (LLDP), a module exchanges multicast addresses with the device to which it is wired on the Ethernet interface. Although some switches (CMM4, for example) do not pass LLDP addresses upward in the network, a radio can pass it as the value of the Multicast Destination Address parameter value in the connected device that has it populated.</p>
Latitude Longitude Height	<p>Physical radio location data may be configured via the Latitude, Longitude and Height fields.</p> <p>Latitude and Longitude is measured in Decimal Degree while the Height is calculated in Meters.</p>

General page - PTP 450i BHM

The General page of BHM is explained in below table. The General page of PTP 450 BHM looks the same as PTP 450i BHM.

Table 26 :General page attributes - PTP 450i BHM

Link Speeds	
Link Speed :	Auto 1000F/100F/100H/10F/10H ▼
Ethernet Link :	<input checked="" type="radio"/> Enabled <input type="radio"/> Disabled
Ethernet Bounce Timeout :	0 Minutes (Range : 0—60 Minutes, 0 = Disable)
PoE	
802.3at Type 2 PoE Status :	Not Present (Ignored)
PoE Classification :	<input type="radio"/> Enabled <input checked="" type="radio"/> Disabled
Sync Setting	
Sync Input :	Generate Sync ▼
Free Run Before GPS Sync :	<input type="radio"/> Enabled <input checked="" type="radio"/> Disabled
Region Settings	
Region :	Other - Regulatory ▼
Country :	Other ▼
Web Page Configuration	
Webpage Auto Update :	0 Seconds (0 = Disable Auto Update)
Bridge Configuration	
Bridge Entry Timeout :	25 Minutes (Range : 25—1440 Minutes)
Bridging Functionality :	<input type="radio"/> Disable <input checked="" type="radio"/> Enable
Update Application Information	
Update Application Address :	0.0.0.0
TCP Settings	
Prioritize TCP ACK :	<input checked="" type="radio"/> Enabled <input type="radio"/> Disabled
Layer 2 Discovery Destination Address	
Multicast Destination Address :	<input type="radio"/> Broadcast <input checked="" type="radio"/> LLDP Multicast
Coordinates	
Latitude :	+0.000000 Decimal Degree
Longitude :	+0.000000 Decimal Degree
Height :	0 Meters

Attribute	Meaning
Link Speed	See General page attributes - PMP/PTP 450i AP
Ethernet Link	
Ethernet Bounce Timeout	
802.3at Type 2 PoE Status and PoE Classification	<p>When the PoE Classification functionality is enabled and if Type 2 power is not present, the PAs do not power up and draw too much power.</p> <p>By default, the PoE Classification feature is disabled and the PAs will power up regardless of the classification presented by the power source.</p> <p>This is supported only on 450i Series ODUs.</p>

Attribute	Meaning
	<p>PoE Classification configuration status also can be check under home > General > Device Information tab:</p> <hr/> <p>802.3at Type 2 PoE Status : Not Present (Ignored)</p>
Sync Input	See Configuring synchronization
Free Run Before GPS Sync	See Free Run Before GPS Sync
Region	See General page attributes - PMP/PTP 450i AP
Country	
Webpage Auto Update	
Bridge Entry Timeout	
Bridging Functionality	<p>Select whether you want bridge table filtering active (Enable) or not (Disable) on this BH.</p> <p>Disable: allows user to use redundant BHs without causing network addressing problems. Through a spanning tree protocol, this reduces the convergence time from 25 minutes to few seconds. However, you must disable bridge table filtering as only a deliberate part of your overall network design since disabling it allows unwanted traffic across the wireless interface.</p> <p>Enable: Allows user to enable bridge functionality.</p> <div data-bbox="386 1142 456 1220" style="display: inline-block; vertical-align: middle;">  </div> <div data-bbox="521 1136 1419 1318" style="border: 1px solid black; background-color: #e6f2ff; padding: 5px; margin-left: 20px;"> <p>Note</p> <p>Specify the appropriate bridge timeout for correct network operation with the existing network infrastructure. The Bridge Entry Timeout must be a longer period than the ARP (Address Resolution Protocol) cache timeout of the router that feeds the network.</p> </div>
Update Application Address	See General page attributes - PMP/PTP 450i AP
Prioritize TCP ACK	
Multicast Destination Address	
Latitude	
Longitude Height	

General page - PTP 450i BHS

The General page of PTP 450i BHS is explained in below table. The General page of PTP 450 BHS looks the same as PTP 450i BHS.

Table 27 :General page attributes – PTP 450i BHS

Link Speeds	
Link Speed :	Auto 1000F/100F/100H/10F/10H ▼
Ethernet Link :	<input checked="" type="radio"/> Enabled <input type="radio"/> Disabled <input type="button" value="Bounce Main Ethernet Port"/>
Ethernet Bounce Timeout :	0 Minutes (Range : 0—60 Minutes, 0 = Disable)
PoE	
802.3at Type 2 PoE Status :	Not Present (Ignored)
PoE Classification :	<input type="radio"/> Enabled <input checked="" type="radio"/> Disabled
Sync Setting	
Remote Device Type :	<input type="radio"/> PMP/PTP 100 <input checked="" type="radio"/> Other
Region Settings	
Region :	Other - Regulatory ▼
Country :	Other ▼
Web Page Configuration	
Webpage Auto Update :	0 Seconds (0 = Disable Auto Update)
Bridge Configuration	
Bridge Entry Timeout :	25 Minutes (Range : 25—1440 Minutes)
Bridging Functionality :	<input type="radio"/> Disable <input checked="" type="radio"/> Enable
Frame Timing	
Frame Timing Pulse Gated :	<input checked="" type="radio"/> Enable (If SM out of sync then do not propagate the frame timing pulse) <input type="radio"/> Disable (Always propagate the frame timing pulse)
Layer 2 Discovery Destination Address	
Multicast Destination Address :	<input type="radio"/> Broadcast <input checked="" type="radio"/> LLDP Multicast
Coordinates	
Latitude :	+0.000000 Decimal Degree
Longitude :	+0.000000 Decimal Degree
Height :	0 Meters

Attribute	Meaning
Link Speed	See General page attributes – PMP/PTP 450i AP
Ethernet Link	
Ethernet Bounce Timeout	
802.3at Type 2 PoE Status and	<p>When the PoE Classification functionality is enabled and if Type 2 power is not present, the PAs do not power up and draw too much power.</p> <p>By default, the PoE Classification feature is disabled and the PAs will power up regardless</p>

Attribute	Meaning
PoE Classification	<p>of the classification presented by the power source.</p> <p>This is supported only on 450i Series ODUs.</p> <p>PoE Classification configuration status also can be check under home > General > Device Information tab:</p> <hr/> <p>802.3at Type 2 PoE Status : Not Present (Ignored)</p> <hr/>
Remote Device Type	See General page attributes – PMP 450b SM.
Region	<p>This parameter allows you to set the region in which the radio will operate.</p> <p>The BHS radio automatically inherits the Region type of the master. This behavior ignores the value of the Region parameter in the BHS, even when the value is None. Nevertheless, since future system software releases may read the value in order to configure some other region-sensitive feature(s), this parameter must be always set to the value that corresponds to the local region.</p>
Country	<p>This parameter allows you to set the country in which the radio will operate.</p> <p>The BHS radio automatically inherits the Country Code type of the master. This behavior ignores the value of the Country parameter in the BHS, even when the value is None. Nevertheless, since future system software releases may read the value in order to configure some other region-sensitive feature(s), this parameter must be always set to the value that corresponds to the local region.</p> <p>PMP/PTP 450i Series ODU shipped to the United States is locked to a Region Code setting of “United States”. Units shipped to regions other than the United States must be configured with the corresponding Region Code to comply with local regulatory requirements.</p>
Webpage Auto Update	See General page attributes – PMP/PTP 450i AP
Bridge Entry Timeout	<p>Specify the appropriate bridge timeout for correct network operation with the existing network infrastructure. Timeout occurs when the BHM encounters no activity with the BHS (whose MAC address is the bridge entry) within the interval that this parameter specifies. The Bridge Entry Timeout must be a longer period than the ARP (Address Resolution Protocol) cache timeout of the router that feeds the network.</p> <div style="border: 1px solid black; background-color: #f4a460; padding: 5px; margin-top: 10px;">  <p>Caution</p> <p>This parameter governs the timeout interval, even if a router in the system has a longer timeout interval. The default value of this field is 25 (minutes). An inappropriately low Bridge Entry Timeout setting may lead to temporary loss of communication with some end users.</p> </div>
Bridging Functionality	See General page attributes – PMP/PTP 450i AP
Frame Timing Pulse	If this BHS extends the sync pulse to a BH master or an AP, select either

Attribute	Meaning
Gated	<p>Enable—If this BHS loses sync from the BHM, then do not propagate a sync pulse to the BH timing master or other BHM. This setting prevents interference in the event that the BHS loses sync.</p> <p>Disable—If this BHS loses sync from the BHM, then propagate the sync pulse to the BH timing master or other BHM.</p>
Multicast Destination Address	See General page attributes - PMP/PTP 450i AP
Latitude Longitude Height	See General page attributes - PMP/PTP 450i AP

PMP/ PTP 450 b Series

General page – PMP 450 b SM

The General page of PMP 450b SM is explained in below table.

Table 28 :General page attributes - PMP 450b SM

Link Speeds	
Link Speed :	Auto 1000F/100F/100H/10F/10H ▾
Ethernet Link :	<input checked="" type="radio"/> Enabled <input type="radio"/> Disabled <input type="button" value="Bounce Main Ethernet Port"/>
Ethernet Bounce Timeout :	0 Minutes (Range : 0—60 Minutes, 0 = Disable)
Sync Setting	
Sync Aux Port Config :	Alignment Tone ▾
Region Settings	
Region :	Other - Regulatory ▾
Country :	Other ▾
Web Page Configuration	
Webpage Auto Update :	0 Seconds (0 = Disable Auto Update)
Bridge Configuration	
Bridge Entry Timeout :	25 Minutes (Range : 25—1440 Minutes)
Bridge Table Size :	4096 (Range : 4—4096) (Note: 2 entries in the bridge table are used for internal purpose)
Bridge Table Restriction :	<input type="radio"/> Drop packets if MAC address is not in bridge table <input checked="" type="radio"/> Forward packets even if MAC address is not in bridge table
Frame Timing	
Frame Timing Pulse Gated :	<input checked="" type="radio"/> Enable (If SM out of sync then do not propagate the frame timing pulse) <input type="radio"/> Disable (Always propagate the frame timing pulse)
Layer 2 Discovery Destination Address	
Multicast Destination Address :	<input type="radio"/> Broadcast <input checked="" type="radio"/> LLDP Multicast
Coordinates	
Latitude :	+0.000000 Decimal Degree
Longitude :	+0.000000 Decimal Degree
Height :	0 Meters

Attribute	Meaning
Link Speed	From the drop-down list of options, select the type of link speed for the Ethernet connection. The default for this parameter is that all speeds are selected. The recommended setting is a single speed selection for all APs and SMs in the operator network.
Ethernet Link Enabled/Disabled	<p>Specify whether to enable or disable Ethernet/802.3 connectivity on the wired port of the SM. This parameter has no effect on the wireless link. When you select Enable, this feature allows traffic on the Ethernet/802.3 port. This is the factory default state of the port. When you select Disable, this feature prevents traffic on the port. Typical cases of when you may want to select Disable include:</p> <p>The subscriber is delinquent with payment(s).</p> <p>You suspect that the subscriber is sending or flooding undesired broadcast packets into the network, such as when</p> <ul style="list-style-type: none"> a virus is present in the subscriber's computing device. the subscriber's home router is improperly configured.
Ethernet Bounce Timeout	This parameter allows the operator to configure Ethernet bounce timeout ranging from 0 to 60 minutes. Value 0 disables Ethernet bounce timeout.

Attribute	Meaning
Sync Aux Port Config	Set the Sync Aux Port Config parameter to support the desired functionality. Select Alignment Tone to output a stereo tone on the Timing Port/UGPS TRRS audio connector for link alignment. Select Sync Output to output the GPS timing pulse on this connector for synchronization of a connected remote AP.
Remote Device Type	The Remote Device Type parameter is available when Sync Aux Port Config is set to Sync Output. Choose Other unless you are using the 450b Timing Port/UGPS to provide remote synchronization to a PMP/PTP 100 AP/BHM.
Region	<p>This parameter allows you to set the region in which the radio will operate.</p> <p>The SM radio automatically inherits the Region type of the master. This behavior ignores the value of the Region parameter in the SM, even when the value is None. Nevertheless, since future system software releases may read the value in order to configure some other region-sensitive feature(s), this parameter must be always set to the value that corresponds to the local region.</p>
Country	<p>This parameter allows you to set the country in which the radio will operate.</p> <p>The SM radio automatically inherits the Country Code type of the master. This behavior ignores the value of the Country parameter in the SM, even when the value is None. Nevertheless, since future system software releases may read the value in order to configure some other region-sensitive feature(s), this parameter must be always set to the value that corresponds to the local region.</p> <p>PMP/PTP 450i Series ODU shipped to the United States is locked to a Region Code setting of "United States". Units shipped to regions other than the United States must be configured with the corresponding Region Code to comply with local regulatory requirements.</p>
Webpage Auto Update	Enter the frequency (in seconds) for the web browser to automatically refresh the web-based interface. The default setting is 0. The 0 setting causes the web-based interface to never be automatically refreshed.
Bridge Entry Timeout	<p>Specify the appropriate bridge timeout for correct network operation with the existing network infrastructure. Timeout occurs when the AP encounters no activity with the SM (whose MAC address is the bridge entry) within the interval that this parameter specifies. The Bridge Entry Timeout must be a longer period than the ARP (Address Resolution Protocol) cache timeout of the router that feeds the network.</p> <div data-bbox="440 1444 500 1535" style="float: left; margin-right: 10px;"> </div> <div data-bbox="574 1444 1424 1671" style="border: 1px solid black; background-color: #f4a460; padding: 5px;"> <p>Caution</p> <p>This parameter governs the timeout interval, even if a router in the system has a longer timeout interval. The default value of this field is 25 (minutes).</p> <p>An inappropriately low Bridge Entry Timeout setting may lead to temporary loss of communication with some end users.</p> </div>
Bridge Table Size	This parameter allows to restrict devices to connect to the SM. It is configurable from 4 to 4096.

Attribute	Meaning
	<div style="display: flex; align-items: center;">  <div style="border: 1px solid black; background-color: #e6f2ff; padding: 5px;"> <p data-bbox="581 262 646 285">Note</p> <p data-bbox="581 310 1417 401">Configure Bridge Table Restriction parameter to Drop packets if MAC address is not in bridge table option to restrict the number of devices configured from connecting to SM.</p> </div> </div>
Bridge Table Restriction	<p data-bbox="431 430 1417 489">This parameter allows to either allow or restrict devices to connect to SM using the following options:</p> <ul style="list-style-type: none"> <li data-bbox="483 516 1417 575">Drop packets if MAC address is not in bridge table: Select this option to restrict communication from devices not listed in bridge table. <p data-bbox="431 602 1417 661">Forward packets even if MAC address is not in bridge table: Select this option to allow communication from any device.</p>
Frame Timing Pulse Gated	<p data-bbox="431 682 1247 709">If this SM extends the sync pulse to a BH master or an AP, select either</p> <p data-bbox="431 737 1417 827">Enable—If this SM loses sync from the AP, then do not propagate a sync pulse to the BH timing master or another AP. This setting prevents interference in the event that the SM loses sync.</p> <p data-bbox="431 854 1417 913">Disable—If this SM loses sync from the AP, then propagate the sync pulse to the BH timing master or another AP.</p>
Multicast Destination Address	<p data-bbox="431 934 1417 1085">Using Link Layer Discovery Protocol (LLDP), a module exchanges multicast addresses with the device to which it is wired on the Ethernet interface. Although some switches (CMM4, for example) do not pass LLDP addresses upward in the network, a radio can pass it as the value of the Multicast Destination Address parameter value in the connected device that has it populated.</p>
Latitude Longitude Height	<p data-bbox="431 1110 1417 1169">Physical radio location data may be configured via the Latitude, Longitude and Height fields.</p> <p data-bbox="431 1176 1417 1234">Latitude and Longitude is measured in Decimal Degree while the Height is calculated in Meters.</p>

PTP 450 b BHM

Table 29 :General page attributes - PMP 450b BHM

Link Speeds	
Link Speed :	Auto 1000F/100F/100H/10F/10H ▼
Ethernet Link :	<input checked="" type="radio"/> Enabled <input type="radio"/> Disabled
Ethernet Bounce Timeout :	0 Minutes (Range : 0—60 Minutes, 0 = Disable)
Sync Setting	
Sync Input :	Generate Sync ▼
Free Run Before GPS Sync :	<input type="radio"/> Enabled <input checked="" type="radio"/> Disabled
Sync Aux Port Config :	Sync Input ▼
Region Settings	
Region :	Other - Regulatory ▼
Country :	Other ▼
Web Page Configuration	
Webpage Auto Update :	0 Seconds (0 = Disable Auto Update)
Bridge Configuration	
Bridge Entry Timeout :	25 Minutes (Range : 25—1440 Minutes)
Bridging Functionality :	<input type="radio"/> Disable <input checked="" type="radio"/> Enable
Update Application Information	
Update Application Address :	0.0.0.0
TCP Settings	
Prioritize TCP ACK :	<input checked="" type="radio"/> Enabled <input type="radio"/> Disabled
Layer 2 Discovery Destination Address	
Multicast Destination Address :	<input type="radio"/> Broadcast <input checked="" type="radio"/> LLDP Multicast
Coordinates	
Latitude :	+0.000000 Decimal Degree
Longitude :	+0.000000 Decimal Degree
Height :	0 Meters

Attribute	Meaning
Link Speed	From the drop-down list of options, select the type of link speed for the Ethernet connection. The default for this parameter is that all speeds are selected. The recommended setting is a single speed selection for all APs and SMs in the operator network.
Ethernet Link Enabled/Disabled	<p>Specify whether to enable or disable Ethernet/802.3 connectivity on the wired port of the SM. This parameter has no effect on the wireless link. When you select Enable, this feature allows traffic on the Ethernet/802.3 port. This is the factory default state of the port. When you select Disable, this feature prevents traffic on the port. Typical cases of when you may want to select Disable include:</p> <p>The subscriber is delinquent with payment(s).</p> <p>You suspect that the subscriber is sending or flooding undesired broadcast packets into the network, such as when</p> <ul style="list-style-type: none"> • a virus is present in the subscriber’s computing device. • the subscriber’s home router is improperly configured.

Attribute	Meaning
Ethernet Bounce Timeout	This parameter allows the operator to configure Ethernet bounce timeout ranging from 0 to 60 minutes. Value 0 disables Ethernet bounce timeout.
Sync Input	See Configuring synchronization.
Free Run Before GPS Sync	See Free Run Before GPS Sync
Sync Aux Port Config	See Sync Aux Port Config
Region	From the drop-down list, select the region in which the radio is operating.
Country	<p>From the drop-down list, select the country in which the radio is operating.</p> <p>Unlike selections in other parameters, your Country selection requires a Save Changes and a Reboot cycle before it will force the context-sensitive GUI to display related options (for example, Alternate Frequency Carrier 1 and 2 in the Configuration > Radio tab).</p> <p>PMP 450b Series ODU's shipped to the United States is locked to a Region Code setting of "United States". Units shipped to regions other than the United States must be configured with the corresponding Region Code to comply with local regulatory requirements.</p> <p>Country Code settings affect the radios in the following ways:</p> <ul style="list-style-type: none"> • Maximum transmit power limiting (based on radio transmitter power plus configured antenna gain) • DFS operation is enabled based on the configured region code, if applicable <p>For more information on how transmit power limiting and DFS is implemented for each country, see the PMP 450 Planning Guide.</p>
Webpage Auto Update	Enter the frequency (in seconds) for the web browser to automatically refresh the web-based interface. The default setting is 0. The 0 setting causes the web-based interface to never be automatically refreshed.
Bridge Entry Timeout	Specify the appropriate bridge timeout for correct network operation with the existing network infrastructure. The Bridge Entry Timeout must be a longer period than the ARP (Address Resolution Protocol) cache timeout of the router that feeds the network.
Bridging Functionality	<p>Select whether you want bridge table filtering active (Enable) or not (Disable) on this BH.</p> <p>Disable: allows user to use redundant BHs without causing network addressing problems. Through a spanning tree protocol, this reduces the convergence time from 25 minutes to few seconds. However, you must disable bridge table filtering as only a deliberate part of your overall network design since disabling it allows</p>

Attribute	Meaning
	<p>unwanted traffic across the wireless interface.</p> <p>Enable: Allows user to enable bridge functionality.</p> <div style="display: flex; align-items: center;">  <div style="border: 1px solid black; background-color: #e6f2ff; padding: 5px;"> <p>Note</p> <p>Specify the appropriate bridge timeout for correct network operation with the existing network infrastructure. The Bridge Entry Timeout must be a longer period than the ARP (Address Resolution Protocol) cache timeout of the router that feeds the network.</p> </div> </div>
Update Application Address	Enter the address of the server to access for software updates on this BHM and registered BHS.
Prioritize TCP ACK	To reduce the likelihood of TCP acknowledgement packets being dropped, set this parameter to Enabled. This can improve throughput that the end user perceives during transient periods of congestion on the link that is carrying acknowledgements.
Multicast Destination Address	Using Link Layer Discovery Protocol (LLDP), a module exchanges multicast addresses with the device to which it is wired on the Ethernet interface. Although some switches (CMM4, for example) do not pass LLDP addresses upward in the network, a radio can pass it as the value of the Multicast Destination Address parameter value in the connected device that has it populated.
Latitude Longitude Height	Physical radio location data may be configured via the Latitude, Longitude and Height fields. Latitude and Longitude is measured in Decimal Degree while the Height is calculated in Meters.

PTP 450 b BHS

Table 30 :General page attributes - PMP 450b BHS

Link Speeds	
Link Speed :	Auto 1000F/100F/100H/10F/10H ▾
Ethernet Link :	<input checked="" type="radio"/> Enabled <input type="radio"/> Disabled <input type="button" value="Bounce Main Ethernet Port"/>
Ethernet Bounce Timeout :	0 Minutes (Range : 0—60 Minutes, 0 = Disable)
Sync Setting	
Sync Aux Port Config :	Alignment Tone ▾
Region Settings	
Region :	None ▾
Web Page Configuration	
Webpage Auto Update :	0 Seconds (0 = Disable Auto Update)
Bridge Configuration	
Bridge Entry Timeout :	25 Minutes (Range : 25—1440 Minutes)
Bridging Functionality :	<input type="radio"/> Disable <input checked="" type="radio"/> Enable
Frame Timing	
Frame Timing Pulse Gated :	<input checked="" type="radio"/> Enable (If SM out of sync then do not propagate the frame timing pulse) <input type="radio"/> Disable (Always propagate the frame timing pulse)
Layer 2 Discovery Destination Address	
Multicast Destination Address :	<input type="radio"/> Broadcast <input checked="" type="radio"/> LLDP Multicast
Coordinates	
Latitude :	+0.000000 Decimal Degree
Longitude :	+0.000000 Decimal Degree
Height :	0 Meters

Attribute	Meaning
Link Speed	<p>From the drop-down list of options, select the type of link speed for the Ethernet connection. The Auto settings allow the two ends of the link to automatically negotiate with each other the best possible speed, and check whether the Ethernet traffic is full duplex or half duplex.</p> <p>However, some Ethernet links work best when either:</p> <ul style="list-style-type: none"> • both ends are set to the same forced selection • both ends are set to auto-negotiate and both have capability in least one common speed and traffic type combination.
Ethernet Link	This parameter allows the operator to enable or disable Ethernet Link.
Ethernet Bounce Timeout	This parameter allows the operator to configure Ethernet bounce timeout ranging from 0 to 60 minutes. Value 0 disables Ethernet bounce timeout.
Sync Aux Port Config	Set the Sync Aux Port Config parameter to support the desired functionality. Select Alignment Tone to output a stereo tone on the Timing Port/UGPS TRRS audio connector for link alignment. Select Sync Output to output the GPS timing pulse on this connector for synchronization of a connected remote AP.
Remote	The Remote Device Type parameter is available when Sync Aux Port Config is set to Sync

Attribute	Meaning
Device Type	Output. Choose Other unless you are using the 450b Timing Port/UGPS to provide remote synchronization to a PMP/PTP 100 AP/BHM.
Region	<p>This parameter allows you to set the region in which the radio will operate.</p> <p>The BHS radio automatically inherits the Region type of the master. This behavior ignores the value of the Region parameter in the BHS, even when the value is None. Nevertheless, since future system software releases may read the value in order to configure some other region-sensitive feature(s), this parameter must be always set to the value that corresponds to the local region.</p>
Country	<p>This parameter allows you to set the country in which the radio will operate.</p> <p>The BHS radio automatically inherits the Country Code type of the master. This behavior ignores the value of the Country parameter in the BHS, even when the value is None. Nevertheless, since future system software releases may read the value in order to configure some other region-sensitive feature(s), this parameter must be always set to the value that corresponds to the local region.</p> <p>PMP/PTP 450b Series ODU shipped to the United States is locked to a Region Code setting of "United States". Units shipped to regions other than the United States must be configured with the corresponding Region Code to comply with local regulatory requirements.</p>
Webpage Auto Update	Enter the frequency (in seconds) for the web browser to automatically refresh the web-based interface. The default setting is 0. The 0 setting causes the web-based interface to never be automatically refreshed.
Bridge Entry Timeout	Specify the appropriate bridge timeout for correct network operation with the existing network infrastructure. The Bridge Entry Timeout must be a longer period than the ARP (Address Resolution Protocol) cache timeout of the router that feeds the network.
Bridging Functionality	<p>Select whether you want bridge table filtering active (Enable) or not (Disable) on this BH.</p> <p>Disable: allows user to use redundant BHs without causing network addressing problems. Through a spanning tree protocol, this reduces the convergence time from 25 minutes to few seconds. However, you must disable bridge table filtering as only a deliberate part of your overall network design since disabling it allows unwanted traffic across the wireless interface.</p> <p>Enable: Allows user to enable bridge functionality.</p> <div data-bbox="386 1455 456 1535" style="display: inline-block; vertical-align: middle;"> </div> <div data-bbox="516 1451 1422 1629" style="border: 1px solid black; background-color: #e6f2ff; padding: 5px; margin-left: 20px;"> <p>Note</p> <p>Specify the appropriate bridge timeout for correct network operation with the existing network infrastructure. The Bridge Entry Timeout must be a longer period than the ARP (Address Resolution Protocol) cache timeout of the router that feeds the network.</p> </div>
Frame Timing Pulse Gated	<p>If this BHS extends the sync pulse to a BH master or an AP, select either</p> <p>Enable—If this BHS loses sync from the AP, then do not propagate a sync pulse to the BH timing master or another AP. This setting prevents interference in the event that the BHS loses sync.</p>

Attribute	Meaning
	Disable—If this BHS loses sync from the BHM, then propagate the sync pulse to the BH timing master or another AP.
Multicast Destination Address	Using Link Layer Discovery Protocol (LLDP), a module exchanges multicast addresses with the device to which it is wired on the Ethernet interface. Although some switches (CMM4, for example) do not pass LLDP addresses upward in the network, a radio can pass it as the value of the Multicast Destination Address parameter value in the connected device that has it populated.
Latitude Longitude Height	Physical radio location data may be configured via the Latitude, Longitude and Height fields. Latitude and Longitude is measured in Decimal Degree while the Height is calculated in Meters.

PMP/ PTP 450 Series



Note

Refer General page attributes - PMP/PTP 450i AP and General page attributes - PMP 450i SM for PMP 450 AP/SM General page parameters details.

General page - PMP 450 AP

Figure 15 : General page attributes - PMP 450 AP

Link Speeds	
Link Speed :	Auto 1000F/100F/100H/10F/10H ▾
Ethernet Link :	<input checked="" type="radio"/> Enabled <input type="radio"/> Disabled
Ethernet Bounce Timeout :	0 Minutes (Range : 0—60 Minutes, 0 = Disable)

Bandwidth Configuration Source	
Configuration Source :	SM ▾

Sync Setting	
Sync Input :	Generate Sync ▾
Free Run Before GPS Sync :	<input type="radio"/> Enabled <input checked="" type="radio"/> Disabled

Region Settings	
Region :	Other - Regulatory ▾
Country :	Other ▾

Web Page Configuration	
Webpage Auto Update :	0 Seconds (0 = Disable Auto Update)

Bridge Configuration	
Bridge Entry Timeout :	25 Minutes (Range : 25—1440 Minutes)
Translation Bridging :	<input type="radio"/> Enabled <input checked="" type="radio"/> Disabled
Send Untranslated ARP :	<input type="radio"/> Enabled <input checked="" type="radio"/> Disabled
SM Isolation :	Disable SM Isolation ▾
Forward Unknown Unicast Packets :	<input type="radio"/> Enabled - If destination address is not known, forward packet to all SMS. <input checked="" type="radio"/> Disabled - If destination address is not known, drop packet.

Update Application Information	
Update Application Address :	0.0.0.0

TCP Settings	
Prioritize TCP ACK :	<input checked="" type="radio"/> Enabled <input type="radio"/> Disabled

Layer 2 Discovery Destination Address	
Multicast Destination Address :	<input type="radio"/> Broadcast <input checked="" type="radio"/> LLDP Multicast

DHCP Relay Agent	
DHCP Relay Agent :	Disable ▾
DHCP Server (Name or IP Address) :	<input type="radio"/> Append DNS Domain Name <input checked="" type="radio"/> Disable DNS Domain Name 255.255.255.255
Option 82 Circuit ID :	\$apmacbi\$
Option 82 Remote ID :	\$smmacbi\$
Option 82 Vendor Specific ID :	\$smvidbi\$

Coordinates		
Latitude :	+42.052912	Decimal Degree
Longitude :	-88.025598	Decimal Degree
Height :	0	Meters

Attribute	Meaning
Link Speed	See General page attributes - PMP 450i SM
Ethernet Link	
Ethernet Bounce Timeout	
Configuration Source	
Sync Input	
Free Run Before GPS Sync	
Region	
Country	
Webpage Auto Update	
Bridge Entry Timeout	
Translation Bridging	
Send Untranslated ARP	
SM Isolation	
Forward Unknown Unicast Packets	
Update Application Address	
Prioritize TCP ACK	
Multicast Destination Address	
DHCP Relay Agent	
DHCP Server (Name or IP Address)	
Option 82 Circuit ID	
Option 82 Remote ID	
Option 82 Vendor Specific ID	
Latitude	
Longitude	
Height	

General page - PMP 450 SM

Figure 16 : General page attributes - PMP 450 SM

Link Speeds		
Link Speed :	Auto 100F/100H/10F/10H ▼	
Ethernet Link :	<input checked="" type="radio"/> Enabled <input type="radio"/> Disabled	
	Bounce Main Ethernet Port	
Ethernet Bounce Timeout :	0	Minutes (Range : 0—60 Minutes, 0 = Disable)

Sync Setting	
Remote Device Type :	<input type="radio"/> PMP/PTP 100 <input checked="" type="radio"/> Other

Region Settings	
Region :	Other - Regulatory ▼
Country :	Other ▼

Web Page Configuration	
Webpage Auto Update :	0 Seconds (0 = Disable Auto Update)

Bridge Configuration	
Bridge Entry Timeout :	25 Minutes (Range : 25—1440 Minutes)
Bridge Table Size :	4096 (Range : 4—4096) (Note: 2 entries in the bridge table are used for internal purpose)
Bridge Table Restriction :	<input type="radio"/> Drop packets if MAC address is not in bridge table <input checked="" type="radio"/> Forward packets even if MAC address is not in bridge table

Frame Timing	
Frame Timing Pulse Gated :	<input checked="" type="radio"/> Enable (If SM out of sync then do not propagate the frame timing pulse) <input type="radio"/> Disable (Always propagate the frame timing pulse)

Layer 2 Discovery Destination Address	
Multicast Destination Address :	<input type="radio"/> Broadcast <input checked="" type="radio"/> LLDP Multicast

Coordinates		
Latitude :	+0.000000	Decimal Degree
Longitude :	+0.000000	Decimal Degree
Height :	0	Meters

Attribute	Meaning
Link Speed	See General page attributes – PMP 450i SM
Ethernet Link Enable/Disable	
Ethernet Bounce Timeout	
Remote Device Type	
Region	
Country	
Webpage Auto Update	
Bridge Entry Timeout	
Bridge Table Size	
Bridge Table Restriction	
Frame Timing Pulse Gated	
Multicast Destination Address	
Latitude	
Longitude	
Height	

General page – PTP 450 BHM

Figure 17 : General page attributes - PTP 450 BHM

Link Speeds	
Link Speed :	Auto 100F/100H/10F/10H ▼
Ethernet Link :	<input checked="" type="radio"/> Enabled <input type="radio"/> Disabled <input type="button" value="Bounce Main Ethernet Port"/>
Ethernet Bounce Timeout :	0 Minutes (Range : 0—60 Minutes, 0 = Disable)

Sync Setting	
Sync Input :	Generate Sync ▼
Free Run Before GPS Sync :	<input checked="" type="radio"/> Enabled <input type="radio"/> Disabled

Region Settings	
Region :	Other - Regulatory ▼
Country :	Other ▼

Web Page Configuration	
Webpage Auto Update :	0 Seconds (0 = Disable Auto Update)

Bridge Configuration	
Bridge Entry Timeout :	25 Minutes (Range : 25—1440 Minutes)
Bridging Functionality :	<input type="radio"/> Disable <input checked="" type="radio"/> Enable

Update Application Information	
Update Application Address :	0.0.0.0

TCP Settings	
Prioritize TCP ACK :	<input checked="" type="radio"/> Enabled <input type="radio"/> Disabled

Layer 2 Discovery Destination Address	
Multicast Destination Address :	<input type="radio"/> Broadcast <input checked="" type="radio"/> LLDP Multicast

Coordinates	
Latitude :	+0.000000 Decimal Degree
Longitude :	+0.000000 Decimal Degree
Height :	0 Meters

Attribute	Meaning
Link Speed	See General page attributes - PTP 450i BHM
Ethernet Link	
Ethernet Bounce Timeout	
Sync Input	
Free Run Before GPS Sync	
Region	
Country	
Webpage Auto Update	
Bridge Entry Timeout	
Bridging Functionality	
Update Application Address	
Prioritize TCP ACK	
Multicast Destination Address	
Latitude	
Longitude	
Height	

General page – PTP 450 BHS

Figure 18 : General page attributes - PTP 450 BHS

Link Speeds	
Link Speed :	Auto 100F/100H/10F/10H ▾
Ethernet Link :	<input checked="" type="radio"/> Enabled <input type="radio"/> Disabled <input type="button" value="Bounce Main Ethernet Port"/>
Ethernet Bounce Timeout :	0 Minutes (Range : 0—60 Minutes, 0 = Disable)
Sync Setting	
Remote Device Type :	<input type="radio"/> PMP/PTP 100 <input checked="" type="radio"/> Other
Region Settings	
Region :	Other - Regulatory ▾
Country :	Other ▾
Web Page Configuration	
Webpage Auto Update :	0 Seconds (0 = Disable Auto Update)
Bridge Configuration	
Bridge Entry Timeout :	25 Minutes (Range : 25—1440 Minutes)
Bridging Functionality :	<input type="radio"/> Disable <input checked="" type="radio"/> Enable
Frame Timing	
Frame Timing Pulse Gated :	<input checked="" type="radio"/> Enable (If SM out of sync then do not propagate the frame timing pulse) <input type="radio"/> Disable (Always propagate the frame timing pulse)
Layer 2 Discovery Destination Address	
Multicast Destination Address :	<input type="radio"/> Broadcast <input checked="" type="radio"/> LLDP Multicast
Coordinates	
Latitude :	+0.000000 Decimal Degree
Longitude :	+0.000000 Decimal Degree
Height :	0 Meters

Attribute	Meaning
Link Speed	See General page attributes – PTP 450i BHS
Ethernet Link	
Ethernet Bounce Timeout	
Remote Device Type	
Region	
Country	
Webpage Auto Update	
Bridge Entry Timeout	
Bridging Functionality	
Frame Timing Pulse Gated	
Multicast Destination Address	
Latitude	
Longitude	
Height	

General page – PMP 450 MicroPoP AP

Figure 19 : General page attributes - PMP 450 MicroPoP AP

Link Speeds	
Link Speed :	Auto 1000F/100F/100H/10F/10H ▾
Ethernet Link :	<input checked="" type="radio"/> Enabled <input type="radio"/> Disabled
Ethernet Bounce Timeout :	0 Minutes (Range : 0—60 Minutes, 0 = Disable)

Bandwidth Configuration Source	
Configuration Source :	SM ▾

Sync Setting	
Sync Input :	Generate Sync ▾
Free Run Before GPS Sync :	<input type="radio"/> Enabled <input checked="" type="radio"/> Disabled
GNSS Mode :	<input checked="" type="checkbox"/> GPS <input checked="" type="checkbox"/> GLONASS <input type="checkbox"/> Galileo <input type="checkbox"/> Beidou

Region Settings	
Region :	Other - Regulatory ▾
Country :	Other ▾

Web Page Configuration	
Webpage Auto Update :	1 Seconds (0 = Disable Auto Update)

Bridge Configuration	
Bridge Entry Timeout :	25 Minutes (Range : 25—1440 Minutes)
Translation Bridging :	<input type="radio"/> Enabled <input checked="" type="radio"/> Disabled
Send Untranslated ARP :	<input type="radio"/> Enabled <input checked="" type="radio"/> Disabled
SM Isolation :	Disable SM Isolation ▾
Forward Unknown Unicast Packets :	<input type="radio"/> Enabled - If destination address is not known, forward packet to all SMs. <input checked="" type="radio"/> Disabled - If destination address is not known, drop packet.

Update Application Information	
Update Application Address :	10.120.247.95

TCP Settings	
Prioritize TCP ACK :	<input checked="" type="radio"/> Enabled <input type="radio"/> Disabled

Layer 2 Discovery Destination Address

Multicast Destination Address : Broadcast LLDP Multicast

DHCP Relay Agent

DHCP Relay Agent :

DHCP Server (Name or IP Address) : Append DNS Domain Name Disable DNS Domain Name

Option 82 Circuit ID :

Option 82 Remote ID :

Option 82 Vendor Specific ID :

Coordinates

Latitude : Decimal Degree

Longitude : Decimal Degree

Height : Meters

Attribute	Meaning
Link Speed	See General page attributes – PMP 450i SM
Ethernet Link	
Ethernet Bounce Timeout	
Configuration Source	
Sync Input	
Free Run Before GPS Sync	
GNSS Mode	GPS: GLONASS: Galileo: Beidou:

Attribute	Meaning
Region	See General page attributes – PMP 450i SM
Country	
Webpage Auto Update	
Bridge Entry Timeout	
Translation Bridging	
Send Untranslated ARP	
SM Isolation	
Forward Unknown Unicast Packets	
Update Application Address	
Prioritize TCP ACK	
Multicast Destination Address	
DHCP Relay Agent	
DHCP Server (Name or IP Address)	
Option 82 Circuit ID	
Option 82 Remote ID	
Option 82 Vendor Specific ID	
Latitude	
Longitude	
Height	

Configuring Unit Settings page

Applicable products	PMP:	<input type="checkbox"/>	AP	<input type="checkbox"/>	SM	PTP:	<input type="checkbox"/>	BHM	<input type="checkbox"/>	BMS
---------------------	------	--------------------------	----	--------------------------	----	------	--------------------------	-----	--------------------------	-----

The Unit Settings page of the 450 Platform Family contains following options:

- Unit-Wide Changes
- Download Configuration File
- Upload and Apply Configuration File (for AP and BHM)
- LED Panel Settings (for SM and BHS)



Note

LED Panel setting is applicable for SM and BHS only.

Upload and Apply Configuration File attributes are not supported for SM and BHS.

The 450 Platform Family also supports import and export of configuration from the AP/BHM/SM/BHS as a text file. The configuration file is in JSON format. The logged in user must be an ADMINISTRATOR in order to export or import the configuration file.

The exported configuration file contains the complete configuration including all the default values. To keep a backup of the current configuration, the file can be saved as-is and imported later.

The configuration file supports encrypted password. The exported configuration file will contain encrypted password. The import of configuration can have either encrypted or plain text password in Configuration file. A new tab Encrypt the Password is added under Encrypted Password tab to generate encrypted password for a given password.

The Import and Export procedure of configuration file is described in Import and Export of config file.



LED Panel Mode has options select Revised mode and Legacy mode. The Legacy mode configures the radio to operate with standard LED behavior.

Unit Settings page of 450 Platform Family - AP/ BHM

The Unit Setting page of AP/BHM is explained in below table.

Table 31 :Unit Settings attributes - 450 Platform Family AP/BHM

Default Plug Mode	
Set To Factory Defaults Upon Default	<input type="radio"/> Enabled
Plug Mode Detection :	<input checked="" type="radio"/> Disabled
Unit-Wide Changes	
<input type="button" value="Undo Unit-Wide Saved Changes"/> <input type="button" value="Set to Factory Defaults"/>	
Encrypt the Password	
Password :	<input type="text"/>
Encrypted Password :	<input type="text"/>
<input type="button" value="Encrypt the password"/>	
Download Configuration File	
Configuration File :	0a003ea13575.cfg
Upload and Apply Configuration File	
File:	<input type="button" value="Choose File"/> No file chosen
<input type="button" value="Upload"/>	
<input type="button" value="Apply Configuration File"/>	
Status of Configuration File	
<input type="text"/>	

Attribute	Meaning				
Set to Factory Defaults Upon Default Mode Detection	<p>If Enabled is checked, then the default mode functions is enabled. When the module is rebooted with Default mode enabled, it can be accessed at the IP address 169.254.1.1 and no password, and all parameter values are reset to defaults. A subscriber, technician, or other person who gains physical access to the module and uses an override cannot see or learn the settings that were previously configured in it.</p> <p>If Disabled is checked, then the default mode functions are disabled.</p> <div style="display: flex; align-items: center;">  <div style="border: 1px solid black; background-color: #f4a460; padding: 5px;"> <p>Caution</p> <p>When Set to Factory Defaults Upon Default Mode is set to Enable, the radio does not select all of the frequencies for Radio Frequency Scan Selection List. It needs to be selected manually.</p> </div> </div>				
Undo Unit-Wide Saved Changes	<p>When you click this button, any changes that you made in any tab but did not commit by a reboot of the module are undone.</p>				
Set to Factory Defaults	<p>When you click this button, all configurable parameters on all tabs are reset to the factory settings.</p> <div style="display: flex; align-items: center;">  <div style="border: 1px solid black; background-color: #d9e1f2; padding: 5px;"> <p>Note</p> <p>This can be reverted by selecting "Undo Unit-Wide Saved Changes", before rebooting the radio, though this is not recommended.</p> </div> </div>				
Password	<p>This allows to provide encrypted password for a given password. On click of 'Encrypt the password' button, the Encrypted Password field will display encrypted value of entered plain text password in 'Password' field.</p> <div style="border: 1px solid #ccc; background-color: #f0f0f0; padding: 10px; margin-top: 10px;"> <div style="background-color: #0056b3; color: white; padding: 2px 5px; font-weight: bold;">Encrypt the Password</div> <table style="width: 100%; border-collapse: collapse;"> <tr> <td style="border-bottom: 1px solid #ccc; padding: 5px;">Password :</td> <td style="border-bottom: 1px solid #ccc; padding: 5px;">*****</td> </tr> <tr> <td style="border-bottom: 1px solid #ccc; padding: 5px;">Encrypted Password :</td> <td style="border-bottom: 1px solid #ccc; padding: 5px;">54e06861bcf9710630513dade1bf7ff8</td> </tr> </table> <div style="text-align: right; margin-top: 5px;"> <input type="button" value="Encrypt the password"/> </div> </div>	Password :	*****	Encrypted Password :	54e06861bcf9710630513dade1bf7ff8
Password :	*****				
Encrypted Password :	54e06861bcf9710630513dade1bf7ff8				
Configuration File	<p>This allows to download the configuration file of the radio. This configuration file contains the complete configuration including all the default values. The configuration file is highlighted as downloadable link and the naming convention is "<mac address of AP>.cfg".</p>				
Apply Configuration File	<p>This allows to import and apply configuration to the AP.</p> <p>Chose File: Select the file to upload the configuration. The configuration file is named as "<file name>.cfg".</p> <p>Upload: Import the configuration to the AP.</p> <p>Apply Configuration File: Apply the imported configuration file to the AP. The imported configuration file may either contain a full device configuration or a partial device configuration. If a partial configuration file is imported, only the items contained in the file will be updated, the rest of the device configuration parameters will remain the same.</p>				

Attribute	Meaning
	Operators may also include a special flag in the configure file to instruct the device to first revert to factory defaults then to apply the imported configuration.
Status of Configuration file	This section shows the results of the upload.

Unit Settings page of PMP/ PTP 450 i SM/ BHS

The Unit Settings page of PMP/PTP 450i SM/BHS is explained in below table.

Table 32 :SM Unit Settings attributes

Default Plug Mode

Set To Factory Defaults Upon Default Plug Mode Detection :
 Enabled
 Disabled

LED Panel Settings

LED Panel Mode :
 Revised Mode (Optimized For Indoor SM)
 Legacy Mode

Unit-Wide Changes

Encrypt the Password

Password :

Encrypted Password :

Download Configuration File

Configuration File : [0a003ea0a066.cfg](#)

Upload and Apply Configuration File

Configuration file import is currently unsupported over the web proxy.

Status of Configuration File

Attribute	Meaning
Set to Factory Defaults Upon Default Plug Detection	See Unit Settings attributes – 450 Platform Family AP/BHM
LED Panel Settings	Legacy Mode configures the radio to operate with standard LED behavior.
Undo Unit-Wide Saved Changes	See Unit Settings attributes – 450 Platform Family AP/BHM
Password	
Set to Factory Defaults	
Configuration File	
Status of Configuration file	

Setting up time and date

Time page of 450 Platform Family - AP/BHM

Applicable products	PMP:	þ	AP	PTP:	þ	BHM
---------------------	------	---	----	------	---	-----

The Time page of 450 Platform Family AP/BHM is explained in below table.

Table 33 : 450 Platform Family - AP/BHM Time attributes

The screenshot displays the Time configuration interface with the following sections:

- NTP Server Configuration:**
 - NTP Server (Name or IP Address) : Append DNS Domain Name, Disable DNS Domain Name
 - NTP Server 1 (Name or IP Address) : pool.ntp.org
 - NTP Server 2 (Name or IP Address) : 0.0.0.0
 - NTP Server 3 (Name or IP Address) : 0.0.0.0
 - NTP Server(s) In Use : pool.ntp.org (108.61.73.244)
 -
- Current System Time:**
 - Time Zone : UTC : (UTC) Coordinated Universal Time
 - System Time : 20:33:13 06/26/2013 UTC
 - Last NTP Time Update : 20:32:07 06/26/2013 UTC
- Time and Date:**
 - Time : 20 : 33 : 13 UTC
 - Date : 06 / 26 / 2013
 -
- NTP Update Log:**
 - 06/26/2013 : 20:32:07 UTC : Clock Updated, Server 1

Attribute	Meaning
NTP Server (Name or IP Address)	The management DNS domain name may be toggled such that the name of the NTP server only needs to be specified and the DNS domain name is automatically appended to that name.
NTP Server 1 (Name or IP Address)	To have each log in the AP/BHM correlated to a meaningful time and date, either a reliable network element must pass time and date to the AP/BHM or must set the time and date whenever a power cycle of the AP/BHM has occurred. A network element passes time and date in any of the following scenarios: <ul style="list-style-type: none"> A connected CMM4 passes time and date (GPS time and date, if received).

Attribute	Meaning
NTP Server 2 (Name or IP Address)	<ul style="list-style-type: none"> • A connected CMM4 passes the time and date (GPS time and date, if received), but only if both the CMMr is operating on CMMr Release 2.1 or later release. (These releases include NTP server functionality.) • A separate NTP server (including APs/BHMs receiving NTP data) is addressable from the AP/BHM. <p>If the AP/BHM needs to obtain time and date from a CMM4, or a separate NTP server, enter the IP address or DNS name of the CMM4 or NTP server on this tab. To force the AP/BHM to obtain time and date before the first (or next) 15-minute interval query of the NTP server, click Get Time via NTP.</p> <p>The polling of the NTP servers is done in a sequential fashion, and the polling status of each server is displayed in the NTP Update Log section of the Time Configuration page. An entry of 0.0.0.0 in any of the NTP Server fields indicates an unused server configuration.</p>
NTP Server 3 (Name or IP Address)	
NTP Server (s) in Use	Lists the IP addresses of servers used for NTP retrieval.
Time Zone	The Time Zone option may be used to offset the received NTP time to match the operator's local time zone. When set on the AP/BHM, the offset is set for the entire sector SMs (or BHS) are notified of the current Time Zone upon initial registration). If a Time Zone change is applied, the SMs (or BHS) is notified of the change in a best effort fashion, meaning some SMs//BHSs may not pick up the change until the next re-registration. Time Zone changes are noted in the Event Log of the AP/BHM and SM/BHS.
System Time	The current time used by the system.
Last NTP Time Update	The last time that the system time was set via NTP.
Time	This field may be used to manually set the system time of the radio.
Date	This field may be used to manually set the system date of the radio.
NTP Update Log	This field shows NTP clock update log. It includes NTP clock update Date and Time stamp along with server name.

Configuring synchronization

Applicable products PMP: AP PTP: BHM

Sync Input

This section describes synchronization options for PMP and PTP configuration.

Figure 20 : Sync Setting configuration

Sync Setting	
Sync Input :	AutoSync ▾
Free Run Before GPS Sync :	<input type="radio"/> Enabled <input checked="" type="radio"/> Disabled
Device Type :	<input checked="" type="radio"/> Standard <input type="radio"/> Remote
Verify GPS Message Checksum :	<input checked="" type="radio"/> Enabled <input type="radio"/> Disabled
Sync Aux Port Config :	Sync Input ▾
Aux Port Power to UGPS :	<input checked="" type="radio"/> Enabled <input type="radio"/> Disabled Please Note: To enable GPS information on the "Sync Status" page, "UGPS Power" must be enabled here. Enabling "UGPS Power" whilst also providing an alternative power source to a UGPS, is supported. Enabling the Aux Ethernet port will disrupt the Aux Power to UGPS

The Sync Input parameter can be configured under Sync Setting tab of Configure > General page (see General configuration).

PMP/PTP 450i Series has following synchronization input options:

- AutoSync
- AutoSync + Free Run
- Generate Sync

AutoSync

For 450i AP/BHM, 450b BHM and 450m AP, the AP/BHM automatically receives sync from one of the following sources:

- GPS Sync over Timing Port (UGPS, cnPulse, co-located AP GPS sync output, or "Remote" Device feed from a registered SM's GPS sync output)
- GPS Sync over Power Port (CMM4), CMM5, cnPulse module ODU Sync Port.

For 450 AP, the internal GPS is available in addition to the above sync sources. For a 450 BHM the only available sync source is the Timing Port, as GPS Sync Over Power Port is not supported.

Upon AP/BHM power on with the Free Run Before GPS Sync parameter set to disabled, the AP/BHM does not transmit until a valid synchronization pulse is received from one of the sources above. If there is a loss of GPS synchronization pulse after sync is initially established, within two seconds the AP/BHM automatically attempts to source GPS signaling from another source.

In case of PMP, when there are synchronization sources on both the timing port and the power port, the power port GPS source is chosen first.

If no valid GPS signal is received, the AP/BHM ceases transmission and SM/BHS registration is lost until a valid GPS signal is received again on the AP or BHM.



Note

After a reboot of 450m AP, the sync acquisition takes a little longer than it had on 450i (anywhere from 40 seconds to 120 seconds difference).

When the Sync Input field is set to Autosync or Autosync + Free Run, other options become available to be set e.g. UGPS Power and other fields. This is true on APs and BHMs.

AutoSync + Free Run

This mode operates similarly to mode “AutoSync”, but if a previously received synchronization signal is lost and no GPS signaling alternative is achieved, the AP/BHM automatically changes to synchronization mode “Generate Sync - Free Run”. While BHS/SM registration is maintained, in this mode there is no synchronization of APs/BHMs that can “hear” each other; the AP/BHM will only generate a sync signal for the local AP/BHM and its associated SMs/BHS. Once a valid GPS signal is obtained again, the AP/BHM automatically switches to receiving synchronization via the GPS source and SM/BHS registration is maintained.



Note

In mode AutoSync + Free Run with the Free Run Before GPS Sync parameter set to disabled, if a GPS signal is never achieved initially, the system will not switch to “Free Run” mode, and SMs/BHS will not register to the AP/BHM. A valid GPS signal must be present initially for the AP to switch into “Free Run” mode (and to begin self-generating a synchronization pulse).

Also, when an AP/BHM is operating in “Free Run” mode, over a short time it will no longer be synchronized with co-located or nearby APs/BHMs (within radio range). Due to this lack of transmit and receive synchronization across APs/BHMs or across systems, performance while in “Free Run” mode may be degraded until the APs/BHMs operating in “Free Run” mode regain an external GPS synchronization source. Careful attention is required to ensure that all systems are properly receiving an external GPS synchronization pulse, and please consider “Free Run” mode as an emergency option.

Generate Sync (Factory default)

This option may be used when the AP/BHM is not receiving GPS synchronization pulses from either a CMM4/CMM5 or UGPS/cnPulse module, and there are no other APs/BHMs active within the link range. Using this option will not synchronize transmission of APs/BHMs that can “hear” each other; it will only generate a sync signal for the local AP/BHM and its associated SMs/BHS.



Note

When an AP/BHM has its “Regional Code” set to “None”, The radio will not provide valid Sync Pulse Information.

There is a RED warning that the radio will not transmit, but the user might expect to see a valid sync if the radio is connected to a working CMM4 or UGPS.

Free Run Before GPS Sync

This option is available when the Sync Input parameter is configured for either AutoSync mode or AutoSync + Free Run mode. When Free Run Before GPS Sync is set to Enabled, if the radio does not detect a valid GPS synchronization pulse after booting up then it will operate in Generate Sync - Free Run mode until a valid source is detected. While the AP/BHM is in Generate Sync - Free Run mode SMs/BHS will be able to register, but there is no synchronization of APs/BHMs that can “hear” each other; the AP/BHM will only generate a sync signal for the local AP/BHM and its associated SMs/BHS. Once a valid synchronization source is found, the AP/BHM automatically switches to receiving synchronization from the source and SM/BHS registration is maintained. If Free Run Before GPS Sync is set to Disabled, the AP/BHM does not transmit and SMs/BHS will be unable to register until a valid GPS synchronization source is connected.

Device Type

This parameter determines whether the device is configured as a Remote AP or BHM, receiving GPS sync from a co-located AP/BHM GPS sync output or Remote Device feed from a registered SM's or BHS's GPS sync output, or as a Standard AP or BHM. This parameter applies in AutoSync or AutoSync + Free Run modes only. Synchronization behavior is as follows:

Standard: The AutoSync mechanism will source GPS synchronization from the AP's Aux/Timing port, the AP's power port, or from the device on-board GPS module (if present).

Remote: The AutoSync mechanism will source GPS synchronization from the AP's Aux/Timing port or from the device on-board GPS module (if present). GPS synchronization pulses on the Power Port are ignored.

Verify GPS Message Checksum

The Verify GPS Message Checksum parameter enables or disables validation of incoming GPS location messages from a UGPS or cnPulse module connected to the AP's Aux Port. When enabled the AP will discard messages found to have an incorrect checksum and will increment the Invalid Message Count display of the Sync Status tab of the Home GUI page accordingly.

Sync Aux Port Config

The Sync Aux Port Config parameter controls how the Timing Port/UGPS port is used on the AP or BHM. This parameter replaces the Sync Out to Aux Port parameter from earlier software releases.

On the 450m AP, 450i AP/BHM, and 450 AP/BHM, this parameter takes effect when operating in AutoSync or AutoSync + Free Run modes. The available options are Sync Input or Sync Output, equivalent to Disabled and Enabled respectively for the Sync Out to Aux Port parameter:

- When configured for Sync Input, the AP will accept GPS sync in via the Timing Port/UGPS connector from a UGPS, cnPulse, co-located AP GPS sync output, or "Remote" Device feed from a registered SM's GPS sync output.
- When configured for Sync Output, the AP will output the GPS timing pulse on the Timing Port/UGPS connector. In this configuration the AP may serve as a GPS synchronization source for a co-located AP.

The 450b series radios are equipped with a 4-pin TRRS audio Timing Port/UGPS connector in place of the RJ45 or RJ12 connectors used on the 450m/450i/450 series. On the 450b BHM, the available Sync Aux Port Config options are Sync Input, Sync Output, and Alignment Tone:

- Sync Input and Sync Output behave the same as described above for the 450m, 450i and 450 platforms.
- The Alignment Tone option is available only on the 450b BHM. When this option is selected, the BHM will output a tone to both the left and right channels of a pair of stereo headphones plugged into the TRRS audio jack whenever a BHS session is active.



Note

when Sync Aux Port Config is set to Sync Output, the 450b BHM will still generate an alignment tone but it will be audible only on the right stereo channel. When Sync Input is selected the 450b BHM will not generate the alignment tone on either stereo channel.

Aux Port Power to UGPS

The 450 series APs are capable of supplying power to a connected UGPS or cnPulse module via the Aux/Timing Port. Enable the Aux Port Power to UGPS parameter to output power on the port.



Note

The AP is able to receive GPS sync pulses and satellite data via the Aux Port regardless of whether this parameter is Enabled or Disabled. However, on the 450m AP and 450i AP/BHM, the satellite data is displayed on the Sync Status page only when the Aux Port power is enabled.



Caution

When a UGPS module is used to provide GPS sync to two 450m or 450i APs simultaneously, it is recommended to install a separate power supply for the UGPS to prevent the possibility of sync interruption upon reboot of the APs.

Configuring security

Perform this task to configure the 450 Platform system in accordance with the network operator's security policy. Choose from the following procedures:

- Managing module access by password to configure the unit access password and access level
- See Radio Recovery. to ensure that APs are properly secured from external networks
- Encrypting radio transmissions to configure the unit to operate with AES wireless link security
- Requiring SM Authentication to set up the AP to require SMs to authenticate via the AP, WM, or RADIUS server
- Filtering protocols and ports to filter (block) specified protocols and ports from leaving the system
- Encrypting downlink broadcasts to encrypt downlink broadcast transmissions
- Isolating SMs to prevent SMs in the same sector from directly communicating with each other
- Filtering management through Ethernet to prevent management access to the SM via the radio's Ethernet port
- Allowing management only from specified IP addresses to only allow radio management interface access from specified IP addresses
- Restricting radio Telnet access over the RF interface to restrict Telnet access to the AP
- Configuring SNMP Access
- Configuring Security

Managing module access by password

Applicable products	PMP:	þ	AP	þ	SM	PTP:	þ	BHM	þ	BMS
---------------------	------	---	----	---	----	------	---	-----	---	-----

See Managing module access by password in Planning and installation Guide.

Adding a User for Access to a module

The Account > Add User page allows to create a new user for accessing 450 Platform Family - AP/SM/BHM/BHS. The Add User page is explained in below table.

Table 34 :Add User page of account page - AP/ SM/BH

The screenshot shows two sections of a web interface. The top section, titled 'Add User', contains the following fields: 'User Name' (text input), 'Level' (dropdown menu with 'INSTALLER' selected), 'New Password' (text input), 'Confirm Password' (text input), and 'User Mode' (checkbox labeled 'read-only'). An 'Add' button is located at the bottom right of this section. The bottom section, titled 'Account Status', is currently empty.

Attribute	Meaning
User Name	User Account name.
Level	Select appropriate level for new account. It can be INSTALLER, ADMINISTRATOR or TECHNICIAN. See Managing module Access by passwords in Planning and Installation Guide.
New Password	Assign the password for new user account
Confirm Password	This new password must be confirmed in the “Confirm Password” field.
User Mode	User Mode is used to create an account which are mainly used for viewing the configurations. The local and remote Read-Only user account can be created by “Admin”, “Installer” or “Tech” logins. To create a Read-Only user, the “read-only” check box needs to be checked.



Note

The Read-Only user cannot perform any service impacting operations like creating read-only accounts, editing and viewing read-only user accounts, changes in login page, read-only user login, Telnet access, SNMP, RADIUS and upgrade/downgrade.

Deleting a User from Access to a module

The Account > Delete User page provides a drop-down list of configured users from which to select the user you want to delete. The Delete User page is explained in below table.

Table 35 :Delete User page - 450 Platform Family - AP/ SM/BH

Delete User

User : ▼

Account Status

Attribute	Meaning
User	<p>Select a user from drop-down list which has to be deleted and click Delete button.</p> <p>Accounts that cannot be deleted are</p> <ul style="list-style-type: none"> • the current user's own account. • the last remaining account of ADMINISTRATOR level.

Changing a User Setting

The Account > Change User Setting page allows to update password, mode update and general status permission for a user.

From the factory default state, configure passwords for both the root and admin account at the ADMINISTRATOR permission level, using Update Password tab of Change Users Setting page.

The Change User Setting page is explained in below table.

Table 36 :Change User Setting page - 450 Platform Family AP/ SM/BH

Update Password

User : ▼

New Password :

Confirm Password :

Update Mode

User : ▼

User Mode : read-only

General Status Permission

General Status Page Viewable to Guest Users : Enabled
 Disabled

Account Status

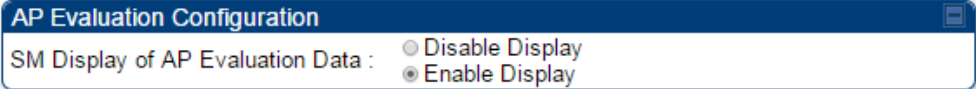
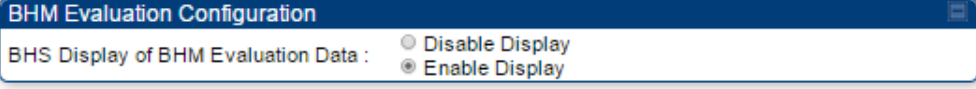
Attribute	Meaning
Update Password tab	This tab provides a drop-down list of configured users from which a user is selected to change password.
Update Mode tab	This tab facilitates to convert a configured user to a Read-Only user.
General Status Permission tab	<p>This tab enables and disables visibility of General Status Page for all Guest users.</p> <p>To display of Radio data on SMs/BHS main Login page for Guest login, it can be enabled or disabled in Security tab of Configuration page.</p> <p>Figure 21 : Evaluation Configuration parameter of Security tab for PMP</p>  <p>Figure 22 : BHM Evaluation Configuration parameter of Security tab for PTP</p> 

Users account

The Account > Users page allows to view all configured users account for accessing the module.

The Users page is explained in below table.

Table 37 :User page -450 Platform Family AP/SM/BH

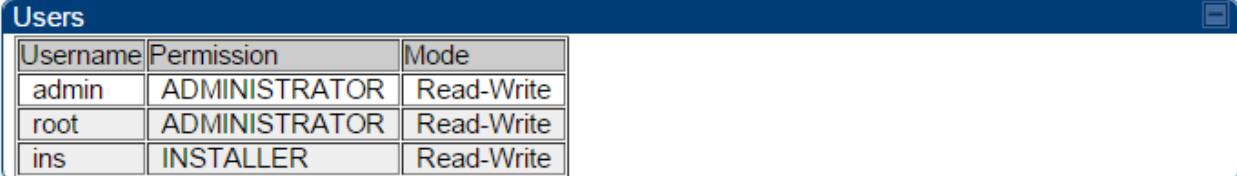

Username	Permission	Mode
admin	ADMINISTRATOR	Read-Write
root	ADMINISTRATOR	Read-Write
ins	INSTALLER	Read-Write

Attribute	Meaning
Username	User access account name
Permission	Permission of configured user - INSTALLER, ADMINISTRATOR or TECHNICIAN
Mode	This field indicate access mode of user - Read-Write or Read-Only.

Overriding Forgotten IP Addresses or Passwords on AP and SM

See Radio Recovery.

Isolating from the internet – APs/ BHM

Applicable products	PMP:	þ	AP	PTP:	þ	BHM
---------------------	------	---	----	------	---	-----

See Isolating AP/BHM from the Internet in Planning and Installation Guide.

Encrypting radio transmissions

Applicable products	PMP:	þ	AP	þ	SM	PTP:	þ	BHM	þ	BMS
---------------------	------	---	----	---	----	------	---	-----	---	-----

See Encryption radio transmission in Planning and Installation Guide.

Requiring SM Authentication

Applicable products	PMP:	þ	AP	þ	SM
---------------------	------	---	----	---	----

Through the use of a shared AP key, or an external RADIUS (Remote Authentication Dial In User Service) server, it enhances network security by requiring SMs to authenticate when they register.

For descriptions of each of the configurable security parameters on the AP, see Configuring Security. For descriptions of each of the configurable security parameters on the SM.

Operators may use the AP's Authentication Mode field to select from among the following authentication modes:

- Disabled—the AP requires no SMs to authenticate (factory default setting).
- Authentication Server —the AP requires any SM that attempts registration to be authenticated in Wireless Manager before registration
- AP PreShared Key - The AP acts as the authentication server to its SMs and will make use of a user-configurable pre-shared authentication key. The operator enters this key on both the AP and all SMs desired to register to that AP. There is also an option of leaving the AP and SMs at their default setting of using the “Default Key”. Due to the nature of the authentication operation, if you want to set a specific authentication key, then you MUST configure the key on all of the SMs and reboot them BEFORE enabling the key and option on the AP. Otherwise, if you configure the AP first, none of the SMs is able to register.
- RADIUS AAA - When RADIUS AAA is selected, up to 3 Authentication Server (RADIUS Server) IP addresses and Shared Secrets can be configured. The IP address(s) configured here must match the IP address(s) of the RADIUS server(s). The shared secret(s) configured here must match the shared secret(s) configured in the RADIUS server(s). Servers 2 and 3 are meant for backup and reliability, not for splitting the database. If Server 1 doesn't respond, Server 2 is tried, and then server 3. If Server 1 rejects authentication, the SM is denied entry to the network, and does not progress trying the other servers.

For more information on configuring the PMP 450 Platform network to utilize a RADIUS server, see Configuring a RADIUS server.

Filtering protocols and ports

Applicable products	PMP:	þ	AP	þ	SM	PTP:	þ	BHM	þ	BMS
---------------------	------	---	----	---	----	------	---	-----	---	-----

The filtering protocols and ports allows to configure filters for specified protocols and ports from leaving the AP/SM/BHM/BHS and entering the network. See Filtering protocols and ports in Planning and Installation Guide.

Protocol filtering page of 450 Platform Family AP/BHM

The Protocol Filtering page of 450 Platform Family - AP/BHM is explained in below table.

Table 38 :AP/BHM Protocol Filtering attributes

Packet Filter Configuration

Packet Filter Types :

- PPPoE
- All IPv4
 - SMB (Network Neighborhood)
 - SNMP
 - Bootp Client
 - Bootp Server
 - IPv4 Multicast
 - User Defined Port 1 (See Below)
 - User Defined Port 2 (See Below)
 - User Defined Port 3 (See Below)
 - All other IPv4
- All IPv6
 - SMB (Network Neighborhood)
 - SNMP
 - Bootp Client
 - Bootp Server
 - IPv6 Multicast
 - All other IPv6
- ARP
- All others

Filter Direction :

- Upstream
- Downstream

User Defined Port Filtering Configuration

Port #1 : (Decimal Value)

TCP : Enabled Disabled

UDP : Enabled Disabled

Port #2 : (Decimal Value)

TCP : Enabled Disabled

UDP : Enabled Disabled

Port #3 : (Decimal Value)

TCP : Enabled Disabled

UDP : Enabled Disabled

AP Specialty Filters

RF Telnet Access : Enabled Disabled

PPPoE PADI Downlink Forwarding : Enabled Disabled

Attribute	Meaning
Packet Filter Types	For any box selected, the Protocol and Port Filtering feature blocks the associated protocol type.

Attribute	Meaning
	<p>To filter packets in any of the user-defined ports, must do all of the following:</p> <p>Check the box for User Defined Port n (See Below) in the Packet Filter Types section of this tab.</p> <p>In the User Defined Port Filtering Configuration section of this tab:</p> <ul style="list-style-type: none"> • provide a port number at Port #n. • enable TCP and/or UDP by clicking the associated radio button
Filter Direction	Operators may choose to filter upstream (uplink) RF packets or downstream (downlink) RF packets.
User Defined Port Filtering Configuration	You can specify ports for which to block subscriber access, regardless of whether NAT is enabled.
RF Telnet Access	RF Telnet Access restricts Telnet access to the AP/BHM from a device situated below a network SM/BHS (downstream from the AP/BHM). This is a security enhancement to restrict RF-interface sourced AP access specifically to the LAN1 IP address and LAN2 IP address (Radio Private Address, typically 192.168.101.[LUID]). This restriction disallows unauthorized users from running Telnet commands on the AP/BHM that can change AP/BHM configuration or modifying network-critical components such as routing and ARP tables.
PPPoE PADI Downlink Forwarding	<p>Enabled: the AP/BHM allows downstream and upstream transmission of PPPoE PADI packets. By default, PPPoE PADI Downlink Forwarding is set to “Enabled”.</p> <p>Disabled: the AP/BHM disallows PPPoE PADI packets from entering the Ethernet interface and exiting the RF interface (downstream to the SM/BHS). PPPoE PADI packets are still allowed to enter the AP’s RF interface and exit the AP’s /BHM’s Ethernet interface (upstream).</p>

Protocol filtering page of SM/BHS

The Protocol Filtering page of SM/BHS is explained in below table.

Table 39 :SM/BHS Protocol Filtering attributes

Packet Filter Configuration

Packet Filter Types :

- PPPoE
- All IPv4
 - SMB (Network Neighborhood)
 - SNMP
 - Bootp Client
 - Bootp Server
 - IPv4 Multicast
 - User Defined Port 1 (See Below)
 - User Defined Port 2 (See Below)
 - User Defined Port 3 (See Below)
 - All other IPv4
- All IPv6
 - SMB (Network Neighborhood)
 - SNMP
 - Bootp Client
 - Bootp Server
 - IPv6 Multicast
 - All other IPv6
- ARP
- All others

Filter Direction :

- Upstream
- Downstream

User Defined Port Filtering Configuration

Port #1 : (Decimal Value)

TCP : Enabled
 Disabled

UDP : Enabled
 Disabled

Port #2 : (Decimal Value)

TCP : Enabled
 Disabled

UDP : Enabled
 Disabled

Port #3 : (Decimal Value)

TCP : Enabled
 Disabled

UDP : Enabled
 Disabled

Attribute	Meaning
Packet Filter Configuration tab	See AP/BHM Protocol Filtering attributes
User Defined Port Filtering Configuration tab	See AP/BHM Protocol Filtering attributes

Port configuration

450 Platform Family ODU's support access to various communication protocols and only the ports required for these protocols are available for access by external entities. Operators may change the port numbers for these protocols via the radio GUI or SNMP.

The Port Configuration page of the AP/SM/BHM/BHS is explained in below table.

Table 40 :Port Configuration attributes - AP/SM/BHM/BMS

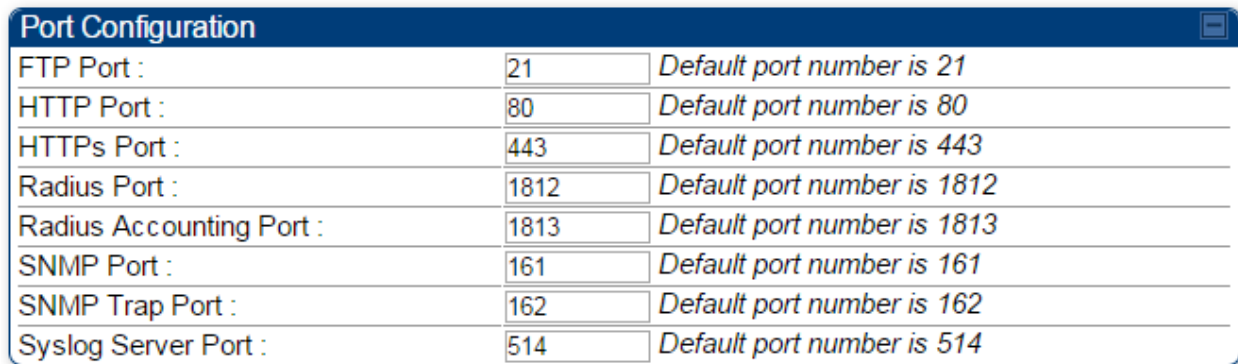

Port Configuration		
FTP Port :	<input type="text" value="21"/>	Default port number is 21
HTTP Port :	<input type="text" value="80"/>	Default port number is 80
HTTPs Port :	<input type="text" value="443"/>	Default port number is 443
Radius Port :	<input type="text" value="1812"/>	Default port number is 1812
Radius Accounting Port :	<input type="text" value="1813"/>	Default port number is 1813
SNMP Port :	<input type="text" value="161"/>	Default port number is 161
SNMP Trap Port :	<input type="text" value="162"/>	Default port number is 162
Syslog Server Port :	<input type="text" value="514"/>	Default port number is 514

Attribute	Meaning
FTP Port	The listen port on the device used for FTP communication.
HTTP Port	The listen port on the device used for HTTP communication.
HTTPS Port	The listen port on the device used for HTTPS communication.
Radius Port	The destination port used by the device for RADIUS communication.
Radius Accounting Port	The destination port used by the device for RADIUS accounting communication.
SNMP Port	The listen port on the device used for SNMP communication.
SNMP Trap Port	The destination port used by the device to which SNMP traps are sent.
Syslog Server Port	The destination port used by the device to which Syslog messaging is sent.

Encrypting downlink broadcasts

See Encryption downlink broadcast in Installation and Planning Guide.

Isolating SMs

See Isolating SMs in Installation and Planning Guide.

Filtering management through Ethernet

See Filtering management through Ethernet in Installation and Planning Guide.

Allowing management only from specified IP addresses

See Allowing management only from specified IP address in Installation and Planning Guide.

Restricting radio Telnet access over the RF interface

RF Telnet Access restricts Telnet access to the AP from a device situated below a network SM (downstream from the AP). This is a security enhancement to restrict RF-interface sourced AP access specifically to the LAN1 IP address and LAN2 IP address (Radio Private Address, typically 192.168.101.[LUID]). This restriction disallows unauthorized users from running Telnet commands on the AP that can change AP configuration or modifying network-critical components such as routing and ARP tables.

The RF Telnet Access may be configured via the AP GUI or via SNMP commands, and RF Telnet Access is set to “Enabled” by default. Once RF Telnet Access is set to “Disabled”, if there is a Telnet session attempt to the AP originating from a device situated below the SM (or any downstream device), the attempt is dropped. This also includes Telnet session attempts originated from the SM’s management interface (if a user has initiated a Telnet session to a SM and attempts to Telnet from the SM to the AP). In addition, if there are any active Telnet connections to the AP originating from a device situated below the SM (or any downstream device), the connection is dropped. This behavior must be considered if system administrators use Telnet downstream from an AP (from a registered SM) to modify system parameters.

Setting RF Telnet Access to “Disabled” does not affect devices situated above the AP from accessing the AP via Telnet, including servers running the CNUT (Canopy Network Updater tool) application. Also, setting RF Telnet Access to “Disabled” does not affect any Telnet access into upstream devices (situated above or adjacent to the AP) through the AP (see RF Telnet Access Restrictions (orange) and Flow through (green)).

The figure below depicts a user attempting two telnet sessions. One is targeted for the AP (orange) and one is targeted for the network upstream from the AP (green). If RF Telnet Access is set to “Disabled” (factory default setting), the Telnet attempt from the user to the AP is blocked, but the attempt from the user to Network is allowed to pass through the Cambium network.

Figure 23 : RF Telnet Access Restrictions (orange) and Flow through (green)

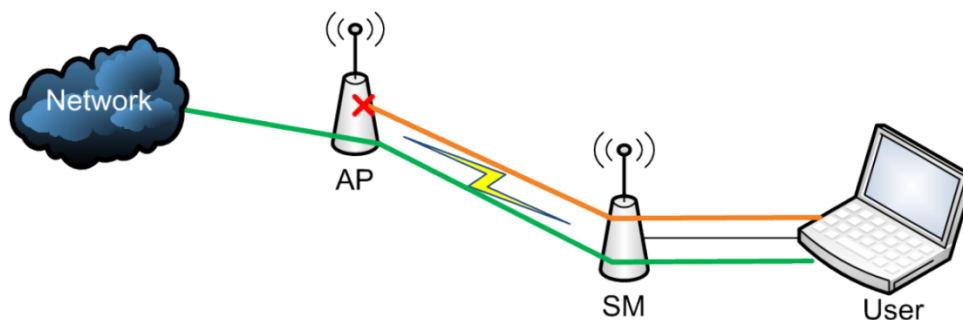

Key Security Considerations when using the RF Telnet Access Feature

To ensure that the network is fully protected from unauthorized AP Telnet sessions, the following topics must be considered:

Securing AP Clusters

When working with a cluster of AP units, to eliminate potential security holes allowing Telnet access, ensure that the RF Telnet Access parameter is set to “Disabled” for every AP in the cluster. In addition, since users situated below the AP are able to pass Telnet sessions up through the SM and AP to the upstream network (while AP RF Telnet Access is set to “Disabled”), ensure that all CMM4 or other networking equipment is secured with strong passwords. Otherwise, users may Telnet to the CMM4 or other networking equipment, and subsequently access network APs (see RF Telnet Access Restriction

(orange) and Potential Security Hole (green)) via their Ethernet interfaces (since RF Telnet Access only prevents Telnet sessions originating from the AP's wireless interface).

Figure 24 : RF Telnet Access Restriction (orange) and Potential Security Hole (green)

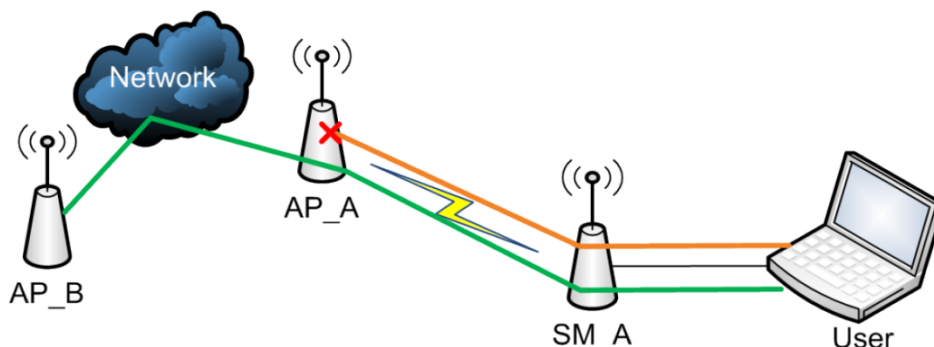

As a common practice, AP administrator usernames and passwords must be secured with strong, non-default passwords.

Restricting AP RF Telnet Access

AP Telnet access via the RF interface may be configured in two ways - the AP GUI and SNMP.

Controlling RF Telnet Access via the AP GUI

To restrict all Telnet access to the AP via the RF interface from downstream devices, follow these instructions using the AP GUI:

Procedure 12 Restricting RF Telnet access:

1	Log into the AP GUI using administrator credentials
2	On the AP GUI, navigate to Configuration > Protocol Filtering
3	Under GUI heading "Telnet Access over RF Interface", set RF Telnet Access to Disabled
	<p>The screenshot shows a configuration window titled 'AP Specialty Filters'. It contains two settings: 'RF Telnet Access' with a radio button selected for 'Disabled', and 'PPPoE PADI Downlink Forwarding' with a radio button selected for 'Enabled'.</p>
4	Click the Save button
5	Once the Save button is clicked, all RF Telnet Access to the AP from devices situated below the AP is blocked.



Note

The factory default setting for RF Telnet Access is disabled and PPPoE PADI Downlink Forwarding is enabled.

Configuring SNMP Access

The SNMPv3 interface provides a more secure method to perform SNMP operations. This standard provides services for authentication, data integrity and message encryption over SNMP. Refer to Planning of SNMPv3 operation in Planning and Installation Guide.



Note

The factory default setting for SNMP is “SNMPv2c Only”.

Procedure 13 Configuring SNMPv3:

1. Log into the AP GUI using administrator credentials
2. On the AP/SM GUI, navigate to Configuration > Security Page

- Under GUI heading “Security Mode”, set SNMP to SNMPv3 Only

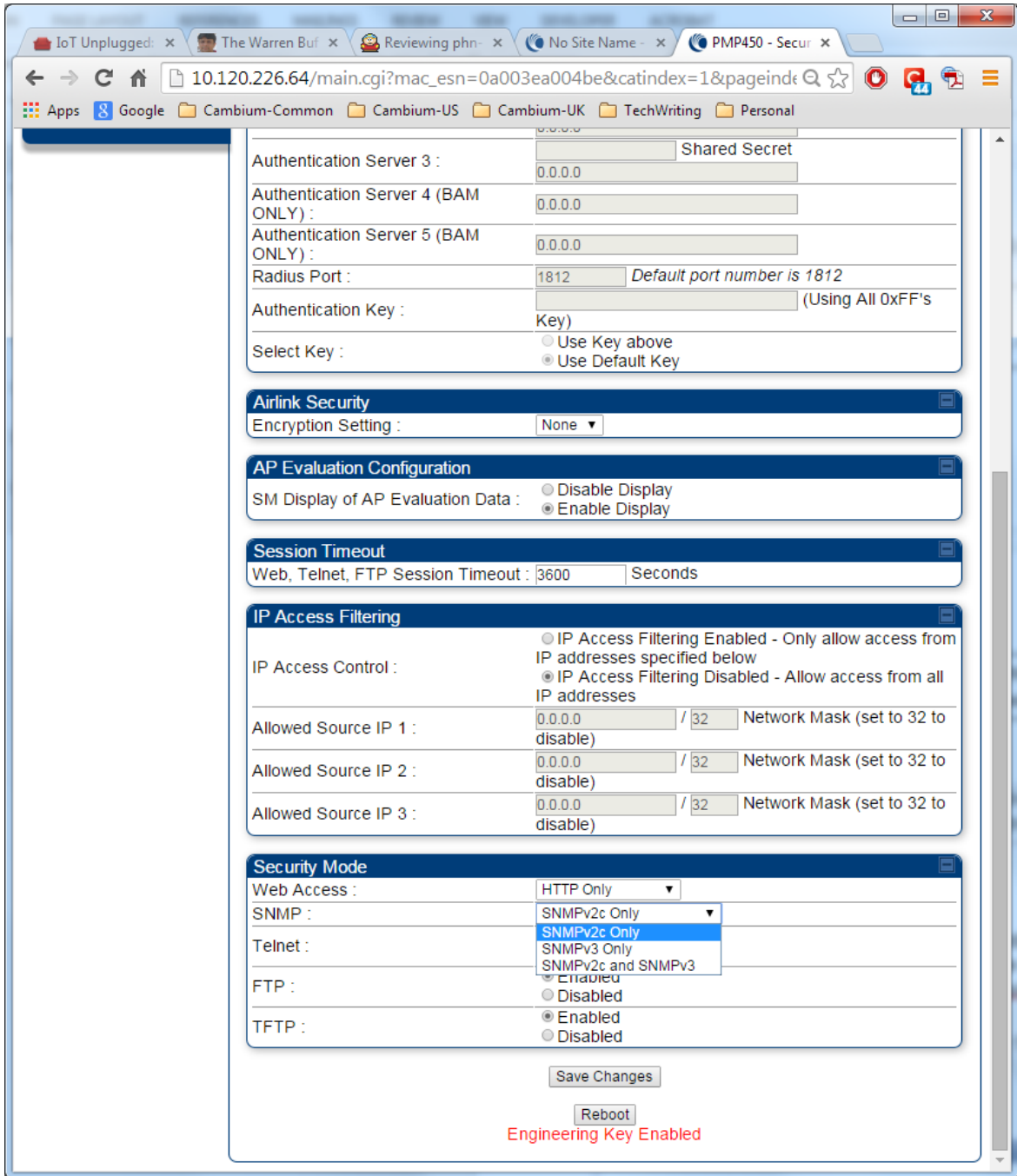

- Click the Save Changes button
- Go to Configuration > SNMP Page
- Under GUI heading “SNMPv3 setting”, set Engine ID, SNMPv3 Security Level, SNMPv3 Authentication Protocol, SNMPv3 Privacy Protocol, SNMPv3 Read-Only User, SNMPv3 Read/Write User, SNMPv3 Trap Configuration parameters:

SNMPv3 Settings		
Engine ID :	800000a1030a003e47d1bc	<input type="button" value="Use Default Engine ID"/>
SNMPv3 Security Level :	noAuth,noPriv ▾	
SNMPv3 Authentication Protocol :	md5 ▾	
SNMPv3 Privacy Protocol :	cbc-des ▾	
SNMPv3 Read-Only User :	Username	Canopyro
	Authorization Key
	Privacy Key
SNMPv3 Read/Write User :	<input type="radio"/> Enable R/W User <input checked="" type="radio"/> Disable R/W User	
	Username	Canopy
	Authorization Key
SNMPv3 Trap Configuration :	Disabled ▾	

7. Engine ID:

Each radio (AP/SM/BHM/BHS) has a distinct SNMP authoritative engine identified by a unique Engine ID. While the Engine ID is configurable to the operator it is expected that the operator follows the guidelines of the SNMPEngineID defined in the SNMP-FRAMEWORK-MIB (RFC 3411). The default Engine ID is the MAC address of the device.

SNMPv3 security level, Authentication and Privacy Protocol

The authentication allows authentication of SNMPv3 user and privacy allows for encryption of SNMPv3 message. 450 Platform Family supports MD5 authentication and CBC-DES privacy protocols.

SNMPv3 Read-Only and Read/Write User

The user can be defined by configurable attributes. The attributes and default values are:

Read-only user

- Authentication Password = authCanopyro
- Privacy Password = privacyCanopyro
- sername = Canopyro

Read-write user (by default read-write user is disabled)

- Authentication Password = authCanopy
- Username = Canopy
- Privacy Password = privacyCanopy

SNMPv3 Trap Configuration

The traps may be sent from radios in SNMPv3 format based on parameter settings. It can be configured for Disabled, Enabled for Read-Only User, Enable for Read/Write User.

Configuring Security

Applicable products	PMP:	p	AP	p	SM	PTP:	p	BHM	p	BMS
---------------------	------	---	----	---	----	------	---	-----	---	-----

Security page – 450 Platform Family AP

The security page of AP is explained in below table.

Table 41 :Security attributes –450 Platform Family AP

Authentication Server Settings	
Authentication Mode :	Disabled
Authentication Server DNS Usage :	<input type="radio"/> Append DNS Domain Name <input checked="" type="radio"/> Disable DNS Domain Name
Authentication Server 1 :	<input type="text"/> Shared Secret <input type="text" value="0.0.0.0"/>
Authentication Server 2 :	<input type="text"/> Shared Secret <input type="text" value="0.0.0.0"/>
Authentication Server 3 :	<input type="text"/> Shared Secret <input type="text" value="0.0.0.0"/>
Authentication Server 4 (BAM ONLY) :	<input type="text" value="0.0.0.0"/>
Authentication Server 5 (BAM ONLY) :	<input type="text" value="0.0.0.0"/>
Radius Port :	1812 <i>Default port number is 1812</i>
Authentication Key 128-bit :	<input type="text"/> (Using All 0xFF's Key)
Select Key 128-bit :	<input type="radio"/> Use Key above <input checked="" type="radio"/> Use Default Key
Disable AES-128 :	<input type="radio"/> AES-128 Encryption Disabled <input checked="" type="radio"/> AES-128 Encryption Available
Authentication Key 256-bit :	<input type="text"/> (Using All 0xFF's Key)
Select Key 256-bit :	<input type="radio"/> Use Key above <input checked="" type="radio"/> Use Default Key
Dynamic Authorization Extensions for RADIUS :	<input type="radio"/> Enable CoA and Disconnect Message <input checked="" type="radio"/> Disable CoA and Disconnect Message
Bypass Authentication for ICC SMS :	<input type="radio"/> Enabled <input checked="" type="radio"/> Disabled

Airlink Security

Encryption Setting :

AP Evaluation Configuration

SM Display of AP Evaluation Data : Disable Display
 Enable Display

Session Timeout

Web, Telnet, FTP Session Timeout : Seconds

IP Access Filtering

IP Access Control : IP Access Filtering Enabled - Only allow access from IP addresses specified below
 IP Access Filtering Disabled - Allow access from all IP addresses

Allowed Source IP 1 : / Network Mask (set to 32 to disable)

Allowed Source IP 2 : / Network Mask (set to 32 to disable)

Allowed Source IP 3 : / Network Mask (set to 32 to disable)

Security Mode

Web Access :

SNMP :

Telnet : Enabled
 Disabled

FTP : Enabled
 Disabled

TFTP : Enabled
 Disabled

NTP server : Enabled
 Disabled

Site Information

Site Information Viewable to Guest Users : Enabled
 Disabled

Site Name :

Site Contact :

Site Location :

Security Banner

Enable Security Banner during Login : Enabled
 Disabled

Security Banner Notice :

User must accept security banner before login : Enabled
 Disabled

Attribute	Meaning
Authentication Mode	<p>Operators may use this field to select from among the following authentication modes:</p> <p>Disabled—the AP requires no SMs to authenticate. (Factory default).</p> <p>Authentication Server —the AP/BHM requires any SM/BHS that attempts registration to be authenticated in Wireless Manager before registration.</p> <p>AP PreShared Key - The AP/BHM acts as the authentication server to its SMs/BHS and will make use of a user-configurable pre-shared authentication key. The operator enters this key on both the AP/BHM and all SMs/BHS desired to register to that AP/BHM. There is also an option of leaving the AP/BHM and SMs/BHS at their default setting of using the “Default Key”. Due to the nature of the authentication operation, if you want to set a specific authentication key, then you MUST configure the key on all of the SMs/BHS and reboot them BEFORE enabling the key and option on the AP/BHM. Otherwise, if you configure the AP/BHM first, none of the SMs/BHS is able to register.</p> <p>RADIUS AAA - When RADIUS AAA is selected, up to 3 Authentication Server (RADIUS Server) IP addresses and Shared Secrets can be configured. The IP address(s) configured here must match the IP address(s) of the RADIUS server(s). The shared secret(s) configured here must match the shared secret(s) configured in the RADIUS server(s). Servers 2 and 3 are meant for backup and reliability, not for splitting the database. If Server 1 doesn’t respond, Server 2 is tried, and then server 3. If Server 1 rejects authentication, the SM is denied entry to the network, and does not progress trying the other servers.</p>
Authentication Server DNS Usage	<p>The management DNS domain name may be toggled such that the name of the authentication server only needs to be specified and the DNS domain name is automatically appended to that name.</p>
Authentication Server 1 to 5	<p>Enter the IP address or server name of the authentication server (RADIUS or WM) and the Shared Secret configured in the authentication server. When Authentication Mode RADIUS AAA is selected, the default value of Shared Secret is “CanopySharedSecret”. The Shared Secret may consist of up to 32 ASCII characters.</p>
Radius Port	<p>This field allows the operator to configure a custom port for RADIUS server communication. The default value is 1812.</p>
Authentication Key 128-bit	<p>This authentication key is a 32-character hexadecimal string used when Authentication Mode is set to AP PreShared Key . By default, this key is set to 0xFF.</p>
Select Key 128-bit	<p>This option allows operators to choose which authentication key is used:</p> <p>Use Key above means that the key specified in Authentication Key is used for authentication</p> <p>Use Default Key means that a default key (based off the SM’s MAC address) is used for authentication</p>
Disable AES 128-bit	<p>This option allows to disable the AES-128 encryption. When AES-128 Encryption is disabled, it prevents the use of AES-128 when encryption is enabled. Since changes to other attributes (e.g. PreSharedKey authentication settings) could cause a need for 128-bit Auth and AES- 128 upon next registration, Disable AES 128-bit parameter is prevented from being changed on the “Security” webpage while the “Reboot Required”</p>

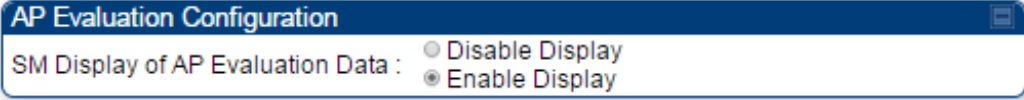
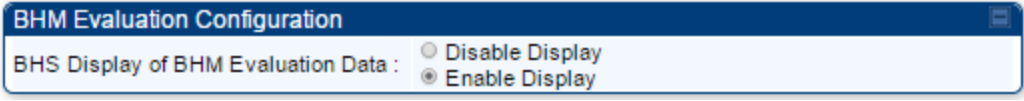
Attribute	Meaning
	<p>AES (Advanced Encryption Standard): An over-the-air link encryption option that uses the Rijndael algorithm and 128-bit keys to establish a higher level of security. AES products are certified as compliant with the Federal Information Processing Standards (FIPS 197) in the U.S.A.</p> <div style="display: flex; align-items: center;">  <div style="border: 1px solid #ccc; background-color: #e6f2ff; padding: 5px; width: fit-content;"> <p>Note</p> <p>This parameter is applicable to BHM.</p> </div> </div>
<p>SM Display of AP Evaluation Data</p> <p>Or</p> <p>BHS Display of BHM Evaluation Data</p>	<p>Allows operators to suppress the display of data about this AP/BHM on the AP/BHM Evaluation tab of the Tools page in all SMs/BHS that register. The factory default setting for SM Display of AP Evaluation Data or BHS Display of BHM Evaluation Data is enabled display.</p> <p>PMP 450/450i Series – SM display of AP Evaluation Data parameter</p>  <p>PTP 450/450i Series – BHS display of BHM Evaluation Data parameter</p> 
<p>Web, Telnet, FTP Session Timeout</p>	<p>Enter the expiry in seconds for remote management sessions via HTTP, telnet, or ftp access to the AP/BHM.</p>
<p>IP Access Control</p>	<p>You can permit access to the AP/BHM from any IP address (IP Access Filtering Disabled) or limit it to access from only one, two, or three IP addresses that you specify (IP Access Filtering Enabled). If you select IP Access Filtering Enabled, then you must populate at least one of the three Allowed Source IP parameters or have no access permitted from any IP address</p>
<p>Allowed Source IP 1 to 3</p>	<p>If you selected IP Access Filtering Enabled for the IP Access Control parameter, then you must populate at least one of the three Allowed Source IP parameters or have no access permitted to the AP from any IP address. You may populate as many as all three.</p> <p>If you selected IP Access Filtering Disabled for the IP Access Control parameter, then no entries in this parameter are read, and access from all IP addresses is permitted.</p>
<p>Web Access</p>	<p>The Radio supports secured and non-secured web access protocols. Select suitable web access from drop-down list:</p> <ul style="list-style-type: none"> • HTTP Only – provides non-secured web access. The radio to be accessed via <a href="http://<IP of Radio>">http://<IP of Radio>. • HTTPS Only – provides a secured web access. The radio to be accessed via

Attribute	Meaning
	<p><a href="https://<IP of Radio>">https://<IP of Radio>.</p> <ul style="list-style-type: none"> • HTTP and HTTPS – If enabled, the radio can be accessed via both http and https.
SNMP	<p>This option allows to configure SNMP agent communication version. It can be selected from drop-down list:</p> <ul style="list-style-type: none"> • SNMPv2c Only – Enables SNMP v2 community protocol. • SNMPv3 Only – Enables SNMP v3 protocol. It is a secured communication protocol. • SNMPv2c and SNMPv3 – It enables both the protocols.
Telnet	This option allows to Enable and Disable Telnet access to the Radio.
FTP	This option allows to Enable and Disable FTP access to the Radio.
TFTP	This option allows to Enable and Disable TFTP access to the Radio.
NTP Server	This option allows to Enable and Disable NTP server access to the Radio.
SSH Server	This option allows to Enable and Diabale SSH server access to the Radio.
Upload Certificate File	
Certificate	
Site Information viewable to Guest Users	This option allows to Enable or Disable displaying site information with Guest users.
Site Name	Specify a string to associate with the physical module.
Site Contact	Enter contact information for the module administrator.
Site Location	Enter information about the physical location of the module.
Enable Security Banner during Login	<p>Enable: The Security Banner Notice will be displayed before login.</p> <p>Disable: The Security Banner Notice will not be displayed before login.</p>
Security Banner Notice	User can enter ASCII (0-9a-zA-Z newline, line-feed are allowed) text up-to 1300 characters.
User must accept security banner before login	<p>Enable: login area (username and password) will be disabled unless user accepts the security banner.</p> <p>Disable: User can't login to radio without accepting security banner.</p>

TLS 1.2 and 1.3

Software release 16.1.5 supports web server using TLS 1.2 and TLS 1.3 for HTTPS connections. Protocol version will be selected after handshake.

User Certificate Import

This feature allows users to import their own certificate to be used by HTTPS server. This option can be found under Configuration > Security.

Users can import a certificate in PKCS12 format which contains a private key and certificate signed CA. Private key can be password protected and a password field is also given to user while importing.

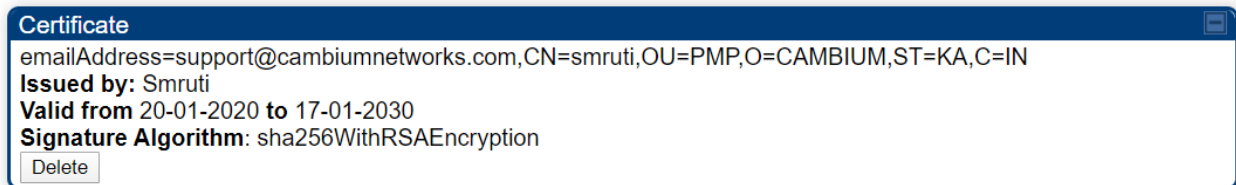
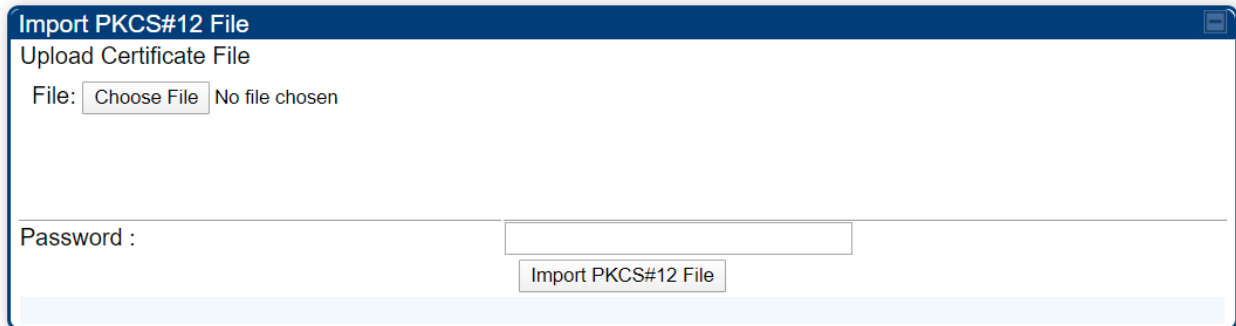

After successful import the certificate information will be displayed as follows.

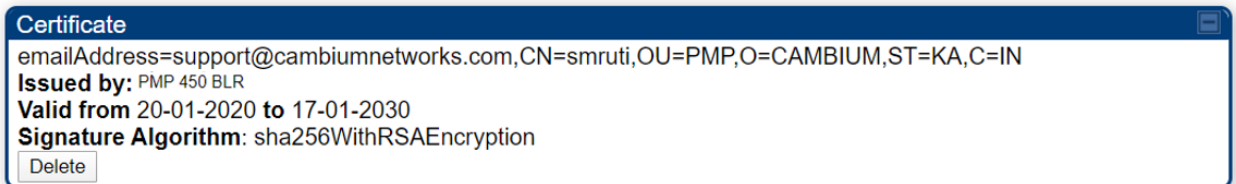

Security page – 450 Platform Family BHM

The security page of AP/BHM is explained in below table.

Table 42 :Security attributes –450 Platform Family BHM

Authentication Mode	
Authentication Mode :	<input type="radio"/> Authentication Required <input checked="" type="radio"/> Authentication Disabled
Authentication Key 128-bit :	<input type="text"/> (Using All 0xFF's Key)

Airlink Security	
24 Hour Encryption Refresh :	<input type="radio"/> Enable <input checked="" type="radio"/> Disable
Encryption Setting :	<input type="text" value="None"/>

BHM Evaluation Configuration	
BHS Display of BHM Evaluation Data :	<input type="radio"/> Disable Display <input checked="" type="radio"/> Enable Display

Session Timeout	
Web, Telnet, FTP Session Timeout :	<input type="text" value="600"/> Seconds

IP Access Filtering	
IP Access Control :	<input type="radio"/> IP Access Filtering Enabled - Only allow access from IP addresses specified below <input checked="" type="radio"/> IP Access Filtering Disabled - Allow access from all IP addresses
Allowed Source IP 1 :	<input type="text" value="0.0.0.0"/> / <input type="text" value="32"/> Network Mask (set to 32 to disable)
Allowed Source IP 2 :	<input type="text" value="0.0.0.0"/> / <input type="text" value="32"/> Network Mask (set to 32 to disable)
Allowed Source IP 3 :	<input type="text" value="0.0.0.0"/> / <input type="text" value="32"/> Network Mask (set to 32 to disable)

Security Mode	
Web Access :	<input type="text" value="HTTP Only"/>
SNMP :	<input type="text" value="SNMPv2c Only"/>
Telnet :	<input checked="" type="radio"/> Enabled <input type="radio"/> Disabled
FTP :	<input checked="" type="radio"/> Enabled <input type="radio"/> Disabled
TFTP :	<input checked="" type="radio"/> Enabled <input type="radio"/> Disabled
NTP server :	<input checked="" type="radio"/> Enabled <input type="radio"/> Disabled

Site Information	
Site Information Viewable to Guest Users :	<input checked="" type="radio"/> Enabled <input type="radio"/> Disabled
Site Name :	<input type="text" value="246 BHTM 4.9/5.9 MIMO PTP450i"/>
Site Contact :	<input type="text" value="No Site Contact"/>
Site Location :	<input type="text" value="Canopy FW Screen Room"/>

Security Banner	
Enable Security Banner during Login :	<input type="radio"/> Enabled <input checked="" type="radio"/> Disabled
Security Banner Notice :	<input type="text"/>
User must accept security banner before login :	<input type="radio"/> Enabled <input type="radio"/> Disabled

Attribute	Meaning
Authentication Mode	<p>Operators may use this field to select from among the following authentication modes:</p> <p>Authentication Required: the BHS requires to be authenticated.</p> <p>Authentication Disabled: the BHM requires no BHS to authenticate. (Factory default).</p>
Authentication Key 128-bit	Refer Security attributes -450 Platform Family AP for parameter details
24 Hour Encryption Refresh	<p>Operators may use this field to select from among the following options:</p> <p>Enabled: Allows BHS re-registration every 24 hours.</p> <p>Disabled: Disables 24-hour encryption refresh.</p> <p>This parameter is disabled by default.</p>
Encryption Setting	Refer Security attributes -450 Platform Family AP for parameter details
BHS Display of BHM Evaluation Data	
Web, Telnet, FTP Session Timeout	
IP Access Control	
Allowed Source IP 1 to 3	
Web Access	
SNMP	
Telnet	
FTP	
TFTP	
NTP Server	
Site Information viewable to Guest Users	Refer Security attributes -450 Platform Family AP for parameter details
Site Name	
Site Contact	
Site Location	
Enable Security Banner during Login	
Security Banner Notice	
User must accept security banner before login	

Security page - 450 Platform Family SM

The security page of 450 Platform Family SM is explained in below table.

Table 43 :Security attributes –450 Platform Family SM

Authentication Key Settings	
Authentication Key 128-bit :	<input type="text"/> (Using All 0xFF's Key)
Select Key 128-bit :	<input type="radio"/> Use Key above <input checked="" type="radio"/> Use Default Key
Disable AES-128 :	<input type="radio"/> AES-128 Encryption Disabled <input checked="" type="radio"/> AES-128 Encryption Available
Authentication Key 256-bit :	<input type="text"/> (Using All 0xFF's Key)
Select Key 256-bit :	<input type="radio"/> Use Key above <input checked="" type="radio"/> Use Default Key

AAA Authentication Settings	
Enforce Authentication :	Disable
Phase 1 :	eapttl
Phase 2 :	MSCHAPv2
Identity/Realm :	<input type="radio"/> Enable Realm <input checked="" type="radio"/> Disable Realm
	Identity <input type="text" value="anonymous"/> @ Realm <input type="text" value="canopy.net"/>
Username :	<input type="text" value="0a-00-3e-bb-40-d2"/> <input type="button" value="Use Default Username"/>
Password :	<input type="password" value="*****"/>
Confirm Password :	<input type="password"/>

RADIUS Certificate Settings	
Upload Certificate File	
File:	<input type="button" value="Browse..."/> No file selected.
<input type="button" value="Import Certificate"/>	
<input type="button" value="Use Default Certificates"/>	
<i>This will delete all current certificates</i>	

Certificate 1

C =US
 S =Illinois
 O =Motorola Solutions, Inc.
 OU =Canopy Wireless Broadband
 CN =Canopy AAA Server Demo CA
 E =technical-support@canopywireless.com
 Valid From: 01/01/2001 00:00:00
 Valid To: 12/31/2049 23:59:59

Certificate 2

C =US
 S =Illinois
 O =Motorola, Inc.
 OU =Canopy Wireless Broadband
 CN =PMP320 Demo CA
 Valid From: 07/01/2009 06:00:00
 Valid To: 12/31/2049 23:59:59

Airlink Security

Encryption Setting :

Session Timeout

Web, Telnet, FTP Session Timeout : Seconds

SM Management Interface Access via Ethernet Port

Ethernet Access : Enabled
 Disabled

IP Access Filtering

IP Access Control : IP Access Filtering Enabled - Only allow access from IP addresses specified below
 IP Access Filtering Disabled - Allow access from all IP addresses

Allowed Source IP 1 :	<input type="text" value="0.0.0.0"/>	/	<input type="text" value="32"/>	Network Mask (set to 32 to disable)
Allowed Source IP 2 :	<input type="text" value="0.0.0.0"/>	/	<input type="text" value="32"/>	Network Mask (set to 32 to disable)
Allowed Source IP 3 :	<input type="text" value="0.0.0.0"/>	/	<input type="text" value="32"/>	Network Mask (set to 32 to disable)

Security Mode	
Web Access :	HTTP Only ▼
SNMP :	SNMPv2c Only ▼
Telnet :	<input checked="" type="radio"/> Enabled <input type="radio"/> Disabled
FTP :	<input checked="" type="radio"/> Enabled <input type="radio"/> Disabled
TFTP :	<input checked="" type="radio"/> Enabled <input type="radio"/> Disabled

Site Information	
Site Information Viewable to Guest Users :	<input checked="" type="radio"/> Enabled <input type="radio"/> Disabled
Site Name :	No Site Name
Site Contact :	No Site Contact
Site Location :	No Site Location

Security Banner	
Enable Security Banner during Login :	<input type="radio"/> Enabled <input checked="" type="radio"/> Disabled
Security Banner Notice :	
User must accept security banner before login :	<input type="radio"/> Enabled <input type="radio"/> Disabled

Attribute	Meaning
Authentication Key 128-bit	Only if the AP to which this SM will register requires authentication, specify the 128-bit key that the SM will use when authenticating. For alpha characters in this 32-character hex key, use only upper case.
Select Key 128-bit	Refer Security attributes -450 Platform Family AP for parameter details.
Disable AES 128-bit	
Authentication Key 256-bit	

Attribute	Meaning
Select Key 256-bit	
Enforce Authentication	The SM may enforce authentication types of AAA and AP Pre-sharedKey. The SM will not finish the registration process if the AP is not using the configured authentication method (and the SM locks out the AP for 15 minutes).
Phase 1	The protocols supported for the Phase 1 (Outside Identity) phase of authentication are EAPTTLS (Extensible Authentication Protocol Tunneled Transport Layer Security) or MSCHAPv2 (Microsoft Challenge-Handshake Authentication Protocol version 2).
Phase 2	Select the desired Phase 2 (Inside Identity) authentication protocol from the Phase 2 options of PAP (Password Authentication Protocol), CHAP (Challenge Handshake Authentication Protocol), and MSCHAP (Microsoft's version of CHAP, version 2 is used). The protocol must be consistent with the authentication protocol configured on the RADIUS server.
Identity/Realm	<p>If Realms are being used, select Enable Realm and configure an outer identity in the Identity field and a Realm in the Realm field. These must match the Phase 1/Outer Identity and Realm configured in the RADIUS server. The default Identity is "anonymous". The Identity can be up to 128 non-special (no diacritical markings) alphanumeric characters. The default Realm is "canopy.net". The Realm can also be up to 128 non-special alphanumeric characters.</p> <p>Configure an outer Identity in the Username field. This must match the Phase 1/Outer Identity username configured in the RADIUS server. The default Phase 1/Outer Identity Username is "anonymous". The Username can be up to 128 non-special (no diacritical markings) alphanumeric characters.</p>
Username	Enter a Username for the SM. This must match the username configured for the SM on the RADIUS server. The default Username is the SM's MAC address. The Username can be up to 128 non-special (no diacritical markings) alphanumeric characters.
Password	Enter the desired password for the SM in the Password and Confirm Password fields. The Password must match the password configured for the SM on the RADIUS server. The default Password is "password". The Password can be up to 128 non-special (no diacritical markings) alphanumeric characters
Upload Certificate File	<p>To upload a certificate manually to a SM, first load it in a known place on your PC or network drive, then click on a Delete button on one of the Certificate description blocks to delete a certificate to provide space for your certificate. Click on Choose File, browse to the location of the certificate, and click the Import Certificate button, and then reboot the radio to use the new certificate.</p> <p>When a certificate is in use, after the SM successfully registers to an AP, an indication of In Use will appear in the description block of the certificate being used.</p> <p>The public certificates installed on the SMs are used with the private certificate on the RADIUS server to provide a public/private key encryption system.</p> <p>Up to 2 certificates can be resident on a SM. An installed certificate can be deleted by clicking the Delete button in the certificate's description block on the Configuration ></p>

Attribute	Meaning
	Security tab. To restore the 2 default certificates, click the Use Default Certificates button in the RADIUS Certificate Settings parameter block and reboot the radio.
Encryption Setting	<p>Specify the type of airlink security to apply to this SM. The encryption setting must match the encryption setting of the AP.</p> <p>None provides no encryption on the air link.</p> <p>AES (Advanced Encryption Standard): An over-the-air link encryption option that uses the Rijndael algorithm and 128-bit keys to establish a higher level of security. AES products are certified as compliant with the Federal Information Processing Standards (FIPS 197) in the U.S.A.</p>
Web, Telnet, FTP Session Timeout	Enter the expiry in seconds for remote management sessions via HTTP, telnet, or FTP access to the SM.
Ethernet Access	<p>If you want to prevent any device that is connected to the Ethernet port of the SM from accessing the management interface of the SM, select Ethernet Access Disabled. This selection disables access through this port to via HTTP (the GUI), SNMP, telnet, FTP, and TFTP. With this selection, management access is available through only the RF interface via either an IP address (if Network Accessibility is set to Public on the SM) or the Session Status or Remote Subscribers tab of the AP.</p> <div data-bbox="409 949 477 1024" style="display: inline-block; vertical-align: middle;"> </div> <div data-bbox="539 940 1424 1155" style="border: 1px solid black; background-color: #e6f2ff; padding: 5px; margin-left: 20px;"> <p>Note</p> <p>This setting does not prevent a device connected to the Ethernet port from accessing the management interface of other SMs in the network. To prevent this, use the IP Access Filtering Enabled selection in the IP Access Control parameter of the SMs in the network. See IP Access Control below.</p> </div> <p>If you want to allow management access through the Ethernet port, select Ethernet Access Enabled. This is the factory default setting for this parameter.</p>
IP Access Control	You can permit access to the SM from any IP address (IP Access Filtering Disabled) or limit it to access from only one, two, or three IP addresses that you specify (IP Access Filtering Enabled). If you select IP Access Filtering Enabled, then you must populate at least one of the three Allowed Source IP parameters or have no access permitted from any IP address
Allowed Source IP 1 to 3	<p>If you selected IP Access Filtering Enabled for the IP Access Control parameter, then you must populate at least one of the three Allowed Source IP parameters or have no access permitted to the SM from any IP address. You may populate as many as all three.</p> <p>If you selected IP Access Filtering Disabled for the IP Access Control parameter, then no entries in this parameter are read, and access from all IP addresses is permitted.</p> <p>A subnet mask may be defined for each entry to allow for filtering control based on a range of IP addresses.</p>
Web Access	The Radio supports secured and non-secured web access protocols. Select suitable web access from drop-down list:

Attribute	Meaning
	<ul style="list-style-type: none"> • HTTP Only - provides non-secured web access. The radio to be accessed via http://<IP of Radio>. • HTTPS Only - provides a secured web access. The radio to be accessed via https://<IP of Radio>. • HTTP and HTTPS - If enabled, the radio can be accessed via both http and https.
SNMP	<p>This option allows to configure SNMP agent communication version. It can be selected from drop-down list :</p> <ul style="list-style-type: none"> • SNMPv2c Only - Enables SNMP v2 community protocol. • SNMPv3 Only - Enables SNMP v3 protocol. It is secured communication protocol. • SNMPv2c and SNMPv3 - It enables both the protocols.
Telnet	This option allows to Enable and Disable Telnet access to the Radio.
FTP	This option allows to Enable and Disable FTP access to the Radio.
TFTP	This option allows to Enable and Disable TFTP access to the Radio.
Site Information viewable to Guest Users	This option allows to Enable or Disable displaying site information with Guest users.
Site Name	Specify a string to associate with the physical module.
Site Contact	Enter contact information for the module administrator.
Site Location	Enter information about the physical location of the module.
Enable Security Banner during Login	<p>Enable: The Security Banner Notice will be displayed before login.</p> <p>Disable: The Security Banner Notice will not be displayed before login.</p>
Security Banner Notice	User can enter ASCII (0-9a-zA-Z newline, line-feed are allowed) text up-to 1300 characters.
User must accept security banner before login	<p>Enable: login area (username and password) will be disabled unless user accepts the security banner.</p> <p>Disable: User can't login to radio without accepting security banner.</p>

Security page –450 Platform Family BHS

The Security page of 450 Platform Family BHS is explained in below table.

Table 44 :Security attributes - 450 Platform Family BHS

Authentication Key Settings	
Authentication Key 128-bit :	<input type="text"/> (Using All 0xFF's Key)
Disable AES-128 :	<input type="radio"/> AES-128 Encryption Disabled <input checked="" type="radio"/> AES-128 Encryption Available
Authentication Key 256-bit :	<input type="text"/> (Using All 0xFF's Key)

Session Timeout	
Web, Telnet, FTP Session Timeout :	<input type="text" value="600"/> Seconds

IP Access Filtering	
IP Access Control :	<input type="radio"/> IP Access Filtering Enabled - Only allow access from IP addresses specified below <input checked="" type="radio"/> IP Access Filtering Disabled - Allow access from all IP addresses
Allowed Source IP 1 :	<input type="text" value="0.0.0.0"/> / <input type="text" value="32"/> Network Mask (set to 32 to disable)
Allowed Source IP 2 :	<input type="text" value="0.0.0.0"/> / <input type="text" value="32"/> Network Mask (set to 32 to disable)
Allowed Source IP 3 :	<input type="text" value="0.0.0.0"/> / <input type="text" value="32"/> Network Mask (set to 32 to disable)

Security Mode	
Web Access :	<input type="text" value="HTTP Only"/>
SNMP :	<input type="text" value="SNMPv2c Only"/>
Telnet :	<input checked="" type="radio"/> Enabled <input type="radio"/> Disabled
FTP :	<input checked="" type="radio"/> Enabled <input type="radio"/> Disabled
TFTP :	<input checked="" type="radio"/> Enabled <input type="radio"/> Disabled

Site Information	
Site Information Viewable to Guest Users :	<input checked="" type="radio"/> Enabled <input type="radio"/> Disabled
Site Name :	<input type="text" value="No Site Name"/>
Site Contact :	<input type="text" value="No Site Contact"/>
Site Location :	<input type="text" value="No Site Location"/>

Security Banner	
Enable Security Banner during Login :	<input type="radio"/> Enabled <input checked="" type="radio"/> Disabled
Security Banner Notice :	<input type="text"/>
User must accept security banner before login :	<input type="radio"/> Enabled <input type="radio"/> Disabled

Site Information	
Site Information Viewable to Guest Users :	<input checked="" type="radio"/> Enabled <input type="radio"/> Disabled
Site Name :	No Site Name
Site Contact :	No Site Contact
Site Location :	No Site Location

Security Banner	
Enable Security Banner during Login :	<input type="radio"/> Enabled <input checked="" type="radio"/> Disabled
Security Banner Notice :	
User must accept security banner before login :	<input type="radio"/> Enabled <input type="radio"/> Disabled

Attribute	Meaning
Authentication Key	Only if the BHM to which this BHS registers requires an authentication, specify the key that the BHS will use when authenticating. For alpha characters in this hex key, use only upper case.
Disable AES 128-bit	Refer Security attributes -450 Platform Family AP for parameter details.
Authentication Key 256-bit	
Web, Telnet, FTP Session Timeout	Enter the expiry in seconds for remote management sessions via HTTP, telnet, or FTP access to the BHS.
IP Access Control	You can permit access to the BHS from any IP address (IP Access Filtering Disabled) or limit it to access from only one, two, or three IP addresses that you specify (IP Access Filtering Enabled). If you select IP Access Filtering Enabled, then you must populate at least one of the three Allowed Source IP parameters or have no access permitted from any IP address
Allowed Source IP 1 to 3	<p>If you selected IP Access Filtering Enabled for the IP Access Control parameter, then you must populate at least one of the three Allowed Source IP parameters or have no access permitted to the BHS from any IP address. You may populate as many as all three.</p> <p>If you selected IP Access Filtering Disabled for the IP Access Control parameter, then no entries in this parameter are read, and access from all IP addresses is permitted.</p> <p>A subnet mask may be defined for each entry to allow for filtering control based on a range of IP addresses.</p>

Attribute	Meaning
Web Access	<p>The Radio supports secured and non-secured web access protocols. Select suitable web access from drop-down list:</p> <ul style="list-style-type: none"> • HTTP Only - provides non-secured web access. The radio to be accessed via http://<IP of Radio>. • HTTPS Only - provides a secured web access. The radio to be accessed via https://<IP of Radio>. • HTTP and HTTPS - If enabled, the radio can be accessed via both http and https.
SNMP	<p>This option allows to configure SNMP agent communication version. It can be selected from drop-down list:</p> <ul style="list-style-type: none"> • SNMPv2c Only - Enables SNMP v2 community protocol. • SNMPv3 Only - Enables SNMP v3 protocol. It is secured communication protocol. • SNMPv2c and SNMPv3 - It enables both the protocols.
Telnet	This option allows to Enable and Disable Telnet access to the Radio.
FTP	This option allows to Enable and Disable FTP access to the Radio.
TFTP	This option allows to Enable and Disable TFTP access to the Radio.
Site Information viewable to Guest Users	Refer Security attributes -450 Platform Family AP for parameter details.
Site Name	
Site Contact	
Site Location	
Enable Security Banner during Login	
Security Banner Notice	
User must accept security banner before login	

Configuring 802.1X authentication

IEEE 802.1x standard defines a client and server-based access control and authentication protocol. This protocol restricts unauthorized clients from connecting to a LAN through publicly accessible ports.

The authentication server authenticates each client connected to SM's ethernet port and enables the port before making available any services offered by the SM, AP, and the network. Until the client is authenticated, 802.1x access control allows only Extensible Authentication Protocol over LAN (EAPoL) traffic through the port to which the client is connected. After authentication is successful, normal traffic can pass through the port.

Two types of authentication mode are supported:

- Port based authentication: This mode needs to be used when single host is connected to the SM. If the authentication is successful by the host connected to the SM, SM port is enabled, and all traffic will pass through.
- MAC Address Based Authentication: This mode needs to be used when multiple hosts are connected to the SM. Each host needs to be authenticated by 802.1X protocol to access the network. The traffic is filtered based on the source MAC Address of the host, only the traffic from authenticated host will be allowed to access the network.

802.1X authentication page of AP

The 802.1X Authentication page of AP is explained in below table.

Table 45 :802.1X authentication attributes –450 Platform Family AP

Attribute	Meaning
802.1X Authentication	This parameter is used to enable or disable 802.1X authentication. It is disabled by default.
802.1X Authentication Server DNS Usage	This parameter is enabled when server address is in fully qualified domain name format.
Shared Secret	This parameter specifies the the shared secret which is configured for this client on RADIUS server. Maximum length of this parameter is 32 characters.
802.1X Authentication Server	This parameter specifies either a dotted decimal notation (IP address) or fully qualified domain name (www.google.com). Maximum length of this parameter is 256 characters.

802.1x authentication page of SM

The 802.1X Authentication page of SM is explained in below table.

Table 46 :802.1X authentication attributes –450 Platform Family SM

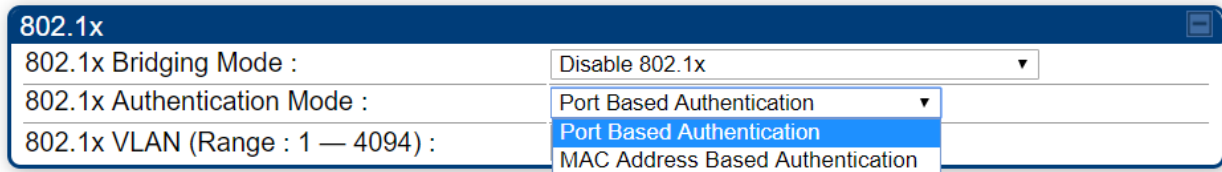

Attribute	Meaning
802.1x Bridging Mode	<p>This parameter specifies the bridging mode used by SM. It is disabled by default.</p> <p>Following are the available options for this parameter.</p> <ul style="list-style-type: none"> • Disable 802.1x: Disable 802.1x authentication. • Require 802.1x for all traffic: 802.1x authentication should be successful for any traffic to pass through the SM (i.e. Authenticator). • Require 802.1x for all non-management traffic: Management traffic will be allowed to pass through the SM without 802.1x Authentication.
802.1x Authentication Mode	<p>This parameter specifies the authentication mode used by SM.</p> <ul style="list-style-type: none"> • Port Based Authentication: SM port is activated once the 802.1x authentication is successful. This configuration needs to be used when single host is connected behind SM. If authentication is successful, SM port is enabled, and all traffic will pass through. • MAC Address Based Authentication: This option needs to be used when multiple hosts are connected behind an SM. Each host needs to be authenticated by 802.1x protocol to access the network. The traffic is filtered based on the source MAC address of the host, only the traffic from authenticated host will be allowed to access the network.
802.1x VLAN (Range : 1 — 4094)	<p>This parameter specifies the number of VLAN configurations. It ranges from 1 to 4094.</p> <p>VLAN configuration is used for sending 802.1x packet on the configured VLAN. If a customer expects EAPoL packets on a VLAN, customer needs to configure the VLAN. Once VLAN is configured, all EAPoL packets are exchanged on the configured VLAN. VLAN 1 is the default configuration which is equivalent to untagged traffic.</p>

Configuring radio parameters

- PMP 450m Series - configuring radio
- PMP/PTP 450i Series - configuring radio
- PMP/PTP 450b Series - configuring radio
- PMP/PTP 450 Series - configuring radio
- Custom Frequencies page
- DFS for 5 GHz Radios

- MIMO-A mode of operation
- Improved PPS performance of 450 Platform Family

PMP 450 m Series – configuring radio

Radio page - PMP 450 m AP 5 GHz

The Radio tab of the PMP 450m AP contains some of the configurable parameters that define how an AP operates.



Note

Only the frequencies available for your region and the selected Channel bandwidth are displayed.

Table 47 :PMP 450m AP Radio attributes - 5 GHz

Radio Configuration	
Frequency Band :	5.4 GHz ▾
Frequency Carrier :	None ▾
Channel Bandwidth :	20 MHz ▾
Frame Period :	<input type="radio"/> 5.0 ms <input checked="" type="radio"/> 2.5 ms
Cyclic Prefix :	One Sixteenth
Color Code :	0 (0—254)
Subscriber Color Code Rescan (When not on a Primary Color Code) :	0 Minutes (0 — 43200)
Subscriber Color Code Wait Period for Idle :	0 Minutes (0 — 60)
Installation Color Code :	<input type="radio"/> Enabled <input checked="" type="radio"/> Disabled
Sector ID :	0 ▾

MAC Control Parameters	
MIMO Rate Adapt Algorithm :	MIMO-A/B ▾
Downlink Maximum Modulation Rate :	8x ▾
Uplink Maximum Modulation Rate :	8x ▾

Frame Configuration	
Max Range :	2 miles ▾ (Range: 1 — 40 miles / 64 km)
Downlink Data :	75 % (Range: 15 — 85 %)
Contention Slots :	3 (Range: 1 — 15)
Broadcast Repeat Count :	2 (Range: 0 — 2)

Power Control	
EIRP :	33 dBm (Range: +22 — +48 dBm)
SM Receive Target Level :	-52 dBm (Range: -77 — -37 dBm) combined power
Adjacent Channel Support :	<input type="radio"/> Enabled <input checked="" type="radio"/> Disabled

Multicast Data Control	
Multicast Data Channel :	Disable ▾
Multicast Repeat Count :	0 (Range: 0 — 2)
Multicast Downlink CIR :	0 (kbps) (Range: 0 — 12187 kbps)

Advanced	
SM Registration Limit :	238 (Range: 1 — 238)
Receive Quality Debug :	<input type="radio"/> Enabled <input checked="" type="radio"/> Disabled
SM Link Test Mode Restriction :	<input type="radio"/> Enabled <input checked="" type="radio"/> Disabled

Attribute	Meaning
Frequency Band	Select the desired operating frequency band.

Attribute	Meaning
Frequency Carrier	Specify the frequency for the module to transmit. The default for this parameter is None. For a list of channels in the band, see the drop-down list on the radio GUI.
Channel Bandwidth	<p>The channel size used by the radio for RF transmission. The setting for the channel bandwidth must match between the AP and the SM. The supported Channel Bandwidths are 5 MHz, 10 MHz, 15 MHz, 20 MHz, 30 MHz, and 40 MHz.</p> <div style="display: flex; align-items: center;">  <div style="border: 1px solid black; background-color: #e6f2ff; padding: 5px;"> <p>Note: 40 MHz is not supported on PMP 450 AP, but is supported on PMP 450 SMs.</p> </div> </div>
Frame Period	Select the Frame Period of the radio. The supported Frame Periods are: 5 ms and 2.5 ms.
Cyclic Prefix	OFDM technology uses a cyclic prefix, where a portion of the end of a symbol (slot) is repeated at the beginning of the symbol to allow multi-pathing to settle before receiving the desired data. A 1/16 cyclic prefix means that for every 16 bits of throughput data transmitted, an additional bit is used.
Color Code	<p>Specify a value from 0 to 254. For registration to occur, the color code of the SM and the AP must match. Color code is not a security feature. Instead, color code is a management feature, typically for assigning each sector a different color code.</p> <p>Color code allows you to force a SM to register to only a specific AP, even where the SM can communicate with multiple APs. The default setting for the color code value is 0. This value matches only the color code of 0 (not all 255 color codes).</p>
Subscriber Color Code Rescan (When not on a Primary Color Code)	<p>This timer may be utilized to initiate SM rescans in order to register to an AP configured with the SM's primary color code.</p> <p>The time (in minutes) for a subscriber to rescan (if this AP is not configured with the SM's primary color code). This timer will only fire once - if the Subscriber Color Code Wait Period for Idle timer is configured with a nonzero value and the Subscriber Color Code Rescan expires, the Subscriber Color Code Wait Period for Idle is started. If the Subscriber Color Code Wait Period for Idle timer is configured with a zero value and the Subscriber Color Code Rescan timer expires, the SM will immediately go into rescan mode</p>
Subscriber Color Code Wait Period for Idle	The time (in minutes) for a subscriber to rescan while idle (if this AP is not configured with the SM's primary color code). This timer will fire periodic events. The fired event determines if any RF unicast traffic (either inbound or outbound) has occurred since the last event. If the results of the event determine that no RF unicast traffic has occurred (SM is idle), then the subscriber will rescan.
Installation Color Code	With this feature enabled on the AP and SM, operators may install and remotely configure SMs without having to configure matching color codes between the modules. While the SM is accessible for configuration from above the AP (for remote provisioning) and below the SM (for local site provisioning), no user data is passed over the radio link. When using the Installation Color Code feature, ensure that the SM is configured with the factory default Color Code configuration (Color Code 1 is "0", Color Code 2-10 set to "0" and "Disable"). The status of the Installation Color Code can be

Attribute	Meaning
	viewed on the AP Eval web GUI page, and when the SM is registered using the Installation Color Code the message “SM is registered via ICC – Bridging Disabled!” is displayed in red on every SM GUI page. The Installation Color Code parameter is configurable without a radio reboot for both the AP and SM. If a SM is registered via Installation Color Code and the feature is then disabled, operators will need to reboot the SM or force it to reregister (i.e. using Rescan APs functionality on the AP Eval page).
Sector ID	This pull-down menu helps in configuring the Sector ID at a configurable value from 0 to 15.
MIMO Rate Adapt Algorithm	This pull-down menu helps in configuring the Rate Adapt Algorithm to MIMO- A/B, MIMO-B only, or MIMO-A only.
Downlink Maximum Modulation Rate	This pull-down menu helps in configuring the Downlink Maximum Modulation Rate at a configurable rate of 1X, 2X, 3X, 4X, 6X, or 8X. The default value is “8X”. The Rate Adapt Algorithm does not allow the modulation to go beyond this limit.
Uplink Maximum Modulation Rate	This pull-down menu helps in configuring the Uplink Maximum Modulation Rate at a configurable rate of 1X, 2X, 3X, 4X, 6X, or 8X. The default value is “8X”. The Rate Adapt Algorithm does not allow the modulation to go beyond this limit.
Max Range	<p>Enter the number of miles or kilometers for the furthest distance from which a SM is allowed to register to this AP. Do not set the distance to any greater number of miles. A greater distance</p> <ul style="list-style-type: none"> • does not increase the power of transmission from the AP. • can reduce aggregate throughput. <p>For example, with a 20 MHz channel and 2.5 ms frame, every additional 2.24 miles reduces the data air time by one symbol (around 1% of the frame).</p> <p>Regardless of this distance, the SM must meet the minimum requirements for an acceptable link. The parameters have to be selected so that there is no overlap between one AP transmitting and another AP receiving. A co-location tool is provided to help with selecting sets of parameters that allow co-location.</p> <p>The default value of this parameter is 2 miles (3.2 km).</p>
Downlink Data	<p>Specify the percentage of the aggregate throughput for the downlink (frames transmitted from the AP to the subscriber). For example, if the aggregate (uplink and downlink total) throughput on the AP is 90 Mb, then 75% specified for this parameter allocates 67.5 Mb for the downlink and 22.5 Mb for the uplink. The default for this parameter is 75%. This parameter must be set in the range of 15% - 85%, otherwise the invalid input will not be accepted and the previously-entered valid setting is used.</p> <div style="border: 1px solid black; background-color: #e6f2ff; padding: 5px; margin-top: 10px;"> <p> Note</p> <p>In order to prevent self-interference, the frame configuration needs to align which includes Downlink Data, Max Range and Contention slots. For DFS regions, the maximum Downlink % for a 5.4 GHz radio is 75% only.</p> </div>

Attribute	Meaning
Contention Slots	This field indicates the number of (reserved) Contention slots configured by the operator. The SM uses reserved Contention slots and unused data slots for bandwidth requests. See Contention slots on page "Contention slots" on page 238.
Broadcast Repeat Count	For PMP systems broadcast packets are not acknowledged. So, they are sent at the lowest modulation rate 1X. This setting adds an automatic retransmission to broadcast packets to give SMs that have poor signal a higher chance to get the packet.
EIRP	This field indicates the combined power level at which the AP will transmit, based on the Country Code. It also includes the antenna gain and array gain.
SM Receive Target Level	Each SM's Transmitter Output Power is automatically set by the AP. The AP monitors the received power from each SM, and adjusts each SM's Transmitter Output Power so that the received power at the AP from that SM is not greater what is set in this field. This value represents the transmitted and received power (combined power) perceived on the SM.
Adjacent Channel Support	For some frequency bands and products, this setting is needed if AP is operating on adjacent channels with zero guard band.
Multicast Data Channel	This pull-down menu of the Multicast Data Control screen helps in configuring multicast packets to be transmitted over a dedicated channel at a configurable rate of 2X, 4X or 6X. The default value is "Disable". If set to the default value, all multicast packets are transmitted over the Broadcast VC data path. This feature is available only for the PMP 450 Series and is not backward compatible with PMP 430 series of radios.
Multicast Repeat Count	This value is the number of packets that are repeated for every multicast VC packet received on the AP (located under Radio tab of Configuration). Multicast (like Broadcast) packets go over a VC that is shared by all SMs, so there is no guaranteed delivery. The repeat count is an attempt to improve the odds of the packets getting over the link. If the user has issues with packets getting dropped, they can use this parameter to improve the performance at the cost of the overall throughput possible on that channel. The default value is 0.
Multicast Downlink CIR	This value is the committed information rate for the multicast downlink VC (located under the Radio tab of Configuration). The default value is 0 kbps. The range of this parameter is based on the number of repeat counts. The higher the repeat count, the lower the range for the multicast downlink CIR.
SM Registration Limit	<p>This parameter allows to configure the limit for maximum number of SMs that can register to a PMP AP. The configurable range is from 1 to 238.</p> <div style="display: flex; align-items: center;">  <div style="border: 1px solid black; background-color: #e6f2ff; padding: 5px;"> <p>Note</p> <p>SM trying to register after the maximum configured limit has been reached is locked out for 15 minutes and a message is displayed at the SM.</p> </div> </div>
Receive Quality Debug	To aid in link performance monitoring, the AP and SM now report the number of fragments received per modulation (i.e. QPSK, 16-QAM, 64-QAM) and per channel (polarization).

Attribute	Meaning
	 <div style="border: 1px solid black; background-color: #e1f5fe; padding: 5px; margin-left: 20px;"> <p data-bbox="540 262 602 285">Note</p> <p data-bbox="540 308 1398 331">Due to CPU load, this will slightly degrade packet per second processing.</p> </div>
SM Link Test Mode Restriction	<p data-bbox="391 373 1224 396">Set to Enabled to allow only SM initiated link tests that pass user traffic.</p> <p data-bbox="391 422 959 445">Set to Disabled to allow all SM initiated link tests.</p>
Force Channel Reassessment	<p data-bbox="391 489 1424 548">Enabling this parameter forces channel reassessment for all registered SMs. This is generally used for demonstrations and other engineering purposes.</p>
Near Field Operation	<p data-bbox="391 604 1424 663">This parameter enables operation in the near field. This is only available when the EIRP is set to 22 dBm or below.</p>
Near Filed Range	<p data-bbox="391 688 1424 747">When Near Field Operation is enabled, the Near Field Range is used to apply compensation to the unit's calibration to support operation in the near field.</p>

Radio page - PMP 450 m AP 3 GHz

Table 48 :PMP 450m AP Radio attributes - 3 GHz

Radio Configuration	
Frequency Band :	3.6 GHz ▾
Frequency Carrier :	None ▾
Channel Bandwidth :	20 MHz ▾
Frame Period :	<input type="radio"/> 5.0 ms <input checked="" type="radio"/> 2.5 ms
Cyclic Prefix :	One Sixteenth
Color Code :	0 (0—254)
Subscriber Color Code Rescan (When not on a Primary Color Code) :	0 Minutes (0 — 43200)
Subscriber Color Code Wait Period for Idle :	0 Minutes (0 — 60)
Installation Color Code :	<input type="radio"/> Enabled <input checked="" type="radio"/> Disabled
Sector ID :	0 ▾

MAC Control Parameters	
MIMO Rate Adapt Algorithm :	MIMO-A/B ▾
Downlink Maximum Modulation Rate :	8x ▾
Uplink Maximum Modulation Rate :	8x ▾

Frame Configuration	
Max Range :	2 miles ▾ (Range: 1 — 40 miles / 64 km)
Downlink Data :	75 % (Range: 15 — 85 %)
Contention Slots :	3 (Range: 1 — 15)
Broadcast Repeat Count :	2 (Range: 0 — 2)

Power Control	
EIRP :	30 dBm (Range: +22 — +52 dBm)
SM Receive Target Level :	-52 dBm (Range: -77 — -37 dBm) combined power
Adjacent Channel Support :	<input type="radio"/> Enabled <input checked="" type="radio"/> Disabled

Multicast Data Control	
Multicast Data Channel :	Disable ▾
Multicast Repeat Count :	0 (Range: 0 — 2)
Multicast Downlink CIR :	0 (kbps) (Range: 0 — 12187 kbps)

Advanced	
SM Registration Limit :	238 (Range: 1 — 238)
Receive Quality Debug :	<input type="radio"/> Enabled <input checked="" type="radio"/> Disabled
SM Link Test Mode Restriction :	<input type="radio"/> Enabled <input checked="" type="radio"/> Disabled

Attribute	Meaning
Frequency Band	Refer PMP 450m AP Radio attributes - 5 GHz for parameter details
Frequency Carrier	
Channel Bandwidth	
Frame Period	
Cyclic Prefix	
Color Code	
Subscriber Color Code Rescan (When not on a Primary Color Code)	
Subscriber Color Code Wait Period for Idle	
Installation Color Code	
Sector ID	
MIMO Rate Adapt Algorithm	
Downlink Maximum Modulation Rate	
Uplink Maximum Modulation Rate	
Max Range	
Downlink Data	
Contention Slots (a.k.a. Control Slots)	
Broadcast Repeat Count	
EIRP	
SM Receive Target Level	
Adjacent Channel Support	
Multicast Data Channel	
Multicast Repeat Count	
Multicast Downlink CIR	
SM Registration Limit	
Receive Quality Debug	
SM Link Test Mode Restriction	
Force Channel Reassessment	
Near Field Operation	

PMP/ PTP 450i Series – configuring radio

Radio page - PMP 450i or 450 MicroPoP Unlimited AP 5 GHz

The Radio tab of the PMP 450i or 450 MicroPoP Unlimited AP contains some of the configurable parameters that define how an AP operates.

Table 49 :PMP 450i or 450 MicroPoP Unlimited AP Radio attributes - 5 GHz

Device Type	
Device Setting :	<input checked="" type="radio"/> AP <input type="radio"/> SM

Radio Configuration	
Frequency Band :	5.4 GHz ▾
Frequency Carrier :	None ▾
Channel Bandwidth :	10 MHz ▾
Frame Period :	<input type="radio"/> 5.0 ms <input checked="" type="radio"/> 2.5 ms
Cyclic Prefix :	One Sixteenth
Color Code :	0 (0—254)
Subscriber Color Code Rescan (When not on a Primary Color Code) :	0 Minutes (0 — 43200)
Subscriber Color Code Wait Period for Idle :	0 Minutes (0 — 60)
Installation Color Code :	<input type="radio"/> Enabled <input checked="" type="radio"/> Disabled
Sector ID :	0 ▾

MAC Control Parameters	
MIMO Rate Adapt Algorithm :	MIMO-A/B ▾
Downlink Maximum Modulation Rate :	8x ▾
Uplink Maximum Modulation Rate :	8x ▾

Frame Configuration	
Max Range :	2 miles ▾ (Range: 1 — 40 miles / 64 km)
Downlink Data :	75 % (Range: 15 — 85 %)
Contention Slots :	3 (Range: 1 — 15)
Auto Contention :	<input type="radio"/> Enabled <input checked="" type="radio"/> Disabled
Broadcast Repeat Count :	2 (Range: 0 — 2)

Power Control	
Transmit Power :	16 dBm (Range: -30 — +27 dBm) (13 dBm V / 13 dBm H)
External Gain :	0 dBi (Range: 0 — +40 dBi)
SM Receive Target Level :	-52 dBm (Range: -77 — -37 dBm) combined power
Adjacent Channel Support :	<input type="radio"/> Enabled <input checked="" type="radio"/> Disabled

Multicast Data Control	
Multicast Data Channel :	Disable ▾
Multicast Repeat Count :	0 (Range: 0 — 2)
Multicast Downlink CIR :	0 (kbps) (Range: 0 — 12187 kbps)

Advanced

SM Registration Limit : (Range: 1 — 238)

SM Registration : All (450i/450) 450i Only

Receive Quality Debug : Enabled Disabled

▼

Frame Alignment Legacy Mode : Choose Legacy Mode setting from the table below based on colocated radio's software revision and sync source:



Sync Src.\ SW Rev.	13.4.1 or higher	12.0 to 13.4 (DFS on)	12.0 to 13.4 (DFS off)	below 12.0
Timing Port	OFF	OFF	OFF	OFF
Power Port	OFF	OFF	ON (Mode 1)	OFF

SM Link Test Mode Restriction : Enabled Disabled

Attribute	Meaning
Device Setting	To configure the radio as an Access Point, select AP. To configure the radio as a Subscriber Module, select SM.
Frequency Band	See PMP 450m AP Radio attributes - 5 GHz
Frequency Carrier	
Alternate Frequency Carrier 1 and 2	Whenever the radio detects a radar pulse in either Channel Availability Check or In-Service Monitoring Modes on carrier frequency it moves the operation to a frequency configured as Alternate Frequency Carrier 1. If the radio detects a radar pulse on Alternate Frequency Carrier 1, it moves the operation to a frequency configured as Alternate Frequency Carrier 2. If the radio detects a radar pulse on Alternate Frequency Carrier 2 it moves the operation back to carrier frequency. So, there are three options in round-robin formation. These parameters are displayed based on Regional Settings. Refer Country
Channel Bandwidth	See PMP 450m AP Radio attributes - 5 GHz
Frame Period	
Cyclic Prefix	
Color Code	
Subscriber Color Code Rescan (When not on a Primary Color Code)	
Subscriber	

Attribute	Meaning
Color Code	
Wait Period for Idle	
Installation Color Code	
Sector ID	
MIMO Rate Adapt Algorithm	See PMP 450m AP Radio attributes - 5 GHz
Downlink Maximum Modulation Rate	
Uplink Maximum Modulation Rate	
Max Range	450 MicroPoP has a limit of 2 miles. To unlock from MicroPoP to MicroPoP Unlimited, a feature key must be purchased to remove this limitation.
Downlink Data	See PMP 450m AP Radio attributes - 5 GHz
Contention Slots (a.k.a. Control Slots)	This field indicates the number of (reserved) Contention slots configured by the operator. The SM uses reserved Contention slots and unused data slots for bandwidth requests. See Contention slots
Auto Contention	This parameter allows the operator to enable or disable Auto Contention.
Broadcast Repeat Count	The default is 2 repeats (in addition to the original broadcast packet, for a total of 3 packets sent for everyone needed), and is settable to 1 or 0 repeats (2 or 1 packets for every broadcast). ARQ (Automatic Repeat reQuest) is not present in downlink broadcast packets, since it can cause unnecessary uplink traffic from every SM for each broadcast packet. For successful transport without ARQ, the AP repeats downlink broadcast packets. The SMs filter out all repeated broadcast packets and, thus, do not transport further. The default of 2 repeats is optimum for typical uses of the network as an internet access system. In applications with heavy download broadcast such as video distribution, overall throughput is significantly improved by setting the repeat count to 1 or 0. This avoids flooding the downlink with repeat broadcast packets.

Attribute	Meaning
Transmit Power	<p>This value represents the combined power of the AP's two transmitters.</p> <p>Nations and regions may regulate transmitter output power. For example</p> <ul style="list-style-type: none"> • 900 MHz, 5.4 GHz and 5.8 GHz modules are available as connectorized radios, which require the operator to adjust power to ensure regulatory compliance. <p>The professional installer of the equipment has the responsibility to</p> <ul style="list-style-type: none"> • maintain awareness of applicable regulations. • calculate the permissible transmitter output power for the module. • confirm that the initial power setting is compliant with national or regional regulations. • confirm that the power setting is compliant following any reset of the module to factory defaults.
External Gain	<p>This value needs to correspond to the published gain of the antenna used to ensure the radio will meet regulatory requirements.</p>
SM Receive Target Level	<p>See PMP 450m AP Radio attributes - 5 GHz</p>
Adjacent Channel Support	<p>For some frequency bands and products, this setting is needed if AP is operating on adjacent channels with zero guard band.</p>
Multicast Data Channel	<p>This pull-down menu of the Multicast Data Control screen helps in configuring multicast packets to be transmitted over a dedicated channel at a configurable rate of 2X, 4X or 6X. The default value is "Disable". If set to the default value, all multicast packets are transmitted over the Broadcast VC data path. This feature is available only for the PMP 450 Series and is not backward compatible with PMP 430 series of radios.</p>
Multicast Repeat Count	<p>This value is the number of packets that are repeated for every multicast VC packet received on the AP (located under Radio tab of Configuration). Multicast (like Broadcast) packets go over a VC that is shared by all SMs, so there is no guaranteed delivery. The repeat count is an attempt to improve the odds of the packets getting over the link. If the user has issues with packets getting dropped, they can use this parameter to improve the performance at the cost of the overall throughput possible on that channel. The default value is 0.</p>
Multicast Downlink CIR	<p>This value is the committed information rate for the multicast downlink VC (located under the Radio tab of Configuration). The default value is 0 kbps. The range of this parameter is based on the number of repeat counts. The higher the repeat count, the lower the range for the multicast downlink CIR.</p>
SM Registration Limit	<p>This parameter allows to configure the limit for maximum number of SMs that can register to a PMP AP. The configurable range is from 1 to 238.</p> <p>450 MicroPoP has a limit of 20 SMs. To unlock from MicroPoP to MicroPoP Unlimited, a feature key must be purchased to remove this limitation.</p>

Attribute	Meaning												
	 <p>Note</p> <p>SM trying to register after the maximum configured limit has been reached is locked out for 15 minutes and a message is displayed at the SM.</p>												
SM Registration	<p>All: This field allows to control registration of all type 450 Platform Family SM including 450 Series SM (450i/450b/450/430) or 450i Series SM.</p> <p>450i Only: This field allows to control registration of 450i Series SM only</p>												
Receive Quality Debug	<p>To aid in link performance monitoring, the AP and SM now report the number of fragments received per modulation (i.e. QPSK, 16-QAM, 64-QAM) and per channel (polarization).</p>  <p>Note</p> <p>Due to CPU load, this will slightly degrade packet per second processing.</p>												
Frame Alignment Legacy Mode	<table border="1"> <thead> <tr> <th>Mode</th> <th>Behavior (non-900 MHz radios)</th> <th>Behavior (FSK 900 MHz radios)</th> </tr> </thead> <tbody> <tr> <td>OFF</td> <td> <p>By default, frame start is aligned with devices with Timing Port synchronization</p> <p>If the synchronization source changes (due to Autosync or otherwise) the radio will dynamically adjust its frame start to maintain alignment with the default frame start timing</p> </td> <td> <p>By default, frame start is aligned with FSK 900 MHz devices with Timing Port synchronization</p> <p>If the synchronization source changes (due to Autosync or otherwise) the radio will dynamically adjust its frame start to maintain alignment with the default frame start timing</p> </td> </tr> <tr> <td>ON (Mode 1)</td> <td>The radio will align with devices running software versions from 12.0 to 13.4.</td> <td>The radio will align with FSK 900 MHz devices running software versions from 12.0 to 13.4.</td> </tr> <tr> <td>ON (Mode 2)</td> <td>N/A</td> <td>The radio will align with FSK 900 MHz devices with software versions 11.2 or older.</td> </tr> </tbody> </table>	Mode	Behavior (non-900 MHz radios)	Behavior (FSK 900 MHz radios)	OFF	<p>By default, frame start is aligned with devices with Timing Port synchronization</p> <p>If the synchronization source changes (due to Autosync or otherwise) the radio will dynamically adjust its frame start to maintain alignment with the default frame start timing</p>	<p>By default, frame start is aligned with FSK 900 MHz devices with Timing Port synchronization</p> <p>If the synchronization source changes (due to Autosync or otherwise) the radio will dynamically adjust its frame start to maintain alignment with the default frame start timing</p>	ON (Mode 1)	The radio will align with devices running software versions from 12.0 to 13.4.	The radio will align with FSK 900 MHz devices running software versions from 12.0 to 13.4.	ON (Mode 2)	N/A	The radio will align with FSK 900 MHz devices with software versions 11.2 or older.
Mode	Behavior (non-900 MHz radios)	Behavior (FSK 900 MHz radios)											
OFF	<p>By default, frame start is aligned with devices with Timing Port synchronization</p> <p>If the synchronization source changes (due to Autosync or otherwise) the radio will dynamically adjust its frame start to maintain alignment with the default frame start timing</p>	<p>By default, frame start is aligned with FSK 900 MHz devices with Timing Port synchronization</p> <p>If the synchronization source changes (due to Autosync or otherwise) the radio will dynamically adjust its frame start to maintain alignment with the default frame start timing</p>											
ON (Mode 1)	The radio will align with devices running software versions from 12.0 to 13.4.	The radio will align with FSK 900 MHz devices running software versions from 12.0 to 13.4.											
ON (Mode 2)	N/A	The radio will align with FSK 900 MHz devices with software versions 11.2 or older.											
SM Link Test Mode Restriction	<p>Set to Enabled to allow only SM initiated link tests that pass user traffic.</p> <p>Set to Disabled to allow all SM initiated link tests.</p>												

Radio page - PMP 450i AP 3 GHz

The Radio tab of the PMP 450i AP 3 GHz is shown in below table.

Table 50 : PMP 450i AP Radio attributes - 3 GHz

Device Type

Device Setting : AP
 SM

Radio Configuration

Frequency Band : 3.6 GHz ▾
Frequency Carrier : None ▾
Channel Bandwidth : 10 MHz ▾
Frame Period : 5.0 ms
 2.5 ms
Cyclic Prefix : One Sixteenth
Color Code : 0 (0—254)
Subscriber Color Code Rescan (When not on a Primary Color Code) : 0 Minutes (0 — 43200)
Subscriber Color Code Wait Period for Idle : 0 Minutes (0 — 60)
Installation Color Code : Enabled
 Disabled
Sector ID : 0 ▾

MAC Control Parameters

MIMO Rate Adapt Algorithm : MIMO-AVB ▾
Downlink Maximum Modulation Rate : 8x ▾
Uplink Maximum Modulation Rate : 8x ▾

Frame Configuration

Max Range : 3 miles ▾ (Range: 1 — 40 miles / 64 km)
Downlink Data : 75 % (Range: 15 — 85 %)
Contention Slots : 3 (Range: 1 — 15)
Auto Contention : Enabled
 Disabled
Broadcast Repeat Count : 2 (Range: 0 — 2)

Power Control

Transmit Power : 22 dBm (Range: -30 — +25 dBm) (19 dBm V / 19 dBm H)
External Gain : 0 dBi (Range: 0 — +70 dBi)
SM Receive Target Level : -52 dBm (Range: -77 — -37 dBm) combined power
Adjacent Channel Support : Enabled
 Disabled

Multicast Data Control

Multicast Data Channel : Disable ▾
Multicast Repeat Count : 0 (Range: 0 — 2)
Multicast Downlink CIR : 0 (kbps) (Range: 0 — 12187 kbps)

Advanced

SM Registration Limit : 238 (Range: 1 — 238)
Receive Quality Debug : Enabled
 Disabled
OFF ▾
Choose Legacy Mode setting from the table below based on colocated radio's software revision and sync source:
Frame Alignment Legacy Mode :

Sync Src.\ SW Rev.	13.4.1 or higher	12.0 to 13.4 (DFS on)	12.0 to 13.4 (DFS off)	below 12.0
Timing Port	OFF	OFF	OFF	OFF
Power Port	OFF	OFF	ON (Mode 1)	OFF

SM Link Test Mode Restriction : Enabled
 Disabled



Note

Refer PMP 450i or 450 MicroPoP Unlimited AP Radio attributes - 5 GHz and PMP 450i SM Radio attributes - 5 GHz for parameter details



Note

Only the frequencies available for your region and the selected Channel bandwidth are displayed.

Radio page - PMP 450i AP 900 MHz

The Radio tab of the PMP 450i AP 900 MHz is described in below table.

Table 51 :PMP 450i AP Radio attributes - 900 MHz

Device Type	
Device Setting :	<input checked="" type="radio"/> AP <input type="radio"/> SM

Radio Configuration	
Frequency Carrier :	None ▾
Channel Bandwidth :	10 MHz ▾
Frame Period :	<input type="radio"/> 5.0 ms <input checked="" type="radio"/> 2.5 ms
Cyclic Prefix :	One Sixteenth
Color Code :	0 (0—254)
Subscriber Color Code Rescan (When not on a Primary Color Code) :	0 Minutes (0 — 43200)
Subscriber Color Code Wait Period for Idle :	0 Minutes (0 — 60)
Installation Color Code :	<input type="radio"/> Enabled <input checked="" type="radio"/> Disabled
Sector ID :	0 ▾

MAC Control Parameters	
MIMO Rate Adapt Algorithm :	MIMO-A/B ▾
Downlink Maximum Modulation Rate :	8x ▾
Uplink Maximum Modulation Rate :	8x ▾

Frame Configuration	
Max Range :	3 miles ▾ (Range: 1 — 120 miles / 193 km)
Downlink Data :	75 % (Range: 15 — 85 %)
Contention Slots :	3 (Range: 1 — 12)
Auto Contention :	<input type="radio"/> Enabled <input checked="" type="radio"/> Disabled
Broadcast Repeat Count :	2 (Range: 0 — 2)

Power Control	
Transmit Power :	22 dBm (Range: -30 — +25 dBm) (19 dBm V / 19 dBm H)
External Gain :	0 dBi (Range: 0 — +40 dBi)
SM Receive Target Level :	-52 dBm (Range: -77 — -37 dBm) combined power

Multicast Data Control	
Multicast Data Channel :	Disable ▾
Multicast Repeat Count :	0 (Range: 0 — 2)
Multicast Downlink CIR :	0 (kbps) (Range: 0 — 4062 kbps)

Advanced

SM Registration Limit : 238 (Range: 1 — 238)

Receive Quality Debug : Enabled
 Disabled

Pager Reject Filter : Enabled
 Disabled
(NOTE: Frequencies 920 MHz and above will not work when enabled.)

OFF

Frame Alignment Legacy Mode :
Choose Legacy Mode setting from the table below based on colocated 900 MHz FSK's software revision and sync source:

Sync Src.\ SW Rev.	13.4.1 or higher	12.0 to 13.4	below 12.0
Timing Port	OFF	OFF	OFF
Power Port	OFF	ON (Mode 1)	ON (Mode 2)

SM Link Test Mode Restriction : Enabled
 Disabled

Attribute	Meaning
Device Setting	To configure the radio as an Access Point, select AP. To configure the radio as a Subscriber Module, select SM.
Frequency Carrier	Specify the frequency for the module to transmit. The default for this parameter is None. For a list of channels in the band, see the drop-down list on the radio GUI.
Channel Bandwidth	The channel size used by the radio for RF transmission. The setting for the channel bandwidth must match between the AP and the SM. The supported Channel Bandwidths are 5, 7, 10 and 20 MHz.
Frame Period	

Attribute	Meaning
Cyclic Prefix	See PMP 450m AP Radio attributes - 5 GHz
Color Code	
Subscriber Color Code Rescan (When not on a Primary Color Code)	
Subscriber Color Code Wait Period for Idle	
Installation Color Code	
Sector ID	
MIMO Rate Adapt Algorithm	
Downlink Maximum Modulation Rate	
Uplink Maximum Modulation Rate	
Max Range	
Downlink Data	
Contention Slots (a.k.a. Control Slots)	
Auto Contention	
Broadcast Repeat Count	

Attribute	Meaning
Transmitter Output Power	See PMP 450i or 450 MicroPoP Unlimited AP Radio attributes - 5 GHz
External Gain	
SM Receive Target Level	See PMP 450m AP Radio attributes - 5 GHz
Multicast Data Channel	
Multicast Repeat Count	
Multicast Downlink CIR	
SM Registration Limit	
Receive Quality Debug	
Pager Reject Filter	
Frame Alignment Legacy Mode	See PMP 450i or 450 MicroPoP Unlimited AP Radio attributes - 5 GHz
SM Link Test Mode Restriction	See PMP 450m AP Radio attributes - 5 GHz

Radio page – PMP 450i SM 5 GHz

The Radio page of PMP 450i SM is explained in below table.

Table 52 :PMP 450i SM Radio attributes – 5 GHz

4.9 GHz

No custom frequencies present.

5.1 GHz

- 5152.5 5155.0 5157.5 5160.0 5162.5 5165.0 5167.5
- 5170.0 5172.5 5175.0 5177.5 5180.0 5182.5 5185.0
- 5187.5 5190.0 5192.5 5195.0 5197.5 5200.0 5202.5
- 5205.0 5207.5 5210.0 5212.5 5215.0 5217.5 5220.0
- 5222.5 5225.0 5227.5 5230.0 5232.5 5235.0 5237.5
- 5240.0 5242.5 5245.0 5247.5

5.2 GHz

- 5252.5 5255.0 5257.5 5260.0 5262.5 5265.0 5267.5
- 5270.0 5272.5 5275.0 5277.5 5280.0 5282.5 5285.0
- 5287.5 5290.0 5292.5 5295.0 5297.5 5300.0 5302.5
- 5305.0 5307.5 5310.0 5312.5 5315.0 5317.5 5320.0
- 5322.5 5325.0 5327.5 5330.0 5332.5 5335.0 5337.5
- 5340.0 5342.5 5345.0 5347.5

5.4 GHz

- 5472.5 5475.0 5477.5 5480.0 5482.5 5485.0 5487.5
- 5490.0 5492.5 5495.0 5497.5 5500.0 5502.5 5505.0
- 5507.5 5510.0 5512.5 5515.0 5517.5 5520.0 5522.5
- 5525.0 5527.5 5530.0 5532.5 5535.0 5537.5 5540.0
- 5542.5 5545.0 5547.5 5550.0 5552.5 5555.0 5557.5
- 5560.0 5562.5 5565.0 5567.5 5570.0 5572.5 5575.0
- 5577.5 5580.0 5582.5 5585.0 5587.5 5590.0 5592.5
- 5595.0 5597.5 5600.0 5602.5 5605.0 5607.5 5610.0
- 5612.5 5615.0 5617.5 5620.0 5622.5 5625.0 5627.5
- 5630.0 5632.5 5635.0 5637.5 5640.0 5642.5 5645.0
- 5647.5 5650.0 5652.5 5655.0 5657.5 5660.0 5662.5
- 5665.0 5667.5 5670.0 5672.5 5675.0 5677.5 5680.0
- 5682.5 5685.0 5687.5 5690.0 5692.5 5695.0 5697.5
- 5700.0 5702.5 5705.0 5707.5 5710.0 5712.5 5715.0
- 5717.5 5720.0 5722.5

Custom Radio Frequency Scan Selection List :

5.7 GHz

- 5727.5 5730.0 5732.5 5735.0 5737.5 5740.0 5742.5
- 5745.0 5747.5 5750.0 5752.5 5755.0 5757.5 5760.0
- 5762.5 5765.0 5767.5 5770.0 5772.5 5775.0 5777.5
- 5780.0 5782.5 5785.0 5787.5 5790.0 5792.5 5795.0
- 5797.5 5800.0 5802.5 5805.0 5807.5 5810.0 5812.5
- 5815.0 5817.5 5820.0 5822.5 5825.0 5827.5 5830.0
- 5832.5 5835.0 5837.5 5840.0 5842.5 5845.0 5847.5
- 5850.0 5852.5 5855.0 5857.5 5860.0 5862.5 5865.0
- 5867.5 5870.0 5872.5 5875.0 5877.5 5880.0 5882.5
- 5885.0 5887.5 5890.0 5892.5 5895.0 5897.5 5900.0
- 5902.5 5905.0 5907.5 5910.0 5912.5 5915.0 5917.5
- 5920.0 5922.5

5 MHz only

<= 10 MHz

<=15 MHz

<=20 MHz

<=30 MHz

Not available in this region

Select All Select All 4.9 Select All 5.1 Select All 5.2 Select All 5.4

Select All 5.7 Clear All Restore

Channel Bandwidth Scan :

- 5 MHz
- 10 MHz
- 15 MHz
- 20 MHz
- 30 MHz
- 40 MHz

Cyclic Prefix :

One Sixteenth

AP Selection Method :

- Power Level
- Optimize for Throughput

Color Code 1 :

0 (0—254) / Priority Primary ▾

Installation Color Code :

- Enabled
- Disabled

Large Data Channel data Q :

- Enabled
- Disabled

Additional Color Codes

Color Code : (0—254) / Priority ▼

Additional Color Codes Table

No additional color codes configured

MAC Control Parameters

MIMO Rate Adapt Algorithm : ▼

Downlink Maximum Modulation Rate : ▼

Uplink Maximum Modulation Rate : ▼

Power Control

External Gain : dBi (Range: 0 — +40 dBi)

Enable Max Tx Power : Enable Disable

LQI Reference EVM

Reference Downlink EVM : dB

Current Downlink EVM : dB

Reference Uplink EVM : dB

Current Uplink EVM : dB



Access Point MAC Address :

Channel Frequency :

Channel Bandwidth :

Advanced

Receive Quality Debug : Enabled Disabled

Attribute	Meaning
Custom Radio Frequency Scan Selection List	Check the frequencies that SM has to scan for AP transmissions. See Radio Frequency Scan Selection List
Channel Bandwidth Scan	<p>The channel size used by the radio for RF transmission.</p> <div style="border: 1px solid black; background-color: #e6f2ff; padding: 5px;"> <p> Note</p> <p>Selecting multiple channel bandwidths will increase registration and re-registration times.</p> </div>
Cyclic Prefix	The cyclic prefix for which AP scanning is executed.
AP Selection Method	<p>Operators may configure the method by which a scanning SM selects an AP. By default, AP Selection Method is set to “Optimize for Throughput”, which has been the mode of operation in releases prior to 12.0.3.1.</p> <p>Power Level: AP selection based solely on power level</p> <div style="border: 1px solid black; background-color: #e6f2ff; padding: 5px;"> <p> Note</p> <p>For operation with a PMP 450m AP, select the Power Level option</p> </div>

Attribute	Meaning
	<p>or</p> <p>Optimize for Throughput: AP selection based on throughput optimization – the selection decision is based on power level (which affects the modulation state), channel bandwidth (which affects throughput) and number of SM registrations to the AP (which affects system contention performance).</p>
Color Code 1	<p>Color code allows you to force the SM to register to only a specific AP, even where the SM can communicate with multiple APs. For registration to occur, the color code of the SM and the AP must match. Specify a value from 0 to 254.</p> <p>Color code is not a security feature. Instead, color code is a management feature, typically for assigning each sector a different color code. The default setting for the color code value is 0. This value matches only the color code of 0 (not all 255 color codes).</p> <p>SMs may be configured with up to 20 color codes. These color codes can be tagged as Primary, Secondary, or Tertiary, or Disable. When the SM is scanning for APs, it will first attempt to register to an AP that matches one of the SM's primary color codes. Failing that, the SM will continue scanning and attempt to register to an AP that matches one of the SM's secondary color codes. Failing that, the SM will continue scanning and attempt to register to an AP that matches one of the SM's tertiary color codes. This is all done in the scanning mode of the SM and will repeat until a registration has occurred.</p> <p>Color codes in the same priority group are treated equally. For example, all APs matching one of the SM's primary color codes are analyzed equally. Likewise, this evaluation is done for the secondary and tertiary groups in order. The analysis for selecting an AP within a priority group is based on various inputs, including signal strength and number of SMs already registered to each AP.</p> <p>The first color code in the configuration is the pre-Release 9.5 color code. Thus, it is always a primary color code for legacy reasons.</p> <p>The color codes can be disabled, with the exception of the first color code.</p>
Installation Color Code	<p>With this feature enabled on the AP and SM, operators may install and remotely configure SMs without having to configure matching color codes between the modules. When using the Installation Color Code feature, ensure that the SM is configured with the factory default Color Code configuration (Color Code 1 is “0”, Color Code 2-10 set to “0” and “Disable”). The status of the Installation Color Code can be viewed on the AP Eval web GUI page, and when the SM is registered using the Installation Color Code the message “SM is registered via ICC – Bridging Disabled!” is displayed in red on every SM GUI page. The Installation Color Code parameter is configurable without a radio reboot for both the AP and SM.</p>
Large Data Channel data Q	<p>SM and BH have a configurable option used to prevent packet loss in the uplink due to bursting IP traffic. This is designed for IP burst traffic particular to video surveillance applications.</p>
Color Code	<p>The Color Code parameter in the Additional Color Codes section allows additional primary, secondary or tertiary color codes to be configured or disabled on the SM. Refer to Color Code 1 above for full details.</p>
MIMO Rate Adapt	<p>This pull-down menu helps in configuring the Rate Adapt Algorithm to MIMO-A/B, MIMO-B only, or MIMO-A only.</p>

Attribute	Meaning
Algorithm	
Downlink Maximum Modulation Rate	This pull-down menu helps in configuring the Downlink Maximum Modulation Rate at a configurable rate of 1X, 2X, 3X, 4X, 6X, or 8X. The default value is "8X".
Uplink Maximum Modulation Rate	This pull-down menu helps in configuring the Uplink Maximum Modulation Rate at a configurable rate of 1X, 2X, 3X, 4X, 6X, or 8X. The default value is "8X".
External Gain	This value represents the antenna gain. For ODUs with integrated antenna, this is set at the correct value in the factory. For Connectorized ODUs with external antenna, the user must set this value to the overall antenna gain, including any RF cable loss between the ODU and the antenna.
Enable Max Tx Power	This field allows to enable or disable maximum transmission power.
Reference Downlink EVM	This parameter records the reference downlink EVM (Error Vector Magnitude). This value is used to calculate the downlink LQI when the AP is configured to use the EVM-based Link Quality Metric. The reference value can be entered manually by the user or set to the current measured value by clicking the Populate EVM button.
Current Downlink EVM	Displays the current measured downlink EVM.
Reference Uplink EVM	This parameter records the reference uplink EVM. This value is used to calculate the uplink LQI when the AP is configured to use the EVM-based Link Quality Metric. The reference value can be entered manually by the user or set to the current measured value by clicking the Populate EVM button.
Current Uplink EVM	Displays the current measured uplink EVM (Error Vector Magnitude).
Access Point MAC Address	Displays the MAC address of the AP that the SM was registered to when the Reference Downlink EVM and Reference Uplink EVM values were set.
Channel Frequency	Displays the channel frequency that the SM was using when the Reference EVM values were set.
Channel Bandwidth	Displays the channel bandwidth that the SM was using when the Reference EVM values were set.
Receive	To aid in link performance monitoring, the AP and SM now report the number of fragments

Attribute	Meaning
Quality Debug	<p>received per modulation (i.e. QPSK, 16-QAM, 64-QAM) and per channel (polarization).</p> <div data-bbox="365 310 435 390" style="display: inline-block; vertical-align: middle;"> </div> <div data-bbox="495 304 1421 399" style="border: 1px solid black; background-color: #e1f5fe; padding: 5px; margin-left: 20px;"> <p>Note</p> <p>Due to CPU load, this will slightly degrade packet per second processing.</p> </div>



Note

The frequencies that a user can select are controlled by the country or a region and the Channel Bandwidth selected. There can be a case where a user adds a custom frequency (from the Custom Frequencies page on page "Custom Frequencies page" on page 234) and cannot see it in the pull down menu.

Radio page - PMP 450i SM 3 GHz

The Radio tab of the PMP 450i SM 3 GHz is shown in below table.

Table 54 PMP 450i SM Radio attributes - 3 GHz

Radio Configuration ☰

3.5/3.6 GHz

3310.000 3320.000 3330.000 3340.000 3350.000
 3360.000 3370.000 3380.000 3390.000 3400.000
 3410.000 3420.000 3430.000 3440.000 3450.000
 3460.000 3470.000 3480.000 3490.000 3500.000
 3510.000 3520.000 3530.000 3540.000 3550.000
 3560.000 3570.000 3580.000 3590.000 3600.000
 3610.000 3620.000 3630.000 3640.000 3650.000
 3660.000 3670.000 3680.000 3690.000

Custom Radio Frequency Scan Selection List :

5 MHz only
≤7 MHz
≤10 MHz
≤15 MHz
≤20 MHz
≤30 MHz
Not available in this region

Channel Bandwidth Scan :

5 MHz
 7 MHz
 10 MHz
 15 MHz
 20 MHz
 30 MHz
 40 MHz

Cyclic Prefix : One Sixteenth

AP Selection Method :
 Power Level
 Optimize for Throughput

Color Code 1 :
 (0—254) / Priority Primary ▼

Installation Color Code :
 Enabled
 Disabled

Large Data Channel data Q :
 Enabled
 Disabled

Additional Color Codes ☰

Color Code :
 (0—254) / Priority Primary ▼

Additional Color Codes Table ☰

No additional color codes configured

MAC Control Parameters	
MIMO Rate Adapt Algorithm :	MIMO-A/B ▼
Downlink Maximum Modulation Rate :	8x ▼
Uplink Maximum Modulation Rate :	8x ▼

Power Control	
External Gain :	0 dBi (Range: 0 — +70 dBi)
Enable Max Tx Power :	<input type="radio"/> Enable <input checked="" type="radio"/> Disable

LQI Reference EVM	
Reference Downlink EVM :	0.0 dB
Current Downlink EVM :	-35.3 dB
Reference Uplink EVM :	0.0 dB
Current Uplink EVM :	-32.3 dB
Access Point MAC Address :	None
Channel Frequency :	None
Channel Bandwidth :	None
<input type="button" value="Populate EVM"/>	

Advanced	
Receive Quality Debug :	<input type="radio"/> Enabled <input checked="" type="radio"/> Disabled



Note
Refer PMP 450i SM Radio attributes - 5 GHz for parameter details.

Radio page - PTP 450i BHM 5 GHz

The Radio page of PTP 450i BHM is explained in below table.

Table 53 :PTP 450i BHM Radio page attributes - 5 GHz

Device Type	
Link Mode :	<input checked="" type="radio"/> Backhaul <input type="radio"/> Multipoint
Timing Mode :	<input checked="" type="radio"/> Timing Master <input type="radio"/> Timing Slave

Radio Configuration	
Frequency Band :	5.4 GHz ▾
Frequency Carrier :	None ▾
Channel Bandwidth :	10 MHz ▾
Frame Period :	<input type="radio"/> 5.0 ms <input checked="" type="radio"/> 2.5 ms
Cyclic Prefix :	One Sixteenth
Color Code :	0 (0—254)
Sector ID :	0 ▾
Large Data Channel data Q :	<input type="radio"/> Enabled <input checked="" type="radio"/> Disabled

MAC Control Parameters	
MIMO Rate Adapt Algorithm :	MIMO-A/B ▾
Downlink Maximum Modulation Rate :	8x ▾
Uplink Maximum Modulation Rate :	8x ▾
Minimum Modulation Rate :	1x ▾ Bridging will be disabled if the transmit modulation rate is below this setting



Frame Configuration	
Downlink Data :	75 % (Range: 15 — 85 %)

Power Control	
Transmit Power :	22 dBm (Range: -30 — +25 dBm) (19 dBm V / 19 dBm H)
External Gain :	0 dBi (Range: 0 — +70 dBi)

Advanced																
Receive Quality Debug :	<input type="radio"/> Enabled <input checked="" type="radio"/> Disabled OFF ▾															
Frame Alignment Legacy Mode :	<p>Choose Legacy Mode setting from the table below based on colocated radio's software revision and sync source:</p> <table border="1"> <thead> <tr> <th>Sync Src.\ SW Rev.</th> <th>13.4.1 or higher</th> <th>12.0 to 13.4 (DFS on)</th> <th>12.0 to 13.4 (DFS off)</th> <th>below 12.0</th> </tr> </thead> <tbody> <tr> <td>Timing Port</td> <td>OFF</td> <td>OFF</td> <td>OFF</td> <td>OFF</td> </tr> <tr> <td>Power Port</td> <td>OFF</td> <td>OFF</td> <td>ON (Mode 1)</td> <td>OFF</td> </tr> </tbody> </table>	Sync Src.\ SW Rev.	13.4.1 or higher	12.0 to 13.4 (DFS on)	12.0 to 13.4 (DFS off)	below 12.0	Timing Port	OFF	OFF	OFF	OFF	Power Port	OFF	OFF	ON (Mode 1)	OFF
Sync Src.\ SW Rev.	13.4.1 or higher	12.0 to 13.4 (DFS on)	12.0 to 13.4 (DFS off)	below 12.0												
Timing Port	OFF	OFF	OFF	OFF												
Power Port	OFF	OFF	ON (Mode 1)	OFF												

Attribute	Meaning
Link Mode	For point-to-point operation (PTP), select Backhaul. For point-to-multipoint operation (PMP), select Multipoint.
Timing Mode	For backhaul master (BHM), select Timing Master. For backhaul slave (BHS), select Timing Slave.
Frequency Band	Select the operating frequency band of the radio. The supported bands are 4.9 GHz, 5.4 GHz and 5.7 GHz.
Frequency Carrier	Specify the frequency for the module to transmit. The default for this parameter is None. For a list of channels in the band, see the drop-down list on the radio GUI.

Attribute	Meaning
Channel Bandwidth	The channel size used by the radio for RF transmission. The setting for the channel bandwidth must match between the BHM and the BHS.
Frame Period	Select the Frame Period of the radio. The supported Frame Periods are: 5 ms and 2.5 ms.
Cyclic Prefix	OFDM technology uses a cyclic prefix, where a portion of the end of a symbol (slot) is repeated at the beginning of the symbol to allow multi-pathing to settle before receiving the desired data. A 1/16 cyclic prefix means that for every 16 bits of throughput data transmitted, an additional bit is used.
Color Code	Specify a value from 0 to 254. For registration to occur, the color code of the BHM and the BHS must match. Color code is not a security feature. Instead, color code is a management feature, typically for assigning each link a different color code. Color code allows you to force a BHS to register to only a specific BHM. The default setting for the color code value is 0. This value matches only the color code of 0 (not all 255 color codes).
Sector ID	This pull-down menu helps in configuring the Sector ID at a configurable value from 0 to 15.
Large Data Channel data Q	Enable Large Data Channel data Q for applications that burst data high rates. Large Qs may decrease effective throughput for TCP application. Disable Large Data Channel data Q if application need not handle bursts of data. Large Qs may decrease effective throughput for TCP application.
MIMO Rate Adapt Algorithm	This pull-down menu helps in configuring the Rate Adapt Algorithm to MIMO-A/B, MIMO-B only, or MIMO-A only.
Downlink Maximum Modulation Rate	This pull-down menu helps in configuring the Downlink Maximum Modulation Rate at a configurable rate of 1X, 2X, 3X, 4X, 6X, or 8X. The default value is "8X". The Rate Adapt Algorithm does not allow the modulation to go beyond this limit.
Uplink Maximum Modulation Rate	This pull-down menu helps in configuring the Uplink Maximum Modulation Rate at a configurable rate of 1X, 2X, 3X, 4X, 6X, or 8X. The default value is "8X". The Rate Adapt Algorithm does not allow the modulation to go beyond this limit.
Minimum Modulation Rate	This pull-down menu helps in configuring the Minimum Modulation Rate at a configurable rate of 1X, 2X, 3X, 4X, 6X, or 8X. The default value is "1X". If the Rate Adapt Algorithm is below this limit, then bridging is disabled. This is used if PTP network can route the traffic through another path.
Downlink Data	Specify the percentage of the aggregate throughput for the downlink (frames transmitted from the BHM to the subscriber). For example, if the aggregate (uplink and downlink total) throughput on the BHM is 132 Mbps, then 75% specified for this parameter allocates 99 Mbps for the downlink and 33 Mbps for the uplink. The default for this parameter is 50%. This parameter must be set in the range of 15% - 85%, otherwise the invalid input will not be accepted and the previously-entered valid setting is used.

Attribute	Meaning
	 <p data-bbox="500 260 1417 369"> Note In order to prevent self-interference, the frame configuration needs to align. This includes Downlink Data, Max Range and Contention slots. </p>
Transmit Power	<p data-bbox="354 401 1211 426">This value represents the combined power of the BHM's two transmitters.</p> <p data-bbox="354 447 1089 472">Nations and regions may regulate transmit power. For example</p> <ul data-bbox="407 499 1382 562" style="list-style-type: none"> • PTP 450i Series modules are available as connectorized radios, which require the operator to adjust power to ensure regulatory compliance. <p data-bbox="354 585 1143 611">The professional installer of the equipment has the responsibility to:</p> <ul data-bbox="407 638 1300 772" style="list-style-type: none"> • Maintain awareness of applicable regulations. • Calculate the permissible transmitter output power for the module. • Confirm that the initial power setting is compliant with national or regional regulations. <p data-bbox="354 800 1417 858">Confirm that the power setting is compliant following any reset of the module to factory defaults.</p>
External Gain	<p data-bbox="354 884 1417 942">This value needs to correspond to the published gain of the antenna used to ensure the radio will meet regulatory requirements.</p>
Receive Quality Debug	<p data-bbox="354 968 1417 1060">To aid in link performance monitoring, the BHM and BHS now report the number of fragments received per modulation (i.e. QPSK, 16-QAM, 64-QAM and 256-QAM) and per channel (polarization).</p>  <p data-bbox="500 1079 1417 1188"> Note Due to CPU load, this slightly degrades the packet during per second processing. </p>
Frame Alignment Legacy Mode	<p data-bbox="354 1220 1167 1245">See PMP 450i or 450 MicroPoP Unlimited AP Radio attributes - 5 GHz</p>

Radio page – PTP 450 i BHS 5 GHz

The Radio page of PTP 450i BHS is explained in below table.

Table 54 :PTP 450i BHS Radio attributes – 5 GHz

Device Type	
Link Mode :	<input checked="" type="radio"/> Backhaul <input type="radio"/> Multipoint
Timing Mode :	<input type="radio"/> Timing Master <input checked="" type="radio"/> Timing Slave

Radio Configuration	
4.9 GHz	
No custom frequencies present.	
5.1 GHz	
<input type="checkbox"/> 5152.5 <input type="checkbox"/> 5155.0 <input type="checkbox"/> 5157.5 <input checked="" type="checkbox"/> 5160.0 <input checked="" type="checkbox"/> 5162.5 <input checked="" type="checkbox"/> 5165.0 <input checked="" type="checkbox"/> 5167.5 <input checked="" type="checkbox"/> 5170.0 <input checked="" type="checkbox"/> 5172.5 <input checked="" type="checkbox"/> 5175.0 <input checked="" type="checkbox"/> 5177.5 <input checked="" type="checkbox"/> 5180.0 <input checked="" type="checkbox"/> 5182.5 <input checked="" type="checkbox"/> 5185.0 <input checked="" type="checkbox"/> 5187.5 <input checked="" type="checkbox"/> 5190.0 <input checked="" type="checkbox"/> 5192.5 <input checked="" type="checkbox"/> 5195.0 <input checked="" type="checkbox"/> 5197.5 <input checked="" type="checkbox"/> 5200.0 <input checked="" type="checkbox"/> 5202.5 <input checked="" type="checkbox"/> 5205.0 <input checked="" type="checkbox"/> 5207.5 <input checked="" type="checkbox"/> 5210.0 <input checked="" type="checkbox"/> 5212.5 <input checked="" type="checkbox"/> 5215.0 <input checked="" type="checkbox"/> 5217.5 <input checked="" type="checkbox"/> 5220.0 <input checked="" type="checkbox"/> 5222.5 <input checked="" type="checkbox"/> 5225.0 <input checked="" type="checkbox"/> 5227.5 <input checked="" type="checkbox"/> 5230.0 <input checked="" type="checkbox"/> 5232.5 <input checked="" type="checkbox"/> 5235.0 <input checked="" type="checkbox"/> 5237.5 <input checked="" type="checkbox"/> 5240.0 <input type="checkbox"/> 5242.5 <input type="checkbox"/> 5245.0 <input type="checkbox"/> 5247.5	
5.2 GHz	
<input type="checkbox"/> 5252.5 <input type="checkbox"/> 5255.0 <input type="checkbox"/> 5257.5 <input checked="" type="checkbox"/> 5260.0 <input checked="" type="checkbox"/> 5262.5 <input checked="" type="checkbox"/> 5265.0 <input checked="" type="checkbox"/> 5267.5 <input checked="" type="checkbox"/> 5270.0 <input checked="" type="checkbox"/> 5272.5 <input checked="" type="checkbox"/> 5275.0 <input checked="" type="checkbox"/> 5277.5 <input checked="" type="checkbox"/> 5280.0 <input checked="" type="checkbox"/> 5282.5 <input checked="" type="checkbox"/> 5285.0 <input checked="" type="checkbox"/> 5287.5 <input checked="" type="checkbox"/> 5290.0 <input checked="" type="checkbox"/> 5292.5 <input checked="" type="checkbox"/> 5295.0 <input checked="" type="checkbox"/> 5297.5 <input checked="" type="checkbox"/> 5300.0 <input checked="" type="checkbox"/> 5302.5 <input checked="" type="checkbox"/> 5305.0 <input checked="" type="checkbox"/> 5307.5 <input checked="" type="checkbox"/> 5310.0 <input checked="" type="checkbox"/> 5312.5 <input checked="" type="checkbox"/> 5315.0 <input checked="" type="checkbox"/> 5317.5 <input checked="" type="checkbox"/> 5320.0 <input checked="" type="checkbox"/> 5322.5 <input checked="" type="checkbox"/> 5325.0 <input checked="" type="checkbox"/> 5327.5 <input checked="" type="checkbox"/> 5330.0 <input checked="" type="checkbox"/> 5332.5 <input checked="" type="checkbox"/> 5335.0 <input checked="" type="checkbox"/> 5337.5 <input checked="" type="checkbox"/> 5340.0 <input type="checkbox"/> 5342.5 <input type="checkbox"/> 5345.0 <input type="checkbox"/> 5347.5	
5.4 GHz	
<input type="checkbox"/> 5472.5 <input type="checkbox"/> 5475.0 <input type="checkbox"/> 5477.5 <input checked="" type="checkbox"/> 5480.0 <input checked="" type="checkbox"/> 5482.5 <input checked="" type="checkbox"/> 5485.0 <input checked="" type="checkbox"/> 5487.5 <input checked="" type="checkbox"/> 5490.0 <input checked="" type="checkbox"/> 5492.5 <input checked="" type="checkbox"/> 5495.0 <input checked="" type="checkbox"/> 5497.5 <input checked="" type="checkbox"/> 5500.0 <input checked="" type="checkbox"/> 5502.5 <input checked="" type="checkbox"/> 5505.0 <input checked="" type="checkbox"/> 5507.5 <input checked="" type="checkbox"/> 5510.0 <input checked="" type="checkbox"/> 5512.5 <input checked="" type="checkbox"/> 5515.0 <input checked="" type="checkbox"/> 5517.5 <input checked="" type="checkbox"/> 5520.0 <input checked="" type="checkbox"/> 5522.5 <input checked="" type="checkbox"/> 5525.0 <input checked="" type="checkbox"/> 5527.5 <input checked="" type="checkbox"/> 5530.0 <input checked="" type="checkbox"/> 5532.5 <input checked="" type="checkbox"/> 5535.0 <input checked="" type="checkbox"/> 5537.5 <input checked="" type="checkbox"/> 5540.0 <input checked="" type="checkbox"/> 5542.5 <input checked="" type="checkbox"/> 5545.0 <input checked="" type="checkbox"/> 5547.5 <input checked="" type="checkbox"/> 5550.0 <input checked="" type="checkbox"/> 5552.5 <input checked="" type="checkbox"/> 5555.0 <input checked="" type="checkbox"/> 5557.5 <input checked="" type="checkbox"/> 5560.0 <input checked="" type="checkbox"/> 5562.5 <input checked="" type="checkbox"/> 5565.0 <input checked="" type="checkbox"/> 5567.5 <input checked="" type="checkbox"/> 5570.0 <input checked="" type="checkbox"/> 5572.5 <input checked="" type="checkbox"/> 5575.0 <input checked="" type="checkbox"/> 5577.5 <input checked="" type="checkbox"/> 5580.0 <input checked="" type="checkbox"/> 5582.5 <input checked="" type="checkbox"/> 5585.0 <input checked="" type="checkbox"/> 5587.5 <input checked="" type="checkbox"/> 5590.0 <input checked="" type="checkbox"/> 5592.5 <input checked="" type="checkbox"/> 5595.0 <input checked="" type="checkbox"/> 5597.5 <input checked="" type="checkbox"/> 5600.0 <input checked="" type="checkbox"/> 5602.5 <input checked="" type="checkbox"/> 5605.0 <input checked="" type="checkbox"/> 5607.5 <input checked="" type="checkbox"/> 5610.0 <input checked="" type="checkbox"/> 5612.5 <input checked="" type="checkbox"/> 5615.0 <input checked="" type="checkbox"/> 5617.5 <input checked="" type="checkbox"/> 5620.0 <input checked="" type="checkbox"/> 5622.5 <input checked="" type="checkbox"/> 5625.0 <input checked="" type="checkbox"/> 5627.5 <input checked="" type="checkbox"/> 5630.0 <input checked="" type="checkbox"/> 5632.5 <input checked="" type="checkbox"/> 5635.0 <input checked="" type="checkbox"/> 5637.5 <input checked="" type="checkbox"/> 5640.0 <input checked="" type="checkbox"/> 5642.5 <input checked="" type="checkbox"/> 5645.0 <input checked="" type="checkbox"/> 5647.5 <input checked="" type="checkbox"/> 5650.0 <input checked="" type="checkbox"/> 5652.5 <input checked="" type="checkbox"/> 5655.0 <input checked="" type="checkbox"/> 5657.5 <input checked="" type="checkbox"/> 5660.0 <input checked="" type="checkbox"/> 5662.5 <input checked="" type="checkbox"/> 5665.0 <input checked="" type="checkbox"/> 5667.5 <input checked="" type="checkbox"/> 5670.0 <input checked="" type="checkbox"/> 5672.5 <input checked="" type="checkbox"/> 5675.0 <input checked="" type="checkbox"/> 5677.5 <input checked="" type="checkbox"/> 5680.0 <input checked="" type="checkbox"/> 5682.5 <input checked="" type="checkbox"/> 5685.0 <input checked="" type="checkbox"/> 5687.5 <input checked="" type="checkbox"/> 5690.0 <input checked="" type="checkbox"/> 5692.5 <input checked="" type="checkbox"/> 5695.0 <input checked="" type="checkbox"/> 5697.5 <input checked="" type="checkbox"/> 5700.0 <input checked="" type="checkbox"/> 5702.5 <input checked="" type="checkbox"/> 5705.0 <input checked="" type="checkbox"/> 5707.5 <input checked="" type="checkbox"/> 5710.0 <input checked="" type="checkbox"/> 5712.5 <input checked="" type="checkbox"/> 5715.0 <input type="checkbox"/> 5717.5 <input type="checkbox"/> 5720.0 <input type="checkbox"/> 5722.5	
Custom Radio Frequency Scan Selection List :	

5.7 GHz

- 5727.5 5730.0 5732.5 5735.0 5737.5 5740.0 5742.5
- 5745.0 5747.5 5750.0 5752.5 5755.0 5757.5 5760.0
- 5762.5 5765.0 5767.5 5770.0 5772.5 5775.0 5777.5
- 5780.0 5782.5 5785.0 5787.5 5790.0 5792.5 5795.0
- 5797.5 5800.0 5802.5 5805.0 5807.5 5810.0 5812.5
- 5815.0 5817.5 5820.0 5822.5 5825.0 5827.5 5830.0
- 5832.5 5835.0 5837.5 5840.0 5842.5 5845.0 5847.5
- 5850.0 5852.5 5855.0 5857.5 5860.0 5862.5 5865.0
- 5867.5 5870.0 5872.5 5875.0 5877.5 5880.0 5882.5
- 5885.0 5887.5 5890.0 5892.5 5895.0 5897.5 5900.0
- 5902.5 5905.0 5907.5 5910.0 5912.5 5915.0 5917.5
- 5920.0 5922.5

- 5 MHz only
- <= 10 MHz
- <=15 MHz
- <=20 MHz
- <=30 MHz
- Not available in this region

- Select All
- Select All 4.9
- Select All 5.1
- Select All 5.2
- Select All 5.4
- Select All 5.7
- Clear All
- Restore

Channel Bandwidth Scan :

- 5 MHz
- 10 MHz
- 15 MHz
- 20 MHz
- 30 MHz
- 40 MHz

Cyclic Prefix : One Sixteenth

Color Code : 0 (0—254)

Large Data Channel data Q : Enabled Disabled

MAC Control Parameters

- MIMO Rate Adapt Algorithm : MIMO-A/B
- Downlink Maximum Modulation Rate : 8x
- Uplink Maximum Modulation Rate : 8x
- Minimum Modulation Rate : 4x Bridging will be disabled if the transmit modulation rate is below this setting

Power Control

- Transmit Power : -17 dBm (Range: -30 — +27 dBm) (-20 dBm V / -20 dBm H)
- External Gain : 0 dBi (Range: 0 — +40 dBi)

LQI Reference EVM

- Reference Downlink EVM : 0.0 dB
- Current Downlink EVM : -32.2 dB
- Reference Uplink EVM : 0.0 dB
- Current Uplink EVM : -31.4 dB
- Access Point MAC Address : None
- Channel Frequency : None
- Channel Bandwidth : None

Populate EVM

Advanced

Receive Quality Debug : Enabled Disabled

Attribute	Meaning
Link Mode	For point-to-point operation (PTP), select Backhaul. For point-to-multipoint operation (PMP), select Multipoint.
Timing Mode	For backhaul master (BHM), select Timing Master. For backhaul slave (BHS), select Timing Slave.
Custom Radio Frequency Scan Selection List	Check any frequency that you want the BHS to scan for BHM transmissions. See Radio Frequency Scan Selection List
Channel Bandwidth Scan	The channel size used by the radio for RF transmission.  Note Selecting multiple channel bandwidths will increase registration and re-registration times.
Cyclic Prefix	The cyclic prefix for which BHM scanning is executed.
Color Code	Color code allows to force the BHS to register to only a specific BHM, even where the BHS can communicate with multiple BHMs. For registration to occur, the color code of the BHS and the BHM must match. Specify a value from 0 to 254. Only one color code can be configured on the BHS.
Large Data Channel data Q	BHM and BHS have a configurable option used to prevent packet loss in the uplink due to bursting IP traffic. This is designed for IP burst traffic particular to video surveillance applications.
MIMO Rate Adapt Algorithm	This pull-down menu helps in configuring the Rate Adapt Algorithm to MIMO-A/B, MIMO-B only, or MIMO-A only.
Downlink Maximum Modulation Rate	This pull-down menu helps in configuring the Downlink Maximum Modulation Rate at a configurable rate of 1X, 2X, 3X, 4X, 6X, or 8X. The default value is "8X". The Rate Adapt Algorithm does not allow the modulation to go beyond this limit.
Uplink Maximum Modulation Rate	This pull-down menu helps in configuring the Uplink Maximum Modulation Rate at a configurable rate of 1X, 2X, 3X, 4X, 6X, or 8X. The default value is "8X". The Rate Adapt Algorithm does not allow the modulation to go beyond this limit.
Minimum Modulation Rate	This pull-down menu helps in configuring the Minimum Modulation Rate at a configurable rate of 1X, 2X, 3X, 4X, 6X, or 8X. The default value is "1X". If the Rate Adapt Algorithm is below this limit, then bridging is disabled. This is used if PTP network can route the traffic through another path.
Transmit Power	Refer PTP 450i BHM Radio page attributes - 5 GHz

Attribute	Meaning
External Gain	
Reference Downlink EVM	Refer PMP 450i SM Radio attributes - 5 GHz.
Current Downlink EVM	
Reference Uplink EVM	
Current Uplink EVM	
Access Point MAC Address	
Channel Frequency	
Channel Bandwidth	
Receive Quality Debug	

PMP/ PTP 450b Series - configuring radio

Radio page – PMP/PTP 450b Mid-Gain/ High Gain and Retro SM 5 GHz

The Radio page of PMP/PTP 450b Mid-Gain/High Gain and Retro SM is explained in below table.

Table 55 :PMP/PTP 450b Mid-Gain/High Gain and Retro SM Radio attributes - 5 GHz

Device Type

Link Mode :

- Backhaul
- Multipoint

Radio Configuration

4.9 GHz

No custom frequencies present.

5.1 GHz

- 5152.5 5155.0 5157.5 5160.0 5162.5 5165.0 5167.5
- 5170.0 5172.5 5175.0 5177.5 5180.0 5182.5 5185.0
- 5187.5 5190.0 5192.5 5195.0 5197.5 5200.0 5202.5
- 5205.0 5207.5 5210.0 5212.5 5215.0 5217.5 5220.0
- 5222.5 5225.0 5227.5 5230.0 5232.5 5235.0 5237.5
- 5240.0 5242.5 5245.0 5247.5

5.2 GHz

- 5252.5 5255.0 5257.5 5260.0 5262.5 5265.0 5267.5
- 5270.0 5272.5 5275.0 5277.5 5280.0 5282.5 5285.0
- 5287.5 5290.0 5292.5 5295.0 5297.5 5300.0 5302.5
- 5305.0 5307.5 5310.0 5312.5 5315.0 5317.5 5320.0
- 5322.5 5325.0 5327.5 5330.0 5332.5 5335.0 5337.5
- 5340.0 5342.5 5345.0 5347.5

5.4 GHz

- 5472.5 5475.0 5477.5 5480.0 5482.5 5485.0 5487.5
- 5490.0 5492.5 5495.0 5497.5 5500.0 5502.5 5505.0
- 5507.5 5510.0 5512.5 5515.0 5517.5 5520.0 5522.5
- 5525.0 5527.5 5530.0 5532.5 5535.0 5537.5 5540.0
- 5542.5 5545.0 5547.5 5550.0 5552.5 5555.0 5557.5
- 5560.0 5562.5 5565.0 5567.5 5570.0 5572.5 5575.0
- 5577.5 5580.0 5582.5 5585.0 5587.5 5590.0 5592.5
- 5595.0 5597.5 5600.0 5602.5 5605.0 5607.5 5610.0
- 5612.5 5615.0 5617.5 5620.0 5622.5 5625.0 5627.5
- 5630.0 5632.5 5635.0 5637.5 5640.0 5642.5 5645.0
- 5647.5 5650.0 5652.5 5655.0 5657.5 5660.0 5662.5
- 5665.0 5667.5 5670.0 5672.5 5675.0 5677.5 5680.0
- 5682.5 5685.0 5687.5 5690.0 5692.5 5695.0 5697.5
- 5700.0 5702.5 5705.0 5707.5 5710.0 5712.5 5715.0
- 5717.5 5720.0 5722.5

Custom Radio Frequency Scan Selection List :

Additional Color Codes	
Color Code :	0 (0—254) / Priority Primary
	<input type="button" value="Add/Modify Color Code"/> <input type="button" value="Remove Color Code"/>
Additional Color Codes Table	
No additional color codes configured	
MAC Control Parameters	
MIMO Rate Adapt Algorithm :	MIMO-A/B
Downlink Maximum Modulation Rate :	8x
Uplink Maximum Modulation Rate :	8x
Power Control	
External Gain Fixed :	23 dBi
Enable Max Tx Power :	<input type="radio"/> Enable <input checked="" type="radio"/> Disable
LQI Reference EVM	
Reference Downlink EVM :	0.0 dB
Current Downlink EVM :	-32.5 dB
Reference Uplink EVM :	0.0 dB
Current Uplink EVM :	-33.0 dB
Access Point MAC Address :	None
Channel Frequency :	None
Channel Bandwidth :	None
	<input type="button" value="Populate EVM"/>
Advanced	
Receive Quality Debug :	<input type="radio"/> Enabled <input checked="" type="radio"/> Disabled

Attribute	Meaning
Link Mode	For point-to-point operation (PTP), select Backhaul. For point-to-multipoint operation (PMP), select Multipoint.
Custom Radio Frequency Scan Selection List	Check the frequencies that SM has to scan for AP transmissions. See Radio Frequency Scan Selection List
Channel Bandwidth Scan	The channel size used by the radio for RF transmission.  Note Selecting multiple channel bandwidths will increase registration and re-registration times.
Cyclic Prefix Scan	The cyclic prefix for which AP scanning is executed.
AP Selection Method	Operators may configure the method by which a scanning SM selects an AP. By default, AP Selection Method is set to “Optimize for Throughput”, which has been the mode of operation in releases prior to 12.0.3.1.

Attribute	Meaning
	<p>Power Level: AP selection based solely on power level</p> <div style="display: flex; align-items: center;">  <div style="border: 1px solid black; background-color: #e1f5fe; padding: 5px;"> <p>Note</p> <p>For operation with a PMP 450m AP, select the Power Level option</p> </div> </div> <p>or</p> <p>Optimize for Throughput: AP selection based on throughput optimization – the selection decision is based on power level (which affects the modulation state), channel bandwidth (which affects throughput) and number of SM registrations to the AP (which affects system contention performance).</p>
Color Code 1	<p>Color code allows you to force the SM to register to only a specific AP, even where the SM can communicate with multiple APs. For registration to occur, the color code of the SM and the AP must match. Specify a value from 0 to 254.</p> <p>Color code is not a security feature. Instead, color code is a management feature, typically for assigning each sector a different color code. The default setting for the color code value is 0. This value matches only the color code of 0 (not all 255 color codes).</p> <p>SMs may be configured with up to 20 color codes. These color codes can be tagged as Primary, Secondary, or Tertiary, or Disable. When the SM is scanning for APs, it will first attempt to register to an AP that matches one of the SM's primary color codes. Failing that, the SM will continue scanning and attempt to register to an AP that matches one of the SM's secondary color codes. Failing that, the SM will continue scanning and attempt to register to an AP that matches one of the SM's tertiary color codes. This is all done in the scanning mode of the SM and will repeat until a registration has occurred.</p> <p>Color codes in the same priority group are treated equally. For example, all APs matching one of the SM's primary color codes are analyzed equally. Likewise, this evaluation is done for the secondary and tertiary groups in order. The analysis for selecting an AP within a priority group is based on various inputs, including signal strength and number of SMs already registered to each AP.</p> <p>The first color code in the configuration is the pre-Release 9.5 color code. Thus, it is always a primary color code for legacy reasons.</p> <p>The color codes can be disabled, with the exception of the first color code.</p>
Installation Color Code	<p>With this feature enabled on the AP and SM, operators may install and remotely configure SMs without having to configure matching color codes between the modules. When using the Installation Color Code feature, ensure that the SM is configured with the factory default Color Code configuration (Color Code 1 is “0”, Color Code 2-10 set to “0” and “Disable”). The status of the Installation Color Code can be viewed on the AP Eval web GUI page, and when the SM is registered using the Installation Color Code the message “SM is registered via ICC – Bridging Disabled!” is displayed in red on every SM GUI page. The Installation Color Code parameter is configurable without a radio reboot for both the AP and SM.</p>
Large Data Channel data Q	<p>SM and BH have a configurable option used to prevent packet loss in the uplink due to bursting IP traffic. This is designed for IP burst traffic particular to video surveillance applications.</p>

Attribute	Meaning
Color Code	The Color Code parameter in the Additional Color Codes section allows additional primary, secondary or tertiary color codes to be configured or disabled on the SM. Refer to Color Code 1 above for full details.
MIMO Rate Adapt Algorithm	This pull-down menu helps in configuring the Rate Adapt Algorithm to MIMO-A/B, MIMO-B only, or MIMO-A only.
Downlink Maximum Modulation Rate	This pull-down menu helps in configuring the Downlink Maximum Modulation Rate at a configurable rate of 1X, 2X, 3X, 4X, 6X, or 8X. The default value is "8X".
Uplink Maximum Modulation Rate	This pull-down menu helps in configuring the Uplink Maximum Modulation Rate at a configurable rate of 1X, 2X, 3X, 4X, 6X, or 8X. The default value is "8X".
External Gain Fixed	<p>This value represents the fixed antenna gain. The fixed antenna gain for Mid-Gain is 16 dBi and High Gain is 23 dBi.</p> <p>For ODUs with integrated antenna, this is set at the correct value in the factory.</p> <p>For Connectorized ODUs with external antenna, the user must set this value to the overall antenna gain, including any RF cable loss between the ODU and the antenna.</p>
Enable Max Tx Power	This field allows to enable or disable maximum transmission power.
Reference Downlink EVM	Refer PMP 450i SM Radio attributes - 5 GHz.
Current Downlink EVM	
Reference Uplink EVM	
Current Uplink EVM	
Access Point MAC Address	
Channel Frequency	
Channel Bandwidth	

Attribute	Meaning
Receive Quality Debug	<p>To aid in link performance monitoring, the AP and SM now report the number of fragments received per modulation (i.e. QPSK, 16-QAM, 64-QAM) and per channel (polarization).</p> <div style="border: 1px solid black; padding: 5px; margin-top: 10px;">  <p>Note</p> <p>The frequencies that a user can select are controlled by the country or a region and the Channel Bandwidth selected. There can be a case where a user adds a custom frequency (from the Custom Frequencies page) and cannot see it in the pull-down menu.</p> </div>

Radio page – PMP/PTP 450b High Gain SM 3 GHz

The Radio page of PMP/PTP 450b High Gain SM is explained in below table.

Table 56 :PMP/PTP 450b High Gain SM Radio attributes – 3 GHz

Device Type

Link Mode : Backhaul Multipoint

Radio Configuration

3.5/3.6 GHz

Custom Radio Frequency Scan Selection List :

<input checked="" type="checkbox"/> 3310.000	<input checked="" type="checkbox"/> 3320.000	<input checked="" type="checkbox"/> 3330.000	<input checked="" type="checkbox"/> 3340.000	<input checked="" type="checkbox"/> 3350.000
<input checked="" type="checkbox"/> 3360.000	<input checked="" type="checkbox"/> 3370.000	<input checked="" type="checkbox"/> 3380.000	<input checked="" type="checkbox"/> 3390.000	<input checked="" type="checkbox"/> 3400.000
<input checked="" type="checkbox"/> 3410.000	<input checked="" type="checkbox"/> 3420.000	<input checked="" type="checkbox"/> 3430.000	<input checked="" type="checkbox"/> 3440.000	<input checked="" type="checkbox"/> 3450.000
<input checked="" type="checkbox"/> 3460.000	<input checked="" type="checkbox"/> 3470.000	<input checked="" type="checkbox"/> 3480.000	<input checked="" type="checkbox"/> 3490.000	<input checked="" type="checkbox"/> 3500.000
<input checked="" type="checkbox"/> 3510.000	<input checked="" type="checkbox"/> 3520.000	<input checked="" type="checkbox"/> 3530.000	<input checked="" type="checkbox"/> 3540.000	<input checked="" type="checkbox"/> 3550.000
<input checked="" type="checkbox"/> 3560.000	<input checked="" type="checkbox"/> 3570.000	<input checked="" type="checkbox"/> 3580.000	<input checked="" type="checkbox"/> 3590.000	<input checked="" type="checkbox"/> 3600.000
<input checked="" type="checkbox"/> 3610.000	<input checked="" type="checkbox"/> 3620.000	<input checked="" type="checkbox"/> 3630.000	<input checked="" type="checkbox"/> 3640.000	<input checked="" type="checkbox"/> 3650.000
<input checked="" type="checkbox"/> 3655.000	<input checked="" type="checkbox"/> 3660.000	<input checked="" type="checkbox"/> 3670.000	<input checked="" type="checkbox"/> 3680.000	<input checked="" type="checkbox"/> 3690.000

5 MHz only
<= 7 MHz
<= 10 MHz
<= 15 MHz
<= 20 MHz
<= 30 MHz
Not available in this region

Channel Bandwidth Scan :

- 5 MHz
- 7 MHz
- 10 MHz
- 15 MHz
- 20 MHz
- 30 MHz
- 40 MHz

Cyclic Prefix : One Sixteenth

AP Selection Method : Power Level Optimize for Throughput

Color Code 1 : (0—254) / Priority

Installation Color Code : Enabled Disabled

Large Data Channel data Q : Enabled Disabled

Additional Color Codes	
Color Code :	0 (0—254) / Priority Primary ▼
	<input type="button" value="Add/Modify Color Code"/> <input type="button" value="Remove Color Code"/>

Additional Color Codes Table	
No additional color codes configured	

MAC Control Parameters	
MIMO Rate Adapt Algorithm :	MIMO-A/B ▼
Downlink Maximum Modulation Rate :	8x ▼
Uplink Maximum Modulation Rate :	8x ▼

Power Control	
External Gain Fixed :	20 dBi
Enable Max Tx Power :	<input type="radio"/> Enable <input checked="" type="radio"/> Disable

LQI Reference EVM	
Reference Downlink EVM :	0.0 dB
Current Downlink EVM :	-29.4 dB
Reference Uplink EVM :	0.0 dB
Current Uplink EVM :	-35.1 dB
Access Point MAC Address :	None
Channel Frequency :	None
Channel Bandwidth :	None
	<input type="button" value="Populate EVM"/>

Advanced	
Receive Quality Debug :	<input type="radio"/> Enabled <input checked="" type="radio"/> Disabled

Attribute	Meaning
Link Mode	Refer PMP/PTP 450b Mid-Gain/High Gain and Retro SM Radio attributes - 5 GHz
Custom Radio Frequency Scan Selection List	
Channel Bandwidth Scan	
Cyclic Prefix	
AP Selection Method	
Color Code 1	
Installation Color Code	
Large Data Channel data Q	
Color Code	
MIMO Rate Adapt Algorithm	
Downlink Maximum Modulation Rate	
Uplink Maximum Modulation Rate	
External Gain Fixed	<p>This value represents the fixed antenna gain. The fixed antenna gain for High Gain is +20 dBi.</p> <p>For ODUs with integrated antenna, this is set at the correct value in the factory.</p> <p>For Connectorized ODUs with external antenna, the user must set this value to the overall antenna gain, including any RF cable loss between the ODU and the antenna.</p>
Enable Max Tx Power	Refer PMP/PTP 450b Mid-Gain/High Gain and Retro SM Radio attributes - 5 GHz
Reference Downlink EVM	Refer PMP 450i SM Radio attributes - 5 GHz.
Current Downlink EVM	
Reference Uplink EVM	
Current Uplink EVM	
Access Point MAC Address	

Attribute	Meaning
Channel Frequency	
Channel Bandwidth	
Receive Quality Debug	

Radio page – PMP/PTP 450b Mid-Gain/ High Gain BHM 5 GHz

The Radio page of the PMP/PTP 450b BHM is explained in below table.

Table 57 :PMP/PTP 450b BHM Radio attributes - 5 GHz

Device Type

Link Mode : Backhaul
 Multipoint

Timing Mode : Timing Master
 Timing Slave

Radio Configuration

Frequency Band : 5.7 GHz ▼

Frequency Carrier : None ▼

Channel Bandwidth : 10 MHz ▼

Frame Period : 5.0 ms
 2.5 ms

Cyclic Prefix : One Sixteenth

Color Code : 0 (0—254)

Sector ID : 0 ▼

Large Data Channel data Q : Enabled
 Disabled

MAC Control Parameters

MIMO Rate Adapt Algorithm : MIMO-A/B ▼

Downlink Maximum Modulation Rate : 8x ▼

Uplink Maximum Modulation Rate : 8x ▼

Minimum Modulation Rate : 1x ▼ Bridging will be disabled if the transmit modulation rate is below this setting

Frame Configuration

Downlink Data : 75 % (Range: 15 — 85 %)

Power Control

Transmit Power : 16 dBm (Range: -30 — +27 dBm) (13 dBm V / 13 dBm H)

External Gain Fixed : 16 dBi

Advanced

Receive Quality Debug : Enabled
 Disabled

OFF ▼

Choose Legacy Mode setting from the table below based on colocated radio's software revision and sync source:

Sync Src.\ SW Rev.	13.4.1 or higher	12.0 to 13.4 (DFS on)	12.0 to 13.4 (DFS off)	below 12.0
Timing Port	OFF	OFF	OFF	OFF
Power Port	OFF	OFF	ON (Mode 1)	OFF

Frame Alignment Legacy Mode :

Attribute	Meaning
Link Mode	See PTP 450i BHM Radio page attributes - 5 GHz
Timing Mode	
Frequency Band	See PMP 450m AP Radio attributes - 5 GHz
Frequency Carrier	
Channel Bandwidth	
Frame Period	
Cyclic Prefix	
Color Code	
Sector ID	
Large Data Channel data Q	
MIMO Rate Adapt Algorithm	
Downlink Maximum Modulation Rate	
Uplink Maximum Modulation Rate	
Minimum Modulation Rate	
Downlink Data	
Transmitter Power	
External Fixed Gain	<p>This value represents the fixed antenna gain. The fixed antenna gain for Mid-Gain is 16 dBi and High Gain is 23 dBi.</p> <p>For ODUs with integrated antenna, this is set at the correct value in the factory.</p> <p>For Connectorized ODUs with external antenna, the user must set this value to the overall antenna gain, including any RF cable loss between the ODU and the antenna.</p>
Receive Quality Debug	See PTP 450i BHM Radio page attributes - 5 GHz
Frame Alignment Legacy Mode	See PMP 450i or 450 MicroPoP Unlimited AP Radio attributes - 5 GHz

Radio page – PMP/PTP 450 b Mid-Gain/ High Gain BHS 5 GHz

The Radio page of PMP 450b BHS is explained in the below table.

Table 58 :PMP/PTP 450b BHS Radio attributes – 5 GHz

Device Type	
Link Mode :	<input checked="" type="radio"/> Backhaul <input type="radio"/> Multipoint
Timing Mode :	<input type="radio"/> Timing Master <input checked="" type="radio"/> Timing Slave

Radio Configuration	
4.9 GHz	
No custom frequencies present.	
5.1 GHz	
<input checked="" type="checkbox"/> 5152.5	<input checked="" type="checkbox"/> 5155.0
<input checked="" type="checkbox"/> 5170.0	<input checked="" type="checkbox"/> 5172.5
<input checked="" type="checkbox"/> 5187.5	<input checked="" type="checkbox"/> 5190.0
<input checked="" type="checkbox"/> 5205.0	<input checked="" type="checkbox"/> 5207.5
<input checked="" type="checkbox"/> 5222.5	<input checked="" type="checkbox"/> 5225.0
<input checked="" type="checkbox"/> 5240.0	<input checked="" type="checkbox"/> 5242.5
<input checked="" type="checkbox"/> 5157.5	<input checked="" type="checkbox"/> 5175.0
<input checked="" type="checkbox"/> 5192.5	<input checked="" type="checkbox"/> 5210.0
<input checked="" type="checkbox"/> 5227.5	<input checked="" type="checkbox"/> 5227.5
<input checked="" type="checkbox"/> 5245.0	<input checked="" type="checkbox"/> 5245.0
<input checked="" type="checkbox"/> 5160.0	<input checked="" type="checkbox"/> 5177.5
<input checked="" type="checkbox"/> 5195.0	<input checked="" type="checkbox"/> 5212.5
<input checked="" type="checkbox"/> 5230.0	<input checked="" type="checkbox"/> 5230.0
<input checked="" type="checkbox"/> 5247.5	<input checked="" type="checkbox"/> 5247.5
<input checked="" type="checkbox"/> 5162.5	<input checked="" type="checkbox"/> 5180.0
<input checked="" type="checkbox"/> 5197.5	<input checked="" type="checkbox"/> 5215.0
<input checked="" type="checkbox"/> 5232.5	<input checked="" type="checkbox"/> 5232.5
<input checked="" type="checkbox"/> 5165.0	<input checked="" type="checkbox"/> 5185.0
<input checked="" type="checkbox"/> 5200.0	<input checked="" type="checkbox"/> 5220.0
<input checked="" type="checkbox"/> 5235.0	<input checked="" type="checkbox"/> 5235.0
<input checked="" type="checkbox"/> 5167.5	<input checked="" type="checkbox"/> 5202.5
<input checked="" type="checkbox"/> 5205.0	<input checked="" type="checkbox"/> 5220.0
<input checked="" type="checkbox"/> 5237.5	<input checked="" type="checkbox"/> 5237.5
5.2 GHz	
<input checked="" type="checkbox"/> 5252.5	<input checked="" type="checkbox"/> 5255.0
<input checked="" type="checkbox"/> 5270.0	<input checked="" type="checkbox"/> 5272.5
<input checked="" type="checkbox"/> 5287.5	<input checked="" type="checkbox"/> 5290.0
<input checked="" type="checkbox"/> 5305.0	<input checked="" type="checkbox"/> 5307.5
<input checked="" type="checkbox"/> 5322.5	<input checked="" type="checkbox"/> 5325.0
<input checked="" type="checkbox"/> 5340.0	<input checked="" type="checkbox"/> 5342.5
<input checked="" type="checkbox"/> 5257.5	<input checked="" type="checkbox"/> 5275.0
<input checked="" type="checkbox"/> 5292.5	<input checked="" type="checkbox"/> 5310.0
<input checked="" type="checkbox"/> 5327.5	<input checked="" type="checkbox"/> 5327.5
<input checked="" type="checkbox"/> 5345.0	<input checked="" type="checkbox"/> 5345.0
<input checked="" type="checkbox"/> 5260.0	<input checked="" type="checkbox"/> 5277.5
<input checked="" type="checkbox"/> 5295.0	<input checked="" type="checkbox"/> 5312.5
<input checked="" type="checkbox"/> 5330.0	<input checked="" type="checkbox"/> 5330.0
<input checked="" type="checkbox"/> 5347.5	<input checked="" type="checkbox"/> 5347.5
<input checked="" type="checkbox"/> 5262.5	<input checked="" type="checkbox"/> 5280.0
<input checked="" type="checkbox"/> 5297.5	<input checked="" type="checkbox"/> 5315.0
<input checked="" type="checkbox"/> 5332.5	<input checked="" type="checkbox"/> 5332.5
<input checked="" type="checkbox"/> 5265.0	<input checked="" type="checkbox"/> 5285.0
<input checked="" type="checkbox"/> 5300.0	<input checked="" type="checkbox"/> 5302.5
<input checked="" type="checkbox"/> 5335.0	<input checked="" type="checkbox"/> 5335.0
<input checked="" type="checkbox"/> 5267.5	<input checked="" type="checkbox"/> 5302.5
<input checked="" type="checkbox"/> 5307.5	<input checked="" type="checkbox"/> 5320.0
<input checked="" type="checkbox"/> 5337.5	<input checked="" type="checkbox"/> 5337.5
5.4 GHz	
<input checked="" type="checkbox"/> 5472.5	<input checked="" type="checkbox"/> 5475.0
<input checked="" type="checkbox"/> 5490.0	<input checked="" type="checkbox"/> 5492.5
<input checked="" type="checkbox"/> 5507.5	<input checked="" type="checkbox"/> 5510.0
<input checked="" type="checkbox"/> 5525.0	<input checked="" type="checkbox"/> 5527.5
<input checked="" type="checkbox"/> 5542.5	<input checked="" type="checkbox"/> 5545.0
<input checked="" type="checkbox"/> 5560.0	<input checked="" type="checkbox"/> 5562.5
<input checked="" type="checkbox"/> 5577.5	<input checked="" type="checkbox"/> 5580.0
<input checked="" type="checkbox"/> 5595.0	<input checked="" type="checkbox"/> 5597.5
<input checked="" type="checkbox"/> 5612.5	<input checked="" type="checkbox"/> 5615.0
<input checked="" type="checkbox"/> 5630.0	<input checked="" type="checkbox"/> 5632.5
<input checked="" type="checkbox"/> 5647.5	<input checked="" type="checkbox"/> 5650.0
<input checked="" type="checkbox"/> 5665.0	<input checked="" type="checkbox"/> 5667.5
<input checked="" type="checkbox"/> 5682.5	<input checked="" type="checkbox"/> 5685.0
<input checked="" type="checkbox"/> 5700.0	<input checked="" type="checkbox"/> 5702.5
<input checked="" type="checkbox"/> 5717.5	<input checked="" type="checkbox"/> 5720.0
<input checked="" type="checkbox"/> 5477.5	<input checked="" type="checkbox"/> 5495.0
<input checked="" type="checkbox"/> 5512.5	<input checked="" type="checkbox"/> 5530.0
<input checked="" type="checkbox"/> 5547.5	<input checked="" type="checkbox"/> 5550.0
<input checked="" type="checkbox"/> 5582.5	<input checked="" type="checkbox"/> 5600.0
<input checked="" type="checkbox"/> 5617.5	<input checked="" type="checkbox"/> 5635.0
<input checked="" type="checkbox"/> 5652.5	<input checked="" type="checkbox"/> 5660.0
<input checked="" type="checkbox"/> 5687.5	<input checked="" type="checkbox"/> 5687.5
<input checked="" type="checkbox"/> 5705.0	<input checked="" type="checkbox"/> 5705.0
<input checked="" type="checkbox"/> 5722.5	<input checked="" type="checkbox"/> 5722.5
<input checked="" type="checkbox"/> 5480.0	<input checked="" type="checkbox"/> 5497.5
<input checked="" type="checkbox"/> 5515.0	<input checked="" type="checkbox"/> 5532.5
<input checked="" type="checkbox"/> 5547.5	<input checked="" type="checkbox"/> 5552.5
<input checked="" type="checkbox"/> 5585.0	<input checked="" type="checkbox"/> 5602.5
<input checked="" type="checkbox"/> 5617.5	<input checked="" type="checkbox"/> 5637.5
<input checked="" type="checkbox"/> 5655.0	<input checked="" type="checkbox"/> 5660.0
<input checked="" type="checkbox"/> 5690.0	<input checked="" type="checkbox"/> 5690.0
<input checked="" type="checkbox"/> 5707.5	<input checked="" type="checkbox"/> 5707.5
<input checked="" type="checkbox"/> 5482.5	<input checked="" type="checkbox"/> 5497.5
<input checked="" type="checkbox"/> 5517.5	<input checked="" type="checkbox"/> 5535.0
<input checked="" type="checkbox"/> 5547.5	<input checked="" type="checkbox"/> 5555.0
<input checked="" type="checkbox"/> 5587.5	<input checked="" type="checkbox"/> 5605.0
<input checked="" type="checkbox"/> 5617.5	<input checked="" type="checkbox"/> 5637.5
<input checked="" type="checkbox"/> 5657.5	<input checked="" type="checkbox"/> 5660.0
<input checked="" type="checkbox"/> 5692.5	<input checked="" type="checkbox"/> 5692.5
<input checked="" type="checkbox"/> 5710.0	<input checked="" type="checkbox"/> 5710.0
<input checked="" type="checkbox"/> 5485.0	<input checked="" type="checkbox"/> 5500.0
<input checked="" type="checkbox"/> 5517.5	<input checked="" type="checkbox"/> 5537.5
<input checked="" type="checkbox"/> 5547.5	<input checked="" type="checkbox"/> 5557.5
<input checked="" type="checkbox"/> 5587.5	<input checked="" type="checkbox"/> 5607.5
<input checked="" type="checkbox"/> 5617.5	<input checked="" type="checkbox"/> 5637.5
<input checked="" type="checkbox"/> 5657.5	<input checked="" type="checkbox"/> 5660.0
<input checked="" type="checkbox"/> 5695.0	<input checked="" type="checkbox"/> 5695.0
<input checked="" type="checkbox"/> 5712.5	<input checked="" type="checkbox"/> 5712.5
<input checked="" type="checkbox"/> 5487.5	<input checked="" type="checkbox"/> 5505.0
<input checked="" type="checkbox"/> 5517.5	<input checked="" type="checkbox"/> 5537.5
<input checked="" type="checkbox"/> 5547.5	<input checked="" type="checkbox"/> 5557.5
<input checked="" type="checkbox"/> 5587.5	<input checked="" type="checkbox"/> 5607.5
<input checked="" type="checkbox"/> 5617.5	<input checked="" type="checkbox"/> 5637.5
<input checked="" type="checkbox"/> 5657.5	<input checked="" type="checkbox"/> 5662.5
<input checked="" type="checkbox"/> 5695.0	<input checked="" type="checkbox"/> 5695.0
<input checked="" type="checkbox"/> 5715.0	<input checked="" type="checkbox"/> 5715.0

Custom Radio Frequency Scan Selection List :

5.7 GHz

- 5727.5 5730.0 5732.5 5735.0 5737.5 5740.0 5742.5
- 5745.0 5747.5 5750.0 5752.5 5755.0 5757.5 5760.0
- 5762.5 5765.0 5767.5 5770.0 5772.5 5775.0 5777.5
- 5780.0 5782.5 5785.0 5787.5 5790.0 5792.5 5795.0
- 5797.5 5800.0 5802.5 5805.0 5807.5 5810.0 5812.5
- 5815.0 5817.5 5820.0 5822.5 5825.0 5827.5 5830.0
- 5832.5 5835.0 5837.5 5840.0 5842.5 5845.0 5847.5
- 5850.0 5852.5 5855.0 5857.5 5860.0 5862.5 5865.0
- 5867.5 5870.0 5872.5 5875.0 5877.5 5880.0 5882.5
- 5885.0 5887.5 5890.0 5892.5 5895.0 5897.5 5900.0
- 5902.5 5905.0 5907.5 5910.0 5912.5 5915.0 5917.5
- 5920.0 5922.5

- 5 MHz only
- ≤ 10 MHz
- ≤ 15 MHz
- ≤ 20 MHz
- ≤ 30 MHz
- Not available in this region

-
-

Channel Bandwidth Scan :

- 5 MHz
- 10 MHz
- 15 MHz
- 20 MHz
- 30 MHz
- 40 MHz

Cyclic Prefix : One Sixteenth

Color Code : (0—254)

Large Data Channel data Q : Enabled Disabled

MAC Control Parameters	
MIMO Rate Adapt Algorithm :	MIMO-A/B
Downlink Maximum Modulation Rate :	8x
Uplink Maximum Modulation Rate :	8x
Minimum Modulation Rate :	1x <small>Bridging will be disabled if the transmit modulation rate is below this setting</small>

Power Control	
Transmit Power :	<input type="text" value="16"/> dBm (Range: -30 — +27 dBm) (13 dBm V / 13 dBm H)
External Gain Fixed :	16 dBi

LQI Reference EVM	
Reference Downlink EVM :	<input type="text" value="0.0"/> dB
Current Downlink EVM :	-33.9 dB
Reference Uplink EVM :	<input type="text" value="0.0"/> dB
Current Uplink EVM :	-34.1 dB
Access Point MAC Address :	None
Channel Frequency :	None
Channel Bandwidth :	None
<input type="button" value="Populate EVM"/>	

Advanced	
Receive Quality Debug :	<input type="radio"/> Enabled <input checked="" type="radio"/> Disabled

Attribute	Meaning
Link Mode	See PTP 450i BHM Radio page attributes - 5 GHz
Timing Mode	
Custom Radio Frequency Scan Selection List	See PMP 450i SM Radio attributes - 5 GHz
Channel Bandwidth Scan	
Cyclic Prefix	
Color Code	
Large Data Channel data Q	
MIMO Rate Adapt Algorithm	
Downlink Maximum Modulation Rate	
Uplink Maximum Modulation Rate	
Minimum Modulation rate	
Transmit Power	
External Gain Fixed	<p>This value represents the fixed antenna gain. The fixed antenna gain for Mid-Gain is 16 dBi and High Gain is 23 dBi.</p> <p>For ODUs with integrated antenna, this is set at the correct value in the factory.</p> <p>For Connectorized ODUs with external antenna, the user must set this value to the overall antenna gain, including any RF cable loss between the ODU and the antenna.</p>
Reference Downlink EVM	Refer PMP 450i SM Radio attributes - 5 GHz.
Current Downlink EVM	
Reference Uplink EVM	
Current Uplink EVM	
Access Point MAC Address	
Channel Frequency	

Attribute	Meaning
Channel Bandwidth	
Receive Quality Debug	



Note
 The frequencies that a user can select are controlled by the country or a region and the Channel Bandwidth selected. There can be a case where a user adds a custom frequency (from the Custom Frequencies page) and cannot see it in the pull down menu.

PMP/ PTP 450 Series – configuring radio

Radio page - PMP 450 AP 5 GHz

The Radio tab of the AP for 5 GHz is as shown in below table.

Table 59 :PMP 450 AP Radio attributes - 5 GHz

Device Type

Device Setting : AP
 SM

Radio Configuration

Frequency Band : 5.4 GHz ▼
Frequency Carrier : None ▼
Channel Bandwidth : 10 MHz ▼
Frame Period : 5.0 ms
 2.5 ms
Cyclic Prefix : One Sixteenth
Color Code : 0 (0—254)
Subscriber Color Code Rescan (When not on a Primary Color Code) : 0 Minutes (0 — 43200)
Subscriber Color Code Wait Period for Idle : 0 Minutes (0 — 60)
Installation Color Code : Enabled
 Disabled
Sector ID : 0 ▼

MAC Control Parameters

MIMO Rate Adapt Algorithm : MIMO-A/B ▼
Downlink Maximum Modulation Rate : 8x ▼
Uplink Maximum Modulation Rate : 8x ▼

Frame Configuration

Max Range : 2 miles ▼ (Range: 1 — 40 miles / 64 km)
Downlink Data : 75 % (Range: 15 — 85 %)
Contention Slots : 3 (Range: 1 — 15)
Auto Contention : Enabled
 Disabled
Broadcast Repeat Count : 2 (Range: 0 — 2)

Power Control

Transmit Power : 16 dBm (Range: -30 — +22 dBm) (13 dBm V / 13 dBm H)
External Gain : 0 dBi (Range: 0 — +40 dBi)
SM Receive Target Level : -52 dBm (Range: -77 — -37 dBm) combined power
Adjacent Channel Support : Enabled
 Disabled

Multicast Data Control

Multicast Data Channel : Disable ▼
Multicast Repeat Count : 0 (Range: 0 — 2)
Multicast Downlink CIR : 0 (kbps) (Range: 0 — 12187 kbps)

Advanced

SM Registration Limit : 238 (Range: 1 — 238)
Receive Quality Debug : Enabled
 Disabled
OFF ▼

Frame Alignment Legacy Mode :
Choose Legacy Mode setting from the table below based on colocated radio's software revision and sync source:

Sync Src.\ SW Rev.	13.4.1 or higher	12.0 to 13.4 (DFS on)	12.0 to 13.4 (DFS off)	below 12.0
Timing Port	OFF	OFF	OFF	OFF
Power Port	OFF	OFF	ON (Mode 1)	OFF

SM Link Test Mode Restriction : Enabled
 Disabled

Attribute	Meaning
Device Setting	See PMP 450i or 450 MicroPoP Unlimited AP Radio attributes - 5 GHz
Frequency Band	
Frequency Carrier	
Channel Bandwidth	
Frame Period	
Cyclic Prefix	
Color Code	
Subscriber Color Code Rescan (When not on a Primary Color Code)	
Subscriber Color Code Wait Period for Idle	
Installation Color Code	
Sector ID	
MIMO Rate Adapt Algorithm	
Downlink Maximum Modulation Rate	
Uplink Maximum Modulation Rate	
Max Range	
Downlink Data	
Contention Slots (a.k.a. Control Slots)	
Auto Contention	
Broadcast Repeat Count	
Transmit Power	
External Gain	
SM Receive Target Level	
Adjacent Channel Support	
Multicast Data Channel	
Multicast Repeat Count	
Multicast Downlink CIR	
SM Registration Limit	
Receive Quality Debug	
Frame Alignment Legacy Mode	
SM Link Test Mode Restriction	

Radio page - PMP 450 AP 3.65 GHz

Table 60 :PMP 450 AP Radio attributes - 3.65 GHz

Device Type	
Device Setting :	<input checked="" type="radio"/> AP <input type="radio"/> SM

Radio Configuration	
Frequency Carrier :	None ▾
Channel Bandwidth :	10 MHz ▾
Frame Period :	<input type="radio"/> 5.0 ms <input checked="" type="radio"/> 2.5 ms
Cyclic Prefix :	One Sixteenth
Color Code :	0 (0—254)
Subscriber Color Code Rescan (When not on a Primary Color Code) :	0 Minutes (0 — 43200)
Subscriber Color Code Wait Period for Idle :	0 Minutes (0 — 60)
Installation Color Code :	<input type="radio"/> Enabled <input checked="" type="radio"/> Disabled
Sector ID :	0 ▾

MAC Control Parameters	
MIMO Rate Adapt Algorithm :	MIMO-A/B ▾
Downlink Maximum Modulation Rate :	8x ▾
Uplink Maximum Modulation Rate :	8x ▾

Frame Configuration	
Max Range :	2 miles ▾ (Range: 1 — 40 miles / 64 km)
Downlink Data :	75 % (Range: 15 — 85 %)
Contention Slots :	3 (Range: 1 — 15)
Auto Contention :	<input type="radio"/> Enabled <input checked="" type="radio"/> Disabled
Broadcast Repeat Count :	2 (Range: 0 — 2)

Power Control	
Transmit Power :	16 dBm (Range: -30 — +25 dBm) (13 dBm B / 13 dBm A)
External Gain :	0 dBi (Range: 0 — +70 dBi)
SM Receive Target Level :	-52 dBm (Range: -77 — -37 dBm) combined power
Adjacent Channel Support :	<input type="radio"/> Enabled <input checked="" type="radio"/> Disabled

Multicast Data Control	
Multicast Data Channel :	Disable ▾
Multicast Repeat Count :	0 (Range: 0 — 2)
Multicast Downlink CIR :	0 (kbps) (Range: 0 — 12187 kbps)

Advanced																
SM Registration Limit :	238 (Range: 1 — 238)															
Receive Quality Debug :	<input type="radio"/> Enabled <input checked="" type="radio"/> Disabled															
	OFF ▾															
Frame Alignment Legacy Mode :	Choose Legacy Mode setting from the table below based on colocated radio's software revision and sync source: <table border="1"> <thead> <tr> <th>Sync Src.\ SW Rev.</th> <th>13.4.1 or higher</th> <th>12.0 to 13.4 (DFS on)</th> <th>12.0 to 13.4 (DFS off)</th> <th>below 12.0</th> </tr> </thead> <tbody> <tr> <td>Timing Port</td> <td>OFF</td> <td>OFF</td> <td>OFF</td> <td>OFF</td> </tr> <tr> <td>Power Port</td> <td>OFF</td> <td>OFF</td> <td>ON (Mode 1)</td> <td>OFF</td> </tr> </tbody> </table>	Sync Src.\ SW Rev.	13.4.1 or higher	12.0 to 13.4 (DFS on)	12.0 to 13.4 (DFS off)	below 12.0	Timing Port	OFF	OFF	OFF	OFF	Power Port	OFF	OFF	ON (Mode 1)	OFF
Sync Src.\ SW Rev.	13.4.1 or higher	12.0 to 13.4 (DFS on)	12.0 to 13.4 (DFS off)	below 12.0												
Timing Port	OFF	OFF	OFF	OFF												
Power Port	OFF	OFF	ON (Mode 1)	OFF												
SM Link Test Mode Restriction :	<input type="radio"/> Enabled <input checked="" type="radio"/> Disabled															

Attribute	Meaning
Device Setting	See PMP 450i AP Radio Attributes - 5GHz
Frequency Band	
Frequency Carrier	
Channel Bandwidth	
Frame Period	
Cyclic Prefix	
Color Code	
Subscriber Color Code Rescan (When not on a Primary Color Code)	
Subscriber Color Code Wait Period for Idle	
Installation Color Code	
Sector ID	
MIMO Rate Adapt Algorithm	
Downlink Maximum Modulation Rate	
Uplink Maximum Modulation Rate	
Max Range	
Downlink Data	
Contention Slots (a.k.a. Control Slots)	
Auto Contention	
Broadcast Repeat Count	
Transmit Power	
External Gain	
SM Receive Target Level	
Adjacent Channel Support	
Multicast Data Channel	
Multicast Repeat Count	
Multicast Downlink CIR	
SM Registration Limit	
Receive Quality Debug	
Frame Alignment Legacy Mode	
SM Link Test Mode Restriction	



Note

When the Channel bandwidth is updated from 20 MHz to 30 MHz not more than 59 subscribers can be registered.

Radio page - PMP 450 AP 3.5 GHz

Table 61 :PMP 450 AP Radio attributes - 3.5 GHz

Device Type	
Device Setting :	<input checked="" type="radio"/> AP <input type="radio"/> SM

Radio Configuration	
Frequency Carrier :	None ▾
Channel Bandwidth :	10 MHz ▾
Frame Period :	<input type="radio"/> 5.0 ms <input checked="" type="radio"/> 2.5 ms
Cyclic Prefix :	One Sixteenth
Color Code :	0 (0—254)
Subscriber Color Code Rescan (When not on a Primary Color Code) :	0 Minutes (0 — 43200)
Subscriber Color Code Wait Period for Idle :	0 Minutes (0 — 60)
Installation Color Code :	<input type="radio"/> Enabled <input checked="" type="radio"/> Disabled
Sector ID :	0 ▾

MAC Control Parameters	
MIMO Rate Adapt Algorithm :	MIMO-A/B ▾
Downlink Maximum Modulation Rate :	8x ▾
Uplink Maximum Modulation Rate :	8x ▾

Frame Configuration	
Max Range :	2 miles ▾ (Range: 1 — 40 miles / 64 km)
Downlink Data :	75 % (Range: 15 — 85 %)
Contention Slots :	3 (Range: 1 — 15)
Auto Contention :	<input type="radio"/> Enabled <input checked="" type="radio"/> Disabled
Broadcast Repeat Count :	2 (Range: 0 — 2)

Power Control	
Transmit Power :	16 dBm (Range: -30 — +25 dBm) (13 dBm B / 13 dBm A)
External Gain :	0 dBi (Range: 0 — +70 dBi)
SM Receive Target Level :	-52 dBm (Range: -77 — -37 dBm) combined power
Adjacent Channel Support :	<input type="radio"/> Enabled <input checked="" type="radio"/> Disabled

Multicast Data Control	
Multicast Data Channel :	Disable ▾
Multicast Repeat Count :	0 (Range: 0 — 2)
Multicast Downlink CIR :	0 (kbps) (Range: 0 — 12187 kbps)

Advanced

SM Registration Limit : (Range: 1 — 238)

Receive Quality Debug : Enabled
 Disabled

▼

Choose Legacy Mode setting from the table below based on colocated radio's software revision and sync source:

Sync Src.\ SW Rev.	13.4.1 or higher	12.0 to 13.4 (DFS on)	12.0 to 13.4 (DFS off)	below 12.0
Timing Port	OFF	OFF	OFF	OFF
Power Port	OFF	OFF	ON (Mode 1)	OFF

Frame Alignment Legacy Mode :

SM Link Test Mode Restriction : Enabled
 Disabled

Attribute	Meaning
See PMP 450i or 450 MicroPoP Unlimited AP Radio attributes - 5 GHz for all parameters details.	

Radio page - PMP 450 AP 2.4 GHz

Table 62 :Table 64 PMP 450 AP Radio attributes - 2.4 GHz

Device Type	
Device Setting :	<input checked="" type="radio"/> AP <input type="radio"/> SM

Radio Configuration	
Frequency Carrier :	None ▾
Channel Bandwidth :	10 MHz ▾
Frame Period :	<input type="radio"/> 5.0 ms <input checked="" type="radio"/> 2.5 ms
Cyclic Prefix :	One Sixteenth
Color Code :	0 (0—254)
Subscriber Color Code Rescan (When not on a Primary Color Code) :	0 Minutes (0 — 43200)
Subscriber Color Code Wait Period for Idle :	0 Minutes (0 — 60)
Installation Color Code :	<input type="radio"/> Enabled <input checked="" type="radio"/> Disabled
Sector ID :	0 ▾

MAC Control Parameters	
MIMO Rate Adapt Algorithm :	MIMO-A/B ▾
Downlink Maximum Modulation Rate :	8x ▾
Uplink Maximum Modulation Rate :	8x ▾

Frame Configuration	
Max Range :	2 miles ▾ (Range: 1 — 40 miles / 64 km)
Downlink Data :	75 % (Range: 15 — 85 %)
Contention Slots :	3 (Range: 1 — 15)
Auto Contention :	<input type="radio"/> Enabled <input checked="" type="radio"/> Disabled
Broadcast Repeat Count :	2 (Range: 0 — 2)

Power Control	
Transmit Power :	16 dBm (Range: -30 — +22 dBm) (13 dBm B / 13 dBm A)
External Gain :	0 dBi (Range: 0 — +40 dBi)
SM Receive Target Level :	-52 dBm (Range: -77 — -37 dBm) combined power

Multicast Data Control	
Multicast Data Channel :	Disable ▾
Multicast Repeat Count :	0 (Range: 0 — 2)
Multicast Downlink CIR :	0 (kbps) (Range: 0 — 12187 kbps)

Advanced																
SM Registration Limit :	238 (Range: 1 — 238)															
Receive Quality Debug :	<input type="radio"/> Enabled <input checked="" type="radio"/> Disabled OFF ▾															
Frame Alignment Legacy Mode :	Choose Legacy Mode setting from the table below based on colocated radio's software revision and sync source: <table border="1"> <thead> <tr> <th>Sync Src.\ SW Rev.</th> <th>13.4.1 or higher</th> <th>12.0 to 13.4 (DFS on)</th> <th>12.0 to 13.4 (DFS off)</th> <th>below 12.0</th> </tr> </thead> <tbody> <tr> <td>Timing Port</td> <td>OFF</td> <td>OFF</td> <td>OFF</td> <td>OFF</td> </tr> <tr> <td>Power Port</td> <td>OFF</td> <td>OFF</td> <td>ON (Mode 1)</td> <td>OFF</td> </tr> </tbody> </table>	Sync Src.\ SW Rev.	13.4.1 or higher	12.0 to 13.4 (DFS on)	12.0 to 13.4 (DFS off)	below 12.0	Timing Port	OFF	OFF	OFF	OFF	Power Port	OFF	OFF	ON (Mode 1)	OFF
Sync Src.\ SW Rev.	13.4.1 or higher	12.0 to 13.4 (DFS on)	12.0 to 13.4 (DFS off)	below 12.0												
Timing Port	OFF	OFF	OFF	OFF												
Power Port	OFF	OFF	ON (Mode 1)	OFF												
SM Link Test Mode Restriction :	<input type="radio"/> Enabled <input checked="" type="radio"/> Disabled															

Attribute	Meaning
See PMP 450i or 450 MicroPoP Unlimited AP Radio attributes - 5 GHz for all parameters details.	

Radio page - PMP 450 SM 5 GHz

Table 63 :PMP 450 SM Radio attributes – 5 GHz

Radio Configuration

5.4 GHz

<input type="checkbox"/> 5472.5	<input type="checkbox"/> 5475.0	<input type="checkbox"/> 5477.5	<input checked="" type="checkbox"/> 5480.0	<input checked="" type="checkbox"/> 5482.5	<input checked="" type="checkbox"/> 5485.0	<input checked="" type="checkbox"/> 5487.5
<input checked="" type="checkbox"/> 5490.0	<input checked="" type="checkbox"/> 5492.5	<input checked="" type="checkbox"/> 5495.0	<input checked="" type="checkbox"/> 5497.5	<input checked="" type="checkbox"/> 5500.0	<input checked="" type="checkbox"/> 5502.5	<input checked="" type="checkbox"/> 5505.0
<input checked="" type="checkbox"/> 5507.5	<input checked="" type="checkbox"/> 5510.0	<input checked="" type="checkbox"/> 5512.5	<input checked="" type="checkbox"/> 5515.0	<input checked="" type="checkbox"/> 5517.5	<input checked="" type="checkbox"/> 5520.0	<input checked="" type="checkbox"/> 5522.5
<input checked="" type="checkbox"/> 5525.0	<input checked="" type="checkbox"/> 5527.5	<input checked="" type="checkbox"/> 5530.0	<input checked="" type="checkbox"/> 5532.5	<input checked="" type="checkbox"/> 5535.0	<input checked="" type="checkbox"/> 5537.5	<input checked="" type="checkbox"/> 5540.0
<input checked="" type="checkbox"/> 5542.5	<input checked="" type="checkbox"/> 5545.0	<input checked="" type="checkbox"/> 5547.5	<input checked="" type="checkbox"/> 5550.0	<input checked="" type="checkbox"/> 5552.5	<input checked="" type="checkbox"/> 5555.0	<input checked="" type="checkbox"/> 5557.5
<input checked="" type="checkbox"/> 5560.0	<input checked="" type="checkbox"/> 5562.5	<input checked="" type="checkbox"/> 5565.0	<input checked="" type="checkbox"/> 5567.5	<input checked="" type="checkbox"/> 5570.0	<input checked="" type="checkbox"/> 5572.5	<input checked="" type="checkbox"/> 5575.0
<input checked="" type="checkbox"/> 5577.5	<input checked="" type="checkbox"/> 5580.0	<input checked="" type="checkbox"/> 5582.5	<input checked="" type="checkbox"/> 5585.0	<input checked="" type="checkbox"/> 5587.5	<input checked="" type="checkbox"/> 5590.0	<input checked="" type="checkbox"/> 5592.5
<input checked="" type="checkbox"/> 5595.0	<input checked="" type="checkbox"/> 5597.5	<input checked="" type="checkbox"/> 5600.0	<input checked="" type="checkbox"/> 5602.5	<input checked="" type="checkbox"/> 5605.0	<input checked="" type="checkbox"/> 5607.5	<input checked="" type="checkbox"/> 5610.0
<input checked="" type="checkbox"/> 5612.5	<input checked="" type="checkbox"/> 5615.0	<input checked="" type="checkbox"/> 5617.5	<input checked="" type="checkbox"/> 5620.0	<input checked="" type="checkbox"/> 5622.5	<input checked="" type="checkbox"/> 5625.0	<input checked="" type="checkbox"/> 5627.5
<input checked="" type="checkbox"/> 5630.0	<input checked="" type="checkbox"/> 5632.5	<input checked="" type="checkbox"/> 5635.0	<input checked="" type="checkbox"/> 5637.5	<input checked="" type="checkbox"/> 5640.0	<input checked="" type="checkbox"/> 5642.5	<input checked="" type="checkbox"/> 5645.0
<input checked="" type="checkbox"/> 5647.5	<input checked="" type="checkbox"/> 5650.0	<input checked="" type="checkbox"/> 5652.5	<input checked="" type="checkbox"/> 5655.0	<input checked="" type="checkbox"/> 5657.5	<input checked="" type="checkbox"/> 5660.0	<input checked="" type="checkbox"/> 5662.5
<input checked="" type="checkbox"/> 5665.0	<input checked="" type="checkbox"/> 5667.5	<input checked="" type="checkbox"/> 5670.0	<input checked="" type="checkbox"/> 5672.5	<input checked="" type="checkbox"/> 5675.0	<input checked="" type="checkbox"/> 5677.5	<input checked="" type="checkbox"/> 5680.0
<input checked="" type="checkbox"/> 5682.5	<input checked="" type="checkbox"/> 5685.0	<input checked="" type="checkbox"/> 5687.5	<input checked="" type="checkbox"/> 5690.0	<input checked="" type="checkbox"/> 5692.5	<input checked="" type="checkbox"/> 5695.0	<input checked="" type="checkbox"/> 5697.5
<input checked="" type="checkbox"/> 5700.0	<input checked="" type="checkbox"/> 5702.5	<input checked="" type="checkbox"/> 5705.0	<input checked="" type="checkbox"/> 5707.5	<input checked="" type="checkbox"/> 5710.0	<input checked="" type="checkbox"/> 5712.5	<input checked="" type="checkbox"/> 5715.0
<input type="checkbox"/> 5717.5	<input type="checkbox"/> 5720.0	<input type="checkbox"/> 5722.5				

Custom Radio Frequency Scan Selection List :

5.7 GHz

<input type="checkbox"/> 5727.5	<input type="checkbox"/> 5730.0	<input type="checkbox"/> 5732.5	<input checked="" type="checkbox"/> 5735.0	<input checked="" type="checkbox"/> 5737.5	<input checked="" type="checkbox"/> 5740.0	<input checked="" type="checkbox"/> 5742.5
<input checked="" type="checkbox"/> 5745.0	<input checked="" type="checkbox"/> 5747.5	<input checked="" type="checkbox"/> 5750.0	<input checked="" type="checkbox"/> 5752.5	<input checked="" type="checkbox"/> 5755.0	<input checked="" type="checkbox"/> 5757.5	<input checked="" type="checkbox"/> 5760.0
<input checked="" type="checkbox"/> 5762.5	<input checked="" type="checkbox"/> 5765.0	<input checked="" type="checkbox"/> 5767.5	<input checked="" type="checkbox"/> 5770.0	<input checked="" type="checkbox"/> 5772.5	<input checked="" type="checkbox"/> 5775.0	<input checked="" type="checkbox"/> 5777.5
<input checked="" type="checkbox"/> 5780.0	<input checked="" type="checkbox"/> 5782.5	<input checked="" type="checkbox"/> 5785.0	<input checked="" type="checkbox"/> 5787.5	<input checked="" type="checkbox"/> 5790.0	<input checked="" type="checkbox"/> 5792.5	<input checked="" type="checkbox"/> 5795.0
<input checked="" type="checkbox"/> 5797.5	<input checked="" type="checkbox"/> 5800.0	<input checked="" type="checkbox"/> 5802.5	<input checked="" type="checkbox"/> 5805.0	<input checked="" type="checkbox"/> 5807.5	<input checked="" type="checkbox"/> 5810.0	<input checked="" type="checkbox"/> 5812.5
<input checked="" type="checkbox"/> 5815.0	<input checked="" type="checkbox"/> 5817.5	<input checked="" type="checkbox"/> 5820.0	<input checked="" type="checkbox"/> 5822.5	<input checked="" type="checkbox"/> 5825.0	<input checked="" type="checkbox"/> 5827.5	<input checked="" type="checkbox"/> 5830.0
<input checked="" type="checkbox"/> 5832.5	<input checked="" type="checkbox"/> 5835.0	<input checked="" type="checkbox"/> 5837.5	<input checked="" type="checkbox"/> 5840.0	<input checked="" type="checkbox"/> 5842.5	<input checked="" type="checkbox"/> 5845.0	<input checked="" type="checkbox"/> 5847.5
<input checked="" type="checkbox"/> 5850.0	<input checked="" type="checkbox"/> 5852.5	<input checked="" type="checkbox"/> 5855.0	<input checked="" type="checkbox"/> 5857.5	<input checked="" type="checkbox"/> 5860.0	<input checked="" type="checkbox"/> 5862.5	<input checked="" type="checkbox"/> 5865.0
<input checked="" type="checkbox"/> 5867.5	<input checked="" type="checkbox"/> 5870.0	<input checked="" type="checkbox"/> 5872.5	<input checked="" type="checkbox"/> 5875.0	<input checked="" type="checkbox"/> 5877.5	<input checked="" type="checkbox"/> 5880.0	<input checked="" type="checkbox"/> 5882.5
<input checked="" type="checkbox"/> 5885.0	<input checked="" type="checkbox"/> 5887.5	<input checked="" type="checkbox"/> 5890.0	<input type="checkbox"/> 5892.5	<input type="checkbox"/> 5895.0	<input type="checkbox"/> 5897.5	

5 MHz only

<= 10 MHz

<=15 MHz

<=20 MHz

<=30 MHz

Not available in this region

Channel Bandwidth Scan :

- 5 MHz
- 10 MHz
- 15 MHz
- 20 MHz
- 30 MHz
- 40 MHz

Cyclic Prefix :	One Sixteenth
AP Selection Method :	<input checked="" type="radio"/> Power Level <input type="radio"/> Optimize for Throughput
Color Code 1 :	0 (0—254) / Priority Primary ▾
Installation Color Code :	<input checked="" type="radio"/> Enabled <input type="radio"/> Disabled
Large Data Channel data Q :	<input type="radio"/> Enabled <input checked="" type="radio"/> Disabled

Additional Color Codes	
Color Code :	0 (0—254) / Priority Primary ▾
<input type="button" value="Add/Modify Color Code"/> <input type="button" value="Remove Color Code"/>	

Additional Color Codes Table	
No additional color codes configured	

MAC Control Parameters	
MIMO Rate Adapt Algorithm :	MIMO-A/B ▾
Downlink Maximum Modulation Rate :	8x ▾
Uplink Maximum Modulation Rate :	8x ▾

Power Control	
External Gain :	0 dBi (Range: 0 — +40 dBi)
Enable Max Tx Power :	<input type="radio"/> Enable <input checked="" type="radio"/> Disable

LQI Reference EVM	
Reference Downlink EVM :	0.0 dB
Current Downlink EVM :	-29.3 dB
Reference Uplink EVM :	0.0 dB
Current Uplink EVM :	-34.8 dB
Access Point MAC Address :	None
Channel Frequency :	None
Channel Bandwidth :	None
<input type="button" value="Populate EVM"/>	

Advanced	
Receive Quality Debug :	<input type="radio"/> Enabled <input checked="" type="radio"/> Disabled

Attribute	Meaning
Custom Radio Frequency Scan Selection List	Check the frequencies that SM has to scan for AP transmissions. See Radio Frequency Scan Selection List
See PMP 450i SM Radio attributes - 5 GHz	



Note

The frequencies that a user can select are controlled by the country or a region and the Channel Bandwidth selected. There can be a case where a user adds a custom frequency (from the Custom Frequencies page) and cannot see it in the pull down menu.

Radio page - PMP 450 SM 3.65 GHz

Table 64 :PMP 450 SM Radio attributes - 3.65 GHz

Radio Configuration	
	<input checked="" type="checkbox"/> 3655.000 <input checked="" type="checkbox"/> 3657.500 <input checked="" type="checkbox"/> 3660.000 <input checked="" type="checkbox"/> 3662.500 <input checked="" type="checkbox"/> 3665.000 <input checked="" type="checkbox"/> 3667.500 <input checked="" type="checkbox"/> 3670.000 <input checked="" type="checkbox"/> 3672.500 <input checked="" type="checkbox"/> 3675.000 <input checked="" type="checkbox"/> 3677.500 <input checked="" type="checkbox"/> 3680.000 <input checked="" type="checkbox"/> 3682.500 <input checked="" type="checkbox"/> 3685.000 <input checked="" type="checkbox"/> 3687.500 <input checked="" type="checkbox"/> 3690.000 <input checked="" type="checkbox"/> 3692.500 <input checked="" type="checkbox"/> 3695.000
Custom Radio Frequency Scan Selection List :	<p>5 MHz only</p> <p><input checked="" type="checkbox"/> <=7 MHz</p> <p><input checked="" type="checkbox"/> <= 10 MHz</p> <p><input checked="" type="checkbox"/> <=15 MHz</p> <p><input checked="" type="checkbox"/> <=20 MHz</p> <p><input checked="" type="checkbox"/> <=30 MHz</p> <p>Not available in this region</p> <p>Select All Clear All Restore</p>
Channel Bandwidth Scan :	<input checked="" type="checkbox"/> 5 MHz <input checked="" type="checkbox"/> 7 MHz <input checked="" type="checkbox"/> 10 MHz <input checked="" type="checkbox"/> 15 MHz <input checked="" type="checkbox"/> 20 MHz <input checked="" type="checkbox"/> 30 MHz <input checked="" type="checkbox"/> 40 MHz
Cyclic Prefix :	One Sixteenth
AP Selection Method :	<input type="radio"/> Power Level <input checked="" type="radio"/> Optimize for Throughput
Color Code 1 :	0 (0—254) / Priority Primary ▾
Installation Color Code :	<input checked="" type="radio"/> Enabled <input type="radio"/> Disabled
Large Data Channel data Q :	<input type="radio"/> Enabled <input checked="" type="radio"/> Disabled

Additional Color Codes	
Color Code :	0 (0—254) / Priority Primary ▾
	Add/Modify Color Code Remove Color Code

Additional Color Codes Table	
No additional color codes configured	

MAC Control Parameters	
MIMO Rate Adapt Algorithm :	MIMO-A/B ▾
Downlink Maximum Modulation Rate :	8x ▾
Uplink Maximum Modulation Rate :	8x ▾

Power Control	
External Gain :	0 dBi (Range: 0 — +70 dBi)
Enable Max Tx Power :	<input type="radio"/> Enable <input checked="" type="radio"/> Disable

LQI Reference EVM	
Reference Downlink EVM :	0.0 dB
Current Downlink EVM :	-32.8 dB
Reference Uplink EVM :	0.0 dB
Current Uplink EVM :	-29.1 dB
Access Point MAC Address :	None
Channel Frequency :	None
Channel Bandwidth :	None
	Populate EVM

Advanced	
Receive Quality Debug :	<input type="radio"/> Enabled <input checked="" type="radio"/> Disabled

Attribute	Meaning
Custom Radio Frequency Scan Selection List	Check the frequencies that SM has to scan for AP transmissions. See Radio Frequency Scan Selection List
See PMP 450i SM Radio attributes - 5 GHz	



Note

The frequencies that a user can select are controlled by the country or a region and the Channel Bandwidth selected. There can be a case where a user adds a custom frequency (from the Custom Frequencies page) and cannot see it in the pull down menu.

Radio page - PMP 450 SM 3.5 GHz

Table 65 :PMP 450 SM Radio attributes - 3.5 GHz

Radio Configuration	
	<input checked="" type="checkbox"/> 3305.000 <input checked="" type="checkbox"/> 3310.000 <input checked="" type="checkbox"/> 3315.000 <input checked="" type="checkbox"/> 3320.000 <input checked="" type="checkbox"/> 3325.000 <input checked="" type="checkbox"/> 3330.000 <input checked="" type="checkbox"/> 3335.000 <input checked="" type="checkbox"/> 3340.000 <input checked="" type="checkbox"/> 3345.000 <input checked="" type="checkbox"/> 3350.000 <input checked="" type="checkbox"/> 3355.000 <input checked="" type="checkbox"/> 3360.000 <input checked="" type="checkbox"/> 3365.000 <input checked="" type="checkbox"/> 3370.000 <input checked="" type="checkbox"/> 3375.000 <input checked="" type="checkbox"/> 3380.000 <input checked="" type="checkbox"/> 3385.000 <input checked="" type="checkbox"/> 3390.000 <input checked="" type="checkbox"/> 3395.000 <input checked="" type="checkbox"/> 3400.000 <input checked="" type="checkbox"/> 3405.000 <input checked="" type="checkbox"/> 3410.000 <input checked="" type="checkbox"/> 3415.000 <input checked="" type="checkbox"/> 3420.000 <input checked="" type="checkbox"/> 3425.000 <input checked="" type="checkbox"/> 3430.000 <input checked="" type="checkbox"/> 3435.000 <input checked="" type="checkbox"/> 3440.000 <input checked="" type="checkbox"/> 3445.000 <input checked="" type="checkbox"/> 3450.000 <input checked="" type="checkbox"/> 3455.000 <input checked="" type="checkbox"/> 3460.000 <input checked="" type="checkbox"/> 3465.000 <input checked="" type="checkbox"/> 3470.000 <input checked="" type="checkbox"/> 3475.000 <input checked="" type="checkbox"/> 3480.000 <input checked="" type="checkbox"/> 3485.000 <input checked="" type="checkbox"/> 3490.000 <input checked="" type="checkbox"/> 3495.000 <input checked="" type="checkbox"/> 3500.000 <input checked="" type="checkbox"/> 3505.000 <input checked="" type="checkbox"/> 3510.000 <input checked="" type="checkbox"/> 3515.000 <input checked="" type="checkbox"/> 3520.000 <input checked="" type="checkbox"/> 3525.000 Custom Radio Frequency Scan Selection List : <input checked="" type="checkbox"/> 3530.000 <input checked="" type="checkbox"/> 3535.000 <input checked="" type="checkbox"/> 3540.000 <input checked="" type="checkbox"/> 3545.000 <input checked="" type="checkbox"/> 3550.000 <input checked="" type="checkbox"/> 3555.000 <input checked="" type="checkbox"/> 3560.000 <input checked="" type="checkbox"/> 3565.000 <input checked="" type="checkbox"/> 3570.000 <input checked="" type="checkbox"/> 3575.000 <input checked="" type="checkbox"/> 3580.000 <input checked="" type="checkbox"/> 3585.000 <input checked="" type="checkbox"/> 3590.000 <input checked="" type="checkbox"/> 3595.000 5 MHz only <input checked="" type="checkbox"/> ≤7 MHz <input checked="" type="checkbox"/> ≤10 MHz <input checked="" type="checkbox"/> ≤15 MHz <input checked="" type="checkbox"/> ≤20 MHz <input checked="" type="checkbox"/> ≤30 MHz Not available in this region <input type="button" value="Select All"/> <input type="button" value="Clear All"/> <input type="button" value="Restore"/>
Channel Bandwidth Scan :	<input checked="" type="checkbox"/> 5 MHz <input checked="" type="checkbox"/> 7 MHz <input checked="" type="checkbox"/> 10 MHz <input checked="" type="checkbox"/> 15 MHz <input checked="" type="checkbox"/> 20 MHz <input checked="" type="checkbox"/> 30 MHz <input checked="" type="checkbox"/> 40 MHz
Cyclic Prefix :	One Sixteenth
AP Selection Method :	<input type="radio"/> Power Level <input checked="" type="radio"/> Optimize for Throughput
Color Code 1 :	0 (0—254) / Priority Primary ▾
Installation Color Code :	<input checked="" type="radio"/> Enabled <input type="radio"/> Disabled
Large Data Channel data Q :	<input type="radio"/> Enabled <input checked="" type="radio"/> Disabled
Additional Color Codes	
Color Code :	0 (0—254) / Priority Primary ▾
	<input type="button" value="Add/Modify Color Code"/> <input type="button" value="Remove Color Code"/>
Additional Color Codes Table	
No additional color codes configured	

MAC Control Parameters	
MIMO Rate Adapt Algorithm :	MIMO-A/B ▼
Downlink Maximum Modulation Rate :	8x ▼
Uplink Maximum Modulation Rate :	8x ▼

Power Control	
External Gain :	0 dBi (Range: 0 — +70 dBi)
Enable Max Tx Power :	<input type="radio"/> Enable <input checked="" type="radio"/> Disable

LQI Reference EVM	
Reference Downlink EVM :	0.0 dB
Current Downlink EVM :	N/A
Reference Uplink EVM :	0.0 dB
Current Uplink EVM :	N/A
Access Point MAC Address :	None
Channel Frequency :	None
Channel Bandwidth :	None
<input type="button" value="Populate EVM"/>	

Advanced	
Receive Quality Debug :	<input type="radio"/> Enabled <input checked="" type="radio"/> Disabled

Attribute	Meaning
Custom Radio Frequency Scan Selection List	Check the frequencies that SM has to scan for AP transmissions. See Radio Frequency Scan Selection List
See PMP 450i SM Radio attributes - 5 GHz	



Note

The frequencies that a user can select are controlled by the country or a region and the Channel Bandwidth selected. There can be a case where a user adds a custom frequency (from the Custom Frequencies page) and cannot see it in the pull down menu.

Radio page - PMP 450 SM 2.4 GHz

Table 66 :PMP 450 SM Radio attributes - 2.4 GHz

Radio Configuration

2402.5 2405.0 2407.5 2410.0 2412.5 2415.0 2417.5
 2420.0 2422.5 2425.0 2427.5 2430.0 2432.5 2435.0
 2437.5 2440.0 2442.5 2445.0 2447.5 2450.0 2452.5
 2455.0 2457.5 2460.0 2462.5 2465.0 2467.5 2470.0
 2472.5 2475.0 2477.5 2480.0

Custom Radio Frequency Scan Selection List :

5 MHz only
 <= 10 MHz
 <=15 MHz
 <=20 MHz
 Not available in this region

Channel Bandwidth Scan :

5 MHz
 10 MHz
 15 MHz
 20 MHz
 30 MHz

Cyclic Prefix : One Sixteenth

AP Selection Method : Power Level Optimize for Throughput

Color Code 1 : 0 (0—254) / Priority Primary

Installation Color Code : Enabled Disabled

Large Data Channel data Q : Enabled Disabled

Additional Color Codes

Color Code : 0 (0—254) / Priority Primary

Additional Color Codes Table

No additional color codes configured

MAC Control Parameters

MIMO Rate Adapt Algorithm : MIMO-A/B

Downlink Maximum Modulation Rate : 8x

Uplink Maximum Modulation Rate : 8x

Power Control

External Gain : 0 dBi (Range: 0 — +40 dBi)

Enable Max Tx Power : Enable Disable

LQI Reference EVM

Reference Downlink EVM : 0.0 dB

Current Downlink EVM : N/A

Reference Uplink EVM : 0.0 dB

Current Uplink EVM : N/A

Access Point MAC Address : None

Channel Frequency : None

Channel Bandwidth : None

Advanced

Receive Quality Debug : Enabled Disabled

Attribute	Meaning
Custom Radio Frequency Scan Selection List	Check the frequencies that SM has to scan for AP transmissions. See Radio Frequency Scan Selection List
See PMP 450i SM Radio attributes - 5 GHz	

Radio page - PMP 450 SM 900 MHz

Table 67 :PMP 450 SM Radio attributes -900 MHz

Radio Configuration

	<input type="checkbox"/> 904.50 <input type="checkbox"/> 905.00 <input checked="" type="checkbox"/> 905.50 <input checked="" type="checkbox"/> 906.00 <input checked="" type="checkbox"/> 906.50 <input checked="" type="checkbox"/> 907.00 <input checked="" type="checkbox"/> 907.50 <input checked="" type="checkbox"/> 908.00 <input checked="" type="checkbox"/> 908.50 <input checked="" type="checkbox"/> 909.00 <input checked="" type="checkbox"/> 909.50 <input checked="" type="checkbox"/> 910.00 <input checked="" type="checkbox"/> 910.50 <input checked="" type="checkbox"/> 911.00 <input checked="" type="checkbox"/> 911.50 <input checked="" type="checkbox"/> 912.00 <input checked="" type="checkbox"/> 912.50 <input checked="" type="checkbox"/> 913.00 <input checked="" type="checkbox"/> 913.50 <input checked="" type="checkbox"/> 914.00 <input checked="" type="checkbox"/> 914.50 <input checked="" type="checkbox"/> 915.00 <input checked="" type="checkbox"/> 915.50 <input checked="" type="checkbox"/> 916.00 <input checked="" type="checkbox"/> 916.50 <input checked="" type="checkbox"/> 917.00 <input checked="" type="checkbox"/> 917.50 <input checked="" type="checkbox"/> 918.00 <input checked="" type="checkbox"/> 918.50 <input checked="" type="checkbox"/> 919.00 <input checked="" type="checkbox"/> 919.50 <input checked="" type="checkbox"/> 920.00 <input checked="" type="checkbox"/> 920.50 <input checked="" type="checkbox"/> 921.00 <input checked="" type="checkbox"/> 921.50 <input checked="" type="checkbox"/> 922.00 <input checked="" type="checkbox"/> 922.50 <input checked="" type="checkbox"/> 923.00 <input checked="" type="checkbox"/> 923.50 <input checked="" type="checkbox"/> 924.00 <input checked="" type="checkbox"/> 924.50 <input type="checkbox"/> 924.75 <input type="checkbox"/> 925.00 <input type="checkbox"/> 925.50
Custom Radio Frequency Scan Selection List :	
	<div style="font-size: small;"> 5 MHz only ≤ 7 MHz ≤ 10 MHz ≤ 15 MHz Not available in this region </div> <div style="display: flex; gap: 5px;"> <input type="button" value="Select All"/> <input type="button" value="Clear All"/> <input type="button" value="Restore"/> </div>
Channel Bandwidth Scan :	<input checked="" type="checkbox"/> 5 MHz <input checked="" type="checkbox"/> 7 MHz <input checked="" type="checkbox"/> 10 MHz <input checked="" type="checkbox"/> 15 MHz <input checked="" type="checkbox"/> 20 MHz
Cyclic Prefix :	One Sixteenth
AP Selection Method :	<input type="radio"/> Power Level <input checked="" type="radio"/> Optimize for Throughput
Color Code 1 :	0 (0—254) / Priority Primary
Installation Color Code :	<input checked="" type="radio"/> Enabled <input type="radio"/> Disabled
Large Data Channel data Q :	<input type="radio"/> Enabled <input checked="" type="radio"/> Disabled

Additional Color Codes

Color Code : 0 (0—254) / Priority Primary

Additional Color Codes Table

No additional color codes configured

MAC Control Parameters

MIMO Rate Adapt Algorithm : MIMO-A/B

Downlink Maximum Modulation Rate : 8x

Uplink Maximum Modulation Rate : 8x

Power Control

External Gain : 0 dBi (Range: 0 — +40 dBi)

Enable Max Tx Power :
 Enable
 Disable

LQI Reference EVM		
Reference Downlink EVM :	0.0	dB
Current Downlink EVM :	-27.0	dB
Reference Uplink EVM :	0.0	dB
Current Uplink EVM :	-34.8	dB
Access Point MAC Address :	None	
Channel Frequency :	None	
Channel Bandwidth :	None	
<input type="button" value="Populate EVM"/>		

Advanced	
Receive Quality Debug :	<input type="radio"/> Enabled <input checked="" type="radio"/> Disabled

Attribute	Meaning
Custom Radio Frequency Scan Selection List	See PMP 450i SM Radio attributes - 5 GHz.
Channel Bandwidth Scan	
Cyclic Prefix	
AP Selection Method	
Color Code 1	
Installation Color Code	
Large Data Channel data Q	
Color Code	
MIMO Rate Adapt Algorithm	
Downlink Maximum Modulation Rate	
Uplink Maximum Modulation Rate	
External Gain	
Enable Max Tx Power	
Reference Downlink EVM	
Current Downlink EVM	
Reference Uplink EVM	
Current Uplink EVM	
Access Point MAC Address	
Channel Frequency	
Channel Bandwidth	
Receive Quality Debug	

Radio page - PTP 450 BHM 5 GHz

Table 68 :PTP 450 BHM Radio attributes -5 GHz

Device Type	
Timing Mode :	<input checked="" type="radio"/> Timing Master <input type="radio"/> Timing Slave

Radio Configuration	
Frequency Band :	5.7 GHz ▼
Frequency Carrier :	None ▼
Channel Bandwidth :	10 MHz ▼
Frame Period :	<input type="radio"/> 5.0 ms <input checked="" type="radio"/> 2.5 ms
Cyclic Prefix :	One Sixteenth
Color Code :	0 (0—254)
Sector ID :	0 ▼
Large Data Channel data Q :	<input type="radio"/> Enabled <input checked="" type="radio"/> Disabled

MAC Control Parameters	
MIMO Rate Adapt Algorithm :	MIMO-A/B ▼
Downlink Maximum Modulation Rate :	8x ▼
Uplink Maximum Modulation Rate :	8x ▼
Minimum Modulation Rate :	1x ▼ Bridging will be disabled if the transmit modulation rate is below this setting

Frame Configuration	
Downlink Data :	75 % (Range: 15 — 85 %)

Power Control	
Transmit Power :	16 dBm (Range: -30 — +22 dBm) (13 dBm V / 13 dBm H)
External Gain :	0 dBi (Range: 0 — +40 dBi)

Advanced																
Receive Quality Debug :	<input type="radio"/> Enabled <input checked="" type="radio"/> Disabled															
	OFF ▼															
Frame Alignment Legacy Mode :	<p>Choose Legacy Mode setting from the table below based on colocated radio's software revision and sync source:</p> <table border="1"> <thead> <tr> <th>Sync Src.\ SW Rev.</th> <th>13.4.1 or higher</th> <th>12.0 to 13.4 (DFS on)</th> <th>12.0 to 13.4 (DFS off)</th> <th>below 12.0</th> </tr> </thead> <tbody> <tr> <td>Timing Port</td> <td>OFF</td> <td>OFF</td> <td>OFF</td> <td>OFF</td> </tr> <tr> <td>Power Port</td> <td>OFF</td> <td>OFF</td> <td>ON (Mode 1)</td> <td>OFF</td> </tr> </tbody> </table>	Sync Src.\ SW Rev.	13.4.1 or higher	12.0 to 13.4 (DFS on)	12.0 to 13.4 (DFS off)	below 12.0	Timing Port	OFF	OFF	OFF	OFF	Power Port	OFF	OFF	ON (Mode 1)	OFF
Sync Src.\ SW Rev.	13.4.1 or higher	12.0 to 13.4 (DFS on)	12.0 to 13.4 (DFS off)	below 12.0												
Timing Port	OFF	OFF	OFF	OFF												
Power Port	OFF	OFF	ON (Mode 1)	OFF												

Attribute	Meaning
	Refer PTP 450i BHM Radio page attributes – 5 GHz for all parameters details.

Radio page - PTP 450 BHS 5 GHz

Table 69 :PTP 450 BHS Radio attributes –5 GHz

Device Type

Timing Mode : Timing Master
 Timing Slave

Radio Configuration

5.4 GHz

<input checked="" type="checkbox"/> 5472.5	<input checked="" type="checkbox"/> 5475.0	<input checked="" type="checkbox"/> 5477.5	<input checked="" type="checkbox"/> 5480.0	<input checked="" type="checkbox"/> 5482.5	<input checked="" type="checkbox"/> 5485.0	<input checked="" type="checkbox"/> 5487.5
<input checked="" type="checkbox"/> 5490.0	<input checked="" type="checkbox"/> 5492.5	<input checked="" type="checkbox"/> 5495.0	<input checked="" type="checkbox"/> 5497.5	<input checked="" type="checkbox"/> 5500.0	<input checked="" type="checkbox"/> 5502.5	<input checked="" type="checkbox"/> 5505.0
<input checked="" type="checkbox"/> 5507.5	<input checked="" type="checkbox"/> 5510.0	<input checked="" type="checkbox"/> 5512.5	<input checked="" type="checkbox"/> 5515.0	<input checked="" type="checkbox"/> 5517.5	<input checked="" type="checkbox"/> 5520.0	<input checked="" type="checkbox"/> 5522.5
<input checked="" type="checkbox"/> 5525.0	<input checked="" type="checkbox"/> 5527.5	<input checked="" type="checkbox"/> 5530.0	<input checked="" type="checkbox"/> 5532.5	<input checked="" type="checkbox"/> 5535.0	<input checked="" type="checkbox"/> 5537.5	<input checked="" type="checkbox"/> 5540.0
<input checked="" type="checkbox"/> 5542.5	<input checked="" type="checkbox"/> 5545.0	<input checked="" type="checkbox"/> 5547.5	<input checked="" type="checkbox"/> 5550.0	<input checked="" type="checkbox"/> 5552.5	<input checked="" type="checkbox"/> 5555.0	<input checked="" type="checkbox"/> 5557.5
<input checked="" type="checkbox"/> 5560.0	<input checked="" type="checkbox"/> 5562.5	<input checked="" type="checkbox"/> 5565.0	<input checked="" type="checkbox"/> 5567.5	<input checked="" type="checkbox"/> 5570.0	<input checked="" type="checkbox"/> 5572.5	<input checked="" type="checkbox"/> 5575.0
<input checked="" type="checkbox"/> 5577.5	<input checked="" type="checkbox"/> 5580.0	<input checked="" type="checkbox"/> 5582.5	<input checked="" type="checkbox"/> 5585.0	<input checked="" type="checkbox"/> 5587.5	<input checked="" type="checkbox"/> 5590.0	<input checked="" type="checkbox"/> 5592.5
<input checked="" type="checkbox"/> 5595.0	<input checked="" type="checkbox"/> 5597.5	<input checked="" type="checkbox"/> 5600.0	<input checked="" type="checkbox"/> 5602.5	<input checked="" type="checkbox"/> 5605.0	<input checked="" type="checkbox"/> 5607.5	<input checked="" type="checkbox"/> 5610.0
<input checked="" type="checkbox"/> 5612.5	<input checked="" type="checkbox"/> 5615.0	<input checked="" type="checkbox"/> 5617.5	<input checked="" type="checkbox"/> 5620.0	<input checked="" type="checkbox"/> 5622.5	<input checked="" type="checkbox"/> 5625.0	<input checked="" type="checkbox"/> 5627.5
<input checked="" type="checkbox"/> 5630.0	<input checked="" type="checkbox"/> 5632.5	<input checked="" type="checkbox"/> 5635.0	<input checked="" type="checkbox"/> 5637.5	<input checked="" type="checkbox"/> 5640.0	<input checked="" type="checkbox"/> 5642.5	<input checked="" type="checkbox"/> 5645.0
<input checked="" type="checkbox"/> 5647.5	<input checked="" type="checkbox"/> 5650.0	<input checked="" type="checkbox"/> 5652.5	<input checked="" type="checkbox"/> 5655.0	<input checked="" type="checkbox"/> 5657.5	<input checked="" type="checkbox"/> 5660.0	<input checked="" type="checkbox"/> 5662.5
<input checked="" type="checkbox"/> 5665.0	<input checked="" type="checkbox"/> 5667.5	<input checked="" type="checkbox"/> 5670.0	<input checked="" type="checkbox"/> 5672.5	<input checked="" type="checkbox"/> 5675.0	<input checked="" type="checkbox"/> 5677.5	<input checked="" type="checkbox"/> 5680.0
<input checked="" type="checkbox"/> 5682.5	<input checked="" type="checkbox"/> 5685.0	<input checked="" type="checkbox"/> 5687.5	<input checked="" type="checkbox"/> 5690.0	<input checked="" type="checkbox"/> 5692.5	<input checked="" type="checkbox"/> 5695.0	<input checked="" type="checkbox"/> 5697.5
<input checked="" type="checkbox"/> 5700.0	<input checked="" type="checkbox"/> 5702.5	<input checked="" type="checkbox"/> 5705.0	<input checked="" type="checkbox"/> 5707.5	<input checked="" type="checkbox"/> 5710.0	<input checked="" type="checkbox"/> 5712.5	<input checked="" type="checkbox"/> 5715.0
<input checked="" type="checkbox"/> 5717.5	<input checked="" type="checkbox"/> 5720.0	<input checked="" type="checkbox"/> 5722.5				

Custom Radio Frequency Scan Selection List :

5.7 GHz

<input checked="" type="checkbox"/> 5727.5	<input checked="" type="checkbox"/> 5730.0	<input checked="" type="checkbox"/> 5732.5	<input checked="" type="checkbox"/> 5735.0	<input checked="" type="checkbox"/> 5737.5	<input checked="" type="checkbox"/> 5740.0	<input checked="" type="checkbox"/> 5742.5
<input checked="" type="checkbox"/> 5745.0	<input checked="" type="checkbox"/> 5747.5	<input checked="" type="checkbox"/> 5750.0	<input checked="" type="checkbox"/> 5752.5	<input checked="" type="checkbox"/> 5755.0	<input checked="" type="checkbox"/> 5757.5	<input checked="" type="checkbox"/> 5760.0
<input checked="" type="checkbox"/> 5762.5	<input checked="" type="checkbox"/> 5765.0	<input checked="" type="checkbox"/> 5767.5	<input checked="" type="checkbox"/> 5770.0	<input checked="" type="checkbox"/> 5772.5	<input checked="" type="checkbox"/> 5775.0	<input checked="" type="checkbox"/> 5777.5
<input checked="" type="checkbox"/> 5780.0	<input checked="" type="checkbox"/> 5782.5	<input checked="" type="checkbox"/> 5785.0	<input checked="" type="checkbox"/> 5787.5	<input checked="" type="checkbox"/> 5790.0	<input checked="" type="checkbox"/> 5792.5	<input checked="" type="checkbox"/> 5795.0
<input checked="" type="checkbox"/> 5797.5	<input checked="" type="checkbox"/> 5800.0	<input checked="" type="checkbox"/> 5802.5	<input checked="" type="checkbox"/> 5805.0	<input checked="" type="checkbox"/> 5807.5	<input checked="" type="checkbox"/> 5810.0	<input checked="" type="checkbox"/> 5812.5
<input checked="" type="checkbox"/> 5815.0	<input checked="" type="checkbox"/> 5817.5	<input checked="" type="checkbox"/> 5820.0	<input checked="" type="checkbox"/> 5822.5	<input checked="" type="checkbox"/> 5825.0	<input checked="" type="checkbox"/> 5827.5	<input checked="" type="checkbox"/> 5830.0
<input checked="" type="checkbox"/> 5832.5	<input checked="" type="checkbox"/> 5835.0	<input checked="" type="checkbox"/> 5837.5	<input checked="" type="checkbox"/> 5840.0	<input checked="" type="checkbox"/> 5842.5	<input checked="" type="checkbox"/> 5845.0	<input checked="" type="checkbox"/> 5847.5
<input checked="" type="checkbox"/> 5850.0	<input checked="" type="checkbox"/> 5852.5	<input checked="" type="checkbox"/> 5855.0	<input checked="" type="checkbox"/> 5857.5	<input checked="" type="checkbox"/> 5860.0	<input checked="" type="checkbox"/> 5862.5	<input checked="" type="checkbox"/> 5865.0
<input checked="" type="checkbox"/> 5867.5	<input checked="" type="checkbox"/> 5870.0	<input checked="" type="checkbox"/> 5872.5	<input checked="" type="checkbox"/> 5875.0	<input checked="" type="checkbox"/> 5877.5	<input checked="" type="checkbox"/> 5880.0	<input checked="" type="checkbox"/> 5882.5
<input checked="" type="checkbox"/> 5885.0	<input checked="" type="checkbox"/> 5887.5	<input checked="" type="checkbox"/> 5890.0	<input checked="" type="checkbox"/> 5892.5	<input checked="" type="checkbox"/> 5895.0	<input checked="" type="checkbox"/> 5897.5	

5 MHz only
<= 10 MHz
<=15 MHz
<=20 MHz
<=30 MHz
Not available in this region

Channel Bandwidth Scan :	<input checked="" type="checkbox"/> 5 MHz <input checked="" type="checkbox"/> 10 MHz <input checked="" type="checkbox"/> 15 MHz <input checked="" type="checkbox"/> 20 MHz <input checked="" type="checkbox"/> 30 MHz <input checked="" type="checkbox"/> 40 MHz
Cyclic Prefix :	One Sixteenth
Color Code :	0 (0—254)
Large Data Channel data Q :	<input type="radio"/> Enabled <input checked="" type="radio"/> Disabled

MAC Control Parameters	
MIMO Rate Adapt Algorithm :	MIMO-A/B
Downlink Maximum Modulation Rate :	8x
Uplink Maximum Modulation Rate :	8x
Minimum Modulation Rate :	1x Bridging will be disabled if the transmit modulation rate is below this setting

Power Control	
Transmit Power :	16 dBm (Range: -30 — +22 dBm) (13 dBm V / 13 dBm H)
External Gain :	0 dBi (Range: 0 — +40 dBi)

LQI Reference EVM	
Reference Downlink EVM :	0.0 dB
Current Downlink EVM :	-31.4 dB
Reference Uplink EVM :	0.0 dB
Current Uplink EVM :	-30.2 dB
Access Point MAC Address :	None
Channel Frequency :	None
Channel Bandwidth :	None
Populate EVM	

Advanced	
Receive Quality Debug :	<input type="radio"/> Enabled <input checked="" type="radio"/> Disabled

Attribute	Meaning
Refer PTP 450i BHS Radio attributes - 5 GHz for all parameters details.	

Radio Frequency Scan Selection List

The SM or BHS scans complete spectrum as per Full Spectrum Band Scan feature. SMs or BHS first boot into the smallest selected channel bandwidth (10 MHz, if selected) and scan all selected frequencies across both the 5.4 GHz and 5.7 GHz frequency bands.

After this scan, if a wider channel bandwidth is selected (20 MHz), the SM/BHS automatically changes to 20 MHz channel bandwidth and then scans for APs/BHSs. After the SM/BHS finishes this final scan it will evaluate the best AP/BHM with which to register. If required for registration, the SM/BHS changes its channel bandwidth back to 10 MHz to match the best AP/BHM.

The SM/BHS will attempt to connect to an AP/BHM based on power level (which affects the modulation state), channel bandwidth (which affects throughput) and number of SM/BHS registrations to the AP/BHM (which affects system contention performance).

If it is desired to prioritize a certain AP/BHM over other available APs/BHMs, operators may use the Color Code Priority feature on the SM/BHS. Utilization of the Color Code feature on the AP/BHM is recommended to further constrain the AP selection.

If the SM does not find any suitable APs/BHMs for registration after scanning all channel bandwidths, the SM restarts the scanning process beginning with the smallest configured channel bandwidth.

Selecting multiple frequencies and multiple channel bandwidths impacts the SM/BHS scanning time. The biggest consumption of time is in the changing of the SM/BHS channel bandwidth setting.

The worst case scanning time is approximately two minutes after boot up (SM/BHS with all frequencies and channel bandwidths selected and registering to an AP/BHM at 10 MHz). If only one channel bandwidth is selected the time to scan all the available frequencies and register to an AP/BHM is approximately one minute after boot up.

Other scanning features such as Color Code, Installation Color Code, and RADIUS authentication are unaffected by the Full Band Scan feature.

Dedicated Multicast Virtual Circuit (VC)

A Multicast VC allows to configure multicast packets to be transmitted over a dedicated channel at a configurable rate of 1X, 2X, 4X or 8X. This feature is available only for the PMP 450 and PMP 450i and is not backward compatible with PMP 430 series of radios.

To configure Multicast VC, the AP must have this enabled. This can be enabled in the “Multicast Data Control” section (under Configuration > Radio page). The default value is “Disable”. If set to the default value, all multicast packets are transmitted over the Broadcast VC data path. To enable, select the data rate that is desired for the Multicast VC Data Rate parameter and click Save Changes button. The radio requires no reboot after any changes to this parameter.

The multicast VC allows three different parameters to be configured on the AP. These can be changed on the fly and are saved on the flash memory.



Note

If the Multicast VC Data Rate is set to a modulation that the radio is not currently capable of or operates in non-permitted channel conditions, multicast data is sent but not received.

Ex: If Multicast VC Data Rate is set to 6x and the channel conditions only permit 4x mode of operation, then multicast data is sent at 6x modulation but the SM will not receive the data.



Note

The PMP 450 AP supports up to 119 VCs (instead of 238 VCs) when configured for 30 MHz channel bandwidth or 5 ms Frame Period. This limitation is not applicable for PMP 450i/450m Series.



Notes

- Actual Multicast CIR honored by the AP = Configured Multicast CIR/ (Multicast Repeat Count + 1).
- Increasing the Multicast data rate has no impact on the Unicast data rate.
- For multicast and unicast traffic mix scenario examples, see Example for mix of multicast and unicast traffic scenarios.

Table 70 :Example for mix of multicast and unicast traffic scenarios

Repeat Count	Multicast (Mbps)	Data Rate	Unicast (Mbps)	Data Rate	Aggregate (Mbps)	DL Data Rate
0	10		40		50	

Repeat Count	Multicast (Mbps)	Data Rate	Unicast (Mbps)	Data Rate	Aggregate (Mbps)	DL Data Rate
1	5		40		45	
2	3.33		40		43.33	

The statistics have been added to the Data VC page (under Statistics > Data VC). The table displays the multicast row on the PMP 450 Platform Family AP. The SM displays the multicast row if it is a PMP 450 Platform Family.

Figure 25 : Multicast VC statistics

Subscriber	VC	CoS	Inbound Statistics								Outbound Statistics					Queue Overflow	High Priority Queue	
			octets	ucast pkts	multicast pkts	discards	errors	QPSK frgmts	16-QAM frgmts	64-QAM frgmts	256-QAM frgmts	octets	ucast pkts	multicast pkts	discards			errors
Site Name - LUID: 002	018	00	2144887	6558	1121	0	0	5649	3378	2019	1950	2060928	7088	63	0	0	0	3972
Multicast	016	00	NA	NA	NA	NA	NA	NA	NA	NA	NA	0	0	0	0	0	0	NA
Broadcast	012	00	NA	NA	NA	NA	NA	NA	NA	NA	NA	592059	16	8523	0	0	0	NA

The AP and SM display Transmit and Receive Multicast Data Count (under the Statistics > Scheduler page), as shown in below figure.

Figure 26 : Multicast scheduler statistics

Transmit Unicast Data Count :	20778
Transmit Broadcast Data Count :	13
Transmit Multicast Data Count :	0
Receive Unicast Data Count :	20828
Receive Broadcast Data Count :	206042
Receive Multicast Data Count :	0
Transmit Control Count :	160
Receive Control Count :	39
In Sync Count :	62
Out of Sync Count :	0
Overrun Count :	0
Underrun Count :	0
Receive Corrupt Data Count :	0
Receive Corrupt Control Data Count :	0
Receive Bad Broadcast Control Count :	0
Unsupported Feature Beacon Received :	0
Unknown Feature Beacon Received :	0
Old Version Beacon Received :	0
Wrong Frequency Beacon Received :	0
Non Lite Beacon Received :	0
Bad In Sync ID Received :	0
Rcv LT Start :	0
Rcv LT Start HS :	0
Rcv LT Result :	0
Xmt LT Result :	0
Frame Too Big :	0
Bad Acknowledgment :	0

Custom Frequencies page

In addition to the Radio tab, AP/SM/BH has another tab called Custom Frequencies as shown in 450 Platform Family AP/SM/BH Custom Frequencies page - 5 GHz.

The custom frequency tab allows to configure custom frequency at 1 kHz raster. It means that the custom frequencies can be at granularity of 1 kHz e.g. 4910.123 MHz, 4922.333 MHz, 4933.421 MHz etc.



Note
 Ensure that a customer frequency exists before using SNMP to set the radio to a Custom Frequency.

Table 71: 450 Platform Family AP/SM/BH Custom Frequencies page - 5 GHz

The screenshot shows two panels from a web interface. The top panel, titled "Custom Frequencies Configuration", features a text input field containing "4950.000" and "MHz (Range: 4902.500 — 4997.500 MHz)". Below the input field are four buttons: "Add Frequency", "Remove Frequency", "Add Default Frequencies", and "Remove All Custom Frequencies". The bottom panel, titled "Custom Frequencies", displays "Number of Custom Frequencies : 12" followed by a list of 12 frequencies: 4905.000 MHz, 4910.000 MHz, 4915.000 MHz, 4920.000 MHz, 4925.000 MHz, 4930.000 MHz, 4935.000 MHz, 4940.000 MHz, 4945.000 MHz, 4950.000 MHz, 4980.000 MHz, and 4990.001 MHz.

Attribute	Meaning
Custom Frequency Configuration	<p>Custom frequencies with a channel raster of 1 kHz can be added from the available range by keying in the frequency and then clicking the Add Frequency button. Click Remove Frequency button to delete a specific frequency keyed in the text box.</p> <p>Click Default Frequencies button to add a pre-defined list of frequencies that can be used in this band. This list can be reduced or increased by manually removing or adding other custom frequencies.</p>
Custom Frequencies	Displays the complete list of user configured custom frequencies.

Table 72 :PMP/PTP 450 SM/BH Custom Frequencies page - 3.65 GHz

Custom Frequencies Configuration

Custom Frequency Configuration : MHz (Range: 3552.500 — 3797.500 MHz)

Custom Frequencies

Number of Custom Frequencies : 27

3552.500 MHz
 3554.500 MHz
 3555.000 MHz
 3564.100 MHz
 3564.200 MHz
 3564.500 MHz
 3652.500 MHz
 3655.000 MHz
 3657.500 MHz
 3660.000 MHz
 3662.500 MHz
 3665.000 MHz
 3667.500 MHz
 3670.000 MHz
 3672.500 MHz
 3675.000 MHz
 3677.500 MHz
 3680.000 MHz
 3682.500 MHz
 3685.000 MHz
 3687.500 MHz
 3690.000 MHz
 3692.500 MHz
 3695.000 MHz
 3697.500 MHz
 3700.000 MHz
 3750.000 MHz

Attribute	Meaning
Custom Frequency Configuration	Custom frequencies with a channel raster of 1 kHz can be added from the available range by keying in the frequency and then clicking the Add Frequency button. Click Remove Frequency button to delete a specific frequency keyed in the text box. Click Default Frequencies button to add a pre-defined list of frequencies that can be used in this band. This list can be reduced or increased by manually removing or adding other custom frequencies.
Custom Frequencies	Displays the complete list of user configured custom frequencies.

Table 73 :PMP/PTP 450 SM/BH Custom Frequencies page - 3.5 GHz

Custom Frequencies Configuration

Custom Frequency Configuration : MHz (Range: 3302.500 — 3597.500 MHz)

Custom Frequencies

Number of Custom Frequencies : 66

3302.500 MHz
 3302.501 MHz
 3302.555 MHz
 3302.600 MHz
 3302.655 MHz
 3305.000 MHz
 3310.000 MHz
 3315.000 MHz
 3320.000 MHz
 3325.000 MHz
 3330.000 MHz
 3335.000 MHz
 3340.000 MHz
 3345.000 MHz
 3350.000 MHz
 3355.000 MHz
 3360.000 MHz
 3365.000 MHz
 3370.000 MHz
 3375.000 MHz
 3380.000 MHz
 3385.000 MHz
 3390.000 MHz
 3395.000 MHz
 3400.000 MHz
 3405.000 MHz
 3410.000 MHz

Attribute	Meaning
Custom Frequency Configuration	<p>Custom frequencies with a channel raster of 1 kHz can be added from the available range by keying in the frequency and then clicking the Add Frequency button. Click Remove Frequency button to delete a specific frequency keyed in the text box.</p> <p>Click Default Frequencies button to add a pre-defined list of frequencies that can be used in this band. This list can be reduced or increased by manually removing or adding other custom frequencies.</p>

DFS for 5 GHz Radios

Dynamic Frequency Selection (DFS) is a requirement in several countries and regions for 5 GHz unlicensed systems to detect radar systems and avoid co-channel operation. DFS and other regulatory requirements drive the settings for the following parameters, as discussed in this section:

- Country Code
- Primary Frequency
- Alternate 1 and Alternate 2 Frequencies
- External Antenna Gain

On the AP, the Home > DFS Status page shows current DFS status of all three frequencies and a DFS log of past DFS events.

Figure 27 : AP DFS Status

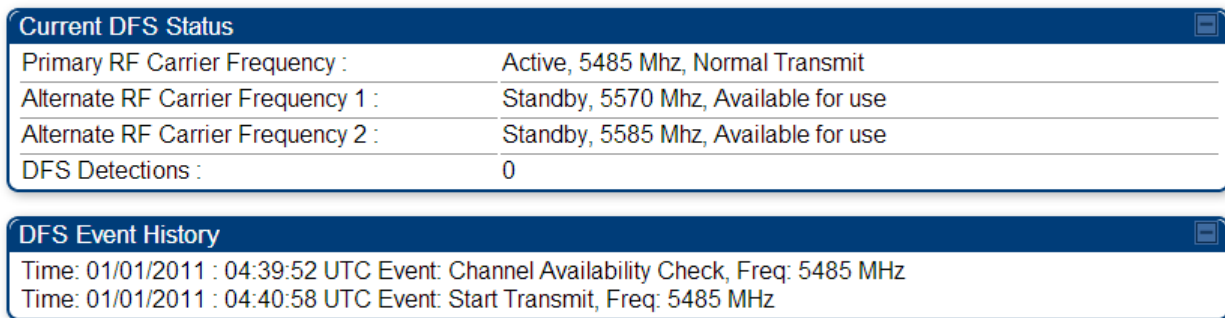

The image shows two panels from a web interface. The top panel, titled 'Current DFS Status', contains a table with the following data:

Primary RF Carrier Frequency :	Active, 5485 Mhz, Normal Transmit
Alternate RF Carrier Frequency 1 :	Standby, 5570 Mhz, Available for use
Alternate RF Carrier Frequency 2 :	Standby, 5585 Mhz, Available for use
DFS Detections :	0

The bottom panel, titled 'DFS Event History', contains a list of events:

- Time: 01/01/2011 : 04:39:52 UTC Event: Channel Availability Check, Freq: 5485 MHz
- Time: 01/01/2011 : 04:40:58 UTC Event: Start Transmit, Freq: 5485 MHz

DFS operation

The ODUs use region-specific DFS based on the Country Code selected on the module's Configuration, General page. By directing installers and technicians to set the Country Code correctly, the operator gains confidence the module is operating according to national or regional regulations without having to deal with the details for each region.

The details of DFS operation for each Country Code, including whether DFS is active on the AP, SM, and which DFS regulations apply is shown in Country & Bands DFS setting.

Contention slots

Contention slots are symbols at the end of the uplink subframe that are reserved for random access (network entry and bandwidth requests) and cannot be used for data transmission. These symbols form the contention space.

The frame is 2.5 ms or 5 ms long, and it is divided into a downlink subframe (data transmitted from the AP to the SM) and an uplink subframe (data transmitted from the SM to the AP).

Figure 28 : Frame structure

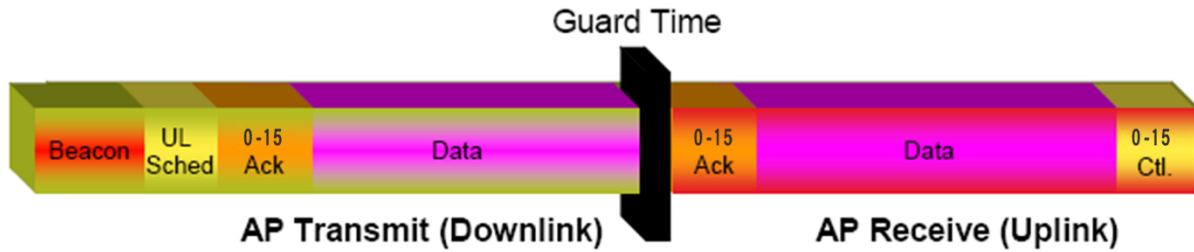

The symbols in the uplink subframe can be scheduled or unscheduled. All scheduled symbols come before all unscheduled symbols. The number of scheduled and unscheduled symbols changes frame by frame depending on the amount of uplink requests received by the AP.

The contention slots number is selected by the operator and indicates the number of symbols that are reserved in the unscheduled portion of the uplink. The total number of unscheduled symbols in each frame is the sum of the contention slots and any additional symbol that was not used in uplink data transmission. This means that the unscheduled portion of the uplink can be as small as the number of contention slots, or as big as the whole uplink. This allows SMs in sectors with a small number of contention slots configured to still successfully transmit bandwidth requests using unused data slots.

Random access

When an SM needs to send an unscheduled message (for network entry or a bandwidth request), it randomly selects one symbol out of the unscheduled portion of the uplink subframe and uses that symbol for transmission. The higher the number of unscheduled symbols, the lower the probability two or more SMs will select the same symbol for transmission and their messages will collide. When two messages collide at the AP receiver, most likely neither will be decoded correctly, and both SMs need to start the random-access process one more time. If this happens frequently, the latency of the system increases.

A higher number of contention slots give higher probability that an SM's bandwidth request will be correctly received when the system is heavily loaded, but with the tradeoff that sector capacity is reduced, so there will be less capacity to handle the request. The sector capacity reduction is about 200 kbps for each contention slot configured in a 20 MHz channel at QPSK SISO modulation, for 2.5 ms frame sizes. The reduction in sector capacity is proportionally higher at MIMO modulations, as shown in the following table.

Table 74 : Throughput penalty per modulation

Modulation mode	Throughput penalty for each additional contention slot	
	2.5 ms frame	5 ms frame
QPSK SISO (1X)	204 kbps	102 kbps
QPSK MIMO (2X)	409 kbps	204 kbps
16-QAM MIMO (4X)	819 kbps	409 kbps
64-QAM MIMO (6X)	1.22 Mbps	614 kbps
256-QAM MIMO (8X)	1.63 Mbps	819 kbps

Throughput penalty per modulation shows that the throughput penalty for each additional contention slot increases with modulation mode. The reason is that at higher modulation modes more fragments can be

transmitted in a symbol. If additional symbols are reserved for random access, the number of fragments that cannot be sent in these symbols is higher at higher modulations, and therefore the throughput penalty is higher. However, the penalty expressed as a percentage of the throughput is the same for each modulation mode. For example, if a frame has 80 total symbols, each additional symbol reserved for random access reduces the sector throughput by 1.25%, regardless of the modulation mode.

Selection of contention slots parameter

The number of contention slots has to be selected according to the specific deployment parameters in each sector. If the number of contention slots is too small, then latency increases in high traffic periods. If the number of contention slots is too high, then the maximum capacity is unnecessarily reduced.

The two main contributing factors to the selection of the number of contention slots are the number of SMs in a sector, and the type of traffic in the sector.

System release 16.1 introduces Auto Contention Slots that eliminates the need to configure optimal number of contention slots. When this feature is enabled, AP dynamically adjusts the number of contention slots resulting in improved uplink performance.



Note

Auto Contention Slots feature is not currently supported on PMP 450m AP.



Note

Contention Slots configuration parameter is used to determine the number of Downlink/Uplink+Contention slots in a Frame. Therefore, there is no need to change Contention Slots parameter, unless AP's Tx/Rx configuration is changed which should be consistent for the entire site for co-location.

Number of SMs in a sector

If the number of SMs in a sector is large, it is recommended to increase the number of contention slots, in order to reduce the probability of two or more requests colliding. The suggested contention slot settings as a function of the number of active Data channels in the sector are shown in below table.

Table 75 :Contention slot settings

Number of SMs	Recommended Number of Contention slots
1 to 10	3
11 to 50	4
51 to 150	6
151 and above	8

Type of traffic in a sector

Besides the number of SMs, the other main factor in contention slots selection is the type of traffic. If the sector experiences a lot of uplink traffic composed of small packets, for example in a sector that serves several VoIP streams, the average number of bandwidth requests transmitted by each SM is high. Another scenario with constant uplink traffic is video surveillance, which also generate a large number of uplink bandwidth requests.

In these cases, the probability of two or more SMs transmitting a request in the same symbol is high. When this happens, the latency of the system increases, and it is recommended to increase the number of contention slots from the number in Contention slot settings. If an AP is experiencing latency or SM-servicing issues, increasing the number of contention slots may increase system performance, depending on traffic mix over time.

Recommendation on Contention Slots number selection

1. Calculate the number of active SMs in the sector.
2. Evaluate the traffic mix that is expected in the sector, more specifically the expected percentage of real-time traffic (ex. VoIP, gaming, video conferencing, and video surveillance).
3. If the expected amount of real-time traffic is small, select the number of contention slots according to Contention slot settings.
4. If the expected amount of real-time traffic is large, select a number of contention slots larger than the number in Contention slot settings.
5. Monitor latency in your system. If the percentage of real-time traffic increases and the sector experiences increasing latency and SM-servicing issues, increase the number of contention slots from the current setting.

This is the reason why the maximum number of contention slots is 15, even if Table 2 shows 8 contention slots for more than 150 data channels. If the number of data channels is more than 150 and a significant portion of the traffic is real-time, the frequency with which bandwidth request messages are transmitted requires a higher number of contention slots, potentially as high as 15. A sector with a high number of video surveillance cameras would also require a larger number of contention slots to reduce the probability of collision between requests.

6. Monitor the percentage of BW requests successfully received and the UL frame utilization: if the frame utilization is high (close to 100%), then it is not recommended to change the number of contention slots, even if the percentage success rate of BW requests is low. However, if the percentage success rate of BW requests is low and the frame utilization is also low, then increasing the number of contention slots is recommended.

Cluster of APs

It is recommended to use care when changing the contention slots configuration of only some APs in a cluster, because changes affect the effective downlink/uplink ratio and can cause co-location issues. In a typical cluster, each AP should be configured with the same number of contention slots to assure proper timing in the send and receive cycles. The number of contention slots is used by the frame calculator to define the downlink and uplink times, which should not overlap from one AP to another. However, if the traffic experienced by two APs in the same cluster is different (for example, one supports significantly more VoIP traffic), the number of contention slots selected for each AP may not be the same. For APs in a cluster of mismatched contention slots setting, it is recommended to use the frame calculator to verify that send and receive times do not overlap (see the Frame calculator for co-location).



Note

Change contention slot configuration in an operating, stable system cautiously and with a back-out plan. After changing a contention slot configuration, monitor the system closely for problems as well as improvements in system performance.

Frame calculator for co-location

The frame calculator is a tool available for the PMP 450 series systems, that calculates the length of the transmit and receive times, together with the number of downlink and uplink symbols, for a given set of

configuration parameters. The frame calculator can be used to verify that co-location of APs using different contention slots settings does not create overlapping transmit and receive times.

Basic rules

For co-location of AP1 and AP2, we want to ensure that AP1 stops transmitting before AP2 starts receiving, and that AP2 stops transmitting before AP1 starts receiving.

These are the rules that have to be satisfied for a correct co-location of the two APs:

- AP1 Receive Start > AP2 Transmit End
- AP2 Receive Start > AP1 Transmit End

Steps for co-location

Let us assume that in a cluster of multiple APs with all the same settings, one AP's settings are modified with a different number of contention slots.

1. Obtain all configuration settings for the APs that do not change parameters (duty cycle, contention slots, max distance)
2. Input these configuration parameters into the OFDM Frame Calculator tool found under "Tools".
3. Click "Calculate"
4. Note the following values from the results:
 - AP Antenna Receive Start: _____
 - AP Antenna Transmit End: _____
5. Access the AP that needs to have a different contention slots setting and use the frame calculator tool found under "Tools"
6. Input the configuration parameters for this AP (same duty cycle and max distance as the other APs, different contention slots)
7. Click "Calculate"
8. Note the following values from the results:
 - AP Antenna Receive Start: _____
 - AP Antenna Transmit End: _____
9. Check that the two following equations are both true:
 - AP2 Receive Start > AP1 Transmit End
 - AP1 Receive Start > AP2 Transmit End
10. If one or both equations are not true, adjust the duty cycle until they become true (or the max distance if possible).

Example

Let us assume that all APs in a cluster have the same Max range settings, a 2.5 ms frame length and a 20 MHz channel BW, but the operator has fine-tuned the DL duty % per AP as follows:

AP1:

Max range: 2 miles

Contention slots: 3

DL duty cycle = 75%

AP2:

Max range: 2 miles

Contention slots: 3

DL duty cycle = 80%

Running the frame calculator as explained in the Steps for co-location, the AP1 Antenna Transmit End and Antenna Receive start times are:

- AP1 Antenna Transmit End = 1.6440 ms
- AP1 Antenna Receive Start = 1.7972 ms

AP2's Antenna Transmit End and Antenna Receive start times are:

- AP2 Antenna Transmit End = 1.7411 ms
- AP2 Antenna Receive Start = 1.8943 ms

The settings in AP1 in the cluster are now modified by changing the number of contention slots from 3 to 7, for example because this sector is constantly experiencing a higher volume of VoIP traffic.

Running the frame calculator again, the new AP1 Antenna Transmit End and Antenna Receive start times are:

- AP1 Antenna Transmit End = 1.5711 ms
- AP1 Antenna Receive Start = 1.7243 ms

The two equations above have to be checked for correct co-location:

- AP1 Antenna Receive Start > AP2 Antenna Transmit End à 1.7243 ms >1.7411 ms NOT OK
- AP2 Antenna Receive Start > AP1 Antenna Transmit End à 1.8943 ms >1.5711ms OK

The first of the two equations are not true. AP2 is still transmitting when AP1 has already started receiving. This creates interference at the AP1 receiver.

To avoid this interference scenario, the duty cycle of AP2 can be further adjusted slightly. For example, changing the duty cycle of AP2 from 80% to 79% changes the AP2 Antenna Transmit End and Antenna Receive start times as follows:

- AP2 Antenna Transmit End = 1.7168 ms
- AP2 Antenna Receive Start = 1.8700 ms

The two equations have to be checked again for co-location:



- AP1 Antenna Receive Start > AP2 Transmit End à 1.7243 ms >1.7168 ms OK
- AP2 Receive Start > AP1 Transmit End à 1.8700 ms >1.5711 ms OK

Now both equations are true and the APs can be co-located.

Cambium co-location tool

As an alternative to using the frame calculator on the AP GUI, cambium provides a co-location tool for these calculations. This tool is a free download available on the Cambium website:

<https://support.cambiumnetworks.com/files/colocationtool/#r2>

PMP/PTP 450/450i/450m CO-LOCATION TOOL AND THROUGHPUT CALCULATOR									
Release 15.1.1									
Device 1 Configuration			Device 2 Configuration						
Mode	PMP		Mode		PMP				
Channel Bandwidth (MHz)	20		Channel Bandwidth (MHz)		20				
Max Range (mi)	2		Max Range (mi)		2				
						Downlink Data		80%	
						Contention slots		3	
						Frame Period (ms)		2.5	
Device 1 Timing (ms)			Device 2 Timing (ms)						
DL end	1.644		DL end		1.741				
UL start	1.797		UL start		1.894				
DL/UL symbols	61/20		DL/UL symbols		65/16				
DL/UL/Total Throughput (Mbps)	98.3/31.1/129.4		DL/UL/Total Throughput (Mbps)		104.9/24.6/129.5				
CHECKS									
Device 1 DL end	1.644	<	Device 2 UL start	1.894	OK				
Device 2 DL end	1.741	<	Device 1 UL start	1.797	OK				

MIMO-A mode of operation

450 Platform Family supports MIMO-B mode using the following modulation levels: QPSK, 16-QAM, 64-QAM and 256-QAM. System Release 13.2 introduces MIMO-A mode of operation using the same modulation levels as the MIMO-B mode. With MIMO-B, the radio sends different streams of data over the two antennas whereas with MIMO-A, the radio uses a scheme that tries to optimize coverage by transmitting the same data over both antennas. This redundancy improves the signal to noise ratio at the receiver making it more robust, at the cost of throughput.

In addition to introducing MIMO-A modes, improvements have been made to the existing rate adapt algorithm to switch between MIMO-A and MIMO-B seamlessly without any intervention or added configuration by the operator. The various modulation levels used by the 450 Platform Family are shown in below table.

Table 76 :450 Platform Family Modulation levels

Rate	MIMO-B	MIMO-A
QPSK	2X MIMO-B	1X MIMO-A
16-QAM	4X MIMO-B	2X MIMO-A
64-QAM	6X MIMO-B	3X MIMO-A
256-QAM	8X MIMO-B	4X MIMO-A

System Performance

For System Performance details of all the 450 Platform Family ODUs, refer to the tools listed below:

Link Capacity Planner for PMP/PTP 450 and 450i:

<https://support.cambiumnetworks.com/files/capacityplanner/>

LINKPlanner for PMP/PTP 450/450i and PMP 450m:

<https://support.cambiumnetworks.com/files/linkplanner/>

Table 77 :Co-channel Interference per (CCI) MCS

MCS of Victim	MCS of Interferer	Channel BW (MHz)	CCI
1X (QPSK SISO)	6X (64-QAM MIMO-B)	5, 7, 10, 15, 20, 30, or 40	10 dB
2X (16-QAM SISO)	6X (64-QAM MIMO-B)	5, 7, 10, 15, 20, 30, or 40	17 dB
3X (64-QAM SISO)	6X (64-QAM MIMO-B)	5, 7, 10, 15, 20, 30, or 40	25 dB
1X (QPSK MIMO-A)	6X (64-QAM MIMO-B)	5, 7, 10, 15, 20, 30, or 40	7 dB
2X (16-QAM MIMO-A)	6X (64-QAM MIMO-B)	5, 7, 10, 15, 20, 30, or 40	14 dB
3X (64-QAM MIMO-A)	6X (64-QAM MIMO-B)	5, 7, 10, 15, 20, 30, or 40	22 dB
4X (256-QAM MIMO-A)	6X (64-QAM MIMO-B)	5, 7, 10, 15, 20, 30, or 40	30 dB
2X (QPSK MIMO-B)	6X (64-QAM MIMO-B)	5, 7, 10, 15, 20, 30, or 40	10 dB
4X (16-QAM MIMO-B)	6X (64-QAM MIMO-B)	5, 7, 10, 15, 20, 30, or 40	17 dB
6X (64-QAM MIMO-B)	6X (64-QAM MIMO-B)	5, 7, 10, 15, 20, 30, or 40	25 dB
8X (256-QAM MIMO-B)	6X (64-QAM MIMO-B)	5, 7, 10, 15, 20, 30, or 40	33 dB

Table 78 :Adjacent Channel Interference (ACI) per MCS

MCS of Victim	MCS of Interferer	Channel BW (MHz)	Guard Band
1X (QPSK SISO)	6X (64-QAM MIMO-B)	5, 7, 10, 15, 20, 30, or 40	None
2X (16-QAM SISO)	6X (64-QAM MIMO-B)	5, 7, 10, 15, 20, 30, or 40	None
3X (64-QAM SISO)	6X (64-QAM MIMO-B)	5, 7, 10, 15, 20, 30, or 40	None
1X (QPSK MIMO-A)	6X (64-QAM MIMO-B)	5, 7, 10, 15, 20, 30, or 40	None
2X (16-QAM MIMO-A)	6X (64-QAM MIMO-B)	5, 7, 10, 15, 20, 30, or 40	None
3X (64-QAM MIMO-A)	6X (64-QAM MIMO-B)	5, 7, 10, 15, 20, 30, or 40	None
4X (256-QAM MIMO-A)	6X (64-QAM MIMO-B)	5, 7, 10, 15, 20, 30, or 40	None
2X (QPSK MIMO-B)	6X (64-QAM MIMO-B)	5, 7, 10, 15, 20, 30, or 40	None
4X (16-QAM MIMO-B)	6X (64-QAM MIMO-B)	5, 7, 10, 15, 20, 30, or 40	None
6X (64-QAM MIMO-B)	6X (64-QAM MIMO-B)	5, 7, 10, 15, 20, 30, or 40	None
8X (256-QAM MIMO-B)	6X (64-QAM MIMO-B)	5, 7, 10, 15, 20, 30, or 40	None

Guard Band

When synchronized, no Guard Bands are needed for the 450*, 450i, and 450m Series.

- For PMP 450 AP (3.6 GHz) and 450 series APs with 450b SM (5 GHz) connected, **Configuration > Radio > Power Control > Adjacent Channel Support** must be enabled.

Adjacent Channel Support :

- Enabled
 Disabled

Improved PPS performance of 450 Platform Family

The 450m, 450i, and 450b Series provides improved packets per second (PPS) performance compared to 450 Series.

Through hardware and software enhancements, the PPS performance of the PMP 450i Series AP and PMP 450b SM has been improved to 40k packets/second, measured through a standard RFC2544 test using 64 bytes packets. With this enhancement, operators are able to provide higher bandwidth including better VoIP and video services to end customers using existing SM deployments.

PMP 450m is capable of supporting more than 100k PPS (packets per second).

Setting up SNMP agent

Operators may use SNMP commands to set configuration parameters and retrieve data from the AP and SM modules. Also, if enabled, when an event occurs, the SNMP agent on the 450 Platform Family sends a trap to whatever SNMP trap receivers configured in the management network.

- SNMPv2c
- SNMPv3

Configuring SM/ BHS's IP over-the-air access

To access the SM/BHS management interface from a device situated above the AP, the SM/BHS's Network Accessibility parameter (under the web GUI at Configuration > IP) may be set to Public.

Table 79 :LAN1 Network Interface Configuration tab of IP page attributes

LAN1 Network Interface Configuration	
IP Address :	169.254.1.1
Network Accessibility :	<input type="radio"/> Public <input checked="" type="radio"/> Local
Subnet Mask :	255.255.255.0
Gateway IP Address :	169.254.0.0
DHCP state :	<input type="radio"/> Enabled <input checked="" type="radio"/> Disabled
DHCP DNS IP Address :	<input checked="" type="radio"/> Obtain Automatically <input type="radio"/> Set Manually
Preferred DNS Server :	10.120.10.12
Alternate DNS Server :	10.120.10.13
Domain Name :	example.com

Attribute	Meaning
IP Address	Internet Protocol (IP) address. This address is used by family of Internet protocols to uniquely identify this unit on a network.
Network Accessibility	Specify whether the IP address of the SM/BHS must be visible to only a device connected to the SM/BHS by Ethernet (Local) or be visible to the AP/BHM as well (Public).
Subnet Mask	If Static IP is set as the Connection Type of the WAN interface, then this parameter configures the subnet mask of the SM/BHS for RF management traffic.
Gateway IP	If Static IP is set as the Connection Type of the WAN interface, then this parameter

Attribute	Meaning
Address	configures the gateway IP address for the SM/BHS for RF management traffic.
DHCP state	If Enabled is selected, the DHCP server automatically assigns the IP configuration (IP address, subnet mask, and gateway IP address) and the values of those individual parameters (above) are not used. The setting of this DHCP state parameter is also viewable (read only), in the Network Interface tab of the Home page.
DNS IP Address	Canopy devices allow for configuration of a preferred and alternate DNS server IP address either automatically or manually. Devices must set DNS server IP address manually when DHCP is disabled for the management interface of the device. The default DNS IP addresses are 0.0.0.0 when configured manually.
Preferred DNS Server	The first address used for DNS resolution.
Alternate DNS Server	If the Preferred DNS server cannot be reached, the Alternate DNS Server is used.
Domain Name	The operator's management domain name may be configured for DNS. The domain name configuration can be used for configuration of the servers in the operator's network. The default domain name is example.com, and is only used if configured as such.

Configuring SNMP

The SNMP page configuration is explained below.



Note

The SNMP page for AP, SM, BHM and BHS has the same parameter attributes.

SNMP page – AP/ SM/ BHM/ BHS

The SNMP page is explained in below table.

Table 80 :SNMP page attributes

SNMPv2c Settings	
SNMP Community String 1 :	Canopy
SNMP Community String 1 Permissions :	<input checked="" type="radio"/> Read Only <input type="radio"/> Read / Write
SNMP Community String 2 (Read Only) :	Canopyro

SNMPv3 Settings	
Engine ID :	800000a1030a003e4586f0 Use Default Engine ID
SNMPv3 Security Level :	auth,priv
SNMPv3 Authentication Protocol :	md5
SNMPv3 Privacy Protocol :	cbc-des
SNMPv3 Read-Only User :	Username Canopyro Authorization Key Privacy Key
SNMPv3 Read/Write User :	<input checked="" type="radio"/> Enable R/W User <input type="radio"/> Disable R/W User Username Canopy Authorization Key Privacy Key
Additional SNMPv3 User1 :	Username <input type="radio"/> Enable User <input checked="" type="radio"/> Disable User Authorization Key Privacy Key <input type="radio"/> ReadWrite User <input checked="" type="radio"/> ReadOnly User
Additional SNMPv3 User2 :	Username <input type="radio"/> Enable User <input checked="" type="radio"/> Disable User Authorization Key Privacy Key <input type="radio"/> ReadWrite User <input checked="" type="radio"/> ReadOnly User
Additional SNMPv3 User3 :	Username <input type="radio"/> Enable User <input checked="" type="radio"/> Disable User Authorization Key Privacy Key <input type="radio"/> ReadWrite User <input checked="" type="radio"/> ReadOnly User
SNMPv3 Trap Configuration :	Disabled

SNMP Accessing Addresses		
Accessing IP / Subnet Mask 1 :	0.0.0.0	/ 0
Accessing IP / Subnet Mask 2 :	0.0.0.0	/ 0
Accessing IP / Subnet Mask 3 :	0.0.0.0	/ 0
Accessing IP / Subnet Mask 4 :	0.0.0.0	/ 0
Accessing IP / Subnet Mask 5 :	0.0.0.0	/ 0
Accessing IP / Subnet Mask 6 :	0.0.0.0	/ 0
Accessing IP / Subnet Mask 7 :	0.0.0.0	/ 0
Accessing IP / Subnet Mask 8 :	0.0.0.0	/ 0
Accessing IP / Subnet Mask 9 :	0.0.0.0	/ 0
Accessing IP / Subnet Mask 10 :	0.0.0.0	/ 0

Trap Addresses

SNMP Trap Server DNS Usage : Append DNS Domain Name
 Disable DNS Domain Name

Trap Address 1 :	0.0.0.0
Trap Address 2 :	0.0.0.0
Trap Address 3 :	0.0.0.0
Trap Address 4 :	0.0.0.0
Trap Address 5 :	0.0.0.0
Trap Address 6 :	0.0.0.0
Trap Address 7 :	0.0.0.0
Trap Address 8 :	0.0.0.0
Trap Address 9 :	0.0.0.0
Trap Address 10 :	0.0.0.0

Trap Enable

Sync Status : Enabled
 Disabled

Session Status : Enabled
 Disabled

LQI Traps

LQI Traps : Enabled
 Disabled

LQI threshold to raise trap (delta from reference LQI value) :

LQI threshold to clear trap (delta from reference LQI value) :

Minimum observation period : Minutes (Range : 1 — 15 Minutes)

Site Information

Site Information Viewable to Guest Users Enabled
 Disabled

Site Name :

Site Contact :

Site Location :

Attribute	Meaning
SNMP Community String 1	Specify a control string that can allow a Network Management Station (NMS) to access SNMP information. No spaces are allowed in this string. The default string is Canopy.
SNMP Community String 1 Permissions	You can designate the SNMP Community String 1 to be the password for WM, for example, to have Read / Write access to the module via SNMP or for all SNMP access to the module to be Read Only.
SNMP Community String 2 (Read Only)	Specify an additional control string that can allow a Network Management Station (NMS) to read SNMP information. No spaces are allowed in this string. The default string is Canopyro. This password will never authenticate a user or an NMS to read/write access.

Attribute	Meaning
	The Community String value is clear text and is readable by a packet monitor. Additional security derives from the configuration of the Accessing Subnet, Trap Address, and Permission parameters.
Engine ID	The Engine ID may be between 5 and 32 hex characters. The hex character input is driven by RFC 3411 recommendations on the Engine ID. The default Engine ID is the MAC address of the device
SNMPv3 Security Level	Specify security model where users are defined and authenticated before granting access to any SNMP service. Each device can configure the security level of SNMPv3 to No authentication/No privacy, Authentication/No privacy, or Authentication/Privacy.
SNMPv3 Authentication Protocol	<p>The SNMPv3 authentication protocol is supported with:</p> <ul style="list-style-type: none"> • MD5 • SHA-1 • SHA-256
SNMPv3 Privacy Protocol	<p>The SNMPv3 privacy protocol is supported with:</p> <ul style="list-style-type: none"> • CBC-DES • CFB-AES
SNMPv3 Read-Only User	<p>This field allows for a read-only user per devices. The default values for the Read-Only users is:</p> <ul style="list-style-type: none"> • Username = Canopyro • Authentication Password = authCanopyro • Privacy Password = privacyCanopyro
SNMPv3 Read/Write User	<p>Read-write user by default is disabled. The default values for the Read/Write users is:</p> <ul style="list-style-type: none"> • Username = Canopy • Authentication Password = authCanopy • Privacy Password = privacyCanopy
Additional SNMP v3 User 1	<p>This field allows to configure the Additional SNMP v3 User 1. The configurations include:</p> <ul style="list-style-type: none"> • Enable/Disable User: These fields allow to enable or disable the user using the Enable User or Disable User radio buttons. • Authorizatoin Key: This field allows to configure an authorization key for the user. • Privacy Key: This field allows to configure a privacy key for the user. <div style="border: 1px solid black; background-color: #e6f2ff; padding: 5px; margin: 10px 0;"> <p> Note Set SNMP v3 Security Level field to: auth, priv to enable the Authorization Key and Privacy Key fields.</p> </div> <p>Enabled User can be set with following privacy settings:</p> <ul style="list-style-type: none"> • ReadWrite User

Attribute	Meaning
	<ul style="list-style-type: none"> • ReadOnly User
Additional SNMP v3 User 2	<p>This field allows to configure the Additional SNMP v3 User 2.</p> <p>The configurations include:</p> <ul style="list-style-type: none"> • Enable/Disable User: These fields allow to enable or disable the user using the Enable User or Disable User radio buttons. • Authorizaton Key: This field allows to configure an authorization key for the user. • Privacy Key: This field allows to configure a privacy key for the user. <div data-bbox="412 621 480 695" style="display: inline-block; vertical-align: middle;"> </div> <div data-bbox="540 615 1424 730" style="border: 1px solid black; background-color: #e6f2ff; padding: 5px; margin-left: 20px;"> <p>Note Set SNMP v3 Security Level field to: auth, priv to enable the Authorization Key and Privacy Key fields.</p> </div> <p>Enabled User can be set with following Privacy settings:</p> <ul style="list-style-type: none"> • ReadWrite User • ReadOnly User
Additional SNMP v3 User 3	<p>This field allows to configure the Additional SNMP v3 User 3.</p> <p>The configurations include:</p> <ul style="list-style-type: none"> • Enable/Disable User: These fields allow to enable or disable the user using the Enable User or Disable User radio buttons. • Authorizaton Key: This field allows to configure an authorization key for the user. • Privacy Key: This field allows to configure a privacy key for the user. <div data-bbox="412 1203 480 1276" style="display: inline-block; vertical-align: middle;"> </div> <div data-bbox="540 1192 1424 1308" style="border: 1px solid black; background-color: #e6f2ff; padding: 5px; margin-left: 20px;"> <p>Note Set SNMP v3 Security Level field to: auth, priv to enable the Authorization Key and Privacy Key fields.</p> </div> <p>Enabled User can be set with following Privacy settings:</p> <ul style="list-style-type: none"> • ReadWrite User • ReadOnly User
SNMPv3 Trap Configuration	<p>When enabling transmission of SNMPv3 traps the read- only or read- write user credentials must be used and selected properly in order for the SNMP manager to correctly interpret the traps. By default transmission of SNMPv3 traps is disabled and all traps sent from the radios are in SNMPv2c format.</p>
Accessing IP / Subnet Mask 1 to 10	<p>Specify the addresses that are allowed to send SNMP requests to this AP. The NMS has an address that is among these addresses (this subnet). You must enter both</p> <ul style="list-style-type: none"> • The network IP address in the form xxx.xxx.xxx.xxx • The CIDR (Classless Interdomain Routing) prefix length in the form /xx

Attribute	Meaning
	<p>For example:</p> <ul style="list-style-type: none"> • the /16 in 198.32.0.0/16 specifies a subnet mask of 255.255.0.0 (the first 16 bits in the address range are identical among all members of the subnet). • 192.168.102.0 specifies that any device whose IP address is in the range 192.168.102.0 to 192.168.102.254 can send SNMP requests to the AP, presuming that the device supplies the correct Community String value. <p>The default treatment is to allow all networks access. For more information on CIDR, execute an Internet search on “Classless Interdomain Routing.” You are allowed to specify as many as 10 different accessing IP address, subnet mask combinations.</p> <p>RECOMMENDATION: The subscriber can access the SM/BHS by changing the subscriber device to the accessing subnet. This hazard exists because the Community String and Accessing Subnet are both visible parameters. To avoid this hazard, configure the SM/BHS to filter (block) SNMP requests.</p>
SNMP Trap Server Usage	The management DNS domain name may be toggled such that the name of the trap server only needs to be specified and the DNS domain name is automatically appended to that name. The default SNMP trap server addresses for all 10 available servers is 0.0.0.0 with the appending of the DNS domain name disabled.
Trap Address 1 to 10	<p>Specify ten or fewer IP addresses (xxx.xxx.xxx.xxx) or DNS names to which SNMP traps must be sent. Traps inform Wireless Manager or an NMS that something has occurred. For example, trap information is sent</p> <ul style="list-style-type: none"> • after a reboot of the module. • when an NMS attempts to access agent information but either • supplied an inappropriate community string or SNMP version number. • is associated with a subnet to which access is disallowed.
Trap Sync Status	If the sync status traps (sync lost and sync regained) have to be sent to Wireless Manager or an NMS, select Enabled. If these traps have to be suppressed, select Disabled.
Trap Session Status	If you want session status traps sent to Wireless Manager or an NMS, select Enabled.
LQI Traps	This field enables and disables traps for LQI.
LQI threshold to raise trap (delta from reference LQI value)	It is configured in percentage. The LQI trap is raised if the LQI values goes below the configured threshold to raise trap from reference LQI. For example, if the LQI threshold to raise trap is set as 30, the LQI trap will be raised once the LQI goes below 70% (100-30).
LQI threshold to clear trap (delta from reference LQI value)	It is configured in percentage. The LQI trap is cleared if the LQI values goes above the configured threshold to clear trap from reference LQI. For example, if the LQI threshold to clear trap is set as 25, the LQI trap will be clear once the LQI goes above 75% (100-25).

Attribute	Meaning
Minimum observation period	It is minimum observation period to raise and clear the traps after LQI threshold. It can be configured between 1 to 15 minutes.
Site Information Viewable to Guest Users	Operators can enable or disable site information from appearing when a user is in GUEST account mode.
Site Name	Specify a string to associate with the physical module. This parameter is written into the sysName SNMP MIB-II object and can be polled by Wireless Manager or an NMS. The buffer size for this field is 128 characters.
Site Contact	Enter contact information for the module administrator. This parameter is written into the sysContact SNMP MIB-II object and can be polled by Wireless Manager or an NMS. The buffer size for this field is 128 characters.
Site Location	Enter information about the physical location of the module. This parameter is written into the sysLocation SNMP MIB-II object and can be polled by Wireless Manager or an NMS. The buffer size for this field is 128 characters.

Configuring syslog

450 Platform Family includes:

- Syslog event logging
- Configuring system logging

Syslog event logging

Following events are logged in syslog as explained in below table.

Table 81 :Syslog parameters

Attribute	Meaning
Timestamp	All syslog messages captured from the radio have a timestamp.
Configuration Changes	This includes any device setting that has changed and includes the old or new parameter value, including the device reboots.
User Login and Logout	Syslog records each user login and logout, with username.
Add or Delete of user accounts through GUI and SNMP	Syslog captures any user accounts that are added or deleted.
Spectrum Analysis	<p>Syslog records a message every time Spectrum Analysis runs.</p> <div style="display: flex; align-items: center;">  <div style="border: 1px solid #ccc; background-color: #e6f2ff; padding: 5px;"> <p>Note</p> <p>Since the AP/BHM must be set to a SM/BHS for Spectrum Analysis, syslog messages are not reported from the radio until the scan is done and the radio mode is switched back to AP/BHM.</p> </div> </div>

Attribute	Meaning
Link Test	Syslog records a message every time a Link Test is run.
Clear Statistics	Syslog sends a message when Statistics are cleared. This is done individually for each statistics page that is cleared.
SM Register or De-register	Syslog records a message when a SM registers or deregisters.
BHS Connect or Disconnect	Syslog records a message when a BHS connects or disconnects.

Configuring system logging

To configure system logging, select the menu option Configuration > Syslog.

Syslog page of AP/ BHM

The Syslog Configuration page for AP/BHM is shown in below table.

Table 82 :Syslog Configuration attributes - AP

Syslog Server Configuration

Syslog DNS Server Usage : Append DNS Domain Name
 Disable DNS Domain Name

Syslog Server :

Syslog Server Port : *Default port number is 514*

Syslog Transmission

AP Syslog Transmit : Enabled
 Disabled

SM Syslog Transmit : Enabled
 Disabled

Syslog Level

Syslog Minimum Level : ▼

Attribute	Meaning
Syslog DNS Server Usage	To configure the AP/BHM to append or not append the DNS server name to the syslog server name.
Syslog Server	The dotted decimal or DNS name of the syslog server address.
Syslog Server Port	The syslog server port (default 514) to which syslog messaging is sent.
AP Syslog Transmit Or BHM Syslog Transmit	When enabled, syslog messages are sent from the AP/BHM.
SM Syslog	When enabled, syslog messages are sent from all the registered SMs/BHS, unless they are

Attribute	Meaning
Transmit Or BHS Syslog Transmit	individually set to override this.
Syslog Minimum Level	This provides a selection for the minimum syslog message severity that is sent to the syslog server. Values range from fatal (highest severity and least verbose) to info (lowest severity, maximum verbosity). For example: If the Syslog Minimum Level is set to notice, then only messages with severity notice and above are sent.

Syslog page of SM

To configure system logging, select the menu option Configuration > Syslog. The Syslog Configuration page is shown in below table.

Figure 29 : Syslog Configuration attributes - SM

The screenshot shows the Syslog Configuration page with the following settings:

- Syslog Server Configuration:**
 - Syslog Configuration Source: AP preferred, use local when AP configuration unavailable; Local only
 - Syslog DNS Server Usage: Append DNS Domain Name; Disable DNS Domain Name
 - Syslog Server: 0.0.0.0
 - Syslog Server Port: 514 (Default port number is 514)
- Syslog Transmission:**
 - Syslog Transmission: Obtain from AP, default disabled
- Syslog Level:**
 - Syslog Minimum Level Source: AP preferred, use local when AP configuration unavailable; Local only
 - Syslog Minimum Level: info

Attribute	Meaning
Syslog Configuration Source	This control determines whether the SM will attempt to use the syslog server definition from the AP, or whether it will use a local server definition. When set to AP preferred, use local when AP configuration unavailable, and if the SM can register with an AP, then it uses the syslog server defined on that AP. If the SM cannot register then it will syslog to its locally defined syslog server through its wired connection, if any. When set to Local only the SM ignores the AP's definition of the syslog server and allows the syslog server to be configured individually for each SM.
Syslog DNS Server Usage	To configure the SM to append or not the DNS server name to the syslog server name.
Syslog Server	The dotted decimal or DNS name of the syslog server address.
Syslog	The syslog server port (default 514) to which syslog messaging is sent.

Attribute	Meaning
Server Port	
Syslog Transmission	Controls the SMs ability to transmit syslog messages. When set to “Learn from AP” the AP will control whether this SM transmits syslog messages. When set to “enable” or “disable” the SM will control whether it sends syslog messages. This allows an operator to override the AP settings for individual SMs in a sector.
Syslog Minimum Level Source	<p>This control determines whether the SM attempts to use the minimum syslog level defined by the AP, or whether it uses a local defined value using the “Syslog Minimum Level” parameter.</p> <p>When set to “AP preferred, use local when AP configuration unavailable”, and if the SM can register with an AP, then it uses the Syslog Minimum Level defined on that AP. If the SM cannot register then it uses its own Syslog Minimum Level setting.</p> <p>When set to “Local only” the SM will always use its own Syslog Minimum Level setting and ignores the AP’s setting.</p>
Syslog Minimum Level	<p>This provides a selection for the minimum syslog message severity that is sent to the syslog server. Values range from fatal (highest severity and least verbose) to info (lowest severity, maximum verbosity).</p> <p>For example: If the Syslog Minimum Level is set to notice, then only messages with severity notice and above are sent.</p>

Syslog page of BHS

The Syslog Configuration page is shown in below table.

Table 83 : Syslog Configuration attributes - BHS

Syslog Server Configuration	
Syslog Configuration Source :	<input checked="" type="radio"/> BHM preferred, use local when BHM configuration unavailable <input type="radio"/> Local only
Syslog DNS Server Usage :	<input type="radio"/> Append DNS Domain Name <input checked="" type="radio"/> Disable DNS Domain Name
Syslog Server :	0.0.0.0
Syslog Server Port :	514 <i>Default port number is 514</i>
Syslog Transmission	
Syslog Transmission :	obtain-from-BHM-default-disabled ▼
Syslog Level	
Syslog Minimum Level Source :	<input checked="" type="radio"/> BHM preferred, use local when BHM configuration unavailable <input type="radio"/> Local only
Syslog Minimum Level :	info ▼

Attribute	Meaning
Syslog Configuration Source	<p>This control determines whether the BHS will attempt to use the syslog server definition from the BHM, or whether it will use a local server definition.</p> <ul style="list-style-type: none"> When set to BHM preferred, use local when BHM configuration unavailable, and if

Attribute	Meaning
	<p>the BHS can register with a BHM, then it uses the syslog server defined on that BHM. If the BHS cannot register then it will syslog to its locally defined syslog server through its wired connection, if any.</p> <ul style="list-style-type: none"> When set to Local only the BHS ignores the BHM's definition of the syslog server and allows the syslog server to be configured individually for each BHS.
Syslog DNS Server Usage	To configure the BHS to append or not to append the DNS server name to the syslog server name.
Syslog Server	The dotted decimal or DNS name of the syslog server address.
Syslog Server Port	The syslog server port (default 514) to which syslog messaging is sent.
Syslog Transmission	Controls the BHSs ability to transmit syslog messages. When set to Learn from BHM the BHM will control whether this BHS transmits syslog messages. When set to enable or disable the BHS will control whether it sends syslog messages. This allows an operator to override the BHM settings for individual BHSs in a sector.
Syslog Minimum Level Source	<p>This control determines whether the BHS attempts to use the minimum syslog level defined by the BHM, or whether it uses a local defined value using the Syslog Minimum Level parameter.</p> <ul style="list-style-type: none"> When set to BHM preferred, use local when BHM configuration unavailable, and if the BHS can register with a BHM, then it uses the Syslog Minimum Level defined on that BHM. If the BHS cannot register then it uses its own Syslog Minimum Level setting. <p>When set to Local only the BHS will always use its own Syslog Minimum Level setting and ignores the BHM's setting.</p>
Syslog Minimum Level	<p>This provides a selection for the minimum syslog message severity that is sent to the syslog server. Values range from fatal (highest severity and least verbose) to info (lowest severity, maximum verbosity).</p> <p>For example: If the Syslog Minimum Level is set to notice, then only messages with severity notice and above are sent.</p>

Configuring remote access

Accessing SM/ BHS over-the-air by Web Proxy

The SM/BHS may be accessed via the AP/BHM management GUI by navigating to Home > Session Status (or Home > Remote Subscribers for AP only) and clicking on the SM's hyperlink.

For example, to access one of the SMs, click LUID: 002 - [0a-00-3e-37-b9-fd], as shown in below table.

Figure 30 : AP Session Status page

Home → Session Status

5.4GHz MIMO OFDM - Access Point - 0a-00-3e-a1-35-75

Session Status Configuration

Show Idle Sessions : Enabled Disabled

Session List Tools

Last Session Counter Reset : None

Last Time Idle SMs Removed : None

Session Status List

Data : [SessionStatus.xml](#)

Device	Session	Power	Configuration
Subscriber	Hardware	Software Version	FPGA Version
LUID: 002 - [0a-00-3e-a0-a0-66] No Site Name	PMP 450	CANOPY 14.1.1	110615 (DES, Sched, US/ETSI) P

The SessionStatus.xml hyper link allows user to export all displayed SM data in Session Status table into an xml file.

To access any one of the SMs, click 450 Platform Family - SM hyperlink, as shown in below figure.

Figure 31: AP Remote Subscribers page

Home → Remote Subscribers

5.4GHz MIMO OFDM - Access Point - 0a-00-3e-bb-00-fb

Remote Subscriber Modules

01. [Site Name - \[0a-00-3e-bb-01-04\] - LUID: 002](#)

Monitoring the Link

Link monitoring procedure

After configuring the link, either an operator in the network office or the SM/BHS INSTALLER user in the field (if read access to the AP/BHM is available to the INSTALLER) must perform the following procedure. Who is authorized and able to do this depends on local operator password policy, management VLAN setup and operational practices.

To monitor the link for performance, follow these instructions:

Procedure 14 Monitoring the AP-SM link

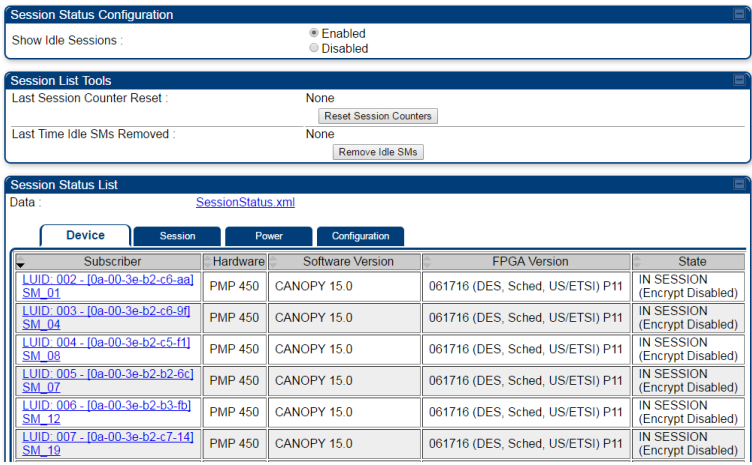
1	Access the web interface of the AP/BHM																												
2	In the left-side menu of the AP/BHM interface, select Home.																												
3	<p>Click the Session Status tab.</p> <p>Figure 32 : Session Status page</p>  <p>The screenshot shows the Session Status page with three main sections: Session Status Configuration, Session List Tools, and Session Status List. The Session Status List section is active, displaying a table with columns for Device, Session, Power, and Configuration. The table lists seven sessions with their respective MAC addresses, hardware (PMP 450), software version (CANOPY 15.0), FPGA version (061716), and state (IN SESSION (Encrypt Disabled)).</p> <table border="1" data-bbox="245 667 982 877"> <thead> <tr> <th>Device</th> <th>Session</th> <th>Power</th> <th>Configuration</th> </tr> </thead> <tbody> <tr> <td>LUID_002 - [0a-00-3e-b2-c6-aa] SM_01</td> <td></td> <td>PMP 450</td> <td>CANOPY 15.0</td> </tr> <tr> <td>LUID_003 - [0a-00-3e-b2-c6-9f] SM_04</td> <td></td> <td>PMP 450</td> <td>CANOPY 15.0</td> </tr> <tr> <td>LUID_004 - [0a-00-3e-b2-c5-f1] SM_08</td> <td></td> <td>PMP 450</td> <td>CANOPY 15.0</td> </tr> <tr> <td>LUID_005 - [0a-00-3e-b2-b2-8c] SM_07</td> <td></td> <td>PMP 450</td> <td>CANOPY 15.0</td> </tr> <tr> <td>LUID_006 - [0a-00-3e-b2-b3-fb] SM_12</td> <td></td> <td>PMP 450</td> <td>CANOPY 15.0</td> </tr> <tr> <td>LUID_007 - [0a-00-3e-b2-c7-14] SM_19</td> <td></td> <td>PMP 450</td> <td>CANOPY 15.0</td> </tr> </tbody> </table>	Device	Session	Power	Configuration	LUID_002 - [0a-00-3e-b2-c6-aa] SM_01		PMP 450	CANOPY 15.0	LUID_003 - [0a-00-3e-b2-c6-9f] SM_04		PMP 450	CANOPY 15.0	LUID_004 - [0a-00-3e-b2-c5-f1] SM_08		PMP 450	CANOPY 15.0	LUID_005 - [0a-00-3e-b2-b2-8c] SM_07		PMP 450	CANOPY 15.0	LUID_006 - [0a-00-3e-b2-b3-fb] SM_12		PMP 450	CANOPY 15.0	LUID_007 - [0a-00-3e-b2-c7-14] SM_19		PMP 450	CANOPY 15.0
Device	Session	Power	Configuration																										
LUID_002 - [0a-00-3e-b2-c6-aa] SM_01		PMP 450	CANOPY 15.0																										
LUID_003 - [0a-00-3e-b2-c6-9f] SM_04		PMP 450	CANOPY 15.0																										
LUID_004 - [0a-00-3e-b2-c5-f1] SM_08		PMP 450	CANOPY 15.0																										
LUID_005 - [0a-00-3e-b2-b2-8c] SM_07		PMP 450	CANOPY 15.0																										
LUID_006 - [0a-00-3e-b2-b3-fb] SM_12		PMP 450	CANOPY 15.0																										
LUID_007 - [0a-00-3e-b2-c7-14] SM_19		PMP 450	CANOPY 15.0																										
4	The Device tab of Session Status List display all displayed SMs - MAC address, PMP/PTP Hardware, Software Version, FPGA Version and State																												
5	<p>Click Session Count tab of Session Status List to display values for Session Count, Reg Count, and Re-Reg Count.</p> <ul style="list-style-type: none"> • Session Count: This field displays how many sessions the SM/BHS has had with the AP/BHM. Typically, this is the sum of Reg Count and Re-Reg Count. However, the result of internal calculation may display here as a value that slightly differs from the sum. • Reg Count: When a SM/BHS makes a Registration Request, the AP/BHM checks its local session database to see whether it was registered earlier. If the AP/BHM concludes that the SM/BHS is not currently in session database and it is valid Registration Request, then the request increments the value of this field. • Re-Reg Count: When a SM/BHS makes a Registration Request, the AP/BHM checks its local session database to see whether it was registered earlier. If the AP/BHM concludes that the SM/BHS is currently in session database, then the request increments the value of this field. • Typically, a Re-Reg is the case where both <ul style="list-style-type: none"> ◦ SM/BHS attempts to reregister for having lost communication with the AP/BHM. ◦ AP/BHM has not yet observed the link to the SM/BHS as being down. <p>See Session tab.</p>																												
6	Click Power tab of Session Status list to display Downlink Rate, AP Rx Power (dBm), Signal Strength Radio (dB) for Uplink and Signal to Noise Radio (dB) for Uplink.																												

	See Power tab.
7	Click Configuration tab of Session Status list to get QoS configuration details: <ul style="list-style-type: none"> • Sustained Data Rate (kbps) • Burst Allocation (kbit) • Max Burst Rate (kbit) • Low Priority CIR (kbps)
8	Briefly monitor these values, occasionally refreshing this page by clicking another tab and then the Session Status tab again.
9	If these values are low (for example, 1, 1, and 0, respectively, meaning that the SM/BHS registered and started a stable session once) and are not changing: <ul style="list-style-type: none"> • Consider the installation successful. • Monitor these values from the network office over the next several hours and days. <p>If these values are greater than 1, 1, and 0, or they increase while you are monitoring them, troubleshoot the link. (For example, Use Receive Power Level for aiming and then use Link Tests to confirm alignment).</p>

Refer Viewing Session Status on page 1 for more details.

Exporting Session Status page of AP/ BHM

The SessionStatus.xml hyper link allows user to export all displayed SMs or BHS data in Session Status table into an xml file.

Figure 33 : Exporting Session Status page of PMP 450m AP

Subscriber	Hardware	Software Version	FPGA Version	State
LUID: 002 - [0a-00-3e-b2-c6-aa] SM_01	PMP 450	CANOPY 15.0	061716 (DES, Sched, US/ETSI) P11	IN SESSION (Encrypt Disabled)

In case of PMP, if the session status page does not list any SM, the SessionStatus.xml will still be visible but the file would be empty. The file will contain data from all of the 5 different tables.

Export from command line

The scripts users can also get this file from command line, you have to authenticate successfully in order to download the file.

<http://169.254.1.1/SessionStatus.xml?CanopyUsername=test&CanopyPassword=test>

Configuring quality of service

Maximum Information Rate (MIR) Parameters

Point-to-multipoint links use the following MIR parameters for bandwidth management:

- Sustained Uplink Data Rate (kbps)
- Uplink Burst Allocation (kb)
- Sustained Downlink Data Rate (kbps)
- Downlink Burst Allocation (kb)
- Max Burst Downlink Data Rate (kbps)
- Max Burst Uplink Data Rate (kbps)

Set each of these parameters per AP or per SM independently.



Note
 You can refer below whitepaper for 450 Platform Family Max Burst MIR:
<http://www.cambiumnetworks.com/resources/pmp-450-maxburst/>

Token Bucket Algorithm

The software uses a token bucket algorithm that has the following features:

- Stores credits (tokens) for the SM to spend on bandwidth for reception or transmission.
- Drains tokens during reception or transmission.
- Refills with tokens at the sustained rate set by the network operator.

For each token, the SM can send toward the network in the uplink (or the AP can send toward the SM in the downlink) an equivalent number of kilobits. Two buckets determine the permitted throughput: one in the SM for uplink and one in the AP for downlink.

The applicable set of Uplink Burst Allocation and Downlink Burst Allocation parameters determine the number of tokens that can fill each bucket. When the SM transmits (or the AP transmits) a packet, the equivalent number of tokens is removed from the uplink (or downlink) bucket.

Except when full, the bucket is continuously being refilled with tokens at rates that the applicable set of Sustained Uplink Data Rate and Sustained Downlink Data Rate parameters specify. The bucket often drains at a rate that is much faster than the sustained data rate but can refill at only the sustained data rate. Thus, the effects of the allocation and rate parameters on packet delay are as follows:

- The burst allocation affects how many kilobits are processed before packet delay is imposed.
- The sustained data rate affects the packet delay that is imposed.

MIR Data Entry Checking

Uplink and downlink MIR is enforced as shown in below figure.



Note
 In these figures, entry refers to the setting in the data rate parameter, not the burst allocation parameter.

Figure 34 : Uplink and downlink rate caps adjusted to apply aggregate cap

$$\text{uplink cap enforced} = \frac{\text{uplink entry} \times \text{aggregate cap for the SM}}{\text{uplink entry} + \text{downlink entry}}$$

$$\text{downlink cap enforced} = \frac{\text{downlink entry} \times \text{aggregate cap for the SM}}{\text{uplink entry} + \text{downlink entry}}$$

For example, in the SM, if you set the Sustained Uplink Data Rate parameter to 2,000 kbps and the Sustained Downlink Data Rate parameter to 10,000 kbps, then the uplink and downlink MIR that is enforced for the SM can be calculated as shown in below figure.

Figure 35 : Uplink and downlink rate cap adjustment example

$$\text{uplink cap enforced} = \frac{2,000 \text{ kbps} \times 7,000 \text{ kbps}}{2,000 \text{ kbps} + 10,000 \text{ kbps}} = 1,167 \text{ kbps}$$

$$\text{downlink cap enforced} = \frac{10,000 \text{ kbps} \times 7,000 \text{ kbps}}{2,000 \text{ kbps} + 10,000 \text{ kbps}} = 5,833 \text{ kbps}$$

In this example case, the derived 1,167-kbps uplink and 5,833-kbps downlink MIR sum to the fixed 7,000-kbps aggregate cap of the SM.

Committed Information Rate (CIR)

The Committed Information Rate (CIR) capability feature enables the service provider to guarantee to any subscriber that bandwidth will never decrease to below a specified minimum unless CIR is oversubscribed or RF conditions are degraded. CIR is oversubscribed when there is not enough available bandwidth to support CIR configuration for all subscribers. In this condition, SMs which are configured with a nonzero CIR will all operate at the maximum data rate supported by the link (subject to Maximum Information Rate and Burst Rate/Allocations). SMs which are configured with a CIR of 0 kbps will not transmit until CIR-configured SMs have completed transmission. CIR may be configured independently for low priority traffic, medium priority traffic, high priority traffic, and ultra high priority traffic.



Note
 CIR settings only apply to the Legacy scheduler. Starting in release 16.1 a new Proportional scheduler can optionally be enabled via Configuration -> Quality of Service -> Scheduler setting. If Proportional Scheduler is set, CIR's are not used.

CIR parameters may be configured in the following ways:

- Web-based management GUI
- SNMP
- Authentication Server (RADIUS) - when an SM successfully registers and authenticates, CIR information is retrieved from the RADIUS server.

Active CIR configuration can be verified via the AP's Home > Session Status page.

Bandwidth from the SM Perspective

In the SM, normal web browsing, e-mail, small file transfers and short streaming video are rarely rate limited with practical bandwidth management (QoS) settings. When the SM processes large downloads such as software upgrades and long streaming video or a series of medium-size downloads, the bucket rapidly drains, the burst limit is reached, and some packets are delayed. The subscriber experience is more affected in cases where the traffic is more latency sensitive.

Interaction of Burst Allocation and Sustained Data Rate Settings

If the Burst Allocation is set to 1200 kb and the Sustained Data Rate is set to 128 kbps, a data burst of 1000 kb is transmitted at full speed because the Burst Allocation is set high enough. After the burst, the bucket experiences a significant refill at the Sustained Data Rate. This configuration uses the advantage of the settable Burst Allocation.

If both the Burst Allocation and the Sustained Data Rate are set to 128 kb, a burst is limited to the Burst Allocation value. This configuration does not take advantage of the settable Burst Allocation.

If the Burst Allocation is set to 128 kb and the Sustained Data Rate is set to 256 kbps, the actual rate is the burst allocation (but in kbps). As above, this configuration does not take advantage of the settable Burst Allocation.

SM Prioritization



Note

This feature is not supported on PMP 450m.

SM Prioritization provides a way to designate a subset of a PMP sector's SMs with a guaranteed portion of air interface resources - slots, which are handled first during scheduling. SMs by default are configured in the SM Prioritization Low Group, and can be configured for the SM Prioritization High Group if desired.

The selection of which prioritization group each SM is configured in Configuration > Quality of Service tab > SM Prioritization Configuration on the SM GUI, as shown in below figure.

Figure 36 : SM Prioritization on SM

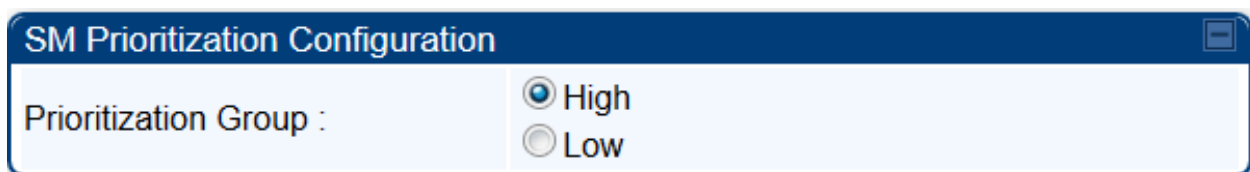

The feature does not take effect, however, until SM Prioritization is enabled on the AP, because the scheduler runs on the AP. Prioritization Allocation percentages per group are configured on the AP to determine how many timeslot resources are dedicated to each priority group.

Enabling of the feature and allocation percentages per group are configured in **Configuration -> Quality of Service tab -> SM Prioritization** Configuration on the AP GUI as shown in SM Prioritization on AP.

With Cambium's SM prioritization feature, we guarantee a percentage of slot resources to each prioritization group. If the resource allocation demands of the SMs in the High Priority allocation group are met without allocating all of that group's allocation percentage, the remaining resources can be used for any unmet demands for SMs in the Low Group. Similarly, if the resource allocation demands of the SMs in the Low Priority allocation group are met without allocating all of that group's allocation percentage, the remaining resources can be used for any unmet demands for SMs in the High Group. If the sector has 100%

utilization, the resource allocation per group will equal the percentages configured on the AP. This feature can be used to provide guaranteed frame allocation to high priority clients, such as business customers. Although SM Prioritization Group 1 is called the “High Priority” group, and SM Prioritization Group 2 is called the “Low Priority” group, this does not mean that 1 group is scheduled resources before the other group. The intention is, by adjusting the number of SMs in the High Priority group and the allocation percentages per group, the SMs in the High Priority group will have a higher “slots/SMs” ratio.

The following figure shows the SM Prioritization configuration at the AP with this feature enabled.

Figure 37 : SM Prioritization on AP

SM Prioritization Configuration	
SM Prioritization Low Group Count :	6 (75%)
SM Prioritization High Group Count :	2 (25%)
SM Prioritization :	<input checked="" type="radio"/> Enabled <input type="radio"/> Disabled
Low Prioritization Allocation :	45 %
High Prioritization Allocation :	55 %

In the example shown in SM Prioritization on AP, 2 of the 8 SMs have been configured for the High Priority Group. The other 6 are in the Low Priority group. 45% of the air interface timeslot resources have been allocated to the Low Priority group. If, for example, all SMs are fully active and all resources in this sector are fully utilized, then 55% of the air interface slot resources will be shared between the 2 High Priority SMs, per direction, and the remaining 45% of the resources will be shared between the other 6 SMs.

If, on the other hand, only 40% of the resources are needed to meet the scheduling demands of the 2 High Priority SMs, the additional 15% that was pre-allocated to the High Priority group can then be used for the Low Priority group, maintaining 100% slot utilization in the sector.

SM Prioritization with CIR

When the SM Prioritization feature is used with CIR, Cambium’s scheduler will first prioritize scheduling of data channels configured with a CIR, but only within the limits of that SMs Prioritization Group allocation. In the example configuration shown in SM Prioritization on AP, there are 6 SMs in the Low Prioritization group. If 3 of those 6 SMs each have a 1Mbps CIR configured, the Cambium scheduler will attempt to meet this 1Mbps CIR per SM before scheduling the other 3 SMs. But if both prioritization groups are overloaded, this 3Mbps committed load on these 3 SMs will only be achieved if it can be done with 55% of the resources or less – per direction.

Weighted Fair Queuing (WFQ)



Note

This feature is not supported on PMP 450m.

This feature lets the user assign a percentage of air interface resources to each of the Data Channel levels. The WFQ apply both to the DL and the UL. Note that there is no BC/MC traffic in the UL direction.

One of the benefits of WFQ is that the configuration can be accomplished at the AP rather than at each individual SMs. This feature can be used with or in place of existing CIR settings. Unlike CIR, which is set in kbps independent of the modulation rate, the WFQ feature operates on a percentage of air interface resources, or timeslots.

Weighted Fair Queuing Configuration is an example of a WFQ configuration on the AP. This can be found in Configuration > Quality of Service tab > Weighted Fair Queuing Configuration on the AP GUI.

In this particular sector, we have 30 Data channels spread across 8 registered SM's. 4 levels of QoS have been configured on 7 of the SM's, 2 levels of QoS have been configured on 1 of the SM's.

Figure 38 : Weighted Fair Queuing Configuration

Weighted Fair Queuing Configuration	
Data Channel Count - Low Priority :	1 (25%)
Data Channel Count - Medium Priority :	1 (25%)
Data Channel Count - High Priority :	1 (25%)
Data Channel Count - Ultra High Priority :	1 (25%)
Weighted Fair Queuing :	<input checked="" type="radio"/> Enabled <input type="radio"/> Disabled
WFQ Configuration :	Valid
Data Channel Allocation - Broadcast/Multicast :	4 %
Data Channel Allocation - Low Priority :	22 %
Data Channel Allocation - Medium Priority :	22 %
Data Channel Allocation - High Priority :	26 %
Data Channel Allocation - Ultra High Priority :	26 %

The above figure shows that 4% of the air interface resources have been reserved for Broadcast/Multicast traffic, 22% of the available air interface timeslot have been reserved for the lowest priority traffic, 22% for medium priority traffic, 26% for high priority traffic, and 26% for the highest priority traffic (Ultra High Priority).

If, at any point in the time, the aggregate traffic load across all SMs on 1 QoS level is less than that level's Weighted Fair Queue allocation, then those unused slots will be allocated for traffic in other QoS levels, based on strict priority.

For example, if, during peak traffic hours, the Ultra High, High, and Low priority Data channels were experiencing heavy traffic loads, but the medium priority aggregate traffic load was light and only used 10% of the scheduling slots in a particular direction, the remaining unused 12% of the slots would be allocated first to the Ultra High priority traffic in queue. When all the Ultra High priority traffic has been scheduled, then any remaining unused slots would be used for High Priority traffic. Finally, after High Priority traffic has been serviced, any remaining slots would be used for Low Priority traffic. The "Low Priority" in the sub-heading "Low Priority SM's WFQ Configuration" shown above simply indicates that the SM Prioritization feature is turned off in this example above. The "Valid" indication in this screenshot is a simple software check to make sure that the configured percentages add up to 100%.

WFQ with CIR



Note

This feature is not supported on PMP 450m.

The WFQ feature can be used with, or as a replacement for, configuring Committed Information Rates (CIR) per data channel. When the WFQ feature is used with CIR's, Cambium's scheduler will first prioritize scheduling of the Data channels configured with a CIR, but only within the limits of that QoS level's WFQ allocation.

Using the example configuration show in Weighted Fair Queuing Configuration, there are 8 high priority Data channels. If 5 of those 8 Data channels have a CIR configured, then the Cambium scheduler will prioritize traffic on those 5 Data channels up to their CIR limits, for those 26% of the timeslots allocated to that QoS level. Operators should try to avoid oversubscription of CIR's. But if CIR's have been oversubscribed at any 1 QoS level such that the desired CIR rates cannot be met within the limits of that level's WFQ allocation, the scheduler will use unallocated slots from another QoS level in strict priority order.

From the prior example, if there is less than 22% of timeslots worth of traffic on the medium priority Data channels, those unused slots would be allocated to Ultra High Priority traffic on Data channels that had not met their CIR commitment within the WFQ allocation, then on High Priority Data channels that had not met their CIR commitment within WFQ allocation, then on Low Priority Data channels that had not met their CIR commitment with WFQ allocation, then on Ultra High Priority traffic above and beyond any CIR configurations, and so on.

WFQ with SM Prioritization



Note
This feature is not supported on PMP 450m.

WFQ with SM Prioritization shows a WFQ configuration with the SM Prioritization feature also enabled.

Figure 39 : WFQ with SM Prioritization

Weighted Fair Queuing Configuration	
Data Channel Count - Low Priority :	1 (25%)
Data Channel Count - Medium Priority :	1 (25%)
Data Channel Count - High Priority :	1 (25%)
Data Channel Count - Ultra High Priority :	1 (25%)
Weighted Fair Queuing :	<input checked="" type="radio"/> Enabled <input type="radio"/> Disabled
WFQ Configuration (SM Prioritization Low Group) :	Valid
Data Channel Allocation - Broadcast/Multicast :	4 %
Data Channel Allocation - Low Priority :	22 %
Data Channel Allocation - Medium Priority :	22 %
Data Channel Allocation - High Priority :	26 %
Data Channel Allocation - Ultra High Priority :	26 %
WFQ Configuration (SM Prioritization High Group) :	Valid
Data Channel Allocation - Low Priority :	25 %
Data Channel Allocation - Medium Priority :	25 %
Data Channel Allocation - High Priority :	25 %
Data Channel Allocation - Ultra High Priority :	25 %

In the example shown in WFQ with SM Prioritization, 2 of the 8 SMs have been configured for the High Priority Group. The other 6 are in the Low Priority group. 45% of air interface timeslot resources have been allocated to the Low priority group. The same allocation rules described above still apply to the WFQ allocation, but now these allocations are done within the confines of each Prioritization group. So, in this configuration shown in WFQ with SM Prioritization, the 2 Medium Priority QoS level Data channels in the High Priority SM Prioritization Group together share 12% of the committed air interface resources per

direction. (.55 x .22 = .12) The same CIR allocation rules apply. The Cambium scheduler will attempt to meet those CIR allocations within the confines of that 12% allocation. If the traffic load on those 2 data channels is light, for example using only 5% of the available slots, then the remaining 7% of resources can be used for other traffic in a strict priority manner. (i.e. attempt to honor CIR's first, then Ultra High Priority traffic, then High Priority traffic, and so on, as described previously).

Proportional Scheduler

This feature, also known as the Rate Plan feature, allows a user to set Plans per SM in units of Kbps. The proportional scheduler maintains the proportions of the SMs' plans when the sector is congested. A default plan setting per direction also exists on the AP and is used in case an SM is not configured with a Plan (for example, the SM is not upgraded to system release 16.1 yet).

Figure 40 : Scheduler Settings on AP

AP Scheduler Settings		
Scheduler :	<input type="radio"/> Proportional	<input checked="" type="radio"/> Legacy
Default Downlink Plan :	0	(kbps) (Range: 1— 310000 kbps)
Default Uplink Plan :	0	(kbps) (Range: 1— 310000 kbps)

When selecting the Proportional scheduler, CIR is no longer applicable.

In system release 16.1, the SM supports a Proportional Scheduler setting section in the Configuration->Quality of Service (QoS) page. These settings are applicable only if the AP is configured to use the Proportional scheduler.

Figure 41 : Proportional Scheduler Settings on AP

Proportional Scheduler settings		
Downlink Plan :	0	(kbps) (Range: 1— 4000 kbps)
Uplink Plan :	0	(kbps) (Range: 1— 4000 kbps)
Weight :	1.0	(Range: 0.1—9.9)
User Lock Modulation :	Disable ▼	
Locked Modulation :	8x ▼	
Threshold Modulation :	8x ▼	

The above 6 settings parameters are described in detail in the Quality of Service (QoS) page of SM later in this document.

The proportional scheduler works in conjunction with the Weighted Fair Queuing feature (in the products that support it), but preserving the plans ratios takes precedence in the scheduler decisions over honoring the WFQ percentages

High-priority Bandwidth Traffic

To support low-latency traffic such as VoIP (Voice over IP) or video, or critical traffic such as control packets, the system implements priority data channels. Prior to PMP 450 Release 15.2, the system allowed for a single High Priority Channel to be configured per SM and per direction, in addition to the default low priority channel. This channel did not affect the inherent latencies in the system but allowed high-priority traffic to be immediately served. The high-priority pipe separates low-latency traffic from traffic that is latency tolerant, such as standard web traffic and file downloads.

From system release 15.2, the system supports up to 4 QoS levels, or data channels, per SM. These are called Low, Medium, High, and Ultra High data channels.

The number of data channels available on the AP is still limited to 238 in release 15.2 This could be 238 SM's each configured with a single Low Priority channel, or, for example, 59 SMs with 4 data channels configured and 1 SM with 2 data channels configured.

A module prioritizes traffic by:

- reading the 802.1p field of the 802.1Q header in a received packet, where VLAN is enabled on the module.
- comparing the 6-bit Differentiated Services Code Point (DSCP) field in the ToS byte of a received packet to a corresponding value in the Diffserv tab of the Configuration page of the module.

Modules monitor ToS bytes with DSCP fields, but with the following differences:

- The 6-bit length of the field allows it to specify one of 64 service differentiations.
- These correlate to 64 individual (CodePoint) parameters in the Diffserv tab of the Configuration page.
- The 8 Class Selector code points are fixed in code and not user settable.
- For any or all of the remaining 56 CodePoint parameters, you can specify a value of
 - 0, 1 for low-priority handling.
 - 2, 3 for medium-priority handling.
 - 4, 5 for high-priority handling.
 - 6, 7 for ultra-high-priority handling.

The above mapping applies if 4 QoS levels are configured. If fewer than that are configured, see the mapping table in the IPv4 and IPv6 Prioritization of this document.



Note

Ensure that your Differentiated Services domain boundary nodes mark any entering packet, as needed, so that it specifies the appropriate Code Point for that traffic and domain. This prevents theft of service level.

An example of the Diffserv page in the Configuration menu and parameter descriptions are provided under DiffServ attributes – AP/BHM on page " DiffServ attributes – AP/BHM" on page 84. This tab and its rules are identical from module type to module type. However, any of the 61 configurable Code Points can be set to a different value from module to module, thus defining unique per-hop behavior for some traffic.

This tab in the AP sets the priorities for the various packets in the downstream (sent from the public network). This tab in the SM sets the priorities for the various packets in the upstream (sent to the public network).

Typically, some SMs attach to older devices that use the ToS byte as originally formatted, and others to newer devices that use the DSCP field. The default values in the Diffserv page allow your modules to prioritize traffic from the older devices roughly the same as they traditionally have. However, these default

values may result in more high-priority traffic as DSCP fields from the newer devices are read and handled. So, after making changes in the Diffserv page, carefully monitor the high-priority channel for high packet rates

- In SMs that you have identified as those to initially set and watch.
- Across your network when you have broadly implemented Code Point values, such as via SNMP.

Traffic Scheduling

The characteristics of traffic scheduling in a sector are summarized in below table.

Table 84 :Characteristics of traffic scheduling

Category	Factor	Treatment
Throughput	Aggregate throughput, less additional overhead	132 Mbps for 20 MHz Higher for 30 MHz or 40 MHz and lower for smaller bandwidths.
Latency	Number of frames required for the scheduling process	1
	Round-trip latency	ff6 ms
	AP broadcast the download schedule	No
Priority Data Channels	Allocation for uplink high-priority data channel traffic on amount of traffic at these higher QoS levels.	Dynamic, based on amount of high-priority traffic
	Allocation for downlink high-priority data channel traffic on amount of traffic at these higher QoS levels	Dynamic, based on amount of high-priority traffic
	Order of transmission	1- Ultra High Priority data channels below CIR limit 2- High Priority data channel's below CIR limit 3- Medium Priority data channels below CIR limit 4- Low Priority data channels below CIR limit 5- Ultra High Priority data channels above CIR limit 6- High Priority data channels above CIR limit 7- Medium Priority data channels above CIR limit 8- Low Priority data channels above CIR limit



Note

This strict priority transmission order is only true in all cases if the SM Prioritization and Weighted Fair Queue features are disabled. If either feature is enabled, see the description of those features in this document for how they impact and interact with this transmission order.

Setting the Configuration Source

The AP includes a Configuration Source parameter, which sets where SMs that register to the AP are controlled for MIR, CIR, VLAN, and the high-priority channel as follows. The Configuration Source parameter affects the source of:

- all MIR settings:
 - Sustained Uplink Data Rate
 - Uplink Burst Allocation
 - Max Burst Uplink Data Rate
 - Sustained Downlink Data Rate
 - Downlink Burst Allocation
 - Max Burst Downlink Data Rate
- all CIR settings:
 - Low Priority Uplink CIR
 - Low Priority Downlink CIR
 - Medium Priority Uplink CIR
 - Medium Priority Downlink CIR
 - High Priority Uplink CIR
 - High Priority Downlink CIR
 - Ultra High Priority Uplink CIR
 - Ultra High Priority Downlink CIR
- all SM VLAN settings
 - Dynamic Learning
 - Allow Only Tagged Frames
 - VLAN Aging Timeout
 - Untagged Ingress VID

- Management VID
- VLAN Membership
- the High Priority Channel setting

Table 85 :Recommended combined settings for typical operations

Most operators who use...	must set this parameter...	in this web page/tab...	in the AP to...
no authentication server	Authentication Mode	Configuration/ Security	Disabled
	Configuration Source	Configuration/ General	SM
Wireless Manager (Authentication Server)	Authentication Mode	Configuration/ Security	Authentication Server
	Configuration Source	Configuration/ General	Authentication Server
RADIUS AAA server	Authentication Mode	Configuration/ Security	RADIUS AAA
	Configuration Source	Configuration/ General	Authentication Server

Table 86 :Where feature values are obtained for an SM registered under an AP with Authentication Mode set to something other than "DISABLED"

Configuration Source Setting in the AP	Values are obtained from		
	MIR Values	VLAN Values	Data Channel Count per SM
Authentication Server	Authentication Server	Authentication Server	Authentication Server
SM	SM	SM	SM
Authentication Server+SM	Authentication Server	Authentication Server, then SM	Authentication Server, then SM



Note

Where Authentication Server, then SM is the indication, parameters for which Authentication Server does not send values are obtained from the SM. This is the case where the Authentication Server is operating on an Authentication Server release that did not support the feature. This is also the case where the feature enable/disable flag in Authentication Server is set to disabled. The values are those previously set or, if none ever were, then the default values.

Where Authentication Server is the indication, values in the SM are disregarded.

Where SM is the indication, values that Authentication Server sends for the SM are disregarded.

For any SM registered under an AP with Authentication Mode set to something other than "DISABLED", the listed settings are derived as shown in below table.

Table 87 :MIR, VLAN, HPC, and CIR Configuration Sources, Authentication Disabled

Configuration Source Setting in the AP	Values are obtained from			
	MIR Values	VLAN Values	Data Channel Count per SM	CIR Values
Authentication Server	AP	AP		
SM	SM	SM	SM	SM
Authentication Server+SM	SM	SM	SM	SM



Note

For the case where configuration source is set to Authentication Server, the Data Channel Count per SM, and the CIR values for those data channels, is defaulted to Low Priority data Channel only with no CIR's configured.

Configuring Quality of Service (QoS)

Quality of Service (QoS) page of AP

The QoS page of AP is explained in below table.

Table 88 :QoS page attributes - AP

AP Bandwidth Settings

(Downlink + Uplink) Sustained Data Rate <= 310000 kbps

Sustained Downlink Data Rate :	155000	(kbps) (Range: 0— 310000 kbps)
Sustained Uplink Data Rate :	155000	(kbps) (Range: 0— 310000 kbps)
Downlink Burst Allocation :	2500000	(kbits) (Range: 0— 2500000 kbits)
Uplink Burst Allocation :	2500000	(kbits) (Range: 0— 2500000 kbits)
Max Burst Downlink Data Rate :	0	(kbps) (Range: 0— 310000 kbps)
Max Burst Uplink Data Rate :	0	(kbps) (Range: 0— 310000 kbps)
Broadcast Downlink CIR :	200	(kbps) (Range: 0— 2333 kbps)

AP Scheduler Settings

Scheduler :	<input checked="" type="radio"/> Proportional <input type="radio"/> Legacy
Default Downlink Plan :	200 (kbps) (Range: 1— 310000 kbps)
Default Uplink Plan :	200 (kbps) (Range: 1— 310000 kbps)

Priority Settings

Priority Precedence :	802.1p Then DiffServ ▼
PPPoE Control Message Priority :	<input type="radio"/> High <input checked="" type="radio"/> Normal
Prioritize TCP ACK :	<input checked="" type="radio"/> Enabled <input type="radio"/> Disabled
Management Data Priority Level :	high ▼

SM Prioritization Configuration	
SM Prioritization Low Group Count :	1 (100%) (Note: SM Prioritization is disabled)
SM Prioritization High Group Count :	0 (0%)
SM Prioritization :	<input checked="" type="radio"/> Enabled <input type="radio"/> Disabled
Note: SM Prioritization is not applicable for proportional scheduler	

Weighted Fair Queuing Configuration	
Data Channel Count - Low Priority :	1 (100%)
Data Channel Count - Medium Priority :	0 (0%)
Data Channel Count - High Priority :	0 (0%)
Data Channel Count - Ultra High Priority :	0 (0%)
Weighted Fair Queuing :	<input checked="" type="radio"/> Enabled <input type="radio"/> Disabled
WFQ Configuration :	Valid
Data Channel Allocation - Broadcast/Multicast :	4 %
Data Channel Allocation - Low Priority :	24 %
Data Channel Allocation - Medium Priority :	24 %
Data Channel Allocation - High Priority :	24 %
Data Channel Allocation - Ultra High Priority :	24 %

Attribute	Meaning
Sustained Downlink Data Rate	<p>Specify the rate at which the AP is replenished with credits (tokens) for transmission to each of the SMs in its sector. This default imposes no restriction on the uplink. See Maximum Information Rate (MIR) Parameters</p> <ul style="list-style-type: none"> Interaction of Burst Allocation and Sustained Data Rate Settings. Configuration Source
Sustained Uplink Data Rate	<p>Specify the rate that each SM registered to this AP is replenished with credits for transmission. This default imposes no restriction on the uplink. See</p> <ul style="list-style-type: none"> Maximum Information Rate (MIR) Parameters Interaction of Burst Allocation and Sustained Data Rate Settings Configuration Source
Downlink Burst Allocation	<p>Specify the maximum amount of data to allow the AP to transmit to any registered SM before the AP is replenished with transmission credits at the Sustained Downlink Data Rate. See</p> <ul style="list-style-type: none"> Maximum Information Rate (MIR) Parameters Interaction of Burst Allocation and Sustained Data Rate Settings Configuration Source

Attribute	Meaning
Uplink Burst Allocation	<p>Specify the maximum amount of data to allow each SM to transmit before being recharged at the Sustained Uplink Data Rate with credits to transmit more. See Maximum Information Rate (MIR) Parameters</p> <ul style="list-style-type: none"> • Interaction of Burst Allocation and Sustained Data Rate Settings • Configuration Source
Max Burst Downlink Data Rate	<p>These parameters allow operators to specify the data rate at which an SM is allowed to transmit (until burst allocation limit is reached) before being recharged at the Sustained Downlink Data Rate with credits to transit more. When set to 0 (default), the burst rate is unlimited.</p>
Max Burst Uplink Data Rate	<p>These parameters allow operators to specify the data rate at which an SM is allowed to transmit (until burst allocation limit is reached) before being recharged at the Sustained Uplink Data Rate with credits to transit more. When set to 0 (default), the burst rate is unlimited.</p>
Broadcast Downlink CIR	<p>Broadcast Downlink CIR (Committed Information Rate, a minimum) supports system designs where downlink broadcast is desired to have higher priority than other traffic. For many other system designs, especially typical internet access networks, leave the Broadcast Downlink CIR at the default.</p> <p>Broadcast Downlink CIR is closely related to the Broadcast Repeat Count parameter, which is settable in the Radio tab of the Configuration page in the AP: when the Broadcast Repeat Count is changed, the total of available bandwidth is also changed, since packets are being sent one, two, or three times, according to the setting in the Broadcast Repeat Count parameter.</p>
Scheduler	<p>This parameter allows the operator to either select the Proportional scheduler or the Legacy scheduler.</p>
Default Downlink Plan	<p>This parameter allows the operator to configure the default downlink plan. The value range for this parameter is 1 - 310000 kbps.</p> <p>Note: Configure this parameter when an SM is not configured with a plan or an SM is still running software older than system release 16.1.</p>
Default Uplink Plan	<p>This parameter allows the operator to configure the default uplink plan. The value range for this parameter is 1 - 310000 kbps.</p> <p>Note: Configure this parameter when an SM is not configured with a plan or an SM is still running software older than system release 16.1.</p>
Priority Precedence	<p>Allows operator to decide if 802.1p or DiffServ priority bits must be used first when making priority decisions.</p>
PPPoE Control Message Priority	<p>Operators may configure the SM to utilize the high priority channel for</p>

Attribute	Meaning
	PPPoE control messages. Configuring the SM in this fashion can benefit the continuity of PPPoE connections when there are issues with PPPoE sessions being dropped in the network. This prioritization may be configured in the DiffServ tab in the Configuration menu of the SM.
Prioritize TCP ACK	To reduce the likelihood of TCP acknowledgement packets being dropped, set this parameter to Enabled. This can improve throughput that the end user perceives during transient periods of congestion on the link that is carrying acknowledgements.
Management Data Priority Level	This parameter allows to set the priority level of the VC used by Management data. Low: Management data uses low priority VC. High: Management data uses highest priority VC
SM Prioritization Low Group Count	This parameter displays the number and percentage of SMs allocated with low prioritization.
SM Prioritization High Group Count	This parameter displays the number and percentage of SMs allocated with high prioritization.
SM Prioritization	To associate a group of SMs at the same prioritization level with a guaranteed percentage of time for data to/from SMs in the group, enable this parameter. Low Prioritization Allocation and High Prioritization Allocation parameters are visible when SM Prioritization is enabled. Note: SM Prioritization is not applicable for proportional scheduler.
Low Prioritization Allocation	This parameter configures the percentage of timeslots dedicated to low prioritization group of SMs
High Prioritization Allocation	Once the Low Prioritization Allocation parameter is configured, this parameter automatically allocates the percentage of slots dedicated to high prioritization group of SMs such that the sum of parameters Low Prioritization Allocation and High Prioritization Allocation is 100%.
Data Channel Count - Low Priority	This parameter displays the percentage of time committed to transfer data to/from VCs at Low Priority QoS level.
Data Channel Count - Medium Priority	This parameter displays the percentage of time committed to transfer data to/from VCs at Medium Priority QoS level.
Data Channel Count - High Priority	This parameter displays the percentage of time committed to transfer data to/from VCs at High Priority QoS level.
Data Channel Count - Ultra High Priority	This parameter displays the percentage of time committed to transfer data to/from VCs at Ultra High Priority QoS level.
Weighted Fair Queuing	To provide a committed frame space for all QoS levels, enable this

Attribute	Meaning
	parameter.
<p>WFQ Configuration (SM Prioritization Low Group):</p> <p>If the percentage of Low Priority SMs is configured as 100%, or SM Prioritization is disabled, or the WFQ feature is disabled, then the GUI displays the following set of five WFQ configuration parameters</p>	
Data Channel Allocation - Broadcast/Multicast	This parameter allows to configure the percentage of frame space allocated for broadcast/multicast.
Data Channel Allocation - Low Priority	This parameter allows to configure the percentage of frame space allocated for low priority QoS level.
Data Channel Allocation - Medium Priority	This parameter allows to configure the percentage of frame space allocated for medium priority QoS level.
Data Channel Allocation - High Priority	This parameter allows to configure the percentage of frame space allocated for high priority QoS level.
Data Channel Allocation - Ultra High Priority	This parameter allows to configure the percentage of frame space allocated for ultra high priority QoS level.
<p>WFQ Configuration (SM Prioritization High Group):</p> <p>If SM Prioritization is enabled and the percentage of Low Priority SMs is configured as anything less than 100%, which means that the percentage of High Priority SMs is not 0, and the WFQ feature is enabled, then the GUI displays the WFQ Configuration (SM Prioritization Low Group) and the following set of five WFQ configuration parameters for High group.</p>	
Data Channel Allocation - Low Priority	This parameter allows to configure the percentage of frame space allocated for low priority QoS level.
Data Channel Allocation - Medium Priority	This parameter allows to configure the percentage of frame space allocated for medium priority QoS level.
Data Channel Allocation - High Priority	This parameter allows to configure the percentage of frame space allocated for high priority QoS level.
Data Channel Allocation - Ultra High Priority	This parameter allows to configure the percentage of frame space allocated for ultra high priority QoS level.

Quality of Service (QoS) page of SM

The QoS page of SM is explained in below table.s

Table 89 : QoS page attributes - SM

MIR Bandwidth Settings

(Downlink + Uplink) Sustained Data Rate <= 310000 kbps

Sustained Downlink Data Rate :	155000	(kbps) (Range: 0— 310000 kbps)
Sustained Uplink Data Rate :	155000	(kbps) (Range: 0— 310000 kbps)
Downlink Burst Allocation :	2500000	(kbits) (Range: 0 — 2500000 kbits)
Uplink Burst Allocation :	2500000	(kbits) (Range: 0 — 2500000 kbits)
Max Burst Downlink Data Rate :	0	(kbps) (Range: 0— 310000 kbps)
Max Burst Uplink Data Rate :	0	(kbps) (Range: 0— 310000 kbps)
Enable Broadcast/Multicast Data Rate :	<input type="radio"/> Enabled <input checked="" type="radio"/> Disabled	
Broadcast/Multicast Uplink Data Rate :	Kbps ▾ 310000	(Range: 1— 310000 kbps/65535 pps)

Data Channel Priority Settings

Number of Data Channels : 1 - Low ▾

Low Priority Channel Configuration :

Low Priority Channel : Enabled

Low Priority Downlink CIR : 0 (kbps) (Range: 0— 4000 kbps)

Low Priority Uplink CIR : 0 (kbps) (Range: 0— 4000 kbps)

Medium Priority Channel Configuration :

Medium Priority Channel : Disabled

High Priority Channel Configuration :

High Priority Channel : Disabled

Ultra High Priority Channel Configuration :

Ultra High Priority Channel : Disabled

Note: CIR values are not applicable for proportional scheduler

Proportional Scheduler settings

Downlink Plan :	0	(kbps) (Range: 1— 310000 kbps)
Uplink Plan :	0	(kbps) (Range: 1— 310000 kbps)
Weight :	0.0	(Range: 0.1—9.9)
User Lock Modulation :	Disable ▾	
Locked Modulation :	8x ▾	
Threshold Modulation :	8x ▾	

Priority Settings

Priority Precedence : 802.1p Then DiffServ ▾

PPPoE Control Message Priority : High
 Normal

Prioritize TCP ACK : Enabled
 Disabled

SM Prioritization Configuration

Prioritization Group : High
 Low

Note: SM Prioritization is not applicable for proportional scheduler

Attribute	Meaning
Sustained Uplink Data Rate	<p>Specify the rate that this SM is replenished with credits for transmission. This default imposes no restriction on the uplink. See Maximum Information Rate (MIR) Parameters</p> <ul style="list-style-type: none"> Interaction of Burst Allocation and Sustained Data Rate Settings Configuration Source
Sustained Downlink Data Rate	<p>Specify the rate at which the AP is replenished with credits (tokens) for transmission to this SM. This default imposes no restriction on the uplink. See Maximum Information Rate (MIR) Parameters</p> <ul style="list-style-type: none"> Interaction of Burst Allocation and Sustained Data Rate Settings Configuration Source
Downlink Burst	<p>Specify the maximum amount of data to allow the AP to transmit to this SM before the AP is replenished at the Sustained Downlink Data Rate with transmission credits. See</p>

Attribute	Meaning
Allocation	<p>Maximum Information Rate (MIR) Parameters</p> <ul style="list-style-type: none"> • Interaction of Burst Allocation and Sustained Data Rate Settings • Configuration Source
Uplink Burst Allocation	<p>Specify the maximum amount of data to allow this SM to transmit before being recharged at the Sustained Uplink Data Rate with credits to transmit more. See Maximum Information Rate (MIR) Parameters</p> <ul style="list-style-type: none"> • Interaction of Burst Allocation and Sustained Data Rate Settings • Configuration Source
Max Burst Downlink Data Rate	<p>These parameters allow operators to specify the data rate at which a SM is allowed to transmit (until burst allocation limit is reached) before being recharged at the Sustained Downlink Data Rate with credits to transit more. When set to 0 (default), the burst rate is unlimited.</p>
Max Burst Uplink Data Rate	<p>These parameters allow operators to specify the data rate at which a SM is allowed to transmit (until burst allocation limit is reached) before being recharged at the Sustained Uplink Data Rate with credits to transit more. When set to 0 (default), the burst rate is unlimited.</p>
Enable Broadcast / Multicast Data Rate	<p>This parameter allows the operator to specify if Broadcast and Multicast data is rate-limited. This data rate can be entered in Kbps or PPS (Packets Per Second).</p>
Broadcast / Multicast Data Rate	<p>This parameter allows the operator to specify a data rate at which Broadcast and Multicast traffic is sent via the radio link.</p>
Number of Data Channels	<p>This parameter allows the operator to specify the number of priority channels to be used for data transmission which is configurable from 1 to 4.</p> <ul style="list-style-type: none"> • 1: Select 1 to enable Low Priority channel. • 2: Select 2 to enable Low and High Priority channels. • 3: Select 3 to enable Low, Medium, and High Priority channels. • 4: Select 4 to enable all channels. <p>For each enabled channel, configure the respective Downlink CIR and Uplink CIR.</p>
Low Priority Channel	<p>This parameter shows whether low priority data channel is enabled or not. Its value is derived based on the number of data channels selected.</p> <p>This parameter is enabled by default.</p>
Low Priority Downlink CIR	<p>This field indicates the minimum rate at which low priority traffic is sent over the downlink (unless CIR is oversubscribed or RF link quality is degraded).</p> <ul style="list-style-type: none"> • Committed Information Rate (CIR)

Attribute	Meaning
	Note: CIR values are not applicable for proportional scheduler.
Low Priority Uplink CIR	This field indicates the minimum rate at which low priority traffic is sent over the uplink (unless CIR is oversubscribed or RF link quality is degraded). <ul style="list-style-type: none"> Committed Information Rate (CIR) Note: CIR values are not applicable for proportional scheduler.
Medium Priority Channel	This parameter shows whether medium priority data channel is enabled or not. Its value is derived based on the number of data channels selected.
Medium Priority Downlink CIR	This field indicates the minimum rate at which medium priority traffic is sent over the downlink (unless CIR is oversubscribed or RF link quality is degraded). <ul style="list-style-type: none"> Committed Information Rate (CIR) Note: CIR values are not applicable for proportional scheduler.
Medium Priority Uplink CIR	This field indicates the minimum rate at which medium priority traffic is sent over the uplink (unless CIR is oversubscribed or RF link quality is degraded). <ul style="list-style-type: none"> Committed Information Rate (CIR) Note: CIR values are not applicable for proportional scheduler.
High Priority Channel	
High Priority Downlink CIR	This field indicates the minimum rate at which high priority traffic is sent over the downlink (unless CIR is oversubscribed or RF link quality is degraded). <ul style="list-style-type: none"> Committed Information Rate (CIR) Note: CIR values are not applicable for proportional scheduler.
High Priority Uplink CIR	This field indicates the minimum rate at which high priority traffic is sent over the uplink (unless CIR is oversubscribed or RF link quality is degraded). <ul style="list-style-type: none"> Committed Information Rate (CIR) Note: CIR values are not applicable for proportional scheduler.
Ultra High Priority Channel	This parameter allows the operator to enable or disable one of the data channels with the highest priority bandwidth.
Downlink Plan	This parameter allows the operator to configure the default downlink plan. The value range for this parameter is 1 - 310000 kbps.
Uplink Plan	This parameter allows the operator to configure the default uplink plan. The value range for this parameter is 1 - 310000 kbps.
Weight	This parameter ranges from 0.1 to 9.9 to prioritize SM services. This is a scaling factor to

Attribute	Meaning
	<p>be applied to the Downlink and Uplink plan.</p> <p>Note: There is only one weight used for a plan in both directions. The default value for this parameter is 1.0.</p>
User Lock Modulation	<p>This parameter contains the following three modes.</p> <p>Disable: When disabled, the Proportional scheduler allocates resources to meet the configured plan. When there is congestion, the Proportional scheduler allocates a reduced value proportional to the other plans regardless of the modulation. If the modulation of one SM degrades, the resources allocated to meet this SM's plan increases, affecting the overall sector capacity. The reduced capacity is divided among all SMs proportional to their plans affecting all SMs.</p> <p>Enable: When enabled, the Locked Modulation drop-down list is enabled supporting values from 1x to 8x.</p> <p>Enable Below Threshold: When enabled, the Threshold Modulation drop-down list is enabled supporting values from 2x to 8x. In this mode, the proportional scheduler behaves as per the Disabled mode until SM's modulation is above the configured Threshold Modulation. If the modulation goes below the Threshold Modulation, then proportional scheduler behaves as per the Enabled mode using the Threshold Modulation as Locked Modulation.</p>
Locked Modulation	<p>Using Locked Modulation, the proportional scheduler guarantees an amount of resources required to transfer data corresponding to the configured plan. If the SM's modulation decreases, the resource allocation is not changed but the SM's throughput is reduced which is no longer proportional to the configured plan. Therefore, the SM's plan is scaled down proportional to the reduced modulation resulting in not affecting other SMs' throughput based on one SM's modulation degrading.</p>
Threshold Modulation	<p>Using Threshold Modulation, if one SM's modulation degrades, then all other SMs' throughputs are affected as long as the degraded modulation is above the threshold. Once the modulation goes below the threshold, the resources are no longer increased for that SM, effectively capping the effect to other SMs.</p>
Priority Precedence	<p>Allows operator to decide if 802.1p or DiffServ priority bits must be used first when making priority decisions.</p>
PPPoE Control Message Priority	<p>Operators may configure the SM to utilize the high priority channel for PPPoE control messages. Configuring the SM in this fashion can benefit the continuity of PPPoE connections when there are issues with PPPoE sessions being dropped in the network. This prioritization may be configured in the DiffServ tab in the Configuration menu of the SM.</p>
Prioritize TCP ACK	<p>To reduce the likelihood of TCP acknowledgement packets being dropped, set this parameter to Enabled. This can improve throughput that the end user perceives during transient periods of congestion on the link that is carrying acknowledgements. This parameter, when enabled, can be particularly useful when running bi-direction FTP sessions over the link. If a link is primarily used for video surveillance, it is recommended to configure this parameter to Disabled.</p>
Prioritization Group	<p>This parameter allows to configure the SM with high or low prioritization.</p>

Quality of Service (QoS) page of BHM

The QoS page of BHM is explained in below table.

Table 90 : QoS page attributes - BHM

Attribute	Meaning
PPPoE Control Message Priority	Operators may configure the BHM to utilize the high priority channel for PPPoE control messages. Configuring the BHM in this fashion can benefit the continuity of PPPoE connections when there are issues with PPPoE sessions being dropped in the network. This prioritization may be configured in the DiffServ tab in the Configuration menu of the BHS.
Prioritize TCP ACK	To reduce the likelihood of TCP acknowledgement packets being dropped, set this parameter to Enabled. This can improve throughput that the end user perceives during transient periods of congestion on the link that is carrying acknowledgements. This parameter, when enabled, can be particularly useful when running bi-direction FTP sessions over the link. If a link is primarily used for video surveillance, it is recommended to configure this parameter to Disabled.

Quality of Service (QoS) page of BHS

The QoS page of BHS is explained in below table.

Table 91 :QoS page attributes - BHS

Attribute	Meaning
PPPoE Control Message Priority	Operators may configure the BHS to utilize the high priority channel for PPPoE control messages. Configuring the BHS in this fashion can benefit the continuity of PPPoE connections when there are issues with PPPoE sessions being dropped in the network. This prioritization may be configured in the DiffServ tab in the Configuration menu of the BHS.
Prioritize TCP	To reduce the likelihood of TCP acknowledgement packets being dropped, set this parameter to Enabled. This can improve throughput that the end user perceives during

Attribute	Meaning
ACK	transient periods of congestion on the link that is carrying acknowledgements. This parameter, when enabled, can be particularly useful when running bi-direction FTP sessions over the link. If a link is primarily used for video surveillance, it is recommended to configure this parameter to Disabled.

Installation Color Code

With this feature enabled on the AP and SM, operators may install and remotely configure SMs without having to configure matching color codes between the modules. While the SM is accessible for configuration from above the AP (for remote provisioning) and below the SM (for local site provisioning), no user data is passed over the radio link. When using the Installation Color Code feature, ensure that the SM is configured with the factory default Color Code configuration (Color Code 1 is “0”, Color Code 2-10 set to “0” and “Disable”). The status of the Installation Color Code can be viewed on the AP Eval web GUI page, and when the SM is registered using the Installation Color Code the message “SM is registered via ICC – Bridging Disabled!” is displayed in red on every SM GUI page. The Installation Color Code parameter is configurable without a radio reboot for both the AP and SM. If an SM is registered via Installation Color Code and the feature is then disabled, operators will need to reboot the SM or force it to reregister (i.e. using the Rescan APs functionality on the AP Eval page).

Figure 42 : Installation Color Code of AP

Radio Configuration	
Frequency Band :	5.4 GHz ▾
Frequency Carrier :	5490.0 ▾
Channel Bandwidth :	10 MHz ▾
Cyclic Prefix :	One Sixteenth ▾
Frame Period :	<input type="radio"/> 5.0 ms <input checked="" type="radio"/> 2.5 ms
Color Code :	254 (0—254)
Subscriber Color Code Rescan (When not on a Primary Color Code) :	0 Minutes (0 — 43200)
Subscriber Color Code Wait Period for Idle :	0 Minutes (0 — 60)
Installation Color Code :	<input type="radio"/> Enabled <input checked="" type="radio"/> Disabled

Zero Touch Configuration Using DHCP Option 66

This feature allows an SM to get its configuration via DHCP option 66. This can be used for the initial configuration of an SM as well as managing the configuration of SMs on an ongoing basis. Here is how it works in brief:

- When the SM boots up, if it is set to use DHCP client, it will send out a DHCP Discover packet which includes a request for DHCP Option 66.
- In case of a brand new SM out of the box, the DHCP Discover packet is sent out if the SM connects to an AP using Installation Color Code (ICC), even though DHCP client is not enabled in factory default config.
- An appropriately configured DHCP server will respond with a DHCP Offer and include a URL in response to the Option 66 request. The URL should point to the configuration file.
- The device will download the configuration file and apply it. The device will reboot automatically if needed. (Note: this requires “rebootIfRequired” flag to be added to the config file. See Creating a Golden config file)

Configuration Steps

Procedure 15 Zero Touch Configuration steps:

1	Create the golden config file(s)
2	Host it on an TFTP/FTP/HTTP/HTTPS server
3	Configure the DHCP server to return the URL of the golden config file in option 66

When the SM boots up, it will get the URL for the golden config from the DHCP server via option 66, download it and apply it.

If all the SMs are configured exactly the same, then you can create just new golden config file that can be used with all SMs.

If the SMs are not configured the same, see if it is possible to group the SMs such that SMs with the same configuration are served by the same DHCP pool. User can then create multiple golden config files and configure the DHCP server to use the appropriate config file for each pool.

User can also create one config file per SM. This provides the most flexibility, but is practical only if you have a software tool/script to generate the config files for each MAC address. The files should be named <mac>.cfg where <mac> is the MAC address of the SM, and stored in the same directory on the file server. The DHCP server should be configured to return the directory name ending with a '/' in option 66. The SM will automatically add "<mac>.cfg" to the path and get its config file.

If some configuration is unique per SM, but rest of the configuration is common, the SMs can be staged with the unique part, and use option 66 to manage the common part. For example, if each SM needs to have its coordinates set, don't include the coordinates in the golden config file. Instead, configure the coordinates for each SM manually. Manage the rest of the configuration using DHCP option 66.

Creating a Golden config file

The easiest way to create the golden config file is to configure an SM, export its configuration and edit it. To export the configuration file from the GUI of the SM, go to "Configuration > Unit Settings" tab, go to the "Download Configuration File" section and click on the "<mac>.cfg" link. This will give you a text file in JSON format. You can edit this file in a text editor but it's easier to use a JSON editor like <https://www.jsoneditoronline.org/>.

Strip down the config file to remove sections and entries that don't care about, and keep only the items that require changes. If there are many required changes, it can easily get confusing. To identify the exact items changes, first reset the SM to factory default, export the config file, make the necessary changes, export a second config file, then use a tool like WinMerge (<http://winmerge.org/>) to identify the differences.

The config file contains the following informational entries at the top level.

"cfgUtcTimestamp": "cfgUtcTimestamp",

"swVersion": "CANOPY 15.1 SM-AES",

"cfgFileString": "Canopy configuration file",

"srcMacAddress": "0a-00-3e-a2-c2-74",

"deviceType": "5.4/5.7GHz MIMO OFDM - Subscriber Module",

"cfgFileVersion": "1.0"

The “cfgUtcTimestamp”, “swVersion”, “srcMacAddress” and “deviceType” lines can be deleted. Do not delete the “cfgFileString” and “cfgFileVersion” entries.

Next, create an object named “configFileParameters” at the top level. Under that, add a parameter called “rebootIfRequired” and set it to true. This tells the SM to reboot automatically if a reboot is needed to apply the new configuration.

A sample configuration file that has been edited for use via DHCP option 66 is given below.

```
{
  "userParameters": {
    "smNetworkConfig": {
      "networkAccess": 1
    },
    "location": {
      "siteName": "Test site"
    },
    "smRadioConfig": {
      "frequencyScanList": [
        5475000,
        5480000
      ],
      "colorCodeList": [
        {
          "colorCode": 42,
          "priority": 1
        }
      ]
    },
    "networkConfig": {
      "lanDhcpState": 1
    }
  },
  "cfgFileVersion": "1.0",
  "cfgFileString": "Canopy configuration file",
  "configFileParameters": {
    "rebootIfRequired": true
  }
}
```

When configuration is imported, only the items that exist in the configuration file are modified. Parameters that are not in the imported file are not changed. If user wish to revert those settings to their factory default values, please add a “setToDefaults” item under “configFileParameters” section with a value of true.

```

“cfgFileVersion”: “1.0”,
“cfgFileString”: “Canopy configuration file”,
“configFileParameters”: {
    “rebootIfRequired”: true,
    “setToDefaults”: true
}

```

In case, the SM needs to fetch the configuration file on each boot up even when not connecting to AP via ICC, set “Network Accessibility” to “Public” and “DHCP State” to “Enabled” in the “Configuration > IP” page before exporting the configuration.

Hosting the config file

Copy the golden configuration file to an FTP, TFTP, HTTP or HTTPS server. This location can be password protected; you just have to include the user name and password in the URL.

DHCP server configuration

Configure DHCP server to return the full URL to the golden config file as the value of DHCP option 66.

The following example explains how to make the change for Windows Server 2008. Adapt it to your specific DHCP server.

Procedure 16 DHCP server configuration

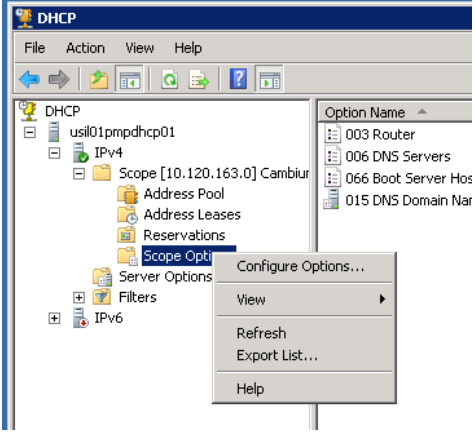
1	Click “Start > Administrative Tools > DHCP”
2	If you have multiple “Scopes” defined, identify the correct “Scope” that will serve IP addresses for the SMs
3	<p>Right click on “Scope Option” under the correct “Scope” and select “Configure Options”</p> 

- In the “Scope Options” dialog, scroll down to “066 Boot Server Host Name”, select the checkbox and enter the full URL to the golden config file as the “String value”. Then click “OK”.

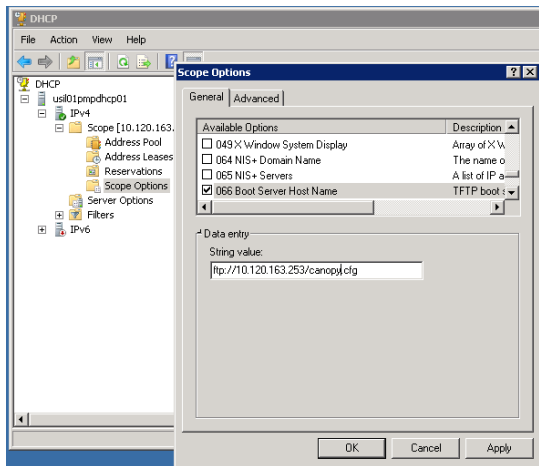

- In the DHCP snap-in window, right click and “Refresh” to see the DHCP option 66 in the list of DHCP options

Supported URL Formats

FTP, TFTP, HTTP and HTTPS URLs are supported. Some examples are given below.

- <ftp://10.120.163.253/canopy.cfg>
- <ftp://admin:admin123@10.120.163.253/canopy.cfg> (login as admin with password admin123)
- <tftp://10.120.163.253/canopy.cfg>
- <http://10.120.163.253/golden-config.cfg>
- <https://10.120.163.253/smconfig/golden-config.cfg>

User can also specify the URL pointing to a directory and not a specific file. Terminate the URL with a ‘/’ to indicate that it is a directory and not a file. Use this format when each SM has its own individual config file. The directory should contain files named “<mac>.cfg”, one for each SM.

For example:

<ftp://10.120.163.253/smconfig/>

In this case, the SM will append “<mac>.cfg” to the path and try to get that file. For example, if the SM’s MAC address is 0a-00-3e-a2-c2-74, it will request for <ftp://10.120.163.253/smconfig/0a003ea2c274.cfg>. This mechanism can be used to serve individual config file for each SM.

Troubleshooting

1	Ensure that the ___14 SM is running 13.3 or newer version of software.
2	If the SM has factory default config, confirm ICC is enabled on the AP, so the SM can connect to it.
3	If the SM is connecting to the AP using a color code other than ICC, make sure the SM has “Network

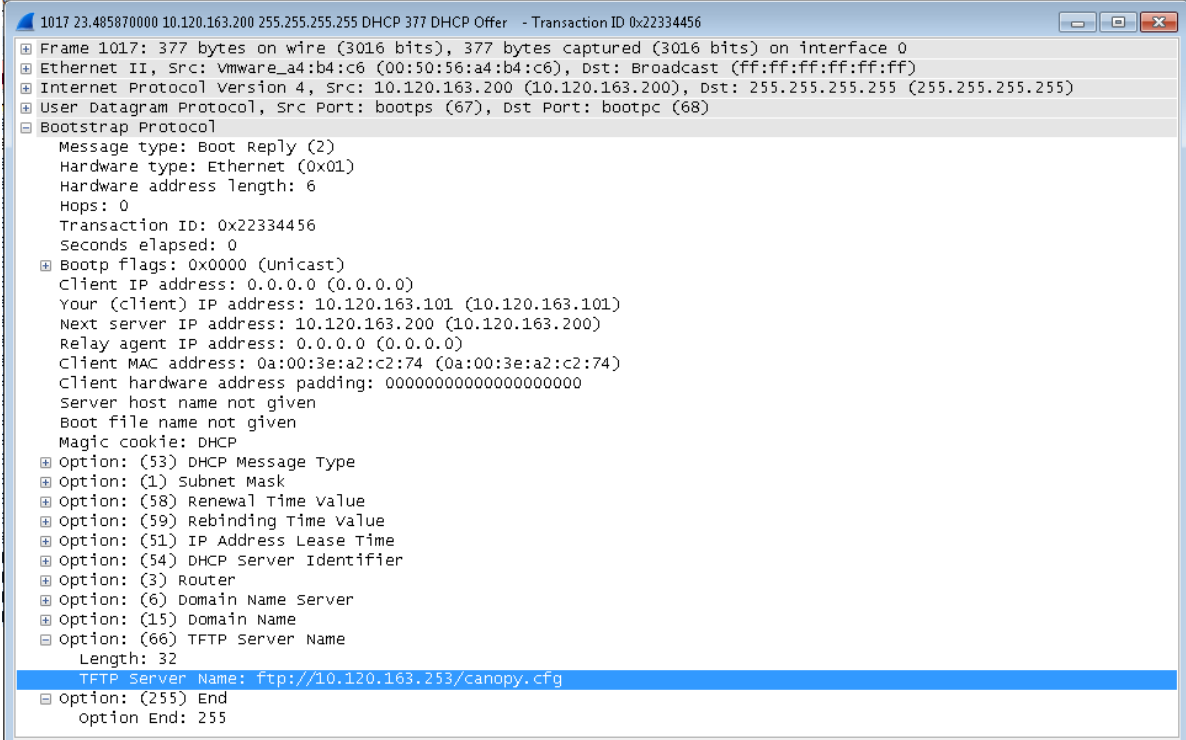
	Accessibility” set to “Public” and “DHCP State” set to “Enabled” in the “Configuration > IP” page.
4	Make sure the golden config file does not turn off “Network Accessibility” or “DHCP State”. If it does, the SM will no longer request the config file when it is rebooted.
5	Check the event log of the SM to see the status of the configuration file import including any errors that prevented it from importing the file.
6	Capture the DHCP Offer packet from the DHCP server to the SM and verify that Option 66 has the expected URL. 

Configuring Radio via config file

The 450 Platform Family supports export and import of a configuration file from the AP or SM as a text file. The configuration file is in JSON format.

To export or import the configuration file, the logged in user needs to be an ADMINISTRATOR and it must not be a “read-only” account.

The exported configuration file contains the complete configuration including all the default values. To keep a backup of the current configuration, the file can be saved as-is and imported later.

While importing a configuration file, it can be either imported the full configuration or a sparse configuration containing only the items that need to be changed. If a sparse configuration file is imported, only the items in the file will be imported. Other configuration will remain unchanged. There could also be used a special flag in the configuration file to tell the device to apply the configuration starting from factory default (ReferProcedure 19 Special Headers for configuration file).

Import and Export of config file

The config file import and export is supported in Configuration > Unit Settings page. The procedure for importing and exporting config file is explained below.

Figure 43 : Configuration File upload and download page

The DHCP server configuration procedure is as follows:

Procedure 17 DHCP server configuration

1	Login to the GUI and go to Configuration > Unit Settings.
2	Under Download Configuration File tab, click on the “<mac>.cfg” link, where <mac> is the MAC address of the device (for example, “01003ea2c274.cfg”).
3	Save the file to the local disk.

The below procedure is to be followed for Importing a config file

Procedure 18 Import the configuration from the GUI

1	Login to the GUI and go to Configuration → Unit Settings.
2	Click on “Browse” button under “Upload and Apply Configuration File” tab and select the configuration file from disk.
3	Click “Upload” followed by “Apply Configuration File” button click.
4	The “Status of Configuration File” section will show the results of the upload.
5	Review it to make sure there are no errors. Then click on “Reboot” to reboot with the imported configuration

The special headers for config file is explained below:

Procedure 19 Special Headers for configuration file

1	A “configFileParameters” section can be added to the header to control the behavior of the device
---	---

	when importing configuration.
2	<p>The “setToDefaults” when set to “true” tell the device to reset to factory default configuration and apply the configuration in the file on top of that. So any attribute not in the configuration file will be set to its factory default value. By default, the configuration in the file is merged with the existing configuration on the device.</p> <p>The “rebootIfRequired” flag when set to “true” tell the device to reboot automatically if needed to apply the configuration change. By default, the device will not reboot automatically.</p> <pre>{ "cfgFileString": "Canopy configuration file", "cfgFileVersion": "1.0", "configFileParameters": { "setToDefaults":true, "rebootIfRequired":true, } }</pre>

Configuring cnMaestro™ Connectivity

450 Platform Family network can be onboarded, configured and managed using cnMaestro™ Cloud or On Premises Server.

Onboarding

Onboarding can be done in one of several ways:

- Using Cambium ID and Onboarding key
- Using Manufacturer’s Serial Number (Only if it starts with an “M” and is 12 characters long)
- On Premises Zero Touch onboarding of AP/SM using DHCP option 43 and 15
- PMP SM Zero touch onboarding to the cnMaestro server where PMP AP is onboarded.

To configure the PMP devices, enable Remote Management under Configuration->cnMaestro as shown in below figure.

Figure 44 : Configuring cnMaestro

Configuration

Remote Management :	<input checked="" type="radio"/> Enable <input type="radio"/> Disable
cnMaestro URL :	<input type="text"/>
Connection Status :	Cambium-ID Not Configured

Credentials

Cambium ID :	<input type="text"/>
Onboarding Key :	<input type="text"/>
AccountID :	<input type="text"/>

Device Agent Information

Device Agent Version :	2.54
------------------------	------

Attribute	Meaning
Remote Management	This field enables/disables remote management of 450 Platform Family products.
cnMaestro URL	This field allows to enter cnMaestro URL e.g. https://cloud.cambiumnetworks.com Or cnMaestro on premises URL
Connection Status	This field indicates cnMaestro connectivity status.
Cambium ID	This field allows to enter Cambium ID for onboarding 450 Platform devices.
Onboarding Key	This field allows to enter Onboarding Key for onboarding.
AccountID	This field indicates Account ID of the customer.
Device Agent Version	This field shows device agent version.

Prerequisites for onboarding to cnMaestro™

- Devices types must be PMP 450m Series, PMP/PTP 450 Series, PMP/PTP 450i/450b Series or PMP 430 Series SMs (interoperability mode only).
- Minimum required software version of 14.2.1. Device software images can be downloaded from <http://support.cambiumnetworks.com> or from the On Premises cnMaestro server by navigating to Operate >Software Update->Manage Images. Select
- Device type to display the available images and then click the download icon as shown in below figure.

Figure 45 : Software Upgrade from cnMaestro™

Select Devices Active Jobs Completed Jobs **Manage Images**

Software Images

Device software images should be downloaded from **Cambium Support**

Device Type: **PMP**

Type	Version	Action
PMP 450i / PTP 450i	14.2.1 (Build 16)	
PMP 430 SM	14.2.1 (Build 16)	
PMP 450 SM	14.2.1 (Build 16)	
PMP 450 AP	14.2.1 (Build 16)	
PTP 450	14.2.1 (Build 16)	

Add Software Image

File

- IP connectivity between PMP Device and the cnMaestro server is established. Ensure Port 443 is open in the firewall as this port is used for secure communication between the PMP device and the cnMaestro server through web sockets. In addition, if the PMP device and cnMaestro™ server are on different subnets, proper routes should be established for communication.
- For PMP AP, a valid DNS setting is required so that the AP will be able to resolve the cnMaestro URL. DNS settings can be verified by performing a DNS lookup under Tools->DNS Test on the AP as shown in below figure.

Figure 46 : DNS Test for cnMaestro™ connectivity

Cambium Networks

- Home
- Configuration
- Statistics
- Tools**
- Logs
- Accounts
- Quick Start
- Copyright
- Logoff

Account: admin
Level: ADMINISTRATOR
Mode: Read-Write
Authentication Method: Local

Link Capacity Test Spectrum Analyzer Remote Spectrum Analyzer OFDM Frame Calculator Subscriber Configuration Link Status

Sessions **DNS Test**

Tools → DNS Test

5.7GHz MIMO OFDM - Access Point
0a-00-3e-bb-01-9b

DNS Test Settings

Fully Qualified Domain Name :

DNS Test Results

cloud.cambiumnetworks.com resolves to: 199.83.134.86

- If the SM is in Bridge mode, then LAN1 must have public equestility with a public IP assigned and corresponding DNS setting.

- If the SM is in NAT mode, then Remote Management should be enabled with the standalone configuration option and DNS settings.

Knowledge Based articles for onboarding

For onboarding the devices to cloud server and troubleshooting the onboarding issues in cloud server please see the following link:

<http://community.cambiumnetworks.com/t5/cnMaestro/Device-On-boarding/td-p/51484>

For onboarding the devices to on Premises server and configuring the DHCP server options for on boarding please see the following link:

<http://community.cambiumnetworks.com/t5/cnMaestro/Device-Onboarding-and-Linux-DHCP-Options-for-cnMaestro-On/m-p/55187#U55187>

Order of Device Onboarding

The device discovery order is as follows in On Premises cnMaestro™ Server. If any of the options is not configured, the discovery method will fallback to the next option:

1. Static cnMaestro URL
2. Zero Touch token (on boarding of PMP SMs when the corresponding AP is on boarded)
3. DHCP Option 43
4. DHCP Option 15
5. <https://cloud.cambiumnetworks.com>

Device Agent Logs

For debugging any onboarding issues please check the device agent logs by navigating to Logs->Device Agent Logs on the PMP device GUI as shown in Device Agent Logs. In addition, a tech support dump can for the PMP device can be obtained from cnMaestro™ by navigating to Monitor->Tools menu after selecting the particular PMP device in the tree and clicking the tech support file icon. This can be send to Cambium support for further troubleshooting.

Figure 47 : Device Agent Logs

The screenshot shows the Cambium Networks PMP device GUI. The left sidebar contains a navigation menu with options: Home, Configuration, Statistics, Tools, Logs (highlighted), Accounts, Quick Start, Copyright, and Logoff. Below the menu, user information is displayed: Account: admin, Level: ADMINISTRATOR, Mode: Read-Write, Authentication Method: Local. The main content area shows a breadcrumb trail: Logs → Device Agent Log. Below this, the device identifier is shown: 5.7GHz MIMO OFDM - Access Point, 0a-00-3e-bb-01-9b. A log window titled 'Device Agent Log' displays the following entries:

```

10/05/2016 : 17:18:27 CDT :: Attempting (re)connection in 5 seconds
10/05/2016 : 17:18:47 CDT :: Timeout in select() - Cancelling!
10/05/2016 : 17:18:47 CDT :: OpenConnection to 10.120.217.150.443 failed
10/05/2016 : 17:18:47 CDT :: Rand_bytes failed, error code : 0
10/05/2016 : 17:18:47 CDT :: Unable to discover cnMaestro URL (re-discover in 61 seconds)
10/05/2016 : 17:18:47 CDT :: Attempting (re)connection in 61 seconds
10/05/2016 : 17:21:45 CDT :: platform_set_fid_index: Failed to get index for field [cambiumCurrentImageVersion]
10/05/2016 : 17:21:45 CDT :: Invalid field [cambiumCurrentImageVersion], please check

```

At the bottom of the log window, there are 'Clear' and 'Refresh' buttons.

Monitoring Tools for PMP Devices on cnMaestro™

cnMaestro™ as of this release offers several debugging tools for PMP devices. Some examples are:

- Pictorial view of network hierarchy
- Device status
- Tech support file
- Throughput
- Alarms
- Reboot
- Debug Logs
- Network connectivity - ping and DNS lookup

Figure 48 : Example cnMaestro™ screenshot

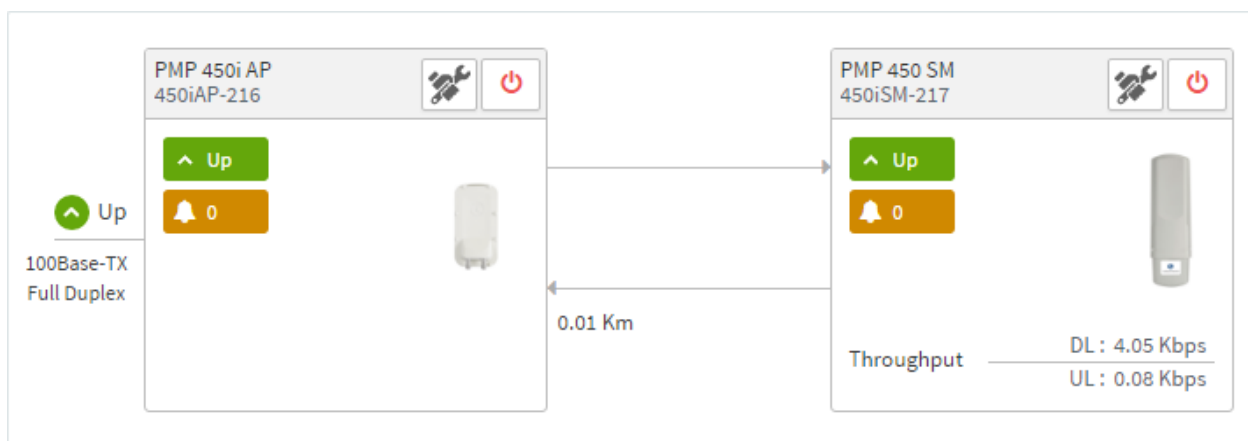

For more information on these tools please see

<http://community.cambiumnetworks.com/t5/cnMaestro/How-to-use-the-cnMaestro-Tools-for-Troubleshooting-Device-or/m-p/54503#U54503>

Zero Touch on boarding of the PMP SMs when the corresponding AP is on boarded

First a link should be established between the PMP AP and SM either by configuring manually or using the ICC. Once the AP and SM link is established, the AP must be onboarded to cnMaestro™ using one of several ways detailed above under the Onboarding section. Once the AP is onboarded to cnMaestro™ Cloud or On premises cnMaestro™server, the SMs under the AP will automatically onboard to cnMaestro™ using a Zero touch token that is communicated between the AP and SMs. This is applicable to existing SMs registered to the AP as well as new SMs registering to the AP for the first time. The SMs appear on the onboarding queue of cnMaestro™ and the operator must “Approve” the devices in order to manage them.

The following operations for PMP Devices are available on cnMaestro™:

- Monitor the device details in the Dashboard page by navigating to the Monitor > Dashboard menu and selecting the PMP AP/SM in the tree.
- Monitor notifications related to the PMP AP/SM by navigating to the Monitor > Notifications Menu and selecting the PMP AP/SM in the tree.

- Monitor device statistics on the statistics page by navigating to the Monitor > Statistics menu and selecting the PMP AP/SM in the tree, then selecting the PMP AP or PMP SM in the Device type dropdown.
- Monitor Performance graphs related to the PMP AP/SM by navigating to the Monitor > Performance menu and selecting the required performance graph (i.e Throughput, SMS, Modulation) and selecting the PMP AP/SM in the tree.
- Troubleshoot the device on the Troubleshooting page by navigating to the Monitor > Tools menu and selecting the PMP AP/SM in the tree.
- Configure the devices by navigating to the Configure > Devices menu and selecting the PMP AP/SM in the tree and selecting the config template that needs to be pushed to the device. Configuration templates need to be created before the configuration can be pushed to the device. The template can be created by copying the existing configuration from the view device configuration link provided in the same page and then modifying the template as needed and then pushing to the same device or other similar devices. Template needs to be properly reviewed for IP Address and other critical parameters to avoid stranding SMs (resulting in a truck roll) by pushing an incorrect configuration. Configuration templates can be created by navigating to the Configure->Templates page and selecting the PMP device type while creating the template.
- Once on 14.2.1, PMP devices can be upgraded to future supported versions from cnMaestro™ by navigating to the Operate > Software Update page and selecting the “PMP Sectors” option from the device type drop-down and the version to which the device needs to be upgraded. It is recommended to upgrade the AP first, then the SMs.
- PMP Device Inventory details can be reviewed by navigating to the Monitor > Inventory page.

Configuring a RADIUS server

Configuring a RADIUS server in a PMP 450 Platform network is optional, but can provide added security, increase ease of network management and provide usage-based billing data.

Understanding RADIUS for PMP 450 Platform Family

PMP 450 Platform modules include support for the RADIUS (Remote Authentication Dial In User Service) protocol supporting Authentication and Accounting.

RADIUS Functions

RADIUS protocol support provides the following functions:

- SM Authentication allows only known SMs onto the network (blocking “rogue” SMs), and can be configured to ensure SMs are connecting to a known network (preventing SMs from connecting to “rogue” APs). RADIUS authentication is used for SMs, but is not used for APs.
- SM Configuration: Configures authenticated SMs with MIR (Maximum Information Rate), CIR (Committed Information Rate), Medium Priority, High Priority, and Ultra High Priority Data channels, and VLAN (Virtual LAN) parameters from the RADIUS server when a SM registers to an AP.
- User Authentication allows users to configure a separate User authentication server along with the SM authentication server. If firmware is upgraded while using this functionality and no User authentication servers are configured, then AP continues to use the SM authentication server for User authentication
- SM Accounting provides support for RADIUS accounting messages for usage-based billing. This accounting includes indications for subscriber session establishment, subscriber session disconnection, and bandwidth usage per session for each SM that connects to the AP.
- Centralized AP and SM user name and password management allows AP and SM usernames and access levels (Administrator, Installer, Technician) to be centrally administered in the RADIUS

server instead of on each radio and tracks access events (logon/logoff) for each username on the RADIUS server. This accounting does not track and report specific configuration actions performed on radios or pull statistics such as bit counts from the radios. Such functions require an Element Management System (EMS) such as Cambium Networks Wireless Manager. This accounting is not the ability to perform accounting functions on the subscriber/end user/customer account.

- Framed IP allows operators to use a RADIUS server to assign management IP addressing to SM modules (framed IP address).

Tested RADIUS Servers

The Canopy RADIUS implementation has been tested and is supported on

- FreeRADIUS, Version 2.1.8
- Aradial RADIUS, Version 5.1.12
- Microsoft RADIUS (Windows Server 2012 R2 version)
- Cisco ACS, Version 5.7.0.15



Note

Aradial 5.3 has a bug that prevents “remote device login”, so doesn’t support the user name and password management feature.

Choosing Authentication Mode and Configuring for Authentication Servers - AP

On the AP’s **Configuration > Security tab**, select the RADIUS AAA Authentication Mode. The following describes the other **Authentication Mode** options for reference, and then the RADIUS AAA option.

- **Disabled:** Requires no authentication. Any SM (except a SM that itself has been configured to require RADIUS authentication by enabling Enforce Authentication as described below) is allowed to register to the AP.
- **Authentication Server:** Authentication Server in this instance refers to Wireless Manager in BAM-only mode. Authentication is required for a SM to register to the AP. Only SMs listed by MAC address in the Wireless Manager database is allowed to register to the AP.
- **AP Pre-Shared Key:** Canopy offers a pre-shared key authentication option. In this case, an identical key must be entered in the Authentication Key field on the AP’s Configuration > Security tab and in the Authentication Key field on each desired SM’s Configuration > Security tab.
- **RADIUS AAA:** To support RADIUS authentication of SMs, on the AP’s Configuration > Security tab select RADIUS AAA. Only properly configured SMs with a valid certificate is allowed to register to the AP.

When RADIUS AAA is selected, up to 3 Authentication Server (RADIUS Server) IP addresses and Shared Secrets can be configured. The IP address(s) configured here must match the IP address(s) of the RADIUS server(s). The shared secret(s) configured here must match the shared secret(s) configured in the RADIUS server(s). Servers 2 and 3 are meant for backup and reliability, not splitting the database. If Server 1 doesn’t respond, Server 2 is tried, and then server 3. If Server 1 rejects authentication, the SM is denied entry to the network, and does not progress trying the other servers.

The default IP address is 0.0.0.0. The default Shared Secret is “CanopySharedSecret”. The Shared Secret can be up to 32 ASCII characters (no diacritical marks or ligatures, for example).

Figure 49 : Security tab attributes

Authentication Server Settings	
Authentication Mode :	Disabled ▾
Authentication Server DNS Usage :	<input type="radio"/> Append DNS Domain Name <input checked="" type="radio"/> Disable DNS Domain Name
Authentication Server 1 :	<input type="text"/> Shared Secret <input type="text" value="0.0.0.0"/>
Authentication Server 2 :	<input type="text"/> Shared Secret <input type="text" value="0.0.0.0"/>
Authentication Server 3 :	<input type="text"/> Shared Secret <input type="text" value="0.0.0.0"/>
Authentication Server 4 (BAM ONLY) :	<input type="text" value="0.0.0.0"/>
Authentication Server 5 (BAM ONLY) :	<input type="text" value="0.0.0.0"/>
Radius Port :	<input type="text" value="1812"/> <i>Default port number is 1812</i>
Authentication Key :	<input type="text"/> (Using All 0xFF's Key)
Select Key :	<input type="radio"/> Use Key above <input checked="" type="radio"/> Use Default Key
Dynamic Authorization Extensions for RADIUS :	<input type="radio"/> Enable CoA and Disconnect Message <input checked="" type="radio"/> Disable CoA and Disconnect Message
Bypass Authentication for ICC SMs :	<input type="radio"/> Enabled <input checked="" type="radio"/> Disabled

Airlink Security	
Encryption Setting :	None ▾

AP Evaluation Configuration

SM Display of AP Evaluation Data : Disable Display
 Enable Display

Session Timeout

Web, Telnet, FTP Session Timeout : Seconds

IP Access Filtering

IP Access Control : IP Access Filtering Enabled - Only allow access from IP addresses specified below
 IP Access Filtering Disabled - Allow access from all IP addresses

Allowed Source IP 1 :	<input type="text" value="0.0.0.0"/> / <input type="text" value="32"/>	Network Mask (set to 32 to disable)
Allowed Source IP 2 :	<input type="text" value="0.0.0.0"/> / <input type="text" value="32"/>	Network Mask (set to 32 to disable)
Allowed Source IP 3 :	<input type="text" value="0.0.0.0"/> / <input type="text" value="32"/>	Network Mask (set to 32 to disable)

Security Mode

Web Access :

SNMP :

Telnet : Enabled
 Disabled

FTP : Enabled
 Disabled

TFTP : Enabled
 Disabled

NTP server : Enabled
 Disabled

Attribute	Meaning
Authentication Mode	<p>Operators may use this field to select the following authentication modes:</p> <p>Disabled—the AP requires no SMs to authenticate.</p> <p>Authentication Server — the AP requires any SM that attempts registration to be authenticated in Wireless Manager before registration.</p> <p>AP PreShared Key - The AP acts as the authentication server to its SMs and will make use of a user-configurable pre-shared authentication key. The operator enters this key on both the AP and all SMs desired to register to that AP. There is also an option of leaving the AP and SMs at their default setting of using the “Default Key”. Due to the nature of the authentication operation, if you want to set a specific authentication key, then you MUST configure the key on all of the SMs and reboot them BEFORE enabling the key and option on the AP. Otherwise, if you configure the AP first, none of the SMs is able to register.</p> <p>RADIUS AAA - When RADIUS AAA is selected, up to 3 Authentication Server (RADIUS Server) IP addresses and Shared Secrets can be configured. The IP address(s) configured here must match the IP address(s) of the RADIUS server(s). The shared secret(s) configured here must match the shared secret(s) configured in the RADIUS server(s). Servers 2 and 3 are meant for backup and reliability, not for splitting the database. If Server 1 doesn’t respond, Server 2 is tried, and then server 3. If Server 1 rejects authentication, the SM is denied entry to the network and does not progress trying the other servers.</p>
Authentication Server DNS Usage	The management DNS domain name may be toggled such that the name of the authentication server only needs to be specified and the DNS domain name is automatically appended to that name.
Authentication Server 1	<p>Enter the IP address or server name of the authentication server (RADIUS or WM) and the Shared Secret configured in the authentication server. When Authentication Mode RADIUS AAA is selected, the default value of Shared Secret is “CanopySharedSecret”. The Shared Secret may consist of up to 32 ASCII characters.</p>
Authentication Server 2	
Authentication Server 3	
Authentication Server 4 (BAM Only)	
Authentication Server 5 (BAM Only)	
Radius Port	This field allows the operator to configure a custom port for RADIUS server communication. The default value is 1812.
Authentication Key	The authentication key is a 32-character hexadecimal string used when Authentication Mode is set to AP Pre- Shared Key . By default, this key is set to 0xFF.
Selection Key	This option allows operators to choose which authentication key is used:

Attribute	Meaning
	<p>Use Key above means that the key specified in Authentication Key is used for authentication</p> <p>Use Default Key means that a default key (based off of the SM's MAC address) is used for authentication</p>
Encryption Key	<p>Specify the type of airlink security to apply to this AP. The encryption setting must match the encryption setting of the SMs.</p> <p>None provides no encryption on the air link.</p> <p>AES (Advanced Encryption Standard): An over-the-air link encryption option that uses the Rijndael algorithm and 128-bit keys to establish a higher level of security. AES products are certified as compliant with the Federal Information Processing Standards (FIPS 197) in the U.S.A.</p>
SM Display of AP Evaluation Data	You can use this field to suppress the display of data about this AP on the AP Evaluation tab of the Tools page in all SMs that register.
Web, Telnet, FTP Session Timeout	Enter the expiry in seconds for remote management sessions via HTTP, telnet, or ftp access to the AP.
IP Access Control	You can permit access to the AP from any IP address (IP Access Filtering Disabled) or limit it to access from only one, two, or three IP addresses that you specify (IP Access Filtering Enabled). If you select IP Access Filtering Enabled, then you must populate at least one of the three Allowed Source IP parameters or have no access permitted from any IP address
Allowed Source IP 1	If you selected IP Access Filtering Enabled for the IP Access Control parameter, then you must populate at least one of the three Allowed Source IP parameters or have no access permitted to the AP from any IP address. You may populate as many as all three.
Allowed Source IP 2	If you selected IP Access Filtering Disabled for the IP Access Control parameter, then no entries in this parameter are read, and access from all IP addresses is permitted.
Allowed Source IP 3	
Web Access	<p>The Radio supports secured and non-secured web access protocols. Select suitable web access from drop-down list:</p> <ul style="list-style-type: none"> • HTTP Only - provides non-secured web access. The radio to be accessed via <a href="http://<IP of Radio>">http://<IP of Radio>. • HTTPS Only - provides a secured web access. The radio to be accessed via <a href="https://<IP of Radio>">https://<IP of Radio>. • HTTP and HTTPS - If enabled, the radio can be accessed via both http and https.
SNMP	<p>This option allows to configure SNMP agent communication version. It can be selected from drop-down list :</p> <ul style="list-style-type: none"> • SNMPv2c Only - Enables SNMP v2 community protocol. • SNMPv3 Only - Enables SNMP v3 protocol. It is secured communication

Attribute	Meaning
	protocol. <ul style="list-style-type: none"> SNMPv2c and SNMPv3 – It enables both the protocols.
Telnet	This option allows to Enable and Disable Telnet access to the Radio.
FTP	This option allows to Enable and Disable FTP access to the Radio.
TFTP	This option allows to Enable and Disable TFTP access to the Radio.
NTP server	This option allows to Enable and Disable NTP server access to the Radio.

SM Authentication Mode – Require RADIUS or Follow AP

If it is desired that a SM will only authenticate to an AP that is using RADIUS, on the SM's Configuration Security tab set Enforce Authentication to AAA. With this enabled, SM does not register to an AP that has any Authentication Mode other than RADIUS AAA selected.

If it is desired that a SM use the authentication method configured on the AP it is registering to, set Enforce Authentication to Disabled. With Enforce Authentication disabled, a SM will attempt to register using whichever Authentication Mode is configured on the AP it is attempting to register to.



Note

Having SMs to use RADIUS by enabling Enforce Authentication avoids the security issue of SMs possibly registering to “rogue” APs, which have authentication disabled.

Table 92 :SM Security tab attributes

Authentication Key Settings	
Authentication Key :	<input type="text" value="(Using All 0xFF's Key)"/>
Select Key :	<input type="radio"/> Use Key above <input checked="" type="radio"/> Use Default Key

AAA Authentication Settings	
Enforce Authentication :	Disable ▾
Phase 1 :	eapttls ▾
Phase 2 :	MSCHAPv2 ▾
Identity/Realm :	<input type="radio"/> Enable Realm <input checked="" type="radio"/> Disable Realm Identity <input type="text" value="anonymous"/> @ Realm <input type="text" value="canopy.net"/>
Username :	<input type="text" value="0a-00-3e-a0-00-8c"/> <input type="button" value="Use Default Username"/>
Password :	<input type="password" value="*****"/>
Confirm Password :	<input type="password"/>

RADIUS Certificate Settings	
Upload Certificate File	
File:	<input type="button" value="Choose File"/> No file chosen
<input type="button" value="Import Certificate"/> <input type="button" value="Use Default Certificates"/> <i>This will delete all current certificates</i>	

Certificate 1	
C =US S =Illinois O =Motorola Solutions, Inc. OU =Canopy Wireless Broadband CN =Canopy AAA Server Demo CA E =technical-support@canopywireless.com Valid From: 01/01/2001 00:00:00 Valid To: 12/31/2049 23:59:59 <input type="button" value="Delete"/>	

Certificate 2	
<i>Certificate 2 deleted.</i>	

Airlink Security	
Encryption Setting :	DES ▾

Session Timeout	
Web, Telnet, FTP Session Timeout :	<input type="text" value="800000"/> Seconds

SM Management Interface Access via Ethernet Port	
Ethernet Access :	<input checked="" type="radio"/> Enabled <input type="radio"/> Disabled

IP Access Filtering

IP Access Control :

IP Access Filtering Enabled - Only allow access from IP addresses specified below

IP Access Filtering Disabled - Allow access from all IP addresses

Allowed Source IP 1 :	0.0.0.0	/32	Network Mask (set to 32 to disable)
Allowed Source IP 2 :	0.0.0.0	/32	Network Mask (set to 32 to disable)
Allowed Source IP 3 :	0.0.0.0	/32	Network Mask (set to 32 to disable)

Security Mode

Web Access : HTTP Only

SNMP : SNMPv2c Only

Telnet : Enabled
 Disabled

FTP : Enabled
 Disabled

TFTP : Enabled
 Disabled

Attribute	Meaning
Authentication Key	The authentication key is a 32-character hexadecimal string used when Authentication Mode is set to AP PreShared Key . By default, this key is set to 0xFF.
Select Key	This option allows operators to choose which authentication key is used: Use Key above means that the key specified in Authentication Key is used for authentication Use Default Key means that a default key (based off of the SM's MAC address) is used for authentication
Enforce Authentication	The SM may enforce authentication types of AAA and AP Pre-sharedKey. The SM will not finish the registration process if the AP is not using the configured authentication method (and the SM locks out the AP for 15 minutes). Enforce Authentication default setting is Disable.
Phase 1	The protocols supported for the Phase 1 (Outside Identity) phase of authentication are EAPTTLS (Extensible Authentication Protocol Tunneled Transport Layer Security) or MSCHAPv2 (Microsoft Challenge-Handshake Authentication Protocol version 2).
Phase 2	Select the desired Phase 2 (Inside Identity) authentication protocol from the Phase 2 options of PAP (Password Authentication Protocol), CHAP (Challenge Handshake Authentication Protocol), and MSCHAP (Microsoft's version of CHAP, version 2 is used). The protocol must be consistent with the authentication protocol configured on the RADIUS server.
Identity/Realm	If Realms are being used, select Enable Realm and configure an outer identity in the Identity field and a Realm in the Realm field. These must match the Phase 1/Outer Identity and Realm configured in the RADIUS server. The default Identity is "anonymous". The Identity can be up to 128 non-special (no diacritical markings) alphanumeric characters. The default Realm is "canopy.net". The Realm can also be up to 128 non-special alphanumeric characters.

Attribute	Meaning
	Configure an outer Identity in the Username field. This must match the Phase 1/Outer Identity username configured in the RADIUS server. The default Phase 1/Outer Identity Username is “anonymous”. The Username can be up to 128 non-special (no diacritical markings) alphanumeric characters.
Username	Enter a Username for the SM. This must match the username configured for the SM on the RADIUS server. The default Username is the SM’s MAC address. The Username can be up to 128 non-special (no diacritical markings) alphanumeric characters.
Password	Enter the desired password for the SM in the Password and Confirm Password fields. The Password must match the password configured for the SM on the RADIUS server. The default Password is “password”. The Password can be up to 128 non-special (no diacritical markings) alphanumeric characters.
Confirm Password	
Upload Certificate File	<p>To upload a certificate manually to a SM, first load it in a known place on your PC or network drive, then click on a Delete button on one of the Certificate description blocks to delete a certificate to provide space for your certificate. Click on Choose File, browse to the location of the certificate, and click the Import Certificate button, and then reboot the radio to use the new certificate.</p> <p>When a certificate is in use, after the SM successfully registers to an AP, an indication of In Use will appear in the description block of the certificate being used.</p> <p>The public certificates installed on the SMs are used with the private certificate on the RADIUS server to provide a public/private key encryption system.</p> <p>Up to 2 certificates can be resident on a SM. An installed certificate can be deleted by clicking the Delete button in the certificate’s description block on the Configuration > Security tab. To restore the 2 default certificates, click the Use Default Certificates button in the RADIUS Certificate Settings parameter block and reboot the radio.</p>
Encryption Setting	<p>Specify the type of airlink security to apply to this AP. The encryption setting must match the encryption setting of the SMs.</p> <p>None provides no encryption on the air link.</p> <p>AES (Advanced Encryption Standard): An over-the-air link encryption option that uses the Rijndael algorithm and 128-bit keys to establish a higher level of security. AES products are certified as compliant with the Federal Information Processing Standards (FIPS 197) in the U.S.A.</p>
Web, Telnet, FTP Session Timeout	Enter the expiry in seconds for remote management sessions via HTTP, telnet or ftp access to the AP.
Ethernet Access	<p>If you want to prevent any device that is connected to the Ethernet port of the SM from accessing the management interface of the SM, select Ethernet Access Disabled. This selection disables access through this port to via HTTP (the GUI), SNMP, telnet, FTP, and TFTP. With this selection, management access is available through only the RF interface via either an IP address (if Network Accessibility is set to Public on the SM) or the Session Status or Remote Subscribers tab of the AP. See IP Access Control below.</p> <p>If you want to allow management access through the Ethernet port, select Ethernet Access Enabled. This is the factory default setting for this parameter.</p>

Attribute	Meaning
IP Access Control	You can permit access to the AP from any IP address (IP Access Filtering Disabled) or limit it to access from only one, two, or three IP addresses that you specify (IP Access Filtering Enabled). If you select IP Access Filtering Enabled, then you must populate at least one of the three Allowed Source IP parameters or have no access permitted from any IP address
Allowed Source IP 1	If you selected IP Access Filtering Enabled for the IP Access Control parameter, then you must populate at least one of the three Allowed Source IP parameters or have no access permitted to the AP from any IP address. You may populate as many as all three. If you selected IP Access Filtering Disabled for the IP Access Control parameter, then no entries in this parameter are read, and access from all IP addresses is permitted.
Allowed Source IP 2	
Allowed Source IP 3	
Web Access	The Radio supports secured and non-secured web access protocols. Select suitable web access from drop-down list: <ul style="list-style-type: none"> • HTTP Only - provides non-secured web access. The radio to be accessed via <a href="http://<IP of Radio>">http://<IP of Radio>. • HTTPS Only - provides a secured web access. The radio to be accessed via <a href="https://<IP of Radio>">https://<IP of Radio>. • HTTP and HTTPS - If enabled, the radio can be accessed via both http and https.
SNMP	This option allows to configure SNMP agent communication version. It can be selected from drop-down list : <ul style="list-style-type: none"> • SNMPv2c Only - Enables SNMP v2 community protocol. • SNMPv3 Only - Enables SNMP v3 protocol. It is secured communication protocol. • SNMPv2c and SNMPv3 - It enables both the protocols.
Telnet	This option allows to Enable and Disable Telnet access to the Radio.
FTP	This option allows to Enable and Disable FTP access to the Radio.
TFTP	This option allows to Enable and Disable TFTP access to the Radio.

SM - Phase 1 (Outside Identity) parameters and settings

The protocols supported for the Phase 1 (Outside Identity) phase of authentication are

eapptls (Extensible Authentication Protocol Tunneled Transport Layer Security) and eapMSChapV2 (Extensible Authentication Protocol - Microsoft Challenge-Handshake Authentication Protocol).

Configure an outer Identity in the Username field. This must match the Phase 1/Outer Identity username configured in the RADIUS server. The default Phase 1/Outer Identity Username is “anonymous”. The Username can be up to 128 non-special (no diacritical markings) alphanumeric characters. If Realms are being used in the RADIUS system (eapptls only), select Enable Realm and configure an outer identity in the Identity field and a Realm in the Realm field. These must match the Phase 1/Outer Identity and Realm configured in the RADIUS server. The default Identity is “anonymous”. The Identity can be up to 128 non-special (no diacritical markings) alphanumeric characters. The default Realm is “canopy.net”. The Realm can also be up to 128 non-special alphanumeric characters.

SM - Phase 2 (Inside Identity) parameters and settings

If using eapptls for Phase 1 authentication, select the desired Phase 2 (Inside Identity) authentication protocol from the Phase 2 options of PAP (Password Authentication Protocol), CHAP (Challenge Handshake Authentication Protocol), and MSCHAPv2 (Microsoft's version of CHAP). The protocol must be consistent with the authentication protocol configured on the RADIUS server. Enter a Username for the SM. This must match the username configured for the SM on the RADIUS server. The default Username is the SM's MAC address. The Username can be up to 128 non-special (no diacritical markings) alphanumeric characters.

Enter the desired password for the SM in the Password and Confirm Password fields. The Password must match the password configured for the SM on the RADIUS server. The default Password is "password". The Password can be up to 128 non-special (no diacritical markings) alphanumeric characters.

Handling Certificates

Managing SM Certificates via the SM GUI

The default public Canopy certificates are loaded into SMs upon factory software installation. The default certificates are not secure and are intended for use during lab and field trials as part of gaining experience with the RADIUS functionalities or as an option during debug. For secure operation, an operator will want to create or procure their own certificates. Resetting a SM to its factory defaults will remove the current certificates and restore the default certificates.

Up to two certificates can be resident on a SM. An installed certificate can be deleted by clicking the Delete button in the certificate's description block on the Configuration > Security tab. To restore the 2 default certificates, click the Use Default Certificates button in the RADIUS Certificate Settings parameter block and reboot the radio.

To upload a certificate manually to a SM, first load it in a known place on your PC or network drive, then click on a Delete button on one of the Certificate description blocks to delete a certificate to provide space for your certificate. Click on Choose File, browse to the location of the certificate, and click the Import Certificate button, and then reboot the radio to use the new certificate.

When a certificate is in use, after the SM successfully registers to an AP, an indication of In Use will appear in the description block of the certificate being used.

The public certificates installed on the SMs are used with the private certificate on the RADIUS server to provide a public/private key encryption system.



Note

Root certificates of more than one level (Example - a certificate from someone who received their CA from Verisign) fails. Certificates must be either root or self-signed.

Figure 50 : SM Certificate Management

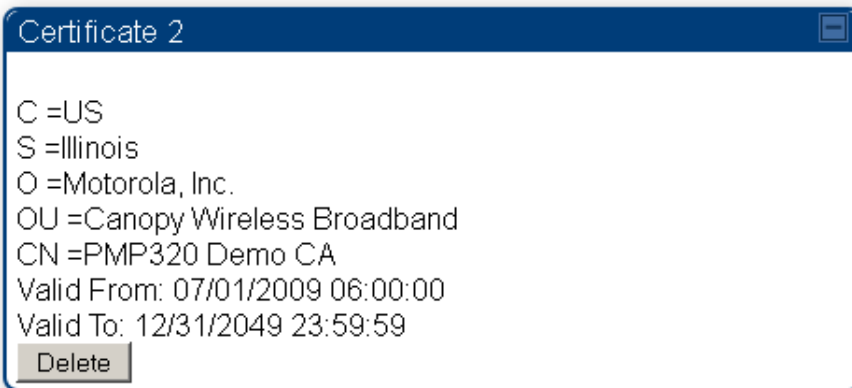
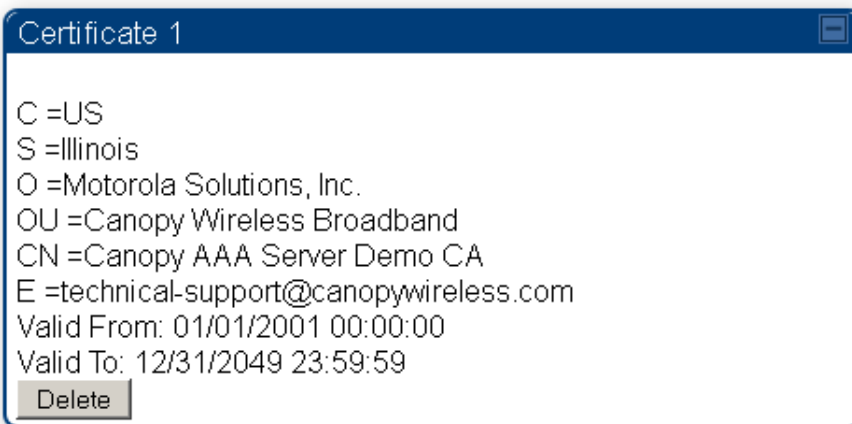
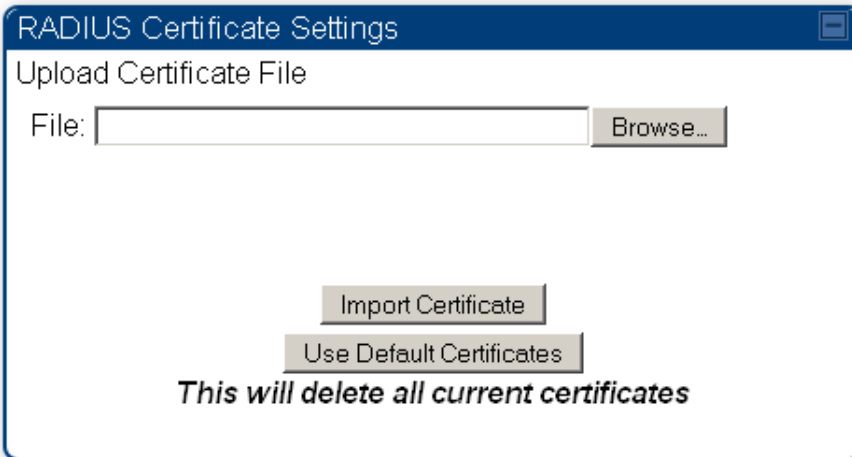

Configuring RADIUS servers for SM authentication

Your RADIUS server must be configured to use the following:

- EAPTTLS or MSCHAPv2 as the Phase 1/Outer Identity protocol.
- If **Enable Realm** is selected on the SM's **Configuration > Security** tab, then the same Realm appears there (or access to it).
- The same Phase 2 (Inner Identity) protocol as configured on the **SM's Configuration > Security** tab under Phase 2 options.
- The username and password for each SM configured on each SM's **Configuration > Security** tab.

- An IP address and NAS shared secret that is the same as the IP address and Shared Secret configured on the AP's **Configuration > Security** tab for that **RADIUS server**.
- A server private certificate, server key, and CA certificate that complement the public certificates distributed to the SMs, as well as the Canopy dictionary file that defines Vendor Specific Attributes (VSAa). Default certificate files and the dictionary file are available from the software site: <https://support.cambiumnetworks.com/files/pmp450> after entering your name, email address, and either Customer Contract Number or the MAC address of a module covered under the 12 month warranty.

Optionally, operators may configure the RADIUS server response messages (Accept or Reject) so that the user has information as to why they have been rejected. The AP displays the RADIUS Authentication Reply message strings in the Session Status list as part of each SM's information. The SM will show this string (listed as Authentication Response on the SM GUI) on the main Status page in the Subscriber Module Stats section.



Note

Aradial AAA servers only support operator-configurable Authentication Accept responses, not Authentication Reject responses.

Assigning SM management IP addressing via RADIUS

Operators may use a RADIUS AAA server to assign management IP addressing to SM modules (framed IP address). SMs now interpret attributes Framed-IP-Address, Framed-IP-Netmask, and Cambium-Canopy-Gateway from RADIUS. The RADIUS dictionary file has been updated to include the Cambium-Canopy-Gateway attribute and is available on the Cambium Software Support website.

In order for these attributes to be assigned and used by the SM, the following must be true:

- The system is configured for AAA authentication
- The SM is not configured for DHCP on its management interface. If DHCP is enabled and these attributes are configured in the RADIUS server, the attributes is ignored by the SM.
- The SM management interface must be configured to be publically accessible. If the SM is configured to have local accessibility, the management interface will still be assigned the framed addressing, and the SM iscome publicly accessible via the assigned framed IP addressing.
- When using these attributes, for the addressing to be implemented by the SM operators must configure Framed-IP-Address in RADIUS. If Framed-IP-Address is not configured but Framed-IP-Netmask and/or Cambium-Canopy-Gateway is configured, the attributes is ignored. In the case where only the Framed-IP-Address is configured, Framed-IP-Netmask defaults to 255.255.0.0 (NAT disabled) / 255.255.255.0 (NAT enabled) and Cambium-Canopy-Gateway defaults to 0.0.0.0.

Configuring RADIUS server for SM configuration

Canopy Vendor Specific Attributes (VSAs) along with VSA numbers and other details are listed in RADIUS Vendor Specific Attributes (VSAs). The associated SM GUI page, tab and parameter are listed to aid cross-referencing and understanding of the VSAs.

A RADIUS dictionary file is available from the software site:

<https://support.cambiumnetworks.com/files/pmp450>

The RADIUS dictionary file defines the VSAs and their values and is usually imported into the RADIUS server as part of server and database setup.



Note

Beginning with System Release 12.0.2, two RADIUS dictionary files are available on the Cambium website - “RADIUS Dictionary file - Cambium” and “RADIUS Dictionary file - Motorola”.

In addition to a renaming of attributes, the Cambium-branded dictionary file contains two new VSAs for controlling uplink and downlink Maximum Burst Data Rate (these VSAs are listed below in RADIUS Vendor Specific Attributes (VSAs)).

If you are transitioning from the Motorola-branded dictionary file to the Cambium-branded dictionary file, ensure that all RADIUS profiles containing Motorola-Canopy attribute references are updated to include Cambium-Canopy attribute references (for all applicable VSAs listed in RADIUS Vendor Specific Attributes (VSAs)). Also, ensure that all RADIUS configuration files reference the new dictionary file (as an alternative, operators may rename the Cambium-branded dictionary file to the filename currently in use by the RADIUS server). Once the profiles are updated and the new Cambium-branded dictionary file is installed on the RADIUS server, restart the RADIUS server to ensure that the new VSAs and attribute names are enabled.

Table 93 :RADIUS Vendor Specific Attributes (VSAs)

Name	Number	Type	Required	Value	
MS-MPPE-Send-Key*	26.311.16	-	Y	-	
-				-	-
MS-MPPE-Recv-Key*	26.311.17	-	Y	-	
-				-	-
Cambium-Canopy-LPULCIR	26.161.1	integer	N	0-65535 kbps	
Configuration > Quality of Service > Low Priority Uplink CIR				0 kbps	32 bits
Cambium-Canopy-LPDLCIR	26.161.2	integer	N	0-65535 kbps	
Configuration > Quality of Service > Low Priority Downlink CIR				0 kbps	32 bits
Cambium-Canopy-HPULCIR	26.161.3	integer	N	0-65535 kbps	
Configuration > Quality of Service > High Priority Uplink CIR				0 kbps	32 bits
Cambium-Canopy-HPDLCIR	26.161.4	integer	N	0-65535 kbps	
Configuration > Quality of Service > High Priority Uplink CIR				0 kbps	32 bits
Cambium-Canopy-HPENABLE	26.161.5	integer	N	0-disable, 1-enable	
Configuration > Quality of Service > High Priority Channel Enable/Disable				0	32 bits

Name	Number	Type	Required	Value	
26.161.6		integer	N	0-100000 kbps	
Configuration > Quality of Service > Sustained Uplink Data Rate				dependent on radio feature set	32 bits
Cambium-Canopy-ULBL	26.161.7	integer	N	0-2500000 kbps	
Configuration > Quality of Service > Uplink Burst Allocation				dependent on radio feature set	32 bits
Cambium-Canopy-DLBR	26.161.8	integer	N	0-100000 kbps	
Configuration > Quality of Service > Sustained Downlink Data Rate				dependent on radio feature set	32 bits
Cambium-Canopy-DLBL	26.161.9	integer	N	0-2500000 kbps	
Configuration > Quality of Service > Downlink Burst Allocation				dependent on radio feature set	32 bits
Cambium-Canopy-VLLEARNEN	26.161.14	integer	N	0-disable, 1-enable	
Configuration > VLAN > Dynamic Learning				1	32 bits
Cambium-Canopy-VLFRAMES	26.161.15	integer	N	0- all, 1- tagged, 2- untagged	
Configuration > VLAN > Allow Frame Types				0	32 bits
Cambium-Canopy-VLIDSET	26.161.16	integer	N	VLAN Membership (1-4094)	
Configuration > VLAN Membership				0	32 bits
Cambium-Canopy-VLAGETO	26.161.20	integer	N	5 - 1440 minutes	
Configuration > VLAN > VLAN Aging Timeout				25 mins	32 bits
Cambium-Canopy-VLIGVID	26.161.21	integer	N	1 - 4094	
Configuration > VLAN > Default Port VID				1	32 bits
Cambium-Canopy-VLMGVID	26.161.22	integer	N	1 - 4094	
Configuration > VLAN > Management VID				1	32 bits
Cambium-Canopy-VLSMMGPASS	26.161.23	integer	N	0-disable, 1-enable	
Configuration > VLAN > SM Management VID Pass-through				1	32

Name	Number	Type	Required	Value	
					bits
Cambium-Canopy-BCASTMIR	26.161.24	integer	N	0- 100000 kbps, 0=disabled	
Configuration > Quality of Service > Broadcast/Multicast Uplink Data Rate				dependent on radio feature set	32 bits
Cambium-Canopy-Gateway	26.161.25	ipaddr	N	-	
Configuration > IP > Gateway IP Address				0.0.0.0	-
Cambium-Canopy-ULMB	26.161.26	integer	N	0-100000 kbps	
Configuration > Quality of Service > Max Burst Uplink Data Rate				0	32 bits
Cambium-Canopy-DLMB	26.161.27	integer	N	0-100000 kbps	
Configuration > Quality of Service > Max Burst Downlink Data Rate				0	32 bits
Cambium-Canopy-UserLevel	26.161.50	integer	N	1-Technician, 2-Installer, 3-Administrator	
Account > Add User > Level				0	32 bits
Cambium- Canopy- DHCP- State	26.161.31	integer	N	1-Enable	
Configuration > IP > DHCP state				1	32 bits
Cambium- Canopy- BCASTMIRUNITS	26.161.28	integer	N		
Configuration > QoS > Broadcast Downlink CIR				0	32 bits
Cambium- Canopy- ConfigFileImportUrl	26.161.29	string	N		
Configuration > Unit Settings				0	32 bits
Cambium- Canopy- ConfigFileExportUrl	26.161.30	string	N		
Configuration > Unit Settings				0	32 bits
Cambium-Canopy-UserMode	26.161.51	integer	N	1=Read- Only 0=Read-Write	
Account > Add User > User Mode				0	32 bits

(*) Contains key for encrypting packets sent by the NAS to the remote host (for Microsoft Point-to-Point Encryption Protocol).



Note
VSA numbering:
26 connotes Vendor Specific Attribute, per RFC 2865
26.311 is Microsoft Vendor Code, per IANA

Configuring RADIUS server for SM configuration using Zero Touch feature

The RADIUS VSA (Vendor Specific Attributes) is updated for Zero Touch feature. This feature enables the ability for a SM to get its configuration via RADIUS VSA. The RADIUS VSA is updated for an URL which points to the configuration file of SM (see RADIUS Vendor Specific Attributes (VSAs) for list of VSA).

The RADIUS will push the vendor specific attribute to SM after successful authentication. The VSA contains URL of config file which will redirect SM to download configuration. If there is any change in SM confirmation, the SM will reboot automatically after applying the configuration.

The RADIUS VSA attributes concerning Zero Touch are as follows:

VSA	Type	String
-----	------	--------

Cambium-Canopy-ConfigFileImportUrl (29) string Maximum Length 127 characters.

Cambium-Canopy-ConfigFileExportUrl (30) string Maximum Length 127 characters.

The updated RADIUS dictionary can be downloaded from below link:

<https://support.cambiumnetworks.com/files/pmp450/>



Note
The feature is not applicable to the AP.

Using RADIUS for centralized AP and SM user name and password management

AP – Technician/ Installer/ Administrator Authentication

To control technician, installer, and administrator access to the AP from a centralized RADIUS server:

Procedure 20 Centralized user name and password management for AP

1	Set Authentication Mode on the AP's Configuration > Security tab to RADIUS AAA
2	Set User Authentication Mode on the AP's Account > User Authentication tab (the tab only appears after the AP is set to RADIUS authentication) to Remote or Remote then Local. <ul style="list-style-type: none">Local: The local SM is checked for accounts. No centralized RADIUS accounting (access control) is performed.

	<ul style="list-style-type: none"> • Remote: Authentication by the centralized RADIUS server is required to gain access to the SM if the SM is registered to an AP that has RADIUS AAA Authentication Mode selected. For up to 2 minutes a test pattern is displayed until the server responds or times out. • Remote then Local: Authentication using the centralized RADIUS server is attempted. If the server sends a reject message, then the setting of Allow Local Login after Reject from AAA determines if the local user database is checked or not. If the configured servers do not respond within 2 minutes, then the local user database is used. The successful login method is displayed in the navigation column of the SM.
--	---

User administration and authentication separation

On the AP, it is possible to configure up to three User Authentication servers, along with their Shared Secret. If none of the User Authentication servers are configured, the AP continues to use SM Authorization servers for User Authentication.

If at least one of the IP addresses is configured, all Authentication, Authorization, and Accounting requests now follow the newly configured User Authorization server.

To configure separate User Authentication and SM Authentication:

Procedure 21 User administration and authentication separation

1	Go to the AP's Account > User Authentication And Access Tracking tab
2	Set User Authentication Mode to Remote or Remote then Local.
3	Set User Authentication Method to EAP-MD5 or EAP-PEAP-MSCHAPv2
4	Configure the Shared Secrets and IP Addresses of: User Authentication Server 1 User Authentication Server 2 User Authentication Server 3 Note: If none of the above User Authentication servers are configured, only SM authentication will be performed.
5	Under RADIUS Certificate Settings, click Browse to upload the RADIUS Certificate files.

Figure 51: User Authentication and Access Tracking attributes

User Authentication And Access Tracking Change User Settings Add User Delete User User

Accounts → User Authentication And Access Tracking

5.7GHz MIMO OFDM - Access Point
0a-00-3e-bb-05-8f

User Authentication

User Authentication Mode : Remote then Local ▾

User Authentication Method : EAP-PEAP-MSCHAPv2 ▾

Allow Local Login after Reject from AAA : EAP-MD5 ▾

User Authentication Server 1 : Shared Secret

User Authentication Server 2 : Shared Secret

User Authentication Server 3 : Shared Secret

RADIUS Certificate Settings

Upload Certificate File

File: No file selected.

This will delete all current certificates

User Authentication Certificate 1

C =US
S =Illinois
O =Motorola Solutions, Inc.
OU =Canopy Wireless Broadband
CN =Canopy AAA Server Demo CA
E =technical-support@canopywireless.com
Valid From: 01/01/2001 00:00:00
Valid To: 12/31/2049 23:59:59
In use

User Authentication Certificate 2

C =US
S =Illinois
O =Motorola, Inc.
OU =Canopy Wireless Broadband
CN =PMP320 Demo CA
Valid From: 07/01/2009 06:00:00
Valid To: 12/31/2049 23:59:59

Server Configuration

Radius Accounting Port : *Default port number is 1813*

Access Tracking Configuration

Accounting Messages : ▾

Accounting Data Usage Interval : *minutes(0=Disabled,min-30,max-10080)*

SM Re-authentication Interval : *minutes(0=Disabled,min-30,max-10080)*

Account Status

Attribute	Meaning
User Authentication Mode	<ul style="list-style-type: none"> Local: The local SM is checked for accounts. No centralized RADIUS accounting (access control) is performed. Remote: Authentication by the centralized RADIUS server is required to gain

Attribute	Meaning
	<p>access to the AP. For up to 2 minutes a test pattern is displayed until the server responds or times out.</p> <ul style="list-style-type: none"> Remote then Local: Authentication using the centralized RADIUS server is attempted. If the server sends a reject message, then the setting of Allow Local Login after Reject from AAA determines if the local user database is checked or not. If the configured servers do not respond within 2 minutes, then the local user database is used. The successful login method is displayed in the navigation column of the AP.
User Authentication Method	<p>The user authentication method employed by the radios:</p> <ul style="list-style-type: none"> EAP-MD5 EAP-PEAP-MSCHAPv2
Allow Local Login after Reject from AAA	<p>If a user authentication is rejected from the AAA server, the user is allowed to login locally to the radio's management interface.</p>
User Authentication Server 1	<p>The IP address and the shared secret key of the User authentication RADIUS server 1.</p>
User Authentication Server 2	<p>The IP address and the shared secret key of the User Authentication Server 2 configured in RADIUS Server.</p>
User Authentication Server 3	<p>The IP address and the shared secret key of the User Authentication Server 3 configured in RADIUS Server.</p>
RADIUS Certificate Settings	<p>Import Certificate - browse and select the file to be uploaded and click on "Import Certificate" to import a new certificate.</p> <p>Use Default Certificates - use the preloaded default certificates.</p>
User Authentication Certificate 1	<p>Certificate provided by default for User authentication.</p>
User Authentication Certificate 2	<p>Certificate provided by default for User authentication.</p>
Radius Accounting Port	<p>The destination port on the AAA server used for Radius accounting communication.</p>
Accounting Messages	<p>Disable - no accounting messages are sent to the RADIUS server.</p> <p>deviceAccess - accounting messages regarding device access are sent to the RADIUS server (see Device data accounting RADIUS attributes).</p> <p>DataUsage - accounting messages regarding data usage are sent to the RADIUS server</p>

Attribute	Meaning
	(see Device data accounting RADIUS attributes). All - accounting messages regarding device access and data usage are sent to the RADIUS server.
Accounting Data Usage Interval	The interval for which accounting data messages are sent from the radio to the RADIUS server. If 0 is configured for this parameter, no data usage messages are sent.
SM Re-authentication Interval	The interval for which the SM will re-authenticate to the RADIUS server.
Account Status	Displays the account status.

SM – Technician/ Installer/ Administrator Authentication

The centralized user name and password management for SM is same as AP. Follow AP - Technician/Installer/Administrator Authentication on page "AP - Technician/Installer/Administrator Authentication" on page 311 procedure.



Note

Remote access control is enabled only after the SM registers to an AP that has Authentication Mode set to RADIUS AAA. Local access control will always be used before registration and is used after registration if the AP is not configured for RADIUS.

Figure 52 : User Authentication and Access Tracking tab of the SM

User Authentication ⊞

Remote Login is enabled only when SM is Registered with an AP and the system is operating with a back-end AAA server. The SM will only do Local Login until these preconditions are met regardless of configuration settings on this page.

Current State: OOSERVICE

User Authentication Mode : Local ▼

Allow Local Login after Reject from AAA : Enabled
 Disabled

Access Tracking Configuration ⊞

Accounting Messages : disable ▼

Account Status ⊞

Table 94 :SM User Authentication and Access Tracking attributes

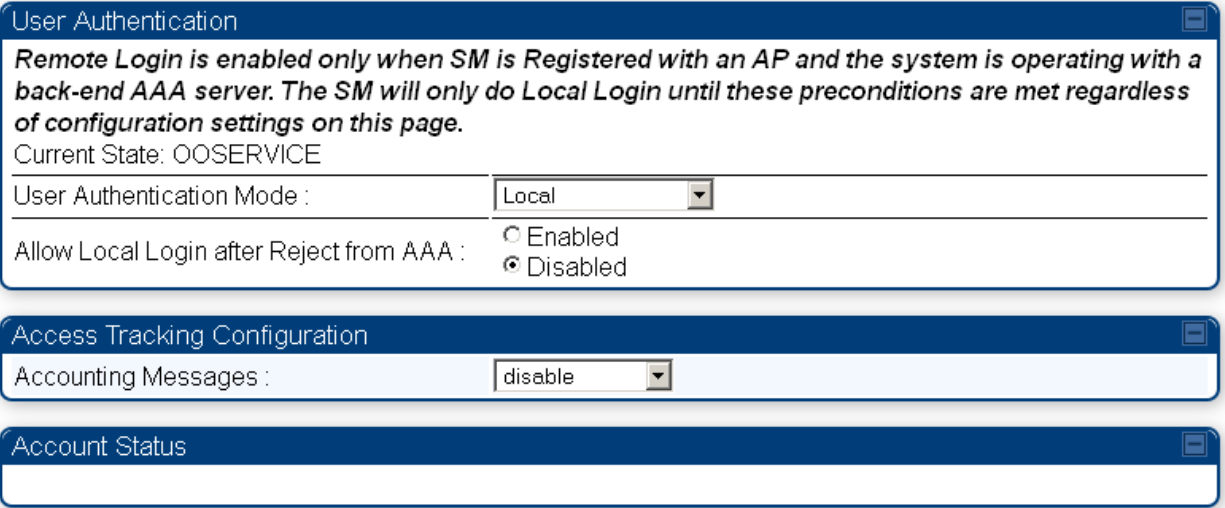

Attribute	Meaning
User Authentication Mode	<ul style="list-style-type: none"> Local: The local SM is checked for accounts. No centralized RADIUS accounting (access control) is performed. Remote: Authentication by the centralized RADIUS server is required to gain access to the SM if the SM is registered to an AP that has RADIUS AAA Authentication Mode selected. For up to 2 minutes a test pattern is displayed until the server responds or times out. Remote then Local: Authentication using the centralized RADIUS server is attempted. If the server sends a reject message, then the setting of Allow Local Login after Reject from AAA determines if the local user database is checked or not. If the configured servers do not respond within 2 minutes, then the local user database is used. The successful login method is displayed in the navigation column of the SM.
Allow Local Login after Reject from AAA	<p>If a user authentication is rejected from the AAA server, the user is allowed to login locally to the radio's management interface. It is applicable ONLY when the User Authentication Mode is set to "Remote then Local".</p> <div style="border: 1px solid black; background-color: #e6f2ff; padding: 5px; margin-top: 10px;"> <p> Note</p> <p>When the radio User Authentication Mode is set to "Local" or "Remote", the Allow Local Login after Reject from AAA does not any effect.</p> </div>
Accounting Messages	<ul style="list-style-type: none"> disable - no accounting messages are sent to the RADIUS server deviceaccess - accounting messages are sent to the RADIUS server regarding device access (see Device data accounting RADIUS attributes).

Access Tracking

To track logon and logoff times on individual radios by technicians, installers, and administrators, on the AP or SM's Account > User Authentication and Access Tracking tab under Accounting (Access Tracking) set Accounting Messages to "deviceAccess".

Device Access Tracking is enabled separately from User Authentication Mode. A given AP or SM can be configured for both, either, or neither.

RADIUS Device Data Accounting

PMP 450 Platform systems include support for RADIUS accounting messages for usage-based billing. This accounting includes indications for subscriber session establishment, subscriber session disconnection, and bandwidth usage per session for each SM that connects to the AP. The attributes included in the RADIUS accounting messages are shown in the table below.

Table 95 :Device data accounting RADIUS attributes

Sender	Message	Attribute	Value	Description
AP	Accounting-Request	Acct-Status-Type	1 - Start	This message is sent every time a SM registers with an AP, and after the SM stats are cleared.
		Acct-Session-Id	Unique per AP session. Initial value is SM MAC, and increments after every start message sent of an in session SM.	
		Event-Timestamp	UTC time the event occurred on the AP	
AP	Accounting-Request	Acct-Status-Type	2 - Stop	This message is sent every time a SM becomes unregistered with an AP, and when the SM stats are cleared.
		Acct-Session-Id	Unique per AP session. Initial value is SM MAC, and increments after every start message sent of an in session SM.	
		Acct-Input-Octets	Sum of the input octets received at the SM over the Low Priority data channel as well as any Medium, High, and Ultra High Priority data channels configured.. Will not include broadcast.	
		Acct-Output-Octets	Sum of the output octets sent from the SM over the Low Priority data channel as well as any Medium, High, and Ultra High Priority data channels configured..	
		Acct-Input-Gigawords	Number of times the Acct-Input-Octets counter has wrapped around 2 ³² over the course of the session	
		Acct-Output-Gigawords	Number of times the Acct-Output-Octets counter has wrapped around 2 ³² over the course of the session	
		Acct-Input-Packets	Sum of unicast and multicast packets that are sent to a particular SM over the regular data VC and the high priority data VC (if enabled). It will not include	

Sender	Message	Attribute	Value	Description
			broadcast.	
		Acct-Output-Packets	Sum of unicast and multicast packets that are sent from a particular SM over the Low Priority data channel as well as any Medium, High, and Ultra High Priority data channels configured..	
		Acct-Session-Time	Uptime of the SM session.	
		Acct-Terminate-Cause	Reason code for session termination	
AP	Accounting-Request	Acct-Status-Type	3 - Interim-Update	<p>This message is sent periodically per the operator configuration on the AP in seconds.</p> <p>Interim update counts are cumulative over the course of the session</p>
		Acct-Session-Id	Unique per AP session. Initial value is SM MAC, and increments after every start message sent of an in session SM.	
		Acct-Input-Octets	Sum of the input octets sent to the SM over the Low Priority data channel as well as any Medium, High, and Ultra High Priority data channels configured.. Will not include broadcast.	
		Acct-Output-Octets	Sum of the output octets set from the SM over the Low Priority data channel as well as any Medium, High, and Ultra High Priority data channels configured.	
		Acct-Input-Gigawords	Number of times the Acct-Input-Octets counter has wrapped around 2^{32} over the course of the session	
		Acct-Output-Gigawords	Number of times the Acct-Output-Octets counter has wrapped around 2^{32} over the course of the session	
		Acct-Session-Time	Uptime of the SM session.	
		Acct-Input-Packets	Sum of unicast and multicast packets that are sent to a particular SM over the regular data VC and the high priority data VC (if enabled). It will not include broadcast.	

Sender	Message	Attribute	Value	Description
		Acct-Output-Packets	Sum of unicast and multicast packets that are sent from a particular SM over the regular data VC and the high priority data VC (if enabled).	

The data accounting configuration is located on the AP's Accounts > User Authentication and Access Tracking GUI menu, and the AP's Authentication Mode must be set to Radius AAA for the menu to appear. The accounting may be configured via the AP GUI as shown in the figures below. By default accounting messages are not sent and the operator has the choice of configuring to send only Device Access accounting messages (when a user logs in or out of the radio), only Data Usage messages, or both. When Data Accounting is enabled, the operator must specify the interval of when the data accounting messages are sent (0 - disabled, or in the range of 30-10080 minutes). The default interval is 30 minutes.

Figure 53 : RADIUS accounting messages configuration

The screenshot shows the 'Access Tracking Configuration' window. It contains three rows of configuration options:

- Accounting Messages :** A dropdown menu with 'dataUsage' selected.
- Accounting Data Usage Interval :** A text input field containing '0', followed by the text 'minutes(min-30,max-10080)'.
- SM Re-authentication Interval :** A text input field containing '0', followed by the text 'minutes(0=Disabled,min-30,max-10080)'.

The data accounting message data is based on the SM statistics that the AP maintains, and these statistics may be cleared on the AP by an operator. If an operator clears these messages and data accounting is enabled, an accounting stop message is sent followed by an accounting start message to notify the AAA of the change.

If an operator clears the VC statistics on the device through the management GUI, a RADIUS stop message and data start message is issued for each device affected. The start and stop messages will only be sent once every 5 minutes, so if an operator clears these statistics multiple times within 5 minutes, only one set of data stop/start messages is sent. This may result in inaccurate data accumulation results.

RADIUS Device Re-authentication

PMP 450 Platform systems include support for periodic SM re-authentication in a network without requiring the SM to re-register (and drop the session). The re-authentication may be configured to occur in the range of every 30 minutes to weekly.

Figure 54 : Device re-authentication configuration

This screenshot is identical to Figure 53, showing the 'Access Tracking Configuration' window with the same settings: Accounting Messages set to 'dataUsage', Accounting Data Usage Interval set to '0', and SM Re-authentication Interval set to '0'.

The re-authentication interval is only configurable on the AP. When this feature is enabled, each SM that enters the network will re-authenticate each the interval time has expired without dropping the session. The response that the SM receives from the AAA server upon re-authentication is one of the following:

- Success: The SM continues normal operation
- Reject: The SM de-registers and will attempt network entry again after 1 minute and then if rejected will attempt re-entry every minutes
- Timeout or other error: The SM remains in session and attempt 5 times to re-authenticate with the RADIUS-REQUEST message. If these attempts fail, then the SM will go out of session and proceed to re-authenticate after 5 minutes, then every 15 minutes.

Although re-authentication is an independent feature, it was designed to work alongside with the RADIUS data usage accounting messages. If a user is over their data usage limit the network operator can reject the user from staying in the network. Operators may configure the RADIUS 'Reply-Message' attribute with an applicable message (i.e. "Data Usage Limit Reached") that is sent to the subscriber module and displayed on the general page.

RADIUS Change of Authorization and Disconnect Message

Prior to this feature, SM will get configuration parameters from a RADIUS server during authentication process. This feature allows an administrator to control configuration parameters in the SM while SM is in session. The configuration changes in SM are done using RADIUS Change of Authorization method (RFC 3576) on the existing RADIUS authentication framework for AP and SM. A typical use case could be changing the QOS parameters after a certain amount of bandwidth usage by a SM.

Figure 55 : RADIUS CoA configuration for AP

Authentication Server Settings	
Authentication Mode :	RADIUS AAA
Authentication Server DNS Usage :	<input type="radio"/> Append DNS Domain Name <input checked="" type="radio"/> Disable DNS Domain Name
Authentication Server 1 :	<input type="text" value="....."/> Shared Secret <input type="text" value="0.0.0.0"/>
Authentication Server 2 :	<input type="text"/> Shared Secret <input type="text" value="0.0.0.0"/>
Authentication Server 3 :	<input type="text"/> Shared Secret <input type="text" value="0.0.0.0"/>
Authentication Server 4 (BAM ONLY) :	<input type="text" value="0.0.0.0"/>
Authentication Server 5 (BAM ONLY) :	<input type="text" value="0.0.0.0"/>
Radius Port :	1812 <i>Default port number is 1812</i>
Authentication Key :	<input type="text"/> (Using All 0xFF's Key)
Select Key :	<input type="radio"/> Use Key above <input checked="" type="radio"/> Use Default Key
Dynamic Authorization Extensions for RADIUS :	<input checked="" type="radio"/> Enable CoA and Disconnect Message <input type="radio"/> Disable CoA and Disconnect Message
Disable Authentication for SM connected via ICC :	<input type="radio"/> Enabled <input checked="" type="radio"/> Disabled

The RADIUS CoA feature enables initiating a bi-directional communication from the RADIUS server(s) to the AP and SM.

The AP listens on UDP port 3799 and accepts CoA requests from the configured RADIUS servers. This CoA request should contain SM MAC address in 'User-Name' attribute as identifier and all other attributes which control the SM config parameters. For security reasons, a timestamp also needs to be added as 'Event-

Timestamp' attribute. Hence the time should also be synchronized between the RADIUS server(s) and the AP to fit within a window of 300 seconds.

Once the configuration changes are applied on the SM, CoA-ACK message is sent back to RADIUS server. If the validation fails, the AP sends a CoA-NACK response to the RADIUS server with proper error code.

A Disconnect-Message is sent by the RADIUS server to NAS in order to terminate a user session on a NAS and discard all associated session context. It is used when the authentication AAA server wants to disconnect the user after the session has been accepted by the RADIUS.

In response of Disconnect-Request from RADIUS server, the NAS sends a Disconnect-ACK if all associated session context is discarded, or a Disconnect-NACK, if the NAS is unable to disconnect the session.



Note

The RADIUS CoA feature will only enabled if Authentication mode is set to RADIUS AAA.

Microsoft RADIUS support

This feature allows to configure Microsoft RADIUS (Network Policy and Access Services a.k.a NPS) as Authentication server for SM and User authentication.

- For SM Authentication, SM will user PEAP-MSCHAPv2 since NPS doesn't [support](#) TTLS protocol.
- For User Authentication, the Canopy software will use EAP-MD5 but the user has to do certain configuration in order to enable EAP-MD5 on NPS.



Note

All this configuration has been tested on Windows Server 2012 R2 version.

This feature is not supported on hardware board type P9 or lower platforms.

SM Authentication Configuration

There are no new configurations on AP. However, SM has to be configured for PEAP authentication protocol.

1. Go to **Configuration > Security** page
2. Select “eappeap” for Phase 1 attribute under tab AAA Authentication Settings.

Figure 51 EAPPEAP settings

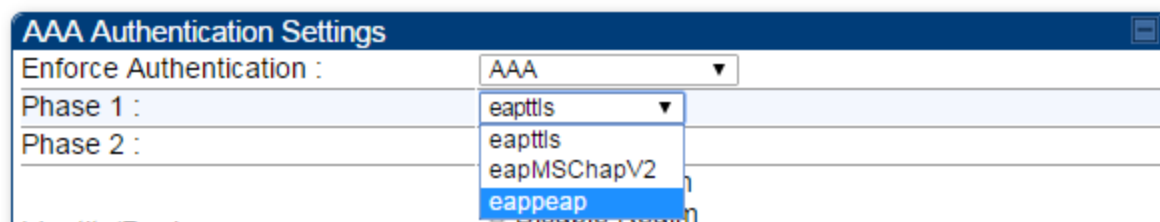

The Phase 2 will change automatically to MSCHAPv2 on select of Phase 1 attribute as EAP-PEAP. Other parameters of Phase 2 protocols like PAP/CHAP will be disabled.

Windows Server Configuration

Import Certificate

The SM certificate has to be imported to Windows Server for certificate authentication.

- Copy the certificate which is configured in SM under Configuration > Security -> Certificate1 to Windows Server machine.
- Right click and select 'Install Certificate'. This will install the certificate and it's ready for use. This certificate will be used while configuring PEAP-MSCHAPv2 in NPS.

NPS Configuration (<https://technet.microsoft.com/en-us/network/bb545879.aspx>)

Following **items** should be configured in NPS Console:

- RADIUS Client
- <https://technet.microsoft.com/en-us/library/cc732929>
- Connection Request Policies
- <https://technet.microsoft.com/en-us/library/cc730866>
- Choose 'Wireless-Other' in NAS-Port-Type
- Network Policy
- <https://technet.microsoft.com/en-us/library/cc755309>
- Choose 'Wireless-Other' in NAS-Port-Type.
- While configuring PEAP, select the above imported certificate.

Figure 56 : Importing certificate in NPS

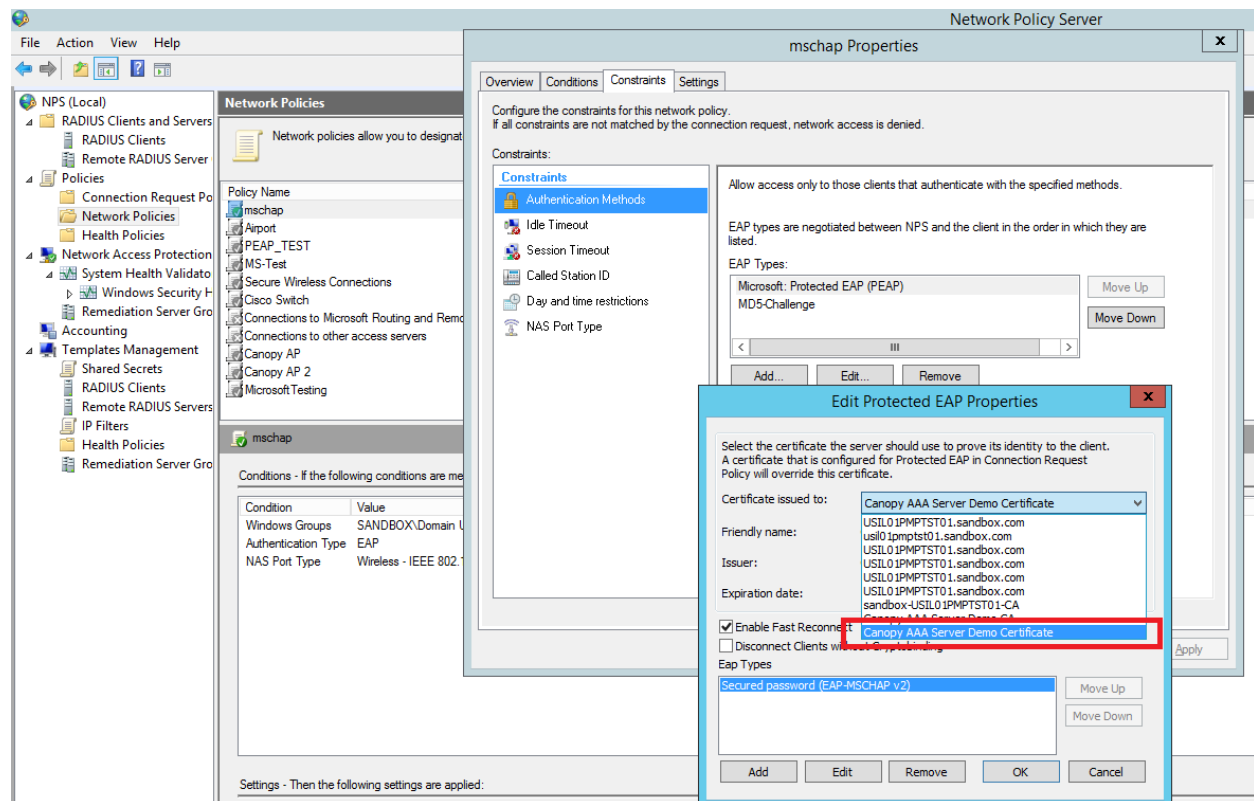

User Authentication Configuration

Enabling EAP-MD5

As mentioned earlier, Microsoft has deprecated the support for MD5 from versions of Windows. To enable MD5, the following steps to be followed:

1. Follow the instructions:

Optionally, the [registry file](#) can be downloaded. It can be installed by double-click it in Windows Registry.

<https://support.microsoft.com/en-us/kb/922574/en-us?wa=wsignin1.0>

2. From NPS Console Network Policy > <Policy Name> > Properties > Constrains > Authentication Method and click Add. Select MD5 and click OK.

Figure 57 : Selecting MD5 from NPS console

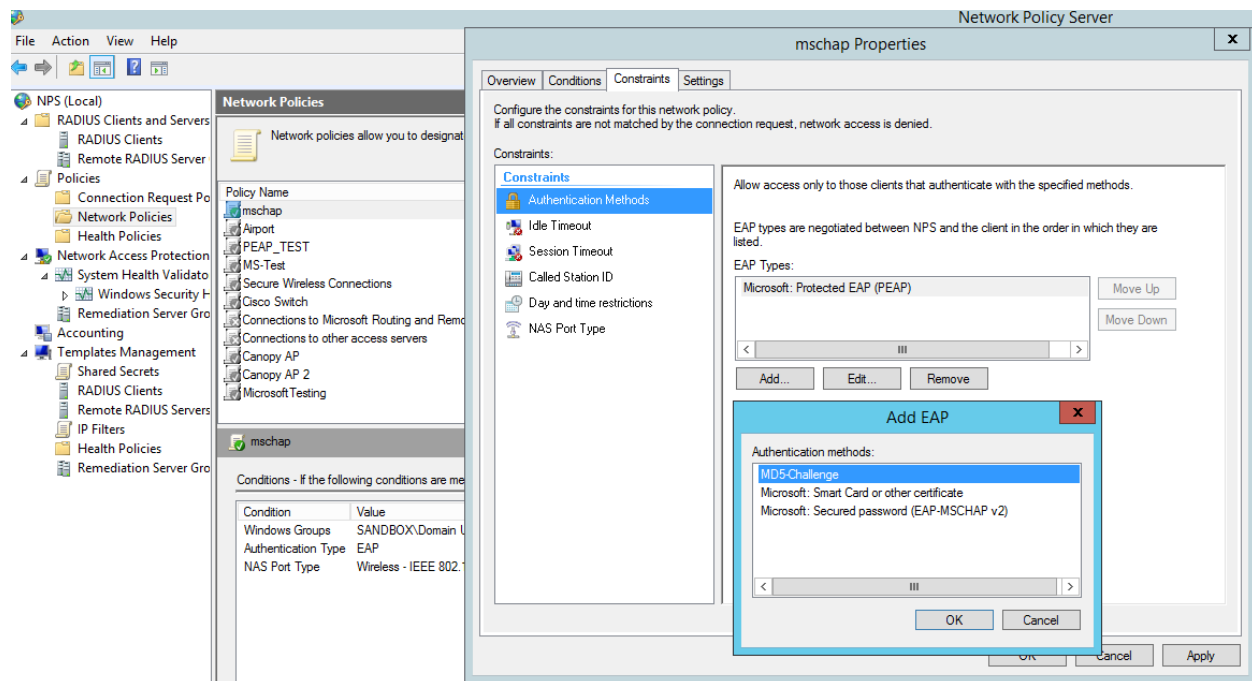

User Configuration in Active Directory

Next open 'Active Directory Users and Computers' and create user.

Make sure user property is configured as shown below.

Figure 58 : User configuration

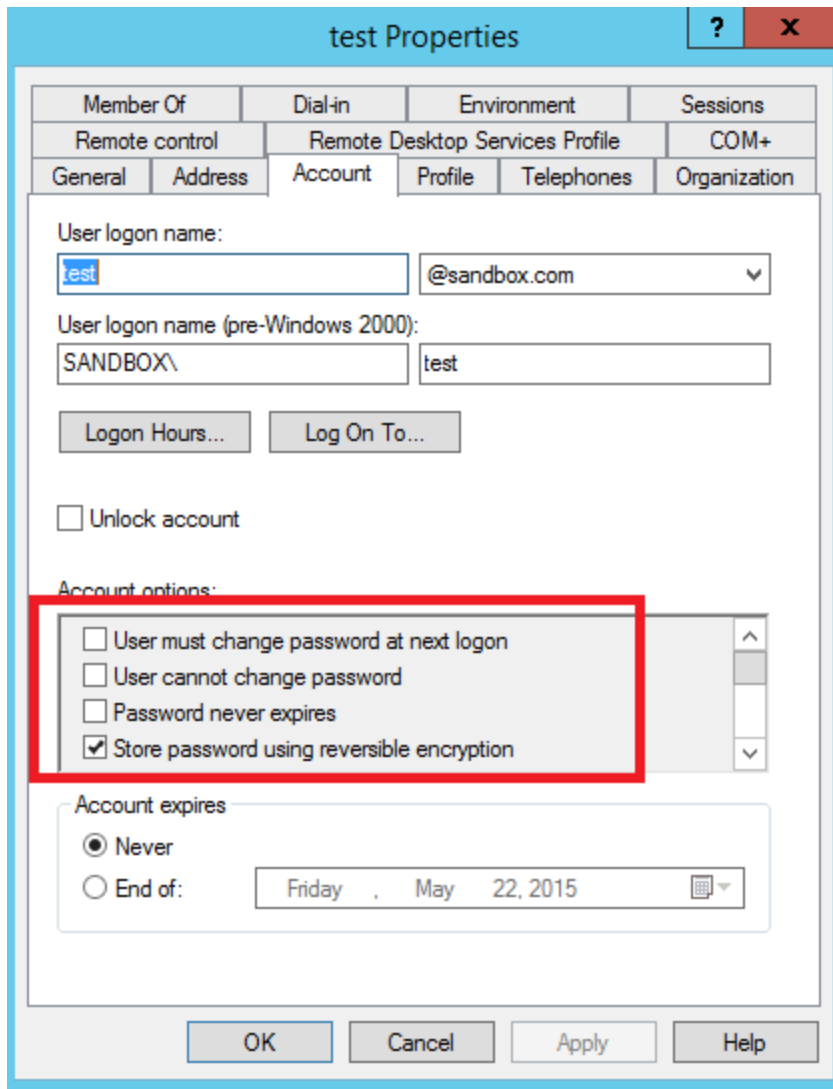

RADIUS VSA Configuration

Before using VSA, the **Cambium-Canopy-UserLevel(50)** VSA must be configured with some access level say ADMIN(3).

Follow below link for configuring VSA:

<https://technet.microsoft.com/en-us/library/cc731611>

The Cambium's vendor code is 161.

Figure 59 : RADIUS VSA configuration

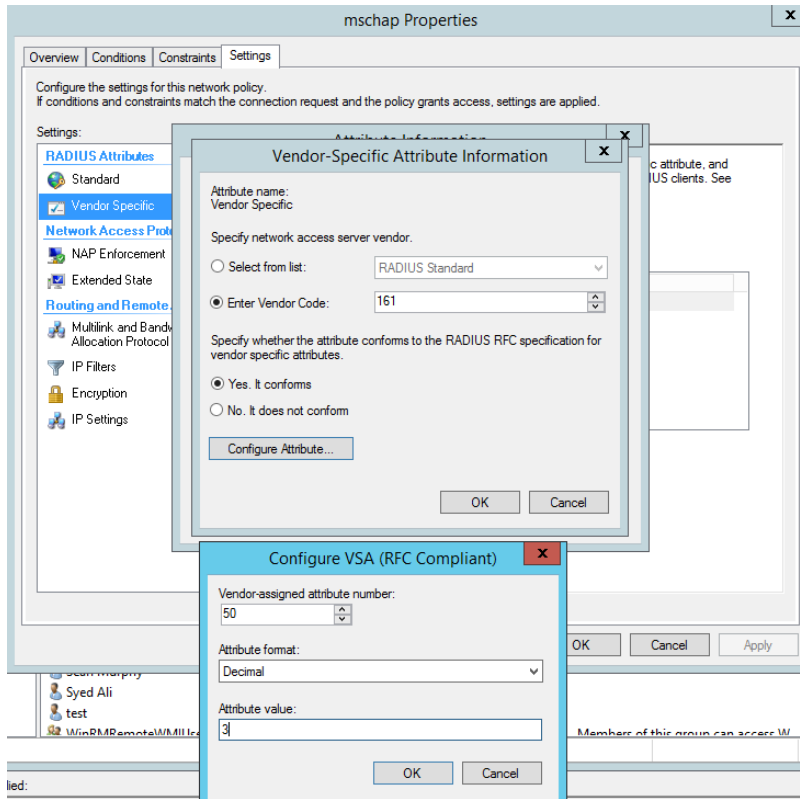

Accounting

User can enable accounting in NPS under **NPS Console > Accounting > Configure Accounting**.

For more details refer <https://technet.microsoft.com/library/dd197475>

Cisco ACS RADIUS Server Support

This briefly explains how to configure Cisco ACS RADIUS server for PEAP-MSCHAPv2 authentication. The configuration had been tested on CISCO ACS Version : 5.7.0.15

Adding RADIUS client

Figure 60 : Adding RADIUS client

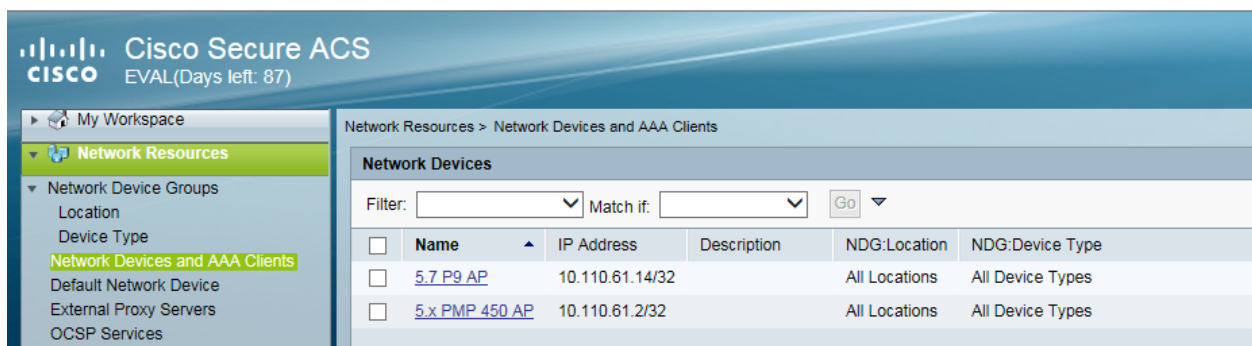

Creating Users

Figure 61: Creating users

Cisco Secure ACS
EVAL(Days left: 87)

My Workspace
Network Resources
Users and Identity Stores
Identity Groups
Internal Identity Stores
Users
Hosts
External Identity Stores
LDAP

Users and Identity Stores > Internal Identity Stores > Users

Internal Users

Filter: Match if: Go

<input type="checkbox"/>	Status	User Name	Identity Group	Description
<input type="checkbox"/>	●	0a-00-3e-a0-e8-60	All Groups	PMP 450 5.x SM
<input type="checkbox"/>	●	0a-00-3e-fe-01-58	All Groups	P9 SM
<input type="checkbox"/>	●	adminremote	All Groups	

Creating RADIUS instance

Figure 62: Creating RADIUS instance

Cisco Secure ACS
EVAL(Days left: 87)

My Workspace
Network Resources
Users and Identity Stores
Policy Elements
Session Conditions
Date and Time

Policy Elements > Authorization and Permissions > Network Access > Authorization Profiles

Authorization Profiles

Filter: Match if: Go

<input type="checkbox"/>	Name	Description
<input type="checkbox"/>	Cambium ACS	

RADIUS protocols

Figure 63: RADIUS protocols

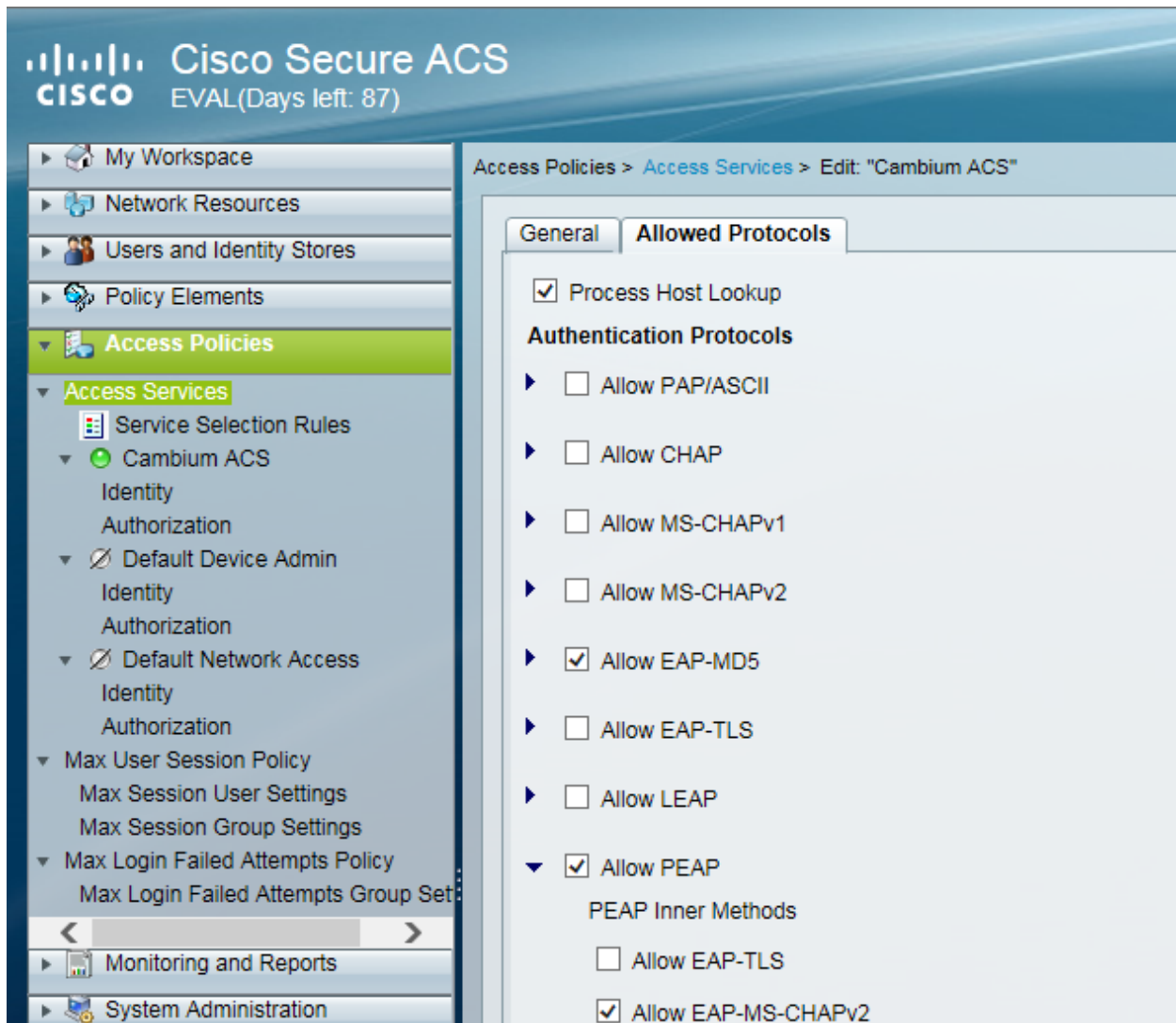

Service selection

Figure 64 : Service selection

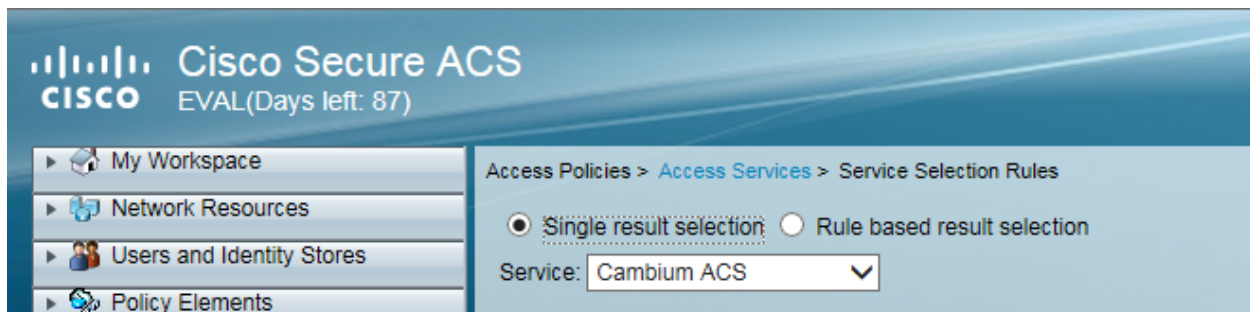

Adding Trusted CA

Figure 65 : Adding Trusted CA

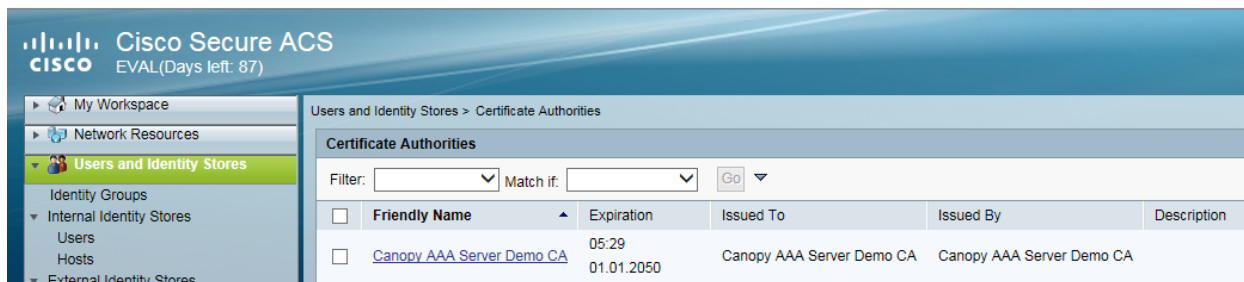

Note that certificate has to be in DER form, so if you have in PEM format convert using openssl.

Openssl.exe x509 -in <path-to->/cacert_aaasvr.pem -outform DER -out <path-to->/cacert_aaasvr.der

Installing Server Certificate

After installing trusted CA, you need to add a server certificate which will be used for TLS tunnel. Generally you have to install same certificate which is installed in your AP, so that AP can trust the radius server.

Figure 66 : Installing Server Certificate

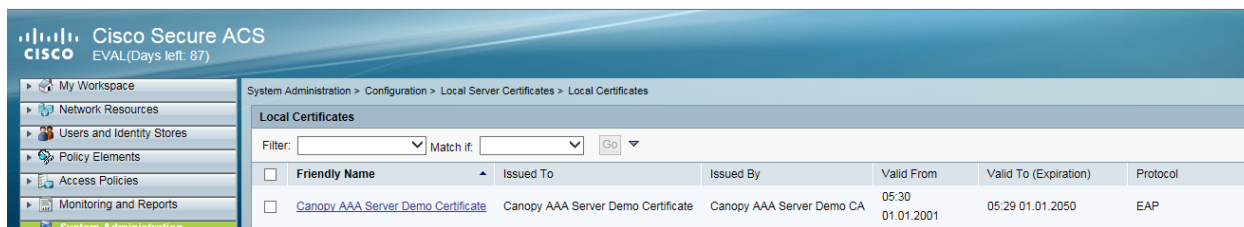

Monitoring Logs

Figure 67 : Monitoring logs



Configuring VSA

Before using VSA , user has to add Cambium Vendor Specific Attribute

Navigate to **System Administration > Configuration > Dictionaries > Protocols > RADIUS > RADIUS VSA > Motorola**

If Motorola is not present you can create [Vendor with ID 161](#) and add all the VSA one by one.

Figure 68 : VSA list

<input type="checkbox"/>	Attribute ▲	ID	Type	Direction	Multiple Allowed
<input type="checkbox"/>	Cambium-Canopy-BCASTMIR	24	Unsigned Integer 32	BOTH	false
<input type="checkbox"/>	Cambium-Canopy-DLBL	9	Unsigned Integer 32	BOTH	false
<input type="checkbox"/>	Cambium-Canopy-DLBR	8	Unsigned Integer 32	BOTH	false
<input type="checkbox"/>	Cambium-Canopy-DLMB	27	Unsigned Integer 32	BOTH	false
<input type="checkbox"/>	Cambium-Canopy-Gateway	25	IP Address	BOTH	false
<input type="checkbox"/>	Cambium-Canopy-HPDLCIR	4	Unsigned Integer 32	BOTH	false
<input type="checkbox"/>	Cambium-Canopy-HPENABLE	5	Unsigned Integer 32	BOTH	false
<input type="checkbox"/>	Cambium-Canopy-HPULCIR	3	Unsigned Integer 32	BOTH	false
<input type="checkbox"/>	Cambium-Canopy-LPDLCIR	2	Unsigned Integer 32	BOTH	false
<input type="checkbox"/>	Cambium-Canopy-LPULCIR	1	Unsigned Integer 32	BOTH	false
<input type="checkbox"/>	Cambium-Canopy-ULBL	7	Unsigned Integer 32	BOTH	false
<input type="checkbox"/>	Cambium-Canopy-ULBR	6	Unsigned Integer 32	BOTH	false
<input type="checkbox"/>	Cambium-Canopy-ULMB	26	Unsigned Integer 32	BOTH	false
<input type="checkbox"/>	Cambium-Canopy-UserLevel	50	Unsigned Integer 32	BOTH	false
<input type="checkbox"/>	Cambium-Canopy-UserMode	51	Unsigned Integer 32	BOTH	false
<input type="checkbox"/>	Cambium-Canopy-VLAGETO	20	Unsigned Integer 32	BOTH	false
<input type="checkbox"/>	Cambium-Canopy-VLFRAMES	15	Unsigned Integer 32	BOTH	false
<input type="checkbox"/>	Cambium-Canopy-VLIDSET	16	Unsigned Integer 32	BOTH	true
<input type="checkbox"/>	Cambium-Canopy-VLIGVID	21	Unsigned Integer 32	BOTH	false
<input type="checkbox"/>	Cambium-Canopy-VLLEARNEN	14	Unsigned Integer 32	BOTH	false
<input type="checkbox"/>	Cambium-Canopy-VLMGVID	22	Unsigned Integer 32	BOTH	true
<input type="checkbox"/>	Cambium-Canopy-VLSMMGPASS	23	Unsigned Integer 32	BOTH	false

Using VSA for users

Navigate to **Access Policies > Access Services > Cambium ACS > Authorization**

1. Change condition to User name

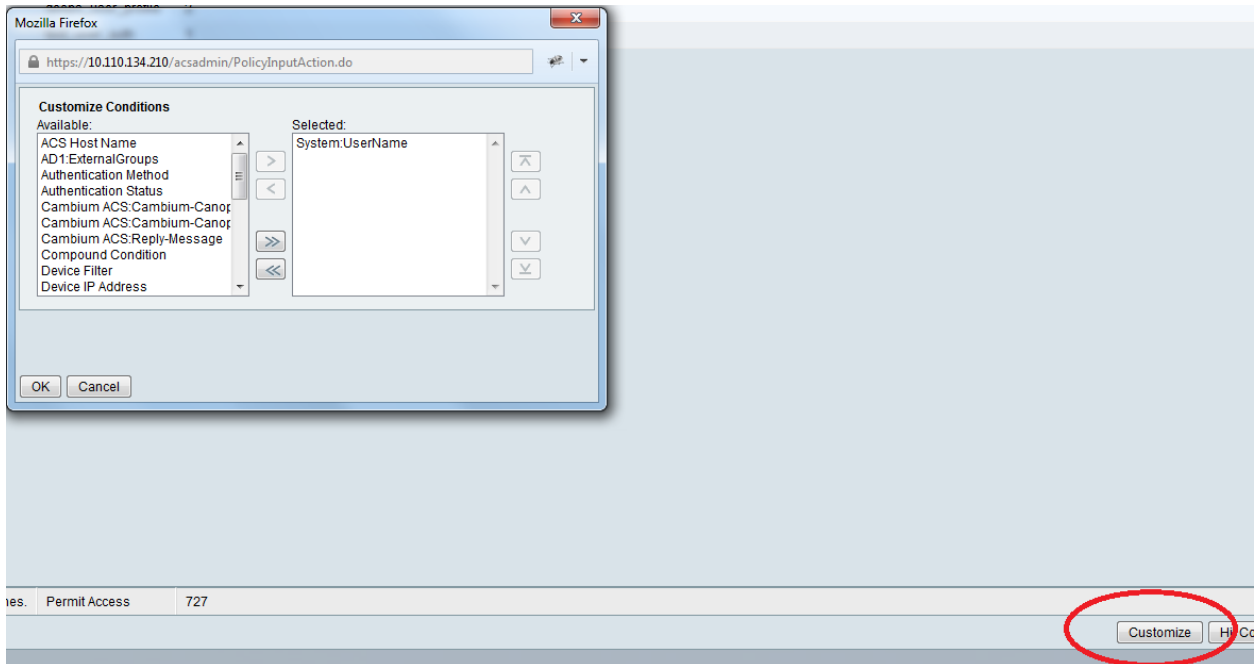

2. Next click Create and then click Select see diagram below

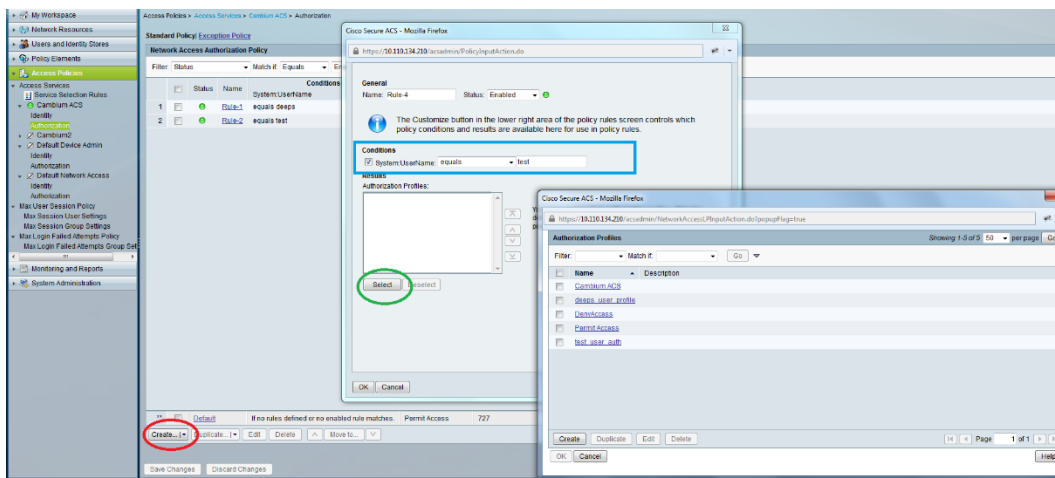

3. Click **Create** from the screen you get following screen

General Common Tasks RADIUS Attributes

Name:

Description:

Required fields

Chose some name and then move to RADIUS Attributes tab

4. Fill attribute which all you want for that particular user

General Common Tasks **RADIUS Attributes**

Common Tasks Attributes

Attribute	Type	Value

Manually Entered

Attribute	Type	Value

Dictionary Type: RADIUS-Motorola

RADIUS Attribute: Cambium-Canopy-UserMode

Attribute Type: Unsigned Integer 32

Attribute Value: Static

3

= Required fields

Important: Click Add for each attribute and when done click Submit.

- Now you are ready to use this Authorization profile for the use Select and Press OK.

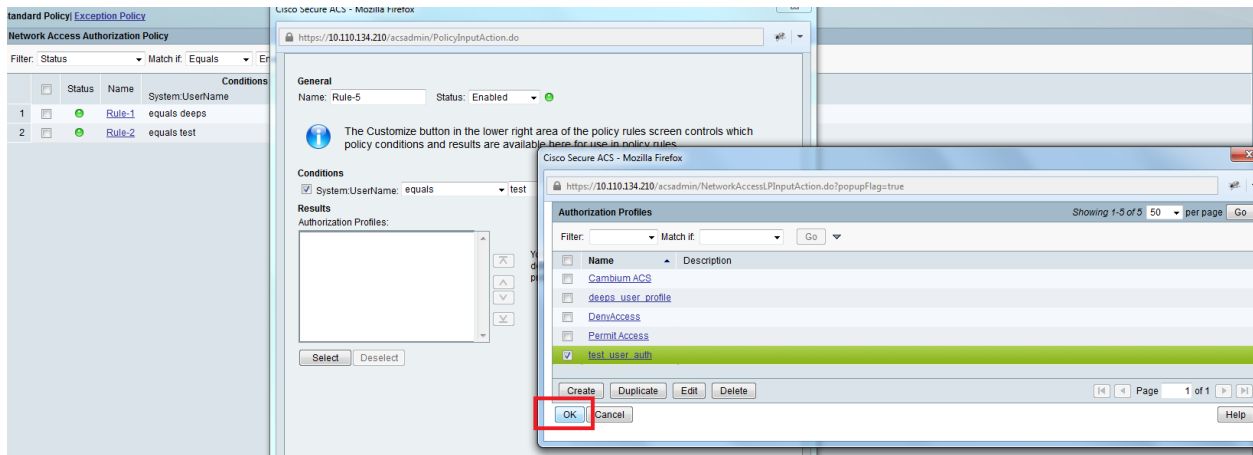

6. Finally press Save Changes and you are ready to use it.

Configuring Ping Watchdog

This feature allows administrator to automatically reboot an AP/SM when there is a network issue to avoid power on reset of radios. This feature is disabled by default.

To enable Ping Watchdog feature, select the menu option Configuration > Ping Watchdog, and configure the parameters listed in the following table.

Table 96 :Ping Watchdog attributes

Ping Watchdog Configuration	
Ping Watchdog :	<input type="radio"/> Enabled <input checked="" type="radio"/> Disabled
IP Address To Ping :	0.0.0.0
Ping Interval :	300 Seconds (Range: 300—86400)
Ping Failure Count To Reboot :	3 (Range: 1—100)
<input type="button" value="Save Changes"/>	
<input type="button" value="Reboot"/>	

Attribute	Meaning
Ping Watchdog	This field enables or disables Ping Watchdog feature.
IP Address To Ping	This field specifies the IPV4 address of the device which needs to be pinged.
Ping Interval	This field specifies the time interval at which ping needs to be initiated. The time interval needs to be specified in seconds.
Ping Failure Count To Reboot	This field specifies the count of ping failures at which reboot needs to be initiated.

Chapter 2: Tools

The AP and SM GUIs provide several tools to analyze the operating environment, system performance and networking, including:

- Using Spectrum Analyzer tool on page "Using Spectrum Analyzer tool " below
- Using the Alignment Tool on page "Using the Alignment Tool" on page 345
- Using the Link Capacity Test tool on page "Using the Link Capacity Test tool" on page 349
- Using AP Evaluation tool on page "Using AP Evaluation tool" on page 357
- Using BHM Evaluation tool on page "Using BHM Evaluation tool" on page 361
- Using the OFDM Frame Calculator tool on page "Using the OFDM Frame Calculator tool" on page 364
- Using the Subscriber Configuration tool on page "Using the Subscriber Configuration tool" on page 368
- Using the Link Status tool on page "Using the Link Status tool" on page 369
- Using BER Results tool on page "Using BER Results tool" on page 375
- Using the Sessions tool on page "Using the Sessions tool" on page 376
- Using the Ping Test tool on page "Using the Ping Test tool" on page 376

Using Spectrum Analyzer tool

The integrated spectrum analyzer can be very useful as a tool for troubleshooting and RF planning, but is not intended to replicate the accuracy and programmability of a high-end spectrum analyzer, which sometime can be used for other purposes.

The AP/BHM and SM/BHS perform spectrum analysis together in the Sector Spectrum Analyzer tool.



Caution

On start of the Spectrum Analyzer on a module, it enters a scan mode and drops any RF connection it may have had. When choosing Start Timed Spectrum Analysis, the scan is run for time specified in the Duration configuration parameter. When choosing Start Continuous Spectrum Analysis, the scan is run continuously for 24 hours, or until stopped manually (using the Stop Spectrum Analysis button).

Any module can be used to see the frequency and power level of any detectable signal that is within, just above, or just below the frequency band range of the module.



Note

Vary the days and times when you analyze the spectrum in an area. The RF environment can change throughout the day or throughout the week.

Mapping RF Neighbor Frequencies

The neighbor frequencies can be analyzed using Spectrum Analyzer tool. Following modules allow user to:

- Use a BHS or BHM for PTP and SM or AP for PMP as a Spectrum Analyzer.
- View a graphical display that shows power level in RSSI and dBm at 5 MHz increments throughout the frequency band range, regardless of limited selections in the Custom Radio Frequency Scan Selection List parameter of the SM/BHS.
- Select an AP/BHM channel that minimizes interference from other RF equipment.



Caution

The following procedure causes the SM/BHS to drop any active RF link. If a link is dropped when the spectrum analysis begins, the link can be re-established when either a 15 minute interval has elapsed or the spectrum analyzer feature is disabled.

Temporarily deploy a SM/BHS for each frequency band range that need to monitor and access the Spectrum Analyzer tab in the Tools web page of the module.

- Using Spectrum Analyzer tool
- Using the Remote Spectrum Analyzer tool



Spectrum Analyzer tool

Analyzing the spectrum

To use the built-in spectrum analyzer functionality of the AP/SM/BH, proceed as follows:

Procedure 22 Analyzing the spectrum

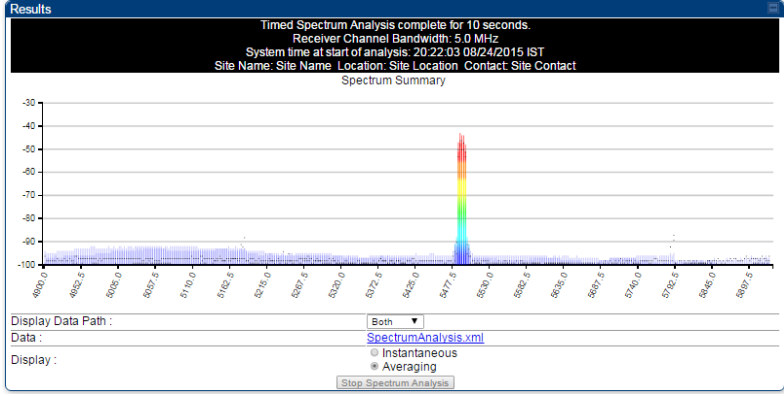
1	Predetermine a power source and interface that works for the AP/SM/BH in the area to be analyzed.
2	Take the AP/SM/BH, power source and interface device to the area.
3	Access the Tools > Spectrum Analyzer web page of the AP/SM/BH.
4	Enter Duration in Timed Spectrum Analyzer Tab. Default value is 10 Seconds
5	Click Start Timed Sector Spectrum Analysis
6	The results are displayed: Figure 69 : Spectrum analysis - Results

	 <div data-bbox="251 630 316 703" style="float: left; margin-right: 10px;">  </div> <div data-bbox="381 625 1409 718" style="background-color: #e1f5fe; padding: 5px;"> <p>Note AP/SM/BH scans for extra 40 seconds in addition to configured Duration</p> </div>
7	Travel to another location in the area to BHS.
8	Click Start Timed Spectrum Analysis
9	Repeat Steps 4 and 6 until the area has been adequately scanned and logged.

As with any other data that pertains to your business, a decision today to put the data into a retrievable database may grow in value to you over time.



Note

Whenever the operator finds the measured noise level is greater than the sensitivity of the radio that is plan to deploy, use the noise level (rather than the link budget) for your link feasibility calculations.

The AP/SM/BH perform spectrum analysis together in the Sector Spectrum Analyzer feature.

Graphical spectrum analyzer display

The AP/SM/BH display the graphical spectrum analyzer. An example of the Spectrum Analyzer page is shown in Spectrum analysis - Results.

The navigation feature includes:

- Results may be panned left and right through the scanned spectrum by clicking and dragging the graph left and right
- Results may be zoomed in and out using mouse

When the mouse is positioned over a bar, the receive power level, frequency, maximum and mean receive power levels are displayed above the graph

To keep the displayed data current, either set “Auto Refresh” on the module’s Configuration > General.

Spectrum Analyzer page of AP

The Spectrum Analyzer page of AP is explained in below table.

Table 97 :Spectrum Analyzer page attributes - AP

Results

Spectrum Analysis not performed.
Receiver Channel Bandwidth: 40.0 MHz
System time at start of analysis:
Site Name: 450i AP-133 Location: No Site Location Contact: No Site Contact

Display Data Path : Both

Data : File does not exist.

Display : Instantaneous
 Averaging

[Stop Spectrum Analysis](#)

Min And Max Frequencies

Min and Max Frequencies in KHz : 5470000 5925000 (Valid Range in KHz: 4900000 - 5925000)

[Set Min And Max To Full Scan](#) [Set Min And Max To Center Scan +/-40MHz](#)

Access Point Stats

Registered SM Count : 1 (2 Data VCs)
Maximum Count of Registered SMs : 1

Spectrum Analyzer Options

SM Scanning Bandwidth : 5.0 MHz

Note: Only SM changing channel bandwidth is currently supported. AP will scan at current channel bandwidth

Timed Spectrum Analyzer

Duration : 10 Seconds (10—1000)

Perform Spectrum Analysis on Boot Up for One Scan : Enable
 Disable

[Start Timed Sector Spectrum Analysis](#)

Note: AP scans for extra 30 seconds

Continuous Spectrum Analyzer

[Start Continuous Spectrum Analysis](#)

Note: Continuous Spectrum Analysis has a max of 24 hours and afterwards will automatically resume transmitting.

Attribute	Meaning
Display Data Path	Both means that the vertical and horizontal paths are displayed or an individual path may be selected to display only a single-path reading.
Data	For ease of parsing data and to facilitate automation, the spectrum analyzer results may be saved as an XML file. To save the results in an XML formatted file, right-click the "SpectrumAnalysis.xml" link and save the file.
Display	Instantaneous means that each reading (vertical bar) is displayed with two horizontal lines above it representing the max power level received (top horizontal line) and the average power level received (lower horizontal line) at that frequency. Averaging means that each reading (vertical bar) is displayed with an associated horizontal line above it representing the max power level received at that frequency.
Min and Max Frequencies in kHz	Enter minimum and maximum frequencies to be scanned.
Set Min And Max to Full Scan	On the button press, it sets minimum and maximum allowed frequencies for scanning.
Set Min And Max to Center Scan +/-40 MHz	On the button press, it sets minimum and maximum frequencies to 30 MHz of center frequency for scanning.
Registered SM Count	This field displays the MAC address and Site Name of the registered SM.
Maximum Count of Registered SMs	This field displays the maximum number of registered SMs.

Attribute	Meaning
SM Scanning Bandwidth	This field allows to select SM's scanning bandwidth.
Duration	This field allows operators to configure a specified time for which the spectrum is scanned. If the entire spectrum is scanned prior to the end of the configured duration, the analyzer will restart at the beginning of the spectrum.
Perform Spectrum Analysis on Boot Up for One Scan	This field when enabled performs Spectrum Analysis on every boot up for one scan.
Continuous Spectrum Analyzer	Start Continuous Spectrum Analysis button ensures that when the SM is powered on, it automatically scans the spectrum for 10 seconds. These results may then be accessed via the Tools > Spectrum Analyzer GUI page.

Spectrum Analyzer page of SM

The Spectrum Analyzer page of SM is explained in below table.

Table 98 :Spectrum Analyzer page attributes - SM

The screenshot displays the Spectrum Analyzer GUI with the following sections:

- Results:** A black box indicates "Spectrum Analysis not performed". Below it, details include "Receiver Channel Bandwidth: 5.0 MHz", "System time at start of analysis:", and "Site Name: 450b LG Location: No Site Location Contact: No Site Contact". There are controls for "Display Data Path" (set to "Both"), "Data" (set to "File does not exist."), and "Display" (radio buttons for "Instantaneous" and "Averaging", with "Averaging" selected). A "Stop Spectrum Analysis" button is present.
- Min And Max Frequencies:** Input fields for "Min and Max Frequencies in KHz" are set to "5400000" and "5900000". A note indicates "(Valid Range in KHz: 4900000 - 5925000)". A "Set Min And Max To Full Scan" button is available.
- Subscriber Module Stats:** Shows "Session Status : REGISTERED VC 18 Rate 8X/6X MIMO-B VC 255 Rate 8X/4X MIMO-B" and "Registered AP : 0a-00-3e-bb-01-77 450i AP-133".
- Spectrum Analyzer Options:** "Scanning Bandwidth" is set to "5.0 MHz".
- Timed Spectrum Analyzer:** "Duration" is set to "10" seconds. "Perform Spectrum Analysis on Boot Up for One Scan" is set to "Disable". "Power Up Mode With No 802.3 Link" is set to "Power up in Operational Mode". A "Start Timed Spectrum Analysis" button is present.
- Continuous Spectrum Analyzer:** A "Start Continuous Spectrum Analysis" button is present. A note at the bottom states: "Note: Continuous Spectrum Analysis has a max of 24 hours and afterwards will automatically resume scanning for APs."

Attribute	Meaning
Display Data Path	Refer Spectrum Analyzer page attributes - AP
Data	
Display	
Min and Max Frequencies in kHz	To scan min to max range of frequencies, enter min and max frequencies in kHz and press Set Min and Max to Full Scan button. To scan +/- 40 MHz from center frequency, enter center frequency in kHz and press Set Min And Max To Center Scan +/- 40kHz button.
Session Status	This field displays current session status and rates. The session states can be Scanning, Syncing, Registering or Registered.
Registered AP	This field displays the information of AP to which this device is registered.
Scanning Bandwidth	This field allows to select the scanning bandwidth when running Spectrum Analysis.
Duration	Refer Spectrum Analyzer page attributes - AP .
Perform Spectrum Analysis on Boot Up for One Scan	This field when enabled performs Spectrum Analysis on every boot up for one scan.
Power Up Mode With No 802.3 Link	This field indicates whether the link has to operate in Aim mode or in operational mode on power up.
Continuous Spectrum Analyzer	Start Continuous Spectrum Analysis button starts the SM in Spectrum Analysis until manually stopped, or it has scanned for 24 hours.

Spectrum Analyzer page of BHM

The Spectrum Analyzer page of BHM is explained in below table.

Table 99 :Spectrum Analyzer page attributes - BHM

Results

Spectrum Analysis not performed.
Receiver Channel Bandwidth: 40.0 MHz
System time at start of analysis:
Site Name: Location: No Site Location Contact: No Site Contact

Display Data Path :

Data : File does not exist.

Display : Instantaneous
 Averaging

Min And Max Frequencies

Min and Max Frequencies in KHz : (Valid Range in KHz: 4900000 - 5925000)

Backhaul Stats

Timing Slave Status : Connected

Spectrum Analyzer Options

BHS Scanning Bandwidth :

Note: Only BHS changing channel bandwidth is currently supported. BHM will scan at current channel bandwidth

Timed Spectrum Analyzer

Duration : Seconds (10—1000)

Perform Spectrum Analysis on Boot Up for One Scan : Enable
 Disable

Note: BHM scans for extra 30 seconds

Continuous Spectrum Analyzer

Note: Continuous Spectrum Analysis has a max of 24 hours and afterwards will automatically resume transmitting.

Attribute	Meaning
Data	Refer Spectrum Analyzer page attributes - AP
Display	
Duration	
Min and Max Frequencies in kHz	Enter minimum and maximum frequencies to be scanned.
Set Min And Max to Full Scan	On the button press, it sets minimum and maximum allowed frequencies for scanning.
Set Min And Max to Center Scan +/- 40 MHz	On the button press, it sets minimum and maximum frequencies to 3 40 MHz of center frequency for scanning.
Timing Slave Status	This field displays the status of any registered Timing Slave.
BHS Scanning Bandwidth	This field allows to select BHS's scanning bandwidth.
Duration	This field allows operators to configure a specified time for which the spectrum is

Attribute	Meaning
	scanned. If the entire spectrum is scanned prior to the end of the configured duration, the analyzer will restart at the beginning of the spectrum.
Perform Spectrum Analysis on Boot Up for One Scan	This field when enabled performs Spectrum Analysis on every boot up for one scan.
Continuous Spectrum Analyzer	Start Continuous Spectrum Analysis button starts the SM in Spectrum Analysis until manually stopped, or it has scanned for 24 hours.

Spectrum Analyzer page of BHS

The Spectrum Analyzer page of BHS is explained in below table.

Table 100 :Spectrum Analyzer page attributes - BHS

Results

Spectrum Analysis not performed.
 Receiver Channel Bandwidth: 5.0 MHz
 System time at start of analysis:
 Site Name: No Site Name Location: No Site Location Contact: No Site Contact

Display Data Path : Both ▾
 Data : File does not exist.
 Display :
 Instantaneous
 Averaging

Min And Max Frequencies

Min and Max Frequencies in KHz : 5470000 5925000 (Valid Range in KHz: 4900000 - 5925000)

Backhaul Stats

Timing Slave Status : Connected

Timing Slave Stats

Session Status : REGISTERED VC 18 Rate 8X/1X MIMO-A VC 255 Rate 8X/8X MIMO-B
 Registered Backhaul : 0a-00-3e-bb-b0-c1

Spectrum Analyzer Options

Scanning Bandwidth : 5.0 MHz ▾

Timed Spectrum Analyzer

Duration : 10 Seconds (10—1000)
 Perform Spectrum Analysis on Boot Up for One Scan :
 Enable
 Disable

 Power Up Mode With No 802.3 Link :
 Power up in Aim Mode
 Power up in Operational Mode

Continuous Spectrum Analyzer

Note: Continuous Spectrum Analysis has a max of 24 hours and afterwards will automatically resume scanning for BHM's.

Attribute	Meaning
Data	Refer Spectrum Analyzer page attributes - AP
Display	
Session Status	This field displays current session status and rates. The session states can be Scanning, Syncing, Registering or Registered.
Registered Backhaul	This field displays MAC address of BHM and PTP model number
Duration	Refer Spectrum Analyzer page attributes - AP
Perform Spectrum Analysis on Boot Up for one scan	This field allows to Enable or Disable to start Spectrum Analysis on boot up of module for one scan.
Continuous Spectrum Analyzer	Refer Spectrum Analyzer page attributes - AP on page "Spectrum Analyzer page attributes - AP" on page 335

Spectrum Analyzer page result of PMP 450 SM

Figure 70 : Spectrum Analyzer page result - PMP 450 SM

Results

Timed Spectrum Analysis complete for 10 seconds.
 Receiver Channel Bandwidth: 20.0 MHz
 System time at start of analysis: 01:11:30 01/01/2011 UTC
 Site Name: No Site Name Location: No Site Location Contact: No Site Contact
 Spectrum Summary -93dBm @ 5900MHz V [max: -93, mean: -93]

Display Data Path : Both ▾
 Data : [SpectrumAnalysis.xml](#)
 Display :
 Instantaneous
 Averaging

Min And Max Frequencies

 Min and Max Frequencies in KHz : (Valid Range in KHz: 5470000 - 5900000)

Subscriber Module Stats

 Session Status : REGISTERED VC 18 Rate 8X/8X MIMO-B
 Registered AP : [0a-00-3e-a1-35-75](#) No Site Name

Spectrum Analyzer Options

 Scanning Bandwidth : 20.0 MHz ▾

Timed Spectrum Analyzer

 Duration : Seconds (10—1000)
 Perform Spectrum Analysis on Boot Up for One Enable
 Scan : Disable

Continuous Spectrum Analyzer

Note: Continuous Spectrum Analysis has a max of 24 hours and afterwards will automatically resume scanning for APs.

Remote Spectrum Analyzer tool

The Remote Spectrum Analyzer tool in the AP/BHM provides additional flexibility in the use of the spectrum analyzer in the SM/BHS. Set the duration of 10 to 1000 seconds, then click the Start Remote Spectrum Analysis button to launch the analysis from that SM/BHS.

In PMP configuration, a SM must be selected from the drop-down list before launching Start Remote Spectrum Analysis.

Analyzing the spectrum remotely

Procedure 23 Remote Spectrum Analyzer procedure

1	The AP/BHM de-registers the target SM/BHS.
2	The SM/BHS scans (for the duration set in the AP/BHM tool) to collect data for the bar graph.
3	The SM/BHS re-registers to the AP/BHM.
4	The AP/BHM displays the bar graph.

The bar graph is an HTML file, but can be changed to an XML file, which is then easy to analyze using scripts that you may write for parsing the data. To transform the file to XML, click the “SpectrumAnalysis.xml” link below the spectrum results. Although the resulting display appears mostly unchanged, the bar graph is now coded in XML. You can now right-click on the bar graph for a Save Target As option to save the Spectrum Analysis.xml file.

Remote Spectrum Analyzer page of AP

The Remote Spectrum Analyzer page of AP is explained in below table.

Table 101: Remote Spectrum Analyzer attributes - AP

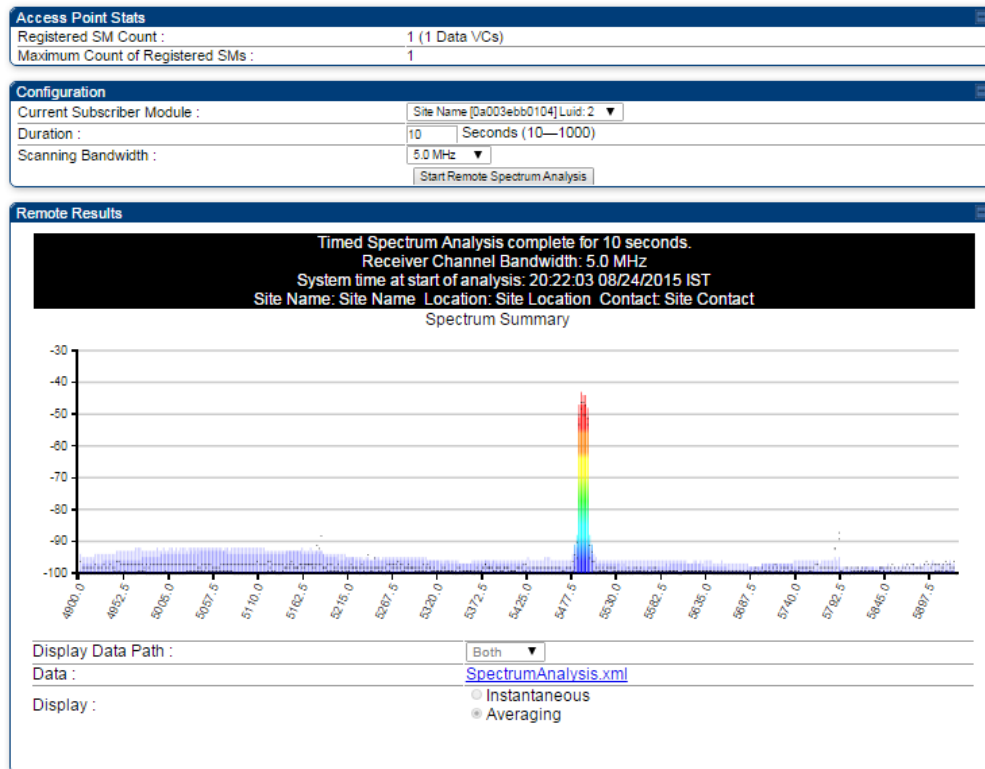

Attribute	Meaning
Registered SM Count	This field displays the number of SMs that were registered to the AP before the SA was started. This helps the user know all the SMs re-registered after performing a SA.

Attribute	Meaning
Maximum Count of Registered SMs	This field displays the largest number of SMs that have been simultaneously registered in the AP since it was last rebooted. This count can provide some insight into sector history and provide comparison between current and maximum SM counts at a glance.
Current Subscriber Module	The SM with which the Link Capacity Test is run.
Duration	This field allows operators to configure a specified time for which the spectrum is scanned. If the entire spectrum is scanned prior to the end of the configured duration, the analyzer will restart at the beginning of the spectrum.
Scanning Bandwidth	This parameter defines the size of the channel scanned when running the analyzer.

Remote Spectrum Analyzer page of BHM

The Remote Spectrum Analyzer page of BHM is explained in below table.

Table 102 :Remote Spectrum Analyzer attributes - BHM

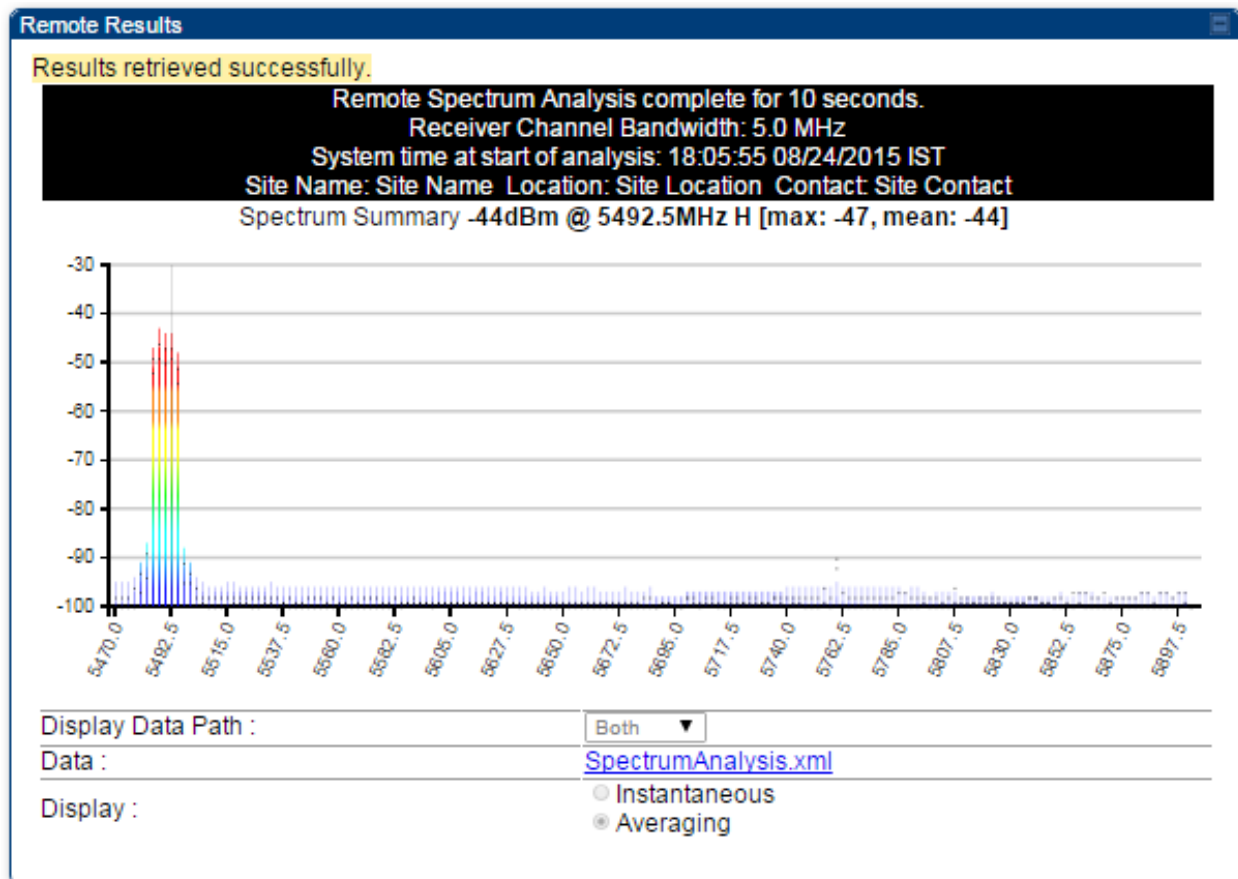

Attribute	Meaning
Duration	Refer Spectrum Analyzer page attributes - AP



Note

To get best performance of the link, the user has to ensure the maximum Receive Power Level during alignment by pointing correctly. The proper alignment is important to prevent interference in other cells. The achieving Receive Power Level green (>- 70 dBm) is not sufficient for the link.

Using the Alignment Tool

The SM's or BHS's Alignment Tool may be used to maximize Receive Power Level, Signal Strength Ratio and Signal to Noise Ratio to ensure a stable link. The Tool provides color coded readings to facilitate in judging link quality.

Figure 71: Alignment Tool tab of SM - Receive Power Level > -70 dBm

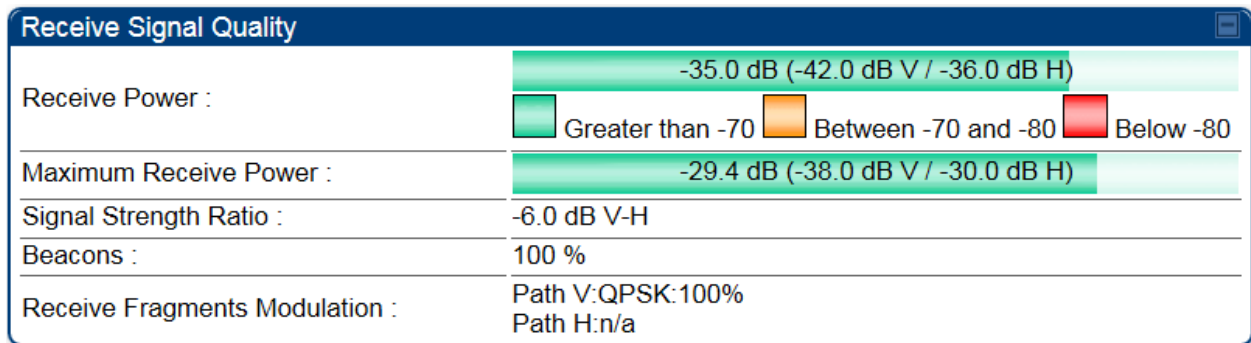

Figure 72: Alignment Tool tab of SM - Receive Power Level between -70 to -80 dBm

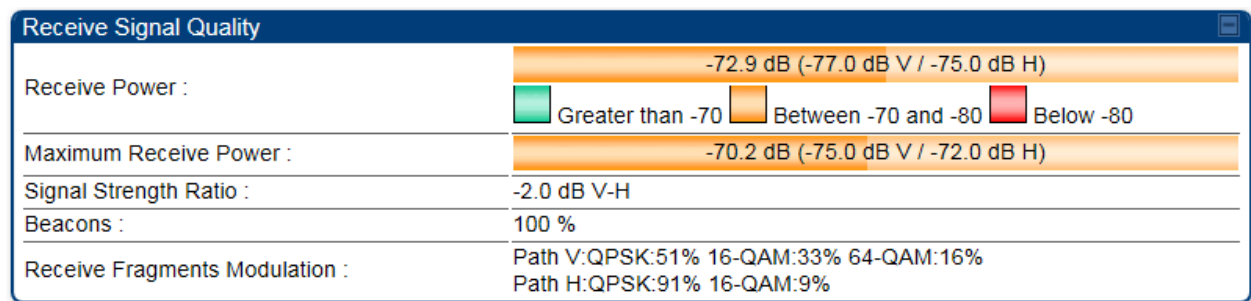





Figure 73: Alignment Tool tab of SM - Receive Power Level < -80 dBm

Receive Signal Quality	
Receive Power :	-81.2 dB (-82.0 dB V / -89.0 dB H)
	 Greater than -70  Between -70 and -80  Below -80
Maximum Receive Power :	-80.5 dB (-82.0 dB V / -84.4 dB H)
Signal Strength Ratio :	7.0 dB V-H
Beacons :	100 %
Receive Fragments Modulation :	Path V:QPSK:59% 16-QAM:33% 64-QAM:7% Path H:QPSK:88% 16-QAM:11%

Aiming page and Diagnostic LED – SM/ BHS

The SM's/BHS's Alignment Tool (located in GUI **Tools -> Aiming**) may be used to configure the SM's/BHS's LED panel to indicate received signal strength and to display decoded beacon information/power levels. The SM/BHS LEDs provide different status based on the mode of the SM/BHS. A SM/BHS in "operating" mode will register and pass traffic normally. A SM/BHS in "aiming" mode will not register or pass traffic, but will display (via LED panel) the strength of received radio signals (based on radio channel selected via **Tools ->Aiming**). See SM/BHS LEDs in Planning and Installation Guide.



Note

For accurate power level readings to be displayed, traffic must be present on the radio link.

Refer SM/BHS LED description in Planning and Installation Guide for SM/BHS LED details.

Aiming page of SM

The Aiming page is similar to Spectrum Analyzer where it scans the spectrum but it does not establish any session with any APs. It has two modes – Single Frequency Only and Normal Frequency Scan List.

The Aiming page of SM is explained in below table.

Table 103 :Aiming page attributes – SM

Tools → Aiming

5.4/5.7GHz MIMO OFDM - Subscriber Module - 0a-00-3e-a0-a0-66

Alignment mode

Aiming Configuration

Aiming Mode : Single Frequency Only
 Normal Frequency Scan List
Note: No beacon information is decoded for 'Single Frequency Only' mode

Single Frequency : ▼

Aiming Mode will be enabled for 15 minutes or until disabled.

Aiming Status

Current Status : SM is in Alignment Mode for selected frequencies

Aiming Results

Current entry:
Frequency: 5745.000 MHz
Power: -31.9 (-50.0 V / -32.0 H) dBm
Users: 1
ESN: 0a-00-3e-a1-35-75
Color Code: 0
Multipoint

Other entries:
Frequency: 5680.000 MHz
Power: -36.5 (-42.0 V / -38.0 H) dBm
ESN: 0a-00-3e-a0-aa-9a
Color Code: 5
Backhaul

Frequency: 5740.000 MHz
Power: -77.8 (-91.0 V / -78.0 H) dBm
Users: 2
ESN: 0a-00-3e-a0-08-08
Color Code: 0
Multipoint

Attribute	Meaning
Aiming Mode	Single Frequency Only: scans only selected single frequency. Normal Frequency Scan List: scans: scans all frequency of scan list.
Single Frequency	Select a particular frequency from drop-down menu for scanning.
Scan Radio Frequency Only Mode	Enabled: the radio is configured to “aiming” or “alignment” mode, wherein the LED panel displays an indication of receive power level. See SM/BHS LED description in Planning and Installation Guide. Disabled: the radio is configured to “operating” mode, wherein the SM registers and passes traffic normally.
Aiming Results	The Aiming Results are displayed in two sections - Current entry and Other entries. Frequency: this field indicates the frequency of the AP which is transmitting the beacon information. Power: This field indicates the current receive power level (vertical channel) for the frequency configured in parameter Radio Frequency. Users: This field indicates the number of SMs currently registered to the AP which is transmitting the beacon information.

Attribute	Meaning
	<p>ESN: This field indicates the MAC, or hardware address of the AP/BHM which is transmitting the beacon information.</p> <p>Color Code: This field displays a value from 0 to 254 indicating the AP's configured color code. For registration to occur, the color code of the SM and the AP must match. Color code is not a security feature. Instead, color code is a management feature, typically for assigning each sector a different color code.</p> <p>Color code allows you to force a SM to register to only a specific AP, even where the SM can communicate with multiple APs. The default setting for the color code value is 0. This value matches only the color code of 0 (not all 255 color codes).</p> <p>Multipoint or Backhaul: this field indicates type of configuration - point-Multipoint (PMP) or Backhaul (PTP).</p>

Aiming page of BHS

The Alignment page of BHS is explained in below table.

Table 104 :Aiming page attributes - BHS

Alignment mode

Aiming Configuration

Aiming Mode : Single Frequency Only
 Normal Frequency Scan List
Note: No beacon information is decoded for 'Single Frequency Only' mode

Single Frequency :

Aiming Mode will be enabled for 15 minutes or until disabled.

Aiming Status

Current Status : BHS is in Alignment Mode for selected frequencies

Aiming Results

No Backhauls available and visible which match current configuration.
Other entries:
Frequency: 5680.000 MHz
Power: -27.0 (-30.0 V / -30.0 H) dBm
Users: 0
ESN: 0a-00-3e-a0-aa-9a
Color Code: 5
Backhaul

Attribute	Meaning
Refer Aiming page attributes – SM for attribute details.	



Note

The Alignment Tone cable for a 450i Series uses an RJ-45 to headset cable

whereas the 450 Series alignment tone cable uses an RJ-12 to headset cable.

Alignment Tone

For coarse alignment of the SM/BHS, use the Alignment Tool located at Tools ->Alignment Tool. Optionally, connect a headset alignment tone kit to the AUX/SYNC port of the SM/BHS and listen to the alignment tone, which indicates greater SM/BHS receive signal power by pitch. By adjusting the SM's/BHS's position until the highest frequency pitch is obtained operators and installers can be confident that the SM/BHS is properly positioned. For information on device GUI tools available for alignment, see sections Aiming page and Diagnostic LED - SM/BHS, Using the Link Capacity Test tool and Using AP Evaluation tool.

Figure 74 : PMP/PTP 450i Series link alignment tone

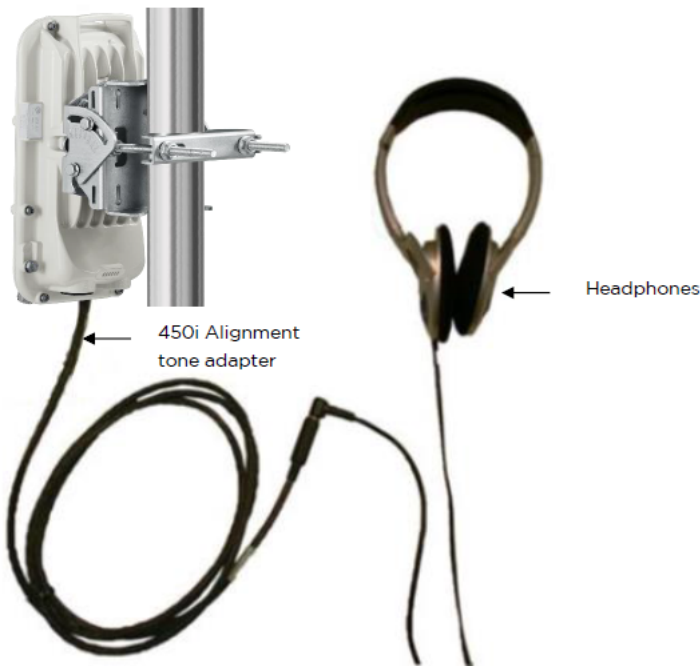

Alignment Tool Headset and alignment tone adapters can be ordered from Cambium and Best-Tronics (<http://btpa.com/Cambium-Products/>) respectively using the following part numbers:

Table 105 :Alignment Tool Headsets and Alignment tone adapter third party product details

Reference	Product description
ACATHS-01A	Alignment tool headset for the PMP/PTP 450 and 450i Series products
BT-1277	Headset alignment cable (RJ-45) for the PMP/PTP 450i Series products
BT-0674	Headset alignment cable (RJ-12) for the PMP/PTP 450 Series products.

Using the Link Capacity Test tool

The Link Capacity Test tab allows you to measure the throughput and efficiency of the RF link between two modules. Many factors, including packet length, affect throughput.

The Link Capacity Test tool has following modes:

- Link Test with Multiple VCs: Tests radio-to-radio communication across selected or all registered VCs, but does not bridge traffic (PMP 450m Series AP only).
- Link Test without Bridging: Tests radio-to-radio communication, but does not bridge traffic.
- Link Test with Bridging: Bridges traffic to “simulated” Ethernet ports, providing a status of the bridged link.
- Link Test with Bridging and MIR: Bridges the traffic during test and also adheres to any MIR (Maximum Information Rate) settings for the link.
- Extrapolated Link Test: Estimates the link capacity by sending few packets and measuring link quality.

The Link Capacity Test tab contains the settable parameter Packet Length with a range of 64 to 1714 bytes. This allows you to compare throughput levels that result from various packet sizes.

The Current Results Status also displayed date and time of last performed Link Capacity Test. If there is any change in time zone, the date and time will be adjusted accordingly.



Note
The Extrapolated Link Test can be run by Read-Only login also.

Performing Link Test

The link test is a tool that allows the user to test the performance of the RF link. Packets are added to one or more queues in the AP in order to fill the frame. Throughput and efficiency are then calculated during the test. The 450 and 450i APs offer link test options to one SM at a time. The 450m AP offers the option of a link test to multiple VCs at the same time. This allows the user to test throughput in MU-MIMO mode, in which multiple SMs are served at the same time.

This new link test can be found under Tools > Link Capacity Test

Link Test with Multiple LUIDs



Note
The “Link Test with Multiple LUIDs” Link Capacity Test is supported for PMP 450m Series AP only.

Figure 75 : Link Capacity Test - PMP 450m Series AP

The screenshot shows two panels of the Link Capacity Test configuration. The top panel, titled "Link Test Configurations", includes fields for "Link Test Mode" (set to "Link Test with Multiple LUIDs"), "Link Test with Multiple Data Channels" (set to "Link Test Low Priority Data Channels"), "MU-MIMO" (radio buttons for Enabled and Disabled), "Ignore Configured CIR" (radio buttons for Enabled and Disabled), and "User Traffic During Link Test" (radio buttons for Block User Traffic and Allow User Traffic). The bottom panel, titled "Link Test Settings", includes fields for "LUID List", "Duration" (set to 2 seconds), "Direction" (set to Downlink Only), "Number of Packets" (set to 0), and "Packet Length" (set to 1714 bytes). A "Start Test" button is visible at the bottom right of the settings panel.

Procedure 24 Performing a Link Capacity Test - Link Test with Multiple LUIDs

Link Test Configurations parameters

1	Access the Link Capacity Test tab in the Tools web page of the module.
2	Set Link Test Mode attribute to Link Test with Multiple LUIDs.
3	Set Link with Multiple Data Channels attribute to Link Test Low Priority Data Channels, Link Test Low and Medium Priority Data Channels, Link Test Low, Medium and High Priority Data Channels, or Link Test All Data Channels.
4	Set the MU-MIMO attribute to Enabled or Disabled. Note: The MU-MIMO feature is enabled on the Low Priority Data Channel only
5	Set the Ignore Configured CIR attribute to Enabled or Disabled.
6	Set the User Traffic During Link Test attribute to Block User Traffic or Allow User Traffic.
Link Test Settings parameters	
7	Enter LUID List (applicable for PMP 450m AP only) The Current Subscriber Module and LUID List are valid only when selecting Link Test with Multiple LUIDs. <ul style="list-style-type: none"> • Current Subscriber Module: select the LUID to perform the link test with • LUID list: select a list or range of LUIDs to include in the link test with multiple LUIDs If left blank, all LUIDs will be included in the link test
8	Type into the Duration field how long (in seconds) the RF link must be tested.
9	Select the Direction attribute to Bi-directional, Uplink Only, or Downlink Only.
10	Type into the Number of Packets field a value of 0 to flood the link for the duration of the test.
11	Type into the Packet Length field a value of 1714 to send 1714-byte packets during the test.
12	Click the Start Test button.

Figure 76 : Link Test with Multiple LUIDs

Current Results Status
 Test Duration: 10 Pkt Length: 1714 Test Direction Bi-Directional

Link Test with Multiple LUIDs

Flood Test Summary

Throughput			Average Group Size	
Downlink	Uplink	Aggregate	Downlink	Uplink
179.86 Mbps	206.49 Mbps	386.35 Mbps	7.0	6.9

Detailed Flood Test Statistics

Subscriber Module	LUID	Data Channel Priority	Tested	Throughput		Efficiency		Average Rate		Grouping Ratio	
				Downlink	Uplink	Downlink	Uplink	Transmit	Receive	Downlink	Uplink
				179.86 Mbps	206.49 Mbps	99%	96%				
SM01 - PMP 450 - 5.4/5.7GHz MIMO OFDM - Row 1-1 - 10 120 247 120 - (0a-00-3e-b4-25-49)	019	Low	Yes	8.48 Mbps	9.78 Mbps	99%	96%	5.5X	5.8X	100%	99%
SM02 - PMP 450 - 5.4/5.7GHz MIMO OFDM - Row 2-1 - 10 120 247 103 - (0a-00-3e-b4-26-df)	017	Low	Yes	8.42 Mbps	9.59 Mbps	99%	94%	5.4X	5.7X	100%	100%
SM03 - PMP 450 - 5.4/5.7GHz MIMO OFDM - Row 1-2 - 10 120 247 104 - (0a-00-3e-b4-26-ba)	004	Low	Yes	8.45 Mbps	9.77 Mbps	99%	96%	5.5X	5.8X	100%	100%
SM04 - PMP 450 - 5.4/5.7GHz MIMO OFDM - Row 2-2 - 10 120 247 105 - (0a-00-3e-b4-25-59)	003	Low	Yes	8.45 Mbps	9.82 Mbps	100%	96%	5.5X	5.8X	100%	99%
SM05 - PMP 450 - 5.4/5.7GHz MIMO OFDM - Row 1-3 - 10 120 247 112 - (0a-00-3e-b4-25-05)	012	Low	Yes	8.47 Mbps	9.74 Mbps	99%	96%	5.5X	5.8X	100%	100%
SM06 - PMP 450 - 5.4/5.7GHz MIMO OFDM - Row 2-3 - 10 120 247 107 - (0a-00-3e-b4-25-3a)	014	Low	Yes	8.46 Mbps	9.80 Mbps	99%	96%	5.5X	5.8X	100%	100%
SM07 - PMP 450 - 5.4/5.7GHz MIMO OFDM - Row 1-4 - 10 120 247 106 - (0a-00-3e-b4-23-bb)	005	Low	Yes	8.56 Mbps	9.77 Mbps	99%	96%	5.5X	5.8X	100%	100%
SM08 - PMP 450 - 5.4/5.7GHz MIMO OFDM - Row 2-4 - 10 120 247 113 - (0a-00-3e-b4-25-5a)	021	Low	Yes	8.49 Mbps	9.73 Mbps	99%	95%	5.5X	5.8X	100%	100%
SM09 - PMP 450 - 5.4/5.7GHz MIMO OFDM - Row 1-5 - 10 120 247 111 - (0a-00-3e-b4-25-a9)	010	Low	Yes	8.57 Mbps	9.74 Mbps	99%	96%	5.5X	5.8X	99%	100%
SM10 - PMP 450 - 5.4/5.7GHz MIMO OFDM - Row 2-5 - 10 120 247 118 - (0a-00-3e-b4-26-23)	022	Low	Yes	8.48 Mbps	9.80 Mbps	99%	96%	5.5X	5.8X	100%	100%
SM11 - PMP 450 - 5.4/5.7GHz MIMO OFDM - Row 1-6 - 10 120 247 119 - (0a-00-3e-b4-26-d1)	018	Low	Yes	8.51 Mbps	9.88 Mbps	99%	97%	5.5X	5.9X	100%	100%
SM12 - PMP 450 - 5.4/5.7GHz MIMO OFDM - Row 2-6 - 10 120 247 117 - (0a-00-3e-b4-26-ce)	020	Low	Yes	8.48 Mbps	9.84 Mbps	99%	96%	5.5X	5.8X	100%	100%
SM13 - PMP 450 - 5.4/5.7GHz MIMO OFDM - Row 1-7 - 10 120 247 121 - (0a-00-3e-b4-25-17)	008	Low	Yes	10.21 Mbps	9.83 Mbps	93%	96%	6.6X	5.8X	99%	100%
SM14 - PMP 450 - 5.4/5.7GHz MIMO OFDM - Row 2-7 - 10 120 247 122 - (0a-00-3e-b4-26-a2)	002	Low	Yes	8.47 Mbps	10.12 Mbps	100%	96%	5.5X	5.8X	100%	94%
SM15 - PMP 450 - 5.4/5.7GHz MIMO OFDM - Row 1-8 - 10 120 247 108 - (0a-00-3e-b4-26-22)	013	Low	Yes	8.46 Mbps	9.78 Mbps	99%	96%	5.5X	5.8X	100%	100%
SM16 - PMP 450 - 5.4/5.7GHz MIMO OFDM - Row 2-8 - 10 120 247 116 - (0a-00-3e-b4-25-fe)	016	Low	Yes	8.47 Mbps	9.88 Mbps	100%	96%	5.5X	5.8X	100%	100%
SM17 - PMP 450 - 5.4/5.7GHz MIMO OFDM - Row 1-9 - 10 120 247 114 - (0a-00-3e-b4-25-b0)	009	Low	Yes	8.46 Mbps	9.89 Mbps	100%	97%	5.5X	5.9X	100%	100%
SM18 - PMP 450 - 5.4/5.7GHz MIMO OFDM - Row 2-9 - 10 120 247 110 - (0a-00-3e-b4-24-21)	011	Low	Yes	8.47 Mbps	10.02 Mbps	99%	97%	5.5X	5.9X	100%	100%
SM19 - PMP 450 - 5.4/5.7GHz MIMO OFDM - Row 1-10 - 10 120 247 102 - (0a-00-3e-b4-25-c7)	015	Low	Yes	8.47 Mbps	9.95 Mbps	99%	97%	5.5X	5.9X	100%	100%
SM20 - PMP 450 - 5.4/5.7GHz MIMO OFDM - Row 2-10 - 10 120 247 115 - (0a-00-3e-b4-26-01)	006	Low	Yes	8.44 Mbps	8.09 Mbps	99%	97%	5.5X	5.8X	100%	100%
SM21 - PMP 450 - 5.4/5.7GHz MIMO OFDM - Row 1-11 - 10 120 247 109 - (0a-00-3e-b4-26-63)	007	Low	Yes	8.48 Mbps	11.57 Mbps	99%	96%	5.5X	5.8X	100%	100%

Slot Grouping

Group Size	% Downlink Distribution	% Uplink Distribution
1 (ungrouped)	0.0	1.8
2	0.0	0.0
3	0.0	0.0
4	0.0	0.0
5	0.0	0.0
6	1.6	0.0
7	98.4	98.2

Link Test ran on 13:07:33 05/09/2019 CDT

Link Test without Bridging, Link Test with Bridging or Link Test with Bridging and MIR

Figure 77 : Link Test without Bridging

Link Test Configurations

Link Test Mode : ▼

Signal to Noise Ratio Calculation during Link Test : Enabled Disabled

Link Test with All Available Data Channels : All Available Data Channels Low Priority Channel only
 Note: All Available Data Channels option requires that the SM already has at least one additional data channel enabled

Link Test Settings

Current Subscriber Module : ▼

Duration : Seconds (2 — 10)

Direction : ▼

Number of Packets : (0 — 64) Zero will flood the link for duration of test

Packet Length : Bytes (64 — 1714 bytes)

Figure 78 : Link Test with Bridging and MIR

Link Test Configurations

Link Test Mode : ▼

Signal to Noise Ratio Calculation during Link Test : Enabled Disabled

Link Test with All Available Data Channels : All Available Data Channels Low Priority Channel only
 Note: All Available Data Channels option requires that the SM already has at least one additional data channel enabled.

Link Test Settings

Current Subscriber Module : ▼

Duration : Seconds (2 — 10)

Direction : ▼

Number of Packets : (0 — 64) Zero will flood the link for duration of test

Packet Length : Bytes (64 — 1714 bytes)

Refer Link Test with Multiple LUIDs for Link Test procedure.

Figure 79 : Link Test without Bridging (1518-byte packet length)

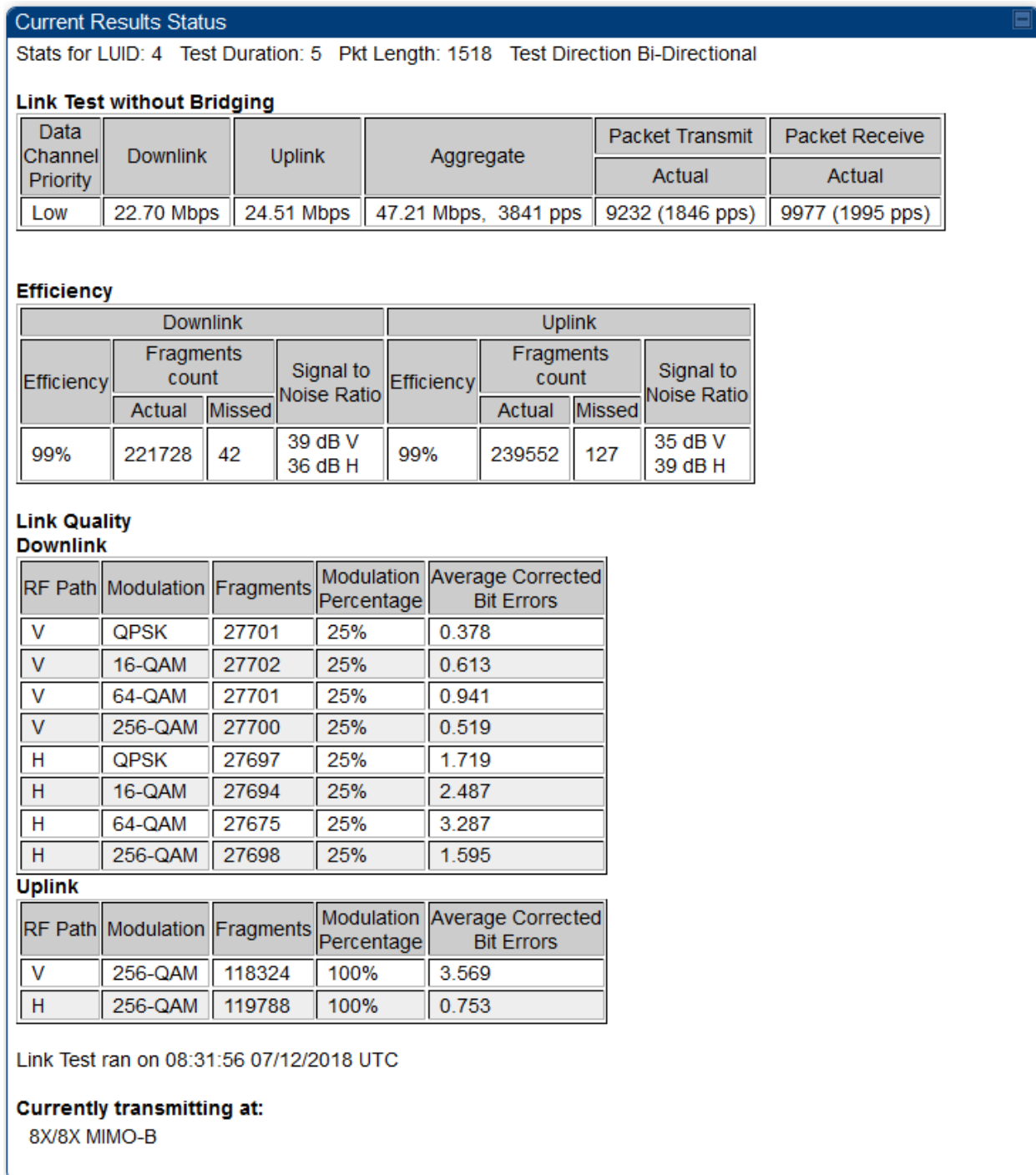

Performing Extrapolated Link Test

The Extrapolated Link Test estimates the link capacity by sending few packets and measuring link quality. Once the test is initiated, the radio starts session at the lower modulation, 1X, as traffic is passed

successfully across the link, the radio decides to try the next modulation, 2X. This process repeats until it finds best throughput to estimate capacity of link.

The procedure for performing Extrapolated Link Test is as follows:

Procedure 25 Performing an Extrapolated Link Test

1	Access the Link Capacity Test tab in the Tools web page of the module.
2	Select Link Test Mode Extrapolated Link Test
3	Click the Start Test button.
4	In the Current Results Status block of this tab, view the results of the test.

Figure 80 : Extrapolated Link Test results

Current Results Status
 Stats for LUID: 2 Test Duration: 1 Pkt Length: 1714 Test Direction Bi-Directional

Extrapolated Link Test

Downlink	Uplink	Aggregate
31.94 Mbps	32.76 Mbps	64.71 Mbps

Transmit modulation Down: 4X Up: 4X
 Efficiencies Down: 100 Up: 100
 Slots carrying data: Downlink/Uplink: 39/40

Note: Extrapolated Link Test just sends over a few packets measuring their quality and extrapolates that to what the expected throughput would be. This is just an approximation to have minimal service impact.

Efficiency

Downlink			Uplink				
Efficiency	Fragments count		Signal to Noise Ratio	Efficiency	Fragments count		Signal to Noise Ratio
	Actual	Missed			Actual	Missed	
100%	6831	0	22 dB V 22 dB H	100%	6831	0	20 dB V 20 dB H

Link Quality

Downlink

RF Path	Modulation	Fragments	Modulation Percentage	Average Corrected Bit Errors
V	QPSK	1708	50%	0.000
V	16-QAM	1709	50%	0.000
H	QPSK	1707	50%	0.000
H	16-QAM	1707	50%	0.000

Uplink

RF Path	Modulation	Fragments	Modulation Percentage	Average Corrected Bit Errors
V	16-QAM	3420	100%	0.013
H	16-QAM	3420	100%	0.000

Link Test ran on 18:48:18 10/23/2018 UTC

Currently transmitting at:
 4X/4X MIMO-B

Link Capacity Test page of AP

The Link Capacity Test page of AP is explained in below table.

Table 106 :Link Capacity Test page attributes – 450m AP

Link Test Configurations	
Link Test Mode :	Link Test with Bridging and MIR ▼
Signal to Noise Ratio Calculation during Link Test :	<input checked="" type="radio"/> Enabled <input type="radio"/> Disabled
SM Link Test Mode Restriction :	<input checked="" type="radio"/> Enabled <input type="radio"/> Disabled
Link Test with All Available Data Channels :	<input type="radio"/> All Available Data Channels <input checked="" type="radio"/> Low Priority Channel only Note: All Available Data Channels option requires that the SM already has at least one additional data channel enabled.
MU-MIMO :	<input type="radio"/> Enabled <input type="radio"/> Disabled
Display results for untested Data Channels :	<input type="radio"/> Enabled <input checked="" type="radio"/> Disabled
Ignore Configured CIR :	<input type="radio"/> Enabled <input checked="" type="radio"/> Disabled

Link Test Settings	
Current Subscriber Module :	Idle [0a003ebb41d2] Luid: 2 ▼
LUID List :	<input type="text"/> (eg. 2 — 22,24,32) Empty field or 0 will flood all registered LUIDs for duration of test
Duration :	2 Seconds (2 — 10)
Direction :	Bi-directional ▼
Number of Packets :	0 (0 — 64) Zero will flood the link for duration of test
Packet Length :	1714 Bytes (64 — 1714 bytes)
<input type="button" value="Start Test"/>	

Attribute	Meaning
Link Test Mode	Select Link Test Mode from drop-down menu: <ul style="list-style-type: none"> • Link Test with Multiple LUIDs (PMP 450m Series AP only) • Link Test without Bridging • Link Test with Bridging • Link Test with Bridging and MIR • Extrapolated Link Test
Signal to Noise Ratio Calculation during Link Test	Enable this attribute to display Signal-to-Noise information for the downlink and uplink when running the link test.
SM Link Test Mode Restriction	Enable this parameter to restrict SM link test mode.
Link Test with All Available Data Channels	This parameter is used to enable or disable usage of either all available data channels or low priority data channel only during the link test.
MU-MIMO	This parameter determines whether the DL flood test packets use MU-MIMO grouping

Attribute	Meaning
	<p>or not.</p> <p>Note: This field is applicable only when the “Link Test Mode” field is set to “Link Test with Multiple VC’s” option.</p> <p>Note: This field is applicable for PMP 450m APs only.</p>
Display results for untested Data Channels	<p>If “Link test with multiple VC’s” is run and a subset of registered VC’s enters into the VC List field, then enabling this field produces a table that displays results for VC’s with traffic which are in session; but not tested as part of the link test.</p> <p>Note: This field is applicable for PMP 450m flood tests only.</p>
Ignore Configured CIR	<p>Enable this parameter to schedule flood data regardless of the CIR configuration for each SM. For system release 16.1 and beyond, the exact impact of this setting depends on which scheduler “mode” has been configured by the operator on the AP’s QoS page.</p> <p>Enabled: ‘Run Link Test with Multiple LUID’s using Legacy scheduler, ignoring configured CIR’s. Legacy scheduler is used here regardless of which scheduling mode has been configured.</p> <p>Disabled: If Legacy scheduler is enabled, test with legacy scheduler, using configured CIR’s. If Proportional scheduler is enabled, test with proportional scheduler.</p>
Current Subscriber Module	<p>The SM with which the Link Capacity Test is run. This field is only applicable for AP (not SM page).</p>
LUID List	<p>This field is displayed for PMP 450m Series AP. It is only applicable for “Link Test with Multiple LUIDs” Test mode.</p> <p>Enter LUID List (e.g. 18 or above for low priority LUIDs and 255 or above for high priority LUIDs or 0 for all registered LUIDs) which needs to be used for link test traffic.</p>
Duration	<p>This field allows operators to configure a specified time for which the spectrum is scanned. If the entire spectrum is scanned prior to the end of the configured duration, the analyzer will restart at the beginning of the spectrum.</p>
Direction	<p>Configure the direction of the link test. Specify Downlink or Uplink to run the test only in the corresponding direction only. Specific Bi-Directional to run the test in both directions.</p>
Number of Packets	<p>The total number of packets to be sent during the Link Capacity Test. When Link Test Mode is set to Link Test Without Bridging this field is not configurable.</p>
Packet Length	<p>The size of the packets in Bytes to send during the Link Capacity Test</p>

Link Capacity Test page of BHM/ BHS/ SM

The Link Capacity Test page of BHM/BHS is explained in below table.

Figure 81: Link Capacity Test page attributes – BHM/BHS

Link Test Configurations

Link Test Mode :

Signal to Noise Ratio Calculation during Link Test : Enabled
 Disabled

Link Test with All Available Data Channels : All Available Data Channels
 Low Priority Channel only
 Note: All Available Data Channels option requires that the SM already has at least one additional data channel enabled.

Link Test Settings

Duration : Seconds (2 — 10)

Direction :

Number of Packets : (0 — 64) Zero will flood the link for duration of test

Packet Length : Bytes (64 — 1714 bytes)

Attribute	Meaning
Link Test Mode	See Link Capacity Test page attributes - 450m AP
Signal to Noise Ratio Calculation during Link Test	
Link Test with All Available Data Channels	
Duration	
Direction	
Number of Packets	
Packet Length	

Using AP Evaluation tool

The AP Evaluation tab on Tools web page of the SM provides information about the AP that the SM sees.



Note

The data for this page may be suppressed by the SM Display of AP Evaluation Data setting in the Configuration > Security tab of the AP.

The AP Eval results can be accessed via SNMP and config file.

AP Evaluation page

The AP Evaluation page of AP is explained in below table.

Table 107 :AP Evaluation tab attributes - AP

AP List

AP Selection Method used: Optimize for Throughput
 Current entry index: 0 Session Status: REGISTERED (via Primary Color Code 181)

Index: 0 Frequency: 3657.500 MHz Channel Bandwidth: 20.0 MHz Cyclic Prefix: 1/16
 ESN: 0a-00-3e-45-11-f2 Region: Other
 Beacon Receive Power: -52.5 (-55.0 V / -56.0 H) dBm Beacon Count: 9 FECEn: 1
 Type: Multipoint Avail: 1 Age: 0 Scans Seen: 1 Lockout: 0 RegFail 0 Range: 0 feet MaxRange: 2 miles TxBER:
 1 EBcast: 0 AES256Rdy: 0
 Session Count: 1 NoLUIDS: 0 OutOfRange: 0 AuthFail: 0 EncryptFail: 0 Rescan Req: 0 SMLimitReached: 0
 NoVC's: 0 VCRsv/430smFail: 0 VCActFail: 0 UnsupportedULMap: 0 Air Delay: 0
 AP Gain: 25 dBm AP RcvT: -55 dBm Color Code: 181 BeaconVersion: 1 SectorUserCount: 0 SyncSrc: 0
 NumULSlots: 41 NumDLSlots: 40 NumULContSlots: 3
 WhiteSched: 0 ICC: 0 Authentication: Disabled
 SM PPPoE: Supported
 AckBeforeMap: Enabled
 Frame Period: 2.5 ms

Last Registered Primary Color Code AP

MAC Address: 0a-00-3e-45-11-f2
 Frequency: 3657.500 MHz
 Channel Bandwidth: 20.0 MHz
 Color Code: 181
 Air Delay: 0
 Receive Power: -33.5 (-37.0 V / -36.0 H) dBm

Scan Statistics

Scan Cycle Count: 1

Beacon Statistics

Unsupported Feature Beacon Received :	0
Unknown Feature Beacon Received :	0
Old Version Beacon Received :	0
Wrong Frequency Beacon Received :	0
Non Lite Beacon Received :	0

Attribute	Meaning
Index	This field displays the index value that the system assigns (for only this page) to the AP where this SM is registered.
Frequency	This field displays the frequency that the AP transmits.
Channel Bandwidth	The channel size used by the radio for RF transmission. The setting for the channel bandwidth must match between the AP and the SM.
Cyclic Prefix	OFDM technology uses a cyclic prefix, where a portion of the end of a symbol (slot) is repeated at the beginning of the symbol to allow multi-pathing to settle before receiving the desired data. A 1/16 cyclic prefixes mean that for every 16 bits of throughput data transmitted, an additional bit is used. The Cyclic Prefix 1/16 only can be selected at this time.
ESN	This field displays the MAC address (electronic serial number) of the AP. For operator convenience during SM aiming, this tab retains each detected ESN for up to 15 minutes. If the broadcast frequency of a detected AP changes during a 15-minute interval in the aiming operation, then a multiple instance of the same ESN is possible in the list. Eventually, the earlier instance expires and disappears and the later instance remains to the end of its interval, but you can ignore the early instance(s) whenever two or more are present.
Region	This field displays the AP's configured Country Code setting.
Power Level	This field displays the SM's combined received power level from the AP's transmission.

Attribute	Meaning
Beacon Count	A count of the beacons seen in a given time period.
FECEn	This field contains the SNMP value from the AP that indicates whether the Forward Error Correction feature is enabled. 0: FEC is disabled 1: FEC is enabled
Type	Multipoint indicates that the listing is for an AP.
Age	This is a counter for the number of minutes that the AP has been inactive. At 15 minutes of inactivity for the AP, this field is removed from the AP Evaluation tab in the SM.
Lockout	This field displays how many times the SM has been temporarily locked out of making registration attempts.
RegFail	This field displays how many registration attempts by this SM failed.
Range	This field displays the distance in feet for this link. To derive the distance in meters, multiply the value of this parameter by 0.3048.
MaxRange	This field indicates the configured value for the AP's Max Range parameter.
TxBER	A 1 in this field indicates the AP is sending Radio BER.
Ebcast	A 1 in this field indicates the AP or BHM is encrypting broadcast packets. A 0 indicates it is not.
Session Count	This field displays how many sessions the SM (or BHS) has had with the AP (or BHM). Typically, this is the sum of Reg Count and Re-Reg Count. However, the result of internal calculation may display here as a value that slightly differs from the sum. In the case of a multipoint link, if the number of sessions is significantly greater than the number for other SMs, then this may indicate a link problem or an interference problem.
NoLUIDs	This field indicates how many times the AP has needed to reject a registration request from a SM because its capacity to make LUID assignments is full. This then locks the SM out of making any valid attempt for the next 15 minutes. It is extremely unlikely that a non-zero number would be displayed here.
OutOfRange	This field indicates how many times the AP has rejected a registration request from a SM because the SM is a further distance away than the range that is currently configured in the AP. This then locks the SM out of making any valid attempt for the next 15 minutes.
AuthFail	This field displays how many times authentication attempts from this SM have failed in the AP.
EncryptFail	This field displays how many times an encryption mismatch has occurred between the SM and the AP.
Rescan Req	This field displays how many times a re-range request has occurred for the BHM that is being evaluated in the AP Eval page of a BHS.

Attribute	Meaning
SMLimitReached	This field displays 0 if additional SMs may be registered to the AP. If a 1 is displayed, the AP will not accept additional SM registrations.
NoVC's	This counter is incremented when the SM is registering to an AP which determines that no VC resources are available for allocation. This could be a primary data channel (a low priority data channel) or one of the other possible data channel priorities (a Medium priority data channel, or High priority data channel, or Ultra High priority data channel)
VCRsvFail	This counter is incremented when the SM is registering to an AP which has a VC resource available for allocation but cannot reserve the resource for allocation.
VCActFail	This counter is incremented when the SM is registering to an AP which has a VC resource available for allocation and has reserved the VC, but cannot activate the resource for allocation.
AP Gain	This field displays the total external gain (antenna) used by the AP.
RcvT	This field displays the AP's configured receive target for receiving SM transmissions (this field affects automatic SM power adjust).
Sector ID	This field displays the value of the Sector ID field that is provisioned for the AP.
Color Code	This field displays a value from 0 to 254 indicating the AP's configured color code. For registration to occur, the color code of the SM and the AP must match. Color code is not a security feature. Instead, color code is a management feature, typically for assigning each sector a different color code. Color code allows you to force a SM to register to only a specific AP, even where the SM can communicate with multiple APs. The default setting for the color code value is 0. This value matches only the color code of 0 (not all 255 color codes).
BeaconVersion	This field indicates that the beacon is OFDM (value of 1).
Sector User Count	This field displays how many SMs are registered on the AP.
NumULHalfSlots	This is the number of uplink slots in the frame for this AP.
NumDLHalfSlots	This is the number of downlink slots in the frame for this.
NumULContSlots	This field displays how many Contention Slots are being used in the uplink portion of the frame.
WhiteSched	Flag to display if schedule whitening is supported via FPGA
ICC	This field lists the SMs that have registered to the AP with their Installation Color Code (ICC), Primary CC, Secondary CC or Tertiary CC.
SM PPPoE	This field provides information to the user whether the SM is supporting PPPoE or not.
Frame Period	This field displays the configured Frame Period of the radio.
Last Registered Primary Color Code AP	

Attribute	Meaning
MAC Address	This field displays the last registered AP's MAC address.
Frequency	This field displays the last registered AP's frequency.
Channel Bandwidth	This field displays the last registered AP's channel bandwidth.
Color Code	This field displays the last registered AP's color code.
Air Delay	This field displays the last registered AP's air delay.
Receive Power	This field displays the last registered AP's receive power.
Scan Statistics	
Scan Cycle Count	The file displays the number of scan cycles. This increments after the SM completes scanning every configured frequency and channel bandwidth.
Beacon Statistics	
Unsupported Feature Beacon Received	Count of beacons that the SM has received that is from a beacon that it does not support, which will prevent registration. If encounter this, upgrade your SM to the latest supported software version.
Unknown Feature Beacon Received	Count of beacons that the SM has received that is from a beacon that is running a feature that is unknown, which will prevent registration. If this stat is encountered, upgrade your SM to the latest supported software version.
Old Version Beacon Received	Count of the beacons where the version in the beacon mismatched and prevented registration.
Wrong Frequency Beacon Received	Count of beacons that was reported on a different frequency than was received.

Using BHM Evaluation tool

The BHM Evaluation tab on Tools web page of the BHS provides information about the BHM that the BHS sees.

BHM Evaluation page of BHS

The BHM Evaluation page of BHS is explained in below figure.

Figure 82 : BHM Evaluation tab attributes - BHS

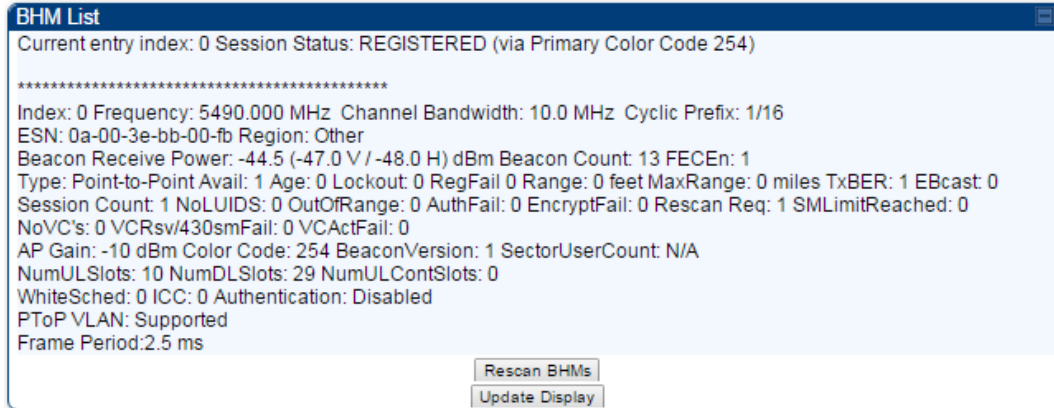

Attribute	Meaning
Index	This field displays the index value that the system assigns (for only this page) to the BHM where this BHS is registered.
Frequency	This field displays the frequency that the BHM transmits.
Channel Bandwidth	The channel size used by the radio for RF transmission. The setting for the channel bandwidth must match between the BHM and the BHS.
Cyclic Prefix	OFDM technology uses a cyclic prefix, where a portion of the end of a symbol (slot) is repeated at the beginning of the symbol to allow multi-pathing to settle before receiving the desired data. A 1/16 cyclic prefixes mean that for every 16 bits of throughput data transmitted, an additional bit is used.
ESN	This field displays the MAC address (electronic serial number) of the BHM. For operator convenience during BHS aiming, this tab retains each detected ESN for up to 15 minutes. If the broadcast frequency of a detected BHM changes during a 15-minute interval in the aiming operation, then a multiple instance of the same ESN is possible in the list. Eventually, the earlier instance expires and disappears and the later instance remains to the end of its interval, but you can ignore the early instance (s) whenever two or more are present.
Region	This field displays the BHM's configured Country Code setting.
Power Level	This field displays the BHS's combined received power level from the BHM's transmission.
Beacon Count	A count of the beacons seen in a given time period.
FECEn	This field contains the SNMP value from the BHM that indicates whether the Forward Error Correction feature is enabled. 0: FEC is disabled 1: FEC is enabled
Type	Multipoint indicates that the listing is for a BHM.
Age	This is a counter for the number of minutes that the BHM has been inactive. At 15 minutes of inactivity for the BHS, this field is removed from the BHM Evaluation tab in the BHS.

Attribute	Meaning
Lockout	This field displays how many times the BHS has been temporarily locked out of making registration attempts.
RegFail	This field displays how many registration attempts by this BHS failed.
Range	This field displays the distance in feet for this link. To derive the distance in meters, multiply the value of this parameter by 0.3048.
MaxRange	This field indicates the configured value for the AP's Max Range parameter.
TxBER	A 1 in this field indicates the BHM is sending Radio BER.
Ebcast	A 1 in this field indicates the BHM is encrypting broadcast packets. A 0 indicates it is not.
Session Count	This field displays how many sessions the BHS has had with the BHM. Typically, this is the sum of Reg Count and Re-Reg Count. However, the result of internal calculation may display here as a value that slightly differs from the sum. In the case of a multipoint link, if the number of sessions is significantly greater than the number for other BHS's, then this may indicate a link problem or an interference problem.
NoLUIDs	This field indicates how many times the BHM has needed to reject a registration request from a BHS because its capacity to make LUID assignments is full. This then locks the BHS out of making any valid attempt for the next 15 minutes. It is extremely unlikely that a non-zero number would be displayed here.
OutOfRange	This field indicates how many times the BHM has rejected a registration request from a BHS because the BHS is a further distance away than the range that is currently configured in the BHM. This then locks the BHS out of making any valid attempt for the next 15 minutes.
AuthFail	This field displays how many times authentication attempts from this SM have failed in the BHM.
EncryptFail	This field displays how many times an encryption mismatch has occurred between the BHS and the BHM.
Rescan Req	This field displays how many times a re-range request has occurred for the BHM that is being evaluated in the BHM Eval page of a BHM.
SMLimitReached	This field displays 0 if additional BHSs may be registered to the BHM. If a 1 is displayed, the BHM will not accept additional BHS registrations.
NoVC's	This counter is incremented when the BHS is registering to a BHM which determines that no data channel resources are available for allocation. This could be a primary data channel (a low priority data channel) or one of the other possible data channel priorities (a Medium priority data channel, or High priority data channel, or Ultra High priority data channel)
VCRsvFail	This counter is incremented when the BHS is registering to a BHM which has a VC resource available for allocation but cannot reserve the resource for allocation.
VCActFail	This counter is incremented when the BHS is registering to a BHM which has a VC

Attribute	Meaning
	resource available for allocation and has reserved the VC, but cannot activate the resource for allocation.
AP Gain	This field displays the total external gain (antenna) used by the BHM.
RcvT	This field displays the AP's configured receive target for receiving BHS transmissions (this field affects automatic BHS power adjust).
Sector ID	This field displays the value of the Sector ID field that is provisioned for the BHM.
Color Code	This field displays a value from 0 to 254 indicating the BHM's configured color code. For registration to occur, the color code of the BHS and the BHM must match. Color code is not a security feature. Instead, color code is a management feature, typically for assigning each sector a different color code. Color code allows you to force a BHS to register to only a specific BHM, even where the BHS can communicate with multiple BHMs. The default setting for the color code value is 0. This value matches only the color code of 0 (not all 255 color codes).
BeaconVersion	This field indicates that the beacon is OFDM (value of 1).
Sector User Count	This field displays how many BHS's are registered on the BHM.
NumULHalfSlots	This is the number of uplink slots in the frame for this BHM.
NumDLHalfSlots	This is the number of downlink slots in the frame for this.
NumULContSlots	This field displays how many Contention Slots are being used in the uplink portion of the frame.
WhiteSched	Flag to display if schedule whitening is supported via FPGA
ICC	This field lists the BHSs that have registered to the BHM with their Installation Color Code (ICC), Primary CC, Secondary CC or Tertiary CC.
SM PPPoE	This field provides information to the user whether the BHS is supporting PPPoE or not.
Frame Period	This field displays the configured Frame Period of the radio.

Using the OFDM Frame Calculator tool

The first step to avoid interference in wireless systems is to set all APs/BHMs to receive timing from a synchronization source (Cluster Management Module, or Universal Global Positioning System). This ensures that the modules are in sync and start transmitting at the same time each frame.

The second step to avoid interference is to configure parameters on all APs/BHMs of the same frequency band in proximity such that they have compatible transmit/receive ratios (all stop transmitting each frame before any start receiving). This avoids the problem of one AP/BHM attempting to receive the signal from a distant SM/BHS while a nearby AP transmits, which could overpower that signal.

The following parameters on the AP determine the transmit/receive ratio:

- Max Range
- Frame Period

- Downlink Data percentage
- (reserved) Contention Slots

If OFDM (PMP 430, PMP 450, PTP 230) and FSK (PMP 1x0) APs/BHMs of the same frequency band are in proximity, or if APs/BHMs set to different parameters (differing in their Max Range values, for example), then operator must use the Frame Calculator to identify compatible settings.

The frame calculator is available on the Frame Calculator tab of the Tools web page. To use the Frame Calculator, type various configurable parameter values into the calculator for each proximal AP and then record the resulting AP/BHM Receive Start value. Next vary the Downlink Data percentage in each calculation and iterate until the calculated AP/BHM Receive Start for all collocated AP/BHMs where the transmit end does not come before the receive start.

The calculator does not use values in the module or populate its parameters. It is merely a convenience application that runs on a module. For this reason, you can use any FSK module (AP, SM, BHM, BHS) to perform FSK frame calculations for setting the parameters on an FSK AP and any OFDM module (AP, SM, BHM, BHS) to perform OFDM frame calculations for setting the parameters on an OFDM AP/BHM.

For more information on PMP/PTP 450 Platform co-location, see

<https://support.cambiumnetworks.com/files/colocationtool/> The co-location is also supported for 900 MHz PMP 450i APs (OFDM) and PMP 100 APs (FSK). Please refer Co-location of PMP 450 and PMP 100 systems in the 900 MHz band and migration recommendations document for details.



Caution

APs/BHMs that have slightly mismatched transmit-to-receive ratios and low levels of data traffic may see little effect on throughput. A system that was not tuned for co-location may work fine at low traffic levels, but encounter problems at higher traffic levels. The conservative practice is to tune for co-location before traffic ultimately increases. This prevents problems that occur as sectors are built.

The OFDM Frame Calculator page is explained in below table.

Table 108 :OFDM Frame Calculator page attributes

OFDM Frame Calculator Parameters	
Link Mode :	<input type="radio"/> Point-To-Point Link <input checked="" type="radio"/> Multipoint Link
Platform Type AP/BHM :	PMP/PTP 450/450i/450m ▼
Platform Type SM/BHS :	PMP/PTP 450/450b/450i ▼
Channel Bandwidth :	10.0 MHz ▼
Cyclic Prefix :	One Sixteenth ▼
Frame Period :	<input type="radio"/> 5.0 ms <input checked="" type="radio"/> 2.5 ms
Max Range :	25 km ▼ (Range: 1 — 40 miles / 64 km)
Downlink Data :	50 %
Contention Slots :	4 (Range: 0 — 15)
SM/BHS One Way Air Delay :	0 ns
<input type="button" value="Calculate"/>	

Calculated Frame Results	
CANOPY 15.2 AP	
Modulation:OFDM	
Total Frame Bits : 25000	
Frame Period : 2.5 ms	
AP Details :	
Data Slots (Down/Up) : 15 /16	
Contention Slots: 4	
Air Delay for Max Range: 86400 ns, 864 bits	
Approximate distance for Max Range: 25885 meters	
AP Antenna Transmit End : 9904, 990.404 μs	
AP Antenna Receive Start : 13027, 1.302747 ms	
AP Antenna Receive End : 23761	
SM Details :	
SM Receive End : 10468	
SM Transmit Start : 12270	
SM One Way Air Delay : 0 ns	
SM Approximate distance : 0 meters	

Attribute	Meaning
Link Mode	For AP to SM frame calculations, select Multipoint Link For BHM to BHS frame calculations, select Point-To-Point Link
Platform Type AP/BHM	Use the drop-down list to select the hardware series (board type) of the AP/BHM.
Platform Type SM/BHS	Use the drop-down list to select the hardware series (board type) of the SM/BHS.
Channel	Set this to the channel bandwidth used in the AP/BHM.

Attribute	Meaning
Bandwidth	
Cyclic Prefix	Set this to the cyclic prefix used in the AP/BHM.
Max Range	Set to the same value as the Max Range parameter is set in the AP(s) or BHM(s).
Frame Period	Set to the same value as the Frame Period parameter is set in the AP(s) or BHM(s).
Downlink Data	<p>Initially set this parameter to the same value that the AP/BHM has for its Downlink Data parameter (percentage). Then, use the Frame Calculator tool procedure as described in Procedure 26 Using the Frame Calculator, you will vary the value in this parameter to find the proper value to write into the Downlink Data parameter of all APs or BHMs in the cluster.</p> <p>PMP 450 Platform Family APs or BHMs offer a range of 15% to 85% and default to 75%. The value that you set in this parameter has the following interaction with the value of the Max Range parameter (above):</p> <p>The default Max Range value is 5 miles and, at that distance, the maximum Downlink Data value (85% in PMP 450 Platform) is functional.</p>
Contention Slots	This field indicates the number of (reserved) Contention Slots configured by the operator. Set this parameter to the value of the Contention Slot parameter is set in the APs or BHMs.
SM/BHS One Way Air Delay	This field displays the time in ns (nano seconds), that a SM/BHS is away from the AP/BHM.

The Calculated Frame Results display several items of interest:

Table 109 :OFDM Calculated Frame Results attributes

Attribute	Meaning
Modulation	The type of radio modulation used in the calculation (OFDM for 450 Platform Family)
Total Frame Bits	The total number of bits used in the calculated frames
Data Slots (Down/Up)	This field is based on the Downlink Data setting. For example, a result within the typical range for a Downlink Data setting of 75% is 61/21, meaning 61 data slots down and 21 data slots up.
Contention Slots	This field indicates the number of (reserved) Contention Slots configured by the operator.
Air Delay for Max Range	This is the roundtrip air delay in bit times for the Max Range value set in the calculator
Approximate distance for Max Range	The Max Range value used for frame calculation
AP Transmit	In bit times, this is the frame position at which the AP/BHM ceases transmission.

Attribute	Meaning
End	
AP Receive Start	In bit times, this is the frame position at which the AP/BHM is ready to receive transmission from the SM/BHS.
AP Receive End	In bit times, this is the frame position at which the AP/BHM will cease receiving transmission from the SM/BHS.
SM Receive End	In bit times, this is the frame position at which the SM/BHS will cease receiving transmission from the AP/BHM.
SM Transmit Start	In bit times, this is the frame position at which the SM/BHS starts the transmission.
SM One Way Air Delay	This field displays the time in ns, that SM/BHS is away from the AP/BHM.
SM Approximate distance	This field displays an approximate distance in miles (feet) that the SM/BHS is away from the AP/BHM.

To use the Frame Calculator to ensure that all APs or BHMs are configured to transmit and receive at the same time, follow the procedure below:

Procedure 26 Using the Frame Calculator

1	Populate the OFDM Frame Calculator parameters with appropriate values as described above.
2	Click the Calculate button.
3	Scroll down the tab to the Calculated Frame Results section
4	Record the value of the AP Receive Start field
5	Enter a parameter set from another AP in the system - for example, an AP in the same cluster that has a higher Max Range value configured.
6	Click the Calculate button.
7	Scroll down the tab to the Calculated Frame Results section
8	If the recorded values of the AP Receive Start fields are within 150 bit times of each other, skip to step 10.
9	If the recorded values of the AP Receive Start fields are not within 150 bit times of each other, modify the Downlink Data parameter until the calculated results for AP Receive Start are within 300 bit time of each other, if possible, 150 bit time.
10	Access the Radio tab in the Configuration web page of each AP in the cluster and change its Downlink Data parameter (percentage) to the last value that was used in the Frame Calculator.

Using the Subscriber Configuration tool

The Subscriber Configuration page in the Tools page of the AP displays:

- The current values whose control may be subject to the setting in the Configuration Source parameter.
- An indicator of the source for each value.

This page may be referenced for information on how the link is behaving based on where the SM is retrieving certain QoS and VLAN parameters.

Figure 83 : SM Configuration page of AP

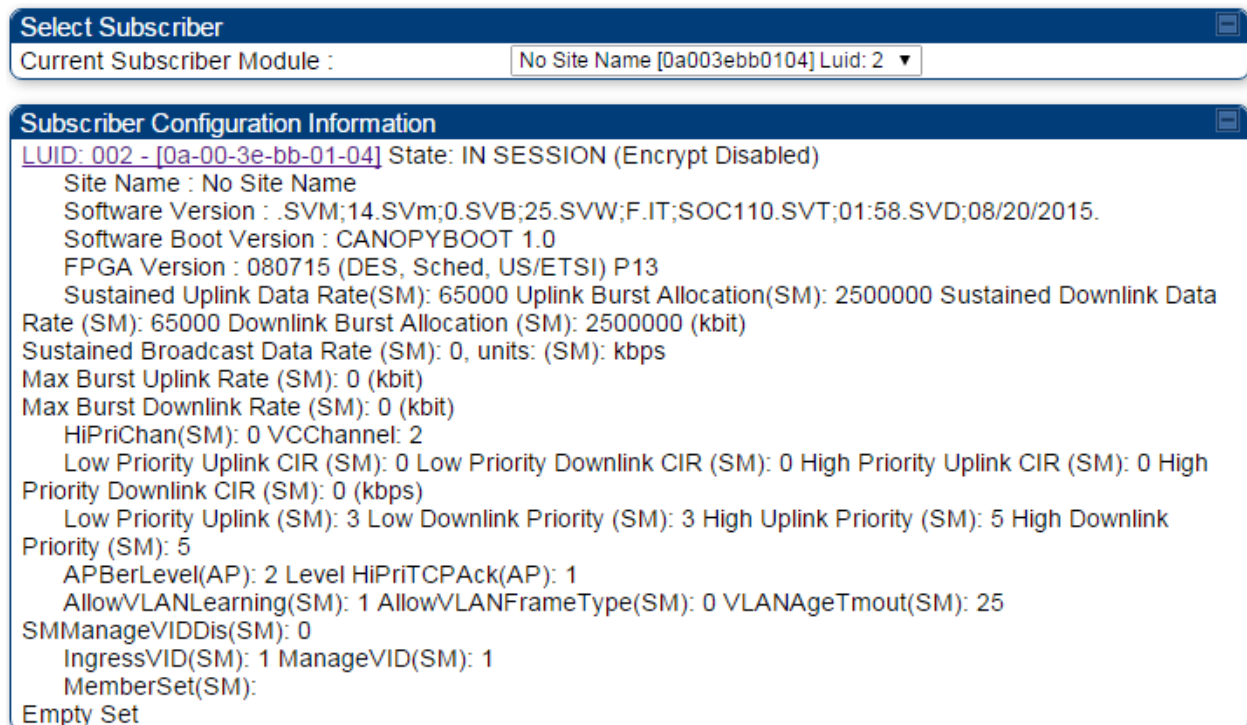

The AP displays one of the following for the configuration source:

- (SM) - QoS/VLAN parameters are derived from the SM's settings
- (APCAP) - QoS/VLAN parameters are derived from the AP's settings, including any keyed capping (for radios capped at 4 Mbps, 10 Mbps, or 20 Mbps)
- (D) - QoS/VLAN parameters are retrieved from the device, due to failed retrieval from the AAA or WM server.
- (AAA) - QoS/VLAN parameters are retrieved from the RADIUS server
- (BAM) - QoS/VLAN parameters are retrieved from a WM BAM server

Using the Link Status tool

The Link Status Tool displays information about the most-recent Link Test initiated on the SM or BHS. Link Tests initiated from the AP or BHM are not included in the Link Status table. This table is useful for monitoring link test results for all SMs or BHS in the system.

The Link Status table is color coded to display health of link between AP/BHM and SM/BHS. The current Modulation Level Uplink/Downlink is chosen to determine link health and color coded accordingly.

Uplink/Downlink Rate Column will be color coded using current Rate as per the table below:

Table 110 :Color code versus uplink/downlink rate column

Actual Rate	1x	2x	3x	4x	6x	8x
SISO	RED	ORANGE	GREEN	BLUE	NA	NA
MIMO-A	RED	ORANGE	GREEN	BLUE	NA	NA
MIMO B	NA	RED	NA	ORANGE	GREEN	BLUE

Link Status – AP/ BHM

The current Uplink Rate for each SM or BHS in Session in now available on AP or BHM Link Status Page. From system release 15.2, a single Rate is used and shown for all data channels of an SM.

The Link Status tool results include values for the following fields for AP/BHM.

Table 111 :Link Status page attributes – AP/BHM

Link Status																
Due to current system load, Downlink Statistics will only be updated at most every 5 seconds.																
Note: To measure the receive modulation of every fragment, Receive Quality Debug must be enabled.																
■ MIMO-B.2X MIMO-A/SISO.1X ■ MIMO-B.4X MIMO-A/SISO.2X ■ MIMO-B.6X MIMO-A/SISO.3X ■ MIMO-B.8X MIMO-A/SISO.4X																
Subscriber	LUID	Downlink Statistics						Uplink Statistics						BER Results	Reg	ReReg
		Beacon % Received Curr/Min/Avg/Max	Power Level dBm: Signal Strength Ratio (dB V - H)	Signal to Noise Ratio (dB)	Average EVM (dB)	Link Test Efficiency	Rate	Power Level dBm: Signal Strength Ratio (dB V - H)	Fragments Modulation	Signal to Noise Ratio (dB)	Average EVM (dB)	Link Test Efficiency	Rate			
vSM - [0a-00-3e-45-11-ed]	002	100/100/100/100	-52.0 (-55.0 V / -55.0 H);0.0	35 V / 36 H	-30 V / -26 H	NA	8X/8X MIMO-B	-54.5 (-56.0 V / -60.0 H);4.0	Path V:QPSK:31% 16-QAM:25% 64-QAM:25% 256-QAM:18% Path H:QPSK:25% 16-QAM:25% 64-QAM:25% 256-QAM:25%	35 V / 37 H	-27 V / -25 H	NA	8X/8X MIMO-B	0.000000e+00	1	0
Path Info :														Path A = -45° Path B = +45°		

Attribute	Meaning
Subscriber	<p>This field displays the MAC address and Site Name of the SM.</p> <div style="border: 1px solid black; padding: 5px; margin-top: 10px;"> <p>Note</p> <p>The MAC is hot link to open the interface to the SM. In some instances, depending on network activity and network design, this route to the interface yields a blank web page. If this occurs, refresh your browser view.</p> <p>Site Name indicates the name of the SM. You can assign or change this name on the Configuration web page of the SM. This information is also set into the sysName SNMP MIB-II object and can be polled by an SNMP management server.</p> </div>
LUID	<p>This field displays the LUID (logical unit ID) of the SM/BHS. As each SM or BHS registers to the AP/BHM, the system assigns an LUID of 2 or a higher unique number to the SM/BHS. If a SM/BHS loses registration with the AP/BHM and then regains registration, the SM/BHS will retain the same LUID.</p>

Attribute	Meaning
	 <p data-bbox="597 268 1414 436"> Note Both the LUID and the MAC are hot links to open the interface to the SM/BHS. In some instances, depending on network activity and network design, this route to the interface yields a blank web page. If this occurs, refresh your browser view. </p>
Downlink Statistics - Beacon % Received Curr/Min/Max/Avg	This field displays a count of beacons received by the SM in percentage. This value must be between 99-100%. If it is lower than 99%, it indicates a problematic link. This statistic is updated every 16 seconds.
Downlink Statistics - Power Level: Signal Strength Ratio	This field represents the received power level at the SM/BHS as well as the ratio of horizontal path signal strength to vertical path signal strength at the SM/BHS.
Downlink Statistics - Signal to Noise Ratio	This field represents the signal to noise ratio for the downlink (displayed when parameter Signal to Noise Ratio Calculation during Link Test is enabled) expressed for both the horizontal and vertical channels.
Downlink Statistics - Average EVM (dB)	This field displays the average EVM statistics that measures RF signal quality.
Downlink Statistics - Link Test Efficiency	This field displays the efficiency of the radio link, expressed as a percentage, for the radio downlink.
Downlink Statistics - SU-MIMO Rate	The SU-MIMO rate applies to all AP platforms. For 450m, this field indicates the rate being used for symbols where this particular VC is not being MU-MIMO grouped with other SMs. For 450 and 450i platforms, there is no grouping and this field indicates the modulation rate for all symbols.
Downlink Statistics - MU-MIMO Rate	This field indicates the modulation rate used for symbols where the low or medium priority data channels are MU-MIMO scheduled by grouping it in the same slot with other low or Medium priority data channels from other SM's.
Uplink Statistics - Power Level: Signal Strength Ratio	This field represents the combined received power level at the AP/BHM as well as the ratio of horizontal path signal strength to vertical path signal strength.
Uplink Statistics - Fragments Modulation	This field represents the percentage of fragments received at each modulation state, per path (polarization).
Uplink Statistics - Signal to Noise	This field represents the signal to noise ratio for the uplink (displayed when parameter Signal to Noise Ratio Calculation during Link Test is enabled) expressed

Attribute	Meaning
Ratio	for both the horizontal and vertical channels.
Uplink Statistics - Link Test Efficiency	This field displays the efficiency of the radio link, expressed as a percentage, for the radio uplink.
Uplink Statistics - SU-MIMO Rate	The SU-MIMO rate applies to all AP platforms. For 450m, this field indicates the rate being used for symbols where a VC is not being MU-MIMO grouped with other SMs. For 450 and 450i platforms, there is no grouping and this field indicates the modulation rate for all symbols.
Uplink Statistics - MU-MIMO Rate	This field indicates the modulation rate used for symbols where the low or medium priority data channels are MU-MIMO scheduled by grouping it in the same slot with other high or ultra high priority data channels from other SM's.
BER Results	This field displays the over-the-air Bit Error Rates for each downlink. (The ARQ [Automatic Resend Request] ensures that the transport BER [the BER seen end-to-end through a network] is essentially zero.) The level of acceptable over-the-air BER varies, based on operating requirements, but a reasonable value for a good link is a BER of 1e-4 (1×10^{-4}) or better, approximately a packet resend rate of 5%. BER is generated using unused bits in the downlink. During periods of peak load, BER data is not updated as often, because the system puts priority on transport rather than on BER calculation.
Reg Requests	A Reg Requests count is the number of times the SM/BHS registered after the AP/BHM determined that the link had been down. If the number of sessions is significantly greater than the number for other SMs/BHS, then this may indicate a link problem (check mounting, alignment, receive power levels) or an interference problem (conduct a spectrum scan).
ReReg Requests	A ReReg Requests count is the number of times the AP/BHM received a SM/BHS registration request while the AP/BHM considered the link to be still up (and therefore did not expect registration requests). If the number of sessions is significantly greater than the number for other SMs/BHS, then this may indicate a link problem (check mounting, alignment, receive power levels) or an interference problem (conduct a spectrum scan).

Link Status – SM/ BHS

The Link Status tool of SM/BHS displays Downlink Status and Uplink Status information.

Table 112 :Link Status page attributes – SM/BHS

Downlink Status	
Receive Power :	-52.5 dBm (-56.0 dBm V / -55.0 dBm H)
Path Info :	Path A = -45° Path B = +45°
Signal Strength Ratio :	-1.0dB V - H
Signal to Noise Ratio :	35 V / 37 H dB
Average EVM :	-30 V / -26 H dB
Beacons :	100 %
Receive Fragments Modulation :	Path V:QPSK:29% 16-QAM:29% 64-QAM:22% 256-QAM:20% Path H:QPSK:27% 16-QAM:27% 64-QAM:27% 256-QAM:18%
Latest Remote Link Test Efficiency Percentage :	NA %
BER Total Avg Results :	0.000000e+00
Beacons Received Last 15 minutes :	100/100/100% (min/avg/max)

Uplink Status	
Transmit Power :	25 dBm (target power [27 dBm] exceeded maximum)
Max Transmit Power :	25 dBm
Power Level :	-54.5 (-56.0 V / -60.0 H) dBm
Signal Strength Ratio :	4.0dB V - H
Signal to Noise Ratio :	36 dB V / 37 dB H
Average EVM :	-27 V / -25 H dB
Latest Remote Link Test Efficiency Percentage :	NA %

Local Status	
Session Status :	REGISTERED 8X/8X MIMO-B
Spatial Frequency :	2048

Link Quality Indicator	
LQI :	100%
Downlink LQI :	100%
Downlink Actual Average Modulation Rate :	8.0X
Downlink Expected Modulation Rate :	8X
Beacon Quality Index :	100%
Uplink LQI :	100%
Uplink Actual Average Modulation Rate :	8.0X
Uplink Expected Modulation Rate :	8X
Re-Registration Quality Index :	100%
Re-Registration Count :	0

Reference LQI	
Reference Downlink Quality Index :	100 %
Reference Uplink Quality Index :	100 %
Access Point MAC Address :	0a-00-3e-45-11-f2

Latest Local Link Test Results	
No test results available.	
<input type="button" value="Run Link Test"/>	

Attribute	Meaning
Downlink Status	
Receive Power	This field lists the current combined receive power level, in dBm.
Path Info	
Signal Strength Ratio	This field displays the difference of the Vertical path received signal power to the Horizontal path received signal power for downlink.
Signal to Noise Ratio	This field lists the current signal-to-noise level, an indication of the separation of the received power level vs. noise floor for downlink.
Average EVM	This field displays the average EVM statistics that measures RF signal quality.
Beacons	Displays a count of beacons received by the SM in percentage. This value must be typically between 99-100%. If lower than 99%, it indicates a problematic link. This statistic is updated every 16 seconds.

Attribute	Meaning
Received Fragments Modulation	This field represents the percentage of fragments received at each modulation state, per path (polarization)
Latest Remote Link Test Efficiency Percentage	This field is not applicable.
BER Total Avg Results	This field displays the over-the-air average Bit Error Rates (BER) for downlink.
Beacons Received Last 15 minutes	The beacon count on the SM can be used to estimate the interference in the channel. The min/avg/max beacon percentage displayed based on this value for the last 15 mins.
Uplink Status	
Transmit Power	This field displays the current combined transmit power level, in dBm.
Max Transmit Power	This field displays the maximum transmit power of SM.
Power Level	This field indicates the combined power level at which the SM is set to transmit, based on the Country Code and Antenna Gain settings.
Signal Strength Ratio	This field displays the difference of the Vertical path received signal power to the Horizontal path received signal power for uplink.
Signal to Noise Ratio	This field lists the current signal-to-noise level, an indication of the separation of the received power level vs. noise floor for uplink.
Average EVM	This field displays the average EVM statistics that measures RF signal quality.
Latest Remote Link Test Efficiency Percentage	This field is not applicable.
Local Stats	
Session Status	This field displays the current state, Virtual channel, channel rate adaptation and MIMO-A/MIMO-B/SISO status of SM.
Spatial Frequency	This field displays the spatial frequency value of the VC or SM.
Run Link Test	<div style="border: 1px solid gray; padding: 5px; display: inline-block; margin-bottom: 10px;">Run Link Test</div> <p>See Exploratory Test section of Performing Extrapolated Link Test</p>
Link Quality Indicator	
LQI	This field displays the quality of the link used for data communication between AP and SM.

Attribute	Meaning
	This value is derived by calculating: Downlink LQI value * Uplink LQI value * Re-Registration Quality Index value
Downlink LQI	This field displays the downlink quality of the link. It is the ratio of Actual Average Modulation Rate of the data packets and the expected modulation rate.
Downlink Actual Average Modulation Rate	This field displays the average value of the actual Downlink modulation rate.
Downlink Expected Modulation Rate	This field displays the expected Downlink modulation rate.
Beacon Quality Index	This field displays the Beacon Quality Index. It is calculated based on the receive beacon percentage.
Uplink LQI	This field displays the uplink quality of the link. It is the ratio of Actual Average Modulation Rate of the data packets and the expected modulation rate.
Uplink Actual Average Modulation Rate	This field displays the average value of the actual uplink modulation rate.
Uplink Expected Modulation Rate	This field displays the expected Uplink modulation rate.
Re-Registration Quality Index	This field displays the number of re-registrations of the SM. When there are no re-registrations, this quality index will be 100%.
Re-Registration Count	This field displays the re-registration count of the SM.
Reference Downlink Quality Index	Downlink reference EVM used for LQI calculations.
Reference Uplink Quality Index	Uplink reference EVM used for LQI calculations.
Access Point MAC Address	This field displays the MAC address of the AP to which this SM is registered.

Using BER Results tool

Radio BER data represents bit errors at the RF link level. Due to CRC checks on fragments and packets and ARQ (Automatic Repeat Request), the BER of customer data is essentially zero. Radio BER gives one indication of link quality. Other important indications to consider includes the received power level, signal to noise ratio and link tests.

BER is only instrumented on the downlink and is displayed on the BER Results tab of the Tools page in any SM. Each time the tab is clicked, the current results are read and counters are reset to zero.

The BER Results tab can be helpful in troubleshooting poor link performance.

The link is acceptable if the value of this field is less than 10^{-4} . If the BER is greater than 10^{-4} , re-evaluate the installation of both modules in the link.

The BER test signal is broadcast by the AP/BHM (and compared to the expected test signal by the SM/BHS) only when capacity in the sector allows it. This signal is the lowest priority for AP/BHM transmissions.

Figure 84 : BER Results tab of the SM

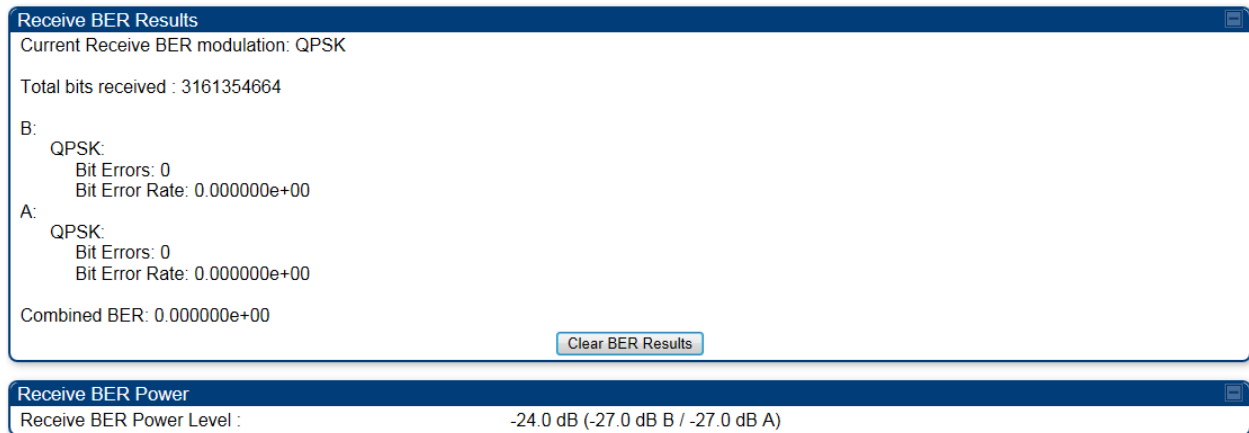

Using the Sessions tool

The PMP 450 Platform Family AP has a tab Sessions under the Tools category which allows operators to drop one or all selected SM sessions and force a SM re-registration. This operation is useful to force QoS changes for SMs without losing AP logs or statistics. This operation may take 5 minutes to regain all SM registrations.

Figure 85 : Sessions tab of the AP

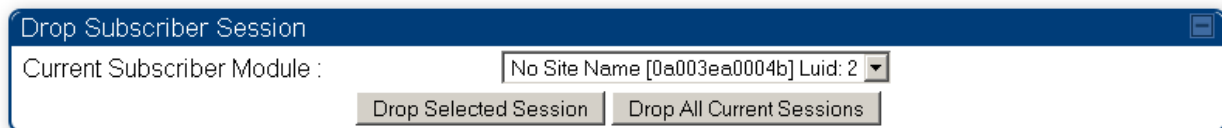

Using the Ping Test tool

The PMP 450 Platform Family AP has a tab Ping Test under the Tools category which allows users to check the accessibility of the given IP V4 address or a valid domain name

Figure 86 : Ping Test tab of the AP

PING Test Settings

IPv4 Address/Fully Qualified Domain Name :

PING Test Results

Pinging www.google.com
[216.58.197.68]

Sent to 216.58.197.68: bytes=64 seq=0
Reply from 216.58.197.68: bytes=64 seq=0 time=70ms
Sent to 216.58.197.68: bytes=64 seq=1
Reply from 216.58.197.68: bytes=64 seq=1 time=110ms
Sent to 216.58.197.68: bytes=64 seq=2
Reply from 216.58.197.68: bytes=64 seq=2 time=110ms
Ping statistics for 216.58.197.68:
Packets: Sent = 3, Received = 3, Lost = 0 (0% loss)
Approximate round trip times in milli-seconds: Minimum = 70ms, Maximum = 110ms, Average = 96ms



Note

When a domain name (for example, www.google.com) is used for ping test, make sure that Preferred DNS Server and Alternate DNS Server parameters are configured in the Configuration > IP tab of the AP.

Chapter 3: Operation

This chapter provides instructions for operators of the 450 Platform Family wireless Ethernet Bridge. The following topics are described in this chapter:

- System information
 - Viewing General Status
 - Viewing Session Status
 - Viewing Remote Subscribers
 - Interpreting messages in the Event Log
 - Viewing the Network Interface
 - Viewing the Layer 2 Neighbors
- System statistics
 - Viewing the Scheduler statistics
 - Viewing list of Registration Failures statistics
 - Interpreting Bridging Table statistics
 - Interpreting Translation Table statistics
 - Interpreting Ethernet statistics
 - Interpreting RF Control Block statistics
 - Interpreting VLAN statistics
 - Interpreting Data Channels statistics
 - Interpreting Proportional Scheduler
 - Interpreting MIR/Burst statistics
 - Interpreting Overload statistics
 - Interpreting DHCP Relay statistics
 - Interpreting Filter statistics
 - Viewing ARP statistics
 - Viewing NAT statistics
 - Viewing NAT DHCP Statistics
 - Interpreting Sync Status statistics

- Interpreting PPPoE Statistics for Customer Activities
 - Interpreting Bridge Control Block statistics
 - Interpreting SNMPv3 Statistics
 - Interpreting syslog statistics
 - Interpreting Frame Utilization statistics
- Radio Recovery

System information

This section describes how to use the summary and status pages to monitor the status of the Ethernet ports and wireless link.

- Viewing General Status
- Viewing Session Status
- Viewing Remote Subscribers
- Interpreting messages in the Event Log
- Viewing the Network Interface
- Viewing the Layer 2 Neighbors

Viewing General Status

The General Status tab provides information on the operation of this AP/BHM and SM/BHS. This is the page that opens by default when you access the GUI of the radio.

General Status page of AP

The General Status page of PMP 450m AP is explained in General Status page attributes – PMP 450m AP

The General Status page of PMP 450 AP is explained in General Status page attributes – PMP 450 AP

The General Status page of PMP 450i AP is explained in General Status page attributes – PMP 450i AP.

Table 113 :General Status page attributes – PMP 450m AP

Device Information	
Device Type :	5.7GHz MU-MIMO OFDM - Access Point - 0a-00-3e-60-34-c8
Board Type :	P14
Product Type :	PMP 450m
Software Version :	CANOPY 15.2 AP
Bootloader Version :	BOOTLOADER 15.1.1/161 2017-06-21 06:50:26 -0500
CPU Usage :	0%
Board MSN :	M9SM0024C4GC
Board Model :	C050045A101A
FPGA Version :	031c76
Uptime :	3d, 03:55:00
System Time :	09:45:10 05/25/2018 UTC
Main Ethernet Interface :	100Base-TX Full Duplex
Region Code :	Other
Regulatory :	Passed
Channel Frequency :	5800.0 MHz
Channel Bandwidth :	10.0 MHz
Cyclic Prefix :	1/16
Frame Period :	2.5 ms
Encryption :	Capable of AES-256 but configured to None
Color Code :	245
Max Range :	25 km
EIRP :	33 dBm
Temperature :	47 °C / 116 °F

Access Point Stats	
Registered SM Count :	1 (1 Data Channels)
Sync Pulse Status :	Receiving Sync (100.0% Sync pulses received)
Sync Pulse Source :	Power Port (Canopy Sync)
Maximum Count of Registered SMs :	1

Frame Configuration Information	
Data Slots Down :	15
Data Slots Up :	16
Contention Slots :	4

cnMaestro Connection Stats	
Connection Status :	Device Approval Pending (qa.cloud.cambiumnetworks.com)
AccountID :	

Site Information	
Site Name :	450m
Site Contact :	No Site Contact
Site Location :	No Site Location

Feature Key Information	
MU-MIMO Mode :	MU-MIMO
AES-256 Encryption Keyed :	False
Time Updated and Location Code :	08/10/2017 09:12:40 - sdf5

Attribute	Meaning
Device Type	This field indicates the type of the module. Values include the frequency band of the device, its module type and its MAC address.
Board Type	This field indicates the series of hardware.
Product Type	The field indicates model number of 450m device. The 450m Series has two model variants. <ul style="list-style-type: none"> PMP 450m: This model works in SU-MIMO mode which is default “limited” mode. The MU-MIMO license can be purchased from Cambium Networks and applied. MU-MIMO: This model works in MU-MIMO mode.
Software Version	This field indicates the system release, the time and date of the release and whether communications involving the module are secured by AES encryption. If you request technical support, provide the information from this field.
Bootloader Version	This field indicates the version of Uboot running on the 450m AP platform.
CPU Usage	This field indicates the current CPU utilization of the device.
Board MSN	This field indicates the Manufacturer’s Serial number. A unique serial number assigned to each radio at the factory for inventory and quality control.
Board Model	This field indicates the Manufacturer’s Model number. A unique serial number assigned to each for inventory and quality control.
FPGA Version	This field indicates the version of the field-programmable gate array (FPGA) on the module. If you request technical support, provide the value of this field.
Uptime	This field indicates how long the module has operated since power was applied.
System Time	This field provides the current time. If the AP is connected to a CMM4, then this field provides GMT (Greenwich Mean Time). Any SM that registers to the AP inherits the system time.
Main Ethernet Interface	This field indicates the speed and duplex state of the Ethernet interface to the AP.
Region Code	A parameter that offers multiple fixed selections, each of which automatically implements frequency band range for the selected region. Units shipped to regions other than restrictions the United States must be configured with the corresponding Region Code to comply with local regulatory requirements.
Regulatory	This field indicates whether the configured Country Code and radio frequency are compliant with respect to their compatibility. 450 Platform Family products shipped to the United States is locked to a Country Code setting of “United States”. Units shipped to regions other than the United States must be configured with the corresponding Country Code to comply with local regulatory requirements.
DFS (Dynamic Frequency)	This field dynamically selects frequency based on detection of radar pulses.

Attribute	Meaning
Selection)	
Channel Frequency	This field indicates the current operating center frequency, in MHz.
Channel Bandwidth	This field indicates the current size of the channel band used for radio transmission.
Cyclic Prefix	OFDM technology uses a cyclic prefix, where a portion of the end of a symbol (slot) is repeated at the beginning of the symbol to allow multi-pathing to settle before receiving the desired data. A 1/16 cyclic prefix means that for every 16 bits of throughput data transmitted, an additional bit is used.
Frame Period	This field indicates the current Frame Period setting of the radio in ms.
Encryption	This field indicates the capability and the encryption configuration of the device.
Color Code	<p>This field displays a value from 0 to 254 indicating the AP's configured color code. For registration to occur, the color code of the SM and the AP must match. Color code is not a security feature. Instead, color code is a management feature, typically for assigning each sector a different color code.</p> <p>Color code allows you to force a SM to register to only a specific AP, even where the SM can communicate with multiple APs. The default setting for the color code value is 0. This value matches only the color code of 0 (not all 255 color codes).</p>
Max Range	This field indicates the setting of the Max Range parameter, which contributes to the way the radio transmits. Verify that the Max Range parameter is set to a distance slightly greater than the distance between the AP and the furthest SM that must register to this AP.
EIRP	This field indicates the combined power level at which the AP will transmit, based on the Country Code.
Temperature	This field indicates the current operating temperature of the device board.
Registered SM Count	This field indicates how many SMs are registered to the AP.
Sync Pulse Status	<p>This field indicates the status of synchronization as follows:</p> <p>Generating Sync indicates that the module is set to generate the sync pulse.</p> <p>Receiving Sync indicates that the module is set to receive a sync pulse from an outside source and is receiving the pulse.</p> <p>No Sync Since Boot up / ERROR: No Sync Pulse indicates that the module is set to receive a sync pulse from an outside source and is not receiving the pulse.</p> <div style="display: flex; align-items: center; margin-top: 10px;">  <div style="border: 1px solid black; background-color: #e6f2ff; padding: 5px;"> <p>Note</p> <p>When this message is displayed, the AP transmitter is turned off to avoid self-interference within the system.</p> </div> </div>
Sync Pulse	This field indicates the status of the synchronization source:

Attribute	Meaning
Source	<p>Searching indicates that the unit is searching for a GPS fix</p> <p>Timing Port/UGPS indicates that the module is receiving sync via the timing AUX/SYNC timing port</p> <p>Power Port indicates that the module is receiving sync via the power port (Ethernet port).</p> <p>On-board GPS indicates that the module is receiving sync via the unit's internal GPS module</p>
Maximum Count of Registered SMs	<p>This field displays the largest number of SMs that have been simultaneously registered in the AP since it was last rebooted. This count can provide some insight into sector history and provide comparison between current and maximum SM counts at a glance.</p>
Data Slots Down	<p>This field indicates the number of frame slots that are designated for use by data traffic in the downlink (sent from the AP to the SM). The AP calculates the number of data slots based on the Max Range, Downlink Data and (reserved) Contention Slots configured by the operator.</p>
Data Slots Up	<p>This field indicates the number of frame slots that are designated for use by data traffic in the uplink (sent from the SM to the AP). The AP calculates the number of data slots based on the Max Range, Downlink Data and (reserved) Contention Slots configured by the operator.</p>
Contention Slots	<p>This field indicates the number of (reserved) Contention Slots configured by the operator. See Contention slots.</p>
Connection Status	<p>This field indicates the device connectivity to cnMaestro (Cambium's cloud-based network management system).</p>
Account ID	<p>This field shows Account ID which is registered with Cambium Networks and it allows operator to manage devices using cnMaestro.</p>
Site Name	<p>This field indicates the name of the physical module. You can assign or change this name in the SNMP tab of the AP Configuration page. This information is also set into the sysName SNMP MIB-II object and can be polled by an SNMP management server.</p>
Site Contact	<p>This field indicates contact information for the physical module. You can provide or change this information in the SNMP tab of the AP Configuration page. This information is also set into the sysName SNMP MIB-II object and can be polled by an SNMP management server.</p>
Site Location	<p>This field indicates site information for the physical module. You can provide or change this information in the SNMP tab of the AP Configuration page.</p>
MU-MIMO Mode	<p>This field displays information about MU-MIMO mode. If AP is keyed as MU-MIMO, it will display "MU-MIMO" (Multi User - MIMO) otherwise it will display "SU-MIMO" (Single User - MIMO).</p>
AES-256 Encryption Keyed	<p>This displays the status of the entered AES-256 Encryption Key.</p>

Attribute	Meaning
	 <div style="border: 1px solid black; background-color: #e1f5fe; padding: 5px; margin-top: 5px;"> <p>Note</p> <p>To enable AES-256 Encryption, a feature key needs to be purchased.</p> </div>
Time Updated and Location Code	This field displays information about the keying of the radio.

Table 114 :General Status page attributes - PMP 450 AP

Device Information	
Device Type :	5.7GHz MIMO OFDM - Access Point - 0a-00-3e-b1-2a-78
Board Type :	P12
Product Type :	PMP 450
Software Version :	CANOPY 15.2 AP
CPU Usage :	Curr/Max: 9%/95%
Board MSN :	6069QU0F0C
FPGA Version :	062618
PLD Version :	20
Uptime :	03:44:31
System Time :	09:11:33 07/12/2018 UTC
Main Ethernet Interface :	100Base-TX Full Duplex
Region Code :	Other
Regulatory :	Passed
Antenna Type :	External
Channel Frequency :	5850.0 MHz
Channel Bandwidth :	20.0 MHz
Cyclic Prefix :	1/16
Frame Period :	2.5 ms
Encryption :	Capable of AES-128 but configured to None
Color Code :	171
Max Range :	3 Miles
Transmit Power :	0 dBm
Total Antenna Gain :	0 dBi
Temperature :	29 °C / 85 °F

Access Point Stats	
Registered SM Count :	1 (1 Data Channels)
Sync Pulse Status :	Generating Sync
Sync Pulse Source :	Self Generate
Maximum Count of Registered SMs :	1

Frame Configuration Information	
Data Slots Down :	40
Data Slots Up :	41
Contention Slots :	3

cnMaestro Connection Stats	
Connection Status :	Connected (cloud.cambiumnetworks.com)
AccountID :	GRE001

Site Information	
Site Name :	No Site Name
Site Contact :	No Site Contact
Site Location :	No Site Location

Feature Key Information	
AES-256 Encryption Keyed :	False
Time Updated and Location Code :	05/09/2017 06:23:21 - INTL

Attribute	Meaning
Device Type	See General Status page attributes - PMP 450m AP for details
Board Type	
Product Type	This indicates model of the device.
Software Version	See General Status page attributes - PMP 450m AP for details
CPU Usage	This field indicates the current CPU utilization of the device.
Board MSN	This field indicates the Manufacturer's Serial number. A unique serial number assigned to each radio at the factory for inventory and quality control.
FPGA Version	See General Status page attributes - PMP 450m AP for details
PLD Version	This field indicates the firmware version on the Programmable Logic Device.
Uptime	See General Status page attributes - PMP 450m AP for details
System Time	
Main Ethernet Interface	

Attribute	Meaning
Region Code	See General Status page attributes - PMP 450m AP for details
Regulatory	
Antenna Type	
Channel Center Frequency	
Channel Bandwidth	
Cyclic Prefix	
Frame Period	
Color Code	
Max Range	
Transmit Power	This field indicates the combined power level at which the AP is set to transmit, based on the Country Code and Antenna Gain settings.
Temperature	See General Status page attributes - PMP 450m AP for details
Total Antenna Gain	This field indicates the total antenna gain.
Sync Pulse Status	See General Status page attributes - PMP 450m AP for details
Sync Pulse Source	
Maximum Count of Registered SMs	
Data Slots Down	
Data Slots Up	
Contention Slots	
Connection Status	
Account ID	
Site Name	
Site Contact	
Site Location	
Time Updated and Location Code	

Table 115 :General Status page attributes - PMP 450i AP

Device Information	
Device Type :	5.4GHz MIMO OFDM - Access Point - 0a-00-3e-bb-01-77
Board Type :	P13
Product Type :	PMP 450i
Software Version :	CANOPY 15.1.5 AP-None
CPU Usage :	2%
Board MSN :	PMP450IMSN
Board Model :	C050045A010A
FPGA Version :	020118
Uptime :	2d, 07:56:57
System Time :	17:58:46 01/03/2016 UTC
Main Ethernet Interface :	100Base-TX Full Duplex
Aux Ethernet Interface :	Disabled (PoE Disabled)
Region Code :	Other
Regulatory :	Passed
DFS :	Idle
Antenna Type :	External
Channel Frequency :	5705.0 MHz
Channel Bandwidth :	40.0 MHz
Cyclic Prefix :	1/16
Frame Period :	2.5 ms
Color Code :	133
Max Range :	2 Miles
Transmit Power :	27 dBm
Total Antenna Gain :	40 dBi
Temperature :	36 °C / 97 °F

Access Point Stats	
Registered SM Count :	1 (1 Data Channels)
Sync Pulse Status :	Receiving Sync (100.0% Sync pulses received)
Sync Pulse Source :	Power Port (Canopy Sync)
Maximum Count of Registered SMs :	1

Access Point Stats	
Registered SM Count :	1 (1 Data VCs)
Sync Pulse Status :	Generating Sync
Sync Pulse Source :	Self Generate
Maximum Count of Registered SMs :	1

Frame Configuration Information	
Data Slots Down :	129
Data Slots Up :	43
Contention Slots :	3

cnMaestro Connection Stats	
Connection Status :	Cambium-ID Not Configured
AccountID :	

Site Information	
Site Name :	450i AP-133
Site Contact :	No Site Contact
Site Location :	No Site Location

Feature Key Information	
Time Updated and Location Code :	11/01/2017 13:21:54 - INTL

Attribute	Meaning
Device Type	See General Status page attributes - PMP 450m AP for details
Board Type	
Product Type	This indicates model of the device.
Software Version	See General Status page attributes - PMP 450m AP for details
CPU Usage	This field indicates the current CPU utilization of the device.
Board MSN	This field indicates the Manufacturer's Serial number. A unique serial number assigned to each radio at the factory for inventory and quality control.
Board Model	This field indicates the Manufacturer's Model number.
FPGA Version	See General Status page attributes - PMP 450m AP for details
Uptime	
System Time	
Main Ethernet Interface	
Aux Ethernet Interface	See General Status page attributes - PMP 450m AP for details
Region Code	See General Status page attributes - PMP 450m AP for details
Regulatory	
Antenna Type	
Channel Center Frequency	
Channel Bandwidth	
Cyclic Prefix	
Frame Period	
Color Code	
Max Range	
Transmit Power	
Total Antenna Gain	This field indicates the total antenna gain.
Temperature	See General Status page attributes - PMP 450m AP for details
802.3at Type 2 PoE Status	The field displays whether PoE Classification functionality is enabled or disabled. It is only applicable for 450i Series devices.
Registered SM Count	See General Status page attributes - PMP 450m AP for details

Attribute	Meaning
Sync Pulse Status	See General Status page attributes - PMP 450m AP for details
Sync Pulse Source	
Maximum Count of Registered SMs	
Data Slots Down	
Data Slots Up	
Contention Slots	
Connection Status	
Account ID	
Site Name	
Site Contact	
Site Location	
Time Updated and Location Code	

General Status page - SM

The SM's General Status page is explained in below table.



Note
For accurate power level readings to be displayed, traffic must be present on the radio link.

Table 116 :General Status page attributes - SM

Device Information	
Device Type :	4.9/5.9GHz MIMO OFDM - Subscriber Module - 0a-00-3e-78-15-10
Board Type :	P15
Product Type :	PMP 450b High Gain
Software Version :	CANOPY 15.2 SM
CPU Usage :	3%
Board MSN :	M9SM00Z7P2P2
Board Model :	C050045C012A
FPGA Version :	051918
Uptime :	3d, 03:53:38
System Time :	09:49:44 05/25/2018 UTC
Main Ethernet Interface :	No Link
Region Code :	Other
DFS :	Idle
Antenna Type :	Integrated
Frame Period :	2.5 ms
Encryption :	None
Temperature :	68 °C / 155 °F

Subscriber Module Stats	
Session Status :	REGISTERED VC 18 Rate 8X/6X MIMO-B VC 255 Rate 8X/6X MIMO-B
Session Uptime :	1 d, 17:17:57
Registered AP :	0a-00-3e-bb-01-77 450i AP-133
Color Code :	133 (Primary)
Sector ID :	0
Channel Frequency :	5800.0 MHz
Channel Bandwidth :	40.0 MHz
Cyclic Prefix :	1/16
Air Delay :	0 ns, approximately 0.000 miles (0 feet)
Receive Power :	-61.5 dBm
Signal Strength Ratio :	-1.0dB V - H
Signal to Noise Ratio :	30 V / 31 H dB
Beacons :	99 %
Transmit Power :	19 dBm (target power [34 dBm] exceeded maximum)
Total Antenna Gain :	16 dBi

Frame Configuration Information	
Data Slots Down :	129
Data Slots Up :	43
Contention Slots :	3

Region Specific Information	
Region Code :	United Kingdom

cnMaestro Connection Stats	
Connection Status :	Resolving URL (cloud.cambiumnetworks.com - Default Cloud URL)
AccountID :	

Site Information	
Site Name :	450b LG
Site Contact :	No Site Contact
Site Location :	No Site Location

Feature Key Information	
Maximum Throughput :	Unlimited
Time Updated and Location Code :	03/02/2018 09:16:11 - INTL

Attribute	Meaning
Device Type	This field indicates the type of the module. Values include the frequency band of the SM, its module type and its MAC address.
Board Type	This field indicates the series of hardware.
Product Type	This indicates model of the device.
Software Version	This field indicates the system release, the time and date of the release. If you request technical support, provide the information from this field.
CPU Usage	This field indicates the current CPU utilization of the device.
Board MSN	This field indicates the Manufacturer's Serial number. A unique serial number assigned to each radio at the factory for inventory and quality control.
Board Model	This field indicates the Manufacturer's Model number.
FPGA Version	This field indicates the version of the field-programmable gate array (FPGA) on the module. When you request technical support, provide the information from this field.
Uptime	This field indicates how long the module has operated since power was applied.
System Time	This field provides the current time. Any SM that registers to an AP inherits the system time, which is displayed in this field as GMT (Greenwich Mean Time).
Ethernet Interface	This field indicates the speed and duplex state of Ethernet interface to the SM.
Regional Code	A parameter that offers multiple fixed selections, each of which automatically implements frequency band range restrictions for the selected region. Units shipped to regions other than the United States must be configured with the corresponding Country Code to comply with local regulatory requirements.
DFS	This field indicates that DFS operation is enabled based on the configured region code, if applicable.
Antenna	The current antenna type that has been selected.

Attribute	Meaning
Type	
Frame Period	This field indicates the current Frame Period setting of the radio in ms.
Encryption	This field indicates the capability and the encryption configuration of the device.
Temperature	The current operating temperature of the board.
Session Status	<p>This field displays the following information about the current session:</p> <p>Scanning indicates that this SM currently cycles through the radio frequencies that are selected in the Radio tab of the Configuration page.</p> <p>Syncing indicates that this SM currently attempts to receive sync.</p> <p>Registering indicates that this SM has sent a registration request message to the AP and has not yet received a response.</p> <p>Registered indicates that this SM is both:</p> <ul style="list-style-type: none"> • registered to an AP. • ready to transmit and receive data packets.
Session Uptime	This field displays the duration of the current link. The syntax of the displayed time is hh:mm:ss.
Registered AP	Displays the MAC address and site name of the AP to which the SM is registered to. This parameter provides click-through proxy access to the AP's management interface.
Color Code	<p>This field displays a value from 0 to 254 indicating the SM's configured color code. For registration to occur, the color code of the SM and the AP must match. Color code is not a security feature. Instead, color code is a management feature, typically for assigning each sector a different color code.</p> <p>Color code allows you to force a SM to register to only a specific AP, even where the SM can communicate with multiple APs. The default setting for the color code value is 0. This value matches only the color code of 0 (not all 255 color codes).</p>
Channel Frequency	This field lists the current operating frequency of the radio.
Channel Bandwidth	The size in MHz of the operating channel.
Cyclic Prefix	OFDM technology uses a cyclic prefix, where a portion of the end of a symbol (slot) is repeated at the beginning of the symbol to allow multi-pathing to settle before receiving the desired data. A 1/16 cyclic prefix means that for every 16 bits of throughput data transmitted, an additional bit is used.
Air Delay	This field displays the distance in feet between this SM and the AP. To derive the distance in meters, multiply the value of this parameter by 0.3048. Distances reported as less than 200 feet (61 meters) are unreliable.
Receive	This field lists the current combined receive power level, in dBm.

Attribute	Meaning
Power	
Signal Strength Ratio	This field displays the difference of the Vertical path received signal power to the Horizontal path received signal power.
Signal to Noise Ratio	This field lists the current signal-to-noise level, an indication of the separation of the received power level vs. noise floor.
Beacons	Displays a count of beacons received by the SM in percentage. This value must be typically between 99-100%. If lower than 99%, it indicates a problematic link. This statistic is updated every 16 seconds.
Transmit Power	<p>This field lists the current combined transmit power level, in dBm.</p> <div data-bbox="386 678 456 751" style="float: left; margin-right: 10px;"> </div> <div data-bbox="524 674 1422 1024" style="border: 1px solid black; padding: 10px; background-color: #e6f2ff;"> <p>Note</p> <p>The red SM message “target power exceeded maximum” does not necessarily indicate a problem.</p> <div style="border: 1px solid black; padding: 5px; margin: 5px 0;"> <p>7 dBm (target power [24 dBm] exceeded maximum)</p> </div> <p>In this case, the AP is requesting the SM to transmit at a higher power level, but the SM is restricted due to EIRP limits or hardware capabilities. This message can be an indication that the SM is deployed further from the AP than optimal, causing the AP to adjust the SM to maximum transmit power.</p> </div>
Data Slots Down	This field lists the number of slots used for downlink data transmission.
Data Slots Up	This field lists the number of slots used for uplink data transmission.
Contention Slots	This field indicates the number of (reserved) Contention Slots configured by the operator. See Contention slots .
Site Name	This field indicates the name of the physical module. You can assign or change this name in the SNMP tab of the SM Configuration page. This information is also set into the sysName SNMP MIB-II object and can be polled by an SNMP management server.
Site Contact	This field indicates contact information for the physical module. You can provide or change this information in the SNMP tab of the SM Configuration page. This information is also set into the sysName SNMP MIB-II object and can be polled by an SNMP management server.
Site Location	This field indicates site information for the physical module. You can provide or change this information in the SNMP tab of the SM Configuration page.
Maximum Throughput	This field indicates the limit of aggregate throughput for the SM and is based on the default (factory) limit of the SM and any floating license that is currently assigned to it.
Time	This field displays information about the keying of the radio.

Attribute	Meaning
Updated and Location Code	



Note

For PMP 450 SM 900 MHz, there is additional parameter Path Info (under Subscriber Module Stats) which displays polarization path(A & B) information.

Device Information	
Device Type :	900MHz - Subscriber Module - 0a-00-3e-45-fc-36
Board Type :	P11 C120
Software Version :	CANOPY 14.2 (Build 12) SM-DES
Board MSN :	6069RU0TYJ
Board Model :	C009045C001A
FPGA Version :	040716
Uptime :	00:30:16
System Time :	02:36:06 02/13/2011 IST
Main Ethernet Interface :	No Link
Region Code :	Other
Antenna Type :	External
Frame Period :	5.0 ms
Temperature :	78 °C / 172 °F

Subscriber Module Stats	
Session Status :	REGISTERED VC 18 Rate 8X/6X MIMO-B
Session Uptime :	00:26:35
Registered AP :	0a-00-3e-45-86-f0 SIT-waterfall
Color Code :	86 (Primary)
Channel Frequency :	912.00 MHz
Channel Bandwidth :	10.0 MHz
Cyclic Prefix :	1/16
Air Delay :	175 ns, approximately 0.016 miles (86 feet)
Receive Power :	-71.9 dBm
Signal Strength Ratio :	3.0dB B - A
Signal to Noise Ratio :	28 B / 28 A dB
Path Info :	Path A = -45° Path B = +45°
Beacons :	100 %
Transmit Power :	25 dBm
Total Antenna Gain :	0 dBi (0 dBi external + 0 dBi internal)

General Status page of BHM

The BHM's General Status page is explained in below table.

Table 117 :General Status page attributes - BHM

Device Information	
Device Type :	5.7GHz MIMO OFDM - Backhaul - Timing Master - 0a-00-3e-bb-b0-c1
Board Type :	P13
Product Type :	PTP 450i
Software Version :	CANOPY 15.1.5 BHUL450-None
CPU Usage :	2%
Board MSN :	M9TJ1G92GCJH
Board Model :	C050045B001A
FPGA Version :	020118
Uptime :	01:01:51
System Time :	23:19:08 01/02/2016 UTC
Main Ethernet Interface :	100Base-TX Full Duplex
Aux Ethernet Interface :	Disabled (PoE Disabled)
Region Code :	Other
Regulatory :	Passed
Antenna Type :	External
Channel Frequency :	5750.0 MHz
Channel Bandwidth :	40.0 MHz
Cyclic Prefix :	1/16
Frame Period :	5.0 ms
Color Code :	38
Transmit Power :	16 dBm
Total Antenna Gain :	0 dBi
Temperature :	31 °C / 88 °F
802.3at Type 2 PoE Status :	Not Present (Ignored)

Backhaul Stats	
Timing Slave Status :	Connected
Sync Pulse Status :	Generating Sync
Sync Pulse Source :	Self Generate

Frame Configuration Information	
Data Slots Down :	191
Data Slots Up :	192

cnMaestro Connection Stats	
Connection Status :	Remote management using cnMaestro is disabled
AccountID :	

Site Information	
Site Name :	
Site Contact :	No Site Contact
Site Location :	No Site Location

Feature Key Information	
Time Updated and Location Code :	01/03/2018 05:59:03 - FXGD

Attribute	Meaning
Device Type	This field indicates the type of the module. Values include the frequency band of the BHM, its module type and its MAC address.
Board Type	This field indicates the series of hardware.

Attribute	Meaning
Product Type	This indicates model of the device.
Software Version	This field indicates the system release, the time and date of the release. If you request technical support, provide the information from this field.
CPU Usage	This field indicates the current CPU utilization of the device.
Board MSN	This field indicates the Manufacture's Serial number. A unique serial number assigned to each radio at the factory for inventory and quality control.
Board Model	This field indicates the Manufacturer's Model number.
FPGA Version	This field indicates the version of the field-programmable gate array (FPGA) on the module. When you request technical support, provide the information from this field.
Uptime	This field indicates how long the module has operated since power was applied.
System Time	This field provides the current time. Any BHS that registers to a BHM inherits the system time, which is displayed in this field as GMT (Greenwich Mean Time).
Ethernet Interface	This field indicates the speed and duplex state of Ethernet interface to the BHM.
Antenna Type	The current antenna type that has been selected.
Temperature	The current operating temperature of the board.
Session Status	<p>This field displays the following information about the current session:</p> <p>Scanning indicates that this BHS currently cycles through the radio frequencies that are selected in the Radio tab of the Configuration page.</p> <p>Syncing indicates that this BHM currently attempts to receive sync.</p> <p>Registering indicates that this BHM has sent a registration request message to the BHM and has not yet received a response.</p> <p>Registered indicates that this BHM is both:</p> <ul style="list-style-type: none"> • Registered to a BHM. • Ready to transmit and receive data packets.
Session Uptime	This field displays the duration of the current link. The syntax of the displayed time is hh:mm:ss.
Registered Backhaul	Displays the MAC address and site name of the BHM to which the BHS is registered to. This parameter provides click-through proxy access to the BHM's management interface.
Channel Frequency	This field lists the current operating frequency of the radio.
Receive Power	This field lists the current combined receive power level, in dBm.
Signal	This field displays the difference of the Vertical path received signal power to the

Attribute	Meaning
Strength Ratio	Horizontal path received signal power.
Transmit Power	This field lists the current combined transmit power level, in dBm.
Signal to Noise Ratio	This field lists the current signal-to-noise level, an indication of the separation of the received power level vs. noise floor.
Beacons	Displays a count of beacons received by the BHM in percentage. This value must be typically between 99-100%. If lower than 99%, it indicates a problematic link. This statistic is updated every 16 seconds.
Air Delay	This field displays the distance in feet between this BHS and the BHM. To derive the distance in meters, multiply the value of this parameter by 0.3048. Distances reported as less than 200 feet (61 meters) are unreliable.
Data Slots Down	This field lists the number of slots used for downlink data transmission.
Data Slots Up	This field lists the number of slots used for uplink data transmission.
Regional Code	A parameter that offers multiple fixed selections, each of which automatically implements frequency band range restrictions for the selected region. Units shipped to regions other than the United States must be configured with the corresponding Country Code to comply with local regulatory requirements.
Site Name	This field indicates the name of the physical module. Assign or change this name in the Configuration > SNMP page. This information is also set into the sysName SNMP MIB-II object and can be polled by an SNMP management server.
Time Updated and Location Code	This field displays information about the keying of the radio.

General Status page of BHS

The BHS's General Status page is explained in below table.

Table 118 :General Status page attributes - BHS

Device Information	
Device Type :	4.9/5.9GHz MIMO OFDM - Backhaul - Timing Slave - 0a-00-3e-bb-ae-1b
Board Type :	P13
Product Type :	PTP 450i
Software Version :	CANOPY 15.1.5 BHUL450-DES
CPU Usage :	2%
Board MSN :	M9TJ1DRLGM5L
Board Model :	C050045B001A
FPGA Version :	020118
Uptime :	01:00:23
System Time :	23:22:08 01/02/2016 UTC
Main Ethernet Interface :	No Link
Aux Ethernet Interface :	Disabled (PoE Disabled)
Region Code :	Other
DFS :	Idle
Antenna Type :	External
Frame Period :	5.0 ms
Temperature :	27 °C / 81 °F
802.3at Type 2 PoE Status :	Not Present (Ignored)

Timing Slave Stats	
Session Status :	REGISTERED VC 18 Rate 8X/1X MIMO-A VC 255 Rate 8X/8X MIMO-B
Session Uptime :	00:59:53
Registered Backhaul :	0a-00-3e-bb-b0-c1
Channel Frequency :	5750.0 MHz
Channel Bandwidth :	40.0 MHz
Cyclic Prefix :	1/16
Air Delay :	100 ns, approximately 0.009 miles (49 feet)
Receive Power :	-42.9 dBm
Signal Strength Ratio :	2.0dB V - H
Signal to Noise Ratio :	43 V / 43 H dB
Transmit Power :	16 dBm
Total Antenna Gain :	0 dBi
Beacons :	100 %

Frame Configuration Information	
Data Slots Down :	191
Data Slots Up :	192

Region Specific Information	
Region Code :	Other

cnMaestro Connection Stats	
Connection Status :	Device Not Claimed (cloud.cambiumnetworks.com - Default Cloud URL)
AccountID :	

Site Information	
Site Name :	No Site Name
Site Contact :	No Site Contact
Site Location :	No Site Location

Feature Key Information	
Time Updated and Location Code :	01/03/2018 06:11:06 - HJDJ

Attribute	Meaning
Device Type	See General Status page attributes - BHS
Board Type	
Software Version	
CPU Usage	
Board MSN	
Board Model	
FPGA Version	
Uptime	
System Time	
Ethernet Interface	
Antenna Type	
Temperature	
Session Status	
Session Uptime	
Registered Backhaul	
Channel Frequency	
Receive Power	
Signal Strength Ratio	
Transmit Power	
Signal to Noise Ratio	
Beacons	
Air Delay	
Data Slots Down	
Data Slots Up	
Regional Code	
Site Name	
Site Contact	
Site Location	
Time Updated and Location Code	

Viewing Session Status

The Session Status page in the Home page provides information about each SM or BHS that has registered to the AP or BHM. This information is useful for managing and troubleshooting a system. This page also includes the current active values on each SM or BHS for MIR and VLAN, as well as the source of these values, representing the SM/BHS itself, Authentication Server, or the Authentication Server and SM/BHS.



Note

For accurate power level readings to be displayed, traffic must be present on the radio link.

The Session Status List has four tabs: Device, Session, Power, Configuration, and Link Quality.

The Session Status .xml hyper link allows user to export session status page from web management interface of AP or BHM. The session status page will be exported in xml file.

Device tab

The Device tab provides information on the Subscriber's LUID and MAC, Hardware, Software, FPGA versions and the state of the SM/BHS (Registered and/or encrypted).

Table 119 : Device tab attributes

Subscriber	LUID	Hardware	Software Version	FPGA Version	State
No Site Name [0a-00-3e-42-a9-4d]	002	PMP 450	CANOPY 15.2	062618 P11	IN SESSION

Attribute	Meaning
Subscriber	<p>This field displays the LUID (logical unit ID), MAC address and Site Name of the SM/BHS.</p> <div data-bbox="362 1360 430 1436" data-label="Image"> </div> <div data-bbox="495 1354 565 1381" data-label="Section-Header"> <h3>Note</h3> </div> <div data-bbox="495 1400 1429 1497" data-label="Text"> <p>The MAC is a hot link to open the interface to the SM/BHS. In some instances, depending on network activity and network design, this route to the interface yields a blank web page. If this occurs, refresh your browser view.</p> </div> <p>Site Name indicates the name of the SM/BHS. Change this name on the Configuration web page of the SM/BHS. This information is also set into the sysName SNMP MIB-II object and can be polled by an SNMP management server.</p>
LUID	<p>This field displays the LUID (logical unit ID) of the SM/BHS. As each SM or BHS registers to the AP/BHM, the system assigns an LUID of 2 or a higher unique number to the SM/BHS. If a SM/BHS loses registration with the AP/BHM and then regains registration, the SM/BHS will retain the same LUID.</p>

Attribute	Meaning
	 <p>Note</p> <p>Both the LUID and the MAC are hot links to open the interface to the SM/BHS. In some instances, depending on network activity and network design, this route to the interface yields a blank web page. If this occurs, refresh your browser view.</p>
Hardware	This field displays the SMs or BHS hardware type.
Software Version	This field displays the software release that operates on the SM/BHS, the release date and time of the software.
FPGA Version	This field displays the version of FPGA that runs on the SM/BHS
State	<p>This field displays the current status of the SM/BHS as either</p> <ul style="list-style-type: none"> • IN SESSION to indicate that the SM/BHS is currently registered to the AP/BHM. • IDLE to indicate that the SM/BHS was registered to the AP/BHM at one time, but now is not. <p>This field also indicates whether the encryption scheme in the module is enabled.</p>

Session tab

The Session tab provides information on the SMs or BHS Session Count, Reg Count, Re-Reg Count, Uptime, Air delay, PPPoE State and Timeouts.

Table 120 :Session tab attributes

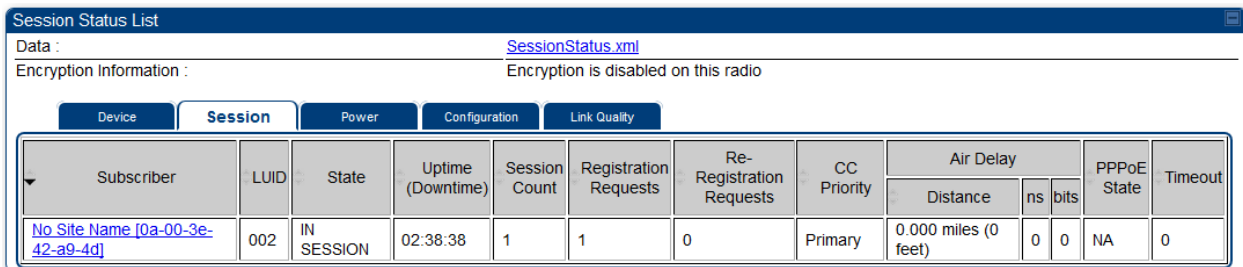

Subscriber	LUID	State	Uptime (Downtime)	Session Count	Registration Requests	Re-Registration Requests	CC Priority	Air Delay			PPPoE State	Timeout
								Distance	ns	bits		
No Site Name [0a-00-3e-42-a9-4d]	002	IN SESSION	02:38:38	1	1	0	Primary	0.000 miles (0 feet)	0	0	NA	0

Attribute	Meaning
Subscriber	See Device tab attributes
LUID	See Device tab attributes
State	This field displays the status of the registered SM.
Uptime (Downtime)	Once a SM/BHS successfully registers to an AP/BHM, this timer is started. If a session drops or is interrupted, this timer is reactivated once re-registration is complete.
Session	This field displays how many sessions the SM/BHS has had with the AP/BHM. Typically,

Attribute	Meaning
Count	<p>this is the sum of Registration Requests and Re-Registration Requests. However, the result of internal calculation may display here as a value that slightly differs from the sum.</p> <p>If the number of sessions is significantly greater than the number for other SMs or BHS, then this may indicate a link problem or an interference problem.</p>
Registration Requests	<p>When a SM/BHS makes a Registration Request, the AP/BHM checks its local session database to see whether it was registered earlier. If the AP/BHM concludes that the SM/BHS is not currently in session database and it is valid Registration Request, then the request increments the value of this field.</p> <p>In ideal situation, the Registration Requests indicates total number of connected SMs to an AP.</p> <div style="display: flex; align-items: center;">  <div style="border: 1px solid black; background-color: #e6f2ff; padding: 5px;"> <p>Note</p> <p>The user can clear Registration Requests by dropping all current sessions of SM (or BHS) from Configuration > Tools > Sessions menu.</p> </div> </div>
Re-Registration Requests	<p>When a SM/BHS makes a Registration Request, the AP/BHM checks its local session database to see whether it was registered earlier. If the AP/BHM concludes that the SM/BHS is currently in session database, then the request increments the value of this field.</p> <p>Typically, a Re-Registration Requests is the case where both:</p> <ul style="list-style-type: none"> • SM/BHS attempts to reregister for having lost communication with the AP/BHM. • AP/BHM has not yet observed the link to the SM/BHS as being down. <p>It is possible for a small period of time if there is no downlink traffic and AP/BHM still assumes the session is up, but the SM/BHS, loses session and quickly re-connects before the AP/BHM knew the session had dropped. This is how a re-registration happens.</p> <p>If the number of sessions is significantly greater than the number for other SMs or BHS, then this may indicate a link problem (check mounting, alignment, receive power levels) or an interference problem (conduct a spectrum scan).</p>
CC Priority	The field displays Color Code Priority (ICC, Primary, Secondary or Tertiary) of all connected SM.
AirDelay	This field displays the distance of the SM/BHS from the AP/BHM in meters, nanoseconds and bits. At close distances, the value in this field is unreliable.
PPPoE state	This field displays the current PPPoE state (whether configured) of the SM/BHS.
Timeout	This field displays the timeout in seconds for management sessions via HTTP, ftp access to the SM/BHS. 0 indicates that no limit is imposed.

Power tab

Table 121: Power tab attributes

Session Status List

Data : [SessionStatus.xml](#)

Encryption Information : Encryption is disabled on this radio

Device Session Power Configuration Link Quality

Subscriber	LUID	Hardware	Downlink Rate		Uplink Rate		AP Rx Power (dBm)	Signal Strength Ratio (dB)	Signal to Noise Ratio (dB)
			SU-MIMO	MU-MIMO	SU-MIMO	MU-MIMO			
LUID: 010 - [0a-00-3e-b0-12-9f]	010	NA	NA	NA	NA	NA	NA	NA	NA
LUID: 011 - [0a-00-3e-70-3f-b5]	011	NA	NA	NA	NA	NA	NA	NA	NA
LUID: 013 - [0a-00-3e-b4-d3-03]	013	NA	NA	NA	NA	NA	NA	NA	NA
SM15 [0a-00-3e-b4-d2-c9]	012	PMP 450	8X/8X MIMO-B	8X/8X MIMO-B	8X/8X MIMO-B	8X/8X MIMO-B	-50.0	0.0dB V - H	35 V / 38 H
SM1 11 [0a-00-3e-b4-24-1a]	003	PMP 450	8X/8X MIMO-B	8X/8X MIMO-B	8X/8X MIMO-B	8X/1X MIMO-A	-51.2	0.5dB V - H	35 V / 38 H
SM2 12 [0a-00-3e-b4-24-08]	008	PMP 450	8X/8X MIMO-B	8X/8X MIMO-B	8X/8X MIMO-B	8X/8X MIMO-B	-50.0	0.0dB V - H	34 V / 38 H
SM3 13 [0a-00-3e-b4-d2-e0]	007	PMP 450	4X/4X MIMO-B	4X/4X MIMO-B	4X/4X MIMO-B	4X/4X MIMO-B	-50.5	1.0dB V - H	20 V / 20 H
SM4 21 [0a-00-3e-b4-d3-36]	002	PMP 450	4X/4X MIMO-B	4X/2X MIMO-A	4X/4X MIMO-B	4X/4X MIMO-B	-50.4	-0.8dB V - H	20 V / 20 H
SM5 24 [0a-00-3e-b4-d2-fe]	005	PMP 450	8X/8X MIMO-B	8X/8X MIMO-B	8X/6X MIMO-B	8X/6X MIMO-B	-50.5	1.0dB V - H	27 V / 32 H
SM6 22 [0a-00-3e-b4-d2-ff]	009	PMP 450	8X/8X MIMO-B	8X/8X MIMO-B	8X/6X MIMO-B	8X/6X MIMO-B	-51.0	0.0dB V - H	26 V / 33 H
SM7 23 [0a-00-3e-b4-c2-5c]	004	PMP 450	8X/8X MIMO-B	8X/8X MIMO-B	8X/6X MIMO-B	8X/6X MIMO-B	-51.6	0.8dB V - H	26 V / 33 H
SM8 26 [0a-00-3e-b4-c2-65]	006	PMP 450	8X/8X MIMO-B	8X/8X MIMO-B	8X/8X MIMO-B	8X/8X MIMO-B	-51.3	-0.7dB V - H	32 V / 36 H

Attribute	Meaning
Subscriber	See Device tab attributes
LUID	
Hardware	This field displays the SMs or BHS hardware type.
Downlink Rate SU-MIMO	<p>This field displays whether the high-priority channel is enabled in the SM/BHS and the status of rate adapt. For example, if “8X/4X” is listed, the radio is capable of operating at 8X but is currently operating at 4X, due to RF conditions.</p> <p>This field also states whether it is MIMO-A or MIMO-B radio e.g. “8X/8X MIMO-B” indicates MIMO-B and “8X/4X MIMO-A” indicates MIMO-A.</p> <p>A data channel starts at its lowest modulation and slowly rate adapts up, as traffic is successfully transmitted over the data channel. From system release 15.2, all data channels in a single SM will have the same modulation rates.</p> <p>Note: The SU-MIMO rate applies to all AP platforms. For 450m, this field indicates the rate being used for symbols where this particular VC is not being MU-MIMO grouped with other SMs.</p>
Downlink Rate MU-MIMO	This field indicates the modulation rate used for symbols where the low or medium priority data channels are MU-MIMO scheduled by grouping it in the same slot with other low or Medium priority data channels from other SM’s.
Uplink Rate SU-MIMO	<p>This field the status of rate adapt. For example, if “8X/4X” is listed, the radio is capable of operating at 8X but is currently operating at 4X, due to RF conditions.</p> <p>This field also states whether it is MIMO-A or MIMO-B radio e.g. “8X/8X MIMO-B” indicates MIMO-B and “8X/4X MIMO-A” indicates MIMO-A.</p> <p>A data channel starts at its lowest modulation and slowly rate adapts up, as traffic is successfully transmitted over the data channel. From system release 15.2, all data channels in a single SM will have the same modulation rates.</p> <p>Note: The SU-MIMO rate applies to all AP platforms. For 450m, this field indicates the rate being used for symbols where this particular VC is not being MU-MIMO grouped with other SMs.</p>

Attribute	Meaning
Uplink Rate MU-MIMO	This field indicates the modulation rate used for symbols where the MUMIMO groupable data channels are MU-MIMO scheduled by grouping it in the same slot with other MU-MIMO groupable data channels from other SM's.
AP Rx Power (dBm)	This field indicates the AP's or BHM's combined receive power level for the listed SM/BHS.
Signal Strength Ratio (dB)	This field displays the ratio of the Vertical path received signal power to the Horizontal path received signal power. This ratio can be useful for determining multipathing conditions (high vertical to horizontal ratio) for Uplink.
Signal to Noise Ratio (dB)	This field lists the current signal-to-noise level, an indication of the separation of the received power level vs. noise floor. In other words, it indicates signal to noise ratio for Uplink.

Configuration tab

The Configuration tab provides information on the SMs or BHS Uplink or Downlink (UL/DL) Sustained Data Rate, UL/DL Burst Allocation, UL/DL Burst Rate, UL/DL Low Priority CIR, UL/DL Medium Priority CIR, UL/DL High Priority CIR, UL/DL Ultra High Priority CIR, the UL/DL Broadcast or Multicast Allocation, SM Prioritization Group, RADIUS Authentication Reply, and RADIUS Authentication Server. This data is refreshed based on the Web Page Auto Update setting on the AP's or BHS's General Configuration page.

Table 122 :Configuration tab attributes

The screenshot shows a web interface titled "Session Status List" with a "Data:" link to "SessionStatus.xml". Below it, "Encryption Information:" states "Encryption is disabled on this radio". There are five tabs: "Device", "Session", "Power", "Configuration" (selected), and "Link Quality". The Configuration tab displays a table with the following data:

Subscriber	LUID		Sustained Data Rate Cap (kbps)	Sustained Data Rate (kbps)	Burst Allocation (kbit)	Max Burst Rate (kbit)	Low Priority CIR (kbps)	Medium Priority CIR (kbps)	High Priority CIR (kbps)	Ultra High Priority CIR (kbps)	Broadcast/Multicast Allocation	SM Prioritization Group (Disabled)	RADIUS Authentication Reply	RADIUS Authentication Server
No Site Name [0a-00-3e-42-a9-4d]	002	Uplink	4000	4000(AAA)	2900(AAA)	5000(AAA)	0(D)	NA	0(D)	NA	50000(D)	Low(D)	SM on 10.110.207.101	10.110.207.101
		Downlink		4000(AAA)	2900(AAA)	5000(AAA)	0(D)	NA	0(D)	NA				

Attribute	Meaning
Subscriber	See Device tab attributes
LUID	
Sustained Data Rate Cap (kbps)	This field specifies the maximum sustained data rate between SM/BHS and AP/BHM. If this field displays "Uncapped", then there is no limit set for data rate. If this field displays 4000, then the maximum sustained data rate between SM/BHS and AP/BHM is limited to 4000 kbps.
Sustained Data Rate (kbps) - Uplink	This field displays the value that is currently in effect for the SM/BHS, with the source of that value in parentheses. This is the specified rate at which each SM/BHS registered to this AP/BHM is replenished with credits for transmission. The configuration source of the value is indicated in parentheses.

Attribute	Meaning
	See Maximum Information Rate (MIR) Parameters on page 1.
Sustained Data Rate (kbps) - Downlink	<p>This field displays the value that is currently in effect for the SM/BHS, with the source of that value in parentheses. This is the specified the rate at which the AP/BHM should be replenished with credits (tokens) for transmission to each of the SMs/BHS's in its sector. The configuration source of the value is indicated in parentheses.</p> <p>See Maximum Information Rate (MIR) Parameters.</p>
Burst Allocation (kbit) - Uplink	<p>This field displays the value that is currently in effect for the SM/BHS, with the source of that value in parentheses. This is the specified maximum amount of data that each SM/BHS is allowed to transmit before being recharged at the Sustained Uplink Data Rate with credits to transmit more. The configuration source of the value is indicated in parentheses.</p> <p>See Interaction of Burst Allocation and Sustained Data Rate Settings.</p>
Burst Allocation (kbit) - Downlink	<p>This field displays the value that is currently in effect for the SM/BHS, with the source of that value in parentheses. This is the specified the rate at which the AP/BHM should be replenished with credits (tokens) for transmission to each of the SMs/BHS's in its sector. The configuration source of the value is indicated in parentheses.</p> <p>See Interaction of Burst Allocation and Sustained Data Rate Settings.</p>
Max Burst Rate (kbit) - Uplink	<p>The data rate at which an SM/BHS is allowed to burst (until burst allocation limit is reached) before being recharged at the Sustained Uplink Data Rate with credits to transit more. When set to 0 (default), the burst rate is unlimited.</p> <p>See Interaction of Burst Allocation and Sustained Data Rate Settings.</p>
Max Burst Rate (kbit) - Downlink	<p>The data rate at which an SM/BHS is allowed to burst (until burst allocation limit is reached) before being recharged at the Sustained Downlink Data Rate with credits to transit more. When set to 0 (default), the burst rate is unlimited.</p> <p>See Interaction of Burst Allocation and Sustained Data Rate Settings.</p>
Low Priority CIR	This field indicates the minimum rate at which low priority traffic is sent over the uplink and downlink (unless CIR is oversubscribed or RF link quality is degraded).
Medium Priority CIR	This field indicates the minimum rate at which medium priority traffic is sent over the uplink and downlink (unless CIR is oversubscribed or RF link quality is degraded).
High Priority CIR	This field indicates the minimum rate at which high priority traffic is sent over the uplink and downlink (unless CIR is oversubscribed or RF link quality is degraded).
Ultra High Priority CIR	This field indicates the minimum rate at which ultra high priority traffic is sent over the uplink and downlink (unless CIR is oversubscribed or RF link quality is degraded).
Broadcast/Multicast Allocation	This field displays the data rate at which Broadcast and Multicast traffic is sent via the radio link.

Attribute	Meaning
SM Prioritization Group	This field displays the priority level configured on the SM under SM Prioritization Group.
RADIUS Authentication Reply	This field displays whether RADIUS server is reachable or not.
RADIUS Authentication Server	This field displays the associated RADIUS Authentication Server for each SM where it was authenticated. This information is useful when there are multiple RADIUS servers (maximum three servers supported by Cambium). If one server is not reachable, other configured servers are tried in sequential order as a fall-back. In this scenario, the Session Status is useful to identify associate RADIUS Authentication Server for all connected SMs.

Table 123 :Session Status > Configuration CIR configuration denotations

Attribute	Meaning
(SM)	QoS/VLAN parameters are derived from the SM's/BHS's settings
(APCAP)	QoS/VLAN parameters are derived from the AP's settings, including any keyed capping (for radios capped at 4 Mbps, 10 Mbps, or 20 Mbps)
(D)	QoS/VLAN parameters are retrieved from the device, due to failed retrieval from the AAA or WM server.
(AAA)	QoS/VLAN parameters are retrieved from the RADIUS server
(BAM)	QoS/VLAN parameters are retrieved from a WM BAM server

Link Quality tab

The Link Quality tab provides information on the Subscriber's UID, Link quality, Downlink, Uplink, Beacon, ReReg, and the Uptime.

This data is refreshed based on the Link Quality Update Interval parameter configuration under the Sessions Status page.

Link Quality Metric parameter offers an option to choose either EVM or Rate based LQI calculation.

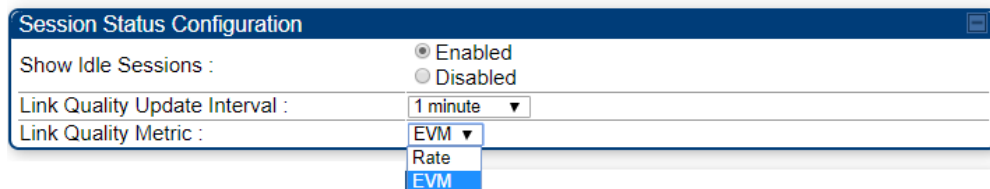

The Link Quality tab displays the calculated Link Quality Indicator (LQI) for the configured interval (Link Quality Update Interval parameter).

Table 124 :Link Quality tab attributes

Link Quality Metric: Rate

Session Status List

Data : [SessionStatus.xml](#)

Encryption Information : Encryption is disabled on this radio

Device Session Power Configuration **Link Quality**

Subscriber	LUID	Link Quality Indicator	Downlink					Uplink			Re-Reg		Uptime
			Quality Index	Actual Average Rate	Expected Rate	Beacon Quality Index	Beacon %	Quality Index	Actual Average Rate	Expected Rate	Quality Index	Count	
SM15 [0a-00-3e-b4-d2-c9]	012	100	100%	8X	8X	100%	100%	100%	8X	8X	100%	0	02:38:46
SM1_11 [0a-00-3e-b4-24-1a]	003	100	100%	8X	8X	100%	100%	100%	8X	8X	100%	0	02:38:13
SM2_12 [0a-00-3e-b4-24-08]	008	100	100%	8X	8X	100%	100%	100%	8X	8X	100%	0	02:38:13
SM3_13 [0a-00-3e-b4-d2-e0]	007	100	100%	4X	4X	100%	100%	100%	4X	4X	100%	0	02:38:17
SM4_21 [0a-00-3e-b4-d3-36]	002	100	100%	4X	4X	100%	100%	100%	4X	4X	100%	0	02:38:17
SM5_24 [0a-00-3e-b4-d2-fe]	005	100	100%	8X	8X	100%	100%	100%	6X	6X	100%	0	02:38:15
SM6_22 [0a-00-3e-b4-d2-f]	009	100	100%	8X	8X	100%	100%	100%	6X	6X	100%	0	02:38:15
SM7_23 [0a-00-3e-b4-c2-5c]	004	100	100%	8X	8X	100%	100%	100%	6X	6X	100%	0	02:38:17
SM8_26 [0a-00-3e-b4-c2-65]	006	100	100%	8X	8X	100%	100%	100%	8X	8X	100%	0	02:38:15

Link Quality Metric: EVM

Session Status List

Data : [SessionStatus.xml](#)

Encryption Information : Encryption is disabled on this radio

Device **Session** Power Configuration Link Quality

Subscriber	LUID	Link Quality Indicator	Downlink					Uplink			Re-Reg		Uptime
			Quality Index	Actual Average EVM	Expected EVM	Beacon Quality Index	Beacon %	Quality Index	Actual Average EVM	Expected EVM	Quality Index	Count	
vSM [0a-00-3e-45-11-ed]	002	99	99%	-28.1	-29.0	100%	100%	100%	-27.1	-25.0	100%	0	3 days, 18:16:17

Attribute	Meaning
Subscriber	See Device tab attributes
LUID	
Link Quality Indicator	This field displays quality of the link. It is calculated based on receive power, modulation rate, re-registrations and beacon percentage.
Downlink - Quality Index	This field displays the downlink quality in percentage. It is calculated based on Downlink receiver power, modulation rate, and beacon percentage.
Downlink - Actual Average Rate	This field displays the average Downlink modulation rate. For 450m, this field specifies the SU-MIMO Modulation Rate. When Rate based LQI is selected, only actual rate and expected rate will be displayed.
Downlink - Actual Average EVM	This field displays the average Downlink EVM rate.
Downlink - Expected Rate	This field displays the expected modulation rate based on receive power in Downlink. When EVM based LQI is selected, only actual EVM and expected EVM will be displayed.

Attribute	Meaning
Downlink Beacon Quality Index	- This field displays the beacon quality index. It is calculated based on beacon percentage.
Downlink Beacon %	- This field displays the received beacon percentage.
Uplink Quality Index	- This field displays the uplink quality in percentage. It is calculated based on Uplink receiver power and modulation rate.
Uplink Actual Average Rate	- This field displays the average Uplink modulation rate.
Uplink Actual Average EVM	- This field displays the average Uplink EVM rate.
Uplink Expected Rate	- This field displays the expected modulation rate based on receive power in Uplink.
Re-Reg - Quality Index	This field displays the re-registration quality. It is calculated based on the re-registration count.
Re-Reg Count	This field displays the number of re-registrations.
Uptime	This field displays the uptime of the device.

Viewing Remote Subscribers

This page allows to view the web pages of registered SMs or BHS over the RF link. To view the pages for a selected SM/BHS, click its link. The General Status page of the SM opens.

Figure 87 : Remote Subscribers page of AP

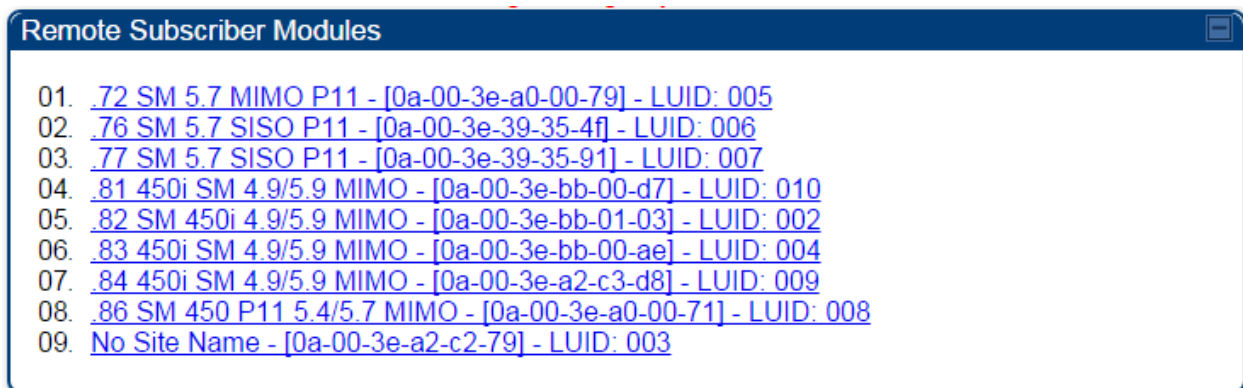

Remote Subscriber Modules	
01.	.72 SM 5.7 MIMO P11 - [0a-00-3e-a0-00-79] - LUID: 005
02.	.76 SM 5.7 SISO P11 - [0a-00-3e-39-35-4f] - LUID: 006
03.	.77 SM 5.7 SISO P11 - [0a-00-3e-39-35-91] - LUID: 007
04.	.81 450i SM 4.9/5.9 MIMO - [0a-00-3e-bb-00-d7] - LUID: 010
05.	.82 SM 450i 4.9/5.9 MIMO - [0a-00-3e-bb-01-03] - LUID: 002
06.	.83 450i SM 4.9/5.9 MIMO - [0a-00-3e-bb-00-ae] - LUID: 004
07.	.84 450i SM 4.9/5.9 MIMO - [0a-00-3e-a2-c3-d8] - LUID: 009
08.	.86 SM 450 P11 5.4/5.7 MIMO - [0a-00-3e-a0-00-71] - LUID: 008
09.	No Site Name - [0a-00-3e-a2-c2-79] - LUID: 003

Interpreting messages in the Event Log

Each line in the Event Log of a module Home page begins with a time and date stamp. However, some of these lines wrap as a combined result of window width, browser preferences and line length. You may find this tab easiest to use if you expand the window till all lines are shown beginning with time and date stamp.

Time and Date Stamp

The time and date stamp reflect one of the following:

- GPS time and date directly or indirectly received from the CMM4.
- NTP time and date from a NTP server (CMM4 may serve as an NTP server)
- The running time and date that you have set in the Time & Date web page.



Note

In the Time & Date web page, if you have left any time field or date field unset and clicked the Set Time and Date button, then the time and date default to **00:00:00 UT: 01/01/00**.

A reboot causes the preset time to pause or, in some cases, to run in reverse. Additionally, a power cycle resets the running time and date to the default **00:00:00 UT: 01/01/00**. Thus, whenever either a reboot or a power cycle has occurred, must reset the time and date in the Time & Date web page of any module that is not set to receive sync.

Event Log Data Collection

The collection of event data continues through reboots and power cycles. When the buffer allowance for event log data is reached, the system adds new data into the log and discards an identical amount of the oldest data.

Each line that contains the expression WatchDog flags an event that was both:

- considered by the system software to have been an exception
- recorded in the preceding line.

Conversely, a Fatal Error () message flags an event that is recorded in the next line. Some exceptions and fatal errors may be significant and require either operator action or technical support.

Figure 88 : Event log data

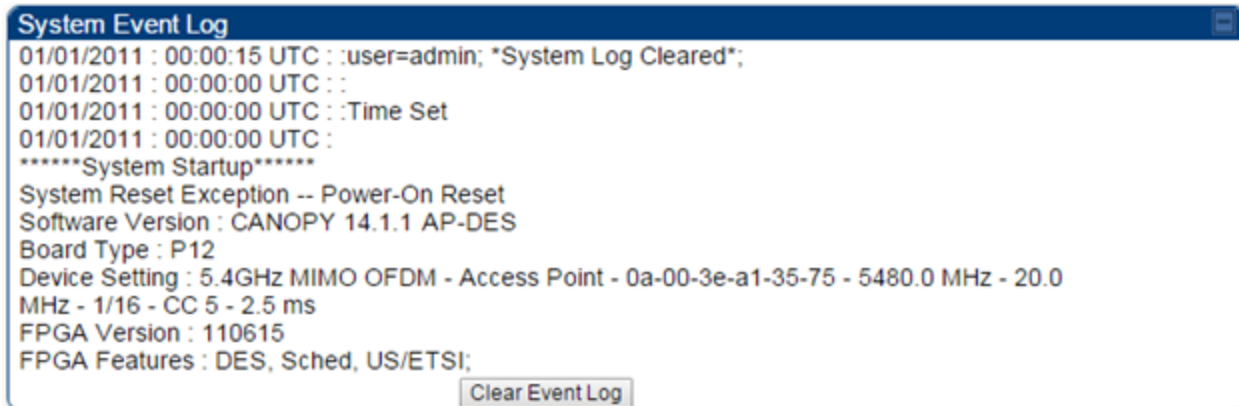

Messages that Flag Abnormal Events

The messages listed below flag abnormal events and, case by case, may signal the need for corrective action or technical support.

Table 125 :Event Log messages for abnormal events

Event Message	Meaning
Expected LUID = 6 Actual LUID = 7	Something is interfering with the control messaging of the module. Also ensure that you are using shielded cables to minimize interference. Consider trying different frequency options to eliminate or reduce interference.
FatalError ()	The event recorded on the line immediately beneath this message triggered the Fatal Error ().
Loss of GPS Sync Pulse	Module has lost GPS sync signal.
Machine Check Exception	This is a symptom of a possible hardware failure. If this is a recurring message, begin the RMA process for the module.
RcvFrmNum = 0x00066d ExpFrmNum = 0x000799	Something is interfering with the control messaging of the module. Also ensure that you are using shielded cables to minimize interference. Consider trying different frequency options to eliminate or reduce interference.
System Reset Exception -- External Hard Reset	The unit lost power or was power cycled.
System Reset Exception -- External Hard Reset WatchDog	The event recorded on the preceding line triggered this WatchDog message.

Messages that Flag Normal Events

The messages listed below record normal events and typically do not signal a need for any corrective action or technical support.

Table 126 :Event Log messages for normal events

Event Message	Meaning
Acquired GPS Sync Pulse.	Module has acquired GPS sync signal.
FPGA Features	Type of encryption.
FPGA Version	FPGA (JBC) version in the module.
GPS Date/Time Set	Module is now on GPS time.
Reboot from Webpage	Module was rebooted from management interface.
Software Boot Version	Boot version in the module.
Software Version	The software release and authentication method for the unit.
System Log Cleared	Event log was manually cleared.

Viewing the Network Interface

In any module, the LAN1 Network Interface section of this tab displays the defined Internet Protocol scheme for the Ethernet interface to the module. In SM/BHS devices, this page also provides an RF Public Network Interface section, which displays the Internet Protocol scheme defined for network access through the master device (AP/BHM).

Figure 89 : Network Interface tab of the AP

LAN1 Network Interface	
Ethernet Interface :	1000Base-TX Full Duplex
IP address :	10.120.226.64
Subnet Mask :	255.255.254.0
Gateway IP address :	10.120.226.254
Preferred DNS Server :	10.120.12.31
Alternate DNS Server :	10.120.12.30
DHCP status :	DHCP not enabled

Figure 90 : Network Interface tab of the SM

LAN1 Network Interface	
Ethernet Interface :	1000Base-TX Full Duplex
IP address :	10.120.216.220
Subnet Mask :	255.255.255.0
Gateway IP address :	10.120.216.254
Preferred DNS Server :	0.0.0.0
Alternate DNS Server :	0.0.0.0
DHCP status :	DHCP not enabled

Viewing the Layer 2 Neighbors

In the Layer 2 Neighbors tab, a module reports any device from which it has received a message in Link Layer Discovery Protocol within the previous two minutes. Given the frequency of LLDP messaging, this means that the connected device will appear in this tab 30 seconds after it is booted and remain until two minutes after its shutdown.

Figure 91: Layer 2 Neighbors page



System statistics

This section describes how to use the system statistics pages to manage the performance of the PMP/PTP 450 Platform Family link.

Viewing the Scheduler statistics

The Statistics > Scheduler page is applicable for all modules (AP/SM/BHM/BHS) and the parameters are displayed as shown below:

Table 127 :Scheduler tab attributes

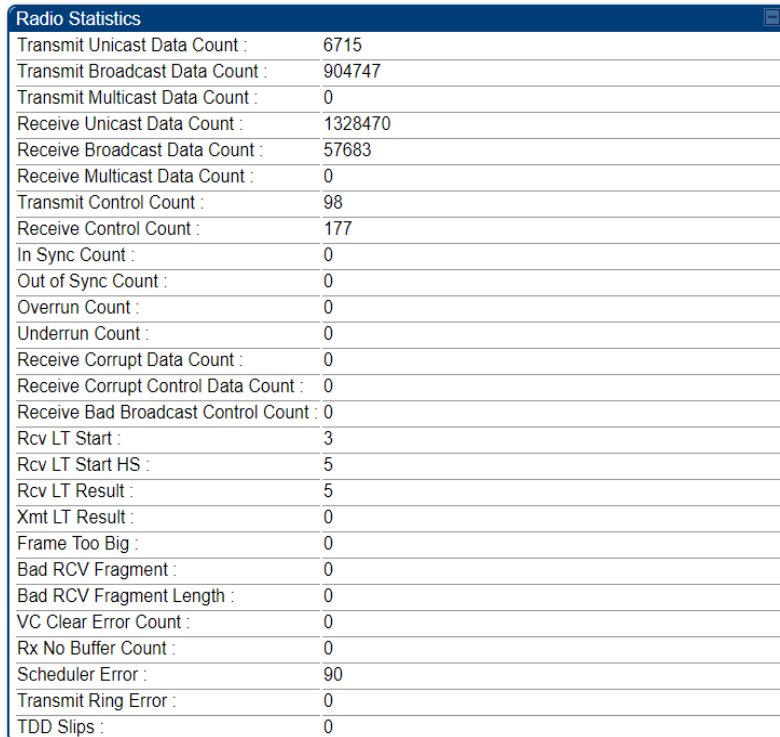

Radio Statistics	
Transmit Unicast Data Count :	6715
Transmit Broadcast Data Count :	904747
Transmit Multicast Data Count :	0
Receive Unicast Data Count :	1328470
Receive Broadcast Data Count :	57683
Receive Multicast Data Count :	0
Transmit Control Count :	98
Receive Control Count :	177
In Sync Count :	0
Out of Sync Count :	0
Overrun Count :	0
Underrun Count :	0
Receive Corrupt Data Count :	0
Receive Corrupt Control Data Count :	0
Receive Bad Broadcast Control Count :	0
Rcv LT Start :	3
Rcv LT Start HS :	5
Rcv LT Result :	5
Xmt LT Result :	0
Frame Too Big :	0
Bad RCV Fragment :	0
Bad RCV Fragment Length :	0
VC Clear Error Count :	0
Rx No Buffer Count :	0
Scheduler Error :	90
Transmit Ring Error :	0
TDD Slips :	0

Attribute	Meaning
Transmit Unicast Data Count	Total amount of unicast packets transmitted from the radio
Transmit Broadcast Data Count	Total amount of broadcast packets transmitted from the radio
Transmit Multicast Data Count	Total amount of multicast packets transmitted by the radio
Receive Unicast Data Count	Total amount of unicast packets received by the radio
Receive Broadcast Data Count	Total amount of broadcast packets received by the radio
Receive Multicast Data Count	Total amount of multicast packets received by the radio
Transmit Control Count	Amount of radio control type messages transmitted (registration requests and grants, etc.)
Receive Control Count	Amount of radio control type messages received (registration requests and grants, etc.)
In Sync Count	Number of times the radio has acquired sync. When GPS synchronization is used it is number of times GPS sync acquired. For the SM, it is the number of times the SM successfully obtained sync with an AP.
Out of Sync Count	Number of times the radio lost same sync lock
Overflow Count	Number of times FPGA frame has overrun its TX Frame
Underrun Count	Number of times FPGAs TX Frame aborted prematurely
Receive Corrupt Data Count	Number of times a corrupt packet has been received at the FPGA.
Receive Corrupt Control Data Count	Number of times a corrupt control data packet has been received at the FPGA.
Receive Bad Broadcast Control Count	Number of times the radio has received an invalid control message via broadcast (SM only).
Rcv LT Start	Number of Link Test Start messages received. A remote radio has requested that this radio start a link test to it.
Rcv LT Start HS	Number of Link Test Start Handshake messages received. This radio requested that a remote radio start a link test and the remote radio has sent a handshake back acknowledging the start.

Attribute	Meaning
Rcv LT Result	This radio received Link Test results from the remote radio under test. When this radio initiates a link test, the remote radio will send its results to this radio for display.
Xmt LT Result	This radio transmitted its link test results to the remote radio under test. When the remote radio initiates a link test, this radio must send its results to the remote radio for display there.
Frame Too Big	This statistic indicates the number of packets received and processed by the radios which were greater than max packet size 1700 bytes.
Bad Acknowledgment	This statistic indicates the number of packets received as bad acknowledgment. It is for engineering use only.
Bad Fragment	This statistic indicates number of fragments tagged internally as bad. It is for engineering use only.
VC Clear Error Count	This statistic indicates number of times VC clear failed.
Rx No Buffer Count	Currently unused
Scheduler Error	This error is incremented when the scheduler cannot send or get scheduled to send a packet. It is also called as "VC Error".
Transmit Ring Error	This is a state that records when Canopy's MAC Transmit Ring Error. One or more of these will cause the session to drop and be re-established. That static should be zero. If you are seeing this statistic increment, please contact Cambium support.
TDD Slips	TDD Slips indicate that the 450m AP processor is heavily loaded and could lead to buffer discards.

Viewing list of Registration Failures statistics

SM Registration Failures page of AP

The SM Registration Failures tab identifies SMs that have recently attempted and failed to register to this AP. With its time stamps, these instances may suggest that a new or transient source of interference exists.

Table 128 :SM Registration Failures page attributes - AP

Registration Failures Statistics	
Number of Registration Grant Failures :	1

Most Recent Registration Failure List	
MAC : 0a-00-3e-04-a7-26	AAA Session Retry 12/31/2010 : 19:23:30 CST : Status : 17 Flag : 0

Attribute	Meaning
Status Flag 0	No response was received from the AAA server and hence SM is trying to send a session request again.

BHS Registration Failures page of BHM

Table 129 :BHS Registration Failures page attributes - BHM

Registration Failures Statistics

Number of Registration Grant Failures : 1

Most Recent Registration Failure List

MAC : 0a-00-3e-04-a7-26 AAA Session Retry 12/31/2010 : 19:23:30 CST : Status : 17 Flag : 0

Attribute	Meaning
Status 17 Flag 0	No response was received from the AAA server and hence BHS is trying to send a session request again.

There is a list of flags from 0 to 20 as shown in Flags status and the “Flags” can be ignored.

Table 130 :Flags status

Flag	Meaning	Flag	Meaning
0	Normal	11	AP Lite Limit Reached
1	Out of Range	12	Only Ver 9.5+ Allowed
2	No Luids	13	Temporary Data VC for AAA
3	BH ReRange	14	AAA Authentication Failure
4	Auth Fail	15	Registration Grant Reject
5	Encrypt Fail	16	Blank
6	Power Adjust	17	AAA Session Retry
7	No VCs	18	AAA Reauth Failure
8	Reserve VC Fail	19	RegReq at zero power
9	Activate VC Fail	20	RegReq no time ref
10	Hi VC Setup Fail	-	-

Interpreting Bridging Table statistics

If NAT (network address translation) is not active on the SM/BHS, then the Bridging Table page provides the MAC address of all devices that are attached to registered SMs/BHS (identified by LUIDs).

The SM/BHS management MAC addresses are also added in bridge table upon SMs/BHS registration. These entries will be removed automatically from the table once SMs/BHS is de-registered. This alleviates the arp cache > bridge cache timeout problems.

The bridging table allows data to be sent to the correct module as follows:

- For the AP/BHM, the uplink is from RF to Ethernet. Thus, when a packet arrives in the RF interface to the AP/BHM, the AP/BHM reads the MAC address from the inbound packet and creates a bridging table entry of the source MAC address on the other end of the RF interface.
- For the SM/BHS, the uplink is from Ethernet to RF. Thus, when a packet arrives in the Ethernet interface to one of these modules, the module reads the MAC address from the inbound packet and creates a bridging table entry of the source MAC address on the other end of the Ethernet interface.

Figure 92 : Bridging Table page

Statistics → Bridging Table

5.4GHz MIMO OFDM - Access Point - 0a-00-3e-bb-00-fb

Physical Address	Dest LUID	Age	Hash	Ent
0A003EBB00FB	258	-1	0576	02
0A003EBB0104	002	-1	0959	02
1A003EBB00FB	259	-1	0576	02
1A003EBB0104	002	-1	0959	02

Used: 4 BridgeFree: 4092 BridgeFullErr: 0

The Bridging Table supports up to 4096 entries.

Interpreting Translation Table statistics

When Translation Bridging is enabled in the AP, each SM keeps a table mapping MAC addresses of devices attached to the AP to IP addresses, as otherwise the mapping of end-user MAC addresses to IP addresses is lost. (When Translation Bridging is enabled, an AP modifies all uplink traffic originating from registered SMs such that the source MAC address of every packet is changed to that of the SM which bridged the packet in the uplink direction.)

Figure 93 : Translation Table page of SM

Mac	IpAddress	Age
Mac:002275394384	IpAddress:192.168.2.1	Age:0
Mac:001F3B4AC679	IpAddress:192.168.2.7	Age:0
Mac:902155C788E8	IpAddress:192.168.2.2	Age:0
Mac:000D4B76388B	IpAddress:192.168.2.4	Age:0
Mac:AC81128BCCF4	IpAddress:192.168.2.3	Age:0
Mac:0004236DA056	IpAddress:192.168.2.8	Age:3
Mac:00265507A92B	IpAddress:192.168.2.5	Age:4
Mac:902155C788E8	IpAddress:173.158.9.186	Age:68
Mac:5CDAD4818A2F	IpAddress:192.168.2.9	Age:50
Mac:001F3B4AC679	IpAddress:192.168.50.137	Age:26

Interpreting Ethernet statistics



The Statistics > Ethernet page reports TCP throughput and error information for the Ethernet connection of the module. This page is applicable for all modules (AP/SM/BHM/BHS).

The Ethernet page displays the following fields.

Table 131: Ethernet tab attributes

Ethernet Control Block Statistics	
Ethernet Link Detected :	1
Ethernet Link Lost :	0
Undersized Toss Count :	0
inocets Count :	139159
inucastpkts Count :	420
Innucastpkts Count :	86
indiscards Count :	0
inerrors Count :	0
inunknownprotos Count :	0
outocets Count :	56864
outucastpktsCount :	184
outhucastpkts Count :	3
outdiscards Count :	0
outerrors Count :	1
RxBabErr :	0
TxHbErr :	0
EthBusErr :	0
CRCError :	0
RcvFifoNoBuf :	0
RxOverrun :	0
LateCollision :	0
RetransLimitExp :	0
TxUnderrun :	0
CarSenseLost :	0
No Carrier :	1

Attribute	Meaning
Ethernet Link Detected	1 indicates that an Ethernet link is established to the radio, 0 indicates that no Ethernet link is established
Ethernet Link Lost	This field indicates a count of how many times the Ethernet link was lost.
Undersized Toss Count	This field indicates the number of packets that were too small to process and hence discarded.
inocets Count	This field displays how many octets were received on the interface, including those that deliver framing information.
inucastpkts Count	This field displays how many inbound subnetwork-unicast packets were delivered to a higher-layer protocol.
Innucastpkts Count	This field displays how many inbound non-unicast (subnetwork-broadcast or subnetwork-multicast) packets were delivered to a higher-layer protocol.
indiscards Count	This field displays how many inbound packets were discarded without errors that would have prevented their delivery to a higher-layer protocol. (Some of these packets may have been discarded to increase buffer space.)
inerrors Count	This field displays how many inbound packets contained errors that prevented their delivery to a higher-layer protocol.

Attribute	Meaning
inunknownprotos Count	This field displays how many inbound packets were discarded because of an unknown or unsupported protocol.
outoctets Count	This field displays how many octets were transmitted out of the interface, including those that deliver framing information.
outucastpkts Count	This field displays how many packets for which the higher-level protocols requested transmission to a subnetwork-unicast address. The number includes those that were discarded or not sent.
outnucastpkts Count	This field displays how many packets for which the higher-level protocols requested transmission to a non-unicast (subnetwork-broadcast or subnetwork-multicast) address. The number includes those that were discarded or not sent.
outdiscards Count	This field displays how many outbound packets were discarded without errors that would have prevented their transmission. (Some of these packets may have been discarded to increase buffer space.)
outerrors Count	This field displays how many outbound packets contained errors that prevented their transmission.
RxBabErr	This field displays how many receiver babble errors occurred.
TxHbErr	This field displays how many transmit heartbeat errors have occurred.
EthBusErr	This field displays how many Ethernet bus errors occurred on the Ethernet controller.
CRCErr	This field displays how many CRC errors occurred on the Ethernet controller.
RcvFifoNoBuf	<p>This field displays the number of times no FIFO buffer space was able to be allocated.</p> <div style="display: flex; align-items: center;">  <div style="border: 1px solid black; background-color: #e6f2ff; padding: 5px;"> <p>Note:</p> <p>PMP 450 AP running in Gigabit Ethernet Mode displays error “RcfFifoNoBuf” which indicates packet loss.</p> <p>For 450 AP platforms, if ethernet auto-negotiation is set to Gigabit, then it is a known limitation that “RcfFifoNoBuf” error will be seen. This issue is not seen if autonegotiation is set to 100Mbps or lower, and the issue is not seen on 450i or 450m AP’s.</p> </div> </div>
RxOverrun	This field displays how many receiver overrun errors occurred on the Ethernet controller.
Late Collision	<p>This field displays how many late collisions occurred on the Ethernet controller. A normal collision occurs during the first 512 bits of the frame transmission. A collision that occurs after the first 512 bits is considered a late collision.</p> <div style="display: flex; align-items: center;">  <div style="border: 1px solid black; background-color: #ffe4c4; padding: 5px;"> <p>Caution</p> <p>A late collision is a serious network problem because the frame being transmitted is discarded. A late collision is most commonly caused by a mismatch between duplex configurations at the ends of a link segment.</p> </div> </div>
RetransLimitExp	This field displays how many times the retransmit limit has expired.

Attribute	Meaning
TxUnderrun	This field displays how many transmission-underrun errors occurred on the Ethernet controller.
CarSenseLost	This field displays how many carrier sense lost errors occurred on the Ethernet controller.
No Carrier	This field displays how many no carrier errors occurred on the Ethernet controller.

Interpreting RF Control Block statistics

The Statistics > Radio page is applicable for all module (AP/SM/BHM/BHS). The Radio page of the Statistics page displays the following fields.

Table 132 :Radio (Statistics) page attributes - RF Control Block

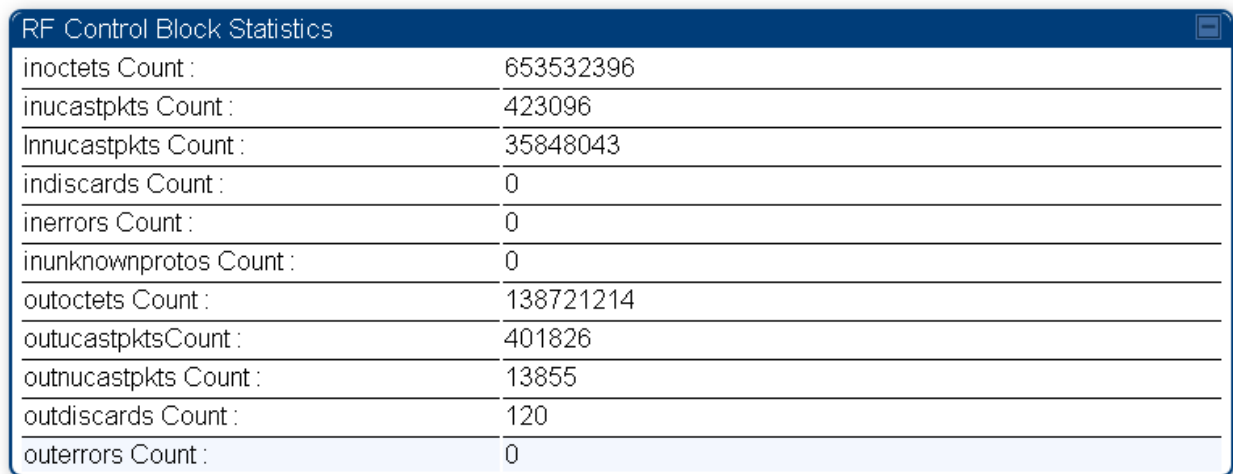

RF Control Block Statistics	
inocets Count :	653532396
inucastpkts Count :	423096
Innucastpkts Count :	35848043
indiscards Count :	0
inerrors Count :	0
inunknownprotos Count :	0
outocets Count :	138721214
outucastpktsCount :	401826
outnucastpkts Count :	13855
outdiscards Count :	120
outerrors Count :	0

Attribute	Meaning
inocets Count	This field displays how many octets were received on the interface, including those that deliver framing information.
inucastpkts Count	This field displays how many inbound subnetwork-unicast packets were delivered to a higher-layer protocol.
Innucastpkts Count	This field displays how many inbound non-unicast (subnetwork- broadcast or subnetwork-multicast) packets were delivered to a higher-layer protocol.
indiscards Count	<p>This field displays how many inbound packets were discarded without errors that would have prevented their delivery to a higher-layer protocol. This stat is pegged whenever corrupt data is received by software or whenever the RF Software Bridge queue is full.</p> <p>Corrupt data is a very unusual event because all packets are CRC checked by hardware before being passed into software.</p> <p>The likely case for indiscards is if the RF bridge queue is full. If this is the case the radio is most likely PPS limited due to excessive small packet traffic or a problem at</p>

Attribute	Meaning
	the Ethernet interface. If there is a problem at the Ethernet interface there is likely to be discards at the Ethernet as well.
inerrors Count	This field displays how many inbound packets contained errors that prevented their delivery to a higher-layer protocol.
inunknownprotos Count	This field displays how many inbound packets were discarded because of an unknown or unsupported protocol.
outoctets Count	This field displays how many octets were transmitted out of the interface, including those that deliver framing information.
outucastpkts Count	This field displays how many packets for which the higher-level protocols requested transmission to a subnetwork-unicast address. The number includes those that were discarded or not sent.
outnucastpkts Count	This field displays how many packets for which the higher-level protocols requested transmission to a non-unicast (subnetwork-broadcast or subnetwork-multicast) address. The number includes those that were discarded or not sent.
outdiscards Count	This field displays how many outbound packets were discarded without errors that would have prevented their transmission. (Some of these packets may have been discarded to increase buffer space.)
outerrors Count	This field displays how many outbound packets contained errors that prevented their transmission.

Interpreting Sounding statistics for AP

In the 450m AP GUI, sounding statistics can be found under Statistics > Sounding Statistics.

Table 133 :Sounding Statistics - 450m AP page attributes

Sounding Statistics							
Subscriber	LUID	Spatial Frequency	Azimuth (Degrees)	Downlink		Uplink	
				Sounding State	MU-MIMO Rate	Sounding State	MU-MIMO Rate
SM4 21 [0a-00-3e-b4-d3-36]	002	879	-59.7, -9.1, 41.6	TRACKING	4X/2X MIMO-A	TRACKING	4X/4X MIMO-B
SM1 11 [0a-00-3e-b4-d4-1a]	003	2	-50.6, 0.1, 50.7	TRACKING	8X/8X MIMO-B	TRACKING	8X/1X MIMO-A
SM7 23 [0a-00-3e-b4-c2-5c]	004	879	-59.7, -9.1, 41.6	TRACKING	8X/8X MIMO-B	TRACKING	8X/6X MIMO-B
SM5 24 [0a-00-3e-b4-d2-fe]	005	879	-59.7, -9.1, 41.6	TRACKING	8X/8X MIMO-B	TRACKING	8X/6X MIMO-B
SM8 26 [0a-00-3e-b4-c2-65]	006	879	-59.7, -9.1, 41.6	TRACKING	8X/8X MIMO-B	TRACKING	8X/8X MIMO-B
SM3 13 [0a-00-3e-b4-d2-e0]	007	2	-50.6, 0.1, 50.7	TRACKING	4X/4X MIMO-B	TRACKING	4X/4X MIMO-B
SM2 12 [0a-00-3e-b4-d4-08]	008	2	-50.6, 0.1, 50.7	TRACKING	8X/8X MIMO-B	TRACKING	8X/8X MIMO-B
SM6 22 [0a-00-3e-b4-d2-ff]	009	879	-59.7, -9.1, 41.6	TRACKING	8X/8X MIMO-B	TRACKING	8X/6X MIMO-B
SM15 [0a-00-3e-b4-d2-c9]	012	2	-50.6, 0.1, 50.7	TRACKING	8X/8X MIMO-B	TRACKING	8X/8X MIMO-B

Attribute	Meaning
Subscriber	This field displays the MAC address and Site Name of the SM/BHS. As each SM or BHS registers to the AP/BHM.
LUID	This field displays the LUID (logical unit ID) of the SM/BHS. As each SM or BHS registers to the AP/BHM, the system assigns an LUID of 2 or a higher unique number to the SM/BHS. If a SM/BHS loses registration with the AP/BHS and then regains registration, the SM/BHS will retain the same LUID.

Attribute	Meaning
Spatial Frequency	This field displays the spatial frequency value of the LUID or SM. Values 0 to 1023 are valid and value 2048 is considered as invalid.
Azimuth	<p>This field displays the Azimuth range in degrees corresponding to the spatial frequencies of the bin. The zero-degree azimuth is boresight.</p> <div style="border: 1px solid black; padding: 5px; margin-top: 10px;">  <p>Note Some SF ranges correspond to multiple azimuth ranges. This is because for some spatial frequencies the AP generates beams in multiple azimuth directions. The SM can be physically located in any of the azimuth ranges.</p> </div>
Downlink - Sounding State	<p>Different types of Sounding states are:</p> <ul style="list-style-type: none"> • UNKNOWN: SM has recently registered to the AP but not registered with the channel manager yet. • NEW: SM has been registered with the channel manager and will soon transition to ASSESSING. • ASSESSING: AP will instruct SM to take the channel measurements. Channel estimates and spatial frequencies will be calculated. • TRACKING: Valid measurements resulted in good channel estimates and spatial frequency. This SM can now be used for MU-MIMO. • INVALID: Inconsistent measurements resulting in no channel estimate or spatial frequency. This SM cannot be used for MU-MIMO and it will ultimately be re-assessed. • NOT ELIGIBLE: Due to poor RF link conditions, the RF link as rate adapted down to SU-MIMO transmissions.
Downlink - MU- MIMO Rate	This field indicates the modulation rate used for symbols where this particular LUID is MU-MIMO scheduled by grouping it in the same slot with other LUIDs.
Uplink - Sounding State	This field indicates the status of uplink sounding.
Uplink - MU- MIMO Rate	This field indicates the modulation rate used for symbols where the MU-MIMO groupable data channels are MU-MIMO scheduled by grouping it in the same slot with other MU-MIMO groupable data channels from other SM's.

Interpreting VLAN statistics

The Statistics > VLAN page provides a list of the most recent packets that were filtered because of VLAN membership violations. It is applicable for all modules (AP/SM/BHM/BHS).

Table 134 :VLAN page attributes

VLAN Statistics Configuration

VLAN Statistics Configuration : (Range : 1 — 4094 or 0 for Priority-tagged)

VLAN Statistics

VID : 1

VID Stats Frames Received : 1823

Bytes Received : 586624

Frames Transmitted : 1640

Bytes Transmitted : 585735

Most Recent Filtered Frames

No Ingress Filtered Frames

Ingress : Total Frames Filtered : 0 Total Bytes Filtered : 0

Egress : Total Frames Filtered : 0 Total Bytes Filtered : 0

Attribute	Meaning
Unknown	This must not occur. Contact Technical Support.
Only Tagged	The packet was filtered because the configuration is set to accept only packets that have an 802.1Q header and this packet did not.
Ingress	When the packet entered through the wired Ethernet interface, the packet was filtered because it indicated an incorrect VLAN membership.
Local Ingress	When the packet was received from the local TCP/IP stack, the packet was filtered because it indicated an incorrect VLAN membership. This must not occur. Contact Technical Support.
Egress	When the packet attempted to leave through the wired Ethernet interface, the packet was filtered because it indicated an incorrect VLAN membership.
Local Egress	When the packet attempted to reach the local TCP/IP stack, the packet was filtered because it indicated an incorrect VLAN membership.

Interpreting Data Channels statistics

The Statistics > Data Channels page displays information about data channels used in data communications. This page is applicable for all modules (AP/SM/BHM/BHS).

The Data VC tab displays the fields as explained in Data Channel page attributes.

Table 135 :Data Channel page attributes

Data Channel Statistics														
Subscriber	LUID	Channel Priority	Inbound Statistics					Outbound Statistics					Queue Overflow	High Priority Queue
			octets	ucast pkts	nucast pkts	discards	errors	octets	ucast pkts	nucast pkts	discards	errors		
SM4_21	002	Low	88471406	8	51742	0	0	78002604	681	45566	0	0	0	160
SM4_21	002	Medium	107730	0	63	0	0	107730	0	63	0	0	0	0
SM4_21	002	High	107730	0	63	0	0	107730	0	63	0	0	0	0
SM4_21	002	Ultra High	1038574	6678	100	0	0	152829	158	311	0	0	0	406
SM1_11	003	Low	1959	4	2	0	0	99422	777	0	0	0	0	241
SM1_11	003	Medium	0	0	0	0	0	0	0	0	0	0	0	0
SM1_11	003	High	0	0	0	0	0	0	0	0	0	0	0	0
SM1_11	003	Ultra High	648533	3960	36	0	0	41899	158	198	0	0	0	356
SM7_23	004	Low	10998303	5	5375	0	0	98431	811	1	0	0	0	292
SM7_23	004	Medium	0	0	0	0	0	0	0	0	0	0	0	0
SM7_23	004	High	0	0	0	0	0	0	0	0	0	0	0	0
SM7_23	004	Ultra High	636897	4008	37	0	0	45099	158	248	0	0	0	406
SM5_24	005	Low	10893173	5	6372	0	0	98204	764	1	0	0	0	234
SM5_24	005	Medium	0	0	0	0	0	0	0	0	0	0	0	0
SM5_24	005	High	0	0	0	0	0	0	0	0	0	0	0	0
SM5_24	005	Ultra High	671486	4291	37	0	0	45099	158	248	0	0	0	406
SM8_26	006	Low	14487593	5	8474	0	0	95888	742	1	0	0	0	224
SM8_26	006	Medium	0	0	0	0	0	0	0	0	0	0	0	0
SM8_26	006	High	0	0	0	0	0	0	0	0	0	0	0	0
SM8_26	006	Ultra High	751670	4625	36	0	0	45057	157	248	0	0	0	405
SM3_13	007	Low	12993053	5	7600	0	0	89789	670	1	0	0	0	154
SM3_13	007	Medium	0	0	0	0	0	0	0	0	0	0	0	0
SM3_13	007	High	0	0	0	0	0	0	0	0	0	0	0	0
SM3_13	007	Ultra High	636026	3966	36	0	0	45099	158	248	0	0	0	406
SM2_12	008	Low	21802973	5	12752	0	0	94194	739	1	0	0	0	220
SM2_12	008	Medium	0	0	0	0	0	0	0	0	0	0	0	0
SM2_12	008	High	0	0	0	0	0	0	0	0	0	0	0	0
SM2_12	008	Ultra High	637607	3981	36	0	0	45099	158	248	0	0	0	406
SM6_22	009	Low	10908563	5	6381	0	0	100175	801	1	0	0	0	275
SM6_22	009	Medium	0	0	0	0	0	0	0	0	0	0	0	0
SM6_22	009	High	0	0	0	0	0	0	0	0	0	0	0	0
SM6_22	009	Ultra High	696681	4521	36	0	0	45099	158	248	0	0	0	406
SM15	012	Low	22323135	3924	12741	0	0	142215	946	250	0	0	0	675
Multicast	252	NA	NA	NA	NA	NA	NA	86504	0	415	0	0	NA	NA
Broadcast	255	NA	NA	NA	NA	NA	NA	1006314	18	15912	0	0	NA	NA

Data Channel Statistics														
Subscriber	LUID	SM P1	Channel Priority	Inbound Statistics					Outbound Statistics					
				octets	ucast pkts	nucast pkts	discards	errors	octets	ucast pkts	nucast pkts	discards	errors	
Broadcast	255	NA	NA	NA	NA	NA	NA	NA	NA	5527765	389	25160	0	0
Multicast	252	NA	NA	NA	NA	NA	NA	NA	NA	0	0	0	0	0
No. Site Name	002	Low	Low	1948	4	1	0	0	2019	7	0	0	0	0
No. Site Name	002	Low	High	8112944	49563	396	0	0	6033604	46613	4010	0	0	0

Fragments Modulation							
Subscriber	LUID	Receive Fragments Modulation					Transmitted Fragments
		QPSK	16-QAM	64-QAM	256-QAM		
No. Site Name	002	44171	43026	43594	231	0	

Attribute	Meaning
Subscriber	This field displays the MAC address and Site Name of the SM/BHS.
LUID	This field displays the LUID (logical unit ID) of the SM/BHS. As each SM or BHS registers to the AP/BHM, the system assigns an LUID of 2 or a higher unique number to the SM/BHS. If a SM/BHS loses registration with the AP/BHS and then regains registration, the SM/BHS will retain the same LUID. <div style="border: 1px solid black; padding: 5px; margin-top: 10px;">  <p>Note</p> <p>Both the LUID and the MAC are hot links to open the interface to the SM/BHS. In some instances, depending on network activity and network design, this route to the interface yields a blank web page. If this occurs, refresh your browser view.</p> </div>
Channel Priority	This field displays the channel priority for the virtual channel. The values supported are Low, Medium, High, and Ultra High.
Inbound Statistics, octets	This field displays how many octets were received on the interface, including those that deliver framing information.
Inbound Statistics, ucastpkts	This field displays how many inbound subnetwork-unicast packets were delivered to a higher-layer protocol.
Inbound	This field displays how many inbound non-unicast (subnetwork- broadcast or

Attribute	Meaning
Statistics, nucastpkts	subnetwork-multicast) packets were delivered to a higher-layer protocol.
Inbound Statistics, discards	This field displays how many inbound packets were discarded without errors that would have prevented their delivery to a higher-layer protocol. Inbound discard statistics are incremented similar to the indiscards stat on the RF control block stats page. The sum of all data VC indiscards must be close to the RF control block in discards. If indiscards are evenly distributed across SMs, then the radio is PPS limited due to either excessive small packet transmissions, or a problem at the Ethernet link. If indiscards are contained to one or a few SMs, then there is likely a problem at or underneath the SM which is incrementing the count.
Outbound Statistics, octets	This field displays how many octets were transmitted out of the interface, including those that deliver framing information.
Outbound Statistics, ucastpkts	This field displays how many packets for which the higher-level protocols requested transmission to a subnetwork-unicast address. The number includes those that were discarded or not sent.
Outbound Statistics, nucastpkts	This field displays how many packets for which the higher-level protocols requested transmission to a non- unicast (subnetwork- broadcast or subnetwork- multicast) address. The number includes those that were discarded or not sent.
Outbound Statistics, discards	This field displays how many outbound packets were discarded without errors that would have prevented their transmission. Outbound discard statistics are incremented if a VC is not active when a packet is ready to send. This is a rare condition.
Outbound Statistics, errors	This field displays how many outbound packets contained errors that prevented their transmission.
Queue Overflow	This is a count of packets that were discarded because the queue for the VC was already full. If Queue Overflows are being seen across most or all SMs, then there is either an interferer local to the AP or the APs RF link is at capacity. If Queue Overflows are being seen at one or only a few SMs, then it is likely that there is a problem with those specific links whether it is insufficient signal strength, interferer, or a problem with the actual SM hardware.
High Priority Queue	This is a count of packets that were received on high priority queue.
Fragments Modulation - Receive Fragments Modulation	
QPSK	This field displays how many inbound fragments were received via the QPSK modulation scheme.
16-QAM	This field displays how many inbound fragments were received via the 16-QAM modulation scheme.
64-QAM	This field displays how many inbound fragments were received via the 64-QAM modulation scheme.
256-QAM	This field displays how many inbound fragments were received via the 256-QAM

Attribute	Meaning
	modulation scheme.
Retransmitted Fragments	This field displays how many outbound fragments were retransmitted.

Interpreting Proportional Scheduler

The Statistics > Proportional Scheduler page displays information:

Table 136 :MIR/Burst page attributes for AP

Trial active. Device is running in MU-MIMO mode. Please obtain a key to permanently enable MU-MIMO mode.

Subscriber		Configuration			Downlink Statistics					Uplink Statistics				
Subscriber	LUID	Lock Modulation	Modulation	Weight	Rate Plan (Kbps)	Current Modulation	Slots Percentage	Guaranteed Minimum Throughput(Kbps)	Sustained Data Rate (Kbps)	Rate Plan (Kbps)	Current Modulation	Slots Percentage	Guaranteed Minimum Throughput(Kbps)	Sustained Data Rate (Kbps)
Broadcast	255	Disable		1.0	1000	1X	11.9%	998	NA	NA	NA	NA	NA	NA
SM11 - SF4	002	Disable		1.0	10000	8X	4.4%	2949	155000	10000	8X	5.0%	3441	155000
SM3 - SF1	003	Enable Below Threshold	4X	1.0	10000	2X	8.8%	1475	155000	10000	2X	10.0%	1720	155000
SM10 - SF4	004	Disable		1.0	20000	8X	8.8%	5898	155000	20000	8X	10.0%	6881	155000
SM8 - SF3	005	Disable		1.0	10000	8X	4.4%	2949	155000	10000	8X	5.0%	3441	155000
SM9 - SF3	006	Disable		1.0	10000	8X	4.4%	2949	155000	10000	8X	5.0%	3441	155000
SM7 - SF3	007	Disable		1.0	20000	8X	8.8%	5898	155000	20000	8X	10.0%	6881	155000
SM12 - SF4	008	Disable		1.0	10000	8X	4.4%	2949	155000	10000	8X	5.0%	3441	155000
SM5 - SF2	009	Disable		1.0	10000	8X	4.4%	2949	155000	10000	8X	5.0%	3441	155000
SM2 SF1	010	Disable		1.0	10000	4X	8.8%	2949	155000	10000	4X	10.0%	3441	155000
SM4 SF2	011	Disable		1.0	20000	8X	8.8%	5898	155000	20000	8X	10.0%	6881	155000
SM6 - SF2	012	Disable		1.0	10000	8X	4.4%	2949	155000	10000	8X	5.0%	3441	155000
SM1 SF1	013	Disable		1.0	20000	4X	17.6%	5919	155000	20000	4X	20.0%	6881	155000
Total					161000		99.9%	46729	1860000	160000		100.0%	53331	1860000

Attribute	Meaning
Subscriber	See Device tab attributes
LUID	
Lock Modulation	This field displays the Lock Modulation mode of all registered SMs.
Modulation	The database configured Lock Modulation value if lock modulation is set to Enable below threshold or Enabled.
Weight	This field displays the weight of each registered SM. For more information about Weight, See QoS page attributes - AP.
Downlink Statistics	This field displays the Downlink statistics of every registered SM.
Uplink Statistics	This field displays the Uplink statistics of every registered SM.
Rate Plan	This field displays the rate plan associated with each SM.
Current Modulation	The currently operating modulation of this SM.
Slots Percentage	This field displays the percentage of slot used by each SM.
Guaranteed minimum throughput	Guaranteed minimum throughput based on the SM's Rate Plan configuration, its current modulation rate, and any Lock Modulation settings. For 450m AP's the maximum possible Throughput shown here assumes all SUMIMO scheduling. MUMIMO scheduling will result in higher TPUT.
Sustained Data Rate	This field displays the preset rate limit of data transfer for every SM.

Interpreting MIR/ Burst statistics

The Statistics > MIR/Burst page displays information about MIR/Burst. This page is applicable for all modules (AP/SM).

The MIR/Burst tab displays the fields as explained in MIR/Burst page attributes for AP and MIR/Burst page attributes for SM.

Table 137 :MIR/Burst page attributes for AP

MIR / Burst Statistics										
Note: Uplink values are configuration values only. Live uplink values will be shown on the SM.										
Subscriber	Current Downlink Bucket Size	Downlink MIR	Downlink MIR Per 500ms Interval	Downlink Max Bucket Size	Current Max Burst Bucket Size	Downlink Max Burst MIR	Downlink Max Burst MIR Per 500ms Interval	Uplink MIR	Uplink Max Bucket Size	Uplink Max Burst MIR
No Site Name - LUID: 002	2500000000	30000000	15000000	2500000000	0	0 (Not Limited)	0 (Not Limited)	30000000	2500000000	0 (Not Limited)

Attribute	Meaning
Subscriber	This field displays the LUID (logical unit ID), MAC address and Site Name of the SM/BHS. As each SM or BHS registers to the AP/BHM, the system assigns an LUID of 2 or a higher unique number to the SM/BHS. As of release 15.2, if an SM/BHS loses registration with the AP/BHM and then regains registration, the SM/BHS retains the same LUID.
Current Downlink Bucket Size	This field displays the number of bits in the bucket to be potentially consumed at above-MIR rates, up to Max Burst MIR rate.
Downlink MIR	This field displays the active configured MIR rate per second. This is the rate that the bucket is filled with bits.
Downlink MIR Per 500ms Interval	This field displays the rate that the bucket is filled with bits at every 500 ms interval.
Downlink Max Bucket Size	This field displays the configured maximum bucket size, which is the maximum number of bits that can be in the bucket. The bucket fills at MIR rate and can hold this number of bits, which is a configuration value.
Current Max Burst Bucket Size	If Max Burst is enabled, there is a secondary "bucket" that controls the maximum rate of bit consumption. If Max Burst is not enabled (which means not limited), this will be 0 as the bucket is not used.
Downlink Max Burst MIR	This field displays the configured value of the Max Burst rate. This is the maximum rate at which bits can be consumed above MIR. Once excess (> MIR) bits have been consumed, the link will be throttled to MIR.
Downlink Max Burst MIR Per 500ms Interval	This field displays the configured value of the Max Burst rate at every 500 ms interval.

Attribute	Meaning
Uplink MIR	This field displays the active configured MIR rate per second in the SM.
Uplink Max Bucket Size	This field displays the configured maximum bucket size of the SM, which is the maximum number of bits that can be in the bucket. The bucket fills at MIR rate and can hold this number of bits, which is a configuration value.
Uplink Max Burst MIR	This field displays the configured value of the MaxBurst rate of the SM. This is the maximum rate at which bits can be consumed above MIR. Once excess (> MIR) bits have been consumed, the link will be throttled to MIR.

Table 138 :MIR/Burst page attributes for SM

MIR / Burst Statistics												
Note: Downlink values are configuration values only. Live downlink values will be shown on the AP.												
Current Uplink Bucket Size	Uplink MIR	Uplink MIR Per 100ms Interval	Uplink Max Bucket Size	Current Max Burst Bucket Size	Uplink Max Burst MIR	Uplink Max Burst MIR Per 100ms Interval	Uplink Broadcast Credit	Uplink Broadcast MIR	Uplink Broadcast MIR Type	Downlink MIR	Downlink Max Bucket Size	Downlink Max Burst MIR
2500000000	155000000	15500000	2500000000	0	0 (Not Limited)	0 (Not Limited)	0	0	kbps	155000000	2500000000	0 (Not Limited)

Attribute	Meaning
Current Uplink Bucket Size	This field displays the number of bits in the bucket to be potentially consumed at above-MIR rates, up to Max Burst MIR rate.
Uplink MIR	This field displays the active MIR rate per second. This is the rate that the bucket is filled with bits.
Uplink MIR Per 100ms Interval	This field displays the rate that the bucket is filled with bits at every 100 ms interval.
Uplink Max Bucket Size	This field displays the maximum bucket size, which is the maximum number of bits that can be in the bucket. The bucket fills at MIR rate and can hold this number of bits, which is a configuration value.
Current Max Burst Bucket Size	If Max Burst is enabled, there is a secondary “bucket” that controls the maximum rate of bit consumption. If Max Burst is not enabled (which means not limited), this will be 0 as the bucket is not used.
Uplink Max Burst MIR	This field displays the configured value of the Max Burst rate. This is the maximum rate at which bits can be consumed above MIR. Once excess (> MIR) bits have been consumed, the link will be throttled to MIR.
Uplink Max Burst MIR per 100ms Interval	This field displays the configured value of the Max Burst rate at every 100 ms interval.
Uplink Broadcast Credit	This field displays the broadcast credit.
Uplink Broadcast MIR	This field displays the broadcast MIR rate per second.

Attribute	Meaning
Uplink Broadcast MIR Type	This field displays the type of the broadcast MIR.
Downlink MIR	This field displays the active configured MIR rate per second. This is the rate that the bucket is filled with bits.
Downlink Max Bucket Size	This field displays the configured maximum bucket size, which is the maximum number of bits that can be in the bucket. The bucket fills at MIR rate and can hold this number of bits, which is a configuration value.
Downlink Max Burst MIR	This field displays the configured value of the Max Burst rate. This is the maximum rate at which bits can be consumed above MIR. Once excess (> MIR) bits have been consumed, the link will be throttled to MIR.

Interpreting Throughput statistics

The 450 Platform Family has a Statistics > Throughput page which shows historical information about sector or backhaul throughput and packet discards. This page is applicable for AP and BHM modules. This information can be useful to identify an overloaded sector or heavy bandwidth users. This page also shows the user throughput in terms of data rate (kbps) and packet rate (packets per second, or PPS), as well as the average packet size during the sample period.

Operators may set the AP/BHM to send an SNMP trap when it detects an RF overload condition based on a configurable threshold.

The following configuration parameters are available on the Throughput tab GUI pane and a radio reboot is not required when configuring these parameters:

Table 139 :RF overload Configuration attributes - AP/BHM

Attribute	Meaning
Throughput Monitoring	This enables or disables the monitoring of sector throughput and packet discards. This parameter is disabled by default.
SNMP Trap on RF Overload	This enables or disables the sending of an SNMP trap when an AP/BHM overload condition is reached (based on Downlink RF Overload Threshold).

Attribute	Meaning
Downlink RF Overload Threshold	This parameter determines the overload threshold in percent of packets discarded that triggers the generation of an SNMP trap.
Downlink RF Link Status	This field displays the status of the capacity of the RF link.
Time Period Length Time Period Ending	These two configuration parameters determine what set of collection samples to show on the GUI display. The Time Period Length can be set from one to three hours. Time Period Ending allows the operator to set the end time for the set of collection samples to display.

Following configuration settings are three tables that display the statistics that are collected.

Board Performance statistics

This table contains a row that corresponds to each 1 minute statistics collection interval. Each row contains the following data aggregated for the entire AP/BHM:

- Ethernet Throughput - Statistics collected at the Ethernet port:
 - kbps in - average throughput over the collection interval in Kbps into the AP/BHM on the Ethernet Interface
 - kbps out - average throughput over the collection interval in Kbps out of the AP/BHM on the Ethernet Interface
 - PPS in - average packets per second over the collection interval into the AP/BHM on the Ethernet Interface
 - PPS out - average packets per second over the collection interval out of the AP/BHM on the Ethernet Interface
- RF Throughput - Statistics collected at the RF Interface:
 - kbps in - average throughput over the collection interval in Kbps into the AP/BHM on the RF Interface
 - kbps out - average throughput over the collection interval in Kbps out of the AP/BHM on the RF Interface
 - PPS in - average packets per second over the collection interval into the AP/BHM on the RF Interface
 - PPS out - average packets per second over the collection interval out of the AP/BHM on the RF Interface
- Aggregate Through Board - Sum of bidirectional data transferred through (not originating or terminating at) the AP/BHM:
 - kbps - average bidirectional throughput over the collection interval in Kbps
 - PPS - average bidirectional packets per second over the collection interval
 - Ave Pkt Size - Average Packet size over the collection interval of bidirectional data transferred

Board Throughput statistics

This table contains a row that corresponds to each one minute statistics collection interval. This table may be used to determine if there are problems with any of the interfaces. For example, if the Ethernet in packets is much higher than the RF out packets it could indicate a denial of service (DoS) attack on the AP/BHM. Each row contains the following data aggregated for the entire AP/BHM:

- Ethernet Statistics - Statistics collected at the Ethernet port:
 - inOctets - Number of octets (bytes) received by the AP/BHM at the Ethernet Interface over the collection interval
 - outOctets - Number of octets (bytes) sent by the AP/BHM at the Ethernet Interface over the collection interval
 - inPkts - Number of packets received by the AP/BHM at the Ethernet Interface over the collection interval
 - outPkts - Number of packets sent by the AP/BHM at the Ethernet Interface over the collection interval
 - Discards (in/out) - Number of packets that had to be discarded by the AP/BHM at the respective Ethernet Interface Queue
- RF Statistics - Statistics collected at the RF Interface:
 - inOctets - Number of octets (bytes) received by the AP/BHM at the RF Interface over the collection interval
 - outOctets - Number of octets (bytes) sent by the AP/BHM at the RF Interface over the collection interval
 - inPkts - Number of packets received by the AP/BHM at the RF Interface over the collection interval
 - outPkts - Number of packets sent by the AP/BHM at the RF Interface over the collection interval
 - Discards (in/out) - Number of packets that had to be discarded by the AP/BHM at the respective RF Interface Queue during the collection interval
 - Discards % (in/out) - Percent of the total packets received / transmitted that had to be discarded during the collection interval

LUID RF Throughput statistics

This table contains a row that corresponds to each active LUID served by the AP/BHM. Note that an LUID may be assigned 1 or 2 VCs. If the LUID is assigned 2 VCs, then the data in the table is the sum of the activity for both VCs. This table may be used to determine which LUIDs are experiencing overload so that corrective action can be taken (i.e. fixing a poor RF link or moving a heavily loaded link to a less congested AP/BHM). Each row contains counters and statistics related to the RF Interface that are updated once per minute:

- Inbound Statistics - Statistics collected at the RF Interface for the Uplink:
 - octets - Number of octets (bytes) received by the AP/BHM at the RF Interface for this LUID over the collection interval
 - pkts - Number of packets received by the AP/BHM at the RF Interface for this LUID over the collection interval
 - Ave Pkt Size - Average size of the packets received by the AP/BHM at the RF Interface for this LUID over the collection interval
 - discards - Number of packets received by the AP/BHM at the RF Interface for this LUID over the collection interval that had to be discarded because the RF In Queue was full

- discards % - Percent of the total packets received by the AP/BHM at the RF Interface for this LUID over the collection interval that had to be discarded because the RF In Queue was full
- Outbound Statistics - Statistics collected at the RF Interface for the Downlink:
- octets - Number of octets (bytes) transmitted by the AP/BHM at the RF Interface for this LUID over the collection interval
- pkts - Number of packets transmitted by the AP/BHM at the RF Interface for this LUID over the collection interval
- Ave Pkt Size - Average size of the packets transmitted by the AP/BHM at the RF Interface for this LUID over the collection interval
- discards - Number of packets to be transmitted by the AP/BHM at the RF Interface for this LUID over the collection interval that had to be discarded because the RF Out Queue was full
- discards % - Percent of the total packets to be transmitted by the AP/BHM at the RF Interface for this LUID over the collection interval that had to be discarded because the RF Out Queue was full.

Interpreting Overload statistics

The Statistics > Overload page displays statistics on packet overload and resultant packet discards. Unlike the other fields, the Total Packets Overload Count is expressed in only this page. It is not a count of how many packets have been lost, but rather of how many discard events (packet loss bursts) have been detected due to overload condition.

This statistics page is applicable for all modules (AP/SM/BHM/BHS) and explained in below table.

Table 140 :Overload page attributes - AP/SM/BHM/BHS

Packet Overload Statistics	
Total Packets Overload Count :	0
Ethernet In Discards (Statistics=>Ethernet=>RxOverrun + Statistics=>Bridge Control Block=>ErrApFecQSend) :	
Ethernet Out Discards (Statistics=>Ethernet=>outdiscards count) :	0
RF In Discards (Sum of all VCs of: Statistics=>Data VC=>indiscards count) :	
RF Out Discards (Statistics=>Radio=>outdiscards count) :	0

Attribute	Meaning
Total Packets Overload Count	This field represents the sum of all RF and Ethernet in/out discards.
Ethernet In Discards	This field represents the number of packets tossed due to the Ethernet queue being full. If a climb in this stat accompanies a climb in RF Out Discards stat, then most likely the board is at RF capacity either due to traffic exceeding the RF pipe, or interference temporarily limiting the RF throughput. If this stat climbs without the RF Out Discards stat climbing, then the radio is most likely PPS limited.

Attribute	Meaning
Ethernet Out Discards	This field represents the number of packets tossed due to an Ethernet out overload. This stat must not climb in normal operation because the Ethernet link is much higher capacity than the RF link. If this stat is incrementing, then either the Ethernet link is established at a low speed (i.e. 10Mbps - half duplex), or there is a problem with cabling/Ethernet hardware.
RF In Discards	This field indicates the number of packets tossed due to no resources available within the radio to process them. This stat also must not be increasing because the system is designed to shed packets on the RF Out interface. If this stat is incrementing the board, it is most likely congested due to high PPS rate in combination with an Ethernet Out problem, which limits packet flow off the device.
RF Out Discards	This field indicates the number of packets tossed due to RF link at capacity. This stat will increase whenever the RF link is at capacity. When the internal FPGA RF input queue overflows, this stat is incremented. If this stat is seen to be incrementing at the AP, then the sector is congested. If seen at the SM, the number of Contention Slots must be looked at to ensure that enough Contention Slots are allocated to allow for bandwidth requests to be seen at the AP.



Note

450m Overload:

The 450m Series AP is designed to handle high load in terms of high throughput and high PPS. In terms of throughput, 450m is designed to achieve 3x or more throughput improvement over 450 and 450i Series products. In terms of packets per second (PPS), 450m is designed to handle up to 100k PPS.

Overload occurs when the offered load exceeds the above limits. When overload occurs, 450m will start discarding packets and TCP throughput will degrade due to packet loss.

It's worth noting that Frame Utilization statistics (Statistics > Frame Utilization tab: Frame Utilization: Downlink and Uplink) are not necessarily indicative of overload condition. They show how much the TDD frame is utilized. High frame utilization depends on:

- High traffic during busy periods: those statistics will be close to 100% and almost all slots will be utilized. In this case if the Overload statistics show that packets are discarded then this is an indication of overload condition.
- High percentage of VCs with low modulation with moderate traffic. Those VCs will require more slots to service them (due to low modulation) and the frame utilization will be high. In this case the TDD frame is fully utilized but the system is at low capacity and is not in an overload condition.

450m has higher PPS than 450 and 450i and supports higher throughput through spatial multiplexing, therefore when a 450m replaces an overloaded 450 or 450i AP the 450m will not be overloaded under the same conditions but the frame utilization may still show close to 100%; this should not alarm the customer. The overload statistics shall be monitored on 450m to see if it is overloaded or not.

Interpreting DHCP Relay statistics

The Statistics > DHCP Relay page displays requests and replies received, relayed and discarded when the AP is configured as a DHCP relay. Typically, in a working DHCP relay configuration a one-to-one ratio is established between requests and replies that are received and relayed. This statistics page is only applicable for PMP (AP and SM modules) and it is explained in below figure.

Figure 94 : DHCP Relay page attributes - AP/SM

DHCP Relay Statistics	
Requests Received :	0
Requests Relayed :	0
Requests Discarded :	0
Replies Received :	0
Replies Relayed :	0
Replies Discarded :	0
Untrusted Message Discards :	0
Max Hop Exceeded Discards :	0
Invalid Relay Agent Address Discards :	0
Relay Info Exceeding Max Message Size (DHCP message relayed without Option 82) :	0

DHCP Relay Option 82 Data					
Subscriber	LUID		Circuit ID \$apmacbi\$	Remote ID \$smmacbi\$	Vendor Specific ID \$smvidbi\$
Binary Option 82 Data					
		Binary	0a003ea0005b	0a003ebb016a	000000a106130401025858
No Site Name	002	ASCII			XX

Attribute	Meaning
Requests Received	This field represents the number of DHCP relay requests received by the AP.
Requests Relayed	This field represents the number of DHCP relay requests relayed by the AP.
Requests Discarded	This field represents the number of DHCP relay requests discarded by the AP due to errors in the request.
Replies Received	This field represents the number of DHCP relay replies received by the AP.
Replies Relayed	This field represents the number of DHCP relay replies relayed by the AP.
Replies Discarded	This field represents the number of DHCP relay replies discarded by the AP due to errors in the reply.
Untrusted Message Discards	This field indicates messages that were discarded because the message already contained Option 82 information with no Relay Agent specified.
Max Hop Exceeded Discards	This field indicates messages that have been relayed too many times, exceeding the max hop count (16).
Invalid Relay Agent Address Discards	This field indicates messages that have been discarded because the message relay agent address is already in place (relay agent address

Attribute	Meaning
	does not equal address of the AP).
Relay Info Exceeding Max Message Size (DHCP message relayed without Option 82)	This field indicates DHCP messages too large to fit Option 82 data. These messages are sent on without Option 82 information.
Subscriber	See Device tab attributes
LUID	
Circuit ID	
Remote ID	This field displays the option 82 data of the SM in binary and ASCII formats.
Vendor Specific ID	

Interpreting Filter statistics

The Statistics > Filter page displays statistics on packets that have been filtered (dropped) due to the filters set on the Protocol Filtering page. The filter page of SM is explained in below table.

Table 141: Filter page attributes - SM

Packet Filter Statistics	
PPPoE Count :	0
All IPv4 Count :	0
All Other IPv4 Count :	0
SMB Count :	0
SNMP Count :	0
Bootp Client Count :	0
Bootp Server Count :	0
IPv4 Multicast Count :	0
All IPv6 Count :	0
All Other IPv6 Count :	0
IPv6 SMB Count :	0
IPv6 SNMP Count :	0
IPv6 Bootp Client Count :	0
IPv6 Bootp Server Count :	0
IPv6 Multicast Count :	0
ARP Count :	0
All Others Count :	0
User Defined Port1 Count :	0
User Defined Port2 Count :	0
User Defined Port3 Count :	0

Attribute	Meaning
PPPoE Count	Number of PPPoE packets filtered.
All IPv4 Count	Number of IPv4 packets filtered.
All Other IPv4 Count	Any IPv4 message that was not SMB, SNMP, Bootp, Multicast or one of the user defined filters, that was filtered out.
SMB Count	Number of IPv4 Server Message Block (file sharing) packets filtered.
SNMP Count	Number of IPv4 SNMP packets filtered.
Bootp Client Count	Total number of IPv4 DHCP requests filtered.
Bootp Server Count	Total number of IPv4 DHCP replies filtered.

Attribute	Meaning
IPv4 Multicast Count	Number of IPv4 Multicast messages filtered.
All IPv6 Count	Number of IPv6 messages filtered.
All Other IPv6 Count	Any IPv6 message that was not SMB, SNMP, Bootp, Multicast or one of the user defined filters, that was filtered out.
IPv6 SMB Count	Number of IPv6 Server Message Block (file sharing) packets filtered
IPv6 SNMP Count	Number of IPv6 SNMP messages filtered
IPv6 Bootp Client Count	Total number of IPv6 DHCP replies filtered
IPv6 Bootp Server Count	Total number of IPv6 DHCP replies filtered
IPv6 Multicast Count	Number of IPv6 Multicast messages filtered
ARP Count	Total number of ARP packets filtered.
All other Count	The count of any messages that did not fit above that were filtered out
User Defined Port1 Count	Number of packets defined by the user port1 that were filtered.
User Defined Port2 Count	Number of packets defined by the user port2 that were filtered.
User Defined Port3 Count	Number of packets defined by the user port3 that were filtered.

Viewing ARP statistics

The Statistics > ARP page in a SM module correlated the IP address of the Ethernet-connected device to its MAC address and provides data about the connection.

Figure 95 : ARP page of the SM

IP Address	Physical Address	Interface	Pending	Create Time	Last Time
192.168.2.7	00-1f-3b-4a-c6-79	et1	N	20:52:44 01/01/2011	21:02:43 01/01/2011

Viewing NAT statistics

When NAT is enabled on a SM, statistics are kept on the Public and Private (WAN and LAN) sides of the NAT and displayed on the Statistics > NAT Stats page. The NAT page of SM is explained in below table.

Table 142 :NAT page attributes - SM

Private NAT Statistics	
Packet In Count :	0
Packet Out Count :	0
Packet Out Toss Count :	0
Out Of Resources Count :	0
Failed Hash Insert Count :	0

Public NAT Statistics	
Packet In Count :	0
Packet Out Count :	0
Packet Out Toss Count :	0
Out Of Resources Count :	0
Failed Hash Insert Count :	0

Attribute	Meaning
Private NAT Statistics, Packet In Count	This field represents the number of packets received on the SM's LAN/Ethernet interface
Private NAT Statistics, Packet Out Count	This field represents the number of packets sent from the SM's LAN/Ethernet interface
Private NAT Statistics, Packet Out Toss Count	This field represents the number of packets that we not sent from the SM's LAN/Ethernet interface due to addressing issues.
Private NAT Statistics, Out of Resources Count	This field represents the number of times the NAT table for the SM's LAN/Ethernet interfaces has been filled.
Private NAT Statistics, Failed Hash Insert Count	This field represents the number of times that the device failed to insert an address binding into the NAT hash table.
Public NAT Statistics, Packet In Count	This field represents the number of packets received on the SM's WAN/wireless interface
Public NAT Statistics, Packet Out Count	This field represents the number of packets sent from the SM's WAN/wireless interface
Public NAT Statistics, Out of Resources Count	This field represents the number of packets that we not sent from the SM's WAN/wireless interface due to addressing issues.
Public NAT Statistics, Failed Hash Insert Count	This field represents the number of times the NAT table for the SM's WAN/wireless interfaces has been filled.

Viewing NAT DHCP Statistics

The Statistics > NAT DHCP page displays NAT enabled DHCP client statistics. This is statistics page is applicable for SM only.

When NAT is enabled on a SM with DHCP client (DHCP selected as the Connection Type of the WAN interface) and/or DHCP Server, statistics are kept for packets transmitted, received and tossed, as well as

a table of lease information for the DHCP server (Assigned IP Address, Hardware Address and Lease Remained/State).

Table 143 :NAT DHCP Statistics page attributes - SM

DHCP Client Statistics

PktXmt Count: 34
 PktRcv Count: 0
 PktToss ARPUnresolved Overflow Count: 0
 PktToss Unsupported MsgType Count: 0
 PktToss XID Mismatch Count: 0
 PktToss NoSID Count: 0
 PktToss SID Mismatch Count: 0
 Failure To Reset Client Count: 0

DHCP Server Statistics

Assigned IP Address	Hardware Address	Lease Remained/State
169.254.1.2	001eec1e0260	0d, 00:01:30

PktXmt Count: 2
 PktRcv Count: 2
 PktToss Count: 0

Attribute	Meaning
PktXmt Count	Represents the number of DHCP packets transmitted from the client
PktRcv Count	This field represents the number of DHCP packets received by the client
PktToss ARPUnresolved Overflow Count	This field represents the number of packets tossed due to failed attempts to resolve an IP address into a physical MAC address
PktToss Unsupported MsgType Count	This field represents the number of packets tossed due to the receipt of an unsupported message type (cannot be interpreted by DHCP client)
PktToss XID Mismatch Count	The field represents the number of packets that were tossed due to a transaction ID mismatch
PktToss NoSID Count	This field represents the number of packets that were tossed due to lack of a DHCP session ID
PktToss SID Mismatch Count	Represents the number of packets tossed due to a session ID mismatch
Failure to Reset Client Count	This field represents the number of times the DHCP client was unable to be reset (resulting in no IP address being served).

Interpreting Sync Status statistics

The Statistics > Sync Status page of AP is only displayed when the Sync Input is set to AutoSync or AutoSync+Free Run.

The Sync Status page is explained in below table.

Table 144 :Sync Status page attributes - AP

Sync Status	
Sync Pulse Source :	Power Port
Sync Pulse Status :	Receiving Sync
Sync Pulse Status - Timing Port/UGPS :	No Sync
Sync Pulse Status - Power Port :	Receiving Sync
UGPS Power Status :	Power Off

Attribute	Meaning
Sync Pulse Source	This field indicates the status of the synchronization source: <ul style="list-style-type: none"> • Searching indicates that the unit is searching for a GPS fix • Timing Port/UGPS indicates that the module is receiving sync via the timing AUX/SYNC timing port • Power Port indicates that the module is receiving sync via the power port (Ethernet port).
Sync Pulse Status	This field indicates synchronization source pulse status.
Sync Pulse Status - Timing Port/UGPS	This field indicates synchronization pulse status over Timing Port/UGPS port.
Sync Pulse Status - Power Port	This field indicates synchronization pulse status over power port.
UGPS Power Status	This field indicates UGPS power up status (on or off).

This information may be helpful in a decision of whether to climb a tower to diagnose a perceived antenna problem.

Interpreting PPPoE Statistics for Customer Activities

The page can be access under Statistics > PPPoE of SM GUI.

When the PPPoE feature is enabled on the SM, PPPoE statistics provide data about activities of the customer.

The PPPoE Statistics of SM is explained in below table.

Table 145 :PPPoE Statistics page attributes - SM

PPPoE Statistics	
IP address :	0.0.0.0
PPPoE Session Status :	Connecting
PPPoE AC Name :	
PPPoE Service Name :	
PPPoE Session ID :	0
PPPoE Session Uptime :	00:00:00
PPPoE Session Idle Time :	00:00:00
PPPoE Session MTU :	0
Primary DNS Address :	0.0.0.0
Secondary DNS Address :	0.0.0.0
PPPoE Control Bytes Sent :	168
PPPoE Control Bytes Received :	0
PPPoE Data Session Bytes Sent :	0
PPPoE Data Session Bytes Received :	0

Attribute	Meaning
IP address	This field displays the IP address of the PPPoE session initiator (situated below the SM)
PPPoE Session Status	This field displays the operational status of the PPPoE Session
PPPoE AC Name	This field displays access concentrator name used in the PPPoE session
PPPoE Service Name	This field displays the PPPoE service name associated with the PPPoE server in use
PPPoE Session ID	This field displays the current PPPoE session ID
PPPoE Session Uptime	This field displays the total session uptime for the PPPoE session
PPPoE Session Idle Time	This field displays the total idle time for the PPPoE session
PPPoE Session MTU	This field displays Maximum Transmission Unit configured for the PPPoE session
Primary DNS Address	This field displays the primary DNS server used by the PPPoE session
Secondary DNS Address	This field displays the secondary DNS server used by the PPPoE session
PPPoE Control Bytes Sent	Displays the total number of PPPoE session control bytes sent from SM
PPPoE Control Bytes Received	This field displays the total number of PPPoE session control bytes received by the SM
PPPoE Data Session Bytes Sent	This field displays the total number of PPPoE data session (non-control/non-session management user data) sent by the SM
PPPoE Data Session Bytes Received	This field displays the total number of PPPoE data session (non-control/non-session management user data)

Interpreting Bridge Control Block statistics

The Statistics > Bridge Control Block page displays statistics of Bridge FEC, Bridge ratio and Bridge error. The page is applicable for all modules (AP/SM/BHM/BHS). The Bridge Control Block Statistics page is explained in below table.

Table 146 :Bridge Control Block page attributes - AP/SM/BHM/BHS

Bridge FEC Stats	
FEC bin :	437
FEC bout :	24
FEC btoss :	0
FEC btossap :	0
FEC uin :	3915
FEC uout :	5745
FEC utoss :	0
FEC utossap :	0

Bridge Eth Aux Stats	
Eth Aux bin :	0
Eth Aux bout :	0
Eth Aux btoss :	0
Eth Aux btossap :	0
Eth Aux uin :	0
Eth Aux uout :	0
Eth Aux utoss :	0
Eth Aux utossap :	0

Bridge Radio Stats	
RF bin :	3
RF bout :	441
RF unknown ucast floods :	0
RF btoss :	0
RF btossap :	0
RF uin :	331
RF uout :	9
RF utoss :	0
RF utossap :	0

Bridge Error Stats	
ErrNI1QSend :	0
ErrNI2QSend :	0
ErrBridgeFull :	0
ErrSendMsg :	0
ErrApFecQSend :	0
ErrApRfQSend :	0

Attribute	Meaning
Bridge FEC Stats	
FEC bin	This field indicates the number of broadcast packets received by the bridge control block on the Main Ethernet interface
FEC bout	This field indicates the number of broadcast packets sent by the bridge control block on the Main Ethernet interface
FEC btoss	This field indicates the number of broadcast packets tossed out by the bridge control block on the Main Ethernet interface

Attribute	Meaning
FEC btosscap	This field indicates the number of broadcast packets tossed out at the Main Ethernet interface due to MIR cap being exceeded.
FEC uin	This field indicates the number of unicast packets received by the bridge control block on the Main Ethernet interface
FEC uout	This field indicates the number of unicast packets sent by the bridge control block on the Main Ethernet interface
FEC utoss	This field indicates the number of unicast packets tossed by the bridge control block on the Main Ethernet interface
FEC utosscap	This field indicates the number of unicast packets tossed out at the Main Ethernet interface due to MIR cap being exceeded.
Bridge Eth Aux Stats	
FEC bin	This field indicates the number of broadcast packets received by the bridge control block on the Aux Ethernet interface
FEC bout	This field indicates the number of broadcast packets sent by the bridge control block on the Aux Ethernet interface
FEC btoss	This field indicates the number of broadcast packets tossed out by the bridge control block on the Aux Ethernet interface
FEC btosscap	This field indicates the number of broadcast packets tossed out at the Aux Ethernet interface due to MIR cap being exceeded.
FEC uin	This field indicates the number of unicast packets received by the bridge control block on the Aux Ethernet interface
FEC uout	This field indicates the number of unicast packets sent by the bridge control block on the Aux Ethernet interface
FEC utoss	This field indicates the number of unicast packets tossed by the bridge control block on the Aux Ethernet interface
FEC utosscap	This field indicates the number of unicast packets tossed out at the Aux Ethernet interface due to MIR cap being exceeded.
Bridge Radio Stats	
RF bin	This field indicates the number of broadcast packets received by the bridge control block on the radio interface
RF bout	This field indicates the number of broadcast packets sent by the bridge control block on the radio interface
RF btoss	This field indicates the number of broadcast packets tossed by the bridge control block on the radio interface
RF btosscap	This field indicates the number of broadcast packets tossed out at the radio interface due to MIR cap being exceeded.

Attribute	Meaning
RF uin	This field indicates the number of unicast packets received by the bridge control block on the radio interface
RF uout	This field indicates the number of unicast packets sent by the bridge control block on the radio interface
RF utoss	This field indicates the number of unicast packets tossed by the bridge control block on the radio interface
RF utosscap	This field indicates the number of unicast packets tossed out at the radio interface due to MIR cap being exceeded.
Bridge Error Stats	
ErrNI1QSend	This field indicates that a packet which was sourced from the radio network stack interface 1 (Ethernet interface) could not be sent because the radio bridge queue was full. The packet was tossed out.
ErrNI2QSend	This field indicates that a packet which was sourced from the radio network stack interface 2 (RF interface) could not be sent because the radio bridge queue was full. The packet was tossed out.
ErrBridgeFull	This field indicates the total number of times the bridging table was full and could not accept new entries.
ErrSendMsg	This field displays the error message from bridge core call back routine.
ErrApFecQSend	This field indicates that a packet which was received on the Ethernet interface could not be processed because the radio bridge queue was full and packet was tossed out.
ErrApRfQSend	This field indicates that a packet which was received on the RF interface could not be processed because the radio bridge queue was full. The packet was tossed out.

Interpreting Pass Through Statistics

The Statistics > Pass Through Statistics page displays radius related statistics. The page is applicable for PMP 450 Platform Family - AP only. The Pass Through Statistics page is explained in below table.

Table 147 : Pass Through Statistics page attributes – AP

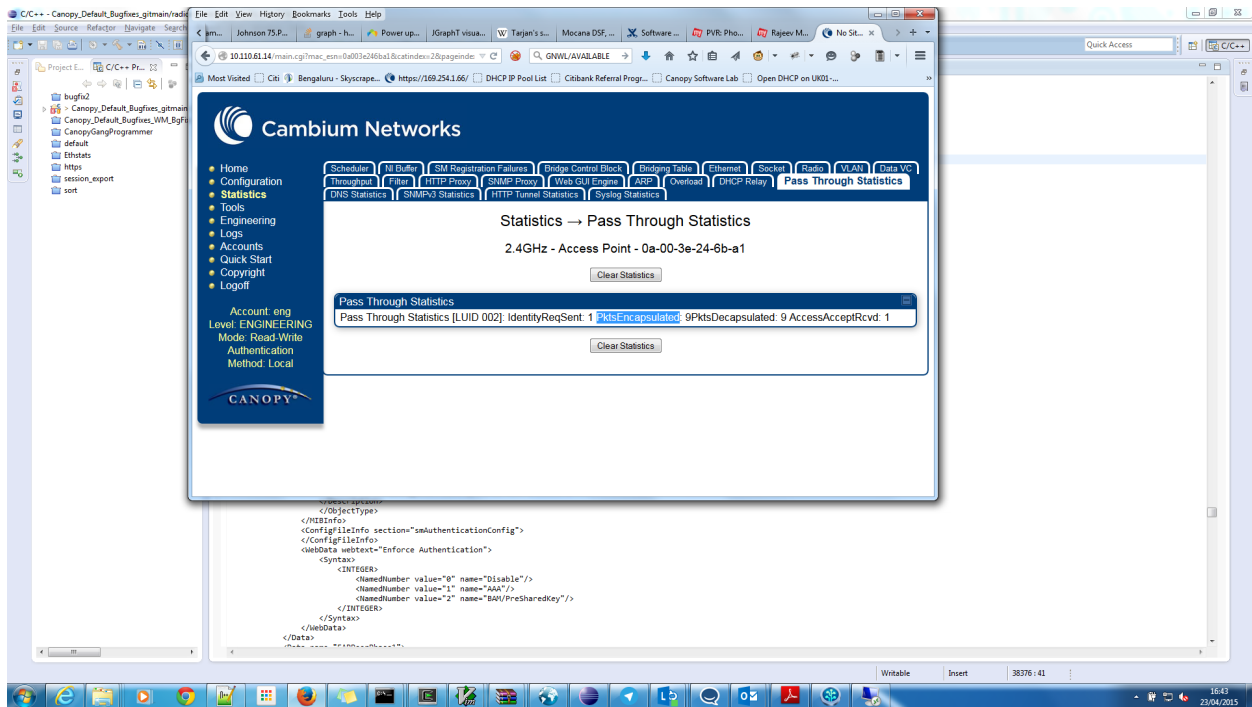

Attribute	Meaning
IdentityReqSent	This field indicates the number of EAP Identity requests sent through the AP with respect to an SM.
PktsEncapsulated	This field indicates no of packets received from the SM which are encapsulated by the AP.
PktsDecapsulated	This field indicates no of packets received from the radius server and are decapsulated by the AP with respect to an SM
AccessAcceptRcvd	This field indicates no of RADIUS Access Accept message received by the AP with respect to an SM.

Interpreting SNMPv3 Statistics

The Statistics > SNMPv3 Statistics page displays all SNMPv3 related statistics. The page is applicable for all type of ODUs of PMP 450 Platform. The SNMPv3 Statistics page is explained in below table.

Table 148 :SNMPv3 Statistics page attributes - AP

```

SNMPv3 Statistics
Statistics for snmpMPDStats group
snmpUnknownSecurityModels = 0
snmpInvalidMsgs = 0
snmpUnknownPDUHandlers = 0
Statistics for usmStats group
usmStatsUnsupportedSecLevels = 0
usmStatsNotInTimeWindows = 0
usmStatsUnknownUserNames = 0
usmStatsUnknownEngineIDs = 0
usmStatsWrongDigests = 0
usmStatsDecryptionErrors = 0
Statistics for snmpTargetObjects group
snmpTargetSpinLock = 0
snmpUnavailableContexts = 0
snmpUnknownContexts = 0
Statistics for usmUser group
usmUserSpinLock = 0
Statistics for vacmMIBViews group
vacmViewSpinLock = 0
Value of Globals
engine id = 80 00 00 a1 03 0a 00 3e a0 2b c8
engineId length = 11
number of engine boots = 237
time since engine is up = 54598
next saltId = 0
next messageId = 100
next localPortNum = 2000
max msg size = 1460
default context =
authoritative = YES
localize keys = YES
Misc. statistics
assertsFailed = 0
lenassertsFailed = 0
oidlenassertsFailed = 0
delFailed = 0
Compile time options
Authentication = enabled
Privacy = enabled
CipherEngine = disabled
SNMP over IPv6 = disabled

```

Attribute	Meaning
Statistics for snmpMPDStats group	SNMP Message Processing and Dispatching RFC 3412
snmpUnknownSecurityModels	The total number of packets received by the SNMP engine which were dropped because they referenced a securityModel that was not known to or supported by the SNMP engine.
snmpInvalidMsgs	The total number of packets received by the SNMP engine which were dropped because there were invalid or inconsistent components in the SNMP message.
snmpUnknownPDUHandlers	The total number of packets received by the SNMP engine which were dropped because the PDU contained in the packet could not be passed to an application responsible for handling the pduType, e.g. no SNMP application had registered for the proper combination of the contextEngineID and the pduType.
usmStatsUnsupportedSecLevels	The total number of packets received by the SNMP engine which were dropped because they requested a securityLevel that was unknown to the SNMP engine or otherwise unavailable.
usmStatsNotInTimeWindows	The total number of packets received by the SNMP engine which were dropped because they appeared outside of the authoritative SNMP engine's window.
usmStatsUnknownUserNames	The total number of packets received by the SNMP engine which were dropped because they referenced a user that was not known to the

Attribute	Meaning
	SNMP engine.
usmStatsUnknownEngineIDs	The total number of packets received by the SNMP engine which were dropped because they referenced a snmpEngineID that was not known to the SNMP engine.
usmStatsWrongDigests	The total number of packets received by the SNMP engine which were dropped because they didn't contain the expected digest value.
usmStatsDecryptionErrors	The total number of packets received by the SNMP engine which were dropped because they could not be decrypted.
snmpTargetSpinLock	This object is used to facilitate modification of table entries in the SNMP-TARGET-MIB module by multiple managers.
snmpUnavailableContexts	The total number of packets received by the SNMP engine which were dropped because the context contained in the message was unavailable.
snmpUnknownContexts	The total number of packets received by the SNMP engine which were dropped because the context contained in the message was unknown.
usmUserSpinLock	The use of usmUserSpinlock is to avoid conflicts with another SNMP command generator application which may also be acting on the usmUserTable.
vacmViewSpinLock	An advisory lock used to allow cooperating SNMP Command Generator applications to coordinate their use of the Set operation in creating or modifying views.
snmpEngineBoots	It is a count of the number of times the SNMP engine has re-booted/re-initialized since snmpEngineID was last configured
snmpEngineTime time since engine is up	which is the number of seconds since the snmpEngineBoots counter was last incremented

Interpreting syslog statistics

The Statistics > Syslog Statistics page displays statistics of syslog messages. The page is applicable for all modules (AP/SM/BHM/BHS). The Syslog Statistics page is explained in below table.

Table 149 :Syslog statistics page attributes - AP/SM/BH

Syslog Transmission Stats	
Syslog Server :	0.0.0.0
Syslog Server Port :	514
Syslog Status :	Enabled
Syslog Message Transmissions :	12781
Syslog Messages Dropped :	0

Attribute	Meaning
Syslog Server	This displays dotted decimal or DNS name (if the DNS is enabled) of the syslog server address.
Syslog Server Port	The syslog server port (default 514) to which syslog messaging is sent.
Syslog Status	This indicates status of syslog messaging. It can be Enable or Disabled based on configuration
Syslog Message Transmissions	This field indicates the count of syslog messages sent to UDP layer.
Syslog Message Dropped	This field indicates the count of dropped syslog messages.

Interpreting Frame Utilization statistics

The Frame Utilization Statistics is a feature helps user to understand how effectively the RF channel is being utilized. This feature allows to check Time Division Duplex (TDD) frame utilization pattern and diagnose for any excessive usage in uplink or downlink direction.

This forms the first step of identifying the TDD frame utilization information. If the user finds excessive utilization based on these stats, the second step would be to take several actions like sectorization, tuning the uplink/downlink ratio etc. to improve RF channel utilization. Efficient use of the TDD frame will help to achieve optimum performance of link.



Note

The backhuls (BHM and BHS) will have only the downlink scheduler-based statistics

Table 150 :Frame utilization statistics for 450m

MU-MIMO Utilization		
Slot Grouping		
Group Size	% Downlink Distribution	% Uplink Distribution
1 (ungrouped)	34.9	11.5
2	0.3	0.0
3	0.3	88.5
4	0.5	0.0
5	3.2	0.0
6	32.3	0.0
7	28.7	0.0

Additional Statistics		
	Downlink	Uplink
Average MU-MIMO Group Size - Data	4.5	2.8
Multiplexing Gain	2.9	2.2

Sector Utilization		
	Downlink	Uplink
SU-MIMO	31%	8%
MU-MIMO	57%	58%
ACK	3%	29%
MU-MIMO ACK		5%
Broadcast & Multicast	0%	
Total Utilization	91%	100%

Slot Counts				
Uplink and Downlink Slot Counts				
	Downlink		Uplink	
	Slots	%	Slots	%
Per Frame Average	7		7	
Low Priority	170082	17.7	161228	16.4
Medium Priority	0	0.0	0	0.0
High Priority	0	0.0	0	0.0
Ultra High Priority	8	0.0	163	0.0
Broadcast & Multicast	153	0.0		
Authentication and Configuration	0	0.0	0	0.0
Registration and Control	1	0.0	167	0.0
MAC Acknowledgements	8330	0.9	4579	0.5
Contention Slots Average Per Frame			37	
Bandwidth Requests Received			10487	
Bandwidth Requests Missed			9745	
Total	178574	18.6	166137	16.9

Frame Utilization	
Downlink :	19 %
Uplink :	17 %
Bandwidth Request Success :	52 %

Maximum Possible Counts	
Downlink :	960000
Uplink :	984000
Contention :	1056000

Packet Discard Counts	
Ethernet indiscards :	0
Ethernet outdiscards :	0
Radio indiscards :	0
Radio outdiscards :	0

Attribute	Meaning
Frame Utilization Interval	
Statistics Display interval	This allows to configure timer interval to monitor and display the frame utilization statistics. It can be configured for 1 minute (low interval), 5 minutes (medium interval) or 15 minutes (high interval) based on requirement.
Next Update	This field displays when the next update will occur.
MU-MIMO Utilization	
Slot Grouping - Group Size	<p>This specifies the distribution of group size for the past 1/5/15 minutes. For each group size, from 1 to 7, the table shows the percentage of slots using that group size.</p> <ul style="list-style-type: none"> • A group size of 1 corresponds to beamformed transmissions. • A group size of 2 to 7 corresponds to MU-MIMO transmissions.
Additional Statistics	
Average MU-MIMO Group Size - Data	This specifies the average number of users in the MU-MIMO groups formed in the last 1/5/15 minutes for data traffic only.
Total Utilization	This is a percentage of available timeslots used in the past 1/5/15 minutes.
Multiplexing Gain	<p>This specifies the ratio between the number of logical slots and the number of physical slots used.</p> <p>A physical slot is an OFDM symbol. In non MU-MIMO mode, each logical slot is sent during one physical slot. In MU-MIMO mode a number of logical slots are sent during a physical slot, equal to the number of VCs in the group. A logical slot carries new information; if data is repeated in a group, because some VCs have more data to send than others, then the repeated transmissions are not counted as a logical slots.</p> <p>Without MU-MIMO operation, the multiplexing gain would always be equal to 1.</p> <p>With MU-MIMO operation, this number accounts for parallel transmissions to multiple users in the MU-MIMO group.</p> <p>The difference between the Average MU-MIMO Group Size and the Multiplexing Gain is that the Average MU-MIMO Group Size only considers the MU-MIMO groups, and it averages the number of VCs in the Group. The Multiplexing Gain also considers non MU-MIMO transmissions, which are counted as groups of size 1.</p>
Sector Utilization	
SU-MIMO	This specifies the portion of the Total Utilization used for SU-MIMO transmissions.
MU-MIMO	This specifies the portion of the Total Utilization used for MU-MIMO transmissions.

Attribute	Meaning
ACK	This specifies the portion of the Total Utilization used for acknowledgments transmission.
MU-MIMO ACK	This specifies the portion of the Total Utilization used for acknowledgments transmissions that are MU- MIMO scheduled. Currently only the UL direction supports MU-MIMO scheduling of ACK's.
Broadcast & Multicast	This specifies the portion of the Total Utilization used for broadcast and multicast transmissions.
Slots Counts - Uplink and Downlink Slot Counts	
Per Frame Average	This indicates the average data per frame in the downlink traffic.
Low Priority	The number of downlink data slots used for low priority downlink traffic.
Medium Priority	The number of downlink data slots used for medium priority downlink traffic.
High Priority	The number of downlink data slots used for high priority downlink traffic.
Ultra High Priority	The number of downlink data slots used for ultra high priority downlink traffic.
Note: The above Low, Medium, High, and Ultra High Priority Counts are physical slot transmissions. For MU-MIMO scheduling, some transmissions can contain data from more than 1 data channel priority. In those cases, the highest data channel used is "counted" in these statistics, and the other data channels are not, to avoid overcounting.	
Broadcast & Multicast	The number of downlink data slots used for broadcast and multicast traffic.
Authentication and Configuration	The number of slots used for registration and control message transmissions
Registration and control	The number of slots used for Authentication and Configuration transmissions.
MAC Acknowledgements	The number of downlink data slots used as ACKs.
Contention Slots Average Per Frame	It is the average number of contention slots in a frame for the last duration. Duration is 1/5/15 mins.
Bandwidth Requests Received	This indicates the number of Bandwidth Requests received from SMs.
Bandwidth Requests Missed	This indicates how many of Bandwidth Requests are colliding.
Total	This indicates the sum of all downlink data slots used in the configured interval.
Frame Utilization	
Downlink	This indicates the percentage of downlink data slots used against the maximum number of slots possible in the configured interval.
Uplink	This indicates the percentage of uplink data slots used against the

Attribute	Meaning
	maximum number of uplink slots possible in the configured interval.
Bandwidth Request Success	<p>The "Bandwidth Request Success" is a message sent from the SM to the AP asking to be scheduled for bandwidth to send in the uplink. This gets transmitted in the unscheduled portion of the uplink. Unscheduled uplink is defined as Contention Slots + unscheduled uplink slots. Since this is sent in the unscheduled portion of the uplink, it will result in collisions when SMs randomly pick the same slot.</p> <p>The "Bandwidth Request Missed" metrics are to add data to know how many of requests are colliding. If it is near 100%, then near all of the SM's bandwidth requests are getting through to the AP, so this is a near perfect scenario. If it is significantly less than that, you may be experiencing uplink latency as your SMs are attempting to request bandwidth and are unable to do so.</p> <p>Also note that if it is consistently at 100% the AP may be able to reduce its contention slots to a lower value and gain more data slots.</p>
Maximum possible counts	
Downlink	This indicates the maximum possible downlink data slots in the configured interval. This is based on the configuration of Channel Bandwidth, Frame period, uplink/downlink allocation, contention slots and configured Statistics Display interval.
Uplink	This indicates the maximum possible uplink data slots in the configured interval. This is based on the configuration of Channel Bandwidth, Frame period, uplink/downlink allocation, contention slots and configured Statistics Display interval.
Contention	This indicates the maximum possible contention slots.
Packet Discard counts	
Ethernet indiscards	This indicates the number of Ethernet packets discarded in the IN queue.
Ethernet outdiscards	This indicates the number of Ethernet packets discarded in the OUT queue.
Radio indiscards	This indicates the number of packets discarded over radio in the IN queue.
Radio outdiscards	This indicates the number of packets discarded over radio in the OUT queue.

Table 151: Frame utilization statistics for 450, 450i

Frame Utilization Interval	
Statistics Display Interval :	1 minute ▾
Next Update :	17 seconds

Frame Utilization	
Downlink :	33 %
Uplink :	37 %
Bandwidth Request Success :	100 %

Downlink Counts	
Total :	688898
Per Frame Average :	29
Low Priority :	384
Medium Priority :	0
High Priority :	680083
Ultra High Priority :	0
Broadcast/Multicast :	204
Canopy MAC Acknowledgments :	8227
Authentication and Configuration Messages :	0
Registration and Control Messages :	0

Uplink Counts	
Total :	704389
Per Frame Average :	29
Low Priority :	3433
Medium Priority :	0
High Priority :	676800
Ultra High Priority :	0
Authentication and Configuration Messages :	0
Canopy MAC Acknowledgments :	24156
Contention Slots :	1431611
Contention Slots Average Per Frame :	60
Reserved Contention Slots Average Per Frame :	9
Bandwidth Requests Received :	7963
Bandwidth Requests Missed :	0

Maximum Possible Counts	
Downlink :	2064000
Uplink :	2064000
Contention :	2136000

Packet Discard Counts	
Ethernet indiscards :	0
Ethernet outdiscards :	0
Radio indiscards :	0
Radio outdiscards :	0

Attribute	Meaning
See Frame utilization statistics for 450m.	

Interpreting Spatial Utilization statistics

Table 152 :Spatial Utilization statistics



Spatial Utilization						
Instantaneous Distribution						
Group	Median Slot Count	Downlink				
		LUIDs in Group				
Top LUID	3584	19				
Top 2 LUIDs	3584	18				
Top 4 LUIDs	3584	15, 16				
Top 8 LUIDs	3584	4, 5, 7, 9				
Top 16 LUIDs	3428	2, 3, 6, 8, 10, 12, 21, 22				
Top 32 LUIDs	3368	11, 13, 14, 17, 20				
Top 64 LUIDs	0					
Top 128 LUIDs	0					
Top 256 LUIDs	0					

Spatial Utilization						
Spatial Frequency	LUIDs in Range	Downlink				Azimuth (degrees)
		Instantaneous (%)	Total (%)	Max (%)	Min (%)	
0 - 31	2	100	100	100	99	(-50.7 - -49.3), (0.0 - 1.4), (50.7 - 52.0)
32 - 63	5	100	100	100	99	(-49.3 - -47.9), (1.4 - 2.8), (52.0 - 53.4)
64 - 95	9	100	100	100	99	(-47.9 - -46.5), (2.8 - 4.2), (53.4 - 54.8)
96 - 127		100	100	100	99	(-46.5 - -45.1), (4.2 - 5.5), (54.8 - 56.2)
128 - 159	14	100	100	100	99	(-45.1 - -43.7), (5.5 - 6.9), (56.2 - 57.6)
160 - 191		100	100	100	99	(-43.7 - -42.3), (6.9 - 8.3), (57.6 - 59.0)
192 - 223	8	100	100	100	99	(-42.3 - -40.9), (8.3 - 9.7), (59.0 - 60.0)
224 - 255	19	100	100	100	99	(-40.9 - -39.5), (9.7 - 11.1)
256 - 287	11	100	100	100	99	(-39.5 - -38.1), (11.1 - 12.6)
288 - 319		100	100	100	99	(-38.1 - -36.7), (12.6 - 14.0)
320 - 351	22	100	100	100	99	(-36.7 - -35.2), (14.0 - 15.4)
352 - 383	18	100	100	100	99	(-35.2 - -33.8), (15.4 - 16.9)
384 - 415		100	100	100	99	(-33.8 - -32.3), (16.9 - 18.3)
416 - 447	3	100	100	100	99	(-32.3 - -30.9), (18.3 - 19.8)
448 - 479	8	100	100	100	99	(-30.9 - -29.4), (19.8 - 21.3)
480 - 511		100	100	100	99	(-29.4 - -27.9), (21.3 - 22.7)
512 - 543		100	100	100	99	(-27.9 - -26.4), (22.7 - 24.3)
544 - 575	4	100	100	100	99	(-26.4 - -24.9), (24.3 - 25.8)
576 - 607	17	100	100	100	99	(-24.9 - -23.3), (25.8 - 27.3)
608 - 639	10	100	100	100	99	(-23.3 - -21.8), (27.3 - 28.9)
640 - 671		100	100	100	99	(-21.8 - -20.2), (28.9 - 30.5)
672 - 703	7	100	100	100	99	(-20.2 - -18.5), (30.5 - 32.1)
704 - 735	20	100	100	100	99	(-18.5 - -16.9), (32.1 - 33.8)
736 - 767		100	100	100	99	(-16.9 - -15.2), (33.8 - 35.5)
768 - 799	12	100	100	100	99	(-15.2 - -13.5), (35.5 - 37.2)
800 - 831		100	100	100	99	(-13.5 - -11.7), (37.2 - 38.9)
832 - 863	16	100	100	100	99	(-11.7 - -9.9), (38.9 - 40.7)
864 - 895	13	100	100	100	99	(-9.9 - -8.1), (40.7 - 42.6)
896 - 927	21	100	100	100	99	(-8.1 - -6.2), (42.6 - 44.5)
928 - 959		100	100	100	99	(-6.2 - -4.2), (44.5 - 46.5)
960 - 991	15	100	100	100	99	(-4.2 - -2.1), (46.5 - 48.5)
992 - 1023		100	100	100	99	(-2.1 - 0.0), (48.5 - 50.7)

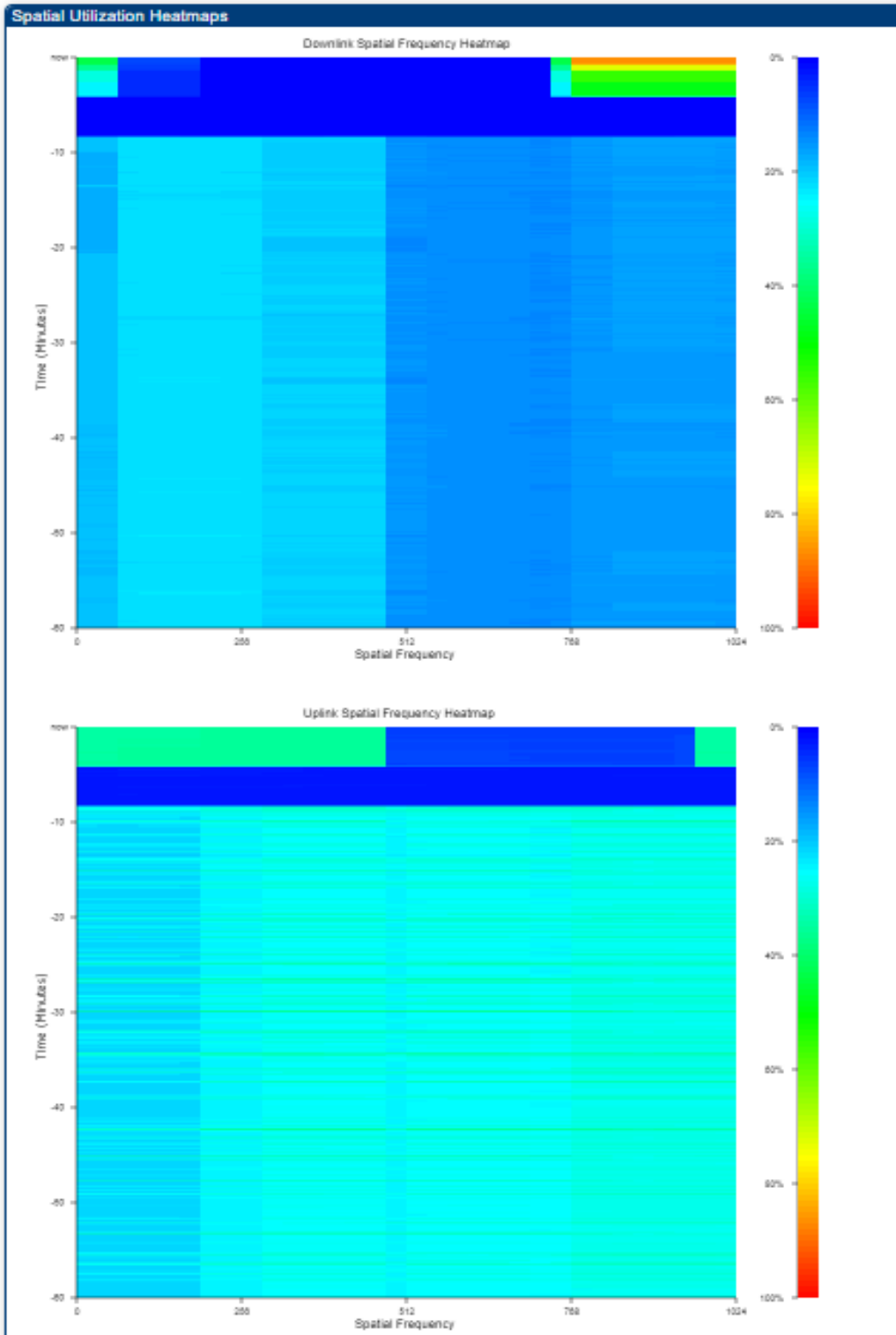
Spatial Frequency Heatmap



Attribute	Meaning
	This table is updated every 500 ms and displays the following:

Attribute	Meaning
Instantaneous Distribution	<ul style="list-style-type: none"> Group: Each row corresponds to the top (most active) 1, 2, 8, 16, 32, 64, 128 and 256 VCs. Median Slot Count: Median value of the average number of slots scheduled for the VCs in each group in the past 500 ms. <hr/> <ul style="list-style-type: none"> LUIDs in Group: List of LUIDs belonging to each bin.
Spatial Utilization	<p>This is a table (32 rows) that lists frame utilization for each spatial frequency (SF) range with following information:</p> <ul style="list-style-type: none"> Spatial Frequency: Range of spatial frequency for each bin. Each bin includes 32 consecutive spatial frequency values. Azimuth (degrees): Azimuth range in degrees corresponding to the spatial frequencies of the bin. The zero-degree Azimuth is boresight. <div style="border: 1px solid black; background-color: #e6f2ff; padding: 5px; margin-top: 10px;">  <p>Note</p> <p>Some SF ranges correspond to multiple azimuth ranges. This is because for some spatial frequencies the AP generates beams in multiple azimuth directions. The SM can be physically located in any of the azimuth ranges.</p> </div>
Spatial Utilization (Contd.)	<ol style="list-style-type: none"> Instantaneous (%): Frame utilization for the SF bin, updated every 500 ms. The frame utilization percentage accounts for all traffic, sector mode, beamforming mode, and MU-MIMO mode. Total (%): Average utilization in the SF bin for the past 1/5/15 minutes, as selected in the Statistics Display interval. Max (%): Maximum instantaneous utilization in the 1/5/15 minute interval. Min (%): Minimum instantaneous utilization in the 1/5/15 minute interval. VCs in Range: List of VCs with spatial frequency falling in the bin. LUIDs in Range: List of LUIDs with spatial frequency falling in the bin. <div style="border: 1px solid black; background-color: #e6f2ff; padding: 5px; margin-top: 10px;">  <p>Note</p> <p>The size of each SF bin is smaller than the beam generated by the AP during a MU-MIMO transmission. This means that when a VC in a bin is scheduled for a MU-MIMO transmission, the adjacent bins also receive the signal, and the transmission is counted towards their utilization as well. Bins with consistent low utilization indicate the areas of the sector where more SMs could be installed, or the customers that could be offered higher data plans.</p> </div>
Spatial Frequency Heatmap	<p>The spatial frequency heatmap allow the operator to see how the 450m spatial frequency have been occupied (utilised) over the previous hour of operation. There are two heatmaps the first displays downlink utilisation and the lower the uplink utilisation. The heatmaps are useful when operators are identifying:</p> <ul style="list-style-type: none"> congested spatial directions spare capacity in spatial directions <p>The heatmap uses a graduated colour scale to represent the percentage utilisation. The</p>

Attribute	Meaning
	graphic to the right-hand side of the heatmap should be used as a key to interpret the GUI. Where dark blue represents zero percent utilisation and red represents 100% utilisation.

Radio Recovery

This section describes:

- How to recover a PMP/PTP 450i and PMP 450m Series ODUs from configuration errors or software image corruption
- How to override a PMP/PTP 450 Series ODUs from forgotten IP address and password to factory default

Radio Recovery Console– PMP/ PTP 450 i/ 450 b and PMP 450 m

Recovery mode allows to restore IP address and password. Also, it allows new main application software to be loaded even when the integrity of the existing main application software image has been compromised. The most likely cause of an integrity problem with the installed main application software is where the power supply has been interrupted during a software upgrade.



Note

When Recovery has been entered through a power on/off/on cycle, the ODU will revert to normal operation if no web access has been made to the unit within 30 seconds. This prevents the unit remaining inadvertently in recovery following a power outage.

Options in recovery mode are:

- Boot with normal operation
- Boot with default Canopy system software settings
- Load a previous SW image

The last most recent software images loaded to the board are retained. However the factory image is not retained.

Boot with default Canopy system software settings (similar to the hardware Default Plug based on 450 Platforms Family).



Note

The unit may enter recovery console automatically, in response to some failures.



Note

Once the unit has entered recovery, it will switch back to normal operation if no access has been made to the recovery web page within 30 seconds.

Use below procedure to enter in recovery console manually.

Procedure 27 Radio Recovery Console:

1	Apply power to PSU for at least 10 seconds.
2	Remove power from the PSU, and then re-apply it as soon as the power indicator light goes out (about 1 - 2 seconds).
3	When the unit is in recovery mode, access the web interface by entering the default IP address 169.254.1.1. The Recovery Image Warning page is displayed.
4	Review the Boot Selection (Recovery Options attributes).
5	Select a recovery option

Figure 96 : Recovery Options page

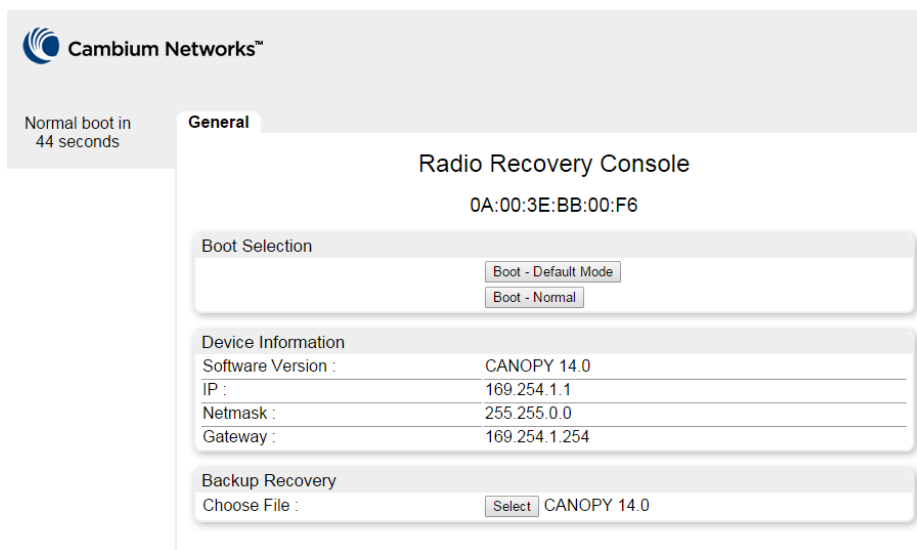

Table 153 :Recovery Options attributes

Attribute	Meaning
Boot Selection	<p>Boot - Default Mode: Use this option to temporarily set the IP and Ethernet attributes to factory defaults until the next reboot.</p> <p>Boot - Normal: Use this option to reboot the unit.</p>
IP address, Netmask, Gateway	These fields display IP address, Netmask and Gateway of the radio while it is in recovery or default mode.



Note

The radio enters recovery mode when a short power cycle is used. The radio will boot normally if power has been removed for a longer period (typically 5 - 10 seconds).

Default Mode (or Default/Override Plug) - PMP/PTP 450 Series

The default mode allows to temporarily override some PMP/PTP 450 Series ODU settings and thereby regain control of the module by powering the module on with the Default Plug inserted into the unit's synchronization (RJ11) port.

This override plug is needed for access to the module in any of the following cases:

- You have forgotten either
 - the IP address assigned to the ODU.
 - the password that provides access to the ODU.
- The ODU has been locked by the No Remote Access feature.
- You want local access to a module that has had the 802.3 link disabled in the Configuration page.

You can configure the module such that, when it senses the override plug, it responds by either

- resetting the LAN1 IP address to 169.254.1.1, allowing access through the default configuration without changing the configuration, whereupon you will be able to view and reset any non-default values as you wish.
- resetting all configurable parameters to their factory default values.



Note

The Default Plug is available from Best-Tronics Manufacturing, Inc. See <https://btpa.com/Cambium-Products/> as Part BT-0583 (RJ-11 Default Plug). Alternatively, you can fabricate an override plug. See Override plug cable in Planning and Installation Guide for pinout.

Using the Default/Override Plug

The following section details usage of the override plug to regain access to PMP/PTP 450 Series ODU.



Note

While the override plug is connected to a PMP/PTP 450 Series ODU, the ODU can neither register nor allow registration of another ODU.



Note

Since the 900 MHz SM is based on the 450 Series, it only supports the "Default Plug" mode of overriding.

Use below procedure to enter in default mode manually.

Procedure 28 Default mode

1	Insert the override plug into the RJ-11 GPS utility port of the module.
2	Power cycle by removing, then re-inserting, the Ethernet cable. RESULT: The module boots with the default IP address of 169.254.1.1, password fields blank, and all other configuration values as previously set.

3	Wait approximately 30 seconds for the boot to complete.
4	Remove the override plug.
5	Set passwords and IP address as desired.
6	Change configuration values if desired.
7	Click the Save Changes button.
8	Click the Reboot button.

Chapter 4: Reference information

This chapter contains reference information and regulatory notices that apply to the 450 Platform Family ODUs.

The following topics are described in this chapter:

- Equipment specifications contains specifications of the 450 Platform Family, ODU specifications including RF bands, channel width and link loss.
- Data network specifications shows the 450 Platform Family Ethernet interface specifications.
- Wireless specifications lists the safety specifications against which 450 Platform Family ODU has been tested and certified. It also describes how to keep RF exposure within safe limits.
- Country specific radio regulations describes how the 450 Platform Family complies with the radio regulations that are enforced in various countries.
- Equipment Disposal describes the Equipment Disposal system for Electronic and Electric Equipment.

Equipment specifications

This section contains specifications of the AP, SM, BHM and BHS associated supplies required for 450 Platform Family installations.

Specifications for 5 GHz PMP 450 m Series - AP

The 5 GHz PMP 450m AP conforms to the specifications listed in below table.

Table 154 :5 GHz PMP 450m Series - AP specifications

Category	Specification
Model Number	PMP 450m AP
Spectrum	
Channel Spacing	Configurable on 2.5 MHz increments
Frequency Range	4900 to 5925 MHz
Channel Bandwidth	5, 10, 15, 20, 30, and 40 MHz
Interface	
MAC (Media Access Control) Layer	Cambium Proprietary
Physical Layer	14x14 Multi-User MIMO OFDM
Ethernet Interface	100/1000BaseT, half/full duplex, rate auto negotiated (802.3 compliant)
Protocols Used	IPv4, UDP, TCP, IP, ICMP, Telnet, SNMP, HTTP, FTP
Network Management	HTTP, HTTPS, Telnet, FTP, SNMP v3
VLAN	802.1ad (DVLAN Q-in-Q), 802.1Q with 802.1p priority, dynamic port VID

Category	Specification	
Sensitivity		
Nominal Receive Sensitivity (w/ FEC) @ 5 MHz Channel	4.9 GHz	1x = -99.4 dBm, 2x = -96.9 dBm, 4x = -90.5 dBm, 6x = -84.3 dBm, 8x = -76.9 dBm
	5.1 GHz	1x = -100.6 dBm, 2x = -97 dBm, 4x = -90.5 dBm, 6x = -84 dBm, 8x = -76.3 dBm
	5.2 GHz	1x = -100.5 dBm, 2x = -96.7 dBm, 4x = -90.1 dBm, 6x = -83.7 dBm, 8x = -76.1 dBm
	5.4 GHz	1x = -101.2 dBm, 2x = -96.2 dBm, 4x = -90.3 dBm, 6x = -83.9 dBm, 8x = -76.5 dBm
	5.8 GHz	1x = -100.8 dBm, 2x = -96.5 dBm, 4x = -90.3 dBm, 6x = -84 dBm, 8x = -76.3 dBm
Nominal Receive Sensitivity (w/ FEC) @ 10 MHz Channel	4.9 GHz	1x = -97.5 dBm, 2x = -94.8 dBm, 4x = -88.4 dBm, 6x = -82.3 dBm, 8x = -75.1 dBm
	5.1 GHz	1x = -97.9 dBm, 2x = -94.3 dBm, 4x = -87.8 dBm, 6x = -81.5 dBm, 8x = -74.2 dBm
	5.2 GHz	1x = -97.9 dBm, 2x = -93.9 dBm, 4x = -87.4 dBm, 6x = -81.1 dBm, 8x = -73.9 dBm
	5.4 GHz	1x = -98.1 dBm, 2x = -94.1 dBm, 4x = -87.5 dBm, 6x = -81.3 dBm, 8x = -74.2 dBm
	5.8 GHz	1x = -98.4 dBm, 2x = -94.3 dBm, 4x = -87.8 dBm, 6x = -81.5 dBm, 8x = -74.4 dBm
Nominal Receive Sensitivity (w/ FEC) @ 15 MHz Channel	4.9 GHz	1x = -96 dBm, 2x = -93.2 dBm, 4x = -86.7 dBm, 6x = -80.3 dBm, 8x = -73.5 dBm
	5.1 GHz	1x = -96.5 dBm, 2x = -92.8 dBm, 4x = -86.4 dBm, 6x = -80 dBm, 8x = -72.8 dBm
	5.2 GHz	1x = -96.4 dBm, 2x = -92.2 dBm, 4x = -85.4 dBm, 6x = -79.1 dBm, 8x = -72.2 dBm
	5.4 GHz	1x = -96.7 dBm, 2x = -92.4 dBm, 4x = -85.7 dBm, 6x = -79.4 dBm, 8x = -72.6 dBm
	5.8 GHz	1x = -97.4 dBm, 2x = -92.8 dBm, 4x = -86.2 dBm, 6x = -80 dBm, 8x = -73 dBm
Nominal Receive Sensitivity (w/ FEC) @ 20 MHz Channel	4.9 GHz	1x = -94.7 dBm, 2x = -92.1 dBm, 4x = -85.5 dBm, 6x = -79.2 dBm, 8x = -72.5 dBm
	5.1 GHz	1x = -95.2 dBm, 2x = -91.5 dBm, 4x = -85.1 dBm, 6x = -78.7 dBm, 8x = -71.7 dBm
	5.2 GHz	1x = -95.2 dBm, 2x = -91.3 dBm, 4x = -84.8 dBm, 6x = -78.5 dBm, 8x = -71.5 dBm

Category		Specification		
	5.4 GHz	1x = -95.6 dBm, 2x = -90.8 dBm, 4x = -84.8 dBm, 6x = -78.5 dBm, 8x = -71.5 dBm		
	5.8 GHz	1x = -96.3 dBm, 2x = -91.3 dBm, 4x = -85.2 dBm, 6x = -78.8 dBm, 8x = -71.6 dBm		
Nominal Receive Sensitivity (w/ FEC) @ 30 MHz Channel	4.9 GHz	1x = -92.6 dBm, 2x = -89.9 dBm, 4x = -83.6 dBm, 6x = -77.4 dBm, 8x = -70.9 dBm		
	5.1 GHz	1x = -93.1 dBm, 2x = -89.0 dBm, 4x = -83.0 dBm, 6x = -76.7 dBm, 8x = -69.8 dBm		
	5.2 GHz	1x = -93.1 dBm, 2x = -88.7 dBm, 4x = -82.5 dBm, 6x = -76.2 dBm, 8x = -69.4 dBm		
	5.4 GHz	1x = -93.6 dBm, 2x = -89.1 dBm, 4x = -82.9 dBm, 6x = -76.5 dBm, 8x = -69.7 dBm		
	5.8 GHz	1x = -94.1 dBm, 2x = -89.4 dBm, 4x = -83.2 dBm, 6x = -76.8 dBm, 8x = -69.9 dBm		
Nominal Receive Sensitivity (w/ FEC) @ 40 MHz Channel	4.9 GHz	1x = -91.5 dBm, 2x = -88.8 dBm, 4x = -82.5 dBm, 6x = -76.3 dBm, 8x = -69.7 dBm		
	5.1 GHz	1x = -92.1 dBm, 2x = -88.1 dBm, 4x = -82.0 dBm, 6x = -75.5 dBm, 8x = -68.2 dBm		
	5.2 GHz	1x = -92.0 dBm, 2x = -87.7 dBm, 4x = -81.7 dBm, 6x = -75.3 dBm, 8x = -67.9 dBm		
	5.4 GHz	1x = -92.7 dBm, 2x = -87.4 dBm, 4x = -81.8 dBm, 6x = -75.4 dBm, 8x = -68.2 dBm		
	5.8 GHz	1x = -93.0 dBm, 2x = -87.9 dBm, 4x = -82.1 dBm, 6x = -75.6 dBm, 8x = -68.1 dBm		
Performance				
Subscriber Per Sector		Up to 238		
ARQ		Yes		
Cyclic Prefix		1/16		
Frame Period		2.5 ms, 5 ms		
Modulation Levels (Adaptive)	Modulation Levels	MCS	SNR (in dB)	
	2x	QPSK	10	
	4x	16-QAM	17	
	6x	64-QAM	24	
	8x	256-QAM	32	

Category		Specification
Latency		10 ms, typical (MU-MIMO introduces additional latency for the traffic that is MU-MIMO scheduled.)
Maximum Deployment Range		Up to 40 miles (64 km)
GPS Synchronization		Yes, via Autosync (UGPS)
Quality of Service		Diffserv QoS
Link Budget		
Antenna Beam Width	5 GHz	90° integrated sector (Dual polarity, H+V)
Antenna Gain		+14 dBi
Maximum EIRP		+48 dBm
Physical		
Data, Sync/AUX and SFP port	RJ45	<ul style="list-style-type: none"> • 1000BASE-T Ethernet Data • AUX port for UGPS or PoE out to 802.3at
Antenna Connection		Integrated Sector Array
Surge Suppression (with LPU)		EN61000-4-5: 1.2 us/50 us, 500 V voltage waveform Recommended external surge suppressor: Cambium Networks Model # C000065L007B
Mean Time Between Failure		> 40 Years
Environmental		IP66, IP67
Temperature / Humidity		-40°C to +60°C (-40°F to +140°F) 0-95% non-condensing
Weight	Integrated	Approx. 14.2 kg (31 bs)
Wind Loading - Front Facing		@90 mph / 144 kph 376 N
		@110 mph /177 kph 562 N
Dimension (HxWxD)	Integrated	52 x 65 x 11 cm (20.3" x 25.7" x 4.4")
Power Consumption		70 W typical, 80 W peak (up to 110 W max with AUX port PoE enabled)

Category		Specification
Input Voltage		58 V, 1.7 A
Mounting		Pole mount with included brackets
Security		
Encryption		128-bit AES and 256-bit AES
		 <div style="border: 1px solid black; background-color: #e1f5fe; padding: 5px; display: inline-block;"> <p>Note AES-256 requires a license key.</p> </div>

Specifications for 3 GHz PMP 450m Series - AP

The 3 GHz PMP 450m AP conforms to the specifications listed in below table.

Table 155 : 3 GHz PMP 450m Series - AP specifications

Category		Specification
Model Number		3 GHz PMP 450m AP
Spectrum		
Channel Spacing		Customizable channel selection to 50kHz raster
Frequency Range		3300 - 3900 MHz
Channel Bandwidth		5, 7, 10, 15, 20, 30 and 40MHz
Interface		
MAC (Media Access Control) Layer		Cambium Networks Proprietary
Physical Layer		8x8 Multi-User MIMO OFDM
Ethernet Interface		100/1000BaseT, full duplex, rate auto negotiated (802.3 compliant), dual SFP support for 1 Gbps optical
Protocols Used		IPv4, IPv6, UDP, TCP/IP, ICMP, Telnet, SNMP, HTTP, FTP
Network Management		IPv4/IPv6 (dual stack), HTTP, HTTPS, Telnet, FTP, SNMPv2c and v3, Cambium Networks cnMaestro™
VLAN		802.1ad (DVLAN Q-inQ), 802.1Q with 802.1p priority, dynamic port VID
Sensitivity		
Nominal Receive Sensitivity (w/ FEC) @ 5 MHz Channel	3.5 GHz	1x = -97.6 dBm, 2x = -95 dBm, 4x = -88.7 dBm, 6x = -82.5 dBm, 8x = -75 dBm
	3.6 GHz	1x = -96.9 dBm, 2x = -94.4 dBm, 4x = -88.1 dBm, 6x = -81.7 dBm, 8x = -74 dBm
Nominal Receive	3.5 GHz	1x = -96.1 dBm, 2x = -93.4 dBm, 4x = -87.1 dBm, 6x = -81.1 dBm,

Category		Specification		
Sensitivity (w/ FEC) @ 7 MHz Channel		8x = -74.7 dBm		
	3.6 GHz	1x = -96 dBm, 2x = -92.9 dBm, 4x = -86.6 dBm, 6x = -80.6 dBm, 8x = -73.6 dBm		
Nominal Receive Sensitivity (w/ FEC) @ 10 MHz Channel	3.5 GHz	1x = -95.2 dBm, 2x = -92.8 dBm, 4x = -86.4 dBm, 6x = -80.3 dBm, 8x = -73.2 dBm		
	3.6 GHz	1x = -94.6 dBm, 2x = -92.5 dBm, 4x = -86 dBm, 6x = -79.6 dBm, 8x = -72.8 dBm		
Nominal Receive Sensitivity (w/ FEC) @ 15 MHz Channel	3.5 GHz	1x = -93.6 dBm, 2x = -91.1 dBm, 4x = -84.6 dBm, 6x = -78.4 dBm, 8x = -71.8 dBm		
	3.6 GHz	1x = -92.8 dBm, 2x = -90.4 dBm, 4x = -84 dBm, 6x = -78 dBm, 8x = -71.1 dBm		
Nominal Receive Sensitivity (w/ FEC) @ 20 MHz Channel	3.5 GHz	1x = -92.3 dBm, 2x = -89.8 dBm, 4x = -83.4 dBm, 6x = -77.2 dBm, 8x = -70.7 dBm		
	3.6 GHz	1x = -91.5 dBm, 2x = -89.3 dBm, 4x = -82.9 dBm, 6x = -76.5 dBm, 8x = -70 dBm		
Nominal Receive Sensitivity (w/ FEC) @ 30 MHz Channel	3.5 GHz	1x = -89.7 dBm, 2x = -87.2 dBm, 4x = -81.1 dBm, 6x = -74.8 dBm, 8x = -68.7 dBm		
	3.6 GHz	1x = -89 dBm, 2x = -86.6 dBm, 4x = -80.7 dBm, 6x = -74.4 dBm, 8x = -68.1 dBm		
Nominal Receive Sensitivity (w/ FEC) @ 40 MHz Channel	3.5 GHz	1x = -88.7 dBm, 2x = -86.3 dBm, 4x = -80.1 dBm, 6x = -73.7 dBm, 8x = -67.4 dBm		
	3.6 GHz	1x = -88 dBm, 2x = -85.5 dBm, 4x = -79.5 dBm, 6x = -73.3 dBm, 8x = -66.7 dBm		
Performance				
Subscriber Per Sector		Up to 238		
ARQ		Yes		
Cyclic Prefix		1/16		
Frame Period		2.5 ms, 5 ms		
Modulation Levels (Adaptive)		Modulation Levels	MCS	SNR (in dB)
		2x	QPSK	10
		4x	16-QAM	17
		6x	64-QAM	24
		8x	256-QAM	32
Latency		10 ms, typical		

Category		Specification	
Maximum Deployment Range		Up to 40 miles (64 km)	
GPS Synchronization		Yes, via Autosync (UGPS, CMM5 (GPS only, no power))	
Quality of Service		Diffserv QoS	
Link Budget			
Antenna Beam Width (Azimuth)		90° integrated sector (3dB rolloff), 120° (6dB rolloff), (dual slant polarity, 345°	
Antenna Beam Width (Elevation)		2° Electrical Downtilt, 8° Elevation (with Null Fill)	
Antenna Gain		+16 dBi	
Maximum EIRP		+52 dBm (or up to maximum allowed by regulation)	
Physical			
Data ports			
Main port	RJ45	1000BASE-T Ethernet Data	
Aux port	RJ45	100BASE-T with 802.3at PoE out; UGPS power/sync	
SFP port 1	SFP	Single channel SFP, 1 Gbps	
SFP port 2	SFP	Dual channel SFP, 1 Gbps	
Power	4-pin	DC power input	
Antenna Connection		Integrated Sector Array	
Surge Suppression (with LPU)		MAIN and AUX ports: EN61000-4-5: 10/700us, 4 kV voltage waveform. Recommended external surge suppressor: Model # C000065L007B DC IN port: EN61000-4-5: 1.2/50us, 2 kV/4 kV. Recommended external surge suppressor: Model # C000000L114A	
Mean Time Between Failure		> 40 Years	
Environmental		IP66, IP67	
Temperature / Humidity		-40°C to +60°C (-40°F to +140°F) / 100% condensing	
Weight	Integrated	Without Mounting Brackets: 20.4 kg (45 lbs) With Mounting Brackets: 22.6 kg (49.8 lbs)	
Wind Loading - Front Facing		@90 mph / 144 kph	521 N
		@110 mph /177 kph	787 N
		@124 mph/ 200kph	986 N

Category		Specification
Dimension (HxWxD)	Integrated	69 x 61 x 17.5 cm (27.2" x 24" x 7")
Power Consumption		140 W typical, 150 W peak (up to 180 W max with AUX port PoE enabled)
Input Voltage		40 - 60 V DC
Mounting		Pole mount with included brackets (1.25" to 4" pole diameter)
Security		
Encryption		FIPS-197 128-bit AES, Optional 256-bit AES
		 <div style="border: 1px solid black; background-color: #e1f5fe; padding: 5px; display: inline-block;"> <p>Note AES-256 requires a license key.</p> </div>

Specifications for PMP 450i Series - AP

The PMP 450i AP conforms to the specifications listed in below table.

Table 156 :PMP 450i Series - AP specifications

Category		Specification
Model Number		PMP 450i AP
Spectrum		
Channel Spacing		5, 7, 10, 15, 20, 30, and 40 MHz Channel Bandwidth Configurable on 2.5 MHz increments
Frequency Range		902 to 928 MHz
		3300 - 3900 MHz
		4900 - 5925 MHz
Channel Bandwidth	902 - 928 MHz	5, 7, 10, 15, and 20 MHz
	3300 - 3900 MHz	5, 7, 10, 15, 20, 30, and 40 MHz
	4900 - 5925 MHz	5, 10, 15, 20, 30, and 40 MHz
Interface		
MAC (Media Access Control) Layer		Cambium Proprietary
Physical Layer		2x2 MIMO OFDM
Ethernet Interface		10/100/1000BaseT, half/full duplex, rate auto negotiated (802.3 compliant)

Category		Specification
Protocols Used		IPv4, UDP, TCP, IP, ICMP, Telnet, SNMP, HTTP, FTP
Network Management		HTTP, HTTPS, Telnet, FTP, SNMP v3
VLAN		802.1ad (DVLAN Q- in- Q), 802.1Q with 802.1p priority, dynamic port VID
Sensitivity		
Nominal Receive Sensitivity (w/ FEC) @ 5 MHz Channel	900 MHz	1x = -91.9 dBm, 2x = -87.9 dBm, 4x = -80.9 dBm, 6x = -75 dBm, 8x = -68.8 dBm
	3.5 GHz	1x = -92.7 dBm, 2x = -88.7 dBm, 4x = -82.7 dBm, 6x = -75.8 dBm, 8x = -69 dBm
	3.6 GHz	1x = -92.7 dBm, 2x = -87.3 dBm, 4x = -81 dBm, 6x = -74.9 dBm, 8x = -68.3 dBm
	4.9 GHz	1x = -91.6 dBm, 2x = -87.6 dBm, 4x = -80.4 dBm, 6x = -73.2 dBm, 8x = -66 dBm
	5.1 GHz	1x = -91.4 dBm, 2x = -88 dBm, 4x = -80.8 dBm, 6x = -73.7 dBm, 8x = -67 dBm
	5.2 GHz	1x = -91.8 dBm, 2x = -87.3 dBm, 4x = -80 dBm, 6x = -73.9 dBm, 8x = -66.6 dBm
	5.4 GHz	1x = -92 dBm, 2x = -87 dBm, 4x = -80.8 dBm, 6x = -73.7 dBm, 8x = -66.6 dBm
	5.8 GHz	1x = -91.5 dBm, 2x = -87 dBm, 4x = -80.2 dBm, 6x = -73.1 dBm, 8x = -66 dBm
Nominal Receive Sensitivity (w/ FEC) @ 7 MHz Channel	900 MHz	1x = -90 dBm, 2x = -85.9 dBm, 4x = -79.9 dBm, 6x = -73.9 dBm, 8x = -67.9 dBm
	3.5 GHz	1x = -91.8 dBm, 2x = -87.7 dBm, 4x = -80.8 dBm, 6x = -74.7 dBm, 8x = -67.3 dBm
	3.6 GHz	1x = -90 dBm, 2x = -87 dBm, 4x = -79.8 dBm, 6x = -73.8 dBm, 8x = -67.2 dBm
Nominal Receive Sensitivity (w/ FEC) @ 10 MHz Channel	900 MHz	1x = -90.6 dBm, 2x = -85.2 dBm, 4x = -79.1 dBm, 6x = -73.2 dBm, 8x = -66.2 dBm
	3.5 GHz	1x = -90.2 dBm, 2x = -86.2 dBm, 4x = -80 dBm, 6x = -73.1 dBm, 8x = -66.7 dBm
	3.6 GHz	1x = -89.5 dBm, 2x = -85.7 dBm, 4x = -79.8 dBm, 6x = -72.8 dBm, 8x = -66.3 dBm
	4.9 GHz	1x = -89.1 dBm, 2x = -85 dBm, 4x = -77.9 dBm, 6x = -71.8 dBm, 8x = -64.6 dBm
	5.1 GHz	1x = -89.5 dBm, 2x = -85 dBm, 4x = -78.3 dBm, 6x = -72 dBm, 8x = -65 dBm

Category		Specification
	5.2 GHz	1x = -88.6 dBm, 2x = -84.7 dBm, 4x = -78 dBm, 6x = -71.5 dBm, 8x = -64.6 dBm
	5.4 GHz	1x = -89.5 dBm, 2x = -85.4 dBm, 4x = -78.2 dBm, 6x = -72.2 dBm, 8x = -64.8 dBm
	5.8 GHz	1x = -89.5 dBm, 2x = -84.7 dBm, 4x = -77.8 dBm, 6x = -71.6 dBm, 8x = -64 dBm
Nominal Receive Sensitivity (w/ FEC) @ 15 MHz Channel	900 MHz	1x = -88.2 dBm, 2x = -83.2 dBm, 4x = -76.3 dBm, 6x = -70.2 dBm, 8x = -64.3 dBm
	3.5 GHz	1x = -89 dBm, 2x = -84 dBm, 4x = -77.9 dBm, 6x = -72 dBm, 8x = -64.8 dBm
	3.6 GHz	1x = -87.6 dBm, 2x = -83.7 dBm, 4x = -77.5 dBm, 6x = -71.6 dBm, 8x = -64.5 dBm
	4.9 GHz	1x = -87.2 dBm, 2x = -83 dBm, 4x = -75.8 dBm, 6x = -69.6 dBm, 8x = -62.6 dBm
	5.1 GHz	1x = -87.4 dBm, 2x = -83.5 dBm, 4x = -76.2 dBm, 6x = -70.3 dBm, 8x = -63.1 dBm
	5.2 GHz	1x = -87.5 dBm, 2x = -82.9 dBm, 4x = -76.5 dBm, 6x = -69.5 dBm, 8x = -62.8 dBm
	5.4 GHz	1x = -87.2 dBm, 2x = -83.3 dBm, 4x = -76.2 dBm, 6x = -70.1 dBm, 8x = -63 dBm
	5.8 GHz	1x = -87.7 dBm, 2x = -82.7 dBm, 4x = -75.5 dBm, 6x = -69.6 dBm, 8x = -62.4 dBm
Nominal Receive Sensitivity (w/ FEC) @ 20 MHz Channel	900 MHz	1x = -86.99 dBm, 2x = -82 dBm, 4x = -75.9 dBm, 6x = -69.9 dBm, 8x = -62.9 dBm
	3.5 GHz	1x = -87.4 dBm, 2x = -83 dBm, 4x = -76.9 dBm, 6x = -69.9 dBm, 8x = -63 dBm
	3.6 GHz	1x = -86.4 dBm, 2x = -82.5 dBm, 4x = -76.4 dBm, 6x = -69.4 dBm, 8x = -62.9 dBm
	4.9 GHz	1x = -86.1 dBm, 2x = -82.1 dBm, 4x = -74.8 dBm, 6x = -68.8 dBm, 8x = -61.7 dBm
	5.1 GHz	1x = -86.9 dBm, 2x = -82 dBm, 4x = -75.2 dBm, 6x = -69.1 dBm, 8x = -61.8 dBm
	5.2 GHz	1x = -85.5 dBm, 2x = -81.6 dBm, 4x = -75 dBm, 6x = -68.6 dBm, 8x = -61.6 dBm
	5.4 GHz	1x = -86.6 dBm, 2x = -81.3 dBm, 4x = -75.5 dBm, 6x = -68.6 dBm, 8x = -62 dBm
	5.8 GHz	1x = -85.8 dBm, 2x = -80.7 dBm, 4x = -74.6 dBm, 6x = -68.7 dBm, 8x = -61 dBm

Category		Specification		
Nominal Receive Sensitivity (w/ FEC) @ 30 MHz Channel	3.5 GHz	1x = -85.6 dBm, 2x = -81.7 dBm, 4x = -74.5 dBm, 6x = -68 dBm, 8x = -61.5 dBm		
	3.6 GHz	1x = -85.5 dBm, 2x = -80.5 dBm, 4x = -74.4 dBm, 6x = -68.4 dBm, 8x = -61.5 dBm		
	4.9 GHz	1x = -84.1 dBm, 2x = -80 dBm, 4x = -73 dBm, 6x = -66.4 dBm, 8x = -59.6 dBm		
	5.1 GHz	1x = -84.5 dBm, 2x = -80 dBm, 4x = -73.2 dBm, 6x = -67.1 dBm, 8x = -60 dBm		
	5.2 GHz	1x = -84.5 dBm, 2x = -80 dBm, 4x = -73.4 dBm, 6x = -67.3 dBm, 8x = -58.3 dBm		
	5.4 GHz	1x = -84.5 dBm, 2x = -80 dBm, 4x = -73.5 dBm, 6x = -67.4 dBm, 8x = -60.2 dBm		
	5.8 GHz	1x = -84.1 dBm, 2x = -80 dBm, 4x = -73 dBm, 6x = -66.5 dBm, 8x = -59.4 dBm		
Nominal Receive Sensitivity (w/ FEC) @ 40 MHz Channel	3.5 GHz	1x = -83.9 dBm, 2x = -79.5 dBm, 4x = -73 dBm, 6x = -66 dBm, 8x = -58.5 dBm		
	3.6 GHz	1x = -82.8 dBm, 2x = -79 dBm, 4x = -73 dBm, 6x = -66 dBm, 8x = -59 dBm		
	4.9 GHz	1x = -83.9 dBm, 2x = -78.9 dBm, 4x = -72 dBm, 6x = -66 dBm, 8x = -56.6 dBm		
	5.1 GHz	1x = -84.2 dBm, 2x = -79 dBm, 4x = -72.2 dBm, 6x = -66.3 dBm, 8x = -57.2 dBm		
	5.2 GHz	1x = -84 dBm, 2x = -79.8 dBm, 4x = -72.6 dBm, 6x = -66.4 dBm, 8x = -57 dBm		
	5.4 GHz	1x = -83.7 dBm, 2x = -78.5 dBm, 4x = -72.4 dBm, 6x = -66 dBm, 8x = -58 dBm		
	5.8 GHz	1x = -83.8 dBm, 2x = -78.4 dBm, 4x = -72 dBm, 6x = -66 dBm, 8x = -57 dBm		
Performance				
ARQ		Yes		
Cyclic Prefix		1/16		
Frame Period		2.5 ms or 5.0 ms		
Modulation Levels (Adaptive)		Modulation Levels	MCS	SNR (in dB)
		2x	QPSK	10
		4x	16-QAM	17

Category		Specification
		6x 64-QAM 24
		8x 256-QAM 32
Latency		2.5 - 5 ms
Maximum Deployment Range		Up to 40 miles (64 km) Up to 120 miles (190 km) for 900 MHz
GPS Synchronization		Yes, via Autosync (CMM4), via UGPS
Quality of Service		Diffserv QoS
Link Budget		
Antenna Beam Width	900 MHz	65° sector antenna (Dual Slant)
	3 GHz	90° sector for integrated (Dual polarity, slant +45° and -45°)
	5 GHz	90° (3 dB roll off) sector for integrated (Dual polarity, H+V)
Antenna Gain (Does not include cable loss, -1dB)	900 MHz	13 dBi
	3 GHz	17 dBi integrated 90° sector or external
	5 GHz	17 dBi integrated 90° sector or external
Transmit Power Range		-27 dB dynamic range (to EIRP limit by region) (1 dB step)
Maximum Transmit Power		+27 dBm combined output (for 5 GHz) +25 dBm combined output (for 3 GHz) +25 dBm combined output (for 900MHz)
Physical		
Sync/AUX port	RJ45	<ul style="list-style-type: none"> • 10/100/100BASE-T Ethernet Data • PoE output (planned for future release) • Sync input or output (Connection and powering of UGPS Sync input)
Antenna Connection		50 ohm, N-type (Connectorized version only)
Surge Suppression EN61000-4-5		EN61000- 4- 5: 1.2 us/50 us, 500 V voltage waveform Recommended external surge suppressor:

Category		Specification
		Cambium Networks Model # C000000L033A
Mean Time Between Failure		> 40 Years
Environmental		IP66, IP67
Temperature / Humidity		- 40°C to +60°C (- 40°F to +140°F), 0- 95% non-condensing
Weight	Connectorized	Approx. 2.0 kg (4.5 lbs)
	Integrated	Approx. 2.5 kg (5.5 lbs)
Wind Survival	Connectorized	322 km/h (200 mi/h)
	Integrated	200 km/h (124 mi/h)
Dimension (HxWxD)	Connectorized	26.0 x 13.4 x 6.4 cm (10.3" x 5.3" x 3.3")
	Integrated	37.0 x 37.0 x 6.3 cm (14.5" x 14.5" x 3.2")
Power Consumption		15 W typical, 25 W max, 55 W max with Aux port PoE out enabled
Input Voltage		48-59 V DC, 802.3at compliant
Mounting		Wall or Pole mount with Cambium Networks Model # N000045L002A
Security		
Encryption		128-bit AES and 256-bit AES
		 <div style="border: 1px solid black; background-color: #e1f5fe; padding: 5px; display: inline-block;"> <p>Note AES-256 requires a license key.</p> </div>

Specifications for PMP 450 MicroPoP - AP

The PMP 450 MicroPoP conforms to the specifications listed in below table.

Table 157 :PMP 450 MicroPoP Series - AP specifications

Category	Specification
Model Number	PMP 450 MicroPoP AP
Spectrum	
Channel Spacing	5, 10, 15, 20, 30, and 40 MHz Channel Bandwidth Configurable on 2.5 MHz increments
Frequency Range	4900 - 5925 MHz
Channel Bandwidth	5, 10, 15, 20, 30, and 40 MHz

Category		Specification
Interface		
MAC (Media Access Control) Layer	Cambium Proprietary	
Physical Layer	2x2 MIMO OFDM	
Ethernet Interface	10/100/1000BaseT, half/full duplex, rate auto negotiated (802.3 compliant)	
Protocols Used	IPv4, IPv6, UDP, TCP, IP, ICMP, Telnet, SNMP, HTTP, FTP	
Network Management	IPv4/IPv6 (dual stack), HTTP, HTTPS, Telnet, FTP, SNMPv2c and v3, Cambium Networks cnMaestro	
VLAN	802.1ad (DVLAN Q-in-Q), 802.1Q with 802.1p priority, dynamic port VID	
Sensitivity		
Nominal Receive Sensitivity (w/ FEC) @ 5 MHz Channel	900 MHz	1x = -91.9 dBm, 2x = -87.9 dBm, 4x = -80.9 dBm, 6x = -75 dBm, 8x = -68.8 dBm
	3.5 GHz	1x = -92.7 dBm, 2x = -88.7 dBm, 4x = -82.7 dBm, 6x = -75.8 dBm, 8x = -69 dBm
	3.6 GHz	1x = -92.7 dBm, 2x = -87.3 dBm, 4x = -81 dBm, 6x = -74.9 dBm, 8x = -68.3 dBm
	4.9 GHz	1x = -91.6 dBm, 2x = -87.6 dBm, 4x = -80.4 dBm, 6x = -73.2 dBm, 8x = -66 dBm
	5.1 GHz	1x = -91.4 dBm, 2x = -88 dBm, 4x = -80.8 dBm, 6x = -73.7 dBm, 8x = -67 dBm
	5.2 GHz	1x = -91.8 dBm, 2x = -87.3 dBm, 4x = -80 dBm, 6x = -73.9 dBm, 8x = -66.6 dBm
	5.4 GHz	1x = -92 dBm, 2x = -87 dBm, 4x = -80.8 dBm, 6x = -73.7 dBm, 8x = -66.6 dBm
	5.8 GHz	1x = -91.5 dBm, 2x = -87 dBm, 4x = -80.2 dBm, 6x = -73.1 dBm, 8x = -66 dBm
Nominal Receive Sensitivity (w/ FEC) @ 10 MHz Channel	900 MHz	1x = -90.6 dBm, 2x = -85.2 dBm, 4x = -79.1 dBm, 6x = -73.2 dBm, 8x = -66.2 dBm
	3.5 GHz	1x = -90.2 dBm, 2x = -86.2 dBm, 4x = -80 dBm, 6x = -73.1 dBm, 8x = -66.7 dBm
	3.6 GHz	1x = -89.5 dBm, 2x = -85.7 dBm, 4x = -79.8 dBm, 6x = -72.8 dBm, 8x = -66.3 dBm
	4.9 GHz	1x = -89.1 dBm, 2x = -85 dBm, 4x = -77.9 dBm, 6x = -71.8 dBm, 8x = -64.6 dBm
	5.1 GHz	1x = -89.5 dBm, 2x = -85 dBm, 4x = -78.3 dBm, 6x = -72 dBm, 8x = -65 dBm

Category		Specification
	5.2 GHz	1x = -88.6 dBm, 2x = -84.7 dBm, 4x = -78 dBm, 6x = -71.5 dBm, 8x = -64.6 dBm
	5.4 GHz	1x = -89.5 dBm, 2x = -85.4 dBm, 4x = -78.2 dBm, 6x = -72.2 dBm, 8x = -64.8 dBm
	5.8 GHz	1x = -89.5 dBm, 2x = -84.7 dBm, 4x = -77.8 dBm, 6x = -71.6 dBm, 8x = -64 dBm
Nominal Receive Sensitivity (w/ FEC) @ 15 MHz Channel	900 MHz	1x = -88.2 dBm, 2x = -83.2 dBm, 4x = -76.3 dBm, 6x = -70.2 dBm, 8x = -64.3 dBm
	3.5 GHz	1x = -89 dBm, 2x = -84 dBm, 4x = -77.9 dBm, 6x = -72 dBm, 8x = -64.8 dBm
	3.6 GHz	1x = -87.6 dBm, 2x = -83.7 dBm, 4x = -77.5 dBm, 6x = -71.6 dBm, 8x = -64.5 dBm
	4.9 GHz	1x = -87.2 dBm, 2x = -83 dBm, 4x = -75.8 dBm, 6x = -69.6 dBm, 8x = -62.6 dBm
	5.1 GHz	1x = -87.4 dBm, 2x = -83.5 dBm, 4x = -76.2 dBm, 6x = -70.3 dBm, 8x = -63.1 dBm
	5.2 GHz	1x = -87.5 dBm, 2x = -82.9 dBm, 4x = -76.5 dBm, 6x = -69.5 dBm, 8x = -62.8 dBm
	5.4 GHz	1x = -87.2 dBm, 2x = -83.3 dBm, 4x = -76.2 dBm, 6x = -70.1 dBm, 8x = -63 dBm
	5.8 GHz	1x = -87.7 dBm, 2x = -82.7 dBm, 4x = -75.5 dBm, 6x = -69.6 dBm, 8x = -62.4 dBm
Nominal Receive Sensitivity (w/ FEC) @ 20 MHz Channel	900 MHz	1x = -86.99 dBm, 2x = -82 dBm, 4x = -75.9 dBm, 6x = -69.9 dBm, 8x = -62.9 dBm
	3.5 GHz	1x = -87.4 dBm, 2x = -83 dBm, 4x = -76.9 dBm, 6x = -69.9 dBm, 8x = -63 dBm
	3.6 GHz	1x = -86.4 dBm, 2x = -82.5 dBm, 4x = -76.4 dBm, 6x = -69.4 dBm, 8x = -62.9 dBm
	4.9 GHz	1x = -86.1 dBm, 2x = -82.1 dBm, 4x = -74.8 dBm, 6x = -68.8 dBm, 8x = -61.7 dBm
	5.1 GHz	1x = -86.9 dBm, 2x = -82 dBm, 4x = -75.2 dBm, 6x = -69.1 dBm, 8x = -61.8 dBm
	5.2 GHz	1x = -85.5 dBm, 2x = -81.6 dBm, 4x = -75 dBm, 6x = -68.6 dBm, 8x = -61.6 dBm
	5.4 GHz	1x = -86.6 dBm, 2x = -81.3 dBm, 4x = -75.5 dBm, 6x = -68.6 dBm, 8x = -62 dBm
	5.8 GHz	1x = -85.8 dBm, 2x = -80.7 dBm, 4x = -74.6 dBm, 6x = -68.7 dBm, 8x = -61 dBm

Category		Specification
Nominal Receive Sensitivity (w/ FEC) @ 30 MHz Channel	3.5 GHz	1x = -85.6 dBm, 2x = -81.7 dBm, 4x = -74.5 dBm, 6x = -68 dBm, 8x = -61.5 dBm
	3.6 GHz	1x = -85.5 dBm, 2x = -80.5 dBm, 4x = -74.4 dBm, 6x = -68.4 dBm, 8x = -61.5 dBm
	4.9 GHz	1x = -84.1 dBm, 2x = -80 dBm, 4x = -73 dBm, 6x = -66.4 dBm, 8x = -59.6 dBm
	5.1 GHz	1x = -84.5 dBm, 2x = -80 dBm, 4x = -73.2 dBm, 6x = -67.1 dBm, 8x = -60 dBm
	5.2 GHz	1x = -84.5 dBm, 2x = -80 dBm, 4x = -73.4 dBm, 6x = -67.3 dBm, 8x = -58.3 dBm
	5.4 GHz	1x = -84.5 dBm, 2x = -80 dBm, 4x = -73.5 dBm, 6x = -67.4 dBm, 8x = -60.2 dBm
	5.8 GHz	1x = -84.1 dBm, 2x = -80 dBm, 4x = -73 dBm, 6x = -66.5 dBm, 8x = -59.4 dBm
Nominal Receive Sensitivity (w/ FEC) @ 40 MHz Channel	3.5 GHz	1x = -83.9 dBm, 2x = -79.5 dBm, 4x = -73 dBm, 6x = -66 dBm, 8x = -58.5 dBm
	3.6 GHz	1x = -82.8 dBm, 2x = -79 dBm, 4x = -73 dBm, 6x = -66 dBm, 8x = -59 dBm
	4.9 GHz	1x = -83.9 dBm, 2x = -78.9 dBm, 4x = -72 dBm, 6x = -66 dBm, 8x = -56.6 dBm
	5.1 GHz	1x = -84.2 dBm, 2x = -79 dBm, 4x = -72.2 dBm, 6x = -66.3 dBm, 8x = -57.2 dBm
	5.2 GHz	1x = -84 dBm, 2x = -79.8 dBm, 4x = -72.6 dBm, 6x = -66.4 dBm, 8x = -57 dBm
	5.4 GHz	1x = -83.7 dBm, 2x = -78.5 dBm, 4x = -72.4 dBm, 6x = -66 dBm, 8x = -58 dBm
	5.8 GHz	1x = -83.8 dBm, 2x = -78.4 dBm, 4x = -72 dBm, 6x = -66 dBm, 8x = -57 dBm
Performance		
ARQ	Yes	
Cyclic Prefix	1/16	
Frame Period	2.5 ms or 5.0 ms	

Category		Specification	
Modulation Levels (Adaptive)	Modulation Levels	MCS	SNR (in dB)
	2x	QPSK	10
	4x	16-QAM	17
	6x	64-QAM	24
	8x	256-QAM	32
Latency	3 - 5 ms		
Maximum Deployment Range	Up to 2 miles (3.2 k) With license key up to 40 miles (64 km)		
GPS Synchronization	Yes, via Autosync (CMM4), via UGPS		
Quality of Service	Diffserv QoS		
Link Budget			
Antenna Beam Width	Omni	360-degree integrated omni (dual polarity, vertical and horizontal)	
	Sector	90- degree integrated (dual polarity, vertical and horizontal)	
Antenna Gain	Omni	9 dBi	
	Sector	13 dBi	
Transmit Power Range	54 dB dynamic range (to EIRP limit by region) (1 dB step)		
Maximum Transmit Power	+27 dBm		
Physical			
Sync/AUX port	RJ45	<ul style="list-style-type: none"> • 10/100/100BASE-T Ethernet Data • PoE output (planned for future release) • Sync input or output (Connection and powering of UGPS Sync input) 	
Surge Suppression	EN61000-4-5: 10x700us, 4kV, EN 61000-4-2: ESD 30 kV contact / 30 kV air		
Mean Time Between Failure	> 40 Years		
Environmental	IP67		
Temperature / Humidity	Omni	-40C to +60C (-40F to +140F) 0-95% non-condensing	
	Sector	-40C to +60C (-40F to +140F) 0-100% condensings	

Category		Specification
Weight	Omni	1.2 kg (includes mounting bracket)
	Sector	2 kg (includes mounting bracket)
Wind Survival	Omni	200 km/Hr
	Sector	200 km/Hr
Dimension (HxWxD)	Omni	56 x 9 x 9 cm (22" x 3.5" x 3.5"), mount standoff 11 cm (4.3")
	Sector	31 x 17 x 10 cm (12" x 6.7" x 3.7"), mount standoff 11 cm (4.3")
Power Consumption		9 W typical, 12 W peak
Input Voltage		48-59 V DC, 802.3at compatible
Mounting		Wall or Pole mount with Cambium Networks Model # N000045L002A
Security		
Encryption		128-bit AES and 256-bit AES
		 <div style="border: 1px solid black; background-color: #e1f5fe; padding: 5px; display: inline-block;"> <p>Note AES-256 requires a license key.</p> </div>

Specifications for PMP 450i Series - SM

The PMP 450i SM conforms to the specifications listed in below table.

Table 158 : PMP 450i Series - SM specifications

Category		Specification
Model Number		PMP 450i SM
Spectrum		
Channel Spacing		5, 7, 10, 15, 20, 30, and 40 Channel Bandwidth Configurable on 2.5 MHz increments
Frequency Range		3300 - 3900 MHz
		4900 - 5925 MHz
Channel Bandwidth	3300 - 3900 MHz	5, 7, 10, 15, 20, 30, and 40 MHz
	4900 - 5925 MHz	5, 10, 15, 20, 30, and 40 MHz

Category		Specification
Interface		
MAC (Media Access Control) Layer		Cambium Proprietary
Physical Layer		2x2 MIMO OFDM
Ethernet Interface		10/100/1000BaseT, half/full duplex, rate auto negotiated (802.3 compliant)
Protocols Used		IPv4, UDP, TCP, IP, ICMP, Telnet, SNMP, HTTP, FTP
Network Management		HTTP, HTTPS, Telnet, FTP, SNMP v2c and v3
VLAN		802.1ad (DVLAN Q-in-Q), 802.1Q with 802.1p priority, dynamic port VID
Sensitivity		
Nominal Receive Sensitivity (w/FEC) @ 5 MHz Channel	3.5 GHz	1x = -92.6 dBm, 2x = -89.22 dBm, 4x = -83.19 dBm, 6x = -76.5 dBm, 8x = -69.1 dBm
	3.6 GHz	1x = -92 dBm, 2x = -88.08 dBm, 4x = -82.3 dBm, 6x = -75.9 dBm, 8x = -68.6 dBm
	4.9 GHz	1x = -92.5 dBm, 2x = -88.5 dBm, 4x = -81 dBm, 6x = -74.2 dBm, 8x = -66 dBm
	5.1 GHz	1x = -92 dBm, 2x = -88.7 dBm, 4x = -81.2 dBm, 6x = -74.4 dBm, 8x = -67 dBm
	5.2 GHz	1x = -92 dBm, 2x = -88.8 dBm, 4x = -81.3 dBm, 6x = -74.7 dBm, 8x = -67 dBm
	5.4 GHz	1x = -93 dBm, 2x = -89.1 dBm, 4x = -81.5 dBm, 6x = -74.8 dBm, 8x = -67.4 dBm
	5.8 GHz	1x = -92 dBm, 2x = -88.3 dBm, 4x = -80.8 dBm, 6x = -74 dBm, 8x = -66.2 dBm
Nominal Receive Sensitivity (w/FEC) @ 7 MHz Channel	3.5 GHz	1x = -92 dBm, 2x = -88.4 dBm, 4x = -81.4 dBm, 6x = -75.37 dBm, 8x = -68.1 dBm
	3.6 GHz	1x = -91.02 dBm, 2x = -87.87 dBm, 4x = -80.82 dBm, 6x = -73.6 dBm, 8x = -67.32 dBm
Nominal Receive Sensitivity (w/FEC) @ 10 MHz Channel	3.5 GHz	1x = -90.787 dBm, 2x = -86.6 dBm, 4x = -80.2 dBm, 6x = -73.52 dBm, 8x = -66.34 dBm
	3.6 GHz	1x = -89.8 dBm, 2x = -86 dBm, 4x = -79.84 dBm, 6x = -72.92 dBm, 8x = -66 dBm
	4.9 GHz	1x = -90.2 dBm, 2x = -85.2 dBm, 4x = -78.8 dBm, 6x = -71.4 dBm, 8x = -64.5 dBm
	5.1 GHz	1x = -90.4 dBm, 2x = -85.6 dBm, 4x = -79.2 dBm, 6x = -71.7 dBm, 8x = -64.2 dBm

Category		Specification
	5.2 GHz	1x = -90.6 dBm, 2x = -85.5 dBm, 4x = -79 dBm, 6x = -71.8 dBm, 8x = -64.5 dBm
	5.4 GHz	1x = -90 dBm, 2x = -85.8 dBm, 4x = -78.5 dBm, 6x = -72.2 dBm, 8x = -64.8 dBm
	5.8 GHz	1x = -89.9 dBm, 2x = -84.9 dBm, 4x = -78.5 dBm, 6x = -71.2 dBm, 8x = -63.8 dBm
Nominal Receive Sensitivity (w/ FEC) @ 15 MHz Channel	3.5 GHz	1x = -88.57 dBm, 2x = -84.5 dBm, 4x = -78.4 dBm, 6x = -71.47 dBm, 8x = -65.22 dBm
	3.6 GHz	1x = -87.6 dBm, 2x = -84.1 dBm, 4x = -77.1 dBm, 6x = -71.03 dBm, 8x = -64.8 dBm
	4.9 GHz	1x = -88.2 dBm, 2x = -83.1 dBm, 4x = -76.9 dBm, 6x = -70.5 dBm, 8x = -62.3 dBm
	5.1 GHz	1x = -88.4 dBm, 2x = -83.6 dBm, 4x = -77.3 dBm, 6x = -71 dBm, 8x = -62.9 dBm
	5.2 GHz	1x = -88.6 dBm, 2x = -83.6 dBm, 4x = -77.5 dBm, 6x = -70.2 dBm, 8x = -62.9 dBm
	5.4 GHz	1x = -87.7 dBm, 2x = -83.9 dBm, 4x = -76.6 dBm, 6x = -70.4 dBm, 8x = -63 dBm
	5.8 GHz	1x = -88 dBm, 2x = -82.9 dBm, 4x = -76.7 dBm, 6x = -69.4 dBm, 8x = -62.3 dBm
Nominal Receive Sensitivity (w/ FEC) @ 20 MHz Channel	3.5 GHz	1x = -87 dBm, 2x = -83.45 dBm, 4x = -76.25 dBm, 6x = -70.33 dBm, 8x = -63.23 dBm
	3.6 GHz	1x = -86.9 dBm, 2x = -82.9 dBm, 4x = -76.9 dBm, 6x = -69.8 dBm, 8x = -62.8 dBm
	4.9 GHz	1x = -86.8 dBm, 2x = -81.8 dBm, 4x = -75.8 dBm, 6x = -68.5 dBm, 8x = -61.4 dBm
	5.1 GHz	1x = -87.4 dBm, 2x = -82.5 dBm, 4x = -76 dBm, 6x = -69 dBm, 8x = -61.5 dBm
	5.2 GHz	1x = -87 dBm, 2x = -82.6 dBm, 4x = -75.4 dBm, 6x = -69.1 dBm, 8x = -61.8 dBm
	5.4 GHz	1x = -87 dBm, 2x = -82.8 dBm, 4x = -75.6 dBm, 6x = -69.3 dBm, 8x = -61.6 dBm
	5.8 GHz	1x = -85.9 dBm, 2x = -81.5 dBm, 4x = -74.8 dBm, 6x = -68.7 dBm, 8x = -61.2 dBm
Nominal Receive Sensitivity (w/ FEC) @ 30 MHz Channel	3.5 GHz	1x = -86 dBm, 2x = -80.9 dBm, 4x = -75 dBm, 6x = -67.9 dBm, 8x = -61.1 dBm
	3.6 GHz	1x = -85.5 dBm, 2x = -80.6 dBm, 4x = -74.5 dBm, 6x = -67.5 dBm, 8x = -61 dBm

Category		Specification		
	4.9 GHz	1x = -84.9 dBm, 2x = -80.9 dBm, 4x = -73.2 dBm, 6x = -67.4 dBm, 8x = -59.3 dBm		
	5.1 GHz	1x = -85.1 dBm, 2x = -81 dBm, 4x = -74 dBm, 6x = -67.9 dBm, 8x = -59.8 dBm		
	5.2 GHz	1x = -85.4 dBm, 2x = -80.4 dBm, 4x = -74.3 dBm, 6x = -68 dBm, 8x = -59.9 dBm		
	5.4 GHz	1x = -85.2 dBm, 2x = -80.2 dBm, 4x = -74.1 dBm, 6x = -67.9 dBm, 8x = -59.8 dBm		
	5.8 GHz	1x = -84.9 dBm, 2x = -80 dBm, 4x = -73.2 dBm, 6x = -67.4 dBm, 8x = -59.1 dBm		
Nominal Receive Sensitivity (w/ FEC) @ 40 MHz Channel	3.5 GHz	1x = -83.2 dBm, 2x = -79 dBm, 4x = -72.4 dBm, 6x = -66 dBm, 8x = -58.4 dBm		
	3.6 GHz	1x = -82.5 dBm, 2x = -79 dBm, 4x = -71.3 dBm, 6x = -65.4 dBm, 8x = -58.3 dBm		
	4.9 GHz	1x = -84.2 dBm, 2x = -79.3 dBm, 4x = -72.3 dBm, 6x = -66 dBm, 8x = -56.8 dBm		
	5.1 GHz	1x = -84 dBm, 2x = -79.1 dBm, 4x = -73 dBm, 6x = -66 dBm, 8x = -57.8 dBm		
	5.2 GHz	1x = -84.2 dBm, 2x = -79.3 dBm, 4x = -73.1 dBm, 6x = -66 dBm, 8x = -56.9 dBm		
	5.4 GHz	1x = -84.2 dBm, 2x = -79.1 dBm, 4x = -73.1 dBm, 6x = -66 dBm, 8x = -56.9 dBm		
	5.8 GHz	1x = -83.6 dBm, 2x = -78.7 dBm, 4x = -72.5 dBm, 6x = -66.4 dBm, 8x = -56.3 dBm		
Performance				
ARQ		Yes		
Cyclic Prefix		1/16		
Frame Period		2.5 ms or 5.0 ms		
Modulation Levels (Adaptive)		Modulation Levels	MCS	SNR (in dB)
		2x	QPSK	10
		4x	16-QAM	17
		6x	64-QAM	24
		8x	256-QAM	32
Latency		3 - 5 ms		

Category		Specification
Maximum Deployment Range		Up to 40 miles (64 km)
GPS Synchronization		Yes, via Autosync (CMM4)
Quality of Service		Diffserv QoS
Link Budget		
Antenna Beam Width		10° azimuth for 23 dBi integrated antenna
Antenna Gain (Does not include cable loss, -1dB)	5 GHz	+23 dBi H+V, integrated or external
	3 GHz	+19 dBi dual slant, integrated or external
Transmit Power Range		40 dB dynamic range (to EIRP limit by region) (1 dB step)
Maximum Transmit Power		+27 dBm combined output (for 5 GHz)
		+25 dBm combined output (for 3 GHz)
Physical		
Sync/AUX port	RJ45	<ul style="list-style-type: none"> • 10/100/1000BASE-T Ethernet Data • PoE output (planned for future release) • Sync input or output (Connection and powering of UGPS Sync input)
Antenna Connection		50 ohm, N-type (Connectorized version only)
Surge Suppression EN61000-4-5		EN61000-4-5: 1.2us/50us, 500 V voltage waveform Recommended external surge suppressor: Cambium Networks Model # C000000L033A
Mean Time Between Failure		> 40 Years
Environmental		IP66, IP67
Temperature / Humidity		-40°C to +60°C (-40°F to +140°F), 0-95% non-condensing
Weight	Connectorized	Approx. 2.0 kg (4.5 lbs)
	Integrated	Approx. 2.5 kg (5.5 lbs)
Wind Survival	Connectorized	322 km/h (200 mi/h)
	Integrated	200 km/h (124 mi/h)

Category		Specification
Dimension (HxWxD)	Connectorized	26.0 x 13.4 x 6.4 cm (10.3" x 5.3" x 3.3")
	Integrated	31.0 x 31.0 x 6.4 cm (12" x 12" x 2.5")
Power Consumption		15 W typical, 25 W max, 55 W max with Aux port PoE out enabled
Input Voltage		48-59 V DC, 802.3at compliant
Mounting		Wall or Pole mount with Cambium Networks Model # N000045L002A
Security		
Encryption		128-bit AES and 256-bit AES
		 <div style="border: 1px solid black; background-color: #e1f5fe; padding: 5px; display: inline-block;"> <p>Note AES-256 requires a license key.</p> </div>

Specifications for PTP 450i Series - BH

The PTP 450i BH conforms to the specifications listed in below table.

Table 159 : PTP 450i Series - BH specifications

Category		Specification
Model Number		PTP 450i BH
Spectrum		
Channel Spacing		5, 7, 10, 15, 20, 30, and 40 MHz Channel Bandwidth Configurable on 2.5 MHz increments
Frequency Range		4900 - 5925 MHz
Channel Bandwidth	4900 - 5925 MHz	5, 10, 15, 20, 30, and 40 MHz
Interface		
MAC (Media Access Control) Layer		Cambium Proprietary
Physical Layer		2x2 MIMO OFDM
Ethernet Interface		10/100/1000BaseT, half/full duplex, rate auto negotiated (802.3 compliant)
Protocols Used		IPv4, UDP, TCP, IP, ICMP, Telnet, SNMP, HTTP, FTP
Network Management		HTTP, HTTPS, Telnet, FTP, SNMP v2c and v3
VLAN		802.1ad (DVLAN Q-in-Q), 802.1Q with 802.1p priority, dynamic port VID

Category		Specification
Sensitivity		
Nominal Receive Sensitivity (w/ FEC) @ 5 MHz Channel	3.5 GHz	1x = -92.7 dBm, 2x = -88.7 dBm, 4x = -82.7 dBm, 6x = -75.8 dBm, 8x = -69 dBm
	3.6 GHz	1x = -92.7 dBm, 2x = -87.3 dBm, 4x = -81 dBm, 6x = -74.9 dBm, 8x = -68.3 dBm
	4.9 GHz	1x = -93 dBm, 2x = -88.3 dBm, 4x = -82 dBm, 6x = -74.4 dBm, 8x = -67.9 dBm
	5.1 GHz	1x = -93 dBm, 2x = -88.7 dBm, 4x = -81.2 dBm, 6x = -74.7 dBm, 8x = -67.6 dBm
	5.2 GHz	1x = -93 dBm, 2x = -89 dBm, 4x = -81.5 dBm, 6x = -75 dBm, 8x = -67.5 dBm
	5.4 GHz	1x = -93 dBm, 2x = -88.4 dBm, 4x = -81.3 dBm, 6x = -75.5 dBm, 8x = -67.8 dBm
	5.8 GHz	1x = -93.2 dBm, 2x = -88.3 dBm, 4x = -80.8 dBm, 6x = -74.3 dBm, 8x = -66.8 dBm
Nominal Receive Sensitivity (w/ FEC) @ 7 MHz Channel	3.5 GHz	1x = -91.8 dBm, 2x = -87.7 dBm, 4x = -80.8 dBm, 6x = -74.7 dBm, 8x = -67.3 dBm
	3.6 GHz	1x = -90.0 dBm, 2x = -87.0 dBm, 4x = -79.8 dBm, 6x = -73.8 dBm, 8x = -67.2 dBm
Nominal Receive Sensitivity (w/ FEC) @ 10 MHz Channel	3.5 GHz	1x = -90.2 dBm, 2x = -86.2 dBm, 4x = -80.0 dBm, 6x = -73.1 dBm, 8x = -66.7 dBm
	3.6 GHz	1x = -89.5 dBm, 2x = -85.7 dBm, 4x = -79.8 dBm, 6x = -72.8 dBm, 8x = -66.3 dBm
	4.9 GHz	1x = -90 dBm, 2x = -85 dBm, 4x = -78.6 dBm, 6x = -72.5 dBm, 8x = -65 dBm
	5.1 GHz	1x = -90.4 dBm, 2x = -85.4 dBm, 4x = -79 dBm, 6x = -73 dBm, 8x = -65.5 dBm
	5.2 GHz	1x = -90.4 dBm, 2x = -85.5 dBm, 4x = -79.2 dBm, 6x = -72 dBm, 8x = -65 dBm
	5.4 GHz	1x = -89.8 dBm, 2x = -85.5 dBm, 4x = -78.7 dBm, 6x = -72.3 dBm, 8x = -65 dBm
	5.8 GHz	1x = -89.9 dBm, 2x = -84.8 dBm, 4x = -78.5 dBm, 6x = -71.4 dBm, 8x = -64 dBm
Nominal Receive Sensitivity (w/ FEC) @ 15 MHz Channel	3.5 GHz	1x = -89.0 dBm, 2x = -84.0 dBm, 4x = -77.9 dBm, 6x = -72.0 dBm, 8x = -64.8 dBm
	3.6 GHz	1x = -87.6 dBm, 2x = -83.7 dBm, 4x = -77.5 dBm, 6x = -71.6 dBm, 8x = -64.5 dBm

Category		Specification
	4.9 GHz	1x = -88 dBm, 2x = -83.9 dBm, 4x = -76.9 dBm, 6x = -70.7 dBm, 8x = -63.6 dBm
	5.1 GHz	1x = -89.3 dBm, 2x = -83.3 dBm, 4x = -76.9 dBm, 6x = -70.7 dBm, 8x = -63.6 dBm
	5.2 GHz	1x = -88.5 dBm, 2x = -83.3 dBm, 4x = -76.9 dBm, 6x = -70.7 dBm, 8x = -63 dBm
	5.4 GHz	1x = -88 dBm, 2x = -84.2 dBm, 4x = -76.9 dBm, 6x = -70.8 dBm, 8x = -62.7 dBm
	5.8 GHz	1x = -87.8 dBm, 2x = -82.8 dBm, 4x = -76.6 dBm, 6x = -69.3 dBm, 8x = -62.1 dBm
Nominal Receive Sensitivity (w/ FEC) @ 20 MHz Channel ¹	3.5 GHz	1x = -87.4 dBm, 2x = -83.0 dBm, 4x = -76.9 dBm, 6x = -69.9 dBm, 8x = -63.0 dBm
	3.6 GHz	1x = -86.4 dBm, 2x = -82.5 dBm, 4x = -76.4 dBm, 6x = -69.4 dBm, 8x = -62.9 dBm
	4.9 GHz	1x = -86.9 dBm, 2x = -82.5 dBm, 4x = -75.7 dBm, 6x = -69.4 dBm, 8x = -62.3 dBm
	5.1 GHz	1x = -87.3 dBm, 2x = -83.3 dBm, 4x = -76 dBm, 6x = -69.9 dBm, 8x = -62.6 dBm
	5.2 GHz	1x = -87.4 dBm, 2x = -82.6 dBm, 4x = -75.4 dBm, 6x = -69.2 dBm, 8x = -62 dBm
	5.4 GHz	1x = -87 dBm, 2x = -82.6 dBm, 4x = -75.5 dBm, 6x = -69.3 dBm, 8x = -61 dBm
	5.8 GHz	1x = -85.8 dBm, 2x = -81.7 dBm, 4x = -75 dBm, 6x = -68.4 dBm, 8x = -61.2 dBm
Nominal Receive Sensitivity (w/ FEC) @ 30 MHz Channel	3.5 GHz	1x = -86.4 dBm, 2x = -81.7 dBm, 4x = -75.1 dBm, 6x = -68 dBm, 8x = -62 dBm
	3.6 GHz	1x = -85.5 dBm, 2x = -80.5 dBm, 4x = -74.4 dBm, 6x = -68.4 dBm, 8x = -61.5 dBm
	4.9 GHz	1x = -85 dBm, 2x = -80.7 dBm, 4x = -73.7 dBm, 6x = -66.5 dBm, 8x = -60 dBm
	5.1 GHz	1x = -85 dBm, 2x = -81 dBm, 4x = -74 dBm, 6x = -68 dBm, 8x = -60.7 dBm
	5.2 GHz	1x = -85.2 dBm, 2x = -80.4 dBm, 4x = -74.2 dBm, 6x = -67.1 dBm, 8x = -60 dBm
	5.4 GHz	1x = -85.3 dBm, 2x = -80.5 dBm, 4x = -74.2 dBm, 6x = -67.2 dBm, 8x = -60 dBm

Category		Specification		
	5.8 GHz	1x = -84.6 dBm, 2x = -80 dBm, 4x = -73,3 dBm, 6x = -66.5 dBm, 8x = -59.1 dBm		
Nominal Receive Sensitivity (w/ FEC) @ 40 MHz Channel	3.5 GHz	1x = -83.7 dBm, 2x = -79.6 dBm, 4x = -73.5 dBm, 6x = -66.7 dBm, 8x = -58.6 dBm		
	3.6 GHz	1x = -83.4 dBm, 2x = -79.3 dBm, 4x = -72.3 dBm, 6x = -66 dBm, 8x = -58.0 dBm		
	4.9 GHz	1x = -84.1 dBm, 2x = -79.3 dBm, 4x = -73 dBm, 6x = -66 dBm, 8x = -58.8 dBm		
	5.1 GHz	1x = -84.4 dBm, 2x = -79.7 dBm, 4x = -73.5 dBm, 6x = -67.2 dBm, 8x = -59.2 dBm		
	5.2 GHz	1x = -84.7 dBm, 2x = -79.4 dBm, 4x = -73.2 dBm, 6x = -66.8 dBm, 8x = -59 dBm		
	5.4 GHz	1x = -84.5 dBm, 2x = -79.4 dBm, 4x = -73.3 dBm, 6x = -66.5 dBm, 8x = -58 dBm		
	5.8 GHz	1x = -84 dBm, 2x = -79 dBm, 4x = -72 dBm, 6x = -66 dBm, 8x = -58 dBm		
Performance				
ARQ		Yes		
Cyclic Prefix		1/16		
Frame Period		2.5 ms or 5.0 ms		
Modulation Levels (Adaptive)		Modulation Levels	MCS	SNR (in dB)
		2x	QPSK	10
		4x	16-QAM	17
		6x	64-QAM	24
		8x	256-QAM	32
Latency		3 - 5 ms		
Maximum Deployment Range		Up to 40 miles (64 km)		
GPS Synchronization		Yes, via Autosync (CMM4)		
Quality of Service		Diffserv QoS		
Link Budget				
Antenna Beam Width	900 MHz	37° azimuth for 12 dBi Yagi antenna		
	5 GHz	10° azimuth for 23 dBi integrated antenna		

Category		Specification
Antenna Gain (Does not include cable loss, -1dB)	900 MHz	12 dBi Yagi antenna
	5 GHz	+23 dBi H+V, integrated or external
Transmit Power Range		40 dB dynamic range (to EIRP limit by region) (1 dB step)
Maximum Transmit Power		+27 dBm combined output
Physical		
Sync/AUX port	RJ45	<ul style="list-style-type: none"> • 10/100/1000BASE-T Ethernet Data • PoE output • Sync input or output (Connection and powering of UGPS Sync input)
Antenna Connection		50 ohm, N-type (Connectorized version only)
Surge Suppression EN61000-4-5		EN61000- 4- 5: 1.2 us/50us, 500 V voltage waveform Recommended external surge suppressor: Cambium Networks Model # C000000L033A
Mean Time Between Failure		> 40 Years
Environmental		IP66, IP67
Temperature / Humidity		-40°C to +60°C (-40°F to +140°F), 0-95% non-condensing
Weight	Connectorized	Approx. 2.0 kg (4.5 lbs)
	Integrated	Approx. 2.5 kg (5.5 lbs)
Wind Survival	Connectorized	322 km/h (200 mi/h)
	Integrated	200 km/h (124 mi/h)
Dimension (HxWxD)	Connectorized	26.0 x 13.4 x 6.4 cm (10.25" x 5.25" x 3.25")
	Integrated	31.0 x 31.0 x 6.4 cm (12" x 12" x 2.5")
Power Consumption		15 W typical, 25 W max, 55 W max with Aux port PoE out enabled
Input Voltage		48-59 V DC, 802.3at compliant
Mounting		Wall or Pole mount with Cambium Networks Model #N000045L002A
Security		
Encryption		128-bit AES and 256-bit AES
		<div style="border: 1px solid black; background-color: #e1f5fe; padding: 5px;"> <p>Note AES-256 requires a license key.</p> </div>

Specifications for PMP 450b 5 GHz Mid-Gain Series - SM

The PMP 450b 5 GHz Mid-Gain conforms to the specifications listed in below table.

Table 160 :PMP 450b 5 GHz Mid-Gain Series - SM specifications

Category		Specification
Model Number		5 GHz PMP 450b Mid-Gain
Spectrum		
Channel Spacing		Configurable in 2.5 MHz increments
Frequency Range		4900 - 5925 MHz
Channel Bandwidth		5, 10, 15, 20, 30, and 40 MHz
Interface		
MAC (Media Access Control) Layer		Cambium Proprietary
Physical Layer		2x2 MIMO OFDM
Ethernet Interface		100/1000BaseT, half/full duplex, rate auto negotiated (802.3 compliant)
Protocols Used		IPv4, UDP, TCP, IP, ICMP, Telnet, SNMP, HTTP, FTP
Network Management		HTTP, HTTPS, Telnet, FTP, SNMP v2c and v3
VLAN		802.1ad (DVLAN Q-in-Q), 802.1Q with 802.1p priority, dynamic port VID
Sensitivity		
Nominal Receive Sensitivity (w/ FEC) @ 5 MHz Channel	4.9 GHz	1x = -93 dBm, 2x = -88 dBm, 4x = -81.4 dBm, 6x = -74.9 dBm, 8x = -66.2 dBm
	5.1 GHz	1x = -92.6 dBm, 2x = -88.5 dBm, 4x = -80.8 dBm, 6x = -74.2 dBm, 8x = -65.8 dBm
	5.2 GHz	1x = -92.6 dBm, 2x = -88.5 dBm, 4x = -80.8 dBm, 6x = -74.2 dBm, 8x = -65.8 dBm
	5.4 GHz	1x = -92.6 dBm, 2x = -88.5 dBm, 4x = -81.3 dBm, 6x = -73.7 dBm, 8x = -66 dBm
	5.8 GHz	1x = -92.1 dBm, 2x = -88.1 dBm, 4x = -81.5 dBm, 6x = -73.9 dBm, 8x = -66.4 dBm
Nominal Receive Sensitivity (w/ FEC) @ 10 MHz Channel	4.9 GHz	1x = -89.7 dBm, 2x = -84.8 dBm, 4x = -78.4 dBm, 6x = -72 dBm, 8x = -64.2 dBm
	5.1 GHz	1x = -90 dBm, 2x = -85.3 dBm, 4x = -78.8 dBm, 6x = -71.6 dBm, 8x = -64.8 dBm
	5.2 GHz	1x = -90 dBm, 2x = -85.3 dBm, 4x = -78.8 dBm, 6x = -71.6 dBm, 8x = -64.8 dBm

Category		Specification
	5.4 GHz	1x = -89.6 dBm, 2x = -85.6 dBm, 4x = -78.2 dBm, 6x = -71.9 dBm, 8x = -64.8 dBm
	5.8 GHz	1x = -89.6 dBm, 2x = -85.6 dBm, 4x = -78.3 dBm, 6x = -72.1 dBm, 8x = -64.8 dBm
Nominal Receive Sensitivity (w/ FEC) @ 15 MHz Channel	4.9 GHz	1x = -88 dBm, 2x = -83.7 dBm, 4x = -76.6 dBm, 6x = -70 dBm, 8x = -63 dBm
	5.1 GHz	1x = -87.7 dBm, 2x = -83.7 dBm, 4x = -76.4 dBm, 6x = -70 dBm, 8x = -63 dBm
	5.2 GHz	1x = -87.8 dBm, 2x = -83.7 dBm, 4x = -76.6 dBm, 6x = -70 dBm, 8x = -63.2 dBm
	5.4 GHz	1x = -88 dBm, 2x = -83.5 dBm, 4x = -76.5 dBm, 6x = -70.5 dBm, 8x = -63 dBm
	5.8 GHz	1x = -88.1 dBm, 2x = -84.1 dBm, 4x = -76.9 dBm, 6x = -70.7 dBm, 8x = -63.4 dBm
Nominal Receive Sensitivity (w/ FEC) @ 20 MHz Channel	4.9 GHz	1x = -86.3 dBm, 2x = -81.3 dBm, 4x = -75.4 dBm, 6x = -69.3 dBm, 8x = -61.4 dBm
	5.1 GHz	1x = -86.4 dBm, 2x = -82 dBm, 4x = -75.2 dBm, 6x = -69.3 dBm, 8x = -62 dBm
	5.2 GHz	1x = -86.7 dBm, 2x = -82.2 dBm, 4x = -75.5 dBm, 6x = -69.3 dBm, 8x = -62 dBm
	5.4 GHz	1x = -86.5 dBm, 2x = -82 dBm, 4x = -76 dBm, 6x = -70 dBm, 8x = -61.5 dBm
	5.8 GHz	1x = -86.4 dBm, 2x = -82 dBm, 4x = -75 dBm, 6x = -69.2 dBm, 8x = -61.6 dBm
Nominal Receive Sensitivity (w/ FEC) @ 30 MHz Channel	4.9 GHz	1x = -84.8 dBm, 2x = -80.5 dBm, 4x = -73.6 dBm, 6x = -67 dBm, 8x = -58.2 dBm
	5.1 GHz	1x = -84.2 dBm, 2x = -80.4 dBm, 4x = -73.8 dBm, 6x = -67.2 dBm, 8x = -59.2 dBm
	5.2 GHz	1x = -84.6 dBm, 2x = -79.8 dBm, 4x = -73.3 dBm, 6x = -67.4 dBm, 8x = -59 dBm
	5.4 GHz	1x = -84.8 dBm, 2x = -79.8 dBm, 4x = -73.6 dBm, 6x = -67.5 dBm, 8x = -59.5 dBm
	5.8 GHz	1x = -84.7 dBm, 2x = -80.4 dBm, 4x = -73.2 dBm, 6x = -67.2 dBm, 8x = -59 dBm
Nominal Receive Sensitivity (w/ FEC) @ 40 MHz Channel	4.9 GHz	1x = -83.4 dBm, 2x = -79.4 dBm, 4x = -72 dBm, 6x = -66.5 dBm, 8x = -56.4 dBm
	5.1 GHz	1x = -83 dBm, 2x = -78.9 dBm, 4x = -72 dBm, 6x = -66 dBm, 8x = -56.9 dBm

Category		Specification		
	5.2 GHz	1x = -83.2 dBm, 2x = -79.3 dBm, 4x = -72.1 dBm, 6x = -65.9 dBm, 8x = -57 dBm		
	5.4 GHz	1x = -83.6 dBm, 2x = -78.6 dBm, 4x = -72.4 dBm, 6x = -66 dBm, 8x = -57 dBm		
	5.8 GHz	1x = -83.5 dBm, 2x = -78 dBm, 4x = -71.9 dBm, 6x = -66 dBm, 8x = -56 dBm		
Performance				
ARQ		Yes		
Cyclic Prefix		1/16		
Frame Period		2.5 ms or 5.0 ms		
Modulation Levels (Adaptive)		Modulation Levels	MCS	SNR (in dB)
		2x	QPSK	10
		4x	16-QAM	17
		6x	64-QAM	24
		8x	256-QAM	32
Latency		3 - 5 ms		
Maximum Deployment Range		Up to 40 miles (64 km)		
GPS Synchronization		Yes, via Autosync (CMM4)		
Quality of Service		Diffserv QoS		
Link Budget				
Antenna Beam Width		15° azimuth for 16 dBi integrated antenna 30° elevation for 16 dBi integrated antenna		
Antenna Gain	5 GHz	+16 dBi H+V, integrated		
Transmit Power Range		40 dB dynamic range (to EIRP limit by region) (1 dB step)		
Maximum Transmit Power		+27 dBm combined output		
Physical				
Sync/AUX port	RJ45	<ul style="list-style-type: none"> • 100/1000BASE-T Ethernet Data • PoE output (planned for future release) • Sync input or output (Connection and powering of UGPS Sync input) 		
Antenna Connection		50 ohm, N-type (Connectorized version only)		

Category		Specification
Surge Suppression EN61000-4-5		EN61000-4-5: 10us/700us, Level 4, 4kV voltage waveform Recommended surge suppressor: Cambium Networks Model # C000000L065A
Mean Time Between Failure		> 40 Years
Environmental		IP55
Temperature / Humidity		-40°C to +60°C (-40°F to +140°F), 0-95% non-condensing
Weight	Integrated	Approx. 0.5 kg (1.1 lb. including mounting bracket)
Wind Survival	Integrated	190 km/h (118 mi/h)
Dimension (HxWxD)	Integrated	12.4 x 25.1 x 11.9 cm (4.9" x 9.9" x 4.7")
Power Consumption		9 W nominal, 12 W peak
Input Voltage		20 - 32 V DC,
Mounting		Wall or Pole mount
Security		
Encryption		128-bit AES and 256-bit AES  <div style="border: 1px solid black; background-color: #e1f5fe; padding: 5px; display: inline-block;"> <p>Note AES-256 requires a license key.</p> </div>

Specifications for PMP 450b 5 GHz High Gain Series – SM

The PMP 450b High Gain SM conforms to the specifications listed in below table.

Table 161 :PMP 450b High Gain Series – SM specifications

Category		Specification
Model Number		PMP 450b High Gain SM
Spectrum		
Channel Spacing		Configurable in 2.5 MHz increments
Frequency Range		4900 - 5925 MHz
Channel Bandwidth		5, 10, 15, 20, 30, and 40 MHz
Interface		
MAC (Media Access Control) Layer		Cambium Proprietary
Physical Layer		2x2 MIMO OFDM

Category		Specification
Ethernet Interface		100/1000BaseT, half/full duplex, rate auto negotiated (802.3 compliant)
Protocols Used		IPv4, UDP, TCP, IP, ICMP, Telnet, SNMP, HTTP, FTP
Network Management		HTTP, HTTPS, Telnet, FTP, SNMP v2c and v3
VLAN		802.1ad (DVLAN Q-in-Q), 802.1Q with 802.1p priority, dynamic port VID
Sensitivity		
Nominal Receive Sensitivity (w/ FEC) @ 5 MHz Channel	4.9 GHz	1x = -93 dBm, 2x = -88 dBm, 4x = -81.4 dBm, 6x = -74.9 dBm, 8x = -66.2 dBm
	5.1 GHz	1x = -92.6 dBm, 2x = -88.5 dBm, 4x = -80.8 dBm, 6x = -74.2 dBm, 8x = -65.8 dBm
	5.2 GHz	1x = -92.6 dBm, 2x = -88.5 dBm, 4x = -80.8 dBm, 6x = -74.2 dBm, 8x = -65.8 dBm
	5.4 GHz	1x = -92.6 dBm, 2x = -88.5 dBm, 4x = -81.3 dBm, 6x = -73.7 dBm, 8x = -66 dBm
	5.8 GHz	1x = -92.1 dBm, 2x = -88.1 dBm, 4x = -81.5 dBm, 6x = -73.9 dBm, 8x = -66.4 dBm
Nominal Receive Sensitivity (w/ FEC) @ 10 MHz Channel	4.9 GHz	1x = -89.7 dBm, 2x = -84.8 dBm, 4x = -78.4 dBm, 6x = -72 dBm, 8x = -64.2 dBm
	5.1 GHz	1x = -90 dBm, 2x = -85.3 dBm, 4x = -78.8 dBm, 6x = -71.6 dBm, 8x = -64.8 dBm
	5.2 GHz	1x = -90 dBm, 2x = -85.3 dBm, 4x = -78.8 dBm, 6x = -71.6 dBm, 8x = -64.8 dBm
	5.4 GHz	1x = -89.6 dBm, 2x = -85.6 dBm, 4x = -78.2 dBm, 6x = -71.9 dBm, 8x = -64.8 dBm
	5.8 GHz	1x = -89.6 dBm, 2x = -85.6 dBm, 4x = -78.3 dBm, 6x = -72.1 dBm, 8x = -64.8 dBm
Nominal Receive Sensitivity (w/ FEC) @ 15 MHz Channel	4.9 GHz	1x = -88 dBm, 2x = -83.7 dBm, 4x = -76.6 dBm, 6x = -70 dBm, 8x = -63 dBm
	5.1 GHz	1x = -87.7 dBm, 2x = -83.7 dBm, 4x = -76.4 dBm, 6x = -70 dBm, 8x = -63 dBm
	5.2 GHz	1x = -87.8 dBm, 2x = -83.7 dBm, 4x = -76.6 dBm, 6x = -70 dBm, 8x = -63.2 dBm
	5.4 GHz	1x = -88 dBm, 2x = -83.5 dBm, 4x = -76.5 dBm, 6x = -70.5 dBm, 8x = -63 dBm
	5.8 GHz	1x = -88.1 dBm, 2x = -84.1 dBm, 4x = -76.9 dBm, 6x = -70.7 dBm, 8x = -63.4 dBm

Category		Specification		
Nominal Receive Sensitivity (w/ FEC) @ 20 MHz Channel	4.9 GHz	1x = -86.3 dBm, 2x = -81.3 dBm, 4x = -75.4 dBm, 6x = -69.3 dBm, 8x = -61.4 dBm		
	5.1 GHz	1x = -86.4 dBm, 2x = -82 dBm, 4x = -75.2 dBm, 6x = -69.3 dBm, 8x = -62 dBm		
	5.2 GHz	1x = -86.7 dBm, 2x = -82.2 dBm, 4x = -75.5 dBm, 6x = -69.3 dBm, 8x = -62 dBm		
	5.4 GHz	1x = -86.5 dBm, 2x = -82 dBm, 4x = -76 dBm, 6x = -70 dBm, 8x = -61.5 dBm		
	5.8 GHz	1x = -86.4 dBm, 2x = -82 dBm, 4x = -75 dBm, 6x = -69.2 dBm, 8x = -61.6 dBm		
Nominal Receive Sensitivity (w/ FEC) @ 30 MHz Channel	4.9 GHz	1x = -84.8 dBm, 2x = -80.5 dBm, 4x = -73.6 dBm, 6x = -67 dBm, 8x = -58.2 dBm		
	5.1 GHz	1x = -84.2 dBm, 2x = -80.4 dBm, 4x = -73.8 dBm, 6x = -67.2 dBm, 8x = -59.2 dBm		
	5.2 GHz	1x = -84.6 dBm, 2x = -79.8 dBm, 4x = -73.3 dBm, 6x = -67.4 dBm, 8x = -59 dBm		
	5.4 GHz	1x = -84.8 dBm, 2x = -79.8 dBm, 4x = -73.6 dBm, 6x = -67.5 dBm, 8x = -59.5 dBm		
	5.8 GHz	1x = -84.7 dBm, 2x = -80.4 dBm, 4x = -73.2 dBm, 6x = -67.2 dBm, 8x = -59 dBm		
Nominal Receive Sensitivity (w/ FEC) @ 40 MHz Channel	4.9 GHz	1x = -83.4 dBm, 2x = -79.4 dBm, 4x = -72 dBm, 6x = -66.5 dBm, 8x = -56.4 dBm		
	5.1 GHz	1x = -83 dBm, 2x = -78.9 dBm, 4x = -72 dBm, 6x = -66 dBm, 8x = -56.9 dBm		
	5.2 GHz	1x = -83.2 dBm, 2x = -79.3 dBm, 4x = -72.1 dBm, 6x = -65.9 dBm, 8x = -57 dBm		
	5.4 GHz	1x = -83.6 dBm, 2x = -78.6 dBm, 4x = -72.4 dBm, 6x = -66 dBm, 8x = -57 dBm		
	5.8 GHz	1x = -83.5 dBm, 2x = -78 dBm, 4x = -71.9 dBm, 6x = -66 dBm, 8x = -56 dBm		
Performance				
ARQ		Yes		
Cyclic Prefix		1/16		
Frame Period		2.5 ms or 5.0 ms		
Modulation Levels (Adaptive)		Modulation Levels	MCS	SNR (in dB)

Category		Specification
		2x QPSK 10
		4x 16QAM 17
		6x 64QAM 24
		8x 256QAM 32
Latency		3 - 5 ms
Maximum Deployment Range		Up to 40 miles (64 km)
GPS Synchronization		Yes, via Autosync (CMM4)
Quality of Service		Diffserv QoS
Link Budget		
Antenna Beam Width		7° azimuth for 23 dBi integrated antenna 7° elevation for 23 dBi integrated antenna
Antenna Gain	5 GHz	+23 dBi H+V, integrated
Transmit Power Range		22 dB dynamic range (to EIRP limit by region) (1 dB step)
Maximum Transmit Power		+27 dBm combined output (+22 dBm @ 256QAM)
Physical		
Sync/AUX port	RJ45	<ul style="list-style-type: none"> 100/1000BASE-T Ethernet Data PoE output (planned for future release) Sync input or output (Connection and powering of UGPS Sync input)
Antenna Connection		50 ohm, N-type (Connectorized version only)
Surge Suppression EN61000-4-5		EN61000-4-5: 10us/700us, Level 4, 4kV voltage waveform Recommended surge suppressor: Cambium Networks Model # C000000L065A
Mean Time Between Failure		> 40 Years
Environmental		IP67
Temperature / Humidity		-40°C to +60°C (-40°F to +140°F), 0-95% non-condensing
Weight	Integrated	Approx. 3.1 kg (7 lb. including mounting bracket)
Wind Survival	Integrated	145 km/h (90 mi/h)
Dimension (HxWxD)	Integrated	47 cm diameter x 28 cm (18.5" diameter x 11.2")

Category		Specification
Power Consumption		9 W nominal, 12 W peak
Input Voltage		20 - 32 V DC,
Mounting		Wall or Pole mount
Security		
Encryption		128-bit AES and 256-bit AES
		<div style="border: 1px solid black; background-color: #e6f2ff; padding: 5px;"> <p>Note AES-256 requires a license key.</p> </div>

Specifications for PMP/ PTP 450b 3 GHz High Gain Series – SM/ BHS

The PMP/PTP 450b 3 GHz High Gain - SM/BHS conforms to the specifications listed in below table.

Table 162 :PMP/PTP 450b 3 GHz High Gain Series specifications

Category		Specification
Model Number		PMP/PTP 450b 3 GHz High Gain - SM/BHS
Spectrum		
Channel Spacing		Customizable channel selection to 50 kHz raster
Frequency Range		3300 - 3900 MHz
Channel Bandwidth		5, 7, 10, 15, 20, 30, and 40 MHz
Interface		
MAC (Media Access Control) Layer		Cambium Networks Proprietary
Physical Layer		2x2 MIMO OFDM
Ethernet Interface		100/1000BaseT, half/full duplex, rate auto negotiated (802.3 compliant)
Protocols Used		IPv4, UDP, TCP, IP, ICMP, Telnet, SNMP, HTTP, FTP
Network Management		HTTP, HTTPS, Telnet, FTP, SNMP v2c and v3
VLAN		802.1ad (DVLAN Q-in-Q), 802.1Q with 802.1p priority, dynamic port VID
Sensitivity		
Nominal Receive Sensitivity (w/ FEC) @ 5 MHz Channel	3.5 GHz	1x = -93 dBm, 2x = -90.1 dBm, 4x = -83.8 dBm, 6x = -77.6 dBm, 8x = -70.1 dBm
	3.6 GHz	1x = -93 dBm, 2x = -89.7 dBm, 4x = -82.8 dBm, 6x = -76.8 dBm, 8x = -69.9 dBm

Category		Specification		
Nominal Receive Sensitivity (w/ FEC) @ 7 MHz Channel	3.5 GHz	1x = -92 dBm, 2x = -88.2 dBm, 4x = -82.2 dBm, 6x = -76 dBm, 8x = -68.4 dBm		
	3.6 GHz	1x = -92 dBm, 2x = -87.9 dBm, 4x = -81.1 dBm, 6x = -75.1 dBm, 8x = -67.8 dBm		
Nominal Receive Sensitivity (w/ FEC) @ 10 MHz Channel	3.5 GHz	1x = -91 dBm, 2x = -87 dBm, 4x = -80.4 dBm, 6x = -74.4 dBm, 8x = -67.4 dBm		
	3.6 GHz	1x = -80 dBm, 2x = -86 dBm, 4x = -80 dBm, 6x = -74 dBm, 8x = -66.7 dBm		
Nominal Receive Sensitivity (w/ FEC) @ 15 MHz Channel	3.5 GHz	1x = -89 dBm, 2x = -85.1 dBm, 4x = -79 dBm, 6x = -72.7 dBm, 8x = -65.9 dBm		
	3.6 GHz	1x = -89 dBm, 2x = -84.9 dBm, 4x = -78.1 dBm, 6x = -71.9 dBm, 8x = -64.9 dBm		
Nominal Receive Sensitivity (w/ FEC) @ 20 MHz Channel	3.5 GHz	1x = -88 dBm, 2x = -84 dBm, 4x = -77.8 dBm, 6x = -71.5 dBm, 8x = -64.5 dBm		
	3.6 GHz	1x = -87.9 dBm, 2x = -83 dBm, 4x = -76.8 dBm, 6x = -70.2 dBm, 8x = -63.9 dBm		
Nominal Receive Sensitivity (w/ FEC) @ 30 MHz Channel	3.5 GHz	1x = -86.5 dBm, 2x = -82 dBm, 4x = -75.8 dBm, 6x = -67.5 dBm, 8x = -62 dBm		
	3.6 GHz	1x = -86 dBm, 2x = -80.8 dBm, 4x = -74.7 dBm, 6x = -68.5 dBm, 8x = -61.7 dBm		
Nominal Receive Sensitivity (w/ FEC) @ 40 MHz Channel	3.5 GHz	1x = -85 dBm, 2x = -80.7 dBm, 4x = -74.4 dBm, 6x = -68 dBm, 8x = -60 dBm		
	3.6 GHz	1x = -84.2 dBm, 2x = -80.2 dBm, 4x = -73 dBm, 6x = -67 dBm, 8x = -59.3 dBm		
Performance				
ARQ		Yes		
Cyclic Prefix		1/16		
Frame Period		2.5 ms or 5.0 ms		
Modulation Levels (Adaptive)		Modulation Levels	MCS	SNR (in dB)
		2x	QPSK	10
		4x	16-QAM	17
		6x	64-QAM	24
		8x	256-QAM	32
Latency		3 - 5 ms		

Category		Specification
Maximum Deployment Range		Up to 40 miles (64 km)
GPS Synchronization		Yes, via Autosync (CMM4)
Quality of Service		Diffserv QoS
Link Budget		
Antenna Beam Width		12° azimuth for 20 dBi integrated antenna 12° elevation for 20 dBi integrated antenna
Antenna Gain		+20 dBi H+V, integrated
Transmit Power Range		40 dB dynamic range (to EIRP limit by region) (1 dB step)
Maximum Transmit Power		29 dBm combined output (23 dBm @ 256-QAM)
Physical		
Sync/AUX port	RJ45	<ul style="list-style-type: none"> • 100/1000BASE-T Ethernet Data • PoE output (planned for future release) • Sync input or output (Connection and powering of UGPS Sync input)
Antenna Connection		50 ohm, N-type (Connectorized version only)
Surge Suppression EN61000-4-5		EN61000-4-5: 1.2us/50us, 500 V voltage waveform
Mean Time Between Failure		> 40 Years
Environmental		IP67
Temperature / Humidity		-40°C to +60°C (-40°F to +140°F), 0-95% non-condensing
Weight	Integrated	Approx. 3.1 kg (7 lb. including mounting bracket)
Wind Survival	Integrated	145 km/h (90 mi/h)
Dimension (HxWxD)	Integrated	47 cm diameter x 28 cm (18.5" diameter x 11.2")
Power Consumption		9 W nominal, 12 W peak
Input Voltage		20 - 32 V DC,
Mounting		Wall or Pole mount
Security		
Encryption		128-bit AES and 256-bit AES
		 <div style="border: 1px solid black; background-color: #e1f5fe; padding: 5px; display: inline-block;"> <p>Note AES-256 requires a license key.</p> </div>

Specifications for PMP 450 Series - AP

The PMP 450 AP conforms to the specifications listed in below table.

Table 163 :PMP 450 Series - AP specifications

Category		Specification
Model Number		PMP 450 AP
Spectrum		
Channel Spacing		5, 7, 10, 15, 20 and 30 MHz Channel Bandwidth Configurable on 2.5 MHz increments
Frequency Range	2.4 GHz	2400 - 2483.5 MHz
	3.5 GHz	3300 - 3600 MHz
	3.65 GHz	3500 - 3850 MHz
	5 GHz	5470 - 5875 MHz
Channel Bandwidth	3.5 and 3.65 GHz	5, 7, 10, 15, 20 and 30 MHz
	2.4 and 5 GHz	5, 10, 15, 20 and 30 MHz
OFDM Subcarriers		512 FFT
Interface		
MAC (Media Access Control) Layer		Cambium Proprietary
Physical Layer		2x2 MIMO OFDM
Ethernet Interface		10/100/1000BaseT, half/full duplex, rate auto negotiated (802.3 compliant)
Protocols Used		IPv4, UDP, TCP, IP, ICMP, Telnet, SNMP, HTTP, FTP, TFTP, RADIUS
Network Management		HTTP, HTTPS, Telnet, FTP, SNMP v3, TFTP, Syslog
VLAN		802.1ad (DVLAN Q-in-Q), 802.1Q with 802.1p priority, dynamic port VID
Sensitivity		
Nominal Receive Sensitivity (w/ FEC) @ 5 MHz Channel	2.4 GHz	1x = -92 dBm, 2x = -87.8 dBm, 4x = -80.4 dBm, 6x = -74.4 dBm, 8x = -66.5 dBm
	3.5 GHz	1x = -92.4 dBm, 2x = -88.3 dBm, 4x = -81.3 dBm, 6x = -75.3 dBm, 8x = -67.7 dBm
	3.65 GHz	1x = -91 dBm, 2x = -86.1 dBm, 4x = -80.2 dBm, 6x = -73.1 dBm, 8x = -66 dBm
	5.4 GHz	1x = -88.7 dBm, 2x = -84 dBm, 4x = -77.6 dBm, 6x = -71.6

Category		Specification
		dBm, 8x = -63.7 dBm
	5.8 GHz	1x = -88.5 dBm, 2x = -84 dBm, 4x = -77.6 dBm, 6x = -71.5 dBm, 8x = -63 dBm
Nominal Receive Sensitivity (w/ FEC) @ 7 MHz Channel	3.5 GHz	1x = -90.5 dBm, 2x = -86.4 dBm, 4x = -80.3 dBm, 6x = -73.4 dBm, 8x = -66.9 dBm
	3.65 GHz	1x = -89.1 dBm, 2x = -85.1 dBm, 4x = -78.1 dBm, 6x = -72.1 dBm, 8x = -64.5 dBm
Nominal Receive Sensitivity (w/ FEC) @ 10 MHz Channel	2.4 GHz	1x = -89.9 dBm, 2x = -85.6 dBm, 4x = -80 dBm, 6x = -73.5 dBm, 8x = -66.9 dBm
	3.5 GHz	1x = -89.8 dBm, 2x = -85.6 dBm, 4x = -80 dBm, 6x = -73 dBm, 8x = -66.3 dBm
	3.65 GHz	1x = -89 dBm, 2x = -85.2 dBm, 4x = -78.1 dBm, 6x = -72.1 dBm, 8x = -64.5 dBm
	5.4 GHz	1x = -86.1 dBm, 2x = -82.2 dBm, 4x = -75.3 dBm, 6x = -69.3 dBm, 8x = -61.3 dBm
	5.8 GHz	1x = -86 dBm, 2x = -82.2 dBm, 4x = -75.1 dBm, 6x = -69 dBm, 8x = -60 dBm
Nominal Receive Sensitivity (w/ FEC) @ 15 MHz Channel	2.4 GHz	1x = -88.4 dBm, 2x = -84.1 dBm, 4x = -77.1 dBm, 6x = -71.4 dBm, 8x = -65 dBm
	3.5 GHz	1x = -88.5 dBm, 2x = -84.5 dBm, 4x = -77.5 dBm, 6x = -71.5 dBm, 8x = -64.3 dBm
	3.65 GHz	1x = -87.4 dBm, 2x = -83.7 dBm, 4x = -76.3 dBm, 6x = -69.7 dBm, 8x = -62.2 dBm
	5.4 GHz	1x = -84.2 dBm, 2x = -80.2 dBm, 4x = -73.2 dBm, 6x = -67.2 dBm, 8x = -60 dBm
	5.8 GHz	1x = -85 dBm, 2x = -80 dBm, 4x = -74.3 dBm, 6x = -67 dBm, 8x = -58 dBm
Nominal Receive Sensitivity (w/ FEC) @ 20 MHz Channel	2.4 GHz	1x = -87 dBm, 2x = -82.4 dBm, 4x = -76.4 dBm, 6x = -70 dBm, 8x = -63.4 dBm
	3.5 GHz	1x = -87.5 dBm, 2x = -83.5 dBm, 4x = -76.5 dBm, 6x = -69.5 dBm, 8x = -62.5 dBm
	3.65 GHz	1x = -86 dBm, 2x = -82.3 dBm, 4x = -75.2 dBm, 6x = -68.5 dBm, 8x = -61.2 dBm
	5.4 GHz	1x = -83.1 dBm, 2x = -78.9 dBm, 4x = -72 dBm, 6x = -66 dBm, 8x = -56.8 dBm
	5.8 GHz	1x = -83 dBm, 2x = -78.8 dBm, 4x = -71.8 dBm, 6x = -66 dBm, 8x = -56 dBm

Category		Specification		
Nominal Receive Sensitivity (w/ FEC) @ 30 MHz Channel	2.4 GHz	1x = -85.4 dBm, 2x = -80.4 dBm, 4x = -74 dBm, 6x = -68 dBm, 8x = -61 dBm		
	3.5 GHz	1x = -85.5 dBm, 2x = -81.5 dBm, 4x = -74.5 dBm, 6x = -68.2 dBm, 8x = -61.3 dBm		
	3.65 GHz	1x = -84 dBm, 2x = -79.5 dBm, 4x = -73.4 dBm, 6x = -66.4 dBm, 8x = -59.2 dBm		
	5.4 GHz	1x = -81 dBm, 2x = -76.9 dBm, 4x = -70.9 dBm, 6x = -63.8 dBm, 8x = -55.8 dBm		
	5.8 GHz	1x = -80.9 dBm, 2x = -76.8 dBm, 4x = -70 dBm, 6x = -63.8 dBm, 8x = -55 dBm		
Performance				
Subscribers Per Sector		Up to 238		
ARQ		Yes		
Cyclic Prefix		1/16		
Frame Period		2.5 ms or 5.0 ms		
Modulation Levels (Adaptive)		Modulation Levels	MCS	SNR (in dB)
		2x	QPSK	10
		4x	16QAM	17
		6x	64QAM	24
		8x	256QAM	32
Latency		3 - 5 ms for 2.5 ms Frame Period 6-10 ms for 5.0 ms Frame Period		
Maximum Deployment Range		Up to 40 miles (64 km)		
Packets Per Second		12,500		
GPS Synchronization		Yes, via CMM3, CMM4 or UGPS		
Quality of Service		Diffserv QoS		
Link Budget				
Antenna Gain (Does not include cable loss, -1dB)	2.4 GHz	18 dBi Dual Slant		
	3.5 GHz	16 dBi Dual Slant		
	3.65 GHz	16 dBi Dual Slant		
	5 GHz	17 dBi Horizontal and Vertical		
Combined Transmit Power		- 30 to +22 dBm (to EIRP limit by region) in 1 dB-		

Category		Specification
		configurable intervals (2.4 GHz, 5 GHz) - 30 to +25 dBm (to EIRP limit by region) in 1 dB-configurable intervals (3.5 GHz) - 30 to +25 dBm (to EIRP limit by region and channel bandwidth) in 1 dB-configurable intervals (3.6 GHz)
Maximum Transmit Power		22 dBm combined OFDM (2.4 GHz, 5 GHz) (dependent upon Region Code setting) 25 dBm combined OFDM (3.5 GHz, 3.6 GHz), (dependent upon Region Code setting)
Physical		
Wind Survival		200 mph (322 kph)
Antenna Connection		50 ohm, N-type (Connectorized version only)
Surge Suppression EN61000-4-5		EN61000-4-5: 10us/700us, Level 4, 4kV voltage waveform Recommended surge suppressor: Cambium Networks Model # C000000L065A
Environmental		IP66, IP67
Temperature / Humidity		-40°C to +60°C (-40°F to +140°F) / 0-95% non-condensing
Weight	2.4 GHz	15 kg (33 lbs) with antenna 2.5 kg (5.5 lbs) without antenna
	3.5 GHz	15 kg (33 lbs) with antenna 2.5 kg (5.5 lbs) without antenna
	3.6 GHz	15 kg (33 lbs) with antenna 2.5 kg (5.5 lbs) without antenna
	5 GHz	5.9 kg (13 lbs) with antenna 2.5 kg (5.5 lbs) without antenna
Dimension (HxWxD)	2.4 GHz	Radio: 27 x 21 x 7 cm (10.6" x 8.3" x 2.8") Antenna: 112.2 x 24.5 x 11.7 cm (44.2" x 9.6" x 4.6")
	3.5 GHz	Radio: 27 x 21 x 7 cm (10.6" x 8.3" x 2.8")
	3.6 GHz	Radio: 27 x 21 x 7 cm (10.6" x 8.3" x 2.8")
	5 GHz	Radio: 27 x 21 x 7 cm (10.6" x 8.3" x 2.8") Antenna: 51 x 13 x 7.3 cm (20.2" x 5.1" x 2.9")

Category		Specification
Power Consumption		14 W
Input Voltage		22 to 32 VDC
Security		
Encryption		128-bit AES and 256-bit AES
		<div style="border: 1px solid black; background-color: #e1f5fe; padding: 5px;"> <p>Note AES-256 requires a license key.</p> </div>

Specifications for PMP 450 Series - SM

The PMP 450 SM conforms to the specifications listed in below table.

Table 164 :PMP 450 Series - SM specifications

Category		Specification
Model Number		PMP 450 SM
Spectrum		
Channel Spacing		5, 7, 10, 15, 20, 30, and 40 MHz Channel Bandwidth Configurable on 2.5 MHz increments
Frequency Range	900 MHz	902 - 928 MHz
	2.4 GHz	2400 - 2483.5 MHz
	3.5 GHz	3300 - 3600 MHz
	3.65 GHz	3500 - 3850 MHz
	5 GHz	5470 - 5875 MHz
Channel Bandwidth	900 MHz,	5, 7, 10, 15, and 20 MHz
	2.4 GHz, 3.5 GHz, 3.65 GHz and 5 GHz	5, 10, 15, 20, 30, and 40 MHz Note: 2.4 GHz band does not support 40 MHz.
OFDM Subcarriers		512 FFT
Interface		
MAC (Media Access Control) Layer		Cambium Proprietary
Physical Layer		2x2 MIMO OFDM
Ethernet Interface		10/100 BaseT, half/full duplex, rate auto negotiated (802.3 compliant)
Protocols Used		IPv4, UDP, TCP, IP, ICMP, Telnet, SNMP, HTTP, FTP

Category		Specification
Network Management		HTTP, HTTPS, Telnet, FTP, SNMP v3
VLAN		802.1ad (DVLAN Q-in-Q), 802.1Q with 802.1p priority, dynamic port VID
Sensitivity		
Nominal Receive Sensitivity (w/ FEC) @ 5 MHz Channel	900 MHz	1x = -94.6 dBm, 2x = -90.6 dBm, 4x = -85.6 dBm, 6x = -79.6 dBm, 8x = -72.6 dBm
	2.4 GHz	1x = -92.5 dBm, 2x = -89.9 dBm, 4x = -82.9 dBm, 6x = -75.9 dBm, 8x = -67.9 dBm
	3.5 GHz	1x = -93.5 dBm, 2x = -89.4 dBm, 4x = -83.5 dBm, 6x = -76.4 dBm, 8x = -68.3 dBm
	3.65 GHz	1x = -91.3 dBm, 2x = -89.1 dBm, 4x = -82.2 dBm, 6x = -75.2 dBm, 8x = -67.3 dBm
	5.4 GHz	1x = -89.3 dBm, 2x = -87.3 dBm, 4x = -80.3 dBm, 6x = -74.3 dBm, 8x = -66.3 dBm
	5.8 GHz	1x = -89 dBm, 2x = -87 dBm, 4x = -80 dBm, 6x = -73.9 dBm, 8x = -64.9 dBm
Nominal Receive Sensitivity (w/ FEC) @ 7 MHz Channel	900 MHz	1x = -92.6 dBm, 2x = -89.6 dBm, 4x = -83.6 dBm, 6x = -77.6 dBm, 8x = -71.6 dBm
	3.5 GHz	1x = -92.2 dBm, 2x = -88.5 dBm, 4x = -81.4 dBm, 6x = -74.5 dBm, 8x = -67.6 dBm
	3.65 GHz	1x = -90.4 dBm, 2x = -87.3 dBm, 4x = -80.6 dBm, 6x = -73 dBm, 8x = -65.6 dBm
Nominal Receive Sensitivity (w/ FEC) @ 10 MHz Channel	900 MHz	1x = -91.6 dBm, 2x = -87.6 dBm, 4x = -81.6 dBm, 6x = -75.6 dBm, 8x = -69.6 dBm
	2.4 GHz	1x = -90.5 dBm, 2x = -86.5 dBm, 4x = -80 dBm, 6x = -73.5 dBm, 8x = -66.5 dBm
	3.5 GHz	1x = -90.5 dBm, 2x = -86.5 dBm, 4x = -80.5 dBm, 6x = -73.5 dBm, 8x = -66.9 dBm
	3.65 GHz	1x = -89.3 dBm, 2x = -86.3 dBm, 4x = -79.3 dBm, 6x = -72.3 dBm, 8x = -64.8 dBm
	5.4 GHz	1x = -86.7 dBm, 2x = -84 dBm, 4x = -77.5 dBm, 6x = -70.8 dBm, 8x = -62.5 dBm
	5.8 GHz	1x = -87.2 dBm, 2x = -83.2 dBm, 4x = -77.2 dBm, 6x = -70.2 dBm, 8x = -62.2 dBm
Nominal Receive Sensitivity (w/ FEC) @ 15 MHz Channel	900 MHz	1x = -88.6 dBm, 2x = -85.4 dBm, 4x = -78.1 dBm, 6x = -72.2 dBm, 8x = -65.2 dBm
	2.4 GHz	1x = -88.5 dBm, 2x = -84.5 dBm, 4x = -77.5 dBm, 6x = -70.5 dBm, 8x = -63.5 dBm

Category		Specification
		= -71.5 dBm, 8x = -64.5 dBm
	3.5 GHz	1x = -89.5 dBm, 2x = -84.5 dBm, 4x = -78.5 dBm, 6x = -71.5 dBm, 8x = -65.1 dBm
	3.65 GHz	1x = -87.3 dBm, 2x = -84.3 dBm, 4x = -77.3 dBm, 6x = -70.3 dBm, 8x = -62.2 dBm
	5.4 GHz	1x = -84.5dBm, 2x = -82.5 dBm, 4x = -75.5 dBm, 6x = -69.5 dBm, 8x = -59.5 dBm
	5.8 GHz	1x = -85.2 dBm, 2x = -82.2 dBm, 4x = -75.2 dBm, 6x = -69 dBm, 8x = -57 dBm
Nominal Receive Sensitivity (w/ FEC) @ 20 MHz Channel	900 MHz	1x = -87.6 dBm, 2x = -84.6 dBm, 4x = -78 dBm, 6x = -71.6 dBm, 8x = -64.6 dBm
	2.4 GHz	1x = -86.9 dBm, 2x = -82.9 dBm, 4x = -75.9 dBm, 6x = -69.9 dBm, 8x = -63.5 dBm
	3.5 GHz	1x = -87.5 dBm, 2x = -83.5 dBm, 4x = -76.5 dBm, 6x = -69.5 dBm, 8x = -63.1 dBm
	3.65 GHz	1x = -86 dBm, 2x = -83 dBm, 4x = -76.2 dBm, 6x = -68.2 dBm, 8x = -61 dBm
	5.4 GHz	1x = -83.4 dBm, 2x = -81.7 dBm, 4x = -74.4 dBm, 6x = -67.2 dBm, 8x = -57.3 dBm
	5.8 GHz	1x = -84 dBm, 2x = -80.5 dBm, 4x = -74 dBm, 6x = -66.9 dBm, 8x = -56 dBm
Nominal Receive Sensitivity (w/ FEC) @ 30 MHz Channel	2.4 GHz	1x = -85.9 dBm, 2x = -80.9 dBm, 4x = -73.9 dBm, 6x = -67.8 dBm, 8x = -60.9 dBm
	3.5 GHz	1x = -86.5 dBm, 2x = -81.5 dBm, 4x = -74.5 dBm, 6x = -68.5 dBm, 8x = -61.2 dBm
	3.65 GHz	1x = -84.3 dBm, 2x = -80.3 dBm, 4x = -74.3 dBm, 6x = -66.2 dBm, 8x = -58 dBm
	5.4 GHz	1x = -82 dBm, 2x = -78.3 dBm, 4x = -72.3 dBm, 6x = -65.3 dBm, 8x = -53.3 dBm
	5.8 GHz	1x = -81.7 dBm, 2x = -78.6 dBm, 4x = -71.6 dBm, 6x = -64.4 dBm, 8x = -54 dBm
Nominal Receive Sensitivity (w/ FEC) @ 40 MHz Channel	3.5 GHz	1x = -83.1 dBm, 2x = -79.3 dBm, 4x = -72.9 dBm, 6x = -66 dBm, 8x = -56.3 dBm
	3.65 GHz	1x = -83.6 dBm, 2x = -79.6 dBm, 4x = -72.3 dBm, 6x = -65.3 dBm, 8x = -54.4 dBm
	5.4 GHz	1x = -82.4 dBm, 2x = -78 dBm, 4x = -71.2 dBm, 6x = -64.3 dBm, 8x = -51 dBm

Category		Specification		
	5.8 GHz	1x = -82.5 dBm, 2x = -78.8 dBm, 4x = -70.7 dBm, 6x = -64.8 dBm, 8x = -51 dBm		
Performance				
Subscribers Per Sector		Up to 238		
ARQ		Yes		
Cyclic Prefix		1/16		
Frame Period		2.5 ms or 5.0 ms		
Modulation Levels (Adaptive)		Modulation Levels	MCS	SNR (in dB)
		2x	QPSK	10
		4x	16QAM	17
		6x	64QAM	24
		8x	256QAM	32
Latency		3 - 5 ms for 2.5 ms Frame Period 6-10 ms for 5.0 ms Frame Period		
Maximum Deployment Range		Up to 40 miles (64 km)		
GPS Synchronization		Yes		
Quality of Service		Diffserv QoS		
Link Budget				
Antenna Gain (Does not include cable loss, ~1dB)	900 MHz	12 dBi Yagi antenna		
	2.4 GHz	7 dBi Dual Slant, integrated patch		
	3.5 GHz	8 dBi Dual Slant, integrated patch		
		19 dBi Flat Plate, integrated patch		
	3.65 GHz	8 dBi Dual Slant, integrated patch		
		19 dBi Flat Plate, integrated patch		
	5 GHz	9 dBi H+V, integrated patch		
		25 dBi H+V, integrated dish		
Combined Transmit Power		-30 to +22 dBm (to EIRP limit by region) - 2.4, 5 GHz -30 to +25 dBm (to EIRP limit by region) - 3.5, 3.6 GHz 25 dBm - 3 GHz		

Category		Specification
Maximum Transmit Power		22 dBm combined OFDM (2.4 GHz, 5 GHz) (dependent upon Region Code setting) 25 dBm combined OFDM (900 MHz, 3.5 GHz, 3.6 GHz), (dependent upon Region Code setting)
Reflector antenna gain	2.4 GHz	+12 dBi
	3.5 GHz	+11 dBi
	3.65 GHz	+11 dBi
	5 GHz	+15 dBi
Other antenna (5 GHz only)	CLIP Gain	+8 dBi
	LENS Gain	+5.5 dBi
Physical		
Wind Survival		200 mph (322 kph)
Antenna Connection		50 ohm, N-type (Connectorized version only)
Surge Suppression EN61000-4-5		EN61000-4-5: 10us/700us, Level 4, 4kV voltage waveform Recommended surge suppressor: Cambium Networks Model # 600SSH
Environmental		IP55
Temperature / Humidity		-40°C to +60°C (-40°F to +140°F) / 0-95% non-condensing
Weight	2.4 GHz	15 kg (33 lbs) with antenna 2.5 kg (5.5 lbs) without antenna
	3.5 GHz	15 kg (33 lbs) with antenna 2.5 kg (5.5 lbs) without antenna 2.5 kg (5.5 lbs) for 450 ruggedized
	3.6 GHz	15 kg (33 lbs) with antenna 2.5 kg (5.5 lbs) without antenna 2.5 kg (5.5 lbs) for 450 ruggedized
	5 GHz	5.9 kg (13 lbs) with antenna 2.5 kg (5.5 lbs) without antenna 3.5 kg (7.7 lbs) for 450d
Dimensions (H x W x D)		30 x 9 x 9 cm (11.75" x 3.4" x 3.4")

Category		Specification
		50 x 50 x 38 cm (19.69" x 19.69" x 14.96") for 450d 31.0 x 31.0 x 6.4 cm (12" x 12" x 2.5") for 450 ruggedized
Power Consumption		12 W
Input Voltage		20 to 32 VDC
Security		
Encryption		128-bit AES and 256-bit AES 
		<div style="border: 1px solid black; background-color: #e1f5fe; padding: 5px; display: inline-block;"> <p>Note AES-256 requires a license key.</p> </div>

Specifications for PTP 450 Series - BH

The PTP 450 BH conforms to the specifications listed in below table.

Table 165 :PTP 450 Series - BH specifications

Category		Specification
Model Number		PTP 450 BH
Spectrum		
Channel Spacing		5, 7, 10, 15, 20, 30, and 40 MHz Channel Bandwidth Configurable on 2.5 MHz increments
Frequency Range		902 to 928 MHz
		3300 - 3600 MHz
		3500 - 3850 MHz
		5470 - 5875 MHz
Channel Bandwidth	900 MHz	5, 7, 10, 15, and 20 MHz
	3.5 GHz, 3.6 GHz, and 5 GHz	5, 7, 10, 15, 20, 30, and 40 MHz 7 MHz Channel bandwidth configurable for 3.5 GHz and 3.65 GHz band only.
OFDM Subcarriers		512 FFT
Interface		
MAC (Media Access Control) Layer		Cambium Proprietary
Physical Layer		2x2 MIMO OFDM

Category		Specification
Ethernet Interface		10/100 BaseT, half/full duplex, rate auto negotiated (802.3 compliant)
Protocols Used		IPv4, UDP, TCP, IP, ICMP, Telnet, SNMP, HTTP, FTP, TFTP, RADIUS
Network Management		HTTP, HTTPS, Telnet, FTP, SNMP v2c and v3, TFTP, Syslog
VLAN		802.1ad (DVLAN Q-in-Q), 802.1Q with 802.1p priority, dynamic port VID
Sensitivity		
Nominal Receive Sensitivity (w/ FEC) @ 5 MHz Channel	900 MHz	1x = -92.2 dBm, 2x = -90.2 dBm, 4x = -83.2 dBm, 6x = -77.2 dBm, 8x = -71.2 dBm
	3.5 GHz	1x = -93 dBm, 2x = -90.3 dBm, 4x = -83 dBm, 6x = -76 dBm, 8x = -69 dBm
	3.6 GHz	1x = -94 dBm, 2x = -89.3 dBm, 4x = -82.3 dBm, 6x = -75.2 dBm, 8x = -68.4 dBm
	5.4 GHz	1x = -90.4 dBm, 2x = -86 dBm, 4x = -79.4 dBm, 6x = -73.2 dBm, 8x = -65.4 dBm
	5.8 GHz	1x = -90 dBm, 2x = -85.4 dBm, 4x = -79.4 dBm, 6x = -73.4 dBm, 8x = -64.9 dBm
Nominal Receive Sensitivity (w/ FEC) @7 MHz Channel	900 MHz	1x = -92.2 dBm, 2x = -88.2 dBm, 4x = -82.2 dBm, 6x = -76.2 dBm, 8x = -69.2 dBm
	3.5 GHz	1x = -92.1 dBm, 2x = -88 dBm, 4x = -81 dBm, 6x = -74 dBm, 8x = -67 dBm
	3.6 GHz	1x = -92 dBm, 2x = -87.3 dBm, 4x = -81.3 dBm, 6x = -74.3 dBm, 8x = -66.4 dBm
Nominal Receive Sensitivity (w/ FEC) @10 MHz Channel	900 MHz	1x = -91.3 dBm, 2x = -86.2 dBm, 4x = -80.2 dBm, 6x = -75.2 dBm, 8x = -68 dBm
	3.5 GHz	1x = -91 dBm, 2x = -87.2 dBm, 4x = -80 dBm, 6x = -73 dBm, 8x = -65.6 dBm
	3.6 GHz	1x = -90.4 dBm, 2x = -86.3 dBm, 4x = -80 dBm, 6x = -73 dBm, 8x = -64.5 dBm
	5.4 GHz	1x = -87.6 dBm, 2x = -82.5 dBm, 4x = -76.5 dBm, 6x = -70.5 dBm, 8x = -61.5 dBm
	5.8 GHz	1x = -87.5 dBm, 2x = -82.7 dBm, 4x = -76.8 dBm, 6x = -70.5 dBm, 8x = -61.4 dBm
Nominal Receive Sensitivity (w/ FEC) @15 MHz Channel	900 MHz	1x = -90 dBm, 2x = -84.3 dBm, 4x = -78.2 dBm, 6x = -72.2 dBm, 8x = -65.3 dBm

Category		Specification	
	3.5 GHz	1x = -89 dBm, 2x = -85 dBm, 4x = -78 dBm, 6x = -71.1 dBm, 8x = -64.7 dBm	
	3.6 GHz	1x = -89 dBm, 2x = -84.3 dBm, 4x = -78 dBm, 6x = -71 dBm, 8x = -63 dBm	
	5.4 GHz	1x = -85.6 dBm, 2x = -81.6 dBm, 4x = -74.5 dBm, 6x = -68.5 dBm, 8x = -57.5 dBm	
	5.8 GHz	1x = -85.6 dBm, 2x = -80.9 dBm, 4x = -75 dBm, 6x = -68 dBm, 8x = -58 dBm	
Nominal Receive Sensitivity (w/ FEC) @20 MHz Channel	900 MHz	1x = -87.4 dBm, 2x = -84 dBm, 4x = -77.3 dBm, 6x = -70.3 dBm, 8x = -64.3 dBm	
	3.5 GHz	1x = -88 dBm, 2x = -84 dBm, 4x = -77 dBm, 6x = -70 dBm, 8x = -62.2 dBm	
	3.6 GHz	1x = -87.3 dBm, 2x = -83.3 dBm, 4x = -76.3 dBm, 6x = -69.3 dBm, 8x = -62 dBm	
	5.4 GHz	1x = -84.5 dBm, 2x = -80.5 dBm, 4x = -73.4 dBm, 6x = -66.4 dBm, 8x = -56.4 dBm	
	5.8 GHz	1x = -84.8 dBm, 2x = -80.8 dBm, 4x = -74.7 dBm, 6x = -66.4 dBm, 8x = -56 dBm	
Nominal Receive Sensitivity (w/ FEC) @ 30 MHz Channel	3.5 GHz	1x = -86 dBm, 2x = -82 dBm, 4x = -75 dBm, 6x = -68 dBm, 8x = -60 dBm	
	3.6 GHz	1x = -86 dBm, 2x = -81.3 dBm, 4x = -74.3 dBm, 6x = -67.3 dBm, 8x = -59 dBm	
	5.4 GHz	1x = -82.5 dBm, 2x = -78.5 dBm, 4x = -71.5 dBm, 6x = -64.4 dBm, 8x = -53.4 dBm	
	5.8 GHz	1x = -82.5 dBm, 2x = -78.5 dBm, 4x = -71.5 dBm, 6x = -64.4 dBm, 8x = -54 dBm	
Nominal Receive Sensitivity (w/ FEC) @ 40 MHz Channel	5.4 GHz	1x = -81.8 dBm, 2x = -77.5 dBm, 4x = -70.5 dBm, 6x = -63.5 dBm, 8x = -52.6 dBm	
	5.8 GHz	1x = -83.0 dBm, 2x = -78.0 dBm, 4x = -71.0 dBm, 6x = -63.3 dBm, 8x = -50 dBm	
Performance			
ARQ		Yes	
Cyclic Prefix		1/16	
Frame Period		2.5 ms or 5.0 ms	
Modulation Levels (Adaptive)		Modulation Levels	MCS SNR (in dB)

Category		Specification												
		<table border="1"> <tr> <td>2x</td> <td>QPSK</td> <td>10</td> </tr> <tr> <td>4x</td> <td>16QAM</td> <td>17</td> </tr> <tr> <td>6x</td> <td>64QAM</td> <td>24</td> </tr> <tr> <td>8x</td> <td>256QAM</td> <td>32</td> </tr> </table>	2x	QPSK	10	4x	16QAM	17	6x	64QAM	24	8x	256QAM	32
2x	QPSK	10												
4x	16QAM	17												
6x	64QAM	24												
8x	256QAM	32												
Latency		3 - 5 ms for 2.5 ms frame period 6 - 10 ms for 5.0 ms frame period												
Packets Per Second		12,500												
Maximum Deployment Range		Up to 40 miles (64 km)												
GPS Synchronization		Yes, via Autosync (CMM4)												
Quality of Service		Diffserv QoS												
Link Budget														
Combined Transmit Power	-	30 to +22 dBm (to EIRP limit by region) in 1 dB-configurable intervals (5 GHz) -30 to +25 dBm (to EIRP limit by region) in 1 dB-configurable intervals (3.5 GHz) -30 to +25 dBm (to EIRP limit by region and channel bandwidth) in 1 dB-configurable intervals (3.6 GHz)												
Antenna Gain (Does not include cable loss, ~1dB)	3.5 GHz	8 dBi Dual Slant, integrated patch												
		19 dBi Flat Plate, integrated patch												
	3.65 GHz	8 dBi Dual Slant, integrated patch												
		19 dBi Flat Plate, integrated patch												
	5 GHz	9 dBi H+V, integrated patch												
		25 dBi H+V, integrated dish												
Transmit Power Range		40 dB dynamic range (to EIRP limit by region) (1 dB step)												
Maximum Transmit Power		22 dBm combined OFDM (5 GHz) (dependent upon Region Code setting) 25 dBm combined OFDM (3.5 GHz, 3.6 GHz), (dependent upon Region Code setting)												
Reflector antenna gain	3.5 GHz	+11 dBi												
	3.65 GHz	+11 dBi												
	5 GHz	+15 dBi												

Category		Specification
Other antenna (5 GHz only)	CLIP Gain	+8 dBi
	LENS Gain	+5.5 dBi
Physical		
Sync/AUX port	RJ45	<ul style="list-style-type: none"> 10/100/1000BASE-T Ethernet Data PoE output Sync input or output (Connection and powering of UGPS Sync input)
Antenna Connection		50 ohm, N-type (Connectorized version only)
Surge Suppression EN61000-4-5		EN61000-4-5: 1.2us/50us, 500 V voltage waveform Recommended external surge suppressor: Cambium Networks Model # C000000L033A
Mean Time Between Failure		> 40 Years
Environmental		IP66, IP67
Temperature / Humidity		- 40°C to +60°C (- 40°F to +140°F), 0- 95% non-condensing
Weight		15 kg (33 lbs) with antenna 2.5 kg (5.5 lbs) without antenna
Wind Survival		200 mph (322 kph)
Dimension (HxWxD)		30 x 9 x 9 cm (11.75" x 3.4" x 3.4")
Maximum Power Consumption		14 W
Input Voltage		22 to 32 VDC
Security		
Encryption		128-bit AES and 256-bit AES
		 <div style="border: 1px solid black; background-color: #e1f5fe; padding: 5px; display: inline-block;"> <p>Note AES-256 requires a license key.</p> </div>

PSU specifications

The PMP/PTP 450i AC+DC Enhanced Power Injector conforms to the specifications listed in below table.

Table 166 :PMP/PTP 450i AC power Injector specifications

Category	Specification
Dimensions	137 mm (5.4 in) x 56 mm (2.2 in) x 38 mm (1.5 in)

Category	Specification
Weight	0.240 Kg (0.5 lbs)
Temperature	-40°C to +60°C
Humidity	90% non-condensing
Waterproofing	Not waterproof
Altitude	Sea level to 5000 meters (16000 ft)
AC Input	Min 90 V AC, 57 - 63 Hz, max 264 V AC, 47 - 53 Hz.
DC output voltage to the ODU	58V +2V/- 0V
AC connector	IEC-320-C8
Efficiency	Better than 85%, efficiency level 'VI'
Over Current Protection	Hiccup current limiting, trip point set between 120% to 150% of full load current
Hold up time	At least 10 milliseconds



Warning

Use the above PSU to only power up 450i and 450m products.

The PMP/PTP 450 power supply conforms to the specifications listed in below table.

Table 167 :PMP/PTP 450 power supply specifications (part number: N000900L001A)

Category	Specification
Dimensions	118 mm (4.66 in) x 45 mm (1.75 in) x 32 mm (1.25 in)
Weight	0.240 Kg (0.5 lbs)
Temperature	0°C to +40°C
Humidity	20 to 90%
AC Input	90-264 VAC, 47 - 63 Hz, 0.5 A rms at 120 VAC, 0.25 A rms at 240 VAC.
DC output voltage to the ODU	30 V 3 5%
AC connector	IEC-320-C8
Efficiency	Better than 85%, efficiency level 'V'
Over Current Protection	Short circuit, with auto recovery; Should restart between every 0.5 to 2 sec.
Hold up time	10mS min at max load, 120VAC



Note
The 30bV PSU (part number: #N000900L001A) has to be used for PMP 450 900 MHz SM.



Warning
The PMP 450 Ruggedized High Gain Integrated Subscriber Module (Cambium part numbers C035045C014A and C036045C014A), while encapsulated in a 450i-type enclosure, contains 450 circuitry which must be powered via 30VDC. Powering these SMs with 56 VDC will damage the device.

Data network specifications

This section contains specifications of the PMP/PTP 450 platform Ethernet interface.

Ethernet interface

450 m/ 450 i Series

The 450m/450i Series Ethernet port conforms to the specifications listed in below table.

Table 168 : 450m/450i Series Main and Aux Ethernet bridging specifications

Ethernet Bridging	Specification
Protocol	IEEE 802.3 compatible
QoS	IEEE 802.1p, IEEE 802.1Q, IEEE 802.1ad, DSCP IPv4
Main Ethernet port	10/100/1000 BaseT, half/full duplex, rate auto negotiated
Aux Ethernet port	10/100 BaseT, half/full duplex, rate auto negotiated
Maximum Ethernet Frame Size	1700 Bytes

450/450 b Series

Table 169 :450 Series Ethernet bridging specifications

Ethernet Bridging	Specification
Protocol	IEEE 802.3 compatible
QoS	IEEE 802.1p, IEEE 802.1Q, IEEE 802.1ad, DSCP IPv4
Interface	10/100/1000* BaseT, half/full duplex, rate auto negotiated
Maximum Ethernet Frame Size	1700 Bytes

* 450 SM does not support 1000 BaseT.

* 450 AP supports 1000 BaseT, but with known CRC errors and it is not recommended to use.



Note

Practical Ethernet rates depend on network configuration, higher layer protocols and platforms used.

Over the air throughput is restricted to the rate of the Ethernet interface at the receiving end of the link.

Wireless specifications

This section contains specifications of the 450 Platform Family wireless interface. These specifications include RF bands, channel bandwidth, spectrum settings, maximum power and link loss.

General wireless specifications

The wireless specifications that apply to all 450 Platform variants are listed under below table.

Table 170 :450 Platform Family - wireless specifications

Item	Specification		
Channel selection	Manual selection (fixed frequency).		
Manual power control	To avoid interference to other users of the band, maximum power can be set lower than the default power limit.		
Duplex scheme	Adaptive TDD		
Range	Band	Platform	Range
	900 MHz	PMP 450i Series - AP and PMP 450 Series - SM	120 mi / 193 km
	2.4 GHz	PMP 450 Series	40 mi / 64 km
	3.5 GHz	PMP/PTP 450/450b Series	40 mi / 64 km (PMP) 186 mi/ 299 km (PTP)
	3.65 GHz	PMP/PTP 450/450b Series	40 mi / 64 km (PMP) 186 mi/ 299 km (PTP)
	5 GHz	PMP/PTP 450/450i/450b Series and PMP 450m Series AP	40 mi / 64 km (PMP) 186 mi/ 299 km (PTP)
Over-the-air encryption	128-bit AES and 256-bit AES		
Error Correction	Rate 3/4 RS coder		

Link Range and Throughput

Link range and throughput estimates are based on site-specific attributes and configuration parameters. For the most up-to-date information on link range and throughput for your equipment see the Capacity Planner and LINKPlanner software tools:

- For average-deployment link range and throughput planning information, see:
 - <https://support.cambiumnetworks.com/files/capacityplanner/>
- For site-specific link range and throughput planning information, see:
 - <https://support.cambiumnetworks.com/files/linkplanner>

Country specific radio regulations

This section describes how the 450 Platform Family complies with the radio regulations that are enforced in various countries.



Caution

Changes or modifications not expressly approved by Cambium could void the user's authority to operate the system.

Type approvals

This system has achieved Type Approval in various countries around the world. This means that the system has been tested against various local technical regulations and found to comply. The frequency bands in which the system operates may be 'unlicensed' and, in these bands, the system can be used provided it does not cause interference. The system is not guaranteed protection against interference from other ODUs and installations.

The radio specification type approvals that have been granted for 450 Platform frequency variants are listed in below table.

Table 171: Radio certifications

Variant	Region	Specification (Type Approvals)
900 MHz PMP 450i	Canada	RSS Gen and RSS 210
	USA	FCC Part 15.247
	Mexico	NOM-121-SCT1-2009
2.4 GHz PMP 450	Canada	RSS Gen and RSS 210
	USA	FCC Part 15 Class B
3.5 GHz PMP/PTP 450	Canada	RSS Gen and RSS 192
	Europe	ETSI EN 302 326-2 V1.2.2
3.6 GHz PMP/PTP 450	Canada	RSS Gen and RSS 197
	USA	FCC Part 15 Class B
3.5 GHz PMP 450m	Canada	RSS Gen and RSS 192
	Europe	ETSI EN 302 326-2 V1.2.2
3.6 GHz PMP 450m	Canada	RSS Gen and RSS 197
	USA	FCC Part 90Z and Part 15 Class B
	Europe	ETSI EN 302 326-2 V1.2.2

Variant	Region	Specification (Type Approvals)
4.9 GHz PMP/PTP 450i/450b/450m/450 MicroPoP/450b Retro	USA	FCC Part 90 Subpart Y
	Canada	RSS Gen and RSS 111
5.1 GHz PMP/PTP 450i/450b/450 MicroPoP/450b Retro	USA	FCC Part 15 Class B
5.1 GHz PMP 450m	USA	FCC Part 15E and Part 15B
	Europe	ETSI EN 302 625 V1.1.1
5.2 GHz PMP 450m	USA	FCC Part 15E and Part 15B
5.2 GHz PMP/PTP 450i/450b/450 MicroPoP/450b Retro	USA	FCC Part 15 Class B
	Canada	RSS Gen and RSS 247
5.4 GHz PMP/PTP 450 and 450i/450 MicroPoP/450b Retro	Europe	ETSI EN 301 893 v1.6.1
	USA	FCC Part 15 Class B
5.4 GHz PMP 450m	USA	FCC Part 15E and Part 15B
	Canada	RSS Gen and RSS 247
	Europe	ETSI EN 301 893 v1.8.1 ETSI EN 301 893 v2.1.1 Clause 4.8
5.8 GHz PMP/PTP 450 and 450i/450 MicroPoP/450b Retro	Canada	RSS Gen and RSS 210
	USA	FCC Part 15 Class B
	Europe	ETSI EN 302 502 v1.2.1
5.8 GHz PMP 450m	USA	FCC Part 15E and Part 15B
	Canada	RSS Gen and RSS 247
	Europe	ETSI EN 302 502 v2.1.1

DFS for 2.4 and 5 GHz Radios

Dynamic Frequency Selection (DFS) is a requirement in several countries and regions for 2.4 and 5 GHz unlicensed systems to detect radar systems and avoid co-channel operation.

The details of DFS operation and channels available for each Country Code, including whether DFS is active on the AP, SM, which DFS regulation apply, and any channel restrictions are shown in below table.

Table 172 :Country & Bands DFS setting

Region Code	Country Code	Band	AP	SM	Weather Notch-Out	Radar
North America	USA	2.4 GHz	No effect	No effect	No	
		5.2 GHz	FCC DFS	No effect	No	

Region Code	Country Code	Band	AP	SM	Weather Notch-Out	Radar	
		5.4 GHz	FCC DFS	No effect	No		
		5.8 GHz	No effect	No effect	No		
	Canada	2.4 GHz	No effect	No effect	No		
		5.2 GHz	RSS-247 Iss2 DFS	No effect	No		
		5.4 GHz	RSS-247 Iss2 DFS	No effect	Yes		
		5.8 GHz	No effect	No effect	No		
	Mexico	2.4 GHz	No effect	No effect	No		
		5.2 GHz	ANATEL Res506-2008	No effect	No		
		5.4 GHz	ANATEL Res506-2008	No effect	No		
		5.8 GHz	No effect	No effect	No		
	South America	Brazil	5.4 GHz	ETSI EN 301 893 v2.1.1DFS	No effect	No	
			5.8 GHz	No effect	No effect	No	
Europe	ETSI	5.4 GHz	ETSI EN 301 893 v2.1.1 DFS	ETSI EN 301 893 v2.1.1 DFS	Yes		
		5.8 GHz	ETSI EN 302 502 v2.1.1 DFS	ETSI EN 302 502 v2.1.1 DFS	Yes		
Other-Regulatory	Other-FCC	2.4 GHz	No effect	No effect	No		
		5.2 GHz	FCC DFS	No effect	No		
		5.4 GHz	FCC DFS	No effect	No		
		5.8-GHz	No effect	No effect	No		
	Other-	5.4	ETSI EN 301 893	ETSI EN 301 893	No		

Region Code	Country Code	Band	AP	SM	Weather Notch-Out	Radar
	ETSI	GHz	v2.1.1 DFS	v1.7.1 DFS		
		5.8 GHz	ETSI EN 302 502 v2.1.1 DFS	ETSI EN 302 502 v1.2.1 DFS	No	

Equipment Disposal

Waste (Disposal) of Electronic and Electric Equipment

<p>Waste (Disposal) of Electronic and Electric Equipment</p>	<p>Please do not dispose of Electronic and Electric Equipment or Electronic and Electric Accessories with your household waste. In some countries or regions, collection systems have been set up to handle waste of electrical and electronic equipment. In European Union countries, please contact your local equipment supplier representative or service center for information about the waste collection system in your country.</p>
--	---

Country specific band range maximum transmit power

Maximum transmit power 900 MHz band

Table 173 :Frequency range and Maximum transmit power – 900 MHz band PMP 450i Series

Region	Country	Band range		Device Type	Antenna Type		EIRP Limit /Conducted Power Limit (dBm)						
		Lower	Upper				5 MHz	7 MHz	10 MHz	15 MHz	20 MHz	30 MHz	40 MHz
North America	Other FCC, USA, Canada, Mexico, Puerto, Rico	902	928	Any	Any	EIRP	36	36	36	36	36	-	-
						CPL							
Oceania	Australia	915	928	Any	Any	EIRP	30	30	30	30	-	-	-
						CPL	19	19	19	19	-	-	-
	915	928	Any	Any	EIRP	30	30	30	36	-	-	-	
					CPL	19	19	19	19	-	-	-	

Region	Country	Bang range		Device Type	Antenna Type		EIRP Limit /Conducted Power Limit (dBm)							
		Lower	Upper				5 MHz	7 MHz	10 MHz	15 MHz	20 MHz	30 MHz	40 MHz	
South America	New Zealand	920.5 (7 MHz)	924.5 (7 MHz)	Any	Any	EIRP	30	30	30	36	-	-	-	
						CPL	19	19	19	19	-	-	-	
	Brazil	919.5 (5 MHz)	925.5 (5 MHz)	Any	Any	EIRP	30	30	30	36	-	-	-	
						CPL	19	19	19	19	-	-	-	
	Ecuador	902	907.5	Any	Any	EIRP	36	36	36	36	-	-	-	
						CPL								
			915	928	Any	Any	EIRP	36	36	36	36	-	-	-
							CPL					-	-	-
			902	928	Any	Any	EIRP						-	-
							CPL	27	27	27	27	27	-	-
	Colombia, Panama, Venezuela	902	928	Any	Any	EIRP	36	36	36	36	36	-	-	
						CPL							-	-
Others	Others	902	928	Any	Any	EIRP						-	-	
						CPL							-	-

CPL= Conducted Power Limit

Maximum transmit power 2.4 GHz band

Table 174 :Frequency range and Maximum transmit power – 2.4 GHz band PMP/PTP 450 Series

Country	Band range		Device Type	Antenna Type		EIRP Limit /Conducted Power Limit (dBm)					
	Lower	Upper	5 MHz			10 MHz	15 MHz	20 MHz	30 MHz	40 MHz	
Other FCC, USA, Canada	2400	2483.5	AP	Sector	EIRP	36	36	36	36	-	-
					CPL	18	18	18	18	-	-
			SM, BH	Integrated	EIRP	36	36	36	36	-	-
					CPL					-	-
				Reflector	EIRP	36	36	36	36	-	-
					CPL	24	24	24	24	-	-
				Integrated Dish (450d)	EIRP	36	36	36	36	-	-
					CPL	11	11	11	11	-	-
Others	2400	2483.5	Any	Any	EIRP						
					CPL	30	30	30	30	30	30

CPL= Conducted Power Limit

Maximum transmit power 3 GHz band

Table 175 :Frequency range and Maximum transmit power - 3 GHz band PMP/PTP 450 Series

Country	Band range		Device Type	Antenna Type		EIRP Limit /Conducted Power Limit (dBm)						
	Lower	Upper	5 MHz			7 MHz	10 MHz	15 MHz	20 MHz	30 MHz	40 MHz	
Other	3300 (1)	3850 (1)	Any	Any	EIRP							
					CPL							
FCC	3650	3700	Any	Any	EIRP	37	38.5	40	41.7	43	44.7	46
					CPL	19	20.5	22	23.7	25	26.7	28
ETSI	3410 (2)	3800 (2)	Any	Any	EIRP							
					CPL							
India	3300 (3)	3800 (3)	Any	Any	EIRP							
					CPL							
Indonesia	3600	3800	Any	Any	EIRP							
					CPL							

Country	Bang range		Device Type	Antenna Type		EIRP Limit /Conducted Power Limit (dBm)							
	Lower	Upper				5 MHz		7 MHz	10 MHz	15 MHz	20 MHz	30 MHz	40 MHz
China	3300	3400	Any	Any	EIRP								
					CPL								
Malaysia					EIRP								
					CPL								
Pakistan					EIRP								
					CPL								
Canada	3450	3650	Any	Any	EIRP	62	62	62	62	62	62	62	
					CPL								
	3650	3700	Any	Any	EIRP	37	38.5	40	41.7	43	44.7	46	
					CPL	19	20.5	22	23.7	25	26.7	28	
USA	3550 (4)	3700 (4)	Any	Any	EIRP	44	45.5	47	48.7	50	51.7	53	
					CPL	24	25.5	27	28.1	30	30	30	
	3650	3700	Any	Any	EIRP	37	38.5	40	41.7	43	44.7	46	
					CPL	19	20.5	22	23.7	25	26.7	28	
Mexico	3300	3750	Any	Any	EIRP								
					CPL								
Australia	3300	3800	Any	Any	EIRP	57	58.9	60	61.7	63	63	-	
					CPL							-	-
Brazil	3400	3600	Any	Any	EIRP						-	-	
					CPL							-	-

CPL= Conducted Power Limit

1. = Frequencies between 3850 and 3900 can also be selected, but performance is not guaranteed in this portion of the band. For example, sensitivity is degraded
2. = No PTP support in ETSi region
3. = Either ETSI or FCCC
4. = This band follows the CBRS rules (devices need to connect to a SAS to be granted a channel)

Maximum transmit power 4.9 GHz band

Table 176 :Default combined transmit power per country - 4.9 GHz band PMP/PTP 450i Series

Countries	Device Type	Antenna Type	Channel BW	Antenna Gain (dBi)	Conducted Power Limit (dBm)	EIRP Limit (dBm)
USA, Canada, Other FCC	AP	Sector	5 MHz	16	24	40
			10 MHz	16	24	40
			15 MHz	16	24	40
			20 MHz	16	24	40
		Omni	5 MHz	12	24	36
			10 MHz	12	24	36
			15 MHz	12	24	36
			20 MHz	12	24	36
	SM, BH	Flate plate	5 MHz	27	24	51
			10 MHz	27	24	51
			15 MHz	27	24	51
			20 MHz	27	24	51
		4ft parabolic	5 MHz	32	24	56
			10 MHz	32	24	56
			15 MHz	32	24	56
			20 MHz	32	23	52
		6ft parabolic	5 MHz	36	24	60
			10 MHz	36	24	60
			15 MHz	36	24	60
			20 MHz	36	24	60
Brazil	AP	Sector	5 MHz	16	27	43
			10 MHz	16	27	43
			15 MHz	16	27	43
			20 MHz	16	27	43

Countries	Device Type	Antenna Type	Channel BW	Antenna Gain (dBi)	Conducted Power Limit (dBm)	EIRP Limit (dBm)
Mexico	AP	Sector	5 MHz	16	22	38
			10 MHz	16	22	38
			15 MHz	16	22	38
			20 MHz	16	22	38
			30 MHz	16	22	38
			40 MHz	16	22	38
Other	Any	Any	Any	-	27	-

Table 177 :Default combined transmit power per country - 4.9 GHz band PMP 450b Series

Countries	Device Type	Antenna Type	Channel BW	Antenna Gain (dBi)	Conducted Power Limit (dBm)	EIRP Limit (dBm)
FCC	SM	16 dBi Mid-Gain	5 MHz	16	26	42
			10 MHz	16	26	42
			15 MHz	16	26	42
			20 MHz	16	26	42
		23 dBi High Gain	5 MHz	23	26	49
			10 MHz	23	26	49
			15 MHz	23	26	49
			20 MHz	23	26	49

Table 178 :Default combined transmit power per country - 4.9 GHz band PMP 450m Series

Countries	Device Type	Antenna Type	Channel BW	EIRP Limit (dBm)
USA, Canada, Other FCC	AP	Sector	5 MHz	42 dBm (in sector mode)/ 48 dBm (in beamforming mode)
			10 MHz	
			15 MHz	
			20 MHz	
Brazil	AP	Sector	5 MHz	
			10 MHz	
			15 MHz	
			20 MHz	
Mexico	AP	Sector	5 MHz	
			10 MHz	
			15 MHz	
			20 MHz	
			30 MHz	
			40 MHz	
Other	AP	Sector	Any	

Maximum transmit power 5.1GHz band

Table 179 :Default combined transmit power per Country - 5.1 GHz band PMP/PTP 450i Series

Countries	Device Type	Antenna Type	Channel BW	Antenna Gain (dBi)	Conducted Limit (dBm)	Power	EIRP (dBm)	Limit
USA, Other FCC and Canada	AP	Sector	5 MHz	16	14		30	
			10 MHz	16	17		33	
			15 MHz	16	18		34	
			20 MHz	16	20		36	
			30 MHz	16	20		36	
			40 MHz	16	20		36	
		Omni	5 MHz	12	16		28	
			10 MHz	12	19		31	
			15 MHz	12	22		34	
			20 MHz	12	24		36	
			30 MHz	12	24		36	
			40 MHz	12	24		36	
	SM, BH	Flat plate	5 MHz	23	24		47	
			10 MHz	23	27		50	
			15 MHz	23	27		50	
			20 MHz	23	27		50	
			30 MHz	23	27		50	
			40 MHz	23	27		50	
		4ft parabolic	5 MHz	33	14		47	
			10 MHz	33	17		50	
			15 MHz	33	18		51	
20 MHz			33	20		53		
30 MHz			33	20		53		
40 MHz			33	20		53		
		6ft parabolic	5 MHz	36	11		47	
			10 MHz	36	14		50	
			15 MHz	36	15		51	
			20 MHz	36	17		53	
			30 MHz	36	17		53	
			40 MHz	36	17		53	

Table 180 :Default combined transmit power per country - 5.1 GHz band PMP 450b Mid Gain and High Gain

Countries	Device Type	Antenna Type	Channel BW	Antenna Gain (dBi)	Conducted Power Limit (dBm)	EIRP Limit (dBm)
FCC	SM	16 dBi Mid-Gain	5 MHz	16	31	47
			10 MHz	16	34	50
			15 MHz	16	35	51
			20 MHz	16	37	53
			30 MHz	16	37	53
			40 MHz	16	37	53
		23 dBi High Gain	5 MHz	23	24	47
			10 MHz	23	27	50
			15 MHz	23	28	51
			20 MHz	23	30	53
			30 MHz	23	30	53
			40 MHz	23	30	53

Table 181 :Default combined transmit power per Country - 5.1 GHz band PMP 450m Series

Countries	Device Type	Antenna Type	Channel BW	EIRP Limit (dBm)
USA	AP	Sector	5 MHz	30
			10 MHz	33
			15 MHz	34
			20 MHz	36
			30 MHz	36
			40 MHz	36
ETSI	AP	Sector	5 MHz	33
			10 MHz	36
			15 MHz	37
			20 MHz	39
Mexico	AP	Sector	20 MHz	23
			30 MHz	23
			40 MHz	23

Countries	Device Type	Antenna Type	Channel BW	EIRP Limit (dBm)
Other	Any	Any	5 MHz	42
			10 MHz	42
			15 MHz	42
			20 MHz	42
			30 MHz	42
			40 MHz	42



Note

For releases 16.0 and later, although sector transmission mode EIRP is limited to 42 dBm, ROW GUI configuration limit allows a setting of up to 48 dBm. This allows the software to transmit as high as 48 dBm for ROW regions, depending on the modulation mode and transmission mode in use. For a detailed explanation, see the Release 16.0 training slides available at:

<https://learning.cambiumnetworks.com/learn/course/121/PMP450SoftwareRelease16>

Maximum transmit power 5.2 GHz band



Note

The selection of 5 MHz channel is not available for the PMP 450 AP and the PTP 450 BHM. It is available for the PMP/PTP 450i AP/SM and the PMP 450m AP.

Table 182 :Default combined transmit power per country – 5.2 GHz band PMP/PTP 450i Series

Countries	Device Type	Antenna Type	Channel BW	Antenna Gain (dBi)	Conducted Power (dBm)	EIRP (dBm)	Limit
USA, Other FCC	AP	Sector	5 MHz	16	8	24	
			10 MHz	16	11	27	
			15 MHz	16	12	28	
			20 MHz	16	14	30	
			30 MHz	16	14	30	
			40 MHz	16	14	30	
USA, Other FCC	SM, BH	Omni	5 MHz	12	12	24	
			10 MHz	12	15	27	
			15 MHz	12	16	28	
			20 MHz	12	18	30	
			30 MHz	12	18	30	
			40 MHz	12	18	30	

Countries	Device Type	Antenna Type	Channel BW	Antenna Gain (dBi)	Conducted Power Limit (dBm)	EIRP Limit (dBm)
USA, Other FCC	SM, BH	Flat plate	5 MHz	23	27	50
			10 MHz	23	27	50
			15 MHz	23	27	50
			20 MHz	23	27	50
			30 MHz	23	27	50
			40 MHz	23	27	50
USA, Other FCC	SM, BH	4ft parabolic	5 MHz	32	27	59
			10 MHz	32	27	59
			15 MHz	32	27	59
			20 MHz	32	27	59
			30 MHz	32	27	59
			40 MHz	32	27	59
USA, Other FCC	SM, BH	6ft parabolic	5 MHz	36	27	63
			10 MHz	36	27	27
			15 MHz	36	27	27
			20 MHz	36	27	27
			30 MHz	36	27	27
			40 MHz	36	27	27
Mexico	Any	Any	5 MHz	-	-	24
			10 MHz	-	-	27
			15 MHz	-	-	28
			20 MHz	-	-	30
			30 MHz	-	-	30
			40 MHz	-	-	30
Other	Any	Any	Any	-	-	-

Table 183 :Default combined transmit power per country – 5.2 GHz band PMP 450b Mid-Gain and High Gain

Countries	Device Type	Antenna Type	Channel BW	Antenna Gain (dBi)	Conducted Power Limit (dBm)	EIRP Limit (dBm)
FCC	SM	16 dBi Mid-Gain	5 MHz	16	8	24
			10 MHz	16	11	27
			15 MHz	16	12	28
			20 MHz	16	14	30
			30 MHz	16	14	30
			40 MHz	16	14	30
		23 dBi High Gain	5 MHz	23	1	24
			10 MHz	23	4	27
			15 MHz	23	5	28
			20 MHz	23	7	30
			30 MHz	23	7	30
			40 MHz	23	7	30
Other	SM	16 dBi Mid-Gain	5 MHz	16	27	43
			10 MHz	16	27	43
			15 MHz	16	27	43
			20 MHz	16	27	43
			30 MHz	16	27	43
			40 MHz	16	27	43
		23 dBi High Gain	5 MHz	16	27	43
			10 MHz	16	27	43
			15 MHz	16	27	43
			20 MHz	16	27	43
			30 MHz	16	27	43
			40 MHz	16	27	43

Table 184 :Default combined transmit power per Country – 5.2 GHz band PMP 450m Series

Countries	Device Type	Antenna Type	Channel BW	EIRP Limit (dBm)
USA, Other FCC	AP	Sector	5 MHz	24
			10 MHz	27
			15 MHz	28
			20 MHz	30
			30 MHz	30
			40 MHz	30
Mexico	AP	Sector	5 MHz	24
			10 MHz	27
			15 MHz	28
			20 MHz	30
			30 MHz	30
			40 MHz	30
Other	Any	Any	5 MHz	42
			10 MHz	42
			15 MHz	42
			20 MHz	42
			30 MHz	42
			40 MHz	42



Note

For releases 16.0 and later, although sector transmission mode EIRP is limited to 42 dBm, ROW GUI configuration limit allows a setting of up to 48 dBm. This allows the software to transmit as high as 48 dBm for ROW regions, depending on the modulation mode and transmission mode in use. For a detailed explanation, see the Release 16.0 training slides available at:

<https://learning.cambiumnetworks.com/learn/course/121/PMP450SoftwareRelease16>

Maximum transmit power 5.4 GHz band

Table 185 :Default combined transmit power per country - 5.4 GHz band PMP 450m Series

Countries	Device Type	Antenna Type	Channel BW	EIRP Limit (dBm)
FCC	AP	Sector	5 MHz	24
			10 MHz	27
			15 MHz	28
			20 MHz	29
			30 MHz	30
			40 MHz	30
ETSI	AP	Sector	5 MHz	24
			10 MHz	27
			15 MHz	28
			20 MHz	30
			30 MHz	30
			40 MHz	30
RoW	AP	Sector	5 MHz	42
			10 MHz	42
			15 MHz	42
			20 MHz	42
			30 MHz	42
			40 MHz	42
RoW Other	AP	Sector	-	42



Note

- The selection of 5 MHz channel is not available for the PMP 450 AP and the PTP 450 BHM. It is available for PMP/PTP 450i AP/SM, PMP 40b SM, and PMP 450m AP.
- Power reduction at the band edges is required in some cases.

Table 186 :Default combined transmit power per country – 5.4 GHz band PMP/PTP 450i Series

Countries	Device Type	Antenna Type	Channel BW	Antenna Gain (dBi)	Conducted Power Limit (dBm)	EIRP Limit (dBm)
USA, Other FCC	AP	Sector	5 MHz	16	8	24
			10 MHz	16	11	27
			15 MHz	16	12	28
			20 MHz	16	14	30
			30 MHz	16	14	30
			40 MHz	16	14	30
		Omni	5 MHz	12	12	24
			10 MHz	12	15	27
			15 MHz	12	16	28
			20 MHz	12	18	30
			30 MHz	12	18	30
			40 MHz	12	18	30
	SM, BH	Flat plate	5 MHz	27	27	54
			10 MHz	27	27	54
			15 MHz	27	27	54
			20 MHz	27	27	54
			30 MHz	27	27	54
			40 MHz	27	27	54
		4ft parabolic	5 MHz	32	27	59
			10 MHz	32	27	59
			15 MHz	32	27	59
			20 MHz	32	27	59
			30 MHz	32	27	59
			40 MHz	32	27	59

Countries	Device Type	Antenna Type	Channel BW	Antenna Gain (dBi)	Conducted Power Limit (dBm)	EIRP Limit (dBm)
Brazil, Mexico, Australia, ETSI	Any	Any	5 MHz	36	27	63
			10 MHz	36	27	63
			15 MHz	36	27	63
			20 MHz	36	27	63
			30 MHz	36	27	63
			40 MHz	36	27	63
Other	Any	Any	Any	-	27	-

Table 187 :Default combined transmit power per country - 5.4 GHz band PMP 450b Mid-Gain and High Gain

Countries	Device Type	Antenna Type	Channel BW	Antenna Gain (dBi)	Conducted Power Limit (dBm)	EIRP Limit (dBm)
FCC, ETSI	SM	16 dBi Mid-Gain	5 MHz	16	8	24
			10 MHz	16	11	27
			15 MHz	16	12	28
			20 MHz	16	14	30
			30 MHz	16	14	30
			40 MHz	16	14	30
		23 dBi High Gain	5 MHz	23	1	24
			10 MHz	23	4	27
			15 MHz	23	5	28
			20 MHz	23	9	30
			30 MHz	23	9	30
			40 MHz	23	9	30

Table 188 :Default combined transmit power per country - 5.4 GHz band PMP 450 Series

Countries	Device Type	Antenna Type	Channel BW	Antenna Gain (dBi)	Conducted Power Limit (dBm)	EIRP Limit (dBm)
United States, Canada, Brazil, Australia, Denmark, Finland, Germany, Greece, Liechtenstein, Norway, Portugal, Spain, UK, Vietnam	AP	Sector	5 MHz	16	8	24
			10 MHz	16	11	27
			15 MHz	16	12	28
			20 MHz	16	14	30
			30 MHz	16	14	30
			40 MHz	16	14	30
	SM,BH	Flat plate (Gain: 27), 4ft parabolic (Gain: 32), 6ftparabolic (Gain: 36)	5 MHz	-	27	-
			10 MHz	-	27	-
			15 MHz	-	27	-
			20 MHz	-	27	-
			30 MHz	-	27	-
			40 MHz	-	27	-
Austria, Belgium, Bosnia & Herzegovina, Bulgaria, Croatia, Cyprus, Czech Republic, France, Hungary, Ireland, Italy, Latvia, Lithuania, Luxembourg, Macedonia, Malta, Netherlands, Poland, Romania, Slovakia, Slovenia, Sweden	AP	Sector	5 MHz	16	8	24
			10 MHz	16	11	27*
			15 MHz	16	12	28
			20 MHz	16	14	30
			30 MHz	16	14	30
			40 MHz	16	14	30
Algeria	AP	Sector	5 MHz	16	14	30
			10 MHz	16	14	30
			15 MHz	16	14	30
			20 MHz	16	14	30
			30 MHz	16	14	30
			40 MH	16	14	30

Countries	Device Type	Antenna Type	Channel BW	Antenna Gain (dBi)	Conducted Power Limit (dBm)	EIRP Limit (dBm)
Other	AP	Sector	5 MHz	16	-	No EIRP limit
			10 MHz	16	19	
			15 MHz	16	-	
			20 MHz	16	19	
			30 MHz	16	-	
			40 MHz	16	-	

(*) At 5.4 GHz, EU regulations are harmonized. 5600 – 5650 MHz excluded, as ten-minute Channel Availability Check (CAC) is required.



Note

For releases 16.0 and later, although sector transmission mode EIRP is limited to 42 dBm, ROW GUI configuration limit allows a setting of up to 48 dBm. This allows the software to transmit as high as 48 dBm for ROW regions, depending on the modulation mode and transmission mode in use. For a detailed explanation, see the Release 16.0 training slides available at: <https://learning.cambiumnetworks.com/learn/course/121/PMP450SoftwareRelease16>

Maximum transmit power 5.8 GHz band

Table 189 :Default combined transmit power per Country – 5.8 GHz band PMP 450m Series

Countries	Device Type	Antenna Type	Channel BW	EIRP Limit (dBm)
USA, Other FCC	AP	Sector	5 MHz	36
			10 MHz	36
			15 MHz	36
			20 MHz	36
			30 MHz	36
			40 MHz	36
Mexico	AP	Sector	5 MHz	30
			10 MHz	33
			15 MHz	34
			20 MHz	36
			30 MHz	36
			40 MHz	36

Countries	Device Type	Antenna Type	Channel BW	EIRP Limit (dBm)
ETSI	AP	Sector	5 MHz	30
			10 MHz	33
			15 MHz	34
			20 MHz	36
			30 MHz	36
			40 MHz	36
Other	AP	Sector	5 MHz	42
			10 MHz	42
			15 MHz	42
			20 MHz	42
			30 MHz	42
			40 MHz	42

Table 190 :Default combined transmit power per country - 5.8 GHz band PMP/PTP 450i Series

Countries	Device Type	Antenna Type	Channel BW	Antenna Gain (dBi)	Conducted Power Limit (dBm)	EIRP Limit (dBm)
USA, Canada, Brazil, Other FCC	AP	Sector, Omni	5 MHz	16	20	36
			10 MHz	16	20	36
			15 MHz	16	20	36
			20 MHz	16	20	36
			30 MHz	16	20	36
			40 MHz	16	20	36
	SM, BH	Flat plate, 4ft parabolic, 6ft parabolic	5 MHz	-	27	-
			10 MHz	-	27 (26 for 5733 MHz and below)	-
			15 MHz	-	27	-
	Note Canada is limited to 4ft parabolic Antenna type.		20 MHz	-	27	-
			30 MHz	-	27	-
			40 MHz	-	27	-

Countries	Device Type	Antenna Type	Channel BW	Antenna Gain (dBi)	Conducted Power Limit (dBm)	EIRP Limit (dBm)
Mexico	Any	Any	5 MHz	-	-	30
			10 MHz	-	-	33
			15 MHz	-	-	34
			20 MHz	-	-	36
			30 MHz	-	-	36
			40 MHz	-	-	36
Other	Any	Any	5 MHz	-	27	-

Table 191 :Default combined transmit power per country – 5.8 GHz band PMP 450b Mid-Gain and High Gain

Countries	Device Type	Antenna Type	Channel BW	Antenna Gain (dBi)	Conducted Power Limit (dBm)	EIRP Limit (dBm)
FCC	SM	16 dBi Mid-Gain	5 MHz	16	20	36
			10 MHz	16	20	36
			15 MHz	16	20	36
			20 MHz	16	20	36
			30 MHz	16	20	36
			40 MHz	16	20	36
		23 dBi High Gain	5 MHz	23	13	36
			10 MHz	23	13	36
			15 MHz	23	13	36
			20 MHz	23	13	36
			30 MHz	23	13	36
			40 MHz	23	13	36

Countries	Device Type	Antenna Type	Channel BW	Antenna Gain (dBi)	Conducted Power Limit (dBm)	EIRP Limit (dBm)
ETSI/Other ETSI	SM	16 dBi Mid-Gain	5 MHz	16	14	30
			10 MHz	16	17	33
			15 MHz	16	18	34
			20 MHz	16	20	36
			30 MHz	16	20	36
			40 MHz	16	20	36
		23 dBi High Gain	5 MHz	23	7	30
			10 MHz	23	10	33
			15 MHz	23	11	34
			20 MHz	23	13	36
			30 MHz	23	13	36
			40 MHz	23	13	36

Table 192 :Default combined transmit power per country – 5.8 GHz band PMP 450 Series

Countries	Device Type	Antenna Type	Channel BW	Antenna Gain (dBi)	Conducted Power Limit (dBm)	EIRP Limit (dBm)
Australia, India, United States	AP	Sector	5 MHz	16	20	36
			10 MHz	16	20	36
			15 MHz	16	20	36
			20 MHz	16	20	36
			30 MHz	16	20	36
			40 MHz	16	20	36
Vietnam	AP	Sector	5 MHz	16	8	24
			10 MHz	16	11	27
			15 MHz	16	12	28
			20 MHz	16	14	30
			30 MHz	16	14	30
			40 MHz	16	14	30

Countries	Device Type	Antenna Type	Channel BW	Antenna Gain (dBi)	Conducted Power Limit (dBm)	EIRP Limit (dBm)
Brazil	AP	Sector	5 MHz	16	20	36
			10 MHz	16	20	36
			15 MHz	16	20	36
			20 MHz	16	20	36
			30 MHz	16	20	36
			40 MHz	16	20	36
Canada	AP	Sector	5 MHz	16	10	26
			10 MHz	16	20	36
			15 MHz	16	20	36
			20 MHz	16	20	36
			30 MHz	16	20	36
			40 MHz	16	20	36
Denmark, Finland, Germany, Greece, Iceland, Ireland, Liechtenstein, Norway, Portugal, Serbia, Spain, Switzerland, United Kingdom,	AP	Sector	5 MHz	16	14	30
			10 MHz	16	17	33
			15 MHz	16	18	34
			20 MHz	16	20	36
			30 MHz	16	20	36
			40 MHz	16	20	36
Indonesia	AP	Sector	5 MHz	16	14	30
			10 MHz	16	17	33
			15 MHz	16	18	34
			20 MHz	16	20	36

Table 193 :Extrapolated EIRP and Tx power limits for PMP 450 MicroPoP Series

	5/10 MHz			20/40 MHz		
	Rounded EIRP	MicroPop Omni Tx power	MicroPop Sector Tx power	Rounded EIRP	MicroPop Omni Tx power	MicroPop Sector Tx power
4.9 GHz		26 dBm	26 dBm		24 dBm	24 dBm
5.1 GHz	26 dBm	17 dBm	13 dBm	32 dBm	23 dBm	19 dBm

	5/10 MHz			20/40 MHz		
	Rounded EIRP	MicroPop Omni Tx power	MicroPop Sector Tx power	Rounded EIRP	MicroPop Omni Tx power	MicroPop Sector Tx power
5.2 GHz	25 dBm	16 dBm	12 dBm	25 dBm	16 dBm	12 dBm
5.4 GHz	25 dBm	16 dBm	12 dBm	25 dBm	16 dBm	12 dBm
5.8 GHz	32 dBm	23 dBm	19 dBm	31 dBm	22 dBm	18 dBm



Note

For releases 16.0 and later, although sector transmission mode EIRP is limited to 42 dBm, ROW GUI configuration limit allows a setting of up to 48 dBm. This allows the software to transmit as high as 48 dBm for ROW regions, depending on the modulation mode and transmission mode in use. For a detailed explanation, see the Release 16.0 training slides available at: <https://learning.cambiumnetworks.com/learn/course/121/PMP450SoftwareRelease16>

Country specific frequency range

Frequency range 900 MHz band

Table 194 :Frequency range per country – 900 MHz band

Region	Country	Channel center Frequency limits (MHz)	
		Lower	Upper
Other	Other	902	928
	Other-FCC	902	928
North America	Canada	902	928
	United States	902	928
	Mexico	902	928
	Puerto Rico	902	928
Oceania	Australia	915	928
	New Zealand	915	928
		920.5 (7 MHz)	924.5 (7 MHz)
South America	Brazil	902	907.5
		915	928
	Ecuador	902	928

Region	Country	Channel center Frequency limits (MHz)	
		Lower	Upper
	Colombia	902	928
	Panama	902	928
	Venezuela	902	928

Frequency range 2.4 GHz band

Table 195 :Frequency range per country - 2.4 GHz band PMP/PTP 450 Series

Countries	Antenna Typ	Channel BW	Channel center Frequency limits (MHz)	
			Lower	Upper
Canada, United States, Other, Other-FCC	Any	5 MHz	2402.5	2481
		10 MHz	2405	2478.5
		15 MHz	2407.5	2476
		20 MHz	2410	2473.5
		30 MHz	2415	2468.5

Frequency range 3.5 GHz band

Table 196 :Frequency range per country - 3.5 GHz band PMP/PTP 450/450i/450b Series

Countries	Antenna Type	Channel BW	Channel center Frequency limits (MHz)	
			Lower	Upper
Brazil, Other-ETSI	Any	5 MHz	3402.5	3597.5
		7 MHz	3403.5	3596.5
		10 MHz	3405	3595
		20 MHz	3410	3590
China, Indonesia	Any	5 MHz	3302.5	3397.5
		7 MHz	3303.5	3396.5
		10 MHz	3305	3395
		20 MHz	3310	3390

Frequency range 3.65 GHz band

Table 197 :Frequency range per country - 3.65 GHz band PMP/PTP 450/450i/450b Series

Countries	Antenna Type	Channel BW	Channel center Frequency limits (MHz)	
			Lower	Upper
Australia, India, Other	Any	5 MHz	3302.5	3797.5
		7 MHz	3303.5	3796.5
		10 MHz	3305	3795
		15 MHz	3307.5	3792.5
		20 MHz	3310	3790
		30 MHz	3315	3785
		40 MHz*	3320	3780
		Note Australia does not support 40 MHz channel bandwidth.		
Other - ETSI	Any	5 MHz	3402.5	3847.5
		10 MHz	3405	3845
		15 MHz	3407.5	3842.5
		20 MHz	3410	3840
		30 MHz	3415	3835
		40 MHz	3420	3830
Indonesia	Any	5 MHz	3602.5	3797.5
		7 MHz	3603.5	3796.5
		10 MHz	3605	3795
		20 MHz	3610	3790
		40 MHz	3620	3780
Mexico	Any	5 MHz	3302.5	3747.5
		10 MHz	3305	3745
		20 MHz	3310	3740
		40 MHz	3320	3730

Frequency range 4.9 GHz band

Table 198 :Frequency range per country - 4.9 GHz band PMP/PTP 450i Series

Countries	Antenna Type	Channel BW	Channel center Frequency limits (MHz)	
			Lower	Upper
USA, Mexico, Canada, Other FCC	Any	5 MHz	4942.5	4987.5
		10 MHz	4945	4985
		15 MHz	4947.5	4982.5
		20 MHz	4950	4980
Brazil	Any	5 MHz	4912.5	4987.5
		10 MHz	4915	4985
		15 MHz	4917.5	4982.5
		20 MHz	4920	4980
Other	Any	5 MHz	4942.5	4987.5
		10 MHz	4945	4985
		15 MHz	4947.5	4982.5
		20 MHz	4950	4980
		30 MHz	4955	4975
		40 MHz	4960	4970

Table 199 :Frequency range per country - 4.9 GHz band PMP 450b Series

Countries	Antenna Type	Channel BW	Channel center Frequency limits (MHz)	
			Lower	Upper
FCC	16 dBi Mid-Gain	5 MHz	4942.5	4987.5
	23 dBi High Gain	10 MHz	4945	4985
		15 MHz	4947.5	4982.5
		20 MHz	4950	4980
		30 MHz	4955	4975
		40 MHz	4960	4970

Table 200 :Frequency range per country - 4.9 GHz band PMP 450m Series

Countries	Antenna Type	Channel BW	Channel center Frequency limits (MHz)	
			Lower	Upper
USA, Mexico, Canada, Other FCC	Any	5 MHz	4942.5	4987.5
		10 MHz	4945	4985
		15 MHz	4947.5	4982.5
		20 MHz	4950	4980
Brazil	Any	5 MHz	4912.5	4987.5
		10 MHz	4915	4985
		15 MHz	4917.5	4982.5
		20 MHz	4920	4980
Other	Any	5 MHz	4942.5	4987.5
		10 MHz	4945	4985
		15 MHz	4947.5	4982.5
		20 MHz	4950	4980
		30 MHz	4955	4975
		40 MHz	4960	4970

Frequency range 5.1GHz band

Table 201 :Frequency range per country – 5.1 GHz band PMP/PTP 450i Series

Countries	Antenna Type	Channel BW	Channel center Frequency limits (MHz)	
			Lower	Upper
United States, FCC	Any	5 MHz	5157.5 ¹	5247.5
		10 MHz	5160 ²	5245
		15 MHz	5165 ³	5242.5
		20 MHz	5170 ⁴	5240
		30 MHz	5180 ⁵	5235

¹Center frequency 5160 is the lowest allowed at full power. Max power for edge frequency is 20 dBm.

²Center frequency 5165 is the lowest allowed at full power. Max power for edge frequencies is 22 dBm.

³Center frequency 5170 is the lowest allowed at full power. Max power for edge frequencies is 23 dBm.

⁴Center frequency 5177.5 is the lowest allowed at full power. Max power for edge frequency is 23 dBm.

⁵Center frequency 5190 is the lowest allowed at full power. Max power for edge frequency is 22 dBm.

Countries	Antenna Type	Channel BW	Channel center Frequency limits (MHz)	
			Lower	Upper
		40 MHz	5180 ¹	5230
ETSI	Any	5 MHz	5155	5245
		10 MHz	5155	5245
		15 MHz	5157.5	5242.5
		20 MHz	5160	5240
Other	Any	5 MHz	5152.5	5247.5
		10 MHz	5155	5245
		15 MHz	5157.5	5242.5
		20 MHz	5160	5240
		30 MHz	5165	5235
		40 MHz	5170	5230

Table 202 :Frequency range per country - 5.1 GHz band PMP 450b Mid-Gain Series

Countries	Antenna Type	Channel BW	Channel center Frequency limits (MHz)	
			Lower	Upper
FCC	16 dBi	5 MHz	5155	5247.5
		10 MHz	5155	5245
		15 MHz	5157.5	5242.5
		20 MHz	5160	5240
		30 MHz	5165	5235
		40 MHz	5170	5230

Table 203 :Frequency range per country - 5.1 GHz band PMP 450 MicroPoP Series

¹Center frequency 5205 is the lowest allowed at full power. Max power for edge frequency is 22 dBm.

Countries	Antenna Type	Channel BW	Channel center Frequency limits (MHz)	
			Lower	Upper
FCC	16 dBi	5 MHz	5155	5247.5
		10 MHz	5155	5245
		15 MHz	5157.5	5242.5
		20 MHz	5160	5240
		30 MHz	5165	5235
		40 MHz	5170	5230

Table 204 :Frequency range per country - 5.1 GHz band PMP 450b High Gain Series

Countries	Antenna Type	Channel BW	Channel center Frequency limits (MHz)	
			Lower	Upper
FCC	23 dBi	5 MHz	5155	5245
		10 MHz	5155	5245
		15 MHz	5157.5	5242.5
		20 MHz	5160	5235
		30 MHz	5165	5235
		40 MHz	5170	5230

Table 205 :Frequency range per country - 5.1 GHz band PMP 450m Series

Countries	Antenna Type	Channel BW	Channel center Frequency limits (MHz)	
			Lower	Upper
United States, FCC	Any	5 MHz	5162.5	5247.5
		10 MHz	5160 (26 dBm)	5197.5 (26 dBm)
			5200 (33 dBm)	5245 (33 dBm)
		15 MHz	5165 (26 dBm)	5197.5 (26 dBm)
			5200 (34 dBm)	5242.5 (34 dBm)
		20 MHz	5170 (26 dBm)	5197.5 (26 dBm)
			5200 (36 dBm)	5240 (36 dBm)
		30 MHz	5165 (30 dBm)	5180 (30 dBm)
			5182.5 (33 dBm)	5192.5 (33 dBm)
			5195 (36 dBm)	5235 (36 dBm)
		40 MHz	5170 (30 dBm)	5185 (30 dBm)
			5187.5 (33 dBm)	5197.5 (33 dBm)
5200 (36 dBm)	5230 (36 dBm)			
ETSI	Any	5 MHz	5152.5	5247.5
		10 MHz	5155	5245
		15 MHz	5157.5	5242.5
		20 MHz	5160	5240
Other	Any	5 MHz	5152.5	5247.5
		10 MHz	5155	5245
		15 MHz	5157.5	5242.5
		20 MHz	5160	5240

Frequency range 5.2 GHz band

Table 206 :Frequency range per country - 5.2 GHz band PMP/PTP 450i Series

Countries	Antenna Type	Channel BW	Channel center Frequency limits (MHz)	
			Lower	Upper
United States, FCC	Any	5 MHz	5252.5	5342.5
		10 MHz	5255	5340
		15 MHz	5257.5	5337.5
		20 MHz	5260	5332.5 ¹
		30 MHz	5265	5332.5 ²
		40 MHz	5270	5325 ³
Other	Any	5 MHz	5252.5	5347.5
		10 MHz	5255	5345
		15 MHz	5257.5	5342.5
		20 MHz	5260	5340
		30 MHz	5265	5335
		40 MHz	5270	5330

Table 207 :Frequency range per country - 5.2 GHz band PMP 450b Mid-Gain Series

Countries	Antenna Type	Channel BW	Channel center Frequency limits (MHz)	
			Lower	Upper
FCC	16 dBi	5 MHz	-	-
		10 MHz	5255	5340
		15 MHz	5257.5	5337.5
		20 MHz	5260	5337.5
		30 MHz	5265	5330
		40 MHz	5270	5330 (*)

(*) Last channel at full power is 5325. Channel centers 5327.5 and 5330 need a power back off of 5 dB.

Table 208 :Frequency range per country - 5.2 GHz band PMP 450b High Gain Series

¹Center frequency 5330 is the highest allowed at full power. Max power for edge frequency is 20 dBm.

²Center frequency 5317.5 is the lowest allowed at full power. Max power for edge frequency is 20 dBm.

³Center frequency 5310 is the lowest allowed at full power. Max power for edge frequencies is 20 dBm.

Countries	Antenna Type	Channel BW	Channel center Frequency limits (MHz)	
			Lower	Upper
FCC	23 dBi	5 MHz	-	-
		10 MHz	5255	5340
		15 MHz	5257.5	5337.5
		20 MHz	5260	5335
		30 MHz	5265	5332.5
		40 MHz	5270	5330

Table 209 :Frequency range per country - 5.2 GHz band PMP 450m Series

Countries	Antenna Type	Channel BW	Channel center Frequency limits (MHz)	
			Lower	Upper
United States, FCC	Any	5 MHz	5252.5	5347.5
		10 MHz	5255	5300
			5302.5	5340
		15 MHz	5257.5	5300
			5302.5	5335
		20 MHz	5260	5300
			5302.5	5340
		30 MHz	5265	5335
40 MHz	5270	5330		
Other	Any	5 MHz	5252.5	5347.5
		10 MHz	5255	5345
		15 MHz	5257.5	5342.5
		20 MHz	5260	5340
		30 MHz	5265	5335
		40 MHz	5270	5330

Frequency range 5.4 GHz band

Table 210 :Frequency range per country - 5.4 GHz band PMP/PTP 450i Series

Countries	Antenna Type	Channel BW	Channel center Frequency limits (MHz)	
			Lower	Upper
Mexico	Any	5 MHz	5472.5	5722.5
		10 MHz	5475	5720
		15 MHz	5477.5	5717.5
		20 MHz	5480	5715
		30 MHz	5485	5710
		40 MHz	5490	5685
Other	Any	5 MHz	5472.5	5722.5
		10 MHz	5475	5720
		15 MHz	5477.5	5717.5
		20 MHz	5480	5715
		30 MHz	5485	5710
		40 MHz	5490	5705
Other	FCC	5 MHz	5475	5720
		10 MHz	5475	5717.5
		15 MHz	5480	5717.5
		20 MHz	5482.5	5715
		30 MHz	5487.5	5710
		40 MHz	5497.5	5705
Other	ETSI	5 MHz	5472.5	5597.5
			5652.5	5720
		10 MHz	5475	5595
			5655	5720
		15 MHz	5477.5	5592.5
			5657.5	5717.5
		20 MHz	5480	5590
			5660	5715
Other	ETSI	30 MHz	5485	5585
			5665	5710
		40 MHz	5490	5580
			5670	5705

Table 211 :Frequency range per country – 5.4 GHz band PMP 450b Mid-Gain Series

Countries	Antenna Type	Channel BW	Channel center Frequency limits (MHz)	
			Lower	Upper
FCC	16 dBi	5 MHz	-	-
		10 MHz	5477.5	5720
		15 MHz	5480	5717.5
		20 MHz	5482.5	5715
		30 MHz	5487.5	5710
		40 MHz	5490 (*)	5705

(*) First channel at full power is 5495. Channel centers 5490 and 5492.5 need a power backoff of 5 dB.

Table 212 :Frequency range per country – 5.4 GHz band PMP 450b High Gain Series

Countries	Antenna Type	Channel BW	Channel center Frequency limits (MHz)	
			Lower	Upper
FCC	23 dBi	5 MHz	-	-
		10 MHz	5480	5720
		15 MHz	5487.5	5717.5
		20 MHz	5490	5715
		30 MHz	5495	5710
		40 MHz	5490	5705

Table 213 :Frequency range per country – 5.4 GHz band PMP/PTP 450 Series

Countries	Antenna Type	Channel BW	Channel center Frequency limits (MHz)	
			Lower	Upper
FCC	23 dBi	5 MHz	-	-
		10 MHz	5480	5720
		15 MHz	5487.5	5717.5
		20 MHz	5490	5715
		30 MHz	5495	5710
		40 MHz	5490	5705

Region code	Country Code	Channel BW	Channel center Frequency limits (MHz)	
			Lower	Upper
Other	Any	5 MHz	5472.5	5722.5
		10 MHz	5475	5720
		15 MHz	5477.5	5717.5
		20 MHz	5480	5715
		30 MHz	5485	5710
		40 MHz	5490	5705
	Other-FCC (Any non-US country that follows FCC rules)	5 MHz	5475	5720
		10 MHz	5477.5	5717.5
		15 MHz	5477.5	5717.5
		20 MHz	5480	5715
		30 MHz	5485	5710
		40 MHz	5490	5705
	Other-ETSI (Any country that follows ETSI rules)	5 MHz	5472.5	5597.5
			5652.5	5722.5
		10 MHz	5475	5595
			5655	5720
		15 MHz	5477.5	5592.5
			5657.5	5717.5
		20 MHz	5460	5590
			5640	5715
		30 MHz	5485	5585
5665			5710	
40 MHz		5490	5580	
		5670	5705	
Oceania	Australia	5 MHz	5472.5	5597.5
			5652.5	5722.5
		10 MHz	5475	5595
			5645	5720

Region code	Country Code	Channel BW	Channel center Frequency limits (MHz)			
			Lower	Upper		
Oceania	Australia	15 MHz	5477.5	5592.5		
			5657.5	5717.5		
		20 MHz	5465	5490		
			5640	5715		
		30 MHz	5485	5585		
			5665	5710		
		40 MHz	5490	5580		
			5670	5705		
North America	Canada	10 MHz	5475	5597.5		
			5655	5722.5		
		15 MHz	5477.5	5592.5		
			5657.5	5717.5		
		20 MHz	5480	5590		
			5660	5715		
		30 MHz	5485	5585		
			5665	5710		
		40 MHz	5490	5580		
			5670	5705		
		South America	Brazil	10 MHz	5475	5720
				15 MHz	5477.5	5717.5
20 MHz	5480			5715		
30 MHz	5485			5710		
40 MHz	5490			5705		
Asia	Vietnam	10 MHz	5475	5720		
		15 MHz	5477.5	5717.5		
		20 MHz	5480	5715		
		30 MHz	5485	5710		
		40 MHz	5490	5705		

Region code	Country Code	Channel BW	Channel center Frequency limits (MHz)	
			Lower	Upper
Africa	Algeria	5 MHz	5472.5	5667.5
		10 MHz	5475	5665
		15 MHz	5477.5	5662.5
		20 MHz	5480	5660
		30 MHz	5485	5655
		40 MHz	5490	5650
Europe	Europe (Denmark, Finland, France, Germany, Greece, Iceland, Ireland, Italy, Liechtenstein, Norway, Portugal, Serbia, Spain, Switzerland, United Kingdom)	10 MHz	5475	5595
			5655	5720
		15 MHz	5477.5	5592.5
			5657.5	5717.5
		20 MHz	5465	5490
			5660	5715
		30 MHz	5485	5585
			5665	5710
		40 MHz	5490	5580
			5670	5705

Table 214 :Frequency range per country - 5.4 GHz band PMP 450m Series

Countries	Antenna Type	Channel BW	Channel center Frequency limits (MHz)	
			Lower	Upper
United States, FCC	Any	5 MHz	5475	5720
		10 MHz	5475	5477.5
			5480	5720
		15 MHz	5477.5	5482.5
			5485	5717.5
		20 MHz	5480	5487.5
			5490	5715
		30 MHz	5485	5710
40 MHz	5490	5705		

Countries	Antenna Type	Channel BW	Channel center Frequency limits (MHz)	
			Lower	Upper
ETSI	Any	5 MHz	5472.5	5597.5
			5652.5	5722.5
		10 MHz	5475	5595
			5655	5720
		15 MHz	5477.5	5592.5
			5657.5	5717.5
		20 MHz	5480	5590
			5660	5715
		30 MHz	5485	5585
			5665	5710
		40 MHz	5490	5585
			5670	5705
Other	Any	5 MHz	5472.5	5722.5
		10 MHz	5475	5720
		15 MHz	5477.5	5717.5
		20 MHz	5480	5715
		30 MHz	5485	5710
		40 MHz	5490	5705

Frequency range 5.8 GHz band

Table 215 :Frequency range per country - 5.8 GHz band PMP/PTP 450i Series

Countries	Antenna Type	Channel BW	Channel center Frequency limits (MHz)	
			Lower	Upper
USA, Canada, Brazil, Other FCC	Any	5 MHz	5730	5845
		10 MHz	5730	5845
		15 MHz	5732.5	5842.5
		20 MHz	5735	5840
		30 MHz	5740	5835
		40 MHz	5745	5830

Countries	Antenna Type	Channel BW	Channel center Frequency limits (MHz)	
			Lower	Upper
Mexico	Any	5 MHz	5727.5	5847.5
		10 MHz	5730	5845
		15 MHz	5732.5	5842.5
		20 MHz	5735	5840
		30 MHz	5740	5835
		40 MHz	5745	5830
Other	Any	5 MHz	5727.5	5922.5
		10 MHz	5730	5920
		15 MHz	5732.5	5917.5
		20 MHz	5735	5915
		30 MHz	5740	5910
		40 MHz	5745	5905
ETSI	Any	5 MHz	5727.5	5872.5
		10 MHz	5730	5870
		15 MHz	5735	5867.5
		20 MHz	5737.5	5865
		30 MHz	5740	5860
		40 MHz	5745	5855

Table 216 :Frequency range per country – 5.8 GHz band PMP 450b Mid-GainSeries

Countries	Antenna Type	Channel BW	Channel center Frequency limits (MHz)	
			Lower	Upper
FCC	16 dBi Mid-Gain	5 MHz	5730	5845
		10 MHz	5730	5845
		15 MHz	5732.5	5842.5
		20 MHz	5735	5840
		30 MHz	5740	5835
		40 MHz	5745	5830

Table 217 :Frequency range per country – 5.8 GHz band PMP 450b High Gain Series

Countries	Antenna Type	Channel BW	Channel center Frequency limits (MHz)	
			Lower	Upper
FCC	23 dBi High Gain	5 MHz	5730	5845
		10 MHz	5730	5845
		15 MHz	5732.5	5842.5
		20 MHz	5735	5840
		30 MHz	5740	5835
		40 MHz	5745	5830

Table 218 :Frequency range per country – 5.8 GHz band PMP/PTP 450 Series

Countries	Antenna Type	Channel BW	Channel center Frequency limits (MHz)	
			Lower	Upper
Denmark, Norway, United Kingdom, Finland	Any	10 MHz	5730	5790
			5820	5845
		15 MHz	5732.5	5787.5
			5822.5	5842.5
		20 MHz	5735	5785
			5825	5840
		30 MHz	5740	5780
			5830	5835
		40 MHz	5745	5775
5835	5830			
Germany	Any	10 MHz	5760	5870
		15 MHz	5762.5	5867.5
		20 MHz	5765	5865
		30 MHz	5770	5860
		40 MHz	5775	5855

Countries	Antenna Type	Channel BW	Channel center Frequency limits (MHz)	
			Lower	Upper
Spain	Any	10 MHz	5730	5790
			5820	5850
		15 MHz	5732.5	5787.5
			5822.5	5847.5
		20 MHz	5735	5785
			5825	5845
		30 MHz	5740	5780
			5830	5840
40 MHz	5745	5775		
	5835	5835		
Greece	Any	10 MHz	5730	5790
		15 MHz	5732.5	5787.5
		20 MHz	5735	5785
		30 MHz	5740	5780
		40 MHz	5745	5775
Portugal, Iceland, Serbia	Any	10 MHz	5730	5870
		15 MHz	5732.5	5867.5
		20 MHz	5735	5865
		30 MHz	5740	5860
		40 MHz	5745	5855

Countries	Antenna Type	Channel BW	Channel center Frequency limits (MHz)			
			Lower	Upper		
Switzerland, Liechtenstein	Any	10 MHz	5730	5790		
			5820	5870		
		15 MHz	5732.5	5787.5		
			5822.5	5867.5		
		20 MHz	5735	5785		
			5825	5865		
		30 MHz	5740	5780		
			5830	5860		
		40 MHz	5745	5775		
			5835	5855		
		Australia	Any	5 MHz	5727.5	5847.5
				10 MHz	5730	5845
15 MHz	5732.5			5842.5		
20 MHz	5735			5840		
30 MHz	5740			5835		
40 MHz	5745			5830		
Canada, United States	Any	5 MHz	5727.5	5847.5		
		10 MHz	5730	5845		
		15 MHz	5732.5	5842.5		
		20 MHz	5735	5840		
		30 MHz	5740	5835		
		40 MHz	5745	5830		
India	Any	5 MHz	5727.5	5872.5		
		10 MHz	5730	5870		
		15 MHz	5832.5	5867.5		
		20 MHz	5735	5865		
		30 MHz	5840	5860		
		40 MHz	5845	5855		

Countries	Antenna Type	Channel BW	Channel center Frequency limits (MHz)	
			Lower	Upper
Brazil, Vietnam	Any	5 MHz	5727.5	5847.5
		10 MHz	5730	5845
		15 MHz	5732.5	5842.5
		20 MHz	5735	5840
		30 MHz	5740	5835
		40 MHz	5745	5830
Indonesia	Any	5 MHz	5727.5	5822.5
		10 MHz	5730	5820
		15 MHz	5732.5	5817.5
		20 MHz	5735	5815
Malaysia	Any	5 MHz	5727.5	5872.5
		10 MHz	5830	5870
		20 MHz	5835	5865

Table 219 :Frequency range per country – 5.8 GHz band PMP 450m Series

Countries	Antenna Type	Channel BW	Channel center Frequency limits (MHz)	
			Lower	Upper
United States, FCC	Any	5 MHz	5730	5845
		10 MHz	5730	5845
		15 MHz	5732.5	5842.5
		20 MHz	5735	5840
		30 MHz	5740	5835
		40 MHz	5745	5830
ETSI	Any	5 MHz	5727.5	5872.5
		10 MHz	5730	5870
		15 MHz	5735	5867.5
		20 MHz	5737.5	5865
		30 MHz	5740	5860
		40 MHz	5745	5855

Countries	Antenna Type	Channel BW	Channel center Frequency limits (MHz)	
			Lower	Upper
Other	Any	5 MHz	5727.5	5922.5
		10 MHz	5730	5920
		15 MHz	5732.5	5917.5
		20 MHz	5735	5915
		30 MHz	5740	5910
		40 MHz	5745	5905

FCC specific information

FCC compliance testing

With GPS synchronization installed, the system has been tested for compliance to US (FCC) specifications. It has been shown to comply with the limits for emitted spurious radiation for a Class B digital device, pursuant to Part 15 of the FCC Rules in the USA. These limits have been designed to provide reasonable protection against harmful interference. However, the equipment can radiate radio frequency energy and, if not installed and used in accordance with the instructions, may cause harmful interference to other radio communications. There is no guarantee that interference does not occur in a particular installation.



Note

A Class B Digital Device is a device that is marketed for use in a residential environment, notwithstanding use in commercial, business and industrial environments.



Note

Notwithstanding that Cambium has designed (and qualified) the 450 Platform Family ODUs to generally meet the Class B requirement to minimize the potential for interference, the 450 Platform Family ODU range is not marketed for use in a residential environment.

FCC IDs

Table 220 :US FCC IDs





FCC ID	Product	Frequency Band	Channel Bandwidth	Frequencies	Maximum Combined Tx Output Power
Z8H89FT0021 and Z8H89FT0022	900 MHz PMP 450i AP & PMP 450 SM	900 MHz	5 MHz	904.5 - 925.5 MHz	25 dBm
			7 MHz	905.5 - 924.5 MHz	25 dBm
			10 MHz	907.0 - 923.0 MHz	25 dBm

FCC ID	Product	Frequency Band	Channel Bandwidth	Frequencies	Maximum Combined Tx Output Power
			15 MHz	909.5 - 920.5 MHz	25 dBm
			20 MHz	912.0 - 918.0 MHz	25 dBm
Z8H89FT0003 and Z8H89FT004	2.4 GHz PMP 450 AP & SM	2.4 GHz	5 MHz	2402.5 - 2480.0 MHz	19 dBm
			10 MHz	2405.0 - 2477.5 MHz	19 dBm
			15 MHz	2407.5 - 2475.0 MHz	19 dBm
			20 MHz	2410.0 - 2472.5 MHz	19 dBm
			30 MHz	2415.0 - 2467.5 MHz	19 dBm
Z8H89FT0009 and Z8H89FT0010	3.5 GHz PMP 450i AP & SM	3.5 GHz	5 MHz	3452.5 - 3647.5 MHz	25 dBm
			7 MHz	3453.5 - 3646.5 MHz	25 dBm
			10 MHz	3455.0 - 3645 MHz	25 dBm
			15 MHz	3457.5 - 3642.5 MHz	25 dBm
			20 MHz	3460.0 - 3640 MHz	25 dBm
			30 MHz	3465.0 - 3635 MHz	25 dBm
			40 MHz	3470.0 - 3630 MHz	25 dBm
Z8H89FT0009 and Z8H89FT0010	3.65 GHz PMP 450i AP & SM	3.65 GHz	5 MHz	3652.5 - 3697.5 MHz	19 dBm
			7 MHz	3653.5 - 3696.5 MHz	21 dBm
			10 MHz	3655.0 - 3695.0 MHz	22 dBm
			15 MHz	3657.5 - 3692.5 MHz	24 dBm



FCC ID	Product	Frequency Band	Channel Bandwidth	Frequencies	Maximum Combined Tx Output Power
			20 MHz	3660.0 - 3690.0 MHz	25 dBm
			30 MHz	3665.0 - 3685.0 MHz	25 dBm
			40 MHz	3670.0 - 3680.0 MHz	25 dBm
Z8H89FT0009 and Z8H89FT0010	3.5 GHz PMP 450 AP & SM	3.5 GHz	5 MHz	3452.5 - 3647.5 MHz	22 dBm
			7 MHz	3453.5 - 3646.5 MHz	22 dBm
			10 MHz	3455.0 - 3645 MHz	22 dBm
			15 MHz	3457.5 - 3642.5 MHz	22 dBm
			20 MHz	3460.0 - 3640 MHz	22 dBm
			30 MHz	3465.0 - 3635 MHz	22 dBm
			40 MHz	3470.0 - 3630 MHz	22 dBm
Z8H89FT0009 and Z8H89FT0010	3.65 GHz PMP 450 AP & SM	3.65 GHz	5 MHz	3652.5 - 3697.5 MHz	19 dBm
			7 MHz	3653.5 - 3696.5 MHz	21 dBm
			10 MHz	3655.0 - 3695.0 MHz	22 dBm
			15 MHz	3657.5 - 3692.5 MHz	22 dBm
			20 MHz	3660.0 - 3690.0 MHz	22 dBm
			30 MHz	3665.0 - 3685.0 MHz	22 dBm
			40 MHz	3670.0 - 3680.0 MHz	22 dBm

FCC ID	Product	Frequency Band	Channel Bandwidth	Frequencies	Maximum Combined Tx Output Power
Z8H89FT0053	3.5 GHz PMP 450b High Gain SM	3.5 GHz	5 MHz	3452.5 - 3647.5 MHz	27 dBm
			7 MHz	3453.5 - 3646.5 MHz	27 dBm
			10 MHz	3455.0 - 3645 MHz	27 dBm
			15 MHz	3457.5 - 3642.5 MHz	27 dBm
			20 MHz	3460.0 - 3640 MHz	27 dBm
			30 MHz	3465.0 - 3635 MHz	27 dBm
			40 MHz	3470.0 - 3630 MHz	27 dBm
Z8H89FT0053	3.65 GHz PMP 450b High Gain SM	3.65 GHz	5 MHz	3652.5 - 3697.5 MHz	27 dBm
			7 MHz	3653.5 - 3696.5 MHz	27 dBm
			10 MHz	3655.0 - 3695.0 MHz	27 dBm
			15 MHz	3657.5 - 3692.5 MHz	27 dBm
			20 MHz	3660.0 - 3690.0 MHz	27 dBm
			30 MHz	3665.0 - 3685.0 MHz	27 dBm
			40 MHz	3670.0 - 3680.0 MHz	27 dBm
Z8H89FT0001, Z8H89FT0002 and QWP-50450I	5 GHz PMP 450/450i AP, SM & PTP 450/450i BH	4.9 GHz (PMP/PTP 450i only)	5 MHz	4942.5 - 4987.5 MHz	27 dBm
			10 MHz	4945.0 - 4985.0 MHz	27 dBm
			15 MHz	4947.5 - 4982.5 MHz	27 dBm
			20 MHz	4950.0 -	27 dBm

FCC ID	Product	Frequency Band	Channel Bandwidth	Frequencies	Maximum Combined Tx Output Power
				4980.0 MHz	
			30 MHz	4955.0 - 4975.0 MHz	27 dBm
			40 MHz	4960.0 - 4970.0 MHz	27 dBm
Z8H89FT0001, Z8H89FT0002 and QWP-50450I	5 GHz PMP 450/450i AP, SM & PTP 450/450i BH	5.1 GHz (PMP/PTP 450i only)	5 MHz	5160.0 - 5247.5 MHz	21 dBm
			10 MHz	5165.0 - 5245.0 MHz	23 dBm
			15 MHz	5170.0 - 5242.5 MHz	23 dBm
			20 MHz	5177.5 - 5240.0 MHz	23 dBm
			30 MHz	5190.0 - 5235.0 MHz	22 dBm
			40 MHz	5205.0 - 5230.0 MHz	22 dBm
Z8H89FT0001, Z8H89FT0002 and QWP-50450I	5 GHz PMP 450/450i AP, SM & PTP 450/450i BH	5.2 GHz (PMP/PTP 450i only)	5 MHz	5252.5 - 5330.0 MHz	20 dBm
			10 MHz	5255.0 - 5340.0 MHz	27 dBm
			15 MHz	5257.5 - 5337.5 MHz	27 dBm
			20 MHz	5330.0 - 5332.5 MHz	21 dBm
			30 MHz	5317.5.0 - 5332.5 MHz	21 dBm
			40 MHz	5310.0 - 5325.0 MHz	21 dBm
Z8H89FT0001, Z8H89FT0002 and QWP-50450I	5 GHz PMP 450/450i AP, SM & PTP 450/450i BH	5.4 GHz	5 MHz	5475.0 - 5720.0 MHz	27 dBm
			10 MHz	5477.5 - 5717.5 MHz	27 dBm
			Note For 10 MHz, lower frequency at 5475.0 is also		

FCC ID	Product	Frequency Band	Channel Bandwidth	Frequencies	Maximum Combined Tx Output Power
				allowed with a maximum power limited to 12 dBm.	
			15 MHz	5478.0 - 5717.5 MHz	27 dBm
Z8H89FT0001, Z8H89FT0002 and QWP-50450I	5 GHz PMP 450/450i AP, SM & PTP 450/450i BH		20 MHz	5482.5 - 5715.0 MHz	27 dBm
				<p>Note</p> <p>For 20 MHz, center frequency at 5495.0 is the lowest allowed at full power and the maximum power for edge frequency is limited to 17 dBm.</p>	
			30 MHz	5487.5 - 5710 MHz	27 dBm
				<p>Note</p> <p>For 30 MHz, center frequency at 5495.0 is the lowest allowed at full power and the maximum power for edge frequency is limited to 23 dBm.</p>	
			40 MHz	5497.5 - 5705 MHz	27 dBm
Z8H89FT0001, Z8H89FT0002 and QWP-50450I				<p>Note</p> <p>For 40 MHz, center frequency at 5507.5 is the lowest allowed and the maximum power for edge frequency is limited to 22 dBm.</p>	
Z8H89FT0001, Z8H89FT0002 and QWP-50450I	5 GHz PMP 450/450i AP SM & PTP 450/450i BH	5.8 GHz	5 MHz	5730.0 - 5872.5 MHz	27 dBm
			10 MHz	5730.0 - 5870.0 MHz	27 dBm
				<p>Note</p> <p>For 10 MHz, Tx power for lower frequencies at 5730 and 5732.5 is limited to 26 dBm.</p>	
			15 MHz	5732.5 - 5867.5 MHz	27 dBm
				<p>Note</p> <p>For 15 MHz,</p>	

FCC ID	Product	Frequency Band	Channel Bandwidth	Frequencies	Maximum Combined Tx Output Power
				Tx power for lower frequency at 5732.5 and 5732 is limited to 26 dBm. Tx power for higher frequencies at 5842.5, 5840, 5837.5 is limited to 26 dBm.	
			20 MHz	5735.0 - 5865.0 MHz	27 dBm
				Note For 20 MHz, Tx power for lower frequencies at 5735 and 5737.5 is limited to 26 dBm.	
			30 MHz	5740.0 - 5860.0 MHz	27 dBm
			40 MHz	5745.0 - 5855.0 MHz	26 dBm
Z8H89FT0032	5 GHz PMP 450b Mid-Gain SM	4.9 GHz	5 MHz	4942.5 - 4987.5 MHz	26 dBm
			10 MHz	4945.0 - 4985.0 MHz	26 dBm
			15 MHz	4947.5 - 4982.5 MHz	26 dBm
			20 MHz	4950.0 - 4980.0 MHz	24 dBm
		5.1 GHz	5 MHz	5155 - 5247.5 MHz	9 dBm
			10 MHz	5155 - 5245.0 MHz	6 dBm
			15 MHz	5157.5 - 5242.5 MHz	6 dBm
			20 MHz	5160.0 - 5240.0 MHz	6 dBm
			30 MHz	5165.0 - 5235.0 MHz	6 dBm
			40 MHz	5170.0 - 5230.0 MHz	6 dBm

FCC ID	Product	Frequency Band	Channel Bandwidth	Frequencies	Maximum Combined Tx Output Power
Z8H89FT0032	5 GHz PMP 450b Mid-Gain or 450 MicroPoP	5.2 GHz	5 MHz	5252.5 - 5347.5 MHz	27 dBm
			10 MHz	5255.0 - 5340.0 MHz	3 dBm
			15 MHz	5257.5 - 5337.5 MHz	6 dBm
			20 MHz	5260.0 - 5337.5 MHz	6 dBm
			30 MHz	5265.0 - 5330.0 MHz	6 dBm
			40 MHz	5270.0 - 5325.0 MHz	6 dBm
				Note For 40 MHz, channel center frequencies 5327.5 and 5330 need a power back off of 5 dB.	
		5.4 GHz	5 MHz	5475.0 - 5720.0 MHz	27 dBm
			10 MHz	5477.5 - 5720.5 MHz	3 dBm
			15 MHz	5480.0 - 5717.5 MHz	8 dBm
			20 MHz	5482.5 - 5715.0 MHz	8 dBm
			30 MHz	5487.5 - 5710 MHz	8 dBm
			40 MHz	5495.0 - 5705 MHz	8 dBm
				Note For 40 MHz, channel center frequencies 5490 and 5492.5 need a power back off of 5 dB.	
		5.8 GHz	5 MHz	5730.0 - 5845.0 MHz	19 dBm
			10 MHz	5730.0 - 5845.0 MHz	19 dBm

FCC ID	Product	Frequency Band	Channel Bandwidth	Frequencies	Maximum Combined Tx Output Power
			15 MHz	5732.5 - 5842.5 MHz	19 dBm
			20 MHz	5735.0 - 5840.0 MHz	19 dBm
			30 MHz	5740.0 - 5835.0 MHz	19 dBm
			40 MHz	5745.0 - 5830.0 MHz	27 dBm
Z8H89FT0042	5 GHz PMP/PTP 450b High Gain or 450b Retro	4.9 GHz	5 MHz	4942- 5 - 4987.5 MHz	26 dBm
			10 MHz	4945.0 - 4985.0 MHz	26 dBm
			15 MHz	4947.5 - 4982.5 MHz	26 dBm
			20 MHz	4950.0 - 4980.0 MHz	24 dBm
		5.1 GHz	5 MHz	5155.0 - 5245.0 MHz	10 dBm
			10 MHz	5155.0 - 5245.0 MHz	8 dBm
			15 MHz	5157.5 - 5242.5 MHz	8 dBm
			20 MHz	5160.0 - 5240.0 MHz	8 dBm
			30 MHz	5165.0 - 5235.0 MHz	8 dBm
			40 MHz	5170.0 - 5230.0 MHz	8 dBm

FCC ID	Product	Frequency Band	Channel Bandwidth	Frequencies	Maximum Combined Tx Output Power		
		5.2 GHz	5 MHz	-	-		
			10 MHz	5255.0 - 5340.0 MHz	2 dBm		
			15 MHz	5257.5 - 5337.5 MHz	3 dBm		
			20 MHz	5260.0 - 5337.5 MHz	3 dBm		
			30 MHz	5265.0 - 5332.5 MHz	3 dBm		
			40 MHz	5270.0 - 5330.0 MHz	3 dBm		
		5.4 GHz	5 MHz	-	-		
			10 MHz	5480.0 - 5720.0 MHz	3 dBm		
			15 MHz	5480.0 - 5717.5 MHz	6 dBm		
			20 MHz	5482.5 - 5715.0 MHz	6 dBm		
			30 MHz	5487.5 - 5710.0 MHz	6 dBm		
			40 MHz	5490.0 - 5705.0 MHz	6 dBm		
		5.8 GHz	5 MHz	5730.0 - 5845.0 MHz	21 dBm		
			10 MHz	5730.0 - 5845.0 MHz	21 dBm		
			15 MHz	5732.5 - 5842.5 MHz	21 dBm		
			20 MHz	5735.0 - 5840.0 MHz	21 dBm		
			30 MHz	5740.0 - 5835.0 MHz	21 dBm		
			40 MHz	5745.0 - 5830.0 MHz	21 dBm		
		Z8H89FT0001, Z8H89FT0002	5 GHz PMP 450 AP, SM & PTP	5.4 GHz	5 MHz	4945.0 - 4985.0 MHz	27 dBm

FCC ID	Product	Frequency Band	Channel Bandwidth	Frequencies	Maximum Combined Tx Output Power		
and QWP-50450I	450 BH		10 MHz	4947.5 - 4982.5 MHz	27 dBm		
			15 MHz	4950.0 - 4980.0 MHz	27 dBm		
			20 MHz	4955.0 - 4975.0 MHz	27 dBm		
			30 MHz	4960.0 - 4970.0 MHz	27 dBm		
			40 MHz	5490.0 - 5705 MHz	22 dBm		
			5.8 GHz	5 MHz	5730.0 - 5872.5 MHz	22 dBm	
		10 MHz	5730.0 - 5870.0 MHz	22 dBm			
		15 MHz	5732.5 - 5867.5 MHz	22 dBm			
		20 MHz	5735.0 - 5865.0 MHz	22 dBm			
		30 MHz	5740.0 - 5860.0 MHz	22 dBm			
		40 MHz	5745.0 - 5855.0 MHz	22 dBm			
		QWP-30450M	3.65 GHz PMP 450m AP	3.65 GHz	5 MHz	3652.5 - 3697.5 MHz	37 dBm
					20 MHz	3660.0 - 3690.0 MHz	39 dBm
40 MHz	3670.0 - 3680.0 MHz				43 dBm		
QWP-50450M	5 GHz PMP 450m AP	4.9 GHz	5 MHz	4942.5 - 4987.5 MHz	48 dBm		
			10 MHz	4945.0 - 4985.0 MHz	47 dBm		

FCC ID	Product	Frequency Band	Channel Bandwidth	Frequencies	Maximum Combined Tx Output Power
			15 MHz	4952.5 - 4982.5 MHz	48 dBm
			20 MHz	4950.0 - 4980.0 MHz	48 dBm
		5.1 GHz	5 MHz	5152.5 - 5247.5 MHz	36 dBm
			20 MHz	5160.0 - 5240.0 MHz	36 dBm
			40 MHz	5170.0 - 5230.0 MHz	36 dBm
		5.2 GHz	5 MHz	5252.5 - 5347.5 MHz	30 dBm
			20 MHz	5260.0 - 5340.0 MHz	30 dBm
			40 MHz	5270.0 - 5330.0 MHz	30 dBm
		5.4 GHz	5 MHz	5472.5 - 5722.5 MHz	30 dBm
			20 MHz	5480.0 - 5715.0 MHz	30 dBm
			40 MHz	5490.0 - 5705.0 MHz	30 dBm
		5.8 GHz	5 MHz	5727.5 - 5845 MHz	36 dBm
			20 MHz	5735.0 - 5840.0 MHz	36 dBm
			40 MHz	5745.0 - 5830.0 MHz	36 dBm

(*) 27 dBm conducted power for 450i Series and 22 dBm conducted power for 450 Series

FCC approved antenna list

The lists of antennas which have been approved for operation by the FCC are provided in:

- USA approved antenna list 4.9 GHz for 4.9 GHz
- USA approved antenna list 5.1 and 5.2 GHz for 5.1 and 5.2 GHz
- USA approved antenna list 5.4 GHz for 5.4 GHz
- USA approved antenna list 5.8 GHz for 5.8 GHz



Note

Any antenna of the same type and of gain equal or lower than the one approved by the FCC can be used in the countries following the FCC rules.

Table 221 :USA approved antenna list 4.9 GHz

Directivity	Type	Manufacturer	Reference	Stated Gain (dBi)
Directional	Integrated flat plate	Cambium Networks	N/A	23.0
	2 ft dual polarised flat plate	Mars Antennas	MA-WA56-DP-28N	28.0
	4 ft parabolic dual polarised	Gabriel Antennas	Dual QuickFire QFD4-49-N	33.7
	6 ft parabolic dual polarised	Gabriel Antennas	QuickFire QF6-49-N	37.2
Sector	Integrated 90° sector flat plate	Cambium Networks	A005240	16.0
	Integrated 90° PMP 450i AP	Cambium Networks	N/A	17.0
	90° sectorised	Cambium Networks	85009324001	17.0
	60° sectorised	Cambium Networks	85009325001	17.0
Omni-directional	Dual polar omni-directional	KP	KPPA-5.7-DPOMA	13.0

Table 222 :USA approved antenna list 5.1 and 5.2 GHz

Directivity	Type	Manufacturer	Reference	Stated Gain (dBi)
Directional	Integrated flat plate	Cambium Networks	N/A	23.0
	2ft dual polarised flat plate	Mars Antennas	MA- WA56- DP-	28.5

Directivity	Type	Manufacturer	Reference	Stated Gain (dBi)
			28N	
	4ft parabolic dual polarised	Gabriel Antennas	PX4F-52-N7A/A	34.5
Sector	Integrated 90° sector flat plate	Cambium Networks	A005240	16.0
	Integrated 90° PMP 450i AP	Cambium Networks	N/A	17.0
	90° sectorised	Cambium Networks	85009324001	17.0
	60° sectorised	Cambium Networks	85009325001	17.0
Omni-directional	Dual polar omni-directional	KP	KPPA- 5.7-DPOMA	13.0
	Dual polar omni-directional	Mars Antennas	MA-WO56-DP10	10.0

Table 223 :USA approved antenna list 5.4 GHz

Directivity	Type	Manufacturer	Reference	Stated Gain (dBi)
Directional	Integrated flat plate	Cambium Networks	N/A	23.0
	2 ft dual polarised flat plate	Mars Antennas	MA- WA56- DP-28N	28.5
	2 ft dual polarised parabolic	MTI	MT-486013-NVH	28.5
Sector	Integrated 90° sector flat plate	Cambium Networks	A005240	16.0
	Integrated 90° PMP 450i AP	Cambium Networks	N/A	17.0
	90° sectorised	Cambium Networks	85009324001	17.0
	60° sectorised	Cambium Networks	85009325001	17.0
Omni-directional	Dual polar omni-directional	KP	KPPA- 5.7-DPOMA	13.0
	Dual polar omni-directional	Mars Antennas	MA-WO56-DP10	10.0

Table 224 :USA approved antenna list 5.8 GHz

Directivity	Type	Manufacturer	Reference	Stated Gain (dBi)
Directional	Integrated flat plate	Cambium Networks	N/A	23.0
	2 ft dual polarised flat plate	Mars Antennas	MA- WA56- DP- 28N	28.0
	4 ft parabolic dual polarised	Gabriel Antennas	PX4F-52-N7A/A	35.3
	6 ft Parabolic dual polarised	Gabriel Antennas	PX6F-52/A	38.1
Sector	Integrated 90° sector flat plate	Cambium Networks	A005240	16.0
	Integrated 90° PMP 450i AP	Cambium Networks	N/A	17.0
	90° sectorised	Cambium Networks	85009324001	17.0
	60° sectorised	Cambium Networks	85009325001	17.0
Omni-directional	Dual polar omni-directional	KP	KPPA- 5.7- DPOMA	13.0

Innovation Science and Economic Development Canada (ISED) specific information

900 MHz ISED notification

Radio Standards Specification RSS-247, Issue 1, Digital Transmission Systems (DTSs), Frequency Hopping Systems (FHSs) and License-Exempt Local Area Network (LE-LAN) Devices, is a new standard to replace annexes 8 and 9 of RSS-210, Issue 8.

4.9 GHz ISED notification

The system has been approved under ISED RSS-111 for Public Safety Agency usage. The installer or operator is responsible for obtaining the appropriate site licenses before installing or using the system.

Utilisation de la bande 4.9 GHz FCC et ISED

Le système a été approuvé en vertu d' ISED RSS-111 pour l'utilisation par l'Agence de la Sécurité publique. L'installateur ou l'exploitant est responsable de l'obtention des licences de appropriées avant d'installer ou d'utiliser le système.

5.2 GHz and 5.4 GHz ISED notification

This device complies with ISED RSS-247. Operation is subject to the following two conditions: (1) This device may not cause harmful interference, and (2) This device must accept any interference received, including interference that may cause undesired operation. Users should be cautioned to take note that high power radars are allocated as primary users (meaning they have priority) of 5250 – 5350 MHz and

5650 – 5850 MHz and these radars could cause interference and/or damage to license-exempt local area networks (LELAN).

For the connectorized version of the product and in order to reduce potential radio interference to other users, the antenna type and its gain should be so chosen that the equivalent isotropically radiated power (EIRP) is not more than that permitted by the regulations. The transmitted power must be reduced to achieve this requirement.

Utilisation de la bande 5.2 and 5.4 GHz ISEDC

Cet appareil est conforme à ISEDC RSS-247. Son fonctionnement est soumis aux deux conditions suivantes: (1) Ce dispositif ne doit pas causer d'interférences nuisibles, et (2) Cet appareil doit tolérer toute interférence reçue, y compris les interférences pouvant entraîner un fonctionnement indésirable. Les utilisateurs doivent prendre garde au fait que les radars à haute puissance sont considérés comme les utilisateurs prioritaires de 5250 à 5350 MHz et 5650 à 5850 MHz et ces radars peuvent causer des interférences et / ou interférer avec un réseau local ne nécessitant pas de licence.

Pour la version du produit avec antenne externe et afin de réduire le risque d'interférence avec d'autres utilisateurs, le type d'antenne et son gain doivent être choisis afin que la puissance isotrope rayonnée équivalente (PIRE) ne soit pas supérieure à celle permise par la réglementation. Il peut être nécessaire de réduire la puissance transmise doit être réduite pour satisfaire cette exigence.

ISEDC notification 5.8 GHz

RSS-GEN issue 3 (7.1.3) Licence-Exempt Radio Apparatus:

This device complies with ISEDC license-exempt RSS standard(s). Operation is subject to the following two conditions: (1) this device may not cause interference, and (2) this device must accept any interference, including interference that may cause undesired operation of the device.

In Canada, high power radars are allocated as primary users (meaning they have priority) of the 5600 – 5650 MHz spectrum. These radars could cause interference or damage to license-exempt local area network (LE-LAN) devices.

Utilisation de la bande 5.8 GHz ISEDC

RSS-GEN issue 3 (7.1.3) appareil utilisant la bande sans licence:

Le présent appareil est conforme aux CNR d'Industrie Canada applicables aux appareils radio exempts de licence. L'exploitation est autorisée aux deux conditions suivantes : (1) l'appareil ne doit pas produire de brouillage, et (2) l'utilisateur de l'appareil doit accepter tout brouillage radioélectrique subi, même si le brouillage est susceptible d'en compromettre le fonctionnement.

Au Canada, les radars à haute puissance sont désignés comme utilisateurs principaux (ils ont la priorité) dans la bande 5600 à 5650 MHz. Ces radars peuvent causer des interférences et / ou interférer avec un réseau local ne nécessitant pas de licence.

ISEDC certification numbers

Table 225 :ISEDC Certification Numbers – PMP 450i

ISEDC Cert.	Product	Frequency Band	Channel Bandwidth	Frequencies	Maximum combined Tx output power
109W-0028	3 GHz	3.45 GHz	5 MHz	3452.5 – 3647.5 MHz	46 dBm

ISED Cert.	Product	Frequency Band	Channel Bandwidth	Frequencies	Maximum combined Tx output power
	AP, SM & BH		20 MHz	3460.0 - 3640.0 MHz	45 dBm
			40 MHz	3470.0 - 3630.0 MHz	46 dBm
			3.65 GHz	5 MHz	3652.5 - 3697.5 MHz
			20 MHz	3660.0 - 3690.0 MHz	42 dBm
			40 MHz	3670.0 - 3680.0 MHz	41 dBm
109AO- 504501	5 GHz AP, SM & BH	4.9 GHz	5 MHz	4942.5 - 4987.5 MHz	24 dBm
			10 MHz	4945.0 - 4985.0 MHz	24 dBm
			15 MHz	4952.5 - 4982.5 MHz	24 dBm
			20 MHz	4950.0 - 4980.0 MHz	24 dBm
109AO- 504501	5 GHz AP, SM & BH	5.2 GHz	5 MHz	5252.5 - 5342.5 MHz	11 dBm
			10 MHz	5255.0 - 5340.0 MHz	11 dBm
			15 MHz	5257.5 - 5337.5 MHz	11 dBm
			20 MHz	5260.0 - 5332.5 MHz	11 dBm
			30 MHz	5265.0 - 5332.5 MHz	11 dBm
			40 MHz	5270.0 - 5325.0 MHz	11 dBm
109AO- 504501	5 GHz AP, SM & BH	5.4 GHz	5 MHz	5472.5 - 5722.5 MHz	11 dBm
			10 MHz	5475.0 - 5720.0 MHz	14 dBm
			15 MHz	5477.5 - 5717.5 MHz	14 dBm

ISED Cert.	Product	Frequency Band	Channel Bandwidth	Frequencies	Maximum combined Tx output power
			20 MHz	5480.0 - 5715.0 MHz	16 dBm
			30 MHz	5485.0 - 5710.0 MHz	16 dBm
			40 MHz	5490.0 - 5705.0 MHz	16 dBm
109AO- 50450I	5 GH AP, SM & BH	5.8 GHz	5 MHz	5730.0 - 5845.0 MHz	28 dBm
			10 MHz	5730.0 - 5845.0 MHz	28 dBm
			15 MHz	5732.5 - 5842.5 MHz	28 dBm
			20 MHz	5735.0 - 5840.0 MHz	28 dBm
			30 MHz	5740.0 - 5825.0 MHz	28 dBm
			40 MHz	5745.0 - 5820.0 MHz	28dBm

Table 226 :ISED Certification Numbers - PMP 450m

ISED Cert.	Product	Frequency Band	Channel Bandwidth	Frequencies	Maximum EIRP
109AO- 30450m	3 GHz PMP 450m AP	3.45 GHz	5 MHz	3452.5 - 3647.5 MHz	57 dBm
			20 MHz	3460.0 - 3640.0 MHz	57 dBm
			40 MHz	3470.0 - 3630.0 MHz	57 dBm
		3.65 GHz	5 MHz	3652.5 - 3697.5 MHz	57dBm
			20 MHz	3660.0 - 3690.0 MHz	57 dBm
			40 MHz	3670.0 - 3680.0 MHz	57dBm
109AO- 50450M	5 GHz PMP 450m AP	4.9 GHz	5 MHz	4942.5 - 4987.5 MHz	48 dBm
			10 MHz	4945.0 - 4985.0	48 dBm

ISED Cert.	Product	Frequency Band	Channel Bandwidth	Frequencies	Maximum EIRP
				MHz	
			15 MHz	4952.5 - 4982.5 MHz	48 dBm
			20 MHz	4950.0 - 4980.0 MHz	48 dBm
109A0-50450M	5 GHz PMP 450m AP	5.4 GHz	5 MHz	5472.5 - 5722.5 MHz	23.5 dBm
			10 MHz	5475.0 - 5720.0 MHz	27 dBm
			15 MHz	5477.5 - 5717.5 MHz	29 dBm
			20 MHz	5480.0 - 5715.0 MHz	30 dBm
			30 MHz	5485.0 - 5710.0 MHz	30 dBm
			40 MHz	5490.0 - 5705.0 MHz	30 dBm
109A0-50450M	5 GHz PMP 450m AP	5.8 GHz	5 MHz	5730.0 - 5845.0 MHz	36 dBm
			10 MHz	5730.0 - 5845.0 MHz	36 dBm
			15 MHz	5732.5 - 5842.5 MHz	36 dBm
			20 MHz	5735.0 - 5840.0 MHz	36 dBm
			30 MHz	5265.0 - 5332.5 MHz	36 dBm
			40 MHz	5270.0 - 5325.0 MHz	36 dBm

Canada approved antenna list

Under ISED regulations, this radio transmitter may only operate using dedicated external antenna of a type and maximum (or lesser) gain approved for the transmitter by ISED . To reduce potential radio interference to other users, the antenna type and its gain must be so chosen that the equivalent isotropically radiated power (EIRP) is not more than that necessary for successful communication.

Conformément à la réglementation d'Industrie Canada, cet émetteur radio peut fonctionner avec une antenne externe dédiée d'un type et un gain maximal (ou moins) approuvé pour l'émetteur par Industrie Canada. Afin de réduire le risque d'interférence radio pour les autres utilisateurs, le type d'antenne et son

gain doivent être choisis afin que la puissance irradiée isotrope équivalente (EIRP) ne dépasse pas l'intensité nécessaire à l'établissement d'une communication satisfaisante.

This radio transmitter (identify the device by certification number) has been approved by ISEDC to operate with the antenna types listed in Country specific radio regulations, Innovation Science and Economic Development Canada (ISEDC) specific information, Canada approved dedicated external antenna list 4.9 and 5.8 GHz with the maximum permissible gain and required antenna impedance for each dedicated external antenna type indicated. Antenna types not included in this list, having a gain greater than the maximum gain indicated for that type, are strictly prohibited for use with this device.

Cet émetteur radio (identifier l'appareil par son numéro de certification) a été approuvé par Industrie Canada pour fonctionner avec les types d'antenne externe dédiée énumérées dans les règlements radiophoniques spécifiques au pays, Country specific radio regulations, Innovation Science and Economic Development Canada (ISEDC) specific information, Canada approved dedicated external antenna list 4.9 and 5.8 GHz et ayant un gain admissible maximal et l'impédance requise pour chaque type d'antenne. Les types d'antenne s'ils ne sont pas inclus dans cette liste, ou dont le gain est supérieur au gain maximal indiqué, sont strictement interdits pour le fonctionnement de l'émetteur.

Table 227 :Canada approved dedicated external antenna list 4.9 and 5.8 GHz

Antenna type	Description	Manufacturer	Reference	Gain (dBi)	
				4.9 GHz	5.8 GHz
Directional	Integrated flat plate	Cambium Networks	N/A	23	23
	2 ft dual polarised flat plate	MARS Antennas	MA- WA56- DP- 28N	28.5	28
	4 ft parabolic dual polarised	Andrews Antennas	PX4F-52-N7A/A	N/A	35.3
	6 ft Parabolic dual polarised	Gabriel Antennas	QF6-49-N	37.2	N/A
Sector	Integrated 90° sector flat plate	Cambium Networks	A005240	16	16
	Integrated 90° PMP 450i AP	Cambium Networks	N/A	17.0	
	90°sector	Cambium Networks	85009324001	17	17
	60° sectorised	Cambium Networks	85009325001	16	16
Omni-directional	Omni-directional	KP Antennas	KPPA- 5.7- DPOMA	13	13
	Omni-directional	MARS Antennas	MA-WO56-DP10	10	10

Table 228 :Canada approved dedicated external antenna list 5.2 and 5.4 GHz

Directivity	Type	Manufacturer	Reference	Stated Gain (dBi)
Directional	Integrated flat plate	Cambium Networks	N/A	23.0
	2ft dual polarised flat plate	Mars Antennas	MA- WA56- DP-28N	28.5
	2ft dual polarised parabolic	MTI	MT-486013-NVH	28.5
Sector	Integrated 90° sector flat plate	Cambium Networks	A005240	16.0
	Integrated 90° PMP 450i AP	Cambium Networks	N/A	17.0
	90° sectorised	Cambium Networks	85009324001	17.0
	60° sectorised	Cambium Networks	85009325001	17.0
Omni-directional	Dual polar omni-directional	KP	KPPA- 5.7-DPOMA	13.0
	Dual polar omni-directional	Mars Antennas	MA-WO56-DP10	10.0

Chapter 5: Troubleshooting

This chapter contains procedures for identifying and correcting faults in a 450 Platform Family link. These procedures can be performed either on a newly installed link, or on an operational link if communication is lost, or after a lightning strike.

The following topics are described in this chapter:

- General troubleshooting procedure
- Troubleshooting procedures
- Power-up troubleshooting
- Power-up troubleshooting
- Logs

General troubleshooting procedure

General planning for troubleshooting

Effective troubleshooting depends in part on measures that you take before you experience trouble in your network. Cambium recommends the following measures for each site:

- Identify troubleshooting tools that are available at your site (such as a protocol analyzer).
- Identify commands and other sources that can capture baseline data for the site. These may include:
 - Ping
 - Tracert or traceroute
 - Link Capacity Test results
 - Throughput data
 - Configuration tab captures
 - Status tab captures
 - Session logs
 - Web browser used
- Start a log for the site.
- Include the following information in the log:
 - Operating procedures
 - Site-specific configuration records

- Network topology
- Software releases, boot versions and FPGA firmware versions
- Types of hardware deployed
- Site-specific troubleshooting processes
- Escalation procedures

Capture baseline data into the log from the sources listed above

General fault isolation process

Effective troubleshooting also requires an effective fault isolation methodology that includes the following:

- Attempting to isolate the problem to the level of a system, subsystem, or link, such as
 - AP to SM
 - AP to CMM4
 - AP to GPS
 - Backhaul (BH)
 - Backhaul (BH) to CMM4
 - Power
- Researching Event Logs of the involved equipment
- Interpreting messages in the Event Log
- Answering the questions listed in the following sections.
- Reversing the last previous corrective attempt before proceeding to the next.
- Performing only one corrective attempt at a time.

Questions to help isolate the problem

When a problem occurs, attempt to answer the following questions:

- What is the history of the problem?
 - Have we changed something recently?
 - Have we seen other symptoms before this?
- How wide-spread is the symptom?
 - Is the problem on only a single SM? (If so, focus on that SM.)
 - Is the problem on multiple SMs? If so

- is the problem on one AP in the cluster? (If so, focus on that AP)
 - is the problem on multiple, but not all, APs in the cluster? (If so, focus on those APs)
 - is the problem on all APs in the cluster? (If so, focus on the CMM4 and the GPS signal.)
- Based on data in the Event Log
 - does the problem correlate to External Hard Resets with no WatchDog timers? (If so, this indicates a loss of power. Correct your power problem.)
 - is intermittent connectivity indicated? (If so, verify your configuration, power level, cables and connections and the speed duplex of both ends of the link).
 - does the problem correlate to loss-of-sync events?
 - Are connections made via shielded cables?
 - Does the GPS antenna have an unobstructed view of the entire horizon?
 - Has the site grounding been verified?

Secondary Steps

After preliminary fault isolation is completed through the above steps, follow these:

- Check the Canopy knowledge base (<http://community.cambiumnetworks.com/> to find whether other network operators have encountered a similar problem.
- Proceed to any appropriate set of diagnostic steps. These are organized as follows:
 - Module has lost or does not establish connectivity
 - NAT/DHCP-configured SM has lost or does not establish connectivity
 - SM Does Not Register to an AP
 - Module has lost or does not gain sync
 - Module does not establish Ethernet connectivity
 - CMM4 does not pass proper GPS sync to connected modules
 - Module Software Cannot be Upgraded
 - [Module Functions Properly, Except Web Interface Became Inaccessible](#)

Troubleshooting procedures

Proceed to any appropriate set of diagnostic steps. These are organized as follows:

- Module has lost or does not establish connectivity
- NAT/DHCP-configured SM has lost or does not establish connectivity
- SM Does Not Register to an AP
- Module has lost or does not gain sync
- Module does not establish Ethernet connectivity
- CMM4 does not pass proper GPS sync to connected modules

- Module Software Cannot be Upgraded
- Module Functions Properly, Except Web Interface Became Inaccessible

Module has lost or does not establish connectivity

To troubleshoot a loss of connectivity, perform the following steps:

Procedure 29 Troubleshooting loss of connectivity

1	Isolate the end user/SM from peripheral equipment and variables such as routers, switches and firewalls.
2	Set up the minimal amount of equipment.
3	<p>On each end of the link:</p> <ul style="list-style-type: none"> • Check the cables and connections. • Verify that the cable/connection scheme—straight-through or crossover—is correct. • Verify that the LED labeled LNK is green. • Access the General Status tab in the Home page of the module. • Verify that the SM is registered. • Verify that Received Power Level is -87 dBm or higher. • Access the IP tab in the Configuration page of the module. • Verify that IP addresses match and are in the same subnet. • If RADIUS authentication is configured, ensure that the RADIUS server is operational
4	<p>On the SM end of the link:</p> <ul style="list-style-type: none"> • Verify that the PC that is connected to the SM is correctly configured to obtain an IP address through DHCP. • Execute ipconfig (Windows) or ifconfig (linux) • Verify that the PC has an assigned IP address.
5	<p>On each end of the link:</p> <ul style="list-style-type: none"> • Access the General tab in the Configuration page of each module. • Verify that the setting for Link Speeds (or negotiation) matches that of the other module. • Access the Radio tab in the Configuration page of each module. • Verify that the Radio Frequency Carrier setting is checked in the Custom Radio Frequency Scan Selection List. • Verify that the Color Code setting matches that of the other module.

	<ul style="list-style-type: none"> • Access the browser LAN settings (for example, at Tools > Internet Options > Connections > LAN Settings in Internet Explorer). • Verify that none of the settings are selected. • Access the Link Capacity Test tab in the Tools page of the module. • Perform a link test • Verify that the link test results show efficiency greater than 90% in both the uplink and downlink • Execute ping. <ul style="list-style-type: none"> ◦ Verify that no packet loss was experienced. ◦ Verify that response times are not significantly greater than <ul style="list-style-type: none"> • 15 ms from SM to AP • 4 ms from AP to SM ◦ Replace any cables that you suspect may be causing the problem. <div style="border: 1px solid black; background-color: #e6f2ff; padding: 5px; margin-top: 10px;">  <p>Note A ping size larger than 1494 Bytes to a module times out and fails. However, a ping of this size or larger to a system that is behind a Canopy module typically succeeds. It is generally advisable to ping such a system, since Canopy handles that ping with the same priority as is given all other transport traffic. The results are unaffected by ping size and by the load on the Canopy module that brokers this traffic.</p> </div>
6	After connectivity has been re-established, reinstall network elements and variables that you removed in Step 1.

NAT/DHCP-configured SM has lost or does not establish connectivity

Before troubleshooting this problem, identify the NAT/DHCP configuration from the following list:

- NAT with DHCP Client (DHCP selected as the Connection Type of the WAN interface) and DHCP Server
- NAT with DHCP Client (DHCP selected as the Connection Type of the WAN interface)
- NAT with DHCP Server
- NAT without DHCP

To troubleshoot a loss of connectivity for a SM configured for NAT/DHCP, perform the following steps.

Procedure 30 Troubleshooting loss of connectivity for NAT/DHCP-configured SM

1	Isolate the end user/SM from peripheral equipment and variables such as routers, switches and firewalls.
2	Set up the minimal amount of equipment.
3	On each end of the link:

	<ul style="list-style-type: none"> • Check the cables and connections. • Verify that the cable/connection scheme—straight-through or crossover—is correct. • Verify that the LED labeled LNK is green.
4	<p>At the SM:</p> <ul style="list-style-type: none"> • Access the NAT Table tab in the Logs web page. • Verify that the correct NAT translations are listed. <p>RESULT: NAT is eliminated as a possible cause if these translations are correct.</p>
5	<p>If this SM is configured for NAT with DHCP, then at the SM:</p> <ul style="list-style-type: none"> • Execute ipconfig (Windows) or ifconfig (Linux) • Verify that the PC has an assigned IP address. • If the PC does not have an assigned IP address, then <ul style="list-style-type: none"> • enter ipconfig /release “Adapter Name”. • enter ipconfig /renew “Adapter Name”. • reboot the PC. • after the PC has completed rebooting, execute ipconfig • if the PC has an assigned IP address, then <ul style="list-style-type: none"> • access the NAT DHCP Statistics tab in the Statistics web page of the SM. • verify that DHCP is operating as configured.
6	<p>After connectivity has been re-established, reinstall network elements and variables that you removed in Step 1.</p>

SM Does Not Register to an AP

To troubleshoot a SM failing to register to an AP, perform the following steps.

Procedure 31 Troubleshooting SM failing to register to an AP

1	Access the Radio tab in the Configuration page of the SM.
2	Note the Color Code of the SM.
3	Access the Radio tab in the Configuration page of the AP.
4	Verify that the Color Code of the AP matches that of the SM.
5	Note the Radio Frequency Carrier of the AP.
6	Verify that the value of the RF Frequency Carrier of the AP is selected in the Custom Radio Frequency Scan Selection List parameter in the SM.
7	In the AP, verify that the Max Range parameter is set to a distance slightly greater than the distance between the AP and the furthest SM that must register to this AP.
8	Verify that no obstruction significantly penetrates the Fresnel zone of the attempted link.
9	Access the General Status tab in the Home page of each module.
10	Remove the bottom cover of the SM to expose the LEDs.
11	Power cycle the SM.

	RESULT: Approximately 25 seconds after the power cycle, the green LED labeled LNK must light to indicate that the link has been established. If the orange LED labeled SYN is lit instead, then the SM is in Alignment mode because the SM failed to establish the link.
12	If the AP is configured to require authentication, ensure proper configuration of RADIUS or Pre-shared AP key.
13	In this latter case and if the SM has encountered no customer-inflicted damage, then request an RMA for the SM.

Module has lost or does not gain sync

To troubleshoot a loss of sync, perform the following steps.

Procedure 32 Troubleshooting loss of sync

1	Access the Event Log tab in the Home page of the SM
2	Check for messages with the following format: RcvFrmNum = ExpFrmNum =
3	If these messages are present, check the Event Log tab of another SM that is registered to the same AP for messages of the same type.
4	If the Event Log of this second SM does not contain these messages, then the fault is isolated to the first SM. If the Event Log page of this second SM contains these messages, access the GPS Status page of the AP.
5	If the Satellites Tracked field in the GPS Status page of the AP indicates fewer than 4 or the Pulse Status field does not indicate Generating Sync, check the GPS Status page of another AP in the same AP cluster for these indicators. GPS signal acquisition must not take longer than 5 minutes from unit startup.
6	If these indicators are present in the second AP, then: <ul style="list-style-type: none"> • Verify that the GPS antenna still has an unobstructed view of the entire horizon. • Visually inspect the cable and connections between the GPS antenna and the CMM4. If this cable is not shielded, replace the cable with shielded cable.
7	If these indicators are not present in the second AP, visually inspect the cable and connections between the CMM4 and the AP antenna. If this cable is not shielded, replace the cable with shielded cable.

Module does not establish Ethernet connectivity

To troubleshoot a loss of Ethernet connectivity, perform the following steps:

Procedure 33 Troubleshooting loss of Ethernet connectivity

1	Verify that the connector crimps on the Ethernet cable are not loose.
---	---

2	Verify that the Ethernet cable is not damaged.
3	If the Ethernet cable connects the module to a network interface card (NIC), verify that the cable is pinned out as a straight-through cable.
4	If the Ethernet cable connects the module to a hub, switch, or router, verify that the cable is pinned out as a crossover cable.
5	Verify that the Ethernet port to which the cable connects the module is set to auto-negotiate speed.
6	Verify VLAN configuration in the network, which may cause loss of module access if the accessing device is on a separate VLAN from the radio.
7	Power cycle the module. RESULT: Approximately 25 seconds after the power cycle, the green LED labeled LNK must light up to indicate that the link has been established. If the orange LED labeled SYN is lit instead, then the module is in Alignment mode because the module failed to establish the link.
8	In this latter case and if the module has encountered no customer-inflicted damage, then request an RMA for the module.

CMM4 does not pass proper GPS sync to connected modules

If the Event Log tabs in all connected modules contain Loss of GPS Sync Pulse messages, perform the following steps.

Procedure 34 Troubleshooting CMM4 not passing sync

1	Verify that the GPS antenna has an unobstructed view of the entire horizon.
2	Verify that the GPS coaxial cable meets specifications.
3	Verify that the GPS sync cable meets specifications for wiring and length.
4	<p>If the web pages of connected modules indicate any of the following, then find and eliminate the source of noise that is being coupled into the GPS sync cable:</p> <ul style="list-style-type: none"> • In the GPS Status page: <ul style="list-style-type: none"> • anomalous number of Satellites Tracked (greater than 12, for example) • incorrect reported Latitude and/or Longitude of the antenna • In the Event Log page: <ul style="list-style-type: none"> • garbled GPS messages • large number of Acquired GPS Sync Pulse messages <p>GPS signal acquisition must not take longer than 5 minutes from unit startup.</p>
5	If these efforts fail to resolve the problem, then request an RMA for the CMM4.

Module Software Cannot be Upgraded

If your attempt to upgrade the software of a module fails, perform the following steps.

Procedure 35 Troubleshooting an unsuccessful software upgrade

1	Download the latest issue of the target release and the associated release notes.
2	Verify that the latest version of CNUT is installed.
3	Compare the files used in the failed attempt to the newly downloaded software.
4	Compare the procedure used in the failed attempt to the procedure in the newly downloaded release notes.
5	If these comparisons reveal a difference, retry the upgrade, this time with the newer file or newer procedure.
6	If, during attempts to upgrade the FPGA firmware, the following message is repeatable, then request an RMA for the module: Error code 6, unrecognized device

Module Functions Properly, Except Web Interface Became Inaccessible

If a module continues to pass traffic and the SNMP interface to the module continues to function, but the web interface to the module does not display, perform the following steps:

Procedure 36 Restoring web management GUI access

1	Enter telnet DottedIPAddress. RESULT: A telnet session to the module is invoked.
2	At the Login prompt, enter root.
3	At the Password prompt, enter PasswordIfConfigured.
4	At the Telnet +> prompt, enter reset. RESULT: The web interface is accessible again and this telnet connection is closed.
	 <div style="background-color: #e1f5fe; padding: 5px; border: 1px solid #ccc;"> <p>Note</p> <p>The module may also be rebooted via an SNMP-based NMS (Wireless Manager, for example)</p> </div>
5	If the issue persists, turn off any SNMP-based network/radio monitoring software and repeat steps 1-4.

Power-up troubleshooting

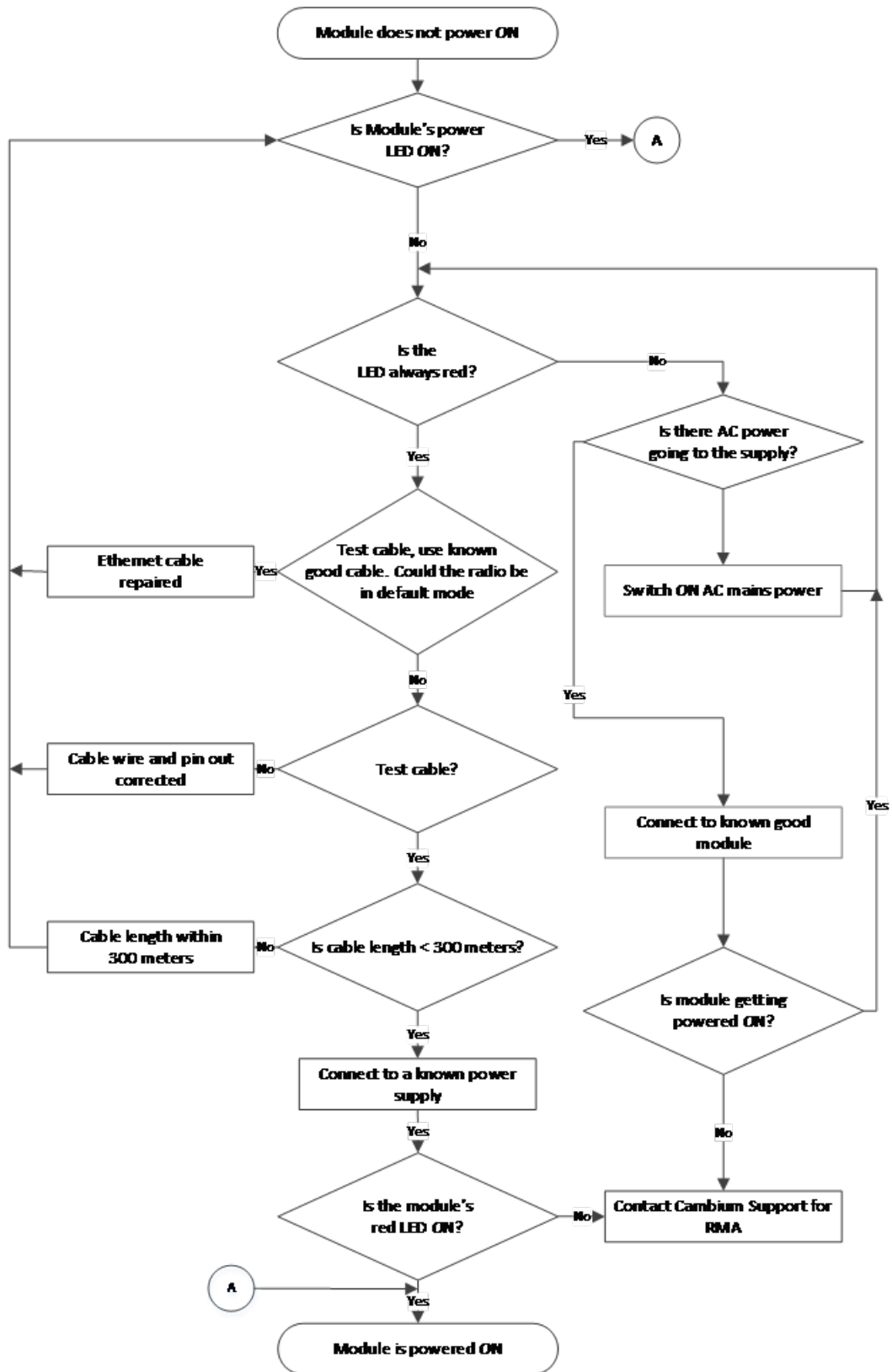

Registration and connectivity troubleshooting

SM/ BMS Registration

If no SMs are registered to this AP, then the Session Status tab displays the simple message No sessions. In this case, try the following steps.

1	More finely aim the SM or SMs toward the AP.
2	Recheck the Session Status tab of the AP for the presence of LUIDs.
3	If still no LUIDs are reported on the Session Status tab, click the Configuration button on the left side of the Home page. RESULT: The AP responds by opening the AP Configuration page.
4	Click the Radio tab.
5	Find the Color Code parameter and note the setting.
6	In the same sequence as you did for the AP directly under Configuration Link for Test in Planning and Installation Guide, connect the SM to a computing device and to power.
7	On the left side of the SM Home page, click the Configuration button. RESULT: The Configuration page of the SM opens.
8	Click the Radio tab.
9	If the transmit frequency of the AP is not selected in the Custom Radio Frequency Scan Selection List parameter, select the frequency that matches.
10	If the Color Code parameter on this page is not identical to the Color Code parameter you noted from the AP, change one of them so that they match.
11	At the bottom of the Radio tab for the SM, click the Save Changes button.
12	Click the Reboot button.
13	Allow several minutes for the SM to reboot and register to the AP.
14	Return to the computing device that is connected to the AP.
15	Recheck the Session Status tab of the AP for the presence of LUIDs.

Logs

Persistent Logging

PMP 450 SM supports logging information such as session logs, authentication logs, and authorization logs that are persistent through reboots and connectivity losses.

Navigate to Logs to view:

- SM Session
- SM Authentication
- SM Authorization

All the SM logs are saved to flash and displayed upon reboot.

Figure 1: *SM Logs*

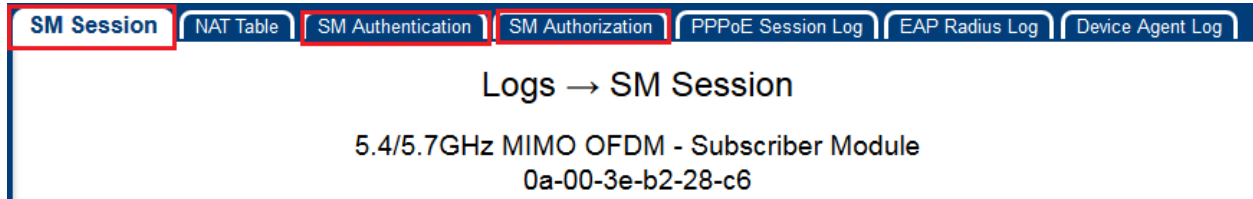

Figure 2: *SM Session log*

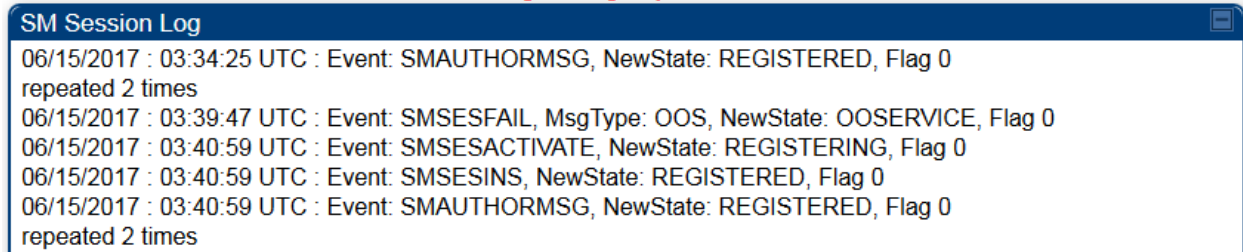

Figure 3: *SM Authentication log*

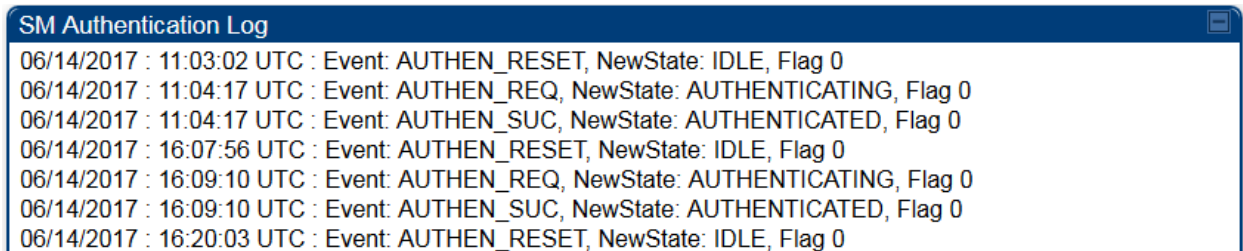
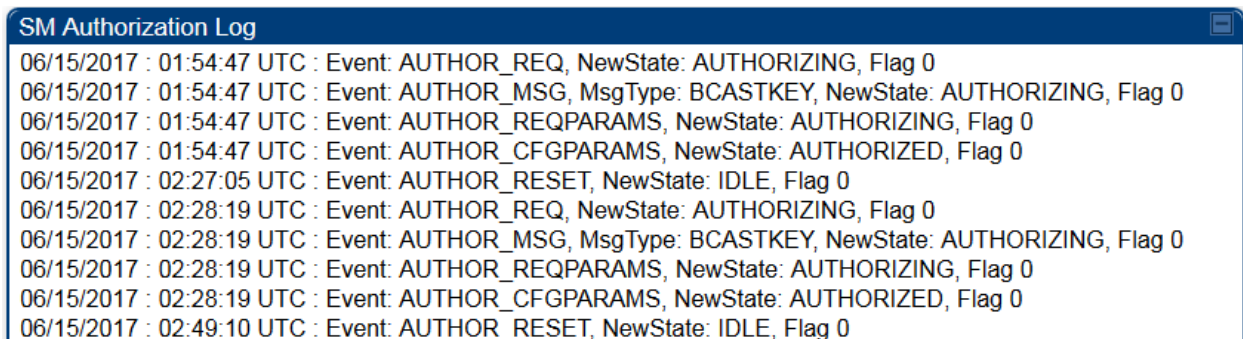

Figure 4: *SM Authorization log*



450 m Reference information

A.1 Specifications

Please see the Specification sheets listed on the Cambium Networks website for the most up-to-date 450m Series AP specifications:

<http://www.cambiumnetworks.com/resource/pmp-450m/>

A.2 450m overload

The 450m Series AP is designed to handle high load in terms of high throughput and high PPS. In terms of throughput, 450m is designed to achieve 3x or more throughput improvement over 450 and 450i Series products. In terms of packets per second (PPS), 450m is designed to handle up to 100k PPS.

Overload occurs when the offered load exceeds the above limits. When overload occurs, 450m will start discarding packets and TCP throughput will degrade due to packet loss. The 450 family of products have a set of overload statistics that can be used to monitor overload conditions (Statistics >Overload tab).

Cambium Networks

- Home
- Configuration
- Statistics**
- Tools
- Engineering
- Logs
- Accounts
- Quick Start
- Copyright
- Logoff

Account: eng
Level: ENGINEERING
Mode: Read-Write
Authentication Method: Local

CANOPY
cnMedusa

Scheduler | NI Buffer | SM Registration Failures | Bridge Control Block | Bridging Table | Ethernet | Socket | Radio
VLAN | Data VC | MIR/Burst | Throughput | Filter | HTTP Proxy | SNMP Proxy | Web GUI Engine | ARP
Overload | DHCP Relay | Pass Through Statistics | DNS Statistics | SNMPv3 Statistics | HTTP Tunnel Statistics
Syslog Statistics | Frame Utilization

Statistics → Overload

5.7GHz MU-MIMO OFDM - Access Point
0a-00-3e-60-32-65

Clear Statistics

Packet Overload Statistics	
Total Packets Overload Count :	0
Ethernet In Discards (Statistics=>Ethernet=>RxOverrun + Statistics=>Bridge Control Block=>ErrApFecQSend) :	0
Ethernet Out Discards (Statistics=>Ethernet=>outdiscards count) :	0
RF In Discards (Sum of all VCs of: Statistics=>Data VC=>indiscards count) :	0
RF Out Discards (Statistics=>Radio=>outdiscards count) :	0

Clear Statistics

The above statistics shall be monitored over time for overload conditions over consecutive periods. Refer to Interpreting Overload statistics for description of those statistics.

It's worth noting that Frame Utilization statistics (Statistics >Frame Utilization tab: Frame Utilization: Downlink and Uplink) are not necessarily indicative of overload condition. They show how much the TDD frame is utilized. High frame utilization depends on:

1. High traffic during busy periods: those statistics will be close to 100% and almost all slots will be utilized. In this case if the Overload statistics show that packets are discarded then this is an indication of overload condition.
2. High percentage of VCs with low modulation with moderate traffic. Those VCs will require more slots to service them (due to low modulation) and the frame utilization will be high. In this case the TDD frame is fully utilized but the system is at low capacity and is not in an overload condition.

450m has higher PPS than 450 and 450i and supports higher throughput through spatial multiplexing, therefore when a 450m replaces an overloaded 450 or 450i AP the 450m will not be overloaded under the same conditions but the frame utilization may still show close to 100%; this should not alarm the customer. The overload statistics shall be monitored on 450m to see if it is overloaded or not.

Quality of Service (QoS) Glossary

Term	Definition
10Base-T	Technology in Ethernet communications that can deliver 10 Mb of data across 328 feet (100 meters) of CAT 5 cable.
169.254.0.0	Gateway IP address default in Cambium fixed wireless broadband IP network modules.
169.254.1.1	IP address default in Cambium fixed wireless broadband IP network modules.
255.255.0.0	Subnet mask default in Cambium fixed wireless broadband IP network modules and in Microsoft and Apple operating systems.
802.3	An IEEE standard that defines the contents of frames that are transferred through Ethernet connections. Each of these frames contains a preamble, the address to which the frame is sent, the address that sends the frame, the length of the data to expect, the data, and a checksum to validate that no contents were lost.
Access Point Cluster	Two to six Access Point Modules that together distribute network or Internet services to a community of subscribers. Each Access Point Module covers a 60° or 90° sector. This cluster covers as much as 360°. Also known as AP cluster.
Access Point Module	Also known as AP. One module that distributes network or Internet services in a 60° or 90° sector.
ACT/4	Second-from-left LED in the module. In the operating mode, this LED is lit when data activity is present on the Ethernet link.
Address Resolution Protocol	Protocol defined in RFC 826 to allow a network element to correlate a host IP address to the Ethernet address of the host. See http://www.faqs.org/rfcs/rfc826.html .
Aggregate Throughput	The sum of the throughputs in the uplink and the downlink.
AP	Access Point Module. One module that distributes network or Internet services to subscriber modules.
ARP	Address Resolution Protocol. A protocol defined in RFC 826 to allow a network element to correlate a host IP address to the Ethernet address of the host. See http://www.faqs.org/rfcs/rfc826.html .
APs MIB	Management Information Base file that defines objects that are specific to the Access Point Module. See also Management Information Base.
ASN.1	Abstract Syntax Notation One language. The format of the text files that compose the Management Information Base.
Attenuation	Reduction of signal strength caused by the travel from the transmitter to the receiver, and caused by any object between. In the absence of objects between, a signal that has a short wavelength experiences a high degree of attenuation nevertheless.
BER	Bit Error Rate. The ratio of incorrect data received to correct data received.
BHM	Backhaul Timing Master (BHM)- a module that is used in a point to point link. This module controls the air protocol and configurations for the link..

Term	Definition
BHS	Backhaul Timing Slave (BHS)- a module that is used in a point to point link. This module accepts configuration and timing from the master module.
Bit Error Rate	Ratio of incorrect data received to correct data received.
Box MIB	Management Information Base file that defines module-level objects. See also Management Information Base.
Bridge	Network element that uses the physical address (not the logical address) of another to pass data. The bridge passes the data to either the destination address, if found in the simple routing table, or to all network segments other than the one that transmitted the data. Modules are Layer 2 bridges except that, where NAT is enabled for an SM, the SM is a Layer 3 switch. Compare to Switch and Router, and see also NAT.
Buckets	Theoretical data repositories that can be filled at preset rates or emptied when preset conditions are experienced, such as when data is transferred.
Burst	Preset amount limit of data that may be continuously transferred.
CAT 5 Cable	Cable that delivers Ethernet communications from module to module. Later modules auto-sense whether this cable is wired in a straight-through or crossover scheme.
CIR	Committed Information Rate. For an SM or specified group of SMs, a level of bandwidth that can be guaranteed to never fall below a specified minimum (unless oversubscribed). In the Cambium implementation, this is controlled by the Low Priority Uplink CIR, Low Priority Downlink CIR, Medium Priority Uplink CIR, Medium Priority Downlink CIR parameters, High Priority Uplink CIR, High Priority Downlink CIR parameters, Ultra High Priority Uplink CIR, and Ultra High Priority Downlink CIR parameters.
Cluster Management Module	Module that provides power, GPS timing, and networking connections for an AP cluster. Also known as CMM4.
CMM	Cluster Management Module. A module that provides power, GPS timing, and networking connections for an Access Point cluster.
CodePoint	See DiffServ.
Color Code Field	Module parameter that identifies the other modules with which communication is allowed. The range of valid values is 0 to 255.
Community String Field	Control string that allows a network management station to access MIB information about the module.
Connectorized	The 450 Platform Family Connectorized Radio solution provide RF port to connect external antenna. It gives flexibility to connect to a variety of external antennas.
Country Code	A parameter that offers multiple fixed selections, each of which automatically implements frequency band range restrictions for the selected country. Units shipped to countries other than the United States must be configured with the corresponding Region Code and Country Code to comply with local regulatory requirements.
CRCErrors Field	This field displays how many CRC errors occurred on the Ethernet controller.

Term	Definition																									
Data Encryption Standard	Over-the-air link option that uses secret 56-bit keys and 8 parity bits. Data Encryption Standard (DES) performs a series of bit permutations, substitutions, and recombination operations on blocks of data.																									
Demilitarized Zone	Internet Protocol area outside of a firewall. Defined in RFC 2647. See http://www.faqs.org/rfcs/rfc2647.html .																									
DES	Data Encryption Standard. An over-the-air link option that uses secret 56-bit keys and 8 parity bits. DES performs a series of bit permutations, substitutions, and recombination operations on blocks of data.																									
DFS	See Dynamic Frequency Selection																									
DHCP	Dynamic Host Configuration Protocol, defined in RFC 2131. Protocol that enables a device to be assigned a new IP address and TCP/IP parameters, including a default gateway, whenever the device reboots. Thus DHCP reduces configuration time, conserves IP addresses, and allows modules to be moved to a different network within the system. See http://www.faqs.org/rfcs/rfc2131.html . See also Static IP Address Assignment.																									
DiffServ	<p>Differentiated Services, consistent with RFC 2474. A byte in the type of service (TOS) field of packets whose values correlates to the channel on which the packet should be sent. The value is a numeric code point. The PMP 450 AP's support four levels of QoS. The mapping of these eight priority values to data channels is determined by the number of data channels configured per SM as shown in the table below:</p> <table border="1" data-bbox="412 1020 1401 1325"> <thead> <tr> <th>Number of QoS levels →</th> <th>1</th> <th>2</th> <th>3</th> <th>4</th> </tr> </thead> <tbody> <tr> <th>Level 1</th> <td>0-7</td> <td>0-3</td> <td>0-1</td> <td>0-1</td> </tr> <tr> <th>Level 2</th> <td>-</td> <td>4-7</td> <td>2-3</td> <td>2-3</td> </tr> <tr> <th>Level 3</th> <td>-</td> <td>-</td> <td>4-7</td> <td>4-5</td> </tr> <tr> <th>Level 4</th> <td>-</td> <td>-</td> <td>-</td> <td>6-7</td> </tr> </tbody> </table> <p>For example, for an AP that uses the default table shown above has configured 3 QoS levels per SM, would see codepoints 0 through 15 mapped to the Low Priority data channels, codepoint 16 would be mapped to the Medium Priority data channels, and so on.</p> <p>Note that CodePoints 0, 8, 16, 24, 32, 48, and 56 are predefined to the fixed values shown in Table 22 DiffServ attributes - AP/BHM and are not user configurable. Operator cannot change any of these fixed priority values. Among the configurable parameters, the priority values (and therefore the handling of packets in the high or low priority channel) are set in the AP/BHM for all downlinks within the sector and in the SM/BHS for each uplink.</p>	Number of QoS levels →	1	2	3	4	Level 1	0-7	0-3	0-1	0-1	Level 2	-	4-7	2-3	2-3	Level 3	-	-	4-7	4-5	Level 4	-	-	-	6-7
Number of QoS levels →	1	2	3	4																						
Level 1	0-7	0-3	0-1	0-1																						
Level 2	-	4-7	2-3	2-3																						
Level 3	-	-	4-7	4-5																						
Level 4	-	-	-	6-7																						
DMZ	Demilitarized Zone as defined in RFC 2647. An Internet Protocol area outside of a firewall. See http://www.faqs.org/rfcs/rfc2647.html .																									

Term	Definition
Dynamic Frequency Selection	A requirement in certain countries and regions for systems to detect interference from other systems, notably radar systems, and to avoid co-channel operation with these systems.
Dynamic Host Configuration Protocol	See DHCP.
Electronic Serial Number	Hardware address that the factory assigns to the module for identification in the Data Link layer interface of the Open Systems Interconnection system. This address serves as an electronic serial number. Same as MAC Address.
ESN	Electronic Serial Number. The hardware address that the factory assigns to the module for identification in the Data Link layer interface of the Open Systems Interconnection system. This address serves as an electronic serial number. Same as MAC Address.
Ethernet Protocol	Any of several IEEE standards that define the contents of frames that are transferred from one network element to another through Ethernet connections.
ETSI	European Telecommunications Standards Institute
Fade Margin	The difference between strength of the received signal and the strength that the receiver requires for maintaining a reliable link. A higher fade margin is characteristic of a more reliable link. Standard operating margin.
FCC	Federal Communications Commission of the U.S.A.
Field-programmable Gate Array	Array of logic, relational data, and wiring data that is factory programmed and can be reprogrammed.
File Transfer Protocol	Utility that transfers of files through TCP (Transport Control Protocol) between computing devices that do not operate on the same platform. Defined in RFC 959. See http://www.faqs.org/rfcs/rfc959.html .
FPGA	Field-programmable Gate Array. An array of logic, relational data, and wiring data that is factory programmed and can be reprogrammed.
Free Space Path Loss	Signal attenuation that is naturally caused by atmospheric conditions and by the distance between the antenna and the receiver.
Fresnel Zone	Space in which no object should exist that can attenuate, diffract, or reflect a transmitted signal before the signal reaches the target receiver.
FTP	File Transfer Protocol, defined in RFC 959. Utility that transfers of files through TCP (Transport Control Protocol) between computing devices that do not operate on the same platform. See http://www.faqs.org/rfcs/rfc959.html .
Global Positioning System	Network of satellites that provides absolute time to networks on earth, which use the time signal to synchronize transmission and reception cycles (to avoid interference) and to provide reference for troubleshooting activities.
GPS	Global Positioning System. A network of satellites that provides absolute time to networks on earth, which use the time signal to synchronize transmission and reception

Term	Definition
	cycles (to avoid interference) and to provide reference for troubleshooting activities.
GPS/3	Third-from-left LED in the module. In the operating mode for an Access Point Module, this LED is continuously lit as the module receives sync pulse. In the operating mode for a Subscriber, this LED flashes on and off to indicate that the module is not registered.
GUI	Graphical user interface.
HTTP	Hypertext Transfer Protocol, used to make the Internet resources available on the World Wide Web. Defined in RFC 2068. See http://www.faqs.org/rfcs/rfc2068.html .
HTTPS	Hypertext Transfer Protocol Secure (HTTPS)
ICMP	Internet Control Message Protocols defined in RFC 792, used to identify Internet Protocol (IP)- level problems and to allow IP links to be tested. See http://www.faqs.org/rfcs/rfc792.html .
Integrated	The 450 Platform Family integrated Radio solution provides integrated antenna..
IP	Internet Protocol defined in RFC 791. The Network Layer in the TCP/IP protocol stack. This protocol is applied to addressing, routing, and delivering, and re-assembling data packets into the Data Link layer of the protocol stack. See http://www.faqs.org/rfcs/rfc791.html .
IP Address	32-bit binary number that identifies a network element by both network and host. See also Subnet Mask.
IPv4	Traditional version of Internet Protocol, which defines 32- bit fields for data transmission.
ISM	Industrial, Scientific, and Medical Equipment radio frequency band, in the 900 MHz, 2.4 GHz, and 5.8 GHz ranges.
L2TP over IPsec	Level 2 Tunneling Protocol over IP Security. One of several virtual private network (VPN) implementation schemes. Regardless of whether Subscriber Modules have the Network Address Translation feature (NAT) enabled, they support VPNs that are based on this protocol.
Late Collision Field	This field displays how many late collisions occurred on the Ethernet controller. A normal collision occurs during the first 512 bits of the frame transmission. A collision that occurs after the first 512 bits is considered a late collision. A late collision is a serious network problem because the frame being transmitted is discarded. A late collision is most commonly caused by a mismatch between duplex configurations at the ends of a link segment.
Line of Sight	Wireless path (not simply visual path) direct from module to module. The path that results provides both ideal aim and an ideal Fresnel zone.
LNK/5	Furthest left LED in the module. In the operating mode, this LED is continuously lit when the Ethernet link is present. In the aiming mode for a Subscriber Module, this LED is part of a bar graph that indicates the quality of the RF link.
Logical Unit ID	Final octet of the 4-octet IP address of the module.
LOS	Line of sight. The wireless path (not simply visual path) direct from module to module.

Term	Definition
	The path that results provides both ideal aim and an ideal Fresnel zone.
LUID	Logical Unit ID. The final octet of the 4-octet IP address of the module.
MAC Address	Media Access Control address. The hardware address that the factory assigns to the module for identification in the Data Link layer interface of the Open Systems Interconnection system. This address serves as an electronic serial number.
Management Information Base	Space that allows a program (agent) in the network to relay information to a network monitor about the status of defined variables (objects).
Maximum Information Rate (MIR)	The cap applied to the bandwidth of an SM or specified group of SMs. In the Cambium implementation, this is controlled by the Sustained Uplink Data Rate, Uplink Burst Allocation, Sustained Downlink Data Rate, and Downlink Burst Allocation parameters.
MIB	Management Information Base. Space that allows a program (agent) in the network to relay information to a network monitor about the status of defined variables (objects).
MIR	See Maximum Information Rate.
MU-MIMO	Multi User- Multiple Input Multiple Output
NAT	Network Address Translation defined in RFC 1631. A scheme that isolates Subscriber Modules from the Internet. See http://www.faqs.org/rfcs/rfc1631.html .
NEC	National Electrical Code. The set of national wiring standards that are enforced in the U.S.A.
NetBIOS	Protocol defined in RFC 1001 and RFC 1002 to support an applications programming interface in TCP/IP. This interface allows a computer to transmit and receive data with another host computer on the network. RFC 1001 defines the concepts and methods. RFC 1002 defines the detailed specifications. See http://www.faqs.org/rfcs/rfc1001.html and http://www.faqs.org/rfcs/rfc1002.html .
Network Address Translation	Scheme that defines the Access Point Module as a proxy server to isolate registered Subscriber Modules from the Internet. Defined in RFC 1631. See http://www.faqs.org/rfcs/rfc1631.html .
Network Management Station	See NMS.
NMS	Network Management Station. A monitor device that uses Simple Network Management Protocol (SNMP) to control, gather, and report information about predefined network variables (objects). See also Simple Network Management Protocol.
Default Mode	Device that enables the operator to regain control of a module that has been locked by the No Remote Access feature, the 802.3 Link Disable feature, or a password or IP address that cannot be recalled. This device can be either fabricated on site or ordered.
PMP	See Point-to-Multipoint Protocol.
Point-to-	Defined in RFC 2178, which specifies that data that originates from a central network

Term	Definition
Multipoint Protocol	element can be received by all other network elements, but data that originates from a non-central network element can be received by only the central network element. See http://www.faqs.org/rfcs/rfc2178.html . Also referenced as PMP.
PPPoE	Point to Point Protocol over Ethernet. Supported on SMs for operators who use PPPoE in other parts of their network operators who want to deploy PPPoE to realize per-subscriber authentication, metrics, and usage control.
PPS	Packet Per Second
PPTP	Point to Point Tunneling Protocol. One of several virtual private network implementations. Regardless of whether the Network Address Translation (NAT) feature enabled, Subscriber Modules support VPNs that are based on this protocol.
Protective Earth	Connection to earth (which has a charge of 0 volts). Also known as ground.
Proxy Server	Network computer that isolates another from the Internet. The proxy server communicates for the other computer, and sends replies to only the appropriate computer, which has an IP address that is not unique or not registered.
PTP	A Point-to-Point connection refers to a communications connection between two nodes or endpoints.
Radio Signal Strength Indicator	Relative measure of the strength of a received signal. An acceptable link displays a Radio Signal Strength Indicator (RSSI) value of greater than 700.
Reflection	Change of direction and reduction of amplitude of a signal that encounters an object larger than the wavelength. Reflection may cause an additional copy of the wavelength to arrive after the original, unobstructed wavelength arrives. This causes partial cancellation of the signal and may render the link unacceptable. However, in some instances where the direct signal cannot be received, the reflected copy may be received and render an otherwise unacceptable link acceptable.
Region Code	A parameter that offers multiple fixed selections, each of which automatically implements frequency band range restrictions for the selected region. Units shipped to regions other than the United States must be configured with the corresponding Region Code to comply with local regulatory requirements.
RF	Radio frequency. How many times each second a cycle in the antenna occurs, from positive to negative and back to positive amplitude.
RJ-12	Standard cable that is typically used for telephone line or modem connection.
RJ-45	Standard cable that is typically used for Ethernet connection. This cable may be wired as straight-through or as crossover. Later modules auto-sense whether the cable is straight-through or crossover.
Router	Network element that uses the logical (IP) address of another to pass data to only the intended recipient. Compare to Switch and Bridge.
RSSI	Radio Signal Strength Indicator. A relative measure of the strength of a received signal. An acceptable link displays an RSSI value of greater than 700.

Term	Definition
Self-interference	Interference with a module from another module in the same network.
SFP	Small Form-factor Pluggable
Simple Network Management Protocol	Standard that is used for communications between a program (agent) in the network and a network management station (monitor). Defined in RFC 1157. See http://www.faqs.org/rfcs/rfc1157.html .
SM	Customer premises equipment (CPE) device that extends network or Internet services by communication with an Access Point Module or an Access Point cluster.
SNMP	See Simple Network Management Protocol, defined in RFC 1157.
SNMPv3	SNMP version 3
SNMP Trap	Capture of information that informs the network monitor through Simple Network Management Protocol of a monitored occurrence in the module.
Spatial Frequency	Spatial Frequency is associated with an LUID or SM registered with an AP and it is visible on both AP and SM GUIs. It is grouped into bins where each bin includes 32 consecutive spatial frequency values.
Static IP Address Assignment	Assignment of Internet Protocol address that can be changed only manually. Thus, static IP address assignment requires more configuration time and consumes more of the available IP addresses than DHCP address assignment does. RFC 2050 provides guidelines for the static allocation of IP addresses. See http://www.faqs.org/rfcs/rfc2050.html . See also DHCP.
Subnet Mask	32-bit binary number that filters an IP address to reveal what part identifies the network and what part identifies the host. The number of subnet mask bits that are set to 1 indicates how many leading bits of the IP address identify the network. The number of subnet mask bits that are set 0 indicate how many trailing bits of the IP address identify the host.
Subscriber Module	Customer premises equipment (CPE) device that extends network or Internet services by communication with an Access Point Module or an Access Point cluster.
Sustained Data Rate	Preset rate limit of data transfer.
Switch	Network element that uses the port that is associated with the physical address of another to pass data to only the intended recipient. Compare to Bridge and Router.
Sync	GPS (Global Positioning System) absolute time, which is passed from one module to another. Sync enables timing that prevents modules from transmitting or receiving interference . Sync also provides correlative time stamps for troubleshooting efforts.
TCP	Alternatively known as Transmission Control Protocol or Transport Control Protocol. The Transport Layer in the TCP/IP protocol stack. This protocol is applied to assure that data packets arrive at the target network element and to control the flow of data through the Internet. Defined in RFC 793. See http://www.faqs.org/rfcs/rfc793.html .
TDD	Time Division Duplexing. Synchronized data transmission with some time slots

Term	Definition
	allocated to devices transmitting on the uplink and some to the device transmitting on the downlink.
telnet	Utility that allows a client computer to update a server. A firewall can prevent the use of the telnet utility to breach the security of the server. See http://www.faqs.org/rfcs/rfc818.html , http://www.faqs.org/rfcs/rfc854.html , and http://www.faqs.org/rfcs/rfc855.html .
Tokens	Theoretical amounts of data. See also Buckets.
TxUnderrun Field	This field displays how many transmission-underrun errors occurred on the Ethernet controller.
UDP	User Datagram Protocol. A set of Network, Transport, and Session Layer protocols that RFC 768 defines. These protocols include checksum and address information but does not retransmit data or process any errors. See http://www.faqs.org/rfcs/rfc768.html .
udp	User-defined type of port.
U-NII	Unlicensed National Information Infrastructure radio frequency band, in the 5.1 GHz through 5.8 GHz ranges.
VID	VLAN identifier. See also VLAN.
VLAN	Virtual local area network. An association of devices through software that contains broadcast traffic, as routers would, but in the switch-level protocol.
VPN	Virtual private network for communication over a public network. One typical use is to connect remote employees, who are at home or in a different city, to their corporate network over the Internet. Any of several VPN implementation schemes is possible. SMs support L2TP over IPSec (Level 2 Tunneling Protocol over IP Security) VPNs and PPTP (Point to Point Tunneling Protocol) VPNs, regardless of whether the Network Address Translation (NAT) feature enabled.