

# HIGH FIDELITY

MAY 1978 \$1.25

ICD © 08398

## How to Keep Your Stereo Sounding like New

- Easy Home Upkeep for Components
- Pinpointing Trouble Step by Step
- Getting the Most for Your Service Dollar

**Irving Berlin**  
"He Is American Music"

**Sizing up Amps**  
**Amps**  
**New Approach**

DAVID S BUCHANAN  
APT 26 UNIV APPS  
WOODLAND AVE  
ASHLAND KY  
41101

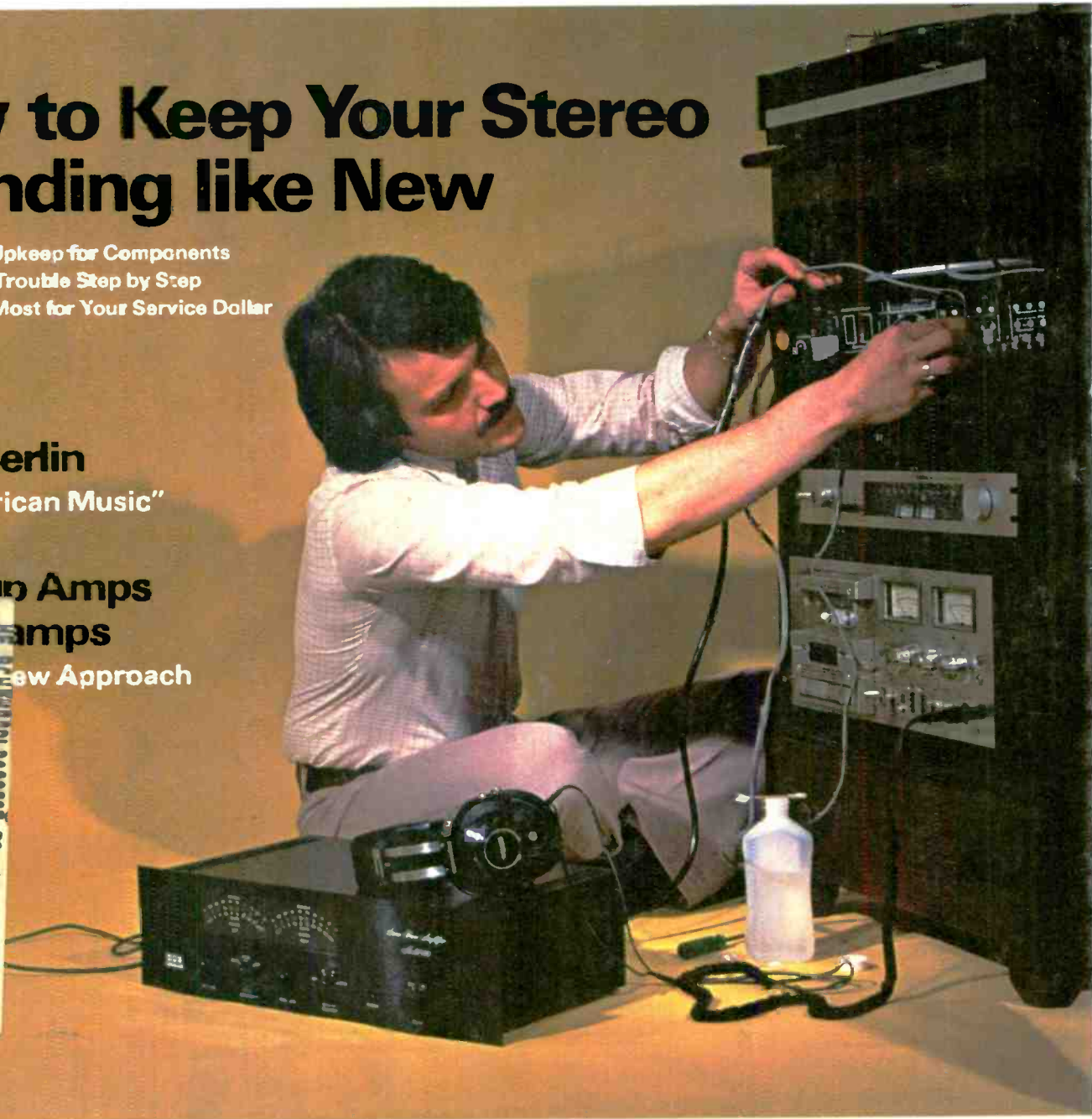

## Lab/Listening Reports

Apt/Holman preamp • Kenwood KX-1030 cassette deck  
Keith Monks M9BA Mk.3 Improved tone arm • Marantz 940 speaker system  
Realistic LAB-400 turntable • Tandberg TR-2075 Mk.II receiver



# PRESENTS ACT II. STAND MADE THEM BETTER.

to let you get everything out of your tuner. Perfectly.

Our output stage, for example, features a new parallel push-pull circuit that reduces total harmonic distortion to less than 0.1%. Again, well below anything you can possibly hear.

To all but eliminate cross-talk, the SA9500II comes with a separate power transformer for each channel, instead of the usual single transformer for both.

And where some amps give you two, or three tone controls, the SA9500II gives you four. Two for regular treble and bass, and two for extended treble and bass. They're calibrated in 2 decibel click stops, which means you have a virtually endless variety of ways to get the most out of your music.

But that's only the beginning. To get the most out of your cartridge, the 9500II has a switch that lets you "tune" the amplifier to the cartridge manufacturer's optimum capacitance. And to get the most out of your records, our three-stage phono equalizer features an incredibly high phono overload level of 300 millivolts. With no more than 0.2 dB variation from the RIAA curve. So even the most complicated passage on one of today's highly engineered records will sound exactly the way it was recorded in the studio.

Obviously, both the SA9500II and the TX9500II are very sophisticated pieces of equipment. But all of the engineering skill that went into making them has also gone into every other tuner and amplifier in our new series II. No matter what the price, no matter what the specifications.

And that's something you don't have to be an expert to appreciate.

	SA9500II TX9500II	SA8500II TX8500II	SA7500II	SA6500II TX6500II	SA5500II TX5500II
POWER MIN. RMS, 20 TO 20,000 HZ	80	60	45	30	15
TOTAL HARMONIC DISTORTION	0.1%	0.1%	0.1%	0.1%	0.5%
PHONO OVERLOAD LEVEL	300mV	250mV	200mV	200mV	130mV
INPUT: PHONO/AUX/ TAPE	2/1/2	2/1/2	1/1/2	1/1/2	1/1/1
SIGNAL TO NOISE RATIO	95dB	95dB	95dB	93dB	87dB
FM SENSITIVITY (11.7" 58)	1.5uV	1.8uV	not applicable	1.9uV	1.9uV
SELECTIVITY	(wide) 35dB (narrow) 85dB	(wide) 35dB (narrow) 80dB	not applicable	60dB	60dB
CAPTURE RATIO	(wide) 0.8dB (narrow) 2.0dB	(wide) 0.8dB (narrow) 2.0dB	not applicable	1.0dB	1.0dB

U.S. Pioneer Electronics Corp., 75 Oxford Drive, Moonachie, New Jersey 07074.

\* Minimum RMS continuous power output at 8 ohms, from 20 to 20,000Hz, with no more than 0.1% total harmonic distortion.



TX9500II  
SA9500II



TX6500II  
SA7500II

High Fidelity Components  
**PIONEER**  
WE BRING IT BACK ALIVE.

## NEW PIONEER AMPS AND TUNERS.

CIRCLE 29 ON READER-SERVICE CARD



# Better stereo records are the result of better playback pick-ups

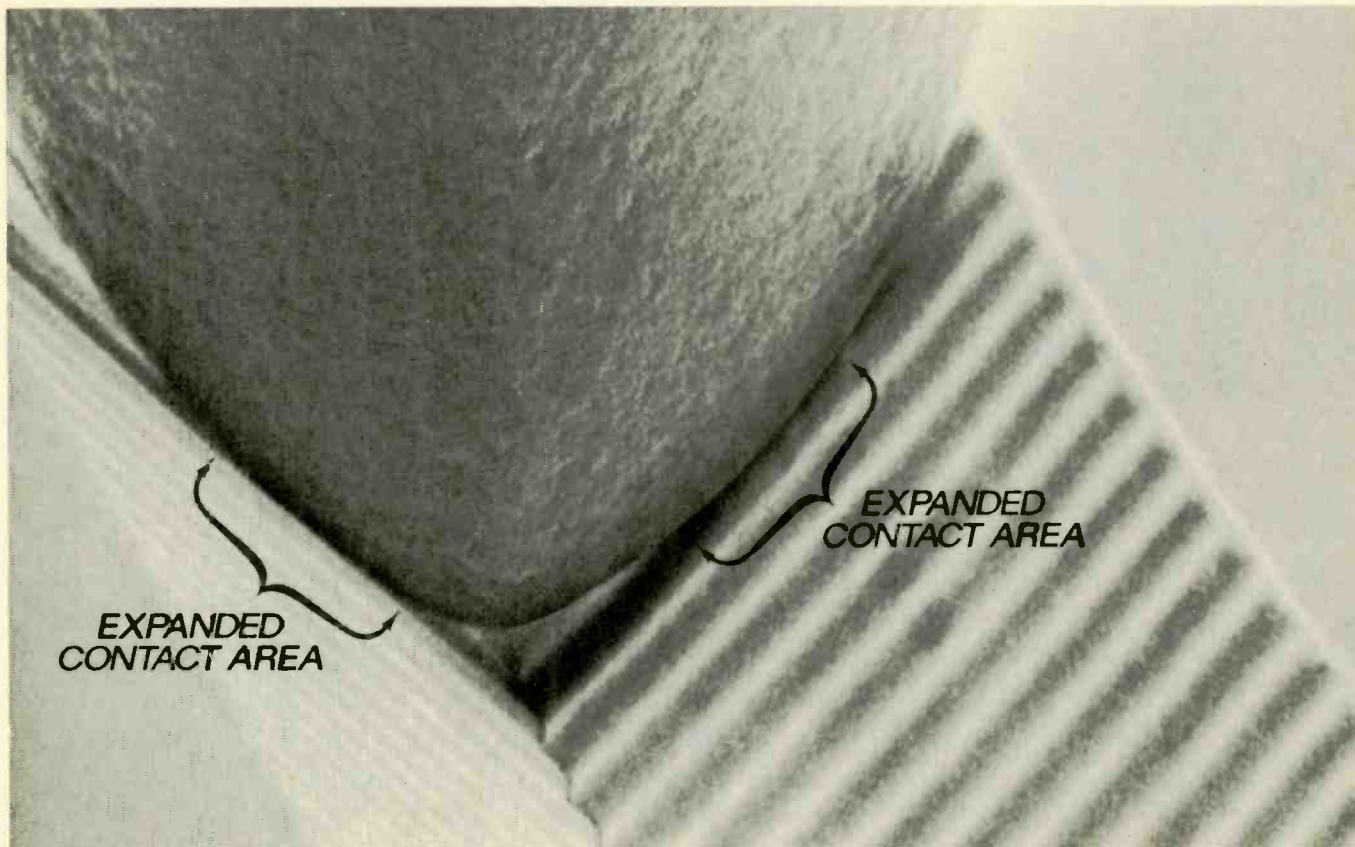

© Stanton Magnetics, Inc., 1977

Scanning Electron Beam Microscope photo of Stereohedron Stylus; 2000 times magnification. Brackets point out wider contact area.

## Enter the New Professional Calibration Standard, Stanton's 881S

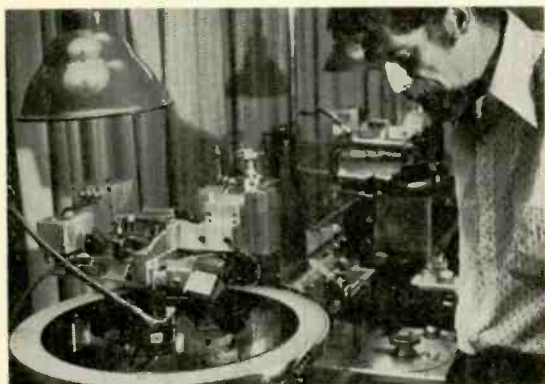

Mike Reese of the famous Mastering Lab in Los Angeles says: "While maintaining the Calibration Standard, the 881S sets new levels for tracking and high frequency response. It's an audible improvement. We use the 881S exclusively for calibration and evaluation in our operation."

The recording engineer can only produce a product as good as his ability to analyze it. Such analysis is best accomplished through the use of a playback pick-up. Hence, better records are the result of better playback pick-up. Naturally, a calibrated pick-up is essential.

There is an additional dimension to Stanton's new Professional Calibration Standard cartridges. They are designed for maximum record protection. This requires a brand new tip shape, the Stereohedron®, which was developed for not only better sound characteristics but also the gentlest possible treatment of the record groove. This cartridge possesses a revolutionary new magnet made of an exotic rare earth compound which, because of its enormous power, is far smaller than ordinary magnets.

Stanton guarantees each 881S to meet the specifications within exacting limits. The most meaningful warranty possible, individual calibration test results, come packed with each unit.

Whether your usage involves recording, broadcasting or home entertainment, your choice should be the choice of the professionals... the STANTON 881S.



For further information write to Stanton Magnetics, Terminal Drive, Plainview, New York 11803

CIRCLE 37 ON READER-SERVICE CARD

# PIONEER PRESENTS WE STARTED WITH THE BEST

Last year, the experts paid Pioneer's integrated amps and tuners some of the highest compliments ever.

The challenge was obvious: to build even better amps and tuners. Amps and tuners that would not only surpass anything we'd ever built before, but anything anyone ever built before.

Here's how we did it.

## THE NEW PIONEER TX9500II TUNER: EVEN CLOSER TO PERFECT.

When Popular Electronics said our TX9500 tuner was as "near to perfect" as they'd encountered, they obviously hadn't encountered our TX9500II. It features technology so advanced, some of it wasn't even perfected until this year.

Our front end, for example, features three newly developed MOS FETs that work with our 5-gang variable capacitor to give the TX9500II an incredible FM sensitivity of 8.8dB $\mu$ . In mono. In English, this means you can pull in beautiful FM reception no matter how far you live from the transmitter.

Where most tuners give you one bandwidth for all FM stations, the TX9500II gives you two. A wide band with a surface acoustic wave filter to take advantage of strong stations, and a narrow band

with five ceramic filters to remove all the interference and noise from weaker ones. (Distortion measured stereo at one kilohertz is an incredibly low 0.07% in the wide band; and 0.25% in the narrow band. Both well below the threshold of human hearing.)

Where conventional multiplex circuits cut out some of the frequencies that add depth and presence to music, the multiplex circuit in the TX9500II doesn't. It features an exclusive integrated circuit that's far more accurate than anything else around. Plus a multipath switch that lets you align your antenna perfectly without an oscilloscope.

And where you simply have to guess about the proper recording levels off most tuners, the TX9500II provides you with a tone generator that lets you pre-set the recording levels on your tape deck before the broadcast starts.

So your tapes can sound just as clear and beautiful as your tuner.

## THE NEW SA9500II AMPLIFIER: HOW TO GET THE MOST OUT OF THE BEST.

After building one of the world's best tuners, we had no choice but to create an amplifier that could match it.

The result is the new SA9500II. An 80-watt integrated amp that was designed



TX9500II  
SA9500II

# THE TYPE II A

# LAST YEAR'S REVIEWS PRESENTED US WITH A TOUGH ACT TO FOLLOW.

**"IT CANNOT BE FAULTED."**

*SA9500 — Stereo Review*

**"AS NEAR TO PERFECT  
AS WE'VE ENCOUNTERED."**

*TX9500 — Popular Electronics*

**"CERTAINLY ONE OF THE BEST...  
AT ANY PRICE."**

*TX9500 — Modern Hi Fi*



# HIGH FIDELITY

MAY 1978 VOLUME 28, NUMBER 5

## MUSIC AND MUSICIANS

- 16 **Music U.S.A.: England's Music—Doing Without**  
*Gene Lees*
- 65 **Behind the Scenes**
- 76 **Irving Berlin** *Joshua Logan*  
A 90th-birthday salute to the American master
- 83 **Mozart's Tito: A Masterpiece** *Andrew Porter*
- 85 **The Budapest Quartet in England** *Harris Goldsmith*
- 88 **Humperdinck but Not Hänsel** *David Hamilton*

## AUDIO AND VIDEO

- 4 **Video—The Second Wave** *Leonard Marcus*
- 25 **News and Views**
- 26 **Equipment in the News**
- 32 **Too Hot to Handle**
- 36 **Video Topics**  
Akai's portables  The cost of color
- 47 **Equipment Reports**  
Apt/Holman preamplifier  
Keith Monks M9BA Mk. 3 Improved tone arm  
Kenwood Model KX-1030 cassette deck  
Tandberg Model 2075 Mk. II receiver  
Marantz Model 940 speaker  
Realistic LAB-400 turntable
- 68 **Keeping Your Stereo System Sounding like New**  
*Howard Roberson*
- 74 **New Math vs. Old Myth** *Robert Long*  
New approaches to quantifying how an amp sounds

## REVIEWS

- 83 **Featured Recordings**  
*La Clemenza di Tito*  Budapest Quartet   
*Königskinder*
- 93 **Classical Records**  
*Adriana Lecouvreur*  Bach cantatas   
*Solti's Pathétique*
- 94 **Critics' Choice**
- 118 **The Tape Deck** *R. D. Darrell*

## BACKBEAT

- 121 **Roberta Flack: Survivor** *Leida Snow*
- 125 **Harry Fox and the RIAA** *Harvey Rachlin*  
Watchdogs of the industry
- 128 **1978 NAMM Western Market** *Fred Miller*
- 130 **Input Output**
- 131 **Records**  
Steeleye Span  Loretta Lynn  Manhattans
- 140 **New Wave, Second Surge**  
*Toby Goldstein*

## ET CETERA

- 6 **Letters**
- 40 **HiFi-Croctic** *William Petersen*
- 97 **Reader-Service Cards**
- 99 **Advertising Index**



High Fidelity is published monthly at The Publishing House, Great Barrington, Mass. 01230 by ABC Leisure Magazines, Inc., a subsidiary of American Broadcasting Companies, Inc. Copyright © 1978 by ABC Leisure Magazines, Inc. The design and contents are fully protected by copyright and must not be reproduced in any manner. Second-class postage paid at New York, New York, and at additional mailing offices. Authorized as second-class mail by the Post Office Department, Ottawa, and for payment of postage in cash. Yearly subscription in U.S.A. and Possessions \$9.95; elsewhere \$12.95. Single copies \$1.25. Subscribers: Send subscriptions, inquiries, and address changes to High Fidelity, 1 Sound Ave., Marion, Ohio 43302. Change of address: Give old and new addresses, including ZIP code. Enclose address label from last issue and allow five weeks for change to become effective. Postmaster: Send Form 3579 to High Fidelity, 1 Sound Ave., Marion, Ohio 43302. Postal Identification Number 24382.

## Video—The Second Wave

This month we reinstate our "Video Topics" column on a more-or-less bimonthly schedule. More-or-less because, first, if something of immediate importance to the home video field breaks during the preparation of a "wrong" issue, we won't necessarily hold up publication of the information for a month and, second, the vicissitudes of that stage of magazine production spoken of with trepidation throughout the publishing industry as "layout day" may at times doom a particular feature. (Let this second explanation serve as my answer to those readers who threaten us with legal action, financial retaliation, and physical violence when, on rare occasions, otherwise insoluble layout problems force "The Tape Deck" or the "HiFi-Croistic" out of an issue.)

What will the column cover? Certainly not reviews of *Laverne and Shirley*, although if we think it is pertinent to our readers' interest we will not hesitate to discuss programming and programs, both those available for purchase on tape (or—we're still waiting—on disc?) and those that can be picked up from the airwaves. (John Culshaw has also devoted several of his "Culshaw at Large" columns to this topic.) We will keep you abreast of new developments and products in the video field and will even apprise you of marketing and distribution plans if they affect the availability or price of these products. In short, we will keep our eye on the entire field and will let you know what we consider important to those of you who are at all interested in it. Speaking of which, I'd like to know how many of you are. Drop me a line.

In February 1967, after several years of reporting on video in our "News and Views" column, we inaugurated "Video Topics" (originally "VTR Topics"). The late 1960s was a time of great activity in the video tape recorder industry, and VTRs were being proclaimed as imminent home-entertainment products. Sony, Ampex, Panasonic, GE, Craig, Akai, and many other companies were showing or announcing new open-reel video recorders for the home, and Columbia was touting its EVR (electronic video recording) system. Audio-Technica released its first home video tape, and we soon heard about video discs and VCRs (video cassette recorders).

By the end of that year we had changed our audio editor's title to audio-video editor, and shortly afterward we altered the column's name. But despite all the hoopla, video devices did not find a niche next to the home stereo system or TV set, and the column's career reflected our growing acknowledgment of a static market. After nearly two years as a monthly feature, it became bimonthly, then sporadic, then merely an occasional inset in "News and Views." By the mid-1970s we had come full circle, reporting on video events without any reference to the dormant column.

Now, as Audio-Video Editor Robert Long pointed out in his March article, all that is changing. Everybody and his subsidiary is coming out with video hardware, from VCRs and cameras to projection television. But today, unlike ten years ago, as fast as manufacturers can produce these products, voracious consumers consume them. This second wave of video recorders has long since cleared the \$1,000 barrier, thus stimulating demand even more. (This month's column cites the anomaly that prices keep coming down although demand greatly exceeds supply.) True, the first wave also spewed out VTRs well under \$1,000 before it crested and collapsed, but consumers then were hardly willing to get their feet wet. Now the products are being displayed not only—in fact, not even primarily—in deluxe "audio salons," but between the TVs and "hi-fis" at Macy's.

Of course, it's possible that we are again being overoptimistic. Industry predictions of half a million or more sales this year may be merely wishful thinking. You should easily be able to tell. If some month you happen to see the "Video Topics" logo dropped into "News and Views"—

*Leonard Marcus*

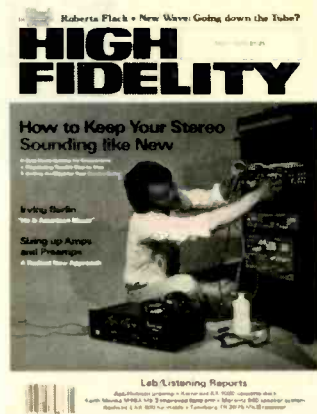

Cover photo: Roy Lindstrom

LEONARD MARCUS  
Editor

ROBERT S. CLARK  
Editorial Director

KENNETH FURIE  
Music Editor

ROBERT LONG  
Audio-Video Editor

HAROLD A. RODGERS  
Associate Audio-Video Editor

SHIRLEY FLEMING  
Editor, Musical America

SUSAN ELLIOTT  
Popular Music Editor

WAYNE ARMENTROUT  
Director of Production

REBECCA ABBOTT  
Copy Editor

LYNDA CARLOTTA  
CYNTHIA PEASE  
Assistant Editors

GAIL KOOKOOLIS  
Editorial Assistant

ROY LINDSTROM  
Graphics Director

EDWARD J. FOSTER  
Consulting Editor

EDWARD GREENFIELD  
European Editor

DICK ROSMINI  
Studio Equipment Consultant

ROYAL S. BROWN  
JOHN CULSHAW  
R. D. DARRELL  
ALFRED FRANKENSTEIN  
HARRIS GOLDSMITH  
DAVID HAMILTON  
DALE HARRIS  
PAUL HENRY LANG  
GENE LEES  
IRVING LOWENS  
ROBERT C. MARSH  
FRED MILLER  
H. C. ROBBINS LONDON  
Contributing Editors

DAVID LEE  
Circulation Director

WARREN B. SYER  
Publisher





## Yes, the new Dual 604 is direct drive. Now let's talk about something really important.

You may have noticed that most turntable stories begin and end with the drive system. The tonearm is more or less an afterthought.

But not with Dual. Because the tonearm can make a big difference in how records sound and how long they last. Which is why Dual is very serious about tonearm design and performance. And why we can be very serious about tonearms in our advertising.

Let's consider the 604 tonearm.

The straight-line tubular design provides maximum rigidity with minimum mass. The four-point gimbals centers and pivots the tonearm precisely where the vertical and horizontal axes intersect. And the counterbalance houses two specially-tuned anti-resonance filters that absorb parasitic resonances originating in the tonearm/cartridge system and chassis.

Operation is semi-automatic, with another unique

Dual difference: the mechanical sensor. Switch it in and you feel when the stylus is positioned precisely over the 12" and 7" lead-in grooves. At the end of play, the tonearm lifts and returns to its post, and the motor shuts off. Automatically.

Now let's talk about the drive system. It employs a newly developed DC electronic motor with a highly sensitive CMOS regulator circuit and integral frequency generator. Platter speed is checked against rated speed 120 times per revolution. Wow and flutter are less than 0.03 percent, rumble is better than 70 dB. Well beyond the limits of audibility.

But the important story with any turntable is simply this. The drive system merely turns the record. It's the tonearm that plays it.

Dual 604, semi-automatic, less than \$260. Dual 621, fully automatic plus continuous repeat, less than \$300. Both with base and cover. Actual resale prices are determined individually and at the sole discretion of authorized Dual dealers.

**Dual**<sup>®</sup>

*For the life of your records*

United Audio, 120 So. Columbus Ave., Mt. Vernon, NY 10553

## COMING NEXT MONTH

It has become our June tradition to zero in on **Speakers**, and true to form our next issue offers fresh insights into their design and performance along with test reports on leading new models from Koss, JBL, Advent, and others. Mark F. Davis speculates upon **What's Really Important in Loudspeaker Performance?**, and J. Robert Ashley, who designed Koss's new CM Series loudspeakers, heralds **The Third Speaker Revolution: Bi-amplification**. In **BACKBEAT** Toby Goldstein interviews **Television**, and Diane Rapaport gives us the inside dope on how **Independent Labels** battle the giants. "Input Output" features use tests of the Rhodes electric piano and the new Sony electret condenser studio mike. Plus a special report on a sure-to-be-controversial product—a startling departure by one of this country's most respected audio manufacturers.

## SOLUTION TO HIFI-CROSTIC NO. 34

[ZOLTÁN] KODÁLY: *Folk Music of Hungary*

For centuries priests of every confession attacked the flower songs, or secular love songs. In our own day many folksongs deal with erotic aspects of life in a completely uninhibited way. The greatest composers set them to music with even more sophisticated candor.

## ADVERTISING

**Main Office:** Leonard Levine, Director of Advertising Sales, The Publishing House, Great Barrington, Mass. 01230. Telephone: 413-528-1300.

**New York:** ABC Leisure Magazines, Inc., 130 E. 59th St., 15th floor, New York, N.Y. 10022. Seymour Resnick, National Advertising Manager, 212-826-8381. George Dickey, 212-826-8383. Michael Littleford, Classified Advertising Manager, 212-826-8394.

**New England:** ABC Leisure Magazine, Inc., 137 Newbury St., Boston, Mass. 02116. Telephone: 617-261-3145. Myles Grossman, New England Advertising Manager.

**Midwest:** ABC Leisure Magazines, Inc., 190 N. State St., Room 632, Chicago, Ill. 60601. Telephone: 312-782-1173. William P. Gordon, Midwest Advertising Manager.

**Los Angeles:** ABC Leisure Magazines, Inc., ABC Entertainment Center, 2040 Avenue of the Stars, Suite 270, Century City, Calif. 90067. Telephone: 213-553-2000. Andrew Spanberger, Western Advertising Manager. Janet Endrjonas, Associate Western Advertising Manager.

**Tokyo:** Japan Advertising Communications, Inc., New Ginza Bldg., 7-3-13 Ginza, Chuo-ku, Tokyo 104, Japan. Telephone: (03) 571-8748, Shigeru Kobayashi, President.

**High Fidelity** and **High Fidelity/Musical America** are published monthly by ABC Leisure Magazines, Inc., a subsidiary of American Broadcasting Companies Inc. Warren B. Syer, President. Herbert Kepler, Vice President. Photographic Publishing Division: Warren Tuohy, Vice President. Finance: Catherine Aloisi, Assistant to the President. Member Audit Bureau of Circulation. Indexed in Reader's Guide to Periodical Literature. Current and back copies of **High Fidelity** and **High Fidelity/Musical America** are available on microfilm from University Microfilms, Ann Arbor, Mich. 48106. Microfilm copies of these magazines (1973 forward) are available through Bell & Howell Micro Photo Division, Old Mansfield Road, Boston, O. 44691.

**Editorial correspondence** should be addressed to The Editor, **High Fidelity**, Great Barrington, Mass. 01230. Editorial contributions will be welcomed, and payment for articles accepted will be arranged prior to publication. Unsolicited manuscripts should be accompanied by return postage.



## More Horowitz

After reading Caine Alder's "The Unknown Recordings of Vladimir Horowitz" [January], I was prompted to exhume my copy of **HIGH FIDELITY** in which he compiled a discography of Horowitz' commercial releases. [July 1973]. In so doing, I discovered that I own a Horowitz piano roll that is not listed. The roll is Duo-Art 74508, containing performances of two Rachmaninoff Op. 32 Preludes, No. 10 in B minor and No. 8 in A minor. No other recording of either composition is given in the list of commercial releases or the list of unknown recordings. Furthermore, to my knowledge, neither prelude has appeared on any commercial recording released since the publication of the 1973 article. Therefore, the roll apparently provides the only example of Horowitz' interpretation of them.

Dr. J. A. Brooker  
Mogadore, Ohio

Mr. Alder replies: *I was not aware that Horowitz had ever performed the two Rachmaninoff preludes, much less recorded them for Duo-Art. I have hundreds of his programs and recital reviews from the 1920s on but have never noticed a reference to either piece. This situation is not unusual, however, for Horowitz has eliminated other works from his repertoire since those early days.*

## BACKBEAT Bouquets

I sympathize with some of the reader criticism of **BACKBEAT**; I wonder about the appropriateness of mixing jazz with the popular music reviews. A jazz review in that section may not receive the same emphasis **HIGH FIDELITY** previously gave to that musical genre.

However, I must praise **BACKBEAT**'s "Input Output." Fred Miller's honest discussions of equipment applications (rather than just a listing of specs) make one much more aware of the specific uses of the vast array of accessories available. My only wish is that the column be enlarged. There's tremendous catching up to be done, and the field is growing by leaps and bounds.

Barry Goldstein  
Statesville, N.C.

Our initiation of **BACKBEAT** affected our

jazz coverage in just one way: There are now two jazz reviewers—John S. Wilson and Don Heckman—and thus more jazz reviews than before.

To echo Mr. Goldstein, we hope for expansion of "Input Output" too. It will depend on our readers' expression of enthusiasm. How about it?

Unlike William T. Reinick ["Letters," February], I enjoy **BACKBEAT**. It presents a comprehensive view of the pop music world.

Charles E. McHugh  
Hinesville, Ga.

## Furtwängler as Composer

I do not understand Dr. Hans Illing's claim ["Letters," December 1977] that I said Furtwängler thought of himself as a conductor rather than a composer. From early childhood until his death, Furtwängler always saw himself as a composer.

In 1946 he wrote Ludwig Curtius: "My conducting career is not worth serious mention; my occasional ability to give performances that are humane, warm, natural, and real might be, because these are rarely heard otherwise. In reality conducting was the protective cover I sought because I felt I could not survive as a composer."

John Burnett ["Letters," September 1977] was accurate in his appraisal of Furtwängler's situation. Shortly before his death, Furtwängler made some corrections in his Third Symphony and wrote in titles for the three movements.

Elisabeth Furtwängler  
Clarens, Switzerland

## Praise for Billy Joel

In "Billy Joel: Up from Piano Man" [**BACKBEAT**, January] Susan Elliott reports that Joel's radio-concert recording of "Captain Jack," aired over station WMMR in Philadelphia, generated a "rush of requests." "Rush" is too modest a word; since I was music director of WMMR at the time, I'll fill in the details.

After I produced the concert, from the Sigma Sound Studios remote, I submitted a tape copy of the song to the station's general manager for review. He decided against airing it, since its lyric contained such searing terms as "masturbate" and

There's music in the air everywhere. Imagine having it all at your fingertips.



Imagine encountering a stereo receiver light-years ahead in styling, operation and performance.

You've never seen anything quite like it before—its timeless elegance immediately commands your attention.

You extend your hand. An effortless touch brings the entire system to life. There are no buttons to push, levers to flip, nor knobs to turn. The receiver, instead, responds to your every command at the briefest touch of its fingertip sensors.

Its awesome performance, finally, leads you to conclude that it is the product of an infinitely advanced intelligence.

You'd be surprised, then, to learn that the 730 Receiver is available on earth at a Nakamichi dealer. You owe it to yourself to see, hear and, most importantly, touch the Nakamichi 730... especially if you are totally satisfied with your present stereo system.

Write for more information:

220 Westbury Avenue, Carle Place, New York 11514.



 **Nakamichi**

Products of unusual creativity and competence...

CIRCLE 27 ON READER-SERVICE CARD

# BOB LIFTIN THINKS PEOPLE ARE READY FOR GRAND MASTER™ TAPE.

# ROY CICALA HAS HIS DOUBTS.

"Who wouldn't be knocked out by a tape with specs like Grand Master?"

*Bob Liftin,  
Recording Engineer,  
Regent Sound Studios,  
New York City*



"Sure, they'll know Grand Master sounds better. But they won't know how much better unless they actually test it."

*Roy Cicala,  
Recording Engineer,  
The Record Plant,  
New York City*

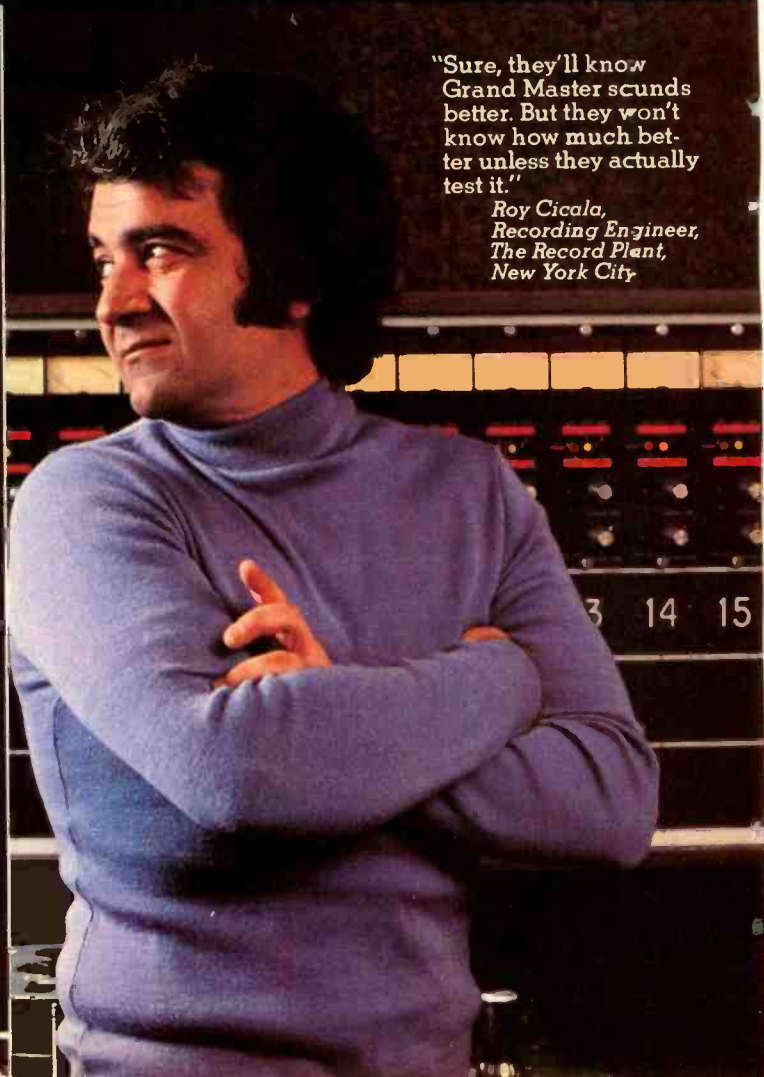

We asked Bob Liftin and Roy Cicala if audio buffs are ready for a tape as sophisticated as Grand Master for use at home.

They should know. Both are nationally famous recording engineers who've been using Grand Master Studio Mastering tape since it first came out in 1973.

Bob said, "Sure they're ready. Grand Master's dramatic 4 to 8 dB improvement in signal-to-noise ratio allows a guy to hit the tape 3 to 6 dBs harder and still get better distortion figures."

Roy wasn't so sure. "Of course, Grand Master's lower distortion and higher output mean a lot to pros. But I wonder how many home systems are sensitive enough to pinpoint the improvement. Unless you run side-by-side tests with identical equipment, you can't tell how much better it is."

Noting the difference of opinion, we asked other top engineers. Most agreed with Bob.

(Sorry, Roy.)

They felt the uniform response of Grand Master would allow a more realistic playback. And yield a cleaner sound as a result.

Which confirmed what we thought all along: You're ready for a very sensitive, high-output, low-distortion tape to use at home.

So now there are 3 new versions of Grand Master. An exciting cas-

sette with lots of exclusive precision features. A completely redesigned 8-track cartridge. And a

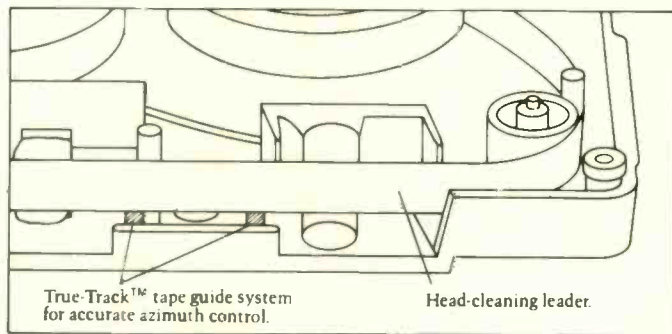

professionally constructed quarter-inch open reel as well.

So now it's up to you.

For the first time, you can actually buy the kind of recording tape only the pros could get their hands on.

We think you're ready for it. Even if Roy Cicala isn't sure.



**GRAND MASTER  
BY AMPEX.  
WE THINK YOU'RE  
READY FOR IT.**

CIRCLE 4 ON READER-SERVICE CARD

**AMPEX**

Ampex Corporation, Magnetic Tape Division  
401 Broadway, Redwood City, California 94063 415/367-3887

**Now there is a speaker whose principal limitation is the source material itself.**

**Infinity's Quantum Reference Standard. \$6500.**

At Infinity, over the years of our young corporate life, we've spared neither time, ingenuity nor financial commitment in obsessive pursuit of our objective: the world's most accurate speaker system.

Our first speaker system ten years ago—the Servo Statik—became an instant legend in the audio world. Its sound was, and is, magnificent (although admittedly, a diva's temperament was not its most endearing quality).

Our Quantum Line Source introduced the technology of our EMIT™ Electromagnetic Induction Tweeter and the Infinity/Watkins Dual-Voice-Coil Woofer™\*, broadening the parameters of high and low-frequency reproduction.

And now the Quantum Reference Standard introduces the most important midrange advance in our history: EMIRM™, our Electromagnetic Induction Ribbon Midrange driver—in a speaker whose accuracy is no less than astonishing.

Each speaker of the mirror-image pair employs EMIRM, as well as EMIT, in dipole line-sources of 186 cm, resulting in a homogenous, coherent source of mid and high-frequency energy.

The QRS woofer extends the Watkins principle to a diameter of 38cm/15" to further increase power-handling at very low frequencies: from below 20 to 80 Hz.

An electronic crossover and equalization control center allows one to help compensate for varying listening environments and program material. Hinged baffles aid in facilitating stereo imaging under different listening conditions.

What does it all add up to? A speaker system with better transient performance, lower coloration, smoother and more extended response, better stereo imaging and higher power-handling capacity than any we have ever heard (our own Servo Statik included).

Response is 17 Hz through 32 kHz  $\pm$  2 db. QRS performs optimally with other state-of-the-art components; we recommend an amplifier of at least 100 watts per channel for the mid and high-frequency sections and one of at least 150 watts for the bass section.

A virtuoso performer, QRS can comfortably deliver jackhammer rock at levels guaranteed to straighten your cochlea; it can reveal seldom-heard warmth and presence in the human voice; it can reproduce the sound of the full symphony playing at full volume—with every section delineated, every color and nuance articulated.

So precise is QRS that one can distinguish the kind of concert grand being played; clearly hearing the difference between the crisp, centered tone of the Steinway and the romantic sonority and bravura of the Blüthner.

If you want to know more, please ask an Infinity dealer (or ask us) for a QRS brochure.

But if, like most of us, you don't happen to have an extra \$6500 in the cookie jar, don't despair; there are other speakers bearing the Infinity name, technology and performance standards, and they range in cost down to a little more than \$100. Each is incomparable at its price.

Few of us can afford the Reference Standard. But there's a Quantum for everyone.

 Infinity

We get you back to what it's all about. Music.

©1978 Infinity Systems, Inc., 7930 Deering Ave., Canoga Park, CA 91304. (213) 883-4800  
TWX (910) 494-4919. Manufacturer's suggested retail price is optional with dealer.  
\*Manufactured by Infinity Systems, Inc. under license from Watkins Engineering.



"get you high." Undaunted by his decision, I induced several of the station's DJs to play the song while he was away. (He was eventually relieved of his position—after getting me first.)

The response to "Captain Jack" was overwhelming. It became WMMR's most requested song, beating "Under My Thumb" by the Rolling Stones. The general manager finally let us play the song after 6:00 p.m., when, he reckoned, no one listening would be offended. No one was, and the rest is history.

They say nice guys finish last. Not Billy—he's No. 1 on my charts, and I'm happy to see his new album just went platinum.

Dennis Wilen  
Hollywood, Calif.

As a new reader of HIGH FIDELITY, I wanted to let you know how much I enjoyed the article on Billy Joel. I would like to get my hands on his "Cold Spring Harbor" album, which the article said is now a collector's item. Do you know where I can find it?

Bill Hutton  
Douglaston, N.Y.

A mere 60,000 copies of "Cold Spring Harbor" were initially distributed, and that was seven years ago. The only thing we can suggest is to plow through as many cutout bins as you can. (Sorry, our copy's not for sale.)

#### DG Double Standard?

Harris Goldsmith's strictures about the surfaces on Martha Argerich's new DG recording of the Chopin preludes [February] moved me to write that I am pleased to see your reviewers are commenting on what we, the collectors, have noticed for some time: a deterioration of Deutsche Grammophon pressing quality. The list of my recent bad DG purchases would be a long one.

I heard a nasty rumor that the company has two sets of quality-control standards: one very stringent, for the "sophisticated" European market, and another less stringent, for the U.S. market. Would DG—which recently increased the price of its records again—care to comment?

A. Finkstein  
Boston, Mass.

Yes it would. We consulted Deutsche Grammophon and were told that all pressings for the French, German, and U.S. markets are done at the Hannover, Germany, plant. The quality-control stage occurs well before the recordings are sorted into market groups. The DG spokesman acknowledged that an occasional lemon is likely to get into any batch, and reiterated that DG records are unconditionally guaranteed against manufacturing defects and that discs with such defects may be exchanged at the place of purchase.

#### Rosita Renard Remembered

It pays to read HIGH FIDELITY with fidelity. After hunting for twenty-nine years, I finally obtained the recording of Rosita Renard's 1949 concert, Harris Goldsmith's somewhat too easy dismissal of her playing in "Gems and Curios from the International

It's true. Quanta turntables by BSR are good looking. But many people think our specs are even better than our bodies.

For instance, consider the 500. It's a single-play turntable with an exclusive feature. "The Final Touch." What is it? Well, at the end of a record, the power shuts off. Then, magically and silently, the arm rises from the record and returns to its rest position. Automatically.

The 500 is made with DC Servo-Controlled Motor, which is the quietest motor made. It's belt driven. And it's got electronic speed control to assure you constant record speed. Wow and flutter are less than .06% (WRMS). Rumble is better than -65 dB (Din B).

If you like those specs but prefer a multiple play turntable, then think about Quanta's 550-S.

Of course, both the 500 and the 550-S have a few things in common with our other Quanta turntables. Great value as well as great beauty. So come take a look at the entire Quanta line at your nearest Quanta dealer.

We give you a lot to choose from because we want you to like us for more than our good looks.

**BSR**

BSR CONSUMER PRODUCTS GROUP  
Route 303, Blauvelt, N.Y. 10913

## Beauty and the best.



**QUANTA**<sup>TM</sup>  
by BSR

CIRCLE 8 ON READER-SERVICE CARD

**TDK**  
MADE IN JAPAN

**AKAI**  
METAL FEEL  
MADE IN JAPAN

**AKAI**

**PI 1000**  
6-TRACK STEREO

POWER REEL SIZE AUTO PLAY TAPES SPEED CUE PAUSE REC

**AKAI**

P/B HEAD EQUALIZER METER SELECTOR MONITOR

PLAYBACK OUT INPUT 1/LEFT INPUT 2/PAN INPUT 3/PAN INPUT 4/RIGHT MASTER VOLUME

REVERSE LEVEL INPUT 1 SELECTOR INPUT 2 SELECTOR PAN PAN INPUT 3 SELECTOR INPUT 4 SELECTOR BIAS

AKAI's Pro-1000



# IT TOOK THE BEST HEADS IN THE INDUSTRY TO MAKE AKAI'S NEWEST PROFESSIONAL DECK.

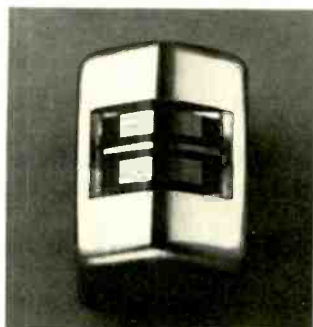

1/2 track GX record head

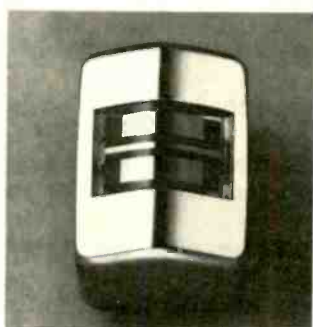

1/2 track GX playback head

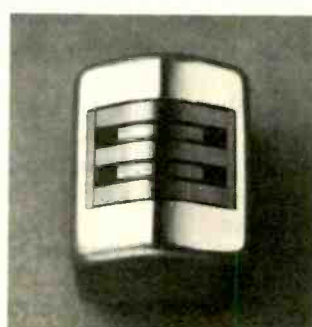

1/4 track GX playback head

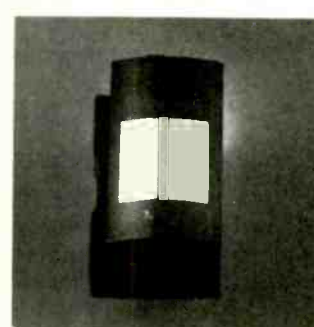

Erase head

For years, AKAI's patented glass and crystal heads have been making recording history. Not only for unsurpassed sound quality, but for unequalled wearability as well. Guaranteed, in fact, for 150,000 hours; the equivalent of playing 24 hours a day for almost 17½ years.

Now AKAI puts its heads together in the deck designed to put greater frequency response, more dynamic range — and more creative flexibility — into the hands of the people who know how to use it. The result: the Pro-1000. The four head, 2-track mastering machine that's as much at home on location as it is in the studio. The deck with such tremendous head room that it's virtually impossible to overload a good quality tape. The deck with specs and features that speak for themselves. See the Pro-1000 at your AKAI dealer or write AKAI America, Ltd., 2139 E. Del Amo Blvd., P.O. Box 6010, Compton, CA 90224. But do it soon. Because it's already turning the heads of a lot of people.

**FEATURES**  3 Motors  3 Speeds  4 Heads  1/2 Track Record/Play and 1/4 Track Play  10½" Reel Capacity  Large Illuminated 40 dB meters; read Peak, VU, and Bias  Four In./Two Out Mixer, built-in  Panpots  20 dB Microphone input attenuators  Variable EQ and Bias controls  Special inputs for outboard noise reduction units, i.e. "DOLBY," "DBX."  Double Capstan, Closed Loop Drive System  Remote Control operation (optional RC-17 or RC-18)  Feather touch, full logic solenoid control system  NAB playback standards  Fade-in and fade-out controls  Separate sections for tape transport and tape amplifier with heavy duty carrying handles on both sections  Pre-set clutches on all input level controls

**SPECIFICATIONS** Wow and Flutter 15 IPS: 0.025% WRMS, 7½ IPS: 0.04% WRMS, 3¾ IPS: 0.08% WRMS  Frequency Response 15 IPS @ 0 VU: 40-24 KHz ± 1 dB, 7½ IPS @ 0 VU: 50-20 KHz ± 3 dB, 3¾ IPS @ 0 VU: 60-12 KHz ± 3 dB  Overall Distortion Not more than 1% @ 1 KHz @ 0 VU for all speeds  Signal to Noise Ratio 62 dB  Heads (4) 1/2 Track GX Record, 1/2 Track GX Playback, 1/4 Track GX Playback, Full Track Erase  Motors (3), (1) AC Servo Capstan Drive Motor, oil circulating, center pole generated (CPG). (2) Eddy Current Motors, for fast forward and rewind, oil circulating  Inputs Microphone (4), Line (4)  Outputs Line (4), Mixer (2), Headphone (1).

# AKAI

TDK L3600M tape (3600 ft.) free with Pro-1000 — a \$35 value.

7,2,4, **NEXT RECORD**, 1,1,3, **NEXT RECORD**, 1,  
 5,6,2,4, **NEXT RECORD**, 2,4,4, **RAISE RECORDS**.

That's Microprocessor language. The language of the new Accutrac®+6.

The message?

Play tracks 7, 2 and 4 in that order on the first record. Then, track 1, 1 again and 3 on the next record. And so on.

The Accutrac+6 is the only turntable in the world that offers you computerized, customized listening. So you can hear the tracks on each of the six records in any order you like, as often as you like, even skip the tracks you don't like.

And you never have to touch the tonearm to do it, because the Accutrac+6 is engineered with a computerized "hands-off" tonearm.

In fact, once you close the dust cover you never have to touch the records or tonearm again to hear your programmed selections.

But the brain in the Accutrac+6 is smart enough to do even more: it doesn't drop your records!

No more "plop!" The Accutrac+6 is engineered to protect your records. It lowers each record v-e-r-y g-e-n-t-l-y onto the platter. Like an elevator.

And since elevators go up and down, so does the Accuglide™ Spindle. Just touch the "raise record" key, and it lifts all six records back up to the starting position.

If you think you've had enough miracles for one day, here's another one:

With Accutrac+6 model 3500R you can control everything from across the room with a full-system remote control transmitter and receiver. There's even remote volume control on model 3500RVC.

No other 6 record system gives you the record safety, convenience and control of the new Accutrac+6. But the truly incredible feature of the new Accutrac+6 is its low price. From under \$300\* for model 3500.

So forget everything you know about 6 record systems. And remember to see the new Accutrac+6. It's as easy to operate as 1, 2, 3.

**ADC Accutrac+6**  
 A BSR Company

\*Price shown in this ad is approximate. Selling price is determined by the individual dealer. ©Accutrac is a registered trademark of Accutrac Ltd.  
 ADC Professional Products. A Division of BSR Consumer Products Group, Rte. 303, Blauvelt, N.Y. 10913.

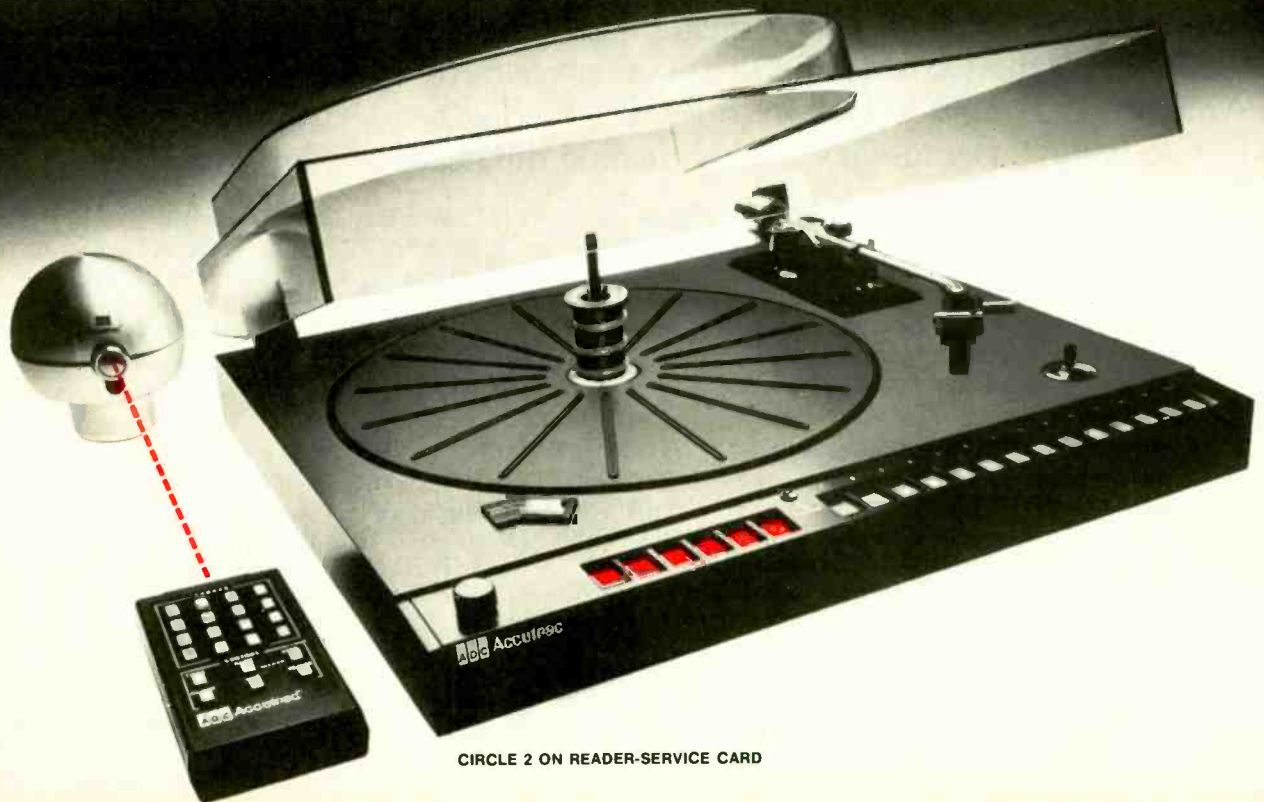

CIRCLE 2 ON READER-SERVICE CARD

Piano Archives" [February] notwithstanding.

I attended that concert, and IPA 120/1 is a fine document of that final recital. (Revard died a few months after this appearance.) The mono sound quality paints an accurate picture of Carnegie Hall and renders a true remembrance of a lovely musician.

Curtis Michel  
New York, N.Y.

### Who's Got the Fibich?

In the winter of 1975-76 we visited the Prague National Opera and heard *Sárka* (1897), a masterly work by Zdeněk Fibich. A local store was selling an old Supraphon recording of the work, but regrettably we failed to purchase it at the time. Since then we have been unable to find either this recording or any other Fibich works on disc. (We've been told his melodrama, *Hipodamia*, was once recorded.) We would be most grateful if you or your readers could assist in locating any such recordings of the music of Smetana's worthy successor in music drama.

Mark Germer  
Alain Klein  
Cincinnati, Ohio

The only Fibich listing we find in the current Supraphon catalog (not terribly handy, since its arrangement is strictly numerical) is a disc coupling his F minor Piano Trio and D major Piano Quintet (1 11 1617). Perhaps other recordings remain available in Czechoslovakia that are not included in the export catalog and, then again, perhaps not; in any event, nothing else seems to be available "from the source." Maybe other readers can shed some light on this subject.

### Karajan vs. Masur

Please! Enough of this lip service to your advertisers. By printing Harris Goldsmith's review of the new Deutsche Grammophon recording of Beethoven's symphonies [February], you persist in the seemingly endless attempt by the media to pass off Herbert von Karajan as a major conductor. The man is little more than a hack. His early career was founded on how many women, sports cars, planes, and orchestras he could drive too fast. Now it seems that his silver years are to be judged on how many times he can record the Beethoven symphonies. How many millions of dollars were wasted on Herbert's meditations this time? I've never heard of anything so absurd! Endless tapings and study! Where are the repeats?

Give the money to Kurt Masur. He could record half the standard repertoire with what DG has wasted this time. Where is your review of Masur's Beethoven? Are you waiting for the corporate go-ahead?

Laurance Maney  
Chelsea, Vt.

We did review Masur's Beethoven symphony cycle, in December 1974. Unfortunately the album, a limited run by JVC, is no longer available in this country.

# Is it live, or is it Memorex? Well, Melissa?



We put Melissa Manchester to the Memorex test: was she listening to Ella Fitzgerald singing live or a recording on Memorex cassette tape?

It was Memorex with MRX<sub>2</sub> Oxide, but Melissa couldn't tell.

It means a lot that Memorex can stump a singer, songwriter and musician like Melissa Manchester.

It means a lot more that Memorex can help you capture and play back your favorite music the way it really is.

**MEMOREX** Recording Tape.  
Is it live, or is it Memorex?



© 1978, Memorex Corporation, Santa Clara, California 95050, U.S.A.

CIRCLE 25 ON READER-SERVICE CARD

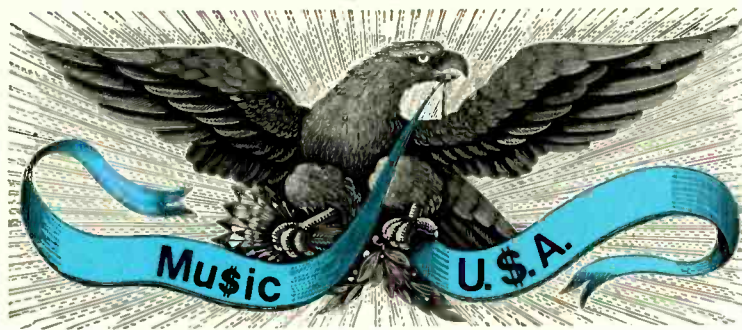

## 15. England's Music: Doing Without

by Gene Lees

IN THE EFFORT to discover why the English are such an amusical people, one might be tempted to lay responsibility at the feet of Cromwell and Calvinism. Under Cromwell, dancing was forbidden. Choral singing was banished from churches by the Puritans, which had the effect of cutting children off from one of the most affecting kinds of early musical exposure. Indeed the Puritans seem to have done their best to ban pleasure of all kinds from the nation's experience. One wonders if it was during this period that English cooking acquired its world-famous dullness, its stalwart avoidance of anything pleasing to the palate. (Winston Churchill, who employed a French chef, once said that his patriotism had nothing to do with the national cuisine.)

I am smiling slightly as I write that, but I am not being facetious. Having been raised in an English family—my parents and grandparents were born in England—I have for years been amused by the peculiar pride the English seem to take in how much they can do without. Their tasteless cooking, for which I have a perverse affection through childhood conditioning, in my opinion bespeaks a national attitude, as do their ill-heated homes.

The idea that Calvinism is responsible for England's lack of musicality seems to gain credibility when you consider that the doctrine also took strong root in Switzerland, whose contributions to music have been comparably minor. Beyond Arthur Honegger, Othmar Schoeck, Frank Martin, and Ernest Bloch, they have given us little in classical music—and Bloch was Jewish.

The Swiss, whose population is

mostly of French, German, and Italian lineage, certainly do not share ethnic origins with the English. They do share with them a brisk, no-nonsense industriousness and a passion for order, although these qualities may now be breaking down in the English. If either nation had disappeared from the face of the earth in, say, the fifteenth century, the history of music would have been altered hardly an iota. Handel would have been spared London winters, and we in more recent times would have been spared a fifteen-year flood of English imitations of American popular music.

But the problem, I think, goes deeper than Calvinism, though it may well have been a contributing factor. Consider for a moment the difficulty the English appear to have in communicating emotion and even in experiencing it freely. It is evident in much of their literature: in plays such as *The Browning Version* and *Hobson's Choice*; in novels such as *The Four Feathers*, *Good-by Mr. Chips*, and certainly those of D. H. Lawrence, who was preoccupied with the escape from inhibition and the attainment of feeling; and even in those music-hall poems of Marriott Edgar that Stanley Holloway recorded for *Angel* some years ago, such as *Albert and the Lion*, a devastating parody of English parents' lack of feeling for their children.

The latter characteristic seems to predate Calvinism. In a book called *A True Account of the Island of England*, an Italian diplomat who had been posted there wrote, in about 1500:

I have never noticed anyone, either at court or among the lower orders, to be in love: Whence one must con-

clude either that the English are the most discreet lovers in the world or that they are incapable of love. . . . The want of affection in the English is strongly manifested towards their children: For after having kept them at home till they arrive at the age of seven or nine years at the utmost, they put them out, both males and females, to hard service in the houses of other people and few are born who are exempted from this fate, for everyone, however rich he may be, sends away his children into the houses of others, whilst he, in return, receives those of strangers into his own.

The custom of sending children away was formalized in the English public school system—what we call private schools—whose cruelties have been recounted in various novels, including *Tom Brown's Schooldays*. Compare this with the way the Italians raise their families. Or visit a park in Paris and observe the way French mothers hover protectively while their children play.

Compare the formal, distant handshake with which the English greet each other with the back-slapping and hugging of the Italians, the Mexicans, and the Brazilians. Latin Americans want to stand much closer when they are talking with you than Anglo-Saxons do.

The last overlay on the ethnic body we now call the English was Viking. Danish Vikings invaded; later, the so-called Norman French—actually Vikings who had been in northwestern France for 150 years—conquered the country. When William defeated Harold at Hastings in 1066, it was a matter of one Viking group knocking over another. The Vikings, for all their ferocity, had democratic leanings. Indeed they established in Iceland what is now the oldest parliament on earth. They had a well-defined jury system for trying both criminal and civil cases. And they had a genius for organization. Their imprint is on England—and on all the English-speaking countries—to this day.

The Scandinavian countries, as well, have strong democratic tendencies but weak musical ones. The best they have given us were Berwald, Grieg, and Nielsen. (Sibelius, a Finn, was not of the same ethnic stock. The Finns have the same tribal origins as the Estonians and Hungarians.)

England, Switzerland, Norway, Sweden, and Denmark. Is there a connection between the facts that these countries have democratic traditions and that they have produced little if any important music? I suspect there is, and I will explore the links in the next issue.

# We admit that the Sansui G-9000 is not the world's only great DC receiver...



The Sansui G-9000 is, without doubt, a great receiver — perhaps the most advanced receiver available today. Never before has music reproduction been so clean, brilliant and true. Just listen to a pure power G-9000. You will actually hear its distinctly superior performance. Now look at the specifications and you'll understand why.

The amplifier section (patent pending) is genuine DC: its frequency response extends all the way from 0Hz (DC) to 200kHz (from main-in, -3dB). It is also Direct Coupled (which means no capacitors in the signal path or negative feedback loop) for fastest response to all musical signals. The slew rate is extraordinarily high, 80V/ $\mu$ sec. — with a rise time of 1.4 $\mu$ sec.

Our sophisticated amplifier design virtually eliminates distortion. Total harmonic distortion is all the way down to 0.02% at full rated power: 160 watts per channel, min. RMS, both channels driven into 8 ohms from 20-20,000Hz.

Such outstanding specifications ensure superb music reproduction. And we at Sansui believe that your audio components must also provide great creative versatility and be a pleasure to operate. So through long months of research and testing, we've developed a receiver that is truly human engineered. The full complement of controls are beautifully positioned and outstandingly accurate. Just touch them and fall in love with the special "Sansui feel."

Why then, with the unmatched specifications, incomparable design, and the amazingly reasonable suggested retail price (\$1,050) of the G-9000, don't we at Sansui claim exclusive superiority for the G-9000? Because...

Sansui

## The State of the Art— Where Is It Now?

It is probably a good idea that those of us involved in high fidelity music reproduction remind ourselves regularly that the key word in the phrase denoting our chosen endeavor is "music." This is especially true when we are appraising the sea of equipment onto which technology has launched us, for while ideals such as the distortionless amplifier or massless phono stylus will prove forever elusive, the industry can produce auditory illusions good enough to fool most ears most of the time.

But of course *illusion* remains the crux of the game, as anyone given to walking about while listening to his stereo system can readily confirm. The sound may be quite convincing when one is stationary and reasonably placed in front of the speakers, but listening while moving to or from a remote location or one that is far off axis will convince the most optimistic audiophile that acoustic holography, which would replicate the sound field of the recording environment in the listening environment, is still far in the future. But then, with the present quality of the illusion, who needs it?

One of the legendary (or apochryphal) makers of audio *bon mots* has said, "If two components reproduce the same music with a different sound quality, one of them is at fault, and probably both are." But what would he say of components that are so close in sound as to defy the listener to distinguish between them? Are they perfect? Or is there some technological "barrier" on which all components of that type will finally hang up? And if differences are discernible, what is their significance?

By and large, though often inflated by overly subjective product reviews, the differences between competing electronics of similar quality are quite subtle, not to say microscopic. And transducers (phono cartridges, microphones, loudspeakers, tape heads, etc.), the only area in which many significant differences can still be found, are beginning to catch up. We noted recently, for example, that many of our favorite discs, having been played numerous times and with a wide variety of phono cartridges—all of high quality—still sound excellent and not at all lacking when compared to brand-new discs. Moreover, sonic distinctions between cartridges designed for top-of-the-line status have become exceedingly small. Loudspeakers, too, have fewer problems than one might think. We'll have more on that next month.

But what about the differences in sound, even the little ones? Don't they matter? In one way, yes: If you change loudspeakers, it is bound to take a while to get used to the new sound. But that would very likely be true as well if you couldn't reserve your favorite seat in a concert hall and had to settle for an unfamiliar location.

Ultimately we are talking about personal preference. At a live musical event, some people are "front sitters" and some are "back sitters." It seems reasonable to suppose that they probably want their home music systems to be consistent with their live preferences, but no one system, however "perfect," is going to satisfy both groups. Science can tell us how to design hardware and hook it together to get close to the result we want. Beyond that, decisions are matters of art to be made by ear. Comfortingly, with equipment as well engineered as it is, no one is likely to go far wrong via that route.

## JVC Nudges Technology On

JVC's appraisal of the state of the art in audio apparently is not too different from our own. One engineer who spoke to us at a recent company technical seminar noted that basic performance in amplifiers and tuners—and to an extent in tape equipment—is very close to being as good as it will get, at least in the foreseeable future. JVC has concentrated most of its research effort of late on particular details whose effects lie mostly in the "small but significant difference" category. Thus some of the company's new equipment will contain digital power supplies (whose superior regulation and dynamic behavior should help to upgrade amplifiers), DC amplifiers (whose minimal use of capacitors—which can contribute to distortion—will help to simplify the signal path), and a plasma-display audio level meter (whose virtually instantaneous response assures that it will indicate program peaks correctly).

More dramatic was a phase-tracking loop FM detector, which incorporates properties of the phase-locked loop and the quadrature detector. As such it can be adjusted for a particular tradeoff between selectivity and bandwidth. Furthermore, since the oscillator used in a PLL configuration contributes noise, a tuner using a PTL (which needs no oscillator) should have a better quieting curve. Most surprising was the extraordinary degree to which a PTL tuner can disentangle stations on the same channel.

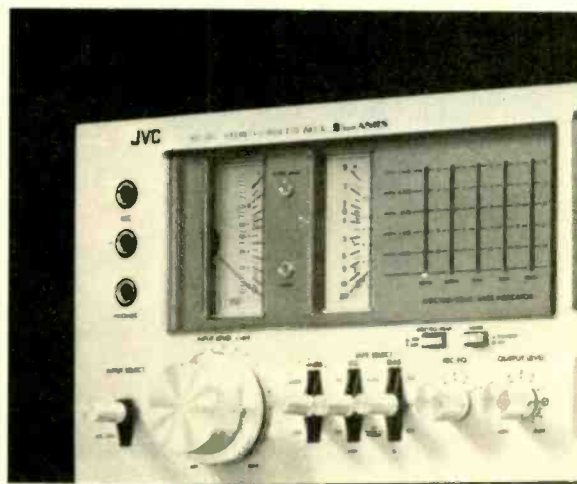

KD-85 cassette deck features Spectro Peak Indicator

Another area full of interesting developments is loudspeakers. JVC has been using computer simulation of wave propagation from tweeters. Now, with another computer simulation, its engineers "observe" the behavior of loudspeaker cones as they vibrate at various frequencies.

Possibly the biggest news of the day, however, was that

JVC has joined the few hardware manufacturers with recording and erase heads capable of handling metal-particle tape. Though the introduction of decks equipped with these heads probably will be delayed until tape manufacturers have settled certain points of standardization, this new development is not far away and bids to put cassette equipment almost on a par with open-reel decks.

For closing the gap between potential and realized performance with any tape—present or future—JVC has produced the Spectro Peak Indicator: essentially a five-band real-time analyzer that displays the spectrum of the music and allows the user to set recording levels so that overloads do not occur in any band yet maximum use is made of the tape's headroom. Likewise, adjustable recording EQ, a feature to be included in new JVC cassette decks, will enable each tape type to deliver its best frequency response without the need for adjusting the bias away from the point of minimum distortion.

All of this activity on the part of just one company (and even more was revealed) instills confidence in us that high fidelity equipment will keep on getting better. It is likely, however, that the improvements will be won with difficulty by gleaning small gems from obscure corners—at least until digital audio is ready for its consumer debut.

## Also . . .

Recognizing that the lack of a sound finance plan is often a major obstacle to prospective buyers of Tascam Series recording equipment, Teac has arranged with FinanceAmerica, a service company of BankAmerica, to allow qualified customers to make such purchases on credit. FinanceAmerica indicates that, in addition to the usual information required to obtain credit, an applicant will be asked to list the name of an agent or personal manager, union card number, and past, present, and future bookings. The plan, which Teac calls an industry first, thus takes the financial realities of a musician's way of life into account and considers potential as well as current earnings in judging creditworthiness.

Peerless Audio Manufacturing Corporation, well known as a supplier of loudspeaker drivers to systems manufacturers, has announced that for the first time some of its products will be made available under its own brand name. The Mix & Match line, as Peerless collectively dubs the products, will be sold through dealers in the U.S. and Canada.

---

## Equipment in the News



### High-power amp from A.E.A.

Analogue Engineering Associates has produced a power amplifier, the A-620, said to deliver 325 watts (25% dBW) per channel from 5 Hz to 40 kHz with no greater than 0.05% intermodulation distortion. A.E.A. attributes this output to its power supply, rated at 4 kilowatts. Two front-panel power output meters are calibrated in watts into 8 ohms or in a linear decibel scale at the touch of a switch. LEDs on the meters indicate short-term transients or high-power conditions. A three-position sensitivity switch is included, along with a gain control and reset switch for the protector circuit. The A-620, in a rack-mountable case, costs \$1,090.

CIRCLE 141 ON READER-SERVICE CARD

### Synergistics introduces speaker series

The S-42A bookshelf speaker is one of eight systems in the A Series from Synergistics, a new name in speaker manufacturing. The S-42A, a three-way model, employs a 10-inch woofer, 4-inch midrange, and 2½-inch tweeter. Rated frequency response is 28 Hz to 20 kHz with cross-overs at 1,500 and 7,500 Hz. The recommended power range is 10 to 100 watts (10 to 20 dBW). A Series speakers range in price from \$100 to \$600, the S-42A falling in at \$230.

CIRCLE 142 ON READER-SERVICE CARD



# To get a superb performance, you need a precision machine.

To command a great performance, a cassette shell and cassette tape must be engineered to the most rigorous standards. Which explains why we get so finicky about details. Consider:

**Precision Molded Cassette Shells**—are made by continuously monitored injection molding that virtually assures a mirror-image parallel match. That's insurance against signal overlap or channel loss in record or playback from A to B sides. Further insurance: high impact styrene that resists temperature extremes and sudden stress.



**Five-Screw Assembly**—for practically guaranteed warp-free mating of the cassette halves. Then nothing—no dust or tape snags—can come between the tape and a perfect performance.

**Perfectly Circular Hubs and Double Clamp System**—insures there is no deviation from circularity that could result in tape tension variation producing wow and flutter and dropouts. The clamp wedges the tape to the hub with a curvature impeccably matched to the hub's perimeter:

**An Ingenious Bubble Surface Liner Sheet**—commands the tape to follow a consistent running angle with gentle, fingertip-embossed cushions. Costly lubricants forestall drag, shedding, friction, edgewear, and annoying squeal. Checks channel loss and dropouts.

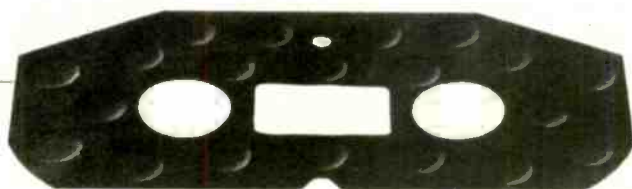

**Head Cleaning Leader Tape**—knocks off foreign matter that might interfere with superior tape performance, and prepares the heads for...



**Tapered, Flanged Rollers**—direct the tape from the hubs and program it against any up and down movement on its path towards the heads. Stainless steel pins minimize friction and avert wow and flutter; channel loss.

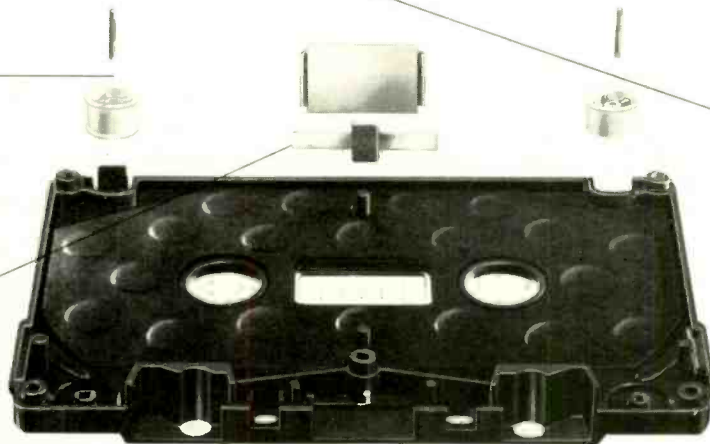

**Our famous SA and AD Tape Performance**—two of the finest tapes money can procure are securely housed inside our cassette shells. SA (Super Avilyn) is the tape most deck manufacturers use as their reference for the High (CrO<sub>2</sub>) bias position. And the new Normal bias AD, the tape with a hot high end, is perfect for any type of music, in any deck. And that extra lift is perfect for noise reduction tracking.

**Resilient Pressure Pad and Holding System**—spring-mounted felt helps maintain tape contact at dead center on the head gap. Elegant interlocking pins moor the spring to the shell, and resist lateral slipping.

TDK Cassettes—despite all we put into them, we don't ask you to put out a lot for them. Visit your TDK dealer and discover how inexpensive it is to fight dropouts, level variation, channel loss, jamming, and other problems that interfere with musical enjoyment. Our full lifetime warranty\* is your assurance that our machine is the

machine for your machine. TDK Electronics Corp., Garden City, N. Y. 11530. Canada: Superior Electronics Ind., Ltd.



**TDK**  
The machine for your machine.

\*In the unlikely event that any TDK cassette ever fails to perform due to a defect in materials or workmanship, simply return it to your local dealer or to TDK for a free replacement.

CIRCLE 40 ON READER-SERVICE CARD



## Sherwood's new tuner, the HP-5500



The HP-5500 stereo tuner from Sherwood has dual cross-coupled audio amplifiers. The IF, detector, and multiplex sections, which are designed without coils, are said to be permanently aligned for minimum noise and distortion. FM sensitivity is rated at 1.6 microvolts for 30 dB of quieting. A 75/25-microsecond de-emphasis switch is provided on the front panel, as well as FM muting and noise filter switches and a tape recording jack. Meters include signal strength, center tune, and Sherwood's proprietary Positune indicator. The HP-5500 has walnut-veneer end panels and is priced at \$500.

CIRCLE 145 ON READER-SERVICE CARD

## DBX 100: a boon for bass nuts

Now available to consumers from DBX is the Model 100 Boom Box, a subharmonic synthesizer designed to generate low-frequency signals and enhance bass reproduction. It works, according to DBX, by duplicating signals in the region between 55 and 110 Hz one octave lower (i.e., 27.5 to 55 Hz) and mixing them back into the program, using the tape monitor loop. This action is governed by a low-frequency boost control and by a level control that regulates the amount of synthesized signal fed back to the program. Also provided are a bypass switch and an LED to indicate when subharmonics are being added. The price of the DBX Model 100 is \$199.

CIRCLE 144 ON READER-SERVICE CARD



## Features abound in Yamaha amp

Yamaha's Model CA-610 II integrated amp has features for the audiophile and amateur alike. A phono equalizer section includes a subsonic filter and has a rated frequency range of 30 Hz to 15 kHz,  $\pm 0.3$  dB. The defeatable bass and treble controls of the tone-control amp offer two turnover frequencies each. The power amp section is said to deliver 45 watts ( $16\frac{1}{2}$  dBW) into 8 ohms from 20 Hz to 20 kHz with no more than 0.05% total harmonic distortion. Front-panel features include output level meters for an 8-ohm load—with switchable sensitivity range—and a high filter switch. For the purist, another switch (MAIN DEFEAT) allows the signal from the equalizer or tuner to be fed directly to the power amp via the volume and balance controls. The price of the CA-610 II is \$290.

CIRCLE 143 ON READER-SERVICE CARD

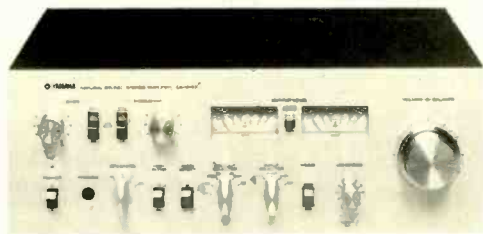

## New Criterion from Lafayette

Lafayette's latest line of Criterion speakers, called Series 3000, all project high frequencies through Heil Air-Motion Transformers. The Model 3002 uses in addition a 10-inch woofer and 10-inch foam-edged passive radiator. Its recommended power range is 20 to 160 watts (13 to 22 dBW), with a rated frequency response of  $\pm 3$  dB, 35 Hz to 25 kHz. The single crossover is at 2 kHz. Model 3002 has a walnut-veneer cabinet and costs \$239.99. The two other speakers in the line, the 3001 and 3003, cost \$199.99 and \$299.99, respectively.

CIRCLE 146 ON READER-SERVICE CARD



# Nikko Sounds as Professional as it Looks

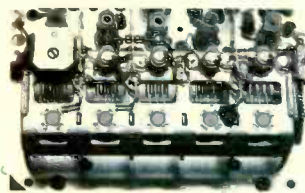

5-gang capacitor

Alpha II amplifier.

One look at the front panel controls and it is obvious these units possess an unusual combination of creative features. Nikko engineers also developed the advanced technology you can't see.



Toroidal power transformer

only the signal you want to hear.

The thinline Beta I preamp employs high voltage FET's for exceptionally fast signal reaction and extremely high efficiency and linearity in the high frequency range. A toroidally wound power transformer reduces hum radiation while the phono overload rejection capability is one of the highest ever measured.

If you thought Nikko only makes rock-solid, quality-built receivers, we have some pleasant surprises.

For the discerning listener, we present a selection of rack-mountable stereo components from Nikko Audio's Professional Series. The Gamma I FM tuner, The Beta I preamp and the

On the Alpha II amplifier, totally independent, dual power supplies offer far greater dynamic range and lessened crosstalk than the usual split single power supply and significant headroom. (120



Dual power supplies

watts per channel, both channels driven into 8 ohms, from 15 Hz to 20 kHz with THD and IM distortion a phenomenally low 0.03%.)

These are but a few examples why Nikko sounds as professional as it looks. Nikko designs and builds all its stereo equipment with dedication to total reliability, highest quality and superb performance. And the price is

always affordable.

Take another look at the features and controls. Then visit your Nikko dealer and experience true professional sound.

Available with black or brushed aluminum front panel

## Nikko Audio

For those who take their stereo seriously

Nikko Electric Corp. of America  
16270 Raymer St., Van Nuys, Calif. 91406 (213) 988-0105  
In Canada: Superior Electronics, Inc. © Nikko Audio 1978

# WHY YOU OUGHT TO INVEST IN A FISHER SPEAKER SYSTEM RATHER THAN SOMEBODY ELSE'S.

Building a great speaker is something like building a great violin. Although there are many violin manufacturers, the design artistry and painstaking craftsmanship of the Stradivarius won it the reputation as the world's finest.

Making speakers, like making fine musical instruments, is something of an inexact science . . . even with today's computers. It still takes artistry, craftsmanship, and most of all, experience to produce a great sounding speaker.

Our new Studio Standard ST400 series speakers, manufactured at our modern speaker plant in Milroy, Pa., are the culmination of everything we've learned in producing hundreds of thousands of speakers. At the top of this new line is the ST461 — a speaker that critical listeners consistently rank among the two or three best they've ever heard.

The ST461 combines the staggering bass capability of the 15" Fisher model 15130 woofer, the flawless midrange of two 5" model 500 midrange drivers, and the ultra-high definition of the 3" model 350 horn tweeter. Plus a precision crossover network with adjustable midrange presence and treble brilliance,

and a resettable circuit breaker overload protector. All in a beautifully finished genuine walnut cabinet, at the reasonable price of \$350\*. Other ST400 series speakers start at \$120\*.

So, if you'd like to own the "state-of-the-art" in speakers, listen to Fisher's new ST400 series.

Fisher components are available at selected audio dealers or the audio department of your

favorite department store. For the name of your nearest dealer, call toll-free 1-800-528-6050, ext. 871 from anywhere in the U.S. (In Arizona, call toll-free 1-955-9710, ext. 871).

\*Manufacturer's suggested retail value. Actual selling price is determined solely by the individual Fisher dealer.

 **FISHER**

The first name in high fidelity.



## Replacement channels in A.E.C. amp



The Thomas 7 amplifier from A.E.C. employs independently wired channels, allowing continuous sound in case of failure in one channel and user-replacement of the defective channel. Malfunction is indicated by a caution light. The user can snap out a bad channel, return it to the company, and receive a replacement. This feature, which permits a spare channel to be kept on hand, is also said to prevent obsolescence, as the channels can be updated. The Thomas 7 amp has a power-output rating of 200 watts (23 dBW) per channel, from 20 Hz to 20 kHz with 0.1% total harmonic distortion. It costs \$1,400 with meters and two-step power controls; a version without these features is available for \$975.

CIRCLE 148 ON READER-SERVICE CARD

## Auto/home speakers from Ultralinear

Ultralinear has unveiled a line of speakers called CARponents, although they have home as well as auto applications. The first model in this line is the M-15, which uses a 4½-inch bass/midrange driver and 1-inch soft-dome tweeter. The wood-core cabinet of the M-15 comes in either an ebony-matte or walnut-grain finish; both have perforated metal grilles. The speaker comes packaged with adjustable mounting brackets and costs \$99.95.

CIRCLE 147 ON READER-SERVICE CARD



## J. C. Penney's Modular Components

Modular Component Systems is the name of J. C. Penney's new series of high fidelity components. Included in the series is the Model 3253, a 53-watt (17¼-dBW) stereo receiver. The FM multiplex section uses a phase-locked-loop circuit and includes a low-pass filter. The preamp section offers tone controls with two-step turnover frequency selection and defeat switching, as well as two-step high and low filters. Rated frequency response of the power amp is 20 Hz to 20 kHz into 8 ohms with no more than 0.5% total harmonic distortion. Provision is made for tape monitoring and dubbing. Price of the 3253 is \$399.95.

CIRCLE 152 ON READER-SERVICE CARD



## First monitor speaker from Braun

Braun's first studio monitor speaker, Model L-1030, is now available in the United States through Adcom. Part of Braun's "high performance series," the L-1030 is a three-way, acoustic-suspension system using the same midrange and high-frequency drivers as the L-300 plus a new low-frequency transducer that the company credits with improved bass reproduction. The speaker also utilizes a new dividing network for smoother transition between drivers. Rated frequency response is 20 Hz to 25 kHz with a recommended power-handling range of 25 to 100 watts (14 to 20 dBW). The L-1030 is available in a walnut-veneer or black hardwood finish and costs \$420.

CIRCLE 150 ON READER-SERVICE CARD



## Clubman stereo home/pro mixer

Meteor Light and Sound Company's Clubman One-One M has all the features of a lightweight portable disco unit, including two VU meters, a turntable rumble filter, a talk-over switch, headphone jack, and microphone input. There are two slide pots for line-level sources, and a cross-fade slider as well. In addition, the One-One M has level controls for the headphone output and microphone input and cue circuitry for preview of program material on the channel not in use. The price is \$249.

CIRCLE 151 ON READER-SERVICE CARD



**FOR  
EVERY  
SYSTEM  
WORTH  
MORE THAN  
\$500**



If you've invested \$500 or even \$5000 in your high fidelity system, read on. Because what we have to say can have a lot to do with the quality of sound you're hearing.

Unfortunately, one of the most overlooked components in a fine sound system is the cartridge. And all too often, it can be the one place where you skimped on quality. (Out of sight, out of mind, as they say).

We sincerely believe that an investment in a Sonus cartridge will truly surprise you with the way it improves the quality of your record reproduction. The analytical quality of the Sonus brings out the inner voices of complex musical passages clearly and cleanly. Listening fatigue disappears. And a Sonus introduces no extraneous coloration of its own.

But what we're talking about is said even better by Sonus owners. "Excellent clarity," "more fulfilling sound," "open, airy 3-D sound," "superb depth and definition," "clean, accurate and transparent sound," are typical of thousands of enthusiastic comments we have received from owners of Sonus cartridges.

Make sure your cartridge matches up to the rest of your system. Write us for further information and the name of the Sonus dealer nearest you.

Manufactured in the U.S.A. by:

**SONIC RESEARCH, INC.,**

27 Sugar Hollow Rd., Danbury, Conn. 06810

**SONUS**

**High Definition Phono Cartridges**

CIRCLE 32 ON READER-SERVICE CARD



**Too Hot to  
Handle**

I recently purchased a Stanton 681EEE-S pickup to replace a Shure M-91ED. When I use the Stanton, which has an output of 0.74 millivolt, I have to turn the volume up considerably to get the same listening level as with the Shure, which has an output of 3.5 millivolts. Why is the Stanton's output so low, and what, if anything, can I do to use it without cranking the volume so high?—Jim Siniscalchi, Hamden, Conn.

According to our laboratory data (from CBS Technology Center), the Shure delivers an output of 5.4 millivolts (fairly high) tracking a groove at a recorded velocity of 5 centimeters per second; the Stanton under those conditions yields 3.5 millivolts (about average for a top model). The numbers you quote represent different reference levels and are not directly comparable. The actual difference is less than 4 dB, which should cause no problem unless the noise performance of your preamp is marginal. We see no reason to worry about the position of the volume control.

I listen to classical records through Koss ESP/10 earphones with a Lux PD-121 turntable and SME-3009/S2 tone arm with a Micro-Acoustics 2002-e cartridge. The preamp and amp are McIntosh, Models C-22 and MC-2100, respectively. I use a DBX Model 3BX expander.

My sound is beautifully clean except in louder choral passages, in which the middle and upper voices have a grainy texture. The amount of grittiness varies from one record to another. All components are new except the preamp, which is ten years old. The preamp tubes are good, and all tone arm adjustments check out properly. What could cause the grainy distortion of the choral voices? Can you suggest a solution?—Morris Reagan, Greenfield, Wis.

You may be overdoing it with the DBX 3BX expander. Because of the three-band nature of this device, the frequency balance of its output signal varies as it operates. Backing off a little on the amount of expansion might help. But the problem may well be with the records: Loud choral sound is not easy to record.

I recently purchased a set of Polk Audio sound cables, which according to Polk literature have received enthusiastic consumer response. Yet when I connected them between my Yamaha CA-600 and I. M. Fried Model Q speakers, there was no audible difference that I could discern. Are these cables any good—or is there a problem with my equipment?—Richard Abrams, New York, N.Y.

We are a little skeptical of "transmission line" speaker cables on theoretical grounds, but having done no tests, we cannot make

any definitive statements about them. We have arranged to test these cables and will report on them in a future issue. In any event, it appears that—like any cure—they can make an appreciable difference only if the system exhibits a demonstrable ill without them.

Testers of medium- to high-quality record-playing equipment write of the importance of compatibility of cartridge compliance and arm mass in matching the resonance and damping characteristics. I know that HIGH FIDELITY uses a standard arm and cartridge as a reference in testing different equipment, but this does not enable the average buyer to achieve a good match between the turntable/arm he has and the wide range of cartridges from which he might select.

Considering that a good match improves the sound, while a poor match—even with a good cartridge—produces an inferior sound, how can one go about assuring this compatibility?—T. P. Limber, San Francisco, Calif.

Read our reviews of tone arms and cartridges, in which this problem is addressed on a product-by-product basis, keeping in mind that the higher the values for both arm mass and pickup compliance, the lower the resonant frequency—which ideally should fall at around 10 Hz. If it is much higher, boomy deep bass can result (particularly with speakers having extended bass and/or a setup that permits acoustic feedback), requiring that the arm/pickup values be raised; as resonance frequency drops, warp-tracking problems increase, requiring lower mass and/or compliance to eliminate them.

I own a pair of CM-15A loudspeakers, which I find in general to be excellent. However, as the frequency-response curve given in HIGH FIDELITY's review confirms [March 1976], there is a fairly pronounced peak in the region of 5–6 kHz. Most of the time the effect is not all that bad, but sometimes the extra brightness afforded to brasses and woodwinds drives me close to distraction. I have tried using a graphic equalizer, which removes the peak but substitutes an unpleasant coloration of its own. Is there any better way to solve this problem?—Anthony M. Spencer, New Haven, Conn.

Audio International (formerly CM Laboratories) is aware of the difficulty and has a cure. If you will return the speakers to the factory, the modification will be performed at no charge. Should you elect to save the shipping costs, the job can be done by any competent repairman (or by yourself, for that matter). All that is necessary is to carefully remove the woofer and fiber-glass stuffing from the enclosure to gain access to the circuit board at the rear of the cabinet. On the board is a 150-ohm, 2-watt resistor, which

CIRCLE 23 ON READER-SERVICE CARD →

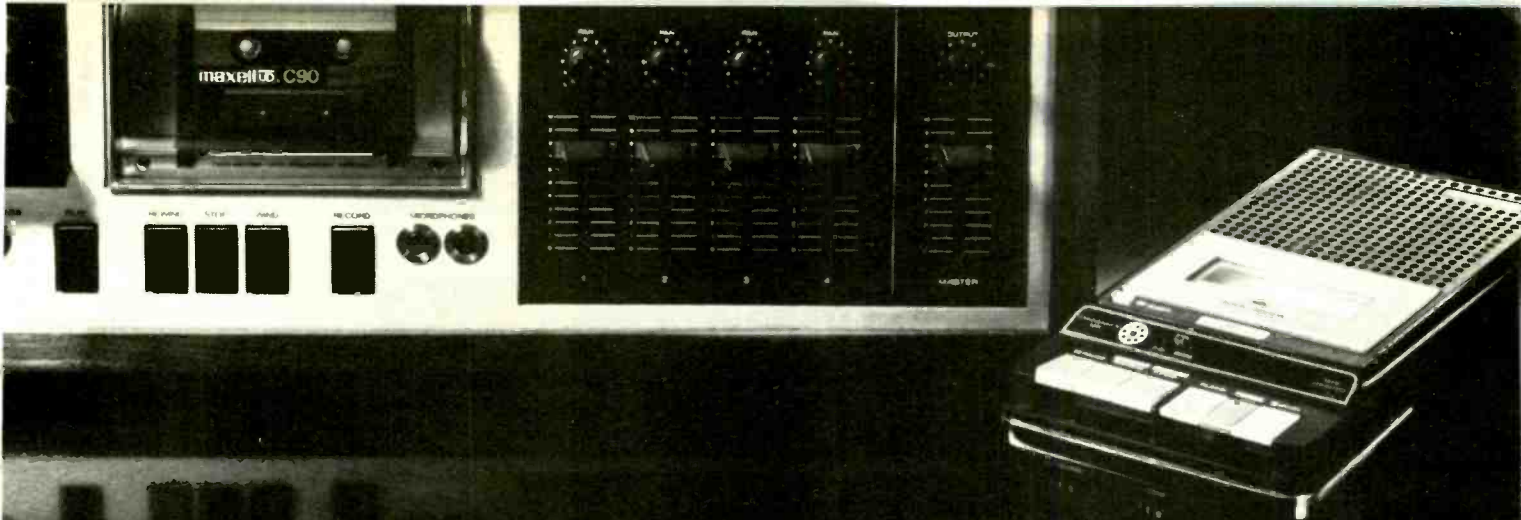

# It's hard to find a \$1,000 tape deck that doesn't use Maxell. Or a \$100 tape deck that shouldn't.

If you spent \$1000 on a tape deck, you'd be concerned with hearing every bit of sound it could produce.

That's why owners of the world's best tape decks use Maxell more than any other brand.

But if you're like most people, you don't own the best tape deck in the world and you're probably not using Maxell. And chances are, you're not hearing every bit of sound your tape deck is capable of producing.

Whatever you spent for your tape deck, it's a waste not to get the most

out of it. So spend a little more and buy Maxell.

Maxell. You can think of us as expensive tape. Or the cheapest way in the world to get a better sounding system.



**maxell** |||

Maxell Corporation of America, 60 Oxford Drive, Moonachie, N.J. 07074.

# If your cartridge is more than three years old, don't replace your stylus!

Don't get us wrong. There is nothing worse than playing your records with a worn stylus. And no better way to restore your old unit to its original glory than a new diamond.

But frankly, there have been significant strides made recently in the phono cartridge field. And the new cartridges of today stand head and shoulders above even the finest of a few short years ago.

Here's the choice: Get fresh—but outdated—performance with a replacement stylus, or enjoy all the benefits of modern cartridge research and development for just a few dollars more. You'll find that you can update your system for far less than you might imagine. It's probably the most dramatic single improvement you can make.

For instance, Audio-Technica offers Universal cartridges equipped with a genuine Shibata stylus and our uniquely effective Dual Magnet system beginning at just \$75.00 list. Or you can replace your present cartridge with a fresh new Audio-Technica cartridge with highly-polished elliptical tip for as little as \$45.00 list.



AT11E  
\$45.00

AT12Sa  
\$75.00

AT13Ea  
\$65.00

AT15Sa  
\$125.00

Are these new models worth the difference? Absolutely. You'll be amazed at what you hear from today's generation of phono cartridges. Improved frequency response. Lower distortion. Better separation. Less record wear. Truly better sound.

A new Audio-Technica cartridge.  
Your best value in hi-fi.

 **audio-technica**  
INNOVATION □ PRECISION □ INTEGRITY

AUDIO-TECHNICA U.S., INC., Dept. 58H, 33 Shilawsee Avenue, Fairlawn, Ohio 44131  
Available in Canada from Superior Electronics, Inc.

CIRCLE 6 ON READER-SERVICE CARD

should be replaced with a 56-ohm, 2-watt resistor. Then put back the packing and the woofer, making sure that a good seal is formed between the rim of the woofer and the enclosure. The modified speakers will sound best if placed on stands 12 to 18 inches high.

Why don't other brands offer the sort of pressure-sensitive cassette labels that come with the Maxell UDXL products? The finished cassette looks so much neater with typed labels, and when you rerecord you can change the label without messy erasures, which can leave debris to get inside the cassette.—James S. Donaldson, New London, Conn.

Some others do. Ampex' new Grand Master cassettes have similar stick-on labels, for example. Pressure-sensitive file-folder labels will fit most brands (don't worry if the upper corners go slightly beyond the angled label area of typical cassettes) and fit Memorex and (especially) the newer TDK cassettes as though custom-made for the purpose. And they hold a lot more information than the Maxell or Ampex stick-ons.

My system consists of a Thorens TD-125AB and Rabco ST-7 turntable with a variety of "top of the line" cartridges, Crown IC-150 preamplifier, and a custom electronic crossover that feeds two Sony 3200F amplifiers that drive a pair of Altec A7-500-8 speakers. The system is equalized by an Altec 729A and is complemented by auxiliary electronic devices—a DBX 119, a Burwen 1201, a Source Engineering Noise Suppressor, and a Phase Linear 1000—individually controlled via a switch box. It also has a delay channel generated by an Audio Pulse One, powered by a Marantz 140, and using a couple of Rectilinear 7 speakers. The listening room is very close to the ideal dimensions and, save the wall behind the main speakers, is covered with absorbing material.

But whenever I attend a concert, and especially an opera, I will be upset by the system for a few days: The thing just sounds unnatural. The problem seems to be the dynamic balance of the music (I listen to classical exclusively), but I am not really sure. I am always willing to replace any component to improve my system, but I do not seem to be able to find anything that sounds better than what I have. Nothing leaves me with a feeling like that of a live performance. What would you suggest?—E. Auyang, Lilburn, Ga.  
The problem could very well be in the dynamic range of your recordings. You might want to try some direct-to-disc and other specialty recordings.

I have had a Jensen CC-1 Stereo Headphone Control Center for many years. It features a "space perspective" control that seems to take the sound away from your ears and spread it out just above your head. I think it adds tremendously to the concert hall effect. My connecting cables (coming from a speaker selector switch) run to the back of this unit, and my phones plug into the front.

I wish to upgrade my headphones. However, I am told that I must give up the control center if I buy any phones that use a "box"—electrostatics and such. Is this true?—Samuel J. Neiditch, Wrightwood, Calif.  
Yes.

CIRCLE 41 ON READER-SERVICE CARD →

# THE MOST IMPORTANT FEATURE IN THESE DECKS IS BASED ON A TIMELESS IDEA.



The features and specifications of TEAC decks have changed, but the timeless constant has been TEAC reliability. Every improvement we've made has added to this reliability. It's our most important feature.

Every TEAC cassette deck from the least expensive to the most expensive is built to last a long, long time. That's been true since the first TEAC was built more than 25 years ago.

#### A-103 Specifications

Wow & Flutter:  
0.10% (NAB weighted)  
Signal-to-noise ratio:  
50dB (without Dolby)  
55dB (with Dolby at 1kHz)  
60dB (with Dolby over 5kHz)  
Frequency Response:  
30-14,000Hz (CrO<sub>2</sub>/FeCr)  
30-11,000Hz (Normal)

Take the new A-103, one of the least expensive TEAC's you can buy.

Despite its low price, the A-103 is manufactured to the same tolerances as decks costing three times as much. And, where most decks have a maze of hand-wired switches, harnesses and boards inside, the A-103 boasts an innovative design which replaces all that with a single circuit board directly coupled to the front control panel.

#### A-640 Specifications:

Wow & Flutter:  
0.06% (NAB weighted)  
Signal-to-noise ratio:  
57dB (without Dolby)  
62dB (with Dolby at 1kHz)  
67dB (with Dolby over 5kHz)  
Frequency Response:  
30-16,000Hz (CrO<sub>2</sub>)  
30-14,000Hz (Normal)

TEAC's more expensive A-640 brings engineering sophistication to a new high with plug-in circuit boards, two motors and electronically operated push buttons for leather-touch, maintenance-free reliability. People who work with tape recorders know

TEAC tape recorders work and keep on working. That's the reason people whose living depends on sound judgement, depend on TEAC. You can, too.

**TEAC**  
First. Because they last.



\*Dolby is a trademark of Dolby Laboratories, Inc.

TEAC Corporation of America • 7733 Telegraph Road, Montezello, California 90640 • In Canada TEAC is distributed by White Electronic Development Corporation (1956) Ltd.





## Needle in the hi-fi haystack

*Even we were astounded at how difficult it is to find an adequate other-brand replacement stylus for a Shure cartridge. We recently purchased 241 random styli that were not manufactured by Shure, but were being sold as replacements for our cartridges. Only ONE of these 241 styli could pass the same basic production line performance tests that ALL genuine Shure styli must pass. But don't simply accept what we say here. Send for the documented test results we've compiled for you in data booklet # ALS48. Insist on a genuine Shure stylus so that your cartridge will retain its original performance capability—and at the same time protect your records.*

Shure Brothers Inc.  
222 Hartrey Ave., Evanston, IL 60204  
In Canada: A.C. Simmonds & Sons Limited

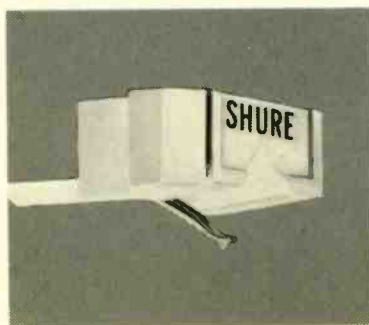
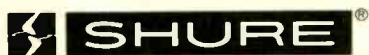

Manufacturers of high fidelity components, microphones, sound systems and related circuitry.  
CIRCLE 30 ON READER-SERVICE CARD

## Video Topics

**How low will VCR prices go?** In recent months we have witnessed an anomaly in textbook economics: a video-cassette recorder market in which demand generally was outstripping supply and yet prices appeared to be falling. In some cities, deck prices like \$1,050, \$995, \$900, and even lower have been salvaged back and forth in full-page advertisements. Yet often there were not enough units to go around.

At a time when prices for such things as digital watches and pocket calculators and CB radios have fallen astonishingly, it's easy to assume that tomorrow's VCRs will cost no more than today's cassette decks. Don't hold your breath; the video-tape situation is quite different.

One consideration that seems to be affecting the demand/supply price equation is the competition between formats. With three basic ones (Beta, VHS, and Great Time Machine) making simultaneous strong bids for consumer purchase, those who make and sell them don't want the virtues of their respective designs to be passed over for the sake of a \$100 or \$200 saving in cost. The result appears to be that present profits are intentionally whittled away against the expectation of future manufacturing economies due to increased production and sales to match. This is a rather iffy undertaking when the value of the yen continues to rise at the expense of the dollar—a trend that, if it continues, can only drive U.S. prices back up in time.

Another reason for the relatively low advertised prices of VCRs is their very popularity. A store obviously will attract more attention if it advertises a price reduction on a "hot" item than if it applies the same reduction to less glamorous merchandise. At the moment, VCRs are hot, indeed.

Either way, the price reductions have nothing in common with those in digital watches and the like, where overproduction born of a rapidly expanding market produced stocks that had to be liquidated at almost any cost. It appears, in fact, that VCR manufacturers are very wary of such runaway overproduction; despite the dramatic growth in VCR sales in the last year, production is not expected to catch up with projected demand until, at minimum, sometime in 1979.

**Whither Akai?** While everybody has been talking about video tape these last ten years or so, Akai has been doing something about it. Its line of portable—really portable—camera/recorders has changed, but it has remained available, which is more than can be said for some of the "breakthrough" home decks marketed in that period. Home users haven't heard much about Akai's equipment because prices have generally been on the high side. Professionals in the news-gathering, industrial, and scientific communities have been very interested, however; one man can carry both the deck (slung over a shoulder) and the camera (in one hand) and go virtually anywhere to get the needed video-tape images.

Akai's newest, for example, is the VT-350 black-and-white cassette system, which (with a VC-300 camera) costs a little over \$2,000 and weighs scarcely 17 pounds total. The deck has a frame-matching edit feature (to prevent picture flop wherever taping was interrupted) and slow/freeze motion options; the camera has a built-in mike and a C-mount (standard) 8:1 zoom lens. There also is an electronic viewfinder/monitor that can be used on the camera (to see what you're recording) or the deck (to check what you've recorded). The cassettes hold up to a half-hour apiece.



Akai VT-350 with VC-300 camera

An accessory RF converter can be used to feed the deck's output to the antenna terminals of a regular TV set—making it, in effect, a home video-tape viewing system. Nobody we know of is rushing to make prerecorded programming available for it, however; remember that it's a black-and-white system, while Akai's color portables use open reels. So despite the home playback capability, the Akai decks are not head-on competitors for the VHS and Beta home video cassette decks, all of which take the color capability for granted.

Akai has announced that it will have such a deck by the end of this year. It is expected to be the VHS-2 type: that is, the original JVC VHS, without the half-speed option. (We say "expected" because, with so many months left in the year, it's possible that plans may

# While others are reaching for this technology, Sony brings it within your reach.

It takes a sharpened technical sense to deliver innovation at sensible prices.

Who else but Sony could manage it? We know turntables backwards and forwards. As far back as 1966, we were breaking ground: in that year, we applied a slow-speed, servo-controlled motor to turntables.

Today, we present the PS-X7, X6 and X5. Three fully automatic, direct drive turntables that are a direct challenge to the competition.

And the competition will soon find that we've got the features they don't want to face.

## **The X-tal Lock. X-act speed accuracy.**

A traditional servo system doesn't serve you well enough. It can heat up, creating speed drift.

More critically, increased friction between the stylus and record during loud passages can slow the speed into a range where a conventional servo isn't sensitive enough to read. But your conventional ears can.

Sony's X-tal Lock system cannot be accused of the above. A quartz generator perfectly regulates the servo, locking in speed *electronically*. It's impervious to temperature, load, or voltage changes.

## **Our brushless and slot-less is matchless.**

Sony's new motor gives brushes the brush. The ring shaped permanent magnet rotor and fixed coil eliminate cogging. The torque is high. The rotation smooth. The start-up, quick.

## **Sony's Speed Monitoring System. Like millions of tiny State Troopers.**

The X-tal Lock system is worth x-actly nothing, unless the right information is relayed to it. Our system uses a precise magnetic pulse signal, recorded on the platter's outer rim.



Sony PS-X7

An 8-pole magnetic pick-up head receives it. Then transmits it to the servo electronics.

Most systems use only one pole. By using 8—and averaging them—we get above average accuracy.

## **Want functional controls? The case is closed!**

Our dust cover lives down to its name. It remains closed, protecting record and machine, allowing immediate access to controls without lifting the cover. (On the X7 and X6, the controls are touch sensitive.)

Underneath the cover, you'll find a safety clutch mechanism to protect the tone arm, should it accidentally be grabbed while in motion.

And on the X7 and X6, an optical sensing system—to automatically return the arm at record's end. (In the X7, a carbon fiber tone arm.)

These turntables are even worth more dead, than alive. Because their cabinets are made from an acoustically dead material. They won't vibrate.

Vibration is also cut by our thick rubber mat, heavy aluminum platter and viscous filled rubber feet. (The X7's mat is filled with the same damping material).

Much has been engineered into these turntables that we haven't mentioned, including lightweight tone arms with a cast aluminum alloy headshell.

So tightly built are they that we didn't even have room for bigger prices.

Cartridges are not included

# SONY®

© 1977 Sony Corp. of America, 9 W. 57 St., N.Y., N.Y. 10019. SONY is a trademark of Sony Corp.

# A SCOTCH® CASSETTE FOR EVERY SWITCH POSITION.

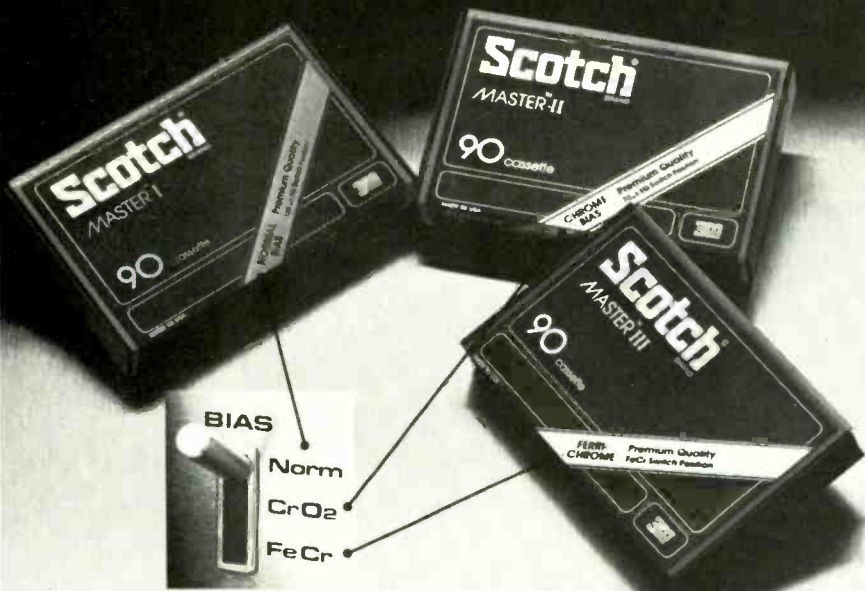

**SCOTCH® RECORDING TAPE.  
THE TRUTH COMES OUT.**



change somewhat before the deck appears.) This, then, will be Akai's "home" format—as opposed to its away-from-home battery portables.

Or will it? We hear rumors that JVC may be coming out with a portable variant of its VHS, and Akai has not ruled out a comparable model for itself. Since VHS decks are inherently bulkier than Akai's present formats, they presumably will not adapt as well for real fieldwork. But the dividing line between the two types seems to be growing a bit fuzzy. It will be interesting to see where they take us.



JVC Vidstar with GC-3300U camera

In search of inexpensive color. Bulk is not the only hangup preventing the video cassette from making an assault on the home-movie market, as pundits once expected it would. Another is the cost of color cameras. When JVC announced its Vidstar GC-3300U last year, it called it "America's first color home video camera" because at \$1,500 it was a bargain unheard of in professional circles. Toshiba also has a color camera for about \$200 more, but these prices (plus about \$1,000 for a deck) hardly represent a significant threat to Super-8, with some pretty nifty sound models selling for under \$500.

That, as a matter of fact, is the price that RCA says it hopes to achieve before it markets a color video camera. And when will that be, you ask? Ah, when indeed! RCA isn't saying.

We interrupt this program. . . . A company called H & G Trading has come up with a gadget to give the Master of the Household (or whomever) control over equipment use. It is a box called the Interrupter that is inserted into the power cord of the equipment and includes a locking power switch: You need the key to get the AC.

The original idea behind the Interrupter, the company says, was to enforce no-TV-on-school-night rules. It also can be used to keep the kids from fussing with the VCR or the stereo. And it certainly costs less than typical repairs on either: \$9.95 apiece, or \$18 for a pair, postpaid from H & G Trading Company (353 E. 77th St., New York, N.Y. 10021).

## FREE McIntosh CATALOG and FM DIRECTORY

Get all the newest and latest information on the new McIntosh Solid State equipment in the McIntosh catalog. In addition you will receive an FM station directory that covers all of North America.



### MX 113

FM/FM STEREO - AM TUNER AND PREAMPLIFIER

**SEND TODAY!**

McIntosh Laboratory, Inc.  
East Side Station P.O. Box 96  
Binghamton, N.Y. 13904

NAME \_\_\_\_\_  
ADDRESS \_\_\_\_\_  
CITY \_\_\_\_\_ STATE \_\_\_\_\_ ZIP \_\_\_\_\_

If you are in a hurry for your catalog please send the coupon to McIntosh.  
For non rush service send the Reader Service Card to the magazine.

CIRCLE 24 ON READER-SERVICE CARD

CIRCLE 36 ON READER-SERVICE CARD →



## THE SPARKOMATIC SOUND.

# IF YOU'RE A TRAVELIN' MAN WHO THINKS CAR SPEAKERS SHOULD LOOK TOUGH BUT ACT SENSITIVE.

Car speakers have never looked as exciting. Or sounded as extraordinary.

Because these Sparkomatic "component" look 3-way speakers are a totally new outlook for 6X9 rear deck audio. And because they reproduce high fidelity like you were sitting center aisle instead of center lane.

With these Sparkomatic car speakers you get the most technologically advanced auto sound you can own. They're magnificently responsive across the full frequency range with minimum distortion, optimum dispersion, and can easily handle 50 watt power peaks.

Beneath the acoustically transparent heavy gauge wire

mesh grilles are foam-edge air suspension woofers with 20 ounce magnets, foam-edge air suspension midrange speakers with 3 ounce ceramic magnets and dome horn tweeters.

So, if you're a travelin' man who likes to travel in style, these speakers are tailored just for you.

Visit a Sparkomatic dealer for a beautiful eyeful and a magnificent earful.

**SPARKOMATIC**  
For the Travelin' Man™

Car Sound/CB Equipment/Auto Clocks/Shifters/Creepers

For our free complete Car Sound Catalog write: "For The Travelin' Man", Dept. HF, Sparkomatic Corporation, Milford, PA 18337.

E	1	P	2	K	3	F	4	J	5	V	6		C	7	Y	8	B	9	N	10		R	11	G	12	A	13	D	14	
I	15	C	16	J	17	O	18		L	19	W	20	M	21	V	22		P	23	YY	24	Z	25		Y	26	C	27		
E	28	I	29	J	30	B	31		K	32	N	33	H	34		F	35	R	36		S	37	Y	38	P	39	A	40		
I	41	C	42		L	43	B	44	M	45	V	46		B	47	U	48	T	49	XX	50		Y	51	J	52	ZZ	53		
R	54	K	55	C	56	Z	57	O	58		F	59	N	60	I	61	C	62	R	63	Y	64	G	65	L	66		X	67	
V	68	L	69	T	70	Q	71	N	72	F	73	A	74	YY	75	C	76		B	77	D	78	V	79	XX	80	I	81	R	82
U	83		K	84		E	85	M	86	V	87	P	88	L	89		ZZ	90	N	91	Y	92	C	93	I	94				
Q	95	F	96	G	97	J	98	Z	99		B	100	XX	101	A	102	L	103	O	104		N	105	D	106	R	107	C	108	
X	109		I	110	K	111	O	112	B	113	W	114	M	115	F	116		XX	117	O	118	K	119		P	120	H	121		
D	122	V	123		YY	124	O	125	C	126	Z	127	ZZ	128	N	129		B	130	XX	131	A	132	I	133	X	134	M	135	
YY	136	P	137		Z	138	T	139	C	140	F	141		V	142		G	143	S	144	U	145	B	146		YY	147			
X	148		K	149	M	150	I	151	Y	152	L	153	V	154	T	155	ZZ	156		H	157	C	158	Z	159	Y	160	B	161	
A	162	V	163	S	164	R	165	O	166	E	167		W	168	Y	169	L	170		H	171	C	172	G	173	E	174	L	175	
V	176	R	177	I	178	D	179	K	180	Y	181	ZZ	182		M	183	O	184		YY	185	J	186	V	187	C	188	S	189	
		E	190	X	191		U	192	N	193	M	194		J	195	C	196	P	197	A	198	Y	199	R	200	N	201	B	202	
K	203	L	204	V	205	I	206		A	207	N	208	D	209	C	210														

### DIRECTIONS

To solve these puzzles—and they aren't as tough as they first seem — supply as many of the Output words as you can in the numbered dashes following the Input. Unless otherwise specified in the Input, the Output consists of one English word. "Comp." means compound, or hyphenated, word.

Transfer each letter to the square in the diagram that bears the corresponding number. After only a few correct guesses you should begin to see words and phrases emerging in the diagram, which when filled in will contain a quotation related to music, recordings, or audio.

The words in the quotation are separated by darkened squares and do not necessarily end at the end of a row.

Try to guess at these words and transfer each newly decoded letter back to its appropriate dash in the Output. This will supply you with further clues.

A final clue: The source of the quotation — the author and his work — will be spelled out by the first letters in Output, reading down.

The answer to HiFi-Crostic No. 35 will appear in next month's issue of HIGH FIDELITY.

### INPUT

- A. Torelli, Borgatti, or De Luca
- B. See Word ZZ. (2 wds.)
- C. Millocker operetta (2 Ger. wds.)
- D. Crumb's \_\_\_\_\_ of Time and the River
- E. American poet (1874-1963)
- F. Oblique-angled equilateral parallelogram
- G. American ballet dancer (b. 1919), created *Lover-in-Experience* in Tudor's *Pillar of Fire*, appeared in many movies
- H. Affirmative votes
- I. Tamino finds it "bezaubernd schön" (2 Ger. wds.)
- J. Excellent (Brit. slang)
- K. \_\_\_\_\_ Singers, recorded *Messiah* on Angel
- L. After *The*, Lehár operetta (2 wds.)
- M. Of a performance or work, showing taste and skill
- N. Choreographer of *Push Comes to Shove* (full name)

### OUTPUT

- 40 74 162 13 102 207 198 132
- 100 47 9 174 202 161 130 77
- 44 146 113 31
- 126 158 196 7 27 56 210 76
- 108 93 188 172 42 62 16 140
- 78 179 106 209 122 14
- 85 28 190 167 1
- 96 141 116 73 35 4 59
- 12 143 97 173 65
- 34 121 171 157
- 133 81 41 206 151 178 61 29
- 110 15 94
- 52 17 186 195 30 98 5
- 111 32 149 203 3 119 180 84
- 55
- 69 175 103 66 89 43 153 170
- 204 19
- 86 21 135 150 194 45 183 115
- 201 105 129 208 72 193 10 33
- 91 60

### INPUT

- O. Israeli conductor who recorded Schumann symphonies for Philips
- P. Composer Joel: *Street Scene* and *Daisy* on Opus One
- Q. Gunter \_\_\_\_\_
- R. With Word V., Austrian-American contralto (1861-1936), "the last of the titans"
- S. After *The Shostakovich* opera
- T. Soprano role in Mozart's *Idomeneo*
- U. American ballet theater
- V. See Word R. (comp.)
- W. L' \_\_\_\_\_ del Cairo unfinished Mozart opera
- X. Small keyless flutes
- Y. Dallapiccola opera, recorded by British Decca (3 lt. wds.)
- Z. \_\_\_\_\_ Power Biggs
- XX. Benatzky, Gari, or Kirkpatrick
- YY. American music critic (1886-1955), long with the *N.Y. Times*
- ZZ. With Word B., Sessions composition

### OUTPUT

- 125 184 112 104 58
- 88 2 39 137 23 120 197
- 95 71 118 166 18
- 54 11 82 36 200 177 107 63
- 165
- 164 144 37 189
- 70 49 139 155
- 48 145 192 83
- 163 154 46 205 79 142 123 87
- 6 68 187 176 22
- 20 114 168
- 148 134 191 109 67
- 26 51 152 199 64 160 169 8
- 38 181 92
- 127 25 138 57 159 99
- 131 80 50 101 117
- 75 147 124 24 136 185
- 53 90 182 156 128

# A GUIDE TO RECORD CARE

---

## THE PHONOGRAPH DISC

combines maximum fidelity with the most reproducible and cost effective music storage system yet developed.

## YOUR RECORD COLLECTION

represents huge investments of purchase time, personal involvement and money.

**PRESERVATION** of your investment is possible. Not by gadgets, mythology or wild claims. Preservation is a result of applied Science and Research.

## THE AUDIOPHILES AT

**DISCWASHER** hope this Guide will benefit you and your musical investment.

### III. DON'T AGE YOUR VINYL

#### The Problem:

Record vinyl contains additives—chemical stabilizers—which protect the vinyl from aging and breakup during both pressing and playback. If stabilizers are extracted from the record surface, then the life of the vinyl is shortened, and the vinyl surface begins to break down during playback because of chemical weakness. (Typical stylus pressures exceed 16 tons psi, even with the finest equipment.) Long-term record life is very much dependent on leaving bound stabilizers in the vinyl.

#### Common Errors:

Large amounts of almost any liquid (even water) on the record surface will extract tiny amounts of stabilizers. But large amounts of these precious stabilizers are extracted with a "cleaning operation" that uses liquids containing large amounts of alcohols, common detergents, alkaline soaps, or many standard anti-static agents. All of these compounds, very common in record cleaners, are much more destructive to record vinyl when combined with a physical brushing action.

#### An Answer From Research:

The exclusive Discwasher System is chemically buffered, tested, and designed to preserve record vinyl. D3 fluid is "targeted" to remove record contamination but not stabilizers from the vinyl surface. This patented chemistry, developed at the Discwasher laboratories, allows the directional fibers of the Discwasher pad to pick up both debris and solubilized contamination. All without shortening vinyl life. Only Discwasher has this perfect combination of safety and function.



#### COMPARATIVE STABILIZER EXTRACTION

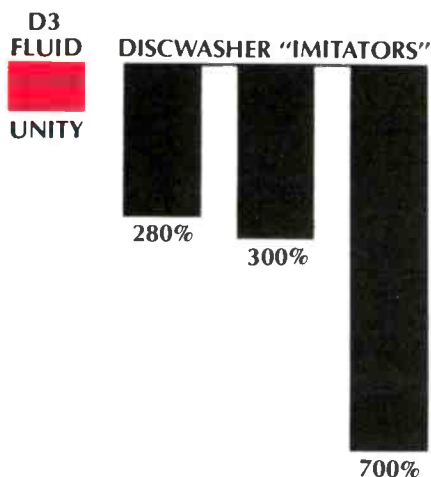

 **discwasher<sup>®</sup>, inc.**  
1407 N. Providence Rd.  
Columbia, Missouri 65201



## Record Ecology in DiscKit Form —you'll save more than money

DiscKit is a milled walnut tray and dust cover that saves you 15% with the Discwasher products in the kit. (\$46 versus \$54 separately)

DiscKit includes: 1) The Discwasher System Record Cleaner with D3 Fluid, 2) the Zerostat anti-static pistol and test light, and 3) the SC-1 Stylus Cleaner.

But you'll save more than money. You'll save your rec-

ords from imbedded micro-dust, your cartridge stylus from abrasion and your ears from a lot of static.

Record Ecology from Discwasher—a substantial bargain.

(Walnut tray and dust cover are available separately as the Discorganizer, \$12.50.)

All from Discwasher, Inc., 1407 N. Providence Rd., Columbia, Missouri 65201.





# Empire's Blueprint for Better Listening...

No matter what system you own, a new Empire phono cartridge is certain to improve its performance. The advantages of Empire are threefold. One, your records will last longer. Unlike other magnetic cartridges, Empire's moving iron design allows our diamond stylus to float free of its magnets and coils. This imposes much less weight on the record surface and insures longer record life. Two, you get better separation. The small, hollow iron armature we use allows for a tighter fit in its positioning among the poles. So, even the most minute movement is accurately reproduced. Three, Empire uses 4 poles, 4 coils, and 3 magnets (more than any other cartridge) for better balance and hum rejection. The end result is great listening. Audition one for yourself or write for our free brochure, "How To Get The Most Out Of Your Records." After you compare our performance specifications we think you'll agree that, for the money, you can't do better than Empire.

Empire Scientific Corp., Garden City, New York 11530

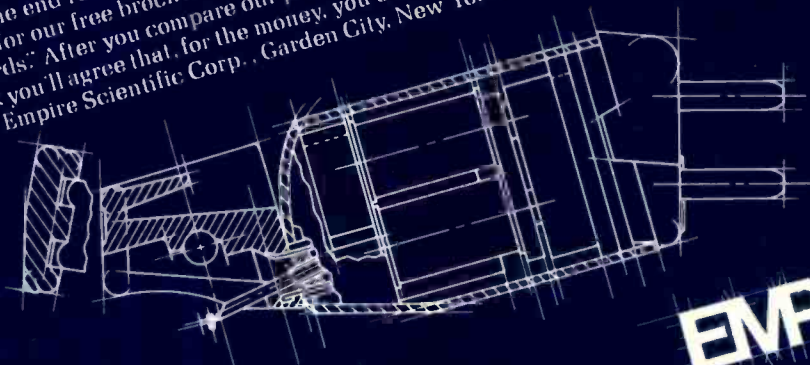

**EMPIRE**  
Already your system sounds better.

MODEL	4000 D/III	4000 D/I	2000 E/III	2000 E/II	2000 E/I	2000 E	2000	2000	
FREQUENCY RESPONSE	10Hz-50kHz ± 3 dB	15Hz-45kHz ± 3 dB	20Hz-20kHz ± 2 dB	20Hz-20kHz ± 1½ dB	20Hz-20kHz ± 2 dB	20Hz-20kHz ± 2 dB	20Hz-20kHz ± 3 dB	20Hz-20kHz ± 3 dB	
TRACKING FORCE RANGE	1-1½ gm	1-1½ gm	¾-1½ gm	¾-1½ gm	¾-1½ gm	¾-1½ gm	1-2 gm	1½-2½ gm	
SEPARATION	15Hz to 1kHz 28 dB 1kHz to 20kHz 23 dB 20kHz to 50kHz 20 dB 20Hz to 500Hz 30 dB 500Hz to 15kHz 25 dB 15kHz to 20 kHz 15 dB	15Hz to 1kHz 24 dB 1kHz to 20kHz 20 dB 20kHz to 50kHz 15 dB	20Hz-20kHz 20 dB 20Hz-20kHz 18 dB 20Hz-20kHz 27 dB 20Hz-20kHz 22 dB	20Hz-20kHz 18 dB 20Hz-20kHz 27 dB 20Hz-20kHz 22 dB	20Hz-20kHz 20 dB 20Hz-20kHz 28 dB 20Hz-20kHz 20 dB	20Hz-20kHz 20 dB 20Hz-20kHz 25 dB 20Hz-20kHz 18 dB	20Hz-20kHz 18 dB 20Hz-20kHz 23 dB 20Hz-20kHz 15 dB	20Hz-20kHz 18 dB 20Hz-20kHz 23 dB 20Hz-20kHz 15 dB	20Hz-20kHz 16 dB 20Hz-20kHz 21 dB 20Hz-20kHz 13 dB
I.M. DISTORTION @ 3.54 cm/sec	2% 2kHz-20kHz	2% 2kHz-20kHz	0.8% 2kHz-20kHz	0.8% 2kHz-20kHz	1% 2kHz-20kHz	1.5% 2kHz-20kHz	2% 2kHz-20kHz	2% 2kHz-20kHz	
STYLUS	2 mil bi-radial	2 mil bi-radial	2 x 7 mil elliptical	2 x 7 mil elliptical	2 x 7 mil elliptical	2 x 7 mil elliptical	2 x 7 mil elliptical	3 x 7 mil elliptical	
EFFECTIVE TIP MASS	4 milligram	4 milligram	2 milligram	2 milligram	6 milligram	6 milligram	6 milligram	9 milligram	
COMPLIANCE	30x10 <sup>11</sup> cm/dyne	30x10 <sup>11</sup> cm/dyne	30x10 <sup>11</sup> cm/dyne	30x10 <sup>11</sup> cm/dyne	20x10 <sup>11</sup> cm/dyne	18x10 <sup>11</sup> cm/dyne	17x10 <sup>11</sup> cm/dyne	16x10 <sup>11</sup> cm/dyne	
TRACKING ABILITY	32 cm/sec @ 1kHz @ 1 gm	30 cm/sec @ 1kHz @ 1½ gm	38 cm/sec @ 1kHz @ 9 gm	38 cm/sec @ 1kHz @ 1 gm	32 cm/sec @ 1kHz @ 1 gm	28 cm/sec @ 1kHz @ 1½ gm	28 cm/sec @ 1kHz @ 1½ gm	28 cm/sec @ 1kHz @ 1½ gm	
CHANNEL BALANCE	within 1 dB @ 1kHz	within 1½ dB @ 1kHz	within ½ dB @ 1kHz	within 1 dB @ 1kHz	within 1 dB @ 1kHz	within 1½ dB @ 1kHz	within 1½ dB @ 1kHz	within 1½ dB @ 1kHz	
INPUT LOAD	100k Ohms/ channel	100k Ohms/ channel	47k Ohms/ channel	47k Ohms/ channel	47k Ohms/ channel	47k Ohms/ channel	47k Ohms/ channel	47k Ohms/ channel	
TOTAL CAPACITANCE	under 100 pF/channel	under 100 pF/channel	300 pF/channel	300 pF/channel	400-500 pF/channel	400-500 pF/channel	400-500 pF/channel	400-500 pF/channel	
OUTPUT @ 3.54 cm/sec	3 mV/channel	3 mV/channel	3 mV/channel	3 mV/channel	4.5 mV/channel	4.5 mV/channel	7 mV/channel	7 mV/channel	

**A CONSUMER'S GUIDE**

# New Equipment Reports

Preparation supervised by  
Robert Long, Harold A. Rodgers,  
and Edward J. Foster  
Laboratory data (unless otherwise noted)  
supplied by CBS Technology Center

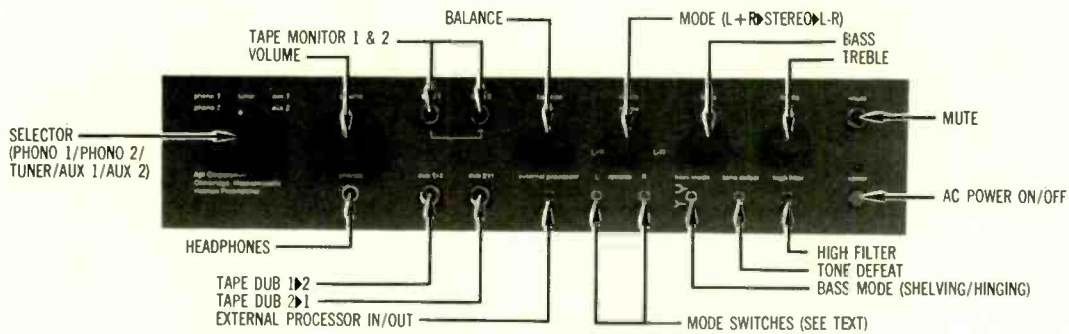

## Apt's Radical Approach to Preamp Design

**The Equipment:** The Holman Preamplifier, a stereo control preamp, in metal case. AC convenience outlets: 3 switched, 2 unswitched (1,000 watts total). Dimensions: 15 by 3¼ inches (front panel), 8¼ inches deep (case). Price: \$447. Warranty: "limited," three years parts and labor. Manufacturer: Apt Corp., P.O. Box 512, Cambridge, Mass. 02139.

**Comment:** It is not unusual for a creative component manufacturer to re-examine an accepted concept or design principle before employing it in a new design. Such re-examination is, in fact, expected of the "better" companies, though expectation isn't always gratified by fact. What is unusual is the sort of total re-examination Apt appears to have given the genus before essaying its first product—the Holman preamp, named after engineer Tomlinson Holman, who carried out the project. And the results are, we think, outstanding.

Let's begin with the phono section since this is where the want of optimum performance in some rote-designed units is best recognized. In the Holman Preamplifier, particular care has been taken to design for best possible noise performance with real cartridge loads, as opposed to the shorted inputs normally used in testing. (It is possible to create a phono input stage that responds best to the bench-test situation and is somewhat noisier in typical in-use setups.) As billed, the Apt is superbly quiet and better than the lab's respectable noise figures suggest.

Not only is the phono section designed to minimize undesirable interaction with pickups (and we could find no practical evidence of it), but back-panel switches offer five choices of capacitive load (50, 100, 200, 300, and 400 picofarads) and two of resistive load (47,000 and 100,000 ohms, representing the standard loads for stereo and CD-4 pickups, respectively). These affect PHONO 1 only; PHONO 2 presents a standard/average load of 47,000 ohms and

100 picofarads. (Presently in preparation is an internal, plug-in optional pre-preamp to convert PHONO 2 for use with low-output moving-coil cartridges.)

In addition, there is a back-panel switch for a subsonic filter that, while it shaves response by only about ½ dB at 20 Hz, rolls off at 18 dB per octave in the warp-frequency region. It is not in the phono preamp alone, however; it cuts subsonics (should they exist) in the tuner and Aux inputs as well. We found it very effective—not only for keeping muddiness out of the sound in listening to records, but in preventing tape-recorder overload in the presence of warps or subsonic recorded rumble.

There also is a supersonic filter, normally on but removable via the TONE DEFEAT. It is intended to limit the slew rate demanded of the amplifier fed by the preamp and hence prevent transient intermodulation distortion in the amp. It has no detectable effect on the sound from the preamp; indeed it *should* not as long as both the program material and the amplifier are of good quality.

The treble control delivers about 10 dB of maximum boost and cut (less than average, but offering adequate range and fine control) at 10 kHz and above, with virtually no "bending" of the response below 1 kHz—altogether an excellent characteristic. There are two bass-control options: One hinges at about 500 Hz and shelves at a maximum boost or cut of about 15 dB below 60 Hz; the other

**REPORT POLICY** Equipment reports are based on laboratory measurements and controlled listening tests. Unless otherwise noted, test data and measurements are obtained by CBS Technology Center, Stamford, Connecticut, a division of Columbia Broadcasting System, Inc., one of the nation's leading research organizations. The choice of equipment to be tested rests with the editors of HIGH FIDELITY. Manufacturers are not permitted to read reports in advance of publication, and no report, or portion thereof, may be reproduced for any purpose or in any form without written permission of the publisher. All reports should be construed as applying to the specific samples tested; neither HIGH FIDELITY nor CBS Technology Center assumes responsibility for product performance or quality.

hinges at about 270 Hz and reaches the same maximum points only at the bottom of the frequency range. The first is intended to alter the basic balance between the bass and the rest of the spectrum; the second can also be applied to program equalization, though it is intended primarily for loudness compensation.

This too is a subject on which Apt appears to have done a lot of original homework. The company's study of the available data on loudness perception effects (some of which are recent and tend to supersede the classic work of Fletcher and Munson) leads it to two conclusions: 1) High-frequency loudness perception varies little if at all with level and therefore requires no compensation (a conclusion not unique to Apt); 2) While the restoration of natural-sounding bass response at reduced listening levels does require some boost, it is not as large in the extreme bass as past theory has led us to believe—and is not required at all from 400 Hz up. Thus computer analysis of the data yielded the sort of boost curves supplied by Apt's second (hinging, as opposed to hinging-shelving) bass control. The computer appears to have done its work well; the curves (and their adjustability—to allow for the variables of gain in the associated amplifier, efficiency in the speakers, and liveness in the listening room) make for the most convincing loudness compensation we have yet heard.

The mode controls, too, are unique. The main knob has a detented center position for normal stereo. As you rotate it counterclockwise there is progressive blending of the two channels (which, if necessary, can be used to minimize "hole-in-the-center" stereo—for example, with excessively wide speaker placement—or to move the stereo panorama a little closer) until full L + R mono is achieved. As the knob is rotated clockwise, the sound seems to become a little more remote; at the extreme (L-R) position, centered material is canceled out. This may seem an odd option to offer, but it can be used for precise balancing of the two channels (phono trimmer adjustments are accessible through the left end of the case) or—if you're of a mind to do so—for the virtual removal of a centered soloist for play-along (or sing-along) purposes. (In some recordings the in-between positions can offer fascinating spatial options: a touch of L-R to emphasize the ambience, or a touch of L + R to "dry up" the sound a bit.) There also are switches for left-only and right-only mono; when both are engaged, the result is reverse stereo.

The front-panel MUTE is not the usual 20-dB attenuator. It is tied to an automatic output-killer that triggers during periods of low line voltage and turnon and turnoff to keep

transients out of the amplifier and speakers. The manual switch is intended for headphone listening. The Holman preamp has a built-in headphone amp and easily drives our headsets to comfortable listening levels. (Not all preamps do.)

It also has buffer stages in all the ancillary outputs (tape and EXTERNAL PROCESSOR) to prevent interaction with the signals "passing by" and to optimize these outputs for the sort of loads they will have to drive. Again, many preamps lack this feature, which is symptomatic of the exceptional care that appears to have been taken with every detail of the preamp, such as minimum RF susceptibility, minimum crosstalk of one source into another, and so on. The list of possible subjects for discussion defies reduction to the scale of a product review.

From its front panel on, the Holman exudes subtle thoughtfulness. The performance data, excellent though it is, doesn't begin to express the experience of using the product, which is one of communicating with its designer. In both controls and circuitry he speaks quietly, self-effacingly (particularly in the uncompromisingly plain cosmetics); yet the message is bold, fresh, and exciting. The Holman Preamp is, we believe, one of those products against which others will be measured.

CIRCLE 136 ON READER-SERVICE CARD

### Apt Holman Preamp Additional Data

Output at clipping (channels driven simultaneously)		
L ch:	8.3 V	
R ch:	8.4 V	
Frequency response	+ ¼, -½ dB, 10 Hz to 20 kHz + ¼, -3 dB, below 10 Hz to 38 kHz (incl. ultrasonic filter)	
RIAA equalization	± ½ dB, 20 Hz to 20 kHz	
Input characteristics (for 2 volts output)		
	Sensitivity	S/N ratio*
phono 1, 2	5.6 mV	68 dB
tuner	250 mV	86 dB
aux 1, 2	250 mV	89½ dB
tape 1, 2	240 mV	92 dB
Phono overload (clipping point)	120 mV at 1 kHz	
High filter	-3 dB at 8 kHz; 12 dB/oct.	
*See text.		

## Keith Monks's Spartan Road to High Performance

**The Equipment:** Keith Monks KMAL M9BA Mk. 3 Improved tone arm. Price: \$149.95; spare arm elements, \$62.50. Warranty: "limited," three years parts and labor. Manufacturer: Keith Monks (Audio) Ltd., England; U.S. distributor: Keith Monks (U.S.A.), Inc., 42 Tiffany Place, Brooklyn, N.Y. 11231.

**Comment:** Remember those British sports cars of the 1950s and '60s? They typically rode as if the springs were made of granite, had cockpit amenities rivaling those of a jail cell, and offered convertible tops that you could, with luck, get closed before the downpour had stopped. But many of them could run like hell and take corners at

speeds that seemed suicidal to most of their competition. Well, the Keith Monks M9BA Mk. 3 Improved tone arm reminds us of them. Installing one can best be described as an exercise for building moral fiber (not to mention manual dexterity). The reward of virtue in this case is truly outstanding performance.

In its design, the Monks arm is unusual indeed. It is totally separable from its support, the principal contact between the two being a single-point bearing on which the arm pivots. Lest any twisting of the signal leads from the cartridge exert torque that might interfere with tracking, those four leads terminate in pins whose only contact with the stationary part of the assembly is via small pools of

# We just raised the standard of the industry.



© 1977 Koss Corp.

## The new Koss PRO/4 Triple A.

We did it again. We took the incredible sound and precision craftsmanship of the Koss PRO/4AA that has long made it the standard of the industry and made it even better. Because the PRO/4 Triple A's extra large voice coil and oversized Triple A diaphragm reproduce a dynamic, full bandwidth Sound of Koss that carries you back to the live performance like nothing you've ever heard before. You remember it all: the expectant hush of the crowd . . . until suddenly . . . the night explodes with the glittering splendor of the all engulfing

performance. You're drawn to the full blown fundamentals and harmonics of each instrument. To the spine-tingling clarity of the lead singer's magical voice. To the rhythmic kick of the drum and the throbbing of the bass.

You see it and hear it all again, yet you're relaxed at home in your own private realm of listening pleasure. The PRO/4 Triple A's extra light construction and unique Pneumalite® suspension dual headband make wearing them as much of a pleasure as listening to them. And all the while, the Triple A's special, human-

engineered, direct-contoured Pneumalite® earcushions create a gentle yet perfect seal for flat, low bass response to below audibility.

It's a whole new experience in stereophonic listening. A new performance standard for those who set their standards high. Write c/o Virginia Lamm for our free full-color stereophonic catalog. Or better yet, take your favorite records or tapes to your Audio Dealer and listen to them like you've never heard them before . . . live on the new Koss PRO/4 Triple A.

 **KOSS**® stereophones  
**hearing is believing™**

**KOSS CORPORATION**, 4129 N. Port Washington Ave., Milwaukee, Wisconsin 53212  
Koss International/London, Dublin, Paris, Frankfurt • Amsterdam • Koss Limited/Ontario • Koss K.K./Tokyo  
CIRCLE 22 ON READER-SERVICE CARD

# HITACHI

## The New Leader In Audio Technology



...introduces the world's most powerful 50 watt receiver.

The new Hitachi SR 804 stereo receiver has the revolutionary Class G amp that instantly doubles its rated power from 50 to 100 watts to prevent clipping distortion during those demanding musical peaks (note the clipped and unclipped waves in the symbolic graph above). The SR 804 is conservatively rated at 50 watts RMS, 20-20,000 Hz into 8 ohms with only 0.1% THD.

Class G is just one example of Hitachi's leadership in audio technology. Power MOS/FET amplifiers, R&P 3-head system cassette decks, Uni-torque turntable motors, and gathered-edge metal cone speakers are just some of the others. There's a lot more. Ask your Hitachi dealer.



**HITACHI**

When a company cares,  
it shows.



mercury that complete the conductive path to the preamp input. Moving the pins through the dense mercury requires some energy, of course, but the effect is essentially like damping and is compensated by another feature of the design.

Surrounding the central pivot is a cup that the installer of the arm is directed to fill halfway with a viscous silicone fluid provided in the package. (The mercury cups also are filled at this stage.) This arrangement damps the motion of the arm in all directions; the effect of the mercury just adds to the overall damping. The counterweight adjusts for lateral as well as longitudinal balance, and the correct setting, once achieved, can be made permanent by tightening a setscrew.

An interesting option is that of using a separate arm section for each of your favorite cartridges, allowing interchange without arm rebalancing. Care should be taken to turn the preamp off before you make the change; the buzz of the two unterminated phono channels can shatter ears—and speakers. Conveniently, antiskating bias is built into the arm with no adjustment required or possible. Not so conveniently, the arm is supported in its rest position only by the cueing device. The latter can, after some adjustment, be set so that side drift is no problem.

According to the lab data, pivot friction in the Keith Monks arm is negligible. In the useful range of tracking forces, each turn of the adjuster screw provides 1.96 mil-

linewtons (0.2 gram) of force, just as the instruction manual says. Resonant frequency of the Shure V-15 Type III pickup mounted in the arm is 10.5 Hz, close to ideal and just about the best we have ever seen with this pickup. Damping proves to be excellent, as the rise in amplitude at resonance is a mere 1¾ dB. Our experience with this unit suggests that the resonant frequency of any cartridge will depend mainly on the mass and compliance of the cartridge itself, with the Monks arm making only a small contribution.

In the listening room, the arm gives a virtuoso performance. We have a number of records containing passages (strong highs and middles in combination with strong bass) that tend to give many cartridges fits. The Monks, to an astonishing degree, clears up the sonic jumble we had expected to hear. Checking the arm with a pair of vented loudspeakers, we found none of the subsonic dancing of the woofer cones so often in evidence.

Separate tone arms are not for everyone, and quite frankly the Keith Monks arm is one of the most demanding separates we have ever run across. (A better instruction manual would go a long way toward alleviating this.) The unit is capable of extraordinary performance, but its lack of convenience features makes it difficult to love. Its engineering and sonic capabilities, on the other hand, are worthy of the highest respect.

CIRCLE 132 ON READER-SERVICE CARD

## Adjustable Bias, Off-the-Tape Monitoring in Kenwood's Premier Deck

**The Equipment:** Kenwood Model KX-1030, a stereo cassette deck in metal case. Dimensions: 17 by 16½ inches (front panel), 11¾ inches deep (case). Price: \$400. Warranty: "limited," one year parts and labor. Manufacturer: Trio Electronics, Japan; U.S. distributor: Kenwood Electronics Corp., 15777 S. Broadway, Gardena, Calif. 90248.

**Comment:** Cassette-equipment designers are nibbling at the remaining weaknesses of the medium as inexorably as weather wears down mountains. The Kenwood KX-1030, for example, in addition to such "high-end" niceties as input mixing via controls with friction-clutched elements for left and right channels, offers both a three-head monitoring scheme (which contributes flexibility of use and accuracy of reproduction) and subtly variable bias. The difficulties of finding a tape "tailored" to a given recorder have been thoroughly expounded in these pages. But, with the bias system of the KX-1030, the roles are reversed: This recorder can be tailored to the tape.

The separate bias and equalization switches have posi-

tions for the three basic classes of tape—CHROME, NORMAL, and RESERVE (ferrichrome). The bias on each channel can be varied separately within a range above and below the nominal point (represented by detents) with the dual bias-adjustment control. The Kenwood deck includes two built-in test tones to facilitate the adjustment. Once the deck is set up to record and the oscillator button is depressed, it alternately records the two tones (400 Hz and 10 kHz). The playback is monitored simultaneously on the meters, and the bias adjusted until the levels are equal at the two frequencies. This determines two points on the frequency-response curve. Over a reasonably wide range of tapes, you can expect that the other points on the curve will fall pretty much in line—that response will be close to flat.

As long as the same brand of tape is used, we see little reason to set the bias for every cassette, though some variation is normal from one lot to another. When you switch brands, however, you can and should tweak the bias for the new type. And a periodic bias check will reveal the condition of the heads. If the 10-kHz response is lower than it

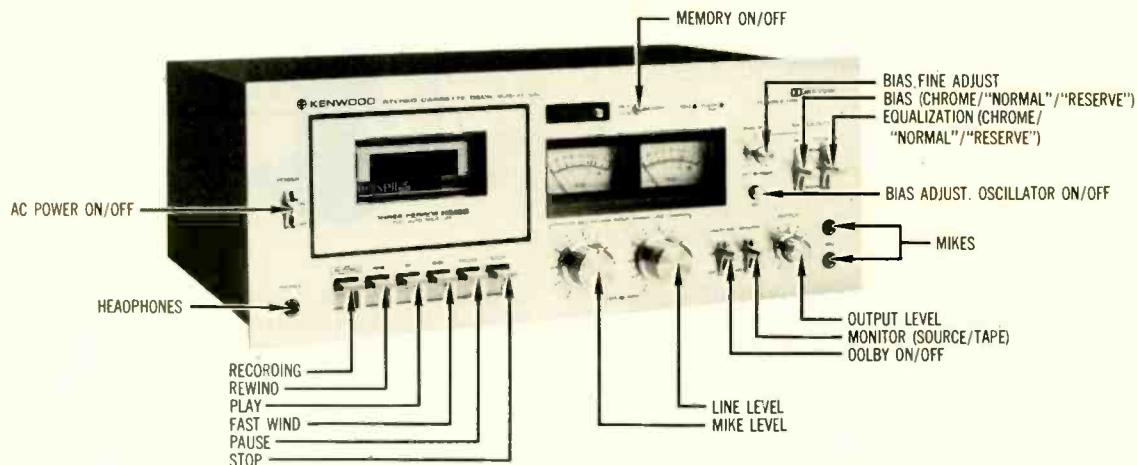

had been with the same tape and bias setting, the heads may be magnetized, dirty, or worn.

Lab tests indicate that playback equalization conforms well with standards. The record/play frequency response was measured after bias adjustment (which, though we find no mention of it in the manual, should be carried out with the Dolby switch OFF) for each of the tapes recommended by Kenwood: TDK SA for CHROME, TDK SD for NORMAL, and Sony Duad for RESERVE. The specific tape recommendations in the manual are exceptionally reliable because the deck itself can accommodate differences that other lists—where they are available at all—simply ignore. (No deck can do well by both Maxell UDXL-1 and TDK D, for example, without some adjustment, yet both appear on lists for several nonadjustable decks.) As the curves show, response is exceedingly flat with all three tapes, although (curiously) the high-frequency rolloff is reached sooner on the ferrichrome product than on the other two. The exceptionally fine performance might have been extended still

further (though only marginally) by including multiplex-filter defeat switching.

The erasure and signal-to-noise figures are representative of the quality we have come to expect from cassette decks, and a check of the Dolby indicates that it provides the full 10-dB noise reduction of which it is capable above about 2 kHz. Note that there is no sensitivity ("Dolby recording level") adjustment. With the output level control at maximum (otherwise it affects playback metering), you should be certain the TAPE indication in the bias test is not radically different from the meter reading when monitoring SOURCE; otherwise, as the manual clearly points out, Dolby tracking will be affected and the tape in question an undesirable choice for Dolby recordings.

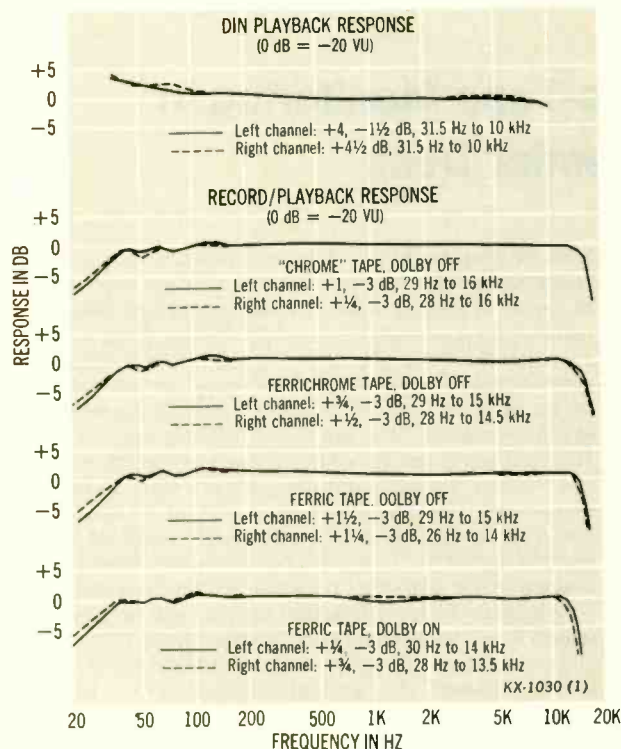

### Kenwood KX-1030 Additional Data

Speed accuracy	0.6% fast at 105, 120, & 127 VAC	
Wow and flutter	playback: 0.07% record/play: 0.10%	
Rewind time (C-60 cassette)	70 sec.	
Fast-forward time (same cassette)	70 sec.	
S/N ratio (re 0 VU, Dolby off; CBS weighting)	playback L ch: 54 dB R ch: 54 dB record/play L ch: 50 1/2 dB R ch: 51 dB	
Erasure (333 Hz at normal level)	65 dB	
Channel separation (at 333 Hz)	record left, play right: 30 dB record right, play left: 31 dB	
Sensitivity (re DIN 0 VU)	line input L ch: 165 mV R ch: 140 mV mike input L ch: 0.37 mV R ch: 0.31 mV	
Meter action (re DIN 0 VU)	L ch: 5 dB high R ch: 3 dB high	
Total harmonic distortion (at -10 VU)	<0.89%, 50 Hz to 5 kHz <0.53%, 100 Hz to 5 kHz	
Maximum output (re DIN 0 VU)	L ch: 1.3 V R ch: 1.2 V	

The channel separation, somewhat less than on the average deck, is certainly good enough for all practical purposes. Remember that few phono cartridges can claim channel separation significantly better than 30 dB.

Our listening tests were performed with the same three tapes that were used for the lab tests. As an experiment, we set the bias for TDK SA and then checked the response on the other two tapes *without* a touchup readjustment. (Of course, we did switch the bias lever to the appropriate position.) TDK SD was down about ½ dB at 10 kHz, and Sony Duad was up about ½ dB at the same point. Obviously, then, one setting will suffice for this trio of tapes, although slightly better performance can be eked out by readjusting. We hasten to point out that the three tapes we chose presumably were Kenwood's "design centers"; the match among a different trio is not likely to be so close.

The meters are rather fast-acting but limited in range (marked -20 to +5, corresponding roughly to -25 to 0 re the DIN standard). The peak-indicator LED is therefore very much to be appreciated. We relied on it more than on the meters in setting the level and were well rewarded by some excellent tapes. TDK SA, in particular, accommodates high-frequency transients well on the Kenwood, and its high-end loss with Dolby is barely apparent.

The playback head is electrically separate from, but physically in the same housing as, the record head. Thus, the gaps are very close together and playback is almost simultaneous with recording. Not only does this design elim-

inate the need for azimuth adjustment of the recording head, but it greatly facilitates an accurate A/B comparison between source and tape. Furthermore, the tape and source levels are well matched in the KX-1030 (assuming a tape of appropriate sensitivity), another aid in perceiving differences.

With so many virtues, are there any real flaws in the design? Some users might prefer the meters to read "absolute" playback levels without full monitoring output, but this point is both minor and arguable. The want of Dolby level adjustments is, in our view, pre-empted by the ability to check tapes for good record/play level match on the deck and hence is no loss—however useful it may be in some other decks. Head access for cleaning and degaussing is neither particularly easy nor (especially among front-loaders) particularly difficult. We take exception to the PAUSE on the ground that it leaves a slight click on the tape during recording and—at least in our samples—sometimes produces a noticeable "wowing in" of steady tones; but it is otherwise fast-acting and leaves no gap in the recording. It is therefore more useful than those on some more expensive decks, if less self-effacing than those on some cheaper ones we know of.

That leaves us with a deck of exceptional response and generally excellent performance with line/mike input mixing, unusual flexibility in meeting tape bias requirements, and simultaneous off-the-tape monitoring. That's a lot of quality—and qualities—for \$400.

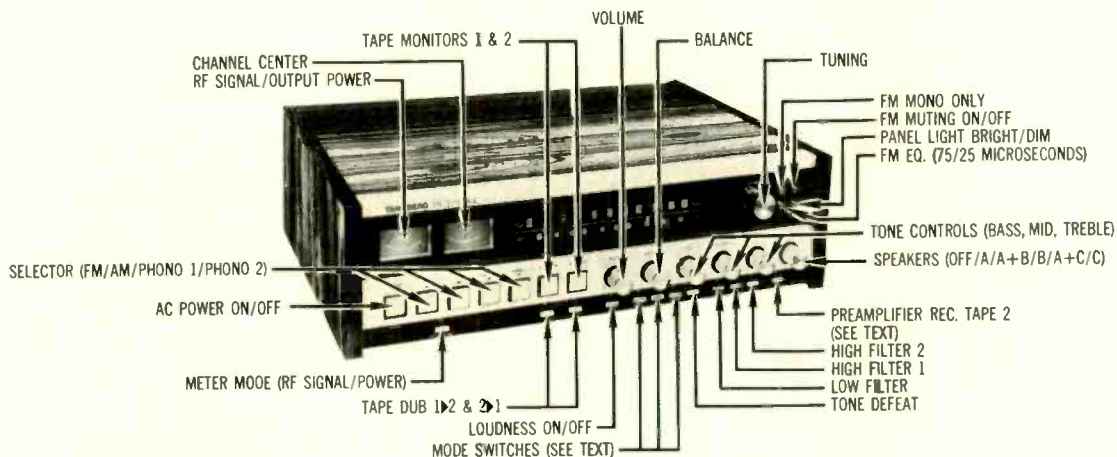

## A Superreceiver—Tandberg Style

**The Equipment:** Tandberg Model TR-2075 Mk. II, a stereo FM/AM receiver in rosewood cabinet. Convenience AC outlets: one switched (100 watts), 2 unswitched (200 watts total). Dimensions: 20¼ by 6 inches (front), 14 inches deep (case). Price: \$1,100; with optional clear plastic cabinet, \$1,200. Warranty: "limited," five years parts, three years labor. Manufacturer: Tandberg, Norway; U.S. distributor: Tandberg of America, Inc., Labriola Ct., Armonk, N.Y. 10504.

**Comment:** The top Tandberg receiver is unlike any other we have come across. For one thing, its chassis is in three virtually independent parts: Approximately the upper half is a stereo FM/AM tuner; below it is a control preamp; tucked in below that and behind the preamp's lowest rank of control buttons is a stereo power amplifier. Each of the

sections has its special qualities, and in aggregate they constitute a superreceiver such as only Tandberg could have conceived.

At first glance, the front panel seems deceptively simple because of the way in which the controls are grouped. On closer examination, it is full of surprises. As might be expected from a company that "thinks tape," the provisions for dubbing and monitoring are particularly unusual. Not only can you dub in either direction between the two decks for which there are connections, but you can listen simultaneously to any of the other inputs: the tuner section or either phono—there is no aux. The PREAMP REC switch, which applies only to TAPE 2, feeds the deck *after* the signal has passed through the tone controls and filters so that the "sweetened" version—from any input including TAPE 1—can be recorded. (For reasons the otherwise informa-



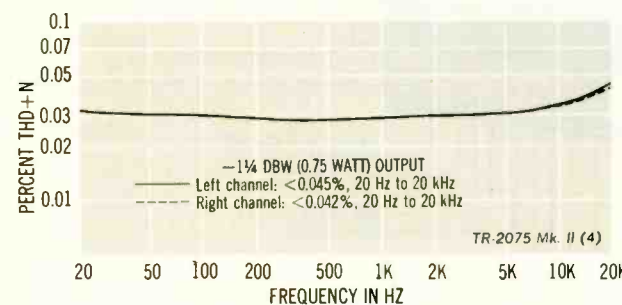
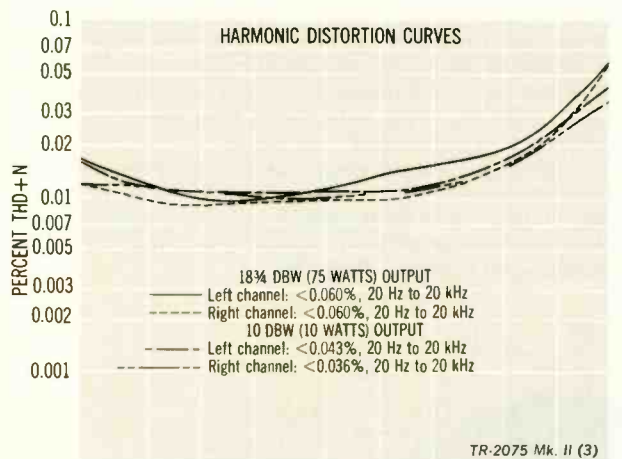
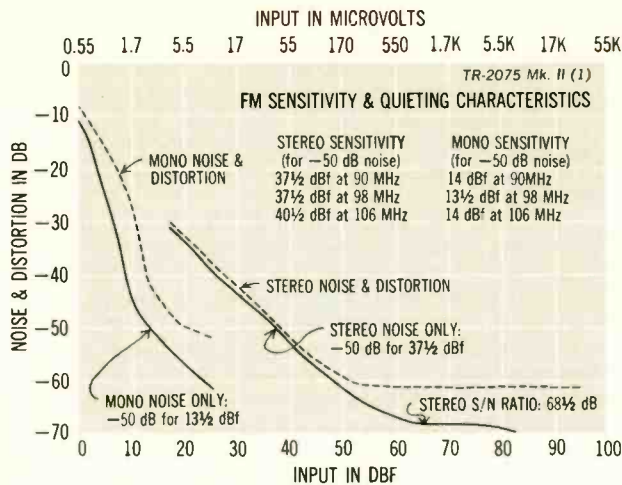

tive manual does not explain, use of the PREAMP REC feature reduces output to the power amp section by 20 dB.)

The slope of the low-cut filter is steep enough and begins low enough that it will leave most popular music intact while taking a somewhat heavier toll on the underpinnings of classical music. It works well against audible rumble; the first line of defense against phonographic subsonics is elsewhere. Three degrees of filtration are available for the highs. All have approximately the same hinge frequency; the slopes involved cut the top end gently (FILTER 2), moderately (FILTER 1), or radically (both together).

The tone controls have separate elements (but without friction clutching) for the two channels, well-chosen inflection points, and nice slopes, though there is a slight inter-

### Tandberg TR-2075 Mk. II Additional Data

Tuner Section			
Capture ratio	1½ dB		
Alternate-channel selectivity	82 dB		
S/N ratio (mono, 65 dBf)	76 dB		
THD + N	Mono	L ch	R ch
80 Hz	0.38%	0.28%	0.26%
1 kHz	0.22%	0.08%	0.08%
10 kHz	0.17%	0.24%	0.22%
IM distortion	0.20%		
19-kHz pilot	-62 dB		
38-kHz subcarrier	-62 dB		
Frequency response	mono + 0, -2½ dB, 20 Hz to 15 kHz		
	L ch + ¼, -1½ dB, 20 Hz to 15 kHz		
	R ch + ½, -2 dB, 20 Hz to 15 kHz		
Channel separation	> 44 dB, 450 Hz to 9 kHz		
	> 34 dB, 110 Hz to 15 kHz		
Amplifier Section			
Power output at clipping (channels driven simultaneously)	L ch 19 dBW (81 watts)		
	R ch 19 dBW (81 watts)		
Frequency response	+ 0, -¼ dB, 20 Hz to 40 kHz		
	+ 0, -2 dB, below 10 Hz to 100 kHz		
RIAA equalization	+ 0, -1 dB, 27 Hz to 20 kHz		
	+ 0, -2 dB, 20 Hz to 20 kHz		
Input characteristics (for rated output at full gain)	Noise	Sensitivity	S/N ratio
phono 1 (max.)	2.2 mV	-55¼ dBW	74 dB
phono 1 (min.)	8.5 mV	-57¼ dBW	76 dB
phono 2	2.9 mV	-55¼ dBW	74 dB
tape 1, 2 (max.)	145 mV	-67¼ dBW	86 dB
tape 1, 2 (min.)	615 mV	-69¼ dBW	88 dB
Phono overload (clipping point at max. sensitivity)	125 mV at 1 kHz		
Damping factor	60 at 1 kHz		
	55 at 50 Hz		
High filters	1 -3 dB at 9.2 kHz; 12 dB/oct.		
	2 -3 dB at 9.5 kHz; 6 dB/oct.		
	both -3 dB at 7.5 kHz; 18 dB/oct.		
Low filter	-3 dB at 48 Hz; 12 dB/oct.		

**If Your Records Are Valuable**

# LOOK FOR THE RED BOTTLE

## Why?

**General Need:** Tests by the Discwasher Labs show that fingerprints are absolutely not totally removed by "dry cleaning" in any form, either brush or adhesive rollers. Long term record care requires the complex integration of micro-dust pick-up (not spreading around), with removal of chemical contamination such as fingerprints; plus an in-process reduction of static charge so that dust particles are not immediately sucked back onto the surface. And all of this must be done without leaving a residue.

D3 fluid, used with the Discwasher System for capillary removal of fluid/contamination achieves the results required for record survival. But the hidden requirements of a record cleaner are much more complex than integrated function alone.

**Chemical Integrity:** The trick is not to simply clean—but to clean with vinyl safety and extremely low "solute load" or fluid content. D3 is a solution that typically has half the dry weight residue of tap water and about one-fifth the median for other "record cleaners". D3 typically has the dry weight residue of distilled water sold in drug stores—and yet D3 has an activity in surface tension reduction/fingerprint removal that is greater than any fluid with twice the solute load of D3.

D3 fluid contains a complex blend of buffered surfactants conjugated in the labs of Discwasher, Inc. These provide cleaning "activity" against real-world record contamination, like fingerprints and airborne oils. But not against artificial "test conditions" of mineral oils and sheep wax (lanolin). Because if D3 removed waxes and oils of this nature, then D3 would also begin to soften critical vinyl stabilizers which are essential for record survival under the incredible heat and pressure of a tracking audio stylus. Alcohols and many cleaners pull stabilizers and age vinyl.

Some cleaning fluids contain large molecules of fatty acids to "float" dirt—but these "molecules" positively stick to vinyl and are literally a dust trap.

D3 fluid does not dramatically reduce static charge forever. The only liquid that can is one which leaves a coating. But D3 does reduce static charge during cleaning (using 3 drops on the Discwasher brush), and actual static voltage is reduced during playback to about one-half the normal levels.

**The Discwasher "Systems Approach":** Any cleaning fluid, when left on the record, only spreads out contamination. With three drops of D3 on the special directional micro-fibers of the Discwasher brush, dust is lifted out of the grooves, without "follow up" or adhesive oxide removal of the vinyl.

In addition, the Discwasher System wicks up D3 fluid plus suspended contamination. The fluid is drawn deep into the absorbent backing of the Discwasher brush. No liquid, dust or contamination "dries back" when the system is properly used. The "systems approach" of Discwasher includes a hand-rubbed, milled walnut handle. Something to outlast plastic wonders and out-perform everything else. Your records can't do better than the Red Bottle inside the "system".



# As you would expect from LUX, our new R-1050 tuner/amplifier “is no mere run-of-the-mill receiver.”

When LUX Audio entered the U.S. audio scene in 1975, we brought with us a worldwide reputation for excellence. But since we also brought only our separate amplifiers and tuners, relatively few audiophiles could enjoy the special qualities of LUX performance.

Now, everyone who would like a LUX tuner, preamplifier and power amplifier—on a single chassis—can have them just that way. We choose to call these new models “tuner/amplifiers,” although you probably think of them as “receivers.” What’s more important is how Hirsch-Houck Labs described the R-1050 in *Stereo Review*:

“Given its features, appearance and performance, this is no mere run-of-the-mill receiver... The excellent audio-distortion ratings... obviously place it among the cleanest of the currently available receivers... every aspect of the receiver’s operation and handling was as smooth and bug-free as its fine appearance would suggest.”

Typical of the circuitry and features that result in such fine performance are these: a dual-gate MOSFET front end for high sensitivity, and a special linear-phase filter array for high selectivity, low distortion and wide stereo separation. The preamplifier section has a two-stage direct-coupled amp for accurate

RIAA equalization and a good phono overload capability. And the power amplifier is direct-coupled DC, in a true complementary symmetry configuration, for excellent transient and phase response.

Operating features include a six-LED peak level indicator for each channel; tape-to-tape dubbing with simultaneous listening to other program sources; turn-on time delay speaker protection plus automatic overload shutdown.

The sound of the R-1050 has been appreciated as much in England as here. For example, the British magazine *HiFi at Home* said: “...treble quality was light and delicate, something LUX engineers always seem to achieve... bass output seemed plentiful and strong, as is often the case with enormous, low impedance power supplies.”

If we’ve encouraged you to experience the sound of a LUX tuner/amplifier, your next step is to visit one of our carefully selected dealers. We’ll be pleased to send you the names of those in your area.

**Luxman R-1050:** 55 watts per channel. THD 0.05%. Suggested price, \$595. Other Luxman tuner/amplifiers: R-1040, 40 watts per channel. THD 0.05%. Suggested price, \$445. R-1120, 120 watts per channel. THD 0.03%. Suggested price, \$895. (Power ratings are minimum continuous output per channel, with both channels driven simultaneously into 8 ohm loads, from 20 to 20,000 Hz, and no more than quoted total harmonic distortion.)

## LUX Audio of America, Ltd.

160 Dupont Street, Plainview, New York 11803 • In Canada: White Electronics Development Corp., Ontario



action between the controls. More important, we found that two samples required some bass boost beyond the indicated "0" position for flat response—unless, of course, we used the TONE DEFEAT.

The speaker switching allows for use of three stereo pairs and wisely limits to two the number that can be used simultaneously. Output power can be read off what normally is the signal-strength meter—with the help of a chart in the manual, since the meter's calibration is in microvolts. The mode switching is ingenious (though a rotary switch like that for the speakers might have made it easier to assimilate) in that its three pushbuttons allow five choices: mono from either channel alone, left-plus-right mono, stereo, or reverse stereo.

Another extra included in this receiver is electronic input switching. Not only does this guard against noise due to corroded or worn switch contacts and offer essentially transient-free switching, but it gives a particularly luxurious "feel" to the operation, and the inherent delay allows the user a fraction of a second to correct a switching mistake without losing the desired input.

On the back panel, there are input sensitivity adjustments for PHONO 1 and both tape decks. (Incidentally, there are DIN-socket options for all phono and tape connections; if you use them, note that the manual transposes the diagram for phono with that for tape.) And there are removable PRE-OUT/MAIN-IN jumpers. The connections for both 300- and 75-ohm FM antennas are heavy brass screws like those for the speaker connections, which seem best used with spade-lug leads; there is no coaxial 75-ohm input.

The laboratory data show that, in mono, the FM tuner section achieves 50 dB of quieting at a commendably low input level while maintaining sensitivity almost constant across the band. The input required for the same quieting in stereo is, of course, higher but still just about on a par with fine separate tuners. Some sensitivity (about 3 dB) is lost toward the high end of the band. Alternate-channel selectivity is very good, and the mono signal-to-noise ratio enters territory that, to the best of our knowledge, is inhabited by very few receivers. Capture ratio is very good, especially in light of the high selectivity. So is stereo distortion—even in the often troublesome 10-kHz test. Leak-through of the 19-kHz stereo pilot and 38-kHz subcarrier is suppressed very well indeed.

In the listening room the FM section provides a generally high level of performance. As the frequency response data suggest, the sound is free of coloration; the usual, slight rolloff in the low bass is almost impossible to detect by ear.

The fine separation of the TR-2075 throughout the range where the ear can detect directionality affords a stereo image of unusual depth and clarity. The muting circuit, however, allows considerable breakthrough as the unit is scanned rapidly across the band; in addition, the tuning dial is miscalibrated on one of our samples, and there is no high-blend mode for weak stereo stations. Offsetting pluses include the smooth feel of the tuning knob and the sensitive and apparently accurate meters.

Despite the reticent appearance of this receiver, it contains a power amplifier section whose capabilities seem to exceed its modest 18% dBW (75-watt) rating. At this level and below, the unit remains in substantial compliance with its relatively low distortion specs. There is a tendency for THD + N to rise slightly as 20 kHz is approached. This is probably a tradeoff for the reduction in high-frequency negative feedback that Tandberg uses as insurance against transient distortion. The trade seems well judged; the amp projects a very clean sound.

What is really outstanding about the Tandberg is its ability to pass high-level peaks without clipping. While the headroom for clipping of a steady tone is but a small fraction of a dB above rated power, the dynamic headroom (measured in our listening room by an approximation of the proposed IHF method) is better than 2 dB. That is, instantaneous peaks equivalent to well over 100 watts of sine wave can be passed cleanly.

Both phono inputs are very quiet. Overload, even in the most sensitive position of PHONO 1, is adequate without overkill. The pickup cartridge used in the test, designed for a load that is just about average these days, was accepted gracefully by the phono section. Judging by the slight falloff in the RIAA equalization at 20 Hz, which is not really audible, the section appears to contain a nondefeatable subsonic filter.

In its basic performance, the Tandberg TR-2075 Mk. II is fine indeed. Both the tuner and the amplifier display a level of competence that is quite out of the ordinary. Also unusual—even, perhaps, idiosyncratic—are the philosophy and orientation that underlie the entire concept. This should startle nobody familiar with Tandberg products, which at times have "broken the rules" to brilliant purpose. If the purposes of some innovations in this receiver are neither immediately apparent nor entirely unflawed, its concepts may yet convert its skeptics. The receiver certainly is not cheap, but it represents a creative approach, bearing in itself a high degree of sophistication. And that can't be cheap.

CIRCLE 134 ON READER-SERVICE CARD

## From Marantz: A Speaker with a Variable Vent

**The Equipment:** Marantz Model 940, a floor-standing speaker system in inlaid-veneer wood cabinet. Dimensions: 15 by 45¾ inches (front), 12 inches deep plus grille. Price: \$399.95. Warranty: "full," five years parts and labor. Manufacturer: Marantz Co., Inc., 20525 Nordhoff St., Chatsworth, Calif. 91311.

**Comment:** If we had to pick a sign of the zodiac appropriate to the Marantz 940, it would be Gemini. Astrologers will tell you that Geminis have a dual personality, and that characteristic surely applies to the 940, which can be converted from an infinite baffle to a ported design by removal

of its Vari-Q acoustical plug. The plug is a cylinder in a high-density plastic foam. When wedged into the vent, it seals the enclosure.

The finely crafted cabinet is contemporary in styling, with rounded corners and oiled-walnut veneer on all sides. The top and the upper surface of the base are inlaid with matched veneers.

The design of the enclosure places the woofer axis 18½ inches above the floor and the tweeter and supertweeter at roughly the ear level of a seated listener. Connection to the amplifier is made via color-coded, spring-loaded terminals in the cavity below the enclosure proper. The cloth grille



stretches over a framework that clips onto the front surface. The mounting arrangement is not as secure as it might be, and the plastic tabs used to affix the grille break easily.

Most of the measurements made in the anechoic chamber were performed with the speaker in the sealed mode. After the Vari-Q plug had been removed for an on-axis response measurement, the response in the region between 50 and 75 Hz was boosted by about 2 dB, while some increase was apparent from 40 to 150 Hz.

With the enclosure sealed and with the level controls in their FLAT position, the average omnidirectional response is very smooth and nearly flat from 100 to 3.5 kHz, with a slight rolloff above that band and some rise below it. Comparison of the omnidirectional response curve with the front hemisphere and on-axis curves indicates good dispersion out to 2 kHz. Some anomalies appear higher up.

The Marantz 940 provides rather generous control ranges—about +2 to -4 dB for the midrange and +4 to -12 dB for the tweeter. The supertweeter control behaves more erratically, defying numerical characterization. Data from the lab suggest that the midrange control is effective from about 350 Hz to 8 kHz, the tweeter control from about 1 kHz on up, and the supertweeter control above about 7 kHz. The wide overlap between drivers and the relatively wide-range controls afford a practically infinite variety of adjustments.

The nominal impedance works out to 6.4 ohms, which also represents a rough average over the band. As the upper drivers come into play, the impedance drops off to about 4 ohms in the region between 1.5 and 8 kHz and finally reaches 3.6 ohms near 20 kHz. We'd advise against paralleling pairs of the speaker on amplifiers not capable of driving 2-ohm loads.

Efficiency of the 940 is on the low side. An average anechoic sound pressure level of 80¾ dB at 1 meter results from a 0-dBW (1-watt) pink-noise signal over the music band (250 to 6,000 Hz). On a continuous basis, the 940 produces 106¾ dB SPL at 300 Hz with a 20-dBW (100-watt) input. Pulses of 114 dB SPL can be reached without

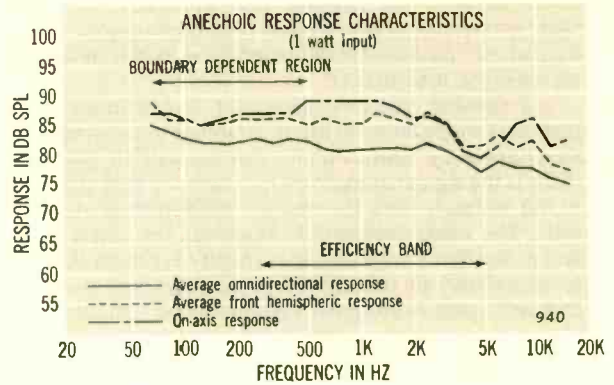

gross distortion from an input of 27¼ dBW (533 watts) peak—the limit of the test amplifier.

Above 1 kHz, where the smaller drivers are functioning, the combined second and third harmonic distortion remains at 0.25% or less at the 0-dBW level. At a drive level equivalent to 100 dB SPL at 300 Hz, the high-frequency distortion averages about 0.5%, although strong second harmonic content (3%) can be found at 8 kHz. The woofer, driven by 0 dBW, approaches 1% distortion at 50 and 100 Hz and reaches 2½% at 30 Hz. At the higher input level, the distortion exceeds 2.5% at 200 Hz and 5.5% at 100 Hz, and it hits 10% at about 45 Hz. Fortunately, the second harmonic predominates.

In our listening room, we experimented with the placement of the 940s as well as with the tonal balance controls. We finally settled on a slight boost in the tweeter response and flat settings for the midrange and supertweeter. We found that placing the speakers away from walls helps to tighten the bass somewhat—a definite advantage, in our opinion—and also to enhance an already excellent image depth. While some listeners might prefer to remove the Vari-Q plug and place the speakers against the wall for maximum bass, we find the sound overwhelming and quite tubby under such conditions.

The 940 is a very gutsy speaker with a prodigious apparent bass and dynamic range that should greatly appeal to rock fans. While the bass is abundant, it is not the clearest we have heard, probably because of the relatively high levels of second harmonic distortion. For our ears, the system's strong suit lies in its excellent presence and convincing stereo image. Sounds float freely in space and are not confined to the source. The transient response is quite good, and instruments whose sonic energy lies mainly in the middle and upper registers—violins, woodwinds, brasses, and such—are handled very well indeed. So is a piano played in the upper octaves.

In its personality, the Marantz 940 is more multifaceted than even a Gemini. The already powerful bass is augmented by removing the Vari-Q plug. In the midrange and treble, the drivers can be blended via the level controls to produce a variety of hues, some of which may be just what you've been looking for; visually it is almost certain to be welcome.

CIRCLE 131 ON READER-SERVICE CARD

More on page 60

**CORRECTION:** A printing error in our April issue transposed the response graph for the Electro-Voice Interface D loudspeaker with that for the Ohm L.

# Start playing with a full deck.

The AIWA AD-6800. It has everything you should expect in a top-flight cassette deck. And that includes our Flat Response Tuning System (FRTS) that adjusts to the optimum bias level for any tape on the market, precisely and effortlessly.

The AIWA AD-6800 uses its own circuitry to measure the precise bias figure of not just one or two, but every brand of cassette tape, whether it's LH, FeCr or CrO<sub>2</sub>. The result; a flatter-than-ever frequency response with any tape on the market.

And the new AIWA 3-head Flat Response Tuning System is a snap to use.

First, slip in a cassette and the AD-6800 will load it automatically.

Next, set the Input Selector to "test" and push the "record" key to automatically activate the 400Hz and 8kHz built-in oscillators. You're all set for test recording.



Bias Fine Adjustment allows precise fine tuning for optimum response.

Slide the Azimuth Adjust control for optimum head alignment and adjust the Bias Fine Adjust knob that corresponds to the type of tape you're using. The AD-6800 will let you know the exact bias necessary for the flattest possible response when the right (8kHz) and left (400Hz) VU meters are in corresponding positions. Now you're ready to record. It's that simple.

AIWA's new 3-head Flat Response Tuning System (FRTS) lets you monitor a tape simply by observing characteristics of the frequency response. You can actually "see" the sound so you can record at optimum levels.

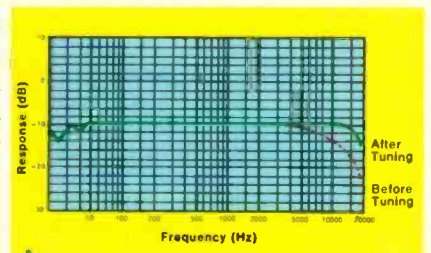

The AIWA Flat Response Tuning System achieves flattest response possible for maximum recording results.



AIWA's exclusive Double Needle Meters let you check both VU and Peak levels at a glance because they're combined on the same meter.

AIWA's new 3-head Flat Response Tuning System (FRTS) lets you monitor a tape simply by observing characteristics of the frequency response. You can actually "see" the sound so you can record at optimum levels.

The AD-6800 provides another exclusive feature—Double Needle Meters. AIWA has combined VU and Peak readout on each meter so you can monitor both functions at a glance. A convenience feature you won't find on any other cassette deck. The AD-6800 includes a Peak Hold function, too.

And with the AD-6800 you get an incredibly low wow and flutter of 0.05% (WRMS), and with Dolby\* on and FeCr tape, an S/N ratio of 65dB, and a frequency response of 20 to 19,000 Hz.

With all this in one great cassette deck and AIWA's exclusive new Synchronized Recording Operation (when used with the AIWA AP-2200 Turntable) you'll begin to understand what precision recording is all about.

The AIWA AD-6800. See it at your AIWA dealer now and start playing with a full deck.



Distributed in the U.S. by:  
MERITON ELECTRONICS INC., 35 Oxford Drive,  
Moonachie, New Jersey 07074

Distributed in Canada by: SHIRO (CANADA) LTD.

\*Dolby is a trademark of Dolby Laboratories, Inc.

CIRCLE 3 ON READER-SERVICE CARD



## Radio Shack's Top-but-Bargain Turntable

**The Equipment:** Realistic LAB-400, a two-speed (33 and 45 rpm) direct-drive automated single-play turntable, with walnut-veneer base and detachable hinged dust cover. Dimensions: 17¼ by 14½ inches (top); 5⅝ inches high with dust cover closed, 17 inches clearance required with cover fully open. Price: \$199.95 including a magnetic pickup. Warranty: "limited," one year parts and labor. Manufacturer: Radio Shack, Div. of Tandy Corp., 2617 W. Seventh St., Fort Worth, Tex. 76107.

**Comment:** With the exception of a few notable diehards, the bulk of today's high-end turntables are equipped with servo-controlled DC motors whose driveshaft is connected directly to the platter. Such is the case with the Realistic LAB-400, the luminary of the Radio Shack line. Its automatic features, powered by a second DC motor, include arm return in three modes: manual cueing, automatic cueing, and automatic repeat (with a 15-second cycle time). The output is muted during automatic cueing and arm return.

The tone arm is the conventional S-shaped tubular type with a removable universal headshell. The tracking force is set via a counterweight calibrated in 5-millinewton (½-gram) increments. The lab could find no measurable error in these calibrations over the range from 5 to 30 millinewtons (that is, to 3 grams). The antiskating knob is calibrated for spherical styli (with a conversion table for elliptical and Shibata styli in the owner's manual), but in our sample it measures considerably lower than average for tracking forces in the range where most quality magnetic pickups operate and catches up only above the 2-gram (20-millinewton) calibration.

Arm friction in the vertical plane is negligible. Laterally, the arm has a tendency to home in to a stable position when near the end of the side. The lab reports that a 0.6-millinewton (60-milligram) force is required to move the arm from this position. On most records, the "sticky" place would occur in the lead-out groove and cause no unbalance in groove-wall forces and consequent increase in distortion. The trip operates with a low enough tracking force to be satisfactory.

As we've come to expect from direct-drive turntables, the flutter and audible rumble figures on the LAB-400 are excellent. So is the speed accuracy. Once set to the correct speed, the turntable is completely oblivious to line-voltage variations within the test range, and the two basic speeds can be adjusted—via separate controls—to run from about a quarter-tone flat to about a semitone sharp.

Our sample was supplied with the Realistic/Shure R-1000E magnetic cartridge. The lab found the tone-arm resonance of this combination to be quite low in frequency (6.5 Hz) but reasonably well controlled in amplitude (+4 dB). A repeat of the measurements with the Shure V-15 Type III yielded roughly equivalent figures (+4 dB at 6.7 Hz). Our listening tests were made tracking the R-1000E at 12.5 millinewtons (1.25 grams) and turned up fewer potential warp-tracking problems than the low resonance frequency suggests.

The cue control operates with exceptional accuracy, and the stylus returns to within one groove at both the outer and inner diameters of the disc. This degree of accuracy was maintained even with a disc cut practically to the label (and therefore including the "sticky" region).

Every Achilles has his heel. With the LAB-400, it is the suspension—abetted, we suspect, by the low tone-arm resonance with the very compliant pickup. We found it virtually impossible to raise or lower the dust cover without causing mistracking, and even moderate shocks to the (sturdy) support on which it rested were likely to induce a skip and bounce, even with maximum recommended tracking force.

Many listeners will, no doubt, be perfectly willing to contend with the few foibles of the LAB-400 in order to enjoy a fully automatic direct-drive turntable at such a reasonable price. The unit's handsome cosmetics and the able overall performance, taken with the price, are sure to aid in attracting buyers.

CIRCLE 133 ON READER-SERVICE CARD

### Realistic LAB-400 Additional Data

Speed control range	
33 rpm	-3.8 to +7.3%
45 rpm	-3.7 to +5.5%
Weighted peak flutter (ANSI/IEEC)	
average	0.04%
max. instantaneous	0.06%
Audible rumble (ARLL)	-61 dB
Min. stylus force for automatic trip	
2.25 millinewtons (225 milligrams)	

For more reports on equipment, see BACKBEAT.

# Presenting the JVC MusicTowers.



JVC LX-3000 MusicTower with JVC components, as shown, from top to bottom: T-3030 Digital FM Stereo Tuner, P-3030 Control Preamplifier, SEA-7070 10-Band S.E.A. Graphic Equalizer, KD-95 Stereo Cassette Deck, QL-10 Quartz-Locked Turntable, M-3030 DC Stereo Power Amplifier, SK-1000 3-Way Speaker Systems.





## JVC MusicTowers give you total convenience and flexibility.

As you can see from the suggested JVC systems shown, your choice of components and MusicTowers depends on your own special requirements and budget. And regardless of which combination you select, one thing you can be certain of: all JVC components are designed to complement each other to produce the best possible sound reproduction.

So if you agree that a good music system should be heard—and seen—visit your JVC dealer. Select your JVC system from the most innovative collection of quality components we've ever offered. Then match it up with a JVC MusicTower. And you'll see how beautifully JVC lends a hand to component handlers.

JVC LK-12 MusicTower (from top to bottom) JL-A20 Semi-Automatic Turntable; JR-S61W AM/FM Stereo Receiver; KD-25 Stereo Cassette Deck

JVC LX-2000 MusicTower (from top to bottom) JT-V77 AM/FM Stereo Tuner; JA-S77 DC Integrated Stereo Amplifier; QL-A7 Direct Drive Quartz Turntable with automatic lift; KD-85 Stereo Cassette Deck; SEA-50 Stereo Graphic Equalizer

JVC LK-1000 MusicTower (from top to bottom) QL-5 Direct Drive Quartz Turntable; JT-V22 AM/FM Stereo Tuner; JA-S55 DC Integrated Stereo Amplifier; KD-55 Stereo Cassette Deck; SEA-50 Stereo Graphic Equalizer. Protective glass door for components and record compartment.

JVC LK-44/MK-44 MusicTower (from top to bottom) QL-A2 Direct Drive Quartz Turntable with automatic return; JT-V22 AM/FM Stereo Tuner; JA-S22 DC Integrated Stereo Amplifier; KD-25 Stereo Cassette Deck; SEA-20G Stereo Graphic Equalizer. Glass panelled record compartment.

JVC LK-500 Horizontal MusicTower. QL-5 Direct Drive Quartz Turntable; KD-S201 Stereo Cassette Deck; JR-S301 DC Integrated AM/FM Stereo Receiver. SK-700 3-Way Speaker Systems. Extra-wide record compartment.

# JVC

JVC America Company, Division of US JVC Corp., 58-75 Queens Midtown Expressway, Maspeth, N.Y. 11378 (212) 476-8300  
Canada: JVC Electronics of Canada, Ltd., Scarborough, Ont.

©1978 JVC America Company, Div. of US JVC Corp.

We build in what the others  
leave out.

# JVC

Take our LX-3000 MusicTower. This strikingly styled unit with gleaming walnut veneer sides, is designed for nineteen-inch rack-mounted components, and can house JVC's Professional Series. Each component represents the finest JVC offers. And the great thing is that it's easier than ever to make the proper interconnections after each component slides securely into place. Then, because JVC believes distractions belong in the back, not the front, all interconnecting wires vanish from sight within each of the two vertical supports. You can even move the whole works from one listening area to another; the LX-3000 MusicTower glides smoothly over any floor surface on heavy duty casters that lock into place. This JVC MusicTower takes the center spotlight in any listening room.

People who are into good music reproduction are proud of their high fidelity component system. They like to put it where everyone can see as well as hear it. And rightfully so, because visually, today's components are a tribute to the finest expression of contemporary design. That's why JVC is introducing its series of MusicTowers. They're for people who like to display their JVC component system in one place. Or any place. To meet just about any requirement for a JVC component system, our handsomely styled MusicTowers give you the opportunity to select the JVC components you want: anything from a basic system (receiver, turntable, cassette deck, speakers) to one that accommodates a total system of separate components.

Because we think a good music system should be heard.  
And seen.

## Behind The Scenes

**A Corner on Superdiscs?** Audio-Technica, heretofore known primarily as a phono cartridge manufacturer, seems to be on its way to monopolizing the "super-sonic" disc market. For some time the company has been distributing the direct-cut discs of the Umbrella, Sonic Arts, and Telarc labels. Now it has added Gale Maximum Fidelity Recordings and some selections from the RCA label produced by the RVC Corporation of Japan (a joint venture of RCA and JVC). The Gales were previously obtainable through their own distribution organization here (see HF, October 1977), but the RCAs are being made available in the U.S. for the first time. The latter are mostly direct-cut releases recorded at 45 rpm to reduce distortion and enhance dynamic range.

Ironically, with only seven RCAs and five Gales, Audio-Technica has added two recordings of Beethoven's *Appassionata* Sonata to its catalog: Peter Frankl's on Gale backed with the *Waldstein* and Ikuyo Kamiya's, which takes two sides of the faster-spinning RCA. Three of RCA's discs are devoted to jazz. As with the rest of Audio-Technica's catalog, the new labels are list-priced at \$14.95 for a single disc, \$21.95 for a double album.

**Verdi binge.** In addition to completing its *Nabucco* ("Behind the Scenes," November 1977), EMI planned to record the Verdi Requiem in London in February, both with Riccardo Muti conducting the Philharmonia Orchestra. Scheduled soloists for the Requiem were soprano Renata Scottò, mezzo Fiorenza Cossotto, tenor Veriano Luchetti, and bass Yevgeny Nesterenko. Meanwhile in Milan, the next operas contemplated for recording in Claudio Abbado's DG Verdi series are *Don Carlos* and *Ballo in maschera*; details remain sketchy.

As noted here in January, DG also plans a new *Rigoletto*, to be conducted by Carlo Maria Giulini; at last report it too will use La Scala forces, with Piero Cappuccilli in the title role and Ileana Cotrubas as Gilda. But DG's is only one of three *Rigolettos* on the horizon. A Dresden recording has been released in West Germany on Acanta, the new classical label of Bellaphon, which has absorbed parts of the dismantled BASF catalog, including the historical vocal issues. (Acanta, like BASF classics before it, is imported by German News Company.) Francesco Molinari-Pradelli, who conducted EMI's last *Rigoletto*, leads Dresden State Opera forces in the new German recording (sung in Italian), with Rolando Panerai in the

title role, Margherita Rinaldi as Gilda, Franco Bonisolli as the Duke, Viorica Cortez as Maddalena, and Bengt Rundgren as Sparafucile.

Finally, this summer Sherrill Milnes is slated to record his second *Rigoletto*, for EMI in London, with Beverly Sills as Gilda, Alfredo Kraus as the Duke (his third recording), Mignon Dunn as Maddalena, and Julius Rudel conducting.

**Footnotes: Rossini, Donizetti, Lehár.** From some of the same sources as the *Rigolettos* will come cheerier doings. Acanta, for one, has a Dresden-made recording of Rossini's *L'Italiana in Algeri* conducted by Gary Bertini, with Lucia Valentini-Terrani in the title role (in which she made her Met debut several seasons back), supported by Ugo Benelli, Sesto Bruscantini, and Alfredo Mariotti.

Sills will be adding two merrier heroines to her discography: Lehár's *Merry Widow* and Norino in Donizetti's *Don Pasquale*. Excerpts from the Lehár operetta (in English) were recorded in New York this winter with Alan Titus as Danilo and New York City Opera forces under Rudel. In *Don Pasquale*, scheduled along with *Rigoletto* for this summer, Sills will again be romantically involved with Kraus (as Ernesto) but with happier results. They will be joined by two colleagues with whom Sills has long been closely associated, but never before on records: Donald Gramm will sing the title role, and Sarah Caldwell (fresh from conducting Donizetti's other great comedy, *L'Elisir d'amore*, at the Met) will make her first recording.

**Caballé's Wagner.** Montserrat Caballé has made her first recording of Wagner, joining Alain Lombard and the Strasbourg Philharmonic in excerpts from *Tannhäuser* (the Overture, "Dich, teure Halle," and "Allmächte Jungfrau") and *Tristan und Isolde* (the Prelude and *Liebeshod*) for Erato.

The *Tristan* excerpts, by the way, are a foretaste of the Caballé/Lombard production planned for the 1980 Strasbourg Festival, in which Jean-

Pierre Ponnelle will direct the soprano in her first *Isolde*, to be filmed and recorded. (Also in the talking stage is a *Tristan* to be conducted by Rafaël Kubelik, with Catarina Ligendza and James King.) Other Caballé plans include a live recording of Cherubini's *Medea* in Strasbourg in November and two Verdi projects: *Attila* for EMI, with Plácido Domingo and Nicolai Ghiaurov, conducted by Riccardo Muti; and *Ballo in maschera* for Philips, with José Carreras and Ingvar Wixell, conducted by Colin Davis.

**DG in Washington.** DG has made its first recordings with the National Symphony: Leonard Bernstein conducts the premiere recording of his recently completed *Songfest*, and Mstislav Rostropovich accompanies Martha Argerich in the Schumann piano concerto and Chopin's Second Concerto.

**Rostropovich and EMI.** Speaking of Rostropovich, the busy cellist/conductor has signed an extensive (though nonexclusive) contract with EMI, among whose specifics is a project close to his heart: a new recording of Shostakovich's *Katerina Ismailova*, scheduled to be made in March and April of this year in London with the London Philharmonic. Not surprisingly, the title role is taken by Galina Vishnevskaya.

**Martha in Munich.** The fragile charms of Flotow's lovely *Martha* are uncommonly vulnerable to saccharine operetta-style reduction, which gives Eurodisc's new coproduction with Bavarian Radio more than casual interest—at least on paper. The conductor is the excellent and too little-known Heinz Wallberg (whose EMI premiere recording of Humperdinck's *Königskinder* comes in for high praise this month from David Hamilton), and the cast includes two of present-day Germany's more potent-voiced singers: tenor Siegfried Jerusalem as Lionel and bass Karl Ridderbusch as Plunkett. Lucia Popp sings the role of Lady Harriet.

**Baker's Brahms.** Janet Baker has recorded a disc of Brahms songs for EMI (including the *Four Serious Songs* and the two Op. 91 songs with viola obbligato, here played by Cecil Aronowitz), accompanied at the piano by André Previn. A few days before the recording, Previn had accompanied Baker in a Royal Festival Hall recital that included the premiere of a song cycle (settings of poems by Philip Larkin) that he wrote especially for her. ●

# Face Reality.

Introducing The DM Factor. Dual Monaural construction. Exclusively Mitsubishi.

It means inside our stereo preamplifier are two perfectly matched mono preamplifiers.

Just like our dual monaural power amplifiers.

Just like your ears.

It means Mitsubishi has achieved more than stereo. But inter-channel separation at more than 80dB at 20kHz. For separation 30dB more than conventional designs.

For THD at less than 0.002% from 20Hz to 20kHz. For effective elimination of leaks, crosstalk, any influence able to distort the stereo image. In both the depth and breadth of the image.

Our new preamplifier was also developed to effectively

handle the moving coil cartridge. For a signal-to-noise ratio of -77dB. Unheard of in any other preamplifier.

Introducing our new frequency synthesizing tuner. With new capabilities, new features, new design.

With THD in stereo at barely 0.08% at 1kHz. Conservative, at that. With switched selectivity for uncompromising reception. With digital read-out. With LED's to determine signal strength and precise tuning. With an uncanny ability to zero in on the quietest signal.

And along with unique electronic engineering, Mitsubishi offers unique mechanical engineering.

Like The Docking System.

It means preamplifier can be linked with amplifier neatly and compactly. Without a myriad of crossed wires.

But no matter what we tell you, the truth is, nothing will

tell you more about our audio equipment than your own audio equipment.

So, use your ears, and by all means compare.

Compare the difference The DM Factor makes. Compare the convenience The Docking System makes. Compare the capabilities of our new tuner.

And you'll know why Mitsubishi made them part of The System.

The only high performance audio system with one name, one look, one warranty, one standard: what comes out must be as real as what went in.

Because reality is what it's all about.

 **MITSUBISHI**  
AUDIO SYSTEMS

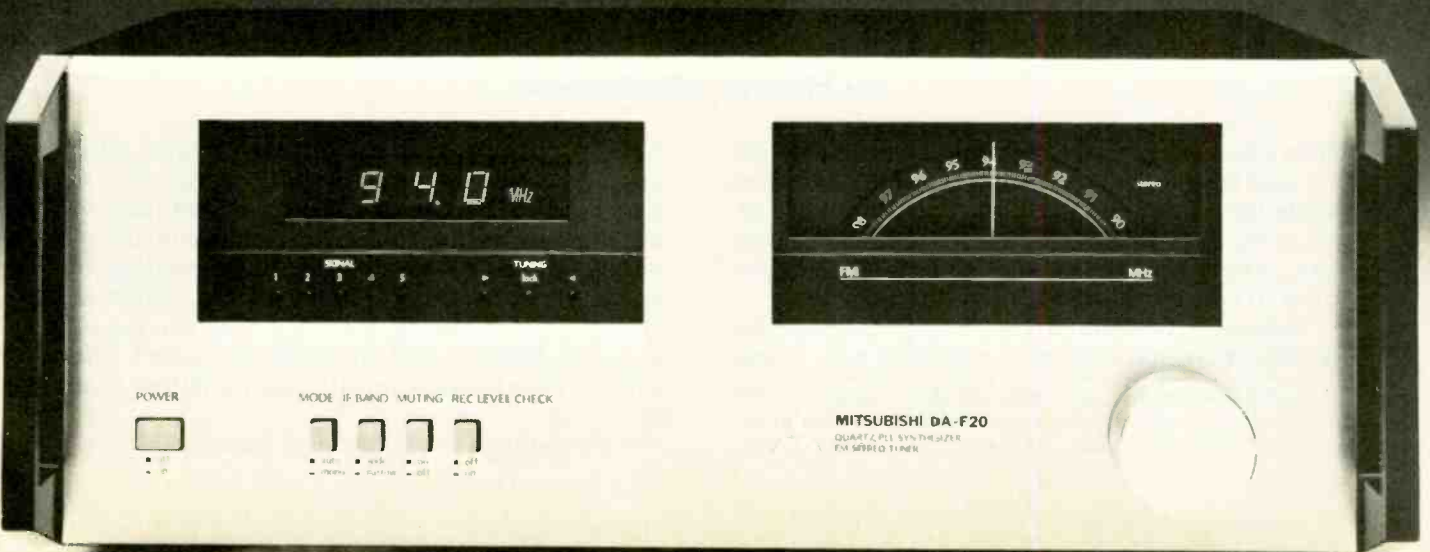
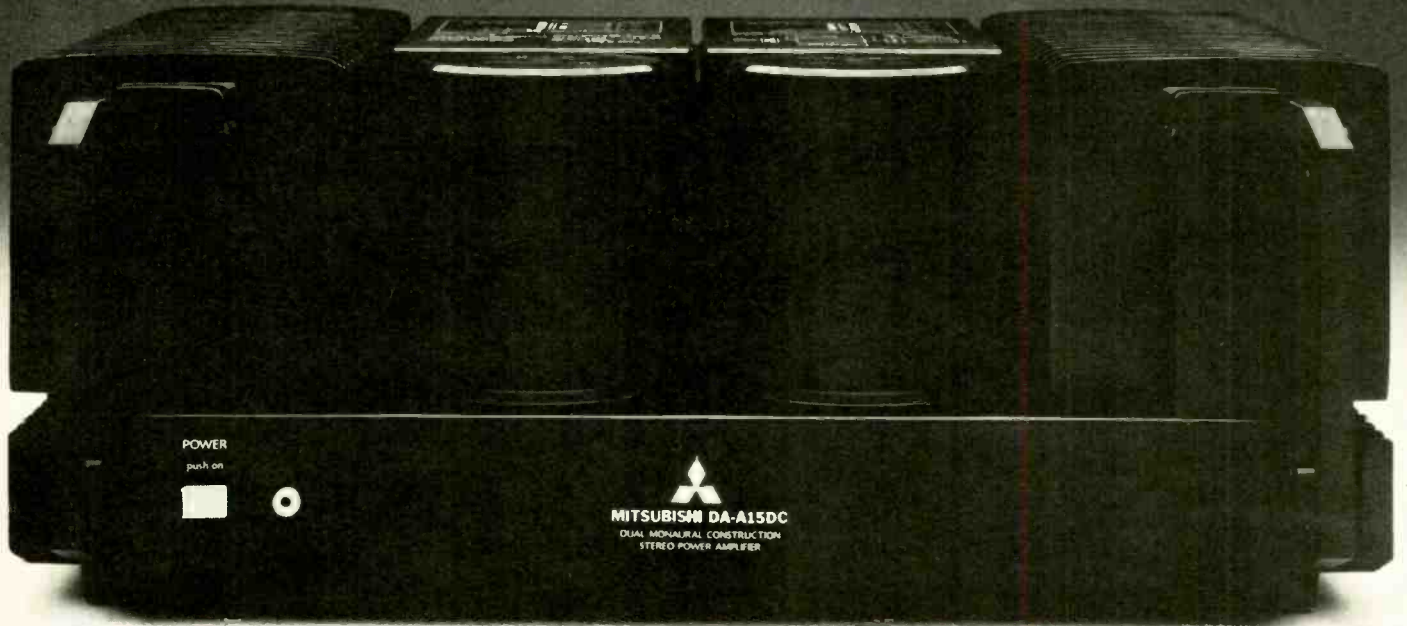
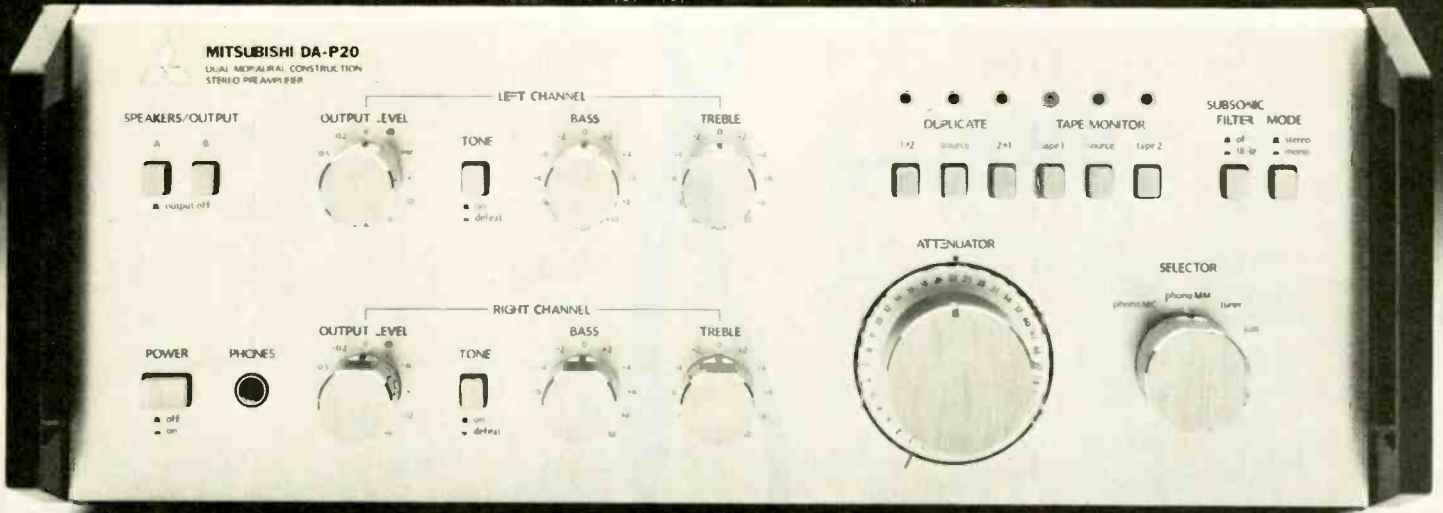



# How to Keep Your Stereo System Sounding like New

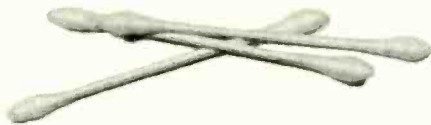

A few minutes spent doing some simple upkeep and acquiring a basic understanding of how your components work can help keep the serviceman from your door — and minimize aggravation and cost when you must call him in.

by **Howard Roberson**

IT HAS BEEN a hard day. You push the power switch on your system, put a record on the turntable, and settle back into your favorite chair for a little relaxation. But what happened to the sound? Your heart sinks; now, on top of everything else, you have to cope with the blankety-blank stereo.

Unless you're devoted to tinkering and not to listening—in which case this article is not, essen-

*Howard Roberson, a professional audio engineer and acoustical consultant, operates Sound Measurements Laboratory in Pittsfield, Mass., and writes for audio journals.*

tially, written for you—the prospect is grim. There are, however, things you can do to minimize the possibility of that prospect, and others that will minimize its trauma when it does occur. By and large, these measures require little exertion beyond the exercise of common sense. There are chores involved, to be sure, but they are far less onerous than the sort that system-owners often subject themselves to needlessly by letting panic take over.

It can happen to anyone. For example, a reader

from eastern Long Island—a man whose credentials for intelligence, maturity, and responsibility are unassailable—recently told a harrowing tale of taking his esoteric open-reel deck to a Manhattan repair shop. In three such trips much time and money was lost—but not the intermittency in one channel that had prompted the repair. Ten minutes of experimentation by a cooler head finally turned up the culprit: an elderly interconnect cable with a mashed connector. If only he could have read this article first—

## Preventive Maintenance

Turntables and tape recorders both employ transducers that must contact a moving surface to generate the small electrical signals they produce. A regular part of any preventive maintenance plan must include keeping these contact areas clean; the effects of dirt as noise or dropouts are magnified by the necessary preamplification.

Even if your discs are kept immaculate, a stylus brush *specifically made for the purpose* should be employed as often as close inspection dictates. Don't use any "handy little brush"; it may damage the stylus mounting. The tape recorder should have its heads cleaned regularly to prevent the accumulation of oxide particles and other material deposited by the tape. Some machines and tape types will require cleaning much more frequently than others. Do it as often as the appearance of the heads—or of a cotton swab applied to them—seems to dictate. At the same time, clean other areas where dirt is accumulating, especially the capstan and its idler. Examine all arms, lifters, flutter filters, guides—anything over which the tape must pass.

Isopropyl alcohol and cotton-tipped swabs, both available in drugstores, are a good combination for most cleaning tasks, including removal of oxide particles that build up around the heads. Do not use rubbing alcohol, which has additives that will goo things up. Special cleaning solvents for recorders may do a better job and not attack plastic parts or head varnish, as alcohol sometimes does. Try to keep pressure pads clean by brushing them; solvents like alcohol could loosen the mounting glue. Demagnetize (with a degausser designed for the purpose) the heads, guides, etc., after several hours of operation and immediately before any recording of particular interest.

Signal sometimes is lost because controls and switches have not been moved from day to day. The majority have contacts that are designed to scour, so to speak, as they are used. Without this scouring action, corrosion can develop right around the point of contact, causing the control to become intermittent in the very setting where you want to keep it. To forestall this eventuality, regularly rotate all switches and controls through all

positions (and activate all levers and pushbuttons), whether you normally use them or not. Don't overlook those that are built into your speakers. Do this with the power off, perhaps once a month—more or less, depending upon your local pollution rating. You also should check the indexing of the knobs and tighten any that are loose.

Less frequently, perhaps twice a year, examine all power and signal cabling, and its connectors, for evidence of damage or poor contact. Don't forget to check the FM antenna, downlead, and rotor. Clean, repair, or replace according to need. Unplug the cartridge shell and examine the mating contacts of the shell and arm. Clean as needed using a soft, pencil-type eraser (such as Faber No. 7066), being careful not to leave debris in contact areas. Tools made for cleaning battery contacts may also work, but take care not to bend the "fingers" or scratch contact points. Check the stylus mounting for evidence of damage. (Note: The normal nonplaying position of the cantilever may slope steeply downward.) It is possible to detect gross damage with a pocket microscope, but this is not an adequate means to check for wear. In fact, it is difficult to examine styli with many microscopes because of poor resolution and mechanical positioning. If your dealer has a good inspection setup, take advantage of it. If not, it is probably best to replace the stylus every six months to a year, depending on use. Having a spare stylus is a good idea; a sudden change in record quality may indicate damage, which may be confirmed or ruled out by substituting the spare.

Most turntables and recorders require some oil periodically on rotating shafts, so adhere rigidly to the lubrication schedules in your manuals. Observe strictly the cautions on excessive oiling, which can cause the transfer of oil to surfaces that must be kept clean and dry. At the same time you do this, look for signs of bent parts, rubbing, or wear—particularly in tape heads. If you find any, maintenance may be called for to prevent deterioration of performance.

The inside of the recorder or turntable has a number of mechanisms that usually require periodic, but less frequent, cleaning and lubrication for best performance. First, with the aid of your manuals and the dealer, find out whether any measures are recommended. Those not explained in the manual should not be attempted by the neophyte and will require the step-by-step instructions provided in a service manual, which sometimes can be obtained directly from the manufacturer by writing to the address on the warranty card. Expect to pay a nominal charge. Radio parts stores will have the Howard Sams Fotofact series on various types of equipment. Each manual covers more than one unit, but it is well worth the cost if you are bent on doing this sort of work. Remember that even simple removal of a chassis from a cabinet can quickly become a disaster if the

wrong screws are loosened. If you do take steps to bare the guts of your machine, take the time to examine the various mechanisms and learn the function of all the clutches, belts, and so on.

If you're feeling a little adventurous and want to get some reference data to help you in later troubleshooting, your tape recorder's meters can be used to measure levels throughout a system that is operating correctly at present. If, for example, you have a separate tuner, you can compare its direct output to that normally delivered via the tape-recording output of your preamp or integrated amp. The levels may be worth recording both for your favorite station and for interstation noise. You can note the differences in dB that the two hookups deliver with the same type of signal and recording-level setting, or you can adjust levels for the same meter reading and note the settings required. You can make a similar check on the output from the turntable (using the mike input), noting the level settings for a 0-VU meter reading. The

output from a preamp can be checked for normal listening level, or whatever. There are other variations, of course, but the idea is to get some data on your "standard" levels, noting control settings to permit rechecking in the future. But don't forget to turn off the power whenever you change a connection in the signal path.

And never, under any circumstance, switch from one source to the other with the volume control turned up. The resulting transient can be very damaging both to the power amplifier and to the speakers. It is true that you might be able to get away with the practice most of the time, but it takes just one misadventure to cause a lot of damage, including a noticeable assault on your wallet. Don't forget: If you have tubed equipment, you should test the tubes perhaps once every two years, depending on use. This is most important for rectifier and power-output tubes, which may become emission-limited, if maximum performance is to be maintained.

## Troubleshooting

A homemade "map" of your stereo system can be a big help when you come to troubleshoot it. In this basic collection of separates we are assuming a turntable, tuner, and tape deck; a separate preamp with fairly simple controls; a power amplifier with its own gain controls; and a pair of speakers. Your diagram should show all elements—including any speaker controls—that may affect the signal path in ways that you can check. To show how we might use such a diagram, let's suppose that, when we turn on the system to play FM, we find the right speaker dead. We might check the speaker first and work backward (any systematic approach will do), but let's begin at the input to the control preamp. Is the tuner not feeding it a right-channel signal, or is it killing the right channel input for any source?

Fig. 1) We put a record on the turntable and rotate the selector switch. The phono right channel is dead too, so the problem is not peculiar to the tuner and appears to be after the selector switch. We set up the tape deck to record and find that the meters indicate a right-channel signal for both tuner and phono. We have established that the fault is after the tape-recording feed. Perhaps the mode switch or the use of headphones at the preamp's output will help pinpoint the fault.

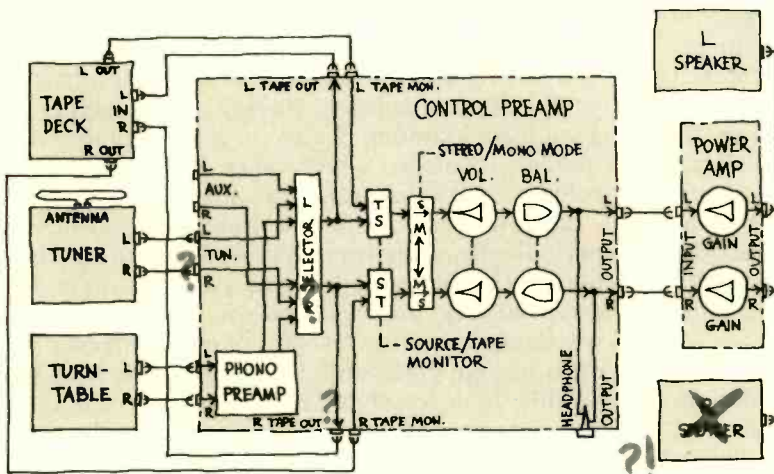

Fig. 1

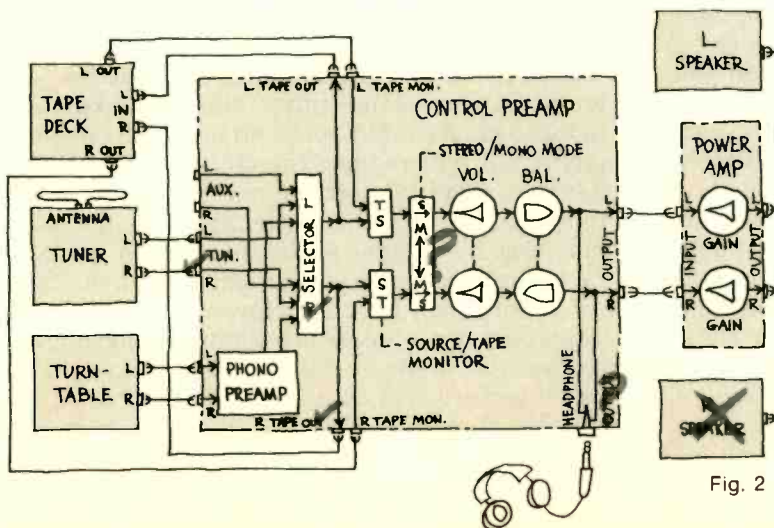

Fig. 2

## Corrective Maintenance

When something goes wrong with the sound of your system, the change will occur in one of two basic ways: Either the quality will deteriorate over a period of time or the change will be abrupt. If the latter is the case, ask yourself a couple of questions. First, what did you do last? Second, what might someone else have done? There are many so-called cockpit errors that we miss if we don't stop and think. Here are some examples: You forgot to turn the circuit-breaker back on after replacing a wall switch; someone turned off a wall switch that no one "ever" turns off; perhaps someone inadvertently pushed a normally unused tape monitor or remote speaker switch. It also is possible that a knob has slipped, giving an incorrect indication of system settings. Mr. Nobody is responsible for many such goofs, so be prepared for anything.

If there is no sound at all from your system,

check the pilot lights. If they are all dead, see whether the turntable will operate or use a lamp to make certain that the wall outlet has power. If necessary, use an extension cord to feed power to the system. If it remains dead, turn off the power switch and check the condition of the various fuses—line, B+, and speaker—that protect circuitry. Manuals normally give fuse locations. You may find that there is a fuse inside some equipment; before you check it, be certain of two things: that the power plug is disconnected from the outlet and that you understand the procedure of disassembly required. Before replacing blown fuses, check the condition of the connections, particularly the amplifier outputs to the speakers. Clean up poor connections, making certain there are no stray bared wires that could short an output. If replacement fuses blow immediately, a trip to a service agency is in order.

If all of the pilot lamps are on, listen very closely to the speakers, one at a time. If there is complete

## with Pencil and Paper

Fig. 2) The right speaker remains dead in both positions of the mode switch, but both earpieces are live in both switch positions. The fault therefore is somewhere between the headphone connections and the speaker. It could be at the very output of the preamp, at the input of the power amp, or at its output.

Fig. 3) We can narrow the field by adding masking tape "flags" to the demonstrably faultless left-channel cable from the preamp output to the amp input and interchanging it, at the power-amp input, with the right-channel cable. Suddenly (when we restore power) it is the left channel that has gone bad, and the right speaker has revived. That eliminates the power amp and the speakers as the source of the system's trouble.

Fig. 4) The fault may be at the output of the preamp, or it may be in the right-channel cable. We switch the other ends of the cables, this time at the preamp, so that the questionable unflagged cable now runs from the left preamp output to the left power-amp input. The left speaker remains dead. We can now deduce that the problem is in the cable and the cure easy: Buy a new cable.

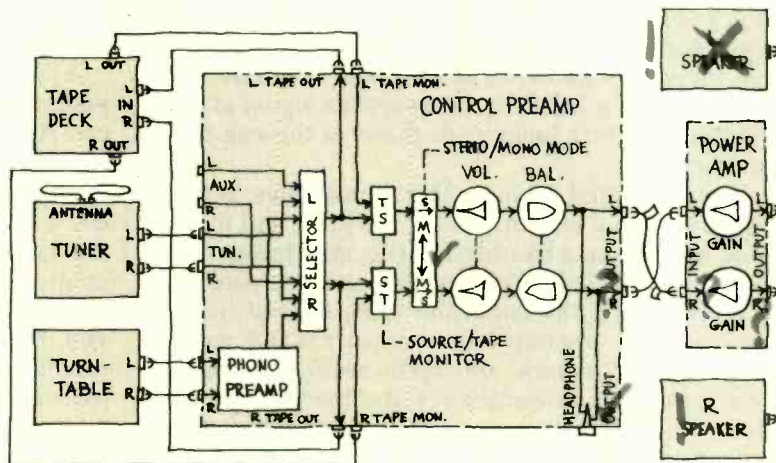

Fig. 3

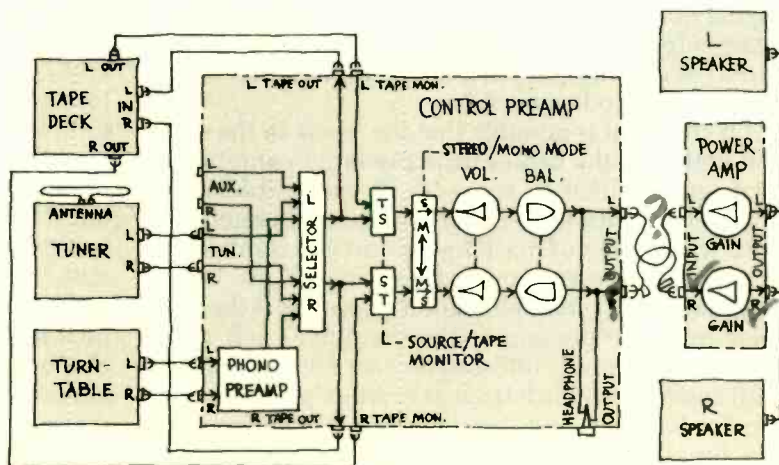

Fig. 4





absence of sound from either of the speakers, even with the volume control all the way up, double check for shorted amplifier outputs or blown B+ or speaker fuses. If these seem in order, disconnect the output cables from the amplifier. It is doubtful that the speakers could have been blown out without your knowing about it, but you can check them by alternately making and breaking connections from a flashlight battery to the speaker leads. Current passing from the battery through the voice coils should produce a noticeable "clunk" with each make or break.

Assuming the speaker test to be positive, you must now use logic to localize the problem—keeping in mind the signal routing in your system. A good signal at the headphone jack may prove, for example, that signals are normal most of the way through the amplifier or only through the preamp, depending on the circuit point from which the headphone signal is taken. It may be helpful to use your recorder as a diagnostic tool—with the headphones in its jack and your eye on the meters, you can monitor whatever the recorder is connected to. You can, for instance, compare the signal at the normal TAPE-OUT jacks with those at the PRE-OUT connections.

If one channel is dead, that's bad news; but it also means that one channel is working, and that's good news from a troubleshooting standpoint. Set the selector switch to each of the possible sources to confirm that the condition affects all of them. Now, if your preamp has a MONO/STEREO mode switch, work it back and forth several times to clear a possible intermittency and then leave it in MONO if the defective channel remains silent. The PRE-OUT connections normally will be the next "checkpoint" in the signal path after this switch. If, when you monitor PRE-OUT, there is normal sound in both sides, switch back to STEREO. If the signal now disappears on one side, the problem is at or before the mode switch. If the signal, even in MONO, is on only one side, the break in signal flow is after the mode switch.

Of course, it is possible that the break in the signal path is in the cables from preamp to amplifier or from amplifier to speakers. If your cables are not coded, mark each end of the good-channel cables with pieces of masking tape so you don't lose track of them when you change connections. Let's say that the left channel is good. Disconnect the cables from the preamp at the amplifier's left and right inputs (power off!) and reverse them. If sound still comes from the left speaker when you turn the power back on, and the right one remains silent, the break in the signal flow occurs after the right

input connection on the amplifier. If the live and dead speakers have switched positions, the signal loss is before the end of the "dead" cable to the amplifier and after any earlier point that is working correctly. Interchanging the connections at the preamp end of the stereo cable will show whether the failure is in the cable itself.

It will help if you draw a block schematic of your stereo system showing all the units with their switches and other controls that effect the signal path, together with all interconnect points. By penciling in the temporary connections, you can see what the path *should* be as an aid in deducing where the fault lies. And as you eliminate one possibility after another, you can check it off on the diagram.

Sometimes a problem is caused by poor contact between a cable plug and the jack. Whenever you change connections for any reason, look to see whether either would benefit from cleaning with the eraser. If there is a loud buzz in one channel, it might be caused by poor contact between the jack shell and the tabs on the plug. With the power off, pull out the plug and bend down the tabs to hold the jack shell tightly upon reinsertion. If the tabs will not hold, replace the cables with a quality product that will make such contact tightly.

Any of the switches or controls in the signal paths can cause a loss of sound from your speakers. A volume control will rarely break the path over its entire rotation, though its wiper may lose contact at some point. When it does, it is time to use a control cleaning solvent—best applied with the knob removed. After application, rotate the control over a large arc to aid in the cleaning. If the control remains intermittent, perhaps even after you have removed its cover to spray cleaner directly into the elements, it will have to be replaced. Switches that lose contact can also be treated with cleaner in a similar fashion, but the cover or cabinet must be removed so you can gain access to the contacts.

Sometimes the contacts of a rotary switch will make and break when you push back and forth on the shaft. With careful observation, you may be able to pinpoint what the problem is. Dirty contact areas, warped switch wafers, and cold-solder joints on connecting wires are among the possibilities. Follow the general rule that contact areas are to be worked on only when the power is off. A blade-type burnishing tool may restore contact, but it must be used with care or it may bend contact fingers. If you are inclined to repair, be ready with your pencil soldering iron (not a gun, which can too easily damage delicate parts) for the suspicious connections. Finally, remember that the cleaner is needed only on pot elements and switch contacts; do not spray anywhere else.

Gradual deterioration in sound quality can be caused by such things as a dirty or worn phono

stylus, dirty or worn tape recorder heads, and various electronic components—including, of course, aging vacuum tubes. A sneaky one for FM listeners is the loosening of antenna clamps and the rotation of the antenna to an undesired (and unknown) orientation. A drop in level of the highest audio frequencies could be caused by loss of contact in the tweeter's level control. A sudden drop in the maximum output level, perhaps in just one channel, could be caused by the failure of an output transistor. In rare instances, the corrosion in a control makes it behave like a semiconductor: There is no sound in the output until the voltage at the contact point reaches a critical value, and thus the sound jumps in, so to speak, at a medium to high level out of silence. The cure is contact cleaner and rotation to help buff off the corrosion.

### Professional Maintenance

The previous sections cover the majority of tasks that most consumers, not being expert and having no special test equipment, can handle. What do you do when these resources run out? Perhaps you have proven to your own satisfaction that in the tuner's left channel the signal path is broken within the preamp. Even though you have not been able to find the exact point of the failure, you know which unit is at fault. Your observations will be an aid to a professional, saving him time and perhaps minimizing the charges.

There are two basic repair categories: warranty and nonwarranty. Almost invariably, warranty work must be done at an authorized repair station. Not only will most manufacturers refuse to pay for work done anywhere else, but many warranties stipulate that they become void if such work is done. It can be very frustrating to have the original dealer tell you he is not authorized to perform a warranty repair, but do accept that this practice is a protection for you as well.

A manufacturer-approved service agency is probably a good place for nonwarranty repairs as well. For one thing, it will have information direct from the manufacturer on parts and procedures for repairing your equipment. There is some probability that it will have a needed part in stock and will know exactly what to order if something else is needed. If the failure in your unit is the result of a design limitation, the agency could have modification data from the manufacturer to ensure that the failure does not recur. If you are particular about keeping equipment performance to the manufacturer's specifications, substitution of parts made by others may not suffice.

Expect the hourly rate for repair work to be around \$20-\$25—perhaps more. The minimum charge usually is at least half the hourly rate. Sometimes there will be a fixed charge for repairing a certain type of equipment, whatever the

problem. Such charges might be \$25 for a turntable, \$30-\$35 for a cassette deck, and \$35-\$45 for a receiver. Many shops will provide estimates only on request—at a charge of \$15 or so, applied against the total charge for the repair.

You will want to know how long the repair will take, but don't be surprised when the time estimate is given reluctantly or not at all. Without knowing which specific part(s) need replacement, your serviceman cannot promise results within a certain length of time. If you push him for speedy action, you could get inadequate procedures or parts—and, consequently, marginal performance. The typical dealer/service agency handles a number of lines of equipment with many models using literally thousands of parts, not all of which it can afford to stock.

Dealers commonly give a parts-and-labor warranty of 90 days on repairs. Some will lend you equipment to use while yours is laid up, but this is not a widespread practice.

As in doing your own servicing, you must be sensible and logical if you are to get the best out of a repair service. It is all too easy, for example, to be suspicious about whether the charges represent fair value. Perhaps you feel that the hourly rate for labor is too high, but remember that the overhead costs for servicing high fidelity equipment are higher than those for most comparable businesses. These costs include the investment not only in parts inventory, but in test equipment: \$10,000 is common for the latter, but the tab can easily run \$5,000 or more for each test bench. The parts investment, too, can vary greatly—up to \$50,000 or more. These costs must be covered by the income from service charges, a good proportion in the labor charge and some applied to parts. Understand that the technician working on your amplifier does not get the \$20 per hour, but only what is left after the overhead costs are covered.

The high investment in sophisticated instrumentation is required to test to the specifications you find in the advertisements and in your owner's manuals—and included in more and more warranties. Even one expensive, recently introduced FM alignment generator hardly meets the specs of new tuners and receivers. So, in general, it is difficult for a dealer to be enthusiastic about warranty work. Most feel that reimbursements by many of the manufacturers are inadequate to cover the high costs involved.

One hopes that your repairman will be patient with you, realizing that you are being deprived of more than an assembly of transistors and switches: You are without music. But understanding the problems he encounters will help you to be patient with the time and money service will cost you. Patience will encourage maximum help when you need it—and may even save you from seeking help when you don't. ●

# NEW MATH vs. OLD MYTH

Numbers probably never will characterize exactly how an amp or preamp sounds, but some new approaches bring them closer to that ideal.

by Robert Long

APPROXIMATELY CONCURRENT with the appearance of this issue, the Institute of High Fidelity will be asking its members—which include most of the major component manufacturers—to ratify a standard for the testing of amplifiers and preamps. Whether or not the membership does so, beginning this month we are adopting some of the IHF Amplifier Standards Committee's recommendations, which we find a substantial advance over previous standards.

It has, in fact, been some years since the Institute officially had a standard at all; the old one was made invalid, in effect, by some provisions of the Federal Trade Commission's rules on advertising amplifier power. The proposed new IHF standard, however, does far more than satisfy the arbitrary definitions of the FTC. It re-examines the whole subject of amplifier measurements and specifications, and it takes bold new steps along the road by which the industry seeks to make "the numbers" relate ever more closely to the actual listening quality of its products.

Consider power. The FTC, by insisting on continuous-power ratings, has outlawed a number of questionable techniques used—particularly for mass-market products—in the past, but at the same time it has prevented any attempt to tie wattage numbers to actual music performance. Among the proscribed ratings, that for "music power" tried to address itself to the fact that music is not constituted of continuous tones and that the limiting factor in reproducing music is the nature and amplitude of its transients.

The music power rating scheme had some inherent flaws that surfaced long before the FTC banned it. The new standard approaches the same subject in a different—and, in our view, much more useful—way, by providing a measurement called "dynamic headroom." Like "clipping headroom" (which we have been talking of for some time in our amplifier reports and which is spelled out in the new standard), it is measured in dB above the rated continuous output power. Thus, if the amplifier is rated at 20 dBW or 100 watts per channel and it clips a steady 1-kHz sine wave at 21 dBW (125 watts) but will pass the tone-burst signal used for the dynamic test to 22½ dBW (175 watts), it is said to have clipping headroom of 1 dB and a dynamic headroom of 2½ dB.

The dynamic headroom is very important since it actually represents maximum capability of handling music signals cleanly. The test signal is a 20-millisecond burst of 1-kHz tone, repeated every half-second. The "spaces" between the bursts contain only a low-level sine-wave signal and thus allow the amplifier's power supply to "recover"—just as it does in reproducing mu-

sic (but not the continuous tones of the FTC rating). Thus, if two amplifiers of identical continuous-power ratings have dynamic headroom ratings of 2 and 5 dB, respectively, the latter actually can be made to sound 3 dB louder (representing twice the power level in watts) before the onset of clipping in music. This, obviously, is a distinction that should be made. From now on we will report this specification in all tests of power amps and power-amp sections.

Note that both headroom ratings deal in power ratios; that is, differences expressed in dB. As regular readers must be well aware, we have been expressing power in dBW (in dB with respect to a "zero" reference level of 1 watt) since our June 1976 issue because we believe this way of approaching power to be very useful in conceptualizing the relationships (headroom, for example) in terms that relate to audibility. Correspondence from our readers often verifies that the standard wattage numbers can obscure those relationships. So we are very pleased to see that the new standard stipulates that power may be specified either in watts or in dBW.

The dBW numbers become even more useful when coupled with those for dynamic headroom. For example, an amplifier rated at 17 dBW (50 watts) continuous power with a dynamic headroom of 4 dB will pass musical peaks of 21 dBW without clipping them. Similarly an amplifier rated at 19 dBW (80 watts) with 2 dB of dynamic headroom will deliver the same 21-dBW maximum on music. In other words, in this case the 50-watt amplifier has essentially the same musical capability as the 80-watt amplifier—all other things being equal, as the saying goes. The ability to make this comparison readily is, we believe, a vital step forward in the search for ways to express performance in terms that are genuinely beneficial to the prospective purchaser.

Another related measurement that appears for the first time in the new standard is called "transient overload recovery time." Like dynamic headroom, it uses a tone-burst test signal that has a low-level sine wave between the high-level bursts. To measure recovery time, the amplifier under test is severely overdriven by the tone bursts and the continuous tone examined on an oscilloscope to see how long, following the end of the burst, it takes to resume its normal waveform. This test can be used to answer the important question, "How gracefully does this amplifier recover from clipping?" While the previous tests measure how much signal the amp will accommodate without misbehaving, this one tells you how badly it misbehaves when the signal level exceeds the misbehavior threshold. The shorter the recovery time, the less you will be aware of the clipping when it does occur.

## Terminations and the Real World

Also significant in the new standard is the area of termination procedures. The idea here is to reproduce, as closely as reasonably possible, the system hookup in which the amplifier or preamp will operate in the user's home. Power outputs continue to be loaded by 8-ohm resistors. (This is a weak point and always has been. Loudspeakers simply don't behave like resistors. The problem, of course, is that of finding a single load that can reasonably be expected to come closer than an 8-ohm resistor for all—or even most—of the loudspeakers that may be hooked to the power terminals.

---

*Audio-Video Editor Robert Long was a member of the IHF Amplifier Standards Committee, of which Consulting Editor Edward J. Foster was chairman.*

And, in any event, the FTC has made resistor loading mandatory.) Line outputs are terminated by 50,000-ohm resistors, line inputs and regular magnetic-cartridge inputs by 1,000 ohms, and those for moving-coil pickups by 100 ohms.

Most of these specifics will make little difference for the majority of products, though the phono loading is important. Industry practice (with some notable exceptions) has been to short-circuit the phono inputs, particularly for noise measurements. As a result, one could design a preamp stage to perform better in a bench test than with a cartridge connected to the input. The establishment of a standard load will help prevent that.

Also helpful for best actual performance is a specification for phono input impedance. Under the standard, the manufacturer has the option of either stating the equivalent combination of resistance and shunt capacitance (so many ohms in parallel with so many picofarads) or—if capacitance varies with frequency so that a single value can't be given for the whole audio range—the resistance value only. Therefore, if the spec reads "47,000 ohms, 400 picofarads," you know that it will present exactly the right load for a magnetic pickup whose recommended loading includes about 500 picofarads with turntable leads rated (as most are today) at 100 picofarads. If the manufacturer says only "47,000 ohms," you know that the phono input impedance is complex and that it may for that reason prove problematic when you come to choose a pickup.

But to return to the loads applied to the amplifier or preamp under test, these are only part of the system developed to match measurements to in-use practices. The standard states input and output reference levels, and in most tests the volume control is adjusted to deliver these levels. The intent is not only to make the measurement with a representative in-use setting, but to reference noise to one level so that the measurements will be comparable for the same listening level in all equipment—which of course they aren't when measured relative to arbitrary levels such as rated output. The reference levels for line inputs and outputs is 0.5 volt; for power outputs it is 0 dBW (1 watt). (Because many separate power amps have no level controls, all are excepted from the technique outlined above and measured at full gain.)

These stipulations, taken in toto, mean that noise numbers measured under the new standard will be entirely different from those measured in conventional ways. So, while they may make many comparisons easier and more valid once all noise is measured the new way, they will not bear direct comparison with present S/N-ratio numbers. This will not change the technique of our test reports immediately, desirable though the change is in some respects, because we (like everybody else using the new standard) will be trying to make the transition with as little confusion as possible.

## Distortion

Beginning in this issue you will see a new term in our amplifier test reports: THD+N. For many years, total harmonic distortion measurements have been made on instruments that cannot distinguish between true distortion and noise. For that reason "harmonic distortion" measurements were defined as including noise and were often termed "total garbage" measurements by en-

gineers. More recently, spectrum-analysis equipment—by means of which noise can be distinguished—has come into use. For some time, our tape-recorder measurements (where, of course, noise levels are relatively high) have been taken via spectrum analysis.

Under the new standard, only measurements made that way are to be termed total harmonic distortion (THD); those made with conventional equipment are to be called total harmonic distortion plus noise (THD+N). So, finally, the terminology of amplifier measurements falls in line with that commonly used for tuners, where separate measurements for "distortion plus noise" and "noise only" are made.

One specific of the standard probably will prove an interim situation. While THD or THD+N measurements remain a primary factor among the ratings for amplifiers and preamps, intermodulation has slipped to the status of an "optional disclosure." There are several reasons for this. First, many engineers feel that IM and THD reveal performance properties so closely related as to be virtually redundant. Second, the common method of measurement (now specified as SMPTE-IM) has a companion in the standard—a sweeptone method that can reveal more about the product's behavior. This alternate method is called IHF-IM. Third, there is a good deal of hope that the present investigations of dynamic intermodulation measurement techniques (transient IM, for example) will yield even more significant information about the product and may ultimately supplant conventional IM. Since there is no consensus among engineers about the possible techniques and the significance of their results, the standard says only that, if dynamic intermodulation is specified, the method of measuring it must be specified too.

\* \* \*

Two other specifics of the new standard are being introduced immediately in our test reports. One concerns damping factor, which can be represented either as a curve with respect to frequency or as a single number, measured at 50 Hz. This is in the range where damping factor is most important in terms of the amplifier's ability to control underdamped woofer cones (and prevent so-called floppy bass). Our previous listings have been measured at 1 kHz—giving, roughly, a median of the values (which can vary a good deal from one end of the spectrum to the other) that would be represented in the curve. But now that a useful 50-Hz standard has been proposed, we will adopt it.

The second specific is the establishment of a rigorous distinction between "channel separation" and "crosstalk." Channel separation refers only to the two or more channels that *should* be active from a given program source at a given time; crosstalk refers to separate sources—for example, "leakage" of tuner signals into the output when you are switched to phono.

There are, of course, many provisions of the new standard. We can only gloss them here and save detailed comment until after the standard is accepted by the Institute's membership—and we trust it will be. We felt, however, that it represents so positive a development that we should let our readers in on its main outlines immediately. And, again, where we felt that its specifics would enhance our test-report coverage whether or not the standard is adopted by the IHF, we have incorporated them at once. ●

The almost uncanny fecundity of Berlin's gifts is symbolized here by scenes from three memorable musicals, two for stage and one for screen, all written in a period of less than five years. Right, Ethel Merman at parade rest in *Annie Get Your Gun* (1946); below left, Fred Astaire tripping the light fantastic in the film *Blue Skies* (also 1946); and below right, the Soldier's Dream scene from *This Is the Army* (1943). Directly below, their creator steps from behind the curtain to acknowledge the audience's applause—one in a lifetime of such moments.



★  
**Irving Berlin**  
 ★

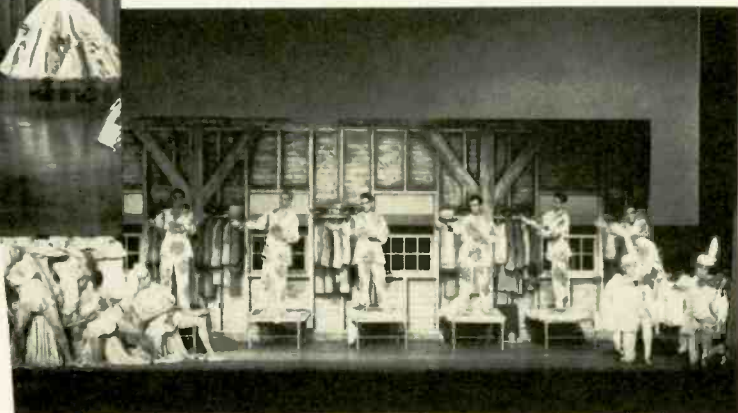

Photos, from top: Bettmann Archive; ASCAP, Paramount Pictures; Culver Pictures.

---

## A ninetieth-birthday salute to the master of American song by Joshua Logan

---

**I** FIRST KNEW HIM as a disembodied voice on the telephone. The year was 1942.

I had been inducted into the service only hours before, and I was sitting on a beer crate at Ft. Dix, peeling potatoes and feeling forlorn. Someone tapped me on the shoulder: "Your name Logan? You're wanted on the telephone."

Wondering how anyone in the world could have found me, there among my spuds, I went to the phone. "Hello, Josh?" a hoarse and unfamiliar voice said. "This is Irving Berlin."

Now you must understand that then his name, to my mind, belonged in the pantheon that includes Bizet, Mark Twain, Molière, and Moses. Imagine, then, my shock and excitement—not to mention a touch of fear—on hearing the name on the phone.

"Yes, Mr. Berlin," I must have said. "What can I do for you?"

"You've got to come and help us out," he replied. "My show *This Is the Army* opens in eleven days, and it's in terrible shape. I need somebody to pull it together. I've seen your work, and you're the one I want."

To work with Irving Berlin! A young director's dream! "But Mr. Berlin," I said, "what about the Army? I just got to Ft. Dix."

"Don't worry about that," he said with brisk assurance. "I've already got the wheels in motion. You'll be here this afternoon."

And incredibly, I was. I walked down the aisle of a darkened Broadway theater and saw a smallish, wiry man with a thin Mediterranean face and black, black hair—a face I knew well from photographs in magazines. He was pumping my hand, as excited as a schoolboy, telling me where to sit. It seemed they were going to put the show on for me immediately.

From the moment the curtain went up, I thought the show was marvelous and spectacular. With a cast of 300 members of the armed forces, it had

been directed by Ezra Stone and Bob Sidney, and beautifully, I thought. There was, I told Berlin, very little anyone else could do to it except hurt it. But he was adamant. He wanted me to take full charge.

To please him, more than anything, I stayed on and reorganized the show a bit, with a snip or two of the scissors here and a little glue there. Actually, I contributed very little to that wonderful show.

It opened to rave reviews, and I soon asked to be transferred out, so that I could stop playing gin rummy in the wings and join some part of the

fighting forces. Berlin at last agreed to let me go. I joined the Air Corps, becoming a lieutenant and an intelligence officer in the 50th Troop Carrier Wing under the command of Col. George Chappell. I imagined that I would not work with Berlin again until after the war, if at all. How wrong I was, and how little I understood his energy and tenacity.

Our unit was sent to England sometime before D-Day. We were to drop parachutists on the French coast the night before the long-awaited landing on the Continent. We were stationed at a little town named Cottes-

more, and on my first weekend I went to London, which was all blackout shades and lineups for buses and food. In Trafalgar Square, I ran into a soldier whose face I vaguely recognized from *This Is the Army*, and he told me Berlin was looking for me. *This Is the Army* had crossed the ocean before me and was being readied for a London opening, but Berlin wanted to talk to me first.

I went immediately to his hotel, the Savoy, and found him a bundle of nerves. He wanted to add a new sketch before the show left London to play to military personnel around the world. The sketch was on the bawdy side. It was about a private desperate to sleep with his wife, a lieutenant in the WACs. But to get to her, he had to go through channels, and standing in his way was a ferocious



woman, her first sergeant who also happened to be his mother-in-law. Hardly highbrow, but surefire stuff for a GI audience. I thought the sketch was hilarious; Berlin thought I had an evil enough mind to stage it properly—this was his ultimate accolade. But—

There was my C.O., Col. Chappell. Berlin told me not to worry about him. With a flourish he picked up the phone and called Eisenhower—Gen. Dwight Eisenhower, supreme commander of the Allied forces in Europe, who was preparing the most massive invasion in history and could be presumed to have a couple of things on his mind other than the problems of an Army show and the destiny of one Joshua Logan. Eisenhower assured Berlin he would take care of it, and an order came down through channels to the desk of Col. Chappell. Now, with the invasion imminent, unit commanding officers had the absolute and final say about any shifts of personnel. And Chappell was a good combat commander. So what he said to the request was, "No!"

Berlin was incredulous and in a frustrated rage—not at Chappell, mind you, but at Eisenhower. Until now his requests for talent had always gone through unchallenged. He grabbed the phone and put in a transatlantic call to the Pentagon and Gen. "Hap" Arnold, then chairman of the Joint Chiefs of Staff; above Hap there was only the President and maybe the Statue of Liberty. Gen. Arnold promptly approved Berlin's request and dispatched a cable to that effect, which duly arrived on the desk of Col. Chappell, who wrote on it, "Request disapproved."

Berlin by now seemed on the verge of apoplexy. He denounced Arnold and Eisenhower as a pair of "weaklings," then demanded Col. Chappell's phone number from me. Hesitantly, I gave it to him. Berlin called while I listened nervously on an extension.

"Col. Chappell," he said, "this is Irving Berlin." A long silence. and Berlin said, "Hello? Hello?"

Chappell's voice, taut and strangled, came back: "Did you say Irving Berlin? Not *the* Irving Berlin!"

"Of course," Berlin snapped. "Now, listen, colonel, I want Logan for three weeks, and no more crap!"

"But—but certainly, Mr. Berlin. You can have him as long as you want. Longer than that!" Chappell evidently was so rattled that he did not realize he still held an open telephone in his hand, because I heard him say, "Sergeant, do you know who just called me? And *personally*, for Christ's sake! Irving Berlin!"

It has always seemed to me that that story says something not only about Berlin and his stature in the public mind, but about Americans. Col. Chappell was utterly unimpressed by brass. But Irving Berlin? That was a different matter.

When someone asked the late Jerome Kern what

place he thought Berlin held in American music, he replied, "Irving Berlin has no place in American music. He is American music."

Berlin more than any other man defined the very character of the popular song. Before him, popular music in this country, particularly that of the theater, was dominated by the influence of Viennese operetta and Gilbert and Sullivan. Victor Herbert was in his heyday. Although Rudolf Friml and Sigmund Romberg were still to come, it was Berlin's 1911 hit "Alexander's Ragtime Band" that was the catalyst of a revolution in popular music.

His family had come to America when Irving (then called Isidore Baline) was four. They lived in a crowded New York tenement on Cherry Street. His father, a cantor, died when Irving was eight, but not before he had taught his children the sacred songs of his faith. To help the family, Irving sang on street corners for pennies. He got only as far as the second grade in school, which makes the grace and strength of his lyrics all the more amazing.

He became a singing waiter at Mike Salter's Pelham resort at 12 Pell Street. Irving collaborated with the pianist there, one Nick Nicholson, on a song called "Marie from Sunny Italy," from which he ultimately derived royalties of thirty-seven cents. No matter, he was on his way, and music publisher Ted Snyder, who liked Irving's lyrics, put him on a retainer of \$25 a week. Then came "Alexander's Ragtime Band."

It is hard to overestimate the importance and influence of that song. For one thing, it stimulated a craze for dancing, and that craze in turn contributed to the rise of that peculiarly American institution, the nightclub.

A year after the success of "Alexander's Ragtime Band," Irving married Dorothy Goetz, a sister of E. Ray Goetz, a prominent theatrical producer and songwriter at the time. (He wrote "For Me and My Gal" and "Yaaka Hula Hickey Dula," among others.) Irving's young bride died of typhoid fever within five months of the wedding. For a long time, disconsolate, he was unable to write.

But his best was yet to come, including "Oh, How I Hate to Get up in the Morning," composed for his great World War I soldier show, *Yip Yip Yaphank*. His success continued to grow, and soon he was a producer and theater owner (as well as publisher of his own songs). With Sam Harris, he built the Music Box Theater and filled it with his own Music Box Revues of 1921, '22, '23, and '25. I can still remember seeing, while on summer vacation from Culver Academy, the 1925 edition, with Joseph Santley and Ivy Sawyer on opposite sides of the stage singing "All Alone by the Telephone." A year after that show, Irving married Elin Mackay, over the bitter opposition of her father, Clarence H. Mackay, president of the Postal Telegraph Company. (more)



At left, Irving Berlin as a boy of thirteen; at right, the Pelham (New York) saloon, 1907, where he got his start as a singing waiter.

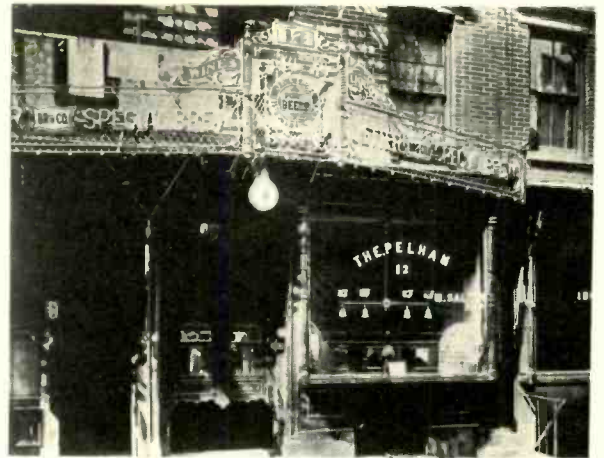

Above: Berlin (at far right) was one of the founders, in 1914, of ASCAP (American Society of Composers, Authors, and Publishers). With him here are other charter members, among them Jerome Kern (far left), Rudolf Friml (fourth from left), Oscar Hammerstein I (at the piano), and John Philip Sousa (with the white goatee). At right, while composing the score for the film *Follow the Fleet* (1936), he sings into a device of self-criticism called a microradiophone, which cut electrical recordings on the spot.



Photos: ASCAP

The songwriter was instrumental in the construction of the Music Box Theater in New York; it opened in 1921, and subsequent Music Box Revues were showcases for such hits as "What'll I Do?," "Say It with Music," and "All Alone." Berlin is flanked by cofounder Sam Harris and New York Mayor Jimmy Walker here as they formally declare the Music Box open for another season.



Legends have grown up about Berlin, some of them malicious and some of them contradictory. One is that he can't read a note of music. It's true. Neither could Ezio Pinza, one of the greatest musical talents with whom I ever worked. Neither could Frank Loesser. Another legend is that Irving can compose only in the key of F sharp and has a special piano on which there is a crank that shifts the keyboard for him so that he can play in other keys. That piano does indeed exist: He calls it his Buick.

It is perhaps time to confront the slander that Irving did not write his songs and, if I can, lay it to rest permanently. There used to be a joke that he employed a little black boy from Harlem who wrote all his songs.

I have directed three Berlin shows, if you include my advice on *This Is the Army*. After the war, I directed *Annie Get Your Gun* and, later, *Mr. President*. I have watched him work and seen his incredible creative energies in operation. He wrote songs profusely. No one else could have done that work for him.

*Annie Get Your Gun* was my first show after the war, and my first smash hit. Richard Rodgers and Oscar Hammerstein II produced it. Kern was supposed to write the score, but he became fatally ill while I was still at Ft. Dix waiting to get out of service. Rodgers, Hammerstein, and I began considering other composers. Irving's name was at the top of the list. He had not been asked, as no one thought he would work on a show he had not conceived himself. Oscar said, "I don't believe in scratching anyone's name until we at least ask him." To everyone's amazement, Irving said he'd consider it. But first he wanted to go off by himself to see if he was able to write songs in the hillbilly Americana style that the show required. During that weekend, he wrote four. What were they? "They Say It's Wonderful," "Doin' What Comes Natur'lly," "You Can't Get a Man with a Gun," and "Moonshine Lullaby." Only then did he say, "Okay, I'll do the show."

At one point, he threw out "There's No Business like Show Business" because he thought that Dick and Oscar and I had not reacted with sufficient enthusiasm when he first sang it for us. We set up such a howl that he soon put it back. (He always stands very close when he sings you a new song, and sings right up your nose, putting you under some sort of magnifying glass so that he can judge your reaction. And it's a good thing, too, because as someone once said, "You have to hug him to hear him.")

Just before we went into rehearsal with *Annie*, we had a final meeting to discuss scenery and costumes. Irving was off at the other side of the room. I whispered to Oscar that I thought there ought to be another song between *Annie* and *Frank* in the second act. Oscar said, "Keep your voice down. I

don't want to make Irving nervous when he's still working on the score. If you start talking about a new song at this point, it's liable to worry him."

At that moment, Berlin, who seemed to have smelled that we were talking about him, leaned over Oscar's shoulder and said, "Another song?" His eyes were gleaming.

I stuttered, "Well, uh, yes, Irving, if it's not too much trouble."

"What kind of song?"

"I don't know," I said. "But don't worry about it yet."

Irving called for silence and announced, "There's been talk of a new song for *Annie* and *Frank*. Question: What kind of a song should it be?"

Someone said hesitantly, "Could it be a love song, Irving?"

"Of course not," he said impatiently. "They hate each other at this point. They are competitors, they're rivals, they're getting ready for a shooting contest."

Rodgers said, "What about a challenge song?"

"A challenge song!" Irving said. "Right! G'bye, everybody, we can all go home now." The important problem—his—had been settled.

My wife and I immediately took a cab from Oscar's house at Sixty-third and Madison to our hotel, the Lombardy, at Fifty-sixth and Park, a trip of no more than six minutes. As we entered our room, the phone was ringing. It was Berlin. "Josh," he said, "listen to this." And he sang, "Anything you can do, I can do better. I can do anything better than you. . . ." And he finished singing the whole first chorus of the song.

"When the hell did you write that?" I asked in amazement.

"In the taxi."

"But so fast."

"I had to do it fast. We go into rehearsal day after tomorrow!"

No doubt the myth that Irving did not write all his songs grew out of not only their number (about 850 published), but their incredible variety. But anyone who has examined his life's work in chronological sequence would never for a moment entertain the thought that they were not all his. From "Alexander's Ragtime Band" through the simple "Easter Parade" to the highly sophisticated "Piccolino" and "Change Partners," there is a direct, consistent, and steady evolution of his style. As the music of America changed and grew more sophisticated, Irving changed with it and, indeed, usually led the change. And the lyrics, too, forthright and almost naive, have a total consistency and a recognizable personal imprint.

I worked again with Irving in 1962 on *Mr. President*. Before the New York opening, we played a gala benefit in Washington for the Kennedy Foundation, attended by all the sisters and in-laws as

well as Jack and Jackie. No one in the audience dared laugh at a joke until they looked first to see if the President was laughing. The atmosphere was chilly, to say the least. I ran into Irving at intermission. He said, "They didn't come to see a show, they came to be a show."

He has always been a bit jealous of big successes by other people. When Dick Rodgers and Oscar Hammerstein and I were trying out *South Pacific* in New Haven, Irving was working with Moss Hart on *Miss Liberty*. *South Pacific* was already the hottest news in show business, and it disturbed and rankled Irving that someone had a bigger hit than he might have.

One day, when he and Moss were pacing up and down the living room of his house overlooking the East River, Moss looked out and saw a little tug towing a long chain of barges piled high with waste paper, heading up the river. He pointed out the window and said, "You know what's piled on those barges, don't you? Mail orders going up to New Haven for *South Pacific*." Irving watched them grimly. At the end of the day, Moss saw another tug pulling loaded barges downstream: "You know what's on those barges, don't you, Irving? That's the money coming down from New Haven to be put in the bank." Moss howled with laughter at Irving's stone face.

All these years later, I remind myself that the human tornado named Irving Berlin was born May 11, 1888, in Temun, Siberia, which means of course that he is ninety this month. Irving Berlin ninety! It is hard to digest. He looks, moves, and acts like a young man. He still writes every day—often some very funny novelty songs. I'm sure he still has at least three shows in him.

I won't hear from him for a year or so, and then one day he'll call and we'll talk for hours and laugh and brag. Like any good friend, I always know he's there. He and his wife have a beautiful woodland home in the Catskills and a handsome town house on Beekman Place in New York. Irving's room is on the top floor, under the mansard roof, overlooking the river. He spends his time playing his "Buick," writing or painting, turning out smallish primitive portraits. If one of them happens to resemble one of his friends, he sends it to the person, suitably inscribed. One year he sent me a little flower painting with my wife's photograph pasted on it. It was inscribed, "To Josh from Irving," along with a couple of bars of music reading, "May all your Christmases be white." These little oils are full of excitement and therefore are true to his spirit. They are as colorful and humorous as those of Bombois, Grandma Moses, or perhaps Chagall.

I always found Irving easy to work with. If for some reason I wanted a new song for a show or wanted one changed, he never objected. On the contrary, he loved the challenge. And I never

Friedman-Abeles



Mr. President was in rehearsal when its composer provided one of the moments of horseplay he is notorious for. Obviously delighted are Nanette Fabray and Robert Ryan, principals in the show, and the author of this article, who was the director.

knew anyone who more enjoyed writing for the theater or better understood how to write for it. "I can't resist a story conference," he said to me once.

In the three shows I did with him—and I hope there will be more—I was continually amazed at his almost mystical way of concocting a new tune or an idea for an entire show. There has always been in him a passionate, unquenchable enthusiasm, a powerhouse quality that sets anyone near him on fire. He is an encourager, a lifter of spirits who laughs loud and long at your jokes and makes you feel they are funnier than they really are. And he is never at a loss for ideas.

Perhaps that is the real cause of the violent jealousy that Berlin has often inspired. There seems to be a human tendency to view with suspicion, even fear, a prolific man with brilliant, inexplicable talent. Balzac's incredible output of novels and plays caused his furious competitors to accuse him of having a stable of writers in his employ. Scholars are still "proving" that another, better-educated subject of Elizabeth I must have written Shakespeare's plays. Rumors that Mozart was poisoned by a jealous rival found their way into the works of both Pushkin and Rimsky-Korsakov. And an article in last February's *HIGH FIDELITY* described how Paganini's superb playing inspired tales that he was in league with the devil.

One wonders if, had Irving Berlin been born more than 200 years ago in Salem, Massachusetts, he would have been burned as a witch. ●

# For about \$15 you can buy the only total record care system or something less.

You have a choice. You can buy a fancy handled record cleaner. Or, for about the same money, you can have the only total record care system there is.

That is, our new Sound Guard™ record cleaner and our famous Sound Guard® record preservative. Both in one package.

The Sound Guard™ Total Record Care System.

With it, you do more than clean everything off your favorite records from dust particles to oily fingerprints.

You actually protect your record's life with a microscopically thin, dust-resistant patented lubricant.

If you want the most for your \$15\* (and

the best for your records), you have to have the only total record care system there is.

Like all Sound Guard products, the Sound Guard Total Record Care System is sold in audio and record outlets.

\*Suggested retail price.



## Sound Guard® keeps your good sounds sounding good.



Sound Guard preservative—Sound Guard cleaner—Sound Guard Total Record Care System  
Sound Guard is Ball Corporation's registered trademark. Copyright © Ball Corporation, 1978. Muncie, IN 47302

CIRCLE 34 ON READER-SERVICE CARD



At the *Clemenza* recording sessions: Minton, Baker, Popp, Von Stade, Lloyd, and (at the right) conductor Colin Davis



Mike Evans/Phonogram

HERE ARE two tales of *Tito*:

1) In July 1791, Mozart, mortally ill and desperately short of money, accepted a thoroughly uncongenial commission, to compose an opera seria for the Prague coronation of Leopold II. In August he dropped work on *The Magic Flute* and set out for Prague, arriving there on August 28, and in great haste—for a first performance on September 6—slapped together a string of arias and ensembles, most of them short and unadventurous in form, harmony, and instrumentation. The connecting recitatives he left to his pupil Süssmayr. For some reason, this potboiler, this piece of hackwork redeemed only by one or two fine things such as “*Non più di fiori*,” appealed to early-nineteenth-century taste and became popular; then, rightly, it was banished from the canon of Mozart’s great operas.

2) In the spring of 1789, Mozart was in Prague, the city where *Figaro* had made its biggest hit and for which he had composed *Don Giovanni*, and with the impresario Guardasoni laid plans for his next opera, a new grand setting of *La Clemenza di Tito*. He began work on it; *Così fan tutte* and *The Magic Flute* intervened, but when Guardasoni steered the coronation commission his way, all he had to do was to set down the splendid piece that had been forming in his head, and partly on paper, for more than two years. In a sense, according to this tale, *Tito* is the most carefully considered of all his operas.

And here is a true tale of critical reaction to *La Clemenza di Tito* as observed by a critic who has been encountering the opera fairly regularly over nearly three decades: From the 1949 Salzburg Festival (in a version concocted by Bernhard Paumgartner jollied up by gems from *Idomeneo*) through the 1969 Cologne Opera production (Yvonne Minton as Sesto,

## Mozart’s *Clemenza di Tito*: A Masterpiece, No Doubt

*Colin Davis’ Philips recording, with a cast headed by Janet Baker, establishes Tito’s claim for inclusion among Mozart’s great operas.*

by Andrew Porter

conductor István Kertész, director Jean-Pierre Ponnelle), admiration for the work gradually grew. Nevertheless, the basic judgment—a disappointing opera, alternately short-breathed and long-winded, with too many duets and trios for a rich, formal opera seria like Mozart's *Lucio Silla* but too many formal arias for a swift-moving music drama, and with characters that Alfred Einstein rightly described as puppets—was modified only by increasing appreciation for a few numbers that showed Mozart's irrepressible dramatic flair.

Until, in April 1974, Covent Garden put on a production of *Tito* (conductor Colin Davis, director Anthony Besch) that literally made history. Vol. VII of the *Oxford History of Music* appeared at much the same time, containing received opinion about the opera; just how wrong that opinion was was proved by the Covent Garden performance. Essentially, although with some cast changes, the Philips recording under review presents that performance, and it, too, should make history, for in it *La Clemenza di Tito* is revealed as a great opera. For that reason—since the greatness of Mozart's other great operas needs no demonstration—I am tempted to rate it as the most important of all Mozart opera recordings in the catalog.

To return to those first two tales above: 1) is what we still find in most of the standard Mozart biographies, and 2) is told in a note accompanying the Philips album. Neither is exactly true, but truth about the composition of *Tito* is hard to establish. The work and its genesis have been much studied in recent decades: writings since 1959 are conveniently listed in Alan Tyson's article "*La Clemenza di Tito* and its chronology" in the March 1975 issue of *The Musical Times*. My own conclusion, summarily stated, is that the idea of composing a *Tito* had been in Mozart's mind for some time and had been discussed with Guardasoni (the wording of the contract for the coronation opera suggests this) and with Caterino Mazzolà, the poet who rewrote the Metastasio libretto for Mozart's use; but that, with the possible exception of "*Non più di fiori*," Mozart did not begin to set his opera down on paper—however much he may have been thinking about it—until the definite commission arrived. (The first sketches for *Tito* are on the same paper as drafts for the *Magic Flute* finale.) He began by writing the ensembles, and arias for the one singer (Antonio Baglioni, his *Tito*, the original Don Ottavio) whose voice he knew; common sense and Tyson's research into paper types point the same way. And he completed the opera in Prague, working directly with the cast.

By this reckoning, the opera was written in haste, but it was not unconsidered, and it was not hackwork. It was the mature Mozart's handling of a high drama that had already engaged some forty composers since Caldara first set the Metastasio text, for Vienna in 1734—not a dying man's hurried attempt to fulfill a commission in an uncongenial and moribund form, but a glorious landmark on a highway that leads from Gluck and *Idomeneo*, through Spontini and Bellini, to *Les Troyens* and *Aida*.

Commentators have often had fun with the non-stop clemency of Titus, that emperor who said "*Amici, diem perdidit*" ("Friends, I've wasted the day") if he allowed the sun to set without having

done his good deed for the day. In the opera we first meet him contributing handsomely to the Vesuvius Relief Fund, and thereafter engaged in high-minded forgiveness and renunciation. But the leading character is the prima donna, Vitellia, the daughter of an emperor, proud, passionate, ambitious, and unscrupulous. (Has anyone written a study of the fierce, vindictive women recurrent in Mozart's operas?) Scarcely less important is the primo uomo, Sesto, Vitellia's lover and Tito's friend, torn between sexual enslavement and moral imperatives.

Toward the end of the opera, each of them has a great rondo—Sesto's "*Deh, per questo instante*" and Vitellia's "*Non più di fiori*"—neither of them to Metastasio words, although introduced by Metastasio recitatives. To turn *Tito* into what Mozart called "a real opera," Mazzolà did far more than just tinker with the original. Again and again one finds him basing a new number on ideas in Metastasio's dialogues, which are more dramatic than his arias. As for the musical planning of this "real opera"—the use of key, motif, form, and instrumental color for dramatic meaning—see Daniel Hertz's article "*Mozart's Overture to Titus as Dramatic Argument*" in the January 1978 issue of *The Musical Quarterly*, the most important piece of writing on the work since Tyson's, and about far more than just the overture.

The new Philips performance is not perfect. In particular, there are passing moments when the mezzos, all three of them, singing out fearlessly along exposed lines, raise doubts whether their pitch is spot-on. There are some single numbers that one might prefer to listen to, if out of context, in the London recording. But the performance of the opera as a dramatic whole is magnificent, controlled by a sense of emotional pacing, sometimes very deliberate in tempo, yet always urgent and ardent, which brings both Mozart's music and the characters and their situations vividly to life.

The limitations of Janet Baker's voice have been sufficiently discussed in these pages recently: Admittedly, the compass is short for Vitellia, a role that spans over two octaves (in fact, she omits the single high D, in the Act I trio, but the omission is not important). And, to my ear, she gives an inspired, incandescent performance—bold, passionate, delicate, fired by greatness. Her complicated timbres, always skillfully turned to expressive effect, contrast well with Yvonne Minton's smoothly knit tones in the castrato role. Minton sings with more force and fire than does Teresa Berganza, the London Sesto. Robert Lloyd is sound and shapely in Publio's single aria.

The others were not in the original Covent Garden production. Frederica von Stade, who has recorded the big arias of Vitellia and Sesto (Philips 9500 098, March 1977), here takes the subaltern role of Annio, and expounds "*Tu fosti tradito*" with wonderful clarity and firmness. In his first recitative, Stuart Burrows, the *Tito*, delivers his sentences a phrase at a time—like someone dictating to a secretary without shorthand—but later he captures the sweep of the noble oratory. His singing is fluent, well-turned, and lyrical, a little less imperial in manner than Eric Tappy's at Covent Garden, but more so than Werner Krenn's for London. The diddle-diddle divisions of "*Se all'impero*" defeat him, as they have defeated every other *Tito* of my experience. In the small role of

Servilia, Lucia Popp is neat but rather thin and peaky of tone—as in the London set.

Colin Davis reaches his finest form in works that he passionately believes in and that called for a champion: *Mahagonny*, *Les Troyens*, *The Midsummer Marriage*, now *Tito*. The performance bears the print of his enthusiasm and of his feeling for the import of a sudden harmonic or instrumental change. For example, a sudden, bare D flat, *sf*, in the dialogue before the Act I finale makes a hair-raising effect. In the overture, the playing of the Vienna orchestra under Kertész, in the London album, is more finely grained—but the sense of the piece is far more strongly realized in the Philips version. There is also an air of confidence, on everyone's part, in the work's greatness, which must have come from the success of the production in London and then at La Scala, to which it was taken. It was a neo-classical staging, grand and simple, without Ponnellian gimmickery—and that, too, is reflected in the security of the musical style.

The recitatives (not by Mozart, and commonly attributed to Süssmayr) are shortened, but far less drastically than in the London recording, where im-

portant plot points are omitted. In both sets, "blunt endings" (repeated notes instead of appoggiaturas) abound. Baker adds some stylish adornments to her first aria. Cadenzas are omitted or reduced to a note or two.

The London booklet has a much longer and far more informative essay on the piece than has the Philips, and valuable illustrations, but the libretto in the latter is more agreeably printed. Both firms, however, show no respect—Philips is the worse offender—for the lineation of Metastasio's and Mazzola's verses. Philips' sound is clear, natural, and well balanced, but some of the dialogues ping-pong from speaker to speaker with distracting effect.

**MOZART: La Clemenza di Tito.**

Servilia	Lucia Popp (s)	Annio	Frederica von Stade (ms)
Vitellia	Janet Baker (ms)	Tito	Stuart Burrows (t)
Sesto	Yvonne Minton (ms)	Publio	Robert Lloyd (bs)

John Constable, harpsichord; Chorus and Orchestra of the Royal Opera House, Covent Garden, Colin Davis, cond. PHILIPS 6703 079, \$26.94 (three discs, manual sequence). Tape: ●● 7699 038, \$17.95.

*Comparison:*  
Casula, Berganza, Krenn, Popp, Fassbaender, Kertész Lon. OSA 1387

## The Budapest Quartet's Missing Links

*Columbia offers an invaluable four-disc set of 1932-36 performances plus a sobering reminder of the Budapest's weak 1952 Beethoven.*

by Harris Goldsmith

FOR YEARS I have been urging that EMI revive the Budapest Quartet's extraordinary early HMV recordings, which document the formative periods of the most famous of all string quartets. Now, at last, we are offered four LPs' worth—from Columbia!

The new four-disc Odyssey set is certainly a treasure trove (and, at the modest price, a fantastic bargain), a must for all chamber music lovers. Wonderful as it is, however, I find that it has whetted my appetite for more. At the risk of sounding greedy, I would suggest that the Budapest's tremendous musical and historical importance warrants a full-scale retrospective on the order of RCA's Rachmaninoff and Heifetz homages of recent years. Over the quartet's nearly half-century history, almost all of its numerous personnel dispositions have been recorded, and a systematic retrospective, apart from the considerable musical pleasure to be had, would help clarify the group's evolution.

Columbia's simultaneous reissue of the Budapest's 1952 Beethoven late quartets (which completes the restoration of that cycle to the catalog) does tell us something about that evolution, forcing as it does a re-evaluation of the frequent assertion that the quartet deteriorated progressively over its last decade and a half. Far more valuable would be a reissue of some of the earliest Budapest recordings—for ex-



The Budapest Quartet in the '30s: Joseph Roisman, Alexander Schneider, Istvan Ipolyi, and Mischa Schneider

ample, the excellent Dvořák American Quartet done by violinists Emil Hauser and Imre Pogany, violist István Ipolyi, and cellist Harry Son (all original members except Pogany, the successor to Alfred Indig, who had left the group by the time of its first recordings, in 1926). Such reissues would dispel the myth that the Budapest reached true stature only with the arrival of the Schneider brothers.

The Schneiders undoubtedly were important, and their effect can be heard in the *Odyssey* set, culled from the period 1932-36 when they were both in place: Mischa had replaced cellist Son before the quartet's 1930-31 U.S. debut tour; Alexander filled the vacancy created in 1932 by the switch of Joseph Roisman (who had replaced Pogany in 1927) from second to first violin upon the sudden departure of Hauser. These performances still include the last original Budapest member, violist Ipolyi, who remained until 1936. When Boris Kroyt replaced him, the modern Budapest Quartet as we know it (composed entirely of Russians who did not even speak Hungarian!) was set except for the second-violin chair, which Alexander Schneider vacated in 1944. (His place was taken successively by Edgar Ortenberg and Jac Gorodetzky before he was persuaded to return following Gorodetzky's death in 1954.)

Innumerable quartet players have called Mischa Schneider the king of ensemble cellists. He was a solid rather than flamboyant player, and his golden sound and subtly pointed rhythm were a pillar of supportive strength. To appreciate Alexander Schneider's contribution, one need only compare the recordings that include him with those made during his absence—as, for example, the 1951-52 Beethoven cycle, about which more below.

The 1932-36 performances have miraculous polish, grace, and swiftness. Of course the appropriate-

ness of their mercurial refinement varies from work to work: This Beethoven Op. 130, for example, is a bit glib (particularly in the last movement) alongside the marvelously incisive, more thoughtfully shaped version in the 1961 stereo cycle. Similarly, the savagery and "modernisms" of Bartók's pungent Second Quartet have been realized more ardently by others.

On the other hand, fleet writing such as the central part of the *Canzonetta* of Mendelssohn's Op. 12 Quartet, the *Till Eulenspiegel*-like *Wolf Italian Serenade*, and Schubert's *Quartettsatz* reach luminous heights in these standard-setting interpretations. The fine-spun lyricism also allows the intricate counterpoint of Mozart's great K. 499 Quartet to quiver with life, and the combination of meticulous rhythmic poise, nuanced chiaroscuro, and spot-on ensemble puts this Beethoven Op. 59, No. 2, far ahead of either subsequent Budapest recording.

Throughout these performances—including the Beethoven Op. 130, whatever my reservations about it—there is a meticulousness of ensemble and a technical magnificence beyond the reach of all but a few select quartets. The New Music Quartet of the early 1950s may have surpassed the Budapest by virtue of its greater incisiveness and motor energy (its *Wolf* serenade carries the youthful Budapest's approach to even greater heights), but it is fair to say that this was the first truly modern string quartet.

In sum, this set is of a quality to inspire delirium. If

---

## How the Legendary Budapest 78s Got onto LP

by R. Peter Munves

President, Quintessence Records & Tapes

FOR MORE THAN three decades (most of my record-collecting existence) I have cherished the wonderful performances that the Budapest Quartet committed to records in their first great period, the early 1930s, when the Russians—Joseph Roisman, first violin, Alexander Schneider, second violin, and his brother Mischa, cello—look over what had heretofore been a predominantly Hungarian ensemble. These Budapest 78s, produced in Berlin and London, initially appeared on EMI's His Master's Voice and affiliated labels in Europe. Through a reciprocal release agreement with EMI, American music lovers were able to purchase them on RCA Victor's Musical Masterpiece sets.

The Victor sets, pressed on extremely high-grade shellac, generally had remarkably silent surfaces. Many were preserved in mint condition by wealthy collectors who had large libraries of 78s and rarely if ever played them. When the albums started turning up in second-hand shops in the late '40s and early '50s after the introduction of the LP, I got as many as I could find, much as a book collector would search out rare first editions. And the Budapest recordings of the '30s were indeed rare: far fewer than 1,000 of each set were originally pressed.

Few older record fanciers knew just how well recorded many of their 78s were, for playback equipment in the '30s was technologically far behind the recording and manufacturing process. Played on today's sophisticated equipment (with a special Fairchild 78-rpm cartridge equipped with a 3-mil diamond stylus, produced in the early 1960s especially for radio stations), the results are startling. These first pressings possess a vigorous immediacy and presence. The music fairly leaps out of their grooves. Currently, the industry is making a big fuss over direct-to-disc recording, but 78s were just that: instantaneous recordings inscribed directly on to wax masters or, later, acetate discs that are still being used to cut LP masters.

In 1959, EMI decided to beef up their three-year-old Angel label, which had been built on recordings from their English Columbia label with such prestigious stars as Maria Callas and Herbert von Karajan, by including new recordings from the HMV catalog. They severed their longtime reciprocal lease arrangement with RCA, as they had their licensing deal with Columbia four years earlier, and chances seemed remote that these treasured Budapest Quartet recordings, which by then had

been out of print for a decade, would reappear.

But the enthusiasm and perseverance of a record buff should never be underestimated. For seventeen of my twenty-five years in the classical record industry, I had worked in the merchandising division of Columbia Masterworks. One of the side benefits of my position was the opportunity to attend recording sessions of many great artists, including the Budapest Quartet. They had been recording for Columbia since 1941, when as part of a large raid on RCA's Red Seal label, many artists formerly associated with Little Nipper switched their allegiance to Columbia.

The four immediately set about recording many of the Beethoven quartets they hadn't got around to doing for either EMI or RCA. Their first Columbia set—a beautiful performance of Beethoven's C sharp minor Quartet—was chosen the best chamber music record of 1941 by David Hall in his newly published *Record Book*. Within a few years the Quartet had to its credit superb readings of most of the late Beethoven works, the string quintets of Mozart (with violist Milton Katims), the Debussy and Ravel quartets, and the Mozart D minor, K. 421, among others.

I had to choose one favorite performance, difficult as that is, it would be the winged realization of Brahms's last, and finest, quartet. The Budapest's stereo version is extremely fine (in some ways rather similar to this 1932 account), but in the face of such incandescence all other performances are bound to seem pale. Ipolyi's playing of the exposed third-movement viola solo is wondrously concise and expressive, and Roisman's work, uneven in later years, is marvelously aristocratic throughout.

A special word of praise is due Ward Marston, who transferred the source material to tape. Side breaks, always problematical with 78s, are virtually undetectable, and the overall sound is warm, lustrous, and honest. The Brahms and the Beethoven Op. 59, No. 2, lack some of the rich-toned amplitude of the originals, but this slight loss may result from cramming so much material onto the LP sides.

If commercial recordings are to be believed, Alexander Schneider's departure from the quartet in 1944 dealt it a severe blow. The few recordings made with Ortenberg are excellently played, yet these slightly cool and impersonal performances nonetheless leave an unmistakable impression that something important has gone. But it was during the Gorodetzky years that the quartet really fell on hard times.

I hate to place all the blame on Gorodetzky, who was by all accounts a fine violinist and musician. The alarmingly high percentage of failures among the

Budapest recordings of that era can be attributed to several factors, outstanding among them the unworthy recorded sound. In order to use the superb Stradivarius instruments in the Library of Congress' collection, the Budapest had to record in the Library's auditorium (the instruments could not be removed from the building), and many of these readings were scrambled beyond redemption by the cramped and echo-ridden acoustics of the audienceless auditorium.

Acoustics aside, much of the playing in those years—as is abundantly documented in such *Odyssey* reissues as the last three Schubert quartets (Y3 33320), the Mozart *Haydn* Quartets (Y3 31242), and the 1951-52 Beethoven cycle—was tepid and un-rhythmic, lacking the luster of the earlier recordings or the firm contouring of many of the later ones.

Comparison of the 1952 and 1961 late Beethoven quartets is complicated by the huge disparity in recorded sound. The stereo versions are uniformly crisp, even astringent, and such close microphoning will cruelly expose any ensemble imperfections; indeed I find myself bothered far less by the variable intonation than by the instances of wavering bow pressure and microscopically inaccurate ensemble. The mono performances are sonically inconsistent, as if the engineers were trying to find ways of defeating the unflattering echo.

In Op. 127 the sound is harsh and brittle; HF's C. G.

As wonderful as these performances were they weren't recorded with the kind of acoustic presence that the EMI recordings had in abundance. The sound had neither the transparency nor warmth of the earlier ones. But since Columbia had produced, in the LP and stereo era, so many brilliant Budapest Quartet recordings, it made sense to me that they should reissue the legendary recordings from the Quartet's first great period.

About a year ago I was lunching with Marvin Saines, who is chief of Columbia Masterworks, and suggested that the early Budapest recordings ought to be made available once again. They were, I reasoned, inimitable and historic. No quartet before the Budapest of the early '30s had played with such dramatic sweep and fire, warmth and expression. The speechlike inflection of their performances left an indelible stamp on everything they played. Marvin, himself a violist and chamber music devotee, didn't need much convincing. We began singing our favorite passages from these old recordings. The more we sang, the more we remembered. The more we remembered, the more we wanted these unique recordings to be reissued. Finally, Marvin said, "If you don't do it, I will."

Several weeks later I received a phone call from a young, enthusiastic jazz pianist, Ward Marston, who happens to be one of the most ardent lovers of historic 78s I have ever met. Ward

told me that Marvin was obtaining the rights to EMI's Budapest recordings from the 1930s. EMI had sent Columbia dubs made from metal parts, but Columbia was not satisfied with these transfers and had commissioned Ward to make new ones from the original shellac pressings. I had told Marvin that I had several copies of these Budapest sets in immaculate condition and Ward was calling me to ask for my two best copies of each selection. Within hours of the call, the records were in a friend's car on the way to Ward's studio on the outskirts of Philadelphia.

Using elliptical diamond styli housed in a Shure V-15 Type III cartridge and a 12-inch SME tone arm mounted on a variable-speed turntable, Ward set about his work. Styli of widths ranging from 2.7 to 4 mils (made by Expert Pick-ups Limited, in England) were needed to cope with the different groove widths cut in Berlin and in London. Even within a single set, groove widths could vary from one side to another. To obtain the cleanest reproduction from the 78s a stylus had to hug the groove walls and not scrape the bottom, for additional noise and distortion might be picked up. With the aid of a graphic equalizer, Ward zeroed in on the optimum recording curve of each disc. Filters were used to suppress hiss caused by the shellac material in the treble range and low-frequency rumble in the bass.

The variable-speed turntable was a must. In the early days of electrical

recording there was no way of assuring that the speeds of the turntables on which the masters were cut would remain exactly the same during a recording session. Except for those with perfect pitch, listeners could seldom retain an aural memory of the correct pitch between the frequent side breaks of the 78 sets and were thus not disturbed by discrepancies. But when one is joining two sides together, accurate speeds are a necessity.

Ward also developed a technique for assuring continuity of ambience through the original side breaks. Most engineers simply splice the sides together: Ward recorded adjacent sides on separate tape tracks and mixed the two together where they joined, so that the ambience was blended.

Now that the project has begun so auspiciously, Columbia is planning to release all the rest of the 1932-36 series of recordings the Quartet made for HMV: the Haydn Op. 54, No. 1, in G; Schubert's A minor, D. 804; Grieg's G minor; the Sibelius D minor, never before released except as part of a Sibelius Society set; Mozart's *Dissonant* and F major, K. 590; Beethoven's Op. 18, Nos. 2 and 3, and Op. 74; Brahms's A minor Quartet, F major and G major Quintets, and G major Sextet; Dvořák's A major Sextet; and Tchaikovsky's *Andante cantabile*.

I've got them all in mint condition. If you have any problems with the EMI dubs, Marvin—



Burke likened the sound of the original issue to that of ancient wind instruments. The new mastering improves the tone so that it resembles a consort of viols; however there is an additional distraction: what sounds like a ventilating system. Opp. 130 and 131 are pleasantly murky, with heavy bass; the violins squeal, and the cello—particularly in pizzicato passages—tends to dominate like a possessive bullfrog. There is a burst of static at the beginning of the recapitulation in Op. 130's first movement and an uneven thumping rumble at the beginning of Op. 131, defects I don't recall from the originals.

In Op. 132 the cello almost disappears, and the total sound—in this most richly scored of the quartets—lacks weight and substance. There is also an uneven high-frequency accentuation of the violins in the "Thanksgiving," which again I don't recall hearing before. In the *Grosse Fuge* and Op. 135 the sound is better balanced than before, in fact quite acceptable, but I found Op. 135 plagued on several copies with pops and tics.

The 1952 Op. 127 is the best thing in that set: intense and comparable to the later version, which nevertheless seems a bit stronger and more rhythmic. The 1952 Op. 130 is slack and amorphous: Even apart from the garbled sound, the playing—sloppy and listless—resembles a metronome ticking unevenly; both the 1936 and the 1961 versions are incomparably superior. Op. 131 begins with a decently played fugue, but after a while the stream of glossy, uninflected sound goes nowhere. For all its rasping tone and technical lapses, the 1961 version carries immeasurably greater conviction. In fact, the 1952 performance has at least as many technical mishaps.

The 1961 Op. 132 similarly carries the listener along with its greater solidity and thrust. One point of interest in this quartet: The later performance startles by taking Beethoven's *L'istesso tempo* instruction in the second-movement trio to apply to the measure rather than to the individual note values; in the 1952 version, this passage is interpreted in the

conventional manner and sounds rather wan and stodgy as a result. The 1952 *Grosse Fuge* and Op. 135 once seemed to me superior to the later ones, chiefly for their more reliable intonation, but on rehearing I find myself relatively undisturbed by the intonation of the later accounts, both of which now strike me as immeasurably wiser and more vigorous.

The 1952 Beethoven performances would, I suppose, have a place in a comprehensive Budapest retrospective, but short of that their reappearance, rather than enhancing our image of the quartet, does it a distinct disservice. Even as a budget offering, the late-quartet set is outclassed by the Yale Quartet's on Vanguard Cardinal, which offers accurate performances in lively stereo sound and perspective. Columbia does, however, have valuable Budapest material gathering dust in the vaults: for example, the 1940-42 Beethoven Opp. 127, 131, and 132 (I recall the contemporaneous Op. 135 less happily), the 1957 Mozart quintets with Walter Trampler, and the 1942 Schubert C major Quintet with Benar Heifetz.

**H** **BUDAPEST QUARTET:** The EMI Recordings, 1932-36. Budapest Quartet (Joseph Roisman and Alexander Schneider, violins; István Ipolyi, viola; Mischa Schneider, cello). ODYSSEY Y4 34643, \$15.92 (four discs, mono, manual sequence) [from HMV/VICTOR originals].

**BARTÓK:** Quartet No. 2, in A minor, Op. 17. **BEETHOVEN:** Quartets: No. 8, in E minor, Op. 59, No. 2; No. 13, in B flat, Op. 130. **BRAHMS:** Quartet No. 3, in B flat, Op. 67. **MENDELSSOHN:** Quartet in E flat, Op. 12. **MOZART:** Quartet No. 20, in D, K. 499. **SCHUBERT:** Quartet No. 12, in C minor, D. 703 (*Quartettssatz*). **WOLF:** Italian Serenade.

**R** **BEETHOVEN:** Late Quartets. Budapest Quartet (Joseph Roisman and Jac Gorodetzky, violins; Boris Kroyt, viola; Mischa Schneider, cello). ODYSSEY Y4 34644, \$15.92 (four discs, mono, manual sequence) [from COLUMBIA SL 174, 1952].

Quartets for Strings: No. 12, in E flat, Op. 127; No. 13, in B flat, Op. 130; No. 14, in C sharp minor, Op. 131; No. 15, in A minor, Op. 132; No. 16, in F, Op. 135. *Grosse Fuge*, Op. 133.

*Comparisons—Beethoven late quartets:*  
Budapest Qt (1961)  
Yale Qt

Col. M5S 677  
Van. Card. VCS 10101/4

## A Humperdinck Opera That's Not Hänsel

*Electrola's premiere recording of Königskinder, smartly conducted by Heinz Wallberg, reveals a work of uncommon craft and appeal.*

by David Hamilton

AS FAR AS the active repertory is concerned, Engelbert Humperdinck (1854-1921) is a one-work composer, and not even the record companies have ventured until now beyond that one work, the charming, perfectly gauged and crafted kindergarten distillation of Wagnerian epic, *Hänsel und Gretel*. Humperdinck wrote other music, of course: other operas, including several on similar librettos; much incidental music for Max Reinhardt (notably the score for the famous pantomime *The Miracle*); a few orches-

tral pieces and chamber works; and numerous choruses and songs. But, except for *Hänsel*, his most frequently recorded work is probably the noisy concert ending to Wagner's "Siegfried's Rhine Journey" favored by Toscanini and other conductors.

Humperdinck imbibed his Wagnerianism at the source, hearing the first Munich *Ring* cycle while he was at the conservatory there, and meeting the Master in 1880 in Naples while traveling on a fellowship; he was quickly pressed into rehearsing performers



Geraldine Farrar (with friends) as the Goose-Girl in the Met Premiere—an admirably picturesque performance

for a private performance of the Grail Scene from *Parsifal*. In 1881 and 1882 Humperdinck lived in Bayreuth, making two copies of the *Parsifal* full score—one for the printer, one for the conductor—and then rehearsing the children's chorus for the premiere. (The authorship of part of the Transformation Music in Act I is sometimes attributed to Humperdinck; in fact, he did "compose" an extra repetition of some of the music, required when the stage machinery took too long over the scenic transformation, but this was not incorporated into the score and was abandoned at Bayreuth as soon as the machinery got working properly.)

After Wagner's death, Humperdinck traveled, composed, conducted, taught, served as a publisher's reader for Schott, without really settling down or making any strong impression. With *Hänsel*, which began as a song cycle to texts by his sister, he found his perfect subject, and its 1893 premiere in Weimar (Richard Strauss conducting) brought him a worldwide success that he was never able to duplicate.

The closest he came was with *Königskinder* (*The Kingly Children*), another fairy-tale subject. This began as a play by Elsa Bernstein-Porges, daughter of a fellow Wagnerian (she wrote under the name of "Ernst Rosmer"), for which incidental music was desired. Humperdinck was so taken by the subject that he set it in full as melodrama: music accompanying speech, its rhythms and relative pitches notated. This remarkable prefiguration of Schoenberg's *Sprechgesang* wasn't a success at its first performance in 1897; few understood what the composer was trying to do, and many compromises had to be made. But the story retained its hold on Humperdinck's mind, and over a decade later he took it up again, reworking the text and making a full-scale opera of it, incorporating much material from the earlier setting.

The rights for the new *Königskinder* were acquired for the Metropolitan Opera by Gatti-Casazza, and it was first performed in New York with great réclame in December 1910, just a few weeks after the comparably ballyhooed premiere of Puccini's *Fanciulla del West*. The reception was good, and in four

seasons Humperdinck's work was presented thirty times—more often than Puccini's work, in fact, although the latter has caught up in recent years. Certainly, the admirably picturesque performance of the Goose-Girl by Geraldine Farrar played an important part in the success of *Königskinder*. Performance in English had originally been intended, but the translation wasn't ready in time—perhaps fortunately: The "English singing words" in the old Rullman libretto are inept and frequently inaccurate as well. On its home ground, *Königskinder* was less well received. Not long thereafter, the composer suffered a heart attack; this, and growing deafness, reduced his activity for the remainder of his life.

The "Rosmer" story, in the way of fairy tales both real and concocted, sets a number of resonances vibrating, sometimes in confusing or conflicting ways. That some of these resonances are Wagnerian was probably inevitable, given the time and place of its origin; more ambitious in scope than *Hänsel*, *Königskinder* manages to avoid the didactic heaviness that oppresses us in Hofmannsthal's *Frau ohne Schatten*, for example. Since Electrola's booklet gives no synopsis, only a German libretto (and a historical essay in German and English), and neither libretto nor score seems to be in print at the present time, a brief summary of the story is worth giving here.

The Goose-Girl lives in the wood, held in captivity by the Witch; at curtain's rise they are engaged in appropriate domestic chores, including the baking of a loaf of bread that the Witch hides after laying a mortal curse upon it. She then goes off to the swamp to collect herbs and dig snails. The King's Son, who has left his home to find adventure and maturity, comes upon the Goose-Girl and they fall in love, but she cannot break the Witch's spell and follow him. The Witch returns, scolds the girl and sends her indoors. Three worthies from the nearby town of Hella—a Woodcutter and a Broommaker, both frightened and verbose, and a cheery, forceful Fiddler—arrive seeking advice: Their King has died without issue, and they need a ruler. The Witch tells them that whoever enters the town the next day at noon shall be their King. Delighted at the prospect of having the new ruler in their debt, the Woodcutter and Broommaker go off, but the Fiddler has spied the Goose-Girl at the cottage window and he waits and makes the Witch bring her out. He establishes that she is an orphaned child of royal blood, and this knowledge gives her the strength to break the spell and set off with the Fiddler toward Hella.

The second act shows the townspeople preparing to greet their as-yet-unknown ruler. The King's Son is there, looking for work, but can find no better position than that of swineherd. After various episodes illustrating the smugness, snobbishness, and stinginess of the city folk, the midday bells sound and the gates open, revealing the Goose-Girl and her flock; she sees the King's Son and tells him she is now ready to share his crown. The populace bursts into laughter and sends them packing—a swineherd and a goose-girl as rulers, indeed! Only a child protests, and is left whimpering on-stage as the curtain falls.

The third act returns to the forest, in deep winter. The Witch has been put to death for her discredited prophecy, and the Fiddler, after having been imprisoned, is now living in her deserted cottage. The

Broommaker and Woodcutter ask him to return to the town: all the children of Hella bear a grudge against their elders for mistreating him and the *Königskinder*. The Fiddler will have nothing of it, but finally agrees, at the urgent pleading of the children, to lead them on a search for the missing pair. The two craftsmen remain behind, to keep warm in the cottage. Now—naturally—the *Königskinder* turn up, starving and frozen: they beg for food at the cottage door, to no avail. Finally the two village worthies discover a loaf of bread in the cottage (remember the Witch's baking in Act I?), and they force the King's Son to barter his crown for it. The lovers eat and then die quietly, covered by falling snow. The Fiddler and the children return and discover what has happened: they carry the bodies off into the sunset.

Quite obviously, this tale inhabits a Wagnerian universe, right down to the kindergarten version of Siegfried's funeral at the final curtain. It touches upon questions of growing up, of finding out who you are (and of recognizing who others are despite outward appearances), of learning to care for others, and of keeping faith. Some of it is sentimental: That final episode must be even harder to bring off without provoking laughter than the swan's funeral in *Parsifal*. Some of it is theatrically impractical, though evidently not impossible: The gaggle of geese that attends the heroine must be even more of a problem than Fricka's ram-driven chariot, and unfortunately more essential to the story (one of the geese has to hide and then recover the King's Son's crown!).

But much of it is genuinely touching—not least because Humperdinck has the gift of simplicity and directness; his debts to Wagner are at once obvious and in firm control, so that the music never overreaches and swamps the story. For example, the festival scene in Act II owes a great deal to *Die Meistersinger*, but is in no way a copy: Humperdinck keeps it on a smaller scale, and the climactic moment when the deep bells begin striking noon is both original and impressive (sure, the idea came from *Parsifal*, but its treatment here is really quite different). At this distance, as perhaps was not possible in 1910, we can hear what is distinctive about this music at least as clearly as what is derivative.

All of the Wagnerian apparatus is scaled down to match the directness and simplicity of the material—much of it, as in *Hänsel*, of basically folklike character. There are leitmotifs, of course, and musical form is built by departures from and returns to thematic material and key areas, with great skill in transition. The textures are lively and beautifully scored, rhythmic movement is never sacrificed to contrapuntal complexity. Only at the opera's end—a theatrical danger point, as already suggested—does the music fail to contribute much more than sentimentality; elsewhere, it is unfailingly strong and vivid, varied and coherent.

Electrola's recorded performance isn't perfect, but it's enormously effective, thanks to Heinz Wallberg's sure hand on the helm. His orchestra is not of the top rank, but it plays with much spirit and feeling, and the shape of the opera, as well as its always ingenious orchestration, is well conveyed. The full, rich recorded

sound helps too; unlike some EMI issues from Germany, it achieves that fullness without sacrifice of detail—note the firm, solid timpani strokes. At only one point was I conscious of an intermediary hand between me and the performance: When the Fiddler goes off with the children in Act III, he sings a folk-like tune that verges on sentimentality to start with, and Hermann Prey's voice has been packaged in an obviously fake echo that raises the corn quotient to near-unacceptability.

Prey is one of the strong features of the cast, his bluff manner ideally suited to the Fiddler (it was a pleasure to come back to him after hearing the dry, ungenerous singing of Otto Goritz, the original Fiddler of the Met production), even when his singing is rougher than it might ideally be. Helen Donath, too, has the right spirit and manner for the Goose-Girl, though I can imagine a tone with slightly more bloom; in my imaginary opera house, Judith Blegen will be cast in this part. Hanna Schwarz is billed as an alto, but she has to push her chest register a good deal to make the right effect as the Witch; one supposes that Humperdinck had Schumann-Heink's voice or vocal type in mind (Louise Homer sang it at the Met but left no recordings), and there aren't many of those around these days.

The weakest bit of casting is Adolf Dallapozza as the King's Son, a part that wants a good deal of ring in the tone without suffering the heft of the true Wagnerian tenor. Hermann Jadlowker and Karl Jörn did it at the Met, and there is an old Cologne Radio tape in which Peter Anders shows us how it should sound; Dallapozza simply hasn't the ring or, indeed, the technique to manage all the notes with security. Karl Ridderbusch is a luxury as the Woodcutter, though I suspect he would not be so bland were he to essay the part on-stage a few times; Gerhard Unger, more accustomed to character roles, is more vivid as his sidekick. The others are more than tolerable.

Among the operatic exhumations of recent years, *Königskinder* strikes me as one of the most rewarding—at least on records. (I'd love to see it in the theater, but the problems of casting and staging are so formidable that I have small expectation of encountering it there.) More ambitious than *Hänsel*, it is as expertly made and sincerely felt; if short of the blazing genius that we find in Richard Strauss's contemporaneous works, it is also without the glaring lapses of taste that sooner or later mar them. I hope it will give you as much pleasure as it has given me.

#### HUMPERDINCK: *Königskinder*.

Goose-Girl	Helen Donath (s)
Broommaker's Daughter	Brigitte Lindner (s)
Witch	Hanna Schwarz (ms)
Innkeeper's Daughter	Heidrun Ankersen (ms)
Stable Maid	Ortrun Wenkel (a)
King's Son	Adolf Dallapozza (t)
Broommaker	Gerhard Unger (t)
Tailor	Friedrich Lenz (t)
Fiddler	Hermann Prey (b)
Senior Councillor	Theodor Nicolai (b)
Woodcutter	Karl Ridderbusch (bs)
Innkeeper	Gunter Wewel (bs)

Tölz Boys' Choir, Bavarian Radio Chorus and Orchestra, Heinz Wallberg, cond. [Theodor Holzinger and Helmut Storzjohann, prod.] EMI ODEON 1C 157 30698/700, \$29.94 (three SQ-encoded discs, manual sequence; distributed by Peters International).

Maxell? TDK? Scotch? BASF? Memorex? Ampex? Sony?

**Suddenly there's a  
new name that eliminates  
the confusion (and ad-fusion):**



# Supertape Gold.



"I'm Peter Nero. I kid you not. Supertape Gold is everything they say it is even though the guy who wrote the ad is a personal friend."

Could a Radio Shack own-make cassette tape be the greatest new formula in ferric-oxide 5-step-calendering audio tape? And isn't it neat that Supertape Gold requires no special bias settings? Well, we've built the tape, we've compared it in our labs with the summa cum hi-fi brands named above. And now it's your turn to see if your ears and your tape head confirm our findings. Fortunately, the price for your experiment is trifling. If we're right, and Supertape Gold is indeed a breakthrough, then we both win. You get cleaner sound. And Radio Shack gets to be your cassette tape company — all 6,444 of our American and Canadian stores and dealers. 'Tis a consummation devoutly to be wished!

**SUPERTAPE<sup>®</sup> GOLD. Sold Only at:**  
**Radio Shack<sup>®</sup>**

A Division of Tandy Corporation, Fort Worth, Texas 76102

# IT'S NOT WHAT IT DOES, BUT WHAT IT UNDOES.

It's no wonder your records are flat. Before they're pressed, about half of the music's dynamic range has been squeezed out.

The vice is the recording process. Live music's dynamic range can be more than 100dB, but the studio recorders have only 58dB of useable dynamic range capacity. So the engineer has to compress the signal, making the loud sounds quieter and quiet ones louder. And that's where the live gets squeezed out of it. Your con-

ventional discs offer less than 50dB of dynamic range.

You can undo much of the damage. Just add a dbx 3BX Dynamic Range Expander to your system, and you'll restore most of the missing dynamic range in your records, tapes and FM broadcasts. The 3BX unsqueezes all kinds of music, making everything sound richer, clearer and fuller than you've ever heard. And with dramatically less noise as well.

The 3BX works equally well with bud-

get-priced equipment and state-of-the-art systems. You won't need an audio engineer's ears to hear the remarkable improvement in the quality of your recorded music.

But we suggest you hear it for yourself. Take your favorite record or tape to your dbx dealer and ask for a demonstration. Once you hear the 3BX in action, you'll wonder how you ever listened to music without it.

# dbx

dbx, Incorporated  
71 Chapel Street  
Newton, Massachusetts  
02195  
617/964-3210

## 3BX three band dynamic range expander



CIRCLE 9 ON READER-SERVICE CARD

# Classical

reviewed by ROYAL S. BROWN  
 SCOTT CANTRELL  
 ABRAM CHIPMAN  
 R. D. DARRELL  
 PETER G. DAVIS  
 ROBERT FIEDEL  
 SHIRLEY FLEMING  
 ALFRED FRANKENSTEIN  
 KENNETH FURIE  
 HARRIS GOLDSMITH  
 DAVID HAMILTON  
 DALE S. HARRIS  
 PHILIP HART  
 PAUL HENRY LANG  
 IRVING LOWENS  
 ROBERT C. MARSH  
 ROBERT P. MORGAN  
 JEREMY NOBLE  
 CONRAD L. OSBORNE  
 ANDREW PORTER  
 WILLIAM RADFORD-BENNETT  
 H. C. ROBBINS LANDON  
 PATRICK J. SMITH  
 SUSAN THIEMANN SOMMER



ABC/Seon

Gustav Leonhardt  
 Continuing a wonderful series

version the aria is heard as Bach wrote it: violoncello piccolo in duet with the voice, and in trio with violin and oboe when the voice is done. Ruud van der Meer, as ever, is a smooth but vivid bass, and Kurt Equiluz a stylish but not exceptionally vivid tenor.

No. 66, *Erfreut euch*, opens with a splendid bustle and busyness, instrument after instrument in turn breaking into coloratura against the regular pattern of the others. (And Leonhardt's is the more colorful of the two bands.) Within the chorus there is a duet passage, here taken by soloists, of extraordinary chromatic poignancy. As in No. 60, Fear (alto) and Hope (tenor) have a dialogue and a duet. No. 67, *Halt im Gedächtnis*, as Ludwig Finscher rightly says in his introduction, "is one of the most magnificent works of the first Leipzig set, and from a formal and technical point of view one of the most magnificent Bach cantatas altogether." The tenor aria—with Equiluz at his best—has a marvelously catchy tune and rhythm; an alto recitative is interrupted by a chorale; and the penultimate movement, before the closing chorale, has something of Beethoven's Fourth Piano Concerto slow movement about it, as a solo bass, wind-accompanied, "calms" the fierce battle of the strings and the chorus.

The essay accompanying the volume, by Gunno Klingfors, is a mind-boggling study in Bach numerology. It seems to me that these people go too far. You count all the notes in, say, an oboe part and get 128. Then you can choose between its being twice 64, or four times 32; or  $1+2+8=11$ ; or  $1 \times 2 \times 8=16$ , which is also the reversal of 61 (and also  $1+6=7$ ). If  $A=1$ ,  $B=2$ , etc. ( $I$  and  $J$  counting as one letter), then  $BACH=14$ , and  $JOHANN SEBASTIAN BACH=158$ ; and  $1+5+8=14$ , too. And  $J.S. BACH=41$ , which is 14 reversed.  $BACH, 14$ , is also  $2 \times 7$ ; and  $JESUS, 70$ , is  $10 \times 7$ .  $MESSIAS$  or  $Messiah$  has seven letters; there were Seven Last Words from the Cross; and there are seven words in the first sentence of Luther's Bible. The fourteenth ( $2 \times 7$ ) chapter of Revelations, says Dr. Klingfors, "is the climax of the New Testament." Since numbers can also refer to verses from the Bible, or to psalms, it seems to me that you have only to think of a number, any number, and by one or another of these methods you simply can't fail to find a significance for it! But we are assured that "J. S. Bach knew and believed in this symbolism." And there are just enough plausible correspondences to make the results of all this counting not quite dismissable.

The usual slight grumbles about the Telefunken presentation. We are told that the text of No. 65, the Epiphany cantata, "links up with epistle and gospel of the day" but not what that epistle and gospel are. The verse of the librettos is not printed as verse. And the translations are "rhythmic" rather than accurate. "From Sheba shall many men be coming, Gold and incense bringing, here the Saviour's Name to magnify" is not good English and does not represent the German, which Isaiah 60.6 translates precisely: "All they from Sheba shall come: they shall bring gold and incense; and they shall show forth the praises of the Lord."

And the usual gratitude for the next installment of an enterprise that seems to me

**BACH:** Cantatas, Vol. 17. Peter Jelosits, boy soprano (in No. 58); Paul Esswood, counter-tenor (in Nos. 66, 67); Kurt Equiluz, tenor (in Nos. 65-67); Ruud van der Meer (in Nos. 65, 68) and Max van Egmond (in Nos. 66, 67), bass-baritones; Tölz Boys' Choir, Vienna Concentus Musicus, Nikolaus Harnoncourt, cond. (in Nos. 65, 68); Hannover Boys Choir, Ghent Collegium Vocale, Leonhardt Consort, Gustav Leonhardt, cond. (in Nos. 66, 67). TELEFUNKEN 26.35335, \$15.96 (two discs).

Cantatas: No. 65, *Sie werden aus Saba alle kommen*; No. 66, *Erfreut euch, Ihr Herzen*; No. 67, *Halt im Gedächtnis Jesum Christ*; No. 68, *Also hat Gott die Welt geliebt*.

The wonderful series continues, and volume by volume new marvels unfold. The four cantatas in Vol. 17 all make imaginative and abundant use of wind instruments—oboes, oboes da caccia, oboes d'amore, tenor oboe, horns, trumpet, cornett, trumpet da caccia, trombones—and so they gain much, over everyday Bach performances of the twentieth century, by being rendered in the true colors provided by the Concentus Musicus and the Leonhardt Consort. The former, under Harnoncourt, plays in Nos. 65 and 68, which are coupled on the first of the two records. (The strict numerical sequence is broken so that No. 66, an unusually long cantata, and No. 67, an unusually short one, can share the second disc; the total playing time of the four sides is just over seventy-five minutes—this series has always been laid out in a rather luxurious way.)

No. 65, *Sie werden aus Saba*, is a broad Epiphany cantata. I find Harnoncourt's

handling of the 12/8 opening chorus somewhat lumbering: Does authenticity really demand that the beats should be thumped out so emphatically? Harnoncourt's way with the pause mark in chorales is to make the chords thus indicated shorter, not longer, and forge ahead in strict tempo. I can't pretend to like it; Leonhardt's way—picking up the next phrase with an extra attack—is less disconcerting.

No. 68, *Also hat Gott*, contains "My heart ever faithful," borrowed and delightfully rearranged from the *Hunting Cantata*, BWV 208. It has been recorded by Isobel Baillie, Elsie Suddaby, Schumann-Heink, Germaine Lubin, and Charles Panzéra, among others. Peter Jelosits, the bright star of this cantata series, yields to none; when John Steane produces a new edition of *The Grand Tradition*, he will have to be in it. (Ernest Lough is there in a footnote.) In this

## Explanation of symbols

### Classical:

- B** Budget
- H** Historical
- R** Reissue

### Recorded tape:

- Open Reel
- ⊙ 8-Track Cartridge
- Cassette

one of the most important things the phonograph has undertaken. A.P.

**BACH:** Cantatas. Edith Mathis, soprano (in Nos. 10, 30); Anna Reynolds, mezzo; Peter Schreier, tenor; Dietrich Fischer-Dieskau, baritone (in Nos. 24, 30, 135); Kurt Moll, bass (in No. 10); Munich Bach Choir and Orchestra, Karl Richter, cond. [Gerd Ploebusch, prod.] ARCHIV 2533 329 and 2533 330, \$8.98 each. Tape: 3310 329 and 3310 330, \$8.98 each.

**2533 329:** Cantatas: No. 10, *Meine Seel' erhebt den Herrn*; No. 24, *Ein ungefärbt Gemüte*; No. 135, *Ach Herr, mich armen Sünder*. **2533 330:** Cantata No. 30, *Freue dich, erlöste Schar*.

No. 30, *Freue dich*, is a large midsummer cantata in two parts. The words were written for St. John's Day, when *Die Meistersinger* and Tippet's *The Midsummer Marriage* take place, but in fact the music was composed earlier, to a different text, to honor the lord of a manor near Leipzig. In its secular form it is a music drama, with Time, Fate, Happiness, and the river Elster in its cast. Richter flaws the cantata by taking the alto aria, a marvelous movement, far too slowly. To the opening and (musically identical) closing choruses, modern trumpets bring that kind of "Bach squawk"

of jubilation that used to be found acceptable, and even exciting, until Leonhardt and Harnoncourt, in the Telefunken *Alte Werk* complete cantata series-in-progress, taught us what eighteenth-century rejoicing should really sound like. The soloists are good singers, but Fischer-Dieskau's alternation between beautiful cooing and bounciness can seem rather affected after the Bach singing of Ruud van der Meer. Unrecommended; there is a better performance of the piece in Vol. 8 of the *Alte Werk* series (26.35034).

All four cantatas were recorded in sessions spread across the early months of 1974 and in January 1975; I suppose each soloist was caught while she or he happened to be in town—the town being Munich; the recordings were made in the Herkules-Saal of the Residenz. The sound quality changes from time to time—for example, at the second number of No. 10, *Meine Seel'*, where the level drops and the orchestra seems to recede. This cantata is a German *Magnificat* in which God puts down the mighty not merely from their seat but "into the sulphur pit." Kurt Moll's singing of the aria concerned has been admired, but I find his aspiration of the coloratura—"Gewa(ha-ha-ha-ha)ltige"—unpleasing. No. 135, *Ach Herr*, is a fine piece, especially

the opening chorus, where from two oboes frond after frond of melody pours down, strand lapping upon strand; and it is well performed. No. 24, *Ein ungefärbt Gemüte* ("An unpainted spirit of German constancy and truth makes us fair before God and men"), is an austere cantata, containing a beautiful tenor solo accompanied by lapped oboes d'amore. The Munich performance cannot bear comparison with Harnoncourt's in the *Alte Werk* Vol. 7 (26.35033).

In fact these Richter cantata performances, whatever their merits, arrive too late. For practical reasons we still accept, in churches and concert halls, the substitution of women's voices for boys', and of modern instruments for those of Bach's day, but on the phonograph there is no longer any reason to do so now that the real thing is available. Other important questions, of articulation, phrasing, and balance, can be more stylishly answered when they are posed in terms of Bach's sounds. There are movements in which Leonhardt and Harnoncourt can be found mannered, but there are just as many, maybe more, in which Richter can be found dull.

The *Alte Werk* volumes contain full scores and general essays on the aspects of the cantatas as well as particular introductions to those represented; the Archiv discs have only the latter. In presentation they score only by printing verse of the librettos as verse and translating them accurately rather than "rhythmically," and by citing the gospel reference for the day of each cantata; the movement-by-movement instrumentation, a useful feature of the *Alte Werk* presentation, is not given. A.P.

## Critics' Choice

### The most noteworthy classical releases reviewed recently

- ARNE:** Symphonies. Montgomery. HNH 4041, March.  
**BACH:** Harpsichord Partitas Nos. 3, 4. Kipnis. ANGEL S 36098, March.  
**BACH:** Violin Sonatas and Partitas. Luca. NONESUCH HC 73030 (3), March.  
**BEETHOVEN:** Leonore. Moser, Cassilly, Adam, Blomstedt. EMI SLS 999 (3), Apr.  
**BEETHOVEN:** Symphonies (9). Karajan. DG 2740 172 (8), Feb.  
**BLOCH:** Sacred Service. Lawrence, Abravanel. ANGEL S 37305, March.  
**BORODIN:** Symphonies (3); Polovetsian Dances. A. Davis. COLUMBIA M2 34587 (2), March.  
**BRIAN:** Symphonies Nos. 6, 16. Fredman. HNH 4029, Feb.  
**BRUCKNER:** Symphony No. 9. Giulini. ANGEL S 37287, March.  
**CHOPIN:** Preludes. Argerich. DG 2530 721, Feb.  
**DONIZETTI:** L'Elisir d'amore. Cotrubas, Domingo, Wixell, Evans, Pritchard. COLUMBIA M3 34585 (3), March.  
**DVOŘÁK:** Overtures; Legends. Kubelik. DG 2530 785, 2530 786, Feb.  
**EWALD:** Brass Quintets. Empire Brass Quintet. SQN/SUPERBA SA 2012, Apr.  
**FALLA:** Seven Popular Spanish Songs. De los Angeles, Soriano. ANGEL S 37425 (with Grandados: Tona-dillas). Berganza, Yepes. DG 2530 875 (with Lorca songs), Apr.  
**HANDEL:** Oboe Concertos. Holliger, Leppard. PHILIPS 6500 240, March.  
**HANDEL:** Royal Fireworks Music et al. Mackerras. ANGEL S 37404, March.  
**HINDEMITH:** Four Temperaments; Nobilissima Visione. De Preist. DELOS DEL 25440, Feb.  
**LISZT:** Transcendental Etudes; Concert Etudes. Arrau. PHILIPS 6747 412 (2), Feb.  
**OCKEGHEM:** Vocal Works. Pomerlum Musices, Blachly. NONESUCH H 71336, Feb.  
**SCHOENBERG:** String Quartets (5). Juilliard Qt. COLUMBIA M3 34581 (3), March.  
**SESSIONS:** When Lilacs Last in the Dooryard Bloom'd. Ozawa. NEW WORLD NW 296, Feb.  
**SIBELIUS:** Symphony No. 1; Swan of Tuonela. Stokowski. COLUMBIA M 34548. En Saga; Ta-piola; Swan of Tuonela; Finlandia. Karajan. ANGEL S 37408, March.  
**EUGEN DOMBOIS:** Baroque Lute, Vol. 2. ABC/SEON AB 67019, Apr.  
**PHILIP JONES BRASS ENSEMBLE:** In Switzerland. HNH 4037, Feb.  
**THE RECORD OF SINGING.** EMI RLS 724 (12), Apr.  
**CONCHITA SUPERVIA:** Operatic and Song Recital. SERAPHIM 60291, Apr.  
**BENITA VALENTE:** Song Recital. With Goode. DESMAR DSM 1010, Apr.

**BACH:** Chamber Music, Vol. 3. Leopold Stastny, flute; Alice Harnoncourt and Walter Pfeiffer, violins; Kurt Theiner, viola; Nikolaus Harnoncourt, viola da gamba, cello; Herbert Tachezi, harpsichord. TELEFUNKEN 26.35350, \$15.96 (two discs, manual sequence).

A Musical Offering, S. 1079 (from 6.41124, 1971). Sonatas for Viola da Gamba and Harpsichord: No. 1, in G, S. 1027; No. 2, in D, S. 1028; No. 3, in G minor, S. 1029 [from 6.41242, 1970]. Sonata for Two Violins and Continuo, in C, S. 1037 (probably by Johann Gottlieb Goldberg).

Comparison—Musical Offering:

Leonhardt

ABC/Seon 67007

Unlike its predecessors, Vol. 3 of Telefunken's series covering Bach's chamber music draws on previously released recordings: *The Musical Offering* is available on 6.41124, the gamba sonatas on 6.41242. In the new format, however, the disc containing the gamba sonatas includes as a filler the S. 1037 Trio Sonata—a curious choice, since this is now thought to have been composed by Johann Gottlieb Goldberg.

Anyone seeking to perform the *Musical Offering* has immediately to confront at least two sets of perplexing questions, and it is interesting to see how such eminent Bach authorities as Nikolaus Harnoncourt (and Gustav Leonhardt, on his recently released ABC/Seon recording) resolve them. The first set of questions has to do with the order in which the various sections of the *Musical Offering* are to be performed. The autograph having long since vanished, we have only the original printed edition to

Angel Records  
presents  
**MUSIC FOR  
CELLO...**



S-37457

**FLUTE...**

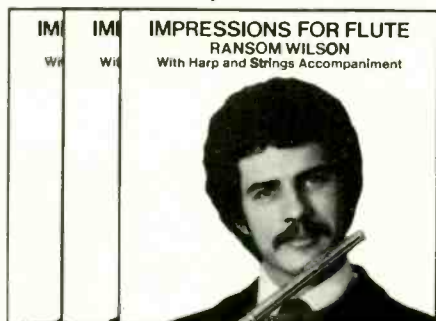

S-37308

**TWO VIOLINS...**



S-37406

**& DIVA.**



S-37500



Arié Plas/Phonogram

companying notes leave us in the dark: Of the Leonhardt performance we are told nothing, and Telefunken merely quotes the instrumentation suggestions of the Peters edition as if they were definitive.

However wise the decisions about instrumentation, though, Harnoncourt's performance is a real disappointment. There is surprisingly little to suggest more than a competent rendering of notes, and a mechanical player could hardly be less sensitive than harpsichordist Herbert Tachezi is here. In the Leonhardt performance one is immediately struck by the much more extroverted manner and the richness of detail. So profoundly intellectual a work benefits doubly from Leonhardt's care with rhythmic and dynamic nuances, and one comes away convinced that this is music for the heart as well as the mind—quite as Bach would have had it, I think.

Harnoncourt richly redeems himself in his transcendent playing of the gamba sonatas. The 1667 Jacobus Stainer gamba yields a tone of unearthly beauty, and Harnoncourt manages to project something like an ideal balance of passion and aristocratic reserve. Anyone wishing to understand the real spirit of baroque music could do no better than to hear Harnoncourt and Tachezi performing the G major Sonata. Here are all those subtleties of articulation, of shaping individual notes and phrases, of elegantly rendered ornaments, so often discussed in the old treatises but so seldom realized in performance; here, in the Andante, is a master lesson in the tremendous power of agogic accents to animate what might otherwise seem empty figuration: here is music-making at once sublime and visceral.

It's a pity, given the otherwise lavish presentation of this album, that more has not been offered in the way of notes on the music. What we are given is satisfactory as far as it goes, but the wholly inadequate discussion of the problems of order and instrumentation in the *Musical Offering* is inexcusable. To make matters worse, Telefunken has again assigned responsibility for the English version of the original German notes to a certain Frederick A. Bishop, whose penchant for grotesque mistranslations must now be legend. Cannot someone be found who knows better than to translate *klavier* (in this context) as "piano," or *dreistimmigen* as (!) "ternary form"? S.C.

**BEETHOVEN:** Late Quartets. For a feature review, see page 85.

**BEETHOVEN:** Sonatas for Piano: No. 5, in C minor, Op. 10, No. 1; No. 6, in F, Op. 10, No. 2; No. 15, in D, Op. 28 (*Pastoral*). Vladimir Ashkenazy, piano. [Richard Beswick and James Walker, prod.] LONDON CS 7024, \$7.98. Tape: ●● CS5 7024, \$7.95.

**BEETHOVEN:** Sonatas for Piano: No. 8, in C minor, Op. 13 (*Pathétique*); No. 14, in C sharp minor, Op. 27, No. 2 (*Moonlight*); No. 28, in A, Op. 101. Misha Dichter, piano. PHILIPS 9500 319, \$8.98. Tape: ●● 7300 591, \$8.95.

**BEETHOVEN:** Sonatas for Piano: No. 30, in E, Op. 109; No. 31, in A flat, Op. 110. Eunice

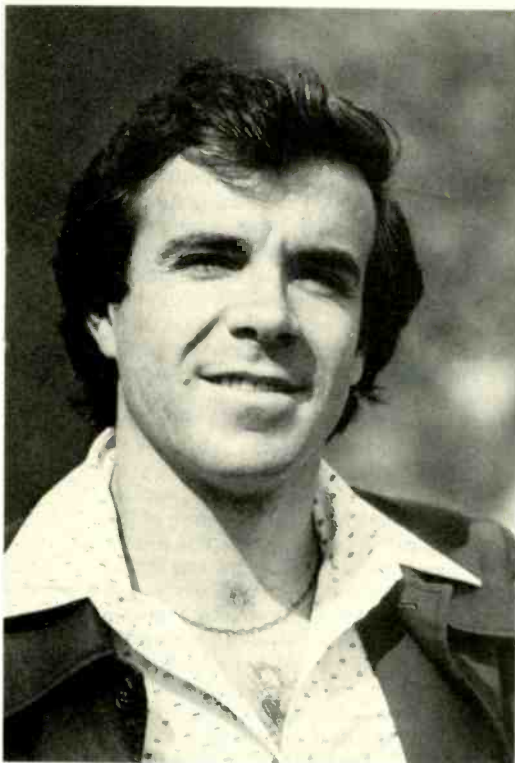

Misha Dichter  
*Polished Beethoven sonatas*

consult, and it is almost certain that the layout of this first edition was determined at least partially by exigencies of paper-binding and printing. There have been several conjectural "reconstructions" of Bach's planned sequence (probably the most persuasive being that of Hans T. David, in an edition published by G. Schirmer), but neither Harnoncourt nor Leonhardt alters the order of the original printing—certainly a valid point of view. What is surprising is that the notes accompanying the Leonhardt recording wholly ignore the question, and it is mentioned only in passing in the Telefunken annotations.

The second set of questions has to do with instrumentation, which in the original edition is specified only for two of the canons (Nos. 3b and 9, in the BWV numbering) and the trio sonata (No. 8). Both Harnoncourt and Leonhardt follow these directives, and they both opt for solo harpsichord in Nos. 1, 3a, 5, and 6. Elsewhere Harnoncourt follows the very logical and convincing instrumentation suggested in the Peters edition (the source of the miniature scores included with the album), and while Leonhardt explores some interesting alternatives I find myself consistently preferring Harnoncourt's choices. He clearly makes more sense of the four-voice canon (No. 7) by having a violin, a flute, and a second violin, respectively, take the three top voices (all of which are in unison), while a cello plays the fourth voice (written two octaves lower); Leonhardt's decision to use harpsichord results in a jangling imbroglia of sound in which the counterpoint is hopelessly obscured. Here again the ac-



Podis, piano. [Robert Woods, prod.] TELARC 5030, \$7.98.

Ashkenazy's latest Beethoven sonata disc, characteristically straightforward and smoothly rendered, reflects a certain casualness creeping into his music-making of late. In the two Op. 10 pieces, the comfortable tempos, easygoing rhythm, and generality of detail add up to rather superficial readings. In the slow movement of Op. 10, No. 1, for example, Ashkenazy fails to project the harmonic significance of the suspensions hovering about the final restatement of the principal melody. In Op. 10, No. 2, he misses much of the first movement's

sarcasm and drains much of the poignancy from the problematical Allegretto by paying little heed to the rests—or absence of them.

The more genial, relaxed Op. 28 is less harmed by Ashkenazy's gentility, and this is one of its better recordings, though I still prefer Schnabel's (in Vol. 2 of his Beethoven sonatas, Seraphim IC 6064) and, among more recent recordings, Claude Frank's stylistically rather similar one (in his cycle, Victrola VICS 9000). The recording, made in All Saint's Church, Petersham, has Decca/London's characteristic creamy resonance but with greater focus and compactness, less brittle clangor than some of

Ashkenazy's recent Kingsway Hall discs.

Misha Dichter's first recordings in nearly a decade—a simultaneously issued Schumann coupling is reviewed separately, and other works, including the Brahms concertos, await release—find him as polished as before and often stronger in interpretive profile. His *Moonlight* is a provocative and consistent statement. The opening Adagio, though actually rather brisk, emerges in dreamy half-tints and seems almost fragile. The central Allegretto is rhythmically perky and interestingly voiced, providing the needed repose before the finale, here rendered in conventional bravura style. The *Pathétique* is orthodox in tempos and phrasing, alert in articulation—note the clearly projected mordents in the first movement's second theme.

Dichter's former preoccupation with the cosmetic aspects of music-making, marked by overly smooth legato and overuse of the sustaining pedal, fortunately is less in evidence here, particularly in Op. 101, stylistically the most elusive and demanding of these three sonatas. Contrapuntal textures are impeccably clear, dynamic contrasts and accents well placed, tempos flowing and agile. About my only cavil is the occasional oversophisticated pointing of harmonic details, which results in a slightly tricky overall effect. Philips' engineering is plush, the processing typically smooth—though my copy has a slight warp.

Impressive too is the outstanding technical standard demonstrated by the Cleveland-based Telarc label, whose silent pressing captures magnificently clinging, resonant sound—the ideal sonority for the polyphonic, bass-oriented writing of Opp. 109 and 110, encompassing both warmth and astringent plangency. Eunice Podis, a Cleveland musician who has worked with Rudolf Serkin and Arthur Rubinstein, sometimes loses sight of the overall structure with her episodic rubato and lingering over details, but she shows good technique and loving devotion to the music, along with familiarity with textual options. Abetted by such appropriate reproduction, these respectful and often expressive interpretations add up to one of the better couplings of these much-recorded works. H.G.

**BEETHOVEN:** Symphony No. 3, in E flat, Op. 55 (*Eroica*); Egmont Overture, Op. 84. London Symphony Orchestra, Eugen Jochum, cond. [Christopher Bishop, prod.] ANGEL S 37410, \$7.98 (SQ-encoded disc). Tape: 4XS 37410, \$7.98.

Comparison—*Eroica*: Jochum/Concertgebouw Phi. 839 779

**BEETHOVEN:** Symphony No. 3, in E flat, Op. 55 (*Eroica*). Symphonica of London, Wyn Morris, cond. [Isabella Wallich, prod.] PETERS INTERNATIONAL PLE 020, \$7.98. Tape: PCE 020, \$7.98.

**R** **BEETHOVEN:** Symphony No. 3, in E flat, Op. 55 (*Eroica*). Vienna State Opera Orchestra, Hermann Scherchen, cond. [Kurt List, prod.] WESTMINSTER GOLD WG 8352, \$3.98 [from WESTMINSTER WST 14045, 1958].

**R** **BEETHOVEN:** Symphony No. 3, in E flat, Op. 55 (*Eroica*). Cleveland Or-

# Ohm's Law 4:

**It is possible to make a loudspeaker that doesn't sound like a loudspeaker.**



Traditional loudspeaker design states that a small driver can't reproduce bass notes, and a large driver can't reproduce high notes.

So most loudspeakers use two or more piston-like drivers of varying sizes (woofers, mid-rangers and tweeters) to achieve wide frequency response.

Unfortunately, large drivers respond slower to the audio signal than small drivers. So "time delay" distortion is added to the music.

And time delay distortion is what makes

a loudspeaker sound like a loudspeaker.

But Ohm F loudspeakers boldly defy the traditional laws of loudspeaker design.

They employ a *single* patented Walsh Transmission Line Driver that not only reproduces all audible frequencies, from the lowest lows to the highest highs, but it does it without adding the time delay distortion to the music.

That's why when you listen to music with Ohm F loudspeakers, you hear the *music*... not the loudspeakers.



**We make loudspeakers correctly**  
241 Taaffe Place, Brooklyn, N.Y. 11205

CIRCLE 50 ON READER-SERVICE CARD

# Here's your **FREE** "at home" shopping service!



It's easy! All you do is use the Reader Service card at right.

- 1 Just circle the number on the card that matches the number below the ad or editorial mention that interests you.  
You'll also find the key numbers for advertised products in the Advertiser's Index.
- 2 Then type or print your name and address. Don't forget your zip code.

- 3 Drop the postage-paid card into the mail.  
You'll receive literature, colorful brochures and specifications about the products that interest you... free and without obligation!  
Use **HIGH FIDELITY's** "at home" shopping service today!

## MAIL ORDER BUYER'S SERVICE

Now you can enjoy the best in both musical worlds—in one colorful magazine:  
**HIGH FIDELITY/MUSICAL AMERICA**



For the full story of music and musicians, include **MUSICAL AMERICA** as part of your High Fidelity subscription.

**MUSICAL AMERICA** covers the live musical scene completely. You'll get news, reviews and reports of important musical events all over the world—written by critics who know the score and how to write about it. You'll meet today's outstanding composers, conductors and performers... learn how they work and live... what they think and say about music.

**MUSICAL AMERICA** adds a new dimension to High Fidelity—and to your enjoyment of music. Use the postage-free card to start copies coming your way regularly.

(**MUSICAL AMERICA** is available only by subscription... and only with High Fidelity. It is not sold on newsstands. Another important reason to order your subscription now!)

1	2	3	4	5	6	7	8	9	10	11	12	13	14	15
16	17	18	19	20	21	22	23	24	25	26	27	28	29	30
31	32	33	34	35	36	37	38	39	40	41	42	43	44	45
46	47	48	49	50	51	52	53	54	55	56	57	58	59	60
61	62	63	64	65	66	67	68	69	70	71	72	73	74	75
76	77	78	79	80	81	82	83	84	85	86	87	88	89	90
91	92	93	94	95	96	97	98	99	100	101	102	103	104	105
106	107	108	109	110	111	112	113	114	115	116	117	118	119	120
121	122	123	124	125	126	127	128	129	130	131	132	133	134	135
136	137	138	139	140	141	142	143	144	145	146	147	148	149	150
151	152	153	154	155	156	157	158	159	160	161	162	163	164	165

1	2	3	4	5	6	7	8	9	10	11	12	13	14	15
16	17	18	19	20	21	22	23	24	25	26	27	28	29	30
31	32	33	34	35	36	37	38	39	40	41	42	43	44	45
46	47	48	49	50	51	52	53	54	55	56	57	58	59	60
61	62	63	64	65	66	67	68	69	70	71	72	73	74	75
76	77	78	79	80	81	82	83	84	85	86	87	88	89	90
91	92	93	94	95	96	97	98	99	100	101	102	103	104	105
106	107	108	109	110	111	112	113	114	115	116	117	118	119	120
121	122	123	124	125	126	127	128	129	130	131	132	133	134	135
136	137	138	139	140	141	142	143	144	145	146	147	148	149	150
151	152	153	154	155	156	157	158	159	160	161	162	163	164	165

NAME \_\_\_\_\_

ADDRESS \_\_\_\_\_

CITY \_\_\_\_\_

STATE \_\_\_\_\_

ZIP \_\_\_\_\_

I am a subscriber  I am not a subscriber  
(Please allow 4-6 weeks for processing and literature to arrive.)

5 6 7 8

NAME \_\_\_\_\_

ADDRESS \_\_\_\_\_

CITY \_\_\_\_\_

STATE \_\_\_\_\_

ZIP \_\_\_\_\_

I am a subscriber  I am not a subscriber  
(Please allow 4-6 weeks for processing and literature to arrive.)

5 6 7 8

1	2	3	4	5	6	7	8	9	10	11	12	13	14	15
16	17	18	19	20	21	22	23	24	25	26	27	28	29	30
31	32	33	34	35	36	37	38	39	40	41	42	43	44	45
46	47	48	49	50	51	52	53	54	55	56	57	58	59	60
61	62	63	64	65	66	67	68	69	70	71	72	73	74	75
76	77	78	79	80	81	82	83	84	85	86	87	88	89	90
91	92	93	94	95	96	97	98	99	100	101	102	103	104	105
106	107	108	109	110	111	112	113	114	115	116	117	118	119	120
121	122	123	124	125	126	127	128	129	130	131	132	133	134	135
136	137	138	139	140	141	142	143	144	145	146	147	148	149	150
151	152	153	154	155	156	157	158	159	160	161	162	163	164	165

NAME \_\_\_\_\_

ADDRESS \_\_\_\_\_

CITY \_\_\_\_\_

STATE \_\_\_\_\_

ZIP \_\_\_\_\_

I am a subscriber  I am not a subscriber  
(Please allow 4-6 weeks for processing and literature to arrive.)

5 6 7 8

FIRST CLASS  
PERMIT  
NO. 570  
MARION, OHIO

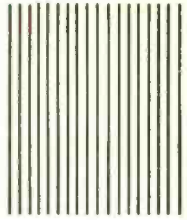

### BUSINESS REPLY MAIL

No Postage Necessary if Mailed in the United States

Postage will be paid by:

**HIGH FIDELITY**

1 Sound Avenue  
Marion, Ohio 43302

# Here's your **FREE** "at home" shopping service!

It's easy! All you do is use the Reader Service card at right.



- 1 Just circle the number on the card that matches the number below the ad or editorial mention that interests you. You'll also find the key numbers for advertised products in the Advertiser's Index.
- 2 Then type or print your name and address. Don't forget your zip code.
- 3 Drop the postage-paid card into the mail. You'll receive literature, colorful brochures and specifications about the products that interest you . . . free and without obligation! Use HIGH FIDELITY's "at home" shopping service today!

## MAIL ORDER BUYER'S SERVICE

### Three Great Buyer's Guides from HIGH FIDELITY—Order Now!



1978 Test Reports \$3.95 circle 161

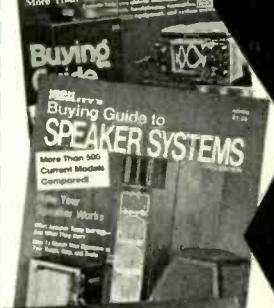

1978 Buyer's Guide to Speaker Systems \$1.95 circle 162

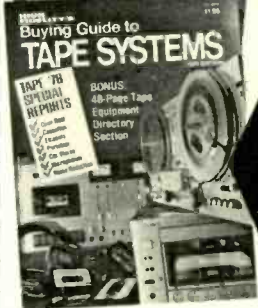

1978 Buyer's Guide to Tape Systems \$1.95 circle 163

To order, circle the number on the attached card that matches the number of the Buyer's Guide you want, enclose payment with your order and mail to:

Reader Service 78  
P. O. Box 1143  
Pittsfield, Mass. 01201

(Enclose payment. No credit orders.)

#### BUSINESS REPLY MAIL

No postage stamp necessary if mailed in the United States

Postage will be paid by—

**HIGH FIDELITY**

Reader Service 78  
P. O. Box 1143  
Pittsfield, Mass. 01201

First Class  
Permit No. 550  
Pittsfield, Mass.

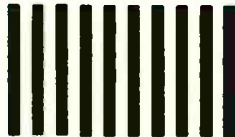

#### BUSINESS REPLY MAIL

No postage stamp necessary if mailed in the United States

Postage will be paid by—

**HIGH FIDELITY**

Reader Service 78  
P. O. Box 1143  
Pittsfield, Mass. 01201

First Class  
Permit No. 550  
Pittsfield, Mass.



Please enter my subscription to HIGH FIDELITY magazine at the special rate of:

- 15 issues for only \$9.47     22 issues for only \$13.88  
 33 issues for only \$18.87

I prefer a full year of High Fidelity/MUSICAL AMERICA. I'll receive all of High Fidelity plus 40 pages each month of news and reviews of important musical happenings throughout the world—concerts, opera, etc.—for only \$20.00     payment enclosed     bill me

Name \_\_\_\_\_

Address \_\_\_\_\_

City \_\_\_\_\_ State \_\_\_\_\_ Zip \_\_\_\_\_

(Please allow 5-8 weeks for your first copy to be mailed.)

For postage outside U.S.A. & possessions: E8DR  
 High Fidelity—15 issues add \$3.00; 22 issues add \$6.00; 33 issues add \$9.00.  
 High Fidelity/MUSICAL AMERICA—for one year add \$3.00.

#### BUSINESS REPLY MAIL

No postage stamp necessary if mailed in the United States

Postage will be paid by—

**HIGH FIDELITY**

Reader Service 78  
P. O. Box 1143  
Pittsfield, Mass. 01201

First Class  
Permit No. 550  
Pittsfield, Mass.



## ADVERTISING INDEX

Key No.	Page No.
1	ADC Phono Cartridge, A Div. of BSR Consumer Products Group ..... 102
2	ADC Professional Products, A Div. of BSR Consumer Products Group ..... 14
47	ADC Professional Products Group, A Division of BSR (USA) Ltd. .... 110
3	AIWA ..... 59
	Akai America Ltd. .... 12, 13
	AKG Acoustics ..... 100
4	Ampex ..... 8, 9
5	Angel Records ..... 95
6	Audio Technica U.S., Inc. .... 34
	Audio Technica U.S., Inc. .... 106
7	Bang & Olufsen of America ..... 112
	Bose Corp. .... 112
8	BSR (USA) Ltd. .... 11
	Classified Ads ..... 142, 143
9	DBX, Inc. .... 92
10	Discount Music Club ..... 137
	Discwasher, Inc. .... 41, 45, 55
17	Dual ..... 5
11	Empire Scientific Corp. .... 46
13	Fisher Corp. .... 30
	High Fidelity's Test Report ..... 136
14	Hitachi Sales Corp. .... 50
15	Icelandic Airlines ..... 141
16	Illinois Audio ..... 136
18	Infinity Systems, Inc. .... 10
19	J & R Music World ..... 137
20	JVC America, Inc. .... 61, 64
	Kenwood ..... Cover IV
22	Koss Corp. .... 49
	Lux Audio of America ..... 56
	Marantz Co., Inc. .... 146, Cover III
23	Maxell Corp. .... 33
24	McIntosh Laboratory ..... 38
25	Memorex Corp. .... 15
	Micro-Acoustics Corp. .... 108
26	Mitsubishi Audio Systems ..... 66, 67
	Music Listeners Book Service ..... 113, 117
27	Nakamichi Research (USA), Inc. .... 7
28	NCI Premium Distributors ..... 139
	Nikko Audio ..... 29
50	Ohm Acoustics ..... 96
48	Ortofon ..... 107
	Phase Linear Corp. .... 111
29	Pioneer High Fidelity ..... Cover II, 1
	Radio Shack ..... 91
49	SAE, Inc. .... 119
35	Sansui Electronics Corp. .... 17, 24
	Schwann Publications ..... 114
30	Shure Brothers, Inc. .... 36
31	Shure Brothers, Inc. .... 104, 105
32	Sonic Research, Inc. .... 32
33	Sony Corp. of America ..... 37
34	Sound Guard ..... 82
12	Sound Reproduction ..... 139
36	Sparkomatic ..... 39
37	Stanton Magnetics ..... 2
38	Stereo Corp. of America ..... 145
	Stereo Discounters ..... 115
39	Tandberg of America ..... 109
40	TDK Electronic Corp. .... 27
41	Teac Corp. of America ..... 35
42	Technics by Panasonic ..... 101
	3M Company ..... 38
43	Top Discount Audio ..... 115
17	United Audio Products ..... 5
44	Vanguard Records ..... 103
45	Video Center, The ..... 116
46	Wisconsin Discount Stereo ..... 145
	Yamaha Audio ..... 120

**B**chestra, George Szell, cond. ODYSSEY Y 34622, \$3.98 [from EPIC BC 1001, 1957, and COLUMBIA M7X 30281, 1971].

**Comparison:**

Toscanini/NBC Sym.

Victrol VIC 8000, RCA (Germany) AT 121

As Eugen Jochum's last Beethoven cycle, with the Concertgebouw for Philips, slips out of SCHWANN, we have from Angel the first installment in his new cycle with the London Symphony, a cultivated and intelligently paced *Eroica* with a cantabile quality and intimacy reminiscent of Bruno Walter at his best.

The new *Eroica* starts out with three advantages over its Philips counterpart: It is a dollar cheaper, it gets the first movement (with repeat) and Funeral March uninterrupted on Side 1, and it offers as a bonus the *Egmont Overture*. There are also advantages the other way: Philips' taut, brightly focused sound scores over the more distant domestic Angel sonics, and the Concertgebouw, with its tougher, more astringently rhythmic style, seems to me to have been more highly sensitized than the London Symphony to the conductor's direction. *Egmont* moves along smartly (this is not a weighty Germanic reading), with bright definition and sophisticated instrumental refinement. I would like more rhythmic tension and fire in both works, but this is nonetheless a fine release.

There are several textual curiosities in the Angel *Eroica*, one of which may be a tape-editing flaw: A strange lurching at bar 123 of the scherzo (and again in the repeat) suggests the mistaken insertion of bar 381, the corresponding bar of the da capo, which is in duple rather than triple meter. This oddity did not occur in the Philips recording, but two other unconventional choices did: For some reason Jochum runs the scherzo without break into the finale, and in the first ending of the trio he binds the three horn chords into a single tied note. The latter was also done in Jochum's old DG recording, and Klemperer and Toscanini (in all his performances from 1945 on) followed this variant. Weingartner, however, considered it incorrect, and I too prefer the fresh attack on each measure, which sounds more characteristically rhythmic.

Times certainly change. Four *Eroicas* in one month, and three of them (all but Szell) observe the once rarely encountered first-movement repeat. Wyn Morris paces the movement at a believable allegro con brio and conveys much of the nobility and sincerity of the Funeral March (which is split between sides). His scherzo is really too fast; I am all for the basic approach, particularly the bold, fearless trio, but there is a lack of poise. This problem is compounded by the cautious, even pedantically paced finale that follows. What keeps this version out of contention is the rather tepid, shapeless playing of the smallish ensemble. The Symphonica of London is not a bad orchestra, but as in the Walter recordings one senses a slight but serious lack of precision in short chords, a failure to get all accents and details exactly in place.

Hermann Scherchen's 1958 stereo remake of the *Eroica* also uses a smallish orchestra, whose modest virtuosity is pressed

to—and often far beyond—the limit by the conductor's feverish tempos, which often approach Beethoven's metronome markings. Scherchen, too, is one of the few conductors to prefer the unadorned original orchestration at the end of the first movement, where even relative purists like Karajan, Klemperer, and Erich Kleiber touch up the trumpet parts—wisely, I think, for reasons of intelligibility and balance. Some of the playing is audaciously bad and tonally strident, but for all that I find the performance surprisingly moving and intense. The participants really seem caught up in the music, and the result suggests to me the uncompromising, revolutionary impact this music must have had on its early hearers.

The new mastering of the Scherchen *Eroica* fits the whole of the Funeral March on Side 1; now I hope that Westminster Gold restores more of Scherchen's Beethoven. Many of the overture performances are splendidly exciting in their raw-nerved ferocity, and the Second, Fourth, and Eighth Symphonies—recorded with Beecham's Royal Philharmonic (alias the "Philharmonic-Symphony of London")—are not only true to the music, but brilliantly virtuosic as well.

Szell's *Eroica* is expectedly on a far higher level of orchestral sophistication and easily takes its place among the best budget editions—for that matter among the best at any price. If my memory of the original serves, the current mastering has more warmth and suavity with no loss of detail. The sound is still aggressively spiky (Szell obviously wanted a close-up, unblended sonority), but for the *Eroica* this seems appropriate enough. The performance is decidedly cool—even antiseptically aloof in the Funeral March. My choice for a kinetic *Eroica* remains unswervingly Toscanini's great 1953 account, which in its German remastering sounds fuller and more robust than you could imagine: in fact the sound is at least as good as Szell's. Still, the *Odyssey* reissue is eminently welcome: such musicianship and craftsmanship are sadly dwindling commodities these days. H.G.

**BEETHOVEN:** Symphony No. 6, in F, Op. 68 (*Pastoral*). Royal Philharmonic Orchestra, Antal Dorati, cond. MERCURY SRI 75119, \$7.98.

**R** **BEETHOVEN** Symphony No. 6, in F, Op. 68 (*Pastoral*). Concertgebouw Orchestra, Erich Kleiber, cond. LONDON TREASURY R 23233, \$3.98 (mono) [from LONDON LL 916, 1953].

**R** **GEORGE SZELL CONDUCTS THE NEW YORK PHILHARMONIC.** ODYSSEY Y3 35231, \$11.94 (three discs, mono) [from COLUMBIA originals, 1951–55].

**BEETHOVEN:** Symphony No. 6, in F, Op. 68 (*Pastoral*). **MENDELSSOHN:** A Midsummer Night's Dream (incidental music), Opp. 21/61: excerpts. **SMETANA:** Má Vlast: The Moldau; From Bohemia's Meadows and Forests. **WAGNER:** Overtures to Rienzi, Der fliegende Holländer, Tannhäuser, Die Meistersinger. **WEBER:** Overtures to Der Freischütz, Oberon.

If Antal Dorati's *Pastoral* is a fair indication, his new Beethoven symphony cycle with the Royal Philharmonic (of which

# AKG



The AKG  
K-240  
Cardan Sextett

**"Extra wide response...  
low distortion...  
reminiscent of the very  
best electrostatics!"**

Now you can take a giant step closer to reality by recreating the depth and dimension of the original performance with remarkable fidelity... before the sound enters your ear. Even the best phones around today put left channel sound through the left earpiece... right channel sound through the right earpiece. Good sound, yes... but certainly not the sound you'd expect from an expensive, top-line speaker system.

Now listen to the AKG K-240 Sextett. Hear the difference. **Six passive (slave) diaphragms surround a main driving transducer** to reproduce in depth the sound of a live performance with a spacial quality that you've never heard from headphones.



Len Feldman (Feldman Report, *Tape Deck Quarterly*) writes "... the AKG headphones tend to minimize exaggerated and unnatural stereo effects... a listening quality reminiscent of what we hear (with) the very best electrostatic headphones around. Considering cost, that's quite an accomplishment."

And they're light on your head, too. Ultra-soft pads assure virtually no wearer fatigue. Earcups are fitted to the AKG auto-adjust headband. For modest budgets listen to the AKG K-140.

At selected dealers everywhere.



PHILIPS AUDIO VIDEO SYSTEMS CORP.  
A NORTH AMERICAN PHILIPS COMPANY  
91 McKee Drive, Mahwah, N.J. 07430 • (201) 529-3800



Sheldon Soifer/Mgmt.

Shura Cherkassky  
*Beautiful tone and quality*

Nos. 4, 5, 8, and 9 have already appeared in England) is a pleasant prospect. Even more than in his two previous recordings of the *Pastoral*, Dorati here conveys real love for the symphony in addition to the expected orderliness of outline and texture. He permits a bucolic singing quality to temper his classical severity, and I am reminded of the Weingartner and Toscanini/BBC accounts, save for a thunderstorm that is, in its firm deliberation, more reminiscent of Klemperer/Angel. I suspect that Dorati's new *Pastoral*, which includes the first-movement repeat, will be an easy version to live with.

Two reissues must also be added to the lengthening "short list" of memorable *Pastorals*: although neither Erich Kleiber nor George Szell quite avoided the slight chill of overcalculation, Kleiber's rapid tempos in every movement but the "Scene by the Brookside"—where he atypically rhapsodizes (more, certainly, than he did in his earlier recording, with the London Philharmonic), producing a brook that seems to linger without really flowing—are made to appear even more stringent by the edginess of London's new transfer, in which the ravishing sweetness and purity of the beautiful original has been perceptibly spiked. A treble cut somewhat tames the violins but also diminishes the bloom: even so, the sound remains splendid for its time, and the Concertgebouw plays ravishingly.

Szell's stereo *Pastoral* with the Cleveland Orchestra has moments of heavy accentuation and even outright mannerism, but these are less in evidence in his earlier version, newly reissued in Odyssey's three-disc set containing most of his recordings with the New York Philharmonic. A few questionable details do intrude. While the introductory measures promise an unusually winged first movement, by bar 30 the heavy tenutos on the repeated violin fig-

uration reduce the tempo to something altogether more stolid. And, as in the Cleveland version, Szell's idea of an *andante meno mosso* tempo for the brookside differs radically from mine: He goes to the opposite extreme from Kleiber, and the result seems uncomfortably ruthless and icy. Elsewhere this is a wonderful performance, happily without the Cleveland version's willful mauling of forward motion when the second theme returns in the finale.

As the rest of the Odyssey set demonstrates, it is difficult to generalize about Szell. This legendary martinet was as likely to display mellowness and expansiveness in his later performances as in his earlier work. Certainly the Philharmonic *Moldau* seems uptight and uncommunicative, as does the impeccably organized but bloodlessly methodical *Rienzi* Overture. Much happier examples of the Szell virtuosity at work are the pristine, tautly aristocratic *Flying Dutchman* Overture and *Meistersinger* Prelude and the disciplined Mendelssohn *Midsummer Night's Dream* music, which along with its pedantic touches has some dignified humor—e.g., the hint of oafishness to suggest the braying donkey in the Overture.

Even if I generally miss in Szell's work the magically intuitive response that raised Toscanini's work to a more communicative plane, he was unquestionably one of the century's great conductors, and the Odyssey set—whose spacious mono sound holds up very well—also serves as a reminder of how well the New York Philharmonic has on occasion been able to play. H.G.

**CHOPIN:** Scherzos (4). Shura Cherkassky, piano. [Wladyslaw Glowacz, prod.] HNH RECORDS 4022, \$7.98.

Scherzos: No. 1, in B minor, Op. 20; No. 2, in B flat minor, Op. 31; No. 3, in C sharp minor, Op. 39; No. 4, in E, Op. 54.

**SHURA CHERKASSKY:** Piano Recital. Shura Cherkassky, piano. [Peter Wadland and Raymond Ware, prod.] OISEAU-LYRE DSLO 15, \$7.98.

SCHUMANN: Symphonic Etudes, Op. 13. ALBÉNIZ-GODOWSKY: Tango. CHOPIN: Ballade No. 3, in A flat, Op. 47. Etudes: in C sharp minor, Op. 10, No. 4; in C sharp minor, Op. 25, No. 7; in B minor, Op. 25, No. 10. SCHUBERT-GODOWSKY: Moment musical, in F minor, D. 780, No. 3.

Shura Cherkassky's notably beautiful tone and exquisite singing quality are at the service of a volatile imagination that ranges from ravishing poetry to exasperating salon tastelessness.

HNH's Chopin scherzos were studio-recorded in Switzerland by Tudor, while the Oiseau-Lyre disc derived from a 1975 recital in London's Queen Elizabeth Hall. Cherkassky's untrammelled style seems to become sharper and more vital in front of an admiring audience. The Schumann *Symphonic Etudes* (played in the standard text, without any of the five posthumous variations) is riveting. Cherkassky "orchestrates" the music, bringing out all sorts of inner voices (many of his own devising), bathing the music in a wealth of rainbow color, and for the most part opting for winged, even headlong, tempos. A few smudged details and dropped notes aside—this is, after all, a live concert—this is a first-rate performance by an old-school master

# What 0.02% THD doesn't tell you about the SE-9060, waveform fidelity will.

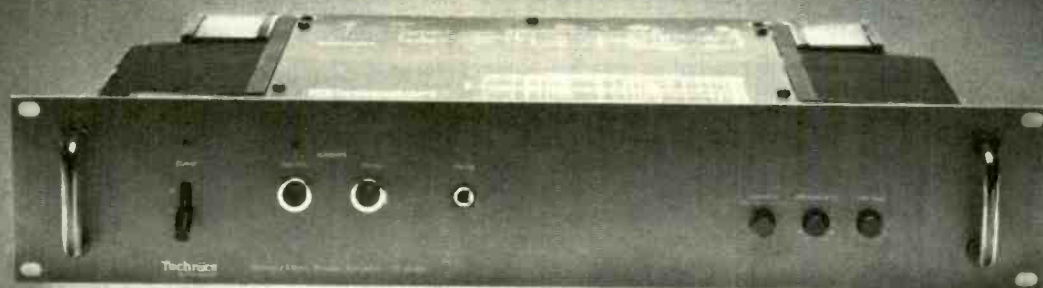

THD as low as 0.02% says a lot about any amplifier. But oscilloscope readings show it all. Look at the waveforms. The output waveform of the SE-9060 is virtually a mirror image of the input.

One way Technics achieved this goal was with dual FETs in the differential amplifier. They give the SE-9060 the DC stability necessary for the highest gain in the crucial first stage. While the constant current load and current feedback used in the voltage amplifier keep distortion to a minimum.

And since the SE-9060 is a DC amplifier, each amplifier section and the NFB loop are directly coupled without the use of any capacitors. So the SE-9060 not only has virtually nonexistent phase shift, it also boasts flat frequency response from DC to 100 kHz. And with completely

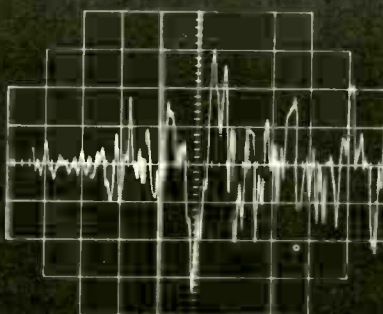

Input Waveform.

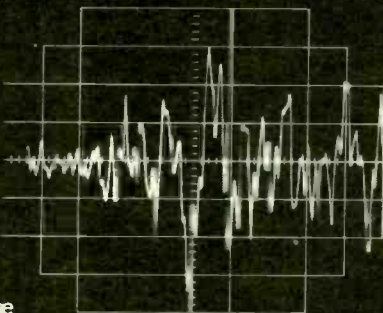

Output Waveform.

independent power supplies for each channel, Technics eliminated all signs of interchannel crosstalk distortion.

Compare specifications. And you'll realize there's no comparison.

**POWER OUTPUT:** 70 watts per channel (stereo), 180 watts (monaural) minimum RMS into 8 ohms from 20 Hz to 20 kHz with no more than 0.02% total harmonic distortion.

**POWER BANDWIDTH:** 5 Hz-50 kHz, -3 dB. **S.N.:** 120 dB (IHF A). **RESIDUAL HUM & NOISE:** 100  $\mu$ V. **INPUT SENSITIVITY & IMPEDANCE:** 1 V/47 kilohms. **INTERMODULATION DISTORTION (60 Hz: 7 kHz, 4:1):** 0.02%. **FREQUENCY RESPONSE:** DC ~ 100 kHz, +0 dB, -1 dB.

Technics SE-9060. A rare combination of audio technology. A new standard of audio excellence.

**Technics** Professional Series  
by Panasonic



## Now you can hear the music you're missing.

You can't hear everything that's in the grooves unless you have an extremely sensitive cartridge. A cartridge that can pick up all the subtle harmonics you are probably now missing. A cartridge like the ZLM by ADC.

The ZLM has the unique ALIPIC™ stylus. Which combines better stereo reproduction with less wear to your records.

What's more, the frequency response is always ruler flat  $\pm 1$ dB to 20kHz and  $\pm 1/2$ dB to 26kHz. It tracks at  $1/2$  to  $1/4$  grams.

So listen to the ZLM cartridge. It's like listening to a whole new record collection.



Audio Dynamics Corporation  
Pickett District Road  
New Milford, Conn. 06776  
A BSR COMPANY

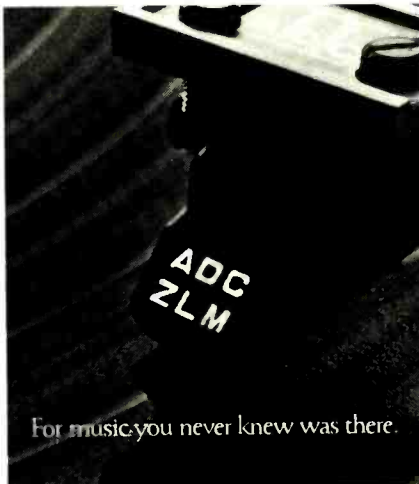

CIRCLE 1 ON READER-SERVICE CARD

at the peak of his form, a worthy addition to the recordings of Kempff, Hess, Cortot, and, most recently, Perahia (Columbia M 34539, January 1978). (I have not heard Richter's recording, on Eurodisc 85 742 MK, but judging from his Carnegie Hall performance some years back it ought to be in this exalted class.)

The Chopin A flat Ballade, for all its lovely color, seems rather flippant and unstructured, though some may like its intimate scale. The three etudes, which call for less sustained architecture, are altogether more pleasing. The two Godowsky arrangements contrast instructively with Cherkassky's recent studio-recorded versions (Oiseau-Lyre DSLO 7, March 1976). I remarked in my review of the earlier recording that his *Moment musical* was more restrained than Josef Hofmann's Casimir Hall account (IPA 5007/8); the live performance, however, finds Cherkassky pulling phrases about and playing with the tasteless Godowsky inner voices almost as audaciously as his onetime mentor. Still, if Godowsky's god-awful version is to be done at all, why not play it to the hilt? At least Cherkassky, unlike Hofmann, is given beautiful reproduction. The Albéniz tango, salon music more deserving of the Godowsky treatment, is, in fact, now available in three Cherkassky readings: This one, which combines the singing tone of the one on DSLO 7 with some of the extravagant decadence of the live performance from the International Piano Archives gala of December 9, 1974 (Desmar DSM 1005), is to my mind the most convincing. Aside from a few coughs and shuffles, the audience is quiet and attentive.

The Chopin scherzos display much the same interpretive and coloristic traits, but in the studio Cherkassky rarely gathers as much force as in the concert hall. These are admirably played versions, but after a while the many little exaggerations and prolongations of phrase, the capricious accentuations and inner-voice underlinings tend to rob the music of its demonic power. Arthur Rubinstein's more solid, traditional readings (RCA LSC 2368) will, I think, have more staying power. The sound is quite beautiful, however, and the HNH pressing is generally admirable. (My copy is a trifle noisy on Side 2.) H.G.

### CILEA: Adriana Lecouvreur.

Adriana Lecouvreur	Renata Scotto (s)
Mlle. Jovenot	Lilian Watson (s)
Principessa di Bouillon	Elena Obratzsova (ms)
Mlle. Dangeville	Ann Murray (ms)
Maurizio	Plácido Domingo (t)
Abbé de Chazeuil	Florindo Andreoli (t)
Poisson, Major-Domo	Paul Crook (t)
Michonnet	Sherrill Milnes (b)
Principe di Bouillon	Giancarlo Luccardi (bs)
Quinault	Paul Hudson (bs)

Ambrosian Opera Chorus, Philharmonia Orchestra, James Levine, cond. [Roy Emerson, prod.] COLUMBIA M3 34588, \$23.98 (three SQ-encoded discs, automatic sequence).

#### Comparison:

Tebaldi, Simionato, Del Monaco, Capuana  
Lon. OSA 13126

Having started to listen to these records without much regard for the merits of *Adriana Lecouvreur*, I found myself at the end of them converted to enthusiasm. The op-

era, to be sure, is no great work of art. There remains something cloying, even enervating, about Cilea's overuse of his melodic material. Whether his failure to develop his tunes into some sort of musico-dramatic structure, however primitive, results from conscious choice or technical limitations is less important than the fact that, because of his compositional mode, his characters have no emotional resonance. Neither does the drama in which they are involved.

There is nothing illuminating about human nature to be gained from this opera, nothing about ourselves to be learned from witnessing the story of Adriana's downfall, merely the thrill of eavesdropping on lives utterly different from our own. At every twist in the plot we are confronted by what we already know about the characters: Poor Adriana is never anything more than the humble servant of art that she proclaims herself to be at the beginning of Act I in her entrance aria, "*Io sono l'umile ancella*," whose opening phrases follow her around thereafter like a signature tune. Neither her lover, Maurizio, nor her rival and poisoner, the Principessa di Bouillon, is more than a foil for her vulnerability and pathos. All three are monomorphic, in themselves uninteresting. They exist only for the sake of the strong plot, which like all melodrama is dependent for its success less on plausibility than on the author's conviction and style. Luckily, Cilea's materials are excellent. The tunes in *Adriana Lecouvreur* are attractive, immediately arresting, varied in manner. The action, complicated to an almost ludicrous degree and full of unexplained lacunae, is carried along smoothly and swiftly by a stream of lively musical ideas.

Or so I now realize. Having previously encountered the opera only in the hands of less than first-rate maestros—Varviso, Gavazzeni, Cleva in the opera house; Simonetto, Del Cupolo, Capuana on records—I was unprepared for the transforming power of James Levine's brilliance, the sweep he brings to the big romantic passages, his buoyancy and mercurial grace. Every so often he sacrifices musical (and verbal) intelligibility to sheer bustle, as he does in the opening pages of Act I. On occasion he robs feeling of its necessary energy: "*Io sono l'umile ancella*" is more like a dirge than an implicit plea for sympathy. The second half of Act III runs the risk of an emotionality too drooping to sustain one's involvement. But on the whole he shows himself to be both a master of dramatic incident and a technical virtuoso who can draw from the excellent Philharmonia Orchestra playing of the greatest beauty and transparency.

In this recording Renata Scotto is his peer. She cannot easily negotiate the soft, slow ending of "*Io sono l'umile ancella*," with its succession of octave leaps (first on F, then on G) and its final sustained A flat. Nor anywhere from F upward does she produce pure, rounded, unforced tone. Yet even with these limitations her skill is evident: She negotiates high-lying passages with a discretion that minimizes her difficulties, showing the kind of shrewdness that could only derive from artistic self-awareness. In every other respect she is the

complete mistress of the role's vocal demands—as she is of its interpretive ones. The spontaneity and vividness with which she delineates Adriana's swiftly changing emotions in the dialogue with the Principessa that leads up to their confrontation at the end of Act II is a lesson in vocal acting.

As the Principessa, Elena Obraztsova is thrilling but less specific. There is something so awesome about her vocal power and about the prodigality with which she unleashes it, especially in the chest register, that details of characterization get swept away in a tide of intense emotionality. Plácido Domingo, a more self-considerate artist and therefore less prone to vocal recklessness, is nevertheless hardly Obraztsova's inferior when it comes to magnificence of sound. A large-scale performer, Domingo has always been prepared to sacrifice the finer points of character portrayal for tonal refulgence and a general air of commitment—though, for all that, he remains more a musician than a vocal braggart. As Michonnet, Adriana's old admirer, Sherrill Milnes is diligent and vocally well cast: This is a part that requires presence more than firm, full sound such as the baritone no longer commands.

The smaller roles are adequately filled. In this respect the London recording, the only current rival to the new one, has the advantage of more seasoned performers, and it has in Giulio Fioravanti a Michonnet of greater depth than Milnes. Renata Tebaldi's Adriana is emphatic in manner, rather leathery in sound, and for me unengaging. Mario del Monaco comes on like a tornado as Maurizio, annihilating everything around him, especially Cilea's charm. Giulietta Simionato is a marvelously authoritative Principessa. Franco Capuana conducts inoffensively. Columbia's is the recording to get.

A libretto is enclosed, and there are weak, derivative notes that say nothing about the opera but a lot about the eighteenth-century actress on whose life the opera is vaguely based. D.S.H.

#### **H** DONIZETTI: Don Pasquale.

Norina	Adelaide Saraceni (s)
Ernesto	Tito Schipa (t)
A Notary	Giordano Callegari (t)
Dr. Malatesta	Afro Poli (b)
Don Pasquale	Ernesto Badini (b)

La Scala Chorus and Orchestra, Carlo Sabajno, cond. [from HMV/VICTOR 78s, recorded 1932].

**TITO SCHIPA:** Recital. Tito Schipa, tenor; La Scala Chorus and Orchestra, Giuseppe Antonicelli, Franco Ghione, and Carlo Sabajno, cond. [from HMV/VICTOR 78s, recorded 1932-37].

**BELLINI:** La Sonnambula: Prendi, l'anel ti dono (with Toti dal Monte, soprano). **GLUCK:** Orfeo ed Euridice: Che farò senza Euridice? **MASCAGNI:** L'Amico Fritz: Suzel, buon dì (with Mafalda Favero, soprano). **MASSENET:** Werther: Pourquoi me réveiller (in Italian). **A. SCARLATTI:** Sento nel core.

SERAPHIM IC 6084, \$11.94 (three discs, mono, automatic sequence).

Comparison—Don Pasquale: Sciutti, Onclna, Krause, Corena, Kertész Lon. OSA 1260

On the face of it, an LP reissue of the celebrated 1932 HMV *Don Pasquale* must have seemed like a good idea, especially on a

budget label. Though the sound could hardly be expected to match up to current standards, the name of Tito Schipa is still potent among collectors of recorded vocalism and the single performance of the opera currently available, that on London, is not on the whole successful. As it happens, Seraphim's idea turns out to have been a dubious one. Carlo Sabajno, from 1905 onward the virtual house conductor for HMV's Italian vocal recordings, holds things together idiomatically but lacks the right kind of ebullience for this most sparkling of scores, the result being that an air of inhibition hangs over much of the performance.

There is not much help from the singers.

In the title role Ernesto Badini, then fifty-six and approaching the end of a distinguished stage career (he sang Ford under Toscanini at La Scala in 1913 and seven years later created the title role in *Gianni Schicchi* both at La Scala and at Covent Garden), is little more than vocally adept, his portrayal being quite deficient in gusto and individuality. This is surprising, given his renown both as Don Pasquale and (in his younger days) as Dr. Malatesta, a part that also calls for lively characterization. In the latter role the twenty-seven-year-old Afro Poli is similarly bland. (Precisely what is missing from these two performances in the way of personality and characterization may be heard from Giuseppe de

## GREAT ARTISTS OF OUR TIME

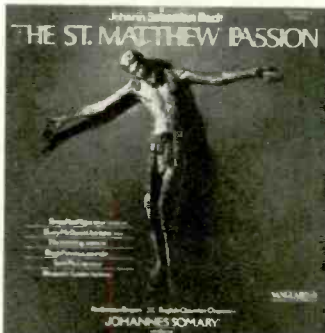

### BACH: SAINT MATTHEW PASSION

Ernst Haefliger (Evangelist), Barry McDaniell (Jesus), Elly Ameling, Birgit Finnilae, Seth McCoy, Benjamin Luxon; Ambrosian Singers; English Chamber Orchestra; Johannes Somary, cond.

VSD 71231/4 (4 discs)



### BRAHMS PIANO QUARTETS (complete), Opp. 25, 26 and 60

Alexander Schneider, vln.; Walter Trampler, vla.; Leslie Parnas, cello; Stephanie Brown, piano

VSD 71221/2 (2 discs)



### MOZART: FOUR QUARTETS FOR FLUTE AND STRINGS (complete), K. 285, 285a, 285b and 298

Paula Robison and members of the Tokyo String Quartet

VSD 71228

"With Miss Robison weaving liquid phrases of disarming grace and limpid beauty, the two Mozart confections (K. 285a and 298, with members of the Tokyo String Quartet) could scarcely have sounded more elegant or musically refreshing."

Peter G. Davis, NEW YORK TIMES



### GIDON KREMER PLAYS MOZART VIOLIN CONCERTO NO. 3, K. 216 and CONCERTONE, K. 190

Vienna Symphony Orchestra, Kremer conducting

VSD 71227

### 1977 GRAND PRIX DU DISQUE

a violinist "clearly not out to dazzle but to give his audiences something of substance to ponder . . ."

Peter G. Davis, NEW YORK TIMES



### THE ART OF ALFRED DELLER

An anthology of traditional songs, English madrigals and airs, European vocal music and Purcell arias — sung by the world's greatest counter-tenor.

VSD 729/30 (2 discs)

### CHARLES ROSEN PLAYS HAYDN

Piano Sonatas in C minor, H. 20; in A-flat major, H. 46; and in G minor, H. 44

VCS 10131

### MUSIC FOR THE SPANISH GUITAR

Santiago Navascues plays Albeniz, Falla, Rodrigo, Sanz and Turina, including Gaspar Sanz's *Twelve Dances* from "Instruccion de Musica Sobre la Guitarra Espanola" (1674), of especial interest to folklorists.

VCS 10137

**VANGUARD**  
RECORDINGS FOR THE CONNOISSEUR

Sugg. list price:

VSD 71221/2, 71227, 71228, 71231/4 — \$7.98 per disc

VCS 10131, 10137 — \$3.98 each

VSD 729/30 — \$8.98 (2 discs for the price of 1)

Vanguard Recording Society, Inc., 71 West 23rd St., New York, NY 10010

CIRCLE 44 ON READER-SERVICE CARD



**fact:**  
**the IV does more...**  
*much more!*

**new! Shure V15 Type IV**  
**SUPER TRACK IV™**  
 Stereo Dynetic® Phono Cartridge



Era IV begins! The new Shure V15 Type IV phonograph cartridge is an altogether new pickup system that exceeds previous cartridge performance levels by a significant degree. It systematically solves not one, but several problems prevalent in modern disc sound reproduction:

**Demonstrably improved trackability across the audible and subaudible range at ultra-light tracking forces**

The V15 Type IV has a new stylus assembly design for dramatically increased trackability. The effective stylus mass has been lowered significantly by utilizing a telescoped shank structure and a new lightweight high-energy magnet. The reduced effective mass of the new structure helps improve trackability in the critical mid and high frequencies. A newly designed two-function bearing system has been independently optimized for low frequencies and for high frequencies so that trackability is enhanced across the audio spectrum.

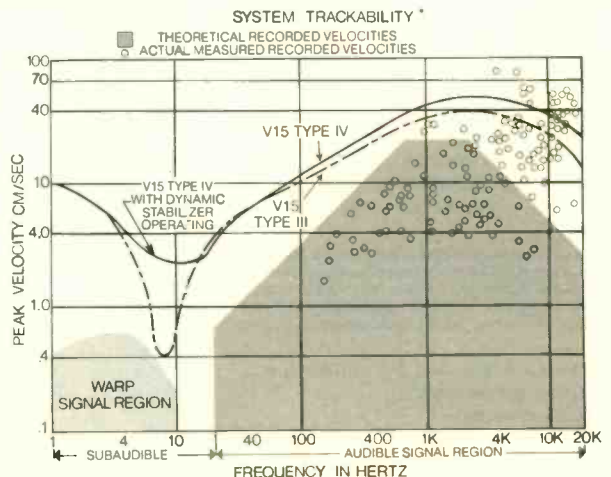

\*Cartridge-tone arm system trackability as mounted in SME 3009 tone arm at 1 gram tracking force.

See top of next page

The shaded area at right in the Trackability chart on preceding page represents recommended theoretical limits of record cutting velocities. However, the scattered points are the "hottest" recorded velocities actually measured on today's difficult-to-track records. The new V15 Type IV tracks far more of the "hottest" points at a low stylus force than any other existing cartridge! (The curve shown is for 1 gram tracking force. By increasing this to 1¼ grams, even more of these points — which encompass virtually all records produced thus far — will be tracked.)

**Dynamically stabilized tracking that overcomes record warp problems**  
**Our war on warp...**

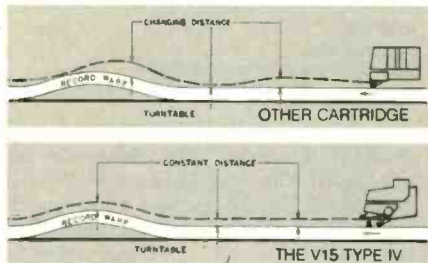

**The warp problem**

Note the shaded area (at bottom left of the Trackability chart at left) which represents actual warp signals found on records, and the revolutionary subaudible warp trackability characteristics of the SUPER TRACK IV. Reactions of the playback system to these very low frequency warps (between 0.5 and 8 Hz) existing on virtually all recordings can result in gross changes in the distance between the cartridge and the record. This distance change alters the stylus tracking force and the vertical tracking angle and can result in groove skipping, cartridge bottoming, signal wow, and even amplifier and/or speaker overload. Trackability at all frequencies is diminished by these warp-caused changes in tracking force!

Also, at some very low frequency (from 5 to 15 Hz), the tone arm-cartridge combination has a resonance frequency. When this resonance frequency is excited by the warp, all the above symptoms are intensified.

**The Super Track IV total design solution:**

A viscous-damped Dynamic Stabilizer on the V15 Type IV combines with a new stylus assembly to minimize or completely eliminate warp-related problems. It raises the arm-cartridge resonance frequency and attenuates the arm-cartridge system resonance effect.

**An electrostatically-neutralized record surface**

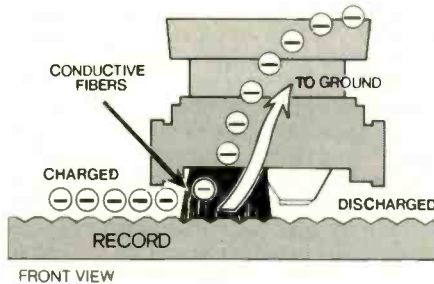

**The static problem:**

Static charges are omnipresent and unevenly distributed on all records. These charges can attract the cartridge unevenly and change the arm-to-record distance, the vertical tracking angle, and stylus tracking force. The result is wow and flutter. Also, static discharge through the stylus and amplifying system can be a cause of annoying pops and clicks.

**The Super Track IV total design solution:**

Electrically conductive fibers in the Dynamic Stabilizer of the V15 Type IV ride on the surface of the record and continuously sweep the grooves just ahead of the stylus. This picks up the static electricity and discharges it to ground, much like a miniature lightning rod. The record surface is thus electrically neutralized. The static charge is prevented from affecting the arm-to-record distance, or from causing static noise in the system. Discharging the static stabilizes tracking force during the entire record playing process and does away with the electrostatic attraction of dust to the record surface. In addition, the conductive fibers effectively sweep the record surface to remove loose dust and lint.

**Ultra-flat response**

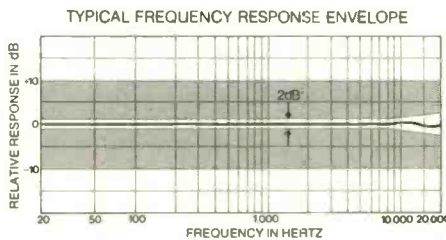

Each V15 Type IV cartridge is individually tested for frequency response that is well within the 2 dB envelope shown here.

**Dramatically reduced distortion**

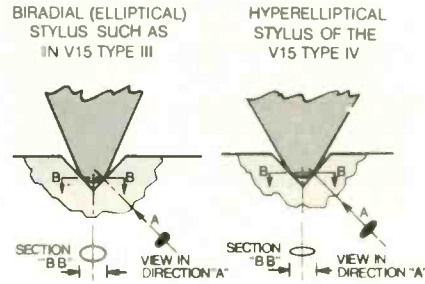

The Hyperelliptical nude diamond tip configuration of the V15 Type IV represents a significant advance in tip design for stereo sound reproduction. As the above figures show, its "footprint" (represented by the black oval) is longer and narrower than the traditional Biradial (Elliptical) and narrower than long-contact shapes (such as the Hyperbolic). This results in an optimized tip-groove contact area and dramatically reduces both harmonic distortion (white bars in graph) and intermodulation distortion (black bars).

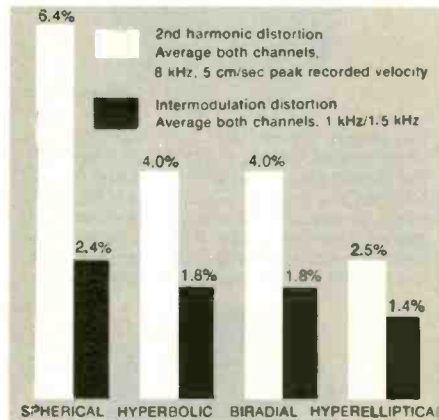

HARMONIC AND INTERMODULATION DISTORTION FOR VARIOUS TIP SHAPES

Hear this singularly musical, technically unsurpassed, and supremely uniform new pickup system at your high fidelity dealer's showroom, or write for the complete story. (Ask for AL 569):



Shure Brothers Inc., 222 Hartrey Avenue, Evanston, IL 60204  
 In Canada: A. C. Simmonds & Sons Limited  
 Manufacturers of high fidelity components, microphones, sound systems and related circuitry.

# Take a close look at a better record cleaner. Audio-Technica AT6002

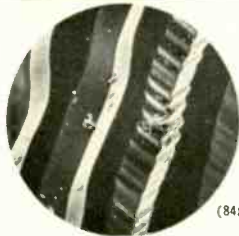

(84x enlargement)

This is an A-T scanning electron microscope photo of the dirt that must be removed if your records are to sound clean. It's dirt that is falling on your records even as you listen.

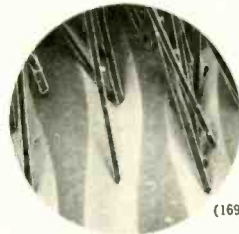

(169x enlargement)

Our unique carbon fiber brush sweeps each groove literally hundreds of times as the record plays, just before the stylus touches the groove. The carbon fiber brush helps conduct static charges away, making groove cleaning easier. And the incredibly small 6 micron diameter reaches deep into the groove for the smallest particles.

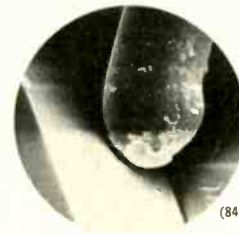

(844x enlargement)

Immediately behind the brush, our velvet pad captures and holds dust particles as you play. And moisture released from an inner reservoir helps to dissolve stubborn deposits to prevent static build-up.



This 4-way attack on dirt (brush, pad, liquid, and conductive path to ground) is uniquely effective. For proof, clean a record with any other system. Then "play" it with the AT6002. You'll find dirt removed by the AT6002 that was left behind by other cleaners. Try it today. Just \$9.95 at all Audio-Technica dealers.



**audio-technica**  
INNOVATION □ PRECISION □ INTEGRITY  
AUDIO-TECHNICA U.S., INC.  
Dept. 58-H, 33 Shiawassee Ave.  
Fairlawn, Ohio 44313  
In Canada: Superlor Electronics, Inc.

Luca and Ferruccio Corradetti in the brilliant 1907 Fonotopia recording of the buffo duet from Act III, which has been included in EMI's indispensable anthology "The Record of Singing," RLS 724, distributed by Peters International.) Poli is also technically at sea in music like "Bella siccome un angelo" and the duet "Pronta io son," where all the florid passages are heavily aspirated. Still, he and Badini are listenable. The soprano is not. To the painfulness of a truly ugly voice—backward in placement, constricted in sound, vibrato-ridden, unsteady—Adelaide Saraceni adds the impediments of dreadfully inaccurate intonation (she is mostly sharp), obfuscated enunciation, and utter charmlessness. She exemplifies, in short, all the worst in Italian singing of the years between the two world wars.

Schipa, on the other hand, represents the best. He was not without faults. The voice—to my ears, affecting rather than beautiful—was a short one, particularly at the lower end of the staff. There is, too, a suspicion of whine in his tone in certain high-lying, sustained notes. (Suspicion becomes fact in the painful soft high A with which he ends his part in the Cherry Duet from *L'Amico Fritz*.) Like so many other singers of his time, moreover, he did not know how to deal with ornaments. Nor, alas, could he get by for long without recourse to aspirates, as his "Che farò senza Euridice?" distressingly reveals. But he alone of this cast has the necessary combination of voice, taste, and personality. His Act II lament ("Cercherò lontana terra"), the serenade in Act III ("Com'è gentil"), and the duet that follows ("Tornami a dir") are marked by a highly individual introspectiveness that creates a mood at once wistful and poetic. These are the very qualities that make his *Werther* recordings, both live and commercial, so memorable.

Indeed, among the miscellaneous selections on Side 6, that from *Werther* is probably the outstanding one. The Cherry Duet is also very attractive (the final phrase notwithstanding), as is the *Sonnambula* duet (though the opening finds Schipa in husky voice).

The sound of *Don Pasquale* is rather opaque. Side 6, presumably taken from the tapes made for the long-deleted Schipa recital in the Great Recordings of the Century series, is clearer and brighter. The surfaces of my review copy are poor. No information on the performers is supplied, and there are no texts of any kind. A note on the album liner suggests that, had Seraphim gone to the expense of supplying a libretto, it would have been impossible to issue these records at a modest price; in light of what other companies manage to do—and of what Seraphim itself has done in the past—I find this assertion questionable. The supplying of texts for vocal discs seems to me a responsibility of the issuing company, and so, I would add, is the proofreading of what copy is supplied. Here Carlo Sabajno becomes Charlo Sabajno and Donizetti is named as the composer of *La Sonnambula*. And since Seraphim has raised the matter of cost, it should be noted that London's *Don Pasquale*, which unlike the HMV is uncut, takes four sides (list price: \$15.96),

while Seraphim's takes five (list price: \$11.94), the last of them running a mere 11:33. D.S.H.

**HUMPERDINCK:** KönigsKinder. For a feature review, see page 88.

**MOZART:** La Clemenza di Tito. For a feature review, see page 83.

**B MOZART:** Serenades: No. 4, in D, K. 203 (with March in D, K. 237); No. 5, in D, K. 204 (with March in D, K. 215). English Chamber Orchestra, Pinchas Zukerman, violin and cond. [Paul Myers, prod.] COLUMBIA MG 34586. \$8.98 (two discs, manual sequence).

**Comparisons:**  
Ughi, De Waart/Dresden State Orch.  
Phi. 6500 965 (K. 203), 6500 967 (K. 204)

As a sequel to their Angel Haffner Serenade (S 36915, November 1973), Zukerman and the English Chamber Orchestra offer two more Mozart serenades. Nos. 4 and 5, packaged (along with their related marches) in one specially priced set. These serenades provide Zukerman with tempting opportunities to double as soloist, since, like No. 3, K. 185, they contain miniature three-movement concertos expressly tailored for a virtuosissimo fiddler.

Zukerman enacts both roles with obvious enthusiasm, but for me his unduly romanticized approach is lacking in essential Mozartean sensitivities. In the competitive Philips No. 5, both conductor Edo de Waart and soloist Uto Ughi come considerably closer to my ideals of authentic Mozartean rhythmic lilt and zestful but still taut control. And while De Waart's Dresden State Orchestra is somewhat less graceful and more tense in No. 4, it still strikes me as preferably crisp and straightforward.

The Philips recordings, too, though a bit less bright and warm than Columbia's, are free from the latter's occasional high-register sharp-edgedness. And I prefer Philips' handling of the related marches, each of which properly precedes its associated serenade. In Mozart's own Salzburg, c. 1774-75, a same-key march customarily served as entrance music for the players in an *al fresco* serenade performance, and it sometimes was repeated as exit music. But in the Columbia set, each march (located, oddly, at the beginning of Side 3 and the end of Side 4) only follows the appropriate serenade. R.D.D.

**ORFF:** Trionfo di Afrodite. Isabella Nawe, Renate Krahrmer, and Regina Werner, sopranos; Eberhard Büchner and Horst Hies-termann, tenors; Karl-Heinz Stryczek, baritone; Reiner Süss, bass; Berlin Radio Chorus, Leipzig Radio Chorus and Symphony Orchestra, Herbert Kegel, cond. PHILIPS 9500 150, \$8.98.

**Comparison:**  
Smelaček/Prague Sym. Supr. 1 12 0877

Philips' *Trionfo di Afrodite* is only the second stereo recording of the work that concludes the triptych begun with the more fa-

miliar *Carmina Burana* and *Catulli Carmina*, but for once this neglect has some justification. Whatever the controversial aesthetic merits or weaknesses of the earlier works, they do command undeniable theatrical excitements that are but weakly, if at all, echoed in *Afrodite*. Even the expert team of conductor Herbert Kegel, his Leipzig forces, and the German engineers, which triumphed so brilliantly in its *Carmina Burana* (9500 040, December 1976) and *Catulli Carmina* (6500 815, November 1975), is unable to muster comparable conviction here.

Even so, this version is far preferable to Smetáček's on Supraphon. But lamentably it too fails to provide either original Latin and Greek texts or English translations. Besides its jacket notes, there is a trilingual insert card, but this (unlike the fine texts with Kegel's *Carmina Burana* and *Catulli Carmina*) inexplicably contains only further notes, "story" synopses, and some text paraphrases. R.D.D.

**POULENC:** *Gloria*. \* **STRAVINSKY:** *Symphony of Psalms*.\* Judith Blegen, soprano\*, Westminster Choir\* and English Bach Festival Chorus\*, New York Philharmonic\* and London Symphony Orchestra\*, Leonard Bernstein, cond. [John McClure, prod.] COLUMBIA M 34551, \$7.98. Tape: \*\* MT 34551, \$7.98.

An intriguing and revealing coupling that should have been thought of a long time

ago. Although one does not automatically associate the straightforward lyricism and general ingenuousness of Poulenc with the more austere structures of Stravinsky, there is more Stravinsky than one might expect in Poulenc, whose career as a composer began in a Paris still dazzled by the music of the Russian émigré. (There is also, from time to time, a bit of Poulenc in Stravinsky, such as in the latter's sonata for two pianos.) The opening chordal motif of the 1959 *Gloria*, for instance, is modeled on a chordal progression heard in the opening "Hymn" from Stravinsky's 1925 *Serenade for Piano*. (Poulenc first used this in a piano *Hymne* he composed in 1928.)

Both the *Gloria* and Stravinsky's *Symphony of Psalms* (1930) make great use of an essentially triadic harmonic language given bite through added notes, wide-interval voicing (especially in Stravinsky), and bright, well-defined instrumentation. The two composers, furthermore, stress the more ritualistic side of musical religiosity, so that both works often give more the impression of participatory chant than of concert works of devotion.

But there is no question that, in the end, Poulenc creates a deliberately warmer impression than Stravinsky. Where Poulenc uses lush harp glissandos, Stravinsky brings in repeated octaves on the harp that give the music its almost unsettling archaic quality. Where the chanting of Poulenc's "*Laudamus te*" has a melodic orientation and often bursts into brief, joyous swells,

Stravinsky in the final section of the *Symphony* sets the words "*Laudate eum*" to a unison, ominously repeated midrange E sung by the altos and tenors and antiphonally broken by brief outbursts in characteristic rhythmic figures from the orchestra.

And Stravinsky's instrumentation has a bone-dry leanness to it. Eliminating the violins and violas, he assigns the upper registers more often than not to the sharper timbres of the high woodwinds, also using the percussiveness of the piano and the resonance of the harp to create unusual replacements for the normal string sonorities. Yet in spite of everything, by the end of the *Symphony* Stravinsky reaches directly to the emotions by resetting, in a stunning contrast, the "*Laudate eum*" passage (from Psalm 150) in closer, choral harmonies that justify the striking and unusual (for him) chromatic modulations.

There is a great deal to admire in Leonard Bernstein's interpretations of these two works. Although he starts off the *Gloria* a bit heavy-handedly, he paces the work very well indeed in a well-contrasted performance that brings out many inner details easy to slough off. He is blessed with soprano Judith Blegen's unstrained, limpid voice in this performance. I do wish that a somewhat larger sound could have been obtained from the chorus, since many of Poulenc's rich choral harmonies do not sound as fully as they should. I was also aware of a certain lack of discipline in

## Play it as it lays.

Only one company makes both a cutterhead to lay the music into the grooves, and a line of cartridges to play it. Ortofon.

Our patented VMS (Variable Magnetic Shunt) cartridges all feature a unique, low-mass ring magnet to create a super-sensitive flux field that responds to stylus movement with incredible accuracy. It produces a true three-dimensional sound that sets new standards in spatial realism.

VMS is available in a full line of magnetic cartridges, starting as low as \$40. Each plays the music exactly as the music was laid down.

Ortofon, 122 Dupont St., Plainview, NY 11803.

ortofon  
THE VMS CARTRIDGES



CIRCLE 48 ON READER-SERVICE CARD

# Because music is mostly transients.



## Our 282-e cartridge.

From the attack of an organ note to the bite of a plucked string, music is mostly transients: sudden bursts of sound at all frequencies. On a stereo record, transient signals define the characteristic attack and decay of musical sounds, differentiating one instrument from another.

Until Micro-Acoustics' direct-coupled design (U.S. Pat. No. 3952171), all high-fidelity cartridges concentrated on *tracking ability*: maintaining contact between stylus and groove at low forces, for minimum record/stylus wear. This reduces *transient ability*, because under-damped moving assemblies tend to remain in motion, impairing clarity and definition. On the other hand, earlier cartridges with stiffer stylus assemblies had better transient ability, but greater wear.

Unlike these single-pivot cartridges, which maximize one ability, Micro-Acoustics' 282-e has twin pivots optimized for *both* abilities. Resulting in superior transient and tracking performance from one cartridge on *all* records, including warped discs. Performance totally independent of tonearm cable capacity or preamp input impedance.

Visit your MA dealer and let your ears convince you. Or use our unique test record for evaluating and comparing cartridge tracking and transient ability. Just send \$5.00 for a postpaid copy, or write for free information. Micro-Acoustics Corporation, 8 Westchester Plaza, Elmsford, N.Y. 10523. In Canada, H. Roy Gray Ltd., Markham, Ont.

# ma

## Micro-Acoustics

"Because good tracking isn't enough."

© 1977, Micro-Acoustics Corporation.

many of the entrances from the orchestra and even more from the chorus.

Bernstein gets even better results from the English groups he conducts in the *Symphony of Psalms*, which benefits from his increased attention these days to the vertical structure of music. For some the second section (a four-voice double fugue between orchestra and chorus) will be too deliberate, but I find that Bernstein's sharp definition of the contrapuntal textures paradoxically enhances the nonintellectual atmosphere behind the Stravinsky neoclassicism. And throughout, he manages to keep a solid grip on the constantly changing yet interlocking instrumental and rhythmic configurations.

To end on a negative note, I must take exception to the remarks made about Poulenc by Philip Ramey in the liner notes. Why does Columbia assign the task to somebody so basically out of tune with the composer?

R.S.B.

**B PURCELL:** Harpsichord Works. János Sebestyén, harpsichord. [Thomas Gallia, prod.] Vox SVBX 5481, \$10.98 (three discs, manual sequence).

Suites: No. 1, in G; No. 2, in G minor; No. 3, in G; No. 4, in A minor; No. 5, in C; No. 6, in D; No. 7, in D minor; No. 8, in F. A Choice Collection of Lessons (selections). Musick's Handmaid, Part II (selections). Various other works.

Listening to some of the more recent recordings of the French harpsichord literature—Kenneth Gilbert's François Couperin (for British RCA) and Rameau (Archiv 2710 020, three discs) and Alan Curtis' Louis Couperin (Archiv 2533 325) come immediately to mind—one is struck by the profundity of stylistic sympathy that has been achieved by the best players of this music during the past few years. Too often, though, the search for similarly satisfying performances of much of the rest of the harpsichord repertory remains a frustrating pursuit.

Nowhere are the record catalog's inadequacies more egregious than in the English keyboard literature. The late Thurston Dart did much to bring this music to light, of course, but his own weaknesses as a performer—he could be woefully dull or else unduly idiosyncratic—usually kept his recordings from providing a wholly satisfactory musical experience. With only a couple of exceptions matters have scarcely improved in recent years, although I hope we shall soon have some new offerings from Oiseau-Lyre's Florilegium series.

Purcell's harpsichord works are not the most distinguished pieces of the repertory to have been ill represented, but clearly they deserve a better presentation than they receive in this new recording by János Sebestyén. His playing has a certain degree of intensity—not an unworthy consideration—but the stiff, nervous ornaments, the erratic articulation, and the rather uniformly overdone detachment of upbeats demonstrate something less than stylistic understanding.

What is much worse, though, is the impossibly ugly sound of Sebestyén's harpsichord (can it be a Pleyel?): even a single eight-foot register produces an astonishingly brittle and steely noise, and the

addition of the four-foot yields an unbearable jangle. The sound is hardly enhanced by the recording, which seems to have been made in a small closet full of last year's furs, and there are often audible speed irregularities. Even Joseph Braunstein's generally good program notes (he generously provides Z. numbers) have their problems: On the first page alone there are at least two incorrect dates, evidently typographical errors.

A hasty listening to Gerald Ranck's Purcell recording for Musical Heritage Society (OR 420/1—two discs, against Sebestyén's three), on which the playing is most sympathetic and the instrument (a Herz) more agreeable to the ear, left a better impression. Even so, the overall effect is marred by the inappropriate use of the sixteen-foot register. I'm afraid that Purcell's keyboard music still awaits a satisfactory recording.

S.C.

### ROSSINI: *Tancredi*.

Amenaide  
Tancredi  
Isaura  
Argiro  
Roggiero  
Orbazzano

Hannah Francis (s)  
Patricia Price (ms)  
Elizabeth Stokes (ms)  
Keith Lewis (t)  
Peter Jeffes (b)  
Tom McDonnell (b)

Gordon Kember, harpsichord; London Voices, Orchestra of the Centre d'Action Musicale de l'Ouest (Rennes), John Perras, cond. [Ariane Segal, prod.] PETERS INTERNATIONAL/ARION PLD 017/9, \$20.94 (three discs, automatic sequence).

*Tancredi*, the opera that together with *L'Italiana*, which followed it three months later, established young Rossini's supremacy in veins serious and comic, has been much in the news lately. This recording derives from a production in Rennes in December 1976 which went round the French provinces—Orleans, Angers—and came to London. In 1977 the Houston Grand Opera opened its season with *Tancredi* in a new critical edition by Philip Gossett, and Rossini's alternative tragic finale, instead of his perfunctory happy ending, had its first performances since 1813. Marilyn Horne, the Tancred of that show, went on to sing the opera in Rome: it became front-page news there not because of Rossini, but because of the enormous fee that Miss Horne received for each performance and the public protest thereat. As I write, another *Tancredi* is billed in Carnegie Hall, to be conducted by Eve Queler, again with Horne in the title role. It has not yet been announced whether the CBS engineers will be present—as at Queler's *Le Cid*, *Gemma di Vergy*, and *Edgar* [Editor's update: No].

The Arion/Peters *Tancredi* is a product of Anglo-French entente cordiale with an American in charge. John Perras, a New York-born flutist and conductor (founder of the Dorian Quintet, once conductor for Paul Taylor's dance company) who now lives in London, assembled and worked with a cast of young British singers. The musical forces then went to France to appear in a production directed by Cherif Khasnadar, the director of the Maison de la Culture in Rennes. It is a carefully prepared performance, very much all of a piece. None of the cast fudges or smudges her or his way through the music: this is one of the

most limpid and accurate performances of a Rossini opera to be heard on record. Epithets that cannot be applied to it are those like fiery, incisive, commanding, heroic. What is missing is the sort of bravura Marilyn Horne brought to the Houston production. Nevertheless, what is present is such as to leave one with a far higher esteem for the work than it seemed to win in Houston. There, a common reaction was: "Aren't Horne and Joan Carden (the Amenaide) terrific! But it's not a very interesting piece." After hearing the album, a listener's reaction might well be: "What a splendid piece! How one would like to hear someone like Horne sing it."

Stendhal's phrase for *Tancredi* was "candeur virginale." The score has the freshness and felicity of a young genius enjoying his mastery, a kind of springtime assurance such as also marks *Idomeneo* and *Nabucco*. It is less grand than those works (though the beneficent influence of *Figaro* can be heard at times) but it gives delight; especially notable are the first-act finale, the powerful and moving aria for Argirio that opens Act II (it lies very high, reaching to D<sub>5</sub>, which Keith Lewis sings truly; in Houston, cuts were made), and the first of Amenaide's two arias in that act.

The plot turns on a single situation artificially sustained: An intercepted letter of Amenaide's inviting the exiled Tancred to return to Syracuse and rule over her heart and the city is assumed by everyone, including Tancred himself, to have been addressed to the besieging Turkish commander. (The few words of explanation that could put everything straight are never spoken.) Publicly, Tancred fights as Amenaide's champion, but privately he spurns her love. The truth is at last revealed, off-stage, when Tancred conquers the foe, and he returns to Amenaide either for a happy reunion or, in the Ferrara version, mortally wounded.

After the London performance, a colleague described the singing of the ladies as suggesting Caballé at half-steam: which nicely characterizes, on the credit side, their freshness, flexibility, accuracy, and sweetness of timbre and, on the debit side, the lack of passion, attack, rhythmic incisiveness, bite. But Perras has coached all his cast (only Amenaide, Tancredi, and Argirio are important; the others are subaltern) to true, shapely, unforced, and loving delivery of the music. In recitatives the singers show the emotion and variety too often missing from their numbers. In his first solos, set into the *introduzione*, Keith Lewis lacks trenchancy; in his first recitative he is now loving and tender, now fiery. The recitatives are done complete: they are vividly handled (even though the British Italian abounds in things like "invanno," "ingratto," "generoso") and reveal themselves as carefully composed and eloquent—not the jabbered pitter-patter stretches to which star singers impatient to reach the next number sometimes reduce them.

The opera—as it was not in Houston—is done without cuts, and gains thereby. The note says nothing about the edition used except that it was prepared by Perras with the collaboration of Philip Gossett and Al-

berto Zedda, and that several sources were consulted. It follows in the main the text of the 1854 Ricordi vocal score: i.e., essentially the Venice original except for the penultimate number, Tancred's "*Perchè turbar la calma*," which was composed for Ferrara. After that it reverts to the Venice happy ending. But there are several rectifications derived from the autograph. Decoration is minimal but Hannah Francis adds some stylish, pretty adornment to the second verse of "*E tu quando tornerai*." Roggiero, a contralto *travesti* role, is usurped by a tenor.

The orchestra playing is neat, unobtrusive, and good enough to show how mas-

terly Rossini's scoring is. More could have been made of the *sf-p* effects in the extraordinary tone picture that opens the final scene, painting "the streams' fearful clangor, the winds' grim raging midst the crags" even before Tancred sings of them. The chorus, thirteen male voices, is rather feeble. The recording is clean, simple, accurately balanced, and—in keeping with the general manner of the performance, perhaps unfairly furthering that impression—somewhat lacking in body. A.P.

**SCHUMANN:** Kreisleriana, Op. 16; Waldszene, Op. 82. Michel Béroff, piano. CONNOIS-



## FOR SUPERIOR CASSETTE RECORDINGS, START WITH A SUPERIOR CASSETTE RECORDER

The TCD 310 Mk II is considered one of the finest cassette decks in the world at any price, according to test reports by hi-fi magazines in many countries.

From its superior drive system, incorporating three motors & dual capstans, advanced features such as automatic electronic servo tape tension and fast-acting, equalized peak-reading meters, to its specially-designed electronics capable of outstanding performance in the vital & interrelated areas of Frequency Response, Signal-to-Noise Ratio and Distortion, the TCD 310 Mk II is built to provide consistently superior cassette recording.

Don't be misled by an endless array of knobs, switches, dials and lights that other manufacturers tag on for sales appeal. Performance is more important.

Ask your Tandberg dealer for a demonstration of the remarkable TCD 310 Mk II, which shares many of the same advanced performance parameters of the



no-compromise TCD 330 shown at the left, which with its three motor/dual capstan drive system, three separate heads and numerous exclusive features, offers cassette performance exceeded only by the best reel-to-reel recorders.

For the name of your nearest authorized dealer, write: Tandberg of America, Inc., Labriola Court, Armonk, N.Y. 10504; or call toll-free 800-431-1506.

# TANDBERG

CIRCLE 39 ON READER-SERVICE CARD

# Fine tune your living room.

Drapes muffle lows.

Rugs soak up lows.

Wood floors bounce highs.

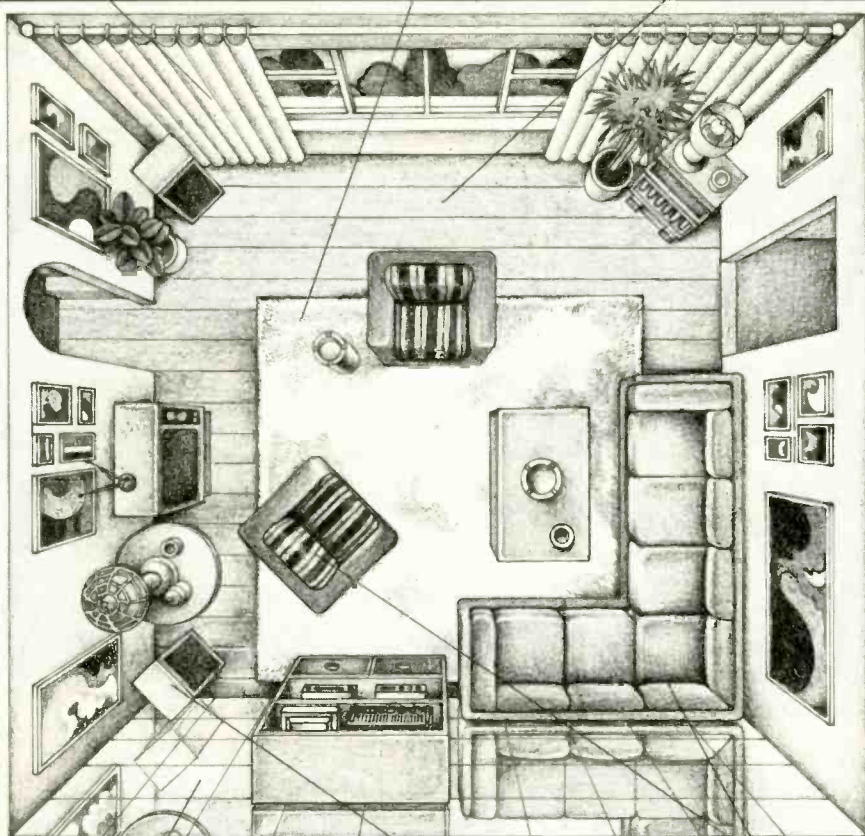

Mirrors reflect highs.

Poorly placed speakers, poor sound.

Upholstery soaks up lows.

Your stereo probably doesn't have the sound you thought you bought. Because you first heard it in a sound room. Unfortunately, most stereos are set up in rooms designed for living. Not listening.

That's why you need a Sound Shaper One or Two. The frequency equalizers that re-shape music to fit your ears. And your living room.

Sound Shaper One has ten frequency controls, five for each stereo channel. But if your system is more sophisticated, you'll want Sound Shaper Two with twenty-four frequency controls (twelve for each stereo channel). So highlight the vocal. Suppress the bass. Wipe out the flute entirely. And if you want the real professional touch, get the SLM-100 Sound Level Meter which can help you to achieve perfectly flat frequency response.

Without redesigning your living room, turn it into a listening room.

## Sound Shaper<sup>TM</sup> One and Two



ADC PROFESSIONAL PRODUCTS  
A Division of BSR Consumer Products Group  
Route 303, Blauvelt, N.Y. 10913  
A BSR COMPANY

CIRCLE 47 ON READER-SERVICE CARD

SEUR SOCIETY CS 2138, \$7.98.

**SCHUMANN:** Symphonic Etudes, Op. 13 (with posthumous etudes); Fantasy in C, Op. 17. Misha Dichter, piano. PHILIPS 9500 318, \$8.98.

Comparison—Waldszenen:

Richter Heliodor (Germany) 2548 231

Comparisons—Symphonic Etudes:

Perahia Col. M 34539  
Cherkassky Oiseau DSLO 15

Michel Béroff's Schumann recalls Robert Casadesus's (the latter recorded the *Waldszenen* twice) in the cool, crystalline transparency of texture and judiciously minimal use of rubato. At first, these readings can seem rather clipped and spare, but before long the sophistication and sensitivity become subtly apparent. Richter's 1956 mono *Waldszenen* (long gone from SCHUMANN but possibly obtainable in a 1975 German Heliodor reissue), for me still the finest recorded performance, adds an extra dash of atmospheric color and dynamic abandon, but on an only slightly lower level Béroff's interpretation is wonderfully appropriate. In the more introspective *Kreisleriana* I might wish for more expressive accenting, thicker textures, and freer rhythms, but Béroff's swift-flowing simplicity of outline is refreshing nonetheless. The lustrous EMI-derived sound helps make this a most distinguished release.

Misha Dichter's performance of the noble C major Fantasy is rather low-keyed but beautifully detailed. While I miss a certain fervor, or even aggressiveness (particularly in the first two movements), the rich sonority and singing color, the thoughtful expertise of the playing make this one of the work's better recordings. Dichter's self-effacing *Symphonic Etudes*, however, sounds somewhat perfunctory and tonally percussive alongside Murray Perahia's admirably structured recent recording for Columbia (reviewed in January) and Shura Cherkassky's provocatively coloristic live performance for Oiseau-Lyre (reviewed in this issue).

Nor am I happy with the way Dichter has incorporated the five supplementary etudes into the standard 1837/1852 text. Particularly disruptive are the insertions of post-humous variations (respectively, the fourth and fifth) between the theme and No. 1 and between No. 11 and the finale—two sequences that ought never to be tampered with. Perahia uses an eminently sensible solution that preserves these vital transitions: placing the third posthumous variation between Nos. 1 and 2, the fourth between Nos. 5 and 6, the second and fifth between Nos. 7 and 8, and the first between Nos. 9 and 10. Beautiful as the supplementary pieces are, I would rather do without them (as Cherkassky does, for example) than have them interpolated in a way that damages Schumann's cumulative musical argument.

Incidentally, Dichter, Perahia, and Cherkassky all use the revised version of the finale. H.G.

**SCRIABIN:** Sonatas for Piano: No. 1, in F minor, Op. 6; No. 3, in F sharp minor, Op. 23. Lazar Berman, piano. COLUMBIA/MELODIYA M 34565, \$7.98. Tape: MT 34565, \$7.98.

As with Beethoven's symphonies, it is Scriabin's odd-numbered piano sonatas that have gained the most popularity, and it was in Nos. 1 and 3 that the composer reached the peak of the post-Romantic style that led to his later cosmic mysticism. These sonatas are marked by anything but a straightforward lyricism, however: Inner, chromatic voices are constantly defined in intricate cross-rhythms, while the musical movement is carried forward much more by the harmonies than by the themes.

Lazar Berman's problem with both of these works lies in the impetuous, unrelenting drive he seems to apply to just about everything he plays. While nicely highlighting some of the lyrical rise and fall, Berman's playing swallows up too much of what transpires *within* the music to be entirely satisfying. His weakest area, it seems to me, is rhythmic definition: Phrases taper off into nothingness rather than affirming the vitality of a given cell. And in several instances he approaches the music from the wrong direction—in the second movement of the First Sonata, for example, he tries to find a melody at the top of the mysteriously acid chords rather than stressing the harmonic sonorities that are really what this movement is all about. I am also somewhat mystified as to how any pianist—or piano maker—could desire the metallic tone heard in the upper registers (most apparent in the opening of the Third Sonata).

Berman does not indulge in the annoying excesses of some other Scriabin inter-

preters, such as Michael Ponti, and his decently recorded interpretation of these two sonatas can be pleasing enough to the casual listener. But they do not really do the composer justice. R.S.B.

**STRAVINSKY:** *Symphony of Psalms*—See Poulenc: Gloria.

**TCHAIKOVSKY:** *Manfred, Op. 58*. London Symphony Orchestra, Yuri Aranovich, cond. [Heinz Wildhagen and Cord Garben, prod.] DEUTSCHE GRAMMOPHON 2530 878, \$8.98. Tape: ●● 3300 878, \$8.98.

*Comparisons:*  
Toscanini/NBC Sym.  
Abravanel/Utah Sym.  
Maazel/Vienna Phil.

Victr. VICS 1315  
Can. QCE 31079  
Lonc. CS 6786

Yuri Aranovich's *Manfred* departs freely from the score (phrase endings are stretched; tempo changes are anticipated with slowdowns or speedups; dynamics are twisted), ostensibly for expressive purposes, and there are some lovely touches—for example, the lifting treatment of the slow movement's second theme with its gossamer strings. But in general the performance seems to me characterized by limp rhythm and articulation, fuzzy instrumental balances, and a lack of forward impetus.

I wish I could muster more enthusiasm for the current crop of *Manfreds*. Toscanini (whose recording is available domestically in RCA's rechanneling) remains thrilling in

his iron grip on the music's surging drama, but he makes that infamous 117-bar cut in the finale. Abravanel's shy but sensitive account is as good as any of the modern ones, particularly given the budget price, and Maazel's brash one can be lived with. Might one hope for a reappearance of Mark-evitch's near-ideal Philips version? A.C.

**TCHAIKOVSKY:** *The Sleeping Beauty, Op. 66: Excerpts (Aurora's Wedding)*. National Philharmonic Orchestra, Leopold Stokowski, cond. [Paul Myers and Roy Emerson, prod.] COLUMBIA M 34560, \$7.98. Tape: ●● MT 34560, \$7.98.

In his last British recording sessions, Stokowski returned—with incredibly undiminished fervor, even at ninety-five—to several favorites from his earlier years, among them this Tchaikovsky ballet music, which he still unregenerately chopped up into arbitrary selected excerpts. The series is subtitled (like the mono 78-rpm disc set of 1948) *Aurora's Wedding*, after a shortened version of *Sleeping Beauty* based mainly on its Act III, which the Diaghilev company in its penurious last days was forced to substitute for its famous full-length earlier production.

Whatever the titling, the various Stokowski *Sleeping Beauty* recordings vary somewhat in their contents. The present disc bears no labeling identifications, and the jacket notes refer only to ballet-action

## A GREAT AMP. UPGRADED.

Five years ago, Phase Linear introduced an out-of-this-world amplifier at a down to earth price. The Phase Linear 400. It made history. And while the rest of the world played catch-up, we improved it.

The Phase Linear 400-Series Two Power Amplifier has inherited the original Phase 400's quality. Craftsmanship. And value. Everything that made its predecessor one of the greatest selling amplifiers in the world.

With some significant improvements. Inside and out.

Inside, we've refined our knowledge of amplifier design. It's the same high technology that's responsible for the awesome Dual 500-Series Two.

From the FET inputs with low noise/low distortion circuitry, to the individual sensitivity controls, the increased performance and efficiency enables the Phase 400-Series Two to deliver a sonic clarity second to none in medium power applications.

Outside, the smooth, professional styling of the gold anodized front panel includes an exclusive 32-segment LED display that's capable of instantaneous indication of output activity.

It incorporates a special 4-segment LED clipping indicator that warns of hazardous overloads.

Even under the most demanding conditions, a large extruded aluminum heat sink assembly maintains adequate cooling for the 400-Series Two.

Other built-in protection systems include electronic energy limiters that prevent the possibility of damage to the speakers or amplifier from overloads. And independent fusing of the power supply for the prevention of any potentially damaging effects caused by short circuits.

This Is Only An Ad.

There's only so much we can tell you in this ad. To fully appreciate the 400-Series Two, we recommend a visit to your authorized Phase Linear dealer.

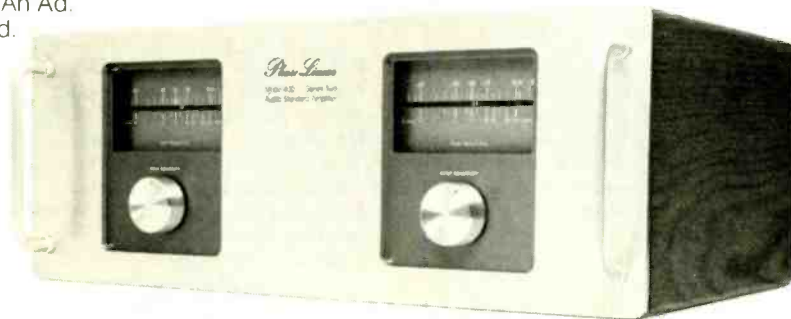
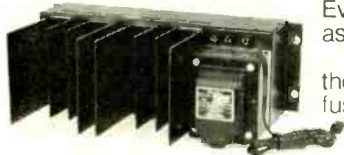

*Phase Linear*  
THE POWERFUL DIFFERENCE

Phase Linear Corporation  
20121 - 48th Avenue West  
Lynnwood, Washington 98036

Made in U.S.A. Distributed in Canada by H. Roy Gray Ltd. and in Australia by Megasound Pty. Ltd.



# Hand Music

The Beomaster 2400 receiver. Music at your fingertips from anywhere in your listening room. Cordless remote control makes music so convenient, so accessible, that it's woven naturally into your life.

Our portfolio of literature explains this sophisticated receiver in detail. Write to us for it.



# Bang & Olufsen

Bang & Olufsen of America, Inc. • 515 Busse Rd. • Elk Grove Village, IL 60007 • Dept. 11

CIRCLE 7 ON READER-SERVICE CARD

## A speaker unlike any other.

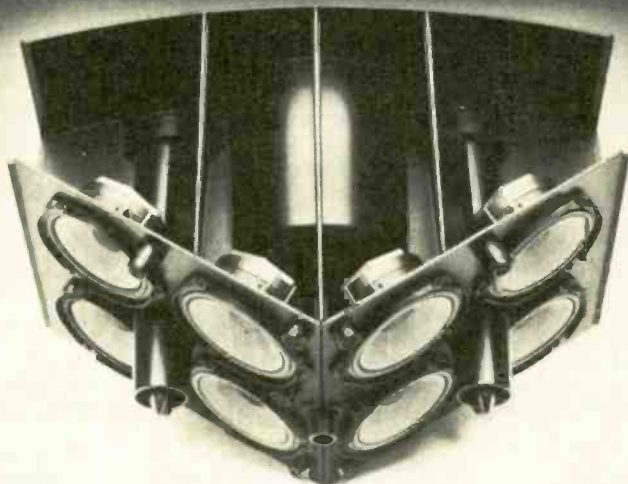

Introducing the Bose 901® Series III: the most innovative new speaker since the original Bose 901 was introduced in 1968. The 901 Series III reproduces music with spaciousness and realism unequalled, we believe, by any other speaker. Yet it uses less than 1/3 as much power as the original 901, due to a new, high-efficiency driver. Outstanding bass performance is made possible by the unique Acoustic

Matrix™ enclosure (shown in this photo of the 901 III without its grille and walnut veneer cabinet). To fully appreciate its performance, ask a Bose dealer to play the 901 III in comparison to any other speaker, regardless of size or price. For a free brochure, write Bose, Box NY, The Mountain, Framingham, MA 01701.

**BOSE**®

Patents issued and pending. Copyright © 1977 Bose Corp.

sections and subtitles. So it may be helpful to cite the exact sequence of just what is played here (using the Tchaikovsky Foundation piano-score numbering also followed in the *World Encyclopedia of Recorded Music's* third-edition chart of *Sleeping Beauty* recordings): Side 1: Introduction; (Act III) No. 21; (Prologue) Nos. 3a, 3b, and Vars. 1-6; (Act II) Nos. 12a, 12b, 12c; Nos. 13a, 13b. Side 2: (Act III) No. 22a; No. 25; Nos. 24a, 24b, 24c, 24d; Nos. 27e, 27 Intro. (five bars), 27b; Nos. 29a, 29b.

Purist balletomanes and Tchaikovskians will of course find no competition here for the Previn/London Symphony *Sleeping Beauty* (Angel SCLX 3812, March 1975), the first truly complete recording since the memorable Dorati/Mercury mono album of 1955, now out of print. But Stokowski fans will be thrilled anew by the unbelievably fierce power and dramatic grip. Perhaps the National Philharmonic's tutti sonorities don't match the admirable tonal appeals of its soloists; the reverberant recording is marred by some top-end harshness in the climactic moments; and, if you aren't completely bowled over, you can hardly avoid noting some loss of the relaxed yet still sure control of the conductor's earlier years. But that's quibbling. It's unlikely that anyone will be able to listen with cool objectivity to this latest—and still not last—Stokowskian miracle.

R.D.D.

**TCHAIKOVSKY:** Symphony No. 5, in E minor, Op. 64. Boston Symphony Orchestra, Seiji Ozawa, cond. [Rainer Brock, prod.] DEUTSCHE GRAMMOPHON 2530 888, \$8.98. Tape: ●● 3300 888, \$8.98.

Comparisons:

Ozawa/Chicago Sym.  
Markevitch/London Sym.

RCA LSC 3071  
Phi. 802 703

**TCHAIKOVSKY:** Symphony No. 6, in B minor, Op. 74 (*Pathétique*). Chicago Symphony Orchestra, Georg Solti, cond. [Ray Minshull, prod.] LONDON CS 7034, \$7.98. Tape: ●● CS5 7034, \$7.95; ●● CS8 7034, \$7.95. [Available for a limited time at special price.]

Comparisons:

Glulini/Chicago Sym.  
Horenstein/London Sym.  
Haitink/Concertgebouw  
Stokowski/London Sym.  
Furtwangler/Berlin Phil.

Sera. S 60031  
Van. Card. VCS 10114  
Phi. 6500 081  
RCA ARL 1-0426  
Sera. 60231

Seiji Ozawa's Fifth works well enough but suffers from the interpretive casualness that comes with taking old warhorses for granted. Thus the first movement has its share of unasked-for rhythmic distentions, while in the Andante cantabile the frequent tempo-change markings are often overlooked. The contours of the finale are blurred: The andante maestoso opening is firm, even appropriately pompous, but goes perceptibly faster when it recurs in the coda; the main allegro vivace starts off with immense frenetic energy, but by the recapitulation of that material it has run down a bit. Ozawa's somewhat tighter Chicago Symphony recording was more consistent in these matters, but the new one is more successful in handling hairpin dynamics and in bringing lilt and nostalgia to the waltz movement.

It should be emphasized that nothing here outsteps the bounds of interpretive

tradition. Ozawa's rhythmic control is good, he has a great orchestra at his disposal (though I wish the second-movement horn solo had been redone to avoid the slight crack going into the fourth measure), and DG provides radiantly ample and lucid sonics. You won't go seriously wrong with this version, but to hear what the music can sound like with due consideration of textual points like those noted above, I suggest grabbing Markevitch's Philips recording before it disappears from the catalog.

Georg Solti has organized his *Pathétique* in precise conformity to Tchaikovsky's printed directions and metronome markings, and the results are staggering in their frenzy, virtuosity, and color. Those who prefer languishing melancholy will find the forward thrust too much, but in fact the only place I fault Solti's interpretation is in the big tam-tam stroke of the finale, where he anticipates the *poco rallentando* marked at bar 140. A minor point, especially set against the prodigies of instrumental detail captured by the team of conductor, orchestra, and recording crew—although the closeup recording doesn't help much with the extreme soft dynamics requested in many places.

The current lists include a number of impressive alternatives for the *Pathétique*—for example, the magisterial (and budget-priced) Giulini/Seraphim, the blunter (and also budget-priced) Horenstein/Vanguard Cardinal, the sonorous if somewhat complacent Haitink/Philips, the ripely emotive Stokowski/RCA, the personalized and noble Furtwängler/Seraphim—but among the modern recordings I have heard none as cogently organized or as crisply detailed as Solti's.

A.C.

## Recitals and Miscellany

**P.D.Q. BACH:** Portrait of P.D.Q. Bach. Various performers. [Seymour Solomon and Peter Schickele, prod.] VANGUARD VSD 79399, \$7.98.

**P.D.Q. BACH:** *Missa Hilarious* (John Ferrante, counter-tenor; Harris Poor, bass; Duh Brooklyn Boys Chorus, New York Pick-Up Ensemble, Peter Schickele, cond.); *Echo Sonata* (John Solum, flute; Leonard Arner, oboe; Lorin Gilckman, bassoon; Theodore Weis, trumpet; William G. Brown, horn; Neal Di Biase, trombone); *A Consort of Choral Christmas Carols* (Duh Brooklyn Boys Chorus, James McCarthy, cond.); **SCHICKELE:** *Eine kleine Nichtmusik* (New York Pick-Up Ensemble, Peter Schickele, cond.).

It's a bit sobering (if you'll pardon a contradiction in terms) to realize that the P.D.Q. Bach "revival" is now more than ten years old and that it has engendered more than half a dozen record albums and even a book. What is even more remarkable is that there seems to be no diminishing of the audience's appetite or of the creator's productivity. The P.D.Q. Bach output has been of uneven inspiration—as humor necessarily is—but the best of the albums do demonstrate quite a rare mastery of multilevel humor, ranging from blatant slapstick to erudite musicological puns.

"Portrait of P.D.Q. Bach" may not be among its creator's most inspired productions ("An Hysterical Return" and "On the Air" remain my own favorites), but it proves that Peter Schickele's imagination remains perversely fertile. While I fear that the humor of the *Echo Sonata* ("for Two Unfriendly Groups of Instruments") was lost on me, I found much of the rest of the material delightful. Schickele's *Eine kleine Nichtmusik* reveals quite a mind for counterpoint, neatly superimposing an astonishing array of tunes on Mozart's serenade; the verbal wit of the "Consort of Choral Christmas Carols" (including "Throw the Yule Log On, Uncle John," "O Little Town of Hackensack," and "Good King Kong

Looked Out") is scarcely less accomplished. Portions of the *Missa Hilarious*—which gives new meaning to the term "parody Mass"—may offend those of very delicate religious sensibilities, but my own feeling is that it is handled with commendable discretion. The Kyrie is a gem (albeit in the rough, of course): It starts out in pig Latin ("Yriekay Leisonay"), and ends up stuttered to that silly tune about "Kuh-kuh-kuh-Katie." The *Angus Dei* (sic) concludes the whole mess(e) with the petition, "Dona nobis pasta." They're cheap gags, perhaps—but who else would have thought of them?

Everything is performed with the requisite élan, and there is even some surprisingly polished string playing in the

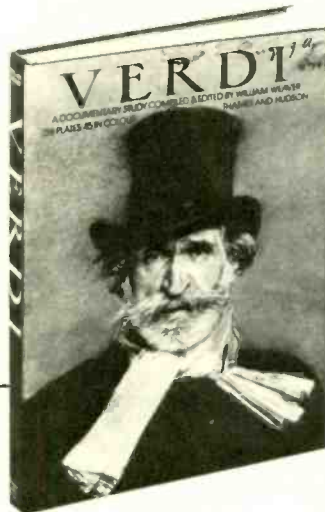

318 illustrations, 54 in color  
8 1/2" x 11 7/8"  
256 pages  
\$37.50

HIGH FIDELITY'S  
Music Listener's  
Book Service offers

# Verdi

A Documentary Study  
Compiled, edited,  
and translated  
by William Weaver

- A wealth of visual and written insight into the life and work of Italy's greatest operatic composer.
- The man and his time take shape in over three hundred illustrations of people, places, documents, and stage productions.
- Revelations of the composer's powerful and complex character through the words of his contemporaries:

William Weaver is Italian opera correspondent to the *London Financial Times* and the *International Herald Tribune* and a leading writer and broadcaster on the history of opera. He is also one of the most distinguished living translators of Italian into English.

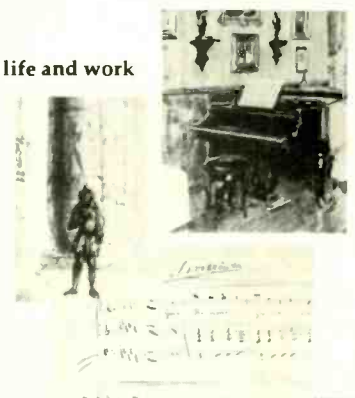

MAIL TO: Music Listener's Book Service  
High Fidelity Magazine, Great Barrington, MA 01230

Yes! Please send \_\_\_\_\_ copy(ies) of William Weaver's *Verdi* for 15-days trial examination. If dissatisfied in any way, I may return my order for a full refund or credit within 15 days. I pay \$37.50 per book plus \$1.00 for shipping.

I enclose \$\_\_\_\_\_ (Residents of Ohio, N.Y. and Mass. add applicable sales tax.)

Charge to:  
 Master Charge  Visa

My credit card number is: \_\_\_\_\_

Master Charge Interbank number: \_\_\_\_\_ Card expires \_\_\_\_\_ Signature \_\_\_\_\_

Name \_\_\_\_\_

Address \_\_\_\_\_

City \_\_\_\_\_ State \_\_\_\_\_ Zip \_\_\_\_\_

Allow 4 to 6 weeks for delivery

# Enjoy Music More

If the recorded music you purchase and listen to is important in the way you enjoy life ... you ought to know about this source of helpful information.

## Schwann Record & Tape Guide



is a compilation of information about records and tapes of many classifications. This wonderfully useful catalog uncovers titles you didn't know were available, helps you select versions by conductors and artists whose work you prefer ... shows you money-savings reprints on budget labels ... and much, much more.

More than 65,000 records and 8-track and cassette tapes are listed in the monthly *Schwann-1* and its semi-annual companion, *Schwann-2*. All are available through your record dealer if you ask for them by Schwann title and number. Schwann opens up rich rewards in your record collecting hobby. See your record dealer for latest copies.

**Schwann-1 Monthly.** Hundreds of new listings in many categories. Also nearly 45,000 available recordings on 686 record labels, 230 tape labels, 84 quadruphonic labels, in classical, recent popular, rock, jazz, musical shows, country, opera, ballet, electronic, etc. \$1.00 at your dealer's.

**Schwann-2** The semi-annual companion catalog for specialized categories: popular, rock, etc. more than two years old, classic jazz, classical classics of the prestereo era, also the the great re-issue catalogs. International pop & folk on domestic labels, spoken, educational, religious, etc. 95¢ at your dealer's.

### SPECIAL PRICE SAMPLE OFFER

If your favorite store doesn't carry Schwann, order samples by mail, BUT PLEASE TRY YOUR DEALER FIRST. Prices include postage and handling.

- Latest Schwann-1 (monthly) . . . . \$1.60 ea.
- Latest Schwann-2 (semi-annual) . . \$1.50 ea.
- Combination Offer: latest Schwann-1 (monthly) and latest Schwann-2 (semi-annual) . . . . . \$2.85

I enclose \$ \_\_\_\_\_ for the items checked above.

Name \_\_\_\_\_

Address \_\_\_\_\_

City \_\_\_\_\_

State \_\_\_\_\_ Zip \_\_\_\_\_

Dealer's Name & Address \_\_\_\_\_

**Schwann Record & Tape Guide**  
130 EAST 59th STREET, NEW YORK, N.Y. 10022

*Nichtmusik*. I'm afraid, though, that I had some difficulty listening to the carols; perhaps I'm being tiresome, but I wonder whether grotesquely inaccurate intonation is a part of "authentic" P.D.Q. Bach performance practice. S.C.

**CARLO BERGONZI:** Song Recital. Carlo Bergonzi, tenor; John Wustman, piano. [Larry Morton, prod.] COLUMBIA M 34558, \$7.98.

**BELLINI:** *Vaga luna che inargenti*. **BUZZI-PECCIA:** *Lolita*. **DE CURTIS:** *Non ti scordar di me*. **DENZA:** *Se; Occhi di fata*. **DONAUDY:** *O del mio amato ben; Vaghiissima sembianza*. **DONIZETTI:** *Me voglio fa'na casa*. **MASCAGNI:** *Serenata*. **ROSSINI:** *La Promessa; La Danza*. **TIRINDELLI:** *O primavera*. **TOSTI:** *Tormento; L'alba separa dalla luce l'ombra; Ideale*. **VERDI:** *Stornello*.

This album, made in CBS's studios last year, is essentially a souvenir of the concert given by Bergonzi at Avery Fisher Hall in March 1977, his first American appearance as a recitalist. On that occasion the tenor seemed to have enjoyed a great success with both the public and the press. (The liner notes include a substantial quotation from the *New York Times's* enthusiastic review.)

Those who did not attend the concert and thus have only the present recording to go by will possibly find it hard to understand the reason for this success. Bergonzi's voice, though well preserved for a man in his early fifties, is no longer capable of responding fully to all the demands made on it. True, the middle register is admirably firm and rich when produced at a mezzo-forte, and the high B flat at the end of "*L'alba separa dalla luce l'ombra*" rings out with impressive freedom. But the lower end of Bergonzi's scale is weak, and in all parts of his voice there is now a noticeable lack of tonal security whenever he does any soft, sustained singing—though it should be pointed out that the long-held final note of "*Se*" is a welcome exception. The same kind of insecurity undermines his attempts to produce a *diminuendo*, as one can hear only too clearly at the end of "*O del mio amato ben*."

Of course, the very fact that Bergonzi essays such refinements of manner as soft notes and *diminuendos* is enough to mark him out from the general run of today's tenors, among whom he has the reputation of being the most fastidious artist. Perhaps he is. Nevertheless, he is by no means a paragon of style. His handling of the ornaments that give expressivity and grace to Bellini's melodic line, for instance, is technically clumsy and stylistically insensitive. Above all, he lacks legato. Throughout this recital we are made forcibly aware of the fact that instead of linking one note to the next with properly supported tone he mostly avails himself of aspirates, an ugly and musically crude way of dealing with technical difficulties.

Yet ultimately the recital seems to me to fail not for reasons like the foregoing, but because Bergonzi has so little of the ingratiating charm, the intimacy and warmth, that would bring most of these delightful songs to life. Part of the problem is his lack of variety, the monochromatic nature of his voice; part is his stiffness of manner, a musical personality too unbending to admit of small intimacies. The result to my ears is

singularly unbeguing, for all that John Wustman's accompaniments are exemplary and the recording is first-rate. Less satisfactory is the packaging: The liner notes offer little more than a boost for Bergonzi, with not a single word about the music he sings nor a line of text and translation. D.S.H.

**BUDAPEST QUARTET:** The EMI Recordings. For a feature review, see page 85.

**SHURA CHERKASSKY:** Piano Recital—See Chopin: Scherzos.

### CONTEMPORARY PIANO PROJECT, VOLS. 1-3.

Dwight Peltzer, piano. [Mullen Boyd, prod.] SERENUS SRS 12069, 12070, and 12071, \$6.98 each.

Vol. 1: **BESTOR:** Sonata. **BREHM:** Variations. **PLESKOW:** *Pentimento*. **WATTS:** Sonata.

Vol. 2: **RUSH:** *Oh, Susanna; A Little Travelling Music; Soft Music, Hard Music*.

Vol. 3: **CUSTER:** *Found Objects No. 7*. **RUSH:** *Hexahedron*. **THORNE:** Sonata.

Dwight Peltzer is one of a relatively small number of gifted pianists who devote themselves primarily to new music. These three discs are given over entirely to recent works by American composers (the earliest dates from 1958, and most were written in the 1970s); and a note promises that "circumstances being propitious, more albums will follow." Which is all to the good judging by the first three volumes.

Especially featured is composer Loren Rush, whose works fill one complete disc and part of a second. This is also to the good, as Rush—a Californian who is best known on the West Coast (I was surprised to discover that he currently has no SCHWANN listings)—is a composer with talent and originality; his pieces seem more distinctive to me than the others included here. Best is his *Oh, Susanna*, a programmatic composition of sorts in which the pianist plays the role of Mozart's Figaro, ruminating at the keyboard about his past and, especially, his bride Susanna. This conceit provides an effective framework for the work's structure: a very free set of "reverse" variations on the wedding march from the Mozart opera. The composition opens with music in a quietly lyrical contemporary vein, out of which gradually coalesce fragments from the Mozart, until finally the latter appears in more-or-less unadorned form at the end.

I also liked Rush's *Hexahedron*, a sectional work conceived as a kind of garden that the pianist is able to explore through a number of alternative paths. What this means formally is that the sections can be connected with one another in a number of possible sequences. The series of contrasts that result, at least in the version recorded here, creates a fascinating interplay of diverse musical gestures.

Less interesting are two "drone" pieces, *A Little Travelling Music* and the *HARD MUSIC* portion of *soft music HARD MUSIC*. The former is a work for computer-generated tape and piano based largely on an expanded dominant-type sonority (built

on the first ten partials of a fundamental E). Its original version is for four-channel tape, in which apparently an important role is played by the changing spatial location of the sounds. But in the stereo version recorded here this no-doubt crucial dimension of the composition is almost completely missing. Also, the "resolution" to A, hinted at earlier in the work and stated explicitly at the end, sounds trite and is very much a letdown after the suspended quality of what precedes it.

Nevertheless, this piece has a considerable degree of surface variety to relieve its tonal monotony. In *HARD MUSIC*, however, the force of a tremolo on the fundamental of a similarly static harmonic surface virtually drowns out the subtle transformations taking place above it. But Rush is clearly a composer with an individual imagination and an ability to sustain musical ideas over long spans of time.

Of the other works included, Francis Thorne's sonata is the longest and most ambitious. It is an eclectic, virtuosic work with something for everyone, including toccata-like figurations, large-scale climaxes, and occasional quotations. The works by John Watts, Alvin Brehm, and Charles Bestor are all based loosely on classical formal models, though each manages to assert some character of its own. Raoul Pleskow's *Pentimento* is more difficult to classify; it represents an interesting attempt to restate thematic material from the first of its three movements in radically different contexts in the remaining two. Arthur Custer's *Found Objects No. 7* for piano and tape is highly dramatic but strikes me as being unclear in organization and rather chaotic in effect.

Peltzer plays all of these pieces quite well, though the fast movements in the Thorne would be more effective if the tempos were brisker. *Serenus'* sound is variable, and there is a good bit of surface noise at times on my pressings. One interesting technical note: On the disc devoted exclusively to Rush, the composer asks the listener to observe individual volume control settings for each of his pieces. These make an important—and beneficial—difference in the aural effect. R.P.M.

**GREATEST HITS OF 1720.** Philharmonia Virtuosi of New York, Richard Kapp, cond. [Judith Sherman, prod.] COLUMBIA M 34544, \$7.98. Tape: ●● MT 34544, \$7.98; ●● MA 34544, \$7.98. [Available for a limited time at special reduced price, with X prefix.]

I hate to be a sourpuss, but I'm not amused by this latest attempt to bring baroque-era classics to pop audiences. (Well, even I must admit that the pop-chart jacket cover is an ingenious notion, as are the c. 1720 London music-season reports in lieu of notes on the music actually played.) While the ensemble of toponotch New York players is robustly if variably recorded, its doggedly labored, bottom-heavy reading of the Pachelbel Canon sets the pattern for the stiff, self-conscious performances of six other short pieces or excerpted movements by Bach, Corelli, and Handel—plus a couple of livelier, more brilliant high-trumpet (Ge-



Choose from over 75 of the top-name brands in Hi-Fi equipment and accessories, plus the latest in records and tapes - all at incredibly discounted prices!

• VISA • MASTERCHARGE

Toll Free Ordering  
1-800-638-3920  
we give quotes by Phone

**STEREO  
DISCOUNTERS**

6730 Santa Barbara Court  
Baltimore, Md. 21227

Send for our Free Catalog and compare our Selection and Prices. You'll see how we get our name! Over 75 major brand names.

Name \_\_\_\_\_  
Addr. \_\_\_\_\_  
City \_\_\_\_\_  
State \_\_\_\_\_ Zip \_\_\_\_\_ HF-5

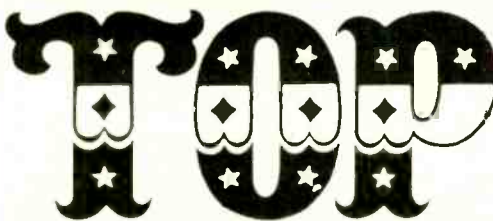

**DISCOUNT  
AUDIO**

1150 N. Powis Rd.  
West Chicago, IL 60185

**YOUR NATIONAL HEADQUARTERS FOR  
NAME BRAND ELECTRONICS BY MAIL**

• RECEIVERS • SPEAKERS • COMPACTS

**MILLION  
\$\$\$  
INVENTORY**

**ORDER YOUR CAR  
HI-FI SYSTEM  
NOW... IN TIME  
FOR SUMMER-LONG  
SOUND ENJOYMENT!**

**ALL ORDERS  
Shipped in  
Factory-  
sealed  
Cartons**

• TUNERS • AMPLIFIERS • CALCULATORS

**TOP DISCOUNT  
AUDIO**

1150 N. Powis Rd.  
West Chicago, IL 60185  
(312) 293-1825

We Honor VISA and  
MASTERCHARGE

Send me a quote on \_\_\_\_\_

MR. \_\_\_\_\_  
MS. \_\_\_\_\_  
(First) (Initial) (Last) (Date)

(Number and Street)

(City) (State) (Zip code)

Call or Write for the LOWEST PRICES Anywhere!

• TAPE DECKS • CHANGERS • CARTRIDGES • HEADPHONES

CIRCLE 43 ON READER-SERVICE CARD

# THE VIDEO CENTER

8621 Wilshire Blvd., Bev. Hills, Ca. 90210  
(213) 659-8881

## SPECIAL OF THE MONTH

\* JVC VHS VHS

3 hr. VHS Home Video Recorder

Digital Timer

VHF-UHF Tuner

Compact Size, 29.7 lbs.

List Price...\$1280 OUR PRICE...\$849

Optional For VTR, B & W Panasonic hand-held camera...\$269.95



### VIDEO RECORDERS—Beta Format

Sony SL 8200 w/timer, 2 hr.	\$ 899.00
Sony SL 8200 w/wireless remote	1049.00
Sony SLD 320/RM 300 indust. Recdr.	1350.00
Sony SLP 300/RM 300 indust. Player	1150.00
Sony SLD 340/OXC 1610 Betamax portable & Color Camera	4599.00
Sony VTC 9100 w/built in timer, 2 hr.	799.00
Zenith JR 9000 w/timer, 2 hr.	849.00

### VHS Format

RCA Selectavision w/timer, 4 hr.	849.00
Wireless Remote Control for above	59.95
Panasonic Omnimotion II or IV	CALL

### V-Cord I & II Formats

Featuring pause/still frame

Sony VTC 8203 (or 4) built in timer, 2 hr.	799.00
Sony VTC 8 timer for above	60.00
Sony VTC 7250X slo-mo portapak system	1695.00
RF Modulator for above, ch. #3 or 4	195.00
Sony VTC 8400, 2 hr.	699.00
Sony VTC 8410 player, 2 hr.	599.00
RF Adaptor for above units, ch. #3 or 4	69.95

### 3/4" UMATIC RECORDER PLAYERS

JVC CR 6300U Recorder w/timer	1577.00
JVC 6060U Recorder	1398.00
JVC CR 4400U, portapak VCR	2195.00
JVC CP 5000U Player	895.00
RF adapt. for above	75.00
Panasonic NV 9100, player	1175.00
Panasonic NV 9300	1639.00
RF Adaptor for above, Ch. #5 or 6	75.00
Sony VO 2600/VO 3800 etc.	CALL

### COLOR CAMERAS

Hitachi FP 3030A complete ensemble, portable	3695.00
JVC GC 3300U	1299.00
Macro zoom, electronic finder for above	599.00
GBC w/electronic finder & zoom lens	1595.00
Sony VCC 9000 Studio type 6-1 rear control zoom, color bar gen.	2598.00
Sony DXC 1610	3395.00

### VIDEO CENTER SPECIALS

Velvetine cover for Advent 710 or 750 screens	
Admiral Blue, Rally Red, Steel Grey, Bottle Green, Char Brown	69.95
Audio Video Color RF Modulators	195.00

### PRODUCTS

New: Sony, Hitachi, JVC, Panasonic, Sanyo, Advent  
RCA, GBC, Vicon, Canon & many more...WRITE  
Used: We buy & sell pre-owned equipment...WRITE

### PROJECTION SYSTEMS

THE VIDEO CENTER carries virtually every projection system avail. For information, please...CALL

### MOVIES

50 TITLES... Available on VHS & BETAMAX tape from \$49.95, send for catalog...CALL

### VIDEO GAMES

Atari CX 2600, comp. sys. w/Combat cart	159.00
Air Sea Battle, Star Ship, Street Racer, Olympics, Black Jack, Surround, Basic Math carts for above	17.95
Atari C 380 Video Pinball	79.00

### TAPE SALE

KCA 60 FAMOUS BRAND Up to 24, ea.	19.95
Memorex UCA 60	22.95
Memorex UCA 30	16.50
Memorex UCS 20	16.50
Maxell KCA 60	23.95
Maxell KCA 30	17.95
Sony L 500 (Beta)	14.50
Sony L 250 (Beta)	10.95
Sanyo L 500 (Beta)	14.25
Sanyo L 250 (Beta)	10.75
Sanyo V 120 (V-Cord)	17.50
JVC T-120 (VHS)	18.95
RCA VK 250 (VHS)	21.95
RCA VK 125 (VHS)	15.95
For Large Orders, please...CALL	

For placing orders, ask for Mail Order Department. Send clipping of ad with order. Minimum order \$50. All orders under \$100, \$4 minimum shipping and handling charge.

GUARANTEE: All mde. is Brand New Factory Fresh w/mfg. Guarantee unless specified otherwise. No return without prior approval. All prices valid for mail order only. PAYMENTS: Enclose cashiers check or Money Order, 20% in advance on C.O.D. MasterCard and VISA accepted. A copy of the written warranty can be obtained from upon specific written request. All prices subject to change and F.O.B. Beverly Hills, California.

CIRCLE 45 ON READER-SERVICE CARD

rard Schwarz) showpieces: a Mouret rondeau (the *Masterpiece Theater* theme) and Campra's *Tancredi* March.

My adverse verdict well may be a minority one, but it's reinforced every time I compare any of these versions with earlier, more zestful and idiomatic ones. And I must register my frequent complaint over the inclusion of Giizzotto's travesty of the "Albinoni" Adagio, an annoyance compounded by the shameless schmaltz with which it is further inflated. R.D.D.

**BERNARD HERRMANN CONDUCTS.** London Philharmonic Orchestra, Bernard Herrmann, cond. [Tony D'Amato, prod.] LONDON-PHASE-4 SPC 21173, \$7.98. Tape: SPC5 21173, \$7.95.

**DUKAS:** The Sorcerer's Apprentice. **LISZT:** Les Préludes. **SAINT-SAËNS:** Samson et Dalila; Bacchanale. **SIBELIUS:** Finlandia, Op. 26.

It has become all but axiomatic that a piece conducted by the late Bernard Herrmann will strike the listener as a good deal slower than he is used to hearing it. This is due not only to the pacing, which does tend toward the deliberate, but also to his microscopic attention to every detail—motivic, rhythmic, instrumental. Forward momentum all but disappears, and if the listener can often appreciate the revelation of a wealth of previously unnoticed minutiae, Herrmann's conducting often leaves a sense of unfulfillment and heaviness.

This is certainly true of his *Finlandia*. Herrmann starts off on such a highly accented, drama-laden level that he leaves himself nowhere to go, in spite of all his efforts to attain the climax at the end. For all this, he does manage, through careful attention to the harmonic voicing, to impart a warm, hymnlike quality to the work's famous central theme. *Les Préludes* fares no better, and for much the same reasons. Interestingly enough, the two French works (*The Sorcerer's Apprentice* and the *Samson "Bacchanale"*), because of their more transparent textures and their more vertically conceived aesthetics, withstand Herrmann's scrutinizing much better than the Liszt and Sibelius, which must have their horizontal momentum.

These performances—first issued in England in 1969 (without the "Bacchanale") as "The Great Tone Poems"—now appear here for the first time. The sound is marvelously rich, the stereo balance excellent. R.S.B.

**PHILIP JONES BRASS ENSEMBLE:** Diver-timento. Philip Jones Brass Ensemble. [Chris Hazell, prod.] Argo ZRG 851, \$7.98.

**ARBAN:** Etude caractéristique (arr. Howarth). **ARNOLD:** Fantasy for Trombone. **R. R. BENNETT:** Fanfare. **HOWARTH:** Pasce Tuos (after Dufay). **MAURER:** Four Pieces. **PREVIN:** Four Outings. **SIMON:** Quartet In the form of a sonatine. **TCHAIKOVSKY:** The Sleeping Beauty, Op. 66: Waltz (arr. Fletcher).

After this group's recent masterpiece of musical humor, the superb "In Switzerland" program (HNH Records 4037, February 1978), it would be too much to expect another triumph demanding commendation beyond the hard core of brass-music specialists who wouldn't miss anything

done by Jones and his men.

To be sure, the playing (as always) is matchless, and the recording is a model of sonic transparency and golden "ring." But the music itself is highly variable in its appeal. By far the best works are the most extremely contrasted: a new example of combined musical wit and bravura, John Fletcher's incredible arrangement and multidubbed performance of a four-tuba version of the *Sleeping Beauty* waltz; and Elgar Howarth's profoundly serious, even devout, meditation on a three-part Dufay motet.

For the rest, the rarely heard nineteenth-century brass originals by Ludwig Maurer and Anton Simon will be welcomed by specialists, as will the short present-day pieces by Richard Rodney Bennett and Malcolm Arnold. But while these last two have the great merit of concision, the program's presumed feature—André Previn's set of brass-quintet Outings—not only has nothing much to say (for me, anyway), but doesn't know when to stop saying it. R.D.D.

**TREVOR PINNOCK:** At the Victoria and Albert Museum. Trevor Pinnock, virginal and harpsichords. [Roy Carter and Simon Lawman, prod.] CRD 1007, \$7.98 (distributed by HNH Records).

**ANON.:** My Lady Wynkfylds Rownde. **ARNE:** Sonata No. 3, in G. **J. C. BACH:** Sonata In C minor. **BYRD:** The Bells; The Queenes Alman. **CROFT:** Suite No. 3, in C minor. **HANDEL:** Suite No. 5, in E (*Harmonious Blacksmith*).

For this very appealing program of English keyboard music (surely one may stretch the definition to include Handel and J. C. Bach), Trevor Pinnock plays three historical instruments from the collection of London's Victoria and Albert Museum: The three Tudor pieces are performed on a virginal thought to have belonged to Queen Elizabeth I, the Handel and Croft suites are played on an early-eighteenth-century English harpsichord, and a 1776 Kirkman is heard in the Arne and Bach sonatas.

The sonorities, obviously, could hardly be more authentic, and Pinnock's performances are no less authoritative. Having admired his recent recording of the A minor and E minor Suites of Rameau (CRD 1010, April 1978), I was pleased to note that Pinnock's accomplished musicianship is by no means limited to the French literature. He again demonstrates thorough technical mastery, a strong sense of rhythm, and a welcome freedom from preciosity. His playing is clean and well controlled, and the subtleties of rhythmic inflection—so crucial in harpsichord and organ performance—are handled with sensitivity and discretion.

The recorded sound seems quite natural (although the surfaces are not always ideally silent), and we are given commendable program notes by Nicholas Anderson. It's rather a disappointment, though, that we are denied photographs of the instruments, while the entire back cover of the album is devoted to a picture of the performer. S.C.

**CLARA ROCKMORE:** Theremin Recital. Clara

Rockmore, theremin; Nadia Reisenberg, piano. [Shirleigh Moog, prod.] DELOS DEL 25437, \$7.98.

Here's a musical/technological document of uncommon historical importance: a program demonstrating the powers (and limitations) of one of the earliest all-electronic instruments, played by its most skillful early exponent, one given an imprimatur by inventor Léon Theremin himself. Clara Rockmore, coming out of her concert retirement to make these recordings, has lost none of her old mastery of this singular "space-controlled" instrument. She is deftly accompanied by her sister, the well-known pianist Nadia Reisenberg, and both are admirably recorded, with the theremin given precedence, of course.

Perhaps most remarkably of all, it is today's outstanding electronic-instrument inventor, Robert Moog, who sponsors the program and contributes a detailed history and description of the theremin.

Credit thus duly paid, it must be added that there should be a label warning: The swooning portamentos of the theremin well may be dangerous to the health and peace of mind of any listener susceptible to musical mal de mer. For the less queasy, there is at least a horrid fascination, and considerable atmospheric evocation, to the few most suitable selections: the "Pantomime" from Falla's *Amor brujo*, Rachmaninoff's "Song of Grusia," and Tchaikovsky's *Sérénade mélancolique*. But no vox humana organ stop or gypsy fiddler's uninhibited vibrato has approached the theremin-throbbled versions of Rachmaninoff's "Vocalise," Saint-Saëns's "Swan," Ravel's *Habanera*, Glazunov's *Chant du ménestrel*, and the other familiar encore pieces here.

R.D.D.

**TITO SCHIPA:** Recital—See Donizetti: Don Pasquale.

**GERARD SCHWARZ:** Turn of the Century Cornet Favorites. Gerard Schwarz, cornet; Columbia Chamber Ensemble, Gunther Schuller, arr., cond., and prod. COLUMBIA M 34553, \$7.98. Tape: ■ MT 34553, \$7.98; ● MA 34553, \$7.98.

It's rare indeed that any highly successful novelty program can be followed by a more-of-much-the-same sequel that actually excels its predecessor. But that's the case with star trumpeter Gerard Schwarz's second venture in resurrecting the great days of cornet playing at the turn of the century. His earlier "Cornet Favorites" program (Nonesuch H 71298, November 1974) was the first in modern times to give full justice to the cornet, the trumpet's stubbier, blander-toned, but fabulously agile poor cousin—once the favorite vehicle of the musical matinee idols of summer bandstand concerts.

Schwarz dips again into the mostly forgotten repertory of showpiece favorites by such onetime stars as Herbert L. Clarke (five pieces not included in the earlier program) and the French cornet pioneer, J.-B.

Arband (this time, his *Norma* variations). The great Czech-American virtuoso Bohumir Kryl is represented by his *Josephine*, the virtuoso/inventor/manufacturer Vincent Price by his *Hungarian Melodies*, the ragtime master Joplin by his *Pleasant Moments*, and the danceband leader George Morrison by a lullaby. More adventurous is the choice of a *Mephisto Masqué*, originally composed for ophicleide by the early black expatriate Edmond Dédé and performed here with the versatile Schwarz shifting gears from high to low (i.e., from cornet to euphonium).

Even more versatile is producer/conduc-

tor Schuller, who also provides the arrangements and orchestrations, interludes and modulatory segues between some of the selections, and informative jacket notes. I'm surprised he let Messrs. Tonkel, Kenty, and Brosnan do all the audio engineering! As it is, everyone involved in any way has a field day—one to be relished as fine musical entertainment no less than as valuable Americana.

R.D.D.

**GEORGE SZELL CONDUCTS THE NEW YORK PHILHARMONIC**—See Beethoven: Symphony No. 6

High Fidelity's Music Listener's Book Service offers the reprint edition of  
**Clough and Cuming's**  
**The World's**  
**Encyclopaedia**  
**of Recorded**  
**Music**

The most comprehensive reference work on classical recordings of the electrical and early microgroove eras from 1925 through 1955, this 3-volume set (commonly called "Worm") is the ultimate addition to the record collector's library shelf. For years unavailable except through the catalogs of out-of-print booksellers, now the complete original text is yours in sturdy, library-bound Greenwood reprint editions. Over 1,700 pages of information, some only available from this source.

- Basic Volume (1925-1950) Including; First Supplement (1950-51). xviii, 890 pages.
- Second Supplement (1951-52). xxii, 262 pages.
- Third Supplement (1953-55). xxvi, 564 pages.

**All three volumes \$87.50, plus \$2.75 shipping.**



MAIL TO:  
 Music Listener's Book Service  
 High Fidelity Magazine, Great Barrington, MA 01230

Yes! Please send \_\_\_\_\_ set(s) of Clough and Cuming's *The World's Encyclopaedia of Recorded Music* for \$87.50 per set plus \$2.75 for shipping.

I enclose \$\_\_\_\_\_ (Residents of Ohio, N.Y. and Mass. add applicable sales tax.)

Charge to  Master Charge  BankAmericard/Visa

My credit card number is

Master Charge Interbank number  Card expires \_\_\_\_\_ Signature \_\_\_\_\_

Name \_\_\_\_\_

Address \_\_\_\_\_

City \_\_\_\_\_ State \_\_\_\_\_ Zip \_\_\_\_\_

Allow 4 to 6 weeks for delivery

**Spring housecleaning.** It's becoming more and more difficult to keep abreast of new music cassette releases. Since the most newsworthy of them, musically or technically, tend to monopolize "Tape Deck" space, I've accumulated a considerable number of worthwhile programs that have been crowded out of recent columns. Following are a number of such unfairly neglected items (all Dolby-processed and all, unless otherwise noted, list-priced at \$7.95 or \$7.98).

- Advent E 1056 and E 1059 bolster keyboard purists' contentions that modern grands give a false—however impressive—idea of what late-eighteenth-century piano music sounded like in its time. Specialist Malcolm Bilson, playing replicas of c. 1790 Walter and c. 1795 Dulcken fortepianos, provides new tonal slants on two Mozart rondos and both Beethoven Op. 27 Sonatas (E 1056), and Mozart's K. 311 Sonata and Haydn's Sonatas Nos. 54 and 62 (E 1059).
- Angel 4XS 37219 demonstrates how brilliantly today's technology can enhance the sonic effectiveness of Rachmaninoff's piano transcriptions of favorites by Bach, Bizet, Kreisler, Mendelssohn, Mussorgsky, Rimsky-Korsakov, Schubert, and Tchaikovsky—plus his own "Daisies," "Lilacs," and several short pieces. It also demonstrates how boldly young Garrick Ohlsson challenges the memory of the composer's own performances.
- Archiv 3310 330 continues Karl Richter's Munich series of Bach cantatas with one of the most fervently festive of all: No. 30, *Freue dich, erlöste Schar*. This robustly recorded version features Edith Mathis and Dietrich Fischer-Dieskau among the soloists.
- Columbia MT 34530 is a precious reminder of cellist Jacqueline du Pré's artistic growth before she was so tragically incapacitated. Her 1970 live performance of the Elgar cello concerto (with the Philadelphia Orchestra under her husband, Daniel Barenboim) may be somewhat remotely recorded, but it reveals notable maturation over her earlier version with John Barbirolli. And the coupling, Barenboim's *Enigma* Variations with the London Philharmonic, benefits from more up-to-date sonic transparency and presence.
- Deutsche Grammophon 3300 674 represents Herbert von Karajan's latest thoughts (interpretatively and sonically more powerful than before) on Bruckner's Fourth (*Romantic*) Symphony. The result may at times be too fierce for some Brucknerites, but the

by R. D. Darrell

## The Tape Deck

awesome dynamic-range extremes will electrify even them.

- London CS8 7009, one of a new series of Dolby eight-track cartridges (the first since Columbia pioneered them), makes the most of the background-quieting technique in pianist Alicia de Larrocha's latest, quite incomparable recording of the complete Granados *Goyescas*. And while I haven't yet heard the cassette edition—likely to be of more appeal to most readers—I'm sure it'll be as treasurable, if not more so.

Among the recent cassette-only London releases is one that was nudged out of my earlier holiday-gift recommendations: the current D'Oyly Carte Company's robust if somewhat sharp-edged recording of Gilbert and Sullivan's *Trial by Jury*—an operetta short enough to allow the inclusion of Sullivan's rarely heard *Macbeth* Overture and two *Henry VIII* excerpts also conducted by Royston Nash (OSA5 1167).

- Monitor/CCC 51 (\$5.95 presents the 1972 Charles Cros Grand Prix winner, Stoika Milanova's boldly played, vividly recorded coupling, with Vassil Stefanov and the Bulgarian Radio Orchestra, of the two Prokofiev violin concertos. Hers is a new name to me, but one I hope to hear often.
- Musical Heritage MHC 5640 is not just another of the many Franck D minor Symphony recordings: The performance by Alain Lombard and the Strasbourg Philharmonic may not be the most polished or virtuosic, but this version ranks near if not at the very top of the discography for its idiomatically French reading and warm, superbly full-blooded recorded sonics.
- Peters International PLE 003 provides evidence for the claim that Schumann's violin concerto and Op. 131 Fantasy have been unjustly neglected. Soloist Patrice Fontanarosa, conductor Paul Capolongo, the orchestra (from the ORTF), and the French Decca engineers plead the case with persuasive romantic intensity.
- Philips 7300 362, Bernard Haitink's superb performance of Mahler's *Das Lied von der Erde*, boasts the irresistible appeals of Janet Baker's singing (co-soloist James King is less distinc-

tive) and the Concertgebouw Orchestra's playing. There are notes but lamentably no texts, also lacking in the competitive Minton/Kollo/Solti/Chicago cassette version, London OS5 26292.

- Quintessence P4C 7048 (\$4.95) is a delectable, still vivid coupling (resurrected from the onetime limited Reader's Digest series) of the Bizet Symphony in C and Tchaikovsky *Francesca da Rimini* by Charles Munch and the Royal Philharmonic, both in their best form.
- RCA Red Seal ARK 3-2046 (boxed, \$23.94) brings to cassettes last summer's *Giordano Andrea Chénier* starring Renata Scotto and Plácido Domingo with the John Alldis Choir and National Philharmonic under James Levine. *Chénier* connoisseurs won't give up their favorite older versions (none available on tape), but this one has distinctive appeals, not least the sound—strong and vivid if sometimes overresonant. (There is also a Stereotape open-reel edition, EOP 3-2046 U, \$27.95.)
- Sine Qua Non SQN 7739 (\$4.98 list; \$2.98 sticker price) is a Bach *Magnificat* novel for its inclusion of the original edition's four Christmas interpolation movements—all in a brightly recorded, spirited performance by soloists Helen Donath, Birgit Finnilä, Peter Schreier, and Barry McDaniel with a Stuttgart chorus and orchestra under Wolfgang Gönnenwein.
- Vox CT 2120 (\$4.98), "Great Wagnerian Love Scenes," predictably proves to be the *Tristan* Prelude and *Liebeshod* (plus the Act III Prelude) and the *Tannhäuser* Overture and "Venusberg Music"—all in sumptuous recordings of reasonably orthodox readings by Stanislaw Skrowaczewski and the Minnesota Orchestra.

**Unicorn/Nielsen reel series.** There is more good news for the open-reel faithful as well. Barclay-Crocker leads off its second Unicorn release list with the first of three reels devoted to the generally acclaimed 1973-74 Nielsen symphony cycle by Ole Schmidt and the London Symphony. Unicorn/B/C K 0326 (\$7.95, from Barclay-Crocker, 11 Broadway, New York, N.Y. 10004) couples Symphonies Nos. 3 (*Sinfonia espansiva*) and 6 (*Sinfonia semplice*), and if Schmidt's restrained No. 3 is no match in sheer excitement for the high-voltage 1965 Bernstein/Columbia version, the latter is no longer available on tape. In any case, his No. 6 and the reel processing throughout are unqualified triumphs. ●

# Para - Power

## (Parametric Equalizers by SAE)

SAE has long been involved in the field of tone equalization. From our pioneering efforts in variable turn over tone controls to our more recent advancements in graphic equalizers, we have continually searched for and developed more flexible and responsive tone networks. From these efforts comes a new powerful tool in tone equalization — the Parametric Equalizer. Now you have the power of precise control.

Our 2800 Dual Four-Band and 1800 Dual Two-Band Parametrics offer you controls that not only cut and boost, but also vary the bandwidth and tune the center frequency of any segment of the audio range.

With this unique flexibility, any problem can be overcome precisely, and any effect created precisely.

With either of these equalizers, you have the power to correct any listening environment or overcome any listening problems that you are faced with. Whether you need a third octave notch filter, tailored bandwidth to resurrect a vocalist, or a tailored cut to bury an overbearing bass, the control flexibility of Parametric Equalizers can fill these needs and many more. And of course, as with all SAE products, they offer the highest in sonic performance and quality of construction.

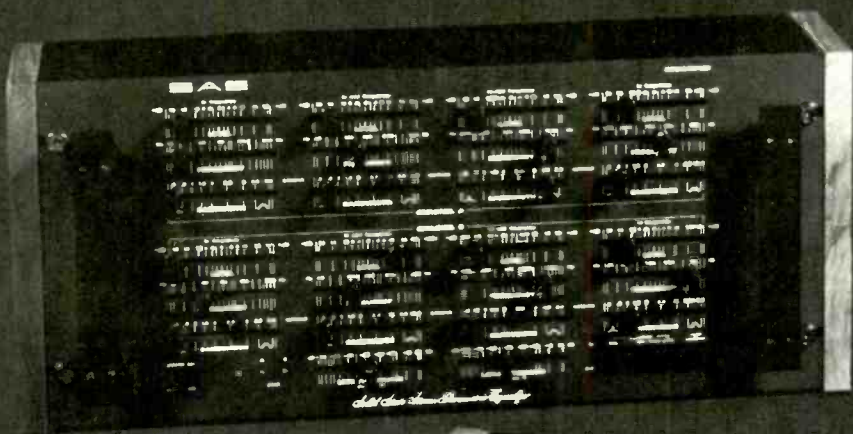

For Complete Information Write:

**SAE**  
Scientific Audio Electronics, Inc.  
P. O. Box 60271 Terminal Annex, Los Angeles, CA 90060



# The one alternative to separates: The Yamaha CA-2010 Integrated Amplifier.

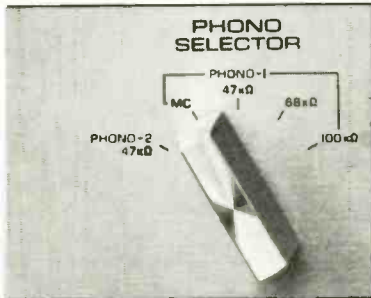

**The Head Amplifier.** Discerning music lovers all over the world are discovering the transparent highs and extended frequency response of the moving coil phono cartridge. While other manufacturers require the addition of an expensive preamp or step-up transformer to boost the low output signal, Yamaha included a special head amplifier in the CA-2010. It's available with the flip of a switch on the front panel. And to help you get the most out of moving magnet cartridges, there's a 3-position phono impedance selector.

**The Preamplifier.** To assure exact, repeatable bass and treble settings, the controls are precision calibrated in 1/2dB steps. Dual turnover frequencies for both ranges double the versatility of these accurate tone controls. Completely independent Input and Output Selectors let you record one source while listening to another. And the power meters are easily switched to REC OUT readings in millivolts, so you can monitor the actual output level to your tape deck for cleaner, distortion-free recordings.

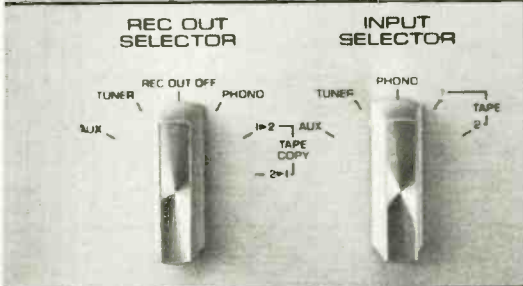

**The Power Amplifier.** 120 watts RMS, with no more than 0.03% THD 20Hz to 20,000Hz into eight ohms.

For tighter, cleaner bass response, the amplifier can be switched to DC operation. Class A operation is switchable on the front panel, delivering 30 watts RMS, with no more than 0.005% THD 20Hz to 20,000Hz into eight ohms.

The twin power meters are fast-rise, peak delay—they can track even the briefest of transient bursts. Plus they can respond to levels from 1mW to 316W (into eight ohms).

**Real Life Rated.™** The specifications of the individual components of the CA-2010 are superior to many separates. Individual specifications alone, however, can't possibly reflect actual in-system performance. That's why Yamaha measures overall performance from phono in to speaker out, rather than at designated points along the signal path. Furthermore, we measure noise and distortion together over a broad output range, rather than individually at the optimum output.

Our Real Life Rated measurement is called Noise-Distortion Clearance Range (NDCR). On the CA-2010, NDCR assures no more than 0.1% combined noise and distortion from 20Hz to 20kHz at any power output from 1/10th watt to full-rated power.

**Superb tonality from a musical tradition of technical excellence.** The tonal accuracy of our audio components is referenced to the same standards used to evaluate the tonal accuracy of our world-renowned musical instruments. The result is a rich, clear tonality that is unknown elsewhere. You really must hear it.

You really must hear the same resolutely accurate music reproduction available from all four Yamaha Integrated Amplifiers and four superb tuners. All are made to a single standard of excellence—a standard rooted in a 90-year tradition of musical perfection.

For a personal audition of the new Yamaha CA-2010, as well as the rest of our complete line of components, just visit your nearest Yamaha Audio Specialty Dealer. If he's not listed in your Yellow Pages, drop us a line.



## YAMAHA

Audio Division, P.O. Box 6600, Buena Park, CA 90622

**.03%**  
-96dB S/N

**Real Life  
Rated**™

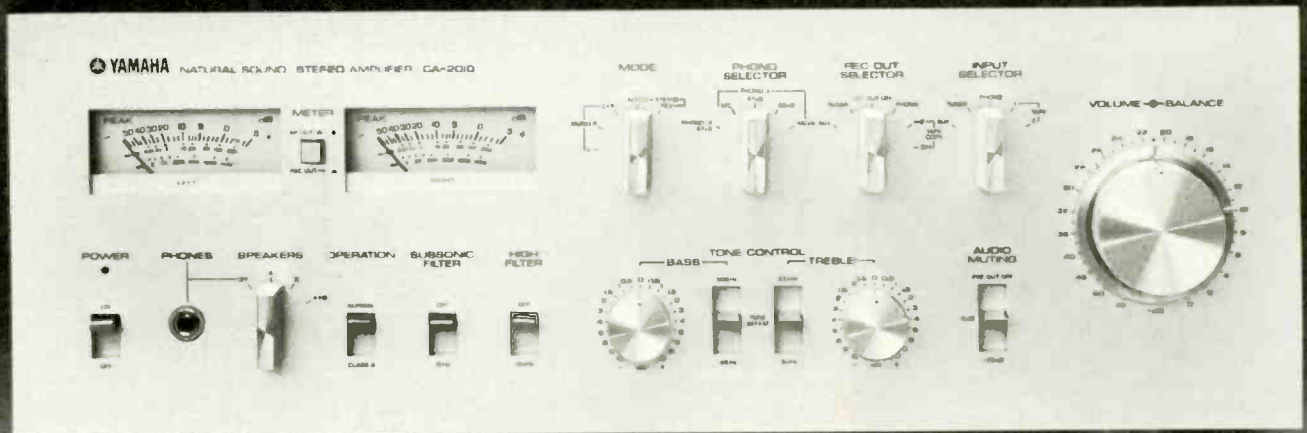

# Backbeat

## Inevitably, Roberta Flack

by Leida Snow

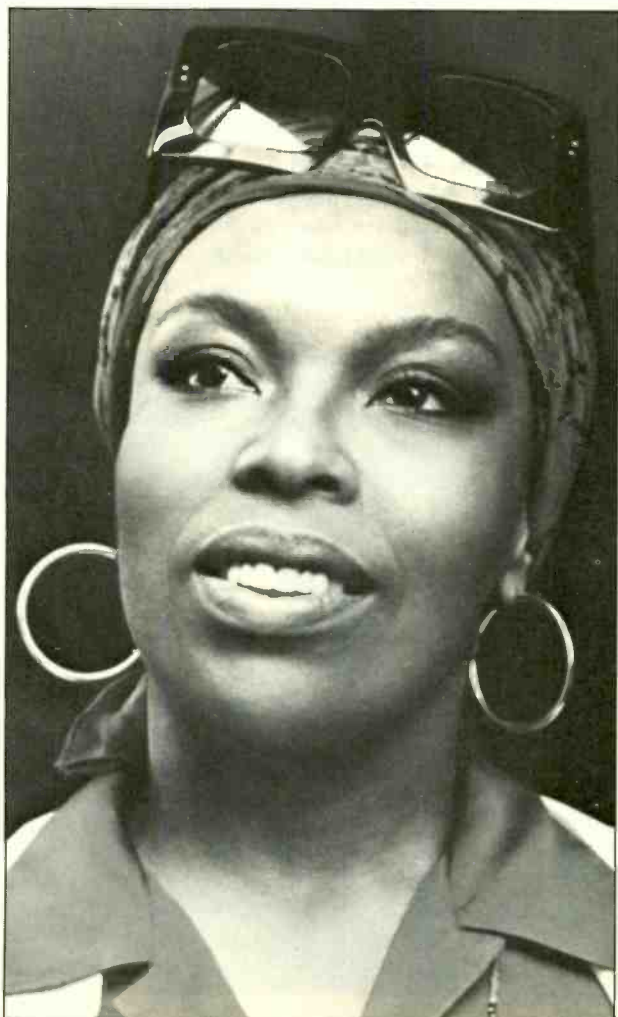

**T**ake yourself back ten or fifteen years. Imagine a young, gifted classical pianist. As a woman in a male-dominated field, what would her chances be? Add to the scales that she's black, and where does that leave her?

It left Roberta Flack taking education courses, because the dean of Howard University told her that to do anything else was unrealistic. "I was devastated," she says. "But once I realized that what he was saying was true, that it simply couldn't happen for me in that field, I knew I had to do something else." It was a long time ago, but the wound has not healed. "Even today the black ones that are allowed in are all of a certain kind. They all have features that are almost Caucasian."

She first put her education courses to use teaching in the segregated, backward town of Farmville, North Carolina. She was supposed to be teaching music, but her students couldn't read, so she taught them English as well. She continued her own musical education, practicing many hours a day with no particular goal in sight—no star trip, no plans to land a recording contract—just a simple need to hone her craft.

We're drinking apple tea and honey in Roberta's apartment on Manhattan's Upper West Side. "Gracious" is the first word that comes to mind. It's cream-colored and glass and glove-leather with green, luxurious plants. The living room is dominated by a nine-foot, six-inch Bösendorfer concert grand. Ro-

---

*Leida Snow's lyrics have been recorded by Nancy Wilson and Jane Olivor, among others. She is the author of several books, and an on-air personality on WPIX-FM in New York.*

berta explains that the Bösendorfer is the Rolls Royce of pianos—these particular models are all made by hand and sell for about \$45,000. Hers was a gift from her label, Atlantic records, on the occasion of the signing of her second contract. The wall opposite the piano is totally mirrored, so the room seems filled with it. But not crowded. Gracious.

And a long way from her beginnings. She grew up in Arlington, Virginia, where she shared a two-bedroom basement apartment with her parents, two sis-

---

**“‘The First Time Ever I Saw Your Face’ was originally done in three-part harmony by her students.”**

---

ters, one brother, one grandmother, and her aunt and uncle. How did she come to sing? Well, as she reminds the listener, music plays a large part in the black community. But unlike the gospel shouting that was going on at the Baptist church down the block, Roberta's experience was in the Negro spiritual, since that was what was sung at her local African Methodist Episcopal (AME) Zion Church. It was also there that she got her first real job at the age of thirteen—accompanying the choir for \$4.00 per month. (“That was a lot of money for a thirteen-year-old then.”) And she listened “to anything that sounded good”—from Patti Page, Jo Stafford, and Lillian Green to the Coasters, Ray Charles, Ma Rainey, Nat King Cole, Bessie Smith, Billie Holiday, and Mahalia Jackson.

Roberta is acutely conscious of her black heritage. Part of this comes from her upbringing, but perhaps an even larger part comes from her teaching experiences. Of her year in Farmville she has said, “I wanted to give them so much. They’d never sung four-part harmony before. . . . And the kids loved it. [Parenthetically, she talks about how *The First Time Ever I Saw Your Face* was originally done in three-part harmony by her students.] They’d come to a rehearsal after picking tobacco all day when they couldn’t even come to school.”

She has often given black musicians their first crack at important arranging or producing assignments. Witness Leon Pendarvis’ work on her album of three years back, “Feel like Makin’ Love.” That was his first arranging job for anyone “big.” Ralph MacDonald was in her band for two years before she found out he wrote songs of the quality of *Where Is the Love*. Despite opposition from those around her, she insisted on recording it, and it later won a Grammy award.

Others she’s helped include Eric Gale, Richard Tee, and Patti Austin (one of Roberta’s backup singers on the road). Roberta says that she gave each of her backup singers a solo spot, and that Patti consistently got rave reviews. Helping talented blacks has become almost a “cause,” since, she says, black people don’t help each other enough. They “seem to be their own worst enemies. They’re jealous of their own success, and they seem to pull each other down.” She is

quick to point out that her own first career breakthrough came from black comedian Bill Cosby. His choosing her as a featured guest on his *Third Bill Cosby Special* in 1970 was a milestone, she says, be-

---

**“Black people don’t help each other enough. They seem to be their own worst enemies.”**

---

cause she was black. (Although Roberta mentions such things again and again, they don’t grate on the listener. She states them simply, as facts, without sermonizing.)

She talks about Henry Yaffe, who heard her sing and eventually brought her to his place in Washington, D.C., Mr. Henry’s Upstairs. Wait a minute, where did he hear her sing? Oh, yes. In 1962, after the year in North Carolina, she moved to D.C. and taught in various parts of the city for the next six years. In the evenings she would accompany various singers at the Tivoli Club until 2 a.m. Between sets, she and a growing group of fans would head for the back room where Roberta would sing and play blues, folk, and pop standards on the old upright. It was there that Yaffe found her.

Her time at Mr. Henry’s has become legend. Musicians would stop by and jam with her after their own shows or on their nights off. “It was all so pure,” she says now. There was none of the worry about lights or fancy arrangements. “You know, sometimes I’d sing *First Time Ever* in each set. I’d come in, maybe hoarse from the night before, and I’d do it in a lower key the first set. Usually the same people would come night after night, and they’d see how the song would change and grow. And I could take risks and try things. They’d know that if I wasn’t perfect, that wasn’t what the experience was about. That to me is pure music.”



*The author and her subject*



Roberta—"everybody has that little quiet place"

In the summer of 1968, Roberta performed a concert at Tony Taylor's Bohemian Caverns for the benefit of the Inner City Ghetto Children's Library Fund. Atlantic jazz singer Les McCann was in the audience and, after expressing disbelief that she didn't already have a recording contract, arranged for an audition with his label. "I was so naive," she says, "so trusting. I signed with Atlantic without ever meeting anyone from the company. It was all done because of Les and through Les."

Her first album, released in 1969, was called "First Take." And, indeed, almost all of the tracks were first takes. "I didn't know any better so I just went in and recorded. But those songs were a part of me so it worked." It was as if the listener had stopped by one evening at Mr. Henry's. "There was very little of the overdubbing and fixing and perfecting that usually goes on," she continues. "What are most of today's records? They're *perfect*. And why are they perfect? Because you have a little bit from this take and a little from that one, and it's all businesslike and cold and dead. That first album was pure."

Other albums followed, each more "professional," each further away from what she keeps calling her "pure" approach. But it's hard to knock success: "Chapter Two" (1970) bore two chart singles in *Reverend Lee* and *Do What You Gotta Do*. In 1971 Atlantic released the "Soul to Soul" album, which featured Roberta, Wilson Pickett, the Staples, Ike & Tina Turner, and the Voices of East Harlem in live performance at a festival in Ghana. Later that year her third solo effort, "Quiet Fire," yielded only one single, *Will You Still Love Me Tomorrow*.

Then in 1972 she hit the jackpot. The Clint East-

wood movie, *Play Misty for Me*, featured her recording of *The First Time Ever I Saw Your Face* from her first album. The film was a box-office success. Atlantic rush-released the record as a single, and seven weeks later it went to No. 1 on the charts. It was the usual story: An artist who already had several albums out and more than ten years behind her as a performer was nonetheless deemed by the press an "overnight success." *First Time Ever* went gold, as did "First Take" and "Quiet Fire." Her luck continued as *Where Is the Love*, recorded with Donny Hathaway, climbed to the top of the charts and went gold, and *Down Beat* named her the year's Top Female Vocalist. Six months later she cleaned up at the fifteenth annual Grammy Awards. *First Time Ever* was named Record of the Year for Roberta and Song of the Year for writer Ewan MacColl, and *Where Is the Love* Best Pop Vocal by a Duo. Meanwhile her latest single, *Killing Me Softly with His Song* was on its way to No. 1 on both the pop and r&b charts.

"There have been a lot of stories about *Killing Me Softly*," says Roberta, "but here's what happened with it. I heard that beautiful song on the plane when I was flying from Los Angeles to New York, and it was being sung by Lori Lieberman. And to tell you the truth, my ego got involved because, for me, that song wasn't 'finished.' What I mean is, sometimes a song will be done by a Streisand or someone like that, and I simply feel that there's no need for me to do it. It's not a matter of one artist being better than another. It's only that when something has really been *done*, there's nothing you can do—no matter how great you are yourself—to improve on it. But this song was not finished.

"By the time I got to New York, I knew I had to do that song, and I knew I'd be able to add something to it. And my classical background made it possible for me to try a number of things with it. I wasn't just limited to taking the song off the page. That little thing that I do in the middle [here she hums softly] . . . that's all mine. That doesn't exist anywhere in the original music. And I changed parts of the chord structure. Now I don't mean that I sat down and mechanically made these changes. . . . I just knew what to do—instinctively.

"You know, popular music almost requires that you add your own little things. Many black singers do

---

**"There are some awfully talented women engineers and producers who just don't get the opportunities they should."**

---

this by embellishing the melody, but my background lets me do more than that. And I also chose to end that song on a major chord. It wasn't written that way."

The "Killing Me Softly" album was certified gold within two weeks of its release in 1973, and it remained on the pop, r&b, and jazz charts for 37 weeks. It also won three Grammys for Record of the Year, Song of the Year (Norman Gimbel-Charles Fox), and Best Pop Vocal by a Female. The icing on the cake was

the success of *Feel like Makin' Love* (by Eugene McDaniels), which bulleted up the charts late in 1974 to become Roberta's eighth million-seller in the period of less than two and a half years since the reissue of *First Time Ever*.

With each successive album, Roberta has become more and more involved as a producer. "There's no way that a person with musical background could not be considered a producer of her own album," she says. "Anybody else is your coproducer. The most important part of any production is the material and how it's chosen and arranged and performed. Paul Simon, Stevie Wonder, and others like them . . . they're very much involved in the production of their records. And so am I. We don't need somebody pouring us into some mold and telling us what and how we should sing. That's a different kind of record—it's so unartistic and so uninvolved. It may be beautiful and become a big hit, but it's not a genuine reflection of what the artist can do. I can't give that responsibility to someone else. I am totally immersed in the thing from the time I go in until it's over. So I produce it—with technical, creative, and artistic assistance.

"But you know, in the recording business, as in most businesses, the acceptance of the fact that women can produce and do so successfully is something we're going to have to struggle for. And it's really sad because there are some awfully talented women engineers and producers, and they just don't get the opportunities they should."

For her next album she wants to rehearse with the musicians outside of the studio first and then, when everyone is comfortable with the material, go in and just record a few whole takes live. She wants to simplify. All but one cut from "First Take" was laid down in nine hours of actual recording (ten hours more were spent on *First Time Ever*), and she wants to return to what she was able to bring to that LP.

---

### "It's not art, the record business. Music is art, but the business is the business."

---

Then why did her last two releases, "Feel like Makin' Love" (1975) and the current "Blue Lights in the Basement," take so long to finish? "We ran into all kinds of problems," she says. Producer Joel Dorn, who had worked on all of her albums through "Killing Me Softly," decided to leave when Roberta brought in Gene McDaniels to coproduce "Feel like Makin' Love." "I was deeply hurt when Joel left. But I suppose that Gene getting something meant that Joel would be getting less." Unfortunately Gene wanted more and more control, so he too left the project, leaving Roberta to produce most of it (crediting herself as "Rubina Flake" on the LP's liner notes) with Pendarvis.

"You know," she continues. "I was just trying to help these black musicians. I just wanted to give them a shot. And when I had to do it all myself, I made a lot

of mistakes. It was a very hard time for me. There were days when I just cried and cried. But you press on. You press on."

"Blue Lights," which lists Ahmet Ertegun as executive producer and Rubina Flake as one of three additional producers, was in the works for three years before its release last December. No explanation was forthcoming for this, other than her own perfectionism as both a producer and performer. In any case, the wait was worth it. Just last week the LP went gold and jumped into the Top 20 winners circle on *Billboard's* charts. Another banner year in the works? Another clean sweep at the Grammys? She doesn't seem too concerned about that—she's already planning her next album. She gets more animated as she talks about a song for it called *Goodbye*, which is off the \$50 Stuart Scharf "Disguises" album (HF, November 1976: "50 Bucks for a Stuart *Who* Record?"). According to Roberta, Scharf didn't want to get mixed up in the business of the record business when he made his own album, so he got some friends to help him out and produced and distributed it himself. "It's not art, the record business," Roberta says. "It's just that: a business. Music is art, but the business is the business."

The Scharf album has become something of a collector's item, with many recognizable names on it. Roberta Flack, of course. And musicians such as Eric Weissberg, Ralph MacDonald, Bernard Purdie, and violinist Anahid Ajemian. As Roberta puts it on the turntable she marvels at the way the Jewish Scharf has captured the black idiom and chuckles at how white singer Lesley Miller sounds black and black singer Maeretha Stewart sounds white.

Will she write something for her new album? The question seems to put her on the spot. She does feel that her own writing talents will have to be tested someday, "but how can I write lyrics when there are people around like Stuart who write so beautifully?" I remind her that she doesn't have to do it all—she *can* find a collaborator. She is silent for a moment and then asks me if I would put words to a song of hers. Knowing that she could choose anyone she wanted to write with, I am terribly moved. I feel very close to her, as though I've known her for years.

Incredibly, it is almost dark outside. We've been talking for hours, but Roberta says she wants to be sure every question has been answered.

What about the fact that the songs most closely associated with her seem to run counter to the orgasmic "hit" formulas? "Everybody has that little quiet place," she says. "and I think that is probably my forte when it comes to performing popular music. And I think it's a blessing. Because there's a need for people to be able to play music that is haunting and beautiful and addresses itself to that little space. And I am most in tune as an artist with that kind of song."

And what about her aborted classical career? Any regrets? An emphatic but quiet "No." And in her explanation what comes through is a conviction: Somewhere, some kind of power must have had a better plan for her than she had for herself. Because in looking back, it all seems so inevitable now. ●

## Harry Fox and the RIAA: Watchdogs of the Record Industry

by Harvey Rachlin

In February's "InSights" story we traced the intricate channels through which your record-buying dollar flows to reach the artist, producer, songwriter, record company, publisher, and so on. The processes involved are not automatic—far from it—and two organizations, the Harry Fox Agency and the Recording Industry Association of America (RIAA), exist for the purpose of keeping these interlocking components operating smoothly. Simply stated, Harry Fox protects the industry from internal dissension by overseeing the relationship between the record companies and music publishers. The RIAA, on the other hand, looks after the interests of the recording industry as a whole by certifying units sold when awarding gold and platinum status, keeping an eye on pirates, bootleggers, and counterfeiters, and acting in many other ways for the general protection and advancement of its fifty-two member labels.

Harry Fox handles mechanical-rights licensing for 3,500 music publishers—75 per cent of those in the U.S. A mechanical right is the right to reproduce a copyrighted work (in this case an owned piece of music) mechanically—on phonograph records, tapes, or any other electrical transcriptions for broadcast or public consumption. Do not confuse a mechanical right with a performance right, which is the right to publicly perform a copyrighted work—either live or over the air waves—and is generally monitored by ASCAP, BMI, or SESAC. When a label wants to record, press, or distribute a song owned by one of Fox's member publishers, Fox will issue it a mechanical agreement or license to record. The agency will also collect royalties as they accrue on behalf of the publisher and periodically audit the record company's books to be sure that the publisher is paid fairly.

*Harvey Rachlin is the author of The Songwriter's Handbook, which was reviewed in these pages in March.*

Since mechanical reproduction is not limited to the record industry, Fox is also involved similarly with film, television, and video tape. In fact, it was initially created in 1927 by the National Music Publishers Association (NMPA) to license music synchronization rights to a young motion-picture industry just beginning to incorporate sound onto film.

Fox, a nonprofit corporation, draws a current commission of 3 per cent on the gross mechanical income it collects. Annual collections average in excess of \$50 million and pay for nearly all of NMPA's overhead expenses. (The agency is a wholly owned corporate subsidiary of NMPA.) Fox's licenses state that record manufacturers must pay whatever royalty has been specified (usually 2¾ cents per song as of January 1) on a quarterly basis, 45 days after the close of each quarter. What happens when they don't? Howard Balsam, assistant to president Albert Berman, claims this usually occurs because the label doesn't understand its obligations or because it "is in financial difficulty." Since lawsuits abound in the music industry, I asked him why one doesn't often hear about publishers suing record companies for royalties past due. His reply was that the vast majority of situations are settled before they ever get to court.

Record companies are audited every two years. The audits are conducted by Prager and Fenton, an independent accounting firm, and they are always scheduled in advance—no surprises. Do labels ever "adjust" their books in light of this? "Record companies conduct themselves in a businesslike manner," says Balsam. "It wouldn't be worth their time and trouble. Some record companies quite frankly welcome our audits because it helps them to straighten out certain situations they might not have been aware of. It is a routine, very objective process. We're not like the Internal Revenue Service."

Can a publisher request an independent audit of a specific label? "We audit record manufacturers on



*Howard Balsam of the Harry Fox Agency*

behalf of all publishers whose material is being used by that manufacturer," says Balsam. "We do, however, alert our auditors to be on the lookout for specific situations a publisher may bring to our attention." Can a publisher hire his own auditor if he is not satisfied with Fox's results? "I doubt the record company would permit this," says Balsam. "once Fox completed its audit."

Most of the publishers I spoke with are satisfied with the agency's services. One that is not affiliated with HFA, or any other mechanical-rights organization, is Dick James Music, Inc., whose catalog includes tunes by Elton John, the Beatles, and the Hollies. General manager Arthur Braun believes that the advantage is in being able to do their own audits. "We want to carry on the true tradition of the independent publisher," he says. "So we do our own auditing, licensing, copyrighting, administration, etc. Everybody here has dual functions. For instance, our accountant is also involved with administration."

### **"Harry Fox handles mechanical-rights licensing for 3,500 music publishers."**

In essence, Fox acts as an impartial clearing house, balancing the books and keeping the peace between two of the music industry's most vital components: the publisher/songwriter and the record label. You simply can't have one without the other, and Fox helps to keep the relationship on the up and up, and consequently healthy.

The functions of the Recording Industry Association of America are more complex and varied than those of Fox. Essentially a trade organization, it was founded in 1952 to provide a collective voice in Washington for a rapidly growing yet loosely organized recording industry. Today, the RIAA is probably best known for certifying units sold and awarding gold and platinum single and LP status. ("Gold" signifies one million units sold in the case of a single and a half million in the case of an album. "Platinum," granted to recordings released on or after January 1, 1976, applies to singles that have sold 2 million units and albums that have sold 1 million.) Executive director Henry Brief points out that it is quite an achievement for a record to attain either status "when you consider there are about 10,000 new recordings released each year. In 1977 we certified a total of 238 out of the 10,000. It is a rather elite group." (Certification comes

as a result of a sales-figure audit conducted by the RIAA through an independent accounting firm. Both member and non-member labels may request the audit.)

Still recognized in Washington as the record industry's legitimate representative, the RIAA was extremely active during the recent copyright law revisions. Its intensive—and expensive—lobbying to keep the lid on the mechanical royalty rate (raised from 2 to 2¾ cents per song) proved quite to the benefit of its member labels. [In fairness, we must add that this works to the detriment of publishers and songwriters.] And, since record companies rely extensively on the mails, the RIAA has a special postal committee that works with the Postal Service on postage rates. Other functions include sitting in on industry negotiations between unions and label management, sponsoring joint audits of foreign licensees, and perhaps most important, mounting a vigorous antipiracy battle. We'll get to that later.

Label members pay annual dues ranging from \$50 to hundreds of thousands of dollars, depending on their annual sales volumes. (If the latter sounds high, consider that industry sales in 1976 were \$2.74 billion.) According to Brief, RIAA-member companies manufacture 90 per cent of all U.S. recordings. The only major label that is not a member is Motown. Michael Lushka, Motown's executive vice president of marketing, says that it is simply "company policy not to belong to RIAA."

One of the RIAA's favorite activities is conducting industry-wide surveys. A few years ago it commissioned the Cambridge Research Institute in Cambridge, Massachusetts, to do a study of the record industry based on 1965–74 sales. Some of the findings would depress any hopeful musician. In 1972 an average sale of 46,000 copies of one single was required if the company was to break even on its initial investment. Yet 81 per cent of all singles released in 1972 failed to reach that point. The break-even average for an LP was 61,000; 77 per cent of all albums failed to reach it. For classical albums, 22,000 was the break-even point, and 95 per cent did not make it.

With the stakes so high, record companies are reluctant to forfeit dollars to the many illegal sales out-



*Henry Brief, RIAA's executive director*

lets commonly referred to as pirates, bootleggers, and counterfeiters. Pirating is the unauthorized reproduction and selling of legitimate recordings—a pirated recording will have either no label or logo at all or will carry one of the pirate's own devising. Bootlegging is the unauthorized taping of a performance, live or over the air, and counterfeiting is identical to pirating, with one significant exception: The graphics, logo, etc., are duplicated with the intent of palming the product off as the real McCoy.

According to another of those RIAA surveys, in 1972 piracy—which for our purposes will include all three categories—drained \$250 million in revenue from the industry. In that same fateful year, one pirated tape was sold for every two legitimate 8-track, cassette, or open-reel tapes. Which is not to say that pirates aren't almost as crafty when it comes to vinyl: Today, an estimated 15 per cent of all pirated product is in disc form. Part of the blame for this enormous rip-off lies in the astonishing fact that until 1972 there was no federal protection against piracy. And the audio field's rapid technological advances and the growing popularity of prerecorded tapes weren't helping the situation. "That technological boom," Brief says emphatically, "proved to be our bane because it made piracy easier. So much easier than the unauthorized duplication of phonograph records that in desperation we finally went clamoring to the Congress in 1971 and said, 'Hey, if you guys sit around and wait for an omnibus revision bill to be enacted before you include a copyright in sound recordings, we may finally get protection when there's no industry left to protect!'"

**"The RIAA is probably best known for awarding gold and platinum single and LP status.**

State governments were slow to act as well. (Today's state laws are still the only protection for recordings made before 1972.) Until the late Sixties, the only recourse a record company had was to bring the pirate to court in civil litigation, charging unfair competition. "Penalties were minimal," says Brief, "and assuming you did obtain an injunction against a pirate—after spending months and months trying to uncover his operation—all he did was move across the state line where he was no longer under the jurisdiction of the court that issued the injunction. And then he would start his operations all over again. So it was a matter of chasing the pirate from state to state." New York, the first to declare piracy a criminal offense, didn't do it until 1967. Since then, every state, with the exception of Vermont and Wyoming, has followed suit. But you can't take your 1957 Buddy Holly record out to Wyoming and legally duplicate and distribute it. MCA, his label, would sue you and win hands down on the basis of unfair competition.

*Helping the RIAA in the fight against piracy: the FBI, U.S. Customs, state and local police*



**"In 1972 piracy drained \$250 million in revenue from the industry."**

That is, if MCA could find you. One of the reasons piracy remains a problem despite the new state and federal legislation is that pirates are undercover experts. For example, a good deal of piracy is attributable to inside jobs. Stories abound about label executives and studio personnel "leasing" master tapes or selling huge quantities of promotional albums. One tale recounts how an employee of a major label brought down shopping baskets full of promotional albums from the company's high-rise offices to a waiting vehicle on the street, which promptly delivered the merchandise to a Harlem emporium. According to a recent issue of *Billboard* magazine, an employee theft ring uncovered at Springboard Records in New Jersey had systematically stolen several hundred thousand dollars worth of albums from the label's warehouse over the past three years.

Jules Yarnell, who heads RIAA's Antipiracy Intelligence Bureau, says the Mafia is also an active participant: "Elements of organized crime are deeply involved directly or indirectly through covert financing and providing of protection." In 1973, Tommy (Ryan) Eboli, a key figure in the Genovese Mafia family, was murdered in Brooklyn. New York's Organized Crime Control Bureau discovered that he had been on the payroll of a piracy operation in Paterson New Jersey—general manager, earning \$1,000 a week. Yarnell's Antipiracy Bureau maintains a full-time staff of undercover agents who work closely with the FBI, state and local police, the Department of Justice, U.S. Customs, and IRS Intelligence. And not without success—Yarnell says the \$250 million loss to pirates in 1972 has been cut in half.

Although the interests served by the RIAA would seem to be quite different from those served by the Fox agency, both, in governing fair industry practices, work with the goal of maintaining a healthy recording industry. With sales figures like \$2.74 billion it would seem that their *raison d'être* is justified.



# The 1978 NAMM Western Market Convention

by Fred Miller

The National Association of Music Merchandisers holds two conventions every year in major U.S. cities, with the basic purpose of bringing musical instrument manufacturers and dealers together and introducing new products to the general trade and the press. The most recent one, geared to and titled the Western Market, was held in late January at the Disneyland convention complex in Anaheim, California. Compared to both of last year's (one in Anaheim, and one—for the national market—in Atlanta), this one was relatively light on innovation and new products. Still, there were enough goodies to make it a musician's dream.

For starters, this will apparently be the year of the guitar synthesizer. Instrument manufacturers are making increasing use of electronics. In fact, integrated circuitry, microprocessors, and the like have revolutionized the trade. One can recall just a few years ago when browsing through a music store meant looking at drums, guitars, and a display case full of band instruments. Today's dealer stocks and instructs potential buyers in the uses of synthesizers, ring modulators, electronic drums, PA systems, microphones, speakers, recording equipment, and a host of related items.

Walking around the vast convention floor I saw guitar synthesizers from Arp and Selmer, the Synare and Syndrum drum synthesizers from Star Instruments and Pollard Industries, respectively, and Moog, Arp, Cat, Korg, Roland, and Multivox keyboard synthesizers—to name a few. There were electronic grand pianos from Helpinstill and Yamaha, digital delays from Ibanez, Electro-Harmonix, Morley, and MXR, and enough footswitch-controlled signal-processing devices to keep every foot in a National Guard battalion stomping for days.

Some of the keyboards were strictly acoustic, some acoustic and electric, some completely electric or electronic—and some played themselves. How about an electric player piano? Or an organ that can be programmed (via a built-in sequencer module) to play all the inner voices of a Bach fugue? How about a stage amplifier the size of two shoeboxes that sounds about five times its size?

Traditional instruments were also well represented: oboes and saxes from Lin-

ton and Conn, acoustic guitars from Norlin, electric basses and Mexican *guitarrones* from Guild, acoustic drums from Ludwig, Sonor, and Tama, among others. Altogether, 222 exhibitors were represented at the NAMM Western Market, including sheet music publishers, guitar strap manufacturers, road case builders, magazine publishers, and even one or two finance companies—just in case there were a few dozen items you had to have right then.

Among the relatively few technically "new" developments, Arp Instruments had redesigned its entire line of synthesizers, with simplified block diagrams on the Omni, for instance. Musitronics, makers of the Mu-Tron, introduced the Gizmo, a kind of bowing device for electric guitars. Norlin has a new, beautiful sounding snare drum for its Pearl Drums line. It incorporates the new Vari-Pitch

tuning system, which allows simple re-tuning of the drum for different styles of play. Pollard Industries demonstrated the Syndrum at a press conference with the help of an extremely talented seven-foot robot. Star Instruments showed off its new Synare 3, a round, drum-shaped synthesizer that can be made to sound amazingly like a bass drum, tom tom, or snare drum. The demonstration had five model 3s hooked up to form a totally synthetic drum kit. Arp's Avatar guitar synthesizer, like a similar unit from Selmer, allows the player to control virtually any synthesizer on the market today. Nasty Cordless displayed its new wireless transmitter, which eliminates the need for a cable between instrument and amplifier. Barcus Berry was on hand to introduce new expanded PA mixers and to continue familiarizing dealers with the Audioplate, a highly unconventional high-frequency device that disperses sound omnidirectionally.

The NAMM Western Market showed that the musical instrument and accessory business is supporting its expansion with solid marketing expertise, high-quality technology, and some fascinating musical gadgetry that is bound to expand our musical consciousness. And yours too as a BACKBEAT reader. ●



*A pedal steel player in the Sierra booth*

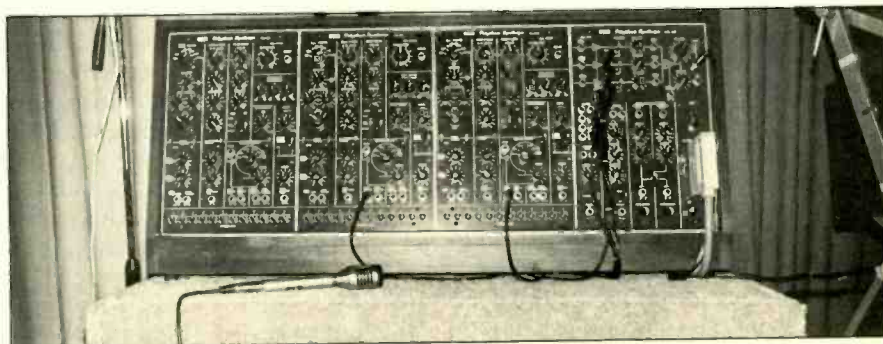

*The Korg 3300 polyphonic synthesizer*



*The Roland Corporation captures the youth market*

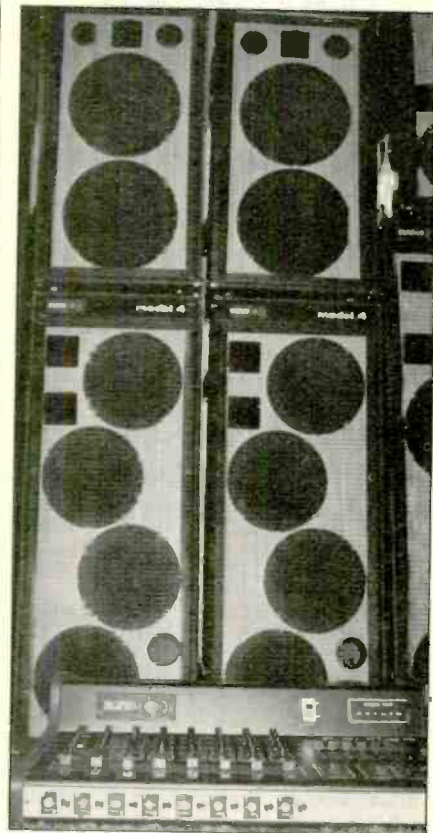

*Amplifiers and mixers from Sunn*

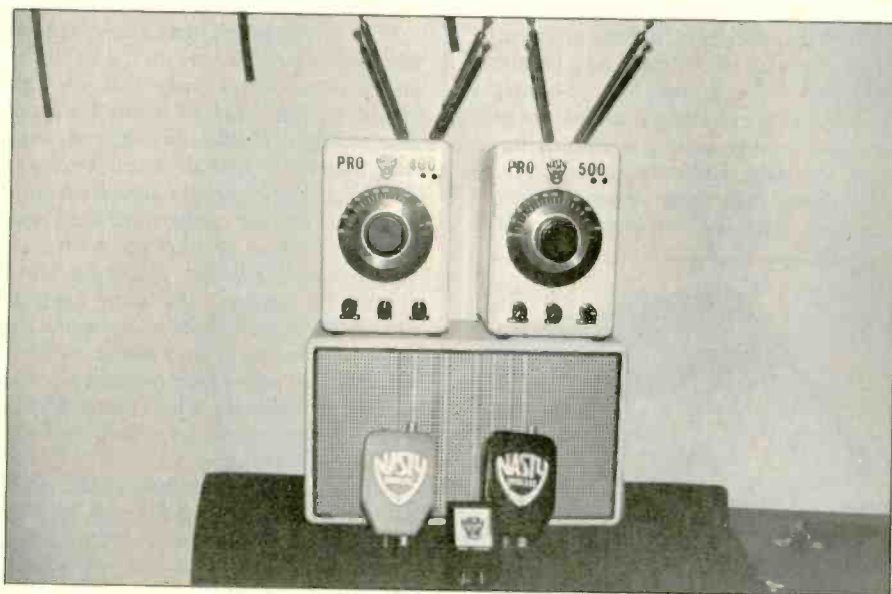

*The Nasty Cordless on display—no strings attached*



*A new drum design that perhaps evolved from the tuba's bell*



*The Stick gets a test run*

# Input Output

Instruments and  
Accessories

## The MC-8 MicroComposer

Synthesizers may not be every musician's cup of tea, and the wide variety of sounds they can produce offsets the fact that they don't create perfect copies of "real" instruments. But for a keyboard player "flutelike" does quite nicely, and for this reason synthesizers have been selling like hot cakes for some time. Their acceptance has spurred manufacturers on, with the result that the equipment has grown steadily more sophisticated and more versatile: Nowadays, if you can play an instrument—any instrument—you can transfer your chops to a synthetic sound.

But suppose you can't. Suppose you are obsessed with the desire to make beautiful music but you are not a keyboard player, guitarist, or percussionist? Don't go away. The Roland Corporation has just gained by one light-year in the musical space race: Their MC-8 MicroComposer will operate your synthesizer for you. Learn to program it, and you will have the technique of a superman. No need to practice for thirty years, just get the MC-8's simplified computer language down pat, load it in, and set the tempo.

When we first heard rumors about this unit we were skeptical. But an afternoon spent working with it at Roland's offices in Los Angeles dispelled our doubts—completely. It does more than we had been told, and does it without any serious restrictions, compromises, or limitations. It is worth the \$4,500 list price and then some. Some comparisons may help prove the point.

There are simpler devices called sequencers that can run your synthesizer, but they are limited in their ability to store long pieces. One for \$850 can play a maximum sequence of 256 notes as long as they are all of the same value. If you want any time variation, the number of notes is reduced and each silence (rest) costs you a position. When used to run a

single synthesizer, the MC-8 will produce 1,200 notes of differing time value, and rests don't count in the total. To say that the MicroComposer is a digital sequencer is a gross understatement: It can store in memory the parameters of synthesizer control for pitch, time, and volume and will play your synthesizer until you are satisfied with what you have. Effectively, this machine is music paper that makes music, complete with pencil and eraser.

And there are helpful little extras such as a provision for duplicating identical sections without complete re-entry, a way to insert extra measures into a piece without erasing what you already have, and extensive computer-style readouts to indicate such things as what measure you are working on and how much



*The Microcomposer—blacksmiths beware*

memory you have left. Tempo is variable without changing pitch, so you can make your piece fit the timing requirements of motion-picture scoring or television commercials. The location of a note within a bar is almost infinitely adjustable, and the unit will program small and extremely subtle timing variations—it doesn't have to play click-click-click. If you like, you can even program it for sloppy play. It can run eight synthesizers at the same time with each playing a different sequence of notes, or four synthesizers playing individual lines with complete dynamic control of each note. And there are sections of the MC-8 that we never even got to see in operation! Additional memory is available; if 1,200 notes impose unwelcome brevity on your mu-

sic, you can have 4,000 more for \$500. Each programmed command uses a few bits of memory, so more sophisticated musical pieces cannot use the full 1,200 notes. But you can expect several minutes' running time, even if your program is complex in its memory requirements. Completed programs can be stored on cassettes with a standard audio recorder and reloaded later—you don't have to lose your masterpiece when you shut the MC-8 down for the day.

If all of this hasn't been enough to get you excited, try this one on for size: The unit will generate a pulse that you can record on one track of a multichannel tape recorder. Throw a switch, and it will read that sync pulse as a reference for overdubs. The computer actually counts measures, so your synthesized horn section plays only in the bars you want it to. With a 4-track recorder you can achieve symphonic density, and with 8-tracks you can synthesize Mahler! Someone capable of reading music could, without the ability to play an instrument, accomplish in an afternoon what it took Walter Carlos a year to do on "Switched-On Bach" ten years ago.

Most musicians seem to consider practice or "apprenticeship through pain" a virtue. But it can be genuinely wasteful, since it is no guarantee that you will be any good. In our opinion, this sequencer/controller that is based on the 8080 microprocessor marks the beginning of a new level of electronic music. Musical talent will still be necessary, but the expenditure of human energy required to gain—and maintain—technical proficiency on an instrument will not. For this reason, this new tool will be the subject of much dissension and discussion. But it cannot be ignored. The situation is similar to the two crazy guys flying powered kites at Kitty Hawk or the appearance of a carriage without a horse pulling it. Blacksmiths beware: Electronic music is by now a solid component of the artistic mainstream, but with gadgets like the Roland MicroComposer, it may become *the* mainstream.

DICK ROSMINI

CIRCLE 121 ON READER-SERVICE CARD

# Records

KEN EMERSON      JOHN STORM ROBERTS  
 TODD EVERETT      SAM SUTHERLAND  
 TOBY GOLDSTEIN      NICK TOSCHES  
 SAM GRAHAM      KEN TUCKER  
 DON HECKMAN      JOHN S. WILSON

**Blondie: Plastic Letters.** Richard Gottehrer, producer. *Chrysalis CHR 1166*, \$7.98. *Tape: ■■ CCH 1166, ●● 8CH 1166*, \$7.98.

The bubblegum superficiality charges leveled against its debut album have led Blondie to struggle against a "nostalgia band" image, and the results of that struggle are all too clear in "Plastic Letters." If the first record's melodies were easily singable, the bulk of tunes on this disc are no picnic for vocalist Debbie Harry to get through, never mind a listener who might like to hum along. If the band earlier raised doubts that it was capable of complex instrumentation, it here dispels that impression, substituting technical ability for emotional appeal.

Blondie appears to be without proper guidance. It has swung like a pendulum from oversimplified to ponderously advanced, while its best work from both albums hovers on middle ground. That center point is almost achieved on this LP's first side, but unfortunately the band's genuine cleverness is best exhibited by a cover version of the early '60s hit, *Denise*. Ms. Harry flips the song's gender and sings in French to her Gallic boyfriend, "Denis." Its soft focus shines



Deborah Harry—fighting the bubblegum

in marked contrast to the leaden political overtones of much of "Plastic Letters."

This album is definitely meant to imply some kind of radical politic: The front cover displays the members sprawled about a police car, the back shows their slightly scruffy portraits. But as the band rushed to run away from terminal cuteness, it didn't give enough thought to the requirements of overtly social-minded composition. It has enlarged the scope of performance, and both Chris Stein's lead guitar and the multi-keyboards of James Destri pack skillful little leads into the appropriately edgy *Youth Nabbed as Sniper* and the deceptively smooth *Bermuda Triangle Blues (Flight 45)*.

However, while Debbie Harry's limited range was sufficient to fit a pop image, it seems incapable of fielding songs with musical layering or detailed story lines. *Contact in Red Square*, which describes a hasty meeting between two agents, is well written and played with the nervous fury it demands, but the band falls all over itself trying to get the harmonies right. Similarly, when Ms. Harry sings *No Imagination*, the dead tone of her lead may fit the song's mood, but the audience just isn't going to bother suffering through that kind of dullness. There has got to be some way for Blondie to blend its pop writing strengths, instrumental expansion, and even vocal limitations into a genuine music. Both the surface pleasure of the first album and the plastic feelings of "Plastic Letters" only take them part way to that goal. T.G.

**Joe Ely: Honky Tonk Masquerade.** Chip Young, producer. *MCA 2333*, \$6.98. *Tape: ■■ MCAC 2333, ●● MCAT 2333*, \$7.98.

It's good that there are at least a few young men making country music who are neither tortured troubadours manqué nor homunculi born of some mystical union of Edith Sitwell and Kris Kristofferson. Joe Ely is one of the few.

This second Ely album, far better than the first, is almost all that country music, or, for that matter, any music, should be: poetry with hot licks. Although he still

cannot sing as powerfully as barroom masters such as Delbert McClinton, Ely is one of the finest songwriters in Texas. In *Because of the Wind*, he turns lines that are no less pretty than they are cruel: "She is to me like the breeze that blows from Corpus Christi." Dante never spoke truer of Beatrice. *Honky Tonk Masquerade* is one of the rare neon



Joe Ely—poetry with hot licks

weepers that transcends the usual droll clichés. *I'll Be Your Fool* is a very happy, very drunken portrait of poison, love, and masochism. And *Fingernails*—I say this without exaggeration—is simply the best song about fingernails I have heard.

Butch Hancock, a songwriter who was part of the Flatlanders, an old Ely band, is represented here by two unassailable pieces. *Boxcars* and *Jericho (Your Walls Must Come Tumbling Down)*, and a stiff with the indicative title of *West Texas Waltz*. An ultra-raunchy version of Hank Williams' *Honky Tonkin'*, in which every member of the band seems to be fighting against some last call of the soul, ends the album. It's good, too. N.T.

**Robert Gordon with Link Wray: Fresh Fish Special.** Richard Gottehrer & Rob-

ert Gordon, producers. *Private Stock PS 7008, \$7.98. Tape: 5300 7008, 8300 7008, \$7.95.*

Robert Gordon's second album, like his first, consists mostly of cover material from the '50s and '60s sung in an unnervingly sincere operatic croon and immodestly embellished by lead guitarist Link Wray. The single new song on "Fresh Fish Special" is Bruce Springsteen's *Fire*. It was written specifically for this record and fits in smoothly because of its Phil Spectorish cavernousness—yet another rock style is saluted and made to serve Gordon's purposes. But none of the other cuts top their original renditions; it is also worrisome that there is nothing as witty and jolting as the first album's *Red Hot*.

Still, Gordon commands our respect, and his bravery and skill continue to be

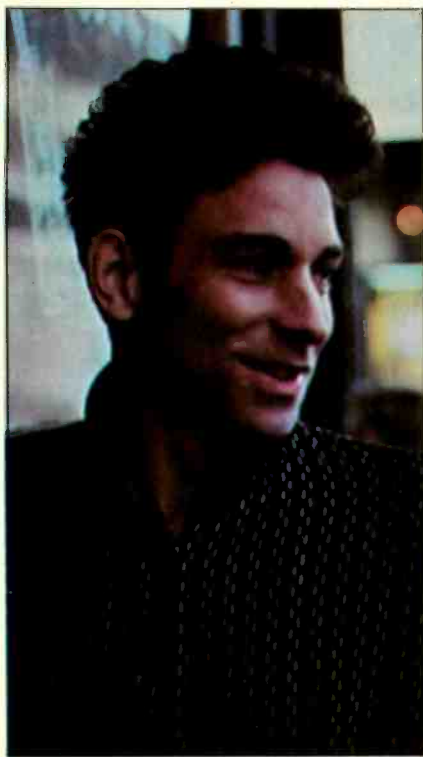

Gordon—almost great

touchingly obvious. He can deliver a macho anthem like *The Way I Walk* without swagger, underlining its pride and energy to bring it into the present. And his throaty earnestness adds spunk and poignance to the banal lament of a Ricky Nelsonish rocker such as *Red Cadillac and a Black Mustache*.

Gordon's band, incited by Link "I coulda been a contender" Wray, is a tight little rockabilly outfit. Wray sounds slightly tame compared to the last album and is confined to curt solos here and there. So everything centers on Gordon's singing, which, unlike all other current New York rockers, lacks that sense of



Little Feat with props—their first live LP is a success

distance: The situations and sentiments of these old songs are his, without modification. Such an attitude often makes him sound naive, but it also gives him an automatic irony that he puts to clever, and occasionally powerful, use. Someday Gordon will strike the right balance between scholar's respect and rebel's passion. When he does, he'll be a first-rate rock & roller.

K.T.

**Little Feat: *Waiting for Columbus*.** Lowell George, producer. *Warner Bros. 2BS 3140, \$9.98. Tape: L5 3140, L8 3140, \$9.98.*

"Waiting for Columbus" is an exuberant affirmation of Little Feat's reputation as a superb live ensemble, as well as an intelligent summary of the band's songs from the past seven years. Either achievement would have been sufficient justification for the release of a double package, but the coherence of performance and material throughout most of the four sides makes the first live Feat album especially impressive. It's a concert recording you can pass along to friends who normally find live rock albums uninteresting. Without superseding the power of the originals, these new concert versions compare favorably with their models.

Until recently, Little Feat's onstage prowess was almost literally legendary. They seldom toured, and generally played smaller clubs when they did. As a consequence, only a segment of their cult-sized following witnessed their transformation from a quirky, song-based rock band into an r&b-paced outfit of sure-footed rhythm arrangements and virtuoso keyboard and guitar work. Since they've graduated to concert halls and arenas, the new album serves as an introduction to their live sound for a sig-

nificant public sector. Not coincidentally, its anthological approach could enlarge that audience further.

The album begins on a typically eccentric note—a loony, a cappella chant (*Join the Band*) that starts almost off-mike as the singers wander onto the stage. Only after the crowd roars in recognition does the band slip effortlessly into the rock-steady syncopation and off-center time signature of *Fat Man in the Bathtub*. It's a funny slice of Latino surrealism frosted by Bill Payne's rich chordal fanfares on Oberheim synthesizer. From that point on, the pace rarely slows until the fourth side, with short pauses between each cut approximating the band's quick reaction time onstage.

Presumably for editorial purposes, most of the songs are presented singly, rather than in the medley format of a live show. On Side 3, however, Little Feat demonstrate their finesse in shifting gears with an extended version of *Dixie Chicken* that slides seamlessly into *Tripe Face Boogie*. This is the latter's third recorded outing, yet Payne's dramatically altered piano- and synthesizer-break quickly explains its inclusion. Together with his polyrhythmic synthesizer runs on the first song, it is the most vivid showcase for his playing to date.

Other highlights include a brisker, stinging *All That You Dream*, the gut-bucket blues whimsy of *A Apolitical Blues* ("Telephone was ringin'/And they told me it was Chairman Mao.../I don't care if it's John Wayne/I don't wanna talk to him now..."), and the shuffling finale, *Feats Don't Fail Me Now*. In producing the set, principal songwriter, guitarist, and singer Lowell George has achieved a stunning balance between the clarity of close-miked, multichannel recording and the excited ambience of the crowd.

s.s.

**Loretta Lynn: Out of My Head and Back in My Bed.** Owen Bradley, producer. MCA 2330, \$6.98. Tape: ●● MCAC 2330, ●● MCAT 2330, \$7.98.

In many ways, only a few of which are good. Loretta Lynn is the essence of modern country music. She is a more than capable singer, but her work is rarely inspired, usually formulaic and trite. To hear her sing would be a pleasure were it not for what she sings.

As with most of her albums and, to be fair, most country albums, the songs here fall into three categories. First the cutesy-poo stuff: *Old Rooster* (celebration of senility), *Black-Eyed Peas and Blue-Eyed Babies* (celebration of mediocrity), and *God Bless the Children* (celebration of penny-dreadful pathos). Next there is the heartache stuff: *Three Rid-*



Loretta—poor puns, silly songs

*dles, The Dead Is a'Risn', and You Snap Your Fingers (And I'm Back in Your Hands)*, all of which seem to strive to bare the soul by drawing extensively upon the literature of poor puns. Then there is the stuff on which Loretta's fame has been built: Those silly, almost-dirty songs enjoyed by truant housewives and men with strange, stiff hair who smile to one another in the cocktail lounges of highway-exit motels as *Out of My Head and Back in My Bed* unfurls its stale metaphors from the jukebox. True devotees of grade-school lewdness will here find (in addition to the title song) *Spring*

*Fever, His Lovin' Told Me He Was Gone, and I'm Gonna Do Somebody Right*, all full of as many hot lines as you'll find on daytime TV.

I know Southern women weren't always like this. William Faulkner would have moved to Jersey City. N.T.

**Manhattans: There's No Good in Goodbye.** Bobby Martin & the Manhattans, producers. Columbia JC 35252, \$7.98. Tape: ●● JCT 35252, ●● JCA 35252, \$7.98.

The Manhattans, quite aptly, refer to their music as "progressive doo-wop." Theirs is street-corner singing done up, if not for the Seventies, at least for the Sixties with glossy but not overbearing orchestrations and more-or-less contemporary material. Still trying to recapture the million-plus impact of *Kiss and Say Goodbye*, they have recorded here a set of ballads in a similar mood, three of them containing the word "goodbye" in their titles. Can't accuse these guys of excess subtlety in their packaging, however inventive their vocal harmonies are!

To their credit, the Manhattans have done a number of songs that were written by neither themselves nor their producer, including *Tomorrow*, from the Broadway hit *Annie*, the vintage country hit *Then You Can Tell Me Goodbye*, and Billy Joel's *Everybody Has a Dream*. Reaching outside for tunes helps counteract the tendency to sameness that results from the general "down" feeling of a set composed exclusively of romantic ballads. Singing throughout is excellent, though again a bit more variety wouldn't have hurt. Why confine such a great bass to narratives (cutting Barry White at his own game along the way) and background harmonies? In the future, the Manhattans might consider placing the boast "no disco" as prominently on their albums as Queen used to brag "no synthesizers" on theirs. Talent beats trendiness every time. T.E.



Martyn—the artist triumphs

**John Martyn: One World.** Chris Blackwell, producer. Island ILPS 9492, \$7.98. Tape: ●● ZC1 9492, ●● Y81 9492, \$7.98.

Were his career masterminded by the most calculating star-maker, John Martyn would still seem a dark horse for popular success. As a precocious Glasgow folksinger, Martyn relocated to London in the mid-'60s. Shortly thereafter, his sweet tenor was overtaken by a husky quality whose fevered attack subordinated verbal clarity to the more elemental view of voice as pure instrument. Likewise, his clean fingerpicking blossomed into an eclectic fusion of stinging modal folk harmony and jazz and Third World melodic elements. Those changes mirrored his writing, which had left behind the tidy conventions of the narrative ballad to explore his own dualistic passions.

Martyn's historic indifference to the practical wisdom of pop survival is commensurate with his idiosyncratic music. "One World" is his first studio album in



The Manhattans: Sonny, Kenny, Gerry, and Blue

over three years, following a surprising retreat from public attention that struck some observers as suicidal. On the concert circuit abroad, he had just begun to reap the attention long predicted for him, yet he clearly wasn't using conventional standards to measure his success. Perhaps that explains the slow-burning charm of his new album, as well as its probable destiny as yet another neglected Martyn gem.

Not that the new set is his best. Producer Chris Blackwell has taken over after years of Martyn's virtual self-production, and his string arrangements, in several instances, only disperse the effortless intimacy of his subject's voice and guitar. On *Certain Surprise*, the effect is mostly deleterious, transforming an already precariously sentimental love song into little more than a classy movie ballad appropriate for long shots of lovers strolling on a windswept beach. Barry Manilow might kill for such an effect, but in Martyn's work, this kind of sensibility seems out of place.

Ironically, only Martyn's fans are likely to notice such lapses (yet they will doubtless constitute most of this LP's audience). The artist's enduring style ultimately triumphs, and if the songs are of a somewhat narrower range of tempo and dynamics than those of his best collections, they still achieve the narcotic allure of most of his recordings since 1970. *Couldn't Love You More* is an archetypal Martyn love song, punctuated with elegantly expressive pauses that say more than the lyrics, while *Dancing* taps a lightly whirling momentum driven by his delicate electric guitar lines and the softer edge of his upper vocal range. Elsewhere, on *Small Hours* and *Dealer*, his impressionistic guitar playing ranges from hovering, nearly static tonal clusters to the turbulent percussive pulse he achieves through Echoplexing. s.s.

**Santa Esmeralda 2: The House of the Rising Sun.** Nicolas Skorsky & Jean Manuel de Scarano, producers. *Casa-blanca* NBLP 7088, \$7.98. *Tape:* ●● NBLP5 7088, ●● NBLP8 7088, \$7.98.

Recordings by groups that lurk anonymously behind communal titles are immediately subject to suspicion: Many are yet another bland piece of funk created by yet the same bunch of sessionmen. Such was my prejudice when I approached Santa Esmeralda 2, which nonetheless won me over in about two shakes of a gypsy's tale.

The first side claims to contain two numbers—that fine old slice of ham *The House of the Rising Sun* and *Quasimodo Suite*—but they run into each other and share a magnificently compulsive hook. Together they amount to fifteen minutes



Steeleye Span—among their best, perhaps their last

of no-holds-barred whoopee, complete with flamenco guitar, tearing brass riffs (both Spanish bullring *pasodoble* and r&b), clappin', stompin', pell-mell organ playing, and a shouting vocal by Jimmy Goings. The whole thing is full-blooded and imaginative, with a magnificently manic, if-it's-tasty-heave-it-in-and-give-it-a-stir eclecticism. It's nice to know that disco can still throw off the plastic covers and come out dancing.

The second side is patchier. *Dance You Down Tonight* is a here-we-go-again concoction relieved only by a pretty, pseudo-flamenco acoustic guitar solo, which would have been groovy had it not been used much more effectively on the A side. *Nothing Else Matters* is a standard cheek-to-cheeker sung no better or worse than a zillion such, with an equally standard backing. *Hey! Gip* is another matter: a stomping piece of tear-away soul out of big-city black music's heartland, with a heavy, bluesy vocal and guitar and an abundance of slightly mean joviality. But I suspect your flip still will be pristine when your A side is worn gray. J.S.R.

**Steeleye Span: Storm Force Ten.** Steeleye Span & Mike Thompson, producers. *Chrysalis* CHR 1151, \$7.98. *Tape:* ●● CCH 1151, ●● 8CH 1151, \$7.98.

Steeleye Span recently announced plans to disband following an upcoming tour, but like the sturdy traditional ballads that have been its vehicle, one suspects the sextet's presence will outlast such reports, if only on record. "Storm Force Ten" hardly sounds like a final knell. It marks a reunion for founding members Maddy Prior and Tim Hart with Martin Carthy, a singer, guitarist, and student of traditional English music. Carthy's impact with and on his peers has extended far beyond that of his live and recorded work as a soloist and collaborator.

Together with Ashley Hutchings, who

left Fairport Convention to help launch Steeleye Span, Carthy envisioned the band as the logical culmination of British folk rock—an electric group armed with modern instruments and studio techniques that would play traditional songs. He left after two albums, apparently dissatisfied with the contemporary trappings of that synthesis. But the reshuffled Steeleye Span went on to achieve the broadest commercial acceptance of any act to emerge from London's late '60s electric folk movement.

Given the band's increasing use of rock dynamics and electronic effects, Carthy's return would seem to suggest an attempt to re-emphasize the traditional elements of its founding; the new recordings confirm that. Where the group's more flamboyant rock exercises tended to undercut the atmospheric charm of the material, "Storm Force Ten" restores much of it, making the songs, rather than vocal and instrumental signatures, the central concern. That process is explicitly measured in the subtler instrumental roles taken by guitarist Carthy and concertina player John Kirkpatrick, who replace the departed Bob Johnson (guitar) and Peter Knight (violin). Kirkpatrick's approach is particularly telling, for in lieu of Knight's extroverted solo excursions, he provides a deceptively subdued instrumental voice with piquant, ornamental counter-melodies and haunting chordal textures.

There is also more of a balance in vocal duties. Maddy Prior's ringing voice is still favored, but Carthy and Hart prove at least as vital to Steeleye's stirring harmonies, which is displayed in an a cappella context on *Sweep, Chimney Sweep*. Prior's long experience in duets with Hart (they worked as a duo before forming Steeleye) yields the melodic grandeur of the opening *Awake, Awake*, while *Some Rival* boasts both evocative choral harmonies and restrained instrumental work.

The set's sleepers turn out to be the band's first two experiments with "contemporary" material. *The Wife of the Soldier* and *The Black Freighter*, both with lyrics by Bertolt Brecht. While the latter, a Weill collaboration from *The Threepenny Opera*, is better known. *The Wife of the Soldier* (written with Johnny Scott) fits more seamlessly into the overall Steeleye canon. Rendered as a stately march, the song gradually gathers an abrasive, yet still reined force that foreshadows the wife's final, ironic gift from her campaigning husband—the widow's veil. Steeleye Span here rediscover their personal tradition by breaking from it. One can only hope subsequent solo projects will preserve their traditionally close attention to material. s.s.

**Wha-Koo: Berkshire.** Ferris Ashley, producer. *ABC AA 1043, \$7.98.* Tape: ●● 5 1043AB, ●● 8 1043 AB, \$7.98.

Admirers of early Steely Dan take note: Wha-Koo, now on its second album, plays a densely textured pop/rock that is utterly without guile, but still elliptical and cagey, much in the manner of the Dan's first two albums. Wha-Koo's unsettling viewpoint is provided by chief lyricist Danny Douma, a scratchy-voiced romantic graced with a wryness that is rarely grating. His lyrics are neither witty nor profound: in fact, on songs like *Fat Love* and *Expire on Me* he seems to toss out any old line that fits metrically. But that's okay, because he never abandons the mood of chummy intelligence set by his voice and the rest of the band.

Wha-Koo's melodies are all wiry hooks, with the guitars of Douma and Nick van Maarth supplying a firm bed of rhythm on which Richard Kosinski's

keyboards and a chirpy horn section bounce briskly. "Berkshire" is no masterpiece, but every song on it has a few charms, from the lovely melody of *Mother of Pearl*—with the sort of clean softness that Firefall ought to have had—to the absolutely regal pace and build of *(You're Such a) Fabulous Dancer*. The latter's appeal is compounded by its unutterable silliness—if you happen to catch its lyric. Wha-Koo kingpin Douma isn't Becker or Fagen, and it sounds as if he's not ambitious enough to try to be. But it also sounds like he's capable of creating a lot of peppy, unpretentious hits. K.T.

**Bob Weir: Heaven Help the Fool.** Keith Olsen, producer. *Arista AB 4155, \$7.98.* Tape: ●● ATC 4155, ●● AT 84155, \$7.98.

Jerry Garcia, with his peculiar voice, his nimble guitar, and his very presence, embodies the ethos of the Grateful Dead. But while fellow guitarist/singer Bob Weir has never shared Garcia's image of eccentric, paternal omniscience, his songs (*Sugar Magnolia*, *Truckin'*, the recent *Estimated Prophet*) have regularly been among the Dead's best and most popular. Now, in his second solo album in some six years, Weir has firmly established a presence very much apart from his veteran band.

Under the direction of Keith Olsen, who also produced the Dead's "Terrapin Station," Weir has framed his songs in a setting that is at once full and energetic. There is little hint of the band's loping gait and malleable harmonic approach in tunes like *Bombs Away* and *Heaven Help the Fool*; the strongest feeling here is one of crisp r&b (a Dead influence no doubt, but hardly predominant), fla-

vored with jazz and pop. And while Weir's fine guitar playing is well represented—particularly in a couple of very rare solos—textures tend to be dominated instead by keyboards. Tom Scott's horns, and a very tightly arranged chorus of background singers. Given the success of these various elements in combination, it seems likely that Weir's music will enjoy a more broad-based appeal than that of the Dead.

"Heaven Help the Fool" is not without its faults. Weir is a confident singer, yet his rather clipped phrasing sometimes fails to generate much flow from one melodic line to the next. And although his interpretation of Little Feat's *Easy to Slip* is fresh and imaginative, his version of Marvin Gaye's *I'll Be Doggone* adds little to the original. His own

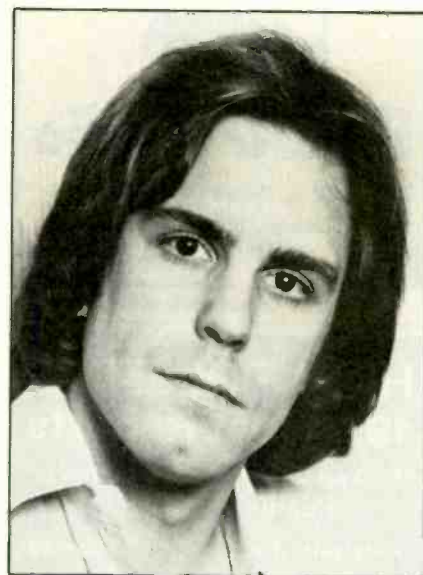

Bob Weir

songs, however, even when they aren't particularly provocative musically (as in *Salt Lake City* or *This Time Forever*), consistently avoid the mundane thanks to collaborator John Barlow's lyrics. Clever and articulate, Barlow is as complementary a lyricist as the Dead's Robert Hunter. S.G.

## JAZZ

**Doc Cheatham and Sammy Price: Doc and Sammy.** Bill Smith & John Norris, producers. *Sackville 3013, \$6.98.*

Doc Cheatham and Sammy Price are two of a growing group of jazz veterans who seem to be having an autumnal flowering. This is at least partly because jazz has not been old enough until now to acquire a body of vigorous septuagen-



Wha-Koo—a mood of chummy intelligence



# SAVE!

MONEY • TIME • FREIGHT

QUALITY STEREO EQUIPMENT  
AT LOWEST PRICES.

YOUR REQUEST FOR QUOTA-  
TION RETURNED SAME DAY.

FACTORY SEALED CARTONS—  
GUARANTEED AND INSURED.

SAVE ON NAME BRANDS LIKE:

AKAI	PIONEER
B.I.C.	SANSUI
DUAL	SHERWOOD
KENWOOD	TEAC
MARANTZ	TECHNICS

AND MORE THAN 50 OTHERS

BUY THE MODERN WAY  
BY MAIL—FROM

## illinois audio

12 E. Delaware Place  
Chicago, Illinois 60611  
312-664-0020

CIRCLE 16 ON READER-SERVICE CARD

## HIGH FIDELITY'S 1978 Test Reports

Packed with over 300 pages of  
valuable information.

Receivers Tuners Tape Equipment  
Speakers Headphones Amplifiers  
Turntables & Pickups ... and more!



High Fidelity's Test Reports  
1978 Edition

1 Sound Avenue, Marion, Ohio 43302

Please send me \_\_\_\_\_ copies of the 1978  
High Fidelity's Test Reports at \$3.95  
each, plus \$.50 postage and handling,  
total \$4.45.

NAME \_\_\_\_\_

ADDRESS \_\_\_\_\_

CITY \_\_\_\_\_ STATE \_\_\_\_\_ ZIP \_\_\_\_\_

narians. (Doc is seventy-three and Sammy is seventy.) And it is partly because of the current interest in jazz musicians who can represent an earlier era with full authority and flavor.

Doc, a trumpet player, has been a sideman all his life—with Sam Wooding in the '20s, with Latin bands in the '40s and '50s, with Benny Goodman in the '60s. It was not until 1977 that he played as a leader for the first time, heading a trio in New York. Pianist Sammy, on the other hand, has been a ubiquitous sideman, leader, accompanist, and soloist throughout his career. On this disc they bring to their performances a richness of experience that puts them far beyond the capabilities of more recent-vintaged musicians—a group that includes pianists who scarcely use their left hands and trumpeters whose concept of a solo is running the changes.

Between them, Doc and Sammy fill out these pieces with body, color, and great variety of shading. The masterpiece of the set is *Summertime*, with one solo chorus apiece—Doc's poignant and penetrating, Sammy's full and orchestral—and a final chorus in which Doc soars lyrically over a suggestion of stop-time by Sammy. There is also a brilliant *I Can't Give You Anything but Love* with Doc playing a slow, singing growl. On *Ain't Misbehavin'* Sammy summons the jaunty spirit of Fats Waller without losing his own forceful personality. *Dear Old Southland* invites comparison with the Louis Armstrong-Buck Washington version. They are actually quite differ-

ent: Louis' is a virtuoso performance focused totally on his horn, while the Cheatham-Price treatment is mellow and romantic with some of the strongest playing coming from Sammy's piano in the tango passage. The entire set captures the full flavor of both Doc and Sammy, as soloists and as imaginative accompanists. And it shows two very accomplished artists at work in a manner that has been woefully neglected for many years. J.S.W.

**Chick Corea: The Mad Hatter.** Chick Corea, producer. *Polydor: PD 1-6130, \$7.98. Tape: CT 1-6130, 8T 1-6130, \$7.98.*

The resources of modern recording—from the magic of synthesizers to studio equipment itself—have rarely been realized to their full creative potential. With "The Mad Hatter," Chick Corea joins a rather elite group of composers/performers (Stevie Wonder, Herbie Hancock, Steely Dan) who have successfully combined their own musical skills with the technology available to them. As a unifying theme he has chosen the story of *Alice in Wonderland* with lyrics here and there (*Falling Alice, Dear Alice*) by singer Gayle Moran. The instrumentation varies from a synthesizer ensemble (overdubbed by Corea) to a jazz quartet to a thirteen-piece consort of strings and brass. The results, despite their creative unevenness, are always provocative.

One of the most effective moments comes at the very opening, in a segment

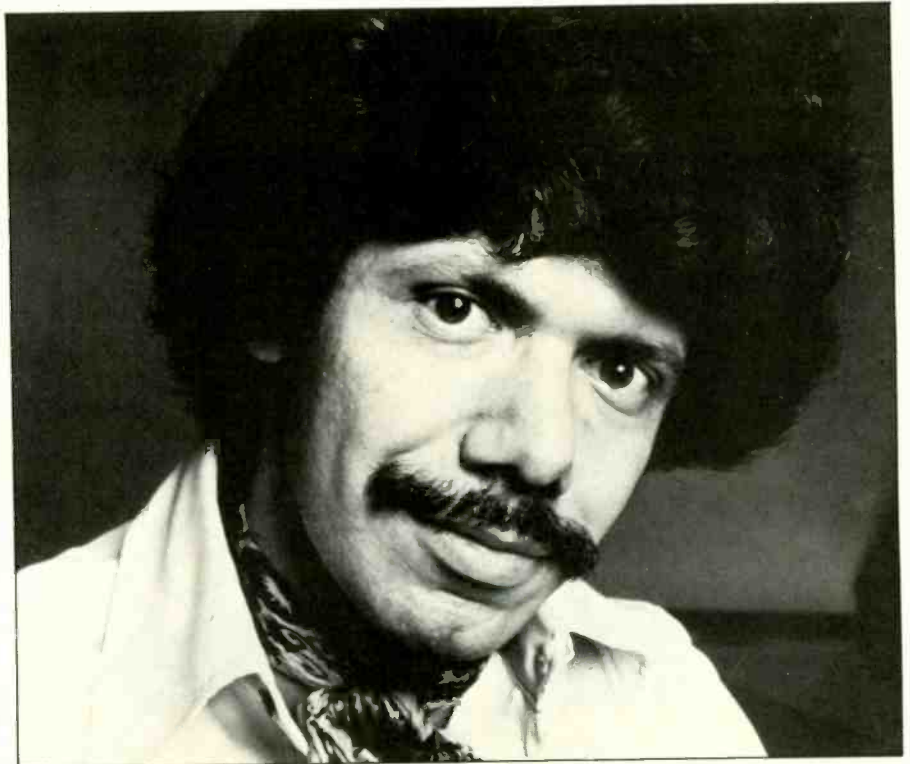

Chick Corea—musical skill, technical competence

titled *The Woods*. Corea plays MXR digital delay, marimba, acoustic piano, Moog 15. Arp Odyssey, Mini-Moog, Oberheim 8-voice, Eventide Harmonizer, Polymoog, and Moog Sample and Hold. The assemblage is quite remarkable, pulsing and vibrating with the aura of the woods at night. At times specific sounds emerge, such as the unmistakable swoop of the Oberheim unit or some astonishing brass simulations. It is one of the most amazingly effective uses of synthesizers that I've ever heard.

Corea is less successful with his use of strings. On *Tweedle Dee* and *Tweedle Dum*, in particular, one senses that he has been brainwashed by Bartók; the technical mastery shows in his writing, but a sense of Corea's own identity does not. Moran's lyrics seem to have provoked a similarly colorless reaction from Corea: He has set them to melodies as characterless as the lyricist's singing.

The best moments come in the pure jazz sections. *Humpty Dumpty* is a driving quartet with a gutsy tenor solo from Joe Farrell. And Side 2 contains two long, samba-based pieces in *Dear Alice* and *Mad Hatter Rhapsody*. The former spotlights an energetically inventive bass solo by Eddie Gomez, and the latter is dominated by an exchange between Corea on acoustic piano and Herbie Hancock on Fender Rhodes.

Corea's music sometimes has a studied, overly cool quality, but it gets better with each new recording. At its worst, it is never less than fascinating. One small carp: There seems to have been ample space for a long string of personal acknowledgments from Corea to various friends and associates. Why, I wonder, wasn't there enough room to mention Lewis Carroll? Curiouser and curiouser, Alice.

D.H.

**Larry Coryell & Steve Khan: Two for the Road.** Steve Khan, producer. *Arista AB 4156, \$7.98. Tape: ATC 4156, AT8 4156, \$7.98.*

It must have seemed like a wonderful idea when it first came up: Put guitarists Larry Coryell and Steve Khan together for a series of duo concerts. Both are superb stylists, technical masters, and imaginative soloists; and both are good enough to deal with the stringent demands of acoustic instruments.

So far, so good. But I'll bet no one, even in their most optimistic fantasies, imagined just *how* well it would work. Because it does, superbly. And, as with all good collaborations, each player has been stimulated to reach into personal areas that might otherwise lie unexplored. At times Khan and Coryell even approach the intense drive and quick spontaneity of the Django Reinhardt-

Stéphane Grappelli encounters.

Both musicians are flash players with technique to burn, but Coryell usually seems to get the best of the dramatic, high energy stuff, with Khan favoring the more lyrical entries. Bobby Hutcherson's *Bouquet* is a good example of the latter. *Son of Stiff Neck*—obviously an impromptu invention by the duo—is a tougher, funkier workout. Coryell excels on some stunning cadenza work on his own *St. Gallen*, and both players are overwhelming in an up-up-up-tempo version of Wayne Shorter's 6/8 tune, *Footprints*.

This is, very simply, state of the art guitar playing from two contemporary masters. These guys are so good that they make the work of most rock guitarists (especially some biggies who shall remain nameless) sound like the noisy chatter of children with toys. If you want to know what really can be done with an acoustic guitar, don't miss "Two for the Road."

D.H.

**Stéphane Grappelli: Parisian Thoroughfare.** Alan Bates, producer. *Arista-Freedom AF 1033, \$7.98.*

This is Stéphane Grappelli's most challenging record to date. The seventy-year-old violinist established his reputation in the early '30s with Quintet of the Hot Club of France. Since that time he has been pursued by echoes of the Quintet's swing style, repertory, and, often, string accompaniments. Even when he was teamed with modernist Jean-Luc Ponty, the electric violinist who wavers between jazz and rock, he still carried the Quintet's aura.

There is relatively little of that on this disc. Only three of the eight tunes—*Love for Sale*, *Hallelujah*, and *Fascinating Rhythm*—could be said to have the old connotation. Its elimination is largely due to the fact that pianist Roland Hanna, bassist George Mraz, and drummer Mel Lewis act as relative coequals throughout the set. Hanna contributed two pieces in *Perugia* and *Too Cute*. The first is built on a bowed bass and violin duet and played with a wistfully sad sense of longing. In contrast, *Too Cute* is a bright and jaunty piece that starts off as a pizzicato violin and bass duet.

And it is Hanna who transforms the potentially Quintet-like *Love for Sale* into something else again with his lively, dissonant chordal accompaniment and his own rolling, leaping solo. But Grappelli is completely the star on Bud Powell's *Parisian Thoroughfare*, a hard-swinging tour de force that includes a driving chase with Mraz's bass. He also does a meltingly beautiful improvisation of Chopin's Prelude in E minor, an ap-

Continued on page 139

**TDK AMPEX**

Minimum Order 12 Tapes

## Blank Tapes

at wholesale prices!

CASSETTE TAPES	
AMPEX C-90 3 pk/w stackette	\$4.99 for 3
BASE Studio C-90	2.39
Fuji FX C-90	2.80
Maxell LN C-90	1.99
Maxell UD C-60	1.93
Maxell UD C-90	2.84
Maxell UD C-120	3.84
Maxell UDXL 1 or 2 C-60	2.47
Maxell UDXL 1 or 2 C-90	3.47
Memorex C-90 3 pk	5.99 for 3
Scotch C-90 3 pk	4.99 for 3
Scotch Master 2 or 3 C-90	3.29
Sony C-90	1.79
TDK D C-60	1.14
TDK D C-90	1.56
TDK D C-180 (180 minutes)	2.88
TDK AD C-60	1.62
TDK AD C-90	2.40
TDK AD C-120	3.30
TDK SA C-60	1.98
TDK SA C-90	2.88
REEL-TO-REEL	
Maxell UD 50-60 (1200 ft.)	4.31
Maxell UD 35-90 (1800 ft.)	4.99
Maxell UDXL 35-90B (1800 ft.)	6.07
Maxell UD 35-180 (3600 ft. 1/2"*)	12.99
Scotch 212 (1800 ft.)	3.79
Scotch 207 (1800 ft.)	4.99
TDK L-1800 (1800 ft.)	4.64
8-TRACK	
AMPEX 382 8T 90 min	1.49
Maxell LN 8T 90 min	1.99
Memorex 2 pk 90 min	3.99 for 2
Scotch 2 pk 90 min	3.99 for 2

**J & R Music World**  
 33 Park Row, N.Y.C. 10038  
 (212) 732-8600

MAIL ORDERS: For shipment within 48 hours send money order or certified check. Two weeks delay on personal checks. Please add \$2.50 per order for shipping & handling. N.Y.S. Residents add tax. NO C.O.D.'s. ALL TAPES 100% GUARANTEED  
 Minimum Order 12 Tapes

Write for prices on other tapes  
 CIRCLE 19 ON READER-SERVICE CARD

**FREE** details **A DIFFERENT KIND OF RECORD CLUB**

**TREMENDOUS SAVINGS**  
 on every record and tape in print —  
 no agree-to-purchase obligations of any kind.

**DISCOUNTS OF 43% TO 73%**  
 off mfg. suggested list. special catalog  
 features hundreds of titles and artists

**ALL LABELS AVAILABLE**  
 including most imports through special custom  
 ordering service — guarantees satisfaction.

**SCHWANN CATALOG**  
 lists thousands of titles.  
 classical, pop, jazz, country, etc.

**DISCOUNT DIVIDEND CERTIFICATES**  
 Dividend Gifts — certificates  
 redeemable immediately for extra discounts.

**NEWSLETTERS**  
 informational news and happenings in the  
 world of music — special super-sale listings.

**DISCOUNT ACCESSORY GUIDE**  
 Diamond needles, cloths, tape cleaners, etc.

**QUICK SERVICE**  
 same day shipping on many orders  
 rarely later than the next several days

**100% IRON-CLAD GUARANTEES**  
 on all products and services — your total  
 satisfaction is unconditionally guaranteed.

Discount Music Club is a no-obligation membership club that guarantees tremendous discounts on all stereo records and tapes and lets you buy what you want...when you want...or not at all if you choose.

These are just a few of the money-saving reasons to write for free details. You can't lose so why not fill out and mail the coupon below for immediate information.

**DISCOUNT MUSIC CLUB, INC. DEPT. 08-0578**  
 650 Main Street, New Rochelle, N.Y. 10801

Name \_\_\_\_\_  
 Address \_\_\_\_\_  
 City \_\_\_\_\_  
 State \_\_\_\_\_ Zip \_\_\_\_\_

CIRCLE 10 ON READER-SERVICE CARD

# Pop/Rock

BY KEN TUCKER

**Be Bop Deluxe: Drastic Plastic.** Bill Nelson & John Leckie, producers. *Capitol SW 11750*, \$7.98. *Tape: 4XW 11750, 8XW 11750*, \$7.98.



Hear Be Bop leader Bill Nelson contort himself into the polite but misguided son of Bryan Ferry and David Bowie. The second side's melodies have lots of peppy hooks, but there is a pervasive indecision, masquerading as arty complexity, that once again undermines Nelson's smart guitar-band instincts.

**Yvonne Elliman: Night Flight.** Robert Appere, producer. *RSO RS 1-3031*, \$7.98. *Tape: CT 1-3031, 8T 1-3031*, \$7.98.

Elliman sings soft rock with a folksinger's austere demeanor and self-effacing technique. Her natural reticence is further frozen by the cool West Coast sessionmen that back her on all of the cuts except *If I Can't Have You* from *Saturday Night Fever*. The slick frenzy of disco suits her voice and detached manner, but since her preference remains Ronstadtville, Elliman is caught in a self-imposed stylistic quandary.

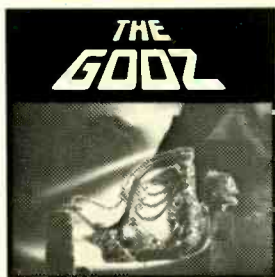

**The Godz.** Don Brewer, producer. *Millennium MNLP 8003*, \$7.98. *Tape: MNLP5 8003, MNLP8 8003*, \$7.98.

At one point, the Godz aver, "Gotta keep a runnin'! That's rock & roll." Sorry guyz, rock & roll is standing and fighting. Not as pretentious as you'd think from their name, but perfectly mediocre boogie nonetheless—sort of Kiss cum Black

Oak Arkansas.

**Dennis Linde: Under the Eye.** Dennis Linde, producer. *Monument MG 7608*, \$6.98.

A Southern rockabilly eccentric, Linde here offers a UFO rocker more incisive than *Close Encounters* in *Under the Eye*, a classic pop ballad in *There Goes My Heart Again*, and a clutch of quirky movers. Oddly produced, murky of sound, and heavy on the drum thuds, Linde is no smoothie. He is all the better for his good-humored obsessions.

**Barry Manilow: Even Now.** Ron Dante & Barry Manilow, producers. *Arista AB 4164*, \$7.98. *Tape: ATC 4164, AT8 4164*, \$7.98.

The lyrics offer a nicer, more magnanimous Manilow (*A Linda Song, Even Now*), but he didn't write them. The melodies, which he did write, are nearly self-parodying: puffily orchestrated, building to great swells again and again, until each becomes as predictable as bad disco. Their ponderousness even obscures Manilow's straightforward piano playing. A maudlin lemon.



**Manfred Mann's Earth Band: Watch.** Manfred Mann & Earth Band, producers. *Warner Bros. BSK 3157*, \$7.98. *Tape: M5 3157, M8 3157*, \$7.98.

As determinedly eclectic an album as the Earth Band has cut, "Watch" includes a precise ballad, *California*, a rollicking love song, *Davy's on the Road Again*, and a contemplation on a building, *Chicago Institute*. Also a funny, poignant version of the lugubrious *Quinn the Eskimo*. Artful perversity that charms rapidly.

**Raydio.** Ray Parker Jr., producer. *Arista AB 4163*, \$7.98. *Tape: ATC 4163, AT8 4163*, \$7.98.

Raydio, guided by veteran session guitarist Ray Parker Jr., is Earth, Wind & Fire without the muddy mysticism and P-Funk without the nutty anarchism. This is funk with hooks, and if the big single, *Jack and Jill*, becomes tedious in its studied simplicity, such honest directness makes *Is This a Love Thing* ("Or just a sex thing") a magnanimous, witty beauty.



**Striker.** Harry Maslin, producer. *Arista AB 4165*, \$7.98. *Tape: ATC 4165, AT8 4165*, \$7.98.

You say you like lots of loud guitars, heavy lyrics, and tricky arrangements? Striker may be your men, but they aren't mine: Thick hard rock pretensions fail to disguise four nasty little minds so eager for the Big Time that even their women-despising sounds perfunctory.

**Van Halen.** Ted Templeman, producer. *Warner Bros. BSK 3075*, \$7.98. *Tape: M5 3075, M8 3075*, \$7.98.

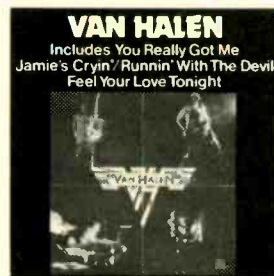

Produced by Doobie Brothers slickie Ted Templeman, Van Halen's heavy metal is smooth and ordinary—sort of a Black Sabbath with middle-class Californian professionalism. The result is a confusion that tries to pass for range: a Neanderthal version of the Kinks's *You Really Got Me*, a sneer at balladry in *Little Dreamer*. None of it is pulled off with the audacity that their chain-belted leather pants and hairy chests would seem to promise.



Ralph MacDonald—a great idea that bore no fruit

appropriate setting for the warm glow of his tone and for Hanna's sensitive touch. Aside from a rather bland treatment of Jobim's *Wave*, the set shows the stimulating results of moving highly talented musicians into contexts that shake them up a bit. J.S.W.

**Ralph MacDonald: The Path.** Ralph MacDonald, William Salter, & William Eaton, producers. *Marlin 2210*, \$7.98. *Tape*: *MAR 2210*, \$7.98.

Super-percussionist Ralph MacDonald obviously had high hopes for this recording—one side of which is a tribute to his family history called *The Path*. Understandably proud of a heritage that stretches from Nigeria to Trinidad to Manhattan, he has tried to articulate those feelings in the heavily rhythmic music he knows best. One can hardly fault his objectives; a genealogy that includes shango percussion, calypso steel drums, and Seventies disco jazz is indeed something to boast about. The problem lies in the delivery. As so often happens with contemporary re-creations of music from other cultures and times, the power and thrust, the real-world reference points of the original are lost in too-facile mimicry.

*The Path* is divided into three sections. *Part One's* African sources are buried in the even metrics of MacDonald's studio vision. *Part Two* works better, but its success has everything to do with the buoyant clarinet playing of the delightfully nicknamed Clinton "Came to Play" Thobourne and almost nothing to do with MacDonald's intention to recall his father's calypso band. Similarly, *Part Three* moves too quickly into the mainstream of contemporary crossover. The spirit and the soul of the *Path* may have been there when MacDonald first

thought of the idea, but it drifted away long before the LP was completed.

Side 2 is no improvement. Standard disco/funk, for the most part, it reveals just how good MacDonald can be in a commercial setting, but it provides no real testing ground for his skills. D.H.

**Michal Urbaniak: Urbaniak.** Michal Urbaniak, producer. *Inner City IC 1036*, \$7.98.

I think if I had first heard this recording with a blindfold on I would have called it an impressive representative of contemporary crossover jazz. Exceptional? Not really, yet certainly right up there with the best work of Bob James, Donald Byrd, etc. But when one considers that the three principal performers here are all of Eastern European background, the results are genuinely remarkable: a solid tribute to the continuing international viability of jazz.

Michal Urbaniak is a wonder, equally proficient on electric violin and lyricon (a single-reed electronic instrument that is played very much like a straight saxophone). Doubling on a string and woodwind instrument is not exactly commonplace and doing it with flair and creativity is almost unheard of. Saxophonist Zbigniew Namyslovski is also a fine, original voice. In an era of swarming, blues-inflected sax styles, Namyslovski seems content to opt for the traditional virtues of invention and spontaneity. And singer Urszula Dudziak continues to be one of the most underrated performers on the jazz scene. Her maturity and sophistication are still growing by leaps and bounds.

If there are difficulties, they lie in the choice of material. Both Urbaniak and Namyslovski (who, between them, have

Continued on page 145

Sound Reproduction  
A PIONEER IN MAIL ORDER

**A PIONEER IN DISCOUNTING**

SEND FOR OUR CATALOG ON

**PIONEER AND OVER 40 OTHER FAMOUS BRAND AUDIO COMPONENTS AT LOW DISCOUNT PRICES.**

**PIONEER**  
SX-980 AM/FM STEREO RECEIVER—Continuous power output of 80 watts per channel, min. RMS at 8 ohms from 20 hertz to 20,000 hertz with no more than 0.05% total harmonic distortion.  
LIST \$550.00 **387<sup>00</sup>**

**PIONEER**  
2265B AM/FM STEREO RECEIVER—65 watts per channel into 8 ohms minimum continuous power output from 20Hz to 20kHz with no more than 0.05% total harmonic distortion.

**Order Now By Mail From...**  
**SOUND REPRODUCTION INC.**  
460 CENTRAL AVE., EAST ORANGE, N.J. 07018  
**(201) 673-0600**  
Closed Mondays June 1st to Labor Day

CIRCLE 12 ON READER-SERVICE CARD

**ALL MAJOR BRANDS AT WHOLESALE PRICES**

CALL (914) 425-1200 or Write: Dept. H-4  
**NCI PREMIUM DISTRIBUTORS**  
32 South Central Avenue, P. O. Box 8  
Spring Valley, New York 10977  
Send \$4.00 (Refundable 1st Order) For our new 265 page Illustrated Wholesale Price Catalog

- PANASONIC • RCA • QUASAR • ZENITH • SONY • JVC
- PIONEER • SANYO • MARANTZ • TEAC • JENSEN
- SANSUI • KENWOOD • DUAL • GARRARD • BIC • MEMOREX
- TDK • MAXELL • SCOTCH • ATARI • PHONEMATE
- BEARCAT & OTHERS

• Any Quantities • Never a Minimum order • Factory Sealed Cartons • Full Manufacturers Warranty • Prompt Delivery • Shipped Anywhere

CIRCLE 28 ON READER-SERVICE CARD

## New Wave, Second Surge

by Toby Goldstein

**Ian Dury: New Boots and Panties!!** Various producers. *Arista-Stiff STF 0002*, \$7.98. *Tape: STC 0002, ST8 0002*, \$7.98.

**Pere Ubu: The Modern Dance.** Pere Ubu & Ken Hamann, producers. *Blank Records 001*, \$7.98.

**Radio Birdman: Radios Appear.** John Sayers & Charles Fisher, producers. *Sire SRK 6050*, \$7.98.

**The Real Kids.** The Real Kids & Marty Thau, producers. *Red Star RS 2*, \$6.98.

**Suicide.** Craig Leon & Marty Thau, producers. *Red Star RS 1*, \$6.98.

**The Suicide Commandos: Make a Record.** Paul Stark & the Suicide Commandos, producers. *Blank Records 002*, \$7.98.

**Tuff Darts!** Tony Bongiovi, Lance Quinn, & Bob Clearmountain, producers. *Sire SRK 6048*, \$7.98.

**Wire: Pink Flag.** Mike Thorne, producer. *Harvest ST 11757*, \$6.98.

While there may not be a superstar image like the Sex Pistols or the Ramones in the bunch, the eight new bands represented here are illustrative of

the Second Wave's artistic and geographic diversity: from avant-garde to immediately accessible, from Massachusetts to Australia. Loosely, their debut albums can be divided into three categories: neo-Ramones speed, power, and drive; unpredictable, uncomfortable, or self-limiting; well-written songs, a joyous rock beat, and competent playing style. The last group is the smallest and, potentially, the most accessible.

The music of the Suicide Commandos (Minneapolis) and Wire (England) is driven, rhythmically propelled, and knife-edged. Both bands deliver in jagged, staccato bursts of between one and three minutes, and several of Wire's concepts are less than sixty seconds long, resulting in an impression of constant change. Neither recording is suited to seated reflection, nor is Wire's suited to the comprehension of individual songs.

Though similar in brevity and frenetic energy, the two bands differ in meaning and purpose. The Suicide Commandos take the form of a classic guitar-bass-drums power trio, clearly articulating a somewhat hoody stance with

rebellious, predictable songs such as *I Need a Torch* and *Call of the Wild*. Wire sound and play to suit their name, with vocals and guitars buzzing in sympathetic vibration as they liken themselves to a wire-service dispatch in *Reuters*, or mechanize their attack in *12XU*. The result is an uneasy but captivating compilation of unfamiliar imagery in a hurried framework of twenty-one cuts.

Pere Ubu and Suicide, both well-established on the underground circuit, make no attempt to placate anybody except those who share their understanding of sound. True to their surrealist name, the Cleveland-based Pere Ubu distort both words and instruments, creating an unrecognizable set of agonized impressions that seem closer to atonal jazz than rock. Too close, in fact, for this listener. The avant-garde is bet-



Alan Vega of Suicide



The Suicide Commandos: Steve Almaas, Dave Ahl, Chris Osgood

ter brought to one's living room by the mysterious duo Suicide, who are New York landmarks. Alan Vega and Martin Rev inherit a fondness for droning from the Velvet Underground, accompanying each of Vega's vocal tracks with hypnotic variations on a basic rhythm. The brief pieces of Side 1 are curious and haunting, but Vega's shrieks of torment on the second side's lengthy *Frankie Teardrop*, while in character for the song, are not the sort of thing that goes well with hot milk, sweet dreams, and headphones.

For light pleasure, Ian Dury's vaudevillian "New Boots and Panties!!" deftly combines music-hall song and dance with pungent portrayals of *Sex and Drugs and Rock'n'Roll*. Dury's deadpan manner and authentic Cockney accent intone honesty, irony, or absolute viciousness, and from *Wake Up and*



Radio Birdman—Australia and Detroit



Tuff Darts—nasty attacks

*Make Love with Me* all the way through *Blackmail Man*, he makes not a false step nor seems anything but unique—a real character, in the best sense.

It's anyone's guess as to why almost every Boston band plays rock & roll that is directly connected to Chuck Berry and the early Rolling Stones. The Real Kids are no exception. Alone among actual New Wavers here, they cover a 1950s tune, Buddy Holly's *Rave On*, and seem unafraid to use rock's whole encyclopedia. Standard quartet lineup and danceable songs like *All Kindsa Girls* or *My Baby's Book* indicate their potential acceptance in the Aerosmith/Ted Nugent world outside punk.

Tuff Darts, who have to their credit the classic *All for the Love of Rock & Roll* from "Live at CBGB's" (Atlantic SD2 508, 1976), make an equally entertaining debut here. The band is capable of writing poppish harmony numbers like *Who's Been Sleeping Here?* as well as nasty, not-to-be-taken-seriously attacks such as (*Your Love Is like*) *Nuclear Waste*. They at last appear ready to move past the personnel problems that have bogged them down for almost three years.

Potentially the most commercial album comes from the unlikely source of Australia: Radio Birdman, led in compositional talents by ex-Detroiter Deniz Tek. The quintet is blessed with the ability to incorporate skillful Sixties-reminiscent keyboard and guitar leads into forceful, melodious tunes. And about their vision—anyone who is capable of weaving the *Hawaii Five-O* theme into a clever tale of crime (*Aloha Steve & Danno*) is deserving of both respect and success. In fact the diversity of New Wave's output from labels large and small confirms our early confidence in its musical promise. Whatever its ultimate fate, it will be around for awhile.



## Next time you plan a trip to Europe, make sure you visit the unique country.

Where can you find: Europe's blondest blondes?  
Europe's highest geysers?  
Europe's greatest glaciers?  
Europe's largest waterfalls?

And where can you find moonlike craters where the astronauts trained? More volcanos than anywhere else on earth? Historic landmarks of the world's oldest continuous parliament? Celebrations marking Europe's youngest republic?

The answer to all of these questions is—ICELAND. Next time you plan a trip to Europe, make sure you visit Iceland.

The only thing it may cost you is time well spent. Because you'll save enough money on Icelandic's lowest jet fares to Luxembourg to pay for your stopover in Iceland. Or, you can hop over from New York or Chicago for longer tours. See an erupting volcano. Take a cross-country pony trek.

Next time you plan a trip to Europe, ask your travel agent about Icelandic Airlines. Or phone Icelandic Airlines, for folders about Iceland and lowest jet fares to Europe. In New York State, phone (212) 757-8585. Elsewhere in U.S., phone (800) 555-1212 for local toll free number.

CIRCLE 15 ON READER-SERVICE CARD

### Moving?

Be sure and send us your new address 8 weeks before you move so you won't miss any copies of HIGH FIDELITY.

And please include an old mailing label from our magazine when writing us about your subscription.

Write to:

**HIGH FIDELITY,**  
1 Sound Avenue, Marion, Ohio 43302

- Change of address.  
 Enter new subscription, 1 year \$8.95  
 payment enclosed  bill me

AFFIX LABEL

If you have no label handy, print OLD address here

name \_\_\_\_\_ please print  
address \_\_\_\_\_  
city \_\_\_\_\_  
state \_\_\_\_\_ zip-code \_\_\_\_\_

New Address

name \_\_\_\_\_  
address \_\_\_\_\_ please print  
city \_\_\_\_\_  
state \_\_\_\_\_ zip-code \_\_\_\_\_

Add'l postage: \$3 per year outside U.S., its poss.

# HIGH FIDELITY CLASSIFIED

130 East 59th St., New York, N.Y. 10022  
Phone: (212) 826-8393/94

**CLASSIFIED RATES: (15 WORD MINIMUM.)** 1-time \$1.60 per word per issue. 6 consecutive issues—\$1.50 per word per issue. 12 consecutive issues—\$1.40 per word per issue. Words in caps—10¢ extra each.

Box Numbers: \$1.00 additional per insertion to cover cost of handling and forwarding mail. Count 10 extra words for box number and address.

**DISPLAY CLASSIFIED AND DISCOUNTS:** 1 inch by 1 column—\$275. 2 inch by 1 column—\$550. 3 inch by 1 column \$825. Also 6 and 12 consecutive issue discount rates. Deadline is two months prior to publication date. **FULL PAYMENT MUST ACCOMPANY ALL COPY FOR CLASSIFIED ADS.**

## for sale

3600" New L/N Scotch or Ampex tape, 10 1/2" metal reel, 5 for \$38.00. 24 page booklet on tape editing 80¢. Soundd POB 338, Dunwoody, Ga. 30338.

PERFECTIONISTS PREFER \*DYNAKITS. BEFORE Purchase You Owe Yourself Our Quote. MAINLINE IIH, 971 Fronheiser, Johnstown, Pa. 15902.

PROTECT YOUR RECORDS POLY SLEEVES for jackets 9¢ Roundbottom record sleeves 7¢ Poly lined paper sleeves 15¢ White jackets 35¢ Postage \$1.50. Record Supply House, Hillburn, New York 10931.

AUDIOPHILES WANTED!! Put your knowledge to use, earn an excellent spare time income. We need campus Dealers to sell name brand stereo equipment at substantial discounts in your area. No investment necessary. For information and application please write: ABCO, Dept. CR, 1201 East Main Street, Meriden, Conn. 06450. Call (203) 238-7979.



## BUILD STEREO SPEAKERS WITH JUST GLUE AND STAPLES.

Save up to 50% of the cost of ready-bult speakers by assembling Speakerlab kits. We've done the design, carpentry and wiring, leaving you only the actual installation of the speaker drivers. Most people take less than two hours to assemble a kit. Illustrated, easy-to-follow instructions check you each step of the way. (And if you still can't finish the kit, we'll do it for you for just the cost of return freight.)

When you're through, you have a high quality, multi-element stereo speaker with a resonance-free enclosure, fiberglass damping, a crossover with level controls, and drivers that are some of the best in the industry.

Send for our free 52-page catalog. It's practically a manual on speaker building.



Dept. HF-G 5500 35th N.E., Seattle, WA 98105

STEREO REPRESENTATIVES NEEDED!!! LOWEST POSSIBLE PRICES!!! OVER 100 BRANDS!!! KRASCO, 998 Orange Ave., West Haven, Conn. 06516.

STEREO COMPONENTS and SONY TV's at rock bottom prices. Why pay up to 40% more? Nedco Distributors, 68-D Watertown Street, Watertown, Mass. 02172.

HI-FI ENTHUSIASTS WANTED!! Earn more than just spare money in your spare time. We need campus representatives to sell name brand stereo components at discount prices in your area. No investment required. Serious inquiries only, please. Contact: Mail Order Dept., K&L Sound Services Co., 75 No. Beacon St., Watertown, Mass. 02172. (617) 926-6100.

PROFESSIONAL HI-FI COURSE—Instructors include Len Feldman, Julian Hirsch, Larry Klein, Larry Zide. Home study course available. Send \$2.00 for full color Audio Primer and information on Joining Society Audio Consultants (SAC), 49 E. 34th St., Dept. HF, NYC, NY 10016.

## New Lambda Series from SpeakerKit

Featuring the newest Philips and Electro-Voice drivers with computer-assisted crossover design. Outstanding quality at a surprisingly affordable price. Assemble it yourself. Write for details.



SpeakerKit Box 12HF, Menomonie, WI 54751

WOOD SPEAKER STANDS raise speakers 5 inches off floor. Reduce boominess and enhance sound. 14" x 18" stained walnut color. Holds any size speaker up to 350 lbs. regular \$35.00—now \$25.00 pair ppd. Shilo, 3312 Kingsley Drive, Bloomington, Indiana 47401.

STEREOS, UP TO 40% SAVINGS, FOR PRICE QUOTE OR CATALOG. CORATHERS, 169 S. St. John #249, Pasadena, CA 91123.

## A SINGER'S DREAM!



### REMOVES VOCAL FROM MOST STEREO DISCS

The Thompson Vocal Eliminator can actually remove most or all of a solo vocalist from a standard stereo record and yet leave the background music virtually untouched! Not an equalizer! We can prove it works on the phone. Write for a brochure and demo record below. COST: \$195.00

## ECHO

We do it BETTER FOR LESS

You know how fantastic the quad results are. Works with even a mono source! We utilize the LATEST advances in analog delay to produce better bandwidth and longer delays. Only direct sales make price possible. Guaranteed results. Price \$299-\$425 several models. Write for Brochure and demo record. Include \$1.00 to cover costs (refundable with purchase).

Write to: L T SOUND, Dept. HF, P.O. Box 1061, Decatur, GA. 30031 (404) 377-9595

HIGH DEFINITION RECORDINGS offers the most complete mail order service of direct-to-disk recordings, EMI's, audiophile pressings and accessories. Write for free catalog. HIGH DEFINITION RECORDINGS, P.O. Box 82556, Dept. BB-2 San Diego, California 92138.

FANTASTIC DISCOUNTS!! Most brands—components, furniture, television!! Quotations only. Allegheny CoHF, Box 1029, Johnstown, Pa. 15907.

THE ABSOLUTE SOUND™, in its new issue, takes a long look at components that threaten to re-define the state-of-the-art, including the Beveridge Electrostatic, the Electro-Research amplifier; the Grado Signature II cartridge; Stewart Hegeman's first preamp in a decade, the Hapi One; and the Magneplanar I-D. There's a special report on "mini"-speakers, the Rogers/BBC monitor, the JR 149, the Sendor SA-1; and the Fried Model B. There's also a special report on Direct-to-disc recordings, with reviews of nearly all. But, wait, there's more. We sneak-preview the SME 3009 Series III arm, the Threshold 400A amplifier; and David Haller's new preamplifier. And we review the all-tube Conrad-Johnson preamplifier; the Cizek Model One speaker; the Signet cartridge; the RAM strain-gauge cartridge; the new ADC tone arms and ZLM cartridge; the Dynavector arm; the Quatre Gain Cell amplifier; and the Van Alstine modified Audio Research SP-3a. Not only that but we evaluate a fascinating spectrum analyzer, the Ivie 10A. And there's a report on the Winter CES. All this is yours for \$16 (four issues, first class mail); add \$1 in Canada, \$2, outside North America (air). Send your money to The Absolute Sound, Box 5, Drawer B, Northport, New York, 11768.

**ERASE HEADS ARE NOT ENOUGH!**  
**THE BLACK MAX**  
TAPE ERASER CLEANS NEW AND PRERECORDED AUDIO, VIDEO AND COMPUTER TAPE BELOW VIRGIN LEVELS. PROFESSIONAL RECORDINGS START AT THE TAPE ERASER.  
THE BLACK MAX \$69.00  
BLACK MAX II WITH THERMAL OVERLOAD PROTECTION \$78.00  
VISA AND MASTERCARD ACCEPTED  
LAUDERDALE ELECTRONIC LABS  
16 S. W. 13th Street, Fort Lauderdale, Florida 33315  
Tel. (305) 764 7755

New 1977-78 Catalog—Raw speakers, custom foam speaker grills, crossovers, parts, wood veneers. High quality, low prices. Send 10c. Custom Sound, Algonac, Michigan 48001.

DYNAKITS, SME—Lowest Prices. Fastest Service. MC/VISA. Underground, 324b Broadwater, Arnold, MD 21012. (301) 647-0919.

FOR PEOPLE WHO LISTEN, Contemporary Sound Associates, 35 Little Falls Rd., Fairfield, N.J. 07006. (201) 575-1135.

ENGLISH HiFi/Records, any model, any quantity, obsolete/valve equipment, deleted records. Send requirements. Prices/Lists free, full catalogues \$2.00. F.G.S. Electronics, 8, St. Margarets Close, Leeds 18, England.

200 BRANDS! LOWEST prices! ESOTERIC. Videotape. TV's. For INSTANTANEOUS quote: Stellar Sound, P.O. B. 49285, Austin, Texas 78765.

## miscellaneous

DIAMOND NEEDLES and Stereo Cartridges at Discount prices for Shure, Pickering, Stanton, Empire, Grado and ADC. Send for free catalog. All merchandise brand new and factory sealed. LYLE CARTRIDGES, Dept. H, Box 69, Kensington Station, Brooklyn, New York 11218. For Fast Service, call TOLL FREE 800-221-0906.

PROTECT YOUR ALBUMS. WHITE CARDBOARD REPLACEMENT JACKETS 35¢. PLASTIC LINED INNER SLEEVES 15¢. POSTAGE \$1.25. OPERA BOXES, 78 SLEEVES AVAILABLE. FREE CATALOG. CABCO 301-3, BOX 8212, COLUMBUS, OHIO 43201.

The Best New Stereo Systems Deserve The Best New Stereo Records (Tapes too)! You need the Monthly SCHWANN RECORD CATALOG available from record shops everywhere or, for a sample copy PP. Send \$2.50 to: ABC-SCHWANN Publications, Inc., 130 East 59th St., New York, N.Y. 10022.

## new equipment for sale

BRITISH AND EUROPEAN EQUIPMENT DIRECT TO YOU. Most quality makes of equipment available at advantageous prices. Price list and price quotes send International Reply Coupon. For specific brochures send \$2.00 bills. Audio T, Dept A, 190 West End Lane, London NW6, phone 01-794 7848. Visitors welcome.

## The Comfortable Alternative to Headphones

### YEAPLE Stereopillow

Model 900—reviewed in High Fidelity, \$79.95 Stereo Review  
Model 490—New compact version \$34.95



FREE reviews and dealer list from: Yeaple Corp., Dept. HF, 1255 University Ave., Rochester, NY 14607

LOWEST PRICES ON STEREO-ESOTERIC components!!! Over 150 brands. Audio Unlimited, 401 Reynolds Circle # 2, San Jose, CA 95112 (408) 985-2285.

BUY DIRECT from England's Hi-Fi Mail Order Specialists? Save on British and European Hi-Fi components. Ariston, Armstrong, Celestion, Decca, JR149, Lecson, LS3/4A, Radford, Revox, SME, Tandberg, Tannoy, Transcriptors, Michell Electronic/Hydraulic, etc. Shipping 11st free or send \$3, cash bills only please, to include literature Goodwins, 7 The Broadway, Wood Green, London N22. Phone 888-0077. Visitors welcome. Mastercharge, Bank Americard accepted.

## Buy with confidence

### SONY PS-T2 SEMI-AUTOMATIC DIRECT DRIVE TURNTABLE SYSTEM

• Direct Drive System • Brushless & Slot-Less Motor • Wow & Flutter: (WRMS) 0.03/2



Lowest price of any reputable mail order house. Call or write for quotes & free catalog.

BUY FROM NEW ENGLAND'S LARGEST STEREO HOUSE

ARSTON Sales  
Mon.-Fri. 9:00-5:30  
Sat. 9:00-3:00  
146 Old Brookfield Road, Danbury, Conn. 06810  
(203) 744-6421 (212) EN9-6212

SANSUI and PICKERING! BELOW mail order prices! Send to: GSH Super Savings, P.O. Box 86, Eden, N.C. 27288 (919) 627-1919.

FREE! DYNAVECTOR 505 TONEARM (\$580 list) with the purchase of Trevor G. Lees newly introduced tube preamplifier. Positive Vibrations. Limited supply available. Guaranteed to sound better than Mark Levinson's \$3,000 LNP2. Positive Vibrations features DC voltage feedback and costs \$1,050. 15 day money-back guarantee with return of tonearm. Also have Trevor Lees MK3 tube pre-amplifier, \$350; and Class A state of the art rated (Sound Advice, Sept. '77) Dyna Mod-Kit for Pas 2 or 3, \$175. MasterCharge and VISA accepted. C.O.D.'s 25% down, balance on delivery. Write for reviews, Dworkin Audio Products, 2000 Center St., Suite 7000 B, Berkeley, Calif. 94704. (415) 549-0541 ext. 717.

## tapes & records

RARE OPERA, SYMPHONIC MUSIC ON OPEN REEL TAPE. Historic performances. EUROPEAN, DOMESTIC. Free Catalogue. Underhill, Box "U," Bellport, NY 11713.

"SOUNDTRACKS, SHOW, NOSTALGIA & JAZZ—FREE Catalog & Offering List—A-1 Record Finders, P.O. Box 75071-H, L.A. CAL. 90075."

BLANK TAPE SALE		
MAXELL	TDK SA-C60	\$2.07
UDXL C60 (1 or II)	TDK SA-C90	2.95
UDXL C90 (1 or II)	TDK AD-C90	2.39
LN-C90	Scotch Master II C-90	2.79
LN-C90	Scotch Master II or III C-90	3.24
UD35-90	BASF Studio or CRP C-90	2.69
UDXL 35-90B	BASF Prof. II or III C-90	3.09

Minimum order 12 pieces. All tapes can be assorted. PA add sales tax. Shipping \$2.50 per order. Or write for complete catalog. (412) 287-5595  
**Tape World** 220 Spring St., Butler, PA 16001

SCOTCH RECORDING TAPE, LOWEST PRICES. TAPE CENTER. Box 4305C, Washington, D.C. 20012.

CUT-OUT RECORDS. HUGE STOCK. ALL NEW. No catalog, Cohn, 2205 Marylane, Broomall, Pa. 19008.

RAREST CLASSICAL, SOUNDTRACKS, SHOWS, PERSONALITY LPs. Huge catalog 50c. Grammy's Attic, Box 181, Bluffton, SC 29910.

"HISTORICAL OPERA DISC & TAPE—Magnificent quality, speedy service. Greatest live performances of past 50 years. Reel, cassette, disc. Free Catalog. Historical Recording Enterprises, Box 12, Kew Gardens, N.Y. 11415."

"LIVE OPERA TAPES. Reels—Cassettes. Unbelievable treasures since 1926. Over 2,500 selections. Free DELUX Catalog: MR. TAPE, Box 138, Murray Hill Station, NYC 10016."

BASF TAPE: All widths 40—50% off. All tapes guaranteed! INTERGALACTIC, 1043 Kirts, Troy, Michigan 48084.

YOUR MAIL-ORDER TAPE SPECIALIST IN WASH. D.C. SAME DAY SHIPMENT-DISCOUNT PRICES. BASF, SCOTCH, MAXELL, TDK & CAPITOL. FREE PRICE LIST. SAXITONE TAPE SALES, 1776 COLUMBIA RD. N.W. WASHINGTON, D.C. 20009.

¾" VIDEO CASSETTES, KCA60/KCA30 KAREX duplication one-pass. Quantities available. dealers invited. Write: KENT, BOX 516, S.F., CA 94101.

Rknrol pop/rock auction. V. Luppins, B-1, 80 Simons, Hartford 06118.

BEAUTIFUL ARABIAN MUSIC, 60 Minutes, CASSETTE \$4.00, 8-TRACK \$5.00. TECHNOMICS, 5937 Pima, Tucson, AZ 85712.

SOUSA RECORDS. Free catalog upon request. Stafford, Box 36163, Grosse Pointe, Mich. 48236. Dealer inquiries invited.

VIENNESE LIGHT MUSIC SOCIETY WALTZES, POLKAS. Overtures on imported Dolby cassette. Most Non Schwann. K.C. Company, Box 793, Augusta, Maine 04330.

DISCONTINUED RECORDS, CLASSICAL, POPULAR, lists. Steinmetz. One Seaview, Massapequa, NY 11758.

TDK, MAXELL, MEMOREX, CASSETTES, REELS, 8-Track Free Catalog, New Guaranteed. S&S AUDIO, P.O. BOX 56039, Harwood Heights, IL 60656.

SEARCHING? WRITE DISCONTINUED RECORDS, 444 South Victory, Burbank, California 91502.

SHOW ALBUMS—Rare, out-of-print lps, 64-page list \$1.00. Bakers Wife cast LP \$9.95. Broadway-Hollywood Recordings, Georgetown, CT. 06829.

EVERYTHING ON OPEN REEL! Classical, Popular, Dolby, Quadraphonic. Latest releases. For "Reel News," send \$1.00. Barclay-Crocker, Room 857 H, 11 Broadway, New York 10004.

RECORDING TAPE—OUTSTANDING VALUES! Cassettes, 8-tracks, open reels, video, data tapes, bulk cassettes, accessories. New. Fully guaranteed. Free catalog. Write: Magne House, 2015-D, 17th Street, San Francisco, CA 94103.

1930-1962 RADIO PROGRAMS. INFORMATIVE 200 page catalog, \$1.25. AM TREASURES, Box 192HF, Babylon, NY 11702.

OLDIES ON OPEN REEL TAPE, FREE BROCHURE. Rock N' Reel Rental Dept. HF, 4 Prescott Ave., Dix Hills, N.Y. 11746.

RARE RECORD/TAPE COLLECTOR'S DIRECTORY. Treasury of over 100 addresses—annotated—for collectors. Send \$4.95 COLLECTORS DIRECTORY, 550 E. Rustic Road, Santa Monica, Calif. 90402.

RARE OUT-OF-PRINT LPs. Factory Sealed—99¢ to \$3.99 ea. Over 25,000 in stock. List—\$1.00 Record Warehouse, Box 4617, Rochester, New York 14613.

LIVE OPERA TAPES, CASSETTES. Incredible selection. Performances since 1930's. Personal, quick service guaranteed. Free bonuses. Magnificent free catalogue. Live Opera, Box 3141, Steinway Station, L.I.C., N.Y. 11103.

FANTASTIC OLD RADIO PROGRAMS ON TAPE. Reels, cassettes, 8-track. Free introductory catalog. Radio Memories, Box 2297, Newport News, VA 23602.

UNIQUE, COLLECTOR'S TAPE RECORDINGS—NEW and old radio programs. Exclusive shows, features, oddities, music! \$3.00 brings 30 minute demo (reel/cassette), literature included. MCP Studios, Box 521-H, Newberry, S.C. 29108.

Percussion recording of superior quality. Write Percussion, Dept. HF, P.O. Box 88, Palisades Park, N.J. 07650.

WORLD'S LARGEST, computerized, catalogue of rare records. 18,000 entries. Classical, Showbiz, Popular, Jazz, Comedy, Spoken. \$2.00 refundable. RoundSound West, PO Box 2248, Leucadia, CA 92024.

CASSETTE SAMPLER SPECIALS (DOLBY). Piano Concerti: Mozart No. 21, Beethoven No. 2. \$2.49 each, both \$3.98. Free catalog. Musical Concepts, Box 53H, Cedarhurst, N.Y. 11516.

VOICE RECITALS & SYMPHONIC RECORDS imported from Russia. Free catalog. Znanie, 5237 Geary Blvd., San Francisco, Calif. 94118.

SOUNDTRACK CATALOG 25c. Robin and Marion, Caine Mutiny, many others. STAR-184, Box 7, Quarryville, PA 17566.

CLASSICAL CASSETTES. Stereo-Dolby. FREE Catalog. Quality Guaranteed. Credit Cards Accepted. EKR Classics, GPO Box 1977HD, New York, N.Y. 10001.

MET OPERA-SYMPHONY TAPES. KAPINOS, R.D.3, Box 105, Boonton Twp., N.J. 07005.

## publications

*Penguin Stereo Record Guide Second Edition*  
 Edward Greenfield, Robert Layton and Ivan March  
 \$8.95 at all bookstores.  
**PENGUIN BOOKS**  
 625 Madison Avenue, New York, N.Y. 10022



## services

COLLEGIATE RESEARCH PAPERS. Thousands on file. All academic subjects. Send \$1.00 for mail order catalog. Box 25916-R, Los Angeles, Calif. 90025 (213) 477-8474.

## business opportunities

CABLE FM BROADCASTING: Unique no investment, no experience business. Spare time home operation possible. Excellent income. "CAFM," Box 5516-D5, Walnut Creek, CA 94596.

## wanted to buy

WANTED—Betamax 2X recording BREAKHEART PASS, GUNS OF NAVARRONE, WHERE EAGLES DARE, and FANTASTIC VOYAGE. George Kershner, 125 West High, Springfield, Ohio 45502.

## quad

Now enjoy concert hall sound with our QS-100 & SQ-100 quadraphonic decoders. Brochure 25c. PHOTOLUME CORPORATION, 118 E. 28th Street, New York, N.Y. 10016.

# NOTICE: Record Raters Wanted

(No experience required) Each month you will receive nationally released albums to rate. **There is no extra charge for the LP's you receive** — all you pay is a small membership fee which covers all costs of the LP's including postage and handling. In return for your opinion you will build a substantial album collection — "first come basis." For application write:

**E.A.R.S. INC.**  
 Box 10245 Dept. HF  
 5521 Center St., Milwaukee, WI 53210  
 "Guaranteed" © 1975 E.A.R.S. INC.

## HIGH FIDELITY

Classified Advertising Department  
 130 East 59th St., New York, N.Y. 10022 212-826-8393/94  
 Michael Littleford, Classified Advertising Manager

Please run the following classified advertisement in the next available issue.

Name \_\_\_\_\_

Address \_\_\_\_\_

City \_\_\_\_\_

State \_\_\_\_\_

Zip \_\_\_\_\_

Telephone \_\_\_\_\_

**RATE:** For Regular and Display, see schedule above. \*CASH MUST ACCOMPANY ORDER. Closing two months prior to issue.



# Country

BY NICK TOSCHES

**Hoyt Axton: Free Sailin'.** Hoyt Axton, producer. *MCA 2319*, \$6.98. *Tape: MCAC 2319, MCAT 2319*, \$7.98.

Hoyt Axton's problem remains the same. He seems to write very fine songs, then quickly prune and disinfect them with an eye toward commerciality. While this sometimes results in a hit for him, it has not yet yielded an album that doesn't annoy with its self-inflicted shortcomings. And when will these characters quit posing with their old ladies for the backs of album covers?



**Jerry Clower: On the Road.** Snuffy Miller, producer. *MCA 2281*, \$6.98. *Tape: MCAC 2281, MCAT 2281*, \$7.98.

I am sure there are many people who think Jerry Clower, our foremost country comedian, is a scream. Yes. But I wouldn't let any of them marry my daughter, no sir.

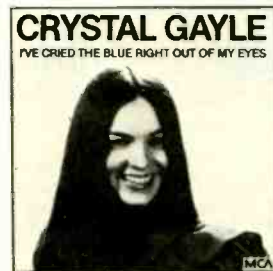

**Crystal Gayle: I've Cried the Blue Right out of My Eyes.** Owen Bradley, producer. *MCA 2334*, \$6.98. *Tape: MCAC 2334, MCAT 2334*, \$7.98.

This is what Crystal Gayle recorded for Decca before she found fame with United Artists in 1974. If you like Loretta Lynn's kid sister, as I do, you'll

find this incunabula to be enjoyable stuff—girl singing at its best.

**Merle Haggard and the Strangers: Eleven Winners.** Ken Nelson & Fuzzy Owen, producers. *Capitol ST 11745*, \$6.98. *Tape: 4XT 11745, 8XT 11745*, \$7.98.

What we have here is an anthology of some of Haggard's best and some of his worst recordings for Capitol. The former group includes *It's Not Love (But It's Not Bad)*, one of the seediest songs ever spewed from Hank Cochran's brilliant mind; *Everybody's Had the Blues*; *Carolyn*, one of the nastiest songs Merle has sung; and that fine tribute to rutting *Old Man from the Mountain*. The good and the bad of this album make it representative of Haggard's output. The good makes it worth having.

**Tom T. Hall: New Train—Same Rider.** Roy Dea & Tom T. Hall, producers. *RCA APL 1-2622*, \$6.98. *Tape: APK 1-2622, APS 1-2622*, \$7.98.



Tom T. Hall once wrote some honest, moving songs. In recent years, he has fancied himself a Poet of the Common Man, and his work has softened and melted into a mass of pompous, overbearing triteness. If Rod McKuen is only a bit too heavy for you, buy this LP.

**The Original Texas Playboys: Live & Kickin'.** Tommy Allsup, producer. *Capitol ST 11725*, \$6.98. *Tape: 4XT 11725, 8XT 11725*, \$7.98.

These alumni of the late Bob Wills's Texas Playboy bands have made the most authentic, perhaps the most enjoyable album of Western Swing you're likely to hear this year. Recorded at Knotts Berry Farm last fall, "Live and Kickin'" features many of the Playboy standards, such as *Faded Love*, *Steel Guitar Rag*, and *Stay All Night, Stay a Little Longer*. Contrary to what many have believed in recent years, Western Swing will probably never make a comeback—but it's sure a lot of fun.

**Charley Pride: Someone Loves You Honey.** Jerry Bradley & Charley Pride, producers. *RCA APL 1-2478*, \$6.98. *Tape: APK 1-2478, APS 1-2478*, \$7.98.

When Charley Pride is good, he's very, very good: Witness *Heaven Watches over Fools like Me* and *I'm Never Leaving You*. But when Charley Pride is bad (*The Days of Sand and Shovels*)—Mississippi's strangest son continues to be strange.

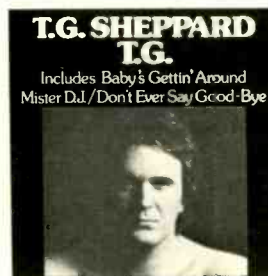

**T.G. Sheppard: T.G.** Jack Gilmer & T.G. Sheppard, producers. *Warner Bros. BSK 3133*, \$7.98. *Tape: M5 3133, M8 3133*, \$7.98.

T.G. is about halfway down the road to becoming a good old country singer, as songs such as *She Pretended We Were Married (While I Pretended She*

*Was You)* and *Where Do We Go (When We've Gone All the Way)* attest in all their parenthetical splendor. Now if only he'd quit talking like a disc jockey.

**Conway Twitty: Georgia Keeps Pulling on My Ring.** Owen Bradley, producer. *MCA 2328*, \$6.98. *Tape: MCAC 2328, MCAT 2328*, \$7.98.

You can always expect at least a handful of great performances from every Conway Twitty album. Here you've got *Let It Ring* (a weeper about telephonitis), *Mabellene* (yes, the Chuck Berry song), and *Victim of My Needs* (the title says it all). *The Grandest Lady of Them All*, however, is a tribute to the Grand Ole Opry that may make you want to raze the Ryman.



Michael Urbaniak—wizard of the electric violin

written all seven pieces on the album) are too entranced by ostinato bass patterns, crossover rhythms, and floating melodies. A sameness infects too much of their work. Only when they break out—as on the hard-rocking *Strife*, the unusually patterned *Mountaineers*, or Namyslovski's Ornette Coleman-influenced *Stray Sheep*—do these superb Polish musicians begin to show us the real range of their gifts. D.H.

**Bob Wilber and the Scott Hamilton Quartet.** Hank O'Neal, producer. *Chiaroscuro CR 171, \$7.98.*

For thirty years Bob Wilber has been traveling a somewhat lonesome road in jazz. Musically rooted in the '20s and '30s, his career did not start until the mid-'40s when jazz was turning its back on the past and most jazz musicians of his age were into bop. Since then Wilber and a few of the kids he started with (Dick Wellstood, Eddie Hubble, Kenny Davern) have led a precarious existence, refusing to be lured from the styles that nurtured them. Recently, as the cycle of interest in jazz has turned, things have been picking up for them—Wellstood tours the world with great regularity, Wilber and Davern have combined to form Soprano Summit. No one else of their breed came along for the last three

decades, until a year ago Scott Hamilton turned up playing tenor saxophone as though time had stopped in the late '30s. Wilber lost no time in grasping the hand of this musical companion.

Hamilton's quartet was formed in Providence and emigrated to New York. It features Chris Flory on guitar, Phil Flanagan on bass, and Chuck Riggs on drums. Despite the fact that it is Hamilton's group, the performances bear Wilber's stamp, since they are all either his arrangements or his originals. That stamp is less evident on his playing than it is on his riffing. Ellington small-group style of writing. His clarinet playing is heard most frequently, and, while it is pleasant enough, it's not particularly distinguished. It serves as a sharp contrast to his gorgeously translucent soprano saxophone on *All Too Soon* and the gutty, bubbling alto sax that drives through the boisterous *144 W. 54th* (the address of Eddie Condon's, where Hamilton's group plays on Sunday nights). Here he emerges from the relatively withdrawn manner that characterizes most of the disc, erupting with a rough-toned, exuberant attack.

The rest of the set tends to be perfunctory with interesting ensemble riffs surrounding routine solos. It is not helped by the fact that, without a piano, the rhythm section sounds sodden. J.S.W.

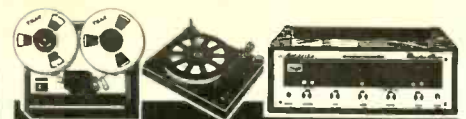

AMERICA'S #1 VALUE LEADER  
STEREO CORPORATION OF AMERICA

**WE'RE THE BEST!!** AND WE'LL PROVE IT!

Our prices are the lowest! Check with us before you buy any stereo equipment. Give us the opportunity to beat the best deal you've been able to find. We weren't rated #1 for nothing.

WRITE OR CALL FOR FREE, BRAND NEW 32 PAGE, STEREO PRICE CATALOG!

- We discount over 60 major brands!
  - We're one of the oldest audio mail-order houses in the U.S.A.
  - Largest inventory/lowest prices!
- We get the best deals from the manufactures, you get the best deals from us.



WRITE US NOW FOR THE LOWEST PRICE QUOTE!

**SHOP BY PHONE!**

(212) 253-8888  
9-5 Mon. thru Sat.  
N.Y. time  
Master Charge  
BankAmericard

**EXCLUSIVE!**

Night Owl Order Line!  
(212) 253-8911  
5-9 P.M. Mon.-  
Thurs. only!  
Orders/Quotes Only!



STEREO CORPORATION OF AMERICA



HF - 1629 Flatbush Ave.  
Brooklyn, New York 11210



CIRCLE 38 ON READER-SERVICE CARD

**SAVE**

HOME & CAR STEREO  
OVER 60 BRANDS  
STOCKED & DISCOUNTED  
SOME EXAMPLES ARE:

PHASE LINEAR	TEAC
PIONEER	SONY
KENWOOD	NIKKO
AKAI	MARANTZ
SANSUI	SHERWOOD
ALTEC-LANSING	BIC

**WDS**  
WISCONSIN DISCOUNT  
STEREO

Write us for a free price sheet  
OR SAVE TIME!!!

If you would like to phone us to save time or discuss your order, we will refund \$1.00 when you place your single order of \$50.00 or more.

2517 Whalen Lane  
Madison, Wisconsin 53713  
608 — 271-6889

CIRCLE 46 ON READER-SERVICE CARD

# Ultimately

## Marantz goes beyond THD to lower TIM (transient intermodulation distortion).

Because TIM doesn't show up on conventional amplifier testing equipment, most manufacturers and their engineers aren't even aware that it exists in their amplifiers. Even if they were, they probably wouldn't know what to do about it.

But because Marantz builds for the music and not just the specs we know how destructive TIM can be to pure sound reproduction. And we've developed a revolutionary new circuit design to eliminate it.

The reduction of TIM can be the single most important element in making an amplifier sound better. For instance, two amplifiers with identical total harmonic distortion (THD) specifications should sound the same when compared... but the one with low TIM will sound audibly better! That's because TIM adds an unnatural harshness to the music. It's not only detrimental to pure sound reproduction, but it can have an emotional effect that you experience as "listening fatigue!"

TIM is caused by an improper design of "negative feedback circuitry" by other manufacturers. Every modern amplifier uses it to lower THD. But *excessive* negative feedback coupled with an insufficient slew rate\* can lead to gross internal overloads under the constantly

changing transient and sound levels of music. That distortion is TIM.

The gentle slopes of continuous sine wave test signals normally used to test an amplifier simply cannot detect TIM distortion. It requires the type of extremely sophisticated spectrum analysis equipment developed by the space industry to analyze radio frequencies.

Our answer to TIM is a circuit design that ensures the widest bandwidth and the lowest obtainable THD *before* negative feedback is applied. The Marantz 170DC Stereo Power Amplifier (the 1152DC, 1180DC and 1122DC also use this circuitry), for instance, needs only 1/100th (-40 dB) the amount of negative feedback commonly required by other amplifiers to yield the same low total harmonic distortion figures.

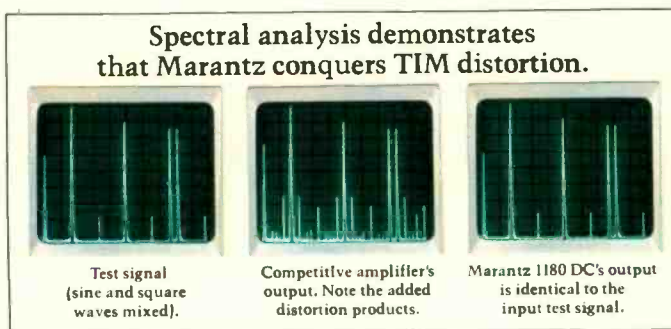

Incredibly, Marantz amplifiers with low TIM design can deliver flat frequency response from 0 Hz to 20 kHz *without* the use of negative feedback. And this same circuit design provides the optimum slew rate for minimum TIM and maximum reliability.

Result: Marantz reduces TIM to an inaudible level, which means you get clear, clean sound from all your records and tapes. Think of Marantz with low TIM as a window to the original performance.

If you truly want the best reproduction of musical sound available anywhere — and are willing to spend a little more to get it — then go for it. Go for Marantz.



*25<sup>th</sup> Anniversary* **marantz®**

\*The maximum change of voltage per unit time. © 1978 Marantz Co., Inc., a subsidiary of Superscope, Inc., 20525 Nordhoff St., Chatsworth, CA 91311. Prices and models subject to change without notice. Your Marantz dealer has the full line of Marantz amplifiers. Look for him in the Yellow Pages.

# It's Marantz. Go For It.



# Only one direct-drive semi-automatic has a concrete advantage.



If you want the precision speed control of direct drive and the convenience of a turntable that shuts itself off, you can choose from many brands.

But only the Kenwood KD-3070 has a solid advantage that can really make a difference.

Because the turntable base is made with dense resin concrete, it virtually eliminates acoustic feedback.

That means that no matter how loud you play your music, the vibration in the air won't couple vibrations to the tonearm and cause howl.

In fact, while we don't recommend it, you can actually place this turntable on top of a speaker and crank up your volume without causing feedback.

The same thought that goes into creating our resin concrete base goes into the design of our tonearm and turntable controls as well.

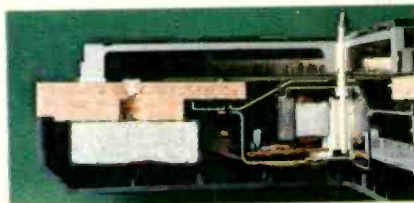

Dense resin concrete in base virtually eliminates vibration.

And if that's not enough to convince you, consider this: You can buy the KD-3070 for less than \$175.00.\*

That's a concrete advantage, too.

\*Nationally advertised value. Actual prices are established by Kenwood dealers. Cartridge optional.



## KENWOOD®

For nearest dealer, see your Yellow Pages, or write Kenwood, P.O. Box 6213, Carson, CA 90749