

# Intel® NUC Board NUC5i5RYB and Intel® NUC Board NUC5i3RYB Technical Product Specification

*May 2017*

*Order Number: H50371-006*

Intel® NUC Board NUC5i5RYB and Intel® NUC Board NUC5i3RYB may contain design defects or errors known as errata that may cause the product to deviate from published specifications. Current characterized errata, if any, are documented in Intel® NUC Board NUC5i5RYB and Intel® NUC Board NUC5i3RYB Specification Update.

# Revision History

---

Revision	Revision History	Date
001	First release of the Intel® NUC Board NUC5i5RYB and Intel® NUC Board NUC5i3RYB Technical Product Specification	December 2014
002	Specification Clarification	June 2015
003	Specification Clarification	March 2016
004	Specification Change	May 2016
005	Specification Change	January 2017
006	Specification Change	May 2017

## Disclaimer

This product specification applies to only the standard Intel NUC Board with BIOS identifier RYBDWi35.86A.

INFORMATION IN THIS DOCUMENT IS PROVIDED IN CONNECTION WITH INTEL® PRODUCTS. NO LICENSE, EXPRESS OR IMPLIED, BY ESTOPPEL OR OTHERWISE, TO ANY INTELLECTUAL PROPERTY RIGHTS IS GRANTED BY THIS DOCUMENT. EXCEPT AS PROVIDED IN INTEL'S TERMS AND CONDITIONS OF SALE FOR SUCH PRODUCTS, INTEL ASSUMES NO LIABILITY WHATSOEVER, AND INTEL DISCLAIMS ANY EXPRESS OR IMPLIED WARRANTY, RELATING TO SALE AND/OR USE OF INTEL PRODUCTS INCLUDING LIABILITY OR WARRANTIES RELATING TO FITNESS FOR A PARTICULAR PURPOSE, MERCHANTABILITY, OR INFRINGEMENT OF ANY PATENT, COPYRIGHT OR OTHER INTELLECTUAL PROPERTY RIGHT. UNLESS OTHERWISE AGREED IN WRITING BY INTEL, THE INTEL PRODUCTS ARE NOT DESIGNED NOR INTENDED FOR ANY APPLICATION IN WHICH THE FAILURE OF THE INTEL PRODUCT COULD CREATE A SITUATION WHERE PERSONAL INJURY OR DEATH MAY OCCUR.

All Intel NUC Boards are evaluated as Information Technology Equipment (I.T.E.) for use in personal computers (PC) for installation in homes, offices, schools, computer rooms, and similar locations. The suitability of this product for other PC or embedded non-PC applications or other environments, such as medical, industrial, alarm systems, test equipment, etc. may not be supported without further evaluation by Intel.

Intel Corporation may have patents or pending patent applications, trademarks, copyrights, or other intellectual property rights that relate to the presented subject matter. The furnishing of documents and other materials and information does not provide any license, express or implied, by estoppel or otherwise, to any such patents, trademarks, copyrights, or other intellectual property rights.

Intel may make changes to specifications and product descriptions at any time, without notice.

Designers must not rely on the absence or characteristics of any features or instructions marked "reserved" or "undefined." Intel reserves these for future definition and shall have no responsibility whatsoever for conflicts or incompatibilities arising from future changes to them.

Intel processor numbers are not a measure of performance. Processor numbers differentiate features within each processor family, not across different processor families: Go to: [Learn About Intel® Processor Numbers](#)

Intel NUC may contain design defects or errors known as errata, which may cause the product to deviate from published specifications. Current characterized errata are available on request.

Contact your local Intel sales office or your distributor to obtain the latest specifications before placing your product order.

Intel and Intel Core are trademarks of Intel Corporation in the U.S. and/or other countries.

\* Other names and brands may be claimed as the property of others.

Copyright © 2016, 2017 Intel Corporation. All rights reserved.

## Board Identification Information

### Basic Intel® NUC Board NUC5i5RYB Identification Information

AA Revision	BIOS Revision	Notes
H40999-502	RYBDWi35.86A.0130	1,2

Notes:

1. The AA number is found on a small label on the component side of the board.
2. The Intel® Core™ i5-5250U processor is used on this AA revision consisting of the following component:

Device	Stepping	S-Spec Numbers
Intel Core i5-5250U	F0	SR26C

### Basic Intel® NUC Board NUC5i3RYB Identification Information

AA Revision	BIOS Revision	Notes
H41000-502	RYBDWi35.86A.0130	1,2

Notes:

1. The AA number is found on a small label on the component side of the board.
2. The Intel® Core™ i3-5010U processor is used on this AA revision consisting of the following component:

Device	Stepping	S-Spec Numbers
Intel Core i3-5010U	F0	SR23Z

## Specification Changes or Clarifications

The table below indicates the Specification Changes or Specification Clarifications that apply to the Intel NUC Board NUC5i5RYB and NUC5i3RYB.

### Specification Changes or Clarifications

Date	Type of Change	Description of Changes or Clarifications
June 2015	Spec Clarification	<ul style="list-style-type: none"> <li>• Updated the following to show the connector used: <ul style="list-style-type: none"> <li>– Table 14</li> <li>– Table 16</li> <li>– Table 17</li> <li>– Section 2.2.3.5</li> </ul> </li> </ul>
March 2016	Spec Clarification	Added a Note to Section 2.2.3.3 to clarify what the Auxiliary Power Connector is used for.
May 2016	Spec Change	Deleted the Near Field Communication (NFC) header and all related text.
January 2017	Spec Change	Deleted references to Intel Integrator Toolkit, including the section "Custom Splash Screen"
May 2017	Spec Change	Remove reference to "RAID 0 auto replace" in section 1.7.2

## Errata

Current characterized errata, if any, are documented in a separate Specification Update. See <http://www.intel.com/content/www/us/en/nuc/overview.html> for the latest documentation.



# Preface

---

This Technical Product Specification (TPS) specifies the board layout, components, connectors, power and environmental requirements, and the BIOS for Intel® NUC Board NUC5i5RYB and Intel® NUC Board NUC5i3RYB.

## Intended Audience

The TPS is intended to provide detailed, technical information about Intel® NUC Board NUC5i5RYB and Intel® NUC Board NUC5i3RYB and its components to the vendors, system integrators, and other engineers and technicians who need this level of information. It is specifically *not* intended for general audiences.

## What This Document Contains

Chapter	Description
1	A description of the hardware used on Intel® NUC Board NUC5i5RYB and Intel® NUC Board NUC5i3RYB
2	A map of the resources of the Intel NUC Board
3	The features supported by the BIOS Setup program
4	A description of the BIOS error messages, beep codes, and POST codes
5	Regulatory compliance and battery disposal information

## Typographical Conventions

This section contains information about the conventions used in this specification. Not all of these symbols and abbreviations appear in all specifications of this type.

## Notes, Cautions, and Warnings



### NOTE

*Notes call attention to important information.*



### CAUTION

*Cautions are included to help you avoid damaging hardware or losing data.*

## Other Common Notation

#	Used after a signal name to identify an active-low signal (such as USBP0#)
GB	Gigabyte (1,073,741,824 bytes)
GB/s	Gigabytes per second
Gb/s	Gigabits per second
KB	Kilobyte (1024 bytes)
Kb	Kilobit (1024 bits)
kb/s	1000 bits per second
MB	Megabyte (1,048,576 bytes)
MB/s	Megabytes per second
Mb	Megabit (1,048,576 bits)
Mb/s	Megabits per second
TDP	Thermal Design Power
xxh	An address or data value ending with a lowercase h indicates a hexadecimal value.
x.x V	Volts. Voltages are DC unless otherwise specified.
*	This symbol is used to indicate third-party brands and names that are the property of their respective owners.





# Contents

---

## Revision History

Disclaimer .....	ii
Board Identification Information .....	iii
Errata.....	iv

## Preface

Intended Audience.....	vi
What This Document Contains.....	vi
Typographical Conventions.....	vi

## Contents

### 1 Product Description

1.1 Overview.....	13
1.1.1 Feature Summary.....	13
1.1.2 Board Layout (Top).....	15
1.1.3 Board Layout (Bottom).....	17
1.1.4 Block Diagram.....	19
1.2 Online Support.....	20
1.3 Processor.....	20
1.4 System Memory.....	21
1.4.1 Memory Configurations.....	22
1.5 Processor Graphics Subsystem.....	23
1.5.1 Integrated Graphics.....	23
1.6 USB.....	26
1.7 SATA Interface.....	26
1.7.1 AHCI Mode.....	26
1.7.2 Intel® Rapid Storage Technology / SATA RAID.....	27
1.7.3 Intel® Smart Response Technology.....	27
1.8 Real-Time Clock Subsystem.....	27
1.9 Audio Subsystem.....	28
1.9.1 Audio Subsystem Software.....	28
1.10 LAN Subsystem.....	29
1.10.1 Intel® I218-V Gigabit Ethernet Controller.....	29
1.10.2 LAN Subsystem Software.....	29
1.10.3 RJ-45 LAN Connector with Integrated LEDs.....	30
1.10.4 Wireless Network Module.....	31
1.11 Hardware Management Subsystem.....	31
1.11.1 Hardware Monitoring.....	31

1.11.2	Fan Monitoring.....	31
1.11.3	Thermal Solution.....	32
1.12	Power Management.....	33
1.12.1	ACPI.....	33
1.12.2	Hardware Support.....	35
<b>2</b>	<b>Technical Reference</b>	
2.1	Memory Resources.....	39
2.1.1	Addressable Memory.....	39
2.2	Connectors and Headers.....	39
2.2.1	Front Panel Connectors.....	40
2.2.2	Back Panel Connectors.....	40
2.2.3	Connectors and Headers (Bottom).....	41
2.3	BIOS Security Jumper.....	49
2.4	Mechanical Considerations.....	51
2.4.1	Form Factor.....	51
2.5	Electrical Considerations.....	52
2.5.1	Power Supply Considerations.....	52
2.5.2	Fan Header Current Capability.....	52
2.6	Thermal Considerations.....	53
2.7	Reliability.....	58
2.8	Environmental.....	58
<b>3</b>	<b>Overview of BIOS Features</b>	
3.1	Introduction.....	59
3.2	BIOS Flash Memory Organization.....	60
3.3	System Management BIOS (SMBIOS).....	60
3.4	Legacy USB Support.....	60
3.5	BIOS Updates.....	61
3.5.1	Language Support.....	61
3.5.2	BIOS Recovery.....	62
3.6	Boot Options.....	63
3.6.1	Network Boot.....	63
3.6.2	Booting Without Attached Devices.....	63
3.6.3	Changing the Default Boot Device During POST.....	63
3.6.4	Power Button Menu.....	64
3.7	Hard Disk Drive Password Security Feature.....	65
3.8	BIOS Security Features.....	66
<b>4</b>	<b>Error Messages and Blink Codes</b>	
4.1	Front-panel Power LED Blink Codes.....	67
4.2	BIOS Error Messages.....	67

## 5 Regulatory Compliance and Battery Disposal Information

5.1	Regulatory Compliance .....	69
5.1.1	Safety Standards .....	69
5.1.2	European Union Declaration of Conformity Statement.....	70
5.1.3	EMC Regulations .....	71
5.1.4	e-Standby and ErP Compliance .....	74
5.1.5	Regulatory Compliance Marks (Board Level).....	75
5.2	Battery Disposal Information .....	76

### Figures

1.	Major Board Components (Top) .....	15
2.	Major Board Components (Bottom) .....	17
3.	Block Diagram.....	19
4.	Memory Channel and SO-DIMM Configuration .....	22
5.	4-Pin 3.5 mm (1/8 inch) Audio Jack Pin Out.....	28
6.	LAN Connector LED Locations .....	30
7.	Thermal Solution and Fan Header.....	32
8.	Location of the Standby Power LED .....	37
9.	Front Panel Connectors.....	40
10.	Back Panel Connectors.....	40
11.	Connectors and Headers (Bottom).....	41
12.	Connection Diagram for Front Panel Header (2.0 mm Pitch).....	46
13.	Connection Diagram for Internal USB 2.0 Dual-Port Header (1.25 mm Pitch).....	48
14.	Location of the CIR Sensor.....	48
15.	Location of the BIOS Security Jumper.....	49
16.	Board Dimensions.....	51
17.	Board Height Dimensions.....	52
18.	Localized High Temperature Zones.....	54
19.	Installation Area of Thermal Pad for Intel NUC Kit NUC5i5RYK/NUC5i3RYK.....	55
20.	Installation area of Thermal Pad for Intel NUC Kit NUC5i5RYKH/NUC5i3RYKH .....	56

### Tables

1.	Feature Summary.....	13
2.	Components Shown in Figure 1.....	16
3.	Components Shown in Figure 2.....	18
4.	Supported Memory Configurations .....	21
5.	DisplayPort Multi-Streaming Resolutions .....	24
6.	Multiple Display Configuration Maximum Resolutions.....	25
7.	Audio Formats Supported by the Mini HDMI and Mini DisplayPort Interfaces .....	25
8.	LAN Connector LED States.....	30
9.	Effects of Pressing the Power Switch .....	33

10.	Power States and Targeted System Power.....	34
11.	Wake-up Devices and Events .....	35
12.	Connectors and Headers Shown in Figure 10 .....	42
13.	SATA Power Header (1.25 mm pitch).....	43
14.	Dual-Port Internal USB 2.0 Header (1.25 mm pitch).....	43
15.	M.2 2280 Module (key type M) Connector .....	43
16.	Auxiliary Power Connector.....	44
17.	Auxiliary Power Connector.....	45
17.	Front Panel Header (2.0 mm Pitch) .....	46
18.	States for a Dual-Color Power LED.....	47
19.	States for a Dual-Color Power LED.....	47
20.	Fan Header Current Capability .....	52
21.	Thermal Considerations for Components.....	57
22.	Tcontrol Values for Components.....	57
23.	Environmental Specifications .....	58
24.	Acceptable Drives/Media Types for BIOS Recovery .....	62
25.	Boot Device Menu Options .....	63
26.	Master Key and User Hard Drive Password Functions.....	65
27.	Supervisor and User Password Functions.....	66
28.	Front-panel Power LED Blink Codes.....	67
29.	Safety Standards .....	69
30.	EMC Regulations.....	71
31.	Regulatory Compliance Marks.....	75

# 1 Product Description

## 1.1 Overview

### 1.1.1 Feature Summary

Table 1 summarizes the major features of Intel® NUC Board NUC5i5RYB and Intel® NUC Board NUC5i3RYB.

**Table 1. Feature Summary**

<b>Form Factor</b>	4.0 inches by 4.0 inches (101.60 millimeters by 101.60 millimeters)
<b>Processor</b>	<ul style="list-style-type: none"><li>• Intel® NUC Board NUC5i5RYB has a soldered-down 5<sup>th</sup> generation Intel® Core™ i5-5250U dual-core processor with up to a maximum 25 W TDP (if thermal margin available)<ul style="list-style-type: none"><li>— Integrated graphics HD6000</li><li>— Integrated memory controller</li><li>— Integrated PCH</li></ul></li><li>• Intel® NUC Board NUC5i3RYB has a soldered-down 5<sup>th</sup> generation Intel® Core™ i3-5010U dual-core processor with up to a maximum 25 W TDP (if thermal margin available)<ul style="list-style-type: none"><li>— Integrated graphics HD5500</li><li>— Integrated memory controller</li><li>— Integrated PCH</li></ul></li></ul>
<b>Memory</b>	<ul style="list-style-type: none"><li>• Two 204-pin DDR3L SDRAM Small Outline Dual Inline Memory Module (SO-DIMM) sockets</li><li>• Support for DDR3L 1600/1333 MHz SO-DIMMs</li><li>• Support for 2 Gb and 4 Gb memory technology</li><li>• Support for up to 16 GB of system memory with two SO-DIMMs using 4 Gb memory technology</li><li>• Support for non-ECC memory</li><li>• Support for 1.35 V low voltage JEDEC memory only</li></ul>
<b>Graphics</b>	<ul style="list-style-type: none"><li>• Integrated graphics support for processors with Intel® Graphics Technology:<ul style="list-style-type: none"><li>— One Mini High Definition Multimedia Interface* (Mini HDMI*) back panel connector</li><li>— One Mini DisplayPort* back panel connector</li></ul></li></ul>
<b>Audio</b>	<ul style="list-style-type: none"><li>• Intel® High Definition (Intel® HD) Audio via the Mini HDMI v1.4a and Mini DisplayPort 1.2 interfaces through the processor</li><li>• Realtek HD Audio via a stereo microphone/headphone 3.5 mm jack on the front panel</li></ul>
<b>Storage</b>	<ul style="list-style-type: none"><li>• SATA ports:<ul style="list-style-type: none"><li>— One SATA 6.0 Gb/s port (blue) for 2.5" storage device</li></ul></li><li>• One SATA 6.0 Gb/s port is reserved for an M.2 storage module supporting M.2 2242, M.2 2260, and M.2 2280 (key type M) modules</li></ul> <p>Note: Intel NUC Board NUC5i5RYB and Intel NUC Board NUC5i3RYB support key type M (PCI Express x1/x2/x4 and SATA)</p>
<b>Peripheral Interfaces</b>	<ul style="list-style-type: none"><li>• USB 3.0 ports:<ul style="list-style-type: none"><li>— Two ports are implemented with external front panel connectors (blue and orange)</li><li>— Two ports are implemented with external back panel connectors (blue)</li></ul></li><li>• USB 2.0 ports:<ul style="list-style-type: none"><li>— Two ports via one dual-port internal 1x8 1.25 mm pitch header (white)</li></ul></li></ul>

	— One port is reserved for an M.2 1216 module
--	---

continued

**Table 1. Feature Summary (continued)**

<b>Expansion Capabilities</b>	One M.2 connector supporting M.2 2242, M.2 2260, and M.2 2280 (key type M) modules
<b>BIOS</b>	<ul style="list-style-type: none"> <li>• Intel® BIOS resident in the Serial Peripheral Interface (SPI) Flash device</li> <li>• Support for Advanced Configuration and Power Interface (ACPI), Plug and Play, and System Management BIOS (SMBIOS)</li> </ul>
<b>Instantly Available PC Technology</b>	<ul style="list-style-type: none"> <li>• Support for PCI Express*</li> <li>• Suspend to RAM support</li> <li>• Wake on PCI Express, LAN, front panel, CIR, and USB ports</li> </ul>
<b>LAN</b>	Gigabit (10/100/1000 Mb/s) LAN subsystem using the Intel® I218-V Gigabit Ethernet Controller
<b>Hardware Monitor Subsystem</b>	<p>Hardware monitoring subsystem, based on a Nuvoton NCT5577D embedded controller, including:</p> <ul style="list-style-type: none"> <li>• Voltage sense to detect out of range power supply voltages</li> <li>• Thermal sense to detect out of range thermal values</li> <li>• One processor fan header</li> <li>• Fan sense input used to monitor fan activity</li> <li>• Fan speed control</li> </ul>
<b>Wireless</b>	<p>Intel® Dual Band Wireless-AC 7265</p> <ul style="list-style-type: none"> <li>• 802.11ac, Dual Band, 2x2 Wi-Fi + Bluetooth 4.0</li> <li>• Maximum Transfer speed up to 867Mbps</li> <li>• Supports Intel® Wireless Display (WiDi)</li> <li>• Supports Intel® Smart Connect Technology</li> </ul>

### 1.1.2 Board Layout (Top)

Figure 1 shows the location of the major components on the top-side of Intel NUC Board NUC5i5RYB and Intel NUC Board NUC5i3RYB.

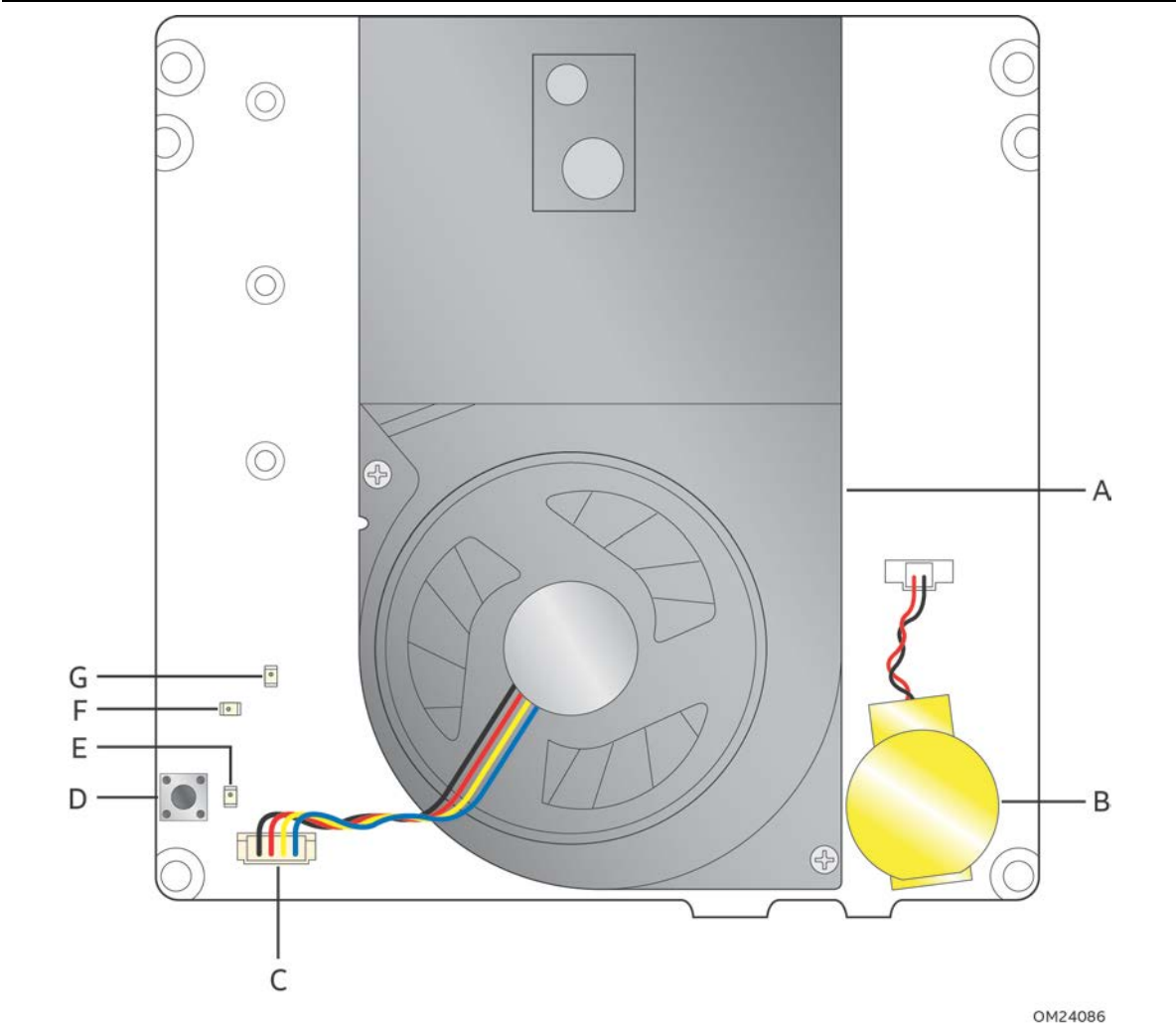

Figure 1. Major Board Components (Top)

Table 2 lists the components identified in Figure 1.

**Table 2. Components Shown in Figure 1**

<b>Item from Figure 1</b>	<b>Description</b>
A	Thermal solution
B	Battery
C	Processor fan header
D	Onboard power button
E	Power LED (Dual Color)
F	Hard Disk Drive LED
G	Standby Power LED



### 1.1.3 Board Layout (Bottom)

Figure 2 shows the location of the major components on the bottom-side of Intel NUC Board NUC5i5RYB and Intel NUC Board NUC5i3RYB.

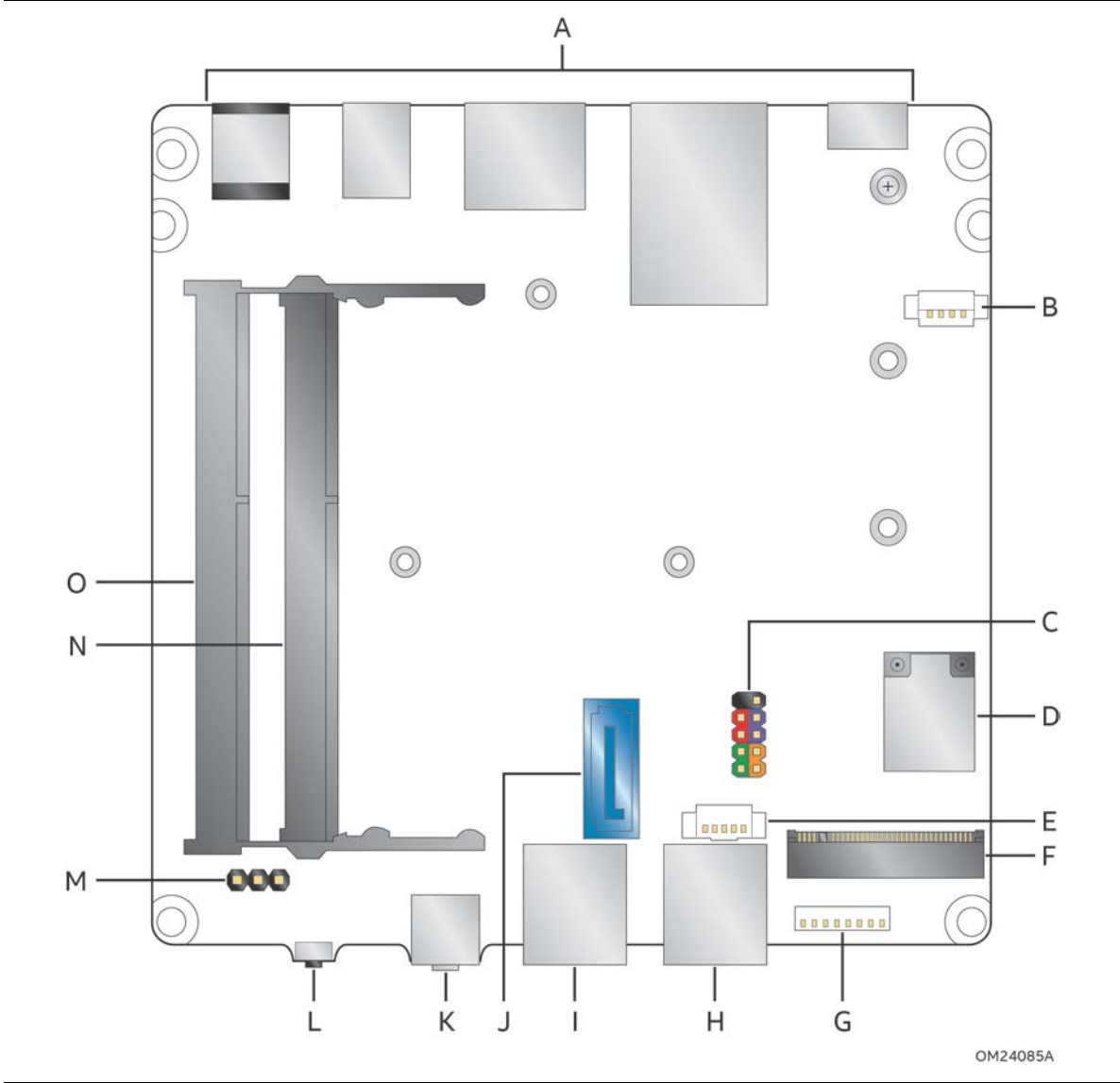

Figure 2. Major Board Components (Bottom)

**Table 3. Components Shown in Figure 2**

<b>Item from Figure 2</b>	<b>Description</b>
A	Back panel connectors
B	Auxiliary power connector
C	Front panel header
D	Intel Dual Band Wireless AC + Bluetooth 7265 module
E	SATA power connector (1.25 mm pitch)
F	M.2 connector (key type M) for 2242, 2260, and 2280 modules
G	Front panel dual-port USB 2.0 header (1.25 mm pitch)
H	Front panel USB 3.0 connector (blue)
I	Front panel USB 3.0 connector (orange, charging)
J	SATA 6.0 Gb/s connector
K	Front panel stereo microphone/headphone jack
L	Consumer Infrared (CIR) sensor
M	BIOS security jumper
N	DDR3L SO-DIMM 1 socket
O	DDR3L SO-DIMM 2 socket

### 1.1.4 Block Diagram

Figure 3 is a block diagram of the major functional areas of the board.

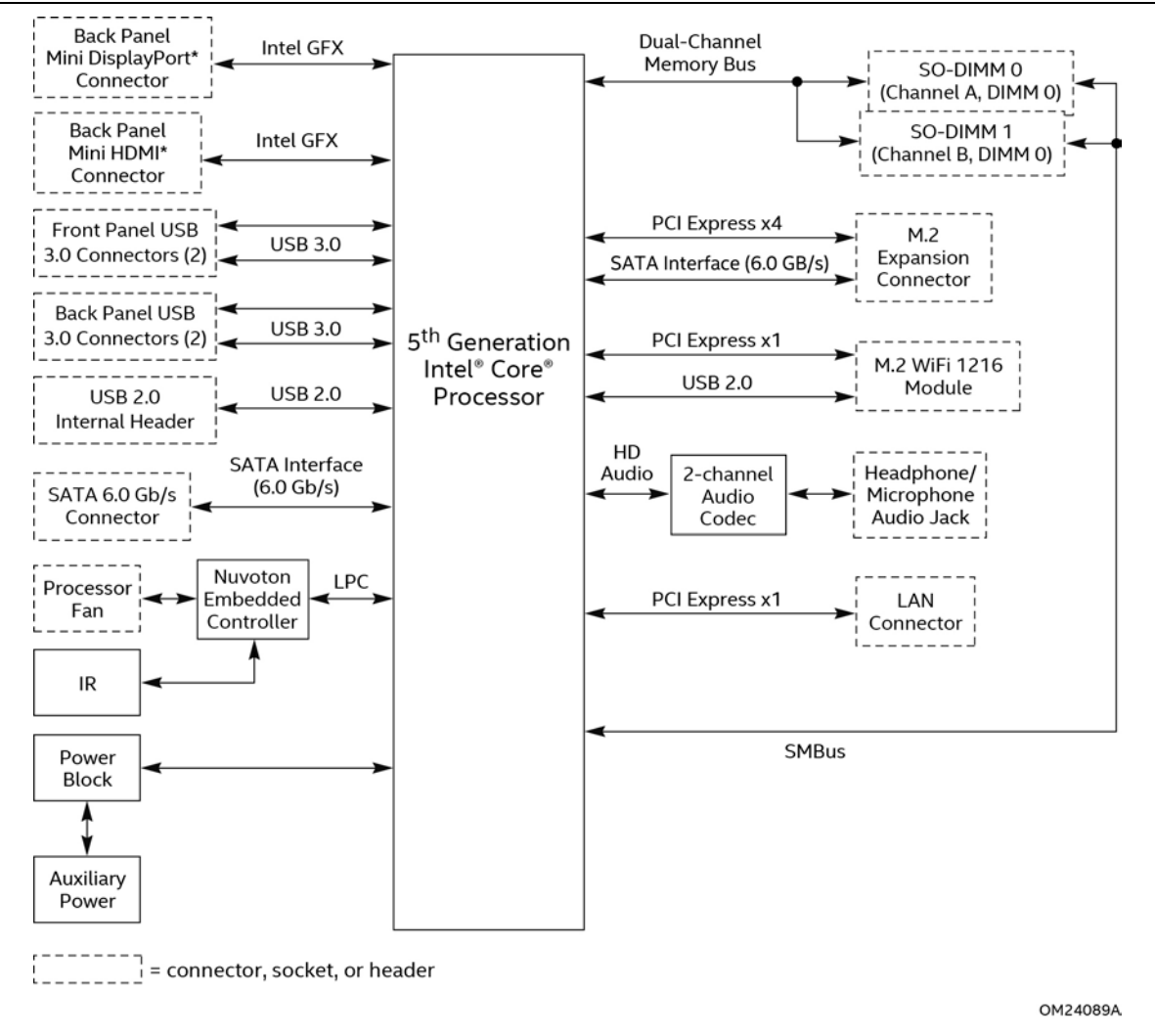

Figure 3. Block Diagram

## 1.2 Online Support

### To find information about...

Intel NUC Board NUC5i5RYB and Intel NUC Board NUC5i3RYB

Intel NUC Board Support

Available configurations for Intel NUC Board NUC5i5RYB and Intel NUC Board NUC5i3RYB

BIOS and driver updates

Tested memory

Integration information

Processor datasheet

### Visit this World Wide Web site:

<http://www.intel.com/NUC>

<http://www.intel.com/NUCSupport>

<http://ark.intel.com>

<http://downloadcenter.intel.com>

<http://www.intel.com/NUCSupport>

<http://www.intel.com/NUCSupport>

<http://ark.intel.com>

## 1.3 Processor

Intel® NUC Board NUC5i5RYB has a soldered-down 5<sup>th</sup> generation Intel® Core™ i5-5250U dual-core processor with up to a maximum 25 W TDP (if thermal margin is available)

- Integrated graphics HD6000
- Integrated memory controller
- Integrated PCH

Intel® NUC Board NUC5i3RYB has a soldered-down 5<sup>th</sup> generation Intel® Core™ i3-5010U dual-core processor with up to a maximum 25 W TDP (if thermal margin is available)

- Integrated graphics with HD5500
- Integrated memory controller
- Integrated PCH



### NOTE

*There are specific requirements for providing power to the processor. Refer to Section 2.5.1 on page 52 for information on power supply requirements.*

## 1.4 System Memory

The board has two 204-pin SO-DIMM sockets and supports the following memory features:

- 1.35 V DDR3L SDRAM SO-DIMMs with gold plated contacts
- Two independent memory channels with interleaved mode support
- Unbuffered, single-sided or double-sided SO-DIMMs
- 16 GB maximum total system memory (with 4 Gb memory technology). Refer to Section 2.1.1 on page 39 for information on the total amount of addressable memory.
- Minimum recommended total system memory: 2048 MB
- Non-ECC SO-DIMMs
- Serial Presence Detect
- DDR3L 1600/1333 MHz SDRAM SO-DIMMs



### NOTE

To be fully compliant with all applicable DDR SDRAM memory specifications, the board should be populated with SO-DIMMs that support the Serial Presence Detect (SPD) data structure. This allows the BIOS to read the SPD data and program the chipset to accurately configure memory settings for optimum performance. If non-SPD memory is installed, the BIOS will attempt to correctly configure the memory settings, but performance and reliability may be impacted or the SO-DIMMs may not function under the determined frequency.

Table 4 lists the supported SO-DIMM configurations.

**Table 4. Supported Memory Configurations**

DIMM Capacity	Configuration <sup>(Note)</sup>	SDRAM Density	SDRAM Organization Front-side/Back-side	Number of SDRAM Devices
4096 MB	DS	2 Gbit	256 M x8/256 M x8	16
4096 MB	SS	4 Gbit	512 M x8/empty	8
8192 MB	DS	4 Gbit	512 M x8/512 M x8	16

Note: "DS" refers to double-sided memory modules (containing two rows of SDRAM) and "SS" refers to single-sided memory modules (containing one row of SDRAM).

#### For information about...

Tested Memory

#### Refer to:

<http://www.intel.com/NUCSupport>

## 1.4.1 Memory Configurations

The processor supports the following types of memory organization:

- **Dual channel (Interleaved) mode.** This mode offers the highest throughput for real world applications. Dual channel mode is enabled when the installed memory capacities of both SO-DIMM channels are equal. Technology and device width can vary from one channel to the other but the installed memory capacity for each channel must be equal. If different speed SO-DIMMs are used between channels, the slowest memory timing will be used.
- **Single channel (Asymmetric) mode.** This mode is equivalent to single channel bandwidth operation for real world applications. This mode is used when only a single SO-DIMM is installed or the memory capacities are unequal. Technology and device width can vary from one channel to the other. If different speed SO-DIMMs are used between channels, the slowest memory timing will be used.

**For information about...**

**Refer to:**

Memory Configuration Examples

<http://www.intel.com/NUCSupport>

Figure 4 illustrates the memory channel and SO-DIMM configuration.

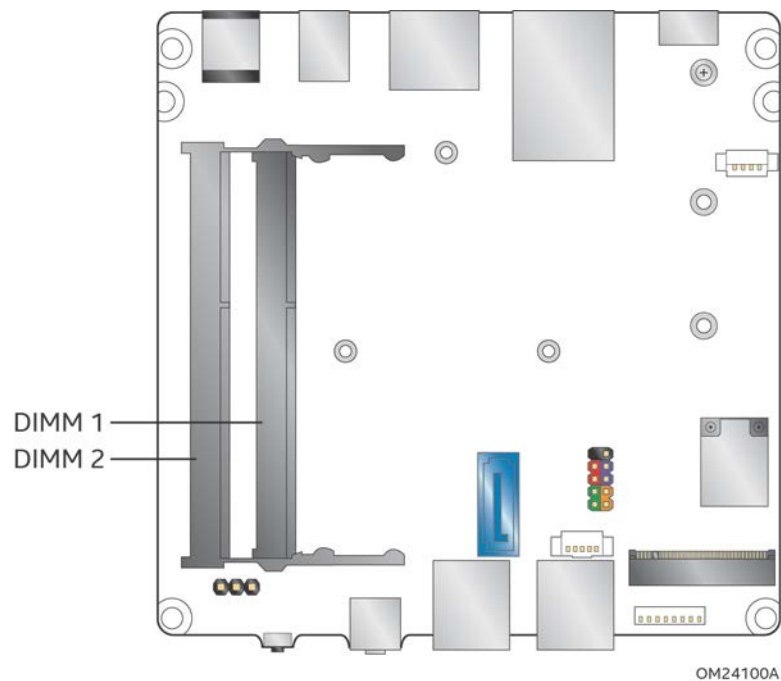

**Figure 4. Memory Channel and SO-DIMM Configuration**

## 1.5 Processor Graphics Subsystem

The board supports graphics through Intel HD Graphics.

### 1.5.1 Integrated Graphics

The board supports integrated graphics via the processor.

#### 1.5.1.1 Intel® High Definition (Intel® HD) Graphics

The Intel HD graphics controller features the following:

- 3D Features
  - DirectX\* 11 support
  - OpenGL\* 4.2 support
- Video
- Next Generation Intel® Clear Video Technology HD support is a collection of video playback and enhancement features that improve the end user's viewing experience
- Encode/transcode HD content
- Playback of high definition content including Blu-ray\* disc
- Superior image quality with sharper, more colorful images
- DirectX\* Video Acceleration (DXVA) support for accelerating video processing
- Full AVC/VC1/MPEG2/H.264 HW Decode
- Partial H.265 encoding via graphics hardware and via the CPU
- Intel HD Graphics with Advanced Hardware Video Transcoding (Intel® Quick Sync Video)



#### **NOTE**

*Intel Quick Sync Video is enabled by an appropriate software application.*

#### 1.5.1.2 Video Memory Allocation

Intel® Dynamic Video Memory Technology (DVMT) is a method for dynamically allocating system memory for use as graphics memory to balance 2D/3D graphics and system performance. If your computer is configured to use DVMT, graphics memory is allocated based on system requirements and application demands (up to the configured maximum amount). When memory is no longer needed by an application, the dynamically allocated portion of memory is returned to the operating system for other uses.

### 1.5.1.3 Mini High Definition Multimedia Interface\* (Mini HDMI\*)

The Mini High-Definition Multimedia Interface (Mini HDMI) is provided for transmitting uncompressed digital audio and video signals to television sets, projectors and other video displays. It can carry high quality multi-channel audio data and all standard and high-definition consumer electronics video formats. The Mini HDMI display interface connecting the processor and display devices utilizes transition minimized differential signaling (TMDS) to carry audio visual information through the same Mini HDMI cable. The processor HDMI interface is designed according to the High-Definition Multimedia Interface Specification with 3D, Deep Color, and x.v.Color. The maximum supported resolution is 1920 x 1200 @ 60 Hz, 24bpp or up to 4096 x 2304 @ 24Hz, 24bpp. The Mini HDMI port is compliant with the HDMI 1.4a specification.

### 1.5.1.4 Mini DisplayPort\*

DisplayPort is a digital communication interface that utilizes differential signaling to achieve a high bandwidth bus interface designed to support connections between PCs and monitors, projectors, and TV displays. DisplayPort is suitable for display connections between consumer electronics devices such as high definition optical disc players, set top boxes, and TV displays. The maximum supported resolution is 3840 x 2160 @ 60 Hz, 30bpp. The Mini DisplayPort is compliant with the DisplayPort 1.2 specification.

DisplayPort output supports Multi-Stream Transport (MST) which allows for multiple independent video streams (daisy-chain connection with multiple monitors) over a single DisplayPort. This will require the use of displays that support DisplayPort 1.2 and allow for this feature.

#### For information about

DisplayPort technology

#### Refer to

<http://www.displayport.org>

#### 1.5.1.4.1 DisplayPort 1.2 Multi-Stream Transport Daisy-Chaining

Table 5 lists the maximum resolutions available when using DisplayPort 1.2 Multi-Stream Transport.

**Table 5. DisplayPort Multi-Streaming Resolutions**

DisplayPort Usage Models	Monitor 1	Monitor 2	Monitor 3
3 Monitors	1920 x 1200 @ 60 Hz	1920 x 1080 @ 60 Hz	1920 x 1080 @ 60 Hz
2 Monitors	2560 x 1600 @ 60 Hz	2560 x 1600 @ 60 Hz	
3 Monitors (with DisplayPort 1.2 hub)	1920 x 1080 @ 60 Hz	1920 x 1080 @ 60 Hz	1920 x 1080 @ 60 Hz

### 1.5.1.5 Multiple DisplayPort and HDMI Configurations

Multiple DisplayPort and HDMI configurations feature the following:

- Two independent displays
- Single HDMI 1.4a with 1080P support
- Single DisplayPort 1.2 with 4K support
- Collage Display



**Table 6. Multiple Display Configuration Maximum Resolutions**

Single Display HDMI	Dual Display DisplayPort and HDMI	Single Display DisplayPort
1920 x 1200 @ 60 Hz	3840 x 2160 @ 60 Hz (DisplayPort) 1920 x 1200 @ 60 Hz (HDMI)	3840 x 2160 @ 60 Hz
4096 x 2304 @ 24Hz	3840 x 2160 @ 30 Hz (DisplayPort) 3840 x 2160 @ 30 Hz (HDMI)	Same as above

Note: Higher resolutions may be achievable but only at lower refresh rates

For information about	Refer to
Multiple display maximum resolutions	<a href="https://www-ssl.intel.com/content/www/us/en/processors/core/CoreTechnicalResources.html">https://www-ssl.intel.com/content/www/us/en/processors/core/CoreTechnicalResources.html</a> (Generic link)

### 1.5.1.6 High-bandwidth Digital Content Protection (HDCP)

HDCP is the technology for protecting high definition content against unauthorized copy or interception between a source (computer, digital set top boxes, etc.) and the sink (panels, monitor, and TVs). The PCH supports HDCP 1.4a for content protection over wired displays (Mini DisplayPort and Mini HDMI).

### 1.5.1.7 Integrated Audio Provided by the Mini HDMI and Mini DisplayPort Interfaces

The Mini HDMI and Mini DisplayPort interfaces from the PCH support audio. The processor supports two High Definition audio streams on two digital ports simultaneously.

Table 7 shows the specific audio technologies supported by the PCH.

**Table 7. Audio Formats Supported by the Mini HDMI and Mini DisplayPort Interfaces**

Audio Formats	Mini HDMI	Mini DisplayPort
AC-3 – Dolby* Digital	Yes	Yes
Dolby Digital Plus	Yes	Yes
DTS-HD*	Yes	Yes
LPCM, 192 kHz/24 bit, 8 channel	Yes	Yes
Dolby True HD, DTS-HD Master Audio* (Lossless Blu-ray Disc Audio Format)	Yes	Yes

## 1.6 USB

The board supports eight USB ports. All eight ports are high-speed, full-speed, and low-speed capable. The port arrangement is as follows:

- USB 3.0 ports:
  - Two ports are implemented with external front panel connectors (blue and orange)
  - Two ports are implemented with external back panel connectors (blue)
- USB 2.0 ports:
  - Two ports via one dual-port internal 1x8 1.25 mm pitch header (white)
  - One port is reserved for an M.2 1216 for the Wireless module



### NOTE

*Computer systems that have an unshielded cable attached to a USB port may not meet FCC Class B requirements, even if no device is attached to the cable. Use a shielded cable that meets the requirements for full-speed devices.*

For information about	Refer to
The location of the USB connectors on the back panel	Figure 9, page 40
The location of the front panel USB headers	Figure 2, page 17

## 1.7 SATA Interface

The board provides the following SATA interfaces:

- One SATA 6.0 Gb/s port (blue)
- One SATA 6.0 Gb/s port is reserved for an M.2 (Type M) 2240, 2260 or 2280 module for SSD

The PCH provides independent SATA ports with a theoretical maximum transfer rate of 6 Gb/s. A point-to-point interface is used for host to device connections.

### 1.7.1 AHCI Mode

The board supports AHCI storage mode.



### NOTE

*In order to use AHCI mode, AHCI must be enabled in the BIOS. Microsoft\* Windows\* 7 and Windows 8.1 include the necessary AHCI drivers without the need to install separate AHCI drivers during the operating system installation process; however, it is always good practice to update the AHCI drivers to the latest available by Intel.*

## 1.7.2 Intel® Rapid Storage Technology / SATA RAID

The PCH supports Intel® Rapid Storage Technology, providing both AHCI and integrated RAID functionality. The RAID capability provides high-performance RAID 0 and 1 functionality on all SATA ports. Other RAID features include hot spare support and SMART alerting. Software components include an Option ROM for pre-boot configuration and boot functionality, a Microsoft Windows compatible driver, and a user interface for configuration and management of the RAID capability of the PCH.



### NOTE

*Intel Rapid Storage Technology / SATA RAID is only supported if an M.2 SATA SSD module is used with the onboard SATA interface. Cannot get RAID with M.2 PCIe SSD module and onboard SATA interface.*

## 1.7.3 Intel® Smart Response Technology

Intel® Smart Response Technology is a disk caching solution that can provide improved computer system performance with improved power savings. It allows configuration of a computer system with the advantage of having HDDs for maximum storage capacity with system performance at or near SSD performance levels.

For more information on Intel Smart Response Technology, go to <http://www.intel.com/support/chipsets/sb/CS-032826.htm>



### NOTE

*In order to use supported RAID and Intel Smart Response Technology features, you must first enable RAID in the BIOS.*

## 1.8 Real-Time Clock Subsystem

A coin-cell battery (CR2032) powers the real-time clock and CMOS memory. When the computer is not plugged into a wall socket, the battery has an estimated life of three years. When the computer is plugged in, the standby current from the power supply extends the life of the battery. The clock is accurate to  $\pm 13$  minutes/year at 25 °C with 3.3 VSB applied via the power supply 5 V STBY rail.



### NOTE

*If the battery and AC power fail, date and time values will be reset and the user will be notified during the POST.*

When the voltage drops below a certain level, the BIOS Setup program settings stored in CMOS RAM (for example, the date and time) might not be accurate. Replace the battery with an equivalent one. Figure 1 on page 15 shows the location of the battery.

## 1.9 Audio Subsystem

The audio subsystem supports the following features:

- Analog line-out/Analog Headphone/Analog Microphone (front panel jack)
- Support for 44.1 kHz/48 kHz/96 kHz/192 kHz sample rates on all analog outputs
- Support for 44.1 kHz/48 kHz/96 kHz sample rates on all analog inputs
- Front Panel Audio Jack Support (see Figure 5 for 3.5 mm audio jack pin out):
  - Speakers only (Stereo)
  - Headphones only (Stereo)
  - Microphone only (mono)
  - Combo Headphone (Stereo)/Microphone (mono)

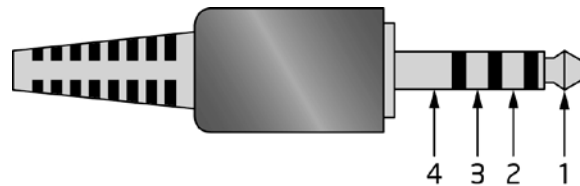

Pin Number	Pin Name	Description
1	Tip	Left Audio Out
2	Ring	Right Audio Out
3	Ring	Common/Ground
4	Sleeve	Audio In/MIC

Figure 5. 4-Pin 3.5 mm (1/8 inch) Audio Jack Pin Out



### NOTE

The analog circuit of the front panel audio connector is designed to power headphones or amplified speakers only. Poor audio quality occurs if passive (nonamplified) speakers are connected to this output.

### 1.9.1 Audio Subsystem Software

Audio software and drivers are available from Intel's World Wide Web site.

#### For information about

Obtaining Audio software and drivers

#### Refer to

<http://downloadcenter.intel.com>

## 1.10 LAN Subsystem

The LAN subsystem consists of the following:

- Intel I218-V Gigabit Ethernet Controller (10/100/1000 Mb/s)
- RJ-45 LAN connector with integrated status LEDs

Additional features of the LAN subsystem include:

- CSMA/CD protocol engine
- LAN connect interface between the Processor and the LAN controller
- Power management capabilities
  - ACPI technology support
  - LAN wake capabilities
- LAN subsystem software

### 1.10.1 Intel® I218-V Gigabit Ethernet Controller

The Intel I218-V Gigabit Ethernet Controller supports the following features:

- Compliant with the 1 Gb/s Ethernet 802.3, 802.3u, 802.3z, 802.3ab specifications
- Multi-speed operation: 10/100/1000 Mb/s
- Full-duplex operation at 10/100/1000 Mb/s; Half-duplex operation at 10/100 Mb/s
- Flow control support compliant with the 802.3X specification as well as the specific operation of asymmetrical flow control defined by 802.3z
- VLAN support compliant with the 802.3q specification
- Supports Jumbo Frames (up to 9 kB)
  - IEEE 1588 supports (Precision Time Protocol)
- MAC address filters: perfect match unicast filters, multicast hash filtering, broadcast filter, and promiscuous mode

### 1.10.2 LAN Subsystem Software

LAN software and drivers are available from Intel's World Wide Web site.

<b>For information about</b>	<b>Refer to</b>
Obtaining LAN software and drivers	<a href="http://downloadcenter.intel.com">http://downloadcenter.intel.com</a>

### 1.10.3 RJ-45 LAN Connector with Integrated LEDs

Two LEDs are built into the RJ-45 LAN connector (shown in Figure 6).

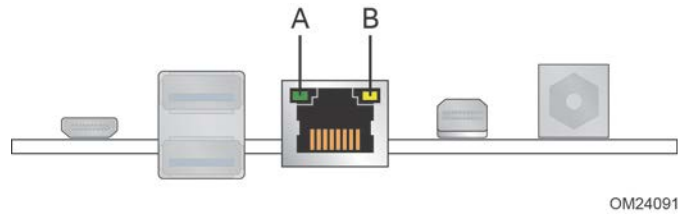

Item	Description
A	Link LED (Green)
B	Data Rate LED (Green/Yellow)

**Figure 6. LAN Connector LED Locations**

Table 8 describes the LED states when the board is powered up and the LAN subsystem is operating.

**Table 8. LAN Connector LED States**

LED	LED Color	LED State	Condition
Link	Green	Off	LAN link is not established.
		On	LAN link is established.
		Blinking	LAN activity is occurring.
Data Rate	Green/Yellow	Off	10 Mb/s data rate is selected.
		Green	100 Mb/s data rate is selected.
		Yellow	1000 Mb/s data rate is selected.

## 1.10.4 Wireless Network Module

The Intel Dual Band Wireless-AC 7265 module provides hi-speed wireless connectivity provided with the following capabilities:

- Compliant IEEE 802.11abgn, 802.11ac, 802.11d, 802.11e, 802.11i, 802.11h, 802.11w specifications
- Maximum bandwidth of 867Mbps
- Dual Mode Bluetooth\* 2.1, 2.1+EDR, 3.0, 4.0 (BLE)
- OS certified with : Microsoft Windows 7, Microsoft Windows 8.1, Linux\* (most features not available on Linux)
- Wi-Fi Direct\* for peer to peer device connections
- Wi-Fi Miracast Source
- Wi-Fi Direct for peer to peer device connections
- Authentication: WPA and WPA2, 802.1X (EAP-TLS, TTLS, PEAP, LEAP, EAP-FAST), EAP-SIM, EAP-AKA
- Encryption: 64-bit and 128-bit WEP, AES-CCMP, TKIP, WPA2, AES-CCMP

For information about	Refer to
Obtaining WLAN software and drivers	<a href="http://downloadcenter.intel.com">http://downloadcenter.intel.com</a>
Full Specifications	<a href="http://intel.com/wireless">http://intel.com/wireless</a>

## 1.11 Hardware Management Subsystem

The hardware management features enable the board to be compatible with the Wired for Management (WfM) specification. The board has several hardware management features, including thermal and voltage monitoring.

For information about	Refer to
Wired for Management (WfM) Specification	<a href="http://www.intel.com/design/archives/wfm/">www.intel.com/design/archives/wfm/</a>

### 1.11.1 Hardware Monitoring

The hardware monitoring and fan control subsystem is based on a Nuvoton NCT5577D embedded controller, which supports the following:

- Processor and system ambient temperature monitoring
- Chassis fan speed monitoring
- Voltage monitoring of +5 V, +3.3 V, Memory Vcc (V\_SM), +Vccp,
- SMBus interface

### 1.11.2 Fan Monitoring

Fan monitoring can be implemented using third-party software.

### 1.11.3 Thermal Solution

Figure 7 shows the location of the thermal solution and processor fan header.

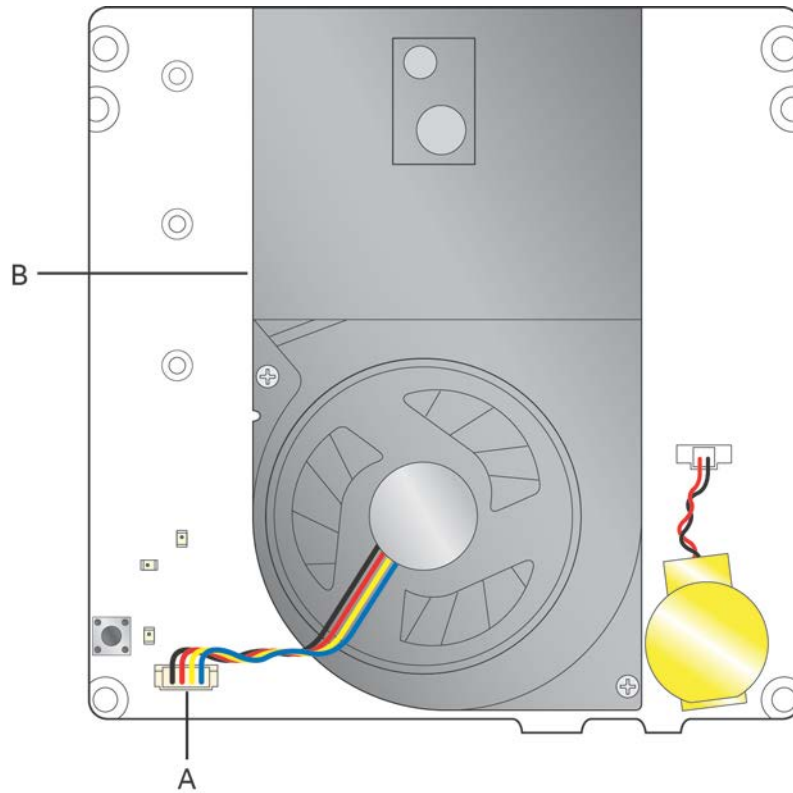

OM24099

Item	Description
A	Processor fan header
B	Thermal solution

**Figure 7. Thermal Solution and Fan Header**



## 1.12 Power Management

Power management is implemented at several levels, including:

- Software support through Advanced Configuration and Power Interface (ACPI)
- Hardware support:
  - Power Input
  - Instantly Available PC technology
  - LAN wake capabilities
  - Wake from USB
  - WAKE# signal wake-up support
  - Wake from S5
  - Wake from CIR
  - +5 V Standby Power Indicator LED

### 1.12.1 ACPI

ACPI gives the operating system direct control over the power management and Plug and Play functions of a computer. The use of ACPI with this board requires an operating system that provides full ACPI support. ACPI features include:

- Plug and Play (including bus and device enumeration)
- Power management control of individual devices, add-in boards (some add-in boards may require an ACPI-aware driver), video displays, and hard disk drives
- Methods for achieving less than 15-watt system operation in the power-on/standby sleeping state
- A Soft-off feature that enables the operating system to power-off the computer
- Support for multiple wake-up events (see Table 11 on page 35)
- Support for a front panel power and sleep mode switch

Table 9 lists the system states based on how long the power switch is pressed, depending on how ACPI is configured with an ACPI-aware operating system.

**Table 9. Effects of Pressing the Power Switch**

If the system is in this state...	...and the power switch is pressed for	...the system enters this state
Off (ACPI G2/G5 – Soft off)	Less than four seconds	Power-on (ACPI G0 – working state)
On (ACPI G0 – working state)	Less than four seconds	Soft-off/Standby (ACPI G1 – sleeping state) <sup>Note</sup>
On (ACPI G0 – working state)	More than six seconds	Fail safe power-off (ACPI G2/G5 – Soft off)
Sleep (ACPI G1 – sleeping state)	Less than four seconds	Wake-up (ACPI G0 – working state)
Sleep (ACPI G1 – sleeping state)	More than six seconds	Power-off (ACPI G2/G5 – Soft off)

Note: Depending on power management settings in the operating system.

### 1.12.1.1 System States and Power States

Under ACPI, the operating system directs all system and device power state transitions. The operating system puts devices in and out of low-power states based on user preferences and knowledge of how devices are being used by applications. Devices that are not being used can be turned off. The operating system uses information from applications and user settings to put the system as a whole into a low-power state.

Table 10 lists the power states supported by the board along with the associated system power targets. See the ACPI specification for a complete description of the various system and power states.

**Table 10. Power States and Targeted System Power**

Global States	Sleeping States	Processor States	Device States	Targeted System Power <sup>(Note 1)</sup>
G0 – working state	S0 – working	C0 – working	D0 – working state.	Full power > 30 W
G1 – sleeping state	S3 – Suspend to RAM. Context saved to RAM.	No power	D3 – no power except for wake-up logic.	Power < 5 W <sup>(Note 2)</sup>
G1 – sleeping state	S4 – Suspend to disk. Context saved to disk.	No power	D3 – no power except for wake-up logic.	Power < 5 W <sup>(Note 2)</sup>
G2/S5	S5 – Soft off. Context not saved. Cold boot is required.	No power	D3 – no power except for wake-up logic.	Power < 5 W <sup>(Note 2)</sup>
G3 – mechanical off AC power is disconnected from the computer.	No power to the system.	No power	D3 – no power for wake-up logic, except when provided by battery or external source.	No power to the system. Service can be performed safely.

Notes:

1. Total system power is dependent on the system configuration, including add-in boards and peripherals powered by the system chassis' power supply.
2. Dependent on the standby power consumption of wake-up devices used in the system.

### 1.12.1.2 Wake-up Devices and Events

Table 11 lists the devices or specific events that can wake the computer from specific states.

**Table 11. Wake-up Devices and Events**

Devices/events that wake up the system...	...from this sleep state	Comments
Power switch	S3, S4, S5 <sup>1</sup>	
RTC alarm	S3, S4, S5 <sup>1</sup>	Monitor to remain in sleep state
LAN	S3, S4, S5 <sup>1,3</sup>	"S5 WOL after G3" must be supported; monitor to remain in sleep state
USB	S3, S4, S5 <sup>1,2,3</sup>	Wake S4, S5 controlled by BIOS option (not after G3)
WAKE#	S3, S4, S5 <sup>1</sup>	Via WAKE; monitor to remain in sleep state
Consumer IR	S3, S4, S5 <sup>1,3</sup>	Will not wake when in Deep S4/S5 sleep state

Notes:

1. S4 implies operating system support only.
2. Will not wake from Deep S4/S5. USB S4/S5 Power is controlled by BIOS. USB S5 wake is controlled by BIOS. USB S4 wake is controlled by OS driver, not just BIOS option.
3. Windows 8.1 Fast startup will block wake from LAN, USB, and CIR from S5.



#### NOTE

*The use of these wake-up events from an ACPI state requires an operating system that provides full ACPI support. In addition, software, drivers, and peripherals must fully support ACPI wake events.*

### 1.12.2 Hardware Support

The board provides several power management hardware features, including:

- Wake from Power Button signal
- Instantly Available PC technology
- LAN wake capabilities
- Wake from USB (not after G3)
- WAKE# signal wake-up support
- Wake from S5
- Wake from CIR
- +5 V Standby Power Indicator LED



#### NOTE

*The use of Wake from USB from an ACPI state requires an operating system that provides full ACPI support.*

### 1.12.2.1 Power Input

When resuming from an AC power failure, the computer returns to the power state it was in before power was interrupted (on or off). The computer's response can be set using the Last Power State feature in the BIOS Setup program's Boot menu.

### 1.12.2.2 Instantly Available PC Technology

Instantly Available PC technology enables the board to enter the ACPI S3 (Suspend-to-RAM) sleep-state. While in the S3 sleep-state, the computer will appear to be off (the power supply is only supplying Standby power, and the front panel LED will be amber or secondary color if dual colored, or off if single colored.) When signaled by a wake-up device or event, the system quickly returns to its last known wake state. Table 11 on page 35 lists the devices and events that can wake the computer from the S3 state.

The use of Instantly Available PC technology requires operating system support and drivers for any installed M.2 add-in card.

### 1.12.2.3 LAN Wake Capabilities

LAN wake capabilities enable remote wake-up of the computer through a network. The LAN subsystem monitors network traffic at the Media Independent Interface. Upon detecting a Magic Packet\* frame, the LAN subsystem asserts a wake-up signal that powers up the computer.

### 1.12.2.4 Wake from USB

USB bus activity wakes the computer from an ACPI S3 state (not after G3)



#### **NOTE**

*Wake from USB requires the use of a USB peripheral that supports Wake from USB.*

### 1.12.2.5 WAKE# Signal Wake-up Support

When the WAKE# signal on the PCI Express bus is asserted, the computer wakes from an ACPI S3, S4, or S5 state.

### 1.12.2.6 Wake from S5

When the RTC Date and Time is set in the BIOS, the computer will automatically wake from an ACPI S5 state.

### 1.12.2.7 Wake from Consumer IR

CIR activity wakes the computer from an ACPI S3, S4, or S5 state.

### 1.12.2.8 +5 V Standby Power Indicator LED

The standby power indicator LED shows that power is still present even when the computer appears to be off. Figure 8 shows the location of the standby power LED.



#### CAUTION

*If AC power has been switched off and the standby power indicator is still lit, disconnect the power cord before installing or removing any devices connected to the board. Failure to do so could damage the board and any attached devices.*

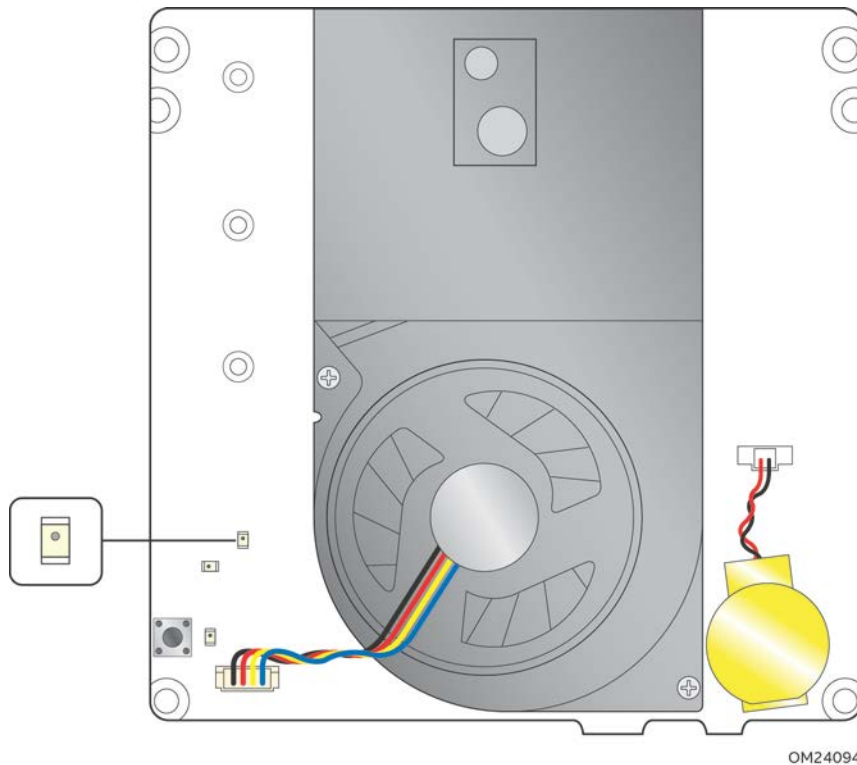

**Figure 8. Location of the Standby Power LED**



## 2 Technical Reference

---

### 2.1 Memory Resources

#### 2.1.1 Addressable Memory

The board utilizes 16 GB of addressable system memory. Typically the address space that is allocated for PCI Conventional bus add-in cards, PCI Express configuration space, BIOS (SPI Flash device), and chipset overhead resides above the top of DRAM (total system memory). On a system that has 32 GB of system memory installed, it is not possible to use all of the installed memory due to system address space being allocated for other system critical functions. These functions include the following:

- BIOS/SPI Flash device (64 Mb)
- Local APIC (19 MB)
- Direct Media Interface (40 MB)
- PCI Express configuration space (256 MB)
- PCH base address registers PCI Express ports (up to 256 MB)
- Memory-mapped I/O that is dynamically allocated for M.2 add-in cards (256 MB)
- Integrated graphics shared memory (up to 512 MB; 64 MB by default)

The board provides the capability to reclaim the physical memory overlapped by the memory mapped I/O logical address space. The board remaps physical memory from the top of usable DRAM boundary to the 4 GB boundary to an equivalent sized logical address range located just above the 4 GB boundary. All installed system memory can be used when there is no overlap of system addresses.

### 2.2 Connectors and Headers



#### CAUTION

*Only the following connectors and headers have overcurrent protection: back panel and front panel USB.*

*The other internal connectors and headers are not overcurrent protected and should connect only to devices inside the computer's chassis, such as fans and internal peripherals. Do not use these connectors or headers to power devices external to the computer's chassis. A fault in the load presented by the external devices could cause damage to the computer, the power cable, and the external devices themselves.*

*Furthermore, improper connection of USB header single wire connectors may eventually overload the overcurrent protection and cause damage to the board.*

This section describes the board's connectors and headers. The connectors and headers can be divided into these groups:

- Front panel I/O connectors
- Back panel I/O connectors
- On-board I/O connectors and headers (see page 41)

## 2.2.1 Front Panel Connectors

Figure 9 shows the location of the front panel connectors for the board.

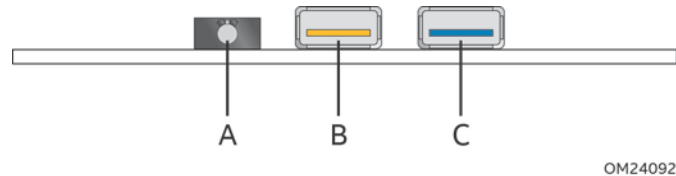

Item	Description
A	Front panel stereo microphone/headphone jack
B	USB 3.0 port (charging) (yellow)
C	USB 3.0 port (blue)

**Figure 9. Front Panel Connectors**

## 2.2.2 Back Panel Connectors

Figure 10 shows the location of the back panel connectors for the board.

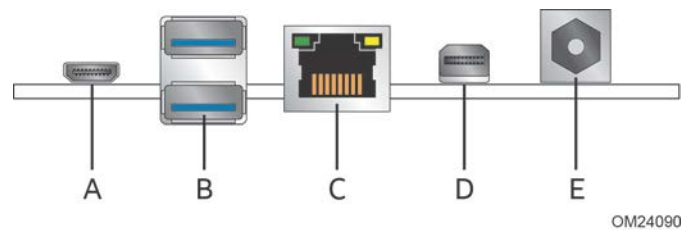

Item	Description
A	Mini HDMI connector
B	USB 3.0 ports (blue)
C	LAN
D	Mini DisplayPort connector
E	12-19 V DC input jack

**Figure 10. Back Panel Connectors**



### 2.2.3 Connectors and Headers (Bottom)

Figure 11 shows the locations of the connectors and headers on the bottom-side of the board.

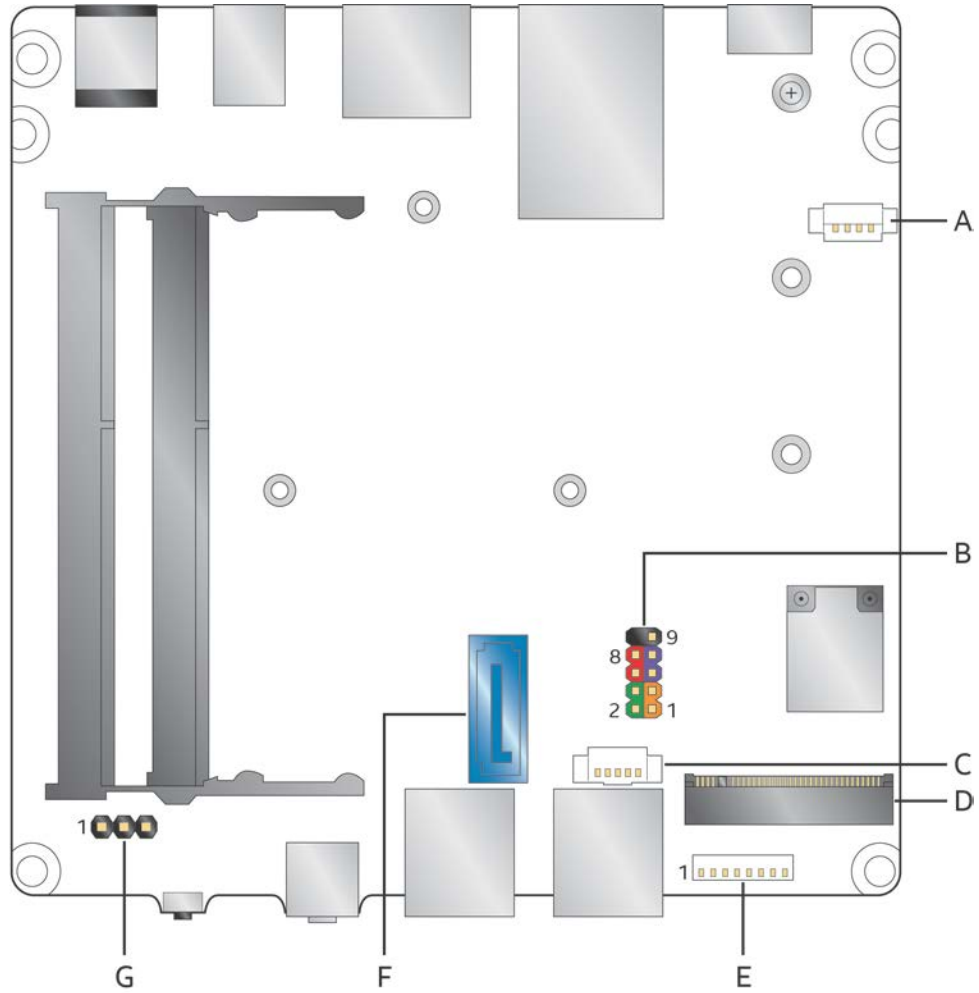

OM24087A

Figure 11. Connectors and Headers (Bottom)

Table 12 lists the connectors and headers identified in Figure 10.

**Table 12. Connectors and Headers Shown in Figure 10**

<b>Item from Figure 10</b>	<b>Description</b>
A	Auxiliary power connector
B	Front panel connector
C	SATA power connector (1.25 mm pitch)
D	M.2 2242, 2260 or 2280 (key type M) connector
E	Front panel dual-port USB 2.0 header (1.25 mm pitch)
F	SATA 6.0 Gb/s connector
G	BIOS Security jumper

### 2.2.3.1 Signal Tables for the Connectors and Headers

**Table 13. SATA Power Header (1.25 mm pitch)**

Pin	Signal Name
1	5 V
2	5 V
3	3.3 V
4	GND
5	GND

**Table 14. Dual-Port Internal USB 2.0 Header (1.25 mm pitch)**

Pin	Signal Name	Pin	Signal Name
1	+5 V DC	2	Data (negative) A
3	Data (positive) A	4	Ground
5	Ground	6	Data (positive) B
7	Data (negative) B	8	+5 V DC



**NOTE**

Connector used is Molex part number 53398-0871, 1.25 mm pitch PicoBlade\* header, surface mount, vertical, lead-free, 8 circuits.

**Table 15. M.2 2280 Module (key type M) Connector**

Pin	Signal Name	Pin	Signal Name
74	3.3V	75	GND
72	3.3V	73	GND
70	3.3V	71	GND
68	SUSCLK(32kHz) (O)(0/3.3V)	69	PEDET (NC-PCIe/GND-SATA)
66	Connector Key	67	N/C
64	Connector Key	65	Connector Key
62	Connector Key	63	Connector Key
60	Connector Key	61	Connector Key
58	N/C	59	Connector Key
56	N/C	57	GND
54	PEWAKE# (I/O)(0/3.3V) or N/C	55	REFCLKP
52	CLKREQ# (I/O)(0/3.3V) or N/C	53	REFCLKN
50	PERST# (O)(0/3.3V) or N/C	51	GND
48	N/C	49	PETp0/SATA-A+
46	N/C	47	PETn0/SATA-A-
44	N/C	45	GND
42	N/C	43	PERp0/SATA-B-

continued

**Table 15. M.2 2280 Module (key type M) Connector (continued)**

Pin	Signal Name	Pin	Signal Name
40	N/C	41	PERn0/SATA-B+
38	DEVSLP (O)	39	GND
36	N/C	37	PETp1
34	N/C	35	PETn1
32	N/C	33	GND
30	N/C	31	PERp1
28	N/C	29	PERn1
26	N/C	27	GND
24	N/C	25	PETp2
22	N/C	23	PETn2
20	N/C	21	GND
18	3.3V	19	PERp2
16	3.3V	17	PERn2
14	3.3V	15	GND
12	3.3V	13	PETp3
10	DAS/DSS# (I/O)/LED1# (I)(0/3.3V)	11	PETn3
8	N/C	9	GND
6	N/C	7	PERp3
4	3.3V	5	PERn3
2	3.3V	3	GND
		1	GND

**Table 16. Auxiliary Power Connector**

Pin	Signal Name	Descriptive Name
1	+5VSB	5V
2	PCH_GPIO24	Power draw sensor
3	GND	Ground
4	+VIN	12V – 19V DC input

**NOTE**

*JTE (JOINT TECH): A1250WRA-S-04P A-Series (Wire to Board) Right Angle SMT Connector, 1.25mm pitch, 1A rating. Mates with JTE A1250 Series Housing.*

### 2.2.3.2 Add-in Card Connectors

The board supports M.2 2242, 2260, and 2280 (key type M) modules.

- Supports M.2 SSD SATA drives
  - Maximum bandwidth is approximately 540 MB/s
- Supports M.2 SSD PCIe drives (PCIe x1, x2, and x4)
  - Using PCIe x4 M.2 SSD maximum bandwidth is approximately 1600 MB/s

### 2.2.3.3 Power Supply Connector

The board has the following power supply connector:

- **External Power Supply** – the board can be powered through a 12-19 V DC connector on the back panel. The back panel DC connector is compatible with a 5.5 mm/OD (outer diameter) and 2.5 mm/ID (inner diameter) plug, where the inner contact is +12-19 ( $\pm 10\%$ ) V DC and the shell is GND. The maximum current rating is 10 A.



**NOTE**

*External power voltage, 12-19 V DC, is dependent on the type of power brick used.*

**Table 17. Auxiliary Power Connector**

Pin	Signal Name	Descriptive Name
1	+5VSB	5V
2	PCH_GPIO24	Power draw sensor
3	GND	Ground
4	+VIN	12V – 19V DC input



**NOTE**

*The Auxiliary Power Connector is a limited voltage source (output) for 5V Standby and the voltage supplied to the board (typically 19V DC) for use by expansion peripherals. The Auxiliary Power Connector is limited to 1.5A max (fused).*



**NOTE**

*JTE (JOINT TECH): A1250WRA-S-04P A-Series (Wire to Board) Right Angle SMT Connector, 1.25mm pitch, 1A rating. Mates with JTE A1250 Series Housing.*

**For information about**

Power supply considerations

**Refer to**

Section 2.5.1, page 52

### 2.2.3.3.1 Power Sensing Circuit

The board has a power sensing circuit that:

- manages CPU power usage to maintain system power consumption below 65 W.
- is designed for use with 65 W AC-DC adapters.



#### NOTE

*It is recommended that you disable this feature (via BIOS option) when using an AC-DC adapter greater than 65 W.*

### 2.2.3.4 Front Panel Header (2.0 mm Pitch)

This section describes the functions of the front panel header. Table 17 lists the signal names of the front panel header. Figure 12 is a connection diagram for the front panel header.

**Table 18. Front Panel Header (2.0 mm Pitch)**

Pin	Signal Name	Description	Pin	Signal Name	Description
1	HDD_POWER_LED	Pull-up resistor (750 Ω) to +5V	2	POWER_LED_MAIN	[Out] Front panel LED (main color)
3	HDD_LED#	[Out] Hard disk activity LED	4	POWER_LED_ALT	[Out] Front panel LED (alt color)
5	GROUND	Ground	6	POWER_SWITCH#	[In] Power switch
7	RESET_SWITCH#	[In] Reset switch	8	GROUND	Ground
9	+5V_DC	Power	10	Key	No pin

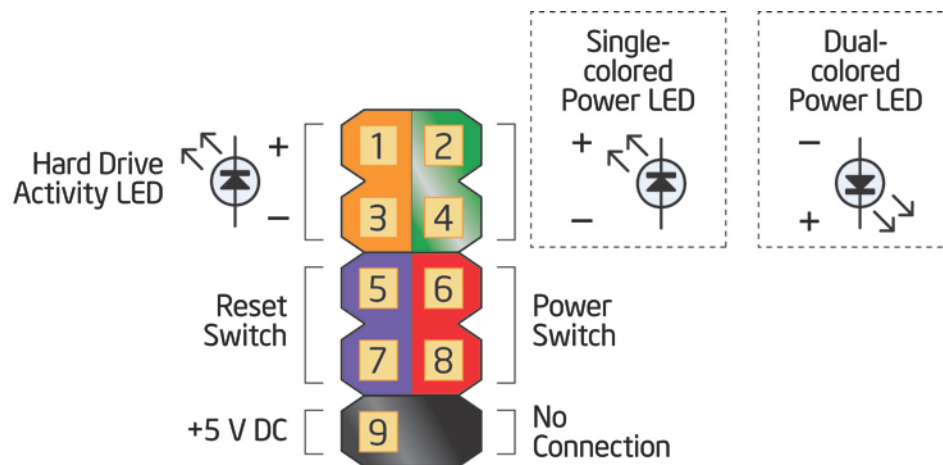

OM20472

**Figure 12. Connection Diagram for Front Panel Header (2.0 mm Pitch)**

**2.2.3.4.1 Hard Drive Activity LED Header**

Pins 1 and 3 can be connected to an LED to provide a visual indicator that data is being read from or written to a hard drive. Proper LED function requires a SATA hard drive connected to an onboard SATA connector.

Note: When using the new M.2 SSD with PCIe there might not be any HDD activity if the storage vendor has not implemented that function.

**2.2.3.4.2 Reset Switch Header**

Pins 5 and 7 can be connected to a momentary single pole, single throw (SPST) type switch that is normally open. When the switch is closed, the board resets and runs the POST.

**2.2.3.4.3 Power/Sleep LED Header**

Pins 2 and 4 can be connected to a one- or two-color LED. Table 18 shows the possible LED states.

**Table 19. States for a Dual-Color Power LED**

LED State	Description
Off	Power off
Blinking	Standby
Steady	Normal operation

**Table 20. States for a Dual-Color Power LED**

LED State	Description
Off	Power off
Secondary color blinking (amber)	Standby
Primary color steady (white)	Normal operation



**NOTE**

*The LED behavior shown in Table 18 is default – other patterns may be set via BIOS setup.*

**2.2.3.4.4 Power Switch Header**

Pins 6 and 8 can be connected to a front panel momentary-contact power switch. The switch must pull the SW\_ON# pin to ground for at least 50 ms to signal the power supply to switch on or off. (The time requirement is due to internal debounce circuitry on the board.) At least two seconds must pass before the power supply will recognize another on/off signal.

### 2.2.3.5 Internal USB 2.0 Dual-Port Header (1.25 mm Pitch)

Figure 13 is a connection diagram for the internal USB header.

Connector used is Molex part number 53398-0871, 1.25 mm pitch PicoBlade header, surface mount, vertical, lead-free, 8 circuits.



#### NOTE

- The +5 V DC power on the USB header is fused.
- Use only an internal USB connector that conforms to the USB 2.0 specification for high-speed USB devices.

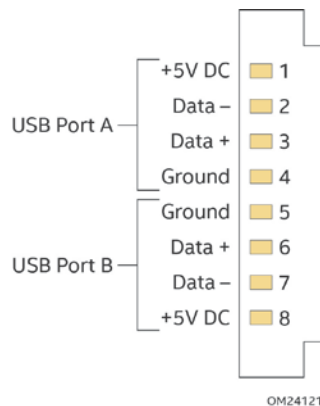

**Figure 13. Connection Diagram for Internal USB 2.0 Dual-Port Header (1.25 mm Pitch)**

### 2.2.3.6 Consumer Infrared (CIR) Sensor

The Consumer Infrared (CIR) sensor on the front panel provides features that are designed to comply with Microsoft Consumer Infrared usage models (RC-6).

The CIR feature is made up of the receiving sensor. The receiving sensor consists of a filtered translated infrared input compliant with Microsoft CIR specifications.

Customers are required to provide their own media center compatible remote or smart phone application for use with the Intel NUC. Figure 14 shows the location of the CIR sensor.



Item	Description
A	CIR Sensor

**Figure 14. Location of the CIR Sensor**



## 2.3 BIOS Security Jumper



### CAUTION

*Do not move a jumper with the power on. Always turn off the power and unplug the power cord from the computer before changing a jumper setting. Otherwise, the board could be damaged.*

Figure 15 shows the location of the BIOS Security Jumper. The 3-pin jumper determines the BIOS Security program's mode.

Table 20 describes the jumper settings for the three modes: normal, lockdown, and configuration.

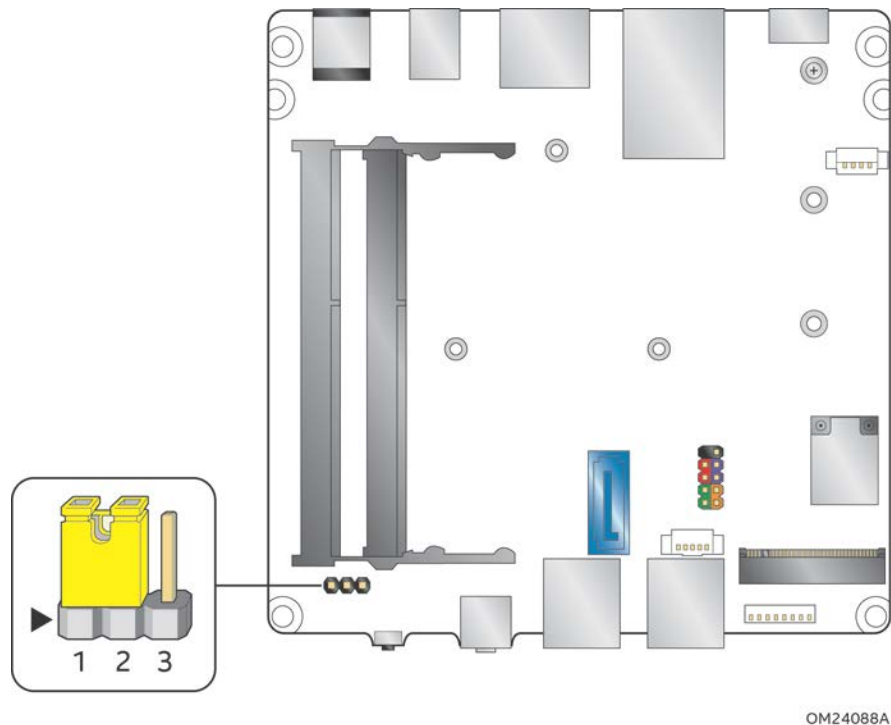

**Figure 15. Location of the BIOS Security Jumper**

Table 20 lists the settings for the jumper.

**Table 20. BIOS Security Jumper Settings**

Function/Mode	Jumper Setting	Configuration
Normal	1-2	The BIOS uses current configuration information and passwords for booting.
Lockdown	2-3	<p>The BIOS uses current configuration information and passwords for booting, except:</p> <ul style="list-style-type: none"> <li>• All POST Hotkeys are suppressed (prompts are not displayed and keys are not accepted. For example, F2 for Setup, F10 for the Boot Menu).</li> <li>• Power Button Menu is not available (see Section 3.7.4 Power Button Menu).</li> </ul> <p>BIOS updates are not available except for automatic Recovery due to flash corruption.</p>
Configuration	None	<p>BIOS Recovery Update process if a matching *.bio file is found. Recovery Update can be cancelled by pressing the Esc key.</p> <p>If the Recovery Update was cancelled or a matching *.bio file was not found, a Config Menu will be displayed. The Config Menu consists of the following (selected Power Button Menu options):</p> <p>[1] Suppress this menu until the BIOS Security Jumper is replaced.</p> <p>[2] Clear BIOS User and Supervisor Passwords.</p> <p>See Section 3.7.4 Power Button Menu.</p>

## 2.4 Mechanical Considerations

### 2.4.1 Form Factor

The board is designed to fit into a custom chassis. Figure 16 illustrates the mechanical form factor for the board. Dimensions are given in inches [millimeters].

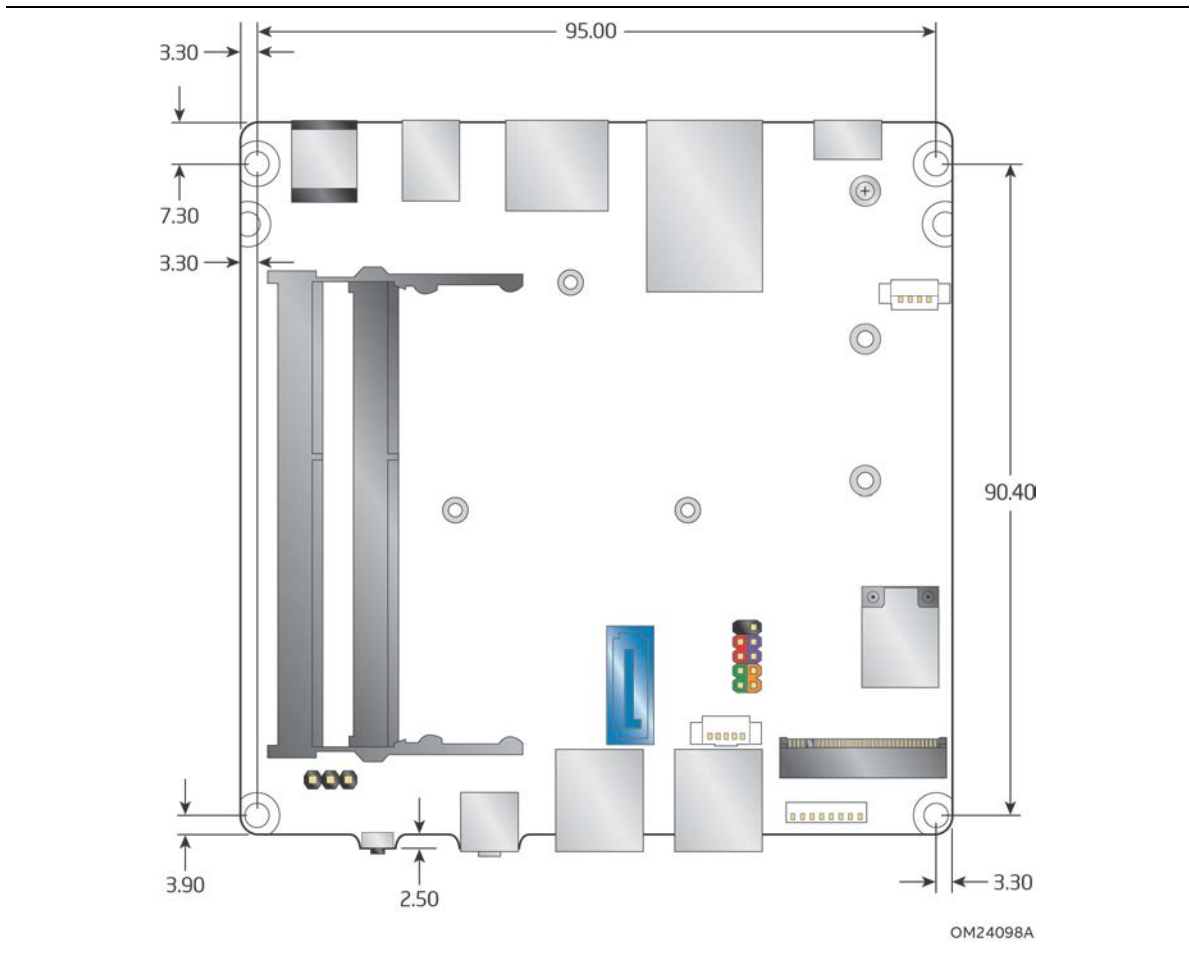

Figure 16. Board Dimensions

Figure 17 shows the height dimensions of the board.

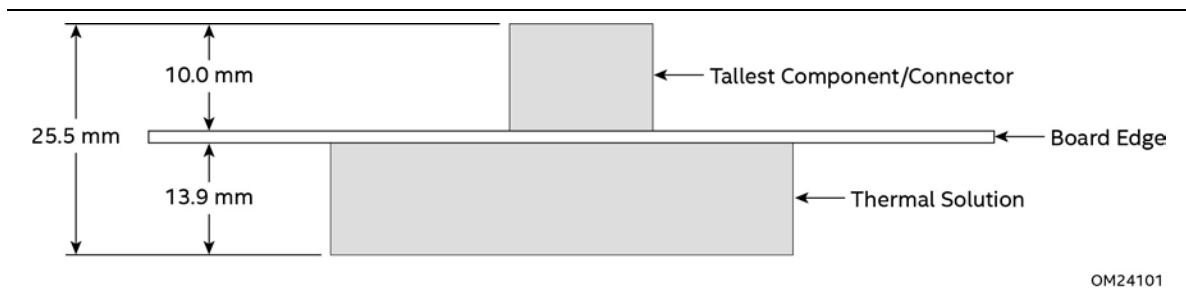

Figure 17. Board Height Dimensions

## 2.5 Electrical Considerations

### 2.5.1 Power Supply Considerations

System power requirements will depend on actual system configurations chosen by the integrator, as well as end user expansion preferences. It is the system integrator’s responsibility to ensure an appropriate power budget for the system configuration is properly assessed based on the system-level components chosen. See Section 2.2.3.3 Power Supply Connector for more information.

### 2.5.2 Fan Header Current Capability

Table 20 lists the current capability of the fan headers.

Table 21. Fan Header Current Capability

Fan Header	Maximum Available Current
Processor fan	.25 A

## 2.6 Thermal Considerations



### CAUTION

*A chassis with a maximum internal ambient temperature of 50 °C at the processor fan inlet is recommended. If the internal ambient temperature exceeds 50 °C, further thermal testing is required to ensure components do not exceed their maximum case temperature.*



### CAUTION

*Failure to ensure appropriate airflow may result in reduced performance of both the processor and/or voltage regulator or, in some instances, damage to the board.*

*All responsibility for determining the adequacy of any thermal or system design remains solely with the system integrator. Intel makes no warranties or representations that merely following the instructions presented in this document will result in a system with adequate thermal performance.*



### CAUTION

*Ensure that the ambient temperature does not exceed the board's maximum operating temperature. Failure to do so could cause components to exceed their maximum case temperature and malfunction. For information about the maximum operating temperature, see the environmental specifications in Section 2.8.*



### CAUTION

*Ensure that proper airflow is maintained in the processor voltage regulator circuit. Failure to do so may result in shorter than expected product lifetime.*

Figure 18 shows the locations of the localized high temperature zones.

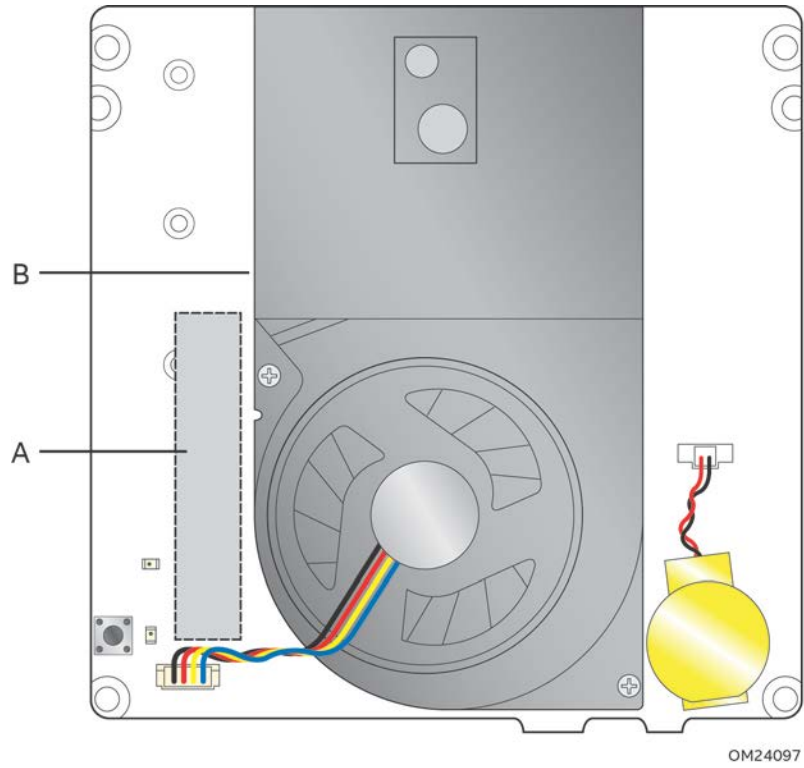

Item	Description
A	Processor voltage regulator area
B	Thermal solution

**Figure 18. Localized High Temperature Zones**

A thermal pad has been installed for the bottom of the chassis to improve the thermal performance when using M.2 devices that operate at higher temperatures. If the thermal pad ever needs to be replaced, Figure 19 shows the installation area of the thermal pad for the Intel NUC Kit NUC5i5RYK/NUC5i3RYK.

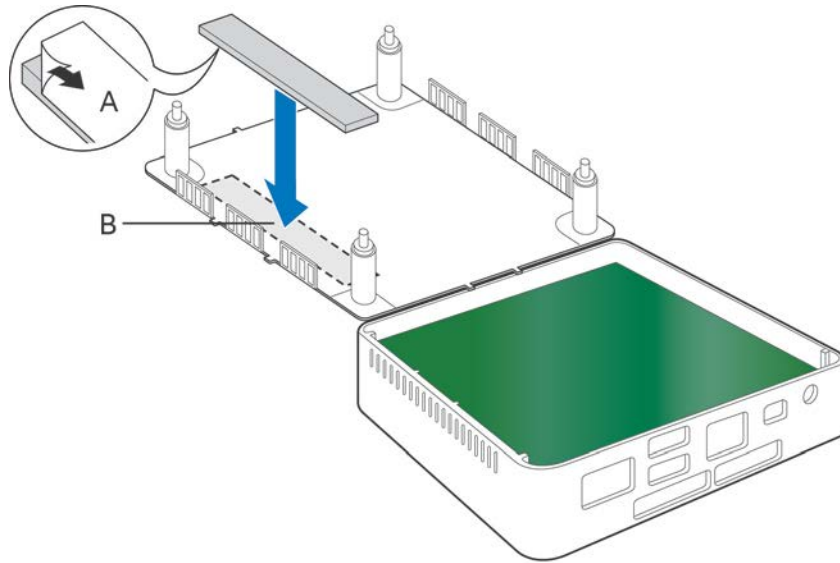

OM24142

Item	Description
A	Thermal Pad
B	Thermal Pad Installation Area

**Figure 19. Installation Area of Thermal Pad for Intel NUC Kit NUC5i5RYK/NUC5i3RYK**

Figure 20 shows the installation area of the thermal pad for the Intel NUC Kit NUC5i5RYKH/NUC5i3RYKH.

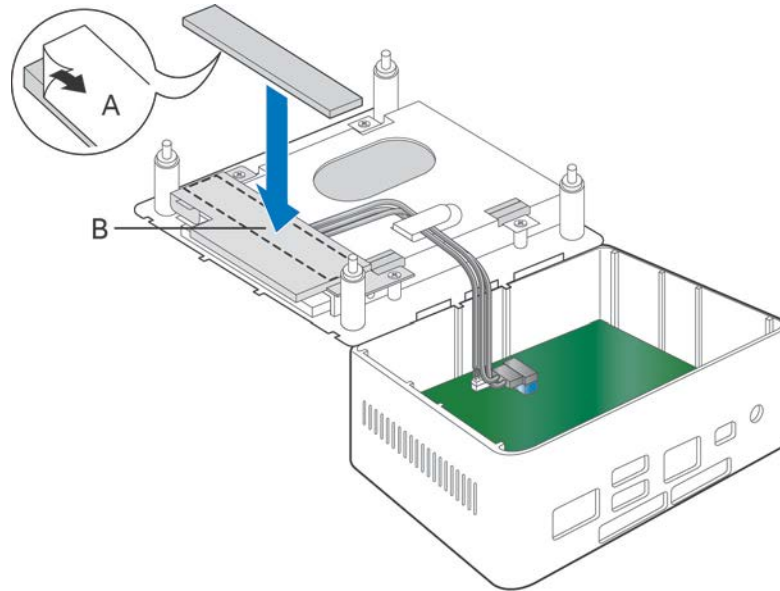

OM24143

Item	Description
A	Thermal Pad
B	Thermal Pad Installation Area

**Figure 20. Installation area of Thermal Pad for Intel NUC Kit NUC5i5RYKH/NUC5i3RYKH**



Table 21 provides maximum case temperatures for the components that are sensitive to thermal changes. The operating temperature, current load, or operating frequency could affect case temperatures. Maximum case temperatures are important when considering proper airflow to cool the board.

**Table 22. Thermal Considerations for Components**

Component	Maximum Case Temperature
Processor	For processor case temperature, see processor datasheets and processor specification updates

To ensure functionality and reliability, the component is specified for proper operation when Case Temperature is maintained at or below the maximum temperature listed in Table 22. This is a requirement for sustained power dissipation equal to Thermal Design Power (TDP is specified as the maximum sustainable power to be dissipated by the components). When the component is dissipating less than TDP, the case temperature should be below the Maximum Case Temperature. The surface temperature at the geometric center of the component corresponds to Case Temperature.

It is important to note that the temperature measurement in the system BIOS is a value reported by embedded thermal sensors in the components and does not directly correspond to the Maximum Case Temperature. The upper operating limit when monitoring this thermal sensor is Tcontrol.

**Table 23. Tcontrol Values for Components**

Component	Tcontrol
Processor	For processor case temperature, see processor datasheets and processor specification updates

For information about	Refer to
Processor datasheets and specification updates	Section 1.2, page 20

## 2.7 Reliability

The Mean Time Between Failures (MTBF) prediction is calculated using component and subassembly random failure rates. The calculation is based on the Telcordia SR-332 Issue 2, Method I, Case 3, 55 °C ambient. The MTBF prediction is used to estimate repair rates and spare parts requirements. The MTBF for Intel NUC Board NUC5i3RYB is 68,099 hours. The MTBF for Intel NUC Board NUC5i5RYB is 66,569 hours.

## 2.8 Environmental

Table 23 lists the environmental specifications for the board.

**Table 24. Environmental Specifications**

Parameter	Specification		
<b>Temperature</b>			
Non-Operating	-40 °C to +60 °C		
Operating	0 °C to +50 °C The operating temperature of the board may be determined by measuring the air temperature from the junction of the heatsink fins and fan, next to the attachment screw, in a closed chassis, while the system is in operation.		
<b>Shock</b>			
Unpackaged	50 g trapezoidal waveform Velocity change of 170 inches/s <sup>2</sup>		
Packaged	Half sine 2 millisecond		
	Product Weight (pounds)	Free Fall (inches)	Velocity Change (inches/s <sup>2</sup> )
	<20	36	167
	21-40	30	152
	41-80	24	136
	81-100	18	118
<b>Vibration</b>			
Unpackaged	5 Hz to 20 Hz: 0.01 g <sup>2</sup> Hz sloping up to 0.02 g <sup>2</sup> Hz 20 Hz to 500 Hz: 0.02 g <sup>2</sup> Hz (flat)		
Packaged	5 Hz to 40 Hz: 0.015 g <sup>2</sup> Hz (flat) 40 Hz to 500 Hz: 0.015 g <sup>2</sup> Hz sloping down to 0.00015 g <sup>2</sup> Hz		

Note: Before attempting to operate this board, the overall temperature of the board must be above the minimum operating temperature specified. It is recommended that the board temperature be at least room temperature before attempting to power on the board. The operating and non-operating environment must avoid condensing humidity.

## 3 Overview of BIOS Features

---

### 3.1 Introduction

The board uses Intel Visual BIOS that is stored in the Serial Peripheral Interface Flash Memory (SPI Flash) and can be updated using a disk-based program. The SPI Flash contains the Visual BIOS Setup program, POST, the PCI auto-configuration utility, LAN EEPROM information, and Plug and Play support.

The BIOS displays a message during POST identifying the type of BIOS and a revision code. The initial production BIOSs are identified as RYBDWi35.86A.

The Visual BIOS Setup program can be used to view and change the BIOS settings for the computer. The BIOS Setup program is accessed by pressing the <F2> key after the Power-On Self-Test (POST) memory test begins and before the operating system boot begins.



#### **NOTE**

*The maintenance menu is displayed only when the board is in configure mode. Section 2.3 on page 49 shows how to put the board in configure mode.*

## 3.2 BIOS Flash Memory Organization

The Serial Peripheral Interface Flash Memory (SPI Flash) includes a 64 Mb flash memory device.

## 3.3 System Management BIOS (SMBIOS)

SMBIOS is a Desktop Management Interface (DMI) compliant method for managing computers in a managed network.

The main component of SMBIOS is the Management Information Format (MIF) database, which contains information about the computing system and its components. Using SMBIOS, a system administrator can obtain the system types, capabilities, operational status, and installation dates for system components. The MIF database defines the data and provides the method for accessing this information. The BIOS enables applications such as third-party management software to use SMBIOS. The BIOS stores and reports the following SMBIOS information:

- BIOS data, such as the BIOS revision level
- Fixed-system data, such as peripherals, serial numbers, and asset tags
- Resource data, such as memory size, cache size, and processor speed
- Dynamic data, such as event detection and error logging

Non-Plug and Play operating systems require an additional interface for obtaining the SMBIOS information. The BIOS supports an SMBIOS table interface for such operating systems. Using this support, an SMBIOS service-level application running on a non-Plug and Play operating system can obtain the SMBIOS information. Additional board information can be found in the BIOS under the Additional Information header under the Main BIOS page.

## 3.4 Legacy USB Support

Legacy USB support enables USB devices to be used even when the operating system's USB drivers are not yet available. Legacy USB support is used to access the BIOS Setup program, and to install an operating system that supports USB. By default, Legacy USB support is set to Enabled.

Legacy USB support operates as follows:

1. When you apply power to the computer, legacy support is disabled.
2. POST begins.
3. Legacy USB support is enabled by the BIOS allowing you to use a USB keyboard to enter and configure the BIOS Setup program and the maintenance menu.
4. POST completes.
5. The operating system loads. While the operating system is loading, USB keyboards and mice are recognized and may be used to configure the operating system. (Keyboards and mice are not recognized during this period if Legacy USB support was set to Disabled in the BIOS Setup program.)
6. After the operating system loads the USB drivers, all legacy and non-legacy USB devices are recognized by the operating system, and Legacy USB support from the BIOS is no longer used.

To install an operating system that supports USB, verify that Legacy USB support in the BIOS Setup program is set to Enabled and follow the operating system's installation instructions.

## 3.5 BIOS Updates

The BIOS can be updated using one of the following methods:

- Intel Express BIOS Update Utility, which enables automated updating while in the Windows environment. Using this utility, the BIOS can be updated from a file on a hard disk, a USB drive (a flash drive or a USB hard drive), or a CD-ROM, or from the file location on the Web.
- Intel Flash Memory Update Utility, which requires booting from DOS. Using this utility, the BIOS can be updated from a file on a hard disk, a USB drive (a flash drive or a USB hard drive), or a CD-ROM.
- Intel® F7 switch during POST allows a user to select where the BIOS .bio file is located and perform the update from that location/device. Similar to performing a BIOS Recovery without removing the BIOS configuration jumper.
- Intel® Visual BIOS has an option to update the BIOS from a valid .bio file located on a hard disk or USB drive. Enter Intel Visual BIOS by pressing <F2> during POST.
- Using Front Panel menu option

Both utilities verify that the updated BIOS matches the target system to prevent accidentally installing an incompatible BIOS.



### NOTE

*Review the instructions distributed with the upgrade utility before attempting a BIOS update.*

For information about	Refer to
BIOS update utilities	<a href="http://support.intel.com/support/motherboards/desktop/sb/CS-034499.htm">http://support.intel.com/support/motherboards/desktop/sb/CS-034499.htm</a>

### 3.5.1 Language Support

The BIOS Setup program and help messages are supported in US English. Check the Intel web site for support.

## 3.5.2 BIOS Recovery

It is unlikely that anything will interrupt a BIOS update; however, if an interruption occurs, the BIOS could be damaged. Table 24 lists the drives and media types that can and cannot be used for BIOS recovery. The BIOS recovery media does not need to be made bootable.

**Table 25. Acceptable Drives/Media Types for BIOS Recovery**

Media Type <sup>(Note)</sup>	Can be used for BIOS recovery?
Hard disk drive (connected to SATA or USB)	Yes
CD/DVD drive (connected to SATA or USB)	Yes
USB flash drive	Yes
USB diskette drive (with a 1.4 MB diskette)	No (BIOS update file is bigger than 1.4 MB size limit)



### NOTE

*Supported file systems for BIOS recovery:*

- *NTFS (sparse, compressed, or encrypted files are not supported)*
- *FAT32*
- *FAT16*
- *FAT12*
- *ISO 9660*

#### For information about

BIOS recovery

#### Refer to

<http://www.intel.com/support/motherboards/desktop/sb/cs-034524.htm>

## 3.6 Boot Options

In the BIOS Setup program, the user can choose to boot from a hard drive, optical drive, removable drive, or the network. The default setting is for the optical drive to be the first boot device, the hard drive second, removable drive third, and the network fourth.

### 3.6.1 Network Boot

The network can be selected as a boot device. This selection allows booting from the onboard LAN or a network add-in card with a remote boot ROM installed.

Pressing the <F12> key during POST automatically forces booting from the LAN. To use this key during POST, the User Access Level in the BIOS Setup program's Security menu must be set to Full.

### 3.6.2 Booting Without Attached Devices

For use in embedded applications, the BIOS has been designed so that after passing the POST, the operating system loader is invoked even if the following devices are not present:

- Video adapter
- Keyboard
- Mouse

### 3.6.3 Changing the Default Boot Device During POST

Pressing the <F10> key during POST causes a boot device menu to be displayed. This menu displays the list of available boot devices. Table 25 lists the boot device menu options.

**Table 26. Boot Device Menu Options**

Boot Device Menu Function Keys	Description
<↑> or <↓>	Selects a default boot device
<Enter>	Exits the menu, and boots from the selected device
<Esc>	Exits the menu and boots according to the boot priority defined through BIOS setup

### 3.6.4 Power Button Menu

As an alternative to Back-to-BIOS Mode or normal POST Hotkeys, the user can use the power button to access a menu. The Power Button Menu is accessible via the following sequence:

1. System is in S4/S5 (not G3)
2. User pushes the power button and holds it down for 3 seconds
3. The system will emit three short beeps from the front panel (FP) audio port, then stop to signal the user to release the power button. The FP power button LED will also change from Blue to Amber when the user can release the power button.
4. User releases the power button before the 4-second shutdown override

If this boot path is taken, the BIOS will use default settings, ignoring settings in VPD where possible.

At the point where Setup Entry/Boot would be in the normal boot path, the BIOS will display the following prompt and wait for a keystroke:

[ESC] Normal Boot  
[F2] Intel Visual BIOS  
[F3] Disable Fast Boot  
[F4] BIOS Recovery  
[F7] Update BIOS  
[F10] Enter Boot Menu  
[F12] Network Boot

**[F2] Enter Setup** is displayed instead if Visual BIOS is not supported.

**[F3] Disable Fast Boot** is only displayed if at least one Fast Boot optimization is enabled.

**[F9] Remote Assistance** is only displayed if Remote Assistance is supported.

If an unrecognized key is hit, then the BIOS will beep and wait for another keystroke. If one of the listed hotkeys is hit, the BIOS will follow the indicated boot path. Password requirements must still be honored.

If Disable Fast Boot is selected, the BIOS will disable all Fast Boot optimizations and reset the system.



## 3.7 Hard Disk Drive Password Security Feature

The Hard Disk Drive Password Security feature blocks read and write accesses to the hard disk drive until the correct password is given. Hard Disk Drive Passwords are set in BIOS SETUP and are prompted for during BIOS POST. For convenient support of S3 resume, the system BIOS will automatically unlock drives on resume from S3. Valid password characters are A-Z, a-z, and 0-9. Passwords may be up to 19 characters in length.

The User hard disk drive password, when installed, will be required upon each power-cycle until the Master Key or User hard disk drive password is submitted.

The Master Key hard disk drive password, when installed, will not lock the drive. The Master Key hard disk drive password exists as an unlock override in the event that the User hard disk drive password is forgotten. Only the installation of the User hard disk drive password will cause a hard disk to be locked upon a system power-cycle.

Table 26 shows the effects of setting the Hard Disk Drive Passwords.

**Table 27. Master Key and User Hard Drive Password Functions**

Password Set	Password During Boot
Neither	None
Master only	None
User only	User only
Master and User Set	Master or User

During every POST, if a User hard disk drive password is set, POST execution will pause with the following prompt to force the user to enter the Master Key or User hard disk drive password:

Enter Hard Disk Drive Password:

Upon successful entry of the Master Key or User hard disk drive password, the system will continue with normal POST.

If the hard disk drive password is not correctly entered, the system will go back to the above prompt. The user will have three attempts to correctly enter the hard disk drive password. After the third unsuccessful hard disk drive password attempt, the system will halt with the message:

Hard Disk Drive Password Entry Error

A manual power cycle will be required to resume system operation.



### NOTE

*As implemented on Intel NUC Board NUC5i5RYB and Intel NUC Board NUC5i3RYB, Hard Disk Drive Password Security is only supported on either SATA port 0 (M.2) or SATA Port 1 (onboard SATA connector). The passwords are stored on the hard disk drive so if the drive is relocated to another computer that does not support Hard Disk Drive Password Security feature, the drive will not be accessible.*

## 3.8 BIOS Security Features

The BIOS includes security features that restrict access to the BIOS Setup program and who can boot the computer. A supervisor password and a user password can be set for the BIOS Setup program and for booting the computer, with the following restrictions:

- The supervisor password gives unrestricted access to view and change all the Setup options in the BIOS Setup program. This is the supervisor mode.
- The user password gives restricted access to view and change Setup options in the BIOS Setup program. This is the user mode.
- If only the supervisor password is set, pressing the <Enter> key at the password prompt of the BIOS Setup program allows the user restricted access to Setup.
- If both the supervisor and user passwords are set, users can enter either the supervisor password or the user password to access Setup. Users have access to Setup respective to which password is entered.
- Setting the user password restricts who can boot the computer. The password prompt will be displayed before the computer is booted. If only the supervisor password is set, the computer boots without asking for a password. If both passwords are set, the user can enter either password to boot the computer.
- For enhanced security, use different passwords for the supervisor and user passwords.
- Valid password characters are A-Z, a-z, and 0-9. Passwords may be up to 16 characters in length.
- To clear a set password, enter a blank password after entering the existing password.

Table 27 shows the effects of setting the supervisor password and user password. This table is for reference only and is not displayed on the screen.

**Table 28. Supervisor and User Password Functions**

Password Set	Supervisor Mode	User Mode	Setup Options	Password to Enter Setup	Password During Boot
Neither	Can change all options (Note)	Can change all options (Note)	None	None	None
Supervisor only	Can change all options	Can change a limited number of options	Supervisor Password	Supervisor	None
User only	N/A	Can change all options	Enter Password Clear User Password	User	User
Supervisor and user set	Can change all options	Can change a limited number of options	Supervisor Password Enter Password	Supervisor or user	Supervisor or user

Note: If no password is set, any user can change all Setup options.

## 4 Error Messages and Blink Codes

---

### 4.1 Front-panel Power LED Blink Codes

Whenever a recoverable error occurs during POST, the BIOS causes the board's front panel power LED to blink an error message describing the problem (see Table 28).

**Table 29. Front-panel Power LED Blink Codes**

Type	Pattern	Note
BIOS update in progress	Off when the update begins, then on for 0.5 seconds, then off for 0.5 seconds. The pattern repeats until the BIOS update is complete.	
Video error <sup>(Note)</sup>	On-off (1.0 second each) two times, then 2.5-second pause (off), entire pattern repeats (blink and pause) until the system is powered off.	When no VGA option ROM is found.
Memory error	On-off (1.0 second each) three times, then 2.5-second pause (off), entire pattern repeats (blinks and pause) until the system is powered off.	
Thermal trip warning	Each beep will be accompanied by the following blink pattern: .25 seconds on, .25 seconds off, .25 seconds on, .25 seconds off. This will result in a total of 16 blinks.	

Note: Disabled per default BIOS setup option.

### 4.2 BIOS Error Messages

Table 30 lists the error messages and provides a brief description of each.

**Table 30. BIOS Error Messages**

Error Message	Explanation
CMOS Battery Low	The battery may be losing power. Replace the battery soon.
CMOS Checksum Bad	The CMOS checksum is incorrect. CMOS memory may have been corrupted. Run Setup to reset values.
Memory Size Decreased	Memory size has decreased since the last boot. If no memory was removed, then memory may be bad.
No Boot Device Available	System did not find a device to boot.



# 5 Regulatory Compliance and Battery Disposal Information

---

## 5.1 Regulatory Compliance

This section contains the following regulatory compliance information for Intel NUC Board NUC5i5RYB and Intel NUC Board NUC5i3RYB:

- Safety standards
- European Union Declaration of Conformity statement
- Product Ecology statements
- Electromagnetic Compatibility (EMC) standards
- Product certification markings

### 5.1.1 Safety Standards

Intel NUC Board NUC5i5RYB and Intel NUC Board NUC5i3RYB comply with the safety standards stated in Table 29 when correctly installed in a compatible host system.

**Table 30. Safety Standards**

<b>Standard</b>	<b>Title</b>
CSA/UL 60950-1	Information Technology Equipment – Safety - Part 1: General Requirements (USA and Canada)
EN 60950-1	Information Technology Equipment – Safety - Part 1: General Requirements (European Union)
IEC 60950-1	Information Technology Equipment – Safety - Part 1: General Requirements (International)

## 5.1.2 European Union Declaration of Conformity Statement

We, Intel Corporation, declare under our sole responsibility that the products Intel NUC Board NUC5i5RYB and Intel NUC Board NUC5i3RYB are in conformity with all applicable essential requirements necessary for CE marking, following the provisions of the European Council Directive 2004/108/EC (EMC Directive), 2006/95/EC (Low Voltage Directive), and 2011/65/EU (ROHS Directive).

The product is properly CE marked demonstrating this conformity and is for distribution within all member states of the EU with no restrictions.



This product follows the provisions of the European Directives 2004/108/EC, 2006/95/EC, and 2011/65/EU.

**Čeština** Tento výrobek odpovídá požadavkům evropských směrnic 2004/108/EC, 2006/95/EC a 2002/95/EC.

**Dansk** Dette produkt er i overensstemmelse med det europæiske direktiv 2004/108/EC, 2006/95/EC & 2002/95/EC.

**Dutch** Dit product is in navolging van de bepalingen van Europees Directief 2004/108/EC, 2006/95/EC & 2002/95/EC.

**Eesti** Antud toode vastab Euroopa direktiivides 2004/108/EC, ja 2006/95/EC ja 2002/95/EC kehtestatud nõuetele.

**Suomi** Tämä tuote noudattaa EU-direktiivin 2004/108/EC, 2006/95/EC & 2002/95/EC määräyksiä.

**Français** Ce produit est conforme aux exigences de la Directive Européenne 2004/108/EC, 2006/95/EC & 2002/95/EC.

**Deutsch** Dieses Produkt entspricht den Bestimmungen der Europäischen Richtlinie 2004/108/EC, 2006/95/EC & 2002/95/EC.

**Ελληνικά** Το παρόν προϊόν ακολουθεί τις διατάξεις των Ευρωπαϊκών Οδηγιών 2004/108/EC, 2006/95/EC και 2002/95/EC.

**Magyar** E termék megfelel a 2004/108/EC, 2006/95/EC és 2002/95/EC Európai Irányelv előírásainak.

**Icelandic** Þessi vara stenst reglugerð Evrópska Efnahags Bandalagsins númer 2004/108/EC, 2006/95/EC, & 2002/95/EC.

**Italiano** Questo prodotto è conforme alla Direttiva Europea 2004/108/EC, 2006/95/EC & 2002/95/EC.

**Latviešu** Šis produkts atbilst Eiropas Direktīvu 2004/108/EC, 2006/95/EC un 2002/95/EC noteikumiem.

**Lietuvių** Šis produktas atitinka Europos direktyvų 2004/108/EC, 2006/95/EC, ir 2002/95/EC nuostatas.

**Malti** Dan il-prodott hu konformi mal-provvedimenti tad-Direttivi Ewropej 2004/108/EC, 2006/95/EC u 2002/95/EC.

**Norsk** Dette produktet er i henhold til bestemmelsene i det europeiske direktivet 2004/108/EC, 2006/95/EC & 2002/95/EC.

**Polski** Niniejszy produkt jest zgodny z postanowieniami Dyrektyw Unii Europejskiej 2004/108/EC, 2006/95/EC i 2002/95/EC.

**Portuguese** Este produto cumpre com as normas da Diretiva Européia 2004/108/EC, 2006/95/EC & 2002/95/EC.

**Español** Este producto cumple con las normas del Directivo Europeo 2004/108/EC, 2006/95/EC & 2002/95/EC.

**Slovensky** Tento produkt je v súlade s ustanoveniami európskych direktív 2004/108/EC, 2006/95/EC a 2002/95/EC.

**Slovenščina** Izdelek je skladen z določbami evropskih direktiv 2004/108/EC, 2006/95/EC in 2002/95/EC.

**Svenska** Denna produkt har tillverkats i enlighet med EG-direktiv 2004/108/EC, 2006/95/EC & 2002/95/EC.

**Türkçe** Bu ürün, Avrupa Birliği'nin 2004/108/EC, 2006/95/EC ve 2002/95/EC yönergelerine uyar.

### 5.1.3 EMC Regulations

Intel NUC Board NUC5i5RYB and Intel NUC Board NUC5i3RYB comply with the EMC regulations stated in Table 30 when correctly installed in a compatible host system.

**Table 31. EMC Regulations**

Regulation	Title
FCC 47 CFR Part 15, Subpart B	Title 47 of the Code of Federal Regulations, Part 15, Subpart B, Radio Frequency Devices. (USA)
ICES-003	Interference-Causing Equipment Standard, Digital Apparatus. (Canada)
EN55022	Limits and methods of measurement of Radio Interference Characteristics of Information Technology Equipment. (European Union)
EN55024	Information Technology Equipment – Immunity Characteristics Limits and methods of measurement. (European Union)
EN55022	Australian Communications Authority, Standard for Electromagnetic Compatibility. (Australia and New Zealand)
CISPR 22	Limits and methods of measurement of Radio Disturbance Characteristics of Information Technology Equipment. (International)
CISPR 24	Information Technology Equipment – Immunity Characteristics – Limits and Methods of Measurement. (International)
VCCI V-3, V-4	Voluntary Control for Interference by Information Technology Equipment. (Japan)
KN-22, KN-24	Korean Communications Commission – Framework Act on Telecommunications and Radio Waves Act (South Korea)
CNS 13438	Bureau of Standards, Metrology, and Inspection (Taiwan)

### **FCC Declaration of Conformity**

This device complies with Part 15 of the FCC Rules. Operation is subject to the following two conditions: (1) this device may not cause harmful interference, and (2) this device must accept any interference received, including interference that may cause undesired operation.

For questions related to the EMC performance of this product, contact:

Intel Corporation, 5200 N.E. Elam Young Parkway, Hillsboro, OR 97124  
1-800-628-8686

This equipment has been tested and found to comply with the limits for a Class B digital device, pursuant to Part 15 of the FCC Rules. These limits are designed to provide reasonable protection against harmful interference in a residential installation. This equipment generates, uses, and can radiate radio frequency energy and, if not installed and used in accordance with the instructions, may cause harmful interference to radio communications. However, there is no guarantee that interference will not occur in a particular installation. If this equipment does cause harmful interference to radio or television reception, which can be determined by turning the equipment off and on, the user is encouraged to try to correct the interference by one or more of the following measures:

- Reorient or relocate the receiving antenna.
- Increase the separation between the equipment and the receiver.
- Connect the equipment to an outlet on a circuit other than the one to which the receiver is connected.
- Consult the dealer or an experienced radio/TV technician for help.

Any changes or modifications to the equipment not expressly approved by Intel Corporation could void the user's authority to operate the equipment.

Tested to comply with FCC standards for home or office use.

### **Canadian Department of Communications Compliance Statement**

This digital apparatus does not exceed the Class B limits for radio noise emissions from digital apparatus set out in the Radio Interference Regulations of the Canadian Department of Communications.

Le présent appareil numérique n'émet pas de bruits radioélectriques dépassant les limites applicables aux appareils numériques de la classe B prescrites dans le Règlement sur le brouillage radioélectrique édicté par le ministère des Communications du Canada.



### Japan VCCI Statement

Japan VCCI Statement translation: This is a Class B product based on the standard of the Voluntary Control Council for Interference from Information Technology Equipment (VCCI). If this is used near a radio or television receiver in a domestic environment, it may cause radio interference. Install and use the equipment according to the instruction manual.

この装置は、情報処理装置等電波障害自主規制協議会（VCCI）の基準に基づくクラスB情報技術装置です。この装置は、家庭環境で使用することを目的としていますが、この装置がラジオやテレビジョン受信機に近接して使用されると、受信障害を引き起こすことがあります。  
取扱説明書に従って正しい取り扱いをして下さい。

### Korea Class B Statement

Korea Class B Statement translation: This equipment is for home use, and has acquired electromagnetic conformity registration, so it can be used not only in residential areas, but also other areas.

이 기기는 가정용(B급) 전자파적합기기로서 주로 가정에서 사용하는 것을 목적으로 하며, 모든 지역에서 사용할 수 있습니다.

## 5.1.4 e-Standby and ErP Compliance

Intel NUC Board NUC5i5RYB and Intel NUC Board NUC5i3RYB meet the following program requirements in an adequate system configuration: EPEAT\*









- Korea e-Standby
- European Union Energy-related Products Directive 2013 (ErP) Lot 6

<b>For information about</b>	<b>Refer to</b>
Electronic Product Environmental Assessment Tool (EPEAT)	<a href="http://www.epeat.net/">http://www.epeat.net/</a>
Korea e-Standby Program	<a href="http://www.kemco.or.kr/new_eng/pg02/pg02100300.asp">http://www.kemco.or.kr/new_eng/pg02/pg02100300.asp</a>
European Union Energy-related Products Directive 2009 (ErP)	<a href="http://ec.europa.eu/enterprise/policies/sustainable-business/sustainable-product-policy/ecodesign/index_en.htm">http://ec.europa.eu/enterprise/policies/sustainable-business/sustainable-product-policy/ecodesign/index_en.htm</a>

## 5.1.5 Regulatory Compliance Marks (Board Level)

Intel NUC Board NUC5i5RYB and Intel NUC Board NUC5i3RYB have the regulatory compliance marks shown in Table 31.

**Table 32. Regulatory Compliance Marks**

Description	Mark
UL joint US/Canada Recognized Component mark. Includes adjacent UL file number for Intel NUC: E210882.	
FCC Declaration of Conformity logo mark for Class B equipment.	
CE mark. Declaring compliance to the European Union (EU) EMC directive, Low Voltage directive, and RoHS directive.  For CE Mark-Related Questions: Intel Corporation Attn: Corporate Quality 2200 Mission College Blvd. Santa Clara, CA 95054-1549 USA	
Australian Communications Authority (ACA) and New Zealand Radio Spectrum Management (NZ RSM) C-tick mark. Includes adjacent Intel supplier code number, N-232.	
Japan VCCI (Voluntary Control Council for Interference) mark.	
Korea Certification mark. Includes an adjacent MSIP (Ministry of Science, ICT & Future Planning) certification number: MSIP-REM-CPU-NUC5i5RYB and MSIP-REM-CPU-NUC5i3RYB	
Taiwan BSMI (Bureau of Standards, Metrology and Inspections) mark. Includes adjacent Intel company number, D33025.	
Printed wiring board manufacturer's recognition mark. Consists of a unique UL recognized manufacturer's logo, along with a flammability rating (solder side).	V-0
China RoHS/Environmentally Friendly Use Period Logo: This is an example of the symbol used on Intel NUC and associated collateral. The color of the mark may vary depending upon the application. The Environmental Friendly Usage Period (EFUP) for Intel NUC has been determined to be 10 years.	

## 5.2 Battery Disposal Information



### CAUTION

*Risk of explosion if the battery is replaced with an incorrect type. Batteries should be recycled where possible. Disposal of used batteries must be in accordance with local environmental regulations.*



### PRÉCAUTION

*Risque d'explosion si la pile usagée est remplacée par une pile de type incorrect. Les piles usagées doivent être recyclées dans la mesure du possible. La mise au rebut des piles usagées doit respecter les réglementations locales en vigueur en matière de protection de l'environnement.*



### FORHOLDSREGEL

*Eksplodingsfare, hvis batteriet erstattes med et batteri af en forkert type. Batterier bør om muligt genbruges. Bortskaffelse af brugte batterier bør foregå i overensstemmelse med gældende miljølovgivning.*



### OBS!

*Det kan oppstå eksplosjonsfare hvis batteriet skiftes ut med feil type. Brukte batterier bør kastes i henhold til gjeldende miljølovgivning.*



### VIKTIGT!

*Risk för explosion om batteriet ersätts med felaktig batterityp. Batterier ska kasseras enligt de lokala miljövårdsbestämmelserna.*



### VARO

*Räjähdysvaara, jos pariston tyyppi on väärä. Paristot on kierrätettävä, jos se on mahdollista. Käytetyt paristot on hävitettävä paikallisten ympäristömääräysten mukaisesti.*



### VORSICHT

*Bei falschem Einsetzen einer neuen Batterie besteht Explosionsgefahr. Die Batterie darf nur durch denselben oder einen entsprechenden, vom Hersteller empfohlenen Batterietyp ersetzt werden. Entsorgen Sie verbrauchte Batterien den Anweisungen des Herstellers entsprechend.*



### AVVERTIMENTO

*Esiste il pericolo di un esplosione se la pila non viene sostituita in modo corretto. Utilizzare solo pile uguali o di tipo equivalente a quelle consigliate dal produttore. Per disfarsi delle pile usate, seguire le istruzioni del produttore.*

**PRECAUCIÓN**

*Existe peligro de explosión si la pila no se cambia de forma adecuada. Utilice solamente pilas iguales o del mismo tipo que las recomendadas por el fabricante del equipo. Para deshacerse de las pilas usadas, siga igualmente las instrucciones del fabricante.*

**WAARSCHUWING**

*Er bestaat ontploffingsgevaar als de batterij wordt vervangen door een onjuist type batterij. Batterijen moeten zoveel mogelijk worden gerecycled. Houd u bij het weggooien van gebruikte batterijen aan de plaatselijke milieuwetgeving.*

**ATENÇÃO**

*Haverá risco de explosão se a bateria for substituída por um tipo de bateria incorreto. As baterias devem ser recicladas nos locais apropriados. A eliminação de baterias usadas deve ser feita de acordo com as regulamentações ambientais da região.*

**AŚCIAROŽZNAŚĆ**

*Існуе рызыка выбуху, калі заменены акумулятар непраўльнага тыпу. Акумулятары павінны, па магчымасці, перепрацоўвацца. Пазбаўляцца ад старых акумулятараў патрэбна згодна з мясцовымі заканадаўствам па экалогіі.*

**UPOZORNĚNÍ**

*V případě výměny baterie za nesprávný druh může dojít k výbuchu. Je-li to možné, baterie by měly být recyklovány. Baterie je třeba zlikvidovat v souladu s místními předpisy o životním prostředí.*

**Προσοχή**

*Υπάρχει κίνδυνος για έκρηξη σε περίπτωση που η μπαταρία αντικατασταθεί από μία λανθασμένου τύπου. Οι μπαταρίες θα πρέπει να ανακυκλώνονται όταν κάτι τέτοιο είναι δυνατό. Η απόρριψη των χρησιμοποιημένων μπαταριών πρέπει να γίνεται σύμφωνα με τους κατά τόπο περιβαλλοντικούς κανονισμούς.*

**VIGYÁZAT**

*Ha a telepet nem a megfelelő típusú telepre cseréli, az felrobbanhat. A telepeket lehetőség szerint újra kell hasznosítani. A használt telepeket a helyi környezetvédelmi előírásoknak megfelelően kell kiselejtezni.*

**注意**

**異なる種類の電池を使用すると、燃焼の危険があります。リサイクルが可能な地域であれば、電池をリサイクルしてください。使用後の電池を破棄する際には、地域の環境規制に従ってください。**



### **AWAS**

*Risiko letupan wujud jika bateri digantikan dengan jenis yang tidak betul. Bateri sepatutnya dikitar semula jika boleh. Pelupusan bateri terpakai mestilah mematuhi peraturan alam sekitar tempatan.*



### **OSTRZEŻENIE**

*Istnieje niebezpieczeństwo wybuchu w przypadku zastosowania niewłaściwego typu baterii. Zużyte baterie należy w miarę możliwości utylizować zgodnie z odpowiednimi przepisami ochrony środowiska.*



### **PRECAUȚIE**

*Risc de explozie, dacă bateria este înlocuită cu un tip de baterie necorespunzător. Bateriile trebuie reciclate, dacă este posibil. Depozitarea bateriilor uzate trebuie să respecte reglementările locale privind protecția mediului.*



### **ВНИМАНИЕ**

*При использовании батареи несоответствующего типа существует риск ее взрыва. Батареи должны быть утилизированы по возможности. Утилизация батарей должна проводиться по правилам, соответствующим местным требованиям.*



### **UPOZORNENIE**

*Ak batériu vymeníte za nesprávny typ, hrozí nebezpečenstvo jej výbuchu. Batérie by sa mali podľa možnosti vždy recyklovať. Likvidácia použitých batérií sa musí vykonávať v súlade s miestnymi predpismi na ochranu životného prostredia.*



### **POZOR**

*Zamenjava baterije z baterijo drugačnega tipa lahko povzroči eksplozijo. Če je mogoče, baterije reciklirajte. Rabljene baterije zavržite v skladu z lokalnimi okoljevarstvenimi predpisi.*



### **คำเตือน**

*ระวังการระเบิดที่เกิดจากเปลี่ยนแบตเตอรี่ผิดประเภท หากเป็นไปได้ ควรนำแบตเตอรี่ไปรีไซเคิล การทิ้งแบตเตอรี่ใช้แล้วต้องเป็นไปตามกฎข้อบังคับด้านสิ่งแวดล้อมของท้องถิ่น.*



### **UYARI**

*Yanlış türde pil takıldığında patlama riski vardır. Piller mümkün olduğunda geri dönüştürülmelidir. Kullanılmış piller, yerel çevre yasalarına uygun olarak atılmalıdır.*



### **ОСТОРОГА**

*Використовуйте батареї правильного типу, інакше існуюватиме ризик вибуху. Якщо можливо, використані батареї слід утилізувати. Утилізація використаних батареї має бути виконана згідно місцевих норм, що регулюють охорону довкілля.*

**UPOZORNĚNÍ**

*V případě výměny baterie za nesprávný druh může dojít k výbuchu. Je-li to možné, baterie by měly být recyklovány. Baterie je třeba zlikvidovat v souladu s místními předpisy o životním prostředí.*

**ETTEVAATUST**

*Kui patarei asendatakse uue ebasobivat tüüpi patareiga, võib tekkida plahvatusoht. Tühjad patareid tuleb võimaluse korral viia vastavasse kogumispunkti. Tühjade patareide äraviskamisel tuleb järgida kohalikke keskkonnakaitse alaseid reegleid.*

**FIGYELMEZTETÉS**

*Ha az elemet nem a megfelelő típusúra cseréli, felrobbanhat. Az elemeket lehetőség szerint újra kell hasznosítani. A használt elemeket a helyi környezetvédelmi előírásoknak megfelelően kell kiselejtezni.*

**UZMANĪBU**

*Pastāv eksplozijas risks, ja baterijas tiek nomainītas ar nepareiza veida baterijām. Ja iespējams, baterijas vajadzētu nodot attiecīgos pieņemšanas punktus. Bateriju izmešanai atkritumos jānotiek saskaņā ar vietējiem vides aizsardzības noteikumiem.*

**DĒMESIO**

*Naudojant netinkamo tipo baterijas įrenginys gali sprogti. Kai tik įmanoma, baterijas reikia naudoti pakartotinai. Panaudotas baterijas išmesti būtina pagal vietinius aplinkos apsaugos nuostatus.*

**ATTENZJONI**

*Riskju ta' splużjoni jekk il-batterija tinbidel b'tip ta' batterija mhux korrett. Il-batteriji għandhom jiġu riċiklati fejn hu possibbli. Ir-rimi ta' batteriji użati għandu jsir skond ir-regolamenti ambjentali lokali.*

**OSTRZEŻENIE**

*Ryzyko wybuchu w przypadku wymiany na baterie niewłaściwego typu. W miarę możliwości baterie należy poddać recyklingowi. Zużytych baterii należy pozbywać się zgodnie z lokalnie obowiązującymi przepisami w zakresie ochrony środowiska.*

