

Model 49i
Primary Standard

Instruction Manual

UV Photometric O₃ Calibrator

Part number 102474-00

11Jan2008



CE

Thermo
SCIENTIFIC

© 2007 Thermo Fisher Scientific Inc. All rights reserved.

Specifications, terms and pricing are subject to change. Not all products are available in all countries. Please consult your local sales representative for details.

Thermo Fisher Scientific
Air Quality Instruments
27 Forge Parkway
Franklin, MA 02038
1-508-520-0430
www.thermo.com/aqi

WEEE Compliance

This product is required to comply with the European Union's Waste Electrical & Electronic Equipment (WEEE) Directive 2002/96/EC. It is marked with the following symbol:



Thermo Fisher Scientific has contracted with one or more recycling/disposal companies in each EU Member State, and this product should be disposed of or recycled through them. Further information on Thermo Fisher Scientific's compliance with these Directives, the recyclers in your country, and information on Thermo Fisher Scientific products which may assist the detection of substances subject to the RoHS Directive are available at: www.thermo.com/WEEERoHS.

Contents

Chapter 1	Introduction	1-1
	Principle of Operation	1-2
	Specifications	1-3
Chapter 2	Installation	2-1
	Lifting.....	2-1
	Unpacking and Inspection	2-1
	Setup Procedure.....	2-3
	Connecting External Devices	2-4
	Terminal Board PCB Assemblies.....	2-4
	Startup	2-8
Chapter 3	Operation	3-1
	Display.....	3-2
	Pushbuttons	3-3
	Soft Keys.....	3-4
	Software Overview	3-4
	Power-Up Screen	3-6
	Run Screen.....	3-6
	Main Menu.....	3-7
	Range Menu	3-7
	Gas Units.....	3-8
	O ₃ Range	3-8
	Set Custom Ranges	3-11
	Averaging Time.....	3-12
	Calibration Factors Menu	3-12
	O ₃ Background.....	3-13
	O ₃ Span Coefficients	3-13
	Instrument Controls Menu	3-15
	Custom Levels.....	3-15
	Pump	3-16
	Temperature Compensation.....	3-16
	Pressure Compensation	3-17
	Datalogging Settings	3-17
	Communication Settings.....	3-27

I/O Configuration.....	3-36
Screen Contrast.....	3-48
Service Mode	3-49
Date/Time	3-49
Diagnostics Menu	3-50
Program Version	3-51
Voltages	3-51
Temperatures	3-53
Pressure.....	3-53
Flows	3-53
Cell A/B O ₃	3-54
Intensities.....	3-54
Analog Input Readings.....	3-55
Analog Input Voltages.....	3-55
Digital Inputs.....	3-55
Relay States	3-56
Test Analog Outputs.....	3-56
Instrument Configuration	3-57
Contact Information	3-58
Alarms Menu	3-58
O ₃ Lamp Temperature.....	3-59
Lamp Temperature	3-60
Bench Temperature.....	3-61
Pressure.....	3-62
Flow A and B	3-63
Intensity A and B	3-64
O ₃ Concentration	3-65
Service Menu	3-66
Pressure Check.....	3-67
Lamp Setting.....	3-69
Detector Calibration	3-69
Intensity Check.....	3-70
O ₃ Response Coefficient	3-71
Manual O ₃ Lamp Setting.....	3-71
Pressure Calibration	3-72
Flow A and B Calibration	3-74
Temperature Calibration.....	3-76
Analog Output Calibration	3-77
Analog Input Calibration	3-79
Display Pixel Test	3-81
Restore User Defaults.....	3-81

	Password Menu.....	3-82
	Set Password	3-82
	Lock Instrument	3-82
	Change Password	3-83
	Remove Password.....	3-83
	Unlock Instrument	3-84
Chapter 4	Preventive Maintenance	4-1
	Safety Precautions	4-2
	Replacement Parts.....	4-2
	Outside Case Cleaning.....	4-2
	Optical Bench Cleaning.....	4-2
	Lamp Replacement	4-3
	Monitoring Detector Frequencies and Noise.....	4-4
	Increasing Lamp Output.....	4-4
	Monitoring Lamp Noise	4-5
	Capillary Service.....	4-5
	Pump Rebuilding.....	4-6
	Leak Test and Pump Checkout	4-7
	External Leaks.....	4-7
	Solenoid Leaks	4-8
	Solenoid Leak Test.....	4-9
Chapter 5	Troubleshooting	5-1
	Safety Precautions	5-1
	Troubleshooting Guides.....	5-2
	Board-Level Connection Diagrams	5-6
	Connector Pin Descriptions	5-8
	Service Locations.....	5-21
Chapter 6	Servicing.....	6-1
	Safety Precautions	6-3
	Firmware Updates.....	6-4
	Accessing the Service Mode.....	6-4
	Replacement Parts List.....	6-4
	Cable List.....	6-6
	External Device Connection Components	6-6
	Removing the Measurement Bench and Lowering the Partition Panel.....	6-8
	Fuse Replacement	6-9
	Pump Replacement.....	6-10
	Fan Replacement.....	6-11
	Analog Output Testing.....	6-12

Analog Output Calibration	6-14
Analog Input Calibration	6-15
Calibrating the Input Channels to Zero Volts	6-15
Calibrating the Input Channels to Full Scale.....	6-16
Optical Bench Temperature Calibration	6-17
I/O Expansion Board (Optional) Replacement	6-18
Digital Output Board Replacement.....	6-19
Motherboard Replacement.....	6-20
Measurement Interface Board Replacement	6-21
Front Panel Board Replacement.....	6-22
LCD Module Replacement	6-23
Optical Bench Replacement	6-25
Photometer Board Replacement.....	6-26
Photometer Lamp Replacement	6-27
Photometer Lamp Voltage Adjustment	6-28
Sample/Reference Solenoid Replacement	6-29
Detector Replacement.....	6-30
Pressure Transducer Replacement	6-31
Pressure Transducer Calibration	6-32
Flow Transducer Replacement	6-34
Flow Transducer Calibration	6-35
Ozonator Lamp Replacement.....	6-36
Ozonator Lamp Heater Replacement.....	6-37
Ozonator Replacement.....	6-39
Ozonator Board Replacement	6-39
Service Locations.....	6-40

Chapter 7 System Description..... 7-1

Hardware	7-1
Optical Bench with Photometer Lamp.....	7-2
Detector System	7-2
Flow Transducers.....	7-2
Pressure Transducer	7-2
Ozonator Assembly	7-3
Ozonator Lamp Power Supply	7-3
Photometer Lamp power Supply.....	7-3
Optical Bench Temperature Thermistor	7-3
Pump.....	7-3
Sample/Reference Solenoid Valves	7-3
Software	7-3
Instrument Control.....	7-4
Monitoring Signals.....	7-4
Measurement Calculations	7-4
Output Communication	7-5

Electronics	7-5
Motherboard.....	7-5
Measurement Interface Board	7-6
Digital Output Board.....	7-7
I/O Expansion Board (Optional)	7-7
Front Panel Connector Board	7-8
I/O Components	7-8
Analog Voltage Outputs.....	7-8
Analog Current Outputs (Optional)	7-9
Analog Voltage Inputs (Optional)	7-9
Digital Relay Outputs	7-9
Digital Inputs.....	7-9
Serial Ports	7-10
RS-232 Connection	7-11
RS-485 Connection	7-11
Ethernet Connection.....	7-12
External Accessory Connector	7-12
Chapter 8 Optional Equipment	8-1
Zero Air Source.....	8-1
Teflon Particulate Filter	8-1
I/O Expansion Board Assembly.....	8-1
Terminal Block and Cable Kits	8-2
Cables	8-2
25-Pin Terminal Board Assembly.....	8-3
Mounting Options.....	8-3
Appendix A Warranty	A-1
Appendix B C-Link Protocol Commands.....	B-1
Instrument Identification Number	B-2
Entering Units in PPB	B-2
Accessing Streaming Data	B-2
Commands	B-2
Measurements	B-8
Alarms.....	B-12
Diagnostics	B-17
Datalogging	B-17
Calibration.....	B-25
Keys/Display	B-28
Measurement Configuration	B-29
Hardware Configuration	B-34
Communications Configuration	B-36
I/O Configuration.....	B-40

Record Layout Definition	B-44
Format Specifier for ASCII Responses.....	B-45
Format Specifier for Binary Responses	B-45
Format Specifier for Front-Panel Layout	B-45

Appendix C MODBUS Protocol.....C-1

Serial Communication Parameters	C-2
TCP Communication Parameters	C-2
Application Data Unit Definition	C-2
Slave Address.....	C-2
MBAP Header	C-2
Function Code.....	C-3
Data.....	C-3
Error Check	C-3
Function Codes.....	C-3
(0x01/0x02) Read Coils / Read Inputs	C-3
(0x03/0x04) Read Holding Registers / Read Input Registers.....	C-5
(0x05) Force (Write) Single Coil.....	C-7
MODBUS Commands Supported.....	C-8

Appendix D Geysitech (Bayern-Hessen) Protocol.....D-1

Serial Communication Parameters	D-1
TCP Communication Parameters	D-2
Instrument Address	D-2
Abbreviations Used	D-2
Basic Command Structure	D-2
Block Checksum <BCC>	D-3
Geysitech Commands	D-3
Instrument Control Command (ST).....	D-3
Data Sampling/Data Query Command (DA)	D-4
Measurements Reported in Response to	
DA Command for 49i and 49i PS.....	D-7
Operating and Error Status	D-8

Figures

Model 49i Primary Standard Flow Schematic	1-3
Remove the Packing Material	2-2
Remove the Shipping Screws	2-2
Model 49i Primary Standard Rear Panel	2-4
I/O Terminal Board Views	2-5
D/O Terminal Board Views	2-6
25-Pin Terminal Board Views	2-7
49i Primary Standard Front Panel Display	3-2
Front Panel Pushbuttons	3-3
Flowchart of Menu-Driven Software	3-5
Pin-Out of Rear Panel Connector	3-10
Capillary Location	4-6
Rebuilding the Pump	4-7
Board-Level Connection Diagram - Common Electronics	5-6
Board-Level Connection Diagram - Measurement System	5-7
Properly Grounded Antistatic Wrist Strap	6-4
Component Layout	6-7
Removing the Measurement Bench and Lowering the Partition Panel	6-8
Replacing the Pump	6-10
Replacing a Fan	6-11
Rear Panel Analog Input and Output Pins	6-13
Replacing the I/O Expansion Board (Optional)	6-19
Rear Panel Board Connectors	6-19
Replacing the Measurement Interface Board	6-22
Replacing the Front Panel Board and the LCD Module	6-23
Replacing the Optical Bench	6-26
Replacing the Detectors	6-31
Ozonator Board Location	6-37
Hardware Components	7-2
Rack Mount Option Assembly	8-4
Bench Mounting	8-5
EIA Rack Mounting	8-6
Retrofit Rack Mounting	8-7
Flag Status	B-12

Figures

Tables

Model 49i Primary Standard Specifications	1-3
I/O Terminal Board Pin Descriptions	2-5
D/O Terminal Board Pin Descriptions	2-7
25-Pin Terminal Board Pin Descriptions	2-8
Front Panel Pushbuttons	3-3
Standard Ranges	3-9
Default Analog Outputs	3-10
Analog Output Zero to Full-Scale Table	3-42
Signal Type Group Choices	3-44
Troubleshooting - General Guide	5-2
Troubleshooting - Alarm Messages	5-4
Motherboard Connector Pin Descriptions	5-8
Front Panel Board Connector Pin Diagram	5-13
I/O Expansion Board (Optional) Connector Pin Descriptions	5-15
Digital Output Board Connector Pin Descriptions	5-16
Measurement Interface Board Connector Pin Descriptions	5-17
Ozonator Power Supply Connector Pin Descriptions	5-19
Photometer Power Supply Connector Pin Descriptions	5-20
Model 49i Primary Standard Replacement Parts	6-4
Model 49i Primary Standard Cables	6-6
External Device Connection Components	6-6
Analog Output Channels and Rear Panel Pin Connections	6-13
Analog Input Channels and Rear Panel Pin Connections	6-14
RS-232 DB Connector Pin Configurations	7-11
RS-485 DB Connector Pin Configuration	7-11
Cable Options	8-2
Color Codes for 25-Pin and 37-Pin Cables	8-3
Mounting Options	8-3
C-Link Protocol Commands	B-3
Averaging Times	B-9
Alarm Trigger Values	B-16
Record Output Formats	B-21
Stream Time Values	B-24
Range Settings	B-30
Contrast Levels	B-34
Reply Termination Formats	B-38
Analog Current Output Range Values	B-40
Analog Voltage Output Range Values	B-41
Default Output Assignment	B-42
Read Coils for 49i Primary Standard	C-8
Read Registers for 49i Primary Standard	C-9
Write Coils for 49i Primary Standard	C-10

Tables

Operating Status for Model 49i and 49i Primary Standard D-8
Error Status for Model 49i and 49i Primary Standard D-8

About This Manual

This manual provides information about operating, maintaining, and servicing the analyzer. It also contains important alerts to ensure safe operation and prevent equipment damage. The manual is organized into the following chapters and appendices to provide direct access to specific operation and service information:

- Chapter 1 “Introduction” provides an overview of product features, describes the principles of operation, and lists the specifications.
- Chapter 2 “Installation” describes how to unpack, setup, and startup the analyzer.
- Chapter 3 “Operation” describes the front panel display, the front panel pushbuttons, and the menu-driven software.
- Chapter 4 “Preventive Maintenance” provides maintenance procedures to ensure reliable and consistent instrument operation.
- Chapter 5 “Troubleshooting” presents guidelines for diagnosing analyzer failures, isolating faults, and includes recommended actions for restoring proper operation.
- Chapter 6 “Servicing” presents safety alerts for technicians working on the analyzer, step-by-step instructions for repairing and replacing components, and a replacement parts list. It also includes contact information for product support and technical information.
- Chapter 7 “System Description” describes the function and location of the system components, provides an overview of the software structure, and includes a description of the system electronics and input/output connections.
- Chapter 8 “Optional Equipment” describes the optional equipment that can be used with this analyzer.
- Appendix A “Warranty” is a copy of the warranty statement.
- Appendix B “C-Link Protocol Commands” provides a description of the C-Link protocol commands that can be used to remotely control an analyzer using a host device such as a PC or a datalogger.

- Appendix C “MODBUS Protocol” provides a description of the MODBUS Protocol Interface and is supported both over RS-232/485 (RTU protocol) as well as TCP/IP over Ethernet.
- Appendix D “Geysitech (Bayern-Hessen) Protocol” provides a description of the Geysitech (Bayern-Hessen) Protocol Interface and is supported over RS-232/485 and TCP/IP over Ethernet.





Safety

Review the following safety information carefully before using the analyzer. This manual provides specific information on how to operate the analyzer, however if the analyzer is used in a manner not specified by the manufacturer, the protection provided by the equipment may be impaired.



Safety and Equipment Damage Alerts

This manual contains important information to alert you to potential safety hazards and risks of equipment damage. Refer to the following types of alerts you may see in this manual.

Safety and Equipment Damage Alert Descriptions

Alert	Description
 DANGER	A hazard is present that will result in death or serious personal injury if the warning is ignored. ▲
 WARNING	A hazard is present or an unsafe practice can result in serious personal injury if the warning is ignored. ▲
 CAUTION	The hazard or unsafe practice could result in minor to moderate personal injury if the warning is ignored. ▲
 Equipment Damage	The hazard or unsafe practice could result in property damage if the warning is ignored. ▲

Safety and Equipment Damage Alerts in this Manual

Alert	Description
	<p>WARNING</p> <p>If the equipment is operated in a manner not specified by the manufacturer, the protection provided by the equipment may be impaired. ▲</p> <p>The service procedures in this manual are restricted to qualified service personnel only. ▲</p> <p>The Model 49i Primary Standard is supplied with a three-wire grounding cord. Under no circumstances should this grounding system be defeated. ▲</p>
	<p>CAUTION</p> <p>If the LCD panel breaks, do not to let the liquid crystal contact your skin or clothes. If the liquid crystal contacts your skin or clothes, wash it off immediately using soap and water. ▲</p>
	<p>Equipment Damage</p> <p>Do not attempt to lift the analyzer by the cover or other external fittings. ▲</p> <p>Some internal components can be damaged by small amounts of static electricity. A properly grounded antistatic wrist strap must be worn while handling any internal component. ▲</p> <p>This adjustment should only be performed by an instrument service technician. ▲</p> <p>Handle all printed circuit boards by the edges only. ▲</p> <p>Do not remove the panel or frame from the LCD module. ▲</p> <p>The LCD module polarizing plate is very fragile, handle it carefully. ▲</p> <p>Do not wipe the LCD module polarizing plate with a dry cloth, it may easily scratch the plate. ▲</p> <p>Do not use Ketonics solvent or aromatic solvent to clean the LCD module, use a soft cloth moistened with a naphtha cleaning solvent. ▲</p> <p>Do not place the LCD module near organic solvents or corrosive gases. ▲</p> <p>Do not shake or jolt the LCD module. ▲</p>

FCC Compliance

Changes or modifications to this unit not expressly approved by the party responsible for compliance could void the user's authority to operate the equipment.

Note This equipment has been tested and found to comply with the limits for a Class A digital device, pursuant to Part 15 of the FCC Rules. These limits are designed to provide reasonable protection against harmful interference when the equipment is operated in a commercial environment. This equipment generates, uses, and can radiate radio frequency energy and, if not installed and used in accordance with the instruction manual, may cause harmful interference to radio communications. Operation of this equipment in a residential area is likely to cause harmful interference in which case the user will be required to correct the interference at his own expense. ▲

WEEE Symbol

The following symbol and description identify the WEEE marking used on the instrument and in the associated documentation.

Symbol	Description
	Marking of electrical and electronic equipment which applies to electrical and electronic equipment falling under the Directive 2002/96/EC (WEEE) and the equipment that has been put on the market after 13 August 2005.

Where to Get Help

Service is available from exclusive distributors worldwide. Contact one of the phone numbers below for product support and technical information or visit us on the web at www.thermo.com/aqi.

1-866-282-0430 Toll Free

1-508-520-0430 International

Chapter 1 Introduction

The Model 49*i* Primary Standard UV Photometric Ozone Calibrator combines proven detection technology, easy to use menu-driven software, and advanced diagnostics to offer unsurpassed flexibility and reliability. The Model 49*i* Primary Standard has the following features:

- 320 x 240 graphics display
- Menu-driven software
- Multiple user-defined analog outputs
- Analog input options
- Fast internal ozonator
- Fast response time
- Short lag time
- Automatic temperature and pressure compensation
- User-selectable digital input/output capabilities
- Standard communications features include RS232/485 and Ethernet
- C-Link, MODBUS, Geysitech (Bayern-Hessen) protocol, and streaming data protocols.

For details of the calibrator's principle of operation and product specifications, see the following topics:

- “[Principle of Operation](#)” on [page 1-2](#) describes the principles by which your calibrator operates.
- “[Specifications](#)” on [page 1-3](#) is a list of the calibrator's performance specifications.

Thermo Fisher Scientific is pleased to supply this UV photometric ozone calibrator. We are committed to the manufacture of instruments exhibiting high standards of quality, performance, and workmanship. Service personnel are available for assistance with any questions or problems that may arise in the use of this calibrator. For more information on servicing, see Chapter 7, “Servicing”.

Principle of Operation

The Model 49*i* Primary Standard operates on the principle that ozone (O₃) molecules absorb UV light at a wavelength of 254 nm. The degree to which the UV light is absorbed is directly related to the ozone concentration as described by the Beer-Lambert Law:

$$\frac{I}{I_o} = e^{-KLC}$$

where:

K = molecular absorption coefficient, 308 cm⁻¹ (at 0°C and 1 atmosphere)

L = length of cell, 38 cm

C = ozone concentration in parts per million (ppm)

I = UV light intensity of sample with ozone (sample gas)

I_o = UV light intensity of sample without ozone (reference gas)

Zero air is supplied to the Model 49*i* Primary Standard through the *zero air* bulkhead and is split into two gas streams, as shown in Figure 1-1. One gas stream flows through a pressure regulator to the reference solenoid valve to become the reference gas (I_o). The second zero air stream flows through a pressure regulator, ozonator, and manifold to the sample solenoid valve to become the sample gas (I). Ozone from the manifold is delivered to the *ozone* bulkhead. The solenoid valves alternate the reference and sample gas streams between cells A and B every 10 seconds. When cell A contains reference gas, cell B contains sample gas and vice versa.

The UV light intensities of each cell are measured by detectors A and B. When the solenoid valves switch the reference and sample gas streams to opposite cells, the light intensities are ignored for several seconds to allow the cells to be flushed. The Model 49*i* Primary Standard calculates the

ozone concentration for each cell and outputs the average concentration to the front panel display, the analog outputs, and also makes the data available over the serial or ethernet connection.

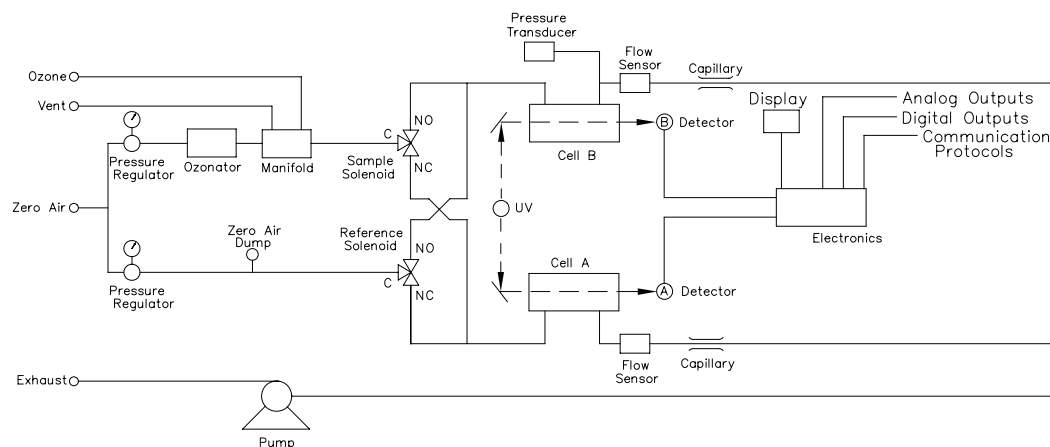

Figure 1-1. Model 49i Primary Standard Flow Schematic

Specifications

Table 1-1. Model 49i Primary Standard Specifications

Photometer	
Preset ranges	50, 100, 200, 500, 1000, 2000, 5000 ppb 100, 200, 500, 1000, 2000, 5000, 10000 $\mu\text{g}/\text{m}^3$
Custom ranges	50 to 5000 ppb 100 to 10000 $\mu\text{g}/\text{m}^3$
Zero roise	0.25 ppb RMS (60 second averaging time)
Lower detectable limit	1 ppb
Response time	20 seconds (0-95%)
Lag time	10 seconds
Linearity	$\pm 1\%$ of full-scale
Flow rate	1–3 LPM
Operating temperature	0–45 °C*
Power requirements	100 VAC @ 50/60 Hz 115 VAC @ 50/60 Hz 220–240 VAC @ 50/60 Hz 150 watts
Physical dimensions	16.75" (W) X 8.62" (H) X 23" (D)

Photometer	
Weight	Approximately 35 lbs.
Analog outputs	6 voltage outputs; 0–100 mV, 1, 5, 10 V (user selectable), 5% of full-scale over/under range, 12 bit resolution, user selectable for measurement input
Digital outputs	1 power fail relay Form C, 10 digital relays Form A, user selectable alarm output, relay logic, 100 mA @ 200 VDC
Digital inputs	16 digital inputs, user select programmable, TTL level, pulled high
Serial Ports	1 RS-232 or RS-485 with two connectors, baud rate 1200–115200, data bits, parity, and stop bits, protocols: C-Link, MODBUS, and streaming data (all user selectable)
Ethernet connection	RJ45 connector for 10Mbps Ethernet connection, static or dynamic TCP/IP addressing
Ozonator	
Output	0.025-1.000 ppm at 3-4 LPM
Response (to 98% or 5 ppb of final value, whichever is greater)	1 minute
Stability	± 4 ppb or ± 1% of reading, whichever is greater

*In non condensing environments.

Chapter 2 Installation

Installing the Model 49i Primary Standard includes the following recommendations and procedures:

- “Lifting” on page 2-1
- “Unpacking and Inspection” on page 2-1
- “Setup Procedure” on page 2-3
- “Connecting External Devices” on page 2-4
- “Startup” on page 2-8

Lifting

When lifting the instrument, use procedure appropriate to lifting a heavy object, such as, bending at the knees while keeping your back straight and upright. Grasp the instrument at the bottom in the front and at the rear of the unit. Although one person can lift the unit, it is desirable to have two persons lifting, one by grasping the bottom in the front and the other by grasping the bottom in the rear.



Equipment Damage Do not attempt to lift the instrument by the cover or other external fittings. ▲

Unpacking and Inspection

The Model 49i Primary Standard is shipped complete in one container. If there is obvious damage to the shipping container when you receive the instrument, notify the carrier immediately and hold for inspection. The carrier is responsible for any damage incurred during shipment.

Use the following procedure to unpack and inspect the instrument.

1. Remove the instrument from the shipping container and set it on a table or bench that allows easy access to both the front and rear.
2. Remove the cover to expose the internal components.

Installation

Unpacking and Inspection

3. Remove the packing material (Figure 2-1).

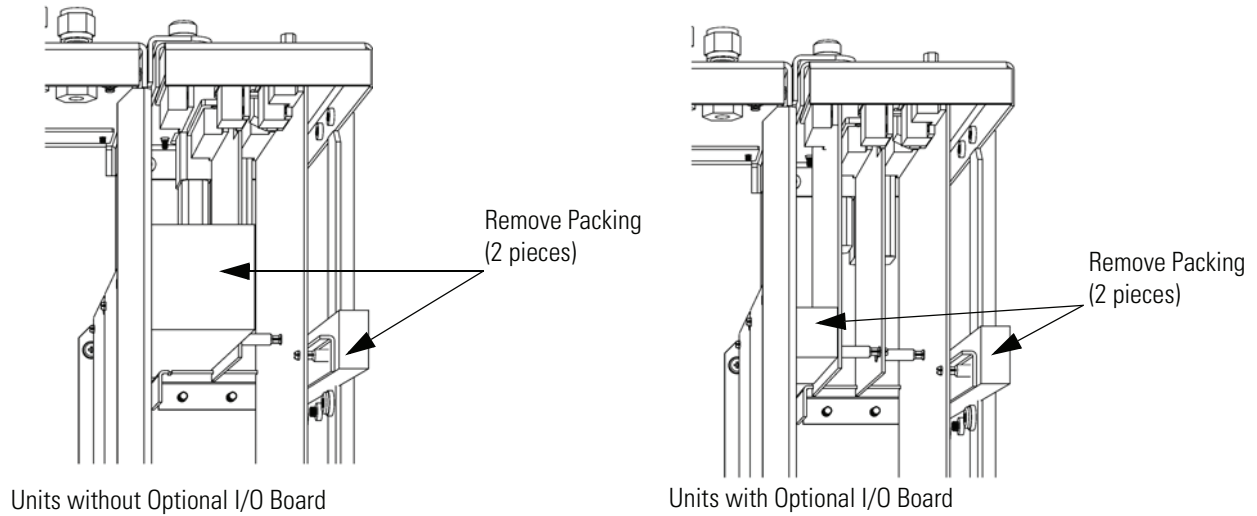

Figure 2-1. Remove the Packing Material

4. Remove the three shipping screws (Figure 2-2).

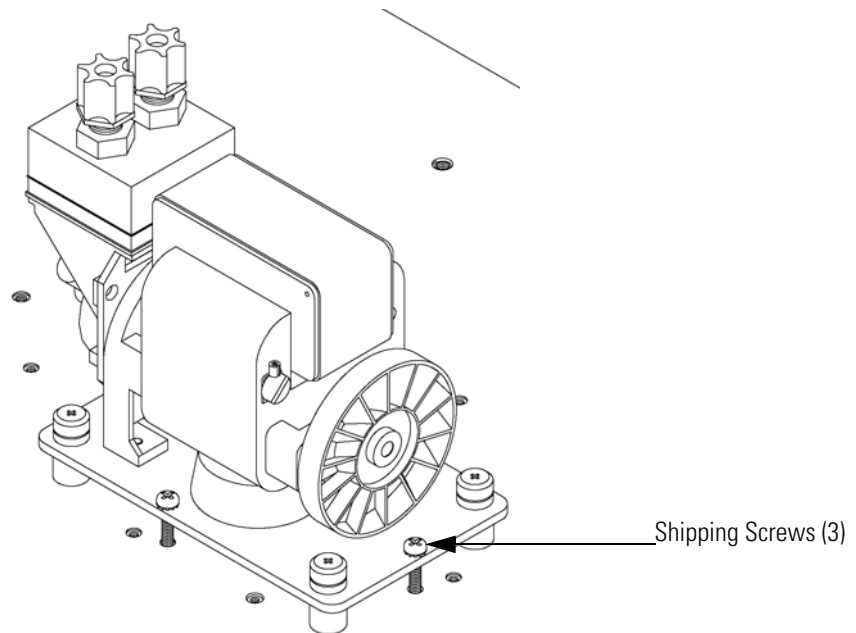

Figure 2-2. Remove the Shipping Screws

5. Check for possible damage during shipment.
6. Check that all connectors and circuit boards are firmly attached.

7. Re-install the cover.
8. Remove any protective plastic material from the case exterior.

Setup Procedure

Use the following procedure to setup the instrument.

1. Connect the zero air supply to the ZERO AIR bulkhead on the rear panel (Figure 2-3). All tubing should be constructed of FEP Teflon®, 316 stainless steel, borosilicate glass, or similar tubing with an OD of 1/4-inch and a minimum ID of 1/8-inch. The length of the tubing should be less than 10 feet.
2. Connect the EXHAUST bulkhead to a suitable vent. The exhaust line should be 1/4-inch OD with a minimum ID of 1/8-inch. The length of the exhaust line should be less than 10 feet. Verify that there is no restriction in this line.
3. Connect a suitable recording device to the rear panel connector. See the “Operation” chapter for more information about the rear panel pin-outs.
4. Plug the instrument into an outlet of the appropriate voltage and frequency.



WARNING The Model 49*i* Primary Standard is supplied with a three-wire grounding cord. Under no circumstances should this grounding system be defeated. ▲

5. Connect the instrument to be calibrated to the OZONE bulkhead. The total flow through the ozonator should be set to at least 1 LPM.

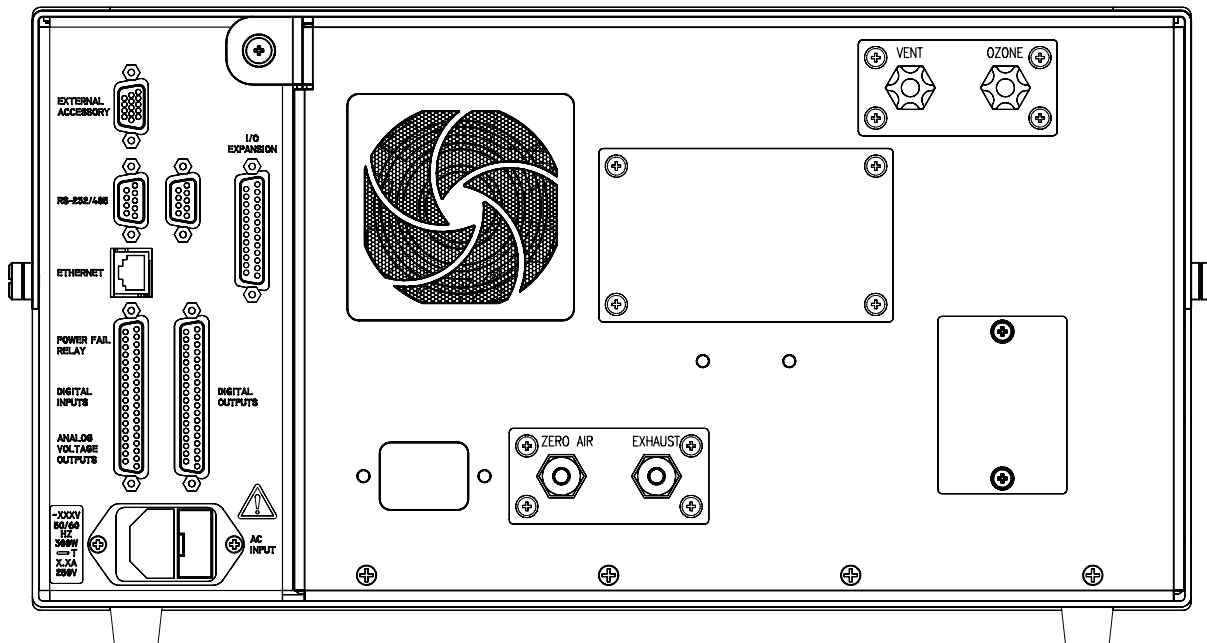

Figure 2-3. Model 49i Primary Standard Rear Panel

Connecting External Devices

Several components are available for connecting external devices to *iSeries* instruments.

These connection options include:

- Individual terminal board PCB assemblies
- Terminal block and cable kits (optional)
- Individual cables (optional)

For detailed information on the optional connection components, refer to the “Optional Equipment” chapter. For associated part numbers, refer to “External Device Connection Components” in the “Servicing” chapter.

Terminal Board PCB Assemblies

The following terminal board PCB assemblies are available for *iSeries* instruments:

- I/O terminal board PCB assembly, 37 pin (standard)

- D/O terminal board PCB assembly, 37 pin (standard)
- 25-pin terminal board PCB assembly, (included with optional I/O Expansion Board)

I/O Terminal Board

Figure 2-4 shows the recommended method for attaching the cable to the terminal board using the included tie-down and spacer. Table 2-1 identifies the connector pins and associated signals.

Note Not all of the available I/O for the instrument are brought out on this terminal. If more I/O is desired, you must use an alternative connection method. ▲

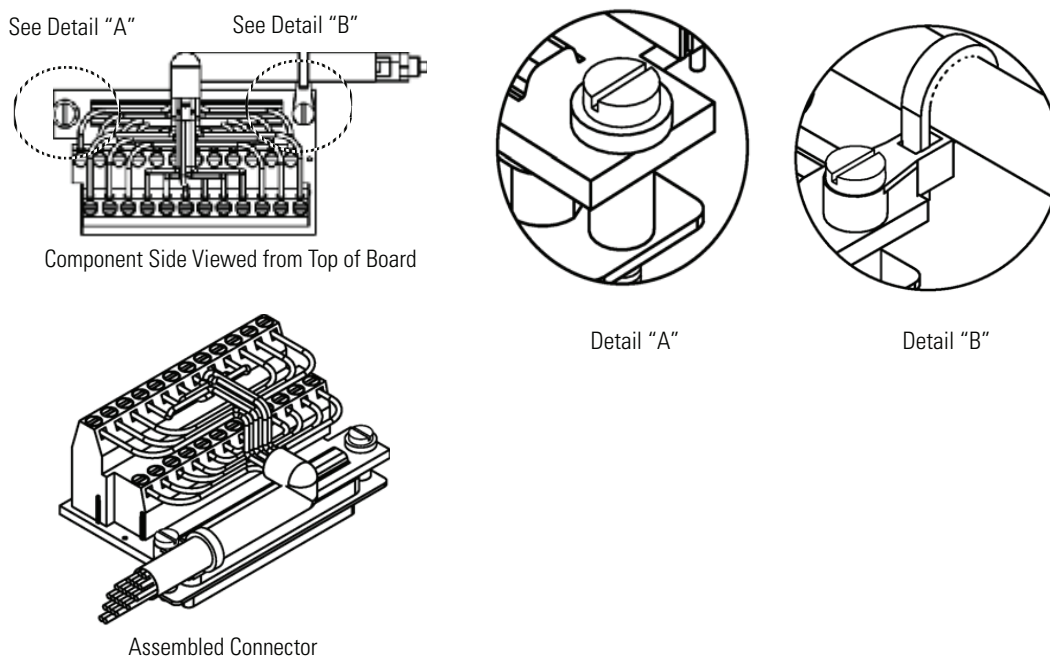

Figure 2-4. I/O Terminal Board Views

Table 2-1. I/O Terminal Board Pin Descriptions

Pin	Signal Description	Pin	Signal Description
1	Analog1	13	Power_Fail_NC
2	Analog ground	14	Power_Fail_COM

Table 2-1. I/O Terminal Board Pin Descriptions, continued

Pin	Signal Description	Pin	Signal Description
3	Analog2	15	Power_Fail_NO
4	Analog ground	16	TTL_Input1
5	Analog3	17	TTL_Input2
6	Analog ground	18	TTL_Input3
7	Analog4	19	TTL_Input4
8	Analog ground	20	Digital ground
9	Analog5	21	TTL_Input5
10	Analog ground	22	TTL_Input6
11	Analog6	23	TTL_Input7
12	Analog ground	24	Digital ground

D/O Terminal Board

Figure 2-5 shows the recommended method for attaching the cable to the terminal board using the included tie-down and spacer. Table 2-2 identifies the connector pins and associated signals.

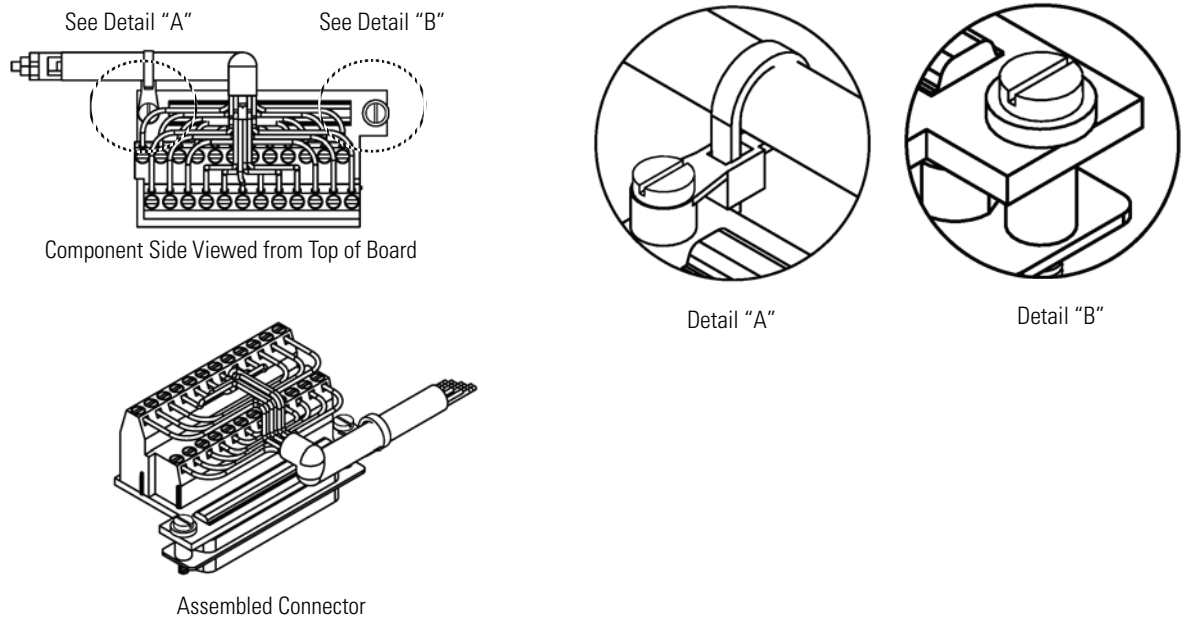

Figure 2-5. D/O Terminal Board Views

Table 2-2. D/O Terminal Board Pin Descriptions

Pin	Signal Description	Pin	Signal Description
1	Relay1_ContactA	13	Relay7_ContactA
2	Relay1_ContactB	14	Relay7_ContactB
3	Relay2_ContactA	15	Relay8_ContactA
4	Relay2_ContactB	16	Relay8_ContactB
5	Relay3_ContactA	17	Relay9_ContactA
6	Relay3_ContactB	18	Relay9_ContactB
7	Relay4_ContactA	19	Relay10_ContactA
8	Relay4_ContactB	20	Relay10_ContactB
9	Relay5_ContactA	21	Solenoid_Drive_Output1
10	Relay5_ContactB	22	+24V
11	Relay6_ContactA	23	Solenoid_Drive_Output2
12	Relay6_ContactB	24	+24V

25-Pin Terminal Board The 25-pin terminal board is included with the optional I/O Expansion Board.

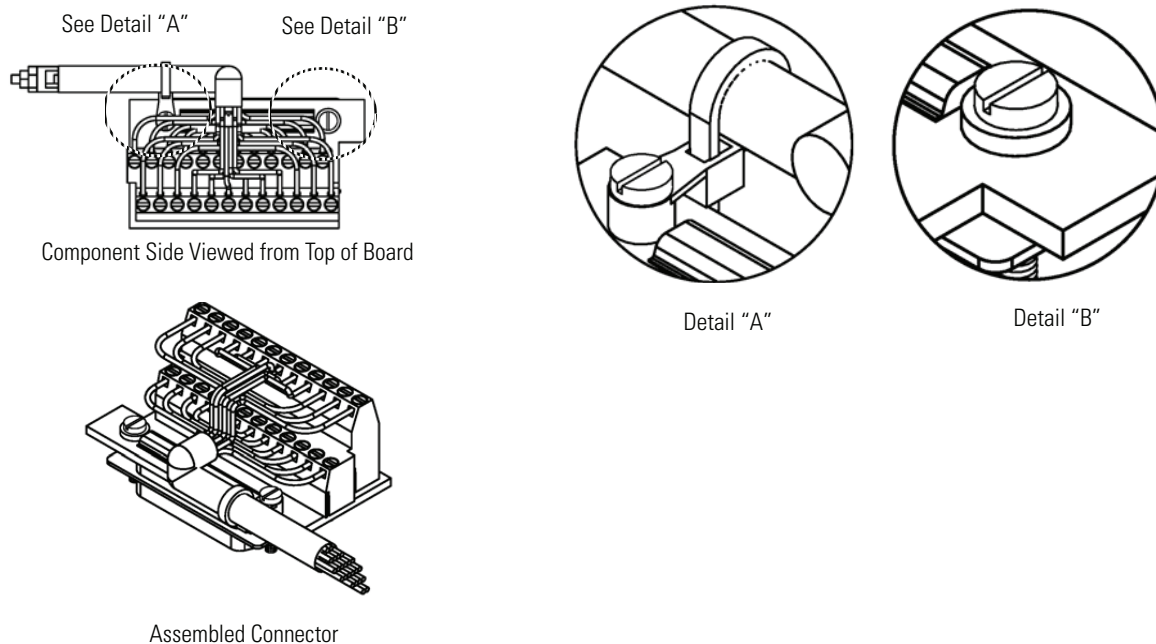

Figure 2-6. 25-Pin Terminal Board Views

Table 2-3. 25-Pin Terminal Board Pin Descriptions

Pin	Signal Description	Pin	Signal Description
1	IOut1	13	Analog_In1
2	GND_ISO	14	Analog_In2
3	IOut2	15	Analog_In3
4	GND_ISO	16	GNDD
5	IOut3	17	Analog_In4
6	GND_ISO	18	Analog_In5
7	IOut4	19	Analog_In6
8	GND_ISO	20	GNDD
9	IOut5	21	Analog_In7
10	GND_ISO	22	Analog_In8
11	IOut6	23	GNDD
12	GND_ISO	24	GNDD

Startup

Use the following procedure when starting the instrument.



1. Turn the power ON.
2. Allow 90 minutes for the instrument to stabilize.
3. Set instrument parameters such as operating ranges and averaging times to appropriate settings. For more information about instrument parameters, see the “Operation” chapter.

Chapter 3 Operation

This chapter describes the front panel display, front panel pushbuttons, and menu-driven software.

- “Display” on page 3-2 describes the LCD graphics display.
- “Pushbuttons” on page 3-3 describes the various front panel pushbuttons and the expected key actions for each.
- “Software Overview” on page 3-4 describes the menu-driven software and submenus.
- “Range Menu” on page 3-7 describes the gas units, O₃ range, and custom ranges.
- “Averaging Time” on page 3-12 describes the averaging period applied to O₃ measurements.
- “Calibration Factors Menu” on page 3-12 describes the calibration factors used to make minor corrections to the O₃ measurement readings.
- “Instrument Controls Menu” on page 3-15 describes the items that control the calibrator.
- “Diagnostics Menu” on page 3-50 describes the diagnostic information and functions.
- “Alarms Menu” on page 3-58 describes a list of items that are monitored by the calibrator.
- “Service Menu” on page 3-66 describes service related menu items.
- “Password Menu” on page 3-82 describes how to enter/change a password, lock and unlock the calibrator.

Display

The 320 x 240 graphics liquid-crystal display (LCD) shows the sample concentrations, instrument parameters, instrument controls, help, and error messages. Some menus contain more items than can be displayed at one time. For these menus, use  and  to move the cursor up and down to each item.

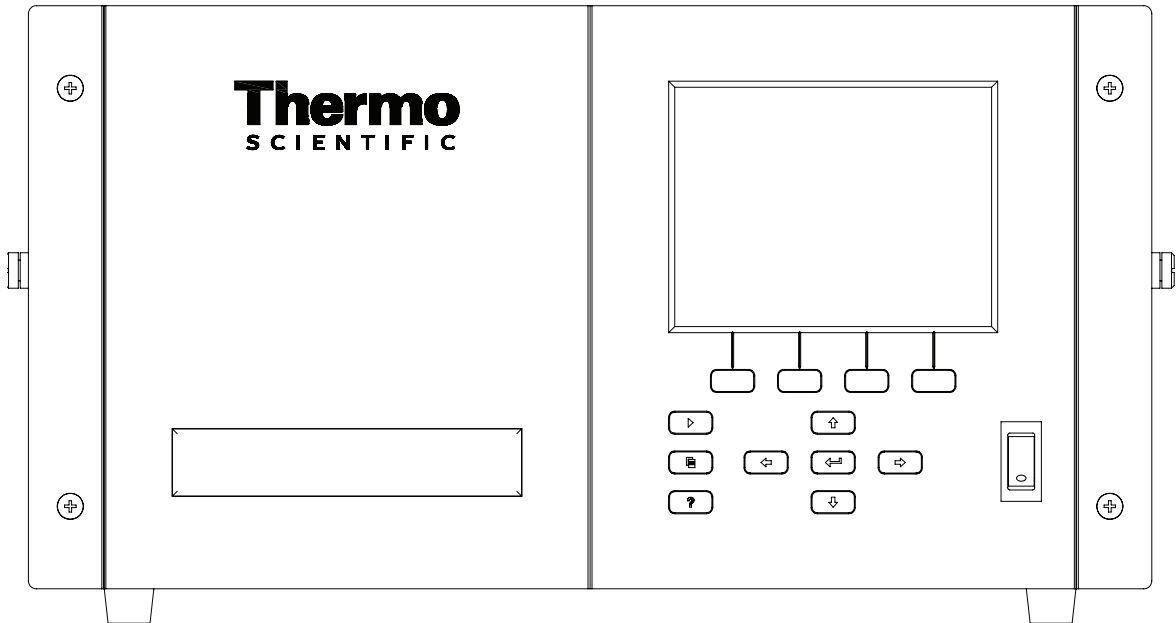

Figure 3-1. 49i Primary Standard Front Panel Display



CAUTION If the LCD panel breaks, do not let the liquid crystal contact your skin or clothes. If the liquid crystal contacts your skin or clothes, wash it off immediately using soap and water. ▲

Pushbuttons

The Pushbuttons allow the user to traverse the various screens/menus.

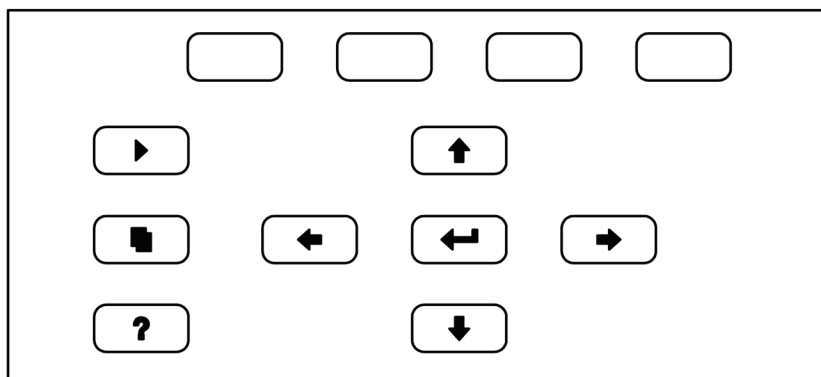

























Figure 3-2. Front Panel Pushbuttons

Table 3-1. Front Panel Pushbuttons

 = Soft Keys	The  soft keys are used to provide shortcuts that allow the user to jump to user-selectable menu screens. For more information on processing soft keys, see “Soft Keys” below.
 = Run	The  is used to display the Run screen. The Run screen normally displays the O ₃ concentration.
 = Menu	The  is used to display the Main Menu when in the Run screen, or back up one level in the menu system. For more information about the Main Menu, see “Main Menu” later in this chapter.
 = Help	The  is context-sensitive, that is, it provides additional information about the screen that is being displayed. Press  for a brief explanation about the current screen or menu. Help messages are displayed using lower case letters to easily distinguish them from the operating screens. To exit a help screen, press  or  to return to the previous screen, or  to return to the Run screen.
  = Up, Down   = Left, Right	The four arrow pushbuttons ( ,  ,  , and ) move the cursor up, down, left, and right or change values and states in specific screens.
 = Enter	The  is used to select a menu item, accept/set/save a change, and/or toggle on/off functions.

Soft Keys

The Soft Keys are multi-functional keys that use part of the display to identify their function at any moment. The function of the soft keys allow immediate access to the menu structure and most often used menus and screens. They are located directly underneath the display and as the keys' functions change this is indicated by user-defined labels in the lower part of the display, so that the user knows what the keys are to be used for.

To change a soft key, place the menu cursor “>” on the item of the selected menu or screen you wish to set. Press  followed by the selected soft key within 1 second of pressing the right-arrow key. The edit soft key prompt will be displayed for configuration for the new label.

Note Not all menu items may be assigned to soft keys. If a particular menu or screen item cannot be assigned, the key assignment screen will not come up upon entering right-arrow-soft key combinations. All items under the Service menu (including the menu itself) cannot be assigned soft keys. ▲



Software Overview

The Model 49i Primary Standard utilizes the menu-driven software illustrated by the flowchart in Figure 3-3. The Power-Up screen, shown at the top of the flowchart, is displayed each time the instrument is turned on. This screen is displayed while the instrument is warming up and performing self-checks. After the warm-up period, the Run screen is automatically displayed. The Run screen is the normal operating screen. It displays the O₃ concentration, depending on operating mode. From the Run screen, the Main Menu can be displayed by pressing . The Main Menu contains a list of submenus. Each submenu contains related parameters and/or functions. This chapter describes each submenu and screen in detail. Refer to the appropriate sections for more information.

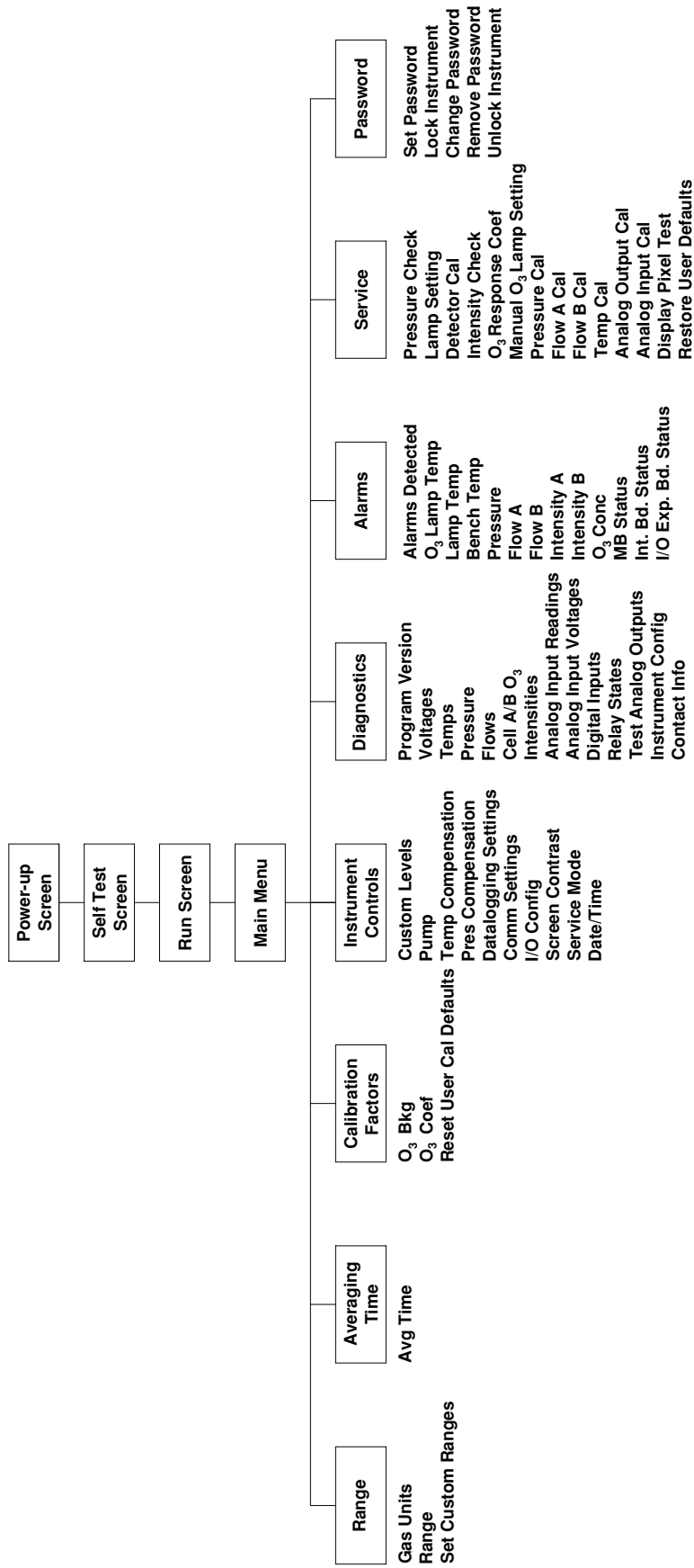





Figure 3-3. Flowchart of Menu-Driven Software

Power-Up Screen

The Power-Up screen is displayed on power up of the Model 49*i* Primary Standard. The Self-Test is displayed while the internal components are warming up and diagnostic checks are performed.





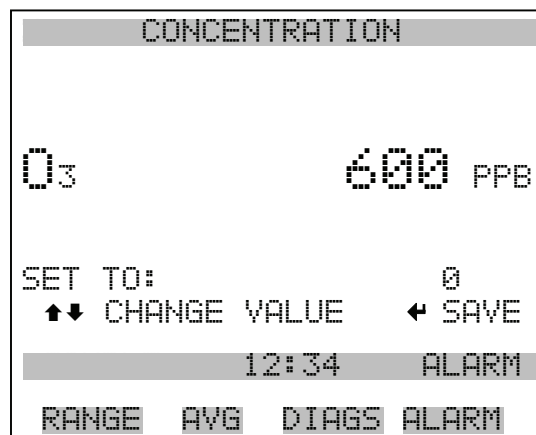

Run Screen

The Run screen displays the O₃ concentration. The status bar displays sample/cal solenoid valve or internal ozonator, time, and alarm status. The word "ZERO" on the bottom left of the display indicates the calibrator is in zero mode. Other modes appear in the same area of the display as "LEVEL 1", "LEVEL 2", "LEVEL 3", "LEVEL 4" and "LEVEL 5", or blank to signify manual mode, as shown below. In manual mode, use  and  to increase and decrease the O₃ output concentration. Press  to scroll through manual, zero or custom levels.



Main Menu

The Main Menu contains a number of submenus. Parameters and features are divided into these submenus according to their function. The concentration appears above the main menu and submenus in every screen. The Service menu is visible only when the calibrator is in service mode. For more information on the service mode, see “Service Mode” later in this chapter.

- Use  and  to move the cursor up and down.
- Press  to select a choice.
- Press  to return to the Main Menu or  to return to the Run screen.

```

MAIN MENU:
>RANGE
  AVERAGING TIME
  CALIBRATION FACTORS
  INSTRUMENT CONTROLS
  DIAGNOSTICS
  ALARMS
  SERVICE
                                     ↓
RANGE  AVG  DIAGS  ALARM

PASSWORD
  
```

Range Menu

The Range menu allows the operator to select the gas units, O₃ range, and to set the custom ranges.

- In the Main Menu, choose **Range**.

```



RANGE:
>GAS UNITS           PPB
RANGE                500
  SET CUSTOM RANGES

RANGE  AVG  DIAGS  ALARM
  
```

Gas Units

The Gas Units screen defines how the O₃ concentration reading is expressed. Gas units of parts per billion (ppb), parts per million (ppm), micrograms per cubic meter ($\mu\text{g}/\text{m}^3$), or milligrams per cubic meter (mg/m^3) are available. The $\mu\text{g}/\text{m}^3$ and mg/m^3 gas concentration modes are calculated using a standard pressure of 760 mmHg and a standard temperature of 20 °C.

When switching the selected units from ppb or ppm to $\mu\text{g}/\text{m}^3$ or mg/m^3 , the analog ranges all default to the highest range in that mode. For example, when switching from mg/m^3 to ppm, all the ranges default to 5 ppm. Therefore, whenever you change units, you should also check the range settings.

- In the Main Menu, choose Range > Gas Units.
- Use  and  to scroll through a list of choices.
- Press  to save the new units.

Note If the units change from ppb/ppm to $\mu\text{g}/\text{m}^3/\text{mg}/\text{m}^3$ or vice-versa, the instrument should be re-calibrated, particularly if the user's standard temperature is different from 20 °C. A display warning will appear that ranges will be defaulted and calibration parameters reset. ▲

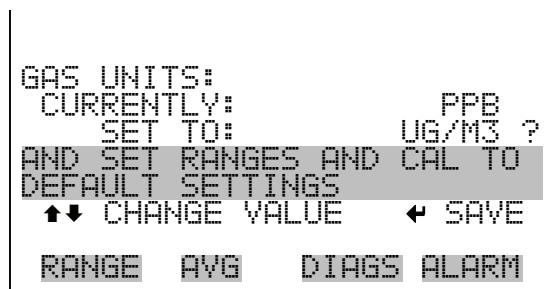



O₃ Range

The O₃ Range screen defines the concentration range of the analog outputs. For example, an O₃ range of 0–500 ppb restricts the analog output to concentrations between 0 and 500 ppb.

The display shows the current O₃ range. The next line of the display is used to change the range.

Table 3-2 lists the standard ranges.

- In the Main Menu, choose Range > O₃ Range.
- Use  and  to scroll through a list of choices.
- Press  to save the new range.

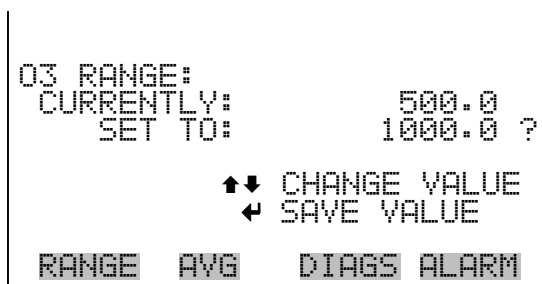

Table 3-2. Standard Ranges

ppb	ppm	µg/m ³	mg/m ³
50	0.05	100	0.1
100	0.10	200	0.2
200	0.20	400	0.4
500	0.50	1,000	1
1,000	1	2,000	2
2,000	2	5,000	5
5,000	5	10,000	10
C1	C1	C1	C1
C2	C2	C2	C2
C3	C3	C3	C3

C1, C2, and C3 are custom ranges. The analog outputs are arranged on the rear panel connector as shown in Figure 3-4. See Table 3-3 for channels and pin connections. For more information about custom ranges, see “Set Custom Ranges” below.

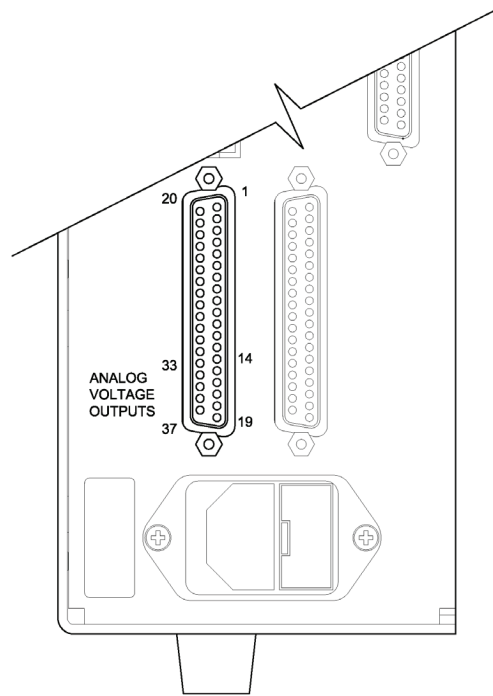

Figure 3-4. Pin-Out of Rear Panel Connector

Table 3-3. Default Analog Outputs

Channel	Pin	I/O Terminal Pin	Description
1	14	1	O ₃ Analog Output
2	33	3	O ₃ Analog Output
3	15	5	None
4	34	7	None
5	17	9	None
6	36	11	None
Ground	16, 18, 19, 35, 37	2, 4, 6, 8, 10, 12	Signal Ground

Note All channels are user definable. If any customization has been made to the analog output configuration, the default selections may not apply. ▲

Set Custom Ranges

The Set Custom Ranges menu lists three custom ranges: C1, C2, and C3. Custom ranges are user-defined ranges. In the standard range mode, any value between 50 ppb (0.05 ppm) and 5,000 ppb (5 ppm) can be specified as a range. In the $\mu\text{g}/\text{m}^3$ (mg/m^3) mode, any value between 100 $\mu\text{g}/\text{m}^3$ (0.1 mg/m^3) and 10,000 $\mu\text{g}/\text{m}^3$ (10 mg/m^3) can be specified as a range.

- In the Main Menu, choose Range > **Set Custom Ranges**.

```





CUSTOM RANGES:
>CUSTOM RANGE 1      550.0
CUSTOM RANGE 2      650.0
CUSTOM RANGE 3      750.0

RANGE  AVG  DIAGS  ALARM
  
```

Custom Ranges

The Custom Ranges screen is used to define the custom ranges.

The display shows the current custom range. The next line of the display is used to set the range. To use the custom full-scale range, be sure to select it (Custom range 1, 2, or 3) in the O₃ Range screen. For more information about selecting ranges, see “O₃ Range” above.

- In the Main Menu, choose Range > Set Custom Ranges > **Custom range 1, 2, or 3**.
- Use  and  to move the cursor left or right.
- Use  and  to increment or decrement the numeric value.
- Press  to save the new range.

```

CUSTOM RANGE 1:
CURRENTLY:      550.0
SET TO:        000550.1 ?



      ←→ MOVE CURSOR
↑↓ CHANGE VALUE  ← SAVE

RANGE  AVG  DIAGS  ALARM
  
```

Averaging Time

The averaging time defines a time period (10 to 300 seconds) over which O₃ measurements are taken. The average concentration of the readings are calculated for that time period. The front panel display and analog outputs are updated every 10 seconds with the calculated averages. An averaging time of 10 seconds, for example, means that the average concentration of the last 10 seconds will be output at each update. An averaging time of 300 seconds means that the moving average concentration of the last 300 seconds will be output at each 10-second update. Therefore, the lower the averaging time, the faster the front panel display and analog outputs respond to concentration changes. Longer averaging times are typically used to smooth output data.

The following averaging times are available: 10, 20, 30, 60, 90, 120, 180, 240, and 300 seconds.

- In the Main Menu, choose **Averaging Time**.
- Use  and  to scroll through a list of choices.
- Press  to save the averaging time.

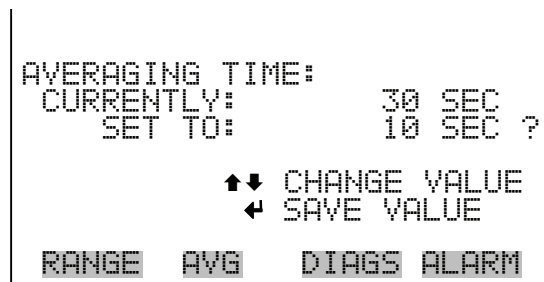

Calibration Factors Menu

Calibration factors are used to make minor compensations to the O₃ concentration, when the Model 49i Primary Standard is being precisely matched to a NIST traceable O₃ calibrator. The Calibration Factors menu displays the calibration factors.

- In the Main Menu, choose **Calibration Factors**



```

CALIBRATION FACTORS:
>O3 BKG          0.0
O3 COEF         1.000
RESET USER CAL DEFAULTS

RANGE  AVG  DIAGS  ALARM
  
```

O₃ Background

The O₃ Background is used to make small adjustments to the zero level. This adjustment should only be made when the Model 49*i* Primary Standard is being precisely matched to a NIST traceable O₃ calibrator. Normally, the Model 49*i* Primary Standard does not require any background compensation.

- In the Main Menu, choose Calibration Factors > **O₃ Background**.
- Use  and  to increment or decrement the proposed background value.
- Press  to save the new background.

```

O3 BACKGROUND:
O3:           4.4
SET BKG TO:   0.0



  ↑↓ INC/DEC
  ← SAVE VALUE

RANGE  AVG  DIAGS  ALARM
  
```

O₃ Span Coefficients

The O₃ span coefficients is s used to make small adjustments to the output level. This adjustment should only be made when the Model 49*i* Primary Standard is being precisely matched to a NIST traceable O₃ calibrator. Normally, the Model 49*i* Primary Standard does not require any compensation.



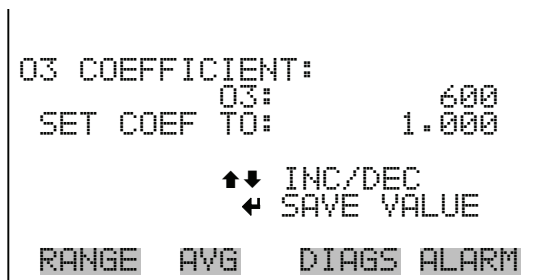

Note The concentration value will show ERROR if the measured concentration is not a valid span value (either higher than the selected range, or 0 or lower). ▲

- In the Main Menu, choose Calibration Factors > O₃ Coef.
- Use  and  to increment or decrement the coefficient value.
- Press  to save the new coefficient.



Reset User Calibration Default

The Reset User Calibration Default screen allows the user to reset the calibration configuration values to factory defaults.

- In the Main Menu, choose Service > Calibration Factors > **Reset User Cal Defaults.**
- Press  to warn user and enable restore with .
- Use  to reset the calibration pressure reference value when pressed after .

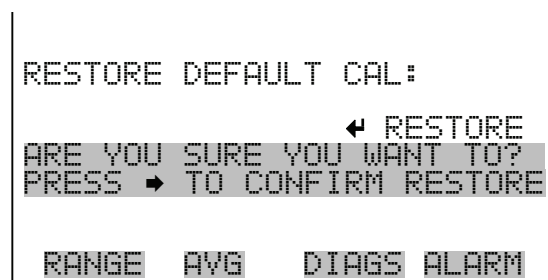
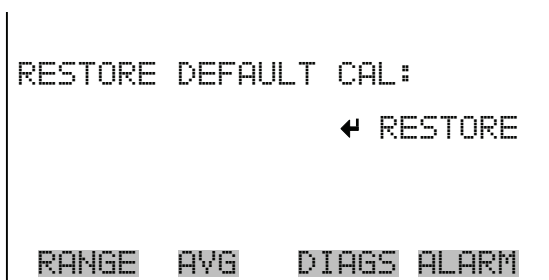

Instrument Controls Menu

The Instrument Controls menu contains items that control the calibrator.

- In the Main Menu, choose **Instrument Controls**.

```

INSTRUMENT CONTROLS:
>CUSTOM LEVELS
PUMP
TEMPERATURE COMPENSATION
PRESSURE COMPENSATION
DATA LOGGING SETTINGS
COMMUNICATION SETTINGS
I/O CONFIGURATION
↓
RANGE  AVG  DIAGS  ALARM
  
```

```

SCREEN CONTRAST
SERVICE MODE
DATE/TIME
  
```

Custom Levels

The Custom Levels menu contains four custom levels: 1, 2, 3, 4 and 5. In the Run screen, use  to scroll through Zero, Level 1, Level 2, Level 3, Level 4, Level 5. Press enter to select a custom level zero.



- In the Main Menu, choose Instrument Controls > **Custom Levels**.

```

CUSTOM 03 LEVELS:
>LEVEL 1           425
LEVEL 2           325
LEVEL 3           215
LEVEL 4           125
LEVEL 5            50
RANGE  AVG  DIAGS  ALARM
  
```

Custom Levels

The Custom Levels screen is used for setting user-defined concentration levels.

- In the Main Menu, choose Instrument Controls > Custom Levels > **Custom Level 1, 2, 3, 4 or 5**.
- Use  and  to increment or decrement the numeric value.
- Press  to save the new level.

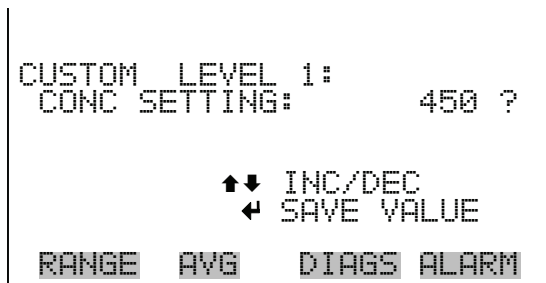

Pump The Pump screen allows the user to toggle the pump on and off.

- In the Main Menu, choose Instrument Controls > **Pump**.
- Press  to toggle and set the pump on or off.



Temperature Compensation

Temperature compensation provides compensation for any changes to the instrument's output signal due to variations in sample gas temperature. The Model 49*i* Primary Standard can be operated with or without temperature compensation.

When temperature compensation is on, the display shows the sample gas temperature (measured by a thermistor on the Interface board). When temperature compensation is off, the display shows the standard temperature of 0.0 °C.

- In the Main Menu, choose Instrument Controls > **Temperature Compensation**.
- Press  to toggle and set the temperature compensation on or off.

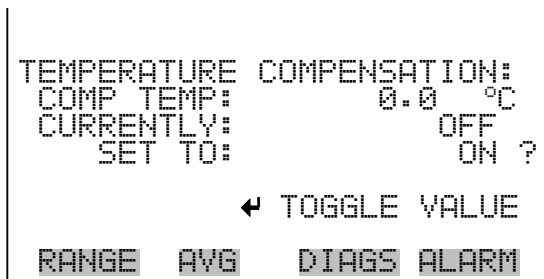

Pressure Compensation

Pressure compensation provides compensation for any changes to the instrument's output signal due to variations of sample pressure. The Model 49i Primary Standard can be operated with or without pressure compensation.

When pressure compensation is on, the first line of the display represents the current sample pressure. When pressure compensation is off, the first line of the display shows the standard pressure of 760 mmHg.

- In the Main Menu, choose Instrument Controls > **Pressure Compensation**.
- Press  to toggle and set the pressure compensation on or off.

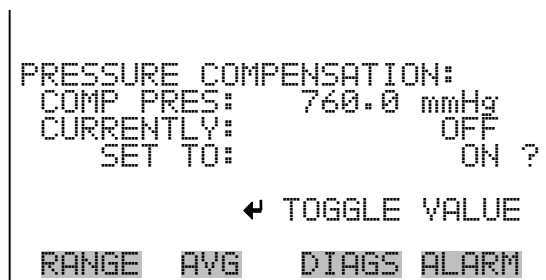

Datalogging Settings

The Datalogging Settings menu deals with datalogging.

- In the Main Menu, choose Instrument Controls > **Datalogging Settings**.

Operation

Instrument Controls Menu

```
DATALOGGING SETTINGS:
>SELECT SREC/LREC      SREC
VIEW LOGGED DATA
ERASE LOG
SELECT CONTENT
COMMIT CONTENT
RESET TO DEFAULT CONTENT
CONFIGURE DATA LOGGING

RANGE  AVG  DIAGS  ALARM
```

Select SREC/LREC

The Select SREC/LREC is used to select short record or long record format for other operations in this menu.

- In the Main Menu, choose Instrument Controls > Datalogging Settings > **Select SREC/LREC**.
- Press  to toggle and set to either short record or long record format.



```
SELECT LOG TYPE:
CURRENTLY:      SREC
SET TO:         LREC ?

      ← TOGGLE VALUE

RANGE  AVG  DIAGS  ALARM
```

View Logged Data

The View Logged Data screen is used to select the start point to view the logged data by number of records or date and time.

- In the Main Menu, choose Instrument Controls > Datalogging Settings > Select SREC or LREC > **View Logged Data**.
- Use  and  to toggle between number of records or date and time.
- Press  to accept.

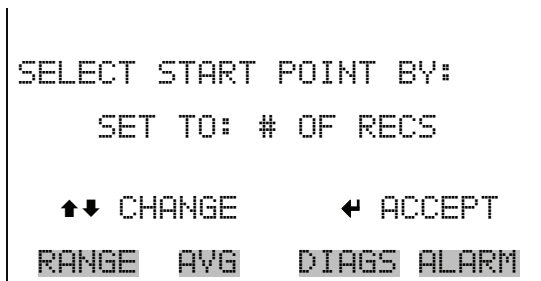

Number of Records

The Number of Records screen is used to select the starting point to display the number of records back to view.

- Use and to move the cursor left or right.
- Use and to increment or decrement the numeric value.
- Press to set the starting record and continue to the record display screen.

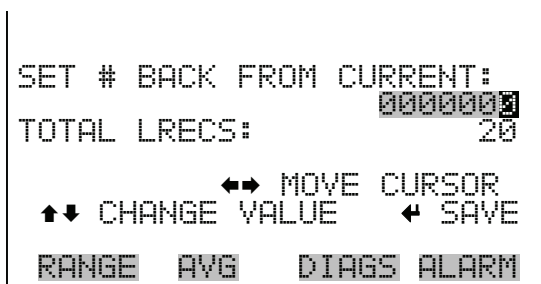

The Record Display screen (read only) displays the selected records.

- Use and to view all the items in the record.
- Use and to view records at different times.

```

time      date      flags
10:00    06/20/05   FC0088900
11:00    06/20/05   FC0088900
12:00    06/20/05   FC0088900
13:00    06/20/05   FC0088900
↑↓ PGUP/DN  ←→ PAN L/R
RANGE  AVG  DIAGS  ALARM
    
```

Date and Time

The Date and Time screen is used to set a start date and time for which to view logged data. For example, if “20 JUN 2005 10:00” is entered, then the first logged data record that is displayed is the first record after this time. If set to one minute logging, this would be at “20 JUN 2005 10:01”.

- Use and to increment or decrement the selected field.
- Use to advance to next field.
- Press to set the date and time of the first record to be displayed and continue to the record display screen.

```

DATE AND TIME:
20 JUN 2005 10:00
↑↓ CHG  DAYS
→ SET CURSOR TO MONTHS
← ACCEPT AS SHOWN
RANGE  AVG  DIAGS  ALARM
    
```

The Record Display screen (read only) displays the selected records.

- Use and to view all the items in the record.
- Use and to view records at different times.

```

time      date      flags
10:01    06/20/05   FC0088900
10:02    06/20/05   FC0088900
10:03    06/20/05   FC0088900
10:04    06/20/05   FC0088900
↑↓ FGUP/DN  ↔ PAN L/R
RANGE  AVG  DIAGS ALARM

```

Erase Log The Erase Log is used to erase all saved data for the selected record type (not all short records and long records).

- In the Main Menu, choose Instrument Controls > Datalogging Settings > Erase Log.
- Press to erase all data.
- Press to confirm erasure.

```

ERASE LREC LOG FILE DATA?
                        ← ERASE
RANGE  AVG  DIAGS ALARM

```

```

ERASE LREC LOG FILE DATA?
                        ← ERASE
ARE YOU SURE YOU WANT TO?
PRESS → TO CONFIRM ERASURE
RANGE  AVG  DIAGS ALARM

```

Select Content The Select Content submenu displays a list of 32 record fields to use and a submenu list of the analog output signal group choices to choose from. Choices are Concentrations, Other Measurements, and Analog Inputs (if the I/O expansion board is installed). This is a temporary list of items for the selected record type that must be committed via the datalogging menu before the changes will apply. Note that committing any changes to this list will erase all currently logged data, as the format of the stored data is changed.

- In the Main Menu, choose Instrument Controls > Datalogging Settings > Select Content.



Choose Item Type

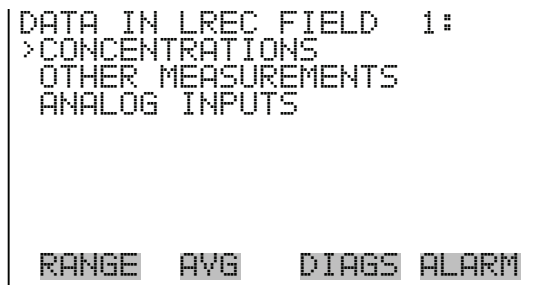

The Choose Item Type submenu displays a list of data that can be logged for the current field. Choices and Concentrations, Other Measurements, and Analog Inputs (if the I/O expansion board is installed).

In the Main Menu, choose Instrument Controls > Datalogging Settings > Select Content > **Field 1-32**.



Concentrations

The Concentrations screen allows the user to select the output signal that is tied to the selected field item. The selected item is shown by “<--” after it. Note that at this point, pressing  indicates that these are proposed changes as opposed to implemented changes. To change the selected record format and erase record log file data, see “Commit Content” below.

- In the Main Menu, choose Instrument Controls > Datalogging Settings > Select Content > Select Field > **Concentrations**.
- Use  and  to move the cursor up and down.
- Press  to select a new choice.



Other Measurements

The Other Measurements screen allows the user to select the output signal that is tied to the selected field item. The selected item is shown by “<--” after it. Items displayed are determined by the options installed. Note that at this point, pressing indicates that these are proposed changes as opposed to implemented changes. To change the selected record format and erase record log file data, see “Commit Content” below.

- In the Main Menu, choose Instrument Controls > Datalogging Settings > Select Content > Select Field > **Other Measurements**.
- Use and to move the cursor up and down.
- Press to select a new choice.

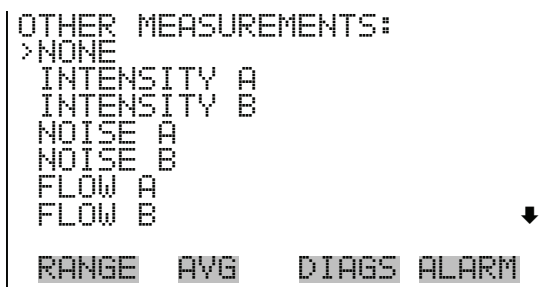

```

PRESSURE
BENCH TEMP
LAMP TEMP
O3 LAMP TEMP
    
```



Analog Inputs

The Analog Inputs screen allows the user to select the output signal (none or analog inputs 1-8) that is tied to the selected field item. The selected item is shown by “<--” after it. Note that at this point, pressing indicates

Operation

Instrument Controls Menu



that these are proposed changes as opposed to implemented changes. To change the selected record format and erase record log file data, see “Commit Content” below.

- In the Main Menu, choose Instrument Controls > Datalogging Settings > Select Content > Select Field > **Analog Inputs**.
- Use  and  to move the cursor up and down.
- Press  to select a new choice.

```
ANALOG INPUTS:
>NONE
ANALOG IN 1
ANALOG IN 2
ANALOG IN 3
ANALOG IN 4
ANALOG IN 5
ANALOG IN 6
                                     ↓
RANGE  AVG  DIAGS  ALARM
```

Commit Content

The Commit Content screen is used to save the selected output signal that is tied to the selected field item. If no changes have been made “NO CHANGES TO RECORD LIST!” will appear. For more information about selecting the analog output signal group choices, see “Select Content” above.

- In the Main Menu, choose Instrument Controls > Datalogging Settings > **Commit Content**.
- Press  to commit changes to selected record format and erase record log file data.
- Press  to confirm changes.



Reset to Default Content

The Reset to Default Content screen is used to reset all of the datalogging field items to default values. For more information about selecting the analog output signal group choices, see “Select Content” above.

- In the Main Menu, choose Instrument Controls > Datalogging Settings > **Reset to Default Content**.
- Press to reset selected record format and erase record log file data.
- Press to confirm reset.



Configure Datalogging

The Configure Datalogging menu deals with datalogging configuration for the currently selected record type.

- In the Main Menu, choose Instrument Controls > Datalogging Settings > **Configure Datalogging**.

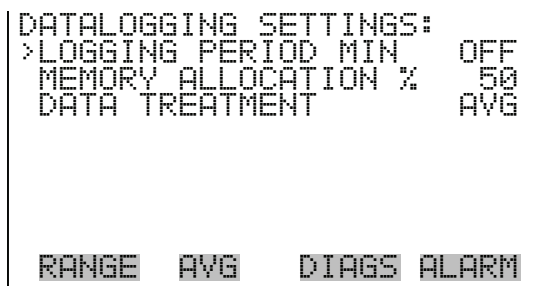

Logging Period Min

The Logging Period Min screen is used to select the logging period in minutes for the record format (srec or lrec). List of choices include: off, 1, 5, 15, 30, and 60 minutes (default).

- In the Main Menu, choose Instrument Controls > Datalogging Settings > Configure Datalogging > **Logging Period Min**.
- Use and to scroll through a list of choices.
- Press to set the logging period.

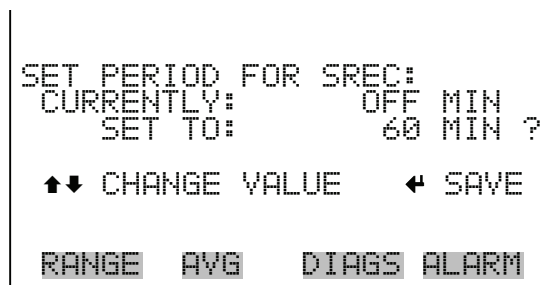

Memory Allocation Percent

The Memory Allocation Percent screen is used to select the percentage of each record type for both short records and long records. Percentages between 0 and 100% are available in increments of 10. Changing this value results in log erasure for both short records and long records.

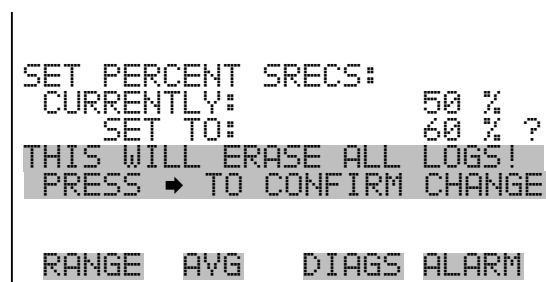
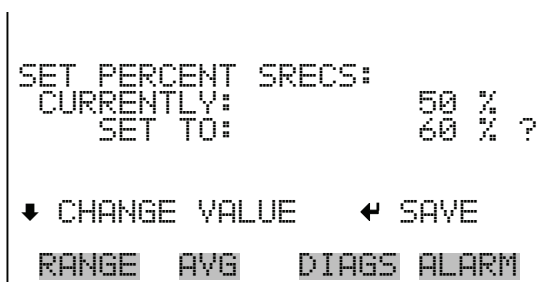

- In the Main Menu, choose Instrument Controls > Datalogging Settings > Configure Datalogging > **Memory Allocation %**.
- Use and to scroll through a list of choices.
- Press to set the percentage for both record types and proceed to the erasure warning screen.

- Press  to confirm change.



Data Treatment

The Data Treatment screen is used to select the data type for the selected record: whether the data should be averaged over the interval, the minimum or maximum used, or the current value logged. Data treatment doesn't apply to all data, just to the concentration measurement. All other data points log the current value at the end of the interval.

- In the Main Menu, choose Instrument Controls > Datalogging Settings > Configure Datalogging > **Data Treatment**.
- Use  and  to scroll through a list of choices.
- Press  to save the data type.

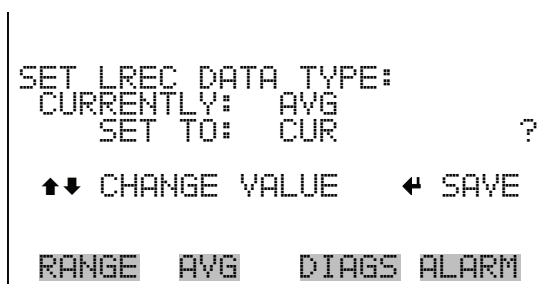



Communication Settings

The Communication Settings menu is used with communications control and configuration.

- In the Main Menu, choose Instrument Controls > **Communication Settings**.



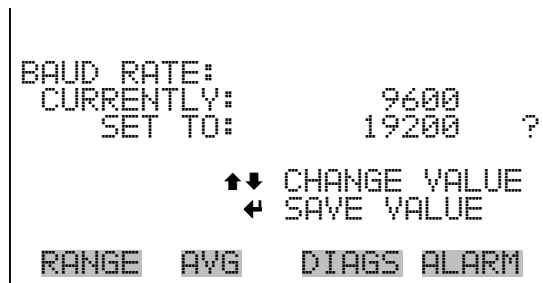

Baud Rate The Baud Rate screen is used to set the RS-232/RS-485 interface baud rate. Baud rates of 1200, 2400, 4800, and 9600, 19200, 38400, 57600, and 115200 are available.

- In the Main Menu, choose Instrument Controls > Communication Settings > **Baud Rate**.
- Use  and  to scroll through a list of choices.
- Press  to save the new baud rate.



Instrument ID The Instrument ID screen allows the operator to edit the instrument ID. The ID is used to identify the calibrator when using C-Link or MODBUS protocols to control the calibrator or collect data. It may be necessary to edit the ID number if two or more of the same calibrator are connected to one computer. Valid Instrument ID numbers are from 0 to 127. The Model 49i Primary Standard has a default Instrument ID of 49. For more information about the Instrument ID, see Appendix B “C-Link Protocol Commands” or Appendix C “MODBUS Protocol”.

- In the Main Menu, choose Instrument Controls > Communication Settings > **Instrument ID**.

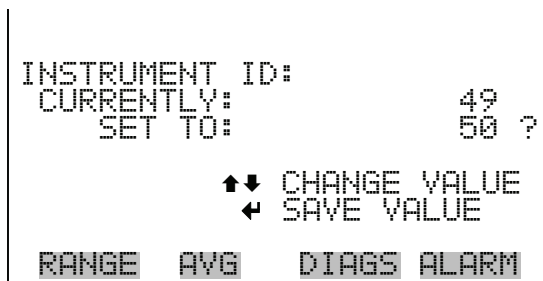

- Use  and  to increment or decrement the ID value.
- Press  to save the new instrument ID.



Communication Protocol

The Communication Protocol screen is used to change the communication protocol for serial communications.

In the Main Menu, choose Instrument Controls > Communication Settings > **Communication Protocol**.

- Use  and  to scroll through a list of choices.
- Press  to save the new protocol.

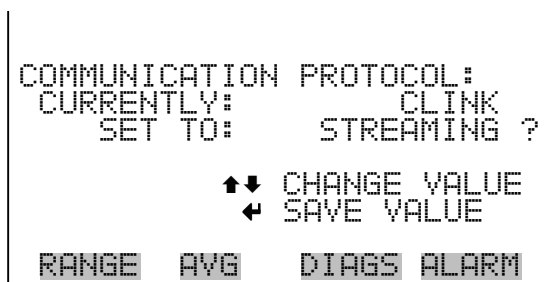

Streaming Data Configuration

The Streaming Data Configuration menu is used to allow for configuration of the 8 streaming data output items, streaming interval, current data format, and current timestamp setting. The Choose Item Signal submenu displays a list of the analog output signal group choices to choose from. Choices are Concentrations, Other Measurements, and Analog Inputs (if the I/O expansion board option is installed).

- In the Main Menu, choose Instrument Controls > Communication Settings > **Streaming Data Config**.

Operation



Instrument Controls Menu

```
STREAMING DATA CONFIG:
> INTERVAL          10 SEC
ADD LABELS         NO
PREPEND TIMESTAMP  YES
ITEM 1             D3
ITEM 2             CELLAI
ITEM 3             CELLBI
ITEM 4             NONE ↓
RANGE  AVG  DIAGS  ALARM
```

```
CHOOSE STREAM DATA:
> CONCENTRATIONS
OTHER MEASUREMENTS
ANALOG INPUTS
RANGE  AVG  DIAGS  ALARM
```

Streaming Data Interval

The Streaming Data Interval screen is used to adjust the streaming data interval. The following interval times are available: 1, 2, 5, 10, 20, 30, 60, 90, 120, 180, 240, and 300 seconds.

- In the Main Menu, choose Instrument Controls > Communication Settings > Streaming Data Config > **Streaming Data Interval**.
- Use  and  to scroll through a list of choices.
- Press  to save the new streaming data period.

```
STREAMING DATA INTERVAL:
CURRENTLY:          10 SEC
SET TO:            20 SEC ?
                ↑↓ CHANGE VALUE
                ← SAVE VALUE
RANGE  AVG  DIAGS  ALARM
```



```



OTHER MEASUREMENTS:
>NONE
INTENSITY A
INTENSITY B
NOISE A
NOISE B
FLOW A
FLOW B
↓
RANGE  AVG  DIAGS  ALARM
    
```

```

PRESSURE
BENCH TEMP
LAMP TEMP
O3 LAMP TEMP
    
```

Analog Inputs

The Analog Inputs screen allows the user to select the analog input signal (none or analog inputs 1-8) that is tied to the selected streaming data item. The selected item is shown by “<--” after it.

- In the Main Menu, choose Instrument Controls > Communication Settings > Streaming Data Config > Select Item > **Analog Inputs**.
- Use  and  to move the cursor up and down.
- Press  to select a new choice.

```



ANALOG INPUTS:
>NONE
ANALOG IN 1
ANALOG IN 2
ANALOG IN 3
ANALOG IN 4
ANALOG IN 5
ANALOG IN 6
↓
RANGE  AVG  DIAGS  ALARM
    
```

RS-232/RS-485 Selection

The RS-232/RS-485 Selection screen allows the user to choose between the RS-232 or RS-485 specification for serial communication.

Note Disconnect the serial cable before changing RS-232 and RS-485 selection to prevent damage to the connected equipment. ▲

- In the Main Menu, choose Instrument Controls > Communication Settings > **RS-232/RS-485 Selection**.

- Press  to leave the warning screen and move to next screen.
- Use  to confirm and save the new selection change.

```

RS-232/RS-485 SELECTION:
** WARNING **
DISCONNECT THE SERIAL
CABLES BEFORE CHANGING
THE SELECTION!
      ← TO CONTINUE

RANGE  AVG  DIAGS  ALARM
  
```

```

RS-232/RS-485 SELECTION:
CURRENTLY:          RS-232
SET TO:             RS-485 ?
MAKE SURE THAT THE CABLE
IS OFF: PRESS → TO CONFIRM
      ← TOGGLE VALUE

RANGE  AVG  DIAGS  ALARM
  
```

TCP/IP Settings The TCP/IP Settings menu is used for defining TCP/IP settings.

Note The instrument power must be cycled after this parameter has been changed for the change to take effect. ▲

- In the Main Menu, choose Instrument Controls > Communication Settings > **TCP/IP Settings**.

```

TCP/IP SETTINGS:
>USE DHCP          OFF
IP ADDRESS         192.168.1.151
NETMASK            255.255.255.0
GATEWAY            192.168.1.1
HOST NAME          iSeries



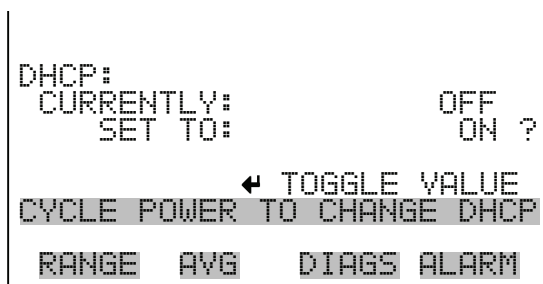

RANGE  AVG  DIAGS  ALARM
  
```

Use DHCP The Use DHCP screen is used to specify whether or not to use DHCP. When DHCP is enabled, the network dynamically provides an IP address for the instrument.

- In the Main Menu, choose Instrument Controls > Communication Settings > TCP/IP Settings > **Use DCHP**.
- Press  to toggle and set DHCP on or off.





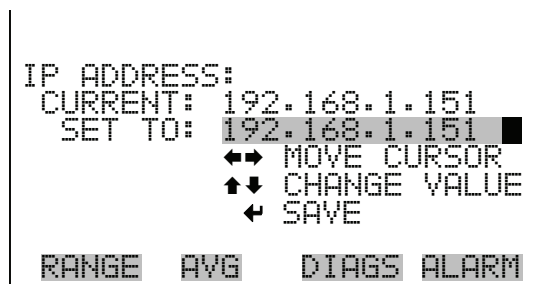

IP Address The IP Address screen is used to edit the IP address. The IP address can only be changed when DHCP is OFF. For more information on DHCP, see “Use DHCP.”

- In the Main Menu, choose Instrument Controls > Communication Settings > TCP/IP Settings > **IP Address**.
- Use , ,  and  to move and change the value of the IP address.
- Press  to save the new address.



Netmask The Netmask screen is used to edit the netmask. The netmask is used to determine the subnet the instrument uses to directly communicate with other devices. The netmask can only be changed when DHCP is OFF. For more information on DHCP, see “Use DHCP.”



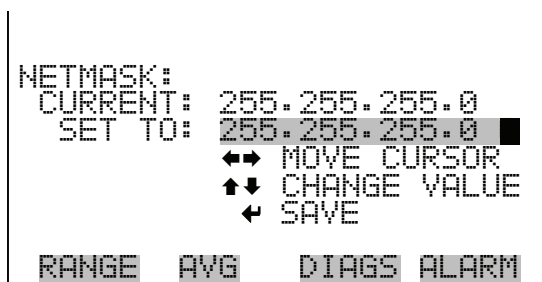

- In the Main Menu, choose Instrument Controls > Communication Settings > TCP/IP Settings > **Netmask**.
- Use , ,  and  to move and change the value of the netmask.

- Press  to save the new netmask.



Default Gateway



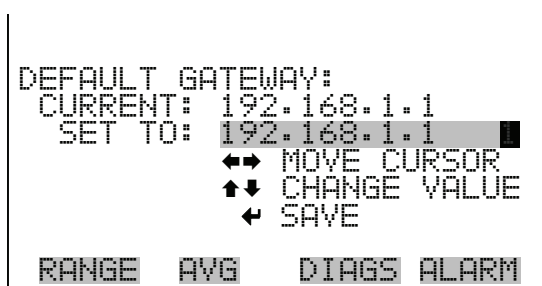

The Default Gateway screen is used to edit the gateway address. Any traffic to addresses that are not on the local subnet will be routed through this address. The default gateway can only be changed when DHCP is OFF. For more information on DHCP, see “Use DHCP.”

- In the Main Menu, choose Instrument Controls > Communication Settings > TCP/IP Settings > Gateway.
- Use , ,  and  to move and change the value of the gateway address.
- Press  to save the new address.



Host Name

The host name screen is used to edit the host name. When DHCP is enabled, this name is reported to the DHCP server.

- In the Main Menu, choose Instrument Controls > Communication Settings > TCP/IP Settings > Host Name.
- Use , ,  and  to move the cursor or change between the edit field and the alpha page.

Operation

Instrument Controls Menu

- Press  to save the new letter in the alpha table or save the new alpha page.

```
HOST NAME:
CURRENT:  I SERIES
          I SERIES ?
          ABCDEFGHIJKLMNOP BKSP
          OPQRSTUVWXYZ      PAGE
          0123456789 . / -  SAVE

RANGE  AVG  DIAGS  ALARM
```

I/O Configuration

The I/O Configuration menu deals with configuration of the calibrator's I/O system. The analog input configuration is displayed only if the I/O expansion board option is installed.

- In the Main Menu, choose Instrument Controls > **I/O Configuration**.

```
I/O CONFIGURATION:
>OUTPUT RELAY SETTINGS
DIGITAL INPUT SETTINGS
ANALOG OUTPUT CONFIG
ANALOG INPUT CONFIG

RANGE  AVG  DIAGS  ALARM
```

Output Relay Settings

The Output Relay Settings menu displays a list of the 10 analog output relays available, and allows the user to select the logic state or instrument parameter for the relay selected.

Note The digital outputs may take up to one second after the assigned state occurs to show up on the outputs. ▲

- In the Main Menu, choose Instrument Controls > I/O Configuration > **Output Relay Settings**.

```

OUTPUT RELAY SETTINGS:
>1  NOP      CONC ALARM
 2  NOP      NONE
 3  NOP      UNITS
 4  NOP      GEN ALARM
 5  NOP      ZERO MODE
 6  NOP      OZ LEVEL 1
 7  NOP      OZ LEVEL 2 ↓
RANGE  AVG  DIAGS ALARM
  
```

Logic State The Logic State screen is used to change the I/O relay to either normally open or normally closed.

- Press  to toggle and set the logic state open or closed.

```

OUTPUT RELAY SETUP:
>LOGIC STATE      OPEN
INSTRUMENT STATE
RANGE  AVG  DIAGS ALARM
  
```



Instrument State The Instrument State submenu allows the user to select the instrument state that is tied to the selected relay output. A submenu lists signal types of either alarm and non-alarm to choose from.

- In the Main Menu, choose Instrument Controls > I/O Configuration > Output Relay Settings > Select Relay > **Instrument State**.

```

CHOOSE SIGNAL TYPE:
>ALARMS
NON-ALARM
RANGE  AVG  DIAGS ALARM
  
```



Alarms The Alarms status screen allows the user to select the alarm status for the selected relay output. The selected item is shown by “<--” after it. The I/O board status alarm is present only if the I/O expansion board is installed. The zero and span check/calibration alarms are present only if the zero/span valve option is installed and the instrument is operating in manual mode.

- In the Main Menu, choose Instrument Controls > I/O Configuration > Output Relay Settings > Select Relay > Instrument State > **Alarms**.
- Use  and  to scroll through a list of choices.
- Press  to save the new selection for the relay.

```
ALARM STATUS ITEMS:
>NONE
GEN ALARM
CONC MAX
CONC MIN
BENCH TEMP
BNCH LMP TEMP
OZ LAMP TEMP
↓
RANGE  AVG  DIAGS  ALARM
```

```
PRESSURE
FLOW A
FLOW B
INTENSITY A
INTENSITY B
CONC ALARM  <--
MB STATUS
IB STATUS
I/O BD STATUS
```

Non-Alarm The Non-Alarm status screen allows the user to select the non-alarm status for the selected relay output. The selected item is shown by “<--” after it.

- In the Main Menu, choose Instrument Controls > I/O Configuration > Output Relay Settings > Select Relay > Instrument State > **Non-Alarm**.
- Use  and  to scroll through a list of choices.
- Press  to save the new selection for the relay.

```

NON ALARM STATUS ITEMS:
>NONE
SERVICE
UNITS
ZERO MODE
SPAN MODE
SAMPLE MODE
OZ LEVEL 1
                                ↓
RANGE  AVG  DIAGS  ALARM

```

```



OZ LEVEL 2
OZ LEVEL 3
OZ LEVEL 4
OZ LEVEL 5
PURGE MODE

```

Digital Input Settings

The Digital Input Settings menu displays a list of the 16 digital inputs available, and allows the user to select the logic state and instrument parameter for the relay selected.

Note The digital inputs must be asserted for at least one second for the action to be activated. ▲

- In the Main Menu, choose Instrument Controls > I/O Configuration > **Digital Input Settings**.
- Use  and  to move the cursor up and down.
- Press  to select a choice.

```

DIGITAL INPUT SETTINGS:
>1  NOP  SET BACKGROUND
2  NOP  OZONATOR LVL 1
3  NOP  OZONATOR LVL 2
4  NOP  AOUTS TO ZERO
5  NOP  AOUTS TO FS
6  NOP  NONE
7  NOP  NONE
                                ↓
RANGE  AVG  DIAGS  ALARM

```

Logic State

The Logic State screen is used to change the I/O relay to either normally open or normally closed. The default state is open, which indicates that a relay connected between the digital input pin and ground is normally open

and closes to trigger the digital input action. If nothing is connected to the digital input pin, the state should be left at open to prevent the action from being triggered.



- Press  to toggle and set the logic state open or closed.

```
DIGITAL INPUT SETUP:
>LOGIC STATE      OPEN
INSTRUMENT ACTION

RANGE  AVG  DIAGS  ALARM
```

Instrument Action

The Instrument Action screen allows the user to choose the instrument action that is tied to the selected digital input.

- In the Main Menu, choose Instrument Controls > I/O Configuration > Digital Input Settings > Select Relay > **Instrument Action**.
- Use  and  to scroll through a list of choices.
- Press  to save the new selection for the relay.



```
CHOOSE ACTION:
>NONE
ZERO MODE
SPAN MODE
OZONATOR LVL 1
OZONATOR LVL 2
OZONATOR LVL 3
OZONATOR LVL 4
OZONATOR LVL 5
SET BACKGROUND
ADUTS TO ZERO
ADUTS TO FS

RANGE  AVG  DIAGS  ALARM
```

Analog Output Configuration

The Analog Output Configuration menu displays a list of the analog output channels available for configuration. Channel choices include all voltage channels, all current channels, voltage channels 1-6, and current channels

1-6 (if the I/O expansion board option is installed). Configuration choices include selecting range, setting minimum/maximum values, and choosing signal to output.

- In the Main Menu, choose Instrument Controls > I/O Configuration > **Analog Output Config.**
- Use  and  to scroll through a list of choices.
- Press  to select a choice.

```

OUTPUT CHANNELS:
>ALL VOLTAGE CHANNELS
ALL CURRENT CHANNELS
VOLTAGE CHANNEL 1
VOLTAGE CHANNEL 2
VOLTAGE CHANNEL 3
VOLTAGE CHANNEL 4
VOLTAGE CHANNEL 5
                                     ↓
RANGE  AVG  DIAGS  ALARM
  
```



```

ANALOG OUTPUT CONFIG:
>SELECT RANGE
SET MINIMUM VALUE
SET MAXIMUM VALUE
CHOOSE SIGNAL TO OUTPUT

RANGE  AVG  DIAGS  ALARM
  
```

Select Output Range

The Select Output Range screen is used to select the hardware range for the selected analog output channel. Possible ranges for the voltage outputs are: 0-100 mV, 0-1, 0-5, 0-10 V.

- In the Main Menu, choose Instrument Controls > I/O Configuration > Analog Output Config > Select Channel > **Select Range.**
- Use  and  to scroll through a list of choices.
- Press  to save the new range.

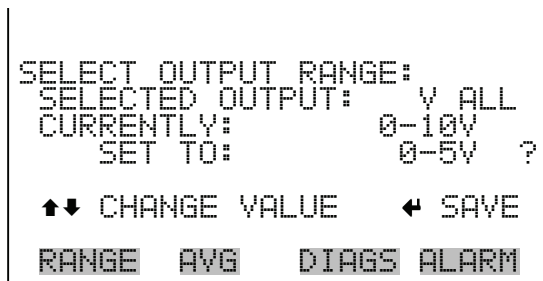

Minimum and Maximum Value

The Minimum Value screen is used to edit the zero (0) to full-scale (100) value in percentages for the selected analog output channel. See Table 3-6 for a list of choices. The minimum and maximum output value screens function the same way. The example below shows the set minimum value screen.

- In the Main Menu, choose Instrument Controls > IO Configuration > Analog Output Config > Select Channel > **Set Minimum** or **Maximum Value**.
- Use and to increment or decrement the numeric value.
- Press to validate and save the new minimum value.

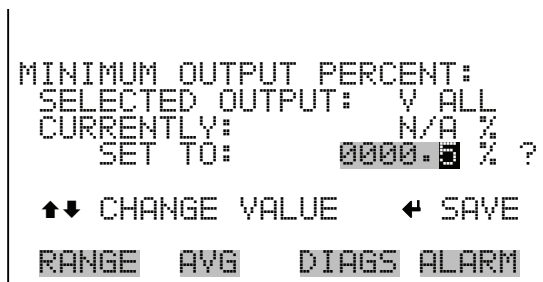

Table 3-4. Analog Output Zero to Full-Scale Table



Output	Zero % Value	Full-Scale 100% Value
O ₃	Zero (0)	Range Setting
Range Status	Recommend not to change the setting for this output	
Intensity A	User-set alarm min value	User-set alarm max value
Intensity B	User-set alarm min value	User-set alarm max value

Table 3-4. Analog Output Zero to Full-Scale Table

Output	Zero % Value	Full-Scale 100% Value
Noise A	Zero (0)	Range Setting
Noise B	Zero (0)	Range Setting
Flow A	User-set alarm min value	User-set alarm max value
Flow B	User-set alarm min value	User-set alarm max value
Pressure	User-set alarm min value	User-set alarm max value
Bench Temp	User-set alarm min value	User-set alarm max value
Lamp Temp	User-set alarm min value	User-set alarm max value
O ₃ Lamp Temp	User-set alarm min value	User-set alarm max value

Choose Signal To Output

The Choose Signal Type To Output screen displays a submenu list of the analog output signal group choices. Group choices are Concentrations, Other Measurements, and Analog Inputs (if the I/O expansion board option is installed). This allows the user to select the output signal to the selected output channel. The Concentrations screen is shown below. See Table 3-7 below for a list of items for each signal group choice.

- In the Main Menu, choose Instrument Controls > I/O Configuration > Analog Output Config > Select Channel > **Choose Signal To Output**.
- Use  and  to move the cursor up and down.
- Press  to select a choice.

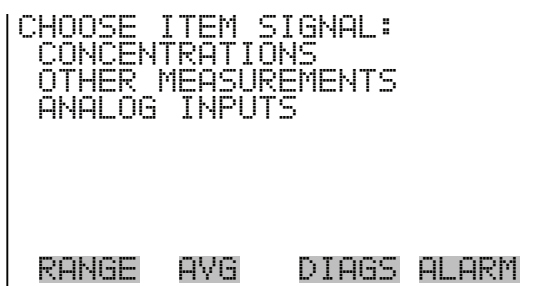

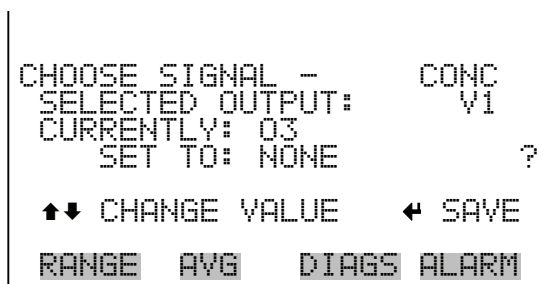

Table 3-5. Signal Type Group Choices

Concentrations	Other Measurements	Analog Inputs
None	None	None
O ₃	Intensity A	Analog Input 1
	Intensity B	Analog Input 2
	Noise A	Analog Input 3
	Noise B	Analog Input 4
	Flow A	Analog Input 5
	Flow B	Analog Input 6
	Pressure	Analog Input 7
	Bench Temp	Analog Input 8
	Lamp Temp	
	O ₃ Lamp Temp	

Analog Input Configuration

The Analog Input Configuration menu displays a list of the 8 analog input channels available for configuration. This screen is only displayed if the I/O expansion board option is installed. Configuration includes entering descriptor, units, decimal places, choice of 1-10 points in the table, and corresponding number of points selected.

- In the Main Menu, choose Instrument Controls > I/O Configuration > **Analog Input Config.**

```

ANALOG INPUT CONFIG:
>CHANNEL 1          IN1
CHANNEL 2          IN2
CHANNEL 3          IN3
CHANNEL 4          IN4
CHANNEL 5          IN5
CHANNEL 6          IN6
CHANNEL 7          IN7↓
RANGE  AVG  DIAGS  ALARM
  
```

```

ANALOG INPUT 01 CONFIG:
>DESCRIPTOR          IN1
UNITS                V
DECIMAL PLACES      2
TABLE POINTS        2
POINT 1
POINT 2
RANGE  AVG  DIAGS  ALARM
  
```

Descriptor The Descriptor screen allows the user to enter the descriptor for the selected analog input channel. The descriptor is used in datalogging and streaming data to report what data is being sent out. The descriptor may be from 1 to 3 characters in length, and defaults to IN1 to IN8 (user input channel number).

- In the Main Menu, choose Instrument Controls > I/O Configuration > Analog Input Config > Select Channel > **Descriptor**.
- Press  to save the new descriptor.

```



ANALOG INPUT DESCRIPTOR:
CURRENTLY: IN1
          IN1
          ABCDEFGHIJKLMN  BKSP
          OPQRSTUVWXYZ    PAGE
          0123456789 ./-  SAVE
RANGE  AVG  DIAGS  ALARM
  
```

Units The Units screen allows the user to enter the units for the selected analog input channel. The units are displayed on the diagnostic screen and in datalogging and streaming data. The units may be from 1 to 3 characters in length, and defaults to V (volts).

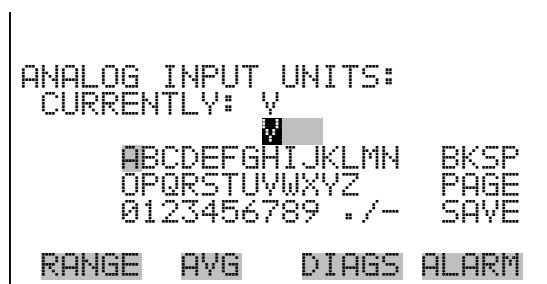
- In the Main Menu, choose Instrument Controls > I/O Configuration > Analog Input Config > Select Channel > **Units**.
- Press  to save the new value.



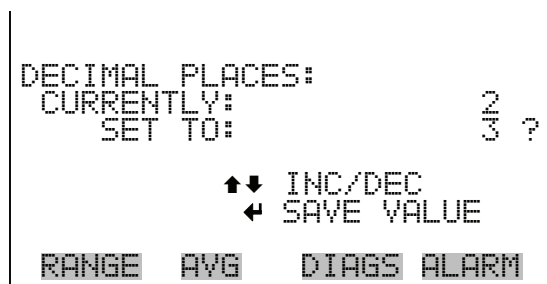

Decimal Places The Decimal Places screen allows the user to select how many digits are displayed to the right of the decimal, from 0 to 6, with a default of 2.

- In the Main Menu, choose Instrument Controls > I/O Configuration > Analog Input Config > Select Channel > **Decimal Places**.
- Use  and  to increment or decrement the value.
- Press  to save the new value.



Number of Table Points The Number of Table Points screen allows the user to select how many points are used in the conversion table. The points range from 2 to 10, with a default of 2.

- In the Main Menu, choose Instrument Controls > I/O Configuration > Analog Input Config > Select Channel > **Table Points**.
- Use  and  to move the cursor up and down.
- Press  to save the new value.

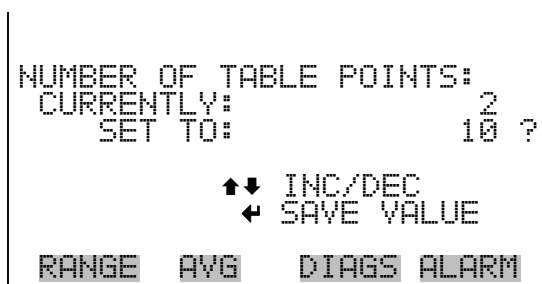
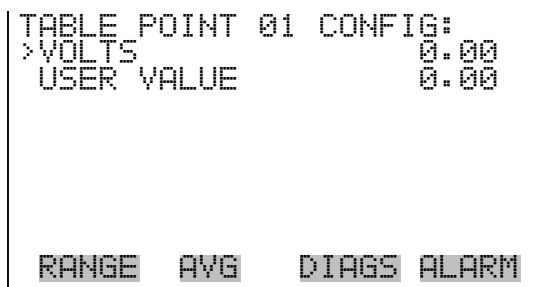



Table Point The Table Point submenu allows the user to set up an individual table point.

- In the Main Menu, choose Instrument Controls > I/O Configuration > Analog Input Config > Select Channel > **Point 1-10**.





Volts The Volts screen allows the user to set the input voltage for the selected table point in the conversion table, from 0.00 to 10.50. The default table is a two-point table with point 1: 0.00 V = 000.0 U and point 2: 10.00 V = 10.0 U.

- In the Main Menu, choose Instrument Controls > I/O Configuration > Analog Input Config > Select Channel > Select Point > **Volts**.
- Use  and  to move the cursor left or right.

Operation



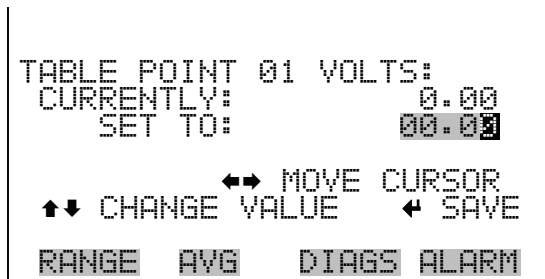

Instrument Controls Menu

- Use  and  to move the cursor up and down.
- Press  to save the new value.



User Value

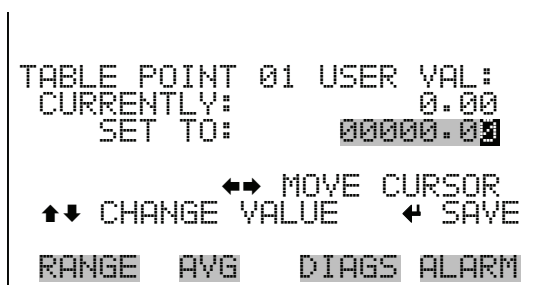

The User Value screen allows the user to set the output value for the corresponding input voltage for the selected table point in the conversion table, from -9999999 to 99999999. The default table is a two-point table with point 1: 0.00 V = 000.0 U and point 2: 10.00 V = 10.0 U.

- In the Main Menu, choose Instrument Controls > I/O Configuration > Analog Input Config > Select Table Point > **User Value**.
- Use  and  to move the cursor left or right.
- Use  and  to move the cursor up and down.
- Press  to save the new value.



Screen Contrast

The Screen Contrast screen is used to change the contrast of the display. Intensities between 0 and 100% in increments of 10 are available. Changing the screen contrast may be necessary if the calibrator is operated at extreme temperatures.

- In the Main Menu, choose Instrument Controls > **Screen Contrast**.
- Use  and  to increment or decrement the screen contrast.
- Press  to accept a change.

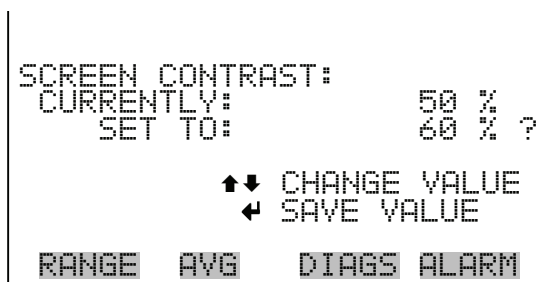

Service Mode

The Service Mode screen is used to turn the service mode on or off. The service mode locks out any remote actions and includes parameters and functions that are useful when making adjustments or diagnosing the Model 49*i* Primary Standard. For more information about the service mode, see “Service Menu” later in this chapter.



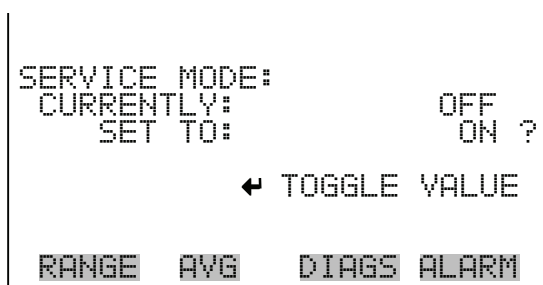

Note The service mode should be turned off when finished, as it prevents remote operation. ▲

- In the Main Menu, choose Instrument Controls > **Service Mode**.
- Press  to toggle and set the service mode on or off.



Date/Time

The Date/Time screen allows the user to view and change the system date and time (24-hour format). The internal clock is powered by its own battery when instrument power is off.

- In the Main Menu, choose Instrument Controls > **Date/Time**.
- Use ,  and  to move and change the value of the date and time.
- Press  to edit and save the new date and time.

```
DATE AND TIME:
19 MAR 2005 12:34:56
PRESS ← TO EDIT

RANGE  AVG  DIAGS  ALARM
```

```
DATE AND TIME:
19 MAR 2005 12:34:56  ?
SETTING: DAYS
  → SET MONTHS
  ↑↓ CHANGE VALUE
  ← SAVE VALUE

RANGE  AVG  DIAGS  ALARM
```

Diagnostics Menu

The Diagnostics menu provides access to diagnostic information and functions. This menu is useful when troubleshooting the instrument. The analog input readings and analog input voltages are only displayed if the I/O expansion board option is installed.

- In the Main Menu, choose **Diagnostics**.

```
DIAGNOSTICS:
>PROGRAM VERSION
VOLTAGES
TEMPERATURES
PRESSURE
FLOWS
CELL A/B D3
INTENSITIES ↓

RANGE  AVG  DIAGS  ALARM
```

```
ANALOG INPUT READINGS
ANALOG INPUT VOLTAGES
DIGITAL INPUTS
RELAY STATES
TEST ANALOG OUTPUTS
INSTRUMENT CONFIGURATION
CONTACT INFORMATION
```

Program Version

The Program Version screen (read only) shows the version number of the program installed. Prior to contacting the factory with any questions regarding the instrument, please note the program version number.

- In the Main Menu, choose Diagnostics > **Program Version**.

```

PROGRAM VERSION:
  PRODUCT:      MODEL 49iPS
  VERSION:      01.04.02.137
  FIRMWARE:     00.06.19

RANGE  AVG  DIAGS  ALARM
  
```

Voltages

The Voltages menu displays the current diagnostic voltage readings. This screen enables the power supply to be quickly read for low or fluctuating voltages without having to use a voltage meter. The I/O board is only displayed if the I/O expansion board option is installed.

- In the Main Menu, choose Diagnostics > **Voltages**.

```

VOLTAGES:
>MOTHERBOARD
  INTERFACE BOARD
  I/O BOARD

RANGE  AVG  DIAGS  ALARM
  
```

Motherboard Voltages

The Motherboard screen (read only) is used to display the current voltage readings on the motherboard.

- In the Main Menu, choose Diagnostics > Voltages > **Motherboard Voltages**.

```
MOTHERBOARD VOLTAGES:
 3.3 SUPPLY      3.3 V
 5.0 SUPPLY      5.0 V
15.0 SUPPLY      15.0 V
24.0 SUPPLY      24.0 V
-3.3 SUPPLY      -3.3 V

RANGE  AVG  DIAGS  ALARM
```

Interface Board Voltages

The Interface Board screen (read only) is used to display the current voltage readings on the interface board.

- In the Main Menu, choose Diagnostics > Voltages > **Interface Board Voltages**.

```
INTERFACE BOARD VOLTAGES:
 3.3 SUPPLY      3.3 V
 5.0 SUPPLY      5.0 V
15.0 SUPPLY      15.0 V
-15.0 SUPPLY     -15.0 V
24.0 SUPPLY      24.0 V
PHOTO LAMP       9.6 V
O3 LAMP          17.2 V

RANGE  AVG  DIAGS  ALARM
```

I/O Board Voltages

The I/O Board screen (read only) is used to display the current voltage readings on the I/O expansion board. This menu is only displayed if the I/O expansion board option is installed.

- In the Main Menu, choose Diagnostics > Voltages > **I/O Board Voltages**.

```
I/O BOARD VOLTAGES:
 3.3 SUPPLY      3.3 V
 5.0 SUPPLY      5.0 V
24.0 SUPPLY      24.0 V
-3.3 SUPPLY      -3.3 V

RANGE  AVG  DIAGS  ALARM
```

Temperatures

The Temperatures screen (read only) displays the current bench temperature, bench lamp temperature, and O₃ lamp temperature (if the ozonator option is installed).

- In the Main Menu, choose Diagnostics > **Temperatures**.

```

TEMPERATURES:
>BENCH          32.3 °C
BENCH LAMP     55.2 °C
O3 LAMP        68.8 °C

RANGE  AVG  DIAGS  ALARM
  
```

Pressure

The Pressure screen (read only) displays the current bench pressure. The pressure is measured by a pressure transducer.

- In the Main Menu, choose Diagnostics > **Pressure**.

```

PRESSURE:          753.4 mmHg

RANGE  AVG  DIAGS  ALARM
  
```

Flows

The Flows screen (read only) displays the current flow rate through Cell A and Cell B. These flows are measured by internal flow sensors. For more information, see Chapter 1, “Operations”.

- In the Main Menu, choose Diagnostics > **Flows**.

```
FLOWS:
CELL A      0.608 LPM
CELL B      0.612 LPM

RANGE  AVG  DIAGS  ALARM
```

Cell A/B O₃ The Cell A/B O₃ screen (read only) displays the current O₃ concentration in each cell, as well as the O₃ reading displayed in the Run screen (the average of the two cells).

- In the Main Menu, choose Diagnostics > Cell A/B O₃.

```
O3   PPB:      600
CELL A      598
CELL B      602

RANGE  AVG  DIAGS  ALARM
```

Intensities The Intensities screen (read only) displays the current intensity in Cell A and Cell B in Hertz. These intensities are read by detectors A and B, respectively.

- In the Main Menu, choose Diagnostics > Intensities.

```
INTENSITIES:
CELL A      100425 Hz
CELL B      100465 Hz

RANGE  AVG  DIAGS  ALARM
```

Analog Input Readings

The Analog Input Readings screen (read only) displays the 8 current user-scaled analog readings (if the I/O expansion board option is installed).

- In the Main Menu, choose Diagnostics > **Analog Input Readings**.

```

ANALOG INPUT READINGS:
>CO          10.2 PPM
SO2          18.2 PPB
CO2          250 PPM
FL1          20.42 LPM
WND          9.86 V
FL2          1.865 LPM
IO7          0.0 V↓
RANGE  AVG  DIAGS  ALARM
  
```

Analog Input Voltages

The Analog Input Voltages screen (read only) displays the 8 raw analog voltage readings (if the I/O expansion board option is installed).

- In the Main Menu, choose Diagnostics > **Analog Input Voltages**.

```

ANALOG INPUT VOLTAGES:
>ANALOG IN 1      6.24 V
ANALOG IN 2      4.28 V
ANALOG IN 3      0.00 V
ANALOG IN 4      0.00 V
ANALOG IN 5      0.00 V
ANALOG IN 6      0.00 V
ANALOG IN 7      0.00 V↓
RANGE  AVG  DIAGS  ALARM
  
```

Digital Inputs

The Digital Inputs screen (read only) displays the state of the 16 digital inputs.

- In the Main Menu, choose Diagnostics > **Digital Inputs**.

```
DIGITAL INPUTS:
>INPUT 1
INPUT 2
INPUT 3
INPUT 4
INPUT 5
INPUT 6
INPUT 7
1
1
1
1
1
1
1
↓
RANGE  AVG  DIAGS  ALARM
```

Relay States

The Relay States screen displays the state of the 10 digital outputs and allows toggling of the state to either on (1) or off (0). The relays are restored to their original states upon exiting this screen.

- In the Main Menu, choose Diagnostics > **Relay States**.

```
RELAY STATE:
>OUTPUT 1
OUTPUT 2
OUTPUT 3
OUTPUT 4
OUTPUT 5
OUTPUT 6
OUTPUT 7
0
0
0
1
0
0
0
↓
RANGE  AVG  DIAGS  ALARM
```

Test Analog Outputs



The Test Analog Outputs menu contains a number of digital to analog converter (DAC) calibration items. Channel choices include all analog outputs, 6 voltage channels, and 6 current channels (if the I/O expansion board option is installed).

- In the Main Menu, choose Diagnostics > **Test Analog Outputs**.

```
TEST ANALOG OUTPUTS:
>ALL
VOLTAGE CHANNEL 1
VOLTAGE CHANNEL 2
VOLTAGE CHANNEL 3
VOLTAGE CHANNEL 4
VOLTAGE CHANNEL 5
VOLTAGE CHANNEL 6
↓
RANGE  AVG  DIAGS  ALARM
```

Set Analog Outputs

The Set Analog Outputs screen contains three choices: Set to full-scale, set to zero, or reset to normal. Full-scale sets the analog outputs to the full-scale voltage, zero sets the analog outputs to 0 volts, and normal operation. The example below shows the selected output state “ALL” is set to normal.

- In the Main Menu, choose Diagnostics > Test Analog Outputs > **ALL**, **Voltage Channel 1-6**, or **Current Channel 1-6**.
- Press  or  to set output.
- Press  to reset to normal.

```

SET ANALOG OUTPUTS:
SETTING:                ALL
OUTPUT SET TO:         NORMAL
↑ SET TO FULL SCALE
↓ SET TO ZERO
← RESET TO NORMAL

RANGE  AVG  DIAGS  ALARM
  
```

Instrument Configuration

The Instrument Configuration screen displays information on the hardware configuration of the calibrator.

Note If the calibrator is in service mode, pressing  on the item will toggle it yes or no (with the exception of purchased options such as dilution and auto calibration). ▲

- In the Main Menu, choose Diagnostics > **Instrument Configuration**.
- Press  to toggle instrument configuration (in service mode only).

```

INSTRUMENT CONFIGURATION:
>I/O EXPANSION BOARD  YES

RANGE  AVG  DIAGS  ALARM
  
```

Contact Information

The Contact Information screen displays the customer service information.

- In the Main Menu, choose Diagnostics > **Contact Information**.

```
CONTACT INFORMATION:
CALL CENTER: 508-520-0430
WEB:        WWW.THERMO.COM

RANGE  AVG  DIAGS  ALARM
```

Alarms Menu

The alarms menu displays a list of items that are monitored by the calibrator. If the item being monitored goes outside the lower or upper limit, the status of that item will go from “OK” to either “LOW” or “HIGH”, respectively. If the alarm is not a level alarm, the status will go from “OK” to “FAIL”. The number of alarms detected is displayed to indicate how many alarms have occurred. If no alarms are detected, the number zero is displayed.

To see the actual reading of an item and its minimum and maximum limits, move the cursor to the item and press .

Items displayed are determined by the options installed. The zero or span check is visible only if the zero/span check or auto calibration options are enabled. The O₃ lamp temperature and ozonator level 1, 2, 3, 4, and 5 checks are visible only if the ozonator option is installed. The motherboard status, interface board status, and I/O expansion board status (if installed) indicates that the power supplies are working and connections are successful. There are no setting screens for these alarms.

- In the Main Menu, choose **Alarms**.

```
ALARMS:
ALARMS DETECTED          0
>O3 LAMP TEMP            OK
LAMP TEMP                OK
BENCH TEMP               OK
PRESSURE                 OK
FLOW A                   OK
FLOW B                   OK↓

RANGE  AVG  DIAGS  ALARM
```

```
INTENSITY A              OK
INTENSITY B              OK
O3 CONCENTRATION         OK
MOTHERBOARD STATUS      OK
INTERFACE STATUS         OK
I/O EXP STATUS            OK
```

O₃ Lamp Temperature

The O₃ Lamp Temperature screen displays the current ozonator lamp temperature and sets the minimum and maximum alarm limits. Acceptable alarm limits range from 65 to 75 °C. If the O₃ lamp temperature reading goes beyond either the minimum or maximum alarm limit, an alarm is activated. The word “ALARM” appears in the Run screen and in the Main Menu.



- In the Main Menu, choose Alarms > O₃ Lamp Temp.

```
O3 LAMP TEMPERATURE:
ACTUAL                   68.8 °C
>MIN                     60.0 °C
MAX                       80.0 °C

RANGE  AVG  DIAGS  ALARM
```

Min and Max O₃ Lamp Temperature Limits

The Minimum O₃ Lamp Temperature alarm limit screen is used to change the minimum O₃ Lamp temperature alarm limit. The minimum and maximum O₃ Lamp temperature screens function the same way.

- In the Main Menu, choose Alarms > O₃ Lamp Temp > **Min** or **Max**.
- Use  and  to increment or decrement the numeric value.
- Press  to save set to value as actual value.

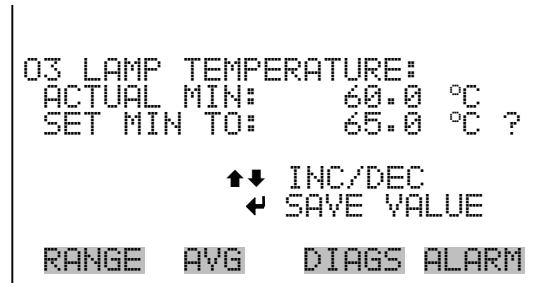

Lamp Temperature



The Lamp Temperature screen displays the current lamp temperature and sets the minimum and maximum alarm limits. Acceptable alarm limits range from 50 to 60 °C. If the lamp temperature reading goes beyond either the minimum or maximum limit, an alarm is activated. The word “ALARM” appears in the Run screen and in the Main Menu.

- In the Main Menu, choose Alarms > **Lamp Temp.**



Min and Max Lamp Temperature Limits

The Minimum Lamp Temperature alarm limit screen is used to change the minimum lamp temperature alarm limit. The minimum and maximum lamp temperature screens function the same way.

- In the Main Menu, choose Alarms > Lamp Temp > **Min** or **Max**.
- Use  and  to increment or decrement the numeric value.
- Press  to save set to value as actual value.

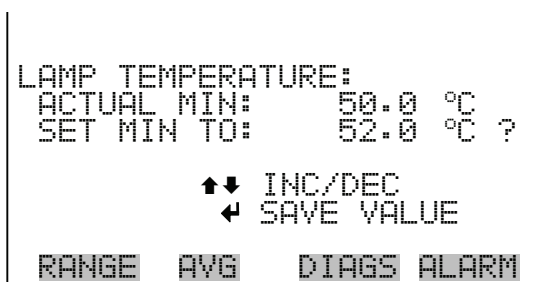

Bench Temperature

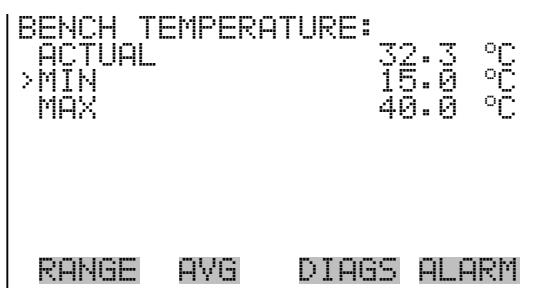

The Bench Temperature screen displays the current bench temperature and sets the minimum and maximum alarm limits. Acceptable alarm limits range from 5 to 50 °C. If the bench temperature reading goes beyond either the minimum or maximum limit, an alarm is activated. The word “ALARM” appears in the Run screen and in the Main Menu.

- In the Main Menu, choose Alarms > **Bench Temp.**



Min and Max Bench Temperature Limits

The Minimum Bench Temperature alarm limit screen is used to change the minimum bench temperature alarm limit. The minimum and maximum bench temperature screens function the same way.

- In the Main Menu, choose Alarms > Bench Temp > **Min** or **Max**.
- Use  and  to increment or decrement the numeric value.
- Press  to save set to value as actual value.

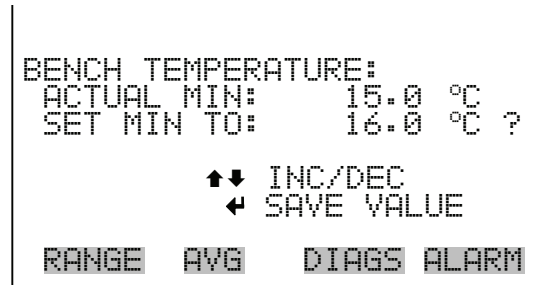

Pressure

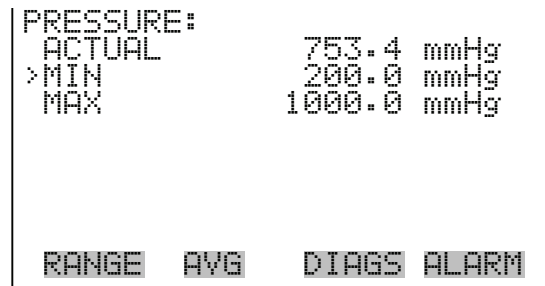

The Pressure screen displays the current pressure and sets the minimum and maximum alarm limits. Acceptable alarm limits range from 200 to 1,000 mmHg. If the pressure reading goes beyond either the minimum or maximum limit, an alarm is activated. The word “ALARM” appears in the Run screen and in the Main Menu.

- In the Main Menu, choose Alarms > **Pressure**.



Min and Max Pressure Limits

The Minimum Pressure alarm limit screen is used to change the minimum pressure alarm limit. The minimum and maximum pressure screens function the same way.

- In the Main Menu, choose Alarms > Pressure > **Min** or **Max**.
- Use  and  to increment or decrement the numeric value.
- Press  to save set to value as actual value.

```

PRESSURE:
ACTUAL MIN: 200.0 mmHg
SET MIN TO: 250.0 mmHg ?

      ↑↓ INC/DEC
      ← SAVE VALUE

RANGE  AVG  DIAGS  ALARM
  
```

Flow A and B

The Flow A screen displays the current sample flow reading in cell A and sets the minimum and maximum alarm limits. Acceptable alarm limits range from 0.4 to 1.6 LPM. If the pressure reading goes beyond either the minimum or maximum limit, an alarm is activated. The word “ALARM” appears in the Run screen and in the Main Menu. The Flow B screen functions the same way.

- In the Main Menu, choose Alarms > **Flow A** or **Flow B**.



```

FLOW A:
ACTUAL          0.600 LPM
>MIN            0.400 LPM
MAX             1.400 LPM

RANGE  AVG  DIAGS  ALARM
  
```

Min and Max Flow Limits

The Minimum Flow A alarm limit screen is used to change the minimum flow A alarm limit. The minimum and maximum flow A and flow B screens function the same way.

- In the Main Menu, choose Alarms > Select Flow > **Min** or **Max**.
- Use  and  to increment or decrement the numeric value.
- Press  to save set to value as actual value.

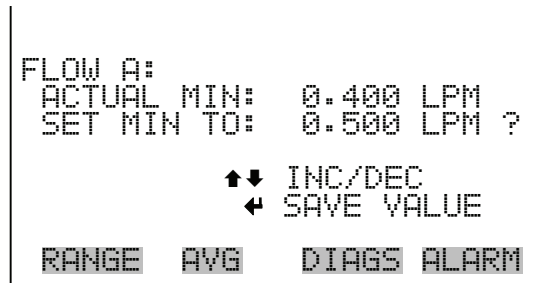

Intensity A and B

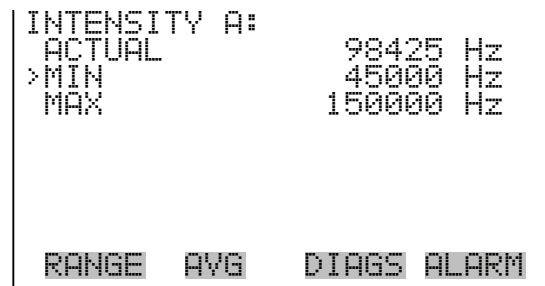

The Intensity A screen displays the current lamp intensity reading in Cell A and sets the minimum and maximum alarm limits. Acceptable alarm limits range from 45,000 to 150,000 Hertz. If the intensity A reading goes beyond either the minimum or maximum limit, an alarm is activated. The word “ALARM” appears in the Run screen and in the Main Menu.

- In the Main Menu, choose Alarms > **Intensity A** or **Intensity B**.



Min and Max Intensity Limits

The Minimum Intensity A alarm limit screen is used to change the minimum intensity A alarm limit. The minimum and maximum intensity A and intensity B screens function the same way.

- In the Main Menu, choose Alarms > Select Intensity > **Min** or **Max**.
- Use  and  to increment or decrement the numeric value.
- Press  to save set to value as actual value.

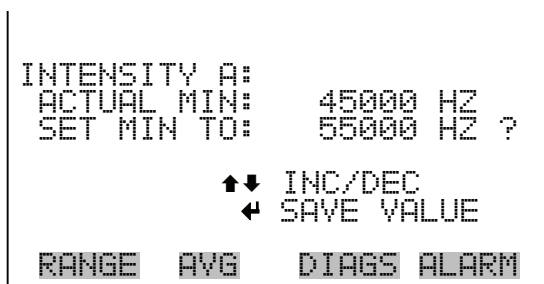

O₃ Concentration



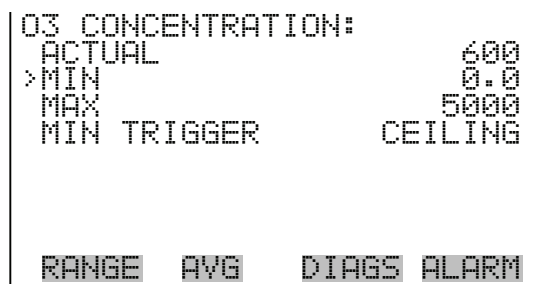

The O₃ Concentration screen displays the current O₃ concentration and sets the minimum and maximum alarm limits. Acceptable alarm limits range from 0 to 5,000 ppb. The minimum alarm may be programmed as a floor trigger (alarm is triggered when the concentration falls below the minimum value) or a ceiling trigger (alarm is triggered when the concentration goes above the minimum value). If the O₃ concentration goes beyond either the minimum or maximum limit, an alarm is activated. The word “ALARM” appears in the Run screen and in the Main Menu.

- In the Main Menu, choose Alarms > O₃ Concentration.



Min and Max O₃ Concentration Limits

The Minimum O₃ Concentration alarm limit screen is used to change the minimum O₃ concentration alarm limit. The minimum and maximum O₃ concentration alarm limit screens function the same way.

- In the Main Menu, choose Alarms > O₃ Concentration > **Min** or **Max**.
- Use  and  to move the cursor left or right.
- Use  and  to increment or decrement the numeric value.
- Press  to save set to value as actual value.

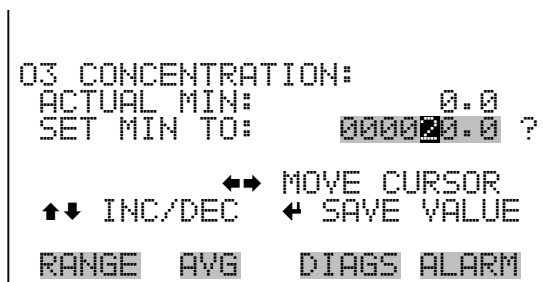

Min Trigger

The Minimum Trigger screen allows the user to view and set the O₃ concentration alarm trigger type to either floor or ceiling. The minimum alarm may be programmed as a floor trigger (alarm is triggered when the concentration falls below the minimum value) or a ceiling trigger (alarm is triggered when the concentration goes above the minimum value).

- In the Main Menu, choose Alarms > O₃ Concentration > **MinTrigger**.
- Press  to toggle and set the minimum trigger to floor or ceiling.

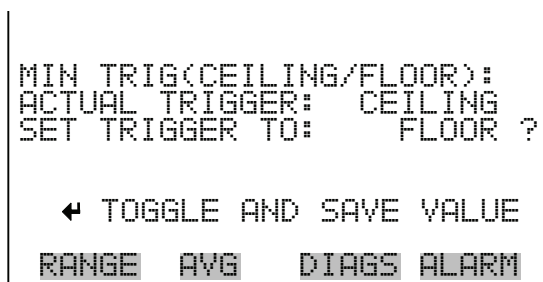

Service Menu

The Service menu appears only when the calibrator is in the service mode. To put the calibrator into service mode:

- In the Main Menu, choose Instrument Controls > **Service Mode**.

Advanced diagnostic functions are included in the service mode. Meaningful data should not be collected when the calibrator is in the service mode.

- In the Main Menu, choose **Service**.

```
SERVICE:
>PRESSURE CHECK
  LAMP SETTING
  DETECTOR CALIBRATION
  INTENSITY CHECK
  O3 RESPONSE COEFFICIENT
  MANUAL O3 LAMP SETTING
  PRESSURE CALIBRATION  ↓
RANGE  AVG  DIAGS  ALARM
```

```
FLOW A CALIBRATION
FLOW B CALIBRATION
TEMPERATURE CALIBRATION
ANALOG OUT CALIBRATION
ANALOG INPUT CALIBRATION
DISPLAY PIXEL TEST
RESTORE USER DEFAULTS
```

Pressure Check

The Pressure Check menu is used to manually control the flow of reference or sample gas through Cell B. This enables the pressure reading of Cell B, with either sample or reference gas, to be determined. Pump pressure is used to test the pump. Selecting any of these menu items will disturb the analog outputs.

- In the Main Menu, choose Service > **Pressure Check**.

```
PRESSURE CHECK:
>SAMPLE PRESSURE
  REFERENCE PRESSURE
  PUMP PRESSURE
RANGE  AVG  DIAGS  ALARM
```

Sample Pressure

The Sample Pressure screen (read only) displays the pressure of the sample gas in Cell B.

- In the Main Menu, choose Service > Pressure Check > **Sample Pressure**.

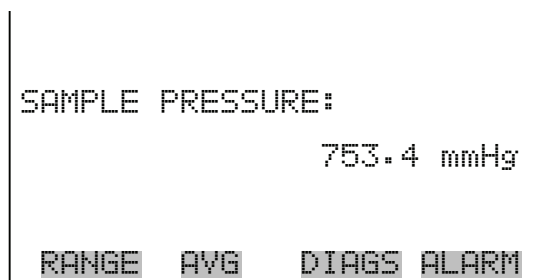

Reference Pressure

The Reference Pressure screen (read only) displays the pressure of the reference gas in Cell B.

- In the Main Menu, choose Service > Pressure Check > **Reference Pressure**.

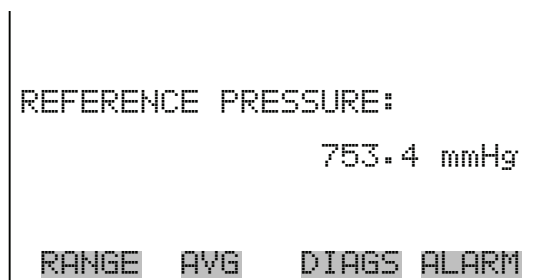

Pump Pressure

The Pump Pressure screen (read only) is used to test the pump. The solenoids are energized such that there is no flow in Cell B. The flow rate for Cell B drops to zero and the pressure reading should drop below 390 mmHg in less than 20 seconds. This indicates the effectiveness of the internal pump. After 20 seconds, if the pressure is greater than 390 mmHg or the flow is greater than 0.010 LPM, the words “PUMP PROBLEM DETECTED” appears. After 20 seconds, if the pressure is less than 390 mmHg and the flow is less than 0.010 LPM, the words “PUMP OK” appears.

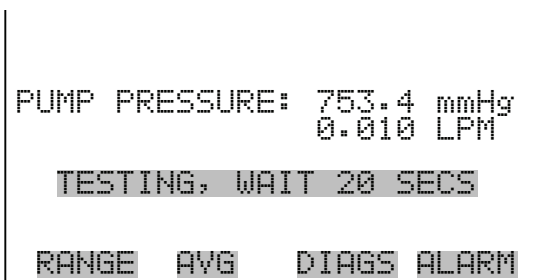

- In the Main Menu, choose Service > Pressure Check > **Pump Pressure**.



Lamp Setting

The Lamp Setting screen is used to adjust the detector intensities. The display shows the intensities of Cell A and Cell B. The next line of the display shows the current lamp setting. Adjust the lamp setting until the intensities are about 100 kHz.

Note This adjustment should only be performed by an instrument service technician. ▲

- In the Main Menu, choose Service > **Lamp Setting**.
- Use  and  to increment or decrement the numeric value.
- Press  to save the new lamp setting.



Detector Calibration

The Detector Calibration screen is used to set the calibration factors for detector A and detector B. Calibration factors are computed so that both detectors read 100,000 Hz on zero air. If either detector reads lower than 75,000 Hz or higher than 125,000 Hz, this calibration will not be successful. It is crucial that the lamp intensity be set such that both detector intensities fall inside this range before performing this calibration.

Note This adjustment should only be performed by an instrument service technician. ▲

- In the Main Menu, choose Service > **Detector Calibration**.

```
DETECTOR CALIBRAITON:
CELL A RAW INT: 76988 HZ
CELL B RAW INT: 67079 HZ
CELL A FACTOR: 1.000
CELL B FACTOR: 1.000
← CALC/SAVE NEW RECORDS

RANGE  AVG  DIAGS  ALARM
```

Intensity Check

The Intensity Check menu is used to manually control the flow of reference or sample gas through either Cell A or Cell B. This enables the intensity and noise reading of each detector to be determined with either reference or sample gas flow. Selecting any of these menu items will disturb the analog outputs.

- In the Main Menu, choose Service > **Intensity Check**.

```
INTENSITY CHECK:
>INT A REFERENCE GAS
INT A SAMPLE GAS
INT B REFERENCE GAS
INT B SAMPLE GAS

RANGE  AVG  DIAGS  ALARM
```

Intensity A/B Check

The Intensity A Reference Gas screen (read only) switches the solenoid valves so that reference gas is flowing through Cell A. The intensity and noise reading are displayed. The Intensity B Reference Gas screen functions the same way. Also, the Intensity A and Intensity B Sample Gas screens function the same way (only with sample gas instead of reference gas).

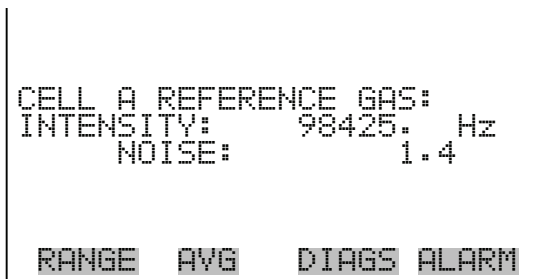

- In the Main Menu, choose Service > Intensity Check > **Int A** or **B Ref** or **Sample**.



O₃ Response Coefficient

The O₃ Response Coefficient screen is used to change the response of the ozonator lamp feedback circuit. The larger the number, the more rapid the response and the higher the noise. Smaller numbers have slower response times and less noise. Normally, this coefficient should be set to 1.0. Valid coefficients range from 0.5 to 1.5. The O₃ response coefficient is visible only when the calibrator is in service mode and if the ozonator option is installed. For more information on the service mode, see “Service Mode” earlier in this chapter.

Note This adjustment should only be performed by an instrument service technician. ▲

- In the Main Menu, choose Service > **O₃ Response Coefficient**.
- Use the  and  to increment or decrement the numeric value.
- Press  to save the new coefficient.

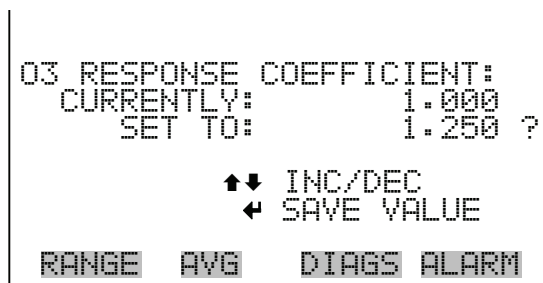

Manual O₃ Lamp Setting

The Manual O₃ Lamp Setting screen is used to manually control the O₃ output concentration by adjusting the ozonator lamp intensity. In this mode, the automatic feedback control of the ozonator is defeated. This is

useful to determine how much ozone is produced at a certain percentage of lamp intensity. The pressure calibration is visible only when the calibrator is in service mode. For more information on the service mode, see “Service Mode” earlier in this chapter.

Note This adjustment should only be performed by an instrument service technician. ▲

- In the Main Menu, choose Service > **Manual O₃ Lamp Setting**.

```
MANUAL O3 LAMP SETTING:
LAMP SETTING:          0.1% ?

          ↑↓ INC/DEC
PRESSURE CALIBRATION

RANGE  AVG  DIAGS  ALARM
```

Pressure Calibration

The Pressure Calibration menu is used to calibrate the pressure sensor to zero, span, or restore factory default values. The pressure calibration is visible only when the calibrator is in service mode. For more information on the service mode, see “Service Mode” earlier in this chapter.

The pressure sensor’s zero counts and span slope are displayed on the menu.

Note This adjustment should only be performed by an instrument service technician. ▲

- In the Main Menu, choose Service > **Pressure Calibration**.

```
PRESSURE SENSOR CAL:
>ZERO                72
SPAN                 1.1447
SET DEFAULTS

RANGE  AVG  DIAGS  ALARM
```

Calibrate Pressure Zero

The Calibrate Pressure Zero screen calibrates the pressure sensor at zero pressure.

Note A vacuum pump must be connected to the pressure sensor before performing the zero calibration. ▲



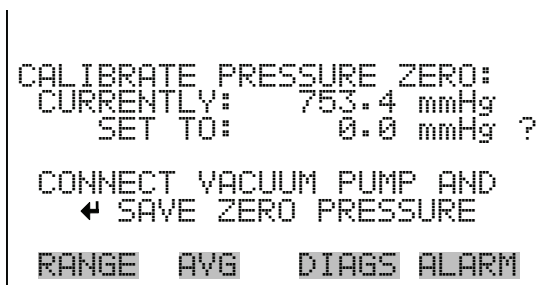

- In the Main Menu, choose Service > Pressure Calibration > **Zero**.
- Press  to save the current pressure reading as the zero reading.



Calibrate Pressure Span

The Calibrate Pressure Span screen allows the user to view and set the pressure sensor calibration span point.



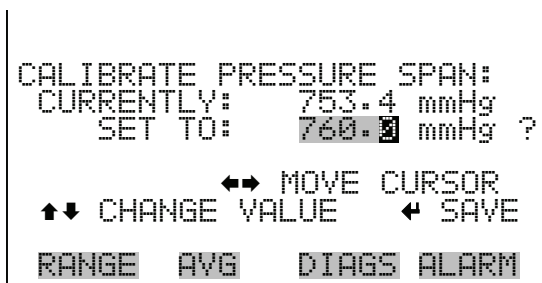

Note The plumbing going to the pressure sensor should be disconnected so the sensor is reading ambient pressure before performing the span calibration. The operator should use an independent barometer to measure the ambient pressure and enter the value on this screen before calibrating. ▲

- In the Main Menu, choose Service > Pressure Calibration > **Span**.
- Use , ,  and  to move and change the value.
- Press  to save set to value as actual value.



Restore Default Pressure Calibration

The Restore Default Calibration screen allows the user to reset the pressure calibration configuration values to factory defaults.

- In the Main Menu, choose Service > Pressure Calibration > **Set Defaults**.
- Press  to warn user and enable restore with .
- Use  to overwrite pressure sensor calibration parameters with factory default values when pressed after .

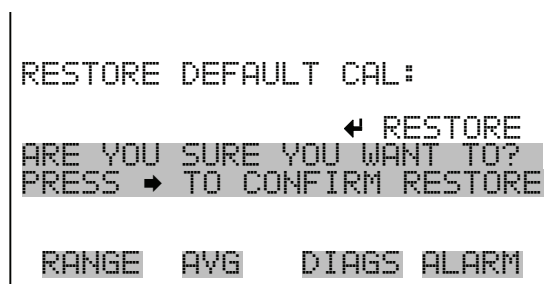
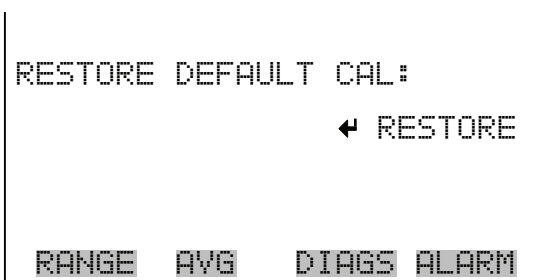

Flow A and B Calibration

The Flow A Calibration menu is used to calibrate the flow A sensor to zero, span, or restore factory default values. The flow A calibration is visible only when the calibrator is in service mode. For more information on the service mode, see “Service Mode” earlier in the chapter. The Flow B Calibration menu functions the same way.

Note This adjustment should only be performed by an instrument service technician. ▲

- In the Main Menu, choose Service > **Flow Calibration A or B**.

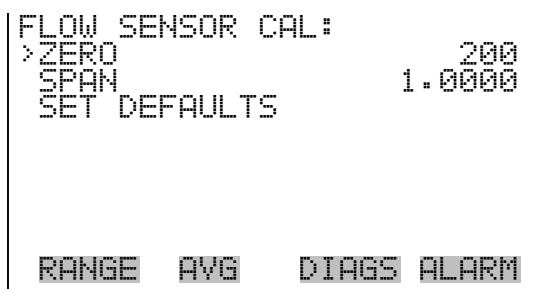

Calibrate Flow Zero

The Calibrate Flow A Zero screen calibrates the flow sensor at zero flow. The Calibrate Flow B Zero screen functions the same way.

Note The pump must be disconnected before performing the zero calibration. ▲

- In the Main Menu, choose Service > Select Flow Calibration A or B > **Zero**.
- Press  to save the current flow reading as the zero reading.

```

CALIBRATE FLOW A ZERO:
CURRENTLY:    0.608 LPM
SET TO:      0.000 LPM ?





DISCONNECT PUMP AND
← SAVE ZERO PRESSURE

RANGE  AVG  DIAGS  ALARM
  
```

Calibrate Flow Span

The Calibrate Flow A Span screen allows the user to view and set the flow sensor calibrate span point. The calibrate Flow B Span screen functions the same way.

Note An independent flow sensor is required to read the flow, then the operator enters the flow value on this screen to perform the calibration. ▲

- In the Main Menu, choose Service > Select Flow Calibration A or B > **Span**.
- Use , ,  and  to move and change the value.
- Press  to save set to value as actual value.

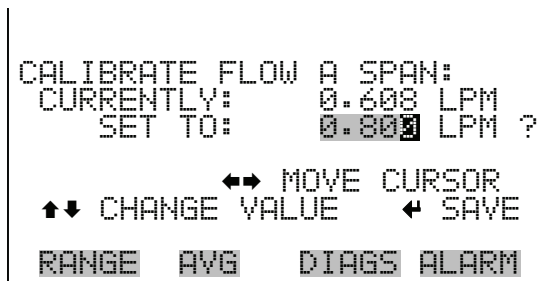

Restore Default Flow Calibration

The Restore Default Calibration A screen allows the user to reset the flow calibration configuration values to factory defaults. The Restore Default Calibration B screen functions the same way.

- In the Main Menu, choose Service > Select Flow Calibration A or B > **Set Defaults**.
- Press to warn user and enable restore with .
- Use to overwrite pressure sensor calibration parameters with factory default values when pressed after .

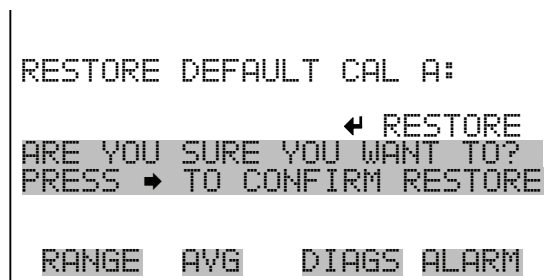





Temperature Calibration

The Temperature calibration screen allows the user to view and set the ambient temperature sensor calibration. The temperature calibration is visible only when the calibrator is in service mode. For more information on the service mode, see “Service Mode” earlier in the chapter.

Note This adjustment should only be performed by an instrument service technician. ▲

- In the Main Menu, choose Service > **Temperature Calibration**.

- Use , ,  and  to move and change the value.
- Press  to save set to value as actual value.

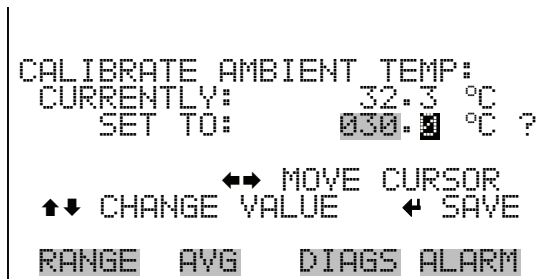

Analog Output Calibration

The Analog Output Calibration menu is a selection of 6 voltage channels and 6 current channels (if I/O expansion board option is installed) to calibrate, and allows the user to select the calibration action zero or span. The analog output calibration is visible only when the calibrator is in service mode. For more information on the service mode, see “Service Mode” earlier in the chapter.

Note This adjustment should only be performed by an instrument service technician. ▲

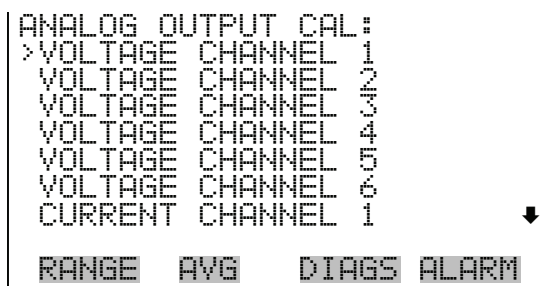

- In the Main Menu, choose Service > **Analog Out Calibration**.

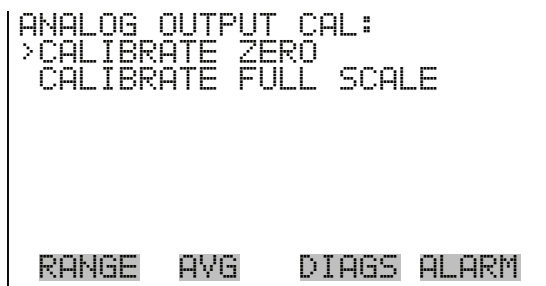



Analog Output Calibrate Zero

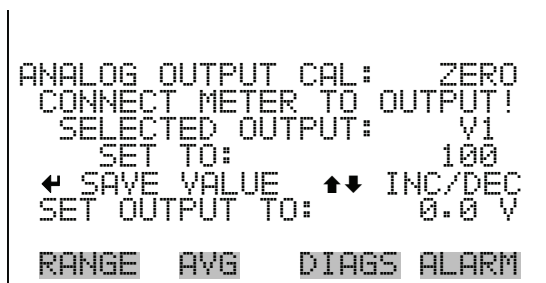

The Analog Output Calibrate Zero screen allows the user to calibrate the zero state of the selected analog output. The operator must connect a meter to the output and adjust the output until it reads 0.0 V on the meter.

- In the Main Menu, choose Service > Analog Out Calibration > Select Channel > **Calibrate Zero**.
- Use the  and  to increment or decrement the numeric value.
- Press  to save the value.



Analog Output Calibrate Full-Scale

The Analog Output Calibrate Full-Scale screen allows the user to calibrate the full-scale state of the selected analog output. The operator must connect a meter to the output and adjust output until it reads the value shown in the set output to: field.

- In the Main Menu, choose Service > Analog Out Calibration > Select Channel > **Calibrate Full Scale**.
- Use the  and  to increment or decrement the numeric value.

- Press  to save the value.

```

ANALOG OUTPUT CAL:  SPAN
CONNECT METER TO OUTPUT!
  SELECTED OUTPUT:  V1
    SET TO: 3697
  ← SAVE VALUE  ↑↓ INC/DEC
  SET OUTPUT TO: 10 V

RANGE  AVG  DIAGS  ALARM
  
```

Analog Input Calibration

The Analog Input Calibration menu is a selection of 8 analog inputs (if the I/O expansion board option is installed) to calibrate, and allows the user to select the calibration action zero or span. The analog input calibration is visible only when the calibrator is in service mode. For more information on the service mode, see “Service Mode” earlier in the chapter.

Note This adjustment should only be performed by an instrument service technician. ▲

- In the Main Menu, choose Service > Analog Input Calibration.

```

ANALOG INPUT CAL:
>INPUT CHANNEL 1
  INPUT CHANNEL 2
  INPUT CHANNEL 3
  INPUT CHANNEL 4
  INPUT CHANNEL 5
  INPUT CHANNEL 6
  INPUT CHANNEL 7
                                     ↓

RANGE  AVG  DIAGS  ALARM
  
```

```

ANALOG INPUT CAL:
>CALIBRATE ZERO
  CALIBRATE FULL SCALE

RANGE  AVG  DIAGS  ALARM
  
```

Analog Input Calibrate Zero

The Analog Input Calibrate Zero screen allows the user to calibrate the zero state of the selected analog input.

In the Main Menu, choose Service > Analog Input Calibration > Select Channel > **Calibrate Zero**. (Hook up a voltage source of 0 V to the analog input channel.)

- Press  to save the value.



```
ANALOG INPUT CAL:  ZERO
DISCONNECT SELECTED INPUT!
SELECTED INPUT:    INPUT 1
CURRENTLY:         6.24 V ?

← CALIBRATE INPUT TO ZERO

RANGE  AVG  DIAGS  ALARM
```

Analog Input Calibrate Full-Scale

The Analog Input Calibration Full-Scale screen allows the user to calibrate the full-scale state of the selected analog input.

- In the Main Menu, choose Service > Analog Input Calibration > Select Channel > **Calibrate Full Scale**. (Hook up a voltage source of 10 V to the analog input channel.)
- Use the  and  to increment or decrement the numeric value.
- Press  to save the value.

```
ANALOG INPUT CAL:  SPAN
PROVIDE VOLTAGE TO INPUT!
SELECTED INPUT:    INPUT 1
CURRENTLY:         6.24 V
SET TO:            10.00 V ?
← CALIBRATE TO VALUE

RANGE  AVG  DIAGS  ALARM
```

Display Pixel Test

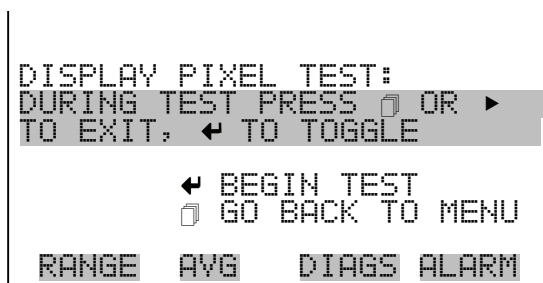

The Display Pixel Test is used to test the LCD display. The display pixel test is visible only when the calibrator is in service mode. For more information on the service mode, see “Service Mode” earlier in the chapter.

- In the Main Menu, choose Service > **Display Pixel Test**.
- Press  to begin test by turning all pixels on, then toggle between on or off.



Restore User Defaults

The Restore User Defaults screen is used to reset the user calibration and configuration values to factory defaults. The restore default user is visible only when the calibrator is in service mode. For more information on the service mode, see “Service Mode” earlier in the chapter.

- In the Main Menu, choose Service > **Restore User Defaults**.
- Press  to warn and enable restore with .
- Press  to overwrite all user settings with factory default values.



Password Menu

The Password menu allows the user to configure password protection. If the calibrator is locked, none of the settings may be changed via the front panel user interface. The items visible under the password menu are determined by the calibrator's password status.

- In the Main Menu, choose **Password**.



```
PASSWORD MENU:
>SET PASSWORD
LOCK INSTRUMENT
CHANGE PASSWORD
REMOVE PASSWORD
UNLOCK INSTRUMENT

RANGE  AVG  DIAGS  ALARM
```

Set Password

The Set Password screen is used to set the password to unlock the front panel. The set password is shown if the calibrator is unlocked and the password not set.

- In the Main Menu, choose Password > **Set Password**.
- Press  to enter password and disable instrument lock.



```
ENTER NEW PASSWORD:
██████████████████

BCDEFGHIJKLMN  BKSP
OPQRSTUVWXYZ   PAGE
0123456789 . / -  SAVE

RANGE  AVG  DIAGS  ALARM
```

Lock Instrument

The Lock Instrument screen is used to lock the calibrator's front panel so users can not change any settings from the front panel. The lock instrument is shown if the calibrator is unlocked and the password set.

- In the Main Menu, choose Password > **Lock Instrument**.
- Press  to enable instrument lock and returns to main menu.

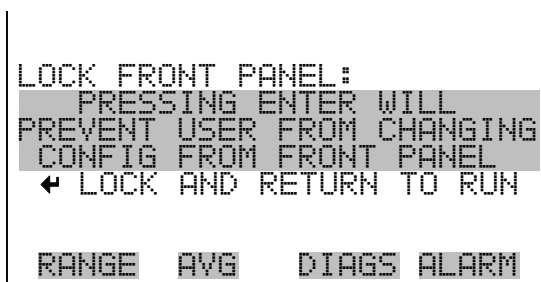

Change Password

The Change Password is used to change the password used to unlock the calibrator's front panel. The change password is shown if the calibrator is unlocked.

- In the Main Menu, choose Password > **Change Password**.
- Press  to change password.



Remove Password

The Remove Password screen is used to erase the current password and disable password protection. The remove password is shown if the calibrator is unlocked and the password set.

- In the Main Menu, choose Password > **Remove Password**.
- Press  to remove password and returns to main menu.



Unlock Instrument

The Unlock Instrument screen is used to enter the password to unlock the front panel. The Unlock Instrument is shown if the calibrator is locked.

- In the Main Menu, choose Password > **Unlock Instrument**.
- Press  to disable instrument lock and returns to main menu.



Chapter 4 Preventive Maintenance

This chapter describes the periodic maintenance procedures that should be performed on the instrument to ensure proper operation.

Since usage and environmental conditions vary greatly, you should inspect the components frequently until an appropriate maintenance schedule is determined. This includes the sample pump and solenoid valves which have a limited life.

Other operations such as cleaning the optics and checking the calibration of the pressure should be performed on a regular basis.

This chapter includes the following maintenance information and replacement procedures:

- “Safety Precautions” on page 4-2
- “Replacement Parts” on page 4-2
- “Outside Case Cleaning” on page 4-2
- “Optical Bench Cleaning” on page 4-2
- “Lamp Replacement” on page 4-3
- “Monitoring Detector Frequencies and Noise” on page 4-4
- “Capillary Service” on page 4-5
- “Pump Rebuilding” on page 4-6
- “Leak Test and Pump Checkout” on page 4-7

Safety Precautions

Read the safety precautions before beginning any procedures in this chapter.



WARNING If the equipment is operated in a manner not specified by the manufacturer, the protection provided by the equipment may be impaired.

The Model 49*i* Primary Standard is supplied with a three-wire grounding cord. Under no circumstances should this grounding system be defeated. ▲



Equipment Damage Some internal components can be damaged by small amounts of static electricity. A properly grounded antistatic wrist strap must be worn while handling any internal component. For more information about appropriate safety precautions, see the “Servicing” chapter. ▲

Replacement Parts

See the “Servicing” chapter for a list of replacement parts.

Outside Case Cleaning

Clean the outside case using a damp cloth being careful not to damage the labels on the case.



Equipment Damage Do Not use solvents or other cleaning products to clean the outside case. ▲

Optical Bench Cleaning

Best results are obtained when the optical bench is cleaned prior to recalibration. The cleanliness of the bench should also be checked any time the detector frequencies drop below 65 kHz, since one source of low output is light attenuation due to dirt in the cell. Dirt particulates are usually effective ozone removers.

Use the following procedure to clean the optical bench.



CAUTION Some internal components can be damaged by small amounts of static electricity. A properly grounded antistatic wrist strap must be worn while handling any internal component. For more information about appropriate safety precautions, see the “Servicing” chapter. ▲

1. Turn off the power and disconnect the power line.

2. Loosen the knurled nut around the tube and carefully slide out tube.
3. Push a piece of lens paper down the tube using a 1/4-inch piece of Teflon® tubing so as not to damage the tube. Use a cotton swab to clean the window surfaces through the holes that the tube fits into.
4. Both absorption tubes are identical, so they can be replaced in either position. Replacement of absorption cells is opposite to that of removal. Since the Model 49*i* Primary Standard is a ratio instrument, and cleaning the absorption tubes does not affect the calibration, it is not necessary to recalibrate the instrument every time the cells are cleaned.
5. Re-install the instrument cover.

If windows are severely contaminated, they are best cleaned by removing the windows from the bench. The windows on the detector side can be removed by removing the detector block and carefully removing the windows. The windows on the source side can be removed by removing the source block to gain access to the windows. It is recommended that the Model 49*i* Primary Standard be recalibrated if the optical bench has been completely disassembled. Always leak-check the system after any component removal.

Lamp Replacement







The lamp control system of the Model 49*i* Primary Standard has been designed to operate the lamp conservatively to increase its life. However, the lamp should be replaced when any one of the following conditions occur:

- No light output.
- Inability to adjust lamp position to obtain an output detection frequency of 65 kHz.
- Noisy output signal, which has been traced to an unstable lamp (see the “Troubleshooting” chapter).

It is not necessary to recalibrate the Model 49*i* Primary Standard since it is a ratio instrument and replacing the lamp does not affect the calibration.

Monitoring Detector Frequencies and Noise

The Model 49*i* Primary Standard measures intensity ratios and not absolute values. Therefore, a large range of detector frequencies are acceptable for proper operation of the instrument. The nominal values are 65 to 120 kHz. These frequencies can be monitored from the Intensities screen in the Diagnostics menu.







1. Press  to display the Main Menu.
2. Use   to scroll to Diagnostics, press  >  to scroll to **Intensities** and press .

The Intensities screen appears.

Degradation of detector frequencies to below 65 kHz indicates either a dirty cell or low lamp output. In addition to degrading the measured detector frequency, dirt in the cells can decompose the ozone and give erroneous readings. Therefore, the cells should first be cleaned and the frequency re-measured.





Increasing Lamp Output

If the frequencies are still low, the lamp output can be increased by using the Lamp Setting screen in the Service mode. If the frequency cannot be set above 65 kHz, replace the lamp.



1. Press  to display the Main Menu.
2. Use   to scroll to Service, press  >  to scroll to **Lamp Setting** and press .

The Lamp Setting screen appears.

If the Service Mode is not displayed on the Main Menu, use the following procedure to display it.







- a. At the Main Menu, press  to scroll to Instrument Controls > press  >  to scroll to **Service Mode** > and press .

The Service Mode screen appears.

- b. Press  to toggle the Service Mode to ON.
- c. Press  >  to return to the Main Menu.

Monitoring Lamp Noise

To monitor the lamp noise, display Intensity Check from the Service mode menu.

1. Press  to display the Main Menu.
2. Use   to scroll to Service, press  >  to scroll to **Intensity Check** and press .

The Intensity Check screen appears.

The noise value displayed after 20 seconds should be below 4.0 Hz for a fully warmed-up lamp (see the “Troubleshooting” chapter if the noise is excessive).

Capillary Service

The capillaries normally only require inspection when performance indicates there may be a flow problem. Use the following procedure to service the capillary (Figure 4-1).

Equipment Required:

Capillary

Wire, less than 0.015-inch OD



Equipment Damage Some internal components can be damaged by small amounts of static electricity. A properly grounded antistatic wrist strap must be worn while handling any internal component. ▲

1. Turn instrument OFF, unplug the power cord, and remove the cover.

2. Remove capillary, check for particulate deposits, clear any blockage with a wire less than 0.015-inch OD, or replace the capillary by following the above steps in reverse.

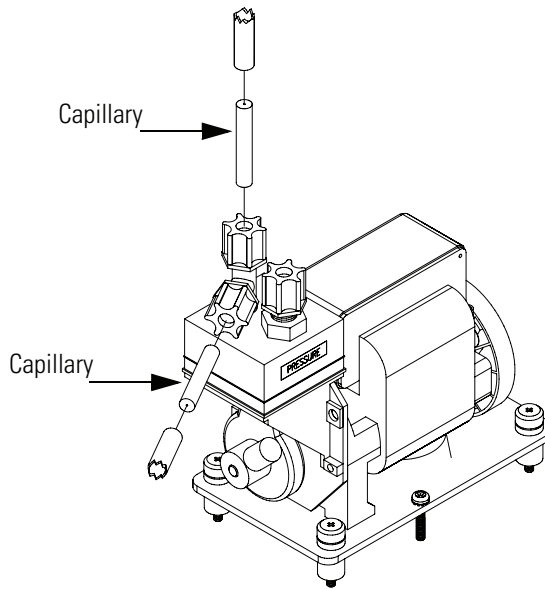

Figure 4-1. Capillary Location

Pump Rebuilding

Use the following procedure to rebuild the pump (Figure 4-2). To replace the pump, see “Pump Replacement” in the “Servicing” chapter.

Equipment Required:

Flatblade screwdriver

Pump rebuild kit (flapper valve and diaphragm)



Equipment Damage Some internal components can be damaged by small amounts of static electricity. A properly grounded antistatic wrist strap must be worn while handling any internal component. ▲

1. Turn instrument OFF, unplug the power cord, and remove the cover.
2. Loosen the fittings and remove both lines going to the pump.

3. Remove the four screws from the top plate, remove top plate, flapper valve, and the bottom plate.

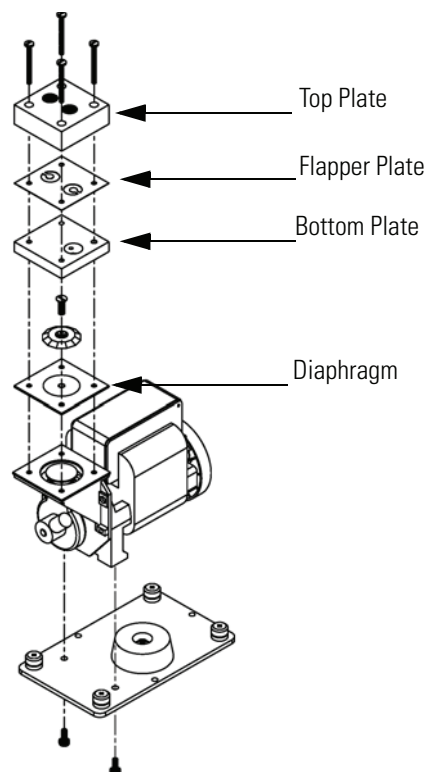

Figure 4-2. Rebuilding the Pump









4. Remove the screw securing the diaphragm to piston and remove diaphragm.
5. Assemble the pump by following the previous steps in reverse, make sure the Teflon[®] (white) side of the diaphragm is facing up and that the flapper valves cover the holes of the top and bottom plate.
6. Perform the “Leak Test and Pump Checkout” procedure described in this chapter.

Leak Test and Pump Checkout

Use the following procedures to test for system leaks and checkout the pump.

External Leaks

Use the following procedure to test for leaks around the fittings.

1. Disconnect the OZONE out line and plug the OZONE fitting.
2. Disconnect the VENT line and plug.
3. Disconnect the zero air supply and plug the fitting.
4. Press  to display the Main Menu.
5. Press   to scroll to Diagnostics and press  to display the Diagnostics menu.
6. Press  to move the cursor to Flows and press  to display the Flows screen. The flow readings should slowly decrease to zero flow.
7. Press  to return to the Diagnostics menu.
8. Press  to move the cursor to Pressure and press  to display the Pressure screen. The pressure reading should drop to less than 250 mm Hg.

If the pump diaphragm is in good condition and the capillary is not blocked, it should take less than 20 seconds from the time the inlet is plugged to the time the reading below 250 mm Hg is obtained.







If a leak is suspected, carefully tighten each fitting until the leak is found and check to see that none of the input lines are cracked or broken.

Solenoid Leaks

Leaks across the solenoid valve can be caused by Teflon cold-flowing across the valve seat or by particulates on the seat.

Use the following procedure to check for solenoid leaks.

1. Generate an ozone concentration of approximately 0.5 ppm.
2. Press  to display the Main Menu.

3. Press   to scroll to Diagnostics and press  to display the Diagnostics menu.
4. Use   to move the cursor to Cell A/B O3 and press  to display the O3 PPB screen. This display presents the concentration for each cell.

Once the instrument stabilizes, the average of 10 successive simultaneous readings should agree within ± 3 percent.







A balanced measurement of better than 3 percent indicates that there are no leaks across the solenoid.

A constant low reading from one cell indicates an imbalance. The imbalance can be caused by a dirty cell, dirty lines to that cell, or by a leaky valve. Refer to the “Solenoid Leak Test” procedure that follows to check for a leaky solenoid.

To check if the imbalance is caused by an absorption cell, interchange the cells. If the imbalanced side switches, the imbalance is caused by the cell.

Solenoid Leak Test

Use the following procedure to test the solenoid valve for leaks.

1. Remove the solenoid valve that appears to be faulty.
2. Connect the pump directly to the common solenoid port.
3. Connect the pressure transducer to the normally open solenoid port.
4. Press  to display the Main Menu.
5. Press   to scroll to Diagnostics and press  to display the Diagnostics menu.
6. Use   to scroll to Pressure and press  to display the Pressure screen.

Preventive Maintenance

Leak Test and Pump Checkout

7. Note the pressure as P_{NO} .
8. Connect the pressure transducer to the normally closed solenoid port.
9. Plug the solenoid power line into the appropriate connector on the measurement interface board. Make sure the solenoid is activated by choosing **Pressure** from the Diagnostics menu.
10. Note the pressure as P_{NC} the solenoid is faulty
11. The solenoid is faulty if either P_{NO} or P_{NC} is greater than the pressure determined in the “External Leaks” section described previously.

Chapter 5 Troubleshooting

This instrument has been designed to achieve a high level of reliability. In the event of problems or failure, the troubleshooting guidelines, board-level connection diagrams, connector pin descriptions, and testing procedures presented in this chapter should be helpful in isolating and identifying problems.

For additional fault location information refer to the “Preventive Maintenance” chapter in this manual.

The service mode in the “Operation” chapter includes parameters and functions that are useful when making adjustments or diagnosing problems.

The Technical Support Department at Thermo Fisher Scientific can also be consulted in the event of problems. See “Service Locations” at the end of this chapter for contact information. In any correspondence with the factory, please note both the serial number and program number of the instrument.

This chapter provides the following troubleshooting and service support information:

- “Safety Precautions” on page 5-1
- “Troubleshooting Guides” on page 5-2
- “Board-Level Connection Diagrams” on page 5-6
- “Connector Pin Descriptions” on page 5-8
- “Service Locations” on page 5-21

Safety Precautions

Read the safety precautions in the Preface and the “Servicing” chapter before performing any actions listed in this chapter.

Troubleshooting Guides

The troubleshooting guides presented in this chapter are designed to help isolate and identify instrument problems.

Table 5-1 provides general troubleshooting information and indicates the checks that you should perform if you experience an instrument problem.

Table 5-2 lists all the alarm messages you may see on the graphics display and provides recommendations about how to resolve the alarm condition.

Table 5-1. Troubleshooting - General Guide

Malfunction	Possible Cause	Action
Does not start up	No power	Check that the instrument is plugged into the proper source (115 or 220 volts) Check instrument fuses
	Power supply	Check power supply voltages using a voltmeter
Cell A or B frequency high	Light adjustment	Readjust Lamp Setting. From the Service Mode menu choose Lamp Setting.
	Defective detector	Interchange detectors at Measurement Interface Board connectors to determine if detector is defective.
Cell A and B frequency high	Lamp supply	Check for 1.7 volt peak to peak waveform at lamp current check point on Lamp Power Supply Board
Cell A or B frequency low or zero	Light adjustment	Readjust lamp setting. From the Service Mode menu choose Lamp Setting.
	One cell excessively contaminated	Clean cell
	Defective detector	Interchange detectors at Measurement Interface Board connectors to determine if detector is defective
Cell A and B frequency low or zero	Dirty cells	Clean cells
	Light adjustment	Check for 1.7 volt peak to peak waveform at lamp current check point on Lamp Power Supply Board

Table 5-1. Troubleshooting - General Guide, continued

Malfunction	Possible Cause	Action
	Lamp	Remove one cell and look for blue light in hole of input block
	Lamp heater	Check lamp temperature. From the Diagnostics menu choose Temperatures.
	±15 volt power supply	Check ±15 volts. From the Diagnostics menu choose Voltages.
Cell A or B noise excessive	Foreign material in one cell	Clean cell.
	Defective detector	Interchange detectors at Measurement Interface Board connectors to determine if detector is defective.
Cell A and B noise excessive	Foreign material in cells	Clean cells
	Lamp failure	Check for 1.7 volt peak to peak waveform at lamp current check point on Lamp Power Supply Board
	±15 volt power supply	Check ±15 volts. From the Diagnostics menu choose Voltages.
Pressure transducer does not hold calibration	Pressure transducer	Replace pressure transducer
Output signal noisy	Recorder	Replace or repair recorder
	Sample is varying	Run instrument on stable ozone source. If quiet, no malfunction.
	Foreign material in cell	Clean cell
	Sticky solenoid valve	Replace with known good solenoid valve.
Slow response	Averaging time	Verify averaging time is set properly
	Contaminated optical bench	Clean bench and then condition system overnight

Table 5-2. Troubleshooting - Alarm Messages

Alarm Message	Possible Cause	Action
Alarm - O ₃ Lamp Temp	Defective lamp heater	Replace ozonator lamp driver board or lamp bench assembly.
Alarm - Lamp Temp	Defective lamp heater	Replace lamp driver board or lamp assembly.
Alarm - Bench Temp	Faulty fan	Replace fan if not operating properly.
	Dirty fan filter	Clean or replace foam filter, refer to "Preventive Maintenance" chapter in this manual.
Alarm - Pressure	High pressure indication	Check the pump for a tear in the diaphragm, replace with pump repair kit if necessary. Refer to "Preventive Maintenance" chapter in this manual. Check that capillaries are properly installed and O-rings are in good shape. Replace if necessary. Check flow system for leaks.
Alarm - Flow A Alarm - Flow B	Flow low	Check sample capillary (0.015 inch ID) for blockage. Replace as necessary. If using sample particulate filter make sure it is not blocked. Disconnect sample particulate filter from the sample bulkhead, if flow increases, replace the filter.
Alarm - Intensity A Alarm - Intensity B	Pre-amp Gain not set properly	Check Gain adjustment.
	Defective measurement interface board	Replace measurement interface board.
Alarm - O ₃ Conc.	Concentration has exceeded range limit	Check to insure range corresponds with expected value. If not select proper range.
	Concentration low	Check user-defined low set point, set to zero.

Table 5-2. Troubleshooting - Alarm Messages, continued

Alarm Message	Possible Cause	Action
Alarm - Motherboard Status	Internal cables not connected properly	Check that all internal cables are connected properly.
Alarm - Interface Status	Board is defective	Recycle AC power to instrument. If still alarming, change board.
Alarm - I/O Exp Status		

Board-Level Connection Diagrams

Figure 5-1 and Figure 5-2 are board-level connection diagrams for the common electronics and measurement system. These illustrations can be used along with the connector pin descriptions in Table 5-3 through Table 5-9 to troubleshoot board-level faults.

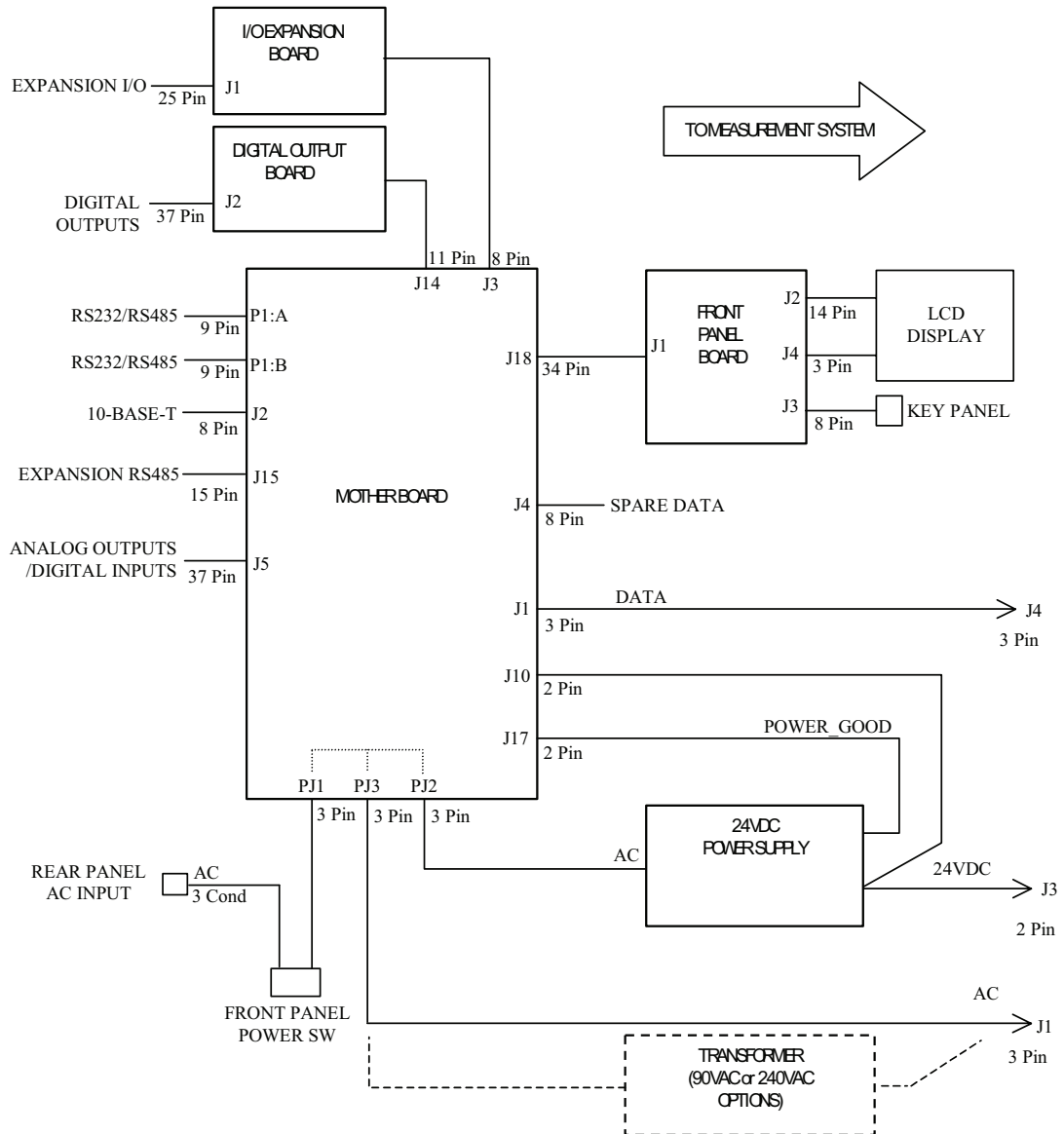

Figure 5-1. Board-Level Connection Diagram - Common Electronics

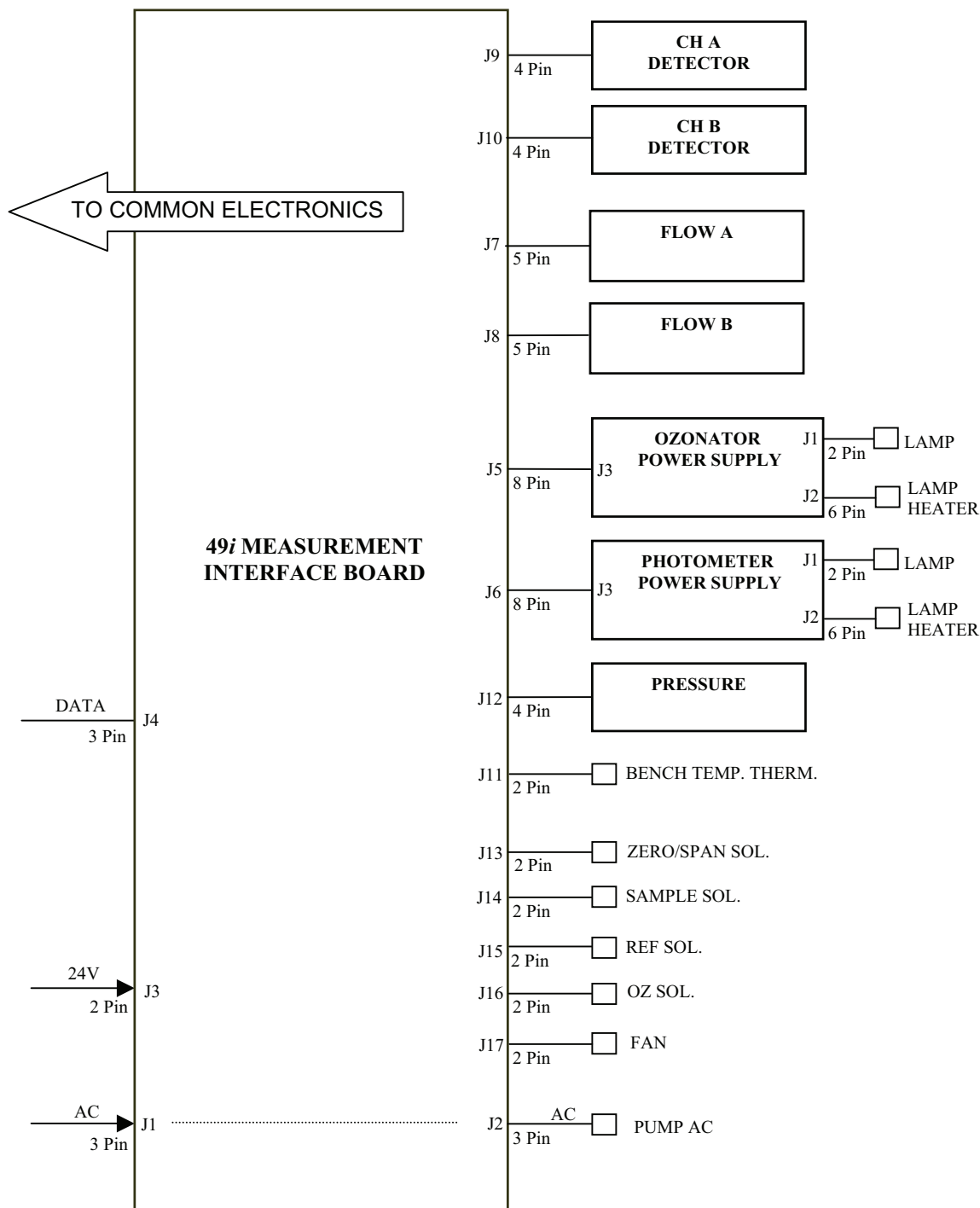

Figure 5-2. Board-Level Connection Diagram - Measurement System

Connector Pin Descriptions

The connector pin descriptions in [Table 5-3](#) through [Table 5-9](#) can be used along with the board-level connection diagrams to troubleshoot board-level faults.

Table 5-3. Motherboard Connector Pin Descriptions

Connector Label	Reference Designator	Pin	Signal Description
INTF DATA	J1	1	Ground
		2	+RS485 to Interface Board
		3	-RS485 to Interface Board
10-BASE-T	J2	1	Ethernet Output (+)
		2	Ethernet Output (-)
		3	Ethernet Input (+)
		4	NC
		5	NC
		6	Ethernet Input (-)
		7	NC
		8	NC
EXPANSION BD	J3	1	+5V
		2	+24V
		3	+24V
		4	Ground
		5	Ground
		6	Ground
		7	+RS485 to Expansion Board
		8	-RS485 to Expansion Board
SPARE DATA	J4	1	+5V
		2	+24V
		3	+24V
		4	Ground
		5	Ground
		6	Ground
		7	+RS485 to Spare Board
		8	-RS485 to Spare Board
I/O	J5	1	Power Fail Relay N.C. Contact
		2	Ground
		3	TTL Input 1

Table 5-3. Motherboard Connector Pin Descriptions, continued

Connector Label	Reference Designator	Pin	Signal Description
		4	TTL Input 2
		5	Ground
		6	TTL Input 5
		7	TTL Input 7
		8	TTL Input 8
		9	TTL Input 10
		10	Ground
		11	TTL Input 13
		12	TTL Input 15
		13	Ground
		14	Analog Voltage Output 1
		15	Analog Voltage Output 3
		16	Ground
		17	Analog Voltage Output 5
		18	Ground
		19	Ground
		20	Power Fail Relay COM
		21	Power Fail Relay N.O. Contact
		22	Ground
		23	TTL Input 3
		24	TTL Input 4
		25	TTL Input 6
		26	Ground
		27	TTL Input 9
		28	TTL Input 11
		29	TTL Input 12
		30	TTL Input 14
		31	TTL Input 16
		32	Ground
		33	Analog Voltage Output 2
		34	Analog Voltage Output 4
		35	Ground
		36	Analog Voltage Output 6

Troubleshooting

Connector Pin Descriptions

Table 5-3. Motherboard Connector Pin Descriptions, continued

Connector Label	Reference Designator	Pin	Signal Description
		37	Ground
SER EN	J7	1	Serial Enable Jumper
		2	+3.3V
24V IN	J10	1	+24V
		2	Ground
DIGITAL I/O	J14	1	+5V
		2	+24V
		3	+24V
		4	Ground
		5	Ground
		6	Ground
		7	SPI Reset
		8	SPI Input
		9	SPI Output
		10	SPI Board Select
		11	SPI Clock
EXT. RS485	J15	1	-RS485 to Rear Panel
		2	+RS485 to Rear Panel
		3	+5V
		4	+5V
		5	+5V
		6	Ground
		7	Ground
		8	Ground
		9	NC
		10	NC
		11	+24V
		12	+24V
		13	+24V
		14	+24V
		15	+24V
24V MONITOR	J17	1	24V Power Monitor
		2	Ground

Table 5-3. Motherboard Connector Pin Descriptions, continued

Connector Label	Reference Designator	Pin	Signal Description
FRONT PANEL BD	J18	1	Ground
		2	Ground
		3	LCLK – LCD Signal
		4	Ground
		5	Ground
		6	LLP – LCD Signal
		7	LFLM – LCD Signal
		8	LD4 – LCD Signal
		9	LD0 – LCD Signal
		10	LD5 – LCD Signal
		11	LD1 – LCD Signal
		12	LD6 – LCD Signal
		13	LD2 – LCD Signal
		14	LD7 – LCD Signal
		15	LD3 – LCD Signal
		16	LCD Bias Voltage
		17	+5V
		18	Ground
		19	Ground
		20	LCD_ONOFF – LCD Signal
		21	Keypad Row 2 Input
		22	Keypad Row 1 Input
		23	Keypad Row 4 Input
		24	Keypad Row 3 Input
		25	Keypad Col 2 Select
		26	Keypad Col 1 Select
		27	Keypad Col 4 Select
		28	Keypad Col 3 Select
		29	Ground
		30	Ground
		31	Ground
		32	Ground

Table 5-3. Motherboard Connector Pin Descriptions, continued

Connector Label	Reference Designator	Pin	Signal Description
		33	+24V
		34	+24V
RS232/RS485:A	P1:A	1	NC
		2	Serial Port 1 RX (+RS485 IN)
		3	Serial Port 1 TX (-RS485 OUT)
		4	NC
		5	Ground
		6	NC
		7	Serial Port 1 RTS (+RS485 OUT)
		8	Serial Port 1 CTS (-RS485 IN)
		9	NC
RS232/RS485:B	P1:B	1	NC
		2	Serial Port 2 RX (+RS485 IN)
		3	Serial Port 2 TX (-RS485 OUT)
		4	NC
		5	Ground
		6	NC
		7	Serial Port 2 RTS (+RS485 OUT)
		8	Serial Port 2 CTS (-RS485 IN)
		9	NC
AC IN	PJ1	1	AC-HOT
		2	AC-NEUT
		3	AC-Ground
AC 24VPWR	PJ2	1	AC-HOT
		2	AC-NEUT
		3	AC-Ground
AC INTF BD	PJ3	1	AC-HOT
		2	AC-NEUT
		3	AC-Ground

Table 5-4. Front Panel Board Connector Pin Diagram

Connector Label	Reference Designator	Pin	Signal Description
MOTHER BOARD	J1	1	Ground
		2	Ground
		3	LCLK – LCD Signal
		4	Ground
		5	Ground
		6	LLP – LCD Signal
		7	LFLM – LCD Signal
		8	LD4 – LCD Signal
		9	LD0 – LCD Signal
		10	LD5 – LCD Signal
		11	LD1 – LCD Signal
		12	LD6 – LCD Signal
		13	LD2 – LCD Signal
		14	LD7 – LCD Signal
		15	LD3 – LCD Signal
		16	LCD Bias Voltage
		17	+5V
		18	Ground
		19	Ground
		20	LCD_ONOFF – LCD Signal
		21	Keypad Row 2 Input
		22	Keypad Row 1 Input
		23	Keypad Row 4 Input
		24	Keypad Row 3 Input
		25	Keypad Col 2 Select
		26	Keypad Col 1 Select
		27	Keypad Col 4 Select
		28	Keypad Col 3 Select
		29	Ground
		30	Ground
		31	Ground

Table 5-4. Front Panel Board Connector Pin Diagram, continued

Connector Label	Reference Designator	Pin	Signal Description
		32	Ground
		33	+24V
		34	+24V
LCD DATA	J2	1	LD0_5V – LCD Signal
		2	LD1_5V – LCD Signal
		3	LD2_5V – LCD Signal
		4	LD3_5V – LCD Signal
		5	LCD_ONOFF_5V – LCD Signal
		6	LFLM_5V – LCD Signal
		7	NC
		8	LLP_5V – LCD Signal
		9	LCLK_5V – LCD Signal
		10	+5V
		11	Ground
		12	-25V
		13	LCD Bias Voltage
		14	Ground
KEYBOARD	J3	1	Keypad Row 1 Input
		2	Keypad Row 2 Input
		3	Keypad Row 3 Input
		4	Keypad Row 4 Input
		5	Keypad Col 1 Select
		6	Keypad Col 2 Select
		7	Keypad Col 3 Select
		8	Keypad Col 4 Select
LCD BACKLIGHT	J4	1	+5V
		2	NC
		3	Ground

Table 5-5. I/O Expansion Board (Optional) Connector Pin Descriptions

Connector Label	Reference Designator	Pin	Signal Description
EXPANSION I/O	J1	1	Analog Voltage Input 1
		2	Analog Voltage Input 2
		3	Analog Voltage Input 3
		4	Ground
		5	Analog Voltage Input 4
		6	Analog Voltage Input 5
		7	Analog Voltage Input 6
		8	Ground
		9	Analog Voltage Input 7
		10	Analog Voltage Input 8
		11	Ground
		12	NC
		13	Current Output Return
		14	Ground
		15	Current Output 1
		16	Current Output Return
		17	Current Output 2
		18	Current Output Return
		19	Current Output 3
		20	Current Output Return
		21	Current Output 4
		22	Current Output Return
		23	Current Output 5
		24	Current Output Return
		25	Current Output 6
MOTHER BD	J2	1	+5V
		2	+24V
		3	+24V
		4	Ground
		5	Ground
		6	Ground

Table 5-5. I/O Expansion Board (Optional) Connector Pin Descriptions, continued

Connector Label	Reference Designator	Pin	Signal Description
		7	+RS485 to Motherboard
		8	-RS485 to Motherboard

Table 5-6. Digital Output Board Connector Pin Descriptions

Connector Label	Reference Designator	Pin	Signal Description
MOTHER BD	J1	1	+5V
		2	+24V
		3	+24V
		4	Ground
		5	Ground
		6	Ground
		7	SPI Reset
		8	SPI Input
		9	SPI Output
		10	SPI Board Select
		11	SPI Clock
DIGITAL OUTPUTS	J2	1	Relay 1 Contact a
		2	Relay 2 Contact a
		3	Relay 3 Contact a
		4	Relay 4 Contact a
		5	Relay 5 Contact a
		6	Relay 6 Contact a
		7	Relay 7 Contact a
		8	Relay 8 Contact a
		9	Relay 9 Contact a
		10	Relay 10 Contact a
		11	NC
		12	Solenoid Drive Output 1
		13	Solenoid Drive Output 2
		14	Solenoid Drive Output 3

Table 5-6. Digital Output Board Connector Pin Descriptions, continued

Connector Label	Reference Designator	Pin	Signal Description
		15	Solenoid Drive Output 4
		16	Solenoid Drive Output 5
		17	Solenoid Drive Output 6
		18	Solenoid Drive Output 7
		19	Solenoid Drive Output 8
		20	Relay 1 Contact b
		21	Relay 2 Contact b
		22	Relay 3 Contact b
		23	Relay 4 Contact b
		24	Relay 5 Contact b
		25	Relay 6 Contact b
		26	Relay 7 Contact b
		27	Relay 8 Contact b
		28	Relay 9 Contact b
		29	Relay 10 Contact b
		30	+24V
		31	+24V
		32	+24V
		33	+24V
		34	+24V
		35	+24V
		36	+24V
		37	+24V

Table 5-7. Measurement Interface Board Connector Pin Descriptions

Connector Label	Reference Designator	Pin	Signal Description
PHOTOMETER	J6	1	Photometer Lamp Intensity Control Voltage Output
		2	Photometer Lamp Intensity Control Voltage Input
		3	Photometer Heater Thermistor

Table 5-7. Measurement Interface Board Connector Pin Descriptions, continued

Connector Label	Reference Designator	Pin	Signal Description
		4	+24V
		5	Ground
		6	Ground
		7	Ground
		8	Ground
DATA	J4	1	Ground
		2	+RS485 from Motherboard
		3	-RS485 from Motherboard
PRES	J12	1	Pressure Sensor Input
		2	Ground
		3	+15V
		4	-15V
FLOW B	J8	1	Sample Flow B Sensor Input
		2	Ground
		3	+15V
		4	-15V
		5	Ground
OZONATOR	J5	1	Ozonator Lamp Intensity Control Voltage Output
		2	Ozonator Lamp Intensity Control Voltage Input
		3	Ozonator Heater Thermistor
		4	+24V
		5	Ground
		6	Ozonator Lamp On/off Control
		7	Ground
		8	Ground
CHA	J9	1	+15V
		2	-15V
		3	Ground
		4	Measurement Frequency A
CHB	J10	1	+15V
		2	-15V

Table 5-7. Measurement Interface Board Connector Pin Descriptions, continued

Connector Label	Reference Designator	Pin	Signal Description
		3	Ground
		4	Measurement Frequency B
FLOW A	J7	1	Sample Flow A Sensor Input
		2	Ground
		3	+15V
		4	-15V
		5	Ground
TEMP	J11	1	Bench Temperature Thermistor
		2	Ground
24V IN	J3	1	+24V
		2	Ground
AC IN	J1	1	AC-HOT
		2	AC-NEUT
		3	AC-Ground
FAN	J17	1	+24V
		2	Ground
AC PUMP	J2	1	AC-HOT
		2	AC-NEUT - Switched
		3	AC-Ground
Z/S SOL.	J13	1	+24V
		2	Zero/Span Solenoid Control
SAMPLE SOL.	J14	1	+24V
		2	Sample Solenoid Control
REF	J15	1	+24V
		2	Reference Solenoid Control
OZ SOL.	J16	1	+24V
		2	Ozone Solenoid Control

Table 5-8. Ozonator Power Supply Connector Pin Descriptions

Connector Label	Reference Designator	Pin	Signal Description
LAMP	J1	1	Ozonator Lamp Voltage Out

Table 5-8. Ozonator Power Supply Connector Pin Descriptions, continued

Connector Label	Reference Designator	Pin	Signal Description
		2	Ozonator Lamp Voltage Return
LAMP HEATER	J2	1	Ground
		2	Ozonator Lamp Thermistor 1
		3	Ozonator Lamp Heater Control
		4	Ground
		5	+24V Heater Current Sense
		6	Ozonator Lamp Thermistor 2
INTF	J3	1	Ozonator Lamp Intensity Control Voltage Input
		2	Ozonator Lamp Intensity Control Voltage Output
		3	Ozonator Heater Thermistor
		4	+24V
		5	Ground
		6	Ozonator Lamp On/off Control
		7	Ground
		8	Ground

Table 5-9. Photometer Power Supply Connector Pin Descriptions

Connector Label	Reference Designator	Pin	Signal Description
LAMP	J1	1	Photometer Lamp Voltage Out
		2	Photometer Lamp Voltage Return
LAMP HEATER	J2	1	Ground
		2	Photometer Lamp Thermistor 1
		3	Photometer Lamp Heater Control
		4	Ground
		5	+24V Heater Current Sense
		6	Photometer Lamp Thermistor 2
INTF	J3	1	Photometer Lamp Intensity Control Voltage Input
		2	Photometer Lamp Intensity Control Voltage Output

Table 5-9. Photometer Power Supply Connector Pin Descriptions, continued

Connector Label	Reference Designator	Pin	Signal Description
		3	Photometer Heater Thermistor
		4	+24V
		5	Ground
		6	Photometer Lamp On/off Control
		7	Ground
		8	Ground

Service Locations

For additional assistance, Thermo Fisher Scientific has service available from exclusive distributors worldwide. Contact one of the phone numbers below for product support and technical information or visit us on the web at www.thermo.com/aqi.

1-866-282-0430 Toll Free

1-508-520-0430 International

Chapter 6 Servicing

This chapter explains how to replace the Model 49i Primary Standard subassemblies. It assumes that a subassembly has been identified as defective and needs to be replaced.

For fault location information refer to the “Preventive Maintenance” chapter and the “Troubleshooting” chapter in this manual.

The service mode in the “Operation” chapter also includes parameters and functions that are useful when making adjustments or diagnosing problems.

For additional service assistance, see “Service Locations” at the end of this chapter.

This chapter includes the following parts information, testing, adjustment, and calibration procedures, and component replacement procedures:

“Safety Precautions” on page 6-3

“Replacement Parts List” on page 6-4

“Firmware Updates” on page 6-4

“Replacement Parts List” on page 6-4

“Cable List” on page 6-6

“External Device Connection Components” on page 6-6

“Removing the Measurement Bench and Lowering the Partition Panel” on page 6-8

“Fuse Replacement” on page 6-9

“Pump Replacement” on page 6-10

“Fan Replacement” on page 6-11

“Analog Output Testing” on page 6-12

- “Analog Output Calibration” on page 6-14
- “Analog Input Calibration” on page 6-15
- “Optical Bench Temperature Calibration” on page 6-17
- “I/O Expansion Board (Optional) Replacement” on page 6-18
- “Digital Output Board Replacement” on page 6-19
- “Motherboard Replacement” on page 6-20
- “Measurement Interface Board Replacement” on page 6-21
- “Front Panel Board Replacement” on page 6-22
- “LCD Module Replacement” on page 6-23
- “Optical Bench Replacement” on page 6-25
- “Photometer Board Replacement” on page 6-26
- “Photometer Lamp Replacement” on page 6-27
- “Photometer Lamp Voltage Adjustment” on page 6-28
- “Sample/Reference Solenoid Replacement” on page 6-29
- “Detector Replacement” on page 6-30
- “Pressure Transducer Replacement” on page 6-31
- “Pressure Transducer Calibration ” on page 6-32
- “Flow Transducer Replacement” on page 6-34
- “Flow Transducer Calibration” on page 6-35
- “Ozonator Lamp Replacement” on page 6-36
- “Ozonator Lamp Heater Replacement” on page 6-37
- “Ozonator Replacement” on page 6-39
- “Ozonator Board Replacement” on page 6-39

“Service Locations” on page 6-40

Safety Precautions

Read the safety precautions before beginning any procedures in this chapter.



WARNING The service procedures in this manual are restricted to qualified service representatives. ▲

If the equipment is operated in a manner not specified by the manufacturer, the protection provided by the equipment may be impaired. ▲

The Model 49*i* Primary Standard is supplied with a three-wire grounding cord. Under no circumstances should this grounding system be defeated. ▲



Equipment Damage Some internal components can be damaged by small amounts of static electricity. A properly grounded antistatic wrist strap must be worn while handling any internal component (Figure 6-1). If an antistatic wrist strap is not available, be sure to touch a grounded metal object before touching any internal components. When the instrument is unplugged, the chassis is not at earth ground. ▲

Handle all printed circuit boards by the edges. ▲

Do not remove the LCD panel or frame from the LCD module. ▲

The LCD polarizing plate is very fragile, handle it carefully. ▲

Do not wipe the LCD polarizing plate with a dry cloth, it may easily scratch the plate. ▲

Do not use alcohol, acetone, MEK or other Ketone based or aromatic solvents to clean the LCD module, use a soft cloth moistened with a naphtha cleaning solvent. ▲

Do not place the LCD module near organic solvents or corrosive gases. ▲

Do not shake or jolt the LCD module. ▲

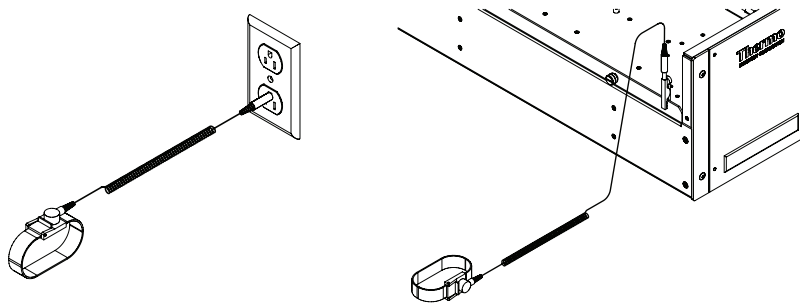









Figure 6-1. Properly Grounded Antistatic Wrist Strap

Firmware Updates

The firmware can be updated by the user in the field via the serial port or over the Ethernet. This includes both the main processor firmware and the firmware in all low-level processors. Refer to the *iPort* manual for the firmware update procedure.

Accessing the Service Mode

If the Service is not displayed on the Main Menu, use the following procedure to display it.

- a. At the Main Menu, press  to scroll to Instrument Controls > press  >  to scroll to **Service Mode** > and press .
- The Service Mode screen appears.
- b. Press  to toggle the Service Mode to ON.
- c. Press  >  to return to the Main Menu.
- d. Return to the procedure.

Replacement Parts List

Table 6-1 lists the replacement parts for the Model 49i Primary Standard major subassemblies. Refer to Figure 6-2 to identify the component location.

Table 6-1. Model 49i Primary Standard Replacement Parts

Part Number	Description
100480-00	Front Panel Pushbutton Board
101491-16	Processor Board
100533-00	Motherboard
100539-00	Digital Output Board

Table 6-1. Model 49i Primary Standard Replacement Parts, continued

Part Number	Description
100542-00	I/O Expansion Board (Optional)
102340-00	Front Panel Connector Board
102496-00	Front Panel Display
101399-00	Transformer, 220-240VAC (Optional)
101863-00	Transformer, 100VAC (Optional)
100874-00	Measurement Interface Board
102554-00	Photometer Board
102458-00	Ozonator Assembly
8645	Ozonator Lamp
100895-00	Ozonator Power Supply Board
101023-00	Pressure Transducer Assembly
102055-00	Flow Transducer
102441-00	Sample/Reference Solenoid Assembly
102443-00	Sample/Reference Solenoid Valve
102455-00	Air Regulator Assembly (Optional)
102439-00	Optical Bench Assembly
8592	Detector Assembly
102472-01	Lamp Heater Assembly
8540	Photometer Lamp
100554-00	Photometer Board
101426-00	Pump 110VAC w/Plate and Fittings
102464-01	Pump, Zero Air Supply 110V (Optional)
102464-02	Pump, Zero Air Supply 220V (Option)
101055-00	AC Receptacle Assembly
100907-00	Fan, 24VDC
8630	Fan Filter
4510	Fuse, 250VAC, 3.0 Amp, SloBlow (for 100VAC and 110VAC models)
14007	Fuse, 250VAC, 1.60 Amp, SloBlow (for 220-240VAC models)
4124	Capillary, Purple, 0.015 ID, (2)
102701-00	Teflon Particulate Filter
14697	Scrubber, Ozone
4291	Charcoal Scrubber Assembly

Cable List

Table 6-2 describes the Model 49i Primary Standard cables. See the “Troubleshooting” chapter for associated connection diagrams and board connector pin descriptions.

Table 6-2. Model 49i Primary Standard Cables

Part Number	Description
101036-00	DC Power Supply, 24V Output
101037-00	115VAC Supply to Measurement Interface Board
101048-00	RS-485/Data
101038-00	AC Power Switch to Motherboard
101364-00	DC Power Supply Status Monitor
101054-00	Motherboard to Front Panel Board
101035-00	DC Power Supply AC Input
101033-00	AC from Receptacle
101377-00	AC to Power Switch
101055-00	Main AC Receptacle Assembly
101706-00	Measurement Interface Board to Photometer Board
102446-00	Measurement Interface Board to Ozonator Board
101267-00	Fan Power Cable

External Device Connection Components

Table 6-3 lists the standard and optional cables and components used for connecting external devices such as PCs and data loggers to an iSeries instrument.

Table 6-3. External Device Connection Components

Part Number	Description
102562-00	Terminal Block and Cable Kit (DB25) (optional)
102556-00	Terminal Block and Cable Kit (DB37) (optional)
102645-00	Cable, DB37M to Open End Cable, Six Feet (optional)
102646-00	Cable, DB37F to Open End, Six Feet (optional)
102659-00	Cable, DB25M to Open End, Six Feet (optional)
6219	Cable, RS-232 (optional)
102888-00	Terminal Board PCB Assembly, DB37F (standard with all instruments)
102891-00	Terminal Board PCB Assembly, DB37M (standard with all instruments)
103084-00	Terminal Board PCB Assembly, DB25M (included with optional I/O Expansion Board in all instruments)

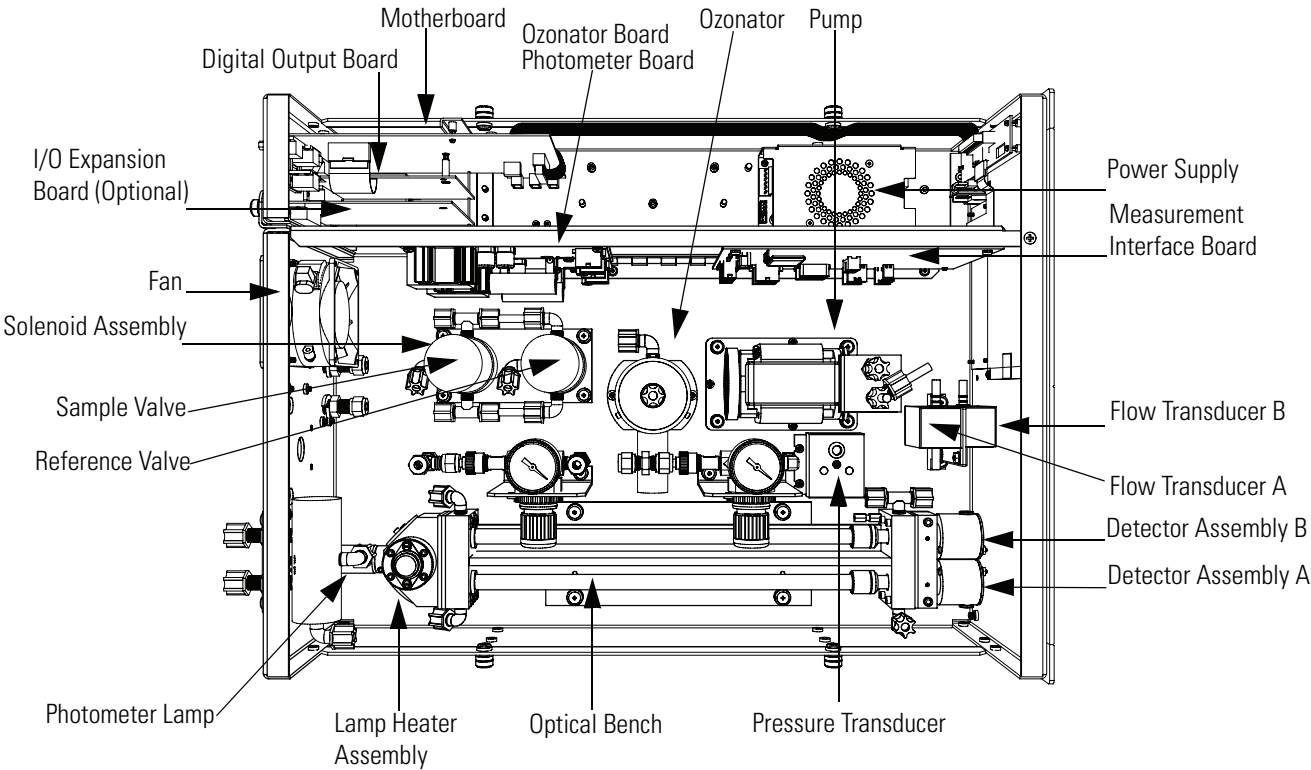

Figure 6-2. Component Layout

Servicing

Removing the Measurement Bench and Lowering the Partition Panel

Removing the Measurement Bench and Lowering the Partition Panel

The measurement bench can be removed and the partition panel can be lowered to improve access to connectors and components. Refer to the following steps when a procedure requires lowering the partition panel (see [Figure 6-3](#)).

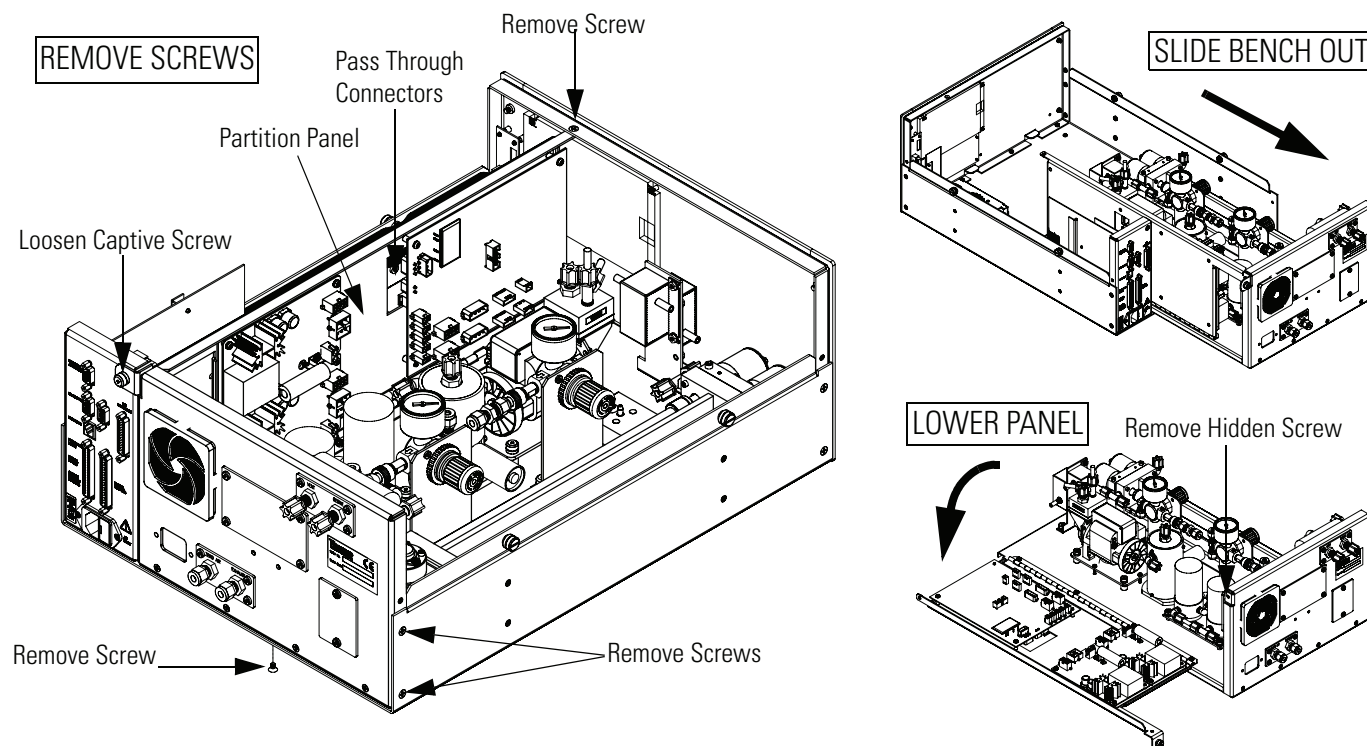

Figure 6-3. Removing the Measurement Bench and Lowering the Partition Panel

Equipment Required:

Philips screwdriver



Equipment Damage Some internal components can be damaged by small amounts of static electricity. A properly grounded antistatic wrist strap must be worn while handling any internal component. ▲

1. Turn instrument OFF and unplug the power cord.
2. If the instrument is mounted in a rack, remove it from the rack.
3. Remove the cover.

4. Disconnect the plumbing connections at the rear of the measurement bench.
5. Disconnect the connectors that pass through the center of the partition panel.
6. Remove two screws from the left side of the case (viewed from rear).
7. Remove one screw from the bottom front of the case.
8. Remove one screw from the top front of the partition panel.
9. While holding the case securely, loosen the captive screw at the rear of the measurement bench, and pull the measurement bench from the rear of the case.
10. Remove the screw at the top rear of the partition panel securing the top of partition panel to the measurement bench, and lower the panel being careful not to put excessive tension on the cables.
11. Replace the measurement bench by following the previous steps in reverse.

Fuse Replacement

Use the following procedure to replace the fuse.

Equipment Required:

Replacement fuses (refer to [“Replacement Parts List”](#) on [page 6-4](#))

1. Turn instrument OFF and unplug the power cord.
2. Remove fuse drawer, located on the AC power connector.
3. If either fuse is blown, replace both fuses.

4. Insert fuse drawer and reconnect power cord.

Pump Replacement

Use the following procedure to replace the pump (see [Figure 6-4](#)). To rebuild the pump, see “Pump Rebuilding” in the “Preventive Maintenance” chapter.

Equipment Required:

110V pump

Philips screwdriver



Equipment Damage Some internal components can be damaged by small amounts of static electricity. A properly grounded antistatic wrist strap must be worn while handling any internal component. ▲

1. Turn instrument OFF, unplug the power cord, and remove the cover.
2. Disconnect pump power line from AC PUMP connector on the measurement interface board.

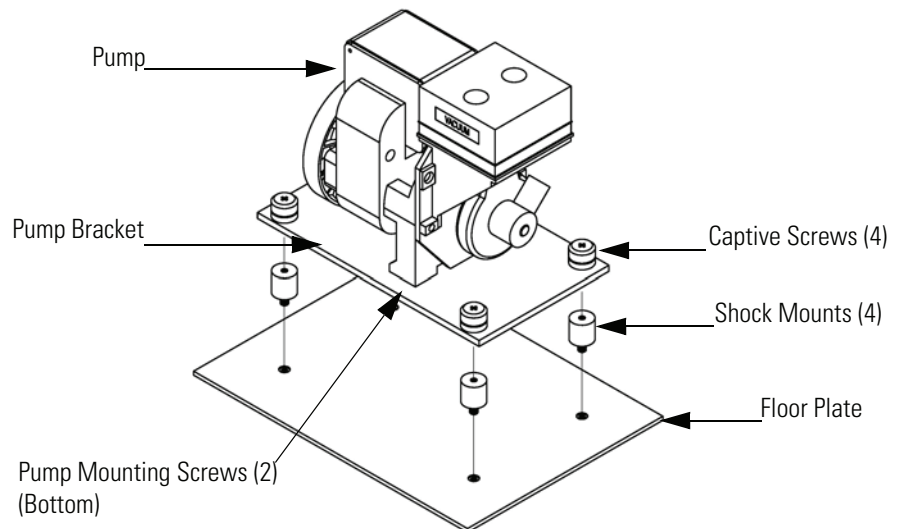

Figure 6-4. Replacing the Pump

3. Remove both lines from pump.
4. Loosen the four captive screws on the mounting plate and remove the pump.

5. Install the new pump by following the previous steps in reverse.

Fan Replacement

Use the following procedure to replace the fan (Figure 6-5).

Equipment Required:

Fan

Philips screwdriver



Equipment Damage Some internal components can be damaged by small amounts of static electricity. A properly grounded antistatic wrist strap must be worn while handling any internal component. ▲

1. Turn instrument OFF, unplug the power cord, and remove the cover.
2. Remove the fan guard from the fan and remove the filter.
3. Pull the power connector off the fan.
4. Remove the four fan mounting screws and remove the fan.
5. Install a new fan following the previous steps in reverse.

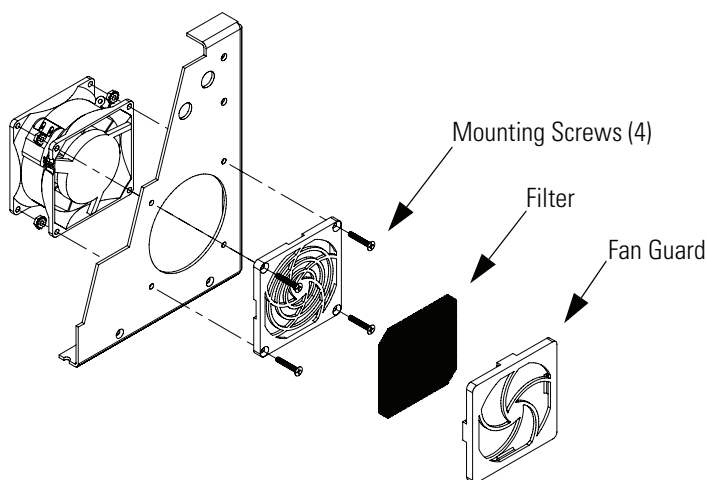

Figure 6-5. Replacing a Fan





Analog Output Testing

The analog outputs should be tested if the concentration value on the front panel display disagrees with the analog outputs. To check the analog outputs, you connect a meter to an analog output channel (voltage or current) and compare the meter reading with the output value displayed on the Test Analog Outputs screen.



Equipment Required:

Multimeter

Use the following procedure to test the analog outputs.

1. Connect a meter to the channel to be tested. [Figure 6-6](#) shows the analog output pins and [Table 6-4](#) identifies the associated channels.
2. From the Main Menu, press  to scroll to Diagnostics, press  >  to scroll to Test Analog Outputs, and press .

The Test Analog Outputs screen displays.

3. Press  to scroll to the channel corresponding to the rear panel terminal pins where the meter is connected, and press .

The Set Analog Outputs screen displays.

4. Press  to set the output to zero.

The Output Set To line displays Zero.

5. Check that the meter is displaying a zero value. If the meter reading differs by more than one percent, the analog outputs should be adjusted. Refer to the “Analog Output Calibration” procedure that follows.

6. Press  to set the output to full scale.

The Output Set To line displays Full Scale.

7. Check that the meter is displaying the full scale value. If the meter reading differs by more than one percent, the analog outputs should be

adjusted. Refer to the “Analog Output Calibration” procedure that follows.

8. Press  to reset the analog outputs to normal.

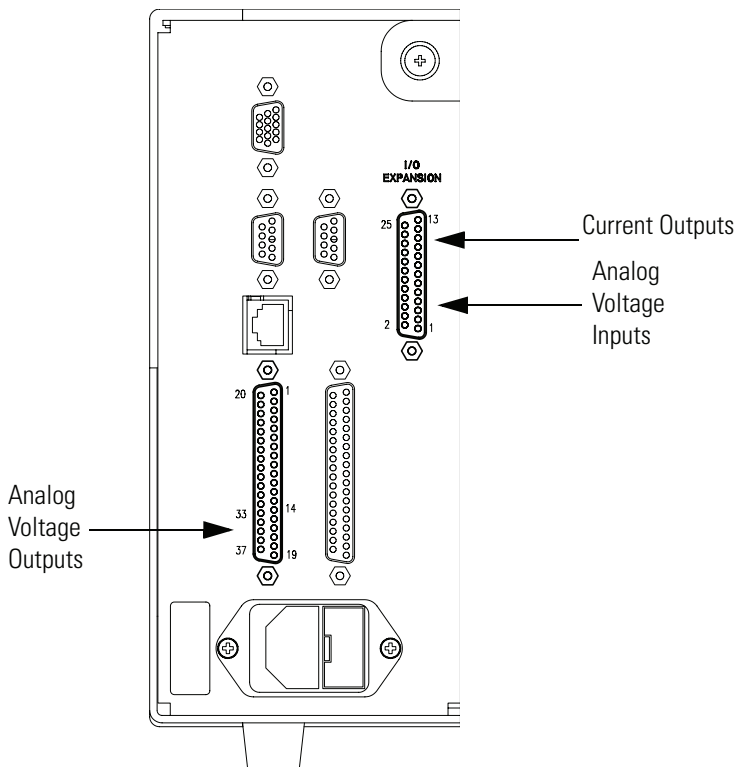

Figure 6-6. Rear Panel Analog Input and Output Pins

Table 6-4. Analog Output Channels and Rear Panel Pin Connections

Voltage Channel	Pin	Current Channel	Pin
1	14	1	15
2	33	2	17
3	15	3	19
4	34	4	21
5	17	5	23
6	36	6	25
Ground	16, 18, 19, 35, 37	Current Output Return	13, 16, 18, 20, 22, 24

Table 6-5. Analog Input Channels and Rear Panel Pin Connections





Input Channel	Pin
1	1
2	2
3	3
4	5
5	6
6	7
7	9
8	10
Ground	4, 8, 11, 14

Analog Output Calibration

Use the following procedure to calibrate the analog outputs if a meter reading in the “Analog Output Testing” procedure differed by more than one percent or after replacing the optional I/O expansion board.



Equipment Required:

Multimeter

1. Connect a meter to the channel to be adjusted and set to voltage or current as appropriate. [Figure 6-6](#) shows the analog output pins and [Table 6-4](#) identifies the associated channels.
2. From the Main Menu, press  to scroll to Service, press  >  to scroll to Analog Out Calibration, and press .









The Analog Output Cal screen displays

Note If Service is not displayed, refer to “[Accessing the Service Mode](#)” on [page 6-4](#), then return to the beginning of this step. ▲

3. At the Analog Output Cal screen, press  to scroll to the voltage channel or current channel corresponding to the rear panel terminal pins where the meter is connected, then press .
4. With the cursor at Calibrate Zero, press .

The Analog Output Cal line displays Zero

Note When calibrating the analog output, always calibrate zero first and then calibrate full scale. ▲

5. Use   until the meter reads the value shown in the Set Output To line, then press  to save the value.
6. Press  to return to the previous screen.
7. Press   to select Calibrate Full Scale.
8. Use   until the meter reads the value shown in the Set Output To line, then press  to save the value.

Analog Input Calibration

Use the following procedures to calibrate the analog inputs after replacing the optional I/O expansion board. These procedures include selecting analog input channels, calibrating them to zero volts, and then calibrating them to full scale using a known voltage source.



Calibrating the Input Channels to Zero Volts

Use the following procedure to calibrate the input channels to zero volts.

1. From the Main Menu, press  to scroll to Service, press  >  to scroll to Analog Input Calibration, and press .

The Analog Input Cal screen displays.



Note If Service is not displayed, refer to “[Accessing the Service Mode](#)” on [page 6-4](#), then return to the beginning of this step. ▲

2. At the Analog Input Cal screen, press  to scroll to a channel, and press .
3. With the cursor at Calibrate Zero, press .

The screen displays the input voltage for the selected channel.

4. Make sure that nothing is connected to the channel input pins and press  to calibrate the input voltage on the selected channel to zero volts.

The screen displays 0.00 V as the voltage setting.





5. Press  >  to return to the Analog Input Cal screen and repeat Steps 2 through 4 to calibrate other input channels to zero as necessary.
6. Continue with the “Calibrating the Input Channels to Full Scale” procedure that follows.

Calibrating the Input Channels to Full Scale





Use the following procedure to calibrate the input channels to full scale by applying a known voltage to the channels.

Equipment Required:





DC voltage source (greater than 0 volts and less than 10 volts)



1. Connect the known DC voltage source to the input channel (1-8) to be calibrated. [Figure 6-6](#) shows the analog input pins and [Table 6-5](#) identifies the associated channels.
2. From the Main Menu, press  to scroll to Service, press  >  to scroll to Analog Input Calibration, and press .

The Analog Input Cal screen displays input channels 1-8.

3. At the Analog Input Cal screen, press  to scroll to the channel selected in Step 1, and press .
4. Press  to scroll to Calibrate Full Scale, and press .

The screen displays the current input voltage for the selected channel.

5. Use   and   to enter the source voltage, and press  to calibrate the input voltage for the selected channel to the source voltage.

6. Press  >  to return to the input channels display and repeat Steps 3-5 to calibrate other input channels to the source voltage as necessary.

Optical Bench Temperature Calibration

Use the following procedure to calibrate the optical bench temperature.

Equipment Required:

Calibrated thermometer or 10K \pm 1% Resistor



WARNING The service procedures in this manual are restricted to qualified service representatives. ▲

If the equipment is operated in a manner not specified by the manufacturer, the protection provided by the equipment may be impaired. ▲







Equipment Damage Some internal components can be damaged by small amounts of static electricity. A properly grounded antistatic wrist strap must be worn while handling any internal component. ▲

1. Remove the instrument cover.
2. Tape the thermistor (plugged into the measurement interface board) to a calibrated thermometer.





Note Since the thermistors are interchangeable to an accuracy of ± 0.2 °C, and have a value of 10K ohms at 25 °C, an alternate procedure is to connect an accurately known 10K resistor to the thermistor input (TEMP) on the measurement interface board, and enter the temperature reading. ▲

A 1 °C change corresponds to a $\pm 5\%$ change in resistance, thus this alternative procedure can be quite accurate as a check; however, it clearly is not NIST traceable. ▲

3. From the Main Menu, press  to scroll to Service > press  >  to scroll to **Temperature Calibration** > and press .

The Calibrate Bench Temp screen appears.

Note If Service is not displayed, refer to ““Accessing the Service Mode” on page 6-4, then return to the beginning of this step. ▲

4. Wait at least 10 seconds for the reading to stabilize, use   and   to enter the known temperature, and press  to save the temperature value.
5. Install the cover.

I/O Expansion Board (Optional) Replacement

Use the following procedure to replace the optional I/O expansion board (Figure 6-7).

Note After replacing the optional I/O expansion board, calibrate the current outputs and the analog voltage inputs. See the “Analog Output Calibration” procedure and the “Analog Input Calibration” procedure in this chapter. ▲

Equipment Required:

I/O expansion board

Nut driver, 3/16-inch



Equipment Damage Some internal components can be damaged by small amounts of static electricity. A properly grounded antistatic wrist strap must be worn while handling any internal component. ▲

1. Turn instrument OFF, unplug the power cord, and remove the cover.
2. Unplug the I/O expansion board cable from the EXPANSION BD connector on the motherboard.
3. Remove the two standoffs holding the I/O expansion board connector to the rear panel (Figure 6-8).
4. Pop off the board from the mounting studs and remove the board.
5. To install the I/O expansion board, follow previous steps in reverse.

6. Calibrate the analog current outputs and the analog voltage inputs as described earlier in this chapter.

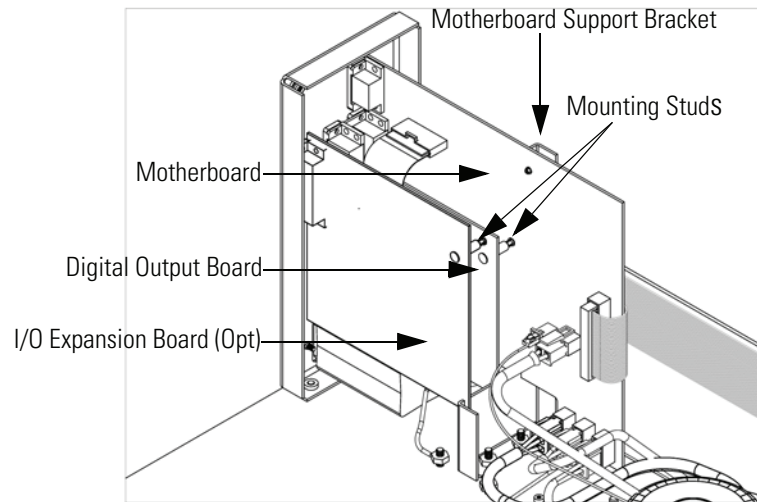

Figure 6-7. Replacing the I/O Expansion Board (Optional)

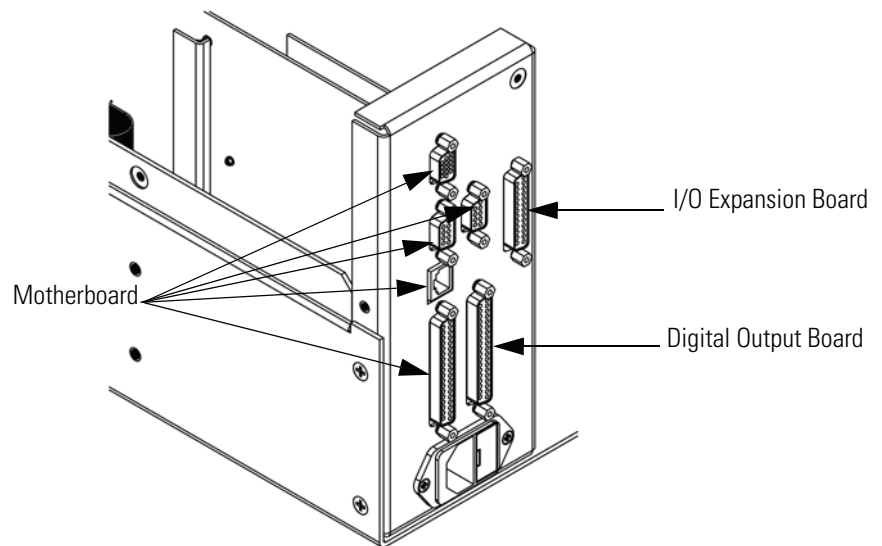

Figure 6-8. Rear Panel Board Connectors

Digital Output Board Replacement

Use the following procedure to replace the digital output board (Figure 6-7).

Equipment Required:

Digital output board

Nut driver, 3/16-inch



Equipment Damage Some internal components can be damaged by small amounts of static electricity. A properly grounded antistatic wrist strap must be worn while handling any internal component. ▲

1. Turn instrument OFF, unplug the power cord, and remove the cover.
2. Remove the I/O expansion board (optional), if used. See the “I/O Expansion Board Replacement” procedure in this chapter.
3. Disconnect the digital output board ribbon cable from the motherboard.
4. Using the nut driver, remove the two standoffs securing the board to the rear panel (Figure 6-8).
5. Pop off the digital output board from the mounting studs and remove the board.
6. To install the digital output board, follow previous steps in reverse.

Motherboard Replacement

Use the following procedure to replace the motherboard (Figure 6-7).

Equipment Required:

Motherboard

Philips screwdriver

Nut driver, 3/16-inch



Equipment Damage Some internal components can be damaged by small amounts of static electricity. A properly grounded antistatic wrist strap must be worn while handling any internal component. ▲

1. Turn instrument OFF, unplug the power cord, and remove the cover.

2. Remove the I/O expansion board (optional), if used. See the “I/O Expansion Board Replacement” procedure in this chapter.
3. Remove the digital output board. See the “Digital Output Board Replacement” procedure in this chapter.
4. Unplug all connectors from the motherboard. Note connector locations to facilitate reconnection.
5. Using the nut driver, remove the eight standoffs securing the board to the rear panel.
6. Pop off the motherboard from motherboard support bracket, and remove the motherboard.
7. To install the motherboard, follow previous steps in reverse.
8. Calibrate the analog voltage outputs as described earlier in this chapter (all ranges).

Measurement Interface Board Replacement

Use the following procedure to replace the measurement interface board (Figure 6-9).

Equipment Required:

Measurement interface board

Philips screwdriver



Equipment Damage Some internal components can be damaged by small amounts of static electricity. A properly grounded antistatic wrist strap must be worn while handling any internal component. ▲

1. Refer to “Removing the Measurement Bench and Lowering the Partition Panel” in this chapter to lower the partition panel, then proceed to the next step below.

Servicing

Front Panel Board Replacement

2. Unplug all connectors. Note the locations of the connectors to facilitate reconnection.
3. Remove the two retaining screws from the top of the board.
4. Pop off the measurement interface board from the two mounting studs and remove the board.

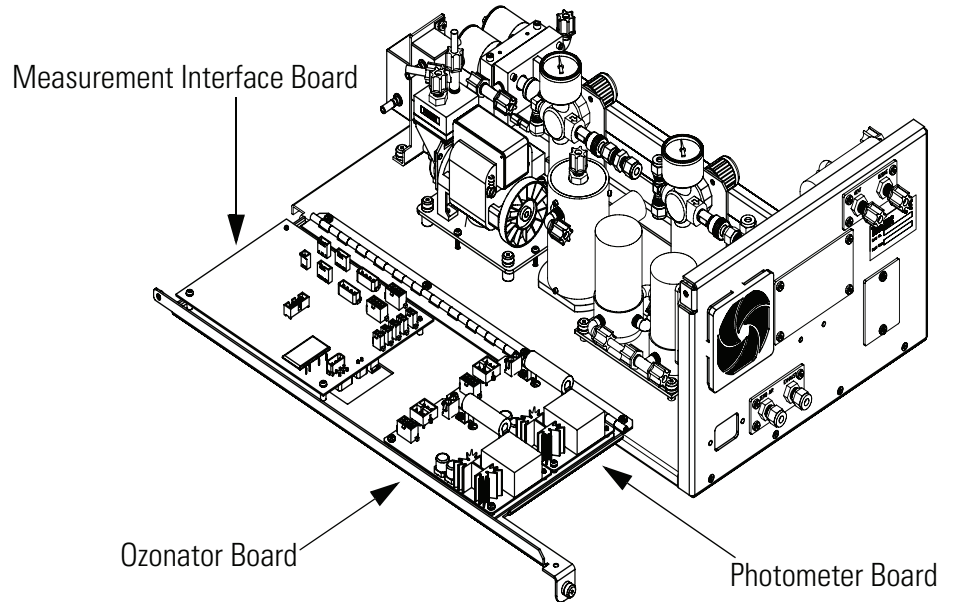

Figure 6-9. Replacing the Measurement Interface Board

5. To install the measurement interface board, follow previous steps in reverse.
6. Re-install the measurement bench. Refer to “Removing the Measurement Bench and Lowering the Partition Panel” in this chapter.
7. Calibrate the pressure transducer, flow transducers, and bench temperature sensor as described earlier in this chapter.

Front Panel Board Replacement

Use the following procedure to replace the front panel board ([Figure 6-10](#)).

Equipment Required:

Front panel board



Equipment Damage Some internal components can be damaged by small amounts of static electricity. A properly grounded antistatic wrist strap must be worn while handling any internal component. ▲

1. Turn instrument OFF, unplug the power cord, and remove the cover.
2. Remove the three ribbon cables and the two-wire connector from the front panel board.
3. Pop off the board from the two top mounting studs and remove the board by lifting it up and off the slotted bottom support.
4. Replace the front panel board by following previous steps in reverse.

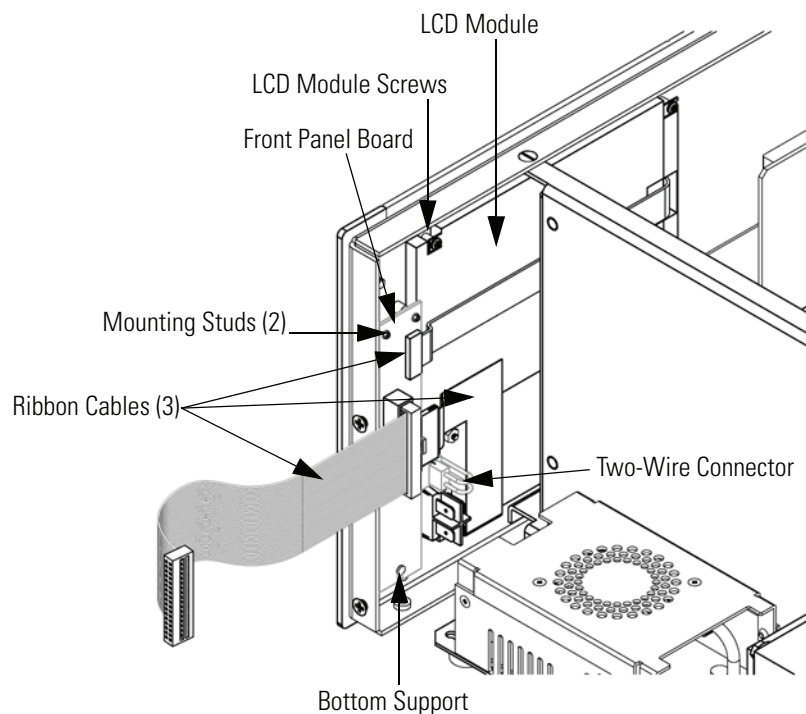

Figure 6-10. Replacing the Front Panel Board and the LCD Module

LCD Module Replacement

Use the following procedure to replace the LCD module ([Figure 6-10](#)).

Equipment Required:

LCD module

Philips screwdriver



CAUTION If the LCD panel breaks, do not let the liquid crystal contact your skin or clothes. If the liquid crystal contacts your skin or clothes, wash it off immediately using soap and water. ▲



Equipment Damage Some internal components can be damaged by small amounts of static electricity. A properly grounded antistatic wrist strap must be worn while handling any internal component. ▲

Do not remove the LCD panel or frame from the LCD module. ▲

The LCD polarizing plate is very fragile, handle it carefully. ▲

Do not wipe the LCD polarizing plate with a dry cloth, it may easily scratch the plate. ▲

Do not use alcohol, acetone, MEK or other Ketone based or aromatic solvents to clean the module, use a soft cloth moistened with a naphtha cleaning solvent. ▲

Do not place the LCD module near organic solvents or corrosive gases. ▲

Do not shake or jolt the LCD module. ▲

1. Turn instrument OFF, unplug the power cord, and remove the cover.
2. Disconnect the ribbon cable and the two-wire connector from the front panel board.
3. Remove the four screws at the corners of the LCD module.
4. Slide the LCD module out towards the right and rear of the instrument.
5. Replace the LCD module by following previous steps in reverse.

Optical Bench Replacement

Use the following procedure to replace the optical bench (Figure 6-11).

Equipment required:

Optical bench

Screwdriver, flatblade



Equipment Damage Some internal components can be damaged by small amounts of static electricity. A properly grounded antistatic wrist strap must be worn while handling any internal component. ▲

Use the following procedure to replace the optical bench.

1. Turn instrument OFF, unplug the power cord, and remove the cover.
2. Disconnect the plumbing and electrical connections.
3. Remove the two screws from the photometer lamp access hole cover on the rear panel and remove the cover.
4. Loosen the captive screws (4) securing the optical bench to the floor plate (Figure 6-11) and remove the bench by first moving the photometer slightly towards the rear through the lamp access hole and then lifting up and towards the front.
5. Perform the previous steps in reverse to install the new optical bench.
6. Calibrate the instrument. Refer to the “Calibration” chapter in this manual.

Servicing

Photometer Board Replacement

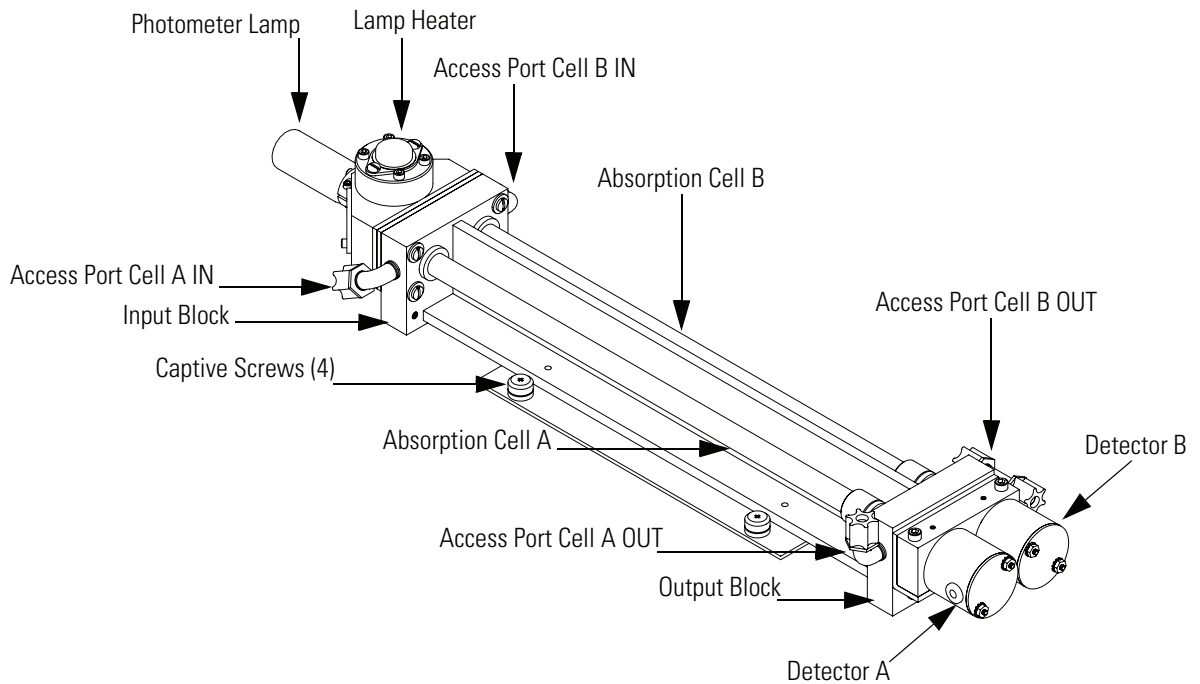

Figure 6-11. Replacing the Optical Bench

Photometer Board Replacement

Use the following procedure to replace the photometer board ([Figure 6-9](#)).

Equipment required:

Photometer board

Philips screwdriver



Equipment Damage Some internal components can be damaged by small amounts of static electricity. A properly grounded antistatic wrist strap must be worn while handling any internal component. ▲

Use the following procedure to replace the photometer board.

1. Turn instrument OFF, unplug the power cord, and remove the cover.
2. Remove the connection cables from the board. Note the locations to facilitate reconnection.

3. Remove the two screws from the top of the board.
4. Pop off the board from the bottom mounting studs and remove the board.
5. To install the new photometer board, follow previous steps in reverse.

Photometer Lamp Replacement

Equipment required:

Photometer lamp

Allen wrench, 7/64-inch and 3/32-inch

Screwdriver - flat - medium size



Equipment Damage Some internal components can be damaged by small amounts of static electricity. A properly grounded antistatic wrist strap must be worn while handling any internal component. ▲

Use the following procedure to replace the photometer lamp.

1. Turn instrument OFF, unplug the power cord, and remove the cover.
2. Disconnect the photometer lamp cable from the LAMP connector on the photometer board.
3. Remove the two retaining screws from the rear panel access hole cover on the rear panel and remove the cover.
4. Slide the insulation off the end of the lamp.
5. Loosen Allen screw on lamp clamp.
6. Loosen two screws holding the clamp to the optical bench.

Servicing





Photometer Lamp Voltage Adjustment

- Carefully slide lamp out of bench and instrument case through access hole.
- Carefully slide new lamp into place until it bottoms. Loosely tighten the Allen screw on clamp. Tighten two screws holding the clamp to the optical bench. Pull the lamp out approximately 1/32-inch to 1/16-inch to allow for expansion when the lamp warms up; tighten Allen screw on the clamp.
- Plug new photometer lamp cable into the LAMP connector on the photometer board.
- Slide the insulation back on the end of the lamp.
- Replace access hole cover and secure with the two retaining screws.
- Re-install the instrument cover.
- Reconnect power and turn instrument ON.
- After lamp has stabilized (approximately 15 minutes), adjust the lamp voltage in the Service Mode menu until the output from each detector is about 100 kHz.

Photometer Lamp Voltage Adjustment



Use the following procedure to adjust the photometer lamp voltage until the output from each detector is approximately 100 kHz.

Note After turning power ON, wait for the lamp to stabilize (approximately 15 minutes) before beginning the following lamp voltage adjustment procedure. ▲

- From the Main Menu, press  to scroll to Service > press  >  to scroll to **Lamp Setting** > and press .

The Bench Lamp Setting screen appears.

Note If Service is not displayed, refer to “[Accessing the Service Mode](#)” on [page 6-4](#), then return to the beginning of this step. ▲

2. At the Bench Lamp Setting screen, use   to increment/decrement the Lamp Setting % until Cell A Int and Cell B Int indicate approximately 100,000 Hz.
3. Press  to save the setting.

Sample/Reference Solenoid Replacement

Use the following procedure to replace a sample/reference solenoid valve.

Equipment required:

Solenoid

Flatblade screwdriver

Open-end wrench, 5/8-inch



Equipment Damage Some internal components can be damaged by small amounts of static electricity. A properly grounded antistatic wrist strap must be worn while handling any internal component. ▲

1. Turn instrument OFF, unplug the power cord, and remove the cover.
2. Disconnect the Sample and Ref connection cables from the measurement interface board.
3. Remove the plumbing from the solenoids.
4. Loosen the four captive screws and lift out the solenoids and the solenoid plate.
5. Remove the solenoid retaining nuts from the underside of the solenoid plate and remove the faulty solenoid.

6. Replace the new solenoid by following the previous steps in reverse making sure that all connections are tight.
7. Perform a leak test. Refer to the “Solenoid Leaks” procedure in the “Preventive Maintenance” chapter.

Detector Replacement

Use the following procedure to replace a detector (Figure 6-11).

Equipment Required:

Detector assembly

Allen wrench, 9/64-inch and 1/16-inch



Equipment Damage Some internal components can be damaged by small amounts of static electricity. A properly grounded antistatic wrist strap must be worn while handling any internal component. ▲

1. Turn instrument OFF, unplug the power cord, and remove the cover.
2. Disconnect the detector electrical connections (CHA and CHB) from the measurement interface board.
3. Loosen the two screws securing the detector clamping block to the optical bench and remove the clamping block and detectors (Figure 6-12).

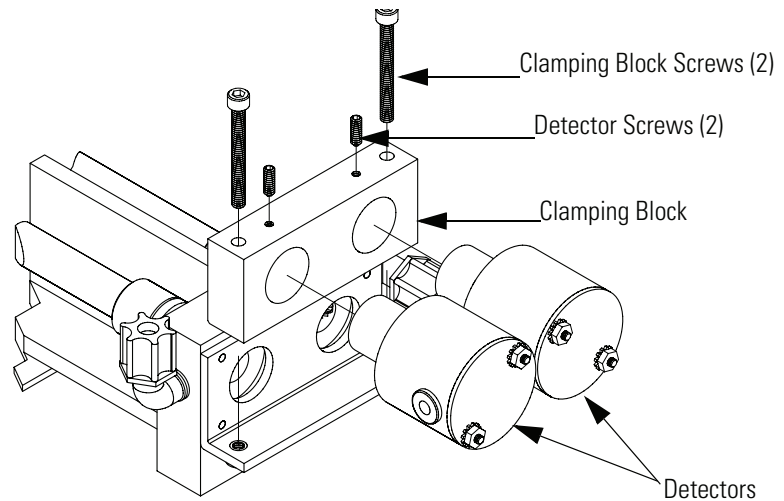

Figure 6-12. Replacing the Detectors

4. Loosen the Allen screw(s) securing the detector(s) in detector block and remove the detector(s).
5. Install the new detector(s) by following the above steps in reverse.
6. Calibrate the instrument. Refer to the “Calibration” chapter in this manual.

Pressure Transducer Replacement

Use the following procedure to replace the pressure transducer.

Equipment Required:

Pressure transducer assembly

Philips screwdriver



Equipment Damage Some internal components can be damaged by small amounts of static electricity. A properly grounded antistatic wrist strap must be worn while handling any internal component. ▲

1. Turn instrument OFF, unplug the power cord, and remove the cover.

2. Disconnect plumbing from the pressure transducer assembly. Note the plumbing connections to facilitate reconnection.
3. Disconnect the pressure transducer PRESS connector from the measurement interface board.
4. Loosen the two pressure transducer retaining screws and remove the pressure transducer by sliding it towards the front of the instrument.
5. Install the new pressure transducer assembly by following the previous steps in reverse.
6. Calibrate the pressure transducer. Refer to the “Pressure Transducer Calibration” procedure that follows.

Pressure Transducer Calibration

Use the following procedure to calibrate the pressure transducer.

Equipment Required:

Vacuum pump



WARNING The service procedures in this manual are restricted to qualified service representatives. ▲

If the equipment is operated in a manner not specified by the manufacturer, the protection provided by the equipment may be impaired. ▲



Equipment Damage Some internal components can be damaged by small amounts of static electricity. A properly grounded antistatic wrist strap must be worn while handling any internal component. ▲





Note An error in the zero setting of the pressure transducer does not introduce a measurable error in the output concentration reading. Therefore, if only a barometer is available and not a vacuum pump, only adjust the span setting.

A rough check of the pressure accuracy can be made by obtaining the current barometric pressure from the local weather station or airport and comparing it to the pressure reading. However, since these pressures are usually corrected to sea level, it may be necessary to correct the reading to local pressure by subtracting 0.027 mm Hg per foot of altitude.

Do not try to calibrate the pressure transducer unless the pressure is known accurately. ▲

1. Remove the cover.

2. Disconnect the tubing from the pressure transducer and connect a vacuum pump known to produce a vacuum less than 1 mm Hg.

3. From the Main Menu, press  to scroll to Service > press  >  to scroll to **Pressure Calibration** > and press .

The Pressure Sensor Cal screen appears.

Note If Service is not displayed, refer to “[Accessing the Service Mode](#)” on [page 6-4](#), then return to the beginning of this step. ▲



4. At the Pressure Sensor Cal screen, press  to select **Zero**.

The Calibrate Pressure Zero screen appears.





5. Wait at least 10 seconds for the zero reading to stabilize, then press  to save the zero pressure value.

6. Disconnect the pump from the pressure transducer.

7. Press  to return to the Pressure Sensor Cal screen.

8. At the Pressure Sensor Cal screen, press   to select **Span**.

The Calibrate Pressure Span screen appears.

9. Wait at least 10 seconds for the ambient reading to stabilize, use   and   to enter the known barometric pressure, and press  to save the pressure value.
10. Reconnect the instrument tubing to the pressure transducer.
11. Install the cover.

Flow Transducer Replacement

Use the following procedure to replace the flow transducer.

Equipment Required:

Flow transducer

Philips screwdriver

Wrench, 5/16-inch



Equipment Damage Some internal components can be damaged by small amounts of static electricity. A properly grounded antistatic wrist strap must be worn while handling any internal component. ▲

1. Turn instrument OFF, unplug the power cord, and remove the cover.
2. Disconnect plumbing from the flow transducer.
3. Disconnect the flow transducer cable (FLOW A or FLOW B) from the measurement interface board.
4. Loosen the retaining nuts (2) and remove the faulty flow transducer from the mounting bracket.
5. Install the new flow transducer by following the previous steps in reverse.
6. Calibrate the flow transducer. Refer to the “Flow Transducer Calibration” procedure that follows.

Flow Transducer Calibration

Use the following procedure to calibrate the flow transducer.

Equipment Required:

Flow sensor







WARNING The service procedures in this manual are restricted to qualified service representatives. ▲

If the equipment is operated in a manner not specified by the manufacturer, the protection provided by the equipment may be impaired. ▲



Equipment Damage Some internal components can be damaged by small amounts of static electricity. A properly grounded antistatic wrist strap must be worn while handling any internal component. ▲

1. Remove the cover.
2. Disconnect the pump cable from AC PUMP connector on the measurement interface board.
3. From the Main Menu, press  to scroll to Service > press  >  to scroll to **Flow A Calibration or Flow B Calibration** > and press .









Depending on your selection, the Flow A Sensor Cal or Flow B Sensor Cal screen appears. For this procedure, Flow A Sensor Cal is used.

Note If Service is not displayed, refer to “[Accessing the Service Mode](#)” on [page 6-4](#), then return to the beginning of this step. ▲

4. At the Flow A Sensor Cal screen, press  to select **Zero**.

The Calibrate Flow A Zero screen appears.

5. Wait at least 10 seconds for the zero reading to stabilize, then press  to save the zero flow value.

6. Reconnect the pump cable to the AC PUMP connector on the measurement interface board.
7. Connect a calibrated flow sensor at the SAMPLE bulkhead on the rear panel.
8. Press  to return to the Flow A Sensor Cal screen.
9. At the Flow A Sensor Cal screen, press   to select **Span**.
The Calibrate Flow A Span screen appears.
10. Wait at least 10 seconds for the reading to stabilize, use   and   to enter the flow sensor reading, and press  to save the value.
11. Install the cover.

Ozonator Lamp Replacement

Use the following procedure to replace the ozonator lamp.

Equipment Required:

Ozonator lamp

Allen wrench, 7/64-inch



Equipment Damage Some internal components can be damaged by small amounts of static electricity. A properly grounded antistatic wrist strap must be worn while handling any internal component. ▲

1. Turn instrument OFF, unplug the power cord, and remove the cover.

2. Unplug the ozonator lamp cable from the LAMP connector on ozonator board (Figure 6-13).

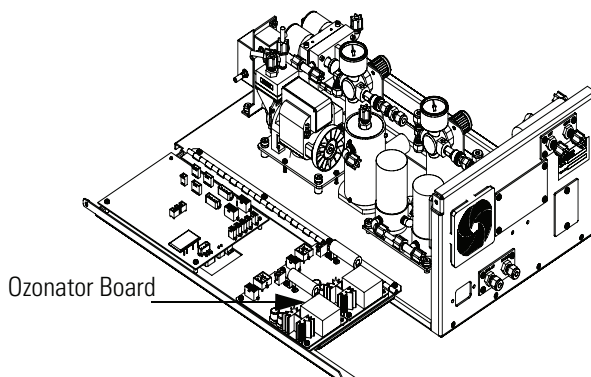

Figure 6-13. Ozonator Board Location

3. Slide insulation off the lamp handle onto the lamp cord.
4. Loosen both lamp clamp screws.
5. Carefully slide lamp out of ozonator housing.
6. Slide insulation off of old lamp and slide onto new lamp.
7. Carefully slide new lamp into ozonator housing until it bottoms. Pull lamp out approximately 1/16-inch (to allow for expansion when the lamp warms up) and tighten the Allen screws on the clamp.
8. Slide the insulation onto lamp against the ozonator assembly.
9. Re-connect the ozonator LAMP connector to the ozonator board.
10. Replace the cover and reconnect power.

Ozonator Lamp Heater Replacement

Use the following procedure to replace the ozonator lamp heater.

Equipment Required:

Servicing

Ozonator Lamp Heater Replacement

Ozonator lamp heater

Allen wrenches: 3/32-inch, 7/64-inch

Philips screwdriver

Heat conductive compound



Equipment Damage Some internal components can be damaged by small amounts of static electricity. A properly grounded antistatic wrist strap must be worn while handling any internal component. ▲

1. Turn instrument OFF, unplug the power cord, and remove the cover.
2. Unplug heater cable from the LAMP HEATER and LAMP connectors on the ozonator board (Figure 6-13).
3. Disconnect plumbing from the ozonator.
4. Remove the two screws securing the ozonator to the floor plate and remove the ozonator.
5. Remove bottom flange of ozonator housing.
6. Remove ozonator lamp heater block from ozonator by removing four Allen screws.
7. Coat new lamp heater block with thin film of heat conductive compound.
8. Install new ozonator lamp heater block by following the above procedure in reverse.
9. Re-install the instrument cover.

Ozonator Replacement

Use the following procedure to replace the ozonator.

Equipment Required:

Philips screwdriver



Equipment Damage Some internal components can be damaged by small amounts of static electricity. A properly grounded antistatic wrist strap must be worn while handling any internal component. ▲

1. Turn instrument OFF, unplug the power cord, and remove the cover.
2. Unplug heater cable from the LAMP HEATER and LAMP connectors on the ozonator board (Figure 6-13).
3. Disconnect plumbing from the ozonator.
4. Remove the ozonator by removing the two screws securing the ozonator to the floor plate and lifting the ozonator straight up.
5. Install new ozonator by following the above procedure in reverse.
6. Re-install the instrument cover.

Ozonator Board Replacement

Use the following procedure to replace the ozonator board (Figure 6-13).

Equipment Required:

Ozonator board

Philips screwdriver



Equipment Damage Some internal components can be damaged by small amounts of static electricity. A properly grounded antistatic wrist strap must be worn while handling any internal component. ▲

1. Turn instrument OFF, unplug the power cord, and remove the cover.

2. Remove the connection cables from the board.
3. Remove the two screws from the top of the board.
4. Pop off the board from the bottom mounting studs and remove the board.
5. To install the new ozonator board, follow previous steps in reverse.

Service Locations

For additional assistance, service is available from exclusive distributors worldwide. Contact one of the phone numbers below for product support and technical information or visit us on the web at www.thermo.com/aqi.

1-866-282-0430 Toll Free

1-508-520-0430 International

Chapter 7 System Description

This chapter describes the function and location of the system components, provides an overview of the software structure, and includes a description of the system electronics and input/output connections and functions.

- “Hardware” on page 7-1 describes the analyzer components.
- “Software” on page 7-3 provides an overview of the software organization and detailed information on the software tasks.
- “Electronics” on page 7-5 describes the system boards, assemblies, and connectors.
- “I/O Components” on page 7-8 describes the input and output communication functions and components.

Hardware

The Model 49i Primary Standard components include:

- Optical bench with photometer lamp
- Detector system
- Flow transducers
- Pressure transducer
- Ozonator assembly
- Ozonator lamp power supply
- Photometer lamp power supply
- Optical bench temperature thermistor
- Pump
- Sample/Reference Solenoid Valves

System Description

Hardware

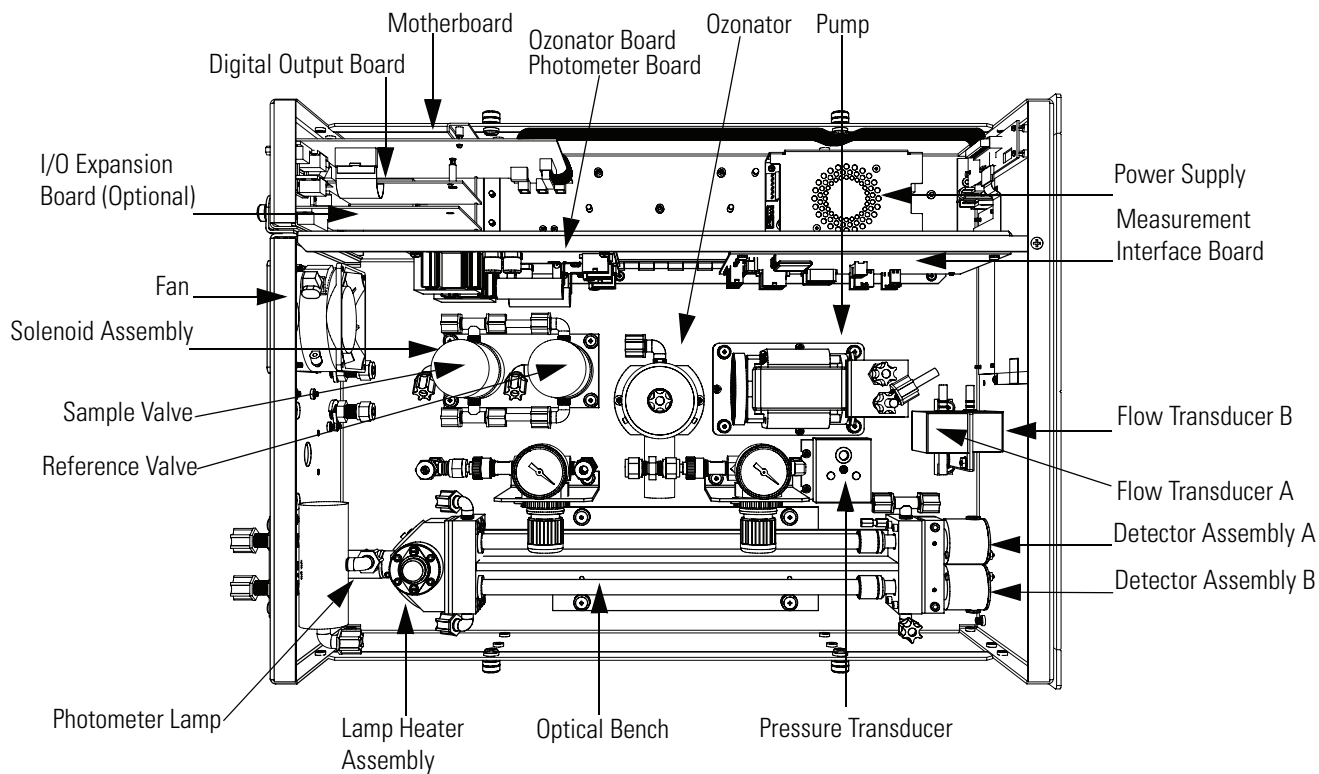

Figure 7-1. Hardware Components

Optical Bench with Photometer Lamp

The optical bench has two airtight chambers that contain the sample and reference gases with a common photometer lamp at one end and two individual detectors at the other end.

Detector System

The photo-diode in each detector transmits light intensity information to the measurement interface board for sample measurement computations.

Flow Transducers

Flow transducers monitor the flow of the sample and reference gases and transmit the data to the measurement interface board.

Pressure Transducer

The pressure transducer measures the pressure of the sample gas.

Ozonator Assembly

The internal ozonator operates on the photolytic principle. The ozone level produced is a function of light intensity at 185 nm and gas flow. The light intensity is varied by changing the current into the lamp. The gas flow is held constant by a pressure regulator followed by a capillary.

Ozonator Lamp Power Supply

The ozonator lamp power supply generates high voltage AC and contains heater control circuits for the ozonator lamp.

Photometer Lamp power Supply

The photometer lamp power supply generates high voltage AC and contains heater control circuits for the photometer lamp.

Optical Bench Temperature Thermistor

The optical bench temperature thermistor is used for maintaining the optical bench at a constant temperature.

Pump

The pump draws the zero air through the optical bench.

Note Total flows of less than 1 LPM (2 scfh) should be avoided since the flush time would be excessive. Total flows of greater than 3 LPM should also be avoided since there would not be enough residence time in the converter to ensure greater than 99% conversion of the ozone. ▲

Sample/Reference Solenoid Valves

The sample/reference solenoid valves allow sample gas to pass through Cell A and reference gas through Cell B, or vice versa, depending upon which cycle the instrument is performing.

Software

The processor software tasks are organized into four areas:

- Instrument Control
- Monitoring Signals
- Measurement Calculations
- Output Communication

Instrument Control

Low-level embedded processors are used to control the various functions on the boards, such as analog and digital I/O and heater control. These processors are controlled over a serial interface with a single high-level processor that also controls the front-panel user interface. The low-level processors all run a common piece of firmware that is bundled with the high-level firmware and loaded on power-up if a different version is detected.

Each board has a specific address that is used to identify to the firmware what functions are supported on that board. This address is also used for the communications between the low-level processors and the high-level processor.

Every tenth of a second the frequency counters, analog I/O, and digital I/O are read and written to by the low-level processor. The counters are accumulated over the past second and the analog inputs are averaged over that second. The high-level processor polls the low-level processors once per second to exchange the measurement and control data.

Monitoring Signals

The instrument includes a sample solenoid valve and a reference solenoid valve. The instrument can be configured to measure O₃ every ten seconds (standard cycle) or every four seconds (fast cycle). Every cycle, the two solenoid valves switch the sample gas and reference gas streams between the two cells. One cell contains sample gas, the other cell contains reference gas and vice versa.

During a standard cycle, the cells are purged for seven seconds and measurements are taken for three seconds. During a fast cycle, the cells are purged for three seconds and measurements are taken for one second.

Measurement Calculations

During every cycle, the instrument calculates the natural logarithm of the sample gas frequency to reference gas frequency ratio in each cell and averages these results to optimize instrument accuracy. These logarithms provide the basis for calculating the ozone concentrations. The logarithms are stored in a rolling stack of 30 logarithms which are averaged by the instrument's averaging time function.

The background values for O₃ are corrected for temperature, pressure, and span and are subtracted from the ozone calculated to yield a corrected value.

Output Communication

The front panel display, serial and Ethernet data ports, and analog outputs are used to communicate the results of the measurement calculations. The front panel displays the O₃ concentration. The display is updated every ten seconds (standard cycle) or every four seconds (fast cycle).

The analog output ranges are user selectable via software. The analog outputs are defaulted based on the measurement range. The defaults are calculated by dividing the data values by the full-scale range for each of the three parameters and then multiplying each result by the user-selected output range. Negative concentrations can be represented as long as they are within -5% of full-scale. The zero and span values may be set by the user to any desired value.

Electronics

All electronics operate from a universal switching supply, which is capable of auto-sensing the input voltage and working over the entire operating range.

Internal pumps and heaters all operate on 110VAC. An optional transformer is required if operating on the 210-250VAC or 90-110VAC ranges.

An on/off switch controls all power to the instrument, and is accessible on the front panel.

Motherboard

The motherboard contains the main processor, power supplies, a sub-processor and serves as the communication hub for the instrument. The motherboard receives operator inputs from the front panel mounted function key panel and/or over I/O connections on the rear panel and sends commands to the other boards to control the functions of the instrument and to collect measurement and diagnostic information. The motherboard outputs instrument status and measurement data to the front-panel mounted graphics display and to the rear-panel I/O. The motherboard also contains I/O circuitry and the associated connector to monitor external digital status lines and to output analog voltages that represent the measurement data. Connectors located on the motherboard include:

External Connectors

External connectors include:

- External Accessory
- RS-232/485 Communications (two connectors)
- Ethernet Communications

- I/O connector with Power Fail Relay, 16 Digital Inputs, and 6 Analog Voltage Outputs.

Internal Connectors

Internal connectors include:

- Function key panel and Display
- Measurement Interface Board Data
- I/O Expansion Board Data
- Digital Output Board
- AC distribution

Measurement Interface Board

The measurement interface board serves as a central connection area for all measurement electronics in the instrument. It contains power supplies and interface circuitry for sensors and control devices in the measurement system. It sends status data to the motherboard and receives control signals from the motherboard.

Measurement Interface Board Connectors

Connectors located on the measurement interface board include:

- Data communication with the motherboard
- 24V and 120VAC power supply inputs
- Fan and solenoid outputs
- 120VAC outputs for the pump
- Flow and pressure sensors inputs
- Detector board inputs - CH A and CH B
- Optical bench temperature thermistor
- Photometer lamp power supply

Flow Sensor Assembly

The flow sensor assembly consists of a board containing an instrumentation amplifier and a flow transducer with input and output gas fittings. The flow transducer output is produced by measuring the pressure difference across a precision orifice. This unit is used for measuring the flow of sample gas in the measurement system.

Pressure Sensor Assembly

The pressure sensor assembly consists of a board containing an instrumentation amplifier and a pressure transducer with a gas input fitting. The pressure transducer output is produced by measuring the pressure difference between the sample gas pressure and ambient air pressure.

Ozonator Lamp Power Supply

The ozonator lamp power supply board includes the circuits that generate high voltage AC to control the lamp heater. A transformer outputting high voltage at approximately 15 kHz drives the lamp. A resistor in series with the output limits the lamp current. The voltage output is adjustable under software control for lamp intensity control. The ozonator lamp can be switched on and off under software control.

The lamp is heated to a specific temperature to ensure reliable operation. The oscillator circuit that drives the high voltage output is inhibited until this operating temperature is reached. A power transistor is used to heat the lamp housing. Thermistors sense the housing temperature for heater control and for status information.

Photometer Lamp Power Supply

The photometer lamp power supply is similar to the ozonator power supply except for the operating temperature set point and the value of the resistor in series with the output. The photometer is always “on” when the operating temperature is reached. Software on/off control is not required.

Digital Output Board

The digital output board connects to the motherboard and provides solenoid driver outputs and relay contact outputs to a connector located on the rear panel of the instrument. Ten relay contacts normally open (with power off) are provided which are electrically isolated from each other. Eight solenoid driver outputs (open collector) are provided along with a corresponding +24VDC supply pin on the connector.

I/O Expansion Board (Optional)

The I/O expansion board connects to the motherboard and adds the capability to input external analog voltage inputs and to output analog currents via a connector located on the rear panel of the instrument. It contains local power supplies, a DC/DC isolator supply, a sub-processor

and analog circuits. Eight analog voltage inputs are provided with an input voltage range of 0V to 10VDC. Six current outputs are provided with a normal operating range of 0 to 20 mA.

Front Panel Connector Board

The front panel connector board interfaces between the motherboard and the front panel mounted function key panel and Graphics display. It serves as central location to tie the three connectors required for the function key panel, the graphics display control lines, and the graphics display backlight to a single ribbon cable extending back to the motherboard. This board also includes signal buffers for the graphics display control signals and a high voltage power supply for the graphics display backlight.

I/O Components

External I/O is driven from a generic bus that is capable of controlling the following devices:

- Analog output (voltage and current)
- Analog input (voltage)
- Digital output (TTL levels)
- Digital input (TTL levels)

Note The instrument has spare solenoid valve drivers and I/O support for future expansion. ▲

Analog Voltage Outputs

The instrument provides six analog voltage outputs. Each may be software configured for any one of the following ranges, while maintaining a minimum resolution of 12 bits:

- 0-100mV
- 0-1V
- 0-5V
- 0-10V

The user can calibrate each analog output zero and span point through firmware. At least 5% of full-scale over and under range are also supported.

The analog outputs may be assigned to any measurement or diagnostic channel with a user-defined range in the units of the selected parameter. The voltage outputs are independent of the current outputs.

Analog Current Outputs (Optional)

The optional I/O Expansion board includes six isolated current outputs. These are software configured for any one of the following ranges, while maintaining a minimum resolution of 11 bits:

- 0-20 mA
- 4-20 mA

The user can calibrate each analog output zero and span point through firmware. At least 5% of full-scale over and under range are also supported.

The analog outputs may be assigned to any measurement or diagnostic channel with a user-defined range in the units of the selected parameter. The current outputs are independent of the voltage outputs. The current outputs are isolated from the instrument power and ground, but they share a common return line (Isolated GND).

Analog Voltage Inputs (Optional)

The optional I/O expansion board includes eight analog voltage inputs. These inputs are used to gather measurement data from third-party devices such as meteorological equipment. The user may assign a label, unit, and a voltage to user-defined unit conversion table (up to 16 points). All voltage inputs have a resolution of 12 bits over the range of 0 to 10 volts.

Digital Relay Outputs

The instrument includes one power fail relay on motherboard and ten digital output relays on the digital output board. These are reed relays rated for at least 500 mA @ 200VDC.

The power fail relay is Form C (both normally opened and normally closed contacts). All other relays are Form A (normally opened contacts) and are used to provide alarm status and mode information from the analyzer, as well as remote control to other devices, such as for controlling valves during calibration. The user may select what information is sent out each relay and whether the active state is opened or closed.

Digital Inputs

Sixteen digital inputs are available which may be programmed to signal instrument modes and special conditions including:

- Zero Gas Mode

- Span Gas Mode
- Set Background
- Ozonator Level 1-5
- Cal to Lo Span
- Cal to High Span
- Ozonator Solenoid
- Aouts to Zero
- Aouts to FS

The actual use of these inputs will vary based on analyzer configuration.

The digital inputs are TTL level compatible and are pulled up within the analyzer. The active state can be user defined in firmware.

Serial Ports

Two serial ports allow daisy chaining so that multiple analyzers may be linked using one PC serial port.

The standard bi-directional serial interface can be configured for either RS-232 or RS-485. The serial baud rate is user selectable in firmware for standard speeds from 1200 to 19,200 baud. The user can also set the data bits, parity, and stop bits. The following protocols are supported:

- C-Link
- Streaming Data
- Modbus Slave
- Geysitech (Bayern-Hessen)

The Streaming Data protocol transmits user-selected measurement data via the serial port in real-time for capture by a serial printer, data logger, or PC.

RS-232 Connection

A null modem (crossed) cable is required when connecting the analyzer to an IBM Compatible PC. However, a straight cable (one to one) may be required when connecting the analyzer to other remote devices. As a general rule, when the connector of the host remote device is female, a straight cable is required and when the connector is male, a null modem cable is required.

Data Format:

1200, 2400, 4800, 9600, 19200, 38400, 57600, or 115200 BAUD

8 data bits

1 stop bit

no parity

All responses are terminated with a carriage return (hex 0D)

Refer to [Table 7-1](#) for the DB9 connector pin configuration.

Table 7-1. RS-232 DB Connector Pin Configurations

DB9 Pin	Function
2	RX
3	TX
7	RTS
8	CTS
5	Ground

RS-485 Connection

The instrument uses a four wire RS-485 configuration with automatic flow control (SD). Refer to [Table 7-2](#) for the DB9 connector pin configuration.

Table 7-2. RS-485 DB Connector Pin Configuration

DB9 Pin	Function
2	+ receive
8	- receive
7	+ transmit
3	- transmit
5	ground

Ethernet Connection

An RJ45 connector is used for the 10Mbps Ethernet connection supporting TCP/IP communications via standard IPV4 addressing. The IP address may be configured for static addressing or dynamic addressing (set using a DHCP server).

Any serial port protocols may be accessed over Ethernet in addition to the serial port.

External Accessory Connector

The external accessory connector is not used in the Model 49i Primary Standard.

This port is used in other models to communicate with smart external devices that may be mounted hundreds of feet from the analyzer using an RS-485 electrical interface.

Chapter 8 Optional Equipment

The Model 49i Primary Standard is available with the following options:

- “Zero Air Source” on page 8-1
- “Teflon Particulate Filter” on page 8-1
- “I/O Expansion Board Assembly” on page 8-1
- “Terminal Block and Cable Kits” on page 8-2
- “Cables” on page 8-2
- “25-Pin Terminal Board Assembly” on page 8-3
- “Mounting Options” on page 8-3

Zero Air Source

The zero air source option is a convenient system for generating pollutant free zero gas for O₃ monitoring requirements. This option includes the pump, filter, filter holder, and Silastic tubing.

Teflon Particulate Filter

A 5-10 micron pore size, two-inch diameter Teflon® element is available for the Model 49i Primary Standard. This filter should be installed just prior to the SAMPLE bulkhead. When using a filter, all calibrations and span checks must be performed through the filter.

I/O Expansion Board Assembly

The I/O expansion board provides six analog current output channels (0-20 mA or 4-20 mA) and eight analog voltage inputs (0-10V). The DB25 connector on the rear panel provides the interface for these inputs and outputs.

Terminal Block and Cable Kits

The optional terminal block and cable kits provide a convenient way to connect devices to the instrument. These kits break out the signals on the rear panel connector to individual numbered terminals.

Two types of terminal block and cable kits are available. One kit is for the DB37 connectors and can be used for either the analog output connector or the relay output connector. The other kit is for the DB25 connector and can be used for the optional I/O expansion board. For associated part numbers, refer to “External Device Connection Components” in the “Servicing” chapter.

Each kit consists of:

- one six-foot cable
- one terminal block
- one snap track

Note Supporting all of the connections on units with the optional I/O expansion board requires:

- two DB37 kits
- one DB25 kit

Cables

[Table 8-1](#) identifies the optional individual cables that are available for the instrument and [Table 8-2](#) provides the cable color codes. For associated part numbers, refer to “External Device Connection Components” in the “Servicing” chapter.

Note [Table 8-2](#) provides the color coding for both 25-pin cables and 37-pin cables. Color codes for pins 1-25 are for 25-pin cables; color codes for pins 1-37 are for 37-pin cables. ▲

Table 8-1. Cable Options

Description	Cable Length
DB37M to open end	Six feet
DB37F to open end	Six feet
DB25M to open end	Six feet
RS-232	

Table 8-2. Color Codes for 25-Pin and 37-Pin Cables

Pin	Color	Pin	Color
1	BLACK	20	RED/BLACK
2	BROWN	21	ORANGE/BLACK
3	RED	22	YELLOW/BLACK
4	ORANGE	23	GREEN/BLACK
5	YELLOW	24	GRAY/BLACK
6	GREEN	25	PINK/BLACK
7	BLUE	End color codes for 25-pin cables continue for 37-pin cables.	
8	VIOLET	26	PINK/GREEN
9	GRAY	27	PINK/RED
10	WHITE	28	PINK/VIOLET
11	PINK	29	LIGHT BLUE
12	LIGHT GREEN	30	LIGHT BLUE/BROWN
13	BLACK/WHITE	31	LIGHT BLUE/RED
14	BROWN/WHITE	32	LIGHT BLUE/VIOLET
15	RED/WHITE	33	LIGHT BLUE/BLACK
16	ORANGE/WHITE	34	GRAY/GREEN
17	GREEN/WHITE	35	GRAY/RED
18	BLUE/WHITE	36	GRAY/VIOLET
19	VIOLET/WHITE	37	LIGHT GREEN/BLACK

25-Pin Terminal Board Assembly

The 25-pin terminal board assembly is included with the optional I/O expansion board. Refer “Terminal Board PCB Assemblies” in the “Installation” chapter for information on attaching the cable to the connector board. For associated part numbers, refer to “External Device Connection Components” in the “Servicing” chapter.

Mounting Options

The analyzer can be installed in the configurations described in [Table 8-3](#) and shown in [Figure 8-1](#) through [Figure 8-4](#).

Table 8-3. Mounting Options

Mounting Type	Description
Bench	Positioned on bench, includes mounting feet, and front panel side-trim ears.

Table 8-3. Mounting Options

Mounting Type	Description
EIA rack	Mounted in an EIA-style rack, includes mounting slides, and front panel EIA-rack mounting ears.
Retrofit rack	Mounted in a Thermo non-EIA rack, includes mounting slides, and retrofit front panel rack-mounting ears.

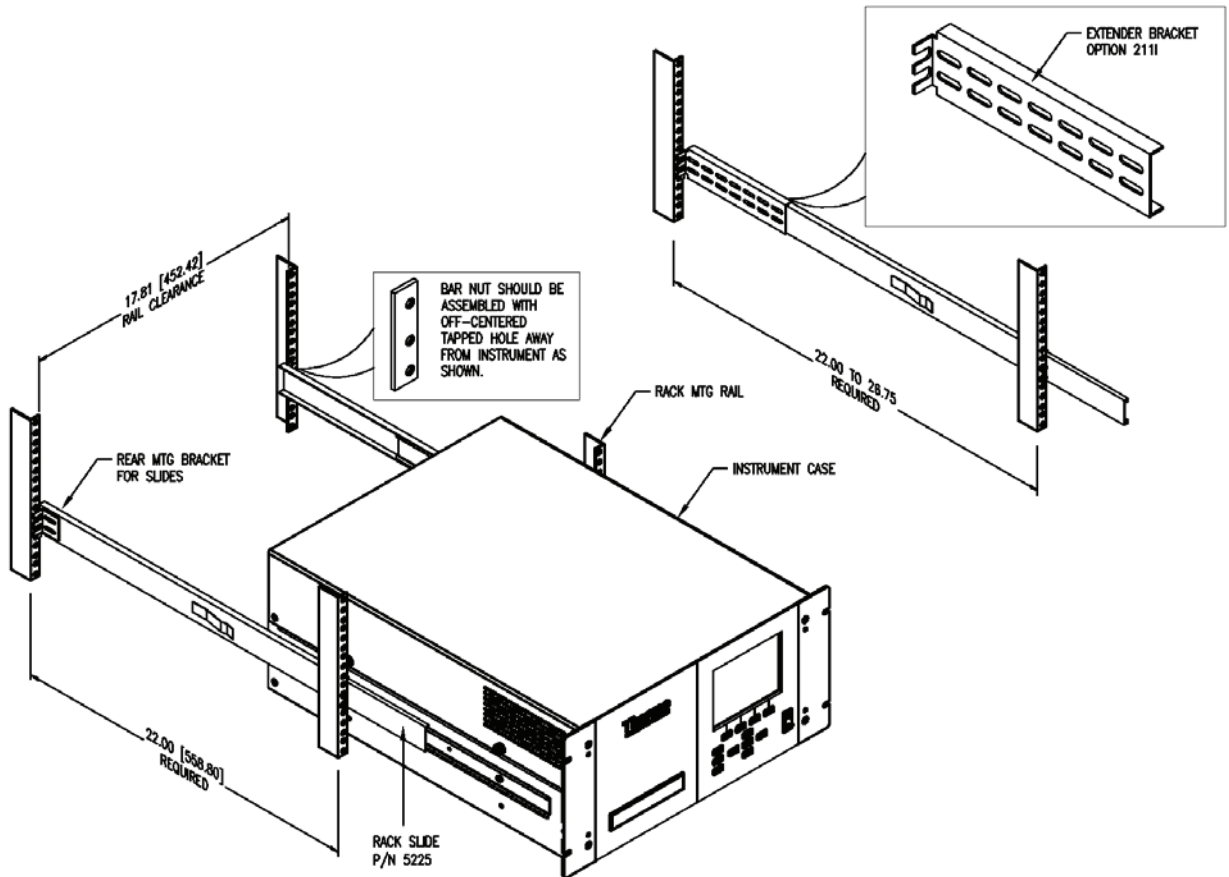

Figure 8-1. Rack Mount Option Assembly

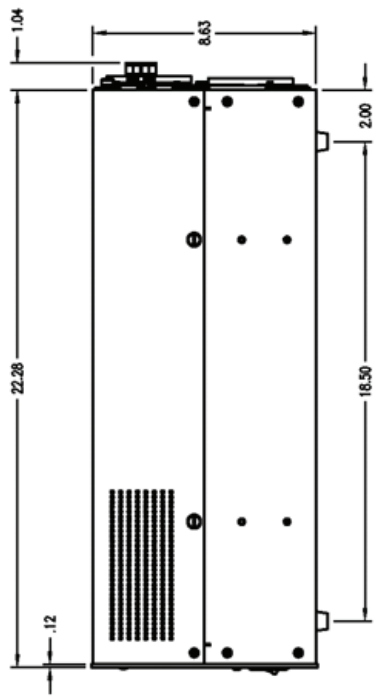
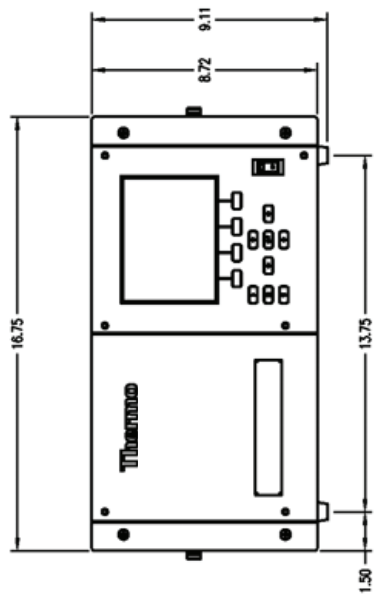
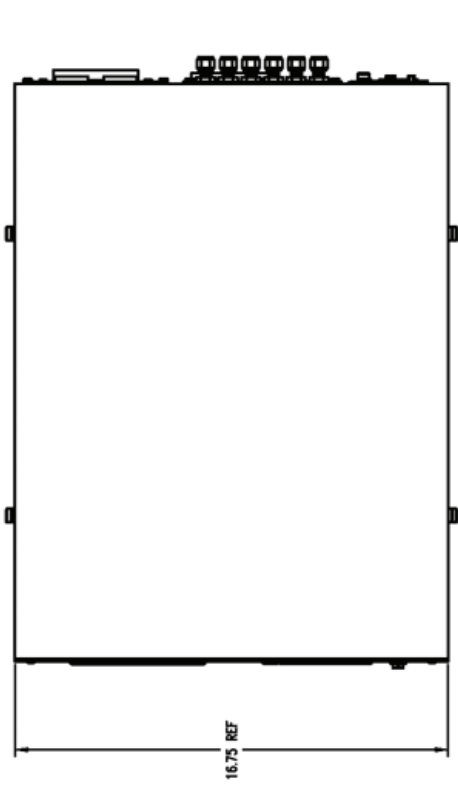

Figure 8-2. Bench Mounting

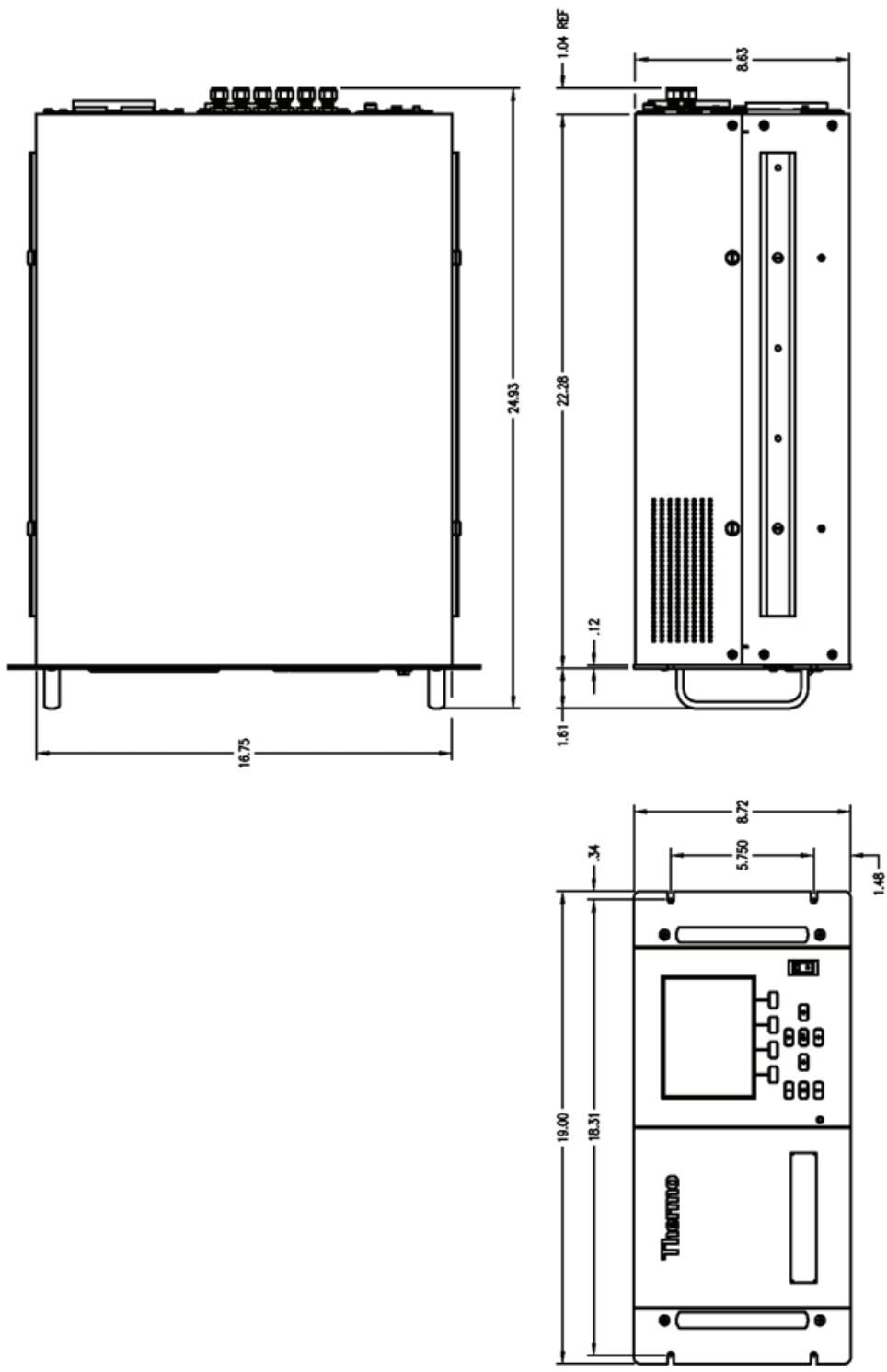

Figure 8-3. EIA Rack Mounting

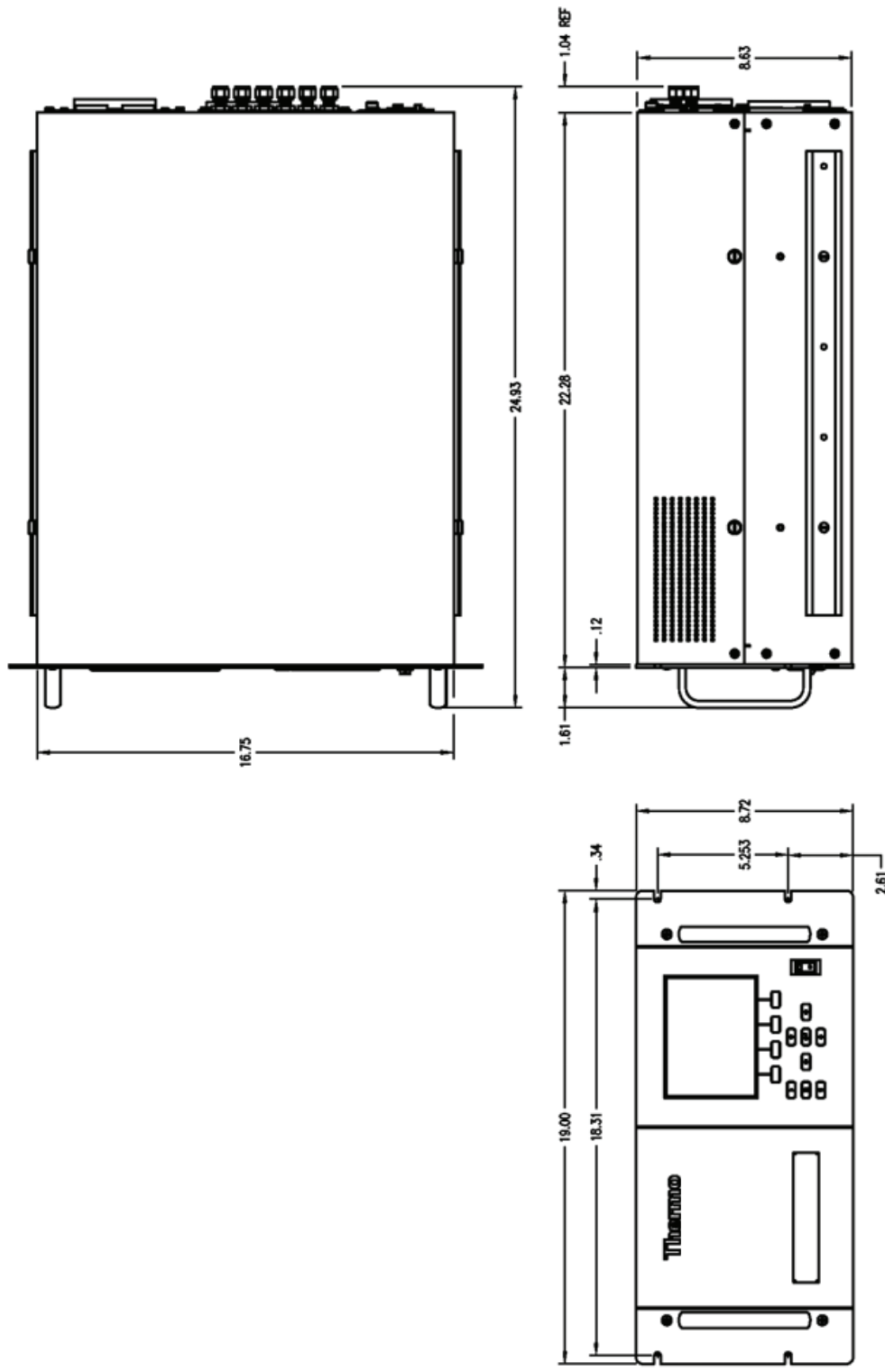

Figure 8-4. Retrofit Rack Mounting

Optional Equipment
Mounting Options

Appendix A Warranty

Seller warrants that the Products will operate or perform substantially in conformance with Seller's published specifications and be free from defects in material and workmanship, when subjected to normal, proper and intended usage by properly trained personnel, for the period of time set forth in the product documentation, published specifications or package inserts. If a period of time is not specified in Seller's product documentation, published specifications or package inserts, the warranty period shall be one (1) year from the date of shipment to Buyer for equipment and ninety (90) days for all other products (the "Warranty Period"). Seller agrees during the Warranty Period, to repair or replace, at Seller's option, defective Products so as to cause the same to operate in substantial conformance with said published specifications; provided that (a) Buyer shall promptly notify Seller in writing upon the discovery of any defect, which notice shall include the product model and serial number (if applicable) and details of the warranty claim; (b) after Seller's review, Seller will provide Buyer with service data and/or a Return Material Authorization ("RMA"), which may include biohazard decontamination procedures and other product-specific handling instructions; and (c) then, if applicable, Buyer may return the defective Products to Seller with all costs prepaid by Buyer. Replacement parts may be new or refurbished, at the election of Seller. All replaced parts shall become the property of Seller. Shipment to Buyer of repaired or replacement Products shall be made in accordance with the Delivery provisions of the Seller's Terms and Conditions of Sale. Consumables, including but not limited to lamps, fuses, batteries, bulbs and other such expendable items, are expressly excluded from the warranty under this warranty.

Notwithstanding the foregoing, Products supplied by Seller that are obtained by Seller from an original manufacturer or third party supplier are not warranted by Seller, but Seller agrees to assign to Buyer any warranty rights in such Product that Seller may have from the original manufacturer or third party supplier, to the extent such assignment is allowed by such original manufacturer or third party supplier.

In no event shall Seller have any obligation to make repairs, replacements or corrections required, in whole or in part, as the result of (i) normal wear and tear, (ii) accident, disaster or event of force majeure, (iii) misuse, fault or negligence of or by Buyer, (iv) use of the Products in a manner for which they were not designed, (v) causes external to the Products such as, but not

limited to, power failure or electrical power surges, (vi) improper storage and handling of the Products or (vii) use of the Products in combination with equipment or software not supplied by Seller. If Seller determines that Products for which Buyer has requested warranty services are not covered by the warranty hereunder, Buyer shall pay or reimburse Seller for all costs of investigating and responding to such request at Seller's then prevailing time and materials rates. If Seller provides repair services or replacement parts that are not covered by the warranty provided in this warranty, Buyer shall pay Seller therefor at Seller's then prevailing time and materials rates. ANY INSTALLATION, MAINTENANCE, REPAIR, SERVICE, RELOCATION OR ALTERATION TO OR OF, OR OTHER TAMPERING WITH, THE PRODUCTS PERFORMED BY ANY PERSON OR ENTITY OTHER THAN SELLER WITHOUT SELLER'S PRIOR WRITTEN APPROVAL, OR ANY USE OF REPLACEMENT PARTS NOT SUPPLIED BY SELLER, SHALL IMMEDIATELY VOID AND CANCEL ALL WARRANTIES WITH RESPECT TO THE AFFECTED PRODUCTS.

THE OBLIGATIONS CREATED BY THIS WARRANTY STATEMENT TO REPAIR OR REPLACE A DEFECTIVE PRODUCT SHALL BE THE SOLE REMEDY OF BUYER IN THE EVENT OF A DEFECTIVE PRODUCT. EXCEPT AS EXPRESSLY PROVIDED IN THIS WARRANTY STATEMENT, SELLER DISCLAIMS ALL OTHER WARRANTIES, WHETHER EXPRESS OR IMPLIED, ORAL OR WRITTEN, WITH RESPECT TO THE PRODUCTS, INCLUDING WITHOUT LIMITATION ALL IMPLIED WARRANTIES OF MERCHANTABILITY OR FITNESS FOR ANY PARTICULAR PURPOSE. SELLER DOES NOT WARRANT THAT THE PRODUCTS ARE ERROR-FREE OR WILL ACCOMPLISH ANY PARTICULAR RESULT.

Appendix B C-Link Protocol Commands

This appendix provides a description of the C-Link protocol commands that can be used to remotely control a Model 49*i* Primary Standard analyzer using a host device such as a PC or a datalogger. C-Link protocol may be used over RS-232, RS-485, or Ethernet. C-Link functions can be accessed over Ethernet using TCP/IP port 9880.

- “Instrument Identification Number” on page B-2 describes the C-Link command format.
- “Commands” on page B-2 lists all the 49*i* Primary Standard C-Link commands in Table B-1.
- “Measurements” on page B-8 describes and gives examples of the measurement commands.
- “Alarms” on page B-12 describes and gives examples of the alarm commands.
- “Diagnostics” on page B-17 describes and gives examples of the diagnostic commands.
- “Datalogging” on page B-17 describes and gives examples of the datalogging commands.
- “Calibration” on page B-25 describes and gives examples of the calibration commands.
- “Keys/Display” on page B-28 describes and gives examples of the keys and display commands.
- “Measurement Configuration” on page B-29 describes and gives examples of the measurement configuration commands.
- “Hardware Configuration” on page B-34 describes and gives examples of the hardware commands.
- “Communications Configuration” on page B-36 describes and gives examples of the communication commands.

- “I/O Configuration” on page B-40 describes and gives examples of the I/O commands.
- “Record Layout Definition” on page B-44 describes and gives examples of the record layouts.

Instrument Identification Number

Each command sent to the analyzer must begin with the American Standard Code for Information Interchange (ASCII) symbol or byte value equivalent of the instrument's identification number plus 128. For example, if the instrument ID is set to 25, then each command must begin with the ACSII character code 153 decimal. The analyzer ignores any command that does not begin with its instrument identification number. If the instrument ID is set to 0, then this byte is not required. For more information on changing Instrument ID, see Chapter 3, “Operation”.

Entering Units in PPB

When interfacing to an instrument via C-link commands, always enter the concentration values in ppb or $\mu\text{g}/\text{m}^3$ units. For example, to set a background value to 20 ppm, enter 20000 (ppb) as the value for the set background command.

Accessing Streaming Data

Streaming data is sent out the serial port or the Ethernet port on a user-defined periodic basis. Streaming data over Ethernet is only generated when a connection is made on TCP port 9881.

Commands

The analyzer must be in the remote mode in order to change instrument parameters via remote. However, the command “set mode remote” can be sent to the analyzer to put it in the remote mode. Report commands (commands that don't begin with “set”) can be issued either in the remote or local mode. For information on changing modes, see Chapter 3, “Operation.”

The commands can be sent in either uppercase or lowercase characters. Each command must begin with the proper instrument identification number (ASCII) character. The command in the example that follows begins with the ASCII character code 170 decimal, which directs the command to the Model 49*i*, and is terminated by a carriage return “CR” (ASCII character code 13 decimal).

<ASCII 170>	T	I	M	E	<CR>
-------------	---	---	---	---	------

If an incorrect command is sent, a “bad command” message will be received. The example that follows sends the incorrect command “set unit ppm” instead of the correct command “set gas unit ppm.”

```
Send:      set unit ppm
Receive:   set unit ppm bad cmd
```

The “save” and “set save params” commands stores parameters in FLASH. It is important that each time instrument parameters are changed, that this command be sent. If changes are not saved, they will be lost in the event of a power failure.

[Table B-1](#) lists the 49i Primary Standard C-Link protocol commands. The interface will respond to the command strings outlined below.

Table B-1. C-Link Protocol Commands

Command	Description	Page
addr dns	Reports/sets domain name server address	B-36
addr gw	Reports/sets default gateway address	B-36
addr ip	Reports/sets IP address	B-36
addr nm	Reports/sets netmask address	B-37
alarm bench lamp temp max	Reports the bench lamp temperature alarm maximum value current setting	B-12
alarm bench lamp temp min	Reports the bench lamp temperature alarm minimum value current setting	B-12
alarm bench temp max	Reports the bench lamp temperature alarm maximum value current setting	B-13
alarm bench temp min	Reports the bench temperature alarm minimum value current setting	B-13
alarm conc o3 max	Reports the concentration O ₃ alarm maximum value current setting	B-13
alarm conc o3 min	Reports the concentration O ₃ alarm minimum value current setting	B-13
alarm intensity a max	Reports the current setting of maximum intensity alarm level for cell a	B-14
alarm intensity a min	Reports the current setting of minimum intensity alarm level for cell a	B-14
alarm intensity b max	Reports the current setting of maximum intensity alarm level for cell b	B-14
alarm intensity b min	Reports the current setting of minimum intensity alarm level for cell b	B-14
alarm level 1	Reports current alarm level 1 offset from the concentration as the alarm trigger point for that level	B-14

Table B-1. C-Link Protocol Commands, continued

Command	Description	Page
alarm level 2	Reports current alarm level 2 offset from the concentration as the alarm trigger point for that level	B-14
alarm level 3	Reports current alarm level 3 offset from the concentration as the alarm trigger point for that level	B-14
alarm level 4	Reports current alarm level 4 offset from the concentration as the alarm trigger point for that level	B-14
alarm level 5	Reports current alarm level 5 offset from the concentration as the alarm trigger point for that level	B-14
alarm oz lamp temp max	Reports the ozonator lamp temperature alarm maximum value current setting	B-15
alarm oz lamp temp min	Reports the ozonator lamp temperature alarm minimum value current setting	B-15
alarm pressure max	Reports the pressure alarm maximum value current setting	B-15
alarm pressure min	Reports the pressure alarm minimum value current setting	B-15
alarm sample flow a max	Reports the sample flow a alarm maximum value current setting	B-16
alarm sample flow a min	Reports the sample flow a alarm minimum value current setting	B-16
alarm sample flow b max	Reports the sample flow b alarm maximum value current setting	B-16
alarm sample flow b min	Reports the sample flow b alarm minimum value current setting	B-16
alarm trig conc o3	Reports the current setting of the concentration O ₃ alarm trigger action minimum alarm	B-16
analog iout range	Reports analog current output range per channel	B-40
analog vin	Retrieves analog voltage input data per channel	B-40
analog vout range	Reports analog voltage output range per channel	B-41
avg time	Reports/sets averaging time	B-8
baud	Reports/sets current baud rate	B-37
bench temp	Reports bench temperature	B-9
cal detectors	Balances the output of both detectors	B-27
cal high o3 coef	Sets/auto-calibrates high range O ₃ coefficient	B-25
cal low o3 coef	Sets/auto-calibrates low range O ₃ coefficient	B-25
cal o3 bkg	Sets/auto-calibrates O ₃ background	B-25
cal o3 coef	Sets/auto-calibrates O ₃ coefficient	B-25
cell a int	Reports the current lamp intensity for cell a	B-17
cell b int	Reports the current lamp intensity for cell b	B-17

Table B-1. C-Link Protocol Commands, continued

Command	Description	Page
clr records	Clears away all logging records that have been saved	B-17
clr srecs	Clears away only short records that have been saved	B-17
contrast	Reports/sets current screen contrast	B-34
copy lrec to sp	Sets/copies current lrec selection into the scratch pad	B-23
copy sp to lrec	Sets/copies current selections in scratch pad into lrec list	B-23
copy sp to srec	Sets/copies current selections in scratch pad into srec list	B-23
copy sp to stream	Sets/copies current selections in scratch pad into stream list	B-23
copy srec to sp	Sets/copies current srec selection into the scratch pad	B-23
copy stream to sp	Sets/copies current streaming data selection into the scratch pad	B-23
custom	Reports/sets defined custom range concentration	B-30
date	Reports/sets current date	B-34
default params	Sets parameters to default values	B-35
dhcp	Reports/sets state of use of DHCP	B-37
diag volt iob	Reports diagnostic voltage level for I/O expansion board	B-17
diag volt mb	Reports diagnostic voltage level for motherboard	B-17
diag volt mib	Reports diagnostic voltage level for measurement interface board	B-17
dig in	Reports status of the digital inputs	B-41
din	Reports/sets digital input channel and active state	B-41
do (down)	Simulates pressing down pushbutton	B-28
dout	Reports/sets digital output channel and active state	B-42
dtoa	Reports outputs of the digital to analog converters per channel	B-42
en (enter)	Simulates pressing enter pushbutton	B-28
er	Returns a brief description of the main operating conditions in the format specified in the commands	B-18
erec	Returns a brief description of the main operating conditions in the format specified in the command	B-19
erec format	Reports/sets erec format (ASCII or binary)	B-20
erec layout	Reports current layout of erec data	B-21
flags	Reports 8 hexadecimal digits (or flags) that represent the status of the ozonator, gas mode, and alarms	B-11
flow a	Reports current measured flow in cell a	B-10
flow b	Reports current measured flow in cell b	B-10
format	Reports/sets current reply termination format	B-38

Table B-1. C-Link Protocol Commands, continued

Command	Description	Page
gas mode	Reports current mode of sample, zero, or span	B-31
gas unit	Reports/sets current gas units	B-32
he (help)	Simulates pressing help pushbutton	B-28
high avg time	Reports/sets high range averaging time	B-8
high o3	Reports O ₃ concentration calculated with high range coefficients	B-9
high o3 coef	Reports/sets high range O ₃ coefficient	B-25
high range	Reports/selects current O ₃ high range	B-29
high sp conc	Sets the high span concentration for autocalibration	B-27
host name	Reports/sets host name string	B-38
instr name	Reports instrument name	B-39
instrument id	Reports/sets instrument id	B-39
isc (iscreen)	Retrieves framebuffer data used for the display	B-28
l1 conc	Reports/sets the current custom level 1 concentration	B-33
l2 conc	Reports/sets the current custom level 2 concentration	B-33
l3 conc	Reports/sets the current custom level 3 concentration	B-33
l4 conc	Reports/sets the current custom level 4 concentration	B-33
l5 conc	Reports/sets the current custom level 5 concentration	B-33
lamp	Reports/sets the current photometer lamp setting.	B-10
lamp setting	Reports the current photometer lamp setting.	B-10
lamp temp	Reports the current bench lamp temperature.	B-10
lamp voltage bench	Reports the bench lamp voltage is volts	B-11
lamp voltage oz	Reports the ozonaor lamp voltage is volts	B-11
layout ack	Disables stale layout/layout changed indicator ('*')	B-40
le (left)	Simulates pressing left pushbutton	B-28
level	Sets the instrument in custom levels 1,2, 3, 4 or 5	B-33
list din	Lists current selection for digital input	B-18
list dout	Lists current selection for digital output	B-18
list lrec	Lists current selection lrec logging data	B-18
list sp	Lists current selection in the scratchpad list	B-18
list srec	Lists current selection srec logging data	B-18
list stream	Lists current selection streaming data output	B-18
list var aout	Reports list of analog output, index numbers, and variables	B-43
list var din	Reports list of digital input, index numbers, and variables	B-43

Table B-1. C-Link Protocol Commands, continued

Command	Description	Page
list var dout	Reports list of digital output, index numbers, and variables	B-43
low avg time	Reports/sets low average time	B-8
low o3	Reports O ₃ concentration calculated with low range coefficients	B-9
low o3 coef	Reports/sets low range O ₃ coefficient	B-25
low range	Reports/sets current O ₃ low range	B-29
low sp conc	Sets the low span concentration for autocalibration	B-27
lr	Outputs long records in the format specified in the command	B-18
lrec	Outputs long records	B-19
lrec format	Reports/sets output format for long records (ASCII or binary)	B-20
lrec layout	Reports current layout of lrec data	B-21
lrec mem size	Reports maximum number of long records that can be stored	B-21
lrec per	Reports/sets long record logging period	B-22
malloc lrec	Reports/sets memory allocation for long records	B-22
malloc srec	Reports/sets memory allocation for short records	B-22
manual	Sets gas mode to sample	B-32
me (menu)	Simulates pressing menu pushbutton	B-28
mode	Reports operating mode in local, service, or remote	B-39
no of lrec	Reports/sets number of long records stored in memory	B-22
no of srec	Reports/sets number of short records stored in memory	B-22
o3	Reports current O ₃ concentration	B-9
o3 bkg	Reports/sets current O ₃ background	B-27
o3 coef	Reports/sets current O ₃ coefficient	B-25
o3 conc	Sets the O ₃ concentration to a user defined value.	B-26
o3 lamp temp	Reports the current ozonator lamp temperature	B-10
o3 setting	Reports what ozone concentration the calibrator is set to output.	B-26
ozonator	Reports/sets ozonator on or off	B-35
pres	Reports current reaction chamber pressure	B-11
pres comp	Reports/sets pressure compensation on or off	B-32
program no	Reports analyzer program number	B-39
pump	Sets the pump on or off	B-33
push	Simulates pressing a key on the front panel	B-28
range	Reports/sets current O ₃ range	B-29

Table B-1. C-Link Protocol Commands, continued

Command	Description	Page
range mode	Reports/sets current range mode	B-31
relay	Reports/sets relay logic status of designated relay(s)	B-43
relay stat	Reports/sets relay logic status of designated relay(s)	B-43
resp coef	Reports/sets the current O ₃ response coefficient	B-25
ri (right)	Simulates pressing right pushbutton	B-28
ru (run)	Simulates pressing run pushbutton	B-28
sample	Sets zero/span valves to sample mode	B-31
save	Stores parameters in FLASH	B-35
save params	Stores parameters in FLASH	B-35
sc (screen)	C-series legacy command that reports a generic response (Use iscreen instead)	B-29
sp conc	Reports/sets the span concentration for autocalibration	B-27
sp field	Reports/sets item number and name in scratch pad list	B-23
span	Sets zero/span valves to span mode	B-31
sr	Reports last short record stored	B-18
srec	Reports maximum number of short records	B-19
srec format	Reports/sets output format for short records (ASCII or binary)	B-20
srec layout	Reports current layout of short record data	B-21
srec mem size	Reports maximum number of short records	B-21
srec per	Reports/sets short record logging period	B-22
stream per	Reports/sets current set time interval for streaming data	B-24
stream time	Reports/sets a time stamp to streaming data or not	B-24
temp comp	Reports/sets temperature compensation on or off	B-33
time	Reports/sets current time (24-hour time)	B-35
up	Simulates pressing up pushbutton	B-28
zero	Sets zero/span valves to zero mode	B-31

Measurements

avg time
high avg time
low avg time

These commands report the averaging time in seconds when operating in single range, or averaging time used with the high and low ranges when operating in dual or auto range mode. The example that follows shows that the averaging time is 300 seconds, according to [Table B-2](#).

Send: avg time

Receive: avg time 11: 300 sec

set avg time *selection*

set high avg time *selection*

set low avg time *selection*

These commands set the averaging time, high and low averaging times, according to [Table B-2](#). The example that follows sets the low range averaging time to 120 seconds.

Send: set low avg time 8

Receive: set low avg time 8 ok

Table B-2. Averaging Times

Selection	Averaging Time (seconds)
0	10
1	20
2	30
3	60
4	90
5	120
6	180
7	240
8	300

bench temp

This reports the current bench temperature. The first temperature reading is the temperature being used in instrument calculations. The second temperature is the actual temperature being measured. If temperature compensation is ON, then both temperature readings are the same. If temperature compensation is OFF, a temperature of 0° C is used as the default temperature even though the actual bench temperature is 32.3° C. The example that follows shows that temperature compensation is on and that the bench temperature is 32.3° C.

Send: bench temp

Receive: bench temp 032.3 deg C, actual 032.3

o3

high o3

low o3

These commands report the measured O₃ concentrations when operating in single range, or high and low O₃ when operating in dual or auto range mode. The example that follows shows that the O₃ concentration is 67.2 ppb.

Send: o3
Receive: o3 6720E-2 ppb

flow a**flow b**

These commands report the sample flow in Cell A and Cell B. The example that follows reports that the current sample flow in Cell A is 0.608 liters/minute.

Send: flow a
Receive: flow a 0.608 l/m

o3 lamp temp

This reports the current ozonator lamp temperature. The example that follows reports that the current ozonator temperature is 68.7° C.

Send: o3 lamp temp
Receive: o3 lamp temp 068.7 deg C

lamp

This reports the current photometer lamp setting. The example that follows reports that the lamp setting is 72.9%

Send: lamp setting
Receive: lamp setting 72.9%

set lamp *ddd.d*

This command sets the photometer lamp setting to *ddd.d*, where *ddd.d* is a floating-point number representing a percentage of the photometer lamp setting. The example that follows sets the photometer lamp to 75.5%.

Send: set lamp 75.5
Receive: set lamp 75.5 ok

lamp setting

This reports the current photometer lamp setting. The example that follows reports that the lamp setting is 72.9%

Send: lamp setting
Receive: lamp setting 72.9%

lamp temp

This reports the current bench lamp temperature. The example that follows reports that the current bench temperature is 55.2° C.

Send: lamp temp
Receive: lamp temp 055.2 deg C

lamp voltage bench

This command reports the bench lamp voltage in volts.

Send: lamp voltage bench
Receive: lamp voltage bench 10.3 V

lamp voltage oz

This command reports the ozonator lamp voltage in volts.

Send: lamp voltage oz
Receive: lamp voltage oz 12.3 V

pres

This reports the current reaction chamber pressure. The first pressure reading is the pressure reading being used in instrument calculations. The second pressure is the actual pressure reading being measured. If pressure compensation is on, then both pressure readings are the same. If pressure compensation is off, a pressure of 760 mm Hg is used as the default pressure even though the actual pressure is 753.4 mm Hg. The example that follows shows that actual reaction chamber pressure is 753.4 mm Hg.

Send: pres
Receive: pres 760.0 mm Hg, actual 753.4

flags

This reports 8 hexadecimal digits (or flags) that represent the status of the ozonator, gas mode, and alarms. To decode the flags, each hexadecimal digit is converted to binary as shown in [Figure B-1](#). It is the binary digits that define the status of each parameter. In the example that follows, the instrument is reporting the instrument is in local mode, the temperature compensation and pressure compensation are OFF, the gas mode status is Sample, gas units are ppb, and intensity B is in high alarm.

Send: flags
Receive: flags 00028000

C-Link Protocol Commands

Alarms

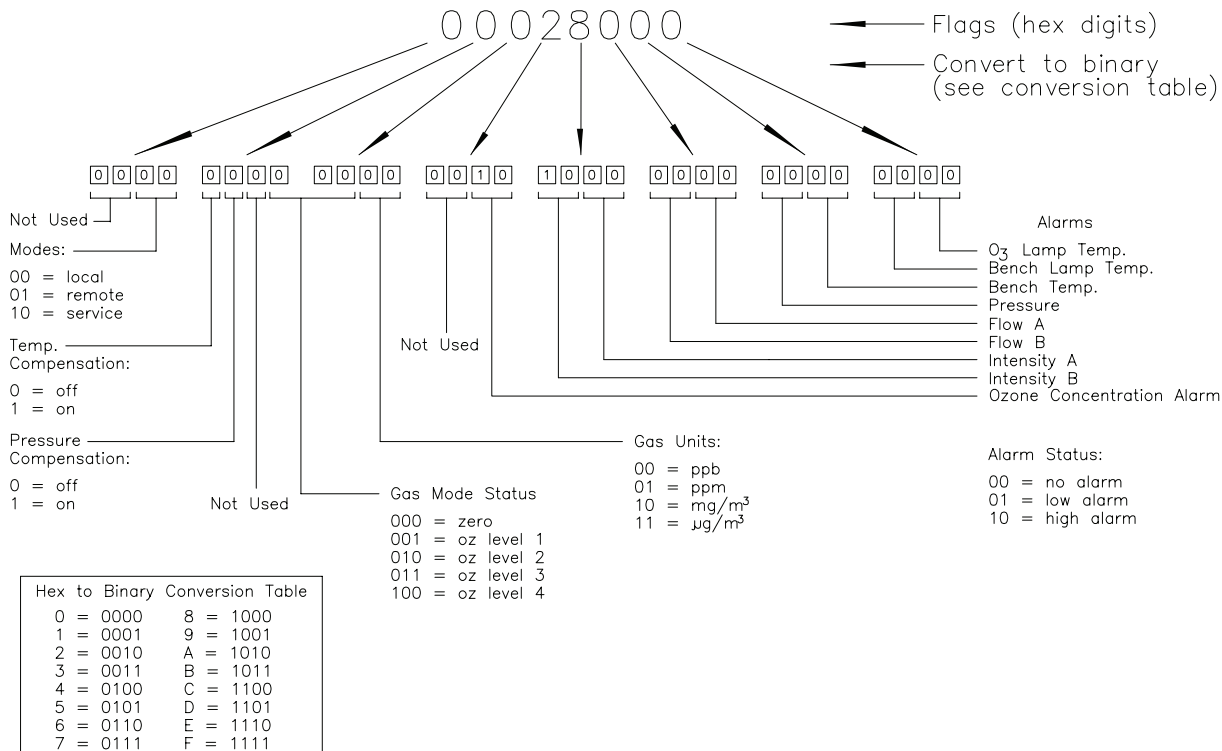

Figure B-1. Flag Status

Alarms

alarm bench lamp temp min

alarm bench lamp temp max

These commands report the bench lamp temperature minimum and maximum value current settings. The example that follows reports that the alarm bench lamp temperature minimum value is 52° C.

Send: alarm bench lamp temp min
 Receive: alarm bench lamp temp 52.0 deg C

set alarm bench lamp temp min *value*

set alarm bench lamp temp max *value*

These commands set the bench lamp temperature minimum and maximum value to *value*, where *value* is a floating-point number representing bench lamp temperature alarm limits in degrees C. The example that follows sets the alarm bench lamp temperature maximum value to 58° C.

```
Send:      set alarm bench lamp temp max 58.0
Receive:   set alarm bench lamp temp max 58.0 ok
```

alarm bench temp min**alarm bench temp max**

These commands report the bench temperature minimum and maximum value current settings. The example that follows reports that the alarm bench temperature minimum value is 15.0° C.

```
Send:      alarm bench temp min
Receive:   alarm bench temp 15.0
```

set alarm bench temp min *value***set alarm bench temp max *value***

These commands set the bench temperature minimum and maximum value to *value*, where *value* is a floating-point number representing bench temperature alarm limits in degrees C. The example that follows sets the alarm bench temperature maximum value to 35° C.

```
Send:      set alarm bench temp max 35
Receive:   set alarm bench temp max 35 ok
```

alarm conc o3 min**alarm conc o3 max**

These commands report the conc O₃ concentrations alarm minimum and maximum value current settings. The example that follows reports that the O₃ concentration minimum value is 5.2 ppb.

```
Send:      alarm conc o3 min
Receive:   alarm conc o3 min 5.2 ppb
```

set alarm conc o3 min *value***set alarm conc o3 max *value***

These commands set the O₃ concentration alarm minimum and maximum value to *value*, where *value* is a floating-point representation of the concentration alarm limits. The example that follows sets the O₃ concentration alarm maximum value to 150.

```
Send:      set alarm conc o3 max
Receive:   set alarm conc o3 max 150 ok
```

alarm intensity a min**alarm intensity a max****alarm intensity b min****alarm intensity b max**

These commands report the cell a or b intensity alarm minimum and maximum value current settings. The example that follows reports that the cell a minimum value is 45000 Hz.

```
Send:    alarm intensity a min
Receive: alarm intensity a min 45000 Hz
```

set alarm intensity a min *value***set alarm intensity a max *value*****set alarm intensity b min *value*****set alarm intensity b max *value***

These commands set the cell a or b intensity alarm minimum and maximum value to *value*, where *value* is a representation of the intensity alarm limits. The example that follows sets the cell a intensity alarm maximum value to 150000 Hz.

```
Send:    set alarm intensity a max 150000
Receive: set alarm intensity a max 150000 ok
```

alarm level 1**alarm level 2****alarm level 3****alarm level 4****alarm level 5**

These commands report the offset value (in ppb) from the concentration stored at ozonator level 1-5 as the alarm trigger point for that level. The example that follows reports that the alarm level 1 offset is 20.5.

```
Send:    alarm level 1
Receive: alarm level 1 20.5
```

set alarm level 1 *value***set alarm level 2 *value*****set alarm level 3 *value*****set alarm level 4 *value*****set alarm level 5 *value***

These commands set the offset *value* (in ppb) from the concentration stored at ozonator level 1-5 as the alarm trigger point for that level. The example that follows sets the alarm level 1 offset to 20.5.

```
Send:      set alarm level 1 20.5
Receive:   set alarm level 1 20.5 ok
```

alarm oz lamp temp min**alarm oz lamp temp max**

These commands report the ozonator lamp temperature minimum and maximum value current settings. The example that follows reports that the alarm ozonator lamp temperature minimum value is 52° C.

```
Send:      alarm ozonator lamp temp min
Receive:   alarm ozonator lamp temp 52.0 deg C
```

set alarm oz lamp temp min *value***set alarm oz lamp temp max *value***

These commands set the ozonator lamp temperature minimum and maximum value to *value*, where *value* is a floating-point number representing bench lamp temperature alarm limits in degrees C. The example that follows sets the alarm ozonator lamp temperature maximum value to 58° C.

```
Send:      set alarm ozonator lamp temp max 58.0
Receive:   set alarm ozonator lamp temp max 58.0 ok
```

alarm pressure min**alarm pressure max**

These commands report the pressure alarm minimum and maximum value current settings. The example that follows reports that the pressure alarm minimum value is 200 mmHg.

```
Send:      alarm pressure min
Receive:   alarm pressure min 200 mmHg
```

set alarm pressure min *value***set alarm pressure max *value***

These commands set the pressure alarm minimum and maximum values to *value*, where *value* is a floating-point number representing pressure alarm limits in millimeters of mercury. The example that follows sets the pressure alarm maximum value to 1000 mmHg.

```
Send:      set alarm pressure max 1000
Receive:   set alarm pressure max 1000 ok
```

alarm sample flow a min**alarm sample flow a max****alarm sample flow b min****alarm sample flow b max**

These commands report the cell a and b sample flow alarm minimum and maximum value current settings. The example that follows reports that the sample flow alarm minimum value is 0.400 LPM.

Send: alarm sample flow min
Receive: alarm sample flow min 0.4 l/min

set alarm sample flow a min *value***set alarm sample flow b max *value*****set alarm sample flow a min *value*****set alarm sample flow b max *value***

These commands set the cell a or b sample flow alarm minimum and maximum values to *value*, where *value* is a floating-point number representing sample flow alarm limits in liters per minute. The example that follows sets the sample flow alarm maximum value to 1.400 LPM.

Send: set alarm sample flow max 1.4
Receive: set alarm sample flow max 1.4 ok

alarm trig conc o3

This command reports the O₃ concentration alarm trigger action for minimum alarm, current setting, to either floor or ceiling. The example that follows shows the O₃ concentration minimum alarm trigger to ceiling, according to [Table B-3](#).

Send: alarm trig conc o3
Receive: alarm trig conc o3 1

set alarm trig conc o3 *value*

These commands set the O₃ concentration alarm minimum *value*, where *value* is set to either floor or ceiling, according to [Table B-3](#). The example that follows sets the O₃ concentration minimum alarm trigger to ceiling.

Send: set alarm trig conc no 1
Receive: set alarm trig conc no 1 ok

Table B-3. Alarm Trigger Values

<i>Value</i>	Alarm Trigger
0	Floor
1	Ceiling

Diagnostics

cell a int

cell b int

The example that follows reports that the lamp intensity in cell A is 98,425 Hz.

Send: cell a int
Receive: cell a int 98425 Hz

diag volt mb

This command reports the diagnostic voltage measurements on the motherboard. The sequence of voltages is: Positive 24, positive 15, positive 5, positive 3.3, and negative 3.3. Each voltage value is separated by a space.

Send: diag volt mb
Receive: diag volt mb 24.1 14.9 4.9 3.2 -3.2

diag volt mib

This command reports the diagnostic voltage measurements on the measurement interface board. The sequence of voltages is: Positive 24, positive 15, negative 15, positive 5, positive 3.3, and positive 15. Each voltage value is separated by a space.

Send: diag volt mib
Receive: diag volt mib 24.1 14.9 -14.9 4.9 3.2 14.9

diag volt iob

This command reports the diagnostic voltage measurements on the I/O expansion board. The sequence of voltages is: Positive 24, positive 5, positive 3.3, and negative 3.3. Each voltage value is separated by a space.

Send: diag volt iob
Receive: diag volt iob 24.1 4.9 3.2 -3.2

Datalogging

clr records

This command will clear all long and short records that have been saved.

Send: clear records
Receive: clear records ok

set clr lrecs

set clr srecs

These commands will clear only the long records or only the short records that have been saved. The example that follows clears short records.

Send: set clr srecs
Receive: set clr srecs ok

list din**list dout**

These commands report the current selection for the digital outputs in the format. Output no Index number variable name active state. The active state for digital outputs is open or closed. The active state for digital inputs is high or low.

```
Send:      list dout
Receive:   list dout
output index variable state
1 23 CONC ALARM open
3 3 UNITS open
4 12 GEN ALARM open
```

list lrec**list srec****list stream****list sp**

These commands report the list of current selections for long record logging data, short record logging data, streaming data output, or the scratch pad (sp) list. The example that follows shows the list for streaming data output.

```
Send:      list stream
Receive:   list stream
field index variable
x x time
1 1 03
2 5 cellai
3 6 cellbi
4 7 noisa
5 8 noisb
6 9 flowa
7 10 flowb
8 11 pres
```

er xy**lr xy****sr xy**

$x = | 0 | 1 |$: Reply termination format (see “set format *format*” command)

$y = | 0 | 1 | 2 |$: Output format (see “set errec/lrec/srec format *format*” command)

These commands report the last long and short records stored or the dynamic data record. In the example that follows, the command requests a long record with no checksum, in ASCII format with text. For details on how to decode the flag fields within these records, see [Figure B-1](#) in the “flags” command.

```
Send:      lr01
Receive:   lr01
13:00 08-12-05 flags 1C00554A o3 0.000 hio3 0.000 cellai 0.000 cellbi
0.000 bncht 999.900 lmp1 999.900 o3lt 0.000 flowa 0.000 flowb 0.000
pres 0.000
```

erec

This command returns a brief description of the main operating conditions at the time the command is issued (i.e. dynamic data). The example that follows shows a typical response. The format is defined by the current settings of “format” and “erec format” commands. For details on how to decode the flag fields within these records, see [Figure B-1](#) in the “flags” command.

```
Send:      erec
Receive:   erec
13:05 08-12-05 flags 1C00554A o3 0.000 1 lo o3 0.000 1 lampi 0000
bncht 999.900 lampt 999.900 ozlampt 0.000 flowa 0.000 flowb 0.000
Pres 0.000 avgt 10 lo avgt 10 O3bkg 0.000 O3 coef 1.000 lo O3 coef
1.000 O3 range 200000.000 lo O3 range 200000.000 int a 0000 int b 0000
sum 46f6
```

lrec

srec

lrec *xxxx yy*

srec *xxxx yy*

lrec *aa:bb oo-pp-qq yy*

srec *aa:bb oo-pp-qq yy*

xxxx = the number of past records

yy = the number of records to return (1 to 10)

aa = hours (01 to 24)

bb = minutes (01 to 59)

oo = month (01 to 12)

pp = day (01 to 31)

qq = year

These commands output long or short records. The output format is determined by the “set lrec format”, and “set srec format” commands. The logging time is determined by the “set lrec per” and “set srec per” commands.

In the following example, there are 100 long records currently stored in memory. When the command `lrec 100 5` is sent, the instrument counts back 100 records from the last record collected, and then returns 5 records. For details on how to decode the flag fields within these records, see [Figure B-1](#) in the “flags” command.

```
Send:      lrec 100 5
Receive:   lrec 100 5
19:00 8/17/05 flags 2c000000 o3 2.504e+02 cellai 100177 cellbi 99747
bncht 3.202e+01 lmpt 5.375e+01 o3lt 6767e+01 flowa 7.278e-01 flowb
7.390e-01 pres 7.557e+02
20:00 8/17/05 flags 2c000000 o3 2.514e+02 cellai 100137 cellbi 99762
bncht 3.262e+01 lmpt 5.325e+01 o3lt 6717e+01 flowa 7.248e-01 flowb
7.310e-01 pres 7.563e+02
21:00 8/17/05 flags 2c000000 o3 2.664e+02 cellai 100115 cellbi 99756
bncht 3.168e+01 lmpt 5.255e+01 o3lt 6597e+01 flowa 7.318e-01 flowb
7.240e-01 pres 7.413e+02
22:00 8/17/05 flags c4000000 o3 2.582e+02 cellai 100173 cellbi 99780
bncht 3.258e+01 lmpt 5.366e+01 o3lt 6672e+01 flowa 7.318e-01 flowb
7.301e-01 pres 7.515e+02
23:00 8/17/05 flags c4000000 o3 2.567e+02 cellai 100205 cellbi 99653
bncht 3.291e+01 lmpt 5.372e+01 o3lt 6714e+01 flowa 7.351e-01 flowb
7.362e-01 pres 7.493e+02
```

where:

```
cellai = Cell A Intensity
cellbi = Cell B Intensity
bncht = Bench Temperature
lmpt = Lamp Temperature
o3lt = Ozonator Lamp Temperature
flowa = Cell A Flow
flowb = Cell B Flow
press = Pressure
```

erec format

srec format

lrec format

These commands report the output format for long and short records, and dynamic data in various formats such as ASCII without text, ASCII with text, or binary. The example that follows shows the output format for long records is ASCII with text, according to [Table B-4](#).

```
Send:      lrec format
Receive:   lrec format 1
```

set errec format *format*

set lrec format *format*

set srec format *format*

These commands set the output format for long and short records, and dynamic data, according to Table B-4. The example that follows sets the long record output format to ASCII with text.

```
Send:      set lrec format 1
Receive:   set lrec format 1 ok
```

Table B-4. Record Output Formats

<i>Format</i>	Output Format
0	ASCII no text
1	ASCII with text
2	binary data

errec layout

lrec layout

srec layout

These commands reports the layout (string indicating the data formats) for data that is sent out in response to the errec, lrec, srec, and related commands. The example that follows shows a typical response. For details on how to interpret the strings, see “Record Layout Definition” later in this appendix.

```
Send:      lrec layout
Receive:   lrec layout %s %s %lx %f %f %f %f %f %f %f %f %f %f %f %f %f
t D L ffffffff
flags no nox hino hinox pres pmtt intt rctt convt smplf ozonf pmtv
```

lrec mem size

srec mem size

These commands report the long and short records that can be stored with the current settings and the number of blocks reserved for long and short records. To calculate the number of short records per block, add 2 to the number of records, and then divide by the number of blocks. The example that follows shows that 7 blocks were reserved for long records, and the maximum number of long records that can be stored in memory is 1426.

```
Send:      lrec mem size
Receive:   lrec mem size 1426 recs, 7 blocks
```

lrec per**srec per**

These commands report the long and short records logging period. The example that follows shows that the short record logging period is 5 minutes.

```
Send:      srec per
Receive:   srec per 5 min
```

set srec per *value***set srec per *value***

value = | 1 | 5 | 15 | 30 | 60 |

These commands set the long and short records logging period to *value* in minutes. The example that follows sets the long record logging period to 15 minutes.

```
Send:      set lrec per 15
Receive:   set lrec per 15 ok
```

no of lrec**no of srec**

These commands report the number of long and short records stored in the long and short records memory. The example that follows shows that 50 long records have been stored in the memory.

```
Send:      no of lrec
Receive:   no of lrec 50 recs
```

malloc lrec**malloc srec**

These commands report the currently set memory allocation for long and short records in percent of total memory.

```
Send:      malloc lrec
Receive:   malloc lrec 10%
```

set malloc lrec *value***set malloc srec *value***

value = 0 to 100

These commands set the percent of memory space allocated for long and short records to *value*, where *value* is a floating-point number representing percent. The example that follows sets the memory allocation for long records to 10.

Note Issuing these commands will clear all the logging data memory. All the existing records should be retrieved using appropriate commands, if required. ▲

```
Send:      set malloc lrec 10
Receive:   set malloc lrec 10 ok
```

set copy sp to lrec**set copy sp to srec****set copy sp to stream**

These commands copy the current selections in scratch pad (sp) into the long record, short record, or streaming data list. The example that follows copies the current list in scratch pad into the long records list.

```
Send:      set copy sp to lrec
Receive:   set copy sp to lrec ok
```

set copy lrec to sp**set copy srec to sp****set copy stream to sp**

These commands copy the current contents of the long record, short record, or streaming data list into the scratch pad (sp). These commands are useful in easy modification of current long record, short record, or streaming data lists. The example that follows copies the current list of long records into the scratch pad.

```
Send:      set copy lrec to sp
Receive:   set copy lrec to sp ok
```

sp field *number*

This command reports the variable *number* and name stored at index in the scratch pad list. The example that follows shows that the field 5 in the scratch pad is set to index number 11, which is for the variable pres.

```
Send:      sp field 5
Receive:   sp field 5 11 pres
```

set sp field *number value*

number = 1-32 is the maximum number of fields in long and short record lists.

number = 1-18 is for streaming data lists.

This command sets the scratch pad field *number* (item number in scratch pad list) to *value*, where *value* is the index number of a variable in the analog out variable list. Available variables and their corresponding index numbers may be obtained using the command “list var aout”. The “set sp field”

command is used to create a list of variables which can then be transferred into the long record, short record, or streaming data lists, using the “set copy sp to lrec”, “set copy sp to srec”, or “set copy sp to stream” commands.

```
Send:    set sp field 5 11
Receive: set sp field 5 11 ok
```

stream per

This command reports the currently set time interval in seconds for streaming data.

```
Send:    stream per
Receive: stream per 10
```

set stream per *number value*

number value = | 1 | 2 | 5 | 10 | 20 | 30 | 60 | 90 | 120 | 180 | 240 | 300 |

This command sets the time interval between two consecutive streaming data strings to *number value* in seconds. The example that follows sets the number value to 10 seconds.

```
Send:    set stream per 10
Receive: set stream per 10 ok
```

stream time

This command reports if the streaming data string will have a time stamp attached to it or not, according to [Table B-5](#).

```
Send:    stream time
Receive: stream time 1
```

set stream time *value*

This command enables *value*, where *value* is to attach or disable time stamp to streaming data string, according to [Table B-5](#). The example that follows attaches a time stamp to streaming data.

```
Send:    set stream time 0
Receive: set stream time 0 ok
```

Table B-5. Stream Time Values

<i>Value</i>	Stream Time
0	Attaches time stamp to streaming data string
1	Disables time stamp to streaming data string

Calibration

set cal o3 coef

set cal high o3 coef

set cal low o3 coef

These commands will auto-calibrate the O₃ coefficient based on the O₃ span gas concentrations. The high and low commands are only available in dual and auto range mode. If the mode is incorrect, the instrument responds with “can’t, wrong settings”. The example that follows shows a successful auto-calibration of the low O₃ coefficient.

```
Send:    set cal low o3 coef
Receive: set cal low o3 coef ok
```

set cal o3 bkg

These commands will auto-calibrate the O₃ background. If the instrument is set to manual O₃ mode, the response to “set O₃ bkg” will be “can’t, wrong settings”. The example that follows shows a successful auto-calibration of the O₃ background.

```
Send:    set cal o3 bkg
Receive: set cal o3 bkg ok
```

o3 coef

high o3 coef

low o3 coef

These commands report the O₃ coefficient in single range mode, or the high and low range coefficients in dual or auto range mode. If the mode is incorrect, the instrument responds with “can’t, wrong settings”. The example that follows reports that the O₃ coefficient is 1.000.

```
Send:    o3 coef
Receive: o3 coef 1.000
```

set o3 coef *value*

set high o3 coef *value*

set low o3 coef *value*

These commands set the O₃ coefficient to user-defined values to *value*, where *value* is a floating-point representation of the coefficient. The example that follows sets the O₃ coefficient to 1.005.

```
Send:    set o3 coef 1.005
Receive: set o3 coef 1.005 ok
```

resp coef

This command reports the current O₃ response coefficient. The example that follows reports that the O₃ response coefficient is 1.000.

Send: resp coef
Receive: resp coef 1.000

set resp coef *value*

This command sets the O₃ response coefficient to user-defined values to *value*, where *value* is a floating-point representation of the coefficient. The example that follows sets the O₃ response coefficient to 1.500.

Send: set resp coef 1.500
Receive: set resp coef 1.500 ok

set o3 conc

This command sets the O₃ concentration to a user defined value. The following example sets the O₃ concentration to 500 ppb.

Send: set o3 conc 500
Receive: set o3 conc 500 ok

o3 setting

This command reports what the O₃ concentration the calibrator is set to output. The following example reports that the calibrator is set to output 500 ppb.

Send: o3 setting
Receive: o3 setting 0500

o3 gas**high o3 gas****low o3 gas**

These commands report the low O₃ span gas concentrations used to auto-calibrate low O₃ coefficients. The high and low commands are only available in dual and auto range mode. If the mode is incorrect, the instrument responds with “can’t, wrong settings”. The example that follows shows that the O₃ low span gas concentration is 240.0 ppm.

Send: low o3 gas
Receive: low o3 gas 2400E-1 ppm

set o3 gas *value***set high o3 gas *value*****set low o3 gas *value***

These commands set the O₃ span gas concentrations used by the auto-calibration routine to *value*, where *value* is a floating-point representation of the gas concentration in current selected units. The gas units are the same as those chosen by the user. The example that follows sets the O₃ span gas concentration to 123.4 ppm.

Send: set o3 gas 123.4
Receive: set o3 gas 123.4 ok

o3 bkg

These commands report the current O₃ background. The example that follows reports that the O₃ background is 5.5 ppb.

Send: o3 bkg
Receive: o3 bkg 5.5 ppb

set o3 bkg *value*

These commands are used to set O₃ background to user-defined values to *value*, where *value* is a floating-point representation of the background in current selected units. The example that follows sets the O₃ background to 5.5 ppb.

Send: set no bkg 5.5
Receive: set no bkg 5.5 ok

set cal detectors

This command is used to balance the output for both detectors so that they read the same value

Send: set cal detectors
Receive: set cal detectors ok

sp conc**high sp conc****low sp conc**

These commands report span concentration in single range mode, or the high and low span concentrations in dual or auto range mode. If the mode is incorrect, the instrument responds with “can’t, wrong settings”. The example below reports the span gas concentration in single range mode.

Send: sp conc
Receive: sp conc 1000

set sp conc *value***set high sp conc *value*****set low sp conc *value***

These commands set the span concentrations to user-defined values to *value*, where *value* is a floating-point representation of the span concentration in current selected units. The example below sets the span concentration to 1000 ppb in the single range mode.

Send: set sp conc 1000
 Receive: set sp conc 1000 ok

Keys/Display

push *button*

do

down

en

enter

he

help

le

left

me

menu

ri

right

ru

run

up

1

2

3

4

button = | do | down | en | enter | he | help | le | left | me | menu | ri | right |
 ru | run | up | 1 | 2 | 3 | 4 |

These commands simulates pressing the front panel pushbuttons. The numbers represent the front-panel soft keys, from left to right.

Send: push enter
 Receive: push enter ok

isc

iscreen

This command retrieves the framebuffer data used for the display on the *i*Series instrument. It is 19200 bytes in size, 2-bits per pixel, 4 pixels per byte arranged as 320 by 240 characters. The data is sent in RLE encoded form to save time in transmission. It is sent as a type '5' binary c_link response with no checksum.

The RLE encoding consists of a 0 followed by an 8-bit count of consecutive 0xFF bytes. The following 'c' code will expand the incoming data.

```

Void    unpackDisplay ( void far* tdib, unsigned char far* rlescreen )
{
int i,j,k;
unsigned char far *sc4bpp, *sc2bpp, *screen, *ptr;

ptr = screen = (unsigned char far *)malloc(19200);
//RLE decode the screen
for (i=0; i<19200 && (ptr - screen) < 19200; i++)
{
    *(ptr++) = *(rlescreen + i);
    if (*(rlescreen + i) == 0)
    {
        unsigned char rlecount = *(unsigned char *)(rlescreen + ++i);
        while (rlecount)
        {
            *(ptr++) = 0;
            rlecount--;
        }
    }
    else if (*(rlescreen + i) == 0xff)
    {
        unsigned char rlecount = *(unsigned char *)(rlescreen + ++i);
        while (rlecount)
        {
            *(ptr++) = 0xff;
            rlecount--;
        }
    }
}
}

```

To convert this data into a BMP for use with windows, it needs to be turned into a 4BPP as that is the smallest windows can display. Also note that BMP files are upside down relative to this data, i.e. the top display line is the last line in the BMP.

sc

screen

This command is meant for backward compatibility on the C series. Screen information is reported using the “iScreen” command above.

Send: screen

Receive: screen This is an I series Instrument. Screen Information not available

Measurement Configuration

range
high range
low range

These commands report the O₃ range in single range mode, or the high and low ranges in dual or auto range mode, according to [Table B-6](#). If the mode is incorrect, the instrument responds with “can’t, wrong settings”. The example that follows reports that the O₃ range is 50 ppb.

Send: range o3
Receive: range o3 0: 5000E-2 ppb

set range selection
set high range selection
set low range selection

These commands select the O₃ full-scale range, according to [Table B-6](#). The example that follows sets the O₃ full-scale to 2,000 ppb.

Send: set range o3 5
Receive: set range o3 5 ok

Table B-6. Range Settings

Code	ppm	mg/m ³
0	0.05	0.1
1	0.1	0.2
2	0.2	0.4
3	0.5	1
4	1	2
5	2	4
6	5	10
7	10	20
8	20	40
9	50	100
10	100	200
11	200	400
12	C1	C1
13	C2	C2
14	C3	C3

custom range
range = | 1 | 2 | 3 |

This command reports the user-defined value of custom *range* 1, 2, or 3. The example that follows reports that custom range 1 is defined to 55.0 ppm.

```
Send:    custom 1
Receive: custom 1 5500E-2 ppm
```

```
set custom range value
set custom 1 value
set custom 2 value
set custom 3 value
set custom 1 range value
set custom 2 range value
set custom 3 range value
```

These commands are used to set the maximum concentration for any of the three custom *ranges* 1, 2, or 3 to range *value*, where *value* is a floating-point number representing concentration in ppm or mg/m³. The example that follows sets the custom 1 range to 55.5 ppm.

```
Send:    set custom 1 range 55.5
Receive: set custom 1 range 55.5 ok
```

range mode

This command reports the current range mode.

```
Send:    range mode
Receive:  range mode single
```

set range mode *mode*

This command sets the current range *mode* to single, dual, or auto. The example that follows sets the range mode to single.

```
Send:    set range mode single
Receive: set range mode single ok
```

gas mode

This command reports the current mode of sample, zero, or span. The example that follows reports that the gas mode is sample.

```
Send:    gas mode
Receive:  gas mode sample
```

set sample

set zero

set span

These commands set the current gas mode to sample, zero, or span. The example that follows sets the instrument to span mode, that is, the instrument is sampling span gas.

Send: set span
Receive: set span ok

set manual

This command sets the current gas mode to sample. The example that follows sets the instrument to sample mode.

Send: set manual
Receive: set manual ok

gas unit

This command reports the current gas units (ppm or mg/m³). The example reports that the gas unit is set to ppb.

Send: gas unit
Receive: gas unit ppb

set gas unit

unit = | ppb | ppm | µg/m³ | mg/m³ |

This command sets the gas units to ppb, ppm, µg/m³, or mg/m³. The example that follows sets the gas units to mg/m³.

Send: set gas unit mg/m3
Receive: set gas unit mg/m3 ok

pres comp

This command reports whether pressure compensation is on or off. The example that follows shows that pressure compensation is on.

Send: pres comp
Receive: pres comp on

set pres comp *onoff*

These commands turn the pressure compensation *on* or *off*. The example that follows turns pressure compensation off.

Send: set pres comp off
Receive: set pres comp off ok

set pump *onoff*

This command turns the pump *on* or *off*. The example that follows turns the pump off.

Send: set pump off
Receive: set pump off ok

temp comp

This command reports whether temperature compensation is on or off. The example that follows shows the temperature compensation is off.

Send: temp comp
Receive: temp comp off

set temp comp *onoff*

These commands turn the temperature compensation *on* or *off*. The example that follows turns temperature compensation off.

Send: set temp comp off
Receive: set temp comp off ok

l1 conc

l2 conc

l3 conc

l4 conc

These commands report the concentration setting of each of the four custom levels. The example that follows reports that custom level 1 is 125 ppb.

Send: l1 conc
Receive: l1 conc 0125 ppb

set l1 conc *value*

set l2 conc *value*

set l3 conc *value*

set l4 conc *value*

set l5 conc *value*

These commands set the concentration for each of the five custom levels. The example that follows sets custom level 1 to 325 ppb.

Send: set l4 conc 325
Receive: set l4 conc 325 ok

level *d*

This command sets the instrument to level *d*, where *d* represents custom levels 1, 2, 3, 4 or 5. The example that follows sets the custom level 1.

Send: set level 1
Receive: set level 1 ok

Hardware Configuration

contrast

This command reports the screen's level of contrast. The example that follows shows the screen contrast is 50%, according to [Table B-7](#).

```
Send:    contrast
Receive: contrast 5: 50%
```

set contrast *level*

This command sets the screen's *level* of contrast, according to [Table B-7](#). The example that follows sets the contrast level to 50%.

```
Send:    set contrast 5
Receive: set contrast 5 ok
```

Table B-7. Contrast Levels

<i>Level</i>	Contrast Level
0	0%
1	10%
2	20%
3	30%
4	40%
5	50%
6	60%
7	70%
8	80%
9	90%
10	100%

date

This command reports the current date. The example that follows reports the date as December 1, 2004.

```
Send:    date
Receive: date 12-01-04
```

set date *mm-dd-yy*

mm = month

dd = day

yy = year

This command sets the date of the analyzer's internal clock. The example that follows sets the date to March 19, 2005.

Send: set date 03-19-05
Receive: set date 03-19-05 ok

set default params

This command sets all the parameters to their default values. This does not affect the factory-calibrated parameters.

Send: set default params
Receive: set default params ok

save

set save params

This command stores all current parameters in FLASH memory. It is important that each time instrument parameters are changed, that this command be sent. If changes are not saved, they will be lost in the event of a power failure. The example that follows saves the parameters to FLASH memory.

Send: set save params
Receive: set save params ok

ozonator

This command reports the ozonator on or off. The example below reports that the ozonator is on.

Send: ozonator
Receive: ozonator on

set ozonator *onoff*

These commands set the ozonator *on* or *off*. The example below sets the ozonator off.

Send: set ozonator off
Receive: set ozonator off ok

time

This command reports the current time (24-hour time). The example that follows reports that the internal time is 2:15:30 pm.

Send: time
Receive: time 14:15:30

set time *hh:mm:ss*

hh = hours

mm = minutes

ss = seconds

This command sets the internal clock (24-hour time). The example that follows sets the internal time to 2:15 pm.

Note If seconds are omitted, the seconds default to 00. ▲

```
Send:      set time 14:15
Receive:   set time 14:15 ok
```

Communications Configuration

addr dns

This command reports the TCP/IP address for the domain name server.

```
Send:      addr dns
Receive:   addr dns 192.168.1.1
```

set addr dns *address*

This command sets the domain name server *address*, where *address* consists of four numbers ranging from 0-255 inclusive, separated by “.”.

```
Send:      set addr dns 192.168.1.1
Receive:   set addr dns 192.168.1.1 ok
```

addr gw

This command reports the default TCP/IP gateway address.

```
Send:      addr gw
Receive:   addr gw 192.168.1.1
```

set addr gw *address*

This command sets the default gateway *address*, where *address* consists of four numbers ranging from 0-255 inclusive, separated by “.”.

```
Send:      set addr gw 192.168.1.1
Receive:   set addr gw 192.168.1.1 ok
```

addr ip

This command reports the IP address of the analyzer.

```
Send:      addr ip
Receive:   addr ip 192.168.1.15
```

set addr ip *address*

This command sets the analyzer's IP *address*, where *address* consists of four numbers ranging from 0-255 inclusive, separated by “.”.

```
Send:      set addr ip 192.168.1.15
Receive:   set addr ip 192.168.1.15 ok
```

addr nm

This command reports the TCP/IP netmask address.

```
Send:      addr nm
Receive:   addr nm 255.255.255.0
```

set addr nm *address*

This command sets the netmask *address*, where *address* consists of four numbers ranging from 0-255 inclusive, separated by “.”.

```
Send:      set addr nm 255.255.255.0
Receive:   set addr nm 255.255.255.0 ok
```

baud

This command reports the current baud rate for the serial port (RS232/RS485). The example that follows reports that the current baud rate is 9600.

```
Send:      baud
Receive:   baud 9600
```

set baud *rate*

rate = | 1200 | 2400 | 4800 | 9600 | 19200 | 38400 | 57600 | 115200 |

This command sets the instrument baud *rate*. The example that follows sets the instrument's baud rate to 115200.

Note After the command is sent, the baud rate of the sending device must be changed to agree with the instrument. ▲

```
Send:      set baud 115200
Receive:   set baud 115200 ok
```

dhcp

This command reports the current state of use of DHCP on or off. DHCP is used to assign an IP address to the analyzer automatically. The example that follows shows that DHCP is on.

```
Send:      dhcp
Receive:   dhcp on
```

set dhcp *onoff*

These commands enables and disables the DHCP service by either *on* or *off*. Changes to this parameter will only take effect when the analyzer is powered up. The example that follows sets the DHCP service on.

Note When DHCP is set to on, the user-supplied `addr gw`, `addr dns`, `addr ip`, and `addr nm` parameters are not used. ▲

```
Send:      set dhcp on
Receive:   set dhcp on ok
```

format

This command reports the current reply termination format. The example that follows shows that the reply format is 00, which means reply with no checksum, according to [Table B-8](#).

```
Send:      format
Receive:   format 00
```

set format *format*

This command sets the reply termination *format*, where *format* is set according to [Table B-8](#). The example that follows sets the reply termination format to checksum.

```
Send:      set format 01
Receive:   set format 01 ok
```

Table B-8. Reply Termination Formats

<i>Format</i>	Reply Termination
00	<CR>
01	<NL> sum xxxx <CR>

where `xxxx` = 4 hexadecimal digits that represent the sum of all the characters (bytes) in the message

host name

This command reports the host name string.

```
Send:      host name
Receive:   host name ISERIES
```

set host name *string*

This command sets the host name *string*, where *string* is 1-13 alphanumeric characters.

```
Send:      set host name analyzer01
```

Receive: set host name analyzer01 ok

instr name

This command reports the instrument name.

Send: instr name
Receive: instr name
03 Analyzer
03 Analyzer

instrument id

This command reports the instrument id.

Send: instrument id
Receive: instrument id 49

set instrument id *value*

This command sets the instrument id to *value*, where *value* is a decimal number between 0 and 127 inclusive.

Note Sending this command via RS-232 or RS-485 will require the host to use the new id for subsequent commands. ▲

Send: set instrument id 50
Receive: set instrument id 50 ok

mode

This command reports what operating mode the instrument is in: local, service, or remote. The example that follows shows that the instrument is in the remote mode.

Send: mode
Receive: mode remote

set mode local**set mode remote**

These commands set the instrument to local or remote mode. The example that follows sets the instrument to the local mode.

Send: set mode local
Receive: set mode local ok

program no

This command reports the analyzer's model information and program version number, which will be dependant on the current version.

Send: program no
 Receive: program no iSeries 49i 01.00.01.074

set layout ack

This command disables the stale layout/layout change indicator (“*”) that is attached to each response if the layout has changed.

Send: set layout ack
 Receive: set layout ack ok

I/O Configuration

analog iout range *channel*

This command reports the analog current output range setting for *channels*, where *channel* must be between 1 and 6, inclusive. The example that follows reports current output channel 4 to the 4-20 mA range, according to [Table B-9](#). This command responds with “feature not enabled” if the I/O expansion board is not detected.

Send: analog iout range 4
 Receive: analog iout range 4 2

set analog iout range *channel range*

This command sets analog current output *channel* to the *channel range* where *channel* is between 1 and 6 inclusive, and *range* is set according to [Table B-9](#). The example that follows sets current output channel 4 to the 0-20 mA range. This command responds with “feature not enabled” if the I/O expansion board is not detected.

Send: set analog iout range 4 1
 Receive: set analog iout range 4 1 ok

Table B-9. Analog Current Output Range Values

<i>Range</i>	Output Range
1	0-20 mA
2	4-20 mA
0 [cannot be set to this, but may report]	Undefined

analog vin *channel*

This command retrieves the analog voltage input *channel* data, both the calculated value and the actual voltage. In the example that follows, the “calculated” value of channel 1 is 75.325 degrees F, volts are 2.796. This command responds with “feature not enabled” if the I/O expansion board is not detected.

Send: analog vin 1
 Receive: analog vin 1 75.325 2.796

analog vout range *channel*

This command reports the analog voltage output *channel* range, where *channel* is between 1 and 6 inclusive, according to [Table B-10](#).

Send: analog vout range 2
Receive: analog vout range 2 3

set analog vout range *channel range*

This command sets analog voltage output *channel* to the range, where *channel* is between 1 and 6 inclusive, and *range* is set according to [Table B-10](#). The example that follows sets channel 2 to the 0-10 V range.

Send: set analog vout range 2 3
Receive: set analog vout range 2 3 ok

Table B-10. Analog Voltage Output Range Values

<i>Range</i>	Output Range
1	0-1 V
2	0-100 mV
3	0-10 V
4	0-5 V
0 [cannot be set to this, but may report]	Undefined

dig in

This command reports the status of the digital inputs as a 4-digit hexadecimal string with the most significant bit (MSB) being input 16.

Send: dig in
Receive: dig in 0xff7f

din *channel*

This command reports the action assigned to input *channel* and the corresponding active state. The example that follows reports the input 5 to be assigned an index number 9 corresponding to action of “analog outputs to zero” with the active state being high.

Send: din 5
Receive: din 5 9 AOUTS TO ZERO high

set din *channel index state*

This command assigns digital input *channel* (1-16) to activate the action indicated by *index* (1-35), when the input transitions to the designated *state* (high or low). Use “list din var” command to obtain the list of supported *index* values and corresponding actions.

```
Send:      set din 1 3 high
Receive:   set din 1 3 high ok
```

dout channel

This command reports the index number and output variable and the active state assigned to output *channel*. The example that follows reports the input 4 to be assigned an index number 11 corresponding to “general alarm” with the active state being open.

```
Send:      dout 4
Receive:   dout 4 11 GEN ALARM open
```

set dout channel index state

This command assigns digital output *channel* to be assigned to the action associated with *index*, and assigns it an active state of *state* (open or closed).

```
Send:      set dout 4 11 open
Receive:   set dout 4 11 open ok
```

dtoa channel

This reports the outputs of the 6 or 12 digital to analog converters, according to [Table B-11](#). The example that follows shows that the DAC 1 is 97.7% full-scale.

```
Send:      dtoa 1
Receive:   dtoa 1 97.7%
```

Note All channel ranges are user definable. If any customization has been made to the analog output configuration, the default selections may not apply. ▲

Table B-11. Default Output Assignment

D to A	Function
1	Voltage Output
2	Voltage Output
3	Voltage Output
4	Voltage Output
5	Voltage Output
6	Voltage Output
7	Current Output

Table B-11. Default Output Assignment, continued

D to A	Function
8	Current Output
9	Current Output
10	Current Output
11	Current Output
12	Current Output

list var aout

list var dout

list var din

These commands report the list of index numbers, and the variables (associated with that index number) available for selection in the current mode (determined by single/dual/auto, gas mode no/no_x or no/no_x) for analog output, digital output and digital inputs. The index number is used to insert the variable in a field location in a list using “set sp *field index*”. The example that follows reports the list of analog output, index numbers, and variables.

```
Send:      list var aout
Receive:   list var aout
index variable
0 none
1 o3
2 no2
5 cellai
6 cellbi
7 noisa
8 noisb
9 flowa
10 flowb
11 pres
12 bncht
13 lmpt
```

relay

relay stat

This command reports the current relay logic normally “open” or normally “closed,” if all the relays are set to same state, that is all open or all closed. The example that follows shows that the status when all the relays logic is set to normally “open”.

```
Send:      relay stat
Receive:   relay stat open
```

Note If individual relays have been assigned different logic, the response would be a 4-digit hexadecimal string with the least significant byte (LSB) being relay no 1. ▲

For example:

Receive: relay stat 0x0001 (indicates relay no 1 is set to normally open logic, all others are normally closed)

Receive: relay stat 0x0005 (indicates relay no 1 and 3 are set to be normally open logic, all others are normally closed)

set relay open

set relay open *value*

set relay closed

set relay closed *value*

These commands set the relay logic to normally open or closed for relay number *value*, where *value* is the relay between 1 and 16. The example that follows sets the relay no 1 logic to normally open.

Note If the command is sent without an appended relay number then all the relays are assigned the set logic of normally open/closed. ▲

Send: set relay open 1

Receive: set relay open 1 ok

Record Layout Definition

The Erec, Lrec, and Srec Layouts contain the following:

- A format specifier for parsing ASCII responses
- A format specifier for parsing binary responses

In addition to these, the Erec Layout contains:

- A format specifier for producing the front-panel displays

In operation, values are read in using either the ASCII or binary format specifiers and converted to uniform internal representations (32-bit floats or 32-bit integers). These values are converted into text for display on the screen using the format specifier for the front-panel display. Normally, the specifier used to parse a particular datum from the input stream will be strongly related to the specifier used to display it (e.g., all of the floating point inputs will be displayed with an 'f' output specifier, and all of the integer inputs will be displayed with a 'd' specifier).

Format Specifier for ASCII Responses

The first line of the Layout response is the scanf-like parameter list for parsing the fields from an ASCII ERec response. Parameters are separated by spaces and the line is terminated by a \n (the normal line separator character). Valid fields are:

```
%s - parse a string
%d - parse a decimal number
%ld - parse a long (32-bit) decimal number
%f - parse a floating point number
%x - parse a hexadecimal number
%lx - parse a long (32-bit) hex number
%* - ignore the field
```

Note Signed versus unsigned for the integer values does not matter; it is handled automatically. ▲

Format Specifier for Binary Responses

The second line of the Layout response is the binary parameter list for parsing the fields from a binary response. Parameters MUST be separated by spaces, and the line is terminated by a '\n'. Valid fields are:

```
t - parse a time specifier (2 bytes)
D - parse a date specifier (3 bytes)
i - ignore one 8-bit character (1 byte)
e - parse a 24-bit floating point number (3 bytes: n/x)
E - parse a 24-bit floating point number (3 bytes: N/x)
f - parse a 32-bit floating point number (4 bytes)
c - parse an 8-bit signed number (1 byte)
C - parse an 8-bit unsigned number (1 byte)
n - parse a 16-bit signed number (2 bytes)
N - parse a 16-bit unsigned number (2 bytes)
m - parse a 24-bit signed number (3 bytes)
M - parse a 24-bit unsigned number (3 bytes)
l - parse a 32-bit signed number (4 bytes)
L - parse a 32-bit unsigned number (4 bytes)
```

There is an optional single digit *d* which may follow any of the numeric fields which indicates that after the field has been parsed out, the resulting value is to be divided by 10^d . Thus the 16-bit field 0xFFC6 would be interpreted with the format specifier 'n3' as the number -0.058.

Format Specifier for Front-Panel Layout

The subsequent lines in the ERec Layout response describe the appearance of the full panel. The full instrument panel as it appears on the screen has two columns of lines. Each line is composed of three major components: (1) a text field, (2) a value field, and (3) a button. None of these three components is required. The text field contains statically displayed text.

The value field displays values which are parsed out of the response to a DATA/ERec command. It also displays, though background changes, alarm status. The button, when pressed, triggers input from either a dialog box or a selection list. There are five kinds of buttons, B, I, L, T, and N.

Each line in the layout string corresponds to one line on the display. The layout string describes each of the three major fields as well as translation mechanisms and corresponding commands.

Text The first field in the layout string is the text. It is delimited by a ':'. The string up to the first ':' will be read and inserted in the text field of the line.

Value String This is followed by a possible string, enclosed in quotes. This is used to place a string into the value field.

Value Source The value source, which is the item (or word) number in the DATA/ERec response, appears next. This is followed by an optional bitfield designator. The datum identified by the value source can be printed as a string 's', hexadecimal 'x', decimal 'd', or floating point 'f', or binary 'b' number. Typically, bitfield extractions are only done for decimal or hexadecimal numbers.

Floating-point numbers can be followed with an optional precision specifier which will be used as an argument to printf's %f format (e.g., a field of '4' would be translated into the printf command of '%.3f'). Alternately, the special character '*' can precede the precision specifier; this causes an indirection on the precision specifier (which now becomes a field number).

This is useful when formatting, for example, numbers which have varying precision depending on the mode of the instrument.

Binary numbers can also have an optional precision specifier which is used to determine how many bits to print. For example, the specifier 'b4' will print the lowest four bits of the parsed number.

There are serious restrictions on where an 's' field may appear: currently sources 1 and 2 must be 's', and no others may be 's'.

Alarm Information The value source is followed by optional alarm information, indicated by a commercial at sign '@' with a source indicator and a starting bit indicator. All alarm information is presumed to be two bits long (low and high). The bitfield extraction is performed on the integer part of the source. Typical alarm information would appear as '@6.4'.

Translation Table Then, there appears an optional translation table within braces '{}'. This is a string of words separated by spaces. An example translation table would be '{Code_0 Code_1 Code_2 Code_3}'. The value, once extracted is used as a zero-based index into the translation table to determine the string to display.

Selection Table Then there appears an optional selection table within parentheses '(...)'. This is a string of numbers separated by spaces '(0 1)'. The selection table lists the translation table entries which the user may select from when setting the parameter. This is not necessarily the same as the entries which may be displayed.

Button Designator Then there appears an optional button designator. This will be one of 'B', 'I', 'L', 'T', or 'N'.

B- Indicates a button which pops up an input dialog prompting the user for a new value using the designated input format. The input format is specified from the 'B' through the subsequent semicolon.

I—Indicates a button which pops up a selection list with input translation. That is, the values read are translated before they are compared to the selection list options.

L—Indicates a button which pops up a selection list without any translation. The output value is number of the selected option.

T—Indicates a button which pops up a selection list with output translation. The number of the option selected is used as an index into the translation table to generate an output string.

N—Indicates a button which only sends the subsequent command to the instrument. No user-prompting happens.

The following string through an optional '|' or the end of the line is the command which is to be sent to the instrument upon the completion of the button selection. The command string should normally contain print-style formatting to include the user input. If a '|' is present, it indicates a command which is sent to the instrument upon successful completion of the button command to update the value field.

This is not currently used.

Examples Some examples ('\n' is the C syntax for an end-of-line character):

'Concentrations\n'

This is a single text-only line.

```
'\n'
```

This is a single blank line.

```
' 03:3s\n'
```

This is a line which appears slightly indented. The text field is '03', the value is taken from the third element of the data response, and interpreted as a string.

```
' 03:18sBd.ddd;set no coef %s\n'
```

This is a line which also appears slightly indented. The next field is also '03', but the value is taken from the eighteenth element of the data response, again interpreted as a string. A button appears on this line which, when pressed, pops up an input dialog which will state "Please enter a new value for 03 using a d.ddd format." The string entered by the user is used to construct the output command. If the user enters, for example, '1.234', the constructed command will be 'set no coef 1.234'.

```
' 03:21f{Code_0 Code_1 Code_2 Code_3 Code_4 Code_5 Code_6 Code_7 Code_8 Code_9 Code_10 Code_11}Lset range no %d\n'
```

This is a line which appears slightly indented, the title is again '03', and the value the twenty-first element of the data response, interpreted as a floating-point number. There is a no-translation button which creates a selection list of twelve "Code nn" options. The number of the user selection is used to create the output command.

```
'Mode:6.12-13x{local remote service service}(0 1)Tset mode %s\n'
```

This is a line which has a title of 'Mode', and value taken from the sixth field of the data response. There is a bitfield extraction of bits 12 through 13 from the source (the value type is not important here because the value is being translated to an output string). Once the bits have been extracted, they are shifted down to the bit-zero position. Thus, the possible values of this example will be 0 through 3. The translation list shows the words which correspond to each input value, the zeroth value appearing first (0 -> local, 1 -> remote, etc.). The selection list shows that only the first two values, in this case, are to be shown to the user when the button is pressed. The 'T' button indicates full translation, input code to string, and user selection number to output string.

```
'\xC'
```

This is a line that starts a new column (the \xC or ^L),

```
' Comp:6.11x{off on}Tset temp comp %s\n'
```

This shows that the bitfield end (the second part of a bitfield specification) is optional. The bitfield will be one bit long, starting in this case at the eleventh bit.

```
'Background:7f*8Bd.ddd;set o3 bkg %s\n'
```

This shows the use of indirect precision specifiers for floating point displays. The background value is taken from the 7th element, and the precision specifier is taken from the 8th. If the asterisk were not present, it would indicate instead that 8 digits after the decimal point should be displayed.

C-Link Protocol Commands

Record Layout Definition

Appendix C MODBUS Protocol

This appendix provides a description of the MODBUS Protocol Interface and is supported both over RS-232/485 (RTU protocol) as well as TCP/IP over Ethernet.

The MODBUS Commands that are implemented are explained in detail in this document. The MODBUS protocol support for the *iSeries* enables the user to perform the functions of reading the various concentrations and other analog values or variables, read the status of the digital outputs of the analyzer, and to trigger or simulate the activation of a digital input to the instrument. This is achieved by using the supported MODBUS commands listed below.

For details of the Model 49*i* Primary Standard MODBUS Protocol specification, see the following topics:

- “Serial Communication Parameters” on page C-2 describes the parameters used to support MODBUS RTU protocol.
- “TCP Communication Parameters” on page C-2 describes the parameters used for TCP connection.
- “Application Data Unit Definition” on page C-2 describes the formats used over serial and TCP/IP.
- “Function Codes” on page C-3 describes the various function codes supported by the instrument.
- “MODBUS Commands Supported” on page C-8 lists the MODBUS commands supported in Table C-1 through Table C-3.

Additional information on the MODBUS protocol can be obtained at <http://www.modbus.org>. References are from MODBUS Application Protocol Specification V1.1a MODBUS-IDA June 4, 2004.

Serial Communication Parameters

The following are the communication parameters that are used to configure the serial port of the *iSeries* to support MODBUS RTU protocol.

- Number of Data bits : 8
- Number of Stop bits : 1
- Parity : None
- Data rate : from 1200-115200 Baud (9600 is default)

TCP Communication Parameters

iSeries Instruments support the MODBUS/TCP protocol. The register definition is the same as for the serial interface.

TCP connection port for MODBUS : 502

Application Data Unit Definition

Here are the MODBUS ADU (Application Data Unit) formats over serial and TCP/IP:

Serial:	Slave Address	Function Code	Data	Error Check
TCP/IP:	MBAP Header	Function Code	Data	

Slave Address

The MODBUS slave address is a single byte in length. This is the same as the instrument ID used for C-Link commands and can be between 1 and 127 decimal (i.e. 0x01 hex to 0x7F hex). This address is only used for MODBUS RTU over serial connections.

Note Device ID '0' used for broadcast MODBUS commands, is not supported. Device IDs 128 through 247 (i.e. 0x80 hex to 0xF7 hex) are not supported because of limitations imposed by C-Link. ▲

MBAP Header

In MODBUS over TCP/IP, a MODBUS Application Protocol Header (MBAP) is used to identify the message. This header consists of the following components:

Transaction Identifier	2 Bytes	0x0000 to 0xFFFF (Passed back in response)
Protocol Identifier	2 Bytes	0x00 (MODBUS protocol)
Length	2 Bytes	0x0000 to 0xFFFF (Number of following bytes)
Unit Identifier	1 Byte	0x00 to 0xFF (Passed back in response)

A Slave address is not required in MODBUS over TCP/IP because the higher-level protocols include device addressing. The unit identifier is not used by the instrument.

Function Code

The function code is a single byte in length. The following function codes are supported by the instrument:

Read Coils	:	0x01
Read Inputs	:	0x02
Read Holding Registers	:	0x03
Read Input Registers	:	0x04
Force (Write) Single Coil	:	0x05
Read Exception Status	:	0x07

If a function code is received that is not in this list, and invalid function exception is returned.

Data

The data field varies depending on the function. For more description of these data fields, see “Function Codes” below.

Error Check

In MODBUS over Serial an error check is included in the message. This is not necessary in MODBUS over TCP/IP because the higher-level protocols ensure error-free transmission. The error check is a two-byte (16-bit) CRC value.

Function Codes

This section describes the various function codes that are supported by the Model 49*i* Primary Standard.

(0x01/0x02) Read Coils / Read Inputs

Read Coils/Inputs reads the status of the digital outputs (relays) in the instrument. Issuing either of these function codes will generate the same response.

These requests specify the starting address, i.e. the address of the first output specified, and the number of outputs. The outputs are addressed starting at zero. Therefore, outputs numbered 1–16 are addressed as 0–15.

The outputs in the response message are packed as one per bit of the data field. Status is indicated as 1 = Active (on) and 0 = Inactive (off). The LSB of the first data byte contains the output addressed in the query. The other outputs follow toward the high order end of this byte, and from low order to high order in subsequent bytes. If the returned output quantity is not a multiple of eight, the remaining bits in the final data byte will be padded with zeros (toward the high order end of the byte). The Byte Count field specifies the quantity of complete bytes of data.

Note The values reported may not reflect the state of the actual relays in the instrument, as the user may program these outputs for either active closed or open. ▲

Request

Function code	1 Byte	0x01 or 0x02
Starting Address	2 Bytes	0x0000 to maximum allowed by instrument
Quantity of outputs	2 Bytes	1 to maximum allowed by instrument
Unit Identifier	1 Byte	0x00 to 0xFF (Passed back in response)

Response

Function code	1 Byte	0x01 or 0x02
Byte count	1 Byte	N*
Output Status	n Byte	n = N or N+1

*N = Quantity of Outputs / 8, if the remainder not equal to zero, then N=N+1

Error Response

Function code	1 Byte	Function code + 0x80
Exception code	1 Byte	01=Illegal Function, 02=Illegal Address, 03=Illegal Data, 04=Slave Device Failure

Here is an example of a request and response to read outputs 2–15:

Request

<i>Field Name</i>	<i>(Hex)</i>
Function	0x01
Starting Address Hi	0x00
Starting Address Lo	0x02
Quantity of Outputs Hi	0x00
Quantity of Outputs Lo	0x0D

Response

<i>Field Name</i>	<i>(Hex)</i>
Function	0x01
Byte Count	0x03
Outputs status 2-10	0xCD
Outputs status 11-15	0x0A

The status of outputs 2–10 is shown as the byte value 0xCD, or binary 1100 1101. Output 10 is the MSB of this byte, and output 2 is the LSB. By convention, bits within a byte are shown with the MSB to the left, and the LSB to the right. Thus the outputs in the first byte are ‘10 through 2’, from left to right. In the last data byte, the status of outputs 15-11 is shown as the byte value 0x0A, or binary 0000 1010. Output 15 is in the fifth bit position from the left, and output 11 is the LSB of this byte. The four remaining high order bits are zero filled.

(0x03/0x04) Read Holding Registers / Read Input Registers

Read holding/input registers reads the measurement data from the instrument. Issuing either of these function codes will generate the same response. These functions read the contents of one or more contiguous registers.

These registers are 16 bits each and are organized as shown below. All of the values are reported as 32-bit IEEE standard 754 floating point format. This uses 2 sequential registers, least significant 16 bits first.

The request specifies the starting register address and the number of registers. Registers are addressed starting at zero. Therefore registers numbered 1–16 are addressed as 0–15. The register data in the response message are packed as two bytes per register, with the binary contents right justified within each byte. For each register, the first byte contains the high order bits and the second contains the low order bits.

Request

Function code	1 Byte	0x03 or 0x04
Starting Address	2 Bytes	0x0000 to maximum allowed by instrument
Quantity of Registers	2 Bytes	1 to maximum allowed by instrument

Response

Function code	1 Byte	0x03 or 0x04
Byte count	1 Byte	2 x N*
Register value	N* x 2 Bytes	n = N or N+1

*N = Quantity of Registers

Error Response

Function code	1 Byte	Function code + 0x80
Exception code	1 Byte	01=Illegal Function, 02=Illegal Address, 03=Illegal Data, 04=Slave Device Failure

Here is an example of a request to read registers 10–13:

Request

<i>Field Name</i>	<i>(Hex)</i>
Function	0x03
Starting Address Hi	0x00
Starting Address Lo	0x09
No. of Registers Hi	0x00
No. of Registers Lo	0x04

Response

<i>Field Name</i>	<i>(Hex)</i>
Function	0x03
Byte Count	0x06
Register value Hi (10)	0x02
Register value Lo (10)	0x2B
Register value Hi (11)	0x00
Register value Lo (11)	0x00
Register value Hi (12)	0x00
Register value Lo (12)	0x64
Register value Hi (13)	0x00
Register value Lo (13)	0x64

The contents of register 10 are shown as the two byte values of 0x02 0x2B. The contents of registers 11–13 are 0x00 0x00, 0x00 0x64 and 0x00 0x64, respectively.

(0x05) Force (Write) Single Coil

The force (write) single coil function simulates the activation of the digital inputs in the instrument, which triggers the respective action.

This function code is used to set a single action to either ON or OFF. The request specifies the address of the action to be forced. Actions are addressed starting at zero. Therefore, action number 1 is addressed as 0. The requested ON/OFF state is specified by a constant in the request data field. A value of 0xFF00 requests the action to be ON. A value of 0x0000 requests it to be OFF. All other values are illegal and will not affect the output. The normal response is an echo of the request, returned after the state has been written.

Request

Function code	1 Byte	0x05
Output Address	2 Bytes	0x0000 to maximum allowed by instrument
Output Value	2 Bytes	0x0000 or 0xFF00

Response

Function code	1 Byte	0x05
Output Address	2 Bytes	0x0000 to maximum allowed by instrument
Output Value	2 Bytes	0x0000 or 0xFF00

Error Response

Function code	1 Byte	Function code + 0x80
Exception code	1 Byte	01=Illegal Function, 02=Illegal Address, 03=Illegal Data, 04=Slave Device Failure

Here is an example of a request to write Coil 5 ON:

Request

<i>Field Name</i>	<i>(Hex)</i>
Function	05
Output Address Hi	00
Output Address Lo	05
Output Value Hi	FF
Output Value Lo	00

Response	
<i>Field Name</i>	<i>(Hex)</i>
Function	05
Output Address Hi	00
Output Address Lo	05
Output Value Hi	FF
Output Value Lo	00

MODBUS Commands Supported

Table C-1 through table C-3 list the MODBUS commands supported for the Model 49i Primary Standard.

Table C-1. Read Coils for 49i Primary Standard

Coil Number	Status
1	NOT USED
2	SERVICE
3	GAS UNITS
4	ZERO MODE
5	SPAN MODE
6	SAMPLE MODE
7	O ₃ LEVEL 1
8	O ₃ LEVEL 2
9	O ₃ LEVEL 3
10	O ₃ LEVEL 4
11	O ₃ LEVEL 5
12	PURGE MODE
13	GEN ALARM
14	CONC MAX ALARM
15	CONC MIN ALARM
16	BENCH TEMP ALARM
17	BENCH LAMP TEMP ALARM
18	O ₃ LAMP TEMP ALARM
19	PRESSURE ALARM
20	FLOW A ALARM
21	FLOW B ALARM
22	INTENSITY A ALARM

Table C-1. Read Coils for 49i Primary Standard, continued

Coil Number	Status
23	INTENSITY B ALARM
24	CONC ALARM
25	NOT USED
26	NOT USED
27	NOT USED
28	NOT USED
29	NOT USED
30	NOT USED
31	NOT USED
32	MOTHERBOARD STATUS ALARM
33	MEASUREMENT INTERFACE BD STATUS ALARM
34	I/O EXP BD STATUS ALARM

Table C-2. Read Registers for 49i Primary Standard

Register Number	Variable
4001&40002	O ₃ CONC
4003&40004	LO O ₃ CONC (Dual/Auto Range mode)
4005&40006	HI O ₃ CONC (Dual/Auto Range mode)
4007&40008	RANGE STATUS
4009&40010	INTENSITY A
4011&40012	INTENSITY B
4013&40014	NOISE A
4015&40016	NOISE B
4017&40018	FLOW A
4019&40020	FLOW B
4021&40022	PRESSURE
4023&40024	BENCH TEMP
4025&40026	LAMP TEMP
4027&40028	O ₃ LAMP TEMP
4029&40030	ANALOG IN 1
4031&40032	ANALOG IN 2
4033&40034	ANALOG IN 3

Table C-2. Read Registers for 49i Primary Standard, continued

Register Number	Variable
40035&40036	ANALOG IN 4
40037&40038	ANALOG IN 5
40039&40040	ANALOG IN 6
40041&40042	ANALOG IN 7
40043&40044	ANALOG IN 8
40045&40046	O3 OUT CONC

Table C-3. Write Coils for 49i Primary Standard

Coil Number	Action
101	ZERO MODE
102	SPAN MODE
103	OZONATOR LEVEL 1
104	OZONATOR LEVEL 2
105	OZONATOR LEVEL 3
106	OZONATOR LEVEL 4
107	OZONATOR LEVEL 5
108	SET BACKGROUND
109	CAL TO LOW SPAN (Dual/Auto Range mode)
110	CAL TO HIGH SPAN (Dual/Auto Range mode)
111	OZONATOR SOLENOID
112	AOUTS TO ZERO
113	AOUTS TO FS

Appendix D Geysitech (Bayern-Hessen) Protocol

This appendix provides a description of the Geysitech (Bayern-Hessen or BH) Protocol Interface and is supported both over RS-232/485 as well as TCP/IP over Ethernet.

The Geysitech Commands that are implemented are explained in detail in this document. The Geysitech protocol support for the *i*Series enables the user to perform the functions of reading the various concentrations and to trigger the instrument to be in sample/zero/span mode if valid for that instrument. This is achieved by using the supported Geysitech commands listed below.

For details of the Model 49*i* Primary Standard Geysitech Protocol specification, see the following topics:

[“Serial Communication Parameters” on page D-1](#)

[“TCP Communication Parameters” on page D-2](#)

[“Instrument Address” on page D-2](#)

[“Abbreviations Used” on page D-2](#)

[“Basic Command Structure” on page D-2](#)

[“Block Checksum <BCC>” on page D-3](#)

[“Geysitech Commands” on page D-3](#)

Serial Communication Parameters

The following are the communication parameters that are used to configure the serial port of the *i*Series to support Geysitech protocol.

Number of Data bits : 8

Number of Stop bits : 1

Parity : None

Data rate : from 1200-115200 Baud (9600 is default)

TCP Communication Parameters

iSeries Instruments support the Geysitech/TCP protocol over TCP/IP. The register definition is the same as for the serial interface.

TCP connection port for Geysitech: 9882

Instrument Address

The Geysitech instrument address has a value between 0 and 127 and is represented by 3 digit ASCII number with leading zeros or leading spaces if required (e.g. Instrument address of 1 is represented as 001 or <SP><SP>1).

The instrument Address is the same as the Instrument ID used for C-Link and MODBUS commands. This can be set via the front panel.

The Instrument Address is represented by <address> in the examples throughout this document.

Note Device IDs 128 through 247 are not supported because of limitations imposed by the C-Link protocol. ▲

Abbreviations Used

The following is a list of abbreviations used in this document:

<CR> is abbreviation for Carriage Return (ASCII code 0x0D)

<STX> is abbreviation for Start of Text (ASCII code 0x02)

<ETX> is abbreviation for End of Text (ASCII code 0x03)

<SP> is abbreviation for space (ASCII code 0x20)

Basic Command Structure

The following is the basic structure of a Geysitech command:

<STX>Command text<ETX><BCC>

OR

<STX>Command text<CR>

Each Command is framed by control characters, <STX> at the start and terminated with either <ETX> or <CR>.

If a command is terminated with <ETX> then additional two characters <BCC> is attached after <ETX>, this is the block checksum.

Block Checksum <BCC>

The block checksum is calculated beginning with a seed value of 00000000, binary (0x00), and bitwise exclusive ORing with each of the characters of the command string (or response) including the framing characters <STX> and <ETX>. The checksum works as an error check. The command terminator determines the presence or absence of <BCC>.

If a command is terminated by <ETX> then the next two characters are the checksum, if the command is terminated with <CR> no checksum is attached

The block checksum is represented by two characters, which represent a 2 digit hex number (1byte). (e.g. 1 byte 0xAB hex checksum will be represented by the two characters 'A' & 'B')

The checksum is referred to as <BCC> throughout this document.

Geysitech Commands

The following commands are supported by the Geysitech protocol:

- Instrument Control Command (ST)
- Data Sampling/Data Query Command (DA)

Instrument Control Command (ST)

There are three control commands supported by the Geysitech protocol.

This <control command> is a single letter, which triggers an action in the instrument. These commands are active only when service mode is inactive and the zero/span option is present.

Command 'N' switches the instrument gas mode to Zero.

For the 49*i* PS, command 'K' switches the instrument gas mode to Level 1.

For the 49*i*, command 'K' is not used unless the Sample/Cal option is present. When the Sample/Cal option is present:

- If the ozonator is present, command 'K' switches the instrument gas mode to Level 1.

- If the the ozonator is not present, command ‘K’ switches the instrument gas mode to Span.

Command ‘M’ switches the instrument gas mode to Sample for the 49*i* and Manual for the 49*i* PS.

The following are the different acceptable formats of the ST command:

<STX>ST<address><control command><ETX><BCC>

OR

<STX>ST<address><control command><CR>

OR

<STX>ST<address><SP><control command><CR>

OR

<STX>ST<address><SP><control command><ETX><BCC>

The <address> is optional, which means it can be left out completely. The <address> if present must match the Instrument Address. Additional space can be present after the <address>.

If the received command does not satisfy the above formats or if the <address> does not match the Instrument Address the command is ignored.

This is a sample command to switch the instrument to zero mode, instrument id 5:

<STX>ST005<SP>N<CR>

Data Sampling/Data Query Command (DA)

This command DA initiates a data transfer from the instrument. The instrument responds with measurement data, which depends on the range mode and is listed in [“Measurements Reported in Response to DA Command for 49*i* and 49*i* PS”](#) on page D-7.

The command structure for a data query command is as follows:

<STX>DA<address><ETX><BCC>

The <address> is optional, which means it can be left out completely. The <address> if present must match the Instrument Address. Additional space can be present after the <address>.

If the <address> is left out then no space is allowed in the query string.

A command with no address is also a valid command.

The following are the different acceptable formats of the DA command with Instrument Address 5:

<STX>DA<CR>

<STX>DA005<CR>

<STX>DA<SP><SP>5<ETX><BCC>

<STX>DA<ETX><BCC>

The data query string is valid and will be answered with data transmission only if the command starts with <STX> which is followed by the characters DA, and the <address> (if present) matches the Instrument Address, and the command is terminated with either <CR> with no checksum or <ETX> followed by the correct checksum <BCC>.

Sample Data Reply String in response to Data Query Command (DA):

In response to a valid data query command (DA) the instrument responds in the following format:

<STX>MD02<SP><address><SP><measured value1><SP><status><SP><SFKT><SP><address+1><SP><measured value2><SP><status><SP><SFKT><ETX><BCC>

The response uses the same command terminators as used by the received command i.e. if the received command was terminated with a <CR> the response is terminated with <CR> and if the command was terminated with a <ETX><BCC> the response is terminated with <ETX> and the computed checksum <BCC>.

The 02 after the MD indicates, that two measurements are present in the reply string, (a 03 for three measurements and so on, this will also determine the length of the reply string).

<address> is the Instrument Address. Each subsequent measurement attached to the response will have the <address + X> where X keeps incrementing by 1 for each measurement included.

<measured value> is the concentration value in currently selected gas units represented as exponential representation with 4 characters mantissa and 2 characters exponent, each with sign.

Mantissa: sign and 4 digits. The decimal point is assumed to be after the first digit and is not transmitted.

Exponent: sign and 2 digits.

Example:

-5384000.0 is represented as -5384+06

+0.04567 is represented as +4567-02

<status>: is formed by < operating status > and < error status > and separated by a space i.e.

<operating status><SP><error status>

Each of the two (<operating status> and <error status>) are formed by two characters each representing a 2 digit hex number which is one byte (8 Bits) operation status and one byte (8 Bits) error status.

These two bytes contain the information about the main operating conditions of the instrument at that instant. For details on how to interpret the status bytes refer to [Table D-1](#) and [Table D-2](#).

<SFKT>: is the space provided for future use for special function, it currently contains a string of ten 0's i.e. <0000000000>.

Example:

Geysitech Protocol with transmission of three concentrations (Instrument ID is 1, Operation Status is 03, Error Status is 04):

Data Query String: <STX>DA<CR>

Reply String:

```
<STX>MD03<SP>001<SP>+2578+01<SP>03 <SP>04<SP>0000000000 <SP>002 <SP>
      ↑       ↑                               ↑
      Address First Concentration(E-format)=25.78 Address+1

+5681+00<SP>03<SP>04<SP>0000000000<SP>003<SP>+1175+01<SP>03<SP>04<SP>
      ↑                               ↑       ↑
      Second Concentration = 5.681 Address+2 Third Concentration=11.75

0000000000<SP><CR>
```

The attached concentrations are in the selected gas units. The measurements that are attached to the response if not valid in a particular mode then a value of 0.0 will be reported.

Measurements Reported in Response to DA Command for 49*i* and 49*i* PS

The following measurements reported in response to DA command are for the Model 49*i* and 49*i* Primary Standard.

Single Range Mode for 49*i* and 49*i* PS

The 1 measurement reported in single range mode for the Model 49*i* and 49*i* Primary Standard includes:

- O₃

Dual/Auto Range Mode for 49*i*

The 2 measurements reported in dual or auto range modes for the Model 49*i* include:

- low O₃
- high O₃

Dual/Auto Range Mode for 49*i* PS

The 2 measurements reported in dual or auto range modes for the Model 49*i* Primary Standard include:

- O₃ Actual
- O₃ Set point

Operating and Error Status

See [Table D-1](#) for operating status and [Table D-2](#) for error status for the Model 49i and the Model 49i Primary Standard.

Table D-1. Operating Status for Model 49i and 49i Primary Standard

	D7	D6	D5	D4		D3	D2	D1	D0
→ Bit	8	7	6	5		4	3	2	1
→ Hex-value	80	40	20	10		08	04	02	01
	MSB					LSB			
Operating status:									
Service Mode (On)	0	0	0	0		0	0	0	1
Maintenance (Local)	0	0	0	0		0	0	1	0
Zero gas (On)	0	0	0	0		0	1	0	0
Span gas (On)	0	0	0	0		1	0	0	0
Not used	0	0	0	1		0	0	0	0
Gas Unit Indication (ppb OR ppm)	0	0	1	0		0	0	0	0
Not used	0	1	0	0		0	0	0	0
Not used	1	0	0	0		0	0	0	0

Table D-2. Error Status for Model 49i and 49i Primary Standard

	D7	D6	D5	D4		D3	D2	D1	D0
→ Bit	8	7	6	5		4	3	2	1
→ Hex-value	80	40	20	10		08	04	02	01
	MSB					LSB			
Error status:									
O ₃ Lamp Temperature Alarm	0	0	0	0		0	0	0	1
Internal Temperature Alarm	0	0	0	0		0	0	1	0
Bench Lamp Temperature Alarm	0	0	0	0		0	1	0	0
Pressure Alarm	0	0	0	0		1	0	0	0
Flow A Alarm	0	0	0	1		0	0	0	0
Flow B Alarm	0	0	1	0		0	0	0	0
Intensity A Alarm	0	1	0	0		0	0	0	0
Intensity B Alarm	1	0	0	0		0	0	0	0