

# Electronic Design 3

VOL. 21 NO.

FOR ENGINEERS AND ENGINEERING MANAGERS

FEB. 1, 1973

Unroll rf-transistor spec sheets and you'll find most don't tell all they should. Important specs, such as S parameters, often don't appear. And you can't rely on

2N-type registration to cover all contingencies. Vendors highlight part of the story: higher power at higher frequencies. Get the full facts, starting on page 46.



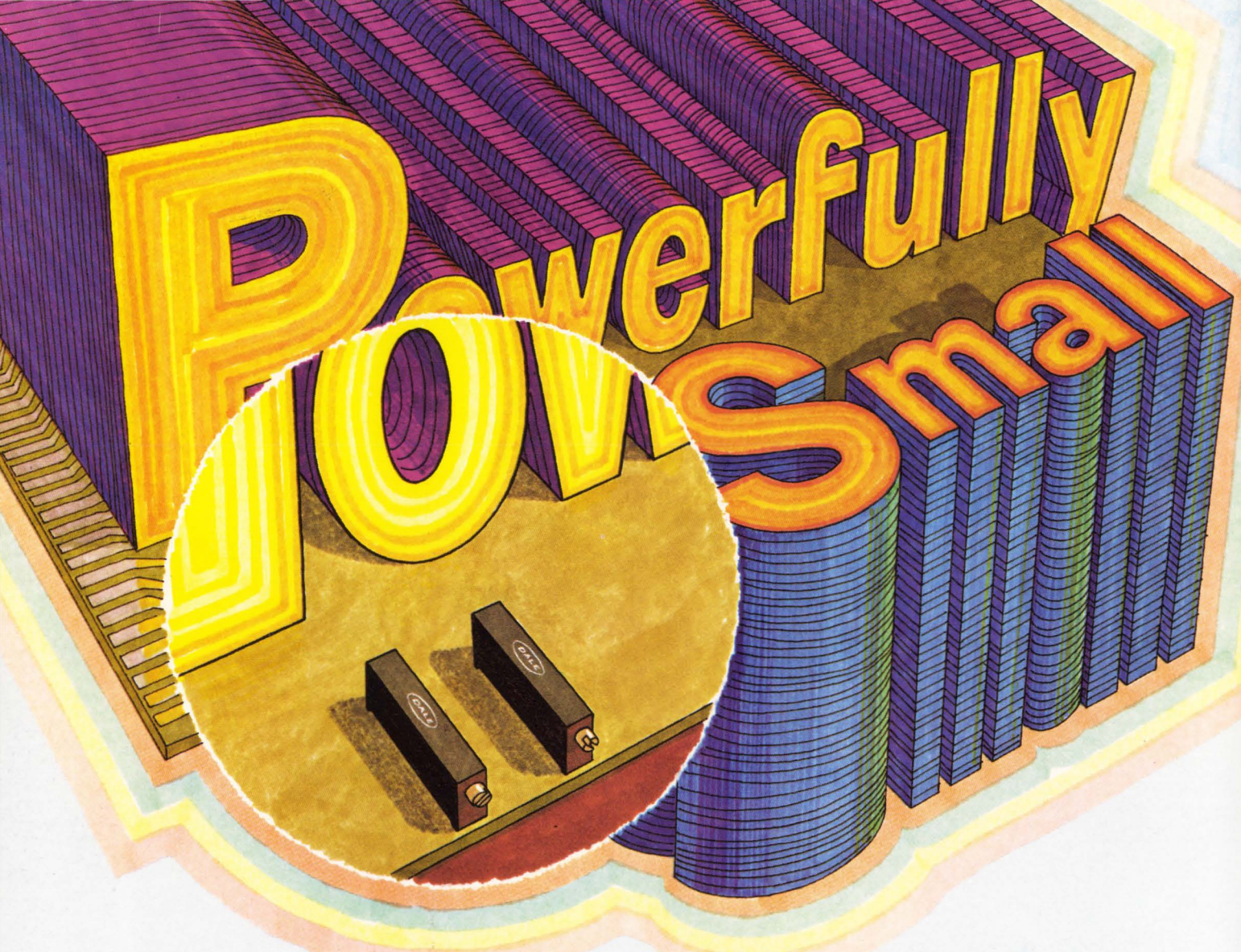

## Wirewound or cermet – Dale's new low profile trimmers have important design advantages for your circuit.

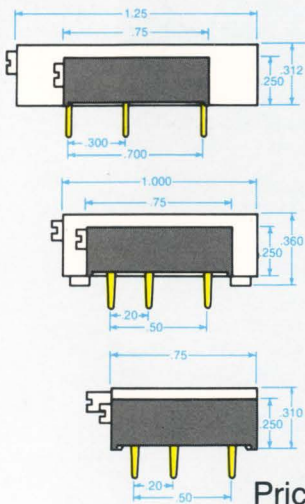

**A full watt in less space** – You can increase both part density and power handling ability with either the 2700 (wirewound) or 8700 (cermet) series. Both dissipate one watt at 70° C.

**More models – greater interchangeability** Choose from three different terminal configurations with pin spacing identical to many larger models. Reduce space as much as 64.6% without sacrificing performance.

**20-turn adjustability** – Wiper arm adjusts smoothly, quickly. Sits tight under vibration and shock inside an immersion-proof case sealed for production soldering and board washing. Flame retardant SE-0 grade material available upon request.

Priced less than 60c in 50,000 quantities. Available fast. Many standard decade values stocked for off-the-shelf delivery. Get the details. Write today or phone 402-564-3131.

SPECIFICATIONS	2700 WIREWOUND	8700 CERMET
Resistance	10-50K ohms	10-2 Meg.
Tolerance	±10%	±10% 100-500K ±20% all other values
T.C.	50 PPM/° C	±100 PPM/° C
Wattage	1 watt/70° C	1 watt/70° C
Operating Temp. Range	-65° C to +150° C	-55° C to +125° C
Adjustability	20 turns (with clutch to prevent overtravel damage)	
Dimensions	.25" high by .165" wide by .75" long	

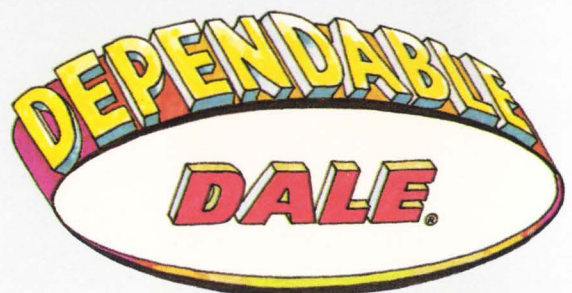

### DALE ELECTRONICS, INC.

1300 28th Ave., Columbus, Neb. 68601

A subsidiary of The Lionel Corporation • In Canada: Dale Electronics Canada, Ltd.

# MERLIN I magic



## for serious weight watchers

A 40% weight reduction topped by a 62% increase in dielectric separation between contacts. That's Amphenol's Merlin® I (Series 118) rear-release connector.

We've reduced the number of connector parts from 122 to 12—in 10-6 and 24-61 configurations. An all-polymer retention disc with integrally molded polymer retainers (no more metal clips) made it possible. With 110 fewer parts you lower total system weight while gaining a lot more reliability.

The Merlin I has an operating range from  $-55^{\circ}\text{C}$

to  $200^{\circ}\text{C}$ . It has excellent resistance to fuels, oils and cleaning solutions. Qualified to both MIL-C-83723 and MIL-C-26482, it is intermateable and intermountable with existing circuitry.

Availability? Right now. For complete information on Merlin I—a true advancement in rear-release design—write or call Michael Ciminella, Amphenol Connector Division, Bunker Ramo Corporation, 2801 S. 25th Avenue, Broadview, Illinois 60153. (312) 261-2000.

Merlin does more with less.

**BUNKER  
RAMO**

**AMPHENOL**

---

# THE SMALLEST

---

## 5 AMP

---

# GENERAL PURPOSE

---

# RELAY

---

**Available now, Teledyne's  
new Mini-T.**

This industrial, heavy-duty 120 volt 5 amp relay features a life expectancy of over 10 million dependable operations. The space-saving 2PDT Mini-T with transparent dust cover has a full line of complementary sockets and hold down clips for P.C. board or chassis mounting. This Teledyne relay employs an unusual shaded pole design that permits direct AC operation without the need for rectifying diodes. Available with either AC or DC coils and demonstrating cost effectiveness that's hard to beat, the United States-manufactured Mini-T is truly worth its one-half ounce weight. The Mini-T . . . another finely-crafted relay from Teledyne. Call our nearest distributor today.

3155 West El Segundo Boulevard  
Hawthorne, California 90250  
Telephone (213) 679-2205



**TELEDYNE  
RELAYS**

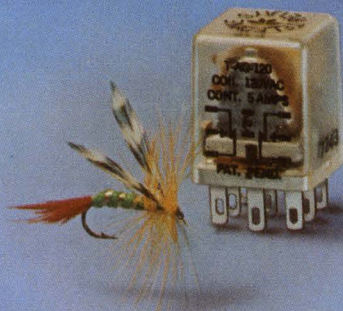

---

## NEWS

- 19 **News Scope**
- 22 **1973 is going to be the year for bubble memories:** A number of prototypes will appear shortly.
- 35 **It's a 40-billion-bit read-only memory, it's a television programmer—it's Disco-Vision!**
- 36 **Pressure sensor offers 20-bit resolution at 10-Q vibration.**
- 38 **Technology Abroad**
- 41 **Washington Report**

---

## TECHNOLOGY

- 46 **Focus on rf transistors:** A special report on the improved bandwidth, output power and reliability of today's devices, and a look at some problems in specification and application.
- 54 **Speed your serial printer** with this automatic, remotely set tabulating system. A single tab code replaces the many space characters in columnar data.
- 60 **Build stable, compact narrowband circuits** with low-frequency, mechanical filters. They will help reduce manufacturing costs and improve reliability.
- 66 **Is Monte Carlo worth the gamble?** Yes, says this manager, and the more that you know about this sampling technique, the more ways you'll find to use it.
- 72 **Ideas for Design:** Minor changes convert an astable multivibrator into a sweep generator . . . Join two unipolar d/a converters and get bipolar operation . . . Use a quad amplifier IC to handle transducer bridge signals.

---

## PRODUCTS

- 79 **Components:** Custom LX displays for small-quantity needs.
- 82 ICs & Semiconductors
- 86 Microwaves & Lasers
- 88 Data Processing
- 89 Packaging & Materials
- 90 Instrumentation
- 92 Modules & Subassemblies

---

## Departments

- 45 **Editorial:** We've got to run faster to stay in place
- 7 Across the Desk
- 94 Evaluation Samples
- 94 Application Notes
- 98 New Literature
- 104 Advertisers' Index
- 106 Product Index
- 106 Information Retrieval Card

**Cover:** Designed and photographed by Art Director, Bill Kelly.

---

ELECTRONIC DESIGN is published biweekly by Hayden Publishing Company, Inc., 50 Essex St., Rochelle Park, N. J. 07662. James S. Mulholland, Jr., President. Printed at Brown Printing Co., Inc., Waseca, Minn. Controlled circulation postage paid at Waseca, Minn., and New York, N. Y., postage pending Rochelle Park, N. J. Copy-right © 1973, Hayden Publishing Company, Inc. 84,392 copies this issue.

# ELIMINATE RESISTOR STOCKPILES

## WITH... BOURNS

# SFR<sup>TM</sup>

SELECTABLE FIXED RESISTOR\*

90 SELECTABLE RESISTANCE VALUES IN 1 TINY UNIT.

Model  
4002

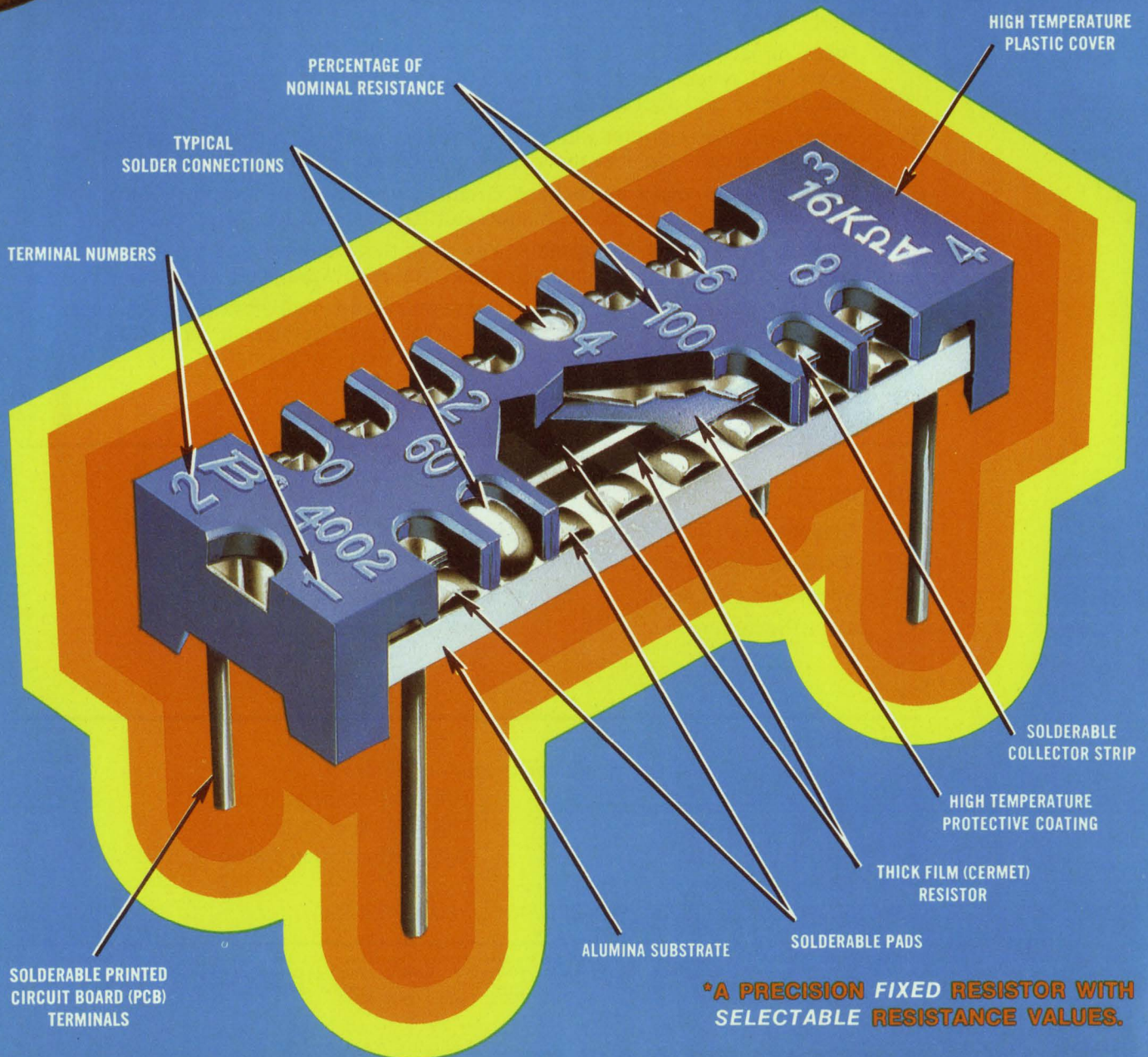
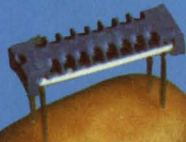

\*A PRECISION FIXED RESISTOR WITH SELECTABLE RESISTANCE VALUES.

# BOURNS NEW... UNIQUE CONCEPT IN RESISTIVE COMPONENTS ALSO OFFERS

- \* 33 ohm to 1.25 megohm combined resistance range over 15 units
- \* Selectability within  $\pm 1\%$  of required resistance value over the entire range

**BOURNS**  
**SFR**™  
SELECTABLE FIXED RESISTOR

- ... IS A STABLE, THICK-FILM, FIXED RESISTOR WITH ADJUSTABILITY OF  $\pm 1\%$  OR BETTER
- ... REPLACES STANDARD FIXED RESISTORS IN APPLICATIONS WHERE FINAL RESISTANCE VALUE REQUIRED CAN'T BE PRECISELY DETERMINED AT THE DESIGN STAGE
- ... REPLACES "ONE-TIME ADJUST" VARIABLE RESISTORS IN APPLICATIONS REQUIRING LONG-TERM STABILITY
- ... RESISTANCE VALUE IS SELECTED, THEN PERMANENTLY, RELIABLY SET BY SOLDERING

## LOOK AT THE \$\$ YOU SAVE ON INVENTORY!!

**FOR EXAMPLE:** Your application requires selection of individual resistance values from 550 ohms to 1000 ohms, or 40 different resistors at 10¢ each. One Model 4002 provides the same resistance selection within  $\pm 1\%$  at 76¢\*.

Result: 40 different resistor values:  $40 \times 10¢ = \$4.00$   
One Model 4002:  $1 \times 76¢ = .76$

## YOU SAVE... \$3.24!!

\*1,000 piece quantity price U.S. dollars, F.O.B., U.S.A.

### it's easy to use

After mounting on PCB; probe the COARSE and FINE adjustment taps (Figures 1 and 2) to determine the precise resistance required. Solder the selected taps (Figure 3) and the SFR RESISTOR is permanently set.

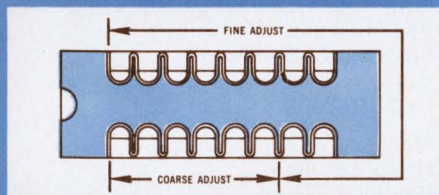

Figure 1

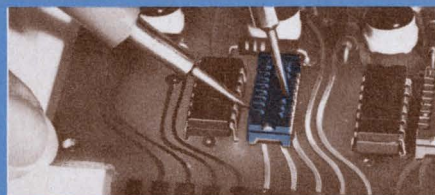

Figure 2

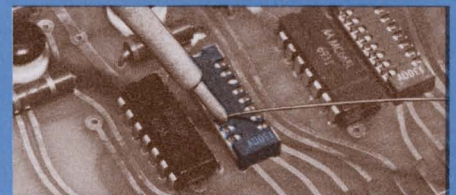

Figure 3

**FOR COMPLETE DETAILS AND A BROCHURE:**

- CALL SFR RESISTOR SALES COLLECT (714) 781-0270
- CONTACT YOUR LOCAL BOURNS REPRESENTATIVE.

**FOR A FREE SAMPLE...** write to the factory answering the following on your company letterhead.

- (a) My application for the Bourns SFR Resistor is . . .
- (b) It will replace (number) of fixed resistors in my inventory
- (c) Approximate anticipated annual quantity usage: (number)

**BOURNS**

"SFR" is a trademark of Bourns, Inc. Patents Pending

BOURNS, INC., TRIMPOT PRODUCTS DIVISION • 1200 COLUMBIA AVE., RIVERSIDE, CALIF. 92507

INFORMATION RETRIEVAL NUMBER 4

**IN STOCK**

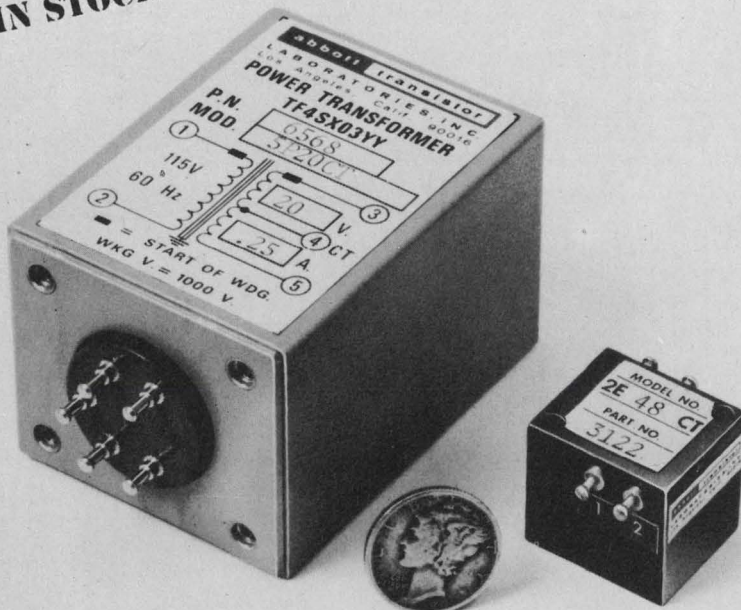

# If You Need A Power Transformer Tomorrow - Call Abbott Today

Now Abbott Stocks 60 Hz and 400 Hz Transformers  
With Output Voltages from 5 to 5000 Volts

Both the 60 Hz and the 400 Hertz transformers are built to meet the specifications of MIL-T-27C. Long life and reliability are inherent in these hermetically sealed, ruggedly built power transformers. The 60 Hertz line comes in eleven power ratings from 5 to 300 watts. The 400 Hz line comes in six power ratings from 2 to 175 watts. Most all of your power transformer needs can be found in this line of Abbott transformers.

	60 Hertz	400 Hertz
<b>Input Primary</b>	115 VAC, 60 Hz $\pm$ 5 Hz, 1 phase	115 V, 400 Hz $\pm$ 20 Hz, 1 phase
<b>Insulation</b>	1750 VAC or 150% of secondary voltage (whichever is higher)	2500 VDC or 150% of secondary voltage (whichever is higher)
<b>Construction</b>	To MIL-T-27C, grade: 4, class: "S", life: "X" (10,000 hrs.), case: steel	To MIL-T-27C, grade: 5, class: "S", life: "X" (10,000 hrs.), case: smaller
<b>Environment</b>	To operate in 105°C maximum ambient temperature. Encapsulated to meet MIL-E-5272C and MIL-E-5400H for vibration, shock, acceleration, sand, dust, humidity, saltspray, fungus, sunshine, rain, explosion, and altitude (to a vacuum)	Encapsulated to meet MIL-E-5272C, including vibration to Proc. XII, temperature to 105°C, shock, sand, dust, humidity, saltspray, fungus, sunshine, rain, explosion, and altitude (to a vacuum)
<b>Secondary</b>	From 5 volts to 5000 volts at 32 milliamperes to 20 amperes	From 5 volts to 5000 volts at 14 milliamperes to 35 amperes

A complete description of all of these power transformers together with their prices is contained in Abbott's 7 page transformer brochure, available FREE on request.

Please see pages 2948 to 2949 of your 1971-72 EEM (ELECTRONIC ENGINEERS MASTER Catalog) for complete information on Abbott Transformers.



**LABORATORIES INCORPORATED**  
5200 W. Jefferson Blvd./Los Angeles 90016 (213) 936-8185  
1224 Anderson Ave./Fort Lee, N.J. 07024 (201) 224-6900

INFORMATION RETRIEVAL NUMBER 5

## Vice President, Publisher

Peter Coley

## Editors

Editorial Offices  
50 Essex St.  
Rochelle Park, N.J. 07662  
(201) 843-0550  
TWX: 710-990 5071  
Cable: Haydenpubs Rochellepark

**Editor-in-Chief:** George Rostky

## Managing Editors:

Ralph Dobriner  
Michael Elphick  
**Associate Editors:**  
Jules H. Gilder  
Richard Lee Goldberg  
Morris Grossman  
Seymour T. Levine  
John F. Mason  
Stanley Runyon  
Edward A. Torrero  
Richard L. Turmail

## Contributing Editor:

Peter N. Budzilovich

## Editorial Field Offices

### East

Jim McDermott, Eastern Editor  
P.O. Box 272  
Easthampton, Mass. 01027  
(413) 527-3632

### West

David N. Kaye, Senior Western Editor  
2930 West Imperial Highway  
Inglewood, Calif. 90303  
(213) 757-0183

### Washington

Heather M. David, Bureau Chief  
2506 Eye St., N.W.  
Washington, D.C. 20037  
(202) 338-3470

## Editorial Production

Marjorie A. Duffy

## Art

**Art Director, William Kelly**  
Richard Luce  
Anthony J. Fischetto

## Production

**Manager, Dollie S. Viebig**  
Helen De Polo  
Maxine Correal  
Anne Molfetas

## Circulation

**Manager, Nancy L. Merritt**  
Ron Deramo

## Information Retrieval

Peggy Long

## Promotion

**Manager, Jeffrey A. Weiner**  
Karen Kerrigan



## across the desk

# The anniversary issue A sampling of reaction

Thank you for sending me the historic issue of ELECTRONIC DESIGN ("The Transistor Years," ED 24, Nov. 23, 1972, pp. 66-134). You did an excellent job on the Patrick Haggerty interview, and I sincerely appreciate your remarks concerning my small contributions.

I joined Texas Instruments in 1959, and much has happened since that time in the electronics industry. Your detailed accounting of the exciting decade of the 60s will be a treasured addition to my files and represents a valuable contribution to historic documentation.

*Richard M. Perdue*

Director, Corporate Public  
Relations

Texas Instruments, Inc.  
P.O. Box 5474  
Dallas, Tex. 75222.

May I congratulate you on your most impressive—or even monumental?—section on transistors in the Nov. 23 issue. It's very well done and very interesting. I'm sure it will become a permanent part of the literature.

*Hal Gettings*

Martin Marietta Corp.  
P.O. Box 5837  
Orlando, Fla.

Your 20th anniversary issue:  
Bravo!

*Howard L. Roberts*

Hewlett-Packard Co.  
1501 Page Mill Rd.  
Palo Alto, Calif. 94304.

As an avid reader of ELECTRONIC DESIGN for the last 10 years, I was

sorely disappointed when I read the childish "Instruments" portion of the history of the transistor story. There was extremely little mention of the connection between what was said in the report to the transistor itself. What in tarnation could I care if Andy Kay did this or that, so long as you can show me how or what the transistor did to help Andy boy and his meters. The story reads like someone's fond recollections or memoirs and has nothing whatever to do with the transistor.

I am a professional design engineer. I see nothing in this report that is of any design value to me, either now or in the future. Perhaps you should hire more professional and competent writers who can serve us better. I am happy to say that I *was* a reader of ELECTRONIC DESIGN.

I would like to see this letter in your "Letters" column but don't think you have the guts to do so.

*Robert Simpson*  
Group Leader

Grumman Aircraft  
Bethpage, N.Y.

*Ed. Note: Evidently ex-reader Simpson failed to note this word in the introduction to "The Transistor Years": "In this issue the magazine departs—just once—from its usual editorial approach to indulge in nostalgia."*

My congratulations on the achievements of ELECTRONIC DESIGN during its 20 long years of existence. It has never let down on its continued editorial excellence.

*(continued on page 11)*

Electronic Design welcomes the opinions of its readers on the issues raised in the magazine's editorial columns. Address letters to Managing Editor, Electronic Design, 50 Essex St. Rochelle Park, N. J. 07662. Try to keep letters under 200 words. Letters must be signed. Names will be withheld on request.

## giga-trim capacitors for microcircuit designers

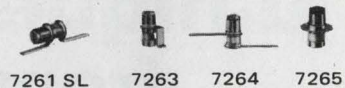

**Giga-Trim®** (gigahertz-trimmers) are tiny variable capacitors which provide a beautifully straight forward technique to fine tune RF hybrid circuits and MIC's into proper behavior. They replace time consuming cut-and-try adjustment techniques and trimming by interchange of fixed capacitors.





**Applications** include impedance matching of GHz transistor circuits, series or shunt "gap-trimming" of microstrips, external tweaking of cavities, and fine tuning of crystal oscillators.

*Johanson*

MANUFACTURING CORPORATION

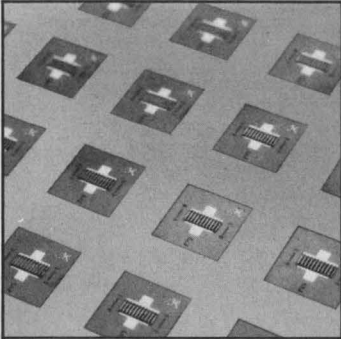
BOONTON, NEW JERSEY 07005  
201 / 334-2676

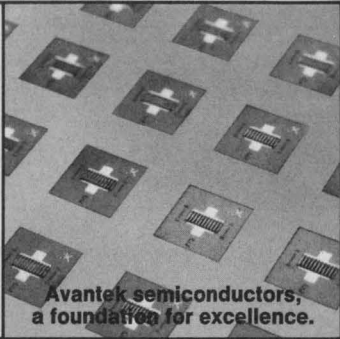
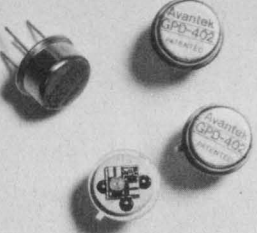
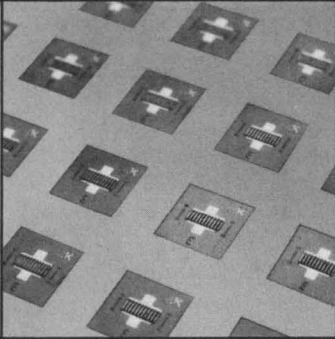
INFORMATION RETRIEVAL NUMBER 6 ►

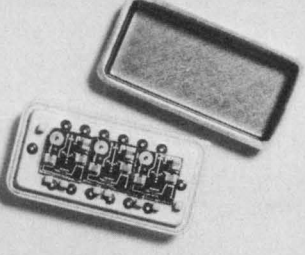
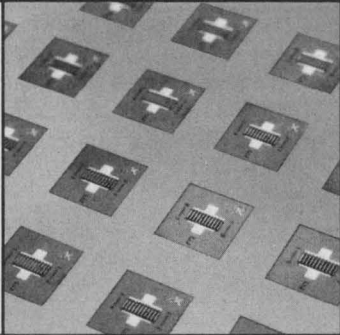
	<p>Avantek's discrete Unit Amplifier family has provided patented modular cascability and broadband performance to design engineers for more than five years. Today, 25 models are available.</p>	 <p>20-300 MHz, 18.5 dB gain, 3.5 dB N.F., +10 dBm P<sub>o</sub></p>	 <p>Avantek semiconductors, a foundation for excellence.</p>
 <p>GPD-402 5-400 MHz, 13 dB gain, 6.0 dB N.F., +6 dBm P<sub>o</sub></p>		<p>The introduction in 1970 of Avantek's UTO MIC-amp® Series expanded upon the Unit Amplifier concept by offering miniature thin film MIC modules with frequency coverage to 2 GHz. 25 standard UTO models are currently being produced.</p>	 <p>UTO-2011, 1-2 GHz, 7.5 dB gain, 5.0 dB N.F., -3 dBm P<sub>o</sub></p>
<p>In 1971, Avantek's low-cost GPD Series began replacing up to 15 different components with a single highly reliable unit of gain. Six models operate at frequencies from 5 to 400 MHz.</p>	<p>Now, the UDP-2032 and three-model UDP-4000 Series introduce a new dimension in microwave system design by offering cascable "connectorless" thin-film amplifiers for high-performance applications to 4 GHz.</p>	 <p>UDP-4001, 2-4 GHz, 5.0 dB gain, 8.5 dB N.F., +5 dBm P<sub>o</sub></p>	

# u·nique (ū-nēk'), adj., 1. different from all others; having no like or equal...

U.S. Patent 3493882 covers a unique circuit design developed by Avantek engineers in the mid-1960's. This design has enabled Avantek to develop and deliver a succession of modular amplifiers, featuring flat gain cascability, that have set the pace in solid-state amplifier miniaturization, flexibility and reliability in the years since.

No one else offers a comparable product line. That's unique. Avantek modular units are available for applications from DC to 4 GHz. A wide selection of models allows the circuit designer to match units to exacting gain, noise and power requirements in packages suitable for his needs. Limiter and variable gain modules are also available.

The cascable amplifier concept, and its continuing refinement over recent years, is representative of Avantek's established technology leadership. Find out about Avantek's unique modular amplifiers by phoning your nearby field representative or contacting the factory directly. Be sure to ask for the August 1972 Component Catalog that gives a complete listing of the entire Avantek amplifier/oscillator line.

**Avantek... years ahead today.**

Quality RFI/EMI  
broadband filters...  
broad line  
availability.



If you're really  
serious about cost,  
be serious about quality.

Allen-Bradley gives you a choice of forty-two broadband filters in Pi, T and L configurations. These "hermetically" sealed low pass filters are designed to suppress conducted interference on DC and low frequency AC (0 to 400 Hz) power lines. Meet or exceed MIL-F-15733. Available with gold or

tin plating. Request Publication 5418. Call your A-B electronics distributor, or write: Allen-Bradley Electronics Division, 1201 S. Second St., Milwaukee, WI 53204. Export: Bloomfield, N. J. 07003. Canada: Allen-Bradley Canada Limited, Galt, Ontario. United Kingdom: Jarow, County Durham NE32 3EN.

Voltage Rating		Minimum Insertion Loss (dB)			
-55°C to +85°C	-55°C to +125°C	0.30 MHz	1.0 MHz	10 MHz	1000 MHz
	200 VDC 125 VAC	12 to 34	23 to 65	58 to 80	70 to 80
150 VDC	100 VDC	16 to 52	35 to 80	65 to 80	70 to 80
100 VDC	50 VDC	26 to 63	37 to 80	66 to 80	70 to 80



Actual Size



**Allen-Bradley**  
Milwaukee, Wisconsin 53204

**Performance is only half the story.  
RCA microwave transistors  
offer the reliability of ESB**

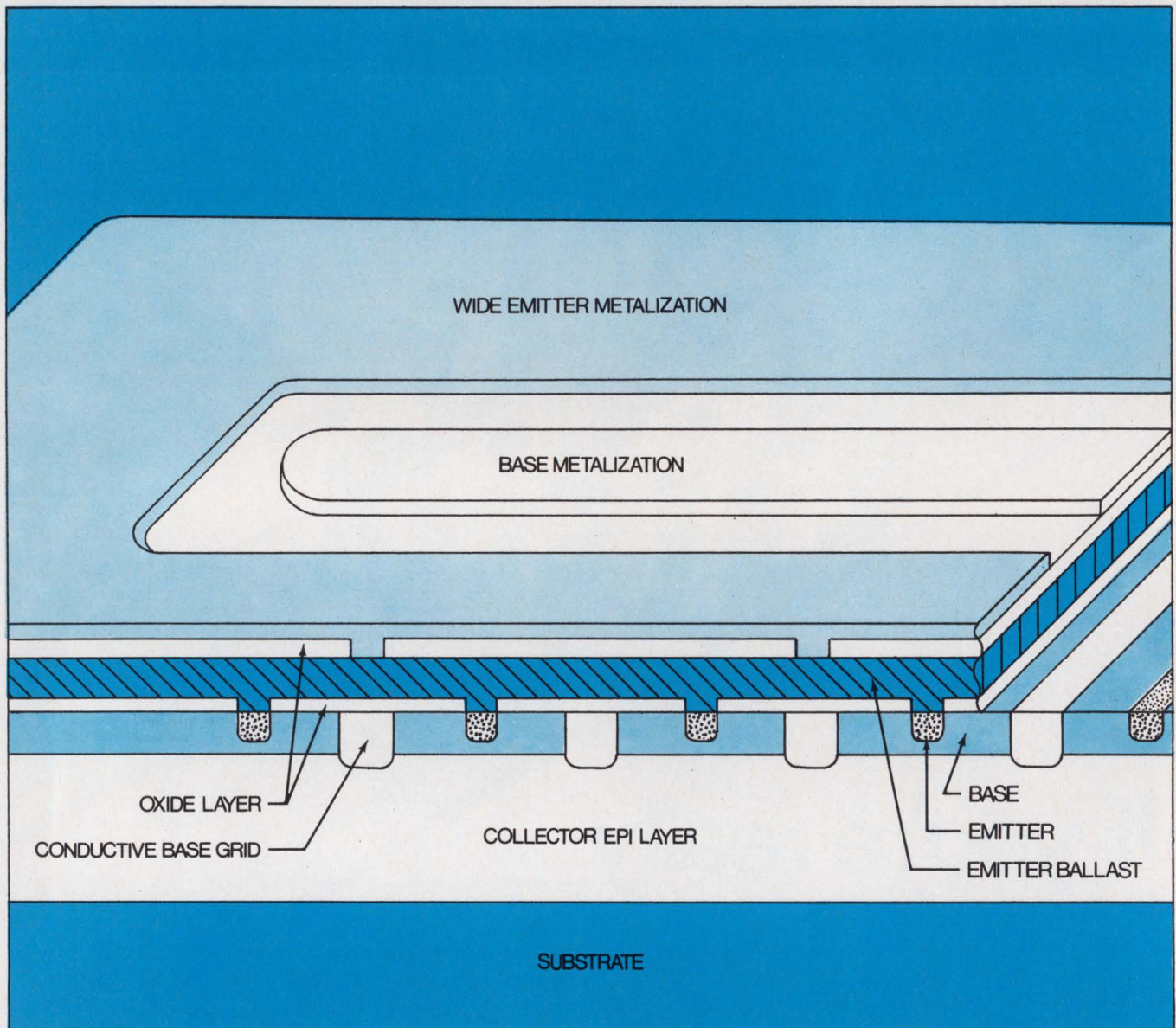

Why choose a microwave transistor on performance alone? These RCA microwave power transistors begin with performance. Then go on to offer you the reliability of ESB—emitter-site ballasting.

RCA's unique overlay design makes practical the effective use of emitter-site ballasting (illustrated above) in fine-line microwave transistor structures. ESB gives you added reliability by reducing hot spot formation. By improving the safe operating area. And by providing greater immunity to failure under high VSWR conditions.

What's more, the design allows use of wider and thicker metal emitter fingers to improve reliability because current density is reduced and aluminum migration is minimized.

Ask your RCA Representative or Solid State Distributor for more information on RCA's broad line of microwave transistors. Or write for your copy of "Microwave Data Package 2L1205," describing our full RF product line. It contains a detailed brochure describing ESB, selection criteria, typical circuit designs, performance data, technical bulletins, and a

complete price list for RCA's broad line of microwave transistors.

RCA, Solid State Division, Section 57B-1/UF18, Box 3200, Somerville, New Jersey 08876 (201) 722-3200.

**RCA Solid State**  
products that make products pay off

(continued from page 7)

And speaking of editorial excellence, the anniversary issue, just received, is a real achievement in writing and editing. It must have been quite a job to condense the engineering feats of the electronics industry during two decades into all so few pages. You and your staff have done a great job of vivid, tight writing.

We are particularly pleased with the article on communications. Keep up the good work. Here's to the next 20 years!

*Edward J. Gerrity Jr.*  
Senior Vice President

International Telephone and  
Telegraph Corp.  
320 Park Ave.  
New York, N.Y.

Your anniversary issue was terrific. I really treasured that. My son, a TV broadcast engineer, saw my copy at home and wanted to take it with him. "No you don't," I told him. "You don't get that one."

*Frank Previti*

U.S. Naval Air Development  
Center  
Warminster, Pa. 18974.

---

## A writing job in 'Frisco, anyone?

Did you ever think about writing for a living? ELECTRONIC DESIGN is looking for a field editor in San Francisco's Bay Area. We need an energetic engineer who can get out and visit companies in the Bay Area, find out what's really important and write about it. The engineer who wins this job will have to really know his stuff and be a penetrating interviewer who can separate the garbage from the important developments.

If you're interested, send a resume to ED's Senior Western Editor, David Kaye, 2930 West Imperial Highway, Inglewood, Calif. 90303.

---

(continued on page 14)

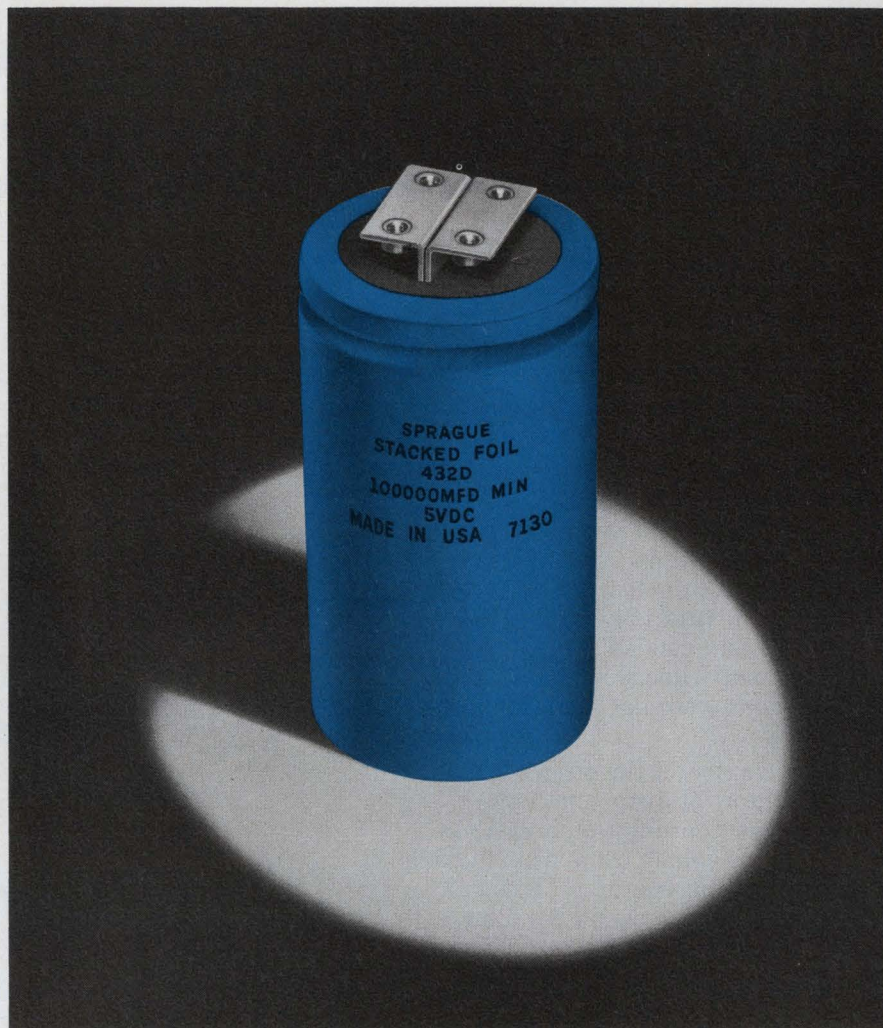

## Stacked...with beautiful curves!

(stacked-foil construction with ultra-low impedance, ultra-low ESR, ultra-low inductance)

Revolutionary new Type 432D COMPULYTIC® Aluminum Electrolytic Capacitors offer capacitance values to 100,000  $\mu$ F with equivalent series resistance of typically less than 0.001 ohm and inductance of only 1 nH in a 3" x 5 $\frac{5}{8}$ " case. This same capacitor will handle 93 amperes of ripple current at 65 C and 1 kHz.

Impedance limits at 10 kHz are as low as 0.001 ohm with typical values of only half of the specified limits.

Terminals are ideal for use with laminated-bus power distribution systems found in modern EDP equipment, where the low ESR and impedance of Compulytic capacitors help insure continued operation of logic circuits even during momentary power outages.

Sprague Type 432D Capacitors are available in nine voltage ratings from 5 to 50 volts d-c, and are designed for operation over the temperature range from -40 to +85 C.

For complete technical data, write for Engineering Bulletin 3443 to: Technical Literature Service, Sprague Electric Co., 347 Marshall St., North Adams, Mass. 01247.

45C-2122  
**SPRAGUE**®  
THE MARK OF RELIABILITY

THE BROAD-LINE PRODUCER OF ELECTRONIC PARTS

INFORMATION RETRIEVAL NUMBER 10

# THE UPS AND DOWNS OF A PLESSEY COMMUNICATIONS IC

Design Plessey 600 series ICs into your next AM/S.S.B. transceiver and down go your costs, size and design time. While your systems reliability and performance shoot way up.

Compared to other, more conventional ICs, they're a circuit designer's dream—a truly integrated line of radio communications circuits. The RF, IF and audio amps...generators...double balanced modulators and mixers are functionally comprehensive. They incorporate features like supply line decoupling and defined A.G.C. They are fully compatible, yet individual specifications were not compromised in any way.

You can forget the often contradictory factors of distortion, noise figure, power consumption and A.G.C. performance—which come from looking at each function separately. In fact, you'll get very high signal handling capabilities out of the RF and IF amps. And low power consumption from the whole family (all units can be operated from a single 6 volt supply over a temperature range of  $-55^{\circ}\text{C}$  to  $+125^{\circ}\text{C}$ ).

Use the SL600 series in your next communications design and ease a lot of design headaches. You'll find it pays to specify Plessey.

## PLESSEY SEMICONDUCTORS

1674 McGaw Avenue, Santa Ana  
California 92705 (714) 540-9945

170 Finn Court, Farmingdale  
New York 11735 (516) 694-7377



Please send me a complete literature packet. Now.

- I would like information only at this time.
- I would like to talk to your representative personally.

Name \_\_\_\_\_

Title \_\_\_\_\_

Firm \_\_\_\_\_

Address \_\_\_\_\_

City \_\_\_\_\_ State \_\_\_\_\_ Zip \_\_\_\_\_

Phone No. \_\_\_\_\_

COM

Minneapolis, Minnesota  
(612) 835-2717

Framingham, Massachusetts  
(617) 879-7920

San Diego, California  
(714) 295-2500

Los Altos, California  
(415) 941-4080

Houston, Texas  
(713) 462-4077

Dallas, Texas  
(214) 233-5711

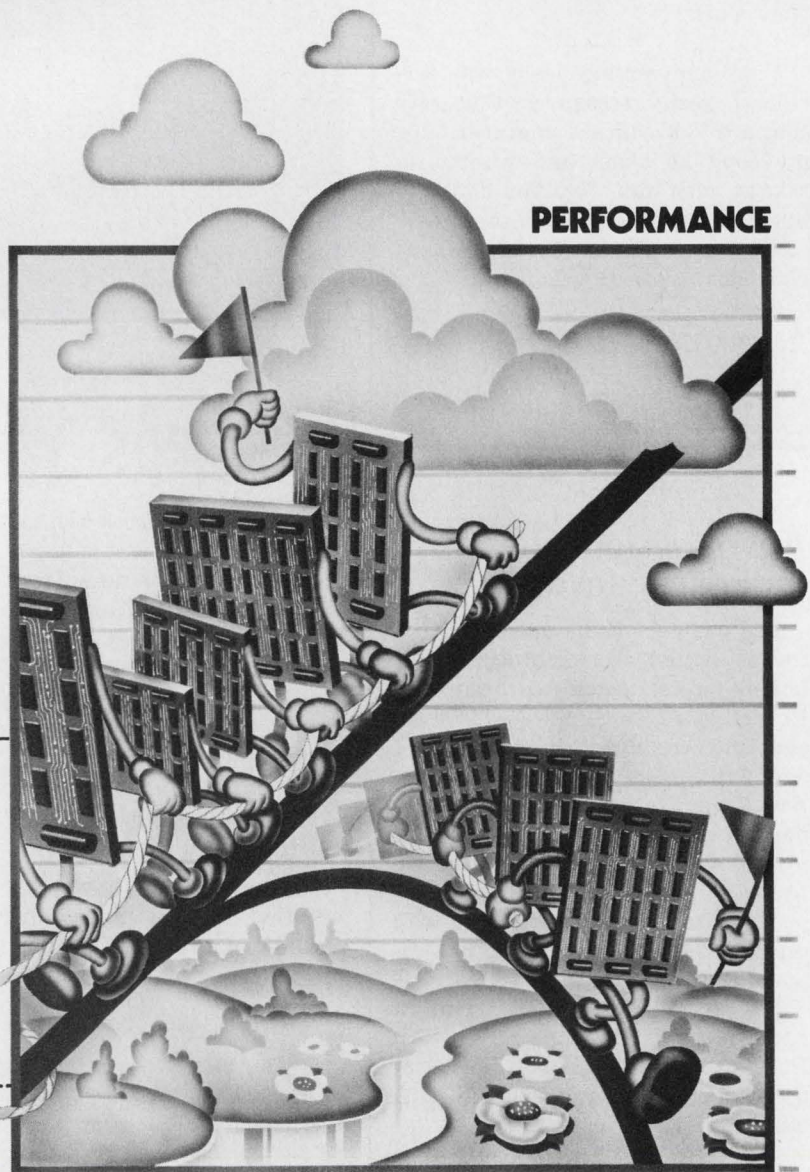

PERFORMANCE

COSTS

To celebrate our 50th Anniversary—1923-1973

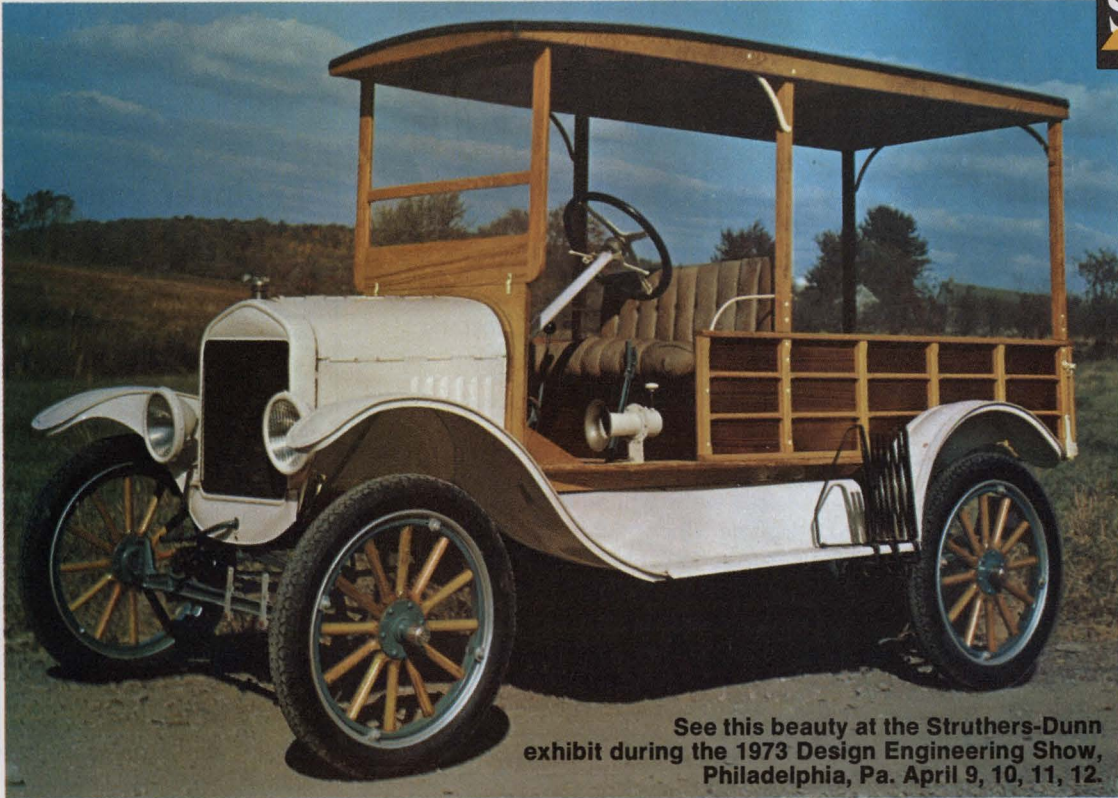

See this beauty at the Struthers-Dunn exhibit during the 1973 Design Engineering Show, Philadelphia, Pa. April 9, 10, 11, 12.

## This 1923 Model T FORD as GRAND PRIZE for your most unusual relay application!

**Second 50th Anniversary prize: TEN \$50.00 U.S. Savings Bonds.**  
**Third Prize: FIVE \$50.00 U.S. Savings Bonds.**

ALL entrants will receive a 9" x 12" four-color print of this photograph by contest end. Perfect for framing.

Yes! A beautifully restored Model T Ford Station Wagon from the same year the first Struthers-Dunn relays came out! It could be yours for telling us about your most unusual or interesting relay application, as detailed in the rules below. You and the car will be the talk of your town from the day it is delivered. Start writing or thinking about your application today! Note those second and third prizes, too! *Be sure to follow the rules below.*

### CONTEST RULES

- (1) Entrants must give a clear and complete description of an unusual, but practical and operating, relay application or solution of a relay problem, using electromechanical or reed relays of any make or price. *Entries must contain nonconfidential matter only.* No purchase necessary.
- (2) Winning entries will be judged on basis of the most unusual applications and/or imaginative thinking of widest interest to relay specifiers.
- (3) The three judges, familiar with design and use of relays, will be from the editorial departments of technical trade publications, and their decision will be final.
- (4) Brevity, clarity and completeness will count. Be formal or informal. Schematics welcome.
- (5) No limit on entries, but keep each entry to one application.
- (6) Entries must be postmarked no later than midnight May 15, 1973. Address: 50th Anniversary Contest, Suite 1500, 1201

Chestnut Street, Philadelphia, Pa. 19107. Do not send entries to Struthers-Dunn or its distributors.

- (7) For anonymity in judging, entries will be coded and identification removed insofar as possible.
- (8) Winning entrants will be notified by July 1, 1973 and publicly announced and identified shortly thereafter.
- (9) Grand prize will be delivered to winner's home.
- (10) All entries become property of Struthers-Dunn, Inc. and none will be returned. Struthers-Dunn reserves the right to use all entries in its advertising and promotion on an anonymous basis, but entrants will be paid \$50.00 for each entry used.
- (11) Contest void where prohibited, regulated or limited by law. Winners will be responsible for taxes, if any, on prizes.
- (12) Employees of Struthers-Dunn, Inc., its sales affiliates, distributors, advertising agencies, contest judges and members of their families are not eligible.



## STRUTHERS-DUNN, INC.

PITMAN, NEW JERSEY 08071

Canada: Struthers-Dunn Relay Div., Renfrew Electric Co., Ltd.

# These new low-priced power amplifiers boost the output power and usefulness of laboratory signal sources.

ENI's highly linear, all solid-state, broadband power amplifiers boost the output power of signal generators, sweep generators and frequency synthesizers—and they do so with a remarkably high performance/price ratio.

## Here's the performance . . .

These high gain RF amplifiers deliver up to 3 watts while faithfully reproducing complex broadband input signals. Unconditionally stable, the amplifiers will operate without damage or oscillation into severe load conditions (from an open to a short). This makes them ideal for driving electro-optical devices, ultrasonic transducers, broadband antennas—any device with an impedance that's a function of applied power and/or frequency. This table contains additional performance parameters as well as prices.

	Model 300L	Model 403L	Model 500L
Frequency Coverage (without tuning)	150KHz-140MHz	100KHz-275MHz	1.7MHz-560MHz
Linear Power Output	3 watts	2.7 watts	300 milliwatts
Price	\$535	\$795	\$295

Prices FOB Rochester for delivery in U.S.A.

## How do we do it for the price?

We use thin film hybrid and microstrip construction. All of the transistor circuitry, except the wideband impedance transformers, is bonded to an alumina substrate through "heat spreaders" that reduce chip temperatures by up to 30° C. This reduces the number of transistors needed to produce the rated output, while increasing the overall reliability.

## It's your move . . .

For your complete catalog of power amplifiers and multicouplers circle our reader service number. For immediate action or to arrange a demonstration write to: ENI, 3000 Winton Road South, Rochester, N.Y. 14623. Call 716-473-6900 or TELEX 97-8283.



**ELECTRONIC NAVIGATION INDUSTRIES**

The world's leader in solid-state power amplifiers.

INFORMATION RETRIEVAL NUMBER 13

ACROSS THE DESK

(continued from page 11)

## Engineer 'shortage' lifts blood pressures

According to your News Scope item of Dec. 7, 1972 ("A Severe Shortage of Engineers Feared," ED 25, p. 25), the U.S. Labor Dept. projects a "severe" shortage of engineers in the future. Isn't that just great. I still remember the last shortage of several years ago, when the average engineer was expected to work long hours of unpaid overtime and his effective income/hour was substantially less than that of a union electrician or plumber.

Let us hope our sons have enough sense to avoid such occupations as electronic engineering, which requires years of preparatory hard work and financial deprivation only to yield relatively poor pay and almost instant obsolescence as the demand for specialization changes.

*Karl R. Tipple*

*Research Engineer*

11112 Staffordshire  
Dallas, Tex. 75238.

With reference to the News Scope item "A Severe Shortage of Engineers Feared":

Does ELECTRONIC DESIGN have to quote the party line, too? It's bad enough that Government propaganda pervades the EJC, the IEEE and columns of the Wall Street Journal. There never was and there never will be a shortage of qualified engineers in the United States. I repeat no shortage from pre-World War II on!

The Wall Street Journal article cited in your news item did not interview one working engineer—just managers, personnel men and one junior engineer. I suggest the Wall Street Journal go interview this junior engineer 10 years from now, and we will get a different tune.

*Dave Weigand*

Gulf & Western Industries, Inc.  
Research and Development Center  
101 Chester Rd.  
Swarthmore, Pa. 19081





# New Licon® LPB switch has a secret!



*Licon's new C-III\* LPB Switch... it's either alternate or momentary action. Just slide the concealed selector to the mode you want. Either action in same compact size.*

Quick-change artist: that's the new low-cost Licon® C-III Lighted Push-Button Switch. You or your distributor can change it from alternate to momentary action and back again. Just by sliding the concealed selector. Only  $2\frac{1}{8}'' \times \frac{5}{8}''$  square, this crisp-operating snap-action lighted switch comes in a selection of lens cap styles, colors, shapes and sizes. Lists as low as \$2.25 each. Features simplicity throughout. For example,

to replace lamp, just pull out cap assembly, insert new lamp, snap back together. Licon's C-III LPB Switch is immediately available in SPDT and DPDT circuitry, and various mounting configurations—including rear or front panel mounting, time-saving snap-in mounting with bezel or bezel barrier configurations. Look into Licon's secret. Call your local Licon rep or distributor for a demo

of the new C-III LPB in your office. Or call or write for a Licon Switch Catalog. **Licon, Division Illinois Tool Works Inc., 6615 W. Irving Park Road, Chicago, Illinois 60634. Phone (312) 282-4040. TWX 910-221-0275.**



\*Patent Applied for

**itw** LICON

The Electronic Group of ITW...LICON ■ ELECTRO MATERIALS ■ PAKTRON ■ CHRONOMATIC

INFORMATION RETRIEVAL NUMBER 14

© ILLINOIS TOOL WORKS INC. 1972



# Don't Miss This Boat!

There's still time to enter *Electronic Design's* 1973 Top Ten Contest. You can win a free Windjammer Cruise in the Caribbean . . . \$1,000 in cash . . . free jet transportation . . . color TV . . . Bulova electronic timepieces . . . free ad reruns. There are 100 prizes in all!

Complete information and rules appeared in the Jan. 4 issue. Dig out your Jan. 4 copy and enter the contest now. (If the entry cards are all torn out, you can use the form that is printed below.) Entries must be postmarked before midnight, February 15.

**DO NOT SELECT ADS FROM THIS ISSUE — USE ELECTRONIC DESIGN ISSUE NO. 1 — THE TOP TEN CONTEST ISSUE — PUBLISHED JANUARY 4, 1973**



A/D and D/A converters unite the worlds of the analog and digital design engineer. However, familiar specs are hard to find. Conversion rates, resolution and coding are mixed with settling time, accuracy and linearity. The converters come in many shapes and sizes. To clarify an often confusing subject, turn to p. XX

## 1973 SUPER TOP TEN CONTEST

HERE'S MY ENTRY FOR:

READER CONTEST

ADVERTISER CONTEST

I have read all of the rules and estimate that the "Top Ten" advertisements receiving the highest Reader Recall "Percent Seen" scores in the January 4, 1973 issue will be:

ADVERTISEMENT OF: (Company or Organization)	INFORMATION RETRIEVAL NUMBER
1	
2	
3	
4	
5	
6	
7	
8	
9	
10	

Do not include the advertisements of Electronic Design, Hayden Publishing Company, or divisions. Show Information Retrieval Number. DO NOT show page numbers.

**ENTRY MUST BE POSTMARKED BEFORE  
MIDNIGHT FEBRUARY 15, 1973**

ENTRANT'S NAME \_\_\_\_\_  
 COMPANY \_\_\_\_\_ TITLE \_\_\_\_\_  
 ADDRESS \_\_\_\_\_  
 CITY \_\_\_\_\_ STATE \_\_\_\_\_ ZIP \_\_\_\_\_

Clip and mail to: Top Ten Contest, c/o Electronic Design,  
50 Essex Street, Rochelle Park, New Jersey 07662.

# TRW LVA diode... the sharpest knee below 10 Volts.

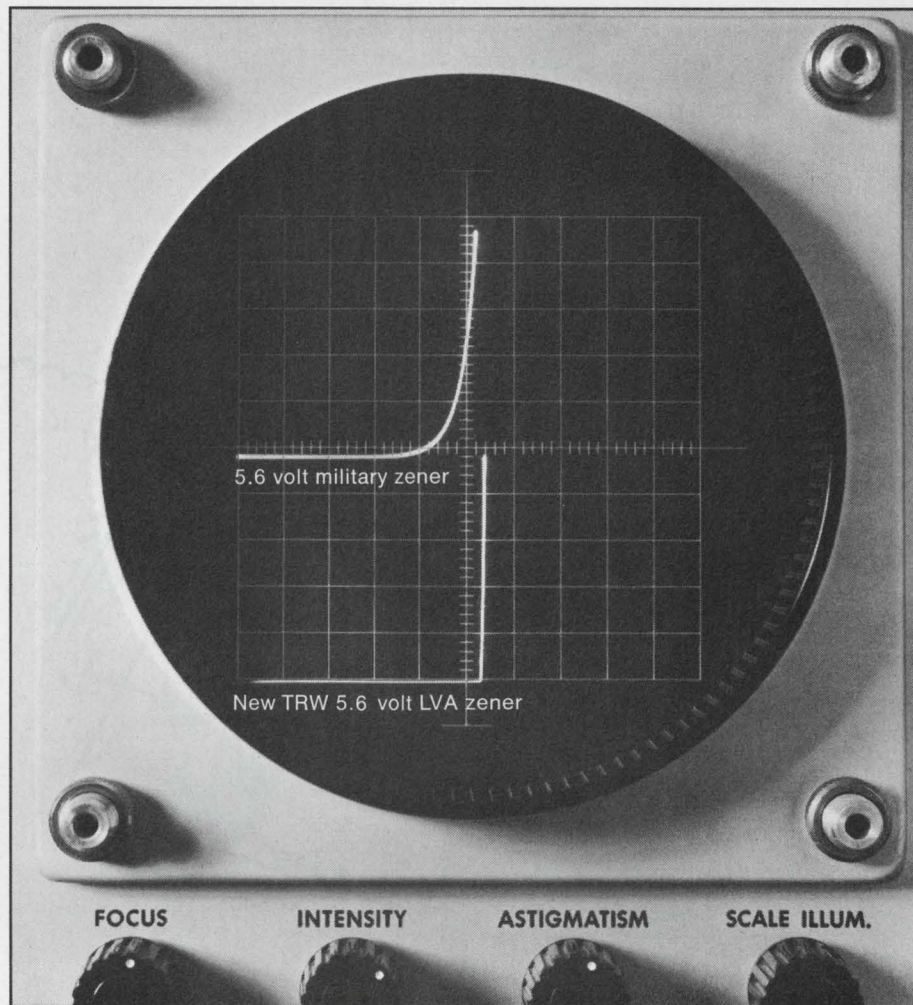

### The current saver.

No other zener can approach TRW's LVA performance below 10 volts. Available for operation down to 4.3 volts, TRW LVA diodes minimize power consumption in portable-battery operated equipment. They're also ideal for instrumentation, where, as reference elements, they draw as little as 50  $\mu$ Amps.

TRW LVA's are available in various package configurations, including passivated chip form for hybrid-

compatible packages. If you have a need for a low current voltage regulator or any other product that demands low current consumption, you should check out TRW LVA zeners. When it comes to current, they're really misers!

For product information and applications assistance write TRW Semiconductors, 14520 Aviation Blvd., Lawndale, California 90260. Phone (213) 679-4561. TWX 910-325-6206.

**TRW**  
SEMICONDUCTORS

INFORMATION RETRIEVAL NUMBER 16

## Beam-Fired\* SCRs.

Fast. New.

Run them for life.

They'll outrun anything else like them.

At the highest current...

highest speed...highest frequency combination in any 110, 235, 380 or 470 ampere device.

The key is low switching losses — and vastly improved reliability. Within  $3 \mu\text{s}$ , dynamic forward drop is down to 3 volts, switching up to 150 amps.

Initial turn-on voltage and dissipation are cut, turn-on time reduced.

High,  $1,000 \text{ A}/\mu\text{s}$  di/dt, without dv/dt sacrifice, is ensured.

Beam-Fired runs cooler, faster, longer.

Its speed is due to advanced technology. State-of-the-art, patent-applied for technology: optimum cathode shunt placement... integrated gate cascade driver stages... simultaneous, large-area, multi-gate turn-on. The A-B-Cs are spelled out in a new brochure.

Take a 235 ampere Beam-Fired unit - the MCR235A series with  $10 \mu\text{s}$  max turn-off. Run it up to 30 kHz. Watch it run...and run...and run.

Evaluate the leading edge of SCR technology. Contact your Motorola distributor about Beam-Fired for inverter, chopper, induction heating and cyclo-converter designs. Write for data sheets, the brochure, a cross-reference list. Box 20912, Phoenix, AZ 85036.

Do it today. Run them for life.

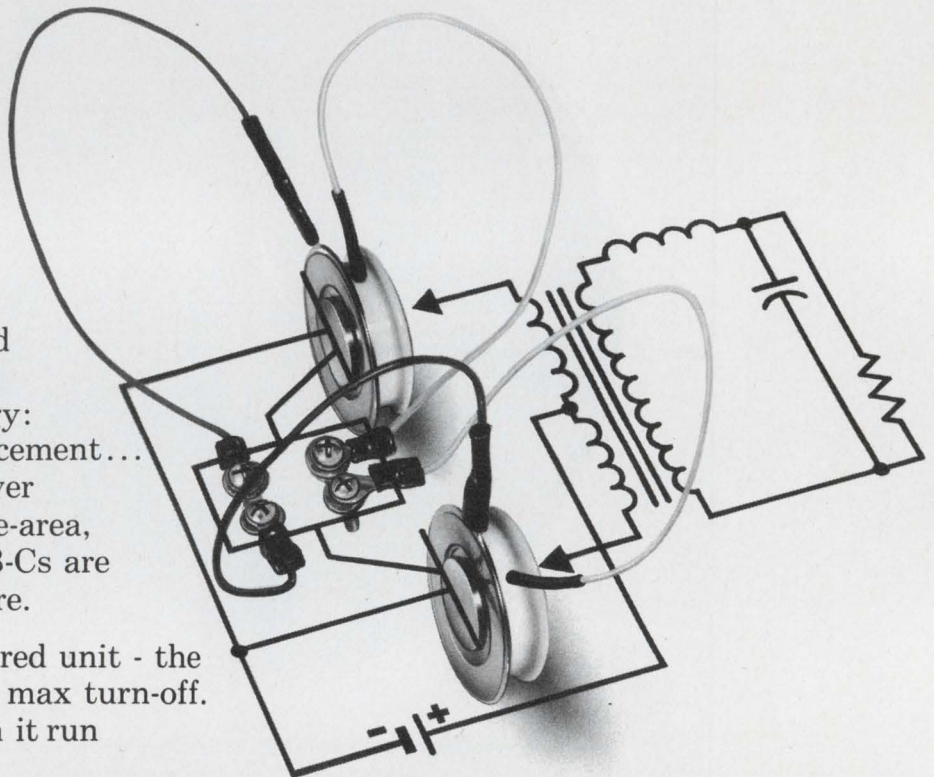

 **MOTOROLA THYRISTORS**  
— 300 Ways To Get Control

Nobody has More to 470 Amps...  
MCR154 Series, Fast Speed,  $10 \mu\text{s}$  max t off  
MCR158 Series, Fast Speed,  $30 \mu\text{s}$  max t off  
2N4361 Series, Phase Control  
MCR235 Series, Fast Speed & Phase Control  
MCR380 Series, Fast Speed & Phase Control  
MCR470 Series, Fast Speed & Phase Control

\*Trademark Motorola Inc.

## Electronic watches: a big step forward

Critics of accuracy, life and serviceability of liquid-crystal displays for electronic watches are dissecting eagerly the latest watch from the Optel Corp., Princeton, N.J.—a timepiece that incorporates significant advances in technology.

A principal factor degrading electronic watch accuracy is shock, which introduces a strain in the wire supporting the crystal in its sealed can (see "How Good Are the New Watches? Electronic Claims Split Industry," ED 20, Sept. 28, 1972, p. 30). Optel is offering improvements.

"The quartz crystal in our watches is shock-mounted to the point where accuracy disturbance due to shock is very small," says Zoltan J. Kiss, the company's president. "In addition to the internal shock mounting of the crystal itself, our crystal assembly is shock-mounted in the PC board with a special high-elasticity foam."

The lifetime of liquid-crystal displays has been generally limited by contamination creeping through the typically glass-to-glass seals.

"Our new display," says Kiss, "is a metal-can package, not glass-to-glass. It is hermetically sealed to about  $10^{-6}$  mm of mercury of pressure. This means that the life and durability of the display is as reliable as that of an integrated-circuit package.

"As far as ease of replacement is concerned, the sealed display fits into a connector socket having 27 spring-mounted leads. The display can be changed easier than replacing a standard watch crystal."

Problems have arisen because of the fragility of glass liquid-crystal assemblies. Optel's metal-can package is rugged, and in addition the rear glass of the display—the reflector—is held in place by a spring mount. Even with shock to the display, Kiss says, the mount

maintains the proper alignment of the rear mirror.

The visibility of Optel's liquid-crystal display has also been markedly improved, according to observers. Kiss declines, however, to disclose how this improvement was obtained.

Optel is supplying watchmakers like Waltham with the electronic package. The new design is selling at retail between \$185 and \$235, depending on the type of case supplied.

## Desktop computer uses PL/I language

A new desktop office computer that can compile and execute the powerful PL/I programming language has been introduced by a small, new company, the Q1 Corp. of New York City.

PL/I, a high-level programming language developed by IBM for commercial, scientific and text-processing applications, has until now been limited to large machines—such as the 360 and 370—because of the large memory required.

Roy Schwartz, marketing manager for Q1, says that his company has overcome that problem by using a new compiling technique, but he declines to elaborate. The big advantage of PL/I over machine language, he notes, is that it permits a reduction of up to 90% in programming costs.

The new computer, which sells for \$10,000 and up, uses magnetic cards instead of cassette tapes to store data. Each card is capable of holding up to 20,000 bits of information. According to Schwartz, the computer is smaller, cheaper and more powerful than electronic accounting machines now being used.

"One of the unusual features of the computer is that it has both

an electronic display and a hard copy printout," the marketing manager notes. "This dual feature enables the operator to spot and correct errors before they are printed. "In addition, the electronic display can be used to provide diagnostic messages without ruining the printed copy."

The processor used is the Intel 8008 integrated circuit, and it operates at 500 kHz, which means that each instruction requires about 15  $\mu$ s. This is compared with the speeds of general-purpose mini-computers, but is sufficiently fast for business applications, Schwartz says. Q1 is considering use of a new Intel processor chip, the 8080, to speed the computer.

Another important feature of the desktop unit, Schwartz notes, is the high-speed printer, which can be operated under program control to produce proportional spacing and line justification.

The basic machine comes with 4 k of memory and is expandable to 16 k in 4-k increments. The 4-k version sells for \$10,000.

## IBM reported building 'electronic notebook'

IBM is reported to be working on an "electronic notebook" similar in appearance to the HP 35 calculator. It has a numerical keyboard, some function keys and the same sort of light-emitting digital display. But the laboratory machine also is said to have a substantial amount of internal storage—10,000 or more digits in a semiconductor memory.

The calculator is not being offered for sale or use at present, but it could be representative of the kinds of calculators that may be offered by IBM and other computer manufacturers very shortly.

## MOS memories seen at 16,000 bits per chip

How complex will MOS semiconductor memories become?

They should increase in complexity till the 16,000-bit-per-chip level is reached, according to John Salzer, a principal in the management consulting firm of Darling & Alsbrook in Los Angeles.

"Above 16 k" he explains, "a whole new production technology would be required. Today's photographic techniques simply won't suffice, due to the wavelength limitation of visible light. And because of the tolerances and complexities involved, the new production methods and equipment would be quite costly and not justifiable in many cases."

Dr. Salzer, whose firm recently completed a multiclient study of IC technologies and markets, estimates that the 16,000-bit-per-chip circuit should reach the market in production quantities in late 1976 or early 1977. After that, he says, "hybrid and multichip technologies will progress to offer other alternatives to increased chip capacity within an integrated-circuit package."

"In a sense," Dr. Salzer says, "1973 marks the beginning of a cross-over point for LSI. The rate of increase in bits per chip starts to slow and the growth rate in the horizontal direction begins to increase rapidly—that is, many new applications open up for LSI."

## HP introduces advanced version of its model 35

More like a computer than a calculator, the HP-80, Hewlett-Packard's latest addition to the calculator scene, contains seven read-only memories that store nearly 18,000 bits of information. It is intended for use by the business and financial communities. It contains hardwired programs to solve the most important equations in banking, finance, accounting, real estate and insurance.

In physical appearance, the HP-80 looks very much like the HP-35, the "electronic sliderule" introduced by Hewlett-Packard nearly a year ago. Its operation however is markedly different. While the HP-35 was designed to solve functions—such as sine, log and so on—with a single key stroke, the HP-80 solves entire equations with a single stroke.

Pressing the key executes a specific program—including subroutines—stored in memory to solve a particular problem.

According to William R. Hewlett, president of the company, the

HP-80 can perform virtually all calculations involving the relationship between money and time quickly and easily. And it is accurate to within a penny in calculations involving a million dollars. For example, in less than a minute the user can determine the bond yields between any two dates, notes Hewlett. There is no need to consult cumbersome financial tables. The necessary data are already stored in the calculator's memory.

Similar problem-solving capability is provided in such areas as compound interest, loan repayment, depreciation and amortization.

A unique feature of the calculator, emphasizes Hewlett, is the two-hundred year calendar that is stored in memory. The calendar is important in projecting cost, interest, future value and other financial data. By simply pressing the appropriate keys, the user can quickly determine the number of days between any two dates from January 1, 1900 to December 31, 2099. Alternatively, the user can enter specific dates and number of days to determine a past or future date.

Like the "electronic sliderule," the HP-80 has a 15-character LED display, a 35-position keyboard and four stacked registers. It uses inverse Polish notation. It differs from the HP-35, however, in that 11 of the keys have dual functions which may be selected by pushing a special shift key.

The HP-80 has a dynamic range from  $10^{-99}$  to  $10^{99}$ . It can be operated for five hours from nickel cadmium batteries and comes with a battery charger. It will be sold by direct mail and through HP's sales offices at a cost of \$395 each, according to Hewlett.

## News Briefs

**MNOS memories are in the works at the North American Rockwell Microelectronics Co.** in Anaheim, Calif. The first product will be a 1024-bit electrically alterable ROM organized in a  $256 \times 4$  configuration. It will be designed to work with a four-bit microprocessor soon to be announced by the company. The MNOS memory is not expected to reach the market until late this year.

## Latest quad op amp needs only one supply

The latest development in the trend toward multiple devices on a chip operating from a single power supply is a new quad operational amplifier from National Semiconductor, Santa Clara, Calif.

According to Tom Frederiksen, head of National's Automotive Linear Integrated Circuit Dept., the new device, known as the LM 324, contains four op amps of 741 quality and can operate from either a single or split supply.

Unlike the quad amp that National introduced last May—a current-operated device—the new quad contains four true differential voltage amplifiers, all internally compensated.

"Compensation is accomplished by using 5-pF capacitors," Frederiksen notes. "This is in contrast to the 30-pF capacitors required for 741s."

The use of a smaller compensating capacitor—made possible by a new transconductance reducing technique that employs multiple rather than single-collector lateral transistors substantially reduces the area required for each op amp.

Even though the new quad operates from a single supply, Frederiksen notes, the input common-mode voltage range includes ground and the output can also swing to ground.

Frederiksen also points out that "all conventional op-amp circuits can be fabricated with the LM 324 without the need for extra dual supplies." The LM 324 operates from 3 to 30 Vdc or from  $\pm 1.5$  to  $\pm 15$  Vdc. Military versions in both ceramic and epoxy are available.

For years, visitors to the International Solid-State Circuits Conference in Philadelphia had to shuttle among the various conference sites on the University of Pennsylvania campus. But no longer. By way of commemorating its 20th anniversary as the "world's leading" solid-state circuitry conference, **this year's meeting Feb. 14-16 will have all conference activities at a single site, the Marriott Motor Hotel.**

specify the  
**BETTER 3/4" LONG**

10-TURN PRECISION POTENTIOMETER

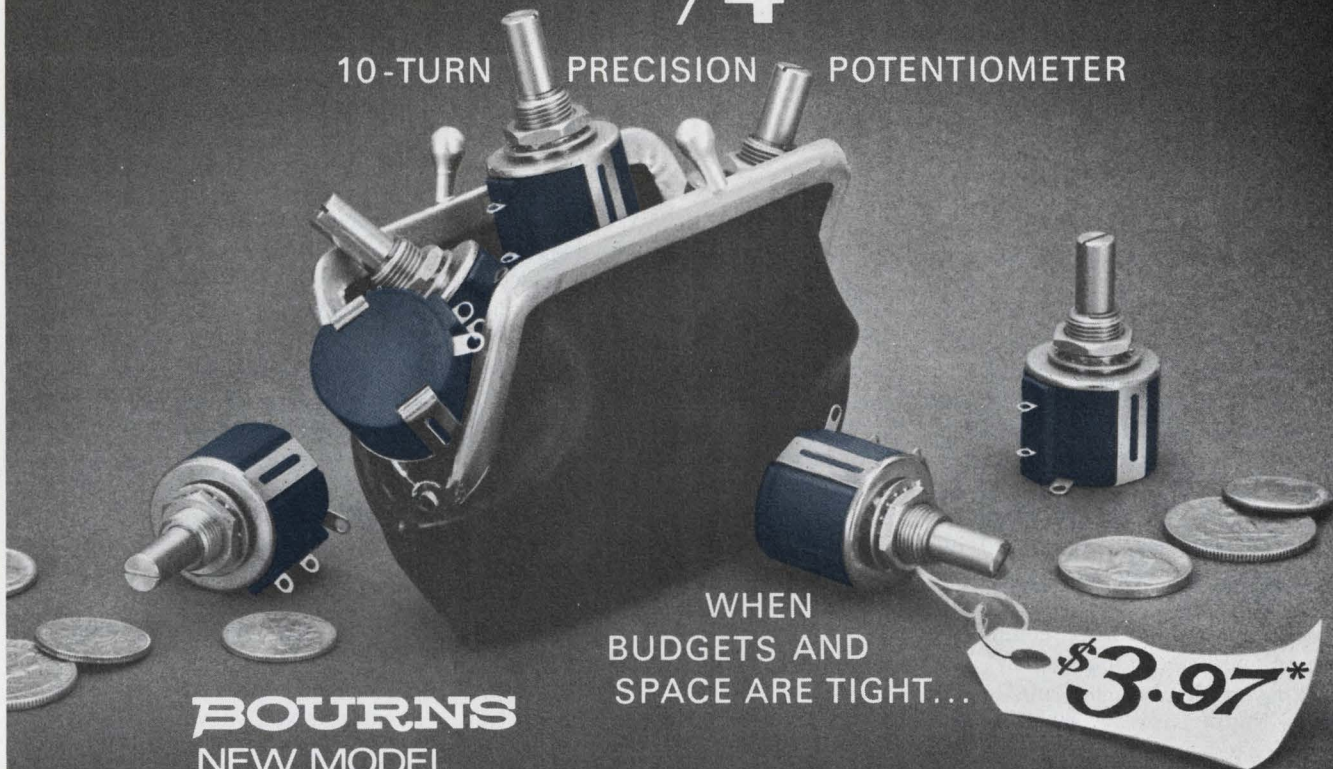

WHEN  
BUDGETS AND  
SPACE ARE TIGHT...

**BOURNS**  
NEW MODEL  
**3540**

*MODEL 3540 IS RUGGED, TOO!  
CHECK THE EXCLUSIVE CONSTRUCTION FEATURES.*

\*1000-1999 quantity  
U.S. Dollars, F.O.B., U.S.A.

- SILVERWELD® UNITIZED TERMINATION — Why settle for multi-joint, terminal-to-element connection? Get the direct element-to-terminal connection method that guards against catastrophic failures
- MOLDED-IN, SHAFT-TO-ROTOR CONSTRUCTION — This Bourns feature optimizes stop-strength and minimizes accidental rotor/shaft displacement and slippage
- NON-CEMENTED, ALL-MECHANICAL ASSEMBLY. Snap-on straps provide all-mechanical assembly. No cemented joints, heat-forming, or ultrasonic welding

*LOOK AT THE SIGNIFICANT SPECS!*

- LINEARITY: 0.25%
- TEMPERATURE RANGE: -55 to +125°C
- RESISTANCE RANGE: 100 ohms to 100K ohms

*FOR COMPLETE DETAILS AND PRICES...CONTACT YOUR LOCAL BOURNS REPRESENTATIVE, FIELD SALES OFFICE, OR THE FACTORY DIRECT.*



BOURNS, INC., TRIMPOT PRODUCTS DIVISION • 1200 COLUMBIA AVE., RIVERSIDE, CALIF. 92507

# It's a year for bubble memories; Prototypes will appear shortly

Although magnetic-bubble technology is still in the laboratory, it won't remain there much longer. Since the 1969 announcement by Bell Laboratories of the tremendous potential of bubbles for storing and manipulating digital data, work has progressed to the point where prototype memories are feasible. According to Joseph Geusic, head of the fundamental memory group at Bell Laboratories, Murray Hill, N.J., such memories should appear before the end of this year.

"A functionally near complete" memory will be announced by Bell in April at the International Magnetics Conference in Washington. When asked for details about the memory, Geusic declined to elaborate, but the consensus in the industry is that it will probably contain about a million bits of storage, operate in the 100-to-500-kHz range and have a density of a million bits per square inch.

**Jules H. Gilder**  
Associate Editor

As for the commercial availability of magnetic bubble memories, William Mavity, program development manager for bubbles at the North American Rockwell Microelectronics Co., Anaheim, Calif., says they will appear in 1975.

To date, most of the work in bubble technology has been concentrated on materials and the fabrication of shift-register devices, to show that the technology works. Most devices fabricated so far have been for in-house use, the largest probably being 10-k-bit registers reported by Bell Laboratories and Monsanto. North American Rockwell, however, has delivered a 64-bit bubble shift register to the Air Force to demonstrate that the technology is workable and that it is possible to get from the outside world of TTL to bubbles and then back out to TTL.

## Some problems anticipated

"Bubble circuit technology is well enough developed to make

practical the fabrication of bubble devices," notes Lubomyr Onysakevych, a bubble researcher at RCA's David Sarnoff Research Center, Princeton, N.J. "The only problem I see that could hold back the commercialization of bubbles is the unavailability of large quantities of the basic material—nonmagnetic garnet with a thin film of magnetic garnet on top of it."

Other researchers see additional problems. Dr. Forest West, research and development project manager for bubble memories at Texas Instruments, says: "While present materials are adequate for demonstration devices, they may not be desirable for production."

Holes and cracking have occurred in the currently used permalloy film. Recent work by Bell on ion-implanted propagating patterns to manipulate bubbles offers many improvements, West explains. The ion-implanted structures promise simpler fabrication of memory chips as well as higher yields. In addition topography-related problems—such as those associated with putting down control conductors—are eliminated.

Further research will be needed, West says, to determine which material is best.

Finally, he notes, a compatible set of elements—bubble generators, detectors and annihilators (to destroy unwanted bubbles), as well as transfer lines and the propagating circuit—must be fabricated.

"While it is true that each of these elements has been individually fabricated," West explains, "they do not all necessarily operate reliably over the same dc bias-field range. Once you get compatible elements, memory design becomes rather straightforward."

North American's Mavity sees no major obstacles to the commercialization of bubbles. "All that is need-

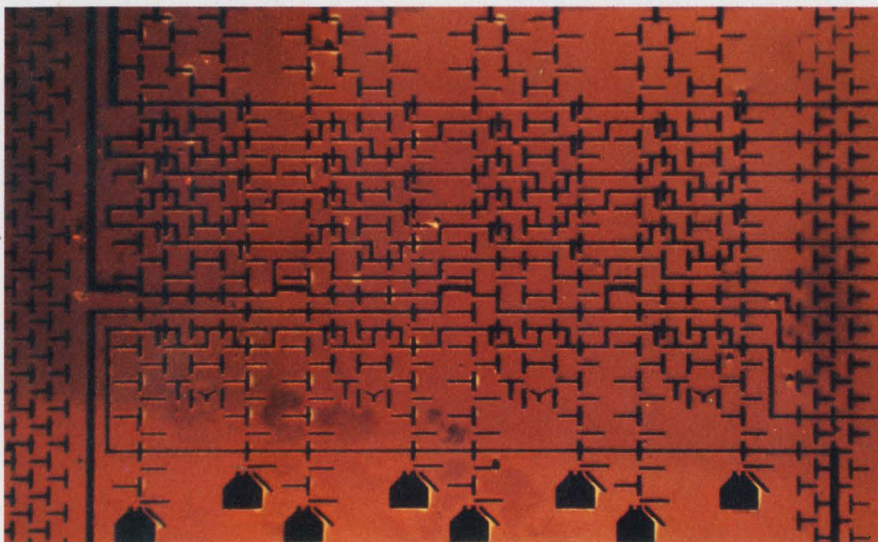

A bubble memory chip fabricated by IBM under a NASA contract contains 64 bits organized into four 16-bit shift registers.



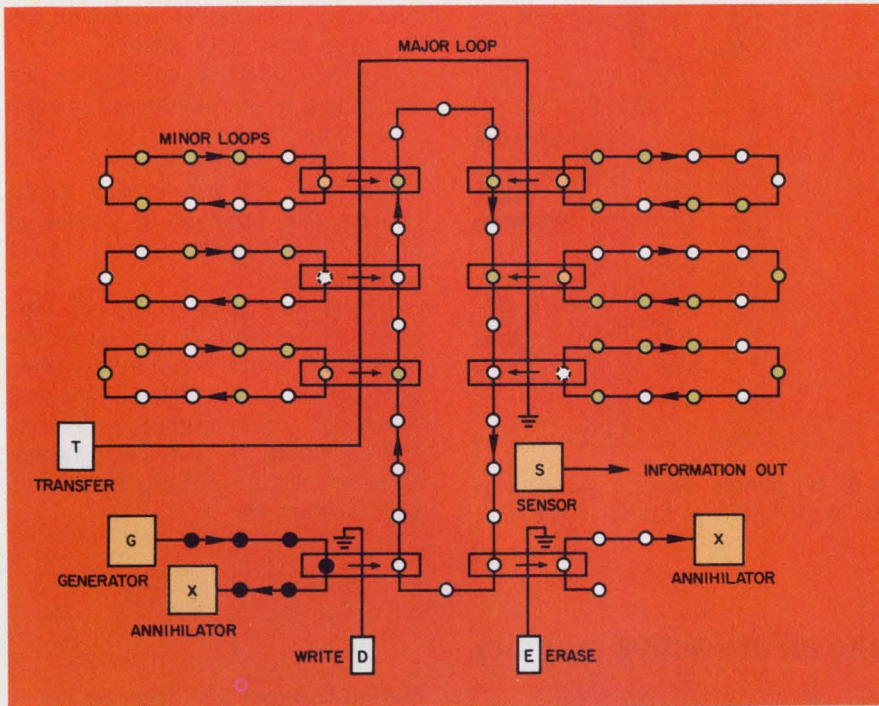

A useful configuration for mass memory applications is the major-minor loop organization. Small recirculating shift registers are interconnected by a larger register, resulting in shorter over-all access times.

ed now," he says, "is some engineering development that doesn't require any scientific breakthroughs."

### 'Smart' memories envisioned

Recent work by researchers at Monsanto indicates that bubbles can be used to perform logic operations and can therefore be combined with bubble memories to produce 'smart' memories. Robert Sandfort, Monsanto's senior research engineer

for bubbles, says that such memories would have a big impact on computer architecture.

"Now," Sandfort explains, "processors are very expensive, so a typical system will use one processor with a lot of memory and many terminals. But if there was a low-cost technology that could incorporate the processor with the memory, systems could be built at a lower level of organization."

Smart memories have many other advantages Sandfort contin-

ues. They can be used to presort data, control blocks of data, reorganize data, perform string manipulations and data comparisons and reduce access time. In short, they can be used to process information instead of just store it.

Smart memories do have some drawbacks, however, according to Richmond Clover, section manager for domain devices at Hewlett-Packard's Central Research Laboratory, Palo Alto, Calif. Present work on bubble logic, he notes, indicates that it has poor operating margins. "If bubble logic is to be combined with memory on the same chip," says Clover, "the margins must be increased."

Initial reaction to the concept of smart memories is in general favorable, with most experts expecting practical devices between 1975 and 1980. The reason for that, notes TI's West, is that by that time bubble memories should be in production and efforts can be concentrated on logic.

Bell's Geusic, however, is a bit skeptical about smart memories. He cites previous claims for other memory technologies and notes that bubbles are relatively slow and that the complex functions needed for smart memories would eat up a lot of real estate.

### Many applications seen

The potential applications for bubble memories are many. They range from fast-access memories (FAMs) to a repertory dialer for telephones.

The immediate and most frequently talked about applications for bubbles will probably be in the replacement of small disc memories, notes Clover. Bubble memories on the order of 1 to 10 million bits are very attractive, because they are economical.

Dr. Paul Bailey, leader of Monsanto's bubble group, has compared tape, drum, disc, core, semiconductor and bubble memories. The results are shown in the accompanying table.

### Future trends

According to Dr. Hsu Chang, manager of exploratory magnetics for IBM's Watson Research Center, Yorktown Heights, N.Y., the densi-

## Memory technologies compared

	Tape	Disc Drum	Core	Si IC	Bubble
Cost/bit ¢	10 <sup>-4</sup>	10 <sup>-1</sup>	1	1	10 <sup>-4</sup>
Average access time—sec.	10	10 <sup>-2</sup>	10 <sup>-6</sup>	10 <sup>-7</sup>	10 <sup>-5</sup>
Bits/in <sup>2</sup>	10 <sup>4</sup>	10 <sup>5</sup>	10 <sup>3</sup>	10 <sup>5</sup>	10 <sup>6</sup>
Power consumption: Joules/bit	10 <sup>-4</sup>	10 <sup>-4</sup>	10 <sup>-9</sup>	10 <sup>-9</sup>	10 <sup>-13</sup>
Volatile	No	No	No	Yes	No
Logic*	No	No	No	No	Yes
Radiation resistance	Fair	Fair	Fair	Poor	Fair**

\* Capability of combining logic and memory operations in the same device.  
 \*\* Based on preliminary data. More tests are required.

ty of bubble devices can be expected to increase from the present  $10^6$  bits per square inch to  $10^8$  bits per square inch. IBM has, in fact, constructed some experimental devices with this density that operate at a 100-kHz data rate, Chang notes. Improvements in materials will allow a maximum data rate of about 10 MHz, he says.

A general-purpose computer constructed entirely of bubble devices is possible, notes Monsanto's Sandfort. A design of such a device has already been completed by Monsanto, but with the present state of the art, construction of such a computer would not be desirable, Sand-

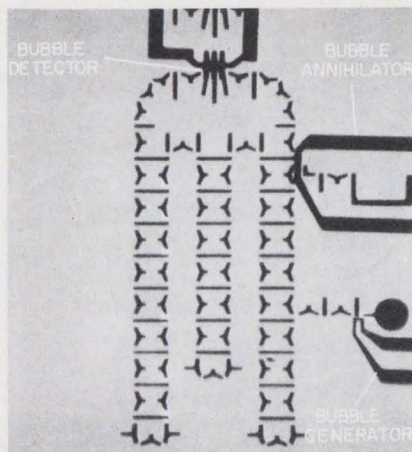

A 64-bit bubble memory was delivered by NARMEC to the Air Force.

fort says, because it would be too slow for most applications.

Another possible application, he continues, is in read-mostly memories, which are nonvolatile electrically alterable stores.

Clover of HP sees future applications for bubbles in dedicated memories for electronic test instruments.

Bubble recorders to replace tape recorders in military and space applications will become possible, says North American's Mavity. They will offer higher reliability and considerably increased storage capacity while minimizing power and weight. ■■

## Magnetic bubbles: They make an attractive memory

A magnetic bubble is a cylindrical magnetic domain in a single-crystal layer of a ferro- or ferrimagnetic material. The magnetization of the domain is normal to the layer. The bubble is bounded by a domain wall which separates material with upward magnetization from material with downward magnetization (Fig. a).

In magnetic bubble material, the upward and downward magnetic domains assume a minimum energy state which results in a serpentine pattern (Fig. b). When an external magnetic bias field is applied in a downward direction, the total energy of the wafer changes in such a way that domains whose polarity is opposite to that of the external field shrink (Fig. c). At a critical value of field intensity, the single walled or island domains—the are two in Fig. c—become cylindrical, resulting in a magnetic bubble (Fig. d).

The movement of magnetic bubbles can be controlled to form useful devices by adding circuit elements of permalloy (Fig. e). In such a device, the bubble is stabilized by the vertical bias field and can be thought of as a vertical bar magnet. When a rotating magnetic drive field is applied, as illustrated, the bubble seeks an energy minimum under pole 1. By uniformly rotating the drive field in a clockwise di-

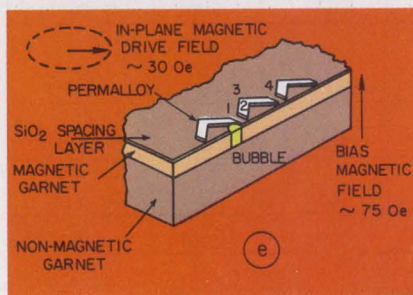
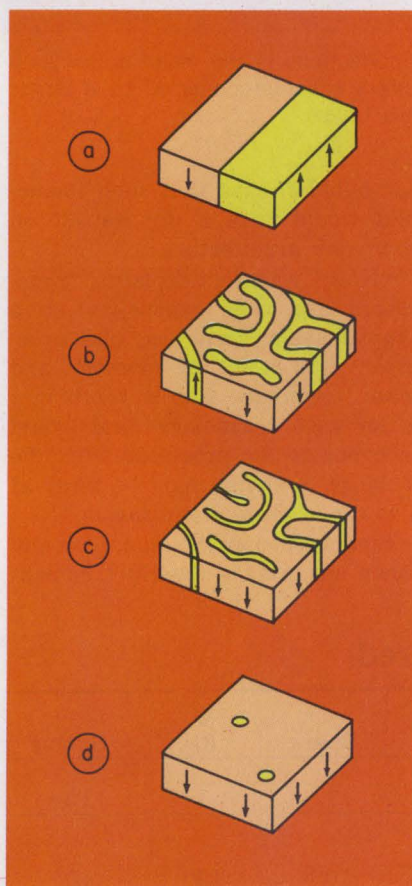

rection through 360 degrees, the bubble can be made to move through one cycle, that is through positions 2 and 3 to position 4.

If the magnetic bias field is applied by some permanent-magnet configuration, the bubbles will remain permanently stable and thus a nonvolatile memory becomes possible.

To enter data into a bubble memory, electrical impulses representing binary bits are converted into bubbles—one bubble per pulse—by means of a bubble generator. In the generator, a source bubble is maintained under a circuit element and generation is achieved by splitting the source bubble in two. One of the bubbles is then propagated along the circuit, while the other remains as a source for further bubble generation.

To read information out of a bubble memory, the presence of a bubble must result in an electrical pulse. The pulse may be produced either by a direct magneto-electrical conversion—such as magneto-resistive change in a permalloy sensor element, or by a magneto-optical conversion—via the Faraday Effect—followed by an opto-electrical conversion. Either way the readout is nondestructive.

If however, bubble destruction after readout is desired, an appropriately controlled bubble annihilator can be used.

# hp MEASUREMENT NEWS

innovations from Hewlett-Packard

FEBRUARY, 1973

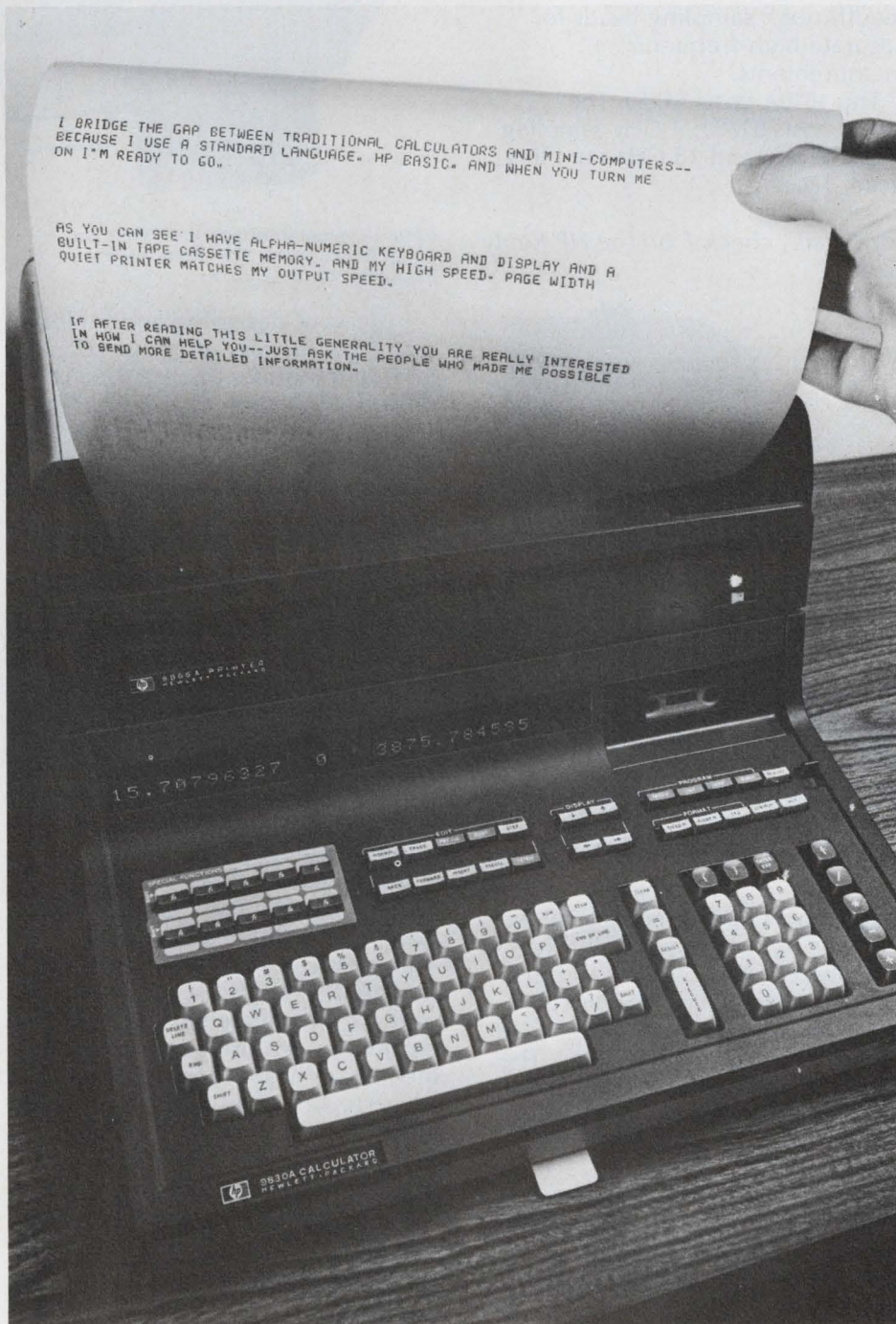

## in this issue

Another new  
pocket calculator

HP's incredibly fast  
computer interface

New ECL logic probe

## World's most powerful desktop calculator

It even talks to you in English.

Where does a calculator stop and a computer begin? That's hard to tell with the powerful new 9830A desktop calculator. This 40-byte system offers computer power with calculator convenience. It uses HP BASIC language, has an alphanumeric keyboard and 32-character display, as well as a built-in 15K byte operating system and a cassette memory. The model 30 is equivalent to a 10K or 12K minicomputer (16-bit words) that stores its compiler in read/write memory. And you can expand the calculator memory with up to 8 plug-in ROM (read-only-memory) modules.

You'll notice part of the calculator keyboard looks like a typewriter.

*(Continued on page 2)*

# Sampling without special controls or training

Despite recent advances in the performance of real-time oscilloscopes, sampling techniques still are preferred for viewing repetitive signals with very fast transitions or signals from high frequency components. But previously you needed extensive training to learn the complicated sampling techniques.

Now, HP sampling plug-ins for the 180 series oscilloscopes provide the easiest and fastest low-level, high-frequency measurements available. Because the plug-in looks and operates like a real-time plug-in, you eliminate the special controls

and training normally associated with sampling scopes.

Both plug-ins have a 2 mV to 200 mV/div deflection factor. The 1810A plug-in is for 1 GHz applications; the 1811A, for 4 to 18 GHz bandwidths with remote feedthrough sampling heads for accurate high-frequency measurements.

The 1810A costs \$1750. The 1811A costs \$1700; 4 GHz sampling head, \$1100; and 18 GHz sampling head, \$2800.

For details, check F on the HP Reply Card.

A dual-channel sampling plug-in enables the 182C scope to display pulse risetimes of <1.2 ns and approximately 2.5 ns.



(Continued from page 1)

That's because the model 30 uses a formal programming language, BASIC, new to the world of calculators. Because BASIC is a combination of algebra and conversational English, it's easy to learn yet powerful enough for your data manipulation and processing.

Unique editing features let you delete, modify or correct program lines or individual characters within a line. The calculator even detects your errors and displays an error note.

A new companion high-speed printer matches the model 30's

output speed and produces hard copy for reports or your files. This quiet page-width printer can print 330 characters/sec. or 250 lines/minute—that's 33 times better than a teletype at 10 characters/sec. The printer fits on top of the calculator and may be added at any time.

The calculator costs \$5975; the printer, \$2975.

There's more, including a comprehensive library of programs. For the full story, check P on the HP Reply Card.

## New interface transfers 1 megaword/second



HP's universal interface is so fast, you could fill an entire 32K memory in 32 milliseconds.

Instead of designing and building your own minicomputer interface, let the new super-fast HP 12930A universal interface card do it. This single plug-in unit quickly interfaces an HP 2100A minicomputer with external I/O devices that use differential or TTL logic. Included are I/O storage registers, dual channel interrupt logic, and a set of programmable switches to meet exacting interface requirements.

Besides simple plug-in installation, the new universal interface boasts:

- Extremely rapid data transfer (up to 1 million 16-bit words/second) to high-speed mass memories, controllers, and other processors.
- Data transfer up to 500 feet using differential logic.
- Dual-channel operation that lets you transfer data and control/status information simultaneously.
- Successive cycle-stealing when operated through the DMA section of the 2100A minicomputer. This means you can use successive memory cycles for data transfer.

The universal interface is available in three variations: differential or TTL logic (ground true/positive true). Each consists of a universal interface card, priority jumper card and diagnostic software. Price: \$800.

For details, check D on the HP Reply Card.

## New analyzer troubleshoots microwave links

To realize the full capability of busy microwave radio relay and satellite communication links, it is important that system operators quickly be able to identify, measure and localize the various forms of distortion occurring in a link.

This is precisely the function of the HP 3710 Microwave Link Analyzer (MLA) system. With modulation bandwidths sufficient for color TV or 1800-voice channels transmissions, the basic MLA covers the baseband (BB) and intermediate frequency (IF) link sections. Adding a down converter (RF to IF) and an up converter (BB to RF) extends the MLA's capability to the RF (1.7 to 11.7 GHz) portion of the link.

The MLA system measures such key parameters as group delay and linearity, differential phase and differential gain, plus mod/demod. sensitivity, attenuation and return loss.

Prices for the microwave link analyzer system start around \$11,000. To learn more, check J on the HP Reply Card.

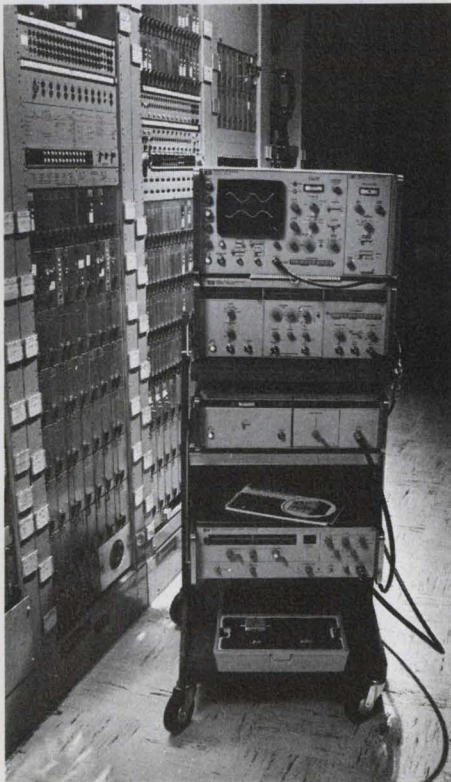

HP's microwave link analyzer is ideal for optimizing radio relay link performance.

## If you're in business, you can't afford to be without it

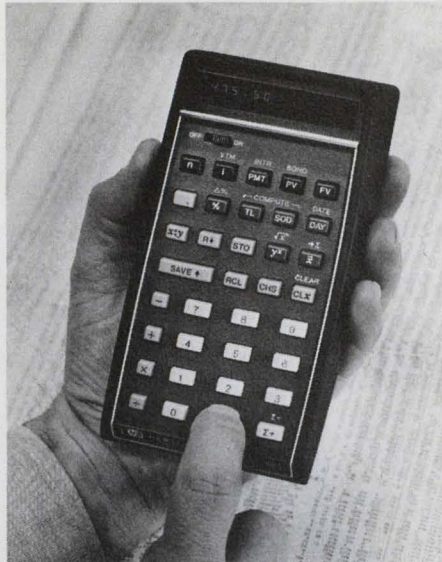

Last year we developed the popular HP-35 scientific calculator. Now, HP announces another major contribution to personal calculation for business and finance. The pocket-sized HP-80 is preprogrammed with 40 specific financial capabilities; and it can solve more than 100 types of business mathematics problems, many of them in less than 2 seconds.

The HP-80 can be used by managers of all kinds, brokers, bankers, insurance and real estate people, retailers, accountants, executives and sales people. Like the HP-35, the nine-ounce HP-80 fits in your palm or pocket; is battery or ac powered; positions the decimal point automatically; has four operating registers and a storage register; and shows answers on a 10-digit display. The mathematical range is from  $10^{-99}$  to  $10^{99}$ . Yet for all its power, it's as simple to operate as an adding machine.

The HP-80 eliminates the need for cumbersome financial tables and time-consuming interpolation. And it's far more accurate than most tables.

Whatever your business or wherever it takes you, you can take the HP-80, and you should. Price: only \$395.

To find out more about the HP-80 and how to get one, check A on the HP Reply Card.

The new HP-80 pocket calculator—best thing that's happened to business since the credit card.

The HP-80 is preprogrammed with the basic four functions (addition, subtraction, multiplication and division) plus 36 separate financial capabilities:

1. Constant storage
2. Selective round-off
3. Percentage calculation
4. Percent difference
5. Square root
6. Power (exponentiation)
7. Running total (summation)
8. Mean (arithmetic average)
9. Standard deviation
10. Number of days between two dates
11. Future date, given number of days
12. Future value of an amount compounded
13. Present value of an amount compounded
14. Effective rate of return for compounded amounts
15. Number of periods for an amount compounded
16. Future value of an annuity
17. Present value of an annuity
18. Effective rate of a sinking fund
19. Effective rate of a mortgage
20. Installment of an annuity, given future value
21. Installment of an annuity, given present value
22. Number of periods for a sinking fund
23. Number of periods for a mortgage
24. Add-on to effective annual rate conversion
25. True equivalent annual rate
26. Linear regression (trend-line) analysis
27. Sum-of-the-years' digits depreciation amortization
28. Rule of 78's finance charge amortization
29. Discounted cash flow analysis
30. Accumulated mortgage interest calculation
31. Remaining principal on a mortgage
32. Accrued interest (360 and 365 day year)
33. Discounted notes (360 and 365 day year)
34. Discounted note yields (360 and 365 day year)
35. Bond price
36. Yield-to-maturity of a bond

And, the HP-80 is a 200-year calendar.

# Swept SWR measurements in coax, 1.8 to 18 GHz

## HP graphic displays for OEM systems

Different size CRTs can be mounted in a modified frame on special order. They range in size from 8 to 21 inches, diagonal measurement (20 to 53 cm).



Need to display computer-generated graphics? The HP 1310A and 1311A displays provide bright, easy-to-see readouts in OEM systems. These high-speed 19 in. (48 cm) and 14 in. (35.5 cm) graphic displays offer unexcelled dynamic performance to meet the broad

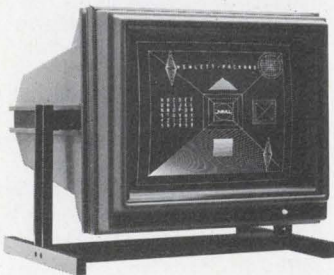

The fast and versatile 1310A OEM graphic display. (Computer-generated graphics courtesy of the Boeing Company.)

requirements of varying OEM applications.

Linear writing speed is an unsurpassed 10 in/ $\mu$ s (25 cm/ $\mu$ s) which allows character strokes to be written in less than 100 ns. Maximum slew rate of the electronics is 100 in/ $\mu$ s (2.5 meters/ $\mu$ s), and large-step jump and settle time is 1  $\mu$ s. This offers tremendous programming simplicity since characters and vectors can be plotted in random fashion from anywhere in the large display area.

Internal construction is modular, rugged, and very servicable. The open-frame construction allows easy mounting in a standard 19-in. (48 cm) rack or in a custom-designed enclosure.

For more information, check E on the HP Reply Card.

Fast yet accurate SWR measurements in coax are now easily made using the HP 817A swept slotted line system and 8755 frequency response test set. The 817A is modified to accept the detectors that are part of the 8755 test set. The result: a measurement system with very broad frequency coverage (1.8 to 18 GHz) and high accuracy (residual SWR < 1.04 at 18 GHz).

The 8755 test set provides high sensitivity, high stability and high resolution for all-around measurement simplicity and convenience. The test set can also be used for wide dynamic range transmission/reflection measurements over its full 0.1 to 18 GHz frequency range.

The 817A opt. H03 slotted line system costs \$1000. A complete 8755 test set with variable persistence CRT display costs \$4200.

For details, check O on the HP Reply Card.

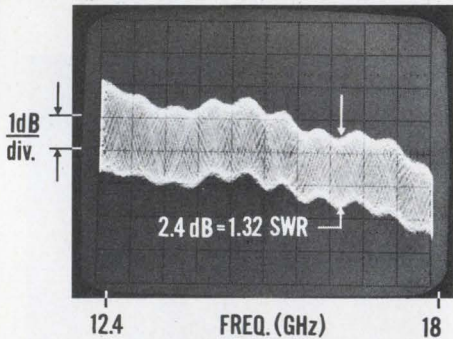

Trace envelope develops as probe is moved along slotted line while frequency is swept. The test device SWR equals the thickness of the envelope.

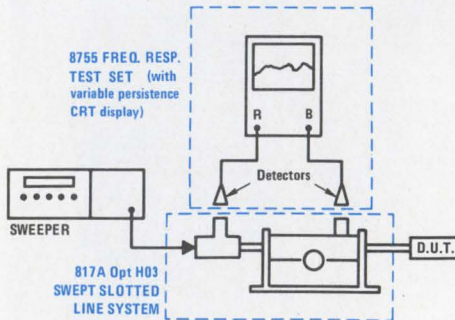

Simplified diagram of swept SWR test setup.

# Fully protected, low voltage dc supplies



HP's fully protected low-voltage dc supplies come in power ratings from 120 to 2000 W.

If your system power requirements call for a dc supply with superior performance and the benefits of built-in overvoltage and overcurrent protection, take a close look at HP's family of low-voltage rack supplies.

These supplies boast load and line regulation of 0.02%, with less than 10 mV peak-to-peak ripple and noise (dc to 20 kHz). Output voltage and current limiting are fully adjustable, while the overvoltage crowbar trip point is adjustable from approximately 10 to 110% of

rated output voltage. Other advantages include automatic crossover between constant-voltage and constant-current modes, remote programming, and remote sensing.

This power supply product line includes 13 models (6256B thru 6274B) covering four output voltage ratings: 10 V at 20, 50 or 100A; 20 V at 10, 20, or 50A; 40 V at 3, 5, 10, 30 or 50A; and 60 V at 3 or 15A. Prices start at \$410.

For more information, check N on the HP Reply Card.

## New data punch formats for any system

Designed for off-line data logging, HP's new 3489A data punch accepts TTL level, BCD coded inputs from measuring instruments, then punches a paper tape that can be fed directly to almost any computer, calculator, or telex system. The punch eliminates tedious and time-

consuming manual data transfer between instrument and system.

The 3489A accepts up to 8 BCD digits of measurement data plus 1 BCD digit for range, 1 for function, and 1 bit for polarity and overload. Your computer's format and character codes are preprogrammed on a pin board, so the data tapes punched by the 3489A can be fed directly into your system. A built-in data counter adds a 4-digit number to each data line if you so desire.

Punching speed is 70 characters per second. During unattended operation, the punch, not the measuring instrument, controls the sampling rate.

Price: \$3000.

For data punch details, check H on the HP Reply Card.

Now, your measuring system can automatically punch a paper tape for just about any computer or calculator.

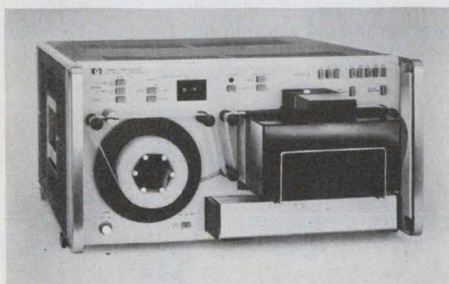

## Portable tape recorder has many uses

The 3960A portable magnetic tape instrumentation recorder records and reproduces four channels simultaneously using either FM or direct recording on any channel. You can select three tape speeds: 15/16 ips for long-term FM recording of slowly-changing phenomena; 3¾ ips for acoustic evaluation and audio range applications; and 15 ips for vibration studies and other applications that require direct recording response up to 60 kHz or FM up to 5 kHz.

The low-speed performance is outstanding, an important asset to medical researchers and others who record slowly-changing variables. The FM signal-to-noise ratio at 15/16 ips is >46 dB, about 10 dB better than previous recorders. At higher speeds, the FM signal-to-noise ratio is >48 dB. A built-in servo drive minimizes flutter and maximizes tape speed accuracy.

Price: \$4285

For details, check K on the HP Reply Card.

The 3960A recorder uses ¼-inch tape on standard 7-inch tape reels, which is less expensive than ½-inch or wider tape.



# Easier way to measure complex low impedance

Complex impedance measurements at low values present some problems for conventional impedance meters. For example, it's difficult to measure the 20 mΩ

impedance of a ground bus using a conventional impedance meter with a 1Ω full scale range; however, you can measure it with a gain phase meter, as shown below:

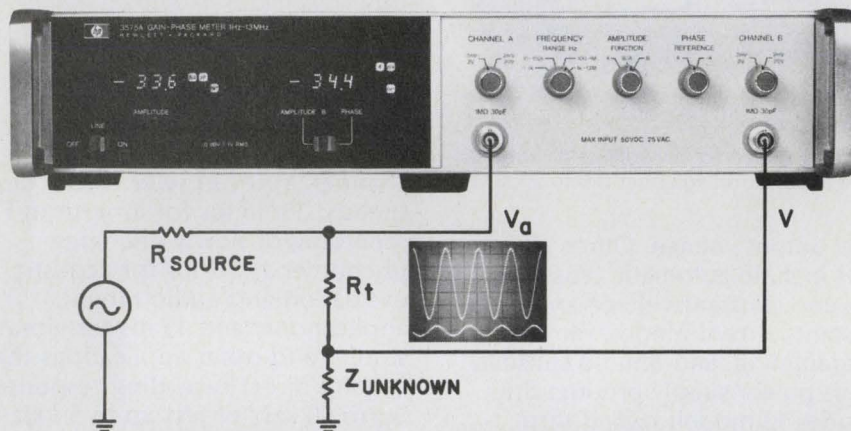

As long as  $R_t$  is much larger than the unknown impedance, voltage  $V_a$  will be directly proportional to the constant current flowing through the known resistance and voltage  $V$  will vary with the unknown impedance. The voltage ratio of  $V$  to  $V_a$  will be proportional to the complex impedance. With  $R_t = 50 \Omega$ , a gain reading of  $-60 \text{ dB}$  on the meter corresponds to  $50 \text{ m}\Omega$ ,

and a reading of  $-80 \text{ dB}$  to  $5 \text{ m}\Omega$ . All that is needed for calculating impedance magnitude is the value of  $R_t$ .

The 3575A costs \$2450 to \$3150.

*For details on the gain phase meter check I on the HP Reply Card. For Application Note 157 on gain phase measurement applications, check R.*

## Take the mystery out of time interval averaging

"Time Interval Averaging," a new application note, describes our technique for increasing the accuracy and resolution of short time interval measurements. Using time interval averaging, the HP 5326/5327 universal counters can

measure intervals as short as 150 ps with resolution to 100 ps (at little or no increase in cost over conventional universal counters that can only measure intervals as short as 10 or 100 ns).

This booklet (AN 162-1) describes when averaging is useful, factors that influence measurement accuracy, and how to verify and evaluate time interval averaging measurements. Other topics include statistics, the need for synchronizers for valid averaging, and simple ways to avoid synchronous repetition rates that could otherwise limit the power of time interval averaging. All major topics are fully illustrated with figures and examples. *For your free copy, mark S on the HP Reply Card.*

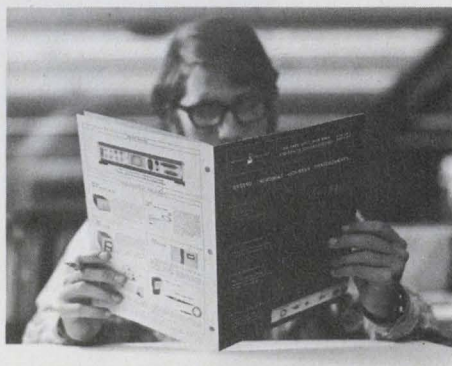

## HP's auto-attenuator for lab and OEM

Broadband programmable attenuators have been optimized for both measurement applications and OEM design usage. The HP 33300 series attenuators (dc to 18 GHz) offer accuracy and repeatability where precision is required. At the same time, the attenuators are fast, compact, reliable and cost-effective for installation in equipment.

At 2/3 the cost of any other programmable attenuator, the 33300 series gives you a broad selection of connectors, ranges and step sizes (1, 6 and 10 dB). Supplied with either 12 or 24V solenoids, simple drive circuitry can be built to fit your needs. Prices start at \$665 each in quantities of 1 to 9. *Check G on the HP Reply Card for specifications.*

No matter what your application—on the bench or in equipment—the 33300 series programmable attenuators are cost-effective selections.

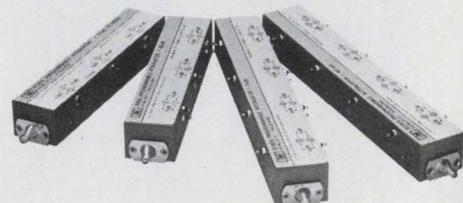



# HEWLETT-PACKARD COMPONENT NEWS

## Now, choose 3, 4 or 5 digit displays

The 5082-7400 LED clusters are 0.11 inches (.28 cm) high.

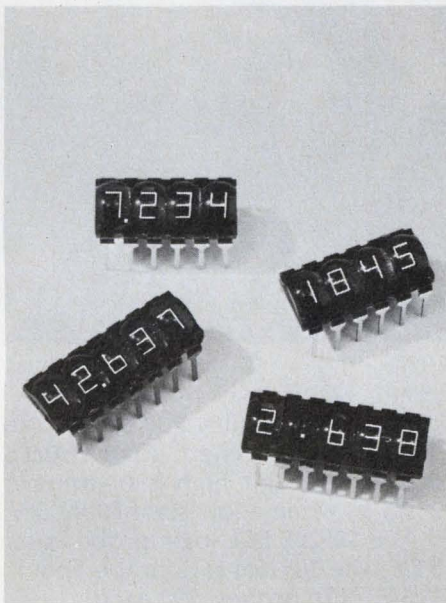

A series of small, end-stackable solid-state displays are now available in three, four and five-digit clusters. The extremely low power requirements (typ. 5 mW/digit) make the 5082-7400 series LEDs ideal for miniature battery-powered devices, such as hand-held calculators.

The displays can be plugged into DIP sockets or soldered onto PC boards. They are IC-compatible and designed for strobed operation. Options include either the standard right-hand decimal point or a centered decimal point. Prices:  
3-digits (1-33) \$12.75 (34-166) \$10.50  
4-digits (1-24) \$17.00 (25-124) \$14.00  
5-digits (1-19) \$21.25 (20- 99) \$17.50

For more information, check L on the HP Reply Card.

## New low-cost LED for commercial market

High-volume production and advanced product design have resulted in low-cost LED lamps for the consumer market. Designed for commercial applications, they can be used in TV sets, appliances or automobile instrument panels. These lamps have red diffused lens and 0.8 millicandelas light output (typ).

Price: only 17¢ each in 100K quantities.

For more information, check M on the HP Reply Card.

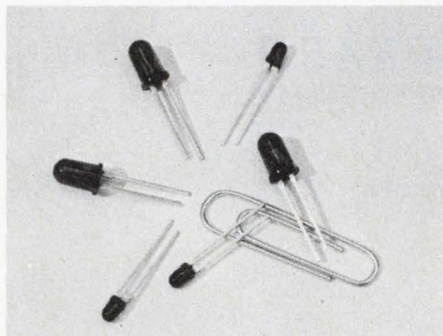

The 5082-4484 LED is  $\frac{1}{8}$  inch in diameter (0.3 cm); the 5082-4850, .200 inch in diameter (0.5 cm).

## New optoelectronics catalog

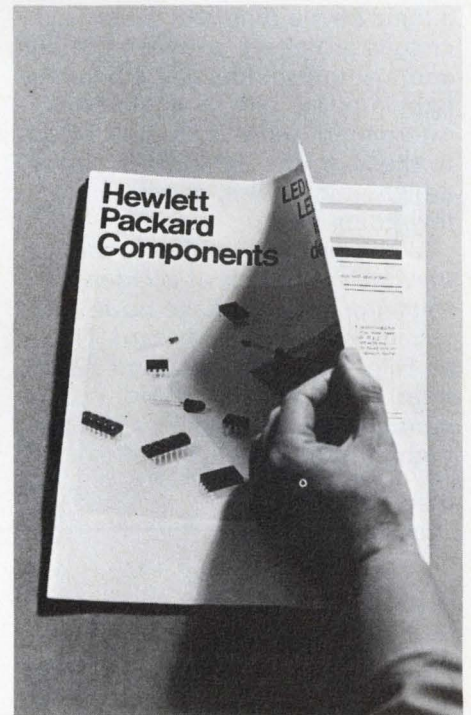

Now, you can get a copy of our 1973 Optoelectronics Designer's Catalog. This 48-page book contains complete up-to-date detailed specifications on the entire HP optoelectronics product line—LED displays, LED lamps, high-speed optically coupled isolators, and PIN photodetectors.

For your free copy of this bound catalog, check T on the HP Reply Card.

# New ECL and HTL logic probes join HP's IC troubleshooters

Two new logic probes bring unique capabilities and fingertip ease to logic troubleshooting: model 10525E is the only probe on the market fast enough to check emitter-coupled logic, while the 10525H probe checks circuits operating in the broad range from 12 to 25 V.

Both probes do everything the time-proven model 10525T does for TTL/DTL circuits—simply touch the circuit node with the probe tip, then read the band of light. A bright light indicates a logic high; no light, a logic low; a dim light, open circuits or voltage between the high and low thresholds; and a blinking light, a pulse train. A single or intermittent pulse is always obvious to the user; the light blinks on for a high-going pulse, or off for a low-going pulse.

When probing in-circuit, the inevitable problem of accidentally touching a high voltage node usually is a potential hazard. Not so; all HP probes will withstand  $\pm 200$  V intermittently and  $\pm 70$  Vdc continuously. HP probes also have high input impedance.

Now, HP offers three different logic probes, one for each major logic family.

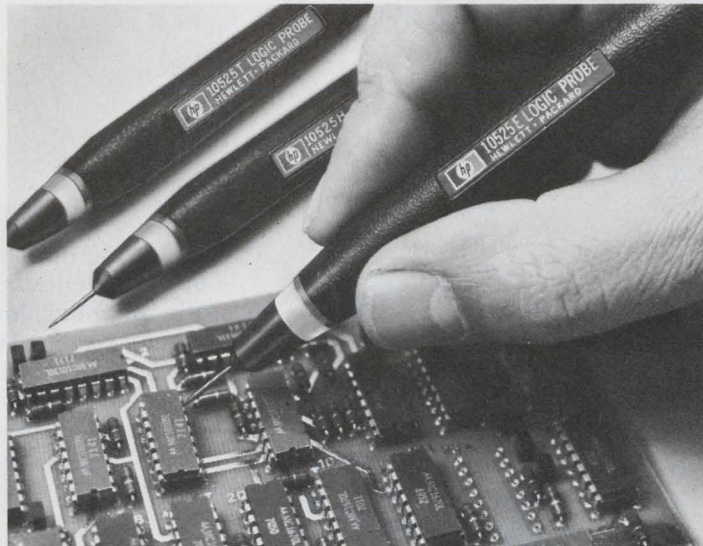

The 10525E probe is the fastest probe available today, able to capture single pulses as narrow as 5 ns. The logic one threshold is  $-1.1 \text{ V} \pm 0.1 \text{ V}$ ; and logic zero,  $-1.5 \text{ V} \pm 0.1 \text{ V}$ . With this super-fast, handheld probe, you can solve most of your ECL troubleshooting problems without resorting to complicated test equipment.

The 10525H troubleshoots HTL,

HiNIL, MOS, relay and discrete-component circuits. Pulses down to 100 ns are "stretched" for a visual indication. Logic high is anything  $> 9.5 \text{ V}$ , while a low state is  $< 2.5 \text{ V}$ .

The 10525E ECL logic probe costs \$125; the 10525H HTL probe and 10525T TTL probes, \$95 each. For more information on the new IC troubleshooters, check B or C on the HP Reply Card.



Measurement, Analysis, Computation

East—W. 120 Century Road, Paramus, N.J. 07652.

Ph. (201) 265-5000.

South—P.O. Box 2834, Atlanta, Ga. 30328.

Ph. (404) 436-6181.

Midwest—5500 Howard Street, Skokie, Ill. 60076.

Ph. (312) 677-0400.

West—3939 Lankershim Boulevard, North

Hollywood, Ca. 91604, Ph. (213) 877-1282.

Canada—275 Hymus Boulevard, Pointe Claire,

Quebec, Canada, Ph. (518) 561-6520

Mexico—Adolfo Prieto 622, Col. del Valle,

Mexico 12, D.F., Mexico, Ph. 543-4232 or 523-1874.

# It's a 40-billion-bit ROM, it's a TV programmer—it's Disco-Vision!

It can store 40-billion-bits of digital information on a 12-inch-diameter Mylar disc similar to a long-playing phonograph record. That's enough storage to cover the Social Security number of every person in the United States.

It can record about 40 minutes of television program material in such a way that the recording can be played back through an unmodified home TV receiver.

What is it? A new "laser phonograph" technology that uses a pressed Mylar disc for information storage and a laser-based optical system for reading the information out. Called Disco-Vision, it has been developed by MCA Disco-Vision, Inc., of Torrance, Calif. Prototypes have been built, and manufacturing and marketing prospects are under study.

Philips of the Netherlands is also investigating the technique.

Kent Broadbent, vice president of MCA Disco-Vision, describes the process this way: "The disc is very similar to a standard long-playing phonograph record. It differs in that it is made of aluminized Mylar, is about 0.010-inch thick, has a groove that spirally runs from the outer diameter of the disc inward with a pitch of 80 micro-inches per revolution and has 12,500 grooves per inch."

A 12-inch disc will generally have from 35,000 to 40,000 grooves. The physical structure of the grooves is currently considered proprietary by Disco-Vision. However, Broadbent notes that to read the information stored in a groove, the laser pickup must be focused to a point of light that is less than  $1\ \mu$  in diameter. A diffraction-limited system is used to do this.

David N. Kaye  
Senior Western Editor

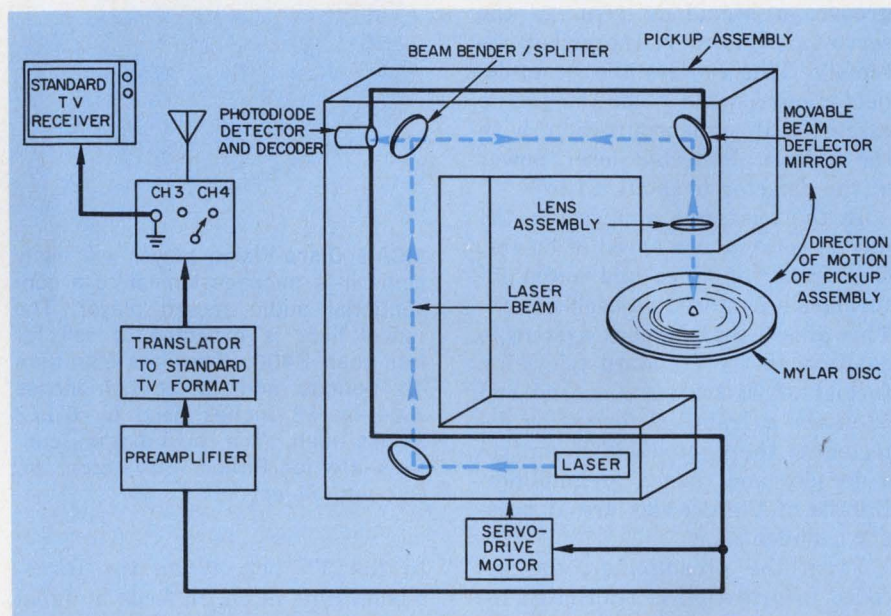

The beam in the "laser photograph" is focused on a grooved Mylar disc. The information on the disc is detected by a photodiode, and a signal is fed back to keep the laser beam tracking the groove on the disc. Information from the disc is decoded, preamplified and translated to standard television format. This signal is then fed into a standard television receiver tuned to either Channel 3 or 4, whichever is unused by a broadcast station in the area.

A high-power laser stylus cuts the master disc. Broadbent says that it will cost only 40 cents to reproduce the disc with a pressing process that is very similar to that used for producing long-playing records.

## Laser tracking a problem

Since the initial market for Disco-Vision is projected by John W. Findlater, president of the company, to be the consumer market of playback through conventional television receivers, the prototypes so far built and demonstrated are designed for that purpose. One unit demonstrated recently had horizontal interference in the picture as viewed on a standard TV set. Broadbent conceded that the interference was due to a difficulty in keeping

the laser pickup optimally positioned on the groove.

The pickup assembly consists of a laser, a system of lenses, mirrors and beam splitters, a photodiode detector and a servo-controlled drive motor. Everything but the motor is housed in a U-shaped pickup assembly that rides across a record (see diagram). The helium-neon laser puts out about 1 mW at 6280 Å. It sits below the turntable. Its beam strikes a 90-degree beam bender mirror and is reflected up to a beam splitter. The beam is then sent on a path parallel to the surface of the record in the upper part of the pickup assembly to a movable beam deflector mirror. From there, the beam goes through a series of lenses and strikes the groove of the record. The reflected beam travels backwards through

the optical system to the beam splitter. At the beam splitter the energy is focused on a photodiode detector.

If the beam deviates from the center of the groove, it strikes a highly reflective surface between the grooves and sharply increases the power detected by the photodiode. This activates a command to the movable beam-deflector mirror to direct the beam back into the groove. As the mirror deflects more and more, to keep tracking the groove, a signal is sent to the servo-motor to move the pickup assembly. This centers the beam-deflector mirror and keeps the pickup assembly in synchronization with the groove. Reflected laser power at the detector is about 0.1 mW.

In the television application, the disc is rotated at a speed of 30 rps. One frame of video and audio information is stored on each groove. This allows the playback system to conform to the standard television format of 30 frames a second and 525 lines a frame. Information detected at the photodiode is sent to a decoder and then a preamplifier. Details of the decoder are at present confidential.

From the preamplifier, the decoded information is translated into standard television format and impressed on one of two carrier frequencies. The two carrier frequencies correspond to Channel 3 and Channel 4 on a standard television receiver. A switch on the back of the playback machine selects the desired carrier. The selection is made so that the Disco-Vision unit feeds an otherwise unused channel on the set.

On the back of the playback machine are two connectors. One is a 300- $\Omega$  twin lead connector that is attached to the drop cable from the TV antenna. The other is a 75- $\Omega$  coaxial connector for the TV set. When the Disco-Vision unit is off, it is bypassed, so that the signal from the TV antenna goes directly

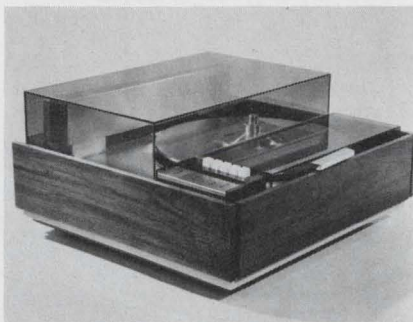

**MCA's Disco-Vision player** will likely come in a package similar to a conventional audio record player. The model here is expected to sell for less than \$400. It weighs less than 40 pounds and is 16-3/4 inches wide by 18 inches deep by 8-1/2 inches high. The push-button controls are for Power, Play, Stop, In, Out and Reject.

to the TV set. When the Disco-Vision unit is on, it feeds a signal of just under 3 mV to the set.

#### Laser reliable but cheap

Laser reliability and cost are key factors in the viability of the system, according to Broadbent. For reliability, a lifetime of at least 7000 to 9000 hours is the goal. To meet this, iron and zirconium cathode lasers are being

considered instead of more common aluminum cathode type.

A replacement cost of no more than \$20 for the laser is the goal. "Several manufacturers feel they can satisfy our requirements," Broadbent notes. "However, a final laser supplier has not yet been selected."

#### High data rate for computers

A minimum data rate of about 30 Mb/s is feasible with the Disco-Vision playback machine in a read-only memory application. For random access, an entire record of 40-billion-bits of information can be scanned in less than 10 seconds. These features open a wide spectrum of potential computer applications. The most obvious is the credit-verification field. Each week a record of all suspect credit-card numbers could be mailed to subscribers. By inserting a credit card in a reader, a subscriber could compare its number with all the numbers on the disc. A simple light could indicate a match if the credit card was found to be unacceptable or counterfeit.

The estimated cost of the consumer Disco-Vision player, according to Findlater, is less than \$400 for a single-disc unit and less than \$500 for an automatic changer that would hold up to 10 discs.

An introduction date for the players has not yet been determined. The Stanford Research Institute in Menlo Park, Calif., is studying manufacturing methods, markets and merchandising techniques for MCA. A report is not due for several weeks. ■■

## Pressure sensor defies 10-g vibration

A high-resolution digital pressure sensor has been developed that is reported virtually insensitive to vibration.

In tests to date, the sensor is said to have met all specifications over a vibration range of 10 g's, from 10 to 2000 Hz, and at shock of up to 15 g's. The sensor works

over a temperature range of -65 to +230 F.

Models have been built for the pressure ranges of 0 to 36 inches of mercury and 0 to 90 inches of mercury—absolute readings, not gauge pressures.

Accuracy achieved so far is reported at  $\pm 0.03\%$  of full scale over

the pressure and temperature range. This includes hysteresis and short-term instability. Long-term stability is given as better than 0.01% full-scale change in output in six months.

Developed by the Garrett AiResearch Manufacturing Co. in Torrance, Calif., the pressure sensor is

described this way by Andrew P. Papadeas, chief of the company's electronic systems: "This sensor is the highest in resolution and the least sensitive to vibration of any on the market."

Papadeas notes that the sensor will find application in tactical aircraft, providing a 20-bit binary word to an airborne data computer.

### Quartz gives stability

A quartz-diaphragm variable capacitor is at the heart of the sensor. As air pressure pushes on the diaphragm, a capacitor plate deposited on the diaphragm gets closer to a pair of capacitor plates deposited in a reference position. This assembly forms two series-variable capacitors whose capacitance is proportional to pressure. The series capacitors are coupled in parallel to a coil. This forms a series LC network. The LC network is transformer-coupled to a variable oscillator that is mounted on the outside of the network's housing. As the capacitance varies with pressure, the frequency of the oscillator varies accordingly.

The basic frequency is about 70 MHz. The oscillator frequency is detected by a sensing coil that provides the input to a buffer amplifier. The output of the buffer amplifier goes to a 20-bit counter. The counter output gives the frequency as a parallel code or, with the use of a parallel-to-serial converter, a serial code.

Quartz is used as the material for the housing as well as for the diaphragms. Quartz parts are fused together.

Papadeas points out why quartz was selected: "The desired accuracy, repeatability and long-term stability could be obtained only by the selection of (1) A material that is fundamentally hysteresis-free and dimensionally stable, and (2) A design that eliminated all mechanical joints, adjustment devices and adhesive bonding of critical parts."

The sensors have already been ordered by Grumman for the F-14 jet fighter, North American Rockwell for the B-1 bomber, Saab for its JA-37 aircraft and the NASA Flight Research Center at Edwards Air Force Base in California. ■■

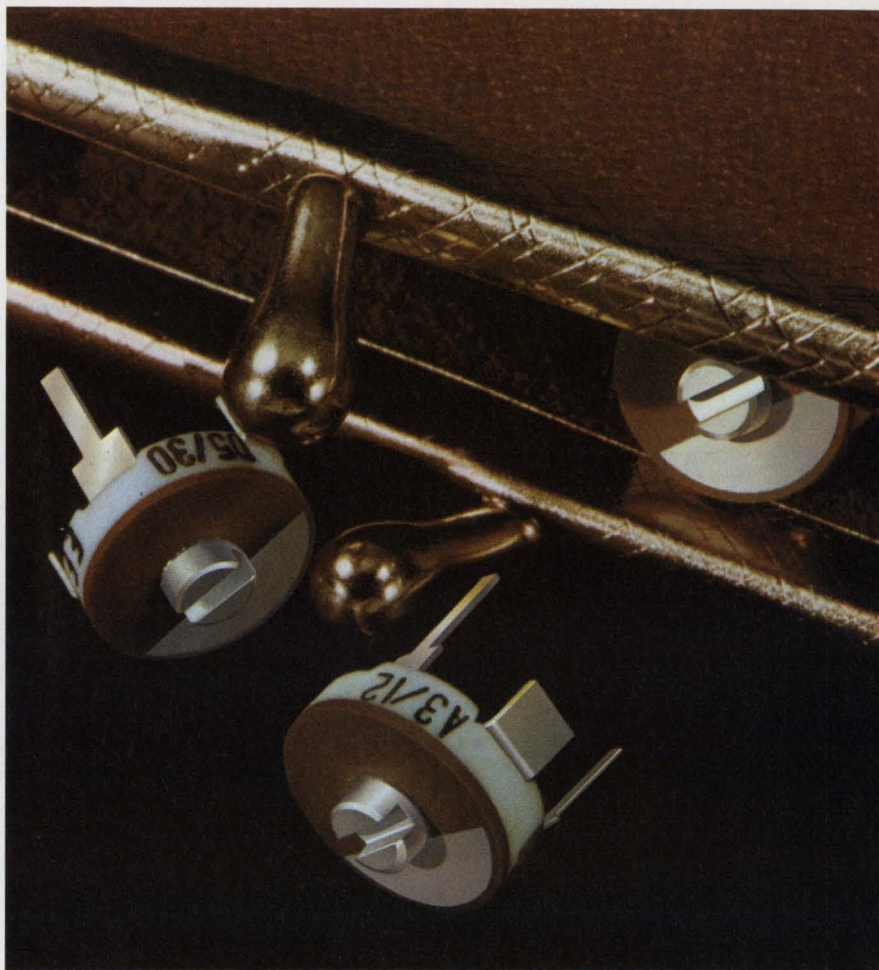

If you could save up to 30% without losing anything by using this new 10mm ceramic trimmer capacitor, wouldn't you want to know it?

That's exactly what we can promise you for many applications. All the performance you need for about a third less than you've been spending.

These new trimmers have five capacity ranges from 3.0pF min. to 30.0pF max. Their operating temperature range is  $-30^{\circ}\text{C}$ . to  $+125^{\circ}\text{C}$ . And they mount interchangeably with other ceramic trimmers for PC applications. Four dielectric types available.

But check them out for yourself. Get the coupon in the mail today.

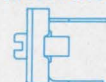

Actual Size

E. F. JOHNSON COMPANY/Waseca, Minnesota 56093. Dept. 3302  
You bet I'd like literature and a free test sample of your new low cost trimmer capacitor if it can do what you say!

Check capacitance (pF) range needed:

- 3.0 to 8.0       3.0 to 12.0       5.0 to 13.0  
 5.0 to 20.0       5.0 to 30.0

\_\_\_\_\_ Please send them directly.

\_\_\_\_\_ Please call me at: \_\_\_\_\_

Name \_\_\_\_\_

Firm \_\_\_\_\_ Title \_\_\_\_\_

Address \_\_\_\_\_

City \_\_\_\_\_ State \_\_\_\_\_ Zip \_\_\_\_\_



**E. F. JOHNSON COMPANY**

INFORMATION RETRIEVAL NUMBER 19

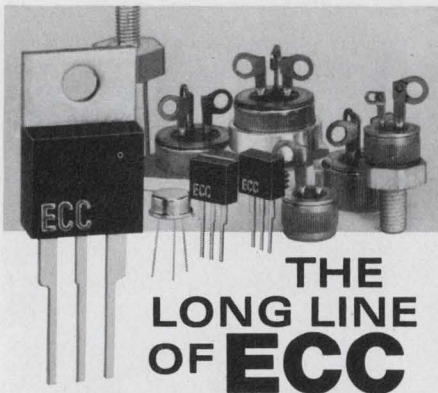

## THE LONG LINE OF ECC

Sensitive and Standard Gate

# SCR's

Fast delivery and competitive prices make ECC's extensive line of SCR's your best buy.

### SENSITIVE GATE SCR's

TO-5 Metal; 5/8" Hex Stud; THERMOPAK\* and THERMOTAB® Packages

$I_{T(RMS)}$  0.8 - 10 amps

$I_{GT}$  50, 200, 1500  $\mu$ amps max

$I_{TSM}$  50, 100 amps min

$V_{DOM}$  30 - 600 volts min

### STANDARD GATE SCR's

TO-5 Metal; 5/8" Hex Stud; THERMOPAK and THERMOTAB; 1/2" Press-Fit and Stud; 3/4" Press-Fit, Stud and TO-3 Packages

$I_{T(RMS)}$  0.8 - 35 amps

$I_{GT}$  10, 25 ma max

$I_{TSM}$  50 - 325 amps min

$V_{DOM}$  30 - 800 volts min

5/8" Hex Stud; THERMOPAK and THERMOTAB; 3/4" Press-Fit, Stud and TO-3 Packages are electrically isolated.

All ECC SCR's feature heavily glass passivated junctions for high reliability. They are available from your nearest ECC Sales Representative or Authorized Distributor.

\*trademark of ECC

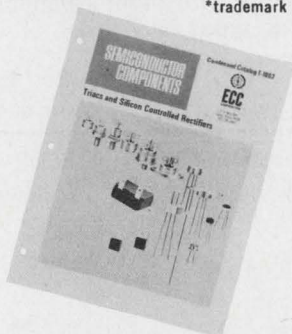

New Condensed Catalog contains technical data on these and other ECC semiconductors. To receive your copy, circle No. 240.

**ECC**  
CORPORATION

P.O. Box 669 • Euless, Texas 76039  
817/267-2601

## technology abroad

A Finnish system to control the mixing of raw materials in cement manufacturing has two new types of analyzers and a small dedicated process computer. Developed by Outokumpu Oy Finland, the system analyzes silicon and aluminum content by neutron-activation analysis and detects calcium and iron by X-rays. A PDP-11 computer converts pulse counts from the neutron and X-ray detectors into element concentrations and checks their validity. It then transforms the concentration to raw-mix quality factors and calculates their deviation from set points. Using a series of control algorithms, the computer selects the best raw-material feed combination for the mill.

CIRCLE NO. 401

British random-noise equalizers/analyzers for use in vibration testing have active filters that can be connected in banks of 40, 80, 120 or 160, depending on the resolution required. Introduced by Derritron Electronics of England, the instruments incorporate a three-color display based on a Sony Trinitron tube. A histogram waveform and an equalization function can be presented in different colors. The display also shows the channel number and the synthesized center frequency.

CIRCLE NO. 402

Significant increases in MOS device speeds may be obtained using a new semiconductor fabrication technique called "epitaxial silicon films on insulation." Now in development at the Siemens Research Laboratories in West Germany, the new process uses an insulating substrate in much the same way as does the silicon-on-sapphire process developed in the United States. However, Siemens' substrate is a spinel crystal, instead of sapphire. To date, Siemens has grown spinel crystals over one inch in diameter. Development has reached the stage of an  $8 \times 126$  diode matrix for

a read-only memory. While speeds approach those of conventional bipolar devices, Siemens reports that the power requirements are much lower.

CIRCLE NO. 403

Josephson junctions 1.2 by 3.1  $\mu$ m for potential use in ultra-fast electronic computer circuits have been made at IBM's Zurich research laboratories in Switzerland. These superconducting junctions have switching times of less than 38 ps with a current density of 1 kA/cm<sup>2</sup>. The power-rise time product is  $3.8 \times 10^8$  J. These junctions were made by contact printing and photoresist-lift-off techniques.

CIRCLE NO. 404

A production process for the reliable reflow soldering of flat-pack ICs onto printed-circuit boards has been developed by Anglade of France. In the process, which is called Microsoltex, a predetermined amount of solder is crimped to the leads of the flat pack, which are formed in the usual way. The flat pack is then positioned by a vacuum chuck and lowered into the board while two heated heads cause the solder to flow cleanly between the leads and mounting pads. Temperature can be closely controlled, and irregular heating of individual leads is thus eliminated.

CIRCLE NO. 405

A homopolar generator with iron-cored liquid metal brushes, believed to be the largest of its type in Britain, has an output of 15,000 A at 6 V. Produced by the International Research and Development Co. in England, the generator has been used to test a number of current collection systems that employ liquid metals. The company says generators with outputs as high as 100,000 A are possible.

CIRCLE NO. 406

# Two new digital multimeters with price and performance you can't refuse.

## 8350A

5½ digits, autoranging  
0.005% accuracy  
5 ranges dc volts  
5 ranges of ohms  
4 ranges ac volts  
\$1495, complete DMM



## 8375A

5½ digits, autoranging  
0.003% accuracy  
Functional self-test  
5 ranges dc volts  
7 ranges of ohms  
4 ranges **true RMS** ac volts  
Powerful systems options  
\$1995, complete DMM



Both instruments use Fluke's patented recirculating remainder a-to-d converter for low parts count, low power consumption and boast a calculated MTBF of at least 10,000 hours. ● Either instrument gives you more multimeter for your money. **Now isn't that an offer you can't refuse?**



For details call your local Fluke sales engineer. In the continental U.S., dial our toll free number, 800-426-0361 for his name and address. Abroad and in Canada, call or write the office nearest you listed below. Fluke, P.O. Box 7428, Seattle, Washington 98133. Phone (206) 774-2211. TWX: 910-449-2850. In Europe, address Fluke Nederland (N.V.), P.O. Box 5053, Tilburg, Holland. Phone 13-670130. Telex: 884-55237. In the U.K. address Fluke International Corp., Garnett Close, Watford, WD2, 4TT. Phone, Watford, 33066. Telex: 934583. In Canada, address ACA, Ltd. 6427 Northam Drive, Mississauga, Ontario. Phone 416-678-1500.

# PTM DUALS.

## A powerful addition to the Sorensen modular line.

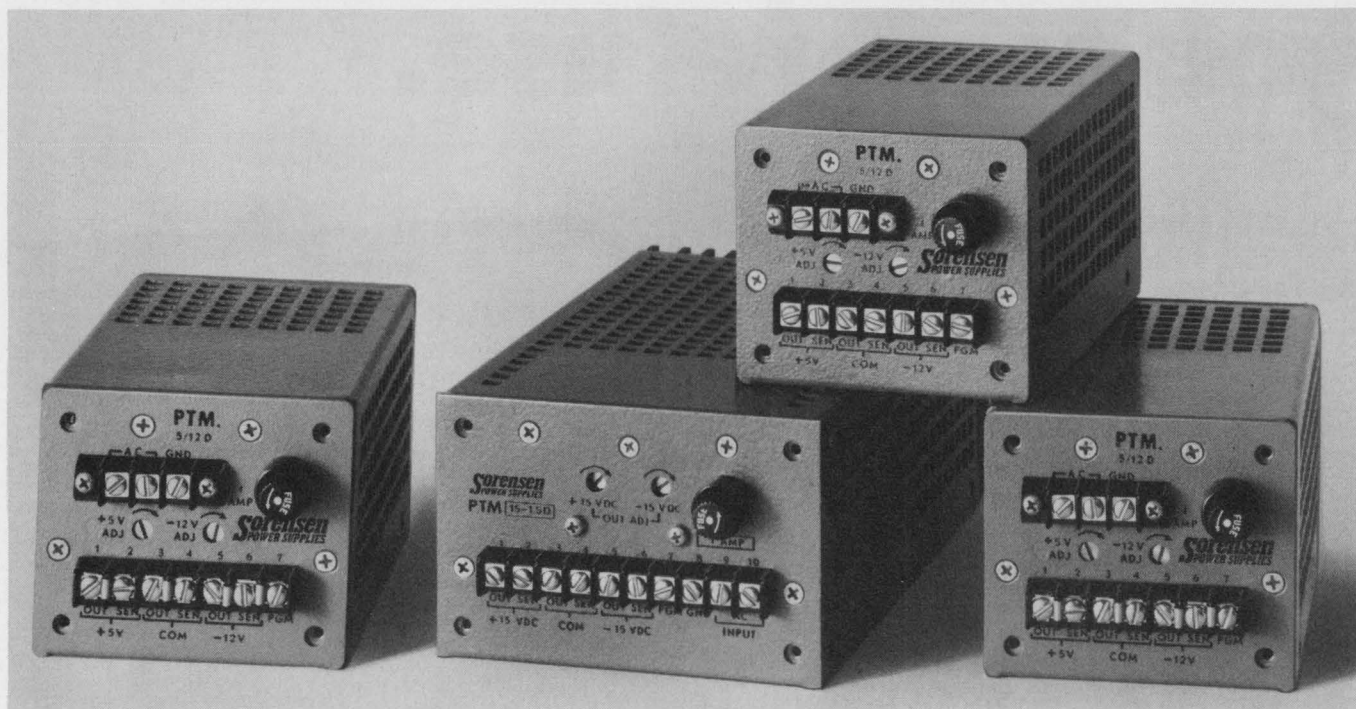

Nine new dual output supplies are everything you expect from Sorensen's compact PTM line. Unmatched power density and built-in overvoltage protection on every model. Plus a unique +5, -12 volt output for MOS applications.

The PTM duals are packed with performance for OEM requirements. Like adjustable tracking accuracy to 0.2%. Regulation of 0.02%. Transient response of 50  $\mu$ sec.

PTM duals. First in performance, first in reliability. Send for complete data. Write Sorensen Company, a unit of the Raytheon Company, 676 Island Pond Rd., Manchester, N.H. 03103. Telephone (603) 668-4500. Or TWX 710-220-1339.

**Sorensen**  
POWER SUPPLIES

SPECIFICATIONS							
Package size I: 3 <sup>5</sup> / <sub>16</sub> x 3 <sup>7</sup> / <sub>8</sub> x 6 <sup>1</sup> / <sub>2</sub>							
Model	Adjust. Range (VDC)		Current Rating (A)				Price*
	Min.	Max.	40°C	50°C	60°C	71°C	
PTM-12-1D	11	13	1.0	0.9	0.7	0.4	\$130
	11	13	1.0	0.9	0.7	0.4	
PTM-15-8D	14	16	0.8	0.72	0.56	0.32	\$125
	14	16	0.8	0.72	0.56	0.32	
PTM-5/12D1	4.75	5.5	2.0	1.8	1.4	0.8	\$135
	11	13	0.5	0.45	0.35	0.2	
Package size II: 3 <sup>5</sup> / <sub>16</sub> x 5 <sup>1</sup> / <sub>8</sub> x 6 <sup>1</sup> / <sub>2</sub>							
PTM-12-1.6D	11	13	1.6	1.44	1.12	0.64	\$155
	11	13	1.6	1.44	1.12	0.64	
PTM-15-1.5D	14	16	1.5	1.35	1.05	0.6	\$150
	14	16	1.5	1.35	1.05	0.6	
PTM-5/12DII	4.75	5.5	3.5	3.15	2.45	1.4	\$160
	11	13	1.0	0.9	0.7	0.4	
Package size III: 3 <sup>5</sup> / <sub>16</sub> x 5 <sup>1</sup> / <sub>8</sub> x 9 <sup>1</sup> / <sub>2</sub>							
PTM-12-3D	11	13	3.0	2.7	2.1	1.2	\$180
	11	13	3.0	2.7	2.1	1.2	
PTM-15-2.8D	14	16	2.8	2.52	1.96	1.12	\$175
	14	16	2.8	2.52	1.96	1.12	
PTM-5/12DIII	4.75	5.5	6.0	5.4	4.2	2.4	\$185
	11	13	1.5	1.35	1.05	0.6	

\*U.S.A. list.



# washington report



Heather M. David  
Washington Bureau

## Drive opens for rise in space spending

Proponents of the space program are trying to persuade members of Congress that the Administration's space budget should be increased. Individual companies already are working on members of the Congressional Space Committees and Appropriations Committees, and copies of a 94-page report on space systems by the American Institute of Aeronautics and Astronauts are being sent to Capitol Hill. The report urges expansion of the space shuttle and space tug programs.

Meanwhile NASA has started trimming programs to adjust to the lower spending level dictated by the White House. Among the results: the space-shuttle project is being slowed; the high-energy astronomy observatory project has been suspended; NASA has stopped work on communications satellites and nuclear propulsion and will slow its efforts on nuclear power sources; and the Quiet Propulsive Lift Short Takeoff and Landing (QUESTOL) research aircraft has been canceled.

## Congress considers metric and technology bills

Two significant bills that died on the vine at the end of the last Congressional session are off to a promising start in the 93d Congress. The new chairman of the House Science and Astronautics Committee, Representative Olin Teague (D., Tex.), has already introduced legislation calling for U.S. conversion to the metric system. Passage by both houses of Congress looks almost certain this year.

In the upper house, Senator Edward Kennedy (D., Mass.) has reintroduced a bill to apply aerospace technology to the solution of civilian problems and to transfer defense and space-oriented scientists and engineers to new fields. This proposal passed the Senate last year, but it died in the House of Representatives. It is thought to have a good chance to clear both houses at this session.

## Nixon still hoping for an American SST

The White House says that President Nixon still favors development of a supersonic transport aircraft. A Presidentially appointed advisory commission on aviation recently recommended that SST be permitted to use U.S. airspace as soon as it can be proved that the planes do not cause serious environmental problems. The panel also called for programs to aid industry in the development of civilian aircraft, and it said the Government should move faster in its program of improving and automating terminal facilities.

In another aviation development, the Federal Aviation Administration

recently awarded Philco-Ford a \$12.3-million contract for development of an electronic voice-switching system aimed at improving communications in its en-route air traffic control system. The FAA will install the first unit at the National Aviation Facilities Experimentation Center at Atlantic City, N.J., for evaluation and testing. If the system works out, the agency may buy 21 more systems.

## **Navy pushing submarine project**

The Navy has started closed-door contractor briefings on its Sanguine extremely-low frequency (ELF) submarine communications project, in preparation for contracting for at least two concept-validation studies. Requests for proposals have been issued to 10 companies: Collins, Continental, GTE Sylvania, GE, ITT, Page, Raytheon, RCA, TRW and Westinghouse. The contracts will call for system design and brass-board construction of an ELF receiver and antenna.

The Navy has also started low-level contract work on a new strategic submarine-launched cruise missile. The low-flying missile has become increasingly attractive as a means of eluding enemy radar defenses, and Navy sources indicate a long-range missile of this sort is feasible if guidance data can be provided through relay points, including possibly satellite.

## **Lasers to simulate Army weapons**

The Army will develop a series of training devices using lasers to simulate the firing of M-16 rifles, M-60 machine guns and heavy gun, or antitank, weapons. The equipment will include two laser transmitters with different power levels and mounting configurations, laser receivers with optical filters and infrared detectors and displays. Although the Army will allow the contractor to choose the type laser to be used, current thinking favors a gallium arsenide semiconductor laser operating in the 9050 Å region. Requests for proposals are expected to be issued this month.

**Capital Capsules:** The Naval Research Laboratory is looking for companies to do **R&D work in the design and fabrication of medium and large-scale integrated circuits.** Experience in the design of nonlinear amplification, especially logarithmic detector amplifiers, is desirable. . . . The Army reportedly will **no longer press for a Safeguard antiballistic missile defense around Washington, D.C.,** but will ask for the newer, less controversial Site Defense program. This simpler ABM program would concentrate on defending missile sites only rather than the entire city. . . . **Japan's color TV imports do not injure domestic producers, the Tariff Commission has ruled,** despite Treasury Dept. findings earlier that the tubes were being "dumped" on the U.S. market. . . . The Boeing Co. and McDonnell Douglas are now in the **second stage of a development program for the advanced Medium STOL Transport** after meeting Air Force requirements for initial design/cost/performance studies. The prototype competition will last almost four years. . . . After studying a number of diversified companies, including ITT, LTV, Litton and Textron, the Federal Trade Commission has concluded that **conglomerate mergers have had no real effect on competition.**

# Automated Systems Software



The TEKTEST™ III Software operating system developed for the Tektronix S-3260 Automated Test System is designed to enable **maximum device throughput** while permitting engineering studies when required. TEKTEST III is a new test language written by Tektronix Software Engineers. The language was designed to be **easily understood by systems engineers** yet **powerful** enough to control the full hardware testing capabilities of the S-3260.

The TEKTEST III Executive disc operating system permits interactive test program preparation. Other features permit *on line editing, on line debugging and functional test pattern editing.*

All commands are as descriptive as practical and are entered in English language format. For more information on TEKTEST III and the S-3260 contact your Tektronix Field Engineer and ask for a copy of *S3260 Automated Test System Control Through TEKTEST III Software and the S-3260 Brochure.*



**TEKTRONIX®**

P.O. Box 500  
Beaverton, Oregon 97005  
in Europe — TEKTRONIX LTD.  
Guernsey, C.I., U.K.

Here's a versatile new IC for  
portable or battery-powered instrumentation

# 150 $\mu$ Watts powers Triple Op Amp

The Siliconix L144 is a *low-power* monolithic IC with three complete op amps and a common bias network on the same substrate. The circuit operates over a power supply range of  $\pm 1.5$  to  $\pm 15$  V, with a supply current set by an external bias resistor. With a  $\pm 1.5$  V battery, only  $50 \mu\text{A}$  is required for all three op amps!

Other features:

- Internal compensation provides stable operation for any feedback circuit—including capacitive loads  $>1000$  pF
- 80 dB gain with  $20\text{K}\Omega$  load
- Typical slew rate  $0.4 \text{ V}/\mu\text{sec}$
- Military or commercial versions available

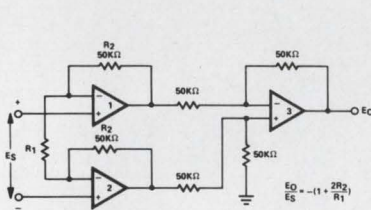

Instrumentation amplifier for high input impedance with differential operation.

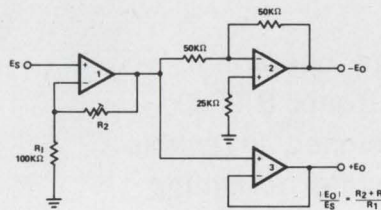

Precision phase splitter with good gain, high input impedance, low output impedance.

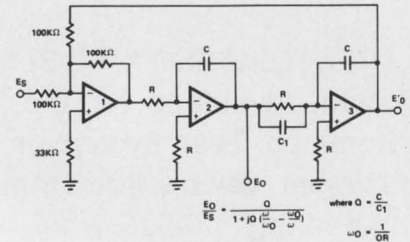

Active filter with high Q and excellent stability.

Applications? Above are three suggestions. There are more: Low-drift sample-and-hold, inverting amplifiers, voltage comparators, and so on. Call us if you have a specific design problem.

## write for data

Applications Engineering: (408) 246-8905



**Siliconix incorporated**

2201 Laurelwood Road, Santa Clara, California 95054

INFORMATION RETRIEVAL NUMBER 24

# We've got to run faster to stay in place

For as long as anybody can remember, we in the U.S. have been the technological leaders of the world. In almost any kind of development, we've been ahead of engineers in Europe, often by many years. That era may now be coming to a close.

ELECTRONIC DESIGN has some 10,000 readers in Europe. And if my mail from these men is any guide, they're not standing still. With an urgency that Americans don't feel, these men are racing to catch up with and pass their U.S. counterparts. Just a few years ago, letters I received from European engineers were good evidence that these men were quite a bit behind us. The circuits they used, while not primitive, were old by American standards. The Europeans used components and test equipment that American engineers had outgrown five years earlier.

That's not the picture today. The letters I get now from ED's European readers are different. The engineers there throw incisive and provocative questions at me. They ask about the very latest components and equipment. They tell me which components they've tried and which they find lacking. They show me circuits they've designed that are every bit as sophisticated as ours. And they describe elegant systems that put some of ours to shame.

Some of these engineers came to the United States many years ago, lured by attractive salaries. They went home again in 1970 and '71 when our recession drove them away. And they took home a deep understanding of how we develop things and a sharp sense of American practicality—a sense that could supplement their own, different, practicality.

If we sit still, if we adopt a business-as-usual attitude, the Europeans (and the Japanese) will shove us into a technological have-not position. Our population will buy foreign televisions, calculators, cars and computers. Our electronics companies will wither, and our engineers will be jobless.

The halcyon days of leisurely design are gone. We'll have to run to stay in place.

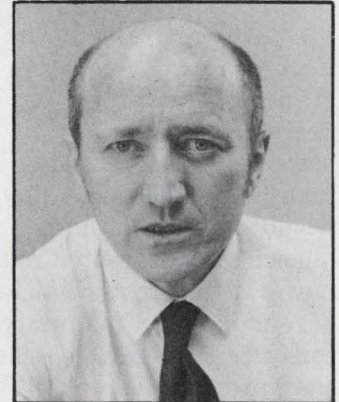

## Our Thanks

The editors wish to extend their deepest appreciation to the hundreds of readers who telephoned or sent heart-warming notes and letters of congratulations on ED's 20th Anniversary Issue. Your encouragement will spur us to even greater efforts in the future.

A handwritten signature in dark ink, reading "George Rostky". The signature is fluid and cursive, with a long horizontal stroke at the end.

GEORGE ROSTKY  
Editor-in-Chief

# FOCUS

on  
RF Transistors

For years, rf. design engineers have wanted better off-the-shelf transistors—devices that would operate at higher frequencies with greater reliability and handle more power with greater efficiency. Now they exist.

A number of manufacturers of power transistors offer dependable, efficient single-chip devices that provide over 50 W of continuous power at hundreds of megahertz. For microwave applications, the devices can deliver tens of watts in the gigahertz range. The power types are rugged enough, handle high enough VSWRs and have sufficient power gain to answer many an rf designer's power problems.

There's a hitch, though.

Most spec sheets don't give the full story of device capabilities, and this makes it tough for the designer both to pick the right transistor and to incorporate it into his design.

Nor is the problem confined solely to power devices. A new generation of small-signal rf transistors is operating with lower noise figures, less distortion and greater stability than ever before. But exactly how the key rf characteristics behave over the rated frequency range is often difficult to determine.

Why don't manufacturers remedy this situation? A few already have. The rest? The exhaustive tests needed to specify the devices fully are expensive and time-consuming, and most producers—especially the smaller ones—can't always afford them for all devices. More complete specification is usually offered with higher-priced devices, however.

Most rf transistors carry Electronic Industries Association 2N-type registration numbers, but these don't cover all key rf characteristics. S-parameters could give the rf characteristics, but

these are hardly ever on the manufacturer's spec sheet.

There are other important things that the buyer should consider:

- Sales promotion suggests that the reliability

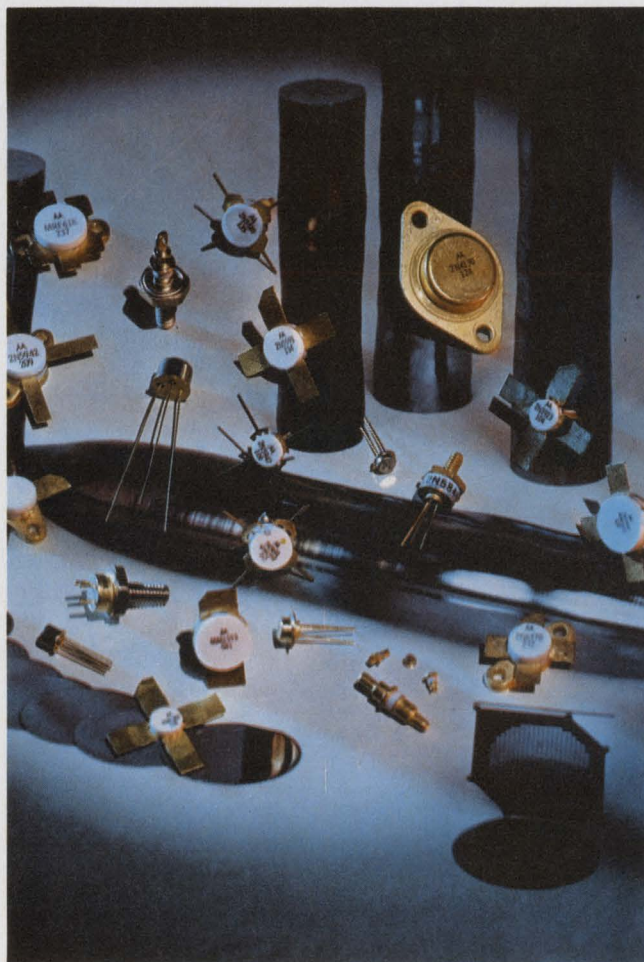

Motorola offers rf transistors in a variety of packages, including TO-3 types and its SOE configuration.

Edward A. Torrero  
Associate Editor

of bipolar rf power transistors depends on the surface geometry (interdigitated, overlay or mesh) or the metallization system (gold or aluminum). But for a host of applications, any geometry with either type of metallization will give dependable transistors.

- No transistor chip can realize good rf performance without a well-designed package. Some of the packaging tradeoffs depend on whether you're using coaxial or stripline transmission, common-emitter or common-base configuration, and the expected environmental hazards are also part of the picture.

- For general, three-terminal applications, you can't ignore field-effect transistors. FETs, which electrically are more like tubes than bipolars are, offer high input impedance, low noise and relatively simple circuit requirements.

Even more than in other areas of electronics, let the buyer beware. The problem of misleading or omitted specs, like most problems connected with rf design, increases with frequency. At the low end of the rf frequency range, and for a number of small-signal applications, specsmanship won't pose as serious a threat as for rf power and high-frequency state-of-the-art designs.

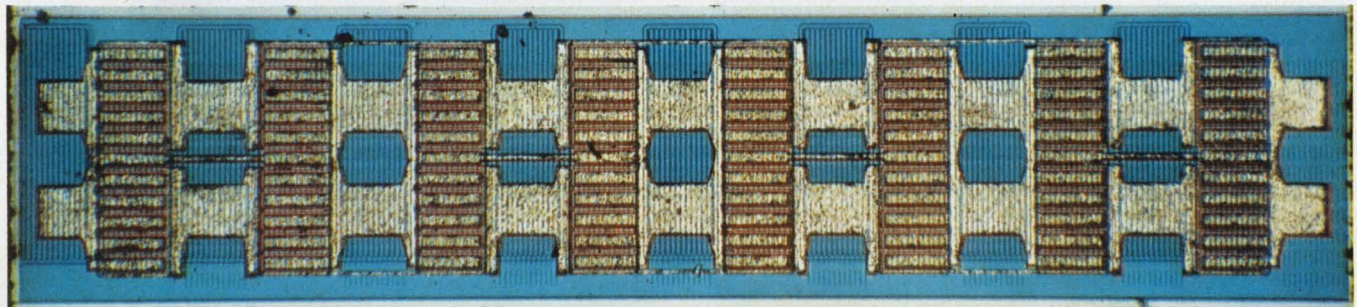

RCA uses the overlay surface geometry for this 2N6267 pellet—a 2-GHz device rated at 10 W of continuous

Perhaps the most useful set of specs are the S-parameters, or a scattering-matrix parameter set. If they're not listed, call the manufacturer and ask for them. For many high-frequency designs—say, 100 MHz and above—these parameters are generally regarded as absolutely essential. And not surprisingly. In their usual application (small-signal or linear designs), S-parameters uniquely and completely define the gain and input/output immittance properties of any active or passive component over a given frequency range. For transistors, the parameters provide forward and reverse insertion gains, as well as input and output reflection coefficients, when the driven and nondriven ports are terminated in convenient, equal impedances—usually 50  $\Omega$ .

But S-parameters normally don't tell large-signal and noise characteristics. Of course, for large-signal operation, the basic S-parameter

characterization could be extended with some difficulty—the range of operation is nonlinear. However, neither small nor large-signal S-parameters appear on most spec sheets.

Where they do appear, S-parameters should be presented as frequency plots. In the terminology of scattering matrices, the transistor represents a two-port device, with four scattering parameters associated with it. These are  $S_{11}$ ,  $S_{22}$ ,  $S_{12}$  and  $S_{21}$ , with subscripts denoting input and output ports. With the parameters plotted over a frequency range, the designer can select parameter values at the frequency or set of frequencies applicable to his design.

The output-power spec—crucially important in rf power designs—can be misleading if the maximum saturated power output is given instead of a lower, and more reliable, rating. While you certainly can achieve the maximum saturated output, given a high enough input power, the cost will be in terms of reliable, steady operation over the working temperature range. And that is due to the resulting higher dissipation and temperatures at the maximum power.

A rule of thumb generally followed for rf power output and power dissipation requires that

power. The manufacturer pioneered the overlay with the introduction of the 2N3375.

the rf power rating always be no more than half the dissipation rating. Even this seemingly wide margin may not be enough for cases of continuous operation at high heat-sink temperatures and with randomly mismatched loads. Under these conditions, limiting junction temperatures to a safe level requires that the device be operated at less than half the dissipation rating.

Another factor affecting the rated power is the VSWR level. Users tend to feel that device protection requires that the rf power transistor be able to withstand near-infinite VSWRs at the rated power and supply voltage. Effects such as component deterioration, leading to load mismatch, eventually cause a high enough VSWR for device failure. And if, say, the load is an antenna, the device may have to deliver into an open or short circuit, depending on whether the antenna is ON or OFF, tuned or mistuned.

For small-signal devices, the problems of incomplete specifications are less severe. In part, this is because such devices are often operated with matched loads. Accordingly high VSWRs don't present the problem that they do in rf-power applications.

But to specify small-signal devices completely, here again the user should have data on S-parameters. In addition some buyers are now asking manufacturers to specify the variation of peak current with the short-circuit, gain-bandwidth product,  $f_t$ . This information can help avoid the problem of selecting an otherwise suitable current value that yields too low a gain.

The figure of merit,  $f_t$ , is one of the more widely used indicators of a device's prowess, and it indicates the upper frequency limit of the transistor. But here, too, caution is advised against too literal an interpretation.

Depending on transistor type,  $f_t$  implies the frequency at which the magnitude of  $h_{fe}$  (small-signal, common-emitter, short-circuit current gain) approximately reaches unity. But at frequencies approaching  $f_t$ , other parameters, especially package parasitics, can cause  $h_{fe}$  to reach unity at a significantly different frequency.

From common-emitter wideband, low-pass amplifiers,  $f_t$  became known as the gain-bandwidth product. This is an optimistic approximation at best, since the product of low-frequency circuit gain and the 3-dB cutoff frequency is less than  $f_t$  by an amount depending on circuit impedances.

The real significance of  $f_t$  lies in the fact that

it does indicate a measure of important internal parameters that do affect high-frequency performance, such as gain. Specifically, good high-frequency noise performance requires that  $f_t$  be high. On the other hand, a high  $f_t$  does not insure that a device will work well at much lower frequencies; gain would be improved, but stability problems can result.

Power ratings for small signal devices can also be a problem if the specifications don't clearly state whether the rating is for linear operation, for 1-dB gain compression or for saturated operation. A linear rating implies that a change in rf input power results in a corresponding change in rf power output. And 1-dB compression ratings give the power values at which a 1-dB change of input power results in less than a decibel of output power. Saturation ratings imply operation well beyond the 1-dB compression point.

Gain specs suffer from a wide variety of definitions:  $G_A$  (max),  $S_{21}$ ,  $h_{21}$  and Mason's gain.  $G_A$  (max)—the best theoretical gain associated with a lossless circuit—and  $S_{21}$  are probably the most useful in small-signal analog designs, since the actual gain normally lies somewhere between the two. For digital circuits,  $h_{21}$  is often needed, while Mason's gain is of major interest to device designers rather than system designers.

Optimum gains and noise figures—which should be stated as typical or guaranteed—occur at different bias points, with optimum noise figure at low bias currents. Hence optimum device gain can't be attained at minimum noise figures.

## 2N devices aren't fully specified

Another major pitfall arises with 2N-numbered models. Users, and most manufacturers, agree that rf transistors are not properly characterized by the EIA format for classification. The present standard—developed by the Joint Electron Device Engineering Council (JEDEC) in 1967 and denoted by a 2N-type model number (2N signifies transistor and IN, diode)—includes dc beta, reverse leakage current, small-signal current gain and breakdown voltages. But it doesn't specify material, frequency range or application. And such critical rf characteristics as large-signal impedance and lead inductance may be ignored or omitted.

One result: Two transistors having the same 2N number from two different manufacturers can have quite different rf characteristics, since they are likely to be manufactured differently and can be either single or multichip devices. A 2N3866 from RCA, for example, uses overlay geometry. But in a 2N3866 from TRW the geometry is interdigitated.

The diffusion patterns vary substantially, too.

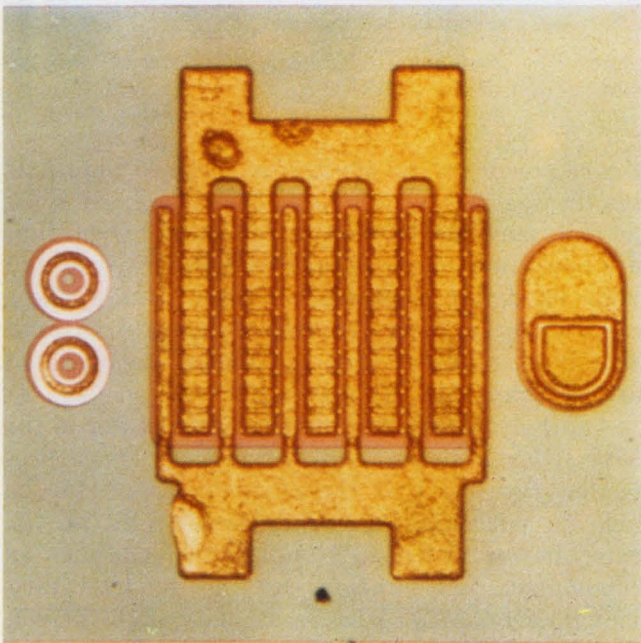

Fujitsu's FT1706 has a gold metallization system for a reported increase in reliability. The transistor can deliver 1 W at 4 GHz in class C operation. Gain reaches 5 dB with a 28-V supply and in coax.



It all depends on the final rf characteristics required. If a manufacturer wants, say, a high  $f_t$ , for a high-frequency response, the diffusion would be shallow; for a lower  $f_t$ , it's deeper. There are characteristics of diffusions that relate to other parameters, so you can't normally interchange devices having the same 2N number. Some users contend that power output is about the only rf characteristic that can be counted on not to vary from one 2N transistor to a like-numbered device.

This kind of latitude leads to more spec-sheet problems. A typical data sheet for a 2N device, for example, gives two test circuits submitted by the manufacturer when he registers his device with the EIA for a 2N designation. Each circuit is different, and each gives ratings for a single different frequency. The user has little else to guide him in determining rf characteristics at any other frequency. And since the circuits are different, a designer may conclude erroneously that the device cannot be used in one circuit and perform well over the rated bandwidth.

Meanwhile devices have been moving steadily toward higher powers at ever higher frequencies. Much of this development has resulted from improved fabrication processes. An important part of these processes is the surface geometry on the chip.

For power transistors, one of three basic surface geometries, or variations of them, are commonly used: interdigitated, overlay or mesh. The basic objective of all three is the same—to increase the active emitter region for handling large currents and thereby boosting power, while holding down the capacitance associated with the base area and thereby raising frequency response.

As frequency increases, the active emitter region moves out to the edges. Accordingly the commonly used figure of merit for high power at high frequencies is the ratio of emitter periphery to base area, or EP/BA. Much of the development of power devices has been concerned with getting ever higher EP/BA ratios.

In an interdigitated structure—the first surface geometry to be developed and now used by TRW and other manufacturers—increased EP/BA ratios are achieved by extending the emitter and base metal contacts into long, fingerlike structures shaped like a comb. An interlocking of the fingers forms the basic interdigitated structure, with emitter stripes alternating with base contact stripes. Variations of this structure include the fishbone, or tree, in which the emitters are interdigitated with the base in two dimensions. Frequency ratings for interdigitated devices reach 3 GHz.

The overlay construction, pioneered by RCA and also used by others, has part of the emitter metal over the base instead of adjacent to it.

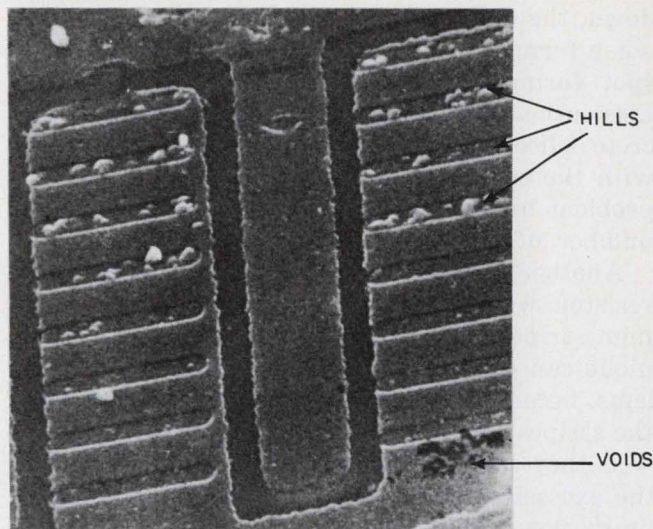

Possible electromigration problems with aluminum systems are shown on a device surface enlarged 600 times. Hills and voids form when current density and junction temperatures become too high.

The emitter current is carried in the metal conductors (fingers) that cross over the base. The actual base and emitter areas are insulated from each other by a silicon dioxide layer. This basic construction is used on devices rated from 30 MHz to 3.5 GHz.

The mesh structure is essentially an inverse overlay geometry. It is being used largely by the Microwave Semiconductor Corp. for devices up to 4 GHz. At that frequency, the manufacturer has a device rated at 5 W—the present state of the art for commercial bipolar transistors.

Regardless of which geometry is used, practical higher output powers are still limited by the manufacturer's ability to increase the EP/BA ratio and to obtain a high enough input impedance at the rated output power to match standard circuit impedances conveniently. And while increasing EP/BA also increases the frequency response, the ratio itself is limited by base transit time and how wide an output-to-input impedance level can be tolerated before the input impedance becomes too low for adequate matching. Underscoring the importance of a good match at the device's input, low-power transistors with fairly high input impedances usually can be made to operate at higher frequencies.

### Reliability increasing

The drive for higher powers at increasingly higher frequencies has been matched by the trend toward more reliable devices. Primarily this has meant substantial reduction in secondary breakdown—forward-biased and reverse-biased emitter-to-base or collector-to-base—and metal migration problems.

Of the several solutions to secondary break-

down, the one receiving the most promotion uses some form of emitter ballasting to eliminate hot-spot formations that can lead to metal-silicon dissolution. In one approach, small external discrete silicon-bar resistors are strapped in series with the emitter. But this only partly solves the problem because each resistor is tied to a large number of emitter sites.

Another technique replaces the silicon-bar resistor with long, narrow, meandering aluminum stripes laid directly on the chip. This technique can suffer from aluminum migration problems, because of high current density. Of course, the stripes could be replaced by diffused resistors—as they are in yet another approach—however, the excessive temperature drift of such resistors limits power applications.

One method of emitter ballasting that seems to have overcome these limitations uses a thin-film nichrome resistor in series with each individual emitter site. The resistors are stable over wide thermal and VSWR ranges and distribute dissipation over large areas for more uniform chip temperatures.

While there appears to be wide industry agreement on the merits of emitter ballasting as a solution to some reliability problems, there is open disagreement over the best solution to the problem of metal migration. Basically the discussion boils down to a choice of aluminum or gold metallization.

Aluminum has long been a favorite for the contact metal. It has low bulk resistivity, excellent adherence to silicon and silicon dioxide, low resistance contact to heavily doped silicon and fabrication advantages. But aluminum is limited by the following: susceptibility to current-induced migration, which forms voids and hills; detrimental interactions with both silicon and its oxide; difficulty in forming fine-line geometries; oxide step coverage problems, and strong susceptibility to electrolytic corrosion.

Current-induced metal migration represents the most severe hazard to long-term reliability. It is reported to be the dominant cause of failure, even when a device is operated within safe limits. For short-term reliability, the chief requirement of a metal system centers on its ability to withstand high junction temperatures without interacting with the silicon contact areas or silicon-dioxide passivation layers.

Most of the reliability problems associated with aluminum can be overcome. And it's not at all certain that the buyer of an rf transistor fabricated with aluminum metallization will experience device failures when operating within safe-area regimes.

Several techniques are being used to avoid the limitations of aluminum-metallized transistors. They include the addition of a small amount of

copper, the use of a glass passivation layer over large grained aluminum (primarily with overlay geometries) and the addition of a small amount of silicon. Each has been reported to result in significant improvements in the device's MTBF (median time to failure). And each alters the basic aluminum system, resulting in higher reliability through increased activation energy. In addition to these techniques, manufacturers are also upgrading initial device design to minimize current density and junction temperatures—the major factors that trigger metallization problems. The redesigns include variations on the geometries toward wider fingers, to reduce current densities.

Still, manufacturers are moving away from aluminum toward gold metallization. The reason most heard: Gold metallization provides the most dramatic increase in electromigration resistance and interfacial layer stability. Some proponents claim a factor of 10 or more improvement in the MTBF over the most reliable aluminum system. In the newer systems the gold layer serves as the main conductive layer, with refractory layers giving adhesions and a barrier against gold-silicon formations. Thus, in practice composite systems—gold with other elements—are employed.

Gold systems, however, do not come without their own limitations. In some cases users have found that the gold lifts off the chip because of adhesion problems in fabrication. Cases of poor electrical contact resistance have also been reported. Vendors using gold respond that these problems are easily overcome if the chip is built properly.

Published MTBF values reflect the battle between the manufacturers of aluminum-metallized devices and gold-metallized devices. In a comparison of the two systems, for example, one vendor using gold reports that most aluminum systems failed a temperature-humidity-bias test without encapsulation. The same manufacturer offers figures for gold systems that are much better. Meanwhile, from an aluminum proponent, comes impressive MTBF figures of several thousand hours for an aluminum-system device at elevated temperature and overstressed current density.

Some users say that the high MTBF values quoted do not include a sufficiently large or fully representative number of samples. And calculated MTBF values unsupported by actual cases are suspect, they contend. It's probably a valid complaint. Reliability ratings generally require a statistical approach, with more accurate figures obtained from a sampling covering the full range of operating conditions and device variations.

Once the transistor is selected, the designer must decide on the package. For both power devices and small-signal devices, this selection can

be as important as choosing the right chip. If thermal properties and reactive parasitics aren't adequate, power characteristics, bandwidth and circuit stability are just a few of the parameters that will suffer.

### Packaging brings its own problems

For power devices, the over-all thermal resistance of the package—from junction to heat sink—is of major importance. But manufacturers normally specify only the junction-to-case ther-

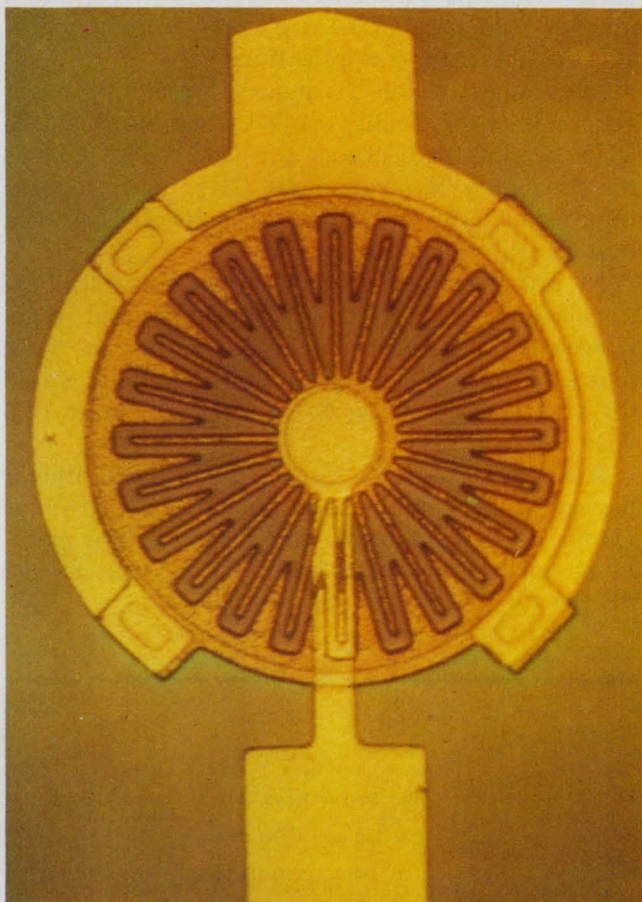

Hewlett-Packard's medium-power device, the 35830, lists 0.5 W of linear power at 2 GHz. The star geometry allows for more uniform heat distribution across the chip.

mal resistance—and then at 25 C. The case-to-heat-sink thermal resistance must also be added to obtain the over-all thermal resistance.

Case-to-heat-sink resistances vary markedly, depending on the packaging. With a 1/4-inch stud package, for example, this resistance increases by a factor of 2-1/2 over that for a half-inch stud package.

Moreover the junction-to-case thermal resistance normally provided by the manufacturer is typically measured at low-power dc levels. Under rf conditions hot spots may occur, and these can lead to substantial departures from the rated thermal resistance.

Some manufacturers are rectifying this situation with the use of infrared scanning for design evaluation. This allows the mapping of thermal resistance for a variety of operating conditions. Other manufacturers, however, find infrared scanning too costly an approach.

The transmission techniques most used are coaxial and stripline, although stripline seems to be gaining for small-signal devices. The advantages of coaxial packages include lower parasitics for broader bandwidth operation and higher package reactances for greater over-all isolation. However, problems of inefficient heat removal can occur.

Stripline offers the advantages of packaging flexibility and favorable thermal properties. But possible multimode transmission problems would seem to favor the coaxial approach at microwave frequencies.

For power amplifiers, an additional tradeoff centers on the use of common-base (CB) vs common-emitter (CE) configurations. Manufacturers offer different packages as well as somewhat different devices depending on the configuration selected.

The CE connection, with more gain at frequencies below  $f_c$  than the CB, has historically been favored for amplifier designs, because the CB connection has had a bad reputation for causing instability and oscillation problems.

But for higher-frequency applications, the CB approach seems to be gaining new acceptance because, among other things, it's less susceptible to CE low-frequency burnouts. While both connections can have such problems, the CE configuration has a higher low-frequency gain and can form low-frequency resonant equivalent circuits—and these characteristics promote low-frequency runaway. Moreover the CB configuration develops a higher frequency for gain fall-off, and that's important for broadbanding designs.

Package parasitics at high frequency alter the stability picture further. In a CE connection, feedback capacitance can produce a negative impedance at some frequency. And negative impedance always implies instability. For a CB configuration, a similar result can occur if the base parasitic inductance isn't minimized.

### FETs offer unique advantages

The field-effect transistor provides an alternative to bipolar devices for designs at rf, just as it does at lower frequencies. Both standard junction and MOS types—JFETs and MOSFETs, respectively—are now operable through microwave frequencies, making them practical for such high-frequency applications as rf front ends and i-f amplifiers. In these applications a chief advantage is that intermodulation distortion can be



**Motorola's Controlled-Q package** reportedly offers a reduction in device Q for increased bandwidth, together with increased package input impedance.

about 60 dB less than for bipolar transistors.

Compared with bipolar devices, FETs have other advantages. Standard off-the-shelf devices reportedly exhibit less noise through the uhf region. In addition a very high input resistance—up to  $10^9 \Omega$ —causes very small power dissipation, while allowing for flexibility in the design of input tuned circuits. And because FETs have square-law transconductance characteristics, they

can handle greater input-voltage swings with weaker unwanted signal components.

Of course, the FET isn't without its drawbacks. Impedance matching is probably the major limitation. As frequency increases, designers may be faced with the prospect of both high and reactive impedances. These complications make computer-aided designs desirable for wideband systems.

Recent developments center on the use of gallium-arsenide (GaAs) technology to build low-noise FETs that cover the bands C through K<sub>u</sub>. For the highest frequencies, GaAs FETs are expected to surpass standard bipolar devices, and a number of GaAs FETs are commercially available for microwave applications.

The highest usable frequency for bipolar transistors is theoretically projected to be about 25 GHz. Similar projections for GaAs FETs place the frequency at around 40 GHz, with process improvements in the technology expected to boost that figure even higher.

At present GaAs FETs for low-noise applications are pretty much in the developmental stage. However, laboratory models list impressive noise figures. Typical values are a noise figure of 2 to 3 dB at 4 GHz, 4 dB at 8 GHz and 5 dB at 12.5 GHz.

Meanwhile the noise figures of standard bipolar devices are keeping pace. A 2-GHz transistor (from Hewlett-Packard) has a guaranteed maximum noise figure of 2.3 dB. At 4 GHz it's 3.3 dB. ■■

## Need more information?

The products cited in this report don't represent the manufacturers' full lines. Readers may consult with the following for additional details by circling the appropriate information retrieval number:

- |   |                       |
|---|-----------------------|
| American Micro-Systems Inc., 3800 Homestead, Santa Clara, Calif. 95051. (408) 246-0330.                                       | <b>CIRCLE 423</b>     |
| Avantek, Inc., 2981 Copper Rd., Santa Clara, Calif. 95051. (408) 739-6170.  | <b>CIRCLE 424</b>     |
| California Eastern Laboratories, 1540 Gilbreth Rd., Burlingame, Calif. 94010. (Nippon Electric Ltd. in Japan) (415) 697-6670. | <b>CIRCLE 425</b>     |
| Calvert Electronics Inc., 220 East 23rd St., New York, N.Y. 10010. (AEI Semiconductors Ltd. in England) (212) 679-1340.       | <b>CIRCLE 426</b>     |
| Communications Transistor Corp., 301 Industrial Way, San Carlos, Calif. 94070. (415) 591-8921.                                | <b>CIRCLE 427</b>     |
| Crystalonics, Div. of Teledyne, 147 Sherman, Cambridge, Mass. 02138. (617) 491-1670.  | <b>CIRCLE 428</b>     |
| Fairchild Microwave and Optoelectronics Div., 4001 Miranda Ave., Palo Alto, Calif. 94304. (415) 493-3100.                     | <b>CIRCLE 429</b>     |
| Ferranti Ltd., E. Bethpage Rd., Plainview, N.Y. 11803. (516) 293-8383.  | <b>CIRCLE 430</b>     |
| Fujitsu Ltd., 6-1, Marunouchi, 2/Chome Chiyoda/Ku, Tokyo, 100, Japan.   | <b>CIRCLE 431</b>     |
| General Instrument Corp., 600 W. John St., Hicksville, N.Y. 11802. (516) 733-3141.  | <b>CIRCLE 432</b>     |
| Hewlett-Packard, 1601 California Ave., Palo Alto, Calif. 94304. (415) 493-1501.   | <b>CIRCLE 433</b>     |
| Hughes Aircraft Co., MOS Dept., 500 Superior Ave., Newport Beach, Calif. 92663. (714) 548-0671.                               | <b>CIRCLE 434</b>     |
| Intersil Inc., 10900 N. Tantau Ave., Cupertino, Calif. 95014. (408) 257-5450.   | <b>CIRCLE 435</b>     |
| KMC Semiconductor Corp., Parker Road, RD 2, Long Valley, N.J. 07853. (201) 876-3811.  | <b>CIRCLE 436</b>     |
| Kertron, Inc., 7516 Central Industrial Dr., Riviera Beach, Fla. 33404. (305) 848-9606.  | <b>CIRCLE 437</b>     |
| Microwave Semiconductor Corp., 100 School House Rd., Somerset, N.J. 08873. (201) 469-3311.                                    | <b>CIRCLE 438</b>     |
| Motorola Semiconductor Products, Inc., P.O. Box 20912, Phoenix, Ariz. 85036. (602) 273-6900.                                  | <b>CIRCLE 439</b>     |
| National Semiconductor, 2900 Semiconductor Dr., Santa Clara, Calif. 95051. (408) 732-5000.                                    | <b>INQUIRE DIRECT</b> |
| Plessey, Ltd., 170 Finn Ct., Farmingdale, N.Y. 11753. (516) 694-7377.   | <b>CIRCLE 440</b>     |
| Power Hybrids, Inc., 1742 Crenshaw Blvd., Torrance, Calif. 90501. (213) 320-6160.   | <b>CIRCLE 441</b>     |
| RCA Solid State Div., Route 202, Somerville, N.J. 08876. (201) 722-3200.  | <b>CIRCLE 442</b>     |
| Raytheon, Special Microwave Devices Operation, 130 Second Ave., Waltham, Mass. 02154. (617) 272-9600.                         | <b>CIRCLE 443</b>     |
| Signetics, 811 E. Arques Ave., Sunnyvale, Calif. 94086. (408) 739-7700.   | <b>INQUIRE DIRECT</b> |
| Siliconix Inc., 2201 Laurelwood Rd., Santa Clara, Calif. 95054. (408) 246-8000.   | <b>CIRCLE 444</b>     |
| Solid State Devices, 12741 Los Nietos, Santa Fe Springs, Calif. 90670. (213) 698-3711.  | <b>CIRCLE 445</b>     |
| Solid State Scientific, Montgomeryville Industrial Center, Montgomeryville, Pa. 18936. (215) 855-8400.                        | <b>CIRCLE 446</b>     |
| Solitron Devices, 1440 W. Indiantown Rd., Jupiter, Fla. 33458. (305) 746-8311.  | <b>CIRCLE 447</b>     |
| TRW, 14520 Aviation Blvd., Lawndale, Calif. 90260. (213) 679-4561.  | <b>CIRCLE 448</b>     |
| Teledyne Semiconductors, 1300 Terra Bella Ave., Mountain View, Calif. 94040. (415) 969-9112.                                  | <b>CIRCLE 449</b>     |
| Texas Instruments, Inc., P.O. Box 5016, Dallas, Tex. 75222. (214) 238-3933.   | <b>INQUIRE DIRECT</b> |
| Toshiba America Inc., 200 Park Ave., Room 1609, New York, New York 10017. (212) 986-9794.                                     | <b>CIRCLE 450</b>     |

# No-hitch Schottky Comparators



**Compatible multi-function plug-ins:  
more speed—more output—more profits in the end.**

Really bugs you, doesn't it? Make your move into ultra high speed comparators—and the penalty whistle goes off. Currently available parts just can't get along with TTL levels, and input characteristics are much too stringent.

Start counting your blessings: 521, 522. Signetics' exclusive linear breakthrough in extremely fast trouble-free dual comparators. There's nothing else on the market today that can touch 521/522 for cost-conscious ease of use, over a unique range of applications. You work *with* the remarkably high speed that Schottky technology delivers, instead of against it.

The 521 typically operates at 6ns, with 10ns guaranteed; 522, from 10-15ns. But you can't take advantage of these major increments in comparator speed if penalties keep cutting you down to size.

Use the 521/522 any place you'd snap your old 710/711/760 and you clear the board for maximized action. Pin-for-pin replacements for 75107/108: but Signetics' no-forfeit performance can't be matched, while requiring fewer auxiliary parts.

Absolutely TTL compatible in both strobes and output structure. Rock-bottom input characteristics for industrial applications. 20  $\mu$ A max input bias current guaranteed—so low you won't load down your input transducers. And you no longer add a preamplifier to detect more minute variations of input voltage.

We built in function flexibility too. You not only reduce parts count, you save on stock variety needs as well. These versatile Schottky-fast dual

comparators are smooth design-in's as zero crossing detectors, Schottky line receivers, and for A/D and D/A conversions. Plus the most popular alternate application to date—as MOS RAM sense amplifiers.

**NE522 COMPARATOR  
USED AS MOS RAM SENSE AMPLIFIER**

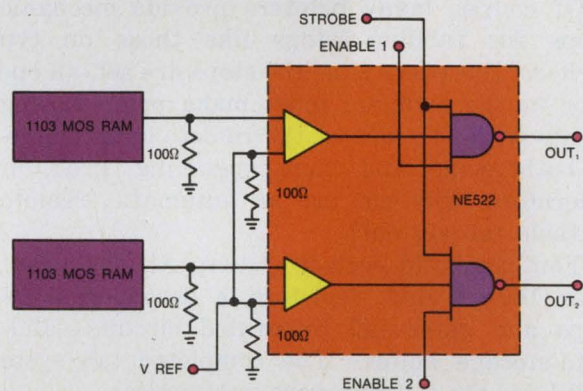

Optimized system performance, with lower costs coming in and going out. That's our commitment to you, the user. From one end of our linear line to the other: from phase locked loops and the IC timer, to these innovative 521/522 high speed Schottky-clamped comparators.

And they're all on the shelf at your distributor. Now.

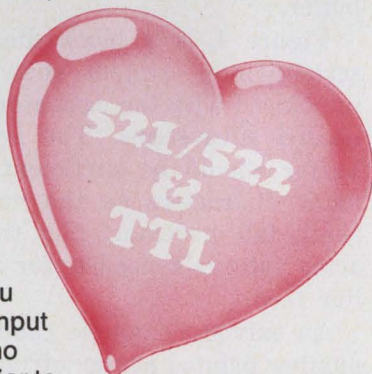

## CLIP THIS COUPON TO YOUR LETTERHEAD FOR IMMEDIATE ATTENTION

- Please send us a free sample of 521/522.
- Include complete specs, data sheets and application literature for ultra high speed 521/522 comparators.

Name \_\_\_\_\_

Title \_\_\_\_\_

Attach this box to company letterhead, and mail to:  
Signetics-Linear  
811 East Arques Avenue  
Sunnyvale, California 94086  
(408) 739-7700

Signetics Corporation. A subsidiary of Corning Glass Works.

# signetics

INFORMATION RETRIEVAL NUMBER 25

# Speed your serial printer with this automatic, remotely set tabulating system. A single tab code replaces the many space characters in columnar data.

Columns of numbers and lists of short statements from computers account for most of the traffic on data-transmission lines. And because the spaces between columns of printed characters are often three or more times greater than those for the characters themselves, a large part of the traffic represents wasted printing time. Substantial savings in both time and cost result if an electronic tabulating system controls the spacing in serial printers.

Of course, many printers provide mechanical stops for tabbing—stops like those on typewriters. But every time the stops are set, an operator at the terminal must make prior arrangements with someone at the remote data source—a bothersome and time-consuming procedure. Therefore, why not use an automatic, remotely settable tab system?

You can build such a system. All you need is four 100-bit shift registers, a dozen or so flip-flops and gates—all integrated circuits—and a data-storage buffer.<sup>1</sup> The completed tab system will have the following characteristics:

- Needs no local operator to set mechanical stops.
- Needs no mechanical alteration of most printers.
- Takes full advantage of the printer's top speed.
- Is easily interfaced with most serial printers.
- Is all-digital and all-electronic.
- Can be applied to both horizontal and vertical tabs (two separate tab systems are needed).
- Provides up to 100 uncommitted tab-stop settings—more than adequate for the standard 132-column printer.

Many types of serial printers, with medium speeds in the range of 30 to 60 characters a second, can be linked to automatic, remotely settable tab systems. Printers with a continuous space-advance feature fall into this class, including such machines as Friden's HSP 30 and Univac's 0769. A fair percentage of these printers also have continuous backspace capabilities, which can further

reduce on-line time, especially when they are used for printing special forms.

## Examining the speed improvement

As an example of the savings that can result with the automatic tab setter, consider the data in Table 1, where each of the 10 columns is separated by seven spaces. By using only one Tab-Right character after the last printed character in each column, you save transmission of six space characters for every column of printed data. This can be a considerable saving in cost, especially in some time-sharing systems where rates are calculated in part by the number of characters sent.

For a printer such as Friden's HSP 30, the spacing (or backspacing) speed is 30 characters per second. When used on a standard 110-baud line, which is slower than the printer's capability, the tab system increases over-all speed almost three times over that of, say, a Model 33 teletypewriter. The data following a tab character is stored in the buffer while the printer is completing its tab move. After the tab move is completed, the printer resumes printing data from the buffer.

Figure 1 is a block diagram of a complete serial-printer system showing the tab system interfaced with the data-storage buffer and other needed subsystems. The length of the storage buffer should be sufficient to hold at least as many characters as the maximum length of a single tab movement plus the two or three character intervals needed for carriage return and line feed.

An extreme example could require only a line number printed at the lefthand margin and about 100 spaces to a printed short statement near the right margin. This situation occurs often on the standard 132-column format. Tabulating over this distance takes about 3.33 seconds on a 30 character-per-second printer—which a 100-character buffer can handle.

The automatic tab system requires the following command input signals:

Charles R. Smiley Jr., Theta-Com, 9320 Lincoln Blvd., Los Angeles, Calif. 90045.

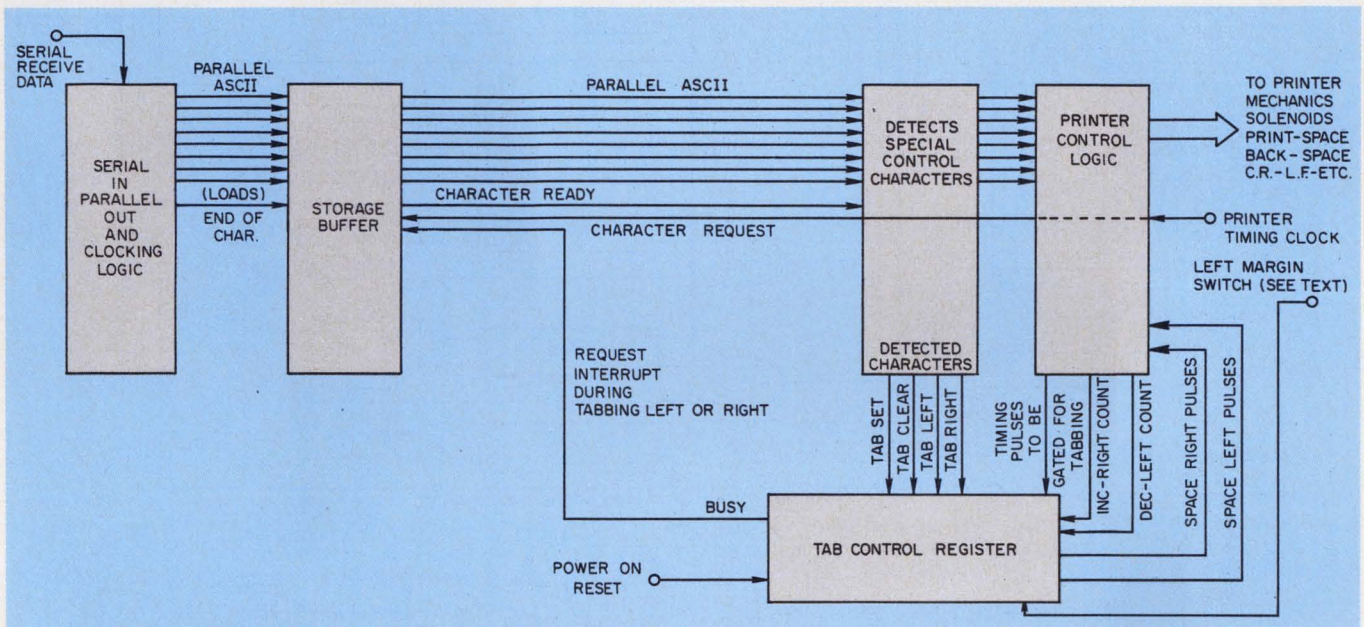

1. The tabulator control register operates, in conjunction with a storage buffer, on serial printers to save substan-

tial time and money in printing columnar data. A single tab character replaces many space characters.

**Table 1. Example of time savings with columnar data**

10	20	10	30	10	30	40	20	50	70
20	20	10	10	10	30	20	20	30	50
30	20	10	20	20	30	40	30	40	70
40	10	10	20	10	20	30	20	30	50
50	10	00	20	20	10	40	20	30	50
60	10	00	20	10	10	30	10	30	40
70	20	10	20	10	30	30	20	40	60
80	20	00	10	10	20	20	10	30	40
90	00	10	20	10	10	30	20	20	40
Column 1									Column 83

**Printing times for a Model 33 teletypewriter at 10 char/second**

**Transmission time** for one line—8.3 seconds (20 characters +63 spaces) × 0.1 seconds.

**Printing execution time** for one line—8.3 seconds (83 characters × 0.1 seconds)

Number of characters sent—83 (per line).

**Printing times for the tab system using a 30 char/second printer at 10 char/second input**

**Transmission time** for one line—2.9 seconds (20 characters +9 tab) × 0.1 seconds.

**Printer execution time**—2.76 seconds (20 printed +63 spaces) × 0.033.

Number of characters sent—29 (per line).

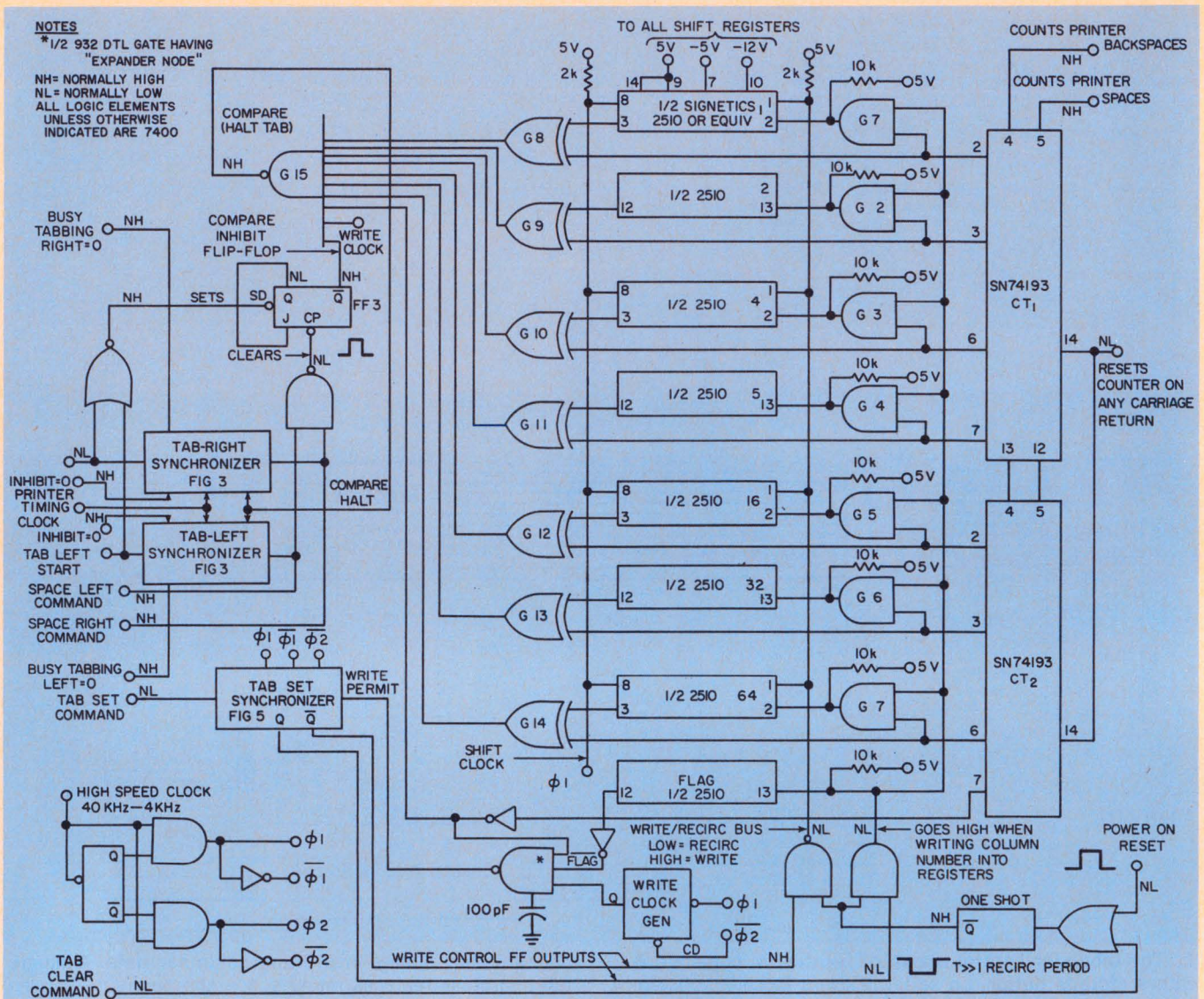

2. Four, dual 100-bit, shift registers can store 100 tab-stops, in random order, as seven-bit binary numbers. The tab-stop numbers recirculate around the shift register

at each printer carriage position, to check whether one of the tab numbers corresponds to the carriage position. Counters CT<sub>1</sub> and CT<sub>2</sub> keep track of the carriage position.

- **Tab Set**—causes a tab location number to be recorded in the tab system's shift-register memory.

- **Tab Clear**—erases all numbers from the shift-register memory.

- **Tab Right**—commands the printer to space to the right until the location number reached corresponds to a number stored in the shift-register memory.

- **Tab Left**—commands printers that can backspace to space to the left until the location reached corresponds to a number stored in the shift register.

In ASCII-encoded terminals, Tab Right is usually assigned to the code for Device Control I. There are no standard assigned codes in ASCII for the three other functions. They can be picked from such codes as those for device-control characters DC 1, DC 2, DC 3, and DC 4, provided they are not used for anything else in the termi-

nal or associated equipment.

The logic circuits required to recognize, or decode, the commands are not included in the tab-system logic. They are considered part of printer logic, since many other command codes are also needed by the printer (Fig. 1).

The output signals from the tab system are as follows:

- **Space Right**—pulses from the printer clock (30 pulses per second, typical) that are directed to the printer's continuous-spacing input from the tab system.

- **Space Left**—the same pulsing as for Space Right. Used only on machines with a backspace feature.

- **Busy**—a high logic-level output provided while the printer is tabbing.

In addition the tab system needs:

- **A high-speed clock**—can be 40 kHz for 30-character-per-second printers, or up to 4 MHz.



- **A power-on reset**—clears the tab memory, resets the column location counter and returns the carriage to the left margin.

- **Right (and left) count**—a level to control the direction of the column counter (count up or down).

- **Carriage reset**—a positive-going step to reset the column counter when the printer carriage returns to the left margin.

### Implementing the tab system

The over-all circuit (Fig. 2) has two 4-bit, bidirectional counters,  $CT_1$  and  $CT_2$ . If the printer has no backspacing capability, then only a one-directional up-counter is needed. The two tandem counters can count to 128. This is adequate for 132-column printers. The counters keep track of the carriage position. Input commands from the printer logic circuit direct them to count up, for forward increments, and down for backspaces (reverse tabbing). A carriage-return command from any source—line, local or auto-return for right margin—will reset the counter.

The power-on reset triggers the one-shot, which provides an approximately 10-ms pulse after the carriage returns. This one-shot can also be triggered by the Tab Clear command.

The pulse rate of the high-speed clock is determined mainly by the recirculate time of the memory shift registers. At least two recirculate periods are required in the time needed to space (or backspace) one column. When a 40-kHz clock is used with the 100-bit shift registers of Fig. 2, the time for one recirculate period is 5 ms. This is adequate for many of the 30 character-per-second printers. However, other printers may require a greater clock speed.

The Signetics 2510 shift registers in Fig. 2 can operate with a clock to 4-MHz. Recirculate time is then reduced to 50  $\mu$ s. The 2510s have dual, 100-bit registers with built-in recirculation paths and they operate on a single clock phase. Four 2510s can provide capacity for storing 100 eight-bit words. In the tab system, only seven shift registers are used to store the column number in straight binary form. The eighth shift register is used to flag the presence of a tab number in the corresponding position of the seven other registers. When a column number is written into the first seven tracks, a ONE is written into the flag track. Thus tab-setting numbers can be entered only where the flag is low.

These numbers may be entered in random order, since the circuit looks at all the stored numbers at each carriage step. The carriage position registered in the up-down counter is compared with all the numbers in the shift register as they are circulated. A match indicates a tab location. For example, five tab locations at columns

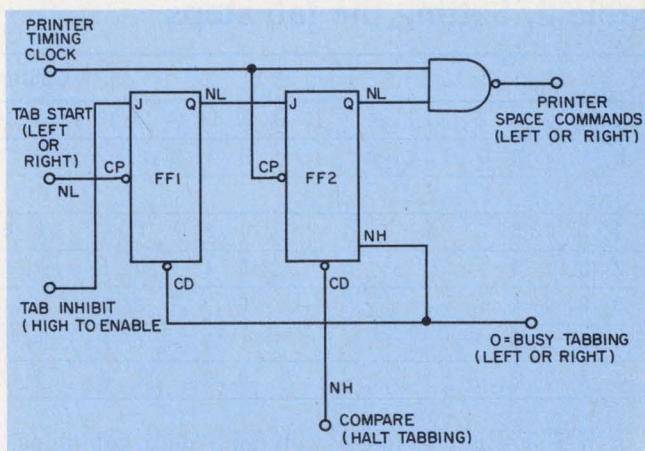

3. Tab-Left and Tab-Right synchronizer circuits have identical configurations, and two such circuits are used in the complete system.

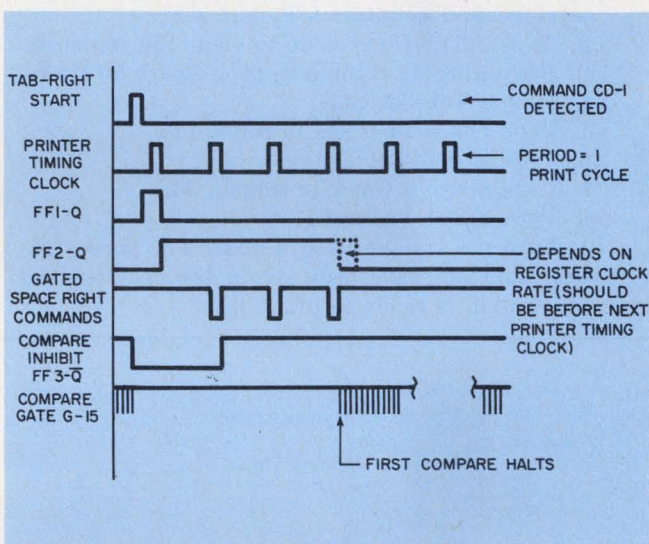

4. This timing diagram, showing a tab-right operation for three carriage positions, is similar for tab-left performance. The system can handle a maximum of 128 steps in any single tab operation.

10, 20, 30, 40 and 80 may appear in the registers in the order 30, 80, 20, 10, 40 and have no effect on the operation. As long as the tab number is in the registers, it will be checked and acted upon in its proper sequence.

### Controlling the printer spacing

Exclusive-OR gates,  $G_8$  to  $G_{14}$ , compare the numbers in the shift register with the printer-carriage position numbers of the up-down counters,  $CT_1$  and  $CT_2$ . The first column on a printer, although usually called column 1, actually corresponds in the up-down counter to a binary value of 0000000. The column-2 position will have a binary value of 0000001, and so on.

The shift registers contain the binary complements of the column numbers, so that the compare gates,  $G_8$  to  $G_{14}$ , deliver a high output when

### Table 2. Setting the tab stops

Column numbers																																						
1	2	3	4	5	6	7	8	9	10	11	12	13	14	15	16	17	18	19	20	21	22	23	24	25	26	27	28	29	30	31	32	33	34	35	36	37	38	
P	A	Y	R	O	L	L	#				H	I	R	E			D	A	T	E				G	R	A	D	E						D	E	P	T	
1	1	0	3								0	2	-	1	4	-	6	5						1	4									A	C	C	T	
2	0	1	9								0	4	-	0	1	-	7	1						3	2										E	N	G	
0	9	9	6								0	2	-	2	3	-	7	0						3	2										E	N	G	
1	2	1	9								1	1	-	1	7	-	6	2						1	9										P	R	O	D
1	4	0	3								0	9	-	3	0	-	7	2						0	8										P	E	R	S

For this example of columnar data, tab stops are required at column numbers 11, 25 and 34. To set the tab stops, the following steps are required:

1. Type a Carriage-Return code to reset printer carriage and counters CT<sub>1</sub> and CT<sub>2</sub>.
2. Type a Tab-Clear code to clear the registers.
3. Beginning at column 1, type Space 10 times.
4. Type a Tab-Set code.
5. Type Space 14 times to column 25.
6. Type a Tab-Set code.
7. Type Space 9 times to column 34.
8. Type a Tab-Set code.
9. Type a Carriage-Return code. The three tab-stop numbers have been set in the register and the system is ready to print data.

The headings—payroll #, hire, date, etc., may then be printed. After word, payroll, is sent, a Tab Right is sent. The receiving printer will then be commanded to space until a compare is made at column 11. Next the words, hire date, are printed, followed by another Tab Right. The printer now self-spaces to column 25 where the word, grade, is printed, and so on. After the headings are completed, the carriage is returned and a line feed steps the paper up to the next line. Then send the numeric data, starting with the 1103, then a Tab Right, 02-14-65, Tab Right, etc. The numeric data can occupy as many columnar spaces as there are spaces between adjacent Tab-Set codes. For example the payroll numbers can be from 1 to 10 digits wide.

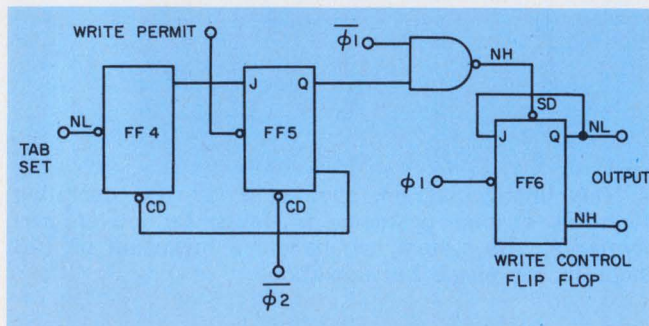

5. The Tab-Set synchronizer circuit controls the loading of tab numbers into the shift-register memory.

the two input numbers are equal. When all seven exclusive-OR gate outputs are high, the 10-input NAND gate, G<sub>15</sub>, has a low output. This low signal level resets flip-flops FF<sub>1</sub> and FF<sub>2</sub> when the up-down counter is on a tab stop (Fig. 3). Note that two identical circuits as in Fig. 3 are required—one for tab right and the other for tab left. Flip-flop FF<sub>2</sub> controls the timing pulses that direct the printer to increment right or left. Figure 4 shows the details of timing for a three-column right command.

The Tab-Right start signal causes the Q output of FF<sub>1</sub> to go high. This output enables the J input of FF<sub>2</sub>. The next falling edge of the printer-timing clock causes the Q output of FF<sub>2</sub> to go high, allowing subsequent printer-timing clock

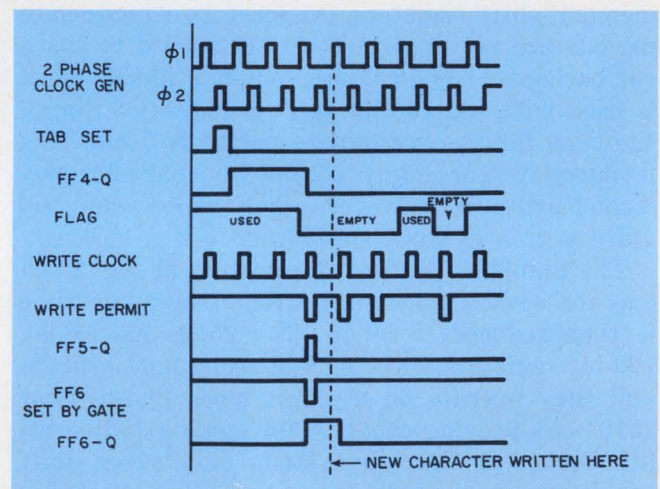

6. Timing diagram for the Tab-Set synchronizer shows how the Flag signal ensures that tab numbers are entered only into empty shift-register stages.

pulses to go to the printer's Space-Right command line. These pulses are directed on the printer to terminals that are usually called the "local space-key terminals."

The compare-inhibit flip-flop, FF<sub>3</sub> in Fig. 3, blocks the compare signal until the carriage has moved at least one space or backspace after stopping on a tab stop. This is done to release flip-flops FF<sub>1</sub> and FF<sub>2</sub> from their otherwise locked-up condition. If a Tab Right start is received with

no numbers in the shift-register memory, the carriage moves to the extreme right while hunting for a nonexistent setting. For this reason the printer should be provided with an auto-carriage return at the extreme right margin that overrides all other functions. At the left margin an empty shift register would automatically find a compare condition, since all entries correspond to the first column (all ZEROs).

If the circuit received a Tab Left command when the carriage (and corresponding counters  $CT_1$  and  $CT_2$ ) was in the first column, the counters would step backwards past ZERO to an all ONES condition. This, of course, would throw everything out of kilter. A left-margin switch that grounds and inhibits the J input to  $FF_1$  on the Tab Left circuit prevents this. As a result, back tabs are ignored until the carriage moves from the left margin. Alternatively, the all-ZEROS state of  $CT_1$  and  $CT_2$  can be detected and used to inhibit the J input to  $FF_1$ .

The busy signal goes high while tabbing is in process. This signal serves to inhibit the flow of data out of a data-storage buffer (Fig. 2), but the incoming data continue to be stored in this buffer.

### Setting the tab stops

Table 2 provides an example and the complete procedure for setting the tab stops. The Tab-Set synchronizer circuit (Fig. 5) has all the logic needed for this function. It consists mainly of flip-flops  $FF_4$ ,  $FF_5$  and  $FF_6$ . The Tab-Set signal's falling edge makes  $FF_4$ 's output high. The next available falling edge of the write-permit signal from the flag circuit strobes the counter number, or tab location, into the register via gates  $G_1$  through  $G_7$ .

It is interesting to note that the same configuration of logic elements used in the synchronizer circuit of Fig. 5 is also used in the Tab-Right and Tab-Left circuits of Fig. 3. The timing diagram (Fig. 6) shows in detail how characters are written into the shift-register memory.

With very few changes, the circuit configuration of Fig. 3 can also be used for vertical tabbing. Of course, a separate, but interlocked, system is required. And additional control codes would have to be assigned. However, the Tab-Clear code and circuit could be shared. In printers that use a sprocket-feed mechanism to advance the paper, an automatic skip-perforation zone is often present—typically three lines above and below the perforation line. Switches for this feature can be used as signal sources to reset the counter for the vertical tab system. ■■

### Reference

1. Smiley, C.R. Jr., "Digital Data Systems Work Faster," Nov. 23, 1972, pp. 150-154.

# OSCILLATORS

1 Hz to 250 MHz

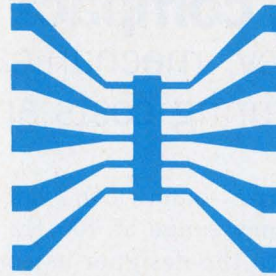

**ACCUTRONICS IS  
NOW COMPATIBLE  
WITH ULTRA-HIGH  
SPEED LOGIC  
MECL III,  
SCHOTTKY**

SURE, ANYONE CAN BUILD . . . their own oscillator between 1 MHz and 50 MHz and maybe even two, BUT TRY TO BUILD one at 250 MHz compatible with high-speed saturated logic, non-saturating Schottky or emitter coupled logic, then come to Accutronics and we'll save you on your prototype or production runs. Accutronics was the first to advertise oscillators compatible with RTL, DTL and TTL logic (Electronic Design October 1965), and we have continued our engineering capabilities to keep up with the latest IC logic.

NEED HELP? Call Dennis Griffin (area) 312-232-2600, and he will be glad to fill you in on the details and send you our new catalog.



Series 110

FREQUENCY: 50 MHz to 250 MHz  
FREQ. TOLERANCE:  $\pm 0.001\%$   
TEMPERATURE RANGE:  $0^\circ\text{C}$  to  $60^\circ\text{C}$   
SUPPLY VOLTAGE: + or  $-5\text{Vdc}$  or  $-5.2\text{VDC}$   
OUTPUT VOLTAGE: Compatible with the newest logic  
SIZE: 38.1 MM x 38.1 MM x 15.8 MM  
1.5" x 1.5" x 0.62" compliments  
70th edition Machinery's Handbook  
MOUNTING: PC board mount

See 1972-73 EEM Pg. 1571

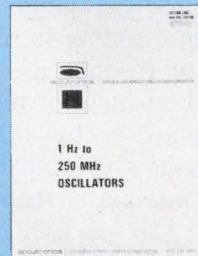

**Please write or  
call for**

**NEW 1973 CATALOG**

Our new catalog covers various types of oscillators: VCXO, LCVC0, RCVC0, high stability, computer clocks, high output power, Navy standard hardware modules and low current drain oscillators from 1 Hz to 250 MHz. We'll even send you three neat conversion charts (3) to hang on your wall and impress your friends.

**accutronics**

A HAMMOND CORPORATION COMPANY

628 NORTH STREET • GENEVA, ILLINOIS 60134

INFORMATION RETRIEVAL NUMBER 26

# Build stable, compact narrowband circuits

with low-frequency, mechanical filters. They will help reduce manufacturing costs and improve reliability.

Temperature-stable, narrow-bandwidth filters that operate in the frequency range of 100 Hz to 50 kHz are now available to the designer as compact, low-cost, mechanical filters. Bandwidths of 0.1 to 2% are achieved through the use of high-Q (500-5000), stable metal/ceramic resonators. The price, reliability and fixed tuning of these filters make them attractive for use in communication modems, navigation equipment, signaling in paging and transportation control systems, and in telemetry and test equipment.

But the cost and size savings that are possible with these filters depend on the equipment designer's knowledge of filter configurations and how they can be combined in his circuit to get the desired response. A good understanding of the filter characteristics is also necessary to make valid comparisons with other filter types, such as crystal, LC and active.

## Tight filter specs cost more

Let's look, then, at some of the characteristics of low-frequency, mechanical filters: size, selectivity, center frequency range, insertion loss and price. The table shows minimum and maximum limits of various parameters based on reasonable cost, size, performance and reliability criteria. The characteristics listed are not all independent, and specified minimums and maximums almost never apply to the same filter. For example, a very-narrow-bandwidth filter will have a high insertion loss, due to the finite Q of the resonators (a 0.2% filter will have an insertion loss of considerably more than 2 dB). The center frequency and fractional bandwidth are closely related to the filter type, while the volume and cost are more influenced by the number of resonators.

Figure 1 shows the frequency responses of one, two and four-resonator filters. Shape factor—the ratio of the bandwidth at X decibels divided by the 3-dB bandwidth—is plotted against attenuation.

Simple one-resonator, one-pole filters can be packaged in a volume of only 0.1 in<sup>3</sup>, and they

may cost as little as \$2 to \$3. At the other extreme, the price of a four-resonator filter may be as high as \$75—if the center frequency, bandwidth and loss specifications are very tight. However, a four-resonator filter with reasonable specifications and tolerances can cost around \$25. Thus it is of paramount importance not to overspecify the filter, particularly in terms of stopband selectivity.

The transmission zeros of the two-pole, two-zero and the four-pole, four-zero curves of Fig. 1 are realized simply by connecting a capacitor from the input terminals of a two-resonator section to the output terminals of that section. The four-resonator filters can be realized either by cascading two-resonator sections or by mechanically coupling four bars or reeds in one section.

## Comparison with other filter types

If the center frequency and bandwidth of a circuit are fixed, then the designer's choice is limited. But if he is free to use frequency translation, then LC, active, crystal and mechanical filters all compete for the application—and size, cost and reliability become the most important criteria for choosing the best filter.

Figure 2 shows two sets of data—the first showing the fractional bandwidth range of various filter types and the second showing the center frequency range. Note in Fig. 2a that if inductors are used with a low-frequency, mechanical filter, its fractional bandwidth can be increased to 10%, thus exceeding the range of a crystal

Table. LFMFs with 1-4 resonators.

Parameter	Min.	Max.
Center frequency	100 Hz	50 kHz
Fractional bandwidth	0.2%	2.0%
Insertion loss	2 dB	15 dB
Termination resistance	5 k $\Omega$	300 k $\Omega$
Temperature coefficient of center frequency	+1 ppm/°C	+25 ppm/°C
Volume	0.10 in <sup>3</sup>	1.25 in <sup>3</sup>
Cost (1000 parts)	\$2.00	\$75.00

Robert A. Johnson and Wes D. Peterson, Senior Engineers, Collins Radio Co., Newport Beach, Calif. 92663.

filter. The basic mechanical filter, however, dominates the fractional bandwidth range between 0.2 to 2% both in terms of size and cost. The size advantage of the low-frequency, mechanical filter is on the order of 10 to 1 compared with crystal and LC filters, while part-cost savings are typically 2 to 1.

Possibly even more significant is the fact that the mechanical filter is a relatively simple device, which makes it reliable and results in low prototype costs and fast deliveries. In addition its fixed tuning eliminates the need for the 1% (or better) components and costly tuning and testing usually required for active filters (not to mention the weeks of design time). Of course, cost and size are not the only criteria in evaluating filter types. We must also consider power consumption, spurious responses, dynamic range, microphonics, shock and vibration resistance, as well as temperature stability, aging, insertion loss and reliability.

In making a specific comparison, the major advantages of the mechanical filter over the LC in the 2-to-10% bandwidth range are size and cost—the lower the center frequency, the greater the advantage. In terms of size, the frequency cross-over point is between 20 and 50 kHz. In terms of cost, the low-frequency, mechanical filter has a decisive advantage for frequencies up to 1 kHz, but at higher frequencies the costs for the competing filters become comparable. In comparison with crystal filters, the low-frequency mechanical has both lower cost and smaller size, regardless of the center frequency.

Compared with active filters, the advantages are, again, size and cost, and the disadvantages are spurious and microphonic responses. In addition the active filter suffers from lower reliability (because of its much greater complexity), the need for a power source and often a low dynamic range of around 50 dB vs a dynamic range of up to 120 dB for the low-frequency, mechanical filter.

With regard to various performance criteria, such as passband response, stopband behavior, phase and delay, the four filter types are almost identical near the 10%-bandwidth end of the spectrum. At the 2% end, the crystal and mechanical filters, with their superior Q and stability, have lower insertion loss, less amplitude and frequency-shift variations with temperature and time, and, when desired, a flatter passband response shape.

Here is a list of major functional filter specs that should be considered when selecting a filter:

- Passband response shape.
- Passband frequency limits.
- Stopband frequency limits.
- Special phase or delay.
- Maximum insertion loss.
- Input voltage levels.

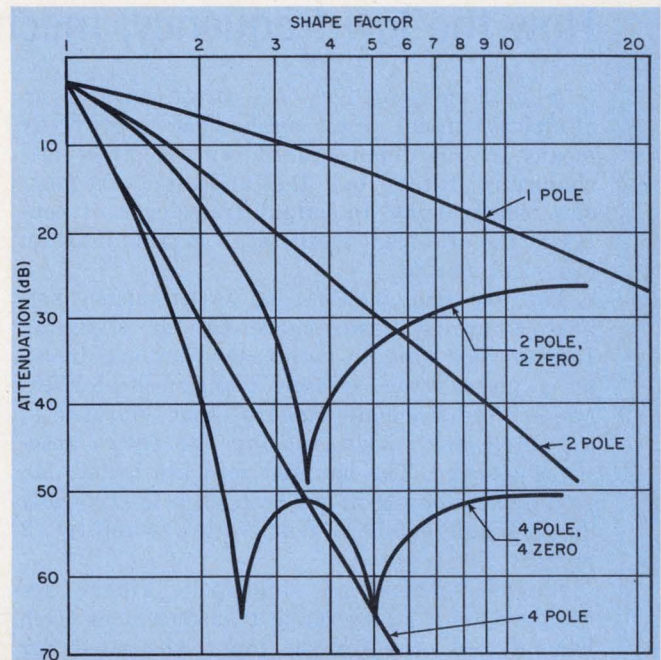

1. The cost and size of low-frequency, mechanical filters rise as attenuation requirements increase, since more resonators are needed for each filter.

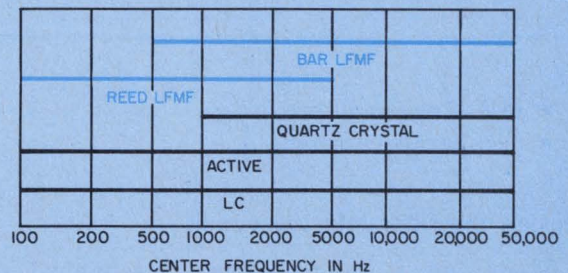
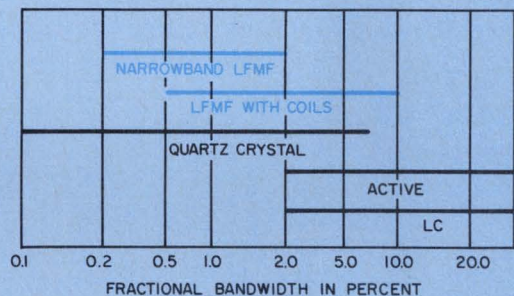

2. A wide range of applications for low-frequency, mechanical filters makes them highly competitive with other types, including crystal, active and LC filters.

- Maximum dimensions.
- Terminating resistance and reactance limits.
- Stopband response (spurious) rejection.
- Shock and vibration requirements.

# How the low frequency, mechanical filter works

A mechanical filter (A) first converts an electrical signal into mechanical energy by means of the input transducer and then mechanically filters out the undesired frequencies. Then, using an output transducer, it converts the filtered mechanical signal into an electrical output.

The two most widely used low-frequency resonators are a flexure-mode bar or a tuning fork or reed (B). In both cases they are driven by a piezoelectric ceramic transducer—for example, lead-zirconate-titanate—that vibrates in an extensional mode, causing the entire resonator to bend. The bar and reed are usually an iron-nickel alloy that has both high Q (typically 20,000) and excellent temperature stability (2 ppm/°C).

Single-resonator, or single-pole, filters are designed with two ceramic transducers on each bar or reed—one for the input, the other for the output.

In two-resonator filters (C) the applied voltage expands and contracts the input transducer, causing the entire bar assembly to bend at the input-signal frequency. This bending is transmitted to the second resonator via coupling

wires, which are attached to the bars at the points where there is no vertical motion, only torsion. The bending motion of the output resonator, in turn, causes its transducer to expand and contract, thus producing a piezoelectrically induced voltage across the output terminals and the load resistance that represents the input impedance of the following network.

If greater stopband selectivity is desired—that is, more pole pairs—more resonators can be added. These do not require ceramic transducers but are inserted between the transducer-carrying resonators shown in C.

The design of both mechanical filters and their surrounding electrical networks is greatly simplified because the filters lend themselves to computer analysis. For analysis, the mechanical filter is represented by its electrical equivalent (C). The parallel tank circuits correspond to the composite ceramic/metal resonators, the series capacitors represent the static capacitance of the transducer, and the series inductor is analogous to the compliance of the coupling wires. The source and load resistances are those required to terminate the filter for obtaining the desired response. ■■

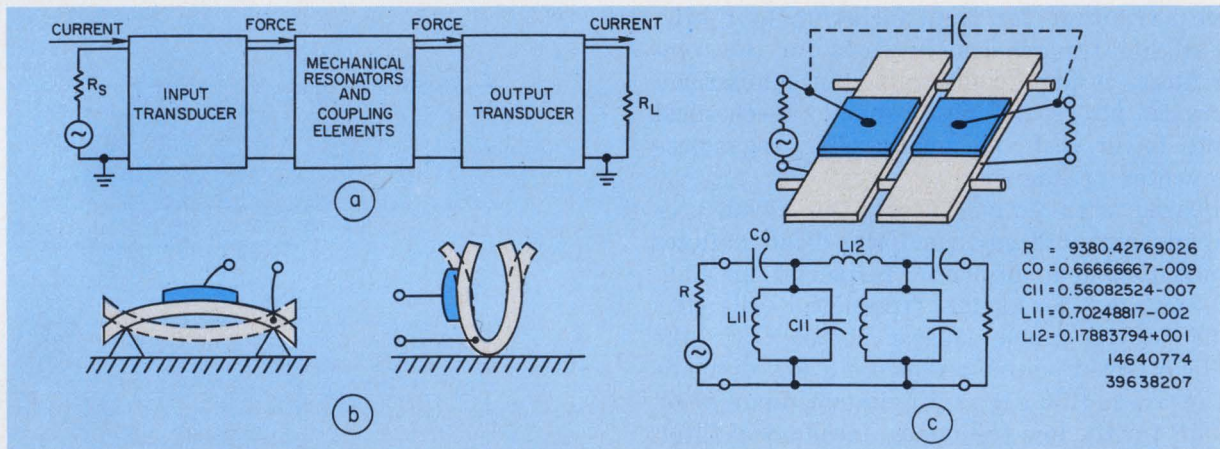

- MIL-Spec requirements.
- Temperature range.

## Design the filter into the circuit

Designing a low-frequency, mechanical filter into a circuit is a relatively simple process involving impedance matching, consideration of stray capacitance, proper mounting of the filter, insertion-loss compensation and delay and phase equalization.

Impedance matching involves designing input and output networks that present a specified value of resistance to the filter. Because the manufacturer measures filter performance in circuits

that provide specified source and load resistances, the user need not be concerned with performance, so long as his own circuit presents the proper impedance. In most cases this impedance is purely resistive, but often a fixed capacitance is also specified to allow for the PC board and other sources of stray capacitance. The sensitivity of the filter characteristic to variations from the specified values of impedance depends somewhat on the particular filter design. But as a rule of thumb, the variations in resistance should not exceed 5%. Improper termination (including excessive shunt capacitance) results in changes of the passband shape and frequency shift.

To make best use of the large dynamic range of

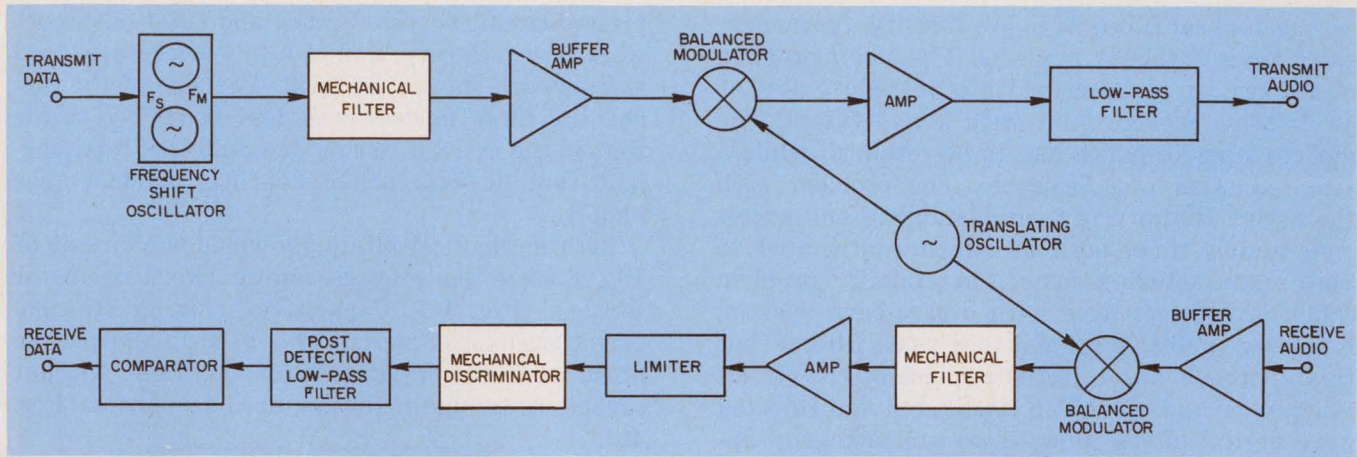

3. **Reduced cost and size without sacrifice in performance result** in an FSK modem when active (or LC) filters are replaced by the mechanical filters. The photo indicates that size reductions of 4 to 1 and 3 to 1 can be obtained when a mechanical filter replaces an LC and an active filter, respectively.

the low-frequency, mechanical filter, place it in mid-circuit, where the signal is of sufficient amplitude to be insensitive to microphonic noise. The signal should be low enough to avoid nonlinearities caused by overdrive. If the filter is used at the front end of a circuit that has to detect microvolt signals under mechanical vibration, special soft mounting might be required to reduce microphonic responses.

For input signals of less than 1 V, the filter response is linear, but with inputs between 1 and 10 V the insertion loss increases and other nonlinear effects appear. The degree of nonlinearity is a function of the filter design, and consequently it can be improved only through design modifications. Regardless of where the filter is placed in the circuit, its insertion loss can be as high as 15 dB (3 to 10 dB is typical), so that an additional stage of amplification might be needed.

There are a number of applications for low-frequency, mechanical filters where phase linearity, phase shift at the center frequency and delay are important considerations in the design of the surrounding circuitry. Modeling the filter for analysis on a computer considerably simplifies the system design. Use of a filter model is also helpful in predicting pulse-response and delay characteristics of those filters with bandwidths on the order of the modulation frequency of a delay test set.

As emphasized previously, the designer should remember that the modulation scheme that determines the center frequency of the filter should be chosen, if possible, to optimize the filter performance. Furthermore, one should design surrounding circuits around the filter rather than trying to fit the filter into a fixed network—which usually results in greater costs and wasted design time.

One promising application area for low-frequen-

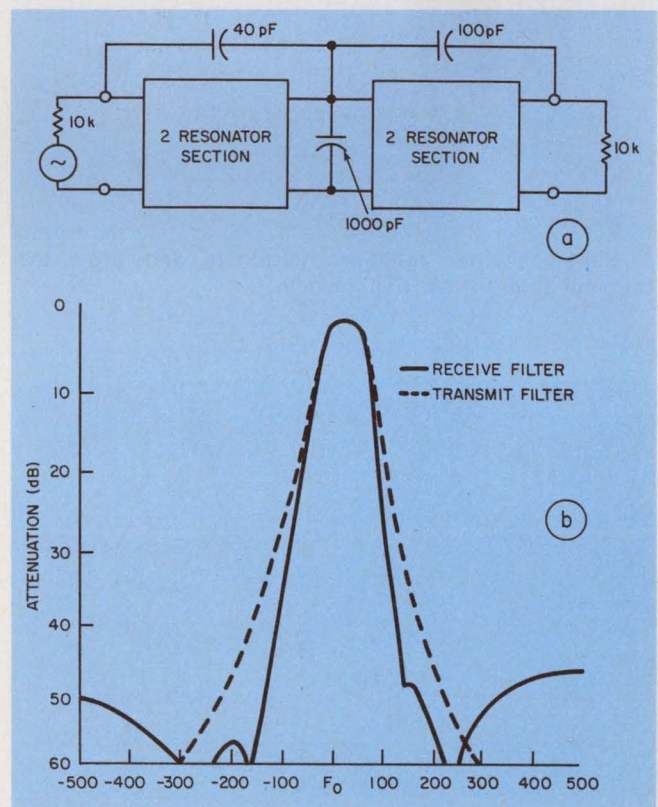
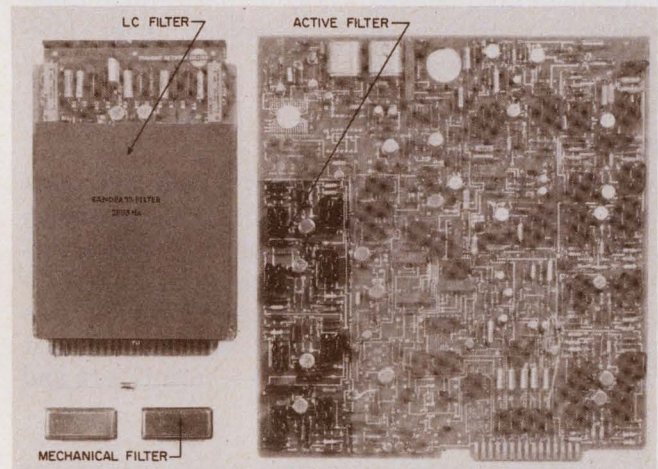

4. **Excellent selectivity and stability are provided** by a four-resonator, or four-pole-pair, filter in an FSK modem that uses identical channel units, with  $F_0 = 10.0$  kHz.

cy, mechanical filters is in low-density, frequency-shift keying (FSK) modems. The main problem in the case to be described was to reduce cost of an existing modem built with active filters. The modem's performance had to be retained, while a size reduction was desirable. The problem with the active filters was their instability and excessive tuning time, both of which contributed to high manufacturing costs. The stability problem could have been solved with a base-band system, involving multipliers and low-pass filters, but this approach was rejected because of the circuit complexity and cost. Also considered and rejected were digital filters, since these are primarily applicable to high-density systems that employ time-sharing; they are not economical under low-density conditions.

### Solving a circuit problem

It was decided to use identical channel units with a center frequency,  $F_0$ , of 10 kHz, which could be mixed down to frequencies ranging between 425 and 3315 Hz. The disadvantage of having to provide additional modulation circuitry was more than compensated for by the reduced cost of manufacturing identical units—both filters and

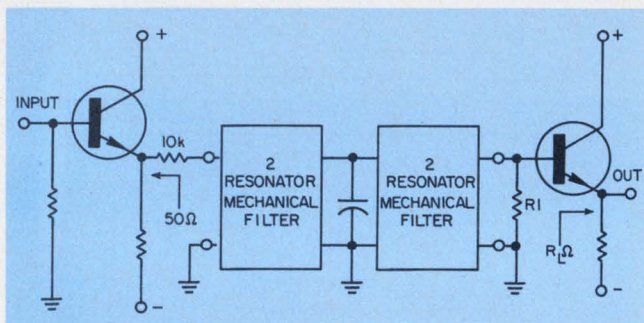

5. Simple emitter followers terminate and drive the transmit filters in an FSK modem.

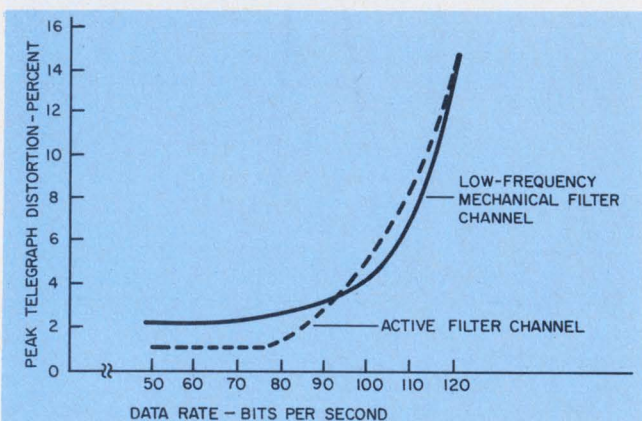

6. Active-filter performance is well matched by mechanical filter. The active filter is slightly superior at lower data rates, while the mechanical is better at higher data rates. Data shown are for 120-Hz channel spacing.

printed-circuit boards. Circuit and filter designers worked very closely, and in a few weeks produced the network shown in Fig. 3. The size of the mechanical-filter modem was less than two-thirds that of the active-filter modem and less than one-half that of the earlier LC-filter modem (see photo).

Both mechanical filters shown in the circuit of Fig. 3 were made by cascading two 2-resonator sections (Fig. 4a). Capacitive bridging (to produce transmission zeros) was used in the receive filter, while the transmit filter was built without capacitors to obtain the required responses (Fig. 4b).

Figure 5 shows emitter-follower networks that drive and terminate the transmit filter: (the receiver filters are driven by a mixer and are terminated in an emitter follower). The filters operate into a 10-k $\Omega$  source and load, so that a 10-k $\Omega$  resistor is connected in series between the input emitter follower (which has a 50- $\Omega$  impedance) and the filter. On the output side the filter looks into an emitter-follower network with an input impedance equal to  $R_1$  in parallel with  $(R_L \times \beta)$ . The value of  $R_1$  is adjusted to make the parallel combination equal to 10 k $\Omega$ . The shunt capacitance of both the input and output networks is only a few picofarads and thus can be ignored in this application.

The discriminator in the block diagram of Fig. 3 also uses a two-resonator low-frequency, mechanical filter and because of its linear phase characteristics, has excellent amplitude linearity. It also appears possible to use a single-resonator filter in both the frequency-shift oscillator (for generating the  $\pm 42.5$ -Hz mark and space frequencies) and the translating oscillator.

The comparison between the mechanical-filter modem and the active-filter version indicates that the active-filter modem is superior at lower data rates while the mechanical-filter type is better at higher data rates (Fig. 6). Some factors contributing to the performance difference are filter delay variation, stopband selectivity (six pole pairs in the active filter vs four in the mechanical filter) and discriminator amplitude linearity. While the system described has relatively narrow, 120-Hz channel spacing, filters for spacings as wide as 480 Hz have been designed.

In general, low-frequency, mechanical filters provide the best over-all size, cost and performance when compared with crystal, LC and active filters over the frequency range of 100 Hz to 50 kHz and for fractional bandwidths between 0.2 to 10%. These advantages account for their popularity in Japan and Western Germany. ■■

### References:

R.A. Johnson, M. Borner, M. Konno, "Mechanical Filters—A Review of Progress," *IEEE Trans., Sonics Ultrason.*, Vol. SU-18, July, 1971, pp. 155-170.



# Are you getting static?

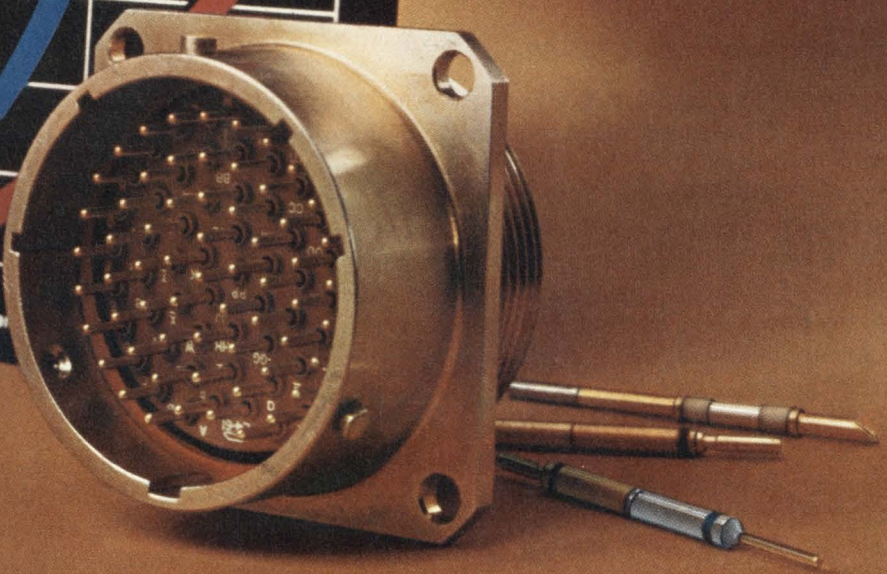
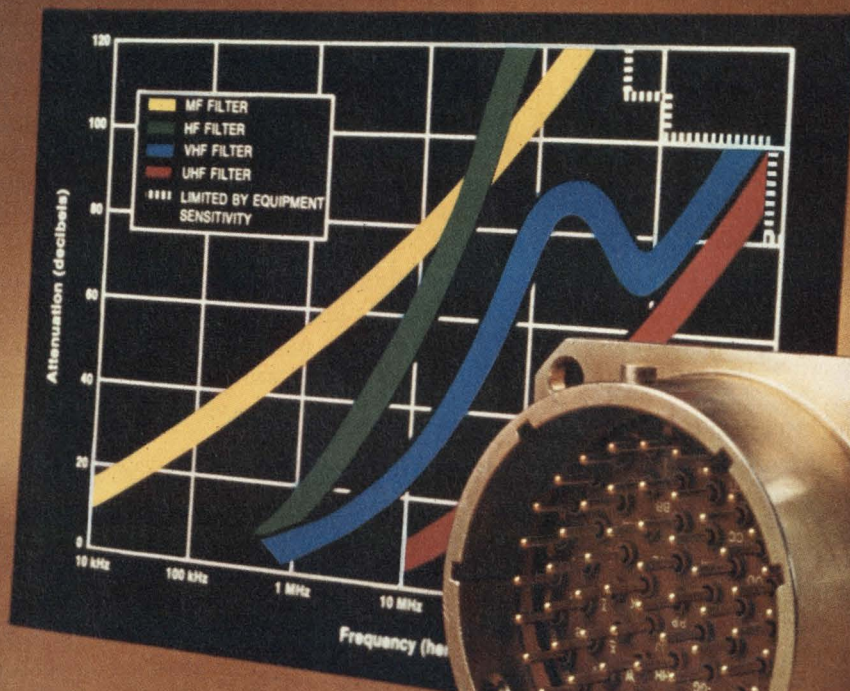

Our filter connectors are designed to eliminate interference from your circuits. See those attenuation curves? They are just a part of our selection. We can mix and match filters to solve your low pass filtering requirements. Small wonder Bendix filter connectors are first choice in the fight against electronic noise pollution.

Bendix filters come packaged in connectors intermateable with MIL-C-26482, MIL-C-83723, MIL-C-38999 and

MIL-C-5015 connectors. In addition, filter contacts can be packaged to mate with other popular connector types including rectangular in military, industrial and commercial applications. There's sure to be one to meet your attenuation and frequency requirements.

You'll like the price, too.

Delivery? We won't give you any static there, either. Write for our brochure. The Bendix Corporation, Electrical Components Division, Sidney, New York 13838.

**Bendix**

## Is Monte Carlo worth the gamble? Yes, says this manager, and the more that you know about this sampling technique, the more ways you'll find to use it.

If you would like to solve problems involving waiting lines, inventory, replacement, transportation, allocation and a host of other management migraines, try placing some of your bets on the Monte Carlo sampling method.

Popularized in Britain during World War II, Monte Carlo is a simulated sampling technique that is useful where sampling is indicated but where the taking of the sample is either impossible or not practical. The method involves replacing the actual universe you are attempting to study by a model, or theoretical counterpart. The universe is described by a series of probability distributions which are sampled from the theoretical population by means of a random number table.

### Knowing how much is too little

One of the uses for Monte Carlo is in inventory control. You know what you have in inventory, and you want it to be enough so people can always draw from the supply without creating a shortage. Yet you don't want too much on hand. On a monthly basis, suppose you plot the probability of someone drawing 60 parts. With these data, you can construct a model, and the Monte Carlo techniques, using a round of tables, will tell you the best level of inventory to keep to satisfy both requirements of too little or too much.

Many purchasers use the Monte Carlo analysis in a haphazard manner. They know that if they don't have part X, it will cost them a lot of money; so they order three times what they need. Then they realize they can't do that, because they've tied up too much capital. Later they're short of the item when they need it.

It's true, of course, that many companies use a computer to keep a balance on inventory. But computers, in most cases, will keep a minimum level and a maximum level, and when the level gets to a certain point, the computer will automatically tell the company to order more, whether it really needs the order or not.

Many managers solve inventory problems with a formula. They know their purchaser well enough to come up with a formula that will produce an optimum inventory level. But in many cases the customer's demands are such that the pattern is probabilistic. It's a pattern that cannot be described with a formula. In this case Monte Carlo is the only way to analyze the requirements.

In other cases there are analytical ways of solving the managerial problems. But sometimes mathematics fails and simulation is the only way out. A staggering problem to solve with mathematical means may be only a day of work with the Monte Carlo method.

Consider assembly lines. Monte Carlo can solve waiting problems. Take, for example, wire bonders in a semiconductor operation. Parts are serviced at a certain station, and backup may occur because it takes a certain amount of time to service the parts.

One of the answers you want to get by using the Monte Carlo method is how many stations will be needed to eliminate the backup.

By simulation, you can do things that you can't with the actual system. For instance, if you want to find out how much better it would be to have six bonding machines instead of three, you would have to buy six machines and try them. With Monte Carlo, you run the model and you assume six machines. And you get the right answer.

There are people who sit in offices all day and run Monte Carlo simulations for manufacturing and for transportation problems. If you have trucks for central distribution, for example, and you want to send parts to different places in town, you can construct probabilistic models and figure out what demand there will be and what

*The best way to understand the Monte Carlo method is through illustration. On the following four pages are examples of management problems in inventory, waiting-lines, and purchasing that can be solved by using this sampling method. The sample figures are not, of course, interchangeable; each example must be worked out, individually.*

---

Al Gomez, Product Manager, Airpax, Fort Lauderdale, Fla. 33313.

## The waiting-line problem and how Monte Carlo can solve it

A hybrid circuit manufacturer has decided to use a lot number of 300 circuits. As the hybrid circuits reach the wire-bonding operation, it is noticed that the time for an operator to complete the lot can vary. Let us assume further that by taking random observations, the probability of the operation taking a certain amount of time is shown in Table I.

As you can see, there is a very small probability of an operator completing the lot in either 1 or 1.6 hours. However, the most probable number is 1.3 hours. The first step in the Monte Carlo method is to calculate the cumulative probability that the event will occur. This is shown in column 3 of Table 1. As you can see, there is a 100% probability of completing the operation in 1.6 hours or less, while there is only a 65% probability of completing the operation in less than 1.3 hours.

The next step is to plot the cumulative distribution for the number of hours at wire bonding. This is done in the accompanying graph. As you can see, the vertical scale goes from zero to one, since those are the limits of the cumulative distribution, while the horizontal scale lists the number of possible hours. The next step is to go to a table of random numbers and select a group of numbers from 000 to 999.

After this collection of random numbers is selected, they are individually looked up on the vertical scale, and the corresponding number of hours is taken from the horizontal scale. An example of this tabulation is shown in Table 2. In this table we have taken only 10 random numbers, and they are written in parenthesis. By making other tables of random numbers, we have now obtained a collection of samples or numbers that reflect the particular probability distribution of the original sample. In other words, once the cumulative probability distribution is plotted, we can use it with the table of random numbers and come up with various experiments or trials that reflect the correct distribution of the original universe.

Once this basic procedure is understood, an enormous number of problems can be solved. For example, in the typical hybrid circuit manufacturing operation there are a series of successive steps that must be performed in a given order. If we know the probability distribution for the time it takes to perform each of these steps and the sequence in which steps are to occur, we can, using the Monte Carlo method, plot the cumulative functions for all the steps and derive from this table the answers to such questions as this: If I start a lot at a certain time, what

**Table 1.**

Hours at Bonding	Probability	Cumulative Probability
1.0	0.05	0.05
1.1	0.1	0.15
1.2	0.2	0.35
1.3	0.3	0.65
1.4	0.2	0.85
1.5	0.10	0.95
1.6	0.05	1.0

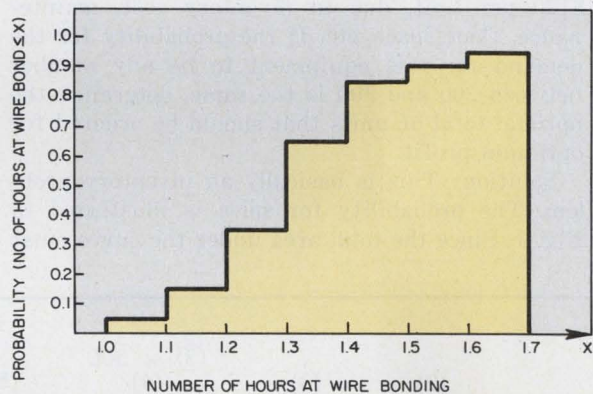

**Table 2.**

Random numbers	Hours
(608)	1.3
(861)	1.5
(215)	1.2
(380)	1.3
(775)	1.4
(022)	1.0
(048)	1.0
(029)	1.0
(333)	1.2
(844)	1.4

is the most probable time in which it will be completed?

In addition, changes in an assembly line, such as the addition of more equipment or the blending of different types of equipment, can be evaluated without the actual expense of purchasing the equipment to find out the effects.

is the best number of trucks to have so people don't have to wait more than a day for their parts.

When using Monte Carlo, keep in mind the following:

- The method is strictly a simulation technique

and is only as good as the created model.

- The simulation must be done several times to check the consistency of results, and although it may always yield the same answer, this does not confirm the correctness of a model.

- The method is useful in cases where analyti-

## The inventory problem

A manufacturing concern sells a very complex piece of equipment that is subject to contamination. A profit of \$500 is made on every piece of equipment sold, but if the equipment is not sold within one month, the manufacturer takes it back at cost. However, he incurs a loss of \$120 per unit, due to inventory cost, maintenance, floor space, etc. If the probability for the demand for this equipment to be any number between 200 and 300 is the same, determine the optimal total of units that should be ordered for optimum profit.

Solution: This is basically an inventory problem. The probability for sales is illustrated in Fig. 1. Since the total area under the curve must

equal 1, the probability of selling any individual machine is equal to 0.01.

The solution to this problem with the Monte Carlo method is shown in Table 1. The first step is to select 20 random numbers. This is done in column 1. Since only sales between 200 units and 300 units are allowed, all random numbers must lie between 200 and 300. In this case there is no need to plot the cumulative probability distribution, because the curve is rectangular. Therefore there is an equal opportunity for every number or every sale to occur. The numbers in column 1 represent a simulated demand curve.

The second column represents a simulation of

(1) Demand	(2) Units ordered	(3) Units sold	③ × 500 (4) Sales income	(5) Units not sold	⑤ × 500 (6) Sales lost	(7) Units returned	⑦ × 120 (8) Money lost due to waste	④ - ⑥ - ⑧ (9) Net profit
231	200	200	100,000	31	15,500	—	—	84,500
233	222	222	110,000	11	5,500	—	—	104,500
257	234	234	117,000	23	11,500	—	—	105,500
294	221	221	110,500	73	36,500	—	—	74,000
258	296	258	129,000	—	—	38	4,560	124,440
217	287	217	108,500	—	—	70	8,400	100,100
224	250	224	112,000	—	—	26	3,120	108,880
289	210	210	105,000	79	39,500	—	1,800	65,500
242	257	242	121,000	—	—	15	1,800	119,200
298	243	243	121,500	55	27,500	—	—	94,000
267	282	267	133,500	—	—	15	1,800	131,700
231	249	231	115,500	—	—	18	2,160	113,340
280	285	280	140,000	—	—	5	600	139,400
276	290	276	133,500	—	—	14	1,680	131,819
276	229	229	114,500	47	23,500	—	—	91,000
220	228	220	110,000	—	—	8	960	109,040
240	277	240	120,000	—	—	37	4,440	115,560
251	227	227	113,500	24	12,000	—	—	101,500
258	292	258	129,000	—	—	34	4,080	124,920
256	248	248	124,000	8	4000	—	—	120,000

cal solutions are either impossible or extremely time-consuming.

Instructors in the School of Quantitative Management attempt to describe management in terms of mathematical symbols and measurable data. They rely heavily on operations research,

which involves all of the sampling techniques. While most problems can be solved with analytical methods, they get extremely complicated. The Monte Carlo method is the only approach that seems able to cut across all of these problems. ■■

(continued on page 70)

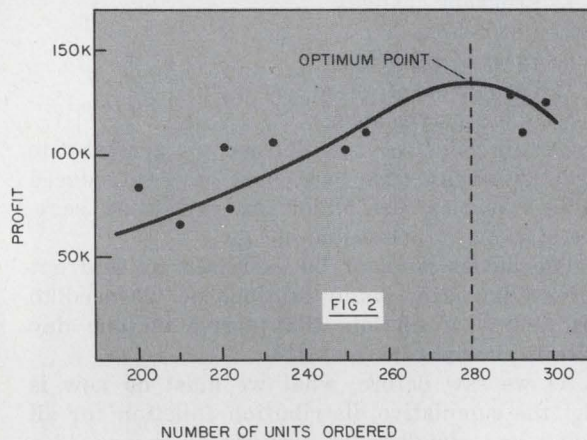
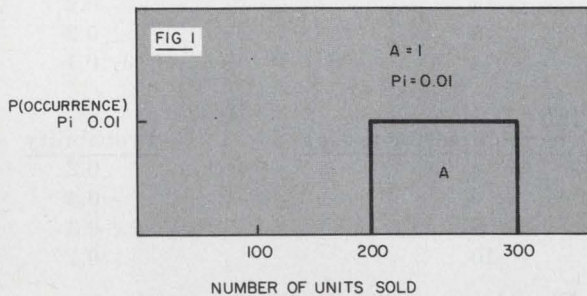

the amount we are going to order. Here again we pick 20 random numbers from 200 to 300 and simulate a random order amount. The third column is the number of units sold. If our demand is higher than the units ordered, we lose sales and write the number of units ordered on column 3. If we order more than our demand, we can sell what we have ordered, so the number of units ordered then goes in column 3.

What we have done so far is to simulate a certain demand, a certain number of units ordered and a certain number of units sold by use of random numbers. If the distribution had not been rectangular, we would have had to plot the cumulative distribution and have the random numbers reflect that particular distribution.

As you can see, we have simulated a schedule of demand, a schedule of units ordered and a schedule of units sold, and these numbers repre-

sent our use of the model.

Column 4 represents the sales income, and it is simply the units in column 3 that were sold multiplied by the \$500 profit on each unit.

Column 5 represents the units not sold—for example, in row 3, column 2, we ordered 234 units, while the demand was 257 units; so we couldn't sell 23 units.

Column 6 shows the dollar sales lost, which occurs when we order more units than we can sell. This column is obtained simply by multiplying the units not sold in column 5 times \$500.

Column 7 is filled in only when the number of units ordered is higher than the number of units sold. Column 8 computes the dollars lost because of units that had to be returned, and it is obtained by multiplying column 7 by the \$120 loss per unit.

Column 9 is the net profit, which is obtained by subtracting the total dollars lost as a result of lost sales and the total dollars lost as a result of waste from the sales income—that is, the net profit is obtained by subtracting the amounts in columns 6 and 8 from column 4.

The last step in our solution is to plot the profit against the amount ordered, which is shown in Fig. 2. As can be seen, the points in this figure seem to arrive at some kind of peak profit in the neighborhood of 280 units. Therefore we conclude that the optimum number of units to order every month is 280.

As you can see, what we have done is simply to simulate a certain total of demand, a total of units sold and a total of units ordered and have simply worked out the problem again and again to see if there is a pattern. After the net profit is obtained, we observe that it peaks at a certain number, and that must be the optimum number of units to order.

This problem has an analytic solution, as follows: Assume  $x$  is the monthly number of units to be ordered for optimum profit. Then the following equation applies:  $(3000 - x) 500 = (x - 200) (120)$ . The optimum point occurs when the cost of lost sales equals the excess production cost:  $x = 280.6$ .

The analytical answer agrees with the Monte Carlo simulation.

## The equipment purchase problem

Another example of the use of the Monte Carlo method deals with the purchase problem and waiting lines that form when people, sub-assemblies, and/or data arrive at a location and need to be serviced by one or more stations. When analytical methods cannot be used practically, the Monte Carlo method can be used to determine such things as:

- how long will the lines be
- how many service stations are required to maintain the lines at an acceptable level
- how long will the objects spend waiting or being serviced.

Let's assume that a large computer manufacturer has decided to inspect 100% of all lots of semiconductors that arrive from various sources, because of the high reject content in the lots and the high expense of field equipment repair. The company's incoming inspection department must purchase additional automatic test equipment to handle the additional load. The question is: How much equipment (stations) to buy?

A. Based on past history it has been determined that the probability of a certain number of lots arriving in one day is as follows:

<u>Lots arriving per day</u>	<u>Probability</u>
5	0.01
6	0.03
7	0.06
8	0.10
9	0.20
10	0.25
11	0.15
12	0.10
13	0.05
14	0.05

Note: All lots are the same size (say 1000 pieces), and they are subdivided into lots of 1000 at incoming inspection.

B. Three types of lots arrived. These are diodes (signal and zener), transistors and integrated circuits. The probability of the lot being of a given type is:

<u>Type</u>	<u>Probability</u>
Diodes	0.1
Transistors	0.4
ICs	0.5

C. The time required for testing a lot per test station can vary. The probability of a lot being completed in a certain amount of time has been determined to be as follows:

<u>ICs</u>	<u>Time required for testing (min)</u>	<u>Probability</u>
	5	0.1

10	0.2
15	0.4
20	0.2
25	0.1

<u>Transistors</u>	<u>Time required for testing (min)</u>	<u>Probability</u>
	3	0.1
	5	0.2
	7	0.4
	9	0.2
	11	0.1

<u>Diodes</u>	<u>Time required for testing</u>	<u>Probability</u>
	4	0.2
	6	0.4
	8	0.3
	10	0.1

The time required for testing varies due to such factors as:

1. Program changes
2. Down-time
3. Type of program
4. Length of program
5. Operator variables.

At this point we have defined the arrival rate and the service time (we could have introduced other variables such as lot size variations, service stations in operation, etc.).

The model can now be exercised to find out things like: How many stations do we need to test 100% of all lots that arrive on one day within an eight-hour shift?

As we saw before, what we must do now is plot the cumulative distribution function for all tables and simulate lot arrivals by means of a table of random numbers. Our table would look something like this:

<u>Number of lots that arrived,</u>	<u>Lot Type</u>
n1	Diodes M <sub>2</sub>
	Transistors n
	ICs n4

<u>Test Time</u>	<u>Total Test Time</u>
n5	
n6	n
n7	8

After a large number of lot arrivals is simulated the total test time (per station) will hopefully start to develop a pattern that will point out how many stations are needed to complete all tests in the next eight hours. Once a given investment in test stations is assumed, then we can study station idle time and future requirements as the incoming lot numbers increase.

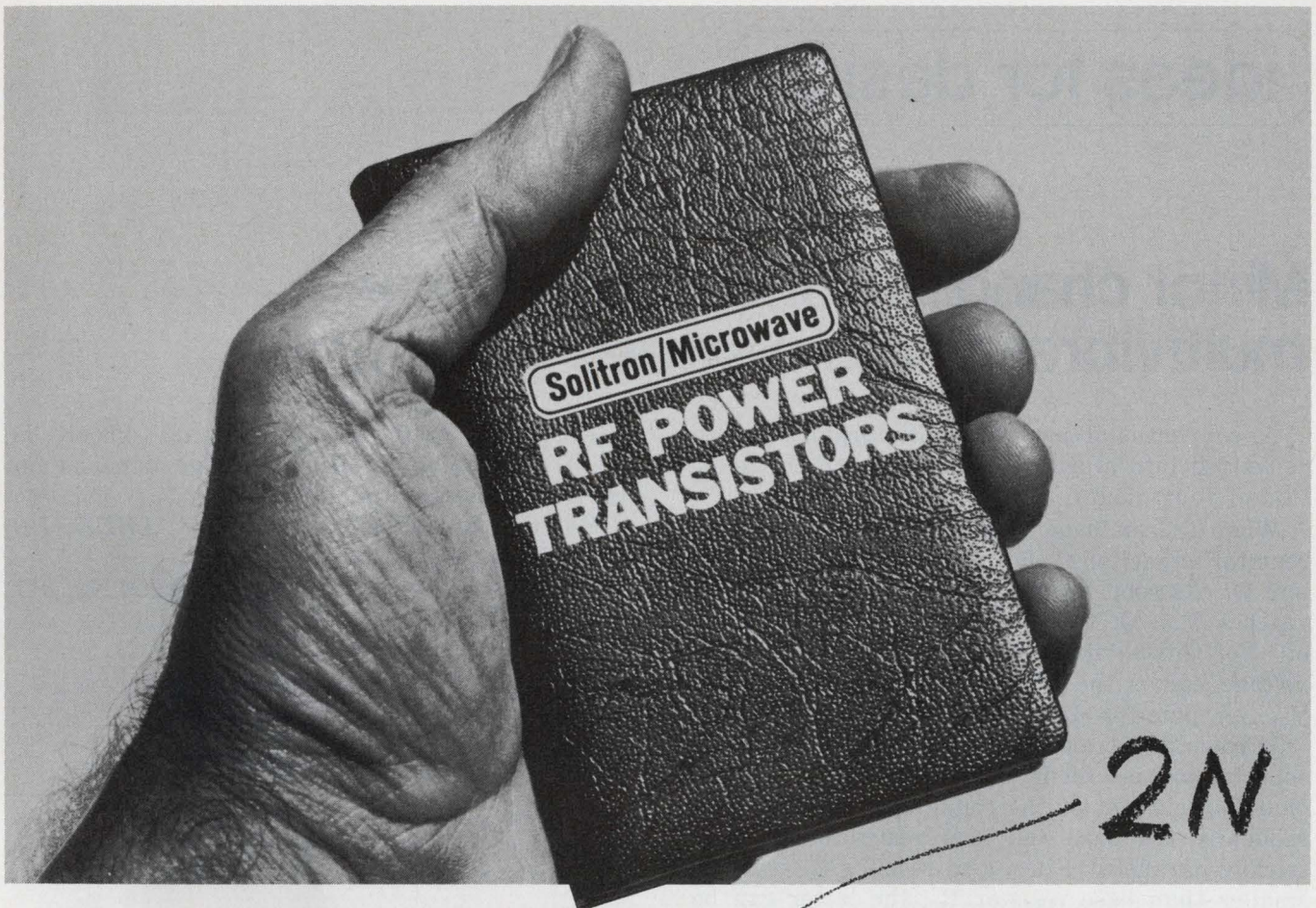

## OUR LITTLE BLACK BOOK IS FILLED WITH 2N NUMBERS!

Big ones. Small ones. All sizes and shapes. When it comes to RF Power Transistors, we've got more than eighty "2 N" types. You'll love them all! They're competitively priced, immediately available and reliability is guaranteed.

2N1506	2N3926	2N4428	2N5070	2N5421	2N5636	2N5687	2N5701	2N5848	2N6080
2N2876	2N3927	2N4429	2N5071	2N5422	2N5637	2N5688	2N5702	2N5862	2N6081
2N3375	2N3948	2N4430	2N5090	2N5423	2N5641	2N5689	2N5703	2N5922	2N6082
2N3553	2N4040	2N4431	2N5102	2N5424	2N5642	2N5690	2N5704	2N5923	2N6083
2N3632	2N4041	2N4440	2N5108	2N5589	2N5643	2N5697	2N5705	2N5924	2N6084
2N3733	2N4127	2N4932	2N5109	2N5590	2N5644	2N5698	2N5773	2N5925	2N6197
2N3866	2N4128	2N4933	2N5177	2N5591	2N5645	2N5699	2N5774	2N5943	2N6198
2N3924	2N4427	2N5016	2N5215	2N5635	2N5646	2N5700	2N5775	2N5947	2N6199

Take a page from Solitron/Microwave's "Little black book." If you want any of our "2N" RF numbers, call us today.

## WHO COULD ASK FOR MORE? YOU CAN.

*Solitron/Microwave offers*

**SCHOTTKY DIODES ■ HI-CURRENT SCHOTTKY RECTIFIERS ■ HI-SPEED SWITCHING TRANSISTORS  
MILITARY COMMUNICATIONS TRANSISTORS ■ MOBILE COMMUNICATIONS TRANSISTORS ■ CATV TRANSISTORS**

### Solitron/Microwave

**SOLID STATE DIVISION**

1440 West Indiantown Road, Jupiter, Florida 33458

Tel: (305) 746-8311 ■ TWX: 510-953-7490

A Division of Solitron Devices, Inc.

**OTHER SOLITRON PLANTS:**

Tappan, New York • Riviera Beach, Florida • Port Salerno, Florida • San Diego, California

## Minor changes convert an astable multivibrator into a sweep generator

A conventional astable multivibrator can be converted into a sweep generator with the addition of four diodes.

When  $Q_1$  conducts (Fig. 1), the charging current for capacitor  $C_1$  flows through  $R_{L1}$ ,  $CR_2$ ,  $R_{B2}$  and  $Q_1$ . As soon as the voltage at the base of  $Q_2$  reaches  $V_{BE}$ ,  $Q_2$  turns on and causes  $Q_1$  to turn off. For this astable action, the maximum output voltage equals the transistor saturation voltage,  $V_{CE(SAT)}$ , plus the diode drop,  $V_D$ .

While either transistor is on, the corresponding collector-to-base diode is forward-biased by the charging current of the coupling capacitor. Consequently the base and load resistors are electrically paralleled. Since load resistor  $R_L$  is much smaller than base resistor  $R_B$ , the latter can be eliminated; most of the capacitor charging current flows through  $R_L$  anyhow.

A sawtooth voltage is obtained (Fig. 2a) by using an OR gate (composed of diodes  $CR_3$  and  $CR_4$ ) connected to each collector circuit, provided  $R_{L1} = R_{L2}$ . The waveforms obtained at key circuit points are shown in Fig. 2b.

The operating frequency,  $f$ , of this circuit can be set from 0.2 Hz to 20 kHz. The formula is

$$f = \frac{V_{cc}}{R_{L1}(C_1 + C_2)V_c + R_{L2}(C_1 + C_2)V_c}$$

with  $V_c = 1.2$  V (output voltage).

Frequency drift in the existing circuit is  $0.1\%/^{\circ}\text{C}$ . The peak output voltage depends on the diode voltage drop  $V_D$  and  $V_{CE(SAT)}$ .

*S. Hari, Special Equipment Div., LRDE, PB 5108, Bangalore 1, India.*

CIRCLE No. 311

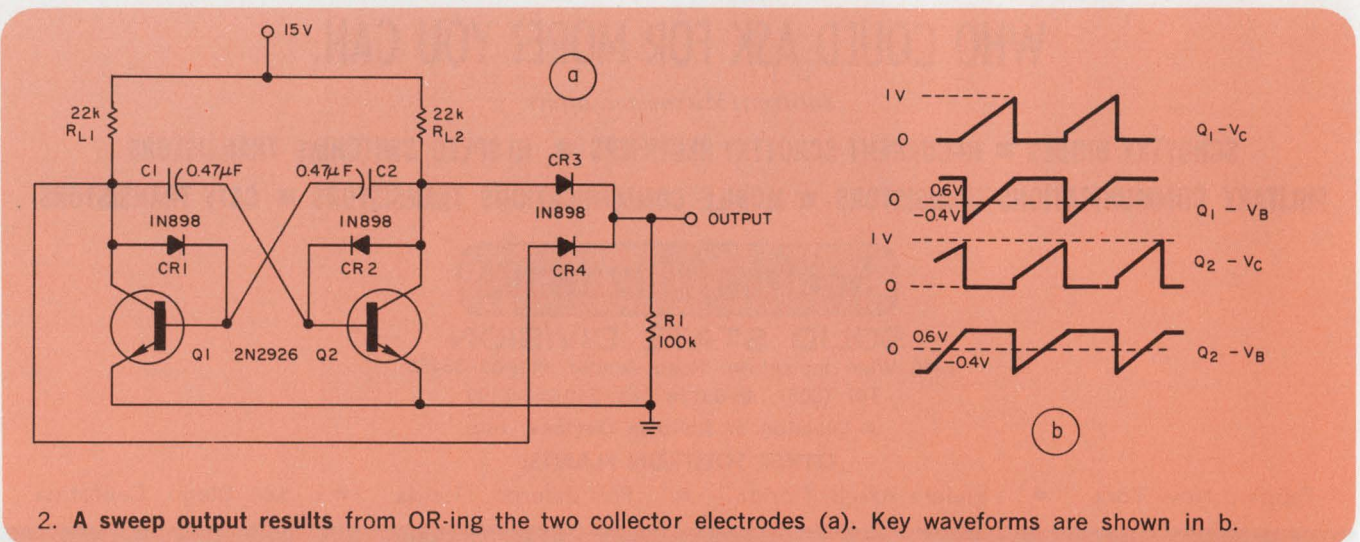
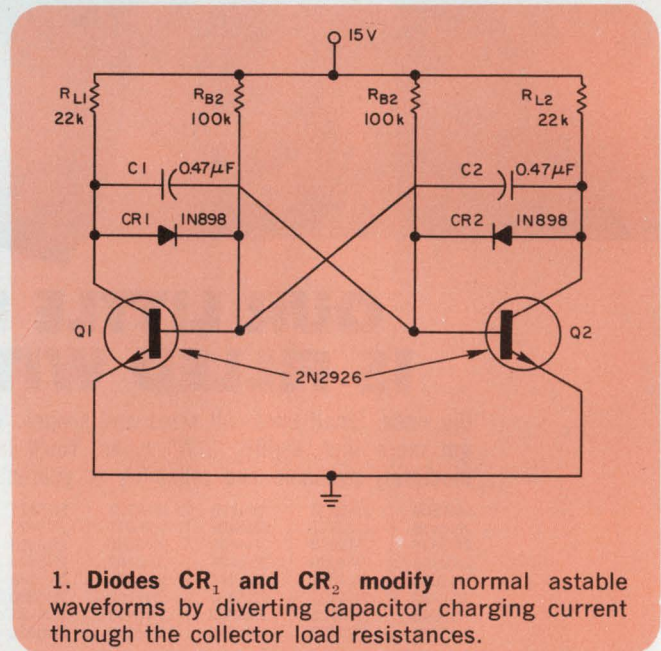



# 191 FLAVORS OF BECKMAN DIPS



All 191 flavors of RESNET™ DIPs offer system compatibility because we use the same packages you use for I.C.s; plus you get ceramic dependability at plastic prices.

Whether you're inserting resistors automatically or by hand — call your local Beckman/Helipot representative and ask how you can save money using RESNET DIPs. He stocks locally for immediate delivery.

To request technical data, call your local Beckman/Helipot representative. Or write to Beckman Instruments, Inc., Helipot Division, 2500 Harbor Blvd., Fullerton, Calif. 92634.

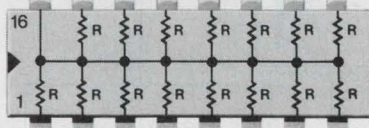

898-1 (15 resistors)  
Price (1,000-4,999) \$0.85

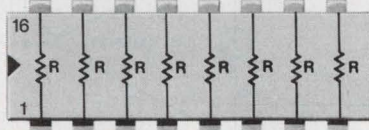

898-3 (8 resistors)  
Price (1,000-4,999) \$0.76

**STANDARD RESISTANCE VALUES**  
(±2% or ±2Ω)

62*	110	330	1.0K	2.2K	6.0K	15.0K
68	150	470	1.5K	3.3K	6.8K	22.0K
100	220	680	2.0K†	4.7K	10.0K	

\*Standard in 898-3 only.  
†Standard in 898-1 only.

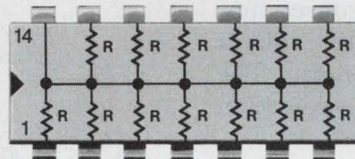

899-1 (13 resistors)  
Price (1,000-4,999) \$0.81

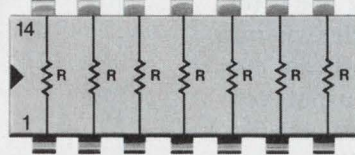

899-3 (7 resistors)  
Price (1,000-4,999) \$0.72

**STANDARD RESISTANCE VALUES**  
(±2% or ±2Ω)

22	62	180	510	1.5K	4.3K	11K
24	68	200	560	1.6K	4.7K	12K
27	75	220	620	1.8K	5.1K	13K
30	82	240	680	2.0K	5.6K	15K
33	91	270	750	2.2K	6.0K	16K
36	100	300	820	2.4K	6.2K	18K
39	110	330	910	2.7K	6.8K	20K
43	120	360	1.0K	3.0K	7.5K	22K
47	130	390	1.1K	3.3K	8.2K	
51	150	430	1.2K	3.6K	9.1K	
56	160	470	1.3K	3.9K	10K	

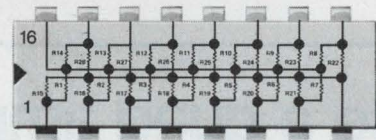

896-5-R220/330  
Pulse squaring TTL terminator.  
Price (1,000-4,999) \$1.45

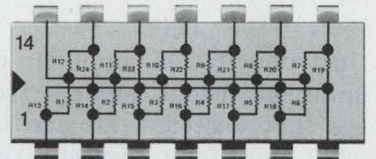

899-5-R220/330  
Pulse squaring TTL terminator.  
Price (1,000-4,999) \$1.35

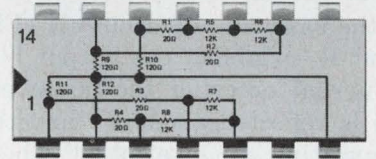

899-19  
DIP interface network providing resistors for μA711 core sense amplifier configuration.  
Price (1,000-4,999) \$1.18

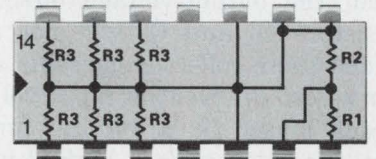

899-40  
DIP network provides six line terminators and the threshold setting divider for the Intel 3208A sense amplifier.  
Price (1,000-4,999) \$1.35

**Beckman**

HELIPOT DIVISION

INFORMATION RETRIEVAL NUMBER 29

# Join two unipolar d/a converters and get bipolar operation

By connecting two unipolar d/a converters, you can build a circuit that operates with bipolar input signals, to obtain a symmetrical bipolar output.

An input signal, biased positively by  $V_{cc}$ , serves as an input to the first multiplying converter, IC<sub>1</sub>. The resulting output current to amplifier A<sub>1</sub> is scaled according to the digital word input. The same positive bias is applied to the input of converter IC<sub>2</sub>. The resultant digitally scaled signal, I<sub>2</sub>, is then subtracted from the output of IC<sub>1</sub> via op amp A<sub>2</sub> to provide symmetrical output about zero volts. For the values shown, a  $\pm 10$ -V input will result in a  $\pm 10$ -V output for a full-scaled digital word.

Alan E. Gross, Senior Electronics Engineer, MTS Systems Corp., Box 24012, Minneapolis, Minn. 55424.

CIRCLE No. 312

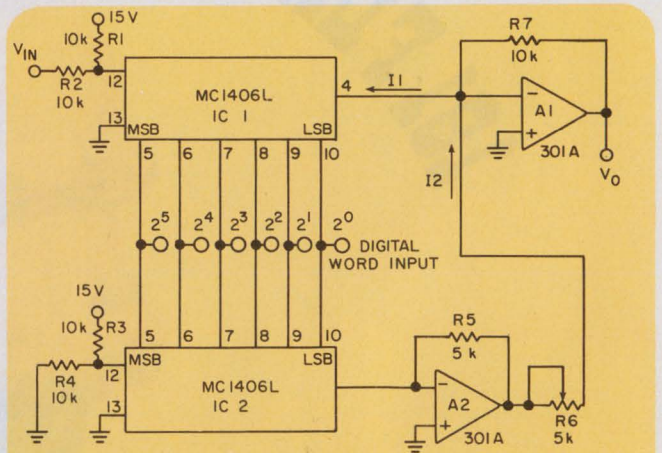

A combination of two unipolar multiplying d/a converters provides a bipolar-output scaled by the digital word input. Resistor R<sub>6</sub> should be set to equal the value of R<sub>5</sub>.

# Use a quad amplifier IC to handle transducer bridge signals

An instrumentation amplifier capable of handling millivolt bridge signals from source impedances that exceed 2 k $\Omega$  can be built with a single IC plus four discrete transistors. The circuit also features a common-mode-rejection ratio of 115 dB.

In the basic amplifier circuit (Fig. 1), resistors R<sub>2</sub> and R<sub>3</sub> establish the output bias of amplifier A<sub>1</sub>. Current entering the noninverting (+) terminal is reflected about V<sup>-</sup> and then drawn into the inverting (-) terminal. The resultant current flow through R<sub>3</sub> establishes the output voltage level. If R<sub>2</sub> = R<sub>3</sub>, with R<sub>2</sub> connected to ground, the output-voltage offset will be zero. Transistors Q<sub>1</sub> and Q<sub>2</sub> will not upset the bias, provided their collector currents are well matched for a zero differential input voltage. Q<sub>1</sub> and Q<sub>2</sub> are each biased by a 100- $\mu$ A current source to insure operation with a high  $\beta$  value and a low offset voltage.

Any differential input voltage,  $\Delta V_{IN}$ , appearing across R<sub>1</sub> causes a current change,  $\Delta I$ , given by

$$\Delta I = \Delta V_{IN} / R_1.$$

This current change appears in the collector cir-

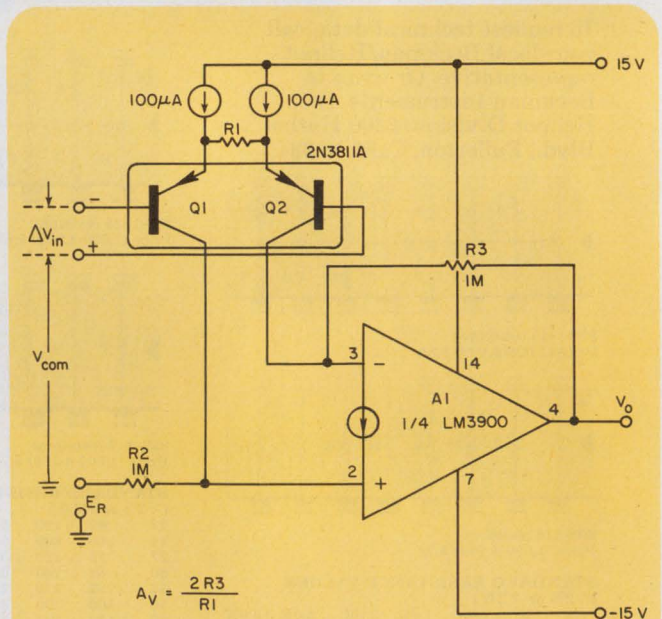

1. Basic instrumentation amplifier sums the differential collector currents of Q<sub>1</sub> and Q<sub>2</sub>, caused by incremental signal  $\Delta V_{IN}$ .

# They're doing wonderful things with MOS/LSI... today's hot technology.

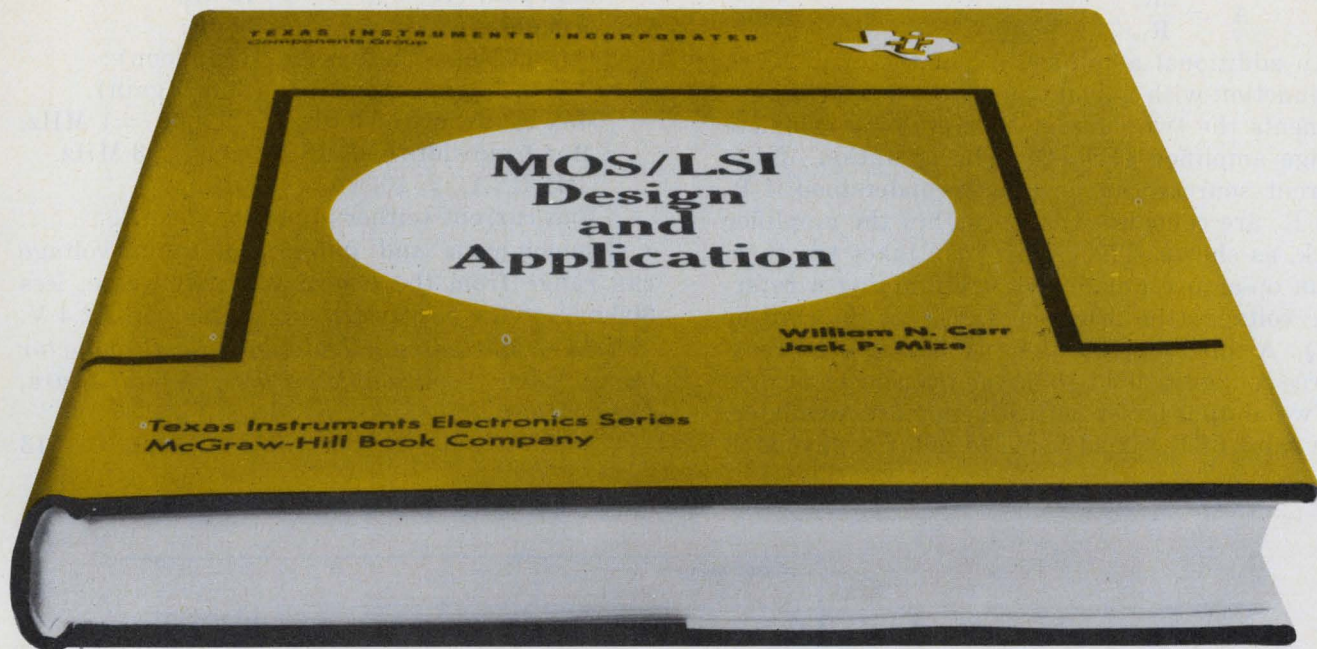

## Maybe you should know a lot more about it.

Fantastically complex circuits...like the "one-chip calculator"...with the equivalent power of tens of thousands of discrete components. Programmable logic arrays. Huge memories. New lows in system costs.

These developments, and others, are pushing MOS/LSI into design after design—and offer enormous potential for the creative engineer.

If you want to know more about MOS/LSI, from basic principles to practical system applications, then you should have a copy of "MOS/LSI Design and Application." Produced by the Texas Instruments Learning Center, and written by Dr. Jack Mize and Dr. William N. Carr of Southern Methodist University, this single volume covers MOS/LSI with concise, yet thorough information.

Among subjects discussed are: device physics • reliability • inverters • static logic • flip-flops • shift registers for data delay, logic and memory • the MOS/bipolar interface • memory applications • programmable logic arrays • analog circuitry • economics of MOS/LSI.

Practical, up-to-date and comprehensive, this book will help you (1) evaluate the usefulness of MOS/LSI in your applications, (2) weigh the advantages of its many options, and (3) plan cost-effective system designs.

Use the coupon and order your copy now. 331 pages, 270 illustrations. McGraw-Hill Book Company.

**TTL book also available.**

Here's a look from the bipolar side—the first book devoted exclusively to the transistor-transistor logic family of in-

tegrated circuits. "Designing with TTL Integrated Circuits" covers design philosophy, economics, basic descriptions, device performance, and practical applications in digital systems. Order below. 322 pages. 399 illustrations. McGraw-Hill Book Company.



.....

To: **Texas Instruments Learning Center**  
P. O. Box 3640, Dallas, Texas 75221

**Please send:**

"MOS/LSI Design and Applications". Price — \$18.50.

"Designing with TTL Integrated Circuits". Price — \$18.50.

Enclosed is check or money order for \$ \_\_\_\_\_.

Name \_\_\_\_\_

Street \_\_\_\_\_

City \_\_\_\_\_

State \_\_\_\_\_ Zip \_\_\_\_\_ ED

.....

11211

**TEXAS INSTRUMENTS**  
INCORPORATED

INFORMATION RETRIEVAL NUMBER 30

cuits of  $Q_1$  and  $Q_2$  with reversed polarity. As before,  $\Delta I_{Q1}$  is drawn into the inverting terminal of  $A_1$ , where it is added algebraically to  $\Delta I_{Q2}$  to cause a total incremental current of  $2 \Delta I$  through  $R_3$ . Therefore

$$\Delta V_o = 2 \Delta I \cdot R_3 = 2 \frac{R_3}{R_1} \Delta V_{in},$$

or 
$$A_v = \frac{2R_3}{R_1}.$$

An additional amplifier,  $A_2$ , of the quad IC in conjunction with a dual transistor,  $Q_3$  and  $Q_4$ , implements the two current sources for a complete bridge amplifier (Fig. 2). The operation of the current sources can be readily understood if  $R_4$  and  $R_5$  are considered to be within the amplifier block, as shown. The circuit then takes the form of an op-amp regulator for maintaining a reference voltage (the drop across  $R_6$ ) at the emitter of  $Q_1$ . A third amplifier,  $A_3$ , is used in a current-source configuration to bias the transducer bridge.

Two output-offset adjustments are available. The value of  $R_{12}$  is adjusted to null the mismatch

in the collector currents of  $Q_3$  and  $Q_4$ . Mismatch in the  $V_{BE}$  of  $Q_1$  and  $Q_2$  is nulled by adjusting  $E_R$  or  $R_2$ , or both. Since both adjustments interact, several trials will be required for best results.

Typical performance characteristics for the circuit include:

Max gain ( $R_1 = 0$ ) = + 72 dB.

Min gain ( $R_1 = \infty$ ) = -34 dB.

Output Noise =  $12mV_{rms}$  (open loop) ;  
 $3mV_{rms}$  (66-dB gain).

Max bandwidth (-3 dB,  $A_v = 1000$ ) = 1 MHz.

Max bandwidth (-3 dB,  $A_v = 1$ ) = 3 MHz.

CMRR ( $A_{vs} = 1000$ ) = 115 dB.

Bias current (either input) = 200 nA.

Common-mode and differential input voltage can range from the negative supply value, less 300 mV, to the positive supply voltage, less 2.4 V.

Helge Mortensen, National Semiconductor Corp., 2900 Semiconductor Dr., Santa Clara, Calif. 95051.

CIRCLE NO. 313

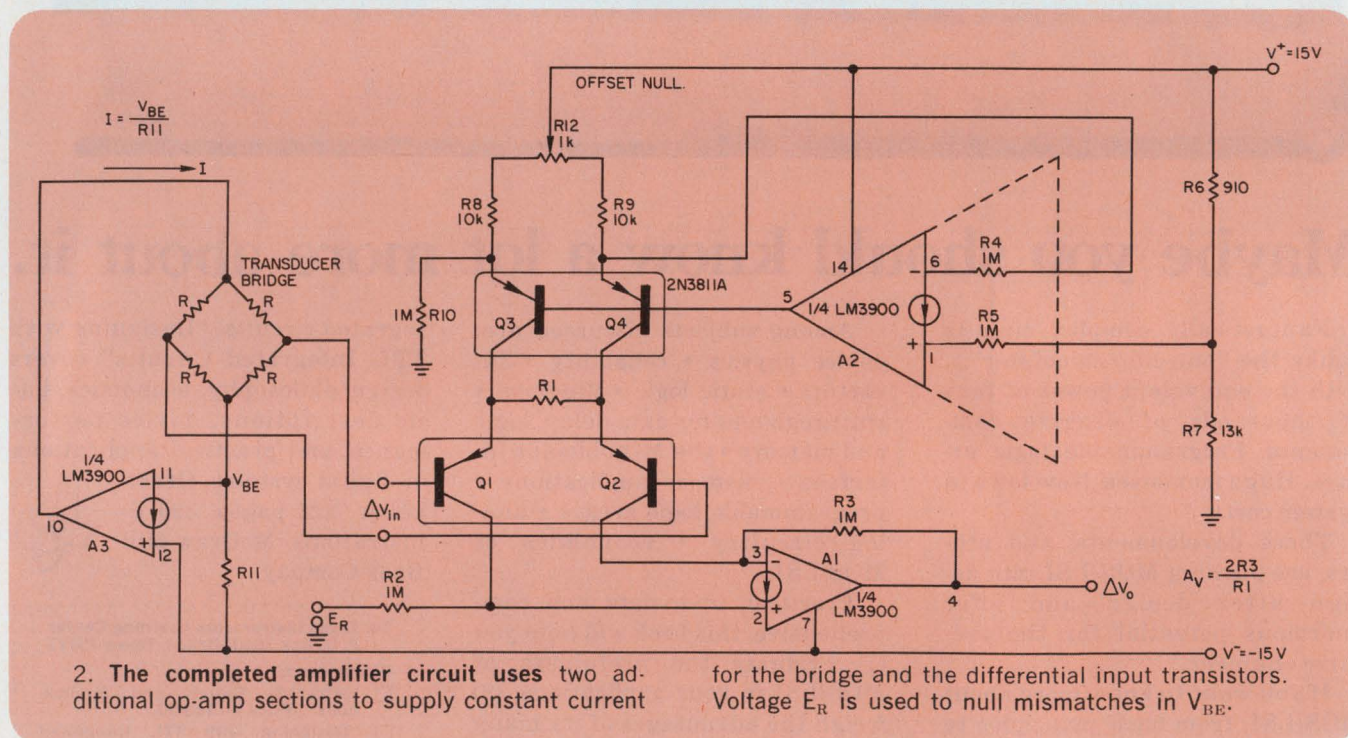

**IFD Winner of September 28, 1972 David G. Larsen**, Instructor, Virginia Polytechnic Institute and State University, Dept. of Chemistry, Blacksburg, Va. 24061. His idea "Triangle-wave generator keeps slopes constant as amplitude changes" has been voted the Most Valuable of Issue Award.

**Vote for the Best Idea in this issue** by circling the number for your selection on the Information Retrieval Card at the back of this issue.

**SEND US YOUR IDEAS FOR DESIGN.** You may win a grand total of \$1050 (cash)! Here's how. Submit your IFD describing a new or important circuit or design technique, the clever use of new component or test equipment, packaging tips, cost-saving ideas to our Ideas for Design editor. Ideas can only be considered for publication if they are submitted exclusively to ELECTRONIC DESIGN. You will receive \$20 for each published idea, \$30 more if it is voted best of issue by our readers. The best-of-issue winners become eligible for the Idea of the Year award of \$1000.

**If you've flown on  
a 747, you've  
enjoyed our  
work.**



When you take the most creative engineering and production people you can find . . . People who grew up in semiconductor technology . . . Develop the best thick-film operation in the industry . . . Complete with such refinements as in-house computer-controlled laser resistor trimming . . . And construct a large volume production capability . . . And offer complete custom services . . . and more . . . you have

Know that nifty entertainment system at your fingertips on the 747 and L1011? Nine channels of music, the movie audio, and stewardess call, etc? In the heart of that system is a sweet little hybrid device built by The Hybrid Professionals at Integrated Microsystems Incorporated. It permits all that information to be multiplexed across one pair of wires. Saves miles of wire, lots of weight, and a significant amount of money. Please think of us on your next flight. There must be something we can hybridize for you.

We also have a line of MOS clock drivers and hybrid building blocks for modems and active filters. Write for data.

**INTEGRATED**  
**MICROSYSTEMS**  
**INCORPORATED**



16845 Hicks Road  
Los Gatos, California 95030  
(408) 268-2410

**THE**  
**HYBRID**  
**PROFESSIONALS**

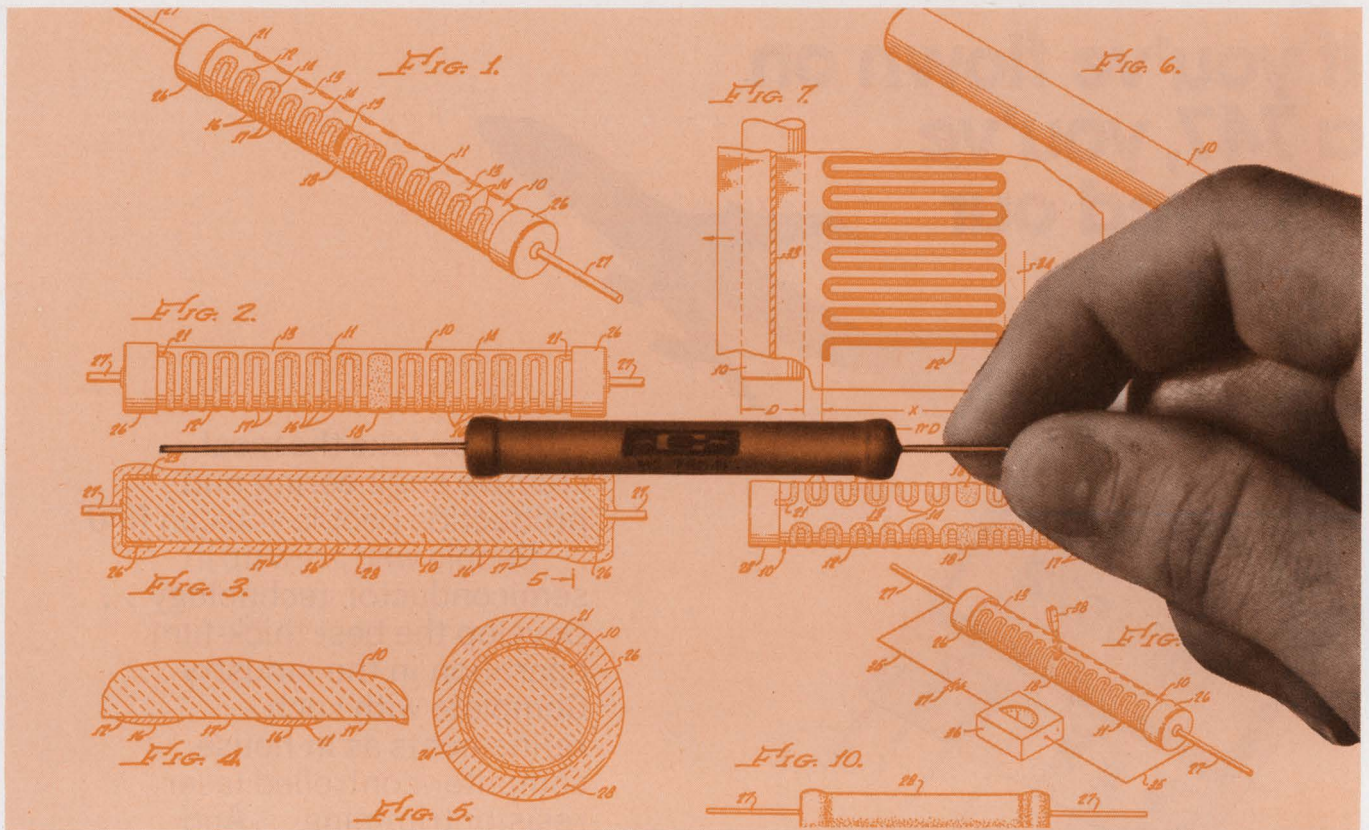

# The new reference point in Non-Inductive Resistors

In the search for a perfectly non-inductive axial-lead resistor Caddock has just taken a giant step forward.

We have developed and perfected a truly non-inductive resistance-only device, built in the rugged and reliable axial-lead configuration, about as inductive as a straight piece of wire the length of the resistor body.

The finished part looks just like any conventional axial-lead resistor, but that's where the resemblance ends. We took the classic non-inductive serpentine resistance pattern and literally wrapped it around a ceramic core (Patents Pending). The serpentine resistance pattern—by far the most efficient non-inductive configura-

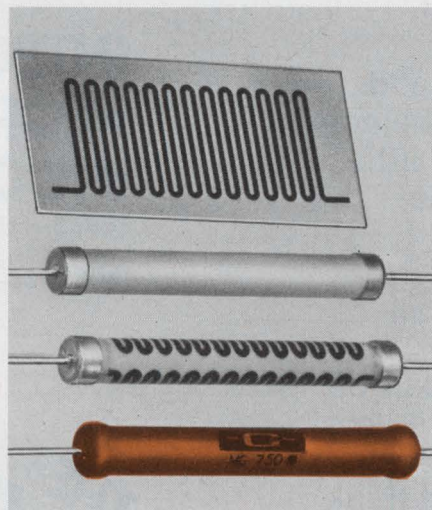

tion—is now available in precision axial-lead film resistors without sacrificing power ratings, resistance ranges, or performance characteristics. Available in a wide range of sizes—up to 15 watts and

up to 2000 megohms, and in tolerances from 1% to .1%.

These non-inductive resistors pay off in delivering the fastest possible settling time for critical fast response applications. Yet, because this unique design is produced in standard catalog items, costs are competitive with conventional resistors.

If you want a free evaluation sample, write to us on your company letterhead. For complete specifications, and application information, circle the Reader Service Number below.

**CADDOCK**   
**ELECTRONICS**

3127 Chicago Ave., Riverside, CA 92507  
Tel: (714) 683-5361 • TWX: 910-332-6108

**In film resistors, a new dimension**

## new products

# Custom LX displays for small-quantity needs

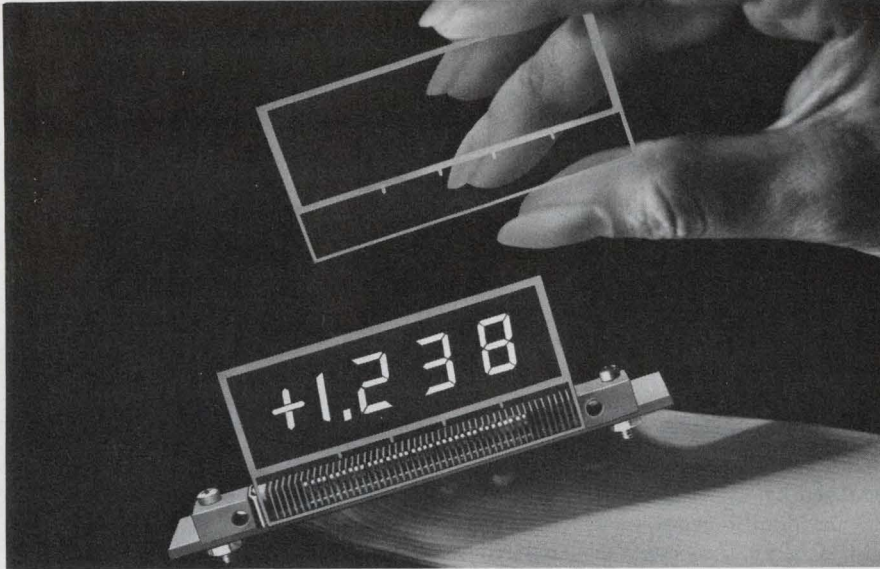

*Industrial Electronic Engineers, Inc., 7740 Lemona Ave., Van Nuys, Calif. 91405. (213) 787-0311. P&A: See text.*

It's no longer necessary to swallow a stiff tooling charge when buying relatively small quantities of custom-pattern liquid-crystal readouts. Industrial Electronic Engineers will produce as few as 5000 transmissive or reflective displays at \$8 per display. And since it's possible to have as many as six numeric digits in a display (though they'd be small), the cost per digit would be as low as \$1.33.

There are several limits to the possible designs. The width of the glass is 2.75 inches, and the display width may not exceed 2 inches. Character height must be no more than 0.628 inches. Stroke width must be at least 40 mils (except for special symbols like V, A and  $\Omega$ , which can use thinner strokes). And the number of external connections cannot exceed 50. That limit is imposed by a matching edge connector with 50 contacts on 50-mil centers, available from IEE at \$2 in quantities of 5000.

Within these limits, an engineer can design almost any character with almost any font, width, height and spacing. He can get first sam-

ples of his custom design in 45 to 60 days, then 5000 units within 90 additional days.

Evaluation samples of a standard LX readout, either transmissive or reflective, are available off the shelf at \$19.95, with a matching 50-contact connector at \$3.

The standard display has 3-1/2 seven-segment digits and a  $\pm$  sign. There are four decimal points and an additional point above the center decimal to form a colon, allowing the unit to serve as a clock or instrument display.

Like most liquid-crystal displays, these consume almost no power—a maximum of 20  $\mu$ W per segment with 40-V pk-pk drive—though, of course, additional power is required for a light source with transmissive displays. Operating voltage can range from 10 to 40 V at 40 to 100 Hz.

With 40-V drive, the rise time (at 20 ms) and decay time (at 70 to 100 ms) are rather fast for a liquid-crystal display, which is commonly rather sluggish. Contrast ratio is at least 15:1, and life expectancy, with 24-V drive at 25 C, is 10,000 hours. The operating temperature is 5 to 55 C, and the device can be stored safely at -10 to 70 C.

CIRCLE NO. 250

## LED lights up in two colors

*Monsanto Commercial Products Co., 10131 Bubb Rd., Cupertino, Calif. 95014. (408) 257-2140.*

A new series of LEDs with two chips in one epoxy header can provide two colors within the one unit by using alternate polarities of dc current. The MV5094 contains two red LED chips and the MV5491, a red and a green chip. Other options are available on factory order. The two diode chips are mounted so that one diode is lit when current flows in one direction and the other diode is lit when the current is reversed. Therefore with the red/red device, a constant red indication results when an ac current flows. Specifications for the MV5094 are typically 1.5 mcd light output at 20 mA and 1.65 V forward voltage. The green diode delivers 0.5 mcd at 20 mA and 2.3 V.

CIRCLE NO. 251

## PC transformers cover wide range of specs

*ADC Products, Inc., 4900 W. 78th St., Minneapolis, Minn. 55435. (612) 929-7881.*

The Lady Bug is ADC's new line of commercial-grade PC transformers. Four case sizes, 46 electrical configurations and a 50 mW to 2 W range of power rating are offered. They operate to 85 C ambient, withstand storage to -40 C and a soldering heat to 260 C for 5 s.

CIRCLE NO. 252

## Neon lamp flashes 20 times brighter

*Glowlite Corp., subsidiary of EL-Tronics, Inc., P.O. Box 698, Pauls Valley, Okla. 73075. (405) 238-5541.*

Glowlite claims 20 times more brightness from its new neon flasher lamp than from any conventional neon lamp. The lamp was originally designed to provide a flashing visual indication in sonar devices. It operates at 1200 V dc and provides an average life of 5000 hr when limited to a 20% duty cycle and 5 mA current.

CIRCLE NO. 253

## Thermal problems?

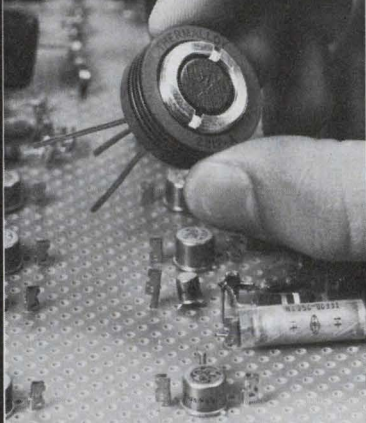

# Mini Sinks<sup>®</sup>

from  
**Thermalloy**

Thermalloy has in stock for immediate delivery, many types of low power Mini-Sinks for printed circuit boards designed to solve your thermal dissipation problems:

- Over 100 standard catalog items for TO-5, TO-66, TO-3, etc.
- Pre-engineered for thermal efficiency
- Low cost from high volume production

Thermalloy's broad line of standard production items and complete staff of skilled thermal engineers assure you quick economical solutions to all your thermal problems.



SEND FOR  
FREE  
CATALOG

**Thermalloy**

P. O. Box 34829  
2019 W. Valley View  
Dallas, Texas 75234  
Phone: 214/243-4321  
TWX: 910/860-5542

## COMPONENTS

### Component oven keeps heat to $\pm 0.0005$ C/ $^{\circ}$ C

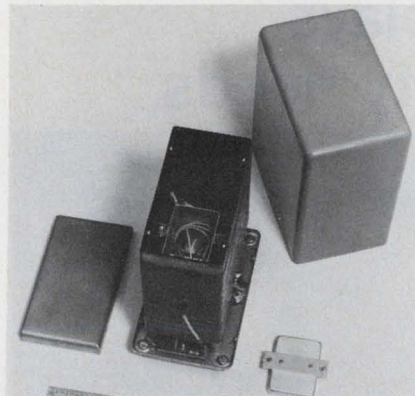

Oven Industries, Inc., 1106 E. Simpson Rd., Mechanicsburg, Pa. 17055. (717) 766-0721.

Oven Industries' Model 3269 component oven provides a temperature stability of  $\pm 0.0005$  C/ $^{\circ}$ C of ambient change. This stability is attained by using a dual-cavity and proportionally controlled regulators. Highly temperature sensitive components can be stabilized in this environment. The outer cavity is maintained at  $\pm 0.05$  C/ $^{\circ}$ C and provides approximately 5 in.<sup>3</sup> of volume for components. Over 3.5 in.<sup>3</sup> of volume is available in the inner cavity.

CIRCLE NO. 254

### Sensor detects objects with reflected infrared

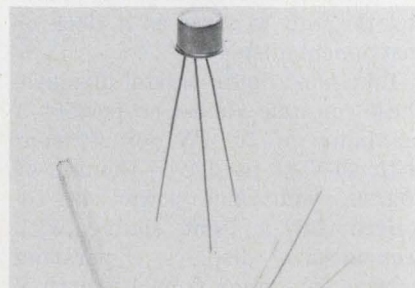

Kolt Engineering, P.O. Box 1172, Los Gatos, Calif. 95030. (408) 356-7244. \$50 (10-24).

Model IR-40 is a sensing device that emits infrared light and detects reflective objects in the light path. The output voltage is easily adjusted, with a small number of external components, to drive TTL or DTL logic, relays or solenoids. The unit operates from a 5-V power supply.

CIRCLE NO. 255

### Precision potentiometer saves space and money

Bourns, Inc., 1200 Columbia Ave., Riverside, Calif. 92507. (714) 684-1700. \$3.97 (1000-1999).

Bourns' new 3/4-in. long, wire-wound precision potentiometer, Model 3540, provides 10-turns with 0.25% linearity, a -55 to +125 C temperature range, a power rating of 2 W, an over-all tolerance of  $\pm 5\%$  and a range of 100 to 100,000  $\Omega$ . Rotational life is 1,000,000 revolutions.

CIRCLE NO. 256

### Molded inductances have wide range of values

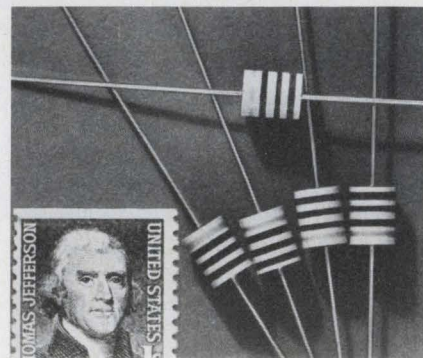

Cambridge Thermionic Corp., 445 Concord Ave., Cambridge, Mass. 02138. (617) 491-5400. Stock.

A wide range of inductances is covered by Cambion's new molded choke family with units from 0.10 to 100,000  $\mu$ H. The series designated as Part Number 551-7109, offers 73 inductance values. They have radial-leads and their dimensions are 0.25 D  $\times$  0.30 L in.

CIRCLE NO. 257

### Instrument brake unit holds by spring action

Simplatrol Products Div., Form-sprag Co., 133 Southbridge St., Auburn, Mass. 01501. (617) 798-0021.

Simplatrol's SAB-43 spring applied brake is designed for applications such as in tape transports. The brake's coil is energized to release the stopping torque. The rated torque is 7 lb-in. and the unit is less than 2 in. diameter by 1-3/8 in. long. Available bores are 1/4, 3/8 and 1/2 in. diameter.

CIRCLE NO. 258



# Godzilla Meets The Linear Monster

Godzilla, alias Bob Widlar, is the well known king of the linear IC underworld. Teledyne, on the other hand, is known as the semiconductor and IC producer of monstrous proportions. We compete in just about all areas of IC's. When we started out to do battle in the linear market, we came up against Godzilla's forces; the 101, 101A, 105, 107, 108, 108A, etc. Now that's a formidable line. You see, Teledyne, though big, is friendly. To oppose such a line would be contrary to our normal cordial, compatible, helpful

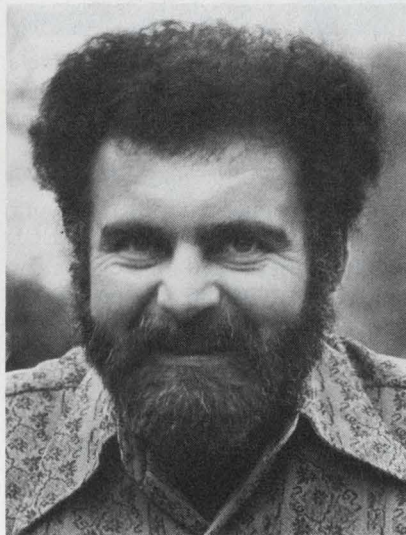
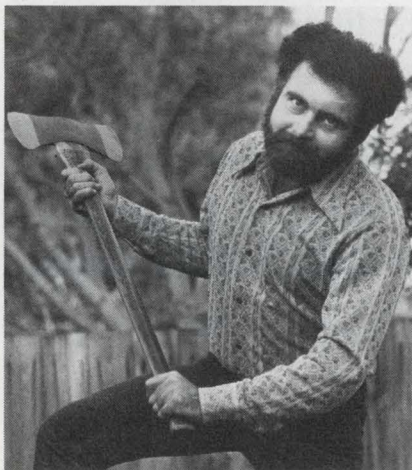

nature. So the only thing to do is join Godzilla's forces. After all, Teledyne can do it in a very big way.

Now, here's the line-up and we're ready to take on all comers:

- 101 Operational Amplifier
- 101A Operational Amplifier
- 105 Positive Voltage Regulator
- 107A Operational Amplifier
- 108 Operational Amplifier
- 108A Operational Amplifier

Just to prove how friendly we really are, we'll give you **absolutely free** one of the above (1 only) IC's . . . plus a signed picture post card of Godzilla . . . if you send us a note on your company letterhead and tell us why you want one free.

**Note:** Bob Widlar; inventor of the 709, 101, 105, and 108; does not work for Teledyne Semiconductor. Bob Widlar does not work.

**I'll drink to that!**

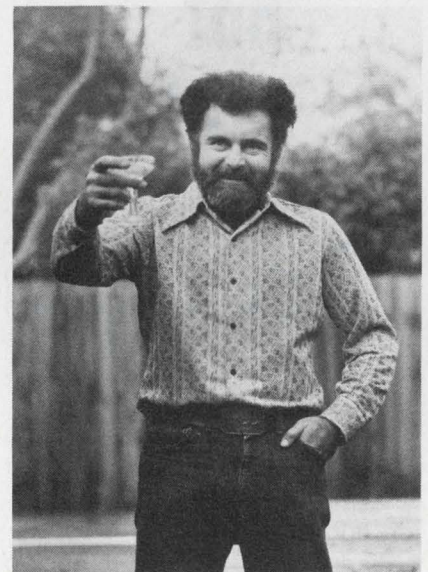

## the challenger

# TELEDYNE SEMICONDUCTOR

1300 Terra Bella Avenue Mountain View, California 94040 (415) 968-9241 TWX: 910-379-6494 Telex: 34-8416



## hot stuff

or cold, CHR's family of TEMP-R-TAPE of Kapton provides outstanding endurance. They retain their excellent mechanical and electrical properties over a wide temperature range,  $-100$  to  $+500^{\circ}\text{F}$ .

Available in thicknesses from .001" to .0045" with a choice of several adhesive systems including adhesive two sides.

Find your CHR distributor in the Yellow Pages under "Tapes, Industrial" or in industrial directories. Or write for complete specification kit and sample. The Connecticut Hard Rubber Company, New Haven, Conn. 06509.



a HITCO company

INFORMATION RETRIEVAL NUMBER 35

### ICs & SEMICONDUCTORS

## First MECL 10 k memory—a 64-bit RAM

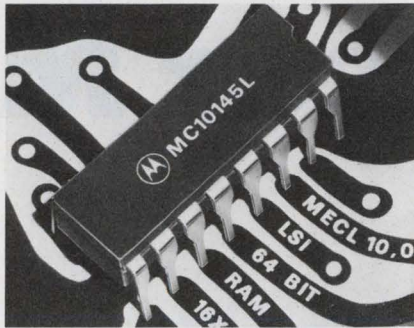

Motorola Semiconductor Products Inc., P.O. Box 20912, Phoenix, Ariz. 85036. (602) 273-3466. \$24 (100 up).

A 64-bit fully address-decoded memory becomes the first memory introduced in the company's MECL 10,000 high speed logic family. Called the MC10145, the new RAM is organized in a 16-word by a four-bit format. Stored-data access time (address-to-output) is 10 ns typical. Read/write cycle time is typically 17.5 ns. Power consumption is only 600 mW per package, typical.

CIRCLE NO. 259

## 4 k-bit static ROM converts codes

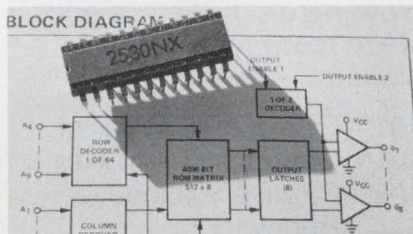

Signetics, 811 E. Arques Ave., Sunnyvale, Calif. 94086. (408) 739-7700. \$16 (100 up); stock.

A 4096-bit static MOS ROM comes with a  $512 \times 8$  organization for microprogramming and code conversion applications. Called the Model 2530, the device has TTL compatible inputs and outputs and requires  $+5$  and  $-12$  V power supplies. Three-state outputs allow OR-tying for implementing larger memories. Two OUTPUT ENABLE lines control the eight output devices without affecting address circuitry. Typical access time is 450 ns.

INQUIRE DIRECT

## MSI chip functions as core memory driver

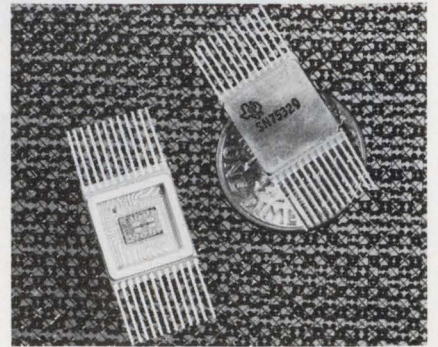

Texas Instruments Inc., P.O. Box 5012, M/S 308, Dallas, Tex. 75222. (214) 238-3741. \$50.50 (100 up); stock.

The SN55329W, an MSI TTL eight-channel memory driver, can be used with linear select magnetic core memory systems and in high-speed military memory systems. This IC contains eight decoded bipolar, tri-state, high current drivers with  $\pm 400$  mA output current capability, a three-line to eight-line decoder; power control, source/sink selection logic and timing.

CIRCLE NO. 260

## Glass passivated rectifier rated at 3 A

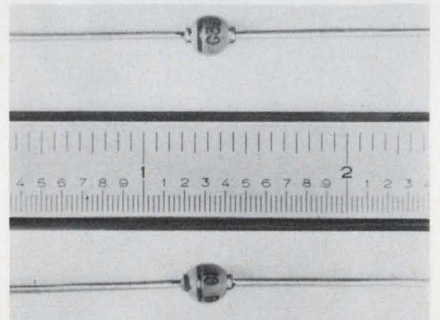

General Instrument Corp., Semiconductor Components Div., 600 W. John St., Hicksville, N.Y. 11802. (516) 733-3234. 39¢ (100 up).

The G3 series of silicon rectifiers list ratings of 1000 V and 3 A. Packaged with the manufacturer's Glass Amp II Glass Passivated construction, the device's 3.0-A forward current rating is at 70 C with a maximum forward voltage drop of 1.0 V. Single cycle surge (JEDEC method) is 125 A. The series can be obtained with reverse voltage ratings of 50 through 1000 V.

CIRCLE NO. 261

tomorrow is  
on our side.

cmos...

FROM SOLID STATE SCIENTIFIC

Four years ago, we made a commitment to the future—developed an organization and delved into a complex and embryonic technology.

And when tomorrow suddenly became today—SOLID STATE was already there. CMOS is the logic of the seventies . . . and SOLID STATE has emerged a leader, a company that can provide innovative, progressive thinking and the products to prove it.

Today SOLID STATE'S CMOS is the power and precision behind the first electronic digital clock to appear on the dashboard of an American car and the first electronic analog clocks in England's and Germany's finest. CMOS because of its noise immunity, minimal power requirement and consistent, reliable operation over a wide voltage and temperature range—SOLID STATE because of technical leadership, fast turn-around and our track record. And we're going to keep going . . . new ideas, new applications, so you can face tomorrow—on our side.

SOLID STATE SCIENTIFIC, INC.

Montgomeryville, Pa. 18936 • (215) 855-8400 • TWX-510-661-7269



INFORMATION RETRIEVAL NUMBER 36

1973 Our 23rd Year  
From LAFAYETTE  
World Leader in 2 and 4-Channel  
Hi-Fidelity Equipment  
The Fabulous LP-4000

TODAY'S  
Most Sophisticated  
4-Channel SQ Hi-Fi Receiver

STORES FROM COAST-TO-COAST

LAFAYETTE  
RADIO ELECTRONICS  
2007 Center and Radio City

**FREE**

The World's Largest  
Consumer  
Electronics Catalog

• Stereo/Hi-Fi Components • Musical Instruments and Amplifiers • CB & Ham Equipment • Tools and Test Equipment • Police and Fire Monitor Receivers • Public Address Systems • Photography Equipment • Semiconductors, Books, Parts • Plus Much More!

Send me the **FREE** LAFAYETTE Catalog

Lafayette Radio Electronics Dept. 45023  
P.O. Box 10, Syosset, L.I., N.Y. 11791

Send Me the Free Lafayette Catalog **45023**

NAME \_\_\_\_\_

ADDRESS \_\_\_\_\_

CITY \_\_\_\_\_

STATE \_\_\_\_\_ ZIP \_\_\_\_\_

(Please include your zip code)

INFORMATION RETRIEVAL NUMBER 37

ELECTRONIC DESIGN 3, February 1, 1973

Newest  
Idea in film  
capacitors!

POLYPROPYLENE  
MICROMATIC®  
CAPACITOR\* . . .  
Self-encased . . .  
wound on its own  
leads . . . no separate  
lead attachment.

The Polypropylene Micromatic, another capacitor first from ITW Paktron. Here's a capacitor truly designed for highly automated production. Close capacitance tolerance:  $\pm 1\%$  to  $\pm 20\%$ . Capacitance value range 100pf to 0.15mfd., 200 and 400 volts. Completely self-encased and wound on its own leads. No outside wrapping, no separate lead attachment needed. High insulation resistance. Low dissipation factor and negative temperature coefficient. Ideal for PC board insertion, replaces polystyrene capacitors in frequency discriminating circuits. Also available in polyester dielectrics. For samples and data, phone or write: Paktron, Division Illinois Tool Works Inc., 1321 Leslie Avenue, Alexandria, Va. 22301. Phone (703) 548-4400. TWX 710-832-9811.

ITW PAKTRON

\* Patent No. 3638086  
Other Patents Pending

The Electronic Group of ITW...PAKTRON • LICON • ELECTRO MATERIALS • CHROMOMATIC

© Illinois Tool Works Inc. 1973

INFORMATION RETRIEVAL NUMBER 38

# innovation yesterday

*M. Hunt.*

*Pin.*

*N<sup>o</sup> 6281. Patented July 10, 1949*

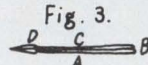
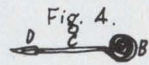
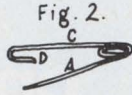
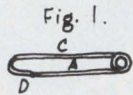

# innovation today



## ECONOMY 'SNAP-IN' THUMBWHEEL Series 25000

The safety pin was a clever idea. It was quick. It was economical, efficient and innovative. Our new "Snap-In" switch is quick, economical and efficient too. And while it won't be found in every household, it won't take people in our business very long to see the advantages. Stamp a rectangular hole in any standard panel and snap in a Thumbwheel switch. Or a row of switches. No end flanges. No mounting holes. And no screws. So, ask about our Series 25000. Ask about the multitude of codes available. Ask about the price. Ask for our new catalog sheet. We think those are great ideas too.

THE **DIGITRAN** COMPANY  
A Division of Becton, Dickinson and Co. **B-D**  
855 So. Arroyo Parkway, Pasadena, Ca. 91105  
Tel. (213) 449-3110 • TWX 910-588-3794

## ICs & SEMICONDUCTORS

### Counter circuits join ECL 10-k line

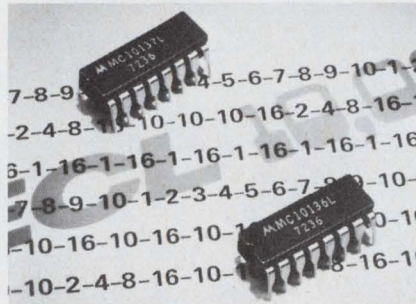

Motorola Semiconductor Products Inc., P.O. Box 20924, Phoenix, Ariz. 85036. (602) 273-3466. MC-10136L and MC10137L: \$14.23 (100 up).

Two IC counters extend the company's MECL 10,000 logic line. One device, the MC10136, is a universal hexadecimal up/down (0 to 15 binary) counter; the other, MC10137, is a universal BCD decade up/down counter. Either can count at rates over 100 MHz (typically 150 MHz). Both units are high-speed synchronous counters.

CIRCLE NO. 262

### Hybrid regulators spec'd at 5 A

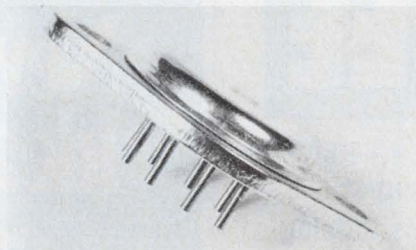

Solitron Devices, Inc., 1177 Blue Heron Blvd., Riviera Beach, Fla. 33404. (305) 848-4311. \$13.49 (100 up); stock.

A dc voltage regulator series lists current ratings of 5 A. Termed CJCA000, the series has three hybrid circuits each for both positive and negative applications. The line features regulation of 0.5% maximum and 0.05% typical at no load to 1.0 A load. Output voltage range is 8 to 50 V with maximum output current of 5.0 A. The family has 40 W dissipation at 25 C case temperature and a temperature coefficient of less than  $\pm 0.02\%/^{\circ}\text{C}$  maximum and  $\pm 0.005\%/^{\circ}\text{C}$  typical.

CIRCLE NO. 263

### 2-k pROM programs in two minutes

Intel Corp., 3065 Bowers Ave., Santa Clara, Calif. 95051. (408) 246-7501. \$45 (100-999); stock.

The 1602A/1702A MOS memory, a 2048-bit programmable read-only device, can be programmed in only two minutes, or about 10 times faster than earlier versions. The two new versions of the memory are an erasable and reprogrammable model (C1702A) and a programmable model (C1602A). Actually, the two models are identical except for packaging. The C1702A is packaged with a quartz lid while the C1602A has a metal lid. Only the former can be erased with UV light.

CIRCLE NO. 264

### Darlington's list betas of 3 k at 10 A

Kertron Inc., 7516 Central Industrial Dr., Riviera Beach, Fla. 33404. (305) 848-9606. \$6 to \$46 (100-999); 4-6 wks.

A line of high-gain Darlington amplifier devices are available with betas as high as 3000 at 10 A and maximum current ratings of 20 A. The maximum breakdown voltage is 150 to 200 V. The units are available in TO-3, TO-66, TO-61 and TO-63 packages and have maximum power dissipation at 25 C of 100 W to 180 W, depending on package.

CIRCLE NO. 265

### 430-A SCR turns off in 10 $\mu\text{s}$

International Rectifier Corp., Semiconductor Div., 233 Kansas St., El Segundo, Calif. 90245. (213) 678-6281.

A 430-A rms stud-package inverter SCR features 10  $\mu\text{s}$  maximum turn-off time for reportedly the fastest turn-off time for a device of this type. Called the 275 RF, the SCR has forward and reverse voltage ratings from 50 to 600 V and features a maximum peak one cycle nonrepetitive surge current rating of 7000; maximum  $I^2t$  rating is 200,000 A<sup>2</sup> sec.

CIRCLE NO. 266

BEAUTY AND  
CRAFTSMANSHIP...

# The Trimline Series

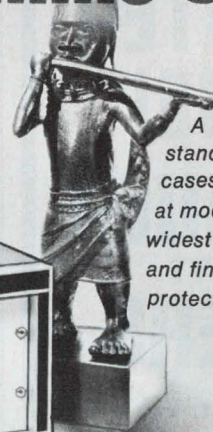
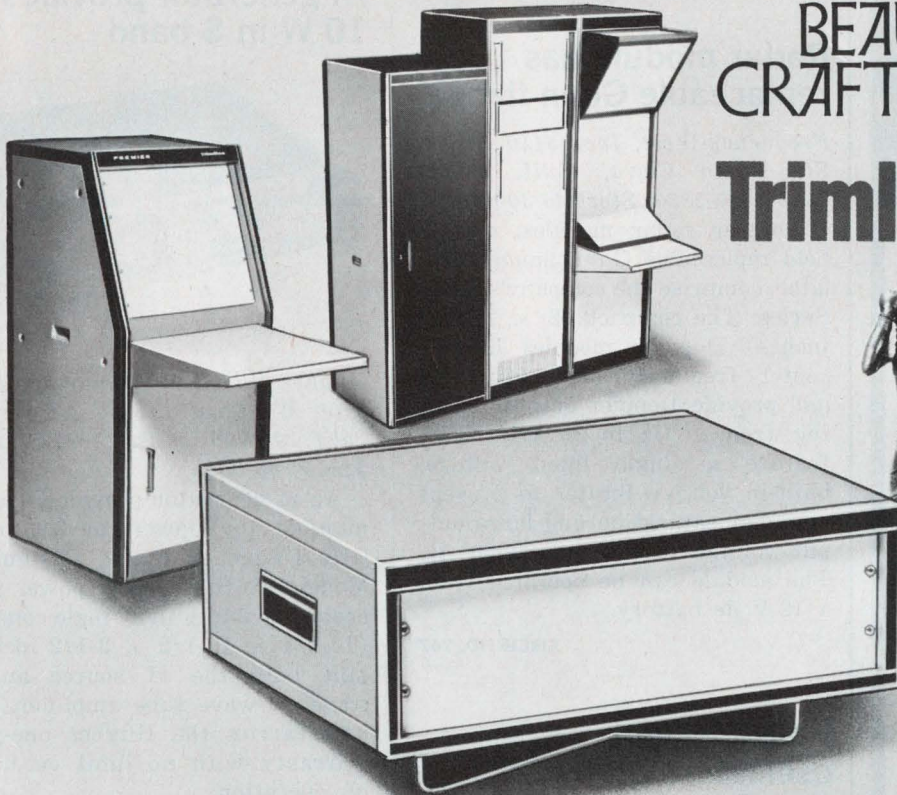

A distinctive line of  
standard enclosures and  
cases, available  
at moderate cost, in the  
widest range of sizes, colors  
and finishes to enhance and  
protect your product.



Complete catalog  
and prices on request.

## PREMIER METAL PRODUCTS COMPANY

A Division of Sunshine Mining Company

337 Manida Street, Bronx, New York 10474 (212) 991-6600

OVER 1,200 ITEMS IN OUR GENERAL CATALOG

INFORMATION RETRIEVAL NUMBER 40



## TWO *New* SCRs from NATIONAL ELECTRONICS featuring

- Patented Regenerative Gate
- High di/dt with low power gate drive

**F-390** 850 A RMS, 500-1300 V. DC motor control and power supplies.

**F-395** 700 A RMS, 100-600V. Fast switching, high frequency for inverter use.



**NATIONAL ELECTRONICS**

a varian division  
geneva, illinois 60134 (312) 232-4300

INFORMATION RETRIEVAL NUMBER 41

ELECTRONIC DESIGN 3, February 1, 1973

## SWITCH/INDICATORS

### UL APPROVED!

100 ma, 5 or 15 amp, alternate or momentary action switches mount on centers as close as  $\frac{1}{32}$ " (15 amp,  $\frac{3}{32}$ "). Minimum life, 100,000 cycles.

Independent, isolated incandescent, neon or LED lamp for indicator. Switch contact rating: 100 ma @ 28 VDC; 5 or 15 amps at 115 VAC, 60 Hz or 28 VDC resistive. Priced as low as \$3.60 in quantities of 100-499.

For more information on UL rated switches — on our complete line of display/control products — write: **TEC, Incorporated**, 9800 N. Oracle Road, Tucson, Arizona 85704. (602) 297-1111.



INFORMATION RETRIEVAL NUMBER 42

# NEW SHORTER CASE! SCHAUER 1-WATT ZENERS



**SAME LOW PRICES FOR  
1% TOLERANCE ZENERS  
ANY VOLTAGE  
FROM 2.0 TO 18.0**

Quantity	Price Each
1-99	\$1.07
100-499	.97
500-999	.91
1000-4999	.86
5000 up	.82

**IMMEDIATE SHIPMENT**  
Send for rating data and  
20%, 10%, 5% and 2%  
tolerance prices.

Semiconductor Division

## SCHAUER

MANUFACTURING CORP.

4511 Alpine Ave., Cincinnati, Ohio 45242  
Telephone 513/791-3030

INFORMATION RETRIEVAL NUMBER 43

## MICROWAVES & LASERS

### Radar module has replaceable Gunn flange

*Frequency-West, Inc., 3140 Alfred St., Santa Clara, Calif. 95050. (408) 249-2850. Stock to 30 days.*

Doppler radar modules, with a field replaceable Gunn flange oscillator, comprise the company's DMX Series. The compact (2 × 2 × 3 inches) Doppler modules have a center frequency of 10.525 GHz and provide Doppler outputs ranging from 3 Hz to 30 kHz. They feature a single input voltage, built-in voltage limiter to prevent amplifier saturation and large output voltage (1.5 V into 1000 Ω). The module can be operated from a 12-V dc battery.

CIRCLE NO. 267

### Phase-locked oscillators offered

*Solid State Technology, 1208 Norman Ave., Santa Clara, Calif. 95050. (408) 252-3244. \$354 to \$969 (small qty); 60 days.*

An array of telecommunication grade local oscillators and low power transmitters comprise the manufacturer's SSX-0101 thru 0120 series of phase-locked oscillators. The units feature 10% (typical) bandwidths between 980 MHz and 13.23 GHz and output power of 10 to 250 mW. Frequency stability is less than 0.0001%/°C. The size of a unit is 3 × 3 × 4 inches.

CIRCLE NO. 268

### Small YAG laser good for range tests

*Raytheon Co., Laser Advanced Development Center, Foundry Ave., Waltham, Mass. 02154.*

The Model SS-219, a hand-held, self-powered laser transmitter for high accuracy range measurements uses a YAG laser crystal and weighs less than four pounds. It is capable of one-pulse-per-second operation continuous duty, delivering 100 millijoules per pulse in the normal mode with a pulse width of approximately 100 μs. Compactly packaged, the laser transmitter measures 8 × 3 × 2 inches.

CIRCLE NO. 269

### Rf generator provides 10 W in S-band



*Hughes Electron Dynamics Div., 3100 W. Lomita Blvd., Torrance, Calif. 90509. (213) 534-2121. \$4550; 90 days.*

An rf generator provides a minimum of 10 W over the 3.0 to 3.5 GHz frequency range. Designated Model 1216H, the new power generator combines in a single compact (16-3/4 × 15-1/2 × 3-1/2 inches) unit both the rf source and a traveling-wave tube amplifier. The unit carries the Hughes one-year warranty with no limit on hours of operation.

CIRCLE NO. 270

### Transistor delivers 75 W at 400 MHz

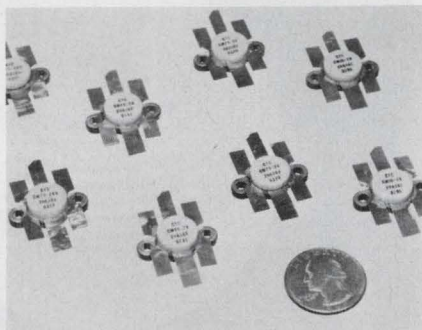

*Communications Transistor Corp., 301 Industrial Way, San Carlos, Calif. 94070. (415) 591-8921. 20 W: \$45; 40 W: \$90; 75 W: \$135 (1-99).*

A series of 400 MHz, 28-V linear rf power transistors are said to be the first that deliver up to 75 W at this frequency. The devices can operate in Class A, AB, B or C broadband or narrowband applications over the frequency range of 200 to 500 MHz. The three transistors in the series are rated at 20, 40 and 75 W. An alternate 75-W transistor is also available for high power CW or pulsed operation.

CIRCLE NO. 271

## Diode modulator lists 2 to 3 dB loss

*Elcom Systems, Inc., 151-15 W. Industry Ct., Deer Park, N.Y. 11729. (516) 667-5800.*

A low-loss diode modulator or rf switch for the 1250 to 1550 MHz frequency range has an insertion loss range of 2 to 3 dB when ON. The loss when OFF is from 20 to 25 dB. The VSWR for the ON mode averages 1.35:1 over the band, and the maximum rf power input is +13 dBm. With an external fixed bias of +7.5 V, the unit may be modulated with 0 to +15 V at 35 mA maximum at a rate of dc to 1 MHz.

CIRCLE NO. 272

## Uhf power transistor for mobile amps

*RCA Solid State Div., Route 202, Somerville, N.J. 08876. (201) 722-3200. \$30 (100 up); stock.*

A silicon npn, epitaxial planar rf power transistor, the RCA-40970, has high-input resistance, low-input Q and 12.5-V supply rating for broadband uhf amplifier applications. It has the overlay multiple-emitter-construction and emitter-ballasting resistors. In addition, the company says that the transistor is fully tested to operate into an infinite load at 15.5-V.

CIRCLE NO. 273

## Antennas cover vhf marine radio band

*Phelps Dodge Communications Co., Route #79, Marlboro, N.J. 07746. (201) 462-1880.*

A series of high efficiency vhf marine antennas for the 156 to 162.55 MHz frequency range include five models. Catalog numbers 1-524, 2-524 and 3-524 have 3 dB gain. Catalog number 4-524 has 6 dB gain and catalog number 5-524, 8 dB of gain. All five are fabricated of white fiber glass except for the 3-524 which is all stainless steel. Nominal input impedance of all five antennas is 50  $\Omega$ , VSWR is 1.5:1 and power rating is listed at 100 W.

CIRCLE NO. 274

# Your custom resistor network is only an idea away!

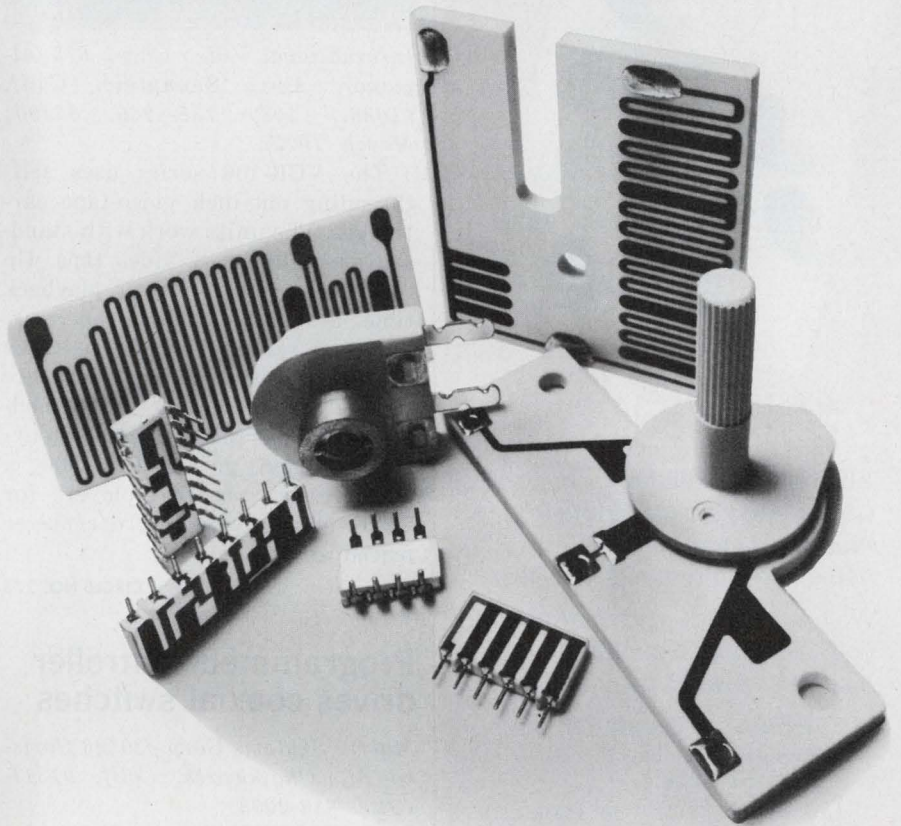

CTS CORPORATION, a pioneer in cermet network packaging, HAS WHAT YOU NEED TO SOLVE "CUSTOM" RESISTOR REQUIREMENTS! Complete thick film facilities save in-house investments: existing tools speed production—cut costs...capabilities you can't afford to overlook. Resistors and resistor networks are our business...not just a sideline.

Whatever your needs, from standard in-line and DIP networks to custom high power/high voltage packages, you can rely on CTS experience and know-how.

Unmatched field reliability, high volume mechanization, and over a decade of cermet thick film-technology make CTS resistors "the engineers' choice". We have what it takes for both standard and custom resistor packages. Call on CTS EXPERIENCE...today! CTS CORPORATION, 905 N. West Boulevard, Elkhart, Indiana 46514, Phone: (219) 293-7511.

**CTS CORPORATION**

Elkhart, Indiana



A world leader in cermet and variable resistor technology.

INFORMATION RETRIEVAL NUMBER 44

# Carter Quality epoxy transistors

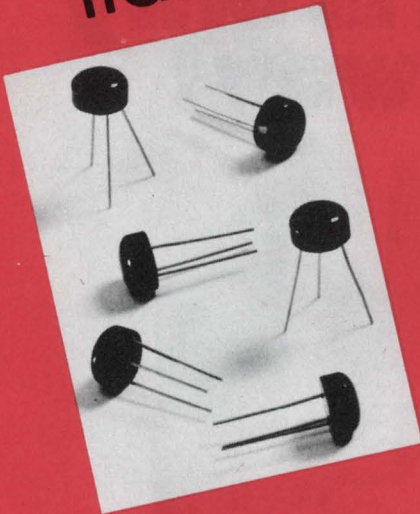

## 2n's, EN's, SE's!

All are now available from Carter and its distributors to meet your most critical delivery requirements.

We have them... and at prices you can't beat. Quantity discounts always available.

We've built our reputation on:

- Competitive Pricing
- On-Time Delivery
- Strictly Enforced Qual Tests

Here are some of our off-the-shelf items:

2N3638	2N3646	2N4250
2N3565	2N3563	2N4354
2N3569	2N4121	2N4916



WRITE TODAY  
FOR OUR  
NEW CATALOG!

**CARTER  
SEMICONDUCTOR,  
INC.**

Diode Facility • 361 Aiken St., Lowell,  
Mass. 01853, (617) 454-9141  
Main Office & Eastern Region •  
6901 Jericho Turnpike, Syosset, N.Y. 11791,  
(516) 364-2244  
Western Region • (415) 941-7066  
MidAmerica Region • (312) 297-8416  
ASK YOUR DISTRIBUTOR FOR CARTER SEMICONDUCTORS

## DATA PROCESSING

### Compact video tape uses one-inch cartridge



*International Video Corp., 675 Al-  
manor Ave., Sunnyvale, Calif.  
94086. (408) 738-3900. \$2300;  
March, 1973.*

The VCR-100 series uses self-threading one-inch video-tape cartridges. The units work with standard or high-energy video tape. Up to one hour of record or playback time is available from one cartridge. A second audio or cue track is standard and all recorders are remotely controllable. Three models will be available: a color playback version priced at \$1900, a monochrome recorder/player for \$2300 and a color recorder/player priced at \$2700.

CIRCLE NO. 275

### Programmed controller drives coaxial switches

*Matrix Systems Corp., 20426 Coris-  
co St., Chatsworth, Calif. 91311.  
(213) 882-2008.*

The Model 5000 controller is designed to control Matrix Systems' line of programmable coaxial and low frequency switching systems. Switchpoint address, mode and sequence are entered in the memory unit by the keyboard unit and are stored as a program. Upon receipt of an external start pulse, the memory unit opens and closes up to 2000 switchpoints in accordance with the stored program. The sequencing rate may be synchronized to an external clock or generated internally. Operating speed of the reed switches determines the maximum rate. Model 5000 also provides a 16-bit TTL-compatible output for controlling other systems in addition to the switching devices.

CIRCLE NO. 276

### Flexible disc drive challenges cassettes

*Memorex Corp., San Tomas at Cen-  
tral Expwy., Santa Clara, Calif.  
95052. (408) 987-2200. \$751; May.*

Operational reliability of the Model 651 flexible disc drive is said to exceed that of available tape cassettes or cartridges. The transfer rate is 250 kbit/s and data can be formatted in either a sector or index mode. Data formats range from a single 4880 byte record to thirty-two 132-byte records per track. The storage disc will permit a minimum of 50-million passes and costs as little as \$6.50 per unit. Storage capacity is 312,500 bytes (2,500,000 bits).

CIRCLE NO. 277

### Serial printer offers lower and upper case

*Litton ABS, 600 Washington Ave.,  
Carlstadt, N.J. 07072. (201) 935-  
2200. \$2088 (large quantity).*

Model OEM 120 printer provides 96 upper and lower-case characters; other character sets are optional. Printing rates of 10, 15, 30, 60 or 120 char/s can be selected by the operator. The unit prints up to 132 char/line spaced at 10 char/in. Vertical spacing is 6 lines/in. Provisions are made for either serial (RS232B) or parallel entry of data. Options include a single-line buffer, vertical tab and horizontal tab.

CIRCLE NO. 278

### Portable calculator replaces slide rule

*Texas Instruments, Inc., P.O. Box  
5012, Dallas, Tex. 75222. (214)  
238-3741. \$149.95 (unit qty.).*

Competing with a conventional slide rule, the Model SR-10 can calculate reciprocals, squares and square roots in addition to the four basic arithmetic operations (+, -, ×, ÷). Calculations are displayed to eight digits. When the result exceeds eight digits, the number is automatically displayed in scientific notation with a two-digit mantissa. The calculator handles numbers from  $1 \times 10^{-99}$  to  $9.9999999 \times 10^{99}$ . Data can be entered in floating point, scientific notation or any combination of the two.

CIRCLE NO. 279



**Allochiral contacts now come in DIP sockets**

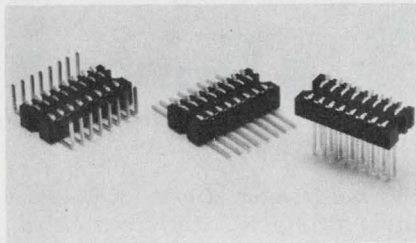

Robinson-Nugent, Inc., 800 E. Eighth St., New Albany, Ind. 47150. (812) 945-0211.

The Allochiral one-piece contact has been extended to a line of "A OK"-DIP sockets, which are available in three configurations. W-type A OK sockets press-mount directly into a drilled board, allowing inexpensive wrapped-wire board prototyping with sockets, and conversion to standard Allochiral boards later, with no change in layout. L-Type sockets provide annealed beryllium-copper terminals that may be easily bent, twisted or cut for any mounting method, yet are strong enough to support the socket body in any position. U-type A OK sockets allow solderless-wrapping on the same side of the board as components, eliminating board-flipping during wiring and check-out, and providing for lowest overall board height. Body height of all three types is just 175 mils overall, and all contacts are equipped with lead-in arms angled at 30° to provide excellent guides for either automatic or manual IC insertions. All terminals are 25-mil square to allow solderless wrapping.

CIRCLE NO. 280

**Air release agent comes in spray bombs**

Isochem, Cook St., Lincoln, R.I. 02865. (401) 723-2100.

Airout eliminates air voids in resin formulations and craters in films. On long term storage, no separation appears. Airout will not downgrade resin formation or adhesion, and will in no way interfere with electrical or physical properties, yields, or finishes.

CIRCLE NO. 281

# Compare Mox to whatever resistor you're using now.

Our Metal Oxide Resistors offer you:

- Small Size ■ Maximum Reliability
- Low Temperature Coefficient
- High Stability
- High Voltage Capability

Set a comparable MOX Resistor beside the wire wound or metal film resistor you're using now. Chances are you'll find ours smaller, giving you greater design possibilities for ultra-critical applications. Our precision? As good as  $\pm 0.5$  per cent. With stability to match, both on the shelf—less than 0.1 per cent drift per year—and off—as little as 1 per cent drift under full load in 2000 hours. MOX Resistors withstand extreme environmental conditions; the effects from temperature cycling are negligible; and they have voltage capabilities far in excess of wire wound and metal film resistors.

We offer you a complete MOX Series to choose from, and we keep them stocked for prompt delivery.

**Mini-Mox**—Miniature high voltage resistors with ratings as high as 5 KV and dissipations to 1 watt. Available with 100 ppm TCR. Compare with bulky metal film types.

**Maxi-Mox**—Rated at 2.5 watts and 7.5 Kv per lineal inch. Available in 1-5" lengths in 1" increments. Approximately 1/2 size of film resistors with equivalent ratings. Compare with metal films with inflated voltage ratings.

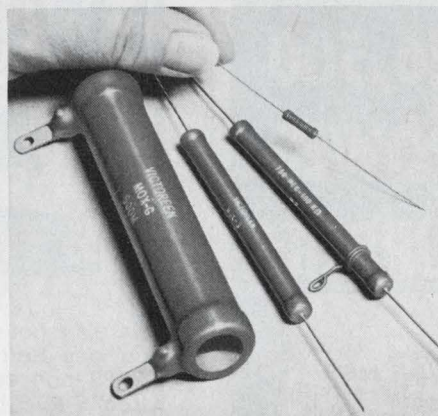

**Divider-Mox**—Single units with one or more taps. Ratios as high as 10,000:1. Input voltages to 37.5 Kv. Output voltage stability  $\pm 0.5$  per cent over temperature extremes. Compare design advantages with discrete resistors.

**Power-Mox** — High voltage, high power resistors with hollow cores for more efficient heat dissipation. Voltages to 45 Kv. Wattages to 45 watts in 70°C air ambient. Compare with voltage limited wire wound resistors.



MOX FACTS and Technical Data Sheets are available from: Victoreen Instrument Div. of VLN Corp. 10101 Woodland Avenue, Cleveland, Ohio 44104. Telephone: 216/795-8200

DMA 681

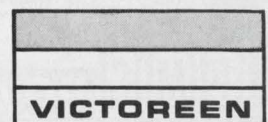

Expertise in high voltage.

## Modules interchange to form measuring system

Heath/Schlumberger Scientific Instruments, Hilltop Rd., St. Joseph, Mich. 49085. (616) 983-3961.

The 200-System is composed of multifunction, interchangeable modules that can be physically and electrically interconnected to form various precision measuring, monitoring, recording and controlling systems. Modules include a 23-speed 10-in. strip chart recorder, a dc-offset module that provides up to 15.1 full scales of calibrated suppress, an input amplifier module that produces a 1-V output for any input between 1 mV and 500 V, a pH/pIon module, a digitizer/indicator module with BCD TTL output, a temperature module that permits measurement of a wide range of °F and °C temperatures, a limit detector module with visual and audible alarms and relay contact outputs, and a 4-channel multiplexer module.

CIRCLE NO. 300

## Voltmeter reads and holds transients

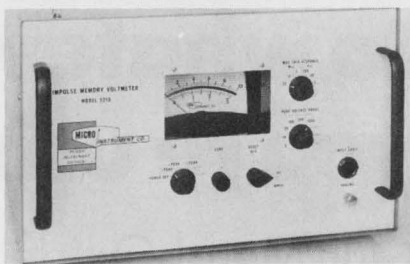

Micro Instrument Co., Power Instrument Div., 580 Oppen St., Escondido, Calif. 92025. (714) 746-2010. 5210; \$1495; stock.

The Model 5210 impulse memory-voltmeter is for use in severe electrical environments. It reads and holds peak transient voltages of arcs, flash-overs and impulses. The instrument has unusual construction: It's housed in a very low-capacitance dual-shielded cabinet. Nine voltage ranges from 3 V to 100-kV FS are provided, with the 30-kV, 60-kV and 100-kV ranges requiring an optionally available vacuum-capacitor divider probe. Readout is on a 5-in. mirror-back taut-band meter, fully EMI screened.

CIRCLE NO. 301

## 20-MHz function gen has internal sweep

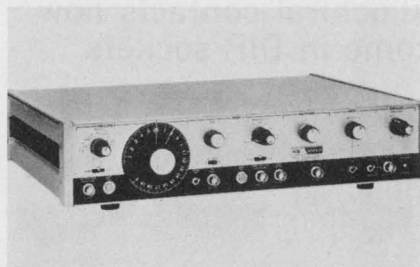

Systron-Donner Corp., Datapulse Div., 10150 W. Jefferson Blvd., Culver City, Calif. 90230. (213) 870-6771. \$895; 4 wks. ARO.

Model 421 function/sweep generator features 20-MHz maximum frequency, an internal sweep generator with calibrated sweep limits, 80-dB attenuation of a 20-V pk-pk output, 10-V dc offset, trigger and gate modes and a distortion indicator when the combination of offset and output exceed ±10 V. The unit should be of interest to those engaged in communication system design and service and amplifier, phase-lock-loop and frequency discriminator design.

CIRCLE NO. 302

# FREE CATALOG

OVER  
26,500  
POWER  
SUPPLIES

Over 26,500 models of DC Power Supplies — up to 1000VDC and 100A. Both wide and narrow range modules, plus Bench and Lab units for all applications. Quality power supplies based on industry-proven Power/Mate UniPower principles, featuring low ripple and excellent regulation. Low-cost, high reliability. 5-year warranty. Most models shipped same day.

SEND FOR YOUR FREE CATALOG

**P/M/C POWER/MATE CORP.**  
514 S. RIVER STREET, HACKENSACK, N. J. 07601  
Phone: (201) 343-8294 TWX: (710) 990-5023

# THE MINNESOTA TWINS

46 of these . . . 0.125 ctrs.



46 of these . . . 0.100 ctrs.

Here's a hot new idea in direct card connectors . . . our new Series 9 has 92 standard models: 0.100 or 0.125-inch centers, any number of dual positions from 5 to 50! Bifurcated dual contacts, 5 mounting options, .025 sq. wrap tails. Between-contact polarization even on the 0.100-inch size. And we won't freeze you out on delivery . . . or cost, they're all standard!

Write for free information today:

## NATIONAL CONNECTOR

5901 So. County Road 18 / Minneapolis, Minnesota 55436 / (612) 935-0133

DIVISION OF **FABRI-TEK INC.**

## Voltmeter also reads phase angle

*Dranetz Engineering Laboratories, Inc., 2385 S. Clinton Ave., Plainfield, N.J. 07080. (201) 755-7080. \$700.*

Series 311 are solid-state, portable phase-sensitive voltmeters. They measure total, fundamental, quadrature and in-phase voltage, as well as phase angle, from 380 to 420 Hz. In addition, these instruments measure total ac voltage from 20 Hz to 20 kHz. Phase is also measured with 0.1°-resolution to ±1.5° accuracy. Bandpass filtering in conjunction with phase-sensitive detection assures noise and harmonic levels below 50 μV rms. Accurate nulling of the minor component is achieved even in the presence of a major component which overloads the instrument by 10 times full scale.

CIRCLE NO. 303

## Digital thermometer resolves to 0.001 C

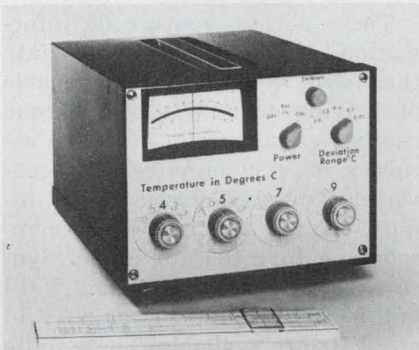

*Massey Engineering, 202 N. Highland St., Arlington, Va. 22201. (703) 525-8010. \$1495; 60-90 days.*

Model LD-1 provides direct real-time temperature readouts over a temperature range of 0 to 111.1 C with resolution to ±0.001% and combined accuracy and stability of up to 0.01% for over 1 year. Using a patented dual element sensing technique, this instrument features a lightweight (12 lbs.) and portable (11 × 8 × 11-in.) design with application in the fields of medicine, ecology, glass and metal processing. Its low probe current of 0.5 mA and battery life of 1200 hrs. makes it an excellent secondary standard. Variations available include a 5-digit readout, range variability and auto-null.

CIRCLE NO. 304

## Pulse/data generators test MOS/bipolar ICs

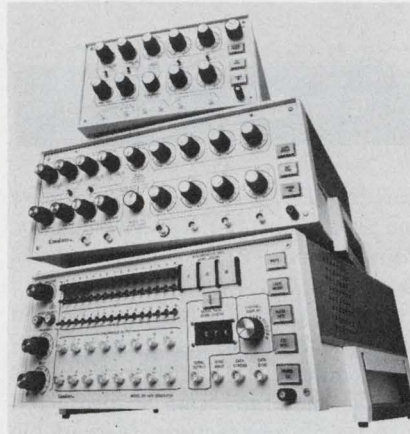

*Comaltest, Inc., Commerce Dr., Danbury, Conn. 06810. (203) 792-3777. 601: \$2500; 610: \$1600; 801: \$3200; stock to 4 wks.*

Three instruments are for designing, testing and characterizing MOS and bipolar ICs. The Model 610, two-phase pulse generator supplies two pulse outputs with continuously-adjustable amplitude over a range of -30 to +12 V. Rise and fall times are adjustable from 10 ns to 100 μs and an offset adjustment from 0 to +5 V. Pulse frequency can be varied over a range of 60 Hz to above 12 MHz. Pulse widths and pulse delays on all channels can be varied from 30 ns to approximately 15 ms or up to 90% of cycle time. The Model 601 is a four-phase version of the 610. A data generator, Model 801, offers 16 parallel channels for use as data inputs or as reference signals.

CIRCLE NO. 305

## 10-MHz scope has triggered sweep

*Eico Electronic Instrument Co., Inc., 283 Malta St., Brooklyn, N.Y. 11207. (212) 949-1100. \$379.95.*

Eico's TR-410 is a solid-state, triggered sweep scope. Its features include: a sweep that automatically "locks in" with complex TV signals; 10-MHz bw; protected FET input stage; a single dual probe that converts from direct to 10:1 low-capacity; quick-connect BNC connector at vertical input; and three calibration voltages: 2, 5 and 10 V.

CIRCLE NO. 306

# Electrical Noise by Solitron

**Any problems or special requirements? Ask the experts in this field!**

A typical noise problem solver:

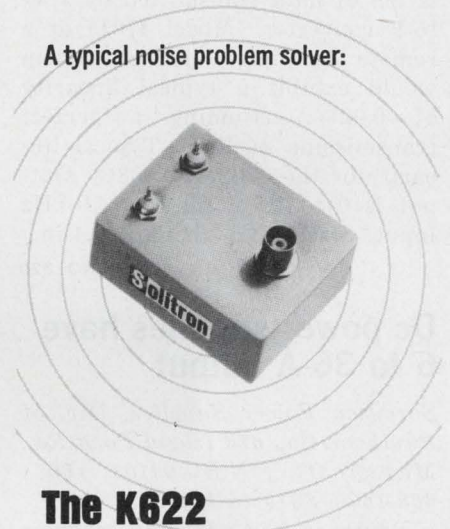

## The K622

Supply Voltage: +15V

Freq. Range: 70 MHz ±20 MHz ±1.0 dB

Noise Level: -48 dBm/100 KHz/50 ohms

Operating Temp.: 0°C to 60°C ±1.0 dB

Terminations: BNC for noise output; solder lugs for bias

Housing: Solder seal metal case, 2" x 2½" x 1" exclusive of terminations.

Available with single turn attenuator (screw driver adjustable), -25 dB range.

Write or contact Dr. Lon Edwards at Solitron for further information.

Hewlett-Packard Spectrum Analyzer Data:

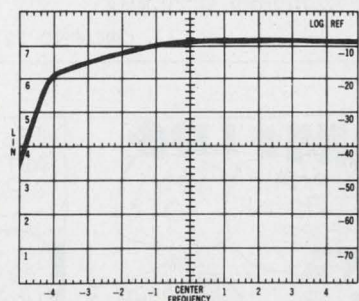

Log. Ref. Level -40 dBm; B.W. 100 KHz; Scan Width 10 MHz; Center Freq. 50 MHz; Vertical 10 dB/CM; H.P. 8554/8552B/141T

**Solitron devices, inc.**  
256 Oak Tree Road  
Tappan, N.Y. 10983  
(914) 359-5050 TWX: 710-576-2654

INFORMATION RETRIEVAL NUMBER 49

### Frequency-to-volts unit is linear to 0.008%

Teledyne Philbrick, Allied Drive at Route 128, Dedham, Mass. 02026. (617) 329-1600. \$51 (100s); stock.

The Model 4702 is Teledyne Philbrick's new Frequency-to-Voltage converter. The most common application of the module is the demodulation of data transmitted by a V-to-F converter (Model 4701) at a remote location. Such a system would exhibit a typical linearity of 0.02%, assuming a perfect transmission medium. Typical linearity of the 4702 is 0.008%. Output is 0 to 10 V for 0 to 10-kHz input. Size is 1.5 × 1.5 × 0.4-in.

CIRCLE NO. 320

### Dc power supplies have 6 to 36-A output

Sorensen Power Supplies, Div. of Raytheon Co., 676 Island Pond Rd., Manchester, N.H. 03103. (603) 668-1600. \$319 to \$329.

Raytheon has added 10 modular dc power supplies to its STM Series. Outputs of the new switching-transistor units range from 3 V at 36 A to 56 V at 6 A. The new units are packaged in nine-pound modules measuring 3-5/16 × 5-1/8 × 14-in. Efficiencies range as high as 75%. Specs include combined regulation better 0.05%, tc less than 0.01%, and stability for 24 hours better than 0.05%. Peak-to-peak ripple is typically less than 30 mV. Audible noise is eliminated through ultrasonic switching at 20 kHz.

CIRCLE NO. 321

### Rear projection display offered for \$9.47/digit

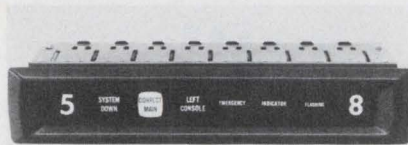

Industrial Electronics Engineers Inc., 7720 Lemona Ave., Van Nuys, Calif. 91405. (213) 787-0311. \$9.47 ea. (1000); 4 wks.

Series 1100 are rear projection displays. Numerals, messages, colors, symbols, etc. (anything reproducible on film) can be projected in a 0.6-in. character size readable from 20 feet. Lamps are front replaceable. When used with commercial IC driver decoders, the Series 1100 (display and connector) accepts 5, 14 or 28 V lamps compatible with DTL/TTL input lines.

CIRCLE NO. 322

### Voltage regulators work to 5 A

Solitron Devices, Inc., 1177 Blue Heron Blvd., Riviera Beach, Fla. 33403. (305) 848-4311. From \$13.49 (100s).

CJCA Series are dc voltage regulators for both positive and negative applications. The hybrid series is available with a FET internal current source as well as current limiter. The line features regulation of 0.5% max., no load to 1.0 A load. Output voltage range is 8 to 50 V with maximum output current of 5.0 A. The family has 40 W dissipation at 25 C case temperature and a tc less than ±.02%/°C. Case size is TO-3.

CIRCLE NO. 323

### Binary unit translates angles to 4-quad sine

Interface Engineering Inc., 386 Lindelof Ave., Stoughton, Mass. 02072. (617) 344-7383. \$80; 30 days.

The DD109 expands the company's Model DD108-A and DD108-B binary angle to sine translators to full four-quadrant sine and cosine operation. When used with the DD108-A, specs include a translation time of 0.95 μs, input resolution of 0.088° (LSB), accuracy of ±0.005° (arctan) and 17-bit output. With the DD108-B the specs are (respectively), 1.5 μs, 0.011° (LSB), ±0.005° (arctan) and 17-bit output. Size is 2 × 4 × 0.4-in.

CIRCLE NO. 324

### Dc-to-synchro converter offers ±30' accuracy

Computer Conversions Corp., 6 Dunton Ct., E. Northport, N.Y. 11731. (516) 261-3300. \$800 (quantity); 4-6 wks. ARO.

These devices convert dc information representing angle into three-wire synchro outputs capable of driving CXs, CTs and torque receivers, and have a standard accuracy of ±30 minutes. The converters are available with dc inputs of ±10 or ±100 V, corresponding to ±180° of angle. Synchro voltage outputs of 11.8 V l-l and 90 V l-l at 400 Hz, or 90 V l-l at 60 Hz are available. These units can drive loads up to 75 Ω l-l at 11.8 V, and 4000 Ω l-l at 90 V. (Up to three sizes 8 or 11 torque receivers.)

CIRCLE NO. 325



**ANALOGY**

INTECH'S A-701 AND A-702 FAST FOUR-QUADRANT MULTIPLIER CAN DOUBLE FREQUENCIES, DIVIDE, SQUARE, SQUARE-ROOT AND DO OTHER MATHEMATICAL COMPUTATIONS. THE A-701'S ACCURACY IS BETTER THAN 0.5% @ ±10V INPUT DIFFERENTIAL AND NEARLY 0.1% AT 5V DIFFERENTIAL. THE 702 IS TRIMMABLE WITH A POT.

**intech** INCORPORATED  
 (408) 244-0500  
 1220 COLEMAN, SANTA CLARA, CALIF. 95050

# Complete RF Network Analysis — IMPEDANCE

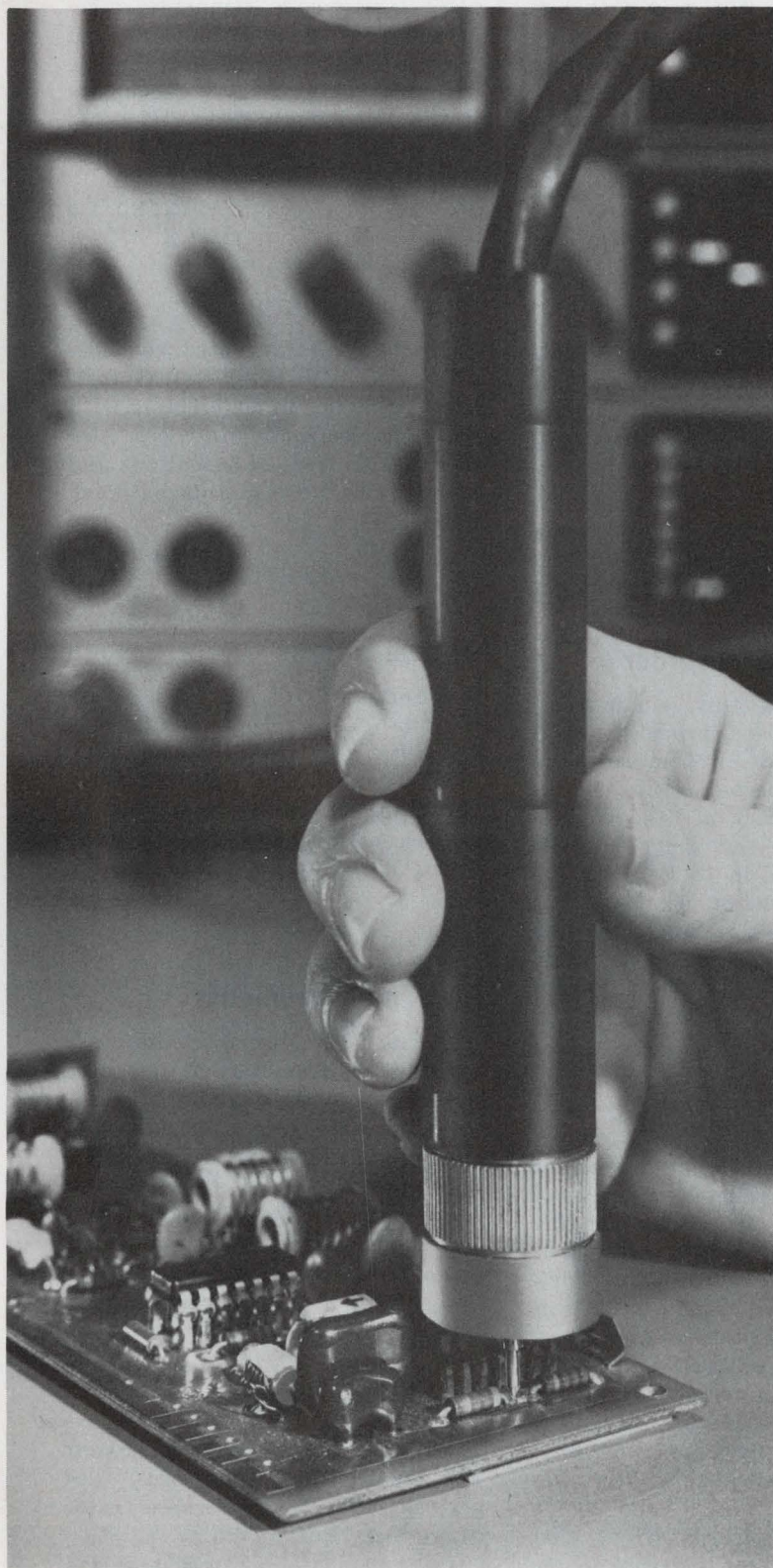

**NEED** to make high-frequency measurements of dielectric materials? To determine transistor  $Y_{22}$  parameters? To match a network to nearly any impedance over a broad frequency range?

**NEED** to study the frequency behavior of resistors, capacitors, and inductors, or to make high-resolution measurements of coaxial standards and components?

**NEED** to determine impedance from  $0.5 \Omega$  to  $1 \text{ M}\Omega$  or admittances from  $1 \mu\text{U}$  to  $2 \text{ U}$ ? Need a pushbutton choice of a phasor display ( $Z \angle \theta$  or  $Y \angle \theta$ ) or a Cartesian/polar display ( $R + jX$  or  $G + jB$ ) — from 400 kHz to 500 MHz?

**NEED** all this for \$595? Then order a GR 1710-P5 Immittance Probe for your 1710 RF Network Analyzer. The 1710-P5 is the latest engineering achievement to expand the versatility of the basic 1710 and to improve **your** high-frequency measurements.

**NEED** a 1710 also? That's only \$6850 for sweep-frequency measurements from 400 kHz to 500 MHz with 115-dB dynamic range and 0.005-dB resolution. In addition to measurements of impedance, the 1710 also provides measurements of transmission and reflection properties in both 50-ohm and 75-ohm systems and measurements of group delay and s-parameters.

**INDEED**, the 1710!



**General Radio**

NEW YORK (N.Y.) 212 964-2722, (N.J.) 201 791-8990 • BOSTON 617 646-0550 • DAYTON 513 294-1500  
CHICAGO 312 992-0800 • WASHINGTON, D. C. 301 948-7071 • ATLANTA 404 457-2485  
DALLAS 214 234-3357 • LOS ANGELES 714 540-9830 • SAN FRANCISCO 415 948-8233  
TORONTO 416 252-3395 • ZURICH (01) 55 24 20

GR COMPANIES • Grason-Stadler • Time/Data • Techware Computing Corp.  
GR ASSOCIATE • Micronetic Systems Inc.

INFORMATION RETRIEVAL NUMBER 51

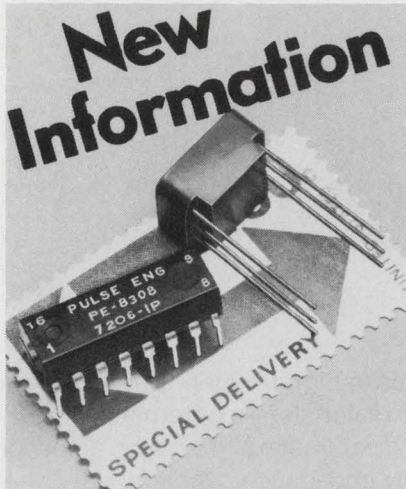

## Immediately available Pulse Transformers Delay Lines

Now you can save time and money by specifying standard Pulse transformers or delay lines from our wide range of in-stock components. We have the most commonly used designs — complete and reliable. And Pulse engineers are ready to assist you with unique designs.

### Typical Applications

1. SCR and TRIAC control
2. Small signal coupling and isolation
3. Baluns
4. Floating switches
5. Line drivers and receivers
6. DC isolation
7. Timing delays

For the broadest selection of in-stock components, available for immediate delivery in any quantity, call our catalog sales department.

### 50% DUTY CYCLE TRANSFORMERS

- DIP Package • Baluns • Floating Switches • In Stock

Catalog Number	Turns Ratio (±5%)	L, Pulse $\mu$ hy	ET V- $\mu$ S Min	Cw/w pf Max	L <sub>L</sub> $\mu$ h Max
9396	1:4	13.2	1.6	15	1.0
9266	1:1	10	1.5	10	0.2
9629	1:1	3.8	2.0	20	0.4
9267	1:4	5	1.5	10	1.0
9353	1:2	15.1	2.0	10	0.5
9268	1:1	160	6.0	16	0.4
9397	1:1:1	35	1.0	14	0.2
30020	1:1	1.15	1.0	15	0.2
30019	12:7	3.3	5.0	15	0.2
30018	1:1	6.06	2.0	20	0.4
30024	1:1	16.8	2.0	20	0.4

Send for Bulletin #57

**Pulse  
Engineering  
Inc.**

A Varian Subsidiary  
P. O. Box 12235  
San Diego, Calif.  
92112  
(714) 279-5900  
TWX 910-335-1527

INFORMATION RETRIEVAL NUMBER 52

## evaluation samples

### DIP sockets

Three socket pins directly accommodate IC and semiconductor device leads to give maximum circuit density by eliminating large socket castings. Easily inserted in 1/16-inch circuit boards, the gold-plated sockets allow DIP devices, with any number of terminals, to be mounted end-to-end or side-by-side. Vector Electronic Co.

CIRCLE NO. 326

### Cable ties

The Model CH-8 nylon cable hangers are designed to snap-lock permanently into 1/4-in. diameter holes and are suitable for securely holding single and/or multiple cables, tubing, etc., up to a 1/2-in. diameter. Heyman Manufacturing Co. (HEYCO).

CIRCLE NO. 327

### Temperature recorder

Hot Spot, a tiny, single-increment heat sensor, provides a permanent record of temperature reached at selected critical points with an accuracy of 1%. The recorder covers the range between 100 and 350 F in 10 F steps. The 1/16-inch diameter window turns irreversibly black from a silver color when exposed to its rated temperature value. Over-all diameter is 3/16-inch. Telatemp Corp.

CIRCLE NO. 328

### Steel-mesh grommets

Met-L-Flex resilient stainless steel-mesh grommets are suited for use in temperatures ranging between -130 F to +400 F or for use in highly corrosive environments. The grommets exhibit all of the temperature- and corrosion-resistant properties of stainless steel at a weight saving of more than 40%. Natural frequency is less than 30% that of solid stainless. Wide range of sizes fits standard size holes and bolts. Barry Wright Corp., Barry Div.

CIRCLE NO. 329

## application notes

### Photon couplers

"Photon Couplers" contains information of different types of couplers, terminology, temperature coefficient of photon couplers and photon couplers with photodiode output. The versatility of couplers is discussed and charts and schematic diagrams are provided. General Electric, Syracuse, N.Y.

CIRCLE NO. 330

### X-ray analysis

Thirty-three illustrated pages describe energy dispersive x-ray analysis techniques in conjunction with scanning electron microscopes. Also included are typical executions and installations. Edax International, Prairie View, Ill.

CIRCLE NO. 331

### Optical filters

A series of technical data sheets describe color selected antireflective filters for use in front of CRT displays, neon gas discharge display tubes, LED displays and incandescent displays. Panelgraphic Corp., W. Caldwell, N.J.

CIRCLE NO. 332

### RMS measurements

"True RMS Measurements," explains what true RMS is and also describes how the quantity is measured by various detectors. Limitations and advantages are given for each method. Critical specifications are explained. The Hickok Electrical Instrument Co., Instrumentation & Controls Div., Cleveland, Ohio.

CIRCLE NO. 333

### Nickel-iron cores

Bulletin MCC-100, "Nickel-Iron and Supermendur Cut Cores," describes applications of these cores. Magnetics, Butler, Pa.

CIRCLE NO. 334

# Introducing the expensive curve tracer that doesn't cost a lot.

The B&K Model 501A.

It hooks up to any scope, old or new. (Like our Model 1460 triggered-sweep scope.)

And it analyzes all semi-conductors including J-FET's, MOS-FET's, signal and power bipolar transistors, SCR's, UJT's and diodes. Fast and easy.

Constant current and voltage steps with 3% accuracy make the Model 501A an exceptional value. You can test transistors in circuit for GO/NO GO condition.

Badly distorted curves will indicate the stage where a fault exists.

Call your B&K distributor. Or write Dynascan Corporation.

**\$129<sup>95</sup>**



Very good equipment  
at a very good price.



Product of Dynascan Corporation  
1801 West Belle Plaine Avenue, Chicago, Illinois 60613

INFORMATION RETRIEVAL NUMBER 53

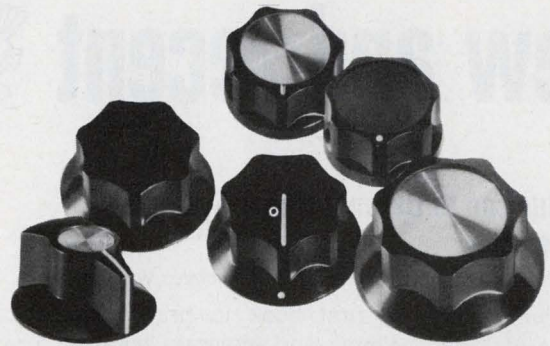

# 1,500,000

## KNOBS TO CHOOSE FROM...

and they're "Warranted for Life"

Kurz-Kasch has over 1½ million low cost, high quality knobs in inventory, ready to ship to you. (You save . . . no tooling cost on stock knobs, specials 4 to 6 weeks delivery.) Your local distributor's stock is available at factory prices. Select instrument and control knobs from 24 families with 367 basic sizes and shapes in general purpose phenolics, melamines and ureas. All Kurz-Kasch knobs are warranted for the life of the product

on which they're used. Send now for free 20 page catalog. (Also found in THOMAS REGISTER "THOMCAT."®)



**Kurz-Kasch, Inc.**

1421 S. Broadway  
Dayton, Ohio 45401  
513/223-8161

INFORMATION RETRIEVAL NUMBER 54

**PERSONNEL  
RECRUITMENT  
ADVERTISING  
IN  
Electronic Design  
REACHES THE  
RIGHT PEOPLE  
AT A LOWER COST  
PER THOUSAND**

*Call the  
HOTLINE  
today  
for complete  
information:  
(201) 843-0550  
extension 209*

# New and recent Spartan Books . . .

## Introduction to Defense Radar Systems Engineering

JAMES N. CONSTANT, *President, RCS Associates, Inc.*

*Just Published!* The first book to bring together all aspects of radar systems and integrate them in a systematic and logical pattern offers all the background needed to specify a system for a given application. Each chapter presents analyses and equations in engineering terms. Among this comprehensive volume's many unique features are: the most extensive treatment of the effects of Electronic Counter Measures (ECM); coverage of the theory of trajectory predictions and array theory; and an in-depth treatment of data processing in radar systems. 260 pp., 6 x 9, illus., #9194, cloth, \$20.00

## Checklists for Management, Engineering, Manufacturing, and Product Assurance

W. B. ROSSNAGEL, *Rossnagel and Associates*

Technically accurate and ready to be applied, these checklists are an excellent means to ensure that a given specification, contract, design, etc., is complete in every respect.

### Volume I, Management Checklists

22 checklists cover computers, engineering, finance, labor relations, manufacturing, marketing, personnel, product assurance, proposals, publications, small business, and other subjects. 192 pp., 6 x 9, illus., #9178, cloth, \$14.00

### Volume II, Electrical and Electronic Checklists

22 detailed lists encompass cables and connectors, communication radios, multi-coders, lasers, microelectronics, integrated circuits, and much more. 192 pp., 6 x 9, illus., #9181, cloth, \$14.00

## Vibration and Acoustic Measurement Handbook

MICHAEL P. BLAKE, *Development Engineer*, and WILLIAM S. MITCHELL, *Vibration and Acoustical Consultant*, both of *Lovejoy, Inc.*

This original 700-page illustrated guide closes the great technological gap between theory and operations in the field. Developed through years of practical testing, it demonstrates the value of vibration and acoustic measurement in terms of actual situations and machine problems. It clearly shows how these measurements can give warning months in advance of 90 percent of equipment problems, allowing time to take corrective action before trouble starts. The net-result: less production stoppage, fewer lost man-hours, better quality control, and lower maintenance costs. 656 pp., 6 x 9, illus., #9195, cloth, \$30.00

## Analysis of Plates

D. E. McFARLAND, B. L. SMITH, and W. D. BERNHART, *Wichita State University*

This comprehensive text presents both classical and computer-oriented solutions for the analysis of thin plates for stresses, strains, and lateral deflections. The coverage includes orthotropic plates, continuous plates, various shapes, plates on elastic foundations, large deflections, and laminated plates. The authors add new insight to the variational approach to plate theory, including many illustrative examples. Although intended as a text in mechanical engineering, the book should be of great interest to engineers in industry. 296 pp., 6 x 9, illus., #9191, cloth, \$18.50

## Control Theory, Volume 1

### Elements of Modern Control Theory

ARTHUR L. GREENSITE, *Convair Division of General Dynamics*

The first of these two volumes on flight control provides the practicing engineer and advanced student with a comprehensive, modern, and up-to-date exposition of all facets of modern control theory. Based on a series of monographs written for NASA, it is recommended as a primary or supplementary reference text. Extensive sample problems and exercises included. 896 pp., 6 x 9, illus., #9154, \$29.95

## Control Theory, Volume 2

### Analysis and Design of Space Flight Vehicle Control Systems

The companion volume treats applications to aerospace vehicles in detail. It examines techniques and methods for the design of launch vehicle control systems, and presents an analytical framework for the study of the performance of satellite attitude control systems. 752 pp., 6 x 9, illus., #9163, cloth, \$29.95

## Modeling of Thinking and the Mind

N. M. AMOSOV, *Academy of Medical Science, U.S.S.R.*

An exciting work on the theory and techniques of simulating the functions of the human intellect by one of the Soviet Union's leading cyberneticists and Lenin Prize winner. Presenting his original hypothesis concerning programs of man's psychic functions, the author outlines methods for modeling these on the computer. 208 pp., 6 x 9, illus., #9147, cloth, \$12.00

SPARTAN BOOKS / HAYDEN BOOK COMPANY, Inc., New York



# ... now available from Hayden

## Pattern Recognition

M. BONGARD, *Translated from the Russian by T. Cheron;*  
*Edited by J. K. Hawkins, Robot Research*

Although primarily directed toward specialists in computers and artificial intelligence, this volume is of importance to engineers and others attempting to understand such brain functions as the ability to "find similarity," "create abstract ideas," and "act by intuition." The Soviet scientist clarifies the meaning of pattern recognition and problem solving. 256 pp., 6 x 9, illus., #9195, cloth, \$12.95

## The Future of Science

MORRIS GORAN, *Roosevelt University*

A provocative, well documented investigation of the scientists' relationships with society, government, and money. It examines three current problems of the scientists: communication, education, and financing. Throughout, discussions are supported by facts rather than moralistic statements. 168 pp., 6 x 9, #9190, cloth, \$8.50

## Technology Gap in Perspective

### Strategy of International Technology Transfer

DANIEL LLOYD SPENCER, *Morgan State College*

An original strategy for visualizing and coping with the technological variants of the modern world. Presenting a novel systems vision, the author deals with the problems of incessant waves of technological impact, and holds that we must view them as a world technology system. 192 pp., 6 x 9, illus., #9180, cloth, \$10.00

## Character Readers and Pattern Recognition

Edited by V. A. KOVALEVSKY, *Institute of Cybernetics, Kiev, U.S.S.R.*

This collection of articles focuses on problems of pattern recognition and computer simulation of various algorithms

and recognition systems. All methods discussed and all work examined are based on procedures used in the development of actual equipment at the Institute of Cybernetics. 280 pp., 6 x 9, illus., #9150, cloth, \$12.00

## Durability and Reliability in Engineering Design

GILBERT KIVENSON

This thought-provoking work places at your disposal highly relevant findings from a variety of technical areas. It examines materials properties, breakdown mechanisms and phenomena, and failure modes along with steps to counter them; provides a capsule course in reliability theory; relates design considerations to the user's needs. 200 pp., 6 x 9, illus., #5851-9, cloth, \$9.95

## Materials Science and Technology for Design Engineers

Edited by ALEX E. JAVITZ

The fundamentals of materials integrated with the hard facts of day-to-day engineering practice. The coverage offered you ranges from basic structure and behavior through new materials and applications, to environmental effects, reliability concepts, and cost effectiveness. 560 pp., 6 x 9, illus., #5640-0, cloth, \$23.95

## The Successful Engineer-Manager

### A Practical Guide to Management Skills for Engineers and Scientists

Edited by ROBERT C. HAAVIND and RICHARD L. TURMAIL

A well-organized, realistic guide to the critical areas of technical management — career, decisions, people, projects, finances, and communications. Articles carefully chosen from *Electronic Design* offer you valuable pointers on financial analysis, person-to-person dealings, project scheduling, promoting new ideas, and much more. 176 pp., 7½ x 9¾, illus., #5879-9, cloth, \$8.95

## 15-DAY FREE EXAMINATION

Please send the book(s) circled on 15-day free examination. At the end of that time, I will remit payment, plus postage, or return the book(s) with no further obligation.

9194	9195	9163	9150	5851-9
9178	9191	9147	9190	5640-0
9181	9154	9195	9180	5879-9

### Save Money!

**Payment Enclosed.** Publisher will pay all shipping and handling charges — same 15-day guarantee.

Name \_\_\_\_\_

Firm \_\_\_\_\_

Address \_\_\_\_\_

City/State \_\_\_\_\_ Zip \_\_\_\_\_

**\$10.00 minimum for free exam orders.** Because of higher billing and collection costs, we must ask for payment in full with any order for less than \$10.00. Same 15-day guarantee.



**HAYDEN BOOK COMPANY, INC., 50 ESSEX STREET, ROCHELLE PARK, N.J. 07662**

ISBN Prefix 0-8104

72-87

## new literature

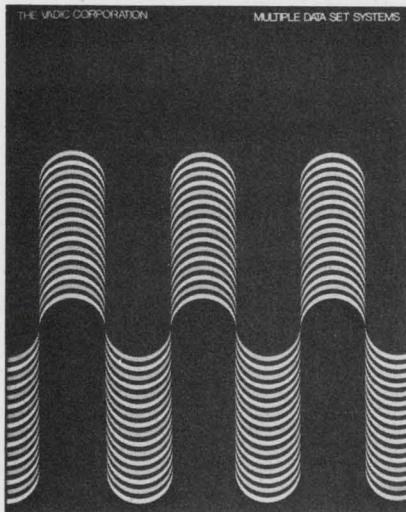

### Data modems

A 20-page brochure covers end-user-oriented data modems and systems. The brochure describes a 16-channel multiple data set system, four-channel chassis, one and two-channel boxes, display and diagnostic functions. Block diagrams explain test circuits and specifications are provided for Bell 103 and 202 compatible modems, IBM modems and automatic dialers. The Vadic Corp., Mountain View, Calif.

CIRCLE NO. 335

### Modular jack panels

A concept in extruded aluminum jack panels, which accept up to 56 telephone jacks mounted to 14 module inserts, is described in a product bulletin. Switchcraft, Inc., Chicago, Ill.

CIRCLE NO. 336

### Disc testing guide

A 24-page guide to magnetic disc testing deals with such areas as the reasons for testing substrates, discs and packs, magnetic recording theory, disc characteristics and magnetic recording techniques as well as equipment selection and costing. It provides a worksheet for cost estimating your own equipment requirements. The text is illustrated with diagrams and photos. Computest Corp., Cherry Hill, N.J.

CIRCLE NO. 337

### Diode, transistor circuits

A 158-page catalog contains complete information on the company's line of diodes and microwave transistors. Of special value are detailed operating characteristics and suggested applications. Included in the catalog is design information on Schottky and high-conductance diodes, microwave specified Schottky diodes, PIN diodes for signal control, microwave-source diodes, microwave transistors and devices for hybrid ICs. Hewlett-Packard, Palo Alto, Calif.

CIRCLE NO. 338

### LSI memory components

Complete technical information on the company's products is described in the Intel Data Catalog. Besides the data sheets on LSI memory components, sections on microcomputers and memory systems are included. The catalog includes a complete memory product selection guide, detailed ordering information, price list, package information, a bibliography of technical articles and application notes, complete pROM programming information and ROM code format instructions and a listing of field sales offices, representatives and distributors. Intel Corp., Santa Clara, Calif.

CIRCLE NO. 339

### Rf power amps

A short-form catalog covers the company's line of solid-state rf power amplifiers. Electronic Navigation Industries, Inc., Rochester, N.Y.

CIRCLE NO. 340

### Snap-action switch

A lighted pushbutton switch with snap-action capability to provide power (on-off) and heavy current switching up to 5 A is outlined in an eight-page catalog. Switchcraft, Inc., Chicago, Ill.

CIRCLE NO. 341

### Microwave components

A 16-page catalog describes the company's solid-state component line. Included are high-frequency transistors, YIG-tuned oscillators, unit amplifiers, thin-film MIC-amp and GPD cascaded amplifier modules as well as dual in-line packaged thin-film amplifiers for operation to 4 GHz. A line of discrete component wideband amplifiers for applications from 1 kHz to 6 GHz is described. Also, discrete units for medium power, video, pulse and voltage requirements are shown. The listing is supplemented with photographs and descriptive material related to applications, mounting, installation ordering and optional features. Avantek, Inc., Santa Clara, Calif.

CIRCLE NO. 342

### Shielded rf inductors

An eight-page data sheet provides information on environmental characteristics, mechanical dimensions, voltage ratings, current capabilities, quality factors, inductance ratings and electrical characteristics for shielded rf inductors for the computer and communications industry. Charts explain the color coding system and text fixtures and methods to be used in the testing of these products. Nytronics Inc., Darlington, S.C.

CIRCLE NO. 343

### FHP motors

Universal, shunt and permanent-magnet fractional-hp motors and gearmotors, which can be custom designed to meet special requirements, are described in a four-page brochure. Specialty Motors Inc., San Fernando, Calif.

CIRCLE NO. 344

### Rf capacitors

The RF Capacitor Handbook details specific design considerations and criteria to further knowledge in the field of circuit design. The handbook is divided into four main categories: topic locators, design equations and explanatory text, test data for circuit design and additional design aids. The book is priced at \$4.95. American Technical Ceramics, One Norden Lane, Huntington Station, N.Y. 11746.



**If you need Custom-Built Timing Controls,  
it will pay you to let us build them.**

That's because we design and build them better — faster at less cost. It is our 28 years of experience that makes it possible... years in which we have filled 5,124 orders for customer timing controls.

In 28 years we have accumulated the knowledge and facilities for design, develop-

ment, purchasing, assembling and testing to provide the right answers to your specific requirements.

Why not put our 28 years of know-how to work for you now. Tell us what you need. Write or call 201-887-2200 for same day service.



Industrial Timer Corp., U.S. Hwy 287, Parsippany, N.J. 07054 201/887-2200

INFORMATION RETRIEVAL NUMBER 59

**environmental  
test chambers**

complete program testing facilities for: high and low temperature, altitude and humidity.

temperature ranges from:  $-150^{\circ}$  to  $+500^{\circ}$ F

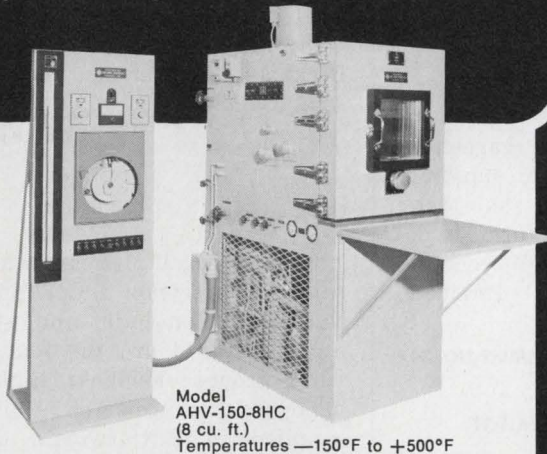

Model AHV-150-8HC  
(8 cu. ft.)  
Temperatures  $-150^{\circ}$ F to  $+500^{\circ}$ F

Custom units, designed and built to *your* specifications. For FREE, NO OBLIGATION quote, send us your temp. range, size and chamber needs.

Get the facts today. Send for our new FREE test chamber brochure.

**CINCINNATI  
SUBZERO  
PRODUCTS INC.**

2612 Gilbert Ave., Cincinnati, Ohio 45206  
Phone: (513) 751-8810

INFORMATION RETRIEVAL NUMBER 60

ELECTRONIC DESIGN 3, February 1, 1973

**Beckman offers a  
high performance line  
of test instruments.**

They're designed to deliver reliable, high-quality operation in your laboratory, industrial application or test system. All instruments feature plug-in IC's for easy, low-cost field maintenance. A few of these stellar performers are:

Model 3020 Line Noise Generator. Serves the dual purpose of generating and measuring line noise.

Model 6421B Frequency Meter — 500 MHz. Direct-read frequencies to one Hz in one second. No prescaling input. Complete hands-off operation.

Model 6401 Counter/Timer — 136 MHz. Extremely versatile, completely programmable counter. Trigger level indicators simplify operation.

Model 1454 Digital Printer. Standard 7-column BCD printout is expandable to 21 columns. Flexibility provides integrated printout from multiple data sources.

Model 1248 Counter Data Terminal. 136 MHz counter provides direct interface to a computer at a very low cost.

For information on our full line, call your local Beckman representative, or call us direct at (312) 671-3300.



**ELECTRONIC INSTRUMENTS DIVISION**

3900 N. River Rd., Schiller Park, Ill. 60176



INFORMATION RETRIEVAL NUMBER 61

# SCHOTTKY BARRIER DIODES

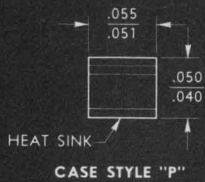

CASE STYLE "P"

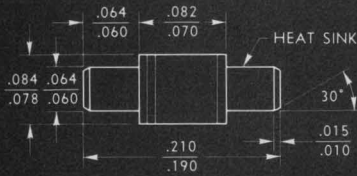

CASE STYLE "L"

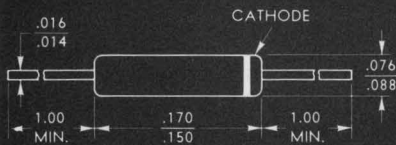

CASE STYLE "H"

## MIXER DIODES \$3 TO \$12<sup>1</sup>

TYPE <sup>2</sup>	BAND	NF dB	I <sub>F</sub> IMP. Ohms	C <sub>J</sub> Case <sup>3</sup> pF Style
A2S101	X	6.0	200-400	.12 P
A2S122	Ku	6.5	175-350	.10 L
A2G172	X	5.5	500	.12 P
A2G132	Ku	6.0	500	.11 L
A2S602	X	6.5	200-500	.12 H
A2S603	X	7.5	200-500	.15 H

## DETECTOR DIODES \$3 TO \$9<sup>1</sup>

TYPE <sup>2</sup>	T <sub>SS</sub> -dBm	R <sub>V</sub> Ohms	OCVS uV/uW	C <sub>J</sub> Case <sup>3</sup> pF Style
A2S206	58.5	1600	5000	0.08 L
A2S207	55.5	1800	3000	0.08 L
A2S211	56.0	1600	6000	0.08 H

## SWITCHING DIODE < \$0.50<sup>1</sup>

TYPE <sup>2</sup>	V <sub>IR</sub> V	C <sub>T</sub> pF	V <sub>f</sub> V	I <sub>r</sub> nA	DIS. mW	Case <sup>3</sup> Style
A2S300	10	1.2	0.40	100	100	H

<sup>1</sup> Production Quantities.

<sup>2</sup> In Type Number, (S) indicates Silicon and (G) Gallium Arsenide.

<sup>3</sup> Also available in beam leads, chips, post, ministrip and LID packages.

Aerotech is a volume producer of PIN, Schottky Barrier, Step Recovery, Tunnel and Backward Diodes.

**Aerotech**  
INDUSTRIES

825 STEWART DR. • SUNNYVALE • CALIF. 94086  
(408) 732-0880 • TWX 910-339-9207

## NEW LITERATURE

BULLETIN 1050

### SERIES 1000 Mass Flow Instruments

(For Precision Measurement and Control of Fluid Flow)

**FEATURES:**

- Rugged Transducer with No Moving Parts
- Low Pressure Drop
- High Signal Output
- Independent of Pressure and Temperature Changes
- Wide Dynamic Range
- True Mass Flow
- Fast Response
- Correct Reading in Pulsating Flow
- Self Cleaning

**Datametrics**  
A subsidiary of **ITE Imperial**

127 Cottage Hill Road, Watertown, Mass. 02172

## Mass flow transducers

The Series 1000 Mass Flow Handbook illustrates how in-line transducers with a variety of electronic plug-in modules provide the simplest single channel to multi-channel mass flow systems. Datametrics, Watertown, Mass.

CIRCLE NO. 345

## Power supplies for logic

Power supplies for IC logic and operational amplifiers are described in a four-page brochure. Single-output 5-V supplies with current ratings from 250 mA to 32 A, and dual-output modules providing  $\pm 5$ ,  $\pm 12$  and  $\pm 15$  V at 25 mA to 8.5 A are included in the listing. Acopian Corp., Easton, Pa.

CIRCLE NO. 346

## Electronic substrates

Gadolinium gallium garnet, a single crystal electronic substrate available in polished substrate, blank or crystal boule form, is described in a four-page brochure. Union Carbide Crystal Products, San Diego, Calif.

CIRCLE NO. 347

## Pyroelectric IR detector

A technical brochure describes the pyroelectric infrared detector. The four-page, three-color booklet contains technical diagrams, product characteristics, temperature ranges, operating conditions and product options. Victory Engineering Corp., Springfield, N.J.

CIRCLE NO. 348

## Stepping relays

A Stepper Catalog details eleven basic types of steppers available in dozens of variations. The catalog is divided into five basic sections: continuous-rotation steppers, electrical-reset steppers, add-and-subtract steppers, sequence relays and a "stepper terminology and application data" section. Guardian Electric Manufacturing Co., Chicago, Ill.

CIRCLE NO. 349

## Platinum thermometers

A line of miniature precision platinum thermometer sensor elements is described in a two-page bulletin. The bulletin provides detailed temperature-resistance tables showing resistance data for every 5 C temperature change from -100 to 600 C. H.E. Sostman & Co., Union, N.J.

CIRCLE NO. 350

## Miniature active filter

A hybrid two-pole, audio-frequency filter that can be used as a basic building block to generate virtually any complex filter function is featured in an eight-page publication. The publication includes complete performance specifications, a full series of descriptive charts and graphs, a simplified tuning procedure which eliminates involved calculations and most of the equations needed for many applications. Helipot Div., Beckman Instruments, Inc., Santa Ana, Calif.

CIRCLE NO. 351

## L-C filters

Catalog No. 11F presents a wide-range of precision L-C filters, including custom-built and stocked units. Covered are the four basic filter groups: low-pass, high-pass, bandpass and bandstop. Units are supplied in Butterworth, Chebyshev, elliptical, gaussian and Bessel designs. Included is a DIP package for low-pass and high-pass filters. The eight-page catalog includes complete specifications, graphs and a glossary of filter terms. Allen Avionics, Inc., Mineola, N.Y.

CIRCLE NO. 352

## Custom ICs

An eight-page brochure describes the Monochip, which replaces most or all discrete components and standard ICs with a single monolithic custom chip. The brochure gives detailed technical and price information. Interdesign, Inc., Sunnyvale, Calif.

CIRCLE NO. 353

## Ceramic EMI filters

Subminiature ceramic EMI filters rated at 15 A at working voltages of 50 and 100 V dc are described in Engineering Bulletin 8132.1. The filters meet the electrical requirements of MIL-F-15733. Sprague Electric Co., N. Adams, Mass.

CIRCLE NO. 354

## Thermal cutoffs

Multiprotectors, which are described in Bulletin MD-153, adapt to current as well as heat sensing applications. Micro Devices Corp., Dayton, Ohio.

CIRCLE NO. 355

## Print controller chip

The CT5006 print controller circuit is described in an eight-page brochure. Cal-Tex Semiconductor, Inc., Santa Clara, Calif.

CIRCLE NO. 356

## Microfilm

A package of four flyers describes Recordak microfilms—their characteristics, processing and handling. Eastman Kodak Co., Rochester, N.Y.

CIRCLE NO. 357

## Time-base circuit

An application note describes uses of the MK 5009 P time-base circuit as a low-power frequency generator and a thumbwheel-programmed timer. Also included is descriptive information about the 5009's on-chip oscillator circuit. Mostek Corp., Carrollton, Tex.

CIRCLE NO. 358

# DO THESE PRODUCTION PESTS "UP" YOUR DOWN TIME?

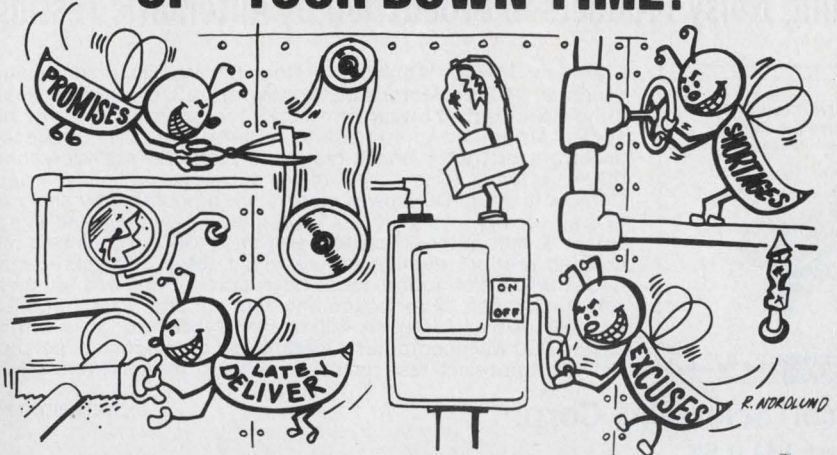

## ALLIED HAS A GUARANTEED CURE!

Immediate Shipment of Thousands of Items—Partial List Below

Here's the sure cure for production line ills—Allied Electronic's Guaranteed Shipment Program. It covers thousands of popular and often hard-to-get items. Check your open order files, then check the list below—it's just a sample of our IN-DEPTH inventory—parts that are ready to be shipped to you today!

And, we back this new program with this statement: you get the parts you order from our published list, or we give you a Credit Voucher for 10% of your total order (good for 90 days) to be applied to your next order. See the next issue of this publication for more Guaranteed Shipment items. Call us now for total service!



AMPHENOL	AMPHENOL	AMPHENOL	ALPHA	ALPHA	BUD	BUD	MALLORY
284-1	26-4401-32P	83-1SP	7053 Bk.	LC-136 Black-	PA-1103 BY	PA-1103 BY	VR3
1309	UG-890U 31-002	83-TSP-1050	FG-1	LC-136 White-	PA-1103 GY	SFA-1833	VR6
1350	UG-1002-1050	UG-1780U 83-188	FIT Tubing Kit	500 Yds	PA-1104 BY	SFA-1834	VR8
1370	UG-290AU 31-003	UG-1790U 83-185	FIT-105 MS-1	PVC-105 3/4"/100	PA-1104 HG	TV-1158	VR10
4101B-1K	UG-3740U 31-008	86-C98	FIT-105 1/4"/25	Bk	PA-1105 HG	TV-2156	RM1
4101B-1K	UG-608-1050	86-PW8	FIT-105 1/4"/100	PVC-105 AWG	PA-1108 HG	UH-70A	RM1R
4101B-10K	UG-306AU 31-009	86-PM11	FIT-105 3/4"/100	2/100 Bk.	PA-1107 HG		RM8R
4101B-50K	UG-009-1050	91-MC3F1	FIT-105 3/4"/25	PVC-105 AWG	PA-1112 HG		RM12
4101B-100K	UG-261AU 31-012	91-MC3M	FIT-105 3/4"/25	8/100 Bk.	RC-7758		RM12R
MS3102A-10SL-3P	UG-598AU 31-018	91-MC4M	FIT-105 1/4"/100	PVC-105 AWG	RR-1248 HG	RV4LAYS4-102A	RM12R2
MS3102A-10SL-4P	UG-123AU 31-028	91-MC6M	FIT-105 3/4"/25	PVC-105 AWG	RV-1249 HG	RV4LAYS4-103A	RM42
MS3102A-14S-2S	UG-857AU 31-102	91-PC3F	FIT-105 1/4"/100	10/100 Bk.	SR-2140	RV4NAY5D-103A	RM401
MS3102A-14S-5P	31-120-1050	91-PC3F	FIT-105 1/4"/25	PVC-105 AWG	SR-2140	62JA-1K	RM502R
MS3102A-14S-6P	UG-896U 31-202	91-MPM3S	FIT-105 1/4"/100	PVC-105 AWG	SC-2131	62JA-10K	RM625
MS3102A-14S-8P	UG-274AU 31-208	91-8B4	FIT-105 1/4"/25	26/100 Bk.	SC-2131	62JA-10K	RM640
MS3102A-18-1P	UG-108-1050	126-011	FIT-105 1/4"/100	18/100 Bk.	SFA-1832	62JA-1000-S	TR126
MS3106A-14S-3S	UG-260AU 31-212	126-011	FIT-105 1/4"/25	PVC-105 AWG	C-1893 HG	380-C1-10K-S	TR132R
MS3106A-14S-4S	UG-491AU 31-218	126-196	FIT-105 1/4"/25	PVC-105 AWG	C-1894 HG	380-C1-10K-S	TR133
MS3106A-14S-5P	31-218-1050	126-197	FIT-221 MS-1	18/100 Cfr.	CB-1371	412 Cloridral	TR133R
MS3106A-14S-6P	UG-914U 31-219	126-197	FIT-221 1/4"/6	TFT-200 AWG	CB-1372		TR134R
MS3106A-14S-8P	UG-109AU 31-220	126-216	Bk.	TFT-200 AWG	FIT-221 1/4"/6		TR135R
MS3106A-14S-8S	UG-492AU 31-220	126-217	FIT-221 1/4"/6	CMA-1930	TFT-200 AWG		TR146X
MS3106A-14S-8P	31-220-1050	126-218	FIT-221 3/32"/6	CMA-1936	TFT-200 AWG		TR165
MS3106A-16S-1P	UG-109AU 31-221	126-219	Bk.	CU-324	20/100		TR175
MS3106A-16S-1P	31-221-1050	126-220	FIT-221 3/32"/6	CU-347	TFT-200 AWG		TR233R
MS-305-3	UG-892AU 31-236	126-225	Whit.	CU-347	24/100		TR286
MS-305-4	57-10500-7	143-010-01	FIT-221 1/4"/6	CU-347	TFT-200 AWG		TR289
MS-305-4A	57-20500-7	143-011-01	Whit.	CU-347	26/100		ZW9
MS-305-5	57-20500-7	143-012-01	FIT-221 1/4"/6	CU-347	TFT-250 AWG		MN1300
MS-305-6A	57-30140	143-018-01	Red	CU-347	29/100		MN140
MS-305-7	57-30240	143-023-01	FIT-221 1/4"/6	CU-347	CU-347		MN1500
MS-305-8A	57-30240	143-023-03	Whit.	CU-347	CU-347		MN2400
MS-305-10	57-30500	146-104	FIT-221 1/4"/4	CU-347	CU-347		MN2600
MS-305-10A	57-40140	146-103	Whit.	CU-347	CU-347		BC-16
MS-305-12	57-40320	146-817	FIT-221 3/16"/6	CU-347	CU-347		SAT5A
MS-305-12A	57-40360	160-2N	Bk.	AC-402	CU-347		SAT4C
MS-305-16	57-40360	160-2N	AC-404	AC-403	CU-347		SAT13D
MS-305-21A	57-40500	160-4N	AC-405	AC-405	CU-347		
MS-305-16A	61-1F10	160-8N	AC-406	AC-406	CU-347		
MS-307-12	61-M10	160-9N	AC-408	AC-408	CU-347		
9790-14	77MPC1F	160-9N	FIT-221 3/4"/4	AC-409	CU-347		
9790-18	77MPC1F	160-9N	Bk.	AC-409	CU-347		
979-513-3	77MPC1F	160-9N	FIT-221 1/4"/6	AC-413	CU-347		
979-513-4	77MPC1F	160-9N	Whit.	AC-414	CU-347		
979-513-6	77MPC1F	160-9N	AC-415	AC-415	CU-347		
979-513-8	77MPC1F	160-9N	AC-416	AC-416	CU-347		
979-513-10	77MPC1F	160-9N	AC-419	AC-419	CU-347		
979-513-12	77MPC1F	160-9N	FIT-221 1/4"/6	AC-420	CU-347		
979-513-16	77MPC1F	160-9N	Whit.	AC-421	CU-347		
3-24	77MPC1F	160-9N	AC-422	AC-422	CU-347		
17-10090	78-PF8	251-535	AC-424	AC-424	CU-347		
17-10250	78-PF8	251-535	AC-425	AC-425	CU-347		
17-20080	78S11	251-1950	AC-429	AC-429	CU-347		
26-159-16	78S11	251-1950	AC-430	AC-430	CU-347		
26-159-24	78S11	251-2533	AC-431	AC-431	CU-347		
26-190-16	79-CC4	225-22221-401	FIT-300 1/4"/6	AC-1409	CU-300A		
26-190-24	80-MC2F1	1171	Bk.	AC-1409	CU-300A		
26-4100-16P	80-PC2F	261-15622-2	AC-1612	AC-1612	CU-300A		
26-4100-24P	80-PC2F	356-200	AC-1611	AC-1611	CU-300A		
26-4200-16S	80-PC2F	UG-255AU 2900	AC-1028 Nat.	AC-1028 Nat.	CU-300A		
26-4200-24S	UG-218AU 82-61	UG-185 4500	AU-1029 Nat.	AU-1029 Nat.	CU-300A		
26-4301-8S	UG-578AU 82-100	UG-625A 5575	CU-1040 Nat.	CU-1040 Nat.	CU-300A		
26-4301-16P	PL-268-49191	5575-1050	FIT-350 1/4"/6	FIT-350 1/4"/6	CU-300A		
26-4301-16S	83-1J	UG-931AU 27000	FIT-350 1/4"/6	FIT-350 1/4"/6	CU-300A		
26-4401-8P	83-1J-1050	UG-932AU 28000	FIT-350 1/4"/6	FIT-350 1/4"/6	CU-300A		
26-4401-16P	83-1J-1050	3677-01	CU-1040	CU-1040	CU-300A		
26-4401-16S	83-1R	36800	C-1584 HG	C-1584 HG	CU-300A		
26-4401-24P	83-1R-1050	68175	C-1585 HG	C-1585 HG	CU-300A		
	PL-259-49190	95725	500 Yds	500 Yds	CU-300A		

### Call Your Nearest Allied Facility Today!

Garden Grove, Calif. (213) 598-6605  
Washington, D.C. (301) 345-4600  
Chicago, Ill. (312) 421-2400  
Boston, Mass. (617) 848-4150  
Detroit, Mich. (313) 846-7720  
Fort Lauderdale, Fla. (305) 772-6464  
Fort Worth, Texas (817) 338-5401

### NEW CATALOG

1973 Edition. Write or phone for your copy today.

## ALLIED ELECTRONICS

DIVISION OF TANDY CORP.

2400 WEST WASHINGTON BLVD., CHICAGO, ILL. 60612

INFORMATION RETRIEVAL NUMBER 64

# Design Data from Manufacturers

Advertisements of booklets, brochures, catalogs and data sheets. To order use Reader-Service Card.  
(Advertisement)

## Catching Noisy Products in Production by Automatic Testing

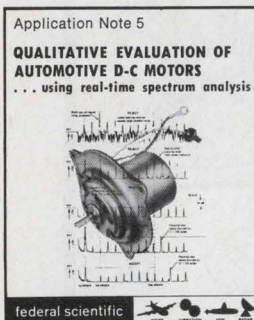

Free new 12-pg. "Application Note 5" reports a continuing program by Ford Motor Co. to integrate a Ubiquitous® Real-Time Spectrum Analyzer into small motor production for high-speed automatic noise-testing. Based on the frequency spectrum of motor under test, an automatic analyzer/computer system makes accept-reject decisions on-line in 4 sec. Defects in small DC blower motors are pinpointed by analysis of freq. peaks or signatures. Automatic evaluation of signatures & computer-generated statistics of reject-causes increases product quality, lowers reject rates. Defects identified: shaft out-of-round, loose bearing retainers, bad brushes, rotor unbalance. Production-line test results were obtained by a Mini-Ubiq™ UA 14A 400-line Analyzer interfaced with a Nova-1200 Mini-computer. Operable by non-technical personnel. Accept-reject test results appear on green & red lights.

**Federal Scientific Corp.**

615 West 131st St.

New York, N.Y. 10027 (212) 286-4400

CIRCLE NO. 171

## Giant Free Catalog! 4,000 Unusual Bargains

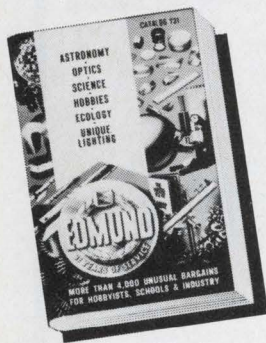

New 164-page catalog! Packed with 1,000's of hard-to-find buys in Optics, Science, Electronics. Loaded with optical, scientific, electronic equipment available from stock. Rare surplus buys. Many "one-of-a-kinds". Ingenious scientific tools. Components galore: lenses, prisms, wedges, mirrors, mounts, accessories. 100's of instruments: pollution test equipment, lasers, comparators, magnifiers, microscopes, projectors, telescopes, binoculars, photo attachments, unique lighting. Shop, save by mail! Request free Catalog "DA".

**Edmund Scientific Co.**

America's Largest Science-Optics-Electronics Mart

300 Edscorp Bldg., Barrington, New Jersey 08007 (609) 547-3488

CIRCLE NO. 172

## Practical Instrumentation Transducers

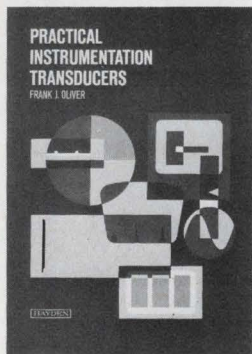

A thorough, authoritative information source on transducer selection and use. This well-planned guide by Frank J. Oliver covers virtually every known device for industrial or aerospace application. Stressing topics neglected elsewhere, it clarifies such areas as interference problems in hard-wire telemetry systems, and transducers as feedback devices in servo systems. Hundreds of diagrams, charts, and tables included. 352 pp., 7-1/8 x 9-3/4, illus., cloth, \$20.00. Circle the reader-service number for 15-day examination copies.

**Hayden Book Company, Inc.**

50 Essex Street  
Rochelle Park, N.J. 07662

CIRCLE NO. 173

# Electronic Design

ELECTRONIC DESIGN's function is:

- To aid progress in the electronics manufacturing industry by promoting good design.
- To give the electronic design engineer concepts and ideas that make his job easier and more productive.
- To provide a central source of timely electronics information.
- To promote communication among members of the electronics engineering community.

**Want a subscription?** ELECTRONIC DESIGN is sent free to qualified engineers and engineering managers doing design work, supervising design or setting standards in the United States and Western Europe. For a free subscription, use the application form bound in the magazine. If none is included, write to us direct for an application form.

If you do not qualify, you may take out a paid subscription for \$30 a year in the U.S.A., \$40 a year elsewhere. Single copies are \$1.50 each.

**If you change your address,** send us an old mailing label and your new address; there is generally a postcard for this bound in the magazine. You will have to requalify to continue receiving ELECTRONIC DESIGN free.

**The accuracy policy** of ELECTRONIC DESIGN is:

- To make diligent efforts to ensure the accuracy of editorial matter.
- To publish prompt corrections whenever inaccuracies are brought to our attention. Corrections appear in "Across the Desk."
- To encourage our readers as responsible members of our business community to report to us misleading or fraudulent advertising.
- To refuse any advertisement deemed to be misleading or fraudulent.

Microfilm copies are available of complete volumes of ELECTRONIC DESIGN at \$19.00 per volume, beginning with Volume 9, 1961. Work is now in process to complete the microfilm edition of Volumes 1-8. Reprints of individual articles may be obtained for \$2.00 each, prepaid (\$.50 for each additional copy of the same article) no matter how long the article. For further details and to place orders, contact the Customer Services Department, University Microfilms, 300 North Zeeb Road, Ann Arbor, Michigan 48106 telephone (313) 761-4700.

**Want to contact us?** If you have any comments or wish to submit a manuscript or article outline, address your correspondence to:

Editor  
ELECTRONIC DESIGN  
50 Essex Street  
Rochelle Park, N.J. 07662

# Electronic Design

## Advertising Sales Staff

Bryce Gray  
Sales Manager

## Rochelle Park, N.J. 07662

Robert W. Gascoigne  
Daniel J. Rowland  
50 Essex Street  
(201) 843-0550  
TWX: 710-990-5071

## Philadelphia

Thomas P. Barth  
50 Essex Street  
Rochelle Park, N. J. 07662  
(201) 843-0550

## Boston 02116

Richard L. Green  
20 Columbus Avenue  
Boston, Mass.  
(617) 482-7989

## Chicago 60611

Thomas P. Kavooras  
Berry Conner, Jr.  
200 East Ontario  
(312) 337-0588

## Cleveland

Thomas P. Kavooras  
(Chicago)  
(312) 337-0588  
(call collect)

## Los Angeles 90303

Stanley I. Ehrenclou  
Burt Underwood  
2930 Imperial Highway  
Inglewood, Calif  
(213) 757-0183

## San Francisco 94022

Jerry D. Latta  
P.O. Box 1248  
Los Altos, Calif.  
(415) 965-2636

## London W. 1

For United Kingdom and Holland  
Brayton C. Nichols

For Eastern Europe  
Peter Kehr

The American Magazine Group  
9 Warwick Street

London, W. 1, England  
Phone: 437 5462

Cable: Ammagnic, London

## 4800 Verviers, Belgium

For Continental Europe

Andre Jamar  
Rue Mallar, 1

(087) 253.85 Telex 41563

## Tokyo

Haruki Hirayama  
Electronic Media Service  
5th Floor, Lila Bldg.,  
4-9-8 Roppongi  
Minato-ku

Phone: 402-4556

Cable: Electronicmedia, Tokyo

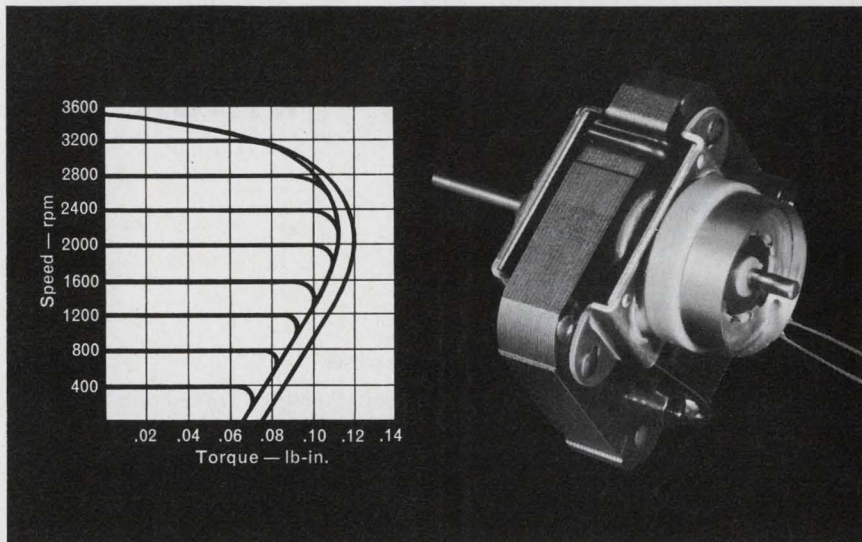

## new shaded-pole motor

### speed regulated with precision speed control

Accurate speed control over a wide torque range (see speed/torque curve). Infinitely variable speed adjustment within speed range while motor is running—selected by externally setting a potentiometer control. No-load to full-load speed regulation throughout the 10:1 speed range of 300—3000 rpm. Up to .01 hp with standard control circuitry. Preassembled speed control circuits now available for prototype model testing. Consult your Barber-Colman representative for details, or write direct for new Bulletin No. F-14897.



## BARBER-COLMAN COMPANY

Electro-Mechanical Products Division  
Dept. N, 12117 Rock Street, Rockford, Illinois 61101

INFORMATION RETRIEVAL NUMBER 65

NEW

## VECTOR-PAK SYSTEM SOLVES PACKAGING PROBLEMS

- CAGES NOW AVAILABLE FULLY OR PARTIALLY ASSEMBLED.
- NEW EASY-TO-ORDER NUMBERING SYSTEM.
- BUILT IN ADJUSTABILITY AND FLEXIBILITY TO SOLVE YOUR PACKAGING PROBLEMS.

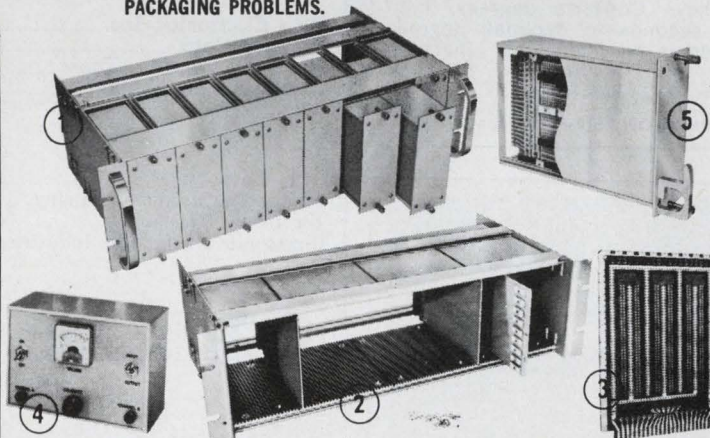

- 1 Rack mountable cage and module systems available in 3½", 5¼", 8¾" heights and 9", 12", 15" depths. Immediate availability— assembled or multi purpose kit versions.
- 2 Rugged Vector Pak Card Cages with extruded ABS or aluminum guides located on .15", .25", or .3" multiples.
- 3 Dozens of new Plugboards for building Plug-In Cards— IC and discrete types.
- 4 Multi-Mod Cases—sleek functional aluminum cases for instruments and other circuitry. 4 slotted interior surfaces for cards, mounting plates.
- 5 EFP modules in 1.6", 2", 3", or 4½" widths have slots for cards 4½" x 6½", 2.7" x 6.5", 8" x 9.6", slide off sides

Send for new specification sheets. NIMS bins and modules also available.

## VECTOR ELECTRONIC CO., INC.

12460 Gladstone Ave., Sylmar, California 91342  
Phone: (213) 365-9661 ■ TWX (910) 496-1539



72-2

INFORMATION RETRIEVAL NUMBER 66

## advertiser's index

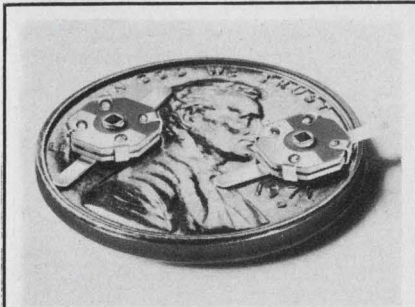

**Thin-Trim® variable capacitors** are designed to replace fixed tuning techniques. Applications include crystal oscillators, CATV amplifiers, communication and test equipment. Series 9410 has high Q's with five capacitance ranges from 1.0 - 4.5 pf to 10.0 - 50.0 pf. Johanson Manufacturing Corporation, Boonton, N. J. (201) 334-2676

INFORMATION RETRIEVAL NUMBER 181



**Dietzgen's new 12-digit electronic slide rule** does even more than your slide rule. All trig. and exponential functions—including hyperbolics and natural log—with a single function key. Converts degrees, minutes, seconds to decimal; degrees to radians or vice versa. Dietzgen Corp., 2425 N. Sheffield, Chicago, 60614. (312) 549-3300.

INFORMATION RETRIEVAL NUMBER 182

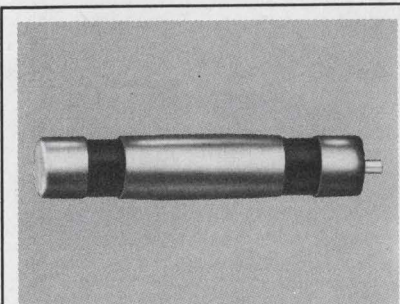

**TIL-16 gas tube arresters stop metallic surges cold!** Will withstand without damage 20 amp. a.c. for 1 sec. repeatedly on any one section, or more than 150mA a.c. for 3 hrs. For sensitive equipment or systems. Telecommunications Ind. Inc., Copiague, N.Y. 516-842-5000.

INFORMATION RETRIEVAL NUMBER 183

Advertiser	Page	Advertiser	Page
Abbott Transistor Laboratories Incorporated .....	6	Johanson Manufacturing Corp.....	7, 104
Accutronics, Inc. ....	59	Johnson Company, E. F. ....	37
Aerotech Industries .....	100	Kurz-Kasch, Inc. ....	95
Allen-Bradley Co. ....	9	Lafayette Radio Electronics .....	83
Allied Electronics, A Subsidiary of Tandy Corp. ....	101	Lambda Electronics Corp. ....	Cover III
Amphenol Connector Division Bunker Ramo Corporation.....	1	Licon, Division Illinois Tool Works, Inc. ....	15
Avantek, Inc. ....	8	Motorola Semiconductor Products Inc. ....	18
Barber-Colman Company .....	103	National Connector Corporation ....	90
Beckman Instruments, Inc., Electronic Instruments Division....	99	National Electronics, Inc. ....	85
Beckman Instruments, Inc., Helipot Division .....	73	Paktron Division, Illinois Tool Works, Inc. ....	83
Bendix Corporation, The Electrical Components Division .....	65	Plessey Semiconductors .....	12
Bourns, Inc., Trimpot Products Division .....	4, 5, 21	Power/Mate Corp. ....	90
Burroughs Corporation .....	Cover IV	Premier Metal Products Co., Inc.....	85
CTS Corporation .....	87	Pulse Engineering, Inc.....	94
Caddock Electronics .....	78	RCA Solid State Division .....	10
Carter Semiconductor .....	88	Schauer Manufacturing Corp.....	86
Cincinnati Sub Zero Products, Inc. ....	99	Signetics Corporation .....	53
Connecticut Hard Rubber Company..	82	Siliconix Incorporated .....	44
Dale Electronics, Inc.....	Cover II	Solid State Scientific, Inc.....	83
Dietzgen Corp. ....	104	Solitron Devices, Inc. ....	91
Digitran Company, The .....	84	Solitron/Microwave, Solid State Division .....	71
Dynascan Corporation .....	95	Sorensen Company, a unit of the Raytheon Company .....	40
ECC Corporation .....	38	Sprague Electric Company.....	11
Edmund Scientific Company .....	102	Spartan Books, Hayden Book Company .....	96, 97
Electronic Design .....	16, 73, 95	Struthers-Dunn, Inc. ....	13
Electronic Navigation Industries.....	14	TEC, Incorporated .....	85
Federal Scientific Corporation.....	102	TRW Semiconductor Division of TRW, Inc. ....	17
Fluke Mfg. Co., Inc., John.....	39	Tektronix, Inc. ....	43
General Radio Company .....	93	Telecommunications Industries, Inc..	104
Hayden Publishing Company, Inc. ....	96, 97, 102, 105	Teledyne Relays, A Teledyne Company .....	2
Hewlett-Packard .....	25, 26, 27, 28, 29, 30, 31, 32, 33, 34	Teledyne Semiconductors .....	81
Industrial Timer, a unit of Esterline Corporation .....	99	Texas Instruments Incorporated.....	75
Intech, Incorporated .....	92	Thermalloy Company .....	80
Integrated Microsystems, Inc. ....	77	Vector Electronic Company, Inc.....	103
		Victoreen Instrument, Div. of VLN Corp. ....	89
		Wagner Electric Corporation.....	106



# Candidate for the PE license this year?

Use these up-to-date guides...  
specifically tailored for  
your study campaign

## HAYDEN PROFESSIONAL ENGINEERING EXAMINATION SERIES

LAWRENCE J. HOLLANDER, Editor-in-Chief,  
Professional Engineer, New York State

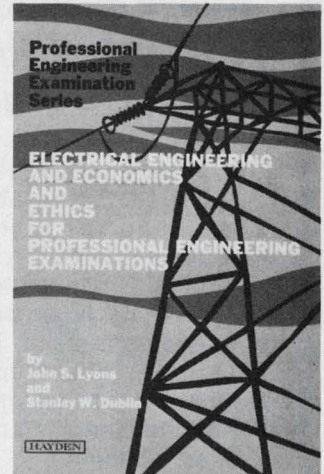
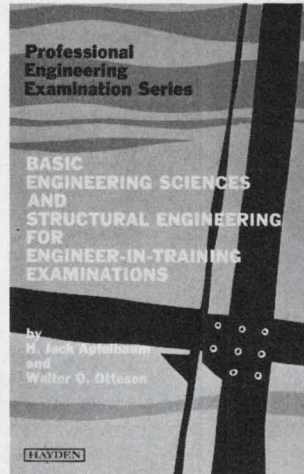

Written with your needs kept foremost,  
these study guides offer . . .

- a wide selection of actual, realistic problems from recent state examinations arranged by subject for convenient study
- detailed step-by-step solutions that bring out underlying principles to equip you to handle the unexpected
- concise background discussions precede the problems, presenting you with a mini-review of theory, principles, terminology
- separate tables of contents for subjects and problems quickly pinpoint the specifics for rapid review or "open book" examinations
- numerous schematic diagrams and detailed drawings to insure in-depth understanding

Review the books that concern you for  
15 full days—FREE!

### FOR 15-DAY FREE EXAMINATION

Please send the book(s) circled below on a 15-day examination basis. At the end of that time, I will remit payment, plus postage, or return the book(s) without further obligation.

5712-1      5715-6      5716-4

(For those ordering by ISBN, the Hayden Prefix is: 0-8104)

Save money! On all prepaid orders Hayden pays postage—  
same 15-day return guarantee! 72-29 ED

Name \_\_\_\_\_

Firm \_\_\_\_\_

Address \_\_\_\_\_

City/State \_\_\_\_\_ Zip \_\_\_\_\_



HAYDEN BOOK COMPANY, INC.  
50 Essex Street, Rochelle Park, N.J. 07662

### BASIC ENGINEERING SCIENCES AND STRUCTURAL ENGINEERING FOR ENGINEER-IN-TRAINING EXAMINATIONS

H. JACK APFELBAUM, P.E., Department of Mechanical Engineering, Lowell Technological Institute; and WALTER O. OTTESEN, P.E., Patent Counsel

Nearly 200 solved problems selected from a nationwide survey of recent E-I-T examinations offer you a complete, well organized review of the concepts and techniques that must be understood to successfully pass the preliminary exam. Unlike other study guides that stress one aspect of the field while shortchanging others, this volume provides balanced coverage of the three broad engineering areas: *the basic sciences*: mathematics, physics, and chemistry; *the engineering sciences*: statics, dynamics, fluid mechanics, thermodynamics, electricity, and engineering economy; and *structural engineering*. More than 300 detailed illustrations pinpoint key concepts and problem-solving techniques.

408 pp., 6 x 9, illus., cloth, #5712-1, \$13.95

### ELECTRICAL ENGINEERING AND ECONOMICS AND ETHICS FOR PROFESSIONAL ENGINEERING EXAMINATIONS

JOHN S. LYONS, P.E., and STANLEY W. DUBLIN, Institute of Environmental Medicine, New York University Medical Center

Concentrating on the subjects and topics that form the foundation of this rapidly changing technology, this book analyzes and solves for you almost 100 problems from a nationwide sampling of recent PE examinations. Its comprehensive, up-to-date coverage includes materials and problems not found in other guides of this type, such as electrical-magnetic-thermal analogs, semiconductors, and power system short circuits. More than 170 detailed illustrations are included. The separate section devoted to economics and ethics features an unusual approach to such topics as interest, costs, valuation, and others—the summarized use of formulas in solving nearly 50 typical problems.

302 pp., 6 x 9, illus., cloth, #5715-6, \$12.95

also available

### MECHANICAL ENGINEERING AND ECONOMICS AND ETHICS FOR PROFESSIONAL ENGINEERING EXAMINATIONS

EUGENE STAMPER, P.E., and STANLEY DUBLIN

Over 200 solved problems in mechanical engineering, along with the same thorough coverage of economics and ethics.

392 pp., 6 x 9, illus., cloth, #5716-4, \$14.95

## Tung-Sol® Bridge Rectifiers Provide High Thermal Efficiencies

Junction sizes and assembly techniques comparable to those used for discrete power rectifiers, are employed in the manufacture of Tung-Sol modular bridge rectifiers. As a result, Tung-Sol bridges offer superior overload capacities, greater thermal efficiencies and increased reliability.

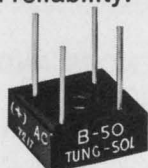

**NEW! B-50 Series—Single phase**  
DC rating—10A @ 75°C. Forward surge rating—300A @ rated load. Ratings from 50 to 600 PRV per leg. Epoxy case construction.

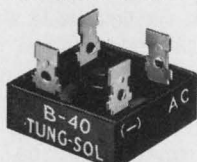

**NEW! B-40 Series—Single phase**  
DC rating—15A @ 75°C. Forward surge rating—300A @ rated load. Ratings from 50 to 1,000 PRV per leg. Epoxy case construction.

### Other Tung-Sol Bridges (With Higher Ratings)

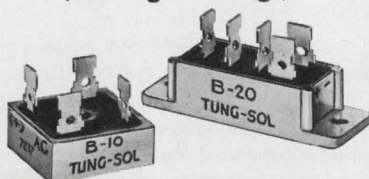

**B-10 Series—Single phase**  
DC rating—30A @ 55°C. Forward surge rating—400A at rated load. 50 to 1,000 PRV per leg.

**B-20 Series—Three phase**  
DC rating—35A @ 55°C. Forward surge rating—400A @ rated load. 50 to 1,000 PRV per leg.

Write for complete information.

SILICON PRODUCTS SECTION  
**WAGNER ELECTRIC CORPORATION**

630 West Mt. Pleasant Ave. Livingston, N.J. 07039  
TWX: 710-994-4865 PHONE: (201) 992-1100  
(212) 732-5426

Trademark TUNG-SOL Reg. U. S. Pat. Off. and  
Marcas Registradas

## product index

Information Retrieval Service. New Products, Evaluation Samples (ES), Design Aids (DA), Application Notes (AN), and New Literature (NL) in this issue are listed here with page and Information Retrieval numbers. Reader requests will be promptly processed by computer and mailed to the manufacturer within three days.

Category	Page	IRN	Category	Page	IRN
<b>Components</b>			converter	92	320
brake, spring action	80	258	dc power supplies	92	321
component oven	80	254	dc/synchro converter	92	325
detector, IR (NL)	100	348	displays	92	322
inductances, molded	80	257	filter, active (NL)	100	351
inductors, rf (NL)	98	343	voltage regulator	92	323
L-C filters (NL)	100	352	<b>Packaging &amp; Materials</b>		
LED, two-color	79	251	air release agent	89	281
LX displays	79	250	magnetic core material		
motors (NL)	98	344	(AN)	94	334
neon, bright flash	79	253	microfilms (NL)	101	357
potentiometer	80	256	modular jack panels (NL)	98	336
relays, stepping (NL)	100	349	sockets, DIP	89	280
sensor, infrared	80	255	substrates (NL)	100	347
switch, snap-action (NL)	98	341			
thermal cutoffs (NL)	101	355			
thermometers, platinum					
(NL)	100	350			
transformers, PC	79	252			
<b>Data Processing</b>			<b>new literature</b>		
calculator, engineering	88	279	chip, controller	101	356
data modems (NL)	98	335	custom ICs	101	353
disc drive, flexible	88	277	data modems	98	335
printer, impact	88	278	detector, IR	100	348
programmer, switch	88	276	diode, transistor circuits	98	338
recorder, video	88	275	disc testing guide	98	337
			filter, active	100	351
<b>ICs &amp; Semiconductors</b>			filters, ceramic EMI	101	354
chip, controller (NL)	101	356	IC	101	358
Darlington amps	84	265	inductors, rf	98	343
IC (NL)	101	358	L-C filters	100	352
IC counters	84	262	LSI memory components	98	339
LSI memory components	98	339	microfilms	101	357
MOS memory	84	264	microwave components	98	342
MSI chip	82	260	modular jack panels	98	336
RAM	82	259	motors	98	344
rectifier	82	261	power amps, rf	98	340
regulators, hybrid	84	263	power supplies	100	346
SCR	84	266	relays, stepping	100	349
			substrates	100	347
<b>Instrumentation</b>			switch, snap-action	98	341
function generator	90	302	thermal cutoffs	101	355
IC tester	91	305	thermometers, platinum	100	350
instruments, scientific	90	300	transducers	100	345
oscilloscope	91	306			
thermometer, digital	91	304			
transducers (NL)	100	345			
voltmeter	90	301			
voltmeter	91	303			
<b>Microwaves &amp; Lasers</b>			<b>application notes</b>		
diode modulator	87	272	magnetic core material	94	334
generator, rf	86	270	optical filters	94	332
marine radio band	87	274	photon couplers	94	330
oscillators	86	268	rms measurement	94	333
power amps, rf (NL)	98	340	x-ray analysis	94	331
power transistor	87	273			
radar module	86	267			
transistor	86	271			
YAG laser	86	269			
<b>Modules &amp; Subassemblies</b>			<b>evaluation samples</b>		
angle/sine converter	92	324	cable ties	94	327
			grommets	94	329
			sockets, DIP	94	326
			temperature recorder	94	328

Do you face a make or buy decision on power supplies?

# BUY LAMBDA'S NEW LT SERIES

a 5V, 7A power supply  
with overvoltage protection for \$80

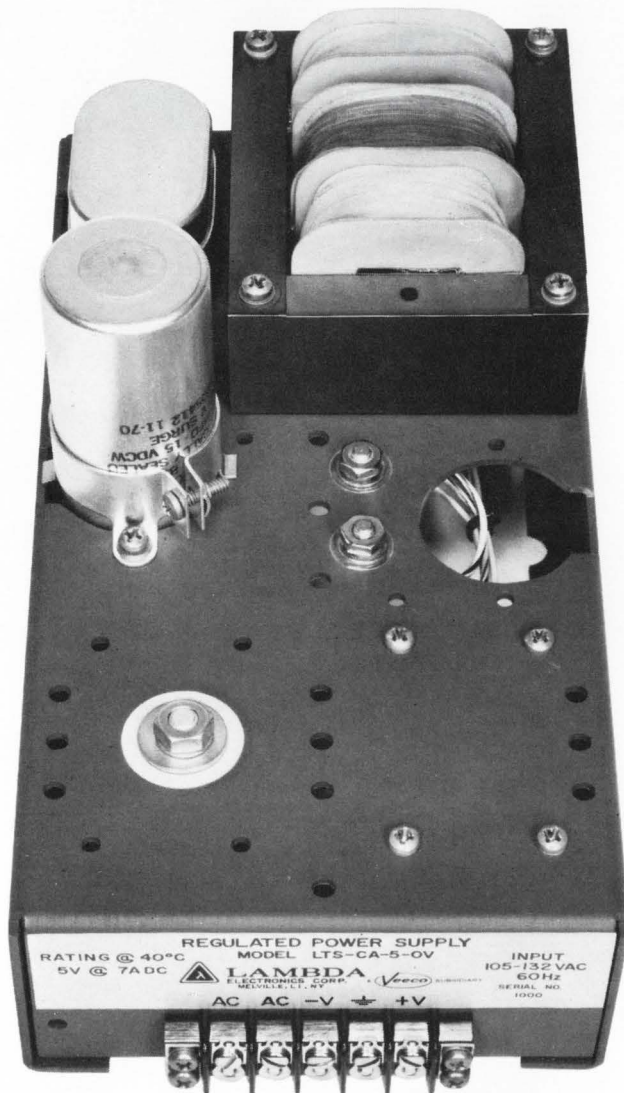

Send for 1973 Power Supply Catalog  
and Application Handbook

Only 13 components  
Line regulation—0.02% Load regulation—0.15%  
Ripple and Noise—1.5 mV RMS  
Temperature coefficient—0.01%/°C  
Lambda's long life voltage regulating  
ferroresonant transformer  
Open construction  
Lambda's 100,000 hours MTBF power hybrid  
voltage regulator  
MIL-R-11 composition resistors  
Heavy duty barrier strip  
MIL-R-26 type wire wound resistors  
Convection cooled chassis  
Computer grade hermetically sealed 10-year life  
electrolytic capacitors  
Efficiencies up to 55%  
Under test for listing in Underwriters'  
Laboratories recognized components index  
1 Day delivery

## 5-YEAR GUARANTEE

### LTS-CA SINGLE OUTPUT MODELS

4<sup>29</sup>/<sub>32</sub>" x 4<sup>19</sup>/<sub>16</sub>" x 9<sup>5</sup>/<sub>16</sub>"

MODEL	FIXED VOLT. RANGE VDC	MAX. AMPS AT AMBIENT OF: 40°C	PRICE
LTS-CA5-OV*	5±1%	7.0	\$80
LTS-CA-6	6±1%	6.6	80
LTS-CA-12	12±1%	4.4	80
LTS-CA-15	15±1%	4.0	80
LTS-CA-20	20±1%	3.1	80
LTS-CA-24	24±1%	2.6	80
LTS-CA-28	28±1%	2.2	80

\*Includes fixed overvoltage protection at 6.8V±10%

### LTD-CA DUAL OUTPUT MODEL

4<sup>29</sup>/<sub>32</sub>" x 4<sup>15</sup>/<sub>16</sub>" x 9<sup>5</sup>/<sub>16</sub>"

MODEL	FIXED VOLT. RANGE VDC	MAX. AMPS AT AMBIENT OF: 40°C	PRICE
LTD-CA-152	±15±1%	2.0	\$110
LTD-CA-122	±12±1%	2.0	110

A-C INPUT: 105-132 Vac, 59.7 to 60.3 Hz (STD. Comm'l  
Line Frequency Spec.), consult factory for operation at  
other frequencies.

 **LAMBDA** ELECTRONICS CORP.

MELVILLE, NEW YORK 11746 515 Broad Hollow Road Tel. 516-694-4200 ARLINGTON HEIGHTS, (CHICAGO) ILL. 60005 2420 East Oakton St., Unit. Q Tel. 312-593-2550  
NORTH HOLLYWOOD, CALIF. 91605 7316 Varna Ave. Tel. 213-875-2744 MONTREAL, QUEBEC 100C Hymus Blvd., Pointe-Claire, Quebec-730 Tel. 514-697-6520

INFORMATION RETRIEVAL NUMBER 233

whatever your computer says...

# SELF-SCAN® SAYS IT BEST

PANEL DISPLAYS



16/18 Character Position Panel, 5 x 7 Dot Matrix, Characters 0.4" High. Available as numeric only or alphanumeric panel with 64-character format.



32/37, 80 Character Position Panel, 5 x 7 Dot Matrix, Characters 0.2" High. Alphanumeric panel with 64-character format.

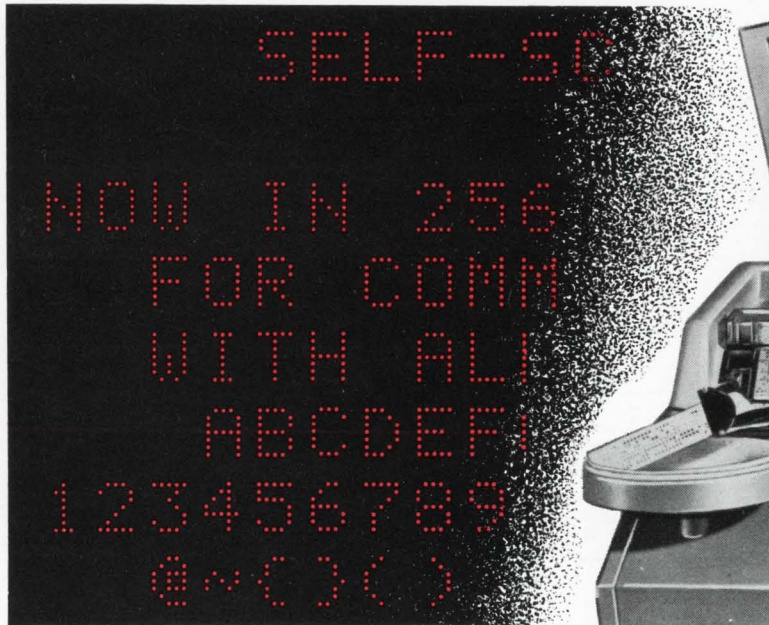

SELF-SCAN Panel Display Subsystem, 256 Character Capacity, 5 x 7 Dot Matrix, Characters 0.25" High. 64-character format, available with all drive electronics including memory, character generator, and timing.



(1)

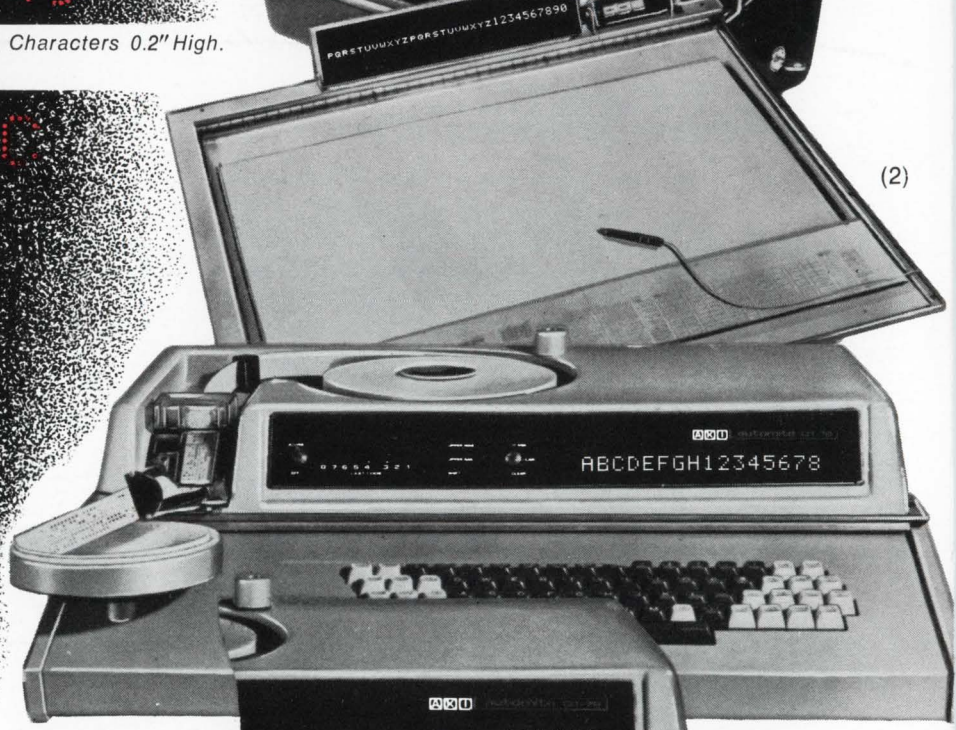

(2)



(3)

Whether it's a police officer in a patrol car requesting information on a suspect, an architect specifying coordinates for plumbing fixtures in a new building, or a type setter verifying type for a mail-order catalog, SELF-SCAN panel displays guarantee the most accurate transfer of data between the operator and the computer. If you need a computer display and demand error-free communications, follow the lead of Kustom Electronics (1) in Chanute, Kansas; Science Accessories Corporation (2) in Southport, Connecticut; Automix Keyboards (3) in Bellevue, Washington, and the many other SELF-SCAN panel display users. Have a Burroughs salesman demonstrate his "terminal in a briefcase." You'll see why the SELF-SCAN panel display is the most effective man/machine interface device available today.

Burroughs Corporation, Electronic Components Division, Plainfield, New Jersey 07061. (201) 757-3400.

