

Miele

The Miele benefits to surgeries and clinics
Washer-disinfectors and accessories

Miele Professional. Immer Besser.



A systematic approach from Miele Professional

A clear decision in hospitals and surgeries



When developing reprocessing solutions for medical instruments, Miele Professional has always valued close cooperation both with experts in the field and with reputable instrument manufacturers. The result of this cooperation based on trust and innovation are machines and processes which convince discerning users all along the line.

Quality

Your patients trust your professional expertise – so why not place your trust in Miele's renowned quality! Mature technical design and high-quality materials underline the first-class reputation Miele Professional enjoys in hospitals and surgeries. And this is equalled by the quality of service which has won Miele numerous awards over the years.

Power output

Washer-disinfectors from Miele Professional have a proven ability to stand up to the stresses and strains of everyday hospital life. With their high performance, extensive accessories and innovative processes, they ensure perfect results and fast instrument turnaround, even of the instruments used in highly specialised applications. This ensures that expensive instruments are ready for use again in next to no time.

Efficiency

Benefit from excellent efficiency every day: appliances from Miele Professional are thorough and fast, affording top-rate protection to materials in the process. Thanks to their high quality, they also require little maintenance and are highly durable, safeguarding your investments in every respect. The efficient use of water and chemicals also equates to low running costs.



With Miele Professional, you are choosing top performance and quality. High-quality products which rise to meet expectations each and every day are the reason for the trust professional users place in our company: 97% of all customers* claim they would buy from Miele Professional again next time round.

Dependability

For four generations, Miele has carried a special responsibility as a family-run company towards its customers, its business partners and its employees, as well as for its products, processes and natural resources.

- Product development with a clear focus on quality, durability and sustainability
- Ground-breaking innovations 'Made in Germany'
- Award-winning ergonomics, functionality and product design
- Entire systems from a single supplier
- Low operating costs over the entire product life cycle
- Highly commended after-sales service offering blanket coverage and a fast response

55
YEARS Medical Technology



Innovative programme cycles

Only available from Miele Professional

Vario TD

The Vario TD method can now be seen as the standard programme for routine instrument cleaning and disinfection, achieving good removal of organic contamination (blood, secretion) from instruments which do not pose a particular challenge. Thermal disinfection takes place at $> 90^{\circ}\text{C}$ for 5 minutes. To protect instruments, the final rinse is ideally performed with demineralised water without surfactant. The programmes on the new generation of machines have been specifically designed to relate to applications and cover a broad range of applications. These include special cycles for ENT, MIS and gynaecology.

VARIOTD

Oxivario

Special programme for instruments classified as critical according to RKI guidelines, e.g. instruments used in trauma surgery as well as high-frequency cauterising instruments which pose particular challenges.

OXIVARIO

Orthovario

Special programme for orthopaedic instruments including transmission systems and other medical products made from aluminium.

ORTHOVARIO

Robotvario

Innovative and comprehensive system comprising a special-purpose programme, specially formulated chemicals and a range of load carriers for the safe and economical reprocessing of common robotic-assisted instruments.

ROBOTVARIO





Recommended by the most discerning

Leading instrument manufacturers place their trust in Miele

Recommendations

Miele Professional stands for the safe and hygienic reprocessing of instruments whilst at the same time ensuring the ultimate in material compatibility and value retention. That is why leading instrument manufacturers recommend using Miele systems to reprocess their instruments.

AESCULAP®

Miele ORTHOVARIO approved for the reprocessing of current-series Aesculap motor systems.

Geuder®
Precision made in Germany

Recommendation to reprocess ophthalmological instruments with the Miele system.

STORZ
KARL STORZ — ENDOSKOPE

Miele OXIVARIO PLUS process approved to prevent the iatrogenic spread of vCJD

OLYMPUS

Safe reprocessing of flexible endoscopes in models ETD4 and mini ETD2 which are designed and manufactured by Miele.

RICHARD WOLF 

spirit of excellence

Value-preserving reprocessing of instruments with the VARIO TD and OXIVARIO processes.

INTUITIVE
SURGICAL®

Approval granted to reprocess robotic-assisted instruments using the Miele ROBOTVARIO system.

KAVO
Dental Excellence

W&H





Washer-disinfectors

PG 8582, PG 8592, PG 8582 CD

Miele Professional has been setting standards in the field of efficient and safe machine-based reprocessing in clinics and surgeries for more than 5 decades. Designed for decentral instrument reprocessing, Miele Professional's PG 8582, PG 8592 and PG 8582 CD washer-disinfectors offer added value: better cleaning performance, improved process security and greater cost-effectiveness.



Contents

PG 8582, PG 8592, PG 8582 CD

Product highlights	9
Machine overview.....	12
Load carrier system, sample feature sets	17
Upper and lower baskets, load carriers, inserts.....	26
Accessories	28

PG 8536

Product highlights	33
Machine overview.....	38
Upper and lower baskets, modules, load carriers, inserts.....	40

Bedpan washer

Product highlights	68
--------------------------	----

Process documentation

Overview of documentation options	72
Components and accessories.....	74
NetBox.2.....	81

Service

Functional safety and preservation of value	83
---	----



Product highlights

PG 8582, PG 8592, PG 8582 CD

Washer-disinfectors from Miele Professional enable the safe and reproducible cleaning and disinfection of instruments used by doctors and surgeons. The approach used is particularly gentle on materials. Leading instrument manufacturers such as Aesculap and Geuder have recommended the reprocessing of their instruments with Miele Professional for many years.



Greater performance

- An innovative heater pump enables both time savings and high standards of efficiency
- The ideal shape of the nozzles and their arrangement ensures a highly effective pattern of jets
- An optimised water circuit and a significant increase in pump pressure at the injector nozzles guarantees the thorough and safe reprocessing of lumened instruments
- 8 DIN mesh trays can now be reprocessed in a single cycle (capacity increased by 100% compared with previous series)



Improved efficiency

- Application-specific programmes
- Variable-speed pump for perfect spray pressure in all programme phases
- Economic and safe reprocessing of even the most intricate of lumened instruments using the central filtration system
- Low-maintenance and highly durable thanks to excellent materials and workmanship



Greater safety

- Multi-stage filtration system is highly efficient in removing dirt particles from the wash water
- Large-surface central filter in upper basket or load carrier guarantees optimum protection against the blockage of narrow-lumened ophthalmological instruments
- Reprocessing excellence is afforded by closely monitoring spray pressure and the rotation of the spray arms in order to prevent any loss in circulation pressure or to immediately identify obstacles in the path of the spray arms
- Conductivity monitoring ensures required water quality

Overview of further product highlights

PG 8582, PG 8592, PG 8582 CD



Design and user interface

- The new control panel is the central design element and represents an intelligent combination of door handle and control panel
- Full flush stainless-steel surface with embedded 'touch-on-steel' controls
- Inclined control panel for improved legibility
- 3-line text display and intuitive user interface for hassle-free operation
- Programmes catering for a wide variety of instruments and soils and vacant programme slots for user-specific programmes
- Freely assignable direct-access buttons and individually selectable programme names for fast access to routine tasks
- Flush, smooth control panel and handle surfaces for simple wipe cleaning



Ergonomics

- An easily accessible salt container in the door and the AutoClose functions simplify the work of those operating these machines
- Patented salt container in door with a capacity of approx. 2 kg
- Replenishing the salt no longer requires bending or stooping as the job can be performed standing upright
- Similarly, there is no longer any need to remove heavy baskets and load carriers to access the salt container
- AutoClose: As a result, only a minimum of effort is required to reliably close and lock the door



Highly efficient drying

- EcoDry: Fast evaporation of moisture and quick drying of load by automatically opening the door at the end of a programme (AutoOpen) at a chamber temperature of below 70°C
- DryPlus: Hot-air drying on the PG 8592 /PG 8582 CD represents an ideal solution when dealing with intricate and narrow-lumened instruments
- Thorough removal of particles from drying air intake through use of upstream HEPA Class H13/H14 filter (depending on model type)
- The filter is easily accessible for servicing via a hatch in the machine toekick panel (PG 8592) or in the side unit (PG 8582 CD)



Hygienic chamber

- High throughput combined with excellent hygiene and purity for analytical experiments
- Laser technology is used to weld the chamber sections to give a perfectly smooth, crevice-free finish offering no nooks or crannies where blood or soil can accumulate
- The removal of heater elements from the chamber removes a further potential source of a build-up of contamination and eliminates the risk of plastic items melting on contact with the heaters
- Increased space in the chamber increases the load capacity per cycle (e.g. 8 DIN mesh trays, 42 GYN speculae)



Rear basket docking system

- The positioning of the docking system for upper and lower baskets and mobile units at the rear of the chamber guarantees the precise feed-in of water and drying air and the economical use of resources.
- Short circulation paths help minimise pressure losses and reductions in water temperature
- Automatically self-sealing valves when not in use ensure uniformly high spray pressure
- Use of same docking system to supply load carriers with water and hot air for internal drying



Optimised spray arms

- The design of the spray arms ensures the ultimate in reliability in reprocessing
- Different nozzle forms ensure the forceful removal of persistent soil and the uniform wetting of wash loads
- Elimination of water reflections in spray curtain thanks to optimum arrangement of nozzles on spray arms
- Lower water consumption per cycle without any trade-off in terms of cleaning performance



Safety through monitoring

- Highly developed sensors: Spray pressure and spray arm monitoring and, depending on the model, conductivity sensors contribute in a major way towards reliable reprocessing
- Blockages caused by protruding load items are immediately detected
- Spray pressure losses as a result, for example, of excessive foaming are reliably detected
- Deviations from the selected conductivity level in the final rinse water are reliably detected
- Thanks to integrated sensors, deviations from the programme parameters are immediately recognised, allowing rapid intervention on the part of users

Appliance overview

PG 8582, PG 8592, PG 8582 CD



Lab washers (left to right)	PG 8582	PG 8592	PG 8582 CD
Width	600	600	900
Undercounter unit, height, depth [mm]	820, 600	820, 600	820, 600
Free-standing unit, height, depth [mm]	835, 600	835, 600	835, 700**
Shortest cycle [mins.]	22*	22*	22*
Cycle capacity			
DIN mesh trays	8	8	8
DIN mesh trays/lumened instruments connected using LuerLock adapters	8/6	8/6	8/6
AN sets	2-3	2-3	2-3
MIS sets	1-2	1-2	1-2
GYN specula	42	42	42
Drying	EcoDry	DryPlus	DryPlus
Integrated dispenser pump (depending on model)	1/2	1	2
Drawer for supply canisters (3 x 5 l or 2 x 10 l)	-	-	•
Electrical connection 3N AC 400 V, 50 Hz	•	•	•
Total rated load [kW]	9.3	9.3	9.3

* VARIO TD ENT Optics, Washing and disinfection, ** Lid not included

Programmes, cycle times, consumption

PG 8582, PG 8592, PG 8582 CD

PG 8582	Washing/disinfection					Drying	
	Cycle time	CW*	HW	DI	Energy	Cycle time	Energy
	[mins.]	[l]	[l]	[l]	[kWh]	[mins.]	[kWh]
Vario TD Instr 4 mesh trays	40	17.4	18.2	9.0	2.1	8	–
Vario TD Instr 6 mesh trays	51	25.2	27.3	13.0	2.8	8	–
Vario TD Instr 8 mesh trays	55	26.6	27.9	13	3.0	6	–
Vario TD MIS	41	18.6	12.5	16.0	2.3	7	–
Vario TD AN	53	25.9	29.6	14.0	2.5	4.5	–
Vario TD GYN	47	17.4	28.2	7.5	1.8	6	–
Ophthalmology	41	13.8	21.7	17.5	2.0	7	–
Ophtha tray	65	11	–	53	2.6	6	–
Vario TD ENT	42	17.4	18.2	9.0	2.3	7	–
Vario TD ENT optics	22	10.0	–	9.0	1.6	6	–
Baby bottles	38	17.4	21.2	7.5	2.3	6	–
Ward utensils	30	17.4	12.2	7.5	1.6	4.5	–
Theatre shoes	28	17.1	12.5	8.5	1.6	3.5	–
Universal	34	4.5	31.5	18.5	1.7	3	–
Special 93°C-10'	52	11.9	29.6	14.0	3.3	3	–
Rinse	4	10.0	–	–	0.01	–	–

PG 8592, PG 8582 CD	Washing/disinfection					Drying	
	Cycle time	CW*	HW	DI	Energy	Cycle time	Energy
	[mins.]	[l]	[l]	[l]	[kWh]	[mins.]	[kWh]
Vario TD Instr 4 mesh trays	40	17.4	18.2	9.0	2.1	47	0.8
Vario TD Instr 6 mesh trays	51	25.2	27.3	13.0	2.8	55	1.0
Vario TD Instr 8 mesh trays	55	26.6	27.9	13	3.0	67	1.1
Vario TD MIS	41	18.6	12.5	16.0	2.3	42	0.7
Vario TD AN	53	25.9	29.6	14.0	2.5	94	1.7
Vario TD GYN	47	17.4	28.2	7.5	1.8	37	0.6
Ophthalmology	41	13.8	21.7	17.5	2.0	57	0.9
Ophtha tray	65	11	–	53	2.6	91	1.4
Vario TD ENT	42	17.4	18.2	9.0	2.3	52	0.8
Vario TD ENT optics	22	10.0	–	9.0	1.6	32	0.5
Baby bottles	38	17.4	21.2	7.5	2.3	62	1.2
Ward utensils	30	17.4	12.2	7.5	1.6	39	0.5
Theatre shoes	28	17.1	12.5	8.5	1.6	44	0.5
Universal	34	4.5	31.5	18.5	1.7	37	0.7
Special 93°C-10'	52	11.9	29.6	14.0	3.3	79	1.4
Rinse	4	10.0	–	–	0.01	–	–
Drying	–	–	–	–	–	40	0.7

Heating: 8.5 kW (3N AC 400V 50Hz), connection to cold water (15°C), hot water (65°C) and demineralised water (15°C)
 *excl. water consumption of steam condenser

Innovative programme cycles

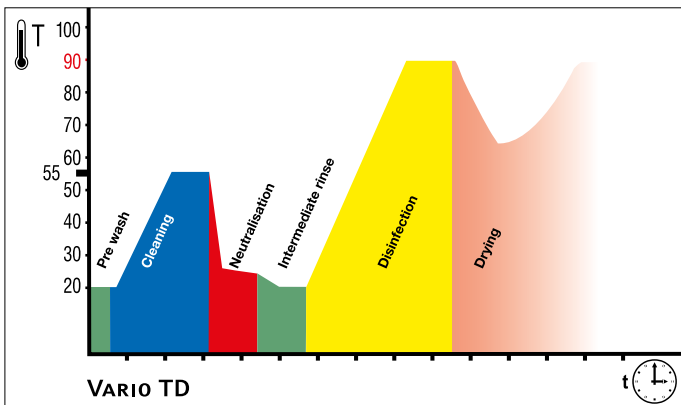

VARIO TD

Vario TD

The Vario TD method can now be seen as the standard programme for routine instrument cleaning and disinfection, achieving good removal of organic contamination (blood, secretion) from instruments which do not pose a particular challenge.

Thermal disinfection takes place at > 90°C for 5 minutes. To protect instruments, the final rinse is ideally performed with demineralised water without surfactant.

- Intensive cleaning below protein denaturation temperature
- Disinfection according to EN ISO 15883
- Exceptional material compatibility

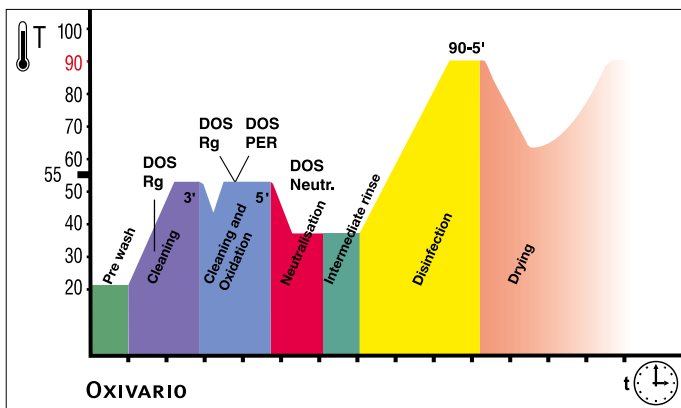

OXIVARIO®

OXIVARIO

Special programme on PG 8536 washer-disinfectors for instruments classified as critical according to RKI guidelines, e.g. instruments used in trauma surgery as well as high-frequency cauterising instruments which pose particular challenges.

- Excellent cleaning and removal of organic soil
- Time-saving as there is no need for pre- and post-treatment

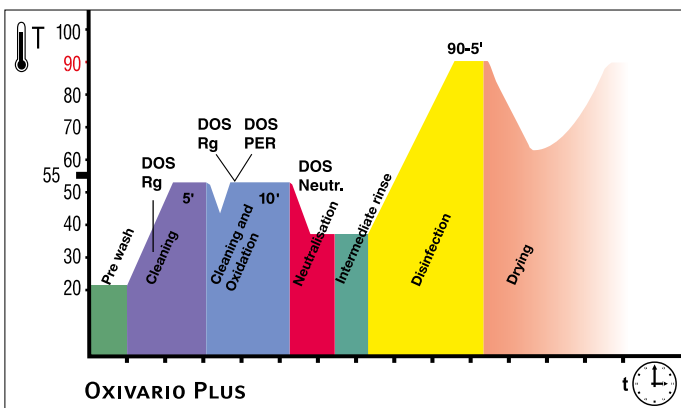

OXIVARIO PLUS®

OXIVARIO PLUS

Special programme on PG 8536 washer-disinfector for the prevention of the iatrogenic spread of vCJD according to RKI Task Force.

- Excellent cleaning and removal of organic soil
- Time-saving as there is no need for pre- and post-treatment

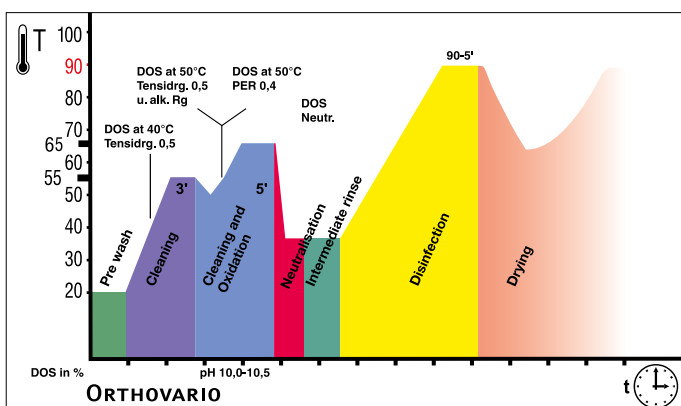

ORTHOVARIO®

ORTHOVARIO

Special programme on PG 8536 washer-disinfectors for orthopaedic instruments including motor systems and other medical products made from aluminium.

- Excellent cleaning performance
- Good material compatibility even on instruments sensitive to alkalinity



ROBOTVARIO

The complexity of the robotic-assisted instruments used in minimally invasive surgery poses extreme challenges with respect to the safety and reliability of reprocessing. The ROBOTVARIO reprocessing system from Miele Professional consists of a specially designed load carrier, a new reprocessing programme and matching process chemicals. The outcome is an innovative approach to the safe and cost-efficient cleaning and disinfection of robotic-assisted surgical instruments.

- Enzymatic cleaning for the most common instruments used in robotic-assisted surgery
- Economical and gentle reprocessing of valuable instruments

Miele innovations to tackle particularly critical cases.

Milestones in the optimisation of cleaning results:

In order to meet the wide-ranging needs of clients, these washer-disinfectors are equipped with numerous application-specific programmes.

For greater efficiency and capacity, Miele offers Vario TD programmes for 4, 6 or 8 mesh trays.

The optimised use of cabinet space and high-performance spray technology allows a maximum of 8 standard DIN mesh trays to be reprocessed per cycle in the new

washer-disinfectors. Different programmes for 4, 6 and 8 mesh trays offer the benefits of curtailing the cycle time for 4 mesh trays by approx. 10-14 minutes and saving approx. 25 l of water.

Miele caters for highly specific applications such as the needs of ENT specialists. The fibre optics used in the ENT discipline are extremely expensive and hence reprocessing turnaround times should be as short as possible. The Vario TD ENT Optics pro-

gramme serves to reprocess slightly soiled ENT fibre optics and has a very short cycle time of only 20 mins. Furthermore, models PG 8582 and PG 8592 each offer 2 vacant programme slots which can be used to cater for users' individual needs.



Innovative load carrier system

Load carriers and inserts offering improved efficiency

In order to ensure that medical products are reprocessed safely and in a manner which retains their value, Miele Professional offers a wide range of accessories including upper and lower baskets, load carriers and inserts for a broad range of instruments. With the introduction of the PG 85 series, the entire load carrier system has undergone a thorough reappraisal.

Improved efficiency

The new load carriers utilise the available space in the chamber to a higher degree, allowing more instruments and other load items to be washed in each cycle. Another benefit accrues from the redesigned water and air circuit: Wash liquor and drying air is fed along a shorter and streamlined circuit and with minimal pressure losses on their way to the spray arms and injector nozzles to best avail. Optimum pressure conditions are also created by the automatically self-sealing docking valves when not occupied.

Sample feature sets for medical applications / recommendations for washer-disinfectors	PG 8582	PG 8592	PG 8582 CD
Sample feature set: 8 mesh trays	•	•	•
1 x A 208 load carrier with 8 x E 142 mesh trays			
Sample feature set: MIS instruments	–	•	•
1 x A 203 load carrier			
Sample feature set: MIS instruments and mesh trays	–	•	•
1 x A 104 upper basket, 1 x A 151 lower basket			
Sample feature set: Anaesthetics	–	•	•
1 x A 201 load carrier			
Sample feature set: Ophthalmology	•	•	•
1 x A 207 load carrier			
Sample feature set: Theatre shoes	•	–	–
1 x A 103 upper basket with A 308 insert, 1 x A 151 lower basket with A 307 insert			
Sample feature set: Gynaecology	•	•	•
1 x A 102 upper basket, 1 x A 151 lower basket, 7 x E 416, 1 x E 378			

Sample feature set: 8 mesh trays

for PG 8582, PG 8592, PG 8582 CD



A 208 load carrier

- Increased capacity: Simultaneous reprocessing of up to 8 DIN mesh trays on 4 levels
- 4 additional LuerLock connections for lumened instruments
- Removable rack level increases vertical clearance on second level from bottom, e.g. for kidney dishes
- Loading dimensions from bottom:
 - Level 1: H 60, W 516, D 490 mm (with frame)
 - Level 1: H 100, W 490, D 490 mm (without frame)
 - Level 2: H 55, W 510, D 500 mm
 - Level 2: H 200, W 510, D 470 mm (w/o Level 3)
 - Level 3: H 130, W 404, D 470 mm
 - Level 4: H 75, W 510, D 500 mm
- H 455, W 530, D 542 mm

8 x E 142 insert 1/2 mesh tray

- DIN mesh tray
- 1 mm wire gauge, 5 mm mesh size, 5 mm wire frame
- Two hinged carrying handles
- Max. load 10 kg
- H 45/55, W 255, D 480 mm

Sample feature set: MIS

for PG 8592, PG 8582 CD



A 203 load carrier

- For minimally invasive surgical instruments
- Loading on 2 levels
- Applications
 - E 451 mesh tray for small items
 - E 457 insert for separable MIS instruments
 - E 460 insert for rigid fibre optics
 - E 473/2 mesh tray for small items
- H 520, W 529, D 542 mm

Scope

- 3 x E 336 irrigation sleeves, 121 mm
- 2 x E 362 blanking screw
- 15 x E 442 injector sleeves, 121 mm, for MIS instruments, Ø 4-8 mm
- 5 x E 443 injector sleeves, 121 mm, for MIS instruments, Ø 8-12 mm
- 1 x E 444 drum for fibre-optic cables and irrigation tubes
- 1 x E 445, 12 caps, for irrigation sleeves, 6 mm
- 1 x E 446, 12 caps, for irrigation sleeves, 10 mm
- 3 x E 447 adapters, female, for LuerLock, male
- 6 x E 448 silicone hoses, 300 mm, 5 x 1.5 mm with male LuerLock adapters
- 5 x E 449 adapters, female, for LuerLock, male
- 1 x E 451 mesh insert 1/6, with lid
- 3 x E 452 injector nozzles, 2.5 x 60 mm
- 8 x E 453 injector nozzles, Ø 4.0 x 110 mm with spring support
- 6 x E 454 injector nozzles for trocar sleeves, 10-15 mm
- 4 x E 456 spring supports for MIS instruments, e.g. scissors, forceps, etc.
- 3 x E 464 adapter for E 454 injector nozzle
- 2 x E 472 spring support for injector nozzle, Ø 4.0 mm

Sample feature set: MIS and mesh trays

for PG 8582, PG 8592, PG 8582 CD

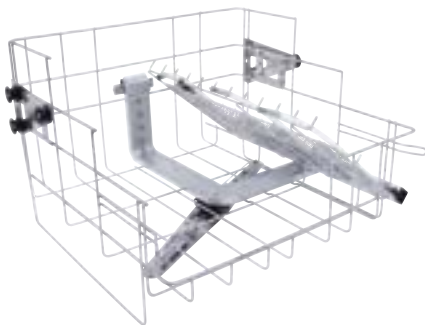

A 104 upper basket/injector unit

- For surgeries with only few lumened instruments
- For instruments from minimally invasive surgery, arthroscopy, urology
- Left-hand side free for inserts (max. clearance H 310, W 240, D 455 mm)
- Right-hand side for 11 lumened instruments (max. length of connected instruments: 430 mm)
- Four additional LuerLock connections for further lumened instruments
- With spray arm: Space for mesh trays on lower level
- H 332, W 528, D 526 mm

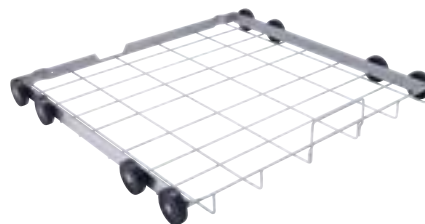

A 151 lower basket/open front

- For various DIN mesh trays and various inserts
- Loading width 490 mm
Loading depth 498 mm
- Vertical clearances in combination with
 - A 101 H 275 ± 30 mm
 - A 102 H 230 ± 30 mm
 - A 103 H 305 mm
 - A 104 H 145 mm
 - A 105 H 210 mm
- H 88, W 529, D 522 mm

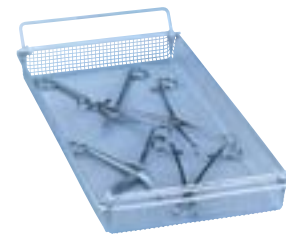

E 142 insert 1/2

- DIN mesh tray
- 1 mm wire gauge
- Mesh size 5 mm
- 5 mm all-round frame
- 2 hinged handles
- Max. load 10 kg
- H 45/55, W 255, D 480 mm



E 379 insert 1/2 mesh tray

- Stainless steel
- Wire mesh: 0.8 mm, mesh size: 1.7 mm
- 5 mm all-round frame
- 2 handles, for upper or lower basket
- H 80/110, W 180, D 445 mm

Sample feature set: Anaesthetics

for PG 8582, PG 8592, PG 8582 CD

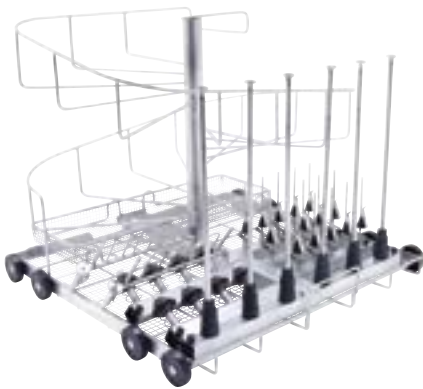

A 201 load carrier

- For AN sets
- 8 nozzles with spring supports for breathing tubes with max. length of 1.5 m
- Spiral rack
- 15 injector nozzles for intubation material
- H 434, W 531, D 546 mm

Scope

- 1 x E 430 mesh tray
- 1 x E 432 holder for 3 - 4 corrugated breathing tubes
- 2 x E 433 holders for 3 - 4 silicone breathing tubes
- 1 x E 434 holder for 3 - 4 paediatric breathing tubes
- 6 x E 466 injector nozzles for breathing bags, 8 x 333 mm
- 1 x E 431 injector nozzle for breathing bags, 8 x 193 mm
- 15 x E 496 injector nozzles, 4 x 120 mm

Sample feature set: Ophthalmology and optional accessories

for PG 8582, PG 8592, PG 8582 CD



A 207 load carrier

- Efficient reprocessing of ophthalmic instruments:
Fast loading and high throughput
- Upper level: Up to 8 trays for lumened instruments attached to LuerLock connectors
- Lower level: 8 trays (4 on each level), horizontal, for further ophthalmic instruments
- Clearances from bottom:
Level 1: H 95, W 494, D 500 mm
Level 2: H 60, W 508, D 455 mm
- H 438, W 530, D 542 mm

A 800 tubular filter

- Filter made from multi-ply stainless-steel mesh for A 105 upper basket and A 204 load carrier
- Mesh size 63 μ m
- Can be cleaned with A 804 cleaning brush
- L 405 mm, \varnothing 22.5 mm

A 804 cleaning brush

- for cleaning A 800 central filter
- Twisted wire brush with spiral bristles
- Handle with grommet
- Length 500 mm, brush length 100 mm

Sample feature set: Theatre shoes

for PG 8582, PG 8592, PG 8582 CD

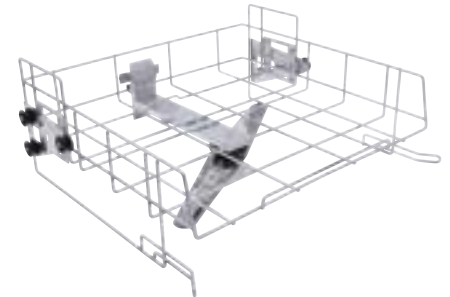

A 101 upper basket/open front

- Open front
- For various inserts
- Height-adjustable
- Vertical clearance 160 +/- 30 mm, Width 475, Depth 443 mm
- Built-in spray arm
- H 206, W 528, D 527 mm



A 308 insert

- For up to 34 theatre shoe insoles
- For use in open-fronted upper or lower baskets
- H 71, W 475, D 445 mm

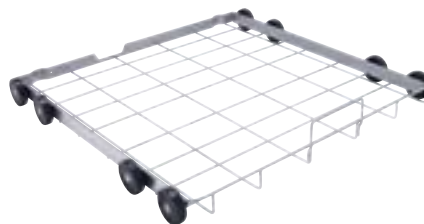

A 151 lower basket/open front

- For various DIN mesh trays and various inserts
- Loading width 490 mm
Loading depth 498 mm
- Vertical clearances in combination with
 - A 101 H 275 ± 30 mm
 - A 102 H 230 ± 30 mm
 - A 103 H 305 mm
 - A 104 H 145 mm
 - A 105/1 H 210 mm
- H 88, W 529, D 522 mm



A 307 insert

- For up to 20 theatre shoes (tines 265 mm long)
- For use in open-fronted lower basket
- Reprocessing of theatre shoes, max. size 48
- H 279, W 475, D 380 mm

Sample feature set: Gynaecology

for PG 8582, PG 8592, PG 8582 CD

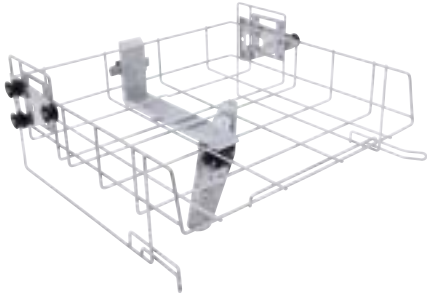

A 102 upper basket/open front

- Open front
- For various inserts
- Vertical clearance 205 +/- 30 mm, Width 475, Depth 443 mm
- Built-in spray arm
- H 206, W 528, D 527 mm



7 x E 416 1/4 insert

- For 6 one or two-piece speculae
- 7 holders, spacing 40 mm
- For upper or lower basket
- H 157, W 178, D 279 mm

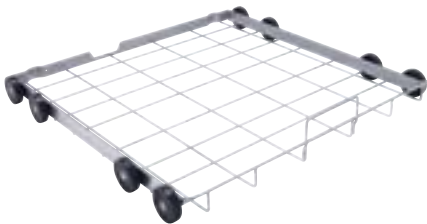

A 151 lower basket/open front

- For various DIN mesh trays and inserts
- Loading width 490 mm
Loading depth 498 mm
- Vertical clearances in combination with
 - A 101 H 275 ± 30 mm
 - A 102 H 230 ± 30 mm
 - A 103 H 305 mm
 - A 104 H 145 mm
 - A 105/1 H 210 mm
- H 88, W 529, D 522 mm



E 379 insert 1/2 mesh tray

- Stainless steel
- Wire mesh: 0.8 mm, mesh size: 1.7 mm
- 5 mm all-round frame
- 2 handles, for upper or lower basket
- H 80/110, W 180, D 445 mm



Overview of upper and lower baskets and load carriers

for PG 8582, PG 8592 and PG 8582 CD

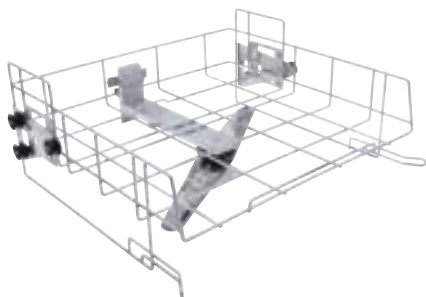

A 101 upper basket/open front

- Open front
- For various inserts
- Height-adjustable
- Vertical clearance 160 mm +/- 30 mm, Width 475, Depth 443 mm
- Built-in spray arm
- H 206, W 528, D 527 mm

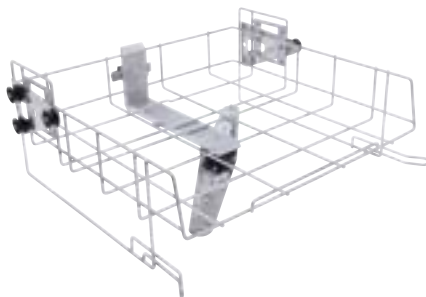

A 102 upper basket/open front

- Open front
- For various inserts
- Vertical clearance 205 +/- 30 mm, Width 475, Depth 443 mm
- Built-in spray arm
- H 206, W 528, D 527 mm

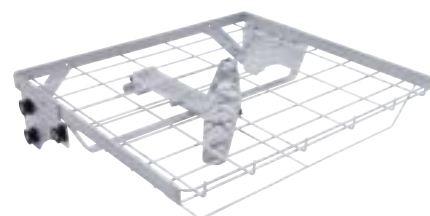

A 103 upper basket/open front

- Open front
- For various inserts
- Loading dimensions H 95, W 505, D 472 mm
- Built-in spray arm
- Particularly suitable for the reprocessing of DIN mesh trays and other shallow loads in combination with A 202 load carrier.
- H 133, W 528, D 528 mm

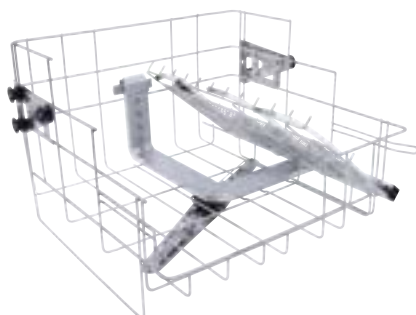

A 104 upper basket/injector unit

- For surgeries with only few lumened instruments
- For instruments from minimally invasive surgery, arthroscopy, urology
- Left-hand side free for inserts (max. clearance H 310, W 240, D 455 mm)
- Right-hand side for 11 lumened instruments (max. length of connected instruments: 430 mm)
- Four additional LuerLock connections for further lumened instruments
- With spray arm: Space for mesh trays on lower level
- H 332, W 528, D 526 mm

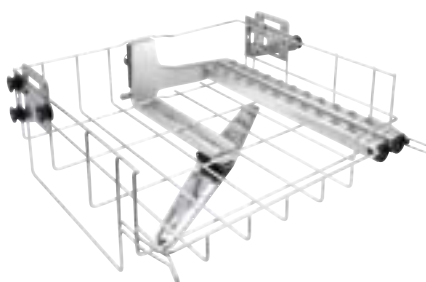

A 105/1 upper basket/injector unit

- Left-hand side free for inserts
- 22 injectors on right-hand side, e.g. for A 817 irrigation sleeve (not supplied)
- Height-adjustable
- A 800 central filter for use in either injector rail (not supplied)
- Built-in spray arm
- Loading dimensions H 225 +/- 30, W 360, D 445 (available depth of 460 mm on the left-hand side over a width of 215 mm)
- H 202, W 528, D 526 mm
- Expected to be available from May 2019

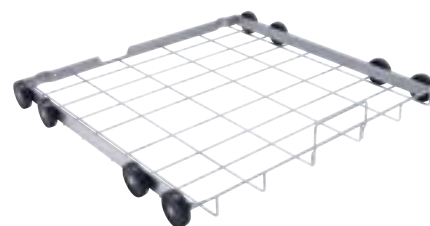

A 151 lower basket/open front

- For various DIN mesh trays and various inserts
- Loading width 490 mm
Loading depth 498 mm
- Vertical clearances in combination with
A 101 H 275 ± 30 mm
A 102 H 230 ± 30 mm
A 103 H 305 mm
A 104 H 145 mm
A 105/1 H 210 mm
• H 88, W 529, D 522 mm

A 837 ENT nozzle set (not illustrated)

- For use in A 105/1 upper basket and the reprocessing of lumened instruments, ENT application
- Includes 22 x A 817 irrigation sleeves

A 836 nozzle set (not illustrated)

- For use in A 105/1 upper basket and the reprocessing of lumened instruments
- Contains 22x A 833 injector nozzles

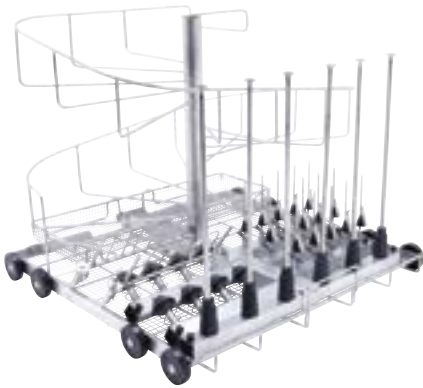

A 201 load carrier

- For AN sets
- 8 nozzles with spring supports for breathing tubes with max. length of 1.5 m
- Spiral rack
- 15 injector nozzles for intubation material
- H 434, W 529, D 546 mm



A 202 load carrier

- For 4 DIN mesh trays on 2 levels
- Built-in spray arm
- Clearances from bottom:
 - Level 1: With connection frame H 95, W 516, D 498 mm, Without connection frame H 135, W 490, D 498 mm
 - Level 2: H 135, W 516, D 498 mm
- Connection frame for DIN mesh trays (can be removed to accommodate bulky items, e.g. kidney dishes)
- 6 additional LuerLock connections for lumened instruments, fitted ex works with E 362 blank stoppers
- H 223, W 529, D 542 mm



A 208 load carrier

- Increased capacity: Simultaneous reprocessing of up to 8 DIN mesh trays on 4 levels
- 4 additional LuerLock connections for lumened instruments
- Removable rack level increases vertical clearance on second level from bottom, e.g. for kidney dishes
- Loading dimensions from bottom:
 - Level 1: H 60, W 516, D 490 mm (with frame)
 - Level 1: H 100, W 490, D 490 mm (without frame)
 - Level 2: H 55, W 510, D 500 mm
 - Level 2: H 200, W 510, D 470 mm (w/o Level 3)
 - Level 3: H 130, W 404, D 470 mm
 - Level 4: H 75, W 510, D 500 mm
- H 455, W 530, D 542 mm



A 203 load carrier

- For minimally invasive surgical instruments
- Loading on 2 levels
- Applications
 - E 451 mesh tray for small items
 - E 457 insert for separable MIS instruments
 - E 460 insert for rigid fibre optics
 - E 473/2 mesh tray for small items
 - E 444 spiral rack for lightguides and irrigation hoses
- H 520, W 529, D 542 mm



A 207 load carrier

- Efficient reprocessing of ophthalmic instruments: Fast loading and high throughput
- Upper level: Up to 8 trays for lumened instruments attached to LuerLock connectors
- Lower level: 8 trays (4 on each level), horizontal, for further ophthalmic instruments
- Clearances from bottom:
 - Level 1: H 95, W 494, D 500 mm
 - Level 2: H 60, W 508, D 455 mm
- H 438, W 530, D 542 mm
- Included:
 - A 800 filter pipe
 - A 804 cleaning brush



A 204 load carrier

- For ophthalmological/micro-instruments
- Built-in spray arm
- Loading on 2 levels:
 - Level 1: For inserts:
 - (e.g. E 441/1 or E 142)
 - Level 2, Right-hand side: 22 connections for lumened instruments
 - (10 LuerLock adapters, male,
 - 10 LuerLock adapters, female)
 - Level 2, Left-hand side: 11 LuerLock adapters,
 - Adapter, male, with hose, horizontal arrangement
 - A 800 central filter for use on all injector rails (not included)
- H 365, W 529, D 542 mm

Accessories for reprocessing with fully demineralised water

for PG 8582, PG 8592 and PG 8582 CD



PG 8595 Aqua Purificator

- Housing unit for 2 water demineralisation cartridges VE P 2000 / VE P 2800
- Compatible with PG 8582, PG 8592, PG 8582 CD
- Generally recommended quality for final rinse <math>< 15 \mu\text{S}/\text{cm}</math>
- H 835 (820), W 300, D 600 mm
- Freestanding appliance, can be built-under
- Outer panelling in stainless steel or white
- Condition as supplied: Empty housing unit. Cartridges and fittings must be ordered separately.



CM/1 Conductivity meter

- Conductivity module for water demineralisation cartridges VE P 2000 and VE P 2800
- Single-line display
- 10-point measurement in 0 - 199.9 $\mu\text{S}/\text{cm}$
Range: 1/3/5/10/15/20/50/75/100/199.9 $\mu\text{S}/\text{cm}$
- Optical and acoustic cartridge replacement indicator
- Optical and acoustic fault indicator
- Wall bracket
- Connection to external LED (optional)
- Manual calibration on site
- H 110, W 125, D 52 mm
- Input: 110 - 240V, 50/60 Hz, 85 mA;
Output: 9V, 400 mA, 3.6 VA
- Includes: Sensor cell with LED indicator and connection lead (length 1.0 m), 1 pressure hose 3/4" (length 1.94 m), 1 hose 3/4" (length 1.5 m)



LP 2800 demineralisation cartridge, empty

- Can be charged with 19 l of single-use resin

E 315 single-use resin

- 20 l of homogeneously mixed resins for LP 2800
- Box with 2 x 10 l bags, vacuum-sealed in plastic bags
- Replacement filter bag

E 316 refill set

- Plastic barrel with lid and funnel for 30 l of single-use resin

SK fast-action coupling for water demineralisation cartridges

- Conversion kit for simple replacement of cartridges consisting of:
- 2 x VA adapters from 3/4" to fast-action for direct connection to cartridge
- 2 x fast-action couplings with 3/4" PVC double nipple including gaskets for existing set of hoses

UfZ conversion kit for second cartridge

- If two cartridges are used, the 2 x VA 3/4" connections can be screwed onto the second cartridge. This avoids the need to change fittings.



VE P 2800 water demineralisation cartridge, charged

- Pressure-proof stainless steel cartridge
- Throughflow max. 800 l/h
- Delivery capacity can be monitored with conductivity module
- Complete with vent and pressure relief valve
- Pressure range 0.5 – 10 bar
- Contains 19 l of mixed, reactivatable resin
- Connection 3/4"
- Stainless-steel casing
- Dimensions: Ø 230 mm, H 570 mm +/- Hose connection radius (installation on either side of PG 8595 / PG 8596 possible)

VE P 2000 water demineralisation cartridge, charged

- Pressure-proof stainless steel cartridge
- Throughflow max. 450 l/h
- Delivery capacity can be monitored with conductivity module
- Complete with vent and pressure relief valve
- Pressure range 0.5 – 10 bar
- Contains 12.5 l of mixed, reactivatable resin
- Connection 3/4"
- Stainless-steel casing
- Dimensions: Ø 230 mm, H 410 mm +/- hose connection radius

Capacity in litres between cartridge reactivation cycles

°d German hardness	5	10	15	20	25	30
µS/cm	150	300	450	600	750	900
VE P 2800	5,600	2,800	1,850	1,400	1,120	930
VE P 2000	4,000	2,000	1,330	1,000	800	660

1°d corresponds to approx. 30 µS/cm.

The information provided in this chart is intended as a guide only.

E 313 wall valve (top)

- For manual delivery of demineralised water
- Pressure hose approx. 1.5 m, pressure-proof to 10 bar

E 314 cabinet mounted valve (bottom)

- For manual delivery of demineralised water
- Pressure hose approx. 1.5 m, pressure-proof to 10 bar

Dispensing accessories, twin-tank water softeners, plinths, conversion kits

for PG 8582, PG 8592 and PG 8582 CD



PG 8596 dispenser unit

- Housing unit for process chemicals and dispenser modules
- H 835 (820), W 300, D 600 mm
- Compatible with PG 8582, PG 8592
- Freestanding appliance, can be built-under
- Unit with removable door
- Outer panelling in stainless steel or white
- Interior dimensions: H 690 / 380 / 285 mm (top drawer removed / lower / upper drawer), W 250 mm, D 555/425 mm (without/with drip tray and dispenser modules)

2 levels:

Removable telescopic drawers with drip tray liners for canisters containing process chemicals

Canister sizes:

Accommodates a total of 6 x 5 l canisters (L 245 x W 145 x H 225 mm*).

Lower drawer offers space for larger canisters:

- 2 x 10 l, 140 x 193 x 307 mm
- 2 x 10 l, 223 x 203 x 321 mm
- 2 x 10 l, 229 x 193 x 323 mm
- 2 x 10 l, 194 x 204 x 353 mm
- 1 x 20 l, 289 x 233 x 396 mm
- 1 x 25 l, 288 x 234 x 456 mm

* Only possible with DOS K 85/1 dispenser module with short siphon.



DOS K 85/1 dispenser module

- For liquid alkaline detergents and chemical disinfectants, neutralising agent
- Peristaltic pump, adjustable via machine's electronic controls
- Integrated dispenser monitoring function ensuring high level of process security
- Short siphon (200 mm) for 5 l canister, incl. level fill monitoring
- Length of connection cable: 3.00 m
- Length of suction hose: 1.80 m



DOS K 85 dispenser module

- As DOS K 85/1
- But with long siphon (300 mm) for 5 l and 10 l canisters
- Option: Conversion kit, Part no. 5458034, for siphon (10-30 l containers) available from Spares.



PG 8597 AquaSoft system, twin-tank water softener

- For continuous delivery of softened water, max. 40°dH
- H 570, W 360, D 360 mm
- Weight (excl. salt) approx. 30 kg
- Freestanding unit on castors. Filled from top.
- Plastic casing
- Capacity: 19 l/min (constant), max. delivery 30 l/min
- Demand-controlled twin-tank system
- Does not require connection to power supply
- Equipped with 2 x 4.5 l resin-filled canisters and 1 container for 20 kg of salt
- Water connection: 2 pressure hoses, approx. 1.5 m, 3/4" threaded union, 1 x cold or hot water, max. 70°C min. 1 bar flow pressure to system, max. static pressure 8 bar
- 2.5 bar min. flow pressure on machines without softener, 3.5 bar min. flow pressure on machines with water softener
- 1 x connection from system to machine
- 2 drain hoses, approx. 1.5 m DN 8 for reactivation water and overflow. Odour trap and non-return valve to be provided on site.
- Water consumption: 19 l/reactivation cycle



UG 30-60/60-85 plinth

- For use on PG 8582 and PG 8592
- Stainless-steel plinth, bolted to machine
- H 300, W 600, D 600 mm



UG 30-90/60-85 plinth

- For use on PG 8582 and PG 8592 in combination with PG 8595 or PG 8596 (installation on either side of PG 8595/PG 8596 possible)
- Stainless-steel plinth, bolted to machine
- H 300, W 900, D 600 mm



UG 30-90/70-85 plinth

- For use with PG 8582 CD
- Stainless-steel plinth, bolted to machine
- H 300, W 900, D 700 mm

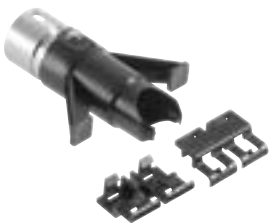

UBS 1 conversion kit

- For use of selected load carriers from G 78 series on PG 85 series
- For older load carriers with drying connection

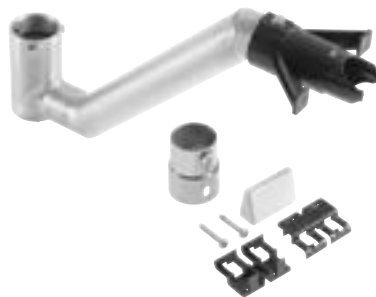

UBS 3 conversion kit

- For use of selected upper baskets from G 78 series on PG 85 series
- For older upper baskets without drying connection



Product highlights

PG 8536

Miele Professional has been setting standards in the field of efficient and safe machine-based reprocessing in clinics and surgeries for more than 5 decades. Designed for decentral instrument reprocessing, Miele Professional's PG 8536 washer-disinfector offers added value: better cleaning performance, improved process security and greater cost-effectiveness.





Product benefit: ROBOTVARIO

Miele quality in the reprocessing of robotic-assisted instruments

The special design of the robotic-assisted instruments used in minimally invasive surgery poses extreme challenges with respect to the thoroughness and reliability of reprocessing. The new ROBOTVARIO reprocessing system from Miele Professional consists of a specially designed load carrier, a new reprocessing programme and matching process chemicals. Together, this provides a safe and economic all-in solution to the cleaning and disinfection of robotic-assisted instruments.



The E 428 load carrier is designed for use in the PG 8536 washer-disinfector. It accommodates 6 EndoWrist instruments with a shaft diameter of 8 mm. Two connections are available for each of these instruments, allowing the separate irrigation of the control housing and the shaft interior, including the critical distal end.

In all stages of programmes, ROBOTVARIO uses fully demineralised water. This prevents residue, particularly on the interior of instruments which are critical to cleaning, and makes a huge contribution towards secure reprocessing results and the safety of patients. The ROBOTVARIO reprocessing programme can be added to the controls on the PG 8536 washer-disinfector by Miele Service.

ROBOTVARIO

Freigegeben durch

INTUITIVE

SURGICAL®

für

da Vinci Surgery

Qualifizierung durch

wfk

The Cleaning Technology Institute

Overview of further product highlights

PG 8536



PerfectTouchControl – Simple operation and cleaning

- Controls with flush, uninterrupted touch glass screen
- Reliable operation possible even when wearing gloves
- Chemical-proof surface is flush with machine front
- Simple and effective wet-wipe disinfection



PerfectPureSensor – Residue-free rinsing

- Patented conductivity monitoring system
- Detection and removal of undesirable substance from process water (e.g. dissolved salts from alkaline or acidic process chemicals)
- Individually definable limits
- Low-maintenance and precise system thanks to contact-free conductivity monitoring
- Reliable documentation and reproduction of validated reprocessing results

**Exclusive
to Miele**



PerfectFlowSensor – Dispensing control

- Ultrasound volumetric control for highest process security
- Precise dispensing of liquid chemicals
- Measuring system independent of viscosity and ambient temperature
- Use of particularly durable bellows-type dispenser pumps

**Exclusive
to Miele**



**PerfectSpeedSensor –
Spray arm monitoring**

- Precise speed control for safe reprocessing results
- Monitoring of all spray arms in machine and on baskets and load carriers
- Hygienic contact-free system with sensor outside chamber
- Safe reproduction of validated reprocessing results through early detection of excessive foaming or blockages

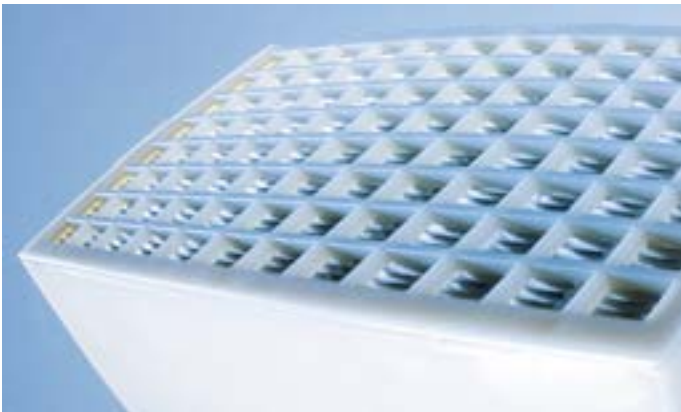

PerfectHEPA Drying

- Exceptional cleanliness, including during the drying phase, is guaranteed by PerfectHepaDrying
- Highly temperature-resistant HEPA-grade Class 13 filters able to filter out more than 95.95% of particles
- Upstream position at entrance to cabinet prevents unwanted particles entering with drying air
- Streamlined air flow: All parts of cabinet are reliably reached by stream of hot air



PerfectDoc

- Network interface for process documentation as standard feature
- PerfectDoc module: Connection to process documentation software and to a hospital's own network
- Documentation of numerous parameters such as temperature over time
- Recording of complete process protocols including A0 values, dispenser quantities, spray arm speeds and conductivity
- Documentation via printer possible

Product overview

PG 8536



Washer-disinfector	PG 8536
Width	900
Free-standing unit, height, depth [mm]	1175, 700
Shortest cycle* [mins.]	27
Cycle capacity	
DIN mesh trays	7
AN sets	3
MIS sets	2
GYN specula	48
Drying	PerfectHEPA Drying
Integrated dispenser pump	2
Drawer for 5 l supply canisters	4
Electrical connection 3N AC 400 V, 50 Hz	•
Total rated load [kW]	10.2

* SHOE-TD-75/2 programme

Programmes, cycle times, consumption

PG 8536



Ophthalmology

The PG 8536 washer-disinfector features an ophthalmology programme specifically designed to cater for applications in eye surgery. Final rinsing with fully demineralised water in this programme reduces chemical residues to a minimum. This is particularly important as even the slightest traces of process chemicals can result in severe complications, e.g. caustic burns to the eye. The precise control and automatic repetition of the final rinse cycle is facilitated by an integrated conductivity meter.

PG 8536	Main wash					Drying	
	Cycle time [mins.]	CW* [l]	HW [l]	DI [l]	Energy [kWh]	Cycle time [mins.]	Energy [kWh]
DES-VAR-TD	54	36.3	24.2	16	3.7	34.3	0.6
DES-VAR-TD AN	57	43	39.5	22	3.7	49.5	0.8
VAR-TD-NR	44	24.3	23.3	16	3.3	34.3	0.5
OPHTHALMOLOGY	48	26.3	36.7	32	2.9	34.3	0.5
ORTHOVARIO	74	34.7	31.3	35	5	34.3	0.4
OXIVARIO	64	38.3	40.7	32	4.4	34.3	0.5
OXIVARIO PLUS	73	27	35	49	4.5	43.3	0.5
SHOE-TD-75/2	27	27.7	35.8	–	1.5	39.3	0.4
SPECIAL 93/10	48	22	25.5	15.5	3.9	39.3	0.7
CHEM-DESIN	38	26.3	51.7	–	1.8	40.5	0.4
LAB STANDARD	33	8.5	38.5	18	2.6	34.3	0.6
LAB UNIVERSAL	35	8.5	55	21	2.3	34.3	0.6
LAB INTENSIVE	43	8.5	40	48	2.7	34.3	0.6
LAB-PIPETTES	46	11.5	74.5	44	2.5	34.3	0.3
PLASTICS	38	62.5	–	20	2.5	44.6	0.4
ORGANICA	41	1	64	21	2.8	34.3	0.6
ANORGANICA	43	4	49	48	2.4	34.3	0.6
LAB-OIL	47	1	80.5	21	2.5	34.3	0.3

Heating: 9 kW (3N AC 400V 50Hz)

Connection to cold water (15°C), hot water (65°C) and demineralised water (15°C)

*excl. water consumption of steam condenser

Upper and lower baskets, modules, load carriers and inserts

for PG 8536

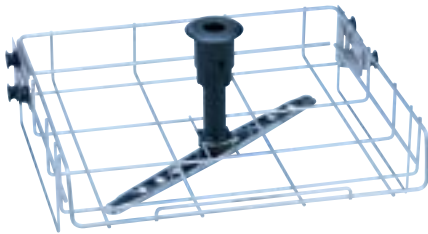

O 188/1 upper basket/open front

- Open front
- For various inserts
- Vertical clearance 165 +/- 20 mm
- Built-in spray arm
- H 215, W 531, D 475 mm

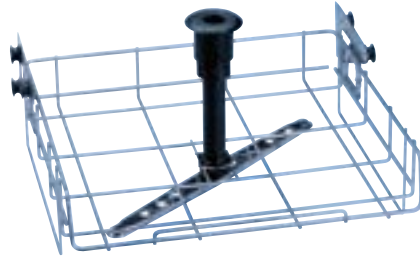

O 190/2 upper basket/open front

- Open front
- For various inserts
- Vertical clearance 215 +/- 20 mm
- Built-in spray arm
- H 265, W 531, D 475 mm
- Powder dispensing not possible

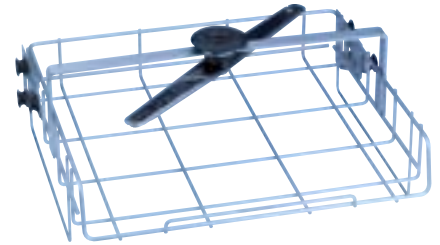

O 191/1 upper basket/open front

- Open front
- For mesh tray (E 142)
- Vertical clearance 115 +/- 20 mm
- Loading width 475 mm
- Loading depth 450 mm
- Built-in spray arm above basket
- H 180 +/- 20 mm, W 531, D 475 mm

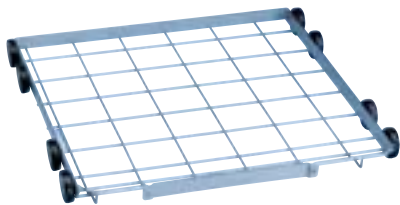
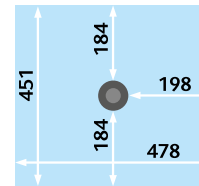
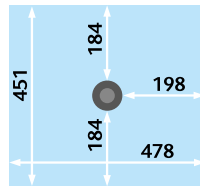
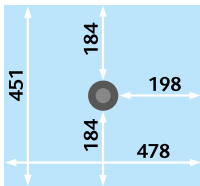

U 874/1 lower basket/open front

- For various inserts
- Vertical clearances in combination with upper basket:
 - O 176 approx. 110 mm
 - O 177/1 approx. 220 mm - 20/- 40 mm
 - O 183 approx. 185 mm +/- 20 mm
 - O 188/1 approx. 270 mm +/- 20 mm
 - O 190/1 approx. 220 mm +/- 20 mm
 - O 191/1 approx. 295 mm
- With holder for ML/2 magnetic strip for automatic load carrier recognition
- H 50, W 534, D 515 mm

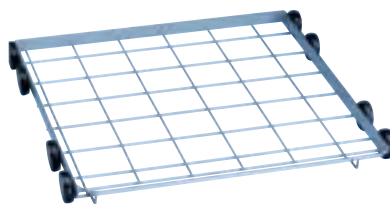

U 874/2

- As per U 874/1
- For standard DIN mesh trays (e.g. Aesculap) and Miele half-inserts
- Without holders for ML/2 magnetic strip

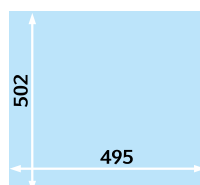

Upper baskets/injector units, load carriers for mesh trays

PG 8536

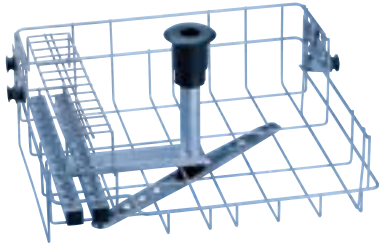

O 177/1 upper basket/injector unit

- Built-in spray arm
- Right-hand side free for inserts
- Left-hand side with 26 silicone adapters: 26 nozzles Ø 4 mm, L 30 mm, 7 funnels supplied, with height-adjustable rack
- Vertical clearance 230/205 mm
- Height adjustable + 20/+ 40 mm
- H 263, W 498, D 455 mm

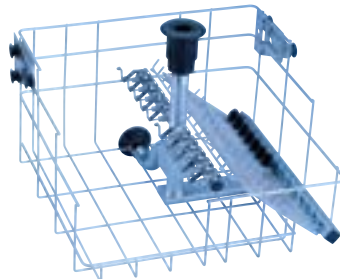

O 176 upper basket/injector unit with drying connector

- For instruments from minimally invasive surgery, arthroscopy, urology
- Left-hand side free for inserts
- Vertical clearance 360 mm, 10 injector nozzles
- Right-hand side for lumened instruments max. length 500 mm, 14 injector nozzles/funnels
- Connection for hot-air drying unit

Powder dispensing not possible

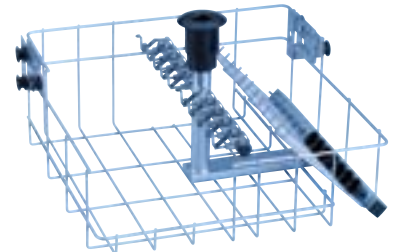

O 183 upper basket/injector unit

- For instruments from minimally invasive surgery, arthroscopy, urology
- Left-hand side free for inserts
- Vertical clearance 285 +/- 20 mm, 10 injector nozzles
- Right-hand side for lumened instruments max. length 370 +/- 30 mm, 14 injector nozzles/funnels

Powder dispensing not possible

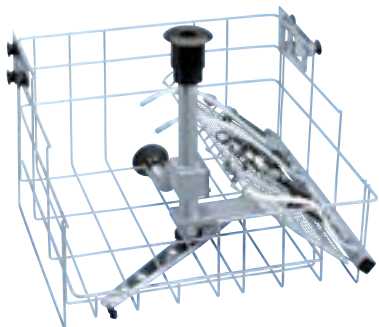
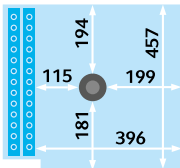

O 176/1 upper basket/injector unit with drying connector

- For instruments from minimally invasive surgery, arthroscopy, urology
- 10 connectors
- Built-in spray arm with magnetic tip
- Note: Magnet for spray arm sensors on PG 8536
- Left-hand side free for inserts
- Right-hand side for lumened instruments, max. length 500 mm
- Vertical clearance 360 mm
- Connection for hot-air drying unit
- Powder dispensing not possible

Scope

- 2 x spray nozzles Ø 2.5 mm
- 4 x spray nozzles Ø 4 mm
- 4 x funnels
- 2 x E 442 irrigation sleeves
- 2 x E 448 silicone hoses, 300 mm, 5 x 1.5 mm with male LuerLock adapters
- 1 x E 452 injector nozzle
- 1 x E 453 injector nozzle
- 1 x E 454 injector nozzle



E 327 load carrier

- For 4 DIN mesh trays on 2 levels
- Built-in spray arm
- Vertical clearances from bottom: Level 1: H 112, W 520, D 510 mm Level 2: H 105, W 512, D 480 mm
- With holder for ML/2 magnetic strip for automatic load carrier recognition
- Load capacity: 40 kg of instruments



E 439/3 load carrier

- For 7 mesh trays on 3 or 4 levels
- 2 built-in spray arms
- Level 2 from bottom removable
- Vertical clearances from bottom: Level 1: H 70, W 488, D 499 mm (without Level 2: H 155 mm) Level 2: H 70, W 509, D 510 mm Level 3: H 90, W 520, D 470 mm Level 4: H 90, W 490, D 460 mm
- With holder for ML/2 magnetic strip for automatic load carrier recognition
- Load capacity: 70 kg of instruments

Mobile injector unit for anaesthetic instruments for PG 8536



E 461/2 load carrier with drying connector

- For 12 breathing tubes up to 1.5 m long, fitted on a spiral rack
- 1 x E 432 holder, for 4 breathing tubes each
- 3 x E 433 holders, for 4 silicone tubes, included
- 1 x E 434 holder for 4 paediatric breathing tubes, included
- 1 x E 430/1 mesh tray
- Connection for hot-air drying unit
- With holder for ML/2 magnetic strip for automatic load carrier recognition
- H 502, W 535, D 515 mm



E 436/3 load carrier with drying connector

- For approx. 3 AN sets
- 8 nozzles with spring supports for breathing tubes with max. length of 1.5 m
- Spiral rack
- Connection for hot-air drying unit
- With holder for ML/2 magnetic strip for automatic load carrier recognition
- H 507, W 535, D 515 mm

Scope

- 1 x E 430 mesh tray
- 1 x E 432 holder for 3 - 4 corrugated breathing tubes
- 2 x E 433 holders for 3 - 4 silicone breathing tubes
- 1 x E 434 holder for 3 - 4 paediatric breathing tubes
- 6 x E 466 injector nozzles for breathing bags, 8 x 333 mm
- 1 x E 431 injector nozzle for breathing bags, 8 x 193 mm
- 10 x E 496 injector nozzles, 4 x 120 mm

Mobile injector unit for anaesthetic utensils

for PG 8536



E 381 injector unit with drying connection

- For intubation material
- 20 nozzles, 4.0 x 30 mm with spring supports
- 5 nozzles, 2.5 x 30 mm (supplied)
- 6 x E 466 injector nozzles for breathing bags, 8.0 x 333 mm
- 2 x E 431 injector nozzle for breathing bags, 8.0 x 193 mm
- Connection for hot-air drying unit
- With holder for ML/2 magnetic strip for automatic load carrier recognition
- H 502, W 535, D 515 mm



E 367 injector unit with drying connection

- For intubation material
- 20 nozzles 2.5 x 30 mm
- 20 nozzles 4.0 x 30 mm
- 40 spring supports for nozzles
- 1 x E 378 insert 1/1 mesh tray H 80 + 30, W 460, D 460 mm
- Connection for hot-air drying unit
- With holder for ML/2 magnetic strip for automatic load carrier recognition
- H 502, W 535, D 515 mm



E 368 mobile injector unit with drying connector for intensive care

- For narrow-gauge breathing tubes, fitted with:
- 10 nozzles, 4.0 x 30 mm with spring supports
- 14 nozzles, 6.0 x 220 mm with spring supports
- 2 x E 431 injector nozzle for breathing bags, 8 x 193 mm
- 1 instrument box, UTS/1 H 93, W 102, D 180 mm
- Connection for hot-air drying unit
- With holder for ML/2 magnetic strip for automatic load carrier recognition
- H 502, W 535, D 515 mm



U 167 lower basket for anaesthetic equipment

- For use on PG 8536
- For 4 soda lime containers, 9 secretion jars and various other utensils
- 20 x 200 mm holders, spacing approx. 95 mm
- Plastic-coated
- H 220, W 535, D 516 mm



E 496 injector nozzle

- For intubation material, 4 x 120 mm



E 427 module

- Rack for 6 laryngoscopes
- H 92, W 210, D 134 mm

Inserts for upper and lower baskets

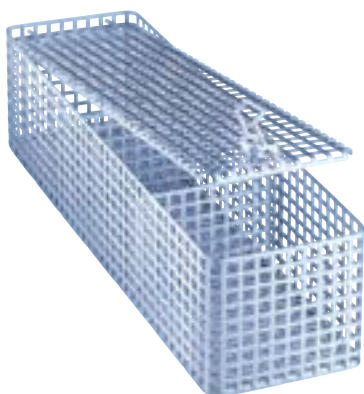

UTS utensil box

- For sundry small items, with lid
- 3 compartments, compartment size 115 x 100 mm
- H 93, W 102, D 350 mm



A 810 cover net 1/2

- Stainless-steel frame made from special silicone material (particularly flexible, resilient and durable)
- Mesh is replaceable; stainless-steel frame reuseable
- Also suitable for ophthalmology
- W 215, D 445 mm



A 810/1 cover net 1/4

- Stainless-steel frame made from special silicone material (particularly flexible, resilient and durable)
- Mesh is replaceable; stainless-steel frame reuseable
- Also suitable for ophthalmology
- W 215, D 206 mm

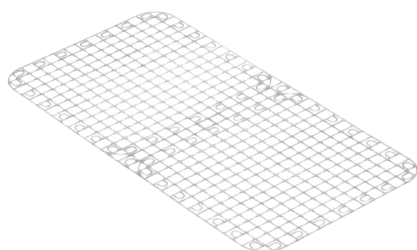

A 811 replacement net 1/2

- For use with A 810
- W 215, D 445 mm

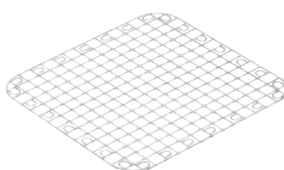

A 811/1 replacement net 1/4

- For use with A 810/1
- W 215, D 206 mm

Inserts for upper and lower baskets



E 417 insert 2/5

- For approx. 30 ear and nose speculae
- 280 compartments, approx. 13 x 13 mm
- Mesh size on base 1.7 mm
- For upper or lower basket
- H 63, W 173, D 445 mm



E 803 insert 2/5

- For ear and nose speculae
- 160 compartments, approx. 13 x 13 mm
- Mesh size on base 1.7 mm
- For upper or lower basket
- H 63, W 165, D 317 mm



E 374 insert 2/5

- For ENT instruments such as inhalation tubes, etc.
- 24 compartments, approx. 45 x 45 mm
- 27 compartments, approx. 12 x 12 mm
- Mesh size on base 1.7 mm
- For upper or lower basket
- H 63, W 173, D 445 mm



E 416 insert 1/4

- For 6 one or two-piece speculae
- 7 holders, spacing 40 mm
- For upper or lower basket
- H 157, W 178, D 279 mm



E 130 insert 1/2

- For 10 trays
- 11 holders, H 170 mm, spacing 35 mm
- For lower basket
- H 180, W 180, D 445 mm



E 806/1 insert

- For 8 half-trays or shallow trays
- 9 holders (8 compartments)
- Max. tray size 290 x 30 mm
- H 114, W 305, D 348 mm

Inserts for upper and lower baskets



E 339/1 insert 3/5

- For 13 half-trays or shallow trays
- 14 holders (13 compartments)
- Max. tray size 290 x 20 mm
- H 115, W 305, D 498 mm



E 131/1 insert 1/2

- For 5 mesh trays/kidney dishes
- 6 holders, H 160 mm, spacing 80 mm
- For lower basket
- H 168, W 180, D 495 mm



E 800 insert

- For 3 mesh trays/kidney dishes
- 3 holders, H 165 mm, spacing approx. 68 mm
- For upper or lower basket
- H 165, W 140, D 290 mm



E 492 insert 1/2

- For 9 kidney dishes
- 9 holders, H 86 mm, spacing 49 mm
- For lower basket
- H 120, W 256, D 474 mm



E 430/1 insert 1/3 mesh tray

- Wire mesh, mesh size 5 mm
- H 40, W 150, D 445 mm



E 468 insert 1/4 mesh tray

- With lid and compartments
- For various utensils
- Made from welded cross-wires/stainless steel with lid and compartments
- Mesh size 5 x 5 x 1 mm
- H 70/76, W 250, D 170 mm



E 146 insert 1/6 (illustrated)

- Mesh size on base 3 mm
- Mesh size on sides 1.7 mm
- Mesh size on lid 8 mm
- 2 hinged handles
- For upper or lower basket
- H 55, W 150, D 225 mm

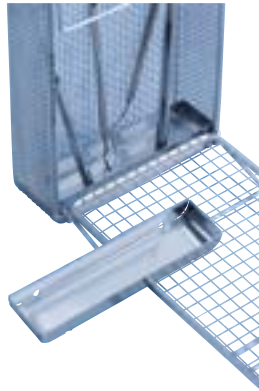

E 328 inlay rack

- For instruments in upright position
- For E 146/E 363



E 373 insert 1/6

- For ENT instruments (e.g. ear funnels)
- Wire mesh, mesh size: Base 3 mm, sides 1.7 mm, lid 3 mm
- 28 upright supports
- 2 hinged handles
- For upper or lower basket
- H 55, W 150, D 225 mm

E 363 insert 1/6

- Mesh size 1 mm, with lid
- For upper or lower basket
- H 55, W 150, D 225 mm



E 441/1 insert 1/4

- For minimally invasive instruments
- Mesh size on base 1.7 mm
- Solid sides, stackable
- Internal divisions with 6 adjustable slats provide the ideal storage for instruments
- For upper or lower basket
- H 60, W 183, D 284 mm

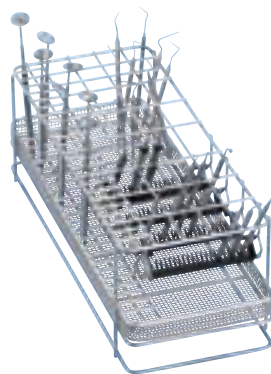

E 337/1 insert

- For micro-instruments, upright
- 12 compartments, approx. 22 x 28 mm
- 4 compartments, approx. 25 x 28 mm
- 4 plastic receptacles
- 48 compartments, approx. 13 x 14 mm
- H 113, W 173, D 445 mm



E 802/1 insert

- For micro-instruments, upright
- 8 compartments, approx. 30 x 28 mm
- 8 compartments, approx. 16 x 28 mm
- 3 plastic receptacles
- 15 compartments, approx. 16 x 20 mm
- H 113, W 163, D 295 mm

Inserts for upper and lower baskets



E 142 insert 1/2

- DIN mesh tray
- 1 mm wire gauge
- Mesh size 5 mm
- 5 mm all-round frame
- 2 hinged handles
- Max. load 10 kg
- H 45/55, W 255, D 480 mm



E 143 insert 1/4

- Mesh tray
- 1 mm wire gauge
- Mesh size 5 mm
- 5 mm all-round frame
- 2 hinged handles
- Max. load 5 kg
- For upper or lower basket
- H 45/55, W 255, D 230 mm



E 378 insert 1/1

- For various utensils
- 0.8 mm wire gauge
- Mesh size 1.7 mm
- 5 mm all-round frame
- 2 handles
- For lower basket
- H 80/110, W 460, D 460 mm



E 473/2 mesh insert with lid

- Mesh basket with lid, for small parts
- Hooks in place
- Easy-to-open lid lock
- H 88, W 66, D 66 mm



E 379 insert 1/2

- For various utensils
- 0.8 mm wire gauge
- Mesh size 1.7 mm
- 5 mm all-round frame
- 2 handles
- For upper or lower basket
- H 80/110, W 180, D 445 mm

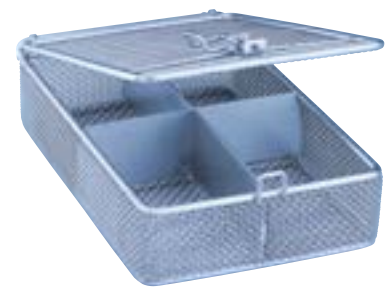

E 451 insert 1/6

- Mesh tray with lid for sundry small items
- Wire gauge: 1 mm base 0.8 mm sides 1 mm lid
- Mesh gauge: 3 mm base 1.7 mm sides 8 mm lid
- Internal divisions removable
- H 55, W 150, D 225 mm

E 484 insert for upper and lower baskets

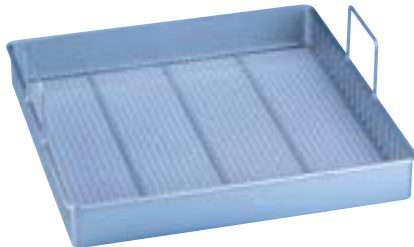

E 484 insert 1/1

- For various utensils
- Wire mesh: 1.4 mm, mesh size: 9 x 9 mm
- For holders:
 - 4 x E 485 for 9 kidney dishes or
 - 4 x E 486 for 4 bowls or
 - 4 x E 487 for 16 theatre shoes or
 - 3 x E 488 for 9 breathing masks or
 - 11 x E 489 universal holders
 e.g. for insoles
- H 65 (150), W 470, D 480 mm

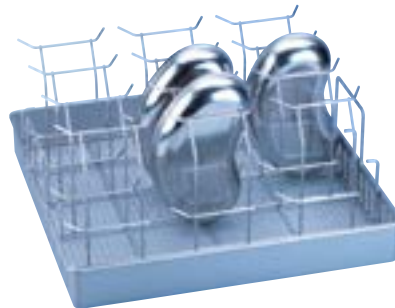

Sample features:

- E 484 with 4 x E 485 holders
- Can be fitted with 4 holders E 485 for 9 kidney dishes

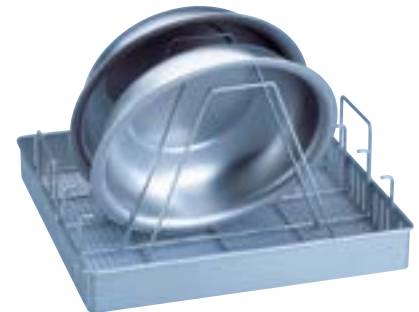

Sample features:

- E 484 with 4 x E 486 holders
- Can be fitted with 4 holders E 486 for 4 bowls

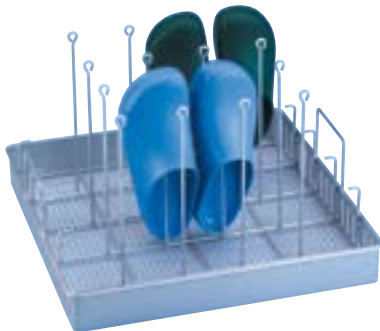

Sample features:

- E 484 with 4 x E 487 long holders
- Fitted with 4 x E 487 holders, each for 4 theatre shoes, height 280 mm
- Dimensions E 487 H 280, W 464, D 10 mm

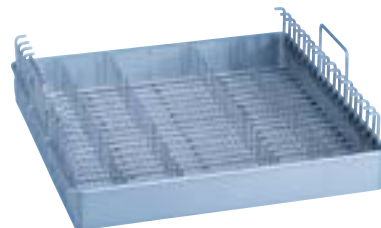

Sample features:

- E 484 with 11 x E 489 universal holders
- Fitted with 11 x E 489 universal holders, e.g. for insoles, height 60 mm
- Dimensions E 489 H 60, W 464, D 10 mm

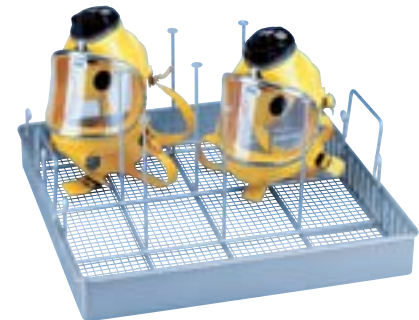

Sample features:

- E 484 with 3 x E 488 holders
- Fitted with 3 x E 488 holders, each for 9 breathing masks

Inserts

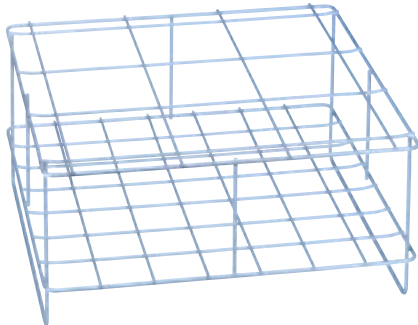

E 125 insert 1/1* (illustrated)

- For 9 bottles, 2,000 ml
- 9 compartments, compartment sizes (bottle) 125 x 125 mm
- Compartment size (neck) 55 x 55 mm
- H 224, W 460, D 460 mm

E 124 insert 1/1*

- For 16 bottles, 1,000 ml
- 16 compartments, compartment sizes (bottle) 100 x 100 mm
- Compartment size (neck) 48 x 48 mm
- H 148, W 460, D 460 mm

E 129 insert 1/1

- For 20 bottles, 500 ml
- 20 compartments, compartment sizes (bottle) 84 x 84 mm
- Compartment size (neck) 46 x 46 mm
- H 113, W 445, D 445 mm

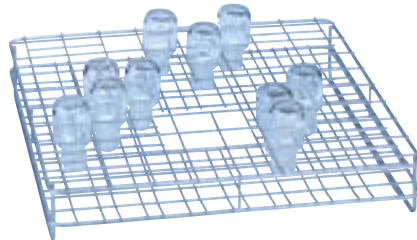

E 128 insert 1/1

- For 24 bottles, 250 ml
- 24 compartments, compartment sizes (bottle) 71 x 71 mm
- Compartment size (neck) 46 x 46 mm
- H 103, W 445, D 445 mm

E 127 insert 1/1

- For 44 bottles, 100 ml
- 44 compartments, compartment sizes (bottle) 57 x 57 mm
- Compartment size (neck) 46 x 46 mm
- H 102, W 445, D 445 mm

E 126 insert 1/1 (illustrated)

- For 48 bottles, 50 ml
- 48 compartments, compartment sizes (bottle) 45 x 45 mm
- Compartment size (neck) 28 x 28 mm
- H 83, W 445, D 445 mm

Description

- Baskets and inserts only suitable for the simple cleaning of infusion bottles
- Neither direct injection nor double spray system according to GMP guidelines

Quality assurance in surgeries and hospitals

Optimum reprocessing of medical instruments



The use of instruments in transurethral resection invariably means instruments contaminated right down to the last lumen and crevice. Furthermore, these often very delicate instruments and the short duration of surgery in this field poses huge challenges in terms of the safe and fast provision of fresh instruments and adequate reprocessing.

There can be no successful disinfection and sterilisation without thorough cleaning.

Miele has developed a systematic and comprehensive approach to the reprocessing of minimally invasive surgical instruments, e.g. from urology, arthroscopy and laparoscopic surgery which allows the decentral reprocessing of entire instrument sets – efficiently, gently and safely. The PG 8536 represents a high-performance washer-disinfector with freely programmable controls. The E 474/4 load carrier and the modular inserts for instruments offer distinct advantages with respect to handling, ergonomics, the protection of personnel and flexibility. This standardised reprocessing method together with documented processes provides the safety margins a commitment to quality demands.

The modules used can be configured to suit individual sets of surgical instruments, which are easily connected using on-board adapters. For urological applications, the E 903 module is available for TUR sets. Sets of instruments from other disciplines, e.g. laparoscopy, require the use of E 905 module inserts for short instruments or the E 906 for long instruments.

For dental clinics, Miele offers the E 919 module for transmission instruments, designed for the reprocessing of large quantities of turbines, contra-angles and hand-pieces. Each module is able to accommodate 10 transmission instruments and hence 3 modules offer ample space for 30 transmission instruments per cycle in the E 474.

Once loaded, the modules are placed in the E 474/4 load carrier and connected. Given the need to accommodate application-specific variations, Miele offers an empty load carrier without modules and inserts, thereby allowing users to configure units individually to meet particular needs, particularly those in the field of minimally invasive surgery.

Note

Miele's systematic approach to reprocessing minimally invasive and TUR surgical instruments is illustrated by the video entitled 'Cleaning and disinfection of minimally invasive instruments', available on DVD.

Mobile injector units for MIS instruments

for PG 8536

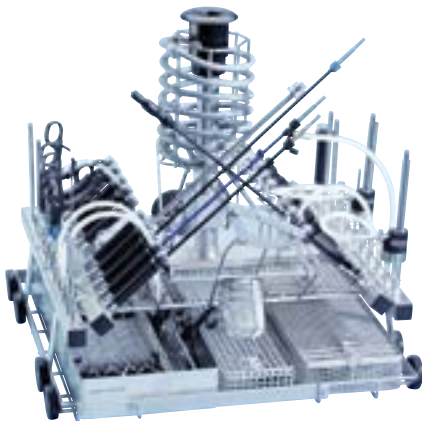

E 450/1 injector unit with drying connection

- For MIS instruments, max. length 550 mm
- E 451 mesh tray for sundry small items
- Loading on 2 levels
- Dimensions/clearance from bottom level upwards:
 - Level 1 = H 110, W 480, D 500 mm (for inserts, e.g. 2 x E 457)
 - Level 2 = H 360, W 350, D 200 mm
- Applications
 - E 451 mesh tray for small items
 - E 457 insert for separable MIS instruments
 - E 460 insert for rigid fibre optics
 - E 473/2 mesh tray for small items
 - E 444 spiral rack for lightguides and irrigation hoses
- Connection for hot-air drying unit
- With holder for ML/2 magnetic strip for automatic load carrier recognition
- H 502, W 535, D 515 mm

Scope

- 3 x E 336 irrigation sleeves, 121 mm
- 2 x E 362 blanking screw
- 15 x E 442 irrigation sleeves, 121 mm, for MIS instruments, 4-8 mm
- 5 x E 443 irrigation sleeves, 121 mm, for MIS instruments, 8-12 mm
- 1 x E 445, 12 caps, for irrigation sleeves, 6 mm
- 1 x E 446, 12 caps, for irrigation sleeves, 10 mm
- 3 x E 447 adapters, female, for LuerLock, male
- 6 x E 448 silicone hoses, 300 mm, 5 x 1.5 mm with male LuerLock adapters
- 5 x E 449 adapters, male, for LuerLock, female
- 1 x E 451 mesh insert 1/6, with lid
- 3 x E 452 injector nozzles, 2.5 x 60 mm
- 8 x E 453 injector nozzles, Ø 4.0 x 110 mm, with spring support
- 6 x E 454 injector nozzles for trocar sleeves, 10-15 mm
- 4 x E 456 spring supports for MIS instruments, e.g. scissors, forceps, etc.
- 3 x E 464 sleeve for E 454 injector nozzles
- 2 x E 472 clamp for injector nozzle, 4.0 mm



E 474/4 injector carriage with drying connection

- Carriage for inserts/modules
- Modular system for up to 2 MIS OP sets
- For lumened instruments in 3 inserts/modules with integrated nozzles/adapters
- Applications:
 - E 903 module insert for MIS instruments/urology
 - E 905 module insert for short MIS instruments
 - E 906 module insert for long MIS instruments
 - E 444 spiral rack for lightguide and irrigation hoses
 - E 460 insert for rigid fibre optics
 - E 457 insert for separable MIS instruments or E 142 DIN mesh tray
- Connection for hot-air drying unit
- With holder for ML/2 magnetic strip for automatic load carrier recognition
- H 507, W 535, D 515 mm

Scope

- 2 x E 362 blanking screw
- 3 x E 447 adapters, female

Modules for E 474/4 MIS instruments

for PG 8536



E 903/1 module

- For TUR sets (transurethral resection)
- For up to 10 lumened instruments
- H 40, W 461, D 510 mm

Scope

- 3 x E 442 irrigation sleeves, 121 mm, for MIS instruments, 4–8 mm
- 1 x E 444 insert/spiral rack for fibre optic cables and irrigation tubes
- 1 x E 447 adapters, female, for LuerLock, male
- 4 x E 448 silicone hoses, 300 mm, 5 x 1.5 mm with male LuerLock adapters
- 3 x E 453 injector nozzles, Ø 4.0 x 110 mm with spring support
- 1 x E 454 injector nozzles for trocar sleeves, 10-15 mm
- 3 x E 467 injector sleeves, 205 mm, for MIS instruments/forceps
- 3 x E 469 injector sleeves, 300 mm, for MIS instruments/urology
- 1 x E 907/1 insert / mesh tray with lid for small parts
- 2 m silicone hose, Ø 5 mm
- 1 plastic support



E 905/1 module

- For short MIS instruments
- For up to 16 lumened instruments
- Sectioned for arthroscopes, laparoscopes, etc.
- H 40, W 461, D 510 mm

Scope

- 1 x E 336 MIBO irrigation sleeves for pipettes/MIS instruments, 11 mm, length 121 mm
- 2 x E 362 blanking screw
- 1 x E 442 irrigation sleeve for MIS instruments, Length 121 mm, 11 mm, with 6 mm cap
- 2 x E 447 adapters, female, for LuerLock, male
- 4 x E 448 silicone hoses, 300 mm, 5 x 1.5 mm with male LuerLock adapters
- 2 x E 449 adapters, male, for LuerLock, female
- 4 x E 452 injector nozzles, 2.5 x 60 mm
- 3 x E 453 injector nozzles, Ø 4.0 x 110 mm with spring support
- 3 x E 454 injector nozzles for trocar sleeves, 10-15 mm
- 1 x E 464 sleeve for E 454 injector nozzles
- 1 x E 907/1 insert / mesh tray with lid for small parts
- 1 x E 472 clamp for injector nozzle, 4 mm



E 906/1 module

- For long shafted MIS instruments
- For up to 10 lumened instruments
- Sectioned for arthroscopes, laparoscopes, etc.
- H 40, W 461, D 510 mm

Scope

- 2 x E 362 blanking screw
- 5 x E 442 irrigation sleeves for MIS instruments
- 3 x E 443 irrigation sleeves for MIS instruments, 8-12 mm
- 2 x E 448 silicone hoses, 300 mm, 5 x 1.5 mm with male LuerLock adapters
- 1 x E 454 injector nozzles for trocar sleeves, 10-15 mm
- 2 x E 456 spring supports for MIS instruments
- 1 x E 464 sleeve for E 454 injector nozzles
- 1 x E 908/1 insert for separable MIS instruments/ inner shafts
- 1 x E 336 irrigation sleeve MIBO

Module for E 474/4 Dental instruments

for PG 8536



E 919 dental module

- For 10 turbines, hand-pieces and contra-angles
- Items should be reprocessed in the VARIO TD programme
- Cleaning should be performed using neutral to mildly alkaline liquid detergents
- Combination with MIS instruments possible

Note

10 AUF supplied.
ADS must be ordered separately.



ADS 1 adapter/silicone for AUF 1 and AUF 2

- Adapter for transmission instruments
- For dental handpieces/turbines with a diameter of approx. 20 mm
- White

ADS 2 adapter/silicone for AUF 1 and AUF 2

- Adapter for transmission instruments
- For dental handpieces/turbines with a diameter of approx. 16 mm
- Green

ADS 3 adapter/silicone for AUF 1 and AUF 2

- Adapter for transmission instruments
- For dental handpieces/turbines with a diameter of approx. 22 mm
- Red



FP filter inserts for AUF 1 and AUF 2

- 20 off
- Porosity 2
- Ø 30 mm



AUF 1

- Holder for transmission instruments
- Consists of: Seal, threaded bush, bracket, holder lower part, holder upper part, 5 filter inserts



AUF 2

- Sleeve for transmission instruments in O 801/2 upper basket
- Consists of: Seal, threaded bush, bracket, holder lower part, holder upper part, 5 filter inserts

Leading manufacturers recommend the reprocessing of transmission instruments in Miele thermal disinfectors.

KAVO

Dental Excellence



MIS inserts and accessories



E 451 insert 1/6

- Mesh tray with lid for sundry small items
- Wire gauge: 1 mm base 0.8 mm sides 1 mm lid
- Mesh gauge: 3 mm base 1.7 mm sides 3 mm lid
- Internal divisions removable
- H 55, W 150, D 225 mm

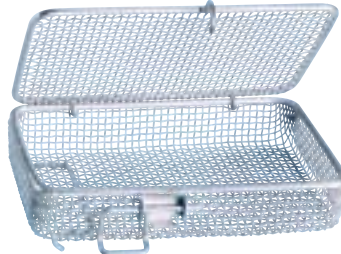

E 907/1 insert/mesh tray

- Mesh tray with lid for sundry small items
- Mesh size 3 x 1 mm
- Hooks to slot into E 905
- H 46, W 129, D 170 mm

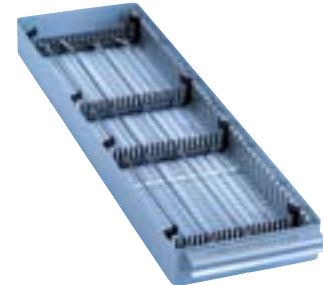

E 908/1 insert

- For separable MIS instruments/inner shafts
- Mesh width 8 x 1 mm, solid sides
- Individual arrangements with 4 holders for securely positioning 8–12 shafts from disassembled MIS instruments
- Hooks to slot into E 906
- H 36, W 130, D 460 mm



E 142 insert 1/2

- DIN mesh tray
- 1 mm wire gauge
- Mesh size 5 mm
- 5 mm all-round frame
- 2 hinged handles
- Max. load 10 kg
- H 45/55, W 255, D 480 mm



E 473/2 mesh insert with lid (not illustrated)

- Mesh basket with lid, for small parts
- Hooks in place
- Easy-to-open lid lock
- H 88, W 66, D 66 mm

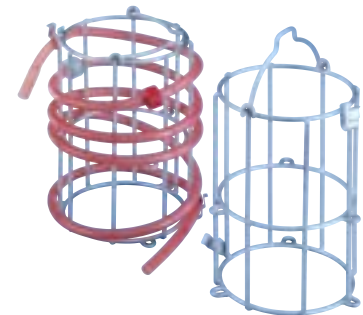

E 444 insert/spiral rack

- For fibre optics and irrigation tubes
- Fibre optics and tubes wound spirally around central rack
- H 168 mm, with folding clip, 214 mm
- Ø 140 mm



E 457 insert 1/2

- For separable MIS instruments (e.g. 12 handles and inserts)
- Mesh base, 3 mm mesh size, solid sides
- Welded holders for 8-12 handles, variable arrangement, with 3 holders for storing and securing 8-12 shafts from disassembled MIS instruments
- H 62, W 192, D 490 mm



E 460 insert 1/4

- For rigid fibre optics of varying lengths
 - Mesh size, base 8 x 1 mm
 - Sides/lid 7 x 7 x 3 mm
 - With 3 holders for 2 rigid fibre optics of varying lengths
 - H 53, W 100, D 430 mm
- Mat. no. 4 861 390, Art. no. 69.5460.01**



E 362 blanking screw

- M 8 x 1 thread, to seal connectors on load carriers
- Mat. no. 3 809 630, Art. no. 69.7362.01**



Mobile injector units for micro-instruments (eye operations)

for PG 8536



E 440/3 injector unit

- For ophthalmological/micro-instruments
- For 4 OP sets
- Built-in spray arm
- Loading on 3 levels
- Levels 1 and 2: For inserts, (e.g. E 441/1) or E 142
- Level 3: left-hand side: 20 connectors for lumened instruments (10 LuerLock adapters, male, 10 LuerLock adapters, female), Connectors for E 478 on feed pipe
- Level 3, right-hand side: 16 LuerLock adapters, male, with horizontal hose arrangement
- With holder for ML/2 magnetic strip for automatic load carrier recognition
- Clearances from bottom: Level 1: 115 mm Level 2: 86 mm Level 3: approx. 110 mm from top of threaded sleeve

Scope

- 1 bag E 476 (50 off)
- 1 bag E 477 (20 off)
- 8 x E 790 LuerLock adapters, female/female
- 8 x E 791 LuerLock adapters, female/male

E 792

- Silicone hose with LuerLock connector, male

E 790

- LuerLock connector, female/female

E 791

- LuerLock connector, female/male

Adapters available individually:

- Pack of 4 x E 790 LuerLock female/female
- Pack of 4 x E 791 LuerLock female/male
- Pack of 4 x E 792 LuerLock male with silicone hose (160 mm)

Geuder AG recommends that their current range of instruments be reprocessed in a Miele washer-disinfector.

Geuder[®]
Precision made in Germany

Accessories for micro-instruments



FP ED

- Stainless-steel filter insert for E 478/1
- Ø 30 mm



E 478/1 adapter

- For 4 narrow-lumened cannulae (Sautter cannulae)



E 441/1 insert 1/4

- For minimally invasive instruments
- Mesh size on base 1.7 mm
- Solid sides, stackable
- Internal divisions with 6 adjustable supports provide the ideal storage for instruments.
- For upper or lower basket
- H 60, W 183, D 284 mm



E 142 insert 1/2

- DIN mesh tray
- 1 mm wire gauge
- Mesh size 5 mm
- 5 mm all-round frame
- 2 hinged handles
- Max. load 10 kg
- H 45/55, W 255, D 480 mm



E 476 adapters

- For use in mesh trays with 5 mm mesh (e.g. E 142)
- 50 per bag
- For instruments with a diameter of 4 to 8 mm

E 479 adapters

- For use in mesh trays with 5 mm mesh (e.g. E 142)
- 50 per bag
- For instruments with a diameter of up to 4 mm



E 477 stoppers

- For use in mesh trays with 5 mm mesh (e.g. E 142)
- 20 per bag

Cross-product accessories



E 469 irrigation sleeve

- For MIS instruments/urology
- Length 300 mm, Ø 11 mm
- Cap, opening Ø 6 mm (Mat. no. 4 174 960)
- Clamp (Mat. no. 4174850)

E 467 irrigation sleeve

- For MIS instruments/forceps
- Length 205 mm, Ø 11 mm

E 336 injector sleeve MIBO

- Length 121 mm, Ø 11 mm

E 442 irrigation sleeve

- For MIS instruments, 4-8 mm, screw thread
- Length 121 mm, Ø 11 mm
- Cap, opening Ø 6 mm (Mat. no. 4174960)
- Clamp (Mat. no. 4174850)

E 443 irrigation sleeve

- For MIS instruments, 8-8.5 mm
- Length 121 mm, Ø 11 mm
- Cap, opening Ø 6 mm (Mat. no. 4174970)
- Clamp (Mat. no. 4174850)

(Illustrations, from left to right)



E 445 caps

- 12 caps for irrigation sleeves
- Opening Ø 6 mm

E 446 caps

- 12 caps for irrigation sleeves
- Opening Ø 10 mm

(Illustrations, from left to right)

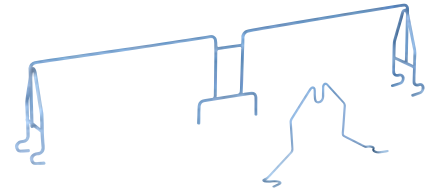

E 456 spring support

- For MIS instruments

E 475 holder bracket

- For MIS insert
- To secure irrigation sleeves

(Illustrations, from left to right)



E 499 adapter

- Adapter for suction and irrigation cannulae with various connectors and Verres cannulae
- Compatible with loading carriages with injector nozzles



E 447 adapter, female

- For LuerLock, male, screw thread for E 450/1, O 176, O 183

E 517 adapter, male, with centre pin

- For LuerLock, female, screw thread for E 450/1, O 176, O 183

E 449 adapter, male, without centre pin

- For LuerLock, female, screw thread for E 450/1, O 176, O 183

E 452 injector nozzle

- Length 60 mm, 2.5 mm, screw thread, for mobile injector unit

E 453 injector nozzle

- Clip bracket
- Length 110 mm, 4 mm, screw thread, for mobile injector unit

E 448 silicone hose

- LuerLock adapter, male
- Length 300 mm, Ø 5 mm
- Nozzle, 8 x 1 mm thread

(Illustrations, from left to right)



E 464 adapter

- For injector nozzle E 454, 13 x 65 mm
- Height-adjustment clip (Mat. no. 4692440)

E 454 injector nozzle

- For trocar sleeves 10-15 mm, 8 x 150 mm
- Height-adjustment clip (Mat. no. 4692430)

(Illustrations, from left to right)

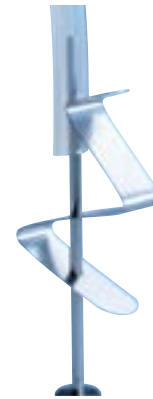

E 471 spring support

- For injector nozzle 2.5 mm, for E 452

E 472 spring support

- For injector nozzle 4.0 mm, for E 351, E 453

Reprocessing and transportation system for baby bottles



Baby bottles are generally washed at ward level. Miele's G 8592 and G 8582 CD washer-disinfectors with a height of 820 mm (excl. lid) are interesting propositions as they can be installed as undercounter units.

Miele has also developed a highly practical container system for transporting, handling, washing and disinfecting baby bottles.

The containers are able to accommodate all standard bottle sizes. Two containers each can be used for reprocessing in the upper and lower baskets. 76 baby bottles can then be washed and disinfected per cycle. Teats and screw-on teat holders are each placed in appropriate inserts.

1. Used and empty baby bottles are placed in E 135 containers with their necks facing up.



2. The container is then sealed with a mesh lid. The container is then turned by 180° (bottle necks facing downwards) and placed in the disinfectant.



3. After washing and disinfection, the lid is removed and the bottles can be refilled whilst still in the container.



4. After filling, the bottles can be sealed and stored in containers.

Inserts for baby bottles and accessories



E 135 insert 1/2 for containers

- Container for 19 baby bottles à 250 ml
Bottle size 56 x 56 mm, Neck 49 x 49 mm
- H 194, W 192, D 447 mm incl. lid
- For upper or lower basket

E 135/2 insert 1/2

- For 19 baby bottles à 90 ml
Bottle size 51 x 51 mm, Neck 42 x 42 mm
- H 125, W 192, D 447 mm
- For upper or lower basket

E 135/1 insert 1/2

- For 19 baby bottles à 110 ml
Bottle size 51 x 51 mm, Neck 45 x 45 mm
- H 135, W 192, D 447 mm
- For upper or lower basket

E 135/3 insert 1/2

- For 19 baby bottles à 120 ml
Bottle size 56 x 56 mm, Neck 49 x 49 mm
- H 135, W 192, D 447 mm
- For upper or lower basket

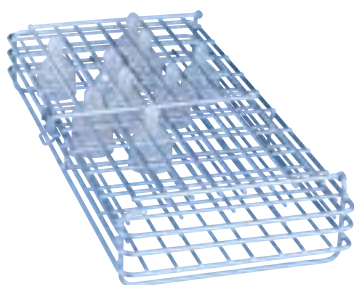

E 364 insert 1/2

- Container for 36 wide-necked teats
- 36 compartments, 41 x 41 mm
- Hinged lid with catch
- H 77, W 215, D 445 mm

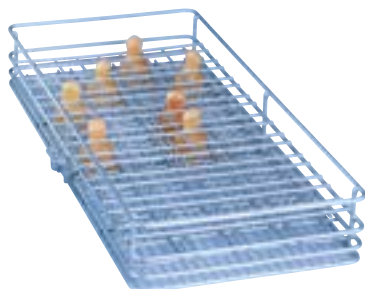

E 458 insert 1/2

- Container for 36 screw-on teats
- 36 compartments, 29 x 29 mm
- Hinged lid with catch
- H 63, W 215, D 445 mm



AK 12 insert 1/2 basket version

- For breast pumps
- For various utensils
- H 67/127, W 225, D 442 mm

(A 14 lid not included)

Baskets for theatre shoes

for PG 8536

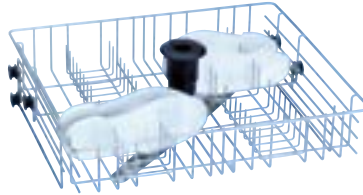

O 167 upper basket

- For up to 28 theatre shoe insoles
- Built-in spray arm
- H 195, W 531, D 475 mm



O 173 upper basket

- For up to 8 theatre shoes, max. Size 41
- Built-in spray arm
- H 195, W 531, D 475 mm

Washing and disinfection of theatre shoes

In most cases, theatre shoes are made from polyurethane (PU). In the past, the automatic reprocessing of these heat-sensitive items relied on chemo-thermal processes and a temperature of 60°C with a 5-minute holding time. However, the chemical disinfectants involved pose handling problems and are costly.

After intensive trials, Miele has now developed a purely thermal reprocessing method for theatre shoes which has been validated in practice.

Reprocessing programme available for PG 8536.

Thorough washing at temperatures below 55°C is followed by thermal disinfection in the last water intake cycle at a temperature of 75°C held for 2 minutes. At 22 minutes (excluding drying), this new process is considerably shorter than chemo-thermal processes (approx. 37 minutes) and dispensing with chemical disinfectants offers both environmental and economical benefits.

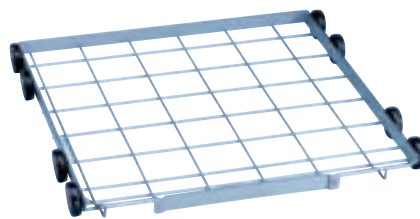

U 874/1 lower basket/open front

- For E 484 adapter
- Open front
- For various inserts
- Vertical clearances in combination with upper basket:
 - 176 approx. 110 mm
 - 177/1 approx. 220 mm – 20/– 40 mm
 - 183 approx. 185 mm +/-20 mm
 - 188/1 approx. 270 mm +/-20 mm
 - 190/1 approx. 220 mm +/- 20 mm
 - 191 approx. 295 mm
- With holder for ML/2 magnetic strip for automatic load carrier recognition
- H 50, W 534, D 515 mm



U 168/1 lower basket

- For up to 20 theatre shoes, max. Size 45
- 20 holders, 295 mm
- With holder for ML/2 magnetic strip for automatic load carrier recognition
- H 315, W 535, D 515 mm

Inserts for theatre shoes

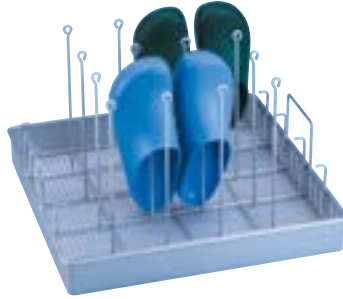

E 484 insert 1/1

- For various utensils
- Wire mesh: 1.4 mm, mesh size: 8 mm
- Fitted with holders
 - 4 x E 487 for 16 theatres shoes or
 - 11 x E 489 universal holderse.g. for insoles
- H 65 (150), W 470, D 480 mm

E 484 with 4 x E 487 long holders

- Fitted with 4 x E 487 holders, each for 4 theatre shoes, height 280 mm
- Dimensions E 487 H 280, W 464, D 10 mm

E 484 with 11 x E 489 universal holders

- Fitted with 11 x E 489 universal holders, e.g. for insoles, height 60 mm
- Dimensions E 489 H 60, W 464, D 10 mm

Dispensing accessories

for PG 8536



DOS S 20

- Bellows-type dispenser pump, retrofittable by Service
- For liquid acidic agents (surfactant, neutralising agent)



DOS NA 120

- Bellows-type dispenser pump incl. ultrasound flow control, retrofittable by Service
- For chemical disinfectant/liquid detergent (chemical disinfectant, liquid detergent, emulsifier)



Example of storage of dispensing canisters:

Canisters can be placed in an existing base unit.

Transport trolleys, accessories



ML/2 magnetic strip

- Magnetic strip for automatic load carrier recognition
- 5 magnets, configurable, 15 combination options

Retrofittable magnetic spray arm

- For spray arm sensing function with retrofittable magnetic spray arms on PG 8535, PG 8536 on baskets/inserts without magnetic spray arms.



MC/2 Mielcar, supply and disposal trolley

- For loading lab washers and handling baskets and inserts
- 2 levels (sloping towards centre)
- Rail handle and docking plate
- Docking height H 640–885 mm, infinitely adjustable
- 4 wheels, of which 2 are lockable
- H 1003, W 600, D 805 mm (with docking plate raised D 960 mm)

For use with PG 8536 and lab washers on 30 cm plinth



MT Mieltrans trolley

- For storing and transporting baskets and inserts
- 4 height-adjustable levels
- Loading dimensions W 549, D 599 mm
- Height-adjustment increments 102.5 mm
- 4 lockable wheels
- H 1985, W 616, D 662 mm



New: PWD 854x
The new bedpan washers

Bedpan washers from Miele - In the service of hygiene

The ultimate in reliability, safety and efficiency



Ensuring hygiene

Miele bedpan washer-disinfectors are designed to prevent the transfer of pathogens. This affords protection not only for patients, but also for the staff who work in these environments. After the cleaning cycle, the machines conduct a thermal disinfection of the wash items in line with current guidelines and recommendations – ensuring that the very highest standards of hygiene are upheld.

Protection and efficiency

There are many ways in which Miele bedpan washer-disinfectors ensure hygiene. The completely smooth stainless steel surfaces, with gaps that are kept as small as possible, are exceptionally easy to clean, and the weld seam-free wash cabinet design discourages residue from adhering to it. Depending on model, some machines allow you to select programmes using your elbow or offer a (semi-)automatic door opening function – for even better hygiene.

Practical accessories for added user convenience

There are different load carriers available. This enables a wide range of washing loads to be processed. Slops basins featuring manual or automatic rim flushing are the perfect addition to the system.

Process chemicals for optimum reprocessing results

The bedpan washer system is perfectly rounded off with process chemicals. These include an alkaline detergent which supports fast and efficient cleaning performance (ProCare Med 10 BPA) and a product to prevent any buildup of limescale in the chamber (ProCare Med 10 BPD). The latter serves to preserve the value of both the machine and bedpans and containers.

Learn more about the Miele bedpan washer system

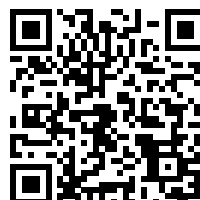



Miele
PROFESSIONAL

Miele



Process documentation

Systematic and flexible

Miele Professional offers flexible solutions for the documentation of instrument reprocessing. The documentation of reprocessing, including all relevant parameters, represents a clear quality benefit – and offers a wide range of opportunities to optimise both processes and costs.

Comprehensive

- The easy-to-use app-based DataDiary with wireless data transfer for selected Miele washer-disinfectors
- The user-friendly Segosoft Miele Edition allows full traceability and secure documentation of important reprocessing steps
- Automatic recording of process reports, routine checks and maintenance work
- Legally compliant documentation

Flexible





- Depending on the requirements of the installation location, documentation can be performed using two different communication modules
- RS232 module: Basic solution for small installations, connection of a report printer and the Segosoft Miele Edition USB kit
- Ethernet module: Standard communication module with extended functionalities and hence particularly suited to direct connection to a PC or a network

Process documentation for Miele washer-disinfectors

Overview of documentation options

For PG 8582, PG 8592 and PG 8582 CD



Process documentation		Communication modules		
				
DataDiary Page 75	APS 200 Sego Page 77	DataDiary Page 75	XKM 3000 L Med Page 74	XKM RS232 10 Med Page 74

For all Miele lab washers



Process documentation		
		
APS 101 Sego Page 77	APH 510 PRT 110 Page 79	APH 500 PRT 100 Page 79

Process documentation

Everything visible at a glance

Process documentation									
		Direct connection between PC and appliance		Connection via surgery network			WiFi connection	Documentation via USB stick	Printer
		Option 1:	Option 2:	Option 3:	Option 4:	Option 5:			
		Connection of PC to machine via serial interface	Connection of PC to appliance with XKM 3000 L Med Ethernet module	Network connection to appliance via serial interface	Network connection to appliance via appliance network interface	Network connection to appliances with XKM 3000 L Med Ethernet module	For appliances with WiFi option		
		e.g. Miele washer-disinfector PWD 853x	e.g. Miele washer-disinfector PG 858x/9x	e.g. Miele washer-disinfector G 78xx	e.g. Miele Washer-disinfector PG 8536	e.g. Miele washer-disinfector PG 8582, PG 8592, PG 8582 CD	e.g. Miele washer-disinfector PG 8582, PG 8592, PG 8582 CD	e.g. Miele washer-disinfector G 78xx, PG 858x/9x (with XKM RS232 10 Med)	e.g. Miele washer-disinfector PG 858x/9x (with XKM RS232 10 Med), PWD 853x
App	Mat. no.								
DataDiary	10689630						X		
PC software									
APS 101 Sego – Segosoft Miele Edition (licence) ¹	10019160	X	X	X	X	X			
APS 200 Sego – Segosoft Miele Edition, USB ¹	10019220							X	
Hardware									
APH 301 – Connection cable Type 1, serial, 3 m	7951420	X (Type 1 or Type 2, depending on appliance type)		X (Type 1 or Type 2, depending on appliance type)					
APH 302 – Connection cable Type 2, serial, 3 m	7951410								
APH 100 – Serial Industrial Converter	9574000	X (optional with two appliances)							
APH 303 – Extension cable Type 3, 3 m for connection cable Type 1 or Type 2	7951430	Option							
APH 304 – Extension cable Type 4, 5 m for connection cable Type 1 or Type 2	7951440	Option							
APH 305 – Extension cable Type 5, 10 m for connection cable Type 1 or Type 2	7951450	Option							
APH 110 Net500 – Network converter (RS 232 to Network RJ45)	9687440			X					
APH 406 – Network cable Type 6, 3 m (network connection)	7951470			X (Type 6 or 7, depending on required length)	X (Type 6 or 7, depending on required length)	X (Type 6 or 7, depending on required length)			
APH 407 – Network cable Type 7, 5 m (network connection)	7951480								
APH 408 – Network cable Type 8, crossover, 3 m (direct connection to PC)	7951490		X (Type 8 or 9, depending on required length)						
APH 409 – Network cable Type 9, crossover, 5 m (direct connection to PC)	7951500								
APH 500 PRT 100, report printer, serial interface	7951540								X
APH 510 PRT 110, report printer, serial interface	11053310								X
APH 530 – Printer cable 15 m, serial, for PRT 100 printer	6095260								X
APH 531 – Null modem adapter for printer cable	9573970								X
RJ 45 connector (enclosed with XKM 3000 L Med)	7076891		Optional (if cable extension is required. Cable length XKM module 1.5 m)			Optional (if cable extension is required. Cable length XKM module 1.5 m)			

X = required, ¹necessary additional service: ServiceCard, software maintenance

Process documentation

Accessories



XKM 3000 L Med Ethernet module

- Communication module for connection to Segosoft Miele Edition or other process documentation software
- Ring buffer for up to 30 process reports and 2 graphic reports
- No additional components needed for direct or network connection
- Supports DHCP (Dynamic Host Configuration Protocol) facilitating automatic selection of network parameters
- Baud rate: 10/100 Mbit/s
- Length of supply lead: 1.5 m
- Cable extension possible using enclosed connector



XKM RS232 10 Med serial module

- Communication module for connection to Segosoft Miele Edition USB kit or PRT 100 and PRT 110 report printers
- Ring buffer for up to 25 process reports
- Adapts report length between short and long to suit customer requirements
- Baud rate: max. 38 kbits
- Length of supply lead: 1.5 m
- Cable extension to total length of 15 m possible

Optional for models PG 8582, PG 8592 and PG 8582 CD.



DataDiary

- WiFi communication module XKM 3100 W CDS
- 5 NFC chipcards
- Installation and operating instructions

Details on DataDiary, cf. Page 75

Comparison of documentation options	DataDiary app	Segosoft Miele Edition PC software	Documentation via USB	Printer
Documentation: Process report	•	•	•	•
Documentation: Temperature/pressure charts (depending on appliance)	–	•	–	–
Documentation: Routine checks	–	•	•	–
Documentation: Maintenance	–	•	•	–
Advanced digital signature with reference to user	–	•	•	–
Manual approval with signature	–	–	–	•
Digital approval with user name/password	•	•	•	–
Convenience of short distances	+++	++	++	+++
Paperless filing	•	•	•	–
Data backup function	–	•	•	–
Serial direct connection	–	•	•	•
Ethernet network connection	–	•	–	–
WiFi connection	•	–	–	–
Legal security	•	•	•	•
Initial outlay	+	+++	++++	+
Medical device	–	•	•	–
ServiceCard/software maintenance required	–	•	•	–

• = available – = not available + = evaluation scale

Accessories	Description	Mat. no.
XKM 3000 L Med	Ethernet module	10440980
XKM RS232 10 Med	Serial module	10444420
DataDiary	App-based process documentation	10689630

App-based solution

Process documentation goes wireless:

DataDiary – simple, efficient, secure

To assist in the gap-free process documentation of instrument reprocessing, Miele Professional is now offering a particularly time-saving plug & play solution in the form of an app. This collects process data automatically from PG 8582, PG 8592 and PG 8582 CD washer-disinfectors and enables reports to be generated using an app from a tablet PC – without cables, USB memory sticks or other intermediate steps.



Easy to operate

With DataDiary, Miele is offering an intuitive, app-based method of process documentation with a modern user interface. It is a plug & play solution – simply connect a product and off you go!



Wireless & secure

Data is transmitted wirelessly and securely between the Miele machine and a tablet PC via encrypted WiFi (WPA2). The WiFi connection is simple to set up with an SSID (Service Set Identifier) and a password.



PDF reports

The successful reprocessing of instruments must be documented in a gap-free manner. For this purpose, DataDiary offers a simple report creation process based on PDF files.

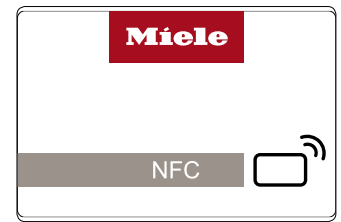

Fast authentication

User authentication is simple using an NFC tag or a user ID with password, if this is supported by the end device.



Further useful information

Download links and an explanatory video are available on our homepage.



System requirements:

Tablet PC, min. 7" with a min. resolution of 1280 x 800 Px and operating system from Android™ 6 or iOS® 10 upwards.

Product	Mat. no.
DataDiary – app and WiFi module (XKM 3100 W CDS)	10689630
DataDiaryID – NFC cards	10735270

The reproducible documentation of reprocessing not only gives dentists the peace of mind of knowing that they are on the right side of the law. It also facilitates the logging of individual process stages for detailed analysis later and therefore lends itself to particularly effective quality management – a real benefit for patients and the surgery team alike.

Segosoft Miele Edition 7

Apart from the Ethernet module, no further hardware is required to connect a PG 858x/9x washer-disinfector to the Segosoft Miele Edition 7 (e.g. converters or adapters, etc.).

Alongside the online activation of licences and automatic configuration of software for fast and simple commissioning, automatic signature updates are also possible during operation.

- Documentation in PDF/A1 format
- Long-term archiving according to ISO 19005-1:2005
- Quality of security functions certified by BSI (German Office of Data Security)
- ServiceCard ensures software is operated in compliance with medical device regulations



Product	Mat. no.
APS 101 Sego – Segosoft Miele Edition (licence) ¹	10019160
APS 200 Sego – Segosoft Miele Edition, USB ¹	10019220
APH 301 – Connection cable, serial, length 3 m (Type 1)	7951420
APH 302 – Connection cable, serial, length 3 m (Type 2)	7951410
APH 100 – Serial Industrial Converter (2 x serial, 1 x USB; for serial direct connection of 2 appliances)	9574000
APH 303 – Extension cable 3 m (Type 3) for connection cable Type 1 or Type 2	7951430
APH 304 – Extension cable 5 m (Type 4) for connection cable Type 1 or Type 2	7951440
APH 305 – Extension cable 10 m (Type 5) for connection cable Type 1 or Type 2	7951450
APH 330 – Gender-changer adapter for Hawo heat-seal unit	7986870
APH 331 – Melag connection cable (Vacuklav 24, 31, Autoclav 25), length 3 m, in addition to Type 1 connection cable	9573240
APH 332 – W&H adapter (Lisa 317, 322, 517, 522), length 3 m, in addition to Type 2 connection cable	9553890
APH 333 – W&H/Madrimed adapter (Lisa MB17, MB22, Madrimed), length 3 m, in addition to Type 1 connection cable	9554370
APH 110 Net500 – Net500 network converter (RS 232 to RJ45)	9687440
APH 406 – Network cable, length 3 m (network connection) (Type 6)	7951470
APH 407 – Network cable, length 5 m (network connection) (Type 7)	7951480
APH 408 – Network cable, crossover, length 3 m (direct PC connection) (Type 8)	7951490
APH 409 – Network cable, crossover, length 5 m (direct PC connection) (Type 9)	7951500
APH 500 PRT 100 – PRT 100 report printer	7951540
APH 510 PRT 110 – PRT 110 report printer To be introduced during 2019 to replace PRT 100	11053310
APH 530 – Printer cable for PRT 100 and PRT 110 printers	6095260
APH 531 – Adapter (null modem) for PRT 100 printer cable	9573970
APH 590 – Printer cartridge for PRT 100	9063390
APH 591 – Paper rolls for PRT 100 and PRT 110, 5 pc., width 76 mm	9063410
APH 592 – Black ink ribbon for PRT 110 printer To be introduced during 2019 together with PRT 110	11053500
APH 550 Sego – Segolabel starter kit, incl. software/printer/labels	7951400
APH 595 – Colour ribbon for PRT 200 label printer	7951520
APH 596 – Labels, 1 roll with 1,000 labels for PRT 200 label printer	7951530
RJ 45 connector	7076891

¹ Required additional service: ServiceCard (software maintenance/support)

Process documentation

Article overview



APS 101 Sego –

Segosoft Miele Edition

- Process documentation software for use in direct PC connections or network connections

Scope

- Software download*, Comfort Plus software package, PDF installation instructions, licence card for 1 machine

Max. number of connections

- Serial connection: 4 appliances
- Network connection: Any number of appliances

Data transmission

- Direct connection of appliance and PC or appliance and surgery network

Appliance compatibility

- Miele washer-disinfectors
- Appliances from other manufacturers on request

APS 200 Sego –

Segosoft Miele Edition: USB

Process documentation software for data transfer via USB stick

Scope

- Complete package for 1 appliance: Software CD*, Comfort Plus software package, installation instructions, USB data logger module incl. 230 V power supply unit, 1.4 m supply lead, serial interface cable for connecting appliance and data logger (cable length: 3 m), USB stick

- Dimensions (H x L x W): 31 x 90 x 109 mm

Appliance compatibility

- Miele washer-disinfectors with TouchControls (PG 8582, PG 8592 and PG 8582 CD)

APH 110 Net500 –

Net500 network converter

- Connection of machines with serial interface to a surgery network (network connection as per Option 3)
- Converts serial data (RS 232) to network protocol (TCP/IP)

Scope

- Transformer/rectifier unit
- Supply lead length: 1.4 m
- Dimensions (H x L x W): 31 x 90 x 109 mm

Connection cable for Net500

- Appliance cable: Serial connection cable (Type 1 or 2, depending on appliance) for connection of Net500 to appliance
- Network cable: (Type 6 or 7, depending on required length) for connection of Net500 to surgery network

System requirements for all software systems

- CPU rate of at least 1.6 GHz, 2.0 GHz or higher recommended
- SVGA graphics with 1024 x 768 Px, 17" monitor or larger, recommended HD 1820 x 1080 Px
- Memory at least 2 GB, 4 GB recommended
- Hard drive with at least 1 GB free memory, 10 GB or higher recommended
- Min. 2 USB ports, 3 recommended, network interface, Internet access
- Operating systems: Windows 7 Professional SP1, Windows 8.1, Windows 10
- Adobe Acrobat Reader, Version 11.08 or higher

Software download

- <https://www.miele.de/professional/service-und-support-52.htm>

Required additional service from Miele service partner:

ServiceCard and services (obligatory for Segosoft Miele Edition!)

- Update of digital signature extending legal validity
- Telephone support, software updates
- Flat-rate fee per surgery: € 215 (excl. SegoAssign Plus)

Note: Legal validity of digital signatures in Segosoft Miele Edition in accordance with BSI (German Federal Office of Data Security). An extension of this legal validity is provided by the ServiceCard. (Flat-rate fee per surgery: € 215 (excl. SegoAssign Plus))

Process documentation

Article overview



APH 301 – Connection cable (Type 1)

3 m serial connection cable

Can be used for:

- PC direct connection: Option 1
Connection of PC to appliance via serial interface
- Network connection: Option 3
Connection of serial machine interface with network converter
- Net500

Appliance compatibility:

- Miele washer-disinfectors G 7831, G 7882, G 7892
- Melag Cliniklav, Euroklav, Vacuklav, Vacuquick, MELAtronic
- Sirona DAC Professional
- W&H Lisa MB 17, Lisa MB 22
- Hawo heat-seal units, additional adapter necessary (Mat. no. 7986870)

APH 302 – Connection cable (Type 2)

3 m serial connection cable

Can be used for:

- PC direct connection: Option 1
Connection of PC to appliance via serial interface
- Network connection Option 3
Connection of serial machine interface with Net 500 network converter

Appliance compatibility:

- Sirona DAC Universal, DAC 2000, Siroclave B, Siromini B
- W&H Lisa 317, Lisa 517, Lisa 322, Lisa 522



Network cable Type 6 (APH 406) and Type 7 (APH 407) for network connection

Can be used for

- Option 3:
For connection of Net500 network converter to surgery network
- Option 4:
Connection of one appliance with network interface to surgery network

- APH 406 –
Network cable 3 m (Type 6)
- APH 407 –
Network cable 5 m (Type 7)

Note: Type 8 or Type 9 used for network connection of Melag sterilisers



Network cable Type 8 (APH 408) and Type 9 (APH 409) for direct connection to PC

For use with Option 2:

For connection of appliance with network interface to PC

- APH 408 –
Network cable, crossover, 3 m (Type 8)
- APH 409 –
Network cable, crossover, 5 m (Type 9)

Note: Type 6 or Type 7 used for PC connection of Melag sterilisers



Extension cable Types 3–5 for connection cable Type 1/2

- For extension of connection cables Type 1 and 2

- APH 303 –
Serial extension cable, 3 m (Type 3)
- APH 304 –
Serial extension cable, 5 m (Type 4)
- APH 305 –
Serial extension cable, 10 m (Type 5)

Appliance compatibility

- For use with all appliances with serial interface



APH 500 PRT 100 –

PRT 100 report printer

- Printer for printing process reports
- Inkjet printer with waterproof ink

Appliance compatibility

- All Miele lab washers
- Miele PG 8582, PG 8592 and PG 8582 CD washer-disinfectors only in conjunction with XKM RS232 10 Med serial communication module

APH 530 – Printer cable for PRT 100 printer

- Printer cable length: 15 m
- Cable to be ordered separately

Cartridges, paper rolls

- APH 590 – Printer cartridge for PRT 100
- APH 591 – Paper rolls, 5 pc., for PRT 100



APH 510 PRT110 –

PRT 110 protocol printer

- Dot matrix printer for printing process reports

Appliance compatibility

- All Miele washer-disinfectors, except PG 8536
- PG 8582, PG 8592 and PG 8582 CD only in combination with XKM RS232 10 Med serial communication module
- APH 530 – Printer cable for PRT 110 printer
- Printer cable length 15 m (cable not supplied with printer)
- Cartridges, paper rolls
- APH 592 – Black ink ribbon for PRT 110
- APH 591 – Paper rolls, 5 off, for PRT 110
- Available from mid-2019.



APH 100 –

Serial Industrial Converter

- For serial connection of max. 2 Miele washer-disinfectors
- USB connection between Serial Industrial Converter and PC
- Galvanic separation of all connections

Scope

- Transformer/rectifier unit
- Supply lead length: 1.4 m
- USB cable 0.5 m

Appliance compatibility

- Miele PWD 8531 and PWD 8532 washer-disinfectors
- Dimensions (H x L x W): 31 x 90 x 109 mm
- Appliances from other manufacturers on request



APH 550 Sego –

Segolabel Miele Edition:

Starter kit

- Complete package consisting of hardware and software to create sterile supply labels

Scope

- Software CD*, installation instructions, PRT 200 label printer incl. power supply unit (cable length: 3.8 m) and USB cable (length 2 m)
- 1 roll of 1,000 labels
- Colour ribbon

APH 595 – Colour ribbon

- Colour ribbon for PRT 200 label printer

APH 596 – Labels

- Labels for PRT 200 label printer

Scope

- 1 roll of 1,000 labels



Ok (Neu)

11

729

PHEN

CabinetTemperature -- AirTemperatureInt -- AirTemperatureExt -- BoilerTemperature -- A0

Air Temperature
Air TemperatureExt
Air TemperatureInt
Cabinet Temperature

ang

Details

Kommentar

Rohtext

Verbrauch

Freigabe

Drucken

NetBox.2

process documentation system

The NetBox2 is a complete documentation system including pre-configured software. The system is connected via an interface to the machine and gathers relevant data from the current cycle. In normal mode, documentation is fully automatic without any intervention on the part of the user. This results in an increase in operational security as the NetBox.2 provides a good level of protection against user errors.

Once collated, process data remains in memory; the NetBox has the capacity to save up to 300,000 batch protocols. Later, data can be saved to a network or a storage device.

In network mode, the unit can be monitored and operated via a PC interface. A flat-screen monitor is also available as an optional extra to plot time/temperature charts. A further optional extra is a barcode scanner or RFID transponder to facilitate the fast and simple identification of loads. The user can also approve or lock batches, depending on process cycles.

Effective process documentation system requirements

- Complete system with high level of process security, including pre-installed and configurable software
- Manipulation-safe
- Simple operation without knowledge of PCs
- Extremely simple installation
- Process visualisation
- Batch-related documentation
- Documented batch approval
- Memory for 300,000 cycles (depending on model)
- Touch screen controls
- User interface
- Machine status monitor
- Archiving of cycle data
- Transfer of load/approval data to EuroSDS©
- Provision of load / approval data for external documentation systems
- Web interface
- Compliant with provisions of EN 80001

System components

- NetBox2 with mouse/barcode scanner (wired) as well as cables for connection to lab washers

Optional

- Flat screen for visualisation of process data and loads
- Barcode scanner (Bluetooth model) for optimum programme control and simple load data acquisition
- Transponder as alternative to barcode system
- Ethernet switch with 4 ports
- Network cable

Commissioning

- The NetBox2 is connected by a Miele Service technician. An IT employee should be present to oversee integration into an on-site network.



Service

Functional safety and preservation of value

Miele Professional is synonymous with exceptional quality – not least when it comes to service. Blanket service coverage enables a response within 24 hours. And, thanks to on-board spares, first service visits result in around 90% first-time fixes. It is no coincidence that Miele's customer service has been awarded top ratings for outstanding service for many years.



Comprehensive service from the very start

Even before a machine is installed, Miele's sales force is available to provide in-depth advice. Experienced experts assist in selecting the most suitable products and configurations to suit individual needs. On request, feasibility calculations can be provided, along with tailored financing packages.

Miele also offers a series of process checks performed at various times throughout an machine's life cycle. Specially trained technicians carry out process tests in accordance with legal requirements and standards as well as country-specific recommendations.

Miele service contracts

Preventative maintenance

- Inspection
- Maintenance
- Incl. high-mortality parts

Full-service maintenance contract

- Inspection
- Maintenance
- Incl. repairs

Machine qualification

Initial validation

- Installation qualification
- Operation qualification
- Performance Qualification

Performance revalidation

- Performance validation without concrete reason
- Performance validation with concrete reason

Service to meet professional expectations

Highly qualified Miele service engineers oversee the delivery and commissioning of products and are available to perform various routine checks during operation. This prevents faults occurring in the first place and offers an opportunity to optimise operating parameters on an ongoing basis. A further advantage: regular checks and maintenance safeguard investments.

- Quality service through blanket network of medical device technicians (more than 220 technicians in Germany alone)
- Short response times and on-site servicing within 24 hours
- 90% of service calls result in first-time fixes
- Reliable spares service, key functional parts available for 15 years after series production ceases

Customised service contracts and inspections

Miele Professional offers surgeries of all sizes tailored service contracts. In honouring these contracts, Miele service engineers regularly assess and evaluate the condition of machines. Depending on the contract concluded, this comprises an analysis of functionality and safety with respect to all key components, including replacement as and when necessary. Scheduled inspection and maintenance prevents breakdowns from happening in the first place, increases the life expectancy of machines and contributes towards safeguarding investments. This offer from the Miele Customer Service Department includes a whole range of performance and process checks which are performed at various points throughout the life of the product.





Miele Professional

Quality and service for professionals

Decades of experience, an unerring pursuit of quality and the power of innovation means that Miele sets the benchmark. High-performance thermal disinfectors from Miele Professional are already recommended by several leading manufacturers for the reprocessing of their instruments. In combination with accessories specific to models and applications, machines from Miele Professional facilitate the fast and simple reprocessing in all hospitals and surgeries.

Power output

- Thorough yet gentle reprocessing with dependable results
- Process control perfectly matches machines and instruments
- All-in system from one single supplier consisting of perfectly matching components (machines, chemicals, software, service)

Quality and economic operation

- Highest-quality materials and workmanship
- Superior product longevity and reduced need for maintenance
- Short cycle times and sparing use of resources

Safety and convenience

- Ergonomic controls simplify everyday work in hospitals and surgeries

Service

- Excellent Miele in-house service operation offering blanket coverage.
- Comprehensive advisory services covering planning, requirement assessment and financing.
- Customised service contracts guaranteeing functional safety and preserving values.
- Convenient navigation avoids mistakes on the part of the user
- Large-scale, easy-to-read text display
- Fully automatic protocolling and documentation of reprocessing

Notes

Germany

Miele & Cie. KG
Miele Germany
Carl-Miele-Straße 29, D-33332 Gütersloh
P.O. box, D-33325 Gütersloh
info@miele-professional.de
www.miele.de/professional

Sales and Service

Tel.: +49 (0)800 22 44 644
Fax +49 (0)800 33 55 533
Mon.–Fri. 8.00-17.30 h

Immer besser

Since 1899, Miele – a family-run company – has subscribed to a clear corporate philosophy condensed into the two words “Immer Besser” (Forever better). This overarching claim is the foundation of Miele's proverbial quality and sustainability and the power of innovation of a brand 'Made in Germany'. A brand promise which gives professional users the certainty of having chosen the right product.

Award-winning

Uncompromising product reliability and service dependability is the reason why customers have repeatedly voted Miele the best and most trustworthy brand. Coveted awards such as the MX Award, the iF and reddot Design Awards and the German Sustainability Prize confirm the distinguished position Miele enjoys with respect to design, quality management and the sparing use of resources.

Proficient

Miele Professional has been developing and manufacturing a broad range of high-quality laundry machines, dishwashers, washer-disinfectors and sterilisers for decades. Carefully selected accessories, comprehensive advisory services and a Miele factory service operation which guarantees a fast response and ensures that machines perform to perfection and offer the ultimate in performance and efficiency.