

AUGUST 1980 Volume 5; Number 8 \$2.50 in USA/\$2.95 in Canada

# BYTE<sup>®</sup>

the small systems journal  
A MCGRAW-HILL PUBLICATION

: DOUBLE

+

DUPLI

THE FORTH LANGUAGE

ROBERT  
30-TIME



# OFTEN FIRST - ALWAYS THE BEST

When we introduced the "S" system last year we knew that we were ahead of the industry. We didn't realize just how far.

## WE KNEW THE NEEDS—

When we began designing the S/09 computer, we knew that the normal eight-bit microprocessor system was not adequate for any but the smallest, single user business applications. What was worse there was little that could be done to expand the capabilities of the system if the customer needed it. There is nothing much worse to a business customer than a "dead end" system.

## MEMORY IS THE KEY—

Obviously a business system should be able to operate with multiple terminals if needed. It should also be able to do a variety of jobs; not just data processing, but also word processing and computer aided instruction. With a system limited to 64K bytes of memory addresses such a system is just not practical. The amount of user memory available to each terminal is too small for useful work.

## HOW DO YOU GET IT—

The common solution to this problem is called bank switching. This process is similar to a selector switch that turns on the bank of memory that you want to work with. This, however, has a few problems. It is inefficient, therefore expensive, plus being slow. It is also extremely clumsy when data must be exchanged between two different programs. Besides with all this you still cannot use more than 64K of memory for any one program. So what is the alternative?

## DO IT RIGHT—

The alternative is an address bus with more than the normal 16 bits found on eight-bit microprocessors. By using 20 address bits you can, for instance, address up to a million memory locations directly.

This way you have access to any part of memory at any time without any intermediate processes. Program interaction is now no problem at all.

## SOFTWARE MUST MATCH—

So far we have a computer system with a large memory capacity and the ability to operate with many terminals, but this is not enough. You need an operating system just as sophisticated as the

hardware to complete the job. It must be a multi-tasking (therefore multiuser) operating system and it must be fast if it is to be useful with multiterminal systems. UniFLEX<sup>®</sup> fills these requirements and more. It also has multiple directories, log-in and password features. UniFLEX<sup>®</sup> was patterned after UNIX<sup>™</sup>, which is one of the most highly regarded operating systems around.

## PERIPHERALS TOO—

To complete the system we offer our smart terminals, and a variety of disk systems. We have everything from a 390K byte floppy to a 40 Meg/byte Winchester drive. All peripherals are compatible and so you can start with a small single terminal system and upgrade if necessary to a fully expanded system—16 terminals, 768 bytes of RAM memory and 96 Meg/bytes of disk storage.

## GET THE WHOLE STORY—

If you are planning to install, or sell business systems you should get our information package on the most versatile and cost effective system on the market, the S/09. You can get a 128K system (less printer) for a little over \$5,000.00.

*\*UNIX is a Trademark of Bell Laboratories.*

---

## SYSTEM SOFTWARE

<b>Languages</b>	<b>Operating Systems</b>
Assembler	FLEX*
BASIC	UniFLEX
FORTRAN	
Pascal	
PILOT	
<b>Data Processing</b>	<b>Word Processing</b>
General Ledger	Word Processing Editor
Accounts Receivable	Text Processor
Accounts Payable	
Payroll	<b>Utilities</b>
Jobcost	Debug Package
Inventory	Sort-Merge
Mail List	Diagnostics

*\*Supplied with over 40 utilities*



**SOUTHWEST TECHNICAL PRODUCTS CORPORATION**  
219 W. RHAPSODY  
SAN ANTONIO, TEXAS 78216 (512) 344-0241

Circle 308 on inquiry card.



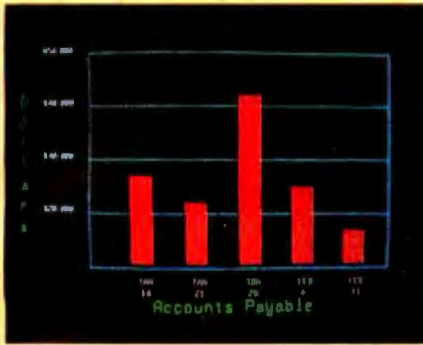

Management Information Display

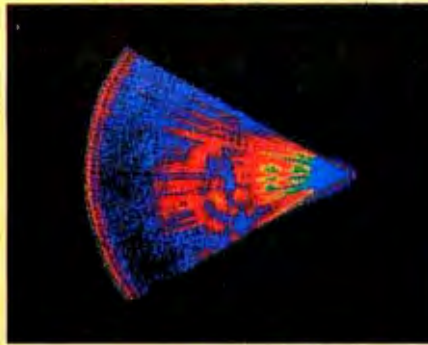

Ultrasonic heart sector scan



High-resolution display with alphanumerics

## Get the professional color display that has BASIC/FORTRAN simplicity

### LOW-PRICED, TOO

Here's a color display that has everything: professional-level resolution, enormous color range, easy software, NTSC conformance, and low price.

Basically, this new Cromemco Model SDI\* is a two-board interface that plugs into any Cromemco computer.

The SDI then maps computer display memory content onto a convenient color monitor to give high-quality, high-resolution displays (756 H x 482 V pixels).

When we say the SDI results in a high-quality professional display, we mean you can't get higher resolution than this system offers in an NTSC-conforming display.

The resolution surpasses that of a color TV picture.

### BASIC/FORTRAN programming

Besides its high resolution and low price, the new SDI lets you control with optional Cromemco software packages that use simple BASIC- and FORTRAN-like commands.

Pick any of 16 colors (from a 4096-color palette) with instructions like DEFCLR (c, R, G, B). Or obtain a circle of specified size, location, and color with XCIRC (x, y, r, c).

\*U.S. Pat. No. 4121283

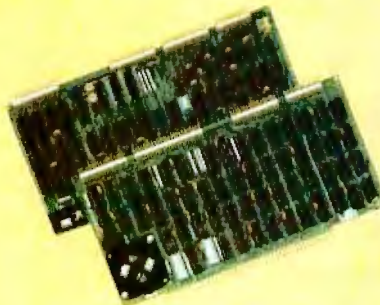

Model SDI High-Resolution Color Graphics Interface

### HIGH RESOLUTION

The SDI's high resolution gives a professional-quality display that strictly meets NTSC requirements. You get 756 pixels on every visible line of the NTSC standard display of 482 image lines. Vertical line spacing is 1 pixel.

To achieve the high-quality display, a separate output signal is produced for each of the three component colors (red, green, blue). This yields a sharper image than is possible using an NTSC-composite video signal and color TV set. Full image quality is readily realized with our high-quality RGB Monitor or any conventional red/green/blue monitor common in TV work.



Model SDI plugs into Z-2H 11-megabyte hard disk computer or any Cromemco computer

### DISPLAY MEMORY

Along with the SDI we also offer an optional fast and novel two-port memory that gives independent high-speed access to the computer memory. The two-port memory stores one full display, permitting fast computer operation even during display.

### CONTACT YOUR REP NOW

The Model SDI has been used in scientific work, engineering, business, TV, color graphics, and other areas. It's a good example of how Cromemco keeps computers in the field up to date, since it turns any Cromemco computer into an up-to-date color display computer.

The SDI has still more features that you should be informed about. So contact your Cromemco representative now and see all that the SDI will do for you.

 **Cromemco**  
 incorporated  
 280 BERNARDO AVE., MOUNTAIN VIEW, CA 94040 • (415) 964-7400  
 Tomorrow's computers today





## Here's the state of the art in low-cost hard-disk computers

### 11 MEGABYTES OF

#### FAST HARD-DISK STORAGE

Yes, the Cromemco Model Z-2H is in a class by itself in the computer field.

These Z-2H features tell you why:

- 11 megabytes of hard-disk storage
- 64 kilobytes of fast RAM
- Two dual-sided floppy disk drives
- Z-80A type processor
- Fast 4 MHz operation—150 nanosecond access time
- Fast hard-disk transfer rate of 5.6 megabits/second
- Low cost

And that's not all you get. Not nearly.

#### BROAD SOFTWARE SUPPORT

You also get Cromemco software support—the broadest software sup-

port in the microcomputer field. Software that Cromemco is known for. Like this:

- Structured BASIC
- FORTRAN IV
- RATFOR (RATIONAL FORtran)
- COBOL
- Z-80 Macro Assembler
- Word Processing System
- Data Base Management

And more all the time.

#### FIELD PROVEN

The Z-2H is clearly in a class by itself. We introduced it last summer. It's field proven. It's reliable.

And it's rugged. Housed in a sturdy, all-metal cabinet.

#### EASILY EXPANDABLE

As always with Cromemco, you get expandability. The fast 64K RAM in this Model Z-2H can be expanded to 512 kilobytes. That amount of RAM combined with 11 megabytes of hard-disk storage gives you enormous

computer power—the equal or even beyond what much larger computers sometimes offer.

What's more, this computer gives you a 12-slot card cage. That's to plug in your special circuits as well as additional RAM and interface cards.

This expandability is supported by still more Cromemco value—the Z-2H's heavy-duty power supply that gives you 30A at 8V and 15A at  $\pm 18V$  to support plug-ins.

#### LOW COST — SEE IT NOW

The Z-2H is real. It's been in the field for many months. It's proven itself.

You should see the Z-2H now. Contact a Cromemco representative and arrange for a demo. Learn that Cromemco is a survey-winner for reliability.

And learn that the Z-2H is under \$10K.

In the long run it always pays to get the best.



**Cromemco**  
i n c o r p o r a t e d

280 BERNARDO AVE., MOUNTAIN VIEW, CA 94040 • (415) 964-7400  
Tomorrow's computers today





Page 22



Page 58

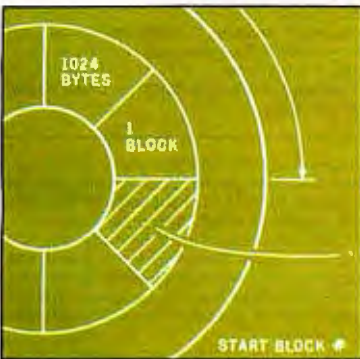

Page 164



Page 210

## Foreground

### 22 A BUILD-IT-YOURSELF MODEM FOR UNDER \$50

by *Steve Ciarcia*

This originate-only modem will allow you to get started in intercomputer communication with minimal expense.

### 58 THE HARD-DISK EXPLOSION: HIGH-POWERED MASS STORAGE FOR YOUR PERSONAL COMPUTER

by *Tom Manuel*

Thanks to new hard-disk technology, personal computer users can add millions of bytes of mass storage to their systems at a reasonable cost.

### 100 WHAT IS FORTH? A TUTORIAL INTRODUCTION

by *John S James*

Here is an overview of FORTH that lays the foundation for the other theme articles in this BYTE.

### 150 BREAKFORTH INTO FORTH

by *A Richard Miller and Jill Miller*

If you can't imagine any personal use for FORTH, can you imagine a 96-line program that plays a fast, animated game with sound on the TRS-80?

### 164 FORTH EXTENSIBILITY: OR HOW TO WRITE A COMPILER IN TWENTY-FIVE WORDS OR LESS

by *Kim Harris*

This tutorial explains the capability for defining new families of FORTH words.

### 210 CONSTRUCTION OF A FOURTH-GENERATION VIDEO TERMINAL, PART 1

by *Theron Wierenga*

Part 1 of this article presents a new design using the 8275 controller and a dedicated Z80 microprocessor.

## Background

### 76 THE EVOLUTION OF FORTH, AN UNUSUAL LANGUAGE

by *Charles H Moore*

The inventor of the language recalls its design and how it evolved over a 10-year period.

### 198 KHACHIYAN'S ALGORITHM, PART 1: A NEW SOLUTION TO LINEAR PROGRAMMING PROBLEMS

by *G C Berresford, A M Rockett, and J C Stevenson*

Now you can study the algorithm that promised to revolutionize linear programming.

## Nucleus

- |  |                           |
|--|---------------------------|
| 6 Editorial: Threads of a FORTH Tapestry                                   | 94 BYTELINES              |
| 14 Letters   | 98 Selected FORTH Vendors |
| 40 Product Review: The Ohio Scientific CA-15 Universal Telephone Interface | 196 A FORTH Glossary      |
| 46 Product Review: The Heath H-89 Computer                                 | 226 Clubs and Newsletters |
| 72 Programming Quickies: Self-Reproducing Programs                         | 230 Event Queue           |
|  | 234 Ask BYTE              |
|  | 248 What's New?           |
|  | 302 Unclassified Ads      |
|  | 303 BOMB, BOMB Results    |
|  | 304 Reader Service        |



## Publishers

Virginia Londoner,  
Gordon R Williamson

## Associate Publisher

John E Hayes

## Assistant

Cheryl A Hurd

## Editorial Director

Carl T Helmers Jr

## Editor-in-Chief

Christopher P Morgan

## Editors

Richard S Shuford, Gregg Williams,

Curtis P Feigel, Harold Nelson

Stan Miastkowski

## Consulting Editor

Mark Dahmke

## Book Editor

Bruce A Roberts

## Chief Copy Editor

David William Hayward

## Copy Editors

Faith Hanson, Warren Williamson,

Robin M Moss, Anthony J Lockwood

## Assistant to the Editors

Faith Ferry

## Assistants

Debe Wheeler, Karen A Cilley

## New Products Editor

## Clubs, Newsletters

Charles Freiberg

## Drafting

Jon Swanson

## Production Director

Nancy Estle

## Assistant Production Director

Christine Dixon

## Production/Advertising Coordinator

Wai Chiu Li

## Production Art

Holly Carmen LaBossierre,

Deborah Porter

## Typographers

Sherry McCarthy, Debi Fredericks,

Donna Sweeney

## Advertising Director

Thomas Harvey

## Assistants

Ruth M Walsh, Ms. Marion Gagnon

Barbara J Greene, Janet Ames

## Special Projects Coordinator

Jill E Callihan

## Marketing Coordinator

Laura A Hanson

## Circulation Manager

Gregory Spitzfaden

## Assistants

Pamela R H Spitzfaden, Agnes E Perry,

Melanie Bertoni, Barbara Varnum,

Louise Menegus, Andrew Jackson

## Dealer Sales

Thomas Yanni

## Controller

Daniel Rodrigues

## Assistant

Mary E Fluhr

## Accounts Receivable Specialist

Karen Burgess

## Accounts Receivable Assistant

Jeanne Cilley

## Receptionist

Jacqueline Earnshaw

## Traffic Department

Mark Sandagata, Rob Hannings



## ON THE COVER

This month's cover by Robert Tinney shows a rocket-like needle threading its way through granite cubes labeled: DOUBLE, DUPLICATE, and +. The threaded path of the needle is a representation of the process used in FORTH and other threaded languages to create a new word (here, DOUBLE) with previously defined words (here, DUPLICATE and +).

Other aspects of this fascinating language are described in the editorial, "Threads of a FORTH Tapestry," and in the theme articles for this issue.

Officers of McGraw-Hill Publications Company: Paul F. McPherson, President; Executive Vice Presidents: James E. Boddorf, Gene W. Simpson; Group Vice President: Daniel A. McMillan; Senior Vice President-Editorial: Ralph R. Schulz; Vice Presidents: Kemp Anderson, Business Systems Development; Stephen C. Croft, Manufacturing; Robert B. Doll, Circulation; James E. Hackett, Controller; William H. Hammond, Communications; Eric B. Herr, Planning and Development; John W. Patten, Sales; Edward E. Schirmer, International.

Officers of the Corporation: Harold W. McGraw Jr, President, Chief Executive Officer and Chairman of the Board; Robert F. Landes, Senior Vice President and Secretary; Ralph J. Webb, Treasurer.

BYTE is published monthly by BYTE Publications Inc, 70 Main St, Peterborough NH 03458, a wholly-owned subsidiary of McGraw-Hill, Inc. Address all mail except subscriptions to above address: phone (603) 924-9281. Address subscriptions, change of address, USPS Form 3579, and fulfillment questions to BYTE Subscriptions, PO Box 590, Martinsville NJ 08836. Controlled circulation postage paid at Waseca, Minnesota 56093 - USPS Publication No. 528890 (ISSN 0360-5280), Canadian second class registration number 9321. Subscriptions are \$18 for one year, \$32 for two years, and \$46 for three years in the USA and its possessions. In Canada and Mexico, \$20 for one year, \$36 for two years, \$52 for three years. \$32 for one year air delivery to Europe. \$32 surface delivery elsewhere. Air delivery to selected areas at additional rates upon request. Single copy price is \$2.50 in the USA and its possessions, \$2.95 in Canada and Mexico, \$4.00 in Europe, and \$4.50 elsewhere. Foreign subscriptions and sales should be remitted in United States funds drawn on a US bank. Printed in United States of America.

Address all editorial correspondence to the editor at the above address. Unacceptable manuscripts will be returned if accompanied by sufficient first class postage. Not responsible for lost manuscripts or photos. Opinions expressed by the authors are not necessarily those of BYTE. Entire contents copyright © 1980 by BYTE Publications Inc. All rights reserved.

BYTE® is available in microform from University Microfilms International, 300 N Zeeb Rd, Dept PR, Ann Arbor MI 48106 USA or 18 Bedford Row, Dept PR, London WC1R 4EJ ENGLAND.



Subscription WATS Line: (800) 258-5485

Office hours: Mon-Thur 8:30 AM - 4:30 PM, Friday 8:30 AM - Noon, Eastern Time

### NATIONAL ADVERTISING SALES REPRESENTATIVES:

**NORTHEAST (617) 444-3946**  
Hajar Associates  
280 Hillside Ave  
Needham Heights MA 02194

**EAST & SOUTH (212) 682-5844**  
Hajar Associates  
521 Fifth Ave  
New York NY 10017

**MIDWEST (312) 864-3467**  
Hajar Associates  
2405 Lawndale  
Evanston IL 60201

**SOUTHWEST (714) 540-3554**  
**NORTHWEST (415) 964-0706**  
Hajar Associates  
1000 Elwell Ct, Suite 227  
Palo Alto CA 94303



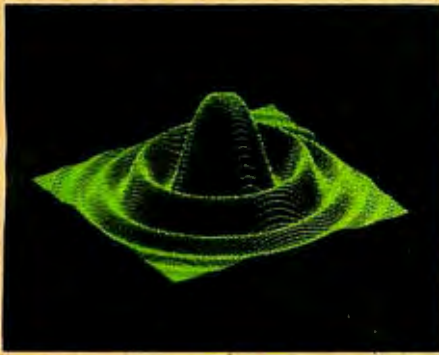

# MICROANGELO

HIGH RESOLUTION GRAPHICS SINGLE BOARD COMPUTER

by

**SCION**  
CORPORATION

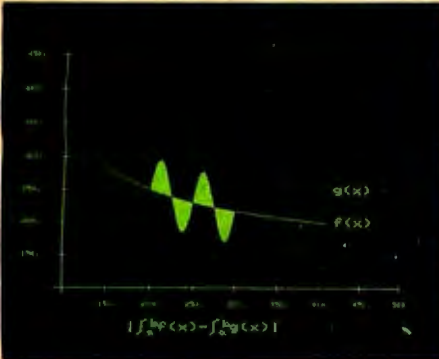

RS-170 composite or direct drive output

Local or external sync generation

4 or 5 Mhz Z80 micro-processor

60 hertz real-time clock

8 level interrupt tie-in

IEEE S100 bus compatible

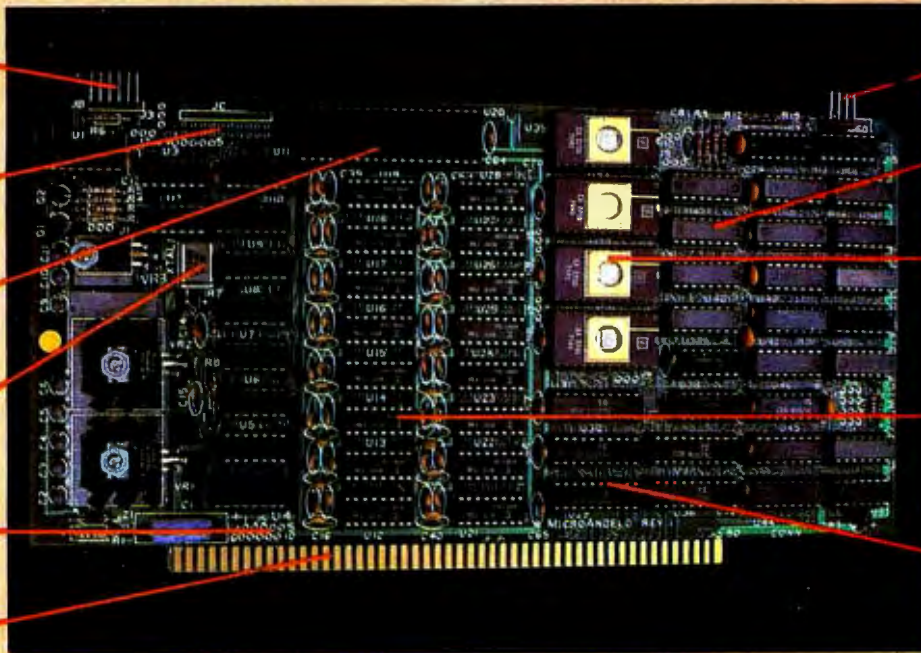

Light pen interface

Time multiplexed refresh

4K resident Screenware™ Pak I operating system

32K RAM isolated from host address space

High speed communications over parallel bus ports

## Screenware™ Pak I

A 4K byte operating system resident in PROM on MicroAngelo™ Pak I emulates an 85 character by 40 line graphics terminal and provides over 40 graphics commands. Provisions exist for user-defined character sets and directly callable user extensions to Screenware Pak I.

## Host Resident Terminal Software

An interface software package that coordinates input/output from the MicroAngelo™ graphics board, the MicroAngelo™ keyboard, and your computer. The result is a flexible, yet sophisticated graphics terminal.

**SCION Corporation**  
8455-D Tyco Road  
Vienna, Va. 22180  
(703) 827-0888

**European Distributor:**  
**Micro Diversions UK Ltd.**  
17/19 Mesnes Street  
Wigan, England WN1 1QP  
09-423 4311



# FREE

You'll save money, have fun, and learn by building it yourself — with easy-to-assemble Heathkit Computers. See all the newest in home computers, video terminals, floppy disk systems, printers and innovative software.

Send today for your **FREE Heathkit Catalog**



If coupon is missing, write Heath Co., Dept. 334-682 Benton Harbor, MI 49022

Send to: Heath Co., Dept. 334-682, Benton Harbor, MI 49022.

Send my free Heathkit Catalog now. I am not currently receiving your catalog.

Name \_\_\_\_\_

Address \_\_\_\_\_

City \_\_\_\_\_ State \_\_\_\_\_

CL-728 Zip \_\_\_\_\_

## Editorial

### Threads of a FORTH Tapestry

**Editor's Note:** This month's editorial is by BYTE Editor Gregg Williams. Gregg was responsible for the preparation of this month's special section devoted to the FORTH language. Carl Helmers returns next month with an editorial...CM

What do a portable heart monitor, the new Craig Language Translator, a peach-sorting machine, and a movie called *Battle Beyond the Stars* have in common? The answer is FORTH, a not-so-new language as comfortable in industrial machinery as it is in a personal computer. In fact, it was originally used by its inventor, Charles H Moore, to control the telescope and equipment at the Kitt Peak Observatory.

Although I have known about FORTH for about a year, it was only during the preparation of this issue that I began to actively keep my ears open for mention of this unusual language. I have uncovered a lot of information (and some experience) about FORTH and its variations. The language is so unusual that no single line of thought could give you a picture of what the language is like. Instead, the following sections represent several threads from the rich tapestry called FORTH.

#### FORTH in the Real World

No language I know of is as comfortable in real-world situations as FORTH. Here are some examples of the breadth of applications that have been created using FORTH:

- Elicon Inc of Brea, California, is using FORTH software to drive the same kind of computer-controlled cameras that were used to film the sophisticated space-battle scenes in *Star Wars*. New World Productions of Venice, California, is using this camera system to film the spaceship sequences in the motion picture *Battle Beyond the Stars*. In a related development, Magicam Inc (which devised a number of the special effects for the recent movie *Star Trek*) is in the process of converting control of its master-slave camera pair from an analog computer to a digital computer running FORTH software. In the Magicam process, the master camera follows actors on a special blue stage while the computer guides the slave camera across a detailed model. Later, the two images are optically combined, producing the effect of the actors actually being in the landscape depicted on the model.

- Allen Test Products of Kalamazoo, Michigan, has developed an ignition analyzer for use in service stations and automobile repair shops that analyzes the behavior of automobile ignition systems and displays both diagnostic and corrective information. Formerly, the voltage waveform from a spark plug was displayed on an oscilloscope, after which a mechanic would attempt repairs based on his interpretation of the waveforms.

- Atari Inc is using FORTH in two of its divisions and is rumored to be contemplating other uses for the language. In its Coin-Operated Division,





# “For reliable data storage, you can’t beat Shugart’s Minifloppy.”<sup>TM</sup>

Raymond Schlitzer, Owner—  
Computerland, San Francisco

“I sell systems my customers can depend on. That’s why most of the personal and small business computer systems sold here feature Minifloppy disk drives. I know from experience I can rely on the Minifloppy.”

Since 1976 Shugart’s Minifloppy has been used by more small computer system manufacturers than any other drive. In fact, more than half-a-million Minifloppys

have been installed. The Minifloppy looks small—but it stores a lot of data. 250 kilobytes on one side, or up to 500 kilobytes in the double-sided model. That’s about 50 pages of printed information on a single-sided Minidiskette, and twice that on the double-sided version. You’ll have plenty of storage capacity for your programs, letters, forms, or ledger entries. And you find your data fast, too, because the Minifloppy is a random access device

that eliminates the need to search for your data serially as you must with a tape cassette unit.

No matter what problem you’re solving with your computer system, you can rely on Shugart’s Minifloppy for data storage. We’re known as the Headstrong company for good reason. We’re Headstrong about reliability, quality, and value. Ask your dealer. He knows us.

## Rely on the Headstrong Company.

 Shugart

TM—Minifloppy is a trademark of Shugart Associates.

475 Oakmead Parkway, Sunnyvale, California 94086



which develops and markets the stand-alone games found in pinball arcades and restaurants, a 6502-based development system employs FORTH software to debug and test arcade circuit boards. In addition, Atari has developed its own custom version of the language, called game-FORTH, that is awaiting its first use to replace machine code as the language used to create arcade games. Someday soon, you may play a coin-operated game without knowing that you are actually running a FORTH program.

In the Consumer Group of Atari, a version of FORTH that has been extended to allow manipulation of the video screen and game peripherals has been developed for the Atari 800 computer. Although no definite plans have been made, Atari may market it as an option for the Atari 800, or, like the Coin-Operated Division, use it in a "transparent" mode to implement games and other programs.

● FORTH is used in a portable 1802-based computer that aids in the treatment of patients with infrequent heart flutter. The device, small enough to be worn comfortably by

the patient during his or her daily activities, constantly updates a "snapshot" of the patient's heart activity every 7 seconds. In addition to recording this information in real time, the device analyzes the data for evidence of a heart murmur. When a murmur is detected, the device stores the data containing the evidence and signals the patient to return with the device to the doctor's office for analysis and diagnosis.

● In another medical application, FORTH is the sole language used in a computer at the Cedar-Sinai Medical Center in Los Angeles, California. Using FORTH, a Digital Equipment Corporation PDP-11/60 simultaneously performs, among others, the following tasks: manages 32 remote terminals; stores patient information from an optical reader into a large data base; runs a statistical package that analyzes the patient data base in search of trends in the physical makeup, treatment, and results of similar patients; and analyzes blood samples and heart behavior in real time while a patient is exercising on a treadmill machine. Spencer SooHoo, in the pulmonary

medicine section, is also developing a portable 6800-based FORTH system to be used for monitoring intensive-care patients.

● A stripped-down version of FORTH was used to create the hand-held Craig M100 Language Translator under time, size, and other design constraints. This same language also runs the software inside the translator unit. In a related product, a hand-held ASCII terminal manufactured by MSI Data Corporation of Costa Mesa, California, also uses FORTH internally.

● In what must be the most interesting FORTH application I have encountered, a central California fruit farming cooperative uses an 8080-based machine running FORTH to adaptively sort and grade peaches. Infrared sensors send information to the computer on the coloring and quality of pitted peach halves that pass the sensors on a conveyer belt. After analyzing this data, the FORTH program causes flippers to knock the peach halves into appropriately graded bins—extra fancy, fancy, etc. In addition, the program keeps track of the percentage of peaches in each bin and changes its selection criteria to maintain a certain fixed ratio among the various grades of peaches.

● Last but not least, FORTH is used in several aerospace applications. A FORTH-like language called IPS (running on an 1802-based system) is orbiting Earth in an amateur radio satellite called the OSCAR Phase III. Avco Inc is using another 1802-based system (again, for the small size and power consumption of the 1802 microprocessor) to monitor temperature and take care of ground-to-satellite and satellite-to-ground telemetry in a military satellite.

#### Who Should Try FORTH?

FORTH is an easy language: a high school student, Arnold Schaeffer, wrote an arcade-type game called BREAKFORTH. (See "Breakforth into FORTH," by A Richard Miller and Judy Miller, on page 150.)

FORTH is a difficult language: it easily beats APL as a "write-only language"; you can write a program in the language, but you can't easily read what you've written.

Given these two valid extremes, your initial reaction might be, "This doesn't make sense." True, learning

A CREATION OF COMPUTER HEADWARE

# WHATSIT?™

*(Wow! How'd All That Stuff get In There?)*

*A sophisticated, self-indexing filing system—flexible, infinitely useful and easy to use, that adapts to your needs.*

WHATSIT comes ready to run on your Apple, NorthStar, or CP/M computer. See your dealer... or write or call:

## HARDHAT Software

P.O. Box 14815 • San Francisco, CA 94114 • Tel: (415) 621-2106



# At Intersystems, "dump" is an instruction. Not a way of life.

(Or, when you're ready for IEEE S-100, will your computer be ready for you?)

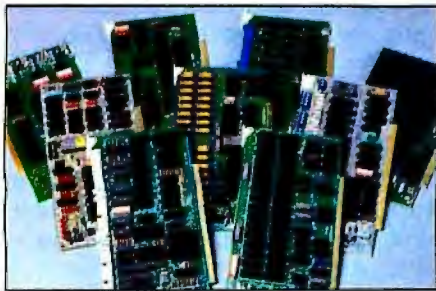

We're about to be gadflies again.

While everyone's been busy trying to convince you that large buses housed in strong metal boxes will guarantee versatility and ward off obsolescence, we've been busy with something better. Solving the *real* problem with the first line of computer products *built from the ground up to conform to the new IEEE S-100 Bus Standard*. Offering you extra versatility in 8-bit applications today. And a full 16 bits tomorrow.

We call our new line Series II™. And even if you don't need the full 24-bit address for up to 16 megabytes (!) of memory right now, they're something to think about. Because of all the perform-

ance, flexibility and economy they offer. Whether you're looking at a new mainframe, expanding your present one or upgrading your system with an eye to the future. (Series II boards are compatible with most existing S-100 systems and *all* IEEE S-100 Standard cards as other manufacturers get around to building them.)

Consider some of the features: Reliable operation to 4MHz and beyond. Full compatibility with 8- and 16-bit CPUs, peripherals and other devices. *Eight* levels of prioritized interrupts. Up to 16 individually-addressable DMA devices, with IEEE Standard overlapped operation. User-selectable functions addressed by DIP-switch or jumpers, eliminating soldering. And that's just for openers.

The best part is that all this heady stuff is available now! In our advanced processor—a full IEEE Bus Master featuring Memory Map™ addressing to a full megabyte. Our fast, flexible 16K Static RAM and 64K Dynamic RAM boards. An incredibly versatile and

economical 2-serial, 4-parallel Multiple I/O board. 8-bit A/D-D/A converter. Our Double-Density High-Speed Disk Controller. And what is undoubtedly the most flexible front panel in the business. Everything you need for a complete IEEE S-100 system. Available separately, or all together in our new DPS-1 Mainframe!

Whatever your needs, why dump your money into obsolete products labelled "IEEE timing compatible" or other words people use to make up for a lack of product. See the future now, at your Intersystems dealer or call/write for our new catalog. We'll tell you all about Series II and the new IEEE S-100 Bus we helped pioneer. Because it doesn't make sense to buy yesterday's products when tomorrow's are already here.

## Intersystems™

Ithaca Intersystems Inc.,  
1650 Hanshaw Road/P.O. Box 91,  
Ithaca, NY 14850  
607-257-0190/TWX: 510 255 4346





FORTH takes some time; it's somewhat like learning a foreign language. So far, my experiences with FORTH remind me of my attempts at learning a smattering of Russian; both languages are so different from any I've seen before—French or Spanish, BASIC or FORTRAN—that I have to mentally shift gears to work in the new language.

You should give FORTH a try if you are excited by what you see here. Especially important in this respect are the articles, "What is FORTH? A

Tutorial Introduction," by John James, and "A FORTH Glossary," pages 100 and 186, respectively. Your best bet is to get to a computer that can run a version of FORTH; or, better yet, get someone who knows the language to demonstrate it to you.

My first experience with FORTH was at the Fourth West Coast Computer Faire in May 1979. A member of the FORTH Interest Group was demonstrating the language using an Apple II and an Advent television screen. First, he defined a word called

COUNT, like this:

```
: COUNT 0 DO 1 . LOOP ;
```

Then he said { 6 COUNT } (note: the braces are not part of the expression; see the accompanying text box), the computer replied with { 0 1 2 3 4 5 OK }. I was instantly hooked on learning more about FORTH. What he had done closely paralleled the *iota* function in APL, and anything that even resembled APL was going to get my full attention.

If you are at all dissatisfied with the capabilities of your current computer, or if you feel that there should be more to computers than BASIC and assembly language, you should try FORTH. Once you get accustomed to its peculiar syntax, you can make it do nearly anything you want it to. In fact, you can even make it have features it did not previously have. Assembly language is like this to some extent, but FORTH is a higher-level language with the same abilities—only magnified. FORTH is what I call a "homebrew" language; its enthusiasts carry with themselves the same look-how-this-works enthusiasm as do most hardware hackers who build their own hardware. If we ever have a homebrew software issue, FORTH will certainly be included.

FORTH is the ultimate software hacker's language because, like a bag of components before a hardware hacker, you can do anything you want to with it. It can be argued that assembly language is the ultimate programming language; strictly speaking, this is true, but it takes so much more time to craft a piece of software in assembly language that it is practically ruled out in most cases.

However, this total freedom carries with it complete responsibility. Since, for example, the FORTH program you write is free to use an array subscript that is out of bounds, you must be responsible enough to either (a) put in error-checking routines (you can take them out later), or (b) build your program up from small tested modules to assure that your program will never execute an improper subscript. If you would rather have the language system do this kind of work for you, stick to BASIC or whatever you're running now.

*Text continued on page 128*

# \$24.95

## ...AND HOLDING



Model HB5-3/OVP

### 5V at 3A with Built-in OVP

Power One's B Case models started at \$24.95. Over 100,000 models and five years later, they're still only \$24.95!

- 115/230 VAC Input
- OVP Built-in
- .05% Regulation
- 2-Year Warranty
- 2-Hour Burn-in
- UL Recognized
- CSA Certified



Get all the details on our 84 standard open frames in our new 1978 catalog.

### IN-STOCK NATIONWIDE...FOR IMMEDIATE DELIVERY

**EASTERN REGIONAL SALES OFFICE:** Schenectady, N.Y. (518) 399-9200 **ALA.:** Huntsville, Rakes Engr. & Marketing Corp. (205) 883-9260 **ARIZ.:** Phoenix, PLS Assoc. (602) 279-1531 **CAL.:** Pasadena, A-F Sis. Engr. (213) 681-5631; San Diego, A-F Sis. Engr. (714) 226-8424; San Jose, Richards Assoc. (408) 246-5860 **COL.:** Denver, PLS Assoc. (303) 773-1218 **CT.:** Litchfield, Digital Sis. Assoc. (203) 567-9776 **FLA.:** Orlando, OEM Marketing Corp. (305) 299-1000 **GA.:** Duluth, Rakes Engr. & Marketing Corp. (404) 476-1730 **ILL.:** Chicago, Coombs Assoc. (312) 298-4830 **IND.:** Indianapolis, Coombs Assoc. (317) 897-5424 **MD.:** Wheaton, Brimberg Sis. Assoc. (301) 946-2670; Baltimore, Brimberg Sis. Assoc. (301) 792-8661 **MASS.:** Waltham, Digital Sis. Assoc. (617) 899-4300 **MICH.:** Southfield, L.H. Dickelmaier Co. (313) 353-8210 **MINN.:** Minneapolis, Engr. Prod. Assoc. (612) 925-1883 **N.J.:** Whippany, Livera-Polk Assoc. (201) 377-3220; Marmora, Holdsworth (609) 398-4340 **N.M.:** Albuquerque, PLS Assoc. (505) 255-2330 **N.Y.:** Roslyn Hts., Livera-Polk Assoc. (516) 484-1276; Syracuse, C.W. Beach (315) 446-9587 **N.C.:** Charlotte, Over & Over Inc. (704) 527-3070 **OHIO:** Cleveland, Marlow Assoc. (216) 991-6500; Dayton, Marlow Assoc. (513) 434-5673 **OKLA.:** Tulsa, Advance Technical Sis. (918) 743-8517 **ORE.:** Portland, Jas. J. Backer (503) 297-3776; Salem, Jas. J. Backer (503) 362-0717 **PENN.:** Pittsburgh, Marlow Assoc. (412) 831-6113; Newtown Sq., Holdsworth & Co. (215) 356-8550 **TEX.:** Dallas, Advance Technical Sis. (214) 361-8584; Solid State Electr. (214) 352-2601; Houston, Advance Technical Sis. (713) 469-6668; Solid State Electr. (713) 772-8483 **UTAH:** Salt Lake City, PLS Assoc. (801) 466-8729 **WASH.:** Seattle, Jas. J. Backer (206) 285-1300; Radar Elec. Co. (206) 282-2511 **WIS.:** Milwaukee, Coombs Assoc. (414) 671-1945 **EUROPE:** Hanex, L.A., CA (213) 556-3807 **CANADA:** Duncan Instr., Weston, Ontario (416) 742-4448; Winnipeg, Manitoba, Cam Gard Supply Ltd. (204) 786-8481



Power One Drive • Camarillo, CA 93010 • Phone: 805/484-2806 • TWX: 910-336-1297

SEE OUR COMPLETE PRODUCT LISTING IN EEM & GOLDBOOK



# Why not kill two birds with one stone?

If you have an Apple\* and you want to interface it with parallel and serial devices, we have a board for you that will do both. It's the AIO.<sup>TM</sup>

## Serial Interface.

The RS-232 standard assures maximum compatibility with a variety of serial devices. For example, with the AIO you can connect your Apple\* to a video terminal to get 80 characters per line instead of 40, a modem to use time-sharing services, or a printer for hard copy. The serial interface is software programmable, features three handshaking lines, and includes a rotary switch to select from 7 standard baud rates. On-board firmware provides a powerful driver routine so you won't need to write any software to utilize the interface.

## Parallel Interface.

This interface can be used to connect your Apple\* to a variety of parallel printers. The programmable I/O ports have enough lines to handle two printers simultaneously with handshaking control. The users manual includes a software listing for controlling parallel printers or, if you prefer, a parallel driver routine is available in firmware as an option. And printing is only one application for this general purpose parallel interface.

## Two boards in one.

The AIO is the only board on the market that can interface the Apple to both serial and parallel devices. It can even do both at the same time. That's the kind of innovative design and solid value that's been going into SSM products since the beginning of personal computing. The AIO comes complete with serial PROM's, serial and parallel cables, and complete documentation including software listings. See the AIO at your local computer store or contact us for more information.



2190 Paragon Drive  
San Jose, California 95131  
(408) 946-7400

\*Apple is a  
TM of Apple  
Computers,  
Inc.

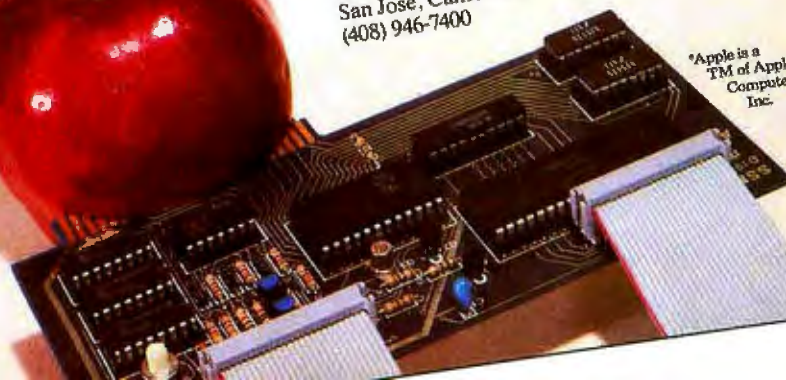

# Maybe we can save you a call.

Many people have called with the same questions about the AIO. We'll answer those and a few more here.

**Q:** Does the AIO have hardware handshaking?

**A:** Yes. The serial port accommodates 3 types—RTS, CTS, and DCD. The parallel port handles ACK, ACK, BSY, STB, and STB.

**Q:** What equipment can be used with the AIO?

**A:** A partial list of devices that have actually been tested with the AIO includes: IDS 440 Paper Tiger, Centronics 779, Qume Sprint 5, NEC Spinwriter, Comprint, Heathkit H14, IDS 125, IDS 225, Hazeltine 1500, Lear Siegler ADM-3, DTC 300, AJ 841.

**Q:** Does the AIO work with Pascal?

**A:** Yes. The current AIO serial firmware works great with Pascal. If you want to run the parallel port, or both the serial and parallel ports with Pascal, order our "Pascal Patcher Disk."

**Q:** What kind of firmware option is available for the parallel interface?

**A:** Two PROM's that the user installs on the AIO card in place of the Serial Firmware PROM's provide: Variable margins, Variable page length, Variable indentations, and Auto-line-feed on carriage return.

**Q:** How do I interface my new printer to my Apple using my AIO card?

**A:** Interconnection diagrams for many popular printers and other devices are contained in the AIO Manual. If your printer is not mentioned, please contact SSM's Technical Support Dept. and they will help you with the proper connections.

**Q:** I want to use my Apple as a dumb terminal with a modem on a timesharing service like The Source. Can I do that with the AIO?

**A:** Yes. A "Dumb Terminal Routine" is listed in the AIO Manual. It provides for full and half duplex, and also checks for presence of a carrier.

**Q:** What length cables are provided?

**A:** For the serial port, a 12 inch ribbon cable with a DB-25 socket on the user end is supplied. For the parallel port, a 72 inch ribbon cable with an unterminated user end is provided. Other cables are available on special volume orders.

The AIO is just one of several boards for the Apple that SSM will be introducing over the next year. We are also receptive to developing products to meet special OEM requirements. So please contact us if you have a need and there is nothing available to meet it.



SSM Microcomputer Products  
2190 Paragon Drive  
San Jose, California 95131  
(408) 946-7400



# The man, the lig





# ht and the Apple.

If you could talk to Thomas Edison, he'd tell you what it was like to turn the lights on in 1879. You could tell him about some bright ideas of the 20th century... particularly, a technological phenomenon that can handle everything from solar heat control to lighting your home via voice command. The Apple personal computer.

## Expand your own inventiveness with the always-expandable Apple.

Take a look inside your local computer store. There's a range of Apple systems for you... whether you want expansion capabilities of four or eight accessory slots... or memory expandable to 64K bytes or 128K bytes. With this kind of flexibility, the possibilities for creating your own computer system are endless.

Want to add an A to D conversion board? Apple makes it happen. Want to plug into time sharing, news and elec-



*With Apple, Edison could've written a program to determine why some filaments burned longer than others.*

tronic mail services? Apple does it all. Because Apple is the most popular personal computer with the least complicated interface, over 100 companies supply peripherals for the Apple family... including an IEEE 488 bus for instant control.

## Disk drives, a tool kit and creativity in color.

Apple was one of the first to use disk drives for increased performance and application versatility. Today, our 5 $\frac{1}{4}$ " disk drive offers high density (143K bytes).

high speed and low cost. No wonder this drive is the most popular on the market.

But now Apple goes one better with the DOS Tool Kit. A series of utility programs, it gives you the freedom to easily design 280h x 192v graphic displays in a palette of living color... depending on your choice of Apple system.

Edison was first with the movie camera and projector. Now, with Apple's DOS Tool Kit, you can be first to work wonders with colorful creative animation.

## Imagine the broadest line of software programs ever.

Apple's broad line of peripherals is equalled only by the most extensive line of software you'll find in the personal computing world. Since more than 170 companies offer software for the Apple family, you can have one of the most impressive program libraries ever.

When you write your own programs, your Apple speaks creatively in BASIC,



*Edison had the first movie camera... and Apple has the DOS Tool Kit that takes you into the colorful world of animation.*

Pascal, FORTRAN, PILOT and 6502 assembly language. Use these languages to score a sonata. Apple will play back your musical masterpiece on its built-in speaker.

Edison listened to his voice on a revolutionary phonograph in the 1800s... now you can listen to the sounds of today with Apple's inventive family of personal computers.

## Where to find even more illuminating Apple experiences.

There's always something new being invented at Apple to set your imagination soaring. And there's always an expert to tell you all about it in detail. Your Apple dealer. If you already own an Apple, there's a whole future ahead to

challenge man, mind and machine.

If you're considering a personal computer, stop by the computer store and compare. Apple's reliability, proven performance and recognized technological leadership will help you see the light. Don't let history pass you by. Visit your nearest Apple dealer, or call 800-538-9696. In California, 800-662-9238.

 **apple® computer**





# Letters

## Programming Knowledge Is Not Enough

Isaac Newton explained it over 300 years ago. Introductory physics students learn it less than three months into their first course. Yet now it seems to be treated as an argument over words, rather than principles, in BYTE's Letters column. I speak of the description of circular motion under the influence of

gravity, and in particular of Delmer Hinrichs' recent contribution "Marsport Forces Resurface" (January 1980 BYTE, pages 16 and 17).

In the situation described, there is *only one force* acting: gravity, given by  $Gm/r^2$ . The other relation Hinrichs presents does *not* show how to calculate another kind of force, but is simply a statement of Newton's second law of motion, namely, if any net force acts on

a body, an accelerated motion will be observed. For circular motion, the acceleration is equal to  $v^2/r$ , and the force giving rise to such motion, *from whatever physical source*, is called a *centripetal* force; ie: a force *toward the center* of the circle, which is quite the opposite of Mr Hinrichs' "centrifugal" force (of which there is *none* in the situation under discussion). The physics here is thus simply to note that the gravitational force acts centripetally, and thus can be equated to  $m$  times the acceleration, or  $ma$ .

It is unfortunate that many people have not yet realized that programming, once one is past the initial hurdles, is no longer a self-sufficient discipline, but must be viewed as a tool within the context of some other discipline in order to acquire real value. If the discipline is economics, for example, the programmer must be a reasonably accomplished economist if one is to trust his results; if the discipline is physics, then the physics must be understood thoroughly, and not just pulled out of some handbook; and so on....

S Leslie Blatt  
Professor of Physics  
The Ohio State University  
Van de Graaff  
Accelerator Laboratory  
1302 Kinnear Rd  
Columbus OH 43212

D  
E  
S  
K  
  
T  
O  
P



C  
O  
M  
P  
U  
T  
E  
R

## Chrislin is First !!!

with deliveries of DEC's Desk Top Computers. Available with LSI 11/2 or LSI 11/23 CPU. Complete system totally enclosed within VT100 Video Terminal. Price **\$4,500** with LSI 11/2 and 64K bytes or **\$8,995** with LSI 11/23 and 256K bytes.

**NOW Available** — PDP 11/23 with 256 KB Memory **\$8,900.**

**SPECIAL** — LSI 11/2 and 32K x 16 Memory **\$1,095.**

**10 MEGA BYTE** Cartridge Disk System with Controller, RT11 compatible **\$6,100.**

**1 MEGA BYTE** RX02 Floppy Disc System **\$3045.**



## Chrislin Industries, Inc.

Computer Products Division

31352 Via Colinas • Westlake Village, CA 91361 • 213-991-2254

## More Marsport Commentary

In Delmer Hinrichs' second letter in the January 1980 BYTE, he continues to miss the point about the nature of forces in circular motion. (See "Marsport, Here I Come," April 1979 BYTE, page 84.) As he points out, the National Aeronautics and Space Administration (NASA) explains circular orbits in terms of *centripetal* force and *gravitational* force, while Mr Hinrichs says, "The attraction of gravity is exactly balanced by the *centrifugal* force at all times." This is not just a matter of "slightly different" terminology. As can be confirmed with a dictionary, a *centripetal* force is one directed toward the center of motion, but a *centrifugal* force is one directed away from the center of motion. Thus the terminology of Mr Hinrichs is in fact opposite that of NASA.

Perhaps the confusion results from the use of two names, *centripetal* and *gravitational*, which suggests the existence of two forces. However, gravita-



TRS-80\* Computer Compatible ...

# Quality is the real difference. Low price is merely a dividend.

**High quality.  
Competitive pricing.  
And a proven track record.**

Three reasons why Percom is the industry's number one independent manufacturer of mini-disk systems for microcomputers.

And if you're looking at mini-disk drives, extra storage capacity is an added bonus.

In fact, you store almost one fifth more data on Percom TFD-100<sup>tm</sup> drives and over two-and-one-fourth times as much on TFD-200<sup>tm</sup> drives.

Besides extra testing and superior design, you get free, with each system, a software patch on minidiskette that not only upgrades TRSDOS\* for operation with the newer 40- and 77-track drives, but also deglitches version 2.1.

Available in 1-, 2- and 3-drive configurations, Percom drives for the TRS-80\* computer start as low as \$399.

## The gift of speech



Called Speak-2-Me-2<sup>tm</sup>, this clever interface module makes a Texas Instruments'

Speak & Spell† the voice of your computer — announcing, imploring, commanding with expressions and sentences created from the Speak & Spell† vocabulary.

Speech is controlled either at the keyboard or by your own Level II BASIC programs. Or by Percom minidiskette word games (available soon).

Speak-2-Me-2<sup>tm</sup> is installed in the battery compartment of your Speak & Spell†, and power is provided from an ordinary calculator power pak. Supplied with an interconnecting cable, operating software and a comprehensive users manual, Speak-2-Me-2<sup>tm</sup> costs only \$69.95.

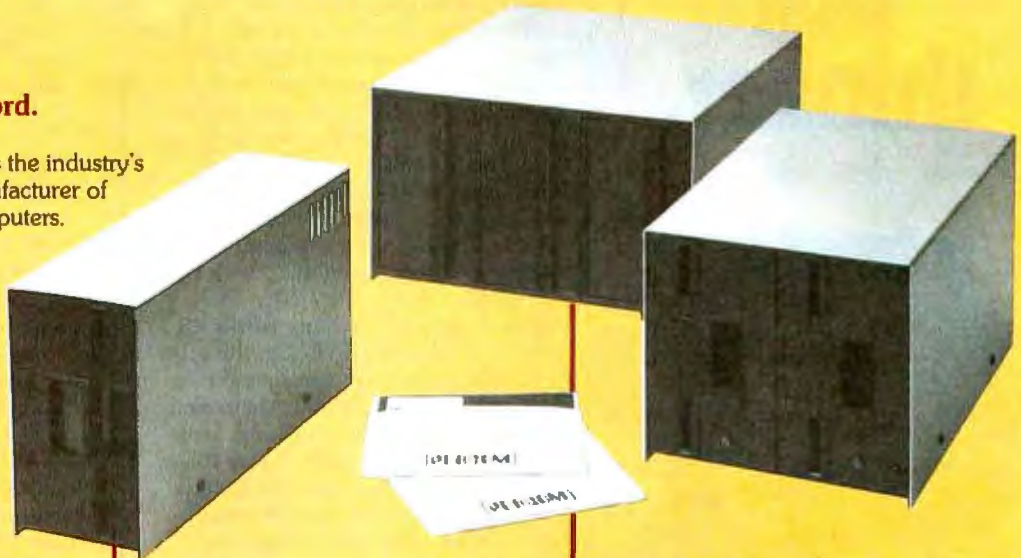

## the Separator:<sup>tm</sup> End "CRC error. Track locked out!"



TRS-80\* computer systems. The SEPARATOR<sup>tm</sup>, so called, is installed in the Expansion Interface without modifying the host system. When installed, data and clock signals are reliably separated during playback, an essential function that the separator circuitry of the host computer performs very poorly. Price is only \$29.95.

Note. Opening the Expansion Interface may void the Tandy limited 90-day warranty.

This plug-in adapter virtually eliminates data read errors, a problem that plagues

## OS-80<sup>tm</sup> uses Level II BASIC commands

With OS-80<sup>tm</sup>, Level II BASIC commands are used for DOS and Disk BASIC functions.

You extend the OS-80<sup>tm</sup> utility set indefinitely with your own BASIC disk-resident utilities.

OS-80<sup>tm</sup> resides in less than 7-Kbytes of RAM.

The program is supplied on minidiskette along with a simple file manager, BASIC disk utilities and an OS-80<sup>tm</sup> "Handbook" that you expand and maintain.

All are helpful programming examples.

Price, with instruction manual, \$29.95.



**NEW! OS-80<sup>tm</sup>  
Machine Language  
SAVE / LOAD  
Utility. Only**

**\$14.95 on  
minidiskette w/instructions.**

Quality Percom products are available at Percom dealers nationwide. **Call Percom's toll-free order number, 1-800-527-1592, for the address of your nearest dealer or to order direct.**

PRICES AND SPECIFICATIONS SUBJECT TO CHANGE WITHOUT NOTICE

PERCOM DATA COMPANY, INC.  
211 N. KIRBY GARLAND, TEXAS 75042  
(214) 272-3421



<sup>tm</sup> trademark of Percom Data Company, Inc.

\* trademark of Tandy Radio Shack Corporation which has no relationship to Percom Data Company.

† trademark of Texas Instruments, Inc.



# Hire a fast thinker.

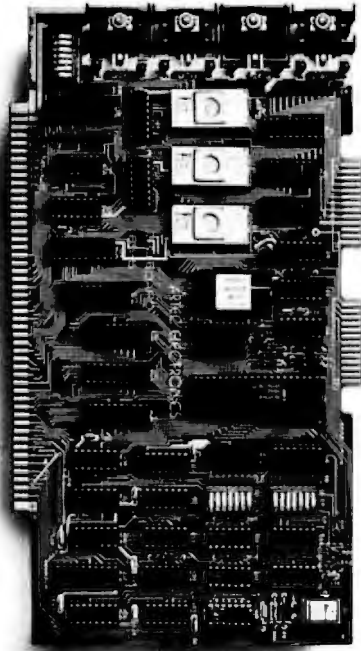

## 5 MHz CPU Card

- Intel 8085A-2 microprocessor
- Hardware floating point
- Performs calculations six times faster than other CPUs
- On-board monitor in PROM
- 1K RAM scratch pad
- Keyboard or RS232C terminal
- Variable clock frequency

PRICE—\$850

(California residents add 6% sales tax)

Call or write Artec for details.

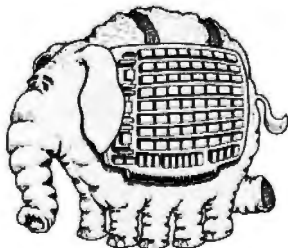

**ARTEC ELECTRONICS, INC.**

605 Old County Rd., San Carlos, CA 94070  
Telephone (415) 592-2740

tional forces are centripetal; ie: directed toward the center (of Mars in this case). In other words, for circular orbits the gravitational force and the centripetal force are one and the same and cannot balance one another.

You might then wonder why two names and two formulas are used for the same force. The answer is that the two different formulas come from two separate types of analysis, one independent of motion, the other requiring motion. The formula for gravitational force,  $F_2 = GMm/r^2$ , comes from measurements of forces between two masses. The two masses might be orbiting each other, in contact, on a collision course, or moving apart. The gravitational-force formula works the same in all of these cases. On the other hand, the formula for centripetal force,  $F_1 = mv^2/r$ , comes from measurements of forces needed to keep a single mass moving in a circular path. These forces can be of any type. Examples include tension in a string, friction between a car's tires and the road surface, electricity, magnetism, and gravity. The centripetal force equation works the same in all of these cases. Notice that both of these formulas apply to circular orbits and can be set equal because the centripetal force is supplied by gravity.

As a high school physics teacher with a Master's degree in physics, I have discussed this subject with over a dozen physicists and hundreds of students. All of the physicists and most of the students would agree with what I have written here.

Robert Reiland  
RR 1  
Portersville PA 16051

### A Message About the Reminder

My article in the January 1980 BYTE "A Computer-Generated Reminder Message" (page 160) has prompted several people to contact me, raising various questions related to the article.

The data conversion routines caused the most comment. They require a BASIC processor which maintains at least seven full decimal digits of precision; many do not. To determine if a given BASIC maintains seven digits of precision, enter "PRINT 9999999". If "9999999" is printed, the BASIC maintains sufficient precision. References for further study of data-processing algorithms may be found in the following articles:

Fliegel and Pan Fladen, "A Machine Algorithm for Processing Calendar Dates," *Communications of the*

*ACM (CACM)*, volume 11, October, 1968.

Robertson, "Remark on Algorithm 398," *Collected Algorithms from CACM*.

Stone, "Tableless Date Conversion," Algorithm 398, *CACM*, volume 13, October, 1970.

Tantzen, "Conversions Between Calendar Date and Julian Day Number," Algorithm 199, *CACM*, volume 6, August, 1963.

The only known error in the January article appears on page 172. The reference to line 9500 should be deleted, since the line was deleted from the program listing.

Another area of questions concerned the conversion of the program to other disk BASICs. I have been asked about TSC BASIC, North Star BASIC, and other versions. The usual two areas of concern are the required seven digits of precision and disk input/output (I/O) methods. Without reference to specific implementations, Microsoft-like BASICs should prove the easiest to convert. Other implementations which do not use FIELD statements are also convertible, though with some increase in difficulty.

Edgar M Pass  
Computer Systems Consultants Inc  
1454 Latta Ln NW  
Conyers GA 30207

### Here's a Good Book on Curve Fitting

In response to F R Ruckdeschel's appeal for a good, balanced reference book on curve fitting (Letters, March 1980 BYTE, page 16), I heartily recommend *Applied Linear Statistical Models* by John Neter and William Wasserman (Richard Irwin & Sons, 1974).

This book features a unified approach to both simple and multiple cases of linear and polynomial regression techniques, and through the use of indicator variables, it also offers a regression approach to basic and multifactor analysis of variance.

It is a good book for both beginners and statisticians alike, since it starts out at an introductory level, introduces matrix theory early, and goes on to show how matrix operations (operations on two-dimensional arrays, which most computer languages can handle) can be applied to a large variety of statistical analyses.

After I had struggled for years in the seemingly muddy area of statistics, this book has been instrumental for me in



# Do more than ever before— spend less than you planned



## Heath makes the All-In-One Computer more versatile

Many satisfied customers know Heath takes the risk out of buying a balanced computer system. With the Heathkit All-In-One Computer, you get 16K Random Access Memory (expandable to 48K), keyboard, video terminal and floppy disk system — together in one self-contained, compact unit — for up to hundreds of dollars less than comparable systems.

Heath now makes the All-In-One Computer more versatile than ever! The new Heathkit H77 Floppy Disk System gives the All-In-One even more data storage and recall capacity. Combined, the All-In-One and H77 Floppy Disk give you up to 300K

bytes of on-line data storage — enough to hold entire files. You can mount operating system and program disks at the same time, to make computing even faster.

You can run programs written in MICROSOFT™ BASIC™ and Assembly Languages, and all current software written for the popular Heathkit H8 Computer.

Heath User's Group (HUG) will share with you a library of over 500 programs to make your computer serve you in ways you never imagined.

There's no better way to learn about computer systems — and save money — than by building one yourself.

Concise, easy-to-follow Heathkit assembly manuals show you the way, from start to finish. And a nationwide network of service centers protects your computer investment.

Join the Heathkit computer family today — and pocket the savings!

For complete details on Heathkit computer systems, as well as nearly 400 other electronic kits for your home, work or pleasure, send today for your free, value-packed Heathkit catalog. Or pick up your copy at the nearest Heathkit Electronic Center.

# Heathkit®

SEND FOR FREE CATALOG

VISIT YOUR HEATHKIT STORE

Write to: HEATH COMPANY,  
DEPARTMENT 334-684,  
BENTON HARBOR, MI 49022



In the U.S. and Canada, visit your nearby Heathkit Electronic Center where Heathkit products are also displayed, sold and serviced. See the white pages of your phone book. In the U.S., Heathkit Electronic Centers are units of Veritechnology Electronics Corporation.



Now for CRTs, TRS-80 Model II and Sorcerer!

# VEDIT CPM Visual Editor

You Customize The Fastest Editor For  
Word Processing, C-Basic, Fortran, Assembler.

## Features:

Screen oriented editor with status line. In visual mode the screen continuously displays the region of the file being edited and a cursor. Changes are made by moving the cursor to any place in the file and typing in new text or hitting a function key. These changes are immediately reflected on the screen and become the changes to the file.

Full array of cursor movements with single key movement to begin and end of lines, tab positions.

Function keys for character delete, line delete and allowing line splitting and concatenating.

Very easy to use text move in visual mode with a text register.

Flexible command mode allows global search and substitute, repetitive editing operations, text move.

Blocks of text are readily copied from one file to another. Files may be merged on input, split on output and other extensive file handling.

Keeps up with the fastest typists!

Extensive manual with sections for both the beginning and experienced user. (Our users say it is the clearest, best manual available).

## Special Features:

Disk buffering can automatically perform Read/Write for files larger than available main memory.

Tabs settable to any positions. Tab key inserts tab character or spaces to next tab position.

Display of clearly marked continuation lines for text lines longer than the screen.

## You Customize It:

To Your screen size (even 40 or 70 lines), screen address and keyboard layout.

Cursor type, blinking, reverse video.

Default Tab positions and various parameters.

Scrolling methods.

Its ideal for diverse hardware, keyboards and applications.

For OEMs too.

**Compatible:** CP/M systems with most memory mapped displays, including VDM, SSM, VIO, Matrox. CRT terminals, H19, VT100, Hazeltines, etc. Also for Sorcerer and TRS-80 Model II.

CP/M is a trademark of Digital Research Corp  
TRS-80 is a trademark of Tandy Corporation

## The Changes You Make on the Screen Become the Changes in the File.

Compare with the other screen oriented editors. Some have most of VEDIT's features, fewer have the special features, but none are customizable like VEDIT. And don't be misled by our lower price! Write or call for more information and discover why VEDIT allows you to edit faster and easier than any other editor. (Even users with other screen oriented editors and word processors tell us they prefer VEDIT!)

**Ordering:** Specify your video board, CRT terminal type or microcomputer, the 8080/Z80 or Z80 code version and disk format desired.

## Need a Fast and Reliable 24 X 80 Video Board

Then you want the S-100 PIICEON V-100. Its I/O mapped, doesn't take up memory space, yet runs at full processor speed. Full character set with lower case descenders. Fully assembled and tested by PIICEON, the company known by OEMs for reliability. Its the ideal companion to VEDIT.

**Standard Package:** For CRTs, Sorcerer, Model II, Piiceon . . . . . \$110

**Memory Mapped Package:** For Memory mapped displays . . . . . \$100

**Manual:** Price refunded with software purchase . . . . . \$ 15

**PIICEON V-100:** 24 X 80 Video display board, 1 Year Warranty . . . . . \$445

**PICKLES & TROUT CP/M:** Super CP/M 2.2 for the TRS-80 MOD II . . \$185

VISA and MASTER CHARGE Welcome. Dealer Inquiries Invited.

# CompuView Products Inc.

1531 JONES DRIVE ANN ARBOR, MICHIGAN 48105  
CALL ANYTIME: (313) 996-1299

clearing the water. And for the experimentally minded computerist, this text winds up with a comprehensive section on experimental design.

Richard Shide  
918 4 Ave S  
 Fargo ND 58103

## Getting Into a Metric Gear

As an avid cyclist, I was glad to see the Programming Quickie in the March 1980 BYTE ("Gear-Ratio Calculation for Bicycle Derailleurs," page 68), but as an ardent proponent of "metrication" I was sorry to see that, contrary to your stated policy, you did not include a metric equivalent. Metric countries use a more rational and intuitively meaningful measure of the gear ratio than our silly system does; they simply measure how far the bicycle will travel in one complete turn of the pedals. The following program (listing 1) should serve to make the principle clear.

### Listing 1.

```
PROGRAM GEARS;
CONST PI = 3.14159;
VAR
  DIAMETER,
  CIRCUMFERENCE,
  DEVELOPMENT,
  CHAINWHEEL, SPROCKET: REAL;
BEGIN WRITE ('WHEEL DIAMETER IN
METERS: ');
  READ (DIAMETER);
  CIRCUMFERENCE := PI * DIAMETER;
  REPEAT WRITE ('TEETH ON CHAIN
WHEEL: ');
  READLN (CHAINWHEEL);
  WRITE ('TEETH ON SPROCKET: ');
  READLN (SPROCKET);
  DEVELOPMENT := (CHAINWHEEL /
  SPROCKET) * DIAMETER;
  WRITELN ('DEVELOPMENT: ',
  DEVELOPMENT: 4:2, ' METERS. ')
  UNTIL EOF
END.
```

David A Mundie  
104 Oakhurst Cir  
Charlottesville VA 22903

## Beware of Handshakes

If any BYTE readers are thinking about installing a dot-matrix printer in their microcomputer system, I have a friendly warning to pass on: pay close attention to your manufacturer's recommendations, or know the risk you're taking if you ignore them.

For example, North Star Computers, Inc recommends that owners connect the Anadex DP-8000 to the parallel interface of its Horizon computer. But comparing printer specifications, I chose to save a few bucks by building a Heath H-14 line printer for the Horizon's serial interface.

I saved some money: the printer kit cost \$625 plus shipping, plus an additional \$82.98 at the Heathkit Electronic



# Mountain Hardware makes more peripherals for the Apple Computer than Anybody.

and ...  
a place to put them

## INTROL X-10

Intelligent Home Controller for lights and appliances. Real-time schedules and energy conservation. Complete applications software package. Home security with random scheduler. Power usage accounting package for home energy cost control. No wiring required.

## APPLE CLOCK

Real-time and date information. Interrupts permit Foreground/Background operation of two programs simultaneously. Battery back-up. Crystal-controlled for  $\pm .001\%$  accuracy. Onboard ROM for easy access from BASICs. Supports PASCAL. Time from one millisecond to one year.

## SUPERTALKER SD200

Input/Output Speech Digitizer. Permits talking programs. I/O capability allows interactive programs with speech-prompted inputs. Use output for speech directed activities in business systems, announcements in a control room, or sound effects in entertainment programs. Easy to use because input as well as output is under user control with special software operating system.

## ROMWRITER

Program your own EPROMs. Create your own firmware. Programs 2K, 2716 5V EPROMs. Disk software package provides easy EPROM programming. EPROMs are verified after BURN. RUN your programs from on-board socket or install them on ROMPLUS+.

## ROMPLUS+

More power for your system through firmware. Six sockets accept 2716 EPROMs or ROM equivalents. Six or any combination can be used at once. Scratch-pad RAM and two TTL connectors. Special 2K ROMs available for powerful system enhancement: Keyboard Filter ROM—COPYROM—Others coming soon.

## MusicSystem

Sophistication previously available only on experimental mini and mainframe computer synthesizers. Digital Instrumental music synthesizer system. 16 voices in stereo. Instrument definitions simulate the sound of real instruments—and more. Fully programmable waveforms. Envelope Control. Composition system—sheet music input using standard music notation. Chords and multi-part scoring up to 16 voices. A true instrument that anyone with an Apple can play.

## A/D+D/A

16 channels analog to digital input. 16 channels digital to analog output. Eight bit resolution. Super-fast  $8\mu$  sec. conversion time. Monitor and output to the real world. All on one card.



## EXPANSION CHASSIS

By popular demand! Eight more slots for your Apple. Attractive sturdy enclosure. Its own heavy duty power supply. Easy to use. Address cards in Expansion Chassis the same way as in your Apple. Only one additional command to specify in Apple or in Expansion Chassis. Compatible with all Apple peripherals.

MOUNTAIN HARDWARE has the most comprehensive line of Apple peripherals available. Anywhere. From anybody. We know the Apple inside and out and are committed to providing the most innovative and unique products to expand and enhance its capabilities and use. After all, we were the first company to make an Apple peripheral—except Apple Computer.

The message is simple. If you have an Apple, you need to know MOUNTAIN HARDWARE.

Available at Apple Dealers worldwide.



### Mountain Hardware

Leadership in Computer Peripherals  
A Division of Mountain Computer, Inc.  
300 Harvey West Blvd.  
Santa Cruz, CA 95060 (408) 429-8600

MORE PERIPHERALS? Send me information.

NAME \_\_\_\_\_

ADDRESS \_\_\_\_\_

CITY \_\_\_\_\_ STATE \_\_\_\_\_ ZIP \_\_\_\_\_

Apple is a trademark of Apple Computer Inc.



Center in Seattle when the H-14 flunked its initial power-on tests. The service personnel replaced two defective CMOS (complementary metal-oxide semiconductor) integrated circuits and repaired three open-foil breaks in the 5 V supply at no charge, but they detected erroneous installation of seven transistors. (Considering the obvious textual errors in the documentation, which would you believe—the text or the pictorials? I guessed wrong and followed the pictorial: customer error!)

My H-14 printer tested perfectly at 4800 bps (bits per second) under HDOS in Seattle. It went ape at 4800 bps on the Horizon after I got it home. A quick phone call to my friendly Horizon dealer divulged the fact that North Star DOS does not test for handshaking signals! (The Heath manual advises to run no faster than 110 bps without handshaking.)

So now I have a 110 bps line printer dawdling along, while the 4 MHz Z80A and I are twiddling our respective thumbs! Does anybody out there want to trade an in-warranty Anadex DP-8000 printer for an in-warranty Heath H-14 plus some extra cash?

John R Dye  
4807 Fifteenth Ave SE  
Lacey WA 98503

## Specialized Business Program

As a charter subscriber to BYTE, I quite often see references by many of your software reviewers and article writers to the lack of good software available for microcomputers in the business field. I thought, to give some perspective, that I would tell BYTE readers about the Electric Log. It is highly specialized and useful in no field other than the operation of a television station; therefore it is directed to a very small group of very small businesses (less than 8000 in the entire US).

The point I would like to make is this: since there is an adequate supply of standard business packages available, the opportunity in business software lies in the specialized application field. These will never be marketed in magazines outside the trade, never by computer companies, and never with any great publicity. There is more of this done than you realize, and this may be the undercurrent that stimulates small business to invest in microcomputers.

Pete Charlton  
The Management  
POB 111  
Aledo TX 76008

## Industrial quality components for S-100 system builders, from California Computer Systems.

single and double density, or 5 1/4 inch disk drives. Shipped with CP/M 2.0, the controller reads and writes IBM-standard single density. Automatically determines disk density—single or double. Supports PerSci auto eject, plus fast-peek for voice coil systems.

**2810 Z80 CPU Board.** Capable CPU for S-100 Systems operates at 2 or 4MHz, is fully Altair/Imesai compatible. Z-80 monitor is available separately. Includes auto addressing to 4K boundaries, plus a serial port for serial devices, including terminals and printers. Supports both front-panel operation and power-on memory jump, plus wait-state generation for slower memories. Compatible with proposed IEEE S-100 standards.

**2032A 32K Static RAM.** Fast static memory operates without wait states at a full 4MHz. Supports full and partial bank select, for expansion beyond 64K. Addressable in 8K blocks at 8K boundaries. Address and data lines are fully buffered, and there are no DMA restrictions.

**2016 16K Static RAM.** Fully buffered board features 2114 static RAMs for +5v operation. Bank select available by bank port or bank byte, for system expansion beyond 64K. Addressable in 4K blocks at 4K boundaries. LED indicators for board selection and bank selection. Available in 200, 300, or 450 nsec versions. All versions support 4MHz operation with no wait states.

**2200A Mainframe.** Rock solid, heavy gauge cabinet includes 12-slot, actively terminated S-100 motherboard, fan, and power supply. Power supply features 105, 115, or 125 volt AC input power; provides +8vDC at 20 amps, ±16v DC at 4 amps. Available in five colors. Includes convenient, front mounted, lighted reset switch.

**2501A Mother Board.** 12 slots, actively terminated, with all S-100 connectors included. Distributed power line bypass, low inductance interconnect—extremely low bus noise.

**Prototype Boards.** Four high quality prototype boards: Solder Tail, Extender/Terminator, Wire Wrap, and Etch.

**P2802AA 6502 CPU.** Stand-alone CPU generates fully S-100 compatible I/O signals; executes 6502 machine language. Operates at 2MHz; capable of DMA operation.

### Available nationally.

California Computer Systems industrial quality S-100 products are available at over 250 computer retailers. Volume customers should contact the marketing department at CCS.

## CCS. Industrial standards.

Figure 1.

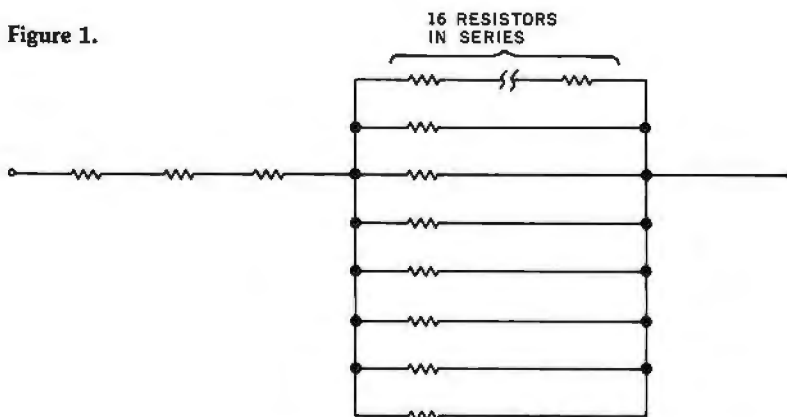

### Pass the Pi

Emory Sprenkle remarked in his letter (February 1980 BYTE, page 16) that  $1/(113/355)$  is a good rational approximation of  $\pi$ , and is easily remembered. In fact,  $355/113$  is the best rational fraction approximation to  $\pi$  having no more than three digits in the numerator.

I was reminded of the following problem which appeared a few years ago in *American Mathematical Monthly*:

What is the smallest number of perfect 1-ohm resistors needed to

create a network with an equivalent resistance of  $\pi$  ohms,  $\pm 10^{-n}$  ohms?

This problem leads one to discover how positive rational fractions may be presented as *continued fractions*. The solution shown in figure 1 includes three resistors in series with a network consisting of sixteen series-connected resistors in parallel with seven parallel-connected resistors, making twenty-six in all.

W Lloyd Milligan  
8604 Maywood Dr  
Columbia SC 29209 ■



# We see the S-100 a little differently.



**We mass-produce S-100 products to deliver industrial quality, at industrial prices.**

You-systems builders who need top quality, full featured, *workhorse* S-100 building blocks at the most competitive prices now have a source. California Computer Systems.

Industrial quality means top grade materials, components, and assembly, plus complete testing for absolute reliability.

Industrial quality means solid designs, a full complement of the important features you require, and a product line that delivers performance.

Industrial pricing comes from mass production. We buy at the right prices, and build *in quantity*, using state-of-the-art facilities and techniques. Including complete burn-in, for full performance right off the shelf.

Our industrial point of view means you get higher performance, greater reliability, and lower prices. If these are features you would like to see in your S-100 system, see things our way.

Because for serious users with serious uses for the S-100, these are the industrial standards.



**California Computer Systems**

250 Caribbean Sunnyvale, CA 94086 (408) 734-5811



## A Build-It-Yourself Modem for Under \$50

Steve Ciarcia  
POB 582  
Glastonbury CT 06033

I receive many personal-computer club newsletters. Some of the larger clubs around the country have put me on their mailing lists to keep me informed of what's going on in their area. One I recently received was significant because it demonstrated the tremendous advancements in personal computing in a very subtle way.

It was not the content of this newsletter that was important. It contained the usual new business, old

business, and other information. The significant point was the preparation of the document itself.

According to an editorial, this publication has an editor/publisher and four columnists spread across the state. Each columnist prepares his textual material on his own personal computer, using a word-processing program. He then telephones the editor's computer and down-loads the text to it. The editor, using his computer, combines the four individual

columns, along with his work, and lays out the complete newsletter. Finally, the editor telephones the print shop and transmits the entire newsletter for typesetting and printing.

The significant point is that all the communication is between computers and is conducted over the telephone lines.

Transmitting and receiving data using the telephone is not a difficult task if you have the correct equipment. Virtually any microcomputer can be configured for this activity. To communicate properly, the system must be a serial terminal or emulate one and be attached to the phone lines through a *modem*.

A "terminal" describes any equipment with hardware and software designed to facilitate serial data communication with prescribed data rates and protocol. My June 1980 article on the COMM-80 was such a hardware package. (See "I/O Expansion for the TRS-80" June 1980 BYTE, pages 42 thru 62.) With the COMM-80 attached and using the communication software provided, the TRS-80 computer emulates a terminal. Any other computer system calling itself a "terminal" and using the same data rates and protocol would be able to communicate with it. This includes all users of The Source and MicroNet timesharing services.

A *modem* is the device that allows the computer to be connected to a telephone.

The problems associated with connecting your computer to a telephone

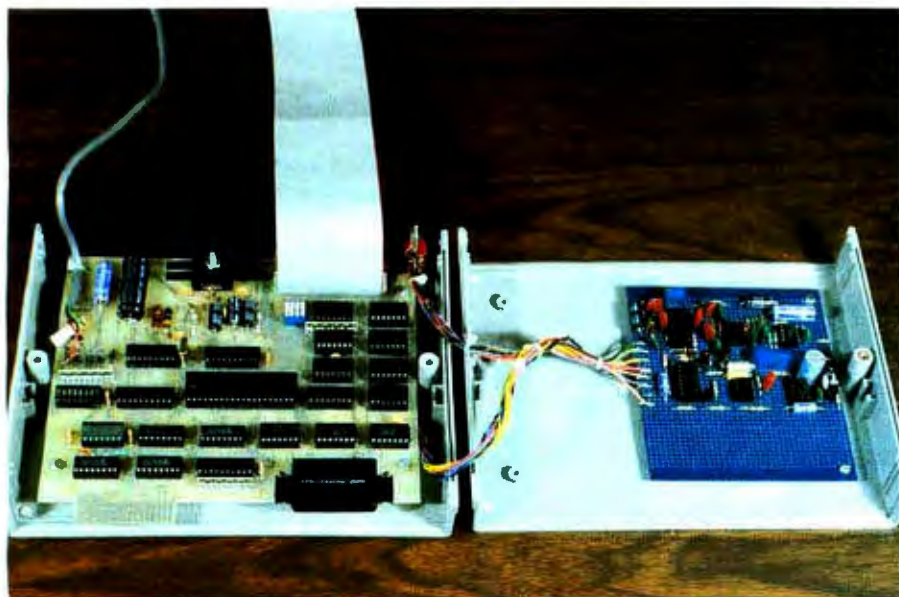

**Photo 1:** The prototype modem circuit of figure 1 was assembled on the blue perforated circuit board as shown. It was then installed under the top cover of a COMM-80 I/O-expansion unit, shown at left. The COMM-80 was described in the June Circuit Cellar. (See "I/O Expansion for the TRS-80, Part 2: Serial Ports," June 1980 BYTE, page 42.) The COMM-80 and this modem are sufficient to turn a Radio Shack TRS-80, or a computer that uses a similar bidirectional bus, into a timesharing terminal. The modem can be used on any computer.



# There are two sides to our story.

## Side One

### The DISCUS™ 2+2 Quad-Density Hardware

Now you can use your S-100 system to tackle big jobs. Because the DISCUS™ 2+2 Quad-Density Disk System puts 1.2 megabytes of fast-access memory on your side for just \$1545.00 complete.

With the DISCUS™ 2+2 System, complete means complete.

You get a full-size (IBM-compatible 8") double-sided/double-density disk drive,

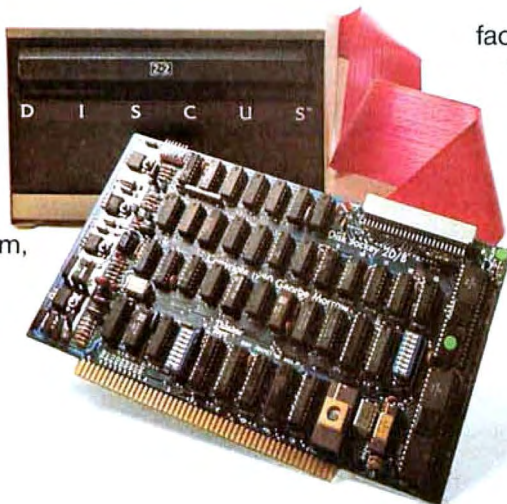

factory mounted in a cabinet with power supply, fully-buffered S-100 single-board controller, and inter-connecting cables. All fully assembled, system-tested and fully warranted.

You get the speed and efficiency of 1.2 megabyte-per-diskette memory... and you get it for 0.13¢ per byte.

## Side Two

### The DISCUS™ 2+2 Quad-Density Software

1.2 megabyte quad-density hardware is only one side of the story. The DISCUS™ 2+2 System price includes all the fully-interfaced, high-performance software you need to take full advantage of your quad capacity.

The system includes our exclusive BASIC-V™ virtual disk BASIC, which allows you to address your quad-density diskettes as easily as main memory. The operating system you get is the widely accepted CP/M\* 2.1. And you get our powerful DISK-ATE text editor/assembler; The most advanced software



development tool available.

Micro-Soft BASIC 5.1 and Micro-Soft FORTRAN are available as options. Both run under CP/M\* 2.1.

Check out the full system price of DISCUS™ 2+2 Quad against any other floppy disk system at your local computer store. At \$1545.00, we think you'll take sides with DISCUS™ 2+2.

If your dealer doesn't carry THINKER TOYS products, write MORROW DESIGNS Inc., 5221 Central, Richmond, CA 94804. Or call (415)524-2101 9-5 weekdays (Pacific Time).

MORROW DESIGNS™ / Thinker Toys™





**Photo 2:** Comparison of two generations of modems. At right is an early model made by Anderson-Jacobson, shown with the covers open. The old modem uses discrete semiconductor components and toroidal inductors. On the left is an example of a current model of modem: a Novation Cat acoustic-coupled modem, which is popular with home-computer hobbyists.



**Photo 3:** First of a series of photos (3 thru 9) showing how you can easily construct an acoustic-coupler pickup. My design for the pickup uses such "exotic" materials as a hot-water pipe foam insulation, a pair of 2-inch, 8-ohm dynamic speakers, a foam-backed dinner placemat, rubber cement, and adhesive tape.

Step 1 of the process (shown here) is to cut a wedge-shaped piece from the insulating foam. The foam I used had an inside diameter of  $1\frac{1}{4}$  inches with a  $\frac{1}{2}$ -inch wall, giving an outside diameter of about  $2\frac{3}{4}$  inches. The high side of the wedge should have a height of about 1 inch, the low side about  $\frac{3}{8}$  inch.

Next, cut and trim a rectangular piece of foam measuring  $\frac{1}{2}$  by  $\frac{1}{4}$  by  $3\frac{1}{2}$  inches. This is used to help fit the speaker snugly into the hole in the wedge-shaped piece previously cut.

Solder the electrical connections to the speaker before proceeding to apply rubber-cement to the rectangular foam piece and wrap it around the voice coil of the speaker. Hold it in place until the cement sets.

are not unlike those associated with the cassette data-storage system on a personal computer. Like the telephone, the cassette recorder is incompatible with digital data and has a very narrow bandwidth (a few thousand hertz). Since all personal computers accommodate cassette data storage, there is obviously a reasonable solution.

Rather than using digital voltage levels, as in a direct-wired communication link, audio-frequency tones are recorded instead. In most systems, one tone of a given frequency signifies a logic 0 and a tone of a different frequency signifies a logic 1. When we change or shift the tones to correspond with the logic input, we are performing *frequency-shift-keyed (FSK) modulation*. When we play back the tape into the computer, a demodulator distinguishes the tones and separates them back into 1s and 0s.

### How Does a Modem Work?

Terminal-to-terminal communication is more complex than a simple cassette system even though it employs similar techniques. Transmission over the two-wire phone system from one terminal, called the *originating* terminal, to another, called the *answering* terminal, uses FSK tones. The major distinction is that terminals, unlike cassette recorders, can operate in full-duplex mode and communicate in both directions over the same pair of wires. Rather than using a single pair of tones, which would be confusing if both terminals tried to transmit at the same time, a modem uses two sets of tones.

One set of tones (1070 Hz and 1270 Hz) is used by the originating terminal and another (2025 Hz and 2225 Hz) is used by the answering terminal. If your computer were connected to a timesharing computer, your computer would be the originating system and all your data would be sent with FSK tones of 1070 Hz and 1270 Hz for logic 0 and 1, respectively. The timesharing computer would answer you with 2025 Hz (logic 0) and 2225 Hz (logic 1) FSK data.

Almost universally, if you are dialing up a large computer network, you are the originating terminal. An *originate-only* modem, which is all

*Text continued on page 28*



# INTRODUCING THE EMULATOR™

The trouble with video terminals today is that most of the low-cost models just don't have the performance to handle your tough applications. And the few that do are usually not compatible with your existing system. But now, Intertec has resolved this age old dilemma with the introduction of its new Emulator™ Video Terminal.

The \$895\* Emulator™ performs exactly as you command. With the depression of just a few keys, Emulator users can select terminal control codes of any one of four popular video terminals. The Lear-Siegler ADM-3A. The Soroc 1Q-120. The DEC VT-52. Or the Hazeltine 1500. Incredible! It's like having four terminals for the price of one.

But, best of all, not only does the Emulator replace these terminals, it outperforms them by offering enhanced user-oriented features. Features that those other terminals just don't have - at any price.

Standard Emulator™ features include: a sharp, crisp 12" non-glare screen with a full 24 line by 80 column display. Twin RS232C serial ports - one for the host computer and one for your printer. Four separate cursor control keys. A separate 18 key numeric pad. Keyboard selectable baud rates and operating modes. And, a host of visual attributes.

No matter which dumb or smart terminal you're using today, don't buy another until you check out our new Emulator™. You'll get the

performance of four terminals for the price of one. And you'll probably save hundreds of dollars over the price you paid for your last terminal. Plus, you'll get unparalleled reliability, nationwide service and quick delivery. Call or write us today for all the details. Intertec terminals are distributed worldwide and may be available in your area now.

 **INTERTEC  
DATA  
SYSTEMS®**

2300 Broad River Rd, Columbia, SC 29210  
(803) 798-9100 TWX. 810-666-2115



\*Quantity one - Dealer inquiries invited.



DEMODULATOR SECTION

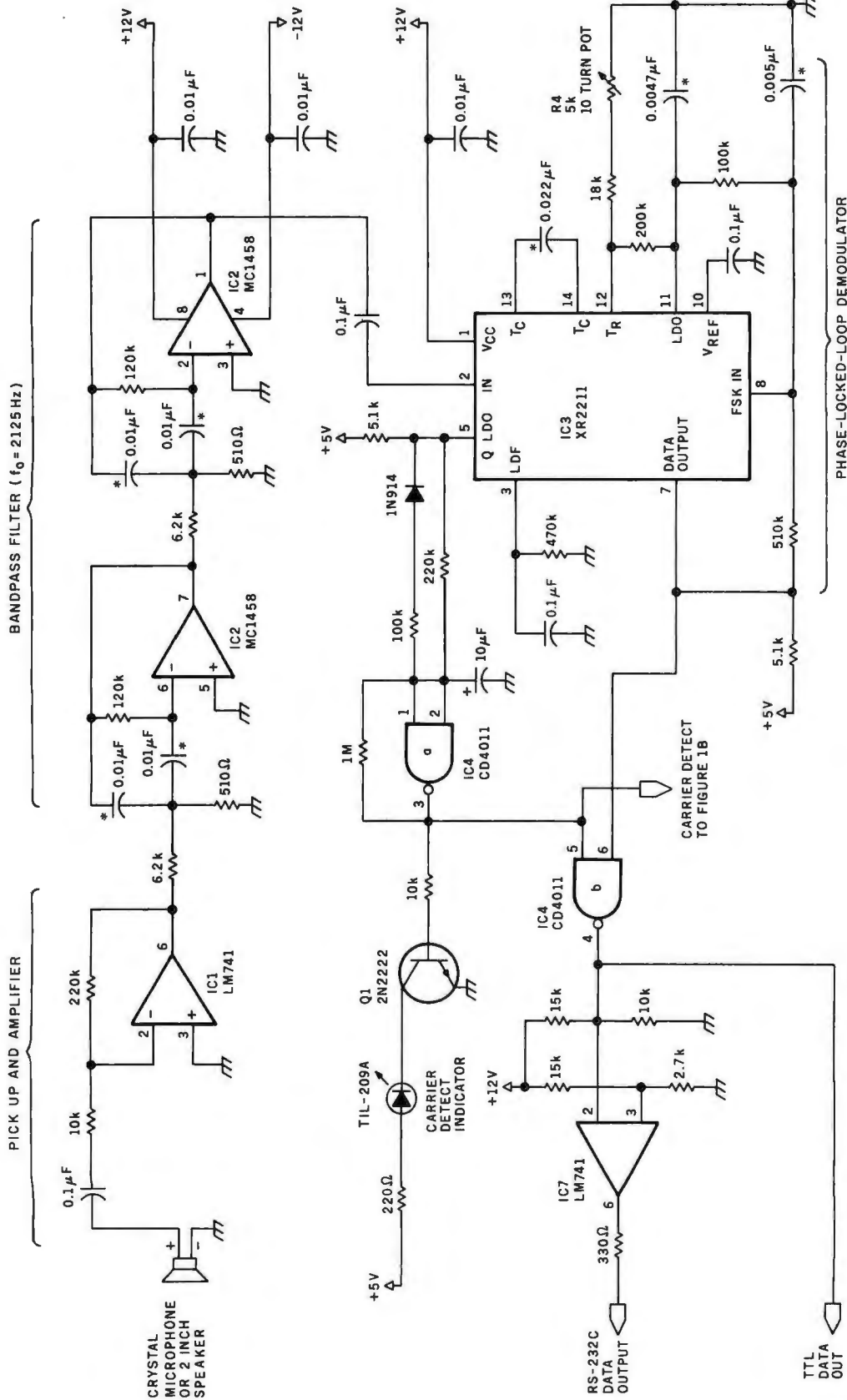

Figure 1a: Originate-only demodulator section of the modem circuit, shown as a schematic diagram. This circuit features automatic muting and LED indication of carrier detection and will operate at data rates from 0 to 300 bps. The demodulator section is more complex than the modulator (shown in figure 1b) and consists of a preamplifier, a bandpass filter, and the phase-locked-loop demodulator.

Capacitors marked with asterisks (\*) must be Mylar or polystyrene types. If

RS-232C compatibility is not needed, the LM741 operational (op) amplifier shown as IC7 can be omitted from the circuit. If a crystal microphone is used, instead of the voice-coil speaker, the op amplifier IC1 might be unnecessary. Components were chosen to operate from power supplies of +12 V and -12 V. The circuit can be made to work for supplies within the range of ±5 V to ±18 V; however, the resistor network associated with IC7 may have to be changed.



# Now! North Star Application Software!

North Star now offers application software for use on the HORIZON! Now you have one reliable source for both hardware and software needs! The first packages available are:

## **NorthWord—**

NorthWord is a simple-to-operate word processing system designed for use with the popular North Star HORIZON. NorthWord enables you to increase office efficiency and cut document typing time and cost. NorthWord incorporates the most sought-after word processing features: easy editing, on-screen text formatting, simultaneous document printing, and much more. NorthWord can be integrated with other North Star software packages to produce customized letters, labels and reports quickly and efficiently.

## **MailManager—**

MailManager enables you to compile and maintain complete organized mailing lists. Lists are easily accessible and can be compiled with a great deal of flexibility. Entries, corrections and deletions are easily made. The North Star MailManager can print your list on individual envelopes, on mailing labels, or in compact summary form.

## **InfoManager—**

InfoManager is a powerful list-oriented, data management system. It will accept up to 50 categories of information for each record and has the ability to select and sort before printing. The North Star InfoManager has power and flexibility for many applications: product inquiry, inventory, customer/client records, calendar reminders, and as an easy way to fill in often-used forms.

## **GeneralLedger—**

General Ledger and Financial Reporting, two programs in one, maintains general ledger accounts based on such input as checks, bank deposits and journal entries, and uses the information in the general ledger to produce customized financial statements and financial reports.

NorthWord is the central building block for all the North Star application software to follow. Packages now being tested include other accounting and professional application packages. For more information or a demonstration, contact your local North Star dealer.

**NorthStar** 

North Star Computers, Inc.  
1440 Fourth Street  
Berkeley, CA 94710  
(415) 527-6950  
TWX/Telex 910-366-7001





MODULATOR SECTION

Number	Type	+5 V	GND	-12 V	+12 V
IC1	LM741			4	7
IC2	MC1458			4	8
IC3	XR2211		4		1
IC4	CD4011	14	7		
IC5	NE567	4	7		
IC6	LM386	6	4		
IC7	LM741			4	7

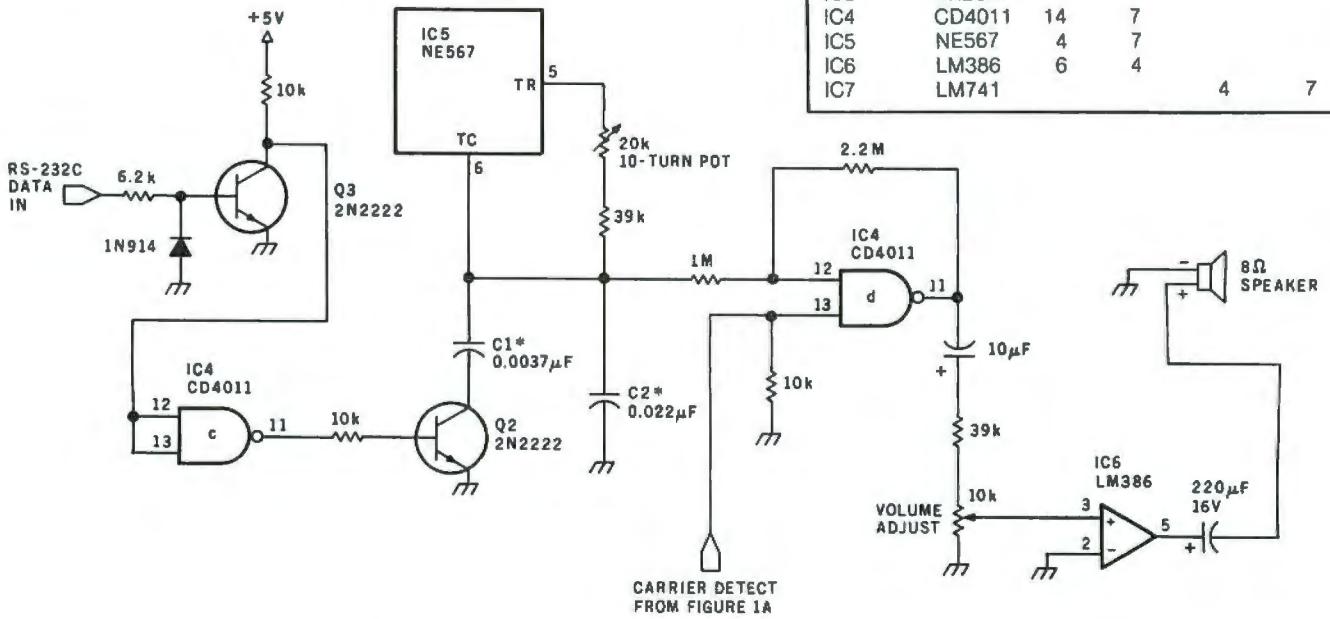

**Figure 1b:** Modulator section of the modem circuit in schematic form. The tone frequency for a mark (1270 Hz) is set up by choosing the proper values for capacitor C2 and adjusting the 20 k-ohm potentiometer. When transistor Q2 gates capacitor C1 in parallel with C2, the oscillator frequency changes to 1070 Hz.

Capacitor C1 (0.0037 µF) may be formed from a parallel combination of two components, a 0.0015 µF and a 0.0022 µF part. For use in the answer mode, the proper value for capacitor C1 is 0.001 µF, and the value for C2 is 0.01 µF.

If RS-232C communication is not a necessity, transistor Q3 may be omitted from the circuit.

Text continued from page 24:

you need in this instance, has a 1070/1270 Hz modulator and a 2025/2225 Hz demodulator. On standard dial-up telephone lines the

acceptable speed limit is 300 bits per second (bps).

An answer modem is necessary when someone else calls you and chooses the originate frequencies for

himself. In the answer mode, the modulator uses 2025/2225 Hz and the demodulator uses 1070/1270 Hz.

The choice is arbitrary: either modem can use originate mode or answer mode so long as they don't both use the same mode. Owning an originate-only modem is not a handicap as long as someone trying to communicate with you can set his modem to the answer mode to accommodate you.

The modem attaches to the serial input/output (I/O) port on the computer. Most serial ports use the RS-232C protocol, and most commercial modems also use RS-232C. While there are various handshaking requirements listed in the complete RS-232 specification, for the most part handshaking is ignored in simple full-duplex modem applications. Usually the only signals required for operation, beyond the data itself, are Carrier Detect and Data Set Ready.

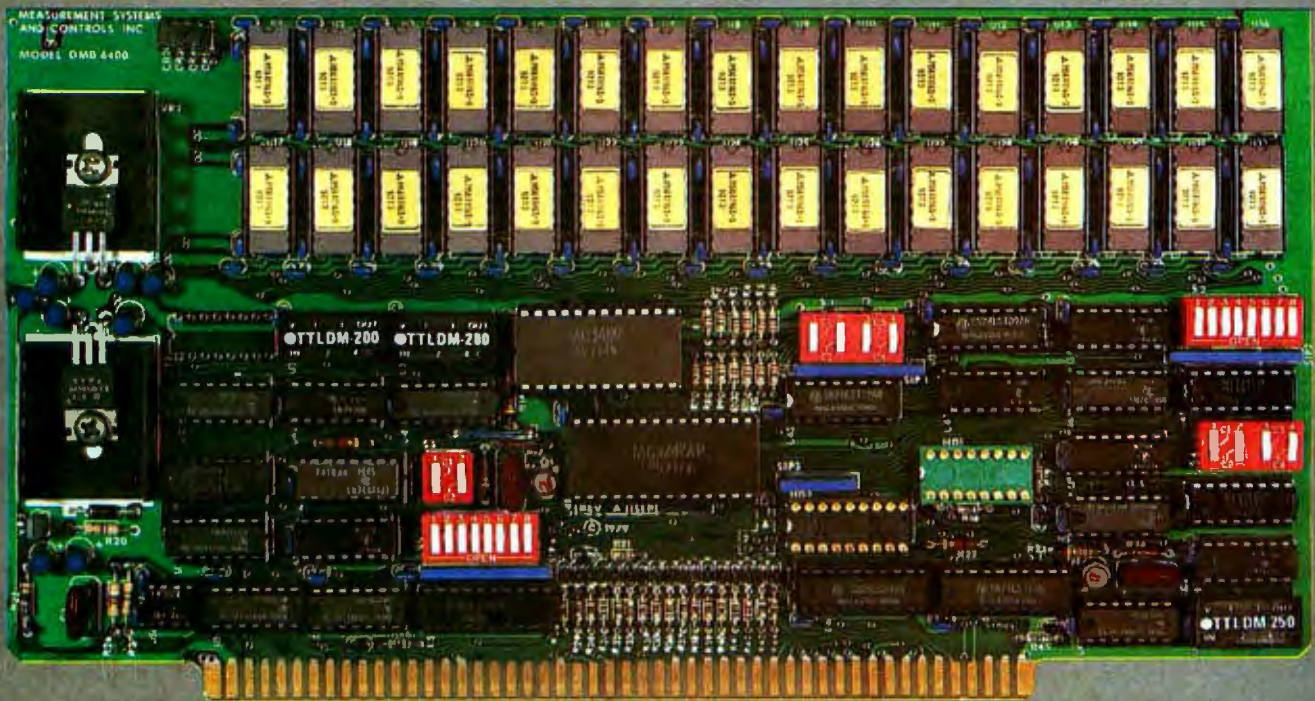

**Photo 4:** Apply rubber cement to the outside of the wedge-shaped piece of pipe insulation.

**Build Your Own Originate Modem**

Gaining the capability to dial up a





## BANK SELECT — 64K BYTE EXPANDABLE MEMORY BOARD

MODEL DMB6400 SERIES  
**FULLY COMPATIBLE WITH:**

**ALPHA MICRO  
 CROMEMCO  
 NORTH STAR  
 MP/M**

and most other  
 S-100 systems

- Four independent, 16K software selectable banks.
- Switch selectable bank sizes — from 16K to 64K in 16K increments.
- Eight banks (512K) per I/O port for each of the 256 ports.
- Z-80 4MHz operation with no wait states.
- Low power — 8 watts maximum.
- Reliable, tested and burned-in memory.
- **ONE YEAR GUARANTEE**
- IEEE S-100 compatible timing.
- Attractive Dealer & OEM Prices

**MEASUREMENT**  
 systems & controls  
 incorporated

867 North Main Street • Orange, CA 92668  
 Telephone: 714/633-4460



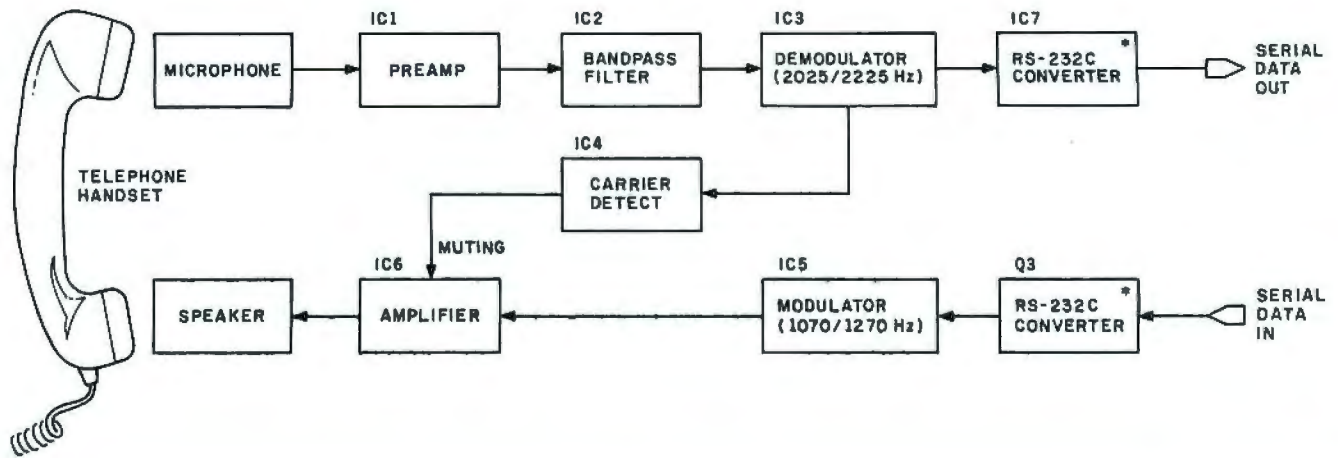

**Figure 2:** Block diagram of the originate-only modem presented in this article. The blocks marked with asterisks (\*) indicate the components that provide RS-232C compatibility; these may be left out of the circuit if RS-232 communication is not needed.

national timesharing network or phone any of a hundred computer-information services on your personal computer is a significant milestone. When connected to these systems, you go beyond the hardware limits of the personal computer and instantly add large-computer capabilities. Figure 1 is the schematic diagram of a 0-to-300 bps originate modem which meets all the requirements for communicating with these systems. The prototype is shown in photo 1, mounted under the

top cover of the COMM-80 serial/parallel interface.

There are two kinds of modems: direct-connect and acoustic-coupled. The former type requires attachment to the telephone wires through a data-coupler transformer. The latter type, the use of which has fewer legal strings attached, employs an acoustic coupler. This is nothing more than a speaker and microphone that sit under the mouthpiece and earpiece of the telephone handset. The speaker transmits the modem's output tones

into the telephone, and the microphone listens for the other terminal's response.

Modems vary in complexity. Fifteen years ago they were very expensive and contained many discrete, precision components, including many toroidal inductors for the filter circuits. Photo 2 shows, on the right, an old Anderson-Jacobson modem. Newer technology is shown on the left: the Novation Cat, which is probably the most popular acoustic modem around. The reduction in size is accomplished through integrated-circuit technology.

Figure 2 is a block diagram of the modem circuit in figure 1. The design I am presenting takes advantage of advanced technology and uses only six integrated circuits for the complete modem. Two additional RS-232-converter devices can be added if RS-232C interfacing is required.

The modem is divided into two sections: modulator and demodulator. It also features carrier detection and automatic muting. A light emitting diode (LED) lights to signify that the answering modem is on the line and connected when the 2025 Hz tone (the "carrier") is detected on the line. A signal generated upon detection of the carrier automatically enables the modulator output (of the 1070 Hz tone) in response. Without this feature, the 1070 Hz tone would be blaring out of the speaker continuously.

The modulator section of figure 1b is not very difficult to understand. Tone decoder IC5 (an NE567 device)



**Photo 5:** Adding pliable material to produce a tight fit around the phone handset. I found a plastic placemat at a discount store with a 1/8-inch foam backing that was perfect. Cut a strip 1 1/2 by 8 inches and glue this around the outside of the wedge as shown. Trim to the exact circumference and cover with a strip of fabric adhesive tape. The latter helps hold everything together.





**The easiest, least expensive way to generate spectacular multi-color graphics, sharp two-color alphanumeric: Your computer, a color tv set and the Percom Electric Crayon™.**

Add the Electric Crayon™ to your system and your keyboard becomes a palette, the tv screen your medium.

You dab and stroke using one-key commands to create dazzling full-color drawings, eye-catching charts and diagrams.

Or you run any of innumerable programs. Your own BASIC language programs that generate dynamic pyrotechnic images, laugh-provoking animations.

From a combined alphanumeric-semi-graphics mode to a high resolution 256- by 192-element full graphics mode, the microprocessor-controlled Electric Crayon™ is capable of generating 10 distinctly different display modes.

Colors are brilliant and true, and up to eight are available depending on the mode.

As shipped, the Electric Crayon™ interfaces a TRS-80\* computer via your Expansion Interface or Printer

Adapter. It may be easily adapted for interfacing to any computer or to an ordinary parallel ASCII keyboard.

**But that's not all**

The Electric Crayon is not just a color graphics generator/controller.

It is also a complete self-contained control computer. With built-in provision for 1K-byte of on-board program RAM, an EPROM chip for extending EGOS™, its on-board ROM graphics OS, and a dual bidirectional eight-bit port — over and above the computer/keyboard port — for peripherals. The applications are endless.

Shipped with EGOS™, 1K-byte of display memory and a comprehensive user's manual that includes an assembly language listing of EGOS™ and listings of BASIC demo programs, the Electric Crayon™ costs only \$249.95.

**Options include:**

- LEVEL II BASIC color graphics programs on minidiskette: \$17.95.
- A 34-conductor ribbon cable to interconnect the Electric Crayon™ to a TRS-80\*: \$24.95.
- RAM chips for adding refresh memory for higher density graphics modes: \$29.95 per K-byte.
- Electric Crayon™ Sketchpad, a sketching grid of proportioned picture elements (pixels) in a tv aspect ratio. For 128 x 192 or 256 x 192 graphics modes. 11-inch by 17-inch, 25-sheet pads: \$3.95 per pad.

**SYSTEM REQUIREMENTS:** the video circuitry of the Electric Crayon™ provides direct drive input to a video monitor or modified tv set. An internal up-modulator for rf antenna input may be constructed by adding inexpensive components to the existing video circuitry.

Prices and specifications subject to change without notice.



PERCOM DATA COMPANY, INC.  
211 N. KIRBY GARLAND, TEXAS 75042  
(214) 272-3421

™ = trademark of Percom Data Company, Inc.

\* = trademark of Tandy Radio Shack Corporation which has no relationship to Percom Data Company.

Get into computer color graphics the easy, low-cost way with a Percom Electric Crayon™. Available at Percom dealers nationwide. Call toll-free, **1-800-527-1592**, for the address of your nearest dealer, or to order direct if there is no Percom dealer in your area.



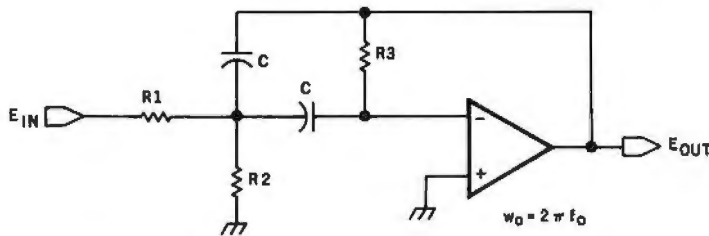

TYPICAL BANDPASS FILTER RESPONSE CURVE

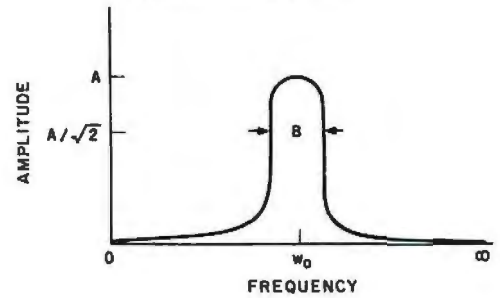

BANDWIDTH  $B = 2/R_3 C$   
 GAIN  $G = -R_3/2R_1$   
 Q FACTOR  $Q = f_0/B$   
 CENTER FREQ.  $\omega_0^2 = 1/R_3 C^2 (1/R_1 + 1/R_2)$

FOR:  $R_1 = 6.2k$   $R_2 = 510\Omega$   $R_3 = 120k$   $C = 0.01\mu F$

CALCULATED PARAMETERS:

$B = 265$  Hz  
 $G = -9.7$   
 $Q = 8$   
 $f_0 = 2117$  Hz

FOR AN ANSWER MODEM WITH

$f_0 = 1170$  Hz USE:

$R_1 = 11k$   
 $R_2 = 910\Omega$   
 $R_3 = 220k$   
 $C = 0.01\mu F$

Figure 3: The multiple-feedback, second-order bandpass filter: schematic diagram, response curve, and parameter-value calculation for given center-of-passband frequency.

is configured as a very stable current-controlled triangular-wave oscillator. The space frequency (1270 Hz) is determined by the setting of the 20 k-ohm 10-turn potentiometer and capacitor C2. In response to a logic 1 input (inverted from logic 0 by IC4c) transistor Q2 gates capacitor C1 in parallel with C2. The oscillator frequency will now be 1070 Hz. This 567

oscillator, while very stable, has a high-impedance output. One section of the CD4011 NAND gate (IC4d) is used as a high-impedance linear amplifier to match the output of IC5 to the 50 k-ohm impedance input of IC6, the LM386 amplifier. Also connected to pin 13 of the CD4011 is the carrier-detect signal, which mutes the tone output

when no 2025 Hz carrier is being received.

The demodulator section of figure 1a is more complicated and accounts for the major expense in a modem. In an acoustic demodulator there are three basic sections: preamplifier, bandpass filter, and demodulator. Either a crystal microphone or a standard 8-ohm speaker (the latter of which is really about the same thing as a dynamic microphone) can be used with this circuit.

The output of the speaker/mike is amplified by IC1, an LM741. You may not need the gain provided by this circuit (22×) if you're using a crystal mike. In that case you should eliminate IC1 and the 10 k-ohm and 220 k-ohm resistors, and feed the microphone output directly to the 6.2 k-ohm resistor leading to IC2. In either case, the signals acquired by the mike are sent through a sharp bandpass filter which passes only signals between 2000 Hz and 2250 Hz.

We use an MC1458 operational amplifier (IC2) to construct a multiple-feedback, second-order bandpass filter. IC2 is configured as two such elements, cascaded to improve response. The mathematical calculations behind component selection in this type of filter are outlined in figure 3. The objective is to pro-

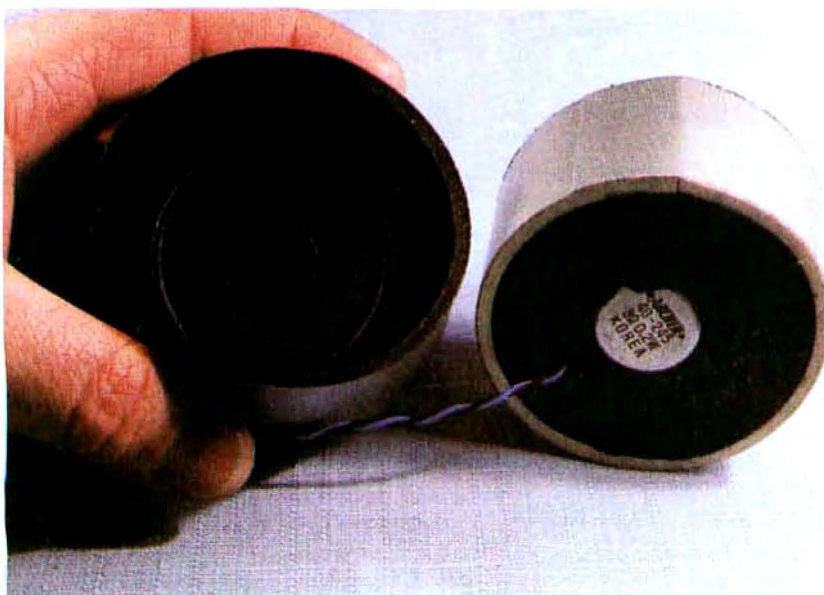

Photo 6: Insert the speaker into the hole and align it with the angle of the foam wedge. In the unit shown, I used a black broad-tip marker to darken the white surfaces on the inside.





**\$7.95\***

**WSU-30M**

**NEW WIRE-WRAPPING TOOL DOES ALL**  
The new WSU-30M "Hobby Wrap" tool performs the complete wire-wrapping function. First, the tool wraps 30 AWG (0.25mm) wire onto standard .025 inch (0.6mm) square DIP Socket Posts. In addition, the tool also unwraps and, finally, it strips 30 AWG wire nick-free.

WSU-30M makes a "modified" style of wrap, in which approximately 1 1/4 turns of insulated wire are wrapped in addition to the bare wire for purposes of added mechanical stability. Designed for the serious amateur, the WSU-30M features compact, all metal construction for years of dependable service. This unique tool is remarkable value performing the work of three separate tools at a fraction of the cost.



MODIFIED WRAP

**PART No.  
WSU-30M**

**Strip**



**Unwrap**



REGULAR WRAP

**PART No.  
WSU-30**

**Wrap**

**WSU-30**  
**\$6.95\***

**WIRE WRAPPING-STRIPPING-UNWRAPPING TOOL**

The compact, inexpensive WSU-30 "Hobby Wrap" Tool does the job of three tools at a fraction of their comparable prices. The tool wraps, unwraps, and even strips wire thanks to a unique built-in stripping blade. Designed for use with 30 AWG (0.25mm) wire on standard .025 inch (0.6mm) DIP Socket Posts. Takes minutes to learn to use; makes perfect connections in seconds without solder.

**OK Machine & Tool Corporation**

3455 Conner St., Bronx, N.Y. 10475 U.S.A.

Tel. (212) 994-6600 Telex 125091

\*Minimum billings \$25.00, add shipping charge \$2.00  
New York State residents add applicable tax



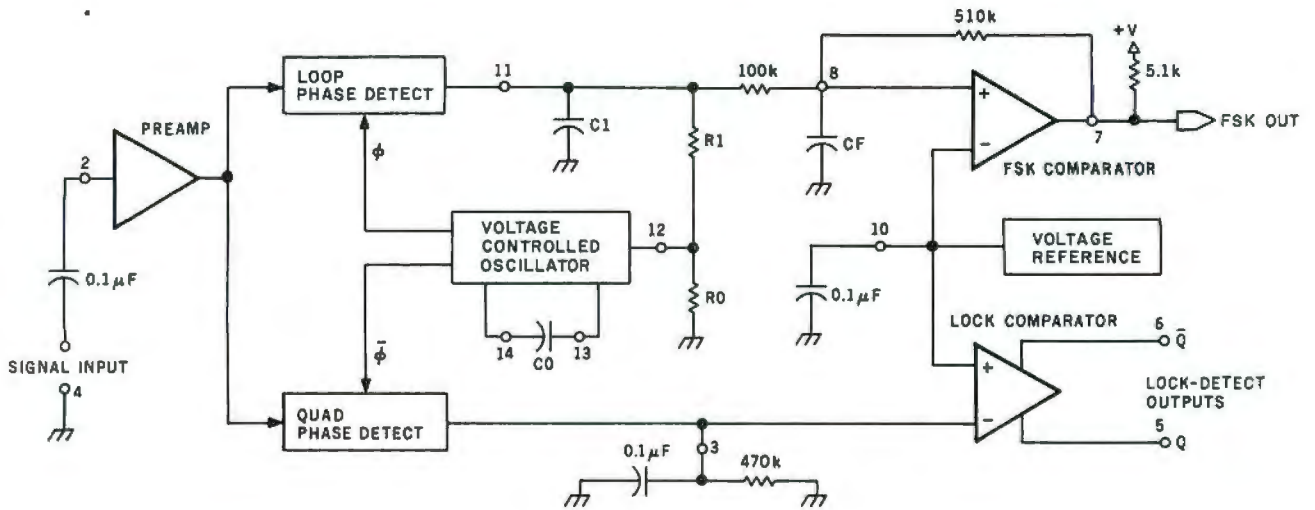

**ORIGINATE MODEM**

$f_1 = 2025 \text{ Hz}$   
 $f_2 = 2225 \text{ Hz}$   
 $R1 = 200 \text{ k}$   
 $R0 = 18 \text{ k}$   
 $C1 = 0.0047 \mu\text{F}$   
 $CF = 0.005 \mu\text{F}$   
 $C0 = 0.022 \mu\text{F}$

**ANSWER MODEM**

$f_1 = 1070 \text{ Hz}$   
 $f_2 = 1270 \text{ Hz}$   
 $R1 = 100 \text{ k}$   
 $R0 = 18 \text{ k}$   
 $C1 = 0.01 \mu\text{F}$   
 $CF = 0.005 \mu\text{F}$   
 $C0 = 0.039 \mu\text{F}$

Figure 4: Block diagram of the XR2211 phase-locked loop component, which is IC3 in figure 1a. Appropriate component values for the two modem modes are shown.

duce a filter with a center-of-passband frequency midway between 2025 Hz and 2225 Hz, with a bandwidth wide enough to allow these two frequencies to pass easily but reject everything else. The computed filter has a center frequency of 2117 Hz, a total gain factor of about 95, and a

bandwidth of 300 Hz. When the telephone handset is inserted in the coupler, nothing is passed except the tones we want.

The output of the filter is sent to IC3, which is an XR2211 monolithic phase-locked loop (PLL) especially designed for FSK data communica-

tion by Exar Integrated Systems. Figure 4 presents a block diagram of this device with pertinent external component selection.

A phase-locked loop is basically an electronic servo loop consisting of a phase detector, a low-pass filter, and a voltage-controlled oscillator (VCO). Its function is to synchronize its own oscillator to the incoming signal. If the incoming signal changes, the phase-detector output changes correspondingly to adjust the VCO to track the signal. In the XR2211, if the signal amplitude at the locked frequency is above a minimal value, the FSK comparator signifies this condition with a binary 1 output. The XR2211 can accommodate analog input signals between 2 mV and 3 V.

As shown in figure 1, the components are chosen for originate frequencies, and the XR2211 is powered by +12 V. (The specification says anything between +4.5 V and +20 V is acceptable, but +5 V is marginal in my experience.)

Alignment is simply a case of adjusting the 5 k-ohm potentiometer (R4). With a 2225 Hz signal applied to the microphone input, adjust R4 until pin 7 of IC3 goes low. Changing the input frequency to 2025 Hz

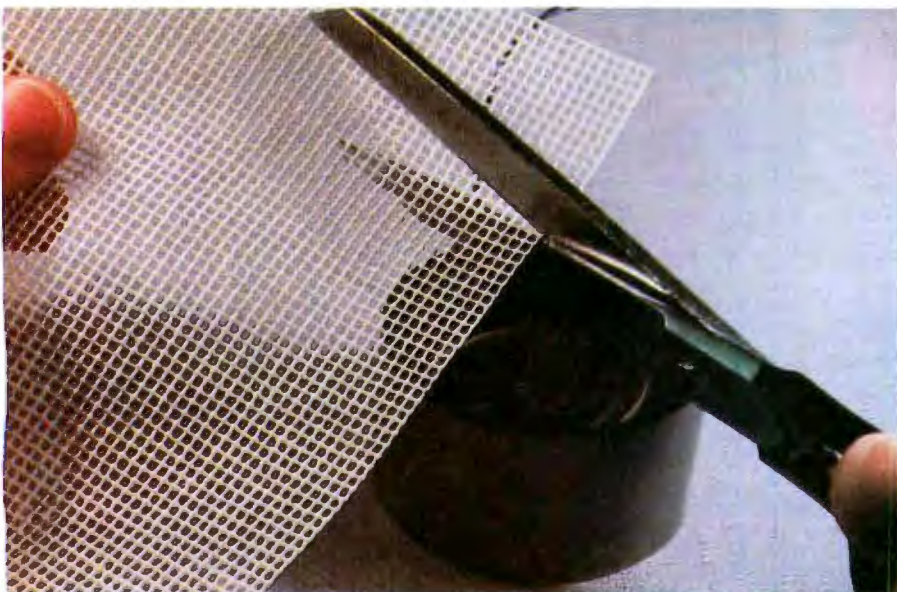

Photo 7: Cutting the grill cloth. The stiff canvas used for needlepointing is ideal. Cut a circular piece and fit it to cover the speaker.



Make your micro

# MI6HTY!



## Get the most out of your microcomputer with Graham-Dorian Business software.

At any given time, your hardware is only as useful as the software you insert in it.

So it pays to rely on Graham-Dorian, the software that gets your micro performing to its fullest — almost like a mini.

Graham-Dorian, the industry leader, offers highly detailed and well-documented programs. All pretested on the job. Each so comprehensive that it takes little time to learn to run a program — even for someone who's never operated a computer before.

Programs are compatible with most major computers using CP/M disk operating systems, and come in standard 8" or on various mini-floppy disks. Each package contains the software program in INT and BAS file form plus a user's manual and hard copy source listing. Graham-Dorian stands behind dealers with technical advice.

Yes, there's a world of difference in business software. Graham-Dorian has more per-package capabilities and more packages. (With new ones added every few months.)

The Graham-Dorian line now includes these packages:

- Medical
- Dental
- Surveying
- Inventory
- Payroll
- Apartment Management
- Construction Job Costing
- Accounts Receivable
- Accounts Payable
- General Ledger
- Cash Register

CBASIC-2

Ask your dealer for a demonstration soon.



**Graham-Dorian  
Software Systems, Inc.**

211 North Broadway / Wichita, KS 67202 | (316) 265-8633



should make this pin go high.

In addition to the FSK output on pin 7, there is a lock-detect output on pin 5, used to denote carrier detec-

tion. It is connected to one section of the CD4011. This circuit is a 1-second-on/2-second-off delayed-trigger monostable multivibrator

(one-shot). Either tone (considered the carrier in this case) has to be present for at least 1 second to trigger the circuit into operation, allow data to flow from the modem to the terminal, and turn on the modulator amplifier.

IC7 and Q3 are added for RS-232C interfacing. If RS-232C communication is not a requirement, then these parts can be eliminated. Using the CD4011 (IC4b), the circuit can directly drive one low-power Schottky (LS) transistor-transistor logic (TTL) input load. A CD4049 inverting buffer or CD4050 buffer can be added to drive more input loads if necessary.

### Construction Hints

We are dealing with high impedances and critical capacitances in this modem circuit. Layout should be compact, and Mylar or polystyrene capacitors should be used where indicated. Shielded cable should be used between the microphone and the modem board to reduce electrical-noise interference.

The acoustic coupler can be salvaged from an old modem, such as the Anderson-Jacobson unit



**Photo 8:** The final assembly can be spray-painted black as I have done, but this is not necessary. Caution: some paints act as solvents on foam and will produce a sticky mess. Test a small sample before spraying the whole unit, and don't spray the speaker cone.

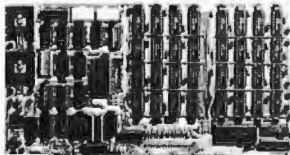

**64K BYTE EXPANDABLE RAM**  
DYNAMIC RAM WITH ON BOARD TRANSPARENT REFRESH GUARANTEED TO OPERATE IN NORTHSTAR, CROMEMCO VECTOR GRAPHICS, SOL, AND OTHER 8080 OR Z-80 BASED S100 SYSTEMS \* 4MHZ Z-80 WITH NO WAIT STATES  
\* SELECTABLE AND DESELECTABLE IN 4K INCREMENTS ON 4K ADDRESS BOUNDARIES  
\* LOW POWER—8 WATTS MAXIMUM  
\* 200NSEC 4116 RAMS  
\* FULL DOCUMENTATION  
\* ASSEMBLED AND TESTED BOARDS ARE GUARANTEED FOR ONE YEAR AND PURCHASE PRICE IS FULLY REFUNDABLE IF BOARD IS RETURNED UNDAMAGED WITHIN 14 DAYS.

	ASSEMBLED / TESTED
64K RAM	\$595.00
48K RAM	\$529.00
32K RAM	\$459.00
16K RAM	\$389.00

**S100 MAINFRAME AND CARD CAGE**

- \* W/ SOLID FRONT PANEL \$239.00
- \* W/ CUTOUTS FOR 2 MINI-FLOPPIES \$239.00
- \* 30 AMP POWER SUPPLY \$119.00
- \* 8 SLOT MOTHERBOARD \$149.00
- \* 19 SLOT MOTHERBOARD \$199.00

### 16K MEMORY EXPANSION KIT ONLY \$59

FOR APPLE, TRS-80 KEYBOARD, EXIDY, AND ALL OTHER 16K DYNAMIC SYSTEMS USING MK4116-3 OR SLOWER DEVICES.

- \* 200 NSEC ACCESS, 375 NSEC CYCLE
- \* BURNED-IN AND FULLY TESTED
- \* 1 YR. PARTS REPLACEMENT GUARANTEE
- \* QTY. DISCOUNTS AVAILABLE



### VISTA V-200 MINI-FLOPPY SYSTEM

- \* S100 DOUBLE DENSITY CONTROLLER
- \* 204 KBYTE CAPACITY FLOPPY DISK DRIVE WITH CASE & POWER SUPPLY
- \* MODIFIED CPM OPERATING SYSTEM WITH EXTENDED BASIC \$895.00
- \* EXTRA DRIVE, CASE & POWER SUPPLY \$395.00

**BETA**  
COMPUTER DEVICES

1230 W. COLLINS AVE.  
ORANGE, CA 92668  
(714) 633-7280

Calif. residents please add 6% sales tax. MasterCard & Visa accepted. Please allow 14 days for checks to clear bank. Phone orders welcome. Shipping charges will be added to all shipments.

### 32K BYTE MEMORY

RELIABLE/COST EFFECTIVE EXPANDABLE RAM FOR 8502 AND 6800 SYSTEM—AIM 65-KIM\*SYM\*PET\*\$44-BUS

- \* PLUG COMPATIBLE WITH THE AIM-65/SYM EXPANSION CONNECTOR BY USING A RIGHT ANGLE CONNECTOR (SUPPLIED) MOUNTED ON THE BACK OF THE MEMORY BOARD.
- \* MEMORY BOARD EDGE CONNECTOR PLUGS INTO THE 6800 S 44 BUS.
- \* CONNECTS TO PET OR KIM USING AN ADAPTOR CABLE.
- \* RELIABLE—DYNAMIC RAM WITH ON BOARD INVISIBLE REFRESH—LOOKS LIKE STATIC MEMORY BUT AT LOWER COST AND A FRACTION OF THE POWER REQUIRED FOR STATIC BOARDS.
- \* USES +5V ONLY, SUPPLIED FROM MOST COMPUTER
- \* FULL DOCUMENTATION ASSEMBLED AND TESTED BOARDS ARE GUARANTEED FOR ONE YEAR AND PURCHASE PRICE IS FULLY REFUNDABLE IF BOARD IS RETURNED UNDAMAGED WITHIN 14 DAYS

ASSEMBLED WITH 32K RAM & WITH 16K RAM	\$419.00
TESTED WITHOUT RAM CHIPS	\$279.00
HARD TO GET PARTS (NO RAM CHIPS) WITH BOARD AND MANUAL	\$109.00
BARE BOARD & MANUAL	\$49.00

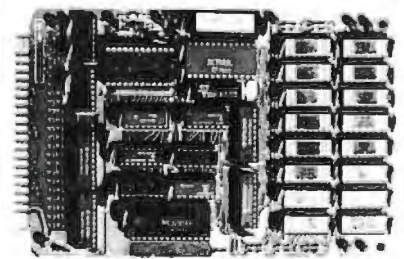

PET INTERFACE KIT—CONNECTS THE 32K RAM BOARD TO A 4K OR 8K PET. CONTAINS: INTERFACE CABLE, BOARD STANDOFFS, POWER SUPPLY MODIFICATION KIT AND COMPLETE INSTRUCTIONS \$49.00

U.S. PRICES ONLY



# Chief Relief

For years many small business system buyers thought that in order to get "real" performance and enough storage to be a "real" business system they would have to sacrifice the family jewels.

But with the introduction of the Smoke Signal Chieftain series office computers a lot of people's minds have been changed.

Because we designed the highly reliable Chieftain small business system with the most innovative combination of performance and efficiency around.

At your fingertips there are 64,000 characters of random access memory and you can address anywhere from 740,000 characters to 2 million characters with Smoke Signal's new double density controller. For larger concerns, there's a 20M byte hard disk available.

At a time when other small computer manufacturers tell you "you're on your own", Smoke Signal offers an abundance of easy-to-use software programs such as order entry, inventory control,

accounts receivable, invoice entry, payroll, word processing and much, much more. There's BASIC, COBOL and FORTRAN — even a multi-user BOS (Business Operating System) that allows for numerous users simultaneously.

Chieftain systems starting at under \$200.00 per month display performance on par with systems costing twice to three times as much.

So call (213) 889-9340 for your nearest authorized Smoke Signal dealer — he'll be glad to demonstrate the Chieftain's high reliability and ease of operation.

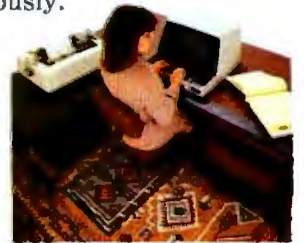

For dealers only, circle 22  
All other inquiries, circle 21

**SMOKE SIGNAL**



**BROADCASTING**

31336 Via Colinas, Westlake Village, California 91361, (213) 889-9340







**OPTIMIZED SYSTEMS SOFTWARE**

PRESENTS

**CONTROL PROGRAM/APPLE**  
the DOS you have been waiting for

OSS CP/A is an all new, disk-based operating system which provides commands and utilities similar to CP/M<sup>®</sup>. CP/A has byte and block I/O, a simple assembly language interface, and direct access via Note and Point. And it's easy to add your own commands or device handlers. CP/A is expandable, flexible, consistent, easy-to-use and available now with compatible program products:

**BASIC** — Some of the features of OSS BASIC are syntax checking on program entry, true decimal arithmetic (great for money applications), 32K byte string sizes, flexible I/O, long variable names (up to 255 significant characters), and the ability to get and put single bytes.

**BUSINESS BASIC WITH PRINT USING** — This is virtually the only basic available on the Apple that has PRINT USING. It also has record I/O statements and all the features of our standard BASIC.

**EDITOR/ASSEMBLER/DEBUG** — OSS EASMD is a total machine language development package. The editor provides functions like FIND, REPLACE, etc. The assembler uses standard 6502 mnemonics, can include multiple files in one assembly, and can place the object code in memory or to a disk file.

Prices of CP/A with:

BASIC .....	\$ 69.95
Business BASIC .....	84.95
EASMD .....	69.95
BASIC + EASMD .....	109.95
Business BASIC + EASMD ....	124.95

Requires 48K RAM and DISK

Add \$3.50 for shipping and handling in continental USA. California residents add 6%. VISA/Master Charge welcome. Personal checks require two weeks to clear.

**SEE YOUR DEALER or ORDER TODAY**

**OPTIMIZED SYSTEMS SOFTWARE**  
is a product of

Shepardson Microsystems, Inc.  
20395 Pacifica Dr., Suite 108B  
Cupertino, CA 95014  
(408) 257-9900



**Photo 9:** With the production of two of the speaker assemblies I have described, we are in business. The one wired to the microphone input of the modem should be placed under the earpiece of the phone, and the one designated as the modem output speaker against the telephone mouthpiece. Dial your favorite computer, place the handset in the coupler, and when you see the carrier-detect indicator light, you are ready to go.

(bought on the surplus market for \$20.00), purchased from the source I listed, or you can make one from readily available materials which cost virtually nothing.

Photos 3 thru 9 illustrate the construction of an acoustic coupler. Both the transmitter and receiver use a 2-inch Radio Shack 8-ohm speaker and such "exotic" materials as foam pipe insulation, a plastic placemat, needlepoint canvas, and rubber cement.

When you are through building the coupler, connect it to the modem circuit and dial your favorite timesharing system. When the telephone connection has been made and you hear the tone, place the handset into the coupler. The carrier-detect LED should light, and you'll be in business.

If you succeed in building the modem and use it to call The Source, send me a message describing your effort. My user-identification number is TCE317.

**Next Month:** A simple remote data-entry terminal for use in home control applications. ■

Readers who wish to obtain the modem may order the following:

- a complete kit of integrated circuits and components as shown in figures 1a and 1b, a printed-circuit board, and directions for assembly—\$39.95
- two commercially made rubber cushions designed to fit 2-inch speakers, for use in acoustic couplers and two 2-inch speakers—\$12.95
- this modem is available combined with the COMM-80 serial/parallel interface (June Circuit Cellar) and called the "chatter box." Assembled and tested with software—\$259.95

Order these from:

The MicroMint Inc  
917 Midway  
Woodmere NY 11598  
(516) 374-6793

Please add \$2 for shipping and handling. New York residents please add 7% sales tax.





## every smart COMPUTER needs an SD SYSTEMS HEART.

We design and manufacture a complete line of industry compatible microcomputer boards and kits that can serve as the heart of your system. All are S-100 Bus compatible and use the Z80 microprocessor.

**MPC-4** — This SD Systems exclusive is a multi port controller which uses the Z80 for multi-user operations offering four serial RS-232 I/O channels.

**SBC 100/200** — A 2.5/4 megahertz range of single board computers which are effective standing alone or combined with the complete SD board range.

**ExpandoRAM III** — For use with 250/200 nanosecond RAM, these high density boards offer 16 to 64K memory; the ExpandoRAM II can achieve RAM capacities up to 256K using 64K chips.

**Versafloppy III** — A floppy disk controller for up to four drives, supporting single/double density and single/double-sided disk formats.

**VDB-8024** — A full function visual display board with a Z80 controller that adds display capabilities to your system.

**Prom 100** — A specialty board of SD Systems which allows you to program 2708/2716/2732 proms.

**Z-80 Starter Kit** — A low-cost entry into the world of microcomputers designed primarily for education and experimentation.

# SD SYSTEMS

P.O. Box 28810 • Dallas, Texas 75228 • 214-271-4667 • Telex 6829016

### NOW YOU CAN SAVE \$25 PER BOARD\*

when you purchase any SD Systems microcomputer board from participating SD Systems dealers listed below. \*Offer expires 10/31/80

**ADVANCED COMPUTER PRODUCTS, INC.**  
Irvine CA • 714-558-8813

**FUTURE ELECTRONICS**  
Natick MA • 617-237-6340

**ANCRONA**  
Culver City CA • 213-641-4064

**JADE COMPUTER PRODUCTS**  
Hawthorne CA • 800-421-5500

**COMPUTER CITY**  
Charlestown MA • 800-343-6652  
or 617-242-3350

**MINI MICRO MART**  
Syracuse NY • 315-422-4467

**THE COMPUTER MART**  
Waltham MA • 617-899-4540

**PRIORITY ONE**  
Sepulveda CA • 800-423-5633 or  
213-894-8171

**COMPUTER PRODUCTS STORES**  
Springfield IL • 217-528-0027

**S-100**  
Clark NJ • 201-382-1318

**CUSHMAN ASSOCIATES**  
Wilmington DE • 302-995-6733

**Q.T. COMPUTER SYSTEMS, INC.**  
Lawndale CA • 800-421-5150  
(ex. CA) or 213-970-0952

**DAL-COMP**  
Dallas TX • 214-350-6895

For complete product information, send for SD Systems' board and kit brochure (BK-101).



# Product Review

## The Ohio Scientific CA-15 Universal Telephone Interface

Gregg Williams, Editor

Imagine the following scenario: a businessman in San Francisco calls his office in Boston. The phone rings four times, then a metallic voice answers.

"Hello," it says, "this is the message service of Morell Pharmaceuticals. If you wish to leave your number, please type it in using your push-button phone. Thank you."

Since the man calling is John Morell, the owner, he knows he can type in a special access code. He types in 999 on the Touch Tone phone. The computer on the other end of the line recognizes this sequence.

"Business status," the metallic voice answers. "Zones 1 thru 8 secure—no intruders. Zones 1 thru 8 report no fire alarms. Do you wish messages?"

Mr Morell types in 9, which stands for yes.

"You had three calls. Mr Morse called at 6:04 PM. Ms Morell called at 7:40 PM. Unidentified caller, phone 555-1501, called at 7:51 PM. Do you wish controls?"

Mr Morell types in another yes.

"Operation?" the computer asks. Mr Morell presses the buttons for the digits 0 and 2.

"Office lights on. Time to turn off?" the computer asks. Mr Morell presses the buttons 1, 0, 4, and 5, instructing the computer to turn the lights off at 10:45 that night.

"Another command?" Mr Morell types in a 6, which stands for no.

"Thank you. Good night," the computer voice says, then hangs up.

Is this another computer user's fantasy? (After all, we know that computers cannot do useful things like start coffee in the morning or water the lawn.) No, the above scene is entirely possible. In fact, I have seen a scaled-down demonstration similar to the above during a recent trip to Ohio Scientific to see its new CA-15 universal telephone interface (UTI).

### Description

The CA-15 universal telephone interface (shown in photo 1) is a one-board peripheral device that will fit in any Model C8P, C2-8P, C2-OEM, or C3-series Ohio Scientific computer. The internal organization of the



Photo 1: The CA-15 universal telephone interface board, shown with its optional Votrax voice synthesis module.

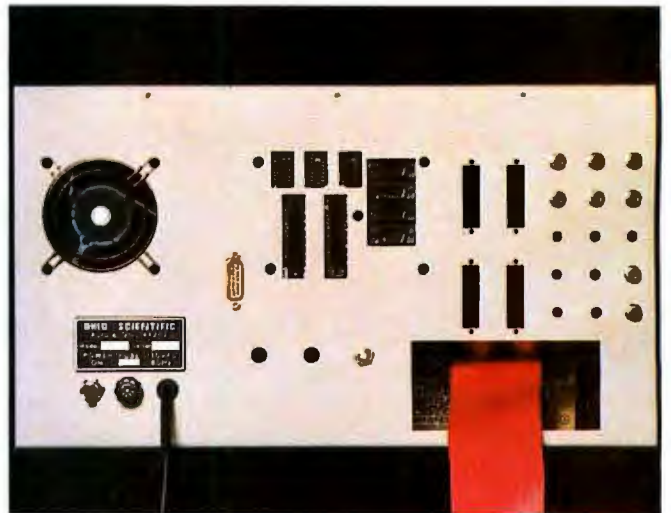

Photo 2: Rear panel of an Ohio Scientific C8P computer, showing connections from the CA-15 universal telephone interface to outside components. The board connects to a CBT-type data coupler through the DB-15 connector (the small gold-colored connector in the center of the back panel). Other connections are made through the six phono jacks in the upper right-hand corner of the back panel. The jacks, listed in row order from left to right, are: cassette-recorder on/off control, phone-line monitor output, Votrax output (if used), cassette-player on/off control, cassette-player input, and auxiliary input.

Touch Tone is a registered trademark of the Bell Telephone System for its dual-tone, multiple-frequency signaling system.



# Little Impact.



## Meet the IMPs. A pair of stylish 3½ inch high impact printers that will look great on any desk.

Styled for desk top use, these sleek units stand just 3½ inches high, yet the unique fan-cooled printing system can knock out 80, 96 or 132 columns of crisp hardcopy with continuous throughput of one line per second.

**A winning pair.** IMP-1, with friction feed, can make multi-copies on plain 8½ inch wide paper, or on teletype rolls. In addition, IMP-2 has tractor feed and full forms control, with tractors adjustable from 1 inch to 9½ inches.

**Interfaces abound.** All IMPs have Centronics parallel and RS232C/20mA serial inputs as standard equipment. But if you need something different, then we make interfaces for just about any system — high speed serial, Apple, Pet, TRS-80, IEEE 488...

**Versatile, too.** 96 ASCII character set is standard. And you can select 6 character sizes, even graphics, under software control. Options include 2K buffering and special character sets.

**Service — a big difference.** No other printer manufacturer offers Axiom's combination of low cost and nation-wide service and distribution — in the USA and eighteen overseas countries.

**Pssst — the price!!!** It's low. \$695 for IMP-1. \$795 for IMP-2. And that's the single unit price.

Better phone, write or mail the bingo card today!

**AXIOM**  
AXIOM CORPORATION

5932 San Fernando Road, Glendale, CA 91202  
Tel: (213) 245-9244 • TWX: 910-497-2283



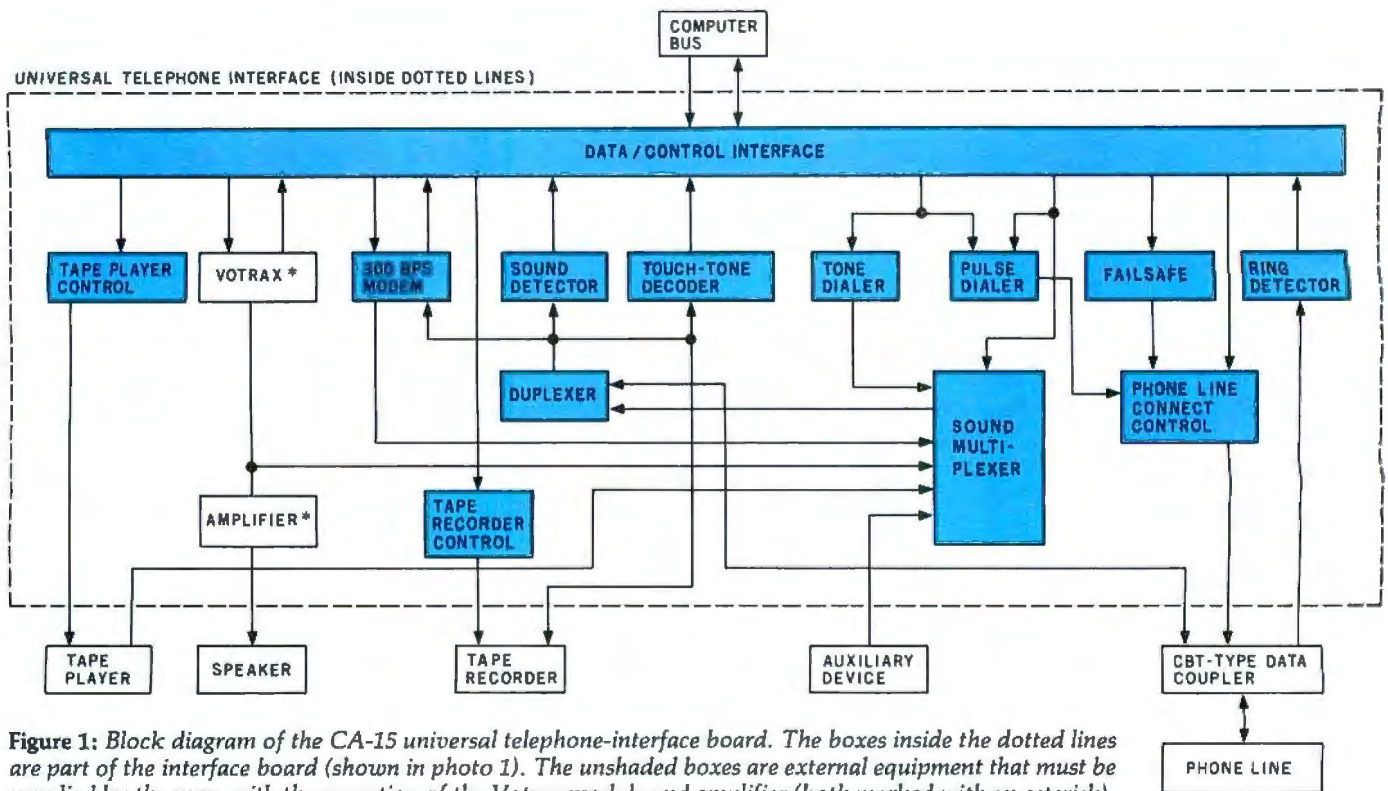

**Figure 1:** Block diagram of the CA-15 universal telephone-interface board. The boxes inside the dotted lines are part of the interface board (shown in photo 1). The unshaded boxes are external equipment that must be supplied by the user, with the exception of the Votrax module and amplifier (both marked with an asterisk), which are optionally supplied with the interface board.

board is shown in figure 1.

The CA-15 interface can:

- Initiate either Touch Tone or rotary pulse dialing of telephone numbers of any length.
- Use Touch Tone dialing to transmit numeric and control data.
- Sense a phone line ringing (on an incoming call) or a busy signal (on an outgoing call).
- Answer incoming calls and disconnect outgoing calls.
- Act as a 300 bits per second (bps) originate-or-answer modem.
- Play a prerecorded message from an external cassette player onto the phone line.
- Record a voice message onto an external cassette recorder.
- Place audio information (eg: computer-generated music from a digital-to-analog converter) on the phone line from an auxiliary input device.
- Optionally, speak using a computer-controlled Votrax speech synthesizer.

The CA-15 interfaces to the outside world via seven output jacks, as shown in photo 2. The board connects to a dedicated (ie: not used for any other purposes) telephone line through a CBT-type data coupler, which can be purchased from Ohio Scientific or rented from the telephone company. The data coupler is necessary to make a reliable, safe, and legal connection between a computer and the telephone line.

The universal telephone-interface board connects to the external data coupler through a DB-15 connector (the

small gold connector in the center of the C8P rear panel shown in photo 2). The remaining six connections are made through the two rows of three jacks each in the upper right-hand corner of the computer's backplane. The jacks, listed in row order from left to right, are: cassette-recorder on/off control, phone-line-monitor output, Votrax output (if used), cassette-player on/off control, cassette-player input, and auxiliary input.

In keeping with Ohio Scientific's "hardware-first" orientation, the interface is controlled through examining and writing to (PEEKing and POKEing, in BASIC) certain memory locations. For example, to dial the three digits 6, 0, 3 (after initializing the interface board), we execute the BASIC instructions:

```
POKE 63494,189
POKE 63494,215
POKE 63494,190
```

The documentation supplied with the CA-15 universal telephone interface includes complete instructions that detail manipulation of the interface through reading and writing the appropriate memory locations.

### Commentary

Coupled to the security and home-control options available in the Ohio Scientific line of computers, the CA-15 universal telephone interface is the link that extends the influence of a computer beyond its immediate environment. This extended environment includes any point within reach of the existing telephone network. With the Ohio Scientific AC-12P wireless remote-control option, the CA-15 interface can control home appliances



# INTRODUCING HP-85.

## A NEW WORLD OF PERSONAL-PROFESSIONAL COMPUTATION.

Imagine the new world that would unfold before you if you had a powerful, portable, completely integrated computer system at your personal disposal. And at an affordable price. That's exactly what Hewlett-Packard has just created.

### THE HP-85: A PERSONAL COMPUTER FOR PROFESSIONALS.

At the lab, on your desk or in your study this 20-pound, self-contained system provides professional computing power when and where you need it. That means no more waiting for data to be remotely processed and returned.

### A COMPLETE COMPUTER SYSTEM IN ONE SMALL PACKAGE.

You get all this in the HP-85:  
**Interactive graphics** under keyboard control.  
**16K RAM Memory** standard.  
**Standard typewriter keyboard** with separate numeric key pad and eight user-definable special function keys.  
**High resolution CRT display** with powerful editing capability.  
**Built-in thermal printer** produces a hard copy of the display on command.  
**Built-in tape cartridge drive.** Each cartridge provides 217K bytes of storage capacity.  
**Operating system and BASIC language,** permanently stored in ROM.

### A SOPHISTICATED COMPUTER AT YOUR FINGERTIPS.

Hewlett-Packard has combined these sophisticated capabilities with advanced design to give you a system that is easy to use yet uncompromised in its power.

A key to this achievement is Hewlett-Packard's choice of BASIC for the HP-85's language. The



You can enhance the system's capability by adding powerful HP peripherals like a high-speed, full-width line printer, full-size plotter, or flexible disc drives.

And HP Application Pacs offer preprogrammed solutions in a wide variety of disciplines on prerecorded magnetic tape cartridges.

So, when you buy the HP-85, you're not just buying a computer system, you're buying the confidence that the Hewlett-Packard name brings and the knowledge that the HP-85 can expand with your changing needs.

For the address of your nearest HP dealer, CALL TOLL-FREE 800-547-3400 except from Hawaii or Alaska. In Oregon, call 758-1010. For details on the HP-85, send the attached coupon, or write: Hewlett-Packard, 1000 N.E. Circle Blvd., Corvallis, OR 97330, Dept. 276C

HP-85 has more than 150 commands and statements to let you solve your problems swiftly and easily.

In addition, sixteen graphic commands have been added to the HP-85's extended BASIC to give you easy control of its amazingly versatile graphic capabilities.

### DESIGNED FOR TODAY AND TOMORROW.

Whether you're in science, engineering, industry or business, the HP-85 you need today can easily be expanded or customized to meet your needs tomorrow.

You can double RAM capacity to 32K or expand ROM firmware to 80K with optional modules that plug right into the HP-85.



## HEWLETT PACKARD

619/26

HEWLETT-PACKARD  
Dept. 276C  
1000 N.E. Circle Blvd.  
Corvallis, OR 97330  
Please send details on HP-85.

NAME \_\_\_\_\_

TITLE \_\_\_\_\_

COMPANY \_\_\_\_\_

ADDRESS \_\_\_\_\_

CITY \_\_\_\_\_

STATE \_\_\_\_\_ ZIP \_\_\_\_\_



# Improved!

## POSTMASTER

# Tomorrow's mail system. Today.

One package does it ALL. Teratek's Postmaster offers the most powerful and flexible mail-management system available for any CP/M or compatible derivative capable of running CBASIC II, now including Apple II.

### Menu Driven.

Up to 250K Records Per File Name.

Up to 16 Drives Supported.

9 Digit Zip Code Supported.

**Batch Entry:** Entering names and addresses to a mailing list is simple. Repeated elements of a record need only be entered once.

**Powerful Record Extraction:** Used in conjunction with the **Optional Reference Field**, this feature allows simple creation of user specified "target-files."

**Dedicated Record Editor:** List, modify or delete records. Allows intact or extracted backup of original file.

**Automatic "ID" Field Insertion:** (optional) Key in a name, and a unique 10 character record identifier will be entered automatically to the Reference area.

**Envelopes:** Postmaster prepares single or continuous envelopes.

**Mailing Labels:** Standard or user-specified formats up to five across. Any number of labels per name.

**Translator Program NAD to Postmaster Provided as Full Source.**

**Form Letters:** Supports courtesy titles, nicknames, single page or continuous form. Optional text or salutation inserts in any letter.

**Dedicated Record Sorting.**

**Attractive Reports:** Neat, paginated reports on either 80 or 132 column paper.

**Clear, Complete Documentation.**

**Quality That's Affordable and Available:** The Postmaster programs are available in a variety of 5" and 8" disk formats (40k of RAM, CP/M and CBASIC2 are required).

Among the formats supported are TRS-80, North Star, Heath H8 and H89, standard 8" IBM, Vector MZ and other CP/M derivatives capable of running CBASIC.

**Sample Data Files Included.**

**Powerful Yet Easy to Use.**

**All Output Programs Provided as Full Source.**

**It's terrific!  
We use it ourselves!**

**COMPLETE PACKAGE:**

**\$150.**

**MANUAL ALONE:**

**\$15.**

(Credited toward subsequent purchase)

\*CP/M is a trademark of Digital Research

Prices reflect distribution on 8" single density diskettes. If a format is requested which requires additional diskettes, a surcharge of \$5. per additional diskette will be added.

Dealer Inquiries Invited

*Plus lots more!  
Just ask!*



LIFEBOAT ASSOCIATES  
1651 Third Avenue, New York, N.Y. 10028 □ (212) 860-0300 □ Telex: 220501

from any Touch Tone telephone. (A dial-type telephone can also be used if the person called has an external device that generates the standard Touch Tones.)

With the AC-17P home-security option, the CA-15 interface allows you to remotely determine whether intrusion, fire, or car alarms have been activated. And, with a sufficiently sophisticated BASIC program running, you can interconnect and control the security and wireless-control options from any telephone.

Other applications that come readily to mind are a sophisticated telephone-answering service (such as the scenario at the beginning of this review) and a stand-alone terminal, which can be used to call up computer bulletin boards, time-sharing services, and other remote devices.

The CA-15 universal telephone interface requires three power-supply voltages (+5 V, +12 V, and -9 V), while the popular model C4P computer (and its predecessor, the C2-4P) supply only +5 V. Other difficulties include the large number of input and output lines the interface requires and the limited number of slots in the C4P and C2-4P. Because of these problems, the interface cannot be used with the above two machines. However, I was told that an area of the CA-15 board has been left blank (see the bottom center of the interface board in photo 1) for a voltage-doubler circuit that would make its use feasible in the C4P and C2-4P. C4P or C2-4P owners interested in this option should express their interest to Eric Davis at Ohio Scientific, 1333 S Chillicothe Rd, Aurora OH 44202.

The CA-15 universal telephone interface is available through Ohio Scientific dealers for \$499, or \$799 with the Votrax voice module added. A Federal Communications Commission (FCC) approved CBT-type telephone line isolator is available for \$199. Finally, a modified disk BASIC called Security BASIC is available for disk-based Ohio Scientific machines only. It is a modified Microsoft 9-digit-precision BASIC with extensions for the wireless remote-control, home-security, and telephone-interface options; these software extensions replace some of the PEEKs and POKEs otherwise used for device control with BASIC-like mnemonic commands. The Security-BASIC language system is available for \$99. ■

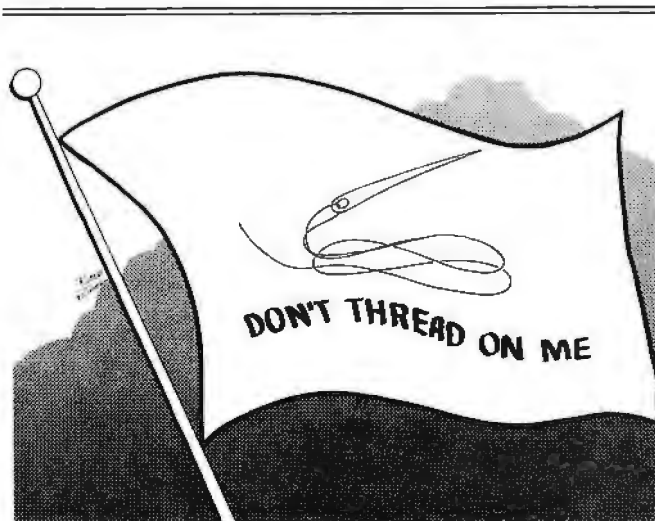

Official Flag of Anti-FORTH Programmers





MODEL 800 • WITH SUNFLOWERS

# A NEW MASTERPIECE IN PRINTERS

The MODEL 800 MST is certainly pleasing to look at, but its true beauty lies beneath the surface. A glimpse at its features reveals why it is rapidly becoming the most sought after printer in the world . . .

- Four standard interfaces:  
 RS-232 (15 baud rates)  
 Centronics compatible parallel  
 IEEE-488  
 20ma current loop
- Six line densities: 64, 72, 80, 96, 120, 132
- 100 CPS at all six densities
- Unidirectional or bidirectional printing
- Sixteen horizontal and ten vertical tabs
- Elongated characters in all six densities
- 1920 character buffer
- Uses either perforated or roll paper
- Fully adjustable tractors to 9½"
- Auto self-test
- Up to 10 character fonts  
 Standard 96 character ASCII  
 User defined character font  
 Provision for up to eight additional fonts
- Dot resolution graphics in six densities
- Variable line spacing control from 0 to 64 dots in half-dot increments
- Auto form-feed for any form length at any line spacing
- Heavy-duty all aluminum chassis
- 110vac or 220vac, 50/60Hz.
- 100 million character printhead
- Measures only 15" wide, 3" high, and 11" deep
- Weighs only 15 lbs.

. . . . but maybe its most attractive feature is the price . . . . \$699.00.



# Product Review

## The Heath H-89 Computer

Mark Dahmke, 1515 Superior St, Apt 15, Lincoln NE 68521

The Heath H-89 is Heath Company's latest in their rapidly expanding line of desk-top computers. The H-89 has a number of unique hardware features, and the same excellent software support and documentation as the original H-8 8080-based system.

Heath Company is promoting the H-89 as the *all-in-one* computer, which it most certainly is. It is based on the Zilog Z80 microprocessor, which makes it upward-compatible with all H-8 8080 software. Not only is the computer based on the Z80, but the video display ter-



Photo 1: The Heath H-89, a Z80-based all-in-one personal computer with built-in 5-inch floppy-disk drive, WH-19 terminal, and 16 K bytes of programmable memory (expandable to 48 K bytes). The price for the assembled unit is \$2295.



Photo 2: Interior of the Heath H-89 computer.

minal and keyboard subsystem also contains a Z80.

The processor board Z80 runs at 2.048 MHz — slightly faster than an 8080 at 2 MHz, but not at the 4 MHz maximum possible with a Z80. Up to 48 K bytes of main memory may be plugged into sockets directly on the processor board, as well as up to six expansion cards on twenty-five pin connectors. The processor board also has single-step and full interrupt logic, a serial RS-232 port that connects to the terminal board, and sockets for three 2708 EPROMs (erasable programmable read-only memories).

The terminal board consists of a Z80, a 6845 video controller chip, two read-only memories, two 2112-2 programmable memory components, an S740 keyboard encoder circuit, and an 8250 UART (universal asynchronous receiver/transmitter) for RS-232 communications. The terminal has a 12-inch video screen that displays twenty-four lines of eighty 5-by-7 dot-matrix characters. The twenty-fifth line is accessible under software control for special applications. Lowercase descenders and thirty-three 8-by-10 dot graphics characters are also provided.

A full keyboard with repeat key (this repeats any key pressed), eight user-definable function keys (see table 1), and a separate numeric keypad are standard on the H-89.

The special function keys generally send out a series of characters such as ESC H for *cursor home*, ESC E for *erase screen*, and so on. Although Heath has its own set of escape functions, the terminal may be placed in the ANSI (American National Standards Institute) mode for a standardized set of the same functions. The numeric keypad actually has three possible modes: the unshifted numeric mode (normal), the keypad shifted mode, and the alternate keypad mode. Table 2 shows the keycodes for each mode. A complete list of escape sequences is shown in table 3.

The ESC r X sequence allows the user to set the data rate from 110 to 9600 bits per second. For example, ESC r C sets the data rate to 300 bits per second.

Another nice feature is the special twenty-fifth line of the screen. This line is separate from the other twenty-four and will not scroll with the rest of the screen. The line may be enabled by sending ESC x 1 from either the computer or the keyboard. After enabling the twenty-fifth line, the cursor must be positioned somewhere in the line before writing characters using the direct cursor addressing sequence: ESC Y (line number) (column number) where the line and column numbers are sent as two ASCII characters after the ESC Y. In this case, the line number is 25 + 31 (31 must be added to the actual line and column number values) which is equal to 56 or "8" in ASCII codes. The column number (1 to 80) may range from 32 (ie: 1 + 31) to 111. To position the cursor



# MEMORY EXPANSION FOR TRS-80\*

All you have to remember is to plug it in

Memory expansion. It's a field packed with intriguing theories. For instance, it has been suggested that the memory areas of the human brain are transferable from one body to another, like transplanted kidneys. In man or machine, a larger memory is always a welcome acquisition.

If you are interested in expanding your TRS-80 memory without shelling out dollars for a full blown expansion interface, we have just the solution.

Introducing the MT-32. Our new, brilliantly designed Printer/Memory expansion module for the TRS-80. This unit will add 16K or 32K of dynamic RAM to your basic 16K machine. The module also contains circuitry to drive Microtek's MT-80P dot matrix printer, or any other Centronics-compatible printer.

No hardware modification to your TRS-80 is required. Just plug into your bus connector and you are ready to go.

All Microtek products are covered by a one year warranty.

Four configurations are available:

Without RAM in kit form  
(MT-32K @ \$79.50)

Without RAM assembled and tested  
(MT-32A @ \$99.50)

With 16K RAM assembled and tested  
(MT-32B @ \$159.50)

With 32K RAM assembled and tested  
(MT-32C @ \$199.50)

Available from Microtek  
or your nearest computer dealer.

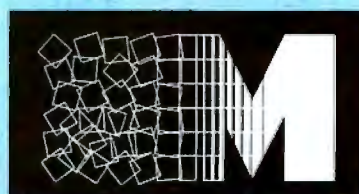

**MICROTEK** inc.

9514 Chesapeake Drive  
San Diego, CA 92123  
Tel. (714) 278-0633  
TWX 910-335-1269

\* TRS-80 is a Registered Trademark of Tandy Corp.

# MEMORY TRANSPLANT





Key	Heath Mode	ANSI Mode
F1	ESC S	ESC O S
F2	ESC T	ESC O T
F3	ESC U	ESC O U
F4	ESC V	ESC O V
BLUE	ESC P	ESC O P
RED	ESC Q	ESC O Q
GRAY	ESC R	ESC O R

**Table 1: Special function keys on the Heath H-89 computer.**

Unshifted Key	Shifted Key	Alternate Keypad Mode
0	0	ESC ? p
1	ESC L	ESC ? q
2	ESC B	ESC ? r
3	ESC M	ESC ? s
4	ESC D	ESC ? t
5	ESC H	ESC ? u
6	ESC C	ESC ? v
7	ESC @	ESC ? w
8	ESC A	ESC ? x
9	ESC N	ESC ? y
ENTER	RETURN	ESC ? n
		ESC ? m

**Table 2: H-89 numeric keypad functions.**

**DEALERS...OEM USERS.**  
**Call on Monday...**  
**your North Star**  
**computer**  
**will be**  
*delivered by*  
**Thursday.**



**WHOLESALE PRICES AVAILABLE.**  
 GBC maintains ready stock on the following products and software:

- North Star
- Centronics
- Perkin-Elmer
- Epson
- NEC Spinwriter
- Turnkey North Star Business Software

**(609) 424-0465**

**GBC inc.**  
 General Business Computers  
 2020 Fairfax Avenue  
 Cherry Hill, New Jersey 08003

in column 1 of line 25, the following sequence would be entered via the keyboard or sent from the computer: ESC "Y" "8" " ". If the sequence is sent from the keyboard, it is necessary to look up the character equivalents for each value (as above), but if the terminal is driven from a program in BASIC, the process is much simpler:

```
PRINT CHR$(27); "Y"; CHR$(56); CHR$(32);
```

Note that the CHR\$(27) causes the ASCII "ESCAPE" code to be sent; 56 and 32 are the line and column numbers, added to 31. The CHR\$ function converts the decimal code number into the corresponding character.

### MTR-88 Monitor Program

The H-89 comes with a monitor program in programable read-only memory that allows the user to operate at machine level or use the system without disk drives (or tape, for that matter). The MTR-88 cassette I/O functions are compatible with the cassette entry points in the PAM-8 front-panel monitor of the H-8, so software written for the H-8 will execute correctly on the H-89.

The monitor supports the following commands:

- Boot** Load HDOS from disk.
- Dump** Dump a program to cassette tape.
- Go** Execute a program at the given address.
- Load** Load a program from cassette tape.
- Program Counter** Set the program counter address (prior to entering the Go command).
- Substitute** Inspect or change memory locations.

The load and dump commands are set up to work with the H-88-5 cassette interface board. MTR-88 also maintains a tick counter in memory. The counter is a 2-byte field at memory addresses 040.033 and 040.034 (in split octal notation) that is incremented by 1 every 2 ms as long as interrupts are enabled. It is possible to assign interrupt vectors for special applications (as with all Heath software) by changing the addresses in the bottom 64 bytes of memory.

### HDOS Disk Operating System

HDOS (Heath Disk Operating System) is a comprehensive disk-management package. HDOS allows the user to create, manipulate, and display the contents of disk files and the disk directory. Other commands allow the user to display disk statistics (ie: usage, remaining space, errors) and to set device options such as console/printer data rate, whether or not a back-space cursor function is available on the terminal in use, uppercase or upper/lowercase mode, tabs, console width, and so on. HDOS provides "device drivers," special subroutines which perform all necessary initialization and housekeeping functions for each peripheral interface — console, line printer, alternate console, and so on. The device drivers may be called by the user's program, saving the user the effort of writing device interface routines.



# The Microsoft Z-80 SoftCard. Leading a Whole New Lineup for Your Apple II.

Plug the new Microsoft Z-80 SoftCard into your Apple II™ and start using all of the system and application software written for Z-80 based computers. Software that you could never use before on your Apple II.

The SoftCard actually contains a Z-80 processor and lets you switch between the Apple's 6502 and the Z-80 with simple commands, so you can use software written for either processor.

**Starting with Two Software Standards.** Versatile CP/M, the most widely used microcomputer operating system ever, is included on diskette in the SoftCard package, ready to run on your Apple II.

You get Microsoft's 5.0 BASIC too, the most powerful version to date of our famous BASIC interpreter.

PRINT USING, 16-digit precision, CALL, and CHAIN and COMMON are just some of the major BASIC features you'll add. Applesoft's graphics extensions are still included.

**More Power Down the Line.** You can get even more programming power and versatility by adding Microsoft's FORTRAN, COBOL, BASIC Compiler and Assembly Language Development System. All are available separately to run with the SoftCard system.

And the whole host of CP/M-based business, scientific and educational applications can be easily transferred to your Apple with SoftCard.

The Microsoft Z-80 SoftCard is compatible with most every Apple product from the Apple II to the Apple II Plus. Language Card and peripherals. Independent peripherals for the Apple are supported, as well. The SoftCard package requires a system with 48K and a disk drive.

Line up a SoftCard demonstration at your Microsoft Consumer Products dealer today. They'll be glad to show you how the Z-80 SoftCard and your Apple computer combine to form a system that can't be beat for either practicality or pure pleasure by any personal computer available today. Or give us a call, 206/454-1315, for more information.

But act quickly. At the low price of \$349 for SoftCard, CP/M, Microsoft BASIC and complete documentation, you may have to stand in line to get one!

™ Apple II is a trademark of Apple Computer, Inc.

\* CP/M is a registered trademark of Digital Research.



## MICROSOFT

**CONSUMER PRODUCTS**

10800 Northeast Eighth, Suite 507  
Bellevue, WA 98004  
(206) 454-1315



All devices on the H-89 have been assigned device names. Table 4 lists all devices. For example, to list a file on the printer, the command

COPY LP:=SY0:FNAME.EXT

is used, where LP: is the destination, and FNAME.EXT is the disk file on device SY0: to be listed.

ESC H	Cursor home
ESC C	Cursor forward (right)
ESC D	Cursor backward (left)
ESC B	Cursor down
ESC A	Cursor up
ESC I	Reverse index
ESC n	Cursor position report
ESC j	Save cursor position
ESC k	Set cursor to previously saved position
ESC Y	Direct cursor addressing
ESC E	Clear display (also shift erase)
ESC b	Erase beginning of display
ESC J	Erase to end of page
ESC I	Erase entire line
ESC o	Erase beginning of line
ESC K	Erase to end of line
ESC L	Insert line
ESC M	Delete line
ESC N	Delete character
ESC @	Enter insert character mode
ESC O	Exit insert character mode
ESC z	Reset to power-up configuration
ESC r Bn	Modify data rate (Bn is a character to select data rates from 110 to 9600 bps.)
ESC x Ps	Set mode: (select Ps from:)
	1 = Enable twenty-fifth line
	2 = No key click
	3 = Hold screen mode
	4 = Block cursor
	5 = Cursor off
	6 = Keypad shifted
	7 = Alternate keypad mode
	8 = Auto line feed on receipt of carriage return
	9 = Auto carriage return on receipt of line feed
ESC y Ps	Reset mode(s): (same as set modes listed above)
ESC <	Enter ANSI escape-sequence mode
ESC [	Enter hold screen mode
ESC \	Exit hold screen mode
ESC p	Enter reverse video mode
ESC q	Exit reverse video mode
ESC F	Enter graphics mode
ESC G	Exit graphics mode
ESC t	Enter keypad shifted mode
ESC u	Exit keypad shifted mode
ESC =	Enter alternate keypad mode
ESC >	Exit alternate keypad mode
ESC }	Keyboard disabled
ESC {	Keyboard enabled
ESC v	Wrap around at end of line
ESC w	Discard at end of line
ESC Z	Identify as DEC VT52 terminal
ESC ]	Transmit twenty-fifth line
ESC #	Transmit page

**Table 3: H-89 escape sequences.**

SY0:	System disk drive #0
SY1:	System disk drive #1 (optional)
TT:	Console device
AT:	Alternate terminal (optional)
LP:	Line printer
ND:	Null device (This eats up characters sent to it.)

**Table 4: H-89 device assignments in HDOS.**

The H-89, Heath's all-in-one computer, has a number of unique hardware features and the same excellent software support and documentation as the original H-8 system.

The two directory-oriented devices are SY0: and SY1: . On these devices (ie: disks), the directory keeps track of what files exist and where they are. Each file can have an eight-character name with a three-character extension. The extension is useful when keeping track of a number of related files. For example:

MYPROG.ASM  
MYPROG.LST  
MYPROG.ABS

Here the .ASM indicates that the first file is the assembler source of MYPROG entered via the text editor. The .LST file is the listing output of the assembler, and .ABS is the object code resulting from the assembler run.

#### HDOS Utilities

HDOS also comes with a number of useful utility programs:

**PIP** (peripheral interchange program)  
A generalized disk-file maintenance program.

**ONECOPY** A program that allows the user with only one disk drive to copy files from one disk to another.

**SET** A very useful program that allows the user to redefine device driver configurations. Table 5 lists all options of the SET command.

**STAT** Displays system performance, number of disk errors, etc.

**FLAGS** Sets disk-file flags to write-protect a file, to suppress normal listing and copying of a file, and (optionally) to lock the file against further flag changes.

#### DEBUG

The Heath console debug program allows the user to enter and debug machine-language programs from the console. DEBUG will perform the following functions:

- Display and alter contents of any memory location.
- Display and alter contents of any 8080 processor register.
- Single step through a program.
- Execute a program.
- Set breakpoints in a program.
- Load or dump user programs to or from a device (eg: tape or disk).

Note that DEBUG supports only the 8080 register set, not the extra registers in the Z80. Also, DEBUG does not have a disassembler feature.



# SUPER BRAIN QD™

Once in a great while someone comes along with a simple improvement for an already great product. Take our SuperBrain, for example. Really a simple concept. A high-powered, low cost micro-computer packaged in an attractive desk top cabinet. So how do you improve on that?

## WE DID IT...

It wasn't enough that our SuperBrain had such standard features as twin double density 5¼" drives with over 300,000 bytes of disk storage. A full 32K of dynamic RAM - expandable to 64K in seconds. A CP/M\* Disk Operating System which assures compatibility to literally hundreds of application packages presently available. A crisp, 12" non-glare screen with a full 24 line by 80 column display. A full ASCII keyboard with a separate keypad and individual cursor control keys. Twin RS232C serial ports for fast and easy connection to a modem and/or a printer. And, dual Z80 processors which operate at 4 MHz to insure lightning-fast program execution. No, it wasn't enough. So we made it better.

## ANNOUNCING SUPERBRAIN QD...

Our new QD model has all of the features of our phenomenally popular SuperBrain with the addition of double-sided disk drives and an extra 32K of dynamic RAM. So, for only a modest increase in price, you can order your next SuperBrain with more than twice the disk and memory storage capability. But, best of all, the new QD model has the same tough, rugged construction and exceptional quality that made our SuperBrain such a success.



## HOW DID WE DO IT?

The secret of SuperBrain QD's incredible disk storage lies within our new double-density double-sided disk drives. A total of nearly 720,000 bytes of data are formatted on two specially designed 5¼" drives. And that's more than enough to get you started with most serious small business applications. And SuperBrain QD's standard 64K of dynamic RAM will handle even the most complicated programming tasks.

Of course, if you're into megabytes instead of kilobytes, you may think neither SuperBrain is right for you. Not so! Intertec offers 20-96 megabytes of hard-disk storage which connects in seconds to either the SuperBrain or SuperBrain QD. So, your original investment is always protected. As you grow. No matter how much your needs expand.

## BUT IS IT RELIABLE?

Our best salesmen are our present users. Not only have SuperBrain users been impressed with the inherent reliability of the system, they tell us that no other microcomputer system available today offers such a unique modular design concept. Just about the only tool required to easily

maintain the system is a common screwdriver. And Intertec's total commitment to product service and customer support, with service outlets in most major cities, insures your original investment will be a valuable one for many years to come.

## THE DECISION IS YOURS.

Whether your next SuperBrain is a regular model or our QD version, you will have the satisfaction of knowing you purchased what is becoming one of the world's most popular micro-computer systems. And regardless of which model you choose, you'll probably never outgrow it because you can keep expanding it.

So, call or write us today for more information. Intertec systems are distributed worldwide and may be available in your area now.

Circle 31 on inquiry card.



2300 Broad River Rd., Columbia, SC 29210  
(803) 798-9100 TWX: 810-666-2115





## The Text Editor

The Heath Text Editor is used to enter and edit assembly and BASIC programs, as well as to create and edit reports, letters, and manuscripts.

EDIT uses all available memory in the system as a text buffer. When the buffer is full, all or part of it may be transferred to a disk file. This allows the user to work on files in size up to the limit that will fit on disk. EDIT has a very unusual command format:

<range> <verb> <qualifier string> <option>  
<parameters>

Range defines the buffer lines the command is to operate on. Characters to indicate certain lines are as follows:

- 1 Defines the first line of the buffer.
- \$ Defines the last line of the buffer.
- + Followed by a decimal number, refers to the *n*th line past the current line pointer.
- Followed by a decimal number, refers to the *n*th line preceding the current line pointer.
- + 'string' The first line in the buffer which contains the 'string' after the current line.
- 'string' The first line in the buffer which contains the 'string' preceding the current line pointer.

Multiple line ranges can be specified by using two of the above range expressions in sequence with a comma between them. A blank preceding a verb will cause the command to operate on the entire buffer. An equals sign reuses the range of the last command.

The verb specifies the action to be taken by the editor. Examples are: Print, Replace, Delete, Read, Write, Use, Search, Bye, and so on.

The qualifier string is a further restraint on the range expression and is optional. For example, it is possible to operate on only those lines that contain a phrase or string of characters. If the phrase is entered in single quotes in the qualifier string field, only those lines containing the specified string will be affected.

The option field determines if the current line is to be displayed before it has been modified, after it has been modified, or both. Use of this field is optional.

The parameter field is a special field used to direct disk I/O actions of the editor.

This is the most difficult editor I have ever tried to work with. Even after carefully reading the manual and spending a great deal of time learning how to use it, it is incredibly frustrating. The range and other fields are unconventional and require some getting used to. When writing programs in BASIC, it is far easier to use the line entry and edit commands in the BASIC interpreter. Trying to write assembler programs with this editor is nearly impossible.

Considering all the excellent software and hardware documentation and support of the H-89, and the powerful intelligent terminal features for full-screen editing, it

# FANTASTIC MAIL ORDER DISCOUNTS!!!



**apple computer**  
**16K\***  
**\$959**

\*ADD 3% IF USING CREDIT CARD ONLY ON APPLE COMPUTERS APPLE II OR APPLE II PLUS

APPLE II 32K \*1040\* APPLE II 48K \*1100\*

### APPLE II ACCESSORIES

CORVUS 10 MEGABYTE DISK DRIVE.....	\$4850	SUPER TALKER SPEECH SYNTHESIZER .....	250
PASCAL LANGUAGE SYSTEM.....	445	ROMPLUS CARD w/ KEYBD. FLTR.....	170
GRAPHICS INPUT TABLET.....	675	HEURISTICS SPEECHLINK 2000.....	225
DISK II WITH CONTROLLER CARD.....	465	DC HAYES MICROMODEM II.....	335
DISK II without controller.....	440	ALF MUSIC SYNTHESIZER.....	245
APPLE SOFT II FIRMWARE CARD.....	155	SSM A10 CARD (KIT).....	120
INTEGER FIRMWARE CARD.....	155	SSM A10 CARD (ASSEMBLED).....	170
PARALLEL INTERFACE CARD.....	155	NOVATION DAY MODE II.....	160
SERIAL INTERFACE CARD.....	180	CCS OPB IEEE INTERFACE.....	285
COMMUNICATIONS CARD.....	190	MICROSOFT 2-80 SOFT CARD w/CP/M.....	340
SUP-R-MOD RF TV MODULATOR.....	25	MICROWORKS DS-65 DISSECTOR.....	340
SUP-R-TERM 80 col. CARD.....	340	ROMWRITER.....	150
DAN PAYMAR Lower case III.....	45	SYMTEC LIGHT PEN CARD.....	220
5VA 8" DISK CONTROLLER CARD.....	340	CCS PROGRAMMABLE TIMER MODULE.....	150
CCS ARITHMETIC PROCESSOR CARD.....	340	CENTRONICS PRINTER INT. CARD.....	180
CLOCK/CALENDAR CARD.....	230	SLIENYPER PRINTER w/INT. CARD.....	520
INTROL X-10 SYSTEM.....	230		

### SOFTWARE

PASCAL LANGUAGE SYSTEM.....	\$445	APPLEWRITER WORD PROCESSOR.....	80
FORTRAN LANGUAGE PACKAGE.....	175	VISA-CALC.....	30
THE CONTROLLER GEN. BUS. SYSTEM.....	520	SARGON II on Disk.....	30
THE CASHIER RETAIL MGT. & INV.....	200	SUPER INVADER ON DISK.....	25
APPLEPOST MAILING LIST SYSTEM.....	45		

WE WILL BLADLY PERFORM WARRANTY REPAIR ON ALL APPLE COMPUTER PRODUCTS.

**MONITORS**  
**LEEDEX VIDEO 100**  
12" BLACK & WHITE MONITOR  
•VIDEO BANDWIDTH 12 MHz±3db  
•COMPOSITE VIDEO INPUT  
**\$139** SOROC IQ 120 \$739  
SOROC IQ 140 \$1295



SANYO 9" B/W Monitor \$169 • SANYO 15" B/W Monitor \$259 • ZENITH 13" Color Monitor \$429

**PRINTERS**

PAPER TIGER ITS 440 w/graphics.....	\$1050	NEC SPINWRITER.....	2695
TRENDCOM T-200.....	550	AXIOM EX-601.....	495
CENTRONICS 737.....	850	AXIOM EX-820.....	750
CENTRONICS 700-9.....	1149	COMPRINT 912S.....	599
ANADIX DP-8000 OR AP.....	650	COMPRINT 912P.....	559
MPI 88-T.....	725	TRENDCOM T-100.....	349

**THE SORCERER II 16K** **\$995**

The SORCERER II is a 280 CPU based micro-computer internally expandable to 48K. 4K ROM resident monitor I/O connector for S-100 expansion Parallel and serial interface. Dual cassette I/O. Graphic resolution of 240 x 512. 30 lines of 64 characters. 8 x 8 dot matrix. Full ASCII set upper and lower case; plus standard graphic symbols. User may define up to 128 characters. Keyboard is 83-key data processing type, plus a 16 key numeric input pad.

S-100 EXPANSION UNIT.....	\$200
WORD PROCESSOR PAC.....	100
DEVELOPMENT PAC.....	80
WE ALSO SELL "QUALITY SOFTWARE" FOR SORCERER II. SEE LIST.	

32K 1,148.00 48K 1,295.00

**ATARI 800** **\$799**

ATARI 800 COMPUTER..... 840  
ATARI 800 PRINTER..... 480  
ATARI 810 DATA DRIVE..... 570  
ATARI 410 PROGRAM READER..... 60  
ATARI 16K RAM MODULE..... 140  
ATARI 64K RAM MODULE..... 300  
ATARI BASIC ROM..... 45  
ASSEMBLER/EDITOR..... 45  
High resolution COLOR Graphics  
•10K Basic ROM  
•8K User RAM expandable to 48K  
•67 Key full stroke keyboard

BASEBALL..... 30  
VIDEO LABEL..... 30  
SUPER BREAKOUT..... 30  
MUSIC COMPUTER..... 45  
COMPUTER CHECK..... 30  
30 TIC TAC TOE..... 30  
STAR WALKER..... 45  
PERSONAL FINANCE..... 45  
•Built-in RF TV modulator  
•High speed serial I/O port  
•Includes ATARI 410 program recorder

### TO ORDER

Phone orders invited, using credit cards. Or send cashiers check or money order that draws on a U.S. bank. Please add 3% (\$5.00 Minimum) for handling, shipping (air service) and insurance, or equipment will be shipped freight collect. California residents add 8% sales tax. All equipment is in factory cartons with the manufacturers warranty. Equipment is subject to price change and availability without notice.



**CS COMPUTER SPECIALTIES**

6363 EL CAJON BLVD., SUITE 205,  
SAN DIEGO, CA. 92115 • (714) 579-0330



**26 MEGABYTES**

**\$4995.**



**DRIVE A HARD BARGAIN!**

Suddenly, S-100 microcomputer systems can easily handle 100 million bytes. Because Morrow Designs™ now offers the first 26 megabyte hard disk memory for S-100 systems—the DISCUS M26™ Hard Disk System.

It has 26 megabytes of useable memory (29 megabytes unformatted). And it's expandable to 104 megabytes.

The DISCUS M26™ system is delivered complete—a 26 megabyte hard disk drive, controller, cables and operating system—for just \$4995. Up to three additional drives can be added, \$4495 apiece.

The DISCUS M26™ system features the Shugart SA4008 Winchester-type sealed media hard disk drive, in a handsome metal cabinet with fan and power supply.

The single-board S-100 controller incorporates intelligence to supervise all data transfers, communicating with the CPU via three I/O ports (command, status, and data). The controller has the ability to generate interrupts at the completion of each command to increase system throughput. There is a 512 byte sector buffer on-board. And each sector can be individually write-protected for data base security.

The operating system furnished with DISCUS M26™ systems is the widely accepted CP/M\* 2.0.

See the biggest, most cost-efficient memory ever introduced for S-100 systems, now at your local computer shop. If unavailable locally, write Morrow Designs,™ 5221 Central Avenue, Richmond, CA 94804. Or call (415) 524-2101, weekdays 10-5 Pacific Time.

\*CP/M is a trademark of Digital Research.



MORROW DESIGNS™  
**Thinker Toys™**



SET VER	prints the version number of the SET program.
SET HELP	gives information on the SET command.
SET TT: HELP	gives information on the SET command for a particular device; TT: in this case.
SET TT:	
Option	Description
NOBKS	uses the back-slash character for errors.
BKS	allows back-spacing to correct typing errors.
BKM	causes back-space (control-H) to be treated as a delete.
NOBKM	lets HDOS receive the back-space character.
MLI	maps lowercase input to uppercase.
NOMLI	allows lowercase input to HDOS.
MLO	maps lowercase output to uppercase.
NOMLO	allows lowercase output from HDOS.
NOTAB	HDOS expands TAB (control-I).
TAB	lets terminal expand TABs (faster).
2SB	uses 2 stop bits (universal).
1SB	uses 1 stop bit (normal).
WIDTH n	sets console width to n characters, 80 is default.
FILL c n	sets c as a character that needs n fill characters following it; for slow hardcopy terminals.
SET LP:	
6LPI	sets the H-14 printer for six lines per inch.
8LPI	sets the H-14 printer for eight lines per inch.
PAGE n	sets the number of lines per page to n.
PORT n	sets the port address for LP: to n.
WIDTH m,n	sets the width control switch position
BAUD n	sets the data rate for LP:
SET AT:	same as for TT:
SET SY:	
STEP n	sets the step time between tracks on the disk drive. (The TEST command is used to determine the value of n.)

Table 5: SET command options.

REPLACE "fname"	replaces "fname" with current program, if it exists; works like SAVE if the file doesn't exist.
CNTRL iexp1,iexp2	CNTRL 0 sets a GOSUB to line iexp2 when a CTL-B is typed. CNTRL 1 sets iexp2 digits before exponential format is used. CNTRL 2 controls the H-8 front panel. Does nothing on the H-89. CNTRL 3 sets the width of a print zone to iexp2 columns. CNTRL 4 controls the state of the HDOS system overlay. iexp2 = 0, swap overlay. iexp2 = 1, keep overlay in memory.
FREE	displays the amount of memory assigned to tables and program text.
FREEZE "fname"	saves BASIC interpreter, current program, and data values on the file "fname".
UNFREEZE "fname"	reloads the file saved with a FREEZE command.
LOCK	protects the program by preventing execution of BUILD, BYE, CHAIN, UNFREEZE, DELETE, RUN, SCRATCH, and CLEAR commands.
UNLOCK	reverses a LOCK command.
UNSAVE "fname"	deletes the file "fname" from disk.

Table 6: Extended Benton Harbor BASIC commands not found in other versions of BASIC.

seems incongruous that this system should have such a difficult editor to work with.

### The Assembler

The Heath Assembler is a very straightforward, absolute 8080 assembler (not Z80) with most of the standard assembler directives (ie: DB, DS, DW, END, EQU, ORG, SET, TITLE). The XTEXT directive is used to include whole disk files of assembler text into a program. This is convenient if there are some standard symbols or memory addresses that are to be incorporated into every assembler program, such as HDOS definitions. Also, useful subroutines may be included in this way. This feature may be used as a macro-instruction library facility, because the assembler does not allow macro-

## Printers

## WHOLESALE

## Printers

<b>IDS PAPER TIGER</b> with graphics & 2K buffer Parallel & RS232C	\$ 950.00	<b>RIBBONS</b>	\$ 2.25/ea
<b>OLIVETTI PR 240</b> Thermal 240 LINES per min. serial	950.00		
<b>CENTRONICS 704</b> 180 CPS Serial	1900.00		28.50/6
<b>NEC SPINWRITER (RO) Serial</b>	2900.00		Fabric 35.90/6
Tractor Add	150.00		Carbon 36.90/6
<b>SIEMENS INK JET 270 CPS SERIAL (KSR)</b>	3700.00		
(Call for Parallel prices) (RO)	3500.00		
<b>SPECIALS:</b>			
<b>CENTRONICS 779 Uppercase/Lowercase mod (no soldering)</b>	\$150.00		
<b>CAT MODEM Orig &amp; Answer RS232C</b>	\$185.00		
<b>MEMOREX Soft Sector</b>	5" \$27.50/10	8" \$28.50/10	
<b>DISK HEAD CLEANING KIT 5" or 8"</b>	\$24.00		



We also carry **DISK DRIVES, TERMINALS, COMPUTERS.** and a complete line of **SUPPLIES.** Call for latest catalog and prices.

**BOX 426  
WESTFORD, MA 01886**

**THE WAREHOUSE**  
A subsidiary of **TEELABCO, Inc.**

**617-692-8408**  
TWX 710-342-8467



# “Now you can multiply your computing power as you grow.”

Geof Karlin  
Director of Systems Development



“At ADDS, we’ve just designed a unique computer family that can take you all the way from small to big.

“We call it ADDS Multivision™—a trio of stacking, CP/M®-compatible computers that lets you multiply computing power as needed. Without a change in operating system or programming languages. Without costly conversion. It works like this:

“MULTIVISION 1 (top module) is a get-started computer with 5 MHz processor, 64K bytes of RAM and mini disk storage capacity of 700K bytes. It lists for \$3,785 without terminal.

“MULTIVISION 2 (top and bottom modules) provides 5M or 10M bytes of additional hard-disk storage. Priced thousands less than other hard-disk systems, it lists for \$7,995 with 5M bytes of disk.

“MULTIVISION 3 (entire stack) tops off the line, giving you a multi-user system with up to 256K bytes of RAM that supports up to four display terminals simultaneously.

“We even offer an ADDS-developed package that lets you use Multivision as a word processor.

“Before you decide upon any small computer, look into ADDS Multivision. For years we’ve been the largest supplier of display terminals to computer giants. Now we’re making a system for you.”

For information write: Systems Division, Applied Digital Data Systems Inc., 100 Marcus Boulevard, Hauppauge, N.Y. 11787. Dealer inquiries invited.

CP/M is a registered trademark of Digital Research, Inc.

# ADDS

**SOMETHING EXTRA IN EVERYTHING WE DO**

# MULTIVISION



instruction definitions. A file comes with HDOS called HDOS.ACM. It contains standard HDOS system-call symbols for easily interfacing a user-written program with HDOS and the device drivers.

### Extended Benton Harbor BASIC

Extended Benton Harbor BASIC (herein referred to as EBH BASIC) is Heath's own version of BASIC. It is an extension of Dartmouth BASIC with some unique features. One of the first differences I noticed was the command that initiates automatic line numbering while entering programs. In most versions of BASIC it is called AUTO, but in EBH BASIC it is BUILD. The BUILD command works exactly like AUTO. Another important difference is the lack of a RUN "FNAME" command. If the user wishes to execute a program that is on disk as the file "FNAME", the following must be entered:

```
OLD "FNAME"
RUN
```

To clear the machine of program and data, the command is SCRATCH, not NEW as in most versions of BASIC.

EBH BASIC has some unique and useful commands. (Table 6 lists these special commands and their functions.) But it is not without its problems. Even the most insignificant of syntax errors, such as leaving out a comma or right parenthesis, causes EBH BASIC to display a simple SYNTAX ERROR message. Unfortunately

since it has to access a disk file called ERROR-MSG.SYS to get the text of the error message, the user is forced to wait several seconds to find out what he or she probably already knows. The philosophy of storing error-message text on disk to save space in memory is a useful one, but in this case it severely hampers development of programs. The best approach would be to have the most frequently occurring error messages in memory and then access the disk for the remainder.

### Microsoft BASIC

Microsoft BASIC is widely used and is very standardized. I will not spend time describing its features.

The Heath implementation of Microsoft BASIC does have one significant fault; when a program is loaded from disk, the disk read head is raised and lowered for each and every sector of the file. This produces an annoying banging sound that seems to go on forever. It is also bad for the drive mechanism and will contribute to the wear and tear of the unit.

### Conclusions

The H-89 has flexibility and does not require the user to understand anything about the hardware to take full advantage of all the features. One important point remains: after all the HDOS operating system utilities are put on a single 5-inch floppy disk, there is very little room for any large user programs. To make the system really useful, a second disk drive is a necessity. If the H-89 were to be used in a business with a really large data base, the data would be a tight fit even with two drives. ■

RACET SORTS — RACET UTILITIES — RACET computers — RACET SORTS — RACET UTILITIES — RACET computers — RACET SORTS — RACET UTILITIES — RACET computers —

### MOD II UTILITY PACKAGE

#### Replacement Debug (DEBUG)

35 basic functions + 8 edit commands! Single step or Multiple step. Automatic trace of logic flow with printing of trace, trace of instructions greater than stack pointer values, and rapid trace. Subroutine calling. Automatic program looping. Dynamic disassembly of instructions!!!

#### Directory Catalog System (XDIR)

Build directory of directories!! Sorts by disk or by program. Abbreviated or full form — full form includes dates of creation and last update, and other directory data.

Wild card select options with masks. Build consolidated directory of all GL#?/BAS files. Select on filename and extension. Save or load XDIR catalog files.

Concatenate new data with loaded file.

#### Extended Copy (XCOPY)

Copies multiple files with a single command using masked select options! Source disk may be non-operating system disk. Single drive capability. Recover bad files — Invalid sectors itemized but copy continues.

Merge files with or without replacement.

#### Superzap (SZAP)

Display or print and modify standard TRSDOS diskette track and sector data. Full screen edit mode. Automatic repeat scan and print. Copy disk sectors — any number of sectors to same or other drive.

#### Directory Fix (DFIX)

Automatic repair of HIT tables! List and flag directory errors.

#### Disk Identification (DISKID)

Change diskette names!

#### Extended Create (XCREATE)

Creates and initializes file to end.

### DOCUMENTATION

Complete documentation of above utilities including a full discussion on recovery of lost data on diskettes!!!

Mod II Utility Package \$150 Manual only \$20 refundable

### DEALER INQUIRIES INVITED

WHEN ORDERING PLEASE  
ADVISE PUBLICATION SOURCE

Telephone Orders Accepted (714) 637-5016

TRS-80 IS A REGISTERED TRADEMARK OF TANDY CORPORATION

**RACET COMPUTES**  
702 Palmdale, Orange, CA 92665

### MOD II BASIC CROSS REFERENCE UTILITY

SEEK and FIND functions for:

Variables, Line Numbers, Strings, Keywords

'All' options available for line numbers and variables.

Load from BASIC - Call with <CTRL> R

Output to screen or printer.

#### BASIC CROSS REFERENCE UTILITY \$50

INFINITE BASIC for MOD I TRS-80™ Tape and Disk System

Extensions to Level II and Disk BASIC \$49.95

Full MATRIX functions — 30 BASIC commands!

50 more STRING functions as BASIC commands!

Includes RACET In-memory sorts. Load only functions you want — where you want in memory! More than you expect!

∞ BUSINESS (Requires Infinite BASIC) \$29.95

Automatic printer pagination. Packed decimal arithmetic - 127 digit accuracy. Binary array searches. Hash code.

#### COMPROC Command Processor for Disk Systems \$19.95

Auto your disk to perform any sequence of commands.

#### GSF (Specify 16, 32 or 48K Memory) \$24.95

18 machine language routines including RACET sorts.

#### DISK SORT MERGE (DSM) for MOD I and MOD II

Random file disk sort merge — multi-diskette files. All machine language stand alone package. Sort on up to 15 fields — ascending or descending. Provides optional output field deletion, rearrangement, and padding. Sort an 85K diskette in less than 3 minutes!

DSM for Mod I (Minimum 32K, 2-drives) \$75 on Disk

DSM for Mod II (Minimum 64K, 1 drive) \$150 on Disk

#### Mod II Development Package \$100

Machine language Superzap — Editor Assembler, Disassembler Patches.

#### Mod II Generalized Subroutine Facility \$50

Sort 1000 elements in 6 seconds!

CHECK, VISA, M/C, C.O.D.

Call. Residents add 6%

Telephone Orders Accepted (714) 637-5016

TRS-80 IS A REGISTERED TRADEMARK OF TANDY CORPORATION

RACET SORTS — RACET UTILITIES — RACET computers — RACET SORTS — RACET UTILITIES — RACET computers — RACET SORTS — RACET UTILITIES — RACET computers —



# You'll be a little richer after building one of these.

H-19 Professional Video Terminal



H-8 Personal Computer with Dual Floppy Disk Storage



H-11A 16-Bit Computer with Dual Floppy Disk Storage



H-89 All-In-One Computer with Floppy Disk Storage



H-14 Serial Printer



Self-Instruction for Assembly and BASIC Programming

## Richer in knowledge

Once you build your own computer, you'll know it inside out. You'll know how to make it work for you, how to make it grow as your skills grow.

## Richer in savings

Build-it-yourself kits cost less — about 30% less than comparable assembled computers. And you'll probably never need to pay someone for service because no one will know your computer better than you.

## Is it hard?

Not at all. Heath makes it simple with easy-to-assemble designs and with step-by-step manuals that guide you from unpacking to final plug-in. And a Heathkit helping hand is always just a phone call away.

## Innovative software

Heath offers you innovative programs for running your home or business, and exciting games for your family. You can have Microsoft™ BASIC™, one of the most powerful and widely used languages.

Heath User's Group (HUG) will share with you a library of over 500 programs to make your computer serve you in ways you never imagined.

## Complete hardware

Choose from three computer systems:

The H89 All-In-One Computer gives you everything in one compact, convenient unit.

The flexible H8 gives you the freedom to combine memory and interfacing for exactly the system you require.

And the powerful H11A gives you 16-bit

power for your most complex programs.

The Heathkit line includes video terminals, matrix and letter-quality printers and a complete selection of accessories. You'll even find award-winning self-instruction packages to teach yourself programming in BASIC or Assembly.

## FREE CATALOG



It's all in the new 104-page Heathkit Catalog, along with nearly 400 electronic kits for your home, work or pleasure. Send for your free catalog today, or pick one up at your Heathkit Electronic Center.\*

# Heathkit®

\*Visit your Heathkit Electronic Center in the U.S. or Canada where Heathkit Products are displayed, sold and serviced. See your white pages for the location nearest you. Heathkit Electronic Centers are units of Veritechnology Electronics Corporation in the U.S.

Write to Heath Company, Dept. 334-686, Benton Harbor, MI 49022  
(In Canada write Heath Company, 1480 Dundas St. E., Mississauga, Ont. L4X 2R7)



# The Hard-Disk Explosion

## High-Powered Mass Storage for Your Personal Computer

---

Tom Manuel  
1208 Apollo Way, Suite 502  
Sunnyvale CA 94086

---

High-performance, high-quality, and large-capacity hard-disk drives are now a low-cost reality for your personal-computer system. Most hard disks use *Winchester* media, head technology, and other modern techniques to achieve high density and high performance in a small space. One side effect is low power consumption. Some of the drives suitable for personal computers use the older 14-inch standard diameter platters. Many new drives use one of two

new small sizes—200 mm (7.87 inch) or 210 mm (8.27 inch) diameter—and one new drive uses 130 mm (5.12 inch) platters. Even so, their data capacities are significantly larger than floppy-disk drives of the same approximate size.

The latest disk drives can be divided into two general categories:

- low-cost, relatively low-performance drives that will eventually replace floppy-disk

drives, especially where multiple drives would normally be necessary to obtain enough storage. For example, instead of adding more floppy drives to increase the storage capacity of a system, one set of dual floppy-disk drives might be replaced with an 8-inch hard-disk drive that fits in the same space. This improves the storage capacity and system performance dramatically. These low-end disk products will compete on a cost-per-drive basis.

- high-capacity, top-performance drives that must compete on a cost-per-byte basis. The 8-inch or smaller versions will likely (at least at first) be more costly per byte than the 14-inch models. However, their advantages of small size, light weight, low noise, and low power requirements make them very attractive for desktop and personal computers as well as small business systems.

The Winchester disk-drive technology developed by IBM provided expensive, large-capacity, high-performance, and low cost-per-byte disk subsystems (ie: the IBM 3350 and 3370 disk-drive systems) for large, expensive computer systems. This technology and development in other areas of disk-drive performance are now being applied to the development of products suitable for smaller systems. The tremendous growth of microcomputers has created a de-

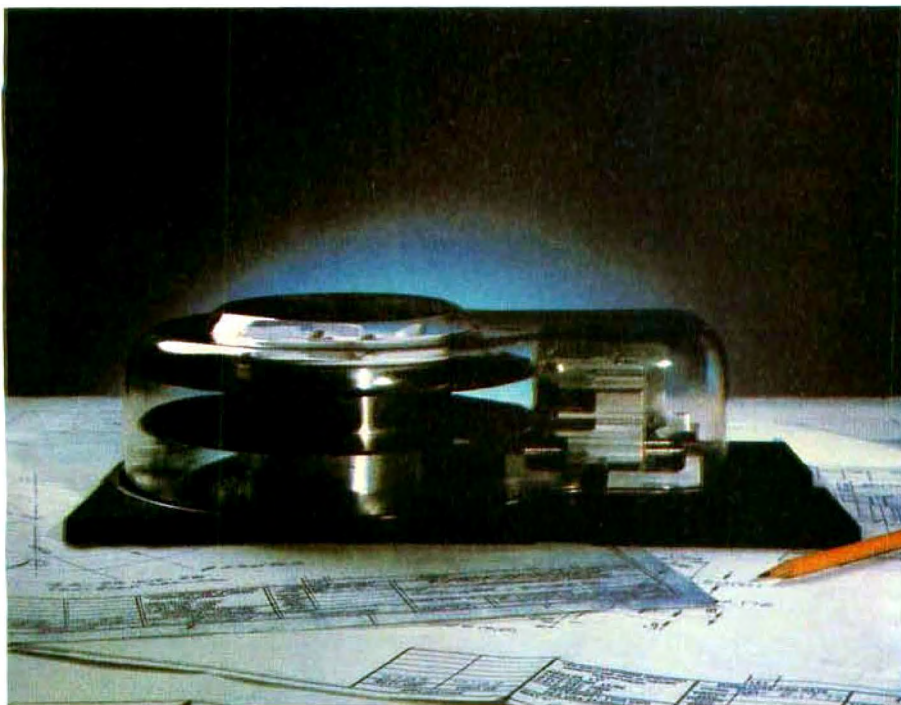

Photo 1: *The Memorex Model 101 hard-disk drive. (Photo courtesy of Memorex.)*



# Grrrraphics.

The Paper Tiger<sup>TM</sup> puts more bite into everything you do.

The Paper Tiger strikes again. With a DotPlot<sup>™</sup> graphics option that lets you make the most of your Apple II,<sup>†</sup> TRS 80,<sup>‡</sup> or other personal computer.

With DotPlot and available software drivers, you can print screen graphics, draw illustrations, write block letters, plot charts. And DotPlot includes an expanded, 2K-byte buffer.

That's not all. Every Paper Tiger gives you 8 software-selectable character sizes. 80 and 132 column formats. Multi-part business forms handling. Forms control. Reliable stepper-motor paper drive. Adjustable width tractor feed. Continuous duty cycle operation. Plus lots more.

<sup>†</sup>Apple II is a trademark of Apple Computer Inc.  
<sup>‡</sup>TRS-80 is a trademark of Radio Shack, a division of Tandy Corp.

The Paper Tiger costs only \$995. The DotPlot option only \$99 more. But don't let these low prices fool you. Because the Paper Tiger is rugged enough to stand up to the most demanding printer-plotter requirements.

For the name of the Paper Tiger dealer nearest you, call toll-free 1-800-343-6412 (except Massachusetts, Alaska, and Hawaii).

Integral Data Systems, 14 Tech Circle, Natick, MA 01760. (617) 237-7610.



Circle 38 on inquiry card.

**Integral Data Systems, Inc.**





mand for small, compact disk drives. The industry has responded and is beginning to produce them. A Winchester disk drive for your personal computer is now, or soon will be, a possibility. However, it may still cost you five to ten times the price of your processor to get a complete small hard-disk subsystem with drive, controller, interface, power supply, and packaging.



Photo 2: Close-up of a Winchester-type read/write head. (Photo courtesy of Kennedy Company.)



Photo 3: The remarkable Shugart Technology Model ST506 hard-disk drive, offering 6 megabytes of mass storage in a 3.5-pound package that fits in the same space as a 5-inch floppy-disk drive. (Shugart Technology is a new company located in Scotts Valley, California, and is not affiliated with either Shugart Associates or Xerox. Photo courtesy of Shugart Technology.)

### What Is Winchester Technology?

Three disk technologies have evolved, all pioneered by IBM. Other manufacturers have refined the designs. These technologies are usually referred to by the model numbers of the original IBM product employing the technology: "2314" technology (in the 1960s), "3330" technology (late 1960s, early 1970s), and "Winchester" technology (1973).

Disk storage, being a special type of add-on memory, can directly affect a computer system's performance, throughput, and reliability. Because of this crucial role, the principal design objectives for disks are large capacity, fast access time, absolute reliability, and low cost.

Each of the three advances has brought a significant increase in storage density. One way to increase density is to reduce the flying height of the heads over the disk surface. Each reduction in height allows an increase in tpi (tracks per inch) and bpi (bits per inch) (see figure 1). Advances in head design and positioning mechanisms have also contributed to increases in tpi and bpi.

Head flying heights have evolved as shown in table 1.

Just prior to 1973, disk-drive technology approached some limits. The flying height had been reduced to 31 microinches. Without further reduction, significant improvement in data density was difficult. At lower flying heights, a single smoke particle, whose diameter may be up to ten times the distance between the head and disk surface, can damage the disk and data. Therefore, cleaner conditions were required. Also, the disk platters and magnetic surfaces were inadequate for large increases in track and bit densities.

The 3340 Winchester disk drive, introduced by IBM in 1973, was the first breakthrough. Storage Technology Corporation announced a similar disk drive around the same time: the STC 8800 superdisk.

### Winchester Characteristics

Winchester disk drives have the following characteristics:

- sealed disk, head, and positioning assemblies
- new trimaran head design—two outriggers supporting a narrower inner hull containing the read/write head (see photo 2)

- thinner magnetic coating: 44 microinches versus 185 microinches in the 2314 disk drive
- lubricated disk surfaces
- heads resting on disk surface when drive is stopped—they take off and fly low when motion starts (normal take-off and landing are done on an area reserved for that purpose)
- light loading force (10 g) and lighter heads.

These characteristics permit many performance improvements: very low flying heights (19 to 20 microinches), improved reliability, and a dramatic reduction in head crashes are possible because of the clean environment, new head and loading designs, and lubrication. Data densities are increased because of lower flying height and thinner platter coating. The higher densities improve throughput performance directly. More bits per inch allow more data to pass under the heads per unit time. More tracks per inch mean that track-to-track access times are shorter. The lighter heads and head mounts have less inertia and can be positioned faster. Throughput performance can be improved by increasing the rotational speed, up to a point—the aerodynamic characteristics of the flying head put some constraints on the rotational speed. The reliability of the Winchester drives surpassed that of any moving-head disk drive that was previously available.

Improvements and refinements have continued from many manufacturers. The costs of many of the most expensive elements in a disk (the motor, head actuator, and control electronics) are relatively independent of the capacity of the disk platters. It is, therefore, cost-effective to increase the density of the platters and the number of platters. The incentive has been to add capacity by any conceivable means, and trends have been toward more platters per spindle and greater bpi and tpi densities (data density has gone from about 1000 bpi on early 2314s to over 8600 bpi on some of the recent disks, and tpi density has gone from 200 tpi on 2314s to over 600 tpi on new products). Cost effectiveness has also been enhanced by reducing the access time and increasing the data flow; the economic payoff is increased throughput and efficiency of the total



# Hard and Fast...



## ...Bulk Storage from Industrial Micro Systems

### THE NEW MODEL 16

The new Industrial Micro Systems Model 16 HardDisk Subsystem is a "fixed-removable" high speed, bulk storage device providing from 32 megabytes (32 million characters) to 96 megabytes of on-line storage for the Industrial Micro Systems 8000 or Series 5000 microcomputer systems. The Model 16 includes a credenza enclosure that provides a quiet, strong and attractive package for office or industrial applications where large memory is required. The Model 16 also includes a fully buffered DMA S-100 bus controller for fast and easy interfacing.

### WINCHESTER TECHNOLOGY WITH BUILT-IN BACKUP

The Model 16 includes a 16 megabyte removable cartridge and a 16, 48, or 80

megabyte fixed media that employs Winchester 3340 technology. Files and programs may be copied between the fixed media and the removable cartridge for fast, easy backup and archival storage.

### FAST ACCESS

The interface between the Model 16 hard disk and the Industrial Micro Systems computer is provided by the Hard Disk Controller. The Hard Disk Controller utilizes Direct Memory Access (DMA) for fast data transfer with minimum processor intervention. The maximum data transfer rate is 1.2 megabytes per second and the controller fully buffers the data, a sector at a time, to and from the disk. **Available in 220 V, 50 HZ Versions**



Now you don't have to look hard for fast computing power. Contact your Industrial Micro Systems Dealer today.

## INDUSTRIAL MICRO SYSTEMS

### Marketing

628 N. Eckhoff, Orange, CA 92668  
(714) 978-6966

### Manufacturing

2800 Lockheed Way, Carson City, NV 89701  
(702) 883-7611



system. In applications where disk storage is a key element, the processor is often disk-I/O-bound. Program execution speed depends on disk speed. Every increase in throughput will improve the total performance.

Other improvements in throughput performance in disk subsystems have

come from RPS (rotational positioning sensing), which frees the disk controller and I/O (input/output) channel for other work during seek time (head actuator movement) and during part of the rotational delay time. Improvements have also included new automatic error detection, correction, and recovery capabilities built into disk controllers.

*Voice-coil actuators*, described in the next section, are common on high-performance disk drives. There are both linear and rotary voice-coil positioners. Rotary voice coils typically take up less space, require less power, and generate less heat than linear voice coils. Stepper motors with band actuators are usually used in lower-performance, lower-cost disk drives. Many of the new small drives use brushless DC (direct current) motors with direct drive on the platters. Designed as part of the spindles, these motors are compact (about 1 inch high), maintain speed more accurately, use less power, and require simpler power supplies than AC (alternating current) motors with belt drives. In many drives, each recording surface is split into inner and outer bands with a head for each band, reducing the average access time by one-half,

because twice the amount of data can be read or written without moving the heads.

### Comparing the New Hard Disks to Floppy-Disk Drives

The current trends toward multi-terminal systems, real-time transaction oriented systems, small business systems, and more powerful personal computers for a great variety of applications have created a demand for more on-line data storage. Floppy-disk drives and tape cassettes often do not have the required performance (access times, throughput, etc), reliability, or capacities. Thus, the need for secondary storage is being filled by new, inexpensive, high-performance, highly reliable small-disk drives with capacities, speeds, and reliability close to the very expensive drives. These new drives are physically much smaller and more reliable than 14-inch cartridge or disk-pack drives. They are aimed initially at a gap between floppy drives and 14-inch drives (eg: Winchester, 5440 cartridges and 3330 type packs). They are designed for use on small business systems, distributed-processing systems, word-processing systems, and advanced personal computer systems.

The new drives offer a lower cost per unit than 14-inch drives, and lower cost per byte than floppy-disk drives. They provide the advantages in capacity and performance of hard disks in a package the same size as an



Photo 4: BASF Systems' 6170 Series 8-inch, fixed hard-disk drive, available in 8- and 24-megabyte versions. (Photo courtesy of BASF.)

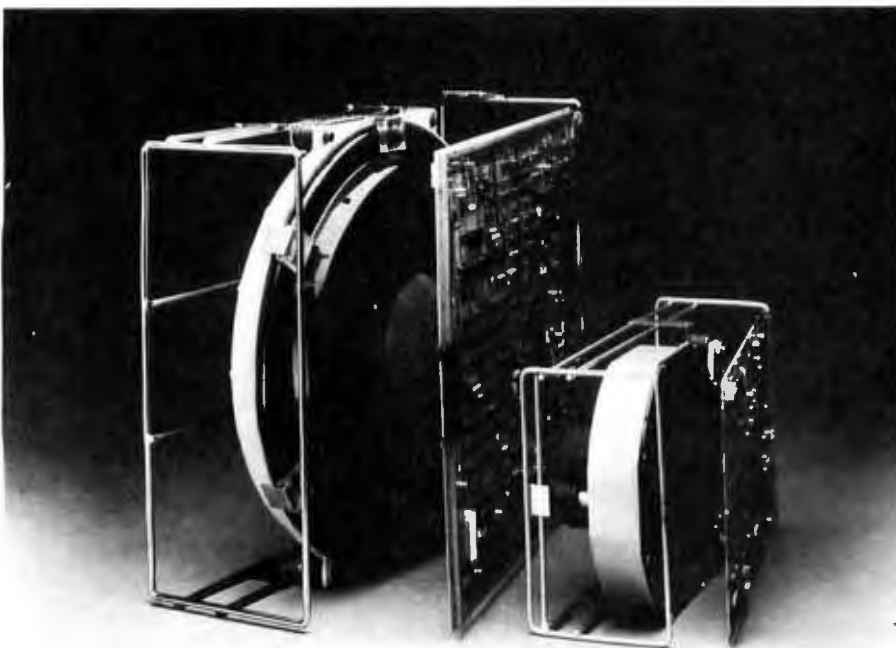

Photo 5: Priam 14-inch (at left) and 8-inch Winchester hard-disk drives. (Photo courtesy of Priam.)



Photo 6: Kennedy Series 7000 8-inch hard-disk drive. (Photo courtesy of Kennedy Company.)



# UniFLEX™



## Multi-User

UniFLEX is the first full capability multi-user operating system available for microprocessors. Designed for the 6809 and 68000, it offers its users a very friendly computing environment. After a user 'logs-in' with his user name and password, any of the system programs may be run at will. One user may run the text editor while another runs BASIC and still another runs the C compiler. Each user operates in his own system environment, unaware of other user activity. The total number of users is only restricted by the resources and efficiency of the hardware in use.



## Multi-Tasking

UniFLEX is a true multi-tasking operating system. Not only may several users run different programs, but one user may run several programs at a time. For example, a compilation of one file could be initiated while simultaneously making changes to another file using the text editor. New tasks are generated in the system by the 'fork' operation. Tasks may be run in the background or 'locked' in main memory to assist critical response times. Inter-task communication is also supported through the 'pipe' mechanism.



## Support

The design of UniFLEX, with its hierarchical file system and device independent I/O, allows the creation of a variety of complex support programs. There is currently a wide variety of software available and under development. Included in this list is a Text Processing System for word processing functions, BASIC interpreter and precompiler for general programming and educational use, native C and Pascal compilers for more advanced programming, sort/merge for business applications, and a variety of debug packages. The standard system includes a text editor, assembler, and about forty utility programs. UniFLEX for 6809 is sold with a single CPU license and one year maintenance for \$450.00. Additional yearly maintenance is available for \$100.00. OEM licenses are also available.

# FLEX™

UniFLEX is offered for the advanced microprocessor systems. FLEX, the industry standard for 6800 and 6809 systems, is offered for smaller, single user systems. A full line of FLEX support software and OEM licenses are also available.



Box 2570, West Lafayette, IN 47906  
(317) 463-2502 Telex 276143

™UniFLEX and FLEX are trademarks of Technical Systems Consultants, Inc.

Circle 40 on inquiry card.



*The days of complicated, unreliable, dynamic RAM are gone:*

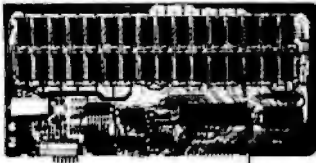

# INTRODUCING JAWS

the ultrabyte memory board

**\$199.95** (complete kit with 16K memory)

Netronics consistently offers innovative products at unbeatable prices. And here we go again — with JAWS, the ultrabyte 64K S100 memory board.

### ONE CHIP DOES IT ALL

JAWS solves the problems of dynamic RAM with a state-of-the-art chip from Intel that does it all. Intel's single chip 64K dynamic RAM controller eliminates high-current logic parts... delay lines... massive heat sinks... unreliable trick circuits.

### REMARKABLE FEATURES OF JAWS

Look what JAWS offers you: Hidden refresh... fast performance... low power consumption... latched data outputs... 200 NS 4116 RAMs... on-board crystal... 8K bank selectable... fully socketed... solder mask on both sides of board... designed for 8080, 8085, and Z80 bus signals... works in Explorer, Sol, Horizon, as well as all other well-designed S100 computers.

**GIVE YOUR COMPUTER A BIG BYTE OF MEMORY POWER WITH JAWS — SAVE UP TO \$90 ON INTRODUCTORY LIMITED-OFFER SPECIAL PRICES!**

UNDECIDED? TRY A WARED 16K JAWS IN YOUR COMPUTER ON OUR 10-DAY MONEY-BACK OFFER (SPECIFY YOUR COMPUTER).

CONTINENTAL U.S. CREDIT CARD BUYERS OUTSIDE CONNECTICUT CALL

**CALL TOLL FREE 800-243-7428**

From Connecticut Or For Assistance, (203) 354-8375 Dept. 88

**NETRONICS RESEARCH & DEVELOPMENT LTD.**  
333 Litchfield Road, New Milford, CT 06776

Please send the items checked below:

- JAWS 16K RAM kit, No. 6416, \$199.95.\*
- JAWS 16K RAM fully assembled, tested, burned in, No. 6416W, \$229.95.\*
- JAWS 32K RAM kit, No. 6432, (reg. price \$329.95), SPECIAL PRICE \$299.95.\*
- JAWS 32K RAM fully assembled, tested, burned in, No. 6432W, (reg. price \$369.95), SPECIAL PRICE \$339.95.\*
- JAWS 48K RAM kit, No. 6448, (reg. price \$459.95), SPECIAL PRICE \$389.95.\*
- JAWS 48K fully assembled, tested, burned in, No. 6448W, (reg. price \$509.95), SPECIAL PRICE \$449.95.\*
- JAWS 64K RAM kit, No. 6464, (reg. price \$589.95), SPECIAL PRICE \$499.95.\*
- JAWS 64K RAM fully assembled, tested, burned in, No. 6464W, (reg. price \$649.95), SPECIAL PRICE \$559.95.\*
- Expansion kit, JAWS 16K RAM module, to expand any of the above in 16K blocks up to 64K, No. 16EXP, \$129.95.\*

\*All prices plus \$2 postage and handling. Connecticut residents add sales tax.

Total enclosed: \$

- Personal Check  Money order or Cashiers Check
- VISA  MASTER CHARGE (Bank No. ....)

Acct. No. \_\_\_\_\_ Exp. Date \_\_\_\_\_

Signature \_\_\_\_\_

Print Name \_\_\_\_\_

Address \_\_\_\_\_

City \_\_\_\_\_

State \_\_\_\_\_ Zip \_\_\_\_\_

Send me more information

8-inch or even a 5-inch floppy-disk drive—many will actually fit the panel openings for floppy-disk drives. Reliability will be better than with floppy and cartridge drives, and power consumption will be significantly lower than that of the 14-inch drives.

Systems based on 16-bit processors or microcomputers often require much more and much faster secondary storage than floppy disks can provide. The more sophisticated multiprogramming and file-management software currently being added to small computer systems requires so much continuous use of mass storage that the high perfor-

mance and durability of hard disks may soon be a necessity.

The new 8-inch and 5-inch disk drives offer several advantages over both floppy and 14-inch hard drives:

- They have five to sixty times the storage capacity of a floppy-disk drive in the same space.
- They access data four times faster than the floppy-disk drive.
- They weigh less, take up less space, and use less power than 14-inch drives.
- They are only three to five times more expensive than floppy-disk drives, with cost reductions likely.

The availability of low-cost-per-function hard disks has long been awaited by the small system marketplace. The wait is all but over. This summer a score of products are scheduled to be available, at least in sample or evaluation quantities.

Though many of the new small disk products are advertised as fitting the same 4.6 by 8.5-inch opening as the standard floppy-disk drive (Shugart Technology's 5-inch Micro Winchester fits a 5-inch floppy-drive opening, see photo 3), a floppy-disk drive cannot literally be pulled out and replaced by the hard drive. To begin with, the packages contain different electronics. Most of the drives

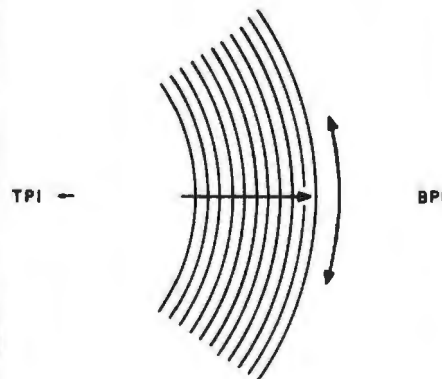

Figure 1: Detail of hard-disk surface, illustrating the ideas of tpi and bpi.

	2314	3330	Winchester
Head flying height (in microinches)	100 to 120	31 to 45	19 to 20

Table 1: Evolution of head flying heights in hard-disk drives.

	Floppy-Disk Drives	Hard-Disk Drives, Cartridges and Disk Packs
Standard platter diameters	8-inch 5-inch	14-inch, 8-inch, and 5-inch
Capacity	100 K bytes to 1 megabyte	2 megabytes to 300+ megabytes
Average Access Time	0.1 to 1 second	25 to 70 ms
Rotational Speed	300 rpm	2400 to 4700 rpm
Reliability and Useful Life Relative to Floppy-Disk Drives	1	2+

Table 2: Technical comparisons between floppy-disk drives and hard-disk drives, cartridges, and disk packs.



# Look what's happened to HIPLØT™



It's grown into a complete family of quality low cost digital plotters

*Yes, they are UL listed! \*\**

In just two short years, The HIPLØT has become the most popular digital plotter among small systems users. With a record like that, what can we do for an encore? WE'VE INTRODUCED A COMPLETE LINE OF HIPLØTS...with a model suited for just about every plotting application.

The HIPLØT DMP Series is a new family of digital plotters with both "standard" and "intelligent" models available with surface areas of 8½" x 11" (DIN A4) and 11" x 17" (DIN A3). For the user needing a basic reliable plotter, we have the "old standard" DMP-2 (8½" x 11") and the "new standard" DMP-5 (11" x 17"). For those needing a little more capability, there are the DMP-3 (8½" x 11") and the DMP-6 (11" x 17")—both

microprocessor controlled and providing easy remote positioning of the X and Y axes (perfect for the OEM). For those who want this intelligence plus the convenience of front panel electronic controls, we've provided the DMP-4 (8½" x 11") and the DMP-7 (11" x 17").

The "standard" plotters come complete with an RS-232-C and a parallel interface. The "intelligent" DMP plotters accept data from either an RS-232-C or Centronics data source. For the "standard" plotters, software is available from our ever expanding "Micrographic Users Group." The "intelligent" HIPLØTs use our exclusive DM/PL™ language which minimizes plot software to a fraction of that normally as-

sociated with digital plotting.

With the new DMP Series, high quality digital plotting can now be a part of your system. It just doesn't make sense to be without this valuable tool when there is a DMP plotter with the plot size, speed and capabilities that are exactly tailored to your specific needs...and your budget.

Prices for the DMP series range from \$1,085\* to \$1,985\*. For complete information and descriptive literature, contact Houston Instrument, One Houston Square, Austin, Texas 78753. (512) 837-2820. In Europe contact Houston Instrument, Rochesterlaan 6 8240 Gistel, Belgium 059/277445. For rush literature requests and sales office information, persons outside Texas call toll free 1-800-531-5205.

**houston instrument**

GRAPHICS DIVISION OF

**BAUSCH & LOMB**



™ HIPLØT and DM/PL are Trademarks of Houston Instrument

Circle number 42 for literature  
Circle number 216 to have a representative call

\*U.S. suggested retail prices only.  
\*\*DMP 2, 3 and 4 UL listed  
DMP 5, 6 and 7 UL listing pending



	Memorex Corporation Santa Clara CA	New World Computer Co Inc Costa Mesa CA	Shugart Associates Sunnyvale CA	Shugart Technology Scotts Valley CA
Model	101	211	SA1002/SA1004	ST506
Unformatted Capacity (millions of bytes)	11.7	2.1	5.33/10.67	6.38
Platter Size millimeters and (inches)	200 (7.87)	8 inch	200 (7.87)	130 (5.12)
Number of Platters	2	1	1 or 2	2
Average Access Time	70 ms	18.825 ms	70 ms	170 ms
Maximum Data Transfer Rate (K bytes per second)	—	756	543	625
Average Latency	10.1 ms	8.825 ms	9.6 ms	8.3 ms
Rotational Speed	2964 rpm	3600 rpm	3125 rpm	3600 rpm
Motor Type	DC	—	AC	brushless DC
Spindle Drive	direct drive	—	belt drive	direct drive
Actuator Type	high speed band	simplified band	band	band
Positioning Mechanism	open loop stepper motor	stepper motor	stepper motor	open loop stepper motor
Density bpi	6100	8000	6270	7690
Density tpi	195	100	172	254
Physical Size (inches)	4.38 by 8.55 by 14	2 by 9.5 by 9.5	4.62 by 8.55 by 14.25	3.25 by 5.75 by 8
Weight (pounds)	10	8	17	3.5
Single Quantity Price	—	\$4,500	\$1,600/\$1,980	\$1,500
OEM Discount Price	\$1,200 <sup>1</sup>	\$1,250	\$1,140/\$1,400	\$925
Cost Per Thousand Bytes (OEM Discount)	\$.103	\$.595	\$.214/\$.131	\$.145
Comments	<sup>1</sup> Includes a data separator	20 heads, 8 tracks per head. Low-end only in capacity, not in performance.		First micro Winchester Drive. Fits 5-inch floppy space

Table 3: Specifications and characteristics of low-end, 5-inch and 8-inch hard-disk drives.

have the basic drive electronics, signal amplifiers, read/write electronics, and motor and servo control circuitry integrated into the package. Some have room to add optional, separately priced controllers to do error-checking and correction, data formatting, and interfacing to the computers.

Stepper-motor actuators are a technique borrowed from floppy drives for use in hard-disk drives. This idea allowed lower prices for Winchester-technology units such as the 14-inch Shugart SA4000 and Century Data Systems Marksman, but at a cost of greater access time and reduced storage capacities when compared with voice-coil actuator-based units.

A voice-coil actuator is a cylindrical, permanent magnet with a hole

machined from pole to pole. A coil rides on bearings within the magnet and moves back and forth. The read/write positioning mechanism with electromagnetic heads is attached to the coil. A voice-coil actuator is positioned by servo-control with servo tracks written on one platter's surface at the factory.

Voice-coil actuators allow increases in data-storage capacity because their accuracy in small movements allows high tpi densities. Since the distance between tracks is smaller, access time is reduced. Also, voice-coil actuators do not impose the additional penalty of settling time.

One disadvantage of a voice-coil actuator is the magnetic field produced by the coil: the coil's magnetic field must not get too close to the disk

platters or it could erase them. Efficient design can keep the magnetic field intensity at a safe level near the recording surfaces. Table 2 gives a partial technical comparison between floppy-disk drives and hard disks.

### Future Technological Progress

Some of the more recent developments in heads (such as thin film heads) and disks (thin-film-plated disks) mean that data densities will probably advance from the presently attainable 8 to 10 megabytes per 8-inch surface to 50 or more megabytes per surface as track densities of 1000 tpi and bit densities of 10,000 bpi are achieved. A small, relatively inexpensive disk drive could then store 100 megabytes or more of data with an additional 100 megabytes added for nominal cost. Thin-film



# AIM 65. The professional's microcomputer.



Printer, display, full keyboard. Under \$500.00.

**MICRO  
POWER**

For professional learning, designing and work, Rockwell's AIM 65 microcomputer gives you an easy, inexpensive head start. That's Rockwell Micropower!

- 20-column printer and display
  - Dual cassette, TTY and general purpose I/Os
  - R6502 NMOS microprocessor
  - System expansion bus
  - Read/write RAM memory
  - Prom/ROM expansion sockets
  - Self-prompt interactive monitor firmware
  - Big terminal-style keyboard
- For more on AIM 65 and how

you can develop programs in assembly language or BASIC, write Rockwell International, Microsystems, RC 55, P.O. Box 3669, Anaheim, CA 92803 or contact your local Rockwell distributor. For application information call (714) 632-3729. For location of nearest dealer call 800-854-8099, in California 800-422-4230.



**Rockwell International**

...where science gets down to business



technology may be the next breakthrough in mass-storage techniques.

Secondary storage and storage backup are currently being supplied by a wide variety of devices, including

- cassette tapes
- 8-inch floppy-disk drives
- 5-inch floppy-disk drives
- reel-to-reel magnetic tapes
- cartridge magnetic tapes
- cartridge-disk drives
- disk-pack drives
- fixed storage Winchester drives
- combinations: fixed Winchester-disk/cartridge-disk drive or fixed Winchester/magnetic-tape cartridge
- streaming-tape drives
- bubble memories
- nonvolatile semiconductor programmable memory
- videocassette recorders
- video disks

The last three or four types are more for the future than now. Bubble memories and nonvolatile integrated circuits will have the great advantage of no moving parts and the potential convenience of plug-in modules; but

they are still quite expensive. At least one interface and controller for American and European standard VCRs (videocassette recorders) is available to provide removable backup for high-capacity disks on small systems (the Corvus Mirror, manufactured by Corvus Systems Inc, San Jose, California). It stores up to 100 megabytes on one videocassette and has a transfer rate of 15 K bytes/second. Video disks have the potential to offer extremely high data-storage capacity and fast access rates (up to 1250 megabytes per 12-inch disk, equal to approximately four times the contents of the Encyclopaedia Britannica).

### Small vs Large Hard-Disk Drives

Hard-disk drives for small systems fall roughly into two size categories: up to 12 megabytes and over 12 megabytes; and two performance categories: slow, with stepping-motor positioning, and fast, with voice-coil positioning. Those with stepping-motor positioning have average access times of 70 ms and capacities of under 12 megabytes. The drives with fast voice-coil positioning have

average access times ranging from 25 ms to 50 ms, with models that fall into both size categories. The less expensive units are aimed at replacing floppy-disk drives directly. Examples of this type of product are the Memorex 101, the Shugart Associates SA-1000 series, and the Shugart Technology ST 506. The high end is led by IBM with the Piccolo drive, which is integrated into the System 34, and is an add-on peripheral for the Series 1. It features a rotary voice coil, 17 ms average access time, and up to 64.5 megabytes of storage capacity. Other contenders in this category offer high performance in a wide range of sizes (eg: the BASF Systems 6170 Series, IMI (International Memories, Inc) 7700 Series, Kennedy Company 7000 Series, Microcomputer Systems MSC-8000, Micropolis Corporation Micro Disk 1200 Series, Perdec Computer Corporation D-8000, and Priam Diskos 2050/3450).

The disk capacity and the performance you need depend on your particular application, which in turn has a significant impact on the cost of a system. Small-system applications, as

## PRINTERS & CRT'S From Orange Micro



**base 2 inc.**

IMPACT PRINTER



**\$649.00**

"The base 2 outperforms every printer in its price range. Do a comparison and see for yourself..."

★ GRAPHICS ★ TRACTORS / FRICTION FEED

- 2K Input Buffer • RS-232 Serial, Centronics® Parallel, IEEE-488, 20 ma • TRS-80 Cable option • 60 LPM - 100 CPS • Fast form feed • User programmable character set • 64, 72, 80, 96, 120, 132 Columns / line • Expanded characters • 9.5" wide paper • Automatic skip-over-perforation • Horizontal & Vertical tabs • Programmable vertical line spacing • Intel 8085 Microprocessor — over 40 software commands • Self test • 15 Baud rates to 9600 Baud • Optional foreign character sets

Interfaces to TRS-80, Apple, Atari, PET, Northstar, and most other computers.

Circle 44 on inquiry card.



### TELEVIDEO CRT'S PRICES SLASHED!

912C \$ CALL  
920C \$ CALL

### PRINTERS

<b>AXIOM</b>	<b>OKIDATA</b>
IMP-1 ..... 629	Microline 80 ..... 659
IMP-2 ..... 715	w/tractors ..... 779
Other models ..... \$ Call	
<b>CENTRONICS</b>	<b>PAPER TIGER</b>
779 w/tractors ..... 1059	IDS 440 ..... 869
730 ..... \$ Call	w/graphics ..... 959
737 ..... \$ Call	
<b>COMPRINT</b>	<b>QUME</b>
912 Parallel ..... 499	Letter Quality 5/45 ..... 2499
912 Serial ..... 535	w/tractors ..... 2684

**TOLL FREE (800) 854-8275**

**CALIF. ONLY (714) 630-3322**

Call for FREE CATALOG

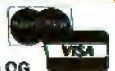

Phone orders WELCOME. Same day shipment for VISA, MASTER CHARGE, and AMERICAN EXPRESS. Personal checks require 2 weeks to clear. Add 3% for shipping and handling. California residents add 6%. Manufacturer's warranty included. Prices subject to revision.

**Orange Micro**



P.O. Box 2076  
Yorba Linda, CA 92686



# What's the difference between BASIC and Pascal?

## COMPARE THESE APPROACHES TO DRAWING A CIRCLE

### in BASIC

"This is easy..."

```
100 MOVE R,0
110 FOR T=0 TO 360 STEP 25
120 DRAW R*COS(T), R*SIN(T)
130 NEXT T
```

"Oops, didn't quite meet..."

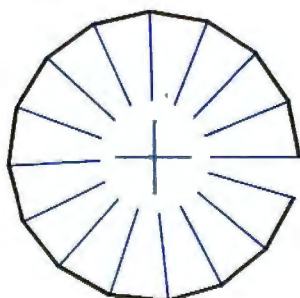

... but that's easy to fix."

```
100 MOVE R,0
110 FOR T=0 TO 360 STEP 25
120 DRAW R*COS(T), R*SIN(T)
130 NEXT T
```

"Oh, now it closes...  
in fact, it overlaps."

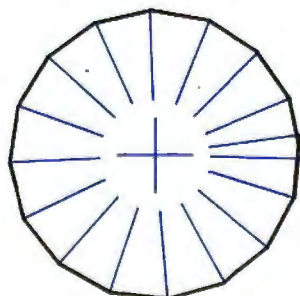

Programming by trial and error

### in Pascal

"The simplest circle drawn with line segments is a regular polygon..."

```
procedure Circle (X, Y, Radius: real);
const Sides = 16; Pi = 3.14159265;
var N: integer; Theta: real;
begin
  Move (X+Radius,Y);
  for N := 1 to Sides do begin
    Theta := 2 * Pi * (N/Sides);
    Draw (Radius * cos (Theta) + X,
          Radius * sin (Theta) + Y);
  end;
end;
```

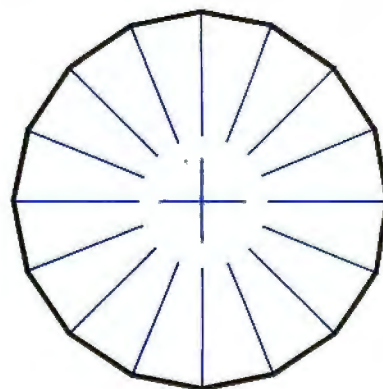

Programming by design

## GET IT RIGHT THE FIRST TIME

### INTERNATIONAL DISTRIBUTORS

Australia: Sydney  
Network Computer Services  
290-3677

Canada: Vancouver  
Valley Software  
(604) 281-0851

England: London  
Real Time Products  
01-588-0867

Japan: Tokyo  
Rikel Corporation  
03-345-1411

If you like the feel of precision tools, give us a call or return this coupon.

# Oregon Software

2340 SW Canyon Road • Portland, Oregon 97201  
(503) 226-7760 • TWX 910-464-4779

Name \_\_\_\_\_

Firm \_\_\_\_\_

Address \_\_\_\_\_

City \_\_\_\_\_

State \_\_\_\_\_ Zip \_\_\_\_\_

By 8



mentioned before, can be placed in two major classes: *single-user, single-task* and *multi-user, multi-task*.

- Single-user, single-task systems are usually stand-alone workstations, intelligent terminals, or personal computers. Their chief use of magnetic storage, in general, is for program storage and data storage. The amount of storage required is often less than 10 megabytes. Because the speed need only match one human operator's response time, there is no benefit to be derived from disks with extremely fast access times. An average access time of 70 ms is usually sufficient in such applications. This class of application is cost-per-unit-oriented, since the storage device is dedicated to one user. It is price-oriented, and performance is not a vital factor. The low-end, small hard-disk drives fill this need splendidly.
- Multi-user, multi-task systems require that more than one, sometimes many, users have access to a common data base.

They typically require from 30 to 100 megabytes of magnetic storage, usually on one spindle. Some require less storage and some will require multiple spindles. The cost per byte of storage is a more important consideration than the cost per drive unit, because the basic device cost is spread over many users.

Multi-user, multi-task systems require an average access time of 50 ms or less because multiple users must contend for the common storage device. The main purpose of these applications is usually not to share the processing power, but rather to share the data. These systems are often "disk-bound" rather than "computer-bound." Disk performance becomes a critical factor in system performance. Even when the disk capacity required might be relatively small (8 to 10 megabytes), the fast performance of the high end mini-disks will be required.

With their faster access times, higher capacities, greater reliability and OEM (original equipment manufacturer) quantity prices ranging from

\$1000 to \$5000 (some may soon drop below \$1000), both classes of the new hard-disk drives should be attractive to personal-computer systems builders who want additional capacity and performance, but not the traditional 14-inch disk size and price per unit. Some complete packages of drives, controllers, interfaces, and power supplies are available for about \$5000. Even though they cost five to ten times as much as the processor, these units are still cheaper per drive than 14-inch drives. They are also applicable where more capacity and performance than a floppy disk can supply are needed, but the space or the cost of a 14-inch disk drive is prohibitive. Tables 3, 4, and 5 list some of the current disk-drive products for small systems. The reliability and maintainability of these products are essentially high and are consistent across the board. (See table 6.)

### Controllers and Interfaces

One of the problems with the new 8-inch hard-disk drives is the variety of interface systems to choose from. Such variety is inevitable at this stage because of the many personal computers already on the market, and the diversity of interface requirements. In the absence of a comprehensive interface standard, many of the drive suppliers have designed their own. A similar situation has developed in the audio industry. Consider the many types of noncompatible audio recording standards including: the LP (long-playing) record, 45 rpm records, open reel tapes, cassettes, and eight-track cartridges. This kind of variety at the outset of new products is not necessarily bad—there is much freedom for innovation.

In August of 1979 an ANSI (American National Standards Institute) Subcommittee (number X3T9.3) began to standardize an interface for 8-inch hard disks. If a standard interface is widely accepted by the industry, users may soon be able to interface drives from several vendors.

### Types of Interfaces

There are two main categories of disk-drive interfaces, *device level* and *host level*. The main characteristics for the device level are:

- serial data transfer
- formatting/de-formatting external to drive

*Text continued on page 138*

# SUPERPASCAL PLUS!

New Features.  
Relocatable Object Modules.  
Reduced Compile Time. AND MORE!

Meet our new, improved Pascal/Z™. The true Z-80 compiler that's 5-10 times faster than P-code, and produces ROMable re-entrant code for true multi-tasking capability.

Our new compiler adds features like variant records, strings and random access. Also included are an improved macro-assembler that generates Microsoft-compatible relocatable object modules; a linker/loader and source on the full library. All six programs on a CP/M®-compatible disk, \$395. (Other formats and OEM licenses available.) For more information, call or write.

## InterSystems™

Ithaca Intersystems, Inc., 1650 Hanshaw Road/P.O. Box 91,  
Ithaca, NY 14850 • 607-257-0190/TWX: 510 255 4346

© 1980, Ithaca Intersystems Inc. CP/M registered trademark of Digital Research



# COMPUTERS—TERMINALS—MODEMS!

**NEW!**

## TI-99/4 Home Computer



Optional color monitor  
\$449

Main console unit  
\$889

(Includes RF modulator for use with any TV)

Write for a list of extensive program modules available—everything in games, education, and home computer applications.

**NEW!**

## From Perkin-Elmer 1250 Super Owl

\$1799



Intelligent CRT

Incredibly powerful and flexible

- 24 fully programmable function keys
- Full screen editing capabilities
- RAM memory for down line loading by host computer
- Built-in printer port
- Full polling capabilities
- Detachable keyboard
- Optional light pen
- Much more!

## Penril 300/1200 Modem

Connect any computer or terminal to the phone lines

- 1200 Baud—Bell 212A **\$799**
- 300 Baud
- Originate/Auto answer
- Full duplex
- RS232
- 1 year warranty



Direct connection to the phone lines via RJ11C standard extension phone jack

## USR-330 Modem

- 0-300 Baud—Bell 103/113
- Originate/Auto answer
- Half/Full duplex
- RS232
- 1 year warranty

**\$339**



Direct connection to the phone lines via RJ11C standard extension phone jack

## USR-1600P Computer

**NEW!**

\$4099



**PASCAL**

With **power** and **speed** for business, educational, and scientific applications.

W.D. Microengine™-based single board computer with 64K RAM

- 1 megabyte of floppy disc
- 2 parallel ports
- 2 serial ports
- Floppy disc controller with DMA
- File manager
- Screen oriented editor
- Single cabinet design
- Includes power supply

## Perkin-Elmer Bantam 550 CRT

\$749



- Transparent mode
- Addressable cursor
- Editing functions
- Upper/lower case
- Compact

## The Phone-Link Acoustic Modem **NEW!**

**\$179**

- Sleek, low profile
  - 0-300 Baud
  - Originate/Answer modes
  - Half/Full duplex
  - Self-test
  - RS232—Will work with any RS232 computer or terminal
  - LED displays of all functions
  - 1 year warranty
- At your computer store now!

## Perkin-Elmer 650/655 CRT Page Printer

- 100 CPS
- Quiet
- Compact
- RS232

Can be added to any CRT with our interface option.

**\$999**

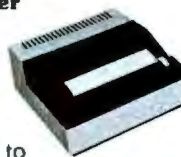

The printer designed to give you rapid, reliable, hard copy of your CRT screen display.



## DEC LA34

**\$995**

- Teletype 43 plug compatible
  - Variable character sizes
  - Full width paper
  - Many more features
- Write for print sample

**Teletype Model 43KSR \$1049**  
**Microterm Mime IIA CRT \$819**  
**Microterm ACT VA . . . . . \$779**



We offer full service, on-site maintenance plans on all equipment. Any product may be returned within 10 days for a full refund.

**U.S. ROBOTICS INC.**  
1035 WEST LAKE ST., CHICAGO, ILL. 60607

SALES  
GENERAL OFFICES  
SERVICE

(312) 733-0497  
(312) 733-0498  
(312) 733-0499



ONE PROGRAM  
THAT DOES IT ALL!

REPORT

CREATE

LABEL

High Tech's  
DATA BASE MANAGEMENT SYSTEM

MODIFY

UPDATE

SORT

DELETE

SELECT

Now you can organize and manipulate large amounts of related data to meet YOUR application needs. DBMS's user-designed system layout and report format allows for wide-range flexibility and utility, making this a truly multi-purpose, highly individualized program.

All this, plus High Technology's unsurpassed combination of performance, clarity, and quality in an affordable program that does it all.

Software with

HIGH TECHcitement

Exciting business solutions using the Apple II.™ See your dealer or write High Tech for details.

High Technology, Inc.™

P.O. Box 14665 - Oklahoma City, Oklahoma 73113  
(405) 840-9900

\*Apple II is a registered trademark of Apple Computer.

## Programming Quickies

### Self-Reproducing Programs

John Burger, David Brill, Filip Machi,  
System Development Corporation, 2500 Colorado Ave,  
Santa Monica CA 90406

Listing 1 is a C program that duplicates itself. When the program is run it produces (on the standard output) a file containing an exact copy of its own source code. This program runs under the UNIX operating system and uses the American Standard Code for Information Interchange (ASCII) character set. If this program is compiled on a system using a different character set, the octal values of "q" and "n" must be changed to the numbers representing that system's codes for the quote and newline (or linefeed) characters, respectively.

#### Why We Wrote a Self-Reproducing Program

A while back, *Pascal News* contained a listing of a Pascal program called PRINTME that performs this feat. (See reference.) The Pascal listing took 46 lines of code.

We are currently writing a large system in the C language. We considered the Pascal program to be an unstated challenge, and in response we wrote a C version of the PRINTME program that works pretty much the same way as the Pascal version. This version is shown in listing 2.

This version is more elegant than the Pascal version and is 12 lines shorter. It takes a total of decimal 1313 bytes to store the source code. Then, one of us who once had done a lot of LISP programming wrote a LISP function that evaluates to itself. This function takes exactly 279 bytes of memory in which to store the print image of the code. The LISP function is shown in listing 3.

A week or so after the LISP function had been written, we were all discussing the similarities of LISP and C. From this discussion, we developed the C program of listing 1. It works like the LISP function and takes 126 bytes in the source code file.

For purists, though, a still shorter C version can be written. The C compiler, like a LISP compiler, sees all programs as a stream of bytes, and linefeed characters are parsed as spaces. Thus a C program *could* be written all on one line. The program in listing 4 is written on a single line in order to remove the necessity of printing linefeeds in the internal print.

Note that the octal ASCII values for the quote and linefeed characters have been replaced by decimal values (gaining one byte per number) and that all linefeeds except the last have been removed. Our C compiler seems to require at least one linefeed at the end of the file. The source code for this program is only 101 bytes long!■



The **MAGIC WAND™** is  
**ALMOST  
PERFECT.**

**We've been saying it for a few months now, and the reviewers seem to agree.**

“ Until I saw the Magic Wand, if I were allowed to own one and only one editor, Word Star\* would have been it. . . . My personal preference is for Pencil or Magic Wand for text creation. ”

**Jerry Pournelle**

*On Computing, Summer 1980*

“ The basic functions of the Magic Wand editor are as easy to learn as those of Electric Pencil\*. . . . Magic Wand dominates in the area of print formatting. ”

**Larry Press**

*On Computing, Summer 1980*

“ Of all the word processors I have used (and that includes a dozen or more), the Magic Wand is the most versatile. The Wand has almost all of the features of other processors, plus many new ones of its own. It measures up to even the word-processing software running on the largest mainframe computers. ”

**Rod Hallen**

*Microcomputing, June 1980*

“ The Magic Wand is one of the most flexible word processing packages available, and should be considered by any potential word processing purchaser. ”

**Glenn A. Hart**

*Creative Computing, August 1980*

**Available for both the CP/M® and OASIS operating systems**

**small business applications, inc.**

3220 Louisiana • Suite 205 • Houston, Texas 77006 • 713-528-5158

Electric Pencil is a trademark of Michael Shroyer Software, Inc.  
WordStar is a trademark of Micro Pro International, Inc.  
CP/M is a registered trademark of Digital Research Corp.



# Software Development Tools

## PASCAL/M™

The CP/M™ compatible language for 8" 8080/Z80 CPU's, NorthStar 2D, Cromemco CDOS & TRS-80 Mod II.

- Random access files
- Runtime debug support
- Over 45 extensions to Standard Pascal
- 9511A math chip version available

**\$175. Manual alone - \$10.**

## ACT™

NEW! CP/M compatible macro assembler for Z80, 8080/85, 6502, & 6800.

FINALLY, one assembler that supports all major 8 bit micros and runs under CP/M. ACT is available now in 8" soft sectored & NorthStar CP/M formats.

COMING SOON: ACT FOR 8086/88 & 6809.

**\$125. Manual alone - \$15.**

## PEARL™

The application software generator.

Pearl asks questions that a programmer would have to answer to code the system. You answer the questions and Pearl uses built-in logic to construct both subroutines and mainline programs. The system then compiles and executes your program code.

- Level 1: For Personal Computing - \$130.
- Level 2: The Business Assistant - \$350.
- Level 3: Advanced Software Development - \$650.

CBASIC2™ required.

Manuals alone - \$25. each

## CBASIC2

Latest release 2.06, CP/M2-MP/M™, or TRS-80 Mod I. Specify CP/M version & format (8" soft-sectored, NorthStar, Micropolis, TRS-80, etc.)

**\$95. Manual alone - \$15.**

## DIGITAL MARKETING

2670 Cherry Lane  
Walnut Creek, CA 94596  
(415) 938-2880

Pascal/M & ACT are trademarks of Sorcim  
CP/M & MP/M are trademarks of Digital Research  
Pearl is a trademark of Computer Pathways  
CBASIC is a trademark of Compiler Systems  
TRS-80 is a trademark of Radio Shack  
Outside USA add \$10. for postage & handling

**Listing 1:** Four-line C program which duplicates itself without any user input. If a non-ASCII character set is used on your system, the values of "q" and "n" must be changed to the values representing that system's quote and newline (linefeed) characters.

```
main()
char q=042,n=012,
*a="main(){@cchar q=042,n=012,@c*a=%c%s%c;@cprintf(a,n,n,q,a,q,n,n);}@c";
printf(a,n,n,q,a,q,n,n);!
```

**Listing 2:** Original self-duplicating C program.

```
char *text [] = {
    "char *text [] = {",
    " 0 };",
    "main () {",
    "    char newline = 012, quote = 042, escape = 0134, *p, **pp;",
    "    printf ("%s%c", *text, newline);",
    "    for (pp = text; *pp; pp++) {",
    "        printf ("%c", *pp);",
    "        for (p = *pp; *p; p++) {",
    "            if (*p == quote)",
    "                putchar (escape);",
    "            putchar (*p);",
    "        }",
    "        printf ("%c,%c", quote, newline);",
    "    }",
    "    for (pp = text + 1; *pp; pp++)",
    "        printf ("%s%c", *pp, newline);",
    "}",
    0 };
main () {
char newline = 012, quote = 042, escape = 0134, *p, **pp;
printf ("%s%c", *text, newline);
for (pp = text; *pp; pp++) {
    printf ("%c", *pp);
    for (p = *pp; *p; p++) {
        if (*p == quote)
            putchar (escape);
        putchar (*p);
    }
    printf ("%c,%c", quote, newline);
}
for (pp = text + 1; *pp; pp++)
    printf ("%s%c", *pp, newline);
```

**Listing 3:** Self-duplicating LISP function which inspired the C program in listing 1.

```
(PRINTME (LAMBDA NIL (PROG (A B)
  (SETQ A (QUOTE (PRINTME (LAMBDA NIL (PROG (A B)
    (SETQ A (QUOTE FOO))
    (SETQ B (COPY A))
    (RPLACA (CDADDR (CADDAR (CDDADR B))) A)
    (RETURN B))))))
  (SETQ B (COPY A))
  (RPLACA (CDADDR (CADDAR (CDDADR B))) A)
  (RETURN B))))
```

**Listing 4:** Final one-line, self-duplicating C program. This program is written on a single line to remove the necessity for code to generate linefeeds. However, the program is too long to display here without breaking the line. The program shown is to be written and compiled as a single line of source code.

```
main(){char q=34,n=10,*a="main(){char q=34,n=10,*a=%c%s%c;printf(a,q,a,q,n);}@c";printf(a,q,a,q,n);}
```

### Reference

Pascal News, Pascal Users' Group, number 12, June 1978. (Pascal Users' Group, c/o Andy Mickel, University Computer Center: 227 EX, 208 SE Union St, University of Minnesota, Minneapolis MN 55455.)



1. Outlasts every competitor—200,000,000 character head warranty
2. No duty cycle limitations—even in demanding business applications
3. Professional print quality—9 x 7 matrix
4. Rugged business use construction—metal chassis—two motors
5. 80 characters per second
6. Upper and lower case—full 96 character ASCII set
7. Double width characters
8. Connects directly to TRS-80™ APPLE® and other computers
9. Block graphics—64 shapes for charts, graphs, diagrams
10. Friction and pin feed
11. Plain paper—up to 3 parts
12. 6 and 8 lines per inch—program controlled paper savings
13. 80 and 132 columns—program controlled
14. Price—the best value in the industry. Call or write today for the name of your local Microline 80 dealer.



# 14 REASONS WHY TRS-80™ OWNERS CHOOSE THE MICROLINE 80

All fourteen are standard with every Microline 80. The only options are snap-on tractors and a buffered (up to 2000 characters) RS232 interface.

## OKIDATA

Okidata Corporation  
111 Gaither Drive, Mount Laurel, New Jersey 08054  
Telephone: 609-235-2600

TRS-80 is a registered trade mark of Radio Shack, a division of Tandy Corp.



# The Evolution of FORTH, an Unusual Language

---

Charles H Moore  
FORTH Inc  
2309 Pacific Coast Hwy  
Hermosa Beach CA 90254

---

## Introduction

When I invented FORTH about 10 years ago, my goal was simply to make myself a more productive programmer. When I first worked with computers at MIT and Stanford in the early 1960s, I figured that in 40 years a very good programmer could write forty programs. And I wanted to write *more* programs than that. There were things out in the world to be done, and I wanted a tool to help me do them. As I worked on programs that ranged from satellite orbits to chromatography to business systems, I developed FORTH in line with my overall goal. For several years now, I have been able to work at ten times my original rate.

As I began thinking of rather drastic improvements to programs, I think I was arrogant. I wanted to do things my way. I was not convinced that I should not be permitted to, and I was a bit hard to get along with. The arrogance was necessary because I felt insecure. I was promoting ideas that everyone said were wrong and that I thought were right. But, if I were right, that meant that all the

other people would have been wrong, and there were many more of them than me. And it took a lot of arrogance to persist in the face of massive disinterest.

FORTH is a polarizing concept. There are people who love it and people who hate it. It's just like religion and politics. If you want to start an argument, say, "Boy, FORTH's really a great language."

This is partly because FORTH is an amplifier. A good programmer can do a fantastic job with FORTH; a bad programmer can do a disastrous job. I have seen very bad FORTH code and have been unable to explain to the author exactly why it was bad. There are some visible characteristics of good FORTH, such as very short definitions (many of them). Bad FORTH often takes the form of one definition per block—big, long, and dense. It is quite apparent, but difficult to explain, why or how a FORTH program is bad.

BASIC and FORTRAN are less sensitive to the quality of the programmer. I was a good FORTRAN programmer; I thought that I was doing the best job possible with FORTRAN, but it was not much better than what everybody else was doing. In this sense, FORTH is an elitist language.

On the other hand, I think that FORTH is a language that a grade school child can learn to use quite effectively, if it is presented in bite-

size pieces with the proper motivation.

FORTH is the first language that has come up from the grass roots. It is the first language that has been honed against the rock of experience before being standardized. I hesitate to say it is perfect; I will say that if you take anything away from FORTH, it is not FORTH any longer—the basic components are all essential to the viability of the language.

## History

What might be called the prehistory of the FORTH language goes back much further than 10 years. The first element of FORTH to exist was the text interpreter, shown in listing 1. This early version, programmed in ALGOL at the Stanford Linear Accelerator Center in the early 1960s, was part of a program called TRANSPORT, which designed electron-beam transport systems. Besides the text interpreter, this print-out also shows an early version of the dictionary. The influence of LISP is evident in the indivisible entity (which in FORTH is called a *word*) named ATOM. As the interpreter reads a word from a punched card, it executes the associated routine, as for DRIFT in this example. The style resembles that of modern FORTH: there is no limit on the length of a word, as you can see by the length of the word SOLENOID, but only the

---

## About the Author

Charles H Moore is Chairman of the Board of FORTH Inc, a firm created in 1973 to provide application programming services and packaged FORTH systems. This article is adapted from a speech delivered at the FORTH Convention held in San Francisco in October 1979.

---



# The best in data base management for your micro-computer

Get the most out of your micro-computer. Use our advanced and progressive data management system.

**HDBS** is an extended hierarchal data base system offering

- fixed length records
- file-level read/write protection
- one-to-many set relationships

**MDBS** is a full network data base system offered as an upgrade from HDBS...or it may be ideal as your initial system. **Unique and versatile**, it adds these features:

- full network CODASYL-oriented data structures
- variable length records
- multiple levels of read/write protection
- one-to-one, many-to-one, and many-to-many sets
- non-redundancy of data, easy updating
- occurrences of a record type may own other occurrences of the same type
- a single set may have multiple owner and member record types

**MDBS-DRS**. As an add-on to MDBS, the DRS system offers extraordinary flexibility in data base restructuring to meet new needs.

- Item, record, and set types can be added, deleted, or renamed in an existing data base as well as other data base characteristics. You can redesign the data base after it is already on-line!

**MDBS-RTL**. As an add-on to MDBS, the RTL (Recovery Transaction Logging) logs all data base transactions, so that in the event of a system failure, the data base can be recovered with minimal loss of information.

- The recovery processor permits selective reloading of the data base from the transaction file. Users can log messages, indicate complex transaction sequences, and effect selective control over the recovery process.

**MDBS-QRS**. An interactive Report-Writer/Query-System for MDBS data bases. Features...

- easy data retrieval for non-technical users
- complex retrieval conditions may be specified
- detailed reports can be quickly generated
- wildcard and "match-one" string specifications included

**HDBS and MDBS Packages Include:**

- DDL data definition language analyzer/editor
- 260-page users manual
- DMS data management routines callable from host language
- Sample application program and DDL files
- Relocator to re-org all routines
- System specific manual for bringing up our software



Coming soon: Multi-User Versions of MDBS, and a Z8000 Version.

54-page "primer" on data base systems for micro-computers — \$10.00 per copy.

**Both HDBS and MDBS Systems . . .**

- Run under...
  - CP/M with Microsoft BASICs, FORTRAN or COBOL; InterSystem PASCAL/Z; Sorcim PASCAL/M; Micro Focus CIS COBOL; Digital Research PL/I
  - MVT/FAMOS with BASIC
  - OASIS with BASIC
  - TRSDOS and NEWDOS (Models I and II) with Disk BASIC
  - North Star DOS with North Star BASIC
  - Apple DOS and Applesoft BASIC
  - Machine Language Interface available on all above systems.
- Up to 254 record-types definable in the data base; each record-type may contain up to 255 item-types; each item-type may be up to 9,999 bytes in length.
- Names of data items, records, sets, and files are wholly user definable.
- Commands to add, delete, update, search, and traverse the data base.
- Straightforward use of ISAM-like structures.
- Records can be maintained in several sorted orders.
- Written in machine language for maximum execution efficiency and minimal memory usage.
- Independent of types and sizes of disk drives. Support data base spread over several disk drives (max.8); disks may be mini- or full-sized floppies or hard disks.
- Available inn versions Z80 (requires approx. 18K), 6502 (approx. 26K), 8080 (approx. 22K)
- 8086 version available. (Call or write for details and prices.)

**Ordering and pricing information:**

(applicable to Z80, 8080 and 6502 versions):

HDBS	\$ 300.00	When ordering, specify intended use with...
MDBS	900.00	1. North Star DOS and BASIC
DRS	300.00	2. CP/M - Microsoft BASIC 4.XX
RTL	300.00	3. CP/M - Microsoft BASIC 5.XX
QRS	300.00	4. CP/M - Microsoft BASIC Compiler or FORTRAN-80
HDBS upgrade to MDBS	650.00	5. CP/M - Microsoft COBOL-80
MDBS with DRS, RTL, and QRS	1500.00	6. CP/M - InterSystem PASCAL/Z
HBDS/MDBS Manual	35.00	7. CP/M - Sorcim PASCAL/M
DRS Manual	5.00	8. CP/M - Digital Research PL/I
RTL Manual	5.00	9. CP/M - Micro Focus CIS COBOL
QRS Manual	5.00	10. TRSDOS/NEWDOS and TRS Disk BASIC (Models I and II)
System Specific Manuals (each)	5.00	11. Apple DOS and Applesoft BASIC
		12. MVT/FAMOS and BASIC
		13. OASIS and OASIS BASIC
		14. Machine Language Programs (Specify operating system)

Within a given operating system, add \$125.00 for each additional language selected.

For prices outside the U.S. and Canada, please ask for price lists.

Add \$2.50 handling fee for non-cash order (\$5.00 outside U.S.)

Indians residents add 4%. We accept Visa and Master Charge.

Finally, our software may cost a little more... but it's worth a lot more in quality and versatility.

**Micro Data Base Systems, Inc.**

Box 248, Lafayette, Indiana 47902  
317-742-7388 or 317-448-1616

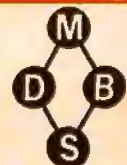



first characters are significant and words are separated by spaces.

Other very early concepts have either changed in form or have evolved dramatically. In listing 2, the word that has become { : } (colon) in modern FORTH is called DEFINE , while END has become { ; } (semicolon).

This listing also shows stack operators being defined. As an example of a concept that has evolved, consider the dictionary being sealed by the word SEAL and broken by the word BREAK . Such sealing and breaking has since been replaced by the idea of vocabularies.

Listing 3 shows another prototype in ALGOL, this time of a FORTH text editor. Here ATOM has become W and I am looking up plus, minus, and the commands T, R, A, and I, to edit a deck program.

Another method of implementing a dictionary is shown in listing 4. I am looking up the words in a conditional statement and setting NEXT, the key routine of modern FORTH's address interpreter, to the index.

Listing 5 shows an early implementation of a stack. Since it is written in BALGOL, which allows assignment statements inside other statements, I could replace STACK[J] with [J+1] in order to push items onto the stack. I did this so that I could manipulate parameters that were interpreted from the card deck as arguments to the routines. When I wanted, for instance, to convert angular measure from one unit to another, this added the ability to use arithmetic operators.

From Stanford I moved to the East Coast, where I programmed on a free-lance basis for several years. Some of you probably remember that, in the 1960s, a programmer at a typical computer center needed to learn about nineteen languages in order to function adequately: JCL (Job Control Language); languages to control utilities and facilities, such as the linking loader; assembly language and the assembler's control language; plus several high-level languages and the methods for controlling their compilers.

Listing 6 shows two of these languages, a PL/I program and the JCL necessary to run it. Note the obvious difference in syntaxes. FORTH developed in response to such conditions. In terms of modern FORTH, the importance of this example lies in the use of NEXT as a procedure that goes off to get the next word and do something with it.

Listing 7 shows a version of FORTH coded for the IBM System/360 with the routines PUSH and POP, which executed in about 15  $\mu$ s. They include stack limit checking, which doubled the cost and was one of the things that led me to believe that execution-time stack checking is not desirable. This was coded in a macroassembler that did not have stack operations, which led to the deck full of statements like L19

**Listing 1:** An early version of the FORTH text interpreter (written in ALGOL).

```
IF ATOM="DRIFT" THEN DRIFT
ELSE IF ATOM="QUAD" THEN QUAD
ELSE IF ATOM="BEND" THEN BEND
ELSE IF ATOM="FACE" THEN FACE(-1)
ELSE IF ATOM="ROTATE" THEN ROTATE
ELSE IF ATOM="SOLENO" THEN SOLENOID
ELSE IF ATOM="SEX" THEN SEX
ELSE IF ATOM="ACC" THEN ACC

ELSE IF ATOM="MATRIX" THEN BEGIN IF NOT FITTING THEN BEGIN
  REAL A;
  WRITE1(3,0,0,CORE[S]); LINE(-(8+42*(ORDER-1)));
  FOR J-1 STEP 1 UNTIL 6 DO BEGIN
    FOR K-1 STEP 1 UNTIL 6 DO WRITE1(2,8,R1[J,K]*UNIT[K]/UNIT[J],2);
    LINE(0) END;
  IF ORDER=2 THEN FOR C-1 STEP 1 UNTIL 6 DO BEGIN
```

**Listing 2:** An early version of the FORTH words { : } (called DEFINE here) and { ; } (called END here).

```
"- "OPEN DEFINE MINUS + END
SEAL "< "OPEN DEFINE - < END BREAK
"NOT "OPEN DEFINE MINUS 1+ END
"> "OPEN DEFINE .< END
"AND "OPEN DEFINE * END
"OR "OPEN DEFINE NOT .NOT AND NOT END
"T 1 1 "REAL DECLARE
"= "OPEN DEFINE T- ; DUP T< . T> OR NOT END
"* "OPEN DEFINE = NOT END
"< "OPEN DEFINE > NOT END
"> "OPEN DEFINE < NOT END
"DUMP "OPEN DEFINE NAME 10 "ALPHA WRITE: 3 10 "REAL WRITE 0 LINE END
```

**Listing 3:** Another prototype of the FORTH text editor, again in ALGOL. In this listing, the word ATOM (the predecessor of the basic unit in FORTH, the word) has been replaced by the word W .

```
120 CYCLE; FILL OUTPUT WITH BUFFER[1],BUFFER[2];
1 WHILE WORD NEQ "END " DO
2 IF W=GM1 THEN REPLY("OK ")
3 ELSE IF NUMERIC THEN L:=MIN(W-1,$OF)
4 ELSE IF W="+" THEN L:=MIN(L+WORD,EOF)
5 ELSE IF W="-" THEN L:=MAX(L-WORD,0)
6 ELSE IF W="T" THEN BEGIN
7 IF WORD=GM1 THEN W:=1; W:=MIN(L+W-1,EOF);
8 FOR L:=L STEP 1 UNTIL W DO BEGIN
9 POSITION; TYPE END; L:=L-1 END
130 ELSE IF W="R" THEN BEGIN
1 POSITION; REPLACE END
2 ELSE IF W="A" THEN BEGIN
3 L:=EOF:=EOF+1; REPLACE END
4 ELSE IF W="I" " OR W="D" THEN BEGIN
5 IF NOT RECOPY THEN BEGIN
6 RECOPY:=TRUE; REWIND(CARD) END;
7 POSITION; IF W="I" THEN BEGIN
8 PLACE; REPLACE END
9 ELSE BEGIN EMPTY:=TRUE; IF WORD NEQ GM1 THEN BEGIN
140 L:=MIN(L+W-1,EOF); SPACE(CARD,L-L0+1); L0:=L+1
1 END END END
```



# SYNCHRO-SOUND

The ORIGINAL Computer People  
who KNOW Computers  
and offer EVERYTHING you need  
in Small Computer Systems



**TERMINALS**  
ADDS Regent 25

**LEAR SIEGLER**  
ADM 3A  
ADM 31  
ADM 42



**SOROC Technology**  
IQ 120  
IQ 140



## PRINTERS

**QUME Sprint**  
5/45 KSR  
5/55



**DECwriter IV**  
LA 34



**TELETYPE**  
43

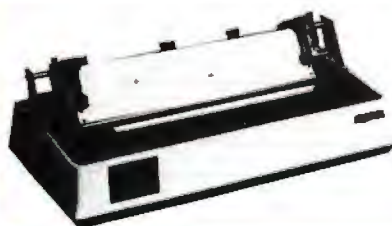

**OKIDATA**  
Microline 80

**A PERFECT  
SUPER SPECIAL MATCHED PAIR!**

**Texas Instrument**  
810 Multi Copy  
Impact Printer  
150 characters per sec.  
bi-directional printing

**Intertec**  
Super Brain  
Computer Terminal  
Dble. Density Dual Mini-  
Floppies, CPM based  
Development or Business System

**ONLY \$3995.**

## COMPUTERS

### DIGITAL SYSTEMS

HDS 4004  
14 Megabyte  
Hard Disk



**NORTHSTAR**  
HORIZON II  
HORIZON II Quad

**CROMEMCO**  
System 3

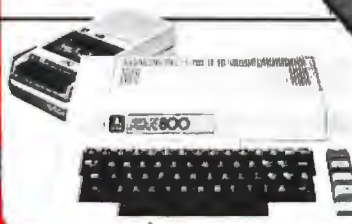

**ATARI**  
400  
800

### MORE SPECIALS

Okidata SL125 . . . . .	\$2595.00	Livermore Acoustic Coupler . . . . .	\$195.00
Okidata SL300 . . . . .	2995.00	Centronics Micro Printer . . . . .	349.00
Persci 277 . . . . .	1395.00	5" Scotch Diskette Box . . . . .	34.95
Integral Data Systems Paper Tiger Printer . . .	895.00	8" Scotch Diskette Box . . . . .	39.95
Televideo 912 . . . . .	825.00		
Televideo 920 . . . . .	895.00		

**MANY OF OUR PRICES ARE TOO LOW  
TO ADVERTISE. PLEASE CALL OR WRITE**

We carry a full line of Alpha-Micro Products.  
We have a full staff of Programmers and Computer  
Consultants to design, configure and deliver a Turnkey  
Computer System to meet your specific requirements.



**SYNCHRO-SOUND** ENTERPRISES, INC.

THE COMPUTER PEOPLE

183-25 Jamaica Ave., Jamaica, New York 11423 • TWX 710-582-5800

PHONE ORDERS CALL  
New York 212/468-7087  
Los Angeles 213/678-1808  
Chicago 312/641-3010  
Dallas 214/742-8000



# HÄNDLER CONCESSIONAIRES DISTRIBUIDORES O.E.M.

AUSGEZEICHNETE GROSS =  
HANDELSPREISE stellen nur einen  
Aspekt unseres Händlerprogrammes  
dar. Treten Sie noch heute mit uns  
in Verbindung. (Wir sprechen  
Deutsch)

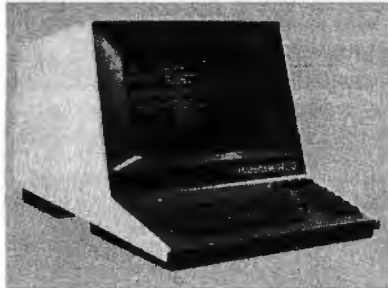

UN EXCELLENT PRIX DE GROS  
ne représente qu'un seul aspect de  
notre programme de distribution in-  
ternationale. Mettez-vous en contact  
avec nous aujourd'hui pour recevoir  
plus de renseignements. (On parle  
français!)



EL EXCELENTE PRECIO AL  
MAYOREO que ofrecemos repre-  
senta sólo un aspecto de nuestro  
programa de distribución inter-  
nacional. Póngase en contacto con  
nosotros para información más  
detallada. (Se habla español!)

A.D.D.S.	IND. MICRO
ANADIX	OKIDATA
APPLE	SOROC
CENTRONICS	SUPERBRAIN
CROMEMCO	TELEVIDEO
HAZELTINE	TEXAS INSTR.



## MICRO-COMPUTER BROKERS INTERNATIONAL

6819-P, North 21st Avenue  
Phoenix, Arizona 85015 U.S.A.

Telephone: (602) 242-9961  
Telex: (0) 668382

### Listing 4: An early version of the FORTH dictionary.

```

8 PROCEDURE RELEVANCE; BEGIN REAL T,KO;
9   J:=0; I:=-1; WHILE WORD NEQ "END " DO
180 IF W="=" " THEN NEXT:=3
1   ELSE IF W="GT " THEN NEXT:=4
2   ELSE IF W="LT " THEN NEXT:=5
3   ELSE IF W="NOT " THEN NEXT:=6
4   ELSE IF W="AND " THEN NEXT:=7
5   ELSE IF W="OR " THEN NEXT:=8
6   ELSE IF W="+" " THEN NEXT:=9
7   ELSE IF W="-" " THEN NEXT:=10
8   ELSE IF W="*" " THEN NEXT:=11
9   ELSE IF W="/" " THEN NEXT:=12
190 ELSE IF KO:=SEARCH1(W) GEQ 0 THEN BEGIN
1   NEXT:=1; NEXT:=K:=KO END
2   ELSE BEGIN
3   NEXT:=2;
4   IF BASE[K]=" " THEN NEXT:=WORDS[0]
5   ELSE NEXT:=W END;
6   NEXT:=0 END;

```

### Listing 5: An early implementation of the FORTH stack, written in BALGOL.

```

7 BOOLEAN PROCEDURE RELEVANT; BEGIN
8   I:=J:=-1; STACK[0]:=1; DO CASE NEXT OF BEGIN
9   J:=-1;
210 STACK[J:=J+1]:=CONTENT;
1   STACK[J:=J+1]:=NEXT;
2   STACK[J:=J-1]:=REAL(STACK[J]=STACK[J+1]);
3   STACK[J:=J-1]:=REAL(STACK[J] GTR STACK[J+1]);
4   STACK[J:=J-1]:=REAL(STACK[J] LSS STACK[J+1]);
5   STACK[J]:=REAL(NOT BOOLEAN(STACK[J]));
6   STACK[J:=J-1]:=REAL(BOOLEAN(STACK[J]) AND BOOLEAN(STACK[J+1]));
7   STACK[J:=J-1]:=REAL(BOOLEAN(STACK[J]) OR BOOLEAN(STACK[J+1]));
8   STACK[J:=J-1]:=STACK[J]+STACK[J+1];
9   STACK[J:=J-1]:=STACK[J]-STACK[J+1];
220 STACK[J:=J-1]:=STACK[J]*STACK[J+1];
1   STACK[J:=J-1]:=STACK[J]/STACK[J+1];
2   END UNTIL J LSS 0;
3   RELEVANT:=BOOLEAN(STACK[0]) END;

```

DC AL2(\*-L18), which gave me a link  
from L19 to the previous label. It  
worked but it was not pleasant.

Listing 8 shows a similar routine,  
this time coded in COBOL. I am set-  
ting up a table of identified words  
that will be interpreted from an input  
stream. Since COBOL does not allow  
parameters for subroutines, it is  
awkward to do anything meaningful.

### New Concepts

About this time, I began to think of  
defining a word that would define  
other words; and at that time, this  
idea was staggering. For example,  
{ ;CODE } was a very esoteric word.  
I explained it to people, but I could  
not express the potential I thought it  
had.

It took time to find out exactly  
what { ;CODE } should do (it  
specified the code to be executed for a  
previously defined word). I do not  
have the records, but I think the ini-  
tial code for { ;CODE } was three or  
four lines long; to simplify that code

was one of the driving forces behind  
the address interpreter—to make it  
possible to code { ;CODE } cleanly.  
This had implications as to what  
registers should be available.

The fact that W should be saved in  
a register for defining words led to  
*indirect*, rather than direct, threaded  
code. That was the most complicated  
concept I had coded in this evolving  
program—probably deserving of a  
patent in its own right.

A little bit later, it seemed that  
there ought to be an analog of  
{ ;CODE } that specified the code to  
be *interpreted* when you executed a  
word. It seemed the natural balance,  
but when the idea first arose, I did not  
have the foggiest notion of what to do  
or what the implementation should  
be. The first definition of this analog,  
called { ;; } (semicolon-colon),  
required three or four lines of code. It  
had to do what { ;CODE } did, and  
then more.

Out of that came the distinction  
between compile-time action and





Please send your free software catalog.  
(Check which software is of particular interest)

C COMPILER. Optimized native code for VAX 11/780, PDP-11, LSI-11, Z80, 8085, 8080. Full C language as defined in Kernighan and Ritchie, with comprehensive portable library. Cross compilers available. Runs under VMS, IAS, RSX-11D, RSX-11M, RSTS/E, RT-11, UNIX, Idris, CDOS, CP/M. From \$600

IDRIS OPERATING SYSTEM. System calls and file system identical to UNIX V6, including pipelines. Utilities include shell, editor, assembler, loader, archiver, compare, copy, grep, etc., plus system utilities for file system maintenance. Runs on LSI-11, PDP-11. From \$1000.

PASCAL COMPILER. Optimized native code for VAX 11/780, PDP-11, LSI-11, Z80, 8085, 8080. Full Pascal language as defined in Jensen and Wirth, with standard library. Includes C compiler and portable library, permitting intermixed C and Pascal. Cross compilers available. Runs under VMS, IAS, RSX-11D, RSX-11M, RSTS/E, RT-11, UNIX, Idris, CDOS, CP/M. From \$750.

Idris is a trademark of Whitesmiths Ltd.  
UNIX is a trademark of Bell Laboratories  
CP/M is a trademark of Digital Research Co

VMS, RSX-11, RT-11, RSTS/E, VAX,  
PDP-11, LSI-11 are trademarks of Digital  
Equipment Corporation

Name \_\_\_\_\_

Company \_\_\_\_\_

Street \_\_\_\_\_

City \_\_\_\_\_ State \_\_\_\_\_ Zip \_\_\_\_\_

**Whitesmiths, Ltd.**  
Software for grownups.  
(212) 799-1200

P.O.B. 1132 Ansonia Station, New York, N.Y. 10023



execute-time action. It was convenient for words to be coded to act this way, but it was expensive. It required not only the address of the code to be executed, but the address of the code to be interpreted, as well as the parameter to be supplied to the code being interpreted so you could do something useful.

Late in the 1960s I went to work for Mohasco Industries, where I put something strongly resembling FORTH on a Burroughs 5500, cross-compiled to the 5500 from an IBM 1130. (There is no assembler on the 5500; there is a dialect of ALGOL called SBOL that Burroughs used to compile operating systems, not

available to users.) Listing 9 shows the code definitions of stack operations on the 5500, which was a stack-oriented processor at a time when stack machines were not popular. The names of some FORTH stack operators stem from that machine's operations; see, for example, DUP. The symbol  $\epsilon$  stands for CODE and distinguishes the assembler's OR from the FORTH OR. (Vocabularies were not yet available.)

Listing 10 gives an example of FIND (a dictionary search routine) coded for the 5500. Notice the word SCRAMBLE, a colon definition making a hashed search. Apparently I had eight threads to the dictionary here, a

concept we added back to FORTH when we developed polyFORTH last year.

## FORTH and the IBM 1130

At Mohasco I also worked directly on an IBM 1130 interfaced with an IBM 2250 graphics display. The 1130 was a very important computer; it had the first cartridge disk, as well as a card reader, a card punch (as backup for the disk), and a console typewriter. The 1130 let the programmer, for the first time, totally control the computer interactively.

FORTH first appeared as an entity on that 1130. It was called F-O-R-T-H, a five-letter abbreviation of FOURTH, standing for fourth-generation computer language. That was the day, you may remember, of third-generation computers and I was going to leapfrog. But because FORTH ran on the 1130 (which permitted only five-character identifiers), the name was shortened.

What came out of the 1130 was a cross-assembler that assembled the instructions, which were then to be executed by the 2250. I think the 2250 had its own memory, and these things had to be programmed carefully. What I accomplished was that the 1130 in FORTRAN in 32 K bytes could draw pictures on the 2250, fairly slowly; and FORTH, in 8 K bytes, could draw three-dimensional moving pictures on the 2250—but it could do that only if every cycle was accounted for and if the utmost was squeezed out. That is why FORTRAN had to go—I required an assembler and could not do an impressive enough job with FORTRAN.

But high-level or colon definitions were not yet compiled—the compiler came much later. The text was stored in the body of the definition, and the text interpreter reinterpreted the text in order to discover what it was to do. This contradicts the efficiency of the language, but I had big words that put up pictures and I did not have to interpret too much. The cleverness was limited to squeezing out extraneous blanks as a compression medium. I am told that this is the way that BASIC acts today in many instances.

This machine had a disk drive, and I am almost certain that the word BLOCK existed in order to access

**Listing 6:** The NEXT procedure in PL/I and its associated JCL (Job Control Language) statements (lines 1 thru 8).

```

1 //UTILITY JOB SYSTEM,OVERHEAD
2 // EXEC PGM=IEBUPDTE,PARM=NEW
3 //SYSPRINT DD SYSOUT=A
4 //SYSUT2 DD DSN=OUTLIB,UNIT=2314,DISP=(NEW,KEEP),
5 // VOLUME=SER=MOORE,SPACE=(TRK,(100,,10)),
6 // DCB=(RECFM=F,LRECL=80,BLKSIZE=80)
7 //SYSIN DD DATA
8 ./ ADD NAME=WORD,LEVEL=00,SOURCE=0,LIST=ALL
9 DECLARE KEYBOARD STREAM INPUT,PRINTER STREAM OUTPUT PRINT;
10 NEXT: PROCEDURE CHARACTER(4);
1 DECLARE (1 TEXT CHARACTER(81) INITIAL((81)" "),
2 C(81) CHARACTER(1), I INITIAL(81),W CHARACTER(4),
3 WORD CHARACTER(32) VARYING BASED(P),P,NUMERIC BIT(1)) EXTERNAL;
4 DO WHILE C(I)="" ; I=I+1;
5 IF I=82 THEN BEGIN; I=1;
6 READ FILE(KEYBOARD) INTO(TEXT); END; END;
7 P=ADDR(C(I));
8 IF C(I)="-" OR C(I)="." OR "0" LE C(I) THEN BEGIN; NUMERIC="1"B;
9 IF C(I) NOT="." THEN DO I=I+1 BY 1 WHILE "0" LE C(I); END;
10 IF C(I)="" THEN DO I=I+1 BY 1 WHILE "0" LE C(I); END; END;
1 ELSE DO; NUMERIC="0"B;
2 IF "A" LE C(I) THEN DO I=I+1 BY 1 WHILE "A" LE C(I) OR C(I)="-";
3 END; ELSE I=I+1; END;
4 W=WORD; RETURN(W);

```

**Listing 7:** The FORTH words PUSH and POP written in IBM 360 assembly language.

```

0056          830 L18 DC AL2(*-L17)
              831 NAME 3,X'445550',0 DUP
03445550     832+      DC AL1(3),X'445550'
00          833+      DC X'0'
              834+      ORG *-2-V0
              835+      DS OH
              836+      ORG *+V0+1
              837+      DC AL1(0*X'40'+X'40'),AL2(4)
400004       00014 838 PUSH A SP,MFOUR COSTS 15 US
5AC0 6014    00000 839 ST T,0,(SP)
5040 C000    00000 840 CR SP,DP
19CB        841 BCR 2,NEXT BHR
0729        842 B ABORT
47F0 667C   0067C 843 L19 DC AL2(*-L18)
001A        844 DC AL1(4),X'44D2CF50',X'40',AL2(8) DROP
0444D2CF50400008
41C0 C004   00004 845 LA SP,4,(SP)
5840 C004   00004 846 POP L T,4,(SP) COSTS 21 US
41C0 C004   00004 847 LA SP,4,(SP)
59C0 602C   0002C 848 C SP, SP00
07C9        849 BCR 12,NEXT BNHR
47F0 667C   0067C 850 B ABORT

```



**“Look at what ONE  
Microcomputer, FAMOS,<sup>™</sup> &  
a bunch of “dumb”  
terminals can do  
TOGETHER!”**

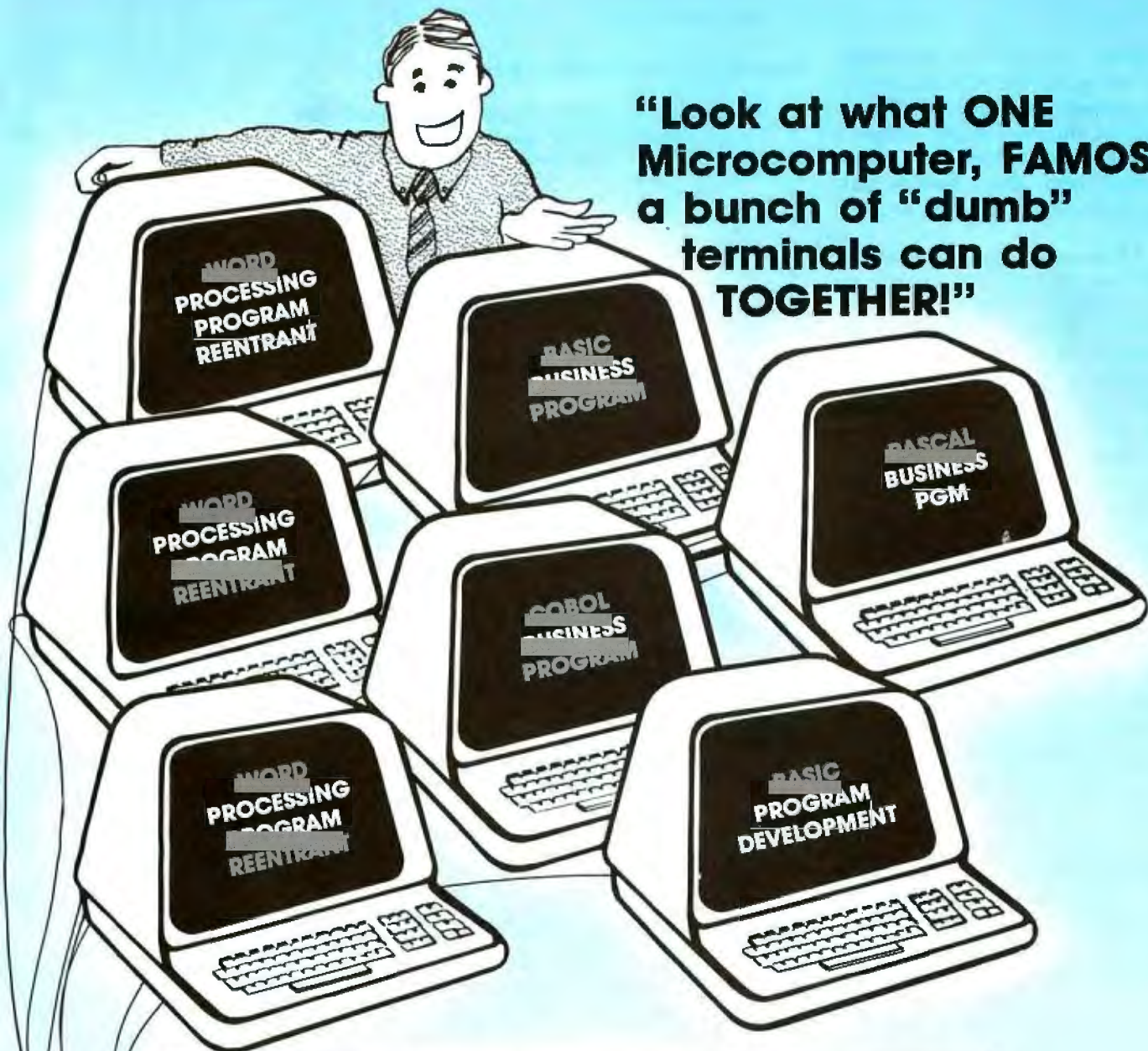

**MEMORY RESIDENT REENTRANT RUN-TIME SYSTEM (24 KBytes)**

**DYNAMIC MEMORY ALLOCATION  
DYNAMIC TASK ALLOCATION  
DYNAMIC BANK ASSIGNMENT**

**DEVICE INDEPENDENT FILE SYSTEM  
MULTI-TASKING  
MULTI-SESSIONING  
AUTOMATIC RECORD LOCKOUTS**

**NEW BASIC COMPILER**

**OPTIMIZED CODE  
AUTO INTEGER REPRESENTATION  
VARIABLE PRECISION (4-18)  
MULTIPLE KEY ISAM**

**REENTRANT OBJECT & RUN-TIME  
SCREEN HANDLING UTILITY  
Z80 VERSION AVAILABLE  
BATCH OPERATIONS UNDER BASIC**

Over 500 users . . . APPLICATIONS AVAILABLE

Another \*@!#  
**CRASH!!!**  
I should have  
used FAMOS!!!



**9241 RESEDA BLVD., SUITE 203, NORTHRIDGE, CA 91324  
Phone: (213) 349-9076 TWX 910 493-2291 MVT NTGE**

**System Software with unique file integrity . . . for the OEM & Manufacturer.**



records off the disk. I do remember that I had to use the FORTRAN I/O (input/output) package and that it would not put the blocks where I wanted them; it put the blocks where it wanted them, and I had to pick them up and move them into my buffers.

At Mohasco I also implemented FORTH on a Univac 1108, interfacing it with their COBOL compiler. Listing 11 displays a set of record descriptions in a Dun and Bradstreet reference file (for looking up bad debts). The layout shows named fields followed by the number of bytes allocated.

The Mohasco programs mark the transition point between something that could be called FORTH and something that could not. All the essential features except the compiler were present by 1968.

### The First Modern FORTHS

The first modern FORTH was coded in FORTRAN. Shortly thereafter it was recoded in assembler. Much later it was coded in FORTH. It took a long time before I thought that FORTH was complete enough to code itself. The first thing to be added to what had already existed was the return stack. That was an important development; the recognition that there had to be exactly two stacks, no more, no less.

The next thing to be added was even more important—the *full-fledged dictionary*, that is, the dictionary in the form of a linked list. Up until then, flags had been set or computed GO TOs had been executed to provide some mechanism for associating a subroutine with a word. The replacement of all that by a code file containing the address of the routine made an incredibly fast way of implementing a word once it was identified.

The first use of modern FORTH occurred when it was written for a Honeywell H316 at the NRAO (National Radio Astronomy Observatory). In 1971 I was hired by George Conant to write a radio-telescope data-acquisition program: that led to the next step, the compiler. This meant the recognition that, rather than reinterpret a string of text, words could be compiled and an average of 5 characters per word could be replaced by 2 bytes per word. This gave a compression factor

Listing 8: A structured table routine, in COBOL.

```

1      MOVE "CONFIGURATION" TO IDENTIFY(4);
2      MOVE "DATA" TO IDENTIFY(5);
3      MOVE "FILE" TO IDENTIFY(6);
4      MOVE "FD" TO IDENTIFY(7);
5      MOVE "MD" TO IDENTIFY(8);
6      MOVE "SD" TO IDENTIFY(9);
7      MOVE "WORKING-STORAGE" TO IDENTIFY(10);
8      MOVE "CONSTANT" TO IDENTIFY(11);
9      MOVE "PROCEDURE" TO IDENTIFY(12);
10     MOVE "INPUT-OUTPUT" TO IDENTIFY(13);

```

Listing 9: Code definitions of FORTH stack operations on the Burroughs 5500, written in SBOL.

```

LIST
0001 ( 'PRIMITIVES' 26 LAST = 30 SIZE=)
0002 * = _S RETURN
0003 * @ <SD RETURN
0004 * + V 241, RETURN
0005
0006 * OR *OR RETURN
0007 * AND *AND RETURN
0008 * NOT 115, RETURN
0009 * DUP *DUP RETURN
000A * SWAP *SWAP RETURN
000B * DROP *DROP RETURN
000C * + +1 RETURN
000D * - -1 RETURN
000E * MINUS *MINUS RETURN
000F * * *1 RETURN
0010 * / /1 RETURN
0011 * MOD *MOD RETURN

```

Listing 10: A dictionary search routine, FIND, written for the Burroughs 5500.

```

0013 *SM *FIND SCRAMBLE <SD *DUP
0014 41 >A 41 >B *BEGIN V <U 1771, *IF
0015     *BEGIN V0 <U 1771, *IF
0016     I <L RESULT
0017     *THEN __ADDR *DUP 1 <L <S
0018     OS WORD <U *EQUAL *IF
0019     V1 __U OS RESULT
001A     *THEN *DUP <SD *BACK
001B *THEN GET *BACK
001C : FIND TOP *FIND *IF UR <UD *B *THEN;

```

Listing 11: Prototype of a file layout, running under FORTH on a Univac 1108. This version of FORTH was written in COBOL.

```

3 DBI DBI/MOORE 33 33
4 DUNS 8 NAME 24 STREET 19 CITY 15 STATE 4 ZIP 5
5 PHONE 10 BORN 3 PRODUCT 19 OFFICER 24 SIC 4 SIC1 4 SIC2 4
6 SIC3 4 SIC4 4 SIC5 4 TOTAL 5.0 EMPL 5.0 WORTH 9.0 SALES 9.0 MFG 1
7 SUBS 1 HDQ 1 HEAD 8 PARENT 8 MAIL 19 CITY1 15 STATE1 4
8 NAME1 19
9 END

```

of 2 or 3, not drastic but appreciable. But execution speed would be much faster. Again I asked myself, as I had done when I first began modifying programs: if it was that easy, why hadn't anyone else done it? It took me a long time to convince myself that you could compile anything and everything.

Interrupts came around this time. It

was important to utilize the interrupt capability of the computer, but it had not been done by me before that—I did not know anything about interrupts. I/O, however, was not yet interrupt-driven. Interrupts were available for the application if it wanted them—FORTH did not bother.

The multiprogrammer came along



# For those who want to test the water before jumping in.



## picoFORTH

If you're thinking of getting into polyFORTH and you'd like an introduction through hands-on experience, then picoFORTH is for you. picoFORTH has been designed by FORTH, Inc. to serve as your entry into a complete polyFORTH programming environment.

picoFORTH™ is a disk-based operating system and interactive high-

level language, complete with compiler, editor, and assembler. It's upgradable to full polyFORTH™. And it's priced at only \$495.

So step forth and get your feet wet. The water's fine.

**For information, call:**

### 213/372-8493

**FORTH, Inc.**

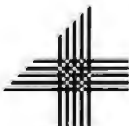

2309 Pacific Coast Highway  
Hermosa Beach, California 90254  
(213) 372-8493

TWX 910-344-6408 (FORTH INC HMBH)



a couple of years later when we developed an improved version of the system for NRAO's telescope at Kitt Peak. This computer was a PDP-11; the multiprogrammer had four tasks. Input was still not interrupt-driven, which was unfortunate.

### The Second FORTH Programmer

Ten years ago there was one FORTH programmer, me. The second FORTH programmer, Elizabeth Rather, came along in 1971. That is quite a quantum jump, from one to two; the next step was four (the next two came out of Kitt Peak National Observatory); the growth can be traced from there to the several thousand today.

The first FORTH user was Ned

Conklin, head of the NRAO station at Kitt Peak, Arizona. NRAO runs a millimeter-wave radio telescope that is in great demand by observers, in part because it is responsible over the last 10 years for discovering half of the interstellar molecules that are known to exist. FORTH is still running on that telescope at Kitt Peak and on a lot of other telescopes.

Given interest from other astronomers, a few believers split off from NRAO in 1973 and formed FORTH Inc. We were deluged by requests for FORTH systems from astronomers and went into business to try to exploit that market. It would still be our principal line of business today except that there are so few new telescopes in the world that you

cannot support a company on that market.

We developed miniFORTH™ (FORTH on minicomputers) with the idea of having a programming tool. An important implementation of the tool came when we put an LSI-11 and FORTH into a suitcase. I think I became the first computer-aided programmer—computer-aided in that I had my computer and took it around with me. I talked to my computer, my computer talked to your computer, and we could communicate much more efficiently than I could communicate directly with your computer before it could run FORTH. Using this tool, we have put FORTH on many computers.

We added the feature of interrupt-driven I/O when FORTH Inc produced its first multiterminal system. It did not speed things up particularly from the user's point of view, but it *did* prevent any loss of characters when several people were typing at the same time. You did not have to look quickly to get the character before the next one came along. They were all buffered and waiting for you, which is an important distinction for multiprogrammed systems.

Data-base management came along at this time. It has been extensively changed, just as FORTH has. But fundamentally, nothing has changed. The concept of files, records, fields, and relational pointers that polyFORTH™ offers dates back from 1974 or so—years and years ago. Listing 12 shows a recent application of the FORTH Inc data-base management system.

With microFORTH™ in 1976 came the first version of our current target compilers. They are very complex things, much more so than I expected them to be. At about the same time, we worked out the current implementation of DOES> .

This new form of { ;: } does not require the address of the code to be interpreted. Since that is supplied by a different mechanism, the parameter can occupy the parameter field as it is supposed to. You can "tick" it and change its value, which is nice. [The FORTH word { ' } (called "tick" above) places the address of the word that follows it onto the stack....GW] But we save 2 bytes for every DOES> word, 2 bytes for very common words—and for 3 years, we did

**Listing 12:** Field and record layouts for a recent FORTH Inc data-base management system.

64 LIST

```
0 ( GLOSSARY FILE)
1 2 ( LINK) 12 BYTES WORD 12 BYTES VOC
2 NUMBER SOURCE NUMBER STACKS 70 BYTES PHRASE
3 210 FILLER ( 4 LINES) 32 FILLER ( 340 B/R, 3/BLOCK) DROP
4 2 24 BYTES WORD+VOC DROP
```

## Hard Disk Made Easy

Now you can move up to hard disk trouble free. Just select the XCOMP X/S series controller for your disk drive: SMD, Cartridge drive, 8 inch disk bus or Shugart® SA1000. Our complete package, including first class support software, will get you up and running fast. And the cost will be less than you would expect. We specialize in getting OEM's into hard disk systems. Our customers include the most successful companies in the microcomputer world.

Move up to hard disk the easy way. Call XCOMP—we'll get you going with hard disk right now.

**XCOMP**  
INCORPORATED

9915A Businesspark Avenue,  
San Diego, CA 92131  
(714) 271-8730







**free  
freight!**



# MICROWORLD®

## New Products

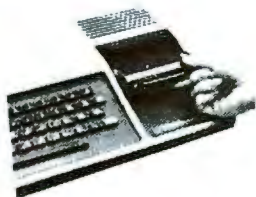

### Texas Instruments 99/4 Home Computer

**FREE Solid State Speech Synthesizer!** The 99/4 talks! Superior sound, 16-color graphics; price includes 13" color monitor and TI BASIC.

List Price: \$1549.95  
Your Price: \$949.00 complete!

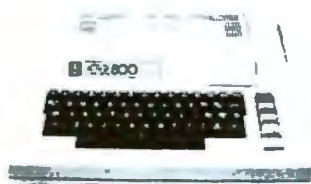

### Atari 800

**FREE joysticks and FREE Star Raiders game!** System features expandable memory, advanced components and comprehensive software library; a "timeless" home computer!

List Price: \$1159.90  
Call For Special Price!

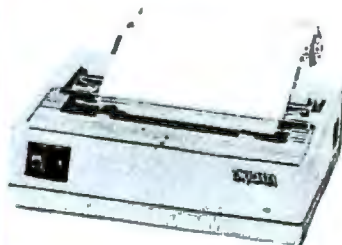

### Okidata Microline 80

Compact, low-cost 80 cps printer: 9 x7 matrix... friction or pin feed! 80 col. w/132 column compressed print graphics, and more! Tractor fed optional.

Call for New Price

Prices subject to change without notice; products subject to availability.

## Complete Systems . . . Solution Packages from MicroWorld®

MicroWorld recognizes the need to provide customers with more than just hardware and peripherals. We provide total, integrated systems as part of a complete solution package . . . including all hardware, interfacing, software and operating systems required.

Our systems are set up especially for your own individual needs, based on the most reliable computers and

peripherals, selected specifically for your environment, application and budget. Our staff is here to assist you in planning your data management needs.

Systems and solutions . . . the expertise of industry-trained professionals . . . backed by commitment and integrity. From MicroWorld; the source you can trust.

### Soroc IQ 120



High-quality, text-editing terminal, 73-key board, built-in 2K RAM, RS232 interface.

List Price: \$995.00  
Special! \$729.00

### Comprint GP



Low-priced electrostatic matrix printer, 225 cps; ideal for personal applications requiring second printer.

Call for Price!

### Televideo 920C



Low-cost terminal loaded with features; full-function keyboard, 24x80 display, blink, reverse, self-test! List Price: \$1030. Your price: \$820.

### Dynabyte System DB8



Compact system with two Z80 processors, two serial and one parallel port, dual 8" floppies . . . double or quad density! Hard disk storage available.

Call for Price!

### TI 810 Fully Loaded

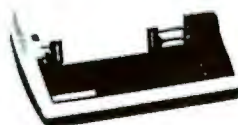

RO printer, low price includes full ASCII, vertical forms control, compressed print, 150 cps, RS232, tractors, 3" to 15" form width, bidirectional printing!

Special! \$1799.00

### Centronics 737



Low-cost 50-90 cps, proportional spacing RO printer. Cable interface, generates full ASCII, pin or friction feed!

Call for Price!

### Zenith-Health Data Systems Z-89 All-in-One Computer (16K)



**FREE HDOS!** Two-80 processors, minifloppy drive, 25 x80 display, memory expandable to 48K!

Call for Price!

### NorthStar Horizon



Quad or double-density! Plus, hard disk drives for expansive storage requirements.

Call for Price!

**TOLL-FREE 1-800-528-1418**



not realize that we had missed the optimum by so much.

I know no way of speeding this process from initial thought to development, except to let a certain amount of time pass. We could sit, we did sit and debate this thing endlessly, and we missed the obvious.

I think that completes the capabilities that I think of as FORTH today. You see how they dribbled in—at no point did I sit down to design a programming language. I solved the problems as they arose. When demands for improved performance came along, I would sit and worry and come up with a way of providing improved performance.

polyFORTH is a condensation of everything that we at FORTH Inc have learned in the last 10 years of developing FORTH. I think it is a very good package. I foresee no fundamental changes in the design of the language except for accommodation to FORTH standards, which are becoming increasingly important.

### Implementations of FORTH

I would like to review the implementations of FORTH of which I am aware. It is actually a tour through the history of computers and it is fascinating that this could all have happened in 10 years.

FORTH has been programmed in FORTRAN, ALGOL, PL/I, COBOL, assembler, and FORTH; and I am sure some of you can come up with other languages with the same history. My list is strictly personal.

FORTH has been implemented on the Burroughs 5500; the IBM 1130; the Univac 1108; the Honeywell 316; the IBM 360; the Data General Nova; the HP 2100 (not by me but by Paul Scott at Kitt Peak); the PDP-10 and PDP-11 (by Marty Ewing at the California Institute of Technology); the PDP-11 (by FORTH Inc); the Varian 620; the Mod-Comp II; the GA SPC-16; the CDC-6400 (by Kitt Peak); the PDP-8; the IV-Phase; the Computer Automation LSI-4; the RCA 1802; the Honeywell Level 6; the IBM Series 1; the Interdata; the 6800; the 8080; the 8086; the TI-9900; and soon the 68000, the Z8000, the 6809, and a Child Inc computer. Some independent groups have 6502s, ILLIAC, and others running FORTH. I raise the question—is it the case that FORTH has been put on

every computer that exists?

Some people think FORTH ought to be machine independent, but that premise is wrong. The equivalence is FORTH—each machine requires meticulous attention to its individual characteristics. You must use all the hardware capabilities of each machine and must then work to force it into the mold specified by FORTH's virtual machine.

For example, we put a subset of FORTH on an SMS-300 microcomputer. It had only eight instructions. The internal characteristics of every

---

**At no point did I sit down to design a programming language. I solved the problems as they arose.**

---

machine can and must be exploited. You do not need any particular number of registers or stacks or anything. All can be simulated, but if you neglect the abilities of the machine, you can end up a factor of 2 down in performance from where you might otherwise be.

### FORTH-in-Hardware Computers

The first FORTH computer I know of was built at Jodrell Bank in England around 1973. It is a redesign of an English Ferranti computer that went out of production. The observatory at Jodrell Bank was going to build their own bit-slice version; they discovered FORTH about the same time, modified the instruction set to accommodate FORTH, and built what I am told is a very fast FORTH computer. I have never seen it, but have talked to its competent designer, John Davies, who is one of the early FORTH enthusiasts.

In 1973, before Dean Sanderson came to FORTH Inc to develop microFORTH, he had a FORTH computer at a company called General Logic. It qualifies as a FORTH computer because it has a FORTH instruction. And there is a story there. Dean showed me his instruction set, and there was this funny instruction that I could not see any reason for—I figured it was some kind of no-op or catchall or

something; it had the weirdest properties, and it could not possibly be useful. It was NEXT. It was a one-instruction NEXT which was beautiful. And it was a very simple modification (this was a bit-slice computer) to the instruction set—a few wires here and there—and that is the first time I saw a FORTH computer, if you will. I call it a FORTH computer because it had the ability to change itself from an ordinary computer into a FORTH computer.

I think that hardware today is in the same shape as software was 20 years ago. No offense, but it is time that the hardware people learned something about software. There is an order or two of magnitude improvement in performance possible with existing technology. We do not need picosecond computers to make really substantial improvements in execution speed. Faced with that realization, there is no point in trying to optimize the software any further until we have taken the first crack at the hardware. The hardware redesign has to be as complete as the software redesign was. The standard microprocessors did not have FORTH in mind. Those minicomputers that can be microprogrammed cannot be microprogrammed well enough to even be worth doing. The improvements available are much greater than you can achieve by these half measures.

I have built a small FORTH computer. The design changes as fast as the chips can be plugged into the board. But it is not difficult to do. Here are the characteristics of a FORTH computer:

- It does not need a lot of memory (16 K bytes is about right—half programmable read-only memory, half user programmable memory, maybe).
- It does not need a lot of I/O ports; in fact, it does not need any I/O ports except for the application requirements.
- A serial line and interface to a disk drive are useful but not required.

We have put FORTH on an 8080-based machine with a virtual disk in memory, enough memory to hold eight blocks. The system is quite viable and has no particular problem with system crashes. Bubble





AUTO LF

SCROLL

POWER

ON

OFF

## **Diablo printers spend more time in this position.**

A printer isn't much good if it can't do the job when it's needed.

That's why, at Diablo, we don't just design printers that work. We design printers that keep on working. In fact, we make them so reliable, you can just open the carton, plug in and play.

Diablo offers the widest range of reliable printers and options to give the flexibility you need. Which stands to reason. After all, we pioneered the daisy wheel technology and we're still the leader in it.

So if your printers spend too much time in the "off" position, you know what to do.

Switch.

### **Diablo Systems**

**XEROX**



memories are coming. A FORTH computer does not need much mass storage; 100 K bytes are adequate, and 250 K bytes are plenty. The fact that FORTH can exist quite happily on a machine that is very small by contemporary standards should be exploited.

### Organizations

Finally, I would like to run through the history of the organizations that have been involved with FORTH. They have formed another thread of the tapestry. It began with Mohasco, of course, followed by NRAO and

Kitt Peak National Observatory; then came FORTH Inc.

The next step was probably DECUS (Digital Equipment Computer Users' Group). Marty Ewing gave his PDP-11 FORTH system to DECUS. FORTH Inc was not sure whether free FORTHS floating around was a good idea at the time. But it turned out that a lot of people were exposed to FORTH who otherwise would not have been.

Cybek came along and provided an entry into the business-systems market. Art Gravina, the president of Cybek, is the person who designed

our data-base management system. He provided us the opportunity to do commercial systems and the ability to handle ten times as many terminals as he could with the BASIC program that preceded it.

In about 1976, a committee of the International Astronomical Union met and adopted FORTH as a standard language. That was a boost in the world of astronomy, although the world of astronomy was no longer the major driving force in the popularity of FORTH.

I think EFUG (the European FORTH Users' Group) came along about that time (1976). It turned out to our surprise that Europe was a hotbed of FORTH activity that we were largely unaware of (and perhaps still are, in that we are not involved in that world and do not appreciate the level of interest). An international FORTH Standards Team probably grew from their first meetings. A couple of years later, the FORTH Interest Group started. Now we have FORML—FORTH Modification Laboratory, an idea-generating organization.

### Conclusion

The tendency seems to be for people to organize themselves in groups. Some of these groups are companies, others are associations. It looks like FORTH is going to be a communal activity in that sense—that it will grow from the work of unstructured clusterings of like-minded people. The suggestion is that this whole world of FORTH is going to be quite disorganized, uncentralized, and uncontrollable. It's not bad, perhaps it's good.

My view of the future is more unsettled today than it has been for years: promising, confusing, perplexing. The implications are perhaps as staggering now as they were 20 years ago. The promise of realization is much higher. My original goal was to write more than forty programs in my life. I think I have increased my throughput by a factor of 10. I do not think that that throughput is program-language limited any longer. So I have accomplished what I set out to do: I have a tool that is very effective in my hands. It seems it is very effective in others' hands as well. I am happy and proud that this is true.

## No typing skills required

It's easier and more accurate to enter alphanumeric data with a BIT PAD than a keyboard. Now anyone can .

- Enter whole lines of characters with a single stroke
- Enter data directly from business forms by simply checking a box.
- Enter variable alphanumeric data from a menu keyboard.

Take a printed form—price list, order form, loan or insurance application, laboratory request—lay it on the BIT PAD tablet and touch the pertinent items with the pen. The information is entered directly into your data processing system.

Plus, the BIT PAD does even more

Try to describe a fluctuating business trend to your computer through a keyboard. With BIT PAD you simply trace the trend with the pen. Special keyboard menus can be created by the user to enter high level languages, foreign languages or special symbols.

Before you order any kind of data entry equipment, ask Summagraphics to give you the full story on the BIT PAD ONE

Summagraphics Corporation, 35 Brentwood Avenue, Fairfield, Connecticut 06430; or call Marketing Department, Peripheral Products (203) 384-1344



**Summagraphics**  
CORPORATION

## The BIT PAD™ alternative to keyboard data entry

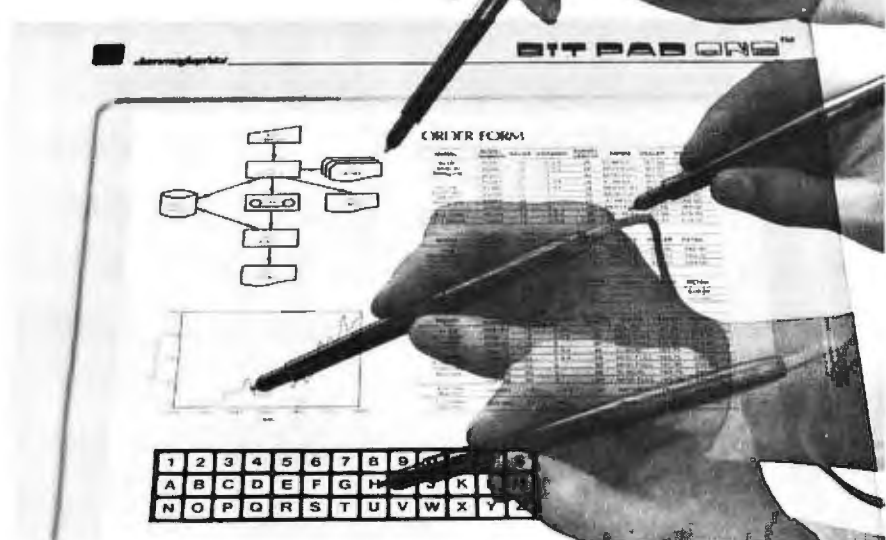



# WordPro™

**"WordPro is the most sophisticated Word Processing Software package available for the Commodore Computer line."**

## **Solve Your Paperwork Problem . . . Let WordPro Software Do The Work**

Using standard typing methods, hundreds of valuable hours are spent erasing, revising, and retyping letters and documents as you work towards a final draft copy. The second, third, or fourth drafts take just as long to type as the first!

With WordPro word processing software you can transform your Commodore computer into a "state of the art" word processing machine with sophisticated word processing features at an affordable price.

There are four versions of WordPro, ranging from the simple to the sophisticated. WordPro 1 on cassette will give computer enthusiasts a full range of text editing capabilities with cassette file storage. WordPro 2 is disk based and allows fast and easy file handling and manipulation. WordPro 3 was designed for professionals and contains the many features required in a business environment such as global search and replace, headers, footers, decimal tabulation, repagination, merging capabilities, and much, much more. WordPro 4 is our best. WordPro 4 runs on the new Commodore 8032, 80-column display computer. WordPro 4 has all the features of WordPro 3, plus additional features usually found only on the most sophisticated and expensive word processing equipment.

WordPro is a new breed of word processing software. Powerful, sophisticated, and easy to use, WordPro was field-tested by dozens of attorneys and commercial customers during 1979. WordPro is now installed and is saving its owners valuable time and money in hundreds of offices nationwide.

WordPro was designed with the user in mind. WordPro's unique "STATUS LINE" constantly interacts with the user by displaying the status of the system. Editing, storing documents, recalling letters, even the most sophisticated commands, are accomplished by a few, easy to remember, keystrokes.

You may find that WordPro alone is reason enough to own a computer. WordPro can be found at most Commodore dealers worldwide. Call us for the number of the dealer nearest you. If you cannot locate a stocking WordPro dealer you may place an order with Professional Software via check or VISA/MasterCharge.



**Actual Photograph of WordPro on CBM Model 8032  
The many features of WordPro 1 - 4:**

**WordPro 1** - Cassette based • Status line • Test Editing • Insert/Delete • Screen Scroll Auto Repeat • String Search • Erase Functions • Link Files • Margin Controls • Tab Functions • Justification • Page Length

**WordPro 2** - Most WordPro 1 Functions Plus + Disk Based • Paragraph Indent • Centering • Text Transfer • Hyphenation • Appending • Margin Release • Variable Blocks (Form Letters) • Multiple Copies • Automatic Disk Commands • Complete Disk File Handling

**WordPro 3** - Commercial Disk Version for 40 Columns • WordPro 2 Functions Plus + Global Functions (Search/Replace/Copy) • Merging Disk File Linkage • 10 or 12 Pitch • Repagination • Duplicate Lines • Auto Delete Word/Sentence/Range • Numeric Mode • Underlining • Continuous Print • Headers/Footers • Auto Page Numbering • Proportional Justification • Forced Paging • Non-Print Comments • BASIC Language File Compatibility

**WordPro 4** - Commercial Disk Version for 80 Columns • WordPro 3 Functions Plus + Displays and Formats Text to Screen for Review

**WordPro 1** — For all 8K RAM units. Requires C2N Peripheral/integrated cassette drive - **\$29.95**

**WordPro 2** — For all 16K RAM units with 40 column screen. Requires 2040 disk drive - **\$99.95**

**WordPro 3** — For all 32K RAM units with 40 column screen. Requires 2040 disk drive - **\$199.95**

**WordPro 4** — For Model 8032 with 80 column screen. Requires 2040 or 8050 disk drive - **\$299.95**

**All four versions of WordPro are written in 6502 machine code.**

## **Professional Software Inc.** **166 Crescent Rd., Needham, MA 02194** **(617) 444-5224**

**\*WordPro Dealer inquires Invited\***

WordPro was developed by Steve Punter of Pro-Micro Software Ltd., and is marketed exclusively by Professional Software Inc.

WordPro is a registered trademark of Professional Software Inc. CBM is a registered trademark of Commodore Business Machines.





## Components of FORTH

FORTH is characterized by five major elements: dictionary, stack, interpreters, assembler, and virtual memory. Although not one of these is unique to FORTH, their interaction in FORTH produces a synergistic effect that creates a programming system of unexpected power and flexibility.

- **Dictionary:** The resident FORTH system is organized into a dictionary that occupies almost all of program memory. The dictionary is a threaded list of variable-length items, each of which defines a word of the vocabulary. The actual content of each definition depends on the type of word: noun, verb, etc. The dictionary is extensible, growing toward high memory. In a multiterminal system, terminal tasks may have private dictionaries that are connected in a hierarchical tree structure.
- **Stack:** Two push-down stacks (last-in, first-out, or LIFO, lists) are maintained for each multiprogrammed task in the system. These provide the primary communication between routines as well as an efficient mechanism for controlling logical flow. A stack normally contains items one computer word long, which may be addresses, numbers, or other objects. Stacks, which are of indefinite size, grow toward low memory.
- **Interpreters:** FORTH is fundamentally an interpretive system, meaning that program execution is controlled by data items rather than by machine code. It is a common assumption that interpreters are severely wasteful of processor time; this is avoided in FORTH by maintaining two levels of interpretation.

The first of these is the text interpreter, also known as the outer interpreter. It works in a conventional manner, parsing text strings that come from terminals or mass storage and looking up each word in the dictionary. When a word is found in the dictionary, it is executed (unless the task is in compile mode) by invoking the address interpreter.

The address interpreter (also known as the inner interpreter) interprets strings of absolute memory addresses by executing the definition pointed to by each. Most dictionary definitions contain addresses of previously defined words that are to be executed by this interpreter. This level of interpretation requires no dictionary search since these words have already been compiled by the text interpreter, which generated the absolute addresses.

The address interpreter has several important properties. First, it is fast. Indeed, on some computers it executes only one instruction for each word, in addition to the code implied by the word itself. Second, it interprets compact definitions. Each word referenced in a definition compiles a single memory location. Finally, the definitions are machine independent because the definition of one word in terms of others does not depend upon the computer that interprets the definitions.

- **Assembler:** FORTH includes a resident assembler, which allows the programmer to define words that will cause specified machine instructions to be executed. This type of definition is necessary to perform device-dependent input and output operations, to implement elementary operations, and to do highly time-critical processing.
- **Virtual memory:** The final key element of FORTH is its blocks: fixed-length segments of disk space that may contain program text or data. A number of buffers are provided in memory; blocks are read into them automatically when referenced. If a block is modified in memory, it is automatically replaced on disk. Explicit read and write operations, therefore, are not required; programmers may presume that program text or data is in memory whenever it is referenced.

[The above paragraphs present a concise overview of FORTH as a language; the following paragraphs describe features of a FORTH Inc product, polyFORTH...GW]

The standard polyFORTH system utilities include the following:

- |                  |  |
|------------------|--|
| Text editor:     | Facilitates editing program source text, both by line and by character.  |
| Source listings: | Prints program source listings and indexes.  |
| Disk copy:       | Provides for disk-to-disk copying of data file and program source files for backup purposes.   |
| Disk diagnostic: | Produces a simple, read-only disk diagnostic that may be run at any time without disturbing other users. (More extensive hardware diagnostics are optional.) |

Each polyFORTH system also contains a Target Compiler™ capability; this allows the user to develop, for run-time applications only, a computer system that does not require the entire operating system. Since FORTH is an interpretive language, an interpreter must always be present; but the target compilation process creates the minimum dictionary necessary, thus allowing a program to be run with a minimum of memory overhead. Typically, this overhead is less than 1000 bytes.

Full data-base management support is available in an optional Extended File Management package. Included within its structure are the essential features of the CODASYL standard along with the characteristic speed, compactness, and flexibility of the FORTH language. Facilities include commands for file definition and formatting and for field and record descriptions, as well as several file-accessing techniques, operators for accessing individual fields by name and fields within specified files, and such utility functions as a report generator and an optional key-sort routine. ■





# BASIC SOFTWARE LIBRARY NOW ★ 10 ★ Volumes and Growing

IS SPONSORING A

## \$10,000.00 Give Away

WHY Pay hundreds of dollars for Software that does Not work when WE offer the BEST available Software for only a few dollars a program. And what is better OURS WORKS!

We have over 100,000 in circulation since 1975 and we are still around and That's more than Anyone else can say. We used to sell hundreds of programs individually, the programs in Volume X were sold for several years at over \$10,000, in Volume III for over \$6,000 but a few years ago we decided to promote software to the mass public and it was an instant success.

For Homeowners, Businessmen, Engineers, Hobbyists, Doctors, Lawyers, Men and Women

<b>Vol. I \$24.95</b>	<b>Vol. II \$24.95</b>	<b>Vol. III \$39.95</b>	<b>Vol. IV \$9.95</b>	<b>Vol. V \$9.95</b>	<b>Vol. VIII \$19.95</b>	<b>Vol. IX \$19.95</b>	<b>Vol. X \$69.95</b>	
Business & Personal Bookkeeping Programs	Animals Four Astronaut Bagel Bio Cycle Cannons Checkers Craps Dogflight Golf Judy Line Up Pony Roulette Sky Diver Tank Teach Me	Binomial Chi-Sq. Coeff Confidence 1 Confidence 2 Correlations Curve Differences Dual Plot Exp-Distri Least Squares Paired Plot Plotpts Polynomial Fit Regression Stat 1 Stat 2 T-Distribution Unpaired Variance 1 Variance 2 XY	Beam Conv Filter Fit Integration 1 Integration 2 Intensity Lola Macro Max Min. Navaid Optical Planet PSD Rand 1 Rand 2 Solve Sphere Trian Stars Track Triangle Variable Vector	Billing Inventory Payroll Risk Schedule 2 Shipping Stocks Switch	Bingo Bonds Bull Enterprise Football Funds 1 Funds 2 Go-Moku Jack Life Loans Mazes Poker Popul Profits Qubic Rates Retire Savings SBA Tic-Tac-Toe	Andy Cap Baseball Compare Confid 10 Descrip Differ Engine Fourier Horse integers Logic Playboy Primes Probal Quadrac Red Baron Regression 2 Road Runner Roulette Santa Stat 10 Stat 11 Steel Top Vary Xmas	1040-Tax Balance Checkbook Instal 78 Deprec 2 APPENDIX C Favorites	Intro. A/R A/P Mer Inv Check Assets Payroll Bal Sh P/L Year End Data Base Tax Up Basic St.
Bond Building Compound Cyclic Decision 1 Decision 2 Depreciation Efficient Flow Installment Interest Investments Mortgage Optimize Order Perit Tree Rate Return 1 Return 2 Schedule 1 Games & Pictures	A. Newman J. F. K. Linus Ms. Santa Nixon Noel Noel Nude Peace Policeman Santa's Sleigh Snoopy Virgin	APPENDIX A	<b>Vol. VI \$49.95</b> Mini-Ledger Payroll A/R Inventory Ledger	<b>Vol. VII \$39.95</b> Chess Medbil Wdproc Utility				

Volume VI — Disk programs are compatible with TRS-80 disk basic. The disk programs in Volumes VI, VII and X are written in (CP/M) M Basic and Disk Extended Microsoft Basic. Other programs written in 8K Basic.

FIRST DRAWING — September 11, 1980 and every week thereafter until December 18, 1980. Winners will be notified within one week. For a list of winners send a self-addressed stamped envelope with a request for the winners list. No PURCHASE Necessary. To enter send name & address on a 3 x 5 card. You are automatically entered every time you make a purchase from us. Void where prohibited by LAW.

**KEMCO, LTD.**  
P.O. Drawer 2208L Petersburg, VA 23803  
Sales HOT LINE 800-241-7131 ext. 440  
In Georgia call 800-282-2686

IN GERMANY  
Ing. W. Hofacker, GmbH  
Holzkirchen, W. Germany

IN HOLLAND  
Nanton Press B.V.  
Bilthoven, Holland

Unconditional Money Back Guarantee.  
Add \$1.50 per volume handling, all domestic shipments sent U.P.S. except APO and P.O. Box which go parcel post. Foreign orders add \$6.00/volume for air shipment and make payable in U.S. dollars only.  
AVAILABLE AT MOST COMPUTER STORES  
Master Charge and Bank Americard accepted.  
Our Software is copyrighted and may not be reproduced or sold.  
Unlike others we have NOT raised our prices in five years

**OVER 116,000 IN USE TODAY**



# BYTE LINES

NEWS AND SPECULATION ABOUT PERSONAL COMPUTING

Conducted by Sol Libes

**P**ersonal Computer Prices Increasing: Both Texas Instruments (TI) and Atari recently announced price increases for their personal computer systems. Radio Shack, Commodore, and Apple are holding the line, at least for the present.

Atari increased the price of its Model 400 from \$550 to \$630 and the Model 800 from \$1000 to \$1080. The company attributed the increase to rising component costs, particularly components that incorporate precious metals.

TI, on the other hand, has subtly unbundled the 99/4 system. Previously, a purchaser bought the keyboard/processor console and a 13-inch color video monitor for \$1150. Now he can buy the console for \$950 and the monitor for \$450, a total of \$1400. Or, he can buy the console and an RF (radio-frequency) modulator (\$75) and hook it up to a standard color television set. This combination costs \$1025, which is only \$125 less than the old complete system price.

Although Radio Shack, Commodore, and Apple have not raised the prices of their basic systems, certain peripheral devices and add-ons have increased in price. Furthermore, when the Federal Communications Commission (FCC) RF-radiation standards go into effect on January 1, 1981, there may be significant price increases.

Most personal-computer marketing experts agree that for personal computing to become a true mass

market, prices must decrease, not increase. The experts are therefore disturbed over what they feel will be a real damper to personal-computing sales.

**S**oftware Piracy: Over the years, software vendors have complained many times about hobbyists copying software from one another instead of buying it. One supplier even has gone so far as to offer a \$10,000 reward for information leading to the conviction of anyone found copying its software. I am not aware that this plan has had any positive results. It has, however, raised the ire of many hobbyists, and there may have been a negative effect on this particular supplier's software sales, because he sells cassette software mostly to hobbyists.

Although copying by hobbyists remains a problem for software vendors, a much greater problem has developed: software piracy for commercial purposes, by pirate vendors who are marketing copies in much the same way as audio- and videocassette pirates do.

For example, Nestar Systems of Palo Alto, California, has charged that its read-only-memory-based "Basic Programmer's Toolkit" (for the Commodore PET) is being distributed in Europe in both cassette and floppy-disk format. The pirating distributor is alleged to have changed the code (relocating it into user

memory) and to have changed the copyright notice. Nestar is taking action in this case.

This type of software piracy will have a more serious financial impact on the software vendor than hobbyist copying. Here, the vendor is actually losing dealer sales, since many dealers are purchasing the software from the pirate at a much lower cost—and probably marking it up more—than if the dealer purchased it from the legitimate vendor. In most instances, end users are not aware that they have purchased a pirated copy until they try to get software support from the rightful vendor.

**T**ektronix Sets Up Handicapped Person's Hot Line: Physically handicapped persons, or people wanting information on special electronic equipment for coping with physical impairments, can get answers to questions by calling the Tektronix Special Interest Group on Computers and the Physically Handicapped in Beaverton, Oregon, at (503) 357-4354.

**I**ntel Releases Data on 32-Bit Microprocessor: Intel, the recognized leader in microprocessor development, has "leaked" advanced information on three new forthcoming 16- and 32-bit microprocessors. Intel is now playing the game of trying to scoop its competition by

announcing products long before they will be available in production. This will, no doubt, have an impact on sales of the Zilog Z8000 and Motorola MC68000, as purchasers may now wait for a more powerful product.

The 32-bit microprocessor will be known as the iAPX-432, and will be a 3-chip set with a brand-new architecture and instruction set. Intel claims that it will provide the power of a medium-scale IBM 370 system. It will directly execute Ada code. Ada is an upward extension of Pascal, and it is the language designed for and to be used by the US Department of Defense. It is interesting to note that at this time there is no Ada compiler up and running.

The two new 16-bit microprocessors are essentially 8086s with integrated functions and higher speed to improve performance. They are intended for multiprogram and multi-user systems.

Intel promises that all three new microprocessors will be available in 1981, with the 32-bit microprocessor becoming available first.

**X**erox Opens Computer Stores: The Xerox Corporation recently opened retail stores in Dallas, Texas, and Denver, Colorado. Apparently these are the first links in a chain of retail computer stores across the country. The store is selling Xerox 510 small-business computers, Apple II com-



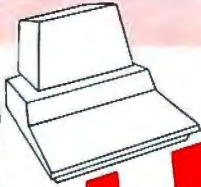

# APPLE/PET BREAKTHROUGHS

"Precise, humanized, well documented an excellent value" are the applauds now being given to United Software's line of software. These are sophisticated programs designed to meet the most stringent needs of individuals and business professionals. Every package is fully documented.

## KRAM

By Ken Germann

**KEYED  
RANDOM  
ACCESS METHOD**

Many times more powerful and efficient than the primitive "relative record" method used by Apple & Commodore.

### FOR APPLE II & COMMODORE PET

KRAM is the **FASTEST** and **MOST POWERFUL** keyed access method available for the Apple & Commodore CBM (Pet) Computers. Written entirely in 6502 machine code, KRAM is extremely fast, comprehensive in scope, very compact, and easy to use. KRAM function calls are invoked via a single instruction.

Using the sophisticated capabilities of KRAM the Apple & CBM (Pet) can now fully meet the requirements of information management applications, such as: Accounts Receivable/Payable, Inventory Control, General Ledger, Payroll, Mailing lists, and Database Management. Programs can now be 30% to 90% shorter and run many times faster! Less experienced users can now create powerful programs!

#### KRAM Release 2.0 Functions:

- Create/Open a dataset
- Put record by Key
- Add & delete records by Key
- Get any record by Full/Partial key in 4/10ths of a second (2/10ths with Corvus Disk)
- Supports multiple disks
- Read next or previous record
- Dynamic space allocation
- Dynamic space reclamation
- Dynamic index compression
- Never needs file reorganization!

An 87 page manual fully documents KRAM 2.0 detailing KRAM functions and illustrating with programming samples. KRAM architecture is fully explained and a sample mailing list application program is included.

#### PET & Apple Requirements

KRAM is designed to work with both Apple's Disk II, or Corvus Systems 10 Megabyte Winchester Disk, and Commodores 2040, 3040, and 8050 Disk units. KRAM 2.0 requires an integer Apple or Apple Plus with integer card and at least one disk drive. KRAM works on any 40/80 column 16K/32K PET.

## Introductory Special \$99.95

### FOR COMMODORE 16K/32K COMPUTERS

**DATABASE MANAGEMENT SYSTEM** — A comprehensive, interactive system like those run on mainframes! Six modules comprising 42K of programming allow you to; create, edit, delete, display, print, sort, merge, etc., etc. - databases of up to 10,000 records. Printer routines automatically generate reports and labels on demand. 60 pages of concise documentation are included. Requirements - 16-32K PET and 2040 Dual Disk (printer optional) ..... **COST \$125**

OTHER SOFTWARE		
Stock Analyzer	.....	22.95
Mortgage	.....	14.95
Space Intruders	.....	
Super Space Wars	.....\$ 9.95	("Best Game of 1979") ..\$19.95
States & Capitals	..... 9.95	Jury/Hostage..... 9.95
Moving Point	.....	Kentucky Derby/Roulette 9.95
Average	..... 19.95	Alien I.Q./Tank..... 9.95
Stock Options	..... 24.95	Tunnelvision/Maze Chase 14.95
Finance	..... 12.95	Submarine Attack..... 9.95
Bonds	..... 12.95	Battle of Midway..... 7.95
		Laser Tank Battle..... 9.95
		Swarm..... 14.95
Stock Options	..... 24.95	Baseball..... 9.95
Finance	..... 12.95	Super Startrek..... 14.95
Bonds	..... 12.95	PET Music Box..... 29.95

## APPLE WORLD

By Paul Lutus

**3-D ANIMATED  
COLOR GRAPHICS**

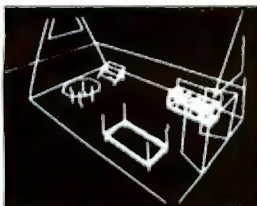

The Program made famous on National TV!

FOR 48K APPLE II COMPUTERS WITH DISK

APPLE WORLD turns your Apple into a sophisticated graphics system capable of creating animated three-dimensional color images, projecting them in true perspective on the screen, rotate them, move them closer, further away, and many other exciting and imaginative things.

A powerful screen-oriented text editor is included to facilitate image formation. This program was recently featured on Tom Snyder's Prime Time Saturday TV Show and is now available for sale.

APPLE WORLD'S powerful editor is so easy to use that children will love it. You can now "sketch" your dream house, boat, car, or fantasy empire. Then view it as it would be seen from 10,000 feet, or you can ZOOM in until the screen is filled with a doorknob. You could then go inside and move from room to room examining furniture placement as your screen rotates within the room. Images or specific parts of images can easily be saved to disk or printer.

Does all this sound like science fiction? You won't think so after you have visited Apple World.

**Introductory Price \$59.95**

36 page manual included

Look for the RED-WHITE-BLUE United Software Display at your local computer dealer, or send check or money order, plus \$3.00 shipping to:

**USA UNITED SOFTWARE OF AMERICA**

750 3RD Avenue,  
New York NY 10017  
(212) 682-0347

Telex 640055

**DEALER INQUIRIES INVITED**



puters, Centronics printers, Hewlett-Packard calculators, and ADT security systems. Xerox plans to open at least 200 such outlets in at least 50 cities within 2 years.

## **A**pple Foundation Awards Grants To

**Schools:** The Apple Education Foundation, chartered by Apple Computer Inc, has awarded \$120,000 worth of equipment to schools and individuals to expand the use of microcomputers in education. The foundation plans to donate another \$250,000 worth of equipment to support programs at all educational levels. Current recipients include Iowa State University; Bowditch Middle School in Foster City, California; North Texas State University; Educational Services Management Corporation in Raleigh, North Carolina; Children's Hospital in Philadelphia; the National Science Foundation; Dr Robert N Noyce, vice president of Intel Corporation; and others.

Other participating contributors include the Bell & Howell Company, Heuristics Inc, and Integral Data Systems Inc.

For more information, contact the Apple Education Foundation, 20605 Lazaneo Dr, Cupertino CA 95014.

## **5** $\frac{1}{4}$ -Inch Mini-Winchester Disk Introduced:

Shugart Technology of Scotts Valley, California (not to be confused with Shugart Associates) has introduced a  $\frac{5}{4}$ -inch Winchester-type hard-disk drive with a 6.38-megabyte unformatted capacity. It is the same size and uses the same power-supply voltages as a standard  $\frac{5}{4}$ -inch floppy-disk drive. [See Tom Manuel's article, "The Hard Disk Explosion," on page 58 of this issue for more details...CM]

Lobo Drives, Goleta, California, plans to make

available a low-cost controller which interfaces the  $\frac{5}{4}$ -inch hard-disk drive and floppy-disk drives to several personal-computer systems. These products should become available in 1981.

## **R**andom News Bits:

Votrax (Division of Federal Screw Works, 500 Stephenson Hwy, Troy MI 48084) has announced a new voice synthesizer with an unlimited vocabulary in seven languages and controllable inflection. The Model VSB, built on a single printed-circuit card, is intended to interface with terminals, electronic typewriters, word processors, and other equipment. The unit is controlled by 8-bit input commands that select phonemes and inflection. Original equipment manufacturer price is \$280....A national FORTH language group is in operation. They publish a newsletter, distribute software, and conduct meetings. For information contact: Jim Flounoy, 17370 Hawkins Ln, Morgan Hill CA 95037....Radio Shack has released a software package for its TRS-80 Model I which enables users to originate Mailgram messages. Users must have a Western Union (WU) Electronic Mail account, and if so, users are billed monthly by WU for messages sent....Matsushita Electric, Osaka, Japan, has introduced a single-component voice synthesizer that generates either 10 seconds of high-quality speech or up to 30 seconds of low-quality speech. The integrated circuit uses only 28 pins and operates from +5 V. The device will probably be used in consumer appliances, cars, etc....National Semiconductor, Santa Clara, California, has introduced a microprocessor that includes a read-only-memory-resident BASIC interpreter and 64 bytes of user memory. The single-chip computer keeps get-

ting closer and closer to reality....CompuServe, the company that provides the MicroNet information utility, has been negotiating with H & R Block about a corporate merger, with intent to become a subsidiary of the income-tax firm.

**R**andom Rumors: A semiconductor manufacturer will soon introduce two integrated circuits that together will handle all interfacing requirements for the S-100 bus, thereby reducing the number of components required by S-100 master and slave boards. The two devices will provide all the necessary bus buffering, control signals, and address decoding and will meet IEEE S-100 specifications....Hewlett-Packard (HP) is rumored to be working on a hand-held calculator that is programmable in BASIC (maybe they should call it a computer). Rumor is that they, and several others, will introduce such units by year end. A few have already been introduced in Japan....Texas Instruments (TI), which has been working on a disk-drive system of its own, is now negotiating with a number of outside suppliers for 8-inch Winchester-type hard-disk drives to be included in a new small-business/word-processor system to be introduced next year. TI, however, is still pursuing in-house designs. TI is also negotiating with several tape-drive suppliers for a backup storage system....The rumor is that Tandon Magnetics, Chatsworth, California, is about to announce a 2-megabyte quad-density  $\frac{5}{4}$ -inch floppy-disk drive with a \$375 original equipment manufacturer price tag....Look for Integral Data Systems to introduce a \$1500 letter-quality dot-matrix printer. It will use overlapping dot-matrix printing. To be called "Paper Tiger Plus," it will

print at 120 cps, with proof copies at over 200 cps.

**T**oo Good To Be True? A rumor recently heard at BYTE says that a major manufacturer will shortly introduce a  $\frac{5}{4}$ -inch floppy-disk drive with a tenfold increase in density. This sounds too good to be true. Will standard media support such an extension?...CH

## **M**icrominis and Micromaxis:

Two new words have been coined to describe the newer microprocessors. If an 8-bit processor is called a "micro," then a 16-bit microprocessor must be a "micromini." That is the conclusion of many in the industry, particularly since many of these new 16-bit microminis will be competing head-on with applications that were previously the exclusive domain of the 16-bit minicomputers.

It therefore follows that the 32-bit microprocessors, which are expected within three years, should be called "micromaxis," since they will most likely compete for applications previously handled by large mainframe computers. At least that is what many industry watchers think.

Well now...my question is: what do we call a 4-bit microprocessor? Is it a "minimicro"?

**MAIL:** I receive a large number of letters each month as a result of this column. If you wish a response, please include a stamped, self-addressed envelope.

**Sol Libes**  
**Amateur Computer**  
**Group of New Jersey**  
**(ACG-NJ)**  
1776 Raritan Rd  
Scotch Plains NJ 07076



# MICROSOFT. NOBODY DOES IT BETTER.

In 1975, Microsoft wrote the first BASIC interpreter for the 8080. Today, hundreds of thousands of microcomputers run with Microsoft software. And tomorrow—a full line of system software for the 8086 and Z8000. With microcomputer software, nobody does it better.

**BASIC Compiler** Microsoft's BASIC compiler is the ideal software tool for the development of BASIC applications programs for resale. Compiled object code for any application may be distributed to your customers on diskette or ROM, thus safeguarding the source program. And execution speeds with our compiled BASIC code are faster than with any other BASIC. Highly optimized, compact object code means maximum efficiency in any application. The BASIC Compiler supports all the language features of our BASIC-80 Interpreter. Comes with macro assembler and loader. Runs with CP/M, ISIS-II, TRSDOS. \$395.

**BASIC Interpreters for 8080, Z80, 8086, 6800, 6809** Language features above and beyond any other BASIC have made Microsoft's BASIC the world's most popular interpreter. And now three new versions are available for the 8086, 6800, and 6809. The latest releases of BASIC-80 and BASIC-86 support the new WHILE conditional, plus CHAINING of programs with COMMON variables, dynamic string space allocation and variable length records in random files. All versions have double precision arithmetic, full PRINT USING, tracing, renumbering, edit mode, and many other features. BASIC-80 for CP/M, ISIS-II, TEKDOS: \$350. BASIC-86 standalone on SBC 86/12: \$600. BASIC-68 for FLEX: \$200. BASIC-69 for FLEX: \$250.

**COBOL-80 Compiler** The best implementation of the world's most widely used programming language is COBOL-80 from Microsoft. As small business applications become not-so-small, COBOL-80 is ready with powerful use of disk files, data manipulation facilities, CHAIN, segmentation and interactive ACCEPT/DISPLAY. Plus three-dimensional arrays, full COPY facility, indexed and relative files and an optional packed decimal format that saves on mass storage by as much as 40%. Comes with macro assembler and loader. Runs on CP/M, ISIS-II, and TRSDOS. \$750.

## NEW! muSIMP/muMATH-79

At last, a sophisticated math package for microcomputers. muMATH performs mathematical operations efficiently and accurately. Use it to solve equations and simplify formulas; or perform exact arithmetic, symbolic integration and differentiation, infinite precision integer arithmetic and symbolic matrix inversion. muMATH is an invaluable tool for engineering and scientific applications involving lengthy, analytical computations. It is also an ingenious teaching method for all levels of math from arithmetic to calculus. muMATH is implemented in muSIMP, a highly structured language for complex symbolic manipulations. muSIMP/muMATH Package, CP/M versions: \$250.

## NEW! muLISP-79

LISP—the lingua franca of the artificial intelligence world—is now available in this efficient, low-cost version for microcomputers. Features include dynamic allocation of storage resources; program control structures such as an extended COND and a multiple exit LOOP; user functions defined as CALL by Value or CALL by Name; and 83 LISP functions. muLISP-79, CP/M version: \$200.

**NEW! XMACRO-86** For the development of 8086 programs, our new XMACRO-86 cross assembler has just been released. It supports the same features as our MACRO-80 assembler. Develop 8086 programs now on your current CP/M, ISIS-II, or TEKDOS system. \$300.

**NEW! Micro-SEED DBMS** If you are developing applications software in-house or bundling hardware and software for resale, a database manager could be the software tool you've been looking for. Micro-SEED is the first CODASYL compatible database management system to run with CP/M; and Microsoft's FORTRAN-80 has been implemented as the host language. When an application becomes limited by traditional floppy disk file handling, but remains overpowered by the cost and maintenance of a minicomputer, the solution is Micro-SEED. \$900.

**FORTRAN-80 Compiler** Microsoft FORTRAN-80 is the most complete microcomputer FORTRAN available. It has all of ANSI-66 FORTRAN (except COMPLEX data), plus unique enhancements for use in the microcomputer environment. An extensive library of single and double

precision scientific functions, too. Comes with macro assembler and loader. Versions for CP/M, ISIS-II, TEKDOS. \$500.

**MACRO-80 Assembler** The most powerful microcomputer assembler on the market today is Microsoft's MACRO-80. It is fast, and it supports Intel-standard macros, relocation pseudo-ops, conditionals and listing controls. MACRO-80 comes with a relocatable linking loader and runs with CP/M, ISIS-II, and TEKDOS. \$200.

**EDIT-80 Text Editor** Random access to floppy disk files makes EDIT-80 the fastest microcomputer text editor. It's the essential tool for creating and maintaining all files. EDIT-80 includes FILCOM, a file compare utility. EDIT-80, CP/M version: \$120.

Prices quoted are USA domestic only. OEMs should contact Microsoft for prices.

MICROSOFT OS	CP/M	ISIS-II	TRSDOS	TRSDOS Md II	TEKDOS
BASIC-80 INTERPRETER	●	●	■	■	●
BASIC COMPILER	●	●	□	●	
FORTRAN-80 COMPILER	●	●	□	■	●
COBOL-80 COMPILER	●	●		●	
muMATH/muSIMP muLISP	●		□		
MICROSEED DBMS	●				
EDIT-80 TEXT EDITOR	●		□	■	
MACRO-80 ASSEMBLER	●	●	□	■	●

● contact Microsoft    ■ contact Manufacturer  
□ contact Microsoft Consumer Products

## MICROSOFT

10800 NE 8th, Suite 819  
Bellevue, WA 98004  
206-455-8080 Telex 328945



We set the standard.



This selected list of FORTH vendors is meant to be an overview only. For complete details contact the vendors. Many of the products, listed as fig-FORTH versions, are implementations of the FORTH Interest Group software customized for a given machine and available in machine-readable (as opposed to printed) form.

When purchasing a version of FORTH, check to see what source the version is based upon. All good versions of FORTH are based on either the FORTH Inc or the FORTH Interest Group versions. Some existing implementations use nonstandard shortcuts that limit the usability of the product; these should be avoided.

Literature on FORTH is scarce, so be prepared to puzzle through cryptic documentation. Miller Microcomputer Services offers a wide selection of books on FORTH (the only selection we know of). Particularly suitable are microFORTH Primer (supplied with the purchase of MMSFORTH) and Using FORTH, both written by FORTH Inc.

STOIC is a FORTH-like language available from the CP/M Users' Group and is listed because of its low price. N/A refers to information unavailable at the time this table was compiled....GW and CHF

## Selected FORTH Vendors

Manufacturer	Product Name(s)	Machine Requirements	Format	Cost	Notes
Acropolis Software 17453 Via Valencia San Lorenzo CA 94580 (415) 276-6050	A-FORTH (based on fig-FORTH)	Any machine running Micropolis disks and MDOS operating system	Floppy disk	\$150	Includes 8085 assembler, double-precision fixed-point math, enhanced disk access, other features.
Cap'n Software POB 575 San Francisco CA 94101 (415) 540-0202	fig-FORTH	Apple II with disk	5-inch floppy disk	\$140	FORTH hot line available for questions. Extra packages (Apple high-resolution graphics, floating point) available at extra cost.
CP/M Users Group 1651 Third Ave New York NY 10028	STOIC (not FORTH, but a FORTH variant)	Any CP/M machine.	8-inch floppy disk	\$20	See editorial for further details.
FORTH Inc 2309 Pacific Coast Hwy Hermosa Beach CA 90254 (213) 372-8493	FORTH, polyFORTH, microFORTH, picoFORTH	Versions for various machines: 8080, 8086, 6800, 1802, LSI-11; also handles versions for minicomputers and mainframes	Varies with machine.	\$2500 up (\$495 for picoFORTH)	These are the inventors of the language; they supply custom packages and extensive support; picoFORTH (for 8080 or 1802) can be directly upgraded to polyFORTH.
FORTH Interest Group POB 1105 San Carlos CA 94070	fig-FORTH	Various machines with 16 K bytes or more: 8080, 6502, 6800, LSI-11, 9900, PACE; disk preferable	Printed listings; must be customized by user.	\$20	\$20 includes installation manual and assembly language source for one processor (8080, etc); requires some work by user to install; quality product at a low price.
FORTH Power 17390 Hawkins Ln Morgan Hill CA 95037 (415) 471-1762	fig-FORTH	Heath WH-89 or 6800 EXORciser	N/A	N/A	
Forthright Enterprises POB 50911 Palo Alto CA 94303 (415) 656-0450	fig-FORTH	CP/M machine, 16 K bytes	8-inch CP/M floppy disk	\$30	Includes all source code.
John James POB 348 Berkeley CA 94701 (415) 526-8815	fig-FORTH	PDP-11, all models; stand-alone or running under RT-11 or RSX-11M; 24 K bytes or more	8-inch floppy disk	\$140	Package includes all documentation and source code; also offers a book of FORTH reprints.
M&B Design 820 Sweetbay Dr Sunnyvale CA 94086 (408) 243-0834	polyFORTH-CP/M	8080 CP/M system	8-inch CP/M floppy disk	\$4000	Multitasking version of FORTH running on CP/M system with 32 K bytes or more; includes utility programs and interface to CP/M; system uses CP/M I/O drivers only.
Miller Microcomputer Services 61 Lake Shore Rd Natick MA 01760	MMSFORTH (based on FORTH Inc micro-FORTH)	TRS-80 Model I, with Level II BASIC, 16 K bytes or more	Cassette or 5-inch floppy disk	\$59.95, cassette \$79.95, disk	Offers support of product, consultation, newsletter, additional FORTH products, and a wide selection of FORTH books.
The Stackworks 321 E Kirkwood Ave Bloomington IN 47401 (812) 336-1600	SL5 (FORTH under a different name)	Any CP/M machine, 8080 or 280	8-inch CP/M floppy disk	\$150 (noncommercial use), \$1500 (commercial use)	This language is essentially an implementation of the 1977 FORTH Standard; SL5 includes a debug package and packages that allow the generation of condensed, stand-alone programs as either CP/M, COM files, or as programs to be placed in read-only memory.
Talbot Microsystems 7209 Stella Link Suite 112 Houston TX 77025 (713) 666-7588	fig-FORTH	Minimum 12 K bytes (20 K better for FLEX 9.0) 6809 SwTPC FLEX 9.0	5-inch floppy disk soft-sectored	\$39.95	Offers telephone support of product.





#### What do you need?

Program listings . . . inventory listings . . . custom logos and letters . . . mailing labels in a multitude of sizes . . . custom forms and the data to complete them . . . curve plotting or bar graphs . . . digitized images from video or bit pads . . . multi-part forms . . . preprinted forms . . . tickets . . . and the list goes on . . .

#### How do we do it?

High speed bi-directional full logic printing; two standard character sets, upper/lower case with descenders; high speed font at 165 cps; letter quality font at 90 cps; expanded characters, solid underlining; programmable character sets; complete dot control graphics; adjustable tractor feed 3"-16"; user adjustable platen; programmable tabs, forms length and line spacing; out of paper signal; self-test; interface options — RS-232C, Centronics parallel, Apple, S-100; and the list goes on . . .

## The Malibu Model 165

Find out if it's the easy solution to your hard copy needs — contact your local computer dealer or you can write or call us today for complete specifications and print samples — you won't be disappointed.

**Versatility, Quality and Reliability: We build it in.**

**malibu**  
Electronics Corporation

*Dealers and OEM'S, call us about our new purchase programs with prices, terms and delivery to meet your needs too.*

2301 Townsgate Road, Westlake Village, CA 91361 (805) 496-1990

a subsidiary of **Datametrics Corporation**



# What Is FORTH?

## A Tutorial Introduction

---

John S James  
POB 348  
Berkeley CA 94701

---

FORTH is a programming language with a small but fast-growing and enthusiastic user community. Though easy to learn at a terminal, it is difficult to explain abstractly because it is so different from other languages. Even advocates do not agree why it is good or how it should be used.

FORTH was developed for control applications (using a computer to run other machinery), data bases, and general business. It is least useful for big number-crunching jobs (eg: writing a matrix inversion routine), although it can link to subroutine packages written in other languages to incorporate such functions. Unlike Pascal, FORTH gives the user complete access to the machine and does not try to guard the programmer against mistakes. But its modularity and other forms of error control allow production of remarkably bug-free application programs—perhaps

more than any other language in common use. The compiler uses much less memory than Pascal does, and its programs run about equally fast. FORTH is much more interactive than most conventional implementations of Pascal. FORTH is available on most common personal computers (eg: Apple, TRS-80) and all major microprocessors (eg: 8080, 6800, 6809, 6502, PACE, LSI-11, and 9900). An international FORTH Standards Team exists, and standard systems are virtually identical among all different machines.

This article will describe what it is like to program in FORTH. A group of annotated terminal sessions, shown in listings 1 thru 10, will provide more details on the language itself.

### The Philosophy of FORTH

FORTH reduces the cost of a subroutine to very little, and the whole language is built on functions that are like subroutine calls. The programmer keeps defining new words (new functions) from old ones until, finally, one of them is the whole job. Most programmers keep each definition short, usually one to three lines not counting comments. The definitions are compiled as entered and are immediately ready to run.

Because FORTH definitions are short, all possible execution paths of the definition can be tested easily. Since most functions work exactly the same when executed as commands from the terminal or when used as components in further definitions,

they can be tested immediately from the terminal. And the functions are so general that there is no sharp distinction between program and data.

Since programmers define their own operations, special application libraries of FORTH words can be developed. The new routines are integrally part of the language, so they do not need any special calling sequences, and they are immediately ready to run. Even the original words supplied with the system (there are about one hundred of them), can be redefined if desired, adapting the language for special circumstances. Also, programmers can create their own data types or operation types (eg: their own kinds of arrays or other data structures, or new classes of operations). This flexibility allows unprecedented "customization" of a language to the requirements of a particular installation or application. The finished programs are easily modifiable when requirements change because they are composed of pretested building blocks specially designed for that kind of program.

### Stack and Postfix Notation

A smaller convenience of FORTH is that you do not have to do much coding when you start a new program. As soon as the system comes up, all your previous work is ready to go, just as if it were originally part of the language.

A feature that some people do not like is FORTH's use of a stack (explained below) and its *postfix notation* (also called *reverse Polish*

---

### Acknowledgments and Availability

Listings 1 thru 7 were run on a FORTH system for the Apple II provided by Cap'n Software, POB 575, San Francisco CA 94101. The PDP-11 examples were run on a system written and distributed by the author. The 8080 example was provided by John Cassidy of the Forth Interest Group, POB 1105, San Carlos CA 94070; a similar 8080 FORTH system is available from Forthright Enterprises, POB 50911, Palo Alto CA 94303. Other members of the Forth Interest Group contributed helpful suggestions. And of course we are indebted to the inventor of FORTH, Charles Moore of FORTH Inc, 2309 Pacific Coast Hwy, Hermosa Beach CA 90254, who started it all.

---



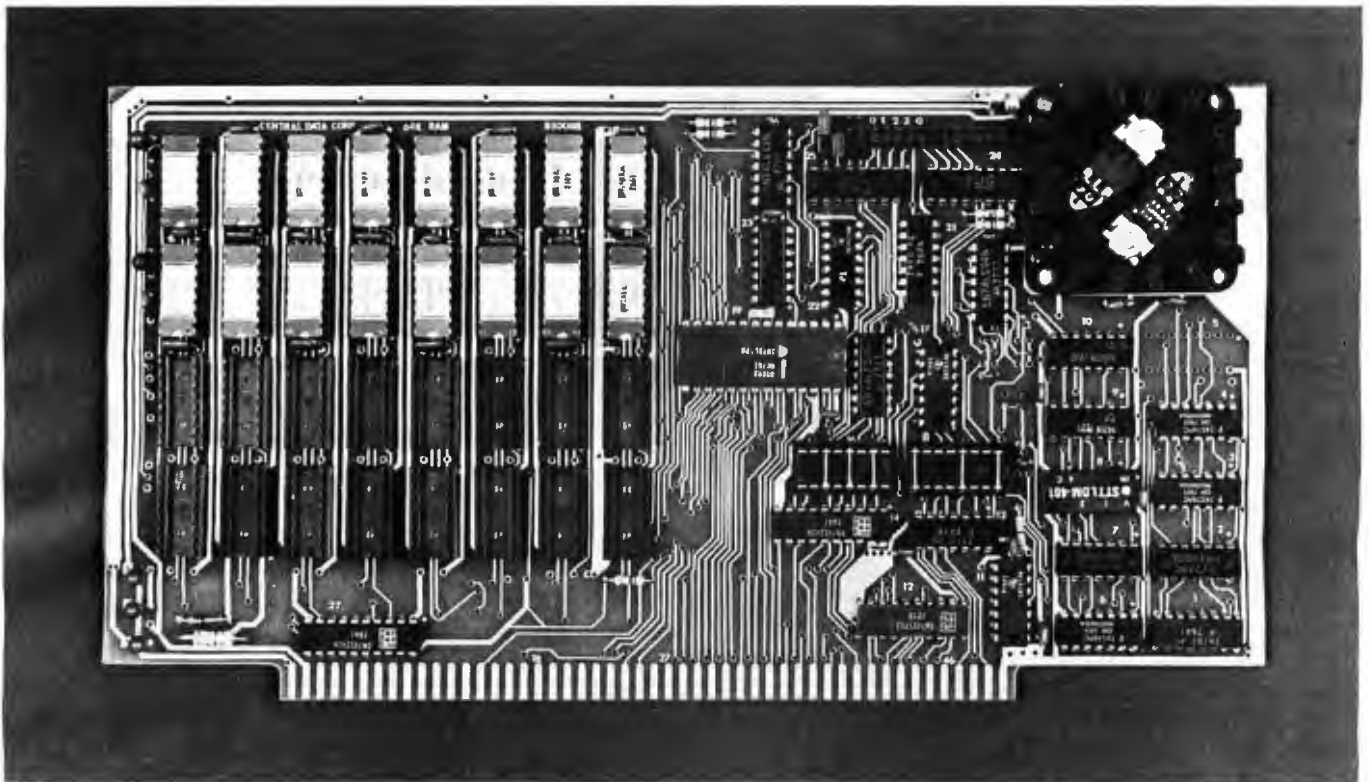

32K Board Pictured Above

# Why Not the Best?

## From The Dynamic RAM Company.

2MHz	4MHz
16K—\$249	\$259
32K—\$375	\$395
48K—\$500	\$530
64K—\$625	\$665

We have now been shipping our 2MHz dynamic RAM boards for over two years. Hundreds of 4MHz boards have been going out every month since early 1979. Our reliability is proven in the thousands of systems which contain our board. Many quality-minded systems houses across the country and overseas are using our boards for their equipment.

**Our prices still beat all.** Despite rising 16K memory chip prices (at least from reputable suppliers), Central Data continues to give you the best buy in memory today. Nobody offers a board with a capacity of 64K, assembled, tested, and guaranteed for a full year at the price we do.

Circle 64 on inquiry card.

**Deselect around PROMs.** Our boards have the important deselect feature which lets you overlap any fixed memory in your system with no interference.

**Our features make the board easily used and expanded.** You address our boards on 16K boundaries with mini-jumps (small shorting plugs that slide over wire-wrap pins) near the top of the board for easy access. If you want to expand your board after you have purchased it, all that you need to do is add memory. We can supply you with expansion packages (\$150-2MHz, \$160-4MHz) which include eight RAMs that you can depend on as well as two mini-jumps for addressing. And of course, our board **never** generates wait states.

**Low power consumption keeps your computer running cool and reliable.** The total power consumption of our 16K board is typically less than 4 watts (+8V @ 300ma, +16V @ 150ma and

—16V @ 20ma). Boards with additional memory typically increase power consumption only 1 watt per 16K!

**Standard S-100 Interface.** Our board is designed to interface with any standard S-100 CPU. All of the timing of the board is independent of the processor chip, and the board is set up for different processors by changing two plugs on the board.

**Call or write us today.** That will guarantee a fast response with more information on the board. Or make an order — you'll probably have the board in two weeks! **If you're interested, also ask for a catalog on our Z8000 16-bit processor board designed for the MULTIBUS.** All of these products are available to your local dealer, also.

Central Data Corporation, 713 Edgebrook Drive, PO Box 2530, Station A, Champaign, IL 61820. (217) 359-8010

**Central Data**



## Most FORTH operations communicate only through a stack.

notation or RPN). In postfix notation (a system used on most Hewlett-Packard calculators), arithmetic formulas are written with the operations after their arguments, not between them. For example, "2+3" becomes { 2 3 + } in FORTH or other postfix systems; "(4+5)\*(6+7)" becomes { 4 5 + 6 7 + \* }. (See explanation below.) No parentheses are needed in postfix.

Some programmers do not like postfix, and they ask, "Why doesn't someone write an algebraic-to-postfix translator for FORTH? That would be easy to do." The reason is that postfix has benefits far more important than the compiler-writer's convenience. It greatly simplifies linkage to subroutines. With postfix, you do not need any CALL statement or argument list, or any formal parameters in the subroutine. While arithmetic-formula operations (add, subtract, etc) must take either one or two arguments and return exactly one result, postfix functions can have any number of arguments or results.

In FORTH, most operations communicate only through a stack. The stack, perhaps the most important data structure in programming, is used in almost all languages, but most languages hide it from the user. In FORTH, the user controls the stack directly.

A *stack* is a pile of numbers where the last ones put in are the first ones taken out; that is, you can only remove the number that is on top of the stack. It is like a stack of trays in a restaurant; trays are conveniently added and removed only at the top. (Unfortunately, computer-science texts do not agree on terminology, and a few call the top of the stack "the bottom.")

To see how a stack works in computation, consider the expression { 2 3 + } above. In FORTH, numbers are compiled as operations which place their values onto the stack. So when the 2 is executed, it is placed on top of the stack, which then looks as follows:

2  
—  
—

where the dashes represent whatever data may have been on the stack before. Then after the 3 has been encountered, the stack becomes:

3  
2  
—  
—

Then the + is executed. The 1-character word + takes two arguments from the stack (destroying them), performs the addition, and leaves the result on the stack. So the stack finally is:

5  
—  
—

The reader can verify that when the formula { 4 5 + 6 7 + \* } is executed, the stack goes through the sequence shown in figure 1.

Now we can see why FORTH is not the best language for big number-crunching jobs. Numbers to be operated on must be moved to the stack in addition to whatever operations are to be carried out, and this extra movement slows FORTH down for this kind of computation. Once on the stack, however, arithmetic is fast (for example, single instruction execution for addition on some 16-bit machines, more for 8-bit machines). Also, FORTH can link the useful instructions of one routine and those of another in as little as one or two instruction executions (depending on machine architecture). This makes FORTH programs much faster than BASIC, usually ten times faster or more (assuming an interactive BASIC, that is—FORTH is always interactive). But a good FORTRAN

STACK		4	5 4	9	6 9	7 6 9	13 9	117	117
OPERATION JUST PERFORMED	{BEGIN}	4	5	+	6	7	+	*	{END}

Figure 1: Evaluation of the postfix-notation expression, { 4 5 + 6 7 + \* }. Numbers are pushed onto the stack at the top. Operators (here, + and \*) pop the top two entries off the stack and push the result of that operation back on the stack. For example, the first plus sign (column 4) replaces the 4 and 5 on the stack with 9, the result of the addition operation.

compiler's code may do number-crunching several times faster still.

### Characteristics of FORTH Code

FORTH is a structured language (as is Pascal) in that it has no GOTO or statement labels in the language. Discussion of structured programming is outside the scope of this article, but its importance for program correctness and maintainability is recognized.

FORTH object code (ie: a compiled program) is extremely compact, even more so than machine language. The reason is that no matter how much work an operation performs, each invocation of it takes the same space in the object program—two bytes. The bigger the program, the greater the memory advantage, since the hierarchical structure of programs allows increasingly powerful and application-targeted operations to be built up. But FORTH has a relatively large run-time memory overhead, so small programs can take less total space in other languages.

[The reason that a FORTH call can be shorter than a normal machine-language subroutine call (usually three bytes) is that a FORTH program is interpreted by a FORTH interpreter (also part of the FORTH language) in much the same way that a BASIC program is interpreted by a BASIC interpreter. The "relatively large run-time memory overhead" mentioned above is the FORTH interpreter plus a core of FORTH words defined in machine language. When a FORTH program is very large, it saves enough memory in FORTH calls to make up for run-time memory overhead....

GW]

The complete FORTH system (itself largely written in FORTH) takes about 7 K bytes, and this whole system including the compiler is com-



# THE NATIONS LEADER IN AFFORDABLE PRINTERS



## \$749

\*Suggested retail price, substantial OEM and dealer discounts available

The first in series of new printers designed specifically for the general use computer market, the MODEL 88T DOT MATRIX PRINTER combines quality construction and attractive styling with capabilities generally associated only with more expensive printers. The Model 88T comes standard with a dual tractor/pressure-roll paper feed system and a serial/parallel interface. The tractor paper feed system provides the precision required to handle multi copy fanfold forms, ranging in width from 1 inch to 9.5 inches. The pressure-roll paper feed can be used with 8.5 inch roll paper. An optional sheet feeder is available for feeding single sheets. A long life ribbon cartridge gives crisp, clean print without messy ribbon changing. The microprocessor based controller has 80, 96, 120 or 132 column formatting capability while printing upper and lower case characters bi-directionally at 100 characters per second. Write for complete specifications, pricing and distributor list.



MICRO PERIPHERALS, INC. / 2099 WEST 2200 SOUTH / SALT LAKE CITY, UTAH 84119 / (801) 973-6053



monly left in memory as a run-time package. Therefore, 16 K bytes and a floppy disk for storing source programs are sufficient hardware for an excellent FORTH system (compare this with the memory requirements of Pascal, 48 K bytes or more). When compactness is especially important, as when programs are burned into read-only memory and embedded in machinery, FORTH's compiler, terminal handler, and operation names—anything not needed to run—can be stripped out of the application program, leaving a run-time package of about 800 bytes,

instead of the usual 7 K bytes.

FORTH programming is *reentrant*; this means that different users can share the same copy of a program in memory while running at the same time. FORTH easily handles multitasking, including multiple terminals used for program development. (At present, however, most of the low-cost systems on the market are still single-user.) FORTH is *recursive*, meaning that routines can invoke themselves.

Suppose you want to link your high-level-language program to a machine-language subroutine (eg:

you may be controlling a high-speed device and need the full speed of the computer to keep up). Many languages make this linkage difficult or impossible. In FORTH, however, it is very convenient. You can type in or load from disk a machine-language routine, using a FORTH assembler, and the new routine can be executed immediately. Listing 9 shows examples for PDP-11 and for 8080.

The word CODE invokes the FORTH assembler and begins the definition of a machine-language routine. Mnemonic instructions and address-mode symbols are understood by this assembler, and the whole power of FORTH is available for address arithmetic at assembly time. FORTH assemblers use postfix notation, so op codes come *after* their addresses, not before as in conventional assemblers.

The machine-language code is generated as the definition is being entered. The completed operation works just like any other FORTH word, so the user does not need to use any special calling sequence, or even need to know which operations are defined in code and which are not. (In fact, about fifty FORTH words are written in machine language—all other words in FORTH are ultimately defined in terms of these fifty words.)

The FORTH assembler allows structured conditionals and loops at the machine-code level; it can also assemble unstructured code if desired. Users can define their own macro-instructions, use custom-made data types, etc.

In other words, the FORTH assembler allows structured programming even in machine code, and it links the resulting machine-language subroutines into the system immediately. No separate assembly and linking-loader passes are needed, and the associated file management overhead is avoided.

### Some More Advantages

FORTH programs are highly transportable between different computers. Any assembly-language routines used by the program must be rewritten, but most applications do not need any assembly, and very few need more than a handful of short, critical routines. When FORTH systems have been designed for compatibility, large applications can be moved among very different

# SOFTWARE FOR THE HARDCORE

We know you hardcore bit hackers will recognize the computing power derived from combining the FORTH language with the 6809, today's most advanced 8 bit microprocessor.

And we know you'll understand this machine's 16 bit math, indirect addressing and two stacks are ideally suited for implementing FORTH.

But...should anyone need further convincing that FORTH provides a new dimension in power, speed and ease of operation, consider the following:

- It's a modern, modular, structured-programming high-level compiled language.
- It's a combined interpreter, compiler, and operating system.
- It permits assembler code level control of machine, runs near speed of assembler code, and uses less memory space than assembler code.
- It increases programmer productivity and reduces memory hardware requirements.

- It replaces subroutines by individual words and related groups of words called Vocabularies. These are quickly modified and tested by editing 1024-character text blocks, called screens, using built-in editor.

**tFORTH** is a basic system implemented for SS-50 buss 6809 systems with the TSC FLEX 9.0 disk operating system. It is available on 5 1/4" or 8" single density soft-sectored floppy disks. **\$100.00**

**tFORTH+** consists of tFORTH plus a complement of the following FORTH source code vocabularies: full assembler, cursor controlled screen editor, case statements, extended data types, general I/O drivers. **\$250.00**

**firmFORTH** is an applications package for use with tFORTH. It provides for recompilation of the tFORTH nucleus, deletion of superfluous code and production of fully rommable code. **\$350.00**

Call or write today.

**KENYON**  
**MICROSYSTEMS**

3350 Walnut Bend, Houston, Texas 77042 • (713) 978-6933



# INDUSTRY LEADER ANNOUNCES MERGER.

## MicroPro proudly announces MailMerge™ capabilities along with WordStar™ 2.0

Now you have another terrific reason to purchase WordStar, the industry's leader in microcomputer word processing. And that reason is called MailMerge. A new option that allows you to churn out letter quality form letters with full substitution capabilities, as well as chained and multiple copy printing.

And lots more.

Plus WordStar 2.0 also offers other new and powerful features. Like hyphen

help, decimal tab, paragraph indent, and copy/rename/run-another-program.

No wonder that in less than a year, more than 7500 people have purchased WordStar from over 350 dealers around the world.

So go ahead. Call (415) 457-8990 for a dealer nearest you. And just think, WordStar was a very popular software package *before* MailMerge.

Imagine how incredibly popular it will be *now*.



INTERNATIONAL CORPORATION

Leads the way.

MicroPro International Corporation 1299 4th Street, San Rafael, California 94901 Telex 340388  
Dealer/Distributor/O.E.M. inquiries invited.



machines, with little or no change. For example, it can be practical to down-load program development from a PDP-11 to a TRS-80 or an Apple II. It is even possible to write the software for a product before a hardware commitment is final.

Another advantage is that FORTH is a self-contained operating system. The 7 K bytes include terminal and disk handlers and a rudimentary file system. No other software is needed anywhere in the computer. Yet, if a monitor in read-only memory is available, FORTH can use it; and FORTH can run as a task under some other operating system (eg: CP/M) when that is wanted. FORTH can link together otherwise incompatible pieces of systems: software in read-only memory, operating systems, subroutine packages, and hardware. It provides a user interface that enables subroutine packages normally used by batch (ie: noninteractive) programs, mostly on older, larger computers, to be used interactively.

FORTH puts you in charge of your computer. You can understand everything happening in your soft-

ware or in any desired parts of it, and you can change it. This means no more "black box" systems that only the manufacturer's specialists can understand, no more dependence on someone else for upgrades, fixes, or documentation, and no more question of who is responsible if software does not work. The whole system is written in FORTH, right down to the bits—your application programs, the compiler, the operating system, the I/O drivers, etc. You do not have to learn some other language or be a systems specialist to modify it.

### Disadvantages

Few FORTH systems used today have floating-point arithmetic. This is not a fault of the language; rather, it reflects its history in microcomputer control applications, where integer arithmetic is often needed for speed. Now there is more pressure for floating point, and it is becoming available.

A more fundamental limitation of FORTH is that it is not a typed language (unlike Pascal). For example, if an integer operation is per-

formed on a floating-point quantity, no message is printed either at compile time or at run time to warn of this error. (However, the user *can* add type checking and other error-preventing operations into any FORTH word.)

It may seem that unreliable code would result from the untyped nature of FORTH, but, in fact, FORTH code is remarkably solid and bug-free. The modularity and excellent testing environment aid error control; and type mismatches are less dangerous than most other mistakes because they are easy to detect.

Another criticism of FORTH is its lack of a directory file structure. Again, this is historical and is not a characteristic of the language, which can be developed to use any kind of files.

The traditional FORTH file system is primitive, but in practice it has worked very well. The entire disk (or disks) is a single virtual array of blocks numbered from 1, with the block size standardized at 1024 bytes regardless of physical disk sector size. The blocks (called *screens* because they can be displayed as sixteen 64-character lines on a terminal) are automatically buffered so that they are physically read and written only when necessary. A LOAD command will read a given screen and treat the information exactly as if it had been typed in a terminal session, thereby compiling source code or executing commands (depending on the contents of the screen). The LOAD instruction can be executed within a screen; in this way, a single LOAD command can control the compilation of large source programs.

This disk-based file system allows any part of the disk to be read or written with a single access. Load screens or data areas can be saved by name, and portions of the disk can be protected by redefining the names of a few input and output operations so that they check before writing and/or reading.

The disadvantage of this system is that there is no directory; when a new disk is inserted, the user or the program must know the block numbers for load screens and data files. Also, FORTH source programs are traditionally stored without tabs or truncation of blank lines, making white-space (ie: unused area on a line) and

## ASCII encoded keyboards: Spillproof. Parallel or serial output, as low as \$69.\*

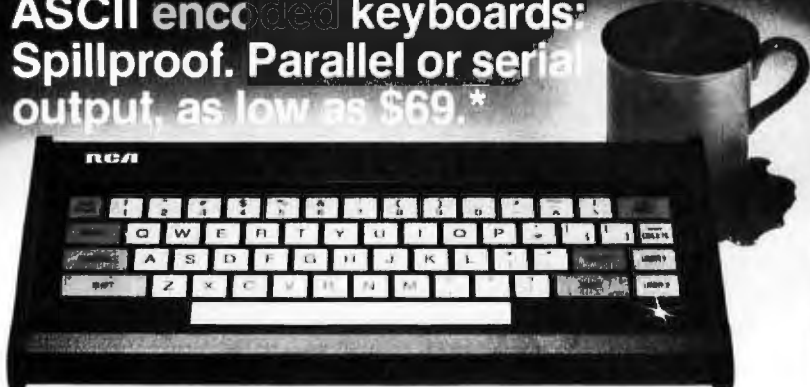

RCA VP-600 series ASCII keyboards are available in two formats. You can choose either a 58-key typewriter format. Or a 74-key version which includes an additional 16-key calculator-type keypad. Both can be ordered with parallel or serial output.

These keyboards feature modern flexible membrane key switches with contact life rated at greater than 5 million operations. Plus two key rollover circuitry. A finger positioning overlay combined with light positive activation key pressure gives good operator "feel," and an on-board tone generator gives aural key press feedback.

The unitized keyboard surface is spillproof and dustproof. This plus high noise immunity CMOS circuitry makes these boards particularly suited for use in hostile environments.

Parallel output keyboards have 7-bit buffered, TTL compatible output. Serial output keyboards have RS 232C compatible, 20 mA current loop and TTL compatible asynchronous outputs with 6 selectable baud rates. All operate from 5 V DC, excluding implementation of RS 232C.

For more information contact RCA Customer Service, New Holland Avenue, Lancaster, PA 17604.

**Or call our toll-free number: 800-233-0094.**



\*Optional user price for VP-601 Dealer and OEM pricing available





## MicroNET is just the tip of the iceberg

We've been telling you that MicroNET, CompuServe's personal computing service, is the best thing that's happened to personal computers since electricity. It still is, but now there's more. A lot more.

Welcome to CompuServe's information service.

- *News. Weather. Sports.* Major regional newspapers. Plus international news services.
- *Finance.* MicroQuote. Updates and historical information on stocks, bonds and commodities.
- *Entertainment.* Theatre, book, movie and restaurant reviews. Plus opera, symphony, ballet, dance, museums, galleries...
- *Electronic Mail.* Create, edit, send and receive messages from any other CompuServe user... nationwide.
- *Home & Educational Reference Service.* Anything you want to know... from encyclopedia information to household tips.
- *CompuServe user information.* In case you need technical help... and information on new services as they become available.

● *MicroNET.* All we've offered before and added lately with more to come. This includes Software Exchange, line printer art gallery, challenging games, programming languages, word processing, business & educational programs... and much, much more.

So we're raising the price. Right?

Wrong! All you pay is a small hook-up charge, and \$5.00 per hour billed in minutes to your charge card. You need a 300 baud modem and we're a local phone call in more than 200 North American cities.

Write for information. This is almost too good to believe, but we're delivering as promised.

## CompuServe

Information Service Division  
5000 Arlington Centre Blvd.  
Columbus, Ohio 43220  
(614) 457-8600



# Lifeboat

Software for most popular 8080/8080\* computer disk systems including  
**NORTH STAR, ICOM, MICROPOLIS, DYNABYTE DBB/2 & DBB/4, EXIDY SORCERER, SD SYSTEMS, ALTAIR, VECTOR MZ, MECA, 8" IBM, HEALTH H17 & H69, HELIOS, IMSAI VDP42 & 44, REX, NYLAC, INTERTEC SUPER-BRAIN, VISTA V80 and V20, TRS-80\* MODEL I and MODEL II, ALTO, OHIO SCIENTIFIC, DIGI-LOG, KONTRON PSI-80, IMS 5000 diskette formats and CSSN BACKUP cartridge tapes**

## CP/M\* VERSION 2 FOR TRS-80 MODEL II NOW AVAILABLE

*Genuine CP/M for Apple II coming soon!*  
*Call for details.* All Lifeboat programs require CP/M, unless otherwise stated.

**CP/M\* FLOPPY DISK OPERATING SYSTEM** - Digital Research's operating system configured for many popular micro-computers and disk systems:

System	Version	Price
North Star Single Density	1.4	145/25
North Star Double Density	2.2	145/25
North Star Double/Quad	2.2	170/25
Durango F-85	2.2	170/25
ICOM Micro-Disk 2411	1.4	145/25
ICOM 3712	1.4	170/25
ICOM 3812	1.4	170/25
Mits 3202/Altair 8800	1.4	145/25
Health H8 + H17	1.4	145/25 m
Health H89	1.4	145/25 m
Health H89 by Magnolia	2.2	300/25
Health H89 by Magnolia	2.2	300/25
Onyx 8001	2.2	300/25
TRS-80 Model I	1.4	145/25 m
TRS-80 Model II	2.2	170/25
TRS-80 Model II + Corvus	2.2	250/25
Processor Technology Helios II	1.4	145/25
Cromemco System 3	1.4	145/25
Intel MDS Single Density	1.4	145/25
Intel MDS Single Density	2.2	170/25
Micropolis Mod I	1.4	145/25 v
Micropolis Mod II	1.4	145/25 v

The following configurations are scheduled for release:

Apple II SoftCard	2.2	350/25
North Star Double/Quad + Corvus	2.2	250/25
North Star Horizon HD-1	2.2	250/25
Ohio Scientific CS	2.2	250/25
Ohio Scientific CS-2	2.2	250/25
Micropolis Mod II	2.2	250/25
Mostek MDX STD Bus System	2.2	350/25**
ICOM 3812	2.2	225/25
ICOM 4511/Retec D3000	2.2	375/25**

\*Software consists of the operating system, text editor, assembler, debugger and other utilities for file management and system maintenance. Complete set of Digital Research's documentation and additional implementation notes included. Systems marked \* and \*\* include firmware on 2708 and 2716. Systems marked + include 5440 media charge. Systems marked @ require the special @ versions of software in this catalog. Systems marked v have minor variants available to suit console interfaces of system. Call or write for full list of options. v includes hardware addition to allow our standard versions of software to run under it.

**DIGITAL RESEARCH**

MP/M	- Installed for single density MDS-800. Multi-processing derivative of the CP/M operating system. Manual includes CP/M2 documentation.	\$300/\$50
MAC-8080	- Macro assembler. Full Intel macro definitions. Pseudo Ops include RPC, IRP, REPT, TITLE, PAGE, and MACLIB. Produces absolute hex output plus symbol table file for use by SID and ZSD (see below).	\$120/\$15
SID-8080	- Symbolic debugger. Full trace, pass count and breakpoint program testing, stack trace and histogram utilities. When used with MAC provides full symbolic display of memory labels and equivalent values.	\$105/\$15
ZSD-280	- Symbolic debugger with all features of SID.	\$130/\$15
TEX	- Text output formatter to create paginated, page-numbered and justified copy. Output can be directed to printer or disk.	\$105/\$15
DESPOOL	- Utility program to permit simultaneous printing from text files while executing other programs.	\$80/\$10

**Z80 DEVELOPMENT PACKAGE** - Consists of: (1) disk file editor, with global inter and intra-line facilities; (2) Z80 relocating assembler, Zilog/Mostek mnemonics, conditional assembly and cross referencing capabilities; (3) linking loader producing absolute Intel hex disk file.

Z80	- Z80 Monitor Debugger to break and examine registers with standard Zilog/Mostek mnemonic disassembly displays. \$35 when ordered with Z80 Development Package.	\$50/\$10
-----	---	-----------

**AVOCET SYSTEMS**

XASM-88	- Non-macro cross-assembler with nested conditionals and full range of pseudo operations. Assemblies from standard Motorola MC6800 mnemonics to Intel hex.	\$200/\$25
XASM-85	- As XASM-88 for MOS Technology MCS-6500 series mnemonics.	\$300/\$25
XASB-48	- As XASM-88 for Intel MCS-48 and UP-41 16-bit mnemonics.	\$200/\$25
XASM-18	- As XASM-88 for RCA 1802.	\$300/\$25
DISTEL	- Disk based disassembler to Intel 8080 or TD/XTian Z80 source code, listing and cross reference files. Intel or TD/XTian pseudo ops optional. Runs on 8080.	\$85/\$10
DISLOG	- As DISTEL to Zilog/Mostek mnemonic files.	\$85/\$10
SMAL/80	- Structured Macro Assembler Language - Package of powerful general purpose text macro processor and SMAL structured language compiler. SMAL is an assembler language with IF-THEN-ELSE, LOOP-REPEAT-WHILE, DO-END, BEGIN-END constructs.	\$75/\$15

**Key C** - Interactive interpretive system for teaching structured programming techniques. Manual includes full source listings.

Key C	-\$105/\$90	
BDS C COMPILER	- Supports most features of language, including Structures, Arrays, Pointers, recursive function evaluation, overlays. Includes linking loader, library manager, and library containing general purpose, file I/O, and floating point functions. Lacks initializers, statics, floats and longs. Documentation by Kernighan and Ritchie.	\$145/\$25
WHITESMITHS C COMPILER	- The ultimate in systems software tools. Produces faster code than a pseudo-code Pascal with more extensive facilities. Conforms to the full UNIX 'version 7 C language, described by Ritchie and makes available over 75 functions for performing I/O, string manipulation and storage allocation. Linkable to Microsoft REL files. Requires 80K CP/M.	\$60/\$30

**MICROSOFT**

BASIC-80	- Disk Extended BASIC. ANSI compatible with long variable names, WHILE/WEND, @ and variable length file records.	\$325/\$25
BASIC COMPILER	- Language compatible with BASIC-80 and 3-10 times faster execution. Produces standard Microsoft relocatable binary output. Includes MACRO-80. Also linkable to FORTRAN-80 or COBOL-80 code modules.	\$550/\$25
FORTRAN-80	- ANSI 68 (except for COMPLEX) plus many extensions. Includes relocatable object compiler, linking loader, library with manager. Also includes MACRO-80 (see below).	\$425/\$25
COBOL-80	- Level 1 ANSI '74 standard COBOL plus most of Level 2. Full sequential, relative, and indexed file support with variable file names. STRING, UNSTRING, COMPUTE, VARYING/UNTIL, EXTEND, CALL, COPY, SEARCH, 3-dimensional arrays, compound and abbreviated conditions, nested IF. Powerful interactive screen-handling extensions. Includes compatible assembler, linking loader, and relocatable library manager as described under MACRO-80.	\$700/\$25
MACRO-80	- 8080/8080 Macro Assembler. Intel and Zilog mnemonics supported. Relocatable linkable output. Loader, Library Manager and Cross Reference List utilities included.	\$148/\$15
XMAC-80	- 8086 cross assembler. All Macro and utility features of MACRO-80 package. Mnemonics slightly modified from Intel ASM86. Compatibility data sheet available.	\$275/\$25
EDIT-80	- Very fast random access text editor for text with or without line numbers. Global and intra-line commands supported. File compare utility included.	\$80/\$15

**PASCALM** - Compiles enhanced Standard Pascal to compressed efficient Pcode. Totally CP/M compatible. Random access files. Both 16 and 32-bit integer. Built-in error recovery. Convenient STRING. OTHERWISE clause on CASE. Comprehensive manual (90 pp. indexed). SEGMENT provides overlay structure. INPUT, OUTPUT and untyped files for arbitrary access for all library modules. Version 1.000 CP/M, 2) Z80 CP/M, or 3) Cromemco CDS.

PASCALM	-\$175/\$20
---------	-------------

**PASCALZ** - Z80 native code PASCAL compiler. Produces optimized, ROMable re-entrant code. All interacting to CP/M is through the support library. The package includes compiler, relocating assembler and linker. Supports 80K CP/M. Supports 32K CP/M records, strings and direct I/O are supported. Requires 56K CP/M.

PASCALZ	-\$395/\$25
---------	-------------

**PASCALMT** - Subset of standard PASCAL. Generates ROMable 8080 machine code. Symbolic debugger included. Supports interrupt procedures, CP/M file I/O and assembly language interface. Real variables can be BCD, software floating point, or AMD 9511 hardware floating point. Includes strings enumerations and record data types. Manual explains BASIC to PASCAL conversion. Requires 32K.

PASCALMT	-\$250/\$30
----------	-------------

**ALGOL-60** - Powerful block-structured language compiler featuring economical run-time dynamic allocation of memory. Very compact (24K total RAM) system implementing almost all program features plus many powerful extensions including string handling direct address I/O etc.

ALGOL-60	-\$199/\$20
----------	-------------

**CBASIC-2** Disk Extended BASIC - Non-interactive BASIC with pseudo-code compiler and run-time interpreter. Supports full control, chaining, nested and extended precision variables, etc.

CBASIC-2	-\$120/\$15
----------	-------------

**MICRO FOCUS**

STANDARD CIS COBOL	- ANSI '74 COBOL standard compiler fully validated by U.S. Navy tests to ANSI level 1. Supports many features to level 2 including dynamic loading of COBOL modules and a full ISAM file facility. Also, program segmentation, interactive debug and powerful interactive extensions to support protected and unprotected CRT screen formatting from COBOL programs used with any dumb terminal.	\$850/\$50
FORMS 2	- CRT screen editor. Output is COBOL data & descriptions for copying into CIS COBOL programs. Automatically creates a query and update program of indexed files using CRT protected and unprotected access formats. Supports program segmentation. Output program directly compiled by STANDARD CIS COBOL.	\$200/\$20

**EIDOS SYSTEMS**

KIBS	- Keyed Index Sequential Search. Offers complete Multi-Keyed Index Sequential and Direct Access file management. Includes built-in utility functions for 16 or 32 bit arithmetic, string/integer conversion and string compare. Delivered as a relocatable linkable module in Microsoft format for use with FORTRAN-80 or COBOL-80, etc.	\$338/\$23
KBASIC	- Microsoft Disk Extended BASIC version 4.51 integrated by implementation of nine additional commands in language. Package includes KISS.REL as described above, and a sample main list program. To licensed users of Microsoft BASIC-80 (MSBASIC) .....	\$595/\$45
KBASIC	- Microsoft Disk Extended BASIC version 4.51 integrated by implementation of nine additional commands in language. Package includes KISS.REL as described above, and a sample main list program. To licensed users of Microsoft BASIC-80 (MSBASIC) .....	\$438/\$45

**YXASIS Interactive Process Control BASIC** - Full disk BASIC features plus unique commands to handle byte rot and shift and to test and set bits. Available in several versions:

Integer ROMable	-\$330/\$25
Integer ROM squared	-\$350/\$25
Integer CP/M	-\$450/\$25
Extended ROMable	-\$450/\$25
Extended ROM squared	-\$480/\$25
Extended CP/M	-\$450/\$25
Extended CP/M Run Time Compiler	-\$550/\$25
Integer CP/M Run Time Compiler	-\$450/\$25

**RECLAIM** - A utility to validate media under CP/M. Program tests a diskette or hard disk surface for errors, restoring the imperfections in invisible files, and permitting continued usage of the remainder. Essential for any hard disk. Requires CP/M version 2.

RECLAIM	-\$85/\$5
---------	-----------

**BASIC UTILITY DISK** - Consists of: (1) CRUNCH-14 - Compacting utility to reduce the size and increase the speed of programs in Microsoft BASIC 4.51, BASIC-80 and TRS-80 BASIC. (2) DPFIN - Double precision routines for computing trigonometric transcendental functions including square root, natural log, log base 10, sine, arc sine, hyperbolic sine, hyperbolic arc sine, etc. Furnished in source on diskette and documentation.

BASIC UTILITY DISK	-\$50/\$35
--------------------	------------

**STRINGZ80** - Character string handling plus routines for direct CP/M BDOS calls from FORTRAN and other compatible Microsoft languages. The utility library contains routines that enable programs to chain to a COM file, retrieve command line parameters, and search file directories with full wild card facilities. Supplied as linkable modules in Microsoft format.

STRINGZ80	-\$85/\$20
-----------	------------

**THE STRING BIT** - FORTRAN character string handling. Routines to find, fill, pack, move, separate, concatenate and compare character strings. This package completely eliminates the problem associated with character string handling in FORTRAN. Supplied with source.

THE STRING BIT	-\$85/\$15
----------------	------------

**VDSORT** - Versatile sort/merge program for fixed length records with fixed or variable length fields. VDSORT can be used as a sub-routine. When used as a sub-routine, VDSORT maximizes the use of buffer space by saving the TPA on disk and restoring it on completion of sorting. Records may be up to 255 bytes long with a maximum of 5 fields. Upper/lower case translation and numeric fields supported.

VDSORT	-\$175/\$20
--------	-------------

**CPM/374X** - Has full range of functions to create or re-name an IBM 3741 volume, display directory information and edit the data set contents. Provides full file transfer facilities between 3741 volume data sets and CP/M files.

CPM/374X	-\$195/\$10
----------	-------------

**BSTAM** - Utility to link one computer to another also equipped with BSTAM. Allows file transfers at full data speed (no conversion to hex), with CRC block control check for very reliable error detection and automatic retry. Use it if it's overall Full wildcard expansion to send e.COM, etc. 9600 baud with wire. 300 baud with phone connection. Both ends need one. Standard and variations can talk to one another.

BSTAM	-\$150/\$10
-------	-------------

**WHATSIIT\*** Interactive data-base system using associative tags to retrieve information by subject. Hashing and random access used for last response. Requires CBASIC-2.

WHATSIIT*	-\$175/\$25
-----------	-------------

**SELECTOR III-C2** - Data Base Processor to create and maintain multi key data bases. Prints formatted and sorted reports with numerical summaries or mailing labels. Comes with sample applications, including Sales Activity, Inventory, Payables, Receivables, Check Register, and Client/Patient Appointments, etc. Requires CBASIC-2. Supplied in source.

SELECTOR III-C2	-\$295/\$20
-----------------	-------------

**LECTOR** - General Ledger option to SELECTOR III-C2. Interactive system provides for customized COA. Unique chart of transaction types insure proper double entry bookkeeping. Generates balance sheets, P&L statements and journals. Two year record allows for statement of changes in financial position report. Supplied in source. Requires SELECTOR III-C2, CBASIC-2 and 56K system.

LECTOR	-\$350/\$25
--------	-------------

Prices reflect distribution on 8" single density diskette. If format is requested which requires additional diskette, purchase of 32 5 1/4" or 5 1/4" diskettes will be added. A surcharge of \$25 will be added for software on CSSN format DC 300XL cartridge. Media charge for 1440 disk is \$10.

**Configurable Business System** is a comprehensive set of programs for defining custom data files and application systems without using a programming language such as BASIC, FORTRAN, etc. Multiple key fields for each data file are supported. Set-up program customizes system to user's CRT and printer. Provides fast and easy interactive data entry and retrieval with transaction processing. Report generator program does complex calculations with stored and derived data, record selection with multiple criteria, and custom formats. Sample inventory and mailing list systems included. No support language required.

Configurable Business System	-\$235/\$40
------------------------------	-------------

**MICRO DATA BASE SYSTEMS**

HOBS	- Hierarchical Data Base System. CODASYL oriented with FILE SET, RECORDS and ITEM which are all user defined. ADD, DELETE, UPDATE, SEARCH, and TRAVERSE commands supported. SET ordering is sorted, FIFO, LIFO, next or prior. One to many set relationship supported. Record/write protection at the FILE level. Supports FILES which extend over multiple floppy or hard disk devices.	\$750/\$40**
MDBS	- Micro Data Base System. Full network data base with all features of HOBS plus multi-level read/write protection for FILE, SET, RECORD and ITEM. Explicit representation of one to one, one to many, many to many, and many to one SET relationships. Supports multiple owner and multiple record types within sets. HOBS files are fully compatible.	\$750/\$40**
MDBS-280 version	-\$750/\$40**	
MDBS-280 version	-\$750/\$40**	

When ordering, specify one of the language interfaces listed below. Additional language interfaces available at time of purchase for \$100 or \$125 (if purchased later).

\*The single manual covering HOBS and MDBS when purchased alone comes without specific language interface manual. Manuals are available for the following Microsoft languages:

- 1) MBASIC 4.51, 2) BASIC-80, 3) 3) Compiled BASIC or FORTRAN-80, 4) COBOL-80, 5) MACRO-80.

**MICROPRO**

SUPER-SORT I	- Sort, merge, extract utility as absolute file executable program or linkable module in Microsoft format. Sorts fixed or variable records with data in binary, BCD, Packed Decimal, EBCDIC, ASCII, floating & fixed point, exponential, field justified, etc. Even variable number of fields per record.	\$225/\$25
SUPER-SORT II	- Above available as absolute program only.	\$175/\$25
SUPER-SORT III	- As II without SELECT/EXCLUDE.	\$125/\$25

**DATABSTAR** - Professional forms control entry and display system for key-to-disk data capture. Menu driven with built-in learning aids. Input field verification by length, mask, attribute (i.e. upper case, lower case, numeric, auto-dup, etc.) Built-in arithmetic capabilities using keyboard, cursor, block move, etc. Visual feedback for ease of forms design. Files compatible with CP/M-MP/M supported languages. Requires 32K CP/M.

DATABSTAR	-\$350/\$35
-----------	-------------

**WORD-STAR** - Menu driven visual word processing system for use with standard terminals. Text formatting performed on screen. Facilities for text pagination, page number, justify, center and underscore. User can print one document while simultaneously editing a second. Edit facilities include global search and replace, Read/Write to other text files, block move, etc. Requires CRT terminal with addressable cursor positioning.

WORD-STAR	-\$445/\$40
-----------	-------------

**WORD-STAR Customization Notes** - For sophisticated users who do not have one of the many standard software or printer configurations in the distribution version of WORD-STAR.

WORD-STAR Customization Notes	-\$445/\$40
-------------------------------	-------------

**WORD-MASTER Text Editor** - In one mode has super-set of CP/M's ED commands including global searching and replacing, forwards and backwards in file in video mode, provides full screen editor for users with serial addressable-cursor terminal.

WORD-MASTER Text Editor	-\$145/\$25
-------------------------	-------------

**TEXTWRITER III** - Text formatter to justify and paginate letters and other documents. Special features include insertion of text during execution from other disk files or console, permitting recipe documents to be created from linked fragments on other files. Has facilities for sorted index, table of contents and footnote insertions. Ideal for contracts, manuals, etc. Now compatible with Electric Pencil! prepared files.

TEXTWRITER III	-\$125/\$20
----------------	-------------

*Now applications software for Microsofts BASIC interpreter.*

**PEACHTREE SOFTWARE**

**GENERAL LEDGER** - Records details of all financial transactions. Generates a balance sheet and an income statement. Flexible and adaptable design for both small businesses and firms performing client wrapup services. Produces reports as follows: Trial Balance, Transaction Registers, Balance Sheet, Prior Year Comparative Balance Sheet, Income Statement, Prior Year Comparative Income Statement and Department Income Statements. Interactive with other PEACHTREE accounting packages. Supplied in source code for Microsoft BASIC.

GENERAL LEDGER	-\$90/\$35
----------------	------------

*New Address*

*New Phone*



- ACCOUNTS PAYABLE - Tracks current and aged payables and incorporates a check writing feature. Maintains a complete vendor file with information on purchase orders and discount terms as well as active account status. Produces reports as follows: Open Voucher Report, Accounts Payable Aging Report and Cash Requirements. Provides input to PEACHTREE General Ledger. Supplied in source code for Microsoft BASIC. \$990/\$30
- ACCOUNTS RECEIVABLE - Generates invoice register and complete monthly statements. Tracks current and aged receivables. Maintains customer file including credit information and account status. The current status of any customer account is instantly available. Produces reports as follows: Aged Accounts Receivable, Invoice Register, Payment and Adjustment Register and Customer Account Status Report. Provides input to PEACHTREE General Ledger. Supplied in source code for Microsoft BASIC. \$990/\$30
- PAYROLL - Prepares payroll for hourly, salaried and commissioned employees. Generates monthly, quarterly and annual returns. Generates employee W-2s and includes tables for federal withholding and FICA as well as withholding for all 50 states plus up to 20 cities from pre-computed or user generated tables. Will print checks, Payroll Register, Monthly Summary and Unemployment Tax Report. Provides input to PEACHTREE General Ledger. Supplied in source code for Microsoft BASIC. \$990/\$30
- INVENTORY - Maintains detailed information on each inventory item including part number, description, unit of measure, vendor and reorder date, item activity and complete information on current item costs, pricing and sales. Produces reports as follows: Physical Inventory Worksheet, Inventory Price List, Departmental Summary Report, Inventory Status Report, The Record Report, Periodic-Data and Year-to-Data reports. Supplied in source code for Microsoft BASIC. \$1190/\$30

**GRAMHAM-DORIAN SOFTWARE SYSTEMS**

- Comprehensive accounting software written in CBASIC-2 and supplied in source code. Each software package can be used as a stand-alone system or integrated with the General Ledger for automatic posting to general accounts. Requires CBASIC-2.
- GENERAL LEDGER ..... \$995/\$35
- ACCOUNTS PAYABLE ..... \$995/\$35
- ACCOUNTS RECEIVABLE ..... \$995/\$35
- INVENTORY SYSTEM ..... \$590/\$35
- JOB COSTING ..... \$995/\$35
- APARTMENT MANAGER ..... \$995/\$35
- CASH REGISTER ..... \$590/\$35

- POSTMASTER - A comprehensive package for mail list maintenance that is completely menu driven. Features include keyed record extraction and label production. A form letter program is included which provides mail labels or single sheet or continuous forms. Compatible with NAD files. Requires CBASIC-2. \$150/\$15

**STRUCTURED SYSTEMS GROUP**

- GENERAL LEDGER - Interactive and flexible system providing proof and report outputs. Customization of COA created interactively. Multiple branch accounting centers. Extensive audit performed at data entry for proof, COA correctness, etc. Journal entries may be batched prior to posting. Closing procedure automatically backs up input files. Now includes Statement of Changes in Financial Position. Requires CBASIC-2. \$1250/\$25
- ACCOUNTS RECEIVABLE - Open item system with output for internal aged reports and customer-oriented statement and billing purposes. On-Line Inquiry permits information for Customer Service and Credit departments. Interface to General Ledger provided if both systems used. Requires CBASIC-2. \$1250/\$25
- ACCOUNTS PAYABLE - Provides aged statements of accounts by vendor with check writing for selected invoices. Can be used alone or with General Ledger and/or with NAD. Requires CBASIC-2. \$1250/\$25
- PAYROLL - Flexible payroll system handles weekly, bi-weekly, semi-monthly and monthly payroll periods. Tips, bonuses, reimbursements, advances, sick pay, vacation pay, and compensation time are all part of the payroll records. Prints government required periodic reports and will post to multiple SSS General Ledger accounts. Requires CBASIC-2 and 64K of memory. \$1250/\$25
- INVENTORY CONTROL SYSTEM - Performs control functions of adding and deleting stock items, adding new items and deleting old items. Tracks quantity of items on hand, on order and back-ordered. Optional hard copy audit trail is available. Reports include Master Item List, Stock Activity, Stock Valuation and Re-order List. Requires CBASIC-2 and \$1250/\$25
- ANALYST - Customized data entry and reporting system. User specifies up to 75 data items per record, interactive data entry, retrieval, and update facility makes information management easy. Sophisticated report generator provides customized reports using selected records with multiple level break-points for summarization. Requires a data set utility such as QSORT, SUPER-SORT or VSORT and CBASIC-2. \$250/\$15
- LETTERRIGHT - Program to create, edit and type letters or other documents. Has facilities to enter, delete, delete and move text, with good video screen presentation. Designed to integrate with MAIL form letter mail merge. Requires CBASIC-2. \$200/\$25
- NAD Name and Address selection system - Interactive mail list creation and maintenance program with output as full reports with reference data or restricted information for mail labels. Transfer system for restriction and transfer of restricted records to create new files. Requires CBASIC-2. \$100/\$20
- QSORT - Fast sort/merge program for files with fixed record length, variable field length information. Up to five ascending or descending keys. Full back-up of input files created. \$100/\$20

★ ★ ★ ★ ★ ★ ★ ★ ★ ★  
**CONDIMENTS**

- HEAD CLEANING DISKETTE - Cleans the drive Read/Write head in 30 seconds. Diskette absorbs loose oxide particles, fingerprints, and other foreign particles that might hinder the performance of the drive head. Lasts at least 3 months with daily use. Specify 5" or 8".  
Single sided ..... \$20 each/\$35 for 3  
Double sided ..... \$25 each/\$45 for 3
- FLOPPY DISK KIT - Templates and instructions to modify single sided 5 1/4" diskettes for use of second side in single sided drives ..... \$12.50
- FLOPPY SAVER - Protection for center holes of 5" and 8" floppy disks. Only 1 needed per diskette. Kit contains centering post, pressure tool and tough 7 mil mylar reinforcing rings for 25 diskettes. .... \$14.95  
5" Rings only ..... \$7.95  
5" Kit ..... \$19.95  
8" Rings only ..... \$6.95
- PASCAL USER MANUAL AND REPORT - By Jensen and Wirth. The standard textbook on the language. Recommended for use by Pascal2, Pascal/M and Pascal/MT users ..... \$12
- THE C PROGRAMMING LANGUAGE - By Kernighan and Ritchie. The standard textbook on the language. Recommended for use by BDS C, lny C, and Whitt-smith's C users ..... \$12
- STRUCTURED MICROPROCESSOR PROGRAMMING - By the authors of SMAIL/80. Covers structured programming, the 6800/6805 instruction set and the SMAIL/80 language ..... \$20
- ACCOUNTS PAYABLE & ACCOUNTS RECEIVABLE - CBASIC - By Osborne/McGraw-Hill ..... \$25
- GENERAL LEDGER - CBASIC - By Osborne/McGraw-Hill ..... \$20
- LIFEBEAT DISK COPYING SERVICE - Transfer data or programs from one media format to another at a moderate cost ..... from \$25

★ ★ ★ ★ ★ ★ ★ ★ ★ ★  
**Hearty Appetite.**

\*CP/M and MP/M are trademarks of Digital Research. Z80 is a trademark of Zilog, Inc. CDS is a trademark of Zilog, Inc. UNIX is a trademark of Bell Laboratories. WHATSIT? is a trademark of Computer Headware. Electric Pencil is a trademark of Michael Shroyer Software. TRS-80 is a trademark of Tandy Corp. Pascal/M is a trademark of Sorcim.

†Recommended system configuration consists of 48K CP/M 2.2 full size disk drives, 24 x 80 CRT and 132 column printer.

Ⓜ Modified version available for use with CP/M as implemented on Heath and TRS-80 Model I computers.

Ⓝ User license agreement for this product must be signed and returned to Lifeboat Associates before shipment may be made.

Ⓞ This product includes/excludes the language manual recommended in Condiments.

Ⓟ Serial number of CP/M system must be supplied with orders.

Ⓠ Requires Z80 CPU.

**Ordering Information**

**MEDIA FORMAT ORDERING CODES**  
When ordering, please specify format code.

**LIFEBEAT ASSOCIATES MEDIA FORMATS LIST**  
Diskette, cartridge disk and cartridge tape format codes to be specified when ordering software for flatbed computer or disk systems. All software products have specific requirements in terms of hardware or software support, such as MPU type, memory size, support operating system or language.

Computer system	Format Code	Computer system	Format Code
Altair 8800 Disk	..... FE	RAII Double Density	..... RE
Apple + Microsoft SoftCard	..... R1	Research Machines 8"*	..... RH
ASIP System F10	..... R2	Research Machines 8"*	..... RH
Biochmark Single Density	..... Q3	RD Systems 8"	..... A1*
Blackhawk Microports Mod II	..... Q2	RD Systems 5 1/4"	..... R3
CDS Versatile 4	..... Q1	Sarcov	..... See Entry Sources
COMPAQ-50	..... Q2	Spacebyte	..... A1
Cromemco System 3	..... R1	Superbrain	..... See Interact
Cromemco Z80	..... R6	Talbot	..... A1*
CSSM BACKUP (top)	..... T1*	TEI 5 1/4"	..... R3
DATA	..... A1*	TEI 8"	..... A1*
Digital Microsystem 10	..... R0	Thierrays	..... See Morrow Discus
Digital Microsystems	..... A1*	TRB-80 Model I	..... R2
Discus	..... See Morrow Discus	TRB-80 Model I + FEO Freedom	..... RN
Dynamic FMS	..... R1	TRB-80 Model I + Micromation	..... A1*
Dynalite DB8/2	..... R1	TRB-80 Model I + Omnicron 8"	..... A1
Dynalite DB8/1	..... A1*	TRB-80 Model I + Shuttlebay 8"	..... A1
Easy Sorcerer + Lifebest CP/M	..... Q2	TRB-80 Model II	..... A1*
Easy Sorcerer + Easy CP/M	..... Q4	VDP-40/32/64/90	..... See IMBAI
Heath 88 + H17497	..... P4	Vector M2	..... Q2
Heath 88 + Lifebest CP/M	..... P2	Versatile	..... See CDS Versatile
Heath 88 + Magnolia CP/M	..... P7	Vista V80 5 1/4" Single Density	..... P5
Hellcat II	..... See Processor Technology	Vista V800 5 1/4" Double Density	..... P6
ICOM 2411 Micro Floppy	..... R3	Zenith Z80 + Lifebest CP/M	..... R4
ICOM 3718	..... A1	Zenith Z80 + Magnolia CP/M	..... P7
ICOM 3812	..... A1*		
ICOM 4511 5440 Cartridge CP/M 1.4 D12	..... D2		
ICOM 4511 5440 Cartridge CP/M 2.2 D22	..... D2		
IMS 5000	..... RA		
IMS 8000	..... A1*		
IMSAI VDP-40	..... R4*		
IMSAI VDP-42	..... R4*		
IMSAI VDP-44	..... R5*		
IMSAI VDP-80	..... A1*		
Inteltek SuperBrain DOS 2.0 X	..... R4		
Inteltek SuperBrain DOS 3.0 X	..... R7		
Intec Interceptor 8062/8306/8900	..... A7		
Kontron 100	..... R2		
Meach 5 1/4"	..... P6		
Microvision (except TRS-80 below)	..... A1		
Microplus Mod I	..... Q1		
Microplus Mod II	..... Q2		
MITB 3200/3200	..... R1		
Mosak	..... A1		
Mosak	..... A1		
MSD 5 1/4"	..... P2		
North Star Single Density	..... Q2		
North Star Double/Dual	..... Q3		
Nytec Single Density	..... Q3		
Ohio Scientific Mod II	..... Q2		
Ohio Scientific C3	..... A3		
Oxy CB01	..... T22		
Parsons POC 2000	..... R4		
Processor Technology Helix I	..... Q2		
RAII Single Density	..... R9		

\*Single-Side Single-Density disks are supplied for use with Double-Density and Double-Side 8" soft sector format systems.

\*RMBL formats are single density with directory offset of zero.

\*A media surcharge of \$25 for orders on tape formats T1 and T2 and of \$100 for orders of disk formats D1 and D2 will be added.

The list of available formats is subject to change without notice. In case of uncertainty, call to confirm the format code for any particular equipment.

space for comments costly in disk space and load time, discouraging good program layout. For these reasons, there is increasing interest in changing to a directory file system. Perhaps it will be written on top of the screen system currently in use.

The most important criticism of FORTH is that its source programs are difficult to read. Some of this impression results from unfamiliarity with a language different from others in common use. However, much of it results from its historical development in systems work and in read-only-memory-based machine control, where very tight programming that sacrifices clarity for memory economy can be justified. Today's trend is strongly toward adequate commenting and design for readability.

FORTH benefits most from a new, different programming style; techniques blindly carried over from other environments can produce cumbersome results. Most FORTH programmers seldom use named variables; they use the stack instead so that the implicit commenting normally available through choice of variable names is only provided through comments and user-defined operation names. Single definitions that would have more than about three unrelated numbers on the stack at any one time are best split into two or more operations; most programmers learn to keep their definitions short.

FORTH enforces extreme modularity, so the decomposition of each task into component parts is critical. Top-down design is especially important. Large jobs should be written as application-oriented libraries of operations to make teamwork and maintenance easier. A much larger fraction of the total programming effort is spent on design, with less on coding and debugging. For these and other reasons, FORTH creates its own issues of style, which are only beginning to be explored.

**A Taste of FORTH**

FORTH is an interactive language best explained by example. Because of this, a series of listings (listings 1 thru 10) with fairly detailed explanations make up the rest of this article. In the listings that follow, underlining denotes user keyboard input.

**NEW! NEW! NEWSLETTER FROM LIFEBOAT**

- Latest Version Numbers List of Software
- Updates on CP/M User Group
- The Great ZOSO Speaks Out from Behind the Scenes

\$18 ppd. for 12 issues (U.S., Canada, Mexico). Elsewhere \$40.  
Send Check to "Lifelines," 1651 Third Avenue, New York, N.Y. 10028 or use your VISA or MasterCard—call (212) 722-1700

Lifeboat Associates  
**THE SOFTWARE SUPER-MARKET**

Prices F.O.B. New York. Shipping, handling and C.O.D. charges extra. Manual cost applicable against price of subsequent software purchase. The sale of each proprietary software package conveys a license for use on one system only.



FORTH uses punctuation in some of its words, which makes representing them in text a difficult problem. For example, one FORTH word is ("), which could be taken to mean one of several character combinations. (For your information, the word has three characters and is made from a left parenthesis followed by a double quote mark and a right parenthesis.)

To decrease the chance of confusion while trying not to clutter text unnecessarily, we will sparingly use braces, { }, to isolate the character string within as a FORTH word or phrase. (For example, the above word would be written { " } .) Braces will be used only under the following situations:

- when the material being quoted is a

phrase of FORTH words (eg: { 26 LOAD } or { 35 + } )

- with the FORTH words { . } (period), { , } (comma), { : } (colon), { ; } (semicolon), { ? } (question mark), { ! } (exclamation point), { ' } (single quote mark), and { " } (double quote mark)
- with any word using the above punctuation marks (eg: { \$ . } or { . " } ).

All other FORTH words will be set apart by a space on either side of the word. So, in this and other FORTH articles in this issue, braces will always signal a FORTH word or phrase. The braces are not part of the word or phrase, and FORTH words will never use braces within the body of a figure or listing....GW

## On the Necessity of Using Camera-Ready Copy

Examination of listings 1 thru 10 will reveal a variety of typefaces used. This variety is present because each listing was created by the printer of the system producing the listing. Such listings are called camera-ready copy, which means that we can reproduce them in BYTE without inadvertently adding the errors that creep in with the retyping of a listing. Contributors to BYTE and onComputing are strongly encouraged to submit camera-ready listings made with a fresh ribbon, since this helps us to improve the accuracy of the article.

# 64KB RAM MEMORIES

LSI-11 - \$750.00 • SBC 80/10 - \$750.00

S-100 - \$750.00 • 6800 - \$750.00 • 6800-2 - \$995.00

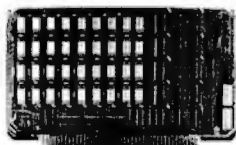

CI-6800-2 64K x 9

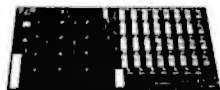

CI-S100 64K x 8

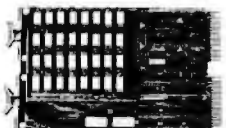

CI-1103 32K x 16

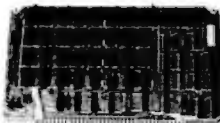

CI-6800 64K x 8



CI-8080 64K x 8

**CI-6800-2** — 16KB to 64KB. Plugs directly into Motorola's EXORciser I or II. Hidden refresh up to 1.5 Mhz. Cycle stealing at 2 Mhz. Addressable in 4K increments with respect to VXA or VUA. Optional on Board Parity. 64K x 9 \$995.00.

**CI-S100** — 16KB to 64KB. Transparent hidden refresh. No wait states at 4 Mhz. Compatible with Alpha Micro and all Major 8080, 8085 and Z80 Based S100 Systems. Expandable to 512 K bytes thru Bank Selecting. 64K x 8 \$750.00.

**CI-1103** — 16KB to 64KB on a single dual height board. On board hidden refresh. Plugs directly into LSI 11/2, H11 or LSI 11/23. Addressable in 2K word increments up to 256 K Bytes. 8K x 16 \$390.00. 32K x 16 \$750.00.

**CI-6800** — 16KB to 64KB on a single board. On board hidden refresh. Plugs directly into EXORciser I and compatible with Rockwell's System 65. Addressable in 4K increments up to 64K. 16K x 8 \$390.00. 64K x 8 \$750.00.

**CI-8080** — 16KB to 64KB on a single board. Plugs directly into MDS 800 and SBC 80/10. Addressable in 4K increments up to 64K. 16 KB \$390.00. 64K \$750.00.

Test and burned-in. Full year warranty.



**Chrislin Industries, Inc.**

Computer Products Division

31352 Via Colinas • Westlake Village, CA 91361 • 213-991-2254

**Listing 1:** FORTH as a calculator. FORTH is easy to approach because it can be used as a calculator. Here, the programmer has not defined any new operation but has used addition, multiplication, and print (the dot means print). These are three of about one hundred operations that are available when FORTH first comes up. Programming consists of defining new operations which can be custom designed for a particular task or a particular industry.

FORTH uses postfix (also called RPN or reverse Polish notation) arithmetic, which is best known from its use in Hewlett-Packard calculators. In postfix notation, the operations are written after their arguments, not between them. The text of this article shows how postfix notation works, using a data structure called the stack, and it explains the formulas in this example.

Postfix notation, which does not use parentheses, is more general than ordinary arithmetic notation. Its biggest advantage is that it greatly simplifies the writing and calling of subroutines.

In these examples, underlining indicates what the user has typed on the terminal. FORTH does not process the line until you type a carriage return. The OK prompt means that the system has completed its work and is ready for new input from the user.

```

2 3 + 5 OK
4 5 + 6 7 + * . 117 OK

```

**Listing 2:** Changing number bases. FORTH can work in different number bases and can change any time, so it serves as an octal/hexadecimal/binary/decimal calculator within the limits of 16-bit numbers (or 32 bits for double precision). The FORTH word HEX converts FORTH into a hexadecimal machine, and all numbers are printed in Listing 2 continued on page 112





# THE NATIONAL COMPUTER SHOWS

# HAVE WE GOT A PROGRAM FOR YOU!

The new computers are showing off. Over \$50 million worth of equipment in over 100,000 square feet of space, including the latest software and hardware for business, government, home and personal use. Everything the NCC show has and more will be on display, and you can buy it all right on the spot.

Computers costing \$150 to \$250,000, mini and micro computers, data- and word-processing equipment, telecommunications, office machines, peripheral equipment and services from leading names in the industry like IBM, Xerox, Radio Shack and Apple will all be there.

There'll be conferences on business uses of small to medium sized computers, and how to make purchasing evaluations.

There'll be robots, computerized video games, computer art and computer music.

Everyone from kids to people who earn their living with computers will have a great time at the largest computer show ever organized in each region.

Admission for adults is \$5. The public is invited, and no pre-registration is necessary.

Don't miss the computer show that mixes business with pleasure. Show up for the show.

## THE MID-ATLANTIC COMPUTER SHOW

**WASHINGTON, D.C.**  
D.C. ARMORY/STARPLEX  
THURSDAY-SUNDAY  
SEPTEMBER 18-21  
11 A.M. TO 9 P.M. THURS.-SAT.  
11 A.M. TO 5 P.M. SUN.

## THE MID-WEST COMPUTER SHOW

**CHICAGO**  
McCORMICK PLACE  
THURSDAY-SUNDAY  
OCTOBER 16-19  
11 A.M. TO 9 P.M. THURS.-SAT.  
11 A.M. TO 5 P.M. SUN.

## THE NORTHEAST COMPUTER SHOW

**BOSTON**  
HYNES AUDITORIUM  
PRUDENTIAL CENTER  
THURSDAY-SUNDAY  
NOVEMBER 20-23  
11 A.M. TO 9 P.M. THURS.-SAT.  
11 A.M. TO 5 P.M. SUN.

Produced by National Computer Shows,  
824 Boylston Street, Chestnut Hill, MA 02167.  
Telephone (617) 739-2000.

Please send me:

- \_\_\_\_\_ adult tickets at \$5 each. I have enclosed the proper amount of \$ \_\_\_\_\_  
 Information on the show's conference program.  
 Hotel registration information       Exhibitor rental information

Please print: Name \_\_\_\_\_

Address \_\_\_\_\_

City \_\_\_\_\_ State \_\_\_\_\_ Zip \_\_\_\_\_

# ELCOMP Books

## Care and Feeding of the Commodore PET

Eight chapters exploring PET hardware. Includes repair and interfacing information. Programming tricks and schematics.  
Order No. 150 \$11.00

## 8K Microsoft BASIC Reference Manual

Authoritative reference manual for the original Microsoft 4K and 8K BASIC developed for Altair and later computers including PET, TRS-80, and OS/1. OS/1 owners please take note!  
Order No. 151 \$ 9.95

## Expansion Handbook for 6502 and 6802

(S 44 Card Manual) Describes all of the 4.5 x 6.5 44 pin S-44 cards incl. RAM, ROM, dig. I/O, MUX/A to O, EPROM Prog. etc. With schematics and funct. descriptions. A must for every KIM, SYM and AIM owner.  
Order No. 152 \$ 9.95

## Microcomputer Application Notes

Reprint of Intel's most important application notes, including 2708, 8085, 8255, 8251 chips. Very necessary for the hardware buff!  
Order No. 153 \$ 9.95

## Complex Sound Generation

New revised applications manual for the Texas Instruments SN 76477 Complex Sound Generator. Circuit board available (\$8.95)  
Order No. 154 \$ 6.95

## Small Business Programs

Complete programs for the business user. Mailing List, Inventory, Invoice Writing and much more. Introduction into Business Applications. Many listings.  
Order No. 156 \$14.90

## The First Book of Ohio Scientific, Vol. I

Contains an introduction to personal computers and describes the Ohio Scientific Line. Contains explanatory diagrams, block, hook up, expansion, tricks, hints and many interesting listings. Hardware and software information not previously available in one compact source. 192 pages.  
Order No. 157 \$ 7.95

## The First Book of Ohio Scientific, Vol. II

Vol. II contains very valuable information about Ohio Scientific microcomputer systems. Introduction to OS-650 and OS65 U. networking and distributed processing, systems specifications, business applications, hard and software hints and tips.  
Order No. 158 \$ 7.95

## Mailing List Program for Challenger C1/C2 8K

Order No. 2004 - Personal Version \$ 9.95

Order No. 2005 - Business Version \$ 9.95

## Ohio Scientific Expansion Information

Conversion of CIP (Cassette) to 52x26 display. Detailed step by step instructions for doubling the CIP speed and display size!  
Order No. 1385 \$12.00

## Important Software for CBM 16K/32K

Most powerful Editor/Assembler for Commodore CBM 16/32K on cassette. Very fast! Editor divides screen into 3 parts. Scrolling text window. 24 direct commands. 19 serial commands, status and error messages. Assembler can be started directly from the editor or from the 11M monitor. Translates in three passes. If an error is encountered, automatic return to the editor. Cassette with DEMO.  
Order No. 3276 \$69.00

## ATTENTION APPLE USERS

Same as above for Apple II or Apple II plus.  
Order No. 3500 \$89.00

## MONJANA/1 makes Machine Language Programming easy!

In every Commodore CBM there is a spare ROM socket waiting for its MONJANA/1. The new MONJANA/1 Machine Language Monitor in ROM offers more user guidance and debugging aids than any other monitor available today. It is indispensable for anyone intending to take full advantage of the computer's features. Trace, link, disassemble, dump, relocate, fine assemble and much more. Every command function has demand printout option. Price includes extensive manual.  
Order No. 2001 \$98.00

## JANA-Monitor on cassette for the PET

Similar to MONJANA/1, very powerful!  
Order No. 2002 \$29.00

### ELCOMP PUBLISHING Inc.

3873-L Schaefer Ave. Chino CA 91710 (714) 591-3130

Please send me the books/software indicated below

I enclose \$ \_\_\_\_\_ send postpaid

Send COD (\$5 extra)

Charge my  VISA  Mastercard

Acct. No. \_\_\_\_\_

Exp. date \_\_\_\_\_

Signature \_\_\_\_\_

Book No. \_\_\_\_\_

Book No. \_\_\_\_\_

Software No. \_\_\_\_\_

1 Year subscription to ELCOMP Newsletter \$9.80

Name \_\_\_\_\_ Phone \_\_\_\_\_

Address \_\_\_\_\_

City \_\_\_\_\_

State \_\_\_\_\_

Zip \_\_\_\_\_

CA add 6% sales tax. We also accept Eurocheck. All orders outside USA must add 15% shipping.

### Listing 2 continued:

hexadecimal until some other operation changes the base again. FORTH always begins a session in decimal radix.

The operations DECIMAL and HEX are built into the system; OCTAL, BINARY, and TRINARY (base 3) are not. So when OCTAL was first used, the error message { OCTAL ? } indicated an undefined word; that is, the system did not recognize the word OCTAL. In the next line, the user defined OCTAL (line 6). This example illustrates FORTH's extensibility; users can extend the language to include new operators.

Incidentally, the second error message { 12885 ? } in line 12 resulted because the system was in binary (from the line above), and, in binary, numbers must contain only the digits 0 and 1, so 12885 was not recognized as a number. It was treated as a word, and, because there was no operation named 12885, the error message was generated.

OCTAL and the other number-base operations work by giving a new value to BASE, a variable used by the system. Defining new operations is more fully explained in listing 3. The { ! } operation (store) is explained later.

Number bases only affect input and output. All internal computation is in binary, so there is no speed penalty for using nondecimal numeric bases.

```

HEX OK
3BEB CB + . 3CBO OK
25 2F * . 6CB OK
DECIMAL 1348 HEX . 544 OK
DECIMAL 1348 OCTAL . OCTAL ?
: OCTAL 8 BASE ! ; OK
DECIMAL 1348 OCTAL . 2504 OK
DECIMAL OK
: BINARY 2 BASE ! ; OK
: TRINARY 3 BASE ! ; OK
12885 BINARY . 110010010101 OK
12885 BINARY . 12885 ?
DECIMAL 12885 BINARY . 110010010101 OK
DECIMAL 12885 OCTAL . 31125 OK
DECIMAL 12885 HEX . 3255 OK
DECIMAL 12885 TRINARY . 122200020 OK
DECIMAL -12885 TRINARY . -122200020 OK
DECIMAL OK
    
```

Listing 3: Defining new operations. Here, a new operation CUBE is created. CUBE replaces whatever number is on top of the stack with the cube of that number. The statements within the parentheses are comments.

The colon, [ : ], begins a FORTH word definition; the word following it is the name being defined. Semicolon, [ ; ], ends the definition.

The new word CUBE will first execute DUP, which duplicates the number on top of the stack, making a second copy. The second DUP leaves three copies. The first \* causes the top two copies to be replaced by the square of the number; the next \* computes the cube, and then all three copies of the original number are gone, leaving the cube of the number on top of the stack.

This colon definition shows one of several ways to create new words in FORTH. Most words that appear inside the definition are compiled and not executed immediately.

All words and numbers in FORTH are separated by one or more blanks (and/or carriage returns). FORTH operation names can be up to thirty-one characters long and can consist of letters, numbers, or any other characters. For example, an operation name could be a number, or it could be nonprinting characters only. In practice such names are rarely used, but they illustrate the flexibility that is available.

Listing 3 continued on page 114

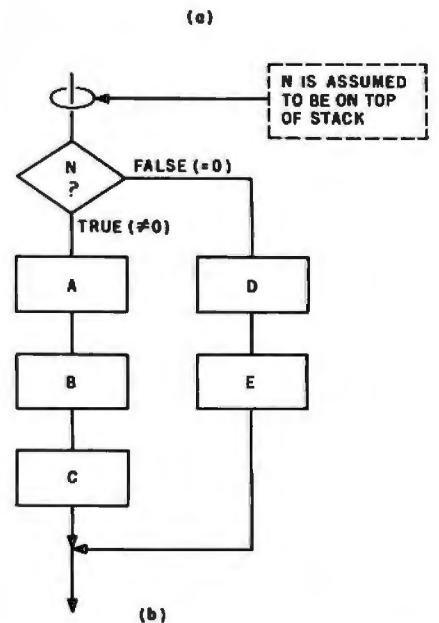
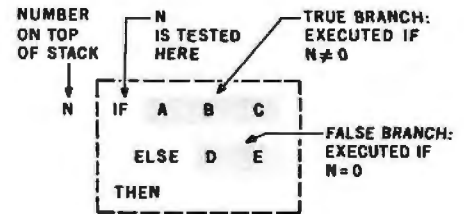

Figure 2: An explanation of the IF...ELSE...THEN construct. (See listing 4.) As shown in figure 2a, the portion of code executed depends on the value of the number on top of the stack when the word IF is encountered. If we call this number N and say that the number has a boolean value of true if its numeric value is nonzero and false if 0, then figure 2b gives the equivalent construct to figure 2a in conventional flowchart notation. Here and in figures 3 thru 5, the dotted box indicates the boundaries of the construct (as opposed to values assumed to be on the stack).



A MCGRAW-HILL PUBLICATION

# onComputing™

GUIDE TO PERSONAL COMPUTING

**GETTING STARTED**  
What You Need And What It Will Cost

**EQUIPMENT REVIEWS**  
TRS-80, Apple, Sorcerer and PET

Best-Selling Author  
**JERRY POURNELLE**  
"Writing With A Microcomputer"  
**THE BINARY WORLD**

Also...  
**A PERSONAL  
COMPUTER DIRECTORY**  
**COMPUTER CLUBS:  
WHO NEEDS THEM?**

Plus... *h much more*  
*for other issues of the guide.*



## When will the Personal Computer Explosion touch YOU?

Are you prepared for the explosive transformation? Right in your own home? Electronic mail. Personalized investment analysis. Foreign language tutorial. Home energy management. Robots. Computer music. Secretarial service. Diet and menu planning. And more, more, more.

**onComputing™** the new McGraw-Hill quarterly, prepares you for the enormous changes coming during the



1980's (Some are already here). **onComputing™** explains in nontechnical language what personal computers are, how they work, and how you can use them at home, for fun and profit.

Don't let the personal computer explosion catch you off guard. Know what's happening and help make it happen! Prepare now for the exciting future with a subscription to **onComputing™!**

**Call Toll-Free**  
**800-258-5485**

**Start your**  
**subscription today.**

**onComputing™** Subscription Dept. P.O. Box 307, Martinsville, NJ 08836

DOMESTIC subscription rate:

U.S. 1 yr. (4 issues) @ \$8.50  Canada & Mexico, 1 yr. (4 issues) @ \$10.00

FOREIGN (to expedite service, please remit in U.S. funds drawn on a U.S. bank.)

Europe (and all other countries, except above), 1 yr. @ \$12.00 — surface delivery.

Bill Visa  Bill Master Charge  Bill me (North America only)

Card Number

Expiration

Signature

Name (please print)

Street/Apartment Number

City

State/Province/Country Code

7B80

Please allow 6-8 weeks for processing.

# CHOOSE...

## Choose an Apple Desk



A compact bi-level desk ideal for an Apple computer system. This 42" x 31½" desk comes with a shelf to hold two Apple disk drives. The top shelf for your TV or monitor and manuals can also have an optional paper slot to accommodate a printer.

## Choose a Micro Desk



Get your micro computer off the desk top and into the micro shelf under our Designer Series desks. Suitable for the North Star, Dynabyte, Vector Graphics, and Altos computers. The desks come in a variety of sizes and colors.

## Choose a Mini Rack

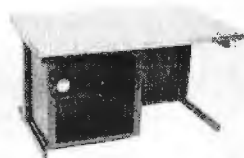

Mini racks and mini micro racks have standard venting, cable cut outs and adjustable RETMA rails. Choose a stand alone bay or a 48", 60", or 72" desk model in a variety of colors and wood tones. A custom rack is available for the Cromemco.

## Choose a Printer Stand



The Universal printer stand fits the:

Centronics 700's	Diablo 1600's & 2300's
Dec LA 34	T.I. 810 & 820
NEC Spinwriter	Okidata Slimline
Lear Siegler 300's	Anadex 9500's

Delivery in days on over 200 styles and colors in stock. Dealer inquiries invited.

**ELECTRONIC SYSTEMS  
FURNITURE  
COMPANY**

17129 S. Kingsview Avenue  
Carson, California 90746  
Telephone: (213)538-9601

### Listing 3 continued:

This listing shows CUBE being executed from the terminal. It can also be used as a component in further definitions. A fundamental property of FORTH is that operations defined by users are indistinguishable from those which were originally part of the system.

```
: CUBE ( N -> N. CUBE A NUMBER)
  DUP DUP ( NOW THERE ARE THREE COPIES)
  * * ( GET THE CUBE)
  ; OK
5 CUBE . 125 OK
-28 CUBE . -21952 OK
HEX 17 CUBE BINARY . DECIMAL 1011110000111 OK
```

**Listing 4: Conditional branching.** The IF ... THEN is for conditional execution. IF takes one argument off of the stack; this argument is interpreted as a boolean or truth value, with 0 meaning false and any nonzero value meaning true. If true, any statements between the IF and THEN are executed. In either case, execution continues after the THEN, which terminates the conditional. There is also an optional ELSE clause that is executed only if the argument is false. (See figure 2.)

Here, the true-clause contains only one word, MINUS, but it could contain almost any FORTH statements, including other conditionals and loops nested to any practical depth. These statements run fast because they are compiled into a form of object program called threaded code.

Incidentally, the FORTH word 0< returns a boolean value indicating whether its argument (the number on top of the stack) is less than zero. The DUP is necessary because 0< follows the FORTH convention that operations should destroy their arguments on the stack. MINUS reverses the sign of its argument (the top stack number).

Items in parentheses are comments. The comment "N -> N" in the first line is to show that this operation takes one number off of the stack and returns one number to it. Perhaps the most important information to put in the comments accompanying each new operation is what arguments it takes off of the stack and what results it returns to the stack.

```
: ABSOLUTE-VALUE ( N -> N. ABSOLUTE VALUE)
  DUP 0< ( GET BOOLEAN, TRUE IF NEGATIVE)
  IF MINUS THEN ( NEGATE THE NUMBER IF TRUE)
  ; OK
10 ABSOLUTE-VALUE . 10 OK
-5 ABSOLUTE-VALUE . 5 OK
```

**Listing 5: The DO ... LOOP, a structured loop with a counting index.** DO takes two arguments from the stack, the initial value of the index (on top) and the final value plus 1. (See figure 3.) These indices are written in reverse order from most other languages, making the loop terminating value (which is more often passed as an argument) more accessible on the stack.

CR simply performs a carriage return. In this example, the index values are literals (10 and 0), but they can also come from variables or from computations of any complexity; anything that gets the indices onto the stack is legitimate.

This listing also shows a timing benchmark; the word TIME-TEST does 30,000 empty loops. On an Apple II running FORTH, TIME-TEST executes in less than 4 seconds. In Apple Integer BASIC (which is a fast BASIC), 30,000 empty loops take 40 seconds.

```
: 10CUBES ( -> . PRINT A TABLE OF CUBES OF 0-9)
  10 0 ( INDICES OF LOOP)
  DO ( START LOOP)
    CR I . I CUBE . ( PRINT A NUMBER AND ITS CUBE)
  LOOP ( END OF LOOP)
  ; OK
10CUBES
0 0
1 1
2 8
3 27
4 64
5 125
6 216
7 343
8 512
9 729 OK
; TIME-TEST 30000 0 DO LOOP ; OK
TIME-TEST OK
```



# The COMPUTER FACTORY

TO ORDER CALL (212) 687-5000

## SUPERBRAIN™

INTERTEC  
DATA  
SYSTEMS  
64K  
ONLY  
**\$2995**

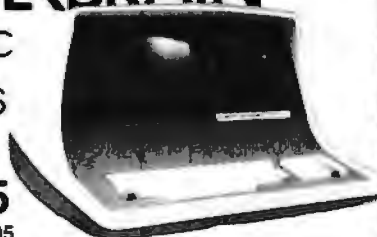

32K \$2795

More than an intelligent terminal, the SuperBrain outperforms many other systems costing three to five times as much. Endowed with a hefty amount of available software (BASIC, FORTRAN, COBOL), the SuperBrain is ready to take on your toughest assignment. You name it! General Ledger, Accounts Receivable, Payroll, Inventory or Word Processing. The SuperBrain handles all of them with ease.

### FEATURES INCLUDE:

• 2 dual-density minifloppies with 360K bytes of disk storage • A CP/M Disk Operating System with a high-powered text editor, assembler and debugger

### Model QD

720K Bytes disk storage and 64K RAM  
**\$3895**

### SUPER BRAIN HARD DISKS

10 Megabyte  
**\$4995**

20 Megabyte  
**\$5995**



## NEW AMPEX HARD DISK

5 Fixed  
5 Removable  
Only **\$5995**



**APPLE II PLUS \$1195**

A complete self-contained computer system with APPLESOFT floating point BASIC in ROM, full ASCII keyboard in a light weight molded carrying case.

### Features Include:

- auto-start ROM • Hi-Res graphics and 15 color video output.
- Expandable to 48K.

Supertalker .....	\$279	Micromodem .....	\$379
Disk .....	595	Superterm (24 x 80) .....	395
Add-on Disk .....	495	Speechlab .....	229
Pascal Card .....	495	Communication Card .....	225
Business Software .....	625	Modem .....	200
Monitor .....	159	Graphics Printer .....	595
Printer Card .....	180	Graphics Tablet .....	795

# apple III

## IS FINALLY HERE

### 128K RAM!!



FOR BEST DELIVERY AND SUPPORT SEE IT AT THE COMPUTER FACTORY

## NEW 80 COLUMN



CBM  
Basic 4.0  
Operating  
System

- 80 column by 25 line display
- 12" CRT
- New screen editor
- Split screen processing
- Super fast string handling
- 15 additional basic commands
- Supports relative record processing

Model 8016 16K memory **\$1495**  
Model 8032 32K memory **\$1795**

## NEW 8050 DUAL DISK

1 million bytes on-line storage and DOS 2.0 operating system

- Supports relative record (Random Access)
- Faster more reliable only **\$1695**

### CENTRONICS 704

• 180 cps Bi-Directional • Up to 15" Paper Width • 9 x 9 Matrix

• Upper/Lower Case • Tractor Feed • RS-232C Serial Interface

**\$1895**  
List \$2500

### CENTRONICS 700-9

**\$1295** List \$1895

• 60 cps • Up to 15" paper width • Tractor Feed • Parallel Interface for Apple & TRS-80 • 2 channel vertical format • Top of Form!

### CENTRONICS (Letter quality)

737 Serial **\$995**  
737 Parallel **\$965**

### CENTRONICS

730 Serial **\$845**  
730 Parallel **\$795**

### NEW XYMEC

1000 with QUADRA-PITCH **\$2495**

10, 12, 15 Pitch & Proportional Spacing

The XYMEC HY-Q 1000 is "Tomorrow's Printer" - with virtually every advancement built in as standard. No other options are required. Its versatility matches your output format - and - it can be used as an off-line typewriter

• 2-80 Controlled • Up to 198 Columns • 30 CPS • Reverse Print • Electronic Digital Display • Multi-Lingual • Automatic recall

### RADIO SHACK • PET • SORCERER • APPLE • COMPUCOLOR • ETC.

#### PRINTERS • PRINTERS • PRINTERS

The COMPUTER FACTORY'S extensive inventory and wide selection of computer printers assures you of finding the printer best suited for your needs and specifications. The following printers work well with all known personal computers.

Centronics 779-2..	\$1195
Centronics 730 ..	745
Eaton 7000 .....	389
Paper Tiger 440G ..	1095
Xerox 1740 .....	2895

## Commodore Computer

These low cost Commodore PET Business Computers have virtually unlimited business capabilities. Accounts Receivable, Inventory Records, Payroll, and other accounting functions.

### PET 16N & 32N COMPUTERS

- Full size keyboard
- 16 or 32,000 Bytes Memory
- Level III Operating System
- Full Screen Editor
- Upper lower case & 64 graphic characters

**\$995**

### PET DUAL FLOPPY DISK

- Stores 360,000 Bytes on-line
- Microprocessor controlled
- Uses single or 5 sided floppies

### HI-SPEED PRINTER

- 150 characters per second • Up to 4 copies 8" wide
- Microprocessor Controlled • Prints All Graphics • Full Formatting Capability

**\$1295**

**\$695**

### PERIPHERALS

• 24K Memory Expansion .....	\$499
• 16K Memory Expansion .....	399
• PET to RS232 Serial .....	179
• 2 Way Serial/Communication .....	229
• Modem Board for PET .....	375
• Analog to Digital Board for 16 Devices .....	275
• Second Cassette Drive .....	95

### Great PET Software

#### DATABASE MANAGEMENT SYSTEM

— Six modules comprising 48K of programming allows you to: create, edit, delete, display, print, sort, merge, etc.— databases of up to 10,000 records. Printer routines included. 60 Pages of documentation for 16-32K PET and 2040 Dual Disk...  
Coat \$125

#### KRAM — Keyed Random Access Method

— The new, ultra-fast access method for the PET Disk, provides keyed retrieval/storage of data. In either direct or sequential mode, by either full or partial key values. 6502 coding

KRAM 2.0 for PET \$99.95  
KRAM 2.0 for Apple \$99.95

### ANDERSON JACOBSON

841 I/O Terminal Ideal for word processing and small businesses.

- ASCII Code
- 15 CPS Printout
- High Quality Selectric Printing
- Reliable heavy duty mechanism
- Completely Refurbished by A.J.

• Delivered FREE to nearest service center

Parallel **\$1130**  
Serial **\$1230**

### NEW Paper Tiger 460G

- Better Graphics
- Correspondence Quality
- Faster & Quieter

Min. Credit Card Order \$75

Open Mon-Fri. 10-6 Sat. 11-5

N.Y. residents add 8% sales tax  
• Same day shipment on prepaid and credit card orders • Add \$5 shipping for computers \$3 for boards \$1 each cassette tape

TO ORDER CALL (212) 687-5000

The COMPUTER FACTORY 485 Lexington Ave., New York, NY 10017 (46th St. Lobby)  
Foreign order desk — Telex 640055

**SAVE MORE THAN 20%**  
**NORTH STAR—INTERTUBE—MICROTEK**  
**ZENITH—HEATH—ITHACA**  
**THINKER TOYS—GODBOUT—SOFTWARE**

*The smartest computers at the smartest price*



FACTORY ASSEMBLED & TESTED	LIST	ONLY
HORIZON-1-16K-DOUBLE DEN KIT	SPECIAL	\$1289
HORIZON-1-32K-DOUBLE DEN KIT		\$1999 1575
HORIZON-2-32K-DOUBLE DEN KIT		2399 1879
HORIZON-1-32K-DOUBLE DEN		2895 2129
HORIZON-2-32K-DOUBLE DEN		3085 2435
HORIZON-2-32K-QUAD DENSITY		3595 2839
HORIZON-2-64K-QUAD+HARD DISK		9329 7229
HORIZON MEMORY 16K 389	32K	579
NORTH STAR HARD DISK 18 Mb		4999 3949
PASCAL FOR NORTH STAR ON DISK		199 190
Powerful NORTH STAR BASIC..The Best.....		FREE
2 NORTH STAR SOFTWARE DISKS w/HORIZON.....		FREE
NORTH STAR BUSINESS PROGRAMS & NORTHWORD,PHONE		PHONE
COLOR! RAINBOW-2000 & CAT-100		PHONE
ITHACA FRONT PANEL COMPUTER 64K	2885	2449
Z-8000 CPU CARD 18-bit ITHACA S-100		PHONE
ITHACA MEMORY 8/18-bit		PHONE
8086 CPU 18 bit 10xfaster SEATTLE COMPUTER		PHONE
SEATTLE COMPUTER MEMORY		PHONE
SSM Z-80 CPU, VIDEO BOARD, MEMORY		PHONE
MEASUREMENT MEMORY 64K A & T 4mHz		650
JAWS MEMORY 64K A & T 4mHz		PHONE
GODBOUT MEMORY - Static, Super Selection & Price		
THINKER TOYS DISCUS/2D A & T	1199	975
THINKER TOYS HARD DISK 26 Mb	4995	4149
DISCUS/2+2 1.2 Mbytes A & T	1545	1285
THINKER TOYS SUPERRAM		PHONE
DELTA COMPUTER & DISK DRIVES		PHONE
TARBELL COMPUTERS & DISK DRIVES		PHONE
INTERTUBE II SMART TERMINAL	995	725
ZENITH-HEATH SMART TERMINAL Z-19 A & T		795



ZENITH COMPUTER-TERMINAL-DISK Z-89	2595	2195
CAT NOVATION MODEM	179	169
MICROTEK PRINTER	795	725
AXIDM PRINTER	795	695
ANADIX PRINTER	995	865
NEC PRINTER Fast Typewriter Quality	2915	2799
SECRETARY WORD PROCESSOR The Best!	85	77
TEXTWRITER III Book Writing Program	125	112
GOFAST NORTH STAR BASIC Speeder Upper	79	71
PDS Super Z-80 ASSEMBLER & More	99	89
COMPILER FOR NORTH STAR \$150 w/PDS & HDS	90	
EZ-80 MACHINE LANGUAGE TUTORIAL \$25	HDS	40
EZ-CODER Translates English to BASIC	79	71
ECOSDFT FULL ACCOUNTING PKG	350	315
DATABASE, THE SOURCE 90, CROSS ASSEMBLERS-CALL		
BOX OF DISKETTES 29 IN PLASTIC CASE	30	
Which Computers are BEST? BROCHURE.....	FREE	
North Star Documentation refundable w/HRZ	20	
ORDER 2 or more COMPUTERS.... BIGGER DISCOUNTS		
FACTORY ASSEMBLED & FACTORY WARRANTY		

**AMERICAN**  
**SQUARE COMPUTERS**  
 KIVETT DR. JAMESTOWN NC 27282  
 (919)-889-4577

**Listing 6: The BEGIN ... UNTIL loop.** This loop takes one argument, a truth value, usually computed within the loop, at the end. If it is false (0), control branches back to the corresponding BEGIN ; if the value is true (nonzero), the loop ends, and control transfers to the next word in the program. (See figure 4.)

Note that the test of the value on top of the stack occurs at the end of the body of the loop; this guarantees that the body of the loop will be executed at least once.

The word = removes the top two numbers from the stack and returns a truth value of 1 if they are equal, 0 otherwise. In this example, the index stays on the stack and is duplicated before each use. The DROP at the end throws away the top stack value; this prevents the used index from cluttering the stack.

The warning message "10CUBES ISN'T UNIQUE" notifies us that the same name has already been defined. The only penalty for reusing a name is that the former definition becomes inaccessible for the rest of the program. Therefore, you do not have to remember a list of reserved words in FORTH; if you do not know about a name or have forgotten about it, you probably were not planning to use it anyway. But, in case of a mistake, the bad definition can be deleted with a FORGET operation, or the source code can be changed on disk.

[Some versions of FORTH use BEGIN ... END instead of BEGIN ... UNTIL .... GW]

```

: 10CUBES ( -> . SAME, USING 'UNTIL' LOOP) 10CUBES ISN'T UNIQUE
0 ( INITIAL VALUE OF INDEX)
BEGIN ( START LOOP)
  CR DUP . DUP CUBE . ( PRINT A # AND ITS CUBE)
  1 + ( INCREMENT)
  DUP 10 = ( TEST FOR INDEX=10)
UNTIL ( END OF LOOP)
DROP ( THROW AWAY USED INDEX)
; OK
10CUBES
0 0
1 1
2 8
3 27
4 64
5 125
6 216
7 343
8 512
9 729 OK
    
```

**Listing 7: The BEGIN ... WHILE ... REPEAT loop.** This looping structure tests the value on top of the stack at the beginning of the loop; because of this, this loop can execute 0 times. REPEAT causes an unconditional branch back to BEGIN , and WHILE branches out of the loop (just beyond REPEAT ) if the truth-value which it finds on top of the stack is false (ie: 0); see figure 5.

All of these looping and conditional branching structures can be nested within each other to any practical depth. Any mismatching can be detected at compile time. Most FORTH systems allow these structures only inside colon definitions; they cannot be executed directly from the terminal.

[Some versions of FORTH use: BEGIN ... IF ... WHILE or WHILE ... PERFORM ... PEND instead of BEGIN ... WHILE ... REPEAT .... GW]

```

: 10CUBES ( -> . SAME, USING 'WHILE' LOOP) 10CUBES ISN'T UNIQUE
0 ( INITIAL VALUE OF INDEX)
BEGIN
  DUP 10 < ( LOOP TEST)
  WHILE
    CR DUP . DUP CUBE . ( PRINT A # AND ITS CUBE)
    1 + ( INCREMENT)
  REPEAT
  DROP ( THROW AWAY USED INDEX)
; OK
10CUBES
0 0
1 1
2 8
3 27
4 64
5 125
6 216
7 343
8 512
9 729 OK
    
```



# NEU!

## MPI MODEL 88T IMPACT MATRIX PRINTER



The first of a series of new, full-capability, low cost, high performance printers designed by MPI to meet the requirements of the general use computer market - hobbyist or professional.

### SPECIFICATIONS

- Impact Bidirectional
- 7x7 Dot Matrix
- 100 Characters Per Second
- 80, 96 and 132 Column
- 10 Lines Per Second
- Tractor and Friction Feed
- Normal Paper: Roll, Fan-fold or Cut Sheets
- 115/230 VAC ±10%, 50/60 Hz
- 96 ASCII Upper and Lower
- RS232C, 20 ma Current Loop
- 110-1200 BAUD
- 2 Line Buffer, 1 or 2 K Optional
- Centronics Parallel
- 41x27x16 cm, 7 Kg

Sigma International, Inc. is master international distributor for MPI and seeks dealers/distributors worldwide. Please write us on your letterhead at the following address:

### SIGMA INTERNATIONAL, INC.

P.O. Box 1118 SCOTTSDALE, AZ 85252 USA  
Tel. (602) 994-3435 Tlx. 165-745 Sigma Cable: SIGMAS

## MICROCOMPUTERHÄNDLER WIR LADEN EIN!

Handeln Sie als Wiederverkäufer mit Microcomputer-systemen und Peripheriegeräten und sehen sich daher gezwungen, mit den immer noch überhöhten Preisen Ihrer jetzigen Lieferanten zu kalkulieren? Dann wählen Sie doch den einfacheren Weg und beziehen direkt aus den USA!

Sigma ist weltweiter Lieferant führender amerikanischer Hersteller und offeriert Preise und Service, wie sie Ihnen keine andere Quelle bieten kann.

Unter anderem verkaufen wir Geräte der Firmen:

Base 2	Impact Data	North Star
Centronics	Industrial Micro	Ohio Scientific
Century Data	Integral Data	PerSci
Control Data	Konam	Qume
Exidy	LRC Eaton	Soroc
Hazeltine	Micro Peripherals	Televideo
Houston Inst	N.E.C.	Texas Instruments

Wir laden Sie daher ein, kostenlos unsere neueste Preisliste anzufordern, und Sie werden feststellen, dass Sie wesentlich günstiger kaufen können. Bitte schreiben Sie - auf Kopfbogen - an folgende Adresse



### SIGMA INTERNATIONAL, INC.

P.O. Box 1118 SCOTTSDALE, AZ 85252 USA  
Tel. (602) 994-3435 Tlx. 165-745 Sigma Cable: SIGMAS

## LRC EATON MODEL 7000+ IMPACT PRINTER

# NEW

- Simple Design
- Simple Maintenance
- Simple Interfacing to:
  - Apple
  - Pet
  - TRS-80
  - Exidy
  - OSI
 and many other personal computers



The 7000+ was designed to provide the personal computer user with an inexpensive, yet reliable printer. Take a look - you won't regret it!

### SPECIFICATIONS

- Impact Unidirectional
- 1.25 LPS; 50 CPS
- 40 or 64 Column
- 5 x 7 Dot Matrix
- Standard Paper Rolls
- 100 Million Character Printhead Life (minimum)
- 6 LPI Line Spacing

Substantial Dealer Discounts are Available.

OEM inquiries are invited. Please contact:

### SIGMA INTERNATIONAL, INC.

P.O. Box 1118 SCOTTSDALE, AZ 85252 USA  
Tel. (602) 994-3435 Tlx. 165-745 Sigma Cable: SIGMAS

## IMPACT DATA MODEL 801 THE HEAVY DUTY WORKHORSE AT THE AFFORDABLE PRICE.

- 7 x 7 Impact Dot Matrix
- 132 CPS (max.)
- 96 Character Upper/Lower ASCII
- 8.0 in. (20.3 cm) Line Length
- 80 or 96 Columns
- 6 LPI Line Spacing
- Tractor or Friction Feed
- 127 Character Buffer - 2 K Optional
- Feed at 50 LPM Printing - 560 LPM Slewing
- Continuous Loop Ribbon with Re-inking Roller - 5 Million Character Life
- Paper is Standard Fan-fold, Multi-copy Computer Forms up to 9-5/8" (24.45 cm)
- 8-bit Parallel (Centronics Compatible), RS232 or 20 ma. Current Loop Interfaces, 110/1200 BAUD, Switch Selectable
- 115 VAC, 3A, 60 Hz. or 220 VAC, 1.5A, 50 Hz.
- 12"H x 18"W x 14"D (30 x 45 x 35 cm)

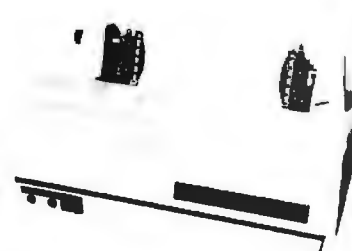

High Quality • High Technology • Low Price

Substantial Dealer/Distributor  
Discounts Available

### SIGMA INTERNATIONAL, INC.

P.O. Box 1118 SCOTTSDALE, AZ 85252 USA  
Tel. (602) 994-3435 Tlx. 165-745 Sigma Cable: SIGMAS

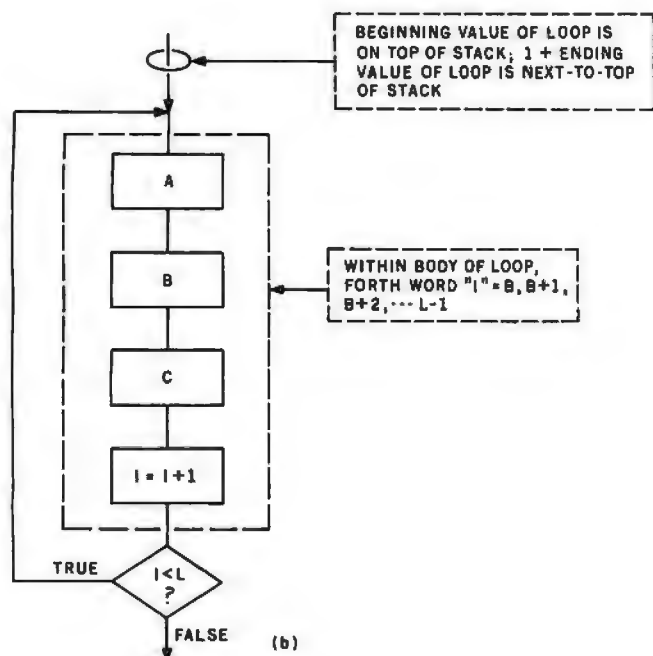
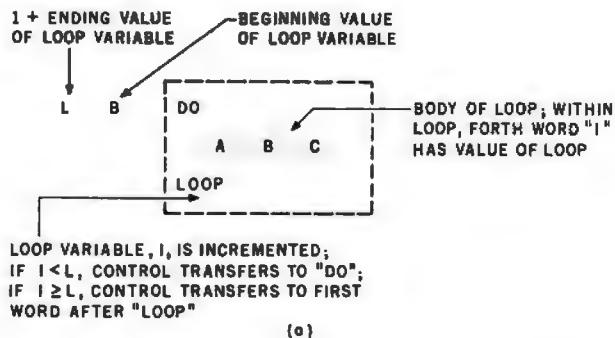

Figure 3: An explanation of the DO ... LOOP construct. As shown in figure 3a, the top number on the stack is taken to be the lower limit of the loop variable, I, and the next-to-top number on the stack is the upper limit of the loop variable + 1. The body of the loop is shaded, and the loop variable is incremented and tested after the body of the loop is executed. Figure 3b gives the equivalent construct in conventional flowchart notation.

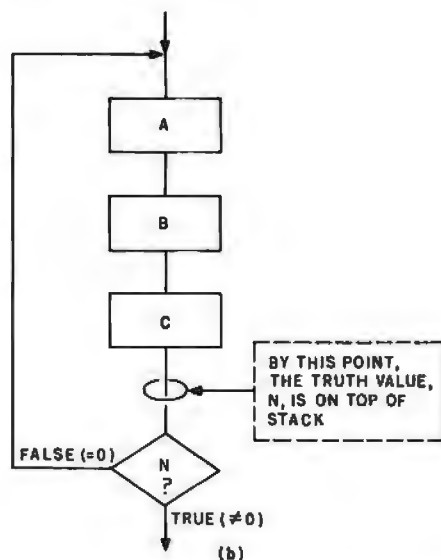
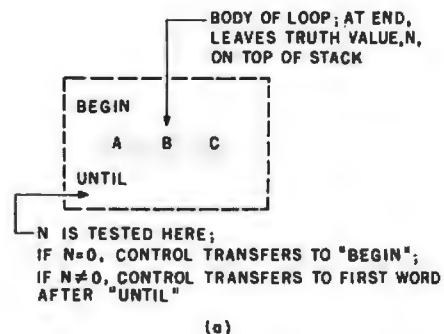

Figure 4: An explanation of the BEGIN ... UNTIL construct. As shown in figure 4a, the body of the loop (shaded) is repeated only if the value on top of the stack when the word UNTIL is reached is false. Figure 4b gives the equivalent construct in conventional flowchart notation.

5280 Trail Lake Drive Suite 14 Ft. Worth, Texas 76133 (817) 294-2510

CP/M is a registered trademark of Digital Research Corp  
TRS 80 is a registered trademark of Radio Shack

**FROM THE ORIGINATOR OF THE TRS-80 PROJECT**

**FMG Corporation — for HIGH LEVEL LANGUAGES**

- FORTRAN • BASIC
- PASCAL • COBOL

Microcomputer software for business applications, engineers, consumers, hobbyists and others who have a serious interest in computers.



SEND FOR **FREE** SOFTWARE CATALOG

- CP/M — Industry Standard Operating System
- USCD PASCAL PACKAGE
- GENERAL LEDGER; PAYROLL; ACCOUNTS RECEIVABLE and ACCOUNTS PAYABLE
- FORTRAN-80 PACKAGE — New Capabilities for TRS-80 Users
- ZSID — Symbolic Debugger
- Custom Programming, Service, Installation and Training are Available at Additional Cost

FMG Corporation is an Independent Software Company — from the ORIGINATOR OF THE TRS-80 PROJECT and THE AUTHOR OF THE FIRST CP/M FOR THE TRS-80.

M-452





# Hard disk and hardtape™ control

## Up to 2400 Megabytes of hard disk control for the S-100 bus.

Konan's SMC-100 interfaces S-100 bus micro computers with all hard disk drives having the Industry Standard SMD Interface. It is available with software drivers for most popular operating systems. Each SMC-100 controls up to 4 drives ranging from 8 to 600 megabytes per drive, including most "Winchester" drives -- such as Kennedy, Control Data, Fujitsu, Calcomp, Microdata, Memorex, Ampex, and others.

SMC-100 is a sophisticated, reliable system for transferring data at fast 6 to 10 megahertz rates with onboard sector buffering, sector interleaving, and DMA.

SMC-100's low cost-per-megabyte advanced technology keeps your micro computer system micro-priced. Excellent quantity discounts are available.

## Konan's HARDTAPE™ subsystem... very low cost tape and/or hard disk Winchester backup and more.

Konan's new DAT-100 Single Board Controller interfaces with a 17½ megabyte (unformatted) cartridge tape drive as well as the Marksman Winchester disk drive by Century Data.

The DAT-100 "hardtape" system is the only logical way to provide backup for "Winchester" type hard disk systems. (Yields complete hard disk backup with data verification in 20-25 minutes.)

Konan's HARDTAPE™ subsystem is available off the shelf as a complete tape and disk mass storage system or an inexpensive tape and /or disk subsystem.

## Konan controllers and subsystems support most popular software packages including FAMOS™, CP/M® version 2.X, and MP/M.

Konan, first (and still the leader) in high-reliability tape and disk mass storage devices, offers OEM's, dealers and other users continuing diagnostic support and strong warranties. Usual delivery is off the shelf to 30 days with complete subsystems on hand for immediate delivery.

Call Konan's TOLL FREE ORDER LINE today:

**800-528-4563**

Or write to Bob L. Gramley  
Konan Corporation, 1448 N. 27th Avenue  
Phoenix, AZ 85009. TWX/TELEX 9109511552

CP/M® is a registered trade name of Digital Research,  
FAMOS™ is a trade name of MVT Micro Computer Systems.  
HARDTAPE™ is a trade name of Konan Corporation.

# KONAN

UNBEATABLE...



APPLE II OR APPLE II PLUS



Shipped direct to you! \$899.00 (Plus Shipping)

We have orchard fresh Apple products ready to ship. Immediate delivery. Send cash or cashiers check for quick shipment. Orders with personal checks shipped after bank clearance.

- 16K UNITS.....\$899
32K UNITS.....\$999
48K UNITS.....\$1099
Apple Disk Drive \$550
Pascal Language Card \$450

Above plus \$20 shipping charge. IMPORTANT—No shipments made within the state of Illinois.

MIGHTY MICROS P.O. BOX 11375 CHICAGO, IL 60611

ORDER FORM

Enclosed \$
For Via U.P.S.
Ship to:
Name
Address (No P.O. Boxes—Street Address Only)
City
State Zip

Listing 8: An example of FORTH looping. A practical use of FORTH's structured looping is this terminal output handler. This example is for a PDP-11; an example for other computers would be similar. Address 177564 (octal) is the output status register of the console terminal; bit 7 of this address is set when the device is ready to receive a character. The ASCII code for the output character can then be placed in address 177566 (the data buffer register).

The FORTH word @ (pronounced fetch) does the work of PEEK in BASIC; it treats the number on top of the stack as an address and replaces it with the contents of that address word. AND does a "bitwise" boolean AND operation. So { 177564 @ 200 AND } indicates true (nonzero) only if bit 7 of the status register is set. Until then, the BEGIN ... UNTIL loop does a waiting loop ending on the above condition. When the device is ready, the argument that was given to TERMINAL-OUT (the ASCII character to be written) is still on top of the stack. { ! } (pronounced store) stores the word that is second on the stack into the address that is on top of the stack; so { 177566 ! } transmits the character to the terminal data buffer register, from which it will be written onto the terminal by the hardware of the PDP-11 system.

The FORTH word ASCII-TEST was written to test the TERMINAL-OUT word. It transmits ASCII values for all of the printable character set.

Listing 9 shows the same device handler, only written in machine-language code with a FORTH assembler.

```
OK
OCTAL OK
: TERMINAL-OUT ( CHAR -) . TERMINAL OUTPUT HANDLER; PDP-11)
  BEGIN 177564 @ 200 AND UNTIL ( WAIT TILL PORT READY)
  177566 ! ( TRANSMIT THE CHARACTER)
  ; OK
: ASCII-TEST ( -) . TEST HANDLER - PRINT CHARACTER SET)
  177 40 ( TRANSMIT ASCII BLANK THROUGH ' ')
  DO I TERMINAL-OUT LOOP ( OUTPUT THE CHARACTERS)
  ; OK
DECIMAL OK
ASCII-TEST !"#%&'()*+,-./0123456789:;<=>@ABCDEFGHIJKLMN0PQRSTUVWXYZ[\]^_`abcde
fghijklmnopqrstuvwxyz{|}~ OK
```

Listing 9: FORTH words defined by machine-language subroutines, for PDP-11 and for 8080 processors. The operation TERMINAL-OUT-2 behaves exactly the same as TERMINAL-OUT defined in listing 8, but it is written in assembly language. FORTH assemblers use postfix notation, so address-mode symbols and operation codes (instruction mnemonics) follow their operands, unlike conventional assemblers. In the PDP-11 example (listing 9a), { 177564 200 # BIT, } in line 2 assembles a "bit test" instruction that does a logical AND between address 177564 and the literal 200 (# indicates literal), setting condition codes. { UNTIL, } assembles a conditional branch back to the corresponding { BEGIN, }. The commas are part of the operation names, not punctuation. The word NE tells the { UNTIL, } what kind of conditional branch to assemble. There are also { IF, }...{ THEN, } and { IF, }...{ ELSE, }...{ THEN, } operations; all these code-level structures can be nested.

In the 8080 example (listing 9b), the machine-language subroutine sets up a call to the character-output routine in the North Star disk operating system. In contrast, the PDP-11 example outputs directly to the hardware without using any software outside of FORTH. Either approach could be used on either machine, of course, and each has its own advantages.

The word CODE, like { : } (colon, introduced in listing 3), creates a new definition in FORTH's dictionary for the word following it. CODE also sets the number base (to octal for PDP-11 and to hexadecimal for 8080), saving the original number base, which is later restored by { C; }. CODE also changes the vocabulary, which allows the same names to have different meanings in the assembler and in the rest of FORTH without confusion. Users can create their own vocabularies and subvocabularies to keep different application libraries separate.

Many FORTH programmers never need to write machine-language subroutines, so they do not need to use an assembler. FORTH assemblers have an unfamiliar postfix notation, but they have the advantage of giving immediate feedback. You know right away whether an operation works, with no wait for assembly passes, linking passes, and file handling. This interactive assembly greatly speeds program development and allows more thorough testing.

Listing 9 continued on page 122



# "WHAT WOULD YOU SAY TO BIG COMPUTER PERFORMANCE FROM YOUR MICROCOMPUTER?"

## "YOU'RE TALKING OUR LANGUAGE: PL/I-80.™"

### New PL/I-80 from Digital Research Brings Big Computer Programming Power to Microcomputer Systems.

**PL/I-80 is the biggest news** for small system users and OEMs since we introduced CP/M® and MP/M. PL/I-80 is ANSI's General Purpose Subset of full PL/I, tailored into a language for 8080, 8085 and Z80 users who expect the software revolution they've seen in hardware—better results at lower cost. PL/I-80 works harder than any other general-purpose language for business, science, research and education.

**The PL/I-80 software package** includes a native code compiler, comprehensive subroutine library, linkage editor and relocating macro assembler. And it's backed by our CP/M and MP/M operating systems.

Best of all, **the complete PL/I-80 system diskette and documentation costs just \$500.**

**PL/I-80:** There's no better way to get big-machine results from your 8-bit processor.

### Single and Multi-User Operating Systems That Set Industry Standards.

**CP/M is the industry standard operating system for small machines.** With thousands of users throughout the world, it's the most popular and widely used. It's the original, hardware-independent 'bus' for users working with a broad array of languages, word-processing and applications software available from scores of suppliers at affordable prices.

Now we've made a great CP/M even better. CP/M 2.2 is the latest release of the efficient, reliable system that's truly universal, able to manage virtually any 8080, 8085 or Z80 micro and its floppy or hard-disk subsystems. Named to the 1979 Datapro Software Honor Roll, CP/M comes on a diskette with its own operating manual, for **just \$150 in unit quantity.**



**MP/M provides big-computer power at small-computer cost.** It provides multi-terminal access with multi-programming at each terminal. And it's CP/M compatible, so you can run many programming languages, applications packages and development software on your system.

Check these advanced capabilities. Run editors, translators, word processors and background print spoolers simultaneously. Use MP/M's real-time facilities to monitor an assembly line and schedule programs automatically, or control a network of micros. Even write your own system processes for operation under MP/M. The possibilities are endless, **yet MP/M costs just \$300 (unit price for diskette and manual).**

### Utilities That Work For You.

**Use our utilities. Thousands do.** They're designed to make your small system work extra hard, yet they cost surprisingly little.:

- MAC™ (Macro Assembler)—\$90.
- SID™ (Symbolic Instruction Debugger)—\$75.
- ZSID™ (Z80 Symbolic Instruction Debugger)—\$100.
- TEX (Text Formatter)—\$75.
- DESPOOL™ (Background Print Utility)—\$50.

All are supplied on a diskette, with operating manual.

# CP/M® SOFTWARE

## 8080 Emulator

RAID is a software-based system rivaling hardware emulators costing thousands of dollars. RAID is absolutely the most advanced and sophisticated debugging system ever developed for a computer. Fully symbolic, including labels, operands and op-code mnemonics, RAID combines real-time and emulation modes in a single package. Tracing by *prime path*, *individual instructions*, *subroutines* and *breakpoints* is supported. Special feature allows emulation and real-time modes to function together for high speed emulations. Other features include memory search facilities, disk access by track and sector, single-step, multi-step, block move, user-selectable radix, etc. Over 70 commands in all. Requires 24K min. CP/M<sup>®</sup> system.

Raid .....\$195  
Manual only .....\$ 25

## ISIS' Conversion

ISIS' to CP/M<sup>®</sup> conversion utilities permit CP/M<sup>®</sup> users to read or write files to or from an ISIS' diskette. The package consists of three utility programs that *read*, *write* and display the ISIS' *directory*.

ISIS' - CP/M<sup>®</sup> Utilities .....\$160  
Manual only .....\$ 5

## Floating Point Package

'FPP' is a set of 8080 assembly language subroutines that provide 12 digit BCD arithmetic functions for *add*, *subtract*, *multiply*, and *divide*. BCD arithmetic means no conversion errors and minimal conversion time. Source code is supplied on standard 8" diskette.

FPP on CP/M<sup>®</sup> diskette .....\$200  
FPP on ISIS' diskette .....\$200  
Manual only .....\$ 10

ISIS is a trademark of Intel Corporation.  
CP/M<sup>®</sup> is a registered trademark of Digital Research.



586 Shades Crest Road  
Birmingham, Al.

Send check or money order to:  
P.O. Box 3373 A  
Birmingham, Al. 35205  
Phone: 205 933-1659

## Listing 9 continued:

Collectively, { : } and CODE are called defining words because they are used to create new FORTH words. There are several other such functions in FORTH, and users can also define their own types of defining words, creating new data types or operation types; see listing 10.

```

CODE TERMINAL-OUT-2 ( CHAR -> , TERMINAL OUTPUT HANDLER, PDP-11) OK
BEGIN, 177564 200 # BIT, NE UNTIL, ( WAIT TILL PORT READY) OK
S )+ 177566 MOV, ( POP FORTH STACK INTO DATA REGISTER) OK
NEXT, ( A 2-INSTRUCTION MACRO TO CONTINUE FORTH EXECUTION) OK
C; ( GET OUT OF THE FORTH ASSEMBLER) OK

OCTAL OK
: ASCII-TEST-2 ( -> , PRINT ASCII CHARACTER SET)
177 40 ( ASCII BLANK THROUGH ' ')
DO I TERMINAL-OUT-2 LOOP ( OUTPUT THE CHARACTERS)
I OK
DECIMAL OK
ASCII-TEST-2 !"##%&'()*+,-./0123456789:;<=>?@ABCDEFGHIJKLMNopRSTUVWXYZ[\]^_`ab
cDEFGHIJKLMNOPQRSTUVWXYZ{|}~> OK
ASCII-TEST !"##%&'()*+,-./0123456789:;<=>?@ABCDEFGHIJKLMNopRSTUVWXYZ[\]^_`abcd
EFGHIJKLMNOPQRSTUVWXYZ{|}~> OK

0 CONSTANT DEV ( DEVICE NO FOR NORTHSTAR DOS ) OK
2000 CONSTANT COUT ( NORTHSTAR DOS CHAR OUT JUMP POINT ) OK
CODE TERMINAL-OUT-2 ( CHAR-> , 8080 WITH NORTHSTAR DOS ) OK
I POP ( CHARACTER IS ON STACK, POP TO HL ) OK
B PUSH ( BC IS INSTRUCTION POINTER, SAVE IT ) OK
I, B MOV ( DOS EXPECTS CHAR IN B REGISTER ) OK
DEV A MVI ( AND DEVICE NUMBER IN ACCUMULATOR ) OK
COUT CALL B POP NEXT JMP C; ( DO IT AND CONTINUE ) OK
    
```

Listing 10: User-defined data types. Because this example is longer, it was not typed in directly like the others, but was stored on disk with an editor (the editor session is not shown here). This example is contained in two disk screens, each of which is a virtual block of 1024 bytes (see text). The commands { 58 LIST } and { 59 LIST } print these screens. The line numbers (0 thru 15) are not part of the program and are used only by the editor.

This example creates table-lookup sine and cosine routines for integer-degree arguments. The results are accurate enough for most graphics applications, making this situation an example of the versatility of FORTH, even without floating-point routines.

The definition of TABLE creates a new data type. When TABLE is executed, it creates a new table of numbers taken from the stack; the number on top of the stack tells how many items there are in the table. In this case, { 91 TABLE SINTABLE } creates a table called SINTABLE with ninety-one entries; these entries are the values of the sine of 0° thru 90°, multiplied by 10,000 so that they can be expressed as integers. SINTABLE gives the sine (scaled by 10,000) of 0° thru 90° degrees; SIN does the same, except that its argument can be any number of degrees (from -32,768 to 32,767).

Incidentally, few FORTH programs use as much depth of stack as this one. The system used for listings 1 thru 7 limits the stack depth in order to use "page 0" memory for speed, so this example would have to be modified to run on it.

The <BUILDS ... DOES> construct, which creates the new data type, is one of the most advanced concepts of FORTH. Briefly, the <BUILDS part is executed when SINTABLE is defined; that is, it creates the table. The DOES> part defines what happens when SINTABLE is executed. Once TABLE has been defined, any number of tables of varying length can be declared using the word. Similar definitions can create special-purpose arrays such as word, byte, or bit arrays, user-defined record structures or other data objects, or user-defined classes of operations. (An excellent explanation of the words <BUILDS and DOES> is given in Kim Harris' article "FORTH Extensibility," also in this issue....GW)

```

OK
58 LIST
SCR # 58
0 ( TRIG LOOKUP ROUTINES - WITH SINE *10000 TABLE)
1 : TABLE ( ... N -> , CREATE 'TABLE' DATA TYPE.)
2 <BUILDS 0 DO , LOOP ( COMPIL N ELEMENTS)
3 DOES) SWAP 2 * + @ ( EXECUTE TABLE LOOKUP)
4 ;
    
```

Listing 10 continued on page 124



# The VP-111 hobby computer: Start programming for only \$99.

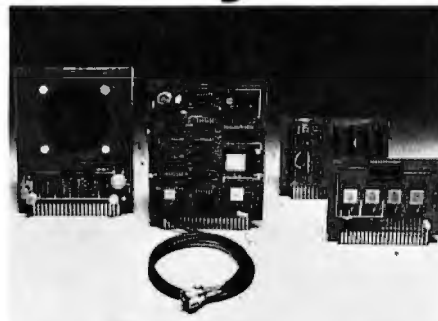

**New! VP-111 Microcomputer .... \$99. Assembled\* and tested.**

**Features:**

- RCA 1802 Microprocessor.
- 1K Bytes static RAM.
- Expandable on-board to 4K.
- Expandable to 32K Bytes total.
- 512 Byte ROM operating system.
- CHIP-8 interpretive language or machine language programmable.
- Hexidecimal keypad.
- Audio tone generator.
- Single 5-volt operation.
- Video output to monitor or modulator.
- Cassette interface—100 Bytes/sec.
- Instruction Manual with 5 video game listings, schematics, CHIP-8, much more!

Ideal for low-cost control applications.

Expandable to full VP-711 capability with VP-114 Kit.

\*User need only connect cables (included), a 5-volt power supply and speaker.

**New low price! \$199. VP-711, only..... \$199. Completely assembled and tested.**

All the features of the VP-111 plus:

- A total of 2K Bytes static RAM.
  - Power supply.
  - 8 Bit input port.
  - 8 Bit output port.
  - I/O port connector.
  - System expansion connector.
  - Built-in speaker.
  - Plastic cover.
- Three comprehensive manuals:
- Instruction Manual—20 video game listings, schematics, much more.
  - User's Guide—operating instructions and CHIP-8 for the beginner.
  - RCA 1802 User's Manual (MPM-201B)—complete 1802 reference guide.

**Add computer power a board at a time.**

With easy-to-buy options, the versatile RCA hobby computer means even more excitement. More challenges in graphics, games and control functions. For everyone, from youngster to serious hobbyist.

Built around an RCA COSMAC microprocessor, our hobby computer is easy to program and operate. Powerful CHIP-8 interpretive language gets you into programming the first evening. Complete documentation provided.

**Send the coupon now...**

Complete the coupon below and mail to: RCA MicroComputer Customer Service, New Holland Ave., Lancaster, PA 17604.

**Or call toll free (800) 233-0094** to place your Master Charge or VISA credit card order. In Pennsylvania, call (717) 397-7661, extension 3179.



Please send me the items indicated.

- VP-111** New low cost! Microcomputer (See description above) ..... \$ 99
- VP-114** Expansion Kit for VP-111—Includes 3K RAM, I/O Port and connectors \$ 76
- VP-711** The original VP Microcomputer (See description above) ..... \$199
- VP-44** RAM On-Board Expansion Kit—Four 2114 RAM ICs. Expands VP-711 memory to 4K Bytes ..... \$ 36
- VP-590** Color Board—Adds color. Four background and eight foreground colors ..... \$ 69
- VP-595** Simple Sound Board—Provides 256 programmable frequencies. For simple music or sound effects. Includes speaker ..... \$ 30
- VP-550** Super Sound Board—Turns VP-111/711 into a music synthesizer! Two independent sound channels. Outputs to audio ..... \$ 49
- VP-551** 4-Channel Super Sound—Includes VP-576 and demo cassette. Requires VP-550 and 4K RAM ..... \$ 74
- VP-570** Memory Expansion Board—Plug-in 4K RAM memory ..... \$ 95
- VP-580** Auxillary Keypad—Adds two-player interactive capability. Connects to VP-590 or VP-585 ..... \$ 20
- VP-585** Keypad Interface Board—Interfaces two VP-580 Auxillary Keypads to VP-111/711 ..... \$ 15
- VP-560** EPROM Board—Interfaces two 2716 EPROMS to VP-111/711 .. \$ 34

- VP-565** EPROM Programmer Board—Programs 2716 EPROMs. With software ..... \$ 99
- VP-575** Expansion Board—Provides 4 buffered and one unbuffered expansion sockets ..... \$ 59
- VP-576** Two-Board Expander—Allows use of 2 Accessory Boards in either I/O or Expansion Socket ..... \$ 20
- VP-700** Tiny BASIC ROM Board—BASIC code stored in 4K of ROM ..... \$ 39
- VP-701** Floating point BASIC for VP-711 on cassette. Requires 16K Bytes RAM (avail. 7/80) ..... \$ 49
- VP-710** Game Manual—Listing for 16 exciting games ..... \$ 10
- VP-720** Game Manual-II—More games .. \$ 15

**ASCII keyboards.**

- VP-601** Keyboard—128-character ASCII encoded alphanumeric 8-bit parallel output ..... \$ 69
- VP-606** Keyboard—Same as VP-601. Asynchronous serial output ..... \$ 99
- VP-611** Keyboard—Same as VP-601 plus 16-key numeric keypad ..... \$ 89
- VP-616** Keyboard—Same as VP-606 plus 16-key numeric keypad ..... \$119
- VP-620** Cable—Connects VP-601/611 to VP-111/711 ..... \$ 20
- VP-623** Cable—Unterminated for VP-601/611 ..... \$ 20
- VP-626** Connector—Male "D" mates to VP-606/616 ..... \$ 7

Enclosed is \$\_\_\_\_\_ for items checked plus shipping & handling charge of \$3.00.

Add your state and local taxes \$\_\_\_\_\_ Total enclosed \$\_\_\_\_\_

I enclose  check or  money order. Or charge my  VISA  Master Charge.

Credit card account No. \_\_\_\_\_

Master Charge Interbank No. \_\_\_\_\_ Expiration date \_\_\_\_\_

Signature (required for credit orders): \_\_\_\_\_

Name (please type or print): \_\_\_\_\_

Street address: \_\_\_\_\_ City: \_\_\_\_\_

State & Zip: \_\_\_\_\_ Telephone:( ) \_\_\_\_\_

Make checks payable to RCA Corp. Prices and specifications are subject to change without notice.



**PERSONAL  
COMPUTER  
SYSTEMS**

A Warner Communications  
Company

**ATARI® 800™**

List \$1080

**ONLY \$849**



**ATARI® 400™, List \$630**

**OUR PRICE ONLY \$499**

820 PRINTER, List \$599.95 ..... \$499  
810 DISK DRIVE, List \$699.95 ..... \$589

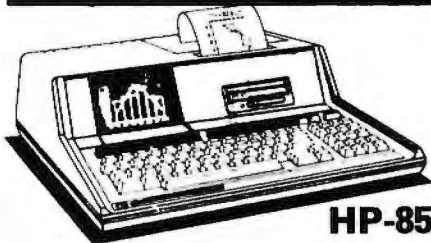

**HP-85**

- Extended BASIC Language **Call for Price**
- Advance Graphics
- CRT Built-In Display
- Magnetic Tape Cartridge for Storage

**CALCULATORS BY**

**HEWLETT  PACKARD**

- HP-41C Calculator, "A System" ... \$289.95
- HP-32E Scientific w/Statistics ... \$ 53.95
- HP-33C Scientific Programmable ... 99.95
- HP-34C Advanced Scientific Programmable ..... 123.95
- HP-37E Business Calculator ..... 58.95
- HP-67 Handheld Fully Advanced Programmable Scientific for Business & Engineering ..... 298.95
- HP-97 Desktop w/Built-in Printer .. 579.95

- APPLE II, 16K, List \$1195 ..... \$ 989
- 32K, List \$1395 ..... \$1169
- 48K ..... 1259

**COMMODORE PET ..... Call for Prices**

Prices do not include shipping by UPS. All prices and offers are subject to change without notice.

**Personal  
PC  
Systems**



609 Butternut Street  
Syracuse, N.Y. 13208  
(315) 478-6800

Circle 81 on inquiry card.

**Listing 10 continued**

```

5 10000 9998 9994 9986 9976 9962 9945 9925 9903 9877
6 9848 9816 9781 9744 9703 9659 9613 9563 9511 9455
7 9397 9336 9272 9205 9135 9063 8988 8910 8829 8746
8 8660 8572 8480 8387 8290 8192 8090 7986 7880 7771
9 7660 7547 7431 7314 7193 7071 6947 6820 6691 6561
10 6428 6293 6157 6018 5878 5736 5592 5446 5299 5150
11 5000 4848 4695 4540 4384 4226 4067 3907 3746 3584
12 3420 3256 3090 2924 2756 2588 2419 2250 2079 1908
13 1736 1564 1392 1219 1045 0872 0698 0523 0349 0175
14 0000 ( 91 ELEMENTS OF TABLE PLACED ON STACK)
15 91 TABLE SINTABLE ( RETURNS SINE, 0-90 DEGREES ONLY)
OK

```

**SCR # 59**

```

0 ( SINE AND COSINE TABLE-LOOPUP ROUTINES)
1 : S180 ( N -> N . RETURNS SINE, 0-180 DEGREES)
2 DUP 90 ) ( IF GREATER THAN 90 DEGREES,)
3 IF 180 SWAP - ENDIF ( SUBTRACT FROM 180)
4 SINTABLE ( THEN TAKE SINE)
5 ;
6 : SIN ( N -> SINE. RETURN SINE OF ANY NUMBER OF DEGREES)
7 360 MOD ( BRING WITHIN + OR - 360)
8 DUP 0( IF 360 + ENDIF ( IF NEGATIVE, ADD 360)
9 DUP 180 ) ( TEST IF GREATER THAN 180)
10 IF 180 - S180 MINUS ( IF SO, SUBTRACT 180, NEGATE SINE)
11 ELSE S180 ENDIF ( OTHERWISE, STRAIGHTFORWARD)
12 ;
13 : COS ( N -> COSINE.)
14 360 MOD ( PREVENT OVERFLOW NEAR 32,767)
15 90 + SIN ; ( COSINE IS SINE WITH 90 DEGREES PHASE SHIFT)
OK

```

OK

```

58 LOAD 59 LOAD OK
1 SIN . 0 OK
0 COS . 10000 OK
90 SIN . 10000 OK
45 SIN . 7071 OK
1 SIN . 175 OK
361 SIN . 175 OK
1000 SIN . -9848 OK
10000 SIN . -9848 OK
10000 COS . 1736 OK
-25281 COS . 1564 OK
32767 SIN . 1219 OK
-32767 COS . 9925 OK
-1 SIN . -175 OK
: SINSCALE ( N DEGREES -> N . SCALE BY SINE)
SIN 10000 */ ( MULTIPLY, THEN DIVIDE; 32 BITS INTERMEDIATE)
; OK
100 45 SINSCALE . 70 OK
10000 45 SINSCALE . 7071 OK
30000 -5 SINSCALE . -2616 OK

```





SERIES OF STATEMENTS  
THAT LEAVE A TRUTH  
VALUE, N, ON TOP OF STACK

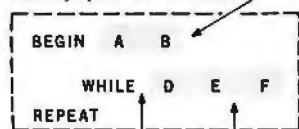

N IS TESTED HERE;  
IF N=0, JUMP TO FIRST  
WORD AFTER "REPEAT"

BODY OF LOOP:  
EXECUTED IF AND ONLY  
IF N ≠ 0

(a)

Figure 5: An explanation of the BEGIN ... WHILE ... REPEAT construct. As shown in figure 5a, the FORTH words between BEGIN and WHILE perform operations that leave a truth value, N, on top of the stack. The value of N determines whether the body of the loop (the words between WHILE and REPEAT) is performed or not. The loop repeats until N evaluates to false (N=0). Figure 5b gives the equivalent construct in conventional flowchart notation.

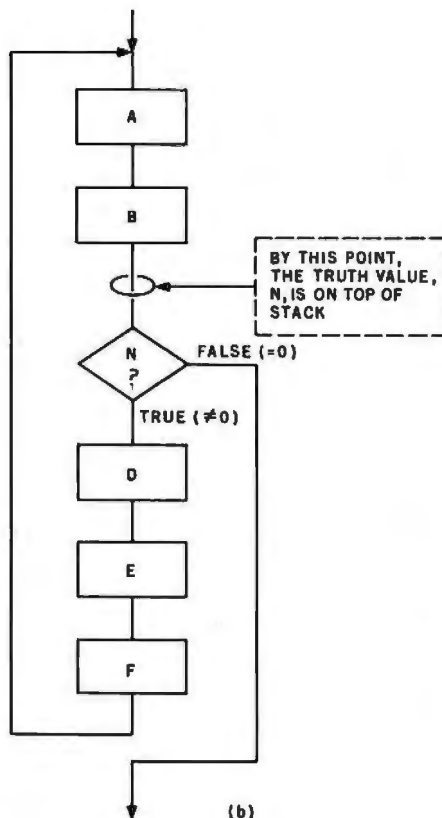

(b)

4. Hicks, S M, "FORTH's Forte is Tighter Programming," *Electronics*, March 15, 1979, pages 114 thru 118.
5. James, J S, "FORTH for Micro computers," *Dr Dobbs Journal of Computer Calisthenics & Orthodontia*, May 1978; reprinted in *SIGPLAN Notices* (Special Interest Group on Programming Languages of the Association for Computing Machinery), October 1978.
6. Meinzer, K, "IPS, an Unorthodox High-Level Language," *BYTE*, January 1979, pages 146 thru 159.
7. Moore, C H, "FORTH: a New Way to Program a Computer," *Astronomy and Astrophysics Supplement*, 1974, number 15, pages 497 thru 511.
8. Moore, C H, and E D Rather, "The FORTH Program for Spectral Line Observing," *Proceedings of the IEEE*, September 1973, pages 1346 thru 1349.
9. Rather, E D, and L Brody, *Using FORTH* (2nd rev ed) FORTH Inc, Hermosa Beach CA, 1980.
10. Rather, E D, and C H Moore, "The FORTH Approach to Operating Systems," *ACM 1976 Proceedings*, Association for Computing Machinery, 1976.
11. Sachs, J, *An Introduction to STOIC*, Technical Report BMEC TR001, Harvard-MIT Program in Health Sciences and Technology, Cambridge MA, June 1976.
12. Stein, P, "The FORTH Dimension: Mini Language Has Many Faces," *Computer Decisions*, November 1975, page 10.
13. Stevens, W R, *A FORTH Primer*, Kitt Peak National Observatory, Tucson AZ, 1979.
14. Taylor, A, "FORTH Becoming Hothouse for Developing Languages," *Computerworld*, July 30, 1979.
15. Taylor, A, "FORTH Setting Coding Trend?," *Computerworld*, August 13, 1979.
16. Taylor, A, "Trade Language Families Can Sprout from FORTH," *Computerworld*, August 27, 1979.
17. Wells, D C, "Interactive Image Analysis for Astronomers," *Computer*, August 1977, pages 30 thru 34.

### SELECTED BIBLIOGRAPHY

1. Bartoldi, P, "Stepwise Development and Debugging Using a Small Well-Structured Interactive Language for Data Acquisition and Instrument Control," *Proceedings of the International Symposium and Course on Mini- and Microcomputers and their Applications*,

- Acta Press, Anaheim CA, 1976, pp 117-122.
2. Ewing, M S, *The Caltech FORTH Manual*, California Institute of Technology, Pasadena CA, 1978.
3. Forsley, L, *URTH Tutorial*, University of Rochester, Rochester NY.

## S-100 USERS: GIVE YOUR COMPUTER THE GIFT OF SIGHT!

The DS-80 Digisector® is a random access video digitizer. It works in conjunction with a TV camera (either interlaced or non-interlaced video) and any S-100 computer conforming to the IEEE standards. Use it for:

- Precision Security Systems
- Moving Target Indicators
- Computer Portraiture
- Fast To Slow Scan Conversion
- Robotics
- Reading UPC Codes, schematics, paper tape, musical scores



● IMAGE PROCESSED BY DS-80 ●

### CHECK THESE FEATURES:

- High resolution** — a 256 x 256 picture element scan
- Precision** — 64 levels of grey scale
- Speed** — Conversion time of 14 microseconds per pixel
- Versatility** — scanning sequences user programmable
- Economy** — a professional tool priced for the hobbyist; comes fully assembled, tested and burned in, with fully commented portrait printing software.

Price: \$349.95 MasterCharge and Visa

THE **MICRO**  
**WORKS**

P.O. BOX 1110, DEL MAR, CA 92014 714-756-2687





## Even at 5:12 a.m., it's hard to quit playing Personal Software™ strategy games.

A quick game before turning in can become an all-night session when you load any of the Personal Software™ strategy games into your Apple,\* PET\* or TRS-80.\* They'll challenge, teach and entertain you. And now there are two new games—Gammon Gambler™ and Checker King™—joining Bridge Partner,™ Time Trek™ and the best-selling Microchess.™

**Gammon Gambler** is a sure bet. With ten levels of skill, you can begin a novice and become an expert. Whichever level you play, the computer moves so quickly you don't have to wait. The program follows U.S. tournament rules, and includes the doubling cube to spice up the game. Written for the Apple and PET by Willy Chaplin.

**Checker King**—you probably forgot how much fun it is! If you move and change your mind, take it back and move again—without a peep from the computer. Play eight skill levels. Add and remove pieces. Save three board positions for later play. And solve three challenging checker puzzles. Written by Michael Marks for the Apple, PET and TRS-80.

**Microchess**, the most widely used personal computer chess program, is a nearly perfect chess opponent for the total novice or the advanced enthusiast. Written by Peter Jennings for the Apple, PET and TRS-80.

**Bridge Partner.** You against the computer in over 10 million different hands of contract bridge. You can even specify the hands' high card points. Written by George Duisman for the Apple, PET and Level II TRS-80.

**Time Trek** is easy to learn, difficult to master and impossible to forget. Take command of a starship in real-time action to make the galaxy safe again. PET version by Brad Templeton. TRS-80 program by Joshua Lavinsky.

Personal Software, Inc., also produces the VisiCalc™ program (the software that's revolutionizing personal

computing), CCA Data Management System, the Vitafacts series and other exciting software for the Apple, PET and TRS-80.

Now that you've read about the Personal Software programs, go see a demonstration. For the name of your nearest Personal Software dealer, call (408) 745-7841 or write to Personal Software Inc., 1330 Bordeaux Dr., Sunnyvale, CA 94086.

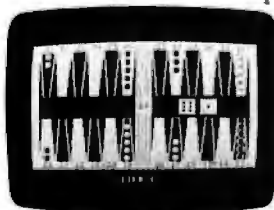

Gammon Gambler

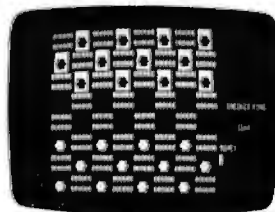

Checker King



Circle 85 on inquiry card.

# PERSONAL SOFTWARE



STRATEGY GAMES SERIES

\*Apple is a trademark of Apple Computer, Inc.; PET is a trademark of Commodore Business Machines, Inc.; TRS-80 is a trademark of the Radio Shack Division of Tandy Corp.

Text continued from page 10:

You should also look at FORTH if you have limited computer or financial resources. FORTH is a big language in a small package, and you can buy a version of FORTH for as little as \$20. (See "Selected FORTH Vendors," on page 98.) Unlike most new languages that gobble up more and more of the 64 K bytes allotted to an 8-bit microcomputer (some won't comfortably fit in 64 K bytes), there is plenty of room for very large FORTH programs even in a 16 K machine. FORTH takes up only about 8 K bytes, and this can be pared down; in an industrial application that will run only one program, the FORTH interpreter can be made as small as 800 bytes. Also, FORTH can be run on cassette-based systems due to its small size; although this is still more inconvenient than running FORTH on a disk system, most languages that use a disk are impractical or impossible on cassette-only systems.

Finally, you may want to consider FORTH for applications where speed is of the utmost importance. Since portions (or all) of a FORTH program can be written in the assembly lan-

guage of the host computer, FORTH programs can be written that compare favorably in speed with machine-language programs. And, again, productivity is higher using FORTH than it is with machine language.

### What Is a Threaded Language?

Imagine a language that starts with a few fundamental subroutines written in the machine language of the host computer; eg: routines to put a character to the display device, to get a character from the keyboard, to multiply two fixed-point numbers. Then imagine that the only way to combine these subroutines is to string them together (with embedded data bytes) as a series of subroutine calls; eg: a routine to get a signed multidigit number from the keyboard is written as a controlled series of calls to the subroutine that gets a character. Then these routines are called by other routines that perform even bigger tasks. For example, a routine to sum a series of signed numbers entered from the keyboard is written as series of subroutine calls that includes the one mentioned just above. The final pro-

### Special Notation Used in This Issue

Because FORTH is such an unusual language (it uses punctuation marks by themselves and within words), a pair of braces, { }, is sometimes used to set apart FORTH words from the rest of the text. Braces are used under the following conditions:

- When the material being quoted is a series of FORTH words; eg: { 26 LOAD } ;
- When the FORTH word is or contains any of the following punctuation marks: period, comma, colon, question mark, exclamation point, single quote mark, or double quote mark. Two examples are { . } and { (") }.

In addition, spaces are always used to separate FORTH words from other words or punctuation—even when this means doing something like "...the words BEGIN, WHILE, and REPEAT are all..." (spaces between FORTH words and the commas that follow them). There are two reasons for doing this: first, for clarity; and second, to emphasize that the FORTH word in question does not include the punctuation that follows. Some FORTH words do contain punctuation (eg: { IF, }), but such words will always be enclosed in braces (except within program listings).

gram in such a threaded language is a series of calls to lower and lower subroutines, dipping repeatedly into machine-language routines under the control of higher-level routines. The addresses in each subroutine that point to the subroutine or machine language under it make up a "thread" of control that runs through the entire program.

FORTH has so far been implemented as a threaded language. Threadedness is a language implementation technique, not an inherent quality of any language; SNOBOL and FORTRAN compilers have been written using threaded code.

## Computer Hardware Professionals

Our clients, highly successful manufacturers and OEMs of Computer Systems, Electronic Systems, and Peripherals, have immediate openings for Hardware Development Professionals to work on FUTURE SYSTEMS PROJECTS. Such projects include COMPUTER ARCHITECTURE, DATA COMMUNICATIONS, PERIPHERAL DEVELOPMENT, and POWER SUPPLY DESIGN. Specific openings currently exist at Senior and Intermediate levels for:

**COMPUTER ARCHITECTS** — Definition and development of Micro- Mini-computer systems.

**POWER SUPPLY DESIGN ENGINEERS** — Switching regulators for Off-Line Power supplies. Experience in High Frequency P.W.M. techniques and AC Power Distribution would be desirable.

**MICROPROCESSOR DESIGN ENGINEERS** — Design/Development of state-of-the-art Microprocessor based systems and interfaces. Experience on any Microprocessor acceptable.

**LSI DESIGN DEVELOPMENT** — Numerous positions with local systems oriented firms in LSI technology development.

**CPU DESIGN ENGINEERS** — BSEE/BCS and/or experience in the design of Digital Computers or Microprocessor systems. Requires an understanding of Software, i.e. ASSEMBLY, FORTRAN, or PL-1.

**DIGITAL LOGIC AND CIRCUIT DESIGN ENGINEERS** — Logic and Circuit design plus a familiarity with TTL, CMOS, LSI/VLSI, etc.

**ANALOG DESIGNERS** — 30 to 40 megahertz Phase Lock loop experience. Experience with 80 megahertz power drivers and DC motors.

**PCB DESIGNERS** — With CAD experience.

**COMMUNICATIONS SYSTEMS DEVELOPERS** — Experience with store and forward message switching, Network Data Link Control, and/or PBX and EPX Systems.

Compensation on all positions ranges from low 20's to low 40's, based upon experience. Client companies are equal opportunity/affirmative action employers, provide excellent benefits, and assume all fees.

Qualified applicants will receive IMMEDIATE RESPONSE and are invited to contact: Don Bateman, in strict confidence, at (617) 861-1020. Or submit current resume to him for review. For those who find it inconvenient to call during working hours, our office will be open until 7:30 p.m.

Contact: Don Bateman

**RC** Robert Kleven and Co., Inc.  
INDUSTRIAL RELATIONS MANAGEMENT CONSULTANTS

Three Fletcher Avenue, Lexington, Massachusetts 02171  
Telephone (617) 861-1020



Member  
Massachusetts Professional Personnel Consultants  
National Computer Associates  
Affiliate, National  
Representing Equal Opportunity Employers M I





# AUTHORIZED TRS-80<sup>®</sup> DEALER A301

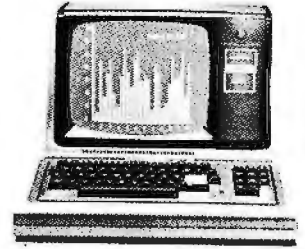

## COMPUTER SPECIALISTS

**10%  
DISCOUNT  
Off  
List**  
26-4002  
64K 1 Drive  
\$3499.00

26-1056 16K Level II System with Keypad.	\$ 700.00
26-1145 RS-232 Board.....	84.00
26-1140 "O" K Interface.....	254.00
26-1141 "16" K Interface.....	381.00
26-1142 "32" K Interface.....	508.00
26-1160 Mini Disk - Drive 0.....	424.00
26-1161 Mini Disk - Additional.....	424.00
26-1154 Lineprinter II.....	720.00
26-1156 Lineprinter III.....	1799.00
26-1157 WP50 Daisy Printer.....	2670.00
26-1180 Voice Synthesiser.....	339.00
26-1181 VOXBOX.....	145.00
26-1104 Factory Upper/Lower Case Modifaction Installed.....	90.00
26-1605 Scripsit - Tape.....	60.00
26-1563 Scripsit - Disk.....	85.00

**15%  
DISCOUNT  
Off  
List**  
26-1054  
4K Level II  
\$527.00



**CENTRONICS**  
Fast 100 CPS Centronics  
730 Printer - \$675.00  
Text Quality Centronics  
737 Printer - \$850.00

ALL OTHER R.S. SOFTWARE  
FURNITURE, STANDS, CABLES  
AND ACCESSORIES DEDUCT  
10% FROM CATALOG PRICE

Novation Cat Modem...\$159.00  
CCA Data Management  
System..... 72.00  
Adventure Games  
Games 1-9..... 14.00

**MICROSOFT**

Model I Basic Compiler.....\$195.00  
Model II Basic Compiler.....395.00

**BASF**

10-5 1/4 Diskettes.....\$45.00  
10-8 Diskettes.....47.00



Plug Compatible Lobo 5 1/4  
Drives - \$375.00

Versatile Lobo Interface,  
8" Drives and Hard Drive.  
**Call For Prices**

**Acorn  
Software  
Products, Inc.**

GAMES:  
Alien Invasion.....\$9.00  
UTILITIES:  
System Savers.....14.00  
EDUCATION:  
Language Teacher.....18.00

**1-800-841-0860 Toll Free Order Entry**

**MICRO MANAGEMENT SYSTEMS, INC.**

No Taxes on Out Of  
State Shipments  
Immediate Shipment  
From Stock.

DOWNTOWN PLAZA SHOPPING CENTER  
115 C SECOND AVE. S.W.  
CAIRO, GEORGIA 31728  
**(912) 377-7120 Ga. Phone No.**

Full Factory Warranty  
on All Items Sold.  
Largest Inventory  
In the S.E. U.S.A.

\*TRS-80 is a registered trademark of the Tandy Corp.

## FORTH: Pro and Con

**Pros:** I have already mentioned most of the advantages of FORTH. The language is:

- Compact;
- Fast, although this is due to its implementation in threaded code, not its inherent qualities;
- Structured: it has the major constructs of structured programming and, in fact, does not have any kind of *goto* statement, thus forcing it to be structured;
- Extensible;
- Highly portable.

These last two features deserve further description. The *extensibility* of FORTH is probably its most important feature. Never before in a high-level language has it been so easy to add new features, new data types, and new operators to a language. Unlike other languages, these new words (everything in FORTH is called a *word*) have the same priority and receive the same treatment as words defined in the standard FORTH vocabulary. For example, you can

define a word 10+ that will add ten to any number it is given; or, in fact, you can even redefine the addition operator +. You can also define entirely new families of words in FORTH. This advanced topic is ably discussed in what I believe is the only written treatment of the subject *anywhere* in FORTH literature by Kim Harris in his article, "FORTH Extensibility," on page 164.

Most FORTH programs can be transferred from, say, a mainframe computer to a microcomputer without modification; therefore, FORTH is *highly portable*. Most of the FORTH words supplied in a given system have been defined to do the same operation regardless of the computer used. Although the vocabulary of words varies from supplier to supplier, most FORTH programs will run with minor or no modifications. A standard set of words, called FORTH-79, collectively developed by many of the major suppliers and users of FORTH, will help in this situation.

**Cons:** Here are some of the disadvantages of FORTH:

- FORTH code is hard to read.

This is probably the most common complaint against the language. As a new user, I can say that you slowly get used to the odd syntax of the language. The stack architecture (see below) of the language contributes to the novice's initial disorientation, but this feeling is usually blamed on the unreadability of the language. In addition, the stack architecture encourages the storage of working values on the stack rather than in variables with names. Variable names, if chosen properly, give vital clues to the workings of a program; this scarcity of variable names makes most FORTH programs less readable. Adequate indentation and comments can help a FORTH program, but programmers of FORTH, like programmers of all other languages, often omit these aids to comprehension.

● The stack architecture of FORTH offers disadvantages as well as advantages. Remember the odd feeling you got the first time you used a Hewlett-Packard calculator and had to punch in "5 ENTER 3 + " instead of the more understandable "5 + 3 = " ? FORTH uses the same *reverse Polish notation* (abbreviated RPN), where the objects being entered come *before* the operators that work on them.

Not only does this take some getting used to (it takes even longer before you can fluently "think in FORTH"), it also encourages a scarcity of named variables, as mentioned above. In addition, stack-manipulating words like SWAP, DUP (for duplicating the top entry on the stack), ROT (for rotating the top three items on the stack), and others muddle the FORTH program and make it hard to tell just what variable is being operated on. This uncertainty is particularly evident during debugging; most of your time is spent finding out why what you *thought* was on the stack isn't there.

● FORTH encourages programming "tricks" in place of plain, easier to read programming. Although the examples to support this statement have already been mentioned, I think the statement as a generality is true. We must remember that, especially since lack of memory is usually not a problem in FORTH, FORTH programmers should name appropriate variables and, in general, worry less about fitting a program on one screen (a basic unit of FORTH program-

## TRS-80, PET, APPLE, SORCERER Communications Interface Systems



- Send & Receive Morse Code / Radioteletype
- Teaches Morse Code! / Copies wire services!
- Complete Hardware & Software Package
- Extensive User Manuals
- From \$129

Write or call for complete catalog

**MACROTRONICS, inc.®**

1125 N. Golden State Blvd. / Suite G  
Turlock, CA 95380 (A)  
(209) 667-2888 / 634-8888

California residents add 6% tax

We are experiencing telephone difficulties, please keep trying.





# The MICROCONDUCTOR™

the ultimate  
database manager  
for your TRS-80® and Apple®

Compose Any Software Program  
By simply answering the questions,  
**YOU** Describe the file layouts  
**YOU** Specify the print formats  
**YOU** Design the update functions.  
The CONDUCTOR DOES THE WORK!!!

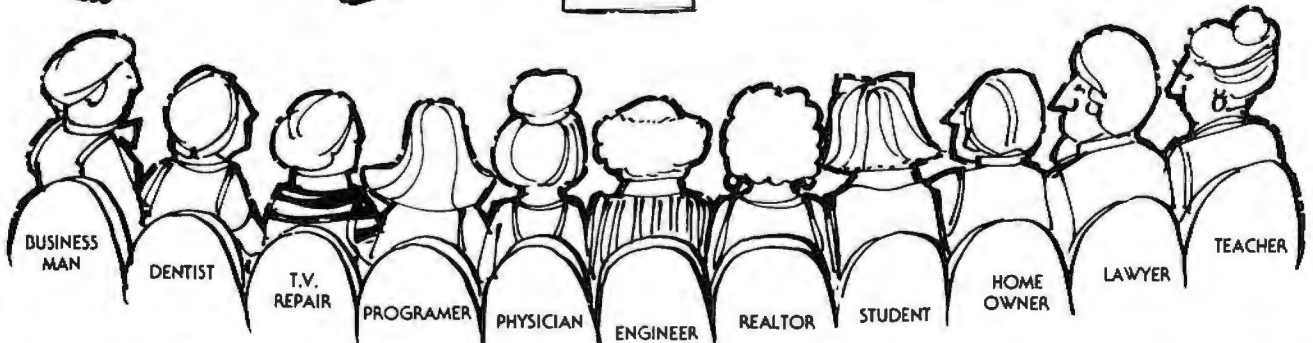
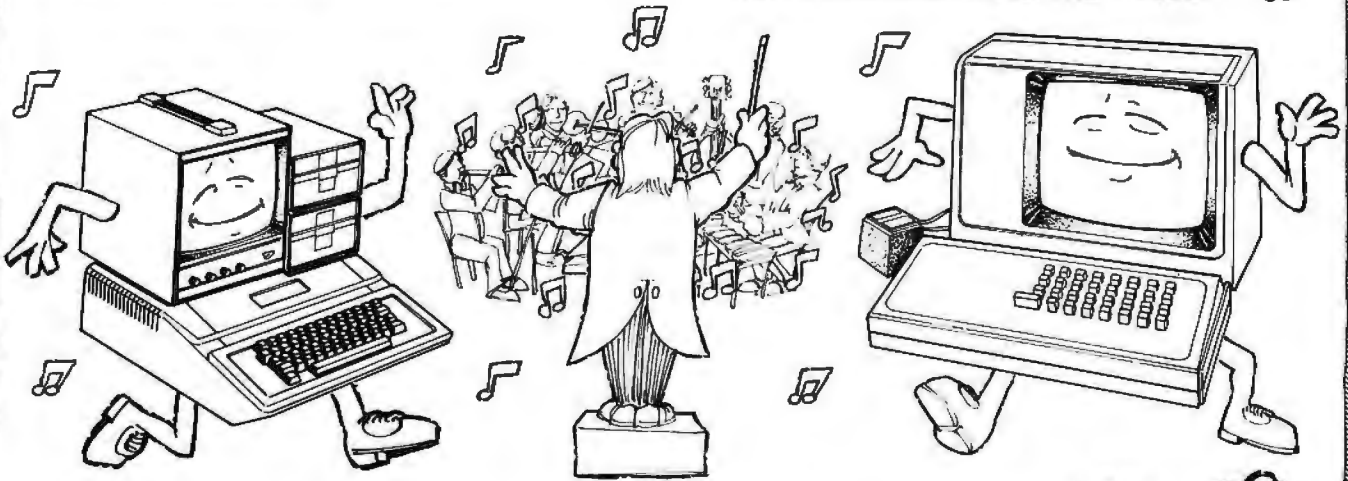

The MICROCONDUCTOR™ directs your computer to compose, organize and summarize all information you need to solve your software and business problems.

With The MICROCONDUCTOR™, your computer will be able to compose any record-keeping software you need. In the office, The MICROCONDUCTOR™ can help with anything from accounts receivable to property management. You'll find that The MICROCONDUCTOR™ is ideal for the shop roo. Let it take care of your inventory records, sales analysis, price lists, and more.

The MICROCONDUCTOR™ is not just a file manager but a true Data Base Management System suitable for both the novice and professional users.

Some of the modules of this masterpiece are:

- DATA FILE—One step file creation. Just set it, and forget it.
- MAINT.— Manipulate your data files with ease; add, delete, modify, scan, relocate, and more.
- SORT— Sort any number of fields, in any sequence, ascending or descending order.
- UPDATE— Single or dual file report and update utility.

### Introductory Prices

TRS-80® Model I.....	\$249
Apple® .....	\$299
TRS-80® Model II .....	\$399

The MICROCONDUCTOR™ is power at your fingertips! Power to set up, maintain, sort, report, and update data files at whim. Just imagine: with the MICROCONDUCTOR™, you can establish a custom mailing list system in 30 minutes, accounts receivable in 2 hours, a complete business system in only a few working days. Never before has your computer been given such power!

DATA FILES—No limit on the number of records a file can have.

FIELDS—Any type (string, integer, single, double). Eight entry modes (including defaults, counting, and suppress).

REPORTS—Four ways to generate reports. Total numeric column(s). Print on any paper in any format (statements, labels, etc.).

SORT—Any field(s) in any combination (i.e. multiple-key sort). Any size file, numeric or ASCII. Ascending or descending.

MAINT.—Command anticipation. Record duplication. Direct access and sequential search.

UPDATING/

MERGING—Add, subtract, multiply, divide fields. Combine results from previous calculations. Test for any condition and take action.

\*Registered trade mark of Apple & Radio Shack.



**MICROCOMPUTER  
TECHNOLOGY  
INCORPORATED**



3304 W. MacArthur • Santa Ana, CA 92704 • (714) 979-9923

ALL PRICES CASH DISCOUNTED

FREIGHT FOB/FACTORY

ASK FOR OUR FREE CATALOGUE

ming) and more about making it readable.

However, drawing a comparison to APL, any language that compresses a lot of program into a small number of lines suffers from readability problems. Broad, powerful algorithms often represent complex processes; when they are described in a terse notation, they look like programming tricks. In this case, the only remedy is to use a lot of comments. The lack of such comments is solely the fault of the programmer, not of the computer language.

● FORTH lacks many of the programming constructs we are used to—strings, arrays, floating-point numbers—but that's not the whole story. Many applications, for example, can get by without floating-point numbers: look at the number of programs written in Integer BASIC for the Apple II. With a maximum absolute numeric value of 32,767, normal FORTH can handle many problems by simply assuming a decimal point. In addition, all versions of FORTH can add all these features and more, simply by defining new words. For example, MMSFORTH, a version

of FORTH for the TRS-80 by Miller Microcomputer Services, has over ten screens (each screen is 16 lines of source code) that implement their version of words for double-precision math, arrays, strings, random numbers, and TRS-80 graphics. You compile a series of screens, thus adding to the size of your resident FORTH interpreter, *only if you need these features*. So you can have all these programming constructs and tools, but only if you write them yourself or get somebody else to write them for you.

### Friends of FORTH

Almost everyone who is working in FORTH professionally is doing good work, but a few people or groups of people deserve special mention. Foremost in this group is Charles H Moore and, through him, the company FORTH Inc. Moore developed the language over a long period of time (see his article "The Evolution of FORTH, an Unusual Language," on page 76) and promoted it through his company FORTH Inc. Elizabeth Rather, who contributed significantly to the

development of the language and who is vice-president at FORTH Inc, should also be mentioned in this context.

Then there is the FORTH Interest Group (POB 1105, San Carlos CA 94070), without whose efforts low-cost versions of FORTH would not be available. Although many people in the group have contributed to its working, names that must be mentioned are Bill Ragsdale (coordinator), Dave Boulton, Kim Harris, John James, and George Maverick. Over the past two years, this group has collectively raised its membership from a few dozen people in northern California to over a thousand members worldwide. In the process, they have also publicized FORTH at numerous conventions and have distributed public-domain versions of FORTH (called fig-FORTH) for all the major microprocessors; ie: 8080, 6800, 6502, 9900, PACE, and LSI-11. Although they supply only listings and documentation, versions customized for various popular microcomputers are available inexpensively. In addition, they are working on standardizing certain extensions to FORTH (floating-point numbers, arrays, etc), and they publish a very professional-looking bimonthly magazine called *FORTH Dimensions*. The group has monthly meetings at the Liberty House Department Store in Hayward, California, on (what else?) the fourth Saturday of each month. Membership in the FORTH Interest Group (which includes a subscription to its magazine) is \$12 per year, \$15 overseas.

A final group that must be mentioned is Miller Microcomputer Services of Natick, Massachusetts, which sells and supports a version of FORTH, called MMSFORTH, and other related FORTH products for the Radio Shack TRS-80 Model I. Not only do they provide a fine version of FORTH with arrays, strings, graphics, and other extensions, they are the only microcomputer-FORTH vendor that supports its product with both information and new vocabularies of FORTH words. (For example, they have a set of FORTH words that add 6- and 15-digit floating-point arithmetic, complex numbers, and a full Z80 assembler, all for \$29.95.) They also publish an *MMSFORTH Newsletter* that always has some

## ARTIFICIAL INTELLIGENCE For Your C/PM® or S-100 SYSTEM

"SHIVA<sup>®</sup>" is a highly-sophisticated VIRTUAL-PERSONALITY<sup>®</sup> multi-level multi-user multi-tasking executive (operating system) for S-100 based systems. It provides your microcomputer system immediately with power comparable to that of large-frame maxi-computers for a remarkably small price, yet SHIVA<sup>®</sup> requires surprisingly little R.A.M. area, and is conversational!!! SHIVA's<sup>®</sup> English-like input/output is interactive, dynamic, and may be reconfigured or expanded by the user. And SHIVA<sup>®</sup> gives you the freedom to expand indefinitely... with tremendous hardware and software choice: SHIVA<sup>®</sup> supports hard disks and floppies... R.A.M. addressing beyond 64 kilobytes... time-sharing... multi-level user-reconfigurable password protection... and features shell-commands similar to UNIX<sup>®</sup> in structure!! SHIVA<sup>®</sup> is compatible with C/PM<sup>®</sup> and C/DOS<sup>®</sup> for easy implementation and near universal software support!!! SHIVA<sup>®</sup> is available for 8080, 8085, MC6800, 6502, and Z80<sup>®</sup>-based systems.

Versions are in development for ZILOG Z8000<sup>®</sup> 16-BIT, INTEL 8086<sup>®</sup> and INTEL 88002<sup>®</sup> 32-BIT PROCESSORS...

And Omega Research<sup>®</sup> is dedicated to non-obsolescence and system superiority in software choice... SHIVA<sup>®</sup> supports BASIC, FORTRAN, COBOL, a MACRO-ASSEMBLER, DATA BASE MANAGEMENT, ALGOL-60, PASCAL... interfaces in development for UNIX<sup>®</sup>, C, LISP, PL/I, APL, and RT-II<sup>®</sup>.

And needless to say, SHIVA<sup>®</sup> is very fast... .

SHIVA<sup>®</sup>... \$350 -- Available on 8" I.B.M. Soft-Sector'd Disks and 5" C/DOS<sup>®</sup> (Cromemco) Diskettes. Includes complete Documentation... M.C. & Visa orders accepted

"SHIVA<sup>®</sup>," "VIRTUAL-PERSONALITY<sup>®</sup>," and "OMEGA RESEARCH<sup>®</sup>" are trademarks of OMEGA RESEARCH.

"RT-II<sup>®</sup>" is a trademark of DIGITAL EQUIPMENT CORPORATION.

"UNIX<sup>®</sup>" is a trademark of BELL LABORATORIES.

"CP/M<sup>®</sup>" is a trademark of DIGITAL RESEARCH OF CALIFORNIA.

"C/DOS<sup>®</sup>" is a trademark of CROMEMCO, Inc.

"Z-80<sup>®</sup>" and "Z-8000<sup>®</sup>" are trademarks of ZILOG, Inc.

"INTEL<sup>®</sup>" is a trademark of INTEL CORPORATION.

No shipments prior to return of signed software license agreement. For detailed information on "SHIVA<sup>®</sup>," send \$1.00 postage and handling to:

**OMEGA RESEARCH**

P.O. Box 479  
Linden, Ca. 95236  
(209) 334-6666

9am to 5pm Mon.-Fri.



CALIFORNIA RESIDENTS ADD 6% SALES TAX





# MAKE YOUR DUMB TERMINAL SMART.

*Teach it to talk back.* The SLC-1 Time Machine replies instantly to requests from your computer. It automatically tells it the date and time, enters log-in codes, gives any responses you specify. No changes are required in your operating system. Simply install it in the RS-232 or 20mA current loop serial link that connects your computer and terminal.

No more operator response errors. No more delays. Now you can automatically re-boot your system after power failure.

Whether you use your computer for business, research, or process control, the Time Machine will save you money. In fact, the first time it prevents a human error, it will more than pay for itself.

The Time Machine doesn't interfere

with your computer's operation. It steps in and responds only when it sees the key phrases you have specified. And because it's battery-supported, it never misses a beat or a bit.

The Time Machine comes with a built-in bonus: it is also an independent microprocessor system. Its 1,000 bytes of RAM (expandable to 12K) lets you use it in the off-line mode to free your computer for other tasks. Applications support is available, including a growing 6502 machine language software library.

The single quantity price is only \$640. Ten-digit display option, \$190. For more information or literature on the SLC-1

Time Machine, contact Digital Pathways, Inc., 1260 L'Avenida, Mountain View, California 94043, or phone (415) 969-7600.

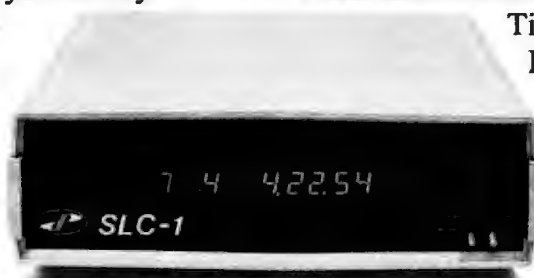

**GET INTO THE TIME MACHINE.**

# DIGITAL PATHWAYS

goodies you'd expect to pay money for. The people at MMSFORTH are A Richard (Dick) Miller and Judy Miller, along with free-lance programmer Tom Dowling, who wrote MMSFORTH for the TRS-80.

In addition, the major vendors of FORTH should be commended for the way they have worked and are working together to help standardize the language. The people mentioned above, along with the European FORTH Users' Group (EFUG), have met as the International FORTH Standards Team to work out a standard set of FORTH words (with standard behavior) that can be used to increase the already high portability of FORTH programs. Once the proposed FORTH-79 standard is approved by this standards team, FORTH Inc, the FORTH Interest Group, and Miller Microcomputer Services have indicated that they will bring out new FORTH versions conforming to this standard.

#### Variants of FORTH

A few other FORTH-like languages should be mentioned here. URTH (University of Rochester Threaded

language) is simply FORTH by another name. I am told that CONVERS, an experimental language that was offered by the Digital Group, is a FORTH-like language.

STOIC is a language that is different from FORTH primarily in some small syntax rules, although its enthusiasts claim it is more powerful than FORTH. From reading the documentation, I have found that STOIC interacts differently and has more sophisticated disk access than FORTH. CP/M Users Group (1651 Third Ave, New York NY 10028) distributes STOIC on two 8-inch single-density CP/M floppy disks; the cost is \$20, which includes postage, documentation (on CP/M DOC files), and group membership fees. STOIC was developed by Roger G Mark and Stephen K Burns in the Biomedical Engineering Center for Clinical Instrumentation, funded by the Harvard-MIT Program in Health Sciences and Technology in Cambridge, Massachusetts.

Also, I am very excited about a book nearing publication: *Threaded Interpretive Languages* by Ron Loeliger. This book, to be published

soon by BYTE Books, delves deeper into the practical aspects of designing and implementing a threaded language than any book I have seen. Not only does it demonstrate exactly how the machine code must work, it also details the specific implementation of ZIP (which looks like FORTH under another name) in Z80 assembly language. The book promises to be *the* definitive work on how threaded languages perform.

#### Final Notes

As we received more and more FORTH articles, I realized that we would soon have too many for this special August issue. I immediately scheduled for subsequent nontheme issues those extra articles we could not use at this time, a process known as "holding down the FORTH." In any case, we have several FORTH articles that will appear in upcoming issues of BYTE. These include an article on recursion in FORTH by George Flammer, a tutorial on string-manipulating FORTH words by John Cassady, a history of the FORTH Standards Team by Bill Ragsdale, and a detailed discussion of the different kinds of threaded codes by Terry Ritter and Gregory Walker.

We hope you will enjoy looking at the FORTH tapestry presented in this issue. ■

**NOBODY CAN MATCH OUR  
DOLLAR/QUALITY RATIO!**

**MS-204 PRINTER**

INTRODUCTORY PRICE:

**\$795**

CABLE: \$34.50

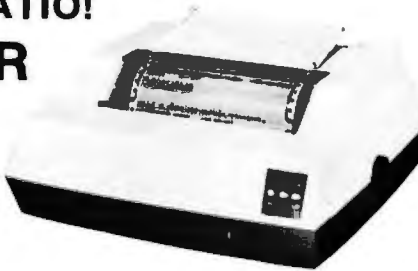

**Compatible with TRS-80, Apple, Pet  
or any other Centronics-type system**

#### Features

- 132/80 Columns, 63 LPM, Bi-Directional, Nominal Thruput
- 100% Heavy Duty Cycle - High Reliability, 100 Million Character Print Head Life
- Sprocket Feed; Variable Forms Width, 2.5" - 9.5"
- Double Width Characters: 40,66 Characters per line
- 9 x 7 Dot Matrix Character Font
- 6-Channel Electronic Vertical Format Unit
- Documentation Included

**Ask about our 8-inch Drives & Software**

**MATCHLESS  
SYSTEMS**

18444 S. Broadway  
Gardena, CA 90248  
(213) 327-1010

© 1980 Matchless Systems & MarketPlan

#### Articles Policy

*BYTE is continually seeking quality manuscripts written by individuals who are applying personal computer systems, designing such systems, or who have knowledge which will prove useful to our readers. For a more formal description of procedures and requirements, potential authors should send a large (9 by 12 inch, 30.5 by 22.8 cm), self-addressed envelope, with 28 cents US postage affixed, to BYTE Author's Guide, 70 Main St, Peterborough NH 03458.*

*Articles which are accepted are purchased with a rate of up to \$50 per magazine page, based on technical quality and suitability for BYTE's readership. Each month, the authors of the two leading articles in the reader poll (BYTE's Ongoing Monitor Box or "BOMB") are presented with bonus checks of \$100 and \$50. Unsolicited materials should be accompanied by full name and address, as well as return postage.*



# CP/M\* compatible software

## SYSTEM MAINTENANCE

**DIAGNOSTICS I:** Easily the most comprehensive set of CP/M compatible system check-out programs ever assembled. Finds hardware errors in your system, confirms suspicions, or just gives your system a clean bill of health. Tests:

- Memory
- CPU (8080/8085/Z80)
- Terminal
- Disk
- Printer

To our knowledge the CPU test is the first of its kind anywhere. Diagnostics I can help you find problems before they become serious. A good set of diagnostic routines are a must in any program library.

Minimal requirements: 24K CP/M. Supplied with complete user manual: \$60.00 Manual alone: \$15.00.

## ACCOUNTING

**ACCOUNTS PAYABLE/RECEIVABLE:** A complete, user oriented package which features:

- automatic postings to general ledger (optional)
- accounts payable
- accounts receivable
- check printing with invoice
- progress billing
- partial invoice payments
- invoice aging
- invoice aging
- customer statements
- invoice aging

The entire package is menu driven and easy to learn and use. It incorporates error checking and excellent user displays. This package can be used stand alone or with the General Ledger below.

Supplied with extensive user manual: \$200.00. Manual alone: \$20.00.

**GENERAL LEDGER:** A complete, user oriented package which features:

- Accepts postings from external programs (i.e. AP/AR above)
- Accepts directly entered postings
- Maintains account balances for current month, quarter, and year and previous three quarters
- Financial reports: trial balance, income statement balance sheet, and more.

Completely menu driven and easy to learn and use. Excellent displays and error checking for trouble free operation. Can be used stand alone or with Accounts Payable/Receivable above.

Supplied with extensive user manual: \$200.00. Manual alone: \$20.00

Both require 48K CP/M, terminal with cursor positioning, home and clear home, one 8" disk or two 5" disks. CBASIC2 required.

## TEXT PROCESSING

**TFS—Text Formatting System:** An extremely powerful formatter. More than 50 commands. Supports all major features including:

- left & right margin justification
- dynamic insertion from disk file
- user defined macros
- underlining and backspace

TFS lets you make multiple copies of any text. For example: Personalized form letters complete with name & address & other insertions from a disk file. Text is not limited to the size of RAM making TFS perfect for reports or any big job.

Text is entered using CP/M standard editor or most any CP/M compatible editor. TFS will link completely with Super-M-List making personalized form letters easy

Requires 24K CP/M.

Supplied with extensive user manual: \$85.00 Manual alone: \$20.00

Source to TFS in 8080 assembler can be assembled using standard CP/M assembler) plus user manual \$250.00.

## MAILING LIST

**SUPER-M-LIST:** A complete, easy to use mailing list program package. Allows for two names, two address, city, state, zip and a three digit code field for added flexibility. Super-M-List can sort on any field and produce mailing labels direct to printer or disk file for later printing or use by other programs. Super-M List is the perfect companion to TFS. Handles 1981 Zip Codes!

Requires 48K CP/M.

Supplied with complete user manual: \$75.00. Manual alone: \$10.00

## UTILITIES

**Utility pack #1:** A collection of programs that you will find useful and maybe even necessary in your daily work (we did!). Includes:

- CMP:** Compare two files for equality
- ARCHIVER:** Compacts many files into one, useful when you run out of directory entries
- Sort:** In core sort of variable length records
- XDIR:** Extended alphabetical directory listing with groupings by common extension
- PRINT:** Formatted listings to printer
- PG:** Lists files to CRT a page at a time
- ... plus more

Requires 24K CP/M

Supplied with instructions on discette \$50.00

## PROGRAMMING LANGUAGES

**FORTH:** a full, extended FORTH interpreter/compiler produces COMPACT, ROMABLE code. As fast as compiled FORTRAN, as easy to use as interactive BASIC.

**SELF COMPILING:** Includes every line of source code necessary to recompile itself.

**EXTENSIBLE:** Adds functions at will.

Z80 & 8080 ASSEMBLERS included

Single license, OEM licensing available

Please specify CPU type: Z80 or 8080

Supplied with extensive user manual and tutorial: \$150.00

Documentation alone: \$25.00

**ENHANCED 'TINY' PASCAL:** We still call it 'Tiny' but it's bigger and better than ever! This is the Famous Chung/Yuen 'Tiny' Pascal with more features added. Features include:

- recursive procedures/functions
- FOR (loop)
- IF ... THEN ... ELSE
- READ & WRITE
- integer arithmetic
- sequential disk I/O
- WHILE
- REPEAT ... UNTIL
- CASE
- one dimensional arrays
- 'PEAK' & 'POKE'
- more

'Tiny' Pascal is fast. Programs execute up to ten times faster than similar BASIC programs

**SOURCE TOO!** We still distribute source, in 'Tiny' Pascal, on each discette sold. You can even recompile the compiler, add features or just gain insight into compiler construction.

'Tiny' Pascal is perfect for writing text processors, real time control systems, virtually any application which requires high speed. Requires: 36K CP/M. Supplied with complete user manual and source on discette: \$85.00.

Manual alone: \$10.00.

## SOFTWARE SECURITY

**ENCODE/DECODE:** A complete software security system for CP/M. Encode/Decode is a sophisticated coding program package which transforms data stored on disk into coded text which is completely unrecognizable. Encode/Decode supports multiple security levels and passwords. A user defined combination (One billion possible) is used to code and decode a file. Uses are unlimited. Below are a few examples:

- data bases
- payroll files
- programs
- general ledger
- correspondence
- tax records
- inventory
- accounts pay/rec
- mailing lists

Encode/Decode is available in two versions.

Encode/Decode I provides a level of security suitable for normal use.

Encode/Decode II provides enhanced security for the most demanding needs.

Both versions come supplied on discette and with a complete user manual

Encode/Decode I: \$50.00

Encode/Decode II: \$100.00 Manual alone: \$15.00

## INTERCOMPUTER COMMUNICATIONS

**TERM:** a complete intercommunications package for linking your computer to other computers. Link either to other CP/M computers or to large timesharing systems. TERM is comparable to other systems but costs less, delivers more and source is provided on discette!

With TERM you can send and receive ASCII and Hex files (COM too, with included conversion program) with any other CP/M computer which has TERM or compatible package. Allows real time communication between users on separate systems as well as acting as timesharing terminal

- Engage/disengage printer
- terminal mode for timesharing between systems
- send files
- error checking and auto retry
- conversational mode
- receive files

Requires: 32K CP/M

Supplied with user manual and 8080 source code: \$110.00

Manual alone: \$15.00.

CP/M Formats: 8" soft sectored, 5" Northstar, 5" Micropolis Mod II, Vector MZ

All Orders and General Information:  
SUPERSOFT ASSOCIATES

P.O. BOX 1628  
CHAMPAIGN, IL 61820  
(217) 359-2112

Technical Hot Line: (217) 359-2691  
(answered only when technician is available)

\*CP/M REGISTERED TRADEMARK DIGITAL RESEARCH



*SuperSoft*

First in Software Technology



**ALIOS**  
COMPUTER SYSTEMS

\*Z80 is a registered trademark of Zilog, Inc

\*\*CP/M and MP/M are registered trademarks of Digital Research, Inc



# ALTOS BREAKS THE MICRO BARRIER.

Yesterday, microcomputer meant micro performance. Once you outgrew it, you had to step up to a mini. Which meant a big step up in price.

Today, there's the new Altos ACS8000-6 single-board microcomputer system.

It's the first system for the OEM, small business-man and personal user, that offers minicomputer performance and minicomputer storage capacities—at a microcomputer price.

## **MULTI-USER, WINCHESTER STORAGE, FLOPPY BACK UP: \$14,260.**

The new Altos ACS8000-6 is a highly advanced Z80\* based microcomputer system with high-speed RAM, floppy disk and Winchester hard-disk controllers, DMA, six serial and two parallel I/O ports and the AMD 9511 floating point processor all on a single board. A typical four-user system configuration with two megabytes of Shugart floppy and 29.0 megabytes of Shugart Winchester storage, including CPU and 208K bytes of RAM, costs only \$14,260—compared to \$30,000 or more for a similar minicomputer system. And that adds up to mini performance at less than half the cost!

## **MULTI-USER EXECUTIVE SUPPORTS FOUR INDEPENDENT USERS RUNNING CP/M\*\* COMPATIBLE PROGRAMS.**

This revolutionary new microcomputer system features the MP/M\*\* Multi-User Executive software program that's unique in two ways. It includes a multi-user CP/M capability and the ability to handle Winchester-type hard disks. The advanced Z80 operating program supports four independent CP/M

compatible programs in any of six popular languages: BASIC, FORTRAN, COBOL, PASCAL, APL, C, and a large assortment of additional business application packages. MP/M is compatible with both the 1.4 and 2.0 versions of Digital Research's CP/M, which means programs based on either version can run under MP/M without modification.

With MP/M at the helm, your Altos ACS8000-6 system can support up to four simultaneous users with 48K bytes of RAM each plus 58 megabytes of Winchester storage and 4 megabytes of floppy back up. And that adds up to the first microcomputer to give you the power and performance of a minicomputer.

## **SINGLE-USER, HARD-DISK SYSTEMS START AT \$9450.**

The Altos ACS8000-6 series. It's a barrier breaker in every sense. Our entry-level, single-user, hard-disk system with floppy back up is priced under \$10,000 and even our 4-user CP/M model is available for under \$12,000. And all configurations are easily upgraded. For specific details about pricing or performance, call or write: Altos Computer Systems,

2360 Bering Drive, San Jose, CA  
(408) 946-6700. TELEX 171562 ALTOS SNJ.

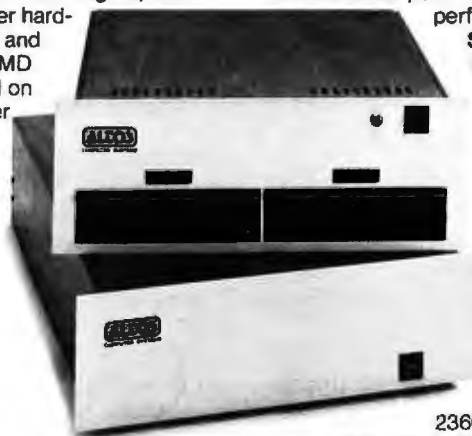

**ALTOS**  
COMPUTER SYSTEMS

	BASF Systems Bedford MA	Corvus Systems, Inc. San Jose CA	IBM Corporation General Systems Div	International Memories Inc (IMI) Cupertino CA
Model	6171/6172	11T	4963 29A/64A	7710/7720
Unformatted Capacity (millions of bytes)	8/24	11	29/64	11/20
Platter Size	210mm (8.27 inch)	200mm (7.87 inch)	210mm (8.27 inch)	200mm (7.87 inch)
Number of Platters	1 or 2	2	3 or 6	2
Average Access Time	42 ms	50 ms	27 ms	50 ms
Maximum Data Transfer Rate (K bytes per second)	800	648	1030	648
Average Latency	8.3 ms	8.3 ms	9.7 ms	8.3 ms
Rotational Speed	3600 rpm	3600 rpm	approx. 3100 rpm	3600 rpm
Motor Type	brushless DC	brushless DC	—	brushless DC
Spindle Drive	direct drive	direct drive	—	direct drive
Actuator Type	linear voice coil	linear voice coil	rotary voice coil	linear voice coil
Positioning Mechanism	servo	servo	servo	servo
Density bpi	6542	5868	8530	5868/6000
Density tpi	500	300	450	300
Physical Size (inches)	4.59 by 8.99 by 18	5.5 by 8.57 by 19.25	—	5.5 by 8.57 by 19.25
Weight (pounds)	20	22	—	22
Single Quantity Price	—/\$3,100 <sup>1</sup>	\$5,350 <sup>2</sup>	approx. \$9,300/\$10,700	\$2,990/\$3,590
OEM Discount Price	Competitive OEM discounts available	—	—	\$1,900/\$2,290 (100)
Cost Per Thousand Bytes (OEM Discount)	—/—	—	—	\$.173/\$.112
Comments	Available with integrated SMD interface @\$3,500 and integrated controller with host bus interface for \$3,900; all prices quoted are for 24 megabyte Model 6172. 1. Includes disk bus interface	Up to 4 drives per subsystem. Add-on drives @\$2,990. Uses IMI 7710 drive. 2. Complete subsystem	Integrated into System/34. Add-on peripheral for Series 1.	Optional integrated controller available @\$500 (quantity 1); \$325 (quantity 100). Power supply @\$250

Text continued from page 70:

- hardware-oriented control and status

The main characteristics for the host level are:

- parallel data transfer
- formatting/de-formatting included in drive electronics
- function-oriented control and status by functional command like read/write sector and format

Device-level interfaces can be divided into four groups:

- ANSI
- ANSI-like

- SMD
- Floppy-disk-like

The *ANSI interface*, as far as it is currently defined, will use a single 50-conductor flat cable. Up to four drives can be connected in a daisy-chain configuration. Differential drivers and receivers will be used only for block and data signals for read and write functions. All other lines will use standard TTL (transistor-transistor logic) signals. Control commands and status information will be transferred over an 8-bit-wide bidirectional bus. The bus control lines use an asynchronous handshake mechanism, allowing simple adaptation of the bus speed to any microprocessor. Data is transferred in

serial NRZ (nonreturn-to-zero) format separated from the clock signal.

In the *ANSI-like interface*, most of the current device-level interfaces are more or less similar to the ANSI interface. Common to all are an 8-bit parallel control bus and serial NRZ data transfer.

*SMD (storage module drive) interface* is a *de facto* industry standard for 14-inch drives and is being adapted for 14-inch drives by ANSI. It has also been implemented for 8-inch drives. The SMD interface uses differential drivers and receivers for all signals. (They give excellent performance as regards high speed, long cable lengths, and high noise immunity.) The drives are connected through



Kennedy Co Altadena CA	Microcomputer Systems Corp Sunnyvale CA	Micropolis Corp Chatsworth CA	Pertec Computer Corp Chatsworth CA	Priam San Jose CA
7000	MSC-8000	1201-I/1202-I/1203-I	D8000	2050/3450
4/12/20	40	9/27/45	20	20/34
210mm (8.27 inch)	8 inch	200mm (7.87 inch)	210mm (8.27 inch)	8 inch
1, 2, or 3	3	1, 2, or 3	2	2 or 3
50 ms	25 ms	42 ms	50 ms	50 ms
—	1200	922	870	1030
8.3 ms	—	8.3 ms	—	6.4 ms
3600 rpm	—	3600 rpm	—	4700 rpm
AC	—	brushless DC	—	brushless DC
belt drive	—	direct drive	—	direct drive
rotary	—	rotary voice coil	—	linear voice coil
servo	—	servo	servo	servo
5280	—	8626	6000	6370
300	—	478	476	480
5.25 by 8.5 by 16.5	—	4.62 by 8.55 by 14.25	4.62 by 8.55 by 14.25	4.62 by 8.55 by 14.25
20	—	22	—	20
\$2,100/\$2,300/\$2,650	—	\$1,962/\$2,591/\$3,007	\$3,000	\$3,000/\$3,750
\$1,680/\$1,840/\$2,120(100)	—	—	\$1,800	\$2,200/\$2,750(100)
\$.42/\$.153/\$.106	—	—	\$.09	\$.11/\$.08

Included in package is an 80 megabyte, 1/2 inch magnetic-tape drive on the same motor spindle for removable back-up storage

Available with integrated controller as Models: 1221-I \$2,834; 1222-I \$3,463; 1223-I \$3,879, single quantities

Table 4: Specifications and characteristics of high-end, 8-inch hard-disk drives.

one daisy-chain cable for control and one radial cable for read/write and additional control. Control information is transferred on a 10-bit-wide unidirectional synchronous bus. Data is transferred in serial NRZ format.

The SMD interface allows very high transfer rates and long cable lengths. Because SMD uses differential drivers and receivers for all signals, it is somewhat more costly than other interfaces using TTL circuits. Because of the 10-bit synchronous bus structure, SMD is not easy to interface to current 8-bit processors. The main advantage of SMD for 8-inch drives is that it is a standard, and controllers are readily available for easy integration into existing or currently supplied systems.

Having a floppy-disk-like interface for 8-inch hard disks allows the combination of floppy-disk drives and hard-disk drives in one system. Because of the differences in transfer rates and other parameters, floppy- and hard-disk drives are not fully interface-compatible. Hard-disk users must add a radial cable for differential read/write signals in addition to the normally used daisy-chain cable. By adding 15% to 20% more circuitry, a hard-disk controller can be designed to also control floppy-disk drives. However, a floppy-disk controller cannot handle a Winchester-type hard-disk drive.

In comparing floppy-disk-like interfaces with other device-level interfaces, there are three major differ-

ences. First, with floppy-disk-like interfaces there is no control bus because commands and status signals are transferred on discrete lines. Second, positioning control is achieved with step and direction signals as opposed to the transfer of a parallel-cylinder address with other interfaces. Third, data is transferred in the raw format as recorded on the disk. This implies that synchronization, separation (or generation) of clock and data, and generation and detection of sector and address marks must all be performed externally to the drive. The floppy-disk-like concept minimizes drive electronics, but puts the burden of developing and producing the balance of the required electronics on the user.

# Anatomy of a Threaded Language

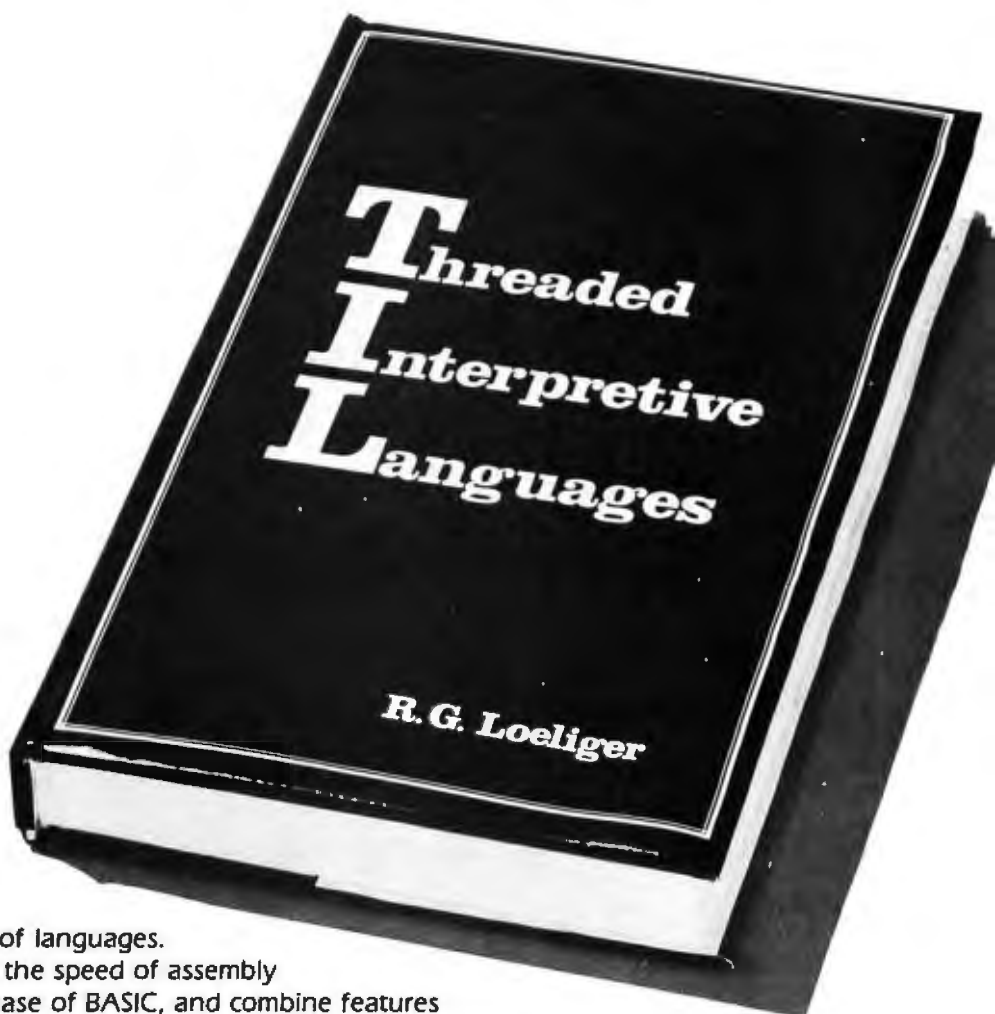

Threaded languages (such as FORTH) are an exciting new class of languages. They are compact and fast, giving the speed of assembly language with the programming ease of BASIC, and combine features found in no other programming languages. An increasing number of people are using them, but few know much about how they work. Is a threaded language interpreted or compiled? How much memory overhead does it require? Just what is an "inner interpreter"? **Threaded Interpretive Languages**, by R. G. Loeliger, concentrates on the development of an interactive, extensible language with specific routines for the ZILOG Z80 microprocessor. With the core interpreter, assembler, and data type defining words covered in the text, it is possible to design and implement programs for almost any application imaginable. Since the language itself is highly segmented into very short routines, it is easy to design equivalent routines for different processors and produce an equivalent threaded interpretive language for other development systems. If you are interested in learning how to write better FORTH programs or you want to design your own powerful, but low-cost, threaded language specific to your needs, this book is for you.



This and other BYTE/McGraw-Hill books are available from BYTE Books or your local computer store.

ISBN 0-07-038360-X  
Price \$18.95

Please send  \_\_\_\_\_ copies of **Threaded Interpretive Languages**

Name	Title	Company	
Street	City	State/Province	Code

Check enclosed in the amount of \$ \_\_\_\_\_  
 Bill Visa      Bill Master Charge  
 Card No. \_\_\_\_\_  
 Exp. Date. \_\_\_\_\_

Available in Nov. 1980



70 Main St.  
Peterborough, NH 03458

Add 75¢ per book to cover postage and handling.  
Please remit in U.S. funds or draw on a U.S. Bank.

B8



# A NEW WORLD OF SMALL COMPUTERS IS AT YOUR FINGERTIPS THIS FALL



## 4th Annual NATIONAL SMALL COMPUTER SHOW

New York Coliseum, October 30 to Nov. 1, 1980

When we say "fingertips" we mean just that: a hands-on-inspection opportunity for you to try the small computers and systems that will write the history of microprocessing in the 1980's.

Manufacturers will fill over 30,000 square feet with computers, software and peripherals. Amazing strides in technology are reflected in exhibits and lecture series.

New hardware and software for business, education, the sciences and professions, graphics and personal use are being gathered for the largest and most beautifully presented National Small Computer

Show ever produced.

As always, the show contains attractions for the seasoned computer professional, as well as those who wish an introduction to the exciting world of small computers for business, professional or personal use. In just a short time, you can discuss your interest with many industry leaders, vendors, technologists, and our expert lecturers.

Registration fee is only \$10 per day, and all registrants have free access to the hourly lectures.

### FREE LECTURES FOR VISITORS

Introduction to Small Systems for Business, Stan Veit, Associated Computer Ind., noon, Oct. 30 & 31.  
 Mailing Lists: Several Directions, Dr. Norman Agin, Matitech, Inc., noon, Oct. 30 & 2 pm, Oct. 31.  
 Selecting A Small Computer for Business, David Benevise, Computer Mart of NJ, 1 pm, Oct. 30 & 31.  
 Evaluating and Improving Your Computer's Performance, Philip Grossman, Raytheon Co., 1 pm, Oct. 30.  
 Law Office Systems Aspects of Word Processing, Bernard Sternin, 2 pm, Oct. 30.  
 Future Smart Machines: 2000 A.D. and Beyond, Dr. Earl Joseph, Sperry Univac, 2pm, Oct. 30.  
 Computer Contracts - Facing the Issues, Alan C. Verbit, Verbit & Co., 3 pm, Oct. 30.  
 Acc'ts Receivable/Acc'ts Payable/Gen'l Ledger, 3pm, Oct. 30.  
 Advantages of Distributed Processing & Multi-Processing, John Stoelzel, QI Corp., 4 pm, Oct. 31.  
 Investment Analysis of Stocks & Commodities on a Microcomputer, Fred Cohen, Shearson Loeb Rhodes, Inc., 4 pm, Oct. 30, 3 pm, Oct. 31.  
 BASIC Programming, Michael Mulcahey, Worcester State College, noon, Oct. 31.  
 Videoprints: Full-Color, Low-Cost, Hard-Copy Computer Graphics, Warren Sullivan, Image Resource Corp., 1pm, Oct. 31.  
 Business Applications Software Development Via Data Base Management, Dr. Andrew Whinston, Micro Data Base Systems, 2 pm, Oct. 31.

Application of PASCAL to Small Systems for Business, Panel, Stan Veit, Associated Computer Ind., Moderator, 3 pm, Oct. 31.  
 Educational Software: The Good, the Bad, the Ugly, Jo Ann Corlito, S.U.N.Y. at Stony Brook, noon, Nov. 1.  
 Introduction to Personal Computing, noon, Nov. 1.  
 Computer-Assisted Mathematics Courses, Dr. Frank Scaizzo, Queensborough Community College, 1 pm, Nov. 1.  
 Artificial Intelligence Update, Prof. Peter Kugel, Boston College, 1 pm, Nov. 1.  
 Compiling and Retrieving Personal Medical Data with a Microcomputer, Derek Elander, MD, St. Luke's Hospital, 2 pm, Nov. 1.  
 The Present State of CP/M Compatible Software, Tony Gold, Lifeboat Associates, 2 pm, Nov. 1.  
 High Volume Data Handling: Intro. to File Processing, Prof. Peter Kugel, Boston College, 3 pm, Nov. 1.  
 Connecting the Computer to the Outside World, Prof. James Gips, Boston College, 3 pm, Nov. 1.  
 Educational Applications in the Home, David Ahl, Creative Computing Magazine, 4 pm, Nov. 1.  
 Household Applications - Some of Them Now, Dr. Dennis J. McGuire, 4 pm, Nov. 1.

(Additional lectures to be announced)

### SPECIAL: EXECUTIVE EDUCATION SESSION FOR BUSY PEOPLE

NSCS offers an intensive five-hour introduction to computers for the executive whose time is limited, but wants to learn how to cope on various levels in business with computers. Covers basics in computer hardware and software, determining your needs, how to buy, how to upgrade, how to get the most out of systems. Given four times, Oct. 29 to Nov. 1. Fee \$200, including run-of-show registration. Call or write for information. Attendance limited.

## REGISTRATION FOR AMERICA'S BIGGEST SMALL COMPUTER SHOW

Please register me for the 4th Annual National Small Computer Show, Oct. 30 - Nov. 1, 1980 New York Coliseum.

NAME \_\_\_\_\_

BUSINESS TITLE (if Any) \_\_\_\_\_

COMPANY (if Any) \_\_\_\_\_

TELEPHONE \_\_\_\_\_

ADDRESS \_\_\_\_\_

ZIP \_\_\_\_\_

#### (Check main job function)

- |  |   |  |
|--|---|--|
| 1 <input type="checkbox"/> Accountant/CPA              | 15 <input type="checkbox"/> Computer Systems Consult. | 29 <input type="checkbox"/> Public Servant         |
| 2 <input type="checkbox"/> Advertising                 | 16 <input type="checkbox"/> Computer Technician       | 30 <input type="checkbox"/> Real Estate            |
| 3 <input type="checkbox"/> Administrator (Business)    | 17 <input type="checkbox"/> Data Processing Mgr.      | 31 <input type="checkbox"/> Religious              |
| 4 <input type="checkbox"/> Architect/BUILDER           | 18 <input type="checkbox"/> Electronic Engineer       | 32 <input type="checkbox"/> Research/Development   |
| 5 <input type="checkbox"/> Art Director                | 19 <input type="checkbox"/> Engineer                  | 33 <input type="checkbox"/> Scientist              |
| 6 <input type="checkbox"/> Banker                      | 20 <input type="checkbox"/> Financial Manager         | 34 <input type="checkbox"/> Stock Broker           |
| 7 <input type="checkbox"/> Chemist                     | 21 <input type="checkbox"/> Industrial Des.           | 35 <input type="checkbox"/> Teacher                |
| 8 <input type="checkbox"/> Commodities Broker          | 22 <input type="checkbox"/> Lawyer/Law Office Mgr.    | 36 <input type="checkbox"/> Transportation         |
| 9 <input type="checkbox"/> Communications              | 23 <input type="checkbox"/> Manufacturer              | 37 <input type="checkbox"/> Utility                |
| 10 <input type="checkbox"/> Computer Dealer            | 24 <input type="checkbox"/> Marketing                 | 38 <input type="checkbox"/> WP Manager             |
| 11 <input type="checkbox"/> Computer Distributor       | 25 <input type="checkbox"/> Medical Doctor            | 39 <input type="checkbox"/> WP Operator            |
| 12 <input type="checkbox"/> Computer Hardware Consult. | 26 <input type="checkbox"/> Medical Technician        | 40 <input type="checkbox"/> Student                |
| 13 <input type="checkbox"/> Computer OEM               | 27 <input type="checkbox"/> Military                  | 41 <input type="checkbox"/> Other (Please specify) |
| 14 <input type="checkbox"/> Computer Software Consult. | 28 <input type="checkbox"/> Office Manager            |  |

- ONE DAY \$10       TWO DAYS \$20  
 THREE DAYS \$30

Mail with payment of \$10 for each day you wish to attend. Use one form per person. Registration badge will be sent by mail in early October. Check or money order only.

**Mail prior to October 10, 1980.**  
**Foreign orders: October 1, 1980.**  
 National Small Computer Show  
 110 Charlotte Place  
 Englewood Cliffs, NJ 07632  
 201-569-8542



	Century Data Systems Anaheim CA	Century Data Systems Anaheim CA	Fujitsu America Inc Santa Clara CA
Model	Marksman M-10/M-20/M-30	Hunter H-32/H-64/H-96	M2282/M2283/M2284
Unformatted Capacity (millions of bytes)	10/20/30	34/67/100	66/133/166
Platter Size (Inches)	14	14	14
Number of Platters	1, 2, or 4	2, 3, or 4	—
Average Access Time	60 ms <sup>1</sup>	30 ms	27 ms
Maximum Data Transfer Rate (K bytes per second)	960	1209	1012
Average Latency	12.5 ms	8.3 ms	10.12 ms
Rotational Speed	2400 rpm	3600 rpm	3000 rpm
Motor Type	—	—	—
Spindle Drive	—	—	—
Acutator Type	band	—	rotary
Positioning Mechanism	stepper motor	servo	servo
Density bpi	—	—	6475
Density tpi	—	—	668
Physical Size (Inches)	8 by 16.5 by 21.5	10.5 by 17.5 by 30	10.3 by 18.9 by 26.6
Weight (pounds)	45	175	100
Single Quantity Price	—	—	\$4,350/\$5,200/\$5,500
OEM Discount Price	—	—	\$3,450/\$4,300/\$4,600 (quantity 100)
Cost Per Thousand Bytes (OEM Discount)	—	—	\$.052/\$.033/\$.028
Comments	Winchester Technology	16.7 megabytes of removable storage on each model (5440 Type)	Optional 655 K byte fixed head storage for \$700

<sup>1</sup> includes settling time

## Host-Level Interface

A typical implementation for host-level interface is the BASF 6170 series drive with integral formatter/controller. The BASF host bus interface uses a single daisy-chain cable that can connect one or more units to the host adapter. Transfer of data, command, and status information is done across one common 8-bit-wide bidirectional asynchronous bus. The eight bus lines, as well as additional lines for bus control and interrupt generation, all use standard TTL drivers and receivers. Using a host-level interface is the easiest and fastest way to interface an 8-inch Winchester drive to a given host system.

## How Intelligent Should a Controller Be?

With the decreasing cost of microprocessors and memories, the trend is toward the use of intelligent subsystems to handle all I/O-related

functions, rather than tying up the processor.

These subsystems can communicate with the main system through a high-level command language (eg: one that is file-oriented as opposed to hardware-oriented). Functions such as automatic backup, automatic error recovery, power-on bootstrap loading, etc, can be completely controlled locally in the subsystem, thus taking the burden off the main processor and improving the system's performance.

Further improvement can be gained by adding hardware and software for such things as double-buffering for data transfer, overlapped operation in a multiple drive configuration, and RPS (rotational-positioning sensing) for access optimization.

There is a limit to the transparency of the disk system to the operating system. If a disk with higher packing density is substituted, the number of sectors on each track or the number

of tracks per surface will likely be different. This information must be communicated to the operating system. (With luck, this is a small parameter change in the I/O driver of a well-designed, modular operating system). But, however easy or difficult it is to change, it must be done to take full advantage of the new higher-capacity drive.

## The Question of Backup for Fixed Disks

The usefulness of removable media on fixed-disk-based systems arises from three needs:

- system backup for crash/fault recovery
- program and data-base dissemination
- archival storage of information

The excellent reliability record of Winchester-technology disks is caus-



Fujitsu America Inc Santa Clara CA	Kennedy Co Altadena CA	Prlam San Jose CA	Shugart Associates Sunnyvale CA
M2201/M2211	5300	3350/6650/15450	SA4000
50/83	14/42/70	33/66/154	14.5/29
14	14	14	14
2 or 3	1, 2, or 3	1	1
30 ms	70 ms	50 ms	87 ms
819	—	1030	—
12.5 ms	10 ms	9.7 ms	—
2400 rpm	3000 rpm	approx. 3100 rpm	—
—	AC	brushless DC	—
—	—	direct drive	—
linear motor	rotary	linear voice coil	band
servo	servo	servo	stepper motor
6135	6000	6370	5534
370	300	480/960/—	172
10.3 by 19 by 30.2	7 by 19 by 22	6.8 by 16.6 by 20	—
150	75	33	—
\$5,400/\$7,200	\$3,200/\$3,700/\$4,200	—	—
\$3,900/\$4,990 (quantity 100)	\$2,560/\$2,960/\$3,360 (quantity 100)	\$1,800/—/—	—
\$.078/\$.060	\$.183/\$.07/\$.048	\$.055/—/—	—
Front-loading cartridge removable storage	Winchester Technology	Winchester Technology	Winchester Technology

Table 5: Specifications and characteristics of 14-inch, hard-disk drives.

ing some system builders and users to take a fresh look at backup requirements for data storage. They are concluding that, for *some* applications, it is no longer necessary to include removable media for backup protection in systems design.

Error-correcting capabilities of system software and intelligent controllers help to eliminate the need for backup in some cases. However, there will probably always be applications—perhaps the majority—in which backup cannot be eliminated. Many systems require removable media for program and data-base dissemination and/or archival storage in addition to any backup considerations. Therefore, it seems that there will be a continuing need for removable-media storage peripherals on some fixed-disk-based systems.

According to many small-system designers and users, system backup is needed regardless of the hardware

reliability of the fixed-storage subsystem. System crashes or failures can be caused by software bugs and human error as well as by hardware faults.

Until the new wave of small Winchester disks came on the scene beginning about a year and a half ago, the small-systems hard-disk market was being served primarily by products based on IBM 5440-type removable-cartridge disk technology. Most of these products have the unique characteristic of having 50% of their spindle capacity removable—in other words, they have built-in backup. But the major drawbacks to their use in small systems are relatively low performance (70 ms average access time); relatively high cost per byte; large physical size; and high maintenance costs that get higher as field engineering labor costs grow. Even with the introduction of cost-effective, small, reliable Winchester-type products, these 5440-based pro-

ducts still have a place in some small systems. After all, the backup problem is solved, whereas no generally accepted backup method has yet emerged for the "mini Winnies" to make most customers feel comfortable. It is a problem yet to be solved.

Several approaches are being tried for backup. There are floppy disks, tape cassettes, tape cartridges, reel-to-reel tape drives, and, in at least one case, videocassettes.

The ideal characteristics of a backup device are:

- The cost of the modular removable medium should be low (less than \$20).
- The cost of the transport device should be low.
- The data-transfer rate should be similar to the transfer rate of the disk.
- A single removable module should hold more, or at least as

### Error Rates

Recoverable	Unrecoverable	Seek Errors
1 in 10 <sup>10</sup> bits	1 in 10 <sup>12</sup> bits to 1 in 10 <sup>13</sup> bits	1 in 10 <sup>9</sup> seeks to 1 in 10 <sup>7</sup> seeks

### Maintainability

Preventive Maintenance	(MTBF) (Mean Time Between Failures) (sealed modules)	(MTBF) (Mean Time Between Failures) (product)	(MTTR) (Mean Time to Repair)	Component Life
None	25,000 hours	8000 to 10,000* POH (power-on hours)	½ to 1 hr	5 years

\* Exception: Kennedy 7000 Series, 1500 hours

Table 6: Reliability data for hard-disk drives.

## Call on John D. Owens for all Your Computer Needs

### COMPUTERS, PRINTERS, CRTs, MODEMS, MAINFRAMES, MEMORY, CONTROLLERS, FLOPPY AND HARD DISK DRIVES, I/O, DISKETTES AND SOFTWARE.

#### IMS 5000 and 8000 Systems

The new rising stars! Beautifully designed and constructed with the Industrial Micro System reputation for fine quality. These systems feature a Z80 CPU, S-100 bus; double density drives (either single or double sided) CP/M®. 5000 series uses mini floppies, 8000 uses maxi floppies.

Model 5-00125 with two double density drives, 32K Static RAM ..... \$2,765  
 Model 8-00125 as above but with 8" drives ..... \$4,185  
 Other configurations available.

TELETYPE Model 4320 AAK .. \$1,185  
 Model 4330 punch/reader. 10 or 30 CPS.  
 8 level, 1" tape ..... \$2,595  
 Limited supply of Model 45 available.

#### DRIVES

Per Sci 277 ..... \$1,210  
 Siemens ..... \$395 Shugart ..... \$525  
 MPI B51 ..... \$265 B52 ..... \$365  
 Innometrics and QUME also available

HAZELTINE 1500 ..... \$885  
 1510 ..... \$980 1520 ..... \$1,210

DEC LA 35/36 Upgrade ..... \$750  
 Increases baud rate to 1200. Microprocessor controlled. Many features include TOP, tabs and margin control.

IBM 3101 CRT Model 10 ..... \$1,195  
 Model 20 ..... \$1,395  
 Selectric-like, detached keyboard. 9x16 dot matrix. Maintenance contract from IBM only \$70 per year.

TELEVIDEO SMART CRTs  
 912 B and C ..... \$780  
 920 B and C ..... \$850

IMS MEMORY 16 K static ..... \$285  
 32 K static ..... \$585  
 64 K Dynamic with parity ..... \$950

TEI MAINFRAMES, S-100  
 12 slot ..... \$500  
 22 slot ..... \$670

TARBELL  
 Double density controller ..... \$420

### COMPLETE SYSTEMS AND WORD PROCESSORS CONFIGURED FOR YOUR PARTICULAR APPLICATION

We have no reader inquiry number.  
 Call on us for product sheets.  
 Dealer inquiry invited.  
 Prices subject to change without notice.

CODs accepted at no extra charge.  
 Shipping \$14 for light printers and CRTs.  
 Credit cards add 4%.  
 NY residents add tax.

**WE EXPORT:** Overseas Callers: TWX 710 588 2844  
 Phone 212 448-6298 or Cable: OWENSASSOC

**We Are Known for Our Prompt and Courteous Service!**

## JOHN D. OWENS

212 448-6283 Associates, Inc. 212 448-6298  
 12 Schubert Street  
 Staten Island, New York 10305

much, data as the fixed disk, preferably an integer multiple of the disk capacity (ie: a 100-megabyte videocassette to back up a 20-megabyte disk).

With the relatively unsophisticated operating-system software present in many small systems today (though this is rapidly changing), the backup strategy is usually to write the entire contents of the disk to a removable backup medium on a daily basis. This procedure results in a significant loss in system availability (while dumping or restoring) unless the backup device has a fast transfer rate and a large capacity.

Perhaps the most appropriate backup for a small Winchester is a device that can be included in the same package, sharing the same spindle drive mechanism and/or some of the same electronics. For the low end this may be a floppy disk; for the high end it can be a cartridge tape drive or a streaming reel-to-reel tape drive. But, except for the very low end where system cost is a prime consideration, a small-capacity, slow floppy disk is not an ideal backup for a large, fast, fixed disk. Streaming tape drives may be good backup devices for high-performance, high-capacity hard disks, but they are too expensive for most personal computer systems. Nevertheless, some streaming tape drives are becoming available. Kennedy Company of Monrovia, California, is delivering (60 to 90 days) its Model 6809 Data Streamer. It is a microprocessor-controlled reel-to-reel (10.5-inch reels) tape transport with formatter for reading, writing, and controlling the 9-track, 100 ips (inches per



second), 1600 character per inch, ANSI- and IBM-compatible half-inch tape drive. It has an unformatted capacity of 46 megabytes per reel. It can transfer 12 megabytes in 75 seconds and 40 megabytes in 250 seconds. It costs about \$2500 in OEM quantities. Data Electronics Inc (DEI), of Pasadena, California, is marketing a 34-megabyte streaming microtape cartridge drive for \$1219 (OEM quantities). Cypher Data Products Inc of San Diego, California, produces a 37-megabyte streaming reel-to-reel tape drive for under \$2000 (OEM quantities). IBM's answer to the backup problem for its 8-inch disk drive is the model 8809 streaming tape drive.

### The Products and the Companies

The specifications in tables 3, 4, and 5 speak for themselves. There are a few special features of some of these products worth mentioning. BASF Systems of Bedford, Massachusetts (whose parent corporation, the BASF Group based in Germany, invented magnetic recording tape in 1934), established a Memory Division in early 1979 to manufacture computer-disk drives. Their first product is the 6170 Series 210 mm Fixed-Disk Drives available in 8- and 24-megabyte versions. The 24-megabyte version with the integrated, micro-programmed BASF host-bus interface and controller at \$3900 (single quantity price, substantial discounts available for OEM quantities) is a cost-effective, high-performance source of reliable data storage for small systems. BASF offers a variety of interfaces. BASF is also a supplier of disk and tape media.

Century Data Systems, a Xerox Company, of Anaheim, California, offers a wide range of disk products for small systems including the 14-inch Marksman model (Winchester technology) with capacities from 10 to 30 megabytes, and the Hunter model with a removable 16.7-megabyte 5440-type cartridge, plus fixed-disk capacity ranging from 16.7 to 83.9 megabytes. Century Data Systems is a long-time manufacturer of computer peripherals. Corvus Systems Inc, San Jose, California, is offering a complete hard-disk subsystem based on the IMI 7710 10-megabyte 8-inch disk. It includes the Z80-based Corvus intelligent disk controller with com-

prehensive diagnostics and interfaces for TRS-80, Apple II, S-100-bus, and LSI-11 computers. As mentioned above, Corvus also markets a 100-megabyte removable backup in the form of an interface to a standard videocassette recorder using the microprocessor and interface bus of the Corvus disk subsystem. IMI was the first manufacturer to deliver a high-performance 8-inch Winchester drive.

Memorex Corporation of Santa Clara, California, is introducing its first in a planned family of 8-inch hard-disk products, the Model 101. It

offers low cost per megabyte, low weight (10 pounds), low power requirements (56 W), and high reliability. With 11.7 megabytes and 70 ms access time, it is a good example of a product in the low-end segment of the small hard-disk-drive market. Memorex has been manufacturing disk drives since 1967 and has been a major supplier of magnetic media since the company was formed in 1961. The MSC-8000 from Micro-computer Systems Corporation of Sunnyvale, California, is an 8-inch disk drive with built-in removable backup in the form of an 80-mega-

## Call on John D. Owens for all Your Computer Needs

### GROUP PLANS AVAILABLE TO COMPUTER CLUBS

#### COMPLETE PET BUSINESS PACKAGE

31 fully integrated programs including Inventory, Sales summary, Accounts Receivable/payable, tax statements, general ledger, etc. etc. Prompts user. Validates each entry. Menu driven. Produced in London by G.W. Computers, Ltd.  
Users manual only (including postage).....\$7  
Complete package.....\$750  
Complete listing only.....\$300

#### ATARI SUMMER SALE

	LIST PRICE	SALE PRICE
Computer, Model 800.....	\$1,080	\$845
Disk Drive, Model 810.....	\$ 699	\$545
Printer, Model 820.....	\$ 599	\$457
Cassette, Model 410.....	\$ 89	\$ 75
Paddle Controller Pair.....	\$ 19	\$ 17

#### MARINCHIP SYSTEMS M9900

Elegant 16 bit CPU, S-100 compatible multi-user, multi-processor operating system. Extended precision commercial BASIC, FORTH, META, PASCAL, Word Processor and Text Editor. Fast and powerful!  
Complete kit and software package..... \$550  
Assembled..... \$750  
We configure complete systems with floppy or hard disk.

#### WORDSMITH Video Subsystem.....\$1,550

S-100 Compatible, 40 lines, 80 columns. Powerful word processor and word processor keyboard.

#### MICROANGELO.....\$1,795

High resolution graphics system. Wordsmith and Microangelo feature 15", 22MHZ, green phosphor screen, 72 key keyboard; includes complete cabling and software. From SCION.

INDUSTRIAL  
MICRO  
SYSTEMS  
TELETYPE  
HAZELTINE  
IBM  
TELEVIDEO  
TEI  
TARBELL  
SIEMENS  
PER SCI  
NEC  
ITHACA  
INTERSYSTEMS  
MARINCHIP  
DATA SOUTH  
QUME  
CENTRONICS  
TEXAS  
INSTRUMENTS  
ATARI  
DEC  
CALIFORNIA  
COMPUTER  
SYSTEMS  
KONAN  
EDGE  
TECHNOLOGY  
INNOTRONICS  
XEROX  
DIABLO  
INTEGRAL  
DATA SYSTEMS  
CROMEMCO  
SOROC  
MICROPRO  
TELETEK  
NOVATION  
FUJITSU  
CDC  
NORTH STAR  
COMMODORE  
SCION  
MPI  
POWER ONE  
MEASUREMENT  
SYSTEMS  
AND CONTROL

SEE OUR AD AND ORDERING DETAILS ON FACING PAGE!

## JOHN D. OWENS

212 448-6283 Associates, Inc. 212 448-6298

12 Schubert Street,  
Staten Island, New York 10305

byte half-inch tape drive on the same motor spindle. Micropolis Corporation, of Chatsworth, California, is offering the largest capacity (now available) 8-inch Winchester disk, the Model 1203-I, with 45 megabytes on five surfaces. The density is high (8626 bpi, 478 tpi), the access time fast (42 ms), and the price reasonable. It is another good example of a high-capacity, high-performance 8-inch disk in the high-end segment. New World Computer Company Inc, of Costa Mesa, California, is making an unconventional, miniature hard disk, the Mikro-Disc 211. It is a cross between a high-performance, one-head-per-track disk and a cost-effective moving head mini-Winchester drive. It is small, light (8 pounds), and very fast (18.825 ms access time). It has relatively low capacity (2.1 megabytes) but makes up for it in performance, price (less than \$1000 in large OEM quantities), size (9½ inch by 9½ inch), weight, and power requirements (less than 50 W). In the words of company president, Phil

Haines, "It's a little screamer." The Mikro-Disc 211 is a versatile storage system suitable for a variety of uses: it can efficiently augment or replace floppy-disk drives, supplement other larger and slower mass-storage devices by acting as a high-speed cache memory, improve system response time by providing fast-access key-directory storage, and be the primary file device in small systems. It has an assembly with twenty proprietary low-cost heads that write and read data onto 0.008-inch-wide tracks. The head assembly is moved only seven 0.010-inch steps (eight positions) across the disk. Each step is accomplished in 5 ms, precisely and accurately, by a low-cost open-loop stepper motor.

The Model 3450 from Priam, San Jose, California, is another example in the high-end segment, along with BASF and Micropolis. It has 34 megabytes on five surfaces, fast transfer rate (1.02 megabytes per second), and high density (6370 bpi, 480 tpi). It is a state-of-the-art product at a

reasonable price. The Shugart Associates SA1000-series drives are another example of the low-end segment along with the Memorex 101 with 5- and 11-megabyte models.

Shugart Technology of Scotts Valley, California (a new company not connected with Shugart Associates or Xerox) has just announced its Model ST506 5-inch 6-megabyte Winchester disk drive. It is the size of a 5-inch floppy drive and weighs only 3.5 pounds — 6 megabytes of reliable Winchester disk storage in the palm of your hand for \$925 (OEM quantity 500)! In the popular parlance, this is a hot little product for the small computer system. Evaluation units are scheduled to be available this month and production quantities by next month.

The latest in disk drives for small systems are these 8-inch and 5-inch wonders. The hard disks are upon us, and they're taking personal computing forward by a giant step. ■

## Directory of Hard-Disk Manufacturers

*BASF Systems  
OEM Peripheral Sales  
Crosby Dr  
Bedford MA 01730  
(617) 271-4000*

*Century Data Systems Inc  
A Xerox Company  
1270 North Kraemer Blvd  
Anaheim CA 92806  
(714) 632-7500*

*Corvus Systems Inc  
900 S Winchester Blvd  
San Jose CA 95128  
(408) 246-0461*

*Fujitsu America Inc  
2945 Oakmead Village Ct  
Santa Clara CA 95051  
(408) 985-2300*

*International Memories Inc  
10381 Bandley Dr  
Cupertino CA 95014  
(408) 446-9779*

*Kennedy Company  
1600 South Shamrock Ave  
Monrovia CA 91016  
(213) 357-8831*

*Memorex Corporation  
Recording Components Div  
San Tomas and Central Expys  
Santa Clara CA 95052  
(408) 987-1000*

*Microcomputer Systems Corporation  
432 Lakeside Dr  
Sunnyvale CA 94086  
(408) 733-4200*

*Micropolis Corporation  
21329 Nordhoff St  
Chatsworth CA 91311  
(213) 709-3300*

*New World Computer Company Inc  
3176 Pullman St, Suite 119  
Costa Mesa CA 92626  
(714) 556-9320*

*Pertec Computer Corporation  
Peripherals Div  
9610 De Soto Ave  
Chatsworth CA 91311  
(213) 999-2020*

*Priam  
3096 Orchard Dr  
San Jose CA 95134  
(408) 946-4600*

*Shugart Associates  
475 Oakmead Pky  
Sunnyvale CA 94086  
(408) 733-0100*

*Shugart Technology  
340 El Pueblo Road, Suite C  
Scotts Valley CA 95066  
(408) 438-6550*



# DYNACOMP

Quality software for: **PET**  
**Apple II Plus**  
**TRS-80 (Level II)**  
**North Star**

All software is supplied with complete documentation which includes clear explanations and examples. Each program will run with standard terminals (32 characters or wider) and within 16K program memory space. Except where noted, all software is available on PET cassette, North Star diskette (North Star BASIC), TRS-80 cassette (Level II) and Apple cassette (*AppleSoft BASIC*). These programs are also available on *PAPER TAPE* (Microsoft BASIC).

**BRIDGE 2.0** Price: \$17.95 postpaid  
 An all-inclusive version of this most popular of card games. This program both BIDS and PLAYS either contract or duplicate bridge. Depending on the contract, your computer opponents will either play the offense OR defense. If you bid too high the computer will double your contract! BRIDGE 2.0 provides challenging entertainment for advanced players and is an excellent learning tool for the bridge novice.

**HEARTS 1.5** Price: \$14.95 postpaid  
 An exciting and entertaining computer version of this popular card game. Hearts is a trick-oriented game in which the purpose is not to take any hearts or the queen of spades. Play against two computer opponents who are armed with hard-to-beat playing strategies.

**FLIGHT SIMULATOR** Price: \$17.95 postpaid  
 (as described in SIMULATION, Volume II)  
 A realistic and extensive mathematical simulation of take-off, flight and landing. The program utilizes aerodynamic equations and the characteristics of a real airfoil. You can practice instrument approaches and navigation using radials and compass headings. The more advanced flyer can also perform loops, half-rolls and similar aerobatic maneuvers.

SIMULATION, Volume II (BYTE Publications): \$6.00

**VALDEZ** Price: \$14.95 postpaid  
 A simulation of supertanker navigation in the Prince William Sound and Valdez Narrows. The program uses an extensive 256x256 element radar map and employs physical models of ship response and tidal patterns. Chart your own course through ship and iceberg traffic. Any standard terminal may be used for display.

**CHESS MASTER** Price: \$19.95 postpaid (available for North Star and TRS-80 only)  
 This complete and very powerful program provides five levels of play. It includes castling, en passant captures, and the promotion of pawns. Additionally, the board may be preset before the start of play, permitting the examination of "book" plays. To maximize execution speed, the program is written in assembly language (by SOFTWARE SPECIALISTS of California). Full graphics are employed in the TRS-80 version, and two widths of alphanumeric display are provided to accommodate North Star users.

**FOURIER ANALYZER** Price: \$14.95 postpaid  
 Use this program to examine the frequency spectra of limited duration signals. The program features automatic scaling and plotting of the input data and results. Practical applications include the analysis of complicated patterns in such fields as electronics, communications and business.

**TEXT EDITOR I (Letter Writer)** Price: \$14.95 postpaid  
 An easy to use, line-oriented text editor which provides variable line widths and simple paragraph indexing. This text editor is ideally suited for composing letters and is quite capable of handling much larger jobs.

**MAIL LIST II** Price: \$19.95 postpaid (available for North Star only)  
 This many-featured program now includes full alphabetic and zip code sorting as well as file merging. Entries can be retrieved by user-defined code, client name or Zip Code. The printout format allows the use of standard size address labels. Each diskette can store more than 1000 entries (single density; over 2000 with double density systems!)

**STARTREK 3.2** Price: \$9.95 postpaid  
 This is the classic Startrek simulation, but with several new features. For example, the Klingons now shoot at the Enterprise without warning while also attacking starbases in other quadrants. The Klingons also attack with both light and heavy cruisers and move when shot at! The situation is hectic when the Enterprise is besieged by three heavy cruisers and a starbase S.O.S. is received! The Klingons get even!

**GAMES PACK I and GAMES PACK II** Price: \$9.95 each postpaid  
 GAMES PACK I contains BLACKJACK, LUNAR LANDER, CRAPS, HORSE RACE, SWITCH and more.  
 GAMES PACK II contains CRAZY EIGHTS, JOTTO, ACEY-DUCEY, LIFE, WUMPUS and more.  
 Why pay \$5.95 or more per program when you can buy a DYNACOMP collection for just \$9.95?

All orders are processed within 48 hours. Please enclose payment with order. If paying by MASTER CHARGE or VISA, include all numbers on card. Foreign orders add 10% for shipping and handling.

Write for detailed descriptions of these and other programs available from DYNACOMP.

**DYNACOMP, Inc.**  
 6 Rippingale Rd.

Pittsford, New York 14534  
 (716) 586-7579

New York State residents please add 7% NYS sales tax.



# MICAH

**OSBORNE COMPATIBLE**  
**READY to RUN**  
**BUSINESS SOFTWARE**

In CBASIC2 or 16K BASIC

\* features \*

\* hardware required \*

- Four Complete Packages--
  - General Ledger
  - Accounts Receivable
  - Accounts Payable
  - Payroll with Cost Accounting
- Strong support from Osborne Manuals
- CBASIC2 runs under CP/M or under CDOS version 1.07 on Cromemco computers
- 16K BASIC runs on Cromemco computers
- Cursor addressing routines for Hazeltine, Lear Siegler and Cromemco (Beehive) Terminals
- Source Codes and Installation Instructions provided along with disks
- Automatic Command Start-up
- Easy to apply to all of your business and systems needs

- One or more 8" or 5" Floppy <sup>☆</sup> Drives
- CRT with cursor addressing
- 132-Column Printer

**\$14500**  
 per package

NO ORDER  
 Add \$5 for shipping  
 Call add a 12% Sales Tax  
 CREDIT CARDS ACCEPTED  
 Osborne Manuals \$25 each

• DEALER INQUIRIES INVITED •

- |  |   |  |
|--|---|--|
| • OSBORNE READY to RUN BUSINESS SOFTWARE | • EXPAND (Run Cromemco Software on CP/M)  | • BCP 3 (Disk Util-ities for Cromemco) |
| • SBIDS (CP/M for Cromemco computers)    | • MICROSPLOT (Versatile Printer Graphics) | • DUP 4 (Double sided)                 |
| • X-105 (MP/M for Cromemco Computers)    | • DRIVE (Customized Printer Drivers)      | • DUP 5 (Disk Util-ities for CP/M)     |
|  |   | • DUP 6 (Disk Util-ities)              |

• Call or Write for Free Catalogue and More Information •

• We will Customize any of our programs at our Standard Consulting Rates •

☆ All orders usually shipped 8" For 5" disks add \$20.00 for downloading

MICAH BOX 2087 WALNUT CREEK CA 94596 ph. 415/933-2783

MICRO Applications and Hardware

• CONSULTANTS and SOFTWARE DEVELOPERS •

# The 2nd Generation is shaping up...

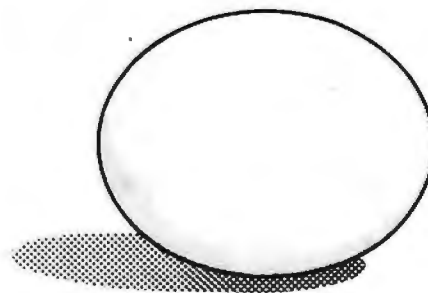

**MEASUREMENT**  
 systems & controls  
 incorporated

**NEECO  
PROUDLY  
INTRODUCES**

# **ALLOS COMPUTERS**

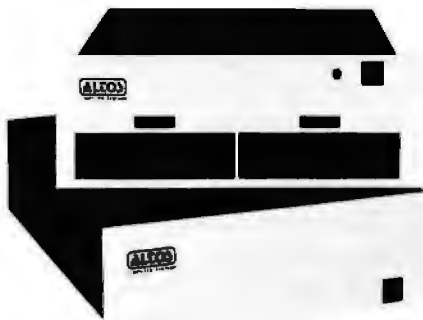

**ALLOS ACS 8000-5**

- Dual 8" floppy disks
- Megabyte storage
- 64K RAM
- Totally expandable to Hard Disk (29MB) and Multi-User

**ALLOS OFFERS OUR USERS  
TOTAL SYSTEM CAPABILITIES  
AND FLEXIBILITY . . .**

- Z80 based • CP/M • Multi-User
- Hard Disk • Seven languages
- MP/M • NEECO system support
- Full Word Processing

**\$5990**

**"ALLOS Computers offer you System Flexibility and Reliability"**

**CONTACT NEECO FOR ADDITIONAL INFORMATION ON HOW ALLOS CAN BECOME YOUR COMPUTER SOLUTION.**

Altos computers range in price from less than \$3000 to over \$14,000. Altos Computer Systems' capabilities range from single disk-single user to 29 Megabytes-Multi-User.

ALLOS computers are distributed to Dealers/OEMs in the N.E. Region by MICROAMERICA

## **SUPERBRAIN SOFTWARE**

(Business Packages written in MicrosoftBASIC)

Trial Tested Osborne Business Packages on the Superbrain

- |                       |          |  |
|-----------------------|----------|--|
| • Accounts Receivable | \$250.00 | <b>Complete 4 Module Package \$795</b> |
| • General Ledger      | \$250.00 |  |
| • Accounts Payable    | \$250.00 | <b>MicrosoftBASIC \$325</b>            |
| • Payroll Package     | \$250.00 |  |

**SUPERBRAIN**

- 32K RAM \$2795**
- 64K RAM \$2995**
- FORTAN \$ 450**

**SPECIAL OFFER!**

Purchase a 64K Superbrain at \$2995 and will include MBASIC5 for only \$250! (regularly \$350)

**SPECIAL OFFER! - Purchase**

a Centronics 704-9 (RS232, 180 CPS, retail \$2380) printer and a 64K Superbrain together for only \$4595 - cash price only.

"The Superbrain is ideal for use as an intelligent terminal or stand alone microcomputer system for OEM's, commercial customers, and other sophisticated computer users."

- Two 5.25" Shugart Minifloppies with over 300 K (CP/M Version 2.2 or later) Disk Storage.
- Integrated in a single compact housing.
- CP/M operating System with MBASIC5 and other interpreters/compiler available.
- 32K or 64K RAM models available.
- 2 I/O Ports - one fully enabled RS232 port for communications. Other port for RS232 serial printer output.
- Too many software packages are now available to list them here.

**OEM/DEALER INQUIRIES**

All pricing and specifications are subject to change.



**\$2995** The Honor Graduate

**SUPERBRAIN™**

**NEECO**

679 Highland Ave.  
Needham, MA  
02194

Mon-Fri 9:30-5:30  
MasterCharge &  
Visa Accepted

**(617) 449-1760**  
Telex: 951021

**MICROAMERICA DISTRIBUTING**

"Nationwide distributors of Computer Equipment"  
21 Putnam Street  
Needham, MA  
02194

**(617) 449-4310**



# NEECO

"Your complete source  
for all CBM Hardware  
and Software Products"

## PROUDLY ANNOUNCES OUR NEW ONE YEAR WARRANTY ON ALL CBM COMPUTERS!

"All CBM Computers purchased between June 15th and Sept. 15th  
will automatically carry a full one year NEECO warranty"

The 8032 CBM Computer is now available!



### CBM™ 8000 SERIES BUSINESS COMPUTERS

The new Commodore 8000 series computers offer a wide screen display to show you up to 80-character lines of information. Text editing and report formatting are faster and easier with the new wide-screen display. The 8000 series also provides a resident Operating System with expanded functional capabilities. You can use BASIC on the 8000 computers in both interactive and program modes, with expanded commands and functions for arithmetic, editing, and disk file management. The CBM 8000 series computers are ideally suited for the computing needs of the business marketplace.

### CBM™ 8050 DUAL DRIVE FLOPPY DISK

The CBM 8050 Dual Drive Floppy Disk is an enhanced version of the intelligent CBM 2040 Disk Drive. The CBM 8050 has all of the features of the CBM 2040, and provides more powerful software capabilities, as well as nearly one megabyte of online storage capacity. The CBM 8050 supplies relative record files and automatic diskette initialization. It can copy all the files from one diskette to another without copying unused space. The CBM 8050 also offers improved error recovery and the ability to append to sequential files.

#### HARDWARE SPECIFICATIONS

Dual Drives  
Two microprocessors  
974K Bytes storage on two  
5.25" diskettes (ss)  
Tracks 70  
Sectors 17-21  
Soft sector format  
IEEE-488 interface  
Combination power (green) and  
error (red) indicator lights  
Drive Activity indicator lights  
Disk Operating System Firmware  
(12K ROM)  
Disk Buffer (4K RAM)

#### FIRMWARE

DOS version 2.0  
Sequential file manipulation  
Sequential user files  
Relative record files  
Append to sequential files  
Improved error recovery  
Automatic diskette initialization  
Automatic directory search  
Command parser for syntax  
validation  
Program load and save

CBM	PRODUCT DESCRIPTION	PRICE
2001-8KN	8K RAM-Graphics Keyboard	\$ 795.00
2001-16KN	16KN RAM-Graphics Keyboard	\$ 995.00
2001-16KB	16K RAM-Business Keyboard	\$ 995.00
2001-32KN	32K RAM-Graphics Keyboard	\$1295.00
2001-32KB	32K RAM-Business Keyboard	\$1295.00
8016	16K RAM-80 Col.-4.0 O/S	\$1495.00 *
8032	32K RAM-80 Col.-4.0 O/S	\$1795.00
2023	Friction Feed Printer	\$ 695.00
2022	Tractor Feed Printer	\$ 795.00

CBM	PRODUCT DESCRIPTION	PRICE
2040	Dual Floppy-343K-DOS 1.0	\$1295.00
2050	Dual Floppy-343K-DOS 2.0	\$1295.00
8050	Dual Floppy-974K-DOS 2.0	\$1695.00 *
C2N Cassette	External Cassette Drive	\$ 95.00
CBM to IEEE	CBM to 1st IEEE Peripheral	\$ 39.95
IEEE to IEEE	CBM to 2nd IEEE Peripheral	\$ 49.95
8010	IEEE 300 Baud Modem	\$395.00 *
2.0 DOS	DOS Upgrade for 2040	\$ 50.00
4.0 O/S	O/S Upgrade for 40 Column	\$ 100.00

\*Asterisks indicate summer delivery—all others are immediately available.

### SPECIAL OFFER ON CBM COMPATIBLE BUSINESS SOFTWARE!

Purchasing software has always been difficult due to the "you buy it - you own it" attitude of most vendors. We at NEECO, recognize this problem and can now, on all of the Software Packages listed, offer a full 30 day refund policy to NEECO's customers. Now you can purchase with confidence. Buy it - try it; if the program package is not suitable for any reason, send it back to us within 30 days and we will refund the full purchase price—less shipping charges!

SOFTWARE	APPLICATION	REQUIRES	AUTHOR	AVAILABILITY	PRICE
Word Pro I	Word Processing	8K + cassette	Pro Micro	Immediate	\$ 29.95
Word Pro II	"	10K + 2040	"	"	99.95
Word Pro III	"	32K + 2040	"	"	199.95
Word Pro IV	"	8032 + 2040/8050	"	"	299.95
BPI Integrated G/L	Business	32K/8032 + 2040	BPI	"	360.00
BPI Inventory	"	"	"	"	T.B.A.
BPI Payroll	"	"	"	"	"
BPI Enhanced A/R	"	"	"	"	"
CMS G/L	"	"	CMS Software	"	295.00
CMS A/R	"	"	"	"	195.00
CMS A/P	"	"	"	"	195.00
CMS Customer Mail List	"	"	"	"	195.00
CMS Payroll	"	"	"	"	350.00
BMB Database	All Business	32K/8032 + 2050/8050	BMB	August/Sept.	295.00

\*Wordprocessing Software requires output printer. We recommend the NEC Spinwriter (\$2995) for letter quality.

\*PET is a registered trademark of Commodore Business Machines. Small Keyboard PETS require a ROM Retrofit Kit.

Multi-Cluster is available in Canada from BMB Compu Science, P.O. BOX 121, Milton, Ontario, L9T2Y3

All prices and specifications are subject to change without notice.

# NEECO

679 HIGHLAND AVE.  
NEEDHAM, MA 02194

NEW ENGLAND ELECTRONICS CO., INC.

"NEW ENGLAND's Largest  
Computer Showroom"

# (617) 449-1760

MASTERCARD OR VISA ACCEPTED  
TELEX NUMBER 951021, NEECO  
MON-FRI, 9:00-5:30

## Editor's Note

We are particularly pleased to include this article by Dick and Jill Miller in this FORTH theme issue. One of the problems with past BYTE language issues has been the lack of concrete examples of the language being showcased—namely, a full, nontrivial program that does something useful or fun and, at the same time, shows an example of the language at its best.

The program BREAKFORTH, written for the MMSFORTH language running on the Radio Shack TRS-80, does show the language FORTH at its best. This real-time video game, which is a version of the arcade-type game that requires the user to chip away at a "brick wall" by directing a bouncing ball at it with a paddle, is what Dick Miller calls "electronic flypaper"—a game so addictive that it keeps people trapped at their TRS-80, unable to stop playing.

In addition to being playable (quite a testament to the speed of FORTH, especially if you have ever seen the same game written in TRS-80 BASIC), the game also gives an example of how a good FORTH program is put together,

as well as how it can be more readable when properly written out with adequate indentation and comments.

Another departure from previous language issues is the availability of the language FORTH at reasonable cost on a wide range of microcomputers (see chart of FORTH sources, elsewhere in this issue). Miller Microcomputer Services (MMS) supplies one of the most complete and well-supported versions of FORTH available, along with a newsletter and other FORTH products available at reasonable prices. (For example, MMS sells a FORTH software package that adds floating-point arithmetic (both single- and double-precision), complex arithmetic, and a full Z80 assembler, all on floppy disk for \$29.95.)

This article was produced with the help of two other people not yet mentioned. The first is Tom Dowling, who wrote the MMSFORTH language for the TRS-80 and who does a large portion of the FORTH programming for MMS. The second person is Arnold Schaeffer, who wrote the

BREAKFORTH program as his first FORTH program. If this achievement were not impressive enough, then I should add that Arnold is a high school student. This is proof that FORTH can be learned by anyone with sufficient enthusiasm for the language.

Analyzing the BREAKFORTH program is a great way to learn about FORTH and how to program in it. The program can be typed in as is on a TRS-80 using MMSFORTH's full-screen editor and virtual memory, but I suggest that you first read John James' article in this issue, "What Is FORTH? A Tutorial Introduction," before seriously studying the BREAKFORTH program.

One final note on alteration: this program is meant to work on a TRS-80 Model I running MMSFORTH. Users of other FORTH systems having a graphic display of 48 by 128 resolution or better can probably get the program running by rewriting some words unfamiliar to their system. Some information designed to help in this conversion effort has been supplied in this article....GW

# BREAKFORTH Into FORTH!

---

A Richard Miller and Jill Miller  
Miller Microcomputer Services  
61 Lake Shore Rd  
Natick MA 01760

---

## About the Authors

A Richard (Dick) and Jill Miller founded Miller Microcomputer Services in 1977 as a consulting firm specializing in support for the Radio Shack TRS-80. After continued dissatisfaction with other languages available for the TRS-80 (FORTRAN, COBOL, Pascal, PILOT, BASIC), they settled on FORTH as a language that combines the seemingly incompatible traits of language complexity, high operating speed, and low memory overhead. They released their first version of MMSFORTH (version 1.5) in June 1979, and have been improving disk and cassette versions of the system ever since. MMSFORTH resembles the FORTH Inc version of the language called microFORTH, and was written independently with permission from that company.

## Introduction to BREAKFORTH

This BREAKFORTH program was created by Arnold Schaeffer. The program, which was purchased by MMS, has received minor modifications and is now included with the purchase of MMSFORTH version 1.9 (on a different range of blocks from those shown here, blocks 69 thru 74). We think it is a classic game as is, and fully expect individuals to modify it in accord with their game preferences—for their individual use.

The BREAKFORTH program is a straightforward one, although it is not a trivial one. It combines many of the techniques of FORTH and can be

followed easily with a little time and study. Figure 1 shows a typical BREAKFORTH video display, with an operator-controlled game paddle at the bottom, a bouncing ball, and a barrier to be knocked out one brick at a time by successive bounces until all the bricks have been cleared away. Each removed brick scores one point or more depending on its level, and there is a surprise bonus for a completely cleared barrier. Ball speed and number of balls are selectable, but be warned that, as you bounce your way up to the higher layers, the ball speed increases! You might want to start with short games using five balls and



NO FRILLS! NO GIMMICKS! JUST GREAT  
**DISCOUNTS**  
 MAIL ORDER ONLY

**ATARI 800**  
 Personal Computer  
 System  
**\$799<sup>00</sup>**



**SOROC**  
 Technology  
 IQ 120 **\$699<sup>00</sup>**  
 IQ 140 **999<sup>00</sup>**



**NORTHSTAR**

Horizon II  
 32K  
 Horizon II Quad  
 Horizon II 64K  
 Horizon Quad 64K



**\$2349<sup>00</sup>**  
**2799<sup>00</sup>**  
**2999<sup>00</sup>**  
**3399<sup>00</sup>**

**CROMEMCO**  
 System 3 **\$5695<sup>00</sup>**  
 Z2H **7995<sup>00</sup>**



**TELEVIDEO**

912 **\$749<sup>00</sup>** | 920 **\$799<sup>00</sup>**

**INTERTEC**  
 Superbrain  
 32K Computer  
**\$2495<sup>00</sup>**



Superbrain 64K  
**\$2795<sup>00</sup>**

**HAZELTINE**

1420 **\$795<sup>00</sup>**  
 1500 **\$849<sup>00</sup>**  
 1510 **\$1049<sup>00</sup>**  
 1520 **\$1229<sup>00</sup>**



**DECwriter IV**  
 LA 34 **\$979<sup>00</sup>**



**TEXAS**  
**INSTRUMENT**  
 810 Multi Copy  
 Impact Printer  
**\$1499<sup>00</sup>**



**OKIDATA**  
 Microline 80  
**\$699<sup>00</sup>**



**We'll meet or beat any advertised prices!**

Most items in stock for immediate delivery. Factory-sealed cartons.  
 Full manufacturer's guarantee.

**DATA DISCOUNT CENTER**

Box 100 135-53 Northern Blvd., Flushing, New York 11354

Visa • Master Charge • N.Y.S. residents add appropriate Sales Tax • Shipping F.O.B. N.Y.

PHONE ORDERS  
 CALL  
 212  
 465-6609

a ball speed of seven. Fifty balls and a speed of four will present a challenge for high scorers.

BREAKFORTH offers some other features, too. As you and your friends try for better scores, a BEST score is kept to challenge your present effort. In addition, the paddle adds backspin in certain cases that we will leave you to discover.

To add sound, plug an external speaker into the EAR jack of your cassette tape recorder, attach the middle cable from the keyboard unit (not the motor remote cable) to the AUX jack of the tape recorder, and open the tape compartment door. While depressing the write-protect detector switch at the left side of the back of this compartment, simultaneously press the Record and Play keys. This procedure allows the cassette tape recorder to be used as an amplifier. The BREAKFORTH program manipulates the cassette port (normally used for writing a program to tape), causing a sound to be amplified by the recorder and played on the speaker.

Like other brands of electronic flypaper, BREAKFORTH may keep you glued to the keyboard. If you have to leave but do not want to give up the game, press shift-@ to pause the game. Pressing any other key will cause the game to resume where you

---

**BREAKFORTH** is developed in the FORTH manner, with top-down design and bottom-up programming.

---

left off. To start a new game in midstream while keeping the BEST score, press the Break key, type in the word BREAKFORTH, and press the Enter (Return) key.

BREAKFORTH is developed in the FORTH manner, with top-down design and bottom-up programming. Figure 2 shows the organization of the program. These modules shown in figure 2, along with the various 1-byte and single-precision (2-byte) variables and constants they invoke, are listed with explanations in table 1, a directory of the BREAKFORTH words that this program will add to the FORTH vocabulary.

The program's source code is on six consecutive blocks, and in this case happens to be located on blocks 50 thru 55; see listing 1. In MMSFORTH, one enters { 50 6 LOADS } to load the program—that is, to compile and execute all the information on blocks 50 thru

55, ending with the immediate execution of the word BREAKFORTH from line 15 of block 55 (which causes the program to be run). (Other versions of FORTH that lack the consecutive-blocks word, LOADS, will have another way of doing this.)

### The First Block

Let us take a detailed look at block 50 in listing 1. Lines 0 thru 2 are all comment lines, as are any words surrounded by parentheses. Notice that because FORTH words are set off by spaces on either side, the "begin comment" word, { ( ) , must be separated from the first word of the comment by at least one space. (Because of the way { ( ) is defined, the closing parenthesis need not be separated from the last word of the comment by a space.)

Most definitions in FORTH begin with a colon ( : ; ) and end with a semicolon ( ; ; ), where the first word after the colon is the word being defined. In line 3, the first word defined is TASK. Since the only word following TASK is the closing semicolon, we can conclude that the word TASK does not do much. However, it does serve as a "bookmark," marking the beginning of the words and variables that are specific to this application (game). We will come back to TASK later, at the end of block 55.

Line 3 also causes two other blocks on the MMSFORTH system disk to be loaded into memory. Block 32, when loaded, adds several special-purpose words having to do with random numbers: RANDOMIZE and RND. Block 33, when loaded, adds several words that have to do with graphics: DCLR, DSET, { D? }, ECLR, ESET, and { E? }. (The last three are the same as TRS-80 BASIC words RESET, SET, and POINT, and the variables beginning with D are the same, but referencing double-width characters.)

Lines 4 thru 6 initialize seven double-byte variables and two single-byte ( CVARIABLE ) variables. In FORTH, unless specified, all variables, constants, and stack entries are 16 bits (2 bytes) long. See table 1 for the meaning of these variables.

Line 7 defines a new word, LINE, using a colon to begin the definition and a semicolon to end it. Several spaces (usually three) are placed be-

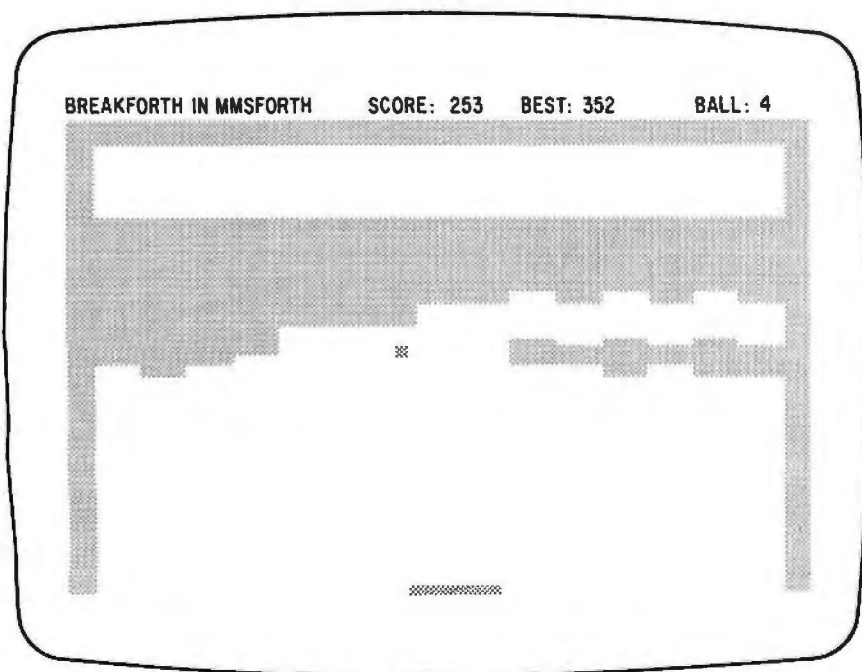

Figure 1: One view of the TRS-80 video screen during a BREAKFORTH game.



# THE NEXT GENERATION OF MICROCOMPUTERS IS HERE AT QUASAR DATA PRODUCTS



**16 BIT POWER  
Z-8000**

AND STILL RUN YOUR 8 BIT SOFTWARE



## IF YOU SEE IT OUR WAY THEN WE THINK WE HAVE THE PRODUCTS FOR YOU:

- THE S-100 BUS IS HERE TO STAY. IT IS NOT THE GREATEST BUT WITH PROPER TERMINATION IT WORKS RELIABLY AT HIGH SPEEDS, AND SINCE IT IS NOW AN IEEE STANDARD, IT IS WELL DEFINED.
- THE 8 BIT SYSTEMS ARE USEFUL BUT THEY ARE THE LIMITING FACTOR FOR MANY APPLICATIONS.
- THE 16 BIT SYSTEMS ARE THE WAY FUTURE SYSTEMS WILL GO. WHY NOT? THERE IS VERY LITTLE PRICE DIFFERENCE AND AN ORDER OF MAGNITUDE PERFORMANCE DIFFERENCE.
- THE REAL USEFULNESS OF THE 16 BIT MICROPROCESSORS WILL BE DETERMINED BY THE SOFTWARE.
- THE SYSTEMS USING 5 1/4 INCH DISK DRIVES REALLY DO NOT HAVE ADEQUATE MEMORY STORAGE OR COMPUTER POWER FOR MANY BUSINESS OR SCIENTIFIC APPLICATIONS.
- SIXTY-FOUR KILOBYTES OF ADDRESSABLE RAM, THE MAXIMUM FOR 8 BIT SYSTEMS, IS NOT ADEQUATE FOR MANY BUSINESS OR SCIENTIFIC APPLICATIONS.
- IT IS NOT WORTH BUYING 8 BIT SYSTEMS OR BOARDS NOW IF YOU CAN GET THE SAME SOFTWARE WITH 16 BIT SYSTEMS AT ABOUT THE SAME PRICE.

- THE NEW 16 BIT MICROPROCESSORS HAVE POWER COMPARABLE TO MINICOMPUTERS BUT DO NOT REQUIRE THE SAME OVERHEAD IN TERMS OF DOWNTIME, MAINTENANCE, OR INITIAL INVESTMENT. THEY ARE MORE VERSATILE IN MANY APPLICATIONS SUCH AS REAL TIME APPLICATIONS.

### THIS IS WHAT QDP HAS AVAILABLE:

- A Z-8000 BOARD THAT CAN PLUG INTO YOUR EXISTING S-100 BUS SYSTEM (SEE BELOW FOR DESCRIPTION)
- A COMPLETE Z-8000 SYSTEM (SEE BELOW FOR DESCRIPTION)
- A Z-8000 SYSTEM CONFIGURED FOR YOUR EXACT NEEDS.
- SOFTWARE TO ALLOW YOU TO RUN ALL THE AVAILABLE Z-80/8080 SOFTWARE INCLUDING CP/M
- SOFTWARE THAT INCLUDES A MONITOR, DEBUGGER, DISASSEMBLER, AND BASIC
- SOFTWARE OPTIONS A) EXTENDED MONITOR B) PASCAL C) SIMULATORS FOR 8080, Z-80, 6800, 6502, 1802
- A Z-80 SYSTEM (QDP-100) THAT IS UPWARD COMPATIBLE WITH THE Z-8000

### THIS IS WHAT IS COMING FROM QDP:

- A 256 KILOBYTE RAM CARD.
- UNIX<sup>2</sup> OPERATING SYSTEM.

## Z-8000 SERIES 16 BIT CPU S-100 BOARD — CAN BE PLUGGED INTO YOUR EXISTING SYSTEM \$695.00

- FULLY S-100 IEEE COMPATIBLE
- SUPPORTS EXISTING 8 BIT MEMORY AND 8 BIT PERIPHERAL BOARDS
- CAPABLE OF READING AND/OR WRITING 8 BIT, 16 BIT OR MIXED 8 BIT AND 16 BIT MEMORIES AUTOMATICALLY
- 8 BIT AND/OR 16 BIT PERIPHERAL MODULES CAN SIMULTANEOUSLY CO-EXIST IN THE SAME BUS WITHOUT ANY MODIFICATIONS
- CAPABLE OF OPERATING AS A SLAVE PROCESSOR TO ENABLE YOUR EXISTING CPU TO CONTROL THE Z-8000

**INDUSTRIAL  
QUALITY**

- SUPPORTS ON-BOARD HARDWARE SINGLE STEPPING
- SUPPORTS EITHER SEGMENTED CPU OR NON-SEGMENTED CPU
- POWER-ON AND RESET JUMP DIP SWITCH SELECTABLE
- JUMPER SELECTABLE 2 OR 4 MHz. OPERATION
- DIP SWITCH SELECTABLE NUMBER AND TYPE OF WAIT STATES
- SOFTWARE
- Z-80 EMULATOR ENABLES YOU TO EXECUTE YOUR EXISTING 8 BIT SOFTWARE WITHOUT ANY MODIFICATIONS AND ALLOWS YOU TO RUN CP/M IMMEDIATELY
- EXTENDED MONITOR, DEBUGGER, DISASSEMBLER

## QDP-8100 WITH 2 MEGABYTES STORAGE STANDARD (OPTIONAL 4 MEGABYTES)

- Z-8000 SERIES 16 BIT CPU S-100 BOARD - SEE ABOVE
- SOFTWARE (PROVIDED WITH SYSTEM)
  - CP/M 2.2<sup>1</sup> OPERATING SYSTEM
  - BASIC
  - Z80/8080 EMULATOR
  - MONITOR, DEBUGGER, DISASSEMBLER
- SOFTWARE OPTIONS: PASCAL
- UNIX<sup>2</sup> OPERATING SYSTEM COMING

**\$6,395.**

## SYSTEMS

## QDP-100 WITH 2 MEGABYTES STORAGE STANDARD (OPTIONAL 4 MEGABYTES)

- Z-80 SERIES 8 BIT CPU S-100 BOARD (4 MHz Z-80, DBL DENSITY DISK CONTROLLER, 2716 PROM BURNER 2 PARALLEL & 2 SERIAL PORTS, REALTIME CLOCK)
- SOFTWARE (PROVIDED WITH SYSTEM)
  - CP/M 2.2<sup>1</sup> OPERATING SYSTEM
  - BASIC
  - ACCOUNTS RECEIVABLE, GENERAL LEDGER, ACCOUNTS PAYABLE, PAYROLL WITH COST ACCOUNTING
  - OPTIONAL SOFTWARE: FORTRAN, PASCAL, COBOL, C

**\$4,995.**

**EACH SYSTEM** • INTELLIGENT CRT TERMINAL (80 CHARACTERS X 24 LINES)

**CONTAINS:** • 64 KBYTES RAM

• TWO 8 INCH, DOUBLE SIDED, DOUBLE DENSITY FLOPPY DISK DRIVES WITH CONTROLLER

• 2 SERIAL AND 1 PARALLEL (2 PARALLEL FOR QDP-100) PORTS

• ATTRACTIVE WOODGRAIN CABINET WITH POWER SUPPLIES AND CABLING

• FULL TECHNICAL SUPPORT FROM THE STAFF AT QUASAR DATA PRODUCTS

CP/M™ DIGITAL RESEARCH  
UNIX™ BELL LABS

**DP**

## 4 Mhz 64K Dynamic RAM

16K - '250<sup>00</sup> 32K - '350<sup>00</sup> 48K - '450<sup>00</sup> 64K - '549<sup>00</sup>

## QUASAR FLOPPY SYSTEM

- Two MFE DBL sided drives • Cable • Case & Power Supply assembled and tested Wood cabinet ..... '1895<sup>00</sup>

## QUASAR 2 MEG FLOPPY

- 2 MFE double sided drives
- Teletek disk controller board
- Power supply & cable
- Wood cabinet
- CP/M version 2.2 & bios
- Assembled & tested ..... '2295<sup>00</sup>

Dealer Inquiries Invited, Hours: 9-5:30 M-F

Specifications Subject To Change

Unix™ - Bell Lab

30 Day ARO

CP/M™ - Digital Research

Call for Apple

Full package options... '1995<sup>00</sup>

## TELETEK DBL. DENSITY, DBL. SIDED

Disk Controller Board..... '395<sup>00</sup>

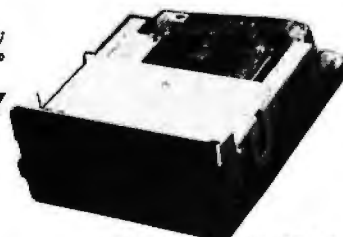

**MFE** Double Sided - Double Density 8" Floppy Disk Drives. (the best) ..... '650<sup>00</sup>  
Using the Teletek Controller under CP/M, THIS DRIVE WILL GIVE YOU ALMOST ONE MEGABYTE PER DISK DRIVE.  
Power supply for above ..... '110<sup>00</sup>

## PAPER TIGER

Includes Graphics ..... '949<sup>00</sup>

Cable for TRS-80 ..... '39<sup>00</sup>

## TI - 820

Serial Printer -



Checks, money orders accepted  
Add \$2.50 freight charges on orders under 10 lbs. Over 10 lbs. F.O.B. Cleveland

**QUASAR DATA PRODUCTS**

25151 Mitchell Dr., No. Olmsted, Ohio 44070 (216)779-9387



## MORE FOR YOUR RADIO SHACK TRS-80 MODEL I !

- ★ **MORE SPEED**  
10-20 times faster than Level II BASIC.
- ★ **MORE ROOM**  
Compiled code plus VIRTUAL MEMORY makes your RAM act larger.
- ★ **MORE INSTRUCTIONS**  
Add YOUR commands to its large instruction set!  
Far more complete than most Forths: single & double precision, arrays, string-handling, more.
- ★ **MORE EASE**  
Excellent full-screen Editor, structured & modular programming  
Optimized for your TRS-80 with keyboard repeats, upper/lower case display driver, single- & double-width graphics, etc.
- ★ **MORE POWER**  
Forth operating system  
Interpreter AND compiler  
Internal 8080 Assembler (Z80 Assembler also available)  
VIRTUAL I/O for video and printer, disk and tape (10-Megabyte hard disk available)

# MMS FORTH

### THE PROFESSIONAL FORTH FOR TRS-80

Prices:  
MMSFORTH Disk System V1.9 (requires 1 disk drive & 16K RAM) ..... just **\$79.95\***  
MMSFORTH Cassette System V1.8 (requires Level II BASIC & 16K RAM) ..... **\$59.95\***

### AND MMS GIVES IT PROFESSIONAL SUPPORT

Source code provided  
MMSFORTH Newsletter  
Programming staff available  
Many demo programs aboard  
MMSFORTH User Groups

FLOATING POINT MATH (L2 BASIC ROM routines plus Complex numbers, Rectangular-Polar coordinate conversions, Degrees mode, more), plus a full Z80 ASSEMBLER; all on one diskette . . . **\$29.95\***  
THE DATAHANDLER, a very sophisticated database management system operable by non-programmers (requires 1 drive and 32K RAM); with manuals . . . . . **\$59.95\***

Other packages under development

### FORTH BOOKS AVAILABLE

MICROFORTH PRIMER — comes with MMSFORTH; separately . . . . . **\$15.00\***  
USING FORTH — more detailed and advanced than above . . . . . **\$25.00\***  
URTH TUTORIAL MANUAL — very readable intro. to U/Rochester Forth . . . . . **\$19.95\***  
CALTECH FORTH MANUAL — good on Forth internal structure, etc . . . . . **\$6.95\***

\* — Software prices are for single-system user license and include manuals. Add \$2.00 S/H plus \$1.00 per additional book; Mass. orders add 5% tax. Foreign orders add 15%. UPS COD, VISA & M/C accepted; no unpaid purchase orders, please.

Send SASE for free MMSFORTH information.  
Good dealers sought.

MMSFORTH is available from your computer dealer or  
**MILLER MICROCOMPUTER SERVICES (B1)**

61 Lake Shore Road, Natick, MA 01760  
(617) 653-6136

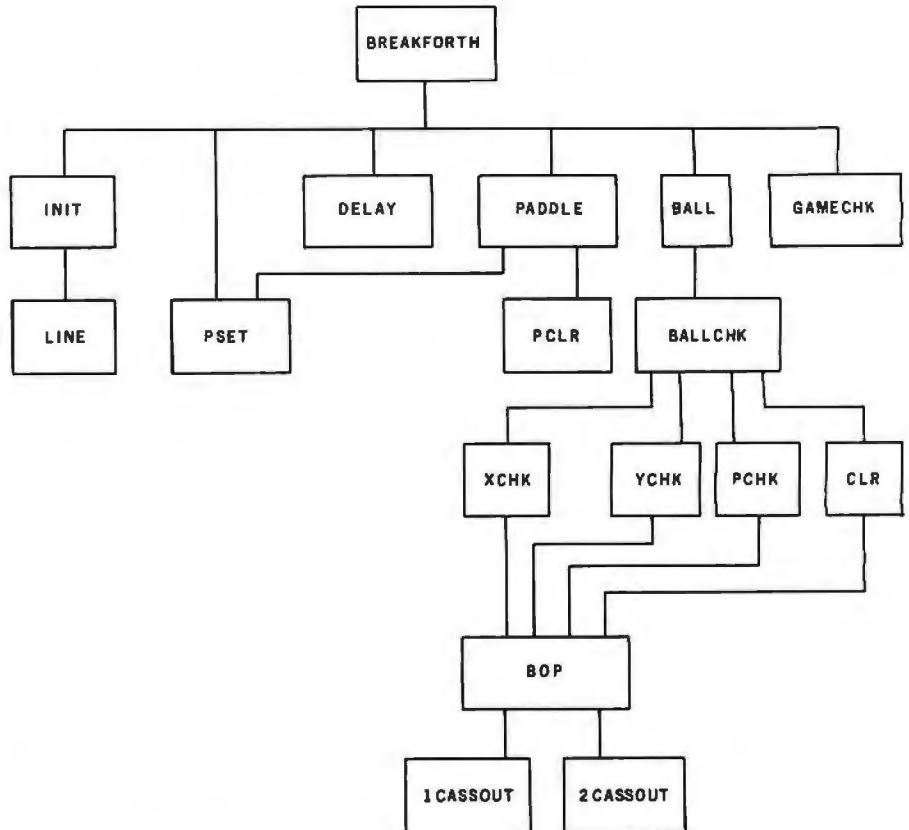

Figure 2: A hierarchical diagram of the BREAKFORTH program. Each box contains a word used within the BREAKFORTH program and is used by the word(s) in the box(es) above it. See table 1 for a definition of each word.

tween the word being defined and the first word of the definition; this adds to the clarity of the definition. PTC (for "put cursor") places the cursor at a given point on the screen, much like the PRINT@ instruction in TRS-80 BASIC. It expects two numbers on the stack, the row (second-to-top) and the column (on top) giving the desired position for the cursor. (For example, { 8 32 PTC } puts the cursor near the center of the screen, 8 rows from the top and 32 characters from the left edge of the screen.)

However, our new word LINE expects only one number on the stack because the first thing it does when it is called is to put a zero on top of the stack. So the words { 0 PTC } put the cursor at the beginning of a given line (that is, at position (x,0), where x is the number on top of the stack when LINE is called).

The FORTH word ECHO (EMIT in some other versions of FORTH) is like the PRINT CHR\$ function in BASIC—it outputs the corresponding ASCII character for the number. In this case, { 30 ECHO } outputs a

clear-to-the-end-of-the-line signal on the TRS-80. (By the way, the 30 is the decimal number thirty; although you can change to hexadecimal with the word HEX or to any other numeric base, MMSFORTH assumes decimal numbers unless told otherwise.)

Now we are finally able to say what the word LINE does: the phrase { x LINE } clears line x and leaves the cursor at row x, column 0. { 0 PTC } puts the cursor at the beginning of the line, and { 30 ECHO } clears the line with a special character (ASCII decimal 30) and leaves the cursor where it is.

The final word described in block 50, INIT, begins in line 8. Its definition is longer than most words, but its function is not at all mysterious once you know a few FORTH words. CLS clears the video screen (as in TRS-80 BASIC), { 0 LINE } clears line zero, and { " } ( { " } in some FORTHS) causes the character string until the next quote mark to be printed, just as PRINT "STRING" does in BASIC. The word #IN causes a single-

Text continued on page 158



**ΩMEGA**  
SALES  
CO.

Circle 104 on inquiry card.

**"WHOLESALE COMPUTER PRICES"**

**DIRECT TO THE PUBLIC**

12 Meeting St., Cumberland, R.I. 02864

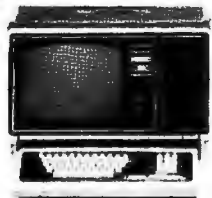

TRS-80  
Model II - \$3,500



Apple II  
16K - \$1049



Atari 800 - \$749



For: TRS-80, Apple, CBM  
(Interface Included)

Epson TX-80 - \$745

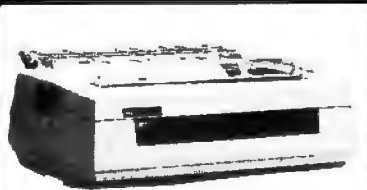

NEC Spinwriter  
5510-5530 - \$2449



Soroc 120 - \$699

## PRODUCT SPECIAL OF THE MONTH!!



### INTERTEC SUPERBRAIN

32K RAM - \$2449.00

64K RAM - \$2649.00

(Prices valid July 15 - Sept. 1, 1980)

Products are  
**NOW**  
IN  
**STOCK**  
AT  
**ΩMEGA**  
Sales  
Co.

## CALL TOLL FREE FOR ΩMEGA'S PRICE!

ΩMEGA OFFERS THE BEST DELIVERY AND PRICE ON:

APPLE • ATARI • TRS-80 MODEL II • INTERTEC •

T.I. 810 • HEWLETT-PACKARD-85 • SOROC •

COMMODORE • NEC • QUME • CENTRONICS

ΩMEGA sells only factory fresh, top quality merchandise to our customers.

ΩMEGA will try to match any current advertised price with similar purchase conditions.

Before you buy anywhere else - be sure to call ΩMEGA Sales Co.

1-401-722-1027 or

# ΩMEGA TOLL FREE

# 1-800-556-7587

ΩMEGA ships via UPS, truck, or air. COD's, VISA, Mastercharge accepted.

"A member in good standing of the better business bureau."



# YOU TOO can become a successful computer ENTREPRENEUR!

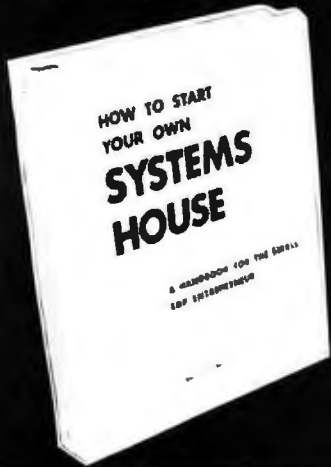

**HOW TO START YOUR OWN SYSTEMS HOUSE** is a practical step-by-step guide for the EDP professional or small businessman who wants to enter the micro-computer systems business.

Written by the founder of a successful systems house, this fact-filled 220-page manual covers virtually all aspects of starting and operating a small systems company. It is abundant with useful, real-life samples: contracts, proposals, agreements and a complete business plan are included in full, and may be used immediately by the reader.

Proven, field-tested solutions to the many problems facing the small systems house are presented.

From the contents:

- New Generation of Systems Houses • The SBC Marketplace • Marketing Strategies • Vertical Markets & IAPs • Competitive Position/Plans of Major Vendors • Market Segment Selection & Evaluation • Selection of Equipment & Manufacturer • Make or Buy Decision • Becoming a Distributor • Getting Your Advertising Dollar's Worth • Your Salesmen: Where to Find Them • Product Pricing • The Selling Cycle • Handling the 12 Most Frequent Objections Raised by Prospects • Financing for the Customer • Leasing • Questions You Will Have to Answer Before the Prospect Buys • Producing the System • Installation, Acceptance, Collection • Documentation • Solutions to the Service Problem • Protecting Your Product • Should You Start Now? • How to Write a Good Business Plan • Raising Capital

6th edition, March 1980 220 pages

**Essex Publishing Co. DEPT. 3**  
285 Bloomfield Avenue Caldwell, N.J. 07006

I would like to order **HOW TO START YOUR OWN SYSTEMS HOUSE** at \$36.00 (New Jersey residents add 5% sales tax)

Check Enclosed  VISA  Mastercharge

Name \_\_\_\_\_

Address \_\_\_\_\_

City \_\_\_\_\_

State \_\_\_\_\_ Zip \_\_\_\_\_

Card # \_\_\_\_\_ exp. \_\_\_\_\_

For immediate shipment on credit card orders call (201) 783-6940

**Listing 1: The BREAKFORTH program.** These six blocks, when loaded into an MMSFORTH system, cause the BREAKFORTH program to compile, execute, and, once finished, erase itself from the system. Tape-based users should omit the last three words in the last block. This program does require that the MMSFORTH words for random numbers (block 32 on the MMSFORTH system disk or cassette) and for TRS-80 graphics (block 33) be available to the FORTH system. If these blocks have already been loaded, delete the two LOAD commands in block 50, line 3. Also, the sequence { A MVI 255 } in lines 10 and 11 of block 51 is the notation FORTH uses for the 8080 assembly-language statement MVI A,255. [To speed up paddle response, you can replace the 3 in block 55, line 8 with a higher value. Personally, I enjoy playing the game at speed level 1, with a 12 replacing the 3....GW]

BLOCK : 50

```

0 ( BREAKFORTH/MMSFORTH, BY ARNOLD SCHAEFFER, PART 1 OF 6 )
1 ( COPYRIGHT 1980 BY MILLER MICROCOMPUTER SERVICES )
2 ( W/SOUND - USE THE LEFT AND RIGHT ARROWS TO MOVE THE PADDLE )
3 : TASK ; 32 LOAD ( RANDOM #'S ) 33 LOAD ( GRAPHICS ) RANDOMIZE
4 0 CARIABLE SPEED 0 CARIABLE SPVAR 0 VARIABLE SCORE
5 0 VARIABLE XPOS 0 VARIABLE YPOS 2 VARIABLE PPOS
6 1 VARIABLE YDIR 1 VARIABLE XDIR 0 VARIABLE BEST
7 : LINE 0 PTC 30 ECHO ;
8 : INIT CLS 0 LINE " SPEED ( 1 - 10, 1 IS FASTEST )"
9 #IN 1 MAX 10 MIN 10 U* SPEED CI
10 0 LINE " NUMBER OF BALLS DESIRED" #IN
11 CLS 64 0 DO 3 I DSET 4 I DSET LOOP
12 48 3 DO I 0 DSET I 63 DSET I 1 DSET I 62 DSET LOOP
13 191 15616 320 FILL 0 SCORE !
14 0 LINE " BREAKFORTH IN MMSFORTH SCORE: 0 BEST:"
15 BEST ? 0 54 PTC " BALL:" ;
    
```

BLOCK : 51

```

0 ( BREAKFORTH/MMSFORTH, BY ARNOLD SCHAEFFER, PART 2 OF 6 )
1
2 : PCLR 32 PPOS @ 16320 + 8 FILL ;
3 : PSET 176 PPOS @ 16320 + 8 FILL ;
4
5 : PADDLE
6 14400 C@ 32 = IF PCLR -1 PPOS @ + 2 MAX PPOS ! PSET THEN
7 14400 C@ 64 = IF PCLR 1 PPOS @ + 54 MIN PPOS ! PSET THEN
8 ;
9
10 CODE 1CASSOUT 1 A MVI 255 OUT NEXT ( THESE 3 LINES )
11 CODE 2CASSOUT 2 A MVI 255 OUT NEXT ( PRODUCE THE SOUND. )
12 : BOP 10 0 DO 1CASSOUT 2CASSOUT LOOP ;
13
14
15
    
```

BLOCK : 52

```

0 ( BREAKFORTH/MMSFORTH, BY ARNOLD SCHAEFFER, PART 3 OF 6 )
1
2 : XCHK
3 XPOS @ 2 < IF XDIR @ MINUS XDIR ! 2 XPOS ! BOP THEN
4 XPOS @ 61 > IF XDIR @ MINUS XDIR ! 61 XPOS ! BOP THEN
5 ;
6
7 : YCHK
8 YPOS @ 5 < IF 1 YDIR ! 5 YPOS ! 1 SPVAR CI BOP THEN
9 YPOS @ 23 < IF SPVAR C@ 4 MIN SPVAR CI THEN
10 YPOS @ 19 < IF SPVAR C@ 3 MIN SPVAR CI THEN
11 YPOS @ 15 < IF SPVAR C@ 2 MIN SPVAR CI THEN
12 ;
13
14
15
    
```

BLOCK : 53

```

0 ( BREAKFORTH/MMSFORTH, BY ARNOLD SCHAEFFER, PART 4 OF 6 )
1
    
```

Listing 1 continued on page 158



# FORTH

## FORTH GENERATION SOFTWARE

### ConcurrentFORTH 64 users/CPU

Data General and compatible systems  
Digital Equipmt Corp PDP 11, LSI 11 VAX 11-780  
IBM Series 1 Texas Instrument 990

### Custom Systems Professional/Commercial/OEM

1802 6502 6800 6809 68000 8080 8085  
280 Z8 Z8000 TI9900 micronova HP21

### Systems level software

File Systems  
Data base management  
Non-procedural query languages  
Word processing Office Automation  
Industrial Control

Send RFP with your requirements to;

# ANCON

17370 Hawkins Lane  
Morgan Hill, CA 95037

Circle 106 on inquiry card.

### PUBLIC SERVICE ANNOUNCEMENT

For general information join FORTH interest group \$12.00 to; P.O. Box 1105, San Carlos, CA 94070. Source code for popular micros \$10.00, installation manual \$10.00, Programming manual "Using FORTH" \$25.00. No purchase orders. Circle 311 on inquiry card.

# The 2nd Generation... It's all that it's Cracked up to be.



## MEASUREMENT systems & controls incorporated

FOR THE APPLE II & APPLE II PLUS\*

# LOOKING FOR THE HOTTEST BUSINESS SOFTWARE?

## COMPARE!

Financial Management System (FMS), developed by Darrell's Appeware is truly the ultimate in totally integrated business systems designed for the small businessman. FMS fills the businessman's needs with a speed comparable to many of the larger systems. FMS packages include a firmware board containing special programming for file maintenance called KSAM (for "Keyed Sequential Access Method"). "KSAM" instantly sorts the files and gives less than 2 second access into any file while maintaining the file in sequence.

- \*OPEN ITEM RECEIVABLES
- \*CARRY-OVER OF TERMS IN POINT OF SALE
- \*REUSE INVOICE/CUSTOMER NUMBERS AFTER DELETION
- \*ALLOWS DISCOUNTS
- \*ACCEPTS CREDIT BALANCES
- \*COMPANY NAME OPTIONALLY PRINTED ON STATEMENTS
- \*SELECTIVELY GENERATE STATEMENTS PASTDUE REPORT
- \*INTEREST APPLICATION PROGRAM RECEIPT OF PAYMENTS BY CUSTOMER NUMBER OR INVOICE
- \*PERPETUAL INVENTORY
- \*UP TO 28,800 LINE ITEMS POINT OF SALES
- \*CREATES RECEIVABLES
- \*MERCHANDISE RETURNS
- \*GENERATES "QUOTATION"
- \*CASH OR CHARGE
- \*ACCOUNTING FOR SHIPPING REORDER REPORT
- \*PARTS RECEIVED REPORT

- LEDGER
- \*MAINTAINS CURRENT AND YEAR TO DATE DATA
- \*MAY BE UPDATED AS DESIRED COMPREHENSIVE LEDGER REPORT INCOME AND BALANCE SHEET REPORTS
- \*PERCENTAGES WITH CURRENT AND YEAR TO DATE TOTALS PAYROLL
- \*PROCESSES 100 EMPLOYEES PER DISKETTE
- \*DOUBLY PASSWORD PROTECTED
- \*USER ENTERED TAX TABLES FOR EASY UPDATING
- \*MAINTAINS EMPLOYEE RECORDS AS REQUIRED
- \*PRODUCES CHECKS WITH COMPREHENSIVE STUB SUBSTANTIAL REPORTS QUARTERLY AND W-2'S

- ACCOUNTS PAYABLE
- \*DISCOUNTS EARNED BY DATE AND PERCENT
- \*PAYMENT BY VENDOR, INVOICE, OR BOTH DETERMINED BY DOLLAR AMOUNT
- \*IMPLEMENTATION OF CREDIT MEMOS
- \*ACCOUNTING FOR CONTINUING PAYABLES (I.E., MORTGAGES)
- \*WITHHOLD PAYMENT BY INVOICE
- \*WILL POST TO SPECIFIC LEDGER EXPENSE ACCOUNTS
- CHART OF ACCOUNTS
- \*HANDLES 250 ACCOUNT NUMBERS
- \*MAINTAINS CURRENT, YEAR 1 AND 2 DATA GENERAL JOURNAL
- \*EASY ENTRY
- \*ALL TRANSACTIONS WRITTEN TO GENERAL JOURNAL

\*APPLE II & APPLE II PLUS are registered trademarks of Apple Computer, Inc.

SEE  
YOUR  
LOCAL  
DEALER

FMS = DESIGN  
NOT  
ADAPTATION

Darrell's  
Appeware, Inc.

11410 S.E. Petrovitsky Rd., Suite 207, Renton, WA. 98055

(206) 226-1224

Financial Management System (FMS) was originally designed and created on the Apple II, thus utilizing all of the computer's special characteristics. Development included confirmation of small business book-keeping techniques and practices by a firm of active CPA's. Unlike some of the financial programming on the market today, there was not the need to make compromises to enable system operation.

Text continued from page 154:

precision number to be entered from the keyboard and placed on top of the stack. The phrase { 1 MAX } causes the number to be replaced by 1 if the number just entered is smaller. Similarly, the phrase { 10 MIN } limits the number on the top of the stack to a maximum value of 10. { 10 U\* } multiplies the number by 10 ( U\* is an unsigned single-precision multiply), and { SPEED C! } stores the value from the top of the stack in the single-byte variable SPEED .

Each of the above phrases contains a number and an operation. Since each operation requires two numbers on the stack, the number entered by #IN is the first number, with the second number always being supplied by the first word of the phrase.

Using the same words as listed above, line 10 again clears line 0, prompts for the number of balls to be used in the game, putting that number on top of the stack with the word #IN .

Line 11 clears the video screen again and sets up the back (top) wall of the BREAKFORTH "court" using a do-loop and double-width graphics. In FORTH, the parameters of the loop go on the stack before the loop is called, so { 64 0 DO } begins the loop, and the word LOOP ends it. The loop will be executed sixty-four times, and the word I puts on top-of-stack the current value of the loop (0, 1, 2, 3, ... ,63); note that I does not take on the limit value of 64. The phrase { 3 I DSET } sets a double-width character at row 3, (double-width) column I; similarly, { 4 I DSET } sets the double-width character on the next row below the first.

Similarly, line 11 sets the right and left walls of the BREAKFORTH court, columns 0 and 1 for the left wall and columns 63 and 64 for the right wall.

The phrase { 191 15616 320 FILL } in line 13 creates the initial wall of bricks by using character code decimal 191 (a whited-out character cell) to fill an area of memory (the video display area of the TRS-80) starting at location 15616 and filling for a total of 320 bytes.

The phrase { 0 SCORE ! } , also in line 13, shows us how we store a

Listing 1 continued:

```

2 2 CONSTANT 2 -2 CONSTANT -2
3
4 : PCHK 0 YPOS @ 47 >=
5 IF 46 YPOS ! XPOS @ PPOS @ - DUP 0 >= OVER 8 < AND
6 IF -1 YDIR ! BOP
7 NCASE 0 1 2 3 4 5 6 7 " -2 -1 -1 -1 1 1 1 2 CASEND
8 XDIR !
9 ELSE DROP 1+
10 THEN
11 THEN
12 ;
13
14
15

```

BLOCK : 54

```

0 ( BREAKFORTH/MMSFORTH, BY ARNOLD SCHAEFFER, PART 5 OF 6 )
1
2 : CLR
3 XPOS @ 2 - 124 AND 2+ DUP 4 + SWAP DO YPOS @ I DCLR LOOP
4 YPOS @ 27 - ABS SCORE +! 0 32 PTC SCORE ? BOP
5 YDIR @ MINUS YDIR !
6 ;
7
8 : BALLCHK YDIR @ YPOS +! XDIR @ XPOS +! XCHK YCHK PCHK
9 YPOS @ XPOS @ D? IF CLR THEN
10 ;
11
12 : BALL YPOS @ XPOS @ DCLR
13 BALLCHK DUP 0= IF YPOS @ XPOS @ DSET THEN ;
14
15 : GAMECHK SCORE @ 1800 MOD 0= IF 191 15616 320 FILL THEN ;

```

BLOCK : 55

```

0 ( BREAKFORTH/MMSFORTH, BY ARNOLD SCHAEFFER, PART 6 OF 6 )
1 : DELAY SPEED C@ SPVAR C@ U* 0 DO LOOP ;
2 : BREAKFORTH
3 BEGIN INIT 0 PSET
4 DO 2000 SPEED C@ / 0 DO DELAY PADDLE LOOP
5 0 60 PTC I 1+ . 5 SPVAR C!
6 2 RND 1 = IF 1 ELSE -1 THEN XDIR ! 1 YDIR !
7 58 RND 2+ XPOS ! 29 YPOS !
8 BEGIN 3 0 DO PADDLE LOOP
9 BALL GAMECHK DELAY
10 END
11 LOOP SCORE @ BEST @ MAX BEST !
12 8 18 PTC " RUN GAME AGAIN " Y/N
13 END
14 ;
15 BREAKFORTH FORGET TASK DIR

```

value (0) in a variable ( SCORE ) by using the store operator [ ! ] . Two points should be mentioned here. First, executing a variable name (like SCORE ) causes the address of the variable, not its value, to be pushed onto the top of the stack. Second, the store operator [ ! ] requires the value to be the second-to-top item in the stack and the address of the variable receiving the new value to be the top item in the stack.

The words in line 14 clear line 0 and print a message on the same line, setting the score to zero but leaving the cursor just after the colon that

ends the message.

In line 15, the phrase { BEST ? } causes the value of BEST to be displayed on the screen, and the rest of line 15 completes the message that is shown on line 0 of the screen. Finally, the semicolon on line 15 ends the definition of INIT begun on line 8.

### The Middle Blocks

Whew, that was a lot of explaining! Now you see why FORTH is not very easy for beginners to read—you are packing a lot of work into a small space, using an ever-more-specialized



# You Know Tarbell



## But, do you know all the components on Tarbell has ready for you?

When someone says "Tarbell" there's no doubt what's meant . . . the cassette interface whose reliability and solid engineering made it an industry standard.

Since that first breakthrough-product, Don Tarbell has expanded his list of useful, dependable components . . . components to meet your needs of today, and keep you prepared for tomorrow.

Check this partial list of quality components Don Tarbell has ready for you. You're probably ready for them, right now.

- When it comes to RAM memory, Tarbell means reliability. 16K and 32K static memory that offers you easier trouble shooting, and far easier maintenance. Remember that.

- Tarbell BASIC brings simplicity and sophistication to your programs. Our BASIC is easier to program, and offers unique commands and statements not found in regular BASICS under any name.

- CP/M® disk operating system is, of course, the standard for software exchange. At Tarbell we provide our own approved CP/M system modified for all Tarbell floppy disk interfaces. Note. We also have MP/M® for those interested in multi user systems.

- The Tarbell VDS line comes as a complete package . . . or, as separate units. For example, the Tarbell mainframe can be ordered with 1 or 2 Shugart or Siemens drives, or no drives. Whichever way you go, you get the reliability of Tarbell tested components.

- With the Tarbell Double Density floppy disk interface, storage capacity, speed and versatility are greatly increased. Under our DD CP/M, single and double density disks may be intermixed, with no penalty. The system automatically determines which is in place.

We also still have our Single Density floppy disk interface. It's specifically designed to operate with many different and unusual drives. Naturally, they're Tarbell tested.

*Tarbell*  
Electronics

950 Dowlan Place, Suite B  
Carson, California 90746  
(213) 538-4251 / 538-2254

\*CP/M & MP/M are products of Digital Research Corp.

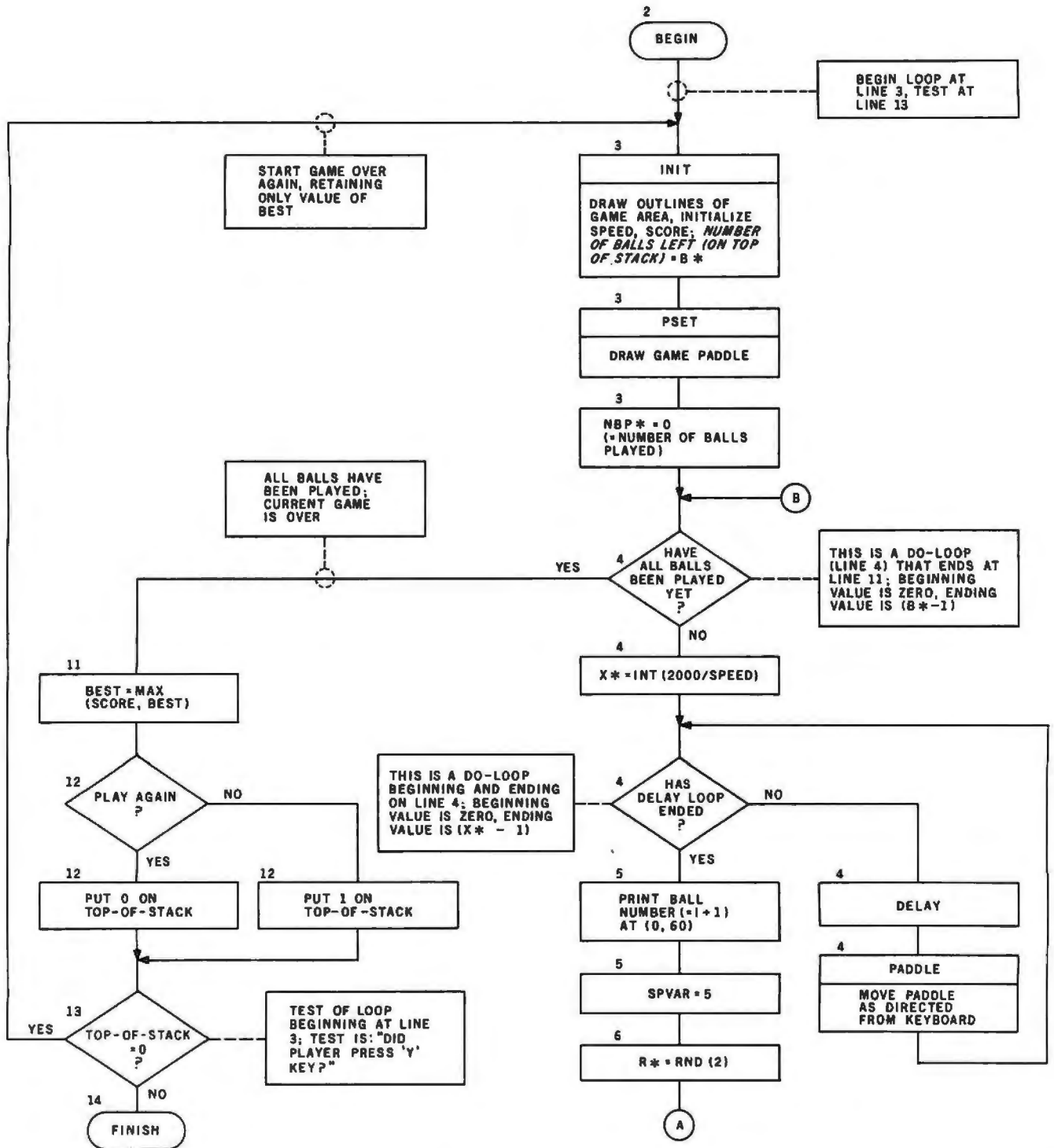

Figure 3: A flowchart for the BREAKFORTH program (given in listing 1, block 55). The number above each box is the line number within block 55 that performs the action of the box. Many calculations in FORTH are done on the stack and do not acquire variable names. Because of this, an asterisk in a variable or procedure name (eg: X\*, 3PADDLE\*) denotes that the name was given only in this flowchart to add clarity.

instruction set. Experience with reading and writing FORTH code makes the process easier, but spacing, indentation, use of descriptive word names, and lots of comments are always helpful. A surprise to the BASIC user: none of these source-

code editing improvements use any extra programmable memory space.

Table 1 explains much of what the words in blocks 51 thru 54 do, but let us look at some of the interesting features contained in these lines of FORTH code.

When the ten-to-twenty times speed increase of FORTH over BASIC is not enough (or when we want to do things that cannot be done with existing FORTH words), we can redefine some FORTH words in the assembly language of the computer



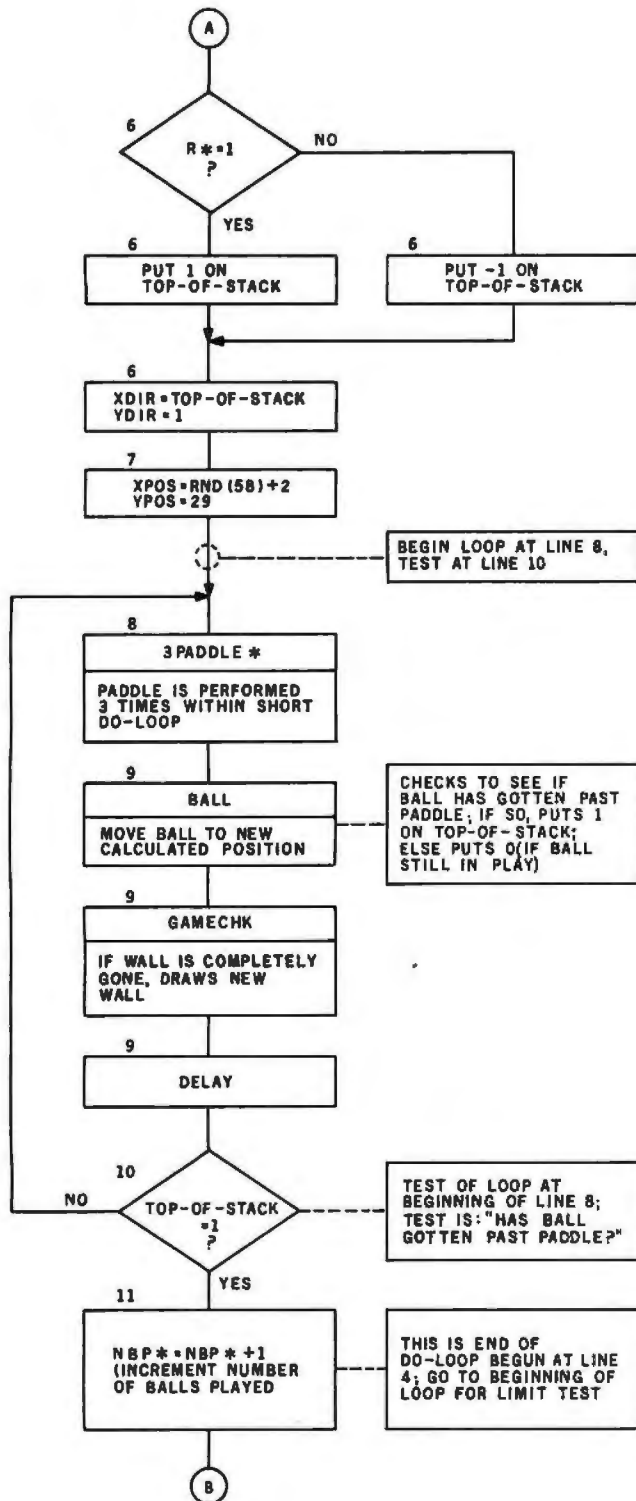

(in the case of the TRS-80, 8080 or Z80 assembly language). When we want a FORTH word (program) to run faster, usually a short assembly-language definition of the word that gets used the most will speed things up sufficiently. Lines 10 and 11 of block 51 are the only two words used in BREAKFORTH that are defined in 8080 assembly language.

(MMSFORTH comes with a compact 8080 assembler built in, like many Z80-based FORTHS. A full Z80 assembler also is available from MMS at a modest price.)

Inspection of lines 10 and 11 of block 51 shows that assembly-language definitions begin with the word CODE (instead of { : } ) and end with the word NEXT (instead

of [ ; ] ). Here, FORTH's 8080 assembler is used to define a new type of word to output to a port. Both 1CASSOUT and 2CASSOUT drive the cassette recorder port (I/O port 255 on the TRS-80), and the word BOP executes both these words in a do-loop ten times to create a short square-wave sound on the external speaker.

The definition of PCHK ("paddle check" of ball location) in block 53 uses two more constructs. There are two *if* constructs, the inner one beginning in line 6 and ending in line 10, the outer beginning in line 5 and ending in line 11. (Notice that only the inner loop uses the optional *else* clause, as in line 9.) The second construct is a numeric *case* construct, NCASE ; as shown in line 7. When NCASE is executed, it expects the number on top of the stack to be one of the numbers listed between NCASE and the double quote marks (here, zero thru seven). The value found causes the execution of the corresponding FORTH action word in the series of apparent numbers between the double quote marks and the word CASEND. (Numbers are words but are not in FORTH's dictionary—when they are "executed," they are pushed on top of the stack. MMSFORTH case statements require their action words to be words in the FORTH dictionary and not numeric literals, so in block 53, line 2, 2 and -2 are defined as constants (FORTH words). 1 and -1 are already defined as constants by standard FORTH. Taking { 2 CONSTANT 2} as an example, the first 2 is the value of the constant, while the second 2 is the name of the constant; we might have used the word TWO in its place.) In our program, { 0 NCASE } causes the word -2 to be executed. { 1 NCASE } , { 2 NCASE } , or { 3 NCASE } cause -1 to be pushed on top of the stack, and so on. Only one of the words is executed; execution then continues with the first word after CASEND . MMSFORTH also has an alpha-numeric case statement that branches on the value of a single character. Each may be thought of as a compact, structured, many-branched alternative to a nested series of *if* statements.

### The Last Block

Block 55, the last block used to

Word Name	Usage
SPEED	CVARIABLE contains speed of play.
SPVAR	CVARIABLE contains speed multiplier, depends on height ball reaches.
SCORE	VARIABLE contains current score.
XPOS	VARIABLE contains current ball X position (range, 2 thru 61).
YPOS	VARIABLE contains current ball Y position (range, 5 thru 47).
PPOS	VARIABLE contains current paddle position (range, 2 thru 54).
XDIR	VARIABLE contains current ball X increment (possible values: -2, -1, 1, 2).
YDIR	VARIABLE contains current ball Y increment (possible values: -1, 1).
LINE	Expects <i>n</i> on top of stack; moves cursor to line <i>n</i> , clears line.
INIT	Asks questions and draws display.
PCLR	Clears paddle.
PSET	Draws paddle.
PADDLE	Checks for right- or left-arrow key being pressed and moves paddle appropriately.
1CASSOUT	8080-code procedure for sound.
2CASSOUT	8080-code procedure for sound.
BOP	Makes one bounce noise.
XCHK	Checks if ball hit either side wall, modifies XDIR and XPOS if necessary.
YCHK	Checks if ball hit top wall and modifies YDIR and YPOS if necessary; also sets speed multiplier.
PCHK	Checks if ball at paddle level; if so, did it hit paddle or is it out of play? Leaves F on top of stack; F = 0 if ball still in play, else 1.
CLR	Clears brick, modifies score and YDIR.
BALLCHK	Increments ball position and checks for wall, paddle, or brick hits. Leaves F on top of stack; F = 0 if ball still in play, else 1.
BALL	Clears old ball position, calls BALLCHK, and draws new ball; see BALLCHK for value left on top of stack.
GAMECHK	Checks if all bricks cleared and draws new barrier if so.
DELAY	Causes a given time delay between ball moves.
BREAKFORTH	Main game loop.

**Table 1:** Table of variable names and FORTH words used in the BREAKFORTH program. Note that all variables leave their address on the stack, that LINE removes one entry from the stack before executing, and that PCHK, BALLCHK, and BALL add one entry to the stack after executing.

define the word BREAKFORTH, defines one last word ( DELAY, in line 1), then puts all the words defined so far together to define the word (which is also the program) BREAKFORTH. This is a good demonstration of how FORTH is meant to work: first you define specialized words that are helpful in solving problems of a given class or application, then you use them to write the specific program needed.

# WHY CAN'T MICROPOLIS DO THINGS LIKE EVERYONE ELSE?



(The building words, if chosen and defined properly, can be used to help write other programs in the same class.)

The word BREAKFORTH is defined in lines 2 thru 14. A flowchart for the program is given in figure 3; the number to the left of each box gives the line number within block 55 which the box is associated with.

Line 15, the last line of block 55, is interesting in that it triggers all the work done so far. The word BREAKFORTH causes the definition of the word to be executed. Once the game is finished, the next words, { FORGET TASK }, are executed; these words cause the word TASK (remember block 50?) and every word defined after it to be erased from the vocabulary of the language. This is done to free up the computer once we are finished playing BREAKFORTH. You can omit these words if you wish, but the disk program is recalled into memory so easily (with the phrase | 50 6 LOADS | ) that most people prefer to keep the FORTH dictionary as uncluttered as possible. The last word, DIR , causes the standard disk

MMSFORTH directory to be displayed on the screen. (The last three words should be deleted if you are running the cassette version of MMSFORTH.)

### Summary

It takes some work to understand your first FORTH program. But this work is only the flip side of the same coin that makes FORTH such a powerful language—where else can you easily write such a large and speedy program in such a small space? [The only other candidate language I can think of is APL, which is also known for its compactness and unreadability to the uninitiated. . . GW] But, of course, your second FORTH program is easier than your first, and so on. Better yet, your second program may be 90% written by your first, thanks to FORTH's structured and modular design.

We hope you have enjoyed this introduction to FORTH. We can assure you that it has just scratched the surface of FORTH, which performs equally well in process control projects and business applications. FORTH improves our programming

skills while improving our computer's effective speed, memory capacity, and instruction set. It is a most satisfying language. ■

*Miller Microcomputer Services offers a number of products and services based on the FORTH language. Version 1.9 of MMSFORTH, the language used in this article, runs on a 16 K-byte or larger TRS-80 Model I with Level II BASIC. The disk version is \$79.95, and the cassette version is \$59.95. Each package contains the complete MMSFORTH system (including a full-screen editor and an 8080 assembler), FORTH source code, documentation, and the microFORTH PRIMER book from FORTH Inc.*

*For further information, send a self-addressed, stamped business envelope to:*

*MMSFORTH Information  
Miller Microcomputer Services  
61 Lake Shore Rd  
Natick MA 01760*

To be honest, we could. But our customers have come to expect a lot more from us.

They've come to appreciate our desire to innovate, to improve upon, to blaze new trails in floppy disk technology. That's how we got our reputation as the industry's undisputed technological leader.

### 96 TPI is nothing new for us.

Consider the current hubbub about "new" 96 TPI disk drives. You should know that what may be new to our competition is anything but new to us.

After all, we brought the 100 TPI MegaFloppy™ disk drive to the marketplace more than two years ago. And we've delivered more than 50,000 drives already.

To us, a 96 TPI drive is no big deal. So for the customer who's looking for a double track drive offering compatibility with 48 TPI drives, Micropolis can deliver.

### Think of us as double headquarters.

We should also mention that our double track disk drives give you all the storage capacity of an 8-inch floppy in the body of a 5¼-inch floppy. And with our double head version, you get up to 1.2 megabytes. That's more than ten times the capacity of other 5¼-inch floppies.

But our innovations don't stop there. Over the years, many of our ideas have gone on to become

industry standard. And many more will.

Things like stainless steel, precision-ground lead screws instead of cheaper, less reliable plastic positioners.

We also developed a special disk centering mechanism that is the most accurate in the industry.

And who do you think successfully adapted Group Code Recording technology to the floppy disk drive industry? None other than Micropolis.

Remarkable as our technical achievements may be, some people still wonder how we got to be number two so rapidly in such a fiercely competitive business.

Obviously, we did it by design.



## MICROPOLIS™

**Where the 5¼-inch OEM drive grew up.**

Micropolis Corporation, 21329 Nordhoff Street, Chatsworth, CA 91311 For the telephone number of your nearest OEM rep. call (213) 709-3300

# FORTH Extensibility

## Or How to Write a Compiler in 25 Words or Less

---

Kim Harris  
1055 Oregon Ave  
Palo Alto CA 94303

---

A computer language should help users solve problems. Languages bridge the gap between the primitive operations the computer can perform (add, fetch from memory, etc), and the tasks a user needs (invert a matrix, search a file, etc). When the operations of an application are well matched to those of a language, the solution can be simplified and developed in less time; in addition, the resulting program becomes more readable.

Because all applications have various needs, it is impossible for a nonextensible computer language to satisfy all needs equally well. Although languages have been produced which attempt to include all possible operations, structures, and facilities, these have not been satisfactory.

FORTH's approach is to provide a few techniques that allow a user to quickly add the special operations his particular application requires. The remainder of this article will describe some of these techniques and give examples that add arrays (with and without subscript range checking), virtual arrays, and a case selection control structure.

### Extending the Language

The ability to add language facilities and compiler structures is called *extensibility*. FORTH is extensible on three levels of increasing power:

- using existing compilers
- creating new compilers
- creating new operating systems

#### Editor's Note

In this article, Kim Harris uses the syntax of FORTH-79, which is different from that of existing FORTH implementations, for his examples. FORTH-79 is a standard set of FORTH words that, if used to build all other FORTH words needed for a given application, insures the complete portability of a given program between different versions of FORTH. Members from FORTH Inc, the FORTH Interest Group, the European FORTH Users' Group, and MMS worked together to define FORTH-79. I have noted the differences between the text and existing FORTH implementations (in particular, fig-FORTH and MMSFORTH) where known....GW

This article focuses on the second level and demonstrates the construction and use of specialized compilers. The specialized compilers are usually simple (definable in a few source lines), but permit entire new classes of language or compiler facilities to be added to a FORTH system.

The compilation of any computer language is diagrammed in figure 1. Compilation is the process of converting a source language program into a form that a computer can use.

FORTH uses multiple compilers to implement different compiler functions. For example, compiling a data structure declaration (eg: an array) is distinctly different from compiling an executable statement. FORTH uses separate compilers for these two activities. Such compilers are many times simpler than the compilers for most popular languages (eg: BASIC, Pascal, COBOL); however, a collection of FORTH compilers can perform all the functions of the other languages' compilers (when these functions are adapted to a FORTH-like environment).

FORTH uses the English word "word" to mean an executable procedure, not a piece of memory. In this article, "word" will be used in the FORTH sense, and storage sizes will be specified in terms of 8-bit bytes.

### User-Defined Words

The input language to the FORTH compilers is a sequence of FORTH source language word-names separated by spaces. (Unlike other languages, a space in FORTH is *very* important.) The output is one *dictionary definition* for each new word (procedure) compiled. The compilation process is controlled by special FORTH procedures called *defining words*. A *source definition*, which is a series of FORTH words including defining words, specifies a procedure that can be compiled by executing (typing in) the sequence. The result of compilation is a



Figure 1: Compilation of any computer language. A program in some computer language is input to a compiler. The compiler produces a functionally equivalent program in a different, object language.



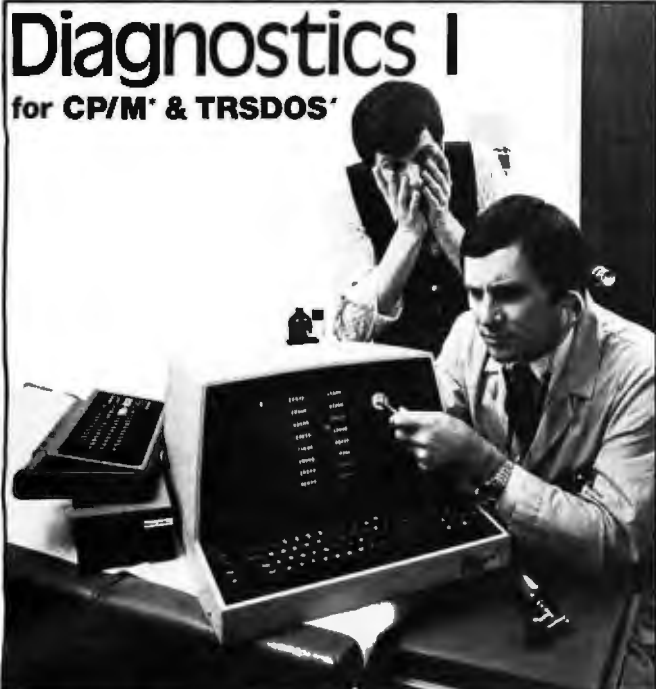

# Diagnosics I

for CP/M\* & TRSDOS\*

Someday your computer is going to break; even the most reliable computer systems "go down". Often, finding exactly what is wrong can account for the most time consuming part of repairing the system, and the longer the system is down, the more money you lose.

DIAGNOSTICS I is a complete program package designed to check every major area of your computer, detect errors, and find the cause of most common computer malfunctions, often before they become serious. For years, large installations have run daily or weekly diagnostic routines as a part of normal system maintenance and check-out procedures.

DIAGNOSTICS I is designed to provide that kind of performance testing for 8080/Z80 micro computers.

DIAGNOSTICS I will really put your system through its paces. Each test is exhaustive and thorough. The tests include:

- Memory Test      -CPU Test (8080/8085/Z80)      -Printer Test
- Disk Test            -CRT Test

To our knowledge, this is the first CPU test available for 8080/Z80 CPU's. Many times transient problems, usually blamed on bad memory, are really CPU errors.

A good set of diagnostics is an indispensable addition to your program library even if your system is working fine. Hours have been wasted trying to track down a "program bug" when actually hardware was to blame!

DIAGNOSTICS I also allows you to be confident of your system.

This can be critical when file merges or sorts and backups are involved. You want to be as sure of your computer as possible during these critical times. Running DIAGNOSTICS I prior to these and other important functions helps to insure that your system is operating at peak performance.

DIAGNOSTICS I is supplied on discette with a complete users manual.

**DIAGNOSTICS I: \$60.00      Manual only: \$15.00**

**Requires: 24K CP/M; 16K disc for TRS-80**

**formats: CP/M 8" SOFT SECTORED, NORTHSTAR CP/M AND TRS-80 DOS**



All Orders and General Information:  
**SUPERSOFT ASSOCIATES**  
 P.O. BOX 1628  
 CHAMPAIGN, IL 61820  
 (217) 359-2112

**Technical Hot Line: (217) 359-2691**  
 (answered only when technician is available)

\*CP/M REGISTERED TRADEMARK DIGITAL RESEARCH  
 \*\*TRSDOS, THE 80 TRADEMARKS TRS-DOS COMP

# MARK GORDON COMPUTERS

DIVISION OF MARK GORDON ASSOCIATES, INC.  
 15 KENWOOD ST., CAMBRIDGE, MASSACHUSETTS 02139  
 (617) 242-2749      (617) 491-7505

## SD SYSTEMS COMPUTER KITS

- ★ EXPANDORAM I (No RAMS) ..... 169.00
- ★ VERSAFLOPPY CONTROLLER I .. 189.00
- ★ SBC-100 Single Board Kit ..... 239.00
- ★ Z80 Starter ..... 269.00

## OTHER SPECIALS

- ★ 16K Memory Kit ..... 59.00
- ★ CAT Modem ..... 159.00
- ★ Leedex Monitor ..... 109.00
- ★ Atari 400 ..... 499.00
- ★ Atari 800 ..... 779.00
- ★ Hazeltine 1410 ..... 699.00

**CALL COLLECT TO ORDER**

### ORDERING INFORMATION

We accept Visa and Mastercharge. We will ship C.O.D. certified check or money order only. All orders must include 4 percent for shipping and handling. Massachusetts residents add 5 percent sales tax.

The Company cannot be liable for pictorial or typographical inaccuracies.

# The 2nd Generation is shaping up...

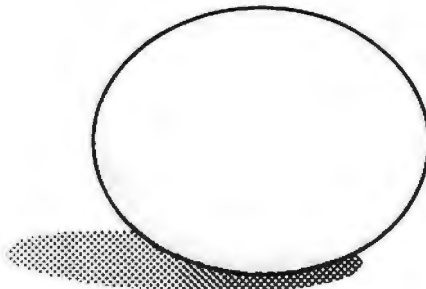

**MEASUREMENT**  
 systems & controls  
 incorporated

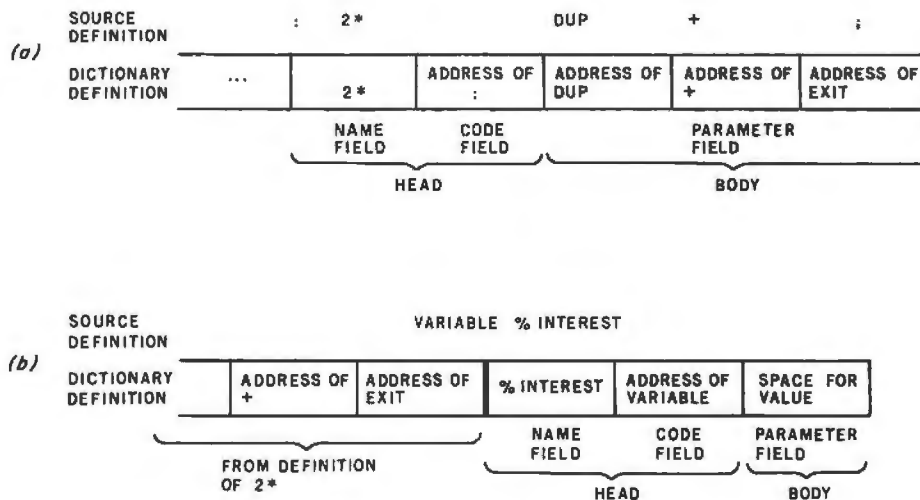

Figure 2: Examples of extending the FORTH language. The first source line adds a new operator named 2\* (see figure 2a); the second source line adds a new operand named %INTEREST (see figure 2b).

dictionary definition, which is a block of FORTH-interpretable instructions. All compiled FORTH words are kept in this dictionary, which is usually located in the computer's memory.

User-defined words are treated the same as system-supplied words. If some new words are defined which behave like operators (eg: triple-precision versions of the FORTH words +, -, \*, /, etc), then the language has been truly extended to include these operators. Subsequent words may use these new words as system-supplied operators.

Examples of standard, system-supplied defining words are { : } (colon), which starts the compilation of subroutine-like procedures, and VARIABLE, which compiles a named memory location for the variable's value.

A source definition consists of a defining word followed by the name of the word being defined and then by other FORTH words and numbers. Figure 2 illustrates the source definitions and the corresponding dictionary definitions for two new words named 2\* and %INTEREST. (FORTH word-names may be made of any nonblank characters.) The word 2\* simulates a multiplication by 2 by adding a value to itself.

The defining word { : } compiles the words that follow it in a definition, which is then added to the dictionary. Each FORTH dictionary definition consists of two parts: a *head* and a *body*. The head contains system-internal information including a *name field* and a *code field*. (A *link*, which points from a definition to a previous definition, is part of the head but will be ignored in this article.) The name field contains the name of the word. The code field contains a pointer to the instructions that will be executed when the word is executed.

For definitions compiled by { : }, the code field points to a procedure that begins the execution of the words referenced in the definition. The body of this kind of definition, called the *parameter field*, is a series of addresses that point in order to each FORTH word in the definition. The addresses of these referenced words are placed in the parameter field by the { : } compiler, and

the definition is ended by the FORTH word { ; } (semicolon). The execution of the word EXIT (compiled at the reference to { ; }) ends the execution of the word.

### Some Examples

The word 2\* will leave a result that is twice the value of its input. (See figure 2a.) Examples in this article will underline the input typed by the user and will end in an unseen carriage return; the computer's response follows. The following line shows the use of the word 2\* :

3 2\* . 6 OK

The use of 2\* causes the words in its definition to be executed, as if the user had typed:

3 DUP	two copies of 3 on the stack
+	add both 3s
.	print result from top of stack

Any subsequently compiled word may call the word 2\* as if it were any other FORTH word. When called, 2\* performs its function and then returns. This is analogous to the execution of a subroutine call in other languages.

A word is called by simply using its name, as in the following source definition for 4\* .

: 4\* 2\* 2\* ;

The defining word { : } has been used to compile another definition into the dictionary.

Using 4\* will cause 2\* to be called and executed twice. Here is an example of the use of the word 4\* .

3 4\* . 12 OK

The second word defined in figure 2 uses the defining word VARIABLE to compile a dictionary definition that contains data. The source word-name %INTEREST is compiled into a new dictionary definition containing a



Level	Method
I	Using standard FORTH defining words to add new operations (programs).
II	Creating new user-defined defining words that, in turn, create new classes of words.
III	Creating new FORTH-like systems through metaFORTH.

**Table 1: Levels of extensibility in FORTH.** Level I refers to the act of defining ordinary words in FORTH using standard defining words. Level II refers to the creation of new defining words that are then used to create a family of ordinary FORTH words. Level III refers to the act of altering and re-compiling FORTH itself (sometimes called metaFORTH) to create significantly different variant FORTH-like systems. Higher levels imply greater capability and flexibility.

2-byte area where the value of the variable will always be stored. (The use of the word-name %INTEREST, either inside or outside a definition, will cause the address of this variable's value to be returned, not the value of the variable.)

The dictionary definition for %INTEREST contains the variable's name, a pointer to the instructions executed when %INTEREST is executed, and a 2-byte data area. The code fields of all words defined by VARIABLE point to a procedure which returns the address of the data area of the variable when the variable's name is referenced. All FORTH words, even data words, have some code that is executable.

The two defining words of this figure are actually different compilers. The defining word { : } compiles procedure definitions, while the defining word VARIABLE compiles data definitions. All user-added operators and operands can be used exactly like the system-supplied ones. Even new control structures can be added to the FORTH compiler by the user.

### Levels of Extensibility in FORTH

As shown in table 1, there are three levels of extensibility supported by FORTH. The two words defined in figure 2 are examples of extensibility level I, the most commonly used level. It comprises the "ordinary" act of programming in FORTH. Although it is very useful, this level is the most restrictive and the least powerful of the three.

The process of writing and using new defining words is the second level of extensibility. Level II, which is more powerful than level I, allows a new "family" of words to be added to the language or compiler. This is done by creating a special word, called a *defining word*, that will be used to create FORTH words in the same family. The user specifies via the defining word how the compilation of a new family member (itself an ordinary FORTH word) is to be performed and what the result will be. Also the user specifies what a member of the family will do when it is executed.

Level III, the highest level of extensibility, is called *metaFORTH*. It uses the entire FORTH system to compile a collection of source definitions (including both lower levels) in order to produce a clone or a mutation of FORTH.

# SSG Writing and Mailing Systems.



Take Letterright for quick document preparation and edit plus NAD Name And Address for extensive mailing list capabilities.

Put them together and you've got a flexible, powerful solution to big and small correspondence problems.

With Letterright you create and edit your document right on the screen. It's much easier to use than a typewriter. The letters are always perfect, and revisions are a snap.

Letterright's "wild card" slots let you create standard letters and forms, then insert information selected from your mailing list to address and "personalize" the letter.

The NAD system will store lots of names and addresses, with identifying information you create. You then print lists, labels, or envelopes of virtually any group you want from the list, or the whole list.

This pair should be working for every microcomputer owner.



Letterright and NAD are part of a full line of working software solutions from Structured Systems Group, all ready to run on any CP/M® microcomputer system. CP/M is a registered trademark of Digital Research.

## Structured Systems

5204 Claremont Oakland, Ca 94618 (415) 547-1567  
Circle 110 on inquiry card.

# DISCOUNT PRICES

Microcomputers & Peripherals

**B**ITS  
BYTES  
BOOKS  
BARGAINS

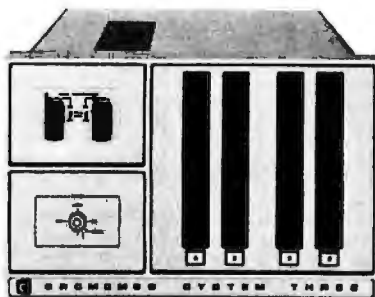

Cromemco • SWTPC • Lear-Slegler  
Hazeltime • RCA • North Star  
Verbatim • Perkin Elmer and others

Fast, off the shelf delivery.  
Call TOLL FREE 800/523-5355

**MARKETLINE SYSTEMS, Inc.**  
2337 Philmont Ave., Huntingdon Valley, Pa. 19006  
215/947-6670 • 800/523-5355

Dealer Inquiries Invited

## APPLE II® DISK SOFTWARE DATA BASE MANAGER - IFO PROGRAM

The IFO (Information File Organizer) can be used for many applications such as sales activity, inventory, check registers, balance sheets, client/patient records, billing and much more. This can be accomplished easily and quickly without prior programming knowledge.

Up to 1000 records with a maximum of 20 headers and 10 report formats can be stored on a diskette. Information can be sorted and searched (3 levels). Mathematical functions can be performed to manipulate the information. Subtotals and totals can be calculated on any numeric field.

Requires 48K and Applesoft II on ROM (or Apple II Plus). Accommodates serial/parallel printers. Error protection devices provided. Program diskette and instruction manual - \$100.

**MAILING LIST PROGRAM** - Print labels sorted or searched by 6 fields. On-screen editing. Line up routine. \$40.00

**Inventory Program** - \$140

**Payroll Package** - \$240 (Specify state)

**Apartment Manager** - \$325

**Professional Time & Billing** - \$325

**Speed Reading** - \$100

Send check/money order to:

**SOFTWARE TECHNOLOGY for  
COMPUTERS (STC)**

P.O. Box 428

Belmont MA 02178

or available from your local dealer

## CONTRACT PROGRAMMERS \$15 to \$30 per Hour

Our clients have immediate short-and long-term assignments available for experienced programmers in either field -- mini/mainframe. Paid weekly; full benefits available.

- Software Tech. Writers
- Software/Hardware Engineers (INTEL 8085)
- Programmer/Analyst (COBOL, IBM, or DEC 10)
- Systems Programmer (Mini/Micro Assembly, FORTRAN, & BASIC plus)



**digital arts group  
CONTRACT  
SERVICES**

For immediate consideration, contact:  
Jim Barry, Suite 101.

Nine Bedford Street  
Burlington, MA 01803  
(617) 273-2780



## MicroByte Software

2415-C Gateway Plaza  
Crabtree Blvd.  
Raleigh, North Carolina 27604

AT LAST! A fully implemented computer based file management system... Only a few minutes of instruction and you are creating and using your own client lists, mailing lists, inventories, bibliographies, vendor lists, and more.

### DBMS80

Files, lists, or records, with user defined formats, can be created, sorted, edited, and printed with ease. Sub-files can be created out of parts of existing files, selecting parts of a record or individual records by a search criterion. ALSO available with DBMS80...

### REPORT80

Build your own custom defined and formatted reports and data summaries. Print labels with user specified formats that will fit your own forms.

DBMS80 and REPORT80 will run under either CP/M or TRSDOS  
DBMS80 ..... \$250.00  
REPORT80 ..... \$100.00  
Manuals each ..... \$25.00

### OTHER PRODUCTS OF MICROBYTE SOFTWARE:

**EDIT80** ..... \$100.00  
Text editor and print formatter which runs under CP/M or TRSDOS  
**DISK80** ..... \$50.00  
Utility which allows you to examine and patch a disk.  
**UTILS** ..... \$50.00  
Apple PASCAL utilities: extensions to Apple Pascal, together with file control utilities, cross-reference, etc.  
**PAYROLL** ..... \$100.00  
Apple PASCAL payroll for 150 employees, full deduction options, etc.

Write or call today for further details on our products.  
Source ID#TCE373 (919) 833-4894

APPLE is a trademark of Apple Computer Corp.  
TRSDOS is a trademark of Tandy Corp.  
CP/M is a trademark of Digital Research



(Please don't be misled by my use of the word "compiler." I have been asked, "Can you write a compiler in FORTH that will compile BASIC, Pascal, COBOL...?" The answer is not easy. Defining words *can* compile application-oriented languages, but those languages should be FORTH-like in nature. Ordinarily, the language being compiled satisfies the syntax of FORTH—words separated by spaces. The compilation will result in FORTH-interpretable instructions that will add to its dictionary of word definitions.

In keeping with the FORTH philosophy of keeping all definitions small, defining-word definitions are also small. This results in compilers (defining words) that are simple and specialized, although the range of complexity of these compilers can vary greatly. A simple defining word such as VARIABLE may accept only one source word and produce a single, simple definition in the dictionary. A more complex defining word such as { : } may take several source words and produces a more complex definition.)

The remainder of this article concentrates on level II, defining new families of words. The scope and usefulness of new defining words are discussed using functional descriptions and examples. New defining words can be created which can later compile application-oriented languages.

### Creating Families of Words

The technique of creating new defining words permits

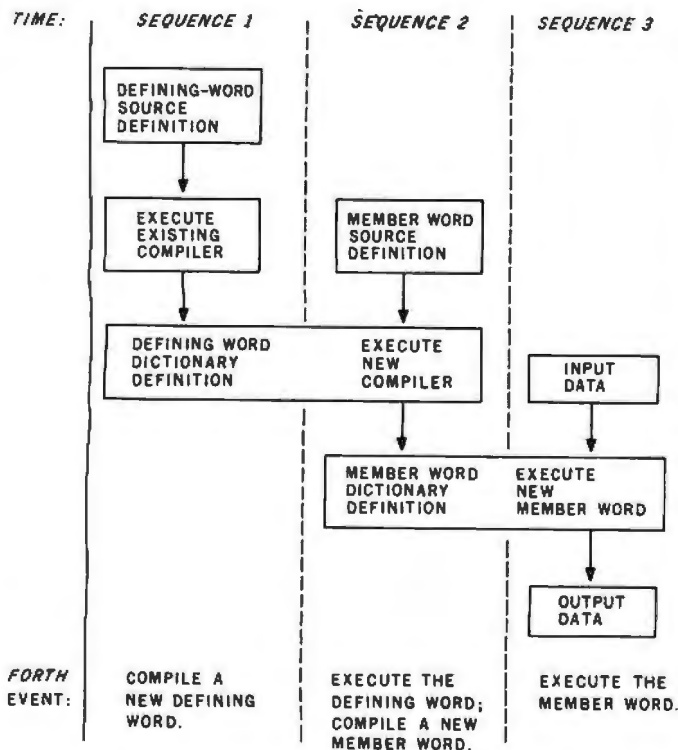

Figure 3: The order of events governing defining words. The first event creates a word that will define a new family of words; this family currently has no members. The second event uses this new family-defining word to create a new family member, a named FORTH word. The third event occurs when any named FORTH word belonging to this family is used.

# The Working Analyst.



If you would like to put a computer to work collecting, organizing, and summarizing the information you need to make better decisions, take a look at Analyst.

Analyst is a software package designed to let you store and analyze virtually any information involving numbers, dollars, dates, and descriptions. Simply tell Analyst what kind of information

you want to store. Analyst creates a computerized file for that information. And Analyst creates an information entry program for your file that asks you for each entry, and checks your data for errors. (You can create any number of different files.)

Then tell Analyst what reports you want from your data file. There are all sorts of record selection and report formatting options, so you can design an unlimited variety of reports to focus on different aspects of the same data file.

Analyst is so flexible, you'll find a million ways to use it. It is easy to use, so you don't need to be a programmer to make your computer really work for you. If this bit of information intrigues you, find out the rest. You'll like what you see.



Analyst is a part of a full line of working software solutions from Structured Systems Group, all ready to run on any CP/M\* microcomputer system. For more information, see your computer retailer, or call us.

\*CP/M is a trademark of Digital Research.

## Structured Systems

5204 Claremont Oakland, Ca. 94618 (415) 547-1567

a user to later create a family of FORTH words that can have any number of members. Each member shares some family traits but can also have individual characteristics. The family members are all the words that have been compiled by a defining word. Their common traits are specified by the defining word. However, each word in the family has individual characteristics that are assigned when added to the family.

For example, the defining word VARIABLE defines a family with individual members, each of which has a different name and value, but all share the same execution trait: specifically, the use of the name of any variable returns the address of its value.

It is important to understand that there are three time-ordered events related to defining words. These are listed in figure 3. These events will be explained using an example.

The compilation of the new words in figure 2 is a sequence 2 event (ie: using a defining word to compile another word). When the defining word VARIABLE is executed, as in:

VARIABLE %INTEREST

the source word %INTEREST is compiled.

Storing a value into the variable is a sequence 3 event.

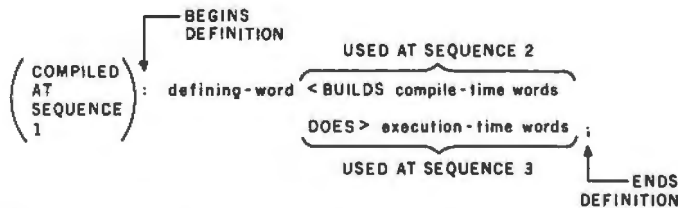

Figure 4: The structure of the source definition of a defining word. These source lines create a defining word for a new family (sequence 1). Execution of the defining word (sequence 2) <BUILDS a dictionary definition for a new family member. The contents of that definition is constructed by the compile-time words. Executing any family member (sequence 3) DOES> (ie: executes) the execution-time words.

The following words store a 5 into the variable.

5 %INTEREST !

Since VARIABLE is system-supplied, the sequence 1 event (the compilation of VARIABLE ) occurred when the FORTH system was generated.

<BUILDS and DOES>

To illustrate a simple sequence 1 event, a definition of VARIABLE is presented.

: VARIABLE <BUILDS 2 ALLOT DOES> ;

The defining word { : } (colon) is used to compile the source definition of VARIABLE . To the word { : }, VARIABLE is an ordinary definition (level 1), and its definition is a sequence 2 event for { : }. VARIABLE is a defining word because the special words <BUILDS and DOES> are used. (The < and > characters are part of the names of the words; they are used like parentheses to indicate that <BUILDS comes before DOES> .)

As illustrated in figure 4, a defining word specifies both the compile-time behavior (sequence 2) and the execution-time behavior (sequence 3) of all words compiled by this defining word. The sequence 2 behavior is specified by <BUILDS and any following words up to DOES> . The sequence 3 behavior is specified by DOES> and any following words up to { ; }. The English meaning of <BUILDS is "compiles" and the meaning of DOES> is "executes."

Figure 5 demonstrates what occurs when VARIABLE is executed. The end result of the execution of VARIABLE is that a new dictionary definition is created for the word %INTEREST . The following describes each step in the compilation of %INTEREST :

1. The execution of VARIABLE causes <BUILDS to be executed. <BUILDS reads the next word-name after the word VARIABLE from the input text stream. (In this example, the next word-name is %INTEREST .)
2. <BUILDS then adds the head of a new definition to the end of the dictionary. Within this head, the name field contains the member's word-name

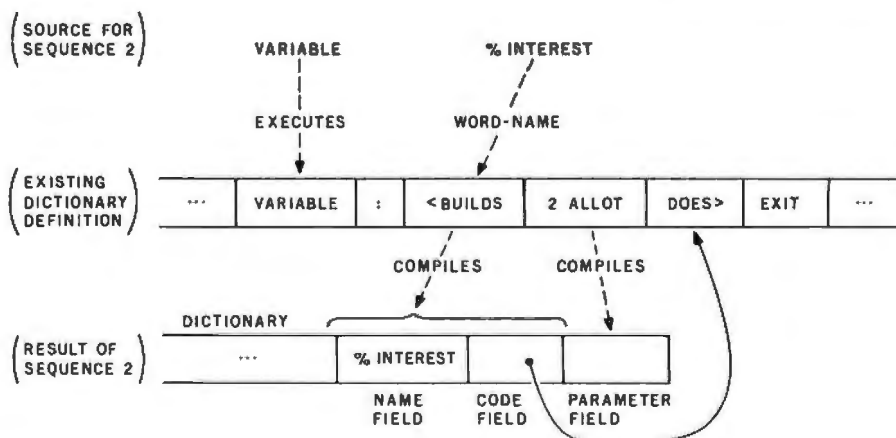

Figure 5: The result of executing a defining word. The first line is executed, resulting in the compilation of the word-name %INTEREST . The result is a new definition in the dictionary.



---

Now there's a new  
generation language  
that can teach  
your old TRS-80\*  
some new tricks.

# TFORTH.

---

A unique growth programming language for the TRS-80\*  
that combines the best features of an interpreter and a compiler  
all in one functional easy-to-use package.

---

Introducing T<sup>F</sup>ORTH from Sirius. A new and unique language that cannot be simply compared with FORTRAN or BASIC. T<sup>F</sup>ORTH serves as an operating system, compiler, assembler, interpreter, virtual memory, file system, etc. all in one. Using concepts like virtual memory and stack organization, T<sup>F</sup>ORTH makes easy, efficient, structures, re-entrant programs a natural consequence.

T<sup>F</sup>ORTH is a procedural language specifying a process rather than a desired result. The ability to have the language grow in the direction the user desires is unusual but excellent for novel applications. New data types and new processes can become part of the language. Due to the modular construction, very compact code is produced which, even so, executes at speeds between machine code speeds and about 20% typical overhead. Memory requirements may be "less" than assembler coding or other high level languages.

T<sup>F</sup>ORTH provides an excellent way to develop new languages, or provide simple control of devices including video monitors, A to D converters, burglar alarms and many other tasks re-

quiring monitoring and decision. Many words to handle peripherals are part of basic T<sup>F</sup>ORTH and others may be added easily. Often, substantial hardware development can be eliminated by using T<sup>F</sup>ORTH to do the major digital logic or reduction of data.

The key to T<sup>F</sup>ORTH's flexibility and ease of use lies in its use of a stack for parameters and a dictionary for WORDS. These WORDS are stated in terms of other WORDS already defined in the dictionary. To execute a "program", the WORD is typed on the console and that WORD is executed.

A rich set of WORDS comes with the basic language, providing IF-THEN-ELSE, DO LOOPS, BEGIN-END, virtual memory, any number base (to base 32) for input or output, a macro assembler, re-entrant code, multithread dictionary, line editor, excellent math package (16 bit integers, Double Precision Floating Point math [standard], SIN, COS, TAN, SQRT, EXP and LOG) and it runs under either TRSDOS\* or NEWDOS. Assembler can be nested with high level in an easy fashion. Complicated drivers for new devices take only a few lines of T<sup>F</sup>ORTH!

T<sup>F</sup>ORTH from Sirius comes complete for the TRS-80\* with as little as 16K of memory and a single Disk Drive using either TRS-DOS or NEWDOS. It is provided on diskettes and an optional Math and Utilities package is available.

T<sup>F</sup>ORTH (on diskette-specify for Standard or 80 Track Drives). . . \$129.95  
\*TM Tandy Corp.

Among the many supported features of T<sup>F</sup>ORTH are:

- A Macro-Assembler
  - Line Editor
  - Advanced Math Package
  - Re-Entrant Code
  - Faster I/O Operation
  - Super Graphics Capabilities
  - High-Speed File Handling
- ... and much more!

**SIRIUS  
SYSTEMS**

7528 Oak Ridge Highway  
Knoxville, TN 37921 (615) 693-6583



( %INTEREST ), and the code field contains a pointer to the instructions that will be executed when %INTEREST is executed (during sequence 3).

3. The two words { 2 ALLOT } are executed next. These will reserve 2 bytes of dictionary space for the value of the variable. This space is in the parameter field of the dictionary definition.
4. Finally, DOES> terminates the compilation of %INTEREST and links the code field of %INTEREST to the execution-time part of VARIABLE .

When %INTEREST is executed (sequence 3), DOES> is executed, followed by the FORTH words between DOES> and the end of the definition. (In this example, there are no words following DOES> ; the word EXIT is a routine left by the end-of-definition word { ; }.) DOES> returns the memory address of the parameter field within the dictionary definition of %INTEREST . Since the parameter field of a word defined by VARIABLE contains only the value of that word, execution of the word %INTEREST returns the address of its value, which is then pushed onto the parameter stack. (That is, in fact, the execution-time behavior of a FORTH variable.)

Figure 6 shows an example of the execution of %INTEREST .

[The above definition and usage of the word VARIABLE are valid for existing FORTHS. However, the definition of VARIABLE supplied with most FORTHS re-

quires the initial value of the variable before the word VARIABLE (eg: { 5 VARIABLE %INTEREST } ). This definition of VARIABLE is: { : VARIABLE <BUILDS , DOES> ; } ...GW]

The previous example demonstrated the following principles:

- Sequence 1: the definition of a defining word specifies both the compile-time behavior and execution-time behavior of all words belonging to the family of the defining word (ie: all words created using the defining word).
- Sequence 2: the execution of a defining word causes the compilation of the word-name(s) that follow. This creates a new dictionary

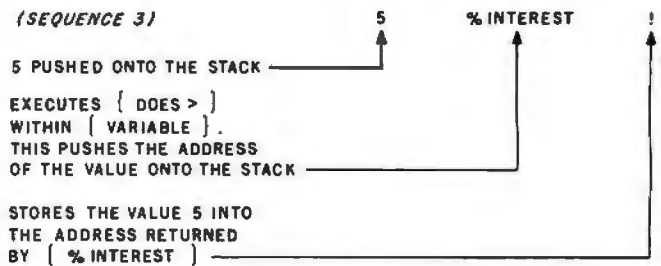

Figure 6: The execution of a family member word. The value 5 is stored in the variable %INTEREST .

# 64K MEMORY FOR THE HEATHKIT H8\* COMPUTER

Assembled	Kit	
\$750	\$650	64K (56K)
615	525	48K
480	400	32K
345	275	16K

Memory Expansion Kit - 16K \$125

PC Board Only - With Documentation \$ 50

Phone for Free Brochure 714/830-2092

\*HEATHKIT and H8 are Registered Trademarks of the Heath Co.



## TRIONYX ELECTRONICS

BOX 5131-C, SANTA ANA, CA 92704

## Main/Frames from \$200

- 14 Basic Models Available
- Assembled & Tested
- Power Supply:  
8v@15A, ± 16v@3A
- 15 Slot Motherboard (connectors optional)
- Card cage & guides
- Fan, line card, fuse, power & reset switches, EMI filter
- 8v@30A, ± 16v@10A option on some models



Write or call for our brochure which includes our application note:  
**'Building Cheap Computers'**  
**INTEGRAND**

8474 Ave. 296 • Visalia, CA 93277 • (209) 733-9288  
We accept BankAmericard/Visa and MasterCharge





## 86-DOS™ 8086 OPERATING SYSTEM - \$95

1. Read Z80 source code file written in CP/M\* format and convert to 86-DOS format.
2. Translator program translates Z80 source code to 8086 source code.
3. Resident assembler assembles the translated 8086 source code to 8086 object code.
4. Minor hand correction and optimization.  
(A recent 19K Z80 program translation took us about four hours to fix up. Even without optimization, it ran twice as fast as the original!)

### 86-DOS™

This operating system is the first complete package of resident software for the 8086 offered in the general marketplace. 86-DOS provides a high-level interface between the program and its hardware environment, with functions such as console I/O of characters and strings, and random and sequential reading and writing of named disk files.

A multi-level hierarchy, made possible by the hardware address relocation inherent in the 8086, allows programs to run other programs. Complete

error trapping of otherwise "fatal" errors (e.g. - disk hard errors) is possible allowing a running program to remain in control or to transfer control to a high level in the hierarchy.

The package includes an 8086 resident assembler, a Z80 to 8086 source code translator, a utility to read files written in CP/M format and convert them to 86-DOS format, a line editor, and disk maintenance utilities. Price (registered SCP CPU owners) - \$95. Others - \$195.

**THE REMAINING \$1290 BUYS OUR 8 MHZ. 16-BIT**

**8086 2-CARD CPU SET TO RUN IT ON**

*Also requires S-100 mainframe, 8-bit or 16-bit static memory (yours or ours), disk subsystem.*

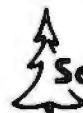

**Seattle Computer Products, Inc.**

1114 Industry Drive, Seattle, WA. 98188

(206) 575-1830

\* CP/M is a registered trademark of Digital Research Corp.

# BUSINESS - PROFESSIONAL - GAME SOFTWARE FOR APPLE AND TRS-80

## HOME FINANCE PAK I: Complete package \$49.95 Apple, TRS-80

- BUDGET:** The heart of a comprehensive home finance system. Allows user to define up to 20 budget items. Actual expense input can be by keyboard or by automatic reading of CHECKBOOK II files. Costs are automatically sorted and compared with budget. BUDGET produces both monthly actual/budget/variance report and a year-to-date by month summary of actual costs. Color graphics display of expenses. . . \$24.95
- CHECKBOOK II:** This extensive program keeps complete records of each check/deposit. Unique check entry system allows user to set up common check purposes and recipient categories. Upon entry you select from this pre-defined menu to minimize keying in a lot of data. Unique names can also be stored for completeness. Rapid access to check files. Check register display scrolls for ease of review. 40 column print-out. Up to 100 checks per month storage. Files accessible by BUDGET program. . . . . \$19.95
- SAVINGS:** Allows user to keep track of deposits/withdrawals for up to 10 savings accounts. Complete records shown via screen or 40 column printer. . . . . \$14.95
- CREDIT CARD:** Keep control of your cards with this program. Organizes, stores and displays purchases, payments and service charges. Screen or 40 column printer display. Up to 10 separate cards. . . . . \$14.95

## THE UNIVERSAL COMPUTING MACHINE: \$39.95 Apple, TRS-80

A user programmable computing system structured around a 20 row x 20 column table. User defines row and column names and equations forming a unique computing machine. Table elements can be multiplied, divided, subtracted or added to any other element. User can define repeated functions common to a row or column greatly simplifying table setup. Hundreds of unique computing machines can be defined, used, stored and recalled, with or without old data, for later use. Excellent for sales forecasts, engineering design analysis, budgets, inventory lists, income statements, production planning, project cost estimates in short for any planning, analysis or reporting problem that can be solved with a table. Unique cursor commands allow you to move to any element, change its value and immediately see the effect on other table values. Entire table can be printed by machine page (user-defined 3-6 columns) on a 40 column printer. Transform your computer into a UNIVERSAL COMPUTING MACHINE.

## COLOR CALENDAR: HI-RES color graphics display of your personal calendar. Automatic multiple entry of repetitive events. Review at a glance important dates, appointments, anniversaries, birthdays, action dates, etc. over a 5 year period. Graphic calendar marks dates. Printer and screen display a summary report by month of your full text describing each day's action item or event. Ideal for anyone with a busy calendar. . . (Apple Only) . . . . . \$19.95

## BUSINESS SOFTWARE SERIES: Entire package \$199.95 Apple, TRS-80

- MICROACCOUNTANT:** The ideal system for the small cash business. Based on classic T-accounts and double-entry bookkeeping, this efficient program records and produces reports on account balances, general ledger journals, revenue and expenses. Screen or 40 column printer reports. Handles up to 500 journal entries per period, up to 100 accounts. Instructions include a short primer in Financial Accounting. \$49.95
- UNIVERSAL BUSINESS MACHINE:** This program is designed to SIMPLIFY and SAVE TIME for the serious businessman who must periodically Analyze, Plan and Estimate. The program was created using our Universal Computing Machine and it is programmed to provide the following planning and forecasting tools.  
CASH FLOW ANALYSIS      PROFORMA BALANCE SHEET      SOURCE AND USE OF FUNDS  
PROFORMA PROFIT & LOSS      SALES FORECASTER      JOB COST ESTIMATOR  
Price, including documentation and a copy of the base program. Universal Computing Machine. . . . . \$89.95
- INVOICE:** Throw away your pads. Use the ELECTRONIC INVOICE facsimile displayed on your CRT. The program accepts and you fill in the data. Includes 3 address fields (yours, Bill to and Ship to), Invoice No., Account No., Order No., Salesman, Terms, Ship Code, FOB Pt. and Date. Up to 10 items per sheet with these descriptions: Item No., No. of units, Unit Price, Product Code, Product Description, Total Dollar amount per item and invoice total dollar amount. Generates, at your option, hard copy invoices, shipping memos, mailing labels, audit copies and disc updates to master A/R files. (48K) . . . . . \$49.95

- BUSINESS CHECK REGISTER:** Expanded version of the Checkbook II program. Handles up to 500 checks per month with complete record keeping. (48K) . . . . . \$29.95
- BUSINESS BUDGET:** As described above and companion program to Business Check Register. Handles 500 transactions per month, up to 20 cost categories. Accesses BCR files for actual costs. (48K) . . . . . \$29.95

## ELECTRICAL ENGINEERING SERIES: Both programs \$159.95 Apple

- LOGIC SIMULATOR: SAVE TIME AND MONEY.** Simulate your digital logic circuits before you build them. CMOS, TTL, or whatever, if it's digital logic, this program can handle it. The program is an interactive, menu driven, full-featured logic simulator capable of simulating the bit-time by bit-time response of a logic network to user-specified input patterns. It will handle up to 1000 gates, including NANDS, NORs, INVERTERS, FLIP-FLOPS, SHIFT REGISTERS, COUNTERS and user-defined MACROS. Up to 40 user-defined, random, or binary input patterns. Simulation results displayed on CRT or printer. Accepts network descriptions from keyboard or from LOGIC DESIGNER for simulation. Specify 1000 gate version (48K required) or 500 gate version (32K required) . . . . . \$89.95
- LOGIC DESIGNER:** Interactive HI-RES Graphics program for designing digital logic systems. A menu driven series of keyboard commands allows you to draw directly on the screen up to 15 different gate types, including 10 gate shape patterns supplied with the program and 5 reserved for user specification. Standard patterns supplied are NAND, NOR, INVERTER, EX-OR, T-FLOP, JK-FLOP, D-FLOP, RS-FLOP, 4 Bit COUNTER and N-BIT SHIFT REGISTER. User interconnects gates just as you would normally draw using line graphics commands. Network descriptions for LOGIC SIMULATOR generated simultaneously with the CRT diagram being drawn. Drawing is done in pages of up to 20 gates. Up to 50 pages (10 per disc) can be drawn, saved and recalled. Specify 1000 gate (48K) or 500 gate (32K) system. . . . . \$89.95

## MATHEMATICS SERIES: Complete Package \$49.95 Apple only

- NUMERICAL ANALYSIS:** HI-RES 2-Dimensional plot of any function. Automatic scaling. At your option, the program will plot the function, plot the INTEGRAL, plot the DERIVATIVE, determine the ROOTS, find the MAXIMA and MINIMA and list the INTEGRAL VALUE. For 16K . . . . . \$19.95
- MATRIX:** A general purpose, menu driven program for determining the INVERSE and DETERMINANT of any matrix, as well as the SOLUTION to any set of SIMULTANEOUS LINEAR EQUATIONS. Disk I/O for data save. Specify 55 eqn. set (48K) or 35 eqn. (32K) . . . . . \$19.95
- 3-D SURFACE PLOTTER:** Explore the ELEGANCE and BEAUTY of MATHEMATICS by creating HI-RES PLOTS of 3-dimensional surfaces from any 3-variable equation. Disc save and recall routines for plots. Menu driven to vary surface parameters. Demos include BLACK HOLE gravitational curvature equations. . . \$19.95

## ACTION ADVENTURE GAMES SERIES: Entire series \$29.95 Apple only

- RED BARDON:** Can you outfly the RED BARDON? This fast action game simulates a machine-gun DOG-FIGHT between your WORLD WAR I BI-PLANE and the baron's. You can LOOP, DIVE, BANK or CLIMB in any one of 8 directions - and so can the BARDON. In HI-RES graphics. . . . . \$14.95
- BATTLE OF MIDWAY:** You are in command of the U.S.S. HORNETS' DIVE-BOMBER squadron. Your targets are the Aircraft carriers, Akagi, Soryu and Kaga. You must fly your way through ZEROES and AA FIRE to make your DIVE-BOMB run. In HI-RES graphics. . . . . \$14.95
- SUB ATTACK:** It's April, 1943. The enemy convoy is headed for the CORAL SEA. Your sub, the MORAY, has just sighted the CARRIERS and BATTLESHIPS. Easy pickings. But watch out for the DE-STROYERS - they're fast and deadly. In HI-RES graphics. . . . . \$14.95
- FREE CATALOG -** All programs are supplied in disc and run on Apple II w/Disc & Applesoft ROM Card & TRS-80 Level II and require 32K RAM unless otherwise noted. Detailed instructions included. Orders shipped within 3 days. Card users include card number. Add \$1.50 postage and handling with each order. California residents add 6 1/2% sales tax. Make checks payable to:

 **SPECTRUM SOFTWARE**  
DEALER INQUIRIES P.O. BOX 2084 - 142 CARLOW, SUNNYVALE, CA 94087  
INVITED FOR PHONE ORDERS - 408-738-4387

definition and adds a new member word to the family of the given defining word. It also extends FORTH because another user-defined procedure is added to the language.

- Sequence 3: the execution of a member word causes the execution of the execution-time words within the defining word that created the member word.

To illustrate the versatility of defining words, examples of new defining words follow. These examples present the creation of new data structures, control structures, and software tools.

### Creating a String-Handling Defining Word

To show how defining words can create data structures, a one-dimensional array of 8-bit values will be created. A defining word named STRING will be constructed. After STRING has been compiled, any number of strings may be created; each can have a different name and size. Before the definition for STRING is shown, an example will first be used to describe how STRING will be used.

To create a string 5 bytes long with the name BEANS, the following words would be used ( BEANS is the name of the string, not the value put into the string):

5 STRING BEANS

This is a sequence 2 event that will create a dictionary definition for BEANS; this definition will contain 5 bytes of data space for the value of the string.

To fetch or store a character in BEANS, a subscript will be passed to BEANS. BEANS will return the address of the subscripted byte. For example, the words

3 BEANS C@

would fetch character number 3 from BEANS. This is a sequence 3 event because it is a normal use of a word defined by STRING. The subscript precedes BEANS because FORTH prefers to pass data values on a stack.

The definition of STRING can now be written as shown in listing 1. This definition is similar to that of VARIABLE.

The parameter for ALLOT is omitted in this definition; the string size declaration at sequence 2 will supply the size parameter for ALLOT. (The word ALLOT looks for the number of bytes to be reserved to already be on the stack; this is why the string size precedes the word STRING when the string variable BEANS is defined.)

Following DOES> is the word +. This will add the address of the start of the string (supplied by DOES>) to the subscript (supplied to BEANS at sequence 3). Figure 7 illustrates how this works.

**Listing 1: A user-defined defining word. The word STRING, once defined, can be used to define new FORTH words with unique properties.**

used at sequence 2 used at sequence 3  
( defined at )  
( sequence 1 ) : STRING <BUILDS ALLOT DOES> + ;



# NEW FROM LOBO:

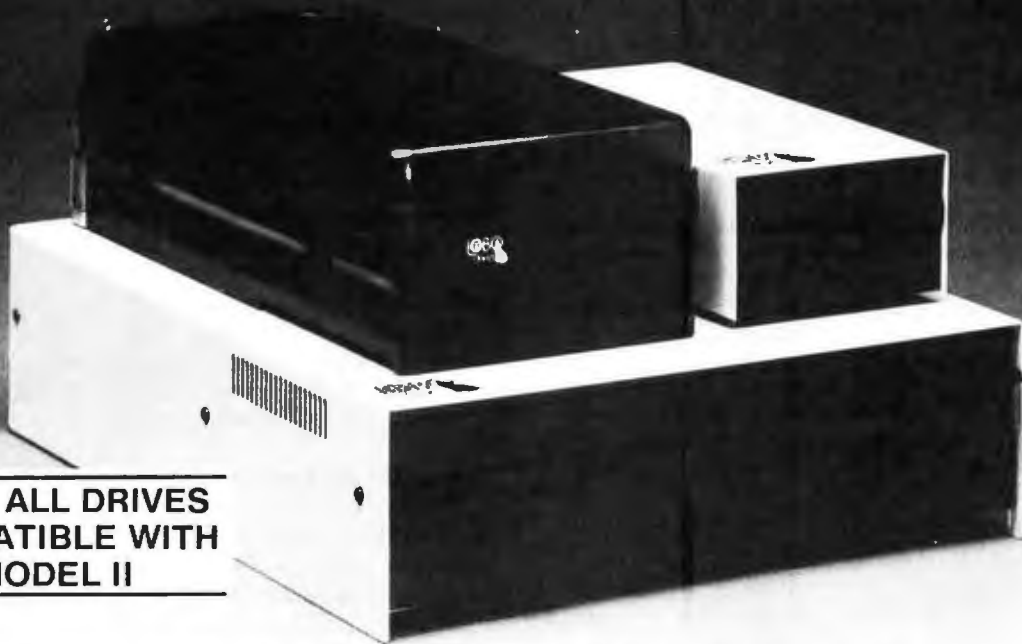

**NOW! ALL DRIVES  
COMPATIBLE WITH  
MODEL II**

## An Entire Family of Disk Drives for APPLE, TRS-80\*, and S-100 Computers

Only LOBO DRIVES offers you an entire family of fully-compatible disk drives to select from. Whatever computer you're using, APPLE, TRS-80, or S-100, you can add a LOBO drive now, with the peace-of-mind of knowing there's a whole family of drives available when you're ready to expand.

And every drive you order comes complete with chassis and high reliability power supply. Each drive is 100% calibrated, burned-in, and performance tested on either an APPLE, TRS-80, or S-100 computer before it's shipped. We are so proud of our drives . . . our quality, reliability, and performance, that we back-up every drive with a one year, 100% parts/labor warranty.

### 400 SERIES FLOPPY DISK DRIVES



Meet our low-cost 5.25-inch mini drive that records data in either hard or soft sectored format. It is available in single or double

density configurations, with a total storage capacity of 220K bytes.

### 800/801 SERIES FLOPPY DISK DRIVES



Here is our dual 8-inch Floppy disk memory unit. It records and retrieves data on standard 8-inch diskettes to provide 800K

bytes of data storage unformatted, or 512K bytes

in IBM format per drive. It is also available with double-sided, double-density capabilities, for a maximum storage capacity of 1.6 Megabytes.

### 7000 SERIES HARD DISK DRIVES



The latest member of our drive family, the Series 7000 is an 8-inch, 10 Mega-byte Winchester Technology, hard disk drive. It is fully

hardware/software compatible and comes complete with disk controller. Now you can have the convenience, speed, reliability, and all the storage capacity you need.

Call or write for the complete LOBO DRIVES story. Find out just how competitively priced a quality drive can be.

Quantity discounts available -- Dealer inquiries invited.

Yes, I want to know more about LOBO Drives and what they can do. Send me information on:

- TRS-80     APPLE     S-100
- 5 1/4-in. Floppy drive     8-in. Winchester hard disk, 10 Mbyte drive
- 8-in. Floppy drive  
Single sided  
Double sided     Double density expansion interface

Name \_\_\_\_\_

Company \_\_\_\_\_

Address \_\_\_\_\_

City \_\_\_\_\_ State \_\_\_\_\_ Zip \_\_\_\_\_

Phone No. \_\_\_\_\_

If dealer, provide resale no. \_\_\_\_\_



935 Camino Del Sur  
Goleta, California 93017  
(805) 685-4546

"CAN YOU REALLY AFFORD  
TO PAY LESS?"

\*TRS-80 is a registered trademark of Radio Shack, a Tandy Company

When `STRING` is executed (sequence 2), it builds a dictionary definition for `BEANS`, which is allotted 5 bytes of data space. When `BEANS` is executed (sequence 3), it does the addition of the subscript on top of the stack to the address of the first character within `BEANS`.

The following examples show how `BEANS` could be used in a `FORTH` program. The word `STUFF-BEANS` will store the American Standard Code for Information

**Listing 2:** Using a `FORTH` word created by a user-defined defining word. The 5-character string variable `BEANS` was previously defined with the `FORTH` statement `{ 5 STRING BEANS }`. Now the word `BEANS` can be used like any other word in `FORTH`. In listing 2a, the five characters of `BEANS` are filled with the letters `A` thru `E`. In listing 2b, the characters are printed out. Listing 2c gives the results of executing the words defined in listings 2a and 2b. (The underline denotes user input followed by a carriage return; the computer output, not underlined, follows.)

```

(a) : STUFF-BEANS 5 0 DO      ( for all of 'BEANS' )
      I 65 +              ( add 65 decimal to )
                               ( do-loop index, yielding )
                               ( an ASCII character )
      I BEANS C!          ( store character in the )
                               ( 'I' th byte of 'BEANS' )
      LOOP
;

(b) : SPILL-BEANS 5 0 DO   ( for all of 'BEANS' )
      I BEANS C@          ( fetch the 'I' th character )
      EMIT                ( print it )
      LOOP SPACE         ( print an extra space )
;

(c) STUFF-BEANS         OK
    SPILL-BEANS        ABCDE OK

```

Interchange (ASCII) characters `A` thru `E` in the string variable `BEANS`. (See listing 2a.) The word `SPILL-BEANS` will print the characters in `BEANS` on the user's terminal. (See listing 2b.) Using these words would produce the results shown in listing 2c.

In a similar way, multidimensional-array defining words may be defined; the size of each element can be any number of bytes.

Since the execution-time function of all family members is specified only once in the definition of the family's defining word, programming time is reduced, memory space is saved, and readability is improved. By changing the definition of the defining word and recompiling the `FORTH` words using it, the capabilities of every member word are changed. This can be done so that the use of all member words in a user's program is the same.

To illustrate the power of this technique, several variations on `STRING` will be presented.

### Variations on the Defining Word `STRING`

The original version of `STRING` did not initialize the contents of the array when it created member arrays. The following version will store blanks in a string when it is created (at sequence 2). It is convenient to first define a word which allocates and blanks dictionary space. The definition of `BLANK&ALLOT` is a sequence 2 event. (See listing 3a.)

Next, we create a new version of `STRING` that is the same as the original, except that `BLANK&ALLOT` is substituted for `ALLOT`. (See listing 3b.) (The redefinition of `STRING` is a sequence 1 event.) This version is used exactly like the original, but initialized strings are created automatically.

Another variation of `STRING` checks if a subscript exceeds the string size when member strings are executed (at sequence 3). If the subscript is less than the string size, the result is the same as before; but, if the subscript is negative or greater than the string size, an error message

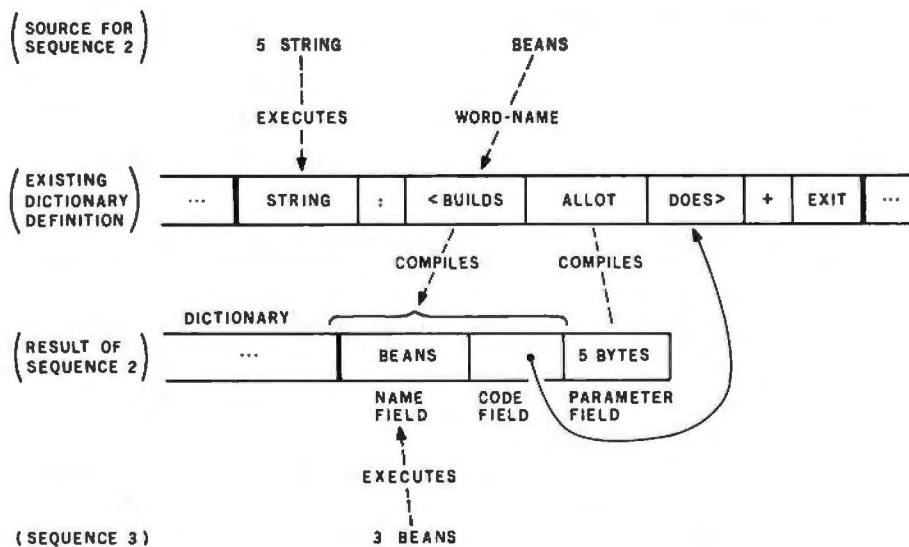

**Figure 7:** The creation and use of a character array. The defining word `STRING` is executed, causing the compilation of a dictionary definition for `BEANS` containing 5 bytes of data space. When `BEANS` is executed (last line), the `DOES>` part of the definition of `STRING` adds the address of the parameter field of `BEANS` to the subscript (which is 3), returning the address of the desired character within `BEANS`.



**Listing 3:** A more sophisticated definition of *STRING*. The word *BLANK&ALLOT* (shown in listing 3a) allocates space for and assigns blanks to a newly defined string. The new definition of *STRING* (shown in listing 3b) uses *BLANK&ALLOT* to blank out a string when it is created.

```
: BLANK&ALLOT
  HERE                ( get the address of the )
                    ( start of the string )
(a)  OVER BLANK      ( store blanks in the string )
     ALLOT           ( allocate space for the array )
;

: STRING <BUILDS BLANK&ALLOT ( used at sequence 2 )
(b)  DOES> +        ( used at sequence 3 )
;
```

**Listing 4:** Another definition of *STRING*. This definition stores the size of the string variable when the variable is created and checks for a correct subscript when a character within the string variable is referenced.

```
: STRING
  ( used at sequence 2: )
  <BUILDS DUP ,      ( store string size in )
                    ( member's parameter field )
                    ( allocate string space )
  ALLOT
  ( used at sequence 3: )
  DOES> 2DUP        ( duplicate both the subscript )
                    ( & parameter field address )
                    ( if the subscript is less )
                    ( than the string size )
                    ( add subscript to address )
                    ( step over the string size )
                    ( stored in the first 2 bytes )
                    ( otherwise the subscript )
                    ( is too large or negative )
  . " RANGE ERROR" ( print error message )
  OVER . @ .        ( print string size and )
                    ( and bad subscript )
  2+                ( leave address of first byte, )
                    ( a "safe" address )
  THEN
;
```

is produced and the illegal subscript is printed. The string size must be stored in the dictionary definition of member strings when they are compiled (at sequence 2) so that the range check can be made when they are executed (at sequence 3).

A new definition of *STRING* (a sequence 1 event) that does the subscript checking defined previously is given in listing 4.

The range check slows the execution of every reference to a member string, but such checking may be useful during program development. Since this version and the original version defining *STRING* are used exactly the same, it is possible to compile this definition of *STRING* while debugging (then compile all references to it or its member strings). After the program has been debugged, the original version can be compiled (followed by the compilation of all references to it or its members), and the program will run faster.

The next version of *STRING* allows very large strings to be created and used.

## CP/M® SOFTWARE TOOLS NEW ED-80 TEXT EDITOR

ED-80 offers a refreshing new approach for the creation and editing of program and data files conversationally—and it saves you money. Its powerful editing capabilities will satisfy the most demanding professional—yet it can still be used by the inexperienced beginner.

### Look at These Outstanding Features:

- FULL SCREEN window displays with forward and backward scrolling for editing your data a page-at-a-time, rather than line-by-line.
- Provides you with all the features found on the large mainframe and minicomputer editors, such as IBM, UNIVAC, CDC, and DEC.
- Commands include forward or backward LOCATE, CHANGE, and FIND; and INSERT, DELETE, REPLACE, APPEND, SAVE, PRINT, WINDOW, MACRO, TABSET, SCALE, DUMP, and others.
- Compatible with existing CP/M edit and text formatted files, with CBASIC, and with Microsoft's MBASIC, FORTRAN, COBOL, and ASSEMBLER.
- CHANGE commands allow you to make conditional changes and to use variable length strings.
- Designed for CP/M and derivative operating systems, including LIFEBOAT, CDOS, IMDOS, DOS-A, ADOS, etc.
- GET and PUT commands for concatenating, moving, duplicating, and merging your edit files on the same or different diskettes.
- Provides you with fast memory-to-memory COPY commands, and an intermediate buffer for copying lines over-and-over.
- Saves your last LOCATE, CHANGE, FIND, and APPEND command for easy re-execution.
- Simple line-oriented commands for character string editing.
- Safeguards to prevent catastrophic user errors that result in the loss of your edit file.
- INLINE command for your character-oriented editing.
- Designed for today's CRT's, video monitors, and teletypewriter terminals.
- Thoroughly field tested and documented with a comprehensive User's Manual and self-instructional tutorial.

And remember — in today's interactive programming environment — your most important software tool is your text editor. ED-80 is already working in industry, government, universities, and in personal computing to significantly cut program development time and to reduce high labor costs. Why not let ED-80 begin solving your text editing problems today? ED-80 is protected by copyright and furnished under a paid-up license for use on a single computer system. Single Density Diskette and Manual: \$99.00, or the Manual alone: \$20.00 (credited with purchase of the Diskette). Specify Disk make/model, 5" or 8", hard or soft sector. ORDER NOW and we'll pay the postage!

SOFTWARE DEVELOPMENT & TRAINING, INC.  
Post Office Box 4511 — Huntsville, Alabama 35802  
Dealer Inquiries Welcomed  
© CP/M is a trademark of Digital Research

# The 2nd Generation... It's all that it's Cracked up to be.

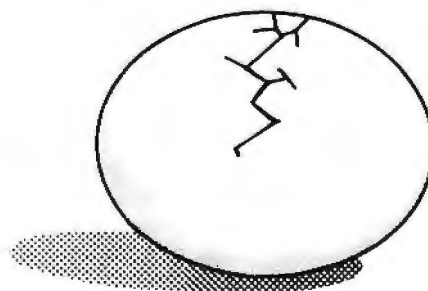

MEASUREMENT  
systems & controls  
incorporated

## Virtual Strings in FORTH

If the maximum string size exceeds the amount of programmable memory in the computer, the only solution is to write your program using *virtual memory management*. This means that data stored on disk or tape is considered part of the memory of the computer, and that all operations working on these data take care of reading and writing data between main memory and the magnetic storage device.

Using virtual memory management, a program can operate on a string array that is larger than main memory; pieces of the string can be read into memory and written back to disk or tape when required. And, although this technique will slow the execution rate of a program using it, it may be the only way to get a problem solved—and better a slow solution than none at all.

(It is more common to need to manipulate large arrays of numbers rather than strings. Still, the same technique described here can be applied to numeric or any other kind of array.)

With most traditional languages, it would be necessary to rewrite the user program so that all array references would call some function that could perform the disk read operations. Execution time could be decreased if frequently referenced array elements were kept in memory as much as possible. Therefore, it would help if our virtual-memory-array program could keep track of what data is in memory as the program executes.

To show the difficulty of implementing this technique in traditional languages, a FORTRAN example will be used. In standard FORTRAN, the statement:

$$\text{ARRAY}(5,7,2) = \text{AR1}(1,2) + \text{AR2}(10,20,30)$$

is equivalent to the FORTH words:

```
1 2 AR1 @ 10 20 30 AR2 @ +
5 7 2 ARRAY |
```

In either FORTRAN or FORTH, if the arrays could not fit into memory and were instead on disk, the array references would have to be changed so that some additional procedures read and wrote selected pieces of data between disk and memory. But in FORTRAN, the entire source program would have to be changed. (In FORTH, the body of the program would remain the same; only the appropriate defining word would be changed.)

The following might be the simplest modification possible in standard FORTRAN to do the previous statement using virtual memory management of the arrays:

```
TEMP = FETCH2(AR1(1,1), 1,2) + FETCH3(AR2(1,1,1),
10,20,30)
CALL STORE3(ARRAY(1,1,1), 5,7,2, TEMP)
```

The functions FETCH2 and FETCH3 are user-written procedures to read the referenced array elements. The subroutine STORE3 is a user-written procedure to write a given value into an assigned array element. If a large program using many normal array references had to be changed to use FETCH and STORE calls, a lot of work would be required.

FORTH's separation of control between defining words and their members permits the necessary changes to be made in the definition of the defining word; in this

Marymac Industries Inc

# Radio Shack

AUTHORIZED SALES CENTER

## Save 10% 15%

OR MORE

DELIVERED TO YOUR DOOR

Owned and operated by Marymac Industries Inc. Houston's only independent Radio Shack® dealer. Warranties will be honored by all company owned Radio Shack® stores and most franchise and dealer authorized sales centers. Store open Mon.-Sat. 10-7. We pay freight and insurance. Save state sales tax. Texas residents add only 5% sales tax. Brand new in factory sealed cartons. Reference: Katy National Bank. Call us for a customer reference near your city. Offered exclusively by Radio Shack® Authorized Sales Center 21969 Katy Fwy., Katy (Houston) Texas 77450

Telephone 1-713-392-0747

### TRS-80™

FOR BUSINESS,  
LEARNING  
AND  
ENTERTAINMENT

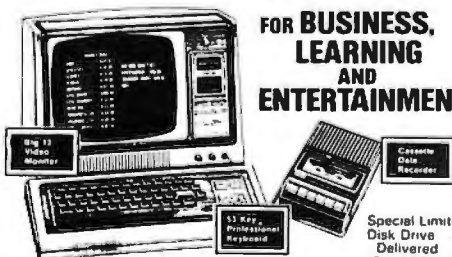

Special Limited Time Only  
Disk Drive \$424.90  
Delivered  
(Cat.#26-1160, 26-1161)

Meet TRS-80's Big Brother!  
The New TRS-80 Model II

We are located just 5 hours  
from the giant Tandy Com-  
puterware House in Ft.  
Worth, Texas.

Call  
Joe McManus  
Today

We've added a bigger, more  
powerful "brother" to the  
TRS-80 family. It's TRS-80  
Model II — a completely  
new microcomputer for  
business applications.



CHARGE IT



## GENERAL LEDGER PAYROLL ACCOUNTS RECEIVABLE & PAYABLE

Flexible and sophisticated business software that is among the highest quality on the market. Originally developed by OSBORNE & ASSOCIATES and rapidly becoming a standard. Our service is support. We will send you these programs with the proper I/O and CRT specific subroutines for your hardware configuration. Get back to business and leave the programming to us. Include hardware description with order.

- Accounts Receivable and Payable ..... 145.00
- Payroll (California) ..... 145.00
- Non California state tax calculations  
(please inquire) ..... 15-250.00
- General Ledger ..... 145.00
- Multiple profit center option for G/L ..... 25.00
- Manuals (each) ..... 20.00

All programs in CBASIC under CP/M (includes source)

These programs are up and running on the following computer systems: Altos, TRS-80 MOD II (under CP/M), Northstar, Vector Graphics, Intertec Super Brain, Cromemco, and others.

## Synergetic Computer Products

508 University Ave • Palo Alto, CA 94301  
(415) 328-5391

Visa • Mastercharge • COD • Certified Check  
CP/M is a trademark of Digital Research



# SAVE / on Software and Hardware for TRS-80® and Apple®

## NEWDOS 80

### A new enhanced NEWDOS for the TRS-80.

The most powerful Disk Operating System for the TRS-80 designed for the sophisticated user and professional programmer who demands the ultimate.

NEWDOS/80 is the planned upgrade from NEWDOS 2.1. Some of the features are:

- New BASIC commands for files with variable record lengths up to 4095.
- Mix or match drives. Use 35, 40 or 77 track 5" disk drives or 8" disk drives, or combo.
- Security boot-up for BASIC or machine code application programs.
- New editing commands.
- Enhanced RENUMber that allows relocation.
- Command chaining.
- Print Spooler.
- DFG function: striking of D, F and G keys allows user to enter a mini-DOS without disturbing program.
- Compatible with NEWDOS & TRSDOS.
- Machine language Superzap/80, 2.1 utilities and enhanced copy by file commands.
- Enter debug any time by pressing 123 keys. Also allows disk I/O.
- Diskette "Purge" command.
- Specifiable system options (limited system type commands).
- Increased directory capacity.

**\$149**

## APEX

### A new disk operating system for the Apple.

Fully Professional DOS for the Apple II. The result of two years of extensive development, APEX provides a complete program development and file management system, both powerful and useable. A comprehensive command set allows the user to perform almost any imaginable disk operation. Here are some of APEX's features:

- Command structure similar to CPM and main frame systems. Contains 20 command words, with ability to treat external programs as transient commands to the operating system.
- Scrolling editor compatible with Videx 80 char. card.
- Easy program Interface. Simple communications between the DOS and user program.
- Capable of handling 5 inch, 8 inch and hard disks.
- Safety features to protect against accidental data loss. Features include backup files, directory, read-after-write and limit checks.
- 4 times faster than CPM.
- Auto default structure eliminates tedious typing by automatically setting up command strings, file names, etc.
- Functional on both single and multi-drive systems. Includes utilities for file copy.
- Device handler structure for interfacing peripherals.

The APEX package includes all of the tools for a complete assembly language development system, high speed two pass resident assembler and a powerful macro editor.

The complete APEX package with operating system, assembler, editor and manuals also includes utilities to maintain files on single or multiple drive systems.

**\$99**

Related Software  
XPL0 ..... **\$79**  
FOCAL™ ..... **\$59**

## Disk Drive Sale!

**\$70 worth of FREE merchandise** with purchase of Shugart SA400 with power supply and chassis, the disk that Radio Shack sells for \$499.

SAVE \$200. ....	<b>\$369</b>
TF-Pertec FD200, 40 track, use both sides. ....	<b>\$389</b>
TF-5 MPI B51, 40 track. ....	<b>\$389</b>
TF-70 Micropolis, 77 track with 195K storage. ....	<b>\$639</b>
TDH-1 Dual Sided drive, 35 track. ....	<b>\$499</b>
NEWDOS+, 40 track ..... \$110	
35 track ..... \$ 99	
Business Programs (Interactive A/R, A/P, & GL) .....	<b>\$349</b>
Radex Data Base Program .....	<b>\$ 99</b>
Mailing List .....	<b>\$59</b>



## Disk Drive Expansion System

• 2 Shugart SA400 drives with power/chassis .....	<b>\$ 738</b>
• 1 Two-Drive Cable .....	<b>\$ 25</b>
• 1 Expansion Interface 32K .....	<b>\$ 499</b>
• 1 35-track DOS+ .....	<b>\$ 99</b>
TOTAL LIST PRICE .....	<b>\$1,361</b>
SPECIAL PRICE ONLY .....	<b>\$1,199</b>

MOD I 8" Disk System	
• One SA800R Floppy	
• 2 Drive Chassis and Power Supply	
• DOS and Cable .....	<b>\$1,095</b>
MOD II 8" Disk System	
• 3 Drive Chassis	
• 2 Drive Expansion System .....	<b>\$1,399</b>
• 3rd Drive ... Add \$479	

## Drives for any microcomputer

Does not include power supply & cabinet.

Pertec FD200 ....	<b>\$ 282</b>	FD250 .....	<b>\$ 399</b>
Shugart SA400 ..	<b>\$ 279</b>	SA800/801 .....	<b>\$ 479</b>
MPI B51 .....	<b>\$ 279</b>	B52 .....	<b>\$ 349</b>

## PRINTERS

Centronics 779 ..	<b>\$1,069</b>
Base 2 .....	<b>\$ 599</b>
Centronics 737	
Text processing capabilities, lower case descenders, underlining, subscripts and superscripts, 80 cps	<b>\$899</b>



Splinwriter ..... **\$2,549**

## More Savings



**NEW SALE PRICE**  
TRS-80 Graphics,  
Olddata Microline 80...  
List \$949  
Our price **\$699**

Save on Apple II 16K  
FREE memory upgrade kit  
to 48K with purchase of  
Apple II 16K ..... **\$1,195**

Introductory Offer —  
Mini-Floppy for Apple  
(2nd Drive) ... Only **\$419**

Apple 8" Disk System • One SA800R Floppy  
• 2 Drive Chassis & Power Supply  
• Controller, Cable and DOS ..... **\$1,449**  
16K Memory Upgrade Kits ..... **\$ 79**



**Apparat, Inc.**

(303) 741-1778

4401 S. Tamarac Pkwy. • Denver, CO 80237 • (303) 758-7275



**MICROCOMPUTER  
TECHNOLOGY  
INCORPORATED**

3304 W. MacArthur • Santa Ana, CA 92704 • (714) 979-9923



**All prices cash discounted / Freight: FOB factory. Ask for our free catalog.**

way, the program that uses the arrays does not have to be changed.

Furthermore, FORTH's virtual memory facility for disk reading and writing automatically keeps track of what data has been read into memory and tries to keep frequently referenced sections in memory.

Figure 8 illustrates how the array will be read in blocks of 1024 bytes into memory buffers. The new definition for the defining word STRING is given in listing 5.

### Adding New Control Structures with Defining Words

The next example illustrates the use of defining words to add control structures to the FORTH compiler. FORTH supplies { IF ... ELSE ... THEN } compiler structures and also loop structures like { DO ... LOOP }, { BEGIN ... UNTIL }, and { BEGIN ... WHILE ... REPEAT } loops.

In this example, we will create a case (choose one of n alternatives) selection mechanism. A case number will designate one of several words to be executed. Figure 9 presents how a case statement selects one of several procedures for execution. No matter which one is chosen, execution continues with one common procedure that follows the case structure.

The new defining word will be named { CASE: } and can be used similarly to { : }, as the following

Listing 5: Another definition of STRING . This definition creates a virtual string array that stores the string on disk and reads it into main memory when necessary. With this definition of STRING , it is possible to manipulate a string that is larger than main memory without changing the program that uses the long string. The disk operations are transparent—that is, the programmer does not know he is using the disk except for response time.

```

: STRING
  ( used at sequence 2 )
  <BUILDS NEXT-BLOCK#( get the next available )
  ( disk block # )
  , ( store it in the member's )
  ( parameter field )
  DISK-ALLOT ( reserve disk space for )
  ( the array )

  ( used at sequence 3 )
  DOES> @ ( get start-block # )
  SWAP ( subscript on top, )
  ( start-block # beneath )
  1024 /MOD ( divide subscript by )
  ( # bytes in a disk block; )
  ( the quotient is the block )
  ( index within the array; )
  ( the remainder is the byte )
  ( index within the block )
  ROT + ( add start-block # to the )
  ( block index )
  BLOCK ( call the FORTH virtual )
  ( disk manager to read the )
  ( referenced block; )
  ( if it is already in memory )
  ( no read is performed )
  + ( add the byte index to the )
  ( memory address of the )
  ( buffer where the block is )
  ( located, the result is )
  ( a memory address of the )
  ( byte specified by the )
  ( subscript before BEANS )

```

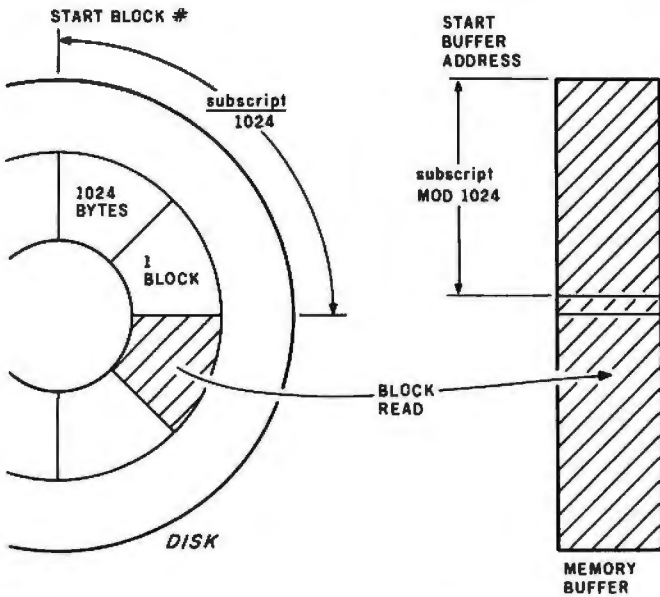

Figure 8: Accessing a virtual array. The data for a large array is kept on a disk. When a byte is referenced, BEANS is executed. One block containing the byte is read into a memory buffer (if it is not already present). Finally, the memory address of the referenced byte is returned by BEANS .

# WE DELIVER!

## Osborne Business Software



- Ready to run — no recompiling!
- Custom configured for your terminal.
- We are committed to fully supporting our users.
- One year maintenance included in price.
- Source programs, with enhancements.

General Ledger with Cash Journal .....	\$95
Accounts Payable .....	\$95
Accounts Receivable .....	\$95
Payroll with Cost Accounting .....	\$95
All four packages .....	\$295

Formats: 8", NorthStar, TRS-80 MOD II etc. Manuals are not included in the above prices — add \$20 per manual desired (AR/AP are in one manual). CP/M and CBASIC2 required. Users must sign licensing agreement. Dealer inquiries invited.

Other high-quality CP/M software available — contact us for our complete price list. Some examples:

WORDSTAR	\$435	TEXTWRITER III	\$120
PEARL II	\$345	PEARL III	\$645
PASCAL/Z	\$385	TINY-C	\$ 95
CP/M and CBASIC2 for TRS-80 MOD II (PGT)			\$285

To order call: (206) 542-8370  
or write: VANDATA  
17541 Stone Avenue North  
Seattle WA 98133

VISA/MC/COD Welcome — TRS-80 is a registered of Radio Shack Inc.



# CompuPro S-100 Motherboards: Designed for the Future, **AVAILABLE NOW**

You won't have to throw away these motherboards when you upgrade your system — they are specifically designed to handle the new generation of 5 to 10 MHz CPUs coming on line, as well as present day 2 and 4 MHz systems. Faraday shielding between all bus signal lines minimizes crosstalk; additionally, when signal lines cross each other on opposite sides of the board, they do so at a 90 degree angle to minimize any chance of stray coupling. You'd expect the company that pioneered active termination to include true active termination, but we've gone one step better by splitting the termination load between each end of every bus line. And you won't have to junk your present computer box with our new motherboards — all sizes fit Godbout, Vector, Imsai, TEL, and similar enclosures.

These high-performance motherboards are available in "unkit" form (edge connectors and termination resistors pre-soldered in place for easy assembly), or fully assembled and ready to go.

- #CK-024 20 slot motherboard with edge connectors — unkit \$174, assm \$214
- #CK-025 12 slot motherboard with edge connectors — unkit \$129, assm \$169
- #CK-026 6 slot motherboard with edge connectors — unkit \$89, assm \$129

NOTE: Most CompuPro boards are available in unkit form (sockets, bypass caps pre-soldered in place), assembled, or qualified under the Certified System Component (CSC) high-reliability program (200 hour burn-in, more). CSC memory boards run at 8 MHz, are guaranteed to run with 6 MHz Z-80s, and draw even less power than standard models.

## CAREFUL . . . NOT ALL S-100 CPU BOARDS ARE CREATED EQUAL!

You'll appreciate the extras that go into our CPU boards; take IEEE spec compatibility, for example. While others may claim compatibility, we meet all timing specs — and we'll be glad to send you timing diagrams for our CPUs to prove it (just include an SASE). You don't have to compromise on another "me-too" board . . . choose CompuPro.

### THE ENHANCED/ADVANCED Z-80A S-100 CPU BOARD

Superior design in an IEEE-compatible board gives the power for future expansion as well as system flexibility. Includes all standard Z-80A features along with power on jump/clear, on-board fully maskable interrupts for interrupt-driven systems, selectable automatic wait state insertion, provision for adding up to 8K of on-board EPROM, 4 MHz operation, and IEEE compatible 16/24 bit extended addressing. \$225 unkit, \$295 assm, \$395 CSC.

### THE COMPUPRO "RAM" SERIES OF STATIC MEMORY

Recommended for commercial, industrial, and scientific applications. 4/5 MHz standard operation, no dynamic timing problems, meets all IEEE specifications, low power/high speed chips used throughout, extensive bypassing, careful thermal design.

S-100 STANDARD MEMORY	unkit	assm	CSC
8K RAM BA.....	\$169	\$189	\$239
16K RAM X-16.....	\$329	\$379	\$479
24K RAM XX-24.....	\$449	\$499	\$599
32K RAM X-32.....	\$599	\$689	\$789

### S-100 EXTENDED ADDRESSING MEMORY

(16/24 address lines; addressable on 4K boundaries)

16K RAM XIV.....	\$299	\$349	\$429
------------------	-------	-------	-------

### S-100 BANK SELECT MEMORY

(Cromemco etc. compatible; addressable on 4K boundaries)

16K RAM XIII-A-16.....	\$349	\$419	\$519
24K RAM XIII-A-24.....	\$479	\$539	\$649
32K RAM XIII-A-32.....	\$649	\$729	\$849

### SBC/BLC MEMORY

32K RAM XI.....	n/a	n/a	\$1050
-----------------	-----	-----	--------

## OTHER S-100 BUS PRODUCTS

Godbout Computer Enclosure.....	\$289 desktop, \$329 rack mount
Active Terminator Board.....	\$34.50 kit
2708 EPROM Board (less EPROMs).....	\$85 unkit
Memory Manager Board.....	\$59 unkit, \$85 assm, \$100 CSC
25 "Interfacer I" I/O Board.....	\$199 unkit, \$249 assm, \$324 CSC
3P Plus S "Interfacer II" I/O Board.....	\$199 unkit, \$249 assm, \$324 CSC
Mullen Extender Board.....	\$59 kit
Mullen Relay/Opto-isolator Control Board.....	\$129 kit, \$179 assm
Vector 8800V S-100 Prototyping Board.....	\$19.95

TERMS: Cal res add tax. Allow 5% for shipping, excess refunded. VISA®/Mastercard® orders (\$25 min) cal (415) 362-0636, 24 hrs. COD OK with street address for UPS. Prices good through cover month of magazine.

### NEW! S-100 DUAL PROCESSOR CPU BOARD

The Dual Processor Board is here . . . and CPU boards will never be the same again. 8088 CPU gives true 16 bit power with a standard 8 bit S-100 bus; an 8085 gives compatibility with CP/M and 8080 software. Accesses up to 16 megabytes of memory, meets all IEEE S-100 bus specifications, runs 8085 and 8086 code in your existing mainframe as well as Microsoft 8086 BASIC and Sorcim PASCAL/M™, runs at 5 MHz for speed as well as power, and is built to the same stringent standards that have established our leadership in S-100 bus components. Introductory prices: \$385 unkit, \$495 assm, \$595 CSC.

8085 single processor version of above: Introductory prices \$235 unkit, \$325 assm, \$425 CSC.

### SPECTRUM S-100 COLOR GRAPHICS BOARD

Includes 8K of IEEE-compatible static RAM; full duplex bidirectional parallel I/O port for keyboard, joystick, etc. interface; and 6847-based graphics generator that can display all 64 ASCII characters, 10 modes of operation, from alphanumeric/semi-graphics in 8 colors to ultra-dense 256 x 192 full graphics. 75 Ohm RS-170 line output and video output for use with FCC approved modulators. Introductory prices: \$339 unkit, \$399 assm, \$449 CSC. Don't settle for black and white graphics or stripped-down color boards; specify the CompuPro Spectrum.

Want graphics software? Sublog's 2D Universal Graphics Interpreter (normally \$35) is yours for \$25 with any Spectrum board purchase.

### 16K DYNAMIC RAM SPECIAL: 8/\$59!

Expand memory in TRS-80® -I and -II, as well as machines made by Apple, Exidy, Heath HB9, newer PETs, etc. Low power, high speed (4 MHz). Add \$3 for 2 dip shunts plus TRS-80® conversion instructions. Limited quantity. \*TRS-80 is a trademark of the Tandy Corporation.

### PASCAL/M™ + MEMORY SPECIAL

PASCAL — easy to learn, easy to apply — can give a microcomputer with CP/M more power than many minis. We supply a totally standard Wirth PASCAL/M™ 8" diskette by Sorcim, with manual, for \$150 with the purchase of any memory board. Specify Z-80 or 8080/8085 version. PASCAL/M™ available separately for \$175; manual available separately for \$10.

## COMING SOON!

We've got a new board coming up that's so versatile some of our people have nicknamed it the "smorgasboard": it includes (among other things) a real-time clock, interval timer, interrupt controllers, and math processor. We've also got a board in the works that greatly enhances the throughput and performance of multi-user (2 or more terminal) systems, by assuming a lot of the overhead functions normally handled by the main CPU. Look for more details on these useful and functional products in the months ahead, or check with finer computer stores for additional information on these and other CompuPro products.

**CompuPro™**  
Bldg. 725, Oakland Airport, CA 94614

from **GODBOUNT**  
ELECTRONICS

example shows. (In this implementation of the *case* construct, the selection of a case causes the execution of one FORTH word. Since there is no restriction as to the internal complexity of a given word, the selection of one case

**Listing 6:** Example of a new user-defined programming construct. In listing 6a, we define the words we want to execute when the numbers 0, 1, and 2 are on top of the parameter stack. In listing 6b, the user-defined defining word { CASE: } defines the word ANIMAL, which will execute OPET, 1PET, or 2PET, depending on the value on top of the parameter stack. Listing 6c illustrates what happens when the case-word ANIMAL is executed. See listing 7 for the definition of { CASE: }.

```
(a)
: OPET  ." AARDVARK " ;      ( print the quoted string )
: 1PET  ." BEAVER " ;       ( when executed )
: 2PET  ." COUGAR " ;

(b)
( sequence 2 )    CASE: ANIMAL  OPET 1PET 2PET ;

(c)
( sequence 3 )    0 ANIMAL  AARDVARK OK
                  1 ANIMAL  BEAVER OK
                  2 ANIMAL  COUGAR OK
```

**Listing 7:** Definition of the defining word { CASE: } in FORTH-79. This word allows the user to create case-words that execute one of several FORTH words depending on the value on top of the parameter stack.

```
: CASE:
  ( used at sequence 2 )
  <BUILDS          ( create head for member )
  |               ( begin ':' compilation )
  ( used at sequence 3 )
  DOES>
  SWAP 2*         ( convert case number to )
                  ( a byte index )
  + @            ( fetch the address of the )
                  ( indexed case word )
  EXECUTE        ( execute the selected word )
```

can cause any combination of conditional, loop, or case structures to be executed.)

In our example, let us first define three words, OPET, 1PET, and 2PET, that are to be executed when the value on top of the stack is 0, 1, or 2, respectively. This is done in listing 6a. Then we use the { CASE: } defining word (which we will look at later) to define the word ANIMAL (listing 6b). Now that ANIMAL and the case words it uses are defined, calling ANIMAL with the appropriate value on the stack executes the proper case word (listing 6c). For example, pushing a 2 onto the stack and calling ANIMAL causes word 2PET to be executed; this causes the English word COUGAR to be printed.

Since { CASE: } is a defining word, ANIMAL is a member of the { CASE: } family. The definition of ANIMAL consists of a list of addresses for the case words associated with ANIMAL.

The definition of { CASE: } is a sequence 1 event. Listing 7 shows the definition of { CASE: } in FORTH-79. [Listings 8a and 8b show the same definition for fig-FORTH and MMSFORTH, respectively....GW] Figure 10 shows how the word ANIMAL is built using { CASE: }. The { : } compiler is used to compile the words following ANIMAL. When ANIMAL is

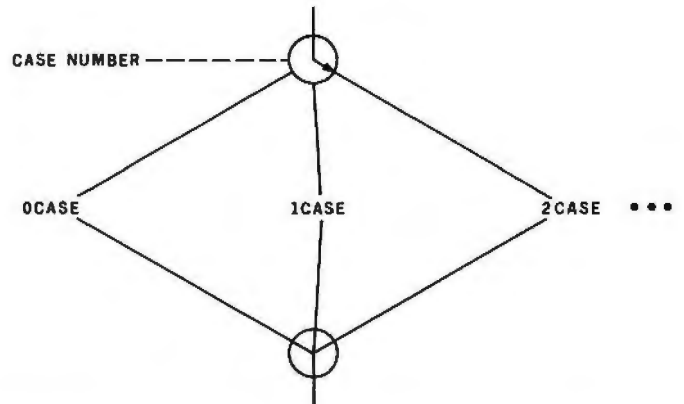

**Figure 9:** The function of a case control structure. The case number selects one of several procedures for execution, then continues along a single exit path.

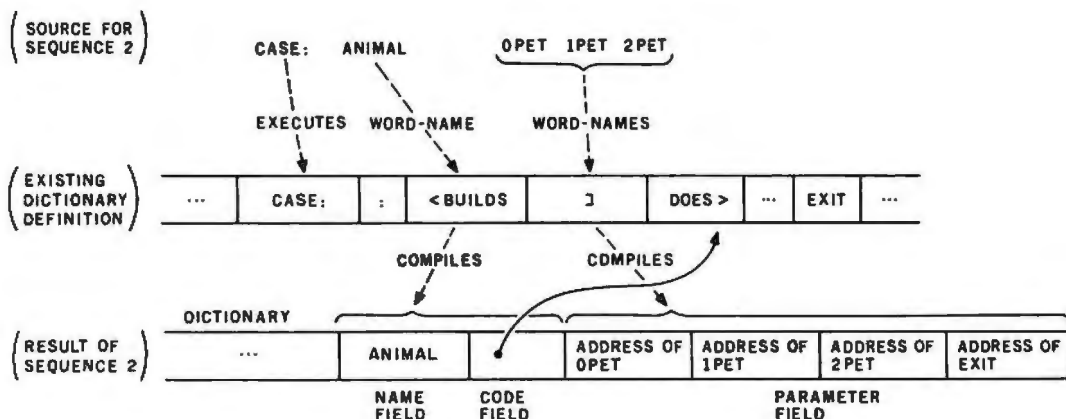

**Figure 10:** The creation of a case control word. The execution of { CASE: } causes a definition for ANIMAL to be appended to the dictionary. The ']' word uses the { : } compiler to compile the addresses of the case words following ANIMAL.



"THE ORIGINAL"

# Personal Computing<sup>®</sup> 80

## Presents: Personal Computing and Small Business Computer Show

### The Largest Personal Computing Show in 1980



### August 21, 22, 23, 24th at the Philadelphia Civic Center

- Major exhibits by the industries leading companies
- Thursday, Aug. 21st, Dealer Day — 12 Noon to 6 P.M.
- Friday and Saturday, Aug. 22, 23rd — 9 A.M. to 6 P.M.
- Sunday, Aug. 24th — 10 A.M. to 5 P.M.
- Free Seminars ● Robotics Contest ● Antique Computer Display
- Special Seminars and Tutorials about Computer Music, Saturday, Aug. 23rd
- 3rd Annual Computer Music Festival, Saturday Evening, Aug. 23rd  
(Computer Music Festival is sponsored by the Philadelphia Area Computer Society-Tickets on sale at show)
- Computer Visual Arts Festival, Sunday, Aug. 24th

#### Advanced Registration Saves Time & Money

Send \_\_\_\_\_ Dealer-Retailer (4 days) Registrations at \$10. each, \$12. at door for Thursday-Sunday, Aug. 21, 22, 23, 24

Send \_\_\_\_\_ Regular Registrations (3 days) at \$8. each, \$10. at door for Friday-Sunday, Aug. 22, 23, 24 only.

Advanced Registrations will be mailed late July - early August. No Advanced Registrations accepted after Aug. 8th.

Send Exhibitor information or Phone 609-653-1188

COMPANY NAME \_\_\_\_\_

NAME \_\_\_\_\_

STREET \_\_\_\_\_

CITY \_\_\_\_\_ STATE \_\_\_\_\_ ZIP \_\_\_\_\_

PHONE \_\_\_\_\_

Send To:

#### PERSONAL COMPUTING 80

Rt. 1, Box 242, Warf Rd., ● Mays Landing, NJ 08330

**Listing 8:** Definition of the defining word { CASE: } in fig-FORTH (listing 8a) and in MMSFORTH (listing 8b).

```
( CASE: as implemented in fig-FORTH)
: CASE: <BUILDS SMUDGE ]
      DOES > SWAP 2*
(a)      + @
      EXECUTE
;
```

```
( CASE: as implemented in MMSFORTH)
( new word ) replaces SMUDGE )
: ) ) STATE C! 21144 ;
: CASE <BUILDS )
      DOES > SWAP 2*
(b)      + @ 2+
      EXECUTE
;
```

**Listing 9:** Definition of a defining word that acts as a programming tool. The word LOADED-BY allows the user to execute (or load) a screen by name rather than by number. For example, if you define { 125 LOADED-BY ACCOUNTING }, executing the word ACCOUNTING will have the same effect as executing the phrase { 125 LOAD }.

```
( sequence 1 ) : LOADED-BY <BUILDS , ( store screen # )
                                     ( in members def. )
      DOES > @ ( fetch screen # )
      LOAD ( load it )
;
```

executed, the case number that precedes it (which is now on top of the stack) is used just like an array subscript to calculate the address of the case word to be executed. Its compiled address is then fetched and executed.

As with array-defining words, many variations of { CASE: } can be constructed. A case number-range check may be added. An "otherwise" case word can be specified to be executed whenever the case number is out of range.

### Defining Words as Programming Tools

The final example applies defining words to the creation of software tools. Such tools are conveniences for the user. Good tools can increase a programmer's productivity, reduce errors, and improve program readability. Defining words can be used to add powerful tools to the FORTH language and operating system.

In FORTH, the word LOAD will compile source definitions from the disk starting at a specified screen number. A screen is a block of disk space where source text can be stored using an editor. Additional screens may be loaded if the initial screen contains more LOAD commands.

Application programs and utility programs begin on various screen numbers determined by the user. The defining word LOADED-BY allows words to be defined which will LOAD a screen without calling it by number.

For example, assume a business application starts on screen 125. Then the defining word LOADED-BY can be used to define a word that will load screen 125 when the member word is executed. When we define:

#### 125 LOADED-BY ACCOUNTING

screen 125 will be loaded when the single word ACCOUNTING is executed. (If LOADED-BY looks strange, think of it as a FORTH word like VARIABLE .)

The definition of LOADED-BY is given in listing 9. This definition is similar to the definition of the word CONSTANT except that, rather than returning the value stored in the definition of the member word, LOADED-BY uses that value to provide a parameter to the word LOAD .

### Summary

FORTH exploits its own extensibility to support a user's need for a variety of language facilities and compiler structures.

A defining word controls the compilation and execution of all words compiled by it. New defining words that define a new family of capabilities may be constructed. Subsequently, any number of individual members can be added to the family.

The source definitions of most defining words are short and simple. Proper use of defining words in a software development project reduces program development time, improves program readability, and makes program modification and maintenance easier.

Defining words are applicable to data structures, control structures used by the FORTH compiler, and software tools. The ability to create new kinds of defining words (which are, in their own way, small compilers) is a unique feature of FORTH and is one of the most powerful programming tools in the language. ■

# NOBODY DOES IT LIKE SYNCHRO-SOUND!



## HAZELTINE 1420 VIDEO TERMINAL

\$775<sup>00</sup>

---



## HAZELTINE 1500 VIDEO TERMINAL

\$849<sup>95</sup>



**SYNCHRO-SOUND**  
The Computer People  
193-25 Jamaica Avenue  
Jamaica, N.Y. 11423

ENTERPRISES, INC.

PHONE ORDERS. CALL:  
New York—212/468-7067  
Los Angeles—213/628-1808  
Chicago—312/641-3010  
Dallas—214/742-6090



# Easy Writer™

The Professional  
Word Processing System  
for your Apple-II Personal Computer

## EasyMailer™

The Continuous Letter Module

## EasyMover™

The Personal Electronic Mail Module

INFORMATION UNLIMITED SOFTWARE, INC.  
The entire EasyWriter  
family of office communication  
products is available through your  
local computer store or directly from  
our office in Berkeley, Ca.

IUS (Information Unlimited Software, Inc.), 281 Arlington Ave., Berkeley, CA 94707 415-525-4046

This glossary is a compilation of most of the FORTH words used in the listings and figures of all the FORTH articles in this issue. It does not include all the standard words in FORTH (there are quite a few), nor does it include user-defined words required by each article. The pronunciations of some words are given in parentheses. Wherever possible, an example is given showing the use of the defined word. The words "before" and "after" show the stack before and after the word is executed. In these representations of the stack, the top of the stack is the rightmost number, and the words influenced by the defined word are depicted in boldface.

The columns marked "uses" and "leaves" show how the execution of a FORTH word affects the top entries of the stack. FORTH words remove the stack entries they use and sometimes leave one or more entries on the stack. Therefore, the number under "uses" and "leaves" should

equal the number of entries in boldface in the "before" and "after" stacks. Asterisks in both columns mean that the numbers are not given for multiword constructs for the purpose of clarity.

Multiword constructs, like the following example:

```
{ IF ... ELSE ... THEN }
```

are enclosed in braces with the keywords separated by ellipses that represent zero or more FORTH words. Also, these constructs are listed only under the first word of the construct. In general, all the words in this table are sorted by ascending ASCII value — for example, the word \* (ASCII hexadecimal 2A) is listed before the word + (ASCII hexadecimal 2B).

This glossary assumes that the output device used by the FORTH system is a video terminal. When any definition refers to the video display or display, it actually refers to whatever output device or devices are currently enabled.

---

# FORTH Glossary

---

Word	Uses	Leaves	Notes
{ ! } (store)	2	0	Sees top-of-stack as address of a 2-byte variable and stores second-on-stack in this variable; for example, suppose that address 20000 points to a 2-byte variable; then: before: 9 9 -1150 20000 after: 9 9 (-1150 is stored in a 1-byte variable.)
{ " }	0	0	{ " HI THERE!" }, when executed, prints HI THERE! on the video display.
{ ' } (tic)	0	1	Puts onto top-of-stack the address of the word that <i>follows</i> it.
{ ( }	0	0	{ ( THIS IS A COMMENT) } , if included in a definition, will not be compiled; { ( } requires a { ) } to end the comment.
*	2	1	Multiplication; example: before: 9 9 3 5 after: 9 9 15 The word * multiplies 5 and 3, leaving 15.
+	2	1	Addition; example: before: 9 9 3 5 after: 9 9 8 The word + adds 5 and 3, leaving 8.
{ , }	1	0	Embeds the number on the top of the stack into a dictionary definition, incrementing the dictionary pointer.
-	2	1	Subtraction; example: before: 9 9 3 5 after: 9 9 -2 The word - subtracts 5 from 3, leaving -2.
{ . }	1	0	Displays the number on the top of the stack; example: before: 9 9 3 5 after: 9 9 3 (5 is printed on screen.)



# YOU KNOW WATSON, HAYDEN SOFTWARE OFFERS THE BEST REASONS TO OWN A MICROCOMPUTER...

I had heard everyone speak about Hayden software. How it was the finest available. "I would be so pleased," said I, "if we could discuss some of their programs."

"Sounds delightful, Watson. This **SARGON II** plays a marvelous game of chess. It has 7 levels of play, and levels 0-3 play in tournament time. It has a randomized opening book for all 7 levels of play through 3 moves. And, a special hint mode is included at all levels of play but 0. Imagine that, old fellow. Small wonder they call it, 'the champ of champs.'"

(\*03403, TRS-80 Level II; \*03404, Apple II; each \$29.95; \*03409, Apple II Disk Version; \*03408, TRS-80 Disk Version; each \$34.95)

I then looked around, and spotted a new program. I lifted the cassette, examined it critically, and then began to speak. "This **DATA MANAGER** looks to be as fine a specimen as that **SARGON II**. It stores up to 96,000 alphanumeric characters on just one floppy disk. And one third of this information may be recovered from Random Access Memory at a time. This means, that on just eleven diskettes one can store and retrieve up to 1,000,000 characters. It is, in my judgment, a clever program to have around."

(\*04909, Apple II Disk, \$49.95)

"Extraordinary. Here's another program for the Apple II. They call it **APPLESOFT UTILITY PROGRAMS**. It contains 9 subroutines, among them 3 statement formatters: REM, PRINT, and POKE writers. You can calculate the decimal address of your machine language programs, get an exact byte and line count, renumber the program in any increment, and much more. I wonder what other fine programs are to be had from Hayden?" (\*03504, Apple II, \$29.95)

Holmes leaned back, still puffing at his black pipe. "Wait a minute," said he. "Here's something."

Apple is a trademark of Apple Computer Company, Inc. and is not affiliated with Hayden Book Company, Inc.

Circle 130 on Inquiry card.



"What is it?" said I.

"It's **APPLE™ ASSEMBLY LANGUAGE DEVELOPMENT SYSTEM**. It features a cursor-based editor, global and local labels, and disk-based macros which allow you to incorporate subroutines into any program. And, one can write and modify machine language programs quickly and easily. It is indeed quite remarkable."

(\*04609, Apple II Disk Version, \$39.95)

"Quite. But let us not forget **BLACKJACK MASTER**, what. Unlike other blackjack programs that emphasize graphics and harmless fun, this is a serious game. Imagine being able to perform complex simulations and evaluations of any playing and betting strategies that are entered into the microcomputer. And, it will tutor one in how to play these strategies! Good gracious, there's also a **\$250.00 BLACKJACK Challenge!** (\*05303, TRS-80 Level II, \$19.95; \*05308, TRS-80 Disk Version, \$24.95)

"What is that?"

"My dear fellow, just see the package for details! Holmes, you do agree then, that these programs are a fine lot?"

"I'm satisfied, Watson."

"A very sensible reply, Holmes. It's simple to see why one would want to own a microcomputer when Hayden software is available. It's easy-to-use, ready-to-run, comes with full documentation, and can be had at any local computer store."

"Or Watson, you can call **TOLL FREE**, 24 hours a day, (1-800-827-3777, ext. 302)\* **TO CHARGE YOUR ORDER TO** Master Charge or Visa! Minimum order is \$10.00; customer pays postage and handling."

"Splendid, Holmes, simply splendid."



Hayden Book Company, Inc.

50 Essex Street, Rochelle Park, NJ 07662

\*From Missouri, call (1-800-892-7655, ext. 302)

/	2	1	Division; example: before: 9 9 13 2 after: 9 9 6 The word / divides 13 by 2, leaving 6. (Remainder is lost.)
0<	1	1	If top-of-stack is <0, it is replaced with a 1 (true); if top-of-stack is ≥ 0, it is replaced with a 0 (false); example: before: 9 9 3 5 after: 9 9 3 0
1+	1	1	Adds 1 to top-of-stack; example: before: 9 9 3 5 after: 9 9 3 6
{ : ... ; }	*	*	{ : } begins the definition of a word; { ; } ends the definition; example: { : 3* 3 * ; } defines the word 3*.
=	2	1	If the two top items on the stack are exactly equal, both of them are removed and replaced with a single 1 (true); if not, both are replaced with a single 0 (false); example: before: 9 9 3 5 after: 9 9 0
<	2	1	If the second item on the stack is less than the top item on the stack, both of them are removed and replaced with a single 1 (true); if not, both of them are replaced with a single 0 (false); example: before: 9 9 3 5 after: 9 9 1

TARGET HOST ► TARGET HOST ► TARGET HOST

### CROSS COMPILE FORTH!

CROSS COMPILING IS THE MOST CONVENIENT WAY TO IMPLEMENT AND EXTEND FORTH. NOW YOU CAN CROSS COMPILE AN ENTIRE FORTH SYSTEM WITH ALL FORWARD REFERENCES RESOLVED IN A SINGLE PASS TO PRODUCE AN EXECUTABLE IMAGE IN MEMORY OR ON DISK AND A LOAD MAP OF ALL DEFINED SYMBOLS. THE CROSS COMPILER IS WRITTEN IN HIGH LEVEL FORTH INTEREST GROUP (FIG) FORTH. A COMPLETE DESCRIPTION OF EACH WORD IN THE CROSS COMPILER IS GIVEN WITH STEP BY STEP STACK CONTENTS. FORTH INTERNALS (NEXT, BUILD, DOES, CREATE, ETC.) ARE ALSO COMPLETELY DESCRIBED. A CROSS COMPILABLE VERSION OF THE FIG MODEL 1.0 IS PROVIDED FOR THE 8080 WITH AN ASSEMBLER / DISASSEMBLER. THIS MAY BE EASILY CONVERTED TO ANY MACHINE. A DETAILED DESCRIPTION IS GIVEN FOR FIRST TIME IMPLEMENTATIONS. THE ENTIRE PACKAGE IS AVAILABLE FOR \$70. FROM:

Nautilus Systems  
P.O. Box 1098  
Santa Cruz, CA. 95061

FOR THE SERIOUS FORTH USER

TARGET HOST ► TARGET HOST ► TARGET HOST

**ANNOUNCING:**

**NEW!**

## MICROSTAT

A complete statistics package for business, scientific, education and research work. No other package has the features of MICROSTAT. For example:

- File oriented with COMPLETE editing
- A Data Management Subsystem for editing, sorting, ranking, lagging, data file transfers PLUS 11 data transformations (e.g., linear, reciprocal, exponential, etc.)
- Frequency distributions
- Simple and multiple regression
- Time series (including exponential smoothing)
- 11 Non-parametric tests
- Crosstabs/Chi-square
- Factorials (up to 1,000,000!), permutations, combinations
- 8 Probability distributions
- Scatterplots
- Hypothesis test (Mean, proportion)
- ANOVA (one and two-way)
- Correlation
- Plus many other unique features

Users manual: \$10.00 (credited towards purchase) and includes sample data and printouts. Uses

**NORTH STAR BASIC** 32K of memory, one or two disk drives (2 recommended). Printer optional. Price: \$200.00



**ECOSOFT**

P.O. Box 68602  
Indianapolis, IN 46268

Phone orders:  
(317) 253-6828



StackWork's

# FORTH

A full, extended FORTH interpreter/compiler produces COMPACT, ROMABLE code. As fast as compiled FORTRAN, as easy to use as interactive BASIC.

## SELF COMPILING

Includes every line of source code necessary to recompile itself.

## EXTENSIBLE

Add functions at will.

## CP/M\* COMPATIBLE

## Z80 & 8080 ASSEMBLERS included

Single license

Supplied with extensive user manual and tutorial:

\$150.00

Documentation alone: \$25.00

OEM's, we have a deal for you!

CP/M Formats: 8" soft sectored, 5" Northstar, 5" Micropolis Mod II.

Please specify CPU type

Z80 or 8080

## All Orders and General Information:

**SUPERSOFT ASSOCIATES**

P.O. BOX 1628

CHAMPAIGN, IL 61820

(217) 359-2112

Technical Hot Line: (217) 359-2691

(answered only when technician is available)



*SuperSoft*  
**First in Software Technology**

\*CP/M registered trademark Digital Research

{ <BUILDS ... DOES > }	*	*	Used to define new defining words; see "FORTH Extensibility" article, figure 4.
>	2	1	Similar to entry for < ; example: before: 9 9 3 5 after: 9 9 0 (3 is not less than 5.)
{ ? }	1	0	Sees top-of-stack as address for 2-byte variable; displays value of that variable; using the example for { ! }, then: before: 9 9 20000 after: 9 9 (-1150, contents of 20000, prints on screen.)
@ (fetch)	1	1	Sees top-of-stack as address for 2-byte variable and replaces it with value of that variable; using the example in { ! } : before: 9 9 20000 after: 9 9 -1150 (-1150 is contents of 2-byte variable at 20000.)
ALLOT	1	0	Sees top-of-stack as number of bytes to be reserved (and filled in later) during the definition of a word.
AND	2	1	Does an AND operation on the corresponding bits of the top two stack entries (both 16-bit numbers); example: before: 9 9 3 5 after: 9 9 1 (3 AND 5, in binary, is 1.)
BASE	0	1	BASE is a 1-byte variable that contains the number base being used; for example, { 2 BASE C! } causes all subsequent input and output to be in binary (base 2); execution of this word causes the address of this 1-byte variable to be placed on top-of-stack.

\*\*\*\*\*  
**SURPLUS  
"SELECTRIC" SPECIAL!**  
\*\*\*\*\*

**"SELECTRIC" TYPEWRITER TERMINAL**

Just imagine; an IBM Model 725 "SELECTRIC" typewriter built into a complete table-top RS-232 terminal! These surplus terminals were formerly on lease and appear to be in good condition (we test 'em to make sure the printer is functional!) These fantastic BCD-Coded terminals feature:

- 15" CARRIAGE
- 725 "SELECTRIC"
- RS-232 I/O
- 132 COLUMNS
- Sim. to IBM 2741
- Std. Typewriter Kbd.
- MAX: 15 CPS RATE
- 10 Chars./Inch
- Removeable Type Sphere
- 134.5 BAUD I/O
- 88 Character Set
- 6 Bit BCD CODE
- Attractive Case
- Upper/Lower SHIFT



**ONLY  
\$469<sup>00</sup>!**  
Ea. !

While we will check out each unit, we MUST offer these unique bargains "AS-IS": Meaning they may need some service but are basically operational. Add \$20.00 for packing crate, you pay shipping on delivery.

**ALSO INCLUDES:** Type ball, I/O circuit boards, power supply & some dats. Sorry, no power cord included

**—SPECIAL OFFER!—**  
Buy 2, take 20% Off the Full Price—  
You Pay Only ..... **2 for \$750<sup>00</sup>**

**"SELECTRIC" PRINTER MAINTAINANCE MANUAL**  
JUST IN! We now have available some excellent printer maintenance manuals. These are the most thorough manuals we've seen. Well worth the price! ..... **ONLY \$25.00 ea.**  
\*SELECTRIC is an IBM Trademark

**CFR Associates, Inc.**

MAIL ADDRESS: P.O. Box 144  
NEWTON, N.H. 03858

WAREHOUSE: 18 GRANITE STREET  
HAVERHILL, MASS. 01830

[617]372-8536  
Phone Orders  
Are Welcome

**At Last!**  
**HIGH RESOLUTION  
S-100 GRAPHICS**



Unretouched photograph

**512 x 640 DOT RESOLUTION  
S-100 PLUG IN  
COMPLETE INTERFACE  
ON-BOARD MEMORY  
ASSEMBLED & TESTED FROM**

**OPTIONS:**  
• 16 COLORS  
• GREY LEVELS  
• LIGHT PEN  
• SOFTWARE

**\$1,200**

Send for brochure and data



**CAMBRIDGE DEVELOPMENT LAB**  
44 Brattle Street Cambridge, MA 02138



# JOIN THE APPLE INFANTRY!

Judging by the letters we've received from buyers of Computer Bismarck,<sup>™</sup> home computer historical wargaming is a great mind-stretching recreation to uncramp the old synapses after a few hours of trying to cram 54K of code into 48K of memory. But before you read any further, let us warn you that our new game, Computer Ambush,<sup>™</sup> is more gut-wrenching than mind-stretching.

## Strategy versus Tactics

Computer Bismarck is a "strategic" wargame, casting you in the role of a British or German admiral coolly deploying fleets of ships and planes. Computer Ambush is "tactical"...tough and dirty street fighting in a half-ruined French town.

## You're a Sergeant

You command a squad of ten infantrymen (either American or German). Each man has a name, rank, and such individual combat skills as footspeed, strength, intelligence, endurance and marksmanship...all of which affect the success of every move you order. Your squad is armed with grenades, rifles, automatic weapons, plastic explosives, bayonets, and even garottes. You fight with carefully-aimed shots, area bursts, explosions, and hand-to-hand combat. They can result in wounds or deaths, depending on time, distance, the individual skills of each soldier, and your ability as a squad leader.

## Battlefield

Street fighting is the most challenging tactical command situation in modern warfare. Using "Higher Text", a character generator, the computer displays a map showing buildings (your plastic explosives can turn them into rubble during the game), walls, hedges, doors, windows (nasty sniper positions), and each of your men by name. The enemy is usually hidden.

## Play the Computer

The computer plays the German squad leader (Feldwebel Kurt Reich) to perfection. It defends the town with sniping, machine guns, grenades, and finally, with hand-to-hand combat.

You're Sergeant Buck Padooka. You maneuver your men and fire at revealed and probable German positions. If you kill all the Germans before they get you, the town is yours. But the computer's a tough, experienced squad leader, so don't expect to win very often.

## Play a Friend

You take turns examining the

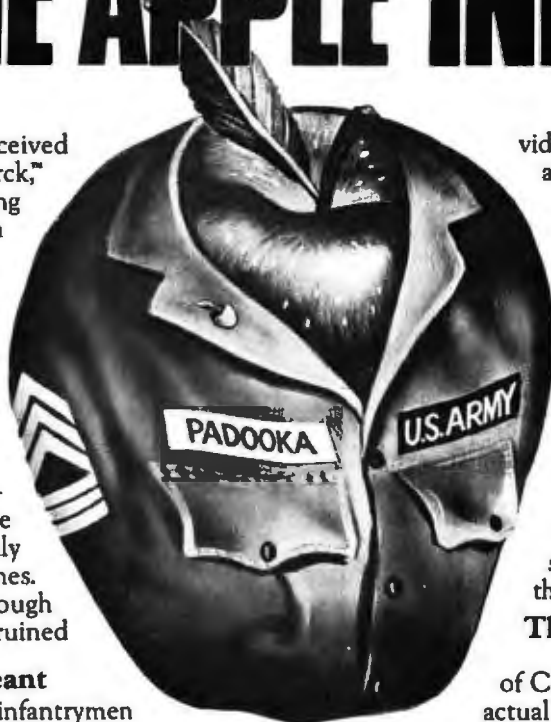

video map display, moving your men, and firing weapons. Your options are limited by casualties, wounds, physical exhaustion, ammo supplies, terrain, and the individual skills of each of your men. The same is true for your opponent. And every action takes precious time, even the flight of a grenade or bullet. (Remember, time is life or death on the battlefield and in Computer Ambush!) After each turn, the computer displays the movements and weapons fire of both squads as tracks on the video map...just once, so watch carefully to figure out where the enemy is, or was.

## The Sweat and Death of War

The time pressure and complexity of Computer Ambush create the stress of actual combat command. Your palms sweat as you watch PFC Chuck Lawson get blown away by that damned Kraut machine gun you forgot when you ordered him to sneak across the alley. If you can imagine a game that's more complex than chess, requires much faster decision-making, rewards courage and cruelly punishes foolhardiness...that's Computer Ambush!

## \$59.95 and an Apple

If you've got an Apple II Plus (or an Apple III or an Apple II with Applesoft Firmware ROM Card) with 48K memory and a 5¼ inch mini-floppy disc drive, you can be playing Computer Ambush in a few days. For \$59.95, you get the game program disc; 2 mapboard charts (for plotting strategies in grease pencil while your opponent is at the computer); 2 squad leader's data cards; and a rule book. You also get a game selection card which tells you how to set

up any of seven wargames: NCO Training, Ambush or Raid against the computer; and Patrol, Ambush, Strongpoint, or Free Form against a human opponent.

Call 800-648-5600 (toll free), and ask Operator 181 to charge Computer Ambush (or Computer Bismarck) to your VISA or MASTERCARD. In Nevada call 800-992-5710. To order by mail, send your check to Strategic Simulations Inc., Dept. B, 450 San Antonio Road, Suite 62, Palo Alto, CA 94306.

With our 14-day money back guarantee, your satisfaction is assured. So come and join our Apple Infantry!



## COMPUTER AMBUSH<sup>™</sup>...You've got a war on your hands.

{ BEGIN ... UNTIL }	*	*	Looping construct that tests at the end of the loop; see "What Is FORTH?" article, figure 4.
{ BEGIN ... WHILE ... REPEAT }	*	*	Looping construct that tests at the beginning of the loop; see "What is FORTH?" article, figure 5; other forms are { BEGIN ... PERFORM ... PEND } and { BEGIN ... IF ... WHILE }.
{ C; }	*	*	Sometimes used to end a machine-code word definition; most versions use NEXT.
{ CI }	2	0	Similar to { I } except that only low byte of second-to-top is stored in 1-byte variable pointed to by top-of-stack; for example, suppose that address 21000 points to a 1-byte variable; then: before: 9 9 103 21000 after: 9 9 (103 is stored in 1-byte variable.) Note that the maximum value that can be stored in 1 byte is 127.
C@	1	1	Same as the word @, only for 1-byte variable; using the example of { CI }, then: before: 9 9 21000 after: 9 9 103 (103 is contents of 1-byte variable at 21000.)
{ CODE ... NEXT }	*	*	Defining words, used like { : } and { ; }, used when defining a new word using assembly language only.
CONSTANT	1	0	Creates a constant that has the value of top-of-stack; for example, before executing the phrase { CONSTANT CON }, the stack looks like: 9 9 25140

MICRO MISCELLANY	
<b>APPLE II PARALLEL INTERFACE</b>  <b>\$79.95</b> Interfaces printers, synthesizers keyboards, and JBE A-D-D-A Converter & Switches. This interface has 4 I/O ports with handshaking logic, 2-8522 VIA's and a 74LS74 for timing. Inputs and outputs are TTL compatible. 79-295K Complete Kit \$69.95 79-295A Assembled \$79.95	<b>SOLID STATE SWITCH</b>  <b>\$44.95</b> <b>\$12.50</b> Your computer can control power (120VAC) to your printer, lights, and other 120VAC appliances up to 720 watts (6AMPS at 120VAC). Input 3 to 15 VDC, 2-13 MA TTL compatible, isolation 1500V. 79-282 1 Channel Kit \$ 9.95 Asm. \$12.50 79-282 4 Channel Kit \$34.95 Asm. \$44.95
<b>Atod DtoA CONVERTER</b>  <b>\$69.95</b> Analog to Digital, Digital to Analog Converter, Atod conversion time 20us. DtoA conversion 5us. Uses include speech and music synthesizing and slow scan TV. Single power supply (5V), 8 Bits wide, latched I/O, strobe lines. 79-287K Complete Kit \$49.95 79-287A Assembled \$69.95	<b>BARE BOARDS</b> <b>SINGLE BOARD COMPUTERS</b> 8088 5-CHIP SYSTEM \$29.95 8085 3-CHIP SYSTEM \$24.95 <b>MEMORY BOARD</b> 8208 64K DYNAMIC \$39.95 <b>ALL PRODUCTS AVAILABLE FROM:</b> <b>JOHN BELL ENGINEERING</b> P.O. Box 338 Dept. 4 Redwood City, CA 94064 (415) 367-1137 Add 6% sales tax in California and \$1.00 shipping and handling for orders less than \$20. Add 4% for VISA or M.C.
<b>JOHN BELL ENGINEERING</b>	

# CAT-100 FULL COLOR GRAPHICS

**The original 256-color imaging system with high resolution video FRAME GRABBER for the S-100 bus.**

Capture and digitize a video frame in 1/60 of a second. Select the best resolution for your application, from 256 to 1280 pixels per TV line. Display your digitized or computer processed image with 256 gray levels or 256 colors on standard B&W, NTSC or RGB color TV monitors.



Compact two-board basic system

**Features:**

- Highest possible quality 480x512x8 digital video image presently available on the market
- Input capability from TV camera or other sources
- Variety of synchronization choices
- 2 selectable video A/D conversion circuits
- Choice of 1, 2, 4, 8, 16 or 32 bits per pixel
- 32K-byte image memory on the basic system
- 32, 64, 128 & 256K byte system capacity
- Lightpen input
- Photographic trigger control input
- Software selectable system parameters
- Interfaces for TRS-80 and other processors
- Comprehensive line of accessories, monitors and support software



340x256 Digitized image, 16 levels



480x512 Computer-generated

**SEND FOR FREE CATALOG**

**DIGITAL GRAPHIC SYSTEMS**  
441 California Ave., Palo Alto, CA 94306 415/494-6088



# Put your applications to work on the Mostek STD-Z80 BUS.



You're ready. You've gone beyond the learning stage and are using your personal computer to implement real time control applications.

We can take you one big step further. By showing you how to take the programs you have developed using your TRS-80 (or other Z80 based computer) and place them in PROM on a low-cost stand-alone micro card system. This will not only free up your main computer for new applications, but will also permit your current application to be "on-line" continuously, or even "cloned" - for multiple installations or sales to other users.

Mostek's MD Series™ of STD-Z80 BUS compatible microcomput-

er cards makes all this possible. There are more than twenty different boards in this off-the-shelf family available now, including data processing boards; memory boards (Static and Dynamic RAM, ROM/PROM); I/O cards; A/D; D/A; high speed floating point math; and floppy disk controller cards.

QC Micro Systems offers all of these products directly, including a full range of support products such as prototyping hardware,

support software and, of course, extensive documentation. And much more. Contact us for details so they can be put to work for you, by sending in the coupon below. Today. QC MicroSystems, P. O. Box 401326, Garland, TX 75040, (214) 343-1282.



Yes! I'm ready for more information on the STD-Z80 BUS products from QC MicroSystems. My application is

Personal  Resale

Industrial Control  Other \_\_\_\_\_

Yes, I would like to use my TRS-80 as my STD BUS development station.

Name: \_\_\_\_\_

Company: \_\_\_\_\_

Address: \_\_\_\_\_

City: \_\_\_\_\_ State: \_\_\_\_\_ Zip: \_\_\_\_\_

# COLOR SOFTWARE

Unless otherwise noted all programs are \$15 each, for Apple II, Atari 16K, TI 99/4

**UNITS:** Practice converting yards-feet-inches, pounds-ounces, metric units, etc.

**3-D STARTREK:** Discover new planets, fight Klingons in 3-dimensional galaxy.

**ROADRACE:** Race around 2.25 mile course. 1 or 2 players. Not for TI 99/4.

**FRACTIONS:** Practice adding, subtracting, multiplying and comparing fractions.

**MAJOR LEAGUE BASEBALL:** Manage Major League teams and make all lineup, batting, pitching and running decisions. \$25. Apple II with 48K, Applesoft ROM and one disk.

**BLACKJACK:** Popular card game for 1 to 3 players. Not for Apple II.

**NUCLEAR REACTOR:** Realistic dynamic model of nuclear power plant in operation.

**COLOR SOFTWARE, 5410 W. 20th St., Indianapolis, IN 46224**

After the phrase has been executed, the stack looks like:

9 9

and the word CON , when executed, will place 25140 on the top of the stack.

CR	0	0	Causes the cursor to jump to the beginning of the next line of the display.
{ DO ... LOOP }	2	0	Looping construct that specifies a beginning and an ending-value-plus-one; see "What Is FORTH?" article, figure 3.
DROP	1	0	Drops top entry from stack; example: before: 9 9 3 5 after: 9 9 3
DUP	1	2	Duplicates item on top-of-stack; example: before: 9 9 3 5 after: 9 9 3 5 5
ECHO	1	0	Isolates the low-order byte of the 2-byte entry on top of the stack and writes it to the video display; example: before: 9 9 32 after: 9 9 (A space, ASCII decimal 32, is printed.) ECHO is named EMIT in some versions.
FILL	3	0	Fills an area of memory with a given value; for example, { 255 3000 100 FILL } fills memory locations from 3000 thru 3099 (100 bytes) with the value 255.
FORGET	0	0	Causes system to delete all definitions including and after the word following FORGET ; for example, { FORGET BASEPGM } causes the system to delete BASEPGM and all FORTH words, variables, and constants defined after it.



### S-100 8086

CPU with \$450.  
Vectored Interrupts  
PROM-I/O \$495.  
RAM \$395.  
8K x 16/16K x 8  
Parallel I/O \$350.  
and Timer

IN STOCK

### A/D - D/A

**S-100 A/D**  
8 Ch. Differential or  
16 Ch. Single-Ended,  
12 Bit, High Speed \$495.

**S-100 D/A** 4 Channel  
12 Bit, High Speed \$395.

**TRS-80 A/D-D/A**  
12-Bit, High Speed  
Available Soon



### S-100 VIDEO DIGITIZATION

Real Time Video \$850.  
Digitizer and Display  
Computer Portrait  
System \$4950.

### S-100 Boards

Video and/or Analog  
Data Acquisition  
Microcomputer Systems



The High Performance S-100 People  
**TECMAR, INC.**  
23414 Greenlawn • Cleveland, OH 44122  
(216) 382-7599



# THE ORIGINAL MAGAZINE FOR OWNERS OF THE TRS-80™\* MICROCOMPUTER

SOFTWARE  
FOR TRS-80™  
OWNERS

# H & E COMPUTRONICS INC.

MONTHLY  
NEWSMAGAZINE  
FOR TRS-80™  
OWNERS

## MONTHLY NEWSMAGAZINE Practical Support For Model I & II

- PRACTICAL APPLICATIONS
- BUSINESS
- GAMBLING • GAMES
- EDUCATION
- PERSONAL FINANCE
- BEGINNER'S CORNER
- NEW PRODUCTS
- SOFTWARE EXCHANGE
- MARKET PLACE
- QUESTIONS AND ANSWERS
- PROGRAM PRINTOUTS
- .... AND MORE

### PROGRAMS AND ARTICLES PUBLISHED IN OUR FIRST 12 ISSUES INCLUDE THE FOLLOWING:

- A COMPLETE INCOME TAX PROGRAM (LONG AND SHORT FORM)
- INVENTORY CONTROL
- STOCK MARKET ANALYSIS
- WORD PROCESSING PROGRAM (FOR DISK OR CASSETTE)
- LOWER CASE MODIFICATION FOR YOUR VIDEO MONITOR OR PRINTER
- PAYROLL (FEDERAL TAX WITHHOLDING PROGRAM)
- EXTEND 16-DIGIT ACCURACY TO TRS-80™ FUNCTIONS (SUCH AS SQUARE ROOTS AND TRIGONOMETRIC FUNCTIONS)
- NEW DISK DRIVES FOR YOUR TRS-80™
- PRINTER OPTIONS AVAILABLE FOR YOUR TRS-80™
- A HORSE SELECTION SYSTEM\*\*\*ARITHMETIC TEACHER
- COMPLETE MAILING LIST PROGRAMS (BOTH FOR DISK OR CASSETTE SEQUENTIAL AND RANDOM ACCESS)
- RANDOM SAMPLING\*\*\*BAR GRAPH
- CHECKBOOK MAINTENANCE PROGRAM
- LEVEL II UPDATES\*\*\*LEVEL II INDEX
- CREDIT CARD INFORMATION STORAGE FILE
- BEGINNER'S GUIDE TO MACHINE LANGUAGE AND ASSEMBLY LANGUAGE
- LINE RENUMBERING
- AND CASSETTE TIPS, PROGRAM HINTS, LATEST PRODUCTS COMING SOON (GENERAL LEDGER, ACCOUNTS PAYABLE AND RECEIVABLE, FORTRAN-80, FINANCIAL APPLICATIONS PACKAGE, PROGRAMS FOR HOMEOWNERS, MERGE TWO PROGRAMS, STATISTICAL AND MATHEMATICAL PROGRAMS (BOTH ELEMENTARY AND ADVANCED)) . AND

**FREE**

WORD PROCESSING PROGRAM (Cassette or Disk) For writing letters, text, mailing lists, etc., with each new subscriptions or renewal.

LEVEL II RAM TEST (Cassette or Disk) Checks random access memory to ensure that all memory locations are working properly.

DATA MANAGEMENT SYSTEM (Cassette or Disk) Complete file management for your TRS-80™

CLEANUP (Cassette or Disk) Fast action Maze Game

ADVENTURE (Cassette or Disk) Adventure #0 by Scott Adams (From Adventureland International)

**FREE**

\* TRS-80™ IS A TRADEMARK OF TANDY CORP

SEND FOR OUR NEW 48 PAGE SOFTWARE CATALOG (INCLUDING LISTINGS OF HUNDREDS OF TRS-80™ PROGRAMS AVAILABLE ON CASSETTE AND DISKETTE). \$2.00 OR FREE WITH EACH SUBSCRIPTIONS OR SAMPLE ISSUE.

# COMPUTRONICS

MATHEMATICAL APPLICATIONS SERVICE™

50 N. PASCACK ROAD  
SPRING VALLEY, NEW YORK 10977

ONE YEAR SUBSCRIPTION \$24 .....

TWO YEAR SUBSCRIPTION \$48 .....

SAMPLE OF LATEST ISSUE \$ 4 .....

START MY SUBSCRIPTION WITH ISSUE .....

(#1 - July 1978 • #7 - January 1979 • #12 - June 1979 • #18 - January 1980)

NEW SUBSCRIPTION ..... RENEWAL .....



**24 HOUR  
ORDER  
LINE**  
**(914) 425-1535**



**NEW TOLL-FREE  
ORDER LINE**  
(OUTSIDE OF N.Y. STATE)  
**(800) 431-2818**

**NEW!!!  
MOD-II NEWSLETTER  
\$12/year (or 12 issues)**

CREDIT CARD NUMBER \_\_\_\_\_ EXP. DATE \_\_\_\_\_

SIGNATURE \_\_\_\_\_

NAME \_\_\_\_\_

ADDRESS \_\_\_\_\_ CITY \_\_\_\_\_ STATE \_\_\_\_\_ ZIP \_\_\_\_\_

\*\*\* ADD \$6/YEAR (CANADA, MEXICO) - ADD \$12/YEAR AIR MAIL - OUTSIDE OF U.S.A., CANADA & MEXICO \*\*\*

H	0	1	2-byte variable containing address of the top of the dictionary; execution of this word causes the <i>address</i> of the variable H (not its value, which equals the address of the top of the dictionary) to be placed on top of the stack.
HERE	0	1	Places the address of the next byte to be used in the dictionary (the <i>value</i> of H) on top of the stack.
I	0	1	When executed within a { DO ... LOOP }, the word I pushes onto the top of the stack the value of the index counter; for example, { 10 0 DO I . LOOP } prints the numbers from 0 thru 9.
{ IF ... ELSE ... THEN }	1	0	Conditional execution of words depending on value of top-of-stack. If nonzero, execute words between IF and ELSE . If zero, execute words between ELSE and THEN ; for example, { IF " NUMBER ON TOP IS NONZERO" ELSE " NUMBER ON TOP IS ZERO" THEN } prints the appropriate message depending on the value on top of the stack.
KEY	0	1	Gets a single character from the keyboard; for example, if the stack before we press the space bar is: 9 9 3 5 Then, after we press the space bar (ASCII value decimal 32), the stack is: 9 9 3 5 32
MAX	2	1	Compares the two top entries on the stack and leaves only the larger; example: before: 9 9 3 5 after: 9 9 5
MIN	2	1	Compares the two top entries on the stack and leaves only the smaller; example: before: 9 9 3 5 after: 9 9 3
MINUS	1	1	Changes the sign of the entry on top of the stack; example: before: 9 9 3 5 after: 9 9 3 -5
OVER	2	3	Copies the second-to-top entry onto the top of the stack; example: before: 9 9 3 5 after: 9 9 3 5 3
PAD	0	1	PAD is a 2-byte variable that points to the beginning of a 64-byte area for temporary storage of character strings; execution of this word causes the <i>address</i> of this 2-byte variable to be placed on top of the stack.
SWAP	2	2	Exchanges the two top entries on the stack; example: before: 9 9 3 5 after: 9 9 5 3
U*	2	1	The <i>lower 8 bits</i> of the two top entries on the stack are isolated and multiplied together, leaving their unsigned 16-bit product; example: before: 9 9 3 5 after: 9 9 15 Each factor will effectively be 255 or less, giving a product that will not overflow in 16 bits.
VARIABLE	1	0	Creates a variable that has the value of top-of-stack; example, before executing the phrase { VARIABLE VAR } , the stack looks like: 9 9 -14017 After the phrase has been executed, the stack looks like: 9 9 and the word VAR , when executed, will place the <i>address</i> of the variable on the stack. (The 2-byte number stored at that address will contain the value -14017.) Unlike a constant, the value of a variable can be changed using { ! } (store).
{ } }	*	*	Resumes compilation of a colon definition. ■



# One small word about computers.

# Osborne

The Leader In Microcomputer Books

ASSEMBLY LANGUAGE is currently being used by thousands of microcomputer programmers. It provides maximum execution speed and utilization of memory crucial to many applications and system programs, and enables the closest control and monitoring of peripheral devices.

OSBORNE continues to provide Assembly Language Programming texts for every major microprocessor, the Z8000 and 6809 forthcoming. The four previous texts, the 6502, Z80, 6800 and 8080A/8085, have already earned the Osborne Assembly Language Programming series an excellent reputation among educators and programmers alike.

CONTENTS. In each book you'll find over 80 programming examples tailored for use on your microcomputer, with source program, object code, flowcharts and explanatory text, entire instruction set

fully explained, assembler conventions, I/O devices and interfacing methods, and how to program the interrupt system.

This July, Osborne will begin a new series of microprocessor texts combining instruction on hardware and logic configurations with usage of assembly language.

The first release will be **The 8086 Book**. A handbook for all 8086 users, this book includes basic 8086 programming information, a thorough analysis of the 8086 instruction set, and detailed hardware and interfacing guides that reveal the full power of the 8086 multiprocessing capabilities. All examples are programmed in Assembly Language, providing the most efficient solutions to many practical problems.

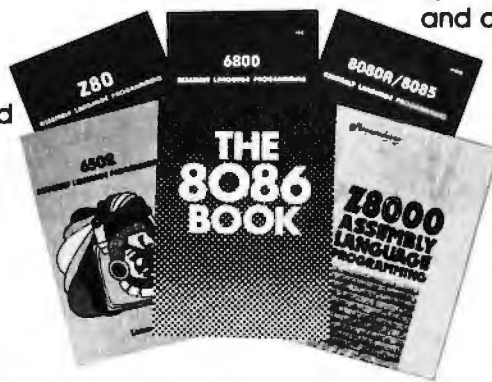

## Learn to program your microcomputer using Assembly Language

Z8000 Assembly Language Programming available August	#36-5	\$12.50	6502 Assembly Language Programming	#27-0	\$12.50
6809 Assembly Language Programming available this fall	#35-7	\$12.50	Z80 Assembly Language Programming	#21-7	\$12.50
The 8086 Book	#29-2	\$15.00	6800 Assembly Language Programming	#12-8	\$12.50
			8080A/8085 Assembly Language Programming	#10-1	\$12.50

To order, return coupon with check or money order. Include 75¢ per item for 4th class mail, \$1.25 per book UPS, or \$2.50 per book air mail in the U.S.  
California residents also include local sales tax. To place an order by phone call 415/548-2805.

Notify me when available:  Z8000 ALP  
 6809 ALP

**OSBORNE/McGraw-Hill**  
630 Bancroft Way Dept. B7  
Berkeley, CA 94710

Book	Price	Quantity	Amount

Name \_\_\_\_\_ Tax

Address \_\_\_\_\_ Shipping

City \_\_\_\_\_ State \_\_\_\_\_ ZIP \_\_\_\_\_

Phone \_\_\_\_\_ HOW TO SHIP \_\_\_\_\_ TOTAL

# Khachiyan's Algorithm, Part 1:

## A New Solution to Linear Programming Problems

---

G C Berresford, A M Rockett, and J C Stevenson  
Dept of Mathematics  
C W Post Center, Long Island University  
Greenvale NY 11548

---

### Editor's Note:

This two-part article presents some of the most difficult mathematics we have ever published in BYTE, but we believe that the attention given to the Khachiyan algorithm of late warrants a complete and rigorous treatment here. Part 2 will contain a linear programming example and a TRS-80 BASIC program designed to illustrate the algorithm....CM

### Khachiyan's Vector Notation

The vector notation used in Khachiyan's paper is different from that used by most Western mathematicians, so a word of explanation is in order. A system of linear equations (or, as in equation (1.1), linear inequalities) can be expressed in the form:

$$A x = b$$

where  $x$  is a column vector of the variables  $x_1$  thru  $x_n$ ,  $b$  is a column vector of the coefficients  $b_1$  thru  $b_m$  (one for each of the  $m$  equations in the system), and  $A$  is an  $m$ -by- $n$  matrix ( $m$  rows,  $n$  columns), where each row of the matrix  $A$  contains the coefficient for the corresponding equation. Khachiyan's notation expresses everything in terms of column vectors. In particular,  $a_i$  is a column vector containing the coefficients of the  $i$ th equation. But since the coefficient vector must be a row vector in order to be multiplied by the column vector  $x$ , we follow Khachiyan's notation and denote the corresponding row vector as  $a_i^t$  where the superscript  $t$  denotes the transposition of column vector  $a_i$ ....GW

The three-column headline "A Soviet Discovery Rocks World of Mathematics" was spread across the bottom of the front page of the *New York Times* for Wednesday, November 7, 1979. In the following weeks, subsequent articles were heralded as "Shazam! A Shortcut for Computers" and "Mathematician Is Obscure No More." Overnight, Leonid Khachiyan became famous as the author of a revolutionary discovery in the field of linear programming.

What has Khachiyan accomplished? All of the articles in the press are based on second- or third-hand reports and interpretations. [In fact, the first *New York Times* article incorrectly heralded the discovery as a solution to the still-unsolved "traveling salesman" problem....GW] Lynn Steen's article in *Science News*, "Linear Programming: Solid New Algorithm," (October 6, 1979) and Gina Bari Kolata's article in *Science*, "Mathematicians Amazed by Russian's Discovery," (November 2, 1979) discuss the basic problem of linear programming and then report on a paper by Peter Gacs and Laszlo Lovasz that discusses Khachiyan's algorithm. The Gacs and Lovasz paper opens with the statement "we have ignored his [Khachiyan's] considerations which concern the precision of real computations..." and then proceeds to describe a modification of Khachiyan's algorithm, although the differences between the two procedures are never made explicit.

---

The notation used in this article, although explained in the text, deserves some attention. In particular, the distinction between boldface and italics is an important one. An italicized variable refers to a scalar quantity (eg:  $x_1=3$ ). A variable in boldface refers to a column vector or a matrix. For example, in the equation  $Ax=b$ ,  $A$  is a matrix and  $x$  and  $b$  are column vectors.

Also, although this article is based on a paper written by Khachiyan, his discovery was not made without the benefit of previous work by other men. Khachiyan's paper is based on earlier work by A Yu Levin, N Z Shor, D B Judin, and A Z Nemirovsky....GW



Combine the **POWER** of **PASCAL**  
with the **MUSCLE** of your **MICRO!**  
Get the tool to do your job right:

# PASCAL/MT<sup>®</sup> 3.0

Executes under  
CP/M<sup>®</sup> in as little as  
32K bytes.

Compiles directly to  
Romable 8080  
object code at up to  
2000 lines per  
minute.

Contains built-in mini  
assembler for in-line  
machine code.

Supports CP/M<sup>®</sup> files  
including CP/M<sup>®</sup> 2.0  
random access files.

Includes program  
chaining facilities.

```
(HANDLE A/D CONVERSION EVERY SECOND FOR 3 HOURS)
PROGRAM SAMPLER:
(* DEMONSTRATES THE POWER OF PASCAL/MT *)
CONST
  RTC___VECTOR=6; (FOR RTC___ISR)
TYPE
  TIME___OF___DAY = RECORD
    HOURS       : 0..24;
    MINUTES     : 0..60;
    SECONDS     : 0..60;
  END;
VAR
  NOW: TIME___OF___DAY;
  SAMPLE: INTEGER;

PROCEDURE INCREMENT___ TIME___OF___DAY;
BEGIN
  (* INCREMENTS NOW BY ONE SECOND *)
END;

PROCEDURE GET SAMPLE; (TALK TO A/D CONVERTER)
BEGIN
  SAMPLE := INPUT [$3B]; (GET I/O PORT DATA)
  OUTPUT [$FA] := SHR (SAMPLE, 3); (USE SHIFT RIGHT)
  WHILE TSTBIT (INPUT [$6C], 2) <> TRUE DO; (WAIT)
  INLINE ("LDA / $FOCD / *STA / $309B); (OJB CODE)
END;

PROCEDURE INTERRUPT [RTC___VECTOR] RTC___ISR;
BEGIN (INTERRUPT SERVICE ROUTINE)
  GET SAMPLE (* EVERY SECOND *)
  INCREMENT___ TIME___OF___DAY
END;

BEGIN
  NOW. SECONDS := 0; NOW. MINUTES := 0; NOW. HOURS := 0;
  INLINE ("MVI A, / $3E / *SIM (80B5)); (START CLOCK)
  GET SAMPLE; (TAKE FIRST SAMPLE)
  WHILE NOW. HOURS <> 3 DO; (SAMPLE FOR 3 HOURS)
  END. (AT END RETURN TO OPERATING SYSTEM)
```

Features a  
SYMBOLIC debugger  
which allows variable  
display and  
breakpoints.

Supports I/O port  
access and interrupt  
procedures.

Contains bit and byte  
manipulation facilities.

Minimum overhead of  
1.25K bytes.

Includes business and  
scientific arithmetic.

Price: \$250 : Business & Scientific Compilers, Runtime Source, Debugger, User's Manual  
\$ 30 : Manual Only, refundable with purchase of total package

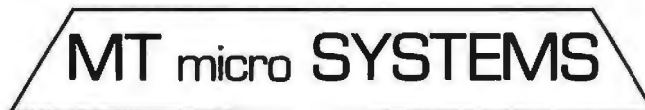

1562 Kings Cross Drive  
Cardiff, CA 92007 (714) 753-4856  
We ship on 8" single density floppies

® PASCAL/MT tradename of MT MICROSYSTEMS, CP/M trademark of Digital Research  
OTHER DISK FORMATS: LIFEBOAT [212] 580-0082, FMG [817] 294-2510

This article will present a summary of and a commentary on Khachiyan's original paper. A graphic example of how the algorithm works is shown in figure 3. We will show how Khachiyan's method handles linear programming problems and discuss some possible improvements in the computer application of Khachiyan's proposals. We will then turn to the practical question: Is Khachiyan's algorithm capable of immediate computer application? Although our conclusion is a qualified "no," we will discuss a BASIC program (in Part 2 of this article) for the TRS-80 that can be used to gain an appreciation of Khachiyan's achievement.

### Khachiyan's Paper

Our discussion of Khachiyan's paper is based on B Seckler's translation of the paper into English. We would like to thank Professor Seckler for making this translation for us. We use Khachiyan's notations in this discussion so that what he did and how he described it will be clear.

Consider the regions of the plane  $R^2$  shown in figure 1. The region in figure 1a is the intersection of the four half-planes  $x_1 \geq 1$ ,  $x_1 \leq 2$ ,  $x_2 \geq 1$ , and  $x_2 \leq 2$ . These inequalities may be rewritten in the form:

$$\begin{aligned} -x_1 + 0x_2 &\leq -1 \\ x_1 + 0x_2 &\leq 2 \\ 0x_1 - x_2 &\leq -1 \\ 0x_1 + x_2 &\leq 2 \end{aligned} \quad (1.1)$$

Since there are points in the plane that satisfy all four inequalities at once, this system of linear inequalities is said to be *consistent*.

In figure 1b, the shaded region on the lower left-hand side is defined by  $x_1 \leq 1$  and  $x_2 \leq 1$ , while the shaded region on the upper right-hand side is given by  $x_1 \geq 2$  and  $x_2 \geq 2$ . If we combine these inequalities into one system:

$$\begin{aligned} x_1 + 0x_2 &\leq 1 \\ 0x_1 + x_2 &\leq 1 \\ -x_1 + 0x_2 &\leq -2 \\ 0x_1 - x_2 &\leq -2 \end{aligned} \quad (1.2)$$

we notice that there is no point in the plane that satisfies all four inequalities at once. Such a system of linear inequalities is said to be *inconsistent*.

We shall use the letters  $a$ ,  $b$ , ... to denote column vectors and  $a'$  to denote the transposition of the column vector into a row vector. (See text box.) We will write  $R^n$  for the usual  $n$ -dimensional Euclidean space. [Readers unfamiliar with vectors and matrices will find descriptions in many engineering mathematics texts. *Advanced Engineering Mathematics by E Kreyszig, Wiley, 1967, 2nd ed, is particularly good....CM*]

Using the above notation, we may let  $x' = (x_1, x_2)$ ,  $a_1' = (-1, 0)$ ,  $a_2' = (1, 0)$ ,  $a_3' = (0, -1)$ , and  $a_4' = (0, 1)$ . Then (1.1) may be rewritten in the form:

$$a_i' \cdot x \leq b_i, \text{ (for } i = 1, 2, 3, 4)$$

where  $b_1 = -1$ ,  $b_2 = 2$ ,  $b_3 = -1$ , and  $b_4 = 2$ .

As we see from figure 1, such a system of linear inequalities may or may not be consistent. We will consider

only inequalities in which all coefficients are integers. This is no loss of generality, since numbers in a computer can be expressed only to a fixed number of decimal places. By multiplying each inequality through by an appropriate power of ten, we may express each inequality in integers alone.

Thus we are led to the following problem. Given a system of linear inequalities:

$$a_i' \cdot x \leq b_i, \text{ for } i = 1, \dots, m \quad (2)$$

with integral coefficients, is the system consistent or inconsistent?

### Advantages of Khachiyan's Algorithm

Khachiyan's algorithm is a procedure for deciding whether the system given in (2) is consistent. In addition, if the system is consistent, it finds the coordinates of a point satisfying all of the inequalities, or it at least determines them within a small margin of error. Furthermore—and this is the "revolutionary" aspect—the method gives at the start a maximum number of steps (each step

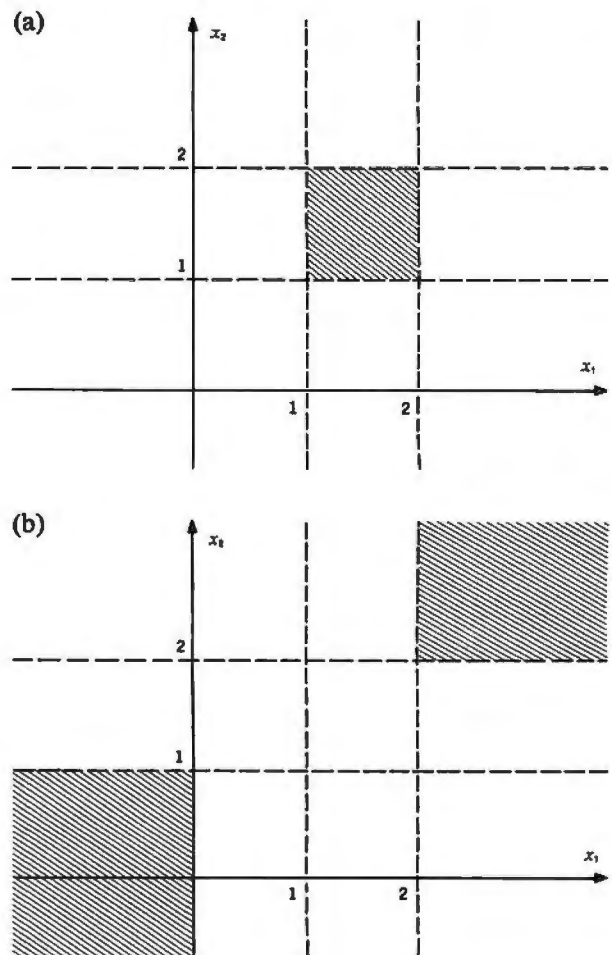

Figure 1: Consistent and inconsistent systems of linear inequalities. The shaded area in figure 1a represents the solution set of the four inequalities,  $x_1 \geq 1$ ,  $x_1 \leq 2$ ,  $x_2 \geq 1$ ,  $x_2 \leq 2$ . Since points exist that satisfy all four inequalities, the system is said to be consistent. The system shown in figure 1b is inconsistent. The lower shaded area is given by the equations  $x_1 \leq 1$  and  $x_2 \leq 1$ ; the upper shaded area is given by  $x_1 \geq 2$  and  $x_2 \geq 2$ . No point satisfies all four inequalities simultaneously.



# The new microcomputer FORTRAN you'll be proud to take anywhere.

Microcomputer users like you want the best of all worlds. A single development and run-time system that can support FORTRAN on hundreds of thousands of systems ... a standard FORTRAN that is available immediately for whatever micro you have... plus the power, portability and completeness of the UCSD™ System. Impossible? It was until now. Until SofTech Microsystems introduced FORTRAN-77, a major extension to the UCSD System.

market your applications to the broadest range of microcomputers possible.

Since UCSD Pascal and our new FORTRAN-77 are fully compatible, you can write applications that use the advantages of each language. For instance, you can utilize powerful Pascal subroutines for data display and graphics and FORTRAN subroutines for numerical calculations. And, because our system is modular, you can start now with

Pascal or FORTRAN and add additional language compilers when you are ready.

## Power... ANSI-77 FORTRAN

FORTRAN-77 is the newest ANSI standard language for engineering and scientific applications, with powerful new features included

for more rapid development of reliable software. Support for structured programming and improved character types are just a few of the FORTRAN-77 features designed to increase your productivity.

And, since most FORTRAN-66 programs can be run with little or no change, you can take advantage of the FORTRAN applications programs that already exist.

## Solution...the complete UCSD System

For all the tools and support you'll ever need, order the UCSD System. Get a complete development and

runtime package that includes an operating system, screen editor, file handler, macro assemblers, linker, P-code interpreter, the language compiler of your choice, and full documentation.

Whether you run UCSD Pascal or our new FORTRAN-77 on whatever microcomputer you have, you'll join the more than 10,000 satisfied UCSD System software users worldwide.

Call or write for more information; Master Charge or Visa orders accepted.

# SOFTech

## MICROSYSTEMS

A SUBSIDIARY OF SOFTECH  
9494 Black Mountain Road, San Diego, CA 92126. (714) 578-6105.

You've got your choice with UCSD™ System Software. Use it on microcomputers with CP/M, or on any system using a Z-80, 8080/8085, LSI-11™ 6502, 6800, 6809, or 9900 microprocessor.

- Send me the Complete set of UCSD System documentation including the FORTRAN and Pascal languages. My check or money order for \$50 is enclosed. \$50
- Send me more information about the UCSD System with FORTRAN
- Send me more information about the UCSD System with Pascal
- Send me more information about the UCSD System with both FORTRAN and Pascal
- Send me Distributor information

Name \_\_\_\_\_

Company \_\_\_\_\_

Address \_\_\_\_\_

City/State/Zip \_\_\_\_\_

Telephone \_\_\_\_\_

Massachusetts and California residents add applicable sales tax. CM-17E-(5/80)

CP/M™ is a registered trademark of Digital Research Corporation. LSI-11 is a registered trademark of Digital Equipment. UCSD Pascal and UCSD are registered trademarks of The Regents of the University of California.

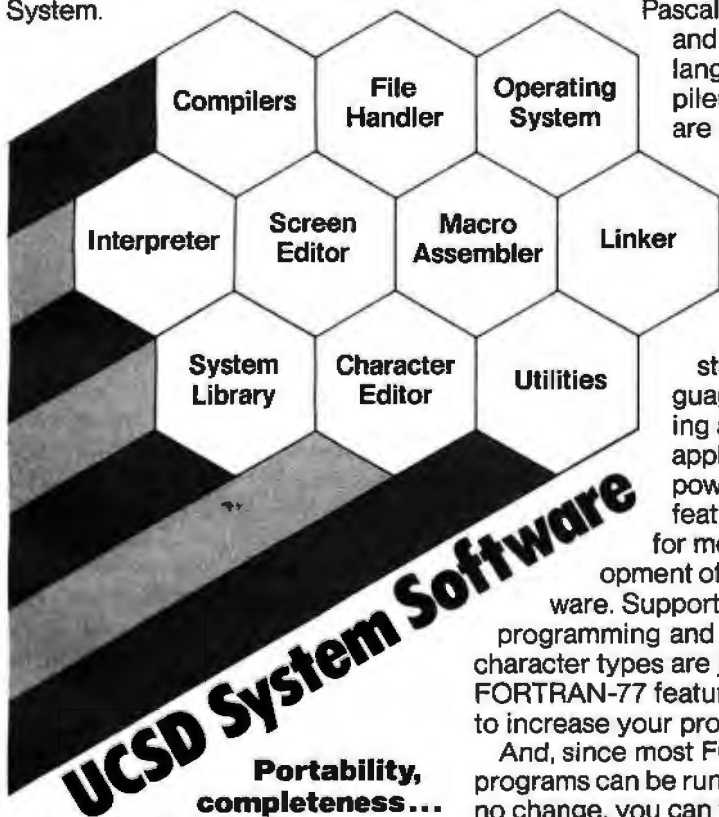

## Portability, completeness... the UCSD System

FORTRAN-77 applications are as portable as UCSD Pascal™ applications. This is because the UCSD System runs on most all major micros... giving you the freedom to choose the hardware best suited to your needs... and the ability to

requiring a fixed number of mathematical operations) that will be required to solve the problem. This maximum number of steps increases as the number of variables in the problem increases. With Khachiyan's method, however, the maximum number of steps grows far more slowly than with any other known method, as will be described shortly.

For a system given by (2), let:

$$L = \left[ \sum_{i=1}^m \sum_{j=1}^n \log_2(|a'_{ij}| + 1) + \sum_{i=1}^m \log_2(|b_i| + 1) + \log_2 nm \right] + 1 \quad (3)$$

where  $\lceil x \rceil$  denotes the greatest integer less than  $x$ . This quantity gives a measure of the size of the system (2) of inequalities and an estimate of the number of binary symbols (0 and 1) needed to pose the system for Turing machine solution.

The execution of the algorithm involves  $N = 16Ln^2$  iterations. The values computed at each step are required to be accurate to  $2^{-37nL}$ . Notice that as the system of inequalities is made more and more complicated, the number of steps in the algorithm increases as a polynomial in  $n$ . This means that the problem of determining the consistency of a system of linear inequalities belongs to the class of problems that are solvable in polynomial time on deterministic Turing machines. But from a practical viewpoint, it must be noted that the precision required also increases tremendously with the size of the problem.

[The phrase "solvable in polynomial time" means that the time (or amount of computation) necessary to solve the problem is always less than a certain computable amount. The amount is computed by evaluating a function of  $n$ , the number of variables in the problem; and when the problem is solvable in polynomial time, the function uses only powers of the function (eg: time  $t = K_n^p$  for Khachiyan's algorithm, for some very large value of  $K$  and some constant value  $p$ ). This is an advantage when solving a linear programming problem because existing methods solve the problem in exponential time (a function that uses the term  $e^n$ ), and, for a sufficiently large value of  $n$ , a solution in exponential time will take much

longer than a solution in polynomial time. To date, the extremely high computation time has made computer solution of very large linear programming problems impossible. The significance of Khachiyan's algorithm being computable in polynomial time is that, on the surface, it opens the possibility of computer solution of these problems....GW]

### Details of the Algorithm

The steps of the algorithm involve four quantities: a vector  $x_k$  in  $R^n$  representing the estimate of a solution at the conclusion of the  $k$ th iteration; an  $n$ -by- $n$  matrix,  $Q_k$ , representing the dimensions of an ellipsoid containing the solutions of the system; the current discrepancy  $\theta_k(x_k)$  which measures how far the current estimate  $x_k$  is from being a solution; and the discrepancy of record,  $\Theta_k$ , which keeps track of the best estimate of a solution found so far by being equal to the smallest  $\theta$  value encountered within its first  $k$  values.

The principle of the algorithm is like the traditional method of catching fish in a net: casting the net over such a large region that some of what is wanted must be inside, then gradually decreasing the volume of the net. When the volume is sufficiently reduced, it becomes obvious whether or not anything has been caught.

At the initial step,  $k = 0$ , we set:

$$\begin{aligned} x_0 &= 0 \\ Q_0 &= 2^L \times I_n \\ \Theta_0 &= \theta_0(x_0) = \max_i (b_i) \end{aligned} \quad (4)$$

(where  $I_n$  is the  $n$ -by- $n$  identity matrix)

The execution of the algorithm at the  $k$ th step begins by finding the current discrepancy

$$\theta_k(x_k) = \max_i (a'_i \cdot x_k - b_i)$$

and recording the value of  $i$  (labeled  $i(k)$ ) of the equation giving this maximum value.  $\theta_k$  measures the discrepancy of the current  $x_k$  from being a solution of (2), while  $i(k)$  specifies the index of the inequality that is the worst offender. The discrepancy of record,  $\Theta_{k+1}$ , is defined as the minimum of  $\Theta_k$  and  $\theta_k(x_k)$ .

## \$ GOLD DISK \$ CP/M® Compatible Z-80 Disassembler

- RECREATES Z-80 ASSEMBLY LANGUAGE SOURCE FILES FROM ABSOLUTE CODE (.COM FILES) FOR ALTERATION.
- FEATURES MNEMONIC LABELS FOR EASY PROGRAM TRACING.
- INCLUDES COMPLETE DOCUMENTATION AND FREE UTILITY FOR SPECIFYING AND DECODING ASCII SECTIONS OF CODE.
- OPERATES UNDER MINIMUM CP/M® CONFIGURATION (16K RAM).
- DOCUMENTATION ONLY: \$12 (MAY BE APPLIED TO DISK ORDER).

**\$62<sup>00</sup>**

POSTPAID

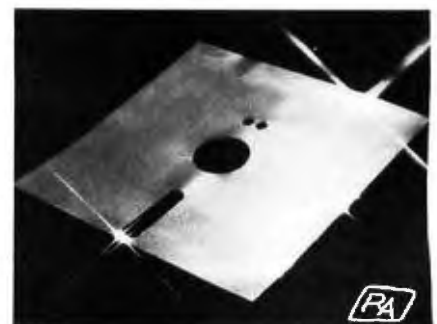

"WORTH ITS WEIGHT IN GOLD"

ONE DAY SERVICE FOR CREDIT CARD CUSTOMERS: ORDER DISK BY PHONE FREE! (WE WILL PAY YOU BACK FOR THE PHONE CALL) CALIF. RESIDENTS ADD 6% SALES TAX.



BOWER-STEWART & ASSOCIATES  
P.O. BOX 1389  
HAWTHORNE, CA. 90250  
(213) 676-5055



SPECIFY DRIVE AND SYSTEM  
AVAILABLE ON 5 1/4" OR 8" IBM SS/SD DISK  
CP/M IS A TRADEMARK OF DIGITAL RESEARCH



```

REM MERGE SORT USING LINK (I) FOR INDEX
FUNCTION MERGE (I,J = INTEGER) = INTEGER
VAR T,KM,M = INTEGER
IF ARRAY (I) < ARRAY (J) THEN
    BEGIN
        M=I
        I=J
        I=M
    END
T=I
KM=T
I=LINK (I)
WHILE I<>0 DO
    BEGIN
        IF ARRAY (I) < ARRAY (J) THEN
            BEGIN
                M=I
                I=J
                I=M
            END
        LINK(KM)=I
        KM=I
        I=LINK(I)
    END
LINK(KM)=I
END=T
FUNCTION SORT (IS,JS = INTEGER) = INTEGER
VAR KS,II,JI = INTEGER
IF IS=JS THEN
    BEGIN
        LINK (IS) = 0
        RETURNED VALUE = IS
        GOTO OEND
    END
KS=IS + ((IS - JS) 2)
II = SORT (IS,KS)
JI = SORT (KS + 1,JS)
RETURNED VALUE = MERGE (II,JI)
OEND
END = RETURNED VALUE

```

## Finally, a language to meet your needs

The new S-BASIC™ language has more computing power than any other true compiler BASIC in the industry.

S-BASIC™ is the ONLY CP/M™ compatible BASIC providing . . .

- Chainable .COM programs with parameter passing.
- Dynamically allocated arrays, sequential and random file buffers.
- Dynamically relocatable variables.
- Common, global, and local variables.
- A choice of: While-Do, Repeat-Until, Begin-End, If-Then-Else, and Case-Of Structures.
- Recursive, Multi-lined functions and procedures.
- Memory image disk storage (no conversions).
- CP/M 2 .xx enhancements usage as well as CP/M™ 1.4 x capable.
- 6 data types: Character, string, integer, single and double precision floating point, and packed BCD.

\*CP/M is a registered trademark of Digital Research.

Besides all of these unique features, S-BASIC™ offers long variable names, digit/string line labels (when required), relocatable code output, multiple libraries, external .COM program execution, all of the flexibility of an enhanced BASIC, and a multitude of conveniences that make programming a pleasure.

As a software house always looking for that ideal, powerful, new language . . . we're excited about making S-BASIC™ available to the software community.

Order your copy now at an introductory price of \$250. from

**MICRO•AP, INC.**  
 9807 Davona Drive  
 San Ramon, CA 94583  
 Telephone (415) 828-6697

Circle 146 on Inquiry card.

**MICRO•AP**

\*S-BASIC is a trademark of Topaz programming.

The algorithm then shifts the center of the ellipsoid net in the "direction" of  $i(k)$  and shrinks the ellipsoid to close in on the desired solution. (See figure 3 and the following geometric interpretation of the algorithm in the text.) This is accomplished by setting:

$$x_{k+1} = x_k + \frac{1}{n+1} \frac{Q_k \cdot F_k}{|F_k|} \quad (5)$$

$$Q_{k+1} = 2^{1/(8n^2)} \times Q_k \cdot \text{Ort}(F_k) \cdot \Lambda_n$$

where:

- $F_k = -Q_k \cdot a_{i(k)}$
- $|F_k|$  is the *norm* (or magnitude) of the column vector  $F_k$
- $\text{Ort}(F_k)$  is an orthogonal  $n$ -by- $n$  matrix (constructed by the Gram-Schmidt process) with the first column equal to  $F_k/|F_k|$  (remember that, because of its orthogonality,  $\text{Ort}(F_k)$  is a distance-

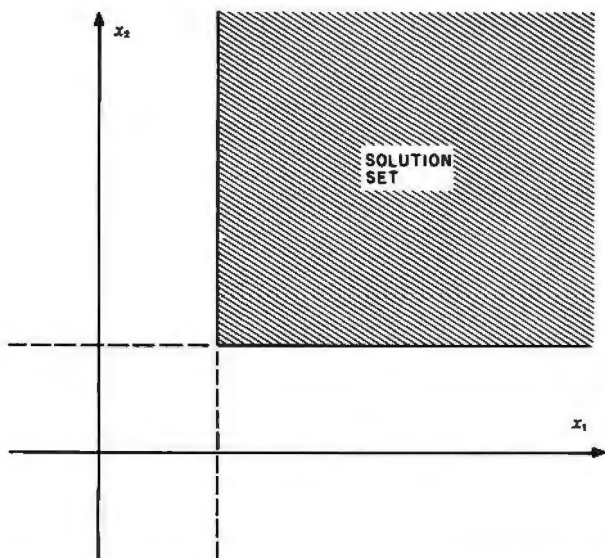

Figure 2: A set of linear inequalities. The shaded area represents the solution set of the two inequalities,  $x_1 \geq 1$  and  $x_2 \geq 1$ . Figure 3 shows how Khachiyan's algorithm solves this system of linear inequalities.

preserving linear transformation)

- $\Lambda_n$  is the  $n$ -by- $n$  diagonal matrix with diagonal entries  $(n/(n+1)), (n/\sqrt{n^2-1}), \dots, (n/\sqrt{n^2-1})$

It is possible to show by induction that the sizes of the quantities in (5) obey the following constraints:

$$|x_k| \leq \frac{1}{2} k 2^{18k}$$

$$|Q_k| \leq 2^{2L+k/n^2} \quad (6)$$

$$2^{nL-k/n} \leq \det(Q_k) \leq 2^{nL-k/(4n)}$$

where the norm of matrix  $Q_k$  ( $|Q_k|$ ) is the square root of the sum of the squares of its entries. It is important to note that the point  $x_k$  generated by this algorithm may jump around in a rather random and sometimes extravagant manner, and that it is only the steady contraction of the region (which has a volume equal to  $\det(Q_k)$ ) that ensures that a solution will ultimately be found.

If  $\theta_k(x_k)$  becomes zero or negative at any step, then  $x_k$  is a solution of the system (2), and the algorithm is terminated. If the algorithm runs through all  $N = 16Ln^2$  steps, the discrepancy  $\Theta_{N+1}$  is calculated and the process ends.

### Geometry of the Algorithm

Geometrically, each solution  $x$  for the system (2) of inequalities can be considered as a point in  $n$ -dimensional space, and the aggregate of all such solution points forms a certain volume, the solution set. In Khachiyan's algorithm, each matrix  $Q_k$  specifies an ellipse  $E_k$  centered at the point  $x_k$  according to  $E_k = \{y: y = x_k + Q_k z, \|z\| \leq 1\}$ . [A less formal description of  $E_k$  is as follows: the  $n$ -dimensional ellipse  $E_k$  is the set of points (or column vectors)  $y$  that are formed by adding the column vector  $Q_k z$  to the current estimate  $x_k$ , where  $z$  is an arbitrary  $n$ -dimensional column vector with a length (magnitude) of 1 or less...GW]

The initial choice of  $x_0$  and  $Q_0$  specifies a sphere of radius  $2^L$  centered at the origin. It can be shown that this sphere contains at least a certain minimum volume of solution points, if any exist. The ellipses then change position and shrink, but they always contain at least the prescribed minimum volume of solutions. Khachiyan's observation is that, once the ellipse has shrunk to that

# OHIO SCIENTIFIC USERS

SOFTWARE - GAME AND UTILITY PROGRAMS FOR AS LOW AS \$1.00. ALL WITH LISTINGS AND COMPLETE DOCUMENTATION.

KITS - UPDATE YOUR COMPUTER TO PLAY MUSIC, INCREASE OPERATING SPEED, HIGH RESOLUTION GRAPHICS AND MUCH MORE. KITS INCLUDE PARTS AND COMPLETE ASSEMBLY INSTRUCTIONS. LOW AS \$3.00.

OUR \$1.00 CATALOG INCLUDES OSI PROGRAMMING TIPS PLUS DESCRIPTIONS OF AVAILABLE PROGRAMS AND KITS.

MITTENDORF ENGINEERING 905 VILLA NUEVA DR. LITCHFIELD PARK, AZ 85340





# PRIAM Hard Disks Now Available from SIRIUS SYSTEMS!

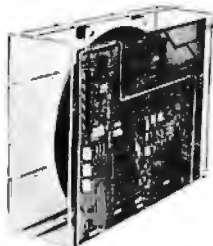

PRIAM's high-performance, low-cost Winchester disc drives speed up throughput and expand data storage from 20 megabytes to 154 megabytes. And a single controller can be used to operate 14-inch-disc drives with capacities of 33, 66, or 154 megabytes or floppy-disc-size drives holding 20 and 34 megabytes. So it's easy to move up in capacity, or reduce package size, without changing important system elements or performance.

- Fast, Linear Voice Coil Positioning
- 10 ms track-to-track positioning
- Fully servoed head positioning
- Dedicated servo tracks
- DC Power required only!
- Simple, parallel Interface
- Optional SMD Interface
- 50 ms Average Positioning time
- 90 ms Maximum Positioning Time
- 6.4 ms Average Latency

## THE PRIAM LINEUP

Model/Disc Size	Capacity	Size	Weight	Price
DISKOS 3350 (14")	33Mbytes	7" x 17" x 20"	33 lbs.	\$2995
DISKOS 6650 (14")	66 Mbytes	7" x 17" x 20"	33 lbs.	\$3749
DISKOS 15450 (14")	154 Mbytes	7" x 17" x 20"	33 lbs.	\$4695
DISKOS 2050 (8")	20 Mbytes	4.62" x 8.55" x 14.25"	20 lbs.	\$2995
DISKOS 3450 (8")	34 Mbytes	4.62" x 8.55" x 14.25"	20 lbs.	\$3745
DISKOS 570	5.3 Mbytes	floppy-size	(low)	(low)
DISKOS 1070	10.6 Mbytes	floppy-size	(low)	(low)

All PRIAM DISKOS Drives have a Transfer Rate of 1.03 Mbytes/Sec. Optional SMD interface available for \$150.

SIRIUS SYSTEMS offer cases and enclosures for all PRIAM Hard Disk Drives. All 14" Winchester Drives will mount in our 14" Standard Case. The 8" Winchester drives have two alternatives: a single drive case and a dual drive case. All SIRIUS SYSTEMS Winchester drive cases include Power Supply, internal cabling, switches, fan, extra AC outlet (not switched, but fused) and possess very adequate ventilation. Drive addressing is done on the rear of the Case and not on the drive itself to provide ease of use during operation. All WINCHESTER DRIVE Cases are Warranted for a full year and come in our standard blue-black color scheme. Consult us for current availability and pricing.

## Remex RFD 4000/4001 8" Floppy Disc Drives Double sided... Double density!!

# \$549<sup>95</sup>

RFD 4001, \$569.95



Offers quality and features found in drives costing much more! ■ Single or Double Density ■ Double-Sided Drive ■ Door Lock INCLUDED ■ Write-Protect INCLUDED ■ 180 Day Warranty ■ Compatible with Shugart 850/851 ■ Low Power Operation ensures LONGER LIFE!! ■ Model RFD 4001 offers Data and Sector Separator

RFD 4000/4001 Technical Manual ..... 6.95  
 Connector Set #3 (AC, DC, Card Edge) ... 10.95  
 Connector Set #4 (AC and DC) ..... 2.95  
 RFD 4000C/B Cabinet (for use with Power Modules) ..... 29.95

## Remex 1000B ... If you've been looking for a less expensive floppy disc drive, but not wanting to sacrifice quality—this is it!

# \$419<sup>95</sup>

You get both in the Remex 1000B! For only \$419.95 look at what you get: ■ 8" Floppy Drive ■ Single or Double Density ■ Hard or Soft Sectoring ■ Media Protection Feature ■ Single Density Data Separator ■ 180 Day Factory Warranty

Door Lock Option ..... \$19.95  
 Interface Adapter ..... \$14.95  
 Write Protect Option ... \$19.95  
 Connector Set #1 (AC, DC, & Card Edge) ... \$10.95  
 RFD 1000B Technical Manual ..... \$5.95  
 RFD 1000B CASE (for use with Power Modules) ..... \$29.95

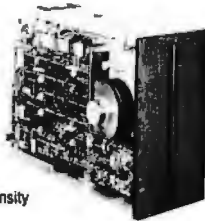

## SIRIUS 8" DISK POWER MODULES

The Single and Dual Drive Power Modules are designed to provide DC and (switched) AC power for one (the Single Drive Power Module) or two (the Dual Drive Power Module—the DDDPM) will power three RFD 4000s or 4001s) 8" Floppy Disk Drives. Many features are included for safe and reliable operation and the Power Modules come with our stand-

ard 180 day WARRANTY (the Open Frame Power Supply warranty is for 2 years). All Power Modules will work with either the RFD 4000C/B or RFD 1000B case (color schemes match also).

Dual Drive Power Module (DDPM) ..... \$139.95

Single Drive Power Module (SDPM) ..... 119.95

## SIRIUS 80+ Perfect Add-Ons for Your Computer System!



The SIRIUS SYSTEMS 80+ Series of Floppy Disk add-ons are designed to provide unmatched versatility and performance for your computer. Consisting of four different add-ons, there is a 80+ Series Floppy Disk to meet your need. All 80+ Series Floppy Disk are compatible with the TRS-80+ and come ready to plug in!

### COMMON CHARACTERISTICS

- 5 ms track-to-track access time
- Auto-eject
- 180 day WARRANTY
- Exceptional speed stability — 1 1/2%
- Single density (FM) or double density (MFM/M2FM)
- Ultra high reliability
- 2 year Power Supply Warranty
- Mix any or all 80+ Series on the same cable!
- Includes user accessible plugboard for drive reconfiguring

### SPECIFIC CHARACTERISTICS

The SIRIUS 80+1 is a single sided, 40 track, highly reliable Floppy Disk add-on. Offering 5 more tracks than the Radio Shack model, it cost \$140 less! Formatted data storage is 102K/20K bytes single/double density.

SIRIUS 80+1 ..... \$359.95

The SIRIUS 80+2 is a dual sided, 70 track (35 per side), highly versatile Floppy Disk unit. It appears to the TRS-80+ as TWO 35 track drives, yet COST LESS THAN HALF THE PRICE! Even greater savings result, since data is recorded on both sides of the media instead of only a single side. Using the plug board, it may be reconfigured for other computer systems! (The 80+2 operates as Drive 0 and any of the other three addresses (with the standard Radio Shack Cable) or as any of four drives (with the SS Standard Cable.) Formatted data storage is 80.6K/161.2K bytes single/double density.

SIRIUS 80+2 ..... \$449.95

The SIRIUS 80+3 is a single sided, 80 track, "Quad" density Floppy Disk unit. Offering 2 1/2 times the storage of a Standard Radio Shack drive, the 80+3 greatly reduces the need for diskettes correspondingly. Additionally, because of the increased storage and faster track-to-track access time, the 80+3 allows tremendously increased throughput for disk based programs!! The 80+3 INCLUDES SIRIUS's TRAKS-PATCH on Diskette. Formatted data storage is 204K/40K bytes single/double density.

SIRIUS 80+3 ..... \$489.95

The SIRIUS 80+4 Floppy Disk add-on is a double sided, 160 track (80 per side), 5 1/4" monster! The ultimate in state-of-the-art 5 1/4" Floppy Disk technology, to 80+4 is seen by the TRS-80+ as two single sided disk drives, each with 80 tracks. Thus, in terms of capacity one 80+4 is equivalent to 4x standard Radio Shack drives — a savings of over 73% (not to mention diskettes!!). (With a double density converter, the available memory is huge!) The 80+4 is similar to the 80+2 in that it arrives configured as Drive 0 and any of the other three addresses (with the standard Radio Shack Cable) or as any of four drives (with the SS Standard Cable). The 80+4 INCLUDES TRAKS-PATCH on Diskette. (The plug board is also included.) Formatted data storage is 408K single density or 816K bytes double density.

SIRIUS 80+4 ..... \$624.95

All 80+ Series Floppy Disk add-ons operate a 5 milliseconds track-to-track access time (eight times faster than the SA 400) but are Expansion Interface Limited to 12 milli-seconds for the TRS-80+.

\*TRS-80© Tandy Corp.

## MPI 51/52... A Great Reliable Mini-Drive!

- Fast! 5ms track to track access
- Exclusive Pulley-Band Design
- Unique Door/Ejector Mechanism
- Reliable 1 1/2% Speed Stability
- Single/Double Density Operation
- Industry/ANSI Standard Interface

MPI 51 (Single Head, 40 tracks, 120K/240K bytes Single/Double Density\*\*) ..... \$259.95

MPI 52 (Dual Head, 70 tracks, (35/side), 218.8K/437.5K Single/Double Density\*\*) ..... \$349.95



## MPI 91/92... NEW STATE-OF-THE-ART DISK DRIVE!

MPI 91 (Single Head, 80 tracks, 240K/480K Single/Double Density\*\*) ..... \$389.95

MPI 92 (Single Head, 160 tracks (80/side), 480K/960K Single/Double Density\*\*) ..... \$499.95

\*\*Unformatted data storage

## Introducing the Versatile, Low-Cost OMEGA Series Controller

As new technological advances bring down the cost of fast, reliable mass data storage, the need for an inexpensive, versatile controller have become greater and greater. To meet this need, SIRIUS SYSTEMS' OMEGA Series Controller was designed.

The SIRIUS OMEGA Series Controller Module utilizes an on-board microprocessor to mediate data transfer to a wide variety of peripherals from an equally wide variety of host computer systems. Up to four Winchester Hard Disks (8" or 14"), four 5 1/4" Floppy Disk Drives and/or up to eight 8" Floppy Disk Drives may be in use at one time. Host systems interfacing is accomplished via a parallel or a serial interface. With the addition of a Personality module, the OMEGA Series Controller Module is directly compatible with many popular computer systems (among them the TRS-80+, Apple, Heath, and others). Provision is made for the addition of a streaming tape drive, also.

### SPECIFIC HARDWARE FEATURES INCLUDE:

- Control of up to twelve Floppy Disk Drives (eight 8" and/or four 5 1/4")
- 8" and/or 5 1/4" Disk Drive Utilization
- Single (FM) or Double (MFM) density data storage
- Hard or Soft sectored diskette usage
- Utilization of "Quad" density (96 tp) 8" or 5 1/4" Disk Drives
- Control of up to four WINCHESTER type PRIAM DISKOS Disk Drives
- 8" or 14" may intermix on the same cable
- Accommodates 8" and/or 14" drives of 5.3Mbytes to 154Mbytes
- Ultra-Fast data transfers
- Extremely flexible host-controller interfacing

### SPECIFIC SOFTWARE FEATURES INCLUDE:

- Dynamic format modifications via command words
- Extremely flexible format acceptance for un-usual data storage formats
- Easily interfaces to standard operating systems (TRS-DOS\*, CP/M\*\*\*, etc)
- Operates in either get/put sector mode or data string mode
- Performance parameters may be changed by EPROM replacement or Dynamic Reprogramming

Dedicated systems cards are also available on a limited basis for the STD-BUS and the S 100. These cards feature shared memory also (again, software selectable) in addition to the regular OMEGA Series Controller Module features. Consult SIRIUS SYSTEMS for current price and availability for the entire line of OMEGA Series Memory Units and Controllers. Dealer inquiries are invited.

## TO ORDER CALL (615) 693-6583

Phone Orders Accepted 9AM-7PM (ESDT)

We accept MC, VISA, AE, COD (requires Certified Check, Cashier's Check or Cash) and Checks (personal checks require 14 days to clear). SHIPPING AND HANDLING: \$7.00 per Floppy Disk Drive or 80+ Module ■ 5% for other items (any excess will be refunded) ■ Foreign Orders add 10% for Shipping & Handling. Payment in U.S. currency ■ Tennessee residents add 6% Sales Tax ■ VOLUME DISCOUNTS AVAILABLE



7528 Oak Ridge Highway  
 Knoxville, Tennessee 37921

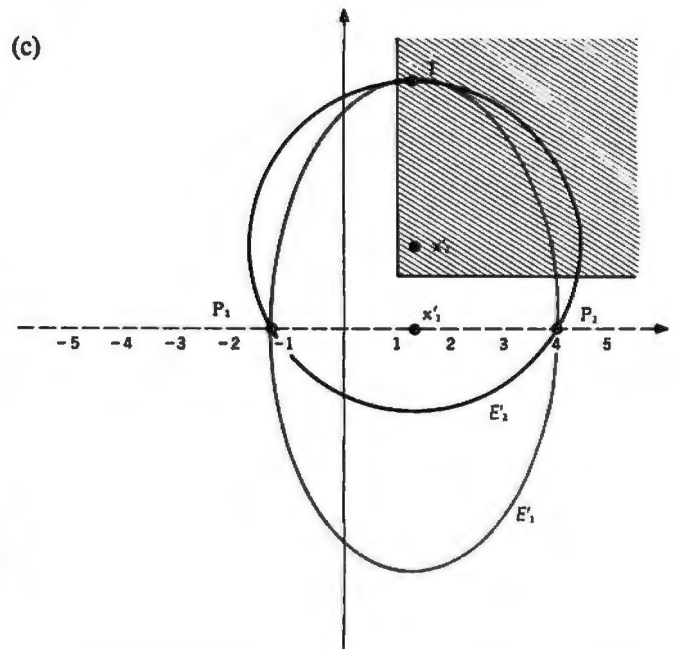
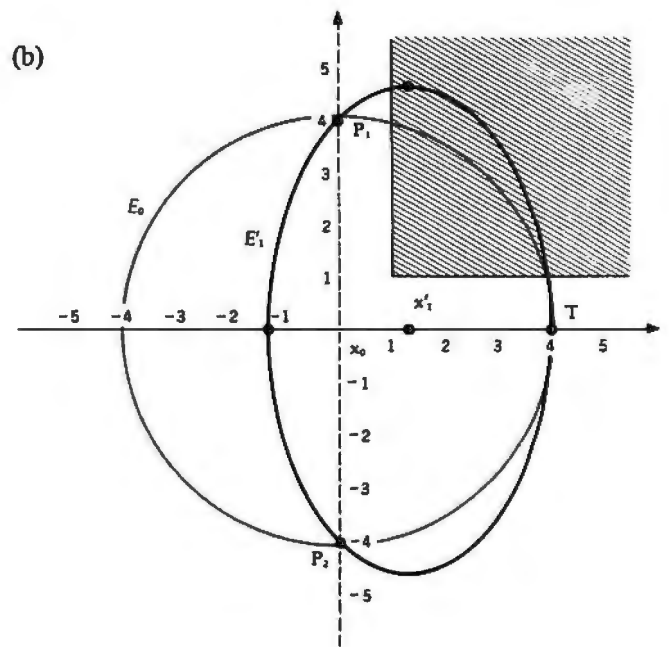
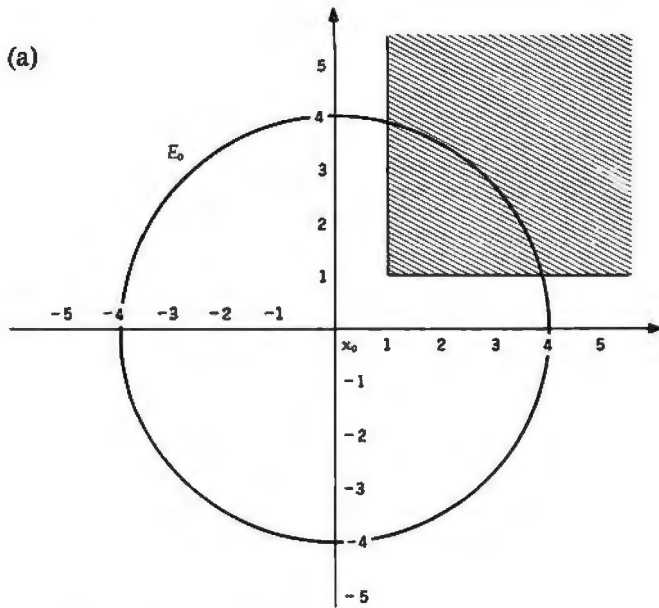

Figure 3: A graphic example of Khachiyan's algorithm. The Khachiyan algorithm (described here for a two-dimensional problem) begins with a circle centered at the origin with a radius of a given size such that the circle is guaranteed to contain the solution points, if they exist. Successive iterations of Khachiyan's algorithm produce ellipses of smaller area that still contain the solution points. Here, the initial circle  $E_0$  is shown in figure 3a. Ellipse  $E_1$  is then computed from  $E_0$ , as shown in figure 3b, and ellipse  $E_2$  is computed from  $E_1$ , as shown in figure 3c. In the last two figures, the current ellipse is shown in black, and the previous ellipse is shown in gray. The shaded area in all three figures describes the inequalities' solution set.



**SAVE \$300**  
now only  
**\$995.00**



**SORCERER II**  
Computer regularly \$1,295.00  
model DP-1000-2 with 16K ram

- Phone orders welcome
- All orders should include 3% postage (10% foreign orders)
- Master Charge and Visa
- Personal checks 2 weeks to clear
- Cal. residents add 6% tax

**"YOUR HEADQUARTERS FOR EXIDY  
HARDWARE AND SOFTWARE"**

The Technology Store  
**NYCOM**  
4500 El Camino Real  
Los Altos, California 94022

**(415) 948-4500**

minimum volume (and it does so within  $16Ln^2$  steps), it can contain *only* solutions. Thus, either the center  $x_k$  is a solution (making the discrepancy  $\leq 0$ ), or there were no solutions in the first place, and the system is inconsistent.

To see graphically how the ellipses evolve, we will consider the following simple system of linear inequalities:

$$\begin{aligned} -x_1 + 0x_2 &\leq -1 \\ 0x_1 - x_2 &\leq -1 \end{aligned}$$

graphed in figure 2. These are, in fact, the first and third inequalities of system (1.1).

To make the diagrams clearer, we do not take  $L = 7$ , as equation (3) would dictate, but  $L = 2$ , which we will later show (in Part 2) is permissible. This makes  $x_0 = 0$  and  $Q_0 = \text{diag}(4,4)$  (a 2-by-2 matrix with 4 in the main diagonal elements, 0 elsewhere). The initial ellipse  $E_0$  is shown in figure 3a.



THE 6502 BOOK YOU'VE WAITED FOR...

# PRACTICAL MICROCOMPUTER PROGRAMMING:™ THE 6502

A complete assembly language course for the 6502 consisting of:

## THE TEXT...

In 20 chapters and more than 100 formal program examples **PRACTICAL MICROCOMPUTER PROGRAMMING: THE 6502** covers fundamental assembly language techniques as applied to the 6502 with the same thoroughness and attention to detail as its predecessors did for the 8080, 6800 and Z80. The "difficult" topics such as interrupts aren't skipped or glossed over but treated in full detail. The example programs address real world programming problems and in many cases can be taken whole from the book for use in application programs. There is no nonsense, no games, just chapter after chapter of solid, accurate programming information. There is nothing else like it available anywhere at any price. If you intend to program the 6502 at assembly level you *need* **PRACTICAL MICROCOMPUTER PROGRAMMING: THE 6502**.

## THE PROGRAMMING SYSTEM...

A complete editor/assembler system which runs directly on the Apple II computer but will run with user supplied I/O on any 6502 based computer with 10K RAM beginning at \$2000. This is an entirely new programming system written specially for this book. It frees the programmer from having to define page zero references at the beginning of the program and contains many pseudo-ops and compound instructions to solve the problems which have made the 6502 difficult to program in the past. Nothing like this system has ever existed for the 6502 before. The full source listing of this system is given in an appendix.

## AND MORE SOFTWARE...

A debugging monitor with self restoring breakpoints, filling and searching of memory, direct viewing of stack contents, memory "windowing" and many other features. This debugging monitor runs specifically on the Apple II but can be modified to run on other 6502 configurations. If you're tired of inserting and removing BRK instructions by hand this program is for you. The source of the debugging monitor is also included in the book.

## AND THE OBJECT IS FREE...

The object of both the editor/assembler and the debugging monitor are sent to book purchasers **without charge** on either Apple II compatible cassette or paper tape when the licensing agreement at the back of the book is returned. The object code is also available on disk for the Apple II for a nominal charge.

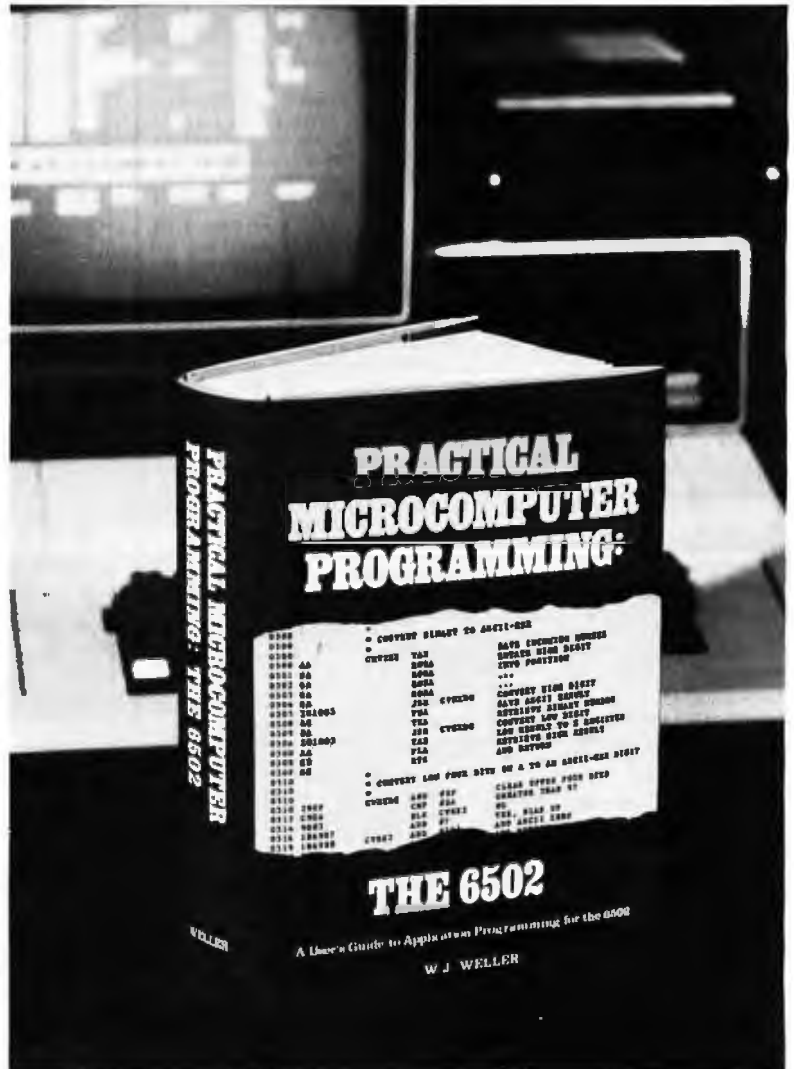

IF YOU NEED TO PROGRAM THE 6502 AT ASSEMBLY LEVEL AND YOU'RE TIRED OF THE "QUICKIES" AND REHASHES OF THE MANUAL, THEN **PRACTICAL MICROCOMPUTER PROGRAMMING: THE 6502** IS FOR YOU. AT \$32.95 YOU WILL NEVER SEE MORE VALUE FOR THE MONEY.

Available August 25th 1980. Please allow 30 days for delivery.

Apple and Apple II are trademarks of Apple Computer Inc., Cupertino, CA

Please send my copy of **PRACTICAL MICROCOMPUTER PROGRAMMING: THE 6502** US Funds only. No COD please.

Check enclosed  Money Order enclosed

NAME \_\_\_\_\_

ADDRESS \_\_\_\_\_

CITY \_\_\_\_\_ STATE \_\_\_\_\_ ZIP \_\_\_\_\_

Send to: Northern Technology Books  
Box 62  
Evanston, IL 60204

# SORCERER\* SOFTWARE!

Unless otherwise noted, all programs are on cassette and require only 8K of memory.

## FORTH

**new!** Now Sorcerer owners can enjoy the convenience and speed of the fascinating FORTH programming language. Based on FIGFORTH and written by James Albanese, this version was designed especially for the Sorcerer and includes the capability to read and write data (screens) to cassette tape and a complete on-screen editor. Requires at least 16K of RAM. **\$49.95**

**new!** **GRAPHICS ANIMATION** by Lee Anders. This package provides the BASIC programmer with a powerful set of commands for graphics and animation. The program is written in machine language but is loaded together with your BASIC program and graphics definitions with a **LOAD** command. Any image from a character to a large graphic shape may be plotted, moved, or erased with simple BASIC commands. Encounters of plotted character sets with background characters are detected and background images are preserved. Contains a medium resolution plotting routine. A keyboard routine detects key presses without carriage returns. Includes a separate program for constructing images. **\$29.95**

**new!** **STARBASE HYPERION™** by Don Ursem. At last, a true strategic space game for the Sorcerer! Defend a front-line Star Fortress against invasion forces of an alien empire. You create, deploy, and command entire ship squadrons as well as ground defenses in this complex tactical simulation of war in the far future. Written in BASIC and Z-80 code. Full graphics and realtime combat status display. Includes full instructions and STARCOM battle manual. Requires at least 16K of RAM. **\$17.95**

**new!** **HEAD-ON COLLISION™** by Lee Anders. You are driving clockwise and a computer-controlled car is driving counter clockwise. The computer's car is trying to hit you head on, but you can avoid a collision by changing lanes and adjusting your speed. At the same time you try to drive over dots and diamonds to score points. Three levels of play, machine language programming, and excellent graphics make this game challenging and exciting for all. At least 16K of RAM is required. **\$14.95**

**new!** **LUNAR MISSION** by Lee Anders. Land your spacecraft softly on the moon by controlling your craft's three propulsion engines. Avoid lunar craters and use your limited fuel sparingly. You can see both a profile view of the spacecraft coming down and a plan view of the landing area. Land successfully and you get to view an animated walk on the moon. Nine levels of play provide a stiff challenge to the most skillful astronaut. Requires at least 16K of RAM. **\$14.95**

**new!** **HANGMAN/MASTERMIND** by Charles Finch. Two traditional games are brought to life by Sorcerer graphics. **HANGMAN** has three different vocabulary levels for you to choose from. In **MASTERMIND**, the computer selects a four-character code and you have to uncover it. These two games provide an enjoyable way for young people to develop their vocabulary and their logical reasoning ability. Written in BASIC. **\$11.95**

**QS SMART TERMINAL** by Bob Pierce. Convert your Sorcerer to a smart terminal. Used with a modem, this program provides the capability for you to communicate efficiently and save connect time with larger computers and other microcomputers. The program formats incoming data from time-sharing systems such as The Source for the Sorcerer video. Incoming data can be stored (downloaded) into a file in RAM. Files, including programs, may be saved to or loaded from cassette, listed on the video, transmitted out through your modem, or edited with an on-board text editor. Interfaces with BASIC and the Word Processor Pac. **\$49.95**

**DPX™ (Development Pac Extension)** by Don Ursem. Serious Z80 program developers will find this utility program to be invaluable. Move the line pointer upward. Locate a word or symbol. Change a character string wherever it occurs. Simple commands allow you to jump directly from EDIT to MONITOR or DDT80 modes and automatically set up the I/O you want for listings. Built-in serial driver. Stop and restart listings. Abort assembly with the ESC key. Save backup files on tape at 1200 baud. Load and merge files from tape by file name. Versions for 8K, 16K, 32K, and 48K Sorcerer all on one cassette. Requires the Sorcerer's Development Pac. **\$29.95**

### Other utility programs:

**PLOT** by Vic Tolomei. High res and low res modes ..... **\$14.95**  
**SHAPE MAKER™** by Don Ursem. An on-screen character maker ..... **\$14.95**  
**DEBUG** by Bob Pierce. Debug machine language programs ..... **\$14.95**  
**SOFTWARE INTERNALS MANUAL** by Vic Tolomei. A 64-page book ..... **\$14.95**

### Other game programs:

**MARTIAN INVADERS™** by James Albanese ..... **\$14.95**  
**NIKE II™** by Charles Finch and Bob Broffel ..... **\$11.95**  
**TANK TRAP** by Don Ursem ..... **\$11.95**  
**MAGIC MAZE™** by Vic Tolomei ..... **\$11.95**  
**FASTGAMMON™** by Bob Christiansen ..... **\$19.95**



## QUALITY SOFTWARE

6660 Reseda Blvd., Suite 105, Reseda, CA 91335  
 Telephone 24 hours, seven days a week: (213) 344-6599

**WHERE TO GET IT:** Ask your nearest Sorcerer dealer to see Quality Software's Sorcerer programs. Or, if you prefer, you may order directly from us. MasterCard and Visa cardholders may telephone their orders and we will deduct \$1 from orders over \$19 to compensate for phone charges. Or mail your order to the address above. California residents add 6% sales tax. **Shipping Charges:** Within North America orders must include \$1.50 for first class shipping and handling. Outside North America the charge for airmail shipping and handling is \$5.00 — payable in U.S. currency.

\*The name "SORCERER" has been trademarked by Exidy, Inc.

Khachiyan's algorithm is an approximation of the following geometric construction of the next ellipse  $E_{k+1}$  with center  $x_{k+1}$  from the known ellipse  $E_k$  with center  $x_k$ . Since this construction does not give the exact results of the formulas in (5), we will denote the results of our construction by  $E'_{k+1}$  and  $x'_{k+1}$ .

The ellipse  $E'_1$  is determined from  $E_0$  and  $x_0$  (see figure 3b) as follows:

- Draw a chord through  $x_0$  parallel to the boundary of the inequality most severely violated (indicated previously as having subscript  $i(k)$ ). This chord cuts the ellipse  $E_0$  at two points,  $p_1$  and  $p_2$ . The solution set of the inequality  $i(k)$  will lie on one side, the "solution side," of the chord. (The solution side of the hyperplane can be determined by examination.)
- The new ellipse  $E'_1$  passes through  $p_1$  and  $p_2$ , has its center on the solution side of the chord, and is tangent to the old ellipse  $E_0$  at the point  $T$ .
- Of the infinite family of ellipses satisfying the above conditions, choose the one with the smallest volume.  $x'_1$  is the center of this new ellipse  $E'_1$ .

The ellipses  $E'_1$  and  $E'_2$  (determined similarly from  $E'_1$ ) are shown in figures 3b and 3c, each with its predecessor drawn in gray. Note that the ellipses are shrinking, the three having approximate areas of fifty, forty, and thirty-two square units respectively. The algorithm ended with ellipse  $E'_2$ , since its center  $x'_2$  is in the solution set.

It is important to notice that, while the requirements of tangency and minimal volume in our construction are aesthetically pleasing, they are impossible to achieve in practice. Remember that Khachiyan is concerned with a calculation procedure having only a limited degree of accuracy. If any of the numbers encountered in the execution of the algorithm could not be exactly represented in the computer, the cumulative effect of the resulting roundoff errors could be fatal, particularly in the detection of the inconsistency of a system of inequalities. The paper of Gacs and Lovasz, mentioned previously as ignoring questions of computational precision, presents a modification of the algorithm that computes the tangent ellipses of minimal volume. Thus the Gacs-Lovasz formulas cannot be expected to be successful in any actual computation.

Khachiyan overcomes this difficulty by choosing his ellipses slightly larger than necessary so that, even with his limited accuracy, he can assure that the region he wants is contained in them. The trick here is that if the ellipses are made too large, they will not shrink down on the solutions fast enough. Khachiyan's formulas in (5) for the ellipses achieve the proper balance between the problem of accuracy and the need for a rapidly shrinking series of ellipses.

If you carry out the calculations for the example of figure 2, you will find that, while  $E'_1$  passes through the points (0, 4)' and (4, 0)', Khachiyan's ellipse  $E_1$  passes through (0, 4.12)' and (4.06, 0)'.

Part 2 of this article will discuss a fundamental shortcoming of Khachiyan's algorithm and will include a program in BASIC for the TRS-80. ■



# THE OASIS RECIPE FOR QUALITY APPLICATION SOFTWARE.

**H**appy customers are fast making Single & Multi-User OASIS recognized as the super system software. BUT, system software is only as good as the applications it runs. And that's where OASIS really cooks.

**A**pplication software developers particularly like OASIS because it lets them blend unique performance features—in other words, build better software. Security features like User Accounting with Logon, Password and Privilege Level; File and Automatic Record Locking; Private, Shared and Public Files. Speed and convenience of Keyed Index (ISAM) Files. Economy from Compiled Re-Entrant BASIC that makes multi-user systems practical on as little as 64K memory. And lots more.

**B**ecause OASIS has better development tools—and more of them—creating very sophisticated software is possible, practical, easier, faster. Just one example: BASIC that is an Interpreter and Compiler with Debugger and Editor. If you do your own development, you'll really appreciate these kinds of features. For software

professionals, they make providing superior products much more cost attractive.

**A**dd all the ingredients together and, whether you do it yourself or buy it off the shelf, the pay-off is a wide selection of top-performing, top-quality application software that does more so you do less.

OASIS; Single or Multi-User with a sizzling array of features and tools; almost unlimited software possibilities (*and application software for Single-User OASIS is Multi-User compatible*); the most extensive documentation in the industry—indeed, you get a lot to like. And *that's* put OASIS System Software\* among the hottest products on the market.

**D**rop us a line today for a complete, free Application Software Directory. And see your OASIS Distributor, or send the coupon direct, to get the products you want. Try us. We believe you'll savor the OASIS recipe.

\* For Z80 based computers.

**OASIS IS AVAILABLE FOR SYSTEMS:** Altos; CompuCorp; Cromemco; Delta Products; Digital Group; Digital Microsystems; Dynabyte; Godbout; IBC; Index; Intersystems; North Star Onyx; SD Systems; TRS 80 Mod II; Vector Graphic; Vorimex.

**CONTROLLERS:** Bell Controls; Cameo; Corvus; Konan; Micromation; Micropolis; Tarbell; Teletek; Thinkertoys; X Comp.

#### APPLICATION SOFTWARE AVAILABLE FOR OASIS:

Accounts Payable; Accounts Receivable; General Ledger; Mail List Pak; Order Entry; Inventory Control; Inventory Tracking Pak; Word Processors.

Architects & Pro Designers Timekeeping & Job Cost Analysis; Cable TV Subscriber Billing Sys; Construction Mgt Pak; Construction Pak; Contractors Tracking Pak; Distributors Pak; Dental Office Mgt Pak; Medical Billing Sys; Pharmacy Prescription Processing with A/R; Management Analysis Pak; Real Estate Office Mgt; Restaurant Pak; Sewer & Water Utility Info Pak.

Bisynchronous Communication Pak; 2780/3780/3270 Emulators; File & Screen Mgr with Report Generator; Full Network Data Base Mgt Sys; Game Pak; Hierarchical Data Base Mgt Sys; Radlogs (Radio Station Logs/Schedules/Programming/Billing with A/R, A/P, G/L).

**THESE ITEMS ARE NOT AVAILABLE DIRECT FROM PHASE ONE SYSTEMS, INC** —please write for ordering instructions and complete, free Application Software Directory. If you have items you would like listed in the Directory, send us complete information )



**MAKES MICROS  
RUN LIKE MINIS**

#### PLEASE SEND ME:

Product	Price with Manual	Manual Only
<b>OPERATING SYSTEM</b> (Includes: EXEC Language, File Management; User Accounting; Device Drivers, Print Spooler; General Text Editor; etc.) SINGLE-USER MULTI-USER	\$150 350	\$17.50 17.50
<b>BASIC COMPILER/INTERPRETER/DEBUGGER</b>	100	15.00
<b>RE-ENTRANT BASIC COMPILER/INTERPRETER/DEBUGGER</b>	150	15.00
<b>DEVELOPMENT PACKAGE</b> (Macro Assembler; Linkage Editor; Debugger)	150	25.00
<b>TEXT EDITOR &amp; SCRIPT PROCESSOR</b>	150	15.00
<b>DIAGNOSTIC &amp; CONVERSION UTILITIES</b> (Memory Test; Assembly Language; Converters; File Recovery; Disk Test; File Copy from other OS; etc.)	100	15.00
<b>COMMUNICATIONS PACKAGE</b> (Terminal Emulator; File Send & Receive)	100	15.00
<b>PACKAGE PRICE</b> (All of Above) SINGLE-USER MULTI-USER	500 850	60.00 60.00
<b>FILE SORT</b>	100	15.00
<b>COBOL-ANSI '74</b>	750	35.00

Order OASIS from:

**Phase One Systems, Inc.**  
7700 Edgewater Drive, Suite 830  
Oakland, CA 94621

Telephone (415) 562-8085  
TWX 910-366-7139

NAME \_\_\_\_\_  
STREET (NO BOX #) \_\_\_\_\_  
CITY \_\_\_\_\_  
STATE \_\_\_\_\_ ZIP \_\_\_\_\_

**AMOUNT \$** \_\_\_\_\_  
(Attach system description;  
add \$3 for shipping;  
California residents add sales tax)  
 Check enclosed  VISA  
 UPS C.O.D.  Mastercharge  
Card Number \_\_\_\_\_  
Expiration Date \_\_\_\_\_  
Signature \_\_\_\_\_

# Construction of a Fourth-Generation Video Terminal, Part 1

Theron Wierenga  
POB 2007  
Holland MI 49423

The construction of this fourth-generation video terminal is a project that began as a detour from the plans for building a 16-bit microcomputer. I have had a long-standing interest in building an advanced-design video terminal that would have a scrolling feature and a large 2000-character display. It was my desire to have the terminal utilize one of the new programmable video-display-controller integrated circuits, and be a stand-alone unit with its own microprocessor that would not steal cycles from or otherwise load down the host computer. The number of additional parts that are needed to add the

microprocessor is quite minimal and, in turn, the microprocessor reduces additional interfacing that would be otherwise needed. The circuitry of this terminal, when wire-wrapped on a single board, could fill one slot in the motherboard of the planned 16-bit microcomputer, or could be used with any other host computer as a stand-alone unit.

Upon receiving a copy of Intel Corporation's *Peripheral Design Handbook* (April 1978 edition), I found a set of plans for just such a terminal. The article is entitled "CRT Terminal Design Using the Intel 8275 and 8279." This circuit and its associated software were the basis for my design. This month, in Part 1, I'll describe the construction up to the point where you can get the 8085 microprocessor operating. Next

month, in Part 2, I shall tell about the procedures for assembling the keyboard and video circuitry, putting the control software into operation, and checking out the system. Readers planning to build this terminal should obtain a copy of the *Peripheral Design Handbook*, as well as the *MCS-85 Users Manual*, which describes the operation of the 8085 microprocessor. Included in the fifty-seven-page article are detailed design theory, system specifications, system hardware and software design, an explanation of software subroutines, and the original design schematics and data sheets on the Intel peripheral circuits that are utilized in the design. The Intel handbooks are available from Intel Corporation, Literature Department, 3065 Bowers Ave, Santa Clara CA 95051.

## REAL WORLD INTERFACE FOR YOUR APPLE II A/D + D/A

Commercial, scientific, and industrial data acquisition and control functions are now practical with Mountain Hardware's A/D + D/A Card. Superfast conversion time permits high frequency and other applications not possible with slower cards.

If you've got a data acquisition or control application, Mountain Hardware has the answer with A/D + D/A. Drop by your Apple dealer and put your world on a silver platter.

### A/D + D/A features:

- \*Single PC card
- \*16 channels analog to digital input
- \*16 channels digital to analog output
- \*8  $\mu$ s conversion time
- \*8 bit resolution
- \*I/O cable assembly available
- \*Operating manual contains sample applications with schematics, parts list, and guides for easy start-ups.
- \*Self-test diagnostic software



**Mountain Hardware**  
LEADERSHIP IN COMPUTER PERIPHERALS  
A Division of Mountain Computer, Inc.  
300 Harvey West Blvd., Santa Cruz, CA 95060  
(408) 429-8600

### Terminal Features

Here are some of the features of this video terminal:

*Display format:* eighty characters per display row, twenty-five display rows.

*Character format:* 5-by-7 character contained within a 7-by-10 matrix, first and tenth lines blanked, first and seventh columns blanked, ninth line cursor position, blinking underline cursor.

*Character recognized:* Displayable characters: sixty-four American Standard Code for Information Interchange (ASCII) uppercase alphanumeric characters,

#### Control characters:

- Line feed (control-J),
- Carriage return (control-M),
- Back space (control-H),

#### Escape sequences:

- Cursor up (ESC, A),
- Cursor down (ESC, B),
- Cursor right (ESC, C),
- Cursor left (ESC, D),
- Clear screen (ESC, E),
- Home (ESC, H),
- Erase to end of screen (ESC, J),
- Erase line (ESC, K).

*Characters transmitted:* sixty-four



# ANNOUNCING COLLECTOR EDITION BYTE COVERS

SIGNED AND NUMBERED  
EDITIONS OF 100.  
\$15 EACH

Robert Tinney Graphics is now issuing limited editions of selected Byte Covers, each signed and numbered by the artist, Robert Tinney. The first four Collector Edition covers are shown at right. Unlike previously published Byte covers, these magazine-size prints are made from the original Byte color separations, and can be offered at a substantially lower price.

Collector Edition Byte Covers offer the following features:

- o THE PRINT—Each Collector Edition Byte Cover is 11"x14", including 1½" borders at top and sides, and a 1¾" border at bottom. The paper stock is a smooth finish, 65 lb. antique cover weight. This heavy, very white sheet reproduces the depth and brilliance of the original art.
- o THE EDITION—All Collector Editions are strictly limited to 100 prints, and the printing plates are destroyed after the run. Mr. Tinney

inspects and approves the quality of each print before personally affixing the individual number and signature at bottom. A Certificate of Authenticity accompanies each print and certifies the number of the edition as well as the destruction of the printing plates. Each certificate is also signed and numbered by Mr. Tinney.

- o SHIPMENT—Collector Edition prints are packed flat between heavy binder boards to avoid rolling and to assure undamaged shipment. However, should any damage occur, your print will be immediately replaced. Shipment, of course, is always first class.
- o PRICE—The price of each Collector Edition Byte Cover is \$15, plus \$3 for postage and handling (\$6 for orders outside the U.S. and Canada). If all 4 covers are ordered, the price is only \$50 plus postage and handling.

If you would like to order one or more of these beautiful Collector Edition Byte Covers, please use the convenient coupon below.



THE SEVEN BRIDGES OF KÖNIGSBERG



FUN AND GAMES



HOMEBREW



SOFTWARE MIRAGE

Feb./Mar. 1980

Nov./Dec. 1979

March 1980

May 1980



"The Seven Bridges of Königsberg" shown mounted in a standard 12"x16" frame. Frame not included.

Please send me the following Collector Edition Byte Covers and Certificates of Authenticity.

Qty.	Cover	Amount
	The Seven Bridges of Königsberg	\$
	Fun and Games	\$
	Homebrew	\$
	Software Mirage	\$
<input type="checkbox"/>	All 4 - only \$50	\$
Post. & hand. (\$3 in US & Can., \$6 overseas)		\$
Total		\$

I have enclosed check or money order to Robert Tinney Graphics.

Visa  Mastercharge

Card # \_\_\_\_\_

Expiration Date \_\_\_\_\_

Signature \_\_\_\_\_

Send my print(s) to:

Name \_\_\_\_\_

Address \_\_\_\_\_

City \_\_\_\_\_

State \_\_\_\_\_ Zip \_\_\_\_\_

Mail this coupon to:

**robert tinney graphics**

P.O. Box 45047

Baton Rouge, LA 70895

Ph. (504) 357-5500



ASCII uppercase alphanumeric characters, ASCII control character set, ASCII escape sequence set.

**Program memory:** 2 K bytes, 2716 erasable programmable read-only memory.

**Display/buffer/stack memory:** 2 K bytes, 2114 static programmable memory.

**Data rates:** 300, 600, 1200, 2400, 4800 bits per second (bps).

**Interface to host computer:** 20 mA current loop.

**Scrolling capability:** Scroll-up feature implemented with 8257 direct-memory-access controller.

The author of the Intel article used an 8080A-based single-board computer, the Intel SDK-80, and an

SBC-905 prototype board for the additional circuitry needed. I wanted everything to fit on a single board and to run off a single 5 V power supply, so extensive changes were made in my design. The schematic diagram appears in figure 1. The completed unit retains all of the original features plus one or two more.

### Hardware Changes

The following are the major hardware changes that were made in my design:

- An 8085 microprocessor was substituted for the 8080A device. Although the parts count is about the same, the 8085 system needs only a single 5 V power supply. The 8085 microprocessor needs an additional 8212 latch for the lower address lines and a 74LS257 multiplexer to produce the control bus. The interfacing to the 8257 direct-memory-access controller is somewhat involved; a detailed schematic of this is provided in the *Peripheral Design Handbook* on pages 1 thru 82.
- The additional 8216 buffer from MEMR and MEMW is unnecessary. These signals can be taken directly from the 74LS257.
- A single 74LS138 decoder was used for enabling the peripheral circuitry (ie: the 8251, 8257, 8275, and 8279 devices).
- A 5 V type, 2513 character-generator read-only memory was substituted for the 2708. This saves programming the sixty-four 5-by-7 matrices into a 2708-type programmable read-only memory.
- The MD (mode) lines on the two 8212s that buffer the 2114 memory integrated circuits are tied to ground instead of +5 V. This is an error in the Intel schematic.
- Interrupt lines for the 8251 and 8275 are not connected into the 8085. The TRAP interrupt is pulled down to ground through a dual-inline pin (DIP) switch. Opening this switch pulls up the TRAP interrupt, vectoring the 8085 microprocessor to a small system monitor.
- Video and sync signals were added together through the use of a 7401 open-collector NAND package and a single transistor to form a composite-video output.

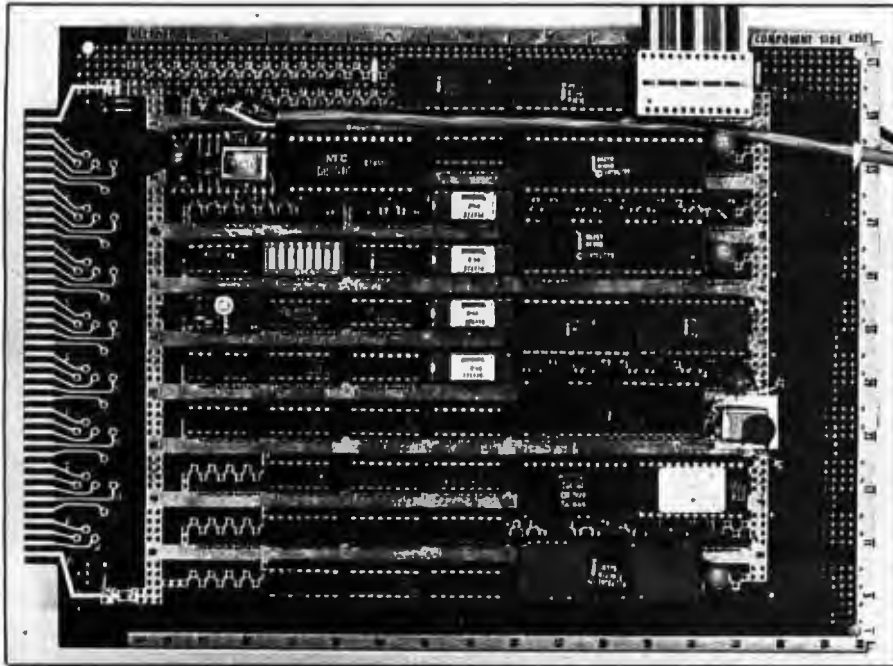

Photo 1: The complete video terminal circuitry constructed on a wire-wrap board. The component side is shown.

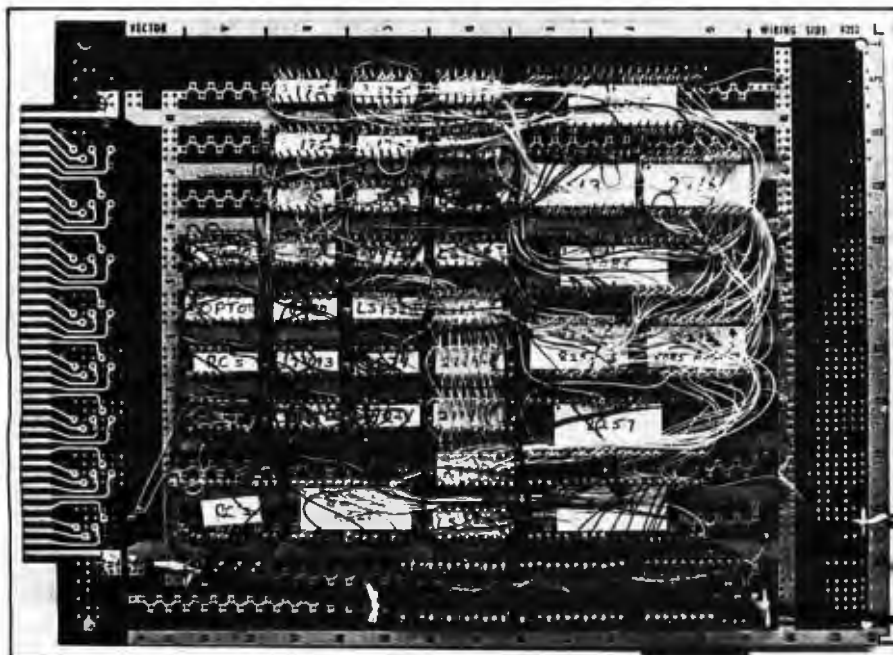

Photo 2: The bottom or wired side of the video terminal board.

Text continued on page 216





# Let this New Series from **BYTE BOOKS™** answer your programming questions

Programming Techniques is a series of collected articles concerned with the art and science of computer programming. The first volume in the Programming Techniques series is entitled **Program Design**. The purpose of the book is to provide the personal computer user with the techniques needed to design efficient, effective, maintainable programs.

ISBN 0-07-037825-8 Pages: 96  
Price: \$6

Editor: Blaise W. Liffick

**Simulation** is the second volume in the Programming Techniques series. Both theoretical and practical applications are included. Particularly stressed is simulation of motion, including wave motion and flying objects, and the use of simulation for experimentation.

ISBN 0-07-037826-6 Pages: 126  
Price: \$6

Editor: Blaise W. Liffick

**Numbers in Theory and Practice** is the third book in the series. It includes information of value to both the novice and the experienced personal computer user. The mechanics of the binary system are discussed, including software division and multiplication, as well as floating point

numbers, numerical methods, random numbers, and the mathematics of computer graphics.

ISBN 0-07-037827-4 Pages: 192  
Price: \$8.95

Editor: Blaise W. Liffick

The 4th volume of the Programming Techniques series, **Bits and Pieces**, covers various topics of interest to programmers. It

is a collection of the best articles from past issues of **BYTE** magazine plus new material collected specifically for the series, on subjects such as multiprogramming, stacks, interrupts optimization, and real time processing.

ISBN 0-07-037828-2 Pages: 160  
Price \$8.95

Editor: Blaise W. Liffick



- Please send  \_\_\_\_\_ copies of **Program Design**  
 \_\_\_\_\_ copies of **Simulation**  
 \_\_\_\_\_ copies of **Numbers in Theory and Practice**  
 \_\_\_\_\_ copies of **Bits and Pieces**

B8

Name \_\_\_\_\_ Title \_\_\_\_\_ Company \_\_\_\_\_

Street \_\_\_\_\_ City \_\_\_\_\_ State/Province \_\_\_\_\_ Code \_\_\_\_\_

- Check enclosed in the amount of \$ \_\_\_\_\_  
 Bill Visa  Bill Master Charge  
 Card No. \_\_\_\_\_ Exp. Date \_\_\_\_\_  
 Add 60¢ per book to cover postage and handling.



70 Main St, Peterborough, NH 03458

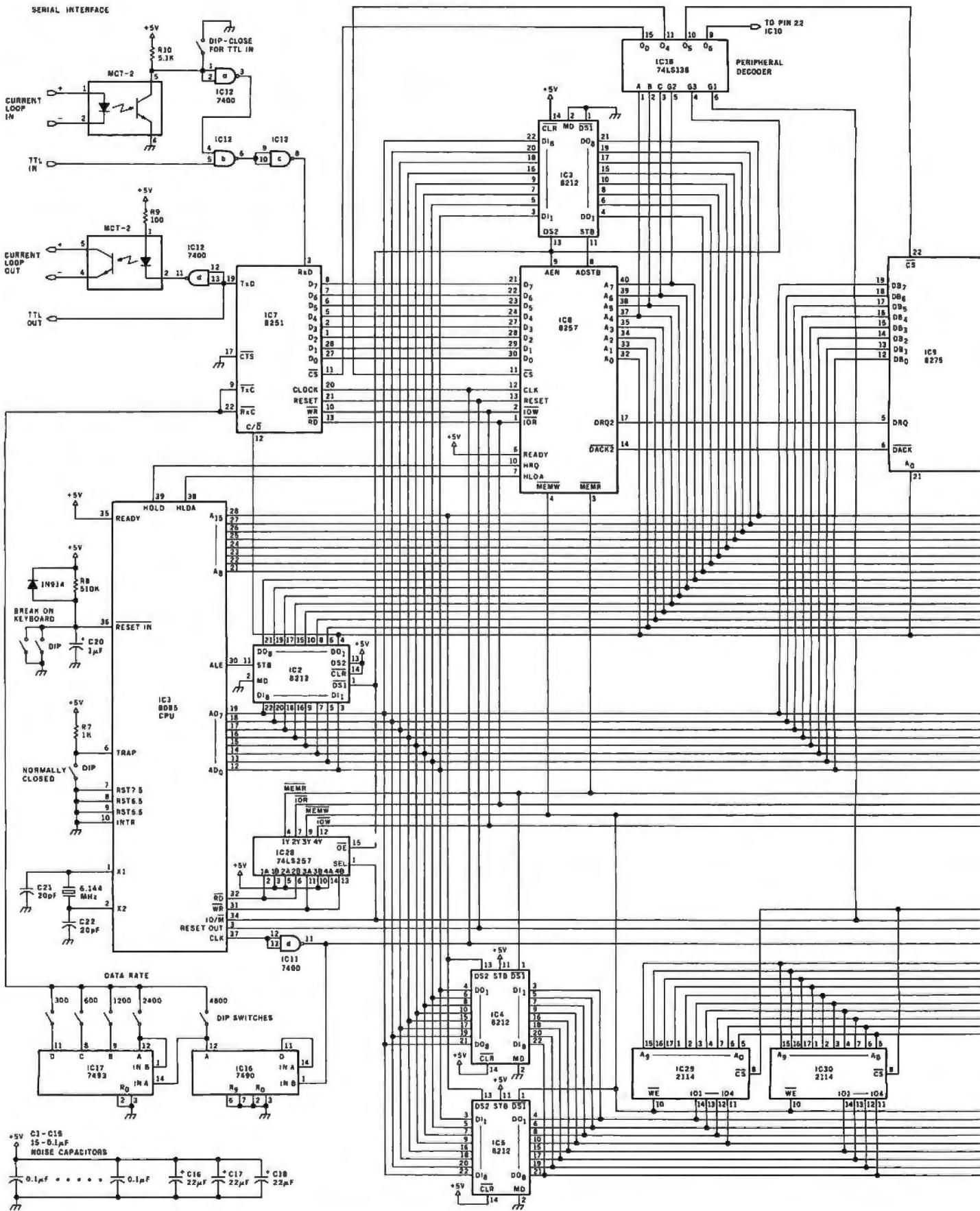
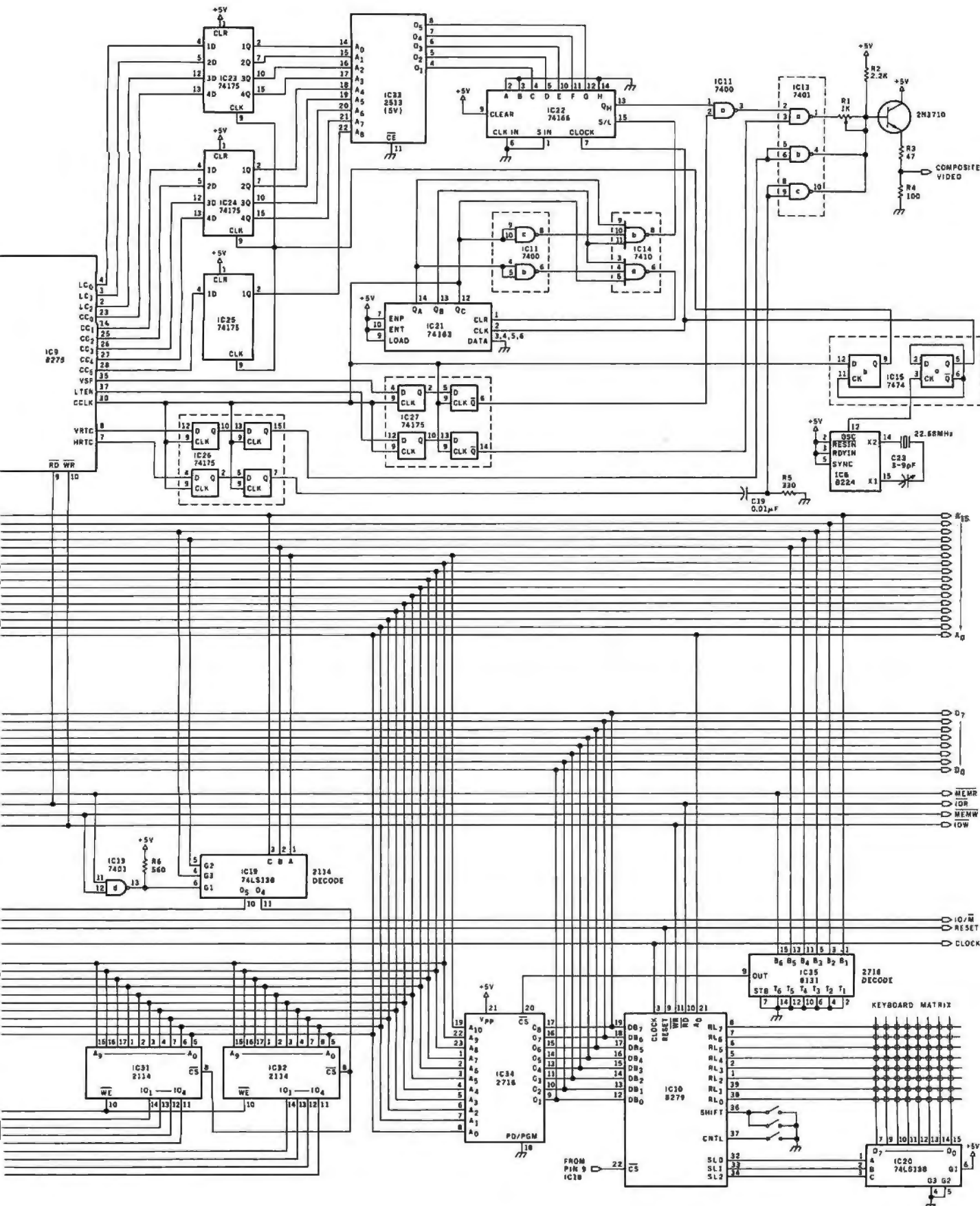

Figure 1: Schematic diagram of the video terminal circuit. The Intel 8275 video-display controller is in the center of the figure.





Text continued from page 212:

- With a system clock of 6.144 MHz, data rates of 300, 600, 1200, 2400, and 4800 bps were generated with a 7490 and 7493 counter. Data-rate selection is through five positions of an eight-position DIP switch.
- A current-loop interface was used, since only a 5 V supply was available. There is also provision for direct access to the universal asynchronous receiver/transmitter (UART) pins.
- An 8131 comparator was substituted for the 74LS138 used for 2716 decoding.
- Decoding was done somewhat differently for the programmable memory, although the addresses still extend from hexadecimal 8000 to 87FF. These addresses make compatibility with the 8257 direct-memory-access controller easy.
- Details are given as to how the

keyboard is connected to the system. This is missing in the original article. An inexpensive unencoded keyboard (available from Jameco Electronics) was mounted using a printed-circuit board as well as some wire-wrap connections.

- The video monitor that I used is a 12-inch Motorola unit that takes a composite-video input signal. It was obtained as surplus in used condition. Whatever brand or size is used, it should have a bandwidth of 12 MHz.

### Software Changes

A number of changes were made in the software as supplied in the Intel articles. Several minor changes have no direct effect on the program execution, but rather just shorten the code. The major changes are as follows:

- The interrupt vectors at the top of the program were removed. A single vector for the TRAP interrupt was left in. When the TRAP switch is opened, the 8085 microprocessor will transfer control to a small system monitor that can be used for debugging.
- A polling system is used in place of the interrupt system to check the states of three of the peripheral systems. First, the system checks to see if a character has been received by the 8212; second, if the 8275 has requested that the 8257 be reinitialized; and third, if the 8279 has a character to be transmitted from the keyboard. A data rate of 4800 bps is still possible using this polling system.
- The table for character lookup for the keyboard has been changed completely. This was done to comply with the way that I had wired the scan matrix for the unencoded keyboard. A few additional ASCII codes were added that can be transmitted from the video terminal. These codes were for keys on the Jameco keyboard.
- The initialization of the 8251 and 8279 was changed. The values used should work for most systems.
- The 8257 was initialized to Mode 0 because of the change to a standard 2513 character generator.
- A system monitor was added at the bottom of the program which has five commands. The use of the monitor is covered in Part 2 of this article.

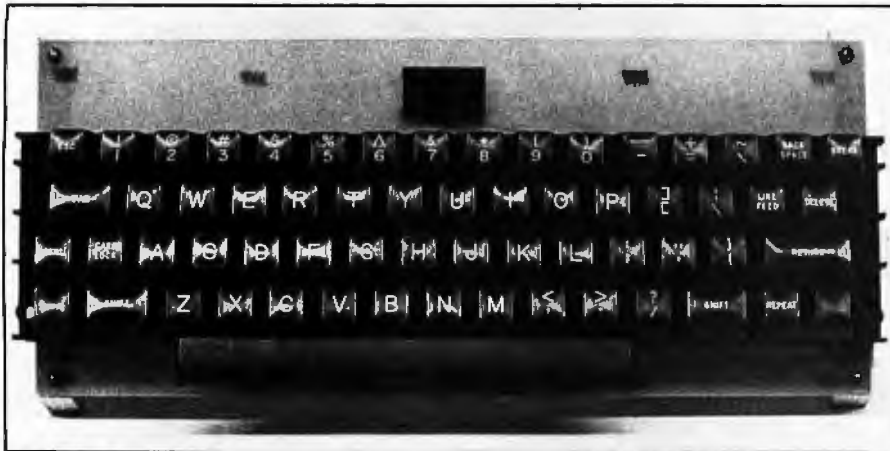

Photo 3: The sixty-three-key Jameco keyboard mounted on its printed-circuit board and installed on support blocks.

# PASCAL/M™: \$175<sup>00</sup>!

Sorcim's software delivers all the advantages of PASCAL — from ease of learning to sophistication of application — at a price you'd expect to pay for BASIC. And, the features are as impressive as the price:

- Totally CP/M\* compatible (for 8080 or Z80 based systems)
- Built-in error checking
- Console cursor controls for word-processing like editing capabilities
- Extensions chosen for compatibility with other popular PASCALS
- Complete random file and longer integer (32 bit, 9 digit) support
- Case statement includes otherwise clause
- Full Wirth implementation
- All I/O totally compatible with CP/M file structure
- Special version available for Z80 + 9511 math chip based systems
- Optional updating service protects your investment
- Runs under both CP/M 1.4 and 2.2
- Full access to CP/M data files written in other languages and stored under CP/M
- Assembly code external support for added flexibility

Still need convincing? The 90 page manual is available separately for \$10, and tells all about PASCAL/M's implementation. Need more background? Jensen and Wirth's definitive book on PASCAL is \$7.90. You may never go back to BASIC again!



2273 CALLE DE LUNA  
SANTA CLARA, CALIFORNIA 95050

**How to order:** PASCAL/M requires 56K of RAM and one floppy disk; specify Z80, 8080, or Z80 + 9511 version (all are \$175). All disks are shipped on single-sided, single-density, soft-sectored CP/M compatible media. We accept UPS COD, Mastercard®, VISA® personal checks (allow time to clear), and certified checks. Californians add sales tax. Add \$10 outside USA.

\*CP/M is a trademark of Digital Research  
PASCAL/M™ is a trademark of Sorcim



## 16 BIT S100 PROCESSOR

The LDP88 single board computer is the first 16 bit processor to put the power of a 16 bit processor on the 8 bit S100 bus. The LDP88 is IEEE S100 bus compatible ensuring that the user has a large number of compatible board products to choose from. The LDP88 uses the Intel 8088 processor which is fully compatible with the 8086 instruction set.

### ANNOUNCING

Lomas Data Products is pleased to announce the availability of the LDP72 floppy disk controller. The LDP72 is also IEEE S100 bus compatible and offers the following advanced features:

- Software selectable single or double density
- Mix minifloppies with standard floppies
- Phase locked loop data separation for data reliability
- Controls up to 4 floppy disks

	Partial Kit	Full Kit	Assembled & Tested
LDP88	\$199.95	\$349.99	\$399.99
LDP72	129.95	219.95	274.95

Coming Soon: A disk operating system for the LDP88, LDP72 combination.

MasterCharge and Visa accepted (Visa add 4%)  
(Mass. residents add 5% sales tax)

### Lomas Data Products

11 Cross Street  
Westborough, MA 01581  
Telephone: (617) 366-4335

# DEC LSI-11 Components

Dependable service  
at discount prices  
Domestic  
and Export

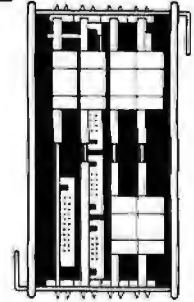

## Mini Computer Suppliers, Inc.

25 Chatham Rd., Summit, N.J. 07901  
Since 1973

(201) 277-6150 Telex 13-6476

©Mini Computer Suppliers, Inc.  
1978



# ECT™

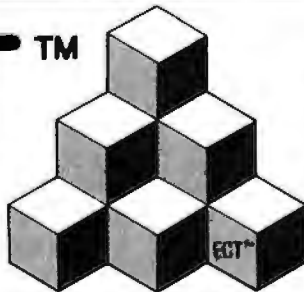

## Building Blocks for Microcomputer Systems, Dedicated Controllers and Test Equipment.

R<sup>2</sup>I/O  
S-100 ROM,  
RAM & I/O  
BOARD

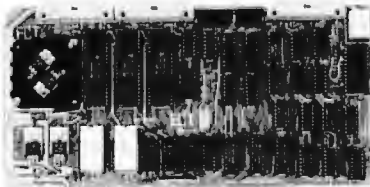

ECT's R<sup>2</sup>I/O is an S-100 Bus I/O Board with 3 Serial I/O Ports (UART's), 1 Parallel I/O Port, 4 Status Ports, 2K of ROM with the 8080 Apple Monitor Program and 2K of Static RAM.

**\$295.00**

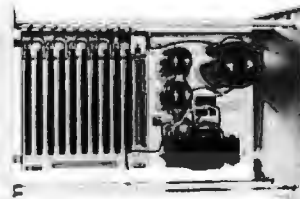

RM-10  
S-100  
RACK MOUNT  
CARD CAGE

ECT's RM-10 is a rack mount 10 slot Card Cage with Power Supply, consisting of an ECT-100 rack mount Card Cage (19"W x 12.25"H x 8"D), the MB-10 Mother Board (with ground plane and termination) all 10 connectors and guides and the PS-15A Power Supply (15A @ 8V, 1.5A @ ± 16V).

**\$295.00**

Specializing in Quality Microcomputer Hardware  
Industrial • Educational • Small Business • Personal

Card Cages, Power Supplies, Mainframes, CPU's, Memory, I/O, OEM Variations

# ECT™ ELECTRONIC CONTROL TECHNOLOGY (201) 686-8080

763 Ramsey Ave., Hillside, NJ 07205

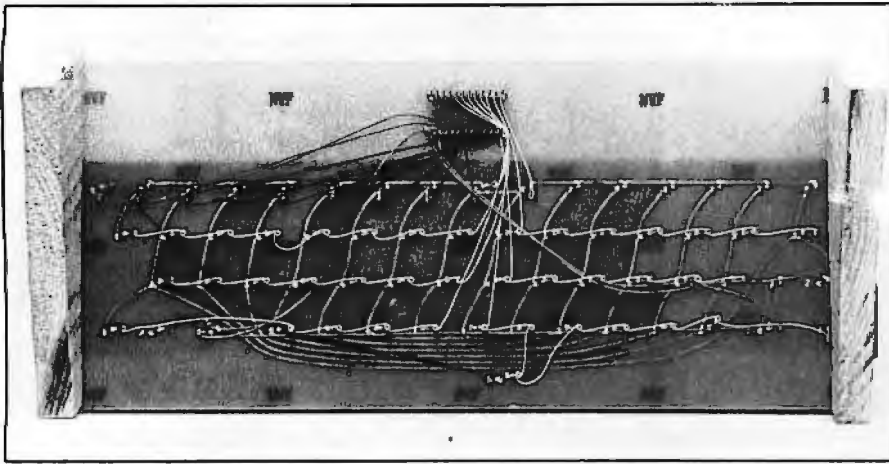

Photo 4: The etch side of the keyboard circuit board, showing the jumper connections made necessary by use of the single-sided board.

- The port numbers for the peripheral circuits have been changed. These values are set at the beginning of the video-control software.

### Construction

The order in which the sections of this video terminal are built is very important. It is most unusual to put together a project as complex as this without having some sort of pro-

blems. Following the order as it is given here will help with some debugging, and hopefully make things go more easily. Do not try to assemble everything and then give it the smoke test.

I chose to connect the electronic parts by wire-wrapping. With the hundreds of connections necessary, it is almost impossible to not make a few wiring errors the first time around. Wire-wrapping allows you

to add or change connections easily if it is necessary. Wire-wrap also allows for a very compact design, which helps to cut down the electrical noise in the system. You should have available an oscilloscope, frequency counter, a general-purpose volt-ohm milliammeter, a wire-wrap gun, 30-gauge wire strippers, and a quantity of 30-gauge wire (as well as the usual pliers, screwdrivers, soldering iron, etc).

A large Vector wire-wrap board (#4350) was used for the circuit, but several other general-purpose wire-wrap boards could also be used. Some individuals may choose one of the S-100 type boards, which would work just as well. Use one that has power and ground planes on it. This makes it easy to distribute the power supply lines to integrated circuits, and provides a good method for installing noise capacitors.

Glue the integrated-circuit wire-wrap sockets in place with an epoxy-type glue that comes in two components and must be mixed before use. After mixing the adhesive, wait until it starts to thicken considerably before applying it to the sockets. If the integrated-circuit sockets that you use do not have a few small holes in the bottom of the plastic body, make two or three holes with a 1/16-inch drill. This will give the glue something to which it can adhere. Do not use any of the "super glue" types of instant-bonding adhesive, as these are very thin and can bleed into the integrated-circuit socket, plugging up the pin holes and cementing the contacts together. An illustration of the parts layout is shown in figure 3.

Following my own particular order, I first make all connections to the power-supply pins on the integrated circuits. These connections are given in table 1. Connect 5 V to the power-supply bus and check out the voltage at the proper pins of each integrated-circuit socket before installing the integrated circuits themselves. When you *do* apply power to the circuit, have an ammeter connected to your power supply. High current readings are a quick indication of serious problems. The entire circuit when completed should draw about 1.6 A at 5 V. The usual precautions against static electricity when handling metal-oxide semiconductors (MOS) should be observed for the memory circuits, as

# 68,000!

The MiniFrame is here and MicroDaSys has it! Now you can own a complete minicomputer featuring the incredible power of the 68000 processor in a versatile turn-key system - all at micro prices! The 68000 processor offers a 16 bit external and 12 bit internal data path, and has many architectural features previously found only in mainframe computers. The MD68K single board computer offers the user all of the power of the 68000 in a complete minicomputer, combining mass memory, double density disk/Winchester controller, interrupt architecture, and multi-user I/O. The MD68K may easily be interfaced to a variety of bus adapters, allowing the use of external peripherals, and RAM expansion to 16 Megabytes. The MiniFrame houses the MD68K, power supplies, I/O connectors and dual eight inch drives. Whether you are looking for the most advanced single board computer, or an amazing turn-key system, the MD68K and MiniFrame are for you!

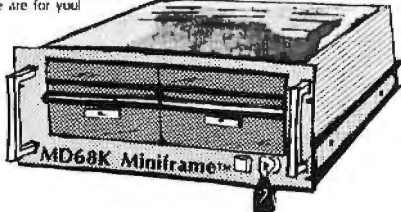

Available

### Hardware:

256K Bytes RAM  
Parity Checking  
Memory Management  
Sophisticated Firmware  
8 Parallel Ports  
8 RS-232 Serial Ports  
Double Density Controller

Winchester Controller  
Dual 8" Floppies  
Multi-User, Multi-Tasking  
Winchester Option  
Bus Adapters Available:  
IEEE 488 S-100  
Intel S550  
DEC etc.

### Software:

DOS  
Resident Assembler  
Cross Assembler  
Linker  
Debugger  
Pascal  
BASIC  
etc.

**MD68K Single Board Computer \$2395**  
**MiniFrame™ with Dual Drives \$3995**

### How To Order:



**MicroDaSys**

By Phone: Call (213) 731-0878 for VISA, MC and COD.  
By Mail: Send check or money order.

P.O.Box J6275, Los Angeles, CA 90016 1WX: 910-121-2378



**IBM + CP/M + OSM**  
**= CP/M Compatible Distributed Processing**  
**Multi-User Computer System**



O S M Computer Corporation is introducing a true multi-user, multi-tasking computer system.

**Hardware features**

1. IBM 3101 terminals.
2. Each user has its own complete system consisting of CPU, memory, console, and printer (optional).
3. Unlike MP/M system there is no speed degradation as you add users.
4. All users share common data base disk storage and host printer.
5. Users can select either host or local printer.
6. Dual floppy and up to 128 mega byte hard disk storage.
7. Up to 128 user terminals.
8. Each user has a hardware CPU reset button. If any of the users "crash" he can reset his CPU without affecting other users.

**Software Features**

1. Use of CP/M 2.2 allows any CP/M compatible software to be used.
2. DPOS/2 multiuser supervisor executive
3. 2 file protect modes (in addition to CP/M's) prevent "fatal embrace" and "interleaved update sequences".
4. Automatic system printer spooling.
5. Messages can be passed among users.

**Prices**

Single user Mainframe (Z80, 64K memory, 2 serial 3 parallel I/O, 1.2 M Byte 8 inch dual disk) . . .	\$5,195.00
Two user Mainframes . . . . .	\$7,790.00
Each additional user (CPU, 64K memory, I/O) . . . . .	\$1,295.00
IBM 3101 terminal . . . . .	\$1,250.00
Texas Instrument 820 RO . . . . .	\$1,695.00
QUME 51/45 RO . . . . .	\$2,550.00
27 Mega Byte Hard Disk . . . . .	\$4,995.00

**OSM Computer Corporation**

2364 Walsh Ave.  
 Santa Clara, CA 95051 (408) 496-6910

Dealer Inquiries Invited

**At last...the**  
**Typewriter Interface!**



**Turn your electric typewriter into a low cost, high quality hard copy printer. 1 Year Warranty**

The patented\* RDI-I/O Pak is fast becoming the industry standard for typewriter output. Why? Because:

1. It takes 2 minutes to initially install and 5 seconds to remove or replace.
  2. You do *not* have to modify your typewriter. All factory warranties and maintenance agreements on your typewriter will be honored.
  3. You can use it with *all* powered carriage return typewriters that have U.S. keyboard. Our Model I works with all *non* Selectrics and our Model II works with Selectrics. Conversion between models takes 2 minutes and the kit (26 plungers) is available for a nominal charge.
  4. You don't have to lug around a bulky printer when you travel. If there is a typewriter at your destination, you can install the light (3 lbs.) I/O Pak in just 2 minutes.
  5. Same interface for TRS-80, Apple and GPIB. Centronics and Pet compatible interfaces are available in third quarter 1980. Electric pencil available.
- Delivery: stock to 2 weeks. Price: \$499.00, FOB Rochester, Do-

See your local distributor or call Bob Giese, 716 385-4336. We have the only "clean" approach to the typewriter/printer market.

**ROCHESTER DATA**

\*Patent Pending

3100 Monroe Avenue, Rochester, New York 14618 incorporated

**Put your computer**  
**in touch with the world.**

**AJ makes it possible for only \$185 with the A 242 acoustic data coupler.**

Experts call it "the best acoustic coupler ever made!" Reliability is phenomenal—historically over 35,000 hours mean time between failure! Thousands are in use by companies all over the U.S.

And now, the A 242 from AJ, refurbished at the factory, can connect to *your* terminal or personal computer, putting you in touch with every other compatible terminal or computer. If you can telephone the site, you can send and receive data.

Bell 103/113 compatible, the originate-mode A 242 features quartz crystal control, RS 232 or TTY terminal interface, and operational speeds up to 450 bps. At just \$185—about half the original price—it's a tremendous bargain. And you can have even greater savings with purchases of 10 or more units.

The A 242 carries our standard 30-day parts and labor warranty, and we're offering a no-risk, 10-day money-back guarantee.\*

Call toll-free for details:  
 (800) 538-9721.  
 California residents call:  
 (408) 263-8520.



**ANDERSON JACOBSON**

\*Details on request.

Prices subject to change without notice.

well as all of the 8000-series Intel circuits.

Next, make a photocopy of the entire schematic diagram. As you begin to wrap connections, use a red pen to trace each connection made on the schematic. This simple method eliminates the need for a wiring table, but establishes a complete bookkeeping system that indicates which connections are installed or incomplete.

It is helpful to use as many different colors of wire as possible. The address bus can be done in one color, the data bus in another, power-supply lines can be red for +5 V and black for ground, and so forth. This is a great help when you have to trace down wires to check connections. Take the time to cut each wire to the exact length needed. Do not make wires any longer than necessary. Route wires neatly in between the wire-wrap sockets, and try to keep the interior portion of the socket area free from bundles of wires. A neat board is much easier to troubleshoot than the "rat's nest" variety.

The few resistors and capacitors that are needed can be mounted on

one 16-pin and one 24-pin header plug. The 22.68 MHz crystal and 2N3710 transistor can also be mounted on the 24-pin header plug. The 6.144 MHz crystal with its two 20 pF capacitors is mounted next to the 8085 with Vector T-49 Klipwrap pins.

### Getting the 8085 Microprocessor Operating

The first integrated circuits to install are the 8085 (IC1), 8212 (IC2, low address latch for the 8085), 74LS257 (IC28), 8131 (IC35), 2716 (IC34), 8251 (IC7), 74LS138 (IC18, peripheral decoder), 7490 (IC16), 7493 (IC17), the eight-position DIP switch, and IC11 (the 7400 NAND package that contains a gate to buffer the clock output of the 8085). All of the connections should be made to these devices. Program the 2716 read-only memory with the 22-byte checkout program that is given in listing 1. Temporarily ground the HOLD input to the 8085 (pin 39) and three of the inputs that are normally driven by the AEN output (pin 9) of the 8257. These inputs are at pin 4 of

IC18 (the 74LS138 peripheral decoder), pin 1 of IC2 (the 8212 latch that holds the low address lines from the 8085), and pin 15 of IC28 (the 74LS257).

After you reset the 8085 microprocessor, the simple test program should send out continuous ASCII "U" characters from the 8251 transmitter data output (pin 19). With the 300 bps switch closed, pin 19 of the 8251 should produce a square wave at 150 Hz, which is 300 bps. The IOW line (pin 12 of the 74LS257) should show 30 Hz on a frequency counter. The negative pulses on IOW are very narrow and may not show up on an inexpensive oscilloscope. If you have these signals present, your 8085 microprocessor and its associated circuitry are working correctly.

Do not go beyond this point in construction until your 8085 microprocessor is functioning correctly. If you have problems, check the following items. Make sure that the clock output of the 8085 is 3.072 MHz, and that this signal is getting to

*Text continued on page 224*

# DISCOUNT SOFTWARE

PS.—We want to be your software source. Give us the opportunity to beat any nationally advertised price!

## CP/M\*

**OSBORNE†** DISK WITH MANUAL / ONLY  
 #General Ledger . . . \$ 59/\$20  
 #Acct Rec/Acct Pay . . . \$ 59/\$20  
 #Payroll w/Cost . . . \$ 59/\$20  
 Buy 2 get 1 free . . . \$118/\$57  
 All 3 and CBASIC2 . . . \$199/\$71

## MICROSOFT

Basic-80 . . . \$284/\$25  
 Basic Compiler . . . \$324/\$25  
 Fortran-80 . . . \$384/\$25

## STRUCTURED SYSTEMS

#General Ledger . . . \$747/\$25  
 #Accts Receivable . . . \$747/\$25  
 #Accts Payable . . . \$747/\$25  
 #Payroll . . . \$747/\$25  
 #Inventory Control . . . \$447/\$25  
 #Analyst . . . \$197/\$15  
 #Letterright . . . \$167/\$25  
 #NAD . . . \$ 87/\$20  
 #OSORT . . . \$ 87/\$20

## MICROPRO

Word-Star . . . \$349/\$40  
 Word-Star  
 /Mail-Merge . . . \$489/\$65  
 DataStar . . . \$329/\$35  
 Word-Master . . . \$119/\$25

CP/M users: specify disk systems and formats. Most formats available.

## GRAHAM-DORIAN

#General Ledger . . . \$793/\$35  
 #Accts Receivable . . . \$793/\$35  
 #Accts Payable . . . \$793/\$35  
 #Payroll . . . \$493/\$35  
 #Inventory . . . \$493/\$35  
 #Cash Register . . . \$493/\$35  
 #Apartment Mgt. . . \$493/\$35  
 #Job Costing . . . \$793/\$35

## PEACHTREE †

‡General Ledger . . . \$449/\$35  
 ‡Accts Receivable . . . \$449/\$35  
 ‡Accts Payable . . . \$449/\$35  
 ‡Payroll . . . \$449/\$35  
 ‡Inventory . . . \$499/\$35  
 ‡Property Mgt. . . \$899/\$35  
 ‡Mailing Address . . . \$399/\$35

## WHITESMITH

\*C Compiler . . . \$600/\$30  
 \*Pascal (incl C) . . . \$750/\$45

## Tiny C

CBASIC-2 . . . \$ 89/\$15  
 Pascal/Z (Ver 3) . . . \$369/\$35  
 Pascal/MT (Ver 3) . . . \$229/\$30  
 Magic Wand . . . \$299/\$45  
 CBS . . . \$279/\$45

Pearl (level 1) . . . \$ 99  
 Pearl (level 2) . . . \$299  
 Pearl (level 3) . . . \$549

## MICRO-AP

#Selector III-C2 . . . \$269/\$20  
 #Glector . . . \$249/\$25  
 S-Basic Compiler . . . \$229/\$25

## DIGITAL RESEARCH

CP/M\* 2.2 Northstar . . . \$149/\$25  
 CP/M\* 2.2 Cromemco . . . \$189/\$25

## APPLE II®

MICROSOFT  
 Softcard (CP/M) . . . \$292

## PERSONAL SOFTWARE

Visicalc\* . . . \$122  
 CCA Data Mgr. . . \$ 86  
 Desktop/Plan . . . \$ 86

## TRS-80® MODEL II

CP/M 2.2 . . . \$149

## TRS-80® MODEL I

CP/M 1.4 . . . \$129  
 CCA Data Mgr. . . \$ 88

Number	Type	+5 V	GND
IC1	8085	40	20
IC2	8212	24	12
IC3	8212	24	12
IC4	8212	24	12
IC5	8212	24	12
IC6	8224	16	8
IC7	8251	26	4
IC8	8257	31	20
IC9	8275	40	20
IC10	8279	40	20
IC11	7400	14	7
IC12	7400	14	7
IC13	7401	14	7
IC14	7410	14	7
IC15	7474	14	7
IC16	7490	5	10
IC17	7493	5	10
IC18	74LS138	16	8
IC19	74LS138	16	8
IC20	74LS138	16	8
IC21	74163	16	8
IC22	74166	16	8
IC23	74175	16	8
IC24	74175	16	8
IC25	74175	16	8
IC26	74175	16	8
IC27	74175	16	8
IC28	74LS257	16	8
IC29	2114	18	9
IC30	2114	18	9
IC31	2114	18	9
IC32	2114	18	9
IC33	2513	24	10
IC34	2716	24	12
IC35	8131	16	8

Table 1: Power connections for the integrated circuits in the schematic diagram of figure 1.

## VISA • MASTERCHARGE

ORDERS ONLY—CALL TOLL FREE

**1-800-854-2003 ext. 823 • Calif. 1-800-522-1500 ext. 823**

Add \$2.50 postage and handling per each item. California residents add 6% sales tax. Allow 2 weeks on checks. C.O.D. ok.

For information write or call **THE DISCOUNT SOFTWARE GROUP**  
 1610 Argyle Ave., Bldg. 102 • Los Angeles, CA 90028 • (213) 665-8280

Prices subject to change without notice. All items subject to availability.

\*—Special Bonus with order †—Requires CBASIC-2 ‡—Requires microsoft BASIC \*—Mfgs. Trademark ‡—Supplied in source code



# Disc/3 MART, INC.

DO IT YOURSELF

## LOW-LOW PRICES

ANADIX PRINTER, DP-8000 .....	\$ 825.00
ANADIX PRINTER, DP-9500 .....	1,425.00
BASE II Printer (complete with options)	645.00
CENTRONICS 730 Matrix Printer .....	745.00
(with 4 free zip pack)	
HAZELTINE 1520 .....	1,319.00
NEC Spinwriter 5510 (RO) .....	2,643.00
SOROC IQ 120 .....	750.00
SOROC IQ 140 Assembled .....	1,225.00
TI 810 Basic (upper & lower case) .....	1,669.00
TI 994 Personal Computer .....	1,150.00
LA 34 DEC Writer Teleprinter .....	1,195.00

CARTRIDGES • DISKETTES • MAG TAPE • ACCESSORIES

ADDS, CENTRONICS, HAZELTINE, IMSAI, LEAR SIEGLER, TECHTRAN, TI, VECTOR GRAPHICS AND OTHERS

STORE HOURS: 9 A.M. - 5:30 P.M. Mon. through Fri.

Call or write for quotes or information.

Circle 129 on inquiry card.

# Disc/3 MART, INC.

1840 LINCOLN BLVD.,  
SANTA MONICA, CA 90404  
(213) 450-5911

# TRS-80 LEVEL II

## \$685

COMPLETE  
SYSTEM

Limited quantity in stock

The world's most popular microcomputer, with 16K of memory and Level II basic for only \$685, complete with full 90 day Radio Shack warranty. We accept check, money order or phone orders with Visa or Master Charge. (Shipping costs added to charge orders).

Disk drives, printers, peripherals, software and games . . . you name it, we've got it (Both Radio Shack & other brands). Write or call for our complete price list.



Shown is Level I. Level II includes alphanumeric keypad.

# C&S ELECTRONICS MART

Ltd.

AUTHORIZED  
DEALERSHIP

# Radio Shack

32 E. Main Street • Milan Michigan 48160 • (313) 439-1400

## Introducing the Ultimate Personal Timeshare Network and the Star Modem

Now Available for Pet IEEE  
and RS232C Ports

Now for the first time ever you can get the Star Modem by Livermore and the nation's most sophisticated new time sharing service, CompuServe, in an introductory package at an unbelievable price.

Imagine access to an ever increasing world of database, investment, financial, and Wall Street information, a daily newspaper, plus U.P.I. and A.P. news, and games. Plus electronic mail which allows instant personal message transmission to users nationwide from a proven industrial timesharing network. A tremendous capability increase for just \$5 per hour of usage.

The Star Modem, the market's most sophisticated acoustic coupler, is compatible with standard RS232C

ports. An exclusive triple seal within the cups locks your phone into the acoustic chamber with a vacuum seal to prevent distortion. Includes full answer, originate and test modes with full and half duplex operation. Quality guaranteed as proven by Livermore's unequalled two year warranty.

DWS marketing international, a leader in electronic marketing since 1975, now offers this introductory package of the Star Modem, adaptor and the CompuServe hookup, (order product #320), for only \$189.95. Star IEEE modem, adaptor and hookup, (order product #330), only \$269.95. Optional



10' cables are available for \$24.95 (order product #280).

Quantities are limited so order today. Charge customers, to order only, call our toll free number 24 hours a day or send your check but please allow time for checks to clear. VISA, Mastercharge or American Express cards are accepted. Add \$5.00 for insured postage and handling. California residents add 6% sales tax.

(800) 854-3831 In California (800) 432-7451

## DWS marketing international

350-A Fischer Avenue, Dept. 99  
Costa Mesa, California 92626

For dealer inquiries or product information call (714) 540-4549.

© DWS marketing international 1980

# Buy By Mail and Save!

## COMPUTERS



**INTERTEC SuperBrain® 32K** . \$2495  
 64K RAM, List \$3345 ..... \$2695  
 64K Quad, List \$3995 ..... \$3395  
**NORTH STAR Horizon I®**  
 16K D.D. Kit ..... \$1259  
 32K D.D. Kit ..... \$1579  
 32K Assembled, List \$2695 .... \$2149  
 Horizon 2 32K DD, Assm., \$3095 \$2439  
 32K QD, Assm., List \$3595 .... \$2859

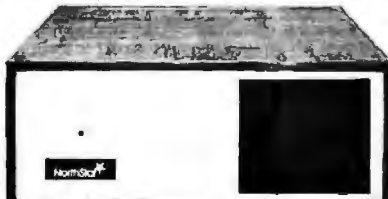

**CROMEMCO Z-2**, List \$995 ... \$ 829  
 System 2, 64K, List \$3990 ..... \$3179  
 System 3, 64K, List \$6990 ..... \$5479  
**ATARI® 400**, List \$630 ..... \$ 489  
 800, List \$1080 ..... \$ 839  
 TI-99/4, List \$1150 ..... \$ 985

## DISK SYSTEMS

**THINKER TOYS® Discus 2D** . \$ 939  
 Dual Discus 2D ..... \$1559  
 Discus 2+2, List \$1549 ..... \$1288

## PRINTERS & TERMINALS

**PAPER TIGER IDS-440** ..... \$ 849  
 with Graphics Option ..... \$ 949  
**CENTRONICS 730-1**, List \$995 . \$ 639  
 737, List \$995 ..... \$ 849  
**T.I. 810** ..... \$1575  
**INTERTUBE II**, List \$995 ..... \$ 729  
**PERKIN-ELMER Bantam 550** .. \$ 789  
**TELEVIDEO 912C** ..... \$779  
 920C ..... \$ 839  
**HAZELTINE 1420** ..... \$ 839  
 1500 ..... \$ 879  
**SOROC 120** ..... \$ 745

## FLOPPY DISKS SPECIAL

5 1/4" Box of 10 ONLY \$29.95

(specify TRS-80, North Star, SuperBrain, etc.)

Most items in stock for immediate delivery. Factory sealed cartons, w/full factory warranty. NYS residents add appropriate sales tax. Prices do not include shipping. VISA and Master Charge add 3%. C.O.D. orders require 25% deposit. Prices subject to change without notice.

# Computers Wholesale

P.O. Box 144 Camillus, NY 13031

VISA (315) 472-2582

**Listing 1: A test program for the 8085 microprocessor section of the video terminal. This should be programmed into the 2716 read-only memory. When the checkout terminal is connected using the temporary interface shown in figure 2 and the 8085 is reset, this program should cause the ASCII character "U" to be printed continuously on the checkout terminal.**

```

; TEST PROGRAM 1 FOR CPU
;
0001  CNCTL EQU 1
0000  CNIN EQU 0
0000  CNOUT EQU 0
;
; INITIALIZE 8251
;
0000  3E7B          MVI A,07BH
0002  D301          OUT CNLH
0004  3E27          MVI A,027H
0006  D301          OUT CNCTL
;
; SEND CONTINUOUS U'S FROM 8251
;
0008  DR01  LOOP:  TN  CNCTL      ;INPUT STATUS
000A  E401          ANI 1          ;MASK READY BIT
000C  CA0800       JZ  LOOP       ;JUMP IF NOT READY
000F  3E55          MVI A,055H     ;LOAD A LETTER 'U'
0011  D300          OUT CNOUT      ;SEND OUT FROM 8251
0013  C30800       JMP LOOP      ;JUMP AND SEND NEXT 'U'
;
END
NO PROGRAM ERRORS
1
BO80 MACRO ASSMBLFR, VER 3.0  ERRORS = 0 PAGE ?

```

## SYMBOL TABLE

* 01							
A	0007	R	0000	G	0001	CNCTL	0001
CNIN	0000 *	CNOUT	0000	D	0002	I	0003
H	0004	I	0005	JUMP	0008	M	0006
PSW	0006	SP	0006				

```

IC CRT280
:10000000.4E7BD3013E27D4010801E601CA08003E57
:0600100055D300C30800F7
:0000000000
$

```

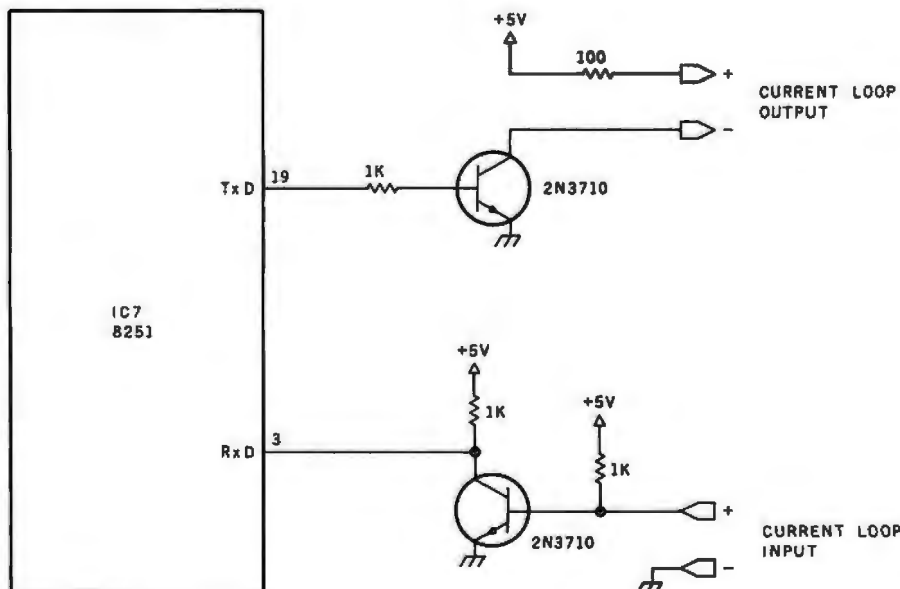

**Figure 2: Schematic diagram of the temporary interface for connecting the checkout terminal to the new terminal for debugging.**



### 779 UPPER CASE/lower case "Conversion Kit I"

Expand the capabilities of your 779 line printer to include word processing!! Available to all Centronics 779/TRS 80 Printer I owners is the option of lower case and changing slash 0 Zero to standard 0. No etch cuts or soldering needed. Installs in minutes with a screwdriver. No program modification or additional interface is required. **Price \$125.00**

### Motor Control "CONVERSION KIT II" FOR ALL CENTRONICS 779/TRS 80 PRINTER I LINE PRINTERS!!

Our "Conversion Kit II" Motor Controller gives your 779 the ability to turn the motor on and off automatically. Removes the annoying noise of constant run, increasing the life span of your 779 / TRS 80 line printer motor! No soldering, software or hardware changes needed. Installs easily. **Price \$95.00**

**SAVE!** Buy Service Technologies "Conversion Kit I" and "Conversion Kit II" together for the single price of **\$199.00**

To order, please send check or money order in the proper amount to:



*Service Technologies, Inc.*  
32 Nightingale Rd.  
Nashua, N.H. 03062  
(603) 883-5369

Visa and Master Charge accepted (please include signature, expiration date and phone number)

Service Technologies will pay all shipping and handling.

### ASI INTEGRATED BUSINESS SOFTWARE

\*\*\*\*\*

RECEIVABLES	ORDER ENTRY
PAYABLES	INVENTORY
PAYROLL	JOB COSTING
GENERAL LEDGER	

\*\*\*\*\*

PLUS TECHNICAL SUPPORT  
FOR END USERS AND DISTRIBUTORS

Available for 8080/Z80 CP/M systems on 8" diskettes and Northstar compatible 5 1/4" diskettes. Runs on Cromenco-Z2H hard disk system.

**ARKANSAS  
SYSTEMS  
INC.**

8901 Kanis Rd.  
Suite 206  
Little Rock, AR 72205  
(501) 227-8471

## New Produced and widely used in England and U.S.A. COMPLETE BUSINESS PACKAGE

**INCLUDES EVERYTHING FROM INVENTORY TO SALES SUMMARY  
PROMPTS USER, VALIDATES EACH ENTRY, MENU DRIVEN**

Approximately 60-100 entries/inputs require only 2-4 hours weekly and your entire business is under control.

**PROGRAMS ARE INTEGRATED-**

- 01 = ENTER NAMES/ADDRESS, ETC
- 02 = ENTER/PRINT INVOICES
- 03 = ENTER PURCHASES
- 04 = ENTER A/C RECEIVABLES
- 05 = ENTER A/C PAYABLES
- 06 = ENTER/UPDATE INVENTORY
- 07 = ENTER/UPDATE ORDERS
- 08 = ENTER/UPDATE BANKS
- 09 = EXAMINE/MONITOR SALES LEDGER
- 10 = EXAMINE/MONITOR PURCHASE LEDGER
- 11 = EXAMINE/MONITOR (INCOMPLETE RECORDS)
- 12 = EXAMINE PRODUCT SALES

**SELECT FUNCTION BY NUMBER-**

- 13 = PRINT CUSTOMER STATEMENTS
- 14 = PRINT SUPPLIER STATEMENTS
- 15 = PRINT AGENT STATEMENTS
- 16 = PRINT TAX STATEMENTS
- 17 = PRINT WEEK/MONTH SALES
- 18 = PRINT WEEK/MONTH PURCHASES
- 19 = PRINT YEAR AUDIT
- 20 = PRINT PROFIT/LOSS ACCOUNT
- 21 = UPDATE END MONTH FILES MAINTENANCE
- 22 = PRINT CASH FLOW FORECAST
- 23 = ENTER/UPDATE PAYROLL (NOT YET AVAILABLE)
- 24 = RETURN TO BASIC

**WHICH ONE? (ENTER 1-24)**

01 SUB. MENU EXAMPLE: 01 = EXAMINE: 02 = INSERT: 03 = AMEND: 04 = DELETE  
05 = PRINT (1,2,3): 06 = NUMERIC COMBINATIONS: 07 = SORT  
VERY FLEXIBLE. ADD YOUR OWN FUNCTIONS. EASY TO INTEGRATE.

All programs in BASIC for CP/M. PET. 6800

G. W. COMPUTERS LTD, the producers of this beautiful package in U.K.

**WE EXPORT TO ALL COUNTRIES:**  
BARCLAYCARD ACCEPTED  
CBM APPROVED

**CALLERS BY APPOINTMENT ONLY**  
89 Bedford Court Mansions  
Bedford Avenue  
London WC1, U.K.

**CONTACT TONY WINTER 01-636-8210**  
BARCLAYCARD ACCEPTED  
CBM APPROVED

CP/M Ver. 9.00 is one 16 K core program using random access releasing both drives for data storage, and 250 word vocabulary is translatable in any foreign language.

CP/M Ver. 9.00 is one 16 K core program using random access releasing both drives for data storage, and 250 word vocabulary is translatable in any foreign language.

PRICES: Programs 1-23 EXC (19,20,22,23) £475

£575 Stock Integrated Option + £100 Bank Integrated Option + £100

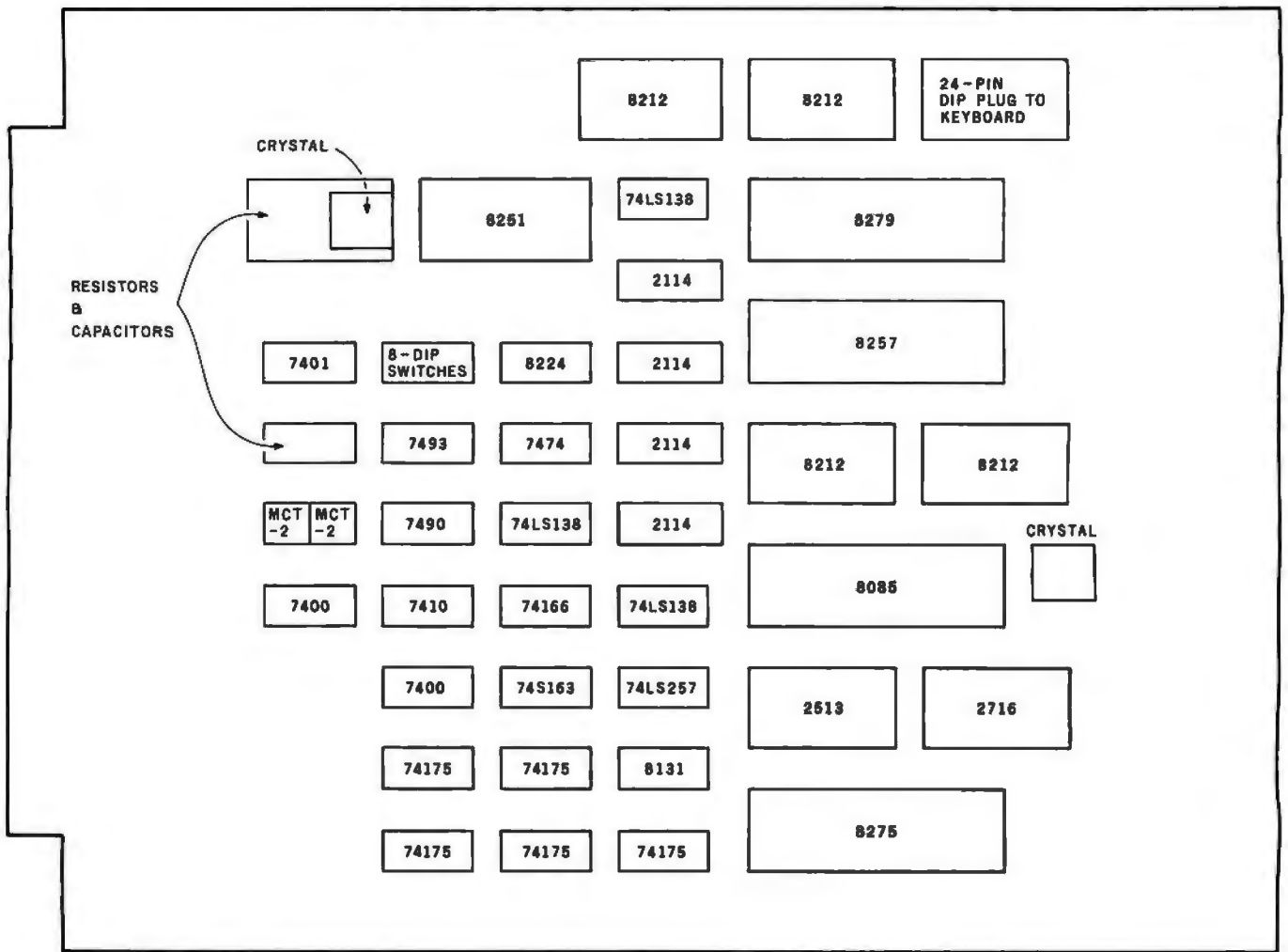

Figure 3: Diagram of the parts layout on the component side of the main circuit board of the video terminal. A type 4350 Vector wire-wrap board was used.

```

LIST300
300 NEXT I
363 F=0
370 FOR I=1 TO N00H
375 IF A(I)X8(I) THEN F=1
380 A(I)=8(I)
390 NEXT I
400 COSUB 700
410 IF F=0 THEN STOP
420 GOTO 130
700 FOR I=1 TO N
710 FOR J=1 TO M
720 Z=(I-1)H+J
730 IF A(Z)=0 THEN PRINT*
740 IF A(Z)=1 THEN PRINT*
750 NEXT J
760 PRINT
770 NEXT I
775 G=CALL(6262)
780 PRINT* G ".C
790 C=C+1
800 RETURN

```

Photo 5: An example of the display produced on the surplus Motorola video monitor.

Text continued from page 220:

pin 20 of the 8251. Check the  $\overline{TxC}$  and  $\overline{RxC}$  inputs of the 8251 (pins 9 and 25). The frequency on these inputs should be sixty-four times the desired data rate (ie: for 300 bps it should be 19,200 Hz). If this frequency is not correct, check the connections on the 7490 and 7493, as well as the data rate switch. The ALE line (pin 30 on the 8085) should have a frequency of about 650.8 kHz on it. There should be no activity on the  $\overline{MEMW}$  line (pin 9 of the 74LS257). The  $\overline{IOR}$  line (pin 7 of the 74LS257) should have a frequency of about 92.2 kHz. The frequencies listed above should all be read with a frequency counter that uses a full 1-second count period, since the pulses on many of these lines do not have a constant duty cycle. Erroneous readings can result from count periods shorter than one

second.

Until next month's BYTE arrives, you will have plenty of time to check the construction of this portion of the circuit. Then, in Part 2, we can proceed with the rest of the project. ■

Portions of this article are copyright by Intel Corporation, and used by permission.

What's going on where people worship today?

Find yourself—with people who worship.

A public service of this publication and the Advertising Council.

Ad Council







# Clubs and Newsletters

## Lifelines from Lifeboat

The primary objective of *Lifelines* is to keep readers informed of the current status of all CP/M-compatible software. Issues include statistics on the wide variety of CP/M-compatible software products distributed by Lifeboat Associates. In addition there will be three sections dealing with changes, bugs, and new products. Letters from users are featured. The newsletter recently published a Pascal review and an article on undocumented Z80 op codes. The subscription rate is \$18 for twelve issues in the US, Canada and Mexico. Elsewhere the rate is \$40. Write *Lifelines*, 1651 Third Ave, New York NY 10028.

## International Computer Chess Association Shifts Headquarters

In order to handle the growing membership more effectively, the headquarters for the International Computer Chess Association (ICCA) has been transferred from Northwestern University in Evanston, Illinois, to Bell Telephone Laboratories in Murray Hill, New Jersey. All inquiries and membership applications should be sent to ICCA, c/o of Ken

Thompson, Rm 2C423, Bell Telephone Labs, Murray Hill NJ 07974. Editorial material for the newsletter should be sent to B Mittman, *ICCA Newsletter*, Vogelback Computing Center, Northwestern University, Evanston IL 60201. Membership dues are \$10. Back issues of the newsletter are \$2 for a set of three.

## Another Club in Florida

The Level II Club is an organization where TRS-80 owners can exchange software. The group has a large program library and will soon offer an ads section and programming contests. There are no membership fees. For more information, write Level II Club, 3713 Bay-to-Bay Blvd, Tampa FL 33609.

## FORTH Interest Group

The FORTH Interest Group meets on the fourth Saturday of each month in the Special Events Room of Liberty House Department Store, Southland Shopping Center, Highway 17 at Winton Ave, Hayward, California. The group also publishes a newsletter, *FORTH Dimensions*. Editorial material is always welcome. A subscription to

*FORTH Dimensions* is free when you join the FORTH Interest Group for \$12 per year in the US, or \$15 overseas. Contact the group by writing, FORTH Interest Group, POB 1105, San Carlos CA 94070.

## International Apple Core

The International Apple Core (IAC) is a nonprofit independent organization that will act as the parent organization for local Apple computer groups. Membership is not open to individuals, although they may subscribe to the IAC's quarterly publication. The organization will offer information on hardware, software, application notes, and programming tips to member groups. The IAC will also make its library accessible to member groups. For more information, Apple user groups can contact the International Apple Core, POB 976, Daly City CA 94017.

## Free Pascal Newsletter

The *Pascal Newsletter* has articles of general interest to computer enthusiasts, such as Pascal standards and programming techniques. Recent newsletter articles have included a history of Pascal compilers, a Pascal

bibliography, a comparison of Rational Data Systems' (RDS) Pascal to competitive products, and a section on matters of programming style. Free subscriptions to RDS's *Pascal Newsletter* and a product brochure are available by writing or calling Rational Data Systems, 245 W 55th St, New York NY 10019, (212) 757-0011.

## A Computer Group in Amarillo

The High Plains TRS-80 Users Group of Amarillo, Texas, meets the second and fourth Tuesdays of every month at the downtown branch of the Amarillo Public Library on 413 E 4th St, from 7 to 9 PM. The annual dues are \$15. For information, write High Plains TRS-80 Users Group, POB 30545, Amarillo TX 79120.

## TBUG-80 in Florida

This group in Tampa Bay, Florida, supports the use of the TRS-80 for games and business applications. Tutorial sessions at the meetings cover everything from the proper operation of the hardware to disk-based programming techniques. The club's newsletter contains program notes, reviews of products for the TRS-80, and letters of

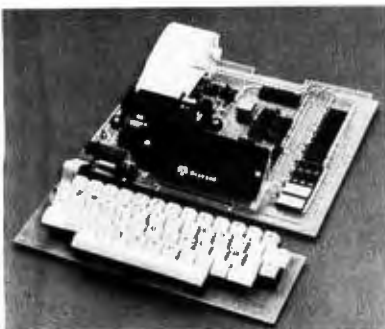

## AIM 65

AIM 65 is fully assembled, tested and warranted. With the addition of a low cost, readily available power supply, it's ready to start working for you. It has an addressing capability up to 65K bytes, and comes with a user-dedicated 1K or 4K RAM.

- Thermal Printer
- Full-Size Alphanumeric Keyboard
- True Alphanumeric Display
- Proven R6500 Microcomputer System Devices
- Built-in Expansion Capability
- TTY and Audio Cassette Interfaces
- ROM Resident Advanced Interactive Monitor
- Advanced Interactive Monitor Commands

**PRICE: \$389.00**

Plus \$4.00 UPS (shipped in U.S. must give street address), \$10 parcel post to APO's, FPO's, Alaska, Hawaii, Canada, \$25 air mail to all other countries

We manufacture a complete line of high quality expansion boards. Use reader service card to be added to our mailing list, or U.S. residents send \$1.00 (international send \$3.00 U.S.) for airmail delivery of our complete catalog.

 **ENTERPRISES**  
INCORPORATED

2967 W. Fairmount Avenue • Phoenix, AZ 85017 • (602) 265-7564

**PRICE: \$139.00**  
We also carry the **SYM-1**  
Microcomputer with manuals **\$229.00**







# FREE COMPUTER FORMS KIT

## EACH KIT CONTAINS:

Samples, Prices, Order Form,  
4 Checks, 2 Statements, 2 Invoices,  
Programming Guides.

We specialize in small quantities, low prices.  
500 CHECKS ONLY \$29.95

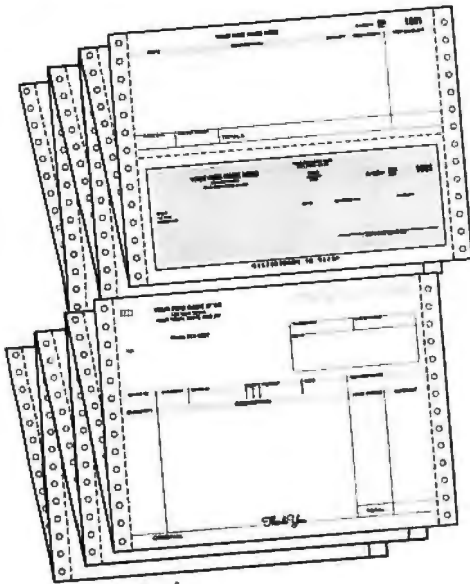

**SEND COUPON, CIRCLE BINGO or  
PHONE TOLL FREE  
1 + 800-225-9540**

**FAST SERVICE** — It is our policy to ship within 6 working days following our receipt of your order. **CODE 459**

Name \_\_\_\_\_

Address \_\_\_\_\_

City \_\_\_\_\_

State, Zip \_\_\_\_\_

**NEW ENGLAND BUSINESS SERVICE, INC.  
GROTON, MASS. 01450**

general interest from members. For information on subscribing to the newsletter, joining the club, or learning about its electronic mail system, write to the Tampa Bay TRS-80 Users Group, *T-BUG 80 Newsletter*, POB 247, Tampa FL 33602.

### Apple for the Teacher

Apple for the Teacher is a user group with emphasis on the educational uses of the Apple computer. Its newsletter features reviews of educational software, plus current information on educational computer grants and research. The group operates the national computer-aided instruction library for the Apple and is receiving donations from throughout the world. Contact Apple for the Teacher, 5848 Riddio St, Citrus Heights CA 95610.

### Computer Society in Washington

The Whidbey Island Computer Society (WICS) is dedicated to promoting education and fellowship in the realm of home computing. The only requirement for membership is an interest in the field of microcomputing. The group currently has an AIM-65, Apple II, Heathkit H8, TRS-80, Exidy Sorcerer, and a Z80 homebrew system. WICS meets monthly on the second and fourth Saturday. For further information, contact Dee Minter, 1616 Larch Dr, Oak Harbor WA 98277, (206) 675-7964.

### Gosub—TRS-80 Users Group

Gosub TRS-80 Users Group was formed to provide TRS-80 users with a place to exchange ideas, information, and other computer-related material. The group meets on the third Sunday of each month in the computer room at the Camar Corporation, 186

Prescott St, Worcester, Massachusetts. The meetings run from 2 to 5 PM. Membership dues are \$6 per year and include a subscription to a monthly newsletter. The mailing address is POB 712, Worcester MA 01613, (617) 845-1851. ■

## BYTE's Bits

### First National Conference on Artificial Intelligence

Stanford University in Palo Alto, California, is hosting the first annual National Conference on Artificial Intelligence. The conference will be held from August 18 thru the 21. It is being sponsored by the newly created American Association for Artificial Intelligence (AAAI) in cooperation with SIGART. The topics will cover robotics, cognitive modeling, vision, problem solving and search, artificial intelligence languages and software, theorem proving, theoretical foundations, mathematical foundations, specialized systems, and more. Many artificial intelligence research groups and manufacturers will be demonstrating AI and other computer hardware and software. A tutorial program on August 18 will examine the current artificial intelligence research in this country. The AAAI is a group whose purpose is to study and disseminate information on AI in the US. AAAI officers are Allen Newell of Carnegie-Mellon University, president; Edward Feigenbaum of Stanford University, president-elect; and Donald Walker of SRI-International, secretary-treasurer. Membership information may be obtained by writing to Dr Bruce Buchanan, AAAI Membership, Computer Science Dept, Stanford University, Stanford CA 94305. ■



## CHECKERS

Our program can solve the difficult endgame problem on the right (solution 22-18, 9-13, 18-15, 13-17, 11-16, 3-8, 16-12, 8-3, 15-11, 17-22, 12-18).

**It also has**

- main lines for most of the ACF 3-move openings in its book
- special coding for 2 kings vs 1 and 3 vs 2 with defenders in the double corners
- the ability to take back moves
- the ability to set up board positions
- recent moves displayed along with text or graphics representation of board position
- 9 levels of play
- the ability to run in 16K RAM on a Z-80
- a \$24.95 price tag

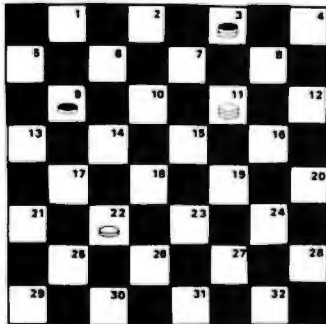

White to win. Dr. T. Brown 1871

**All programs**

... are available for TRS-80 (delivered on level II tape), North Star DOS (delivered on 5" North Star diskettes which need N\* drives to read them), and CP/M (on 5" N\* or 8" single density IBM format disk). Visa or Mastercard accepted. Please add 5 dollars extra for 8" disk. Ontario residents add 7% tax. Canadian residents add 9% tax. Order from



Five Stones Software,  
P.O. Box 1369,  
Station B,  
Ottawa K1P 5R4  
Canada

CP/M is a trademark of Digital Research.  
TRS-80 is a trademark of Tandy Corp.

**Gomoku**

Our Gomoku program was the highest ranking program in the 1980 North American tournament. It has two levels of play, and is available with 19 by 19 (except TRS-80) or 16 by 16 (except CP/M) board. It was written by the 75, 77, 79 North American champion, requires 32K RAM (for N\* DOS must begin at loc. zero), and costs \$29.95.

**Guess Five**

This number guessing program uses five digits, each valued 0 thru 7 making 32768 possible numbers. When the program is guessing it typically makes four guesses from book, one by short calculation and hits on the sixth guess. You have to try this to believe how high that standard is. It requires 8K RAM and costs \$19.95.

# GIVE YOUR COMPUTER A HAND



Have you ever wanted to do more with your micro than play computer games and balance your checkbook? *Robotics Age* gives you all the information you need to transform your home computer into a working **ROBOT!** Every aspect of robot research and experimentation—from the basic principles to the latest developments in laboratories around the world—is covered. Special emphasis is given to plans, circuits, and programs that you can use in your own microcomputer-controlled robot. Each article is designed to be understandable to the novice experimenter, but with technical detail and complete references that will satisfy even the professional researcher. Added to that are robotics-related New Products, Book Reviews, abstracts of selected recent technical papers, and reports on how you can participate in the growing number of robotics and Artificial Intelligence organizations in the US and abroad. Join the thousands of *Robotics Age* readers and learn how you can contribute to the development of the intelligent robots of the future—*Subscribe Today!*

## ROBOTICS AGE

P.O. Box 801, La Canada, CA 91011

- 1 yr (4 issues)—US\$8.50, Canada & Mexico \$10, Foreign \$12
  - 2 yrs (8 issues)—US\$16, Canada & Mexico \$19, Foreign \$23
  - Payment enclosed  Bill me (No. America only)  Bill my Mastercharge  VISA
- Number \_\_\_\_\_
- Signature (required) \_\_\_\_\_ Expiration date \_\_\_\_\_
- Name \_\_\_\_\_
- Address \_\_\_\_\_
- City \_\_\_\_\_ State \_\_\_\_\_ Zip \_\_\_\_\_

## CP/M<sup>®1</sup> - based Business Software for TRS-80<sup>®2</sup> computers on . . . ... the fastest Mod-II CP/M with the most features!!!

- Over 610,000 bytes/disk
  - Downloading package included
  - 1,200 baud operation of serial printers without data loss
  - Single drive backup
  - Mixed single/double density on any of 4 drives (even a 1-drive system)
  - Ultra-fast disk operation
  - Emulation of cursor addressing for any of several "dumb" CRTs
  - Auto-LF printer support & ASCII top-of-form software (LPIII)
  - Supplemental document describing our implementation
  - User-settable function keys
- MOD-II CP/M ..... \$250.00    MOD-I CP/M ..... \$150.00    CBASIC2<sup>®3</sup> (Mod I or II) ..... \$110.00

The following software for Mod-II CP/M only unless otherwise stated (\*-requires CBASIC2):

- RM/COBOL<sup>®4</sup> - Only COBOL for CP/M with alternate keys (multi-key ISAM), CRT screen handling, interactive debug, Z80 code, and the most useful Level 2 features. **Compatible with Tandy's COBOL—but runs faster!** ..... \$495.00
- PMS (Property Management System) - Interactive, menu-driven system includes full G/L, budgeting, cash journal, delinquency list, tenant activity/rent roll, complete audit trail and reports on vacancies, lost rent, and vendors ..... \$650.00\*  
demo disk & manual ..... 75.00\*
- APH (Automated Patient History) - General-purpose question-asking, answer-printing system furnished as self-administered review-of-systems general patient history (Mod-I also) ... \$175.00\*

- MAGIC WAND<sup>®5</sup> - Full-feature word processing, true proportional spacing, file merging, and use of full-screen editor for source programs or data ..... \$400.00
- RPA (Residential Property Analysis) - Analyzes income and expense, financing, taxes, inflation and depreciation on home, condo, or apartments over a user-selectable time. Shows payoff in terms of ROI, Cap rate, cash-on-cash. Amortization schedules and worksheet ..... \$300.00\*  
demo disk & manual ..... 35.00\*
- RBC (Rent/Buy Comparison) - Sales or investment tool to compare renting and savings account investment vs. purchasing a particular property ..... \$250.00\*  
demo disk & manual ..... 35.00\*

- Osborne & Assoc. CBASIC source programs (Mod-I also):  
Payroll w/Cost Accounting ..... \$250.00\*  
Accts. Payable/Accts. Receivable ..... \$250.00\*

- General Ledger w/Cash Journal ..... \$250.00\*
- O&A CBASIC Books (ea.) ..... \$ 20.00

**Verbatim<sup>®6</sup> media: (Qty. 100 prices)**

- 5 1/4" single density ..... \$2.50 ea.
- 8" certified double density ..... \$4.00 ea.
- 8" single density ..... \$ 3.00 ea.
- 450' tape cartridges ..... \$20.00 ea.



8041 Newman Ave., Suite 208  
Huntington Beach, CA 92647  
(714) 848-1922

Registered trademark of:

- 1 Digital Research
- 2 Tandy Corp.
- 3 Compiler Systems, Inc.
- 4 Ryan-McFarland Corp.
- 5 Small Business Applications, Inc.
- 6 Verbatim Corp.



Distributed in U.K. by:  
Microcomputer Applications Ltd.  
11, Riverside Court,  
Caversham, Reading, England  
TEL: (0734) 470425

# M7 Communicator

## A complete A/D and D/A Control System—

Interface your computer to the analog world of process monitoring transducers and controlling actuators.

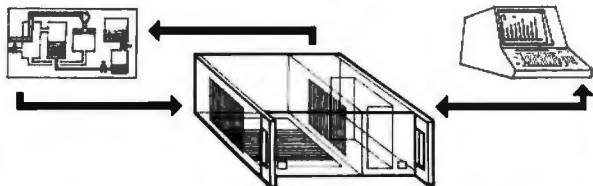

The M7 multiplexes analog and digital signals from your process sensors—temperature, pressure, level, flow, mass, strain, etc.—and continuously down-loads this data in digital form to your computer for display and processing. Simultaneously, command signals are transmitted to the control devices in your process.

## Order a complete basic M7 System ready for round-the-clock process control—

including a 16/32-Channel A/D Input Module (expandable to 256 channels), a Computer Interface Module, and a 4-Channel (expandable) D/A Output Module. Supplied complete with cabinet, power supply, and all necessary hardware and software for basic control. Bus accommodates eight additional modules. Specify computer make and model when ordering . . . each \$2,990

## Or, order individual IEEE S-100 building block modules

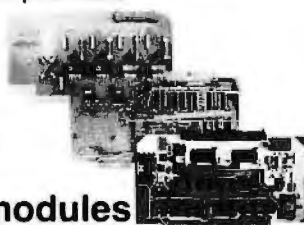

Supplied complete with fundamental control software:

- A/D Module, AIM-12**
  - 16/32 channel • 12-bit precision/accuracy • 30 kHz data rates • 1-1000 gain amplifier optional . . . . . from \$575
- Thermocouple Compensation Module, THM-8**
  - 16 Inputs . . . . . \$350
- Signal Conditioners, SIG-1 • Long-line drive . . . . . \$325**
- Additional Support Programs, PROG A,B,C...**
  - Signal averaging • control functions • special display • etc. . . . . from \$100
- D/A Module, AOM-12**
  - 4-channel (expandable) • 12-bit precision/accuracy • Output: selectable voltage ranges and oscilloscope . . . . . from \$495
- Control Output-Current Module, VIC 4-20**
  - 4-20 mA standard industrial control output • 12-bit precision/accuracy • 4-channel • Use with AOM-12 . . . . \$395
- Programmable Clock/Calendar Module, CLK-24**
  - Minimum 1 year back-up . . . . . \$250
- Parallel Output Module, REL-8**
  - 8-channel on-off (bang-bang) control . . . . . \$325
- Add-On Nonvolatile Memory Modules**
  - 4K and 8K bytes . . . . . from \$320

DUAL SYSTEMS CONTROL CORP.  
1825 Eastshore Hwy.  
Berkeley, CA 94710  
(415) 549-3854



system reliability/system integrity

# Event Queue

## AUGUST 1980

August 4-6

**Data-Entry Management and Supervision Seminar, Chicago IL.** This seminar is designed for data-entry managers and supervisors. Topics will range from data-entry control techniques and improving data-entry operator productivity, to personnel communications and motivation. Contact MIC, 140 Barclay Ctr, Cherry Hill NJ 08034, (609) 428-1020.

August 12-14

**Computer Graphics '80, Birmingham, England.** Computer Graphics '80 will bring together experienced users and specialists to present applications experiences and research findings. In addition to the conference, there will be an equipment exhibition and an animated film festival. To register, contact Paula Stockham, Online, Cleveland Rd, Uxbridge UB8 2DD, England, phone Uxbridge (0895) 39262.

August 14-24

**Electronics/China '80, Guangzhou (Canton), China.** This is the first exhibition of US electronic companies in the People's Republic of China. The United States-China Trade Consultants are the sponsors of the show. Products demonstrated will include circuit components, system elements, test instrumentation, product equipment, and materials. Details are available through Expoconsul Inc, Clapp and Poliak Inc, Princeton-Windsor Office Park, POB 277, Princeton Junction NJ 08550.

August 23-24

**Personal Computer Arts Festival, Philadelphia Civic Center, Philadelphia PA.**

Tutorials, seminars, musical performances, and graphic extravaganzas will be featured in this show. Contact PCAF '80, c/o Philadelphia Area Computer Society, POB 1954, Philadelphia PA 19105.

August 18-21

**First National Conference on Artificial Intelligence, Stanford University, Palo Alto CA.** This is the first annual National Conference on Artificial Intelligence. It is being sponsored by the newly created American Association for Artificial Intelligence in cooperation with SIGART. The topics will cover robotics, cognitive modeling, vision, problem solving and search, artificial intelligence languages and software, theorem proving, theoretical foundations, mathematical foundations, specialized systems, and more. Many artificial intelligence research groups and manufacturers will be demonstrating AI and other computer hardware and software. A tutorial program on August 18 will examine the current artificial intelligence research in this country. Information may be obtained by writing to Dr Bruce Buchanan, AAAI Membership, Computer Science Dept, Stanford University, Stanford CA 94305.

August 25-27

**Summer Computer Simulation Conference, Olympic Hotel, Seattle WA.** Emphasis will be on computer networks, graphics tools for simulation, database management, and management science models, in addition to papers in such traditional areas as simulation. For details, write Simulation Councils Inc, 1980 Summer Computer Simulation Conference, POB 2228, La Jolla CA 92038.



August 25-28

**Implementing Cryptography in Data Processing and Communications Systems**, University of Southern California, Los Angeles CA. For information on this conference, contact the University of Southern California, Continuing Engineering Education, Powell Hall 216, University Park, Los Angeles CA 90007, (213) 746-6708.

August-December

**Short Courses**, George Washington University, Washington DC. These courses will cover programming for beginners, configuration management of software programs, computer performance evaluation, Pascal programming, and more. Contact the Director, Continuing Engineering Education Program, George Washington University, Washington DC 20052, (202) 676-6106, or toll-free (800) 424-9773.

August-December

**Information Management Seminars for Professional Development**, Harvard University, Cambridge MA. Courses on data communications, distributed systems, office automation, minicomputers, data-base management, computer graphics, computer mapping, and more, are being presented by the Laboratory for Computer Graphics. Write the Center for Management Research, 850 Boylston St, Chestnut Hill MA 02167, (617) 738-5020.

---

 SEPTEMBER 1980
 

---

September 9-10

**The Thirteenth International Symposium and Exhibition on Minicomputer and Microcomputer Applications, MIMI'80**, Montreal, Canada. This symposium will cover communications, signal processing, data acquisition, control, robotics, education, hardware, languages, networks, and other topics. It is being held in conjunction with the first

**IASTED International Symposium and Exhibition on Office Automation**. For more information, contact Professor M H Hamza, Dept of Electrical Engineering, University of Calgary, Calgary, Alberta, T2N 1N4 Canada.

September 11-13

**Internecon Semiconductor International Exposition and Conference**, Republic of Singapore. Featuring an exhibition of production machinery, tools, hardware, materials, and test instruments, this show includes conferences keyed to the needs of the engineering, manufacturing, and support personnel of Southeast Asia. It is open to all persons engaged in electronics and semiconductor manufacturing. Contact Industrial and Scientific Conference Management Inc, 222 W Adams St, Chicago IL 60606, (312) 263-4866.

September 16-18

**Wescon/80**, Anaheim Convention Center, Anaheim CA. This year's show will include a large exhibition and a variety of talks covering communications, computers, microprocessors, consumer electronics, energy, office automation, semiconductor technology, and more. Contact Wescon, 999 N Sepulveda Blvd, El Segundo CA 90245, (213) 772-2965.

September 16 thru October 16

**Eastern European Electronics Catalog Exhibit**. Exhibits will focus on production tools and machines, test instrumentation, electronic components and hardware, computers for production, chemicals, and other materials. Symposia will cover electronic manufacturing techniques and progressive production computer technology. The host cities will be: Warsaw, Poland; Bucharest, Rumania; Sofia, Bulgaria; Budapest, Hungary; and Prague, Czechoslovakia.

For more information concerning the dates of ap-

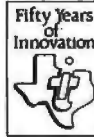

## Career Opportunities in Robotics and Computer Vision Systems

### Immediate Dallas Openings

Texas Instruments has immediate openings for highly motivated, talented individuals with interest in the areas of robotics and pattern recognition. You will be a member of a team whose function is to develop and apply advanced technologies, design and implement working systems, and develop state-of-the-art tools and procedures for a broad range of industrial automation applications.

We have positions for innovative individuals with background in:

#### Hardware/Software

- Computer Architecture
- Operating Systems
- Systems Programming
- Mini/Micro Assembly Language Programming
- Electro Optics
- Video Signal Processing

#### Applications

- Robotics
- Computer Vision System
- Computer Speech I/O
- Intelligent Machines
- Advanced Servo Control Systems
- Vidicon/CCD Cameras

If you have an Associate or higher degree, or equivalent experience, and are looking for a challenging opportunity in any of the above areas, send your resume in complete confidence to: Staffing Manager/P.O. Box 225474, M.S. 217/Dallas, TX 75265.

## TEXAS INSTRUMENTS

INCORPORATED

An equal opportunity employer M/F

# More Printing Terminals From MICROMAIL



**DIABLO 1650**

- Prints at 40 cps, using 88, 92, or 96 char. metalized printwheels.
- Vertical resolution 1/48"; Horizontal 1/120". Capable of proportional spacing, bidirectional printing, and graphics under software control.
- Bidirectional normal and direct tabs. Left, right, top and bottom margins.

R.O. \$2890.00  
KSR \$3285.00



**DEC LA 34**

(Shown with optional forms tractor and numeric keypad)

- Prints 10, 12, 13.2, or 16.5 characters per inch, upper/lower case.
- 2, 3, 4, 6, 8, or 12 lines per inch.
- Friction feed, paper width to 15 inches.

**\$999.00**

**Options:**

- Numeric keypad — \$80.00
- Adjustable forms tractor — \$130.00

**DIABLO 1640**

- Uses plastic printwheel and prints at 45 cps. Otherwise, shares identical features with 1650 including:
  - Friction or tractor feed, up to 15" wide.
  - Cartridge ribbon, fabric or carbon.

R.O. \$2745.00  
KSR \$3140.00



**T.I. 810**

- Includes upper/lower case option.
- Bidirectional printing at 150 cps.
- Tractor-feed forms, 3" to 15" wide.

**\$1599.00**

**Options:**

- Forms length control — \$100.00
- Vertical Format Control with Compressed Print — \$125.00



**TELETYPE 43**

- Prints 132 columns, upper/lower case with true descenders.
- 30 character/second print speed, 110-300 baud.
- Uses 12" wide by 8.5" pinfeed paper.
- Print position scale, paper guide and supply rack.

**\$999.00**

We Also Represent the Following Manufacturers:

**SOROC TEC GTC**

Write or Call In for Our Free Catalogue!



**TO ORDER:** Send check or money order to: MICROMAIL, P.O. Box 3297, Santa Ana, CA 92703. Personal or company checks require two weeks to clear. Terminals in stock are shipped the business day after receipt of certified funds. All equipment includes factory warranty.

**SHIPPING:** We ship freight collect by UPS when possible. Larger terminals are shipped by motor freight. Air and express delivery is available on all products.

pearance in each city and any other information, contact Harry Lepinske, East-West Operations, ISCM Inc, 222 W Adams St, Chicago IL 60606.

September 17-19

**ACM Small/Personal Computer Conference, Rickey's Hyatt House, Palo Alto CA.** This symposium will blend contributed papers with panel and informal discussions. Included will be hardware and software topics involving theory, design, construction, marketing, and applications. Discussions will cover microcomputer applications in business, industry, education, and the home. Details are available from Conference Chairman, Philippe Lehot, PLA, 976 Longridge Rd, Oakland CA 94610.

September 18-21

**Mid-Atlantic Business and Home-Computer Show, DC Armory/Starplex, Washington DC.** This is an end-user exposition featuring small- and medium-sized business systems, scientific and engineering computers, microcomputers, and electrotechnology. Contact Northeast Expositions Inc, POB 678, Brookline Village MA 02147, (617) 524-0000.

September 22-25

**Software INFO, Hyatt Regency, Chicago IL.** This is the first national conference and exhibition on packaged software held in the US. For more information, or to reserve exhibition space, call or write Software INFO, Suite 545, 222 W Adams St, Chicago IL 60606, (312) 263-3131.

September 23-25

**Compton '80 Fall, Capital Hilton Hotel, Washington DC.** Sponsored by the Institute of Electrical and Electronics Engineers (IEEE), this show explores distributed computing and related topics. Discussions will cover interfaces, standards, and protocols; data communications and networking; computer systems; data bases; security; office

systems; and more. Details from Compton '80 Fall, POB 639, Silver Spring MD 20901.

September 24-27

**The Tenth Annual Conference of the Society for Computer Medicine, San Diego Hilton, San Diego CA.** This conference has been planned for physicians, attorneys, administrators, computer professionals, comptrollers, engineers, nurses, and anyone interested in the use of computers for patient care. Sessions on medical subjects, technical subjects, and contributed papers on new research in computer medicine will be offered. For information, contact Society for Computer Medicine, 1901 N Ft Myer Dr, Suite 602, Arlington VA 22209, (703) 525-0098.

September 25-28

**Mid-Atlantic Personal and Business Computer Show, Philadelphia Civic Center, Philadelphia PA.** General admission for adults is \$5. This show is being produced by National Computer Shows, POB 678, Brookline Village MA 02147, (617) 524-0000.

September 26-27

**Classroom Applications of Computers in Grades K Thru 12, Independence High School, San Jose CA.** A visit to "Silicon Valley," tutorials, workshops, and exhibits will highlight this conference. The emphasis will be to inform teachers about the possible uses of computers in all areas of education. Contact Computer-Using Educators, c/o W Don McKell, Independence High School, 1776 Educational Park Dr, San Jose CA 95133.

September 27-28

**New Jersey Personal Computer Show and Flea Market -80, Holiday Inn (North) Convention Center, Newark NJ.** This show will feature an indoor commercial exhibit and sales area, an outdoor flea market with room for 100 sellers, and

Circle 181 on inquiry card.



forums for all popular hobby computing systems. This show is primarily for hobbyists and small-business owners. The admission price is \$4 in advance and \$5 at the door. Contact NJPCS, Kengore Corporation, 9 James Ave, Kendall Park NJ 08824, (201) 297-6918 after 7 PM.

September 29-October 4

**The Eighth International Conference on Computational Linguistics, Tokyo, Japan.** This conference will provide a forum for a variety of computational linguistics topics including theories, methods, and problems of computational linguistics; models of natural language processing; applications of natural language processing; hardware and software supports for language data processing; and more. For information, contact Professor David G Hays, Twin Willows, 5048 Lakeshore Rd, Hamburg NY 14075.

**OCTOBER 1980**

October 6-8

**APL Users Meeting.** Toronto, Canada. This conference is aimed at APL users as well as those considering the future use of APL in their systems. Speakers will present papers that discuss the practical use of APL, managing APL resources, teaching APL, and APL programming techniques will be covered. The registration fee of \$180 (Canadian currency) includes a copy of the proceedings. For a brochure and registration material, contact Rosanne Wild, I P Sharp Associates Ltd, 145 King St W, Toronto Ontario M5H 1J8, Canada.

October 6-9 and 14-17

**The Eighth World Computer Congress, Tokyo, Japan, and Melbourne, Australia.** Computer architecture and hardware, software, data base and information systems, computer networks and communication, information processing and education, and computers in

everyday life are some of the topics that will be discussed at this conference. There will also be a large exhibition of hardware and software at the conferences.

Contact the US Committee for IFIP Congress '80, c/o The Bowery Savings Bank, 110 E 42nd St, New York NY 10017.

October 8-10

**Circulation Computer Systems Symposium,** Chicago Marriott Hotel, Chicago IL. More than 425 newspaper publishers, general managers, circulation directors, controllers, and data-processing managers are expected to attend. Workshop sessions will be held for participants who already have or who are considering automated circulation systems. For more information, contact American Newspaper Publishers Association, The Newspaper Center, POB 17407, Dulles Airport, Washington DC 20041, (703) 620-9500.

October 26-29

**International Data Processing Conference and Business Exposition,** Philadelphia Sheraton Hotel, Philadelphia PA. This conference is being sponsored by the Data Processing Management Association. Contact Conference Coordinator, DPMA International Headquarters, 505 Busse Hwy, Park Ridge IL 60068, (312) 825-8124. ■

*In order to gain optimal coverage of your organization's computer conferences, seminars, workshops, courses, etc, notice should reach our office at least three months in advance of the date of the event. Entries should be sent to: Event Queue, BYTE Publications, 70 Main St, Peterborough NH 03458. Each month we publish the current contents of the queue for the month of the cover date and the two following calendar months. Thus a given event may appear as many as three times in this section if it is sent to us far enough in advance.*

Discover Savings and Service with

**EBS**

MAIL ORDER DIVISION

**ORDER TOLL FREE**

**Cromemco**  
incorporated  
Tomorrow's Computers Today



WE ARE AN AUTHORIZED CROMEMCO DEALER

SYSTEM 3	1 Mbyte	5445.
SYSTEM 2		3190.
Z-2H	11 Mbyte	8445.
HDD-11	11 Mbyte	5945.
HDD-22	22 Mbyte	9995.
3102 CRT		1695.
3779 PRINTER		1270.
3703 PRINTER		2545.
3355A PRINTER		2885.
SCC		380.
BYTESAVER II		210.
ZPU		335.
4FDC		420.
64KZ		1510.
TU-ART		250.
Z3-SDSK		335.
Z3-MDSK		590.
COBOL		90.
FORTRAN IV		90.
MACRO ASSEMBLER		90.
16K BASIC		90.
32K BASIC		275.
DBMS		90.
WORD PROCESSING		90.
RATFOR		180.
TRACE		90.

SOFTWARE	
CBASIC2 w/MANUAL	85.
EBS G/L ACCOUNTING SYSTEM	
GENERAL LEDGER	400.
ACCTS. PAYABLE	500.
ACCTS. RECEIVABLE	500.
PAYROLL (Calif.)	600.
INVENTORY	200.
ORDER ENTRY	200.
MAILING LIST	100.
Manuals included	
Requires dual disk/48K 24x80 CRT with curs addr CBASIC2 and CP/M or CDOS	

**NEW FROM CROMEMCO**

- SYSTEM ZERO - Personal Computer
- RGB-19 - High Resolution Color Monitor
- SDI - High Resolution Color Graphics Interface
- QUADART - 4 Port Serial I/O
- I/O CONTROLLER - Intelligent
- 16FDC - Dbl/Density Floppy Disk Controller
- RPG-II - Compiler, IBM Compatible
- LISP - Artificial Intelligence Research

**CALL FOR PRICES AND AVAILABILITY**

**WE ALSO OFFER:**

- Complete analysis of your system needs
- Installation, training, support & maintenance
- Custom applications software

AT OUR REGULAR CONSULTING RATES  
Phone inquiries welcome

**EXECUTIVE BUSINESS SYSTEMS**

20457 E. Valley Blvd., Walnut, CA 91789  
(714) 594-5736



**TO ORDER:** COLLECT PHONE ORDERS welcome or send check or M.O. Please include phone number. Personal or Co. checks require two weeks to clear. Items in stock will be shipped next business day upon receipt of certified funds. Within Calif. add 6% sales tax. All prices and offers subject to change without notice. Factory warranty included.

**SHIPPING:** We ship freight collect by UPS when possible. Larger items shipped by motor freight. Air and express delivery available.

CDOS<sup>SM</sup> Cromemco, Inc.  
CP/M<sup>SM</sup> Digital Research      CBASIC<sup>TM</sup> Compiler Systems

# You can talk to more computers, faster and easier, with the VET/2 from SCOTT



The Scott VET/2 is a compact, highly versatile Voice Entry Terminal developed for TRS-80 users — and available soon for the PET and APPLE computers. Key features of the VET/2 include:

- Easy to use — all programs may be written in Level II BASIC. One USRn statement is all that's needed to allow your program to be voice controlled.
- Performance comparable to systems costing \$10,000 or more.
- High accuracy (98+%) and fast recognition.
- Supplied with demo programs and software tools.
- Connects directly to screen printer I/O port.
- Simplified training mode with automatic prompting.
- Overlay features make vocabulary size virtually unlimited.

The user manual fully describes the operation and training procedures for the VET/2 and includes complete instructions on interfacing the VET with BASIC programs.

*All hardware covered by 90-day warranty. Software guaranteed for replacement only. Prices subject to change without notice.*

Send coupon or telephone today for more information!

**SCOTT**  
INSTRUMENTS

815 North Elm  
Denton, Texas 76201 817/387-1054

Please place my order for:

VET/2 (includes manual and shipping) \$898.50

VET/2 Operator's Manual \$7.20

Texas residents add 5% tax

California residents add 6% tax

Payment Enclosed

Master Charge

VISA

C.O.D.

Exp. Date \_\_\_\_\_

Card No. \_\_\_\_\_

Ship to: \_\_\_\_\_

Address \_\_\_\_\_

City \_\_\_\_\_ State \_\_\_\_\_ Zip \_\_\_\_\_

Sig. \_\_\_\_\_

All orders must be signed.

# Ask BYTE

Conducted by Steve Ciarcia

In "Ask BYTE," Steve Ciarcia answers questions on any area of microcomputing. The most representative questions received each month will be answered and published. Do you have a nagging problem? Send your inquiry to:

Ask BYTE  
c/o Steve Ciarcia  
POB 582  
Glastonbury CT 06033

If you are a subscriber to *The Source*, send your questions by electronic mail or chat with Steve (TCE317) directly. Due to the high volume of inquiries, personal replies cannot be given. Be sure to include "Ask BYTE" in the address.

## Liquid-Crystal Displays

Dear Steve,

I recently examined a Milton Bradley Microvision miniature video game, which features a 1.5-inch-square liquid-crystal display (LCD) consisting of 16 rows of 16 square blocks. I want to build a circuit to drive this display unit. How difficult would it be to modify the circuit you presented for use with an 8-by-16 array of light-emitting diodes (LEDs)? (See "Self-Refreshing LED Graphics Display," by Steve Ciarcia, October 1979 BYTE, pages 58 thru 69.) The LCD display unit could provide useful capability to a single-board microcomputer.

I have also considered developing a programmable game cartridge for the Microvision console. The console contains two 9 V battery cells, a voltage regulator, a potentiometer "paddle control," a piezoelectric beeper, a 4-by-3 printed-circuit keypad, the LCD unit, and a 40-pin dual-inline-package integrated circuit that appears to be the display driver. The Blockbuster game cartridge that comes with the console contains a 28-pin integrated circuit, a window for the display, and labeled cutouts for four control keys, along with passive components. Com-

munication between the cartridge and the console is via a 24-pin connector.

I don't expect you to design circuits for me; if you did that for everyone who writes, you would not have enough time for your own work. However, you could do me a real favor by identifying two integrated circuits in the Microvision game. The first has 40 pins and is marked "SCUS0488, H 7920." The second has 28 pins and is marked "TMS1100NLL, MP 3450A, DBU7932."

I hope you will keep up the good work.  
Daniel Q Dye Jr

*A lot of people are interested in using the LCD unit you mention. However, LEDs (light-emitting diodes) and LCDs have very different principles of operation. An LED becomes a source of light when you pass an electric current through it, consuming a fair amount of power. LCDs, on the other hand, act as voltage-controlled reflectors of light. When an AC voltage (not DC) is applied to a liquid-crystal display, the liquid changes from transparent to opaque, consuming relatively little power. Because of this, the design approach in my LED project does not work for LCDs. But don't despair! I*

*Continued on page 238*





**BET. YOU DIDN'T KNOW!**

OAE's new PP-2708/16 PROM Programmer is the *only* programmer with all these features:

- Converts a PROM memory socket to a table top programmer: No complex interfacing to wire—just plug it into a 2708 memory socket\*
- A short subroutine sends data over the address lines to program the PROM
- Programs 2 PROMs less than the cost of a personality module. (2708s and TMS 2716s)
- Connect 2 or more in parallel — super for production programming
- Complete with DC to DC switching inverter and 10 turn cermet trimmers (for precision pulse width and amplitude alignment)
- All packaged in a handsome aluminum case

PP-2708/16 .. A & T \$325.

PP-2716 (Programs Intel's 2716) ..... A & T \$295.

**OAE**

Oliver Advanced Engineering, Inc.  
676 West Wilson Avenue  
Glendale, Calif. 91203  
(213) 240-0080

\*Pat's Pending

## What TECO\* does for minis, TED will do for your micro.

Like TECO\*, TED is a character-oriented editor that gives you everything you'd expect. Plus, you get many things you wouldn't expect.

- ▶ 36 command/text buffers
- ▶ 32-entry push-down stack
- ▶ Sophisticated macros
- ▶ Conditional & iterative command execution
- ▶ Conditional & absolute branching
- ▶ Multiple open files

TED and user manual \$90  
Manual alone \$20  
Coupon furnished with manuals purchased separately worth \$20 towards purchase of TED.

You'll also find some elegant enhancements among TED's 90-plus commands.

TED's compatible with Z-80\*-based systems supporting standard CP/M\*. We recommend at least 24K bytes RAM. TED's supplied on CP/M\*-compatible 8-inch disks.

SEND FOR FREE COMMAND SUMMARY

**small system design**

P.O. BOX 4546 MANCHESTER, NEW HAMPSHIRE 03108  
TELEPHONE: 603-432-7929

\*TECO® Digital Equipment Corp., Z-80® Zilog Inc., CP/M® Digital Research Inc

## Omikron's Mapper + NEWDOS/80 8" Drives for the TRS-80

**NEWDOS/80** is Apparat's latest upgrade to NEWDOS. Features include variable length records, chaining, and drivers specifically configured for Omikron's MAPPER II. \$150.

**MAPPER II** adapts the TRS-80 to run both 5" and 8" drives. With NEWDOS/80, storage is increased to 300K per 8" drive. \$99 plus \$10 per cable connector.

**MAPPER I** adapts the TRS-80 to run the vast library of CP/M software as well as the TRS-80 software. All Lifeboat Software may be ordered for the MAPPER I. All MAPPER I CP/M software is compatible with the CP/M for the Model II. With MAPPER II and 8" drives, the Model I becomes disk compatible with the Model II.

Standard features include lower case support, serial and parallel printer drivers, and an addressable cursor. MAPPER I is supplied with complete utilities including a memory test, a disk test, a copy program, and a proprietary program for converting TRS-DOS files to CP/M files. \$199.

**WORD PROCESSING**—MAPPER I supports professional word processors like the Magic Wand and Word Star (see reviews in June 80 Kilobaud). Omikron's implementation includes a blinking cursor, auto repeat, shift lock, de-bouncing, and an input buffer that eliminates missed characters. Magic Wand super discount price \$299.

**FIELD PROVEN DESIGNS**—After one year of MAPPER production, Omikron has established an impeccable reputation for reliability, integrity, and user support. Omikron's customers include the US Government, major corporations, universities, medical doctors, and professionals in all fields.

**SYSTEMS**—Omikron sells complete systems featuring Model II compatible Shugart disk drives. Call for prices and delivery.

**FOREIGN ORDERS** must include full payment in US funds plus \$25 for air shipping and handling.

See reviews in July 80 and August 80 BYTE By Jerry Pournelle.



**OMIKRON**

Products that set Precedents.  
1127 Hearst St Berkeley, CA 94702 (415) 845-8013

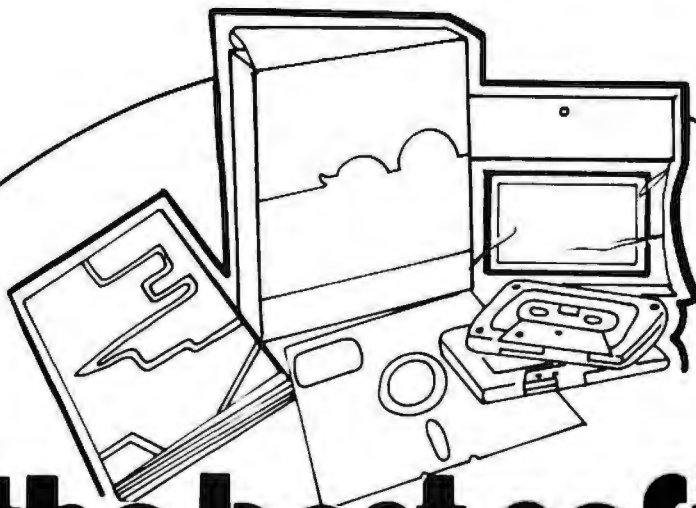

# Buy the best software and get the fastest service - from us.

## TRS-80\*

### APL 80

by Phelps Gates  
The powerful scientific language is now available for the TRS-80. Disk version includes lessons, self-teaching manual, and the book, "APL: An Interactive Approach". Tape version loads in 16K Level II. Disk version permits up to 4 workspaces, user-defined functions, return to DOS without losing workspaces, and many other features.  
16K Level II cassette ..... \$14.95  
32K disk with book ..... \$54.95  
book separately ..... \$15.50 + \$1

### UP PERISCOPE

by Ron Potkin  
Two players are pitted against one another as one tries to defend a convoy crossing the 32 x 32 hex area of sea. Submarine commander player tries to sink as many convoy ships as possible. If sub player sinks 3 or more of the 6 convoy ships, he wins. Standard hex-grid playing surface, torpedoes, ramming power, and depth charge capabilities bring back the thrill of open sea battles.  
16K Level II cassette ..... \$14.95

### INVASION

by Chris Freund  
Your favorite arcade is now available for the TRS-80. Try to hit the descending aliens before they land on the bottom of the screen. Written in machine language for quick response, and no need to [ENTER]. Constantly moving graphics and synchronized sound effects make this a must for the arcade fanatic. Saves on quarters too!  
16K Level II cassette ..... \$9.95  
32K disk ..... \$14.95

## APPLE\*

### MICROSOFT ADVENTURE

The original of ADVENTURE written for the DEC-10 systems is now available for the APPLE. Explore Colossal Cave for treasures while avoiding the dangers hidden within its many passages. 130 different rooms, 15 treasures, and characters ranging from helpful to deadly await you within the cave. Be careful where you step, and also who's behind you!  
32K disk machine language ..... \$29.95

### ANDROID NIM

by Leo Christopherson  
The game that made Leo Christopherson famous is now available for the APPLE! The improved graphics and color of the APPLE make the game even better. Try to be the last one to shoot the androids on the screen, if you do, you win! Also includes realistic sound effects.  
24K cassette machine language ..... \$14.95

### MAGIC PAINT BRUSH

Hi-Res graphics package plus! Draw Hi-Res pictures using all APPLE's colors. Connect any points on screen, fill areas, plot, rotate, and scale shapes, or 'paint' with a set of 9 brushes. Also comes with Shape Table Designer and 2 demo programs, Slot Machine and Applesoft Invaders.  
32K disk Applesoft-ROM ..... \$29.95

### THREE-D

You don't have to be an engineer or scientist to have high resolution graphics for your computer! This program permits rotation, scaling, shift, distortion, and combination of three dimensional graphics on the screen. MP Software.  
48K disk Applesoft-ROM ..... \$29.95

## ATARI\*

### STAR RAIDERS

The best! A ROM cartridge holds the game, a fast-paced, full-color, space battle in which you must defeat the enemy Zylon ships while protecting your home bases. Real-time action, and effects make this game the best space game available. Sixty levels of rating from Garbage Scow 4th Class to Commander make for continuously exciting play.  
ROM cartridge ..... \$59.95

### 3D GRAPHICS

by Tim Hays  
High quality graphics program for the ATARI computer, allows you to rotate, distort, shrink, and combine three dimension graphic projections on the screen. With the high resolution abilities of the ATARI, one of the finest graphics packages available anywhere!  
16K cassette ..... \$29.95

### WALL STREET CHALLENGE 6402

A computer simulation of the Stock Exchange is easy to play and always challenging. Invest in stocks, and try to make it big!  
8K and 16K versions on one cassette ..... \$19.95

### ALL STAR BASEBALL 6401

Two players face each other, one at bat, and the other pitcher and outfield. Innings, balls, strikes, and a variety of plays make for an exciting game. Joysticks are optional. 8K and 16K versions on one cassette ..... \$19.95

## PET\*

### STARFLEET ORION

Command a starfleet! 2 player game system includes rule book, battle manual, control sheets, 2 programs, 22 space ship types and 12 play tested scenarios.  
8K cassette ..... \$19.95

### RESCUE AT RIGEL

Search the moon base and rescue Deilah Rookh from the High Tollah. Automated Simulations.  
24K cassette ..... \$19.95

### MORLOC'S TOWER

Match wits with the evil wizard and try to defeat him! Automated Simulations  
32K cassette ..... \$14.95

### TIME TREK

by Brad Templeton from Personal Software. Real time action Star Trek type game with sound effects. There are no 'turns', the action continues whether you move or not. You and the Klingons can move, steer, and fire at the same time.  
8K cassette ..... \$14.95

*This is only a very small sample of our product line. For a complete selection, send \$1 for our catalog of hardware, software and publications and receive a \$2 credit toward your first order.*

\*TRS-80, APPLE, ATARI and PET are trademarks of Tandy Corp., Apple Computer Co., Warner Communications and Commodore, respectively.

## The Software Exchange

6 SOUTH ST., MILFORD, NH 03055

To order: Call Toll-Free 1-800-258-1790 (in NH call (603)673-5144)

The Software Exchange & HardSide (Div. of Robitaille & Sons, Enterprises, Inc.), SoftSide Publications





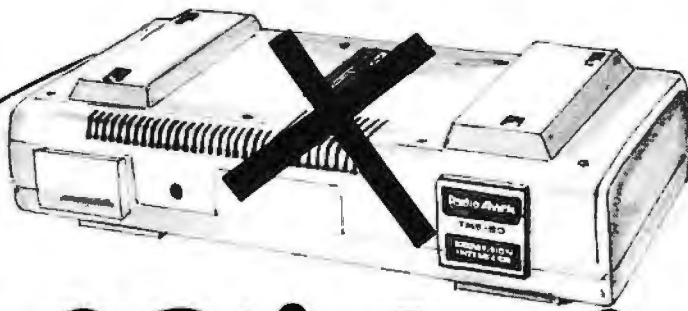

# TRS-80\* interfacing alternatives...

Featuring the Quality Engineering and Manufacturing of Steve Ciarcia and Micromint

## COMM-80



- FULL 8-BIT PARALLEL PORT
- RS-232-C PORT (up to 19,200 baud)
- UP TO 16 UNITS CAN BE CHAINED TOGETHER
- TRS-BUS CONNECTOR FOR FUTURE EXPANSION
- CONNECTS TO KEYBOARD OR E.I.
- ONLY \$179.95

## CHATTER BOX

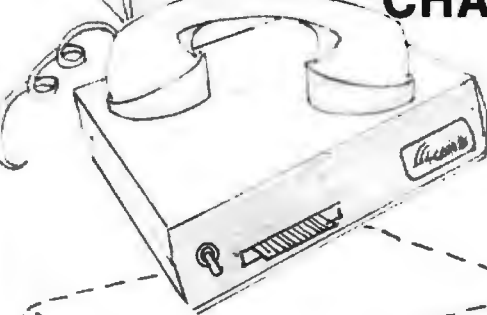

- FULL 8-BIT PARALLEL PORT
- RS-232-C PORT (up to 19,200 baud)
- ACOUSTIC MODEM
- TRS-BUS CONNECTOR FOR FUTURE EXPANSION
- CONNECTS TO KEYBOARD OR E.I.
- INCLUDES TERMINAL SOFTWARE
- ONLY \$259.95

## DISK-80



- DISK CONTROLLER (up to 4 drives)
- DATA SEPARATOR
- INCLUDES 16K OF RAM
- PROVISION FOR AN ADDITIONAL 16K RAM
- TRS-BUS CONNECTOR FOR FUTURE EXPANSION
- Available September 1980
- ONLY \$299.95

## BUSY BOX

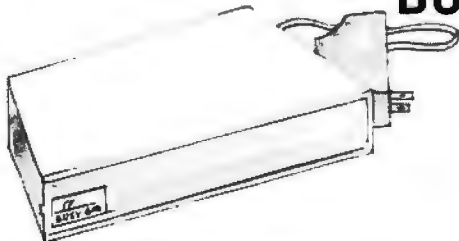

- 8 1/4" x 6 2/5" PLASTIC CASE
- CABLE AND CONNECTOR FOR TRS-80 KEYBOARD E.I.
- OPERATING MANUAL
- INCLUDES BASIC LISTING FOR CONTROL ROUTINE
- LEVEL II MINIMUM SYSTEM
- ONLY \$109.95

\*TRS-80 is a trademark of Tandy Corp.



6 SOUTH ST., MILFORD, NH 03055

To order: Call Toll-Free 1-800-258-1790 (in NH call (603) 673-5144)

The Software Exchange & HardSide (Div. of Robitaille & Sons, Enterprises, Inc.), SoftSide Publications



Continued from page 234: have written a tutorial article on LCDs to be presented in the October Garcia's Circuit Cellar.

Concerning the components in the Microvision: the 28-pin device is a Texas Instruments TMS1000-series 4-bit microprocessor, that uses CMOS (complementary metal-oxide semiconductor) technology. The program for the Blockbuster game (or other game) is contained within it in a read-only memory. The 40-pin part is a custom multiplexed display-driver circuit for the LCD unit. The display driver is driven through the I/O (input/output) lines of the microprocessor. I hope I've helped.

Steve

### The Very Busy Box

Dear Steve,

In all of your articles (which I read avidly) I have not seen any projects directed towards the Heath H8 computer system. I constructed my H8 hoping to learn about computer hardware, but instead found myself only following instructions. I find it very difficult to apply your projects to my system. It would be of great benefit if, in one of your articles, you would include information on interfacing your "house controller" (see "Computerize a Home," January 1980 BYTE, page 28) to the H8.

Bearing in mind that we H8 owners are basically hardware-oriented, I believe that we would be more likely to construct a project than someone who purchased a system completely assembled. Please consider the H8 in future articles; I am sure that the reception will be well worth the effort.

Ted Benglen

Most computers are equal where interfacing is concerned. If you look closely at the bus signals on your H8 you will notice a striking similarity between their names and the names of

signals on the Apple and the Radio Shack TRS-80. The BSR interface (trademarked "Busy Box") requires an I/OWR\* strobe (the "\*" indicates a negative-true signal), address lines A0 thru A7, data lines D0 thru D7, and power. All address and data bus lines on the H8 use inverted logic levels, so

the circuit of figure 1 is necessary to make the system compatible with the TRS-80 attachment shown in the article.

I generally try to list signal inputs so that experimenters will not be discouraged by a title that says "TRS-80" or "Apple." For simple input and output

ports, the signals are often easily accessible and compatible among systems.  
Steve

### A Bit of Music

Dear Steve,

As a composer/performer, I found your article "Sound

Figure 1

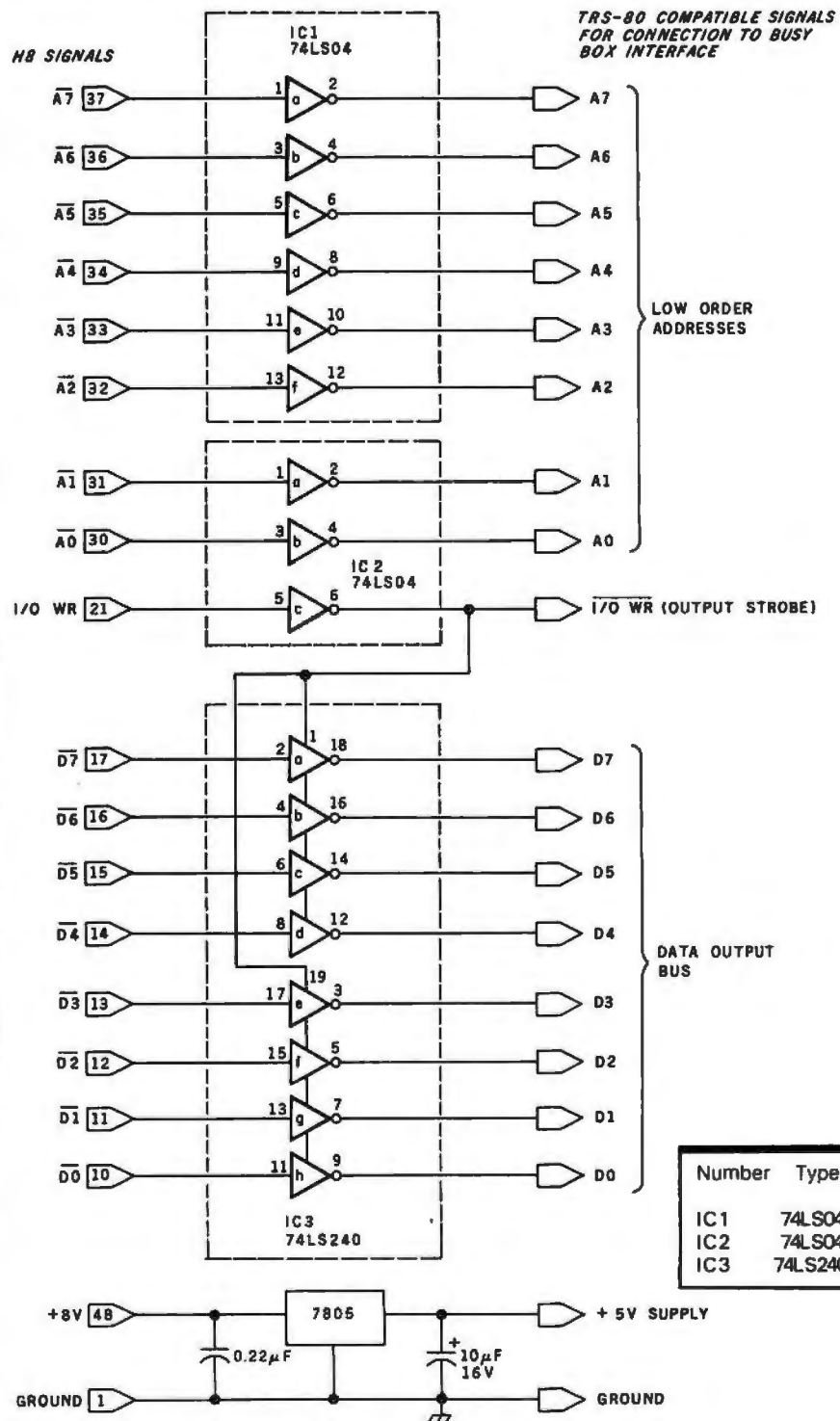



# FREE Catalog

New 4-way relief from problems with minicomputer supplies and accessories.

## 1. One-stop shopping.

Inmac (formerly known as Minicomputer Accessories Corporation) has a catalog of over 1000 products. Everything from racks and line-printer paper to connectors and cables. Each designed to help keep your minicomputer or word processing system up and running.



## 2. Hassle-free ordering.

Inmac lets you order by mail or phone. So keep this free catalog close. It makes those once-tough tasks like ordering your magnetic media easy, fast and foolproof.

## 3. Fast shipment of just the quantity you need.

Inmac ships your order within 24 hours from centers in California, New Jersey and Texas. In a bind? Call us for the many special services that can get your products to your installation even faster, with no minimum-order requirement.

## 4. Field-proven quality means precision performance.

Inmac guarantees every product in these 70 pages for at least 45 days. And even some for up to ten years.

**Inmac** Send for your FREE  
International Minicomputer Accessories Corporation  
Inmac catalog or call  
(408) 727-1970 today!

2465 Augustine Drive, P.O. Box 4780, Santa Clara, CA 95051  
© 1979 International Minicomputer Accessories Corporation

**MICRO B+™ Breaks The Access Barrier.**  
**SEARCH AN INDEX OF OVER  
10,000 KEY VALUES IN LESS  
THAN ONE SECOND ON A  
FLOPPY DISK SYSTEM!**

*And you get this performance  
without ever reorganizing  
your Index Files.*

The world-wide standard for keyed file accessing, MICRO B+, is now available in assembly language for 8080 and Z80 microcomputers. The best is even better.

MICRO B+ offers the convenience of ISAMs and the performance of B-TREES.

Assembly Language Version....\$260.00

Specify MICROSOFT "REL" Files or CBASIC Compatible

BASIC Source Code Version....\$195.00

Specify MICROSOFT Basic-5 or CBASIC-2

Shipping \$2 USA/\$5 Foreign

**FAIR COM**

2606 JOHNSON DRIVE  
COLUMBIA, MO 65201  
(314) 445-3304

We accept VISA and MASTERCARD

# ANNOUNCING VULCAN DBMS Version 1.6

The Complete DataBase Management System for your 8080/Z80 CP/M® System

You tell **Vulcan DBMS** what you want done with your data, not how to do it. **Vulcan DBMS** currently is being used to handle name and address lists, form letter mailing, task scheduling, finance management, telephone lists, and inventories just to name a few. Entire application systems can be built up rapidly by using the interactive capability to design the application and then saving the commands as programs for future use. Specialized needs for data access can be done instantly using the interactive capability.

## FEATURES

- \* Easy to learn, easy to use English-like commands
- \* Full-screen data entry and editing for most 24 X 80 terminals
- \* User customizable full screen formatting for input or display
- \* Indexed sequential organization of databases permits very fast access of selected records (Vulcan DBMS uses B-tree's)
- \* Two separate databases can be processed at once
- \* The only microcomputer DBMS that can implement a relational database model
- \* Report writer allows subtotaling and summary reports
- \* Up to 32 fields per data record
- \* Plus all the features of **Vulcan DBMS** version 1.5 including:
  - \* written in assembly language for fast execution
  - \* records of up to 1000 characters
  - \* databases can be up to 65,535 records long

Requires a 48K or larger CP/M® system

Vulcan DBMS on diskette	\$490
Vulcan DBMS Users Manual	\$ 25

## S C D P

Software Consultation, Design and Production

6542 Greeley Street  
Tujunga, CA 91042 (213) 352-7701

VISA • Mastercharge • COD • Check  
California Residents add 6% sales tax

CP/M® is a registered trademark of Digital Research  
Vulcan DBMS is not associated with Harris Corporation

Figure 2

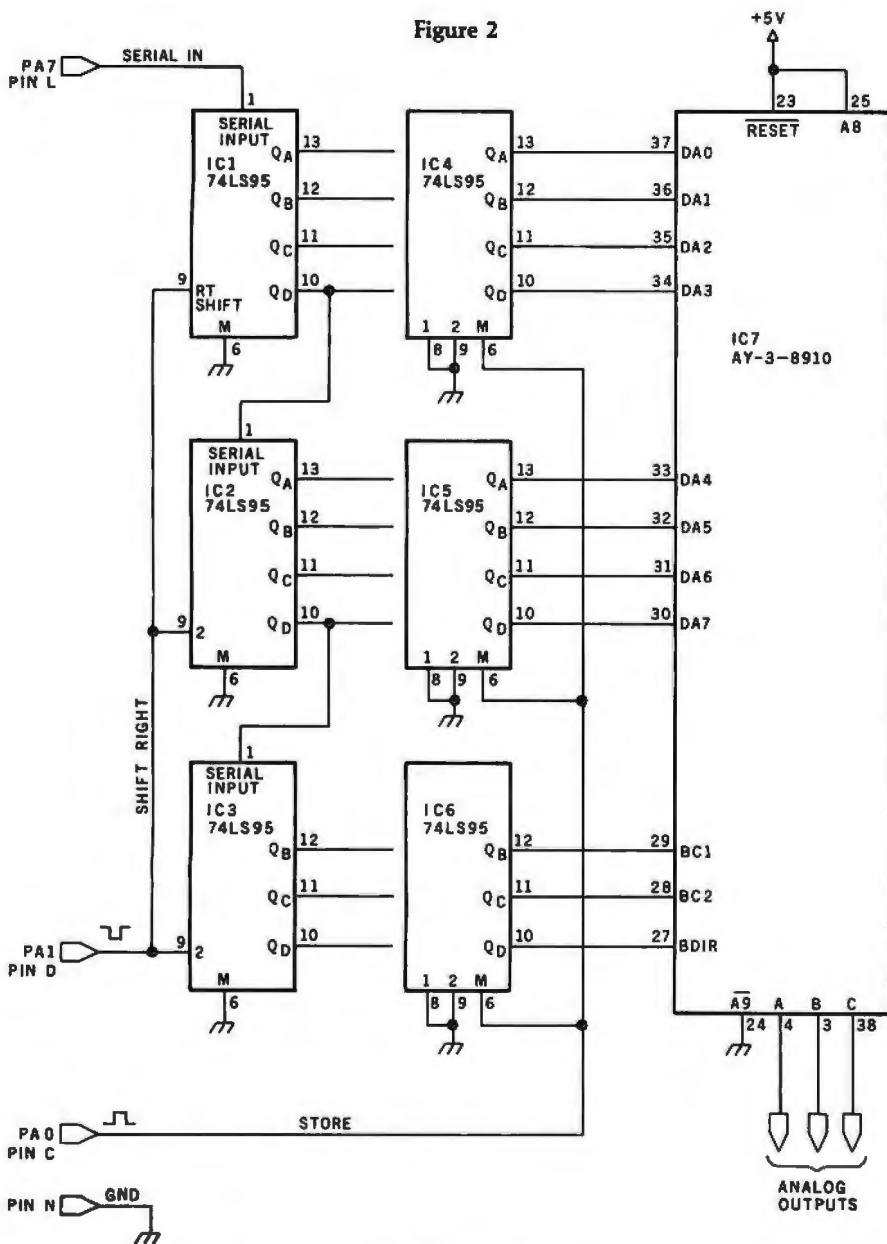

Number	Type	+5V	GND
IC1	74LS95	14	7
IC2	74LS95	14	7
IC3	74LS95	14	7
IC4	74LS95	14	7
IC5	74LS95	14	7
IC6	74LS95	14	7
IC7	AY-3-8910		

Off" (July 1979 BYTE, page 34) quite intriguing. The potential of computer-controlled music generation inspired me to purchase a Commodore PET, but the tones generated by my rudimentary system are not exactly musical.

I would appreciate any improvements and suggestions you might have. The limiting factor in my case, and I am sure this is true for others, is lack of proficiency with the instrument.

Jack Hobson

*My talents are geared more toward building the instrument than making music on it. If you are reasonably adept at building circuitry, there is a way to run the General Instrument AY-3-8910 Programmable Complex Sound Generator from the parallel user port (J2) of the PET. The clocking of the integrated circuit is not critical, only the sequence of events, but the circuit does require 11 bits of information.*

# UCSD\* System for TRS-80 Model II†

The most portable operating system now supports FORTRAN. Pascal and/or FORTRAN modules are compiled in universal P-code, so they can run on most microprocessors, often without recompiling. Programs execute up to 10 times faster than comparable BASIC programs, and use much less memory. Ready to run on TRS-80 Model II (64K).

## FEATURES

- Interactive operating system—dynamic overlays, disk file handling, run-time support and block I/O routines.
- Fast, one pass compilers.
- Two Editors—one screen oriented for programming and text editing, one character oriented for hard copy terminals.
- File handler to manipulate disk files.
- Macro-assembler that produces code for linking with Pascal or Fortran programs.
- Linker for link-editing of object and assembly code modules.
- Library of program modules and utilities.

## PLUS, from PCD Systems

- Disk formatting program to initialize diskettes in single or double density formats.
- Configuration program for serial I/O.
- Disk-set program to permit separate assignment of density and format characteristics for each disk drive.

## DOCUMENTATION

- UCSD System Manual (400 pages).
- Beginner's Guide To UCSD Pascal.
- Pascal User Manual & Report.
- Fortran User's Manual with Fortran systems.

## PRICES

- UCSD System with Pascal Compiler \$350
- with Pascal and Fortran Compilers \$500
- Fortran Compiler alone (requires Version II.0) \$200
- P-Code Interpreter alone (either ILSI-11 or Z-80) \$ 85
- Optional Utility Programs
  - CP/M<sup>‡</sup> to Pascal file conversion \$ 50
  - TRSDOS<sup>§</sup> to Pascal file conversion \$ 50
  - Z-80 Disassembler/Dump program \$ 50

## ALSO AVAILABLE

- UCSD System for MINC<sup>‡</sup> or PDT<sup>‡</sup>.
- Z-80 Adaptable System (you write BIOS).
- UCSD System for CP/M environments.

PCD Systems is a licensed distributor of the UCSD System for Pascal and Fortran. Dealer inquiries are invited.

# PCD Systems, Inc.

PO Box 143 Penn Yan, NY 14527 315-536-3734

\*Trademark of the Regents of the University of California †Trademark of Tandy Corporation ‡Trademark of Digital Research §Trademark of Digital Equipment Corporation



## P&T CP/M® 2 & TRS-80 MOD II versatility!

P&T CP/M 2 is customized to take maximum advantage of the Mod II hardware and still be compatible with standard CP/M.

**So What?** There are hundreds of applications programs available (from dozens of sources) to run under CP/M and most of them can run unmodified on the Mod II with P&T CP/M 2.

**So Why P&T CP/M 2?** When you compare CP/M's for the Mod II you will find that P&T CP/M 2 is way out in front of the pack. We were the first to offer **596K bytes** (610,304 bytes) of storage at double density. We have the **most advanced screen driver** with features like cursor addressing, insert/delete line, optional non-scrolling lines, change cursor size and blink, clear to end of line of screen, read cursor position, read character at cursor, and more. We also support a **time of day clock**, a user supplied real time interrupt routine, and the Line Printer III. Our serial port drivers support, ETX/ACK, XON/XOFF, and status line (CTS and DCD) handshaking.

**Ok - What about documentation?** We supply the 7 standard Digital Research manuals for CP/M plus our own 150 page manual describing in detail how to use P&T CP/M 2.

**What's all this cost? ONLY \$185!**

We also carry:	MAGIC WAND text processor	\$350
	CBASIC2 (improved performance)	\$105
	PASCAL/M	\$175
	Microsoft BASIC-80	\$325

Contact us for latest information.



Prepaid COD, Mastercharge or Visa orders accepted. Shipping extra, California residents add 6% sales tax.

**PICKLES & TROUT**  
P.O. BOX 1206, GOLETA, CA 93017, (805) 967-9563

CP/M is a trademark of Digital Research Inc. TRS-80 is a trademark of Tandy Corp.

## Boards for S-100 BUS from S.C. Digital

"INTERFACE : 1"  
Serial, Parallel, ROM, RAM,  
Cassette Interface Board  
Assembled & Tested  
\$229 Introductory Price

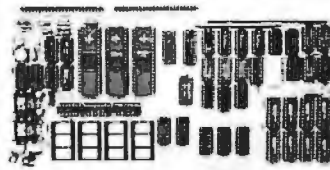

### Features: MODEL - 3SPC

- 3-Serial with hardware UARTS, RS232-C or 20ma Current loops
- 1-Parallel I/O with full handshakes, polarity is SW selectable
- Built in 4K ROM, 4K RAM Capability with SW disables (for 2708's, 2114's, ROM, RAM not supplied)
- Built in Kansas City cassette interface usable to 1200 BAUD
- Interrupts built in on all 4 inputs
- On board BAUD rate osc generates 19.2K 9.6K 4.8K 1.2K, 300, 110 or 134.5 BAUD
- Switch selectable address, ports and BAUD rates

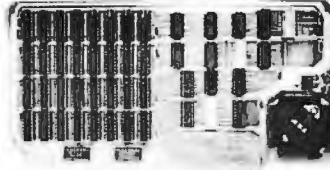

### "UNISELECT"

**16K Static RAM Board**  
Assembled & Tested \$255 with 200nsec  
Low Power Memory Chips

### Features: MODEL - 16K US

- Fully static, uses 2114L'S
- 16K Block Addressing & Bank Select
- Universal Bank Select by port and bits, compatible with CROMEMCO, ALPHA MICRO, NORTH STAR, MARINCHIPS, etc.
- Address, Port, Bits, all SW Settable

All boards meet IEEE-S100 standards

Fully socketed, solder masks, gold contacts, and guaranteed for one full year.

**Delivery:** from stock to 72 hours. **Ordering:** You may call for M.C., Visa or C.D.O. orders. (Add \$4.00 for C.D.O.) Personal checks o.k., but M.O. speeds shipment. Takes 7 to 15 days to clear personal checks before shipping.

Undamaged boards can be returned within 10 days for full refunds. Illinois residents add 5 1/2% sales tax.

D.E.M. PRICING AVAILABLE, DEALER INQUIRY INVITED

**S.C. Digital**

P.O. Box 906 Phone:  
Aurora, IL 60507 (312) 897-7749

## MAKE YOUR BASIC BETTER FOR BUSINESS

Developing business applications without keyed file support is like producing a play without the right cast — you can expend needless time and money, and end up giving an inadequate performance.

### Enter MAGSAM™

MAGSAM picks up where your BASIC leaves off by providing it with a powerful Keyed File Management System that's quick and easy to use. The result is applications that do exactly what you want them to — instead of only what BASIC allows you to.

### Supporting Cast

MAGSAM's advanced features and capabilities include:

- Random, sequential, and generic access by key
- Secondary indexing with any number of keys
- Key and record deletes with automatic space reclamation
- Dynamic file allocation and extension
- Complete compatibility with BASIC files
- Interactive tutorial program
- One year update service

The versatile MAGSAM file management is now available in two major versions. MAGSAM IV, the new high performance assembler version, is ideal for business applications in which response time is critical. Complete with an interface for CBASIC, MAGSAM IV is \$295. MAGSAM III is the standard version and is in use world wide. Written in BASIC, it is available for CBASIC, Microsoft BASIC, or Micropolis BASIC for \$145. The MAGSAM manual alone is \$25.

### You're the Star

MAGSAM is available immediately — off the shelf. So you can begin saving time and money now while providing your customers and clients with applications that truly meet their needs. Send for a free brochure telling the full story on MAGSAM, or see a demonstration at your computer dealer today.

Another Business Solution from:

**MAG** MICRO APPLICATIONS GROUP  
7300 Caldus Avenue, Van Nuys, CA 91606

COMING SOON:

# PRISM™

## The Complete Information Management System For Business

Another Business Solution From:



**MICRO APPLICATIONS GROUP**  
7300 CALDUS AVENUE  
VAN NUYS, CA 91406

The circuit of figure 2 here uses only 74LS95 4-bit parallel-access shift registers. IC1, IC2, and IC3 are paralleled to form a 12-bit shift register, and IC4, IC5, and IC6 make up a 12-bit latch. By setting the appropriate logic level on bit 7 of the user port, the information will be loaded into the 12-bit register when a

high/low/high transition occurs on bit 1. When 12 bits have been loaded, a low/high/low transition on bit 0 can be used to latch the binary value and stabilize the information while more is loaded.

The fast action of the shift and store operations should be fairly transparent to the AY-3-8910, which should

operate as described in the article.

Steve

### A Bit More Music

Dear Steve,

I read with interest your article on the AY-3-8910, and I am presently building the interface for my

Southwest Technical Products 6800 system. Do you intend to publish any software for the 6800-based processors that will drive the circuit?

Arnold Pung

The AY-3-8910 is made by General Instrument on Long Island (600 W John St, Hicksville NY 11802). They

Figure 3

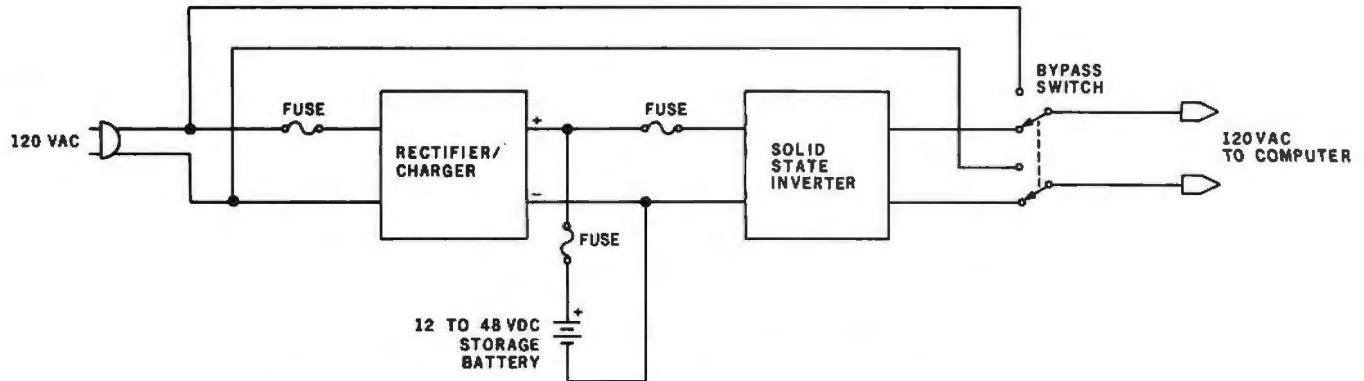

### Power to the Computer

Dear Steve,

I would like to suggest a possible future subject: backup power for micro-computers. I am very interested in home control and security, but the more responsibility and power I give my system, the more strongly I feel that it should have an uninterruptible

power source (UPS).  
Stanly W Pozeisky

Thank you for your suggestion. I have also been considering uninterruptible power supplies. I have a 26 K-byte Z80 computer running 24 hours a day, and an UPS is a requirement. Unfortunately, when we start talking about running the computer and disk

drives, we start talking about quite a bit of power. This could conceivably require several hundred watts, so a system similar to those used in commercial installations might be in order. (See figure 3.)

This system uses battery backup, with a large inverter to supply normal AC during an outage. Designing power inverters is an art in

itself, and considerable care must be taken so as not to run afoul of the FCC radio-frequency interference (RFI) standards. While I mull this over, you might want to obtain a copy of the February 1980 issue of Digital Design for a good article on the subject.

Steve

## Control Your Life!

Now have full computer control of up to 256 lights, appliances and even wall switches **without special wiring**. The SciTronics REMOTE CONTROLLER permits direct control of the inexpensive BSR remote line-carrier switches sold by Sears, Radio Shack and many others.

- Controls all 256 BSR remote switches—not just 16
- Hardware driven—requires minimum software
- No ultrasonic link—prevents erratic operation
- No BSR command module necessary

The controller comes complete with full documentation, sample software and is designed to work with most of the popular computers including any S-100 based system, TRS-80-1, Apple II, Heath H8 and others.

#### Applications:

- Make your entire home or apartment computer controlled
- Save energy by controlling lights & appliances
- Control security systems & alarms



Remote switches not included

CONTROLLER BOARD (S-100) **\$159.**  
ENCASED CONTROLLER (TRS-80, Apple, etc.) **\$184.**

Send check or **SciTronics Inc.**

money order to: 523 S. CILLWELL ST. P.O. BOX 5144  
BETHLEHEM, PA 18015  
(215) 868-7229

Please list system with which you plan to use controller. Master Charge and Visa accepted. PA residents add sales tax.  
Real Time Clock Available. Please Inquire.



# DATA DISK SYSTEMS

## CP/M\* FOR NORTH STAR SYSTEMS

CP/M 2.2 - The industry standard software bus, specially tailored for the North Star disk systems and 8080, 8085, Z80 microcomputers. Fully supports all standard North Star I/O and single, double or quad capacity disk drives. A minimum of 24K of continuous ram memory starting at location zero is required. The following Digital Research (dr) and DataDisk Systems (ds) programs are included on your CP/M diskette: IS150/IS28

**ED (dr)** - Text Editor. Used to write programs in most languages and modify any ASCII data file. Includes substitution, search, clear, string/line number, replace, display block, move, global change, merge, comments, ED in your window to CP/M, command palette software.

**DBT (dr)** - Dynamic Debugging Tool. 8080 assembly language real-time monitor. Real time between break points. Tracing via internal register display and alteration at any 320 single step. Disassembly assembly. The bit goes on and on if you write device controllers, GDT is an invaluable tool.

**DSFAT (dr)** - Multi-purpose Disk Status routine. Capacity assign disk drives to operate with any compression of single density, double density, single side, double side, as well as standard or sequential disk sectoring. An optional sectoring allows LSS stepping and optional sectoring to significantly reduce disk-intensive program execution time. An additional feature permits system re-configuration to equal capacity. This allows double density owners to upgrade with no additional software expense.

**808 (ds)** - 8080 assembler. Uses standard 8080 mnemonics and provides optional conditional assembly, HEX file generation, assemble listings, multi-data file register.

**STAT (dr)** - Status/ratification of logical-to-physical device, disk drive parameters, storage space, file size.

**COPY (ds)** - Diskette duplication and verification.

**PH (dr)** - Peripheral Interchange Program. File transfer between disk and logical devices. Software file routing, concatenation, pagination, text extraction, case conversion, line numbering and much more.

**LOAD (ds)** - Convert 8080 HEX files (out put of 808) into machine executable code. Programs are then executed by typing the program name.

**FORMAT (ds)** - Prepare diskette for use with CP/M 2.2.

**SUBMIT (dr)** - Batch ED, PH, DOT, ASM and associated parameters into user defined process.

**REDCPM (dr)** - Reconfigure your system to another memory size.

**SYSDIR (dr)** - Create new system diskette.

### FOLLOWING SOFTWARE AVAILABLE IN MS-DOS 3.25 AND 8 HIGH FORMATS

**MAC** - 8080 Macro assembler. Z80 instruction library included. Symbol table, an array of output options. **\$65/\$15**

**MY** microSYSTEMS PASCAL/MT - requires 32K minimum memory. Symbolic debugger, BCD or floating point. Optimized for the CP/M environment. Produces compact machine code. **\$200/\$25**

**RESPON** - Simultaneous line print and user operation. **\$40/\$5**

**STRUCTURED SYSTEMS** (requires CBASIC-2) **\$85/\$25**

**TEX** - Text formatter. Quality hard copy. **\$70/\$16**

**GENERAL LEDGER** **\$75/\$15**

**DB** - Symbolic instruction debugger. Multiple pass passes macro, track, histogram, source code labels. **\$85/\$16**

**INVENTORY** **\$65/\$15**

**Z80** - Same as 808 for the Z80 instruction set. **\$85/\$16**

**ACCOUNTS PAYABLE** **\$65/\$15**

**COMPILER SYSTEMS CBASIC-2 ver 2.06**. Compiler extended disk BASIC. Self documenting source code protection, line numbers not required. **\$95/\$18**

**PAYROLL** **\$65/\$15**

California residents and 6% sales tax. Specify single, double or quad capacity. Apparent formats available soon.

**ANALYSIS** **\$25/\$10**

Structure Systems Group programs require CP/M and CBASIC-2. \*CP/M is a registered trademark of Digital Research. \*Software and documentation/documentation only. Contacting for the volume Systems, Etc. Shipping \$7.00 C.S.D. \$3.00

**LETTERPRINT** **\$175/\$20**

**DSORT** **\$35/\$10**

**NOH** **\$15/\$10**

**EMERGENCY HARD DISK 6 mo. warranty direct connection to North Star**

**13.2 MBYTE** **\$499**

**26.4 MBYTE** **\$499**

**LINE PRINTER** - multi-line, multi-language, up to 132 cps, self test, bold face, 125 cps, much more. **\$395**

**VERBATIM** mem-disks (206 of 10) **\$24.05**

DATA DISK SYSTEMS, P.O. BOX 195, POWAY, CA 92064, (714) 578-3831

# TWICE THE BYTE!



## 8" DISK CONTROLLER NOW—DOUBLE SIDED OPTION!

- DOUBLES APPLE II STORAGE
- APPLE DOS COMPATIBLE
- SHUGART 800 OR 850 COMPATIBLE
- IBM 3740 DATA ENTRY CAPABILITY
- CP/M, UCSD PASCAL CAPABILITY

Available at your local APPLE Dealer: \$400.



**SORRENTO VALLEY ASSOCIATES**  
11722 SORRENTO VALLEY RD.  
SAN DIEGO, CA 92121

## THE BEST OF BOTH WORLDS NORTH STAR BASIC — CP/M

### The Fabulous North Star Basic Meets The Industry Standard CP/M Operating System

Not all perfect marriages are made in heaven; this one was made in SoHo! The software professionals at the SoHo group present The MATCHMAKER, an easy-to-use conversion kit which enables North Star owners who also own the CP/M operating system to gain the full power of their North Star Basic, running under CP/M.

You'll have dynamic file allocation, automatic file creation and extension, and automatic reuse of deleted files, all under the control of the powerful instruction set of the outstanding North Star Basic interpreter with its byte-access or random files, multiline functions, and extensive library of software. 32K memory is all you need. No relocation or modification of Basic is necessary. And all your existing North Star programs will run without modification!

The installation takes about 30 minutes and involves no disassembly or machine coding. Every powerful feature of both systems is maintained with this professional piece of software. And the instructions are COMPLETE and easy to follow.

**The SoHo Group**  
140 Thompson St.  
Suite 4-B  
New York, NY 10012

**The MATCHMAKER**  
**\$89.95 ppd.**  
**Manual only, \$9.95**  
**applicable**  
**against purchase**

*NY residents include sales tax*  
Note: CP/M and North Star are registered trademarks of Digital Research and North Star computers, respectively.

## IEEE-488 BUS SYSTEM BUILDING BLOCKS

For Commodore PET/CBM and other computers...



TNW-2000

**TNW-1000**

**Serial Interface: \$129**  
1 channel output only

**TNW-2000**

**Serial Interface: \$229**  
1 channel input and output

**TNW-232D**

**Dual Serial Interface: \$369**  
2 channels input and output plus RS-232 control lines

**TNW-103**

**Telephone Modem: \$389**  
Auto answer/auto dial. Use with DAA.

## SOFTWARE

**PTERM:** A program that turns your PET into a terminal (Use with TNW-2000, TNW-232D, or TNW 103)  
**SWAP:** Allows storage of up to 8 programs in PET memory at once. Run them in any order.  
**PAN:** A sophisticated electronic mail program (use with TNW-103)

Write or call for information today:



**TNW Corporation**  
3351 Hancock Street  
San Diego CA 92110  
**(714) 225-1040**

# the electric pencil II™

for the TRS-80 Model II\* Computer



The Electric Pencil is a Character Oriented Word Processing System. This means that text is entered as a continuous string of characters and is manipulated as such. This allows the user maximum freedom and ease in the movement and handling of text. Since lines are not delineated, any number of characters, words, lines or paragraphs may be inserted or deleted anywhere in the text. The entirety of the text shifts and opens up or closes as needed in full view of the user. Carriage returns as well as word hyphenation are not required since each line of text is formatted automatically.

As text is typed and the end of a screen line is reached, a partially completed word is shifted to the beginning of the following line. Whenever text is inserted or deleted, existing text is pushed down or pulled up in a wrap around fashion. Everything appears on the video display screen as it occurs thereby eliminating any guesswork. Text may be reviewed at will by variable speed or page-at-a-time scrolling both in the forward and reverse directions. By using the search or the search and replace functions, any string of characters may be located and/or replaced with any other string of characters as desired. Specific sets of characters within encoded strings may also be located.

When text is printed, The Electric Pencil automatically inserts carriage returns where they are needed. Numerous combinations of Line Length, Page Length, Character Spacing, Line Spacing and Page Spacing allow for any term to be handled. Right justification gives right-hand margins that are even. Pages may be numbered as well as titled.

## the electric pencil

A Proven Word Processing System

The TRSDOS versions of The Electric Pencil II are our best ever! You can now type as fast as you like without losing any characters. New TRSDOS features include word left, word right, word delete, bottom of page numbering as well as extended course controls for greater user flexibility. BASIC files may also be written and simply edited without additional software.

Our CP/M versions are the same as we have been distributing for several years and allow the CP/M user to edit CP/M files with the addition of our CONVERT utility for an additional \$35.00. CONVERT is not required if only quick and easy word processing is required. A keyboard buffer permits fast typing without character loss.

	CP/M	TRSDOS
Serial Diabla, NEC, Qume	\$ 300.00	\$ 350.00
All other printers	\$ 275.00	\$ 325.00

The Electric Pencil II is still available for TRS-80 Model I users. Although not as sophisticated as Electric Pencil II, it is still an extremely easy to use and powerful word processing system. The software has been designed to be used with both Level I (16K system) and Level II models of the TRS-80. Two versions, one for use with cassettes, and one for use with disk, are available on cassette. The TRS-80 disk version is easily transferred to disk and is fully interactive with the READ, WRITE, DIR, and KILL routines of TRSDOS.

TRC	Cassette	\$ 100.00
TRD	Disk	\$ 150.00

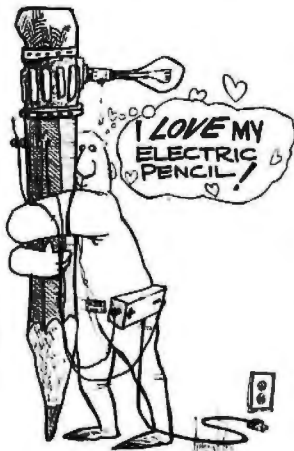

### Features

TRSDOS or CP/M Compatible • Supports Four Disk Drives • Dynamic Print Formatting • Diabla, NEC & Qume Print Packages • Multi-Column Printing • Print Valve Chaining • Page-at-a-time Scrolling • Bidirectional Multispeed Scrolling • Subsystem with Print Value Scoreboard • Automatic Word & Record Number Tally • Global Search & Replace • Full Margin Control • End of Page Control • Non Printing Text Commenting • Line & Paragraph Indentation • Centering • Underlining • Boldface

VISA      master charge

\*TRSDOS is a registered trade name of Radio Shack, a division of Tandy Corp.

m  
ss

**MICHAEL SHROYER SOFTWARE, INC.**  
1198 Los Robles Dr.  
Palm Springs, CA 92262  
(714) 323-1400

are the people to contact about particular applications of that device. If you write or call (516) 733-3107, direct your inquiry to the product manager associated with the circuit.

It is important to talk to the right person since one manager may not be familiar with another's product line. As most companies do, General Instrument Corporation puts out a large amount of application literature.

Steve

### No More Scanner

Dear Steve,

I have been reading BYTE for over a year now and I find your Circuit Cellar articles useful and informative. I would like to read your article "I've Got You in My Scanner: A Computer-Controlled Stepper Motor Light Scanner," November 1978 BYTE, page 76. I am writing you because this article is no longer available

through BYTE's back-issue department. Can you direct me to a source for this article?

Walter A Filimon

Thank you for the vote of confidence. There are a number of sources you can use for articles of BYTE's past: BYTE often has back issues which are available for the cover price plus postage. Give BYTE a call on their toll-free number (800) 258-5485; they'll be glad to help. If your interest is specifically in my articles, let me suggest that you pick up a copy of the compendium book Ciarcia's Circuit Cellar, volume 1, from BYTE Books. It contains most of my articles, including the November 1978 one. It has the extra advantage that any proof errors in the original articles are corrected. BYTE Books may be contacted at 70 Main St, Peterborough NH 03458.

Steve ■

## Micro Computer      Your One Stop For...Quality and Huge Savings

# DISCOUNT Company

COMPARE PRICE★QUALITY★DELIVERY★SERVICE  
you'll know why you don't have to look anywhere else!

<p>★ <b>APPLE</b></p> <p>16K Apple II or Plus ..... \$ 960</p> <p>48K Apple II or Plus ..... 1075</p> <p>Disk w/Controller ..... 539</p> <p>Disk ..... 450</p> <p>Pascal ..... 495</p> <p>★ <b>ATARI</b></p> <p>400 ..... \$ 475</p> <p>800 ..... 777</p> <p>Disk ..... 595</p> <p>★ <b>APF ELECTRONICS</b></p> <p>APF Computer ..... \$ 495</p> <p>★ <b>CENTRONICS PRINTERS</b></p> <p>730-1 Parallel ..... \$ 695</p> <p>730-1 Serial ..... 735</p> <p>*779-2 Tractor ..... 995</p> <p>*704 Serial ..... 1695</p> <p>*700 Parallel ..... 1095</p> <p>★ <b>COMMODORE PET</b></p> <p>8K "N" ..... \$ 695</p> <p>16K "N" or "B" ..... 850</p> <p>32K "N" or "B" ..... 1095</p> <p>2040 Floppy ..... 1095</p> <p>2022 Printer (Tractor) ..... 695</p> <p>8016 ..... 1325</p> <p>8032 ..... 1575</p> <p>8050 ..... 1495</p> <p>C2 "N" Cassette ..... add \$89.90</p>	<p>★ <b>COMPUCOLOR</b></p> <p>16K ..... 1595</p> <p>32K ..... 1695</p> <p>★ <b>CROMEMCO</b></p> <p>System 3 ..... \$ 5445</p> <p>Z-2H ..... 9445</p> <p>★ <b>HAZELTINE</b></p> <p>1210 ..... \$ 825</p> <p>1500 ..... 1095</p> <p>★ <b>INTEGRAL DATA</b></p> <p>440 (Paper Tiger) ..... \$ 880</p> <p>440-Graphics ..... 929</p> <p>★ <b>INTERTEC</b></p> <p>*SuperBrain 32K ..... \$ 2495</p> <p>32K memory upgrade with purchase ..... \$19.95</p> <p>*SuperBrain 64K ..... 2695</p> <p>★ <b>NEC SPINWRITER</b></p> <p>*5530 RO ..... \$ 2695</p> <p>*5520 KSR ..... 2990</p> <p>*5510 RO ..... 2795</p> <p>Tractor add ..... 200</p> <p>★ <b>TEXAS INSTRUMENTS</b></p> <p>99/4 Computer ..... \$ 1095</p> <p>810 Printer ..... 1695</p> <p>★ <b>XEROX TERMINALS</b></p> <p>*1740 RO ..... \$ 2619</p> <p>*1740 KSR ..... 3000</p> <p>*1750 RO ..... 2800</p> <p>*1750 KSR ..... 3170</p> <p>Tractors add ..... 235</p>
<p>★ <b>MAIL ORDER ONLY</b>      <b>PHONE (212) 986-7690</b></p> <p>Send Certified Check (Personal or Company Checks require 2 weeks to clear.)</p> <p>We pay all shipping and insurance charges except items marked with asterisk.</p> <p>VISA, MasterCard add 5%      N.Y.S. Residents add appropriate sales tax.</p> <p>★ <b>Micro Computer Discount Co</b>      * (DENOTES ITEMS SHIPPED F.O.B. NYC)</p> <p>60 E. 42nd St., Suite 411, New York, N.Y. 10017</p>	

## CALIFORNIA DATA CORPORATION'S

# VERSATILE

## S-100 ANALOG I/O SYSTEMS

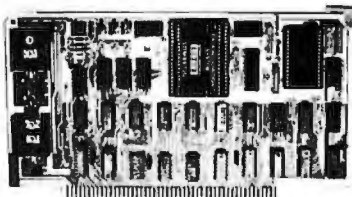

- 16 Channel A/D
- 2 Channel D/A
- 4 Channel D/A

High quality commercial grade S-100 bus compatible systems are designed for industrial and laboratory use.

- 16 channel 12 bit A/D conversion system nominally operates at 25 kHz
- 12 bit resolution, ± the LSB accuracy
- Multiplexer, converter, and sample and hold on the hybrid chip
- 7 control and measurement ports
- Utilizes Z80 and 8080 interrupt modes
- Optional Programmable Gain Instrument Amplifier allows mixing of high and low level signals
- 2 and 4 channel D/A high-speed conversion systems
- Binary and 2's complement inputs
- Outputs: ± 5v, ± 10v, 0 to -10v, or 0 to +10v
- Replaceable output amplifiers protect circuit
- 2 channel board has 16 bit parallel I/O and scope intensification strobe
- A/D's from \$575      D/A's from \$395



**CALIFORNIA DATA CORPORATION**  
3475 Old Conejo Road, Suite C10  
Newbury Park, California 91320  
(805) 498-3651



## FOR SERIOUS USERS OF 8080, 8085, OR Z80 COMPUTERS

**PRINTER WIZARD** — Now add powerful capabilities to your printer. Free your computer for use while simultaneously printing backlogged output on a first-in-first-out basis. Transparent operation without noticeable slowing of the computer. Allows continuous computer and printer operation on programs having sporadic output. Will backlog up to 100 pages when used with a disk system. Adds optional automatic paging with numbers, adjustable margins on 4 sides, indented overflow lines. Occupies less than 2 1/2 K.

	EX80M103	\$45.00
Documentation only	EX80M103D	\$ 7.50

**DISASSEMBLER** — Disassemble machine code into standard source language. Modify or relocate existing programs such as DOS or BASIC using your existing assembler (not included). Disassembles any 8080, 8085, or Z80 code, including embedded data blocks and "trick" codes. Generates symbol and label tables.

	EX80M217	\$75.00
Documentation only	EX80M217D	\$12.50

ALL EXCOM products are fully supported and warranted indefinitely against original defects. Available on single or double density NORTHSTAR 5 1/4" diskettes, 300 or 1200 baud cassettes (specify). Washington residents add 5.3% tax.

# EXCOM

P.O. Box 1802 Bellevue, Washington 98009 U.S.A.  
Telephone (206) 641-6577

## 6809 S-100 **ads**™

### SINGLE BOARD COMPUTER

- **MEETS I.E.E.E. S-100 STANDARD**
  - 10 addressing modes
  - 24 indexed sub modes
  - auto increment/decrement
  - constant indexing from PC
- **4K/8K/16K ROM • 2K RAM**  
ROM/RAM relocatable on 4K boundary
- **ACIA; PIA; 8080 SIMULATED I/O**
- **20 PARALLEL I/O LINES • 256 I/O PORTS**  
ACIA provides RS-232 lines for asynchronous communications with limited modem control at 8 selectable baud rates; I/O locatable at any 4K boundary
- **COMPREHENSIVE MANUAL WITH SOFTWARE LISTINGS**
- **P.C. BOARD: SOLDERMASKED WITH PARTS LEGEND**  
P.C. Board & Manual \$69.95\* + shipping
- **adsMON: ADS MONITOR SUPPORTS BREAKPOINTS**  
User definable interrupt service & more.

Available in PROM, write for prices.  
Illinois residents add sales tax. \*add \$1.00 for shipping & handling

**Ackerman Digital Systems, Inc.**  
110 N. York Rd., Suite 208, Elmhurst, Ill. 60126 (312) 530-8992

## Our Ad Manager is Through!

He's just completed production on our new 36 page catalog and he's exhausted.

So, rather than put him right back to work on our August 2 page spread, we're giving him a break.

Look for our regular ad in September. In the meantime, send for our brand new free catalog. It's the most complete in the industry.

# COMPUMART

270 Third St. Cambridge, Mass 02142  
Dept. 108



## BUY COMPUTERS BY MAIL ORDER AND SAVE 16%

### APPLE

16K	\$ 958.00
32K	\$1,040.00
48K	\$1,100.00

Disk with Controller	\$ 495.00
Disk	\$ 440.00
Pascal	\$ 445.00

### NORTH STAR

Horizon-2-32KDD	\$2,390.00
Memory 16K	\$ 389.00
32K	\$ 579.00

### HAZELTINE

1400	\$650.00
1410	\$710.00
Add Regent 25	\$925.00

Send certified check (regular checks require 2 weeks to clear) or charge to VISA or Master Charge. Customer pays shipping.

### MIRO COMPUTERS, INC.

27 Long Meadow Place, South Setauket, L.I., N.Y. 11720  
(516) 423-7955

### DYNABITE

Save 15%

### CROMEMCO

System 3	\$5,890.00
----------	------------

### VERBATIM & MEMOREX

5 1/4"	\$27.50
--------	---------



## CP/M SOFTWARE

### ADAPT 2.00

Runs Cromemco Software Under CP/M 1.4 or 2.2 ..... \$75

Get Cromemco software to run on your CP/M Version 1.4 or 2.2 system. ADAPT interfaces most of those powerful Cromemco packages to any Z-80 based CP/M system without patching. ADAPT works without changes for any memory size.

### RATFOR-80

Fast RATFOR Language (RATional FORtran) ..... \$95

RATFOR-80 lets you write structured code that translates to Microsoft or Cromemco FORTRAN. TSW's RATFOR-80 (RATional FORtran) pre-compiler runs at more than 1000 statements per minute. Price includes extensive subroutine library. Documentation includes "Software Tools" book by Kernighan and Plauger. (ADAPT and RATFOR packages combined \$150)

### FMT

FMT Word Processing Text Formatter for CP/M ..... \$75

FMT works with any CP/M editor to give you automatic page headings and footings, page numbering, centering, underscoring, external file merging, and in-line console input. FMT works with any video, CRT, or hardcopy terminal and printer combination. With daisy-wheel printers, FMT provides superscripting, subscripting, and half-line spacing.



THE SOFTWARE WORKS  
8369 Vickers  
San Diego, CA 92111  
(714) 569-1721

VISA and MasterCard accepted  
\*CP/M is a trademark of Digital Research

## Business Software in Micropolis Basic

DATASMITH announces the availability of two new turnkey business systems designed especially for MICROPOLIS-Based computers, including the VECTOR MZ. Both systems are completely menu driven and highly interactive, so they can be used effectively by your present office staff.

- **GENERAL LEDGER.** Everything you need to keep the books. Features easy-to-use data entry and error correction, trial balance, posting, and a variety of comprehensive reports. Automatic error detection keeps the books in balance. Writes checks and makes journal entries in one operation.
- **PAYROLL.** A very flexible system that adapts to a wide variety of needs. Features federal, state, and local tax calculations, EIC credit, and special pay and deduction amounts. Prints all necessary reports, paychecks, and W-2 forms.

Put your computer to work with these comprehensive systems now. Call or write for complete details. Custom services also available.

## DATASMITH

15501 West 109th St., Lenexa, KS 66219, (913) 888-8486

## ZS-SYSTEMS ZOBEX

Complete computer on 3 S-100 boards with  
32K RAM for Under \$1000.00\*  
Runs M/PM and C/PM

64K RAM  
4 MHz  
No WAIT States  
IEEE Std.

Low power,  
DMA operation,  
Bank select in 16K sections  
Can be disabled in 4K increments

Z80 CPU  
2-4 MHz  
IEEE Std.

2 or 4 serial ports, 3 parallel, one 4K  
EPROM, Vectored interrupts, real time  
clock, Software controlled baud rates,  
Drives daisy wheel printer directly

DISK CONTROLLER  
8" and 5"  
DRIVES

All digital design for stable and  
reliable performance. No one-  
shots or analog circuitry. BIOS for  
C/PM available.

CARD CAGE  
and Fan

6 slot shielded motherboard  
for good cooling and low noise.

SEND FOR FREE INFORMATIONS  
6 months warranty on our boards with normal use

ZS-SYSTEMS / ZOBEX

5333 Mission Center Rd., San Diego, Ca. 92108  
P.O. Box 1847, San Diego, Ca. 92112  
(714) 447-3997

\*introductory offer for limited time only



## A Message to our Subscribers

From time to time we make the BYTE subscriber list available to other companies who wish to send our subscribers promotional material about their products. We take great care to screen these companies, choosing only those who are reputable, and whose products, services, or information we feel would be of interest to you. Direct mail is an efficient medium for presenting the latest personal computer goods and services to our subscribers.

Many BYTE subscribers appreciate this controlled use of our mailing list, and look forward to finding

information of interest to them in the mail. Used are our subscribers' names and addresses only (no other information we may have is ever given).

While we believe the distribution of this information is of benefit to our subscribers, we firmly respect the wishes of any subscriber who does not want to receive such promotional literature. Should you wish to restrict the use of your name, simply send your request to BYTE Publications Inc, Attn: Circulation Department, 70 Main St, Peterborough NH 03458. Thank you.



# FORTH

VER. 1.7 FOR APPLE II\* COMPUTERS

100 PAGE, PROFESSIONALLY WRITTEN MANUAL  
 FORTH INTEREST GROUP COMPATIBLE  
 DIRECT HOT-LINE TO SYSTEM DEVELOPERS  
 INCLUDES ITS OWN DOS  
 CAP'N SOFTWARE HAS DELIVERED 100's OF  
 WORKING FORTH SYSTEMS  
 UPDATE OFFER: TRADE IN YOUR VER. 1.6. DISK  
 FOR FULL CREDIT OF PURCHASE  
 PRICE TOWARD VER 1.7

RUNS ON APPLE II OR APPLE II+ WITH  
 1 OR MORE DISKS AND 48K.

ALSO RUNS ON LANGUAGE CARD  
 AVAILABLE AT COMPUTER STORES OR  
 DIRECTLY FROM CAP'N SOFTWARE  
 PRICE, SYSTEM \$140, MANUAL ONLY \$20



**CAP'N SOFTWARE**  
 P.O. BOX 575  
 SAN FRANCISCO, CA 94101

ALSO AVAILABLE FOR PDP-11†  
 COMPATIBLE WITH VER. 1.7 FOR APPLE  
 DOWNLOAD PROGRAM DEVELOPMENT  
 OR EXECUTION

RUNS STAND-ALONE OR UNDER RT-11†  
 RSX-11M†, OR RSTS†

AVAILABLE DIRECTLY FROM CAP'N SOFTWARE  
 PRICE, SYSTEM \$145, MANUAL ONLY \$20

\*Trademark of Apple Computer Corp. †Trademark of DEC.

Circle 212

## Introducing ...the NEW ....H-P 85 Peripherals.

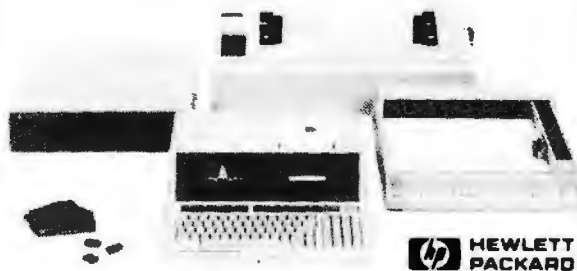

**Hewlett-Packard's New Peripherals  
 Are Available Now.**

Suggested retail prices

HP-85A Computer	\$3250.00
HP 7225A Graphics Plotter	2050.00
HP 2631B Opt. 885 Printer	3650.00
HP-IB Interface Module	395.00

★ WE MEET ANY PRICE IN THE NATION



**FARNSWORTH  
 COMPUTER CENTER**



1891 N. Farnsworth Ave., Aurora  
 (immediately S. of E-W Tollway)  
 Phone (312)-851-3888  
 Weekdays 10-8; Sat. 10-5

# BYTE BACK ISSUES FOR SALE

The following issues are available:

1976: July and November

1977: March, May thru December

1978: February thru October, December

1979: January thru December except March

1980: January thru June except February

Cover price for each issue thru August 1977 is \$1.75

Domestic; \$2.75 Canada and Mexico; \$3.75 Foreign.

September 1977 through October 1979 issues are \$2.50

Domestic; \$3.25 Canada and Mexico; \$4.00 Foreign.

November 1979 to current is \$3.00 Domestic; \$3.75 Canada

and Mexico; \$4.50 Foreign.

Send requests with payment to:

**BYTE Magazine**

70 Main St, Peterborough, NH 03458

Attn: Back Issues



## IS THERE A **GAP** IN YOUR LIFE ?

**GAP** General Accounting Package. Fantastic double entry accounting system with user definable accounts. The account numbers are made up of 7 4-digit fields allowing 7 levels of account classifications. With the use of the Operator Report Selector Generator (OSRG), you can generate any type of report you desire, or use report programs in GAP-GL, GAP-AP, and GAP-AR.

**GAP-GL** Includes all basic GAP functions, plus entry of General Ledger transactions, prints General Journal, General Ledger summary and detail, Balance Sheet, Profit and Loss.

Price \$124.95

**GAP-AR** Requires GAP-GL to run, allows adding A/R invoices, printing Sales Journal, detail A/R report, Account Aging, add/update Cash Receipts with register, Cash Receipts Journal, and A/R Billing.

Price \$99.95

**GAP-AP** Requires GAP-GL to run, allows adding of A/P invoices, printing Purchase Journal, detail A/P report, Aging of Accounts, Check Writing, Check Printing, Cash Disbursements Journal.

Price \$99.95

System requirements are 32K CP/M CP/M is registered trademark of Digital Research

### PROFESSIONAL DATA SYSTEMS



318 E 18 st.  
 BAKERSFIELD CA. 93305  
 (805) 323-0891

# What's New?

## PERIPHERALS

### Printer Uses Plastic and Metallized Daisy Wheels Interchangeably

A series of serial impact printers that produce typewriter-quality output for word processing, data processing, and communications applications has been announced by Diablo Systems Inc, 24500 Industrial Blvd, Hayward CA 94545, (415) 786-5207. The Model 630 daisy-wheel printers use plastic and metallized print wheels interchangeably, with print speeds from 32 to 40 cps (characters per second) depending on the type of print wheel, type style, and text. Model 630 printers accept all Diablo and Xerox plastic and metal print wheels. Friction and pin-feed platens and other paper-handling options are offered. The 630 series supports the RS-232C/V.24 interface for communications applications, and a microprocessor interface that permits direct attachment of the printers to a variety of small office and data processing systems. The price is \$860 in original equipment manufacturer's (OEM) quantities of 500.

Circle 490 on inquiry card.



### An RS-232 Card Reader

The Model 121-4 card reader is capable of reading any common punched or marked card and includes serial RS-232 or card image output (with Hollerith-to-ASCII conversion if necessary), parallel 20 mA current-loop output, self-clocking on both marked and 80-column punched cards, or operation with printed strobe marks on either side of the card. The 121-4 may be set for card feed-through at 6 ips (inches per second), or automatic return of cards to the front after reading. This card reader also has a self-test feature which enables the user to check sensor accuracy. The Model 121-4 operates on either 50 or 60 cps (characters per second) and sells for approximately \$520 in original equipment manufacturers quantities. For more information, contact HEI Inc, Jonathan Industrial Center, Chaska MN 55318, (612) 448-3510.

Circle 492 on Inquiry card.

### Removable Disk Cartridges for CDC and Ampex Drives

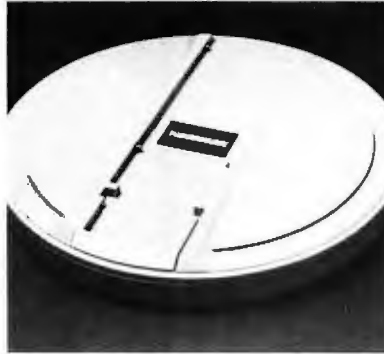

The 4420 is a removable disk cartridge for use on Control Data's cartridge module drive (CMD) 9448 series and equivalent disk drives. The product is capable of storing up to 16 megabytes of data. The disk cartridge uses one surface to record data and one surface to func-



tion as a dedicated servo reference. Density is 348 tracks per inch, with 823 tracks per surface. The cartridge is available with factory formatting. For information, contact Nashua Corporation, 44 Franklin St, Nashua NH 03061. Circle 491 on inquiry card.

### Two Printers from Facit

Facit Inc, 66 Field Point Rd, Greenwich CT 06830, has developed two printers, the 4520 and the 4542. The 4520 is a bidirectional printer with a speed of 100 cps (characters per second) and a noise level of less than 60 dB. The 4520 is microprocessor-controlled, with a 100% duty cycle. The printer utilizes a 9-by-9 dot matrix, while accommodating paper-roll or fanfold forms. A serial or parallel interface is included. The unit price is under \$1000.

The 4542 provides the full graphic capability and control of Facit's 9-by-9 matrix Stored-Force Flex Hammer Head. It features two-color printout, gray scale, and proportioned spacing. All European versions, Katakana, APL, and Libris character sets are available. The 4542 lists for under \$4000.

Circle 493 on inquiry card.

### Modem Eliminator

International Data Sciences Inc, 7 Wellington Rd, Lincoln RI 02865, (401) 333-6200, has introduced the Model 6100 modem eliminator. The unit allows interconnection of data-terminal equipment without modems. It can be used in asynchronous or synchronous modes, and with terminals configured for half- or full-duplex operation. The IDS modem eliminator also eliminates the need for two back-to-back modems operating within a short distance. Features include internal strap selections for primary and secondary RTS/CTS delays, ring memory functions, and clock source. Data-terminal equipment can be located up to 50 feet from the modem eliminator, allowing a maximum separation of 100 feet. Its DTE interface conforms to EIA RS-232C and CCITT V.24 standards. The Model 6100 is priced at \$360.

Circle 494 on inquiry card.

### Where Do New Products Items Come From?

*The information printed in the new products pages of BYTE is obtained from "new product" or "press release" copy sent by the promoters of new products. If in our judgement the information might be of interest to the personal computing experimenters and homebrewers who read BYTE, we print it in some form. We openly solicit releases and photos from manufacturers and suppliers to this marketplace. The information is printed more or less as a first in first out queue, subject to occasional priority modifications. While we would not knowingly print untrue or inaccurate data, or data from unreliable companies, our capacity to evaluate the products and companies appearing in the "What's New?" feature is necessarily limited. We therefore cannot be responsible for product quality or company performance.*



# What's New?

## MISCELLANEOUS



### Computhink Unveils Small-Business Computer

Computhink Inc, 965 W Maude Ave, Sunnyvale CA 94086, (408) 245-4033, is now offering Minimax, a microcomputer system designed for small businesses and independent software organizations. The Minimax can store over 100 K bytes of internal memory. By using various configurations of floppy-disk drives, the system can have an on-line disk storage capacity ranging from 800 K to 4.8 megabytes. A 6502 microprocessor is used in the system. The system features full-screen data entry, field protect and automatic skip to the next field, and split screen operation. The Minimax, with 800 K bytes of disk storage, has a suggested retail price of \$7770. A configuration with a printer is under \$10,000. These prices include business-applications software.

Circle 495 on inquiry card.

### Introducing the QDP-100 System

This product is a Z80A-based S-100 machine. The single-board unit contains the microprocessor; two serial and two parallel ports; a double-sided, double-density disk controller for 5- and 8-inch floppy-disk drives; an Intel-like 2716 programmable read-only memory (PROM) burner; a real-time clock; and a 2 K-byte monitor. The operating system is CP/M 2.2. A 4 MHz, 64 K-byte dynamic memory board is also supplied. The video display is a "smart" terminal with 80-character by 24-line display, a 25th status line, reverse video, blinking and half-intensity characters, protected and unprotected fields, and other features. The display uses a Z80 microprocessor for display operation. A hard-disk system can be integrated into the system. Accounting, data-base management, word processing, real estate, statistics, and other software packages are offered by Quasar. The price for the QDP-100 is \$4795. Details are available from Quasar Data Products Inc, 25151 Mitchell Dr, North Olmsted OH 44070, (216) 779-9387.

Circle 496 on inquiry card.

### A Printer from Mauro

Mauro Engineering, Rt 1, Box 133, Mt Shasta CA 96067, (916) 926-4406, has introduced the MP-250 PROAC pen plotter. It uses standard paper sizes and plots at speeds of up to 2.5 inches per second with 0.005-inch resolution. The standard machine uses one parallel output port and comes with full-vector driver software for 8080, 6502, and 6800 microprocessors. Interfaces are available for the TRS-80, Apple, and serial data ports. The MP-250 can be used for graphics, schematics, music composition, architectural drawings, and other applications involving plotting. The MP-250 costs \$650.

Circle 497 on inquiry card.



### Computer Devices Announces Self-Prompting, Portable Computer

A portable, self-prompting computer for the nontechnical user has been developed by Computer Devices Inc, 25 North Ave, POB 421, Burlington MA 01803, (617) 273-1550. The Miniterm model 1206/PAT operates through the use of preprogrammed application modules. The computer is aimed at industrial, commercial, and financial clients. The 1206/PAT includes 32 K bytes of programmable memory. The application programs are written in either BASIC or Motorola 6800 assembly language. Other standard features of the computer include an 80-column, 50-character per second thermal printer; 5-inch floppy-disk drive; built-in modem; and acoustic coupler. The unit weighs 7.3 kg (17 pounds). The price for the computer is \$5195.

Circle 498 on inquiry card.

### EPROM Programmer with RS-232 Interface

This erasable programmable read-only memory (EPROM) programmer, Model EP-2A-87, with RS-232 and 20 mA loop interfaces, has been introduced by Optimal Technology Inc, Blue Wood 127, Earlysville VA 22936, (804) 973-5482. The programmer includes a 2 K- or 4 K-byte buffer which can be loaded or read by another computer in the on-line mode. Data rates are 110 and 1200 bps (bits per second). In the off-line mode, a keyboard enables the operator to program, verify, and check if the EPROM is erased, and load the buffer from EPROM. EPROMs may be copied in the off-line mode by first loading the buffer from the programming socket. A built-in self-test includes provisions for checking the buffer and whether the EPROM will enter the high-impedance state. Priced at \$600 with a 4 K-byte buffer, personality modules are \$16 to \$35 for programming various EPROMs on the market.

Circle 499 on inquiry card.

### 6502-Based Single-Board Computer

Compas Microsystems, 224 S E 16th St, Ames IA 50010, (515) 232-8187, has announced CSB 2, a stand-alone module based on the 6502 microprocessor. The board is compatible with the Rockwell System 65 bus standard. EXORcisor-based cards may be used with CSB 2 with minor modifications. CSB 2 includes a 6502 microprocessor, 2 K bytes of static programmable memory, four sockets for Intel 2716 or 2764 erasable

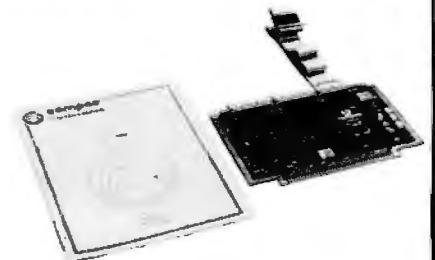

programmable read-only memory (EPROM) integrated circuits, one VIA (6522), one PIA (6520), and one ACIA (6551). CSB 2 provides 30 input/output (I/O) lines, ten buffered output lines, two interval timers, input latching on peripheral ports, an RS-232 port with data speeds from 110 to 19,200 bps (bits per second), and up to 32 K bytes of EPROM space. CSB 2 is priced at \$395 and the manual is available for \$4.

Circle 500 on inquiry card.

# What's New?

## MISCELLANEOUS

### Nuts & Volts

*Nuts & Volts* is a new publication serving amateur radio and computer enthusiasts. It is devoted exclusively to classified and display advertising for new and used equipment. Items are categorized for easy reference, and there are sections for business opportunities and wanted items as well. Classified ads are \$0.10 per word with a \$2 minimum charge. Typesetting and art services are available for display advertisers. *Nuts & Volts* is available monthly for a one-time charge of \$5 from *Nuts & Volts* POB 1111, Placentia CA 92670.

Circle 538 on inquiry card.

### Reset Extender for TRS-80

The Reset Extender is an aid for TRS-80 owners who have trouble accessing the Reset button in the back of the keyboard. Most TRS-80 owners use a pencil to hit the Reset button. With little effort, the Extender attaches to the hood and simplifies reset tremendously. The Reset Extender is available from Emmanuel B Garcia Jr & Associates, 203 N Wabash, Rm 2102, Chicago IL 60601, (312) 782-9750, for \$3.99.

Circle 501 on inquiry card.

### Microprocessor-Controlled Floppy-Disk Drive and Controller

The System 2000/10 is a microprocessor-controlled floppy-disk drive and controller that plugs into the Teletype Model 43, the Texas Instruments Silent 700, and similar typewriter terminals. The System 2000/10 can operate as a stand-alone word processor, or as an on-line, storage, edit, and forward unit. In the on-line mode, the data rate is capable of reaching 9600 bps (bits per second). In the on-line mode, it can be invisible to the host computer. The system can also be used with ADM-3A, Televideo 912, and similar video displays. A software package includes global search and global replace commands. Options include extra programmable memory up to 64 K bytes, a printer port, Telex interface, BASIC and IBM 3740 compatibility. The price for the System 2000/10 is \$1695. Contact Terminal Data Corporation, 11878 Coakley Cir, Rockville MD 20852, (301) 881-7655.

Circle 502 on inquiry card.



### Commercial Calculators from Texas Instruments

Texas Instruments has announced a family of heavy-duty commercial calculators incorporating the Seiko 350 mechanical printer. Ranging in price from \$160 to \$205, the TI-5213, -5215, -5217, and -5219, have been designed for operator comfort and reliability. Each model features two-key rollover and 10-level keyboard buffering. The printer delivers 2.8 lines per second using standard 5.8 cm (2.25 inch) paper and prints up to twelve digits plus commas, decimal point, and two-column audit trail. Other features common to all four models include multiplication and division by a constant, automatic computation of percentage calculations, independent add register, grand total register, grand total on/off switch, decimal selector, automatic rounding, and item count. Inquiries should be addressed to Texas Instruments Inc, POB 10508, M/S 5889, Lubbock TX 79408.

Circle 504 on inquiry card.

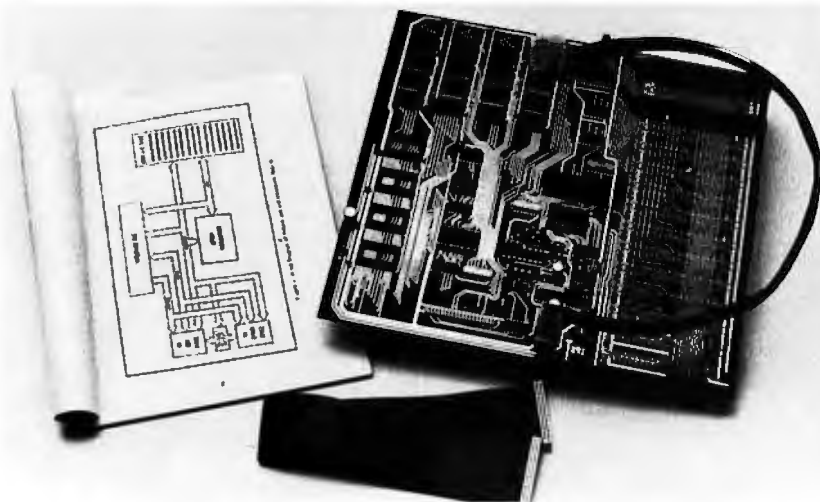

### Memory and Expansion Module for TI's 16-Bit Board

George Goode & Associates Inc, 12840 Hillcrest Rd, Suite 113, Dallas TX 75230, (214) 980-0730, is offering a Memory and Input/Output (I/O) Expansion Module (MEM) for the Texas Instruments University Module 16-bit microcomputer board. The MEM expands the University Module's memory by an additional 8 K bytes and expands I/O address space by an additional 480 bits. An erasable programmable read-only memory (EPROM) programmer

with software driver, cables, and integrated-circuit components are included. The MEM includes sockets for up to 8 K bytes of EPROM and 8 K bytes of programmable memory, two 44-pin connectors for I/O expansion, with space for an additional thirteen connectors, and an EPROM programmer for TMS 2708 and 2716s. The MEM is priced at \$299, including a manual.

Circle 503 on inquiry card.

### Serial Communications and Control on a Single Card

Vantage Data Products has developed a single-card computer for use in communications and control applications. The Z80-based card is used with serial input/output (I/O), parallel I/O, programmable memory, and erasable programmable read-only memory (EPROM). Serial communications are asynchronous RS-232 and programmable to all standard data rates up to 5600 bps (bits per second). Modem-control functions are also included. Power requirements are +5 V and +12 V. Negative voltage for RS-232 communication is generated on the card. Options include a software-monitor program on EPROM for operation of the computer with a terminal, and single power-supply options. The suggested retail price is \$195. Contact Vantage Data Products, 550 W 200 South, Suite 8, Provo UT 84601, (801) 377-6687.

Circle 505 on inquiry card.

# What's New?

## MISCELLANEOUS

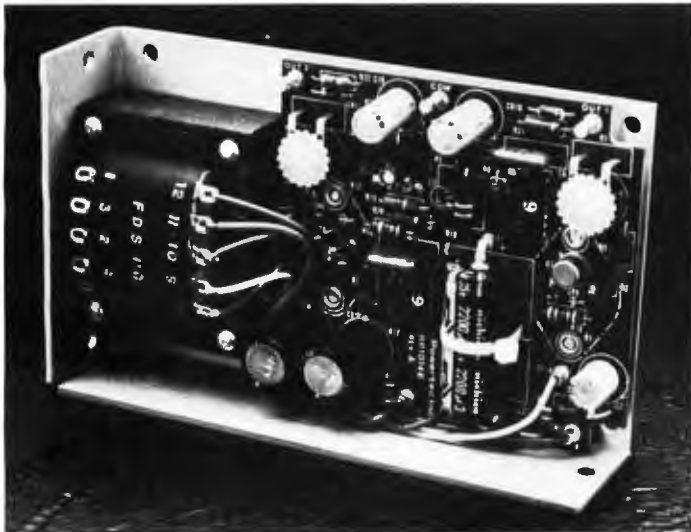

### Floppy-Disk Drive Power Supplies

Powertec Inc, 20550 Nordhoff St, Chatsworth CA 91311, (213) 882-0004, has introduced the FD series of floppy-disk, dual-output power supplies. The FD101 delivers main channel outputs of +5 V at 0.75 A and secondary channel outputs of +12 V at 1.8 V. The FD101 offers flexible strap-selectable inputs of 103-127/206-254 VAC, single phase 47 to 440 Hz. Standard features include overvoltage, overload, short circuit and reverse voltage protections, no turn-on or turn-off overshoot, and a one-year

warranty. The supplies provide line regulation of  $\pm 0.5\%$  for a  $\pm 10\%$  input line change, and static loads of 50 to 100%. Load regulation for the units is  $\pm 0.5\%$  on all outputs for a 0 to 100% load change, 5 mV peak-to-peak maximum ripple, 0.03°C temperature stability over full operating ranges and 0.3% drift for a 24-hour period. Transient response is less than 50 ms for a 50% load change. Contact the company for prices and availability.

Circle 506 on inquiry card.



### Bidirectional Totalizer

The DigiTec Model 8222 bidirectional totalizer is used for counting functions in industrial processes or product-test systems where up-down counting is required. All up-down counting functions, with count direction control, are user-programmable. Operating modes include totalizing two inputs by adding and/or subtracting one from the other based on phase relationship or logic input. Software response ensures that every pulse is

added or subtracted even during simultaneous occurrence. The Model 8222 is available with either a 5- or 7-digit LED (light-emitting diode) display. Both models offer polarity and overflow indication. The unit is 4.8 by 18 by 19 cm (1.89 by 6.6 by 6.86 inches), and the cost is \$415 for the 5-digit model and \$467 for the 7-digit model. Address inquiries to United Systems Corporation, 918 Woodley Rd, Dayton OH 45403, (513) 254-6251.

Circle 507 on inquiry card.

### A Talking Voltmeter



This talking voltmeter allows users to keep their eyes on the probes and avoid shocks, short circuits, and blown integrated circuits. It is also an aid for the visually handicapped. The dual microprocessor-based system provides voltage readings that are automatically announced via an internal 3-inch speaker every 7 seconds, or upon operator command. A slave processor selects the speech elements that are required by the measurement, while the main processor controls the system timing and signal processing. The instrument is powered by a rechargeable nicad battery pack. It weighs 1.1 kg (2.5 lbs) and measures 6.2 by 25.5 by 23 cm (2.5 by 10 by 9 inches). An earphone jack is provided for work in noisy environments. Options include an LCD (liquid-crystal display), current and resistance measurement circuits, and a serial interface for recording the digital output on audio cassette recorders. Foreign languages are also available. The price is \$395. For details, contact the Franklin Institute Research Laboratory Inc, The Benjamin Franklin Pky, Philadelphia PA 19103, (215) 448-1340.

Circle 508 on inquiry card.

### The Connection

The Connection is a modem designed for TRS-80 Models I and II. It eliminates acoustic coupling, so line sensitivity is increased and transmission errors are reduced. The RS-232 port provides the means to simultaneously run a printer or input data from a keyboard. It features a data rate of 300 bits per second (bps), single and duplex mode, direct connection of wires between telephone and computer, software, and instructions. For further details on The Connection, contact The micro-Peripheral Corporation, POB 529, Mercer Island WA 98040.

Circle 509 on inquiry card.



# What's New?

## MISCELLANEOUS

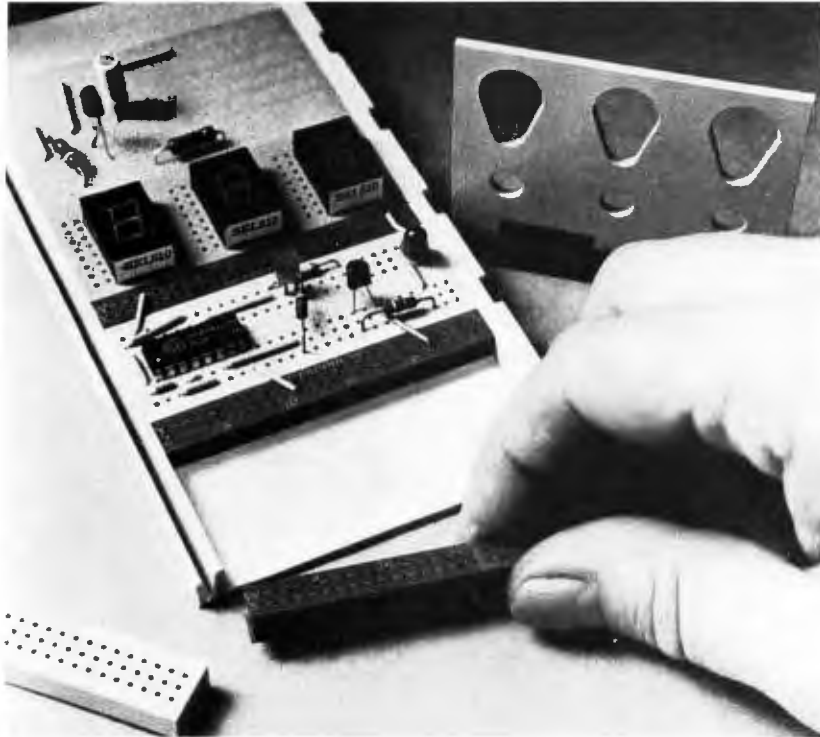

### The Hobby-Blox System

Hobby-Blox is a breadboard system that allows the user to customize the board to fit projects. The system includes plug-in tie points, interchangeable modules, color-keyed and cross-indexed modules. There are two starter packs; one for discrete component projects, the other for integrated circuits projects. The system includes 14 modules that can be purchased individually, most with a suggested retail price below \$3. The

modular packs include a tray, terminal strips, distribution strips, discrete strips, bus strips, display strips, LED (light-emitting diodes) strips, vertical tray, speaker panel, control panel, blank panel, battery holder, binding post strips, and tray extender clips. The two starter packs are priced under \$7. For information, contact A P Products Inc, 1359 W Jackson St, Painesville OH 44077.

Circle 510 on inquiry card.

### SDI Graphics Interface

The Cromemco SDI is a high-resolution graphics interface designed for use in Cromemco computer systems. The SDI displays color or black-and-white images with up to 756-by-484 point resolution. It features color map selection, dual page windowing function, automatic area fill mode, and NTSC broadcast compatibility. The SDI consists of two circuit boards that plug directly into the S-100 bus of any Cromemco microcomputer system. Each pixel of the display may be mapped from one nybble or from one bit of the display memory. Twelve or 48 bytes of memory may be used for the display memory, allowing four basic modes of operation. In nybble-mapped mode any 16 of 4096 possible colors may be displayed in a single picture. In bit-

mapped mode any two of these colors may be displayed in a single picture. For black-and-white nybble-mapped mode there can be 16 shades of grey. A bit-mapped black-and-white picture yields only a black-and-white display. The three outputs of the device can display three different pictures to three different black-and-white monitors simultaneously. The SDI sync signals adhere to the RS-170 standard for the television broadcast industry. The SDI can be synchronized to external television equipment through the use of an external composite RS-170 sync signal, a composite video signal, or external horizontal and vertical sync signals. The SDI graphics interface is available for \$595 from Cromemco Inc, 280 Bernardo Ave, Mountain View CA 94043, (415) 964-7400.

Circle 511 on inquiry card.

### Winter 1980 Catalog from Inmac

Twenty-four new computer supply and accessory products are featured in Inmac's *Winter 1980* catalog. The new offerings include preformatted floppy disks, thirteen Clear Signal microcomputer cables, sound enclosures designed to keep noise in and dust out, floppy-disk hanging file folders, and mini data-cartridge binder leaves. For a free subscription to the full-color catalog, call or write Inmac, Dept BPR, 2465 Augustine Dr, Santa Clara CA 95051, (408) 727-1970.

Circle 512 on inquiry card.

### Computer Products from Electronic Systems

A catalog featuring systems by Apple, Radio Shack, Atari, Compucolor, and other companies is available from Electronic Systems, POB 21638, San Jose CA 95151, (408) 448-0800. Electronic Systems also sells products for S-100 bus systems, tools, software, terminals, and many other items. The catalog includes prices and order forms.

Circle 513 on inquiry card.

### Vector Offers Electronic Packaging Catalog

Vector Electronic Company's catalog has complete details on the company's electronic-packaging products, tools, and kits. Emphasis is placed on micro-computer-interface boards for all conventional buses, a variety of card cages and cabinets, breadboarding components, plus numerous sockets and terminals. Price lists are included along with the names and the addresses of Vector's distributors. Contact Vector Electronic Company, 12460 Gladstone Ave, Sylmar CA 91342, (213) 365-9661.

Circle 514 on inquiry card.

### The Hayden 1980 Computer Science Catalog

This publication contains the complete selection of Hayden titles on everything about computers from introductory information and programming to software and advanced technology. It is available from Hayden Book Company Inc, 50 Essex St, Rochelle Park NJ 07662, (201) 843-0550.

Circle 515 on inquiry card.

# What's New?

## MISCELLANEOUS

### The Z-88 Processor Card

The Z-88 offers 16-bit processing power to S-100 bus users. The card combines a Z80A and an 8088 microprocessor to allow access to all currently available 8080 software without the need to translate into 8086 machine language. The 8088 is fully software compatible with the 8086, so all 16-bit software, such as Microsoft 8086 BASIC, will run on the Z-88. The Z-88 features an 8-bit data bus that uses existing products without modification; direct memory address of 16 megabytes; selectable IEEE Preliminary Standard or Altair/Imsai S-100 bus; no wait states with 450-ns memory access; vectored or noninterrupting modes that transfer control between processors; a 1 K-byte phantom read-only memory (ROM) which initializes the microprocessor; and an 8-level TTL (transistor-transistor logic) priority-vectored interrupt. The cost to build a Z-88 is around \$450. For more information, contact the designers at Programmers Publishing Company, POB 2571, Kalamazoo MI 49003, (616) 344-9323.

Circle 518 on inquiry card.



### Intel MDS-Compatible 10-Megabyte Storage Unit

Advant Corporation, 696 Trimble Rd, San Jose CA 95131, (408) 946-9300, has introduced a 10-megabyte Winchester hard-disk data storage unit. Interfacing with all Intel MDS models, the MicroSupport Model 105 data storage unit utilizes Shugart 8-inch Winchester hard disks. The MicroSupport 105 features built-in error correction, a microprocessor-based controller, and a power supply. For more information, contact the Advant Corporation.

Circle 518 on inquiry card.

### Books from MIT Press

Systems theory, computer sciences, artificial intelligence, programming languages, information, communication, and control are the topics covered by a variety of books published by the MIT Press. The new catalog also contains series and classified listings. For a copy of *Computer, Science, Engineering*, contact the MIT Press, 28 Carleton St, Cambridge MA 02142.

Circle 519 on inquiry card.

### Software for the Atari 800

Atari 800 software is now available through Sebree's Computing. Atari's 3-Dimensional Graphics Package, for \$29.95, will run on 8 K- or 16 K-byte machines. It features multiple-color control, selectable resolution, line clipping and pushing, telephoto and wide angle views, four program listings, and a manual. Using one of the four programs, the user can input any scene, rotate it and view it from any location in three-dimensional space or even from inside of it. *Wumpus Adventure* is a mixture of two popular games that has color graphics and sound effects. The user can control arrow direction and action during the battles. The program is designed for the 16 K-byte unit and costs \$14.95. Contact Sebree's Computing, 456 Granite Ave, Monrovia CA 91016, (213) 359-8092.

Circle 520 on inquiry card.

### FORTH for Four Levels

FORTH is available from Ancon, 17370 Hawkins Ln, Morgan Hill CA 95037, (408) 779-0848. There are four levels offered for the following: the hobbyist; the personal high-level language programmer who wants a ready-made editor and some basic utilities; the engineer in the microprocessor-development laboratory creating products; and the commercial original equipment manufacturer (OEM) or sophisticated end-users. The commercial level includes files, data-base management, source data entry, teleprocessing, distributed processing, and accounting packages. The hobby versions are for the TRS-80 with cassette for \$29.95; Heath H8-H89 for \$49.95; 8080-based systems with an 8-inch floppy disk for \$49.95; and 6809-based systems with a 5-inch FLEX floppy-disk drives for \$49.94. Personal systems include TRS-80 for \$45.95 for cassette and \$65.95 for floppy-disk systems; Apple II disk for \$99.95; KIM-1 for \$90; and 8080 systems with CP/M and 8-inch disks for \$125. Industrial systems are available for the EXORcisor, Rockwell System 65, the Intel MDS, 8080 with CP/M, Apple II, and others. Commercial levels are made for Digital Equipment Corporation PDP-11 and VAX, Data General Nova and Eclipse, IBM Series 1, and others.

Circle 517 on inquiry card.

## The subLOGIC FS1 Flight Simulator\*

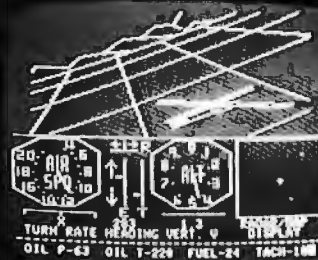

is just one application of our fine graphic software.

Other applications can be yours!

Choose from a coordinated software and hardware collection to fit your graphic needs . . .

### SOFTWARE

A23D1 animation package for the Apple II (\$45 on cassette, \$55 for disk).

8080/Z80 3D package for most S100 systems (\$41 on tarbell cassette or paper tape, \$51 on 5" North Star disk, or \$52 on 8" CPM disk).

### HARDWARE (\$100)

Godbout	\$399
Matrox ALT-256	\$395
Matrox ALT-512	\$595
Micro Angelo	\$1095
Panasonic Color Monitors	\$450 & up

Write or call for an informative catalog describing these and other graphic products and their easy use in your applications.

Most subLOGIC software is at your dealer's. If he doesn't stock it, order direct from subLOGIC. Add \$1.25 for UPS or \$1.75 for first class mail. Visa and Mastercharge accepted.

\*The FS1 Flight Simulator is available for Apple II and TRS-80 Level I & II for \$25 on cassette.

(217) 359-8482  
**subLOGIC**  
 Distribution Corp.  
 Box V, Savoy, IL 61874

The engineering and graphics experts.

# What's New?

## SOFTWARE

### Suprdump for the TRS-80

Definitive Micro Systems, 20 Glenwood Cres, St Alberta, Alberta T8N 1X5, Canada, have announced Suprdump, a disk dump/modify utility for the TRS-80 Model I. Suprdump is designed to expedite the debugging of programs utilizing disk files. It can also create disk-file test data. The utility will dump a specified disk sector onto the video screen in a hexadecimal plus ASCII (American Standard Code for Information Interchange) format. Modification of the information on disk is accomplished by typing over the displayed data. Suprdump is supplied on a floppy disk for \$29.95.

Circle 521 on Inquiry card.

### The Magic Wand

The Magic Wand is a word-processing program that provides underscoring, boldface, superscripting, and subscripting in any combination and even all at once. Boldface can vary in intensity and underlining can be broken or solid. The program provides justification, discretionary hyphens, and other processing capabilities. It can also create form letters from a mailing list, assist in writing standard letters, perform variable line spacing, print with true proportional spacing, print headers and footers on each page, automatic pagination, and more. It is written for the TRS-80 Model II and requires CP/M. The price is \$350 from Pickles & Trout, POB 1206, Goleta CA 93017, (805) 967-9563.

Circle 522 on Inquiry card.

### Attach an Apple to a Malibu

The Malibu/Apple Input/Output (I/O) card serves as an interface between the Apple II and the Malibu Model 165 printer. The Malibu card uses the Apple's microprocessor to provide bidirectional printing, changeable type fonts, high-resolution graphics printout, and other functions. The card is compatible with Integer BASIC, Applesoft, Apple Pascal, as well as Appewriter and EasyWriter. The Malibu card uses a technique whereby it substitutes its software for the Apple's during printing. After the printing is completed, control is passed back to the Apple software. For further information, contact Malibu Design Group Inc, 211109 Nordhoff St, Chatsworth CA 91311.

Circle 523 on Inquiry card.



### 6800 C Compiler

Wintek has introduced a C compiler for the 6800 microprocessor. The compiler includes the features described in the book *The C Programming Language* by Kernighan and Ritchie (Prentice-Hall). C is a structured-programming language for operating systems and numerical, text-processing, data-base programs, and other general applications. Characters, numbers, and addresses can be combined and efficiently moved about with the 6800 arithmetic and logical operations. Consequently, C is very efficient in the amount of 6800 code generated. C provides pointers and the ability to do address arithmetic. Any function can be called recursively and its variables declared in a block-structured fashion. Variables may be internal, external, or global. Functions of a C program can be compiled separately. The C compiler is intended to run under the Wizrd multitasking disk operating system on the Sprint 68 microcomputer. The cost for C is \$495. The cost for the Sprint 68 with 48 K bytes of programmable memory, dual 8-inch floppy-disk drives, and Wizrd is \$3995. Contact Wintek Corporation, 1801 South St, Lafayette IN 47904, (317) 742-8428.

Circle 524 on Inquiry card.

### polyFORTH

polyFORTH is an operating system for microprocessor-development systems and minicomputers. polyFORTH provides the compiler, interpreters, assembler, character editor, virtual memory, and multitasking capability within its 8 K bytes of memory. Applications programs can be coded combining high-level with low-level languages. Program-development time is cut down because the interactive programming environment allows rapid testing and debugging. Memory requirements for complex applications are reduced to as little as half that of assembler programs and to about 10%

### Software for the HP-85: The Pro-Organizer

The Pro-Organizer is for applications ranging from a daily appointment organizer to an index box for maintaining name and address lists, to a data bank for the professional, executive, engineer, or scientist. The program is designed for the 16 K-byte HP-85 computer and is supplied on cartridge. It is completely automatic from power turn-on. Any data-management requirements may be custom formatted. Data may be edited easily. Additional cartridges may be used to build up a library. The suggested retail price is \$95. For details, contact Scelbi Publications, 20 Hurlbut St, Elmwood CT 06110, (203) 522-5515. Circle 525 on Inquiry card.

### Apple FORTH 1.7

With this FORTH Interest Group-compatible system, Apple users can define operations and enter them as components of the language. Machine-language subroutines can be entered directly from the keyboard, where they are assembled immediately and ready to run or test. Apple FORTH 1.7 includes a screen editor that can be customized. It has facilities to manufacture turnkey disks which boot directly into user applications. FORTH is its own operating system and debugger, including compile-time checks. Programs run faster than Integer BASIC, and object code is very compact. This language is compatible with the FORTH International Standard, so programs can be run on 8080- and PDP-11-based systems. A 48 K-byte Apple II or Apple II Plus with one or two disk drives is required. The price is \$140, including a manual, from Cap'n Software, POB 575, San Francisco CA 94101, (415) 848-6913.

Circle 526 on Inquiry card.

that of other high-level languages. Run speed is controlled by the programmer. Time-critical routines can run at full machine speed. All versions of polyFORTH are compatible with a minimal number of machine-dependent features. The language features 16-bit arithmetic on all systems, as well as 32-bit capacity. For \$2500, users receive polyFORTH on a floppy disk, a set of programmable read-only memory (PROM) integrated circuits containing the precompiled system, two manuals, and access to a hot line service and newsletter. Contact FORTH Inc, 2309 Pacific Coast Hwy, Hermosa Beach CA 90254, (213) 372-8493. Circle 527 on Inquiry card.



# 10 Megabyte Hard Disk \$3,495\*



5440-12 Top Load Drive

\* Factory rebuilt 10MB cartridge disk drive only  
A new Cameo Data Systems controller is available for \$1,495  
\$4,495 for a brand new Ampex 10MB drive only



We are the CP/M\*\* and MP/M\*\* specialist of Southern California. We can supply you with the latest CP/M (\$150) or MP/M (\$300) and with Standard BIOS (\$150) or Custom BIOS (\$300). Immediate delivery worldwide. Domestic and foreign inquiries invited...dealers too.

\*\*CP/M and MP/M are Trademarks of Digital Research

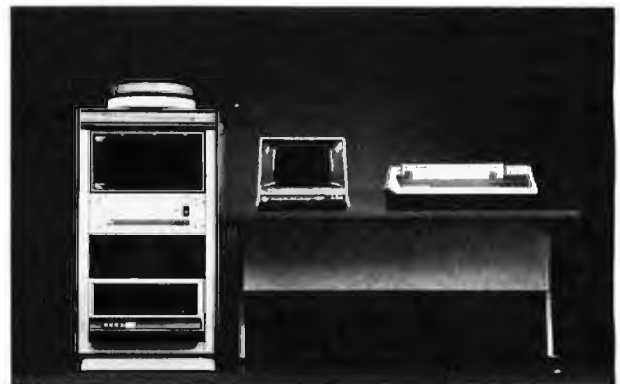

We are a full service computer retailer. We totally integrate hardware and software into high quality, high reliability systems. Systems for use in development, process control and general business. Word processing naturally, multi tasking and multi processing too.

## COMPUTER COMPONENTS

# What's New?

## SOFTWARE

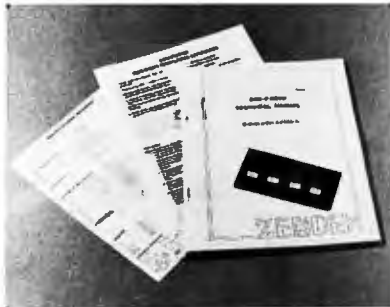

### SBC-FORTH on EPROM

This implementation of FORTH can run in many of Intel's and National's line of SBC-80 microprocessor cards. It runs stand-alone and requires no additional memory, input/output (I/O) devices, or disks to operate. Standard features include a resident compiler, an 8080/8085 assembler, screen editor, and adaptive disk I/O. The disk I/O allows a combination of four single-density drives or four double-density drives with two additional single-density units for a total capacity of 2500 screens. The system price is \$500 including the manual. Contact Zendex Corporation, 6398 Dougherty Rd, Dublin CA 94566, (415) 829-1284.

Circle 528 on inquiry card.

### FLEX for Custom Hardware

A new version of the FLEX disk operating system is available for users of custom or nonstandard 6800 and 6809 systems. Developed by Technical Systems Consultants Inc, POB 2570, 1208 Kent Ave, West Lafayette IN 47906, (317) 463-2502, it is fully compatible with most versions of FLEX. FLEX supports features such as dynamic file-space allocation, random and sequential file accessing, user startup facility, user environment control, English-language error messages, and over twenty commands for normal disk operations. This version contains a manual describing how to write disk and terminal input/output (I/O) routines to adapt FLEX to most any hardware. The only major system requirement is a soft-sectored floppy-disk drive that uses 256 bytes per sector. When the adaptation is complete, the user's system will be capable of running any standard FLEX software. The \$150 price includes the FLEX disk with editor and assembler, and a set of manuals.

Circle 529 on inquiry card.

### The Datahandler

The Datahandler is a data-base management system running in MMSFORTH on the TRS-80 Model I with at least 32 K bytes of programmable memory and one floppy-disk drive. Users can specify up to ten data fields appropriate to each particular job. Standard and special report formats can be output to the screen and the printer. The Datahandler includes mail-list and checking-account programs with custom report commands and sample data files. It can sort a typical 100-record file in 5 seconds, and lookups take less than 1 second. An indexed-key structure incorporates string and value selection mechanisms including normal-compares and values inside or outside a range. One feature allows the program area of the Datahandler disk to be software write-protected, while the data-file area is left open. Regularly used system configurations may be precompiled for 5-second loading times. Additions to the Datahandler will be a report-generator module and a large-data-files module. The Datahandler costs \$59.90 including the *PIMS Manual*. It also requires the MMSFORTH system disk which provides its language and operating system, which costs \$79.95 including an introductory manual. Contact Miller Microcomputer Services, 61 Lake Shore Rd, Natick MA 01760, (617) 653-6136.

Circle 530 on inquiry card.

### SL5—A Software-Development Tool

SL5 is a software-development tool for small systems. It is an interactive programming system with an integral compiler, interpreter, assembler, disk operating system, and library of procedures. SL5 is based on the recommendations of the 1977 FORTH Standards Committee. Since SL5 is written in SL5, it adapts to most microcomputer operating systems. A host-executable code kernel, a source-code kernel, and a system-generation program are provided. The system generation program regenerates the kernel from the source or generates compact stand-alone read-only memory (ROM) object modules. An SL5 development system requires less than 32 K bytes of memory. Most applications programs require less than 8 K bytes. SL5 reads and writes standard CP/M files. Versions are available for both the 8080 and Z80. The Z80 system uses the additional registers and instructions of the Z80, and contains an assembler with Z80 mnemonics. The single-system price of \$150 includes complete source code and a manual. Original equipment manufacturer (OEM) and resale licenses are available. For more information, contact The Stackworks, POB 1596, 321 E Kirkwood Ave, Bloomington IN 47402, (812) 336-1600.

Circle 531 on inquiry card.

### Word Processor and 8810 System from PolyMorphic

Wordmaster II is a menu-driven word processor. The program enables users to create, edit, format, and print documents. It is designed for PolyMorphic Systems 8810 or 8813 computers. The program can print with two-color ribbons, print in boldface, print superscripts, subscripts, and multiple-line headers and footers. Repetitive spelling, phrase, or numerical errors can be easily changed. The System 8810 with Wordmaster II is available for under \$9000, including the NEC Spin-

writer or comparable printer. Contact PolyMorphic Systems, 460 Ward Dr, Santa Barbara CA 93111.

Circle 532 on inquiry card.



# What's New?

## SYSTEMS

### Matrox Computer Systems MACS-10

The MACS-10 microcomputer system combines Multibus-based hardware with the CP/M 2.0 disk operating system. The system is configured around the Z80A microprocessor and includes 48 K bytes of programmable memory and sockets for 8 K bytes of ROM (read-only memory) and EPROM (erasable programmable read-only memory). A 2 K-byte monitor, a dual 8-inch double-density floppy-disk drive, a disk controller, and interfaces for a video terminal and line printer are also included. Other peripherals can be connected through additional ports at the rear of the chassis. The microprocessor and floppy-disk controller cards occupy two slots in the card cage, leaving five slots for systems expansion. If more slots are needed, up to three card cages can be stacked together for a maximum of nineteen free card slots. Optional hardware includes a 128 K-byte programmable-memory card, and an alphanumeric and graphic video-display controllers. The price for the MACS-10 system is \$5990. Details are available from Matrox Electronic Systems Ltd, 5800 Andover Ave, T M R, Quebec H4T 1H4, Canada, (514) 735-1182.

Circle 533 on inquiry card.

### The System 1000 Series from CSSN

CSSN Inc has announced its System 1000 family of microcomputers. This modular, bus-oriented line of systems is organized around the IEEE (Institute of Electrical and Electronic Engineers) S-1000 standard bus. The S/1000 includes a 4 MHz Z80A microprocessor, 64 K bytes of programmable memory, an 8-inch Winchester hard disk, a 13.4-megabyte cartridge-tape data backup, a variety of I/O (input/output) devices and other peripherals, and expansion capability to 16-bit processors. It is available in different configurations of operating systems and peripherals, and retails between \$15,000 and \$20,000. The S/1000 hard-disk cartridge backup combination can store 24 megabytes. Operating systems for the series includes CP/M 2.0, MP/M, OASIS, and CSSN PDOS, a superset of CP/M 1.4. Languages such as BASIC, COBOL, FORTRAN, C, and Pascal, can be run on the systems. For further information, contact CSSN Inc, 120 Boylston St, 4th Fl, Boston MA 02116, (617) 482-2343.

Circle 534 on inquiry card.

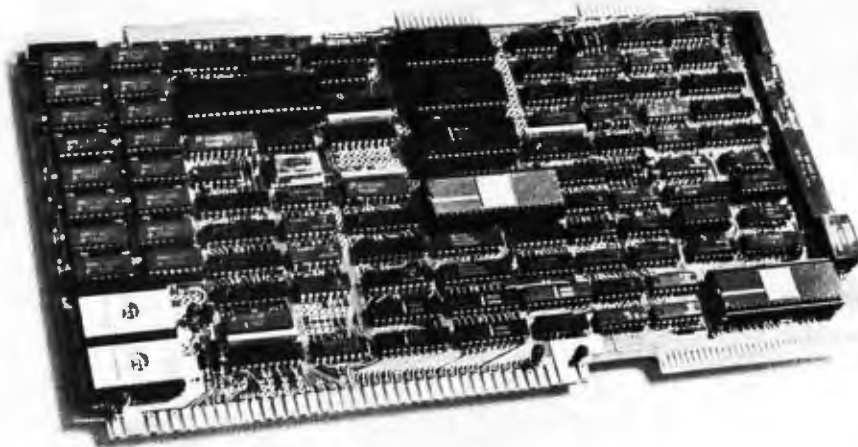

### AmZ800 Single-Board Computer

The Am96/4116 MonoBoard Computer uses the 16-bit processing power of the 4 MHz AmZ8002 microprocessor. Auxiliary support for the AmZ8002 includes 32 K bytes of programmable memory, 8 K bytes of PROM (programmable read-only memory) sockets, two serial and three parallel I/O (input/output) ports, and five programmable counter/timers. The two RS-232 serial ports transmit data from 50 to 9600 bps (bits per second). The parallel I/O ports break down into twenty-four lines or three 8-bit ports that can be programmed for input, output, or bidirectional operation. The computer can accept multiple interrupt channels from twenty-

three independent sources in non-maskable, vectored, and nonvectored modes of operation. Eight interrupt channels are handled by a programmable interrupt controller which allocates priorities, determines modes of operation and supports direct vectoring. The Am9513 System Timing Controller incorporates five independent 16-bit counters that can count up or down in binary or BCD (binary-coded decimal) at rates up to 7 MHz. The price for the Am96/4116 is \$2145. Contact Advanced Micro Computers, 3340 Scott Blvd, Santa Clara CA 95051, (408) 988-7777.

Circle 535 on inquiry card.

### System 800 from IPDI

The System 800 can be expanded from 64 K bytes to 2.04 megabytes of programmable memory and from 11.2 to 31.2 megabytes of disk storage on four drives. The system allows a combination of floppy and hard disks, as well as tape cartridge backup in the same system enclosure. IPDI's video-graphics card produces a display of up to 3000

characters of over 256 user-definable characters and symbols on a 15-inch monitor. The video-display system features sixteen levels of gray or full color and is capable of driving over thirty-two displays. For more information, contact IPDI, 2584 Wyandotte, Mountain View CA 94043, (415) 969-6086.

Circle 536 on inquiry card.

### A Z8000 Board from Quasar Data Products

This 16-bit Z8000 S-100 board conforms to the proposed IEEE (Institute of Electrical and Electronic Engineers) standards. The system can read and write 8-bit, 16-bit or mixed 8- and 16-bit memories. The module also incorporates on-board, single-step circuitry hardware. The clock rate is 4 MHz. An 8080/Z80 emulator enables users to employ most of the software that has been developed for the 8080/Z80 processors. The system

also has provisions to plug an 8-bit microprocessor card in the same bus as the Z8000 module, allowing software to be developed on an 8-bit system and then transferred to and executed by the Z8000. Available software includes a cross assembler, text editor, word processing software, and a business package. The QDP-8100 is available from Quasar Data Products, 25151 Mitchell Dr, North Olmsted OH 44070, (216) 779-9387, for \$6395.

Circle 537 on inquiry card.



# WAMECO

## THE COMPLETE PC BOARD HOUSE EVERYTHING FOR THE S-100 BUSS

- \* **FPB-1 FRONT PANEL BOARD FOR 8080A AND Z80 SYSTEMS IMSAI COMPATIBLE.**  
PCBD ..... \$54.95      KIT ..... \$165.00
- \* **MEM-2 16K RAM 2114's. ADDRESSABLE IN 4K BOUNDARIES.**  
PCBD .... \$31.95      KIT (LESS RAMS) .... \$80.95
- \* **EPM-2 16/32K ROM USES 2716 OR 2708. ADDRESSABLE IN 4K BOUNDARIES.**  
PCBD .... \$31.95      KIT (LESS ROMS) .... \$74.95
- \* **CPU-1 8080A PROCESSOR BOARD WITH VECTOR INTERRUPT.**  
PCBD ..... \$31.95      KIT ..... \$124.95
- \* **IOB-1 I/O BOARD. ONE SERIAL, TWO PARALLEL WITH CASSETTE.**      PCBD ..... \$31.95
- \* **FDC-1 FLOPPY DISC CONTROLLER BOARD USES 1771.**      PCBD ..... \$44.95

- \* **QMB-12 13 SLOT MOTHER BOARD.**  
PCBD ..... \$39.95      KIT ..... \$115.95
- \* **QMB-9 9 SLOT MOTHER BOARD.**  
PCBD ..... \$34.95      KIT ..... \$89.95
- \* **PTB-1 POWER SUPPLY AND TERMINATOR BOARD.**  
PCBD ..... \$29.95      KIT ..... \$49.95
- \* **RTC-1 REAL TIME CLOCK BOARD WITH TWO INTERRUPTS.**  
PCBD ..... \$27.95      KIT ..... \$79.95
- \* **MEM-1 8K RAM, USES 2102's.**  
PCBD .... \$31.95      KIT (LESS RAM) .... \$71.95
- \* **EPM-1 4K 170Z BOARD.**  
PCBD .... \$29.95      KIT (LESS ROM) .... \$59.95

FUTURE PRODUCTS: 80 CHARACTER VIDEO BOARD.  
Z-80 CPU BOARD WITH ROM, 8 PARALLEL PORT I/O BOARD.

**DEALER INQUIRIES INVITED, UNIVERSITY DISCOUNTS AVAILABLE AT YOUR LOCAL DEALER**

MOST PRODUCTS FOR IMMEDIATE SHIPMENT. NO 4-8 WEEK DELAYS REQUIRED FOR OTHERS.



WAMECO, INC., P. O. BOX 877 • 455 PLAZA ALHAMBRA • EL GRANADA, CA 94018 • (415) 726-6378

**C/DIODES (DIODE CLAMPEI)**

4001	35	4027	46	4081	35	74C74	80
4002	35	4028	80	4082	35	74C76	80
4008	117	4029	39	4083	35	74C78	120
4010	46	4030	35	4084	35	74C80	140
4011	46	4031	35	4085	35	74C82	140
4012	46	4032	35	4086	35	74C84	140
4013	46	4033	35	4087	35	74C86	140
4014	46	4034	35	4088	35	74C88	140
4015	128	4040	188	4094	100	74C90	120
4016	128	4041	188	4095	100	74C92	120
4017	128	4042	188	4096	100	74C94	120
4018	80	4043	188	4097	100	74C96	120
4019	80	4044	188	4098	100	74C98	120
4020	110	4045	188	4099	100	74C100	120
4021	110	4046	188	4100	100	74C102	120
4022	35	4071	35	74C10	80	74C104	120
4023	35	4072	35	74C12	80	74C106	120
4024	35	4073	35	74C14	80	74C108	120
4025	35	4074	35	74C16	80	74C110	120

1488 RS232 INTERFACE ..... \$1.40      TMS 4045 25 - 1E x 4 ..... 6.70

2552 STATIC SHFT REG. .... 2.95      7500 78 STATE STAT. SR ..... 1.38      8252Z ..... 2.95

7708 8K EPROM 4K50 ..... 8.98      8251S ..... 2.95

7843-3488 NC 80 875 DYN LR ..... 1.38      8251Z ..... 2.95

2716 (73) 3VOLT TAGS ..... 18.88      8251B ..... 2.95

2716 Round - 1V ..... 4.88      8251C ..... 2.95

2716 4K STAT. RAM 4K50 ..... 4.50      8251D ..... 2.95

7525 4K 512 EPROM ..... 8.00      8251E ..... 2.95

7525 4K 512 EPROM ..... 8.00      8251F ..... 2.95

7525 4K 512 EPROM ..... 8.00      8251G ..... 2.95

7525 4K 512 EPROM ..... 8.00      8251H ..... 2.95

7525 4K 512 EPROM ..... 8.00      8251I ..... 2.95

7525 4K 512 EPROM ..... 8.00      8251J ..... 2.95

7525 4K 512 EPROM ..... 8.00      8251K ..... 2.95

7525 4K 512 EPROM ..... 8.00      8251L ..... 2.95

7525 4K 512 EPROM ..... 8.00      8251M ..... 2.95

7525 4K 512 EPROM ..... 8.00      8251N ..... 2.95

7525 4K 512 EPROM ..... 8.00      8251O ..... 2.95

7525 4K 512 EPROM ..... 8.00      8251P ..... 2.95

7525 4K 512 EPROM ..... 8.00      8251Q ..... 2.95

7525 4K 512 EPROM ..... 8.00      8251R ..... 2.95

7525 4K 512 EPROM ..... 8.00      8251S ..... 2.95

7525 4K 512 EPROM ..... 8.00      8251T ..... 2.95

7525 4K 512 EPROM ..... 8.00      8251U ..... 2.95

7525 4K 512 EPROM ..... 8.00      8251V ..... 2.95

7525 4K 512 EPROM ..... 8.00      8251W ..... 2.95

7525 4K 512 EPROM ..... 8.00      8251X ..... 2.95

7525 4K 512 EPROM ..... 8.00      8251Y ..... 2.95

7525 4K 512 EPROM ..... 8.00      8251Z ..... 2.95

7525 4K 512 EPROM ..... 8.00      8252 ..... 2.95

7525 4K 512 EPROM ..... 8.00      8253 ..... 2.95

7525 4K 512 EPROM ..... 8.00      8254 ..... 2.95

7525 4K 512 EPROM ..... 8.00      8255 ..... 2.95

7525 4K 512 EPROM ..... 8.00      8256 ..... 2.95

7525 4K 512 EPROM ..... 8.00      8257 ..... 2.95

7525 4K 512 EPROM ..... 8.00      8258 ..... 2.95

7525 4K 512 EPROM ..... 8.00      8259 ..... 2.95

7525 4K 512 EPROM ..... 8.00      8260 ..... 2.95

7525 4K 512 EPROM ..... 8.00      8261 ..... 2.95

7525 4K 512 EPROM ..... 8.00      8262 ..... 2.95

7525 4K 512 EPROM ..... 8.00      8263 ..... 2.95

7525 4K 512 EPROM ..... 8.00      8264 ..... 2.95

7525 4K 512 EPROM ..... 8.00      8265 ..... 2.95

7525 4K 512 EPROM ..... 8.00      8266 ..... 2.95

7525 4K 512 EPROM ..... 8.00      8267 ..... 2.95

7525 4K 512 EPROM ..... 8.00      8268 ..... 2.95

7525 4K 512 EPROM ..... 8.00      8269 ..... 2.95

7525 4K 512 EPROM ..... 8.00      8270 ..... 2.95

7525 4K 512 EPROM ..... 8.00      8271 ..... 2.95

7525 4K 512 EPROM ..... 8.00      8272 ..... 2.95

7525 4K 512 EPROM ..... 8.00      8273 ..... 2.95

7525 4K 512 EPROM ..... 8.00      8274 ..... 2.95

7525 4K 512 EPROM ..... 8.00      8275 ..... 2.95

7525 4K 512 EPROM ..... 8.00      8276 ..... 2.95

7525 4K 512 EPROM ..... 8.00      8277 ..... 2.95

7525 4K 512 EPROM ..... 8.00      8278 ..... 2.95

7525 4K 512 EPROM ..... 8.00      8279 ..... 2.95

7525 4K 512 EPROM ..... 8.00      8280 ..... 2.95

7525 4K 512 EPROM ..... 8.00      8281 ..... 2.95

7525 4K 512 EPROM ..... 8.00      8282 ..... 2.95

7525 4K 512 EPROM ..... 8.00      8283 ..... 2.95

7525 4K 512 EPROM ..... 8.00      8284 ..... 2.95

7525 4K 512 EPROM ..... 8.00      8285 ..... 2.95

7525 4K 512 EPROM ..... 8.00      8286 ..... 2.95

7525 4K 512 EPROM ..... 8.00      8287 ..... 2.95

7525 4K 512 EPROM ..... 8.00      8288 ..... 2.95

7525 4K 512 EPROM ..... 8.00      8289 ..... 2.95

7525 4K 512 EPROM ..... 8.00      8290 ..... 2.95

7525 4K 512 EPROM ..... 8.00      8291 ..... 2.95

7525 4K 512 EPROM ..... 8.00      8292 ..... 2.95

7525 4K 512 EPROM ..... 8.00      8293 ..... 2.95

7525 4K 512 EPROM ..... 8.00      8294 ..... 2.95

7525 4K 512 EPROM ..... 8.00      8295 ..... 2.95

7525 4K 512 EPROM ..... 8.00      8296 ..... 2.95

7525 4K 512 EPROM ..... 8.00      8297 ..... 2.95

7525 4K 512 EPROM ..... 8.00      8298 ..... 2.95

7525 4K 512 EPROM ..... 8.00      8299 ..... 2.95

7525 4K 512 EPROM ..... 8.00      8300 ..... 2.95

7525 4K 512 EPROM ..... 8.00      8301 ..... 2.95

7525 4K 512 EPROM ..... 8.00      8302 ..... 2.95

7525 4K 512 EPROM ..... 8.00      8303 ..... 2.95

7525 4K 512 EPROM ..... 8.00      8304 ..... 2.95

7525 4K 512 EPROM ..... 8.00      8305 ..... 2.95

7525 4K 512 EPROM ..... 8.00      8306 ..... 2.95

7525 4K 512 EPROM ..... 8.00      8307 ..... 2.95

7525 4K 512 EPROM ..... 8.00      8308 ..... 2.95

7525 4K 512 EPROM ..... 8.00      8309 ..... 2.95

7525 4K 512 EPROM ..... 8.00      8310 ..... 2.95

7525 4K 512 EPROM ..... 8.00      8311 ..... 2.95

7525 4K 512 EPROM ..... 8.00      8312 ..... 2.95

7525 4K 512 EPROM ..... 8.00      8313 ..... 2.95

7525 4K 512 EPROM ..... 8.00      8314 ..... 2.95

7525 4K 512 EPROM ..... 8.00      8315 ..... 2.95

7525 4K 512 EPROM ..... 8.00      8316 ..... 2.95

7525 4K 512 EPROM ..... 8.00      8317 ..... 2.95

7525 4K 512 EPROM ..... 8.00      8318 ..... 2.95

7525 4K 512 EPROM ..... 8.00      8319 ..... 2.95

7525 4K 512 EPROM ..... 8.00      8320 ..... 2.95

7525 4K 512 EPROM ..... 8.00      8321 ..... 2.95

7525 4K 512 EPROM ..... 8.00      8322 ..... 2.95

7525 4K 512 EPROM ..... 8.00      8323 ..... 2.95

7525 4K 512 EPROM ..... 8.00      8324 ..... 2.95

7525 4K 512 EPROM ..... 8.00      8325 ..... 2.95

7525 4K 512 EPROM ..... 8.00      8326 ..... 2.95

7525 4K 512 EPROM ..... 8.00      8327 ..... 2.95

7525 4K 512 EPROM ..... 8.00      8328 ..... 2.95

7525 4K 512 EPROM ..... 8.00      8329 ..... 2.95

7525 4K 512 EPROM ..... 8.00      8330 ..... 2.95

7525 4K 512 EPROM ..... 8.00      8331 ..... 2.95

7525 4K 512 EPROM ..... 8.00      8332 ..... 2.95

7525 4K 512 EPROM ..... 8.00      8333 ..... 2.95

7525 4K 512 EPROM ..... 8.00      8334 ..... 2.95

7525 4K 512 EPROM ..... 8.00      8335 ..... 2.95

7525 4K 512 EPROM ..... 8.00      8336 ..... 2.95

7525 4K 512 EPROM ..... 8.00      8337 ..... 2.95

7525 4K 512 EPROM ..... 8.00      8338 ..... 2.95

7525 4K 512 EPROM ..... 8.00      8339 ..... 2.95

7525 4K 512 EPROM ..... 8.00      8340 ..... 2.95

7525 4K 512 EPROM ..... 8.00      8341 ..... 2.95

7525 4K 512 EPROM ..... 8.00      8342 ..... 2.95

7525 4K 512 EPROM ..... 8.00      8343 ..... 2.95

7525 4K 512 EPROM ..... 8.00      8344 ..... 2.95

7525 4K 512 EPROM ..... 8.00      8345 ..... 2.95

7525 4K 512 EPROM ..... 8.00      8346 ..... 2.95

7525 4K 512 EPROM ..... 8.00      8347 ..... 2.95

7525 4K 512 EPROM ..... 8.00      8348 ..... 2.95

7525 4K 512 EPROM ..... 8.00      8349 ..... 2.95

7525 4K 512 EPROM ..... 8.00      8350 ..... 2.95

7525 4K 512 EPROM ..... 8.00      8351 ..... 2.95

7525 4K 512 EPROM ..... 8.00      8352 ..... 2.95

7525 4K 512 EPROM ..... 8.00      8353 ..... 2.95

7525 4K 512 EPROM ..... 8.00      8354 ..... 2.95

7525 4K 512 EPROM ..... 8.00      8355 ..... 2.95

7525 4K 512 EPROM ..... 8.00      8356 ..... 2.95

7525 4K 512 EPROM ..... 8.00      8357 ..... 2.95

7525 4K 512 EPROM ..... 8.00      8358 ..... 2.95

7525 4K 512 EPROM ..... 8.00      8359 ..... 2.95

7525 4K 512 EPROM ..... 8.00      8360 ..... 2.95

7525 4K 512 EPROM ..... 8.00      8361 ..... 2.95

7525 4K 512 EPROM ..... 8.00      8362 ..... 2.95

7525 4K 512 EPROM ..... 8.00      8363 ..... 2.95

7525 4K 512 EPROM ..... 8.00      8364 ..... 2.95

7525 4K 512 EPROM ..... 8.00      8365 ..... 2.95

7525 4K 512 EPROM ..... 8.00      8366 ..... 2.95

7525 4K 512 EPROM ..... 8.00      8367 ..... 2.95

7525 4K 512 EPROM ..... 8.00      8368 ..... 2.95

7525 4K 512 EPROM ..... 8.00      8369 ..... 2.95

7525 4K 512 EPROM ..... 8.00      8370 ..... 2.95

7525 4K 512 EPROM ..... 8.00      8371 ..... 2.95

7525 4K 512 EPROM ..... 8.00      8372 ..... 2.95

7525 4K 512 EPROM ..... 8.00      8373 ..... 2.95

7525 4K 512 EPROM ..... 8.00      8374 ..... 2.95

7525 4K 512 EPROM ..... 8.00      8375 ..... 2.95

7525 4K 512 EPROM ..... 8.00      8376 ..... 2.95

7525 4K 512 EPROM ..... 8.00      8377 ..... 2.95

7525 4K 512 EPROM ..... 8.00      8378 ..... 2.95

7525 4K 512 EPROM ..... 8.00      8379 ..... 2.95

7525 4K 512 EPROM ..... 8.00      8380 ..... 2.95

7525 4K 512 EPROM ..... 8.00      8381 ..... 2.95

7525 4K 512 EPROM ..... 8.00      8382 ..... 2.95

7525 4K 512 EPROM ..... 8.00      8383 ..... 2.95

7525 4K 512 EPROM ..... 8.00      8384 ..... 2.95

7525 4K 512 EPROM ..... 8.00      8385 ..... 2.95

7525 4K 512 EPROM ..... 8.00      8386 ..... 2.95

7525 4K 512 EPROM ..... 8.00      8387 ..... 2.95

7525 4K 512 EPROM ..... 8.00      8388 ..... 2.95

7525 4K 512 EPROM ..... 8.00      8389 ..... 2.95

7525 4K 512 EPROM ..... 8.00      8390 ..... 2.95

7525 4K 512 EPROM ..... 8.00      8391 ..... 2.95

7525 4K 512 EPROM ..... 8.00      8392 ..... 2.95

7525 4K 512 EPROM ..... 8.00      8393 ..... 2.95

7525 4K 512 EPROM ..... 8.00      8394 ..... 2.95

7525 4K 512 EPROM ..... 8.00      8395 ..... 2.95

7525 4K 512 EPROM ..... 8.00      8396 ..... 2.95

7525 4K 512 EPROM ..... 8.00      8397 ..... 2.95

7525 4K 512 EPROM ..... 8.00      8398 ..... 2.95

7525 4K 512 EPROM ..... 8.00      8399 ..... 2.95

7525 4K 512 EPROM ..... 8.00      8400 ..... 2.95

7525 4K 512 EPROM ..... 8.00      8401 ..... 2.95

7525 4K 512 EPROM ..... 8.00      8402 ..... 2.95

7525 4K 512 EPROM ..... 8.00      8403 ..... 2.95

7525 4K 512 EPROM ..... 8.00      8404 ..... 2.95

7525 4K 512 EPROM ..... 8.00      8405 ..... 2.95

7525 4K 512 EPROM ..... 8.00      8406 ..... 2.95

7525 4K 512 EPROM ..... 8.00      8407 ..... 2.95

7525 4K 512 EPROM ..... 8.00      8408 ..... 2.95

7525 4K 512 EPROM ..... 8.00      8409 ..... 2.95

7525 4K 512 EPROM ..... 8.00      8410 ..... 2.95

7525 4K 512 EPROM ..... 8.00      8411 ..... 2.95

7525 4K 512 EPROM ..... 8.00      8412 ..... 2.95

7525 4K 512 EPROM ..... 8.00      8413 ..... 2.95

7525 4K 512 EPROM ..... 8.00      8414 ..... 2.95

7525 4K 512 EPROM ..... 8.00      8415 ..... 2.95

7525 4K 512 EPROM ..... 8.00      8416 ..... 2.95

7525 4K 512 EPROM ..... 8.00      8417 ..... 2.95

7525 4K 512 EPROM ..... 8.00      8418 ..... 2.95

7525 4K 512 EPROM ..... 8.00      8419 ..... 2.95

7525 4K 512 EPROM ..... 8.00      8420 ..... 2.95

7525 4K 512 EPROM ..... 8.00      8421 ..... 2.95

7525 4K 512 EPROM ..... 8.00      8422 ..... 2.95

7525 4K 512 EPROM ..... 8.00      8423 ..... 2.95

7525 4K 512 EPROM ..... 8.00      8424 ..... 2.95

7525 4K 512 EPROM ..... 8.00      8425 ..... 2.95

7525 4K 512 EPROM ..... 8.00      8426 ..... 2.95

7525 4K 512 EPROM ..... 8.00      8427 ..... 2.95

7525 4K 512 EPROM ..... 8.00      8428 ..... 2.95

7525 4K 512 EPROM ..... 8.00      8429 ..... 2.95

7525 4K 512 EPROM ..... 8.00      8430 ..... 2.95

7525 4K 512 EPROM ..... 8.00      8431 ..... 2.95

7525 4K 512 EPROM ..... 8.00      8432 ..... 2.95

7525 4K 512 EPROM ..... 8.00      8433 ..... 2.95

7525 4K 512 EPROM ..... 8.00      8434 ..... 2.95

7525 4K 512 EPROM ..... 8.00      8435 ..... 2.95

7525 4K 512 EPROM ..... 8.00      8436 ..... 2.95

7525 4K 512 EPROM ..... 8.00      8437 ..... 2.95

7525 4K 512 EPROM ..... 8.00      8438 ..... 2.95

7525 4K 512 EPROM ..... 8.00      8439 ..... 2.95

7525 4K 512 EPROM ..... 8.00      8440 ..... 2.95

7525 4K 512 EPROM ..... 8.00      8441 ..... 2.95

7525 4K 512 EPROM ..... 8.00      8442 ..... 2.95

7525 4K 512 EPROM ..... 8.00      8443 ..... 2.95

7525 4K 512 EPROM ..... 8.00      8444 ..... 2.95

7525 4K 512 EPROM ..... 8.00      8445 ..... 2.95

7525 4K 512 EPROM ..... 8.00      8446 ..... 2.95

7525 4K 512 EPROM ..... 8.00      8447 ..... 2.95

7525 4K 512 EPROM ..... 8.00      8448 ..... 2.95

7525 4K 512 EPROM ..... 8.00      8449 ..... 2.95

7525 4K 512 EPROM ..... 8.00      8450 ..... 2.95

7525 4K 512 EPROM ..... 8.00      8451 ..... 2.95

7525 4K 512 EPROM ..... 8.00      8452 ..... 2.95

7525 4K 512 EPROM ..... 8.00      8453 ..... 2.95

7525 4K 512 EPROM ..... 8.00      8454 ..... 2.95

7525 4K 512 EPROM ..... 8.00      8455 ..... 2.95

7525 4K 512 EPROM ..... 8.00      8456 ..... 2.95

7525 4K 512 EPROM ..... 8.00      8457 ..... 2.95

7525 4K 512 EPROM ..... 8.00      8458 ..... 2.95

7525 4K 512 EPROM ..... 8.00      8459 ..... 2.95

7525 4K 512 EPROM ..... 8.00      8460 ..... 2.95

7525 4K 512 EPROM ..... 8.00      8461 ..... 2.95

7525 4K 512 EPROM ..... 8.00      8462 ..... 2.95

7525 4K 512 EPROM ..... 8.00      8463 ..... 2.95

7525 4K 512 EPROM ..... 8.00      8464 ..... 2.95

7525 4K 512 EPROM ..... 8.00      8465 ..... 2.95

7525 4K 512 EPROM ..... 8.00      8466 ..... 2.95

7525 4K 512 EPROM ..... 8.00      8467 ..... 2.95

7525 4K 512 EPROM ..... 8.00      8468 ..... 2.95

7525 4K 512 EPROM ..... 8.00      8469 ..... 2.95

7525 4K 512 EPROM ..... 8.00      8470 ..... 2.95

7525 4K 512 EPROM ..... 8.00      8471 ..... 2.95

7525 4K 512 EPROM ..... 8.00      8472 ..... 2.95

7525 4K 512 EPROM ..... 8.00      8473 ..... 2.95

7525 4K 512 EPROM ..... 8.00      8474 ..... 2.95

7525 4K 512 EPROM ..... 8.00      8475 ..... 2.95

7525 4K 512 EPROM ..... 8.00      8476 ..... 2.95

7525 4K 512 EPROM ..... 8.00      8477 ..... 2.95

7525 4K 512 EPROM ..... 8.00      8478 ..... 2.

## TRS-80 SERIAL I/O

- Can input into basic
- Can use LIST and LPRINT to output, or output continuously
- RS-232 compatible
- Can be used with or without the expansion bus
- On board switch selectable baud rates of 110, 150, 300, 600, 1200, 2400, parity or no parity odd or even, 5 to 8 data bits, and 1 or 2 stop bits. D.T.R. line
- Requires +5, -12 VDC
- Board only \$19.95 Part No. 8010, with parts \$59.95 Part No. 8010A, assembled \$79.95 Part No. 8010 C No connectors provided, see below.



EIA/RS-232C connector Part No. D825P \$6.00 with 9' B conductor cable \$10.95 Part No. D825P9

3' ribbon cable with attached connectors to fit TRS-80 and our serial board \$19.95 Part No. 3CAB40

## COMPUCRUISE

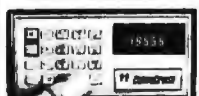

\$129.95, with cruise control \$169.95

## PAPER TIGER

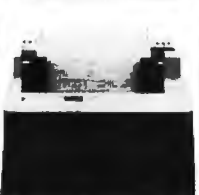

Prints address labels, multicopy invoices and legal-size reports. Adjust the tractor width from 1-3/4 to 9-1/2 inches. 8 switch-selectable forms lengths. Print 6 or 8 lines per inch. Add the software-selectable full dot plotting graphics option to print illustrations, block letters, charts, graphs. Part No. 162172 \$899.95 with graphics option Part No. 162173 \$1099.95

## GAME PADDLES & SOUND



Includes: 2 game paddles, interface, software, speaker, power supply, full documentation including: schematics, theory of operation, and user guide, plus 2 games on cassette (Pong and Starship War). \$79.95 Complete Part No. 7922C

## DIGICOM DATA PRODUCTS INC. Series 312 Acoustic Coupler



300 BAUD Originate, Part No. AC3122, \$219.95. 300 BAUD Answer, Part No. AC3122, \$219.95. 300 BAUD Answer/Originate, Part No. AC3123, \$229.95.

## IBEX LIGHT PEN

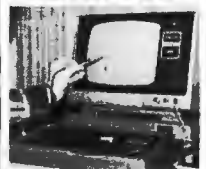

Comes with Backgammon and Tic-Tac-Toe on tape with full documentation and program listing. Requires 9v battery. Part No. IBEX \$19.95

## SYSTEM EXPANSION from LNW Research

- Serial RS232C/20 mA I/O
- Floppy controller
- 32K bytes memory
- Parallel printer port
- Dual cassette port
- Real-time clock
- Screen printer bus
- Onboard power supply
- Software compatible
- Solder mask, silk screen. PC board and user manual, Part No. LNW80, \$69.95.

## DISKETTES



Verbatim  
Box of 10, 5" \$29.95, 8" \$39.95.  
Plastic box, holds 10 diskettes, 5" - \$4.50, 8" - \$6.50.

## 16K RAMS

For the Apple, TRS-80 or Pet \$8 each Part No. 4116/2117.

## LEEDEX MONITOR



12" Black and White • 12 MHz Bandwidth • Handsome Plastic Case • \$139.00

## S-100 INTERFACE

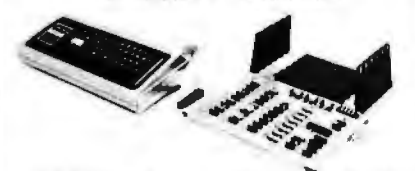

AN S-100 bus Adapter—Motherboard for the TRS-80. Kit, Part No. HUH81 DLXK, \$295.95. Assembled, Part No. HUH81 DLXA, \$375.95.

## NOW! A FULL SUPPORT SYSTEM FOR TRS-80

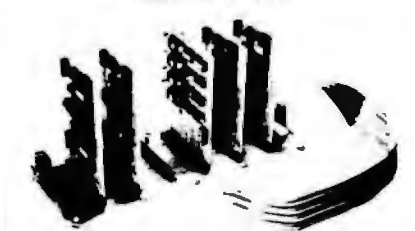

- 32K of RAM
- EPROM firmware
- Disk control
- Data acquisition
- Parallel I/O
- Serial I/O
- Plug into GPA's Motherboard.

GPA's quality design includes 6-44 pin edge connectors • +5V, -5V, +12V, -12V external power supply required • Active termination. The Motherboard, Part No. GPA80, is only \$149.95.

## TAKE ADVANTAGE OF GPA-EXPANSION CARDS FOR THE GPA80

**Memory cards:** Now with Fortran compilers available for your TRS-80, additional expansion memory is a must! Card with sockets only, Part No. GPA801, \$119.95. Card with 16K of 4116 Dynamic Ram, Part No. GPA802, \$224.95. Card with 32K of 4116 Dynamic Ram, Part No. GPA803, \$329.95. All cards come equipped with sockets to accommodate 32K of Ram.

**EPROM firmware card.** Put those valuable subroutines in firmware. Don't waste time loading and unloading tapes and disks. For 2708 or 2716 EPROMS, Part No. GPA806, \$79.95.

**Serial I/O card.** Here's what you've been asking for, a full serial terminal interface, with RS-232C or 20 mA. Current loop. Input/output capabilities. Part No. GPA807, \$79.95.

**Parallel I/O Card.** Control functions in the outside world, monitor and store real time events. Two parallel output ports. Dip switches select ports (0-254). Part No. GPA808, \$79.95.

## FLOPPY DISK STORAGE BINDERS



Three ring binder comes with ten transparent plastic sleeves which accommodate either twenty, five-inch or ten, eight-inch floppy disks. Binder & 10 holders, Part No. 8108—\$9.95 • Extra holders, Part No. 810—69¢ each.

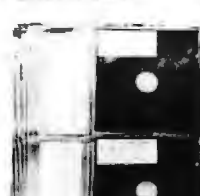

Three-ring binder with ten 5 1/4 inch jackets Part No. 510B—\$9.95 • Jackets only, fits standard 3-ring binders, Part No. 510—69¢ each.

## DIGITAL CASSETTE



5 min. each side. Box of 10 \$9.95. Part No. C-5.

## TRENDCOM PRINTER



TRENDCOM 200, Part No. TRC0200 \$495.95. **Interface** for TRS-80, Part No. T80A \$49.95. For Apple II, Part No. TRCALL, \$75.95. For PET, NO. TRCP2, \$79.95. For Scoocerer, TRCSR1 \$45.95.

## SARGON: A Computer Chess Program

Features the complete program that won the 1978 West Coast Computer Faire Tournament. Part No. 00803 — TRS-80 Level II; Part No. 00804 — Apple II (24K). \$19.95

## SPINWRITER MODELS 5510 and 5520

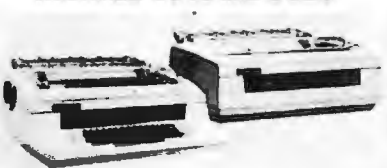

Features—EIA RS-232C/CCITT V24 Interface Standard • 55 Characters Per Second Maximum Print Rate • Impeccable Print Quality (OCR Quality) • Microprocessor Electronics • High Resolution Plotting/Graphing • Lowest Operating Noise Level • Self-Test Printing • Operator Engineered Control Panel • Prints Original and up to Seven Copies • NEC Information Systems new Model 5510 Receive Only and Model 5520 Keyboard Send/Receive SPINWRITER terminals are microprocessor controlled serial, impact terminals designed for remote printing applications where impeccable print quality is required. Model 5510 R, Part No. NECA30759 \$2795.95 • Model 5520 KSR, Part No. NECA30762 \$3095.95

Send for FREE Catalog...a big self addressed envelope with 80¢ postage gets it fastest!

## To Order:

Mention part no., description, and price. In USA shipping paid by us for orders accompanied by check or money order. We accept C.D.D. orders (U.S. only) or a VISA or Master Charge no., expiration date, signature and phone no., shipping charges will be added. CA residents add 6.5% for tax. Outside USA add 15% for air mail postage and handling. Payment must be in U.S. dollars. Dealer inquiries invited. Prices subject to change without notice.



Order Line: (408) 448-0800

# ELECTRONIC SYSTEMS

Dept. B, P.O. Box 21638, San Jose, CA USA 95151

### HEX ENCODED KEYBOARD

Four onboard LEDs indicate the HEX code generated for each key depression. The board requires a single +5 volt supply. Board only \$15.00 Part No. HEX-3, with parts \$49.95 Part No. HEX-3A. 44 pin edge connector \$4.00 Part No. 44P.

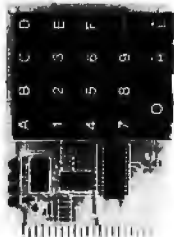

### ASCII TO CORRESPONDENCE CODE CONVERTER

This bidirectional board is a direct replacement for the board inside the Trendata 1000 terminal. The on board connector provides RS-232 serial in and out. Sold only as an assembled and tested unit for \$249.95. Part No. TA 1000C

### ASCII KEYBOARD

59 Keys popular ASR-33 format • Rugged G-10 P.C. Board • Tri-mode MOS encoding • Two-Key Rollover • MOS/DTL/TTL Compatible • Upper Case lockout • Data and Strobe inversion option • Three User Definable Keys • Low contact bounce • Selectable Parity • Custom Keycaps • George Risk Model 753. Requires +5, -12 volts. \$59.95 Kit.

### ASCII KEYBOARD

TTL & DTL compatible • Full 87 key array • Full 128 character ASCII output • Positive logic with outputs resting low • Data Strobe • Five user-definable spare keys • Standard 22 pin dual card edge connector • Requires +5VDC, 325 mA. Assembled & Tested. Cherry Pro Part No. P70-05AB. \$119.95.



### A-to-D D-to-A CONVERTER

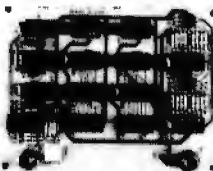

Analog to Digital, Digital to Analog Converter, A-D conversion time 20us. D-A conversion 5us. Uses include speech and music synthesizing and slow scan TV. Single power supply (5V), 8 Bits wide, latched I/O, strobe lines. Part No. 79287K Complete Kit \$49.95 • Part No. 79287A Assembled \$69.95

single power supply (5V), 8 Bits wide, latched I/O, strobe lines. Part No. 79287K Complete Kit \$49.95 • Part No. 79287A Assembled \$69.95

### SOLID STATE SWITCH



Your computer can control power (120VAC) to your printer, lights, and other 120VAC appliances up to 720 watts (6AMPS at 120VAC). Input 9 to 15 VDC, 2-13 MA TTL compatible, isolation 1500V. Part No. 79000K 1 Channel Kit \$9.95 • Assm. \$12.50 • Part No. 79004K 4 Channel Kit \$34.95 • Assm. \$44.95.

### SUPER MODEM



Originate, RS-232 and 20 mA compatible, Full duplex, and half duplex, direct connect or acoustic coupled, on board power supply, carrier detect light, DB25 plug, 300 BAUD, Type 103 compatible frequencies, Bare board Part No. 2000, \$19.95, Kit Part No. 2000A, \$99.95.

### T.V. INTERFACE



• Converts video to AM modulated RF, Channels 2 or 3. So powerful almost no tuning is required. On board regulated power supply makes this extremely stable. Rated very highly in Doctor Dobbs' Journal. Recommended by Apple • Power required is 12 volts AC C.T., or +5 volts DC • Board only \$7.60 part No. 107, with parts \$13.50 Part No. 107A

### TAPE INTERFACE



• Converts a low cost tape recorder to a digital recorder • Works up to 1200 baud • Digital in and out are TTL-serial • Output of board connects to mic, in of recorder • Earphone of recorder connects to input on board • No coils • Requires +5 volts, low power drain • Board only \$7.60 Part No. 111, with parts \$29.95 Part No. 111A

### T.V. TYPEWRITER



• Stand alone TVT • 32 char./line, 16 lines, modifications for 64 char./line included • Parallel ASCII (TTU) input • Video output • 1K on board memory • Output for computer controlled cursor • Auto scroll • Non-destructive cursor • Cursor inputs: up, down, left, right, home, EDL, EOS • Scroll up, down • Requires +5 volts at 1.5 amps, and -12 volts at 30 mA • All 7400, TTL chips • Char. gen. 2513 • Upper case only • Board only \$39.00 Part No. 106, with parts \$145.00 Part No. 106A

### UART & BAUD RATE GENERATOR



• Converts serial to parallel and parallel to serial • Low cost on board baud rate generator • Baud rates: 110, 150, 300, 600, 1200, and 2400 • Low power drain +5 volts and -12 volts required • TTL compatible • All characters contain a start bit, 5 to 8 data bits, 1 or 2 stop bits, and either odd or even parity. • All connections go to a 44 pin gold plated edge connector • Board only \$12.00 Part No. 101, with parts \$35.00 Part No. 101A, 44 pin edge connector \$4.00 Part No. 44P

### 44 BUS MOTHER BOARD



Has provisions for ten 44 pin (.156) connectors, spaced 3/4 of an inch apart. Pin 20 is connected to X, and 22 is connected to Z for power and ground. All the other pins are connected in parallel. This board also has provisions for bypass capacitors. Board cost \$15.00 Part No. 102. Connectors \$3.00 each Part No. 44WP.

### RS-232/20mA INTERFACE



This board has two passive, opto-isolated circuits. One converts RS-232 to 20mA, the other converts 20mA to RS-232. All connections go to a 10 pin edge connector. Requires +12 and -12 volts. Board only \$9.95, part no. 7901, with parts \$14.95 Part No. 7901A.

### SOROC IQ 120



Upper/lower case display • Numeric keypad & cursor keys • Protected fields, 1/2 intensity display • RS 232 interface & aux. port. IQ120—\$799.95 • IQ140 Detachable keyboard—\$1199.95

### MODEM



• Type 103 • Full or half duplex • Works up to 300 baud • Originate or Answer • Serial TTL input and output • connect 8 Ω speaker and crystal mic. directly to board • Requires +5 volts • Board only \$7.60 Part No. 109, with parts \$29.95 Part No. 109A.

### RS-32/TTL INTERFACE

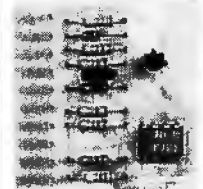

• Converts TTL to RS-232, and converts RS-232 to TTL • Two separate circuits • Requires -12 and +12 volts • All connections go to a 10 pin edge connector, kit \$9.95 Part No. 232A 10 Pin edge connector \$3.00 part No. 10P.

### COMPUCOLOR II



With reg. keyboard MOD3 8K \$1449.95 MOD4 16 K \$1495.95 MOD5 32K \$1699.95 Without disk drive subtract \$450.00. Add-on drives, \$495.00. With 101 key option add \$134.95. With 117 key option add \$179.95.

### DC POWER SUPPLY

• Board supplies a regulated +5 volts at 3 amps., +12, -12, and -5 volts at 1 amp. • Power required is 8 volts AC at 3 amps., and 24 volts AC C.T. at 1.5 amps. • Board only \$12.50 Part No. 6085, with parts excluding transformers \$42.50 Part No. 6085A



Send for FREE Catalog... a big self addressed envelope with 80¢ postage gets it fastest!

### To Order:

Mention part no., description, and price. In USA shipping paid by us for orders accompanied by check or money order. We accept C.O.D. orders (U.S. only) or a VISA or Master Charge no., expiration date, signature and phone no., shipping charges will be added. CA residents add 6.5% for tax. Outside USA add 15% for air mail postage and handling. Payment must be in U.S. dollars. Dealer inquiries invited. Prices subject to change without notice.



Order Line: (408) 448-0800

**ELECTRONIC SYSTEMS** Dept. B, P.O. Box 21638, San Jose, CA USA 95151



### Apple II Or APPLE II PLUS



16K \$975.95, Extra 16K E.S. RAM installed \$74.95, extra 32K E.S. RAM installed \$148.95.

### APPLE II HOBBY/ PROTOTYPING CARD

Part No. 7907 \$14.95

### APPLE II PARALLEL INTERFACE

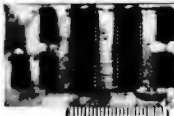

Interfaces printers, synthesizers keyboards, and JBE A-D-D-A Converter & Switches. This interface has 4 I/O ports with handshaking logic, 2-6522 VIA's and a 74LS74 for timing. Inputs and outputs are TTL compatible. Part No. 79295K Complete Kit—\$69.95 • Part No. 79295A Assembled—\$79.95

### REAL TIME 100,000 DAY CLOCK

MT. HARDWARE Double the utility of your S-100 bus computer with a real-time clock that keeps time in 100µs increments for over 273 years. Program events for the entire period with real time interrupts...without derailing the system. Maintain a log of computer usage, time and date transaction printouts, calluplists. On-board battery backup. MHPX004—\$349.00

### 16K EPROM



Uses 2708 EPROMS, memory speed selection provided, addressable anywhere in 65K of memory, can be shadowed in 4K increments. Board only \$24.95 part no. 7902, with parts less EPROMs \$49.95 part no. 7902A.

### PET COMPUTER



With 16K & monitor—\$895.00 • Dual Disk Drive—\$1095.00

### OPTO-ISOLATED PARALLEL INPUT BOARD FOR APPLE II

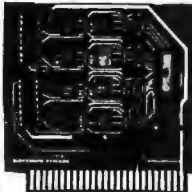

There are 8 inputs that can be driven from TTL logic or any 5 volt source. The circuit board can be plugged into any of the 8 sockets of your Apple II. It has a 16 pin socket for standard dip ribbon cable connection. Board only \$15.00. Part No. 120, with parts \$69.95. Part No. 120A.

### VIDEO TERMINAL

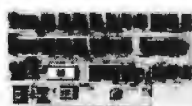

16 lines, 64 columns • Upper and lower case • 5x7 dot matrix • Serial RS-232 in and out with TTL parallel keyboard input • On board baud rate generator 75, 110, 150, 300, 600, & 1200 jumper selectable • Memory 1024 characters (7-21L02) • Video processor chip SFF96364 by Neculonic • Control characters (CR, LF, →, ←, ↑, ↓, non destructive cursor, CS, home, CL • White characters on black background or vice-versa • With the addition of a keyboard, video monitor or TV set with TV interface (part no. 107A) and power supply this is a complete stand alone terminal • also S-100 compatible • requires +16, & -16 VDC at 100mA, and BVDC at 1A. Part No. 1000A \$199.95 kit.

### PARALLEL TRIAC OUTPUT BOARD FOR APPLE II



This board has 8 triacs capable of switching 110 volt 6 amp loads (660 watts per channel) or a total of 5280 watts. Board only \$15.00 Part No. 210, with parts \$119.95 Part No. 210A

### APPLE II\* SERIAL I/O INTERFACE

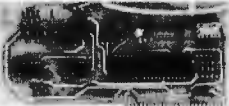

Baud rate is continuously adjustable from 0 to 30,000 • Plugs into any peripheral connector • Low current drain, RS-232 input and output • On board switch selectable 5 to 8 data bits, 1 or 2 stop bits, and parity or no parity either odd or even • Jumper selectable address • SOFTWARE • Input and Output routine from monitor or BASIC to teletype or other serial printer • Program for using an Apple II for a video or an intelligent terminal. Also can output in correspondence code to interface with some selectrics. • Also watches DTR • Board only \$15.00 Part No. 2, with parts \$42.00 Part No. 2A, assembled \$62.00 Part No. 2C

### 8K EPROM PIGEON

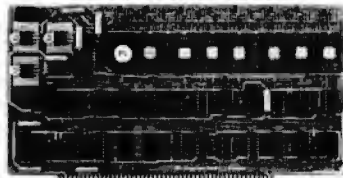

• Programs 2708's address relocation of each 4K of memory to any 4K boundary • Power on jump and reset jump option for "turnkey" systems and computers without a front panel • Program saver software in 1 2708 EPROM \$25. Bare board \$35 including custom coil, board with parts but no EPROMS \$139, with 4 EPROMS \$179, with 8 EPROMS \$219.

### WAMECO PRODUCTS

With ELECTRONIC SYSTEMS parts

- FDC-1** FLOPPY CONTROLLER BOARD will drive shugart, pertek, remax 5" & 8" drives up to 8 drives, on board PROM with power boot up, will operate with CPM (not included). PCB \$42.95
- FPB-1** Front Panel. (Finally) IMSAI size hex displays. Byte or instruction single step. PCB \$42.95
- MEM-1A** 8Kx8 fully buffered, S-100, uses 2102 type RAMS. PCB \$24.95, \$168 Kit
- GMB-12** MOTHER BOARD, 13 slot, terminated, S-100 board only \$34.95
- CPU-1** 8080A Processor board S-100 with 8 level vector interrupt PCB \$25.95
- RTC-1** Realtime clock board. Two independent interrupts. Software programmable. PCB \$89.95 Kit
- EPM-2** 2708/2716 16K/32K EPROM card PCB \$24.95
- GMB-9** MOTHER BOARD. Short Version of GMB-12. 9 Slots PCB \$30.95
- MEM-2** 16Kx8 Fully Buffered 2114 Board PCB \$67.95 Kit
- MEM-3** 16Kx8 Fully Buffered 2114 Board PCB \$25.95, \$269.95 Kit

YOU MUST REFER TO THIS AD TO GET THESE PRICES.

### D.C. HAYES MICROMODEM

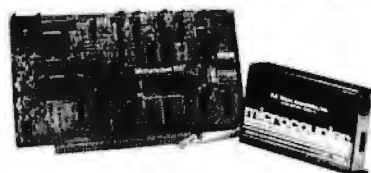

Fully S-100 bus compatible including 16-bit machines and 4 MHz processors. • Two software selectable Baud rates—300 Baud and a jumper selectable speed from 45 to 300 Baud. (110 standard). Supports originate and answer modes. • Direct-connect Microcoupler. This FCC-registered device provides direct access into your local telephone system, with none of the losses or distortions associated with acoustic couplers and without a telephone company supplied data access arrangement. • Auto-Answer/Auto-Call. The MICROMODEM 100 can automatically answer the phone and receive input; it can also dial a number automatically. • Automatic Reset and Disconnect. • Software compatible with the D.C. Hayes Associates 80-103A Data Communications Adapter. Micromodem-DCHA32625—\$379.95

### TIDMA



Tape Interface Direct Memory Access • Record and play programs without bootstrap loader (no prom) has FSK encoder/decoder for direct connections to low cost recorder at 1200 baud rate, and direct connections for inputs and outputs to a digital recorder at any baud rate • S-100 bus compatible • Board only \$35.00 Part No. 112, with parts \$11000 Part No. 112A.

### SYSTEM MONITOR

8080, 8085, or Z-80 System monitor for use with the TIDMA board. There is no need for the front panel. Complete with documentation \$12.95.

### RS-232/TTY INTERFACE



This board has two active circuits, one converts RS-232 to 20 mA, the other converts 20 mA to RS-232. Requires +12 and -12 volts. \$9.95 Part No. 600A Kit.

### SERIAL I/O



Four Serial I/O RS-232 ports. S-100 Bus. Software or jumper selectable baud rate (110, 300, 600, 1200, 2400, 4800, 9600, 19.2K), on board Xtal baud rate generator. Addressing, switch selectable. Parity or no parity (odd or even) switch selectable, 1 or 2 stop bits, 5 to 8 bits/character. Board only \$29.95. Part No. 7908. With parts (kit) \$199.95. Part No. 7908A.

### S-100 BUS ACTIVE TERMINATOR



Board only \$14.95 Part No. 900, with parts \$24.95 Part No. 900A

Send for FREE Catalog...a big self addressed envelope with 80¢ postage gets it fastest!

### To Order:

Mention part no., description, and price. In USA shipping paid by us for orders accompanied by check or money order. We accept C.O.D. orders (U.S. only) or a VISA or Master Charge no., expiration date, signature and phone no., shipping charges will be added. CA residents add 6.5% for tax. Outside USA add 15% for air mail postage and handling. Payment must be in U.S. dollars. Dealer inquiries invited. Prices subject to change without notice.

Order Line: (408) 448-0800

# ELECTRONIC SYSTEMS

Dept. B, P.O. Box 21638, San Jose, CA USA 95151



**COMPUTER SYSTEMS INC.**

15335 South Hawthorne Boulevard  
Lawndale, California 90260  
(213) 970-0952

QUICK & TIMELY

# Look to QT for the **BIG +**

## TELEVIDEO SMART (CRT) TERMINAL

- Reverse Video • Blinking/blank fields
- Upper/lower case character • Protected fields
- Non-glare screen • Underlining • 12 x 10 character resolution • Single stroke editing keys • Function keys • Blinking cursor • TTY keyboard • Numeric pad • 9 Baud rates (75-9600 Baud) • Self-test
- Printer port

812B .....	\$750.00
920B .....	\$850.00
920C .....	\$900.00

OPTION:  
2nd Page Memory ..... \$ 24.95  
Freight Charge ..... \$ 15.00  
Nationwide Field Service available from General Electric Instrumentation and Communication Equipment Service Shops.

## APPLE PRODUCTS

MICRO-MODEM II .....	\$350.00
SORRENTO CONTROLLER for 8" Apple Disk Drive .....	\$360.00
INTROL X-10 SYSTEM (turns appliances on/off) .....	\$275.00
MICRO-MUSIC (Software) .....	\$180.00
AIO/Serial-Parallel Board A&T SSM .....	\$155.00
INTEGER Firmware Card .....	\$178.00
PARALLEL INTERFACE CARD .....	\$ 90.00
VISICALC (Business Software Package) .....	\$124.95
SUPER-MOD II (connects Apple to TV) ...	\$ 29.00
ROM WRITER (Epromburner) Mountain Hardware .....	\$175.00
PROGRAMMER AID #1 .....	\$ 50.00
APPLE CLOCK .....	\$280.00
SANYO 15" MONITOR .....	\$295.00

## SWITCHABLE 2 or 4 MHz

## THE QT Z+80 REV 1

Z-80A CPU with Serial I/O Port  
This CPU can accommodate a 2708, 2716, or 2732 EPROM in SHADOW mode, allowing you to use a full 64K of RAM. The MWRITE signal is generated automatically if you use the board without a front panel. There's also an independent on-board USART to control the RS232 serial port at baud rates from 110 to 9600.

CPU-Z+80K (KIT) .....	\$132.00
CPU-Z+80AT (A&T) .....	\$189.00
CPU-Z+80BB (BARE BOARD) .....	\$ 33.00

## VERBATIM & MEMOREX

Part No.	Sectoring	Pkg. of 2	Box of 10
QTMO 525 01	Soft Sector	\$ 8.95	\$29.95
QTMO 525 10	Hard 10 Sector	\$ 8.95	\$29.95
QTMO 525 16	Hard 16 Sector	\$ 8.95	\$29.95
OTFO32 1000	Hard Sector	\$11.95	\$34.95
OTFO34 1000	Soft Sector	\$11.95	\$34.95

## KASSETTE/10 LIBRARY

Part No.			
CAS-10-8	Grey	8" Diskette Holder	\$4.50
	Black		..... or 3/\$10.00
	Blue		
	Beige		
CAS-10-5	Grey	5" Diskette Holder	\$4.25
	Black		..... or 3/\$10.00
	Blue		
	Beige		

## SPECIAL PACKAGE PRICE

1 Male DB-25, 1 Female DB-25, 1 Cover  
RS-232 SET ..... \$6.50

## APPLE SERIAL/PARALLEL INTERFACE

AI/O Kit .....	\$125.00
AI/O A&T .....	\$165.00

## 16 X 64 VIDEO BD

BY ITHACA AUDIO  
ASSEMBLED & TESTED

- Full upper/lower case ASCII character set, numbers, symbols and Greek letters
- 7 x 9 Dot matrix in 8 x 10 field
- Selectable display modes, normal & reverse video, blinking characters
- Memory addressable to any 1K page
- Software driver simulates TTY, provides full cursor control, scrolling & paging

A&T PRICE ONLY ..... \$139.95

## IN STOCK

All our advertised items are in stock and available for immediate delivery!

## DON SMITH

Don brings to QT the same high level of personal service which he offered as sole owner of Jade Computer before he left in February of 1979.

## DISK DRIVE SYSTEMS S-100

MS-800-1 (Drive with case, cables & power supply) .....	\$1095.00
MS-800-2 (2 Drives with case, cables & power supply) .....	\$1595.00

## 5 1/4" DISK DRIVES

MPI B-51 .....	\$295.00
SHUGART SA400 .....	\$295.00

## 8" DISK DRIVES

SHUGART 8" 801R .....	\$450.00
REMAX RFD 4000 .....	\$635.00

## TEXTPOOL

## ZIP\* DIP II SOCKETS

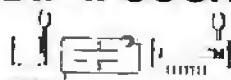

16 PIN ZIP* DIP II .....	\$ 5.50
24 PIN ZIP* DIP II .....	\$ 7.50
40 PIN ZIP* DIP II .....	\$10.25

\*ZERO INSERTION PRESSURE

## QT MEMORY EXPANSION KITS FOR TRS-80 • APPLE • EXIDY

4116 200 ns

8 for \$49.50

2716 (5V - 450 ns)

\$18.00

2716 (5 & 12V-450 ns)

\$14.00

## PAPER TIGER

- 132/80 Columns; 6 or 8 lines per inch
- 1.75"-9.5" Adjustable Tractor and Friction Feed
- Parallel and Serial Interface
- 98 Character ASCII Set
- 8 Software Selectable Character Sizes
- 110, 300, 600 or 1200 Baud

## QT PRICES

PT-132 .....	\$ 950.00
PT-132G (Graphics & 2K Buffer) .....	\$1050.00

## STATIC RAM BOARDS

SR-8K BARE BD (Ithaca Audio) 21L02 ...	\$ 19.00
SR-16K BARE BD (Problem Solvers) 2114 ..	\$ 19.00
SR-16K A&T (Cal. Comp Sys) 2114L 4MHz .....	\$269.95
SR-32K KIT (Uses 2114L) 4MHz .....	\$475.00
SR-32K A&T (Uses 2114L) 4MHz .....	\$500.00

## PARTS

MICROPROCESSORS	EPROMS
Z80 (2 MHz) .....	1702A .....
Z80A (4 MHz) .....	2708 .....
8502 .....	2516 .....
8800 .....	2758 .....
8802 .....	2532 .....
8035 .....	2732 .....
8080A .....	
8085A .....	
8088-4 .....	
8748-8 .....	
8080A SUPPORT	USBT
8212 .....	82350 .....
8214 .....	
8216 .....	
8224 .....	
8228 .....	
8238 .....	
8243 .....	
8251 .....	
8253 .....	
8253-5 .....	
8255 .....	
8257 .....	
8257-5 .....	
8259 .....	
8275 .....	
8278 .....	
8279-5 .....	
8295 .....	
MISCELLANEOUS OTHER COMPONENTS	STATIC RAMS
N8T20 .....	2114L (450 ns) .....
N8T28 .....	2513 (Lower case) .....
N8T97 .....	2114L (300 ns) .....
N8T98 .....	2513 (Upper 5 v) .....
1488 .....	2513 Lower (5 v) .....
1489 .....	
D3205 .....	
D3242 .....	
D3245 .....	
P3404 .....	
TMS5501 .....	
DM8131 .....	
CRT CONTROLLER	UARTS
MC8845P .....	TR1802B .....
KEYBOARD CHIPS	CHARACTER GENERATORS
AY5-2378 .....	2513 (Upper case) .....
AY5-3600 .....	2513 (Lower case) .....
	2513 Upper (5 v) .....
BAUD RATE GENERATORS	2513 Lower (5 v) .....
MC14411 .....	
1.8432 XTAL .....	
BR1841L .....	
DISC CONTROLLER	
1771B01 .....	
1791B01 .....	

## EXPANDORAM I

EXPANDABLE TO 64K USING 4116 RAMS

Interfaces with most popular S-100 boards  
Bank selectable; PHANTOM provision  
Draws only 5 watts fully populated  
Designed to work with Z-80, 8080, and 8085 systems  
No wait states required  
16K boundaries & protect via dip switches  
Kits come with sockets for full 64K  
Invisible refresh

MEM-16K (16K KIT) .....	\$199.00
MEM-16AT (16K A&T) .....	\$269.00
MEM-32K (32K KIT) .....	\$260.00
MEM-32AT (32K A&T) .....	\$329.00
MEM-48K (48K KIT) .....	\$315.00
MEM-48AT (48K A&T) .....	\$379.00
MEM-64K (64K KIT) .....	\$370.00
MEM-64AT (64K A&T) .....	\$439.00

## EXPANDORAM II

THE RANDOM ACCESS MEMORY

S-100 Bus Compatible  
Up to 4Mhz Operation  
Expandable Memory from 16K to 256K  
Dip Switch Selectable Boundaries  
Uses 16K (4116) or 64K (4164) Memory Devices  
Page Mode Operation Allows up to 8 Memory Boards on Bus

Operates with Z80 CPU's  
Phantom Output Disable  
Invisible Refresh (Synchronized with Wait States)

MEMII-16K (KIT) .....	\$250.00
MEMII-16AT (A&T) .....	\$300.00
MEMII-32K (KIT) .....	\$325.00
MEMII-32AT (A&T) .....	\$375.00
MEMII-48K (KIT) .....	\$395.00
MEMII-48AT (A&T) .....	\$475.00
MEMII-64K (KIT) .....	\$475.00
MEMII-64AT (A&T) .....	\$539.00

**QT LOW PRICES!**

## Z-80 STARTER KIT

COMPLETE Z-80 MICROCOMPUTER

On-board keyboard, display, EPROM programmer, and cassette interface  
On-board S-100 Interface  
Wire-wrap area and room for 2 S-100 connectors  
Two 8-bit parallel I/O ports, 4-channel CTC, 5 programmable breakpoints

Examine and change memory, I/O ports, or register

Z-80K (KIT) .....	\$310.00
Z-80AT (A&T) .....	\$369.95

## SD SYSTEMS

### VERSAFLOPPY I

SINGLE DENSITY DISK DRIVE CONTROLLER

S-100 Bus Compatible  
IBM 3740 Compatible Soft-Sector Format  
Operates with both Standard (8") and Mini (5 1/4") Drive  
Provides Control for Single or Double-Sided Operation  
Controls up to Four Drives Simultaneously  
Operates with SDOS or CP/M Disk Operation System  
Operates with Z80, 8080, and 8085 Central Processing Units  
Utilizes FD 1771B-1 Controller Device  
Control and Diagnostic Software Available in PROM  
Interrupt Operation Optional

VF-1K (KIT) .....	\$235.00
VF-1AT (A&T) .....	\$295.00

### VERSAFLOPPY II

DOUBLE DENSITY DISK CONTROLLER

Single or double density floppy disk controller  
985600 bytes on 8" double sided diskettes  
259840 bytes on double sided 5 1/4" diskettes  
S-100 bus (IEEE) standard compatible  
IBM 3740 format in single density  
8" and 5 1/4" drives controlled simultaneously  
Operates with Z-80, 8080, and 8085 CPU's  
Controls up to 4 drives  
Vectored interrupt operation optional

VF-2K (KIT) .....	\$335.95
VF-2AT (A&T) .....	\$385.95

### SBC-100/200

OR 4 MHz SINGLE BOARD COMPUTER

S-100 bus compatible Z-80 CPU  
1K of on-board RAM  
4 EPROM sockets accommodates 2708, 2716, or 2732  
One parallel and one serial I/O port  
4-channel counter timer chip (Z-80 CTC)  
Software programmable serial baud rates

SBC-100K (2 MHz KIT) .....	\$280.00
SBC-100AT (2 MHz A&T) .....	\$340.00
SBC-200K (4 MHz KIT) .....	\$299.00
SBC-200AT (4 MHz A&T) .....	\$359.00

## \$25 REBATE

on any SD Systems  
microcomputer board

Offer expires 10-31-80

VDB-8024

## VIDEO DISPLAY BOARD

WITH ON-BOARD Z80 MICROPROCESSOR

S-100 Bus Compatible  
Full 80 Characters by 24 Lines Display  
Characters Displayed by High Resolution 7 x 10 Matrix  
Composite or TTL Video Output  
Keyboard Power and Interface  
Forward and Reverse Scrolling Capability  
Blinking, Underlining, Field Reverse, Field Protect and Combinations  
Full Cursor Control

96 Upper and Lower Case Characters  
32 Special Character Set  
128 Additional User Programmable Characters (Optional)  
On-Board Z80 Microprocessor  
2K Bytes Independent On-Board RAM Memory  
Glitch-Free Display

VDB-K (KIT) .....	\$365.00
VDB-AT (A&T) .....	\$440.00

## PROM-100

PROGRAMMING BOARD FOR PROM DEVELOPMENT

S-100 Bus Compatible  
Programs the Following EPROMs:  
2708, Intel 2758, 2716, 2732 and Texas Instruments 2516

Dip Switch Selection of EPROM type  
25 VDC Programming Pulse Generated On Board  
Maximum Programming Time: 16,384 Bits in 100 Seconds

Power Requirement: +8VDC at 300 ma; +16 VDC at 100 ma; -16VDC at 60 ma

TTL Compatible  
Software Provides for Reading of Object File from SDOS, CP/M or PROM and Programming into EPROM

Program Verification  
Verification of Erasure  
Zero Insertion Force Socket

PROM-100K (KIT) .....	\$175.95
PROM-100AT (A&T) .....	\$235.00

## S-100 BARE BOARDS

CB1A 8080 CPU .....	\$33.00
VB2 I/O Mapped Video Interface .....	\$33.00
102 Parallel I/O Interface .....	\$33.00
104 2P + 2S I/O Interface .....	\$33.00
SB1 Music Synthesizer .....	\$40.00
OB1 Vector Jump & Prototyping Board .....	\$29.95
MB3 4K 1702 EPROM Board .....	\$30.00
MB6B 8K Static RAM .....	\$27.00
MB7 Low Power 16K Static RAM .....	\$30.00
MB8A 16K 2708 EPROM Board .....	\$30.00
T1 Terminator .....	\$28.00
MT1 15 Slot Motherboard .....	\$40.00
XB1 Extender Board .....	\$13.50

## S-100 KITS & ASSEMBLED BOARDS

<b>CB1A 8080 CPU</b>	
Kit .....	\$148.95
Assembled & Tested .....	\$199.95
<b>CB2 Z-80 CPU</b>	
Kit .....	\$195.00
Assembled & Tested .....	\$275.00
<b>MB3 4K 1702 EPROM Board</b>	
Kit - without EPROMS .....	\$ 65.00
Assembled & Tested .....	\$125.00
<b>MB6B 8K Static RAM</b>	
450 ns RAM	
Kit .....	\$139.95
Assembled & Tested .....	\$199.95

## SSM PRODUCTS

<b>MB7 Low Power 16K Static RAM</b>	
Kit .....	\$325.00
Assembled & Tested .....	\$375.00
<b>MB8A 16K 2708 EPROM Board</b>	
Kit - without EPROMS .....	\$ 99.00
Assembled & Tested .....	\$159.00
<b>MT1 15 Slot Motherboard</b>	
Kit (with Connectors) .....	\$119.95
Assembled & Tested .....	\$149.95
<b>OB1 Vector Jump &amp; Prototyping Board</b>	
Kit .....	\$ 55.00
Assembled & Tested .....	\$ 85.00
<b>PB1 2708/2716 EPROM Programmer</b>	
Kit with Textool sockets .....	\$134.95
Assembled & Tested w/Textools sockets .....	\$174.95
<b>SB1 Music Synthesizer (4)</b>	
Kit .....	\$199.00
Assembled & Tested .....	\$279.00
<b>T1 Active Terminator</b>	
Kit .....	\$ 34.00
Assembled & Tested .....	\$ 64.00
<b>Upgrade Kit for 80x24 Display</b>	
2 MHz .....	\$ 69.00
4 MHz .....	\$ 89.00

VB1B Memory Mapped Video Interface

LIMITED SUPPLY - DISCONTINUED BOARD

Kit .....	\$149.95
Assembled & Tested .....	\$180.00

VB2 I/O Mapped Video Interface

Kit .....	\$180.00
Assembled & Tested .....	\$210.00

VB3 80 Character Video Interface

80x24 Display, 2 MHz	
Kit .....	\$324.95
Assembled & Tested .....	\$399.95

XB1 Extender Board

Kit (with Connector) .....	\$ 19.95
Assembled & Tested .....	\$ 29.95

80x24 Display, 4 MHz

Kit .....	\$369.95
Assembled & Tested .....	\$439.00

IO2 Parallel I/O Interface

Kit .....	\$ 59.00
Assembled & Tested .....	\$ 89.00

IO4 2P + 2S I/O Interface

Kit .....	\$134.95
Assembled & Tested .....	\$199.95

250 ns RAM

Kit .....	\$179.95
Assembled & Tested .....	\$245.00



COMPUTER  
SYSTEMS  
INC.

15335 South Hawthorne Boulevard  
Lawndale, California 90260

QUICK & TIMELY (213) 970-0952

PLACE ORDERS TOLL FREE

1-800-421-5150

(CONTINENTAL U.S. ONLY)

(EXCEPT CALIFORNIA)

TERMS OF SALE: Cash checks money orders, credit cards accepted. Also C O D orders under \$100.00. Minimum order \$10.00. California residents add 6% sales tax. Minimum shipping and handling charge \$2.50. Prices subject to change without notice. International sales in American dollars only.

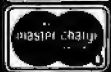



# \$2130.00 COMPUTER GET A JADE INFLATION

## JADE Saves You \$1130

<b>4 MHz BOARD SET</b>	SD Systems
SBC-200 CPU with I/O	A & T Price
Versafloppy II Dbl density controllr	\$430.00
ExpandoRAM II 64K RAM 4 MHz	\$1300.00
<b>Total price</b>	<b>\$2130.00</b>
<b>JADE KIT PRICE</b>	<b>\$1074.95</b>
Less SD Systems Rebate	\$75.00
<b>YOUR COST ONLY</b>	<b>\$999.95</b>

## S-100 Boards

### THE BIG Z - Jade

2 or 4 MHz switchable Z-80 CPU with serial I/O	
CPU-30201K Kit	\$145.00
CPU-30201A A & T	\$199.00
CPU-30200B Bare board	\$35.00

### SBC-100 - SD Systems

2.5 MHz Z-80 CPU with serial & parallel I/O ports	
CPC-30100K Kit	\$257.50
CPC-30100A A & T	\$325.00

### SBC-200 - SD Systems

4 MHz Z-80 CPU with serial & parallel I/O ports	
CPC-30200K Kit	\$399.95
CPC-30200A A & T	\$475.00

### CB2 - S.S.M.

2 or 4 MHz switchable Z-80 CPU with RAM, ROM, & I/O	
CPU-30300K Kit	\$185.00
CPC-30300A A & T	\$249.95

### ExpandoRAM I - SD Systems

2.5 MHz RAM board expandable from 16K to 64K	
MEM-16130K 16K kit	\$189.00
MEM-16130A 16K A & T	\$249.00
MEM-32131K 32K kit	\$234.00
MEM-32131A 32K A & T	\$294.00
MEM-48132K 48K kit	\$279.00
MEM-48132A 48K A & T	\$339.00
MEM-64133K 64K kit	\$324.00
MEM-64133A 64K A & T	\$384.00

### ExpandoRAM II - SD Systems

4 MHz RAM board expandable from 16K to 256K	
MEM-16630A 16K kit	\$249.95
MEM-16630A 16K A & T	\$299.95
MEM-32631K 32K kit	\$309.95
MEM-32631A 32K A & T	\$359.95
MEM-48632K 48K kit	\$369.95
MEM-48631A 48K A & T	\$409.95
MEM-64633K 64K kit	\$429.95
MEM-64633A 64K A & T	\$479.95

### 32K STATIC RAM - Jade

2 or 4 MHz expandable static RAM board uses 2114L's	
MEM-16150K 16K 2 MHz kit	\$249.95
MEM-16150A 16K 2 MHz A & T	\$299.95
MEM-16151K 16K 4 MHz kit	\$259.95
MEM-16151A 16K 4 MHz A & T	\$309.95
MEM-32150K 32K 2 MHz kit	\$399.95
MEM-32150A 32K 2 MHz A & T	\$449.95
MEM-32151K 32K 4 MHz kit	\$409.95
MEM-32151A 32K 4 MHz A & T	\$459.95

### 16K STATIC RAM - Cal Comp Sys

2 or 4 MHz 16K static RAM - a real memory bargain	
MEM-16160K 16K 2 MHz kit	\$249.95
MEM-16160A 16K 2 MHz A & T	\$279.00
MEM-16162K 16K 4 MHz kit	\$279.95
MEM-16162A 16K 4 MHz A & T	\$309.00
MEM-16160B Bare board	\$29.95

## DOUBLE-D - Jade

Double density controller with the inside track	
IOD-1200K Kit	\$299.95
IOD-1200A 8" A & T	\$389.95
IOD-1205A 5 1/4" A & T	\$389.95
IOD-1200B Bare board	\$65.00

## VERSAFLOPPY I - SD Systems

Versatile floppy disk controller for 8" or 5 1/4"	
IOD-1150K Kit	\$219.95
IOD-1150A A & T	\$269.95

## VERSAFLOPPY II - SD Systems

New double density controller for both 8" & 5 1/4"	
IOD-1160K Kit	\$309.95
IOD-1160A A & T	\$369.95

## I/O-4 - S.S.M.

2 serial I/O ports plus 2 parallel I/O ports	
IOI-1010K Kit	\$129.95
IOI-1010A A & T	\$189.95
IOI-1010B Bare board	\$29.95

## PB-1 - S.S.M.

2708, 2716 EPROM board with built-in programmer	
MEM-99510K Kit	\$119.95
MEM-99510A A & T	\$169.95

## PROM-100 - SD Systems

2708, 2716, 2732, 2758, & 2516 EPROM programmer	
MEM-99520K Kit	\$175.00
MEM-99520A A & T	\$225.00

## 32K BYTESAVER - Cromemco

32K EPROM board with on-board 2716 programmer	
MEM-32550A A & T	\$295.00

## 100K DAY CLOCK - Mtn Hardware

Crystal controlled S-100 clock with NiCad backup	
IOK-1400A A & T	\$329.95

## SB1 - S.S.M.

15 Hz to 25K Hz music synthesizer for S-100	
IOS-1005K Kit	\$189.95
IOS-1005A A & T	\$269.95

## TB-4 - Mullen

Extremely versatile extender board with logic probe	
TSX-180K Kit	\$55.00
TSX-180A A & T	\$75.00

## TERMINATOR & EXTENDER - C.C.S.

Can be used as both an S-100 extender and terminator	
TSX-150K Kit	\$39.95

## S-100 EXTENDER - Cal Comp Sys

Puts problem boards within easy reach	
TSX-160A A & T	\$24.95

## VDB-8024 - SD Systems

80 x 24 I/O mapped video board with keyboard I/O	
IOV-1020K Kit	\$324.95
IOV-1020A A & T	\$379.95

## VB3 - S.S.M.

80 x 24 or 80 x 48 memory mapped with graphics	
IOV-1095K Kit, 4 MHz	\$339.95
IOV-1095A A & T, 4 MHz	\$399.00
IOV-1096K 80 x 48 upgrade, 4 MHz	\$89.00

## VIDEO BOARD - Jade

64 x 16 assembled & tested S-100 video board	
IOV-1050B Bare board	\$29.95
IOV-1050A A & T sale price	\$99.95

## 8K RAM BOARDS - Special Sale

Uses 21L02 RAM chips	
2 boards & manual for	\$30.00

## Single Board Computer

### AIM-65 - Rockwell

6502 computer with printer, display, & keyboard	
CPK-50165 1K AIM	\$374.95
CPK-50465 4K AIM	\$449.95
SFK-74600008E 8K BASIC ROM	\$99.95
SFK-64600004E 4K assembler ROM	\$84.95
PSX-030A Power supply	\$59.95
ENX-000002 Enclosure	\$49.95
4K AIM, 8K BASIC, power supply, & enclosure	
<b>Special package price</b>	<b>\$599.00</b>

### 32K RAM - for AIM-65

Dynamic memory board to expand your AIM-65	
MEM-99170A A & T w/out RAM	\$275.00
MEM-16170A A & T w/16K	\$325.00
MEM-32170A A & T w/32K	\$375.00
MEM-99170B Bare board	\$49.00

### DISK CONTROLLER - for AIM-65

Add 5 1/4" or 8" disk drives to your AIM-65	
IOD-3013A A & T	\$575.00

### VISIBLE MEMORY - for AIM-65

Video board with 8K memory & graphics for AIM-65	
IOV-3011A A & T	\$239.95

### MEMORY-MATE - for AIM-65

The master-mate with 48K RAM, I/O, PROM, & music	
MEM-52301A A & T w/16K	\$475.00

### Z-80 STARTER KIT - SD Systems

Z-80 computer with RAM, ROM, I/O, & keyboard	
CPS-30010K Kit	\$289.95
CPS-30010A A & T	\$349.95

## Accessories for Apple

### 16K MEMORY UPGRADE

Add 16K of RAM to your TRS-80, Apple, or Exidy	
MEX-16100K TRS-80 kit	\$49.95
MEX-16101K Apple kit	\$49.95
MEX-16102K Exidy kit	\$49.95

### DISK DRIVE for APPLE

5 1/4" disk drive with controller for your Apple	
MSM-12310C with controller	\$495.00
MSM-123101 w/out controller	\$425.00

### 8" DRIVES for APPLE

Controller, DOS, two 8" drives, cabinet, & cable	
<b>Special package price</b>	<b>\$1475.00</b>

### AIO - S.S.M.

Parallel & serial interface for your Apple	
IOI-2050K Kit	\$115.00
IOI-2050A A & T	\$155.00

### SUP'R TERMINAL - M & R Assoc

80 x 24 video display board for your Apple	
IOV-2100A A & T	\$369.00

### SUPERTALKER - Mtn Hardware

Speech recognition synthesizer w/ speaker & mike	
IOS-2015A A & T	\$275.00

### Z-80 CARD for APPLE

Z-80 CPU card with CP-M for your Apple	
CPX-30800A A & T	\$345.00

### MICROMODEM - D.C. Hayes

Auto answer-dial modem card for Apple or S-100	
IOM-2010A Apple modem	\$349.95
IOM-1100A S-100 modem	\$375.00

### SUP'R MOD II - M & R Assoc

Color or B & W TV interface recommended for Apple	
IOR-5050A A & T	\$29.95

Call for your free 1980 catalog

Call for your free 1980 catalog

# NOW ONLY \$999.95 (JUST ADD SOLDER) FIGHTING KIT TODAY

## Printers

### BASE 2 - Impact Printer

132 cps, bi-directional, tractor feed, & graphics  
PRM-13100 ..... \$625.00

### DP-9500 - Anadex

9 x 9 dot matrix, 176 column, 200 cps, & graphics  
PRM-10500 Standard DP-9500 .... \$1495.00  
PRM-10510 with graphics & 2K .. \$1595.00

### LP-80 - Matchless

9 x 7 matrix, 132 column, 125 cps, bi-directional  
PRM-37204 ..... \$775.00

### PAPER TIGER - Integral Data

132 column, parallel & serial, 150 cps, graphics  
PRM-33440 IDS-440 ..... \$950.00  
PRM-33441 IDS-440 w/graphics .. \$1050.00

### MILOT - Watanabe Instruments

Intelligent graphics plotter uses 7 bit ASCII code  
PRP-10800 ..... \$1075.00

### SPINWRITER - NEC

65 cps, bi-directional, letter quality with tractor  
PRD-55510 with 2K buffer ..... \$2995.00

## Motherboards

### ISO-BUS - Jade

Silent, simple, and on sale - a better motherboard

6 Slot (5 1/4" x 8 1/2")

MBS-061B Bare board ..... \$19.95  
MBS-061K Kit ..... \$39.95  
MBS-061A A & T ..... \$49.95

12 Slot (5 1/4" x 8 1/2")

MBS-121B Bare board ..... \$29.95  
MBS-121K Kit ..... \$69.95  
MBS-121A A & T ..... \$89.95

18 Slot (14 1/4" x 8 1/2")

MBS-181B Bare board ..... \$49.95  
MBS-181K Kit ..... \$99.95  
MBS-181A A & T ..... \$139.95

## Mainframes

### MAINFRAME - Cal Comp Sys

12 slot S-100 mainframe with 20 amp power supply  
ENC-112105 Kit ..... \$309.95  
ENC-112106 A & T ..... \$349.95

### DISK MAINFRAME - NNC

Dual 8" drive cutouts with 8 slot motherboard  
ENS-112320 with 30 amp p.s. .... \$699.95

## Video Monitors

### VIDEO 100 - Leedex

12" B & W video monitor with 12 MHz bandwidth  
VDM-801210 ..... \$139.95

### VIDEO 100-80 - Leedex

81 x 24 version of Video 100 with metal cabinet  
VDM-801230 ..... \$179.95

### B & W MONITOR - Sanyo

High quality, high resolution video monitors  
VDM-700901 9" monitor ..... \$209.95  
VDM-701501 15" monitor ..... \$279.95

### 13" COLOR MONITOR - Zenith

The hi res color you've been promising yourself  
VDC-201301 ..... \$449.00

## Disk Drives

### JADE DISK PACKAGE

Double-D controller kit, two 8" double density  
disk drives, cabinet, power supply, & cables  
Special package price ..... \$1295.00

### DUAL 8" DRIVES - Lobo

A pair of double density Shugarts in a cabinet  
MSF-12800R 2 single sided ..... \$995.00  
MSF-125202 2 double sided ..... \$1425.00

### DISKETTES - Jade

Bargain prices on magnificent magnetic media

5 1/4" single sided, single density, box of 10  
MMD-5110103 Soft sector ..... \$27.95  
MMD-5110083 10 sector ..... \$27.95  
MMD-511603 16 sector ..... \$27.95

5 1/4" double sided, double density, box of 10  
MMD-5220103 Soft sector ..... \$39.95  
8" single sided, single density, box of 10  
MMD-8110103 Soft sector ..... \$33.95

8" single sided, double density, box of 10  
MMD-8120103 Soft sector ..... \$55.95  
8" double sided, double density, box of 10  
MMD-8220103 Soft sector ..... \$57.95

### FLOPPY SAVERS - Tri-Star

Protect your valuable software from spindle damage  
MMA-205 5 1/4" kit ..... \$13.95  
MMA-208 8" kit ..... \$15.95

## Software

### CP/M 2.2 - Digital Research

Latest & most powerful release of CP/M  
SFC-52506000D Manual set ..... \$24.95  
SFC-52506000M 5 1/4" disk & manual \$149.95  
SFC-52506000F 8" disk & manual \$149.95

### MP/M - Digital Research

Multi-user operating system for Z80 computers  
SFC-52507000F 8" disk & manual \$295.00

### PASCAL/MT - MetaTech

A powerful language for CP/M systems  
SFC-73301001F 8" disk & manual .. \$99.95

### SDOS - SD Systems

DOS, BASIC-2, Z80 assembler/editor/linker  
SFX-55001000D Manual set ..... \$24.95  
SFX-55001002M 5 1/4" disks & man \$149.95  
SFX-55001006F 8" disk & manual \$149.95

### WORDSTAR - MicroPro Intl

The finest word-processing package for CP/M  
SFC-13600100F 8" disk & manual \$395.00

### VISICALC - Personal Software

Visible business accounting calculator for Apple  
SFA-24101005M 5 1/4" disk & manual \$145.00

### SINGLE DRIVE COPY - for Apple

Make back-up disks with just a single Disk II  
SFA-51150010M 5 1/4" disk & manual \$19.95

### SUPER-TEXT - Muse

Professional word-processing package for Apple  
SFA-13800085M 5 1/4" disk & manual \$99.95

## Modems

### NOVATION CAT

300 baud, auto answer originate acoustic modem  
IOM-5200A Special sale price ..... \$149.00

### EPROM ERASER - L.S. Engineering

UV eraser for up to 48 EPROMs  
XME-3200 A & T ..... \$39.95

## MICROPROCESSORS

Z-80 ..... \$10.95  
Z-80A ..... \$14.95  
6802 ..... \$11.50  
6800 ..... \$11.95  
6802 ..... \$17.95  
6809 ..... \$39.95  
8035 ..... \$24.00  
8035-8 ..... \$24.00  
8080A ..... \$ 6.95  
8085 ..... \$15.95  
TMS9900II ..... \$39.95

## PROMS

2708 (450ns) \$ 8.95  
2716 (450ns) \$29.95  
2716 (5v) ..... \$29.95  
2732 (5v) ..... \$69.95  
2758 (5v) ..... \$29.95

## RAMS

211.02 (2 MHz) ..... \$ 1.25  
211.02 (4 MHz) ..... \$ 1.50  
211.41 (2 MHz) ..... \$ 5.75  
211.41 (4 MHz) ..... \$ 5.95  
4116 ..... \$ 8.95  
2147 (70ns) ..... \$ 39.95  
4164 (64K x 1) ..... \$175.00  
5257 (2 MHz) ..... \$ 6.75  
5257 (4 MHz) ..... \$ 7.25

## SUPPORT DEVICES

8212 ..... \$ 4.95  
8214 ..... \$ 4.65  
8216 ..... \$ 2.95  
8224 ..... \$ 4.95  
8224-4 ..... \$9.95  
8226 ..... \$ 3.95  
8228 ..... \$ 4.95  
8238 ..... \$ 4.95  
8243 ..... \$ 8.00  
8250 ..... \$14.95  
8251 ..... \$ 6.50  
8253 ..... \$13.95  
8255 ..... \$ 6.50  
8257 ..... \$19.95  
8259 ..... \$17.95  
8275 ..... \$49.95  
8279 ..... \$15.95

## CARTS

AY5-1013A ..... \$5.25  
AY3-1014A ..... \$8.25  
TR1602B ..... \$5.25  
TMS6011 ..... \$5.95  
IM6403 ..... \$9.00

## BAUD RATE GENERATORS

MC14411 ..... \$12.95  
CRYSTAL ..... \$ 4.95

## Z80 SUPPORT

3881 (PIO) ..... \$ 9.50  
3881-4 ..... \$14.50  
3882 (CTC) ..... \$ 9.50  
3882-4 ..... \$14.95  
3883 (SIO) ..... \$29.50  
3884 (SIO) ..... \$49.50

## 6800 SUPPORT

6821P ..... \$ 5.95  
6828P ..... \$11.95  
6834P ..... \$12.95  
6840P ..... \$18.75  
6850P ..... \$ 4.80  
6852P ..... \$ 5.79  
6875L ..... \$ 7.40  
68488P ..... \$25.00

## PLACE ORDERS

### TOLL FREE

Inside California Continental U.S.  
800-262-1710 800-421-5500

For customer service  
or technical inquiries call 213-973-7707

Write for our FREE 1980 catalog

## JADE COMPUTER PRODUCTS

4901 W. Rosecrans, Hawthorne, CA 90250

TERMS OF SALE: Cash, checks, credit cards  
money orders or from recognized institutions  
Purchase orders accepted Minimum order \$10.00  
California residents add 6 1/2% sales tax. Minimum  
shipping and handling charge \$2.50. Prices are for  
U.S. and Canadian delivery only and are subject  
to change without notice. For export prices and  
information send for a JADE INTERNATIONAL  
CATALOG.



Call for your free 1980 catalog

# California Digital

Post Office Box 3097 B • Torrance, California 90503

## NEW from INTEGRAL DATA 460 Paper Tiger

\*\*\*\* All the features of the 440 and more \*\*\*\*

The 460 uses a dot matrix character formation technique in which the placement of the dots overlap both horizontally and vertically to achieve a correspondence-quality printing. The printer's nine-wire print head uses staggered needle rows to create the vertically overlapping dots. The head is driven bidirectionally under microprocessor control by a stepper motor driven mechanism with logic-seeking look ahead capability. Standard "Two-K Byte" buffer allows the printer to accept the entire content of a 1,920-character CRT screen. Weight 27 lbs. suggested list price \$1,295. Calif. Digital price **\$1,076**

## S-100 Mother Board

**Quiet Buss**

The Quiet Buss from California Industrial is quality engineered. No short cuts have been taken to produce this mother board. Active termination circuitry prevents noise and crosstalk. Manufactured from extra heavy FR-4 epoxy glass.

**\$2995**  
8803-18  
18 slot  
1MSAI

## TELETYPE MODEL 43

4320 KEYBOARD

TTL ..... AAA \$ 950  
RS232 ... AAK 1050  
Friction ... AAE 1100 plus shipping  
103 Modem AAB 1575

## WESTERN UNION ENCLOSURE

These enclosures were manufactured for Western Union by Universal Technology. The universal response of the printed circuit mystery but the enclosure is ideally suited for an S-100 mother-board with attached power supply. Removable hand and finger rest front make this enclosure an attractive front end for any loader product. Now surplus in factory bins supplied with three 237 44 wide domain lines. DR-238 communications connector, six foot grounded power cord and 11 key. House dimensions 18 x 14 1/2 x 6 7/8". Shipping weight 8 lbs.

**\$24.95**

## FREE PLASTIC LIBRARY CASE

with purchase of each box of ..... Memorex mini-diskettes. \$5 value.

# \$24.95

BOX OF 10

# DISKETTES

## DB25

each 10+  
male \$250 195  
female 325 305  
hood-7p 125 99  
Centralec 895

## BCD Thumbwheel 195 Switch

Ten Position  
Mfg. by Digilawtech  
1 7/8" high 1 1/2" wide

## Edge Connectors

**GOLD 100 PIN IMAI/ALTAIR**

Imai solder .125 x .250 \$2.95 3/4 7.50  
Imai w/r .125 centars \$4.95 3/13.00  
Altair solderalt. .140 row \$5.95 3/15.00

**SPECIALS**

22/44 Rim outlet. 156" \$1.95 3/45.00  
25/59 solder tab. 156" \$1.99 3/42.00  
36/72 wide pad w/r. 156" \$1.95 3/45.00

## DISK DRIVES

Shugart 85400B 8" floppy \$927  
Shugart 86411B 8" hard disk \$176  
Lobos / Two Shugart 801's with power supply and enclosure \$190  
Two Shugart 801's with power supply and enclosure \$204  
Lobos hard drive for Apple \$205  
18 megabyte T180 \$205  
Lobos hard drive for T180 \$205  
Lobos 100-1 5 1/4 for T180 \$205  
Vista V-40 for T180 \$205  
Crosley 8000 hard drive \$205

**APPL. COMPATIBLE PRODUCTS**

Apple disk drive with power after \$60  
Apple development computer \$69  
Apple Parallel Services \$79  
For key data for Apple \$110  
Mountain Hardware for Mac II \$20  
Mountain Hardware for Mac II \$20  
Mountain Hardware for Mac II \$20  
Apple II software \$199 \$2

**MINI DISK**

Universal Mini System L.P. 300 \$100  
Direct digital P.D.C. Approved \$100  
Lobos Video 100-50 1P \$79  
Novation Cass Assembla \$10

## DISK DRIVES

Shugart 85400B 8" floppy \$927  
Shugart 86411B 8" hard disk \$176  
Lobos / Two Shugart 801's with power supply and enclosure \$190  
Two Shugart 801's with power supply and enclosure \$204  
Lobos hard drive for Apple \$205  
18 megabyte T180 \$205  
Lobos hard drive for T180 \$205  
Lobos 100-1 5 1/4 for T180 \$205  
Vista V-40 for T180 \$205  
Crosley 8000 hard drive \$205

**APPL. COMPATIBLE PRODUCTS**

Apple disk drive with power after \$60  
Apple development computer \$69  
Apple Parallel Services \$79  
For key data for Apple \$110  
Mountain Hardware for Mac II \$20  
Mountain Hardware for Mac II \$20  
Mountain Hardware for Mac II \$20  
Apple II software \$199 \$2

**MINI DISK**

Universal Mini System L.P. 300 \$100  
Direct digital P.D.C. Approved \$100  
Lobos Video 100-50 1P \$79  
Novation Cass Assembla \$10

## Authorized Distributor

# Scotch Data Products

740-0	18 M soft format.	\$39.00	\$3.50
740-2	Double side soft	65.00	8.00
741-0	Double density	53.00	4.90
743-9	Double/Double	70.00	6.60
740-32	8" Hard sector	39.00	3.50
744-(0)(10)(16) 5 1/4" mini		39.00	3.50

Library case for any above; Add \$3.00

834 A Data Cassette 5.50  
D C 100 Mini Cartridge 16.00  
D C 300 Data Cartridge 20.00  
920 ( ) Disk Cartridge 89.90

## Shugart Associates

# SABOO-R Floppy Disk Drive

The most cost effective way to store data processing information, when random recall is a prime factor. The SABOO is fully compatible with the IBM 3740 format. Write protect circuitry, low maintenance & Shugart quality.

**\$449.50**

## XEROX 800 WORD PROCESSING KEYBOARD

ASCII ENCODED

This Xerox word processing keyboard is manufactured by the Xerox Corporation. The keyboard outputs a serial ASCII code along with an eight bit data stream. Most keys to obtain and modify characters are spread throughout the keyboard. This keyboard is designed to interface with the Xerox 800 word processing system. The keyboard is equipped with two mechanical switches for defining the action.

Optional Xerox negotiation case \$100.00  
California Inland \$100.00 price minus \$25.00  
Excellent model. Inland edition on order.

## MEMORY

# TRS-80 APPLE II 49

16k memory (8) 4116's

Installation is simple. Anyone who has ever changed a spark plug should be able to up-grade his microcomputer. How can California Digital offer these memory up-grade sets at 25% below our competition? Simple, we buy in volume, wholesale to dealers and sell the balance directly to owners of personal micro-systems. These 16K dynamic memory circuits are factory prime and unconditionally guaranteed for one full year. NOW, before you change your mind, pick up the telephone and order your up-grade memory from California Digital. Add \$3 for TRS80 jumpers.

STATIC	1-31	32-99	100-5C	-999	1K+
21L02 450nS.	1.19	.99	.95	.90	.85
21L02 250nS.	1.48	1.39	1.25	*	*
2114 1Kx4 450	5.95	5.50	5.25	4.75	4.50
2114 1Kx4 300	8.95	8.50	8.00	*	*
4044 4Kx1 450	5.95	5.50	5.25	*	*
4044 4Kx1 250	9.95	9.50	9.00	*	*
4045 1Kx4 450	8.95	8.50	8.00	*	*
4045 1Kx4 250	9.95	9.50	9.00	*	*
5257 low pow.	5.95	5.50	5.00	4.80	4.60

## DATA INPUT TERMINAL

This keyboard terminal and console is designed for use with the IBM 3740 format. The terminal is designed for manual data entry and is fully compatible with the IBM 3740 format. Write protect circuitry, low maintenance & Shugart quality.

**\$49**

New Regent 30 \$895

## MINIATURE SWITCHES

your choice 1D 50 \$1.98 488 .81

SPDT Miniature Toggle

7107 CR ON-NONE-ON  
7107 Jbt ON-OFF (Cont. ON)  
7108 CR ON-(moment. ON)  
7103 CR ON OFF ON  
Rotary 3P-4-Pos.  
Rotary 3P-6-Pos.  
Push B (NO) \$2.95 ea. 4/31

## 2716 EPROM SALE \$13

\*\*\* THOUSANDS \*\*\*

We have slashed price in an effort to reduce our over stocked inventory. These are Single Five Volt Eproms, manufactured by one of the World's largest producers of semiconductors. Please phone for volume pricing.

## direct connect MODEM Universal Data 103

Connects directly to the new modular phone jack. Fully powered from your existing telephone line. No need to locate external AC power. Crystal control prevents frequency drift. Direct connect feature eliminates loss of information due to carrier compression that is associated with acoustic modems. Runs circles around those other "domesticated" modems.

**\$169**

## DIP Switch

\$129 10 25 100 15  
\$119 100 97 83  
specify #  
T or P.

SPST

## PORTABLE DATA ENTRY SYSTEM

These used data terminals were originally designed for chain store inventory control and order entry systems. The operator enters the inventory control number, merchandise on hand and the unit price. After all pertinent data has been entered into the recorder, the next warehouse is telephoned, the handset is placed in the acoustic coupler and all the recorded information is transmitted back to the master computer. With a little imagination and one of these portable entry systems, you should be able to exchange programs and computer information with associates across the country. All units were removed from service in working condition. Original cost \$2,500. Each system contains complete with:

- Portable Cassette Drive Unit
- Acoustic Coupler
- with 12 1/2" Display
- Five Speed TV Monitor
- Acoustic Coupler
- Battery Charger
- 4825 Cable
- Shoulder strap
- Full Documentation

**\$139.50**

## BSR SYSTEM X-10

The new BSR timer runs your home like clockwork. Turns on lamps and appliances while your away from home. Completely compatible with your existing system X-10 devices.

BSR Timer \$65.00  
Master Console 34.95  
Ultrasonic Controller 19.95  
Modules: Appliance, Lamp or Wall Switch 13.95

\*\*\* THOUSANDS \*\*\*

All merchandise sold by California Digital is premium grade. Shipping: First five pounds \$2.00; each additional add \$4.00 Foreign orders 10% shipping. Excess will be refunded. California residents add 8% sales tax. C.O.D.'s discouraged. Open accounts extended to state supported educational institutions and companies with a "Strong Dun & Bradstreet" Warehouse: 1568 Inglewood Blvd. Visitors by appointment.

**TOLL FREE ORDER LINE (800) 421-5041**

**TECHNICAL & CALIFORNIA 213-679-9001**

Circle 221 on inquiry card.



# page

## DEAL #1

### Hobby Wire Wrap Starter Package



BW2630 WW Tool . . . . . \$19.95  
 BT30 #30 Bit . . . . . 3.95  
 BC1 Batteries & Charger 14.95  
 \*Kit #1 Wire Kit . . . . . 9.95

Regular Price . . . . \$48.80

**\$39<sup>95</sup>**

\*Kit #1 Contains 900 pcs. of precut wire in asst. sizes.

Choose from Red, Blue, White, Black, Green, Orange, Violet, Yellow, or assortment.

## DEAL #2

### Industrial Wire Wrap Starter Package



BW928BF WW Tool . . . . . \$52.95  
 BT30I #30 Bit & Sleeve . . . 29.50  
 BC1 Batteries & Charger 14.95  
 \*Kit #3 Wire Kit . . . . . 32.95

Regular Price . . . \$130.35

**\$119<sup>95</sup>**

\*Kit #2 Contains 4000 pcs. of precut wire in asst. sizes.

Choose from Red, Blue, White, Black, Green, Orange, Violet, Yellow or assortment.

# ★ ★ BIG DEAL ★ ★

## RN IC Sockets by the Tube

RN HIGH RELIABILITY eliminates trouble. "Sidewipe" contacts make 100% greater surface contact with the wide, flat sides of your IC leads for positive electrical connection.

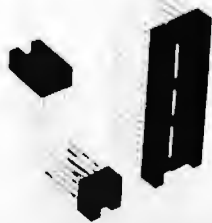

WIRE WRAP SOCKETS	Size	Quantity/Tube	Price ea.*	Price/Tube
08 pin	52	.39	\$20.28	
14	30	.46	\$13.80	
3-level Gold	16	.50	\$13.00	
Closed Entry	18	.68	\$15.64	
Design	20	.85	\$17.85	
	22	.42	\$16.56	
	24	.94	\$15.95	
	28	1.23	\$18.45	
	40	1.60	\$16.00	

\*Sockets sold at these prices by the tube only.  
 Above prices include gold up to \$800/oz.

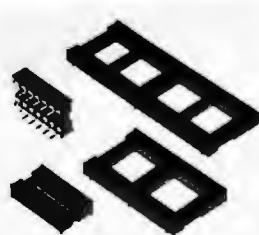

SOLDER TAIL	Price
Low Profile Tin	<b>1¢/pin (over 5 tubes)</b>
Closed Entry	
Design	
	<b>3/4¢/pin (over 100 tubes)</b>

\*Sockets sold at these prices by the tube only.  
 See tube quantities above.

### ORDERING INFORMATION

- Orders under \$25 include \$2 handling
- All prepaid orders shipped UPS Ppd.
- Visa, MC & COD's charged shipping
- All prices good through cover date
- Most orders shipped next day.

Limited to products Page Digital stocks. All discounts are off of list price.  
 Call or write for list prices.

- 10% off on all OK hobby products!**
- 10% off on all Bishop Graphics products!**
- 5% off on all Vector products!**

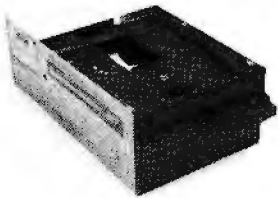

## Qume Datatrak 8

Double sided floppy with NO HEADACHES. Although many think this an impossibility, seeing is believing, and this drive is really something! Shugart compatible, fully optioned, reliable, and rapidly becoming the standard in double-sided diskdom.

\$599. Two/\$549.

## Siemens FDD 100-8D

Single sided 8" floppy drive, the latest & greatest revision. Features double density plus much more. An extremely reliable drive \$439 2/\$409

Hard sector option kit... \$9.95  
Data separator option kit... \$9.95

The following 5 1/4" mini-floppies share most features with their 8" cousins, so without further ado...

Siemens FDD 100-5D..... \$279.  
Qume Datatrak 5 (double sided).... 399.  
BASF Mini mini..... 279.  
SA 400..... 299.  
All the above mini-floppies are fully SA400 compatible.

Manuals for all drives are \$10, refundable against future purchase of drives. Also, all 8" drives can be ordered with 220 v/50 hz for worldwide use.

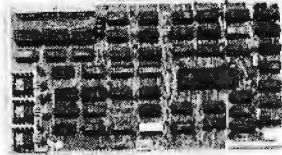

## Disk controllers

Delta Products double density \$349  
Micromation doubler 439  
Tarbell single density, A & T 225  
Tarbell single density, kit 184  
Tarbell double density, DMA 425  
Sorrento Valley 8" single density for Apple 375

## Accessories

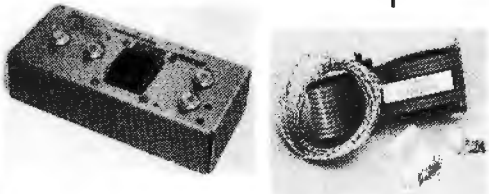

Cable kits for 8" drives with 10' 50 cond. flat cable, power cable, and all connectors. Assembled if desired. One drive 27.50, two 33.95, three 38.95 for mini floppies (34 cond): one 24.95, two, 29.95

CP-206 Power-one power supply. Powers two drives more than adequately, top quality. 2.8A/24V, 2.5A/5V, .5A/-5V. .... \$99.

mini-floppy power supply ..... \$79

## Hard Disk

CII H8 10 MBY fully REMOVEABLE cartridge drive. Complete with controller, personality card, media, power supply, cabling, connectors and documentation. Highlighted by stylish & modern cabinetry. \$6995.

Shugart SA4008 20MBY fixed disk system. S-100, includes controller, power supply, and all that is necessary to run \$6995.

## Electrolabs

POB 4436, Stanford, CA 94305

415-321-5601 800-227-8266  
Telex: 345567 (Electrolab Pla)  
Visa MC Am. Exp.



## ENCLOSURES

Rackmount Mainframe MT-200. This gorgeous beast is so appealing that it can easily function also as stand-alone mainframe. Very modern styling with fully actively terminated S-100 bus.

With two 8" single-sided disk drives... \$1899.  
With two 8" double sided disk drives in place of single-sided variety..... \$2499.

Desktop Mainframe MT-100. Contemporary styling, a handsome cabinet coated with durable epoxy finish colors (blue, beige, off-white & silver). Easy to fit into an office environment. The proper way to start your system.

Above plus two 8" single sided disk drives..... \$1599.  
Above with two 8" double sided disk drives in place of single-sided variety..... \$2199.

\$25 min. order. Calif. residents add 6% sales tax. Orders under \$75, add 5% shipping and handling, over \$75 add 2.5%. All pricing subject to change without notice.

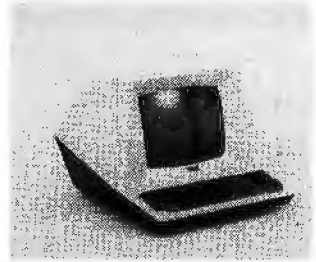

## Electrolabs' Monthly Special!!!

TELEVIDEO 912C ..... \$699  
TELEVIDEO 920C ..... 799

Features typewriter keyboard, microprocessor controls, Upper/lower case, adjustable baud rates (75-9600 baud), special function keys, much more.

Second page memory option \$29.00

## Data Display Monitors

used 12" Sylvania monitors. Composite video, 12 MHz, 120 VAC. with new P-39 or P-4 tube, \$79, used tube \$59, OEM style (without case), subtract \$12. U-fix model, 10/\$300.

## 4116 dynamic RAM, 16K Bonanzall

Set of 8, 16K, for Apple, TRS-80, Exidy, Heath & mora. 200 Ns, prime parts, at the unheard of \$49/8.

Large discounts available for quantity & dealers (500 & up). Offer limited while supply lasts, as these will vanish quickly!!!

## Media

8" ...\$39.99 SS/SD  
8" ...\$49.00 SS/DD  
8" ...\$55.00 DS/SD  
8" ...\$59.00 DS/DD  
5 1/4" \$34.95 SS  
5 1/4" \$59.00 DS

Verbatim, Memorex, Scotch, or equivalent name brand  
Special Introductory Offer!!!  
Wabash 8" diskettes \$29.00 SS  
\$39.00 DS

Price is cheap, but they run like champs!!!!

Diskette head cleaning kit for 5 1/4" or 8" \$28.75 includes everything for 1 drive for 1 year. Alignment Diskette for Floppy Drives..... \$39.00

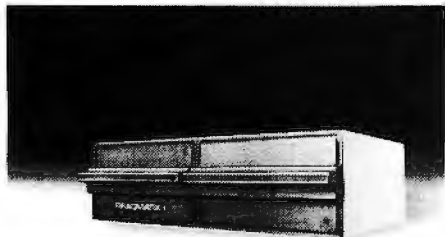

## PRAGMATIX 1

Incredible!! — Two 8" Shugart compatible single sided floppy disk drives (double density), CP-206 power supply, in handsome color coordinated cabinet, with full cabling, connectors, and documentation, plus one box diskettes!!! All for an unprecedented \$1295. Up to one MBY of storage, with Qume Datatrak 8" double-sided drive \$1695





### Keyboard Special 1 !!

CHERRY "PRO" Keyboard  
..... \$119.00  
Streamlined Custom Enclosure  
..... 34.95  
BOTH only .... \$134.95

### Keyboard Special 2 !!

Keytronics 1660 .... \$149.00  
Hard Plastic enclosure 49.00  
BOTH only ..... \$152.00



### ESAT 200B

**BI-LINGUAL 80x24  
Communicating Terminal**  
Scrolling, full cursor, bell, 8x8 matrix, 110-  
19,200 baud, Dual Front Applications.  
Arabic & Hebrew, Multilingual Data Entry  
Forms Drawing, Music, & Switchyards.  
Alone ..... \$279.  
with Cherry Pro keyboard &  
custom metal case ..... \$399.

### Disk Subsystem

Matchmaker Technology  
TURNKEY DISK SUBSYSTEMS



APPLE ..... Single density disk controller. Expanded Apple DOS  
TRS-80 ..... Single or double density. Expansion interface neces-  
sary. Space for 48K dynamic RAM on controller card  
RS232 port  
SORCERER .. Full RS-232 Interface. One S-100 slot for memory ex-  
pansion. Single or double density  
All above units come as follows: Complete, assembled and tested, with  
two 8" floppy disk drives (Apple available in one drive model). Includes  
all cabling, connectors and documentation in a stunning color coordina-  
ted cabinet with power supply. Ready to go, plug in and run!!!

When ordering specify single or double sided drives

Software available for above disk add-ons

TRS-80 & Sorcerer operate on all CP/M compatible software

### Daisy Wheel Printers



NEC Spinwriter 5510/2 \$2899  
NEC Spinwriter 5520/2 call  
NEC Spinwriter 5530/2 for  
prices

### Qume S/5

Sprint 5/45 RO \$2699  
Sprint 5/55 RO 2829  
Sprint 5/45 KSR 3029  
Sprint 5/55 KSR 3159  
Forms Tractor \$210  
Pinfeed platen 155  
paper guide 30  
paper basket 50

many print wheels, ribbons, & more available

### Qume Sprint 3\45

(requires self assembly)  
printer mechanism \$1499  
power supply 349  
combination special 1699  
cases 200  
S-100 interface card 149

Circle 223 on inquiry card.

## Electrolabs

POB 4436, Stanford, CA 94305  
415-321-5601 800-227-8266  
Telex: 345567 (Electrolab Pla)  
Visa MC Am. Exp.

### Peripheral Sale!!

Hiplot Plotter ..... \$875.  
Hipad Digitizer ..... 715.  
IDS 440 Paper tiger ..... 899.  
SD Expandoram II  
(A&T, 64K) ..... 560.  
Imjai 65K dynamic RAM III 399.  
DC Hayes Micromodem 100 .. 399.  
Super switcher power for  
hard disk & more ..... 349.

DC Hayes Micromodem 11  
(for apple) \$344

DC Hayes Micromodem 100 \$349

# SOFTWARE LABS

735 LOMA VERDE, PALO ALTO, CA. 94303

PHONE: 415 493-8186

LSI-11 Z-80 8080 8085 6502

### Database Management Systems

**HDBS** A hierarchical Database Manage-  
ment System featuring fixed length records,  
read/write protection at file level and one  
to many set relationships.

Z-80 Optimized 250.00  
8080 Optimized 325.00  
6502 Optimized 325.00

**MDBS** A large computer DBMS with  
hierarchical and full network data struc-  
tures (CODASYL Oriented). Explicit  
representation of one to one, one to  
many, many to one and many to many  
sets. Routines are callable from BASIC,  
PASCAL, COBOL or Machine Language.

Z-80 Optimized 750.00  
8080 Optimized 825.00  
6502 Optimized 825.00

### Communications

**BISYNC-80/3780** A full function IBM  
2780/3780 emulator that provides one of  
the most widely used communications  
protocols. 550.00

**BISYNC-80/HASP** A full function Hasp  
Multi-leaving Workstation package. 800.00

**BISYNC-80/ASYNC** An asynchronous  
communications package that uses the  
full error correcting BISYNC protocol. 95.00

**BISYNC-80/3270** A full function IBM  
3275 or 3271/3277 terminal emulator  
that converts a "dumb" terminal into a  
very smart one. 550.00

Multiple License Pricing  
- Upon Inquiry -

\* LSI-11, PDP-11 TM DEC, UNIX TM  
Western Electric, CP/M TM Digital Research

### High Level Languages

8080, 8085, Z-80 (Under OS-1 or CP/M)

**BASIC**  
Microsoft Compiler 395.00  
Microsoft "BASIC 80" 350.00

**FORTRAN**  
Microsoft "FORTRAN 80"  
(Includes MACRO 80) 500.00

**COBOL**  
Microsoft "COBOL 80"  
"C" 750.00

Whitesmith's "C" 600.00  
**PL/1**  
Digital Research's PL/1 500.00

**PASCAL**  
M.T. Compiler 250.00

Z-80 Optimized (Under OS-1 or CP/M)

**COBOL**  
R-M Z-80 COBOL ANSI '74 750.00  
**LSI-11\*/PDP-11\*** Under RT-11 or RSTS

**COBOL - ANSI '74 Introducing:**  
**RJ-11 Compiler** 1750.00

### Applications in COBOL '74

Available in R-M COBOL, COBOL 80  
and RJ-11. (Source Included)

**General Ledger** 995.00

**Accounts Receivable** 995.00

**Accounts Payable** 995.00

**Inventory Control** 995.00

**Order Entry/Invoicing** 995.00

**COMPLETE LEGAL** 4200.00

**COMPLETE DENTAL** 4200.00

Why COBOL?  
It's portable (ANSI '74) it's universal!

### OPERATING SYSTEMS

#### Z-80 Optimized

**OS-1<sup>TM</sup>** A breakthrough in microcomputer  
software from Electrolabs! UNIX\*-like OS  
with virtual I/O, bank-select memory control  
to 16 MBY and optional memory protection!  
Totally compatible with all CP/M programs.  
You will be amazed at the difference! Ex-  
cellent brochure available. Includes editor,  
linker-loader, debugger, and one year update.  
249.00

#### 8080, 8085 & Z-80

**CP/M Version 2.2** 150.00  
Manuals only 25.00  
**CP/M - MCZ Version 2.2.** Runs on  
**ZILOG MCZ and PDS-8000** systems.  
Only from Software Labs! 200.00  
Manuals only 35.00

### OUR CATALOGUE

Software  
Supplies  
Media  
Storage Equipment  
Publications  
- Upon Request -

Circle 283 on Inquiry card.

### TO ORDER

\*Price of manuals applied against software  
purchase.

**By Mail:** Send check or money order (or  
P.O. from rated or institutional customers).

**By Phone:** Use Master Charge or Visa No.

**Important Note:** Please specify complete  
system hardware and software configuration  
with each order.



# 7400

SN7400N	19	SN741230N	59
SN7401N	22	SN741250N	39
SN7402N	22	SN741260N	44
SN7403N	22	SN741280N	59
SN7404N	22	SN741320N	69
SN7405N	23	SN741350N	95
SN7406N	23	SN741390N	95
SN7407N	23	SN741411N	99
SN7408N	26	SN741421N	295
SN7409N	23	SN741431N	235
SN7410N	22	SN741441N	235
SN7411N	29	SN741451N	235
SN7412N	29	SN741471N	195
SN7413N	36	SN741481N	130
SN7414N	59	SN741501N	99
SN7415N	29	SN741511N	57
SN7417N	29	SN741521N	67
SN7420N	22	SN741531N	117
SN7421N	35	SN741541N	67
SN7422N	29	SN741551N	62
SN7423N	29	SN741561N	99
SN7424N	29	SN741571N	69
SN7426N	29	SN741581N	185
SN7427N	29	SN741601N	95
SN7429N	45	SN741611N	85
SN7430N	29	SN741621N	99
SN7432N	29	SN741631N	87
SN7437N	29	SN741641N	97
SN7438N	29	SN741651N	97
SN7439N	29	SN741661N	120
SN7440N	29	SN741671N	120
SN7441N	79	SN741701N	169
SN7442N	57	SN741721N	595
SN7443N	79	SN741731N	79
SN7444N	79	SN741741N	88
SN7445N	79	SN741751N	88
SN7446N	79	SN741761N	85
SN7447N	59	SN741771N	85
SN7448N	59	SN741791N	100
SN7450N	23	SN741801N	75
SN7451N	23	SN741811N	175
SN7452N	23	SN741821N	75
SN7454N	23	SN741841N	195
SN7455N	29	SN741861N	135
SN7490N	23	SN741881N	85
SN7470N	39	SN741891N	395
SN7471N	34	SN741901N	115
SN7473N	38	SN741911N	115
SN7474N	38	SN741921N	85
SN7475N	38	SN741931N	85
SN7476N	38	SN741941N	85
SN7477N	49	SN741951N	85
SN7478N	49	SN741961N	85
SN7479N	49	SN741971N	85
SN7480N	59	SN741981N	85
SN7481N	110	SN741991N	85
SN7482N	110	SN741991N	139
SN7483N	55	SN741991N	139
SN7484N	55	SN741991N	139
SN7485N	55	SN741991N	139
SN7486N	55	SN741991N	139
SN7487N	175	SN742731N	105
SN7490N	39	SN742791N	99
SN7491N	85	SN742831N	215
SN7492N	85	SN742841N	395
SN7493N	49	SN742851N	395
SN7494N	72	SN742901N	120
SN7495N	85	SN742981N	95
SN7496N	72	SN743051N	68
SN7497N	85	SN743061N	68
SN74100N	89	SN743071N	79
SN74101N	32	SN743081N	79
SN74102N	53	SN743091N	180
SN74103N	195	SN743101N	180
SN74121N	29	SN744901N	190
SN74122N	36		

# 74LS00

74LS00N	35	74LS164N	119
74LS01N	28	74LS165N	89
74LS02N	28	74LS166N	246
74LS03N	28	74LS168N	189
74LS04N	39	74LS169N	189
74LS05N	39	74LS170N	189
74LS06N	39	74LS171N	189
74LS07N	39	74LS172N	189
74LS08N	39	74LS173N	189
74LS09N	39	74LS174N	189
74LS10N	39	74LS175N	189
74LS11N	39	74LS176N	189
74LS12N	39	74LS177N	189
74LS13N	47	74LS178N	215
74LS14N	135	74LS179N	215
74LS15N	39	74LS180N	98
74LS16N	39	74LS181N	115
74LS17N	39	74LS182N	98
74LS18N	39	74LS183N	98
74LS19N	39	74LS184N	98
74LS20N	39	74LS185N	98
74LS21N	39	74LS186N	98
74LS22N	39	74LS187N	98
74LS23N	39	74LS188N	98
74LS24N	39	74LS189N	98
74LS25N	39	74LS190N	98
74LS26N	39	74LS191N	98
74LS27N	39	74LS192N	98
74LS28N	39	74LS193N	98
74LS29N	39	74LS194N	115
74LS30N	39	74LS195N	98
74LS31N	39	74LS196N	98
74LS32N	39	74LS197N	98
74LS33N	39	74LS198N	98
74LS34N	39	74LS199N	98
74LS35N	39	74LS200N	239
74LS36N	39	74LS201N	239
74LS37N	39	74LS202N	239
74LS38N	39	74LS203N	239
74LS39N	39	74LS204N	239
74LS40N	39	74LS205N	239
74LS41N	39	74LS206N	239
74LS42N	39	74LS207N	239
74LS43N	39	74LS208N	239
74LS44N	39	74LS209N	239
74LS45N	39	74LS210N	239
74LS46N	39	74LS211N	239
74LS47N	39	74LS212N	239
74LS48N	39	74LS213N	239
74LS49N	39	74LS214N	239
74LS50N	39	74LS215N	239
74LS51N	39	74LS216N	239
74LS52N	39	74LS217N	239
74LS53N	39	74LS218N	239
74LS54N	39	74LS219N	239
74LS55N	39	74LS220N	239
74LS56N	39	74LS221N	239
74LS57N	39	74LS222N	239
74LS58N	39	74LS223N	239
74LS59N	39	74LS224N	239
74LS60N	39	74LS225N	239
74LS61N	39	74LS226N	239
74LS62N	39	74LS227N	239
74LS63N	39	74LS228N	239
74LS64N	39	74LS229N	239
74LS65N	39	74LS230N	239
74LS66N	39	74LS231N	239
74LS67N	39	74LS232N	239
74LS68N	39	74LS233N	239
74LS69N	39	74LS234N	239
74LS70N	39	74LS235N	239
74LS71N	39	74LS236N	239
74LS72N	39	74LS237N	239
74LS73N	39	74LS238N	239
74LS74N	39	74LS239N	239
74LS75N	39	74LS240N	239
74LS76N	39	74LS241N	239
74LS77N	39	74LS242N	239
74LS78N	39	74LS243N	239
74LS79N	39	74LS244N	239
74LS80N	39	74LS245N	239
74LS81N	39	74LS246N	239
74LS82N	39	74LS247N	239
74LS83N	39	74LS248N	239
74LS84N	39	74LS249N	239
74LS85N	39	74LS250N	239
74LS86N	39	74LS251N	239
74LS87N	39	74LS252N	239
74LS88N	39	74LS253N	239
74LS89N	39	74LS254N	239
74LS90N	39	74LS255N	239
74LS91N	39	74LS256N	239
74LS92N	39	74LS257N	239
74LS93N	39	74LS258N	239
74LS94N	39	74LS259N	239
74LS95N	39	74LS260N	239
74LS96N	39	74LS261N	239
74LS97N	39	74LS262N	239
74LS98N	39	74LS263N	239
74LS99N	39	74LS264N	239
74LS100N	39	74LS265N	239
74LS101N	39	74LS266N	239
74LS102N	39	74LS267N	239
74LS103N	39	74LS268N	239
74LS104N	39	74LS269N	239
74LS105N	39	74LS270N	239
74LS106N	39	74LS271N	239
74LS107N	39	74LS272N	239
74LS108N	39	74LS273N	239
74LS109N	39	74LS274N	239
74LS110N	39	74LS275N	239
74LS111N	39	74LS276N	239
74LS112N	39	74LS277N	239
74LS113N	39	74LS278N	239
74LS114N	39	74LS279N	239
74LS115N	39	74LS280N	239
74LS116N	39	74LS281N	239
74LS117N	39	74LS282N	239
74LS118N	39	74LS283N	239
74LS119N	39	74LS284N	239
74LS120N	39	74LS285N	239
74LS121N	39	74LS286N	239
74LS122N	39	74LS287N	239
74LS123N	39	74LS288N	239
74LS124N	39	74LS289N	239
74LS125N	39	74LS290N	239
74LS126N	39	74LS291N	239
74LS127N	39	74LS292N	239
74LS128N	39	74LS293N	239
74LS129N	39	74LS294N	239
74LS130N	39	74LS295N	239
74LS131N	39	74LS296N	239
74LS132N	39	74LS297N	239
74LS133N	39	74LS298N	239
74LS134N	39	74LS299N	239
74LS135N	39	74LS300N	239
74LS136N	39	74LS301N	239
74LS137N	39	74LS302N	239
74LS138N	39	74LS303N	239
74LS139N	39	74LS304N	239
74LS140N	39	74LS305N	239
74LS141N	39	74LS306N	239
74LS142N	39	74LS307N	239
74LS143N	39	74LS308N	239
74LS144N	39	74LS309N	239
74LS145N	39	74LS310N	239
74LS146N	39	74LS311N	239
74LS147N	39	74LS312N	239
74LS148N	39	74LS313N	239
74LS149N	39	74LS314N	239
74LS150N	39	74LS315N	239
74LS151N	39	74LS316N	239
74LS152N	39	74LS317N	239
74LS153N	39	74LS318N	239
74LS154N	39	74LS319N	239
74LS155N	39	74LS320N	239
74LS156N	39	74LS321N	239
74LS157N	39	74LS322N	239
74LS158N	39	74LS323N	239
74LS159N	39	74LS324N	239
74LS160N	39	74LS325N	239
74LS161N	39	74LS326N	239
74LS162N	39	74LS327N	239
74LS163N	39	74LS328N	239
74LS164N	39	74LS329N	239
74LS165N	39	74LS330N	239
74LS166N	39	74LS331N	239
74LS167N	39	74LS332N	239
74LS168N	39	74LS333N	239
74LS169N	39	74LS334N	239
74LS170N	39	74LS335N	239
74LS171N	39	74LS336N	239
74LS172N	39	74LS337N	239
74LS173N	39	74LS338N	239
74LS174N	39	74LS339N	239
74LS175N	39	74LS340N	239
74LS176N	39	74LS341N	239
74LS177N	39	74LS342N	239
74LS178N	39	74LS343N	239
74LS179N	39	74LS344N	239
74LS180N	39	74LS345N	239
74LS181N	39	74LS346N	239
74LS182N	39	74LS347N	239
74LS183N	39	74LS348N	239
74LS184N	39	74LS349N	239
74LS185N	39	74LS350N	239
74LS186N	39	74LS351N	239
74LS187N	39	74LS352N	239
74LS188N	39	74LS353N	239
74LS189N	39	74LS354N	239
74LS190N	39	74LS355N	239
74LS191N	39	74LS356N	239
74LS192N	39	74LS357N	239
74LS193N	39	74LS358N	239
74LS194N	39	74LS359N	239
74LS195N	39	74LS360N	239
74LS196N	39	74LS361N	239
74LS197N	39	74LS362N	239
74LS198N	39	74LS363N	239
74LS199N	39	74LS364N	239
74LS200N	39	74LS365N	239
74LS201N	39	74LS366N	239
74LS202N	39	74LS367N	239
74LS203N	39	74LS368N	239
74LS204N	39	74LS369N	239
74LS205N	39		



# The Supermarket for TRS-80\* Add-on Components (and other computers, too)

In stock now. Immediate delivery.

## The VISTA V-80 Disk Drive System

- 23% more storage capacity than TRS-80
- 120 day warranty
- 40 track patch at NO CHARGE



Single drive system ..... \$ 395.00  
Two drive system ..... \$ 770.00  
Four drive system ..... \$1450.00  
Two drive cable ..... \$ 29.95  
Four drive cable ..... \$ 39.95

## The VISTA V-80 Expansion Module

- Provides double density modification to your current Radio Shack interface (lets you format diskettes in either single or double density).
- Increases storage capacity up to 204K bytes (on single 40 track drive).
- Includes all hardware and software.

**\$239.00**



## The VISTA Model II

- Provides one, two or three drives.
- Adds up to 1.5 million bytes of on-line storage.
- 120 day warranty
- Does everything Radio Shack's expansion system will do...for less!



**\$1000.00** Single drive Expansion System  
**\$1550.00** Two drive Expansion System  
**\$2100.00** Three drive Expansion System  
**\$ 525.00** Additional drives alone

## The TRS-80 Printers

Centronics 730... **\$945.00**  
7x7 dot matrix-80 column

Anadex DP8000... **\$895.00**  
9x7 dot matrix-80 column

VISTA Printer... **\$745.00**  
5x7 dot matrix-80 column

Cables ..... **\$27.50 each**



## Other Products

1. VISTA Verbatim diskettes (hard or soft sector) Certified 40 track ..... **\$ 38.95**
2. 16K RPM upgrade kits, guaranteed for 120 days.  
**PRIME PRODUCT** ..... **\$ 74.50**
3. NEW! DOS + ..... **\$ 110.00**
4. LNW expansion bare board ..... **\$ 66.95**
5. H.C. Pennington book, TRS-80 Disk and Other Mysteries ..... **\$ 18.95**
6. DDT Disco-Tech disk drive timer ..... **\$ 19.95**
7. Cryptext (An Encryption Module) ..... **\$299.00**

## Add On Drives

- |         |                                       |                 |
|---------|---------------------------------------|-----------------|
| MPI B51 | 40 Track, Double Density-204K         | <b>\$275.00</b> |
| MPI B52 | Dual Head, Double Density-408K        | <b>\$375.00</b> |
| Siemens | FDD100-5 40 Track Double Density 204K | <b>\$275.00</b> |
| Siemens | FDD100-5 Flippy, records both sides   | <b>\$290.00</b> |
| Siemens | FDD100-8 8" Single Sided Drive        | <b>\$448.00</b> |

## The VISTA V-200 for Exidy

- Completely packaged system, tested and ready to plug in, includes: power supply, two 40 track drives, case, controller, all cabling and total CPM documentation.
  - Storage capacity from 400K to 1.2 meg.
  - System software-VISTA CP/M Disk Operating System and BASIC-E Compiler recorded on 5-1/4" diskettes.
- Price: Starting as low as **\$1199.00**



CALL TOLL-FREE 800-854-8017

\*TRS-80 is a registered trademark of Radio Shack.

The Vista Computer Company 1401 Borchard Street • Santa Ana, California 92705 • 714/953-0523



# PRIORITY ONE ELECTRONICS

## THE STAR MODEM from Livermore

### STARS & STRIPES SPECIAL

LIST PRICE  
**199.00**

OUR CORNER  
THE MARKET PRICE  
**\$139.00**



**FEATURE  
FITS GTE HANDSETS!**

The STAR modem from Livermore represents a significant breakthrough in the development of acoustic modems. The small, lightweight case houses a high-performance modem that competes with the highest quality standard-sized couplers available. Yet, because of its cost effective design, the STAR has become the price/performance leader in the industry.

**CIRCUITRY**  
The switchable, four-section bandpass filter provides the user with excellent out-of-band rejection to assure accurate processing of the received carrier, even at signal levels of less than -47 dBm. Further, the proven soft limiter and phase lock loop discriminator yields data that is essentially jitter free.

The oscillator is built using highly stable, state-variable circuitry that delivers a nearly harmonic free, phase coherent sine wave to the telephone network, assuring compatibility with all other 103 type modems. Because of the pureness of the sine wave, the STAR modem exceeds even the stringent harmonic requirements of all CCITT countries.

**CARRIER DETECT**  
To assure accurate teleprocessing connections, the carrier detect circuitry prevents the modem from attempting to operate when excessive noise would produce errors or cause marginal operation. The circuitry also has a special amplitude sensor that prevents chatter when the received signal fades.

### EXCLUSIVE ACOUSTIC CHAMBERS

The exclusive triple seal of Livermore's new flat mounted cups locks the handset into the acoustic chamber yielding superior acoustic isolation and mechanical cushioning. Designed to adapt to most common handsets used throughout the world, the STAR offers the utmost in flexibility and transmission reliability.

### SELF TEST

The self test feature on the STAR allows the user to verify total operation of the acoustic modem by using the terminal in the full duplex mode. No need for remote assistance in diagnosing terminal or modem problems.

Utilizing the experience gained from building high quality couplers for over twelve years, Livermore has designed a coupler superior to any in its class for cost efficiency in industrial, commercial, business or home situations. You can see why we call it the STAR!

### SPECIFICATIONS

**Data Rate.** 0 to 300 baud.

**Compatibility.** Bell 103 and 113; CCITT.  
**Transmit Frequencies.\*** Originate - 1070 Hz/Space, 1270 Hz/Mark; Answer - 2025 Hz/Space, 2225 Hz/Mark

**Receive Frequencies.\*** Originate - 2025 Hz/Space, 2225 Hz/Mark; Answer 1070 Hz/Space, 1270 Hz/Mark.

**Frequency Stability.** ±0.3 percent.

**Receiver Sensitivity.** -50 dBm ON, -53 dBm OFF.

**Transmit Level.** -15 dBm.

**Modulation.** Frequency shift keyed (FSK).  
**Carrier Detect Delay.** 1.2 seconds ON; 120 msec OFF.

**EIA Terminal Interface.** Compatible with RS 232 specifications.

**Teletype Interface.** 20 milliampere current loop.

**Optional Interfaces.** IEEE 488; TTL; TTY 43.

**\*International (CCITT) frequencies available.**

**Switches.** Originate/Off/Answer; Full Duplex/Test/Half Duplex.

**Indicators.** Transmit Data, Receive Data, Carrier Ready, Test.

**Environmental.** Ambient operating temperature 5° C. to 50° C. Relative humidity 10 to 90 percent (non-condensing).

**Power.** Supplied by 24 VAC/150 MA UL/CSA listed wall-mount transformer. Input 115 VAC, 2.5 watts. (A 220 VAC, 50 Hz adaptor is available upon request.)

**Dimensions.** 10" x 4" x 2"

**Weight.** 1.75 lbs. (2.2 lbs. shipping weight including AC adaptor.)

**Warranty.** Two years on parts and labor, excluding the AC adaptor which carries the manufacturer's warranty.

## CENTRONICS 730 Dot Matrix Printer

LIST PRICE \$795.00

SALE PRICE  
**\$695.00**



**SAVE \$100.**

**STANDARD FEATURES:** • 50 Characters/second • Characters/line • 10 characters/inch • 3-way paper handling system • 7 x 7 dot matrix • 96 character ASCII • microprocessor electronics • unidirectional print at 50 ips • high speed return approximately 10 ips • 21 lpm with 80 columns printed • 58 lpm with 20 columns printed • 80 character buffer • 8 lpi vertical • Centronics Colors and logo

**FORMS HANDLING:** Roll Paper 8.5 in x 5.0 dia with 1 in. core maximum dimension. 3.5 in wide with 38 in core minimum dimension Fan Gold 9.0 in (22.9 cm. wide pin to pin 9.5 in (24.1 cm wide overall. Up to 3 ply paper with 2 carbons (total thickness not to exceed 0.12 inches) Cut Sheet: Maximum width 8.5 inches.

**RIBBON SYSTEM:** Continuous ribbon 9/16" (14mm) wide. 20 yards (18.3 meters) long. Mobius Loop allows printing on upper and lower portion on alternate passes

**OPERATOR CONTROLS:** Power on/off Resel Switch - allows disabling of printer without dropping AC

**DATA INPUT:** 7 or 8 bit ASCII parallel. TTL levels with strobe Acknowledge pulse indicates that data was received

**PHYSICAL DIMENSIONS:** Weight less than 10 lbs/5 kg -Width 14.5 inches/37 cm -Depth 11.0 inches/28cm -Height 4.89 inches/13cm -Dimensions exclusive of roll paper holder

SHIPPING WEIGHT 14 lbs

PRI - 730 - TRS80 - CENTRONICS 70 TRS-80 Interface Cable.....\$19.95

**PRIORITY ONE ELECTRONICS**  
16723K Roscoe Blvd. Sepulveda, CA 91343

Terms: Visa, MC, BAC, Check, Money Order, U.S. Funds Only. CA residents add 6% sales tax. Minimum order \$10.00 Prepaid U.S. orders less than \$75.00 include 5% shipping and handling. MINIMUM \$2.50. Excess refunded. Just in case ... please include your phone no. Prices subject to change without notice. We will do our best to maintain prices thru Aug 1980. \*SOCKET and CONNECTOR prices based on GOLD, not exceeding \$500 per oz.

\*Sale Prices are for prepaid orders only credit card orders will be charged appropriate freight



FOR MORE INFORMATION SEE OUR 52 PAGE AD IN JANUARY BYTE OR SEND \$1.00 FOR CATALOG

• Sale Prices are for prepaid orders only • Quantities are limited, subject to prior sale • CREDIT CARD ORDERS WILL BE CHARGED APPROPRIATE FREIGHT

ORDER TOLL FREE  
**1-800-423-5633**  
except CA., AK., HI., CALL  
**(213) 894-8171**

# PRIORITY ONE ELECTRONICS

## TRS-80/APPLE MEMORY EXPANSION KITS

4116's RAMS

from Leading Manufacturers  
(16Kx1 200/250ns)

**8 for \$48.00**

ADD \$3.00 FOR PROGRAMMING JUMPERS  
FOR TRS-80 KEYBOARD

4116's 100 pcs & UP \$5.20 each  
1000 pcs & UP \$4.45 each



## Factory Rebate Sale

When you purchase any SD SYSTEMS Computer Board, either kit or A&T from PRIORITY 1 ELECTRONICS, you will receive a COUPON FOR A \$25.00 CASH REBATE direct from the Manufacturer, SD

SYSTEMS. Combine the Rebate with our already low prices, and you can hardly afford to pass up this special offer.

For more information, see last month's issue of Byte, or our catalog.

	Reg. Price	Sale Price
SDS-EXPANDORAM I KIT 0K	\$220.00	\$210.00
SDS-EXPANDORAM I KIT 16K		\$249.00
SDS-EXPANDORAM I KIT 32K		\$299.00
SDS-EXPANDORAM I KIT 48K		\$349.00
SDS-EXPANDORAM I KIT 64K		\$398.00
SDS-EXPANDORAM II KIT 0K	\$230.00	\$220.00
SDS-EXPANDORAM II KIT 16K		\$250.00
SDS-EXPANDORAM II KIT 32K		\$325.00
SDS-EXPANDORAM II KIT 48K		\$390.00
SDS-EXPANDORAM II KIT 64K		\$459.00

	Reg. Price	Sale Price
SDS-VERSAFLOPPY I KIT	\$250.00	\$220.00
SDS-VERSAFLOPPY II KIT	\$350.00	\$299.00
SDS-VDB8024 KIT	\$370.00	\$320.00
SDS-PROM-100 KIT	\$200.00	\$175.00
SDS-SBC-100 2 Mhz KIT	\$295.00	\$265.00
SDS-SBC-200 4 Mhz KIT	\$320.00	\$289.00
SDS-Z80 STARTER KIT	\$340.00	\$299.00

SD Systems Kits carry a 90 day limited warranty from SD Systems. 4116 ICs supplied by Priority 1 Electronics for use in SD Expandorams carry a 1 year limited warranty from Priority 1 Electronics.

**Compare our Sale Prices, and then don't forget your Rebate!**

SEND \$1.00 FOR 52 PAGE CATALOG

SEND \$1.00 FOR 52 PAGE CATALOG



COMPUTER  
SYSTEMS  
INC.

**IEEE S-100  
COMPATIBLE**

### Z+ 80 CPU

- 1K Ram On Board • 2 Programmable Timers • Programmable Baud Rate Selection (110 to 9600)
- Switch Selectable 2 or 4 MHz • On-Board EPROM May be Used in Shadow Mode, Allowing Full 64K RAM to be Used
- Power On Jump to On-Board 1K or 2K EPROM (2708-2716-2732) Can be Addressed on any 1K, 2K or 4K Boundary
- On-Board USART for Synchronous or Asynchronous RS-232 Operation (On-Board Baud Rate Generator)

Bare Board \$ 45.00 A&T \$229.95  
Kit \$169.95 1K Memory Kit \$ 12.00

### EXPANDABLE + DYNAMIC MEMORY (16K to 64K)

- Works With Cromenco Systems
- Bank Selectable Write Protect
- Uses 3242 Refresh Chip
- Phantom Output Disable
- 4 Layers Mean A Quiet Board
- Switch Selectable Output Disable

Bare Board \$ 49.95	32K Kit \$369.95	48K A&T \$494.95
16K Kit \$295.95	32K A&T \$419.95	64K Kit \$519.95
16K A&T \$345.95	48K Kit \$444.95	64K A&T \$569.95

### CLOCK CALENDAR +

- Time of Day in Hours, Minutes and Seconds
- 24 Hour Time Format
- Month and Day Date Function
- Simple Read Instructions Allow Simple Interface to Basic, CPM, Etc.
- Will Run With 4 MHz Processors
- Can be Located at any Group of 4 I/O Port Addresses

Bare Board \$45.00 Kit \$99.95 A&T \$149.95

## LOBO 8" DISK DRIVE CABINET



New from Lobo, a dual Cabinet with power supply, and internal data cable hook-up.

- Cabinet accepts 2 801R, 800R, FD120, or FD200 style disk drives.
- Power Supply for 2 drives
- Assembled, tested and guaranteed by Lobo Drives.
- Shipping Weight 30 lbs.

LBO — DUAL 8 PCS..... \$329.00

### BUY CABINET AND DRIVES AND SAVE

WITH 1 DRIVE WITH 2 DRIVES  
LBO-801R-1PSC \$175.00 LBO-801R-2PSC \$125.00

### DISK DRIVE ONLY

SHU-801R.....\$499.00

EXTERNAL DATA CABLES  
CARDEDGE TO CARDEGE \$119.95  
CARDEDGE TO SOCKET \$119.95

## MEMORY HEADQUARTERS

2716 16K 5 Volt only EPROM	\$22.00 ea.
	10/\$200.00
2708 8K 450ns EPROM	8/\$55.00
	\$8.50 ea.
2114-3L 1Kx4 300ns Low Power	8 \$45.00
	100 + \$4.00 ea.
5257-3L 4Kx1 300ns Low Power	8/\$55.00
	100 + \$5.25 ea.
2102AL-2 L/P 250ns in lots of 20	1.25 ea.
	100 + 1.10 ea.

## SPECIAL PURCHASES

POWER SUPPLY  
5 Volt 3 Amp w/OVP  
Input 110/220V Open Frame  
\$19.95



MAGNIFIER  
with T9 fluorescent tube  
List \$94.95  
Sale \$49.95  
LDU-MG-10A \$49.95

## Hitachi V302

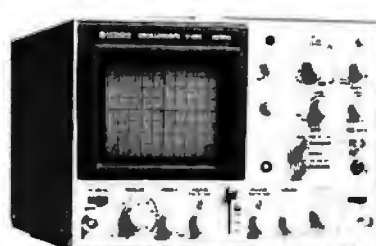

### 30MHZ DUAL TRACE OSCILLOSCOPE

LIST 945.00 - SALE \$798.00

- TV sync-separator circuit
- High-sensitivity 1mV/div
- Sweep-time magnifier (5MHz)
- 2-axis input (intensity modulation)
- Signal delay line
- X-Y operation
- Trace Rotation
- Complete with 2 probes
- CH1, CH2, DUAL, ADD, DIFF, Vertical Deflection Modes
- V152 Dual Trace 15MHz - no delay sweep

LIST 695.00

SALE \$595.00

FOR MORE INFORMATION SEE OUR 52 PAGE AD IN JANUARY BYTE OR SEND \$1.00 FOR CATALOG  
• Sale Prices are for prepaid orders only • Quantities are limited, subject to prior sale • CREDIT CARD ORDERS WILL BE CHARGED APPROPRIATE FREIGHT

ORDER TOLL FREE  
1-800-423-5633  
except CA, AK, HI, CALL  
(213) 894-8171



PRIORITY ONE ELECTRONICS  
16723K Roscoe Blvd. Sepulveda, CA 91343

Terms: Visa, MC, BAC, Check, Money Order, U.S. Funds Only. CA residents add 6% sales tax. Minimum order \$10.00 Prepaid U.S. orders less than \$75.00 include 5% shipping and handling. MINIMUM \$2.50. Excess refunded. Just in case... please include your phone no. Prices subject to change without notice. We will do our best to maintain prices thru Aug 1980.  
\*SOCKET and CONNECTOR prices based on GOLD, not exceeding \$500 per oz.

\*Sale Prices are for prepaid orders only credit card orders will be charged appropriate freight

PRIORITY ONE ELECTRONICS

Circle 229 on Inquiry card.

# PRIORITY ONE ELECTRONICS



**MEET THE ECONORAM FAMILY.....**  
**all ECONORAMS from COMPUKIT include:**

- Fully static memory used throughout to promote reliable operation and facilitate direct memory access. (DMA)
- 4 MHz with Z80 - 5 MHz with 8085
- Buffered tri-state outputs and buffered inputs.
- All lines buffered; address and data lines buffered to 1 low power Schottky TTL load, all other lines buffered to less than 1 TTL load.
- Onboard regulation.
- DIP switch address selection and deselection (no wire jumpers).
- Low power Schottky support ICs.
- S-100 boards have WRITE strobe selections switch - allows use of memory with or without front panel.

- All ICs are socketed (including support chips)
- Unique multi-block configurations for addressing flexibility.
- Industry standard board sizes.
- High quality, double sided, plate through, solder-masked and legended circuit board.
- LOW current consumption and guaranteed specs.
- 1 year limited warranty (not just 90 days).

Most ECONORAMS come in 3 forms: UNKIT (UKT) - (this means that all sockets, disc capacitors are already soldered in place for easy assembly), fully assembled & tested (A&T), or qualified under the Certified System Component (CSC) high-reliability program (200 hour burn-in, guaranteed 4MHz operation over full temperature range, serial numbered, immediate replacement in event of failure with 1 year of invoice date).

**SALE SALE**



**NEW**  
**8K**  
**ECONORAM**  
**IIA**

We realize that this may not look like the 8K, Econoram II board you've known and loved for so many years, however, at Godbout, good things don't come to an end - they just get better! Our NEW 8K Econoram IIA board retains all the best selling features of the old Econoram II PLUS is now 4 MHz STANDARD - still static - with ultra low power consumption S-100 compatible. Single supply required - guaranteed maximum current under 900mA. Typical boards draw 700 to 800mA Phantom feature is included on the new Econoram IIA and is switch selectable. Organized as two 4K independently addressable blocks. Includes switched WRITE protect - block and board disable. Also, has provision for memory management. Shipping Weight 2 lbs

GBT - ECONORAM IIA UKT .....	Reg. \$169.00	Sale \$159.00
GBT - ECONORAM IIA A&T .....	Reg. \$189.00	Sale \$169.00

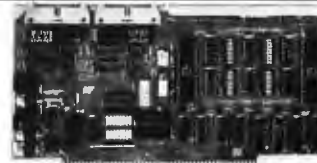

**CK022 S-100**  
**INTERFACER**

Our new I/O board gives you unparalleled flexibility and operating convenience. We include such features as:

- 2 independently addressable serial ports (dip switch selectable addresses)
- Real LSI hardware UARTs for minimum CPU housekeeping
- RS232C, current loop (20mA), & TTL signals on both ports
- Precision, crystal-controlled Baud rates up to 19.2K Baud (individually dip switch selectable)
- Transmit & receive interrupts on both channels, jumperable to any vectored interrupt line
- Industry standard RS232 level converters with five RS232 handshaking lines per port
- Optically isolated current loop with provisions for both on-board & off-board current sources
- UART parameters, interrupt enables & RS232 handshaking lines are software programmable with power-on hardware default to customer specified hard-wired settings for maximum flexibility
- Port connectors mate directly to ribbon cable & DB25 connectors in standard pinouts
- RS232 lines will conform to either master or slave configurations
- Board gives full feature operation with both 2 & 4 MHz systems
- Low power consumption. +8V @ 450mA, +16V @ 150mA, -16V @ 70mA max
- No software initialization required for board operation, although board parameters may be altered by software 2 lbs

GBT - INTERFACER I UKT .....	Reg. \$199.00	Sale \$189.00
GBT - INTERFACER I A&T .....	Reg. \$249.00	Sale \$219.00

**NEW! 32K X 8 ECONORAM X**  
 Static storage for the S-100 buss.

Static storage for the S-100 buss. Guaranteed 4 MHz operation. Configured as two 8K and one 16K block, all independently addressable, protectable & enableable. Suitable for use in phantom systems. Extra select/deselect qualifiers for systems using more than 64K of memory make this board the ideal building block for large memory systems. Maybe you can't believe the low pricing - but you can count on the Econoram performance! Also available populated to 16K. Shipping Weight 2 lbs.

GBT - ECONORAM X 16K UKT .....	Reg. \$329.00	Sale \$308.00
GBT - ECONORAM X 16K A&T .....	Reg. \$379.00	Sale \$319.00
GBT - ECONORAM X 32K UKT .....	Reg. \$599.00	Sale \$559.00
GBT - ECONORAM X 32K A&T .....	Reg. \$689.00	Sale \$589.00

**INTERFACER II**

The new interfacer II I/O board incorporates one channel of serial I/O with all the features of the INTERFACER dual RS232 serial board, plus 3 full duplex Parallel ports. The serial section includes all the features you've come to expect - a hardware UART, on-board crystal controlled Baud rate generator, hardware/software programmability, RS232 handshaking lines with real RS232 drivers, current loop & TTL drivers, full interrupts and more!!! The parallel selection utilizes LSTTL octal latches for latched input & output data with 24mA drive current, attention, enable & strobe bits for each parallel port (each with selectable polarity), interrupts for each input port, separate 25 pin connectors with power for each channel and a status port for interrupt mask and port status. All in all - an incredibly flexible and easy to use board.

GBT - INTERFACER II UKT .....	Reg. \$199.00	Sale \$189.00
GBT - INTERFACER II A&T .....	Reg. \$249.00	Sale \$219.00

**ECONORAM**  
**XIIIA-32**



32K BANK SELECT! S-100 compatible. 4MHz guaranteed operation (0-70 C.) Features two 16K blocks independently addressable on 16K boundaries. Two independent banks - individual phantom - 256 ports DIP switch selectable - each block may be deselected with a single switch. Perfect for use in Alpha Micro Systems, Marinchip & others. Uses 4K x 1 low power STATIC rams. Current consumption guaranteed 3500mA max. Shipping Weight 2 lbs

GBT - ECONORAM XIIIA 16K UKT .....	Reg. \$349.00	Sale \$329.00
GBT - ECONORAM XIIIA 16K A&T .....	Reg. \$419.00	Sale \$369.00
GBT - ECONORAM XIIIA 24K UKT .....	Reg. \$479.00	Sale \$449.00
GBT - ECONORAM XIIIA 24K A&T .....	Reg. \$539.00	Sale \$479.00
GBT - ECONORAM XIIIA 32K UKT .....	Reg. \$649.00	Sale \$598.00
GBT - ECONORAM XIIIA 32K A&T .....	Reg. \$729.00	Sale \$649.00

**ECONOROM**  
**2708**

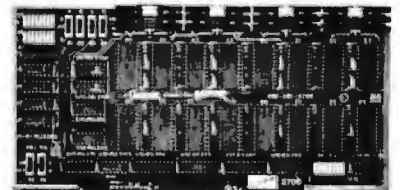

Has provisions for wait states for 4MHz operations. Configured as four 4K blocks - each independently addressable and disableable. Power-on jump. Does NOT include 2708s. Includes all support chips, sockets, regulators, heat sinks, etc. Sold in UNKIT form only. Shipping Weight 2 lbs.

GBT - ECONOROM 2708 UKT .....	Reg. \$85.00
-------------------------------	--------------

<b>NEW</b>	<b>NEW</b>	Reg.	Sale	GBT-CPU-Z80 A&T .....	Reg. 295.00	Sale 269.00	<b>NEW</b>	<b>NEW</b>	Reg.	Sale
GBT-SPECTRUM (Color graphics) KIT.	339.00	319.00	GBT-CPU-8085 KIT .....	235.00	220.00	GBT-CPU-8085/8088 A&T .....	495.00	449.00		
GBT-SPECTRUM (Color graphics) A&T.	399.00	349.00	GBT-CPU-8085 A&T .....	325.00	259.00	GBT-BOX-DESK (S-100 Mainframe) .....	289.00	269.00		
GBT-CPU-Z80 KIT .....	225.00	210.00	GBT-CPU-8085/8088 KIT .....	385.00	365.00	GBT-BOX-RACK (S-100 Mainframe) .....	329.00	309.00		

**ECONORAM XIV**

16K x 8 for S-100. Addressable on any 4K boundary. Direct addressing on up to 24 address lines. Fully meets IEEE S-100 buss. specs. Low power, hi speed static memory. Operates up to 5MHz with newest 8085/8086/8088 CPUs. Can be used with 8080, Z80, 8085, 8086, 8088, Z8000, etc.

GBT - ECONORAM XIV UKT .....	Reg. \$299.00	Sale \$279.00	GBT - ECONORAM XIV A&T .....	Reg. \$349.00	Sale \$298.00
------------------------------	---------------	---------------	------------------------------	---------------	---------------



## S-100 VOICE

The ARTICULATOR board allows you to record, store, and playback any vocabulary on your S-100 computer. Input speech is digitized by the ARTICULATOR and sent to the computer via an on-board port for storage at 1K to 2K bytes/sec. This data is then sent back from the computer to the ARTICULATOR for very high quality playback. On-board VOX switching minimizes memory storage requirements.

PRICE — \$319 A&T  
AVAILABLE NOW

Quintrex, Inc., 9185 Bond  
Shawnee Mission, Ks. 66215  
(913) 888-3353

Circle 230 on inquiry card.

Dial: 402-987-3771

## HOT LINE

YOU NEED CRISP, HIGH CONTRAST BLACK-WHITE and VIVID COLOR ALPHA-NUMERICS/GRAPHICS CAPABILITIES FROM YOUR VIDEO MONITOR IF YOU WANT REALLY SUPER-LOOKING IMAGES FROM YOUR COMPUTER!!

AS SPECIALISTS IN VIDEO IMAGING...we think we have the right monitor or modulator for your system. Our product line includes the popular "Micro-Verter" (OS) and Apple Inc. approved UHF color modulator, a variety of color and B-W monitors, color cameras, B-W cameras, Audio subcarrier kits and parts. FREE CATALOG UPON REQUEST. Dealers welcome. We'll establish program with over 400 dealers.

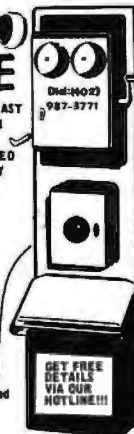

GET FREE  
DETAILS  
VIA OUR  
HOTLINE!!!

ATV Research 13-B BROADWAY DAKOTA CITY, NE. 68731

## SURPLUS ELECTRONICS

ASCII



ASCII

IBM SELECTRIC<sup>®</sup>  
BASED I/O TERMINAL  
WITH ASCII CONVERSION  
INSTALLED \$645.00

- Tape Drives • Cable
- Cassette Drives • Wire
- Power Supplies 12V15A, 12V25A, 5V35A Others, • Displays
- Cabinets • XFMRs • Heat Sinks • Printers • Components

Many other items  
REFUNDABLE FIRST ORDER  
WORLDWIDE ELECT. INC.

130 Northeastern Blvd.  
Nashua, NH 03062

Phone orders accepted using  
VISA or MC  
Call Toll Free 1-800-258-1036

Circle 231 on inquiry card.

## OHIO SCIENTIFIC SYSTEMS

CALL FREE FOR OUR PRICES  
(800) 558-0870

or

WRITE FOR CATALOG

**FARAGHER &  
ASSOCIATES**

7635 BLUEMOUND  
MILWAUKEE, WI 53213  
(414) 258-2588  
In Wisconsin

Circle 232 on inquiry card.

## PASCAL

For programmers learning or desiring to learn PASCAL for the APPLE computer.

### LEARN BY EXAMPLE

Three practical-useful PASCAL programs (Text & Code) are now available on minidisk for only \$55.00. Filecreate, fileupdate, and filesearch will help you produce in just a very short time. Order today from:

**Personal Programs By Victor**  
P.O. Box 60034  
Sunnyvale, CA 94086

(CA Residents add \$3.57 Tax)  
CUSTOM PROGRAMS UPON  
REQUEST

Circle 233 on inquiry card.

## Acoustic Coupler Sale



- 1 Yr Warranty (RTN to Factory)
- Latest Technology (Phase Lock Loop)
- Up to 300 Baud
- EIA and/or 20 Mil

Technology Design 300

\$145ea.\*

\*Texas Residents Add 5% Sales Tax

Please Rush. Qty \_\_\_\_\_ TD300 Coupler

To: \_\_\_\_\_

Check Enclosed zip code \_\_\_\_\_  
Master Charge No \_\_\_\_\_

Visa No. \_\_\_\_\_

Exp. Date \_\_\_\_\_

Signature \_\_\_\_\_

Mail to:

TBI 11332 Mothis Ave./Suite 109  
Dallas, Texas 75229/214-247-1053

Circle 234 on inquiry card.

**Dysan**  
CORPORATION

Solve your disc problems, buy 100% surface tested Dysan diskettes. All orders shipped from stock, within 24 hours. Call toll FREE (800) 235-4137 for prices and information. Visa and Master Card accepted. All orders sent postage paid.

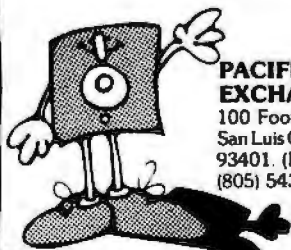

PACIFIC  
EXCHANGES  
100 Foothill Blvd.  
San Luis Obispo, CA  
93401. (In Cal. call  
(805) 543-1037.)

Circle 235 on inquiry card.

Sales  
Installation  
Service  
of  
Computers

JEPSAN, Group K  
Incorporated



\* PERCI DISK REPAIR \*

MINIMIZE DOWN TIME

BY  
CALLING

(616) 698-8700

CROMEMCO Dealer

4180 44th Street S.E.  
Grand Rapids, MI 49508

Circle 236 on inquiry card.

## OHIO SCIENTIFIC

..... With This Ad .....

HAZELTINE 1420 ..... \$780  
CENTRONICS 779 W/TRACTOR \$969  
NEC SPINWRITER ..... \$2250

..... Get the Catalog .....

&  
Our Low Prices

**DATA PRODUCTS  
MAINTENANCE CORP.**  
**OHIO SCIENTIFIC**

9460 Tolstar Avenue (213) 573-5991  
El Monte, CA 91731 (714) 994-4180

Circle 237 on inquiry card.

# DELTA IS READY

Call For  
DEALER  
In Your Area

## Z-80 CPU

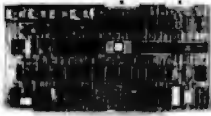

Two serial ports, three parallel ports. 2/4 MHz, on board Prom Monitor Phantoms. (Less cable and Monitor).  
A & T \$325.00

## DOUBLE/SINGLE DISK CONTROLLER

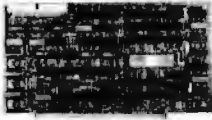

Two stage phase lock loop circuitry for greatest reliability, data transfer at maximum rate. Transparent density selection. 8" or 5" operation 2 or 4 MHz (Some restrictions on DMA).  
DMA — \$425.00  
STD. — \$385.00

## 16K, 32K STATIC RAM

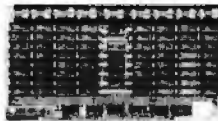

World's most reliable memory, responds to extended address lines A16, A17, cool running, fast.  
16K-\$395.00 32K-\$650.00

## 32K, 48K, 64K DYNAMIC RAM



Basic dynamic board tested to run at 4MHz with our Z-80 board. 4116 chips at 200 nanosecond speed insures most reliable data storage. Double density and DMA compatible.  
32K-\$580.00 48K-\$640.00  
64K-\$750.00

## 32K, 48K, 64K ERROR DETECTING Cromenco/Alfa Micro

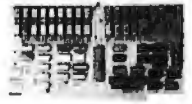

State of the art development. Parity generation and error detection. Compatible with 16 bit CPU designs. 16K bank, select under software control. 4MHz Z-80, 8086, Cromenco, Alpha Micro compatible.  
32K-\$650.00 48K-\$725.00  
64K-\$850.00

## FLOPPYS



8" Shugart . . . . \$550.00  
8" Siemens . . . . \$525.00  
5" Siemens . . . . \$350.00  
(Double Sided)  
8" CDC . . . . \$675.00  
8" Remex . . . . \$645.00

## TELEVIDEO 912



80 x 24—Lower case descenders. Teletype or typewriter keyboard 110/220 VAC. 50 to 19.2K Baud Hex entry pad. Similar to SOROC but better looking with NO FAN NOISE

## TELEVIDEO 920



Similar to TV 912 but has programmable functions keys across top. Excellent for WORDSTAR Text Editing.

## WINCHESTER/SHUGART SA 1000



5 megs now expandable to 10, works alongside floppy disk drive for expanded storage. Use with controller below.  
\$1950.00

## WINCHESTER/CENTURY DATA SYSTEM (Hunter Shown)



20 megs expandable to 40—Marksman series, plugs into our CPU parallel port or MP/M board drive, cabinet, power supply, 2.0 Bios.  
\$4850.00

## FLOPPY DISKS

### DYSAN Quality



8" SSSD . . . . \$4.25  
8" SSDD . . . . \$5.50  
8" DSDD . . . . \$7.60  
5" SSDD . . . . \$4.10  
(Boxes of 10 only)

## MPM<sup>®</sup>/I/O TIMER



Designed for MP/M<sup>®</sup> software of Digital Research. 6 users serial port, three 8 bit parallel ports for hard disk. Timer and vectored interrupt.  
©TM Digital Research

## 80 x 24 VIDEO



Keyboard input, Z-80 Processor, on board RAM makes this a non-memory mapped substitute for a terminal when mated with a keyboard.  
\$430.00

## WINCHESTER/FLOPPY INTERFACE



Allows mixing of Shugart Winchester and floppy drives on same cable when used with DP-DSK. Supplied with software Bios for MP/M<sup>®</sup> and 2.0  
©TM Digital Research

## SOFTWARE/CABLES/PROMS

CP/M<sup>®</sup> 2.2 . . . . \$150.00  
MP/M<sup>®</sup> . . . . \$350.00  
2708 Monitor . . . \$ 25.00  
2716 Monitor . . . \$ 40.00  
Disk 50 Pin . . . \$ 22.00  
RS-232 . . . . \$ 15.00  
CPU to Back . . . \$ 32.00  
Disk DC . . . . \$ 4.50  
Disk AC . . . . \$ 2.50  
Winchester . . . . \$ 28.00

# COMPLETELY NEW FROM DELTA PRODUCTS

## S-100 MAINFRAME



- Twin Vertical Drive Mounting, Fits Shugart, Siemens, Etc.
- Key-Lock Switch
- Detachable Power/Mother Module

- Detachable Drive Platform
- 12-Slot Motherboard, Fully Terminated

LESS DRIVES

**\$849.00**  
INTRODUCTORY SPECIAL

- INCLUDES S-100 MODULE SHOWN AT RIGHT.

## S-100 MODULE

- 30A of +8V  
6A of ±16V
- Disc Power Supply  
6A of +24V  
5A of +5V  
1A of -5V
- 220V or 110V AC  
50 or 60 Cycle Operation

- Connectors Supplied For Up To 4 Drives
- OPTIONAL Fans Mount Neatly On 1 Side For Forced Air Cooling

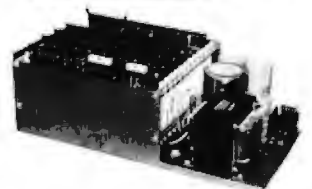
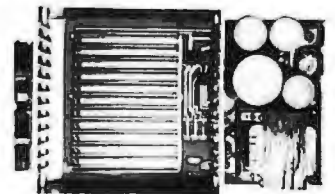

**\$249.00**  
INTRODUCTORY SPECIAL

West:  
**DELTA PRODUCTS**  
15392 Assembly Lane, Unit A  
Huntington Beach, CA 92649  
TELEPHONE: (714) 898-1492



East:  
**DELTA PRODUCTS**  
11 Edison Drive  
New Lenox, IL 60451  
TELEPHONE: (815) 485-9072

Circle 239 on inquiry card.

TELEX: 681-367 DELTMAR HTBH

6502	7.45	10 @	6.95	50 @	6.55	100 @	6.15
6502A	8.40	10 @	7.95	50 @	7.35	100 @	6.90
6520 PIA	5.15	10 @	4.90	50 @	4.45	100 @	4.15
6522 VIA	7.15	10 @	6.95	50 @	6.45	100 @	6.00
6532	7.90	10 @	7.40	50 @	7.00	100 @	6.60
2114-L450	4.75	20 @	4.45	100 @	4.15		
2114-L300	5.95	20 @	5.45	100 @	5.10		
2716 EPROM	21.00	5 @	19.00	10 @	17.00		
4116-200 ns RAM	7.00			8 @	6.25		
6550 RAM (PET 8K)					12.70		
21L02					.90		
S-100 Wire Wrap			2.85	10 @	2.65		
S-100 Solder Tail			2.35	10 @	2.15		

**CASSETTES—AGFA PE-611 PREMIUM**

High output, low noise, 5 screw housing, labels.

C-10 10/5.65 50/25.00 100/48.00

C-20 10/6.45 50/29.50 100/57.00

C-30 10/7.30 50/34.00 100/66.00

All other lengths available. Write for price list.

**DISKS**

(write for quantity prices)



SCOTCH 8" Disks	10/\$31.00
SCOTCH 5.25" Disks	10/ 31.50
Verbatim 5.25" Disks	10/ 24.50
Diskette Storage Pages	10/ 3.95
Disk Library Cases	8" - 2.95 5" - 2.15
BASF 5.25" Disks	10/ 28.00
BASF 8" Disks	10/ 29.00

**ATARI—INTRODUCTORY SPECIAL**

Atari 400, Atari 800, all Atari Modules 20% OFF

**Commodore CBM-PET SPECIALS**

**FREE**—Up to \$235 free merchandise with purchase of one of following CBM-PET items:



8032 32K-80 column CRT	\$1795 235
8016 16K-80 column CRT	1495 205
8050 Dual Disk Drive-950,000 bytes	1695 220
CBM Modem-IEEE Interface	395 50
CBM Voice Synthesizer	395 50
8N full size graphics keyboard	795 100
16N full size graphics keyboard	995 135
32N full size graphics keyboard	1295 170
16B full size business keyboard	995 135
32B full size business keyboard	1295 170
2040 Dual Disk Drive-343,000 bytes	1295 170
2022 Tractor Feed Printer	795 100
2023 Pressure Feed Printer	695 90
C2N External Cassette Deck	95 12
Used 8K PETs (limited quantities)	495

**\*\*\*\* EDUCATIONAL DISCOUNTS \*\*\*\***  
Buy 2 computers, get 1 FREE

CBM Full Size Graphics Keyboard	\$ 74
CBM WordPro I-for 8K PET	25
CBM WordPro II-16 or 32K, 2040, Printer	88
CBM WordPro III-32K, 2040, Printer	178
VISICALC for PET (CBM/Personal Software)	\$128
CBM Assembler/Editor (disk)	89
CBM General Ledger, A/P, A/R NEW!	270
Programmers Toolkit-PET ROM Utilities	\$ 44.90
PET Spacemaker Switch	22.90
Dust Cover for PET	7.90
IEEE-Parallel Printer Interface for PET	79.00
IEEE-RS232 Printer Interface for PET	149.00

Centronics 737 Proportional Spacing Printer	<b>\$845</b>
NEC Spinwriter-parallel	2450

SYM-1 \$209 with 4K RAM	\$ 238
SYM BAS-1 BASIC in ROM	85
SYM RAE-1/2 Assembler in ROM	85
MDT 1000 Synertek Development System	1345
KTM-2/80 Synertek Video Board	349
KIM-1 (add \$34 for power supply)	159
Seawell Motherboard-4K RAM	195
Seawell 16K Static RAM-KIM, SYM, AIM	320
S-100 Static RAM kit SALE	198
Leedex Video 100 12" Monitor	129
Zenith Z19 Terminal (factory asm.)	770

KL-4M Four Voice Music Board for PET	\$34.90
Visible Music Monitor (4 Voice) for PET	29.90
SPECIAL—KL-4M with Visible Music Monitor	59.90

MICROHELLO for PET by Michael Riley	\$9.95
Machine language version—you can't win at Level 5.	

PAPER MATE 60 Command PET Word Processor	\$29.95
Full-featured version by Michael Riley	



**Products 15% OFF**

All Book and Software Prices are Discounted

PET Personal Computer Guide (Osborne)	\$12.75
PET and the IEEE-488 Bus (Osborne)	12.75
6502 Assembly Language (Osborne)	9.45
Programming the 6502 (Zaks)	10.45
6502 Applications Book (Zaks)	10.45
Programming a Microcomputer: 6502	7.75
6502 Software Bookbook (Scelbi)	9.45

**WRITE FOR CATALOG**  
Add \$1 per order for shipping. We pay balance of UPS surface charges on all prepaid orders.

115 E. Stump Road  
Montgomeryville, PA 18936 215-699-5826

**A B Computers**



**CALIFORNIA COMPUTER SYSTEMS**

16K RAM BOARD. Fully buffered addressable in 4K blocks. IEEE standard for bank addressing 2114's. PCBD .....\$27.95 Kit 450 NSEC ...\$249.95

PT-1 PROTO BOARD. Over 2,600 holes 4" regulators. All S-100 buss functions labeled, gold fingers. PCBD .....\$26.95

PT-2 PROTO BOARD. Similar to PT-1 except set-up to handle solder tail sockets. PCBD .....\$26.95

CCS MAIN FRAME. Kit (S-100) .....\$339.95

APPLE EXTENDER. Kit .....\$22.95

APPLE IEEE INSTRUMENTATION INTERFACE KIT 7490. Kit .....\$275.00

ARITHMETIC PROCESSOR FOR APPLE 7811A. Kit .....\$350.00

APPLE ASYNCHRONOUS SERIAL INTERFACE 7710A. Kit .....\$89.95

APPLE SYNCHRONOUS SERIAL INTERFACE 7712A. Kit .....\$89.95

ALL OTHER CCS PRODUCTS AVAILABLE



PB-1 2708 & 2716 Programming Board with provisions for 4K or 8K EPROM. No external supplies required. Textool sockets. Kit .....\$129.95

CB-1A 8080 Processor Board. 2K of PROM 256 BYTE RAM power on/rest Vector Jump Parallel port with status. Kit .....\$129.95 PCBD .....\$27.95

VB-3 80 x 55 VIDEO BOARD. Graphics included. 2 MHZ .....\$294.95 4 MHZ .....\$329.95

IO-4 Two serial I/O ports with full handshaking 20/60 ma current loop: Two parallel I/O ports. Kit .....\$130.00 PCBD .....\$27.95

VB-1B 64 x 16 video board, upper lower case Greek composite and parallel video with software, S-100. Kit .....\$125.00 PCBD .....\$27.95

CB-2 Z80 CPU BOARD. Kit .....\$185.95

AIO APPLE SERIAL/PARALLEL .....\$125.95

ALL OTHER SSM PRODUCTS AVAILABLE



**WAMECO INC.**

FDC-1 FLOPPY CONTROLLER BOARD will drive shugart, pertek, ramac 5" & 8" drives up to 8 drives, on board PROM with power boot up, will operate with CPM™ (not included). PCBD .....\$42.95

FPB-1 Front Panel. IMSAI size, hex displays. Byte, or instruction single step. PCBD .....\$47.50

MEM-1A 8K x 8 fully buffered, S-100, uses 2102 type rams. PCBD .....\$25.95

QM-12 MOTHER BOARD, 13 slot, terminated, S-100 board only .....\$38.95

CPU-1 8080A Processor board S-100 with 6 level vector interrupt. PCBD .....\$27.95

RTC-1 Realtime clock board. Two independent interrupts. Software programmable. PCBD .....\$24.95

EPM-1 1702A 4K Eprom card. PCBD .....\$25.95

EPM-2 2708/2716 16K/32K EPROM CARD. PCBD .....\$25.95

QM-9 MOTHER BOARD. Short Version of QM-12. 9 Slots. PCBD .....\$32.95

MEM-2 16K x 8 Fully Buffered 2114 Board. PCBD .....\$27.95

PTB-1 POWER SUPPLY AND TERMINATOR BOARD. PCBD .....\$27.95

IOB-1 SERIAL AND PARALLEL INTERFACE. 2 parallel, one serial and cassette. PCBD .....\$27.95

2708 .....\$ 8.49 2114L 450 NSEC .....\$5.99

2716 .....\$35.95 2114L 200 NSEC .....\$6.99

**AUG. SPECIAL SALE**

**ON PREPAID ORDERS**  
(Charge cards not included on this offer)

**WAMECO BARE PCBD SALE. 10% OFF THE PRICE OF WAMECO PCBD WHEN 5 OR MORE ARE PURCHASED.**

**MIKOS PARTS ASSORTMENT WITH WAMECO AND CYBERCOM PCBDS**

MEM-2 with MIKOS #7 16K ram	\$249.95
MEM-2 with MIKOS #13 16K ram	\$279.95
CPU-1 with MIKOS #2 8080A CPU	\$ 94.95
QM-12 with MIKOS #4 13 slot mother board	\$ 95.95
RTC-1 with MIKOS #5 real time clock	\$ 59.95
EMP-1 with MIKOS #10 4K 1702 less EPROMS	\$ 49.95
EPM-2 with MIKOS #11 16-32K EPROMS less EPROMS	\$ 59.95
QM-9 with MIKOS #12 9 slot mother board	\$ 89.95
FPB-1 with MIKOS #14 all parts for front panel	\$144.95

MIKOS PARTS ASSORTMENTS ARE ALL FACTORY MARKED PARTS. KITS INCLUDE ALL PARTS LISTED AS REQUIRED FOR THE COMPLETE KIT LESS PARTS LISTED. ALL SOCKETS INCLUDED.

**LARGE SELECTION OF LS TTL AVAILABLE**

VISA or MASTERCARD. Send account number, interbank number, expiration date and sign your order. Approx. postage will be added. Check or money order will be sent post paid in U.S. If you are not a regular customer, please use charge, cashier's check or postal money order. Otherwise there will be a two-week delay for checks to clear. Calif. residents add 6% tax. Money back 30-day guarantee. We cannot accept returned IC's that have been soldered to. Prices subject to change without notice. \$10 minimum order. \$1.50 service charge on orders less than \$10.00.



(415) 726-7593  
P. O. Box 955 • El Granada, CA 94018  
Please send for IC, Xistor and Computer parts list



# WE WILL NOT BE UNDERSOLD

**16K MEMORY UPGRADE KITS** \$54  
for TRS-80\*, Apple II, Sorcerer (specify)

## PRINTERS

### NEC Spinwriter



**Letter Quality High Speed Printer**  
Includes TRS-80\* interface software, quick change print fonts, 55 cps, bidirectional, high resolution plotting, graphing, proportional spacing  
**\$2689**

With Tractor Feed **\$2889**

**DIABLO 1650** R.O. \$2890 KSR **\$3285**

**779 CENTRONICS TRACTOR FEED PRINTER** \$969

Same as Radio Shack line printer I

**737 CENTRONICS FRICTION & PIN FEED PRINTER** \$839

9 x 7 matrix

**730 CENTRONICS FRICTION & PIN FEED PRINTER** \$639

7 x 7 matrix Same as Radio Shack line printer II

**P1 CENTRONICS PRINTER** \$269

Same as Radio Shack quick printer

**PAPER TIGER (IP440)** \$939

Includes 2K buffer and graphics option

**TI-810** Faster than Radio Shack line printer III

Parallel and serial w/TRS-80\* interface software

with upper and lower case and paper tray **\$1575**

**OKIDATA Microline 80 Friction and pin feed** \$559

Tractor Feed, friction, and pin feed

**EATON LRC 7000 + 64 columns, plain paper** \$349

**ANADEX DP-9500** \$1369

**CAT MODEM** Originate and answer same as \$148

Radio Shack Telephone Interface II

**LEDEX MONITOR Video 100** \$129



## DISK DRIVES \$314

More capacity than Radio Shack 35 Track (80 K Bytes) drives. Fully assembled and tested. Ready to plug-in and run the moment you receive it. Can be intermixed with each other and Radio Shack drive on same cable. TRS-80\* compatible silver enclosure.

90 DAY WARRANTY. ONE YEAR ON POWER SUPPLY.

**FOR TRS-80\***

CCI-100 5 1/4", 40 Track (102K Bytes) for Model I **\$314**

CCI-200 5 1/4", 77 Track (197K Bytes) for Model I **\$549**

CCI-800 8" Drive for Model II (1/2 Meg Bytes) **\$795**

**For Zenith Z89**

CCI-189 5 1/4", 40 Track (102K Bytes) add-on drive **\$394**

Z-87 Dual 5 1/4" add-on drive system **\$995**

**DISKETTES** — Box of 10 (5 1/4") — with plastic library case **\$24.95**

8" double density for Model II (box of 10) **\$36.49**

## COMPLETE SYSTEMS

**TRS-80\* LEVEL II-16K with keypad** \$719

**TRS-80\* Expansion Interface** \$269

**ZENITH Z89, 48K all-in-one computer** \$2595

**ZENITH Z19** \$740

**TELEVIDEO** 912B \$745 920B \$769

**ATARI 400 \$489 ATARI 800 \$799 TI 99/4 \$894**

**MATTEL INTELLIVISION** \$249

**NORTH STAR Horizon 1** 32K, Double Density **\$2129**

## DISK OPERATING SYSTEMS

**PATCHPAK #4 by Percom Data** \$ 8.95

**CP/M for Model I, Zenith \$145** • for Model II, Altos **\$169.00**

**NEWDOS Plus** — with over 200 modifications 35track **\$ 89.00**

and corrections to TRS-DOS 40 or 70 Track **\$ 99.00**

## SOFTWARE FOR THE TRS-80\*

Software / Manual  
w/Manual / Alone

**CCI-INVESTMENT PORTFOLIO MANAGER:** This is what investors have been waiting for! This powerful program was developed by security analysts working with software designers. It comes on one cassette — 16K LEVEL II BASIC on one side, 32K DISK BASIC on the other. Store and report data. Review your portfolio. Produce detailed status, value, gain, and security analysis. Compare alternatives. **\$49.95/\$10**

**INTELLIGENT TERMINAL SYSTEM ST-80-II BY LANCE MIKLUS:** Enables a TRS-80\* to act as a dial-up terminal on any standard time sharing network. Provides a TRS-80\* with control key, ESC Key, Repeat Key, Rub Out Key, Break Key, full upper and lower case support, selectable printer output and program selectable transmission rates. **\$139/\$10**

**CCA-DATA MANAGEMENT SYSTEM:** Automate your information processing tasks. You can create a file of customer information; quickly and easily add, delete or update records, search a file, keep a file in order of the value in any field; and print records and labels in any desired sequence or from just a part of a file. Requires 32K TRS-80 and one drive. **\$74.95/\$10**

**CSA-MAILIST SYSTEM:** Creates, maintains and efficiently utilizes a name, address and telephone number file. 400 individual name/address entries can be maintained on a single density mini-floppy, and are manipulated directly by record number (direct access file method). Sorts can be performed, name + address combinations can be coded. Listing-directions and labels can be printed. A conversion facility is provided to convert most sequential name, address file formats into direct. Requires 32K TRS-80 and one drive. **\$49.95/\$10**

**ACCESSORIES**  
**HEAD CLEANING DISKETTE:** Cleans drive Read/Write head in 30 seconds. Diskette absorbs loose oxide particles, fingerprints, and other foreign particles that might hinder the performance of the drive head. Lasts at least 3 months with daily use. Specify 5 1/4" or 8". **\$20 ea/\$45 for 3**

**S & M SYSTEMS**  
**INSEQ-80™:** Indexed Sequential Access Method (ISAM) for the TRS-80 Model I. A must for anyone writing business programs. Eliminates wasted disk space from direct record processing. Split record access to any record. Access data records instantly via alpha numeric "key" eg. Part NR, zip code or sequentially in ascending key sequence. Add/modify records in any order. Access up to three files per program — Files may be spread over multiple disks. Machine language processing from your basic program. Utility program to convert direct files to INSEQ-80 format. **\$49.95/\$10**

**FULLY INTERACTIVE ACCOUNTING PACKAGE:** ISAM (INSEQ-80) based. Includes General Ledger, Accounts Payable, Accounts Receivable and Payroll. System runs "stand alone" or "co-ordinated G/L" at users option. Based on Osborne accounting method. Requires 32K, TRS-80, 2 or 3 drives. N/A CA

General Ledger \$99/\$10  
Accounts Receivable \$99/\$10  
Accounts Payable \$99/\$10  
Payroll \$99/\$10  
Osborne books: Req'd as additional documentation \$20 ea

**INVENTORY** Requires 32K, TRS-80, 1 drive **\$125/\$10**  
**INSERT-80:** Callable form BASIC via USR. Sorts "Random" Disk Files. "Disk" to "Disk" sort times — 350 records in 25 secs, 1000 records in 6 minutes, 3500 records in 12 minutes. Machine language processing. Up to 35 sort keys ascending/descending. Utility to build BASIC program. Runs under NEWDOS. **\$49.95/\$10**

**FLOPPY SAVER:** Protection for center holes of 5 1/4" floppy disks. Only 1 needed per diskette. Kit contains centering post, pressure tool, tough 7-mil mylar reinforcing rings, installation tools and rings for 25 diskettes. **\$11.95**  
Re-orders of rings only: **\$ 7.95**

## CP/M BASED SOFTWARE for Zenith, Altos, Radio Shack, Apple

Software / Manual  
w/Manual / Alone

**MICROSOFT**  
**BASIC-80:** Disk Extended BASIC ANSI compatible with long variable names, WHILE/WEND, chaining, variable length file records. **\$325/\$25**

**BASIC COMPILER:** Language compatible with BASIC-80 and 3-10 times faster execution. Produces standard Microsoft relocatable binary output. Includes MACRO-80. Also linkable to FORTRAN-80 or COBOL-80 code modules. **\$350/\$25**

**FORTRAN-80:** ANSI 66 (except for COMPLEX) plus many extensions. Includes relocatable object compiler, linking loader, library with manager. Also includes MACRO-80 (see below). **\$425/\$25**

**COBOL-80:** Level 1 ANSI 74 standard COBOL plus most of Level 2. Full sequential, relative and indexed file support with variable file names. STRING, UNSTRING, COMPUTE, VARYING/UNTIL, EXTEND, CALL, COPY, SEARCH, 3-dimensional arrays, compound and abbreviated conditions, nested IF. Powerful interactive screen-handling extensions. Includes compatible assembler, linking loader, and relocatable library manager as described under MACRO-80. **\$700/\$25**

**Z80 SOFTCARD FOR APPLE:** Your key to future software expansion. Get the best of both worlds, Apple's 8002 and CP/M Z80. Plug in the card and get a Z80. Supports Apple language card and all Apple peripherals. Comes with set of three manuals. **\$339/\$75**

**CCI-TELNET VERSION 8:** A communication Package which enables microcomputer users to communicate both with Large Mainframes and other microcomputers. Extensive commands make it useful in many applications where communication between computers is necessary. Powerful terminal mode enabling user to save all data from a session on disk. Completely CP/M compatible. Multiple communication protocols supported. Able to transfer files in both directions without protocol where the other machine does not support any protocol. Extensive ON-SCREEN help. Source code provided. **\$149/\$15**

**MICROPRO-WORD-STAR:** Menu driven visual word processing system for use with standard terminals. Text formatting performed on screen. Facilities for text pagination, page number, justify, center and underscore. User can print one document while simultaneously editing a second. Edit facilities include global search and replace, Read/Write to other text files, block move, etc. Requires CRT terminal with addressable cursor positioning. **\$399/\$40**

**BDS 'C' COMPILER:** Supports most features of language, including structures, arrays, pointers, recursive function evaluation, and overlays. Package contains: compiler, linker, library manager; sample source files include games, a terminal emulator with disk I/O plus the source for many standard library functions; BDS 'C' User's Guide; Book - The C Programming Language by Dennis Ritchie and Brian Kernighan. Requires at least 24K of RAM. **\$125/\$20**

**CONFIGURABLE BUSINESS SYSTEM BY DMA:** CBS is a data management system that allows true transaction processing. Custom accounting systems for payables, receivables, inventory control, order entry, and general ledger can be set up without using any programming languages. CBS can be used to define an application such as an inventory control system by specifying master files to describe the inventory, customer and vendor files. Transaction files can then be used to describe activities such as purchases and sales. An extremely easy-to-use data entry program is used to enter information about customers, vendors, inventory, sales and purchases. After data entry is complete, an update program can process the transactions against the various master files, updating account balances and inventory quantities. The system features a screen menu generator and a comprehensive report generator which can be used to produce invoices, purchase orders, re-order reports, mailing labels or other special reports specific to the application. Good documentation and a demonstration inventory system supplied. Requires at least 48K memory. Does not require any support language. **\$295**

DEALER (NATIONAL/INTERNATIONAL) INQUIRIES INVITED **Send for FREE Catalogue**

# The CPU SHOP

TO ORDER CALL TOLL FREE 1-800-343-6522

Massachusetts residents call (617) 242-3361

For detailed technical information, call 617/242-3361

Hours: 10AM-6PM (EST) M-F (Sat. till 5)

\*TRS-80 is a Tandy Corporation Trademark

5 Dexter Row, Dept. B8M  
Charlestown, Massachusetts 02129

Massachusetts residents add

5% sales tax

Quantities on some items are limited



# "State of the art" the DG-80 Z80 CPU!

THE leading edge of  
technology for the  
Heath® H8

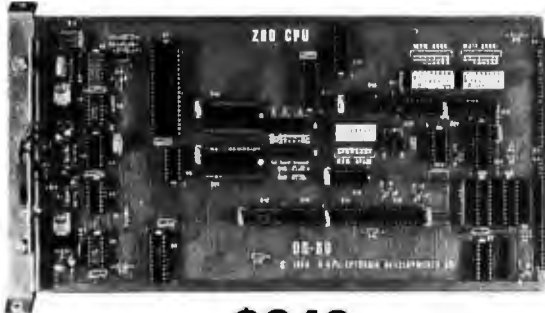

**DG-80 CPU \$249** MANUAL ONLY \$25

16K CHIP SETS (8-4116 Type Dynamic RAMS) for DG-32D, Apple®, TRS-80®, H88/89®, and Pet® (Tested)	\$ 64.00
32K/DG-32D	\$479.00
HALF POPULATED 16K/DG-32D	\$415.00
Documentation only (DG-32D)	\$ 12.00

Heath, H8, TRS-80, Apple, Mostek & Pet are Registered Trademarks.

#### FEATURES

- Compatible with Heath® H8 hardware and software
- Z80 CPU — Enhanced instruction set
- Provisions for up to 8K ROM/EPROM and/or 4K RAM
- Jump-On-Reset to any 1K boundary
- Operational up to 4 MHz (2.048 MHz standard)
- DIP switch selectable wait states for any or all 8K blocks of memory
- All Z80 interrupt response modes available
- Interrupt Acknowledge and Dynamic Memory Refresh signals available on bus
- Frequently selected options by DIP switch or solderless jumper
- Machined contact gold sockets for ROM/EPROM, RAM
- Includes many advanced features for future expansion
- Assembled, tested and guaranteed
- Extensive operations manual and Z80 PROGRAMMING MANUAL

The DG-80 Z80 CPU is the "State of the art" CPU for the Heath® H8. The power of a Z80, coupled with the flexibility designed into every DG-80, lets your imagination set the limits in possible applications with this board.

The DG-80 Z80 CPU maintains compatibility of your current system hardware and software but provides features and flexibility for future expansion. Some of the advanced features include on-board RAM, ROM, and EPROM capability, jump-on-reset to any 1K boundary, and operational speeds up to 4 MHz. The DG-80 affords the user a superior alternative to the 8080A.

Write or call for complete product information.

**D·G ELECTRONIC DEVELOPMENTS CO.**

Ordering Information: Products listed available from D-G Electronic Developments Co., P.O. Box 1124, 1827 South Armstrong, Denison, Tx. 75020. Check, Money Order, VISA or Master Charge accepted. Phone orders (charge only) call (214) 465-7805. No COD's. Freight prepaid. Allow 3 weeks for personal checks to clear. Texas residents add 5%. Foreign orders add 30%.

**THE H8®/DG-80 — THE SOLUTION**

**SAVE  
TRS-80's**



# TRS-80's

DISCOUNTS of 10%, 15% and More available.

WE PAY Domestic U.P.S. shipping and insurance on minimum orders.

NO TAXES are collected on out-of-state shipments.

TOLL FREE Order Number 800/531-7466.

OPEN 8:00 a.m. to 6:00 p.m., Central Time, Monday through Friday;  
9:00 a.m. to 6:00 p.m., Saturday.

**Pan American Electronics**  
Incorporated  
A **Radio Shack**

AUTHORIZED SALES CENTER

1117 CONWAY MISSION, TEXAS 78572

TOLL FREE ORDER NUMBER 800/531-7466

TEXAS AND PRINCIPAL TELEPHONE NUMBER 512/581-2765



**SUMMER SALE!**

**Now a complete OHIO SCIENTIFIC mini-floppy system for just \$797!**

**Here's what you get:**



**Ohio Scientific Superboard II**

The first complete computer system on a board! Includes keyboard, video interface and audio cassette interface. 8K BASIC-in-ROM, 4K RAM. Requires power supply of +5V @ 3 amps .....

**\$299**

**"We heartily recommend Superboard II for the beginner who wants to get into microcomputers with a minimum cost. A real computer with full expandability."**

—POPULAR ELECTRONICS, MARCH, 1979

**"The Superboard II is an excellent choice for the personal computer enthusiast on a budget."**

—BYTE, MAY, 1979

**Buy OHIO SCIENTIFIC's 610 Expander Board and get \$99 off reg. \$299 price of mini-floppy disk drive (including connector cable). ONLY \$200!**

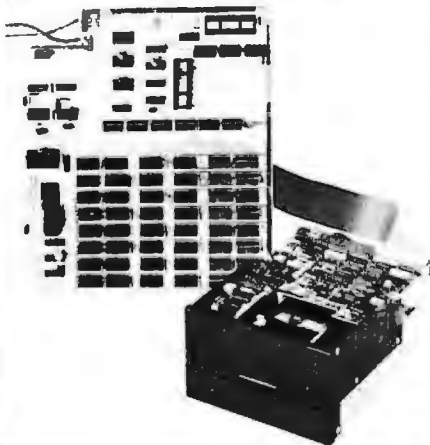

**610 Expander Board**

For use with Superboard II and Challenger 1P. 8K static RAM expandable to 24K or 32K system total. Accepts up to two mini-floppy disk drives. Requires +5V @ 4.5 amps .....

**\$298**

**Mini-Floppy Disk Drive**

Includes Ohio Scientific's PICO DOS software and connector cable. Compatible with 610 Expander Board. Requires +12V @ 1.5 amps and +5V @ 0.7 amps.

**Reg. \$299** .....

**SALE! \$200**

**TOTAL \$797**

- 4KP 4K RAM chip set** \$ 79
- PS003 Mini-floppy power supply** each \$ 29
- PS005 5V 4.5 amp open frame power supply** \$ 35
- SAMS manual C1P/Superboard II** \$ 8
- SAMS manual C4P** \$ 16
- OS-65D V3.2 Disk Operating System with 9-digit extended BASIC, random access from sequential files** \$ 49
- C4P computer 8K RAM expandable to 32K RAM** \$ 750
- C4P MF computer Mini-floppy, 24K RAM** \$1795
- C8P computer 8K RAM expandable to 32K and dual 8-inch floppies** \$ 950
- C8P DF computer 32K RAM expandable to 48K, dual 8-inch floppies** \$2895

**NEW! SAMS manual for the Challenger III Series** \$ 40

**Attention Superboard II and C1P owners:**

You can still take advantage of our summer sale. Purchase the 610 Expander Board for the regular price and get \$99 off on the mini-floppy and cable.

**Step up to mini-floppy operation for only \$498.**

**COMING SOON! Color Video Adaptor for Superboard II and C1P!**

**Freight Policies**

All orders of \$100 or more are shipped freight prepaid. Orders of less than \$100 please add \$4.00 to cover shipping costs. Ohio Residents add 5.5% Sales Tax.

**Guaranteed Shipment**

Cleveland Consumer Computers & Components guarantees shipment of computer systems within 48 hours upon receipt of your order. **Our failure to ship within 48 hours entitles you to \$35 of software, FREE.**

**To Order:**

Or to get our free catalog **CALL 1-800-321-5805 TOLL FREE.**

Charge your order to your **VISA or MASTER CHARGE ACCOUNT** Ohio Residents Call: (216) 464-8047. Or write, including your check or money order, to the address listed below.

**Hours:**

Call Monday thru Friday 8:00 AM to 5:00 PM E.O.T.



**CLEVELAND CONSUMER COMPUTERS & COMPONENTS**  
**P.O. Box 46627**  
**Cleveland, Ohio 44146**

**TO ORDER: CALL**  
**1-800-321-5805**  
**TOLL FREE**



**NEW & IN STOCK**

**77 TRACK DISK DRIVES** **\$599.<sup>00</sup>**  
 • 5¼" drive with power supply and enclosure.

**C-ITOH™ STARWRITER \$2195.00**  
 (DAISY WHEEL PRINTER)

**SUPERBRAIN™ - COMPUSTAR™**  
 300 - K DISK STORAGE 64 K \$2995.00  
 10 Maxell Diskettes FREE WITH EVERY UNIT

---

**TRS-80™ 64 K MODEL II** **\$3626.00**  
 IN STOCK • IMMEDIATE DELIVERY

**ORDER NOW (1) 800 345-8102**

**MODEL II DISK DRIVES**

- 1 drive, single enclosure \$ 899.00
- 1 drive, multiple enclosure \$1099.50
- additional drives for multiple enclosure \$ 540.00

---

**MODEL I DISK DRIVES PERTEC 40 TRK \$340.00**  
 \$159.00 less than Radio Shack

---

**EXPANSION INTERFACES**

0 K \$278.10	16 K \$376.10	32 K \$474.10
--------------	---------------	---------------

<b>List Our Price</b>	<b>Our Price</b>	
TRS-80 4K Level II \$619.00	\$ 575.70	NEC 5510 (In Stock) \$2950.00
TRS-80 16K Level II \$849.00	\$ 789.60	Centronics 730 \$ 695.00
Telephone Modem \$199.00	\$ 185.10	Centronics 737 \$ 950.00
RS 232 \$ 92.10		Centronics 779 Sale \$ 995.00

---

**VR DATA**

**ORDER 1-800-345-8102 NOW (215) 461-5300**

777 HENDERSON BOULEVARD  
 FOLCROFT INDUSTRIAL PARK  
 FOLCROFT, PA 19032

Our Prices Are For Cash  
 Payment Terms. Call For Other Terms.

# V R DATA'S TRS-80™ SWEEPSTAKES

Celebrating V. R. DATA's 8th Anniversary  
**OVER \$1700.00 in PRIZES**  
**GRAND PRIZE - 16 K LII TRS-80**  
**TWO SECOND PRIZES - DISK DRIVES**  
**FOUR THIRD PRIZES - \$50.00 GIFT CERTIFICATES**

## SWEEPSTAKES RULES

1. ALL ENTRIES MUST BE SUBMITTED ON ORIGINAL ENTRY BLANK.
2. ONE ENTRY PER PERSON.
3. WINNERS SELECTED BY RANDOM DRAWING, NOTIFIED BY MAIL.
4. ENTRIES MUST BE RECEIVED BY 10/31/80.
5. VOID WHERE PROHIBITED BY LAW, NO PURCHASE NECESSARY.

---

**MAIL NOW TO ENTER V. R. DATA'S SWEEPSTAKES**

NAME.....  
 ADDRESS.....  
 CITY.....STATE.....ZIP.....  
 TELEPHONE.....OCCUPATION.....  
 COMPUTER EQUIPMENT OWNED.....  
 INTENDED USE.....

**B SEND FOR CATALOG**



**Dual Trace Oscilloscope**  
**HITACHI 30 MHz**

- TV sync-separator circuit
- High-sensitivity 1mV/div (5MHz)
- Sweep-time magnifier (10 times)
- Z-axis input (Intensity modulation)
- Signal delay line
- X-Y operation
- Trace Rotation

**\$945.00**

**More sensitive to your input**

**FUNCTION GENERATOR KIT**  
 XR2286KB  
 OPERATE ON EITHER SINGLE OR DOUBLE SUPPLY  
 Includes all parts to assemble on PC board  
**\$19.95**

**EPROM**  
 2708 **\$1050**

**EPROM**  
 (5 Volt) **\$29.90**

2716

**POWER SUPPLY**  
 5 Volt 3 Amp  
**APS 5-3**

1-9	\$42.50
10 up	\$40.65
25 up	\$38.85

**SD SYSTEMS**

**Z-80 STARTER SYSTEM**

The Z80 Starter Kit by SD Systems uses the powerful Z80 microprocessor as the heart of the complete micro-computer on a single board. Learn a step-by-step introduction to micro-computers with a keyboard and display, audio cassette interface, PROM programmer, wire-wrap expansion area, 4-channel Counter Timer and on Board RAM and PROM. Complete Operation and Instruction Manual included. ZBUG Monitor in ROM.

27004 kit .... \$340 38007 a/t ..... \$450

**8080A**

**MICRO-PROCESSOR \$5.95**

**AP PRODUCTS**

923101	\$ 79.95
923102	124.95
923103	124.95

**NEW HICKOK LX 304**

**DIGITAL MULTIMETER**

Compact Accurate Dependable

**\$89.95**

ALSO - STILL AVAILABLE  
**LX303 ..... \$74.95**

**★ 15% ★ DISCOUNT COUPON**

Bring this COUPON into one of our stores or mail to our Mail Order address shown below and receive a **15% DISCOUNT** on purchases from this Ad of \$100.00 or more.

**Offer EXPIRES on August 31, 1980**

NAME.....  
 ADDRESS.....  
 CITY.....STATE.....  
 ZIP.....PHONE NO.....

Coupons accepted only with full name and address filled in

**SBC-100 SINGLE BOARD COMPUTER KIT**  
 27003 kit ..... \$295

**PROM-100 BOARD KIT PROM Programmer**  
 27014 kit ..... \$200

**PLESSEY**

Metalized Polyester Capacitors

Series 180 MINIBOX SAMPLER  
**\$26.00**

**32K** Part No. DP1000-2 **\$1295**

**SORCERER COMPUTER** SPEAKS FOUR LANGUAGES  
 32K RAM • Dual Channel 100 - 30 Lines of 64 Characters • 64 Dr. Head Channels • 64 User Defined Characters • 512 • 200 Graphic Resolutions • Edge Card Connect from to 5100 Bus • Serial and Parallel I/O

**LOOK - MORE SDC**

**VERSAFLOPPY I FLEXIBLE DISK DRIVE Controller**  
 27002 kit ..... \$250  
 38005 a/t ..... \$335

**VDB-8024 VIDEO DISPLAY BOARD**  
 38013 a/t ..... \$470

**SD Systems EXPANDO RAM**

27001 kit ..... \$220  
 38001 a/t ..... \$480

**Add-On RAM Kit**  
 27010 (16K, 8 devices) \$165

**LIQUID CRYSTAL DISPLAY**

- High Contrast Ratio
- Wide Viewing Angle
- 0.5 in. Digit Height
- ULTRA Low Power Consumption

**LCD106 ..... \$14.50**

**SYM-1 NEW LOW PRICE**

**\$239.00**

KTM-2 CRT/TV Kybd Term \$349

**ANCRONA**

Send check or Money Order to: P.O. Box 23887, Dallas, TX 75220

California residents add 9% sales tax. Minimum Order: \$10.00  
 Add \$1.00 to cover postage and handling. Master Charge and Visa welcomed.  
 Please include your charge card number, Interbank number and expiration date. **PHONE ORDERS: (214) 641-4054**

<b>MAIL ORDER</b> P.O. Box 23887 Dallas, TX 75220 (214) 641-4054	<b>PORTLAND</b> 1126 N.E. 82nd Ave Portland, OR 97220 (503) 254-8541	<b>SANTA ANA</b> 1300 E. 84th Ave Santa Ana, CA 92705 (714) 947-8425	<b>CULVER CITY</b> 11980 Jefferson Blvd Culver City, CA 90230 (213) 380-3553
<b>TUCSON</b> 4518 E. Broadway Tucson, AZ 85711 602-2 681-2348	<b>HOUSTON</b> 2648 Richmond Houston, TX 77098 713-2 626-3488	<b>ATLANTA</b> 2320 Piedmont Rd. N.E. Atlanta, GA 30306 404-2 381-7100	<b>SUNNYVALE</b> 1094 E. El Camino Blvd Sunnyvale, CA 94087 (408) 363-1127

# DIGITAL RESEARCH COMPUTERS

(214) 271-3538

## 32K S-100 EPROM CARD

**NEW!**

**\$74.95**  
KIT

USES 2716's  
Blank PC Board - \$34  
ASSEMBLED & TESTED  
ADD \$30

SPECIAL: 2716 EPROM's (450 NS) Are \$19.95 EA. With Above Kit.

### KIT FEATURES

- |  |  |
|--|--|
| 1 Uses +5V only 2716 (2Kx8) EPROM's          | 7 Any or all EPROM locations can be disabled                   |
| 2 Allows up to 32K of software on line!      | 8 Double sided PC board, solder-masked, silk-screened          |
| 3. IEEE S-100 Compatible                     | 9 Gold plated contact fingers                                  |
| 4 Addressable as two independent 16K blocks  | 10 Unselected EPROM's automatically powered down for low power |
| 5 Cromemco extended or Northstar bank select | 11 Fully buffered and bypassed                                 |
| 6 On board wait state circuitry if needed    | 12 Easy and quick to assemble                                  |

## 8K LOW POWER RAM KIT-S 100 BUSS

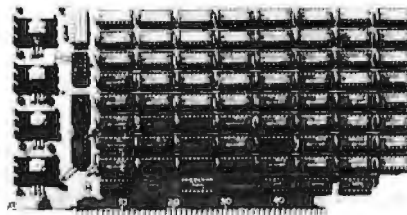

21L02  
(450 NS RAMS!)

**\$119.50**  
KIT

ASSEMBLED & FULLY  
BURNED IN ADD \$35

Thousands of computer systems rely on this rugged, work horse RAM board. Designed for error-free, NO HASSLE, systems use

ADD \$10  
FOR 4 MHZ

Blank PC Board w/Documentation - \$29.95  
Low Profile Socket Set - \$13.50  
Support IC's (TTL & Regulators) - \$9.75  
Bypass CAP's (Disc & Tantalums) - \$4.50

## 16K STATIC RAM KIT-S 100 BUSS

PRICE CUT!

**\$225** KIT

FOR 4MHZ  
ADD \$10

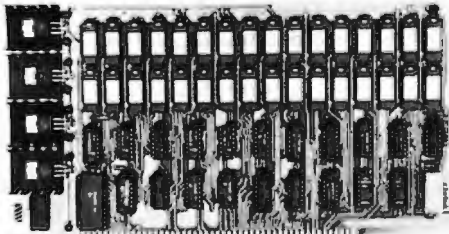

### KIT FEATURES

- 1 Addressable as four separate 4K Blocks
- 2 ON BOARD BANK SELECT circuitry. (Cromemco Standard!) Allows up to 512K on line!
- 3 Uses 2114 (450NS) 4K Static Rams
- 4 ON BOARD SELECTABLE WAIT STATES
- 5 Double sided PC Board, with solder mask and silk screened layout. Gold plated contact fingers
- 6 All address and data lines fully buffered
- 7 Kit includes ALL parts and sockets
- 8 PHANTOM is jumpered to PIN 67
- 9 LOW POWER: under 1.5 amps TYPICAL from the +8 Volt Bus
- 10 Blank PC Board can be populated as any multiple of 4K

BLANK PC BOARD W/DATA-\$33  
LOW PROFILE SOCKET SET-\$12  
SUPPORT IC'S & CAPS-\$19.95  
ASSEMBLED & TESTED-ADD \$35

**OUR #1 SELLING  
RAM BOARD!**

## 16K STATIC RAM SS-50 BUSS

PRICE CUT!

**\$229** KIT

FULLY STATIC!

FOR 2MHZ  
ADD \$10

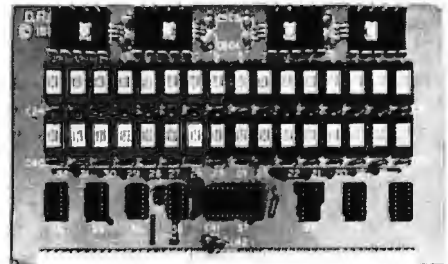

**FOR SWTPC  
6800 BUSS!**

ASSEMBLED AND  
TESTED - \$35

### KIT FEATURES

- 1 Addressable on 16K Boundaries
- 2 Uses 2114 Static Ram
- 3 Fully Bypassed
- 4 Double sided PC Board Solder mask and silk screened layout
- 5 All Parts and Sockets included
- 6 Low Power: Under 1.5 Amps Typical

BLANK PC BOARD-\$26 COMPLETE SOCKET SET-\$12  
SUPPORT IC'S AND CAPS-\$19.95

## NEW! STEREO! S-100 SOUND COMPUTER BOARD NEW!

At last, an S-100 Board that unleashes the full power of two unbelievable General Instruments AY3-8910 NMOS computer sound IC's. Allows you under total computer control to generate an infinite number of special sound effects for games or any other program. Sounds can be called in BASIC, ASSEMBLY LANGUAGE, etc.

### KIT FEATURES:

- \* TWO GI SOUND COMPUTER IC'S
  - \* FOUR PARALLEL I/O PORTS ON BOARD
  - \* USES ON BOARD AUDIO AMPS OR YOUR STEREO
  - \* ON BOARD PROTO TYPING AREA
  - \* ALL SOCKETS, PARTS AND HARDWARE ARE INCLUDED
  - \* PC BOARD IS SOLDERMASKED, SILK SCREENED, WITH GOLD CONTACTS
  - \* EASY, QUICK, AND FUN TO BUILD WITH FULL INSTRUCTIONS
  - \* USES PROGRAMMED I/O FOR MAXIMUM SYSTEM FLEXIBILITY
- Both Basic and Assembly Language Programming examples are included

### SOFTWARE:

SCL™ is now available! Our Sound Command Language makes writing Sound Effects programs a SNAP! SCL™ also includes routines for Register Examine-Modify Memory-Examine-Modify and Play-Memory. SCL™ is available on CP/M™ compatible diskette of 2708 or 2716 Diskette - \$24.95 2708 - \$19.95 2716 - \$29.95 Diskette includes the source EPROMS are ORG at E000H

### COMPLETE KIT!

**\$84.95**

(WITH DATA MANUAL)

BLANK PC  
BOARD W/DATA  
\$31

## 16K EPROM CARD-S 100 BUSS

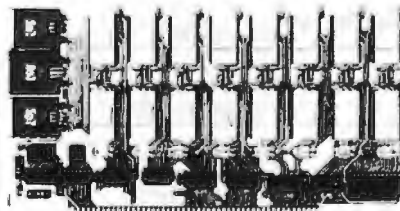

**\$59.95**  
KIT

BLANK PC BOARD - \$28

USES 2708's!

Thousands of personal and business systems around the world use this board with complete satisfaction. Puts 16K of software on line at ALL TIMES! Kit features a top quality soldermasked and silk-screened PC board and first run parts and sockets. Any number of EPROM locations may be disabled to avoid any memory conflicts. Fully buffered and has WAIT STATE capabilities

ASSEMBLED AND FULLY  
TESTED - ADD \$30

OUR 450 NS 2708'S  
ARE \$8.95 EA. WITH  
PURCHASE OF KIT

## RCA CMOS COMPUTER CHIP SET

### INCLUDES:

- |                         |                        |
|-------------------------|------------------------|
| 1-CDP1802CD CPU         | 1-CDP1861CD VIDEO IC   |
| 2-CDP1822CE 256 x 4 RAM | 1-CDP1862CE COLOR GEN. |
| 1-CDP1858CE 4 BIT LATCH | 1-CDP1863CE SOUND GEN. |

COMPLETE SET \$45 LIMITED QTY

## NEW! G.I. COMPUTER SOUND CHIP

AY3-8910 As featured in July, 1979 BYTE! A fantastically powerful Sound & Music Generator. Perfect for use with any 8 Bit Microprocessor. Contains 3 Tone Channels Noise Generator, 3 Channels of Amplitude Control, 16 bit Envelope Period Control, 2-Bit Parallel I/O, 3 D to A Converters, plus much more! All in one 40 Pin DIP. Super easy interface to the S-100 or other buses

SPECIAL OFFER: \$14.95 each Add \$3 for 60 page Data Manual.

TERMS: Add \$1.00 postage we pay balance. Orders under \$15 add 75c handling. No C.O.D. We accept Visa and MasterCard. Tex. Rns add 5% Tax. Foreign orders (except Canada) add 20% P & H. 90 Day Money Back Guarantee on all items. Orders over \$50. add 85c for Insurance.

**Digital Research Computers**  
(OF TEXAS)

P.O. BOX 401565 • GARLAND, TEXAS 75040 • (214) 271-3538





# HOBBYWORLD<sup>®</sup> ELECTRONICS, INC.

Call Toll-Free: USA (800) 423-5387  
In California: (800) 382-3651  
Local & Outside USA: (213) 886-9200

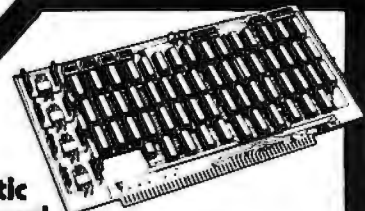

## CCS 16K Static Ram Board

True static RAM board designed specifically for the S-100 bus. Requires only +5VDC. Features true static operation, and all bus signals labeled on-board! Uses 2114 low power static RAMS, S-100 compatible, fully buffered. Silk screened PC board, solder masked on both sides.

Cat No.	Description	Wt	Price
1601A	16K RAM 450ns Kit	1 lb	\$253.50
1601B	16K RAM 200ns Kit	1 lb	\$333.50
1601C	16K RAM 300ns Kit	1 lb	\$293.50
1602A	16K RAM 450ns A & T	1 lb	\$285.75
1602B	16K RAM 200ns A & T	1 lb	\$371.50
1602C	16K RAM 300ns A & T	1 lb	\$328.50
1603	16K RAM Bareboard only	6 oz.	\$ 29.95

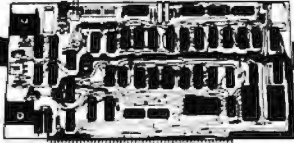

## SSM VB2 VIDEO BOARD

I/O controlled video interface board. With a TV monitor, the VB2 becomes a video terminal! No other I/O card is required for keyboard input and video display. The cursor, linedfeed, carriage return, backspace and clear screen are hardware controlled. The display is 64 X 16. A1 upper case and is selectable for white-on-black or black-on-white.

Produces a clear, bright display and features adjustable picture size and character width. Circuitry is provided to drive a speaker for beep tone.

Cat No.	Description	Price
1438	VB2 kit	\$169.00
1439	VB2 A&T	\$234.00

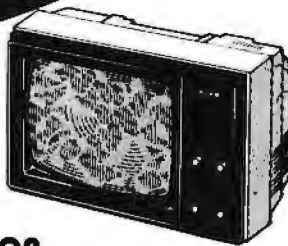

## Leedex VIDEO 100 12" MONITOR

- Compatible with TRS-80 (no interface required)
- Compatible with many home computers!

Now from LEEDEX. One of the most popular low cost, yet high resolution (650 line) monitors currently available. These units compare favorably with monitors costing twice as much. Because of the fact that standard composite video input is utilized no RF modulator is needed. An extremely sharp and stable picture is achieved. The video bandwidth is 12 mhz +/- 3db with a 75 ohm input impedance.

Cat No. 1204	Video 100 Monitor	Wt. 18 lb.	\$149.00
Cat No. 1937	TRS-80/Leedex cable kit	Wt. 6 oz.	\$3.00

## CCS 32K Static RAM Board \$710

Uses 2114, 250ns fully Static Rams, bank selectable in 8K blocks. Enable/Disable on Power up or Reset. Compatible with North Star, Alpha Micro, Cromeco, etc. Also front panel compatible, addressable in 8K blocks. Selectable Wait state. Wt 1 lb. Assembled & tested. Cat No. 2644

## THE PIE 2.0 \$79.95 (Programma Improved Editor)

Don't be misled by the low price of this outstanding wordprocessing package. PIE 2.0 is a powerful text editor and print format processor that has all the bells and whistles expected of wordprocessing software costing three times as much. Some features include:

- 1) Characterline insert and delete
- 2) Complete Cursor mobility
- 3) String search forward and backward
- 4) Single, conditional or global search and replace
- 5) Move and/or copy blocks of text
- 6) Page scrolling
- 7) Tabs, margins, paragraphing, etc.

Research conducted by IBM Corp. revealed that the time required to create, edit and complete a one page document was decreased by as much as 60% when comparing the performance of a Wordprocessing system to an ordinary typewriter. Finding ways to remain competitive these days is a challenge for the business executive. Today's office can substantially improve their daily productivity level with PIE 2.0 Wordprocessing software and an Apple II computer with 32k RAM memory.

As a businessman you want every dollar you spend to count, so wordprocessing makes sense, and PIE 2.0 Wordprocessing software gives you more for your hard earned dollar. PIE 2.0 Wordprocessing software comes complete with program diskette and detailed documentation in a handsome, simulated leather binder. Cat No. 2562

## Continental Specialties LOGIC PROBES

Compact and versatile. Perfect for test and troubleshooting all types of digital applications! Simple to operate... just connect the clip leads to the circuits power supply, flip the logic switch, and test! LEDs indicate test results and circuit conditions. Combines the functions of level detector, pulse detector, pulse stretcher, and memory. Available in three models.

**LP-1** Hand-held instant reading of logic levels for TTL, DTL, HTL, or CMOS.  
Cat No. 2067 **\$44.00**

**LP-1** The economy model without the memory capability. Safer than a voltmeter, more accurate than a scope!  
Cat No. 2068 **\$26.85**

**LP-3** Faster version of the LP-1. High speed logic probe captures pulses as short as 10 nsec.  
Cat No. 2069 **\$69.00**

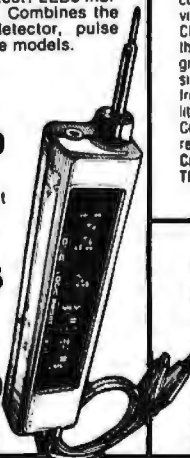

## TRS-80 CP/M

At last, CP/M is available for the TRS-80! Long a standard for software development and interchange for all the "other" 8080/286 computers on the market, CP/M will now provide the same environment for the TRS-80. CP/M is a file-oriented disk operating system that provides a common set of utilities for program development and operation. There are six built-in commands plus utilities called in from disk. CP/M will run on a TRS-80 with as little as 16k of memory and one disk drive. Comes complete with six manuals. CP/M is a registered trade mark of Digital Research.  
Cat No. 1679  
TRS-80 Level II 16k-w/disk **\$149.95**

## CCS 7811B ARITHMETIC PROCESSOR

Assembled & tested, adds advanced arithmetic power to your Apple II. AMD AM 9511 based, 16 and 32 bit fixed point, 32 bit floating point operation. Float to fixed and fixed to float conversions. Trig and inverse functions, square roots, logs, exponentiation, interrupt daisy chain, DMA daisy chain, and much more. Wt 2 lbs.  
Cat No. 1835 **\$399.95**



## 16K MEMORY ADD-ON KIT \$55.00

Everything you need to upgrade your TRS-80, Apple or Exidy! An additional 16K includes illustrated instructions, RAMS and preprogrammed jumpers. No special tools required. Wt. 4 oz.

CAT NO.	DESCRIPTION
1156	TRS-80 Keyboard Unit
1156-A	TRS-80 Exp. Interface (prior to 4/1/79)
1156-B	TRS-80 Exp. Interface (later 4/1/79)
1156-C	for Apple II
1156-D	for Exidy

## SEND FOR FREE FLYER, FEATURING:

Page after page of exciting products. Computerized toys and games, personal computers, disk drives, integrated circuits, semi conductors. Add new dimension to your Apple, Atari, TRS-80, etc with our special application boards and comprehensive software library. Hundreds of products available at terrific Hobbyworld prices. Circle our reader service number or write/phone for your free illustrated flyer today.

## HOW TO ORDER

Pay by check, Mastercharge, Visa, or C.O.D. Charge card orders please include expiration date. Payment in U.S. dollars only. Order by phone, mail or at our retail store. **MINIMUM ORDER \$10.00** Please include phone number and magazine issue you are ordering from. Prices valid thru last day of cover date. **SHIPPING USA** Add \$2.00 for first 2 lbs., .35¢ each add'l lb. for ground. For AIR add \$3.00 first 2 lbs., .75¢ each add'l lb. **FOREIGN** surface \$3.00 first 2 lbs., .60¢ each add'l lb. AIR \$11.00 first 2 lbs., .55¢ each add'l lb. **CODS** add \$1.25 add'l. Not responsible for typographical errors. Some items subject to prior sale or quantity limitations. 120 day guaranteed satisfaction. Exception partially assembled kits.

## DISKETTE DRIVE HEAD CLEANING KIT

Diskette drive heads need periodic maintenance to assure efficient and error-free operation. Unlike other peripheral devices, the read/write head(s) on diskette drives are extremely difficult to clean without partially disassembling the drive. The diskette drive head cleaning kit allows the user to clean the heads in just minutes, without disassembling the drive. Available in 5 1/4" or 8", both single and double sided. Kit contains 2 cleaning diskettes, 4 oz. bottle of CS-85 cleaning solution and an easy pour dispenser. Weight 12 oz.

CAT NO.	DESCRIPTION	PRICE
2499	8" Disk Drive Cleaning Kit	\$30.75
2534	5 1/4" Disk Drive Cleaning Kit	\$30.75

The EMAKO 22 microprinter is a dependable, low cost addition for your personal computer system. It features a 9X7 dot matrix character format, bi-directional printing at 125 CPS and sprocket feed paper mechanism. Line length is selectable at 40, 80 or 132 characters per line. Forms may be loaded either from the bottom or the rear. Available with parallel or asynchronous serial interfacing. Weight 22 lbs.

Cat No.	Description	Price
2455	Parallel interface	\$834.75
2456	RS-232 Serial interface	\$694.00

## EMAKO 22 PRINTER



## VERBATIM 5 1/4" DISKETTES 10 per box

CAT NO.	TYPE	DESCRIPTION	PRICE
1147	525-01	Soft sector, TRS-80, etc.	\$33.00
1148	525-10	10 hole, hard, Apple, North Star	\$33.00
1149	525-16	16 hole, hard, Micropolis	\$33.00
2330	577-01	Soft sector, certified	\$49.95
2331	577-10	10 hole, hard, certified	\$49.95
2332	577-16	16 hole, hard, certified	\$49.95

Dept. B8

19511 Business Center Dr  
Northridge, Calif. 91324

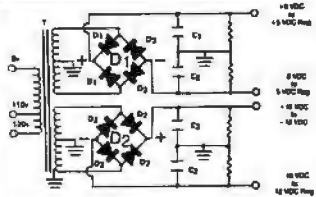

## BUILD YOUR OWN LOW COST MICRO-COMPUTER POWER SUPPLIES FOR S-100 BUS, FLOPPY DISCS, ETC.



### POWER TRANSFORMERS (WITH MOUNTING BRACKETS)

ITEM NO.	USED IN KIT NO.	PRI. WINDING TAPS	SECONDARY WINDING OUTPUTS			SIZE W x D x H	UNIT PRICE
			2x8 Vac	2x14 Vac	2x24 Vac		
T <sub>1</sub>	1	0V, 110V, 120V	2x7.5A	2x2.5A	—	3 3/4" x 3 3/8" x 3 1/8"	21.95
T <sub>2</sub>	2	0V, 110V, 120V	2x12.5A	2x3.5A	—	3 3/4" x 4 3/8" x 3 1/8"	27.95
T <sub>3</sub>	3	0V, 110V, 120V	2x9A	2x2.5A	2x2.5A	3 3/4" x 4 3/8" x 3 1/8"	29.95
T <sub>4</sub>	4	0V, 110V, 120V	2x4A	(28V, CT)	48V, CT, @3A	3 3/4" x 3 3/8" x 3 1/8"	22.95

### POWER SUPPLY KITS (OPEN FRAME WITH BASE PLATE, 3 HRS. ASSY. TIME)

ITEM	USED FOR	PRI. WINDING TAPS	SECONDARY WINDING OUTPUTS					SIZE WxDxH	UNIT PRICE
			@+8 Vdc	@-8 Vdc	@+16 Vdc	@-16 Vdc	@+28 Vdc		
KIT 1	15 CARDS SOURCE	15A	—	—	2.5A	2.5A	—	12" x 6" x 4 7/8"	51.95
KIT 2	SYSTEM SOURCE	25A	—	—	3A	3A	—	12" x 6" x 4 7/8"	58.95
KIT 3	DISC SYSTEM	15A	1A	—	2A	2A	4A	14" x 6" x 4 7/8"	66.95
KIT 4	DISC SOURCE	8A	1A	*(SEE OPTION BELOW)		5A	—	10" x 6" x 4 7/8"	49.95

EACH KIT INCLUDES: TRANSFORMER, CAPACITORS, RESIS., BRIDGE RECTIFIERS, FUSE & HOLDER, TERMINAL BLOCK, BASE PLATE, MOUNTING PARTS AND INSTRUCTIONS. \*OPTION OF KIT 4: SUBSTITUTE ±16V, @4A, FOR +28V, @5A.

### DISC DRIVE POWER SUPPLY "R3" ASSY. & TESTED, OPEN FRAME, SIZE: 9" (W) x 5" (D) x 5" (H) ..... 64.95

SPECS: +5V @ 5A REGULATED, -5V @ 1A REG., +24V @ 5A REG., SHORTS PROTECT. OPTION: SUBSTITUTE ±12V @ 4A IDEAL FOR 2 SHUGART 801/851 OR SIEMANS FDD100-8/200-8 DISK DRIVES & ROCKWELL AIM-65. FOR -5V & +24V.

SHIPPING FOR EACH TRANSFORMER: \$4.75. FOR EACH POWER SUPPLY: \$5.00 IN CALIF. \$7.00 IN OTHER STATES. CALIF. RESIDENTS ADD 6% SALES TAX. OEM WELCOME.

**SUNNY INTERNATIONAL**  
(TRANSFORMERS MANUFACTURER)  
Telephone: (213) 633-8327

STORE:  
7245 E. ALONDRA BLVD.  
PARAMOUNT, CA 90723  
STORE HOURS: 9 AM-6 PM



MAIL ORDER:  
P.O. BOX 4296  
TORRANCE, CA 90510



## BECKIAN ENTERPRISES

ALL PRIME QUALITY — NEW PARTS ONLY  
SATISFACTION GUARANTEED.

### EDGE CARD CONNECTORS: GOLD PLATED:

Abbreviations: S/E Solder Eye . S/T Sold Tail: W/W Wire Wrap.

PART # DESCRIPTION.	Raw Sp.	1-Pcs.	10-24pcs. 25pcs. Up.	.166" CONTACT CENTER CONNECTORS.				'D' TYPE SUBMINIATURE CONNECTORS.						
PART # DESCRIPTION.	Raw Sp.	1-Pcs.	10-24pcs. 25pcs. Up.	PART # DESCRIPTION.	Raw Sp.	1-Pcs.	10-24pcs. 25pcs. Up.	PART NUMBER	DESCRIPTION.	1-Pcs.	10-24pcs.	25-99pc.		
BRAND: TEXAS INST.				15105	8/12 S/E PET/MSB	.140	\$1.00	01.05	01.45	DE 3P	Male	\$1.00ea.	\$1.40ea.	\$1.70ea.
4070	50/100 Inmat/Crom.	.250	\$3.50ea.	15110	8/12 S/T PET/MSB	.140	1.05	1.05	1.50	DE 8S	Female	2.25ea.	2.00ea.	1.80ea.
4090	50/100 Inmat W/W	.250	4.30ea.	15137	8/12 S/T PET/MSB	.200	1.00	1.50	1.45	DE 110003-1	2 pc. Gray Hood.	1.50ea.	1.35ea.	1.20ea.
BRAND: SULLINS: U.L. Reg.				15175	8/ S/E Sgle Row	.140	1.70	1.50	1.30	DA 16P	Male	2.35ea.	2.15ea.	2.00ea.
128885	50/100 Solder Eye	.140	6.00ea.	15270	10/20 S/E	.140	2.15	1.95	1.70	DA 16S	Female	3.25ea.	3.10ea.	2.90ea.
128870	50/100 S/T Inmat	.250	4.50ea.	15275	10/20 S/T	.140	2.00	1.85	1.80	DA 51211-1	1 pc. Gray Hood	1.40ea.	1.20ea.	1.15ea.
128875	50/100 W/W Inmat	.250	5.25	15435	12/24 S/E PET	.140	2.00	2.35	2.10	DA 51220-1	2 pc. Black Hood	2.50ea.	2.22ea.	2.00ea.
128885	50/100 S/T Altair	.140	4.95	15440	12/24 S/T PET	.140	2.05	2.40	2.15	DA 110003-2	2 pc. Gray Hood	1.80ea.	1.35ea.	1.30ea.
128980	60/100 S/T Cromem.	.250	4.75	15445	12/24 S/T PET	.200	2.75	2.50	2.20	DB 26P	Male	2.80ea.	2.60ea.	2.40ea.
OTHER .125" CONTACT CTR CONNECTORS:				15505	15/30 S/E GRI Key	.140	2.50	2.25	2.00	DB 26S	Female	3.80ea.	3.40ea.	3.20ea.
12305	22/44 S/E No Ears	.140	4.15	15510	15/30 S/T GRI Key	.140	2.40	2.15	2.05	DB 51212-1	1 pc. Gray Hood	1.50ea.	1.30ea.	1.10ea.
12750	38/72 S/T	.140	5.40	15515	15/30 W/W GRI Key	.200	2.80	2.35	2.10	DB 51220-2	2 pc. Black Hood	1.80ea.	1.65ea.	1.45ea.
12790	40/80 W/W	.250	6.30	15600	18/36 S/E	.140	3.35	3.05	2.70	DB 110003-3	2 pc. Gray Hood	1.75ea.	1.50ea.	1.35ea.
.100" CONTACT CTR CONNECTORS:				15610	18/36 S/T	.140	3.80	2.70	2.40	DC 37P	Male	4.20ea.	4.00ea.	3.70ea.
10040	13/26 S/E No Ears	.140	3.40	15615	18/36 W/W	.200	3.80	3.20	2.90	DC 37S	Female	6.00ea.	5.75ea.	5.50ea.
10280	26/50 S/E TRS 80	.140	4.50	15700	22/44 S/E KIM/VEC	.140	2.80	2.80	2.75	DC 110003-4	2 pc. Gray Hood	2.25ea.	2.00ea.	1.75ea.
10175	20/40 S/E TRS 80	.140	5.85	15705	22/44 S/T KIM/VEC	.140	3.88	3.30	3.00	DD 50P	Male	5.50ea.	5.10ea.	4.75ea.
10180	20/40 W/W TRS 80	.200	3.30	15710	22/44 W/W KIM/VEC	.200	3.40	3.20	2.85	DD 50S	Female	9.40ea.	8.60ea.	8.00ea.
10180	20/40 S/T TRS 80	.140	3.20	15875	25/50 S/E	.140	4.85	4.20	3.75	DD 51210-1	1 pc. Gray Hood	2.40ea.	2.20ea.	2.00ea.
10485	38/72 S/E Vector	.140	6.50	15880	25/50 S/T	.140	4.55	4.10	3.85	DD 110003-5	2 pc. Gray Hood	2.60ea.	2.40ea.	2.10ea.
10490	38/72 W/E Vector	.200	5.80	15885	25/50 W/W	.200	4.95	4.35	3.90	D 20410-2	Hardware Set (1 Hood Set)	.80ea.	.80ea.	.70ea.
10500	38/72 S/T Vector	.140	5.70	16115	38/72 S/E	.140	6.50	5.85	5.20					
10535	40/80 S/E PET	.140	5.85	16120	38/72 S/T	.140	6.55	5.90	5.25					
10540	40/80 W/W PET	.200	6.00	16125	38/72 S/T	.200	6.75	6.10	5.40					
10550	40/80 S/T PET	.140	5.80	16145	38/72 W/W	.200	6.50	5.85	5.20					
10605	43/86 S/E COS/ELF	.140	8.25	16235	43/86 S/T Mat 8800	.140	8.80	8.35	7.30					
10605	43/86 S/T COS/ELF	.140	8.00	16240	43/86 W/W Mat 8800	.200	7.80	7.05	6.25					
10655	43/86 W/W COS/ELF	.200	8.80	16280	43/86 S/T Mat 8800	.200	8.50	8.05	7.20					
10615	43/86 S/T COS/ELF	.200	6.80	16725	43/86 S/E Mat 8800	.140	7.20	6.50	5.75					
				K-1	Pin-Keys		.15	.12	.10					

<b>I.C. SOCKETS GOLD. W/WRAP 3 TURN</b>	
14 pin	\$0.40 ea.
16 pin	0.44 ea.
<b>800DA PRIME.</b>	
\$5.00 ea.	
<b>EIA &amp; CONDUCTOR CABLES 8ft. Long. CLASS #1 Type Cables.</b>	
1. to 4 pcs.	\$22.00
5 to 9 pcs.	19.00

<b>I.C. SOCKETS TIN.</b>	
14 pin	\$0.15 ea.
16 pin	0.17 ea.
<b>CONNECTORS FOR CENTRONICS 700 SERIES. Amphenol 57-30388</b>	
1 to 4 pcs.	\$8.00 ea.
5 to 9 pcs.	6.00 ea.

<b>COOLING FANS. Extra Quiet.</b>	
1 to 4	\$18.00 ea.
5 to 9	17.00 ea.
<b>PHONE: 213-988-6196</b>	

**TERMS: MINIMUM ORDER: \$15.00 ADD \$1.35 For Handling & Shipping. Orders over \$30.00 in the U.S.A We Pay the Shipping. CALIF. RESIDENTS: Please Add 6% Sales Tax.**

**NOTE: NO C.O.D. OR CREDIT CARD ORDERS WILL BE ACCEPTED.**

**BECKIAN ENTERPRISES**  
**P.O. BOX #3089**  
**SIMI VALLEY, CA 93063**



### NEW PRODUCTS!

**Super Color S-100 Video Kit \$129.95**  
Expandable to 256 x 192 high resolution color graphics. 6847 with all display modes computer controlled. Memory mapped. 1K RAM expandable to 6K. S-100 bus 1802, 8080, 8085, Z80 etc. Delivery January '80.

**1802 16K Dynamic RAM Kit \$149.00**  
Expandable to 32K. Hidden refresh w/clocks up to 4 MHz w/no wait states. Addl. 16K RAM \$43

**Quest Super Basic**

Quest, the leader in inexpensive 1802 systems announces another first. Quest is the first company worldwide to ship a full size Basic for 1802 systems. A complete function Super Basic by Ron Cenker including floating point capability with scientific notation (number range  $\pm 1.7E^{29}$ ), 32 bit integer  $\pm 2$  billion; Multi dim arrays; String arrays, String manipulation; Cassette I/O, Save and load, Basic, Data and machine language programs, and over 75 Statements, Functions and Operators. Easily adaptable on most 1802 systems. Requires 12K RAM minimum for Basic and user programs. Cassette version in stock now. ROM versions coming soon with exchange privilege

**EIF II Adapter Kit \$24.95**  
Plugs into EIF II providing Super EIF 44 and 50 pin bus S-100 bus expansion. (With Super Expansion). High and low address displays, state and mode LED's optional \$18.00.

**Gremlin Color Video Kit \$69.95**  
32 x 16 alpha/numerics and graphics; up to 8 colors with 6847 chip, 1K RAM at 8000. Plugs into Super EIF 44 pin bus. No high res. graphics.

allowing some credit for cassette version. New improved version with improved speed and accuracy now avail. Source list for I/O now incl.

**Super Basic on Cassette \$40.00**

**Tom Pittman's 1802 Tiny Basic Source Listing now available. Find out how Tom Pittman wrote Tiny Basic and how to get the most out of it. Never offered before. \$19.00.**

**S-100 4-Slot Expansion \$ 9.95**

**Super Monitor VI.I Source Listing \$15.00**

Coming Soon: Assembler, Editor, Disassembler, DA/AD, Super Sound/Music, EPROM programmer, String Floppy System.

Same day shipment. First line parts only. Factory tested. Guaranteed money back. Quality IC's and other components at factory prices.

### INTEGRATED CIRCUITS

74007TL	18	LM3231-5	5.85	CD4028	2.50
74008	18	LM3232-12	1.50	CD4027	2.50
74029	29	LM3232-15	1.50	CD4026	2.50
74030	25	LM3231-3	1.35	CD4025	2.50
74031	25	LM3231-12	1.35	CD4024	2.50
74109	20	LM3207-12	1.35	CD4023	2.50
74110	20	LM3207-15	1.35	CD4022	2.50
74111	20	LM3207-18	1.35	CD4021	2.50
74112	20	LM3207-24	1.35	CD4020	2.50
74113	20	LM3207-30	1.35	CD4019	2.50
74114	20	LM3207-36	1.35	CD4018	2.50
74115	20	LM3207-42	1.35	CD4017	2.50
74116	20	LM3207-48	1.35	CD4016	2.50
74117	20	LM3207-54	1.35	CD4015	2.50
74118	20	LM3207-60	1.35	CD4014	2.50
74119	20	LM3207-66	1.35	CD4013	2.50
74120	20	LM3207-72	1.35	CD4012	2.50
74121	20	LM3207-78	1.35	CD4011	2.50
74122	20	LM3207-84	1.35	CD4010	2.50
74123	20	LM3207-90	1.35	CD4009	2.50
74124	20	LM3207-96	1.35	CD4008	2.50
74125	20	LM3207-102	1.35	CD4007	2.50
74126	20	LM3207-108	1.35	CD4006	2.50
74127	20	LM3207-114	1.35	CD4005	2.50
74128	20	LM3207-120	1.35	CD4004	2.50
74129	20	LM3207-126	1.35	CD4003	2.50
74130	20	LM3207-132	1.35	CD4002	2.50
74131	20	LM3207-138	1.35	CD4001	2.50
74132	20	LM3207-144	1.35	CD4000	2.50
74133	20	LM3207-150	1.35	CD3999	2.50
74134	20	LM3207-156	1.35	CD3998	2.50
74135	20	LM3207-162	1.35	CD3997	2.50
74136	20	LM3207-168	1.35	CD3996	2.50
74137	20	LM3207-174	1.35	CD3995	2.50
74138	20	LM3207-180	1.35	CD3994	2.50
74139	20	LM3207-186	1.35	CD3993	2.50
74140	20	LM3207-192	1.35	CD3992	2.50
74141	20	LM3207-198	1.35	CD3991	2.50
74142	20	LM3207-204	1.35	CD3990	2.50
74143	20	LM3207-210	1.35	CD3989	2.50
74144	20	LM3207-216	1.35	CD3988	2.50
74145	20	LM3207-222	1.35	CD3987	2.50
74146	20	LM3207-228	1.35	CD3986	2.50
74147	20	LM3207-234	1.35	CD3985	2.50
74148	20	LM3207-240	1.35	CD3984	2.50
74149	20	LM3207-246	1.35	CD3983	2.50
74150	20	LM3207-252	1.35	CD3982	2.50
74151	20	LM3207-258	1.35	CD3981	2.50
74152	20	LM3207-264	1.35	CD3980	2.50
74153	20	LM3207-270	1.35	CD3979	2.50
74154	20	LM3207-276	1.35	CD3978	2.50
74155	20	LM3207-282	1.35	CD3977	2.50
74156	20	LM3207-288	1.35	CD3976	2.50
74157	20	LM3207-294	1.35	CD3975	2.50
74158	20	LM3207-300	1.35	CD3974	2.50
74159	20	LM3207-306	1.35	CD3973	2.50
74160	20	LM3207-312	1.35	CD3972	2.50
74161	20	LM3207-318	1.35	CD3971	2.50
74162	20	LM3207-324	1.35	CD3970	2.50
74163	20	LM3207-330	1.35	CD3969	2.50
74164	20	LM3207-336	1.35	CD3968	2.50
74165	20	LM3207-342	1.35	CD3967	2.50
74166	20	LM3207-348	1.35	CD3966	2.50
74167	20	LM3207-354	1.35	CD3965	2.50
74168	20	LM3207-360	1.35	CD3964	2.50
74169	20	LM3207-366	1.35	CD3963	2.50
74170	20	LM3207-372	1.35	CD3962	2.50
74171	20	LM3207-378	1.35	CD3961	2.50
74172	20	LM3207-384	1.35	CD3960	2.50
74173	20	LM3207-390	1.35	CD3959	2.50
74174	20	LM3207-396	1.35	CD3958	2.50
74175	20	LM3207-402	1.35	CD3957	2.50
74176	20	LM3207-408	1.35	CD3956	2.50
74177	20	LM3207-414	1.35	CD3955	2.50
74178	20	LM3207-420	1.35	CD3954	2.50
74179	20	LM3207-426	1.35	CD3953	2.50
74180	20	LM3207-432	1.35	CD3952	2.50
74181	20	LM3207-438	1.35	CD3951	2.50
74182	20	LM3207-444	1.35	CD3950	2.50
74183	20	LM3207-450	1.35	CD3949	2.50
74184	20	LM3207-456	1.35	CD3948	2.50
74185	20	LM3207-462	1.35	CD3947	2.50
74186	20	LM3207-468	1.35	CD3946	2.50
74187	20	LM3207-474	1.35	CD3945	2.50
74188	20	LM3207-480	1.35	CD3944	2.50
74189	20	LM3207-486	1.35	CD3943	2.50
74190	20	LM3207-492	1.35	CD3942	2.50
74191	20	LM3207-498	1.35	CD3941	2.50
74192	20	LM3207-504	1.35	CD3940	2.50
74193	20	LM3207-510	1.35	CD3939	2.50
74194	20	LM3207-516	1.35	CD3938	2.50
74195	20	LM3207-522	1.35	CD3937	2.50
74196	20	LM3207-528	1.35	CD3936	2.50
74197	20	LM3207-534	1.35	CD3935	2.50
74198	20	LM3207-540	1.35	CD3934	2.50
74199	20	LM3207-546	1.35	CD3933	2.50
74200	20	LM3207-552	1.35	CD3932	2.50
74201	20	LM3207-558	1.35	CD3931	2.50
74202	20	LM3207-564	1.35	CD3930	2.50
74203	20	LM3207-570	1.35	CD3929	2.50
74204	20	LM3207-576	1.35	CD3928	2.50
74205	20	LM3207-582	1.35	CD3927	2.50
74206	20	LM3207-588	1.35	CD3926	2.50
74207	20	LM3207-594	1.35	CD3925	2.50
74208	20	LM3207-600	1.35	CD3924	2.50
74209	20	LM3207-606	1.35	CD3923	2.50
74210	20	LM3207-612	1.35	CD3922	2.50
74211	20	LM3207-618	1.35	CD3921	2.50
74212	20	LM3207-624	1.35	CD3920	2.50
74213	20	LM3207-630	1.35	CD3919	2.50
74214	20	LM3207-636	1.35	CD3918	2.50
74215	20	LM3207-642	1.35	CD3917	2.50
74216	20	LM3207-648	1.35	CD3916	2.50
74217	20	LM3207-654	1.35	CD3915	2.50
74218	20	LM3207-660	1.35	CD3914	2.50
74219	20	LM3207-666	1.35	CD3913	2.50
74220	20	LM3207-672	1.35	CD3912	2.50
74221	20	LM3207-678	1.35	CD3911	2.50
74222	20	LM3207-684	1.35	CD3910	2.50
74223	20	LM3207-690	1.35	CD3909	2.50
74224	20	LM3207-696	1.35	CD3908	2.50
74225	20	LM3207-702	1.35	CD3907	2.50
74226	20	LM3207-708	1.35	CD3906	2.50
74227	20	LM3207-714	1.35	CD3905	2.50
74228	20	LM3207-720	1.35	CD3904	2.50
74229	20	LM3207-726	1.35	CD3903	2.50
74230	20	LM3207-732	1.35	CD3902	2.50
74231	20	LM3207-738	1.35	CD3901	2.50
74232	20	LM3207-744	1.35	CD3900	2.50
74233	20	LM3207-750	1.35	CD3899	2.50
74234	20	LM3207-756	1.35	CD3898	2.50
74235	20	LM3207-762	1.35	CD3897	2.50
74236	20	LM3207-768	1.35	CD3896	2.50
74237	20	LM3207-774	1.35	CD3895	2.50
74238	20	LM3207-780	1.35	CD3894	2.50
74239	20	LM3207-786	1.35	CD3893	2.50
74240	20	LM3207-792	1.35	CD3892	2.50
74241	20	LM3207-798	1.35	CD3891	2.50
74242	20	LM3207-804	1.35	CD3890	2.50
74243	20	LM3207-810	1.35	CD3889	2.50
74244	20	LM3207-816	1.35	CD3888	2.50
74245	20	LM3207-822	1.35	CD3887	2.50
74246	20	LM3207-828	1.35	CD3886	2.50
74247	20	LM3207-834	1.35	CD3885	2.50
74248	20	LM3207-840	1.35	CD3884	2.50
74249	20	LM3207-846	1.35	CD3883	2.50
74250	20	LM3207-852	1.35	CD3882	2.50
74251	20	LM3207-858	1.35	CD3881	2.50
74252	20	LM3207-864	1.35	CD3880	2.50
74253	20	LM3207-870	1.35	CD3879	2.50
74254	20	LM3207-876	1.35	CD3878	2.50
74255	20	LM3207-882	1.35	CD3877	2.50
74256	20	LM3207-888	1.35	CD3876	2.50
74257	20	LM320			





**SPRINT 68  
MICROCOMPUTER  
CONTROL COMPUTER  
DEVELOPMENT SYSTEM**

6800 MPU, serial I/O, 48K RAM, dual 8" drives, WIZRD multitasking DOS, Editor, Assembler, 12K BASIC all for \$3995.

**SOFTWARE OPTIONS**

C compiler, PL/W compiler, PASCAL

**HARDWARE OPTIONS**

EROM Programmer, analog I/O, parallel I/O, 488 GPIB



1801 South Street  
Lafayette, IN 47904  
Phone: (317) 742-8428

Circle 255 on inquiry card.

APPLE II PLUS WITH 48K RAM	\$1190.
TEXAS INSTRUMENT 99/4 COMPUTER	\$ 989.
T1810 PRINTER	\$1590.
T1820 PRINTER	\$1890.
CENTRONIC PRINTERS:	
730-1 PARALLEL PRINTER	\$ 699.
737-1 PARALLEL INTERFACE	\$ 879.
SPINWRITERS FROM NEC	
5510 R/O SERIAL INTERFACE	\$2499
5520 KSR SERIAL WITH KEYBOARD	\$2790
5530 PARALLEL INTERFACE	\$2499
COMPRINT 912 APPLE, TRS-80, PET	\$ 559
912 SERIAL	\$ 929
PAPER TIGER 440	\$ 980
440G	\$ 559.
BASE-2 800 S.T. PRINTER	
COMMODORE BUSINESS MACHINES	
PET 2001-8K COMPUTER	\$ 695
PET 2001-32K	\$1090.
PET 8032 80 CHAR. SCREEN	\$1595.
PET 2022 TRAC. FEED PRINTER	\$ 749.
PET 2023 FRIC. FEED PRINTER	\$ 679.
PET 2040 DUAL FLOPPY DISK DRIVE	\$1090
PET 8050 1 MEG STORAGE	\$1489
ATARI 800	\$ 889
INTERTEC SUPERBRAIN(32K)	\$2595
NORTH STAR COMPUTERS	
HRZ-2-32K-D-ASM	\$2275.
HRZ-2-32K-Q-ASM	\$2675
DISPLAY TERMINALS	
INTERTUBE II	\$ 775.
HAZELTINE 1410	\$ 775.
1420	\$ 899.
1500	\$ 999.

IMMEDIATE DELIVERY FROM STOCK

MULTI-BUSINESS COMPUTER SYSTEMS  
28 MARLBOROUGH STREET  
PORTLAND, CONN 06480  
(203) 342-2747



Circle 256 on inquiry card.

**COMPUTER  
EQUIPMENT  
& SOFTWARE  
BARGAINS**



EVERY MONTH

BUY, SELL OR TRADE ALL TYPES OF COMPUTER EQUIPMENT AND SOFTWARE (pre-owned and new) among 20,000 readers nationwide in BIG (11x14") pages. Classified ads are only 10¢ per word and are indexed for easy and fast location. Subscription: \$10 a year/12 issues. Bank cards accepted. Money back guarantee.

**COMPUTER SHOPPER**

P.O. Box F-14  
Titusville, FL 32780  
(305) 269-3211

Circle 257 on inquiry card.

**dbis**

YOUR HEADQUARTERS FOR

**OHIO SCIENTIFIC**

SALES • SERVICE • SUPPORT

THE BEST NEW YORK AREA PRICES ON ALL OHIO SCIENTIFIC COMPUTERS - LOCAL USERS GROUP - BUSINESS AND PERSONAL SYSTEMS

PROFESSIONAL BUSINESS SOFTWARE:  
Accounts Receivable Accounts Payable  
Wholesale Industry Distribution  
Grants Accounting System  
Payroll

ALSO AVAILABLE:

- \*Eaton LRC 7000+ Plain Paper Printer...\$356.
- \*Okidata Microline 80 Printer - upper/lower case, graphics, any paper, software selectable print size...\$27.
- \*HazelTine 1420 Terminal...\$948.

MASTERCARD & VISA WELCOME

Designers & Builders of Information Systems, Inc.  
One Mayfair Road - Eastchester, New York 10707

(914)779-5292 (212) 933-4170

Circle 258 on inquiry card.

**DISK DRIVE/CRT  
SALE**

Shugart  
SA801R  
for  
RS MOD. II  
Only  
\$485

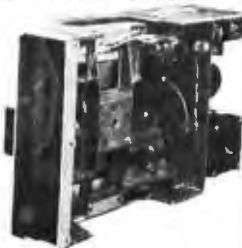

HazelTine 1000 (unused) .....	\$499
Shugart SA400 .....	\$279
Pertec F0200 .....	\$279 F0250.....\$359
MPI B51 .....	\$279 B52.....\$349
SA801R w/PS/Cab .....	\$750
Dual Drives w/PS/Cab .....	\$1640

Limited Quantities



3304 W. MacArthur Blvd.  
Santa Ana, CA 92704  
(714) 979-9923

Circle 259 on inquiry card.

**CROMEMCO  
SYSTEMS**

**DISCOUNTED**

System 2 with 64k RAM—\$3195  
System 3 with 64k RAM—\$5735

Discounts up to 20%  
on most Cromemco hardware.  
We carry the full Cromemco line.

**TORREY PINES BUSINESS SYSTEMS**

14260 Garden Rd., Suite 1B  
Poway, California 92064

(714) 486-3460

Add 3% for shipping and handling  
California residents add 6% sales tax

Circle 260 on inquiry card.

**80X24 VIDEOTERM™  
7X9 MATRIX DISPLAY FOR**

LOWER CASE W/ DESCENDERS **APPLE II®**

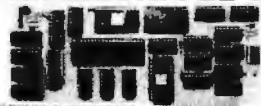

80 columns by 24 lines with easy to read 7x9 dot matrix, upper and lower case with descenders using shift lock feature • 1K firmware incorporates PASCAL and BASIC protocols so user is not required to enter machine language programs or change PASCALS. Misc. info or Gotoxy files • Compatible with all APPLE II peripherals so user won't need new software patches for future software products • Crystal controlled dot clock for excellent character stability • VIDEOTERM is the same size as the Apple language card and power consumption is held to a minimum through the use of CMOS and lower power devices • Character set can be user definable up to a maximum of 128 symbols of 8x16 dot matrix font • Display control character mode and four standard display formats controlled by escape sequences • Built in light pen capability • Inverse display mode • 50/60 HZ operation • Sockets on all IC's.

PRICE: Without graphic EPROM \$345  
OPTIONS: Graphics EPROM (line drug) \$25  
VIDEO SWITCH PLATE, inserts  
in case (not to choose between  
APPLE II™ and VIDEOTERM \$12  
MANUAL: \$15



VIDEX 3060 N.W. Thistle Pl. Corvallis, OR 97330 Phone (503) 758-0521

Circle 261 on inquiry card.

We are interested in buying new or used Zilog computers & accessories and Varian Minicomputers or parts.

Write or telephone:

**Keith Jenkins  
& Associates Inc**

Suite 354, Graybar Building  
420 Lexington Ave  
New York, NY 10170  
(212) 599-0447

Circle 262 on inquiry card.

**MICROCOMPUTERS and  
PHYSIOLOGICAL SIMULATION**

James E. Randall, Indiana University  
School of Medicine, Bloomington

Foreword by Arthur C. Guyton, University  
of Mississippi School of Medicine, Jackson

This book provides microcomputer hardware and programs suited for teaching simulations such as nerve action potential, cardiac action potential, cardiovascular system mechanics, and the glucose tolerance test.

"Sorely needed for those of us who are just beginning to adapt microprocessors to teaching applications in Physiology. Dr. Randall is eminently qualified to do this special job. He has interacted for several years with his potential readers through his activities in the American Physiological Society."

Beverly Bishop

SUNY at Buffalo, School of Medicine

Feb. 1980. 250 pp., illus. Paper 06128 \$14.50

Price is subject to change without notice.

**Addison-Wesley**

Advanced Book Program  
Reading, Mass. 01867, U.S.A.



Circle 263 on inquiry card.

# Precision Engineered Drives...

Power supply guaranteed for one year.

More Capacitance: Insures stable operation over greater line voltage variations (105-125 Vac.)

Scratch resistant steel cover: Primed and baked enamel finish. Virtually eliminates video interference. Color compatible with Radio Shack or Zenith Z89.

Increased ventilation for additional cooling: Top, side and bottom vents mean lower operating temperatures for longer life.

Switch designed with high current ratings (10 AMP).

Transformer designed as integral part of system for best line regulation. Not separately encased to avoid heat build-up providing longer life.

Simpler, more reliable circuitry.

Designed to UL specifications. Wide operating temperature range (0°C to 50°C) Tested to 1500 volts mpil to output isolation for enhanced power surge protection.

Easy access to terminating resistor for easy field conversion from drive 0 to drive 1, 2, or 3.

Extender: Easy plug-in access

3-wire grounded line cord for added operator safety.

With the number of disk drives on the market increasing, more and more people are beginning to ask what's underneath that cover.

The CCI™ series of disk drives have been designed for long life and ease of operation. The features shown above are what set our CCI drives apart from the rest. With a CCI drive you get an integrated professional design!

If you're still not convinced that you get the most for your money with a CCI drive, just ask for our complete specifications sheet. Then, compare our disk drives to anyone else's.

## 5 1/4" DRIVES

CCI-100 40 Track (102K Bytes) for TRS-80\* Model I \$399.00  
CCI-189 40 Track (102K Bytes) for Zenith Z89 \$499.00  
CCI-200 77 Track (197K Bytes) for TRS-80\* Model I \$675.00

## 8" DRIVES

CCI-800 77 Track (1/2 Meg Bytes) for TRS-80\* Model II \$895.00

All CCI drives are also available for 220 Vac (50Hz) operation.

## Operating Systems

NEWDOS Plus for 5 1/4", 40 and 77 Track Drives—with over 200 modifications and corrections to TRSDOS \$110.00  
CP/M for Model I, Zenith \$150.00  
CP/M for Model II, Altos \$199.00

## Software by S&M Systems

INSEQ-80™—Indexed Sequential Access Method (ISAM) for the TRS-80 Model I.

Four machine language programs that can be called from your BASIC program via USR functions to access records either sequentially or randomly. The INSEQ-80 programs maintain all indexes and chains for you. Includes reorganization utility to consolidate files. \$49.95

Professional Business Software using INSEQ-80 for the TRS-80\* Model I and Zenith Z89.

Accounts Payable, Accounts Receivable,

General Ledger, Payroll

Inventory

per package \$99.00

per package \$125.00

# ComputerCity

175 Main Street, Dept. B-8, Charlestown, MA 02129

Hours: 10AM-6PM (EST) Mon.-Fri. (Sat. till 5).

Products also available from: Radio Shack, NEC, Centronics, Paper Tiger, TI, Altos, MPI, Zenith, ATARI, Mattel, PET, OKIDATA, Apple, Eaton/LRC.

FRANCHISE AND DEALER (NATIONAL/INTERNATIONAL) INQUIRIES INVITED

Retail Stores: MA: Burlington, Charlestown, Framingham, Hanover NH: Manchester RI: Providence

**TO ORDER CALL  
TOLL FREE 1-800-343-6522  
TWX: 710-348-1796**

Massachusetts residents call 617/242-3350

For detailed technical information, call 617/242-3350.

Freight Collect, F.O.B. Charlestown.

\*TRS-80 is a trademark of the Tandy Corporation



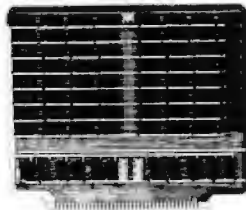

6K BYTE STATIC RAM MODULE FOR THE 6800; COMPATIBLE WITH THE MOTOROLA EXORCISER BUS AND D-2 KIT. TWO SEPARATE 4k ADDRESSES; EACH MAY BE USED AS RAM OR TREATED AS ROM. SWITCHES SET ADDRESSES AND CONTROL RAM/ROM OPTION. ALL IC'S ARE SOCKETED; EACH IC HAS A BYPASS CAPACITOR. ACCESS TIME: 450 NSEC. DIMENSIONS: HEIGHT 8.425IN. WIDTH 9.750 IN THICKNESS .062 IN SIGNALS: R/W, VMA OR VUA (JUMPER), Ø2 STATIC RAM. LOW POWER 2102AN 4L OR EQUIVALENT. THE ALIB8K COMES ASSEMBLED AND TESTED WITH A ONE YEAR WARRANTY. PRICE \$250

APPLIED LOGIC, INC  
P.O. BOX 328  
JAMAICA, NEW YORK 11415  
(212) 459-4064

\*EXORCISER is a trademark of Motorola, Inc.

Circle 265 on Inquiry card.

The World Has Seen  
Tiny Basic, Tiny Pascal, and Tiny C.  
Until Now,  
Microcomputer LISPs Have Been  
"Tiny LISP."

TLC-LISP is tiny in only one way: its introductory price of \$150 for all the features described in the "What's New" column of the May BYTE, page 292. This offer will only last 'til Sept. 2, 1980; after that date, we require \$20 for the manual and \$250 for the complete system. (Cal residents, always add 6% sales tax; and foreign orders, please add \$3 for shipping.)

In All Other Ways, TLC-LISP Is

# BIG

It is a **BIG** subset of MIT's LISP Machine LISP, the world's best LISP. It is **BIG** in performance, averaging 1/3 the speed of a KA-10. It is **BIG** in documentation, supplying a manual written by John Allen, founder of TLC, author of "Anatomy of LISP" and editor of BYTE's special LISP issue. It is **BIG** in quality, being designed and implemented by a team with thirty years combined LISP experience. So, get on the TLC-LISP bandwagon early, discover the power and flexibility of LISP using the **BIG** LISP with the tiny price.

(T.L.C.), The LISP Company  
Box 487 Redwood Estates, CA 95044

Circle 266 on Inquiry card.



## The best choice in mainframes !

- \$100 CARD FRAME
- 22 MHz 12" CRT MONITOR
- 18 AMP POWER SUPPLY
- UPPER & LOWER CASE
- ASCII KEY BOARDS
- AXIAL BLOWER
- ASSEMBLED & TESTED
- READY FOR YOUR CARDS
- \$895.00 OEM QUANT. ONE

**INFINITE**

Celebrating Our 1.5th Year  
810 E. STRAWBRIDGE, MELBOURNE, FL 32901 - (305) 724-1588

Circle 267 on Inquiry card.

### STATIC RAM CHIPS FACTORY PRIME

From the same shipment we use in our professional quality boards.  
2114L 450 ns. \$5.90 200 ns. \$6.90  
4044 450 ns. \$5.90 250 ns. \$6.90  
Add \$5.00 Handling on Orders Under \$200.00

### 32K STATIC RAM BOARD

FOR THE 8550 AND 8550C BUS (SWTP etc.)  
• 8550C Extended Addressing (can be disabled).  
• 4 separate 8K blocks.  
• Low power 2114L RAMS  
• Socketed for 32K  
• Write Protect  
• Gold Bus Connectors

16K ..... \$328.12  
24K ..... \$438.14  
32K ..... \$548.15

Phone, write, or see your dealer for details and prices on our broad range of Boards and Systems for the 8550/8550C bus including our **UNIQUE 80x24 VIDEO BOARD**, and our AC Power Control Products for all computers.

**GIMIX inc.**

1337 W. 37th Place • Chicago, IL 60609  
(312) 927-5510 • TWX 910-221-4055

The Company that delivers.  
Quality Electronic products since 1975.

GIMIX™ and GHOST™ are Registered Trademarks of GIMIX INC.

Circle 268 on Inquiry card.

# 6502 FORTH

... is structured, high-level macro language well suited to microcomputers. 6502 FORTH is available now for KIM, SYM, and AIM systems with at least 12 K of RAM starting at either \$0200 or \$2000. Includes a built-in 6502 assembler, text editor, and virtual memory file software linked to the system cassette interface. (An app. note is provided which shows how 6502 FORTH can easily be interfaced to a low-level disk driver) The package, which includes a commented source listing of the complete system, object code on cassette, and a user manual, sells for \$90.00 (include \$4.00 S&H). Payment must be by U.S. check or money order. (Specify system type and starting location) The user manual is available separately for \$15.00 (include \$1.50 S&H)

ERIC C. REHNKE  
1067 Jadestone Lane  
Corona, CA 91720

Circle 269 on inquiry card.

### H9 OWNERS!

Upgrade your video terminal with one of these long overdue kits:

**GRAFIX** — Graphical display capabilities assembled and tested \$69.95. Kit \$59.95.

**CURSOR CONTROL** — A total of 8 functions assembled and tested \$34.95. Kit \$29.95.

**FLICKER FREE** — 4800 baud operation assembled and tested \$79.95. Kit \$69.95.

All have a full 6 month warranty.

**NORTHWEST COMPUTER SERVICES, INC.**

8503 N.E. 30th Avenue  
Vancouver, WA 98665

Circle 270 on Inquiry card.



- IMPROVE IMAGE CONTRAST
- REDUCE EYE FATIGUE
- ENHANCE SCREEN LEGIBILITY
- PROVIDE A MORE PLEASING DISPLAY
- GIVE A DISTINCTIVE PROFESSIONAL LOOK TO YOUR SYSTEM

The GREEN SCREEN is custom molded to fit nicely over the picture tube. It ingeniously mounts in seconds without any tools.

CALL: (212) 286-5816  
or send \$12.50 + \$2 S&H

**ALPHA product co.**  
85-71, 79th St., Woodhaven, N.Y. 11421

Circle 271 on inquiry card.

### SAVE 15-50% OF YOUR DISK SPACE HUFF n PUFF

- Bit compress your files with savings up to 50%
- Cut your TP connect time by up to 50%
- Z-80 code compatible with CP/M and CROMEMCO CDOS
- Free 30 day money back guarantee

HUFF n PUFF is available on 8" diskette, single or double density for \$75.

(California residents add 6% sales tax)

**J and S SOFTWARE**  
2406 TORREJON PLACE  
CARLSBAD CA. 92008

Circle 272 on Inquiry card.



### SUPER SALE 16K Apple II \$995.00

- or Apple II Plus
- Apple Disk II w/controller \$529.95
- Apple Soft or Integer Cards \$159.95
- Pascal Language Card \$459.95
- 10 Megabyte Disk for Apple \$4695.00
- DC Hayes Modems \$339.95
- Graphics Tablet \$695.00

**UCATAN COMPUTER STORE**  
P.O. BOX 1000 DESTIN FL 32541  
ACROSS FROM RAMADA INN  
904-837-2022

Credit Cards Accepted

Circle 273 on Inquiry card.





Teach Yourself by Computer Software™

Educational Software on ALL subjects for home and school (for Apple® and TRS-80™)

Write for free brochure to Teach Yourself by Computer Software 40 Stuyvesant Manor Geneseo, New York 14454 716-243-3006

™Trademark of Apple Computer Inc. ®Registered of Sandy Corp

Circle 275 on inquiry card.

# GET Paid for using your Computer

FUN! Easy RUSH COUPON FOR FREE FACTS

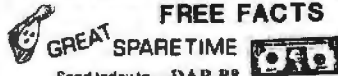

Send today to - DAR-88 3110 Fulton Ave, Sacramento CA 95821

**GASH**

NAME \_\_\_\_\_

STREET \_\_\_\_\_

CITY \_\_\_\_\_

STATE \_\_\_\_\_ ZIP \_\_\_\_\_

Circle 276 on inquiry card.

## SPECIAL PRICES

HARDWARE, SOFTWARE, PERIPHERALS FOR



Most items in stock for immediate delivery. VISA/MC.

For Our Catalog, Contact

Computer Distributors  
PO BOX 9194  
AUSTIN, TX 78766  
(512) 345-9729

Circle 277 on inquiry card.

### COMPUTER FORMS

DISTRIBUTOR OF COMPUTER PAPER PRODUCTS

All paper products are white, blank, tractor feed, (Pinfeed) FANFOLD CONTINUOUS stock.

8" x 4" POSTCARD STOCK (7" width with 1/2" margins). Use as is or trim for 3 1/2" x 5 1/2" card. Pkg 1000 cards...\$17.95 Pkg 2000...\$29.95 Box 4000...\$49.95

STANDARD 9 1/2" x 11" COMPUTER PAPER (8 1/2" x 11" sheet)

Pkg 500 sheets...\$5.95  
Box 3500 sheets...\$27.95  
Box shipping weight...31 lbs

TRY OUR MINI-PAPER! 8" x 8" sheet size (7" width includes 1/2" tractor margins)  
Box 3200 sheets...\$23.95 Sh. Wt. only 17 lbs

CASH ORDER: Include \$2 for shipping, excess will be billed with your order.  
CREDIT CARD ORDER: Shipping will be added to your order. Include ALL credit card information.

Send for FREE Catalog of Paper Products. Postcard stock, address labels, many sizes & types of paper.



COMPUTER FORMS (816) 429-7922  
5588 Caribou, Stevensville, MI 49127

Circle 278 on inquiry card.

## = Diskettes =

8 inch-soft/hard sector:

Sngl side-angl dens \$2.95  
Sngl side-dble dens \$3.55  
Sngl side-reversabl \$4.55  
Dble side-angl dens \$4.55  
Dble side-dble dens \$4.90

5 inch-soft/hard sector:

Sngl side-40 Trk \$2.75  
Dble side-40 Trk \$4.05  
Sngl side-77 Trk \$4.35

Visa/Mst.Chg/COD - call

[206]488-4552

HARREX CORPORATION  
Media Sales Division  
P.O. BOX 249  
Kenmore, Wash. 98028

Circle 279 on inquiry card.

Now on Disk

### Learn FORTH

FORTH is a structured high level language that dramatically cuts program development time. You can expand the FORTH language by defining new operations and data types. FORTH programs are compiled to reduce memory space and speed execution.

tinyFORTH is a complete version of the powerful FORTH language tailored to the TRS-80. The disk tinyFORTH system is a stand-alone operating system with FORTH, a text editor, an assembler, and graphics.

Learn FORTH on your own computer. The tinyFORTH user's manual contains hundreds of examples to teach you FORTH in a hands-on style.

tinyFORTH for 16k level II TRS-80.  
Disk version and full documentation \$49.95  
Cassette version and full documentation \$29.95  
Documentation only (disk version) \$14.95

All orders are fully guaranteed. Add \$1.50 for postage and handling. Order with check, money order, Visa, or MasterCard.

Write for a FREE booklet describing FORTH.

### The Software Farm

Box 2304 Dept. A30 Reston, VA 22090

Circle 280 on inquiry card.

### STRUCTURAL ANALYSIS SOFTWARE For TRS-80 and North Star Computers

SPACE FRAME (Finite Element - Stiffness Method) includes Space Frame, Plane Frame, Space Truss & Floor Grids  
Disk Version \$150.00 Cassette Version \$50.00  
TRS-80 Model II \$200.00 Documentation Only \$25.00 plus postage

TRUSS FORCE (Method of joints solution of Common Trusses)  
Disk Version \$50.00 Cassette Version \$25.00  
Documentation Only \$5.00 plus postage

LINEAR PROGRAMMING (Simplex Method)  
Disk Version \$80.00 Cassette Version \$25.00  
Documentation Only \$5.00 plus postage

ENGINEERING ANALYSIS SOFTWARE  
P.O. Box 26206  
Fort Worth, Texas 76116  
Phone (214) 298-1248

In California Contact:

MICOPS INC.  
421 Royale Park Dr.  
San Jose, Ca. 95136  
Phone (408) 629-5716

Circle 281 on inquiry card.

### FIELD ENGINEERS TECHNICAL SUPPORT FIELD SERVICE MANAGEMENT

SYSTEMS 370/360, H-200, XDS, Univac, CDC All large & medium CPU's

MINI's PDP, NOVA, G.A., HP, etc... All Mini Systems

I/O STC, TELEX, CDC, ITEL, CALCOMP, etc... All Peripheral Experience.

SPECIALIZED PLACEMENT OF THE FIELD SERVICE PROFESSIONAL  
LET US LOCATE THE BEST OPPORTUNITIES FOR YOU

NATIONWIDE

### FIELD SERVICE SEARCH

925 E. RAND RD.  
ARLINGTON HEIGHTS, ILL 60004  
(312) 398-5535

Private Employment Agency - no fees

Circle 282 on inquiry card.

### NOBLE COMPUTER CORPORATION

ADD the ultimate to your computer system "SOUND" 106,000,000 Distinct Sounds

Noble Computer Corporation announces the development and production of a computer SOUND board, for S-100 or S-50 Bus User complete with software, capable of producing 106 Million distinct sounds.

Also available - S-50 INTERFACE

Open up your computer system to the real world. Now at last there is an S-50 to S-100 interface available that allows you to be compatible with any S-100 Bus interface system, I/O media or memory system. This third generation S-50 Bus interface features:

- Selectable memory addressability
- Selectable I/O Device Addressability
- Up to 64K Addressability

Both products are assembled, tested, and guaranteed:

Computer Sound Board - \$179.95  
S-50 to S-100 Interface - \$129.95

Circle 283 on inquiry card.

# DAL - COMP

DAL-COMP gives you the finest lines in electronic hardware, components, computer boards and peripherals.

## SD SYSTEMS

FOR S-100

Memory Boards, Video Boards, CPU Boards, PROM Boards, Single Board Computers, Controller Boards, Software.

## SSM

FOR S-100 — APPLE

Video Boards, IO Boards, Music Boards, CPU Boards, RAM Boards, EPROM Boards, Extender Boards, Terminator Boards.

## AP PRODUCTS

Solderless Plug Boards, Bread Boards, Flat Ribbon Cable Assemblies, Jumper Headers, Test Clips, Connectors, Sockets.

## CALIF. COMPUTER SYSTEMS

FOR S-100 — APPLE — TRS 80

Interface Boards, PROM Boards, Controller Boards, CPU Boards, RAM Boards, Mainframes, Extender Boards, Proto Boards.

## QT COMPUTER SYSTEMS

FOR S-100

Memory Boards, CPU Boards, Clock Calendar, Motherboards, I/O Boards, Video Boards, EPROM Boards, Controller Boards.

## MOUNTAIN HARDWARE

FOR APPLE

Introl X-10, Apple Clock, Super Talker, ROM Writer, ROM Plus, Music System, A/D & D/A, Expansion Chassis.

— PANAVISE — OK MACHINE & TOOL — MODEMS — EPROM ERASERS — DISKS — DISK DRIVES — POWER SUPPLIES — VECTOR ELECTRONICS — IC's — (TTL — CMOS — MEMORY) — SOCKETS — SWITCHES — TERMINALS —

Call Dal-Comp for prices on all your electronic and computing needs. We offer the finest products in the industry at prices you can compare with anyone. Check our fast service and responsive sales people.

**CALL TOLL FREE 800-527-5310**

• TEXAS RESIDENTS  
CALL COLLECT (214) 350-6898

## THIS MONTH'S SPECIAL

<b>4116</b> 250NS	<b>8/\$48.00</b>	<b>2114L</b> 300NS	<b>5.25</b>	<b>DB25P</b> Male Plug	<b>2.95</b>
<b>2708</b>	<b>6.25</b>	<b>2114L</b> 450NS	<b>5.00</b>	<b>DB25S</b> Female Socket	<b>3.60</b>
<b>2716</b>	<b>19.95</b>	<b>1771</b>	<b>26.95</b>	<b>DB25C</b> Cover	<b>1.50</b>
<b>2732</b>	<b>79.95</b>	<b>1791</b>	<b>37.95</b>	<b>RS232</b> Set/1 Ea. of above	<b>6.50</b>
<b>8080A</b>	<b>3.50</b>	<b>1863/AY51015</b>	<b>5.95</b>	<b>UV Eraser</b>	<b>68.95</b>
<b>Z80A</b>	<b>13.95</b>	<b>1602B</b>	<b>3.95</b>	<b>Dip Switches</b>	<b>Call</b>
<b>8253-5</b>	<b>20.25</b>	<b>S-2350</b>	<b>7.95</b>	<b>Zip Dip Sockets</b>	<b>Call</b>
<b>8279-5</b>	<b>18.50</b>	<b>8212</b>	<b>3.50</b>	<b>Lo-Pro Sockets</b>	<b>Call</b>

**DAL - COMP**  
MAIL ORDER DIV.

**TERMS OF SALE:** Cash, checks, money orders, VISA, Master Charge. Minimum Order \$10.00. Texas residents add 5% sales tax. Minimum shipping and handling charge \$3.00. COD orders add \$2.00 COD fee. U.S. funds only. PRICES SUBJECT TO CHANGE WITHOUT NOTICE. SOME ITEMS SUBJECT TO PRIOR SALE. WE RESERVE THE RIGHT TO LIMIT QUANTITIES. 90 DAY GUARANTEE.

**DAL-COMP M/O DIV. 2560 ELECTRONIC LANE, SUITE 108, DALLAS, TEXAS 75220 • (214) 350-6895**



## H89/H8/Z89

### Software Tools That Work

PIE† full screen editor \$29.95  
 TEXT formatter 34.95  
 (order both for word processing)  
 C Compiler\* 39.95  
 Airport (real-time game) 19.95  
 File packer, modem/file-transfer,  
 LISP interpreter, Z80 & 8080  
 macro assemblers, more.

Quality software running under  
 HDOS† (requires 32K RAM).

Available at Heathkit† stores or  
 Walt Bilofsky's

#### Software Tool Works

14478 Glorietta Drive  
 Sherman Oaks, CA 91423

Phone orders: (213) 986-4885

Add \$2/order 1st class postage and handling.

CA residents add 6% sales tax.

\*Documentation complements *The C Program-*

*ming Language*, Kernighan & Ritchie.

†Heathkit, HDOS: TM of Heath Company.

PIE: TM of Programma International, Inc.

Circle 285 on Inquiry card.



A  
 STANDARD  
 fig-FORTH

## A/FORTH FOR THE ALPHA MICRO®

### PROFESSIONAL MANAGEMENT SERVICES

724 Arastradero Rd., Suite 109  
 Palo Alto, California 94306  
 408/252-2218

© A REGISTERED TRADEMARK OF  
 ALPHA MICRO SYSTEMS

Circle 286 on Inquiry card.

## SUPPLIES

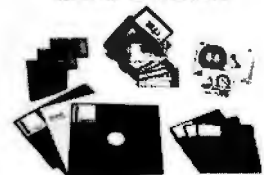

- 3M DISKETTES, MINI OR STANDARD
  - 3M DATA CARTRIDGES, CASSETTES, DISK PACKS
  - RIBBONS, PRINT WHEELS, ELEMENTS, PAPER
- ZAPP**  
 STATIC PROBLEMS???  
 CALL US ON 3M VELOSTAT®  
 ANTISTATIC FLOOR MATS

5555 Magnatron Blvd. #J  
 San Diego, CA 92111  
 (714) 565-4505

**BETA**  
 BUSINESS SYSTEMS, INC.

Circle 287 on Inquiry card.

### Z-80

#### \*\*\*\*\* TESTING/INPUT-OUTPUT \*\*\*\*\* PACKAGE

(Primarily for NORTH STAR DOS users who develop  
 assembler or machine language programs)

Featuring:

(A) Integrated Testing Package

- Full instruction trace
- Breakpoint
- Display/alter RAM contents

(B) Input - Output Package, designed to be called by  
 assembler-oriented programs

- Random or sequential access to diskette files
- Record blocking/deblocking with sequential
- Console input-output assist
- Data compare and set return codes

Both for \$45 on single density 5" diskette, ppd.

Requires 4K beginning at location zero

Test Package may be interfaced to other Z-80  
 systems

I/O Package supports single or double density  
 Full documentation and source included.

Code Construction Co.,

P.O. Box 235

Wentzville, Missouri 63385

P.S. Cross-Pack Catalog Lister

(One listing for all your packs—computes free space)

\$10 with Testing/I/O Package

Circle 288 on inquiry card.

### FOR SALE BY OWNER: MUST SELL!

Pertec/MITS 300

Complete Small Business System . . .  
 or will consider selling components

Altair 8800BT

64 K static RAM

10 Mb Pertec top load hard disk

Qume 45-cps letter quality printer

Lear-Siegler ADM3A CRT

Rack-mount desk

Plus: Microsoft BASIC, utility programs,  
 Word Processing, spare 16K, memory test  
 routines in ROM, up to twenty 3M Disks.

Used 24 mo., now in operation.

Available 8/15.

Steve Livers

215-657-6575

L/L Assoc'd, Inc.

Willow Grove (Phila), PA.

Circle 289 on Inquiry card.

### ALL CP/M & CROMEMCO SYSTEMS

INVENTORY CONTROL (for Manufacturers & Retailers) \$250

Parts explosions for finished goods & assemblies

Parts requirements forecasting & Pull Sheets

Economic Order Quantities & Reorder Reports

1500 items per S.D. 8" disk side

ACCOUNTS PAYABLE/RECEIVABLE \$175/\$175

Replaces all your hand written ledgers

Prints Monthly Ledger Sheets, Checks, Vouchers & Sluts

Aged Trial Balances & Statements

Handles Discounts, Partial Payments, Credits, Etc.

APARTMENT MANAGEMENT SYSTEM \$250

Prints all your Monthly Rent Bills

Reports Late Payments, Vacancies, and Lease Expirations

Links with Accounts Receivable Program.

PAYROLL SYSTEM \$175

300 Employees per S.D. 8" disk side

Federal, State and Local Taxes

Quarterly & Yearly Reports (inc. 941's & W-2's)

Prints Payroll Registers, Checks & Vouchers

MAILING LIST \$99

Maintains your list up to 1700 customers per S.D. 8" disk side

Prints the list by Customer Type, City, State or Zip

Can be used to send Personalized Farm Letters

These programs run FASTER & BETTER than ones costing up to 5

times more. All used over 1 1/2 years by several large corporations.

Hardware Required: 48 KRAM, dual floppy disks, 132 col. printer.

Written in Cromemco 16 K EXTENDED BASIC (runs under CP/M)

FEITH SOFTWARE

Colorlink A-1103

Wyncok, Pa. 19095

(215) 887-0780

Circle 290 on Inquiry card.

## WISCONSIN AREA KOMPUTER CO.

Your Full Service  
 Computer Center

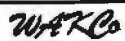

### DISKETTE SPECIALS

10 Verbatim Mini \$26.40

10 Verbatim S.S. 8" \$29.00

Mail Orders or Send for Brochure:

WISCONSIN AREA KOMPUTER CO.

1328 BALSAM PLACE

WEST BEND, WISCONSIN 53095

Wisconsin Residents Add 4% Sales Tax

Add 5% for Shipping & Handling

Circle 291 on Inquiry card.

### MINI FLOPPY SALE

TRS-80 OWNERS

SINGLE SIDED \$365.00

DOUBLE SIDED \$485.00

READY TO GO-CABINET-

POWER SUPPLY-CABLE

ASSEMBLED & TESTED

ADD ON DRIVES

SINGLE SIDED \$225.00

DOUBLE SIDED \$ 345.00

INTERFACE, INC.

20932 CANTARA STREET

CANOGA PARK, CA. 91304

(213) 341-7914

MASTER CHARGE & VISA

Circle 292 on Inquiry card.

### MARKET DATA LISTINGS

14 COMMON STOCKS

▲ DAILY CLOSE & VOLUME

Feb. 28, 1978 to present

▲ FOR THESE STOCKS

ASA BallyMfg HughsIT

AllisCh CornG IBM

AHess EsKod LeviStr

ABdcst GMot NwtInd

Avon Honwil

\$20 Each, \$160 Lot - LISTS

△ Add \$30 Per Lot For Diskette

IBM 8" 2D (IBM 5120 BASIC)

NORTH STAR 5 1/4" (N.S. BASIC)

MC, VISA, CHECK, MONEY ORDER



POST OFFICE BOX 415  
 BURLINGTON, IOWA 52601

Circle 293 on Inquiry card.



11542-1 KNOTT ST.  
GARDEN GROVE,  
CA 92641  
(800) 854-6411  
(714) 891-2663

### CAPACITORS

.1 @ 12 VOLTS  
CERAMIC  
**11¢**  
or  
100 for \$10.00

### 4116's - 200NS.

ADD-ON MEMORY FOR:  
APPLE, TRS-80, HEATH,  
EXIDY, SD. EXPANDORAM.

**8 for \$49<sup>95</sup>**  
**16 for \$95<sup>00</sup>**

### MICROBYTE

### 32K STATIC RAM BOARD

- IEEE/S-100
- 4K Bank Addressable to any 4K Slot within a 64K Boundary
- On-board 8-Bit Output Port
- No DMA Restrictions
- Assembled & Tested
- 4MHz Operation

**\$490<sup>00</sup>**

### IMSAI CONN. 100 PIN GOLD SOLDERTAIL

**\$2<sup>50</sup>** ea.  
or  
**10 for \$2<sup>30</sup>** ea.

### SA800 DISK DRIVES

SHUGART 8" SGL SIDED/DBL DENSITY  
DISK DRIVE, WITH CABINET, PWR. SUPPLY.  
(ASSEMBLED & TESTED)

(1) DRIVE INSTALLED **\$775<sup>00</sup>** (2) DRIVES INSTALLED **\$1250<sup>00</sup>**

### ATARI 400 & 800

#### MODEL 400

- Computer Console
- Basic Language Cartridge
- Basic Language Programming Manual
- Operators Manual
- Power Supply
- TV Switch Box

#### MODEL 800

- Computer Console
- Basic Language Cartridge
- Education System Master Cartridge
- Basic Language Programming Manual
- Operators Manual
- Atari 410 Program Recorder
- Guide to Basic Programming Cassette
- 8K Ram Module
- Power Supply
- TV Switch Box

**CALL FOR PRICE**

AVAILABLE FROM STOCK

### STATIC & DYNAMIC RAM CHIPS

2104 (4K Dynamic) **\$2<sup>25</sup>** ea.  
4108/4115 (8K Dynamic) **\$4<sup>00</sup>** ea.  
5257-3L (4K Static) **\$5<sup>50</sup>** ea.  
250 NS

### MICROBYTE

### 16K STATIC RAM BOARD

- S-100 Compatible
- 4K Bank Addressable
- Extended Memory Management
- No DMA Restrictions
- Assembled & Tested
- 4MHz Operation

**\$250<sup>00</sup>**

### SHUGART

### SA801R

Bare Drives  
Single Sided/  
Sgl/DbI Density

**CALL FOR PRICE AND DELIVERY**

### SPECIAL

### 2114's

(200NS.)  
LO-POWER  
**\$4<sup>75</sup>** ea.  
(1-49)

50 & up **\$4.35 ea.**

### 2716's

5-VOLT ONLY  
(450 NS)

**\$25<sup>00</sup>** ea.

HITACHI, FUJITSU

INTEL's **\$30.00**

### LOBO INTERNATIONAL

### TRS-80 EXPANSION (LX-80) INTERFACE

- CONNECTS DIRECTLY TO KEYBOARD
- TO SERIAL PORTS
- PARALLEL PORT FOR PRINTER, PLUS MANY MORE OPTIONS.

**\$498<sup>00</sup>**

### 74LS244

**\$1<sup>75</sup>** ea.

QTY. PRICES AVAILABLE

### LINEAR COMPONENTS

LM 348 .....**.75**  
LM 377 .....**.90**  
LM 555 .....**.35**  
LM 3900 .....**.42**

### SHUGART SA400

- Enclosed in Metal Case
- Cutouts for Data Cable, Switch, Fuse & Pwr Cord

**\$315<sup>00</sup>**

### CENTRONICS PRINTERS

#### (MODEL #703)

- 180 CPS BI-DIRECTIONAL
- LOGIC SEEKING PRINTER
- 132 COLUMN CARRIAGES
- VFu d CENTRONICS PARALLEL INTERFACE

**\$1850<sup>00</sup>**

### CENTRONICS MODEL

### #737

PRINTER  
(IN STOCK)

**\$825<sup>00</sup>**

### TRS-80 DISK DRIVES

Shugart SA400, Single or Double Density, Soft Sector, up to 218K Bytes, 25 MSec. Access Time, Software Compatible.

**\$395<sup>00</sup>**

### REGULATORS

320T-5 .....**.90**  
320T-12 .....**.80**  
340T-5 .....**.75**  
340T-12 .....**.65**  
78HO5 .....**5.25**

### LO-PRO SOCKETS

	1-99	100 UP
14 PIN	.10	.09
16 PIN	.12	.11
18 PIN	.15	.13
20 PIN	.23	.21
24 PIN	.26	.24
28 PIN	.30	.28
40 PIN	.42	.40

### 2708's (450 NS)

**\$8<sup>00</sup>** ea.

or

**8/\$58<sup>00</sup>**

### ORDERING INFO

Name, Address, Phone  
Ship by: UPS or Mail  
Shipping Charges, Add  
\$2.00 up to (5) lbs.

### TERMS

We Accept Cash,  
Check, Money Order,  
Visa & Master Charge.  
C.O.D.'s on Approval.  
(U.S. Funds Only)  
Tax: 6% Calif. Res.

CATALOG  
AVAILABLE  
CALL  
OR  
WRITE







## JINSAM™ Data Manager

- ★ CUSTOM DATA FILES
- ★ FAST/EASY/MENU DRIVEN
- ★ HELP COMMANDS
- ★ KEYED RANDOM ACCESS
- ★ MULTIPLE SEARCH KEYS
- ★ PRIVACY ACCESS CODES
- ★ WILD CARD SEARCH

For 16K-32K PET, Dual Disk, and Printer

**FREE: LABEL PRINTER MODULE**

**FREE: REPORT GENERATOR MODULE**

Specify CBM 2040 or COMPU/THINK

Package \$150

User's Guide only \$25

Introductory

Demo Tape \$5 Disk \$ 8

Check or Money Order plus \$2 Shipping  
(NY residents add 8% Sales Tax)

- DEALER INQUIRIES WELCOMED -

**JINI MICRO-SYSTEMS, Inc.**

P.O. Box 274-B • Bronx, NY 10463

Circle 296 on inquiry card.

## NEED MASS STORAGE ? DUAL CASSETTE DRIVES



- Cabinet enclosure and dual DFC TU-58 Cassette Drives with internal power supply
- The TU-58 is a random access, fixed-length-block mass storage tape system storing 287 kilobytes of data with a variety of applications.
- Interface is EIA RS-422 balanced and RS 423 unbalanced signals.
- Compatible with RS-232 C
- Optional relay rack mounting

P.O. Box 481  
Greene, New York 13778  
(607) 656-4117



Circle 297 on inquiry card.

## CASSETTE DUPLICATION

TRS-80 (I & II), PET, APPLE, KIM, ATARI

Quality software duplication is more than copying cassettes. Microsette duplication uses a proprietary high speed duplicator designed specifically for computer program duplication. The finished products are of consistent quality, guaranteed to load. Minimum order is 100 with discounts for higher quantities. Call (415) 968-1604 for details.



**MICROSETTE CO.**  
475 Ellis Street  
Mt. View, CA 94043

Circle 298 on inquiry card.

# 2716's \$19.95

ANY QUANTITY

\$5 per order for shipping  
handling & insurance

## floppy drives \$1550

including two Siemens 8"  
drives, cabinet & power

Intelligence Systems, Ltd.

124 South Delaware, Indianapolis, IN  
(317) 631-5514

Circle 299 on inquiry card.

## PRINTER/CRT STAND FROM STOCK!



Sturdy 18 ga. steel, painted  
black textured baked enamel.  
rear or bottom paper feed.  
26" wide x 18" deep x 26" high.  
Easily assembled with six bolts.

**CRT STAND: \$90.00**

**PRINTER STAND  
WITH PAPER TRAY: \$99.00**

Please include payment with your order.

Add for cost of 40 Lb. UPS charges, and 6%  
sales tax if shipment is to be made in Penna.

**AK INDUSTRIES, INC. 2727 Philmont Ave.  
Huntingdon Valley, Pa. 19006**

**Dealer Inquiries Invited**

Circle 300 on inquiry card.

## MEMOREX Floppy Discs

Lowest prices. **WE WILL NOT  
BE UNDERSOLD!** Buy any  
quantity 1-1000. Visa, Mastercharge  
accepted. Call free (800)235-4137  
for prices and information. All  
orders sent postage paid.

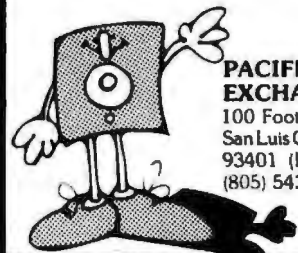

**PACIFIC  
EXCHANGES**  
100 Foothill Blvd.  
San Luis Obispo, CA  
93401 (In Cal. call  
(805) 543-1037.)

Circle 301 on inquiry card.

## SCIENCE MATH STATISTICS ASTRONOMY MUSIC FINANCE

Professionally written TRS-80\* Software  
Star Finder \$9.00  
Linear System Solver \$14.00  
Curve Fitter \$12.00  
Graphics Package \$10.00

Many Others. Free Catalog  
Budget Prices Fully Guaranteed

**BENCHMARK COMPUTING SERVICES**

P.O. Box 385, Providence Ut. 84332

In Europe:

Micro Gems 32 Buckingham Ave.  
Hucknall Nottingham  
NG15 BET England

Master Charge Visa

\*TRS-80 is a trademark of  
Tandy Corporation

Circle 302 on inquiry card.

## CP/M ↔ IBM Compatibility with

## REFORMATTER™

For \$195 you can now transfer  
data between large and small  
systems.

**REFORMATTER™**, a Diskette Utility  
Program, enables you now to  
transfer textual data files in either  
direction between Z-80 or 8080  
based micros operating under  
CP/M and IBM systems using  
3741 diskettes.

For detailed information contact

**MicroTech Exports  
912 Cowper Street  
Palo Alto, CA 94301**

**TWX: 910-370-7457 MUH-ALTOS**

Dealer & OEM discounts available

Circle 303 on inquiry card.

## DISCOUNT PRICES

NORTH STAR  
APPLE II  
MICROTEK  
ANADIX  
TREND/COM  
CENTRONICS  
SOROC  
INTERTUBE  
THINKER TOYS  
SOLID STATE MUSIC  
& OTHERS

Call for Prices  
(301) 694-8884

**FREDERICK COMPUTER  
PRODUCTS**

Municipal Airport  
Frederick, MD. 21701

**If North Star or Cromemco offer it . . .**

**WE HAVE IT!!**

**Immediate Delivery at Discount Prices**



**NORTH STAR  
Horizon® 2**

32K Double Density  
Assembled and Tested  
List \$3095

**ONLY \$2619**

North Star KIT products have been discontinued. MiniMicroMart HAS INVENTORY of most items!

**KITS**

HORIZON 1 16K, DD .. \$1474  
32K, DD, List \$1999 ..... 1684  
32K, QD, List \$2199 ..... 1869  
HORIZON 2, 16K, DD . \$1824  
32K, DD, List \$2399 ..... 2034  
32K, QD, List \$2779 ..... 2359

**ASSEMBLED**

HORIZON 1, DD ..... \$2279  
32K, QD, List \$2995 ..... 2539  
HORIZON 2, 32K, DD . \$2619  
32K, QD, List \$3595 ..... 3049  
48K, DD, List \$3590 ..... 3039  
48K, QD, List \$4090 ..... 3469  
64K, DD, List \$3830 ..... 3239  
64K, QD, List \$4330 ..... 3669

**NORTH STAR APPLICATIONS SOFTWARE**

*Exclusive for use with North Star Disk Systems — specify Double or Quad Density)*

NORTHWORD, List \$399 ..... \$339  
MAILMANAGER, List \$299 ..... 249  
NFOMANAGER, List \$499 ..... 419  
GENERALLEDGER, List \$999 ..... 799  
ACCOUNTSRECEIVABLE, List \$599 ..... 499  
ACCOUNTSPAYABLE, List \$599 ..... 499

**NORTH STAR HARD DISK HD-18**

18 megabytes; plugs into parallel port of North Star Horizon. Utilizes tried-and-proven 14" Century Data Marksman. List \$4999. **OUR PRICE \$4199**

**NORTH STAR MDS-A** — Double (or Quad) Density Disk System, Kit, List \$799. **OUR PRICE \$669**  
Assembled and Tested, List \$899 **SPECIAL \$719**

**NORTH STAR MEMORY BOARDS**

16K Dynamic RAM (RAM-16-A/A), Assembled, List \$499 ..... \$420  
Kit, List \$449 ..... **SPECIAL \$299**  
32K (RAM-32/A), Assembled, List \$739 ..... \$620  
Kit, List \$669 ..... **ONLY \$499**

SHIPPING AND INSURANCE: Add \$15 or Horizons, \$2.50 for Boards and Software. Hard Disk Systems and Cromemco systems shipped freight collect. Advertised prices are for prepaid orders. Credit card and C.O.D. 2% higher. Deposit may be required on C.O.D. All prices subject to change and offers subject to withdrawal without notice.

— WRITE FOR FREE CATALOG —

**MiniMicroMart, Inc.**

1618 James Street, Syracuse, NY 13203 (315) 422-4467

TWX 710-541-0431

Circle 305 on inquiry card.

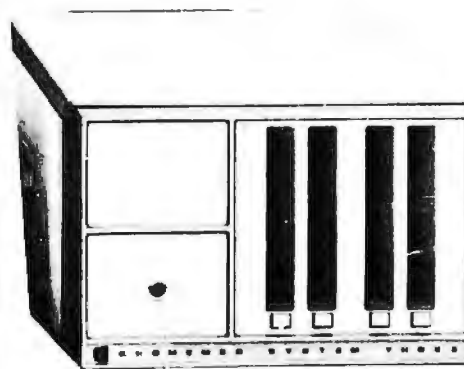

**CROMEMCO  
System 3**

with 64K of RAM  
List \$6990

**OUR PRICE  
\$5890**

**CROMEMCO SYSTEM 2** — Now features dual-sided drives — double the capacity. Similar to System 3, except features dual, double-sided mini floppy disk drives. List \$3990 ..... **ONLY \$3390**

**Z-2 COMPUTER SYSTEM** (can be rack mounted), List \$995 ..... **\$845**

**SINGLE CARD COMPUTER — SCC-W**  
4 MHz. List \$450 ..... **\$382**

**NEW COLOR GRAPHICS INTERFACE — SDI**  
List \$595 ..... **OUR PRICE ONLY \$505**

**CROMEMCO HDD** — 11/22-megabyte Hard Disk for use with existing systems. DMA controller. Transfer rate of 5.6 megabytes/second.

**HDD-11**, List \$6995 ..... **OUR PRICE ONLY \$5939**  
**HDD-22**, List \$11,995 ..... **\$10,189**

**CROMEMCO Z-2H** Full 11-megabyte Hard Disk

system. Fast Z-80A 4 MHz processor, two floppy disk drives, 64K RAM memory, RS232 special interface, printer interface, and extensive software available.  
List \$9995

**OUR PRICE \$8489**





# Computers, Disk Systems

## SUPERBRAIN<sup>®</sup> By INTERTEC



32K or 64K (Double or Quad Density units available). Uses two Z-80 CPU's. Commercial-type terminal with 12" monitor. Dual double density minifloppies. Over 350 kilobytes of storage (twice that with quad density drives). Two serial RS232 ports, I/O ports standard. Expandable with optional S-100 S-100 interface. Comes with CP/M<sup>™</sup> 2.2 operating system. MiniMicroMart includes BASIC interpreter and can supply a wide range of CP/M Development and Application software.

w/32K Double Density, List \$2995. **\$2685**  
w/64K Double Density, List \$3345. .... \$2883  
w/64K Quad Density, List \$3995. .... \$3595  
W/64K Quad — MiniMicroMart  
Upgrade Special. .... \$3395

## MICROMATION



A 64K complete computer with dual density 8" floppies (1 megabyte). Rack or vertical mounting. Systems with double-sided drives, hard disks, and multi-user (MP/M).

Z+ 100 64K RAM, Computer, \$2495. **\$2099**  
Z+ 120 Includes two 8" disks, \$4995. .... \$4199

"Z" system features new distributed processing multi-user concept with one Z-80 per user, with Z-80 for MP/M (Master Satellite concept).

**AS LOW AS \$11,899!**

## SD SYSTEMS

SDS-100, w/32K RAM, \$6995. .... **\$5945**  
SDS-200, List \$8995. .... \$7645

## RADIO SHACK TRS-80<sup>™</sup>

**10% OFF!**

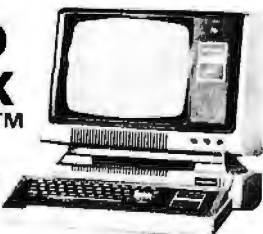

## INTERSYSTEMS formerly ITHACA AUDIO



DPS-1, List \$1795

## LIMITED TIME \$1299\*

The new Series II CPU Board features a 4 MHz Z-80A CPU and a full-feature front panel. 20-slot actively terminated motherboard, with 25 amp power supply (50/60 Hz operation, incl. 68 cfm fan).

**COMPLETE SYSTEM** with InterSystem 64K RAM, I/O Board w/priority interrupt and double density disk controller board. Full 1-year warranty, List \$3595

## LIMITED TIME \$2895\*

Above without disk controller,  
List \$3195. .... **LIMITED TIME \$2539\***

\* Prices good until September 15, 1980.

## HEWLETT-PACKARD HP-85A

Desk-top computer — **Call for Price!**



## MORROW THINKER TOYS<sup>®</sup> DISCUS M26<sup>™</sup>

26 megabytes of formatted storage  
List \$4,995

**\$4,199**



## THINKER TOYS<sup>®</sup> DISK SYSTEMS

Now includes CP/M<sup>®</sup> 2.2

Discus 2D, List \$1199. .... **\$1019**

Discus 2D, dual-drive, List \$1994. .... **\$1694**

Discus 2+2, Assem., List \$1549. .... **\$1319**

Dual Discus 2+2, Assem., \$2748. .... **\$2335**

All Morrow systems now include CP/M<sup>®</sup> 2.2

Circle 306 on inquiry card.

## NORTH STAR DOUBLE DENSITY CONTROLLER BOARDS

Kit, List \$399

**OUR PRICE \$329**

Assembled and Tested, List \$499. .... \$399

*In Stock — First Time in 2 Years!*

## FANTASTIC SAVINGS on a "QUAD" DENSITY HORIZON UPGRADE

North Star Double Density Controller Board (see above) and a quad density MPI-52 (features superior disk handling and door mechanism).

MDS-H-MQ/K Kit form  
List \$999

**OUR PRICE \$699**

MDS-H-MQ/A Assembled form, List \$1099

**\$759**

Shipping and insurance: Add \$6.

## NORTH STAR MDS-A Double Density Mini Floppy Disk System

Double Density, Kit

List \$799

**OUR PRICE \$669**

Assembled and Tested. .... \$719

Quad Version, Kit, List. .... \$836

Assembled, List \$1099. .... \$896

Above MDS-A units do not include cabinet or power supply.

Shipping and Insurance: Add \$7.50.

## Super Special!

## North Star Controller Board, Drive, Cabinet, and Power Supply **\$709**

Complete system similar to above but also includes a cabinet and an assembled/tested power supply for the drive (silver finish). Your choice of Shugart SA-400 or MPI-51 Double Density Drive or MPI-52 quad density drive (MPI drives feature improved door and disk handling mechanism).

w/Controller Bd. kit, SA-400. .... \$709

w/Controller Bd. kit, MPI-51. .... \$709

w/Controller Bd. kit, MPI-52. .... \$809

w/Assembled Bd. and SA-400. .... \$769

w/Assembled Bd. and MPI-51. .... \$769

w/Assembled Bd. and MPI-52. .... \$869

Shipping and Insurance: Add \$6.

For converting existing Horizon 2 to quad, order additional MPI-52

MPI-52 Quad Density Drive. .... \$379

# Terminals and Printers!

## TELEVIDEO TVI-912C



Upper and lower case, 15 baud rates: 75 to 19,000 baud, dual intensity, 24 x 80 character display, 12 x 10 resolution. Numeric pad. Programmable reversible video, auxiliary port, self-test mode, protect mode, block mode, tabbing, addressable cursor. Microprocessor controlled, programmable underline, line and character insert/delete. "C" version features typewriter-style keyboard. List \$950

**OUR PRICE \$789**

920C (with 11 function keys, 6 edit keys and 2 transmission mode keys, List \$1030  
**ONLY \$849**

## Intertec EMULATOR

Software compatible with a Soroc IQ-120, Hazeltine 1500, ADM-3A or DEC VT-52. Features block mode transmission and printer port; 12" anti-glare screen; 18-key numeric keypad; full cursor control. List \$895

**OUR PRICE \$729**

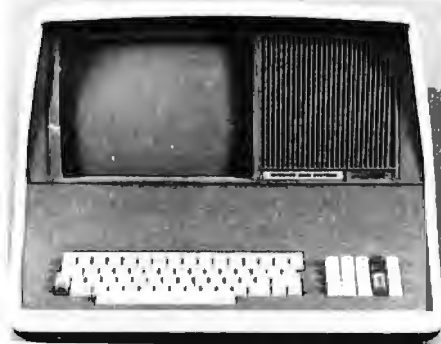

## Intertec INTERTUBE II

List \$995 **ONLY \$799**

12" display, 24 x 80 format, 18-key numeric keypad, 128 upper/lower case ASCII characters. Reverse video, blinking, complete cursor addressing and control. Special user-defined control function keys, protected and unprotected fields. Line insert/delete and character insert/delete editing, eleven special line drawing symbols.

## SOROC



### IQ-120

List \$995

**SPECIAL  
\$729**

IQ-140 List \$1495  
**SPECIAL \$1149**

## HAZELTINE

1500  
**ONLY  
\$879**



1410 w/numeric keypad, List \$900 ..... \$749  
1420 w/lower case and numeric pad ..... 849  
1510, List \$1395 ..... 1089  
1520, List \$1650 ..... 1389

## BANTAM 550

From Perkin-Elmer



**ONLY  
\$799**  
with  
anti-glare  
CRT  
**ONLY \$829**

## CENTRONICS PRINTERS

NEW 730, parallel, friction, tractor ... \$679  
NEW 737 parallel, friction, tractor .... \$849  
779-2 w/tractor (same as TRS-80 Line  
Printer I), List \$1350 ..... 1049  
702 120 cps, bi-direct., tractor, VFU .... 1995  
703 185 cps, bi-direct., tractor, VFU .... 2395  
704 RS232 serial version of 703, \$2350 .. \$1995

Above prices reflect a 2% cash discount (order prepaid prior to shipment). Add 2% to prices for credit card orders, C.O.D.'s, etc. Prices are f.o.b. shipping point. Prices are subject to change and offers subject to withdrawal without notice. **WRITE FOR FREE CATALOG.**

Circle 307 on Inquiry card.

## TI-810



TI-810 Basic Unit, \$1895 . **ONLY \$1695**

TI-810 w/full ASCII (Lower case), vertical forms control, and compressed print . \$1895

TI-745 Complete printing terminal with acoustic coupler, List \$1695 .... **\$1399**

## PAPER TIGER®



IDS-440 Paper Tiger, List \$995 . **\$895**  
w/graphics option, incl. buffer, \$1194 .. \$989  
TRS-80 cable ..... 45

## NEC SPINWRITER™



Terminal/Keyboard as well as RO Printer Only models available.

**CALL FOR PRICES!**

## OKIDATA Microline 80 **ONLY \$649**

Tractor Feed Option ..... \$99

Serial interface ..... \$89

**AXIOM IMP I ..... \$699**

**COMPRINT 912 w/parallel interf. \$559**

912 w/serial interface, List \$699 ..... \$589

**MICROTEK, List \$750 ..... \$675**

**ANADEX 80-Col. Dot Matrix. .... \$849**

# MiniMicroMart, Inc.

1618 James Street, Syracuse NY 13203 (315) 422-4467 TWX 710-541-0431



# Unclassified Ads

**UNCLASSIFIED POLICY:** Readers who are soliciting or giving advice, or who have equipment to buy, sell or swap should send in a clearly typed notice to that effect. To be considered for publication, an advertisement must be clearly noncommercial, typed double spaced on plain white paper, contain 75 words or less, and include complete name and address information.

These notices are free of charge and will be printed one time only on a space available basis. Notices can be accepted from individuals or bona fide computer users clubs only. We can engage in no correspondence on these and your confirmation of placement is appearance in an issue of BYTE.

Please note that it may take three or four months for an ad to appear in the magazine.

**FOR SALE:** New Gluton Rustrack Inkless strip-chart recorder with paper roll. Also, Graphic Sciences Dex 570 and Dex I graphic communications systems. They send photos and legal documents over phones, self-contained. R Qualls, College Inn Apts, Box 238, Durant OK 74701, (405) 924-8306 after 5.

**FOR SALE:** Expander Black Box printer, 80-column for parallel port; \$350. SwTPC MP-N calculator; \$35. Newtech Model 68 music board and software; \$45. SwTPC CT-64 terminal with CT-VM; \$350. All postpaid. Dennis Doonan, 2307 Carlisle Ave, Racine WI 53404.

**FOR SALE:** Two teletypewriters. Friden 7102 with upper and lowercase, full ASCII, 110 baud RS-232/20 mA, paper-tape reader/punch, and wide carriage. \$420 each or \$800 for both plus freight. Gary, (317) 784-9519.

**FOR SALE:** TRS-80 quick printer and/or line printer and cables. Both almost new. Stanley Strauss, (201) 763-7249.

**FOR SALE:** Three 8 K DRC S-100 programmable memories; one 8 K Seals S-100 programmable memory. \$125 each. Perry A Lipford, 5005 Oxford Ave, Mays Landing NJ 08330, (609) 653-1542.

**FOR SALE:** Heath H11A computer system with 64 K bytes memory. Uses DEC LSI-11/2 processor board. Includes serial input/output (I/O) board, all manuals, and documentation. System value over \$2900. Will sell for \$2500 or best offer. Art Lundquist, 13118 Glasgow Way, Ft Washington MD 20022, (301) 868-0005.

**FOR SALE:** HP-67 programmable calculator. With standard accessories, stat, math, standard, and business decisions PAC. Package of blank cards. Must sell. Recently purchased Apple II system. Will ship to first cashier's check or money order for \$525. I pay shipping. 100% operational. D Robblins, 1161 York Ave 1L, New York NY 10021.

**FOR SALE:** Complete collection of BYTE. Both bound editions and single copies in good condition. Outstanding investment in personal computing. Make best offer. M N Andersen, 10684 Esmeraldas Dr, San Diego CA 92124.

**FOR SALE:** BYTE from February 1978 thru February 1980. Available individually or in groups at \$2 apiece. Also, first four issues of *onComputing* magazine for \$8 and February 1979 thru January 1980 *Creative Computing* for \$20. Will answer all inquiries. John Scholze, Rt 5, Box 449, Black River Falls WI 54615.

**FOR SALE:** H8 computer with 24 K Godbout programmable memory plus serial input/output (I/O) and cassette interface. All assembled and tested and includes recent version of Benton Harbor BASIC. All for \$700 plus shipping. Daniel Bush, (404) 394-3341.

**WANTED:** A used terminal printer with acoustic coupler, Bell System 103 compatible, and 300 bps. Also, need a video display terminal. J A Gatlin, 1115 S Main, Ottawa KS 66067.

**WANTED:** BYTE magazines, February 1978 and June 1976. T Higbee, 4572 Trafalgar Dr, La Palma CA 90623.

**FOR SALE:** RCA 1802 Cosmac processor with 16 K static memory, Netronics giant board, ASCII keyboard, Netronics video-display board, Netronics Level III BASIC, 5-card bus, power supply, Tiny BASIC, 15-inch GBC monitor, game cassettes, complete data, and instructions. Everything in good working order. Original cost over \$1000, asking \$600. William Gordon, 11 Canterbury Ln, Short Hills NJ 07078, (201) 467-9792.

**FOR SALE:** Altair 8800A, 16 K, Meca Alpha I tape, 2 SIO, Act I terminal, 8 K, and Extended BASIC. \$1400 takes all, or will separate. D Glatzen, 313 Meadow Ln, Hastings MI 49058, (616) 945-5334.

**FOR SALE:** 48 K Apple II with manuals, paddles, and software on cassette. Software includes the S-C Assembler II, an implementation of the FORTH language, and the Apple Invaders game. \$1100 or best offer. Will ship via UPS. Tim Tillson, 2712 Adobe Dr, Fort Collins CO 80525, (303) 223-7364.

## PASCAL FROM START TO FINISH

### The BYTE Book of Pascal

Edited by

Blaise W. Liffick

Based on the growing popularity of Pascal as a programming language, numerous articles, language forums and letters from past issues of BYTE magazine have been compiled to provide this general introduction to Pascal. In addition, this book contains several important pieces of software including two versions of a Pascal compiler - one written in BASIC and the other in 8080 assembly language; a p-code interpreter written in both Pascal and 8080 assembly languages; a chess playing program; and an APL interpreter written in Pascal. \$25.00 Hardcover pp. 342 ISBN 0-07-037823-1

### Beginner's Guide for the UCSD Pascal System

by Kenneth L. Bowles

Written by the originator of the UCSD Pascal System, this highly informative book is designed as an orientation guide for learning to use the UCSD Pascal

System. For the novice, this book steps through the System bringing the user to a sophisticated level of expertise. Once familiar with the System, you will find the guide an invaluable reference tool for creating advanced applications. This book features tutorial examples of programming tasks in the form of self-study quiz programs.

The UCSD Pascal Software Systems, available from SofTech Microsystems Inc, 9494 Black Mountain Road, San Diego CA 92126, is a complete general purpose software package for users of microcomputers and minicomputers. The package offers several interesting features including:

- Programs which may be run without alteration on the General Automation or DEC PDP-11 minicomputers, or on an 8080, 8085, Z80, 6502, 6800, or 9900 based microcomputers.
- Ease of use on a small, single-user computer with display screen and one or more floppy disk drives.
- A powerful Pascal compiler which supports interactive applications, strings, direct access disks, and separately compiled modules.
- A complete collection of development software: operating system, file handler, screen oriented text editor, link editor, etc.

\$11.95 ISBN 0-07-006745-7

Please send

- \_\_\_\_\_ copies of *Beginner's Guide for the UCSD Pascal System*  
 \_\_\_\_\_ copies of *The BYTE Book of Pascal*



Name \_\_\_\_\_ Title \_\_\_\_\_ Company \_\_\_\_\_

Street \_\_\_\_\_ City \_\_\_\_\_ State/Province \_\_\_\_\_ Code \_\_\_\_\_

Check enclosed in the amount of \$ \_\_\_\_\_

Bill Visa  Bill Master Charge

Card No. \_\_\_\_\_ Exp. Date \_\_\_\_\_

Add 60¢ per book to cover postage and handling.



70 Main Street, Peterborough, NH 03458



**FOR SALE:** BYTE magazines: November 1976 and November 1977 thru June 1979. All twenty-one issues for \$53. I pay postage. Send certified check or money order. David McCracken, 6850 Freedom Blvd, Aptos CA 95003, (408) 688-0358.

**FOR SALE:** Dynamic programmable memory circuits. National MM5280-055 (2107) 4 K by 1. These parts are available due to project cancellation. They are new and guaranteed to meet specifications. Have 300; will sell all or part at \$1.75 each. Doryn Johnson, 12A Triads, Logan UT 84321, (801) 752-9378.

**FOR SALE:** Wang advanced programming calculator. Model 720B with Model 702 plotting output writer. Also, manuals and service schematics. \$950. Frank Shea, 78 Pilgrim Ave, Worcester MA 01604, (617) 798-8485.

**FOR SALE:** 8800B Altair S-100 mainframe; \$650, SSM video VB-1B graphics board; \$95, two Godbout 8 K Econoram memory boards; \$95 each, Altair 88ACR cassette-interface board; \$85. Documentation included with each item. Robert Faulkner, 607 Bryan Ct, Altamonte Springs FL 32701, (305) 830-4387 after 7 PM.

**FOR SALE:** Litton Model 1252 business computer in excellent condition. Includes central processor Model 1801, keyboard, printer (30 cps), punch, reader, and auxiliary storage. Recently serviced. Computer comes complete with operator's manual and software for many business applications. \$3000. Jesse Collum, (919) 847-4053 or (919) 558-4031.

**FOR SALE:** Processor Technology 64KRA-1 (64 K by 8) memory board for S-100 computers with 2 MHz clock such as SOL-20, IMSAI 8080 and 8085, and Altair. Has three different bank select options; includes manual with updates, \$575. John Edwards, 408 13th St #545, Oakland CA 94612, (415) 462-3394.

**FOR SALE:** Ohio Scientific Challenger II-8P cassette-based system with 20 K bytes static memory, 540 video board, 542 polled keyboard, two full parallel ports, OSI Assembler/Editor, some game tapes, and two binders of documentation and notes. This is a plain but reliable computer with a heavy power supply. Cost about \$1250 new; will sell for \$650 or best offer. Gregg Williams, (603) 924-9281 Monday thru Thursday.

**FOR SALE:** Ohio Scientific printed-circuit boards, documentation, backplane, and cabinet for 6800 or 6502 Challenger system. Original cost \$300, will sell for \$200. Included are: #400 processor and input/output (I/O) board, #420 4 K programmable memory boards, #430 cassette A/D and D/A board, #440 Video Graphics board, #450 8 K read-only memory and I/O board, and #480 backplane board. Paul Manos, 28743 Lincoln Rd, Bay Village OH 44140, (216) 331-3010 evenings.

**FOR SALE:** Memorex hard-copy terminal with digital cassette. 80 characters per second. Includes all manuals. Needs some work. \$500. Michael C Lewis, 1602 Shepherd Dr, Duarte CA 91010.

**WANTED:** Clock generator circuit for TMS9900 microprocessor (ie: TIM9904 or 74LS362). Please contact me if you can sell me one or know of a source for one. I am also interested in corresponding with other 9900 users. Andy Hall, 4124-55th St, Des Moines IA 50310, (515) 278-2459.

**FOR SALE:** Sphere 6800 computer, 12 K memory, video board, cassette/modem interface board. Best offer over \$300; original cost \$1000. David Moore, 1518 Jefferson, Quincy IL 62301, (217) 228-1792.

**FOR SALE:** DECwriter II with APL option, current loop and RS-232, writing table, noise shield. Complete with maintenance manual and all schematics. Maintained by DEC and in perfect working order. Reliable hard copy at 30 cps in full ASCII or APL character sets. Character set software-selectable. Asking \$1800. Lloyd Botway, 325 Dartmouth Rd, Kansas City MO 64113, (816) 361-4988.

**WANTED:** Printer (and/or Micromodem II, Disk II without controller) for Apple II. Will trade (or sell) Acoustat X direct-drive electrostatic speaker system and Kenwood KT8300 FM/AM tuner. Also, Applesoft read-only-memory card without Autostart read-only memory for sale; make offer. Charles White, 1712F Newport Cir, Santa Ana CA 92705, (714) 979-9666 days, (714) 751-1296 evenings and weekends.

**FOR SALE:** BYTE from first issue up to current. All original publications in excellent condition. No marks, scribbles, or underlines. Give issues you want and offer. C Tseng, 87-05 Austin St, Forest Hills NY 11375.

**FOR SALE:** Three 16 K dynamic S-100 memory boards (\$75 each); minicomputer system PDP-8/L 4 K memory; four cartridge drives; ASR33; 100 cps printer; and RS-232 interface. Cost of entire system, \$750. Kalon Kelley, 149 Ramallo Rd, Santa Barbara CA 93108, (805) 969-1539.

**WANTED:** PDP-8/E minicomputer or MM8-EJ extended memory option for same. Name your price. Martin J Durbin, 2649 N Sacramento, Chicago IL 60647, (312) 235-1620 evenings.

**FOR SALE:** Memorex 651 floppy-disk drive (new), thirty blank disks, Ken Welles floppy-controller board; all for \$350, 2708s \$5 each, 5204s \$4 each, 1702s \$3 each, 4116s \$5 each. Paper-tape reader; \$10. Gordon Wilson, 819 San Lucas Ave, Mtn View CA 94043.

**FOR SALE:** D C Hayes Micromodem for Apple II. Like new, works perfectly. Only \$320. H Rothman, 218 Huntington Rd, Bridgeport CT 06608, (203) 579-0472.

**WANTED:** Processor Technology VDM-1 board, working or not, and ALS-8 information. Richard Miller, POB 6337, Jacksonville FL 32205.

**WANTED:** Heathkit ET-3400 microprocessor trainer only in kit or assembled; also, Radio Shack TRS-80 Level II with 16 K, integral keyboard, power supply, video monitor, and cassette recorder. All in good condition. Roland Dumont, 731 Jacques Berthiaume, Ste-Foy Quebec, G1V 3T2 Canada.

**FOR SALE:** Chalco high-speed paper-tape reader; 5, 6, 7, or 8 level tape (ASCII or Baudot), 625 cps, self-contained power supply, simple interface. Industrial quality, excellent condition, complete with documentation. New; \$755. Asking \$100. Fred Goldberg, 29 Clearview Rd, E Brunswick NJ 08816, (609) 734-2160 days.

**WANTED:** Schematics (service documentation) for Vogue Instrument Co line printer. Please call Steve Gardner, Birmingham AL 35209, (205) 942-8567.

**FOR SALE:** New P4 video display; \$30. Purchased from Electrolabs; never used. Will ship UPS COD. Frank Snaede, Rt 1 Box 80A, Rawlins VA 23676, (804) 949-7835.

**FOR SALE:** SIM-1 microcomputer with Microsoft BASIC (read-only memory), 4 K monitor, 1 K programmable memory, and power supply. All manuals and documentation supplied. Will ship UPS for \$250. Robert Dixon, Rt 1 Box 239-A, Lynnville TN 38472, (615) 363-7489.

# BOMB

## BYTE's Ongoing Monitor Box

Article #	Page	Article	Author
1	22	A Build-It-Yourself Modem for Under \$50	Ciarcia
2	58	The Hard-Disk Explosion: High-Powered Storage for Your Personal Computer	Manuel
3	76	The Evolution of FORTH, an Unusual Language	Moore
4	100	What Is FORTH? A Tutorial Introduction	James Miller and Miller
5	150	BREAKFORTH Into FORTH	Harris
6	164	FORTH Extensibility: How to Write a Compiler in Twenty-Five Words or Less	Berresford, et al
7	198	Khachiyani's Algorithm, Part 1: A New Solution to Linear Programming Problems	Wierenga
8	210	Construction of a Fourth-Generation Video Terminal, Part 1	

### May BOMB Results Floppy Disks

BYTE readers output their interest in Steve Ciarcia's "I/O Expansion for the Radio Shack TRS-80" (page 22) by expanding Steve's rank with another first place. John Hoepfner also interfaced well with readers, receiving a second place for his floppy-disk-controller article (page 72). First place for May was 1.84 standard deviations above the mean, while second was 1.09, closely followed by Gregory J Walker ("Error Checking and Correcting for your Computer," page 250) in third place and Emory Cook ("The Cassette Lives On," page 12) in fourth place.

# Reader Service

To get further information on the products advertising in BYTE, fill out the reader service card with your name and address. Then circle the appropriate numbers for the advertisers you select from the list. Add a 15-cent stamp to the card, then drop it in the mail. Not only do you gain information, but our advertisers are encouraged to use the marketplace provided by BYTE. This helps us bring you a bigger BYTE. \*Correspond directly with company.

Inquiry No.	Page No.	Inquiry No.	Page No.	Inquiry No.	Page No.	Inquiry No.	Page No.
240	AB Computers 278	248	Digital Research Comp (TX) 283	53	Micro Computer Brokers 80	254	Quest 287
206	Ackerman Digital 245	78	Digital Research Corp (CA) 121	89	Micro Computer Discount 244	230	Quintrex Inc 276
263	Addison-Wesley Publ. Co. 288	161	Discount Software Group 220	89	Microcomputer Tech Inc 131	36	Racet Computes 56
225	Adv Computer Prod 270, 271	162	Disk/3 Mart Inc 221	125	Microcomputer Tech Inc 179	68	RCA Solid State 106
174	AEI 227	179	Dual Systems Control Corp 230	157	MicroDaSys 218	80	RCA Solid State 123
300	AK Industries 298	164	DWS Marketing Int'l 221	52	Micro Data Base Sys 77	269	Eric C Rehne Tech Serv 290
94	Altos 136, 137	96	Dynacomp Inc 147	181	Micromall 232	172	RNB Enterprises 226
271	Alpha Products Co 290	132	Ecosoft 188	87	Micro Management Sys 129	178	Robotics Age 229
74	American Square Comp 116	72	ELCOMP Publ Inc 112	159	Micropolis 162, 163	159	Rochester Data 219
106	Ancon/Forth Generation Software 157	223	Electrolabs 268, 269	43	Micro Pro Int'l 105	43	Rockwell Int'l Micro Sys 67
247	Ancrona 282	156	Electronic Control Tech 217	288	Microsette 298	170	S-100 Inc 225
160	Anderson Jacobson 219	217	Electronic Systems 259, 260, 261	62	Microsoft 97	195	SC Digital 241
139	Apparat 179	73	Electronic Sys Furniture Co 114	303	Microsoft (Cons Prod Div) 49	191	SCDP 239
7	Apple Computer 12, 13	281	Engineering Analysis Software 292	28	Microtech Exports 298	2	Scion Corp 5
35	Applied Digital Data Sys (ADDS) 55	105	Essex Publishing 156	84	Microtek Inc 47	198	Scitronics 242
285	Applied Logic Inc. 290	205	Excom 245	57	The Micro Works 126	183	Scott Instruments 234
Arkansas Systems Inc. 223	190	182	Executive Business Sys 233	241	Micro World 67	24	SD Systems 39
10	Artex Electronics 16	190	Faircom 239	241	Mighty Micros 120	119	Seattle Comp Products 173
294	ASAP 295	232	Farnsworth Computer 247	103	Mikos 278	186	Service Technologies 223
ATV Research 276	290	213	Faragher & Assoc 276	155	Miller Microcomputer Serv 154	23	Shepardson Microsystems 38
174	Automated Equipment Inc (AEI) 227	290	Farnsworth Computer 247	305	Mini Computer Suppliers 217	203	Michael Shrayar Software 244
25	Axiom 41	282	Feith Software 294	306	Mini Micro Mart 299	75	Shugart 7
27	base 2 inc 45	76	Field Service Search 292	306	Mini Micro Mart 300	71	Sigma Int'l 117
171	Basic Magazine 225	55	Five Stones Software 229	307	Mini Micro Mart 301	71	Sirius Systems 205
253	Becklan Enterprises 286	55	FMG Corp 118	207	Micro Computers Inc 245	116	Sirius Systems 171
137	John Bell Engineering 192	55	Forth Inc 85	147	Mittendorf Engineering 204	293	SMA 294
302	Benchmark Computer Services 298	297	Frederick Computer Prods 298	15	Morrow/Thinker Toys 23	49	Small Business Appl 73
287	Beta Business Systems Inc 294	29	G C Controls 298	33	Morrow/Thinker Toys 53	185	Small Sys Design 235
Beta Comp Devices 36	109	28	General Business Computer 48	13	Mountain Hardware 19	21	Smoke Signal Broadcasting 37
145	Bower-Stewart & Associates 202	268	Gimix 290	152	Mountain Hardware 210	22	Smoke Signal Broadcasting (Dealers Only) 37
BYTE Books 140, 213, 302	127	109	Godbout Electronics 161	65	mpl 103	193	Softech 201
BYTE Back Issues 247	109	20	Mark Gordon Computers 165	259	MTI 288	175	Software Concepts 227
BYTE Subscription 246	168	20	Graham Dorlan 35	144	MT Microsystems 199	122	Software Development & Training 177
C & S Electronics 221	142	168	H & W Computers 223	256	Multi Business Comp Sys 288	187	The Software Exchange 236
14	California Comp Sys 20, 21	142	H & E Computronics 195	54	MVT Microcomputer Sys 83	280	The Software Farm 262
204	California Data Corp 244	4	Hardhat Software 8	131	The National Comp Shows 111	283	Software Labs 269
221	California Digital 266	188	Hardside 237	95	National Small Comp Show 141	112	Software Tech for Comp (STC) 168
135	Cambridge Dev Labs 190	279	Harex Corp 292	131	Nautilus Systems 188	285	Software Tool Works 294
169	Cambridge Dev Labs 225	130	Hayden Book Co 187	98	NEECO 148	208	The Software Works 248
211	Cap'n Software 247	3	Heath Company 6	100	NEECO 149	201	The SoHo Group 243
212	Cap'n Software 247	11	Heath Company 17	41	Netronics 84	257	Solid State Sales 258
84	Central Data 101	37	Heath Company 57	82	Netronics 125	123	Scrim 216
134	CFR Assoc Inc 190	26	Hewlett-Packard 43	83	Netronics 125	200	Sorrento Valley Assoc 243
8	Chrislin Industries 14	48	High Technology Inc 72	176	New England Business Service (NEBS) 228	79	Southern Computer Sys 122
70	Chrislin Industries 110	251	Hobbyworld Electronics 285	•	Noble Computer Corp 292	308	Southwest Tech Prod Corp CV II
245	Cleveland Consumer Computers & Components 281	42	Houston Instruments 85	•	Northern Tech Books 207	120	Spectrum Software 174
288	Code Construction Co 294	267	Houston Instruments 65	17	North Star 27	8	SSM 11
140	COLOR Software 194	129	Information Unltd Software 185	270	Northwest Comp Services 290	136	Strategic Simulations 191
312	CompuMart 245	39	Industrial Micro Sys 61	148	Nycom Inc 206	110	Structured Systems Group 167
69	CompuServe (MicroNET) 107	189	inmac 239	310	Ohio Scientific Instr CV IV	115	Structured Systems Group 169
264	ComputerCity 289	38	Integral Data 59	51	Okidata Corp 75	177	SubLOGIC 253
215	Computer Components Inc 255	118	Integrand 172	19	OK Machine & Tool 33	59	Summagraphics 90
277	Computer Distributors 292	299	Intelligence Sys Ltd 298	184	Oliver Advanced Engineering 235	252	Sunny Int'l 286
•	Computer Factory 115	292	Interface Inc 294	90	Omega Research 132	93	SuperSoft 135
278	Computer Forms 292	18	Interfac Data Sys 25	104	Omega Sales Co 155	108	SuperSoft 185
257	Computer Shopper 298	31	Interfac Data Sys 51	188	OnComputing 113	133	SuperSoft 189
32	Computer Specialties 52	46	Ithaca InterSystems 9	•	Orange Micro 86	•	Synchro Sound 79, 184
249	Computer Specialties 284	272	Ithaca InterSystems 70	44	Oregon Software 69	124	Synergistic Comp Prod 178
165	Computers Wholesale 222	220	J & S Software 290	143	Osborne/McGraw-Hill 197	107	Tarbell Electronics 159
12	CompuView 18	216	Jade Comp Prod 264, 265	158	OSM Computer Corp 219	234	TBI 276
250	Concord Computer Components 284	282	Jameco Electronics 296, 297	•	Owens Associates 144, 145	40	Tech Sys Consultants (TSC) 63
242	The CPU Shop 279	236	Keith Jenkins & Assoc Inc 288	235	Pacific Exchanges 278	141	Tec-Mar Inc 184
•	Cromemco 1, 2	296	Jepsan Group K Inc 276	301	Pacific Exchanges 298	180	Texas Instruments 231
•	Cybernetics Inc 229	81	Jini Microsystems 298	222	Page Digital 267	•	Robert Tinney Graphics 211
284	Dal-Comp 293	86	Kemco Ltd 93	244	Pan American Elec 280	202	TNW Corp 243
•	Darrell's Appeware 157	77	Kenyon Micro Systems 104	(A Radio Shack Auth Sales Ctr)	192	•	Torrey Pines Busn Sys 288
276	DAR Sales 292	289	Robert Kieven & Company 128	9	PCD Systems Inc 240	•	Trionyx Electronics 172
199	Data Discount Center 151	•	Konan Corp 119	18	Percom Data 15	275	TYC Software 292
237	Data Disk Systems 243	266	Lifeboat 44, 108, 109	61	Percom Data 31	273	Ucatan Computer Store 290
209	DataSmith 246	121	The Lisp Co 290	128	Personal Computer Sys 124	309	United Business Prod CV III
173	DataSoft 227	154	Lobo Drives Int'l 175	233	Personal Computing '80, 183	•	United Software of America 95
239	Delta Products 277	83	Lomas Data Products 217	85	Personal Progs by Victor 276	47	US Robotics 71
258	Designers & Builders Information Service (DBIS) 288	68	Macrotronics 130	•	Personal Software 127	•	VANDATA 180
243	DG Electronics 280	111	Mallibu Electronics 99	194	Phase One Systems 209	261	Videv 288
58	Diablo (Div of Xerox) 89	123	Marketline 168	5	Pickles & Trout 241	224	Vista Computers 272
113	Digital Arts Group Contract Services 168	92	Marymac Industries 178	228	Power One Inc 10	246	VR Data 282
50	Digital Marketing 74	157, 165, 177	Matchless Systems 134	229	Priority One 273	228	Wameco 258
138	Digital Graphic Systems 192	97	Meas Sys & Controls 29, 147, 157, 165, 177	229	Priority One 274, 275	34	The Warehouse 54
81	Digital Pathways 133	281	MICAH 147	214	Professional Data Sys 247	•	Whitesmith's Ltd 81
		99	Micops Inc 292	286	Professional Management Services 294	255	Wintek Corp 288
		146	Microamerica Distributing 148	60	Professional Software Inc 91	291	Wisconsin Area Komputer Co (WAKCO) 294
		196	Micro Ap 203	139	QC Micro Systems 193	231	Worldwide Electronics 276
		197	Micro Appl Grp (MAG) 241	219	QT Comp Systems 262, 263	58	XCOMP, Inc 86
		274	Micro Appl Grp (MAG) 241	150	Quality Software 208	210	Zs Systems 246
		114	Micro Business World 291	102	Quasar Data Products 153		
			Microbyte Software 168				





# A COMPANY TO RELY ON... UNITED BUSINESS PRODUCTS

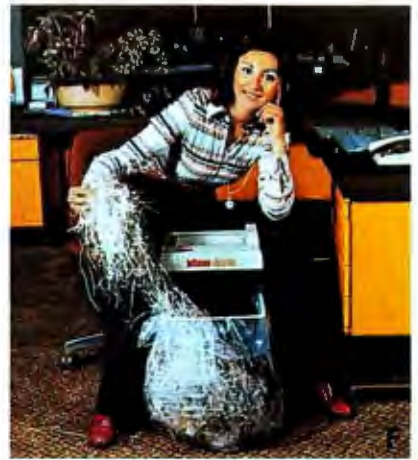

**UNITED BUSINESS PRODUCTS**  
20268 E. Carrey Rd.  
WALNUT, CA. 91789



UNITED  
BUSINESS  
PRODUCTS

(213) 448-4850

(714) 594-5966

NAME OF COMPANY \_\_\_\_\_

ADDRESS \_\_\_\_\_

CITY, STATE, ZIP \_\_\_\_\_

ATTENTION OR DEPT. \_\_\_\_\_

**A**  The swingline table top burster will separate single-ply continuous forms into individual sheets up to 15". Length 2 1/4" to 12". Paper weight 10 to 110 lb. bond. Speed is constant at 125 ft. per minute.

Wt. 95 lbs.

Sale Price \$879.00

**B**  Our custom forms have a guarantee that speaks for itself. Our time on forms range from two to five weeks for custom work and before we start a job we now give a guaranteed shipping date and price, depending on art work, from two to five weeks and for every day we're late we give you a 10% discount. To get a quote just mail the detached portion of this ad with sample of form or layout and we will call you the day we get the information with a price and guaranteed day of shipment.

**C**  The swingline table top decollator is a portable unit which separates both carbon and carbonless continuous computer forms into stacks. The separated carbon is easily and neatly removed from carbon pick-up spool. Form size is up to 15" wide. Wt. is 10 to 110 lb. bond paper, and the speed is variable from 75 to 200 feet per minute and takes only 120 volts AC 60 hertz to operate.

Wt. 40 lbs.

Sale Price \$369.00

**D**  The Datatech Intimus 007 shredder works for Scotland Yard, for government authorities, for important corporations, banks and embassies. The cutting capacity is 12 to 14 sheets at one pass. Cross cut is 1/35 x 3/8. It has a 2 H.P. motor and runs off of 220/380 V 3 phase.

Wt. 320 Lbs.

Sale Price \$6599.00

**E**  The Intimus 306 is designed for trouble free operation and has a switch for forward and reverse rotation. It has 2 motors with terminal overload. Housing consists of coated steel, mounted on rubber cushions for noiseless shredding. The 306 can sit on a table or a stand. Cutting width is 1/4" or 1/2" and has two 150 watt 110 V 60 cycle, 1 phase motors.

Wt. 66 Lbs.

Sale Price \$1189.00

**F**  The Intimus Simplex is designed for security without problems in the office. One push of the button renders confidential information into five illegible paper strips 1/4" thin. The simplex has a wide opening in the middle for throw away of cans, etc. Even a paper clip is simply cut into pieces. The cutting capacity is 8 to 10 sheets at one time. It has a 1/5 H.P. motor and runs off of 110 volts.

Wt. 27 Lbs.

Sale Price \$569.00

**G**  Our catalog consists of more information on equipment in this ad. Other models are available plus a complete line of calculators and typewriters by Adler, Latham time recorders, several varieties of safes, and our disintegrator that destroys paper, aluminum, film and carbon to a complete loss of identity.

Price \$2.00

**H**  Free Brochures and more information:

1.  Business Forms
2.  Calculators
3.  Forms Handling Equipment
4.  Time Recorders
5.  Typewriters

**Terms:** Check or money order U.S. funds only. Prepaid orders add 3% S/H, COD's add 5% S/H (U.S. only). California residents add 6% sales tax.

Prices subject to change without notice. Sale ends Sept. 15, 1980



# The home computer you thought was years away is here.



## C8P DF \$2,895

Ohio Scientific's top of the line personal computer, the C8P DF. This system incorporates the most advanced technology now available in standard configurations and add-on options. The C8P DF has full capabilities as a personal computer, a small business computer, a home monitoring security system and an advanced process controller.

### Personal Computer Features

The C8P DF features ultra-fast program execution. The standard model is twice as fast as other personal computers such as the Apple II and PET. The computer system is available with a GT option which nearly doubles the speed again, making it comparable to high end mini-computer systems. High speed execution makes elaborate video animation possible as well as other I/O functions which until now, have not been possible. The C8P DF features Ohio Scientific's 32 x 64 character display with graphics and gaming elements for an effective resolution of 256 x 512 points and up to 16 colors. Other features for personal use include a programmable tone generator from 200 to 20KHz and an 8 bit companding digital to analog converter for music and voice output, 2-8 axis joystick interfaces, and 2-10 key pad interfaces. Hundreds of personal applications, games and educational software packages are currently available for use with the C8P DF.

### Business Applications

The C8P DF utilizes full size 8" floppy disks and is compatible with Ohio Scientific's advanced small business operating system, OS-65U and two types of information management systems, OS-MDMS and OS-DMS.

The computer system comes standard with a high-speed printer interface and a modem interface. It features a full 53-key ASCII keyboard as well as 2048 character display with upper and lower case for business and word processing applications.

### Home Control

The C8P DF has the most advanced home monitoring and control capabilities ever offered in a computer system. It incorporates a real time clock and a unique FOREGROUND/BACKGROUND operating system which allows the computer to function with normal BASIC programs at the same time it is monitoring external devices. The C8P DF comes standard with an AC remote control interface which allows it to control a wide range of AC appliances and lights remotely without wiring and an interface for home security systems which monitors fire, intrusion, car theft, water levels and freezer temperature, all without messy wiring. In addition, the C8P DF can accept Ohio Scientific's Votrax voice I/O board and/or Ohio Scientific's new universal telephone interface (UTI). The telephone interface connects the computer to any touch-tone or rotary dial telephone line. The computer system is able to answer calls, initiate calls and communicate via touch-tone signals, voice output or 300 baud modem signals. It can accept and decode touch-tone signals, 300 baud modem signals and record incoming voice messages. These features collectively give the C8P DF capabilities to monitor and control home functions with almost human-like capabilities.

### Process Controller

The C8P DF incorporates a real time clock, FOREGROUND/BACKGROUND operation and 16 parallel I/O lines. Additionally a universal

accessory BUS connector is accessible at the back of the computer to plug in additional 48 lines of parallel I/O and/or a complete analog signal I/O board with A/D and D/A and multiplexers.

Clearly, the C8P DF beats all existing small computers in conventional specifications plus it has capabilities far beyond any other computer system on the market today.

C8P DF is an 8-slot mainframe class computer with 32K static RAM, dual 8" floppies, and several open slots for expansion.

## C8P \$950

Or get started with a C8P with cassette interface, 8K BASIC-in-ROM which includes most of the features of the C8P DF except the real time clock, 16 parallel I/O lines, home security interface and accessory BUS. It comes with 8K static RAM and Ohio Scientific's ultra-fast 8K BASIC-in-ROM. It can be expanded to a C8P DF later. Base price \$950. Virtually all the programs available on disk are also available for the C8P cassette system on audio cassette.

Computers come with keyboards and floppies where specified. Other equipment shown is optional.

For literature and the name of your local dealer, CALL 1-800-321-6850 TOLL FREE.

**OHIO SCIENTIFIC**  
1333 SOUTH CHILLICOTHE ROAD  
AURORA, OH 44202 • (216) 831-5600