



GENX
nano
EASY SHIFT

OWNER'S MANUAL

VEHICLE IDENTIFICATION & VEHICLE RECORD

Owner's Name : _____

Address : _____

Selling Dealer Code : _____

Date of Delivery : _____

Date of Registration : _____

Registration No. : _____

Chassis No. : _____

Engine No. : _____

Transaxle No. : _____

Battery Make : _____

Battery Sr. No. : _____

Battery Code : _____



THE WARRANTY ON THIS CAR IS VALID
ONLY WHEN ABOVE INFORMATION IS
FILLED, SIGNED & STAMPED BY
THE SELLING DEALER

DEALER'S SIGNATURE & STAMP

TATA nano GEN^X

Owner's Manual



This owner's manual should be considered as a permanent part of the vehicle and must remain with the vehicle.

TATA MOTORS

Passenger Vehicle Business Unit (PVBU)

● Mumbai ● Pune ●

NOTE

Please read this Owner's Manual carefully before you start driving your car and always keep it safe in the car.

- The recommended routine maintenance servicing along with any running repairs that may be required, should be entrusted to **TATA MOTORS** Authorised Service Centre to ensure that only latest methods and genuine **TATA MOTORS** replacement parts are used for the continued reliability, safety and performance of the vehicle.
- Some of the items / accessories / features shown / given in this book may not be fitted on your vehicle, these may be applicable for other versions of **TATA NANO**.
- (C) Copyright 2014 **TATA MOTORS**
- All rights reserved. The material in this manual shall not be reproduced or copied, in whole or in part, in any form without written permission from **TATA MOTORS**.
- The information and specifications given in this book are valid as on the date of printing. **TATA MOTORS LIMITED** reserves the right to make changes in design and specifications and/or to make additions to or improvements in this product without obligation to install them on products previously sold.
- In the event of the Vehicle being sold, please ensure that this manual is left in the vehicle for the reference of the new owner.

While taking delivery of your new car, you are privileged to have the following :

- | | |
|-----------------------------------|---|
| 01. Owner's Manual & Service Book | 06. Spare Fuses |
| 02. First Aid Kit | 07. Pre-delivery Inspection and Service |
| 03. Advance Warning Triangle | 08. Complimentary fuel in fuel tank |
| 04. Jack & Wheel Spanner | 09. Battery Warranty Card. |
| 05. Tow Hook | |

Dear Customer,

Thank you for selecting **TATA NANO** the most exciting car.

We welcome you to the world of advanced automotive engineering marvel suited to your operating conditions.

This book gives you all the information necessary for making your ownership of this car a delightful experience and help you in all situations.

To assist you in maintaining your car as per recommended service schedule, we have a widespread network of dealers and service centres. Kindly refer Service Network booklet provided alongwith the Owner's Manual.

Please do not hesitate to call on our Regional / Area offices in case you need any special assistance.

Please note that by adhering to the correct operating procedures and by availing the scheduled maintenance services at our authorised service centres, you can obtain the maximum performance from your car.

We request you to go through this book and derive many miles of motoring pleasure.

We wish you Safe and Pleasant Motoring

TATA MOTORS LIMITED

SAFETY SYMBOLS

In this manual, you will find 'CAUTION', 'NOTE', 'WARNING' messages and 'safety symbol' at appropriate places. The significance of these messages are explained below.

CAUTION

This is a warning which may cause injury to people if it is ignored. You are informed what you must or must not do in order to avoid or reduce the risk to yourself and other people.

NOTE

This is a warning which may cause damage to the car or its equipment if it is ignored. You are informed what you must or must not do in order to avoid or reduce the risk of damage to your car and its equipment.

WARNING

Indicates a strong possibility of severe personal injury or death if the instructions are not followed.

SAFETY SYMBOL



In this manual, you will also see a circle with a slash. This means "Do not", "Do not do this", or "Do not let this happen".

NOTE	02
FOREWORD	03
CUSTOMER ASSISTANCE	04
WARRANTY	
Warranty - Terms & Conditions	07
ENVIRONMENT PROTECTION	09
24X7 ON ROAD ASSISTANCE	11
KNOW YOUR NANO AN OVERVIEW	15
Driving Controls	17
Instrument Cluster	19
Gauges & Indicators	21
On Board Diagnostic System	33
Steering Lock cum Ignition Switch	34
Combination Switch	35
Music System & Antenna	39
Heating, Ventilation & Air Conditioning	40
Lamps	44
Rear View Mirrors & Sun visor	46
Vanity Mirror, Grab Handle, Utility pocket/ box	47
Cup holder, Window Winding & Power Socket	48
Parking Brake, Gear Shift Lever & Glove Box	50
Front Hood - Opening & Closing	52
Refuelling	53
GETTING STARTED	
Remote Keyless Entry	54
Door Locks	57
Front Seat & Seat Adjustment	59
Rear Seat & Seat Folding	60
Seat Belts & Child Restraint System	61
DRIVING	
Before Driving & Safety Checks	66
Safety Checks & Driving Safety	68
Fuel Economy	69
Starting, Gear Shifting, Stopping & Parking	71
Driving In Adverse Conditions	78

IN CASE OF EMERGENCY	
Advance Warning Triangle	80
Hazard Warning Switch	
If you have Flat tyre	81
Starting The Engine with Jump Leads	84
Towing the Vehicle	85
Routine Service	87
Preliminary Trouble shooting	88
ELECTRICAL MAINTENANCE	
Fuses & Relays	93
Bulb Specification	96
Accessory Connectors Details	97
VEHICLE CARE	
Car Care	99
MAINTENANCE	
Brake Fluid Level	102
Windshield Washer Fluid Level	103
Engine Access Cover	103
Engine Oil Level	104
Engine Coolant Level	105
Air Filter & Spark Plug	106
Tyre	107
Wheel Alignment & Catalytic converter	109
Battery	110
IMPORTANT TECHNICAL INFORMATION	
Fuel, Lubricants & Coolants	111
Oil Filling & Drain Points	113
Technical Specification	114
Dimensions	117
CAR IDENTIFICATION	
Location of Aggregate Number	118
SERVICE MAINTENANCE SCHEDULE	119
MUSIC SYSTEM OPERATOR'S MANUAL	121
RECORD OF SERVICES PERFORMED	148
RECORD OF REPAIRS CARRIED OUT	150

WARRANTY - TERMS & CONDITIONS

We **WARRANT** each **TATA NANO** and parts thereof manufactured by us to be free from defect in material and workmanship subject to the following terms and conditions :

1. This warranty shall be for **4 Years or 60,000 kms, whichever occurs earlier from the date of sale of the car.**
2. Our obligation under this warranty shall be limited to repairing or replacing free of charge, such parts of the car which, in our opinion, are contributing to improper operation, on the car being brought to us or to our dealers within the period. The parts so repaired or replaced shall also be warranted for quality and workmanship but such warranty shall be co-terminus with this original warranty.
3. Any part which is replaced by us under the warranty shall be our property.
4. As for parts like tyres, battery, electrical equipment, fuel injection equipment etc. not manufactured by us but supplied by other OE Manufacturers, this warranty shall not apply. Buyers of the car shall be entitled to, so far as permissible by law, all such rights as we may have against such parties under their warranties in respect of such parts.
5. This warranty shall not apply if

the car or any part thereof is repaired or altered otherwise than in accordance with our standard repair procedure or by any person other than from our sales or service establishments, our authorized dealers, service centers or service points in any way so as, in our judgment which shall be final and binding, to affect its reliability, nor shall it apply if, in our opinion which shall be final and binding the car is subjected to misuse, negligence, improper or inadequate maintenance or accident or loading in excess of such carrying capacity as certified by us, or such services as prescribed in our Owner's Manual and Service Book are not carried out by the buyer through our sales or service establishments, our Authorized Dealers, Service Centers or Service points.

6. This warranty shall not cover normal wear and tear or any inherent normal deterioration of the car or any of its parts arising from the actual use of the car or any damage due to negligent or improper operation or storage of the car. This warranty shall not apply to normal maintenance services like oils and fluid changes, head lamp focusing, fastener retightening, wheel balancing, tyre rotation, adjustment of valve clearance, fuel timing, ignition timing and consumables like bulbs, fuel

WARRANTY - TERMS & CONDITIONS

- filters and oil filters etc. This warranty shall not apply to any damage or deterioration caused by environmental pollution or bird droppings. This warranty shall not apply to V-belts, hoses and gas leaks (in case of air conditioned cars) & slight irregularities not recognized as affecting the function or quality of the vehicle or parts such as slight noise or vibration and defects appearing only under particular or irregular operations or items considered characteristic of the vehicle.
7. This warranty shall be null and void if the vehicle is subjected to abnormal use such as rallying, racing or participation in any other competitive sports. This warranty shall not apply to any repairs or replacement as a result of accident or collision.
 8. This warranty is expressly in lieu of all warranties, whether by law or otherwise, expressed or implied and all other obligations or liabilities on our part and we neither assume nor authorize any person to assume on our behalf, any other liability arising from the sale of the vehicle or any agreement in relation thereto.
 9. The buyer should have no other rights except those set out above and have, in particular, no right to repudiate the sale, or any agreement or to claim any reduction in the purchase price of the vehicle, or to demand any damages or compensation for losses, incidental or indirect, or inconvenience or consequential damages, loss of vehicle, or loss of time, or otherwise, incurred or accrued.
 10. Any claim arising from this warranty shall be recognized only if it is noticed in writing to us or to our concerned Dealer without any delay soon after such defect as covered and ascertained under this warranty.
 11. This warranty shall stand terminated if the vehicle is transferred or otherwise alienated by the buyer without our prior written consent.
 12. We reserve our rights to make any change or modification in the design of the vehicle or its parts or to introduce any improvement therein or to incorporate in the vehicle any additional part or accessory at any time without incurring any obligation to incorporate the same in the vehicles previously sold.

TATA MOTORS LIMITED

TATA MOTORS LTD. is committed to produce vehicles using environmentally sustainable technology. Many features have been incorporated in Tata Motors passenger vehicles which have been designed to ensure environmental compatibility throughout the life cycle of the vehicle. We would like to inform you that your car meets emission norms and this is being regularly validated at the manufacturing stages.

As a user you too can protect the environment by operating your car in a proactive manner. A lot depends on your driving style and the way you maintain your car. We have given a few tips for your guidance.

DRIVING

- Avoid frequent and violent accelerations / rev-ups.
- Avoid overloading of the engine. Avoid using devices requiring high power consumption during slow city traffic condition.
- Monitor the car's fuel consumption regularly and if showing rising trend get the car immediately attended at the **TATA MOTORS** Authorised Service Centre.
- Switch off the engine during long stops at traffic jams or signals. If you need to keep the engine running, do not

unnecessarily rev-up. Avoid stopping and starting.

- Do not rev-up the engine before turning it off as it unnecessarily burns the fuel.
- Shift to higher gears as soon as it is possible without overloading the engine. Use each gear upto 2/3rd of it's maximum engine speed. A chart indicating gear shifting speeds is given in this book.

MAINTENANCE

- Ensure that recommended maintenance is carried out on the car regularly at the **TATA MOTORS** Authorized Workshop.
- As soon as you see any leakages of oil, fuel or coolant in the car we recommend to get it attended immediately.
- Use only recommended grades and specified quantity of lubricants.
- Get your car checked for emission periodically by an authorised dealer.
- Ensure periodic radiator fins cleaning.
- Ensure that fuel filter, oil filter and breather are checked periodically and replaced, if required, as recommended by Tata Motors.

ENVIRONMENTAL CARE

- Do not pour used oils or coolants into the sewage drains, garden soil or open streams. Dispose the used filters and batteries in compliance with the current legislation.
- Do not allow unauthorised person to tamper with engine settings or to carry modifications on the car.
- Never allow the car to run out of fuel.
- Parts like brake liners, clutch discs should be vacuum cleaned. Do not use compressed air for cleaning these parts which may spread dust in the atmosphere.
- While carrying out servicing or repairs on your vehicle, you should pay keen attention to some of the important engine components which greatly affect emission. These components are:
 1. Fuel pump, Injectors and EMS (Engine Management System) parts.
 2. Air Intake and Exhaust systems (especially for leakages).
 3. Cylinder head/Valve leakages.
 4. All filters such as air, oil & fuel filter (check periodically).

5. Ignition system & Spark plug.
6. Catalytic converter.
7. Carbon Canister.

This Owner's manual contains further information on driving precautions and maintenance care leading to environment protection. Please familiarise yourself with these aspects before driving.

24X7 ROAD ASSISTANCE :

Dear Customer,

It is our responsibility and our endeavour to ensure that you have our complete service backup if ever, wherever and whenever you need the same. When you have a road network that spans wide area, the probability of a breakdown happening within hailing distance of a **TATA MOTORS** Authorized Workshop is very low.

It is Precisely for this reason, we have tied up with My TVS, who will provide breakdown assistance including towing to the nearest **TATA MOTORS** Authorized Workshop through their Authorized Service Providers (ASP)

The **24X7 On Road Assistance** Program shall be automatically available to your vehicle for the duration of Warranty period. The program shall also be available, if you avail the same post warranty.

Response Time ** for the On Road Assistance Program

Within City Limits	60 minutes
On State or National Highways	90 minutes
Ghat Roads and other places	120 min.+/-

** (The response time will depend on the location, terrain, traffic density and the time of the day.)



Standard procedure when calling for On Road Assistance in case of a breakdown:

- Dial the toll free help line number – **1 800 209 7979**
- Identify your vehicle with the Vehicle chassis number that is available in the Owners Service manual.
- Explain your exact location with landmarks and tell us about the problem you face with the vehicle.
- Park your vehicle on the edge of the road, open the bonnet and put on the hazard warning signal.
- Place the advance warning triangle supplied with the vehicle approx. 3 m from the vehicle in the direction of on coming traffic.

COVERAGE UNDER THE 24 X 7 ON ROAD ASSISTANCE PROGRAM :

I. The **24x7 On Road Assistance** Program Service covers the following services on your vehicle during warranty period.

- Wheel change through spare wheel.
- Arrangement of fuel. (Fuel cost will be chargeable at actual cost)
- Re-opening the vehicle in cases of key lock out.
- Rectification of electrical problems related to battery, fuses etc.
- On spot repairs for complaints repairable at site.^
- Vehicle to vehicle towing or winching & towing for non accident cases up to the nearest **TATA MOTORS** authorized workshop. Towing charges at actual cost beyond the same to be paid to the ASP in cash. (Any ferry or toll charges levied in relation to the vehicle being towed to be paid by the customers in actuals in cash).

For accident cases, towing charges to be borne by the customer.

II. The **24x7 On Road Assistance** Program coverage on availing the 24X7 policy, post warranty is upto maximum of 6 instance of assistance in one year for both the plans- Basic and Premium.

In the premium plan, this includes 1 instance of towing upto the nearest **TATA MOTORS** authorised workshop.

EXCLUSIONS

24x7 On Road Assistance Program does not apply to

- Cost of parts consumables and labour for such repairs not covered under warranty*. These charges are to be settled with ASP in cash.
- Toll or ferry charges paid by ASP in reaching to the breakdown site to be settled with ASP in actuals in cash.
- Cases involving accident, fire, theft, vandalism, riots, lightening, earthquake, windstorm, hail, tsunami, unusual weather conditions, other acts of God, flood, etc.
- Vehicles that are unattended, unregistered impounded or abandoned.
- Breakdown/defects caused by misuse, abuse, negligence, alterations or modifications made to the vehicle.
- Lack of maintenance as per the maintenanc schedule as detailed in the owner's manual.
- Cases involving racing, rallies, vehicle testing or practice for such events..

Disclaimer

- The service is not available in some parts of J&K and in Union Territories of Andaman & Nicobar Islands and Lakshwadeep.
- **The reach time is indicative & the actual reach time will be conveyed by the call centre at the time of breakdown call.
- The reach time can vary depending on the traffic density & time of the day.
- The reach time indicated does not account for delays due to but not limited to acts of God, laws, rules & regulations for time being in force, orders of statutory or Govt. authorities, industrial disputes, inclement weather, heavy down pour, floods, storms, natural calamities, road blocks due to accidents, general strife and law & order conditions viz. fire, arson, riots, strikes, terrorist attacks, war etc.
- ^ On spot repairs at breakdown site shall depend on nature of complaints & will be as per the discretion of the ASP.
- *The decision for free of charge repairs will be as per the warranty policy & procedures of **TATA MOTORS LTD.** and as per the interpretation of the same by ASP. You will be duly informed by the ASP & call centre for the change applicable if any.

- All charges wherever applicable need to be settled directly with the ASP.

EXCLUSION OF LIABILITIES :

- It is understood that **TATA MOTORS** shall be under no liability whatsoever in respect of any loss or damage arising directly or indirectly out of any delay in or non delivery of, defect/ deficiency in service/parts provided by ASP.
- In case vehicle cannot be repaired on-site, customers are advised to use the towing facility for taking their vehicle to the nearest **TATA MOTORS** authorized workshop only. In no condition will the vehicle be towed to any unauthorized workshop. **TATA MOTORS** will not be responsible for any repairs carried out in such unauthorized workshop.
- Customer are advised to take acknowledgment from the ASP for the list of accessories/extra fittings and other belongings in the vehicle as well as the current condition related to dents/ scratches breakages of parts/ fitments of the vehicle at the time of ASP taking possession of the vehicle & to verify these items when delivery is taken back by them, Claim for loss of or damage to items, if any should be taken up with ASP directly.

TATA MOTORS shall not be responsible for any such claims, damages/loss or any deficiency of service of the ASP.

- Vehicles will be handled, repaired & towed as per the customer's risk & **TATA MOTORS** shall not be liable for any damages / claims as a result of the same.
- Services entitled to the customers can be refused or cancelled on account of abusive behaviour fraudulent representation, malicious intent and refusal to pay the charges for any charges related services and spare parts during service or on previous occasion on part

Your NANO comes from a family of new generation cars of TATA motors. It is the outcome of extensive research and development by Tata Motors Limited. We are happy to present the NANO to you and hope it brings the joy, pride and utility of owning a car for personal mobility.

The NANO's design and features combined with easy maneuverability and economic life cycle cost makes it ideal for operating under a wide range of conditions.



Stylish, comfortable

The Tata Nano, designed with a family in mind, has a roomy passenger compartment with generous leg space and head room. Four persons can comfortably sit inside the car. Five doors with high seating position make comfortable ingress and egress. All new floor console comes with well-designed utility spaces and the glove box. This is also equipped with music system.

It can effortlessly maneuver on busy roads in cities as well as in rural areas. Its mono-volume design ensure with Electric Power Steering system.

The car is available in various versions. All versions offer a wide range of body colours, and other accessories so that the car can be customised to an individual's preferences and taste.

Fuel-efficient engine

The Tata Nano has a rear mounted rear-wheel drive, all-aluminum, two-cylinder, multi point fuel injection petrol engine. The lean design strategy has achieved minimum weight and maximum performance per unit of energy consumed and delivers high fuel efficiency. Performance is controlled by a specially designed electronic engine management system.

Meets all safety requirements

The Tata Nano's safety performance exceeds current regulatory requirements. With an all sheet-metal body, it has a strong passenger compartment, with safety features such as crumple zones, intrusion-resistant doors, seat belts, strong seats and anchorages, and the rear tailgate glass bonded to the body. Tubeless tyres further enhance safety.

Environment-friendly

The Tata Nano's exhaust emission performance meets present regulatory requirements. The high fuel efficiency also ensures that the car has low carbon dioxide emissions, thereby providing the twin benefits of an affordable transportation solution with a low carbon footprint.

Besides all these, TATA vehicles are backed by a well established service network with trained and skilled manpower that ensures proper maintenance.

DRIVING CONTROLS (MANUAL TRANSMISSION)

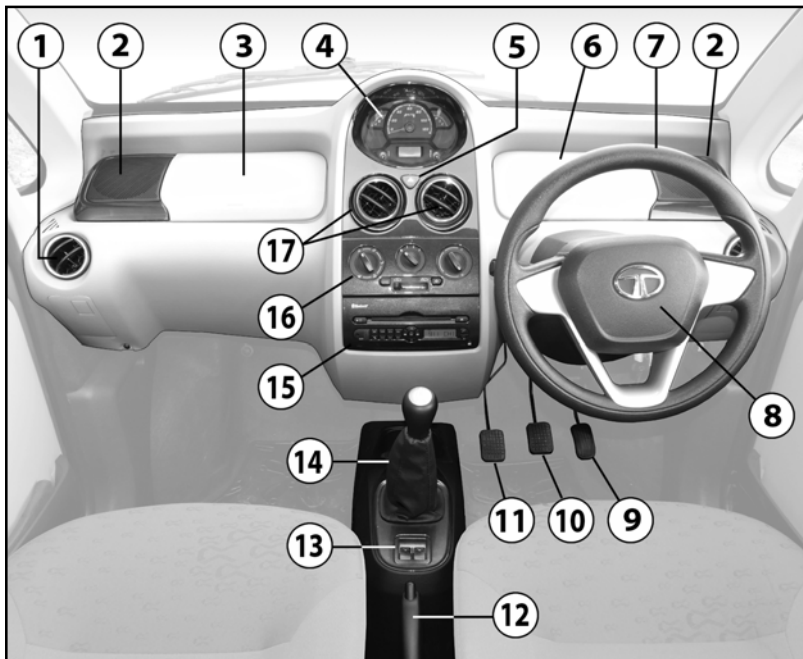

Note : a. HVAC or AC System is applicable to certain models.

b. Music System is part of accessories. It is applicable to certain models.

1.	Side air vents	10.	Brake pedal
2.	Speakers on dashboard (For XT)	11.	Clutch pedal
3.	Glove Box (Co-driver side)	12.	Parking Brake
4.	Instrument Cluster	13.	Window Winding Switch (if fitted)
5.	Hazard Warning Switch	14.	Gear shifting lever
6.	Glove Box (Driver side)	15.	Music System
7.	Steering wheel	16.	HVAC / AC system controls
8.	Horn Pad	17.	Central Air Vents
9.	Accelerator Pedal		

DRIVING CONTROLS (AUTOMATIC MANUAL TRANSMISSION)

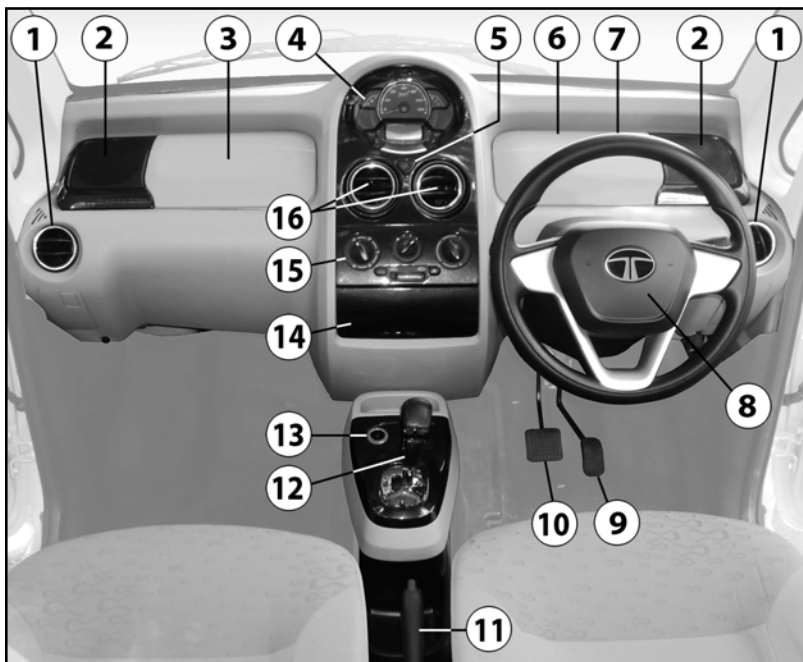

Note : a. HVAC or AC System is applicable to certain models.

b. Music System is part of accessories. It is applicable to certain models.

1.	Side air vents	10.	Brake pedal
2.	Speakers on dashboard (For XT)	11.	Parking Brake
3.	Glove Box (Co-driver side)	12.	Gear shifting lever
4.	Instrument Cluster	13.	Plug Socket
5.	Hazard Warning Switch	14.	Provision for Music System
6.	Glove Box (Driver side)	15.	HVAC / AC system controls
7.	Steering wheel	16.	Central Air Vents
8.	Horn Pad		
9.	Accelerator Pedal Module (APM)		

INSTRUMENT CLUSTER-MT

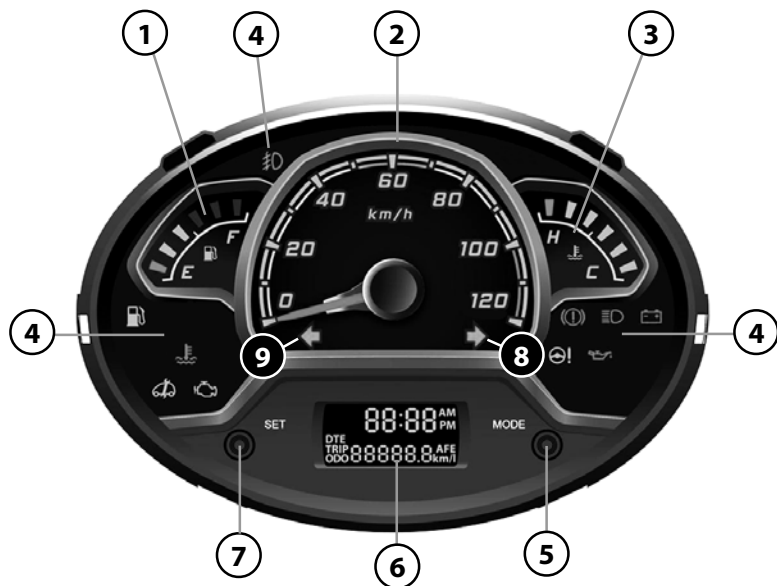

Some Indicators shown may not be applicable to all models.

1.	Fuel Gauge
2.	Speedometer
3.	Temperature Gauge
4.	Tell Tales
5.	MODE knob
6.	LCD (Digital Display)
7.	SET Knob
8.	Turn Indicator - Right
9.	Turn Indicator - Left

INSTRUMENT CLUSTER-VERSION-AMT

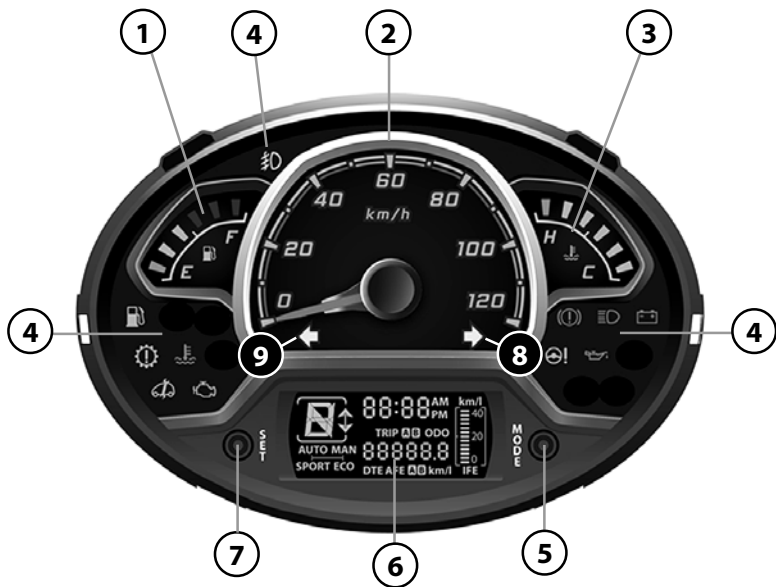

Some Indicators shown may not be applicable to all models.

1.	Fuel Gauge
2.	Speedometer
3.	Temperature Gauge
4.	Tell Tales
5.	MODE knob
6.	LCD (Digital Display)
7.	SET Knob
8.	Turn Indicator - Right
9.	Turn Indicator - Left

Speedometer :

The speedometer indicates speed of the vehicle in unit of km/h

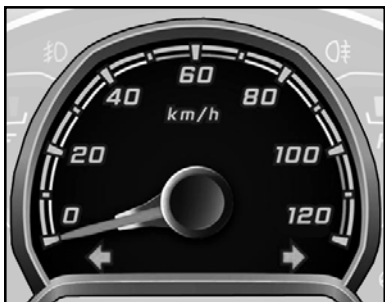

Speedometer

NOTE

At every start speedo needle moves to MAX position and comes back to '0' position. This is welcome strategy and self check feature.

Vehicle Speed Limitation:

The vehicle is designed for a safe speed of 105 kmph. If vehicle is driven above this speed, MIL lamp starts blinking and the vehicle fuel supply will be cut off automatically to restrict the vehicle speed.

Avoid driving the vehicle at speeds above 105 kmph.

Temperature Gauge :

Temperature Gauge

The Gauge indicates the temperature level of the engine coolant after Ignition ON. The red zone at 'H' indicates temperature higher than normal.

NOTE

If the bar graph moves beyond the normal range area toward the "H" position i.e Red bar, it indicates overheating that may damage the engine. It may be due to insufficient coolant in the radiator or due to any other defect. Contact the nearest **TATA MOTORS** Authorized Workshop.

Fuel Gauge :

The fuel gauge indicates the approximate amount of fuel remaining in the fuel tank when the ignition switch is 'ON'.

When fuel in the tank is near to empty position then 1st LED bar (Red Color) will start flashing and low fuel warning tell tale  will be turned 'ON'.



Fuel Gauge (EPS)

takes few seconds to stabilize after the ignition is turned ON. "F" stands for full and "E" stands for Empty.

Do not continue adding fuel after the automatic shut off function is operated if it is equipped on the gasoline pump. The sensor in the fuel tank may misjudge the amount of fuel remaining.

In case of flashing of 1st and last bar of the LED with low fuel warning tell tale please contact **TATA MOTORS** Authorised Service Centre.

WARNING

Running the fuel tank in too low or empty fuel can cause your engine to stall.

You must refuel as soon as possible after 1st LED bar start flashing and low fuel warning tell tale  turned on.

NOTE

On inclines, curves, braking and sudden acceleration due to the movement of fuel in the tank, the fuel level display may fluctuate or the low fuel level warning lamp may illuminate earlier than usual. Always check the fuel level when the vehicle is on level road.

When the ignition switch is in the "ON" position, this gauge gives an approximate indication of the amount of fuel in the fuel tank and it

TELL TALES :**Electric Power Steering Warning Indicator :**

It indicates the malfunctioning of EPS (Electric Power Steering).

It will illuminate momentarily when ignition is switched 'ON'

It will continuously illuminate if malfunctioning of EPS (Electric Power Steering) occurs. Stop the vehicle at safe place and restart the engine, indicator should turn 'OFF' after driving a short distance, If it still continues to illuminate again while driving, contact nearest **TATA MOTORS** Authorised Service Centre.



NOTE

1. Electric power steering is operational only when engine is running.
2. In case of EPS malfunctioning or engine switched 'OFF' condition, increased steering effort will be required.
3. In case of continuous use of steering like driving on steep hill or constraint parking, the steering may become harder. This is normal to protect the electric steering motor from overheating. It will automatically restore during normal driving.

Low Fuel Indicator :

This warning light indicates the fuel tank is nearly empty. When it turns 'ON', refuel as soon as possible. Driving with the fuel level warning light 'ON' or with the fuel level below "E" can cause the engine to misfire and damage the catalytic converter (if equipped).

Turn Signal Indicator :

Turn signal indicators can be operated only when ignition is 'ON'. They can be operated by using the turn indicator switch on the combi-switch. The direction indicator arrow  (LHS) and  (RHS) on the instrument cluster flashes along with external indicators lights as per selection.

⚠ CAUTION

If the turn signal indicators do not blink, then there may be problem in electrical system. If the indicators "Blink rapidly", then this indicates that a side indicator bulb has failed. Get it rectified immediately from **TATA MOTORS** Authorised Service Centre.

Front Fog Lamp Indicator (If equipped) :

Front fog lamps are provided on the front bumper to improve the visibility in foggy weather. The front fog lamp switch is provided on combi switch.

High Beam Indicator :



The indicator light turns 'ON' when the High beam is selected or also when the headlight flasher is operated.

Check Engine lamp:



This symbol indicates the car's engine condition.

1. It turns 'ON' when ignition is switched 'ON' and once engine is cranked, it turns 'OFF'.
2. It remains 'ON' if there is a problem in any of the engine components.

NOTE

If the Service lamp remains 'ON' when the engine is running, the engine's performance deteriorates marginally & sometimes significantly. Take your car to a **TATA MOTORS** Authorised Workshop. .

Malfunction Indication Lamp:



This lamp indicates your vehicle's engine condition when a malfunctioning occurs in the engine, wiring harness, EMS, etc. which affects the emission norms. This lamp indicates as below:

1. Comes 'ON' when key is in 'IGN' position and goes 'OFF' when engine is running.
2. Remains "ON" while the engine is running if malfunctioning occurs.

3. Starts 'BLINKING' if continuous problem of malfunction is observed, contact nearest **TATA MOTORS** Authorised Workshop.

⚠ CAUTION

When "MIL" indicator is ON or blinking while the engine is running, the engine's performance deteriorates marginally and sometimes drastically. Please get the malfunctioning rectified at a nearest **TATA MOTORS** Authorised Workshop.

Low Engine Oil Pressure Indicator :



This symbol lights up when the ignition switch is turned to the 'ON' position and goes out as soon as the required oil pressure is developed after starting the engine. The light will remain 'ON' if there is insufficient oil pressure. If light comes on when driving, contact nearest **TATA MOTORS** Authorised Service Centre immediately. Check the oil level and add oil if necessary.

NOTE

If the low oil pressure indicator does not glow or continues to remain 'ON' even with sufficient oil when the engine is running, it indicates a fault in the electrical circuit/lubrication system. Check and get the problem attended to at **TATA MOTORS** Authorised Workshop.

Driving with low oil pressure may lead to severe damage to the engine.

Parking brake cum low brake fluid warning light :



This indicator has multiple functions as follows :

- It lights up when the parking brake is applied and turns 'OFF' when parking brake is released.
- It also lights up when brake fluid level is low.
- An additional warning chime sounds if vehicle speed exceeds 6 km/h and park brake is engaged. Stop the vehicle release the park brake and then start driving.
- When ignition key is turned to "IGN" position, this indicator lights up and turns 'OFF' when engine starts in normal condition. If it is continuously 'ON' while engine is running, get the problem rectified at **TATA MOTORS** Authorised Workshop.

CAUTION

Drive cautiously when the indicator remains 'ON' while driving. In the state of low brake fluid level, continuous normal driving is dangerous.

Battery Charging Indicator :



Symbol lights up when the 'IGN' is turned 'ON' and goes 'OFF' after the engine starts.

NOTE

If it remains 'ON' while the engine is running. It indicates that the battery is not getting charged. Switch off all unnecessary electrical equipment and get the problem rectified at **TATA MOTORS** Authorised Service Centre.

Engine Coolant High Temperature Indicator :



In case of insufficient coolant in cooling system or malfunctioning of engine due to various reasons, the engine coolant temperature can be higher than normal operating conditions. In such condition, Engine Coolant High Temperature Indicator Lamp will start blinking along with Check Engine lamp. In addition the buzzer will also start to warn the driver.

Avoid driving in this situation and contact nearest TATA MOTORS Authorized Workshop for necessary attention.

If the driver continues to drive in such situation, Coolant temp lamp and buzzer (as described above) will continue and the ECU activates the engine to enter limp home mode by limiting the engine speed. If vehicle is driven further in this mode, the vehicle will be stalled automatically by ECU.

Once vehicle is stalled, vehicle can be re-started only when the engine cools down.

Transmission Warning Lamp: (AMT fault): (If applicable)



It will illuminate momentarily when ignition is switched 'ON'.

If it continues to remain 'ON' when the engine is running it indicates fault in the AMT system. Contact nearest **TATA MOTORS** authorised service centre immediately.

MODE Button :

Mode button is used to scroll the screens of multifunctional display. Refer Driver Information System section for the detail.

DRIVER INFORMATION SYSTEM : (MT)



Multifunctional display is equipped with Clock, Odometer and Trip computer. The trip computer consist tripmeter, average fuel economy and distance to empty and displays when ignition key is in a ignition or crank position. All stored multifunctional display information except Odometer and tripmeter will reset if the battery is disconnected or low level of battery charge.

Press MODE button for less than 1.5 second to select Tripmeter (TRIP), Average fuel economy (AFE) and Distance to empty (DTE) as follows:

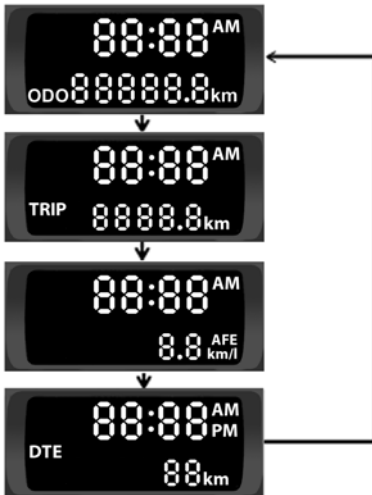
**Odometer :**

ODO 888888 km

The Odometer records the total distance the vehicle has been driven. Keep track of the odometer reading and follow the maintenance schedule regularly for better performance.

Trip meter :

TRIP 88:88 AM
8888.8 km

This mode indicates the distance of trip selected since last trip meter reset. The trip meter working range is from 0.0 to 9999.9 km. Pressing the SET button provided in Cluster

for more than 1.5 second when trip meter (TRIP) is being displayed, reset the trip meter to zero (0.0).

Average fuel economy (AFE) :

88:88 AM
8.8 AFE km/l

This mode indicates average fuel economy since last trip reset.

Resetting of trip meter resets AFE value. Display indicates (— —) and new average fuel economy value will be displayed after driving for more than 500m.

NOTE

AFE value is estimate of fuel economy. It may vary significantly based upon driving conditions, driving habits and condition of vehicle.

AFE gets reset to zero with reconnection of battery negative.

Distance to Empty (DTE)

DTE 88:88 AM/PM
88 km

This mode indicates the estimated distance to empty based on the current usable fuel available in the fuel tank which can deliver to the engine.

When the remaining distance is below 25 km "rEFUEL" will be displayed on DTE screen.

NOTE

- The DTE will update with new value when fuel is added more than 3 Litres at a time.
- The average fuel consumption and distance to empty values may vary significantly based on driving conditions, driving habits, and condition of the vehicle.
- The distance to empty value is an estimate of the available driving distance.
- If low fuel warning light turns 'ON', fill the fuel tank immediately regardless the value of displayed DTE.
- If vehicle is not on level ground and negative of battery has been disturbed, the DTE function may not operate correctly.

This value may differ from the actual driving distance available.

Display illumination setting :



You can adjust night time illumination for display and graphics by using the SET / MODE buttons. User can enter in to this mode by long pressing of MODE button with park lamp ON. Once enter in to the illumination setting mode above

screen will be visible in odometer region.

User can do this setting in max ten steps by short press of set mode once enter into this mode.

In case of battery disconnect illumination level will go to default value.

Digital Clock :



Whenever the battery terminals or related fuses are disconnected you must reset the clock time. This feature is available when ignition switch is in ON position. Clock support for both 24 hour and 12 hour format and you can set clock by using SET and MODE switches as follows

WARNING

Do not adjust clock or other settings while driving.

To adjust the values in Hrs., Min. and AM/PM mode, press 'SET' and 'MODE' knob on instrument cluster for changing the clock settings respectively.

A delayed press on the 'SET' knob for selected value will confirm it and move towards next value.

DRIVER INFORMATION SYSTEM: (AMT)



Multifunctional display indicates Clock, Odometer and Trip computer.

The trip computer displays trip meter, Instantaneous Fuel Economy, Average Fuel Economy, Distance To Empty, Transmission mode (AUTO/MAN), Drive mode (SPORT). Gear number and gear shift indicator.

It will be displayed when ignition key in ignition or crank position. All stored multifunctional display information (except Odometer and tripmeter) will reset if the battery is disconnected or the battery charge level is low.

Press MODE button for less than 1.5 second to select Tripmeter (TRIP A & TRIP B), Average fuel economy (AFE A & AFE B) and Distance to empty (DTE) as follows:

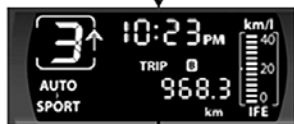
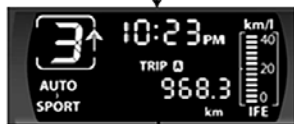

1. Odometer:



The Odometer indicates distance (in kms) travelled by vehicle. Keep track of the odometer reading and follow the maintenance schedule regularly for better performance.

2. Trip meter (TRIP A & TRIP B):

Tripmeter indicates distance travelled by vehicle in selected trip mode. Both tripmeter are resetable. The trip meter working range is from 0.0 to 9999.9 km. Pressing the SET button provided in Cluster for more than 1.5 second when trip meter (TRIP A & B) is being displayed, reset the respective trip meter to zero (0.0).

3. Average fuel economy (AFE A & B):

This mode indicates the average fuel economy for the corresponding Trip from the total fuel used and the distance since the last AFE reset.

When TRIP reset's corresponding AFE automatically reset to zero (0.0). After Average fuel consumption get reset the display will indicate (----) and then will show a new average fuel consumption value after driving for more than 500 meters .

4. Distance to Empty (DTE)

Indicates approximate distance(in kms), vehicle can travel with available fuel in fuel tank and/or current average fuel consumption rate.

When the remaining distance is below 25 km "rEFUEL" will be displayed on DTE screen. The DTE working range is from 25 to 999 km.

NOTE

- The DTE may not register refueling if less than 3 liters of fuel are added to the vehicle.
- The average fuel consumption and distance to empty values may vary significantly based on driving conditions, driving habits, and condition of the vehicle.
- The distance to empty value is an estimate of the available driving distance.
This value may differ from the actual driving distance available.

5. Instantaneous Fuel Economy :

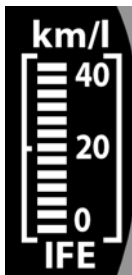

This mode calculates and shows in bar graph the instant behavior of fuel economy.

NOTE

- IFE will vary frequently as per driving pattern.
- The IFE display does not show Fuel Economy of last drive. It indicates Instantaneous Fuel economy of current Drive when Ignition is turned 'ON'.
- The display does not show actual value unless vehicle is moving.
- The indication on the display may be delayed if fuel consumption is affected by driving pattern.

6. Display illumination setting:



You can adjust night time illumination for display and graphics by using the SET/MODE buttons. User can enter in to this mode by long

pressing of MODE button with park lamp ON. Once enter in to the illumination setting mode above screen will be visible in odometer region.

User can do this setting in max ten steps by short press of set mode once enter into this mode.

In case of battery disconnect illumination level will go to default value.

7. Digital Clock :



Whenever the battery terminals or related fuses are disconnected you must reset the clock time. This feature is available when ignition switch is in ON position. Clock support for both 24 hour and 12 hour format and you can set clock by using SET and MODE switches as follows

WARNING

Do not adjust clock or other settings while driving.

To adjust the values in Hrs., Min. and AM/PM mode, press 'SET' and 'MODE' knob on instrument cluster for changing the clock settings respectively.

A delayed press on the 'SET' knob for selected value will confirm it and move towards next value.

8. Gear Indicator



Indicates the current gear engaged. Up or down arrow will be displayed, recommending whenever gear should be shifted to up or down.

9. Drive Mode



This indicates current driving mode of vehicle AUTO or MANUAL mode.

10. Sport Mode



This indication comes when vehicle is in a Sport mode. It is applicable only in AUTO mode. This mode is used to produce more torque from engine.

11. Audio Reminders:

1.1. Park Brake ON reminder

If the vehicle is driven with parking brake engaged condition, telltale will turn 'ON' and buzzer will provide audio warning continuously. Disengage the park brake to stop audio warning.

1.2. Reverse gear reminder

When reverse gear is engaged, audio warning will alert you. This chime is applicable for both Manual and AMT transmission vehicles.

1.3. AMT fault reminder

In case of AMT fault, a 3 sec. audio warning will alert you.

ON BOARD DIAGNOSTICS SYSTEM:

On board Diagnostics or OBD is an automotive term referring to a vehicle's self Diagnostic and reporting capability. The OBD system allows continuous diagnosis of the components of the vehicle correlated with emissions. This system warns the driver, by turning "ON" the Malfunction Indication lamp (MIL) on the instrument cluster, when a fault causes emission levels to increase. The OBD system also has a diagnostic connector that can be interfaced with appropriate diagnostic tools, which makes it possible to read the fault codes stored in the Electronic Control Unit, together with a series of specific parameters for Engine operation and Diagnosis. This check can also be carried out by the traffic police.



The diagnostic connector is located below the dashboard at the RH side of the steering wheel as shown in the above images.

NOTE

In case the fault occurs and MIL on the instrument cluster comes ON, contact nearest **TATA MOTORS** Authorized Workshop. After eliminating the inconvenience, to check the system completely, **TATA MOTORS** Authorized Workshop are obliged to run a bench test and if necessary, road tests which may also call for a long journey. The functioning of MIL lamp may also be checked by the traffic police using specific devices.

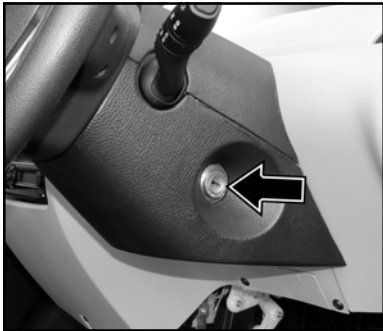
STEERING LOCK CUM IGNITION SWITCH:

Key of ignition switch is common for door lock & steering lock.

The ignition switch is on the right side of the steering column. The switch has four positions.

- LOCK** - Steering Locked
- ACC** - All accessories function 'ON'.
- ON** - Vehicle ON and all electricals 'ON'
- START** - Engine crank

LOCK:

You can insert or remove the key only in this position. The steering column is locked when the key is removed.

ACC :

By turning key to ACC (key in) position, all accessories function like music system will be 'ON'.

ON:

Engine running and all electrical gadgets and accessories ON.

START :

Turn the key further clockwise to the START position (spring loaded) to start the engine. As soon as the engine starts release the ignition key to ON position. While cranking, all accessories will be momentarily 'OFF'.

NOTE

Do not crank the engine for more than 10 seconds continuously. If the engine does not start wait for 15 seconds before cranking it again. Release the key immediately after starting the engine.

By turning the ignition key from 'ON' position to 'ACC' position, engine can be stopped.

WARNING

Do not leave the ignition switch in the 'ON' position if the engine is not running, as the battery will discharge.

SINGLE STALK COMBINATION SWITCH: (if applicable)

Single Stalk Combination Switch is provided on right hand side of steering column. It has wiper and washer control, direction indicator and light control switches.

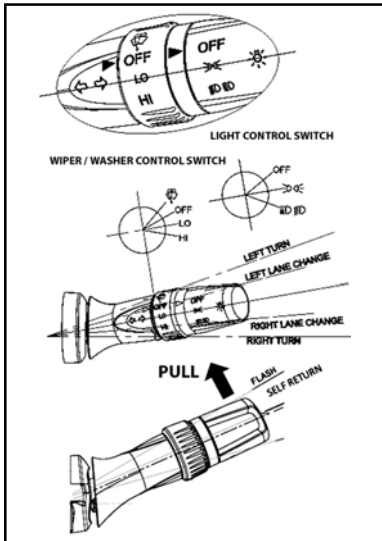

1) Light stalk:

Outer rotary switch on the stalk is provided for selecting position (parking), Tail lamp and head lamps.

Parking lamps operates with/without key In whereas Head lamps are only operated when Ignition switch is at "IGN" position.

a) Head / Position lamp OFF.

Head lamp, position (Parking) lamp and tail lamp will be OFF in this position.

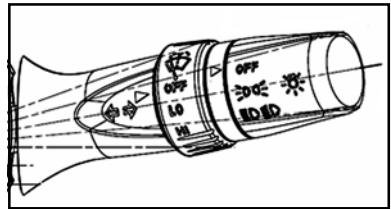

b) Position lamp ON.

Position (Parking) lamp and tail lamp will be ON in this position.



c) Head / Position lamp ON.

Head lamp, position (parking) lamp and tail lamp will be 'ON' in this position. With ignition switch in "ACC" position pull the lever to select high beam flash (spring loaded). Push it towards the dashboard to select high beam.



2) Wiper Rotary Switch :

Inner rotary switch on the stalk is provided for front windshield wipe & wash. The top (1st) position denotes wash (spring return). First position below "OFF" is for low speed wipe and second position is for high speed wipe.

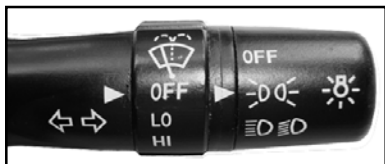

Push the stalk upwards for changing lane or turning to left and downwards for changing lane or turning to right. It has five positions. This function operate in IGN 'ON' condition.

Wipe and wash are separate functions.

3) Side Indicator :

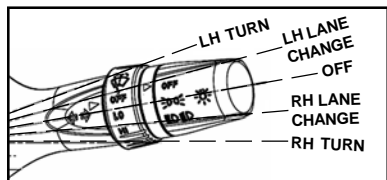

1. Side indicator 'OFF'
2. Left Lane change (Spring return)
3. Right Lane change (Spring return)
4. Left turn indicator (Self cancellation / Manual return type)
5. Right Turn indicator (Self cancellation / Manual return type)

DOUBLE STALK COMBINATION SWITCH: (As applicable)

Double Stalk Combination Switch is provided on steering column.

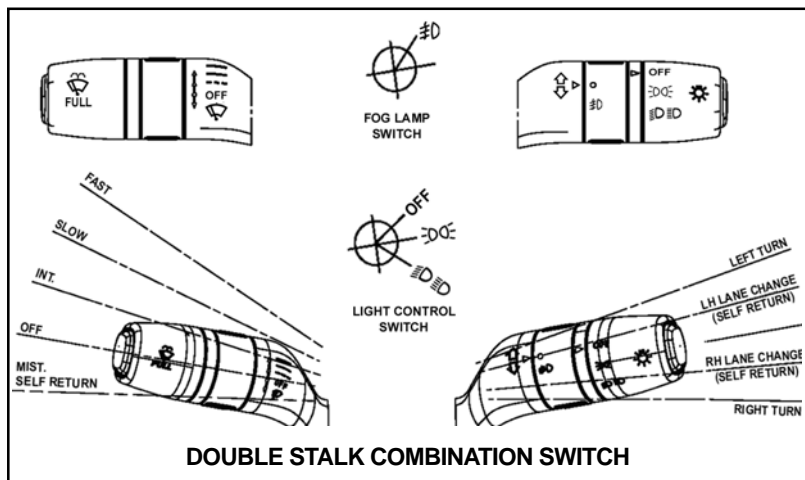

A) RIGHT HAND STALK**1) Light stalk:**

Outer rotary switch on right hand stalk is provided for selecting Position (Parking), Tail lamp and Head lamp. Parking lamp operates with/without key In whereas Head lamps are operated only when Ignition switch is at 'IGN' position.

a) Head / Position lamp OFF.

Head lamp, position (Parking) lamp and tail lamp will be 'OFF' in this position.

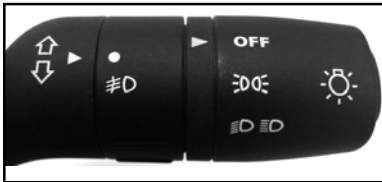
**b) Position lamp in ON.**

Position (Parking) lamp and tail lamp will be 'ON' in this position.

**c) Head / Position lamp ON :**

Head lamp, position (Parking) lamp and tail lamp will be 'ON' in this position. With the Ignition switch at 'ACC' position, pull the lever to select high beam flash (spring loaded). Push towards dashboard to select high beam.

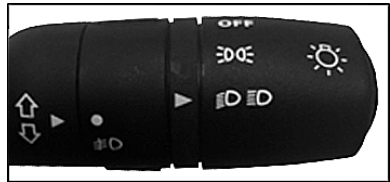
**2) Fog Lamp Rotary Switch :**

Inner rotary switch on the stalk is provided for selecting front fog lamp.

a) Front Fog Lamp

The front fog lamp can be switched 'ON' with parking/ Head lamp 'ON' at ignition 'ON' condition & can be remain 'ON' till the parking lamp & head lamp are switched 'OFF'.

To select the front fog lamps, rotate the inner rotary switch (Latch Type).

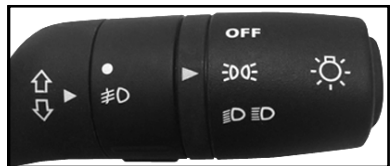
**3) Side Indicator :**

Push the stalk upwards for changing lane or turning to left and downwards for changing lane or turning to right according to requirement. It has three positions.

This function operate in IGN 'ON' condition.

1. Side indicator 'OFF'
2. Lane change for Left or Right Turn (Spring Return)

3. Lane change for Left or Right Turn (Self cancellation / Manual return type)
4. Left turn indicator (Self cancellation / Manual return type)
5. Right turn indicator (Self cancellation / Manual return type)

B) LEFT HAND STALK

1) Front Windshield - Wipe and wash :



Push the stalk clockwise to operate intermittent , low & high speed wipe, push the stalk anti-clockwise to operate MIST wipe.

Pull the stalk towards you for wipe & wash operation.

MUSIC SYSTEM (if applicable) :

The music system can be fitted on the fascia and front speakers are fitted on dashboard and on the parcel shelf.

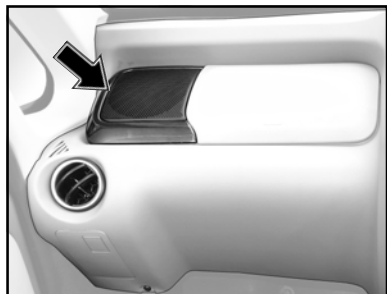

Speakers on Front dashboard

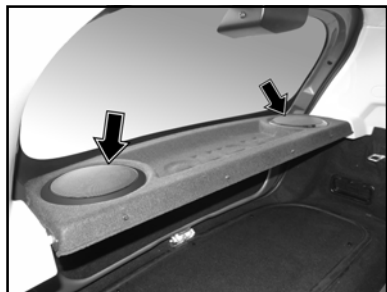

Speakers on Rear parcel shelf

For operation and further information of music system please refer manufacturer's manual.

Antenna :

A collapsible antenna is provided on the roof, above the front windshield glass.



HEATING, VENTILATION & AIR CONDITIONING

AIR FLOW PATTERN

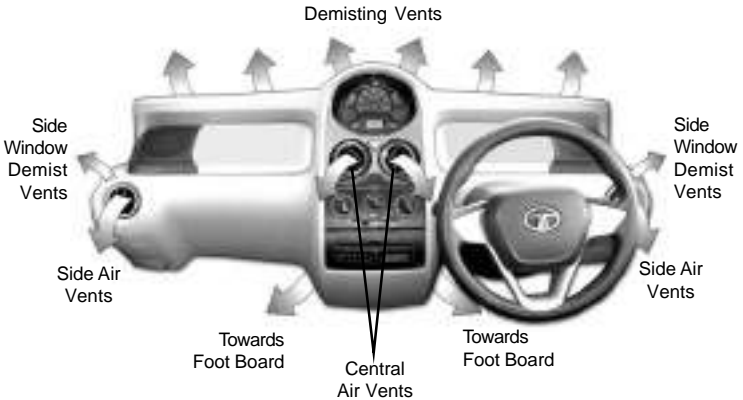

HVAC CONTROLS (Option-1)

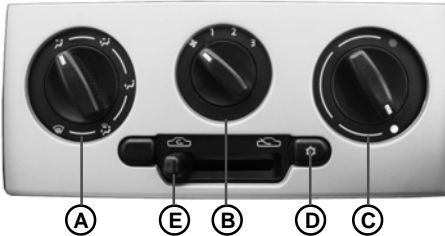

- A** - Air direction mode selection knob
- B** - Blower speed selection knob
- C** - Temperature control knob
- D** - AC ON/OFF switch
- E** - Air recirculation / Fresh air lever

AC CONTROLS (Option-2)

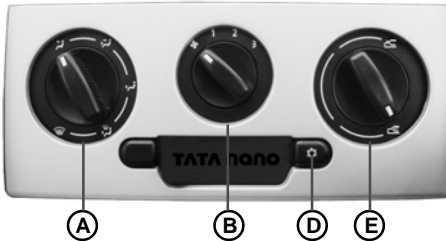

- A** - Air direction mode selection knob
- B** - Blower speed selection knob
- D** - AC ON/OFF switch
- E** - Air recirculation / Fresh air lever

A. Air direction mode selection knob :

The air flow can be changed by turning the knob (A) to the desired direction as shown.



	Towards face
	Towards face and feet
	Towards feet
	Towards feet & windshield (Recommended for clearing mist on windshield)
	Towards windshield (Recommended for clearing heavy fog)

B. Blower Speed selection Knob :

The HVAC system has a three speed blower. The blower speeds can be selected by operating the blower knob (B).



C. Temperature-Control Knob :

The air temperature in the vehicle can be controlled by operating the temperature control knob (C) on the control panel. The temperature can be increased by rotating the knob towards the red dot and decreased by rotating it towards the blue dot.



D. AC ON/OFF Switch :



The AC can be switched 'ON' by pressing the switch (D) on the AC control panel provided the blower is 'ON' and the engine is running. The indicator lamp on switch will show that the AC is 'ON'.

E. Recirculation / Fresh Air knob:

- To put air circulation mode in recirculation, slide the knob 'E' towards recirculation mode (HVAC version) / rotate the knob 'E' towards recirculation mode (AC version) and vice-versa.

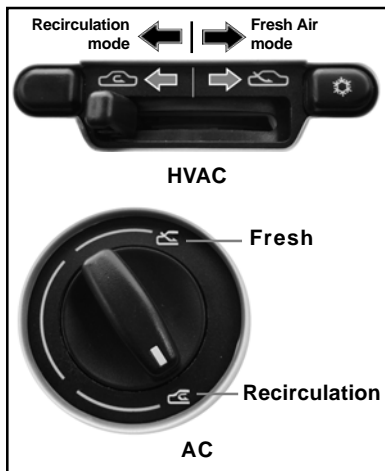

- In recirculation mode, air inside the vehicle is circulated again and again. In Fresh Air mode, air is taken from atmosphere and circulated in the vehicle.

Recirculation mode can be used

- While driving in dusty condition
- To avoid traffic pollution
- To get quick cooling/heating as required.

Whenever discomfort is felt switch to fresh air circulation mode.

NOTE

- We strongly recommend AC to be used in recirculation mode for better cooling.
- Use fresh Air mode only when discomfort is felt.
- The AC can be switched 'ON' only if the blower is 'ON' and

engine is running. When AC is switched 'ON' engine idling RPM increases marginally, to adjust to the AC compressor load. When desired temperature is achieved AC trips 'OFF' automatically.

- The AC compressor is switched 'OFF' automatically when engine gets overheated. The AC is automatically switched 'ON' when the engine cools down.

Ventilator :









The air flow can be adjusted continuously with the rotary control knob at the vents on the dash board. The air vents can be adjusted upward and downward.





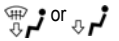

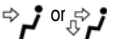
NOTE

Refrigerant charged in the air conditioning circuit has been identified on the label over front body member. Use only refrigerant as given in the label for topping up or recharge, i.e. do not charge the vehicle with some other refrigerant than the existing refrigerant. Always use R134a (Non CFC) refrigerant.

Fresh air is taken from the grill opening provided on the fire wall under the front hood at base of windshield glass outside the vehicle. Keep these openings clear and free.

RECOMMENDED BASIC SETTINGS OF THE CONTROL ELEMENTS OF THE AIR CONDITIONING SYSTEM FOR THE RESPECTIVE OPERATING MODES (HVAC & AC) :

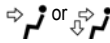
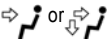
HVAC FUNCTIONS	CONTROL KNOB POSITION			BUTTON POSITION	
	A. Air Flow Direction	B. Blower Speed	C. Air Temperature	D. Air Recirculation	E. AC ON / OFF
					
Normal heating		2 or 3	Desired temp.	Fresh air mode.	Switched OFF
Quick heating		2 or 3	To the right upto the stop	Briefly switch ON to Fresh air mode then Recirculation mode	Switched OFF
Normal Cooling		1,2 or 3	Desired temperature	Recirculation mode	Switched ON
Demisting		2 or 3	Desired temperature	Fresh air mode	Switched ON (Optional)

AC FUNCTIONS	CONTROL KNOB POSITION			BUTTON POSITION
	A. Air Flow Direction	B. Blower Speed	D. Air Recirculation	E. AC ON / OFF
				
Normal Cooling		1,2 or 3	Recirculation mode	Switched ON
Quick Cooling		3	Recirculation	Switched ON mode
Demisting		2 or 3	Fresh air mode	Switched ON (Optional)
Defrosting		3	Fresh air mode	Switched ON (Optional)

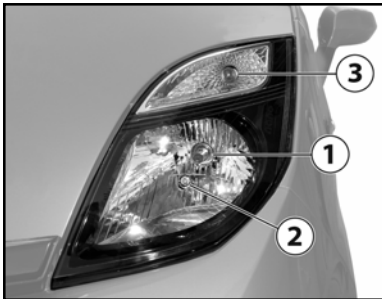
Head Lamp:

1. High / Low Beam
2. Position / Parking Lamp
3. Front Direction Indicator

Head lamps are clear lens type having multi focal reflector and are provided with halogen bulb with double fitment for providing straight ahead illumination of the road for the long distance or deep beam. It illuminates the road immediately ahead for short distance visibility. It also has side indicator lamp and a parking lamp.

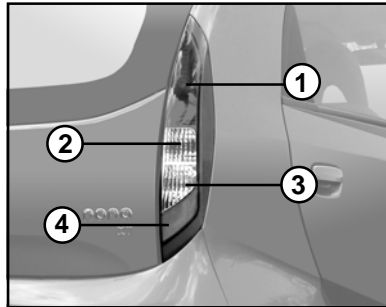
Tail Lamp:

The tail lamp assembly incorporates the following :

1. Tail / Brake Lamp
2. Turn Signal Indicator
3. Reverse Lamp
4. Reflex Reflector

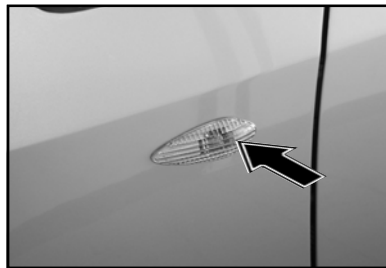
Side Indicator Lamp :**Front Fog Lamp: (If Applicable)**

High Mounted Stop Lamp :

High mounted stop lamp is provided on the rear side of vehicle. It will glow along with stop lamps whenever the brake pedal is applied.

Registration Plate Lamp :

Two concealed lamps are provided for illumination of the rear registration number plate.

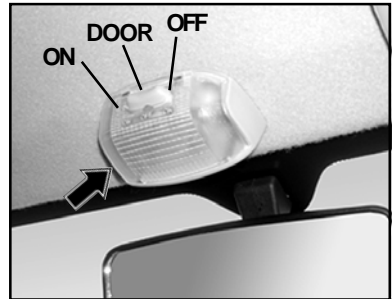
Interior Lamp :

Interior lamp is provided on the roof, near the inner rear view mirror. It's switch has three positions.

ON - The lamp will remain 'ON' when switch is in this position.

DOOR (As applicable) In this position the lamp turns 'ON' when front doors are opened. When the door is closed, the lamp will turn 'OFF'.

OFF - In this position the lamp will be always 'OFF'.

Inner Rear View Mirror :

Inner rear view mirror is provided inside the cab and fitted to windshield glass.

Nano comes with both normal and anti-glare type mirrors (wherever applicable).

It has two positions and can be selected by knob below mirror :

1. Normal position
2. Antiglare position

Use antiglare position only when necessary, as it reduces rear view clarity.

⚠ CAUTION

View in antiglare position reduces rear view clarity as compared to normal position.

Outside Rear View Mirror :

'Tip tap' type mirror is provided only on driver side on selected version, whereas it is provided on both sides in other versions. It can be adjusted manually. In selected variants, mirror is fitted at co-driver side also.

**NOTE**

Be careful when judging the size or distances of a vehicle or other object seen in the side convex mirror. Be aware that objects look smaller and appear farther away than when seen in flat mirror.

Sun visors : (if fitted)

On selected versions, 2 adjustable sun visors are provided inside the cab above the windshield to prevent sun glare, whereas in some versions it is fitted only on driver side. Lower the sun visors to protect the eyes from bright sunlight. The sun visors also move sideways towards the door.

NOTE

When not in use keep the sun visors in their original position other wise they may block the driver's vision.

VANITY MIRROR :(If fitted)

On selected versions, a vanity mirror has been provided on the back of the co-driver side sunvisor.

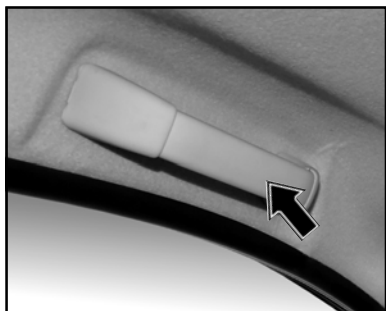
ROOF GRAB HANDLE :(If fitted)

These are provided for comfortable positioning of passengers during journey.

UTILITY POCKET (if applicable):**Utility pocket on front door trim**

Utility pocket is provided to all the doors to keep magazines / books etc.

**Utility pocket on rear door trim**

FLOOR CONSOLE :

Cup holder : (if applicable)

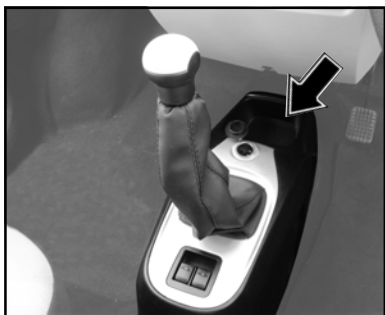

Two cup holders are provided on the floor console near the gear shifting lever.

Power window switch (Front Doors) : if fitted

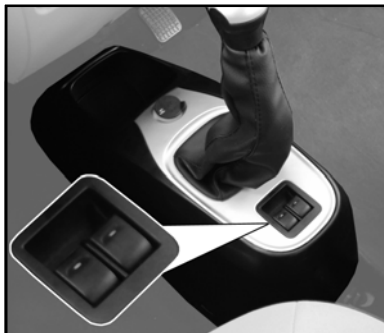

Power Window Switch - MT



Power Window Switch - AMT

Window glasses on front doors can be operated by switches provided on the main control panel located on the floor console. They work only when the key is in the "ACC" position. Glasses are wound up by pulling the switch and are lowered by pressing it down.

Manual window winding :

Manual window winding is provided on rear doors.

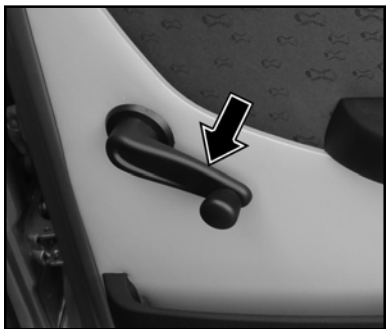

On selected versions, where power windows are not provided, manually operated winder handles are provided. Use winder handle for lowering down or raising up window glasses.

Power Socket / Cigar Lighter (if fitted):**Power Socket - MT****Power Socket - AMT**

A power socket is provided on floor console at the front. Power socket can be used to tap 12V supply (10A Max.) for operating external gadgets.

With ignition switch in 'ACC' position, press cigar lighter fully in. It pops out, when heated to specified temperature. Take the lighter out and light your cigarette. After use place the lighter in its original place.

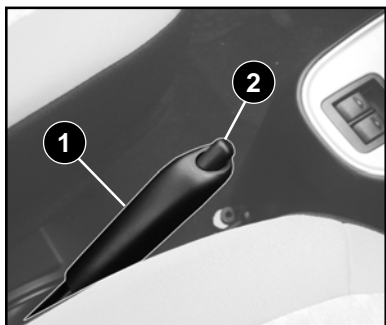
Parking Brake Lever :

- 1. Parking Brake Lever**
- 2. Release Button**

Mechanical parking brake acting only on the rear wheel is provided on your vehicle. The parking brake lever is located behind the gearshift lever. To apply the parking brake, pull the lever up fully. The indicator light on the instrument panel will become 'ON'. To release it, pull the lever up slightly, press the release button and push the lever down. The parking brake indicator on the instrument panel will go 'OFF' when the parking brake lever is fully released.

Glove Box : (If fitted)

Two glove boxes are provided on both the sides of front dashboard i.e. driver side and co-driver side. To open the glove box, press and release the cover lid at the centre. To close the glove box cover lid, press the cover lid gently. It gets automatically locked.

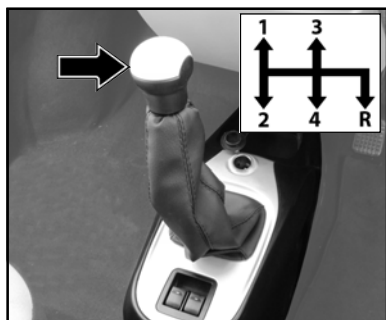
Gear Shift Lever :**Gear Shift Lever - MT**

Gear shift lever is mounted on the central console between the two front seats. The gearshift pattern is shown on the gear shift lever knob.

All gears being synchronized, provide easy & effortless gear shifting. Always remember to press the clutch pedal fully while shifting the gears and also to release the clutch pedal gently.

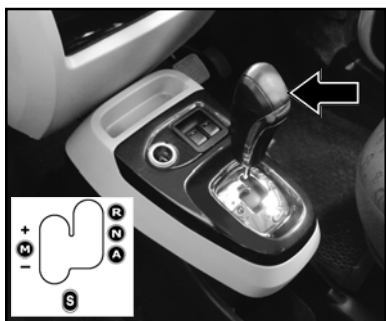
**Gear Shift Lever - AMT**

Opening the front hood :

Ensure that the vehicle is in neutral gear with the parking brake applied.

To open the hood pull the hood release lever located under the right hand corner of the dashboard inside vehicle. The hood will pop up slightly.

**Location of hood release lever**

Lift the hood slightly and slide the secondary lock lever located under the hood centre.



Lift the hood up. Pull the hood stay rod from its clip & insert the free end into the slot in the hood, slide stay rod outward to secure.

**Stay Rod****Closing :**

1. To close the hood disengage the stay rod and clamp it properly.
2. Lower the hood and drop it from a short height to lock.

⚠ CAUTION

Make sure the bonnet is properly locked and latched before driving. If it is not, it can fly up unexpectedly during driving, obstructing your view and resulting in an accident.

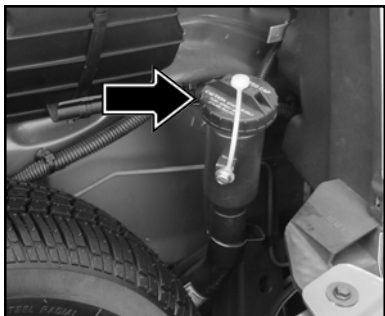
Refuelling :

Fuel filling cap is located inside the front hood. For refueling you need to open the front hood.

Rotate the fuel filler cap anticlockwise and open to fill the fuel. After filling the fuel close the cap by rotating clockwise till you heard clicking sound. Ensure that hood is properly locked.

WARNING

Fuel vapour is extremely hazardous. Always stop the engine before refueling and never refuel near sparks or open flames.

⚠ CAUTION

Remove the fuel filler cap slowly, and wait for any hissing to stop, then remove it. Do not bend on fuel filler cap while opening. The fuel may be under pressure and may spray out, causing injury if the cap is opened suddenly.

Always use only original specification fuel cap or an approved equivalent, available at **TATA MOTORS** Authorized Workshop. The wrong cap can result in a serious malfunction of the fuel system and the emission control system.

Also, do not continue adding fuel after the automatic shut off function is operated.

Remote Keyless Entry (RKE) : (if fitted)**Remote Functions :**

- **Lock** : Press the lock button on remote to activate the functionality. If all doors are properly closed then vehicle shall get locked with 2 flasher feedback.
- **Unlock** : Press the unlock button on remote to activate the functionality. Vehicle shall get unlocked with 1 flasher feedback.
- **Vehicle Seek** : When vehicle is already in lock state with 2 flasher

feedback press the lock button again to activate the functionality. Vehicle shall give 2 flasher feedbacks again.

RKE ECU Functions**1. Central Door Locking & Unlocking (Mechanical Knob & Remote)**

When central doors lock operation is performed by mechanical key or driver door knob or by pressing lock button on remote all the doors get locked simultaneously.

If lock operation is performed by pressing the lock button on remote after successful lock operation 2 flasher feedbacks will be given.

- **Reverse Cycling:**

During lock operation if driver door is at ajar (open) state reverse cycling shall be performed. During reverse cycling all doors shall get locked and again shall get unlocked immediately.

If lock operation is performed by remote a miss-lock sound with out flasher feedback will be provided by the vehicle.

- **Slam Locking:**

During lock operation if other doors (except driver door) are at ajar (open) state slam locking shall be performed.

During slam locking irrespective of other doors ajar state all doors

shall get locked. If the lock operation is performed by remote a miss-lock sound without flasher feedback will be provided by the vehicle.

2. Central Door Unlocking (Mechanical Key / Knob / Remote)

When central doors unlock operation is performed by mechanical key or driver door knob or by pressing unlock button on remote all doors shall get unlocked simultaneously.

If unlock operation is performed by pressing the unlock button on remote after successful unlock operation single flasher feedback will be given and roof lamp will turn ON with dimming effect.

Roof Lamp Control

- Roof Lamp Activation based on lock button press on remote:

Vehicle is in successfully locked state with 2 flasher feedback by operating lock button of remote.

If 'Roof lamp is ON', then 'Roof lamp shall be switched OFF with dimming effect'

- Roof lamp activation based on unlock button press on remote:

Vehicle is in successfully unlocked state with 1 flasher feedback by operating the unlock button on remote.

If 'Roof lamp is OFF' & all doors are in closed condition, then

'Roof lamp shall turned ON with dimming effect for 30 second'

In-between user switched On the IGN then roof lamp get switched off with dimming effect.

If 'Roof lamp is OFF state' & 'Door is open', then 'Roof lamp shall turned ON with dimming effect' && 'Stays ON for 10 min in door ajar state'

If 'Roof lamp is ON state' & 'Door state changes from open to close & again from close to open', then '10 min timer shall restart'

- Roof lamp activation based ON IGN condition

When IGN is turned from OFF to ON & all doors are in closed state, then roof lamp will not get activated.

If any door is ajar then roof lamp gets activated with dimming effect.

3. Vehicle Seek

When vehicle is already in locked state with 2 flasher feedback by operating the lock button on remote. If the user presses the lock button again vehicle seek mode shall be activated. When this feature is active, both turn signals shall flash for 2 times i.e. number of flashes for vehicle seek mode shall be two and vehicle shall continue to be kept in locked state and shall not actuate the actuators.

Alarm Functionality

- **Alarm Activation:** If vehicle is successfully locked state by pressing the lock button on remote with 2 flasher feedback alarm mode shall be activated. During alarm mode if any unauthorised vehicle access is detected i.e. opening any door, turning the IGN to ON or CRANK with key, then RKE ECU shall activate the audible warning for 27 seconds and visual alarm for 4.5 minutes. After 4.5 minutes vehicle shall be remained in alarm mode. Maximum 10 alarm sequences can occur for subsequent trigger event.
- **Alarm Deactivation:** If alarm is active then by pressing any button (lock / unlock) on remote then RKE ECU shall deactivate the alarm.

Battery Replacement:

- Remove the back cover which is snap fit.
- Take out the PCB with key membrane and battery mounted.
- Separate the PCB from key membrane.
- Remove a discharged battery from PCB battery socket.
- Insert a new fully charged battery into the PCB battery socket.
- Ensure that the +Ve polarity shall be facing upward.
- Check the remote functionality on vehicle from at least 15 meters.

4. Remote Learning Procedure

4.1. Precondition

- Battery shall be connected
- Vehicle shall be in unlocked state
- Driver door & Co-Driver door are at open state

4.2. Manual / Entry Mode

- Insert key into IGN barrel
- Turn IGN from 'OFF to ON' and 'ON to OFF' 4 times in 6 seconds
- 2 flashers of left - right turn indicator lamps and tel-tale outputs indicate RKE ECU entered into remote key learn mode.
- 10 second timer shall start immediately after entering to remote key learn mode RKE ECU waits for next input from user (remote).

4.3 Programming Mode

- During this 10 second time period, if user press both 'Lock' and 'Unlock' buttons on remote simultaneously. That remote shall get learnt with the RKE ECU.
- During this 10 second time period, if user press both 'Lock' and 'Unlock' buttons on remote simultaneously. That remote shall get learnt with the RKE ECU.
- The RKE ECU starts another 10 second timer to learn the next remote key.
- For more remote keys , press lock and unlock key simultaneously from remote. It shall repeat above two steps.

- After first remote successful learning all previously learnt remotes shall get unlearn.

4.4 Exit Mode :

- Once the maximum numbers of remote keys (Four) are learnt programming mode is exited.
- After last remote learn, leaving 10 second timer to time out, in programming mode.

NOTE

In case of loss of remote key, contact **TATA MOTORS** Authorized Workshop for new electronically coded remote.

Driver Door :



Locking / unlocking doors with key from outside :

Driver door can be locked or unlocked from outside with key.

Insert the key and turn it anti-clockwise to open or clockwise to lock the door. Pull the Door handle to open an unlocked door.

Where central locking system is provided, if you lock/unlock the driver door with key, the remaining three doors get locked/unlocked simultaneously.

Locking without a key from inside

All the doors can also be locked or unlocked independently from inside by pressing or pulling the knob.

NOTE

When locking doors this way, do not leave the key inside the vehicle.

Opening the doors from inside :**Location of door opening lever/latch**

All doors can be opened from inside. Pull the door knob to unlock the door. pull the door opening lever / latch to open the door.

Tail Gate Locking /Unlocking

Insert the key in the lock barrel and turn it clockwise to open the Tailgate. Open the tailgate with the help of outer handle provided below lock barrel and just by closing the tailgate to its original position, it gets locked.

Tailgate can be opened only from the outside with key.

**Tail Gate Opening Lock****Luggage Space after opening tail gate****NOTE**

As luggage space is above the engine there will be a possibility of increase in temperature.

Avoid keeping items which may get affected due to heat.

FRONT SEATS:

Lever / Slider for forward / backward movement

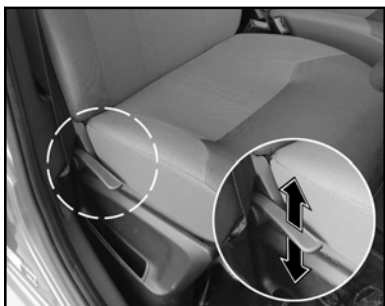

Recliner for adjusting the seat back rest

Bucket type front seats are provided with a track lever and recliner handle knob, to adjust seat positions.

Seat Back Recliner : (As Applicable)

To change the seat back angle, lean forward slightly & raise the recliner lever (2). Then lean back to the position you want and release it. Make sure that recliner lever return to its original position.

Moving the Seat Forward & Backward: (As applicable)

To adjust the seat position, lift the lever (1) under the seat cushion front, then slide the seat to the desired position and release the lever. Once the desired position is achieved release the track lever to lock the seat. Make sure the seat is locked in position.

CAUTION

Only adjust the seats when the vehicle is stationary. You will otherwise be distracted and could lose control of the vehicle as a result of the seat movement.

NOTE

Few versions are fitted with fixed seats at co-driver side.

REAR SEAT

A cushion bench seat is provided for the rear passengers.

Folding of rear seat back rest

Pull Strap provided on Seat back rest top (RH & LH Side) to unlock the seat back rest



2) Fold the seat back rest, once it is unlocked.

**Locking rear seat back rest**

For locking the rear seat back rest, lift the seat back rest and just press it to engage in the lock.

SEAT BELTS :

Occupants safety is of utmost importance.

Your car is equipped with seat belts, both front and rear as a part of occupant restraint system.

Why Seat Belts

Wearing seat belts properly can protect you from being thrown against the inside of the car or against other occupants in case of an accident or sudden braking. It will reduce the chances of severe injury.

How to use seat belts

This car has three point type front seat belts and lap belts for rear seat out board occupants (LH & RH). In normal driving, the belt lets you move freely in your seat. In case of an accident or sudden braking, inertia reel automatically tightens the belt to help restrain your body.

The anchor end of the shoulder belt is adjustable to suit the height of the passenger wearing it. The lap belt has one manually adjusted belt that fits across the hip bone.

Make sure that your seat is adjusted to a good driving position and the back of the seat is upright.

1. Pull the tongue across your body and insert it into the buckle.
2. Check and ensure that the belt is not twisted.



1. Seat Belt
2. Tongue
3. Lock Buckle

WARNING

Twisted seat belts can cause injury in a collision as the full width of the belt isn't available to absorb the impact. This puts more force on the bones beneath the belt, which could break them or cause other serious injury. Don't wear twisted seat belts.

3. Position the lap portion of the belt as low as possible across your hip bone.
4. Pull up the shoulder part of the belt to remove the slack. Make sure that the belt goes over your collar bones and across chest.
5. To unlatch the belt, press the red button on the buckle. Guide the belt to the pillar as it retracts.

WARNING

Improper positioning of the shoulder portion of the seat belt is dangerous. An improperly positioned belt will provide little or no protection in a collision.

Always make sure the shoulder portion of the seat belt is positioned across your shoulder and near your neck, but never under your arm. on your neck, or on your upper arm.

6. The belts are meant (intended) for adult occupants only.
 7. Each belt should be used by one occupant only. The belt must not be put round a child, seated on passengers lap.
 8. When the belt has been in use in a serious accident or shows signs of severe fraying / damage or of having been cut, replace with an approved belt kit.
 9. The belt must not be altered or modified during use.
- WARNING**
- Using one seat belt for more than one person at a time is dangerous. A seat belt used in this way cannot spread the impact forces properly and the two passengers could be crushed together and seriously injured. Never use one belt for more than one person at a time.
10. The belts if required should be replaced, by Authorised personnel only.
 11. The belt should not be disassembled. If required, authorised personnel only should carry out disassembly and assembly.

12. Clean the webbing with a mild soap solution recommended for upholstery. Bleaching or dyeing the webbing may weaken it.

Lap belt:

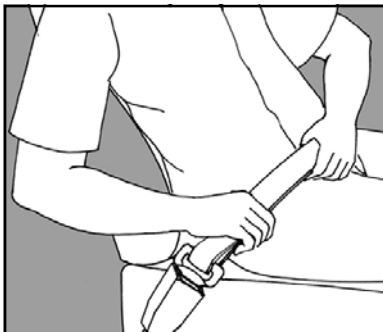

Pull the tongue to the desired length. Insert it into the buckle until you hear a click.

Adjust the belt length. To lengthen the belt, hold the tongue at a right angle to the webbing and pull. To shorten, pull the loose end of the webbing.

To unfasten, depress the button in the buckle.

WARNING

Positioning the lap portion of the Seat Belt too high can be dangerous as in a collision, this would concentrate the impact force directly on the abdominal area, causing serious injury. Wear the lap portion of the belt snugly and as low as possible.

TATA MOTORS strongly urges that the driver and passengers in the car be properly restrained at all times with seat-belts. Failure to do so could increase the chance of injury and / or the severity of injury in accidents.

Injured person :

TATA MOTORS recommends the use of a seat-belt for injured person. Depending on the injury, consult your doctor for specific recommendations.

Expectant mother:



TATA MOTORS recommends the use of a seat-belt. Kindly consult your doctor for specific recommendations. The lap belt should be worn securely and as low as possible over the hips and the waist.

Child Restraint System (CRS) :

TATA MOTORS strongly recommends the use of Child Restraint Systems (CRS) for all children up to age of 12 years.

Children kept unrestrained while travelling, may face serious injuries in case of an accident.

Recommended CRS position:

The suitability of seat position for carriage of children and recommended category of child restraint system is shown in the table below.

Gr.	Mass group	Age Group	Front Passenger	Rear Outboard LH	Rear Outboard RH
0	Up to 10 kg	Up to 9 months	U	X	X
0+	Up to 13 kg	Up to 24 months	U	X	X
I	9 to 18 kg	9 months to 48 months	U	X	X
II	15 to 25 kg	Approx. 3 to 7 years	U	X	X
II	22 to 36 kg	Approx. 6 to 12 years	U	X	X

X: Seat Position not suitable for children in this age group.

U : Suitable for “universal” category restraints approved for use in this age group.

NOTE

Universal is a category in the **AIS072 / ECE R44** norm.

NOTE

If a child is to be seated in the front seat , push the vehicle seat at fully rear most position and move forward by 90 mm or by 6 notches before installing the CRS. Adjust the seat backrest to an upright position.

Storage for CRS:

Always secure CRS safely in the vehicle or stow it in the luggage compartment if not being used.

While the vehicle is in motion an unrestrained CRS could flung through the vehicle interior in the event of a sudden braking, maneuver or an accident. This could cause injuries to the travelling occupants.

WARNING

Replace CRS that has withstood any force during an accident as it could have sustained damage which may not be visible.

Check list:

1. Never carry children on somebody's lap when vehicle is in motion.
2. Always secure children in the vehicle in a CRS. The CRS must be suitable for the child's height, weight and build.
3. Observe the instructions from the manufacturer of the CRS and always keep the instruction manual in the vehicle.
4. Always make sure that the seat belt routing is correct for children and they are sitting in the correct position.
5. Do not leave any toys or other objects loose in the CRS or on the seat while the vehicle is in motion.

WARNING

Each CRS should be used for one child only.



BEFORE DRIVING**Please ensure to check (Refer maintenance)**

1. Tyre pressure and condition of tyres. Inflate to recommended tyre pressure if required.
2. Coolant level to First fill.
3. Engine oil level up to Max mark on dipstick. (Do not overfill)
4. Check Brake fluid level. Make sure that the brake fluid level warning light is off when the parking brake is released with the engine running.
5. Water in windshield washer reservoir. Top up if required.
6. Battery electrolyte level.
7. Fuel level. Ensure sufficient Fuel.

Adjust

1. Check position of seat. If required adjust to your convenience.
2. Check adjustment of all rear view mirrors.

Ensure

1. Hood is fully closed.
2. All doors are properly closed and locked.
3. Check that any items you may be carrying are stored properly and fastened down securely.

4. Seat belts are fastened
5. Ensure all mirrors, windows and lamps are clean and unobstructed. Remove dust, frost, snow or ice if any, on these.
6. All switches & lamps are working
7. Check and ensure that all the gauges and indicators in the instrument cluster are working.
8. Gear shift lever is in neutral position
9. Parking brake is released.
10. Engine oil level.
11. Brake fluid level.
12. Windscreen washer fluid level.
13. Battery solution level.
14. Bonnet latch operation.
15. Pull the bonnet release handle inside the vehicle. Make sure that you cannot open the hood all the way without releasing the secondary latch.
16. Be sure to close the hood securely after checking for proper operation. See All Latches, Hinges and Locks of '**PERIODIC MAINTENANCE SCHEDULE**' in the '**INSPECTION & MAINTENANCE**' section for lubrication schedule.

WARNING

- Avoid breathing exhaust gases. Exhaust gases contain harmful carbon monoxide, a potentially lethal gas that is colorless and odourless. Since carbon monoxide is difficult to detect by itself, be sure to take the following precautions to help prevent carbon monoxide from entering your vehicle.
- Do not park with the engine running for a long period of time, even in an open area. If it is necessary to sit for a short time in a parked vehicle with the engine running, make sure the air intake lever is set to “FRESH AIR” and the fan is at high speed.
- Avoid operating the vehicle with the rear end door open. If it is necessary to operate the vehicle with the rear end door open, make sure all the windows are closed and the fan is at high speed with the air intake lever set to “FRESH AIR”.
- Have the exhaust system inspected periodically for damage and leaks. Any damage or leaks should be repaired immediately.
- Keep the exhaust tail pipe area clear of snow and other material to help reduce the buildup of exhaust gases under the vehicle. This is particular important when parked in blizzard condition.

SAFETY CHECKS

Windshield wiper / windshield washer

Always keep windshield glass clean to avoid any distraction in visibility. Ensure proper working of wipers and condition of wiper blade. Ensure that windshield washer reservoir is full. Do not operate wiper alone when the windshield glass is dry, this would damage the windshield.

Headlights

Keep headlight lenses clean. Check for operation of head lamps in both high/low beam condition. Check for correct focusing of head lamps. Use only recommended type of bulbs. Do not use the high beam unless it is inevitable. Its dazzle may glare the driver of the oncoming car the condition thus causing an accident.

Side indicators / Hazard warning

Ensure that all side indicators / hazard warning switch are always in working condition and they are used when required.

Horn

Ensure the horn is working properly. Horn provides safety to other road users by alerting your presence.

Brakes

Ensure brakes are working properly. Check brake fluid level in reservoir. Do not drive the car when brake warning lamp is 'ON'.

Tyres

Check the condition of tyres for any abnormality. Maintain correct tyre pressure, it is very important particularly when subjected to extreme conditions, such as high speed, bad roads and high outside temperature. Do not use worn or bald tyres specially on the front wheels.

First Aid Kit

First aid kit is provided in your vehicle. This is for use in case of minor injuries. It is to be regularly checked for any disintegration and should be updated regularly.

Documents

Always carry vehicle registration papers, insurance, valid PUC certificate and driving licence with you.

DRIVING SAFETY

Seat Belt

Seat-belts are life saving equipment, use of seat-belt reduces the chance of injury and severity of injury in case of an accident. It is strongly recommended that all the car occupants should always wear seat-belt, while vehicle is in motion.

Influence of Alcohol

Do not drive under the influences of alcohol or drugs. Alcohol and drugs will severely impair your control of the vehicle and increase the risk of injury yourself and others.

Mobile phones

Do not use mobile phones while driving a vehicle. This could divert your attention from the road and result in an accident.

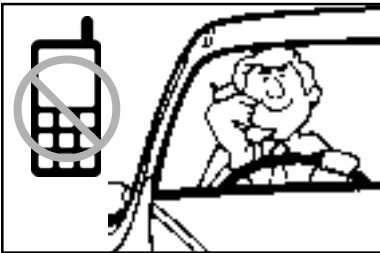

Fatigue 'Rest Revive survive'

Do not attempt driving when you feel tired, sleepy. Long distance driving can tire you very much and fatigue can dull your reflexes and judgment. Take a rest and get refreshed at intervals.

FRIENDLY TIPS TO IMPROVE FUEL ECONOMY :

Your vehicle's fuel economy is mainly dependent on your style of driving. To operate your vehicle as economically as possible, adhere to following driving suggestions.

Avoid Excessive Idling :

Shut Off the engine if you have to wait for more than a minute while you are in traffic.

Avoid fast starts and unnecessary stops :

Start off slowly from traffic lights or stop signs to prevent increased fuel consumption and shortening of engine life. Avoid unnecessary deceleration (stopping or slowing down) and then acceleration which uses more fuel.

Always maintain clean air-filter:

The amount of air supplied will reduce due to clogged air-filter, resulting in loss of power and fuel economy.

Keep weight to a minimum:

The heavier the load, the more fuel the vehicle consumes. Take out any luggage or cargo when it is not necessary.

Maintain correct tyre pressures:

Under-inflated tyres result in increased running resistance of the tyres, leading to wastage of fuel.

(Refer tyre maintenance section)

Proper Driving Practices :

Keep a safe distance from other vehicles to avoid braking suddenly.

NOTE

Do not rest your foot on the clutch pedal. It does not allow full engine power to be transmitted to the vehicle and reduces clutch life.

Fuel economy speeds (MT) :

Always adhere to following fuel economy speeds.

Gear	Speed (kmph)
1st	10
2nd	20 - 30
3rd	30 - 50
4th	50 - 70

FUEL CUT-IN/CUT-OFF STRATEGY:

The ECU has been programmed to limit the speed of the vehicle to **35 km/h in 1st gear, 60 km/h in 2nd gear, 90 km/h in 3rd gear and 105 km/h in 4th gear**. As a good driving practice, always shift to a higher gear before reaching the speed limit specified for that gear. In case the gear is not shifted and you continue to drive in the same gear beyond the specified speed, the ECU will activate the fuel cut-off strategy and restrict vehicle speed to the specified limit. This is to ensure optimum fuel efficiency and prolonged engine life.

Starting the Engine

Before starting :

1. Apply parking brake.
2. Ensure gear lever in neutral.
- A. Insert the key in steering cum ignition lock and turn it to 'ON' position.
- B. Press the clutch pedal fully.
- C. Now crank the engine.
- D. If the engine does not start turn the key to off position and try after 2 mins.

NOTE

Vehicle should not be started by pushing or towing. This starting method could result in permanent damage to the catalytic converter. Use jump leads to start a vehicle with a weak or flat battery.

NOTE

After starting run the engine in idle speed for at least 30 seconds.

⚠ CAUTION

Running Engine under idle condition for long duration and also in high idle (fly-up rpm) should be avoided

“START”. Release the key when the engine starts.

- If the engine does not start after 15 seconds of cranking, wait about 15 seconds, then press down the accelerator pedal to 1/3 of its travel and try cranking the engine again. Release the key and accelerator pedal when the engine starts.
- If the engine still does not start, try holding the accelerator pedal all the way to the floor while cranking. This should clear the engine if it is flooded.

Running-in Period (MT) :

Avoid rapid acceleration and prolonged high speed running of the engine while using the new car for the first 1000 km of operation.

Do not exceed the following road speeds during running in period.

Gear	Kmph
1 st	15
2 nd	25
3 rd	40
4 th	60

Starting a Cold Engine :

- Engine which is started after 6 hours should be treated as cold engine. For Electronic fuel injection models.
- With your foot off the accelerator pedal, crank the engine by turning the ignition key to

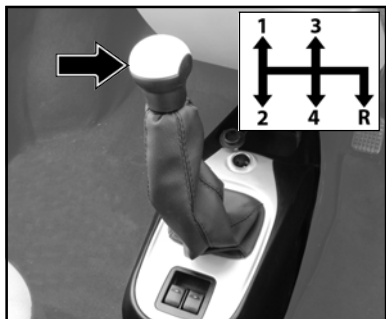
Gear Shifting (MT) :

The gearshift pattern is shown on the gear shift lever knob. All forward gears being synchronized, provide easy and effortless gear shifting. Always remember to press the clutch pedal fully while shifting the gears and also to release the clutch pedal gently.

Avoid sudden clutching i.e. abrupt release of depressed clutch pedal.

NOTE

The reverse gear should be engaged only when the car is stationary. Wait for 5 seconds after de clutching to ensure smooth engagement of the reverse gear.

WARNING

- Reduce your speed and change down to a lower gear before going down a long or steep hill. Avoid riding the brakes or they may overheat, resulting in brake failure.

- When driving on slippery roads, be sure to slow down before changing down. Excessive and or sudden changes in engine speed may cause loss of traction, which could cause you to lose control.
- Make sure that the vehicle is completely stationary before you change into reverse.

⚠ CAUTION

- To help avoid clutch damage, do not use the clutch pedal as a footrest while driving or use the clutch to keep the vehicle stationary on a hill. Depress the clutch fully when changing gear.
- When changing gears or starting off, do not race the engine. Racing the engine can shorten engine life and prevent smooth operation.

Braking :

The distance required to bring a car to a halt increase with the speed of the vehicle. The braking distance needed for vehicle at 60 kmph will be approximately 4 times greater than the braking distance needed at 30 kmph. Anticipate your stop, slowdown gradually and apply brake.

If water gets into the brake drums, brake performance may become poor and unpredictable. After driving through water or washing the underside of the vehicle, test the brake while driving at slow speed to see if they have maintained their normal effectiveness. If the brakes are less effective than normal, dry them by repeatedly applying the brake while driving slowly until the brakes have regained their normal effectiveness.

The booster type braking system is provided in this vehicle. However, the amount of braking effort required by the driver to activate the brakes would be lesser in the brake-booster models.

Stopping :

Before switching off the engine, run the engine in idle condition for at least 30 seconds and then switch 'OFF'. Turn the ignition key to 'ACC' position to stop the engine.

NOTE

The engine being at the rear of the car, its sound characteristics are unique compared to the other vehicles.

Parking

Park the car in a safe place.

Apply the parking brake.

Ensure that all window glasses are closed & all lamps are turned 'OFF'

At night, put on the parking lights if required.

WARNING

Do not leave the key inside the car.

Do not leave children unattended in the car.

Avoid parking the car over inflammable materials, such as dry leaves, grass etc., as the exhaust system is hot enough to initiate 'FIRE'.

NOTE

When parking on a steep slope, do not rely on the parking brake alone to hold the vehicle. Leave the vehicle parked with gear box in low forward gear when facing uphill and reverse gear when facing downhill.

Automated Manual Transmission (AMT) Gearbox : (if fitted)

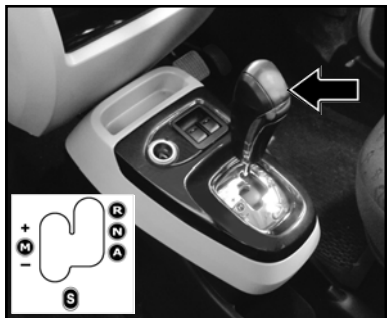

Gear Shift Lever (AMT)

The 5-speed Automated Manual Transmission (AMT) Gearbox offers a choice of two driving modes:

1. Automated mode with the gear lever in position 'A'
2. Manual mode with the gear lever in position 'M'.

Starting :

- a. Engage the parking brake firmly. Press Brake pedal.

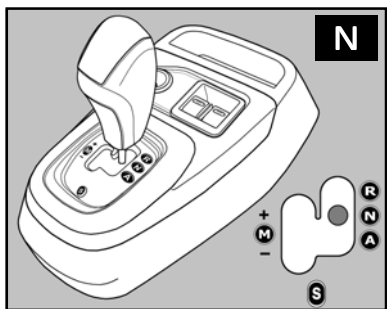

- b. Put the ignition 'ON'
- c. While the brake pedal is pressed, bring the shifter lever

to Neutral - 'N'. Check 'N' on instrument cluster.

- d. Crank to start the engine with the brake pedal still pressed.

Driving:

- a. With the engine running and brake pedal pressed, depending on your requirement shift the lever on R, A or M. Check the position engaged on the Instrument Cluster display.
- b. Release the parking brake.
- c. Release the brake pedal and press the accelerator pedal gently.

NOTE

Use right foot only to press brake or accelerator pedal.

Do not press accelerator and brake pedal simultaneously.

Do not use your left leg to press the pedals during driving AMT vehicle.

NOTE

The engine can only be started when the gearshift lever is in 'N' position with the brake pedal firmly pressed.

NOTE

If **F** is displayed on the Instrument Cluster display, it means 'Fault' condition. Contact a **TATA MOTORS** Authorized Service Centre immediately.

AMT Instruction sticker:

Follow the instructions provided on the sticker before driving the vehicle.



Driving Modes:

Neutral:

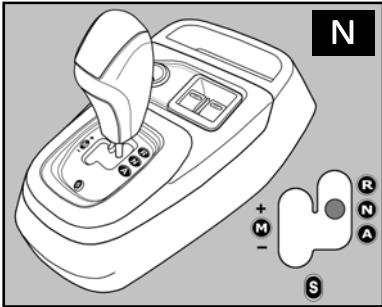

Vehicle is in neutral gear position. This will be indicated in instrument cluster.

WARNING

Always make sure to place the gear shift lever in the “N” position, when the engine is running and vehicle is stationary.

Do not shift the lever in “N” position, even momentarily, when the vehicle is in motion.

Reverse:

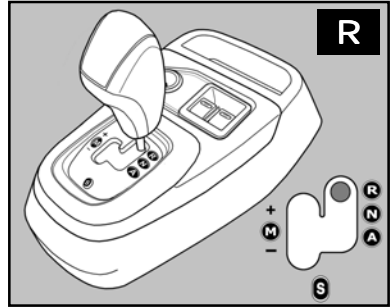

It engages in reverse gear only when vehicle is stationary and brake pedal pressed. An audio signal indicates when reverse gear is engaged. 'R' will be indicated in instrument cluster.

Automatic Mode:

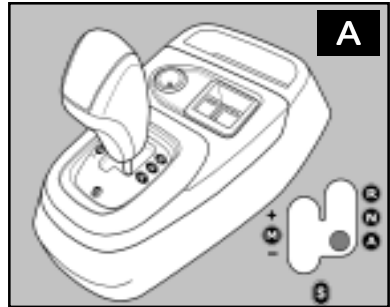

Gear Upshift and Downshift will be done automatically while driving.

Manual Mode:

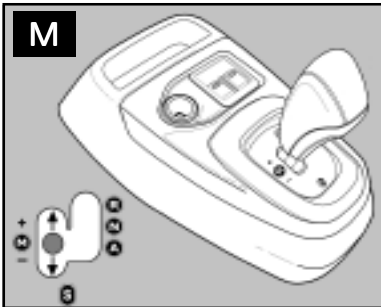

Driver should select the desired gear by shifting lever to:

- + : Upshift the gears.
- : Downshift the gears.

Push the gearshift lever to the '+' direction and release it. Every time the lever is operated, upshifting takes place 1 step in the order of 1st → 2nd → 3rd → 4th → 5th gear.

Pull the gearshift lever to the '-' direction and release it. Every time the lever is operated, downshifting takes place in the order 5th → 4th → 3rd → 2nd → 1st gear.

NOTE

Down shifting occurs automatically while braking/engine rpm reduction.

In manual mode, gears are not shifted automatically unless the engine RPM threshold is reached.

Drive Mode:

Two drive modes 'AUTO' and 'SPORT' are provided. These modes can be used to adjust engine characteristics and vehicle performance in line with desired requirement. **AUTO mode is the default mode.** To activate SPORT mode, Press 'S' button situated on the gear lever grille.

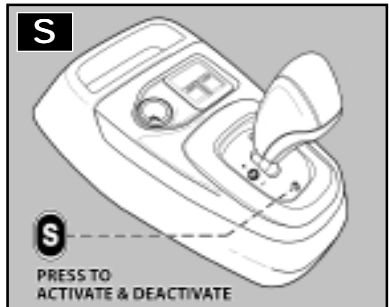

'SPORT' mode activation will be displayed on instrument cluster . It can be activated only in automatic mode.

To deactivate press the 'S' button again.

Stopping:

The vehicle can be stopped by depressing the brake pedal regardless of the gear position. This is because the clutch is automatically disengaged to prevent the engine from stopping.

If the gearshift lever is in the 'A' position, the gear will be downshifted to '1st' when the vehicle stops. Also, if the gearshift lever is in the 'M' position, the gear will be downshifted to '1st' when the vehicle stops.

NOTE

'AUTO' mode will give optimum engine Torque and Power output. Drive the vehicle in 'AUTO' mode to get max fuel economy. If in case of AC discomfort switch to 'SPORT' mode.

NOTE

Exhaust fan in the engine compartment will remain 'ON' for a short while after IGN is switched 'OFF'.

Parking:

AMT does not have a parking position. The vehicle can be parked with the gearshift lever in any position.

1. Apply the parking brake firmly.
2. Depress the brake pedal and shift the gearshift lever to the 'R' position on a downhill slope, or to the drive 'A' mode or the 'M' position in the manual 'M' mode on an uphill slope or flat road and confirm the gear position by

checking the gear position indicator on instrument cluster. Gear engagement (R or A) can be done with ignition ON/engine running condition only.

3. Stop the engine.

Creeping feature:

Creeping function allows the car movement without acc. pedal pressed when the brake pedal is released.

This functionality is generally used in parking maneuvers, with 1st or 'R' gear engaged, in this situations the driver enters and exits from creeping just by pressing the Acc. pedal.

- Creep feature is enabled for Manual as well as Auto Mode for first and reverse gear.
- After vehicle cranking and brake pedal released vehicle starts moving without pressing Acc. Pedal.
- Whenever accelerator pedal is pressed creep function will be disabled
- Whenever driver door is opened and / or parking brake is engaged, creep function will be disabled.

Kick down feature :

In Automatic mode, while driving at a constant speed if the accelerator pedal is quickly pressed the AMT downshifts the gear (if required). It ensures optimum acceleration to complete overtaking in minimal time.

Driving Through Water :

Never venture to drive through water when it flows over the guard stones on a bridge.

Your car's engine may get seriously damaged if attempted to cross through deep water. If at all the situation demands that you have to drive through water then;

- Keep engine in fast idling and crawl the car in low gear.
- After driving through water, apply brakes several times to dry the liners and to regain original braking.
- Do not attempt to start the engine if car gets flooded with water.
- Tow the car to a safe place.
- Take the car to nearest **TATA MOTORS** Authorised Service Centre to check entry of water in cylinders.
- If water has entered the engine, or transaxle, the lubricants will have to be replaced. Get the starter and alternator checked.

Driving on a Rainy Day :

Check brakes, steering, windows, tyres for wear and tyre pressure. Check wiper blades for proper functioning. Avoid harsh braking and sharp turns. It may cause loss of control and lead to a skid. For slowing down, shift to lower gears and brake gently. Keep lights ON if visibility is poor.

Night Driving :

Use head lamp main/dip beam to alert other road users on turns/cross roads etc.

Use side indicators for lane change or turning.

Switch on hazard warning switch in case of hazardous parking or if your vehicle is disabled to warn the passing traffic.

Maintain a speed such that you can stop within illuminated distance of head lamps.

Climbing Sharp Gradients on Loose Surfaces :

Start off smoothly in a suitable gear. Accelerate smoothly so that there is no loss of traction by over-revving of the engine.

Choose as smooth a slope as possible and select the appropriate gear so that gear changing in the middle of the climb is not required.

Changing gears in the middle of the climb can cause loss of momentum and engine stalling. Shifting to lower gear has to be done cautiously to avoid loss of traction.

Under no conditions should the vehicle be moved diagonally across a hill. The danger is in loss of traction and sideways slippage, possibly resulting in toppling over. If unavoidable, choose as mild an angle as possible and keep the vehicle moving.

If the wheels start to slip within few feet of the end of the climb, motion

can be maintained by swinging the steered wheels left and right, thereby providing increased grip.

If the vehicle stalls or losses headway while climbing a steep hill, make a quick shift to reverse and allow the vehicle to move back with the control of engine compression.

Climbing Sharp Gradients using AMT :

Apply the parking brake firmly so that the vehicle does not roll backwards.

Shift the gearshift lever to the “A” position while depressing the brake pedal. Make sure that the gear position indicator in the instrument cluster displays ‘1st’ gear.

Release the brake pedal and depress the accelerator pedal gradually, and when the vehicle starts to move, release the parking brake and depress the accelerator pedal to start off.

On climbing sharp gradients, never hold the vehicle at a stop using only the accelerator pedal or the creeping function. If you perform this operation for a certain period of time, this can also cause excessive damage to the clutch.

Descending Sharp Gradients :

Depending on the severity of the gradient, shift into appropriate gear. Use engine braking judiciously without over-revving the engine.

Brake application under such situations should be done very

smoothly to avoid loss of control. Select appropriate gear so that gear changing or clutch disengagement is not involved while descending the gradient.

NOTE

Creeping function will not operate when vehicle is in standstill condition on inclined surface.

WARNING

Try not to hold the brake pedal down too long or too often while going down a steep or long hill. This could cause the brakes to overheat, resulting in reduced braking efficiency. Failure to take this precaution could result in loss of vehicle control.

⚠ CAUTION

When descending on sharp gradients, NEVER turn the ignition key to the ‘OFF’ position. Emission control system damage may result.

Descending Sharp Gradients using AMT :

Depress the brake pedal and shift the gear shift lever to the ‘A’ position. Make sure that the gear position indicator in the instrumental cluster displays ‘1st’ gear.

Release the brake pedal and depress the accelerator pedal slowly. Even if the accelerator pedal is not depressed, the clutch will be engaged when the vehicle speed increases.

Advance Warning Triangle :



An advance warning triangle is provided along with your vehicle. In case there is a breakdown and or the vehicle is to be parked at the side of road, then the triangle is to be used as per instructions given below:

1. Remove advance warning triangle from it's cover and assemble.
2. Place the triangle on the road behind the vehicle where it is stranded.
3. The triangle must be at least 50 meters behind the vehicle in the same lane of traffic.
4. Increase the distance to 150 meters on a highway or if a bad/hill top obscures the view.

Hazard Warning Switch :



In case of a break-down at night, use hazard warning indicators. Try to park the vehicle on the side of the road to avoid collision with or inconvenience for others.

While driving in emergency or under adverse conditions, it is advisable to switch 'ON' Hazard warning indicators.

Hazard warning switch remains functional even while ignition switch is in OFF condition.

When the situation is under control switch off the hazard warning indicator.

IF YOU HAVE A FLAT TYRE:

1. Reduce vehicle speed gradually keeping it in a straight line. Move cautiously off the road to safe place away from traffic.
2. Park the vehicle on a level and firm ground.
3. Apply parking brake and engage 1st or Reverse gear. Stop the Engine and turn on Hazard warning switch.
4. Ensure that all occupants are out of the vehicle on the side away from traffic.
5. Keep advance-warning triangle at least 50 meters behind the vehicle as an indication of breakdown.



6. Take out the Wheel spanner located below driver seat and besides battery.

NOTE

Do not continue driving with deflated tyre. Driving even for short distance can damage the tyre and wheel beyond repair.

Important information about Tyre sizes of your Car

To achieve the optimum vehicle performance, your vehicle is fitted with differential tyre.

Please note the tyre sizes:

Front : 135/70 R12

Rear : 155/65 R12

Spare : 135/70 R12

In case of flat tyre at rear following instructions and cautions must be observed and strictly followed:

1. It is recommended to drive vehicle with spare tyre in speed limit of 40 to 60 km/hr.
2. Drive cautiously while running on spare wheel especially on sharp gradients.
3. It is recommended to replace the spare tyre with standard tyre immediately at nearest service station.

! CAUTION

Get the punctured tyre repaired and replace at the nearest service station.

Location and Removal of Spare wheel:



Spare Wheel Location

Spare wheel is mounted on front firewall inside the Front hood.

Open the hood (refer fuel filling section) and rotate the wheel mounting screw by hand in anticlockwise direction and remove the spare wheel.

Location of Jack :



Jack Location

Jack is located below co-driver seat. To remove jack, rotate the wing bolt anticlockwise to lower down and release it from mounting hook. While restoring, engage jack in mounting hook, position it properly and rotate

wing bolt clockwise to raise the jack till it secures properly.

Location of Wheel spanner and Tow hook.

They are located below driver seat and besides battery.

Advance Warning Triangle:

Advance warning triangle is located behind rear seat back rest below parcel shelf in a bag. Unlock the rear seat backrest and remove it when required.

Changing the flat tyre

Block the wheel which is diagonally opposite to the flat tyre.

Take out wheel cover (If fitted) and loosen the wheel mounting bolts of flat tyre. (Do not remove the flat tyre at this stage).

Engage the jack properly at correct jacking point (In between dimple marks provided at front & rear sides). Rotate the jack screw in clockwise direction using wheel spanner to lift the vehicle till flat tyre is free from ground.

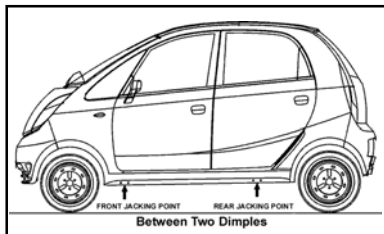

Jacking Points



Front Jacking Point



Rear Jacking Point

Remove wheel-mounting bolts and take out flat tyre and cover (if fitted).

Roll the spare wheel into position and align the holes in the wheel with tapered bolts and tighten them properly.

Lower the jack completely then tighten the wheel bolts one by one using wheel spanner. Fit the wheel cover back (if fitted).

Restore all the tools and jack at its location.

Place the flat tyre at spare wheel location as described and tighten properly.

⚠ CAUTION

Follow the jacking instructions.

Make sure to set the jack properly in the jack point. Raising the vehicle with improperly positioned will damage the vehicle or may cause the personal injury.

Do not carry any other work or never get under the vehicle supported by jack.

Do not start or run the vehicle while supported by jack.

Block the wheel diagonally opposite to flat tyre being changed, if necessary.

Do not lift the vehicle with any passenger inside.

Raise the vehicle only high enough to remove and change the flat tyre.

Starting the Engine with Jump Leads :

The engine with a discharged battery may be started by transferring electrical power from a battery in another vehicle.

This may be dangerous as any deviation from the following instructions could lead to personal injury resulting from any battery explosion, as well as damage to the electrical systems in both vehicle.

CAUTION

Do not allow battery electrolyte to come in contact with eyes, skin, fabrics or painted surfaces. The fluid contains sulphuric acid which can cause injury and severe damage. Wear rubber gloves, to avoid risk of contact.

To lessen the risk of injury, wear eye protection when working near any battery.

- Make sure that the battery providing the jump start has the same rated voltage as the battery in your vehicle (12 V). Its capacity must be approximately the same as the original battery capacity. The rated voltage and capacity are given on the batteries.
- Do not disconnect the discharged battery from the vehicle.
- Switch off all unnecessary electrical loads.
- Do not lean over the battery during jump starting.

- Do not allow the terminals of one lead to touch those of the other lead.
- Apply the hand brake. Keep the gearshift lever in neutral.
- Do not connect the lead to the negative terminal of the discharged battery.
- The connection of the -ve lead point should be as far as away from the discharged battery as possible and close to the starter motor.
- Route the leads so that they cannot get caught by the rotating parts in the engine compartment.
- The engine of the vehicle providing the jump start can be allowed to run during starting.

Attempts to start the engine of the vehicle with the discharged battery should be made at intervals of one minute and should not last more than 15 seconds. After starting, allow both engines to idle for approximately 3 minutes with the leads still connected.

CAUTION

Vehicle provided with MPFI & should not be started by pushing or towing as the fuel pump not work in that condition. This starting method could result in permanent damage to the catalytic converter. Use jump leads to start a vehicle with a weak or flat battery.

Following order should be followed while connecting battery leads :

1. Positive (+) of Good battery to Positive (+) of discharged battery.
2. Negative (-) of Good battery to - a solid metal patch attached to engine block OR unpainted metal (Engine) part which is away from the discharged battery.
3. Crank and start the engine.
4. While disconnecting follow reverse order i.e. disconnect Negative (-) lead followed by Positive (+) lead.

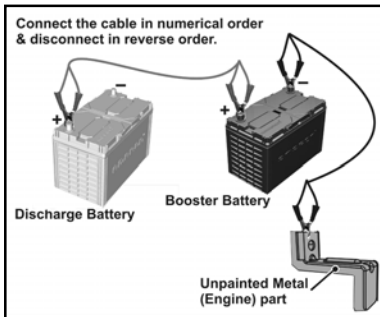

Connect Leads In The Order As Shown In Sketch.

NOTE

Do not connect negative (-) terminal of jump start battery (Good battery) to the negative (-) terminal of discharged battery. This may lead to an explosion.

Towing the Vehicle :

Securing the towing hook at front:

- Provision for fitment of towing hook is provided on front bumper as indicated.



Tow Hook Location at Front

Towing Hook fitment & Removal:

- Take the towing hook and the wheel spanner from the vehicle tool kit.
- Screw and tighten the towing hook clockwise.
- To remove towing hook, unscrew it anti-clockwise.
- Fit the tow hook cover in its place.
- Place the towing hook and wheel spanner back in the vehicle tool kit.

Transporting the vehicle :

The towing hooks can be used to pull the vehicle onto a trailer or transporter for transporting purposes.

To secure, only lash the vehicle down by the wheels or tyres. Your vehicle could otherwise be damaged,

- For towing a vehicle, the best way is to use a wrecker.
- Alternatively use a rigid tow bar.
- Avoid using a flexible cable or rope as your vehicle may crash into the vehicle towing your car when it stops suddenly.
- Switch 'ON' the hazard warning signals of both the vehicle to warn other road users.
- Where possible, keep the engine idling so that brake vacuum is available.
- Limit the speed to 20-30 kmph.
- In case of brake failure, use the parking brake to control the vehicle.

Towing instructions (AMT) :

A) Where vehicle can be shifted in neutral condition :

- Shift the gear lever into neutral.
- Turn the ignition key to the "ACC" position to unlock the steering wheel.
- Release the parking brake.

NOTE

After shifting the AMT gearshift lever to the "N" position, always check the gear position indicator in the instrument cluster shows the "N" position to make sure that the transaxle is disengaged.

If the transaxle cannot be put in neutral, turn the key from the "OFF" to the "ON" position, and move the AMT gearshift lever from "N" to "A",

"M" or "R", then back to "N" again. Then turn the key from the "ON" to the "OFF" position. These procedures may help to put the transaxle in neutral.

If the transaxle still cannot be put in neutral, you cannot tow the vehicle without lifting vehicle from rear side.

B) Where vehicle can not be shifted in neutral condition:

- Secure the rear wheels on a towing lift and the front wheels on the towing trolley.
- Apply the parking brake.

WARNING

A safety chain/belt for tightening the wheels with lift should always be used when you tow your vehicle.

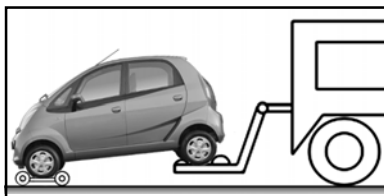

NOTE

Always unlock the steering wheel before towing.

This manual will help you to understand your vehicle. Inspection, maintenance of the vehicle should be entrusted to the professionals only.

Please be careful while personally inspecting / maintaining the vehicle as it may cause damage to the vehicle or may cause injury.

The ignition and fuel systems are highly important in view of emission control and for efficient engine operation. Similarly the brake system for safety. Do not tamper with them.

All inspections and adjustments must be made by a qualified technician. We strongly recommend that all servicing related to these systems be done by **TATA MOTORS** Authorised Service Centre.

OWNER MAINTENANCE

Routine Service

We highly recommend that these items be inspected at least every week.

Engine Oil Level, Engine coolant Level, Brake Fluid Level, Windshield Washer Fluid Level, Battery, Tyre inflation pressure, Radiator fins blockage (specially in rainy season).

Do it Yourself Service

Improper or incomplete service may result in problems.

Several maintenance procedures can be done only by a qualified service technician with special tools. Improper do it yourself maintenance during the warranty period may affect warranty coverage. If you're unsure about any servicing or maintenance procedure, have it done by **TATA MOTORS** Authorised Service Centre.

WARNING

Maintenance procedures:

Performing maintenance work on a vehicle can be dangerous. You can be seriously injured while performing some maintenance procedures. If you lack sufficient knowledge and experience or the proper tools and equipment to do the work, have it done by qualified technician.

PRELIMINARY TROUBLE SHOOTING

These tips are given for your guidance. These preliminary checks can be carried out in an emergency. In normal cases the problems should be attended to in an Authorized Service outlet by following the repair procedures given in the Workshop Manual.

SR NO	PROBLEM OBSERVED	PROBLEM CAUSE	ACTION TO BE TAKEN
ENGINE			
1.	Engine not cranking	Dead battery, loose or improper battery/ electrical connections	Get battery checked and/ or changed.
			Jump start using another battery
			Tighten connections properly. Check spark plug, clean & replace if necessary
2.	Engine cranks but does not start	Air in the fuel system	Get the air removed by bleeding Check leakages & correct
		Fuel pump fuse/EMS blown	Replace the fuse.
		No Fuel	Get the fuel filled
		Fuel filter choked	Get the fuel filter replaced
3.	Charging indicator continuously remains ON	Battery not getting charged due to belt loose	Get the belt tension adjusted. Replace if broken
		Alternator terminal loose	Tighten the charging terminal
		Alternator not working	Get it rectified / Replace
4.	Engine overheats	Brakes binding	Get defect rectified.
		Electric fan not working	Get defect rectified.
		Radiator fins clogged	Clean it.
		Thermostat defective	Get it rectified.
		Coolant level low	Top up
5.	Poor pick up	Accelerator cable loose	Get it adjusted correctly
		Air in the fuel system	Remove the air
		Clogged fuel filter	Clean/ Replace the element
		Clogged air filter	Clean/ Replace the element
		Clutch slipping/ out of adjustment	Adjust the clutch / Get it rectified
		Brakes grabbing	Get it rectified
6.	Does not accelerate	Accelerator cable broken	Get cable replaced
		Fuel filter choked	Replace
7.	Belt squeal	Loose belt	Get belt tension adjusted
		Belt glazed	Get belt replaced

PRELIMINARY TROUBLE SHOOTING

SR NO	PROBLEM OBSERVED	PROBLEM CAUSE	ACTION TO BE TAKEN
ENGINE			
8.	Low engine oil pressure indicator 'ON' when engine is running even though engine oil level is within maximum/ minimum marking.	Pressure transducer faulty, and / or oil pump faulty	Do not run the engine extensively. Take the car to the nearest authorized service outlet & get the fault rectified
CLUTCH			
1.	Clutch slipping	Improper pedal travel	Adjust pedal travel
		Rusted clutch cable	Replace cable
		Oil on clutch disc	Clean or replace disc at Authorized Service outlet
2.	Noisy clutch	Pressure plate & diaphragm spring rattling	Get car attended by authorized Service outlet
TRANSAXLE			
1.	Hard shifting	Inadequate lubricant	Replenish
		Inadequate clutch pedal travel	Adjust
		Distorted or broken clutch disc	Replace
		Damaged clutch pressure plate	Replace clutch cover/ disc
2.	Noise	Inadequate or insufficient lubricant	Replenish
		Damaged or worn bearing(s)	Replace
BRAKES			
1.	Poor brakes	Insufficient brake fluid	Get the brake fluid filled.
		Air in the system	Get the air removed by bleeding.
		Pedal travel excessive due to excessive shoe gap	Rectify automatic adjuster.
		Vacuum leakage (for booster vehicle)	Rectify the leakage.
		Brake oil (line) leaking	Replace the leaking line.
		Oil on the brake drum/ liners seals if leaking.	Get the liners cleaned/ replace.
		Worn brake lining	Get the liners replaced.

PRELIMINARY TROUBLE SHOOTING

SR NO	PROBLEM OBSERVED	PROBLEM CAUSE	ACTION TO BE TAKEN
BRAKES			
2.	Brake pulling to one side	Oil on the brake lining	Clean the brake lining.
		One side shoe/ pad worn on both wheels.	Get the shoe/ pad replaced
		Loose brake anchor plate	Tighten the bolts.
		One side brake pipe clogged	Get the brake line cleaned.
		One side automatic adjuster not functioning	Rectify or replace automatic adjuster.
3.	Brake squeal	Defective brake lining	Replace.
		Glazed lining	Clean or replace lining.
STEERING SYSTEM			
1.	Hard steering (Mech)	Wheel alignment disturbed	Check & adjust
		Rack & pinion need adjustment	Check & replace if necessary
		Low tyre pressure	Adjust correct value
		Grabbing of linkages	Check & rectify
2.	Poor Return ability	Grabbing of linkages	Check & rectify
		Steering gear disturbed	Check & adjust
3.	Excessive play on steering	Rack & pinion attachment loose	Get it tightened
4	Hard Steering or reduced assistance (with EPS Functioning)	Excessive use of steering like, driving in ghat section or constraint parking.	It will automatically restore during normal driving as system cools down.
		Factors external to the EPS system	Stop the vehicle in a safe place & turn off the engine. Reset the system by restarting the engine.
		Factors internal to the EPS system	Stop the vehicle in a safe place & turn off the engine. Reset the system by restarting the engine. If problem still noticed after the above test, take the vehicle to TATA dealer to have it checked.
5	Hard Steering Mechanical (EPS not Functioning)	Electrical power steering system failure	Take the vehicle to TATA dealer to have it checked.
		The engine has not been started.	The engine must be running for getting steering assistance.
6	Excessive play on steering	Rack & Pinion attachment loose. Wear on rack support.	Get it tightened at authorized TATA Motors dealer.

PRELIMINARY TROUBLE SHOOTING

SR NO	PROBLEM OBSERVED	PROBLEM CAUSE	ACTION TO BE TAKEN
WIPER			
1.	Narrow streaks are left on the wind shield making it hard to see	Foreign matter has attached to the blade	Clean the edge of the blade. if streaks still appear, replace the blade edge of the blade is worn out.
2.	The wiper leaves large	Rubber deformed un-wiped spots.	Replace the blade
ELECTRICAL			
1.	Battery charge & engine oil pressure lamp in cluster not operating when key in 'IGN' position	Battery terminal loose or disconnected	Check connections.
		Battery completely dead	Get the battery charged.
		LED fused	Get the LED checked / Replaced.
		Fuse blown	Replace the fuse.
		Loose / open connections	Get the battery properly connected.
2.	Non functioning Elect. accessories such as power windows, head lamps, fuel & temp. gauge, RPM meter, wiper and washer unit & all lamps etc.	Fuse blown in the circuit	Replace the fuse if blown.
		Loose connectors	Get the connection properly tightened / fixed.
		Circuit relay/ controllers loose in the base	Fix the relay firmly.
SUSPENSION			
1.	Abnormal or excessive tyre wear	Tyre out of balance	Check balance and/ or adjust if required.
		Steering geometry disturbed	Adjust steering geometry.
		Tyres not adequately inflated	Adjust tyre pressure.
		Wobbly wheel or tyre	Replace wheel or tyre.
		Defective tyre	Replace tyre.
		Hub play not proper	Replace bearing.
		Brake grabbing	Check & rectify.
		Excessive braking	Modify driving habit.
2.	Abnormal noise from front end	Damaged struts or mounting	Repair mounting or repair strut
		Worn suspension arm bushings	Replace
		Loose wheel bolts	Tighten wheel bolts
		Loose suspension bolts or nuts	Tighten suspension bolts or nuts
		Excessive hub play	Replace bearing.
3.	Ride too soft/ bumpy	Faulty struts	Replace struts
4.	Suspension bottoms	Over loaded	Check loading
		Faulty struts	Replace struts

PRELIMINARY TROUBLE SHOOTING

SR NO	PROBLEM OBSERVED	PROBLEM CAUSE	ACTION TO BE TAKEN
AC / HVAC			
1	Blower motor does not operate	Blown Fuse	Replace Fuse and correct any disconnection in wiring
		Faulty connection	Secure all connections properly.
		Faulty motor	Replace motor if no conductance
		Faulty or poor connection at	Replace resistor block if found defective
		Faulty fan switch	Replace Switch
2	Motor operates but air flow is minimum	Obstruction in the evaporator inlet	Clean Evaporator
		Air Leak	Seal correctly.
3	Insufficient Heating	Air Leak	Seal correctly.
		Kinematic linkage damaged	Get the defect rectified at nearest authorized service center

NOTE : HVAC AC filter should be cleaned after every 5000 kms if vehicles is running in dusty atmosphere

Fuses and Relays :

Your car's electrical circuits have fuses to protect the wiring from short circuits or sustained overload. These are located below dash board on right hand side as shown in the sketch.

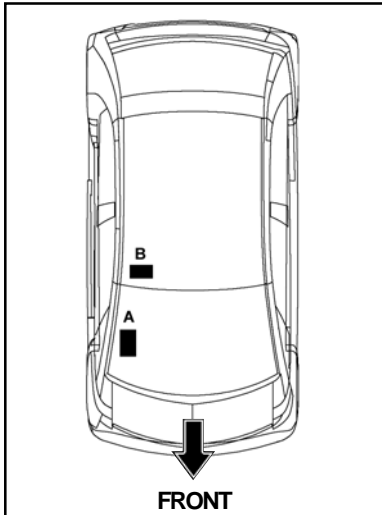

A. FUSE & RELAY BOX

B. BATTERY MOUNTED FUSE BOX

The circuit is connected through fuses and relays and the current rating of each fuse is printed on the fuse box sticker on sunvisor.

Checking and replacing fuses:

If any electrical unit in your car is not functioning, check the fuses first. Please follow the steps below that will guide you to check and replace them -

- Turn the ignition key to the 'LOCK' position.

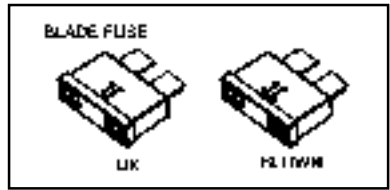

- Identify the defective fuse from it's melted wire.
- Remove blown fuse by fuse puller. The fuse puller is located in the cabin compartment fuse box.
- Find the route cause of the blown fuse and rectify.
- Install a new fuse of the correct rating.
- Ensure that all other fuses are firmly in position. Spare fuses are provided in the fuse box in the cabin.

CAUTION

The electrical system is protected by fuses that are designed to fail and prevent damage to wiring harness. Always replace blown fuse with the same rating as specified to prevent wiring damage that can result in a possible fire.

NOTE

For replacement of fuse, please refer the sticker provided on the driver side sunvisor.

BATTERY MOUNTED FUSE BOX DETAILS (EPS-AMT)

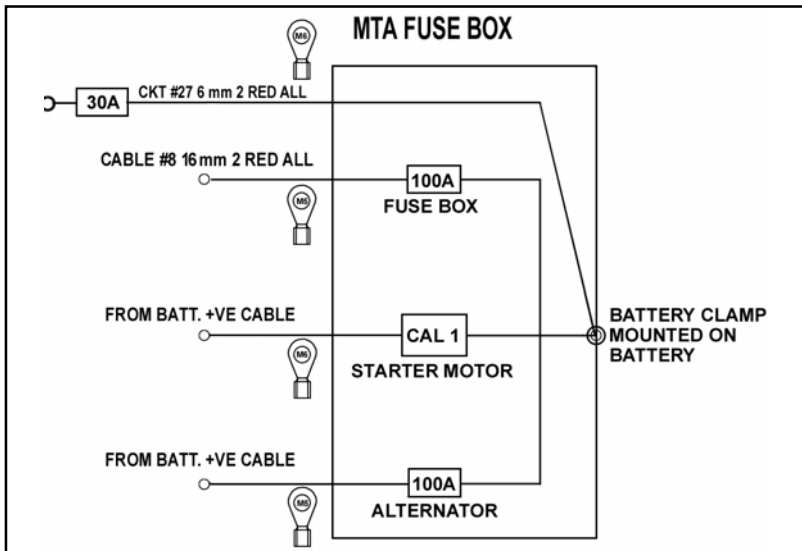

BATTERY MOUNTED FUSE BOX DETAILS (EPS)

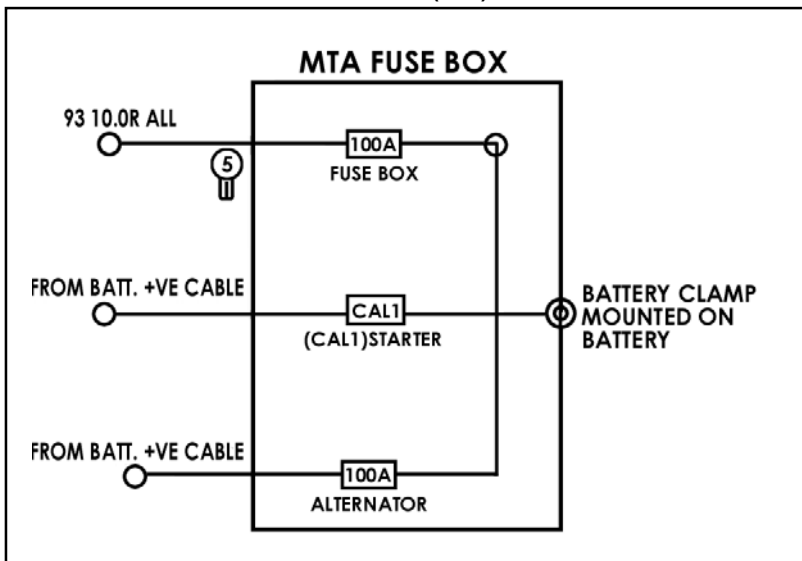

BATTERY MOUNTED FUSE BOX DETAILS (NON-EPS)

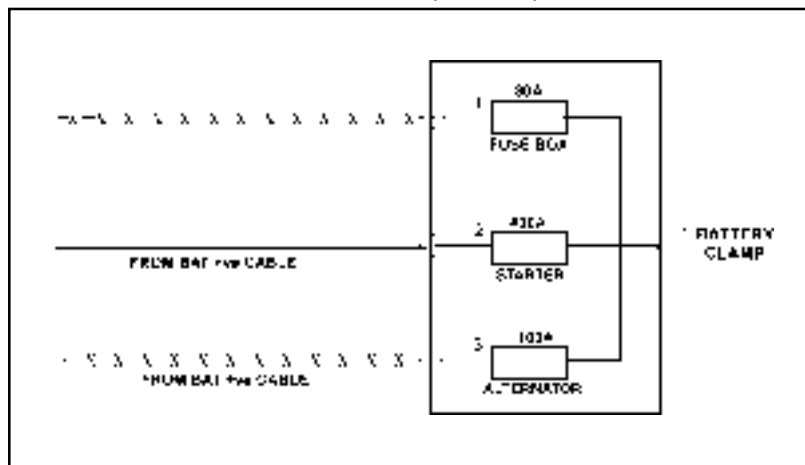

BULB SPECIFICATION

DESCRIPTION	LOCATION	CAP TYPE	SPECIFICATION	QTY
Head lamp-Halogen H4	Head lamp	P43t - 38	H4 12V,60/55 W	2
Parking Lamp	Front	W5W	12V, 5W	2
Front Fog Lamp	Front	PK22s	12V, 19W	2
Side Repeater Indicator	Side	W5W	12V, 5W	2
Rear Direction Indicator	Tail Lamp	BAU15s	12V,21W	2
Rear Stop+ Parking Lamp	Tail Lamp	BA15d	12V, 21/5W	2
Reverse Lamp	Tail Lamp	BA15s	12V,21W	2
Registration Plate Lamp	Rear	W5W	12V, 5W	2
High Mounted Stop Lamp	Rear Windscreen	2.1 X 9.5d	12V, 16W	1
Front Direction Indicator	Front Headlamp	BA15s	12V, 21W	2

ACCESSORY CONNECTOR LOCATIONS / PROVISION ON CAR

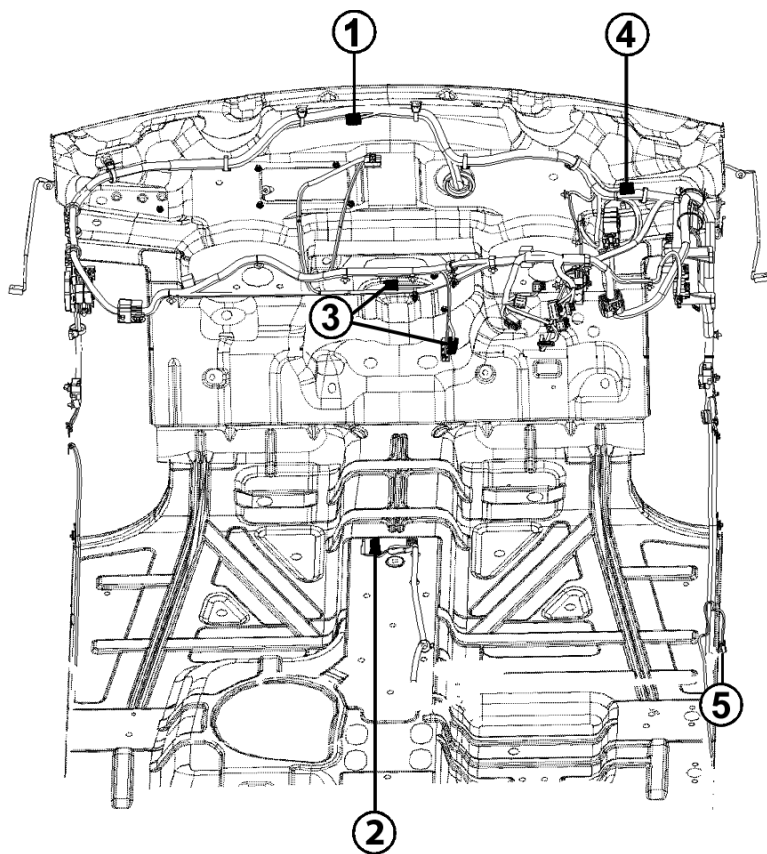

1. Connector for Fog lamp provision- 4 Pole (As applicable)
2. Connector for Cigar Lighter- 2 Pole (As applicable)
3. Accessory connector 4 pole for Music system. (As applicable)
4. Accessory connector 10 pole for RKE near dual flasher. (As applicable)
5. Connector for Rear Parking Aid

* Above accessory connectors are applicable based on the versions

ACCESSORY CONNECTOR LOCATIONS / PROVISION ON CAR

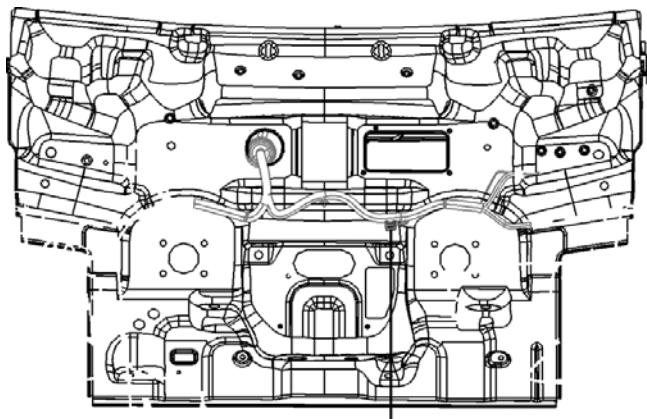

Accessory connector for
Bonnet Switch (3 Pole) :
As applicable

Accessory connector for
Reverse parking (2 Pole):
As applicable

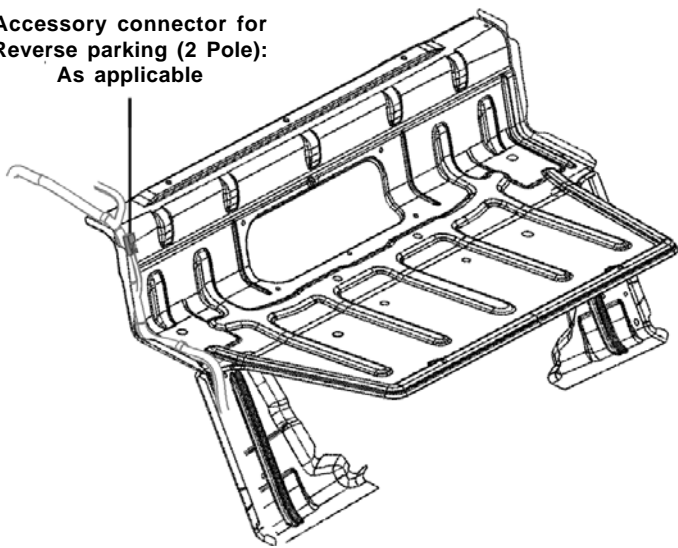

CAR CARE:

Your Car is subjected to many external influences such as climate, road conditions, industrial pollution and proximity to the sea. These conditions demand regular care of the Car body. Dirt, insects, bird droppings, oil, grease, fuel and stone chippings should be removed as soon as possible.

WASHING :

Following these tips while washing your car.

HAND WASH :

1. Always wash your car in shade and the surface is at room temperature.
2. Wash with mild car wash soap like 'Car Shampoo' and use a soft bristle brush, sponge or soft cloth and rinse it frequently while washing. to avoid scratches.
3. To avoid scratches, please wear soft gloves . Remove finger rings, nails, wrist watch while washing.
4. To remove stubborn stains and contaminants like tar, use turpentine or cleaners like 'Stain remover' which are safe for paint surfaces.
5. Avoid substances like petrol, diesel, kerosene, benzene or other solvents that cause damage to paint.

6. Dry your car thoroughly to prevent any damp spots.
7. Rinse all surfaces thoroughly to prevent any traces of soap and other cleaners as this may lead to the formation of stains on the painted surface later.

WARNING

Do not direct high pressure washer fluid/ water jets (Pressure above 0.5 Bar) at electrical devices and connector during wasing. This is to prevent malfunction / failure of electrical system due to water ingress.

After drying the Car, inspect it for chips and scratches that could allow corrosion to start. Apply touch up paint where necessary.

CLEANING OF CARPETS :

Vacuum clean the carpet regularly to remove dirt. Dirt will make the carpet wear out faster. Periodically shampoo the carpet to keep it looking new.

Use carpet cleaners (preferably foam type). Follow the instructions that come with the cleaner. Apply it with a sponge or soft brush. Keep the carpet as dry as possible by not adding water to the foam.

NOTE

Avoid wiping of painted surface in dry condition as it may leave scratches on the painted surface.

CLEANING OF WINDOWS, FRONT AND REAR GLASSES :

Clean the windows inside and outside with commercially available glass cleaners.

This will remove the haze that builds up on the inside of windows. Use a soft cloth or paper towels to clean all glass and plastic surfaces.

RFID TAG is pasted on front windshield from inside. It enables Electronic toll collection.



DO NOT TRY TO PEEL OFF RFID TAG

TML PART NO. 2816 5420 99 05
VENUS WINDSHIELD MOUNT AVI TAG

NOTE

Do not attempt to rip or tamper the tag. It will disable the functionality of the tag.

WAXING :

Waxing and polishing is recommended to maintain the gloss and wet-look appearance of your paint finish.

1. Use a good quality polish and wax for your car.
2. Re-wax your car when the water does not slip off the surface and collects over the surface in patches.

POLISHING :

Polishes and cleaners can restore shine to the painted surface that has oxidised and become dull. They normally contain mild abrasives and solvents that remove the top layer of the finish coat. Polish your Car, if the finish does not regain its original shine after using wax.

PAINT CARE :

FOLLOWING GUIDELINES WILL HELP YOU TO PROTECT YOUR CAR FROM CORROSION EFFECTIVELY.

PROPER CLEANING :

In order to protect your car from corrosion it is recommended that you wash your car thoroughly and frequently in case :

- There is an heavy accumulation of dirt and mud especially on the underbody.
- It is driven in areas having high atmosphere pollution due to smoke, soot, dust, iron dust and other chemical pollutants.
- It is driven in coastal areas.
- The underbody must be thoroughly pressure washed after every three months.

In addition to regularly washing your car, the following precautions need to be taken.

PERIODIC INSPECTION :

- Regularly inspect your car for any damage in the paint film such as deep scratches and immediately get them repaired from **TATA MOTORS** Authorized Workshop, as these defects tend to accelerate corrosion.
- Inspect mud liners for damages.
- Keep all drain holes clear from clogging.

WIPER CARE :

Wiper blade attack angle on windshield glass should be 90° i.e. perpendicular.

Remove wiper blade and root wiper arm on windshield glass in the centre position. Check the gap between arm strip and glass.

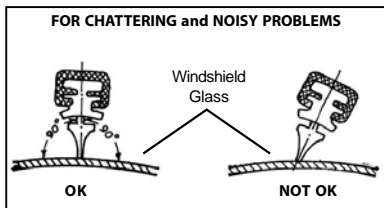
**VEHICLE PARKING AT ONE PLACE FOR LONG DURATION (Non use maintenances) :**

If you need to park your vehicle for an extended period (more than 1 month), there are several things you should do to prepare it for storage. Proper preparation helps prevent deterioration and makes it easier to get your vehicle back on the road :

1. Park the Car in covered, dry and if possible well-ventilated premises. Engage a gear.
2. Fill the fuel tank.
3. Remove the battery terminal cables (first remove the cable from the negative terminal).
4. Make sure the hand brake is not engaged.
5. Clean and protect the painted parts using protective wax.
6. Clean and protect the shiny metal parts using commercially available special compounds.
7. Sprinkle talcum powder on the rubber windscreen wiper and lift them off the glass.
8. Slightly open the windows.
9. Cover the Car with a cloth or perforated plastic sheet. Do not use sheets of imperforated plastic as they do not allow moisture on the Car body to evaporate.
10. Inflate the tyres to 0.5 bar above the normal specified pressure and check it at regular intervals.
11. Check the battery charge every six weeks.
12. Do not drain the engine cooling system.

⚠ CAUTION

If possible , periodically run the Engine until it reaches full operating temperature (the cooling fan cycle ON and OFF twice). Preferably, do this once a month.

Open the front hood for Checking / Topping up brake fluid & windshield washer fluid, (Refer page no. 39 for opening & closing of front hood.)

BRAKE FLUID LEVEL :



Brake fluid reservoir

The level of the brake fluid must be between the min. and max. marks on the side of the brake fluid container. If the level falls below the min. mark, add recommended brake fluid. (Refer chapter - Fuels, coolants and lubricants)

In case of spongy or hard pedal or low brake efficiency, please contact the nearest **TATA MOTORS** Authorised Workshop.

⚠ CAUTION

1. Do not allow brake fluid to make contact with the skin or eyes.
2. Do not allow brake fluid to splash or spill on the paint surface as it will damage the paint. In case of spillage, wipe it off immediately.
3. A rapid fluid loss indicates a leak in the brake system which

should be inspected by our nearest **TATA MOTORS** Authorized Workshop immediately.

4. Brake fluid can harm your eyes and damage painted surfaces. Use caution when refilling the reservoir.
5. Do not use any fluid other than **TATA MOTORS** recommended brake fluid. Do not use reclaimed fluid or fluid that has been stored in old or open containers. It is essential that foreign particles and other liquids are kept out of the brake fluid reservoir.

WINDSHIELD WASHER :



Windshield washer reservoir

Windshield washer fluid container is located inside hood. Check the washer fluid level and top up with recommended windshield washer fluid as required.

NOTE

Do not add detergent or any solvent in the windshield washing water.

Do not use “antifreeze” solution in the windscreen washer reservoir. This can severely impair visibility when sprayed on the windscreen, and can also damage your vehicle’s paint. Damage may result if the washer motor is operated whilst the fluid or fluid nozzles are frozen or with no fluid in the washer tank.

Open the rear engine inspection compartment cover / lid for Checking / Topping up engine oil, coolant level & Air filter element cleaning.

OPENING ENGINE ACCESS COVER:

NOTE

Do not touch directly to engine access cover under carpet, it may be hot after vehicle running”

1. Engine access cover is mounted behind rear seat back rest.



Engine Access Cover (MT)



Engine Access Cover (AMT)

2. Remove the mounting wing bolt & takeout engine access cover.

REFITTING :

1. Place the cover & tighten the wing bolts.
2. Lock the rear seat back rest.

For locking the rear seat back rest, lift the seat back rest and press it to engage in the lock.

ENGINE OIL LEVEL

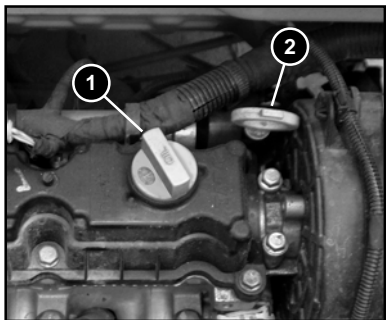

1. Engine Filling Cap 2. Dip Stick

Engine oil level should be checked when engine is cold. Allow at least 30 mins. for engine oil to settle before checking oil level.

1. For checking engine oil level, pull out the dipstick from the engine oil case, wipe it clean with a cloth or a paper napkin.
2. Insert it again to its original position.
3. Pull out the dipstick again and observe the oil level on the dipstick.
4. If the oil level is below the mid point of min. and max. marks, top up using recommended grade of oil.

NOTE

Oil level should not exceed the max. Mark. Always check the oil level when the car is on a level ground and the engine in cold condition.

Check the engine oil level if "low oil pressure" warning comes 'ON' while driving. Failure to check the oil level

regularly could lead to serious trouble due to insufficient oil.

ENGINE OIL TOP-UP

Remove the oil filler cap and pour oil slowly through the filler hole to bring the oil level to the upper limit on the dipstick. Be careful not to overfill. Too much oil is almost as bad as too little oil. After refilling, start the engine and allow it to idle for about a minute. Stop the engine; let the oil settle and check oil level again.

ENGINE COOLANT LEVEL

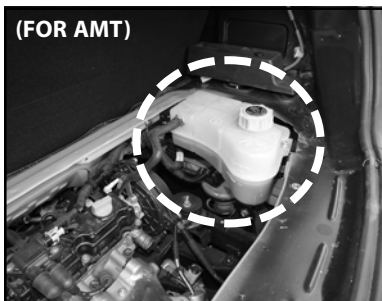

The coolant level in the coolant no-loss tank should be between max. & min. marks. This can be viewed through a translucent reservoir. If less, add coolant up to the max. mark and refit the cap properly.

NOTE

Check coolant level in the radiator, by opening the pressure cap (ensure vehicle is in cold condition). If coolant level is seen below filler neck top, then add specified pre-mixed coolant (60:40).

Check coolant level in 'No-Loss (Reservoir) tank, if lower than the

MAX level, then add specific premixed coolant (60:40) upto refill level.

NOTE

- Do not use only coolant or plain water.
- Do not add extra inhibitors or additives. They may not be compatible with your cooling system.
- Do not mix different types of base coolants. Doing so may result in accelerated seal wear and/or the possibility of severe overheating and extensive engine damage.

NOTE

Check radiator fins for dirt/dust accumulation. Get it cleaned from nearest **TATA MOTORS** Authorised Workshop if required.

NOTE

If 'No loss' tank is found completely empty, top up coolant through radiator as well as auxiliary tank cap.

⚠ CAUTION

Never remove the filler cap when the engine is hot. Use only branded premixed ready to use coolant. In case of emergency use normal water only. When a proper coolant mixture is available, the entire system should be flushed & filled with the same at the earliest.

AIR FILTER :

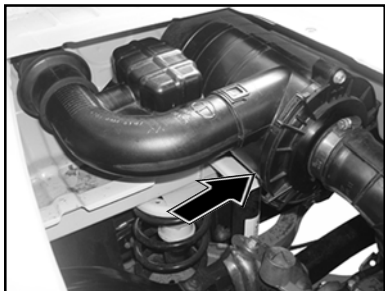

The air filter element should be periodically cleaned.

Always use a genuine air filter element.

The air filter is located on the LH side of the engine compartment.

- a) When a vehicle is driven under dusty conditions, frequent cleaning and replacement of the air-cleaner element is necessary.
- b) Blow air from inside to outside while cleaning the air cleaner element. Clogged air-cleaners lead to greater intake resistance and result in increased fuel consumption. Using low pressure compressed air, blow off dust on the air cleaner element. If the air cleaner element appears to be choked, replace it with a new one.

SPARK PLUG :

Make : Champion RC10YC

Electrode Gap : 0.8 to 0.9 mm

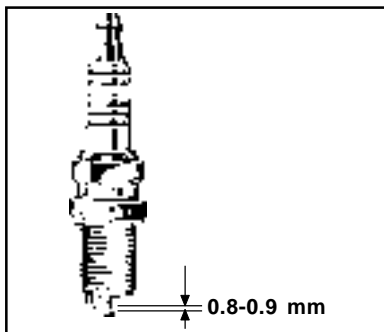

⚠ CAUTION

Tighten the spark plug carefully. Overtightening can damage the threads in the cylinder head. It can affect combustion and cause damage to engine and catalytic converter.

Tyres

Check for inflation and condition of your car tyres periodically.

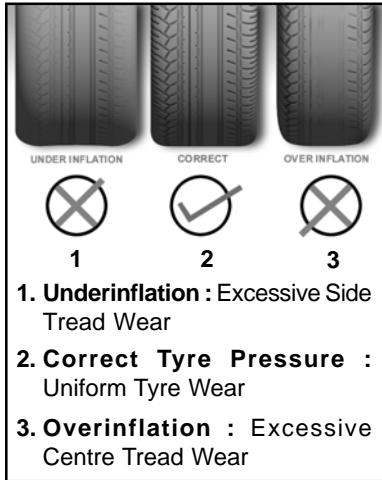

Inflation :

Check the pressure in the tyres when they are cold.

You should have your own tyre pressure gauge and use it at all times. This makes it easier for you to tell if pressure loss is caused by a tyre problem and not by variation between gauges.

Keeping the tyres properly inflated gives you the best combination of comfort, handling, tyre life and better fuel efficiency.

Over inflation of tyres makes the car ride bumpy and harsh. Tyres are more prone to uneven wear and damage from road hazards.

Under inflated tyres reduce your comfort in car handling and are

prone to failures due to high temperature. They also cause uneven wear and more fuel consumption.

⚠ CAUTION

Every time you check inflation pressure, you should also examine tyres for damage, foreign objects and wear.

Recommended Tyre Pressures

Tyres size :

Front	135/70R12
Rear	155/65R12
Spare	135/70R12

Tyre pressure :

Front	26 - 28 psi (1.7-1.9 bar)
Rear	28 - 30 psi (1.9-2.1 bar)
Spare	28 - 30 psi (1.9-2.1 bar)

⚠ CAUTION

Replace the tyre if you find either of these conditions.

- Bumps or bulges in the tread or the side of the tyre.
- Cuts, splits or cracks in the side of the tyre. Replace the tyre if you notice this on the fabric or cord.
- Excessive tread wear or non uniform tyre wear.
- The wear indicators appear between the tread grooves when tread depth is 1.6mm or less.
- Always dispose of worn tires according to local environment regulation.

Repairing a Tyre :

Mark the tyre position (if original colour dot mark is not visible) with respect to valve stem hole to ensure that the tyre is refitted in the original location on the wheel rim.

Ensure that balancing weights are not disturbed during removal of tyres.

Check the balance weight prior to the removal of the tyre. If found loose, mark its location on the rim & refit properly.

Balance the wheel after every dismantling and assembly of tyre on the wheel rim if required.

While fitting wheels on the vehicle ensure that wheel pins are free from dust, scratches, dirt, dents, etc.

NOTE

Do not apply any oil on the wheel pins. Wipe off the oil if present.

Special care for tubeless tyres

1. While removing tyre from wheel rim and mounting it back on wheel rim, take precautions not to damage tyre bead. Use tyre removal and assembly machines. Damage or cut on tyre bead may cause gradual loss of air and deflation of tyre.
2. Do not scratch inside of tubeless tyre with metallic or sharp object. Tubeless tyres are coated with impermeable layer of rubber from inside which holds the air

inside the tyre. Removal of this layer due to scratching may cause gradual loss of air and deflation.

3. If wheel rim gets damaged in service, get the wheel rim repaired/replaced immediately. Running the vehicle with damaged rim may cause deflation of tyre and subsequent dislodging of tyre from rim.
4. Maintain recommended inflation pressure. Over-inflation, in particular, may cause puncture or bursting of tyre.

NOTE

Life and wear pattern of tyres depends on various parameters like tyre pressure, wheel alignment, wheel balancing, tyre rotation, etc. It also largely depends on vehicle speed, load carried, usage, driving habits, road conditions, tyre quality, etc. In case fault is suspected to be due to poor quality of tyres, the same may be taken up with concerned tyre manufacturer.

Wheel alignment :

Incorrect wheel alignment causes excessive and uneven tyre wear. Check wheel alignment at specified intervals from **TATA MOTORS** Authorised Workshop.

Wheel Balancing :

Wheels of your vehicle are balanced for better ride comfort and longer tyre life. Balancing needs to be done whenever tyre is removed from rim.

Wheel Alignment Data :**Front Wheel Alignment Values (Unladen Condition) :**

Camber Angle : 1.0° (+ve)

Castor Angle : 7.6°

Toe-In : 45'

Wheel Lock Angle (Outer) : 37°

LH / RH Variation in Castor : 45'

Rear Wheel Alignment Values (Unladen Condition) :

Camber Angle : 0.75° (+ve)

Toe-out : 9'

Care for the Catalytic Converter:

The catalytic Converter does not require any special maintenance however, following precaution should be taken for the effective functioning of the converter and to avoid damage to the Converter.

- It is mandatory to use only unleaded regular grade petrol. Use of any other petrol or adulterated fuel can increase

the pollutants and may permanently damage the catalytic converter..

⚠ CAUTION

Avoid parking the vehicle over inflammable materials, such as dry leaves, grass etc., as the exhaust system is hot enough to initiate 'FIRE'

⚠ CAUTION

- Maintain the engine in the proper operating condition.
- In the event of an engine malfunction, particularly one involving engine misfire or other apparent loss of performance, have the vehicle serviced promptly.
- Do not turn off the engine or interrupt the ignition when the transmission is in gear and the vehicle is in motion.
- Do not try to start the engine by pushing or towing the vehicle, or coasting down a hill.
- Do not idle the engine with any spark plug wires disconnected or removed, such as during diagnostic testing.
- Do not idle the vehicle for prolonged periods if idling seems rough or there are other malfunctions.
- Do not allow the fuel tank to get near the empty level.

Battery :

Battery is located below driver seat

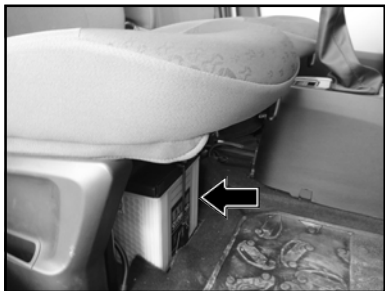

Check the battery for proper electrolyte level and corrosion on the terminals.

1. Check the battery for electrolyte level against the marking on the battery outer case.
2. Check the battery terminals for corrosion (a white or yellowish powder). To remove it, cover the terminals with a solution of baking soda. It will bubble up and turn brown.
3. When this stops wash it off with plain water. Dry off the battery with a cloth or paper towel.
4. Coat the terminal with petroleum jelly to prevent future corrosion.

Use a proper wrench to loosen and remove cables from the terminals.

Always disconnect the negative (-ve) cable first and reconnect it last.

Clean the battery terminals with a terminal cleaning tool or wire brush.

Reconnect and tighten the cables,

coat the terminals with petroleum jelly.

Ensure that battery is securely mounted.

If you need to connect the battery to a charger, disconnect both cables to prevent damage to the vehicle's electrical system.

NOTE

During normal operation, the battery generates gas which is explosive in nature, a spark or open flame can cause the battery to explode causing very serious injuries.

Keep all sparks & open flames and smoking materials away from the battery.

Getting electrolyte in your eyes or on the skin can cause severe burns. Wear protective clothing and a face shield or have a skilled technician to do the battery maintenance.

The battery contains sulphuric acid (electrolyte) which is poisonous and highly corrosive in nature.

Always ensure to get the specific gravity of the battery checked as per the maintenance schedule.

When checking or servicing the battery, disconnect the negative cable. Be careful not to cause a short circuit by allowing metal objects to contact the battery posts and the vehicle at the same time.

**PLEASE USE ONLY FOLLOWING GENUINE OILS, COOLANTS ,
LUBRICANTS , ANTI RUST & SOUND DEADENING COATS, WINDSCREEN
SEALANT, BRANDED BY TATA MOTORS FOR OPTIMUM PERFORMANCE
OF YOUR CAR...**

ITEM	SPECIFICATION	COMPANY & BRAND	QTY
ENGINE OIL	SAE 15W40 API OR ASE 5W30 ACEA A5/B5	CASTROL-Castrol GTX Compact 15W40 CASTROL-Magnatec Professional T5W30 EXXON Mobil - Mobil Super 1000X2 15W40 HPCL 15W40 HP Cruise TGO	2.2 Ltrs
COOLANT (MT)	50:50 ratio premixed Confirming to -JIS K 2234 Class	SCCI - Golden Cruiser Premium 1400 NA HPCL - Thanda Raja P TGO CASTROL - Radicool	2.4 Ltrs (W/O Heater) 4.0 Ltrs (With Heater)
COOLANT (AMT)	50:50 ratio premixed Confirming to -JIS K 2234 Class	SCCI - Golden Cruiser Premium 1400 NA HPCL - Thanda Raja P TGO CASTROL - Radicool	7.2 Ltrs (W/O Heater) 8.3 Ltrs (With Heater)
TRANSAXLE	EP 80	CASTROL - Extreme Pressure 80 EP HPCL - Gear Oil EP 80 TGO	1.4 Ltrs
AMT KIT OIL		Hydraulic Oil PETRONAS TUTELA Cs-Speed	0.5 Ltrs
BRAKE FLUID	DOT 4	HPCL - Super Duty Brake Fluid DOT - 4 CASTROL - Universal Brake Fluid DOT 4 SCCI -Golden Cruiser TGBF DOT 4	As required
ANTI RUST TREATMENT and SOUND DEADENING		DINITROL - Dinitrol WUERTH - Wuerth 3M - 3M	— — —
WIND SCREEN SEALANT		WUERTH - Wuerth 3M - 3M Car System - Car System	— — —

FUEL :

Vehicles with catalytic converter :

Unleaded regular grade petrol confirming to IS 2796/DIN 51607 (or equivalent) & octane rating of more than 81 RON is recommended as fuel (RON stand for Research Octane Number).

⚠ CAUTION

Do not use leaded petrol in the car fitted with catalytic converter. Even single fill of leaded petrol will seriously damage the catalytic converter.

LUBRICANTS :

Engine Oil :

Recommended grade of engine oil confirming to 15W40 API - SJ OR 5W30 ACEA - A5/B5 specification & range of ambient temperature at which these can be used are given in the table below :

Ambient temp. in deg. C	Engine Oil grade
-10° & above	SAE 15W/40 API OR SAE 5W30

Transaxle :

Use recommended brand of EP 80 grade oil.

Grease for steering rack :

EP 2 Servo Gem.

Brake Fluid : IS 8654(2001) / DOT 4.

COOLANTS :

Presence of dirt in coolant chokes up passages in radiator, cylinder head and crankcase, thereby causing overheating of engine.

To prevent rust formation and freezing of coolant inside the passages of radiator, crankcase and cylinder head use premixed coolant as recommended.

It is recommended that the entire cooling system should be drained and filled with fresh premixed coolant.

Engine coolant antifreeze coolant as per JIS K2234, Class 2.

Windscreen Washer Antifrost

- Make - Antifrost- K
- Concentration - 1 : 5 For 0°C
- 1 : 1 For 10°C
- 2 : 5 For 16°C
- 1 : 0 For 37°C

NOTE

We strongly recommend to refill engine coolant only at **TATA MOTORS** Authorised Workshop.

Engine Oil Filling Cap :

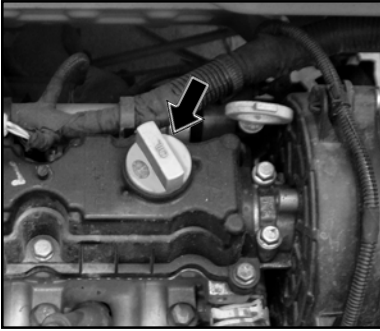

Engine Oil Drain Plug :

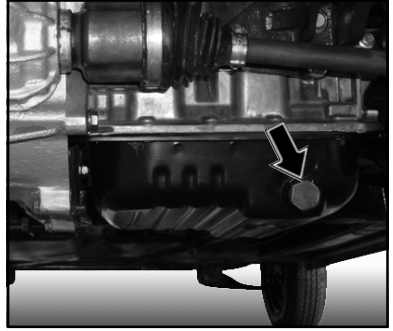

Transaxle Oil Level Plug :

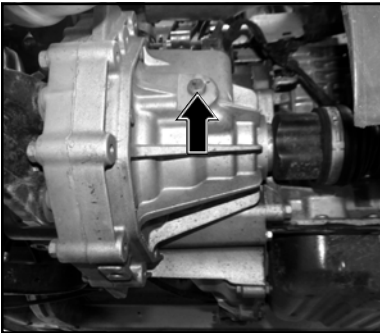

Transaxle Oil Drain Plug :

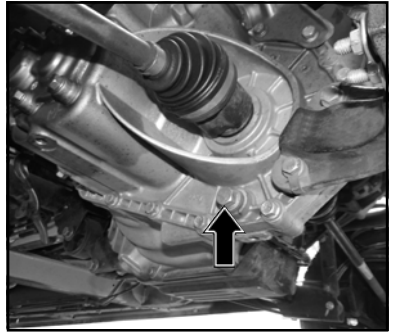

Transaxle Oil Filling Plug :

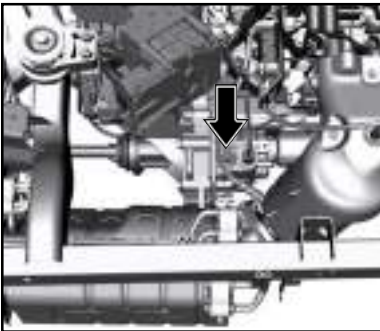

1. ENGINE	
Model	273 MPFI (BS-IV-OBD-II)
Type	4 Stroke, water cooled, multipoint fuel injection system, SOHC, 2V/Cylinder
No. of Cylinders	2 in-line
Bore / Stroke	73.5 mm x 73.5 mm.
Capacity	624 cc
Max. Engine Output	38 PS at 5500 +/-250 rpm as per IS:14599 / ISO :1585
Max. Torque	51Nm at 4000 +/-500 rpm as per IS:14599 / ISO :1585
Engine Oil Capacity	2.2 Litre
Compression Ratio	10.3 : 1
2. CLUTCH	
Type	Single plate dry friction diaphragm type
Outside diameter of clutch lining	160 mm
Friction Area	212 cm ²
3. TRANSAXLE	
Type	Synchromesh on all forward gears, sliding mesh for reverse gear.
Model	TA 59 4 speed (MT) / TA 59 5 speed (AMT)
No. of gears	4 Forward & 1 Reverse (MT) / 5 Forward & 1 Reverse (AMT)
4. SUSPENSION	
Front	Independent suspended.
Rear	Independently Suspended Semi Trailing Arm Suspension with Gas filled Hydraulic Shock Absorber
5. STEERING	
Type	Mechanical Rack & Pinion steering / Mechanical Rack & Pinion steering with electric power steering
Steering Wheel	360 mm dia.
Ratio	15 : 1

6. BRAKES	
Type	Dual circuit, Vertical split type split hydraulic brake.
Front Brakes	180 mm dia. drum brake
Rear Brakes	180 mm dia. drum brake
Parking Brakes	Lever type, Cable operated mechanical linkages acting on rear wheels.
7. WHEELS AND TYRES	
Tyres	Front :135/70R12 (Radial Tubeless)
	Rear: 155/65R12 (Radial Tubeless)
	Spare :135/70R12 (Radial Tubeless)
Wheel Rims	4B X 12
No. of Wheels	Front - 2
	Rear - 2
	Spare Wheel - 1
8. FUEL TANK	
Capacity	24 litres
9. BODY	
Type	Semi-mono Volume, Mini size, 4 door, steel monocoque body.
10.ELECTRICAL SYSTEMS	
System Voltage	12 Volts -ve earth
Battery	12V, 35AHr
Alternator Capacity	12V, 70 A (Option-I) /12V, 70 A (Option-II)
11.PERFORMANCE	
Max. speed	105 kmph (Non EPAS) / 120 kmph (EPAS)
Max. Gradiability @ rated GVW	30%

12. WEIGHTS (kg) (TOLERANCE AS PER EEC 92/21)	
Complete vehicle kerb weight as per ISO:1176 (with spare wheel & tools)	700 (MT Vers-1) / 755 (AMT Vers-1) 710 (MT Vers-2) / 765 (AMT Vers-2) 765 (MT Vers-3)
Gross Vehicle Weight	1000 (MT Vers-1) / 1055 (AMT Vers-1) 1010 (MT Vers-2) / 1065 (AMT Vers-2) 1065 (MT Vers-3)
Payload	300 (For ALL)
13. PASSENGER CAPACITY	
Passenger Capacity	2 front + 2 rear
14. LUGGAGE SPACE	
Net inside loading space	0.1 Cubic Meter Upto rear seat back rest; 0.5 Cubic Meter Upto / front seat back rest when rear seats folded.

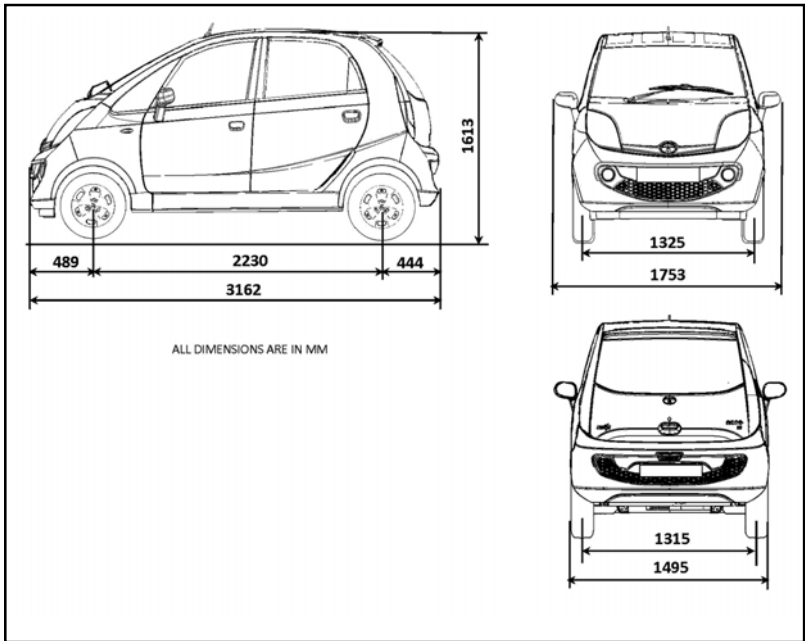

MAIN CHASSIS DIMENSIONS (IN mm)

Wheel Base	2230
Track Front	1325
Track Rear	1315
Front Overhang	489
Rear Overhang	444
Overall Length	3162
Max. Width	1495 - Over body 1753 - Over ORVM
Overall Height (Unladen / laden)	1652 / 1613
Minimum Turning Circle Dia.	8.0 m
Minimum Turning Clearance Circle Dia.	8.3 m
Ground Clearance	152

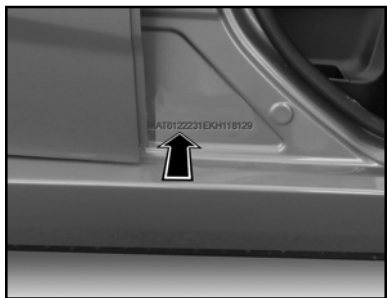

Chassis Number Punching on
RH Front door 'B' Pillar



Chassis Number Plate mounted
on front cross member, below
bonnet

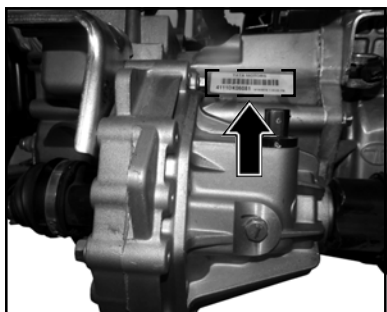

Transaxle Number Location



Engine Number Location

SERVICE MAINTENANCE SCHEDULE

	OPERATION	FREQUENCY	1000-1500	10000-10500	20000-20500	30000-30500	40000-40500	50000-50500	60000-60500	70000-70500	80000-80500	90000-90500	100000-100500
			3	12	24	36	48	60	72	84	96	108	120
		Month											
	GENERAL												
1	Wash the vehicle & clean condenser fins	Every Service	•	•	•	•	•	•	•	•	•	•	•
2	Check & top up fluids (if required) : Engine oil, Coolant, Brake fluid, Wind screen washer fluid. Adjust wind screen washer nozzles if required.	Every Service	•	•	•	•	•	•	•	•	•	•	•
3	Check fuel lines & transaxle housing for leakages	10000		•	•	•	•	•	•	•	•	•	•
4	Check rubber boots & bushes for damage	20000			•			•		•		•	
5	All standard checks as per job card (As applicable)	Every Service	•	•	•	•	•	•	•	•	•	•	•
	ENGINE												
1	Clean air filter element (More frequent cleaning if dust condition is severe)	10000		•	•	•	•	•	•	•	•	•	•
2	Replace air filter element (More frequent replacement, if dust condition is severe)	30000				•			•			•	
3	Change Engine oil and Oil filter (10000 km OR 12 months whichever is earlier)	10000		•	•	•	•	•	•	•	•	•	•
4	Change fuel filter	10000		•	•	•	•	•	•	•	•	•	•
5	Check drive (Alternator & AC) belts for tension, adjust tension if required, replace if necessary	Every Service	•	•	•	•	•	•	•	•	•	•	•
6	Replace Alternator belt (40000 km OR two years whichever is earlier)	40000					•				•		
7	Replace AC compressor belt, if required	100000											•
8	Check timing belt, replace if necessary	40000					•				•		
9	Replace timing belt	100000											•
10	Change coolant (40000 km OR two years whichever is earlier)	40000					•				•		
11	Replace Spark Plug	30000				•			•			•	
12	Check HT lead on engine for cracks or deformation (Only visual check. Do not remove), replace if necessary.	40000					•				•		
13	Check the radiator core for dust, mud or mug accumulation and clean core from outside if required	10000		•	•	•	•	•	•	•	•	•	•
14	Check coolant lines for leakages (Only visual check)	10000		•	•	•	•	•	•	•	•	•	•
15	Exhaust System (abnormal noise from muffler, leakage through gasket joints, rubber hangers & other durability parts) Applicable only for AMT vehicles	10000		•	•	•	•	•	•	•	•	•	•
	TRANSAXLE												
1	Change Transaxle oil and clean drain plug.	20000			•		•		•		•		•
2	Inspect Driveshaft for Boot cuts, etc	Every Service	•	•	•	•	•	•	•	•	•	•	•
3	Check & Adjust free play of Clutch release cable	Every Service	•	•	•	•	•	•	•	•	•	•	•
4	Check AMT Kit oil level, it should be in between min. & Max. level when the vehicle is in standstill and ignition ON condition. Top up AMT kit oil if necessary.	Every Service	•	•	•	•	•	•	•	•	•	•	•
	BRAKES												
1	Check front and rear brake linings. Clean or Replace, if necessary.	20000			•		•		•		•		•

SERVICE MAINTENANCE SCHEDULE

	OPERATION	FREQUENCY x 1000 km	1000-1500	10000-10500	20000-20500	30000-30500	40000-40500	50000-50500	60000-60500	70000-70500	80000-80500	90000-95500	100000-100500
			Month	3	12	24	36	48	60	72	84	96	108
2	Clean the brake drums with air	10000	•	•	•	•	•	•	•	•	•	•	•
3	Replace brake fluid (40000 km OR 2 yrs whichever is earlier)& check brake system components for leakages	40000				•					•		
WHEELS & TYRES													
1	Tyre Swapping with balancing (Front with Front & Rear with Rear)	10000	•	•	•	•	•	•	•	•	•	•	•
FRONT & REAR SUSPENSION													
1	Check and adjust wheel alignment	10000	•	•	•	•	•	•	•	•	•	•	•
ELECTRICAL													
1	Check specific gravity and level of battery electrolyte (10000 km OR Every 1 year)	10000	•	•	•	•	•	•	•	•	•	•	•
2	Check headlamp focusing	30000				•			•			•	
AC SYSTEM													
1	Check AC / HVAC system for satisfactory performance	Every Service	•	•	•	•	•	•	•	•	•	•	•
2	Clean HVAC / AC Unit air filter	Every Service	•	•	•	•	•	•	•	•	•	•	•
3	Replace HVAC / AC Unit air filter	30,000				•			•			•	
DIAGNOSTIC													
1	Check for DTC in the Engine and EPS 'Electronic Control Unit'using diagnostic tool. Take corrective action if necessary, Clear the DTCs	Every Service	•	•	•	•	•	•	•	•	•	•	•

Service Instructions :

The **Tata Nano** has been manufactured to give you economical and trouble free performance. To achieve this please follow the instructions as stated.

Your Car is entitled to Three free services (labour only). The free service coupons are attached to the sales invoice. Please present these coupons to the servicing dealer while availing free services.

1st free service - At 1000-1500 km. OR 3 month whichever is earlier

2nd free service - At 10000-10500 km. OR 12 months whichever is earlier

3rd free service - At 20000-20500 km. OR 24 months whichever is earlier

All services other than free services are chargeable.

Servicing of the car can be done at any **TATA MOTORS** Authorised Dealer Workshop, **TATA MOTORS** Authorised Service Centre (**TASC**). The details of their locations are given in this manual.

Warranty claims can be settled by any **TATA MOTORS** Authorised Dealer for all failures, while all warranty claims excluding the consideration on the replacement of major aggregates, can be settled by any TASC which is authorised for handling warranty claims. **TASPs will not handle warranty repairs.**

1. Features

- AM/FM Tuner
- CD supports CD-DA .mp3 and .wma formats
- USB supports .mp3 and .wma formats
- Aux audio input support
- Power Output: 4 x 25W RMS
- Audio equalizer adjustment for Bass, Treble, Balance, Fader settings
- Audio preset settings: Jazz, Pop, Rock, Classic
- Bluetooth supports Audio streaming (A2DP), Hands Free Profile (HFP) and AVRCP 1.3 (Play, Pause, Mute & Unmute, Previous track & Next track commands)





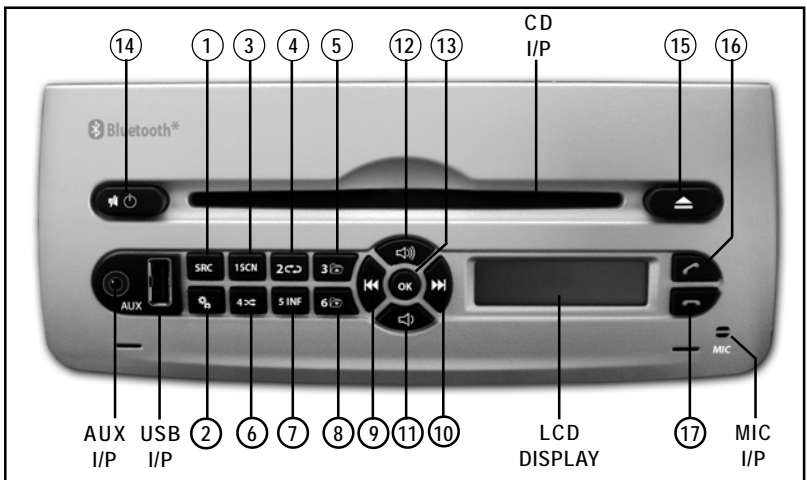
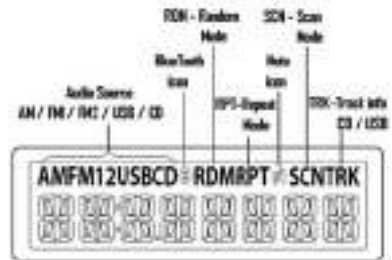

2. Controls





2.1. LCD Display







The display is used to exhibit tuner & media information, CD/USB track/ folder information (English) and play-time etc.



2.2. Button Functions :

No	Key	Name / Function / Description
1		Short press: Audio source change (AM/FM/CD/USB/AUX)
		Long press: Auto Store in tuner (AM/FM) mode
2		Enter / Cancel setting menu
3		Short press: Play stored AM/FM station / frequency in AM/FM mode, Scan tracks in CD/USB playback mode.
		Long press: Store AM/FM station/frequency in AM/FM mode.
4		Short press: Play stored AM/FM station/frequency in AM/FM mode. Repeat track in CD/USB playback mode.
		Long press: Store AM/FM station/frequency in AM/FM mode.
5		Short press: Play stored AM/FM station/frequency in AM/FM mode. Folder Up in CD/USB playback mode.
		Long press: Store AM/FM station/frequency in AM/FM mode.
6		Short press: Play stored AM/FM station/frequency in AM/FM mode. Random track in CD/USB playback mode.
		Long press: Store AM/FM station/frequency in AM/FM mode.

7		Short press: Play stored AM/FM station/frequency in AM/FM mode. Displays track information in CD/USB playback mode.
		Long press: Store AM/FM station/frequency in AM/FM mode.
8		Short press: Play stored AM/FM station/frequency in AM/FM mode. Folder down in CD/USB playback mode.
		Long press: Store AM/FM station/frequency in AM/FM mode.
9		Short press: Manual seek down in AM/FM mode Previous track in CD/USB mode Decrease BASS, TREBLE, BALANCE, FADERR values of audio settings.
		Long press: Auto seek down in AM/FM mode Fast reverse in CD/USB mode
10		Short press: Manual seek up in AM/FM mode. Next track in CD/USB mode. Increases BASS, TREBLE, BALANCE, FADERR values of audio settings.
		Long press: Auto seek up in AM/FM mode. Fast forward in CD/USB mode.
11		Volume down in audio playback mode.
		Traverse/ Select the different audio setting such as BASS, TREBLE, BALANCE, FADERR, Audio presets in the Menu.

12		Volume up in audio playback mode. Traverse/Select the different audio setting such as BASS, TREBLE, BALANCE, FADERR, Audio presets in the Menu
13		Confirms the modified settings in the Menu.
14		Short press: Mutes the Audio playback. Long press: Turns Music system ON/ OFF.
15		Eject the CD
16		Enters into BT mode to pair mobile. Starts audio streaming from mobile if it is connected and audio is being played from mobile Accepts incoming call
17		Short press: Exit BT mode Rejects incoming call Long press: Deletes paired mobile

3. SAFETY PRECAUTIONS

To avoid risk of damage and/or fire, observe the following precautions:

- To avoid short-circuits, never insert metallic objects (for instance: coins or metallic tools) into the unit.
- If you notice that the unit is releasing smoke or strange smell, promptly disconnect the supply and consult the nearest **TATA MOTORS** Authorized Workshop.
- Pay attention not to let the unit fall down, and neither beat the device strongly. Glass internal components of the unit may get damage, making it non-operative.
- If the LCD (Liquid Crystal Display) is damaged or broken as a result of a crash, never touch the liquid crystal fluid inside it. The liquid crystal fluid may be harmful to your health. If that fluid gets in contact with your body or clothes, wash it promptly with water and soap and seek for medical help.
- Do not place 8 cm dia. (3 inches) compact disks into the CD opening. If you try to place into the device an 8cm CD with its adaptor, it may separate from the CD and damage the unit.

Cleaning of the Unit

If the front panel of this unit is dirt, clean it with a dry cloth or slightly soaked in water. If the front panel is too dirty, clean it with a cloth

moistened with neutral soap and then repeat the prior operation.

⚠ CAUTION

Do not use any cleaning spray with this unit, as that can affect its mechanical parts. If you clean the front panel with a rough cloth or using a volatile liquid, like solvent or alcohol, that may scratch the surface or erase some characters.

Important warnings about the use of the Bluetooth device

Your car Infotainment system has a built-in Bluetooth device. As explained in this manual, such device will enable a wireless connection of you Infotainment system to compatible cell phones and multimedia devices which also have a built-in Bluetooth device.

Below are important aspects about the operation of the Bluetooth function in your Infotainment system:

1. The Infotainment system can support only one Bluetooth device pairing at a time. For instance, you cannot use your Infotainment system to pair two cell phones concurrently to undesirable communication.
2. Your Infotainment system will automatically reconnect the cell phone or multimedia device you have paired. If you do not want an automatic connection of your Infotainment system, take one of the following measures to disable this option:

- Turn off the Bluetooth function in the cell phone or multimedia device that would be automatically connected.
- Keep the cell phone or multimedia device that would be automatically connected in the OFF state.
- Delete from the connected BT phone from the Infotainment system.
- Limited reach of some transmitters;
- Distortion caused by signals reflected in local buildings and other obstructions;
- “Shadow zones” wherein the signal reception is obstructed or restricted;

CAUTION

The automatic connection will be always ON, as long as the radio's Bluetooth function is active.

Failure to take any one of the above measures can cause an undesirable communication.



CAUTION

Do not insert sharp objects into and do not obstruct bluetooth microphone holes as that can cause damage or malfunctioning of the same leading to undesirable communication.



4. OPERATIONS

4.1 General operation

4.1.1. ON / OFF Key

- Long Press   Power button to turn the Infotainment system on and off
- If the Accessory is ON radio goes to the last used mode. If the last mode is not available anymore, it goes to the tuner source.
- When the Accessory is turned OFF, the Infotainment system will not turn ON.
- Illumination for the LCD & bezel buttons will follow the park lamp input.

4.1.2. Volume buttons

- Press  button to increase volume
- Press  button to lower the volume

Radio reception

Always memorize the desired stations using the radio memory keys. This will help you select desired station in a faster manner.

AM Reception (Medium Waves)

At most conditions, strong AM signals provide stable sound quality and with low sign noise. At night, however, the atmospheric conditions may sometimes lead to interference from other stations.

FM Reception

FM zone offers best quality sound reception; however, the signal intensity may be subjected to noise caused by:

- Audio volume is adjusted in the Tuner, CD, USB, BTA and Aux-In modes.
- Volume levels range from 0 to 30.



4.1.3. SOURCE CHANGE

Each time the  key is pressed, the available sources can be selected in the following this sequence: FM1→FM2→AM→CD→USB→AUX→FM1



CAUTION

The CD, USB and AUX options can be selected only if devices are available. Tuner option will always be available.

4.1.4. MENU

On pressing  and Each Key press of  /  one of the following music options can be adjusted.

- Bass Adjust
- Treble Adjust
- Balance Adjust
- Fader Adjust
- Equalizer Activation

Press  /  buttons to adjust the selected option.

4.1.5. MUTE / PAUSE

- Short press  Power button to mute / pause the audio source.
- “MUTE” icon will be flashed when muted or volume reduced to zero in AM/FM and AUX modes.
- Radio will pause CD / USB play during mute period and will display “PAUSE”.

- When there is an on-going call via BT of the audio unit then it will enter microphone mute mode. Refer relevant section.
- Mute will automatically get cancelled, when there is a source change or AST or Preset selection or Press of Volume Up/Down buttons.

5. Tuner

5.1. AM Reception (Medium Waves)

At most conditions, strong AM signals provide stable sound quality and with low sign noise. At night, however, the atmospheric conditions may sometimes lead to interference from other stations.

AM signals are susceptible to interference caused by the emissions of electronic control units. Noise amplitudes vary randomly at AM frequencies. Change in noise amplitude modulates the signal and it may get picked up by the tuner.

5.2. FM Reception

FM zone offers best quality sound reception, however, the signal intensity may be subjected to noise caused by limited range of some transmitters and distortion caused by signals reflected in local buildings and shadow zones wherein the signal reception is obstructed or restricted.

FM signals cannot pass though tall buildings, hills and get reflected resulting in poor FM reception.

Phenomenon of multiple reflections from hills and tall buildings may result in no reception or poor reception known as multipath effect.

5.3. Tuner operation



5.3.1. Frequency Band Select

Press  key to access the selected frequency bands FM1, FM2 or AM.

The radio will display Tuner band and frequency to show that the radio is in the tuner source.

5.3.2. Auto seek



In tuner mode, you can execute an automatic seek for the next active infotainment radio station broadcast within the currently selected frequency band.

Press and Hold the  /  key to execute an upward / downward frequency auto seek.

During the auto frequency, LCD will display the frequency of each valid infotainment radio.

If no valid station found then the seek function stop at one round (stop at the frequency where tuner start seeking. During an auto seek process; if user presses any preset buttons then corresponding station will be played.

5.3.3. Manual Frequency Tuning

When the radio is in FM or AM mode, short press the  /  button to step up/down the frequency band by one step.

LCD display will show current frequency.

AM frequency step is 9 kHz and FM frequency step is 100 kHz..

5.3.4. Auto store

When radio is in tuner mode, a long press on  will execute the auto store function.

When the auto-store starts, the radio will sweep the frequency band and try to locate the 6 strongest radio stations and store their frequencies into associated FM1/FM2/AM memory locations 1 - 6. The store sequence is from strongest to weakest (1 to 6).

When auto-store has finished, the radio will switch to the FM1/FM2/AM band at preset location one.

If no active radio stations are located during the auto store operation, the radio will recall preset 1 frequency.

During auto storage process, if seek button is pressed then the ongoing process will be stopped and preset 1 will be played.

During auto storage process, if any preset button is pressed then corresponding station will be played.

5.3.5. Tuner preset 1 to 6

Preset functionality allows storing or selecting a given radio frequency within one of the reception ranges (FM1, FM2 and AM).

The audio channels are briefly muted (during the storing period) to acknowledge the preset has been stored and the display panel

updates with the new preset number.

5.3.6. To select the memories

Short press of a preset button [1] to [6], recalls the radio station frequency from memory; the tuner will change to this recalled frequency.

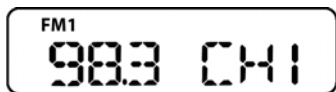

To Store a station

Press & hold preset button [1] to [6], overwrites the frequency previously stored in that memory location with the current frequency.

6. CD Playback

6.1. CD Care and maintenance

6.1.1. CD Opening cleaning

As dust tends to accumulate at the CD opening, clean it up periodically. Remember that your compact disks (CD) may be scratched if placed at the CD opening with accumulated dust.

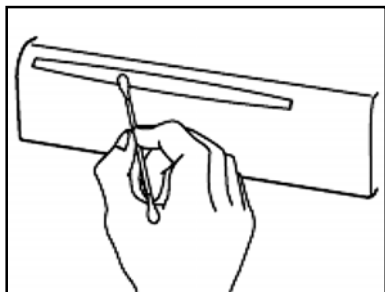

Important : Your audio unit may be damaged if improper objects are inserted into it, like credit cards or coins, through the CD opening.

6.1.2 Precautions regarding operation

- If your car has been parked under the hot sun, let the unit cool down before activating it.
- Be careful not to let juice or soft drinks drip on the unit or on the disks.

6.1.3 Wetness Condensation

In a rainy day or in a very humid region, humidity may be condensed inside the laser reading lenses and on the unit display. If it happens, the unit will not work properly. In this case, remove the disk and wait about one hour until the humidity has evaporated.

6.1.4 CD Handling

- Do not touch the CD recorded surface.

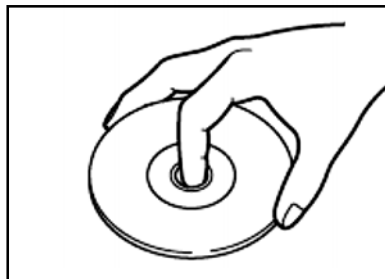

- Do not place them exposed to direct sun light (over the seat or control panel, etc.) or under high temperature.

- Keep the CDs on their boxes or in any other that protects them from being scratched.
- Do not place adhesives or other such materials on the CD. Also, do not use a CD with an adhesive.
- Due to their manufacturing process, CD-R and CD-RW are more susceptible of being damaged than a common musical CD (Compact Disk). Use a CD-R or CD-RW after reading the precaution items in the CD labeling. When using a new CD If the CD central hole or the external margin presents burrs, use it after removing the burrs with a pen.

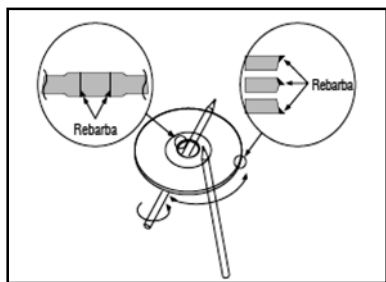

6.1.5 CD Accessories

- Do not use disk accessories
- Do not stick labels nor use disks with sticky paints / residues. Disks may stop turning when used, causing defects or they may be damaged.

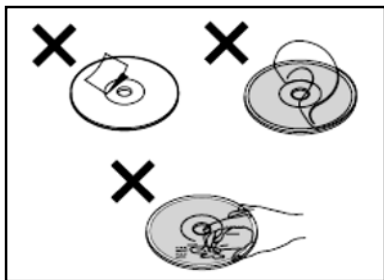

6.1.6 CD Cleaning

Clean CDs using a soft and dry cloth. Movements shall always be made from the center to the edge of the disk and in a soft way.

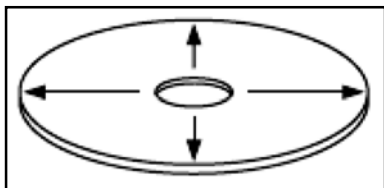

6.1.7 CDs removal

When removing the CDs from this unit, store them at the horizontal position.

6.1.8 CDs that cannot be used

- CDs which are not round shaped cannot be used.

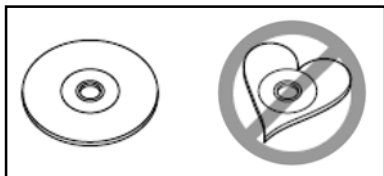

- CDs painted in the recording surface, or those which are dirt cannot be used.

- Do not insert the 80mm CD/ credit or Debit visiting card. Such items cannot be taken out.
- Do not insert the disc with the additional stickers on top of the disc.
- Do not use CDs without the disk mark.



- It is not possible to reproduce a CD-R or CD-RW which has not been formatted. (For the formatting process consult your CD-R / CD-RW software and the instructions manual of the CD-R / CD-RW recorder.

Music disks encoded with copyrights protection

This product has been designed to reproduce disks that comply with the Compact Disk (CD) standard. Recently, some labels have commercialized several encoded music disks with copyrights protection.



It should be noted that, among those disks there are some which do not comply with the CD standard, and it might not be possible to reproduce them in this audio unit.

Important : Some CD-Rs / CD-RWs (depending on the equipment used for recording or the disk condition) might not be played in this unit.

6.2. CD Operation

6.2.1. LOAD

The infotainment will display "LOAD" while the CD mechanism is loading.

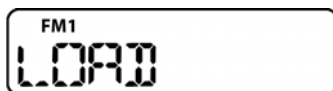

6.2.2. EJECT

Press the  Eject key to eject the CD from the radio.

The radio will display "EJECT" during the ejecting, the timeout is 2s. If the ejected disc is not removed in 12s, it will be reloaded again and the radio shall play the last active tuner source (FM1/FM2/AM).

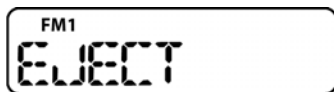

6.2.3. READING :

After a CD is inserted into the slot, the CD-mechanism will initiate playing the CD, the radio will display "READ" to indicate that the radio is start to read the disc. (Before the

radio start to read the disc, radio will still play previous source such as tuner, USB, AUX). If the disc is playable, the radio will start to play the disc and display track information (track number and track play time).

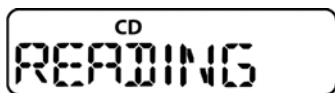

6.2.4. ERROR HANDLING :

If there is CD ERROR encountered during the initiating disc, and the disc cannot be readable, the radio will display "ERROR" for 2s, the bad CD will be ejected, and radio will go to last active tuner source (FM1/FM2/AM). For any disc other than CD-DA/CD-R/CD-RW, ERROR message will be displayed and CD will be ejected. If CD is inserted upside down then ERROR will be displayed for 2s and CD will be ejected out.

6.2.4.1. NO CD :

During Eject operation, if there is no CD within the slot the radio will display "NO CD" for 2s.



6.2.4.2. CD with corrupted tracks

If the CD has corrupted files then display will be updated as "BAD TRK" and the track will be skipped and CD will continue its operation.

6.2.4.3. CD Error

If there is a CD ERROR encountered during the initiating phase or the disc cannot be read, the Infotainment system will display "ERROR" for 2s and the error CD will be ejected out. The Infotainment system will go to last active tuner source (FM1/FM2/AM). For any disc other than CD-DA/CD-R/CD-RW, ERROR message will be displayed and CD will be ejected.

If CD is inserted upside down then ERROR will be displayed for 2s and CD will be ejected out.

6.2.5 Track Information

While the CD-player is playing an MP3/WMA track, the user can view the MP3/WMA track information via (INFO) button press, the default display content is Track number and playing time.

CD insertion during active call.

If a CD is inserted during a call, the CD mechanism will load it and the call will proceed normally.

Important : Once call is concluded, the Infotainment will return to the source you used last, and not to CD source.

6.2.6. MP3 / WMA FILE FORMATS

6.2.6.1. Notes on the MP3 / WMA reproduction

MP3 / WMA files which can be reproduced (hereinafter referred to as audio files) and the media format have the following limitations: audio file out of specification might not be

normally reproduced or the names of files and folders may not be properly viewed.

6.2.6.2. Reproducible Audio Files

- MP3, WMA
- Add the proper extension to the audio file (MP3: ".MP3"; WMA: ".WMA").
- Do not add extensions to other files which are not audio files. The files which do not have an audio file format will not be reproduced.
- Files protected against copy may not be reproduced.

6.2.6.3. Reproducible MP3 file

- MPEG 1, 2 and 2.5 Layer 3 File.
- Throughput in bits: 32-320Kbps.
- Sampling frequency: 32 / 44.1 / 48 KHz

6.2.6.4. Reproducible WMA file

- File compatible with Windows Media Audio 9 standard release.
- Throughput in bits: 32-320Kbps.
- Sampling frequency: 32 / 44.1 / 48 KHz

6.2.6.5. Reproducible Media

- CD-ROM, CD-R, CD-RW (CD-RW with quick format cannot be used).
- When recording the media up to its maximum capacity at once, the recording software should be adjusted for "Disc at once".

6.2.6.6. Format of reproducible disks

- ISO 9660 Levels 1/2.
- Joliet.

⚠ CAUTION

Formats different from those mentioned might not be successfully reproduced and their file names or folder names might not be properly viewed.

6.2.7. Track Information

The radio can display ID3 tag information's (file, folder, title etc.) of the current track via short press (INF).

Maximum Number of Characters showed on the display

- ID3 Label / contents property (WMA and MP3)
- File / folder name is the characters number including the extension.
- ID3 label can only show the Ver 1.0 / 1.1 / 2.2. / 2.3 / 2.4 Label.

6.2.8. File and folder structure limit

- Maximum quantity of folder levels: 8.
- The quantity of files and folders is the result of the sum of all files and folders: 512.

⚠ CAUTION

CD reading time is dependent on no. of files, folders / directory level.



Reproduction order of the audio file

Audio file is reproduced at the sequence defined by the recording software. It is possible to program the reproduction sequence recording the reproduction sequence numbers as for instance from "01" to "99" at the beginning of the file name.

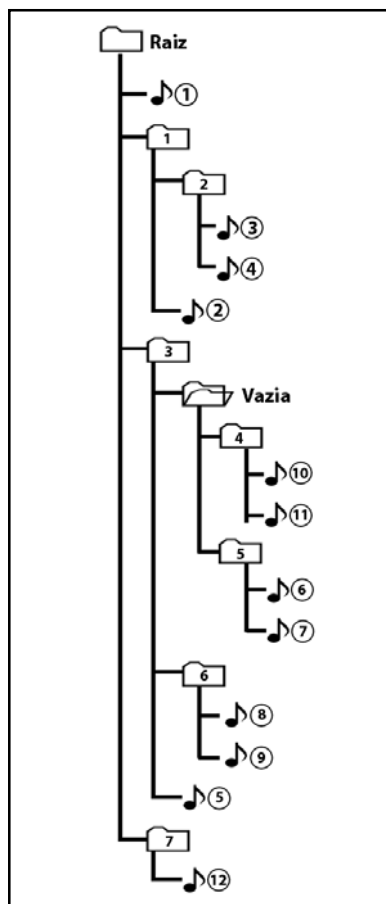

For instance:

- Reproduction order after track ♪ (1) ♪ (2) ♪ (3) ♪ (4) ♪ (5)
- Search forward the file during reproduction ♪ (3) Press ♪ (4)
- To reproduce the prior file, during reproduction ♪ (4)
Press ♪ (3)
- Search next folder during reproduction ♪ (2)
Press key
- Search previous folder during reproduction ♪ (7).
Press key .

6.2.9 Playback order of the audio file on CD :

Audio file is reproduced at the sequence defined by the recording software. It is possible to program the reproduction sequence recording the reproduction sequence numbers as for instance from "01" to "99" at the beginning of the file name.

6.2.9. Folder Up / Down

- Press the key to open previous folder.
- Press the key to open next folder.

6.2.10. Next / Previous Track

- Press the key to jump to the next track
- Press the key to jump to the previous track

If user presses **⏮** key within first 3 seconds of music, it will jump to the previous track. If the track exceeded the first 3 seconds, it will select the start of the current track.

If the first CD track is being played, it will jump to the last one.

6.2.11. Fast forward play

Press the **⏭** key for more than 2 seconds to advance in the track and reach the desired spot.

6.2.12. Fast backward play

Press the **⏪** key for more than 2 seconds to do a fast backward in the track and reach the desired point.

6.2.13. Shuffle Play mode

Press the **4⌘** key for the Random function.

It enables or disables the random selection of tracks.

At the end of such track, another one will be chosen at random.

When this function in ON, the display will read "RDM"; along with source RDM will be cancelled by RPT button press or RDM button press or Scan button press

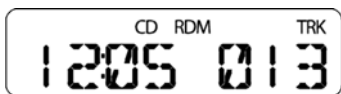

6.2.14. Repeat play mode

Press the **2↻** key to enable or disable the repetition of the current track.

When this function in ON, the display will read "RPT"; the track will be played again.

RPT will be cancelled by button press of RPT or RDM or Skip track or Skip Folder or Scan button

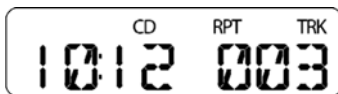

6.2.15. Intro Scan play mode

Press the **1SCN** key to enable or disable the scan function.

When this function is enabled, the radio will play the first 10 seconds of each track.

Once enabled the function, the display reads "SCN";

The function will cycle continuously if not disabled.

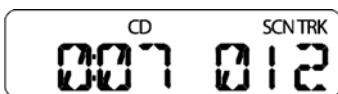

6.2.16. MP3 / WMA Track Information

The default track info for the playing track is track number and playing time

Press **5INF** button to see related Track information.

They will be displayed as "FILE_", "FOLDER_", "TITLE_", "ARTIST_", "ALBUM_" following with the related info, radio will scroll display the info once.

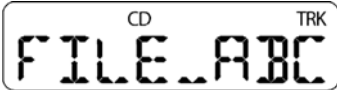

Music time will not be shown while the display is showing other information than track data.



If the playing track is a CDDA track, the INFO button press will be ignored

If current track is completed radio will play next track and the track info will revert back to default track info.

7 USB Playback

7.1 USB Operation

7.1.1 Connecting a USB device

Insert a USB device in the USB slot located on the Trimplate or press [SRC] button to turn Infotainment to USB play mode.

CAUTION

The Infotainment will change to the USB mode automatically by simply connecting a device to the USB input. USB insertion force is less than 35N. Connecting the USB devices while charging through USB port should not be connected into the Audio Systems.

USB device should be inserted into the USB slot in the vertical orientation. Wrong orientation will damage the USB device or the port in the audio unit.

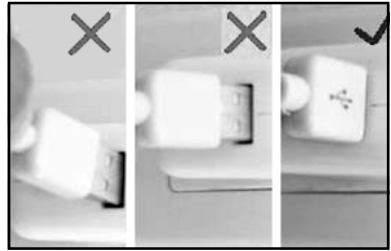

7.1.2. Compatibility of USB devices:

As there is no standardization for such format and this kind of technology is constantly evolving, the manufacturers of USB devices can adopt different profiles for their devices. Therefore, an incompatibility can occur between your radio and the USB device. To avoid this problem, use only devices with the recommended characteristics.

7.1.2.1. Connecting the USB device:

USB should contain MP3 / WMA format audio songs. If the audio Files are not available Radio will show the EMPTY. Performance will be guaranteed

For up to 16GB in USB size. USB read time will be 30sec (Depends on the folder Structure and file count)

USB hard drives / USB HUB will not be supported. Partitioned USB will not be supported. USB with NTFS file format will not be supported.

7.1.2.2. Disconnecting the USB device:

If USB is now the active source and if you unplug it, the radio will turn to

previous Tuner mode and display "NO USB" for 2 seconds.

⚠ CAUTION

It is not advisable to remove a USB device when it is being used; if this occurs, however, the radio will return to the last heard tuner station. USB withdrawal force is greater than 10N.

The radio will start to play the USB from last memory position on ignition toggle; power button toggle and source change, displaying the track number, playing time when the audio is playing a USB device

The radio will play from the first track on the USB device when USB is inserted for the first time.

If the USB device has corrupted files the radio will display "BAD TRK" for 2 seconds, and the current track will be skipped and next track will be processed.

If the USB has no files then display will be updated as "NO FILES" and it will revert back to previous source.

If the USB cannot be read due to different file system or if the USB itself is corrupted then ERROR will be displayed for 2s and radio will go back to last active source.

If there is no USB device connected, the radio will display "NO USB" for 2 seconds, the previous source mode (tuner or CD) will not be interrupted.

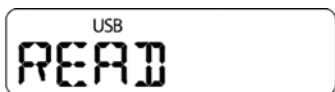

When the infotainment start to read the USB device, the infotainment will display "READING", infotainment will change to USB source and the "USB" icon will be displayed.

During the USB play, if there is a phone incoming/outgoing, the radio will change to BT mode.

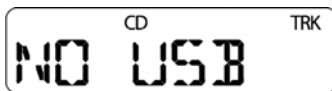

During the USB play, a short press of  Accept button will make the radio change to BT music mode.

NOTE

The USB Port is to be used to charge mobile phones with a current charging capacity of upto 0.5A only.

8. Aux in play back

8.1. Aux in Operation

The radio has a single unbalanced stereo input for connecting external devices; it is available in the front.

8.1.1. Connecting an AUX input

Connect AUX jack to the radio, press  button to access AUX mode.

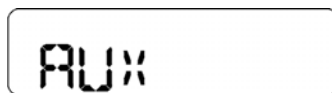

The radio will display "AUX" to indicate that radio is in AUX mode, and if there is an external auxiliary audio input from the bezel AUX connector, the audio can be output via the speakers of the radio.

If AUX jack is not connected, radio can not change to AUX mode when you press **SRC** button. Radio will still remain in current source mode and display "NO AUX" for 2 seconds.

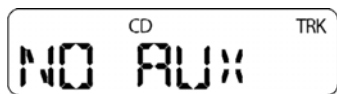

If you press the **SRC** button again in this 2 seconds timeout, radio will change to FM1 mode.

⚠ CAUTION

AUX jack connection will not make the radio change to AUX mode automatically. AUX insertion and Withdrawal force is 4 to 30N.

8.1.2. Disconnecting AUX input

During the AUX play, user can remove the AUX jack, and the radio will revert back to previous tuner mode and display "NO AUX" for 2 seconds.

During the AUX play, if there is a phone incoming, the radio will change to BT mode.

During the AUX play, a short press of **Accept** button will make the radio change to BT mode.

9. Bluetooth

9.1. Bluetooth Operation

9.1.1. What is Bluetooth wireless technology?

Bluetooth® wireless technology is a radio technology that connects devices, such as mobile phones and headsets, without wires or

cords over a short distance of approximately 10 meters (approx. 33 feet). Get more information at www.bluetooth.com.

9.1.2. What are Bluetooth wireless profiles?

Bluetooth wireless profiles are the different ways that Bluetooth devices communicate with other devices. In order to support a certain profile, a phone manufacturer must implement certain mandatory features within the phone's software. The following are the currently supported profiles for the Infotainment unit in your vehicle:

9.1.2.1. Hands-Free Profile (HFP)

HFP is a Bluetooth profile (mode) designed to enable a two-way wireless speaker-phone to be used with a Bluetooth phone.

A Bluetooth car kit will use HFP to connect to a Bluetooth phone, allowing phone calls to take place via the car's audio system.

9.1.2.2. Advanced Audio Distribution Profile (A2DP)

The Advanced Audio Distribution Profile is a Bluetooth profile that allows for the wireless transmission of stereo audio from an A2DP source (typically a Bluetooth connected phone) to the car audio.

9.1.2.3. Audio/Video Remote Control Profile (AVRCP)

This enables music from Bluetooth audio player to be controlled remotely. AVRCP allows some basic

playback control functions such as play/pause, volume up/down and next/previous track in a Bluetooth connected audio player.

9.1.3. What is pairing?

Bluetooth devices will not work if the devices have not been paired. With a mobile phone featuring Bluetooth® technology, you must 'pair' the car Infotainment system with the phone before you use it for the first time. 'Pairing' creates a unique wireless link between the phone with Bluetooth® wireless technology and your car Infotainment system eliminating the need to repeat the pairing process for future use. Pairing process is explained in section 9.1.6 of this manual.

9.1.4. What is PIN?

PIN is a code that you enter on your mobile phone to pair it with the Bluetooth car Infotainment system. This makes your phone and the Bluetooth receiver units recognize each other and automatically work together. The Bluetooth wireless function on your phone has to be turned on to establish automatic connection.

Important : User can establish the phone pairing with default password "1234".

9.1.5. BT Compatibility

Since there is no mutual agreement, the cell phone manufacturers are qualified to use a variety of profiles

in their Bluetooth devices. Therefore, an incompatibility may occur between the telephone system and the hands free, which in some cases may significantly prejudice the system performance. In order to avoid such situation, only the recommended telephones should be used. Please contact your dealer for more information about the updated list of interoperability.

CAUTION

See the manual of your cell phone to make its coupling with the radio.

9.1.6 Pairing with a mobile phone

- Short Press the  Accept button to go into the Bluetooth Mode.
- Activate Bluetooth® on your mobile phone. Please check your mobile phone owner's manual for further details.
- Search for new Bluetooth® device on the mobile phone. This unit's name is "TATA NANO".
- When attempting to connect to the unit, the mobile phone will prompt for a passkey/ pass code/ PIN. User is required enter the PIN: "1234". This is default PIN for the Infotainment system.
- When the Infotainment is in BT mode, the "BT" icon will be displayed. Any incoming call will be automatically diverted to the unit.
- The Bluetooth icon "BT" will indicate that the Infotainment is

in BT mode. Infotainment will display the phone name of the active phone. Only the first 8 characters of the phone name will be displayed.

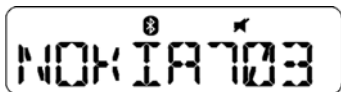

⚠ CAUTION

In any source mode, the user can process a BT phone connection from the BT phone, if the connection has succeeded, the BT phone will be paired and connected. But the Infotainment will still be in current source mode (tuner, CD, USB, AUX).

⚠ CAUTION

Your Infotainment system can support only one Bluetooth device pairing at a time. You cannot use your Infotainment system to pair two cell phones concurrently.

No connectivity :

- If the system cannot fetch the name of the BT phone, "BT PHONE" will be displayed



- If the paired phone is not in vicinity or not connected to the Infotainment system, the system will display "NO PHONE".

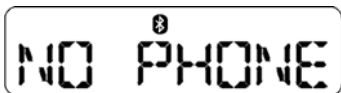

⚠ CAUTION

Once in the Bluetooth mode, the user can only use the Volume Up/ Down, Cal Accept/ Call Reject, & Next Track/ Previous track buttons.

The user is required to come out of the Bluetooth mode to access the other Trimplate buttons.

9.2. Hands Free calling :

9.2.1. Incoming Calling :

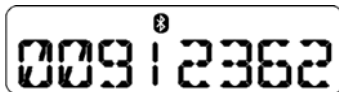

- During power ON, if a call is in progress, the Infotainment system will enter into the BT HFP Mode automatically. The HFP mode is entered/ exited by means Short Press the [] Accept button.
- When an incoming call arrives, the Infotainment system is muted automatically and ring tone is reproduced through your car's speaker.
- The unit temporarily switch to telephone mode and incoming call no. will appear on the display.





NOTE

- The unit will be automatically set as default speaker output every time when there is an incoming call.
- Caller ID is telephone number of the incoming call.
- Only first 8 digits of the number will be displayed.

9.2.2. Answering the call :

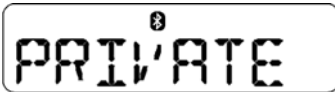
- User can answer an incoming call directly from the unit by Short Press of the  ACCEPT button.
- Alternatively, you may also answer the call by using your phone's answer keypad.
- If there is a phone call in progress, a long press of  ACCEPT button will make the Infotainment system enter into Private BT mode. Infotainment will display "PRIVATE" during the BT phone private mode.



- The BT phone will still be paired and connected, but the phone audio output and input will be from the speaker and microphone of the BT phone itself (i.e., the user can get the call back to his phone and discuss in private).
- Long press the  ACCEPT button again will abort the BT private mode and revert back to normal BT mode. If the call in progress phone call ends, the phone private mode will be aborted

Important : Aborting the BT Private Mode is dependent on paired cell phone.

- Short press of  REJECT button will end the call in

progress and revert back to previous source mode (Tuner, CD, USB, AUX or BT). It will also abort the BT private mode.

- **Speaker mute mode :** When the Infotainment is in BT mode and does not have a call in process, short press  Power button will mute the Infotainment. The "MUTE" icon will be flashed.

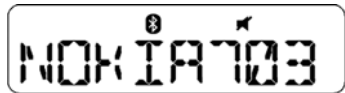

- **Microphone mute mode:** When the Infotainment system is in BT mode and if there is a call in process, short press the  Power button will make the Infotainment enter microphone mute mode.
- Infotainment will display "MIC MUTE" during the microphone mute period, but the "MUTE" icon will not be displayed / flashed.

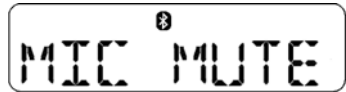

- Short press the  Power button again will abort the BT Microphone mute mode and revert back to normal BT mode.

9.2.3 Rejecting a call

- This function allows you to reject an incoming call via the Infotainment system.
- Short press of  REJECT button will make the Infotainment

reject the incoming call and revert back to previous source mode (tuner, CD, USB, AUX).

- Alternatively, you may also reject the call by using your phone's keypad.

9.2.4 Ending a call

- This function allows you to end a call conversation via the Infotainment system.
- Short press of  REJECT button will make the Infotainment end the incoming call and revert back to previous source mode (tuner, CD, USB, AUX).
- Alternatively, you may also end the call by using your phone's keypad.

9.2.5 Making a call

- A phone call dial out from the active BT phone can also make the Infotainment access BT mode, the "BT" icon indicates that Infotainment is in BT mode.

CAUTION

- Infotainment will display "OUT CALL" during the phone call process period.
- Your Infotainment System will not support Redial function.

9.2.6 Auto Connectivity

- The infotainment will check the BT connection situation between the radio and the bonded BT phone.
- If the BT connection between the radio and BT phone is lost (for

example, BT phone is moved out of the BT capable range, signal weakness, user power off the BT phone etc.), radio will try to reconnect the BT phone. When the BT connection is available, radio will set up the BT connection automatically.



- The infotainment will only be capable to support one BT phone connection. If there already have an active phone (bonded and connection before), the connection/pairing request from another BT phone will fail. If a new phone has to be paired with infotainment, previous bonded phone should be deleted from infotainment by long pressing the reject button. BT de-pairing is given in Section 9.5 of this manual.

9.3. Audio Streaming Profile (A2DP)

When radio is in BT mode, the user can also activate A2DP function, which means the audio output from the BT phone, can be transferred to the radio and output from the speakers.

The A2DP request from the BT phone will not make the radio automatically change to BT mode.

9.3.1. BT Audio Mode

When Infotainment is playing any source (tuner or CD or AUX) a short press of  ACCEPT button will make the Infotainment enter in to BT Audio Mode. Short press of  REJECT button causes the system



to return to the previous active source. During A2DP mode following button presses will be considered as valid: Next Track/Previous track, Mute/Unmute, Volume up/down, Call Accept & Call Reject. Rest of the button presses will be ignored by the system.

The user is required to come out of the BT mode by the short press of  REJECT button to access the SRC button.

9.4. Exiting BT Mode

User can abort the BT mode and make the radio revert back to previous mode (tuner, CD, USB, AUX) via a short press of  REJECT button.

9.5. BT De-Pairing

- When in BT mode, short press of  REJECT button to come out of the BT mode to the last selected mode (tuner, CD, USB, AUX).
- A long press on the  REJECT button will de-pair the existing phone. For successful deletion, the display will show "DELETED"

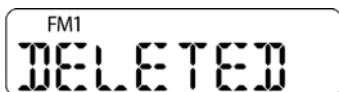

- If the paired BT phone is not available, then the system will continue to play the current source (tuner, CD, USB, AUX).

- Once the BT phone is deleted, if the same phone has to be paired again, then the connect request should be initiated from phone.

NOTE



BT delete is possible only when Infotainment system is not in BT mode. If the current mode is BT, then the user has to come out of BT short press of  REJECT button and then try to disconnect the BT phone by long press on the REJECT button.

9.6. Remot Control Profile (AVRCP)

Radio supports limited functionality in remote control profile. Paired BT phone can be used as a remote control to access the audio controls in Audio Streaming mode. BT phone can issue mute, un-mute, previous track, next track, play and pause command. Radio will receive those and process the action accordingly. Meta data processing will not be supported.

10. Audio Settings

10.1. Volume Control

Press  /  to adjust the audio volume level

There is same volume control across audio sources (Tuner, CD, USB, Aux)

When the volume level has been adjusted the radio displays the volume level for 5 seconds.

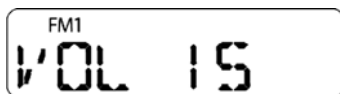

When the volume level is adjusted to zero, the audio will be inaudible, and radio will flash "MUTE" icon. If radio is in CD/MP3 mode, the playing wouldn't be pause infotainment but will be muted.

Infotainment will flash "MUTE" until the user change the volume again. But during the other operations, the associated information will be displayed.

10.2. Standard volume adjustment



When the unit is switched on (Power ON or Ignition ON), the volume will be restored to its previous setting if the previous volume is from 5 to 20.



The volume will be set to 5 if the previous volume is less than 5. The volume will be set to 20 if the previous volume is more than 20.

If there is no previous volume level stored, the volume level will be 5 (default).

10.3. Audio Options:

Press (MENU) key to enter Audio setting.

Press  /  buttons to select the Sub-menu items from the sequence Bass → Treble → Balance → Fade → EQ → Bass.

Press  /  buttons to Adjust the value of each audio setting.

Press OK button to confirm setting.

10.3.1. Bass/Treble tone Control



Default factory setting is zero. This setting is as per vehicle configuration.

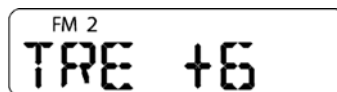
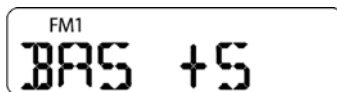

The Bass level will be adjustable from -7 to +7.

The Treble level will be adjustable from -7 to +7

When the bass/Treble tone level is adjusted the radio will display adjusted level.



A short press of  /  button will increase / decrease the bass / treble tone by one level in range (-7...0...+7)

A long press of  /  button will continuous increase / decrease the bass/treble tone in range (-7...0...+7). Default bass/treble tone setting will be zero.

The same bass/treble level will be used between the tuner, CD, USB, AUX and BT audio sources.

10.3.2. Balance & Fader control

The fade setting will have 15 levels of adjustment from Front 7 to Rear 7. The fade defines the relative audio output of the front and rear channels. When the Fade setting level is adjusted the radio will display Fade adjustment level ('F7'...'_0'...'R7')

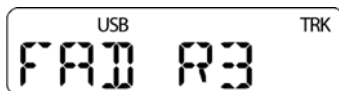



The fade level will change in accordance with the displayed setting.



The default fade level will be 0 (centre).

When the fade is set to "0" front and rear channels will have equal output at the selected volume level.

When the Fade is set to Front 7 the rear speakers will be inaudible and the front speakers output will be at the selected volume.

When the Fade is set to Rear 7 the front speakers will be inaudible and the rear speakers output will be at the selected volume.

A short press of  /  button will change the fade level by one step from F7 to R7; this will attenuate the output level of the Front / Rear speakers in even steps

A long press of  /  button will continuous change the fade level from F7 to R7; this will attenuate the output level of the Front / Rear speakers in even steps.

Similarly balance control can be used to control the audio output in left & right speakers. L7....0....R7. Setting the value to 0 gives equal output in left & right speakers. Setting to L7 gives audio output only in left speaker where as R7 will produce the output only in Right Speakers.

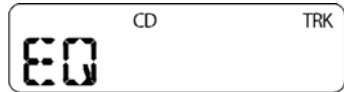

Equalizing Setting

You can adjust the audio EQ setting, which will make the audio output sensitive.

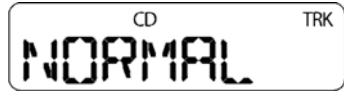

The audio output will change in accordance with the displayed setting. The default Fade level will be "Normal".







Press  /  button to select the favorite EQ setting when you enter EQ setting mode.

The radio has five different EQ setting, they are "Normal, Jazz, Pop, Rock, Classic".

The EQ setting is active via adjusting the Bass and Treble setting.

Mute Control

Short press the   power button will mute the audio output from head unit. Mute will be cancelled by again pressing the   button.

After AFT or Auto seek, mute will be automatically cancelled when user changes to different band or different preset. After AST or Auto Seek mute will be disabled and audio output will be enabled.

Similarly whenever there is a source change mute will be disabled automatically. In BT mode, Mute from headunit will mute the audio output of head unit whereas it sends the PAUSE command to BT phone. Similarly Unmute will unmute the audio from headunit and it will send PLAY command to BT Phone.

11. TECHNICAL SPECIFICATIONS

Technical specifications are subject to change without previous notice.

FM TUNER SECTION

Frequency range.....	87.5 MHz – 108 MHz
Step (Auto / manual tuning)	100 KHz
Presets.....	12
Preset Banks	2
Signal x Noise Relation (for RF – 5.6µV level)	> 30 dB
Frequency response	50 Hz-15 KHz
Signal x Noise Relation (MONO)	50 dB
Stereo split (500 kHz)	30 dB

AM TUNER SECTION

Frequency range	531 kHz- 1602 kHz
Step (Auto / manual tuning)	9 KHz
Presets	6
Preset Banks	1
Signal x Noise Relation (for RF = 10 mV level)	> 40 dB

AUXILIARY INPUT (STEREO)

Stereo signal level	900 mV
Input Impedance	6 to 32 ohms

COMPACT DISC SECTION

Laser diode	GaAlAs (?+780 NM)
Frequency response (± 3 dB) ..	20 Hz-20 kHz
Total harmonic distortion (20 Hz - 20 kHz)	0.1%
Signal x Noise Relation (1 kHz) dynamic range	>70dB
No of Supported Folders + Files	512 (max)

USB Section

Frequency response (±3dB) ..	20 Hz - 20 kHz
Total harmonic distortion (20 Hz - 20 kHz) ..	0.1%
Signal x Noise Relation (1kHz)	>70dB
No of Supported Folders + Files	512 (max)

BLUETOOTH® SECTION

Power class.....	2
Bluetooth versions supported ...	2.0 with EDR
Bluetooth® profile supported	HFP
	0.96, v1.0 & 1.5
A2DP	v1.0
Number of pairing phones	1

AUDIO SECTION

Maximum RMS power – Vdc 14.4; F=1 KHz; Rg=600 ohms	
Analog AMP Output Channels	4
Output Power @ 10% THD (per channel)	25 W

STONE ACTION

Bass:	60 Hz ± 14 dB
Treble:	10 KHz ± 14 dB

GENERAL

Operation volt. (11 V-15 V allowable) ..	13.5 V
Current consumption in standby mode.....	2 mA (max)
Maximum current consumption	10 A
Installation dimension (WxHxD)	179 x51x 230 mm
Weight	1.65 kg

12.ABBREVIATIONS

ABBREVIATIONS	DEFINITIONS
FM	Frequency Modulation
AM	Amplitude Modulation
MP3	3 layer MPEG
WMA	Windows media audio
CD	Compact disc
CDDA	Digital Audio (compact disc)
CDCA	CD Compacted Audio
CD-ROM	Data CD
USB	Universal Serial Bus(data line)
BT	Bluetooth
AUX IN	Auxiliary input
EQ	Equalize
SCN	SCAN (intro scanning CD / USB)
RDM	Random (Shuffle)
RPT	Repeat (repetition)
INF	Information (display options)
THD	Total Harmonic Distortion
A2DP	Advanced Audio Distribution Profile
HFP	Hands Free Profile
AVRCP	Audio Video Remote Control Profile

13. WARRANTY

Statement of Warranty

TATA MOTORS assures to the owner of this appliance a guarantee against eventual assembling defects or of the product components within the Indian Territory for **24 months / 24000 km** of warranty, counted as from the date of the Bill of Sale issuance, issued by the TATA Motors Distributor, since evidenced the defect under normal use conditions.

Eventual repairs executed in the product during the warranty period does not imply in a term extension.

This statement does not comprehend defects or damages caused by accidents, misuse, incorrect assembling, handling and/or installation, or yet for presenting signs of having being violatate or fixed by non-authorized person.

The following items are excluded from this warranty:

- Incorrect installation of the vehicle interference suppressors and antenna.
- Product installation parts in the vehicle, such as extension cables, adapters, fixing supports, belts, noise suppressors, etc.
- Exceeding the maximum quantity allowable for inserting the security code (when applicable).
- Action of fire, water, salt, cleaning products, powder, alcohol or any other external agent, apart from the environmental conditions that

exceeds the product specifications.

- Damages caused by robbery or theft attempts.
- Damages caused by use of bad quality CDs.

In case of defect and in order to take advantage of this warranty, the consumer should contact the Nippon Distributor of his preference, along with the product bill of sale. (This statement excludes expenses with transportation, freight, insurance, and such items are of the consumer's responsibility and onus).

Rear Connection :

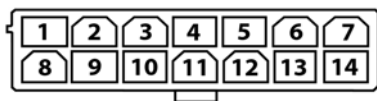

Pin No	Details
1	Speed (PP)
2	Accessory
3	No connect
4	Rear Left -
5	Rear Left +
6	Rear Right -
7	Rear Right +
8	Illumination
9	Ground
10	Battery
11	Front Left -
12	Front Left +
13	Front Right -
14	Front Right +

RECORD OF SERVICE PERFORMED

Recommended Service	Date	Odometer Reading KMs.	Repair Order No.	Servicing Dealer's Sign. & Stamp
At km				
PDI				
1000				
10,000				
20,000				
30,000				
40,000				
50,000				
60,000				
70,000				
80,000				
90,000				
1,00,000				
1,10,000				
1,20,000				
1,30,000				
1,40,000				
1.50,000				
1,60,000				
1,70,000				



TATA MOTORS | SERVICE

RESPONSIVE + RELIABLE + BEST VALUE



HORIZONEXT



 1800-209-7979

 customercare@tatamotors.com

 service.tatamotors.com

Developed by: Technical Literature Cell, ERC

Published by: Content Creation & Publication, Customer Support - PVBU, Pune

5433 5840 99 01