

### Professional Weather Center

model 01036



### CONTENTS

Unpacking Instructions .....	2	5-in-1 Sensor Installation.....	12
Package Contents .....	2	AcuRite Connect .....	13
Product Registration .....	2	Weather Underground .....	13
Features & Benefits: 5-in-1 .....	3	Using the Weather Center .....	14
Features: Display .....	4	Weather Ticker .....	15
Back of Display.....	6	Programmable Alarms.....	17
Setup .....	7	Troubleshooting .....	19
5-in-1 Sensor Setup .....	7	Care & Maintenance.....	22
Display Setup .....	8	Calibration .....	22
Set the Time & Date .....	9	Specifications.....	24
Measurement Units .....	10	FCC Information .....	24
Set Language .....	10	Customer Support .....	25
Placement Guidelines .....	11	Warranty.....	25

**Questions?** Contact Customer Support at (844) 228-5465 or visit [www.AcuRite.com](http://www.AcuRite.com).

**SAVE THIS MANUAL FOR FUTURE REFERENCE.**

# ACURITE®

Congratulations on your new AcuRite product. To ensure the best possible product performance, please read this manual in its entirety and retain it for future reference.

## Unpacking Instructions

Remove the protective film that is applied to the LCD screen prior to using this product. Locate the tab and peel off to remove.

## Package Contents

1. Display with tabletop stand
2. 5-in-1 sensor
3. Sensor mounting bracket
4. Mounting hardware
5. Power adapter
6. USB cable
7. Instruction Manual

## IMPORTANT

PRODUCT MUST BE REGISTERED  
TO RECEIVE WARRANTY SERVICE

### PRODUCT REGISTRATION

Register online  
to receive 1 year  
warranty protection

[www.AcuRite.com](http://www.AcuRite.com)

REGISTER NOW

SUPPORT

Support Forum

Archived Products

▶ Register a Product

## Features & Benefits

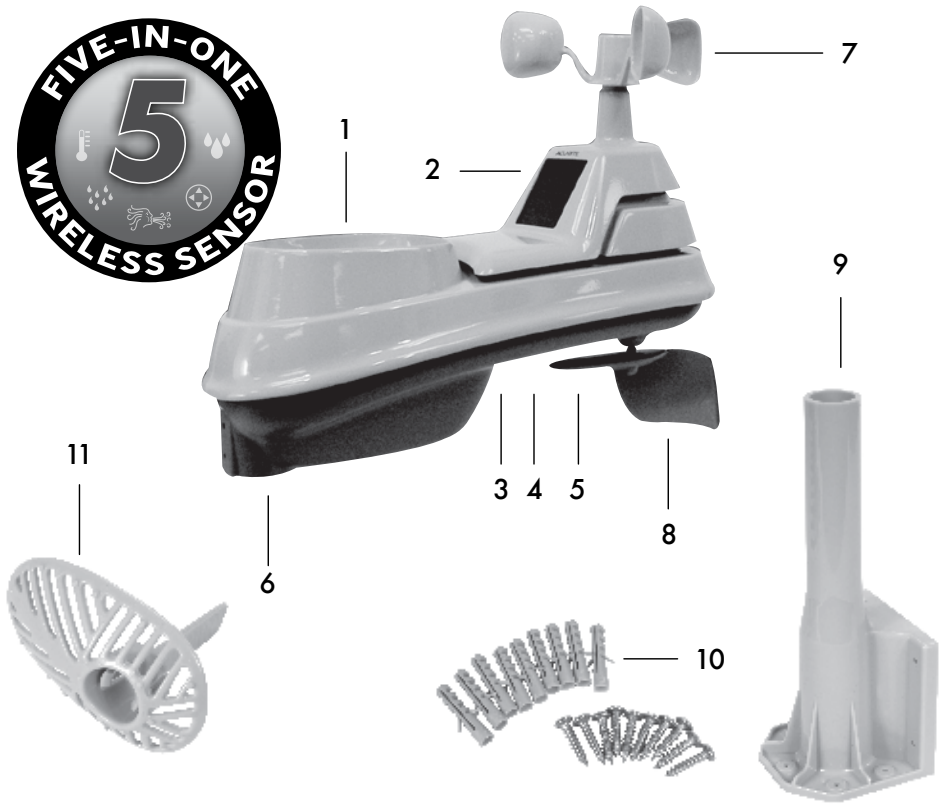

### 5-in-1 SENSOR

#### 1. Rainfall Collector Funnel

#### 2. Solar Cell Panel

Converts sunlight into power to run internal aspirating fan.

#### Internal Aspirating Fan (not shown)

Draws ambient air into sensor to reduce solar radiation heating, resulting in more accurate temperature measurement.

#### 3. A-B-C Switch

ID code that must match display's A-B-C switch to ensure units synchronize.

#### 4. Battery Compartment

#### 5. Temperature & Humidity Sensors (internal)

#### 6. Mounting Point

#### 7. Wind Speed Anemometer

#### 8. Wind Direction Vane

#### 9. Mounting Bracket

#### 10. Mounting Hardware

Includes anchors & screws.

Qty	Diameter	Length
4	#4	1"
2	#6	1/2"

#### 11. Debris Filter

Pre-installed to prevent debris from entering the rain gauge.

# Features & Benefits

## Display

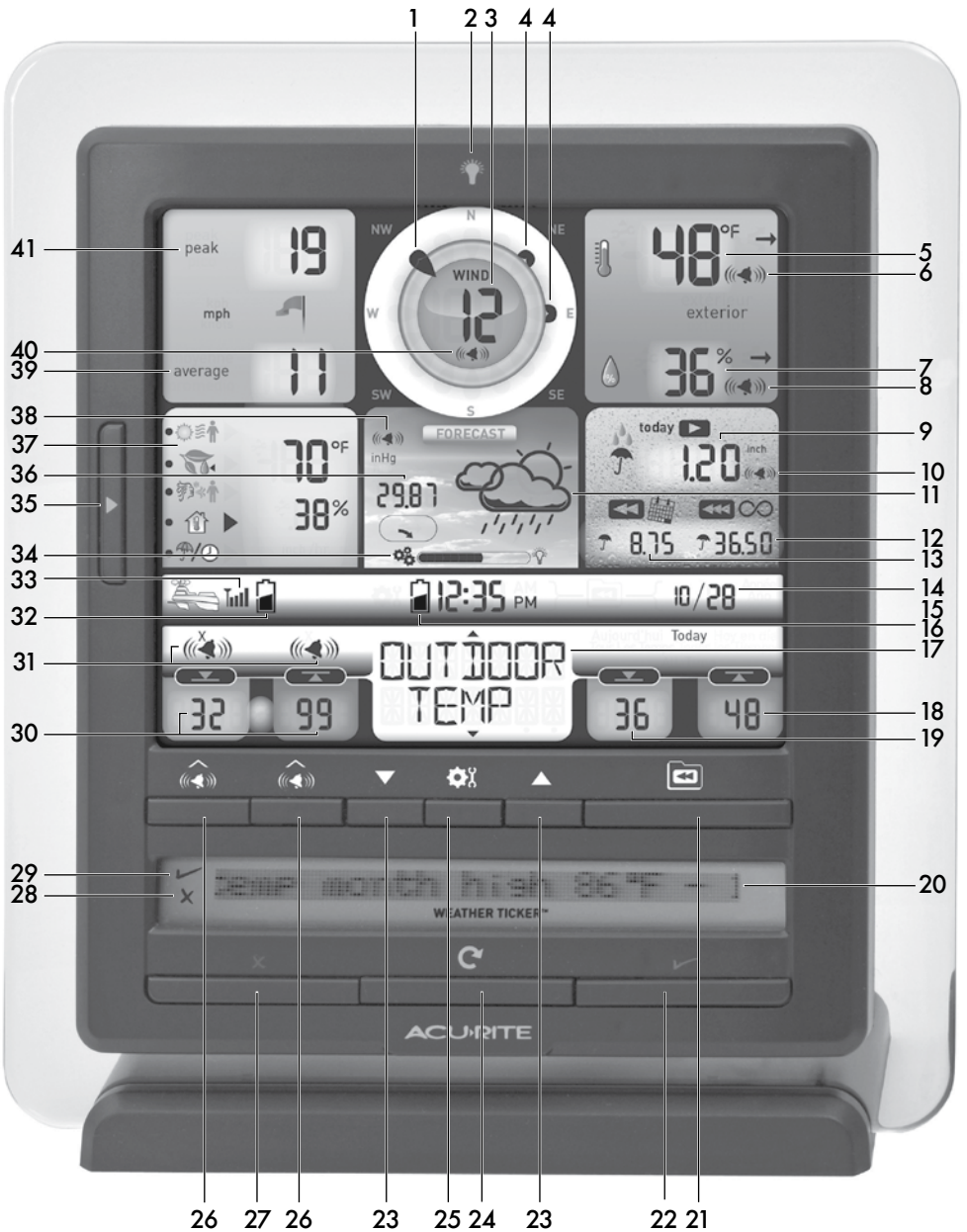

- 1. Current Wind Direction**
- 2. Touch Activated Backlight**  
Momentary during battery power, always on/off for power adapter.
- 3. Current Wind Speed**
- 4. Previous 2 Wind Directions**
- 5. Current Outdoor Temperature**  
Arrow icon indicates direction temperature is trending.
- 6. Outdoor Temperature Alarm On Indicator**
- 7. Current Outdoor Humidity**  
Arrow icon indicates direction humidity is trending.
- 8. Outdoor Humidity Alarm On Indicator**
- 9. Current Rainfall**  
Accumulates data during rainfall.
- 10. Rainfall Alarm On Indicator**
- 11. 12 to 24 Hour Weather Forecast**  
Self-Calibrating Forecasting pulls data from your 5-in-1 sensor to generate your personal forecast.
- 12. All-Time Rainfall**
- 13. Current Month Total Rainfall**
- 14. Date**
- 15. Clock**
- 16. Display Low Battery Indicator**
- 17. Selectable Category**
- 18. Record Highs**  
Shown for current category selected on the display (#17).
- 19. Record Lows**  
Shown for current category selected on the display (#17).
- 20. Weather Ticker™**
- 21. All-Time Records Button**  
Press for all-time low and date recorded for current category selected on display (#17). Press twice for all-time high and date recorded.
- 22. Activate Weather Ticker Message**
- 23. "▲"/"▼" to Select Category (#17) & Adjust Settings**
- 24. Weather Ticker Manual Cycle**  
Press to advance through messages.
- 25. "⚙️" Button**  
for setup preferences.
- 26. Alarm On/Off Button**  
Activate alarm; press and hold to adjust alarm values.
- 27. Deactivate Weather Ticker Message**
- 28. Indicates Deactivated Weather Ticker Message**  
During ticker customization mode.
- 29. Indicates Active Weather Ticker Message**  
During ticker customization mode.
- 30. Programmable Alarm Settings**
- 31. Alarm On/Off Indicator**  
for Selectable Category (#17).
- 32. Low Battery Indicator**
- 33. 5-in-1 Sensor Signal Strength**
- 34. Learning Mode Icon**  
Disappears after weather forecast self-calibration is complete.
- 35. Weather Select Button**  
Press to change the Weather Select category data being displayed.
- 36. Current Barometric Pressure**  
Arrow icon indicates direction pressure is trending.
- 37. Weather Select (top to bottom)**  
Heat index, dew point, wind chill, indoor temperature / humidity, rainfall rate (rain per hour).
- 38. Storm Alert Alarm On Indicator**
- 39. Average Wind Speed**  
of all speeds from past 2 minutes.
- 40. Wind Speed Alarm On Indicator**
- 41. Peak Wind Speed**  
Highest speed from past 60 minutes.

## Back of Display



## BACK OF DISPLAY

- 1. Plug-in for Power Adapter**
- 2. Plug-in for USB Cable**
- 3. Integrated Hang Hole**  
For easy wall mounting.
- 4. MAC ADDRESS**  
12 digit unique ID required for online connectivity functions.
- 5. Backup Battery Compartment**
- 6. A-B-C Switch**  
ID code that must match 5-in-1 sensor's A-B-C switch to ensure units synchronize.

- 7. Clear Today**  
Clears data recorded since 12:00 am.
- 8. Clear All**  
Clears all recorded data without having to reset time and date. Note: USB mode will be reset to Mode 2 (Default).
- 9. Reset**  
Full reset to factory defaults.
- 10. Power Adapter**
- 11. USB Cable for PC Connection**
- 12. Battery Compartment Cover**  
(not shown)

# 5-in-1 Sensor Setup

## 1 Set the A-B-C Switch

Locate the A-B-C switch inside the battery compartment. Set the A-B-C switch to A, B or C. You must select the same letter choices for both the sensor and the display in order for the units to synchronize.

## 2 Install or Replace Batteries

Batteries **MUST** be installed for this product to operate. AcuRite recommends high quality alkaline or lithium batteries for the best product performance. Heavy duty or rechargeable batteries are not recommended.

The 5-in-1 sensor requires lithium batteries in low temperature conditions. Cold temperatures can

cause alkaline batteries to function improperly. Use lithium batteries in the 5-in-1 sensor for temperatures below -4°F / -20°C.

1. Slide off the battery compartment cover.
2. Insert 4 x AA batteries into the battery compartment, as shown. Follow the polarity (+/-) diagram in the battery compartment.
3. Replace the battery cover.

## 3 Remove Rain Gauge Stabilizer

Locate and remove the rain gauge stabilizer (plastic tab) taped into the bottom of the sensor. The rain gauge will not function until this is removed.

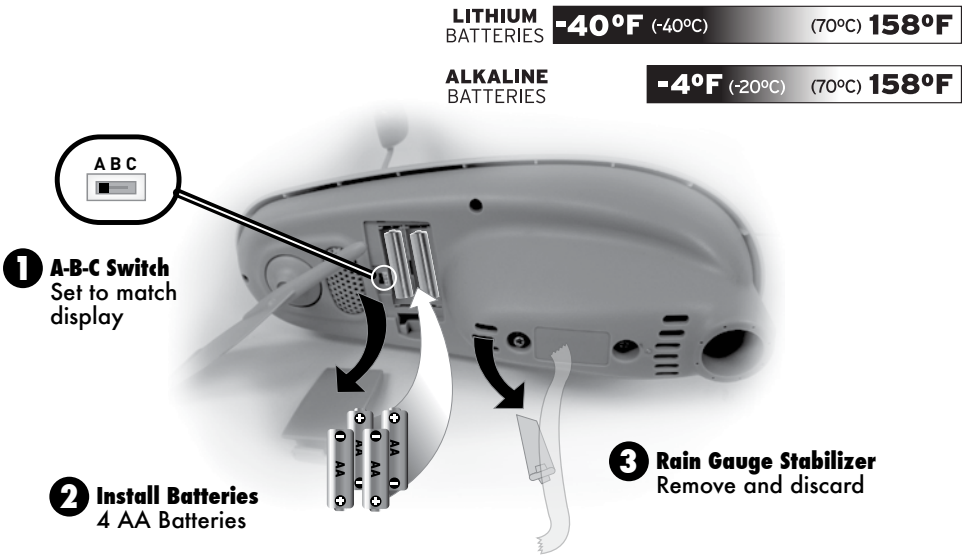



# Display Setup

## 1 Set the A-B-C Switch

The A-B-C switch is located inside the battery compartment. It can be set to A, B or C. However, you must select the same letter choices for both the sensor and the display in order for the units to synchronize.

## 2 Plug Power Adapter into Electric Outlet

## 3 Write Down the MAC ADDRESS

12 digit unique ID needed for online connectivity functions.

## 4 Install or Replace Backup Batteries (optional)

Insert 6 x AA alkaline batteries into the battery compartment, as shown. Follow the polarity (+/-) diagram in the battery compartment.

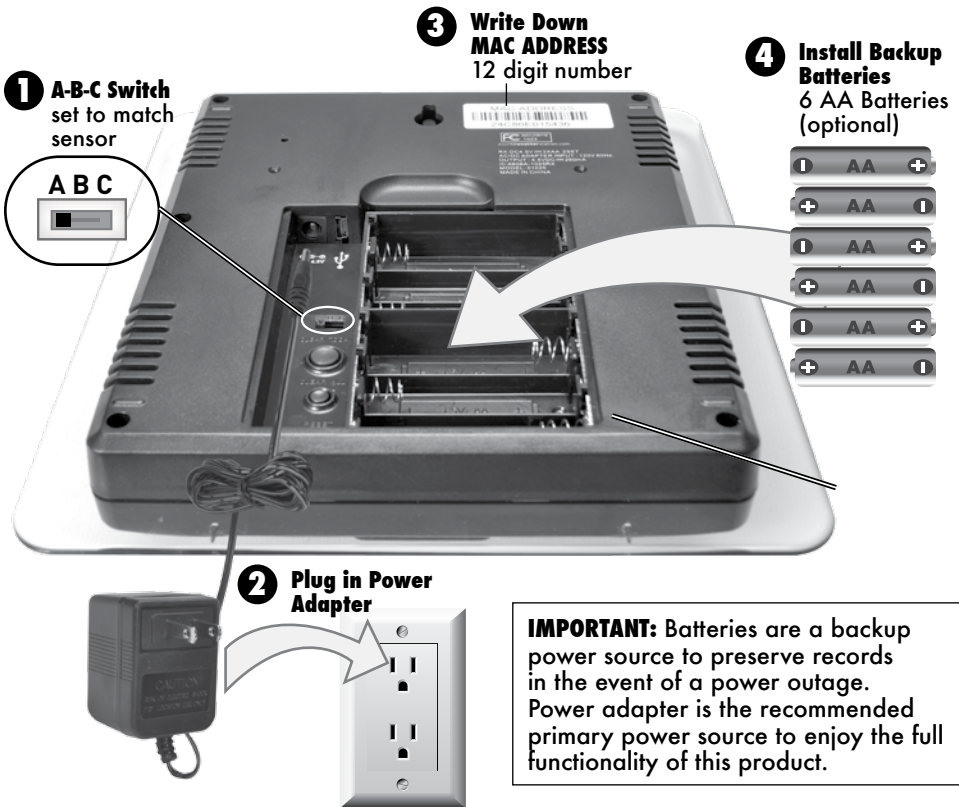

## PLEASE DISPOSE OF OLD OR DEFECTIVE BATTERIES IN AN ENVIRONMENTALLY SAFE WAY AND IN ACCORDANCE WITH YOUR LOCAL LAWS AND REGULATIONS.

**BATTERY SAFETY:** Clean the battery contacts and also those of the device prior to battery installation. Remove batteries from equipment which is not to be used for an extended period of time. Follow the polarity (+/-) diagram in the battery compartment. Promptly remove dead batteries from the device. Dispose of used batteries properly. Only batteries of the same or equivalent type as recommended are to be used. DO NOT incinerate used batteries. DO NOT dispose of batteries in fire, as batteries may explode or leak. DO NOT mix old and new batteries or types of batteries (alkaline/standard). DO NOT use rechargeable batteries. DO NOT recharge non-rechargeable batteries. DO NOT short-circuit the supply terminals.



## Set the Time & Date

The clock and calendar are utilized to time stamp history records and other data, so it is important to set the time and date soon after you power on the display.

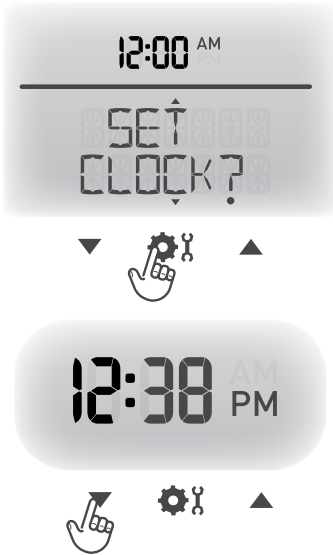

Note: The "?" stays in Selectable Categories, even after setup.



## Set the Time

1. Press the "▲" or "▼" buttons until "SET CLOCK?" is displayed on the Selectable Category part of the display.
2. Press the "⚙️" button to set the clock.
3. Press the "▲" or "▼" buttons to adjust the hour. Note the "AM" and "PM" indicators.
4. Press the "⚙️" button to confirm hour selection.
5. Press the "▲" or "▼" buttons to adjust minutes.
6. Press the "⚙️" button to confirm minute selection.

The clock is now set.

## Set the Date

1. Press the "▲" or "▼" buttons until "SET DATE?" is displayed on the Selectable Category part of the display.
2. Press the "⚙️" button to set the date.
3. Press the "▲" or "▼" buttons to adjust the month.
4. Press the "⚙️" button to confirm month selection.
5. Press the "▲" or "▼" buttons to adjust the day.
6. Press the "⚙️" button to confirm day selection.
7. Press the "▲" or "▼" buttons to adjust the year.
8. Press the "⚙️" button to confirm year selection.

The date is now set.

## Select Measurement Units

To select between standard units (mph, °F, etc.) or metric units (kph, °C, etc.):

1. Press the "▲" or "▼" buttons until "SET UNITS?" is displayed on the Selectable Category part of the display.
2. Press the "⚙️" button to set the unit preference.
3. Press the "▲" or "▼" buttons to select "STAND" for standard or "METRIC" for metric units.
4. Press the "⚙️" button to confirm your selection.
5. Next, you will see "WIND MPH". Press the "▲" or "▼" buttons to select MPH, KPH, or KNOTS for wind speed units.
6. Press the "⚙️" button to confirm your selection.

Units are now set.

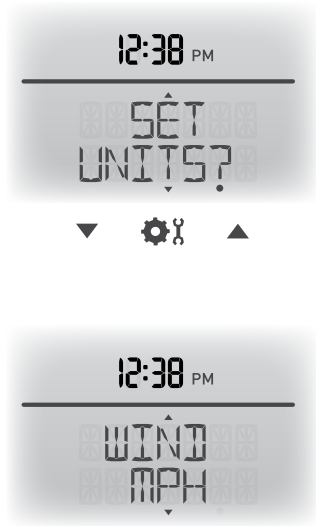

## Set Language

To select between English (default) or French for the display language:

1. Press the "▲" or "▼" buttons until "SET LANG?" is displayed on the Selectable Category part of the display.
2. Press the "⚙️" button to set the language preference.
3. Press the "▲" or "▼" buttons to select the desired language.
4. Press the "⚙️" button to confirm your selection.

Language is now set.

Note: Display reverts to English language when display runs out of power or is reset.

## Placement for Maximum Accuracy

AcuRite sensors are sensitive to surrounding environmental conditions. Proper placement of both the display and the sensor are critical to the accuracy and performance of this product.



### Display Placement

Place the display in a dry area free of dirt and dust. To ensure accurate temperature measurement, place out of direct sunlight and away from heat sources or vents. Display stands upright for tabletop use or is wall-mountable.



### 5-in-1 Sensor Placement

The 5-in-1 sensor is designed to remain outdoors all year long. Choose an open location with no obstructions above or around the sensor for the most accurate measurements.

## Important Placement Guidelines

Display and sensor must be within 330 feet (100 m) of each other.

### MAXIMIZE WIRELESS RANGE

Place units away from large metallic items, thick walls, metal surfaces, or other objects that may limit wireless communication.

### PREVENT WIRELESS INTERFERENCE

Place both units at least 3 feet (.9 m) away from electronic devices (TV, computer, microwave, radio, etc.).

### LOCATE AWAY FROM HEAT SOURCES

Position sensor away from heaters, air conditioners, chimneys, exhaust vents, asphalt and concrete (surfaces that radiate heat).

### LOCATE AWAY FROM HUMIDITY SOURCES

Avoid installing the sensor near pools, spas, or other bodies of water. Water sources may impact humidity accuracy.

### LOCATE AWAY FROM SPRINKLER HEADS

DO NOT install the sensor where it will be sprayed by a sprinkler system. This may force water inside the sensor.

### LOCATE AWAY FROM WIND & RAIN OBSTRUCTIONS

DO NOT mount the sensor with obstructions around it. Consider a location that is a wide open area, with few structures around to ensure accurate wind measurement.

Visit us online to view installation photos and video, or learn more about AcuRite technology:

**[www.AcuRite.com/5in1](http://www.AcuRite.com/5in1)**



View Video

## 5-in-1 Sensor Installation Guidelines

**INSTALLATION HEIGHT** Mount the sensor at least 5 feet (1.5 meters) off the ground in an open area. Higher is better for wind measurement- the National Weather Service recommends 33 feet (10 meters) high!

**MOUNTING OPTIONS** The included mounting bracket is designed to screw directly onto wooden posts or surfaces that are 2" x 4" or larger. The sensor can also be mounted directly to 3/4" steel pipe (available at hardware stores and home centers).

**LEVEL INSTALLATION** Use the bubble level on the top of the sensor to ensure level installation for accurate wind and rain measurement.

**SOLAR CELL INSTALLATION** Install the sensor with the solar cell facing SOUTH. This ensures the cell receives as much sun as possible and orients wind direction.

### 5-in-1 Sensor Installation

1. Fasten mounting base (included) to a post or pole (not included) using the 4 longer screws included in the hardware bag.
2. Insert the mounting base into the hole on the bottom of the sensor.
3. Make sure the arrows on the top of the sensor are pointed in the proper direction and the bubble level is centered. The solar cell should be facing south to properly orient the wind direction.
4. Fasten the sensor into the mounting base using the 2 shorter screws included in the hardware bag.

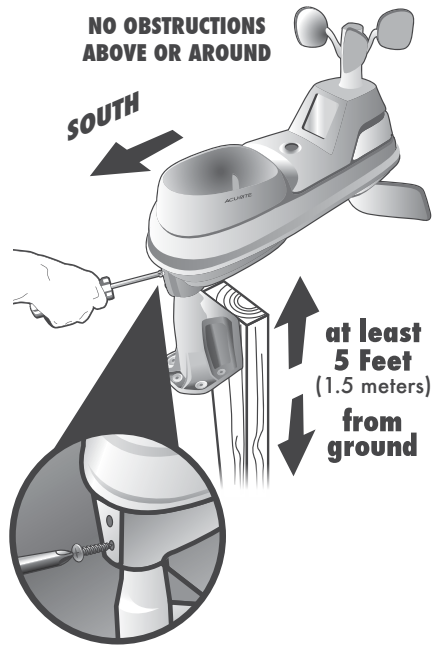

**The 5-in-1 sensor is now ready to use.**

### Clear Data Collected During Installation

When installation is complete, clear erroneous data from the display by pressing the "CLEAR TODAY" button, on the back of the display inside the battery compartment. This button will clear data recorded since 12:00 am.

### Basic Setup is Complete

The 5-in-1 sensor will now synchronize with the display. It may take a few minutes for synchronization to complete. If both or one of the units appear to be functioning improperly, please refer to the troubleshooting section.

## AcuRite Connect

AcuRite Connect works with Windows PC's to provide access to your Weather Center data in the following ways:

- **Data File:** Display logs (or stores) data so that you can download it to a PC in a data file (CSV, or comma-separated values file).
- **Web Browser or Smartphone:** Monitor sensor data remotely using AcuRite's free AcuRite online software, or from a mobile device using the free AcuRite app, available from the iOS App Store or Google Play Store.
- **Weather Underground:** This weather station is compatible for streaming data to the Weather Underground Personal Weather Station Network. Navigate to <http://www.acurite.com/kbase/downloads/AcuRite-Connect.html> for more information.

## USB Mode

To set up AcuRite Connect, you must first select mode 3 on your display to gain access to all functionality. Modes 1, 2 and 4 are not used for the AcuRite Connect software.

1. Press the "▲" or "▼" buttons until "SET USB MODE?" is displayed on the Selectable Category part of the display.
2. Press the "⚙️" button to set the mode preference.
3. Press the "▲" or "▼" buttons to select USB mode #3.
4. Press the "⚙️" button to confirm your selection. AcuRite Connect USB Mode is now set.

## Download the Software

The AcuRite Connect software is available online as a free download. A manual (PDF) is included with the software download.

Before setting up the AcuRite Connect software, verify that the display is ON with the power adapter plugged in. Next, connect the mini-USB (small end of the cable) into the USB port on the display, located inside the battery compartment.



- 1** Download AcuRite Connect software to your computer by visiting:  
**<http://www.acurite.com/kbase/downloads/AcuRite-Connect.html>**

Or, navigate to the link above using the following path:  
www.acurite.com > Support > Downloads > AcuRite Connect

- 2** Click the .exe file that was downloaded in step 1, and follow the on-screen instructions to install the software.

**3** After AcuRite Connect is installed on the computer, the initial configuration will begin automatically. When selecting where to save weather data downloaded from the display, a folder named "AcuRite Weather Station" will be created on the computer.

**4** When prompted by the software to plug in the display, connect the USB (larger end of the cable) into a USB port on the computer.



**AcuRite Connect is installed and ready for use.**

Follow the instructions within the AcuRite Connect app to complete setup and begin using the software.

## OPERATION







### Using the Professional Weather Center

#### Learning Mode

Self-Calibrating Forecasting use a unique algorithm to analyze changes in pressure over a time period (called Learning Mode) to determine your altitude. After 14 days, the Learning Mode icon disappears from the display screen. At this point, the self-calibrated pressure is tuned in to your location and the unit is ready for superior weather prediction.

#### Weather Forecast





AcuRite's patented Self-Calibrating Forecasting provides your personal forecast of weather conditions for the next 12 to 24 hours by collecting data from the sensor in your backyard. It generates a forecast with pinpoint accuracy - personalized for your exact location.

STORM LIKELY	PARTLY CLOUDY	CLOUDY	RAIN LIKELY	SNOW LIKELY	CHANCE OF MIXED RAIN & SNOW
					

View the complete list of icons at [www.AcuRite.com/acurite-icons](http://www.AcuRite.com/acurite-icons)

## Weather Select

Features weather data groups shown at right. To change "Weather Select" category, press the selection arrow button just to the left of the weather select display area.

	= Heat Index
	= Dew Point
	= Wind Chill
	= Indoor Conditions
	= Rainfall Rate (in./hour)

## Rainfall Event

The rainfall feature tracks rain accumulation over all-time, the current month, and current rainfall event. Current event clears when no rain registers for 8 hours OR no rain registers for 1 hour and pressure rises by .03inhg or more.

## Barometric Pressure

Subtle variations in barometric pressure greatly affect the weather. This weather center displays the current pressure with an arrow icon to indicate the direction the pressure is trending (FALLING, STEADY, or RISING).

## Weather Ticker™

The Weather Ticker automatically streams your real-time weather information and alerts as scrolling text in the lower part of the display screen.

You can manually cycle through all the available messages by pressing "↻".

Default WEATHER TICKER messages are pre-loaded as follows:

<b>FORECAST</b>	12 to 24 hour future weather forecast
<b>MOON PHASE</b>	Current moon phase
<b>INDOOR COMFORT</b>	Dry, OK or humid comfort level
<b>IT FEELS LIKE ___ OUTSIDE</b>	Calculates what temperature it feels like outdoors (based on temperature, humidity and wind speed)
<b>OUTDOOR TEMP THIS WEEK HIGH</b>	Highest temperature recorded this calendar week
<b>OUTDOOR TEMP THIS WEEK LOW</b>	Lowest temperature recorded this calendar week
<b>OUTDOOR TEMP THIS MONTH HIGH</b>	Highest temperature recorded this calendar month
<b>OUTDOOR TEMP THIS MONTH LOW</b>	Lowest temperature recorded this calendar month



## Additional Messages Include:

**NEW HIGH TEMPERATURE RECORD**

**NEW LOW TEMPERATURE RECORD**

**NEW WIND SPEED RECORD TODAY**

**CURRENT RAINFALL RATE**

**CURRENT RAIN EVENT STARTED**

**NO RAIN RECORDED SINCE \_\_\_\_\_**

**WEATHER ALARM MESSAGES**

**SENSOR BATTERIES LOW**

**SENSOR SIGNAL LOST**

## Adjust the Weather Ticker Speed

1. Press the "▲" or "▼" buttons until "TICKER SPEED" is displayed on the Selectable Category part of the display.
2. Press the "⚙️" button to set the speed preference.
3. Press the "▲" or "▼" buttons to select a speed: SLOW, NORMAL, or FAST.
4. Press the "⚙️" button to confirm your selection.

Weather Ticker speed is now set.

## Customize Weather Ticker Messages

Customize which messages you want to scroll across the WEATHER TICKER:

1. Press the "↻" button to manually cycle through each message available.
2. During the MANUAL REVIEW: PRESS the "✓" button to activate the current scrolling message. The corresponding "✓" appears on screen to the left of the message to indicate the message is now active in the ticker cycle. PRESS the "✕" button to deactivate the current scrolling message. The corresponding "✕" appears on screen to the left of the message to indicate the message is now deactivated from the ticker cycle.

Please note: Messages can only be added and removed to the ticker cycle during manual review. The "✓" and "✕" buttons do not add or remove messages during the automatic cycle.

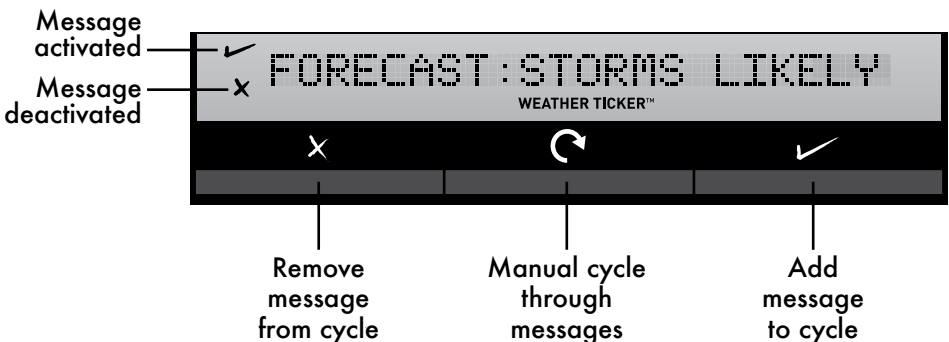

## Programmable Weather Alarms

Each Selectable Weather Category features an alarm option. When an alarm sounds, the display emits audible beeping and flashes the affected category, its alarm settings, and any other relevant data.

Some alarms can be customized to alert you when your programmed value is reached. Alarms include:

OUTDOOR HUMIDITY	LOW	HIGH
OUTDOOR TEMP	LOW	HIGH
STORM ALARM	HIGH	
INDOOR HUMIDITY	LOW	HIGH
INDOOR TEMP	LOW	HIGH
WIND CHILL	LOW	
DEW POINT	LOW	HIGH
HEAT INDEX	HIGH	
RAIN	HIGH	
WIND SPEED	HIGH	

The rain alarm does not require a preset numerical value, but instead sounds as soon as rain is recorded. Similarly, the storm alarm sounds when a large atmospheric pressure drop occurs, which usually indicates an oncoming storm. Note: The storm alarm is NOT intended to be a safety device or warning system.



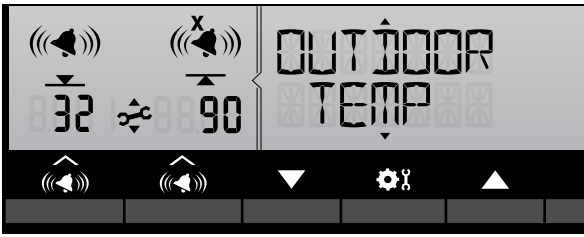

### Set a Weather Alarm

1. Choose the weather category for which you wish to set an alarm by pressing the "▲" or "▼" buttons until the category is displayed on the Selectable Category part of the display.
2. To program a value (only applies to alarms that require a value), press AND HOLD the "((◀))" button underneath the alarm you wish to set until the "⚡" indicator appears and the alarm setting flashes.
3. Adjust the alarm value by pressing the "▲" or "▼" buttons.
4. Press the "((◀))" button to confirm a value.
5. Next, press the "((◀))" button to activate the alarm (the X indicator disappears when alarm is activated).



Alarm is now programmed and turned on.



#### ICON DEFINITIONS

-  = Alarm On
-  = Alarm Off
-  = Adjust Mode
-  = Low Value
-  = High Value

#### BUTTON FUNCTIONS

-  Press to activate or deactivate an alarm.
-  Press and hold to set or adjust an alarm value.

## Silence a Sounding Alarm

The alarm sounds initially for a few minutes, then silences itself. The alarm then sounds every few minutes afterwards until one of the following happens:

1. "SNOOZE" - Press any button. Alarm silences, but sounds again if the alarm condition reoccurs.
2. Turn alarm "OFF" - Deactivates alarm.

# Troubleshooting

Problem	Possible Solution
<p><b>No outdoor sensor reception</b></p>  no bars	<ul style="list-style-type: none"> <li>• Relocate the display and/or the 5-in-1 sensor. The units must be within 330 ft (100 m) of each other.</li> <li>• Make sure both units are placed at least 3 feet (.9 m) away from electronics that may interfere with the wireless communication (such as TVs, microwaves, computers, etc).</li> <li>• Use standard alkaline batteries (or lithium batteries in sensor when temperature is below -4°F/-20°C). Do not use heavy duty or rechargeable batteries. NOTE: It may take up to 20 minutes for display and sensor to synchronize after batteries are replaced.</li> <li>• Synchronize the units:             <ol style="list-style-type: none"> <li>1. Bring both the sensor and display indoors and remove power adapter/batteries from each.</li> <li>2. Reinstall batteries in outdoor sensor.</li> <li>3. Reinstall power adapter/batteries in display.</li> <li>4. Let the units sit within a couple feet of each other for about 20 minutes to gain a strong connection.</li> </ol> </li> </ul>
<p><b>Outdoor temperature is flashing or showing dashes</b></p>	<p>Flashing of the outdoor temperature may be an indication of wireless interference.</p> <ul style="list-style-type: none"> <li>• Make sure the A-B-C switch in the battery compartments of both the display and sensor are switched to the same letter. You may choose A, B or C; but both units must match to sync up. Sometimes changing to a different channel can help.</li> </ul>
<p><b>Weather Ticker Hard to Read</b></p>	<ul style="list-style-type: none"> <li>• Slow down the speed of the ticker (see page 16).</li> </ul>
<p><b>Inaccurate forecast</b></p>	<ul style="list-style-type: none"> <li>• Weather Forecast icon predicts conditions for the next 12 to 24 hours, not current conditions.</li> <li>• Has Learning Mode icon disappeared from the display? Learning Mode must complete before forecast and pressure will be accurate.</li> <li>• Allow unit to run continuously for 33 days. Battery removal or resetting the display will restart Learning Mode. After 14 days, forecast should be fairly accurate, however Learning Mode calibrates for a total of 33 days.</li> </ul>

# Troubleshooting

<b>Problem</b>	<b>Possible Solution</b>
<b>Inaccurate temperature or humidity</b>	<ul style="list-style-type: none"><li>• Make sure both the display and 5-in-1 sensor are placed away from any heat sources or vents (see page 11).</li><li>• Make sure both units are positioned away from moisture sources (see page 11).</li><li>• Make sure 5-in-1 sensor is mounted at least 5 ft off of the ground.</li><li>• Calibrate indoor and outdoor temperature and humidity (see page 22).</li></ul>
<b>No rainfall</b>	<ul style="list-style-type: none"><li>• Check to ensure the rain gauge stabilizer (plastic tab) has been removed from the bottom of the sensor (see page 7).</li><li>• Clear debris, such as leaves, out of the rain collector funnel and debris screen.</li><li>• Calibrate the Rain Gauge (see page 23).</li></ul>
<b>Inaccurate wind readings</b>	<ul style="list-style-type: none"><li>• What is wind reading being compared to? Pro weather stations are typically mounted at 30 ft high or more. Make sure to compare data using a sensor positioned at the same mounting height.</li><li>• Check location of the sensor. Ensure it's mounted a minimum of 5 ft in the air with no obstructions around it (within several feet).</li><li>• Ensure wind cups are spinning freely. If they hesitate or stop try lubricating with graphite powder or spray lubricant.</li></ul>
<b>USB connectivity not working</b>	<ul style="list-style-type: none"><li>• Verify display is in USB mode 3 (see page 13).</li><li>• Unplug USB from display to computer for 20 seconds, and then plug back in.</li><li>• Check that the batteries are installed correctly. Batteries may need to be replaced.</li><li>• Reset the display by pressing the reset button, located on the back of the display. Date and time will need to be entered after a reset.</li></ul>
<b>Display screen not working</b>	<ul style="list-style-type: none"><li>• Check that the batteries are installed correctly. Batteries may need to be replaced.</li><li>• Reset the display by pressing the reset button, located on the back of the display. Date and time will need to be entered after a reset.</li></ul>

# Troubleshooting

Problem	Possible Solution
<b>Cannot access data online or on the AcuRite mobile app</b>	<ul style="list-style-type: none"><li>• Verify that the status in the AcuRite Connect software on your PC indicates that the data was received from the display.</li><li>• Verify that you created an account or logged into an existing account at <a href="http://www.acu-link.com">www.acu-link.com</a> or in the AcuRite app, and that you input the display's MAC ADDRESS as a part of the account setup.</li><li>• Verify that the USB cable is securely connected to the display AND to the PC.</li><li>• Verify the display is powered ON.</li><li>• Verify the PC that the display is connected to is always powered ON.</li><li>• Verify the PC that the display is connected to is always connected to the internet.</li><li>• Verify that the display's MAC ADDRESS is entered correctly in the AcuRite Connect software on your PC.</li><li>• Verify that "Streaming" is enabled in the AcuRite Connect software on your PC.</li><li>• Verify that the display's MAC ADDRESS is correct in your <a href="http://www.acu-link.com">www.acu-link.com</a> and/or AcuRite mobile app account.</li><li>• Follow on-screen troubleshooting steps in the AcuRite Connect software.</li></ul>
<b>AcuRite Connect data is different than the display's data</b>	<ul style="list-style-type: none"><li>• Check that the USB cable is securely connected to the display AND to the PC's USB port.</li><li>• Restart the AcuRite Connect software.</li><li>• Unplug the USB cable from the PC for 1 minute, and then plug the cable back in again.</li><li>• USB port may be malfunctioning, try using another USB port.</li></ul>

**If your AcuRite product does not operate properly after trying the troubleshooting steps, visit [www.AcuRite.com](http://www.AcuRite.com) or call (844) 228-5465 for assistance.**

# Care & Maintenance

## Display Care

Clean with a soft, damp cloth. Do not use caustic cleaners or abrasives. Keep away from dust, dirt and moisture. Clean ventilation ports regularly with a gentle puff of air.

## 5-in-1 Sensor Care

### Clean the Sensor

Clean with a soft damp cloth. Do not use caustic cleaners or abrasives that will mar the polished surfaces of the rain collection funnel or the solar cell. Scratches will result in decreased performance and reliability.

### Insect Prevention

Insects may cause obstructions and interrupt data by nesting in or on the 5-in-1 sensor. To limit this problem, spray sensor with a household insect repellent. Consult the insect repellent instructions prior to use.

### Snow & Freezing Weather

The 5-in-1 sensor will not be damaged by freezing conditions. NOTE: If the rain collector cup fills with snow and then melts, it will register as rain on the display.

### Clean the Rain Collector Cup

Remove and empty rain collector debris filter. The debris filter is located in the rain collector funnel. Remove from the top by gently squeezing and pulling out.

### Clean the Wind Vane & Anemometer

Remove foreign matter from the outside of the sensor for free movement of the wind vane and anemometer. If needed, use a small amount of spray lubricant, clear silicone or graphite powder on the anemometer for improved movement.

# Calibration

## Calibrate Temperature & Humidity

The indoor / outdoor temperature and humidity readings can be calibrated on the display to improve accuracy. Calibration improves accuracy when 5-in-1 sensor placement or environmental factors impact your data accuracy.

1. Choose the weather category you wish to calibrate by pressing the "▲" or "▼" buttons until the category is displayed on the Selectable Category part of the display.
2. Press AND HOLD the "▲", "▼" and "⚙️" buttons all at the same time for 10-15 seconds.
  - The display beeps, and all display data is hidden except for the value being calibrated.
  - "🔧" (calibrate) and arrows appear next to the value being calibrated.



3. Press the "▲" or "▼" buttons to calibrate the data value higher or lower from the actual reading.
4. Press the "⚙️" button to confirm the calibration adjustment.  
Note: The "⚙️" icon remains illuminated next to calibrated values.



## Calibrate the Rain Gauge

The rain gauge on the 5-in-1 sensor can be calibrated to improve accuracy.

**Items Needed:** 5-in-1 sensor, display, plastic cup, pin, screw driver

1. First, ensure 5-in-1 sensor is perfectly level using built-in bubble level.
2. Place display close so you can monitor it during calibration.
3. Make a pin hole in the bottom of a plastic cup. Hold the cup over the rain gauge and fill it with exactly 1 cup (8oz) of water, allowing the water to drip into the rain gauge. You should hear the internal buckets tip and see water drain through the rain gauge.
4. A few seconds after each bucket tip, the display displays rainfall in approximately 0.01" or more increments.
5. The cup of water should take more than 20 minutes to empty; a quicker period will result in inaccurate calibration. Try to simulate a normal steady rainfall. When cup is empty of water, display should register 1.06"

## Tips

- There should be nearly an equal number of water drops (about 25 water drops) between bucket tips. If not, adjust the calibration screws on the bottom of the 5-in-1 sensor until an equal number of water drops are tipping the buckets. Then, restart the calibration procedure.
- If you don't hear the buckets tipping and see water dripping alternately out of each drain, there may be an issue with the rain gauge or it's adjustment. See Troubleshooting on page 21.

## Adjustment

If the rain gauge doesn't register close to 1.06", make an EQUAL adjustment to the two calibration screws on the bottom of the 5-in-1 sensor. Turning screws clockwise increases rainfall; counter clockwise decreases rainfall.

- To adjust the rainfall reading by 2% turn both screws 1/8 of a turn.
- To adjust the rainfall reading by 4% turn both screws 1/4 of a turn.
- To adjust the rainfall reading by 8% turn both screws 1/2 of a turn.

Watch the video at [www.acurite.com/5n1](http://www.acurite.com/5n1)

# Specifications

<b>TEMPERATURE RANGE</b>	Outdoor: -40°F to 158°F; -40°C to 70°C
	Indoor: 32°F to 122°F; 0°C to 50°C
<b>HUMIDITY RANGE</b>	Outdoor: 1% to 99%
	Indoor: 16% to 98%
<b>WIND SPEED</b>	0 to 99 mph; 0 to 159 kph
<b>WIND DIRECTION INDICATORS</b>	16 points
<b>RAINFALL</b>	0 to 99.99 in; 0 to 2540 mm
<b>WIRELESS RANGE</b>	330ft / 100m depending on home construction materials
<b>OPERATING FREQUENCY</b>	433 MHz
<b>POWER</b>	Display: 4.5V AC adapter 6 x AA alkaline batteries (optional)
	Sensor: 4 x AA alkaline or lithium batteries
<b>DATA REPORTING</b>	Wind Speed: 18 second updates; Direction: 30 seconds Outdoor temperature & humidity: 36 second updates Indoor temperature & humidity: 60 second updates PC Connect CSV Data Logging: 12 minute intervals PC Connect to AcuRite Software/App: 18 seconds
<b>DISPLAY MEMORY</b>	512 kilobytes (not expandable)
<b>ACURITE CONNECT SYSTEM REQUIREMENTS</b>	Windows 8.1 / 8 / 7; 1 GHz or faster processor; 1 GB (32-bit) or 2 GB (64-bit) of RAM; available USB port
	High speed internet is required for some advanced features of AcuRite Connect, such as the AcuRite software and app.

# FCC Information

This device complies with part 15 of FCC rules. Operation is subject to the following two conditions:

- 1- This device may NOT cause harmful interference, and
- 2- This device must accept any interference received, including interference that may cause undesired operation.

This equipment has been tested and found to comply with the limits for a Class B digital device, pursuant to Part 15 of the FCC rules. These limits are designed to provide reasonable protection against harmful interference in a residential installation. This equipment generates, uses and can radiate radio frequency energy and, if not installed and used in accordance with the instructions, may cause harmful interference to radio communications. However, there is no guarantee that interference will not occur in a particular installation. If this equipment does cause harmful interference to radio or television reception, which can be determined by turning the equipment off and on, the user is encouraged to try to correct the interference by one or more of the following measures:

- Reorient or relocate the receiving antenna.
- Increase the separation between the equipment and the receiver.
- Connect the equipment into an outlet on a circuit different from that to which the receiver is connected.
- Consult the dealer or an experienced radio/TV technician for help.

NOTE: The manufacturer is not responsible for any radio or TV interference caused by unauthorized modifications to this equipment. Such modifications could void the user authority to operate the equipment.

This device complies with Industry Canada licence-exempt RSS standard(s).

Operation is subject to the following two conditions:

- (1) This device may not cause interference, and
- (2) This device must accept any interference received, including interference that may cause undesired operation of the device.

## Customer Support

AcuRite customer support is committed to providing you with best-in-class service. **For assistance**, please have the model number of this product available and contact us in any of the following ways:



(844) 228-5465



info@chaney-inst.com

24/7 support at [www.AcuRite.com](http://www.AcuRite.com)

- ▶ Installation Videos
- ▶ Register your Product
- ▶ Instruction Manuals
- ▶ Support User Forum
- ▶ Replacement Parts
- ▶ Submit Feedback & Ideas

## IMPORTANT

PRODUCT MUST BE REGISTERED  
TO RECEIVE WARRANTY SERVICE

### PRODUCT REGISTRATION

Register online  
to receive 1 year  
warranty protection

[www.AcuRite.com](http://www.AcuRite.com)

FOR NOW

SUPPORT

Support Forum

Archived Products

▶ Register a Product

## Limited One Year Warranty

At AcuRite, we proudly uphold our commitment to quality technology. Chaney Instrument Co. warrants that all products it manufactures to be of good material and workmanship, and to be free of defects when properly installed and operated for a period of one year from the date of purchase.

We recommend that you visit us at [www.AcuRite.com](http://www.AcuRite.com) for the fastest way to register your product. However, product registration does not eliminate the need to retain your original proof of purchase in order to obtain warranty benefits.

Chaney Instrument Co. warrants that all products it manufactures to be of good material and workmanship, and to be free of defects when properly installed and operated for a period of one year from the date of purchase. Remedy for breach of this warranty is limited to repair or replacement of the defective item(s). Any product which, under normal use and service, is proven to breach the warranty contained herein within ONE YEAR from date of sale will, upon examination by Chaney, and at its sole option, be repaired or replaced by Chaney. Transportation costs and charges for returned goods shall be paid for by the purchaser. Chaney hereby disclaims all responsibility for such transportation costs and charges. This warranty will

not be breached, and Chaney will give no credit for products it manufactures which have received normal wear and tear, been damaged (including by acts of nature), tampered, abused, improperly installed, damaged in shipping, or repaired or altered by others than authorized representatives of Chaney.

The above-described warranty is expressly in lieu of all other warranties, express or implied, and all other warranties are hereby expressly disclaimed, including without limitation the implied warranty of merchantability and the implied warranty of fitness for a particular purpose. Chaney expressly disclaims all liability for special, consequential or incidental damages, whether arising in tort or by contract from any breach of this warranty. Some states do not allow the exclusion or limitation of incidental or consequential damages, so the above limitation or exclusion may not apply to you. Chaney further disclaims all liability from personal injury relating to its products to the extent permitted by law. By acceptance of any of Chaney's products, the purchaser assumes all liability for the consequences arising from their use or misuse. No person, firm or corporation is authorized to assume for Chaney any other liability in connection with the sale of its products. Furthermore, no person, firm or corporation is authorized to modify or waive the terms of this paragraph, and the preceding paragraph, unless done in writing and signed by a duly authorized agent of Chaney. This warranty gives you specific legal rights, and you may also have other rights which vary from state to state.

For in-warranty claims:

Chaney Instrument Co. | 965 Wells St. | Lake Geneva, WI 53147





# ACU RITE®



Weather  
Stations



Temperature  
& Humidity



Weather  
Alert Radio



Kitchen  
Thermometers  
& Timers



Clocks

*It's More than Accurate, it's ACU RITE.*

AcuRite offers an extensive assortment of precision instruments, designed to provide you with information you can depend on to Plan your day with confidence™.

[www.AcuRite.com](http://www.AcuRite.com)

©Chaney Instrument Co. All rights reserved. AcuRite is a registered trademark of the Chaney Instrument Co., Lake Geneva, WI 53147. All other trademarks and copyrights are the property of their respective owners. AcuRite uses patented technology. Visit [www.AcuRite.com/patents](http://www.AcuRite.com/patents) for details.