



USER MANUAL

ENGLISH | NEDERLANDS | DEUTSCH | FRANÇAIS | ESPAÑOL | ITALIANO | PORTUGUÊS
POLSKI | ČESKY | MAGYAR | SLOVENSKÝ

SAFESCAN 2665-S / 2685-S

BANKNOTE COUNTER

INTRODUCTION

Thank you for purchasing a Safescan 2600-series banknote counter. This user manual will help you to get started with your Safescan banknote counter and describes the setup and operating procedures. We recommend that before using the device you carefully read these operating instructions.

PACKAGE CONTENTS

The retail box contains the following items:

- Safescan 2665-S / 2685-S Banknote Counter
- Maintenance kit
- Power cord(s)*
- User Manual

PRODUCT

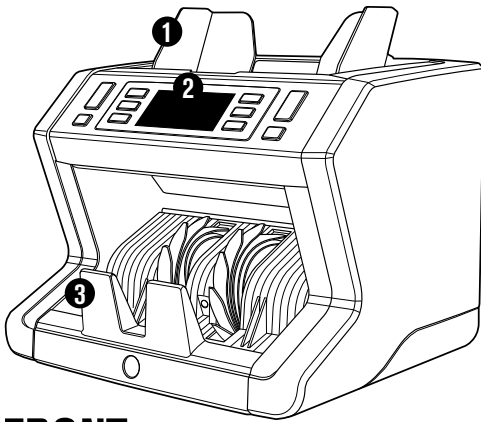

FRONT

1. Hopper with adjustable guides
2. Front panel (display / buttons)
3. Stacker
4. Power connection
5. USB port for connection to PC
6. MicroSD slot for currency updates
7. On/Off switch
8. RJ12 port for printer and external display connection
9. Hopper adjustment wheel
10. Power cord(s)*
11. Maintenance kit

* depending on model / country specification

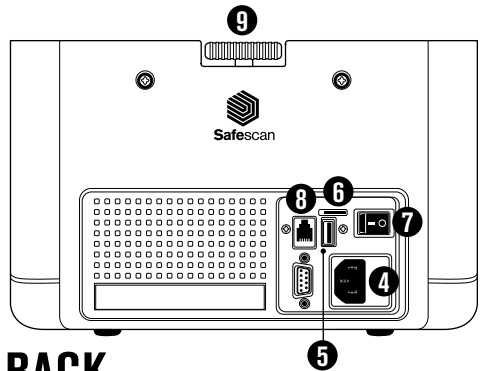

BACK

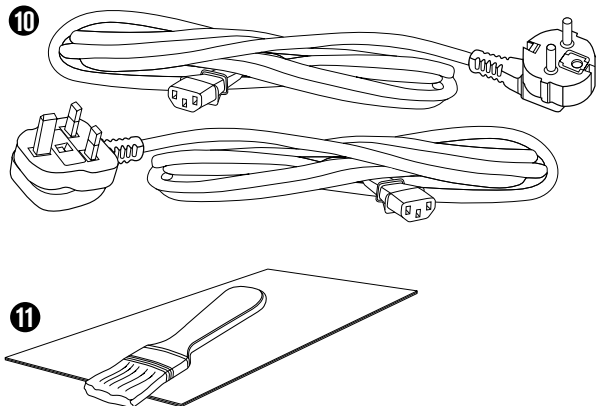

AVAILABLE ACCESSORIES

- Safescan Cleaning Cards for banknote counters (pack of 20 cards), partnumber 136-0546. See www.safescan.com for details.

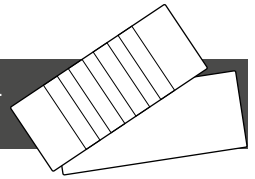

SAFESCAN 2665-S / 2685-S: FEATURES

Counting mode	UP TO 7-POINT COUNTERFEIT DETECTION (UV, MG, MT, IR, SIZE, THICKNESS, COLOR)										DETECT UV, MG	DETECT SIZE
	EUR	GBP	CHF	USD	SEK	NOK	DKK	PLN	CZK	HUF	ALL CUR.	ALL CUR.
MIX	•	2665 – 2685: •	•	–	•	•	•	•	–	–	–	–
SORT	•	•	•	–	•	•	•	•	•	–	•	•
COUNT	•	•	•	•	•	•	•	•	•	•	•	–

BASED ON THE DEFAULT CURRENCIES OF THE STANDARD EU MODELS.

BUTTONS AND OPERATION

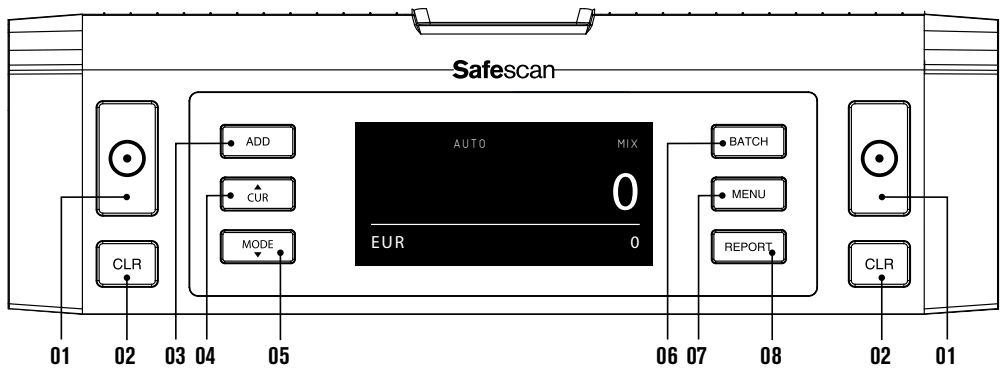

01. Start counting / Confirm selection in menu mode
02. Clear the number of counted banknotes / Go back 1 level (in **MENU** mode)
03. Add function on/off
04. Currency selection
05. Counting method settings: MIX (value counting of unsorted banknotes), COUNT (free count, no size detection) or SORT (count sorted banknotes including size detection)
06. Batch function on/off and set batch number
07. Open / close device menu
08. Show count report on screen / send count report to printer (in MIX mode only)

GETTING STARTED

1. Place the device on a flat and stable surface.

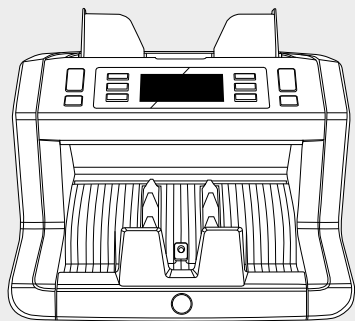

2. Connect the banknote counter to the mains outlet using the supplied power cord.

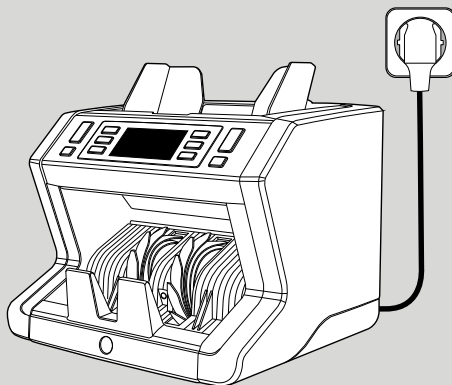

3. Switch on the banknote counter by pushing the power switch at the back in the "1" position.

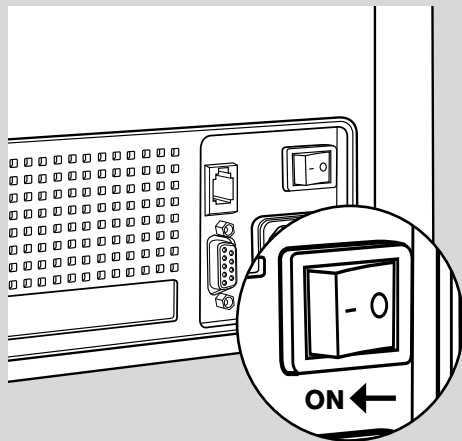

4. Select currency by pressing the **CUR** button.

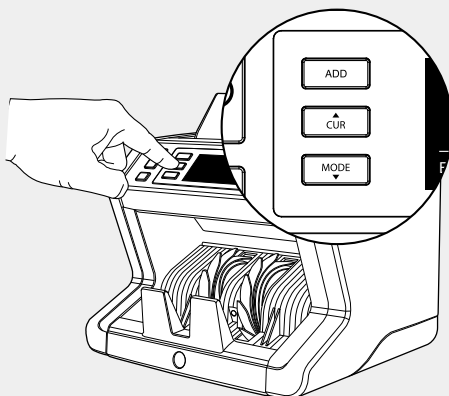

READY FOR COUNTING

The machine is now ready for basic counting. More advanced settings are described in the next chapters of this manual.

COUNTING BANKNOTES

1. CURRENCY

Press the **CUR** key to select the desired currency. Default setting = EURO.

The Safescan 2665-S / 2685-S supports multiple currencies. Depending on the selected currency and its characteristics, not all counting modes may be selectable.



2. COUNTING MODE

Press the **MODE** key to select the desired counting method. Default setting = MIX.

The following counting modes can be selected:

[MIX]: value counting of unsorted banknotes.

[SORT]: banknote counting including size detection. The counter will stop and sound an alarm if a banknote of a different height than the first counted banknote has been detected.

[COUNT]: banknote counting without size detection, also referred to as "free sheet counting".

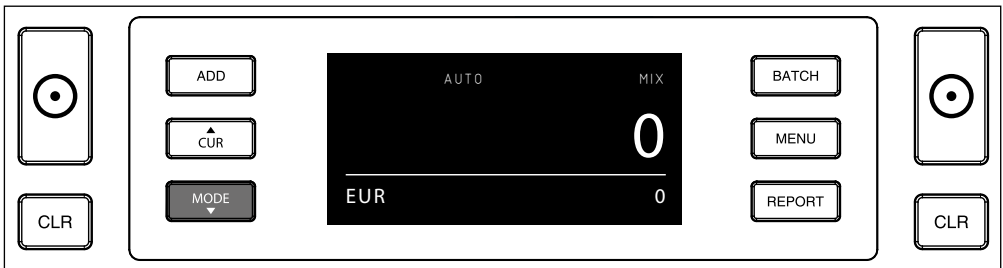

PLEASE NOTE: Depending on the selected currency, not all counting modes may be available due to currency characteristics.

3. AUTO START / MANUAL START

By pressing the [START] button for 2 seconds you can switch between AUTO or MANUAL counting start. When the screen shows 'AUTO', the machine will start counting once banknotes have been placed in the hopper. Default setting = AUTO.

When the device is set to "Manual", press the [START] button to start counting.

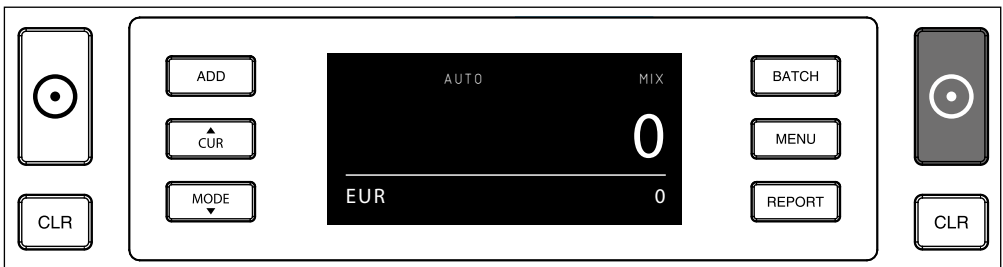

4. START COUNTING BANKNOTES

Start your count by placing the banknotes in the center of the hopper. Use the hopper guides to keep the banknotes centered.

PLEASE NOTE

In **MIX** mode, the banknotes do not have to be sorted before counting. It is advised however to place the largest sized banknotes on the bottom of the stack and the smallest on top.

In **SORT** mode, the banknotes have to be sorted per denomination before counting.

In **COUNT** mode, banknotes do not need to be sorted. Please be advised that in this mode the device simply counts the number of notes that are being fed through the machine, no matter which denominations are in the stack of notes.

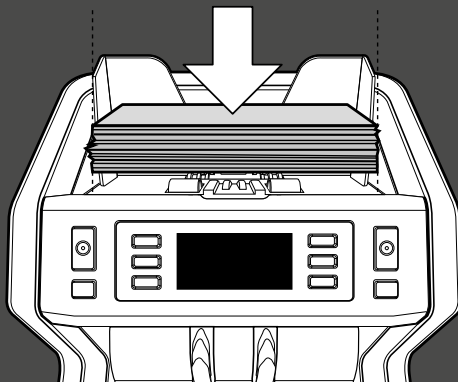

5. WHEN COUNTING HAS FINISHED

The number of banknotes is shown clearly after the count has finished (valid for both **COUNT** and **SORT** counting modes). In **MIX** mode the total value of the counted banknotes is also shown.

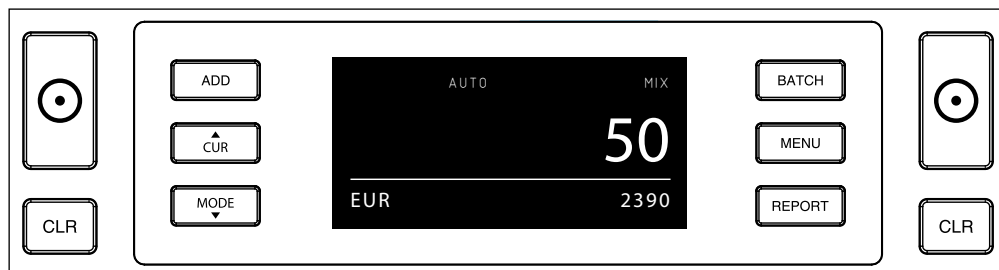

6. BANKNOTE SIZE DETECTION (SORT COUNT MODE ONLY).

When **SORT** counting has been selected, the banknote counter will stop and give a 'height error' notification once it has detected a differently sized banknote during counting. The counter will only detect banknotes with a different height than the first banknote counted (minimum detectable height difference = 3mm).

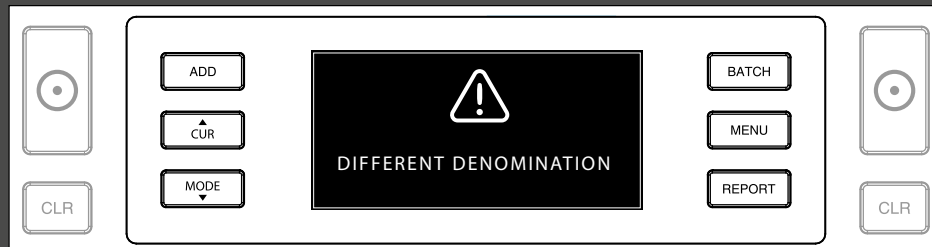

7. VALUE COUNTING (MIX MODE ONLY): VIEW COUNT RESULTS

After you have counted a stack of (un)sorted banknotes in **MIX** mode, you can view, print or export a detailed breakdown of the count results per denomination. Press **[REPORT]** briefly to view the count results on the display.

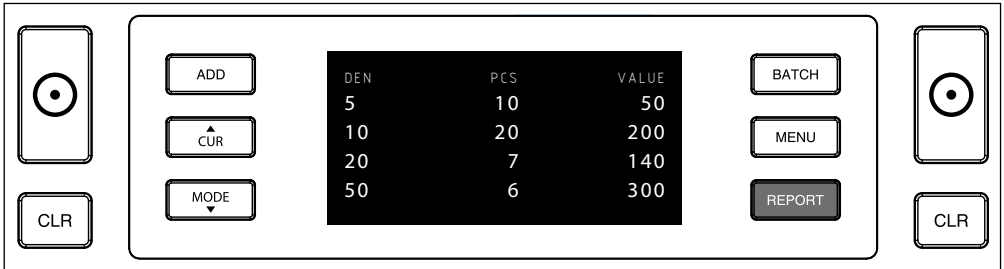

When applicable, press **[MODE]** to scroll to the other denominations of the counted currency.

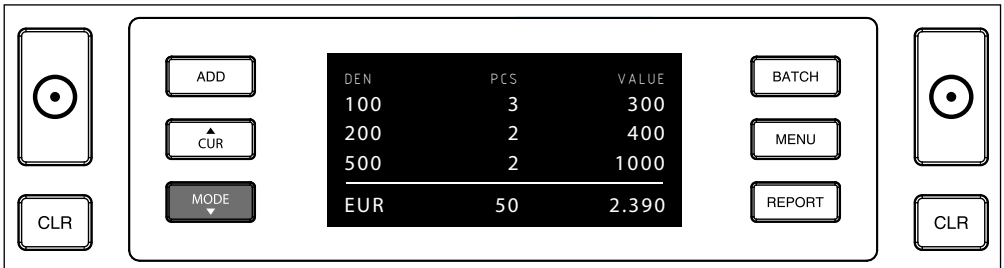

8. VALUE COUNTING (MIX MODE ONLY): PRINT OR EXPORT COUNT RESULTS

When you have connected the optional Safescan TP-230 printer or use the optional Safescan Money Counting Software, press **[REPORT]** for 3 seconds to print the detailed count results or export them to the software.

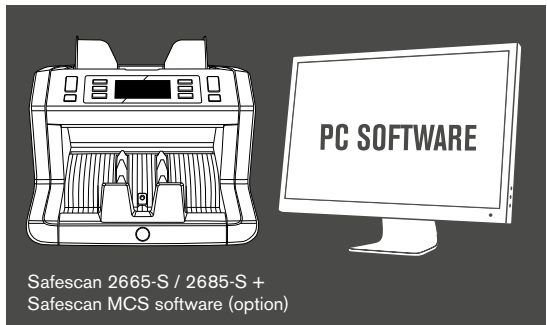
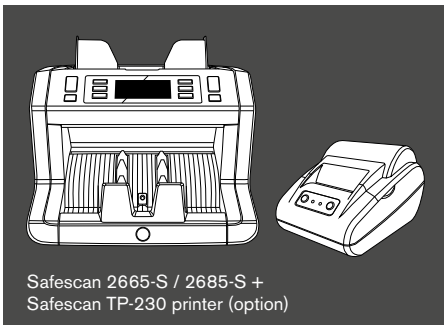
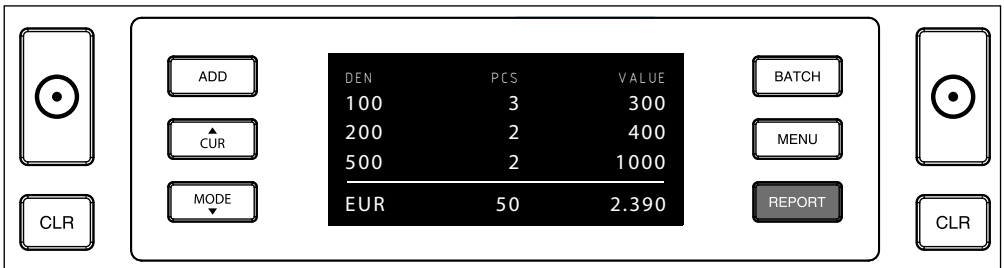

DEVICE MENU

1. In the device menu of the 2665-S / 2685-S you can define specific settings of the machine. To enter the menu, press the **MENU** button



2. The display now shows the various selectable menu items.

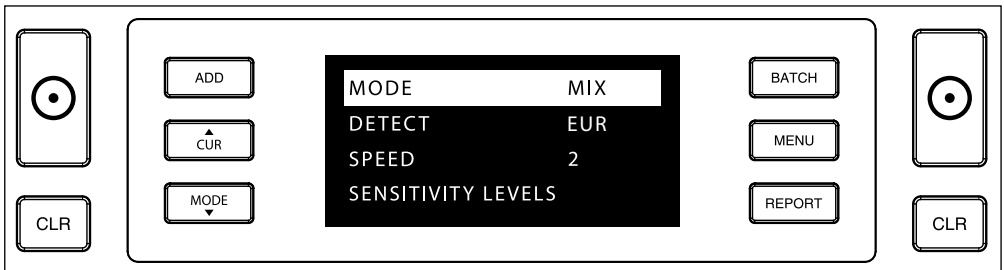

3. Navigate through the menu items with the arrow keys.



4. Press the **START** button to select the desired item. The setting within the selected item starts blinking.

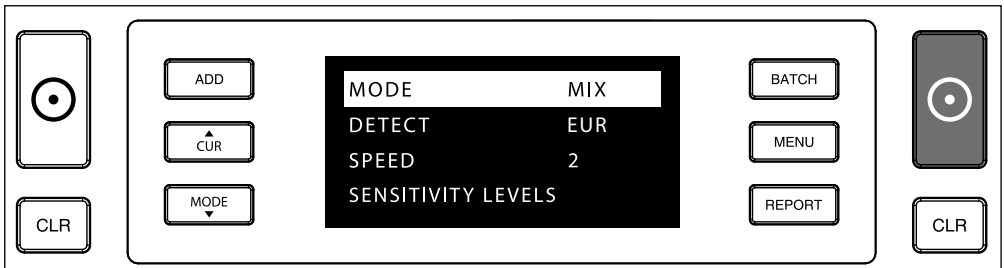

5. Navigate through the various possible settings by using the arrow keys.

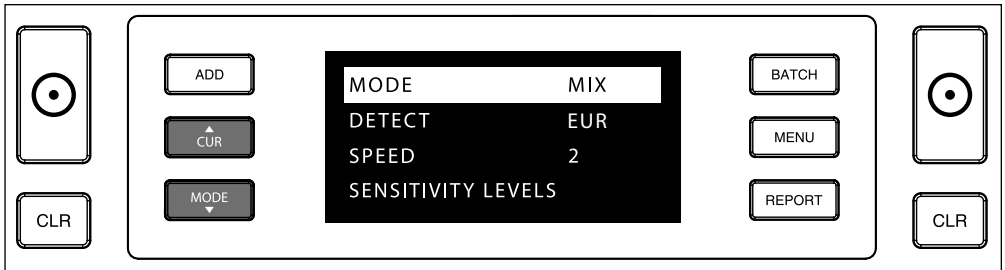

6. Confirm your selection by pressing the **START** button.

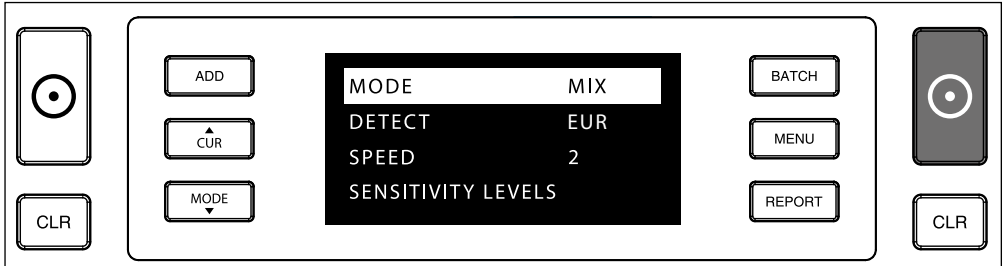

7. After settings have been done, exit the menu by pressing the **MENU** or the **CLR** button. The banknote counter will return to the main screen.

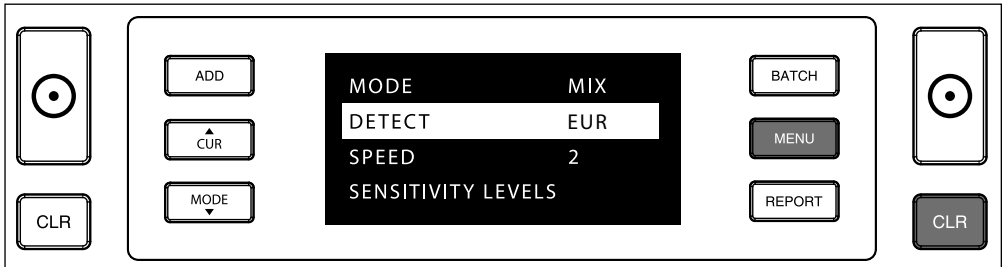

MENU CONTENT

The structure of the menu is as follows:

MODEL	MODE	CURRENCY*	SPEED**	SENSITIVITY LEVEL
2665-S	Mix > Sort > Count	EUR > GBP > USD > CHF > PLN > CZK > HUF > SEK > NOK > DKK > ALL > ALL UV > ALL UV+MG	1 > 2 > 3	UV > MG/MT > Color IR > Height
2685-S	Mix > Sort > Count	EUR > GBP > USD > CHF > PLN > CZK > HUF > SEK > NOK > DKK > ALL > ALL UV > ALL UV+MG	1 > 2 > 3	UV > MG/MT > Color IR > Height

* Due to their specific characteristics, some currencies may not be selectable in certain counting mode(s)

** SPEED SETTINGS: "1" = 800 notes/minute | "2" = 1200 notes/minute | "3" = 1500 notes/minute

ADD AND BATCH FUNCTIONS

1. ADD

The **ADD** function enables you to count cumulatively. Once you remove a stack of counted banknotes and add a new stack, these quantities will be added to the total count.

The function can be activated by pressing the **ADD** button. The indicator in the display will light up.

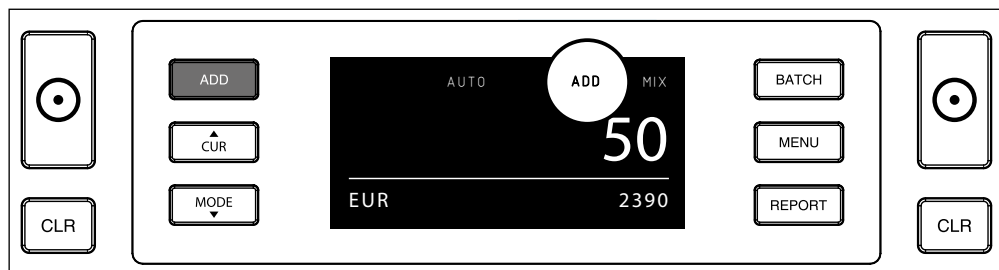

2. BATCH.

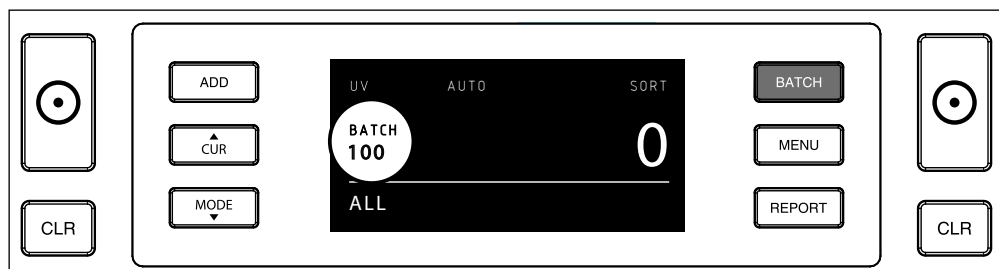

The **BATCH** function enables you to create equal stacks of a pre-set number of banknotes. The counter will stop counting when the set batch quantity has been reached. You can set the batch quantity as follows:

2.1 Press the **BATCH** button to activate the function. The indicator in the display lights up and the batch quantity is blinking for 5 seconds.

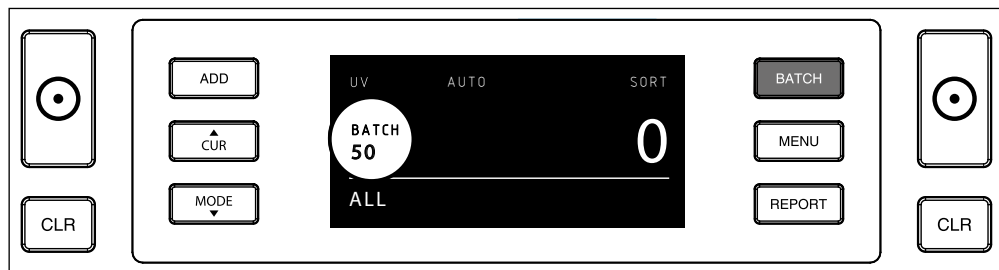

2.2 While the amount is blinking, you can navigate through the preset batch numbers by pressing the **BATCH** button again. The sequence is **100 > 50 > 20 > 10 > 5 > Batch off**.



- 2.3** Use the arrow keys to increase or decrease the batch number 1 piece, starting from the number that is blinking. When the display shows '50', you can go to 51, 52 etc. by pressing  and to 49, 48 etc. by pressing .

5 seconds after you have made your choice, the number stops blinking and your batch number is saved.

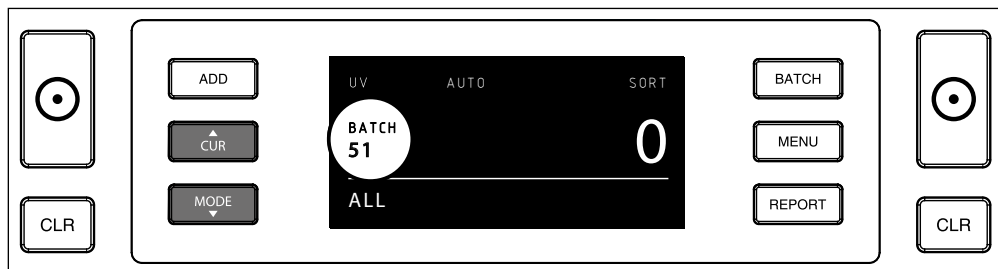

ERROR MESSAGES

The machine will give you a clear audibe and visual notification when a suspected banknote is detected or when a banknote is detected which differs in height from the other notes that are being counted (**SORT** mode). The following messages can be shown:



Counterfeit or suspicious banknote: UV features not detected. Remove the suspect banknote from the stacker and press **START** to continue.

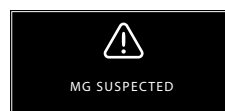

Counterfeit or suspicious banknote. MG features not detected. Remove the banknote from the stacker and press **START** to continue (Safescan 2650-S only).

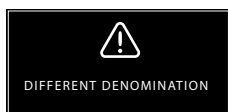

A banknote with a different height has been detected. Remove the different banknote denomination, remove the counted notes and re-count the bundle.

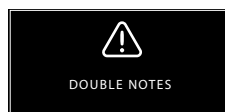

Sometimes banknotes are stuck or folded together. Check the banknotes and re-count. If this error message occurs frequently, adjust the hopper adjustment wheel slightly (+).



Counterfeit or suspicious banknote. IR features not detected. Remove the banknote from the stacker and press **START** to continue



The maximum stacker capacity is 220 banknotes. Remove the banknotes from the stacker.



Slant notes indicate a banknote has not been fed straight through the machine. Make sure that the banknotes are placed neatly and centered onto the hopper. If this error message occurs frequently, adjust the hopper adjustment wheel slightly (+).



Incomplete or damaged banknote. Can occur when a torn banknote is fed through the machine. Remove and check the banknote and press **START** to continue.



A banknote with a non-conforming length has been detected. Remove the different banknote denomination, remove the counted notes and re-count the bundle.

TROUBLESHOOTING

Problem	Cause	Solution(s)
UV error message	<ul style="list-style-type: none"> • Banknote is a suspected counterfeit. • The integrated UV features of banknotes may become weaker when a banknote is old / heavily used or when it has accidentally been washed with the laundry. 	<ul style="list-style-type: none"> • Count the banknote again to double check if the problem persists. • Make sure that the device is not under direct strong light source since this may disrupt the UV sensors. • Clean the sensors and remove any dust that may have accidentally blocked the sensors. • If the banknote is in fact genuine, lower the UV sensitivity level and count the banknote again.
MG error message	<ul style="list-style-type: none"> • Banknote is a suspected counterfeit. • Some currencies are known to have very weak MG features in certain banknote denominations, which are almost impossible to detect. • Some currencies may not have MG features integrated at all. 	<ul style="list-style-type: none"> • Count the banknote again to double check if the problem persists. • Clean the magnetic sensors with a banknote cleaning card. • If the banknote is in fact genuine, lower the MG sensitivity level and count the banknote again.
Size detection does not work	<ul style="list-style-type: none"> • All banknotes within the counted currency are of the same height (for example USD, CHF, CAD, AUD, HUF) • The difference in height between the various denominations may be too little to detect (must be minimum 3 mm) 	
Skewed note error message shows	The banknotes are not being fed straight through the machine.	Ensure the banknotes are placed neatly and are inserted centered on the hopper. Use the hopper guides to center the banknotes and when counting a large stack of banknotes, guide the notes also with your hands during counting.

SOFTWARE UPDATES

Central banks are constantly updating their banknotes to incorporate the newest security features and make it even harder for counterfeiters to succeed. Safescan's dedicated currency management team makes sure your 2665-S/2685-S keeps pace with these changes. We notify you whenever there's an update; all you have to do is install it using the USB port or micro SD slot on the back of the device.

For more information about software updates and update instructions, go to www.safescan.com

HOPPER ADJUSTMENT WHEEL

When counting errors such as Double Notes or Slant Notes occur frequently, or when banknotes are not being fed smoothly through the machine, it may be necessary to adjust the hopper sensitivity wheel. This wheel controls the thickness distance of the banknotes. The position of the hopper wheel has already been set in optimal position in the factory. However, due to the nature of some banknotes an adjustment may be required to ensure optimal feeding.

- When the banknotes are not being counted smoothly: increase the note thickness distance by turning the sensitivity wheel clockwise (+).
- When counting errors like "Double Notes" or "Chained Notes / Double Notes" occur, decrease the note thickness distance by turning the sensitivity wheel anti-clockwise (-).

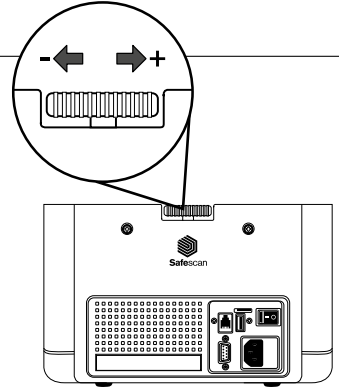

PLEASE NOTE: Since the adjustment wheel is very sensitive, only make minor adjustments.

ADJUSTING COUNTERFEIT DETECTION SETTINGS

Your banknote counter has already been pre-configured with the optimal counterfeit detection settings. On rare occasions it could be required to manually adjust the sensitivity of one or more counterfeit detection settings.

NOTE: only adjust these settings when being advised to do so by a Safescan technical expert.

Counterfeit Detection / Sensor type	Default level	Range
UV sensitivity level	4	0 ~ 8
MG/MT sensitivity level	2	0 ~ 4
Color sensitivity level	4	0 ~ 8
IR sensitivity level	2	0 ~ 8
Height sensitivity level	4	0 ~ 8

RESET TO DEFAULT FACTORY SETTINGS

To return to factory default settings: Press and hold **[CLR]** and switch on the machine. The display will show "**-DEF-**" and "**-H-**". Press **[START]** to save and exit.

MAINTENANCE

The Safescan 2665-S / 2685-S is a high precision device. To ensure that operation and reliability remain at an optimal level, it is important to clean the machine frequently. Use an air-duster to remove dust and dirt. Clean the hopper and stacker with the included dry brush. Use a banknote cleaning card (available as option) to clean the inner parts of the device.

IMPORTANT: Prevent at all times that foreign objects like coins, staples or paperclips accidentally enter the mechanism since this will lead to device malfunctioning.

CLEANING YOUR BANKNOTE COUNTER

To clean the internal parts and sensors of the device:

- CLEAN THE SENSORS AND THE ROTATION WHEELS CAREFULLY WITH A DRY BRUSH OR AIR DUSTER**

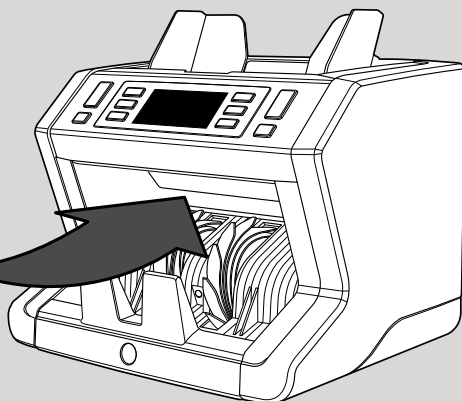
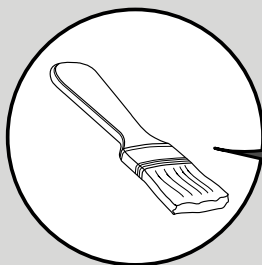

THE USE OF BANKNOTE COUNTER CLEANING CARDS (OPTION)

You can also use the Safescan banknote counter cleaning cards (partno. 136-0546) to clean the roller wheels and magnetic sensors.

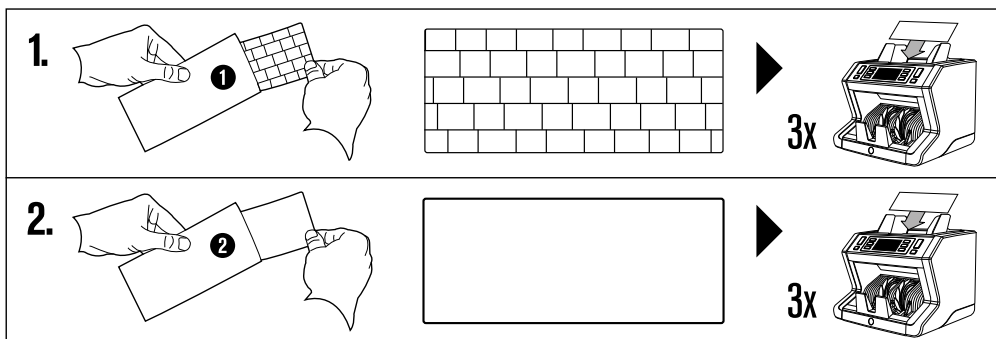

TECHNICAL SPECIFICATIONS

Supported currencies:	EUR, GBP, USD, CHF, PLN, CZK, HUF, SEK, NOK, DKK, all currencies with UV and MG detection
Counting modes:	Mix mode, Sort mode and Count mode
Counting speed:	800 / 1200 / 1500 banknotes/minute
Counterfeit detection:	Up to 7 point counterfeit detection: UV, MG, MT, IR, Color, Size and Thickness. Detectable features may differ per currency.
Banknote size range:	50 x 110 mm ~ 90 x 180 mm
Hopper capacity:	500 notes
Stacker capacity:	250 notes
Power:	AC 100-240V / 50-60Hz
Power consumption:	60W
Dimensions:	24.3 x 28.7 x 24.8 cm / 9.6 x 11.3 x 9.8 inch
Weight:	6.5 kg / 14.3 lbs
Operating Temperature:	0--40°C
Available accessories:	Safescan TP-230 thermal printer Safescan MCS Money Counting Software

WARRANTY

See www.safescan.com for warranty procedure.



This product is in compliance with the essential requirements and other relevant provisions of the applicable European directives. The Declaration of Conformity (DoC) is available via www.safescan.com.



If you want to dispose of the device, take it to a recycling centre. Never throw away electrical products with the household trash.

DO YOU HAVE QUESTIONS OR NEED TECHNICAL ASSISTANCE?

Our support team is available by phone during office hours (GMT +1 timezone) or by e-mail to answer any question you may have regarding the usage of your Safescan device. See www.safescan.com for details.

When calling or e-mailing our support center, always make sure you have the following information at hand: model number, partnumber, serial number (see product sticker at the bottom of the device), software version number (shown at startup of the device), date of purchase.

SAFESCAN® is a registered trademark of Solid Control Holding B.V.

No part of this manual may be reproduced in any form, by print, copy or in any other way without prior written permission of Solid Control Holding B.V. Solid Control Holding B.V. reserves all intellectual and industrial property rights such as any and all of their patent, trademark, design, manufacturing, reproduction, use and sales rights. All information in this manual is subject to change without prior notice. Solid Control Holding B.V. is not liable and/or responsible in any way for the information provided in this manual.

www.safescan.com
info@safescan.com