

# FUSION INNERBAR

## Instruction Manual

V2.0

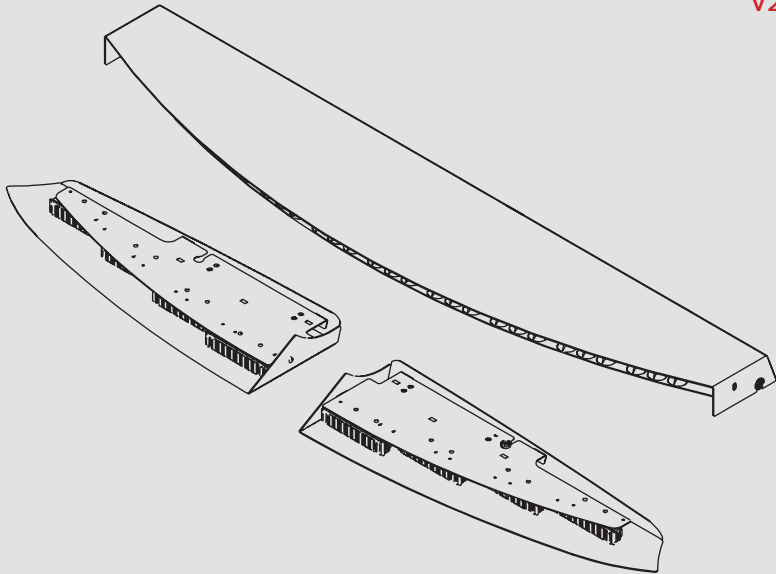

# FUSION

Model # - FN-XXXX,  
\*See website for Part #

This instruction manual serves as a guide for the **Fusion Innerbars**.

**IMPORTANT!** Please read through all provided instructions and any listed warnings in regards to product use.



**Feniex Product Copyrights** This price List and the mentioned Feniex products include or describe copyrighted Feniex material. Laws in the United States and other countries preserve for Feniex Industries and its licensors certain exclusive rights for copyrighted material, including the exclusive right to copy, reproduce in any form, distribute and make derivative works of the copyrighted material. Accordingly, any copyrighted material of Feniex and its licensors contained herein or in the Feniex products described in this Price List may not be copied, reproduced, distributed, merged or modified, transmitted, transcribed, stored in retrieval system or translated into any language or computer language, in any form or by any means, without prior written permission of Feniex Industries, Inc.. Feniex and the stylized Feniex logo are registered in the U.S. Patent & Trademark Office.

<b>Safety Regulations</b> .....	3
<b>Warranty</b> .....	3
Service after Expiration.....	3
<b>Wiring Instructions</b> .....	4
<b>Wiring Diagram</b> .....	5
<b>Mounting Instructions</b>	
Front Mounting.....	6
Rear Mounting.....	8
<b>Brackets</b>	
Split.....	10
Full.....	11
<b>Flash Patterns (Single Color)</b> .....	12
<b>Flash Patterns (Dual Color)</b> .....	13

## Safety Regulations

The following provides all the information necessary to safely operate the previously listed products of Feniex Industries, Inc. Please read this manual thoroughly before installing or operating your new product in order to prevent any damage or injury. Failure to follow the listed instructions in this manual may result in damage to your products or personal injury.

- Proper installation of this product requires good knowledge of automotive systems, electronics and procedures.
- Please guarantee all vital components of the vehicle are not in danger of being damaged by drilling holes necessary for installation. Check all sides of the mounting surface before drilling any holes into the vehicle.
- Do not install this product in any way that interferes with the deployment of the air bag. Doing so may damage the effectiveness of the air bag and can lead to serious personal and vehicle injury. The installer will assume full responsibility of proper installation of the new unit.
- Please clean the mounting surface before installation of the unit when using tape, brackets, magnet, Velcro or suction cups.
- The product's ground wire must be connected directly to the Negative (-) battery post for effective use of the unit. Please follow all wiring guidelines provided to guarantee long lifespan and productivity. Failing to follow these instructions may result in damage to the product.

## Warranty

Feniex Industries, Inc. warrants to the original purchaser that the product shall be free from defects in material and workmanship for 5 years from the date of purchase for all LED products. Feniex Industries warranties speakers, sirens, flashers, and controllers for 2 years.

If a warranty problem occurs, please contact customer support at 1.800.615.8350 or visit the web site at [www.Feniex.com](http://www.Feniex.com). If the product needs to be returned for repair or replacement, call our customer support line to receive a return merchandise authorization number.

Operational times are from 10 a.m. to 5 p.m. central time, Monday through Friday. Please do not send in product without contacting support first for a RMA number.

## Service After Expiration

Feniex Industries will still provide service for all products after expiration of the warranty. For any issues, call the customer support line. In some instances it may be necessary for the product to be shipped, freight prepaid and insured for loss or damage to Feniex headquarters.

**Warning!** Utilizing non-factory screws and mounting brackets may result in loss of warranty coverage.

## Copyright

This instruction manual and the Feniex products described in this instruction manual may include or describe copyrighted Feniex material. Laws in the United States and other countries preserve for Feniex Industries and its licensors certain exclusive rights for copyrighted material, including the exclusive right to copy, reproduce in any form, distribute and make derivative works of the copyrighted material. Accordingly, any copyrighted material of Feniex and its licensors contained herein or in the Feniex products described in this instruction manual may not be copied, reproduced, distributed, merged or modified in any manner without the express written permission of Feniex Industries, Inc.

## Feniex Product Copyrights

The products described in this document are the property of Feniex Industries, Inc. It is furnished by express license agreement only and may be used only in accordance with the terms of such an agreement. Products and documentation are copyrighted materials. Making unauthorized copies is prohibited by law. No part of the product or documentation may be reproduced, transmitted, transcribed, stored in retrieval system or translated into any language or computer language, in any form or by any means, without prior permission from Feniex Industries, Inc.

## Fusion Single Color Wiring Instructions:

**Step 1:** In order to power the unit, extend the red, 12V(+) wire to the 12V(+) post of the vehicle's battery. Extend the black 12V(-) wire to the ground post of the vehicle's battery.

**Step 2:** To turn the lightbar on, connect the brown wire to a 12V(+) source.

**Step 3:** Momentarily connect the yellow wire on a 12V(+) source to change flash patterns.

**Step 4:** For left arrow function, connect the blue wire to a 12V(+) post (switch). There are 2 different left arrow flash patterns. To select a pattern, engage the blue wire to a 12V(+) source and momentarily connect the yellow wire on a 12V(+) source to select the desired pattern.

**Step 5:** For right arrow function, connect the gray wire to a 12V(+) post (switch). There are 2 different right arrow flash patterns. To select a pattern, engage the gray wire to a 12V(+) source and momentarily connect the yellow wire on a 12V(+) source to select the desired pattern.

**Step 6:** In order to achieve a center out directional pattern, connect both the gray and blue wires to a 12V(+) post (switch). There are 2 different center out flash patterns. To select a pattern, engage the blue and gray wires to a 12V(+) source and momentarily connect the yellow wire on a 12V(+) source to select the desired pattern.

**Step 7:** For takedown steady functionality, connect the white wire to a 12V(+) post (switch).

## How to Activate Takedown Flashing for Dual Color Fusion Bars:

**Step 1:** Connect the black wire to the battery's 12V(-) ground.

**Step 2:** Select the wire that will be set as the takedown flashing mode wire, either the green or brown wire.

**Step 3:** Twist the selected mode (green or brown), red, white, and yellow wires together.

**Step 4:** Power the lightbar on by connecting the twisted wires to the battery's positive (+). Once activated, the takedown steady function will engage. To verify takedowns are flashing, disconnect the Takedown Steady (white) wire from power.

**Step 5:** Repeat steps 1 through 3 to deactivate Takedown Flashing.

**Important!** Takedown Steady overrides takedown flashing.

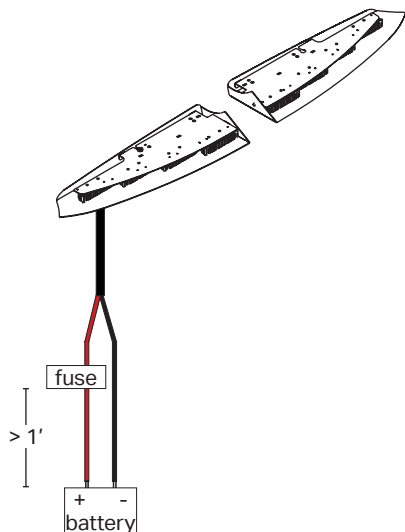

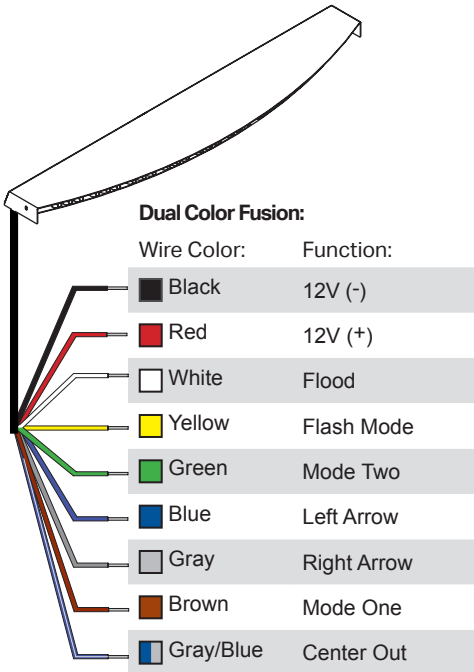
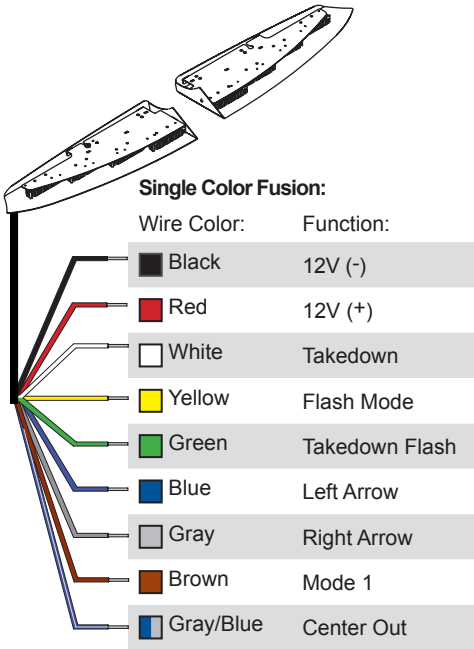

## Can I program takedowns for Fusion Dual Models?

Important Note! Takedown steady overrides takedown flashing

### Activate takedown Flashing for Dual Color:

**Step 1:** Connect the black wire to the battery's 12V(-) ground.

**Step 2:** Select the wire that will be set as the takedown flashing mode wire, either the green or the brown wire.

**Step 3:** Twist the selected mode (green or brown), red, white and yellow wires together.

**Step 4:** Power the lightbar on by connecting the twisted wires to the battery's positive (+). Once activated, the takedown steady function will engage. To verify takedowns are flashing, disconnect takedown steady (white) wire from power.

**Step 5:** Repeat steps 1 through 3 to deactivate takedown flashing.

**Step 1:** Following OEM instructions, remove the vehicle visor clips on the passenger and driver side of the vehicle. Retain the hardware and the visor clips.

**Step 2:** Secure each mounting bracket to the metal frame using the provided hex head bolts or 8-32 screws. These are pre-inserted into the frame. Insert the hex head bolts through the mounting holes on the visor brackets to secure the brackets to the frame.

**Step 3:** Position the opening of each bracket directly under the mounting location of the removed visor clips.

**Important!** The Universal Split model includes an adjustable flashback shield to allow for flexibility in the use of mounting brackets.

### Certifications:

CE Certified

SAE J595 Certified

Meets CCR, Title 13 Requirements

### Fusion Specifications

Voltage: 9-13 VDC

Power < 5 Amps

Dimensions: 0.93"H x 37"W x 5.5"H

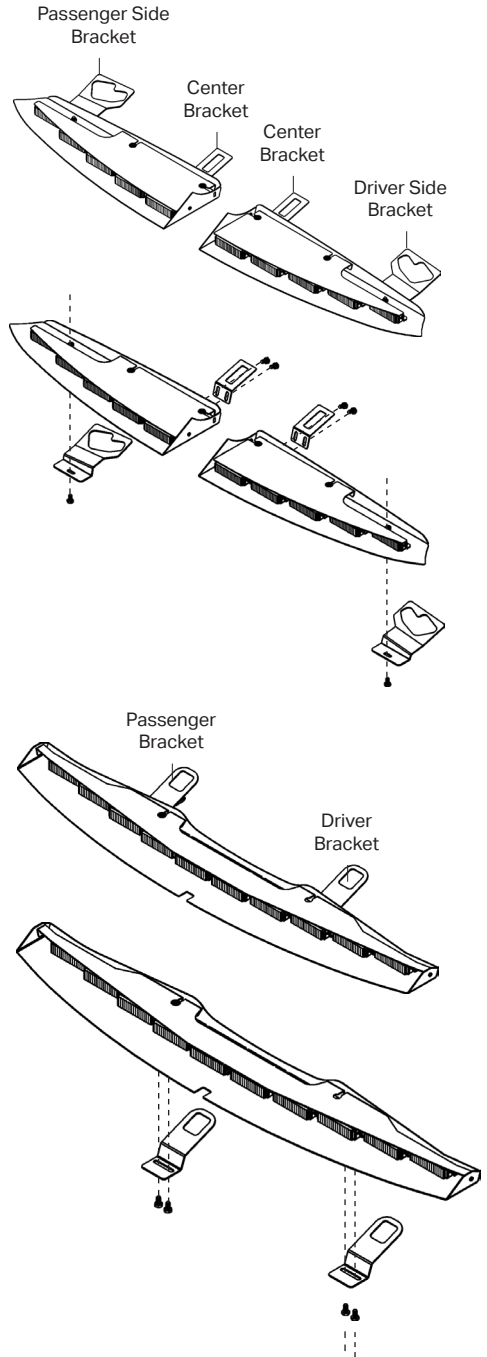

**Step 4:** With the light bar against the headliner and the brackets positioned, reattach the visor clips back into their original position using the original hardware.

**Step 5:** Push the black cable harness through the headliner and proceed with wiring instructions.

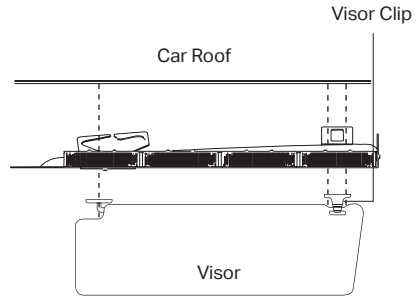

////////////////////////////////////  
**Important!** Depending on vehicle year, additional adjustments may be needed during installation, such as bending the visor clip brackets.  
////////////////////////////////////

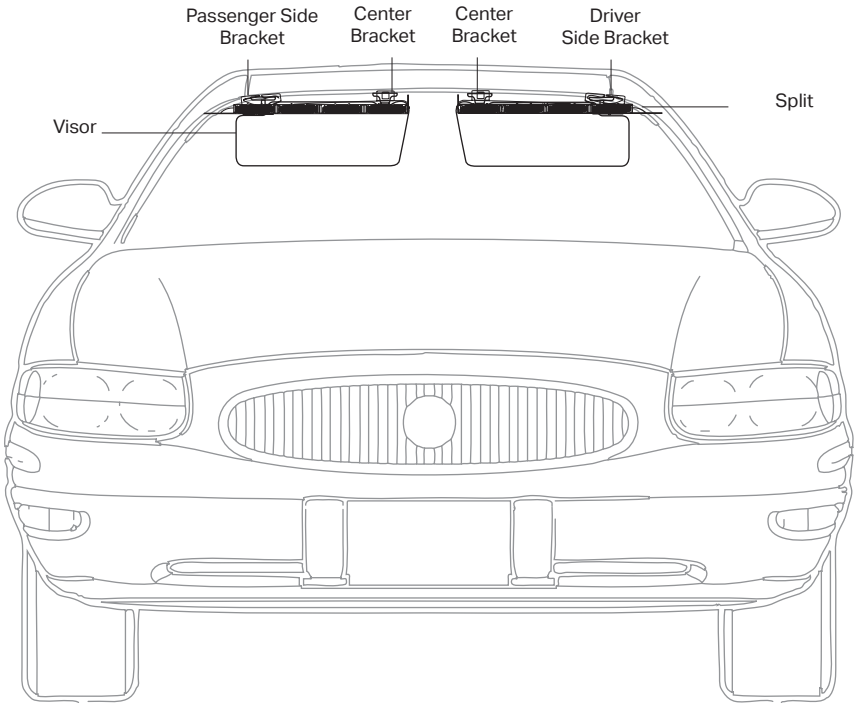

# REAR MOUNTING INSTRUCTIONS

**Step 1:** Following OEM instructions, remove the child restraint brackets on the passenger and driver side of the vehicle. Retain the hardware and the child restraint bracket.

**Step 2:** Secure each mounting bracket to the metal frame using the provided 1/4"x 20 hex head bolts. Insert the hex head bolts through the bottom holes on each side to fasten the light bar frame to the mounting brackets (See page 13 for vehicle specific bracket diagram).

**Step 3:** Position the opening of each bracket directly under the mounting location for the removed child restraint bracket.

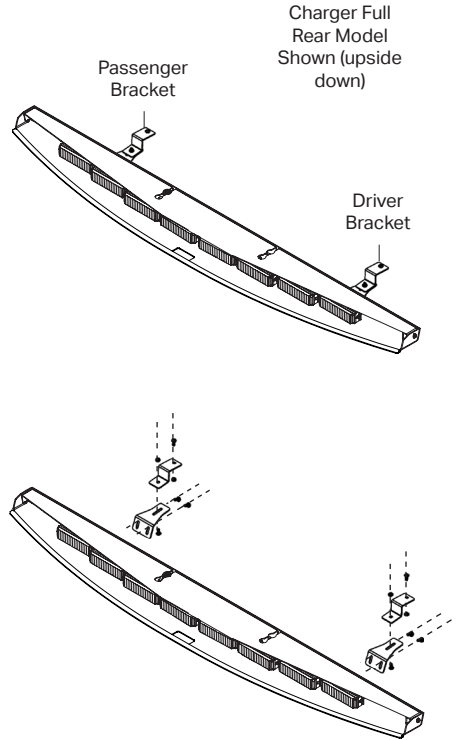

## Certifications:

CE Certified

SAE J595 Certified

Meets CCR, Title 13 Requirements

## Fusion Specifications

Voltage: 9-13 VDC

Power < 5 Amps

Dimensions: 0.93"H x 37"W x 5.5"H

# REAR MOUNTING INSTRUCTIONS

**Step 4:** With the light bar against the rear deck and the brackets positioned, reattach the child restraint brackets back into their original position using the original hardware.



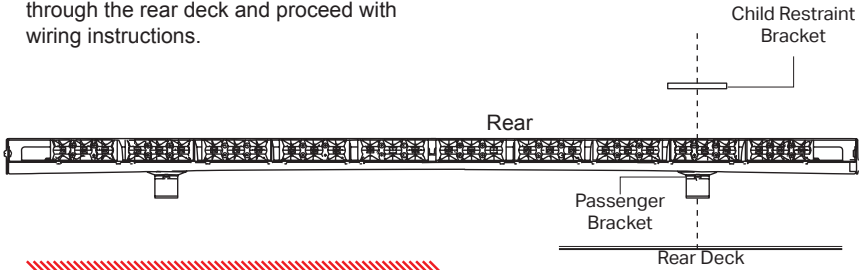



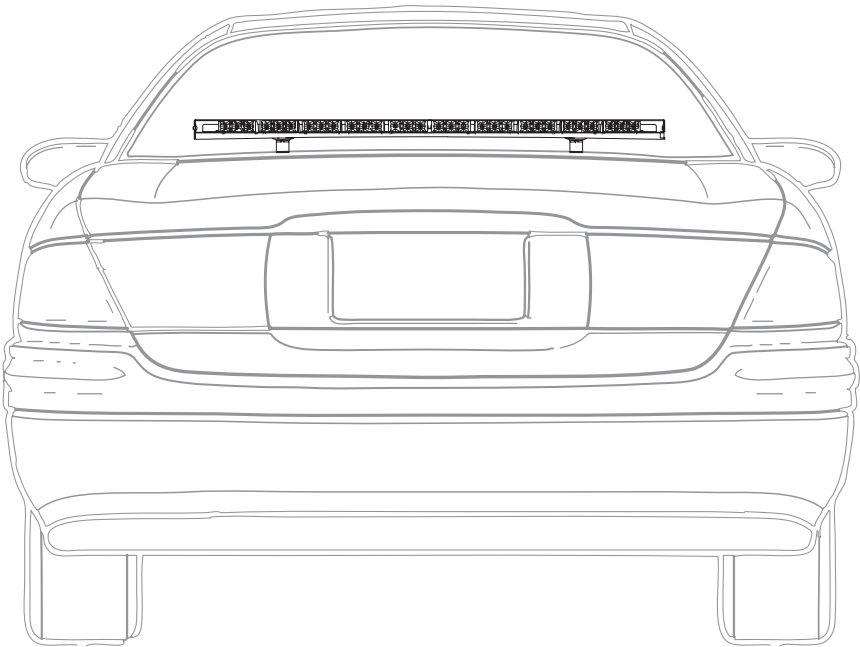





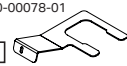

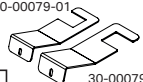
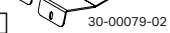

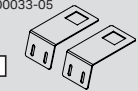
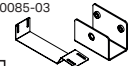

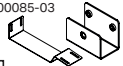





**Step 5:** Push the black cable harness through the rear deck and proceed with wiring instructions.

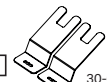

**Important!** Depending on vehicle, additional adjustments may be needed during installation, such as bending the visor clip brackets.

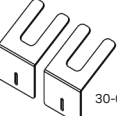

Name:	Driver Side:	Passenger Side:	Center:
<b>Front</b> Caprice 2011+ Split 2011+	30-00041-04  <input type="checkbox"/> 30-00041-02	30-00041-03  <input type="checkbox"/> 30-00041-02	30-00041-05  <input type="checkbox"/> 30-00041-02
<b>Rear</b> Caprice 2011+ Full	 <input type="checkbox"/> 30-00080-04	 <input type="checkbox"/> 30-00080-04	
<b>Front</b> Charger 2011+ Split	 <input type="checkbox"/> 30-00122-02	 <input type="checkbox"/> 30-00122-01	 <input type="checkbox"/> 30-00121-01
<b>Rear</b> Charger 2011+ Full	30-00081-05  <input type="checkbox"/> 30-00081-04	30-00081-05  <input type="checkbox"/> 30-00081-04	
<b>Front</b> Explorer 2011+ Interceptor Utility 2011+ Split	 <input type="checkbox"/> 30-00083-03	 <input type="checkbox"/> 30-00083-06	 <input type="checkbox"/> 30-00083-05
<b>Front</b> F-150 2009-2014 Full	30-00139-01  <input type="checkbox"/>	30-00139-01  <input type="checkbox"/>	
<b>Front</b> F-150 2015+ F-250, 350, 450 2017+ Split	 <input type="checkbox"/> 30-00188-01	 <input type="checkbox"/> 30-00188-02	 <input type="checkbox"/> 30-00187-01
<b>Front</b> F-250, 350, 450 2011-2016 Full	 <input type="checkbox"/> 30-00073-01	 <input type="checkbox"/> 30-00073-01	

Name:	Driver Side:	Passenger Side:	Center:
<b>Front</b> Silverado 2007-2013 Tahoe 2007-2014 Yukon 2007-2014 Avalanche 2007-2013 Split	 30-00032-08 <input type="checkbox"/>	 30-00032-09 <input type="checkbox"/>	 30-00032-10 <input type="checkbox"/>
<b>Front</b> Tahoe 2015+ Surbuban 2015+ Yukon 2015+ Silverado 2014+ Split	 30-00078-01 <input type="checkbox"/>	 30-00078-02 <input type="checkbox"/>	 30-00079-01  30-00079-02 <input type="checkbox"/>
<b>Front</b> Taurus 2011+ Interceptor Sedan 2011+ Split	 30-00033-03 <input type="checkbox"/>	 30-00033-04 <input type="checkbox"/>	 30-00033-05 <input type="checkbox"/>
<b>Rear</b> Taurus 2011+ Full	 30-00085-03  30-00085-04 <input type="checkbox"/>	 30-00085-03  30-00085-04 <input type="checkbox"/>	
<b>Front</b> Universal Split	 30-00114-01  30-00150-01 <input type="checkbox"/>	 30-00114-01  30-00150-01 <input type="checkbox"/>	 30-00114-01  30-00150-01 <input type="checkbox"/>
<b>Front</b> Durango 2015+ Split	 30-00194-01 <input type="checkbox"/>	 30-00194-02 <input type="checkbox"/>	 30-00195-01 <input type="checkbox"/>
<b>Front</b> Expedition 2007-2017 Split	 30-00198-01  30-00199-1 <input type="checkbox"/>	 30-00198-02  30-00199-2 <input type="checkbox"/>	
<b>Front</b> Ram 2011+ Split	 30-00233-01 <input type="checkbox"/>	 30-00233-02 <input type="checkbox"/>	 30-00234-01 (x2) <input type="checkbox"/>

The flash patterns are listed in consecutive order of appearance. To select a certain flash pattern, start with a recognizable pattern and use the yellow wire to cycle through patterns.

## Fusion Single Color Models

1	Cluster
2	Attack
3	Night Ride
4	Combo Slow-Fast
5	Combo Slow
6	Combo Fast
7	Half Half Slow
8	Half Half Fast
9	One One Slow
10	One One Fast
11	Two Two Slow
12	Two Two Fast
13	All On Slow
14	All On Fast
15	In Out Slow
16	In Out Fast
<b>TOTAL = 16</b>	

Directional:	
1	Left Stream Slow
2	Left Stream Fast
3	Left Stream + Blink Slow
4	Left Stream + Blink Fast
5	Right Stream Slow
6	Right Stream Fast
7	Right Stream + Blink Slow
8	Right Stream + Blink Fast
9	Center Out Stream Slow
10	Center Out Stream Fast
11	Center Out + Blink Slow
12	Center Out + Blink Fast
13	All On Blink Fast
14	All on Blink Slow
15	Steady On

The flash patterns are listed in consecutive order of appearance. To select a certain flash pattern, start with a recognizable pattern and use the yellow wire to cycle through patterns.

## Fusion Dual Color Models

1	Color 1-Cluster	25	Color 2-Two Two Fast
2	Color 1-Attack	26	Color 2-All On Slow
3	Color 1-Night Ride	27	Color 2-All On Fast
4	Color 1-Half Half Slow	28	Color 2-In Out Slow
5	Color 1-Half Half Fast	29	Color 2-In Out Fast
6	Color 1-One One Slow	30	Color 2-Combo Slow
7	Color 1-One One Fast	31	Color 2-Combo Fast
8	Color 1-Two Two Slow	32	Color 2-Combo slow-fast
9	Color 1-Two Two Fast	33	Color 1&2-Cluster
10	Color 1-All On Slow	34	Color 1&2-Attack
11	Color 1-All On Fast	35	Color 1&2-Night Ride
12	Color 1-In Out Slow	36	Color 1&2-Half Half Slow
13	Color 1-In Out Fast	37	Color 1&2-Half Half Fast
14	Color 1-Combo slow	38	Color 1&2-One One Slow
15	Color 1-Combo fast	39	Color 1&2-One One Fast
16	Color 1-Combo slow Fast	40	Color 1&2-Two Two Slow
17	Color 2-Cluster	41	Color 1&2-Two Two Fast
18	Color 2-Attack	42	Color 1&2-All On Slow
19	Color 2-Night Ride	43	Color 1&2-All On Fast
20	Color 2-Half Half Slow	44	Color 1&2-In Out Slow
21	Color 2-Half Half Fast	45	Color 1&2-In Out Fast
22	Color 2-One One Slow	46	Color 1&2-Combo Slow
23	Color 2-One One Fast	47	Color 1&2-Combo Fast
24	Color 2-Two Two Slow	48	Color 1&2-Combo Slow-Fast
		<b>TOTAL = 48</b>	

### Directional:

1	Left Stream Slow	11	Center Out + Blink Fast
2	Left Stream Fast	12	All On Blink Fast
3	Left Stream + Blink Slow	13	All on Blink Slow
4	Left Stream + Blink Fast	14	fast dual alternating
5	Right Stream Slow	*Flood Models do not have Fast Dual alternating	
6	Right Stream Fast		
7	Right Stream + Blink Slow		
8	Right Stream + Blink Fast		
9	Center Out Stream Slow		