



for a greener tomorrow

**MITSUBISHI
ELECTRIC**
Changes for the Better

FACTORY AUTOMATION

Energy Measuring Unit EcoMonitorLight



Simple & Easier
Providing Energy Visualization

Eco Monitor Light

GLOBAL IMPACT OF MITSUBISHI ELECTRIC



Through Mitsubishi Electric's vision, "Changes for the Better" are possible for a brighter future.

Changes for the Better

We bring together the best minds to create the best technologies. At Mitsubishi Electric, we understand that technology is the driving force of change in our lives. By bringing greater comfort to daily life, maximizing the efficiency of businesses and keeping things running across society, we integrate technology and innovation to bring changes for the better.

Mitsubishi Electric is involved in many areas including the following

Energy and Electric Systems

A wide range of power and electrical products from generators to large-scale displays.

Electronic Devices

A wide portfolio of cutting-edge semiconductor devices for systems and products.

Home Appliance

Dependable consumer products like air conditioners and home entertainment systems.

Information and Communication Systems

Commercial and consumer-centric equipment, products and systems.

Industrial Automation Systems

Maximizing productivity and efficiency with cutting-edge automation technology.

Simple & Easier Providing Energy Visualization.

Introducing the EcoMonitorLight, an energy measuring unit with an integrated display that provides easy energy visualization in order to provide ways to save energy and to comply with the Energy Saving Act in response to the need for a simple manner to figure out energy consumption.

The EcoMonitorLight is suitable if you are thinking about the following.

Just want to measure energy in a simple low-cost manner.

The integrated display allows you to perform the main unit settings and check measured values quickly.

Considering system expansion in the future. But is this product okay for now?

Firstly from grasping the current situation of the anxious part. Data logging offline in stages Extension to network (B / NET transmission, CC-Link, CC-Link IE field network Basic communication) is also possible.

Want to easily manage measurement data from specific locations.

We can provide you with free software for managing data using a personal computer. You can also link up with an upper-level system by using MODBUS RTU (RS485) communication.



1
2
3
4
5
6
7
8
9

OVERVIEW

Features	3
Product Lineup	7
Examples of EcoMonitorLight Applications	9
Specifications	13
External View	21
Names and Functions of Each Part	25
Connection Configurations / Wiring Precautions	27
Device Installation Procedures	29
Safety Precaution	31

1 Easy and Low-Cost Measurement



■ Simple Measurement / Installation

The built-in LCD screen enables the settings, measurements, and displays required for measuring energy with a single unit.

■ Product Lineup that Provides Easy Equipment Selection

This measuring unit lineup consists of a "Standard Model" , a "High Performance Model, and a "General current transformer Model".

- ①Standard Model: For customers who "want to start measuring energy".
- ②High Performance Model: For customers who want to perform harmonic measurements, alarm monitoring, upper/lower limits monitoring, alarm output and pulse input/output, in addition to the Standard Model features
- ③General current transformer Model: For customers who want to use general current transformer (secondary output 1A or 5A) or connect to the system using MODBUS TCP Communication for system upgrades.

Model	① EMU4-BD1-MB	② EMU4-HD1-MB	③ EMU4-FD1-MB
Appearance			
Current input method	Mitsubishi original split-type current sensor	Mitsubishi original split-type current sensor	General current transformer (Secondary output:1A or 5A)

2 MODBUS RTU (RS-485) Communication as Standard Equipment

Providing MODBUS RTU (RS-485) Communication as standard equipment allows you to connect with the functions listed below, and use it for energy management and as a system terminal.

- ①Host systems (such as EcoWebServerIII*¹ or PLC*², etc.)
- ②Data Acquisition Software (EMU4-SW1)*³
- ③Display device(GOT)

*1: A unit compatible with MODBUS TCP ⇔ MODBUS RTU is required if connecting with a EcoWebServerIII

*2: A unit compatible with MODBUS RTU (RS-485) communication is required if connecting with a PLC.

*3: Data Acquisition Software (EMU4-SW1) can be downloaded for free from the Mitsubishi Electric website. (<http://www.mitsubishielectric.com/fa/products/pmng/ems/items/eng/index.html>)

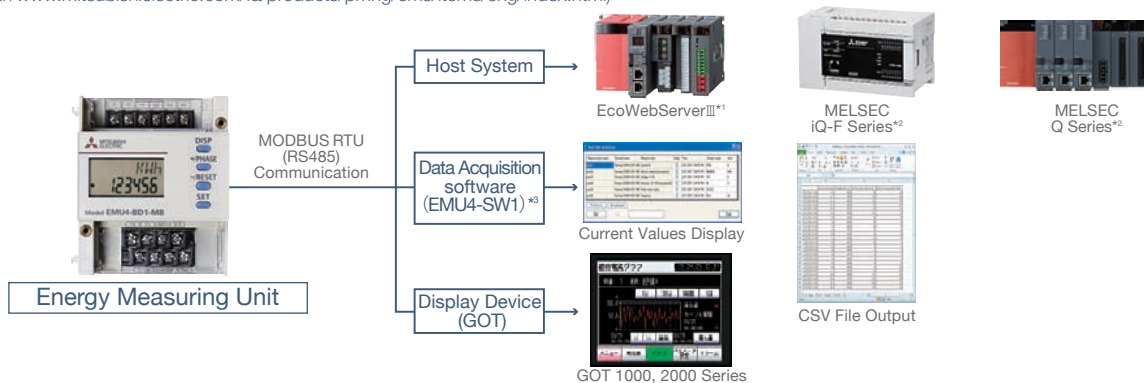

3 Expansion by use of Logging and Communication Units

■ Logging Unit

Use of a logging unit allows you to output various energy (such as current, voltage and power) data measured by the energy measuring unit in CSV file format on an SD memory card for easy data management.

Logging Unit

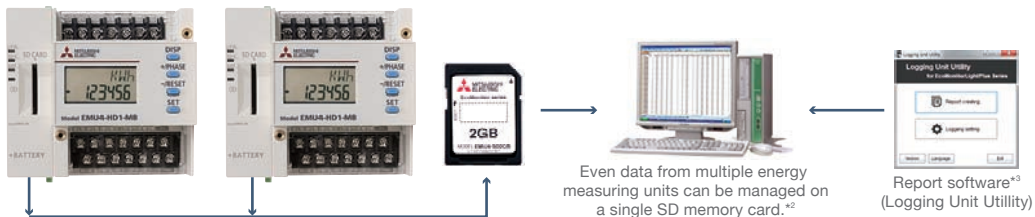

CSV Data
The logging unit stores measurement data for a specified period and outputs it to an SD memory card.*1

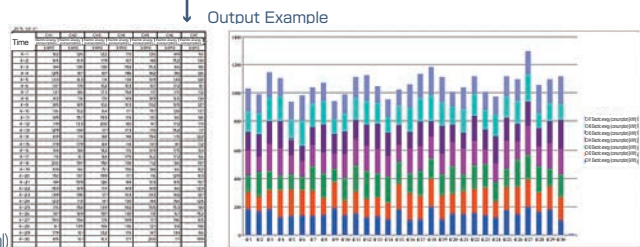

- *1: The data retention period of the logging unit is limited.
- *2: It is necessary to always specify logging ID when collecting measurement data from multiple logging units on a single SD memory card. Refer to the operation manual for details.
- *3: Logging Unit Utility can be downloaded for free from the Mitsubishi Electric website. (<http://www.mitsubishielectric.com/fa/products/pmng/ems/items/eng/index.html>)

■ Communication Unit (CC-Link Communication Unit, MODBUS TCP Communication Unit)

A communication unit can be connected to the system using CC-Link or MODBUS TCP Communication for system upgrades.

Communication Unit

CC-Link Communication

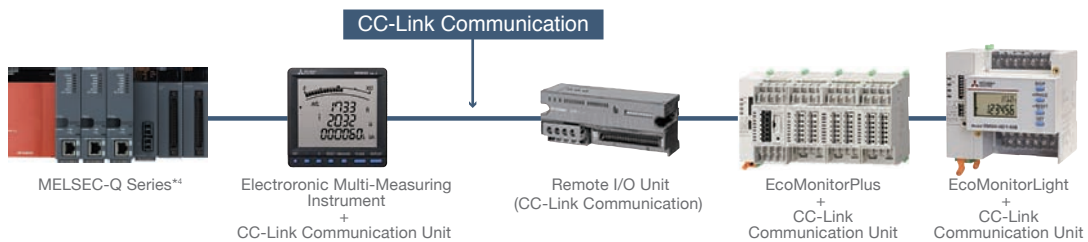

*4: Units compatible with each communication method are necessary if connecting a PLC.

MODBUS TCP Communication*5

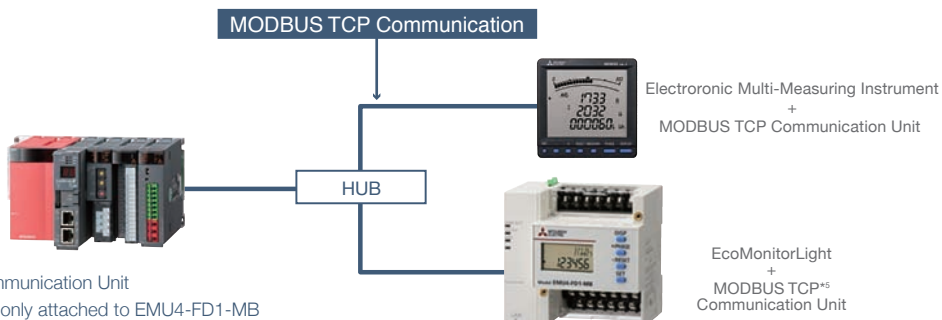

*5: MODBUS TCP Communication Unit (EMU4-CM-MT) is only attached to EMU4-FD1-MB

4 Measurement Functions

High-Precision Measurement

The continuous measurement of energy at sampling cycles of approximately 250 μs allows for measuring even short-cycle loads such as that for spot or solder welding.

*: Data of measured values, including power use as well as voltage, current and similar items, is acquired at update cycles of 250 ms.

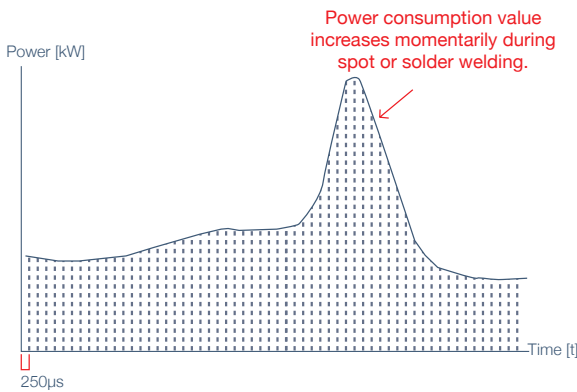

Advantage of High-Precision (Short-Cycle) Measurement

It is possible for measurements to be missed when performing continuous measurement of short-cycle loads because the power used for spot or solder welding is used for an extremely short period. The EcoMonitorLight provide high-precision measurement so that the measurements of short-cycle loads are not missed.

Operating Time Measurement

The current measurement time can be calculated in seconds and the equipment operating time can be displayed in hours (h) in order to utilize the data in diagnosing production equipment service life and for performing preventive maintenance.

*: Operating time can also be output to the host system as CSV data.

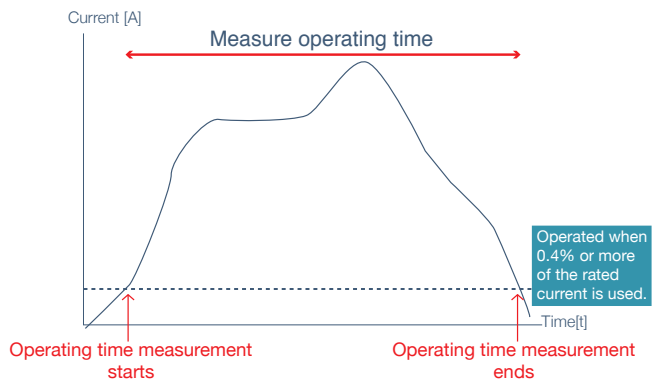

Operating Time Measurement with Specified Inputs as a Trigger

You can specify contact inputs to the energy measuring unit (EMU4-HD1-MB and EMU4-FD1-MB only) as triggers for the start and end of operating time in order to be able to measure operating time according to actual equipment operation.

5 Support Functions

Misconnection Determination Support

This function displays items such as current and voltage phase angles, and energy, current and voltage values for each phase. By checking each displayed value, distinction of whether there is a misconnection in current or voltage input used for measuring is supported.

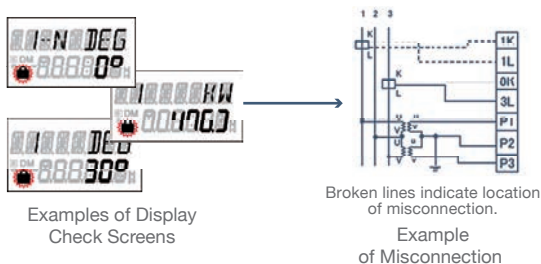

*: The above examples are sample images. Refer to the operation manual for actual screens, the check method, directions for use, etc.
 *: Refer to the operation manual for the table for distinction.

Test Function

This function enables communication of test data to the host system without voltage or current input. By enabling alarm and pulse test signal output, it becomes easy to check wiring and perform system testing.

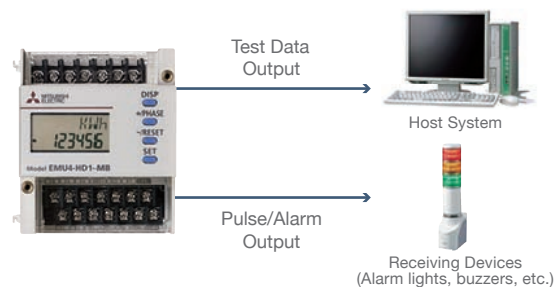

Energy Measuring Unit

The lineup consists of three types of measuring unit to make it simpler to easily visualize energy consumption.

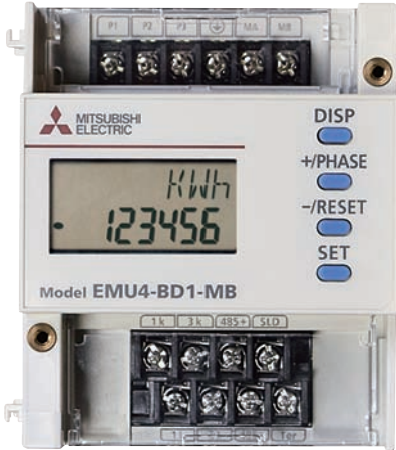

EMU4-BD1-MB

Standard Model

EMU4-BD1-MB

For customers who want to start measuring energy in a simple manner.

- ① Equipped with basic energy measurement functions such as for current, voltage, power and electric energy.
- ② Standard-equipped with MODBUS RTU communication.

Product	Energy Measuring Unit [Standard Model]
Model	EMU4-BD1-MB

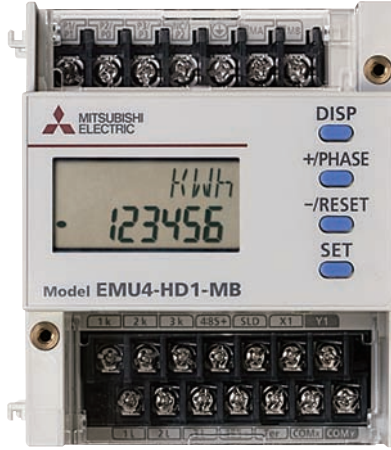

EMU4-HD1-MB

High Performance Model

EMU4-HD1-MB

For customers who need more advanced functions than those of the standard model such as three-phase 4-wire measurement, pulse count and contact input.

- ① Same basic functions as the Standard Model.
- ② Three-phase 3-wire 440V direct voltage input is available.
- ③ Three-phase 4-wire 277V/480V direct voltage input is available.
- ④ Able to display harmonic current and voltage, apparent power, power consumption and CO₂ conversion.
- ⑤ Equipped with pulse and contact input/output functions.

Product	Energy Measuring Unit [High Performance Model]
Model	EMU4-HD1-MB



EMU4-FD1-MB

General Current Transformer Model

EMU4-FD1-MB

For customers who want to use general current transformer (secondary output 1A or 5A) or connect to the system using MODBUS TCP communication for system upgrades.

- ① Compatible with general current transformer
- ② Standard-equipped with MODBUS RTU communication.
- ③ Connecting to MODBUS TCP communication is available.
- ④ Three-phase 3-wire 440V direct voltage input is available.
- ⑤ Three-phase 4-wire 277V/480V direct voltage input is available.
- ⑥ Able to display harmonic current and voltage, apparent power, power consumption and CO₂ conversion.
- ⑦ Equipped with pulse and contact input/output functions.

Product	Energy Measuring Unit [General Current Transformer Model]
Model	EMU4-FD1-MB

Optional Units



Logging Unit

For customers who want to easily manage data using SD memory cards.

▶ **Optional Units**

Product	Logging Unit	CC-Link Communication Unit	CC-Link IE field network Basic communication Unit	MODBUS TCP Communication Unit
Model	EMU4-LM	EMU4-CM-C	EMU4-CM-CIFB	EMU4-CM-MT

*1: MODBUS TCP Communication Unit (EMU4-CM-MT) is only attached to EMU4-FD1-MB



CC-Link Communication Unit

For customers who want to connect to CC-Link communication.



CC-Link IE field network Basic communication Unit

For customers who want to connect to CC-Link IE field network Basic communication.



MODBUS TCP Communication Unit*1

For customers who want to connect to MODBUS TCP communication.

Options

▶ **Options for Logging Unit**

Product	Model	External View
SD memory card for logging unit	EMU4-SD2GB	
Lithium battery for logging unit*	EMU4-BT	

*2: Logging units include one lithium battery when purchased.

▶ **Panel Mounting Installation Option**

Product	Model	External View
Panel mounting attachment	EMU4-PAT	

Accessories (for EMU4-BD1-MB and EMU4-HD1-MB)

▶ **Split-type Current Sensor*3**

Product	Model	External view	UL·CE compatibility
Split-type current sensor**5	EMU-CT5-A		×
	EMU-CT50-A		×
	EMU-CT100-A		×
	EMU-CT250-A		×
	EMU-CT400-A		○
	EMU-CT600-A		○
	EMU-CT50		○
	EMU-CT100		○
EMU-CT250		○	

*3: Split-type Current Sensor can't be used in combination with EMU4-FD1-MB.

*4: Use commercially available cables for the connection of current sensors.

*5: Current sensor cable can be extended up to 50m.(except for EMU2-CT(4W))

*6: 5A current sensor (EMU-CT5,EMU2-CT5-4W) cable can be extended to 10.5m.

*7: EMU2-CB-Q5B(4W) is needed, when using split-type Current Sensor (EMU2-CT5(4W)).

▶ **5A Split-type Current Sensor (Current Sensor Cable)**

Product	Model	Cable length	External view	UL·CE compatibility
5A split-type current sensor*6	EMU2-CT5*7	0.5m		○
	EMU2-CT5-4W*7	0.5m		○
5A split-type current sensor cable	EMU2-CB-Q5B (Single-phase 2-wire, single-phase 3-wire and three-phase 3-wire)	0.5m		○
	EMU2-CB-Q5B-4W*6 (Three-phase 4-wire)	0.5m		○
Extension cable (Standard type)	EMU2-CB-T1M	1m		○
	EMU2-CB-T5M	5m		○
	EMU2-CB-T10M	10m		○
Extension cable (Separate type)	EMU2-CB-T1MS	1m		○
	EMU2-CB-T5MS	5m		○
	EMU2-CB-T10MS	10m		○

1 Configuration Example of Measuring Devices

Basic Installation①(EMU4-FD1-MB)

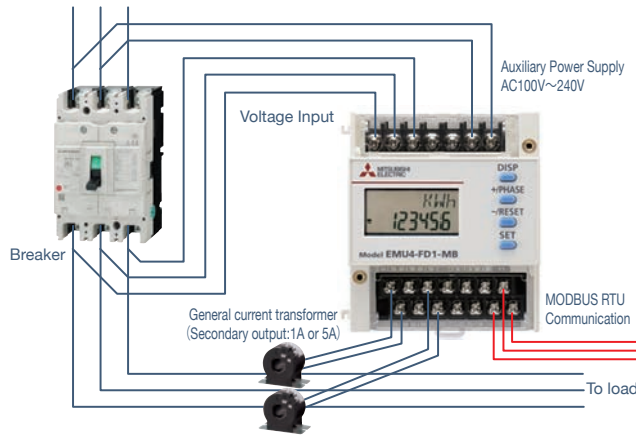

- Since current input by general current transformer (secondary output : 1A or 5A) is possible, Mitsubishi split-type current sensor is not needed.

*: Do not connect together more than one EMU4-FD1-MB on the secondary side of a current transformer.
 *: Do not connect together other units and EMU4-FD1-MB on the secondary side of a current transformer.

Basic Installation②(EMU4-BD1-MB/EMU4-HD1-MB)

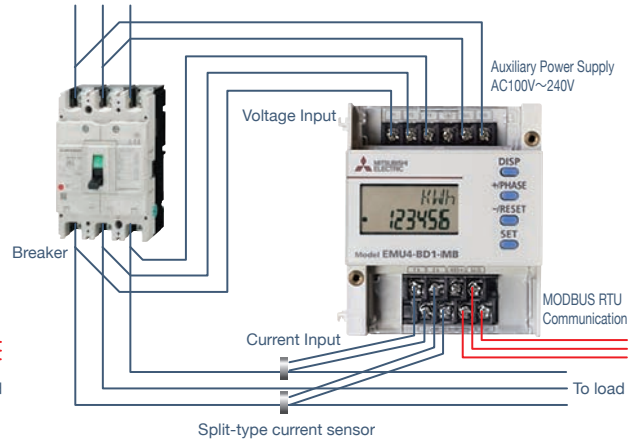

- Easy installation to existing circuit by Mitsubishi split-type current sensors.

2 Visual monitoring (Application example①)

- Monitor measuring devices installed in distribution boards and control panels.
- The easiest way to visualize the energy consumption.

Installation inside a Board

For customers who want to install the unit inside a board for visual management of measured data!



Example of installation inside board



Key Point

Customers visually checking power use with a mechanical Watt-Hour meter can achieve board size reduction and space savings.

Panel Installation

For customers who want to install the display screen on the board surface for monitoring of measurement data.



Key Point

If you do not want the board surface installation screws to be exposed in the board surface, you can use the installation attachment (EMU4-PAT) to cover the screws.



3 Easy Energy Logging (Application example ②)

- Add a logging unit in measuring device, and collect the data through SD card.
- To save labor hour of visual monitoring

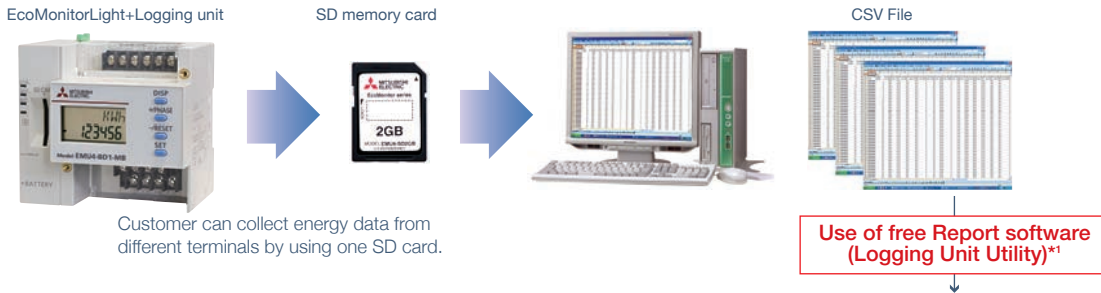

Output Example

Collect energy data into a SD card from EcoMonitorPlus or EcoMonitorLight , Logging unit utility can make a report rom collected data in SD card.

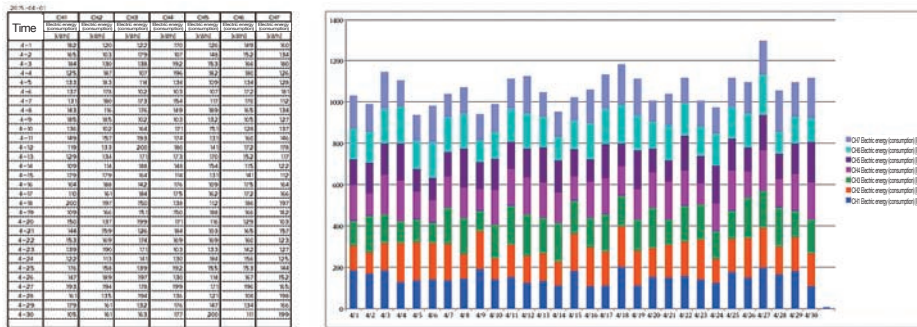

*1: Logging Unit Utility can be downloaded for free from the Mitsubishi Electric website. (<http://www.mitsubishielectric.com/fa/products/pmng/ems/items/eng/index.html>)

4 Energy visualization System with MODBUS RTU communication (Application example ③)

- Energy measuring system can be constructed via MODBUS RTU communication easily.
- You can collect energy data in PC by using data acquisition software.

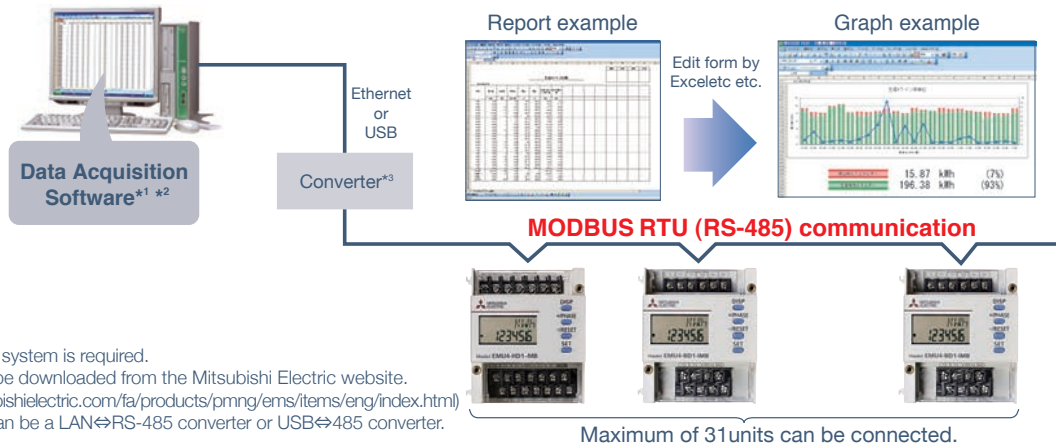

*1: One PC per each system is required.
 *2: EMU4-SW1 can be downloaded from the Mitsubishi Electric website. (<http://www.mitsubishielectric.com/fa/products/pmng/ems/items/eng/index.html>)
 *3: Used converter can be a LAN⇔RS-485 converter or USB⇔485 converter.

5 Visual checking and management monitoring by GOT1000 or 2000 Series (Application example④)

■ On-site Visualization of Energy Data

For customers who want on-site visualization of energy consumption, and to manage the correlation of Production and energy.

[GOT1000,2000 Series+MODBUS RTU(RS-485) Communication Application]

You can directly connect to the Mitsubishi GOT* by using MODBUS RTU communication.

Displaying various energy information on a GOT installed on-site allows you to improve on-site energy-conservation awareness and perform production management to fit the energy conditions.



*: Compatible with GOT1000,2000 series units that are standard-equipped with an RS-485 serial port

Screen example

Examples screen of Mitsubishi GOT

■GT27

<p>Main Screen</p>	<p>Current Value Screen</p>	<p>Graph Screen</p>	<p>Alarm Screen</p>
---------------------------	------------------------------------	----------------------------	----------------------------

■GT14

<p>Main Screen</p>	<p>Current Value Screen</p>	<p>Graph Screen</p>	<p>Alarm Screen</p>
---------------------------	------------------------------------	----------------------------	----------------------------

6 Energy Management Connecting to PLC System (Application example⑤)

- Available uses include preventive equipment maintenance by using energy amount measurement.
- Linking of quality control indicators with production information.

Example of Connection to PLC and GOT

By monitoring the current/voltage of the machine in operation, it helps to grasp the situation in trouble and find the cause immediately.

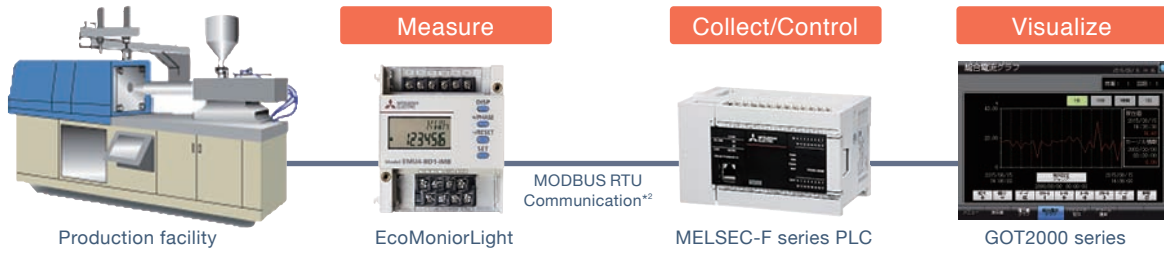

*1: Originally equipped with the energy measuring unit. CC-Link communication is also available with an optional unit.
 *2: Originally equipped with the energy measuring unit. MODBUS TCP communication is also available with an optional unit(Only attached to EMU4-FD1-MB).

CC-Link IE field network Basic communication connection

Data communication is possible Via the same network (Ethernet) as FA equipment installed in the device.

Start-up time of production equipment / machinery equipment · Installation cost · Reduction of wiring work.

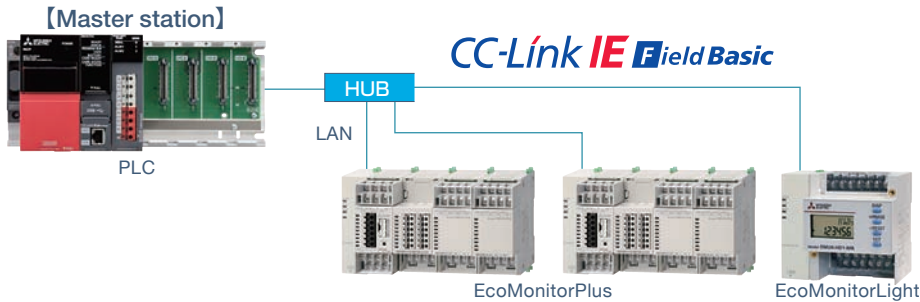

7 Connection to Visualization system with “EcoWebServerIII” (Application example⑥)

- Energy measurement graph can be shown through factory LAN by using EcoWebServerIII
- Remote monitoring of machines and line status can be shown by PC.
- EcoWebServer system helps factory staff to improve awareness of energy saving.

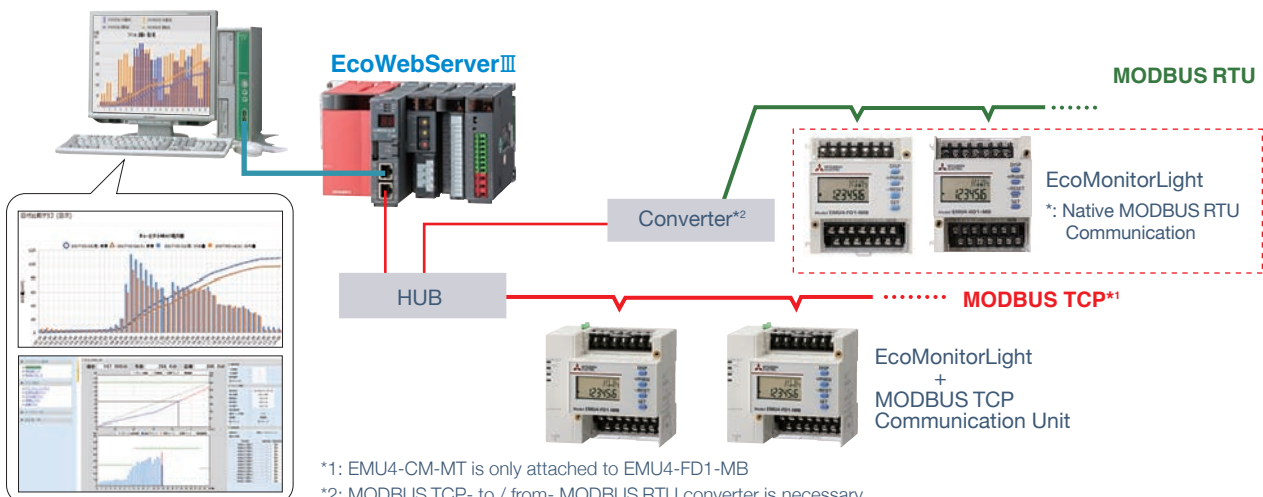

*1: EMU4-CM-MT is only attached to EMU4-FD1-MB
 *2: MODBUS TCP- to / from- MODBUS RTU converter is necessary.

Energy Measuring Unit

► General Specifications

Item		Specifications			
Model		EMU4-BD1-MB	EMU4-HD1-MB	EMU4-FD1-MB	
Phase wire system		Single-phase 2-wire, single-phase 3-wire and three-phase 3-wire (Settings switching)		Single-phase 2-wire, single-phase 3-wire, three-phase 3-wire and three-phase 4-wire (Settings switching)	
Instrument ratings	Voltage circuit	Single-phase 2-wire 3-phase 3-wire	110V, 220V AC Common ^{(*)1}		
		Single-phase 3-wire	110V AC(between wires 1 and 2, and 2 and 3), 220V AC (between wires 1 and 3)		
		3-phase 4-wire	Min.: 63.5V/110V AC , Max.: 277 V/480V AC ^{(*)3}		
	Current circuit	50A, 100A, 250A, 400A, 600A AC (Dedicated split-type current sensor is used. All values indicate primary current values of current sensor.) 5A AC (Dedicated 5A current sensor is used. A transformer (CT) is used in two-step configuration together with the 5A current sensor in order to allow a maximum primary current value setting of 6,000 A.) ^{(*)4}			
Frequency		50 Hz to 60 Hz (Automatic frequency selection)			
Auxiliary power rating		100V—240V AC (+10%, -15%) 50Hz/60Hz			
No. of measurement circuits		1			
Consumption VA	Voltage circuit	For each phase: 0.1 VA (110V AC), 0.2 VA (220V AC), 0.4 VA (440V AC)			
	Auxiliary power circuit	110V AC : 9VA 220V AC : 10VA			
Measured items		Current, demanded current, voltage, power, demanded power, reactive power, power factor, frequency, electric energy (consumption, regenerative), reactive electric energy and operating time			
		— Apparent power, harmonic current, harmonic voltage, pulse count value, periodic electric energy and CO ₂ conversion value			
Main unit tolerances ^{(*)5}		Current, voltage, power, reactive power, apparent power, frequency: ± 1.0% (relative to rated input) Power factor: ± 3.0% Electric energy: ± 2.0% (in 5 to 100% range of rated values; Power factor = 1) Reactive electric energy: ± 2.5% (in 10 to 100% range of rated values; Power factor = 0) Harmonic current, harmonic voltage: ± 2.5%		Current, voltage, power, reactive power, apparent power, frequency: ± 0.5% (relative to rated input) Electric energy: Class0.5S(IEC62053-22) Reactive electric energy: Class2S(IEC62053-23) Harmonic current, harmonic voltage: ± 2.5%	
Data update cycle		250 ms *Electric energy and reactive electric energy are always sampled (following short-cycle load fluctuation also).			
Demand time limit setting		0 sec, 10 sec, 20 sec, 30 sec, 40 sec, 50 sec, 1-15 min. (per 1 min.), 20 min, 25 min and 30 min.			
External input specifications	Input signal format	—	No voltage a contact or open collector 1 input (Function selected from the following)		
	Functions	—	Set to pulse input: Pulse count (0 to 999,999 count)		
	Insulation type	—	Set to contact input:Contact monitoring only.During contact monitoring+ Electric energy measurement during operation (contact on)		
	Rated input voltage/current	—	Photocoupler insulation		
	Input conditions	Pulse	—	Pulse-on time: 30 ms or more Pulse-off time: 30 ms or more Chattering time: 3 ms or less	
		Contacts	—	Contact on time: 30 ms or more Contact off time: 30 ms or less Chattering time: 3 ms or less	
External output specifications	Output signal type	—	Non-voltage contact, 1 output (Select from the below functions)		
	Functions	—	Monitoring of current demand upper limit Monitoring of current demand lower limit Monitoring of voltage upper limit Monitoring of voltage lower limit Monitoring of power demand upper limit Monitoring of power demand lower limit Monitoring of power factor upper limit Monitoring of power factor lower limit Monitoring of pulse count upper limit		
	Insulation type	—	Automatic reset/Self-retention can be selected		
	Rated switching voltage/current	—	Semiconductor relay insulation DC35V,75mA AC24V,75mA(Power factor = 1)		
Pulse Output specifications	Output item	—	Electric energy		
	Output signal type	—	Non-voltage contact, 1 output · Pulse units (kWh/pulse): 0.001, 0.01, 0.1, 1, 10, 100 Refer to the operation manual of a main unit for the details of a pulse setup.		
	Insulation type	—	Semiconductor relay insulation		
	Rated switching voltage/current	—	DC35V,75mA AC24V,75mA (Power factor = 1)		
	Output pulse width	—	0.1~0.15s		
Power interruption backup	Recorded items	Set values, electric energy (consumption, regenerative), reactive electric energy, periodic electric energy, pulse count value and operating time(Stored in the nonvolatile memory)			

Item		Specifications		
Model		EMU4-BD1-MB	EMU4-HD1-MB	EMU4-FD1-MB
Compatible standards		EMC:EN-61326-1:2006 U L:UL61010-1 Safety:EN-61010-1:2010		
Operating environment	Operating temperature range	-5°C~+55°C (daily average temperature of 35°C or less)		
	Operating humidity range	30%~85%(no condensation)		
	Storage temperature range	-10°C~+60°C(daily average temperature of 35°C or less)		
	Altitude	2,000 m or less		
Commercial-frequency withstand voltage		Applies to all terminals(excluding communication and frame GND terminals), between external boards: 2,000V AC for 1 min.		
		Applies to all current/voltage inputs, between auxiliary powers: 2,000V AC for 1 min.		
		Applies to all current/voltage inputs and auxiliary power terminals, between all digital/pulse input, pulse/alarm output and communication terminals: 2,000V AC for 1 min.		
Insulation resistance		In the same locations described above: 10 MΩ or more(500V DC)		
Compatible wiring	Auxiliary power/Voltage input terminal	AWG24-16(Single/Stranded wire) (Single wire: φ0.52 to φ1.29 mm, Stranded wire: 0.21 to 1.30 mm ²)	AWG26-14(Single/Stranded wire) (Single wire: φ0.41 to φ1.62 mm, Stranded wire: 0.13 to 2.0 mm ²)	
	Current input and input/output terminal	AWG22-16(0.3~1.25mm ²) (Single/Stranded wire) (Single wire:φ0.65-φ1.62mm, Stranded wire:0.3-1.3mm ²)		AWG22-14(0.3~2.0mm ²) (Single/Stranded wire) (Single wire:φ0.65-φ1.62mm, Stranded wire:0.33-2.0mm ²)
Tightening torque	Auxiliary power/Voltage input terminal screw	0.8~1.0N·m		
	Current input and input/output terminal screw	0.5~0.6N·m		
	Board installation screw	0.63N·m		
Weight		0.2kg	0.3kg	
External dimensions (units: mm)		75(W)×90(H)×75(D) (Excluding protruding parts)		

- *1: 110V, 220V, 440V AC can be connected to this unit directly. For the circuit over this voltage, transformer (VT) is necessary(Primary voltage of VT can be set up to 6600V, and secondary voltage of VT can be set up to 220V as optional setting).Star- delta connection and delta-star connection transformer of cannot measure definitely to be out of phase. Please use a transformer of the same connection.
- *2: 63.5/110V – 277/480V AC can be connected to this unit directly. For the circuit over this voltage, transformer (VT) is necessary (Primary voltage of VT can be set up to 6600V, and secondary voltage of VT can be set up to 220V as optional setting).Star- delta connection and delta-star connection transformer of cannot measure definitely to be out of phase. Please use a transformer of the same connection.
- *3: 63.5 V / 110 V - 277 V / 480 V can be connected directly. An externally mounted voltage transformer (VT) is needed for voltages greater than those (primary voltage of up to a maximum of 6,600 V).
- *4: The settable primary current when using a 5A current sensor is as follows:5A,6A,7.5A,8A,10A,12A,15A,20A,25A,30A,40A,50A,60A,75A,80A,100A,120A,150A,200A,250A,300A,400A,500A,600A,750A,800A,1000A,1200A,1500A,1600A,2000A,2500A,3000A, 4000A,5000A,6000A (The CT primary side can be freely specified up to 6,000 A. However, the CT secondary side is fixed at 5 A.)
- *5: Refer to “Specifications: Options (Split Current and 5A Current Sensors)” on P.17 for the current sensor error ratios.
- *6: Do not connect together more than one EMU4-FD1-MB on the secondary side of a current transformer. Do not connect together other units and EMU4-FD1-MB on the secondary side of a current transformer.

► Specifications of MODBUS RTU Communication

Item	Specifications
Physical interface	RS-485 2wires half duplex
Communication protocol	MODBUS RTU mode
Transmission method	Asynchronous
Transmission wiring type	Multi-drop bus (either directly on the trunk cable, forming a daisy-chain)
Baud rate	2400,4800,9600,19200,38400bps (default: 19,200 bps)
Data bit	8
Stop bit	1,2(default: 1)
Parity bit	ODD,EVEN,NONE(default:EVEN)
Slave address	1~255(FFh) (default: 1) 0: Broadcast
Response time	1s or shorter from completion of receiving query data to response transmission
Terminating resistor	120Ω 1/2W
Transmission distance	1,200m
Maximum connectable devices	31 devices
Recommended cable	SPEV(SB)-MPC-0.2×1P or more (Mitsubishi cable industries)

Logging Unit

► General Specifications

Item		Specifications
Model		EMU4-LM
Auxiliary power rating		6.4V DC (Power supplied from energy measuring unit)
Power interruption backup		Total power interruption backup time of the lithium battery (EMU4-BT) is one year (avg. daily temp. of 35°C or less); Mitsubishi Electric recommends replacing the battery every three years.
	Set values	Saved in FRAM (non-volatile memory) *: Data is not deleted if there is a power outage.
	Logging data System log data	Saved in SRAM (volatile memory) *: Data is deleted if there is a power outage when the battery voltage is low (BAT.LED lights up).
	Timer operation	*: Timer operation is initialized if there is a power outage when the battery voltage is low (BAT.LED lights up). After the power is recovered, timer operation starts from the time of 2013/01/01 00:00:00.
Clock accuracy		1 min./Month difference
Output data storage media*1*2		SD memory card (SD, SDHC)
Compatible model		Energy measuring unit (EcoMonitorLight) Energy measuring unit (EcoMonitorPlus) EMU4-BD1-MB, EMU4-HD1-MB EMU4-BM1-MB, EMU4-HM1-MB, EMU4-LG1-MB, EMU4-FD1-MB EMU4-A2, EMU4-VA2, EMU4-AX4, EMU4-PX4
CE Marking Compatible standard		EMC:EN-61326-1:2006
Operating environment	Operating temperature range	-5°C~+55°C (daily average temperature of 35°C or less)
	Operating humidity range	30%~85%RH (no condensation)
	Storage temperature range	-10°C~+60°C
	Altitude	2,000 m or less
Weight		0.1 kg *Weight of the logging unit only.
Dimensions (units: mm)		25 (W) x 99 (H) x 60 (D) *: Dimensions of the logging module only.
Expected product life		10 years (Under operating environment conditions)
Parts sold separately		SD memory card (EMU4-SD2GB)*1*2
Consumables sold separately		Lithium battery for logging unit (EMU4-BT)*3

*1: Use the SD memory card (EMU4-SD2GB) made by Mitsubishi Electric.

Use of any memory card other than our product (EMU4-SD2GB) is not covered by the warranty.

*2: For more information Please contact local sales representative.

*3: The lithium battery for logging units is attached at the one time of logging unit purchase.

► Logging Specifications

Item		Specifications
Logging mode	Automatic refresh	Automatic overwrite/refresh
	Date/Time designation	Automatic start based on start time setting
Logging data type	Detailed data	Measurement data is memorized according to the specified "Detailed Data Logging Cycle" (1 sec., and 1, 5, 10, 15 and 30-minute cycles) *: Output as a detailed data file.
	1-hour data	Measurement data is memorized in 1-hour cycles. *: Output as 1-hour and 1-day data files.
Amount of logging element	Detailed data	Detailed data logging cycle: 1 sec. → Max. of 4 elements Detailed data logging cycle: Other than 1 sec. → Max. of 10 elements
	1-hour data	Max. of 10 elements
Internal memory logging period	Detailed data	Detailed data logging cycle: 1 sec. → 20 hours
		Detailed data logging cycle: 1 min. → 20 days
Detailed data logging cycle: 5 min. → 100 days		
Detailed data logging cycle: 10 min. → 200 days		
Detailed data logging cycle: 15 min. → 300 days		
SD memory card (2 GB) Logging period*1	Detailed data logging cycle: 1 sec. → 10 months	
	Detailed data logging cycle: 1, 5, 10, 15 and 30-min. → 10 years or more	
System log data		3,600 records
Output format of logging and system log data		CSV format (ASCII code)

*1: The indicated period is that until the capacity of a 2 GB SD memory card is exceeded when it is constantly connected.

The data amount varies depending on the amount of characters.

The logging period indicates output at maximum capacity.

CC-Link Communication Unit

Basic Specifications

Item		Specifications	
Model		EMU4-CM-C	
Auxiliary power rating		6.4V DC (6.4V DC Power supplied from energy measurement unit)	
Compatible model		Energy measuring unit (EcoMonitorLight) EMU4-BD1-MB, EMU4-HD1-MB EMU4-FD1-MB	Energy measuring unit (EcoMonitorPlus) EMU4-BM1-MB, EMU4-HM1-MB, EMU4-LG1-MB, EMU4-A2, EMU4-VA2, EMU4-AX4, EMU4-PX4
CE Marking Compatible standard		EMC EN-61326-1:2006	
Operating environment	Operating temperature range	-5°C~+55°C (daily average temperature of 35°C or less)	
	Operating humidity range	30%~85%RH (no condensation)	
	Storage temperature range	-10°C~+60°C	
	Altitude	2,000m or less	
Weight		0.1 kg *: Weight of the CC-Link communication unit main unit only.	
Dimensions(units: mm)		25(W)×99(H)×60(D)	
Expected product life		10 years (Under operating environment conditions)	

CC-Link Communication Specifications

Item		Specifications	
Number of Occupied Station		1 Station Remote device station (I/o) data and word data can be transmitted	
CC-Link Ver 1.10 Ver. 2.00 (Set by Version change switch)		Ver. 1.10, Ver. 2.00 (Set by version change switch)	
Remote Station Number (Station Number)		1 to 64	
Baud Rate		156K, 625K, 2.5 M, 5M, and 10Mbps (Changes according to setting) (The interstation cable length and maximum total cable extension distance vary according to the transmission speed.) *: 100m(10M)~1,200m(156k)	
Max.connected device		A maximum of 42 units can be connected if configured using only this module.	
Cable terminating resistance		Use a specified cable for CC-Link communication connection. Resistance values for terminating resistance are different according to the type of specialized cable used.	

CC-Link IE field network Basic communication Unit

Basic Specifications

Item		Specifications	
Model		EMU4-CM-CIFB	
Auxiliary power rating		6.4V DC (6.4V DC Power supplied from energy measurement unit)	
Compatible model		Energy measuring unit (EcoMonitorLight) EMU4-BD1-MB, EMU4-HD1-MB EMU4-FD1-MB	Energy measuring unit (EcoMonitorPlus) EMU4-BM1-MB, EMU4-HM1-MB, EMU4-LG1-MB, EMU4-A2, EMU4-VA2, EMU4-PX4, EMU4-AX4
CE Marking Compatible standard		EMC:EN-61326-1:2006 (EcoMonitorLight) EMC:EN-61326-1:2013 (EcoMonitorPlus)	
Operating environment	Operating temperature range	-5°C~+55°C (daily average temperature of 35°C or less)	
	Operating humidity range	30%~85%RH (no condensation)	
	Storage temperature range	-10°C~+60°C(daily average temperature of 35°C or less)	
	Altitude	2,000m or less	
Weight		0.1 kg *: Weight of the CC-Link communication unit main unit only.	
Dimensions (units: mm)		25(W)×99(H)×60(D)	

CC-Link IE field network Basic communication specification

Item		Specifications	
Interface		1 port (100BASE-TX)	
Transmission method		Base band	
Number of cascade connection stages*1		Max. 2 stages	
Number of occupied stations		One station occupancy	
Transmission speed		100Mbps	
Maximum Inter-Station Distance		100m (Conforming to ANSI / TIA / EIA -568 -B (Category 5 e))	
Connector applicable for external wiring		RJ-45	
Cable		Cable compliant with the IEEE802.3 100BASE-T Standard (Shielded twisted pair cable (STP cable), Category 5 or more)	
Protocol		CC-Link IE Field Basic, SLMP	
Functions supported		Auto MDIX function (straight/crossover cable automatically detected)	

*1: This is the maximum number of cascade connection stages when a repeater hub is used.

For the maximum number of cascade connection stages, contact to the manufacturer for the switching hub used.

Item		Specifications			
		MELSEC iQ-R	MELSEC iQ-F	MELSEC-Q	MELSEC-L
Number of simultaneously connection	Master station	1 units			
	Slave station	64 units (16 units x 4 groups)	6 units	64 units (16 units x 4 groups)	16 units

*: For details, refer to "CC-Link IE Field Network Basic Reference Manual" on Mitsubishi Electric FA website.

MODBUS TCP Communication Unit

► Basic Specifications

Item		Specifications
Product		Energy measuring unit (EMU4-FD1-MB) MODBUS [®] TCP Communication Unit
Model		EMU4-CM-MT
Accommodating model		Energy measuring unit EcoMonitorLight Model:EMU4-FD1-MB
CE Marking Compatible standard		EMC EN-61326-1:2013
Operating environment	Operating temperature	from 5 to +55°C (average daily temperature is not more than +35°C)
	Operating humidity	30-85%RH (No condensation)
	Storage temperature	from -10 to +60°C
	Operating altitude	Not more than 2,000m
Weight		0.1 kg *: Weight of the MODBUS TCP Communication Unit only.
Dimensions (units: mm)		25 (W) x 99 (H) x 60 (D)

► MODBUS TCP Communication Specifications

Item		Specifications
Interface		1 port (10BASE-T/100BASE-TX)
Transmission method		Base band
Number of cascade connection stages*1		Max. 4 stages (10BASE-T), Max. 2 stages (100BASE-TX)
Maximum node-to-node distance		200m (656.16ft.)
Maximum segment length*2		100m (328.08ft.)
Connector applicable for external wiring		RJ45
Cable	10BASE-T	Cable compliant with the IEEE802.3 10BASE-T Standard (unshielded twisted pair cable(UTP cable),Category 3 or more)
	100BASE-TX	Cable compliant with the IEEE802.3 100BASE-T Standard (Shielded twisted pair cable(STP cable),Category 5 or more)
Protocol		MODBUS TCP (Port number 502)
Number of simultaneously connection		Max. 4 connection
Functions supported		Auto negotiation (10BASE-T/100BASE-TX automatically detected) Auto MDIX function (straight/crossover cable automatically detected)

*1: This is the maximum number of cascade connection stages when a repeater hub is used.

For the maximum number of cascade connection stages, contact to the manufacturer for the switching hub used.

*2: Length between a hub and a node

Accessories

► Split-type Current Sensor

Item		Specifications				
Model		EMU-CT50-A	EMU-CT100-A	EMU-CT250-A	EMU-CT400-A	EMU-CT600-A
Rated primary current		50A AC	100A AC	250A AC	400A AC	600A AC
Rated secondary current		16.66mA	33.33mA	66.66mA	66.66mA	66.66mA
Rated load		0.1VA				
Maximum use voltage		460V AC				
Applicable wire size (reference)	IV wire	38mm ²	60mm ²	200mm ²	500mm ²	
	CV wire	22mm ²	60mm ²	150mm ²	400mm ²	
Ratio error		±1% (5 to 100% of rating, RL =10 Ω)				
Phase difference variation		±45 degree or less (10 to 100% of rating, RL =10 Ω) ±60 degree or less (5% of rating, RL =10 Ω)	±40 degree or less (5 to 100% of rating, RL ≤10 Ω)		±40min. (5 to 100% of rating, RL =10 Ω)	
Measurement category		—				III
Degree of contamination		—				2
Operating temperature range		-5~+55 °C (daily average temperature of 35°C or less)				
Operating humidity range		30%~85% RH (no condensation)				
CE marking compatible standard		—			EN61010-2-32	
Maximum voltage compatible with CE marking		—			460V	
Weight		0.05kg	0.1kg	0.2kg	0.3kg	0.4kg

*: Maximum voltage means voltage to ground.

*: Use an electric wire of the size of penetrating this current sensor for a primary side cable, do not use a non-insulation electric wire or a metal for a primary cable.

*: Do not ground the secondary side of the split-type current sensor.

Item		Specifications		
Model		EMU-CT50	EMU-CT100	EMU-CT250
Rated primary current		50A AC	100A AC	250A AC
Rated secondary current		16.66mA	33.33mA	66.66mA
Rated load		0.1VA		
Maximum use voltage		460V AC		
Applicable wire size (reference)	IV wire	60mm ² or less		150mm ² or less
	CV wire	38mm ² or less		150mm ² or less
Ratio error		±1% (5 to 100% of rating, RL = 10 Ω)		
Phase difference variation		±30 min. (5 to 100% of rating, RL = 10 Ω)		
Measurement category		III		
Degree of contamination		2		
Operating temperature range		-5~+55 °C (daily average temperature of 35°C or less)		
Operating humidity range		5~95% RH (no condensation)		
CE marking compatible standard		EN61010-2-32		
Maximum voltage compatible with CE marking		460V		
Weight		0.1kg		

*: Maximum voltage means voltage to ground.

*: Use an electric wire of the size of penetrating this current sensor for a primary side cable, do not use a non-insulation electric wire or a metal for a primary cable.

*: Do not ground the secondary side of the split-type current sensor.

► 5A Split-type current sensor

Item		Specifications	
Model		EMU2-CT5, EMU2-CT5-4W	EMU-CT5-A
Rated primary current		5A AC	5A AC
Rated secondary current		1.66mA	1.66mA
Rated load		0.1VA	0.1VA
Maximum use voltage		260V	460V AC
Applicable wire size (reference)	IV wire	22mm ²	38mm ²
	CV wire	14mm ²	22mm ²
Ratio error		±1% (5~100% of rating)	±1% (5~100% of rating)
Phase difference variation		±30 min. (5 to 100% of rating, RL ≤10 Ω)	±45 min. (10to 100% of rating, RL=10 Ω) ±60 min. (5% of rating, RL=10 Ω)
Measurement category		2	—
Degree of contamination		-5°C~+55°C (daily average temperature of 35°C or less)	-5°C~+55°C (daily average temperature of 35°C or less)
Operating humidity range		5%~95% RH (no condensation)	30%~85% RH (no condensation)
CE marking compatible standard		EN61010-2-32	—
Maximum voltage compatible with CE marking		260V	—
Weight		0.1kg	0.05kg

*: Maximum voltage means voltage to ground.

*: Use an electric wire of the size of penetrating this current sensor for a primary side cable, do not use a non-insulation electric wire or a metal for a primary cable.

*: Do not ground the secondary side of the 5A current sensor.

*: Please use EMU-CT5-A when inputting voltage with 440 V direct to the main body of the instrument.

Optional Parts

▶ SD Memory Card for Logging Unit

Item	Specifications
Model	EMU4-SD2GB
Memory capacity	2GB
Weight	2g

▶ Lithium battery for Logging Unit

Item	Specifications
Model	EMU4-BT
Type	Manganese dioxide lithium battery
Nominal voltage	3V
Capacity	240mAh
Weight	3.8g

*: Logging units include one lithium battery when purchased.

Software

► Data Acquisition Software (EMU4-SW1)

Item		Specifications
Recommended system environment	OS	<ul style="list-style-type: none"> • Microsoft Windows Vista Ultimate 32bit SP2 • Microsoft Windows 7 Professional (32bit/64bit) SP1 • Microsoft Windows 8.1 Pro(32bit/64bit) • Microsoft Windows 10(32bit/64bit)
	Microsoft .NET Framework	<ul style="list-style-type: none"> • Microsoft .NET Framework 2.0 • Microsoft .NET Framework 3.5 • Microsoft .NET Framework 3.5.1
	Microsoft Excel	<ul style="list-style-type: none"> • Microsoft Excel 2007 SP3(32bit/64bit) • Microsoft Excel 2010 SP1(32bit/64bit) • Microsoft Excel 2013 SP1(32bit/64bit) • Microsoft Excel 2016 SP1(32bit/64bit)
Basic specifications	Max. amount of connections	31 units (Maximum connected units of MODBUS RTU communication)
	Languages	Japanese, English
Data collection functions	Periodic collection	Data is collected and logged in 1-min. or 1-hour cycles. (Operated in background by the OS task scheduler.)
	Current value display	Constant communication is performed to display current values (Cannot be displayed during periodic collection.)
	Max. amount of collection points	124 items
Setting functions	Communication settings	MODBUS RTU communication settings (such as baud rate, stop bit length and parity bit)
	Terminal registration	Register the terminal performing data collection
	Terminal settings	Terminal settings functions (such as phase wire, rated current and rated voltage)
	Measured items registration	Measured items of collected data are registered.
	Export/Import	Set values of communication, terminals and measured items are saved in or read out from a file.
Report output	Output format	Paste aggregate data in an Excel template file. (Excel template files can be freely edited.)
	Output types	Monthly, daily and detailed (1-min intervals)

*: Data Acquisition Software (EMU4-SW1) can be downloaded for free from the Mitsubishi Electric website.

(URL:<http://www.mitsubishielectric.co.jp/haisei/lvs/index.htm>)

*: When collecting data continuously for 24 hours, restart PC once a week.

► Logging Unit Utility

Item		Specification	
System requirements	OS	<ul style="list-style-type: none"> • Microsoft Windows 7 Professional SP1 (32bit/64bit) • Microsoft Windows 8.1 Pro Update (32bit/64bit) • Microsoft Windows 10 Pro (32bit/64bit) 	
	NET Framework	• Microsoft .NET Framework 4 Client Profile	
	Microsoft Excel	<ul style="list-style-type: none"> • Microsoft Excel 2010 SP2(32bit) • Microsoft Excel 2013 SP1(32bit) • Microsoft Excel 2016(32bit) 	
	CPU	Conformity with OS system requirements	
	RAM	Conformity with OS system requirements	
	Hard disk	Software requires approximately 20 MB of free space to install (additional space is required for saving document files created by the software).	
	Display	XGA or higher resolution display monitor (65,536 colors, 1024 x 768 pixels or more)	
	Input device	Mouse and keyboard	
	External interface	SD memory card slot or SD memory card reader/writer	
Supported languages		Japanese, English	
Report creation	Output format	Logging data pasted to template Excel file (template Excel file is freely editable)	
	Max. number of sheets	Logging data can be pasted to maximum of 31 sheets (for data of 31 logging units)	
	Document type	Monthly report	Output of 1-day interval data of a period of 1 month
		Weekly report	Output of 1-hour interval data of a period of 7 days
		Daily report	Output of 1-hour interval data of a period of 1 day
		Details (min)	Output of 30-/15-/10-/5-/1-minute interval data of specified period (1 to 24 hours)
Details (sec)	Output of 1-sec interval data of a period of 1 hour		
Logging setting		Creation/editing of logging setting data file (set.csv)	

*: Logging Unit Utility can be downloaded for free from the Mitsubishi Electric website.

(URL:<http://www.mitsubishielectric.co.jp/haisei/lvs/index.htm>)

Energy Measuring Unit

Units (mm)

[Standard Model]

EMU4-BD1-MB

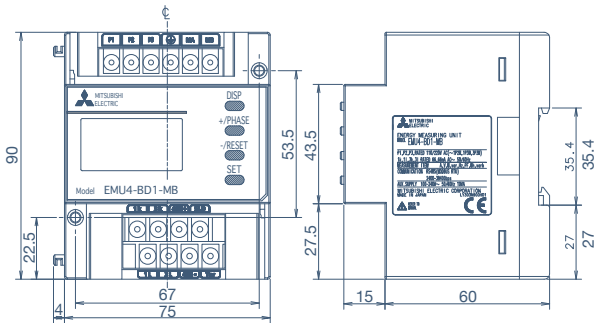

[High Performance Model]

EMU4-HD1-MB

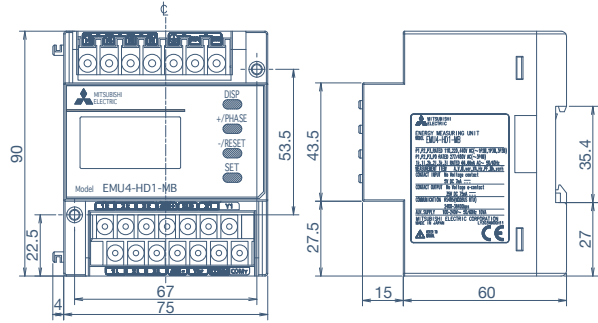

[General current transformer Model]

EMU4-FD1-MB

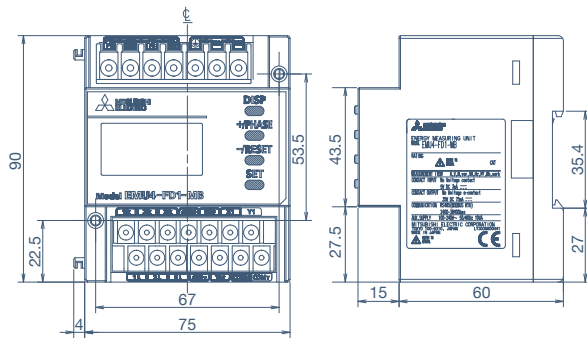

Panel Mounting Attachment

EMU4-PAT

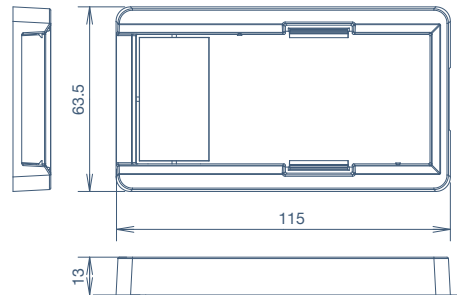

Panel Mounting Attachment

When combined with EMU4-LM /
EMU4-CM-CIFB / EMU4-CM-MT

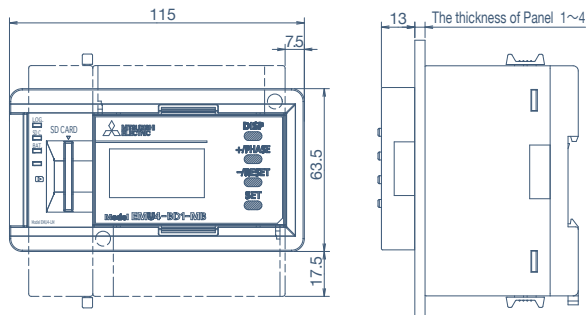

*: The above figure is a combination with a logging unit.

Panel Mounting Attachment

When combined with EMU4-CM-C

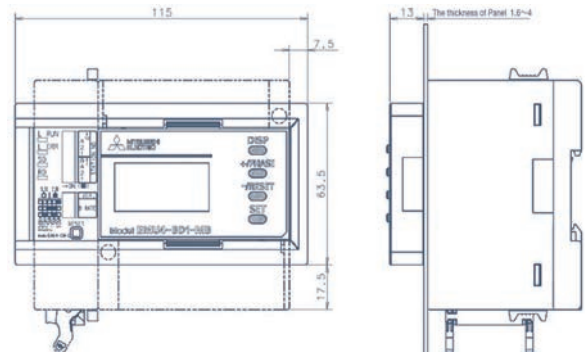

Logging/Communication Unit

Logging Unit
(EMU4-LM)

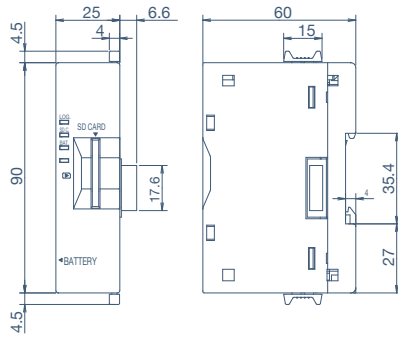

CC-Link Communication Unit
(EMU4-CM-C)

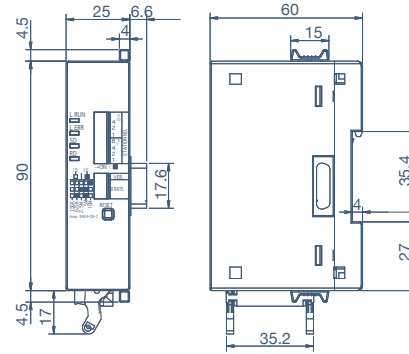

CC-Link IE field network Basic communication Unit
(EMU4-CM-CIFB)

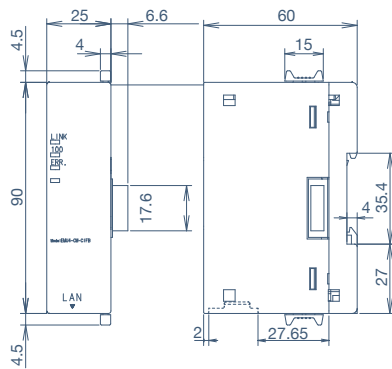

MODBUS TCP Communication Unit
(EMU4-CM-MT)

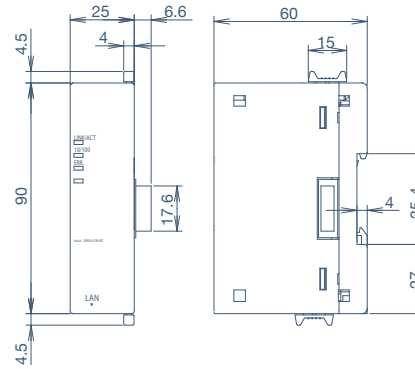

When combined with Optional unit
(EMU4-LM / EMU4-CM-CIFB / EMU4-CM-MT)

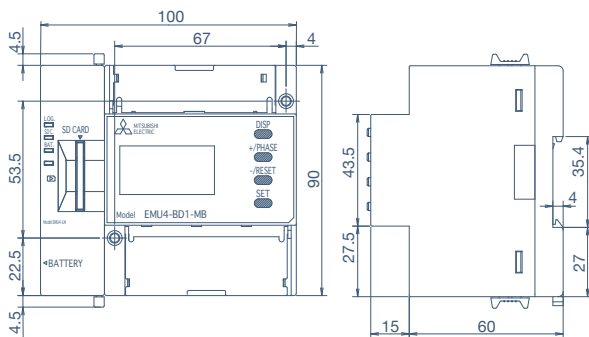

When combined with Optional unit
(EMU4-CM-C)

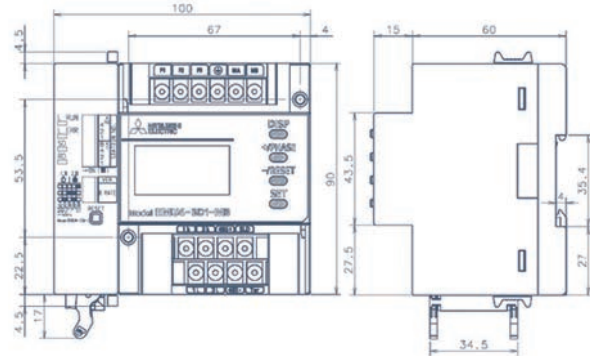

*: The above figure is a combination with a logging unit.

Optional Parts

Units (mm)

[Split-type Current Sensor]

EMU-CT5-A, EMU-CT50-A, EMU-CT100-A

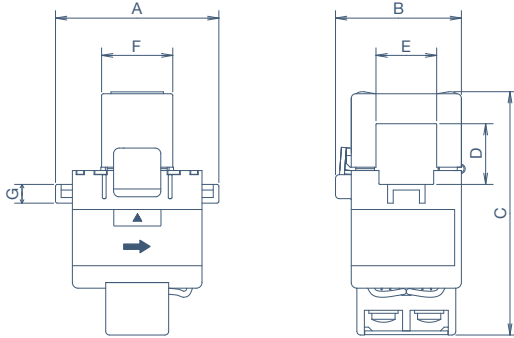

Model	A	B	C	D	E	F	G
EMU-CT5-A/CT50-A	37.4	31.6	57.5	12.2	12.8	14.0	5.0
EMU-CT100-A	43.6	33.6	65.0	16.2	16.2	19.0	5.0

[Split-type Current Sensor]

EMU-CT250-A, EMU-CT400-A, EMU-CT600-A

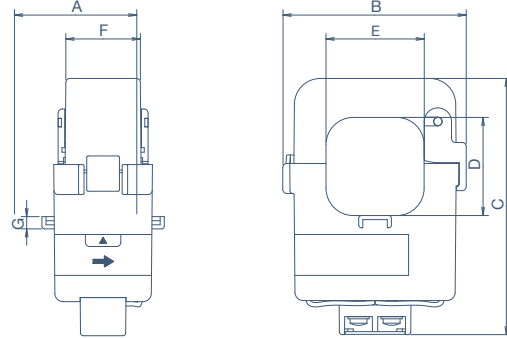

Model	A	B	C	D	E	F	G
EMU-CT250-A	42.6	49.4	74.5	24.0	24.0	25.2	4.5
EMU-CT400-A/CT600-A	44.9	67.2	94.0	36.0	36.0	27.0	4.5

[Split-type Current Sensor]

EMU-CT50, EMU-CT100, EMU-CT250

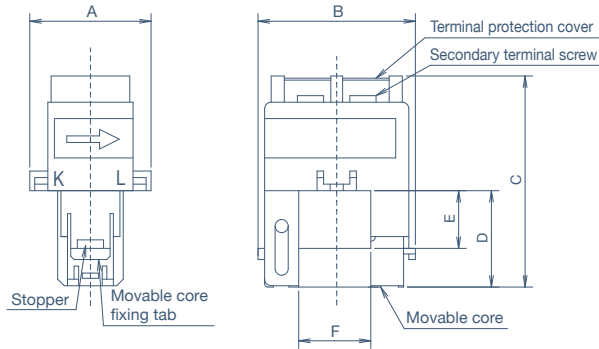

Model	A	B	C	D	E	F
EMU-CT50/CT100	31.5	39.6	55.2	25.7	15.2	18.8
EMU-CT250	36.5	44.8	66.0	32.5	22.0	24.0

[5A Split-type Current Sensor]

EMU2-CT5

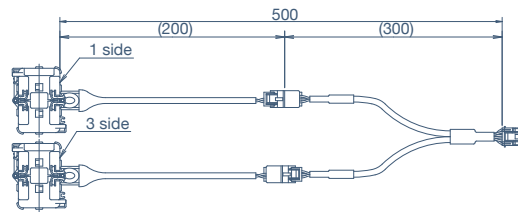

[5A Split-type Current Sensor]

EMU2-CT5-4W

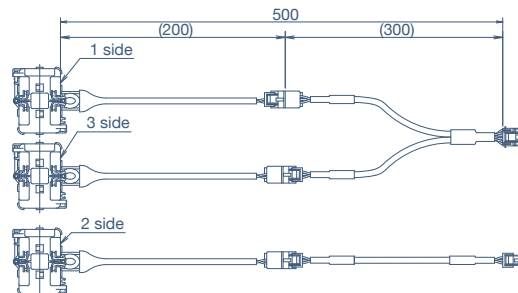

5A Split-type Current Sensor Cable

5A Split-type Current Sensor Cable EMU2-CB-Q5B

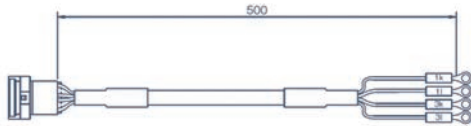

5A Split-type Current Sensor EMU2-CB-Q5B-4W

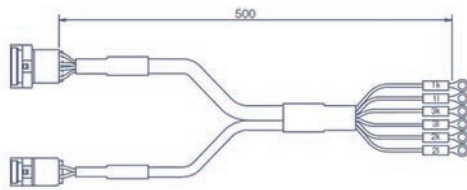

Logging Unit Lithium Battery

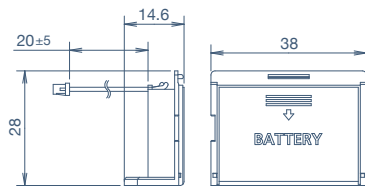

5A Split-type Current Sensor Extension Cable (Standard Type) EMU2-CB-T**M

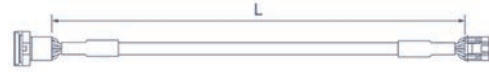

Model	EMU2-CB-T1M	EMU2-CB-T5M	EMU2-CB-T10M
L dimension	1m	5m	10m

5A Split-type Current Sensor Extension Cable (separate Type) EMU2-CB-T**MS

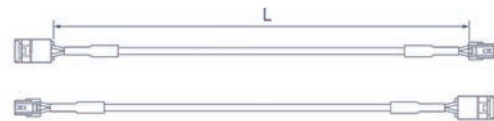

Model	EMU2-CB-T1MS	EMU2-CB-T5MS	EMU2-CB-T10MS
L dimension	1m	5m	10m

** = 1 . 5 . 10

Logging Unit SD Memory Card

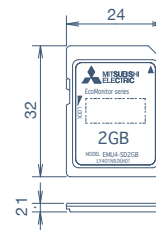

Energy Measuring Unit

[Standard Model] EMU4-BD1-MB

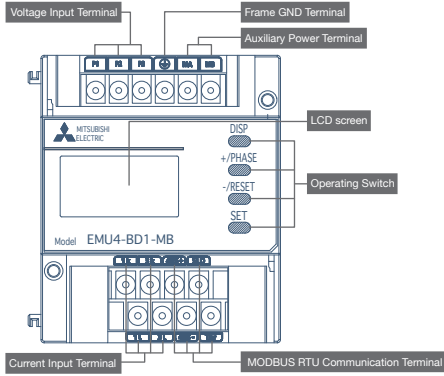

▶ Codes and Functions of Terminal Block

Terminal Code	Function	Description
P1,P2,P3	Input voltage	Connect the voltage input wire for the measuring circuit.
⊕	Frame GND (FG)	Connect to ground (D type ground).
MA,MB	Auxiliary power	Connect the auxiliary power supply.
1k,1L,3k,3L	Input current	Connect the secondary output of the dedicated current sensor connected to the current wire of the measurement circuit.
485+,485-	MODBUS RTU communication	Connect the MODBUS RTU communication wire.
SLD		Connect to ground (D type ground).
Ter		Connect with 485- terminal only if installed at the first terminal (→ Refer to p. 24 for the MODBUS RTU communication system configuration).

[High Performance Model] EMU4-HD1-MB

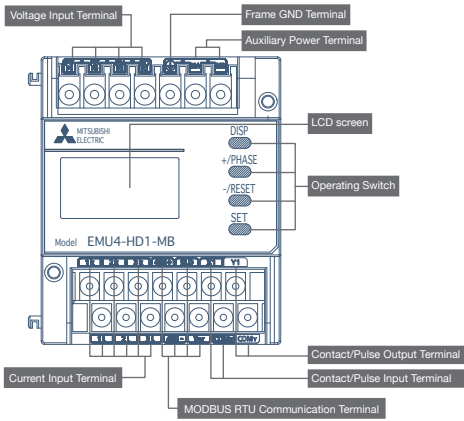

▶ Codes and Functions of Terminal Block

Terminal Code	Function	Description
P1/P1, P2/P0 P3/P3, NC/F2	Input voltage	Connect the voltage input wire for the measuring circuit.
⊕	Frame GND (FG)	Connect to ground (D type ground).
MA,MB	Auxiliary power	Connect the auxiliary power supply.
1k,1L,2k,2L 3k,3L	Input current	Connect the secondary output of the dedicated current sensor connected to the current wire of the measurement circuit.
485+,485-	MODBUS RTU communication	Connect the MODBUS RTU communication wire.
SLD		Connect to ground (D type ground).
Ter		Connect with 485- terminal only if installed at the first terminal (→ Refer to p. 24 for the MODBUS RTU communication system configuration).
X1,COMX	Pulse /Contact input	Connect pulse/contact input wires.
Y1,COMY	Pulse /Contact output	Connect pulse/contact output wires.

[General current transformer Model] EMU4-FD1-MB

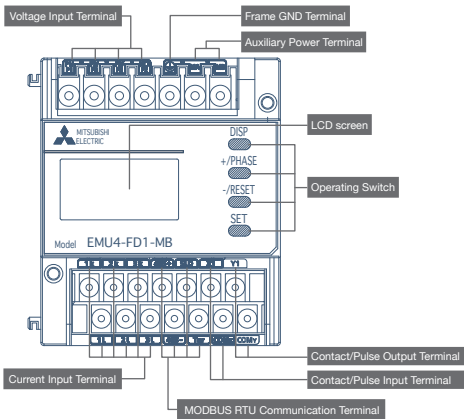

▶ Codes and Functions of Terminal Block

Terminal Code	Function	Description
P1/P1, P2/P0 P3/P3, NC/F2	Input voltage	Connect the voltage input wire for the measuring circuit.
⊕	Frame GND (FG)	Connect to ground (D type ground).
MA,MB	Auxiliary power	Connect the auxiliary power supply.
1k,1L,2k,2L 3k,3L	Input current	Connect the secondary output of the dedicated current sensor connected to the current wire of the measurement circuit.
485+,485-	MODBUS RTU communication	Connect the MODBUS RTU communication wire.
SLD		Connect to ground (D type ground).
Ter		Connect with 485- terminal only if installed at the first terminal (→ Refer to p. 24 for the MODBUS RTU communication system configuration).
X1,COMX	Pulse /Contact input	Connect pulse/contact input wires.
Y1,COMY	Pulse /Contact output	Connect pulse/contact output wires.

Display Screen



No.	Segment Name	Description
1	Measured value display	Digitally displays measured values.
2	Display of measured items	Displays the measured item for the value displayed
3	Communication display	Only lights up if a logging unit or communication unit is connected.
4	Energy measurement display	Lights up when measuring electric energy (consumption).
5	Settings display	The icon lights up when in setting mode. The icon lights up when in setting confirmation mode.

Logging/Communication Unit

Logging Unit EMU4-LM

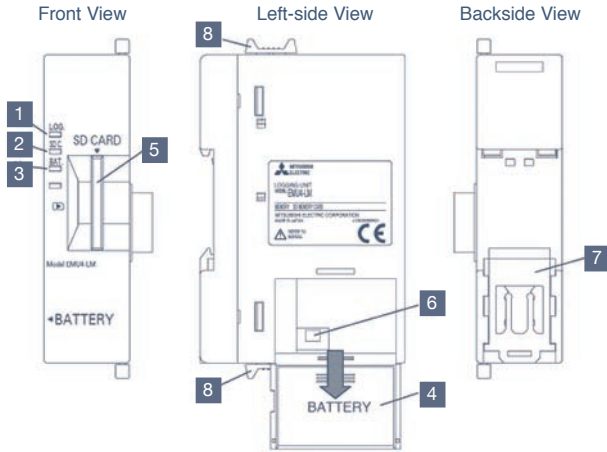

Names and Functions of Each Part

No.	Name	Function
1	LOG.LED	Displays logging operation status. Lit up: Logging is being performed. Not lit up: Logging operation is stopped. Slow flashing*1 (5 sec.): Changing of logging conditions settings has been completed. Fast flashing*2 (30 sec.): Changing of logging conditions settings has failed. Fast flashing*3: Error has occurred.*3
2	SDC.LED	Displays SD memory card communication status. Lit up: Communication is being performed. Not lit up: Communication is stopped. Fast flashing*3: SD memory card error.*3
3	BAT.LED	Displays the battery voltage status Lit up: Battery voltage is low*4. Not lit up: Battery voltage is normal
4	Battery box	Contains the battery for performing backup of current time, logging and system log data.
5	SD memory card slot	Slot for inserting the SD memory card
6	Battery connector	Connector for connecting the battery.
7	IEC rail stopper	Used for fixing to the IEC rail.
8	Coupling tab	Used for fixing the logging unit to the energy measuring unit.

*1: Slow flashing: Lit up for 0.5 sec. → Not lit up for 0.5 sec. → Lit up for 0.5 sec. (pattern is repeated)
 *2: Fast flashing: Lit up for 0.25 sec. → Not lit up for 0.25 sec. → Lit up for 0.25 sec. (pattern is repeated)
 *3: If this is lit up, refer to "Error Display and Recovery Procedures" of the "Operation Manual (Detailed Version)".
 *4: Turning the power off when the battery voltage is low deletes the current time and logging data. (Set values for logging ID, logging mode, logging start time, detailed data logging cycle and logging items are not deleted due to being stored in non-volatile memory.) Replace the battery if BAT. LED lights up.

CC-Link Communication Unit EMU4-CM-C

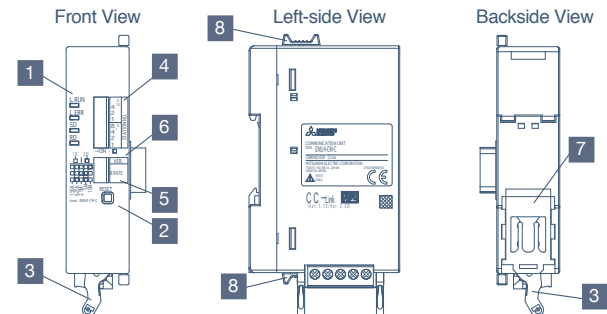

CC-Link Communication Unit EMU4-CM-C

No.	Name	Function
1	L RUN/L ERR/SD/RD LED	Displays the CC-link communication status.
2	Reset switch	Press after setting or changing the STATION, B RATE, VER.
3	CC-Link communication connector	Connect the CC-link signal wire.
4	STATION switch	Station setting switch: Set the CC-Link station number.
5	B RATE switch	Baud rate setting switch. Set the CC-Link transmission speed.
6	VER. switch	Switch for changing the CC-Link version.
7	IEC rail stopper	Used for fixing the IEC rail.
8	Coupling tab	Used for fixing the CC-Link Communication Unit to the energy measuring module.

CC-Link IE field network Basic communication Unit EMU4-CM-CIFB

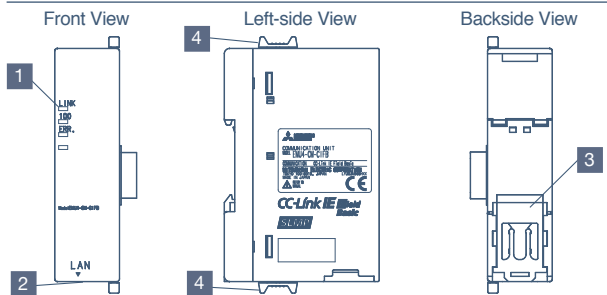

CC-Link IE field network Basic communication Unit EMU4-CM-CIFB

No.	Name	Function
1	LED	Displays the CC-link IE field network Basic communication status.
2	CC-Link IE field network Basic communication connector	LAN cable (100BASE-TX connector(RJ-45)) are connected.
3	IEC rail stop	This is used to fix to an IEC rail.
4	Connection stop	Used for fixing the CC-Link IE field network Basic communication Unit to the energy measuring module.

MODBUS TCP Communication Unit EMU4-CM-MT

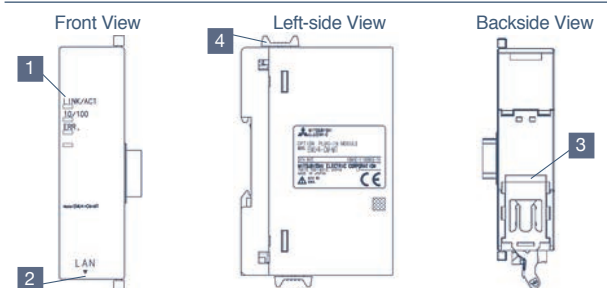

MODBUS TCP Communication Unit EMU4-CM-MT

No.	Name	Function
1	LED	Operation status of MODBUS TCP communication is displayed.
2	Connector for MODBUS TCP communication	10BASE-T/100BASE-TX connector (RJ45)
3	IEC rail stop	This is used to fix to an IEC rail.
4	Connection stop	This is used to connect the MODBUS TCP Communication Unit to the Energy Measuring Unit.

Connection Configurations

For EMU4-BD1-MB

1P2W (For low-voltage circuit)

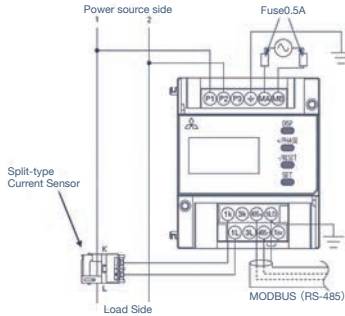

Name	Model	Amount
EcoMonitorLight [Standard Model]	EMU4-BD1-MB	1
Split-type Current Sensor	EMU-CT*** (50/100/250) EMU-CT***-A (50/100/250/ 400/600)	1

1P3W/3P3W(For low-voltage circuit)

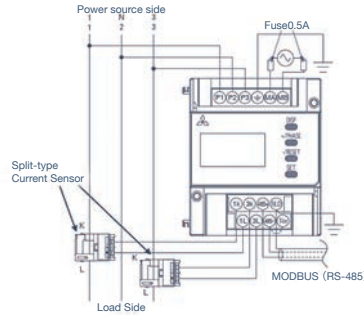

Name	Model	Amount
EcoMonitorLight [Standard Model]	EMU4-BD1-MB	1
Split-type Current Sensor	EMU-CT*** (50/100/250) EMU-CT***-A (50/100/250/ 400/600)	2

3P3W (For high-voltage circuit)

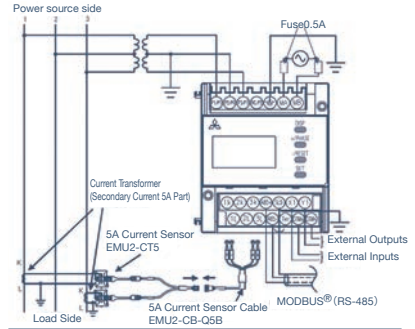

Name	Model	Amount
EcoMonitorLight [Standard Model]	EMU4-BD1-MB	1
Split-type Current Sensor	EMU2-CT5	1
5A Current Sensor Cable	EMU2-CB-Q5B	1

For EMU4-HD1-MB

1P3W/3P3W (For low-voltage circuit)

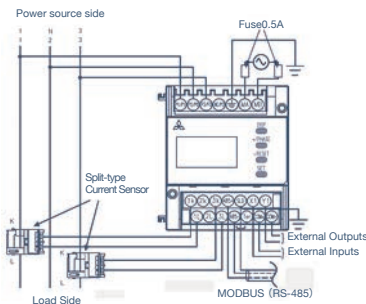

Name	Model	Amount
EcoMonitorLight [High Performance Model]	EMU4-HD1-MB	1
Split-type Current Sensor	EMU-CT*** (50/100/250) EMU-CT***-A (50/100/250/ 400/600)	2

3P4W (For low-voltage circuit)

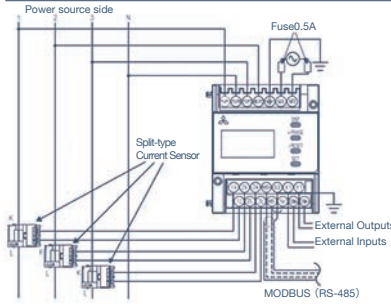

Name	Model	Amount
EcoMonitorLight [High Performance Model]	EMU4-HD1-MB	1
Split-type Current Sensor	EMU-CT*** (50/100/250) EMU-CT***-A (50/100/250/ 400/600)	3

3P4W (For high-voltage circuit)

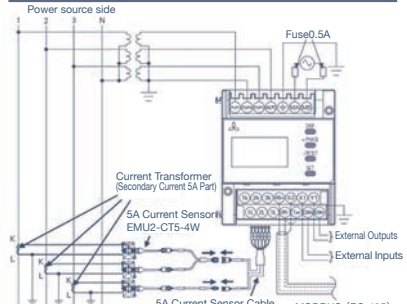

Name	Model	Amount
EcoMonitorLight [High Performance Model]	EMU4-HD1-MB	1
Split-type Current Sensor	EMU2-CT5-4W	1
5A Current Sensor Cable	EMU2-CB-Q5B-4W	1

Note: • The cable (electrical wire) for between EMU-CT*** / EMU-CT***-A and the Split-type Current Sensor headed to prepare by the customer . Check the wiring precautions on p. 24 for the cable(electrical wire) used. • If installing to a low-voltage (600 V or less) circuit, it is not necessary to connect the secondary electrical circuit of the voltage transformer to ground.

*: Fuse is necessary for compatible with UL standard.
*: Do not ground the secondary side of the split-type current sensor or 5A current sensor.

For EMU4-FD1-MB

1P3W/3P3W (For low-voltage circuit)

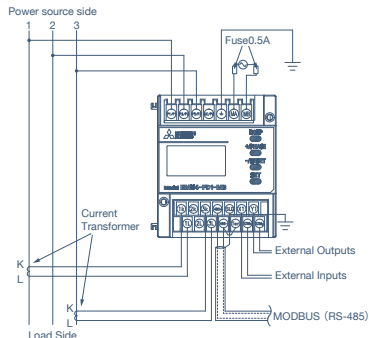

Name	Model	Amount
EcoMonitorLight [General current transformer Mode]	EMU4-FD1-MB	1

3P4W (with the voltage transformer)

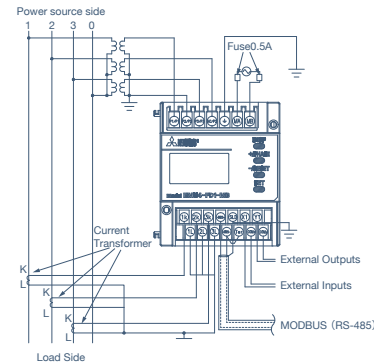

Name	Model	Amount
EcoMonitorLight [General current transformer Mode]	EMU4-FD1-MB	1

*: Fuse is necessary for compatible with UL standard.

- Note1: For low voltage circuits, do not connect to grounding the secondary side of VT and CT.
- Note2: When this unit is used at a high voltage circuit, the terminal P0(P2) must be connected to ground.
- Note3: When grounding a CT line, please make the L side of the CT a common line and connect 1L,2L,3L terminal for the unit side by the shortest course.
- Note4: When connecting the L side of the CT by a common line, please connect 1L,2L,3L terminal for the unit side by the shortest course.
- Note5: Do not connect together more than one EMU4-FD1-MB on the secondary side of a current transformer.
- Note6: Do not connect together other units and EMU4-FD1-MB on the secondary side of a current transformer.

Wiring Precautions

Measuring Unit

CAUTION	• Do not place transmission or input/output signal wires close to or bound together with power or high-voltage lines in order to prevent noise interference. If installing transmission or input/output signal wires next to power and high-voltage lines, maintain the separation distances shown on the right table. (Except for terminal blocks.) • For actual usage, connect the frame GND terminal to ground (D-type ground). Connect it directly to the ground terminal. • Do not connect to frame GND terminal during insulation resistance or voltage resistance testing.	Condition	Distance
		Power lines of 600 V or less	300 mm or more
		Other power lines	600 mm or more

- Use compatible solderless terminals. Refer to the compatible solderless terminals described in below table.
- Use electrical wires as described in below table, and tighten the terminal screws according to the torques described below.

[EMU4-BD1-MB]

	Compatible wire	Tightening torque	Compatible solderless terminal
Auxiliary power and voltage input terminal	AWG24-16 (0.2-1.25mm ²) (Single/Stranded)	0.8~1.0N·m	For M3 screws with an external diameter of 5.6 mm or less
Current input and input/output terminal	AWG22-16 (0.3-1.25mm ²) (Single/Stranded)	0.5~0.6N·m	For M3 screws with an external diameter of 5.6 mm or less

[EMU4-HD1-MB]

	Compatible wire	Tightening torque	Compatible solderless terminal
Auxiliary power and voltage input terminal	AWG26-14 (0.12-2.0mm ²) (Single/Stranded)	0.8~1.0N·m	For M3.5 screws with an external diameter of 5.6 mm or less
Current input and input/output terminal	AWG22-16 (0.3-1.25mm ²) (Single/Stranded)	0.5~0.6N·m	For M3.5 screws with an external diameter of 5.6 mm or less

[EMU4-FD1-MB]

	Compatible wire	Tightening torque	Compatible solderless terminal
Auxiliary power and voltage input terminal	AWG26-14 (0.12-2.0mm ²) (Single/Stranded)	0.8~1.0N·m	For M3 screws with an external diameter of 5.6 mm or less
Current input and input/output terminal	AWG22-14 (0.3-2.0mm ²) (Single/Stranded)	0.5~0.6N·m	For M3 screws with an external diameter of 5.6 mm or less

- Before connecting the cable, make sure that the split-type current sensor is appropriately installed with the correct orientation. K => L is the correct orientation. K: Power source side; L: Load side.
- EMU-CT50, 100, 250, and 50-A, 100-A, 250-A, 400-A and 600-A are used only for low-voltage circuits (Maximum voltage: 460 V). They cannot be used for a high voltage circuit. Use EMU2-CT5-A, EMU2-CT5 and EMU2-CT5-4W transfixed the secondary side (5A) of the current transformer. They can only be used directly in a circuit that is 200 V or less (max. voltage of 260 V).
- The maximum voltage of a circuit directly connected to this unit is 260 V for EMU4-BD1-MB, or 277/480 V for EMU4-HD1-MB and EMU4-FD1-MB. Always be sure to use a transformer for circuits exceeding this voltage. The value for the primary voltage of the transformer can be specified up to 6,600 V when using a transformer for circuits.
- MODBUS RTU communication wiring is recommend to wiring having an extra length of approximately 20 cm.
- Be careful not to touch the projecting parts of the terminal block cover when screwing the terminals at both ends of a terminal block.
- Refer to the following if using external inputs or outputs.

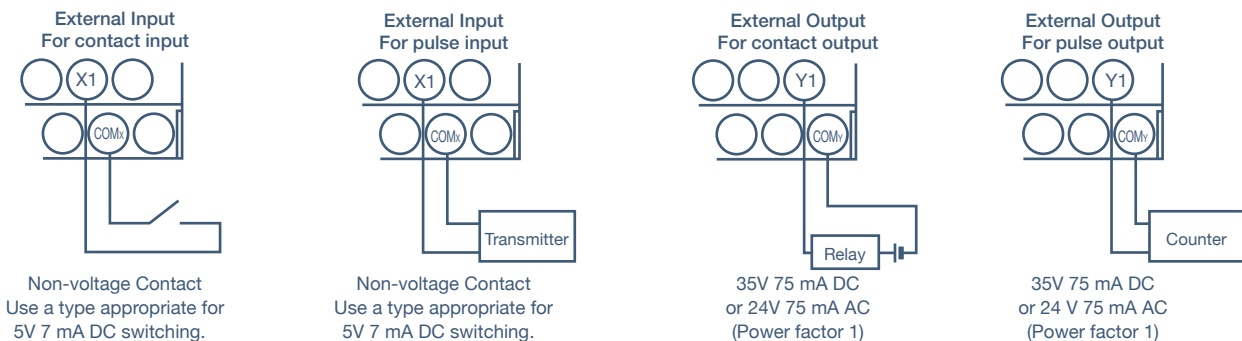

MODBUS RTU (RS-485) Communication

Connection of MODBUS communication terminals (485+, 485-, SLD, and Ter):

1. Use shielded twisted pair cables for transmission wires. (Refer to p. 16 for recommended cables.)
2. Connect terminating resistance (120 Ω) to both ends of devices connected to MODBUS transmission lines. Terminating resistance of 120 Ω can be achieved by short-circuiting terminals "485-" and "Ter" of this unit.
3. Connect to ground by using thick electrical wires so that low impedance is achieved.
4. Do not place MODBUS communication signal wires close to or bound together with high-voltage lines.
5. Ground the SLD terminal at one end.

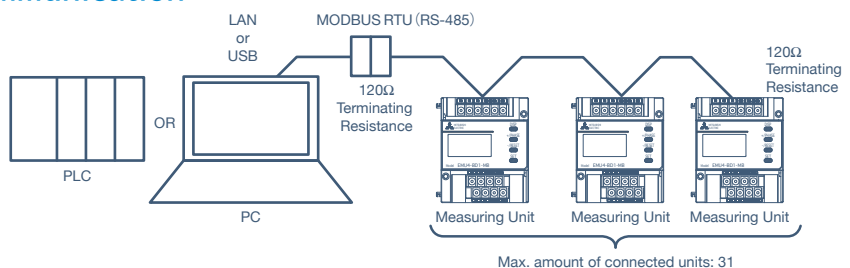

Energy Measuring Unit

IEC Rail Installation (Surface Installation)

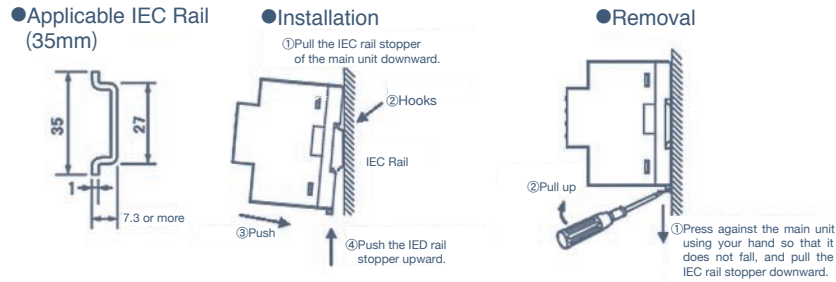

JIS-Compliant Dimensions Installation (Front-Surface Installation)

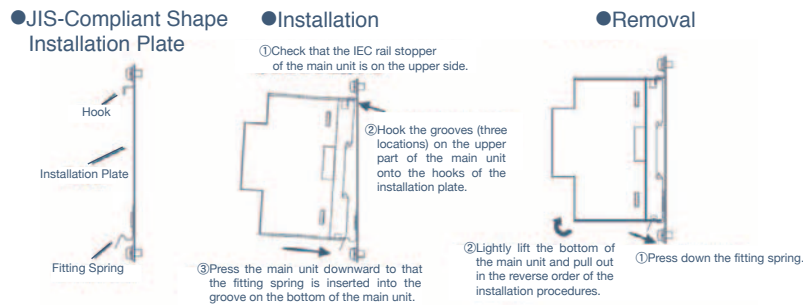

*: If the display part protrudes from the plate surface at IEC rail and JIS-compliant form installation, cut the plate at a point 50 mm or more from door opening/closing support.

Board Installation

●Panel Cutting Dimensions

The panel cutting dimensions are as shown below.
 Panel thickness allowable for installation is 1.6 to 4.0 mm.

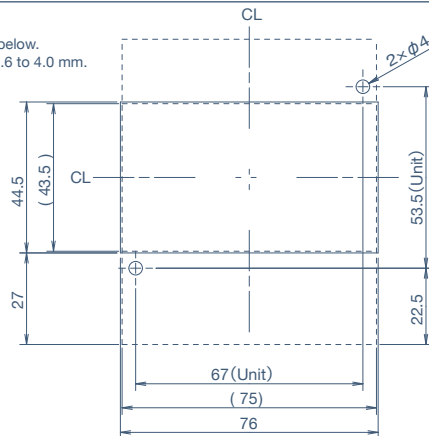

●Installation Procedures

Install the screws (M3 X 10) to the installation plate.
 Tightening torque: 0.63 N/m

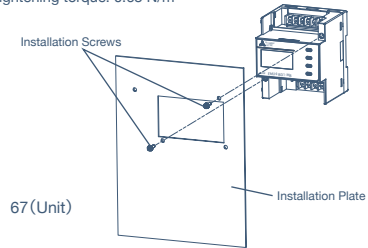

Recommended Installation Screws Cross-recessed head machine screw with spring and plain washers JIS B 1188 M3 x 10, Two screws

*: Panel cut dimensions are made larger than the product considering tolerance in panel cut.

If you want to prevent dust and other intrusion the gap of panel cut, cut the panel according to the product to be mounted.

Board Installation (Using Board Surface Installation Attachment (EMU4-PAT))

●Panel Cutting Dimensions

The panel cutting dimensions are as shown below.
 Panel thickness allowable for installation is 1.6 to 4.0 mm.

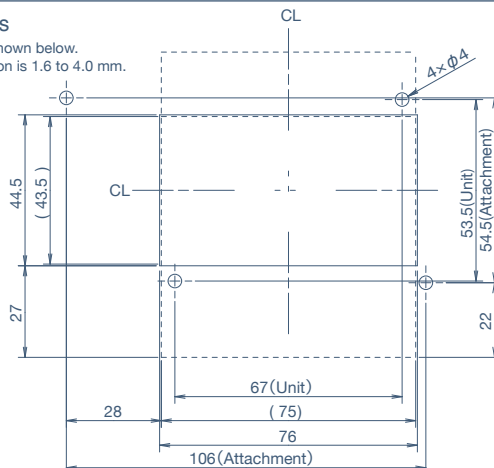

●Installation Procedures

Install to the installation plate using the installation screws (M3 x 10) and install the board surface installation attachment.
 Tightening torque: 0.63 N/m

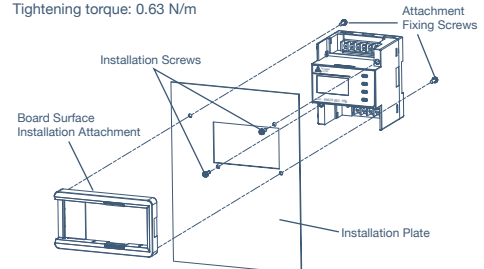

*: Tighten the attachment with the screws in an environment with a large amount of vibration.

*: The installation screws and attachment fixing screws are packaged with the attachment (sold separately).

*: Panel cut dimensions are made larger than the product considering tolerance in panel cut.

If you want to prevent dust and other intrusion the gap of panel cut, cut the panel according to the product to be mounted.

Optional Units

Common for Logging Unit and CC-Link Communication Unit

Connect optional units to the energy measuring unit.

① Peel off the blank label affixed to the left side of the main unit of the energy measuring unit.

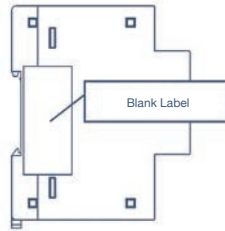

② Insert the connector of the optional unit into the connector of the energy measuring unit to closely attach the unit.

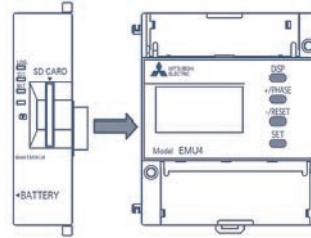

③ Slide the coupling tab (green) on top of the optional unit to lock the optional unit.

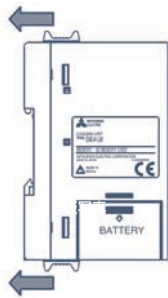

Do not energize when connecting the energy measuring unit and do not perform live-wire installation. Doing so can result in electrical shock, device malfunction, fire and similar problems.

SD Memory Card for Logging Unit

Insert the SD memory card into the logging unit.

Hold the SD memory card straight when inserting into the SD memory card slot and press in until you hear a click sound.

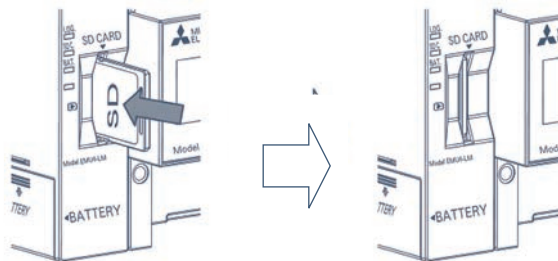

Remove the SD memory card from the logging unit.

Press the SD memory card inward until you hear a click sound. The SD memory card automatically pops out.

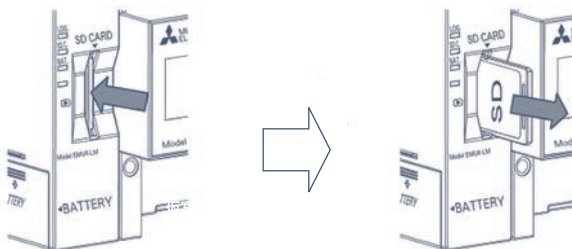

Do not remove the SD memory card until you have checked that the SD C. LED light has gone out. Removing the SD memory card while this unit is communicating with the SD memory card can damage the data in the SD memory card, and result in a malfunction of this unit and the SD memory card.

Precautions for Operating Environment and Conditions for Use

- This unit is premised on being used in a pollution degree 2*1 environment. Protect this unit from pollution on the side where another device is to be assembled when using in an environment with a different pollution degree.
- The measurement category of the measuring circuit in this unit is CAT II*1, and the energization voltage category of the auxiliary power circuit (MA and MB) is also CAT II.
- Do not use this product in the types of locations listed below. Use in such locations can result in malfunctions and decreased product life.
 - The ambient temperature exceeds the operating range temperature (-5 to +55 °C).
 - The relative humidity exceeds the operating range (30-85% RH) or the place where condensation occurs.
 - There are large amounts of dust, corrosive gas, saline or oily smoke.
 - Exposed to rain or water drops.
 - Metal fragments or conductive substance are scattered.
 - The average daily temperature exceeds 35 °C.
 - There is excessive vibration or impacts.
 - Exposed to direct sunlight.
 - There is a strong electromagnetic field or there are large amounts of external noise.
 - The altitude exceeds 2,000 m.

<Protection against Electric Shock>

- This unit is an open type device, meaning that it is designed to be housed within another device in order to prevent electric shock. Be sure to always house this unit within another device such as a grounded control panel before use.
- It is necessary to implement either of the following measures for the control panel in order to protect persons lacking sufficient knowledge about electrical equipment from electric shock.
 - Lock the panel so that only those who have been trained and have sufficient knowledge about electrical equipment can unlock the control panel, or structure the control panel so that the power supply is automatically turned off when the panel is opened.
 - Cover the sections of this module having dangerous voltage. (Required protection code is IP2X or higher.)

*1: Refer to EN61010-1/2010 for the definition of pollution degrees and measurement categories.

Precautions for Pre-operation Preparation

- Be sure that the installation location complies with operating environment and use conditions.
- Be sure to specify the phase wire system, and primary voltage and current for each sensor type before operation.

Precautions for Installation and Connection

Be sure to always read the operation manual before installation and connection.

CAUTION

<Electrical Work Precautions>

- All installation and connection work must be performed correctly by technicians having specialized knowledge in matters such as electrical construction and wiring.
- Perform all installation and wiring work with the power turned off (no parts are energized) and do not perform live-wire work. Failure to do so can result in electric shock, and equipment malfunction or fire.
- Be very careful when creating screw holes or performing wiring so that no foreign material such as chips or cut wire ends get into the unit.
- Thoroughly check the connection diagram when wiring. Improper wiring can result in unit malfunction, or fire or electric shock.
- Do not place transmission or input/output signal wires **close to or bound together with power or high-voltage lines** in order to prevent noise interference.
- Always be sure to place wires to be connected to this module in a duct or clamp wires together to secure them. Failure to secure wires can result in electric wires moving due to looseness or unexpected stretching that causes module breakage or malfunction due to poor wire connections.
- If installing transmission or input/output signal wires next to power and high-voltage lines, maintain the separation distance shown in below table.

Item	Distance
Power lines of 600 V or less	300 mm or more
Other power lines	600 mm or more

<Types of Terminal Blocks>

- Strip wires to the proper length. Excessively long stripping length can result in a short circuit with neighboring wires. Excessively short stripping length can result in poor wiring connections and contact failure.
- Be careful not to cause a short circuit with a nearby pole due to the filament of a core wire. (Do not plate core wires with solder.)
- Do not connect three or more signal wires to one terminal of a terminal block. Doing so can result in weak clamping and wire disconnection.
- Use appropriate sizes of electric wires. Use of an inappropriate size can result in fire due to heat generation.
- Use overcurrent prevention devices (such as a fuse or circuit breaker) for circuits with wires connected to an auxiliary power circuit (MA or MB) in order to prevent short circuiting of connected power wires. (Select an appropriate rating in order to prevent fusing of wires.)
- Tighten screws to the specified torque. Excessive tightening can damage the screw and terminal.
- After tightening the screws, be sure to check that you have not forgotten to tighten a screw. A loose screw can result in module malfunction, fire or electric shock.
- Be sure to attach the terminal cover in order to prevent electric shock.
- Do not directly touch any energized part or terminals of the module. Doing so can result in electric shock, or module failure or malfunction.
- Do not pull wiring parts by hand when removing wires connected to this unit. Pulling on wires still connected to this unit can result in module or wiring damage.

<Connection with Current Sensor>

- A dedicated current sensor (EMU-CT50, EMU-CT100, EMU-CT250, EMU-CT50-A or EMU-CT100-A, EMU-CT250-A, EMU-CT400-A, EMU-CT600-A) is only used for low-voltage circuits. It cannot be used for a high-voltage circuit. Use EMU-CT5-A, EMU2-CT5 or CT5-4W transfixed to the secondary side (5A) of transformer. Connecting with a high-voltage circuit by mistake is extremely dangerous and can cause unit burnout or fire. Refer to “Specifications: Options (Split-type Current and 5A Current Sensors)” on p. 17 for maximum voltages that can be used with current sensors.
- Dedicated current sensors have a given polarity (directionality). Be careful to install in the proper polarity.

<Connecting with Frame GND Terminal>

- Do not exceed the range of specified voltage values when performing insulation resistance or commercial frequency withstand voltage tests. Do not connect the frame GND terminal to ground when performing such tests.
- Ground the frame GND terminal according to actual conditions of use. Use a D-type ground connection (ground resistance is 100 Ω or less).
- Use a crimp-type terminal appropriate for the size of electric wires. Use of an inappropriate crimp-type terminal can result in wire breakage or contact failure that causes module malfunction, failure, burnout or fire.

Precautions Regarding Use

- **This unit cannot be used for transactions or proof of power use as stipulated by the Measurement Act.**
- Before operating this module, thoroughly check that there are no energized bare wires or similar hazards nearby. If there are any exposed conductors or similar hazards, stop operation immediately and implement appropriate measures such as insulation protection.
- A power outage while specify settings will result in such settings not being properly set. Specify the settings again after power has been restored.

DANGER

- Do not touch live part. Doing so can result in electric shock, electric burn injury and equipment damage.
- Do not perform installation or wiring with equipment energized and do not perform live wire work.

CAUTION

- Do not touch charged parts. Doing so can result in electric shock, electric burn injury and equipment damage
- Use within the rating ranges indicated in this manual. Using outside of the rating ranges can not only result in misoperation or equipment malfunction but can also cause fire or burnout. .

Precautions for Maintenance and Inspection

- Wipe off surfaces using a soft cloth. Do not allow any type of chemical cloth to remain touching the unit for an extended period, and do not use benzene, thinner or similar chemicals for cleaning.
- Check for the following items in order to ensure proper operation and long product life of this unit.

(1) Daily Inspection <ul style="list-style-type: none"> ① No damage to the unit ② LED and LCD screens are operating properly. ③ There are no abnormal noises, odor, heat generation or similar problems. 	(2) Periodic Inspection <p>Inspect the following items from every six months to one year.</p> <ul style="list-style-type: none"> • There is no looseness in installation or wiring connections of terminals.
---	---

CAUTION

Always be sure to perform periodic inspection with all power turned off. Failure to do so can result in electric shock, equipment malfunction or fire. Periodically tighten terminals. Failure to do so can result in fire.

Precautions for Storage

- Before storage, turn off the power, remove wires, and place the unit in a plastic bag.
- Do not store the module in the types of locations described below when storing for an extended period. Storing in such places can result in malfunction and reduced service life.

<ul style="list-style-type: none"> • The ambient temperature exceeds the storage range temperature (-10 to +60 °C). • The average daily temperature exceeds 35 °C. • There is excessive vibration or impacts. • Metal fragments or conductive substance are scattered. 	<ul style="list-style-type: none"> • The relative humidity exceeds the humidity range (30-85% RH). • There are large amounts of dust, corrosive gas, saline or oily smoke. • Exposed to rain, water drops or direct sunlight.
--	--

Precautions for Disposal

- Properly dispose of this unit in accordance with the Waste Disposal and Public Cleansing Act.

About disposal of the battery

- When the lithium battery is built in, please process the lithium battery in accordance with the rule of cities, towns and villages.

CAUTION

The removed lithium battery has a possibility that electric power capacity remains. Since there is a possibility of contacting other metal, and generating heat, exploding and igniting, please manage individually.

About Packaging Materials and Operation Manual

- Packaging materials are made of cardboard and the operation manual is printed on recycled paper in order to reduce the load on the environment.

Repairing at Time of Malfunction/Error

- If a product listed in this catalog malfunctions, read the troubleshooting section of the operations manual (detailed version) and confirm the symptoms. If the problem is not listed, please contact a Mitsubishi Electric representative.

*: Refer to the operation manual (Detailed Version) for details.

Global Partner.Local Friend.

Service Network

Country/Region	Corporation Name	Address	Telephone
Australia	Mitsubishi Electric Australia Pty. Ltd.	348 Victoria Road, Rydalmere, N.S.W. 2116, Australia	+61-2-9684-7777
Bangladesh	PROGRESSIVE TRADING CORPORATION	HAQUE TOWER,2ND FLOOR,610/11,JUBILEE ROAD, CHITTAGONG, BANGLADESH	+880-31-624307
	ELECTRO MECH AUTOMATION& ENGINEERING LTD.	SHATABDI CENTER, 12TH FLOOR, SUITES: 12-B, 292, INNER CIRCULAR ROAD, FAKIRA POOL, MOTIJHEEL, DHAKA-1000, BANGLADESH	+88-02-7192826
Belarus	Tehnikon	Oktyabrskaya 19, Off. 705, BY-220030 Minsk, Belarus	+375 (0)17 / 210 46 26
Belgium	Koning & Hartman B.V.	Woluwelaan 31, BE-1800 Vilvoorde, Belgium	+32 (0)2 / 2570240
Brazil	Mitsubishi Electric Do Brasil Comercio E Servicos Ltda.	Av. Adelino Cardana, 293 -21 and. - Bethaville, 06401-147, Barueri/SP - Brasil	+55-11-4689-3000
Cambodia	DHINIMEX CO.,LTD	#245, St. Tep Phan, Phnom Penh, Cambodia	+855-23-997-725
Chile	Rhona S.A.	Vte. Agua Santa 4211 Casilla 30-D (P.O. Box) Vina del Mar, Chile	+56-32-2-320-600
China	Mitsubishi Electric Automation (China) Ltd.	Mitsubishi Electric Automation Building, No.1386 Hongqiao Road, Shanghai,200336	+86-21-2322-3030
	Mitsubishi Electric Automation (China) Ltd. North China Branch	9/F, Office Tower1 Henderson Centre 18 Jianguomennei Dajie DongCheng district BeiJing 100005	+86-10-6518-8830
	Mitsubishi Electric Automation (China) Ltd. NorthEast China Branch	Room2302,President Building Tower C,No.69 Heping North Avenue, Heping District,Shenyang,110003	+86-24-2259-8830
	Mitsubishi Electric Automation (China) Ltd. South China Branch	Room 2512--2516, Great China International Exchange Square, Jintian Rd.S., Futian District,Shenzhen, 518034	+86-755-2399-8272
	Mitsubishi Electric Automation (China) Ltd. South China Branch	Room 1609, North Tower, The Hub Center, No.1068, Xing Gang East Road, Haizhu District, GuangZhou, China 510335	+86-20-8923-6730
	Mitsubishi Electric Automation (China) Ltd. SouthWest China Branch	1501,1502,1503,15F,Guang-hua Centre,Block C,NO.98 Guang Hua North 3th Road Chengdu,610000	+86-28-8446-8030
Colombia	Mitsubishi Electric Automation (Hong Kong) Ltd.	20/F, Cityplaza One, 1111 king's Road, Taikoo shing, Hong Kong	+852-2510-0555
Czech Republic	Proelectrico Representaciones S.A.	Carrera 42 # 75-367 Bod 109 Itagui Colombia	+57-4-4441284
Denmark	AUTOCONT CONTROL SYSTEMS S.R.O	Technologická 374/6, CZ-708 00 Ostrava - Pustkovec	+420 595 691 150
Denmark	BEIJER ELECTRONICS A/S	LYKKEGARDSVEJ 17, DK-4000 ROSKILDE	+45 (0)46/ 75 76 66
Egypt	Cairo Electrical Group	9, Rostoum St. Garden City P.O. Box 165-11516 Maglis El-Shaab,Cairo - Egypt	+20-2-27961337
France	Mitsubishi Electric Europe B.V.	25, Boulevard des Bouvets, F-92741 Nanterre Cedex	+33 (0) 1 / 55 68 55 68
Germany	Mitsubishi Electric Europe B.V.	Mitsubishi-Electric-Platz 1, 40882 Ratingen, Germany	+49 (2102) 4860
Greece	KALAMARAKIS - SAPOUNAS S.A.	IONIAS & NEROMILOU STR., CHAMOIMLOS ACHARNES, ATHENS, 13678 Greece	+30-2102 406000
Greece	UTECO	5, MAVROGENOUS STR., 18542 PIRAEUS, Greece	+30-211-1206-900
Hungary	Meltrade Ltd.	Fertő utca 14. HU-1107 Budapest, Hungary	+36 (0)1-431-9726
India	Mitsubishi Electric India Private Limited	2nd Floor, Tower A&B, Cyber Greens, DLF Cyber City, DLF Phase-III, Gurgaon - 122 022 Haryana, India	+91-124-4630300
Indonesia	PT.Mitsubishi Electric Indonesia	Gedung Jaya 8th floor, J.L.MH. Thamrin No.12 Jakarta Pusat 10340, Indonesia	+62-21-3192-6461
Indonesia	P. T. Sahabat Indonesia	P.O.Box 5045 Kawasan Industri Pergudangan, Jakarta, Indonesia	+62-(0)21-6610651-9
Ireland	Mitsubishi Electric Europe B.V.	Westgate Business Park, Ballymount, IRL-Dublin 24, Ireland	+353 (0)1-4198800
Israel	Gino Industries Ltd.	26, Ophir Street IL-32235 Haifa, Israel	+972 (0)4-867-0656
Italy	Mitsubishi Electric Europe B.V.	Viale Colleoni 7, I-20041 Agrate Brianza (MI), Italy	+39 039-60531
Kazakhstan	Kazpromavtomatika	ul. Zhambyla 28, KAZ - 100017 Karaganda	+7-7212-501000
Korea	Mitsubishi Electric Automation Korea Co., Ltd	9F Gangseo Hangang xi-tower, 401 Yangcheon-ro, Gangseo-gu, Seoul 07528 Korea	+82-2-3660-9572
Laos	AROUNKIT CORPORATION IMPORT- EXPORT SOLE CO.,LTD	SAPHANMO VILLAGE. SAYSETHA DISTRICT, VIENTIANE CAPITAL, LAOS	+856-20-415899
Lebanon	Comptoir d'Electricite Generale-Liban	Cebaco Center - Block A Autostrade Dora, P.O. Box 11-2597 Beirut - Lebanon	+961-1-240445
Lithuania	Rifas UAB	Tinklu 29A, LT-5300 Panevezys, Lithuania	+370 (0)45-582-728
Malaysia	Mitric Sdn Bhd	No. 5 Jalan Pemberita U1/49, Temasya Industrial Park, Glenmarie 40150 Shah Alam,Selangor, Malaysia	+603-5569-3748
Malaysia	Flexible Automation System Sdn Bhd.	60 Jalan USJ/10/1B 47620 UEP Subang Jaya Selangor Darul Ehsan, Malaysia	+603-5633-1280
Malta	ALFATRADE LTD	99 PAOLA HILL, PAOLA PLA 1702, Malta	+356 (0)21-697-816
Marocco	SCHIELE MAROC	KM 7,2 NOUVELLE ROUTE DE RABAT AIN SEBAA, 20600 Casablanca, Maroco	+212 661 45 15 96
Mexico	Mitsubishi Electric Automation, Inc.	Mariano Escobedo 69, Col. Zona Industrial, Tlalnepan, MEX - 54030 - MX	+55-3067-7500
Myanmar	Peace Myanmar Electric Co.,Ltd	NO137/139 Botahtaung Pagoda Road, Botahtaung Town Ship 11161, Yangon, Myanmar	+95-(0)1-202589
Nepal	Watt&Volt House	KHA 2-65, Volt House Dillibazar Post Box:2108,Kathmandu,Nepal	+977-1-4411330
Netherlands	Imtech Marine & Offshore B.V.	Sluisjesdijk 155, NL-3087 AG Rotterdam, Netherlands	+31 (0)10-487-19 11
North America	Mitsubishi Electric Automation, Inc.	500 Corporate Woods Parkway, Vernon Hills, IL 60061 USA	+847-478-2100
Norway	Scanelec AS	Leirvikasen 43B, NO-5179 Godvik, Norway	+47 (0)55-506000
Middle East	Comptoir d'Electricite Generale-International-S.A.L.	Cebaco Center - Block A Autostrade Dora P.O. Box 11-1314 Beirut - Lebanon	+961-1-240430
Arab Countries & Cyprus	Prince Electric Co.	2-P GULBERG II, LAHORE, 54600, PAKISTAN	+92-42-575232,5753373
Pakistan	AL-KAMAL GROUP	OFFICE NO.7&8, 1ST FLOOR, BARKAT ALI KHAN CENTER, 101, CIRCULAR ROAD, LAHORE, PAKISTAN	+92-42-37631632
Philippines	Edison Electric Integrated, Inc.	24th Fl. Galleria Corporate Center, Edsa Cr. Ortigas Ave., Quezon City Metro Manila, Philippines	+63-(0)2-634-8891
Philippines	Integrated Factory Automation Inc.	128 Lopez Rizal St., Brgy. Highway Hills, Mandaluyong City, Philippines	+63-2-532-5876 to 80
Poland	Mitsubishi Electric Europe B.V. Polish Branch	Krakowska 50, 32-083 Balice, Poland	+48 (0) 12 630 47 00
Republic of Moldova	Intehsis SRL	bld. Traian 23/1, MD-2060 Kishinev, Moldova	+373 (0)22-66-4242
Romania	Sirius Trading & Services SRL	RO-060841 Bucuresti, Sector 6 Aleea Lacul Morii Nr. 3	+40-(0)21-430-40-06
Russia	Mitsubishi Electric Europe B.V. Moscow Branch	52, bld. 3 Kosmodamianskaya Nab. 115054, Moscow, Russia	+7 495 721-2070
Saudi Arabia	Center of Electrical Goods	Al-Shuwayer St. Side way of Salahuddin Al-Ayoubi St. P.O. Box 15955 Riyadh 11454 - Saudi Arabia	+966-1-4770149
Singapore	Mitsubishi Electric Asia Pte. Ltd.	307 Alexandra Road, Mitsubishi Electric Building, Singapore 159943	+65-6473-2308
Slovakia	PROCONT, Presov	Kupelna 1/, SK - 08001 Presov, Slovakia	+421 (0)51 - 7580 611
Slovakia	SIMAP	Jana Derku 1671, SK - 91101 Trenčin, Slovakia	+ 421 (0)32 743 04 72
Slovenia	Inea RBt d.o.o.	Stegne 11, SI-1000 Ljubljana, Slovenia	+386 (0)1-513-8116
South Africa	CBI-electric: low voltage	Private Bag 2016, ZA-1600 Isando Gauteng, South Africa	+27-(0)11-9282000
Spain	Mitsubishi Electric Europe B.V. Spanish Branch	Carretera de Rubí 76-80, E-08190 Sant Cugat del Vallés (Barcelona), Spain	+34 (0)93-565-3131
Sweden	Euro Energy Components AB	Järnvägsgatan 36, S-434 24 Kungsbacka, Sweden	+46 (0)300-690040
Switzerland	TriElec AG	Muehlentalstrasse 136, CH-8201 Schaffhausen	+41-(0)52-6258425
Taiwan	Setsuyo Enterprise Co., Ltd	5th Fl., No.105, Wu Kung 3rd, Wu-Ku Hsiang, Taipei, Taiwan, R.O.C.	+886-(0)2-2298-8889
Thailand	United Trading & Import Co., Ltd.	77/12 Bamrungmuang Road,Klong Mahanak Pomprab Bangkok Thailand	+66-223-4220-3
Tunisia	MOTRA Electric	3, Résidence Imen, Avenue des Martyrs Mourouj III, 2074 - El Mourouj III Ben Arous, Tunisia	+216-71 474 599
Turkey	GTS	Bayraktar Bulvan Nutuk Sok. No:5, Posta Kutusu34384, TR-34775 Yukan Dudullu-Uemraniye, Istanbul, Turkey	+90 (0)216 526 3990
United Kingdom	Mitsubishi Electric Europe B.V.	Travellers Lane, UK-Hatfield, Herts. AL10 8XB, United Kingdom	+44 (0)1707-276100
Uruguay	Fierro Vignoli S.A.	Avda. Uruguay 1274 Montevideo Uruguay	+598-2-902-0808
Venezuela	Adesco S.A.	Calle 7 La Urbina Edificio Los Robles Locales C y D Planta Baja, Caracas - Venezuela	+58-212-241-9952
Vietnam	Mitsubishi Electric Vietnam Co.,Ltd. Head Office	Unit01-04, 10th Floor, Vincom Center, 72 Le Thanh Ton Street, District 1, Ho Chi Minh City, Vietnam	+84-8-3910-5945
	Mitsubishi Electric Vietnam Co.,Ltd. Hanoi Branch	Floor 24- Handico Tower- Pham Hung Road, Me Tri Ha, Me Tri Ward, Nam Tu Liem District, Hanoi, Vietnam	+84-24-3937-8075

YOUR SOLUTION PARTNER

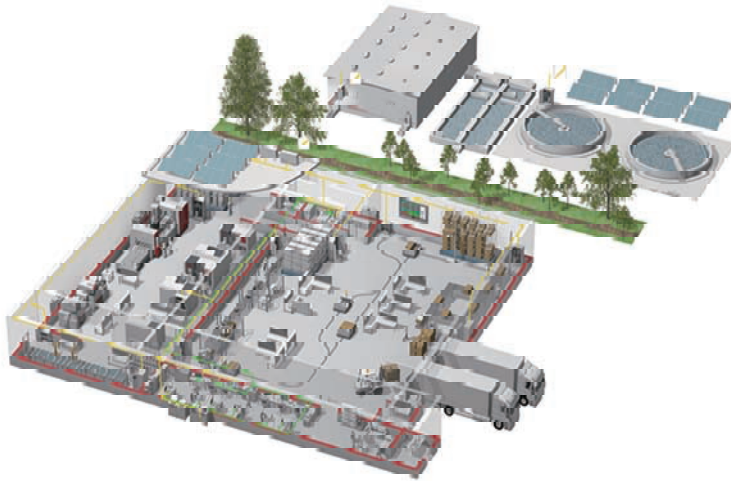

Mitsubishi Electric offers a wide range of automation equipment from PLCs and HMIs to CNC and EDM machines.

A NAME TO TRUST

Since its beginnings in 1870, some 45 companies use the Mitsubishi name, covering a spectrum of finance, commerce and industry.

The Mitsubishi brand name is recognized around the world as a symbol of premium quality.

Mitsubishi Electric Corporation is active in space development, transportation, semi-conductors, energy systems, communications and information processing, audio visual equipment and home electronics, building and energy management and automation systems, and has 237 factories and laboratories worldwide in over 121 countries.

This is why you can rely on Mitsubishi Electric automation solution - because we know first hand about the need for reliable, efficient, easy-to-use automation and control in our own factories.

As one of the world's leading companies with a global turnover of over 4 trillion Yen (over \$40 billion), employing over 100,000 people, Mitsubishi Electric has the resource and the commitment to deliver the ultimate in service and support as well as the best products.



Low voltage: MCCB, MCB, ACB



Medium voltage: VCB, VCC



Power monitoring, energy management



Compact and Modular Controllers



Inverters, Servos and Motors



Visualisation: HMIs



Numerical Control (NC)



Robots: SCARA, Articulated arm



Processing machines: EDM, Lasers, IDS



Transformers, Air conditioning, Photovoltaic systems

* All products are not available in all countries.

Precautions Before Use

- Please consult with a Mitsubishi Electric representative when considering the application of products presented in this catalogue with machinery or systems designed for specialized use such as nuclear power, electrical power, aerospace/outer space, medical, or passenger transportation vehicles.
- Mitsubishi Electric Corporation shall not be liable, to the customer or equipment user, for:
 - 1) Any damage found not to be attributable to a Mitsubishi Electric product.
 - 2) The loss of opportunity or profits for the customer or user caused by any fault in a Mitsubishi Electric product.
 - 3) Damage, secondary damage or accident compensation resulting from special factors regardless of whether or not such factors could be predicted by Mitsubishi Electric.
 - 4) Damage to products of other companies and/or guarantees relating to other services.

For Safety : Please read the instruction manual carefully before using the products in this catalog.
Wiring and connection must be done by the person who has specialized knowledge of electric construction and wirings.

●Trademarks

- Of this product, export (or service trade) permission under this law is required for exports that fall under the safety and trade control related cargo (or service) specified in the Foreign Exchange and Foreign Trade Control Law.
- Windows, Excel is registered trademark in the U.S. of U.S. Microsoft Corporation, and other countries.
- MODBUS® is a registered trademark of Schneider USA Inc.
- Ethernet are registered trademarks of Fuji Xerox Co., Ltd.
- Other company names and product names in this document are trademarks or registered trademarks of their respective owners.



for a greener tomorrow

Eco Changes is the Mitsubishi Electric Group's environmental statement, and expresses the Group's stance on environmental management. Through a wide range of businesses, we are helping contribute to the realization of a sustainable society.



MITSUBISHI ELECTRIC CORPORATION

HEAD OFFICE; TOKYO BUILDING, 2-7-3, MARUNOUCHI, CHIYODA-KU, TOKYO 100-8310, JAPAN