

my **BERNINA**

Sewing Machine
Workbook 1



Basic Operation

For all current BERNINA models
including bernettes

Introduction 3

Sewing Machine Needles 4

Thread 6

Presser Feet 7

Securing Stitches 8

Turning Corners and Needle Stop 9

Zigzag Stitch 10

Blind Hem 11

Triple Straight Stitch 12

Vari-Overlock Stitch 13

Stretch Stitch 14

Gathering Over Cord 15

Buttonholes 16

Manual Buttonholes 17

Automatic Buttonholes 18

Attaching Buttons 20

Stitching Zippers 21

Stitch, Function, and Foot Charts 22



This workbook is designed to be used as a step-by-step guide to familiarize you with the basic operation of your BERNINA or bernette sewing machine. Once you have completed the exercises designated for your machine, attach the sewn samples to the information pages (or add an extra mounting page as a facing page) and insert the pages into plastic page protectors to store in a 3-ring binder. They can then be used as a reference tool in the future as you use your machine and explore the creative possibilities it affords.

Pages 21-23 of this workbook have several charts that are useful when working through the stitching exercises on pages 8-20. Stitch numbers, presser feet, and machine functions are listed for all current BERNINA and bernette models. This will help you determine if your machine can be used for the exercise, and it will make it faster for you to locate particular stitches. Each stitch exercise page has a graphic of the stitch(es) used so you can quickly find it on the chart and on your machine.

Each page that has a stitching exercise ends with a “Sew How” box. This mini-quiz will let you test your knowledge and review the points the exercise is covering. Taking the class is just the first step. Using the information on a regular basis will help make it become part of your sewing skill set, and before long it becomes something you don’t even have to think about as you use your BERNINA machine.

BERNINA strives to provide its customers with quality sewing machines, as well as informative publications and classes. Along with providing My BERNINA Classes, your local BERNINA dealer stocks BERNINA reference books such as Feet-ures and The Serger Technique Reference Book. Plus, BERNINA of America has websites offering free projects and a variety of articles and postings that appeal to all types of stitchers, no matter which machines are their favorites. Visit these BERNINA web sites where you can share ideas and inspiration with other BERNINA enthusiasts!

www.bernina.com
www.weallsew.com

General Information

Along with thread, needles are very important to stitch formation. Many “mechanical” problems and damage to fabrics can be traced to a bent, damaged, or incorrect size or type needle. When selecting the correct needle, consider the following:

Needle system – 130/705H

Needle point – assures proper stitch formation; avoids fabric damage

Needle size – smaller for lightweight fabrics; larger for heavier fabrics

If the needle is:

Too small – the thread can’t stay in the groove to form a loop to be picked up by the hook point

Bent – the thread loop forms too far away from hook point and the hook can’t enter the loop to form a stitch

Blunt – the needle won’t pierce fabric, so no thread loop forms to make a stitch

Need to Know

Needles should be changed after every 4-6 hours of stitching. The needle is the most inexpensive part in your sewing machine but it is crucial for getting good results and keeping your machine running well. Don’t let false economy keep you from doing what is best for your sewing projects and your machine.

Needle “Secret” Code

- DRI = Triple
- E = Embroidery
- J = Jeans
- L, LL, R = Leather
- M = Microtex
- MET = Metallica
- N = Topstitching/Cordonnet
- Q = Quilting
- S = Stretch
- SUK = Fine Ball Point
- SES = Medium Ball Point
- WING = Wing
- ZWI = Double

Needle Size Conversion

Regardless of the system, the greater the number, the larger the diameter of the needle.

European vs. Domestic

60 = 8	90 = 14
70 = 10	100 = 16
75 = 11	110 = 18
80 = 12	120 = 19

Parts of a Needle

Shank (flat side to the back)

Groove (on the front)

Scarf (on the back)

Eye

Point

The selected thread should fit in the groove on the front of the needle. If it isn’t protected by the groove, a needle with a larger groove should be used.

Always make sure needles are fully inserted as high as possible, with the flat side to the back.

Shaft

Needle Size for Fabrics

- | |
|------------------------|
| 60 – very fine batiste |
| 70 – shirt-weight |
| 80 – medium-weight |
| 90 – denim and twill |
| 100/110/120 – canvas |

Type	Sizes	Description
Ballpoint	60-100	Has a rounded point. Size 70 for lingerie, nylon, jersey; 80 for t-shirt; 90 for sweatshirt fleece.
Stretch	70-90	A Stretch needle has a more rounded point than a Ballpoint, and a blue anti-cling coating which helps to prevent skipped stitches in knits and elastic. Sometimes used on Ultrasuede, vinyl, and plastic.
Universal	60-120	A compromise between a Sharp and a Ballpoint; used on both wovens and knits.
Double	1.6/70-8.0/100	Two needles attached to one shank. For pintucks, hems, and decorative work. Available in Universal, Stretch, Jeans, Metallica, and Embroidery needles.
Triple	2.5/90 3.0/90	Three needles attached to one shank. Used to create mock smocking and other decorative effects
Jeans	70-110	Has a sharp point and a shaft that is less prone to flex. The sharpness of the needle is better for use on denim and woven fabrics.
Leather	80-100	Point is a sharp cutting wedge. Used for leather only. Not for vinyl or simulated leathers.
Microtex / Sharp	60-90	Sharp point; thin shaft. Specially designed for microfiber fabrics.
Quilting	75 & 90	Thin, tapered point eliminates potential damage to fabric when seaming and cross-seaming.
Topstitch	70-100	A sharp point with a large eye and deep groove. For use with heavier fabrics – the large groove cradles heavier threads.
Embroidery	75 & 90	Sharp needle with large eye and groove; has a coating and a larger scarf. Prevents shredding of rayon or metallic threads. Two threads may be used through the eye.
Metafil	80	Similar to Embroidery needle with large eye and deep groove. Made of a heat-resistant alloy with a friction-reducing coating. Suitable for manufactured fibers such as polyester, acrylic, and nylon.
Wing	100 & 110	Sharp-pointed needle with a non-cutting metal wedge on each side. Makes a hole without cutting the threads of the fabric. Used for decorative and heirloom work, such as hemstitching.
Double Wing	100	One Universal needle and one Wing needle attached to a single shank.
Metallica	70-100	Designed for metallic threads; has a large eye and deep groove.

To achieve quality stitches, a sewing machine needs three things: suitable thread, correct size needle, and properly adjusted thread tensions. Poor quality or the wrong type of thread can cause inferior stitches on any machine. Inferior thread results in crooked and looped stitches, puckered seams, frayed thread, and/or needle breakage. Did you know that thread passes through the eye of the needle approximately 37 times in a “seesaw” action before it forms a single stitch?

Long staple threads are stronger and smoother than short staple threads. (Staple refers to the length of fibers used to twist together to form a single ply). Most bargain-priced threads are usually short staple and will deposit more lint and fuzz into your sewing machine, potentially causing tension inconsistencies and possibly even damage to your machine over the long term. Using long staple threads also result in less snagging and fraying as you sew.

Ply refers to the number of strands twisted together to make a single thread. The number of plies are usually indicated by a number after the weight of the thread such as 50/3, which means a 3-ply, 50-wt. thread. The lower the weight, the heavier the thread; conversely, higher numbers indicate fine or lightweight thread.

Guidelines for Thread Weights

- 12 wt.— Couching, bobbinwork
- 30 wt.— Embroidery, bobbinwork
- 40 wt.— General construction, quilting, embroidery
- 50 wt.— General construction, piecing, bobbin thread
- 60 wt.— Lingerie, heirloom, appliqué, bobbin thread
- 80 wt.— Extra-fine lingerie, heirloom



Fibers

Fiber refers to the type of material used to produce the thread.

Polyester

Good for clothing construction on man-made, natural or blended fabrics. Tolerates high temperatures. Polyester embroidery thread has a high sheen; excellent for embroidery, very abrasion resistant, and will not fade.

Cotton 2 ply

Mettler 60/2; excellent for French heirloom stitching, delicate machine embroidery, piecing and darning.

Mettler 50/2; excellent for clothing construction on natural fibers. Tighter twist than embroidery cotton thread and less puckering on problem fabrics. Cotton thread stretches less than polyester.

Mettler 30/2; loose twist for a soft, shiny look in machine embroidery, appliqué, and buttonholes.

Rayon

A lustrous embroidery thread; weaker than cotton, it is used for decorative work only.

Silk

Used on silk and wool fabrics, this strong, lustrous fiber is good for construction and decorative details such as buttonholes. Also used for

The exercises in this workbook are designed to be sewn with Mettler thread. Use one of the following in any color of medium value:

- Metrosene Polyester
- Silk-finished 50-wt. cotton

BERNINA Presser Feet:

- are precision engineered for specific functions
- are Swiss-engineered for the highest quality
- are one-piece metal feet, making them sturdy and durable
- are easy to change with one hand, requiring no special tools
- have a white shank, making it easier to see the eye of the needle, resulting in easier threading
- are, in some cases, modeled after commercial feet used in factories to increase speed and production with professional results
- do the job intended in relation to all types of sewing (example: quilting, garment-making, home dec, etc.)
- are supported by the best and most complete educational materials in the industry including reference books detailing each foot and its uses.

Understanding the Numbers/Letters

BERNINA presser feet are numbered and may have one or two additional versions with a letter that follows the number, such as Edgestitch Foot #10C or Jeans Foot #8D.

Number Only—The number *without* a letter refers to a foot engineered for BERNINA models that have a CB Hook and a maximum stitch width of 5.5mm. These feet may also be compatible with models that have a 9mm width when a 9mm width is not desired, such as when making pintucks with feet #30, 31, 32, or 33.

The Letter “C”—When a foot number is followed by a “C”, it indicates a version of the foot made for models that have rotary hook systems and a maximum stitch width of 9mm. The “C” stands for coded and refers to the sensor on the foot that works with the electronics of the machine to engage the wider stitch width. The sole of the “C” foot is usually larger to fit the wider feed dog of the rotary hook machines. *Exceptions: Overlock Foot #2/2A: 2A is larger to fit the wider feed dog but does not have a sensor for a wider stitch because the overlock stitches are not used at wide widths. Extra Wide Gathering Foot #16C: 16C is larger to fit the wider feed dog but does not have a sensor for a wider stitch width.*

The Letter “D”—The feet that have a number followed by a “D” are designed to work with the 8 Series and 7 Series Dual Feed feature. After attaching the foot, the Dual Feed mechanism is positioned in the cutout on the back of the foot, engaging the BERNINA Dual Feed system. It is recommended that the D-Feet be used only when the BERNINA Dual Feed Feature is engaged.

Easy-On/Easy-Off Soles—The BERNINA 350, 330, 215, 1008 and bernette models have simple-to-use, easy-on/easy-off metal soles that attach to a standard shank. The BERNINA models are also compatible with the one-piece full-shank presser feet available as optional accessories for all BERNINA machines.

Fabric: Firm woven fabric, two pieces, 4" x 6" each
Needle: 80/12 Universal
Needle Position: Center
BERNINA Presser Foot: Reverse Pattern Foot #1/1C/1D
with optional Quilting Seam Guide or optional Seam Guides with Rulers
bernette Presser Foot: Zigzag/Universal Foot

Fold each piece of fabric in half lengthwise to be 2" x 6". Stitch one or both of the exercises below depending on the features of your model.

Exercise 1:

Straight Stitch/Reverse

Find the $\frac{5}{8}$ " guide line on the stitch plate. Fold one piece of fabric in half lengthwise. Place it under the presser foot, and align one 6" edge with the $\frac{5}{8}$ " guide line.

Select the straight stitch. Sew a few stitches forward, then press or lift the Quick Reverse Button/Lever; sew a few stitches backward; the machine will sew in reverse until the Quick Reverse Button/Lever is released. Continue stitching the seam; secure the end in the same way.

Exercise 2:

Securing Stitch

Fold the second piece of fabric; align the raw edges with the guide. Place it under the presser foot and align one 6" edge with the $\frac{5}{8}$ " guide line.

Select the Securing Stitch. Begin to sew; machine will automatically secure the stitching, then continue stitching forward. At the end of the seam, press and release the Quick Reverse button. The machine will automatically secure the stitching, then stop.

Securing Stitch: Five straight stitches forward and back at beginning; five stitches backward and forward at end.

Quilter's Securing Stitch: Several very short stitches at the beginning and end.

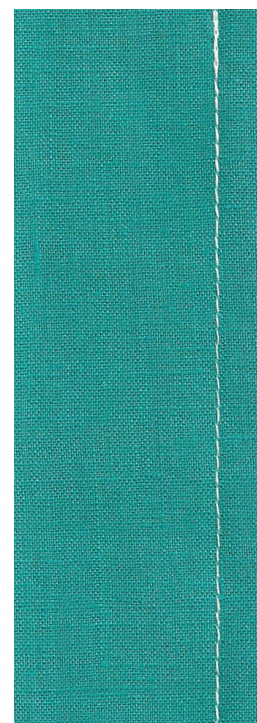
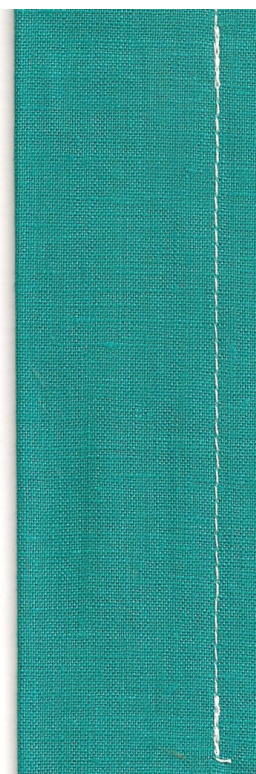
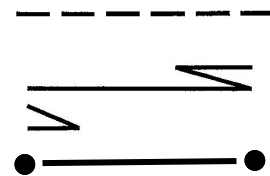

Reverse stitching

Securing stitches

SEW-HOW

Do you know how to:

- Select straight stitch?
- Sew in reverse?
- End a seam with the Securing Stitch?

Needle Stop

Fabric: Firm woven fabric, two pieces, 4" x 6" each
Needle: 80/12 Universal
Needle Position: Center
BERNINA Presser Foot: Reverse Pattern Foot #1/1C/1D
bernette Presser Foot: Zigzag/Universal Foot

Select the straight stitch.

Place the fabric pieces *wrong* sides together.

Place the fabric under the foot and engage the Needle Stop Down function, if available (see below).

Sew several lines of stitching, pivoting to form at least 2 right angle corners and 2 additional corners.

Pivot, using FHS (Free Hand System), if available, to raise the presser foot.

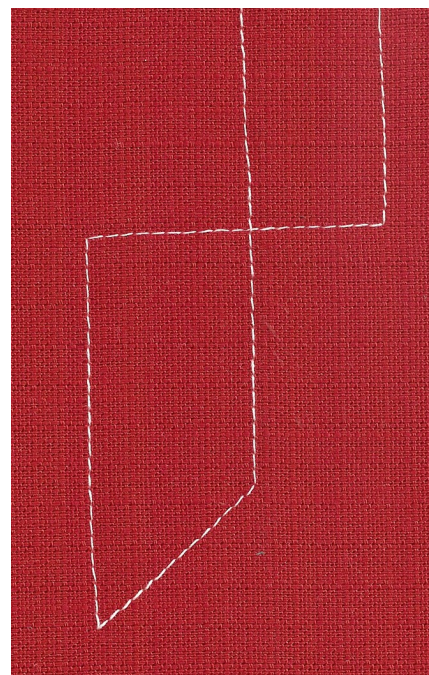

To Access Needle Stop Up/Down:

215, 3 Series, 530, 550: Needle stops in the up position (default). Briefly push the Needle Stop Up/Down button and needle will go up or down. Press & hold button to set needle stop position down or up automatically until reset. Arrow indicator appears on the screen to show if it set to stop up or down.



560, 580, 7 Series, 880: Needle stops in the up position (default). Briefly push the Needle Stop Up/Down button and needle will go up or down. To change needle setting permanently, touch and hold the Needle Stop Up/Down icon on the screen until reset. Arrow indicator appears on the screen to show if it set to stop up or down.



bernette London 8, London 7, Chicago 5, Chicago 7: Press needle Up/Down Button. The machine will take a half stitch, and the needle stop position is remembered during the sewing session.

SEW-HOW

Do you know how to:

- Use the Free Hand System?
- Use the Stitch Plate markings?
- Engage the Needle Stop Down feature?



Fabric: Firm woven fabric, 4" x 6"

Needle: 80/12 Universal

Needle Position: As directed in instructions

BERNINA Presser Foot: Reverse Pattern Foot #1/1C/1D

bernette Presser Foot: Zigzag/Universal Foot

Select the Zigzag Stitch (width = 4, length = 2).

Finish one 6" edge using the following steps.

Guide the edge of the fabric under the middle of the presser foot – **or** – Move needle position to the far right; sew using the inside edge of the right toe as a guide.

The needle should go into the fabric on one stroke of the needle and over the edge on the next stroke.

Tips

Do not use too long a stitch or too wide a stitch; the edge should lie flat, not roll.

Match the weight of the thread to the weight of the fabric.



SEW-HOW

Do you know how to:

- Adjust the stitch width?
- Adjust the stitch length?

Fabric: Heavy flannel, 6" x 7"
Needle: 80/12 Universal
Needle Position: As programmed
BERNINA Presser Foot: Reverse Pattern Foot #1/1C/1D and Blind Hem Foot #5
bernette Presser Foot: Zigzag/Universal Foot and Blind Hem Foot (optional accessory)

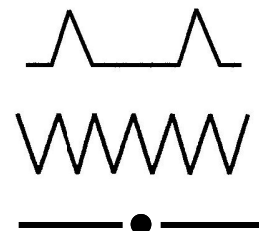

Attach Reverse Pattern Foot #1 or bernette Zigzag/Universal Foot to the machine.

Finish one 6" edge of the fabric using a zigzag stitch and guiding the edge of fabric under the middle of the presser foot. The needle should go into the fabric on one stroke of the needle and over the edge on the next stroke. *Note: This is the same as the exercise on page 10.*

Fold a 2" hem to the wrong side of the fabric and press.

Baste the hem in place, sewing about 1/4" from the upper edge of the hem (the one previously stitched).

Select the Blindstitch and attach the Blind Hem Foot #5 to the machine.

Fold the hem back to the right side over the basting line, exposing the zigzagged edge of the fabric.

Sew on the extended hem allowance, keeping the folded edge next to the guide on the foot.

Adjust the stitch width if needed so that the needle barely stitches into the fold.

Unfold the fabric when finished, and notice that the stitches barely show on the outside of the fabric.

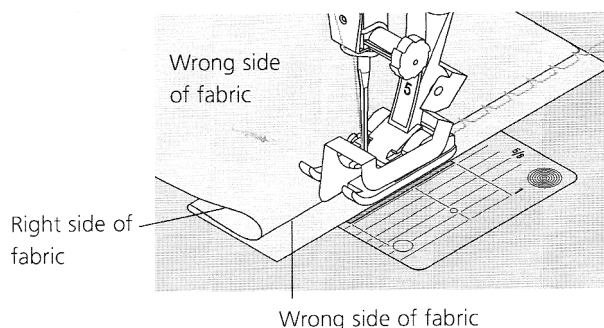

SEW-HOW

Do you know how to:

- Machine baste?
- Distinguish between Blind Hem Foot #5 and Edgestitch Foot #10/10C/10D?

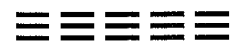

Fabric: Firm woven fabric, two pieces, 4" x 6" each
Needle: 80/12 Universal
Needle Position: As directed in instructions
BERNINA Presser Foot: Reverse pattern Foot #1/1C/1D and Edgestitch Foot #10/10C/10D (optional accessory)
bernette Presser Foot: Zigzag/Universal Foot

Attach Reverse Pattern Foot #1/1C/1D or bernette Zigzag/Universal Foot to the machine.

Select the Triple Straight Stitch.

Position the edge of the fabric on the $\frac{5}{8}$ " mark on the stitch plate. Sew the seam and press it open.

Change to Edgestitch Foot #10/10C/10D and adjust the needle position to the far right.

With the guide of the foot in the ditch of the seam, sew the length of the seam.

Adjust the needle position to the far left and stitch a second time, again with guide of the foot in the ditch of the seam, sewing in the same direction as before.



SEW-HOW

Do you know how to:

- Adjust the needle position?
- Use the stitch plate markings?
- Use Edgestitch Foot #10/10C/10D?



Fabric: Cotton interlock, two pieces, 4" x 6" each
Needle: 80/12 Universal (Ballpoint or Stretch may also be used)
Needle Position: As programmed
BERNINA Presser Foot: Overlock Foot #2/2A
bernette Presser Foot: Overcasting Foot (optional accessory)

Place the two pieces of fabric right sides together.

Select the Vari-Overlock Stitch.

If available, engage the Needle Stop Down function.

Guide the raw edges of the fabric under the pin of the foot and stitch the two layers together. The stitch will form over the pin and the edge of the fabric.

bernette: Guide the fabric against the blade of the foot.
 Adjust the stitch length and width if needed.

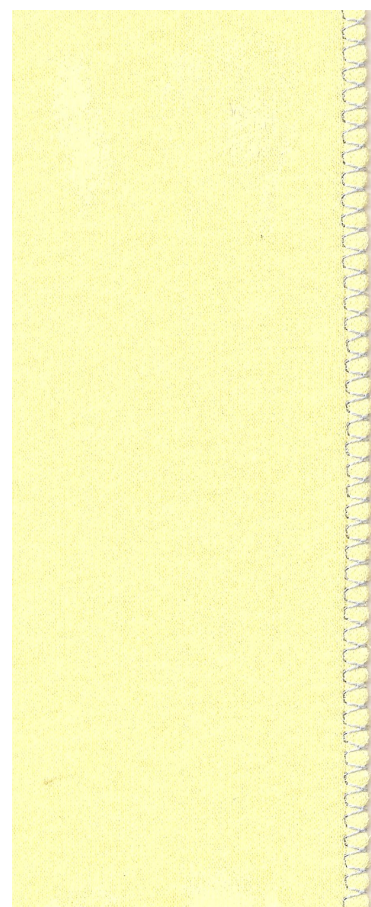

SEW-HOW

Do you know how to:

- Engage the Needle Stop Down feature?
- Position Overlock Foot #2/2A?



Fabric: Spandex, two pieces, 2" x 6" each
Needle: 80/12 Universal (Ballpoint may also be used)
Needle Position: As programmed
BERNINA Presser Foot: Reverse pattern Foot #1/1C/1D
bernette Presser Foot: Zigzag/Universal Foot

Select the Super Stretch stitch.

Place the fabric pieces right sides together.

Position the edge of the fabric on the $\frac{5}{8}$ " marking on the stitch plate; sew the seam and press it open.

Note: If the fabric is pulling and stretching as it is sewn, adjust the presser foot pressure to a lower number to lighten the pressure of the foot on the fabric and eliminate the stretching.

Note: Foot Pressure adjustment is not available on the 215, 1008, or 3 Series models.



SEW-HOW

Do you know how to:

- Adjust the presser foot pressure?



Fabric: Medium weight cotton, 12" x 4" and narrow cord such as perle cotton or embroidery floss, 18"

Needle: 80/12 Universal

Needle Position: Center

BERNINA Presser Foot: Clear Embroidery Foot #39/39C

bernette Presser Foot: Cording Foot (optional accessory)

Attach the desired foot to the machine.

Thread the cord through the center front hole of Clear Embroidery Foot #39/39C or through the center groove of the bernette Cording Foot, leaving a 2"-3" tail behind the foot.

Select the Zigzag stitch and adjust the stitch width to 2.5 mm and the stitch length to 2-2.5 mm.

Stitch $\frac{5}{8}$ " from one 12" edge; sewing over the cord, but not into it.

Tie a knot in the cord at the beginning of the stitching and then pull it to gather the sample to 6".

Notes

- *Gathering over cord adds additional strength, eliminates thread breakage, and allows better control of gathering.*
- *Do not sew through the cording, or it won't be able to move through the channel formed by the stitches*
- *After gathering the fabric, drop the feed dog and sew a bartack (see page 19) at the beginning and end of cord for strength.*



SEW-HOW

Do you know how to:

- Attach a presser foot with one hand?
- Adjust stitch width and length?
- Drop the feed dog?

There are a variety of buttonhole styles available, depending on your model. All models have a standard buttonhole that is appropriate for many types of projects. Below is a list of other styles and types of buttonholes that may be available on your model.

STANDARD BUTTONHOLE: Fine to medium weight fabrics.

HEIRLOOM BUTTONHOLE: Fine to medium weight fabrics.

STRETCH BUTTONHOLE: All stretch fabrics.

ROUND BUTTONHOLE WITH NORMAL BARTACK: Medium to heavy weight fabrics of all types.

ROUND BUTTONHOLE WITH HORIZONTAL BARTACK: Medium to heavy weight fabrics of all types.

KEYHOLE BUTTONHOLE WITH NORMAL BARTACK: Heavy weight, non-stretch fabrics.

KEYHOLE BUTTONHOLE WITH POINTED BARTACK: Firm woven fabric. Jackets, coats, leisure wear.

KEYHOLE BUTTONHOLE WITH HORIZONTAL BARTACK: Firm woven fabrics. jackets, coats, leisure wear.

STRAIGHT STITCH BUTTONHOLE: For bound buttonholes & welt pockets.

HAND-LOOK BUTTONHOLE: For light- to medium-weight woven fabrics.

Buttonhole Presser Feet



Standard Buttonhole Foot #3 for manual buttonholes on CB Hook models



Standard Buttonhole Foot #3C for manual buttonholes on Rotary Hook models



Automatic Buttonhole Foot #3A for automatic buttonholes



Buttonhole Foot with Slide #3B - measuring foot for manual buttonholes

4-Step Buttonhole Foot For the bernette models Seville 4 and London 3.



Automatic Buttonhole Foot For bernette models London 5, London 7, London 8 and Chicago.





Fabric: Heavy flannel, 6" x 6" and Lightweight tear-away stabilizer, 3" x 6" and Narrow cord (perle cotton, embroidery floss, etc.), 18"

Needle: 80/12 Universal

Needle Position: As programmed

BERNINA Presser Foot: Standard Buttonhole Foot #3/3C

bernette Presser Foot: Seville 4 and London 3: 4-step Buttonhole Foot
Foot Note: For making buttonholes with bernette models London 5, London 7, London 8, Chicago 5, and Chicago 7, see Automatic Buttonholes on the following page.

Fold the fabric in half to 3" x 6"; press. Insert the stabilizer between the layers. Draw a line 1½" from the fold along the 6" length. Draw a second line 1" from the first line. Mark two short lines, between the fold and the drawn line, spaced about 1½"-2" apart.

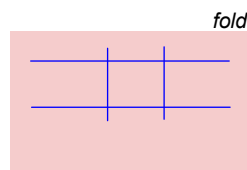

Standard Buttonhole—BERNINA

Select the Standard buttonhole; select the "man" function from the function toolbar, if applicable. Position the foot over the first short line, aligning the fold of the fabric with the 5/8" marking on the stitch plate, behind the foot. Engage Step #1. Sew the first side of the buttonhole. Stop at the drawn line; select step #2. Continue with remaining steps.

Seville 4



Standard Buttonhole—Seville 4 and London 3

Select the buttonhole and adjust the stitch settings: SW = 5 and SL = buttonhole. Position the foot over the first short line, aligning the needle with the 1½" line. Select the steps in order and sew them as shown in the diagrams. When the stitching is complete, remove the fabric from under the foot. Bring thread tails to the back and tie off.

London 3

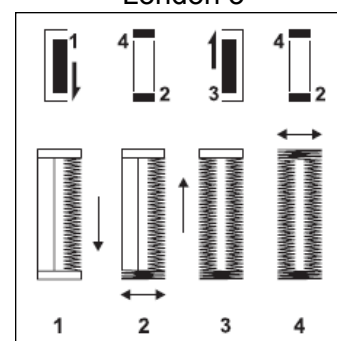

Corded Buttonhole

Fold the cord in half and loop the middle around the center "toe" of the foot (For the bernette – loop the cord at the back of the foot; lock it in the front grooves and tie the ends in front.) Stitch the buttonhole on the second Line as before, then carefully remove the fabric from under the foot. Pull the cord ends until the loop is pulled up under the buttonhole; trim the ends of cord. If working on a knit fabric, knot the cord ends together before trimming.

Tension Tips

A slightly tighter bobbin tension gives a beautiful full look to your buttonholes. The best way to achieve this:

- *CB Hook Machines:* Thread the bobbin thread through the hole in the finger of the bobbin case.
- *Rotary Hook Machines:* Use the embroidery bobbin case and thread the "pigtail."
- *7 Series Machines:* No bobbin adjustments
- *8 Series Machines:* Thread for embroidery.

SEW-HOW

Do you know how to:

- Measure a button for buttonhole size?
- Select a buttonhole?
- Stitch a buttonhole?



Fabric: Heavy flannel, 6" x 6" and Lightweight tear-away stabilizer, 3" x 6"

Needle: 80/12 Universal

BERNINA Presser Foot: Automatic Buttonhole Foot #3A

bernette Presser Foot: Automatic Buttonhole Foot

Note: Models 1008 & 215 do not make Automatic Buttonholes.

Fold each fabric square in half to 3" x 6"; press. Insert the stabilizer between the layers. Draw a line 1½" from the fold along the 6" length.

Automatic Buttonhole—BERNINA

- Attach Automatic Buttonhole Foot #3A; set the red slide marker to the length of buttonhole desired.
- Position the needle over the drawn line, setting it to stitch the buttonhole perpendicular to the line.
- Sew the first bead of the buttonhole; stop when the red mark on the foot aligns with the red slide marker.
- Press and release the Quick Reverse button; this programs the length of the buttonhole. Continue sewing – the buttonhole is completed automatically and the machine will stop when it is finished. This buttonhole is now programmed into the temporary memory.
- Move the foot to another place on the drawn line and sew the programmed buttonhole on the second line. There is no need to stop or press Quick Reverse this time, as the machine will simply repeat the previous buttonhole and stop automatically.

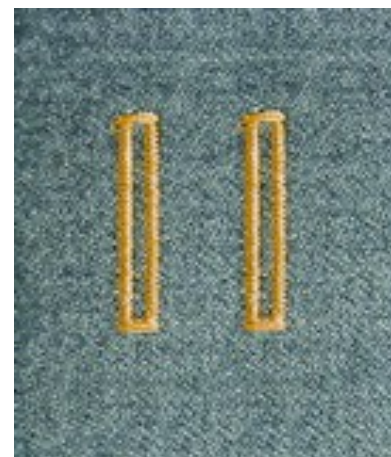

Automatic Buttonhole—bernette London 5, London 7, London 8, Chicago 5 and Chicago 7

- Position the foot over the first short line, aligning the needle (at the front end of the buttonhole) with the drawn line.
- Open the button plate and insert the button.
- Lower the buttonhole lever and push it toward the back of the machine.
- Stitch the buttonhole; the machine will complete the buttonhole automatically.
- When stitching is complete, remove the fabric from under the presser foot.
- Bring the thread tails to back and tie off.
- Push the lever up when not in use.

Note: To make a corded Automatic Buttonhole on bernette models London 5, London 7, London 8, and Chicago, follow the directions on the previous page, looping the cord from the back and securing it at the front of the foot.

SEW-HOW

Do you know how to:

- Program a buttonhole?
- Make repeat buttonholes?
- Open a buttonhole?

Automatic Buttonholes

On-screen Buttonhole Measuring Buttonhole Slit Width Adjustment

Fabric: Heavy flannel, 6" x 6" and Lightweight tear-away stabilizer, 3" x 6"

Button: ¾" (19 mm/30L) two-hole button

Needle: 80/12 Universal

BERNINA Presser Foot: Automatic Buttonhole Foot #3A

Note: On-screen Buttonhole Measuring and Buttonhole Slit Width Adjustment are available on Models 880, 7 Series, 580, and 560.

Fold each fabric square in half to 3" x 6"; press. Insert the stabilizer between the layers. Draw a line 1½" from the fold along the 6" length.

Automatic Buttonhole - On-screen Buttonhole Measuring—BERNINA

- Attach Automatic Buttonhole Foot #3A.
- Select the Standard Buttonhole.
- Expand the information Screen and select the Buttonhole Stitch Length.
- Hold Button on screen. Use Multi-function Knobs to encircle the button.
- Length is calculated directly from the button diameter. 2 mm are automatically added for button ease/thickness.
- Sew the buttonhole - no need to set the length with the Quick Reverse. Buttonhole is repeatable without re-setting.



Automatic Buttonhole - Slit Width Adjustment—BERNINA

- Attach Automatic Buttonhole Foot #3A.
- Select the Standard Buttonhole and set the length using Buttonhole Measuring method.
- Expand Information Screen. Select Buttonhole Slit Width.
- Adjust Buttonhole Slit Width to accommodate thick or unusual buttons. Use Multi-function Knobs to adjust the width.
- Sew the buttonhole - no need to set the length with the Quick Reverse. Buttonhole is repeatable without re-setting.



Note: Buttonhole Bead Width and Stitch Density are also adjustable using the Multi-function Knobs in the sewing view.

SEW-HOW

Do you know how to:

- Program a buttonhole on-screen?
- Adjust the buttonhole slit width?
- Adjust the buttonhole bead width?

Fabric: Firm woven fabric, 4" x 8" and Lightweight tear-away stabilizer, 4" x 4"

Button: ¾" (19 mm/30L) two-hole button

Needle: 80/12 Universal

BERNINA Presser Foot: Button Sew-On Foot #18 (optional)

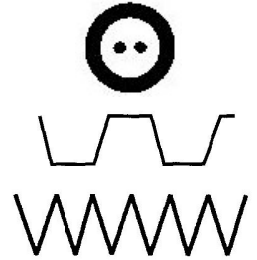

Lower the feed dog, then attach the Button Sew-On Foot to the machine. Select the Button Sew-On stitch, if available. The Universal or Zigzag stitch can also be used by setting the stitch length at 0.0 mm.

Fold the fabric in half to 4" x 4"; press. Insert the stabilizer between the layers of fabric.

Technique #1 – With Thread Shank

Optional: Use a glue stick to hold the button in place.

BERNINA only: For a long shank, adjust the pin on Button Sew-On Foot #18 to the highest position. *Note: A short shank is appropriate for dress-and blouse-weight fabrics; a long shank for coat- and jacket-weight materials.*

Check the distance between the holes of the button by turning the hand wheel. To avoid breaking the needle, adjust the stitch width if necessary so that the left and right swings of the needle fall into the holes of the button. Hold the thread tails as you begin to sew.

If using the Button Sew-on stitch, the machine stops automatically when the program is complete; the thread tails are secured as part of the program.

BERNINA or **bernette**: Use the Universal or Zigzag stitch, sew 6-8 stitches, and stop. Bring the thread tails to the wrong side of the fabric and knot them together; trim the excess thread.

Technique #2 – Without Thread Shank

Using the lowest shank setting and the instructions above, attach a charm(s) or snap or hook and eye. Stitch a ribbon with this technique (the stitch makes a bartack) and then tie the ribbon into a bow.



SEW-HOW

Do you know how to:

- Lower the feed dog?
- Adjust the shank on Button Sew-On Foot #18?



Fabric: Firm woven fabric, two pieces, 4" x 8" each and 4"-7" neckline zipper

Needle: 80/12 Universal

BERNINA Presser Foot: Reverse Pattern Foot #1/1C/1D and Zipper Feet #4 and Zipper Foot with Guide #54 (optional accessory)

bernette Presser Foot: Zigzag/Universal foot and Zipper Foot

Attaching the Zipper to Garment

Place fabric pieces right sides together. Using a straight stitch, sew a $\frac{3}{4}$ " seam from one short end up to where the zipper stop will be about 2". Baste the rest of the seam, sewing 2-3 stitches in reverse at the end to secure the seam; return to a straight stitch length of 2.5 mm.

Press the seam allowances open. Place the right side of the zipper against the seam allowances with the zipper teeth centered over the seam. Pin or baste each side of zipper to the *seam allowances only*.

Change to a zipper foot; adjust the needle position (bernette users slide the zipper foot) to the right or left as needed to stitch close to the zipper teeth. Sew through the *zipper tape and the seam allowance only*, from bottom to top on each side of the zipper. Pin or baste through all layers to hold the sewn zipper to the project.

Topstitching the Zipper—BERNINA

Change to Zipper Foot with Guide #54.

Left Side: Adjust the seam guide to one notch to the right of center. Adjust the needle position to the far left. Sewing from the right side of the fabric and starting at the lower edge, sink the needle into the seam. Sew out about $\frac{3}{8}$ ", stop, pivot and make sure the seam guide is lying in the ditch of the seam. Sew up the left side of the zipper, stitching through all layers.

Right Side: Adjust the guide one notch to left of center; move the needle position to the far right. Repeat the above steps on the right side of the zipper.

Topstitching the Zipper—bernette

Left Side: Adjust the foot to the left of center. Sewing from the right side of the fabric and starting at the lower edge, sink the needle into the seam. Sew out about $\frac{3}{8}$ ", stop, pivot and make sure the edge of the foot is lying in the ditch of the seam. Sew up the left side of the zipper.

Right Side: Adjust foot to right of center. Repeat the above steps, starting at seam and sewing to the right of the zipper.















SEW-HOW

Do you know how to:

- Machine baste a seam?
- Adjust the needle positions?
- Adjust the sliding guide or sole?

The following stitches are used in **Workbook 1: Basic Operation**. The chart gives the stitch number for each model (--- indicates that the stitch is not available).

Stitch	8 Series		7 Series						5 Series						3 Series			2 Series		1000 Series				
	880	790	780	770 QE	750 QE	740	710	580	560	550	530	380	350 PE	330	215	1008	London 3	London 5	London 7	London 8	Seville 4*	Chicago 5 & 7		
 Basting	21	21	21	21	21	30	30	21	30	30	30	23	21	--	--	--	--	--	--	--	--	--	--	
 Blindstitch	9	9	9	9	9	9	9	9	9	9	9	7	7	7	5	3	6	13	7	7	7	7	9	
 Button Sew-On	60	60	60	60	60	60	60	60	60	60	60	14	12	11	--	--	--	--	--	--	--	--	A97	
 Quilter's Securing	1324	1324	1324	1324	1324	1324	1324	1324	1324	1324	1324	104	75	--	--	--	--	--	--	--	--	--	--	
 Securing	5	5	5	5	5	5	5	5	5	5	5	5	5	5	--	--	--	--	--	--	--	--	--	
 Standard Buttonhole	51	51	51	51	51	51	51	51	51	51	51	0	0	11	dial	dial	1	10	10	10	dial	0	0	
 Straight	1	1	1	1	1	1	1	1	1	1	1	1	1	1	1	1	1&2	2	1&2	1&2	1&2	1&2	1&2	
 Stretch	11	11	11	11	11	11	11	11	11	11	11	9	9	9	--	--	16	9	9	9	5	4	4	
 Triple Straight	6	6	6	6	6	6	6	6	6	6	6	6	6	4	5	11&12	17	3	3	3	--	3	3	
 Universal	15	15	15	15	15	15	15	15	15	15	15	19	17	14	--	4	8	6	14	14	--	--	--	
 Vari-Overlock	3	3	3	3	3	3	3	3	3	3	3	3	3	3	--	3	7	5	8	8	6	8	8	
 Zigzag	2	2	2	2	2	2	2	2	2	2	2	2	2	2	2	2	3	3	4	4	3	3	5	

* The stitches on bennette model Seville 4 (formerly 46) are not numbered on the machine but are indicated on the chart in the order they appear on the front of the machine.

The following features and functions are used in Workbook 1: Basic Operation.

Feature / Function	8 Series								7 Series								5 Series						3 Series				2 Series		1000 Series		bernette							
	860	790	780	770 QE	750 QE	740	710	580	560	550	530	380	350 PE	330	215	1008	London 3	London 5	London 7	London 8	Seville 4	Chicago 5 & 8																
Automatic Needle Threader	yes	yes	yes	yes	yes	yes	yes	yes	yes	yes	yes	yes	yes	yes	yes	yes	no	yes	yes	yes	yes	no	yes															
Automatic One-Step Buttonhole	yes	yes	yes	yes	yes	yes	yes	yes	yes	yes	yes	yes	yes	yes	no	no	no	yes	yes	yes	yes	no	yes															
Feed Dog Up/Down	yes	yes	yes	yes	yes	yes	yes	yes	yes	yes	yes	yes	yes	yes	yes	yes	cover	yes	yes	yes	yes	cover	yes															
Free Hand System	yes	yes	yes	yes	yes	yes	yes	yes	yes	yes	yes	yes	opt	opt	no	no	no	no	no	no	no	no	no															
Hopper Mechanism	yes	yes	yes	yes	yes	yes	yes	yes	yes	yes	yes	yes	yes	yes	yes	yes	no	no	no	no	no	no	no															
Maximum Stitch Width	9 mm	9 mm	9 mm	9 mm	9 mm	9 mm	9 mm	9 mm	9 mm	5.5 mm	5.5 mm	5.5 mm	5.5 mm	5.5 mm	5.5 mm	5.5 mm	5 mm	5 mm	7 mm	7 mm	5 mm	7 mm																
Needle Positions	11	11	11	11	11	11	11	11	11	11	11	9	9	9	9	5	2	3	5	5	2	5																
Needle Stop Up/Down	yes	yes	yes	yes	yes	yes	yes	yes	yes	yes	yes	yes	yes	yes	yes	no	no	no	yes	yes	no	yes																
On-screen Button-hole Measuring	yes	yes	yes	yes	yes	yes	yes	yes	yes	no	no	no	no	no	no	no	no	no	no	no	no	no																
Presser Foot Pressure	yes	yes	yes	yes	yes	yes	yes	yes	yes	yes	yes	yes	yes	yes	no	no	yes	yes	yes	yes	yes	yes																
Slide-on Table or Snap-on Box	yes	yes	yes	yes	yes	yes	yes	yes	yes	yes	yes	yes	yes	opt	yes	yes	yes	yes	yes	yes	yes	yes																

The presser feet listed below are included with the purchase of each model as indicated on the chart (-- indicates that the presser foot is not included but may be available as an optional accessory). The BERNINA name and numbers are listed and if the berrette has a corresponding presser foot, it is indicated by the letter stamped on the top of the sole. If the berrette foot does not have a letter, it is indicated by an "X". The highlighted feet have snap-on soles. *Note: This chart shows only a partial listing of optional presser feet available. See your local BERNINA dealer for a complete listing of BERNINA and berrette specialty accessories.*

	8 Series		7 Series					5 Series					3 Series			2 Series		1000 Series		berrette				
	880	790	780	770 QE	750 QE	740	710	580	560	550 QE	530	380	350 PE	330	215	1008	London 3	London 5	London 7	London 8	Seville 4	Chicago 5 & 7		
Presser Feet																								
Reverse Pattern Foot #1/C/1D	1C, 1D	1C, 1D	1C, 1D	1C, 1D	1C, 1D	1C, 1D	1C, 1D	1C	1C	1	1	1	1	1	1	1	J	J	T	T	X	T		
Overlock Foot #2/2A	2A	2A	2A	--	--	--	--	2A	2A	--	2	2	--	2	2	2	opt	G	E	E	--	E		
Standard Buttonhole Foot #3/3C	3C	--	--	--	--	--	--	--	--	--	--	--	--	3	3	B					X			
Auto Buttonhole Foot #3A	3A	3A	3A	3A	3A	3A	3A	3A	3A	3A	3A	3A	3A	--			D	D	D	D		D		
Zipper Foot #4/4D	4D	4D	4D	4D	4D	4D	4D	4	4	4	4	4	4	4	4	4	I	I	opt	I	X	I		
Blind Hem Foot #5	5	5	5	--	5	--	5	5	5	5	5	5	5	5	5	5	opt	opt	F	F	--	F		
Jeans Foot #8/8D	--	8D	8D	--	--	--	--	8	--	--	--	--	--	--	--	--	--	--	--	--	--	--		
Darning Foot #9	--	--	--	--	--	--	--	--	--	--	--	--	--	--	--	--	opt	opt	opt	X	--	X		
Button Sew-On Foot #18	18	--	--	--	--	--	--	--	--	--	--	--	--	--	--	--	X	X	X	X	X	H		
Open Embroidery Foot #20/20C/20D	20C	20C	20C	20C	20C	20C	20C	20C	20C	20	--	20	20	--	--	opt*	X*	X*	A*	A*	--	A*		
Embroidery Foot #26	26	26	26	26 w/emb	26 w/emb	--	--	26 w/emb	--	--	--	--	--	--	--	--	--	--	--	--	--	X		
Patchwork Foot #37/37D or #97/97D	--	--	--	97D	37D	--	--	--	37	--	--	37	--	--	--	--	--	--	--	--	--	--		
Sideways Motion Foot #40C	40C	40C	40C																					
BERNINA Stitch Regulator #42	42	42	42	42	42	--	--	42	--	42	--	--	--	--	--	--								
Walking Foot #50	--	--	--	--	--	--	--	--	50	--	--	50	--	--	--	--								

* satin stitch foot—no open toe