

**We Build Trucks
That Suck !**

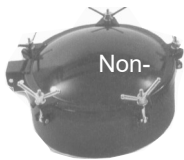

Vacuum Sales, Inc.

51 stone Road, Lindenwold, NJ 08021
(800) 547-7790 (856) 627-7790
(856) 627-3044 ~ Fax
www.VacuumSalesInc.com

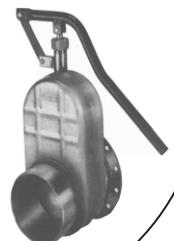



Vacuum Sales, Inc.

51 Stone Road Lindenwold, NJ 08021

800-547-7790 fax:856-627-3044

www.vacuumsalesinc.com

Safety Equipment



**Placard
WT670**

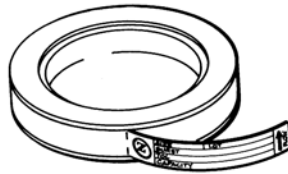

Rupture Disc			
2"		3"	
1451	35 lb.	10000	35 lb.
1453	40 lb.	10001	40 lb.
1485	50 lb.	10002	50 lb.
		10001/15	50 lb. graphite

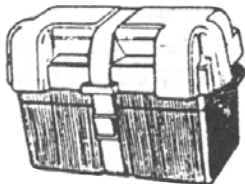

**Battery Box
208**

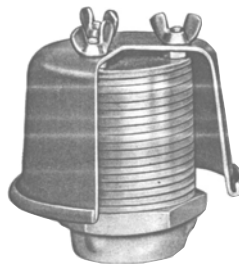

Flame Arrestor	
210	2"
211	3"



Smart Vent	
MC407	4" Smart Vent
MC307B	3" Vent without vacuum
202013	3" Teflon gasket

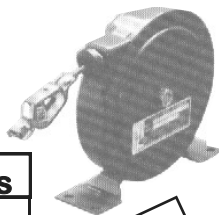

Spring
Rewind

Static Reels	
1449	20'
1498	50'
1485	Clip



Fire Extinguisher	
10003	20 lb. ABC fire extinguisher
1004	Heavy duty mounting bracket



Fusible Cap	
9000	3" S/S
9003	3" C/S

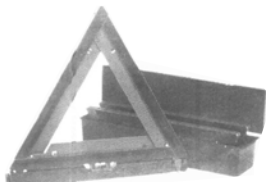

**Triangle Kit
KD610**



Vacuum Sales, Inc.

51 Stone Road Lindenwold, NJ 08021

800-547-7790 fax:856-627-3044

www.vacuumsalesinc.com

Wash Down Pumps



ME23991 Wash Down Pump

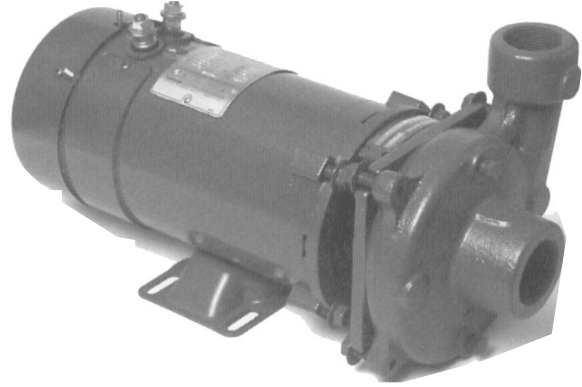

DC10 Burks Wash Down Pump

Hose Reels

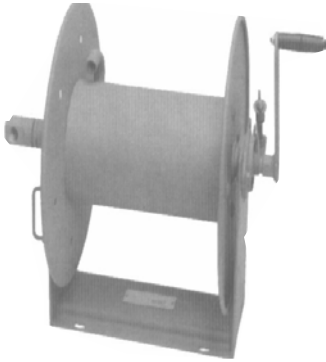

Compact Manual

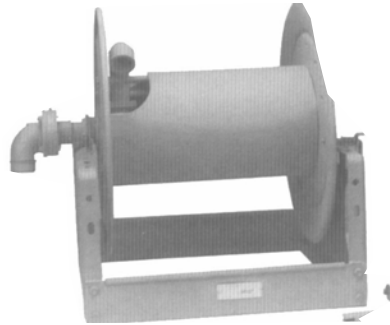

Manual Rewind Reel

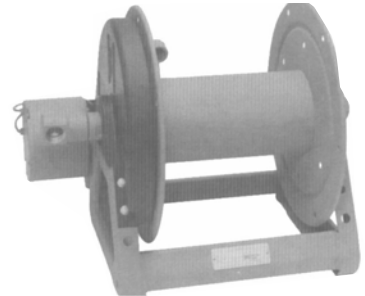

Power Rewind Reel

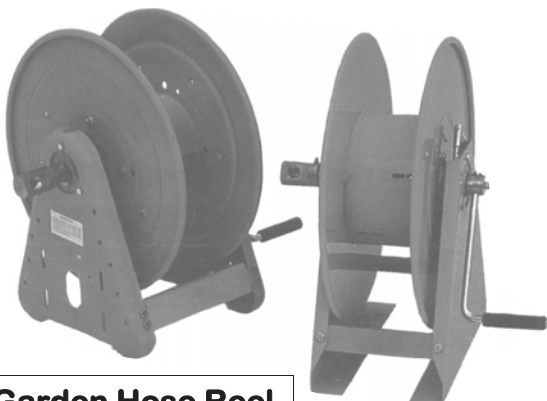

Garden Hose Reel



Spring Rewind

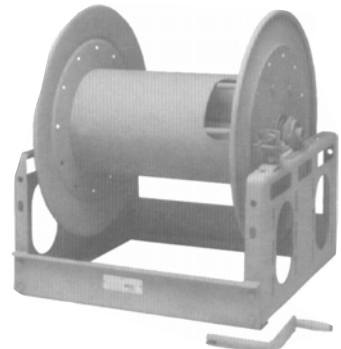

Storage Reels



Vacuum Sales, Inc.

51 Stone Road Lindenwold, NJ 08021

800-547-7790 fax:856-627-3044

www.vacuumsalesinc.com

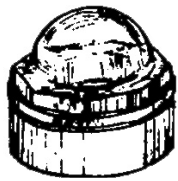

3022C

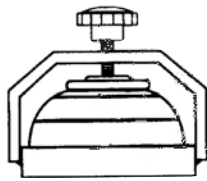

3024C



3023C

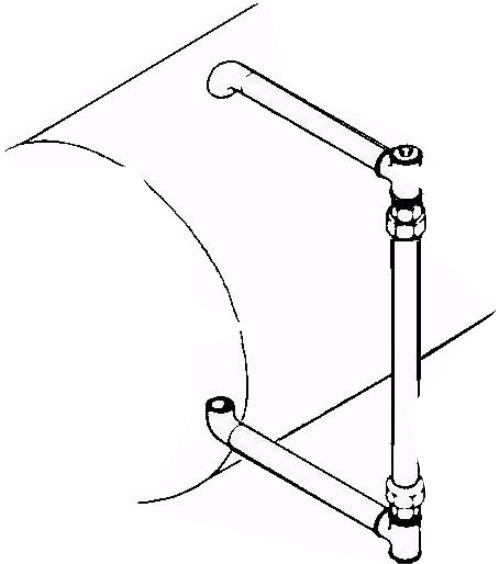

Sight Gauges	
3022C	2" Sight (Steel or Aluminum)
3023C	3" Sight (Steel or Aluminum)
3024C	5" Sight (Steel or Aluminum)
3022	2" Sight Glass with O-Ring
3022G	2" Sight Glass with Gasket
3023	3" Sight Glass with O-Ring
3070	5" Sight Eye Bowl
3071	5" Sight Eye Weldment
3072	5" Pressure Plate
3073	5" Sight Eye Gasket
3074	5" Hand Wheel
SIGHT-TUBE	2" Level Sight Tube (clear PVC)

SIGHT TUBE	2" Level Sight Tube Clear
------------	---------------------------

1102 Level Indicator

Level Indicators	
1102	Level Indicator
1102-1	Stop (2)
1102-A	Packing Gland with Indicator
1102-A-5	Packing Stick
1102-B	3" Buna-N Gasket
1102-C	Flanged Adapter
1102-D	Pointer
1102-E	Gauge Plate
1102-F	Bushing Packing Gland
1102-G	Yoke Assembly
1102-H	Bearing Support
1102-H-1	Bracket
1102-N	Packing Nut
1102-SHAFT	S/S 1/2" Shaft

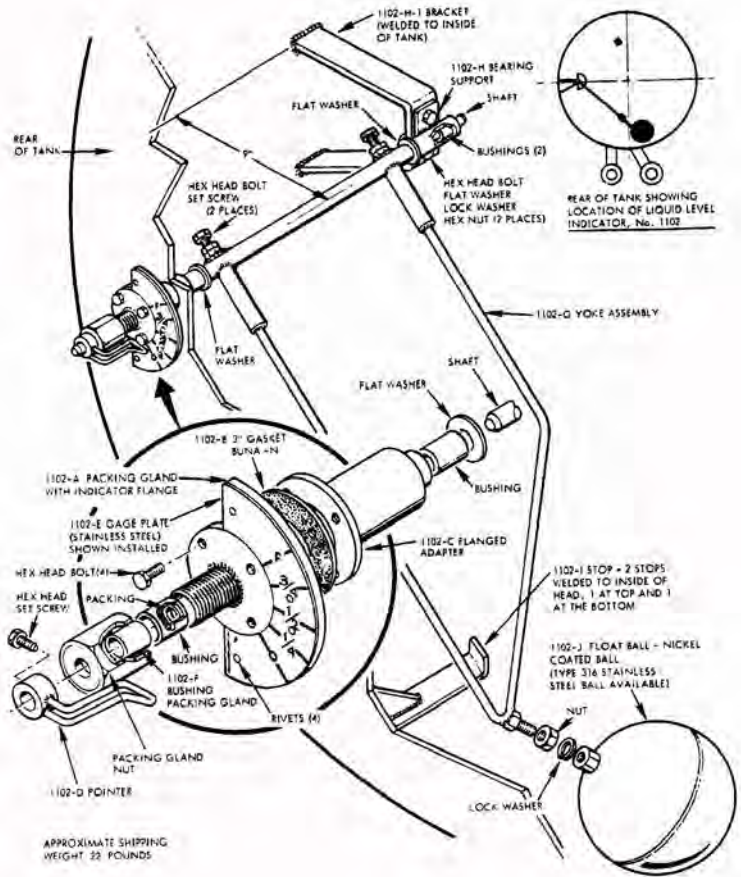



Vacuum Sales, Inc.

51 Stone Road Lindenwold, NJ 08021

800-547-7790 fax:856-627-3044

www.vacuumsalesinc.com



	'O' Ring	Socket
3"	1437	1800
6"	1438	1439

	Primary	Secondary	Muffler
1 1/2"	MP16326	MP16422	MP15472
2 "	MP16329	MP432030	MP15479
3"	MP16347	MP16450	MP15466

Float Balls	
1415	2" S/S float ball
1416	3" S/S float ball
1417	9" S/S float ball
1417T	9" S/S float ball w/tube
1418	8" S/S float ball w/nut
1419	5" 20 ga S/S float ball
1490	6" S/S float ball
1491	14" S/S float ball 304
1492	14" S/S float ball 316
1493	12" S/S float ball Cusco
1502	8" S/S float ball weighted

Float Balls 2" to 9"

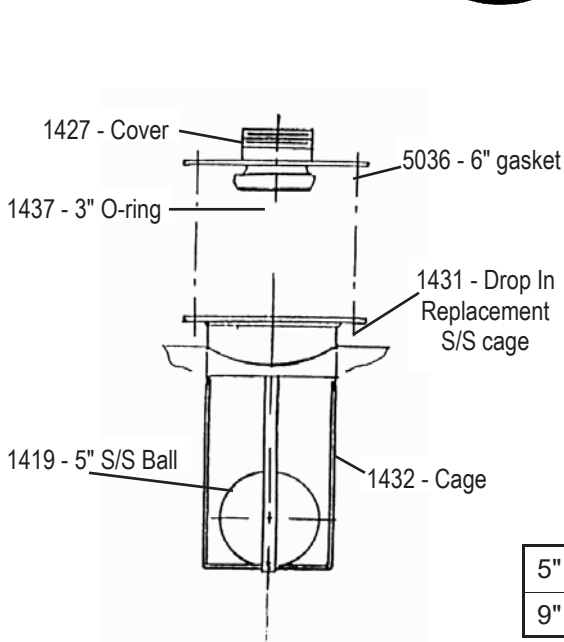
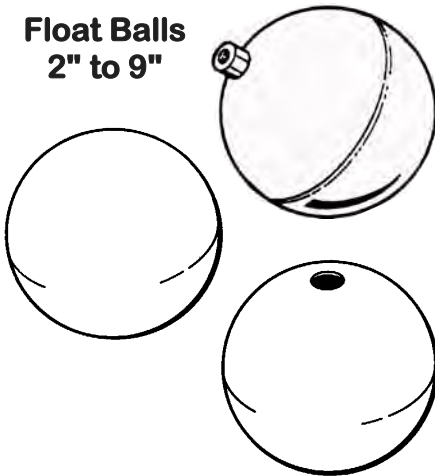

Top Float	
5"	1428
9"	1429

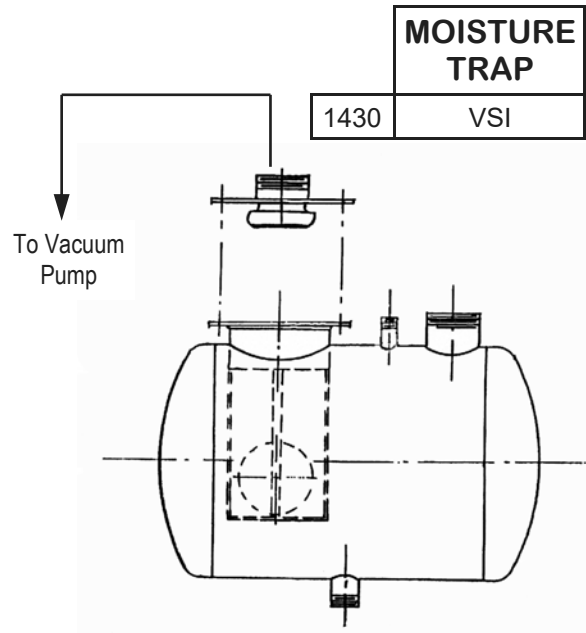



Vacuum Sales, Inc.

51 Stone Road Lindenwold, NJ 08021

800-547-7790 fax:856-627-3044

www.vacuumsalesinc.com

Page 6

Vacuum Truck Component Chart

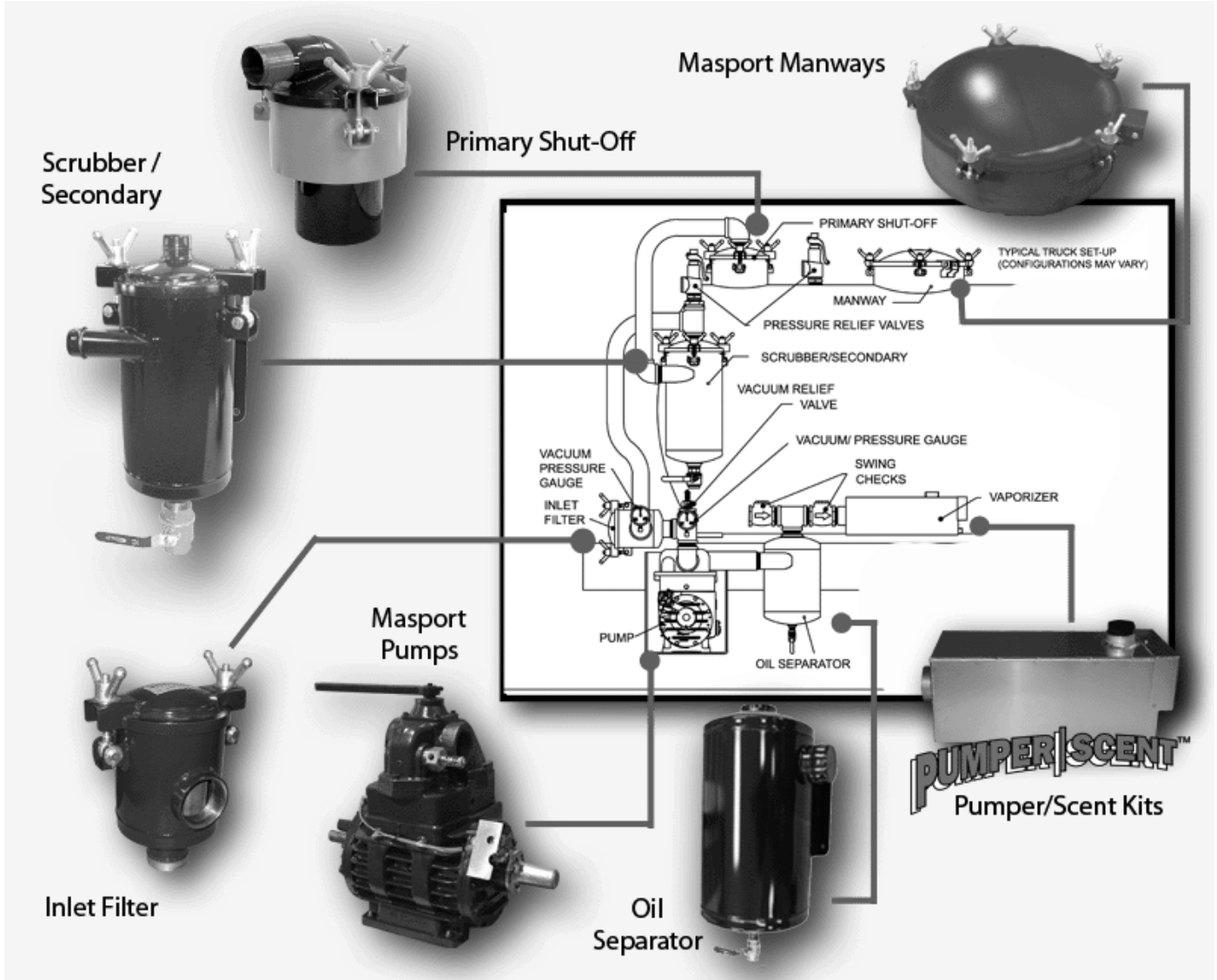

Engine Driven Vacuum Pumps



165CFM

Gas Engine Driven System
165cfm Masport HXL4V Honda



407CFM

Diesel Driven System 407cfm HYDRA Pump
Deutz 24Hp Engine



Vacuum Sales, Inc.

51 Stone Road Lindenwold, NJ 08021

800-547-7790 fax:856-627-3044

www.vacuumsalesinc.com

Manways Code and Non Code	
F-701-304	20" Stainless Steel w/ 6" collar
F-701-3	36" Steel w/ 12" collar
F-701-20	20" Steel w/ 12" collar
F-701-26	20" Steel w/ 6" collar
5F-701-20-	20" Aluminum w/ 12" collar
6348FB	20"N/S ASME 6 lug
5025	20"O/S ASME 8 lug
5027	20" Lid
70120	20" w/ 12" neck
70121	21" (non code)
70126	20" w/ 6" neck(non code)
7012	36" w/ 6" neck
7013	36" w/ 12" neck
5043	10" Pressure fill
5066	10" ASME pressure fill
5067	10" fill lid
1443	1" Pin Wheel
1444	1" Tee Bar
1454	1 1/2" Pin Wheel
1456	1 1/2" Tee Bar

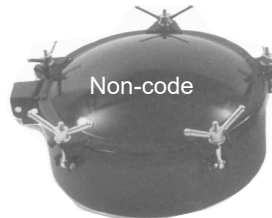

Manways Gaskets	
1112B	12" Thompson
1116B	16" Thompson
1118B	18 Thompson
8010	20" Cusco
5028	20" Manway gasket
5069	20" O/S Viton Collar
5070	20" O/S Hypalon Collar
5072	20" O/STeflon Collar
5074	20" Cover
5076	20" N/S Viton Collar
5075	20" N/S Hypalon Collar
5078	20" N/S Teflon Collar
5073	10" Viton Collar
7062	36" Manway
1525	72" Rear Door
5041	10" Fill Gasket

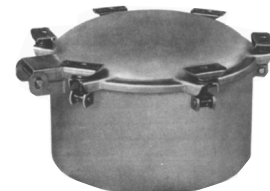



Vacuum Sales, Inc.

51 Stone Road Lindenwold, NJ 08021

800-547-7790 fax:856-627-3044

www.vacuumsalesinc.com

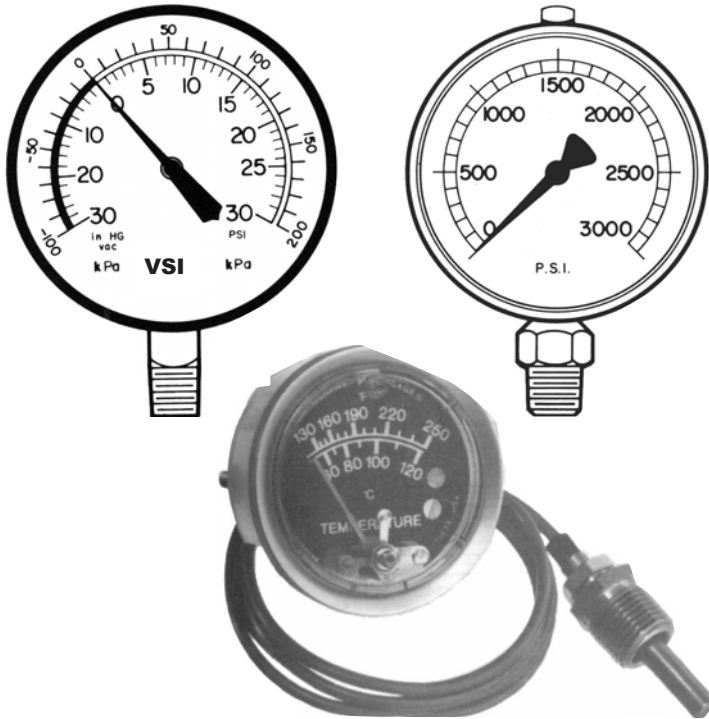

Temperature Gauge

Vacuum-Pressure Gauge	
5500	3.5" 30x30 Dry
5501	3.5" 30x60 Dry
5504	2.5" 30x30 Dry
5505	2.5" 30X15 Dry
5506	4" 30x30 S/S Liquid Filled
5506-2	4" 30X60 S/S Liquid Filled
5508	2.5" 30 x 30 Liquid Filled
5509	2.5" 30 x 60 Liquid Filled

Mudflaps	
223	VSI Mudflaps
224	Anti-Sail Brackets
225	Mudflap Brackets

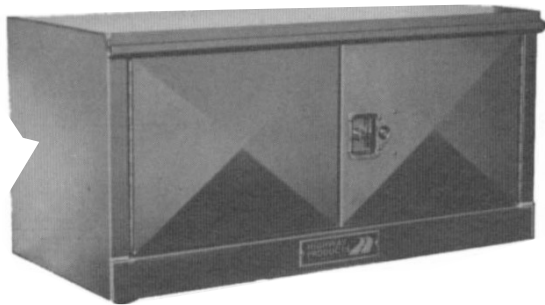

Other toolbox styles available

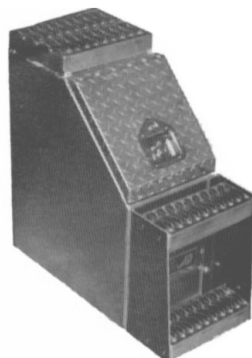
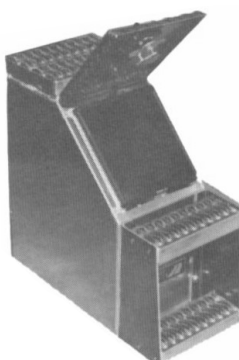

	24"X18"	36" x 18"	48"X18"
Steel	1345	1440	1344
Aluminum	182AL	1440AL	190AL



Vacuum Sales, Inc.

51 Stone Road Lindenwold, NJ 08021

800-547-7790 fax:856-627-3044

www.vacuumsalesinc.com

200-05122 Clearance & Side Marker



40V02122 Stop & Turn

305C07113 Flood, Fog, Spot, Work Lamps



214-09122 Bar Lamps

70-02222 Stop or Turn

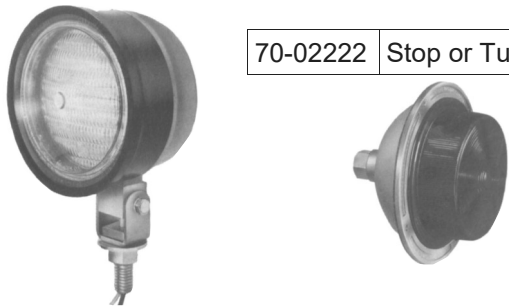

Lighting	
201-122	Red/Amber Replacement Lens
211-05122	Red Clearance or Marker
214-09132	Amber Light Bar
40VA08112	Junction Box Surface Mount
70-02122	Stop/Turn Tail Lamp
70-0322	Stop/Turn Clearance Lamp
70-04112	Clear Back Up Lamp
700013	Stop Lamp Flush Lens
71-122	Flush Replacement Lens B-70
71L-222	B70LA Raised Lens with Tag Light
805-005	B-805 Flood Lamp Adjustable

70-03222 Stop Lamp (Tag Side)

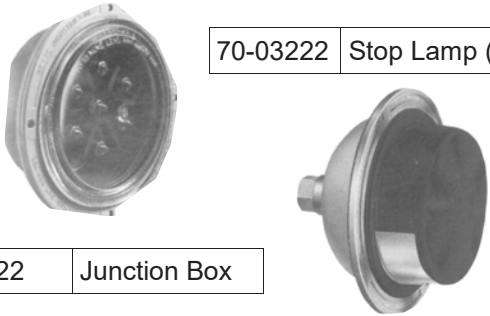

400022 Junction Box

805-07113 Flood, Fog, Spot, Work Lamps



EL-TL030-LED Light Box LH Trucklite LED 3Rnd

EL-TL025-LED Light Box RH Trucklite LED 3Rnd



Vacuum Sales, Inc.

51 Stone Road Lindenwold, NJ 08021

800-547-7790 fax:856-627-3044

www.vacuumsalesinc.com

Lever Gate Valves

Brass	
2"	3002
3"	3003
4"	3004
6"	3006

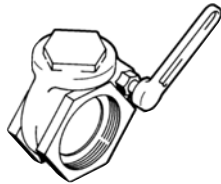

Valves

4-Way Valve	
2"	V125
2 1/2"	V126
3"	V127
4"	V128
6"	V129



Brass Piston Gate Valves

	NPT x NPT	Flanged
4"	3004P	3004F
6"	3006P	3006F
8"	3008P	3008F

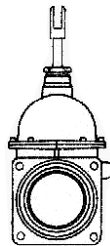
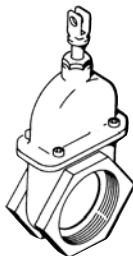

TTM Alum. Air/Spring Isolation Valve

2"	5050
3"	5051
4"	5052
6"	5053



Swing Check Soft Disc

1"	MP25126
1 1/4"	MP25127
1 1/2"	MP25128
2"	MP25129
2 1/2"	MP25130
3"	MP25131

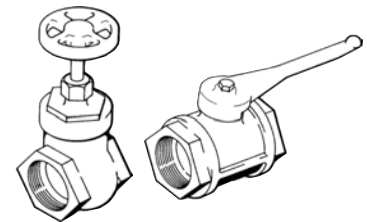

Vacuum Relief

1 1/2"	3021
--------	------

Turnstyle & Ball Valves

	Turnstyle	Ball
1/4"	226	234
3/8"	227	235
1/2"	228	236
3/4"	229	237
1"	230	238
1 1/4"	231	239
1 1/2"	232	240
2"	233	241
3"	2336	242
4"	—	243

Pressure Relief Non Code

3/4"	3016
1 1/4"	3017
1 1/2"	3018
2"	3019

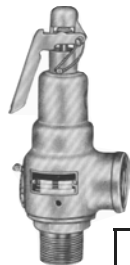

Pressure Relief A.S.M.E. Code

	25 lb.	35 lb.
3/4"	6010ED25	6010ED35
1 1/2"	6010HG25	6010HG35
2"	6010JK25	6010JK35



Vacuum Sales, Inc.

51 Stone Road Lindenwold, NJ 08021

800-547-7790 fax:856-627-3044

www.vacuumsalesinc.com

Quick Action Sliding Valves

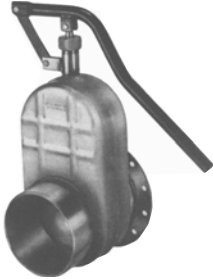

	F x F (TTM)		F x T (TTM)		F x F (ASA)		F x T (ASA)	
	C/S	S/S	C/S	S/S	C/S	S/S	C/S	S/S
3"	5000	5001	5006	5007	5012	5013	5018	5019
4"	5002	5003	5008	5009	5014	5015	5020	5021
6"	5004	5005	5010	5011	5016	5017	5022	5023

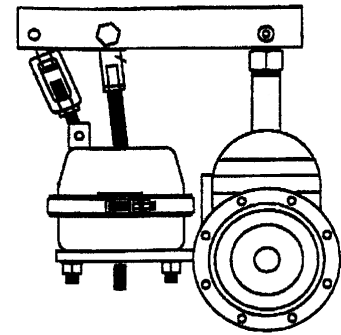

Air Actuated Emergency Valves

	F x F (TTM)		F x T (TTM)		F x F (ASA)		F x T (ASA)	
	C/S	S/S	C/S	S/S	C/S	S/S	C/S	S/S
3"	CS301FFT	SS301FFT	CS301FTT	SS301FTT	CS301FF	SS301FFA	CS301FT	SS301FTA
4"	CS401FFT	SS401FFT	CS401FTT	SS401FTT	CS401FF	SS401FFA	CS401FT	SS401FTA
6"	CS601FFT	SS601FFT	CS601FTT	SS601FTT	CS601FF	SS601FFA	CS601FT	SS601FTA

Air Actuated Emergency Valve Parts List

LEGEND

- SC01 SELF CLOSING GATE VALVE
- SC02 SELF CLOSE ACTUATOR
- SC03 HAND CONTROL SWITCH
- SC04 SAFETY CHECK VALVE
- SC05 1/4" THREADED "T"
- SC06 1/4" STOP VALVE
- SC07 14" HP TUBING ADAPTER
- SC08 1/8" X 1/4" HP TUBE
- SC09 1/4" X CLOSE NIPPLE
- SC10 20' OF 1/4" HP AIR
- SC11 FUSIBLE FRANGIBLE
- SC12 1/8" THREADED PLUG
- SC13 1/4" X 3/8" TUBING ADAPTER
- SC14 10' OF 3/8" HP AIR
- SC15 MOUNTING BRACKET FUSIBLE
- SC16 TENSION BUCKLE ASSEMBLY
- SC17 LINKAGE ARM
- SC18 MOUNTING BRACKET
- SC19 1/8" X 3/8" HP TUBING ADAPTER
- SC20 BALL JOINT / LINKAGE
- SC21 CLEVIS PIN LINKAGE
- SC22 CLEVIS PIN ACTUATOR
- SC23 WASHERS FOR TENSION
- SC24 CLEVIS PIN ARM
- SC25 CLEVIS PIN BUCKLE

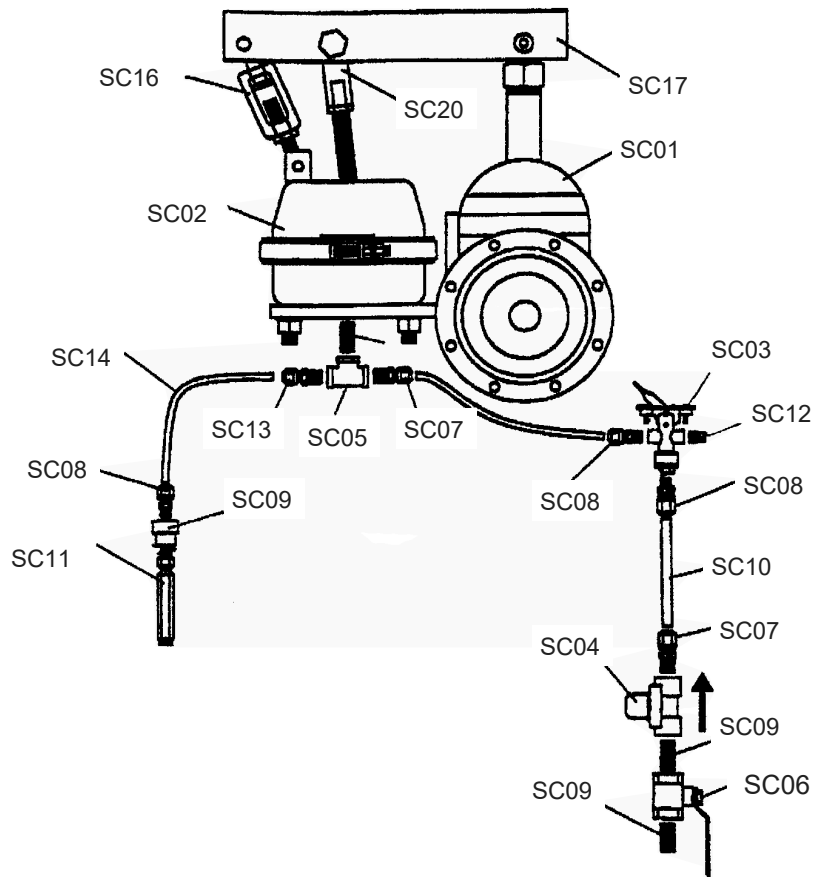



Vacuum Sales, Inc.

51 Stone Road Lindenwold, NJ 08021

800-547-7790 fax:856-627-3044

www.vacuumsalesinc.com

Flange Gaskets, Flanges, & Fittings

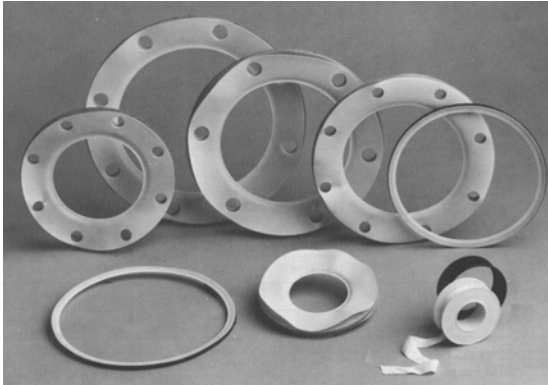

Flange Gaskets

	C/B	Teflon
2"	5037	5044
3"	5034	5045
4"	5035	5042
6"	5036	5046

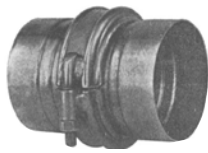

Vectolic

	Coupling	Nipple
2"	6505	6506
2 1/2"	6508	6509
3"	6510	6511

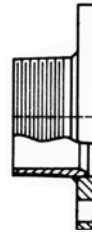

Adapters (TTM)

	Flange X Thread	Flange X Coupling
2"	6501A	6501C
3"	6502A	6502C
4"	6503A	6203C
6"	6504A	6504C

Flued Flanges (TTM)

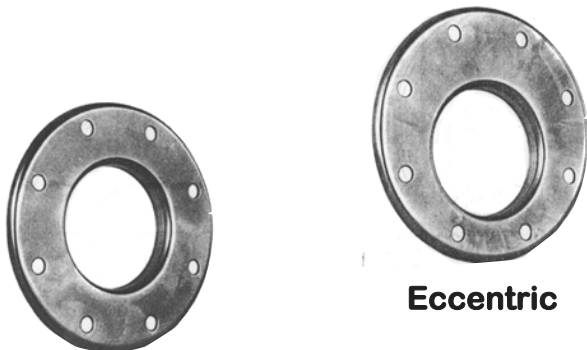

Concentric

Eccentric

	Concentric	Eccentric
4" x 3"	6023	6024
6" x 4"	6021	6022

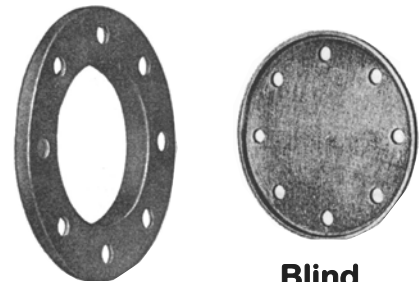

Flued Flange

Blind Flange

	C/S	S/S
2"	6501	6024
3"	6502	6025
4"	6503	6026
6"	6504	6027



**Cam and Groove Fittings
Aluminum**

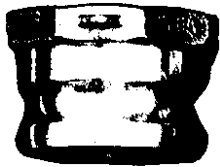

Part "A"

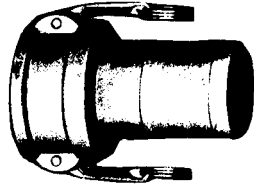

Part "C"

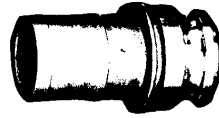

Part "E"

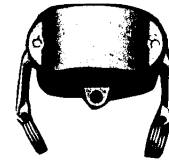

Part "DC"

	"A"	"B"	"C"	"D"	"E"	"F"	"DC"	"DP"
2"	4009	4015	4021	4027	4033	4039	4045	4079
3"	4011	4017	4023	4029	4035	4041	4047	4081
4"	4012	4018	4024	4030	4036	4042	4048	4082
6"	4014	1020	4026	4032	4038	4044	4050	4083

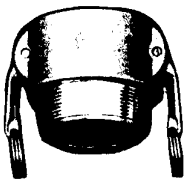

Part "B"

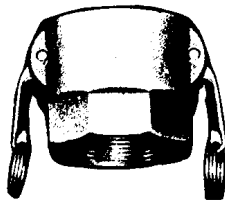

Part "D"

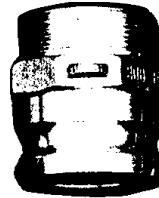

Part "F"

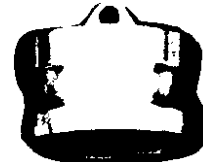

Part "DP"

Combination Nipples	
4000	1/2"
4001	3/4"
4002	1"
4003	1 1/4"
4004	1 1/2"
4005	2"
4006	2 1/2"
4007	3"
4008	4"
4008A	6"

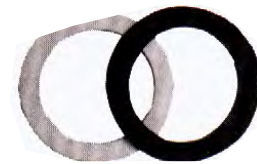
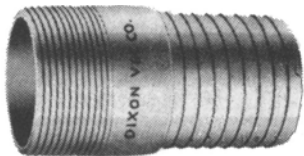

Reducers	
3020DA-AL	3" Female x 2" Male
4020DA-AL	4" Female x 2" Male
4030DA-AL	4" Female x 3" Male
6040DA-AL	6" Female x 4" Male

Cam Lock Gaskets	
4074	2"
4075	3"
4076	4"
4077	6"



Vacuum Sales, Inc.

51 Stone Road Lindenwold, NJ 08021

800-547-7790 fax:856-627-3044

www.vacuumsalesinc.com



Aluminum Pipe
4", 6", 8" - Any Length



Alum. Pipe with Steel
Press Ends Steel

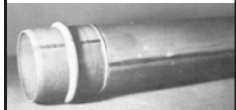

BL-4" - 12" MW Male
weldons ond steel pipe



BL-4" - 12" FW Female
weldons ond steel pipe



Aluminum Coupler
RLM 6" & 8"
Alum. Male Weldons



Aluminum Coupler
RLF 6" & 8"
Alum. Female Weldons



BL-4" , 6" , 8" PEM
Press Ends Male
Couplers Press into
Alum. Pipe

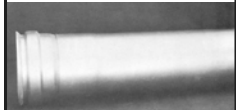

Steel 4" , 6" , 8" PEF
PressEnd Female Coupler
Press into Alum. Pipe

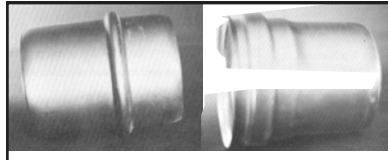

Bandlock BL-4-12MR Male Rubber
Bandlock BL-4-12FR Female Rubber

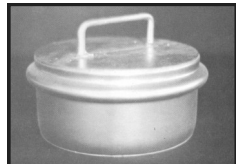

Male & Female End Plugs
4" , 5" , 6" , 8" , 10" , 12"

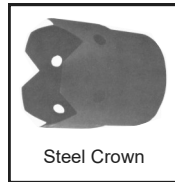

Steel Crown



Crown
Nozzle
6" & 8"

4" , 6" High
Abrasive
Bulk Nozzles Steel
Reinforced

4" & 6"
Bulk
Nozzles

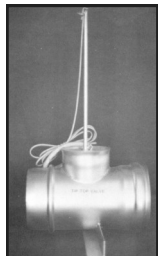

Bandlock Tip Top
Relief Valves
4" , 6" , 8"



Wet Valve 6"
360° Injected



GO-4" to 12"
Rubber
Gaskets

Profile Gaskets
4" to 12"
Hazard. Materials

Bandlock Clamps
Stand. & Inter.
BLB-4" to 12"

Bandlock EZ
Lift Clamps
BLB-EZ 4" to 12"

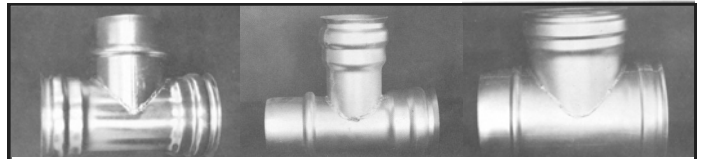

End Tees
BL120 4" to 12"

Special Tees Enlarged or
Reduced Ends Any Size

Side Outlet Tees
BL100 4" to 12"

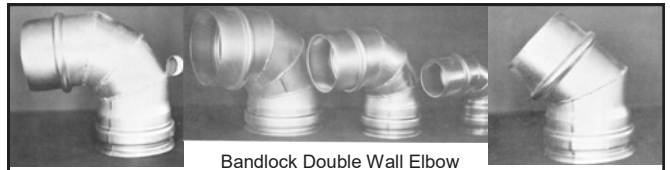

Bandlock 90° Elbow
BL-200 4" to 12"

Bandlock Double Wall Elbow
BL200 90° } 4" to 12"
BL220 45° }

Bandlock 45° Elbow
BL-220 4" to 12"

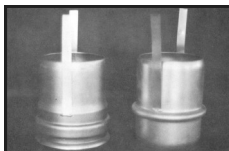

Bandlock Safety Dis.
Female BL-SFR 4"-12"
Male BL-SMR 4"-12"

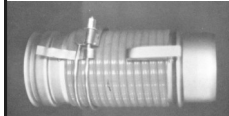

Safety Discharge Coupler
and Power Clamp



Bandlock Safety
Discharge
Coupler Male Clamp,
2 Gaskets, and Clamp
with Safety Straps



Special "Y" Plus
Reducers Any Size

Special "Y" Plus
Reducers Any Size

Special "Y"
Reducers Any Size

Bandlock "Y's
BLY - 4" to 12"



Vacuum Sales, Inc.

51 Stone Road Lindenwold, NJ 08021

800-547-7790 fax:856-627-3044

www.vacuumsalesinc.com

Hose & Clamps

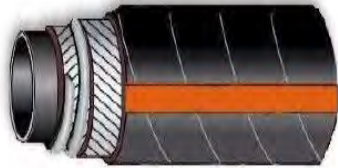

Tank Truck Hose "Oil Suction Hose"	
2"	9408
3"	9410
4"	9411
6"	9412

Miscellaneous	
719262	5/8" Heater hose
9408	2" Oil Suction
9409	2" Clear Nylabraid
9410	3" Tank Truck
9411	4" Rubber Oil
SP-16	MXM 1" 2500 PSI
STC3530	2 1/2" x 3" Hose Shank
4020-DA	4" x 2" Adapter
RHS35	3" Suction Strainer

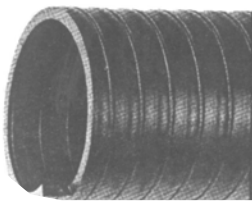

Kanaflex RS220	
2"	9414
3"	9415
4"	9416

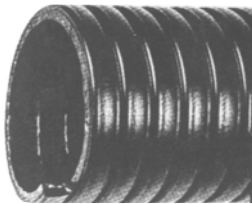

Abrasion Resistant	
180AR-600	6"
180AR-800	8"

Drain Hose	
94135	1/2" Clear Drain
9413	1" Clear Drain

Brass Hose Barb	
BN54	5/8" x 1/2"
BN64	3/4" x 1/2"



Suction Hose EPDM Green & Black	
2"	9423
3"	9424
4"	9425



HiVac / Bumble Bee Hose
Specify Length & Fittings

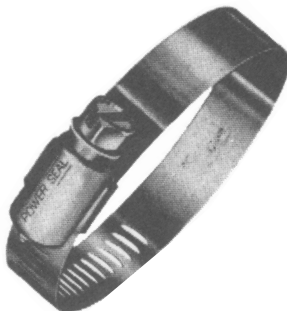

Worm Gear Clamp	
5/8"	HS10
3/4"	HS12
2"	HS36
3"	HS56
4"	HS72
6"	HS104

F Center Punch Clamp	
2 1/2"	F10
3"	F12
3 1/2"	F14
4"	F16
4 1/2"	F18
6"	F24



Vacuum Sales, Inc.

51 Stone Road Lindenwold, NJ 08021

800-547-7790 fax:856-627-3044

www.vacuumsalesinc.com

Page 16

Pump Drive Line Components

Universal Joints	
5170	U-joints - small
5153	U-joints - large
10729	Snap ring for 5-170X



Cable controls	
516	Throttle stop
7009	Vernier hand throttle
7015	Electric auto throttle
7013	P.T.O. cable up to 15'
7014	P.T.O. cable up to 20'



Drive Couplings	
5JE	5JE insert
7500	8JE insert
7501	9JE insert
7502	9B-SD flange
7503	8BSH flange
7521	#30 Centaflex
7523	8S 1 1/4" flange
7524	8S 1 1/2" flange
7525	8S 1 3/8"
7526	9S 1 1/4"
7527	9S 1 1/2"
7528	9S 1 3/8"
7529	9S-42mm
7530	9S-38mm
7531	9S 1 7/16"
L100125	L100 insert
L1101	L100 spider insert
L150	Lovejoy L150
E20-125	E20 coupler hub 1-1/4in bore
E20-1375	E20 coupler hub 1-3/8in bore
E20-150	E20 coupler hub 1-1/2in bore
E20-175	E20 coupler hub 1-3/4in bore
E20-ELEMENT	E20 coupler flex element

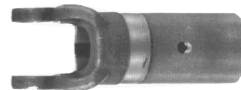
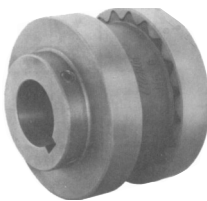

End Yokes	
10423	3/4"
10493	1" x 1/4"
104183	1 1/4" x 1/4"
104123	1 1/4" x 5/16
104293	1 3/8" x 5/16"KW
104223	1 1/2" x 3/8" KW
141233	1 1/2" x 3/8"
2-3-128KX	Large slip
10318	slip assem. small
10332	1.125" hex sleeve
10432	1 1/8" hex
228357	large (weld on)
23533	1 1/4" (L drive shaft)
241053	1 1/2" x 5/16" flange
241233	1 1/2" x 3/8" L
24533	1 1/4" x 5/16"
24573	1 1/4" x 1/4" KW
24803	1 3/8" x 3/8" KW
2401031	Splined large shaft
29428	U bolts
449	Set screw



Vacuum Sales, Inc.

51 Stone Road Lindenwold, NJ 08021

800-547-7790 fax:856-627-3044

www.vacuumsalesinc.com

Keys	
301	3003/16" x 1/4" 12" step
302	1/4" x 5/16" x 12" step
306	3/16" x 1/4" x 4" step
307	1/4" x 5/16" 4" step
308	5/16" x 3/8" x 4" step
311	3/16" x 12" square
312	1/4" x 12" square
313	5/16" x 12" square
314	3/8" x 12" square
316	1/4" x 4" square
317	5/16" x 12" square
318	3/8" x 4" square
319	P.T.O.
309	8mm x 10mm

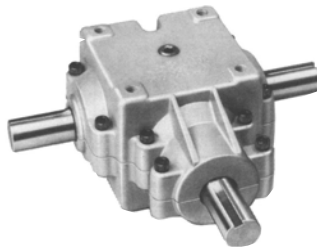
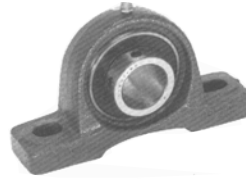
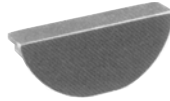
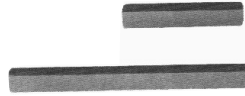

PTO Accessories	
21MA0548	Lock tabs
28P52	P.T.O. oil seal
328380x	Man. P.T.O. linkage kit
32886SX	Air actuator hand control
329202x	Switch P.T.O.
378978	P.T.O. light
50000729	P.T.O. key

Pillow Blocks	
117	1 1/4"
118	1 1/2"

Pulley's	
116	8.OX BX SK
120	4.OX BX SD
121	6O X B X SD



Gearboxes & Parts	
411AFF	1-1/4" T style Gearbox
1447	T-gearbox mount
1801	Input/output shaft seals (dana 40)
1802	Output bearing (dana 40)
1803	Output bearing race (dana 40)
1804	Input bearing (dana 40)
1805	Input bearing race (dana 40)
1806	.005" shim (dana 40)
1807	.010" shim (dana 40)
1808	.020" shim (dana 40)
20003PR	Superior gearbox vent
SG14124	Bearing (411 box)
SG14276	Cup (411 box)
SG412458	Shaft seal (411 box)

Drive Shaft	
102705729	Small shaft assembly
95534724	Large shaft assembly
209172	1 1/4" solid shaft x 6'
230591	1 1/8" hex shaft x 6'

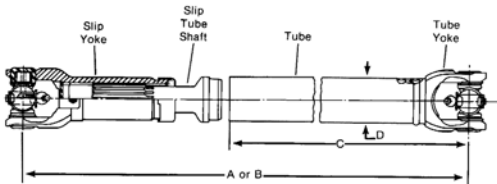



Vacuum Sales, Inc.

51 Stone Road Lindenwold, NJ 08021

800-547-7790 fax:856-627-3044

www.vacuumsalesinc.com

Masport Vacuum Pumps
Models HXL75V, HXL75WV, HXL400WV, H75W, Titan, and Hydra



Model H75V



Model H75WV



Model HXL400WV



407CFM

Hydra
(Liquid-cooled)

Hydra

Vacuum / Pressure Pump

Performance Data – Vacuum

PUMP R.P.M	DISPLACEMENT C.F.M	S.C.F.M and A.C.F.M @ VACUUM										MAXIMUM VACUUM – "Hg		
		5	10	15	18	20	22	24	25	26	27	CONTINUOUS	INTERMITTENT	
1200	343	SCFM	247	187	132	100	81	60	42	22	13	5	25	27
		ACFM	297	282	264	250	246	229	214	136	101	50		
1400	407	SCFM	345	282	215	152	117	94	67	48	24	15	25	27
		ACFM	377	340	326	304	293	285	259	241	152	112		

Performance Data – Pressure

PUMP R.P.M	DISPLACEMENT C.F.M	S.C.F.M @ P.S.I.G						MAXIMUM PRESSURE – P.S.I.G		
		5	10	15	18	20	25	30	CONTINUOUS	INTERMITTENT
1200	343	285	251	244	239	233	230	215	20	30
1400	407	377	313	297	283	279	275	270	20	30

Horsepower Required @ "Hg

PUMP R.P.M	VACUUM "Hg				
	5	10	15	20	27
1200	15	15	15	15	15
1400	19	19	19	19	19

Horsepower Required @ P.S.I.G

PUMP R.P.M	P.S.I.G					
	5	10	15	20	25	30
1200	20	22	26	30	35	38
1400	25	27	31	36	40	45

Titan

Vacuum / Pressure Pump



407CFM

Titan
(Fan-cooled)

Performance Data – Vacuum

PUMP R.P.M	DISPLACEMENT C.F.M	S.C.F.M and A.C.F.M @ VACUUM										MAXIMUM VACUUM – "Hg		
		5	10	15	18	20	22	24	25	26	27	CONTINUOUS	INTERMITTENT	
1200	343	SCFM	247	187	132	100	81	60	42	22	13	5	22	27
		ACFM	297	282	264	250	246	229	214	136	101	50		
1400	407	SCFM	345	282	215	152	117	94	67	48	24	15	20	27
		ACFM	377	340	326	304	293	285	259	241	152	112		

Performance Data – Pressure

PUMP R.P.M	DISPLACEMENT C.F.M	S.C.F.M @ P.S.I.G						MAXIMUM PRESSURE – P.S.I.G		
		5	10	15	18	20	25	30	CONTINUOUS	INTERMITTENT
1200	343	285	251	244	239	233	230	215	20	30
1400	407	377	313	297	283	279	275	270	20	30

Horsepower Required @ "Hg

PUMP R.P.M	VACUUM "Hg				
	5	10	15	20	27
1200	15	15	15	15	15
1400	19	19	19	19	19

Horsepower Required @ P.S.I.G

PUMP R.P.M	P.S.I.G					
	5	10	15	20	25	30
1200	20	22	26	30	35	38
1400	25	27	31	36	40	45



Vacuum Sales, Inc.

51 Stone Road Lindenwold, NJ 08021

800-547-7790 fax:856-627-3044

www.vacuumsalesinc.com

HYDRA Plug & Play Pump Package:
MASPORT Hydra (407cfm) Plug&Play System.
Pre-assembled includes:
Liquid Cooled Vacuum Pump, Mount, Gearbox,
Coupler, Secondary, Demister Muffler, Prefilter,
vacuum 'pressure relief valve, gauge, and
steel oil tank.



407CFM



407CFM

TITAN Plug & Play Pump Package:
MASPORT Titan (407cfm) Plug&Play System.
Pre-assembled includes:
Fan Cooled Vacuum Pump, Mount, Gearbox,
Coupler, Secondary, Demister Muffler, Prefilter,
vacuum 'pressure relief valve, gauge, and
steel oil tank.

4307 (560CFM) & 4310 (940CFM) **High Vacuum Blower Packages**

Installation Ready



Each 4307 or 4310 Pro Pak is designed around our industry leading Challenger Series high vacuum tri-lobe blower and is built in our state of the art fabrication facility with the following standard features:

- 560 CFM or 940 CFM tri-lobe high vacuum blower with complete manifold
- Sound dampening internal air ballast
- Fully insulated stainless steel enclosure
- Powder coat painted 3/8" steel mounting bracket
- All elbows, fittings and high temperature hoses are factory installed
- Factory installed flush kit



Vacuum Sales, Inc.

51 Stone Road Lindenwold, NJ 08021

800-547-7790 fax:856-627-3044

www.vacuumsalesinc.com

PRESVAC VACUUM PUMPS



PV750 Bare

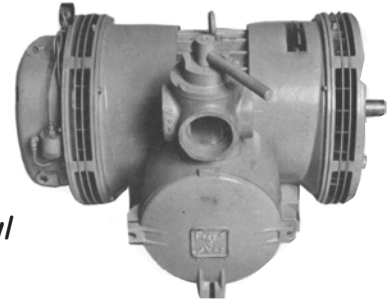

PV750
Complete w/
manifold

Models	Shaft RPM	Vacuum Rating	Pressure Rating	Cu. Ft. Free Air Per Min.	Cu. Ft. Air at 18" per Min.	Max. H.P. Vacuum	Max. H.P. Pressure	Cooling Method
PV-750	1500	29"	43 psi	420	360	28	41	Forced Air

Type	RCF 250	RCF 370	RCF500
Standard drive Direction	Clockwise	Clockwise	Clockwise
Rec. Drive Speed	1400 RPM	1400 RPM	1400 RPM
Net Pump Weight	255 lbs.	385 lbs.	450 lbs.
Maximum Vacuum	27" Hg	28 1/2 Hg	28 1/2 Hg
Maximum Pressure	30 psi	35 psi	35psi
Maximum CFM	150 CFM	259 CFM	320 CFM
HP Max. Vacuum	10 HP	15 HP	20 HP
HP Max. Pressure	18 HP	26 HP	35 HP
Lubrication Oil Pump	Automatic	Automatic	Automatic
Vanes	Fibre (4)	Fibre (8)	Fibre (8)
Intake & Discharge	2" Hose	3" Hose	3" Hose
Fan Cooling Continuous Duty	Yes	Yes	Yes

FRUITLAND PUMPS

RCF 250 - 150 cfm



RCF 370 - 259 cfm



RCF 500 - 320 cfm





Vacuum Sales, Inc.

51 Stone Road Lindenwold, NJ 08021

800-547-7790 fax:856-627-3044

www.vacuumsalesinc.com

Page 22

NVE Challenger Rotary Vane Pumps



Model	R.P.M. Rotor Speed	H.P. @Vacuum	c.f.m.	Cooling
304	1200	8.35	210	AIR
607	1250	25	380	Fan or Liquid
866	1000	25	520	Fan or Liquid
887	1100	30	532	Fan & Ballast

Demag Wittig RFL100





Vacuum Sales, Inc.

51 Stone Road Lindenwold, NJ 08021

800-547-7790 fax:856-627-3044

www.vacuumsalesinc.com

1/8"-3/8" NPT 3-10 GPM
1/2" NPT 8-25 GPM

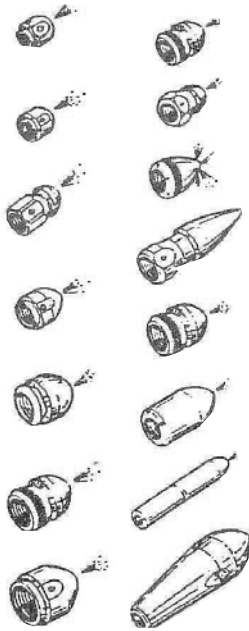

Nozzles & Accessories

3/4" NPT 25-40 GPM



1" NPT Steel Radial 55-80 GPM

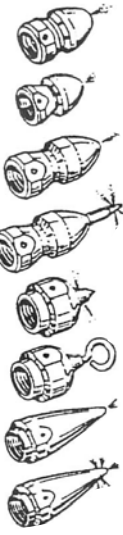

1" NPT Aluminum 55-80 GPM

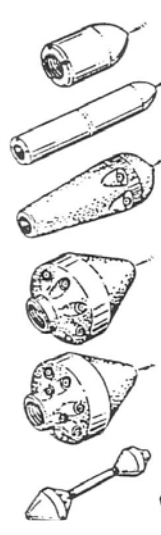

1" NPT Steel Large 55-80 GPM

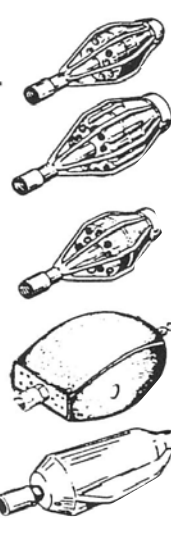

Hoses

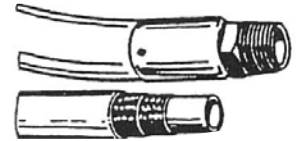

Sizes 1/2" 5/8" 3/4" 1"
Lengths 100, 400, 500, 600

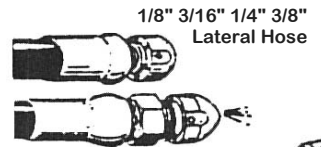

Sizes 1/2" 5/8" 3/4" 1"
Lengths 100, 400, 500, 600

Inserts

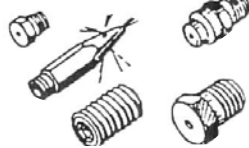

Nozzle Extensions

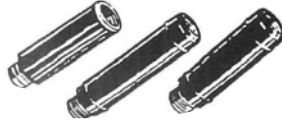

1 1/4" NPT Steel Radial 55-80 GPM

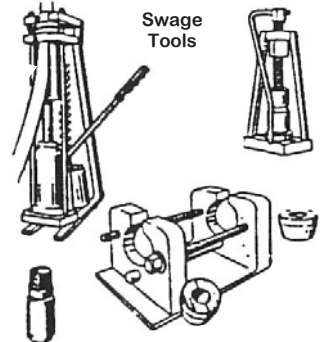
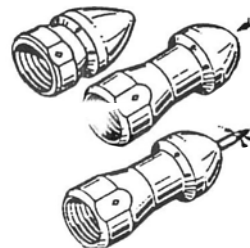

Pumps

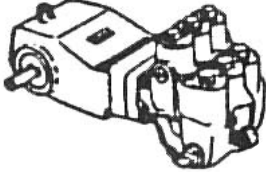

Special

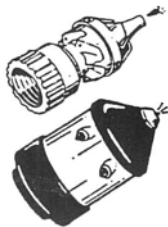

Skids

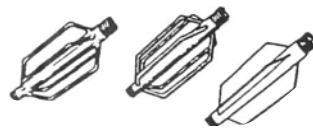

Hose Protectors

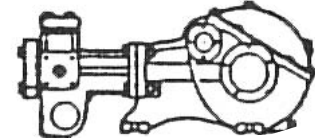
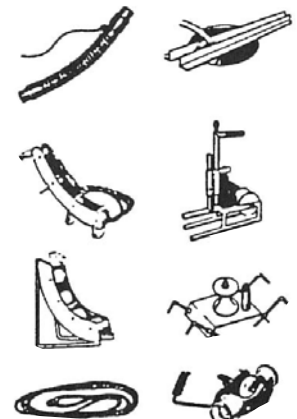

Root Cutters

Pipe Plugs

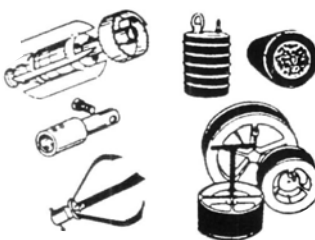

Swivels



Valves

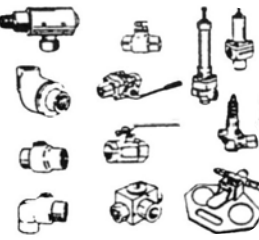

Smoke Blowers



Handi Jet



Guns



Accessories



POWER DRUMMER

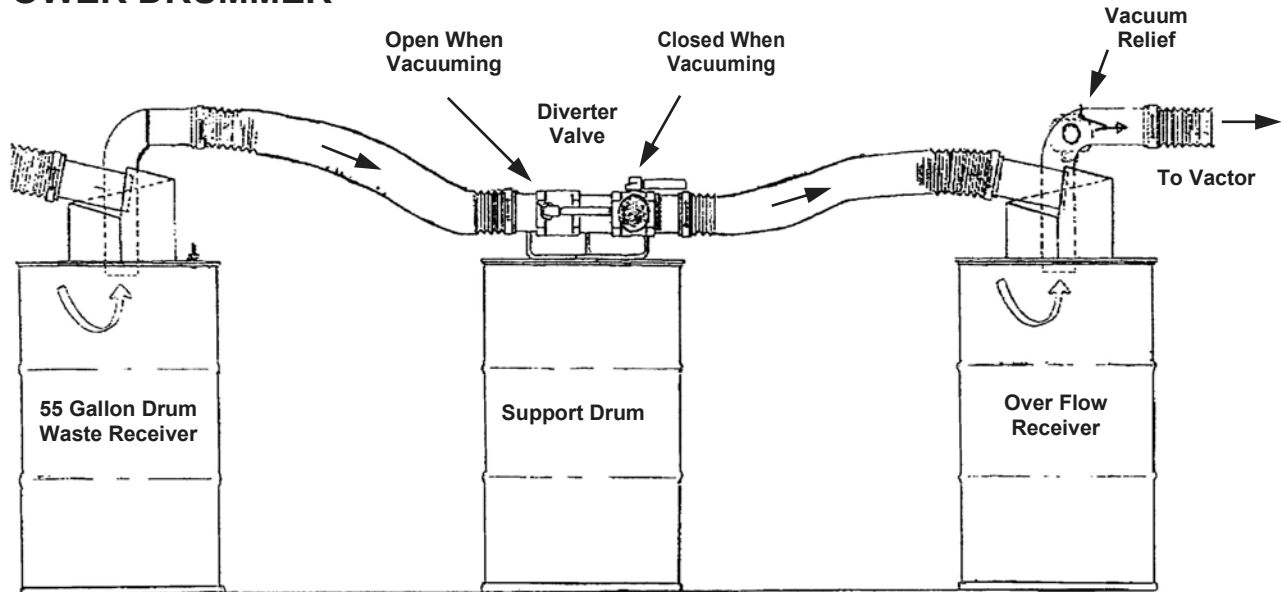

*****REVERSE VALVES TO RELEASE VACUUM ON 1ST STAGE AND CHANGE DRUM WHEN FULL*****

**Slickbar
Slickskim Rigid
Manta Ray Skimmer**

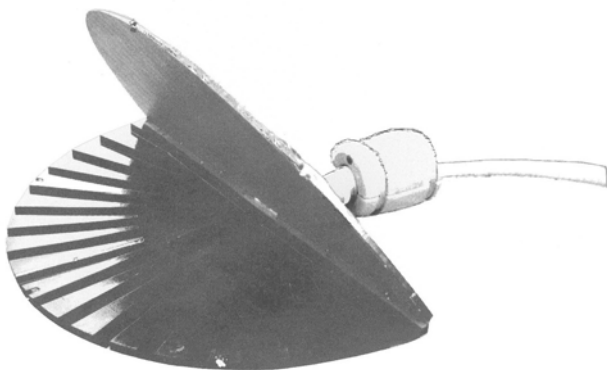

Slickbar Rigid Manta Ray Skimmers are recommended for use in thin slicks under relatively calm conditions where small debris is present. The skimmer's top surface can be quickly opened while in operation to clear straw or small objects and closed to return the unit to efficient recovery of thin cuts of oil.

- Sizes: 1/2" and 1" opening, x 48" diameter
- Hose coupling: 3" male quick opening standard
- 3" to 4" adapter coupling available
- Capacity at 15" hg vacuum: 1/2"-60 gpm, 1"-120 gpm
- Consult factory for recovery of strong solvents with Manta Ray skimmers
- Net weight: (1/2" or 1") 26 ;b. shipping weight 43 lb.
- Floated hose and pump available
- Specifications subject to change without notice



Vacuum Sales, Inc.

51 Stone Road Lindenwold, NJ 08021

800-547-7790 fax:856-627-3044

www.vacuumsalesinc.com

Flow Chart

Inches HG.	PSI	3"	4"	6"	Feet of Lift
1	.50	64	136	395	1.13
2	1.00	93	198	574	2.27
3	1.50	115	246	715	3.41
4	2.0	135	287	835	4.45
5	2.50	152	324	942	5.67
6	3.00	168	358	1039	6.80
7	3.50	182	389	1129	7.94
8	4.00	196	418	1214	9.70
9	4.50	209	445	1294	10.21
10	5.00	221	471	1369	11.34
11	5.50	233	496	1441	12.47
12	6.00	244	520	1511	13.61
13	6.50	254	543	1578	14.74
14	7.00	265	565	1642	15.88
15	7.50	275	587	1705	17.01
16	8.00	285	608	1765	18.14
17	8.50	295	628	1824	19.28
18	9.00	304	648	1881	20.41
19	9.50	313	667	1937	21.55
20	10.00	322	685	1991	22.68
21	10.50	330	704	2044	23.81
22	11.00	339	722	2096	24.95
23	11.50	347	739	2147	26.80
24	12.00	355	756	2197	27.22
25	12.50	363	773	2246	28.35
26	13.00	371	790	2294	29.48
27	13.50	378	806	2341	30.62
28	14.00	386	822	2388	31.75
29	14.50	393	838	2433	32.89
30	15.00	400	853	2478	

Flows other than 100'

20 ft. = 220% x

25 ft. = 211.4% x

50 ft. = 145.4% x

75 ft. = 16.8% x

100 ft. = x

150 ft. = 80.3% x

200 ft. = 68.8% x

Where x = Flow per 100 ft. length

To use chart find lift in feet on chart. Subtract inch of Hg from total then find flow for that amount.

Max HG. "	27"
Lift 10' = 8" HG.	<u>-8</u>
	19" HG.

19" HG. = 3" Hose	313 GPM
20' Hose	<u>x220%</u>
	688.6 GPM

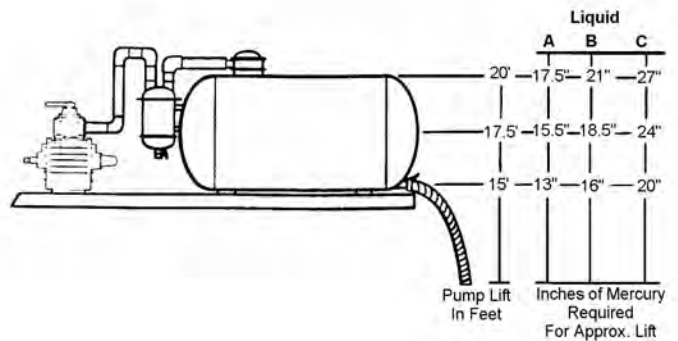

Vacuum Requirements for Solid Column Lifting

Liquid "A" is water with specific weight of 8.4 lb/gal

Liquid "B" is sludge liquid with specific weight of 10 lb/gal

Liquid "C" is sludge liquid with specific weight of 13 lb/gal

The vacuum requirements shown are for Lifting liquids "A", "B", or "C" the designated height in feet. These liquids are given as an example. Vacuum requirements for other liquids will depend on their specific weights.



Vacuum Sales, Inc.

51 Stone Road Lindenwold, NJ 08021

800-547-7790 fax:856-627-3044

www.vacuumsalesinc.com

*Vacuum Tank Evacuation Times (100 - 400 C.F.M.)

	15 Inches	20 Inches	25 Inches	27 Inches
500 Gallon				
100 C.F.M.	0.42	0.70	1.31	2.38
200 C.F.M.	0.21	0.35	0.65	1.15
300 C.F.M.	0.14	0.23	0.43	0.77
400 C.F.M.	0.10	0.17	0.32	0.57
750 Gallon				
100 C.F.M.	0.62	1.06	1.97	3.47
200 C.F.M.	0.31	0.53	0.98	1.73
300 C.F.M.	0.20	0.35	0.65	1.16
400 C.F.M.	0.15	0.26	0.49	0.86
1000 Gallon				
100 C.F.M.	0.85	1.41	2.63	4.63
200 C.F.M.	0.42	0.70	1.31	2.31
300 C.F.M.	0.28	0.47	0.87	1.53
400 C.F.M.	0.21	0.35	0.65	1.15
2000 Gallon				
100 C.F.M.	1.70	2.83	5.26	9.25
200 C.F.M.	0.85	1.41	2.63	4.63
300 C.F.M.	0.56	0.94	1.75	3.08
400 C.F.M.	0.42	0.70	1.31	2.31
3000 Gallon				
100 C.F.M.	2.55	4.24	7.89	13.88
200 C.F.M.	1.27	2.12	3.94	6.95
300 C.F.M.	0.85	1.41	2.63	4.63
400 C.F.M.	0.63	1.06	1.97	3.47
4000 Gallon				
100 C.F.M.	3.41	5.66	10.53	18.50
200 C.F.M.	1.70	2.83	5.26	9.26
300 C.F.M.	1.13	1.88	3.51	6.18
400 C.F.M.	0.85	1.41	2.63	4.63
5000 Gallon				
100 C.F.M.	4.26	7.08	13.16	23.14
200 C.F.M.	2.13	3.54	6.58	11.57
300 C.F.M.	1.42	2.36	4.38	7.71
400 C.F.M.	1.06	1.77	3.29	5.78
6000 Gallon				
100 C.F.M.	5.11	8.49	15.79	27.76
200 C.F.M.	2.55	4.24	7.89	13.88
300 C.F.M.	1.70	2.83	5.26	9.25
400 C.F.M.	1.27	2.12	3.94	6.94

Calculations in Minutes

*The above tank pump down calculations are based on pumps that have true 100, 200, 300 and 400 C.F.M. ratings at 15 inches mercury and that have high vacuum capabilities of more than 27 inches mercury.



Vacuum Sales, Inc.
51 Stone Road Lindenwold, NJ 08021
800-547-7790 fax:856-627-3044
www.vacuumsalesinc.com

VACALL™

Sales ~ Service ~ Parts



D65 - DP 80
Myers Water Pump

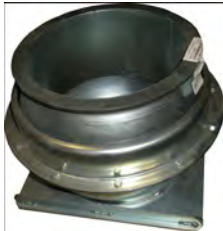

Street Sweepers, Catch Basin Cleaners & Leaf Collectors





Vacuum Sales, Inc.

51 Stone Road Lindenwold, NJ 08021
800-547-7790 fax:856-627-3044
www.vacuumsalesinc.com

Page 28

Vacuum Sales, Inc.
51 Stone Road
Lindenwold, NJ 08021

Toll Free: (888) 822-8648
Voice: (856) 627-7790
Fax: (856) 627-3044

www.VacuumSalesInc.com

Vacuum Sales, Inc. has been selling and servicing high QUALITY vacuum tanks and pumps since 1977. Located at 51 Stone Road, Lindenwold, NJ (200' off Route 30), is our 10,000 square foot facility. Our facility has the capability to repair or modify all makes and models of: Industrial and commercial liquid waste vacuum-pressure tanks and pumps, industrial wet/dry vacuum loaders, and high pressure sewer cleaning and water blasting units.

The key to our success has come from selling high QUALITY equipment and components as well as performing QUALITY service. We guarantee that the units we sell will do their job efficiently and that when repairs are necessary, they are done with as little down time as possible. We stock a large supply of replacement parts and accessories which assist in having your repairs complete in a timely manner.

We will be glad to show you our facility or come to you for a demonstration. We pride ourselves in being a family owned and operated company where service and QUALITY are our major objectives. Call today for a demonstration of our high pressure cleaning unit and/or our combination sewer cleaner /evacuation unit. Call us anytime at our toll free number (800) 547-7790

Sincerely,
James Redstreake
James Redstreake
President

Ordering Information

We stock over 20,000 components so not all are listed in the catalog. Please call our Parts Department for pricing and availability.

Most items are available for overnight delivery if received before 2:00 p.m.



