

Hobby Electronics

ISSN 0142-6192

December '79
45p



SCALEXTRIC CONTROLLER

Ring Modulator

Do It Like A Dalek

Hebot Pt2

Stimulating Ideas

TV Receivers

Seeing The Light

Games Offer

Play The Game

Data Supplement

We Admit All

Bar Graphics

Some New Ideas

Hobby Electronics

Vol. 2, No. 2

December 1979

PROJECTS

Slot Car Speed Controller . . . 11



Express electronics

Hebot part 2 25



Some sense at last

Ring Modulator 47

Exterminate, exterminate???

Bargraph Car Voltmeter 53

Volts on display

FEATURES

Unijunction Transistors 17

Double base

Clever Dick 22

Problems, what problems?

TV Receivers 31



Down the tube

Short Circuits 38, 46, 50, 66

Try these for size

Project Fault Finding 41

Get it going

Chit-Chat 53

Bargraph IC explained

Breaker One-Four 63

American Report

Into Linear ICs 67

Sounding out amplifiers

NEWS AND INFORMATION

Monitor 6

Books 16, 65

Read all about it

Market Place 34

Going cheap

Binders from HE 36

Bound over

Hobbyprints 40

PCB rub downs

Tee-Shirts 44

Be a HE-man

Next Month's HE 45

Telly special

Games Offer 46

An Enterprising deal

Subscriptions 52

Get it every month

Back Numbers 52

Don't miss out

ETI Next Month 58

Big Brother

We Need A Photographer 66

Get in the picture

Classified Ads 73

Bargains Galore

Hobby Electronics

145 Charing Cross Road,
London WC2H 0EE
01-437 1002 (4 lines)

Published by Modmags Ltd.

Distributed by Argus Distribution Ltd.

Printed by QB Ltd, Colchester

Hobby Electronics is normally published on the second Friday of the month prior to the cover date

Editor: Halvor Moorshead

Editorial Asst: Rick Maybury

Project Team: Ray Marston, Steve Ramsahadeo, John FitzGerald, Keith Brindley

Production: Diego Rincon, Dee Camilleri, Lorraine Radmore

Technical Artists: Paul Edwards, Tony Strakas, Joanne Barseghian

Advertising: Chris Surgenor, Steve Rowe, Sandie Neville, Kate Smith

Admin Staff: Margaret Hewitt, Bren Goodwin, Tim Salmon, Tracey Campbell, Lorraine Radmore, Loraine Stout, Marlin Felix, Halina Di-Lallo, Joan Brimm

Copyright. All material in this publication is subject to world-wide copyright protection. Permission to reproduce printed circuit board patterns commercially or marketing kits of the projects must be sought from the Editor. All reasonable care is taken in the preparation of the magazine to ensure accuracy but Modmags cannot be held responsible for it legally.

ABC

Simply ahead . .

ILP'S NEW GENERATION OF HIGH



I.L.P. modular units comprise five power amplifiers, pre-amp which is compatible with the whole range, and the necessary power supply units. The amplifiers are housed and sealed within heatsinks all of which will stand up to prolonged working under maximum operating conditions.

With I.L.P. performance standards and quality already so well established, any advances in I.L.P. design are bound to be of outstanding importance — and this is exactly what we have achieved in our new generation of modular units. I.L.P. professional design principles remain — the completely adequate heatsinks, protected sealed circuitry, rugged construction and excellent performance. These have stood the test of time far longer than normally expected from ordinary commercial modules. So we have concentrated on improvements whereby our products will meet even more stringent demands such, for example, as those revealed by vastly improved pick-ups, tuners, loudspeakers, etc., all of which can prove merciless to an indifferent amplifier system. I.L.P. modules are for laboratory and other specialised applications too.

**PRODUCTS OF THE WORLD'S FOREMOST SPECIALISTS
IN ELECTRONIC MODULAR DESIGN**

and staying there

PERFORMANCE MODULAR UNITS

HY5 PRE-AMPLIFIER

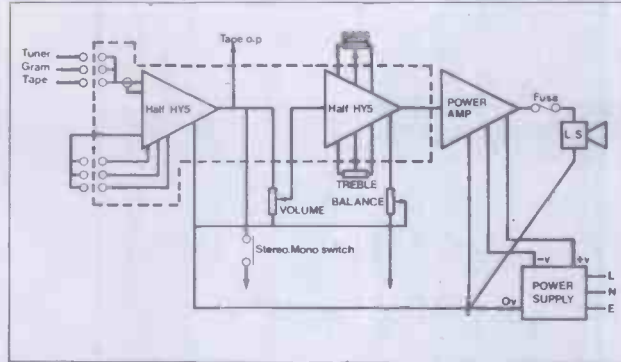
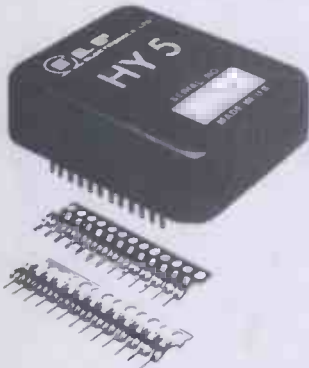

The HY5 pre-amp is compatible with all I.L.P. amplifiers and P.S.U.'s. It is contained within a single pack 50 x 40 x 15 mm, and provides multi-function equalisation for Magnetic/Ceramic/Tuner/Mic and Aux (Tape) inputs, all with high overload margins. Active tone control circuits; 500 mV out. Distortion at 1KHz—0.01%. Special strips are provided for connecting external pots and switching systems as required. Two HY5's connect easily in stereo. With easy to follow instructions.

£4.64 + 74p VAT

THE POWER AMPLIFIERS

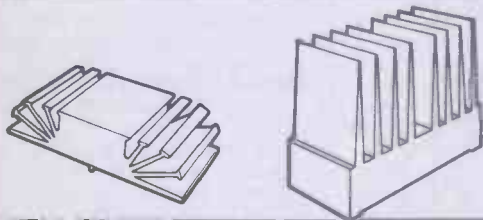
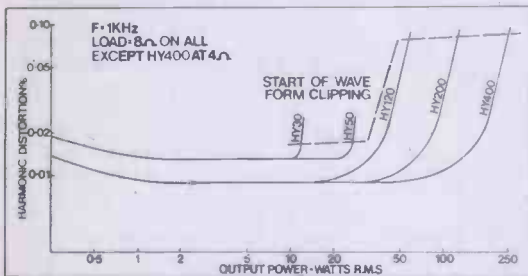

Model	Output Power R.M.S. into 8 Ω	Distortion Typical at 1KHz	Minimum Signal/Noise Ratio	Power Supply Voltage	Size in mm	Weight in gms	Price + V.A.T.
HY30	15 W	0.02%	80dB	-20 -0- +20	105x50x25	155	£6.34 + 95p
HY50	30 W	0.02%	90dB	-25 -0- +25	105x50x25	155	£7.24 + £1.09
HY120	60 W	0.01%	100dB	-35 -0- +35	114x50x85	575	£15.20 + £2.28
HY200	120 W	0.01%	100dB	-45 -0- +45	114x50x85	575	£18.44 + £2.77
HY400	240 W	0.01%	100dB	-45 -0- +45	114x100x85	1.15Kg	£27.68 + £4.15

Load impedance — all models 4 - 16 Ω
 Input sensitivity — all models 500 mV
 Input impedance — all models 100 KΩ
 Frequency response — all models 10Hz - 45KHz - 3dB

THE POWER SUPPLY UNITS

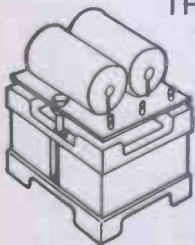

I.L.P. Power Supply Units are designed specifically for use with our power amplifiers and are in two basic forms — one with circuit panel mounted on conventionally styled transformer the other with toroidal transformer half weight and height of conventional laminated types.

PSU 30	± 15V at 100ma to drive up to five HY5 pre-amps.	£4.50 + 68p VAT
PSU 36	for 1 or 2 HY30's	£8.10 + £1.22 VAT
PSU 50	for 1 or 2 HY50's	£8.10 + £1.22 VAT
PSU 70	with toroidal transformer for 1 or 2 HY120's	£13.61 + £2.04 VAT
PSU 90	with toroidal transformer for 1 HY200	£13.61 + £2.04 VAT
PSU180	with toroidal transformer for 1 HY400 or 2 x HY200 Ma	£23.02 + £3.45 VAT

**NO QUIBBLE
 5 YEAR GUARANTEE
 7-DAY DESPATCH ON
 ALL ORDERS
 BUILT-IN PROTECTIVE
 CIRCUITRY
 BRITISH DESIGN AND
 MANUFACTURE
 FREEPOST SERVICE
 — see below**

HOW TO ORDER, USING FREEPOST SYSTEM

ALL U.K. ORDERS DESPATCHED POST PAID

Simply fill in order coupon with payment or credit card instructions. Post to address as below but do not stamp envelope — we pay postage on all letters sent to us by readers of this journal.



ELECTRONICS LTD.
 FREEPOST, 4 Graham Bell House, Roper Close
 Canterbury, Kent CT2 7EP
 Telephone (0227) 54778 Telex 965780

Please supply
 Total purchase price £.
 I enclose Cheque Postal Orders International Money Order
 Please debit my Account/Barclaycard Account No.
 NAME
 ADDRESS
 Signature

Monitor

COMPETITION WINNERS.



Pictured here are the two winners of the famous Hobby Electronics picture competition. First prize (top) was won by Darren Wright from Bodmin in Cornwall. He is shown here receiving his prize, a Calscope double beam oscilloscope from the delightful Joanne Barseghian (we just call her Joanne, its so much easier) who drew Darren's winning entry from the hat.

The second prize, a single beam Calscope was won by Paul Cheesman, he is

receiving his prize from the editor of HE the equally delightful Halvor Moorshead (but not quite so pretty). Both Darren (and his missus Angela) and Paul were given the grand tour of the HE offices, poisoned with several cups of HE coffee and then taken to dinner, and very nice they tasted too. Seriously though, congratulations to both Paul and Darren and all of the runners-up who should have received their Tee-Shirts by now.

YET MORE CATALOGUES

Like the falling leaves of autumn the catalogues from the various component houses are starting to slither across our newly polished desks in some quantity. Best of the latest bunch are the three publications from Carel Components Ltd, Badger Sound Services Ltd and ACE Ltd.

Firstly to the offering from Carel, it is aimed mainly at the specialist end of the market, very few actual components are to be seen, though, a very good selection of reasonably priced tools and accessories as well as some interesting information on flexible printed circuits make it well worth getting. More details can be obtained from Carel Components Ltd, 40-44, The Broadway, London SW19 1SQ.

Badger sounds catalogue is another good example of the specialist market, this time dealing with audio equipment. Included in the catalogue are several practical designs for speaker enclosures and crossover networks, worth getting for that alone. Badger Sound will be awaiting your enquiry at 46 Wood Street, Lytham St Annes, Lancashire FY8 1QG.

The ACE catalogue is a slightly slimmer version of their previous edition nevertheless they have managed to get a good selection of components into the space available. Price is 30p from ACE Mailtronix Ltd, Tootal Street, Wakefield, W. Yorks, WF1 5JR.

IN THE NIC OF TIME



Three new lines from NIC models this month (just hope he realises that he'll never get his review models back). The first offering is a rather cunningly marketed device called a Radatec. Now, no matter what you may think it is not a Radar Detector because they're illegal, it is simply a radio receiver that happens to operate on the so-called X-band. The fact that you could accidentally pick up police radar traps is purely coincidental, you would obviously only be using it to monitor sunspot activity or any local UFO transmissions, wouldn't you! Anyway, for just £23.95 you can own one of these devices, which funnily enough are made in England by Invicta Plastics the Mastermind people. Incidentally it is not illegal to own one.

The second device is a smoke/fire detector, nothing really earth-shattering, just good old-fashioned commonsense, its shrill siren should awaken even the soundest sleeper long before something really nasty happens. This will set you back £15.90.

The third and last plaything is called Wad-dingtons Compute-a-tune. It really is good, as soon as you switch it on it will play one of four tunes stored in its memory. When you get bored with those you can write your own tune (up to 32 notes long) into the machine's memory and play it back or re-write it at will, adding various effects such as variable tempo, echo, chord or change the structure of the note completely making it sound like a synthesiser. All of this for only £21. For NICs address see his Ad in this issue.

GAMES OFFER

Look out for the Games Offer on page 46 this month, we really believe that this one will be a winner. Where else can you get a full function calculator that plays three games as good as these, all with sound effects for only £20.95? You tell us and we'll sell it.

LAP COUNTER

Sorry about the lack of a Lap Counter in this month's issue. Pressure of space and a hold up of vital components have forced us to postpone this circuit for a month or so. We promise it will be worth waiting for, so you can get saving now.

News from the Electronics World

A TOUCH OF GLASS

The trend towards microminiaturisation of electronics has brought with it some unexpected headaches (literally) eyes tend to get strained much more easily these days especially when peering into dark corners of boxes filled with electronic exotica. Looking for faults on PCB tracks can also create problems, particularly when working on commercial equipment using those rather gaudy green coloured resist inks.

To the rescue of all those reluctant retinas we have a new handy looking table top magnifier. It is approximately four inches across made from a shatter-resistant acrylic material. Magnification is of the order of 2X, quite sufficient for most situations.

The magnifier comes from Combined Optical Industries Ltd (COIL for short) who have considerable experience in matters optical. It retails for about £4.40 including VAT and should be on sale in most reputable hobbyist shops and opticians about now. If you have any difficulty, try contacting COIL at 200 Bath Road, Slough SI1 4DW.



A MATTER OF SCIENCE

Time was when you could reliably say to your fellow man, 'man will never fly,' only to discover he had already. Up till only a few years ago you could predict with equal certainty, 'man will never get to the moon'. The trouble is with science, it keeps turning science fiction into fact. Only the other day our HE reporter, the one with his ear permanently glued to the ground discovered that Antimatter has been created for very short periods and in very small quantities. What this will eventually mean to the likes of you and me is anyone's guess. At the moment the problem is not so much what to do with it as how to make enough of it and then keep hold of it. Antimatter you will recall (that's if you've been keeping up with Star Trek) is a physical substance that is 'reversed', that is to say the nucleus would have a negative charge and the electrons would be positive. This means that it is extremely difficult to contain this substance, apparently the only way is to 'suspend' it within a very powerful magnetic field, should it come into contact with any 'matter' it would instantly disintegrate causing a large amount of energy to be released. (Weapon designers please ignore, we've got enough 'doomsday' stuff around already).

Just in case it ever becomes a practical to make and use Antimatter in any quantity we're told that only a few milligrams could yield enough energy to get you to the moon in only a couple of hours. Stay tuned to this space for more information as soon as we have it.

BACK NUMBERS

Please note that as of this month, the price of Back Numbers has been increased from 60 pence to £1.00. Blame this on the Post Office, the Government, inflation and anyone else you may have a grudge against. Sorry.

CHANGE OF ADDRESS

Spectrum Games Ltd would like it to be known that they have changed their address to Spectrum House, 48 Cambridge Road, Barking, Essex. They would now also like to be called Computer Games Ltd, confusing isn't it?

ERRATA

We'll get it right yet. Number one this month is the MiniBoard feature in the November issue. The diagrams for the Opto-Thermo Switch (page 21) got mixed up with the diagram for the Differential Temperature Switch (page 27). The Guitar Tuner also suffered. The overlay and PCB diagrams omitted to show a link between pins and 8 and 9 on IC1, R2 and C2 also got transposed but that won't affect operation. Please note that C1 should be a 0.1µ not 1µ0 as in the diagram. The resistor R3 should also be raised to 100R to reduce current consumption.

R2D2 radio. Fig 1. Q1 emitter should go to 0V and R5 should connect to the junction of C2, R1 and C3.



DIGITAL DILECTRIC

Anyone wishing to know the value of a capacitor to within 0.1% should pin their eyelids back and pay attention. Continental Specialities Corporation or CSC as they are known to their friends have introduced a new digital capacitance meter to their range. It is quaintly named the 3001 and can be yours for just £155 plus VAT. If you're still with us you may be interested to know that it can read any value on its 3½ digit display from 1pF to 0.1999 F and if you come across any capacitors outside that

range we would be most surprised.

To complement the 3001, CSC can supply you with the Model 333 Tri-Mode Comparator, that's a nifty little gadget that hooks up to the 3001 and will indicate via the three lights whether the capacitor under test falls within the pre-set limits on those two sets of thumb-wheels.

If all of this sounds like it is for you then why not get in touch with CSC at: Shire Hill Industrial Estate, Saffron Walden, Essex CB11 3AQ.

MAPLIN

ELECTRONIC SUPPLIES



PRINTED CIRCUIT DRILLS
 Miniature 12V DC drills designed for drilling pcb's.
 Small drill: Order as BW030 Price £8.75
 Large drill: Order as BW02C Price £10.63



ANTI-STATIC MAT & GUN
 Turntable mat removes static from discs while they are playing.
 Order as LX 10L. Price £2.95
 Gun removes static charge from discs. After use dust no longer clings and may be easily brushed off.
 Order as LX04E. Price £4.99

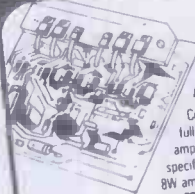

AMP KITS
 Complete kits of parts with full instructions to make hi fi amplifiers with excellent specifications.
 8W amp kit: Order as LW36P Price £3.83
 50W amp kit: Order as LW350 Price £13.73
 150W amp kit: Order as LW32K Price £14.89



HEADPHONES
 High quality stereo headphone with large padded headband and slider volume controls.
 Order as WF140 Price £7.99



CONDUCTIVE PAINT
 Repair pcb's, car demisters, etc., with this silver paint. Phial contains 30ml.
 Order as FY72P. Price £2.59



McKENZIE POWER SPEAKERS
 High quality, high power speakers.
 12in. 50W 8Ω Order as X079L Price £18.79
 12in. 50W 16Ω Order as X080B Price £18.79
 12in. 80W 8Ω Order as X081C Price £26.92
 12in. 80W 16Ω Order as X082D Price £26.92
 15in. 150W 8Ω Order as X083E Price £57.80
 15in. 150W 16Ω Order as X084F Price £57.80

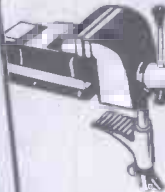

MINIATURE VICE
 Small modellers vice in tough plastic with metal faced jaws. Clamps to bench. Jaws width 41mm, maximum opening 30mm.
 Order as FY53H Price £2.78



20,000 OHM/VOLT MULTIMETER
 A 20,000 ohms per volt multimeter at an incredibly low price. DC volts 5, 25, 125, 500, 2,500. AC volts 10, 50, 250, 1,000. DC amps 0 to 0.05mA, 0 to 250mA, Resistance 0 to 50k, 0 to 5M ohms; Decibels -20 to -22dB. Complete with test leads, battery and instruction leaflet.
 Order as YB83E Price £13.70

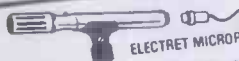

ELECTRET MICROPHONES
 Super quality genuine electret microphones operating on 1.5V battery (IMP7-type) supplied. Cassette type with miniature jack plugs.
 Order as YB33L. Price £3.84
 Omnidirectional low cost with standard jack plug.
 Order as YB34M. Price £3.75
 Unidirectional 600Ω with standard jack plug.
 Order as YB350. Price £9.75
 Unidirectional 600Ω/150kΩ dual with standard jack plug (pictured).
 Order as WF34M. Price £16.77



WIRING TOOLS
 Miniature box jointed wiring pliers with insulated handles and return spring.
 Order as BR69A. Price £4.52
 Miniature box jointed side cutters with insulated handles, return spring and precision cutting edges.
 Order as BR70M. Price £4.45
 End action wire strippers, fully adjustable, insulated handles.
 Order as BR76H. Price £5.85



CLOCK MODULE
 Module requires only transformer and two push switches to operate 4-digit, 0.7in red LED display. Alarm and radio outputs. Battery back up when mains fail. Sleep and snooze timer. Seconds display. Just add speaker for alarm tone. Full details on page 267 of our catalogue.
 Order as XL14Q. Price £8.41



MEGAPHONE
 High quality megaphone with differential microphone. Requires eight HP11 batteries (not supplied). Shoulder strap for portable operation.
 Order as XQ72P. Price £47.61



DEMAGNETISER
 Tape head demagnetiser with curved probe ideal for cassette tape heads. Cures has due to permanently magnetised heads. Amazingly low price.
 Order as FO62S. Price £4.15



CAR AERIAL BOOSTER
 High gain car aerial booster for long, medium, short and VHF bands. Negative earth cars only. Very easy to fit - just plugs in plus one wire to +12V. We have measured gains of 20dB at 90MHz!
 Order as XX37S. Price £5.93



TEACH YOURSELF ELECTRONICS
 There is no better way of learning basic electronics than by practical experience and this set of books is undoubtedly the very best basic course for doing just that. Set of five Basic Electronics books.
 Order as XX10L. Price £7.89



MULTIMETER & TRANSISTOR TESTER
 Superb high sensitivity multimeter and transistor tester in one. Sensitivity 100,000 ohms per volt. DC Ranges DC volts 0.5, 2.5, 10, 50, 250, 1,000. AC volts 5, 10, 50, 250, 1,000. DC current 0.01, 0.025, 0.5, 5, 50, 500mA, 10A. AC current 10A; Resistance 5k, 50k, 5M, 50M ohms; Decibels -10dB to -62dB. Complete with test leads, three leads for transistor tester batteries and instruction leaflet.
 Order as YB87U. Price £39.30



TURNTABLES
 Autochanger complete with stereo ceramic cartridge and circuit to make a complete low cost record player ideal for the young pop fan.
 Order as X000A. Price £16.30
 Single play rim drive turntable with stereo ceramic cartridge.
 Order as XB23A. Price £24.79
 Single play belt drive turntable 'S' shaped tone arm.
 Order as XB25C. Price £30.63



TRANSISTOR TESTER
 Accurate transistor tester measures dynamic gain, identifies unknown transistors, also ideal for matching transistors into pairs.
 Order as LH05F. Price £12.28



QUICKTEST
 A safe and quick way to connect to the mains. Just snap the wires under the sprung keys and close the lid. Completely safe both open and closed.
 Order as YB21X. Price £8.29

All prices include VAT and postage and packing, but if total under £4 please add 30p handling charge. Prices guaranteed until January 11th 1980. Export customers deduct 13% and export postage will be charged extra at cost.

Please use order code. All items in stock at time of going to press.

FOR FULL CATALOGUE DETAILS SEE BACK COVER.

MAPLIN

ELECTRONIC SUPPLIES LIMITED

All mail to PO Box 3, Rayleigh, Essex SS6 8LR. Telephone: Southend (0702) 554155.
 Shop: 284 London Road, Westcliff-on-Sea, Essex (closed on Monday). Telephone: Southend (0702) 554000.



MUSICAL ALARM

Chrono-plays melody on alarm 6 digit 11 functions countdown alarm, Dual time zone, 1/100th sec chrono, 2 piece s/s bracelet

£25.95
inc. VAT p&P

VT20 8mm thick

LADIES COCKTAIL WATCHES
£12.95 inc.

GREEN DISPLAY MAINS ALARM CLOCK RADIO

3 wavebands, LW, MW, FM
Snooze alarm, dimmer control



220x150x60mm

ONLY £19.95
(Inc. VAT, P&P)

ALARM CHRONO with 9 World Time Zones

6 digits, 5 flags.
6 basic functions.
8 further time zones.
Count-down alarm.
Stop-watch to 12 hours 59.9 secs. in 1/10 sec. steps.
Split and lap timing modes.
Alarm.
9mm thick.
Back-light.
Fully adjustable bracelet.



ONLY £29.95
(Inc. VAT, P&P)

VT17

SEIKO MEMORY BANK VT21

Calendar watch M354
Hours, mins., secs.
Month, day, date in 12 or 24 hour format all indicated continuously.
Monthly calendar display month, year and all dates for any selected month over 80 year period.
Memory ban function.
Any desired dates up to 11 can be stored in advance.
2 year battery life.
Water resistant.
Same as ET1 offer

ONLY £74.95 inc. VAT P&P

Low cost 5 function 4 digit — **£7.95** inc.

LCD SNOOZE ALARM

24-hr. alarm Hours, Mins., Secs., date, month, back-light, auto. calendar, adjustable stainless steel bracelet, 12-month guarantee.



ONLY £12.95
(inc. VAT, P&P).

VT10
Same day despatch!

ATARI VCS System — Most popular top range micro-video game

Current cartridges — Air Sea Battle (27), Space War (17), Outlaw (16), Video Olympics (50), Breakout (12), Basketball (2), Surround (14), Blackjack (7), Basic Maths (8), Codebreaker (20) Hunt & Score (8), Miniature Golf (2), Skydiver (5), Street Racer (27), Chess (8) Levels Backgammon (8), Brain Games, Bowling.

VCS Unit — £159.95 inc.
Cartridges mostly — £14.95 inc.
CHESS (8 levels) — £45.00 inc.
BACKGAMMON — £34.50 inc.
SUPERMAN — £23.25 inc.

details on request.
Same day despatch.



SOLAR LCD ALARM CHRONO

★ WATER RESISTANT (no vents)
★ MINERAL GLASS
★ ALL STAINLESS STEEL
★ ONLY 7mm THICK



24-hr. alarm with on/off indication.
1/10 second chronograph measuring net, lap and first and second place times.
Dual time zone facility
night light.

ONLY £29.95 (Inc. VAT, P&P)

Same day despatch

VT16

BELTIME CHRONOGRAPH

9 Functions
Hours, mins, secs, day, date, month, interchange feature, automatic calendar, backlight, net time/lap time. Stainless steel bracelet, 8mm thick



£12.95 (inc. VAT P&P)

VT07
Same day despatch

TELENG TELEVISION COMPUTER SYSTEM — low cost micro-video game — British made

Details on request

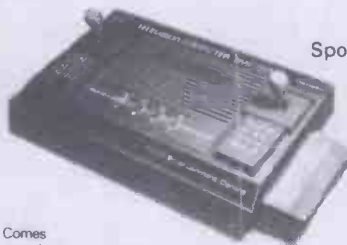

Comes complete with Sportsworld

Sportsworld, Combat, Horse Racing, Maze Maths Two, Far in Raw, Mastermind, Air-Sea Battle, Boxing, Black Jack, Sporting Shotgun, Motor Racing, Maths One Circus

Console — **£89.95** inc.
Cartridges — **£12.95** inc.

LCD ALARM CHRONOGRAPH

All usual features.
Perpetual calendar, day, date.
24-hr. alarm with on/off indication.
1/10 second chronograph measuring net, lap and first and second place times.
Dual time zone facility.
Night light.
12-month guarantee.



ONLY £17.95
(Inc. VAT, P&P)

Same day despatch
Same as ET1 offer

VT06

BELTIME MICROPROCESSOR VT18

★ 2 alarms
★ 2 chronos
★ Hourly chime
★ Mineral glass

Hours (program 12 or 24), minutes, seconds, day (multi-language program), Date, 1/100th sec. chrono 24 hrs., countdown chrono with alarm, backlight.



ONLY £37.95
(inc. VAT P&P)
Same as HE offer

PHILIPS G7000 — HOME VIDEO COMPUTER GAME

— a new dimension to video games
11 exciting VIDEOPACS

PAC 1 — Motor Race, Spin-out, Cryptogram, PAC 2 — Paris, Space Rendezvous, Logic, PAC 3 — American Football, PAC 4 — Air-Sea and Tank Battle, PAC 5 — Blackjack, PAC 6 — Ten Pin Bowling, Basketball, PAC 7 — Maths, Echo, PAC 8 — Baseball, PAC 9 — Computer (Assembler and Machine code), PAC 10 — Golf, PAC 11 — Space Conflict.

G7000 — **£149.95** inc.
VIDEOPACS most each — **£12.95** inc.



full details on request

Same day despatch

G7000 includes controls, adaptor, VIDEOPAC 1.

SOLAR LCD ALARM CHRONOGRAPH

24-hr. alarm with on/off indication
1/10 second chronograph measuring net, lap and first and second place times.
Dual time zone facility.
Night light.

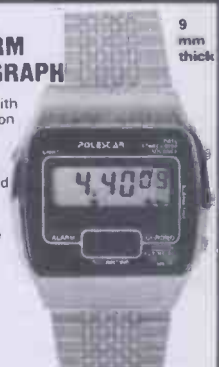

ONLY £19.95
(inc. VAT, P&P)

Same day despatch
VT12

12-month guarantee. 15% VAT included. Cheques or P.O.s or telephone Card No. to Allow 7 days delivery unless specified

VIDEOTIME PRODUCTS, 56 QUEENS ROAD

BASINGSTOKE, HANTS RG21 1REC. Tel: (0256) 56417 or 26620 TLX: 858747

FACTORY AGENTS WANTED MONEY BACK GUARANTEE OFFERS SUBJECT TO AVAILABILITY. TRADE ENQUIRIES WELCOME



Scalextric Controller

Eliminate overheating of hand controllers and car motors with our unique 1- to 4-lane slot car speed control unit. It uses conventional, unmodified hand controllers, is powered from a standard slot car power pack and has independent overload protection on each output.



The Speed Controller set up for a four-lane layout. Refer to the text for setting-up procedure

THE HE DESIGN TEAM recently had the good fortune to acquire a pre-production 4-lane Scalextric "600" slot car racing outfit. Naturally, we subjected this new 'goody' to very thorough evaluation testing (we played 'racing cars' for an aggregate time of one hundred hours in two days) and rapidly became addicted to the game.

We soon noticed, however, that our Scalextric outfit, like all other slot car racing systems, suffered from a few annoying defects. Specifically, we found that the hand control units and the car motors became severely overheated after a long running period. So we set about designing an electronic control system that would overcome these defects. The end results of our design efforts are presented here.

Our controller is unique. It is powered from a conventional slot car power pack and can be used to control any make of 1- to 4-lane slot car system. The unit interfaces with conventional and unmodified hand control units, which have their outputs fed to the inputs of the electronic control unit. The outputs of the con-

troller are fed to the slots of the race track via conventional track connectors.

In our system the hand control units have only a few tens of milliwatts developed across them and thus cannot possibly suffer from overheating problems. The power signal fed to the car motors is a reasonably smooth DC signal that is free of repetitive high-surge currents, rather than a conventional unsmoothed full-wave rectified AC signal that produces a high level of repetitive surge currents. Consequently, our system greatly reduces car motor overheating problems.

Our system has a few other advantages as well. Each one of its outputs is provided with its own electronic overload protection system, so a short on one lane does not disable the supply to the other lanes of the slot car system. Each output is provided with a 'compensation' control, which enables the driver to personalise the action of his own hand control unit to suit his own car and his own level of driving skill. All-in-all, a very good project for the slot car buff.

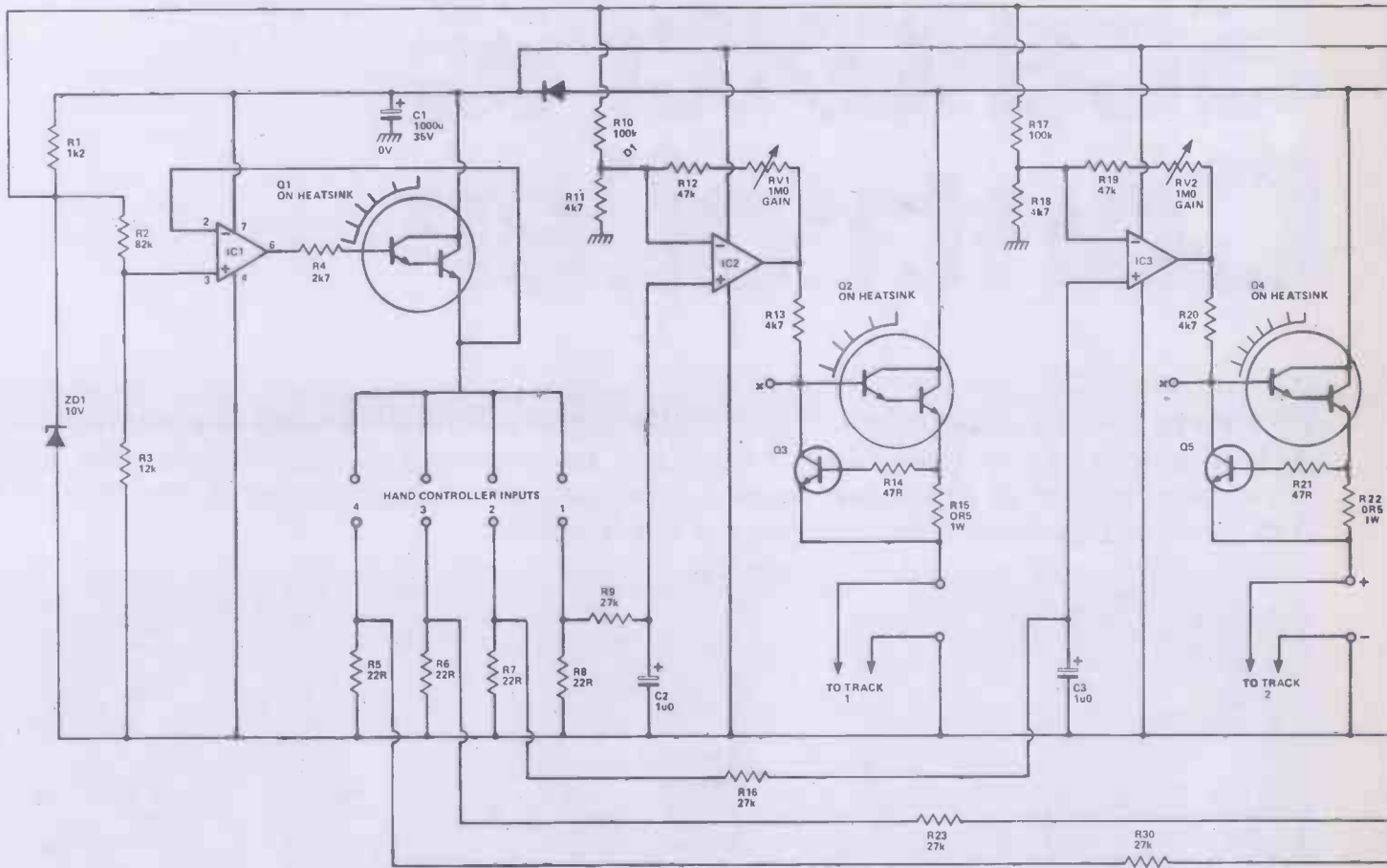

How It Works

Although the unit looks fairly complicated in the circuit diagram it is in reality quite simple and comprises one 'hand controller interface' circuit (Designed around IC1 and Q1) and four identical 'power controller' circuits (IC2-Q2-Q3, IC3-Q4-Q5, etc).

The operation of the 'hand controller interface' circuit is quite simple. IC1 and Q1 are interconnected as a compound high-current voltage follower which produces an output voltage (to the top of the hand controllers) that is identical to the voltage applied to input pin 3 of IC1. A stable potential of 1.2 volts is applied to this pin and is derived from zener diode ZD1 via potential divider R2-R3. Thus, 1.2 volts is applied to the top of each hand controller that is connected to the unit. The bottom of each controller is taken to ground via a 22R resistor. The four outputs of the 'interface' circuit are taken from across these 22R resistors. A maximum power of only a few tens of milliwatts is dissipated in each controller, so the controllers always run cool in this circuit.

Most hand controller units take the form of a simple rheostat that has a basic resistance of about 50R. When the controller is in the OFF mode the rheostat is open circuit and under this condition zero volts appear across the 22R resistors in the

diagram. At the 'minimum' speed setting the rheostat measures 50R and approximately 0.4 volts is developed across the 22R resistors. At the 'maximum' speed setting the rheostat measures zero resistance and under this condition 1.2 volts are developed across the 22R resistors. At intermediate speed settings 0.4 to 1.2 volts are developed across the 22R resistors. These voltages are passed on to the 'power controller' sections of the unit.

All 'power controller' sections of the unit are identical, so let's look at the 'Track 1' (IC2-Q2-Q3) section only. IC2 is an op-amp and connected as a non-inverting amplifier, with a gain determined by the setting of RV1 and with an offset bias of about 0.4 volts applied to its non-inverting (-) pin via R10 and R11. The output of the op-amp is fed to the slot car track via Darlington emitter follower Q2, which has overload protection provided via R15 and Q3. Let's assume that RV1 is set so that the op-amp has a gain of 15.

When the hand controller is in the OFF mode zero volts are developed across R8, so the output of Q2 is also zero and no power is fed to the track. When the controller is at the 'minimum' speed setting 0.4 volts are developed across R8, but this voltage is insufficient to overcome the 0.4 V 'offset'

Scalextric Controller

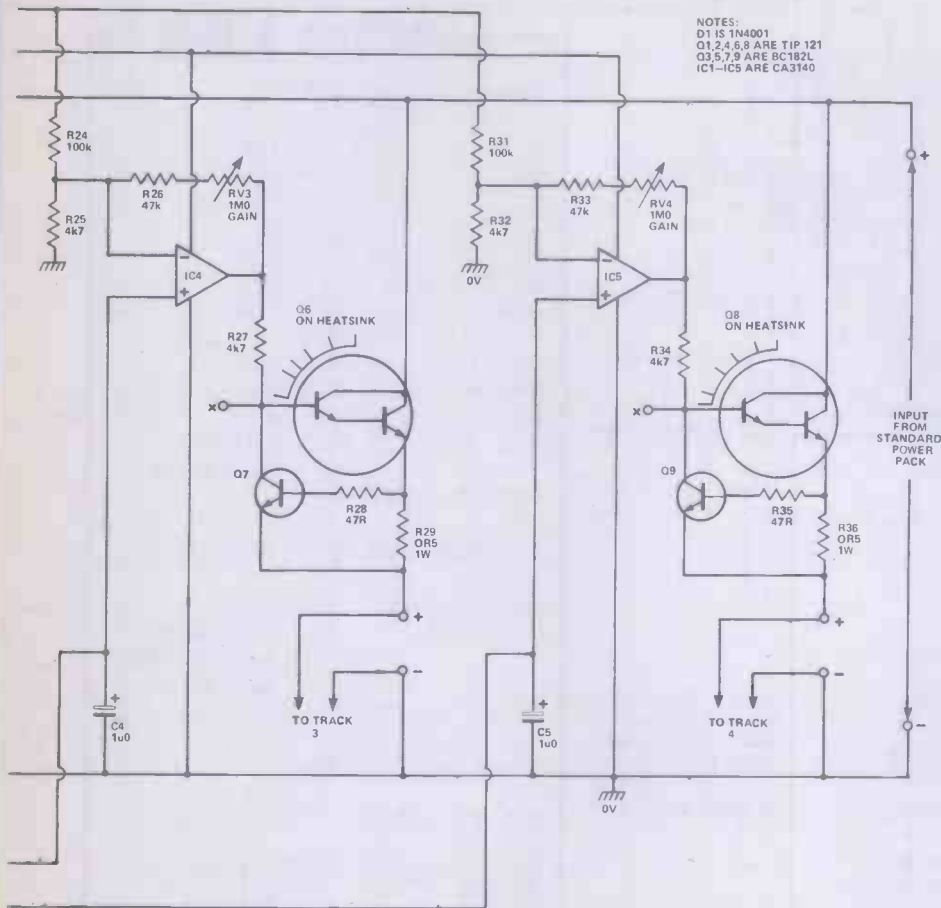

Fig. 1. Circuit diagram for the HE slot-car controller. The transistors Q7, Q4, Q6 and Q8 are obtainable from Watford Electronics (see ad in this issue). Ensure these transistors have a heat-sink.

of IC2, so the output of Q2 is again zero and no power is fed to the track. When the controller is at the 'maximum' speed setting 1.2 V is developed across R8, giving a differential input of 0.8 V to IC2, which thus gives an output of 12 V (0.8 V x 15) and full power is applied to the track. At intermediate settings of the hand controller the R8 voltage varies between zero and 12 volts.

The power feed to the track is derived from the unsmoothed full-wave rectified output of a standard power pack via Q2. At speed settings below full power the unwanted 'tops' of this power feed are cut off by Q2, so the car motors are fed with a reasonably smooth d.c. signal that is devoid of the high-current repetitive surges of 'conventional' controllers. Consequently, our system causes the motor to run far cooler than normal.

In practice, the setting of COMPensation control RV1 can be adjusted to give full power at almost any desired setting of the hand controller unit, thus allowing the controller action to be personalised to suit the characteristics of a given car and the level of skill of the individual driver. The hand controller action can be overridden by applying an external control signal to the point marked 'X' in the diagram.

The Scalextric Controller board, note the heat-sinks. As usual use sockets for the ILS and note the combination of polarised components.

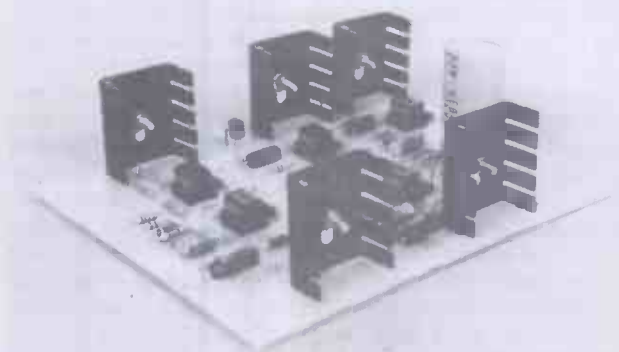

Scalextric Controller

Parts List

RESISTORS (All 1/4W, 5%)

R1	1k2
R2	82k
R3	12k
R4	2k7
R5, R6, R7, R8	22R
R9, R16, R23, R30	27k
R10, R17, R24, R31	100k
R11, R13, R18, R20,	
R25, R27, R32, R34	4k7
R12, R19, R26, R33	47k
R14, R21, R28, R35	47R
R15, R22, R29, R36	OR5 1W wirewound

POTENTIOMETERS

RV1, RV2, RV3, RV4	1MO Lin.
--------------------	----------

CAPACITORS

C1, 1000u	35V electro lytic type PCB mounting
C2, C3, C4, C5	1uO electrolytic

SEMICONDUCTORS

IC1, IC2, IC3,	CA3140
IC4, IC5	
Q1, Q2, Q4,	TIP121
Q6, Q8	BC182L
Q3, Q5, Q7, Q9	IN4001
D1	10V BZY88
ZD1	

MISCELLANEOUS

5 Heatsinks	
Verocase 202-21035F	

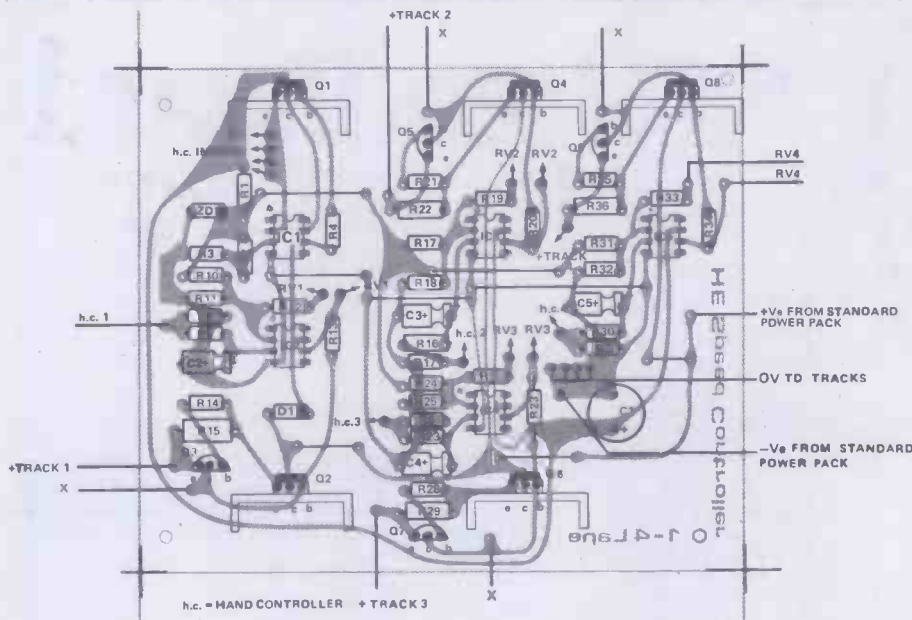

CONSTRUCTION

As you can see from the circuit diagram, the unit comprises one 'hand controller interface' circuit (designed around IC1 and Q1 and four identical 'power controller' circuits (IC2-Q2-Q3, IC3-Q4-Q5, etc). You thus have a few options when it comes to building the unit. You can either build it all in one go as a 4-lane controller, as shown in the total circuit diagram, or you can build it as a less-than-4-lane controller by simply omitting the components of the unwanted 'power controller' sections.

A fair bit of care is necessary when wiring up the components on the PCB. Start construction by soldering the eight links into place on the PCB, as shown on the overlay, and then fit the five IC holders into position. You can then progress with the assembly of the remaining components, taking special care to observe the polarity of all electrolytic capacitors and semiconductor devices. Note that each of the five Darlington power transistors is fitted to an individual heat sink.

When assembly is complete, double check the wiring and then fit the unit into a suitable case and complete the interwiring to the 1MO 'COMPensation' pots and the input and output terminals. You can then give the unit a functional check by powering it from a standard slot car power pack, connecting the unit outputs to the respective lanes of the slot car layout via standard track connectors and connecting standard hand controller units to the respective input terminals of the unit. The respective COMPensation pots can be adjusted by trial and error to give the best hand controller response for a given set of driving conditions. The final setting of each pot is entirely a matter of personal choice.

You are probably wondering about the purpose of the points marked 'X' on the diagrams. These points are supposed to be taken to externally-available terminals mounted on the rear of the completed unit and can be used to override the standard hand controller units. Cars can be stopped by taking these points to ground, or can be set to full speed by taking them to the positive supply line. We may present a 'random fault generator' project that will interface with these points and give simulations of tyre blow-outs and engine breakdowns, etc., sometime in the new year.

Above: The overlay for the speed controller. Bottom right: the PCB foil pattern approximately half size.

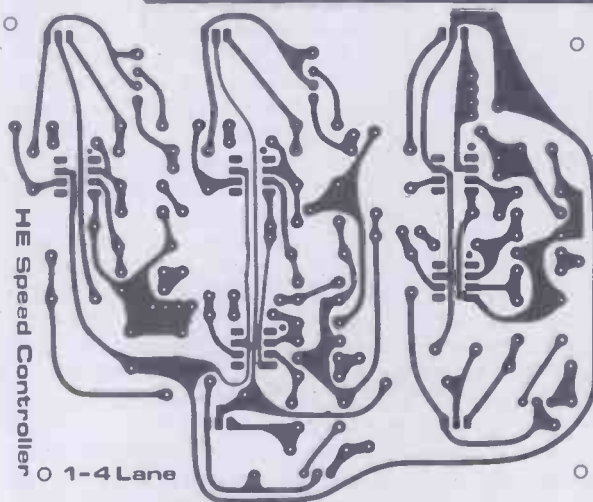

Buylines

The TIP121 may prove a little difficult to obtain at your local component shop, however this device can be purchased from Watford Electronics along with the LM3914.

Britain's Best Breadboard Buy at Breadboard '79

**FREE
ENTRY TICKET
WORTH £1.00
WITH EVERY PURCHASE**

All over Britain, hobbyists are discovering Britain's Best Breadboard Buys. At the London Breadboard exhibition '79 on Stand Nos. F1, F2 and G1, G2, CSC will be exhibiting their full range of breadboards.

Here is your chance to obtain a special ticket for Breadboard '79 worth £1.00 absolutely FREE.

Cut out the coupon below and take it along to one of our listed dealers, and make a purchase of any of our breadboards and receive your special FREE ticket — see you at Breadboard '79.

Take the coupon to any of these main dealers:

LONDON

Rastra Electronics Ltd., 279-281 King Street, Hammersmith, London W6

Cubegate Ltd., Audio Electronics, 301 Edgware Road, London W2 1BN

Technomatic Ltd., 17 Burnley Road, London NW10 1ED

Precision Instrument Labs., Instrument House, 727 Old Kent Road, London SE15

MANCHESTER

Shudehill Supply Co., 53 Shudehill, Manchester M4 4AW

BUCKINGHAMSHIRE

West Hyde Development, Unit 9, Park Street Industrial Estate, Aylesbury, Bucks HP20 1ET

Best Electronics (Slough) Ltd., Unit 4 Farnburn Ave., Slough, Bucks SL1 4XU

KENT

Lawtronics, 13a High Street, Edenbridge, Kent TN8 5AX

NEWCASTLE

Aitken Bros., 35 High Bridge, Newcastle upon Tyne

SCOTLAND

Marshalls, 85 West Regent Street, Glasgow G2

F. Brown & Co., 45 George IV Bridge, Edinburgh EH1 1E3

LEEDS

Leeds Amateur Radio Club, Cookridge Street, Leeds 1

HERTFORDSHIRE

BI-PAK, 3 Baldock Street, Ware, Herts.

CONTINENTAL SPECIALTIES CORPORATION



CSC UK LTD. EUROPE, AFRICA, MIDEAST
Dept 14CC2 Shire Hill Industrial Estate Units 1 and 2, Saffron Walden, Essex CB11 3AQ
Tel: Saffron Walden (0799) 21682. Telex: 817477

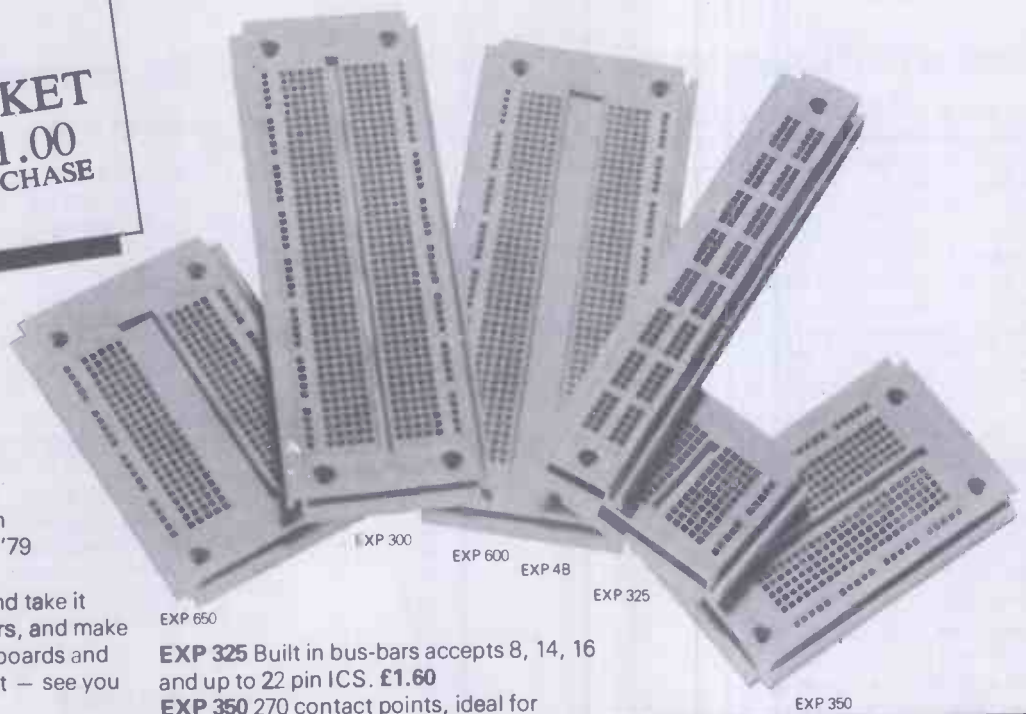

EXP 325 Built in bus-bars accepts 8, 14, 16 and up to 22 pin ICS. **£1.60**

EXP 350 270 contact points, ideal for working with up to 3 x 14 pin DIPS. **£3.15**

EXP 650 For microprocessor chips. **£3.60**

EXP 4B An extra 4 bus-bars in one unit. **£2.30**

EXP 300 The most widely sold breadboard in the UK; for the serious hobbyist. **£5.75**

EXP 600 6" centre channel makes this the Microprocessor Breadboard. **£6.30**

PB6 Professional breadboard in easily assembled kit form. **£9.20**

PB100 Kit form breadboard recommended for students and educational uses. **£11.80**

The above prices do not include P&P and 15% VAT

The Experimenter System

4 ways to order Experimenter Systems

1. EXP 300PC which includes one item.
A matchboard pre-drilled PCB — £1.32
2. EXP 302 which includes three items.
Three 50-sheet scratchboard workpads — £1.68
3. EXP 303 which includes three items.
Two matchboards and an EXP 300 solderless breadboard — £8.60
4. EXP 304 which includes four items.
Two matchboards and EXP 300 breadboard and a scratchboard workpad — £9.30

This coupon entitles the holder to a free ticket worth £1.00 to Breadboard '79, with the purchase of any listed breadboards

1. EXP 325 £2.70	Qty. Reqd.	2. EXP 350 £4.48	Qty. Reqd.
3. EXP 650 £5.00	Qty. Reqd.	4. EXP 4B £3.50	Qty. Reqd.
5. EXP 300 £7.75	Qty. Reqd.	6. EXP 600 £8.39	Qty. Reqd.
7. PB6 £11.73	Qty. Reqd.	8. PB 100 £14.72	Qty. Reqd.

Experimenter System

1. EXP 300PC £2.38	Qty. Reqd.	2. EXP 302 £2.79	Qty. Reqd.
3. EXP 303 £11.04	Qty. Reqd.	4. EXP 304 £11.85	Qty. Reqd.

Boxed prices include P&P and 15% VAT

If no dealer in your area contact CSC direct.

Continental Specialties Corporation, (U.K.) Limited, Dept 14CC2
Unit 1, Shire Hill Industrial Estate, Saffron Walden, Essex Tel: (0799) 21682

NAME

ADDRESS

FREE catalogue tick box

I enclose cheque/PO for £.....
or debit my Barclaycard, Access, American Express card

No. Exp. date
or Tel: (0799) 21682 with your card number and your order will be in the post immediately.

Hobby Electronics Book Service

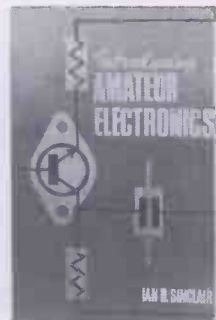

POPULAR ELECTRONICS BOOKS

Sinclair, I. R., <i>Introducing Electronic Systems</i>	£1.80
Sinclair, I. R., <i>Introducing Amateur Electronics</i>	£1.55
Sinclair, I. R., <i>Electronic Fault Diagnosis</i>	£3.45
Sinclair, I. R., <i>Repairing Pocket Transistor Radios</i>	£2.50
Sinclair, I. R., <i>Oscilloscope In Use</i>	£3.00
Sinclair, I. R., <i>Understanding Electronic Components</i>	£4.00
Sinclair, I. R., <i>Understanding Electronic Circuits</i>	£4.00
Kitchen, H. T., <i>Handtools For Electronic Workshop</i>	£2.75
Kitchen, H. T., <i>Electronic Test Equipment</i>	£5.00
Capel, V., <i>How To Build Electronic Kits</i>	£2.20
Darr, J., <i>How to test almost everything electronic</i>	£3.50
Brown, R. M., <i>How to read electronic circuit diagrams</i>	£4.10

AUDIO

Earl, J., <i>Audio Technicians Bench Manual</i>	£3.50
Earl, J., <i>Pickups and Loud Speakers</i>	£3.50
Earl, J., <i>Tuners and Amplifiers</i>	£3.00
Earl, J., <i>Cassette Tape Recorders</i>	£5.25
Earl, J., <i>ABC of Hi-Fi</i>	£4.25
Capel, V., <i>Microphones In Action</i>	£3.00
Capel, V., <i>Improving Your Hi-Fi</i>	£3.50
Capel, V., <i>Creative Tape Recording</i>	£4.00
Hellyer, H. W., <i>Tape Recorders</i>	£4.25
Sinclair, I. R., <i>Audio Amplifiers For Home Construction</i>	£2.75

RADIO CONTROL

Aldridge, D., <i>Transistorised Radio Control For Models</i>	£3.50
Drake, J., <i>Radio Controlled Helicopter Models</i>	£3.95
Jeffries, C. R., <i>Radio Control For Model Yachts</i>	£1.85
Safford, E. L., <i>Radio Control Manual</i>	£2.45

COOKBOOKS

Tracton, K., <i>BASIC Cookbook</i>	£4.10
Lancaster, D., <i>TTL Cookbook</i>	£7.00
Lancaster, D., <i>RTL Cookbook</i>	£4.65
Lancaster, D., <i>CMOS Cookbook</i>	£8.20
Jong, W., <i>IC Op Amp Cookbook</i>	£10.00
Lancaster, D., <i>T.V. Typewriter Cookbook</i>	£7.75
Lancaster, D., <i>Cheap Video Cookbook</i>	£7.00
Jong, W., <i>IC Timer Cookbook</i>	£7.50
Lancaster, D., <i>Incredible Secret Money Machine (a how to cook book for setting up your computer or technical business)</i>	£4.95

QUESTIONS AND ANSWERS

SIMPLE AND CONCISE ANSWERS TO MANY QUESTIONS WHICH PUZZLE THE BEGINNER.

Coker, A. J., <i>Q & A On Electric Motors</i>	£1.90
Hellyer, H., <i>Q & A On Radios and T.V.</i>	£1.90
Hibberd, R., <i>Q & A On Integrated Circuits</i>	£1.90
Jackson, K., <i>Q & A On Electricity</i>	£1.90
Brown, C., <i>Q & A On Hi-Fi</i>	£1.90
Brown, C., <i>Q & A On Transistors</i>	£1.90
Brown, C., <i>Q & A On Electronics</i>	£1.90
Reddihough, J., <i>Q & A On Colour T.V.</i>	£1.90
Miller, H., <i>Q & A On Electric Wiring</i>	£1.90

CONSTRUCTOR GUIDES

Graham, P., <i>Simple Circuit Building</i>	£2.60
Colwell, M., <i>Electronic Diagrams</i>	£2.60
Colwell, M., <i>Electronic Components</i>	£2.60
Colwell, M., <i>Printed Circuit Assembly</i>	£2.60
Ainslie, A., <i>Practical Electronic Project Building</i>	£2.60
Colwell, M., <i>Project Planning and Building</i>	£2.60

BEGINNER'S GUIDE

Sinclair, I. R., <i>Beginner's Guide To Tape Recording</i>	£3.35
Sinclair, I. R., <i>Beginner's Guide To Integrated Circuits</i>	£3.35
Sinclair, I. R., <i>Beginner's Guide To Audio</i>	£3.35
King, G. J., <i>Beginner's Guide To Radio</i>	£3.35
King, G. J., <i>Beginner's Guide To Television</i>	£3.35
King, G. J., <i>Beginner's Guide To Colour T.V.</i>	£3.35
Guilou, F., <i>Beginner's Guide To Electric Wiring</i>	£3.35

PROJECT BOOKS

Marston, R. M., <i>110 Cosmos Digital IC Projects For The Home Constructor</i>	£3.95
Marston, R. M., <i>110 Wave Form Projects For The Home Constructor</i>	£3.95
Marston, R. M., <i>110 Op Amp Projects For The Home Constructor</i> ..	£3.95
Marston, R. M., <i>110 Semiconductor Projects For The Home Constructor</i>	£3.95
Marston, R. M., <i>110 Thyristor/SCR Projects For The Home Constructor</i>	£3.95
Marston, R. M., <i>110 Electronic Alarm Projects for The Home Constructor</i>	£3.95
Marston, R. M., <i>110 Integrated Circuits Projects For The Home Constructor</i>	£3.95
Marston, R. M., <i>20 Solid State Projects For The Car and Garage</i> ..	£3.20
Marston, R. M., <i>20 Solid State Projects For The Home</i>	£3.20

Note that all prices include postage and packing. Please make cheques, etc. payable to Hobby Electronics Book Service (in sterling only please) and send to:

Hobby Electronics Book Service,
P.O. Box 79,
Maidenhead, Berks.

Unijunction Transistors

The UJT is one of the simplest yet least understood of today's semiconductor devices. In the following pages Ray Marston explains how it works, and shows a stack of practical ways of using it.

THE UNIJUNCTION TRANSISTOR (UJT) is one of the simplest, oldest, and least understood semiconductor devices available to the electronics enthusiast. UJTs first became commercially available some twenty-eight years ago (in 1952), and since then have been widely used in oscillator, timing, and thyristor triggering circuits. In the next few pages we explain how the UJT works, and show some practical ways of using it.

UJT BASIC PRINCIPLES

The UJT is a remarkably simple device. It uses the symbol shown in Fig 1a, employs the form of construction shown in Fig 1b, and has the equivalent circuit of Fig 1c. The device is made up of a bar of n-type silicon material with a non-rectifying contact at either end (base 1 and base 2), and with a third, rectifying, contact (emitter) alloyed into the bar part way along its length, to form the only junction within the device (hence the name 'unijunction').

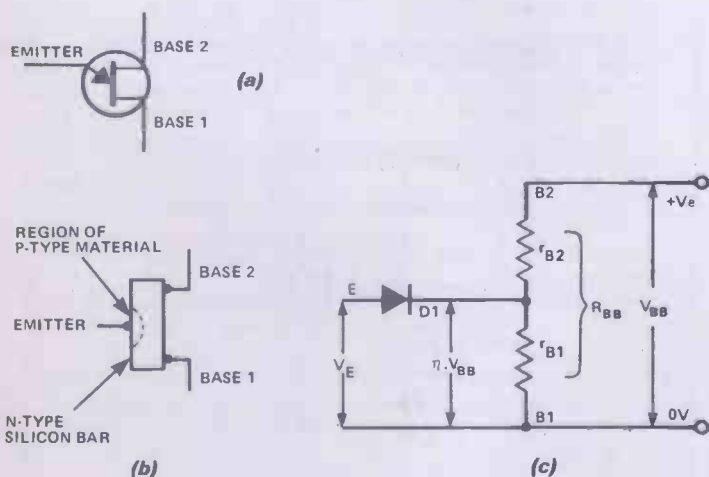

Fig. 1. (a) UJT symbol. (b) UJT construction. (c) UJT equivalent circuit.

Since base 1 and base 2 are non-rectifying contacts, a resistance appears between these two points and is that of the silicon bar. This 'inter-base' resistance measures the same in either direction, has a typical value in the range 4kΩ to 12kΩ, and is given the symbol R_{BB} .

In use, base 2 is connected to a positive voltage and base 1 is taken to zero volts (see Fig 1c), so R_{BB} acts as a voltage divider with a division or intrinsic stand-off ratio (η) that usually has a value between 0.45 and 0.8. A 'stand-off' voltage of $\eta \cdot V_{BB}$ thus appears across the lower (r_{B1}) half of the bar under quiescent conditions. The emitter terminal of the UJT is connected to this voltage via junction D1. Normally, the emitter input voltage, V_E , is less than $\eta \cdot V_{BB}$, so D1 is reverse biased and the emitter appears as the very high impedance of a reverse biased silicon diode, with a typical impedance of many megohms.

If, however, V_E is steadily increased above $\eta \cdot V_{BB}$, a point is reached where D1 starts to become forward biased, so current starts to flow from emitter to base 1. This current consists mainly of minority carriers injected into the silicon bar, and these drift to base 1 and cause a decrease in the effective resistance of r_{B1} . This decrease in r_{B1} causes a decrease in the D1 cathode voltage, so D1 becomes more heavily forward biased, and the emitter-to-base 1 current increases and causes the r_{B1} value to fall even more. A regenerative action thus takes place, and the emitter input impedance falls sharply, typically to a value of about 20Ω.

This, the UJT acts as a voltage-triggered switch, and has a very high input impedance (to the emitter) when it is off, and a low input impedance when it is on. The precise point at which triggering occurs is called the 'peak-point' voltage, V_p , and is about 600 mV above $\eta \cdot V_{BB}$.

It can be seen that the UJT is a rather specialised device. Its most common application is as a relaxation oscillator, as shown in Fig 2a. Here, when the supply is first connected, C1 is discharged and the emitter is at ground potential, so the emitter appears as a very high impedance. C1 immediately starts to charge exponentially towards V_{BB} via R1, but as soon as the emitter reaches V_p the UJT fires and C1 discharges rapidly into

the low impedance of the emitter. Once C1 is effectively discharged the UJT switches off, and C1 then starts to charge up again and the whole process is repeated. Thus, an approximately saw-tooth waveform is continuously generated between the emitter and ground.

In this circuit, final switch-off occurs in each cycle when the total emitter current (capacitor discharge plus R1 current) falls to a 'valley-point' value, I_v , typically of several milliamps. A minimum 'peak-point emitter current', I_p , is needed to switch the UJT on initially, and typically has a value of several microamps. The maximum useable value of R1 is limited by the I_p characteristic, and the minimum R1 value is limited by the I_v characteristic.

The frequency of operation of the Fig. 2a circuit is given approximately by $f = 1/(C.R)$, and is virtually independent of V_{BB} . Typically, a 10% change in V_{BB} results in a frequency change of less than 1%. The value of R1 can typically be varied from about 3k Ω to 500k Ω , so an attractive feature of the circuit is that it can be made to cover a frequency range greater than 100:1 via a single variable resistance. The value of C1 can be varied from a few hundred pF to hundreds of μ F, so the circuit can cover an exceptionally wide frequency range (from several hundred kHz to as low as one cycle every few minutes).

In most circuits, an additional resistor (R3) is wired between base 1 and ground, as shown in Fig 2b, either to control the discharge time of C1 or to give a brief positive output pulse from the discharge of C1. A resistor (R2) may also be wired in series with base 2, either to improve the thermal stability of the oscillator or to enable a negative output pulse to be made available from the discharge of C1.

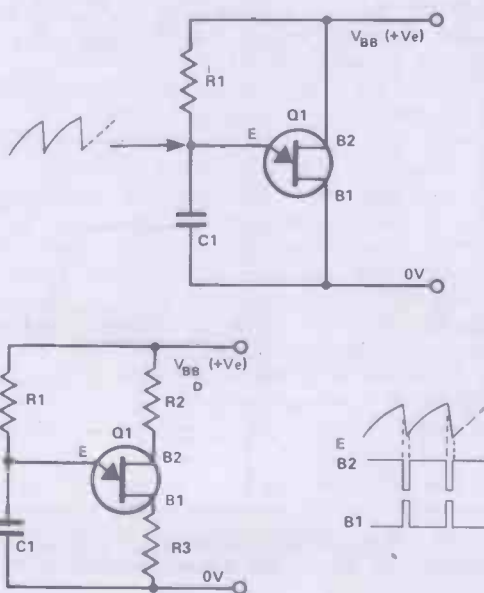

Fig. 2. (a) Basic Relaxation Oscillator. (b) An alternative of the basic circuit.

A PRACTICAL UJT: THE TIS43

The TIS43, made by Texas, is probably the most popular and readily available of all unijunction transistors presently in production. It is modestly priced, can be used

with supplies up to a maximum of 30 volts, and has a maximum peak-point current rating of 5 μ A and a valley-point current rating of 4 mA, thus allowing a wide range of timing resistor values to be accommodated. Basic details of the TIS43, including the outline, are shown in Figure 3.

The TIS43 is used as the basis of all practical UJT projects presented in the rest of this article.

EMITTER REVERSE VOLTS (MAX)	=	30V
V_{BB} (MAX)	=	35V
PEAK EMITTER CURRENT (MAX)	=	1.5 AMPS
POWER DISSIPATION (MAX)	=	300mW
INTRINSIC STANDOFF RATIO, η	=	0.55 TO 0.82
R_{BB}	=	4k Ω TO 9k Ω
I_p (MAX)	=	5 μ A
I_v (MAX)	=	4mA
OUTLINE (TO 92 CASE)	=	

Fig. 3. Basic characteristics and outline of the TIS 43 UJT.

PROJECTS: WAVEFORM GENERATORS

The TIS43 unijunction transistor can be used in a variety of waveform generator applications, and can readily be used to produce pulse, sawtooth, and rectangle waveforms. Figs 4 to 8 show a selection of practical waveform generator circuits.

Figure 4 shows the circuit of a wide-range pulse generator. A large amplitude pulse is available across both R2 and R3. Both pulses are of similar form, but are in anti-phase, and are available at a low impedance level.

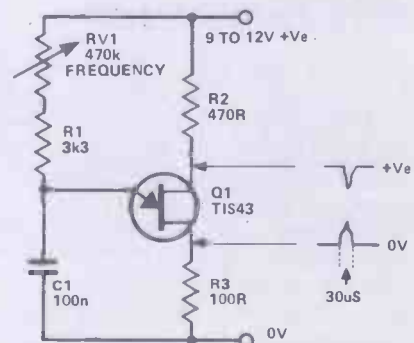

Fig. 4. A wide range pulse generator giving 30 μ S pulses at 25 Hz to 3 kHz.

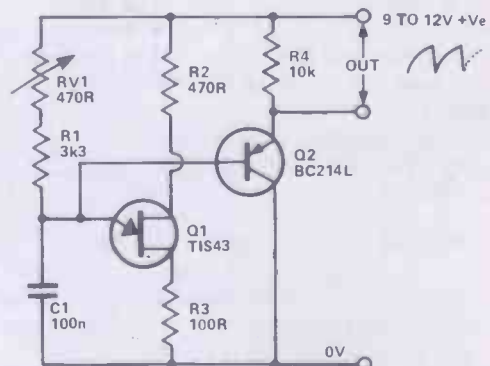

Fig. 5. A wide range (25 Hz to 3kHz) Saw-tooth generator.

Unijunction Transistors

With the component values shown the pulse width is constant at about 30 μ s over the frequency range 25 Hz to 3 kHz (adjustable via RV1). The pulse width and frequency range can be altered by changing the value of C1. Reducing C1 by a decade (to 10 nF) reduces the pulse width by a factor of 10 (to 3 μ s) and raises the frequency range by a decade (250 Hz to 30 kHz). C1 can have any value in the range 100 pF to 1000 μ F.

A sawtooth waveform is generated across C1 in the Fig 4 circuit, but is at a high impedance level and is thus not readily available externally. Access can be gained to this sawtooth either by wiring a one-transistor PNP emitter follower across the timing resistor network, as in Fig 5, or by wiring a two-transistor (Darlington or super-alpha) NPN emitter follower across C1, as in Fig 6.

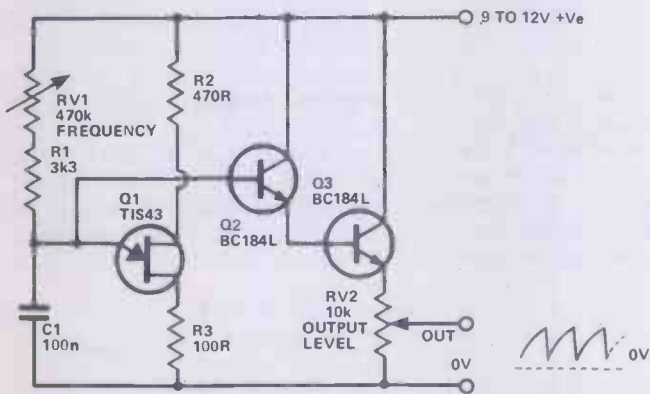

Fig. 6. A wide range (25 Hz to 3 kHz) saw-tooth generator with ground referenced variable amplitude output.

In the case of the Fig 5 circuit, the output is of fixed amplitude and is referenced to the positive supply line. In the case of Fig 6 the output is fully variable in amplitude (via RV2), and is referenced to the zero volts line. In both cases, the output waveform is a non-linear sawtooth. The non-linearity is caused by the fact that C1 charges exponentially, rather than linearly, via the RV1-R1 resistor timing network.

The basic unijunction circuit can be made to generate a linear sawtooth waveform by charging the main timing capacitor (C1) via a constant-current generator, rather than by a resistance network. Figure 7 shows the practical circuit of a linear sawtooth generator, which can also be used as a simple oscilloscope timebase.

In this circuit Q1 is used as the constant current generator. A fixed reference voltage is applied to the base of Q1 via the R1-D1-R2 network, and the collector current (which is used to charge C1) is determined by this voltage and the value of the RV1-R3 emitter network. The linear sawtooth that is generated across C1 is made available externally via the Q3-Q4 emitter follower network, and is variable in amplitude via RV3. With the component values shown, the frequency of the circuit is variable from 60 Hz to 700 Hz via RV1. Alternative frequencies can be obtained by changing the C1 value.

The Fig 7 circuit can be used as a simple oscilloscope timebase generator. In this application the sawtooth output should be taken to the 'external timebase' socket of the 'scope, and positive 'flyback' pulses from R5 can be taken via a high-voltage blocking capacitor and used for beam blanking. The generator can be synchronised

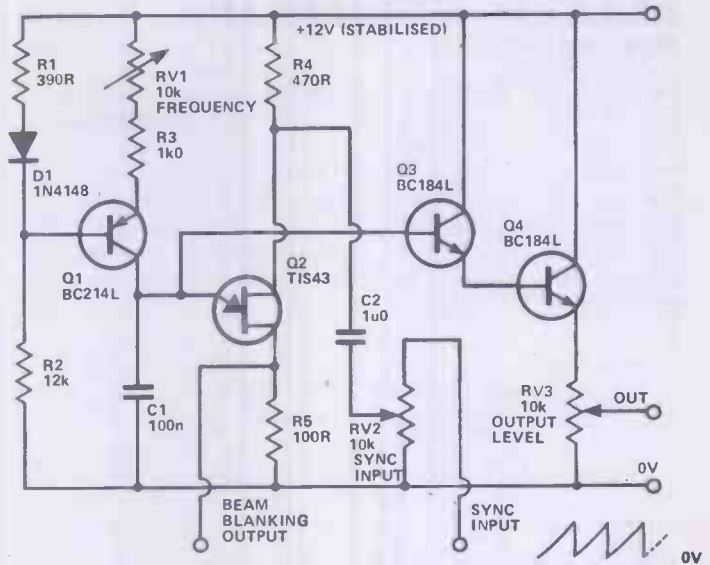

Fig. 7. This linear sawtooth generator can be used as a simple oscilloscope timebase.

to an external signal by feeding that signal to base 2 of the UJT via RV2 and C2. This signal effectively modulates the supply voltage (and thus the triggering point) of the UJT, thus causing it to fire in synchrony with the external signal.

Figure 8 shows how a unijunction transistor can be used to generate either a non-linear sawtooth, or a rectangular waveform with an infinitely variable mark-space ratio. The LF356 is a 'fast' operational amplifier, with a very high input impedance. When S1 is in the SAWTOOTH position this op-amp is connected as a unity-gain voltage follower, so the C1 sawtooth appears across output control RV2.

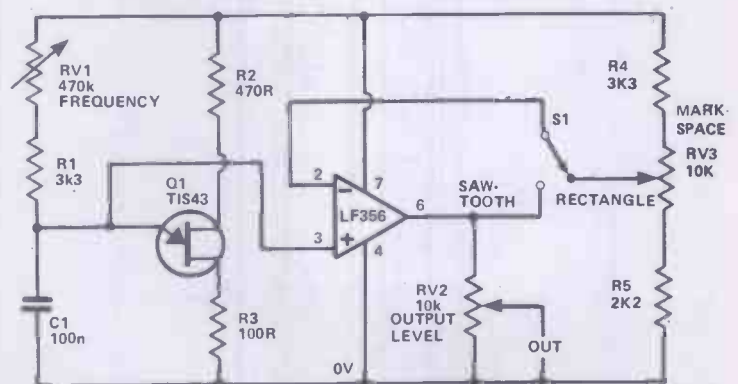

Fig. 8. 25 Hz to 3 kHz generator produces a non-linear sawtooth or a rectangular waveform with infinitely variable M-S ratio.

When S1 is set to the RECTANGLE position, the op-amp is configured as a fast voltage comparator, with the basic sawtooth waveform fed to one input terminal and a dc reference voltage (variable via RV3) fed to the other. This simple arrangement causes the input sawtooth to be converted to a rectangular output waveform, with a mark-space ratio determined by the setting of RV3. The mark-space ratio of the output waveform is independent of the frequency of the sawtooth input.

PROJECTS: GADGETS AND NOVELTIES

Figures 9 to 13 show a number of ways of using the unijunction transistor in miscellaneous gadgets and novelties. Figure 9 is the circuit of a morse-code practice oscillator. Here, the UJT is wired as a simple 300 Hz to 3 kHz oscillator, but has a speaker wired between base 1 and ground and has the morse key wired in series with the positive supply line. Thus, whenever the key is pressed the UJT oscillates and a low-level audible tone is generated in the speaker.

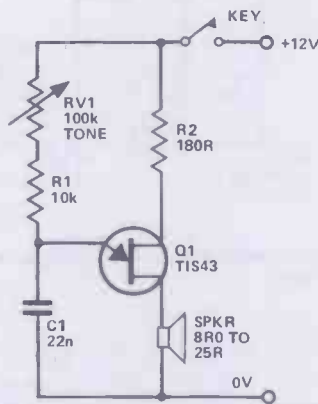

Fig.9. Simple 'code-practice' oscillator with tone variable from 300 Hz to 3 kHz.

Figure 10 is the circuit of a musician's metronome. The beat rate is variable from 20 to 200 per minute via RV1. The output pulses from across R3 are fed to the input of common emitter amplifier Q2, which uses a speaker as part of its collector load. Thus, a distinct 'click' is heard in the speaker each time the UJT completes a timing cycle.

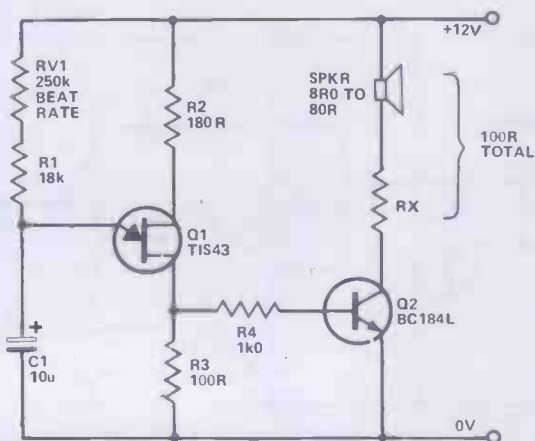

Fig.10. Musician's metronome giving 20 to 200 beats per minute.

Fig 11 is a simple multi-tone signalling system. The UJT oscillator is normally off, but turns on when any one of the PB1 to PB3 push-button switches is closed. Each switch connects its own unique value of timing resistor to the oscillator, so each switch causes a distinct tone to be generated. The circuit can be used with further switches, if required, so long as each switch is given its own distinct value of timing resistor.

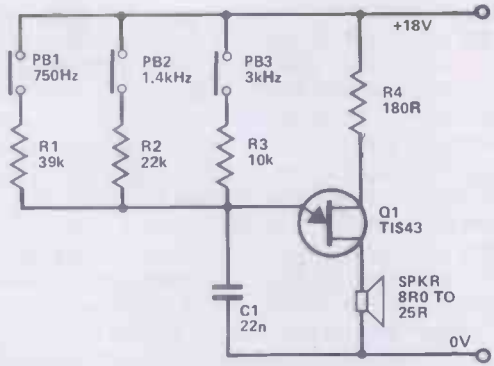

Fig.11. Simple multi-tone signalling system.

Figure 12 is the circuit of a simple rising-tone siren. The circuit operates as follows. When power is first applied, C1 is fully discharged (at zero volts), so the UJT oscillates at a low frequency determined by R3 and C2. As soon as power is applied, however, large value capacitor C1 starts to charge up via R1, so a slowly rising exponential voltage is developed across C1. This voltage is used to add charge to main timing capacitor C2 via R2 and D1, so the frequency of the oscillator slowly rises as C1 charges up. The graph shows how the frequency rises exponentially with time.

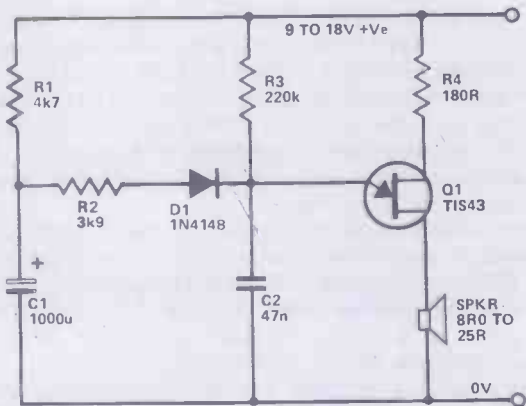
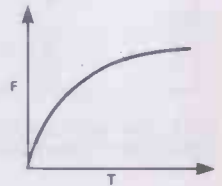

Fig.12. Simple rising-tone siren.

Finally, Fig 13 shows how the UJT can be used as a light-sensitive oscillator by using light-dependent resistor LDR as the main timing resistor of C1. Under dark conditions the value of the LDR is very high, so the operating frequency is very low and is determined mainly by the value of R1. Under very bright conditions the resistance of the LDR is very low, so the operating frequency is high and is determined mainly by R2. At intermediate light levels the operating frequency is determined mainly by the value of the LDR, and thus by the light level. This circuit can thus be used as a simple musical instrument that can be played by the light of a torch or by shadows cast by the hand.

Unijunction Transistors

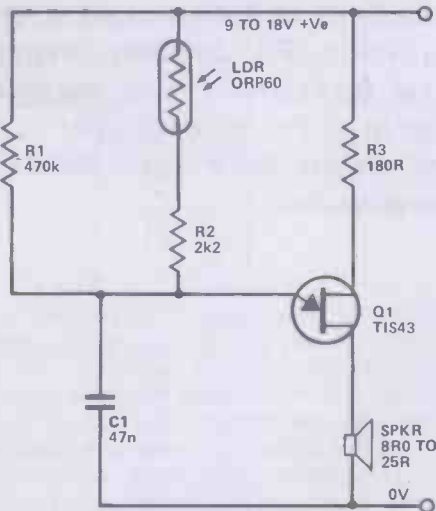

Fig. 13. Light sensitive oscillator.

PROJECTS: THYRISTOR POWER CONTROL

UJT circuit can produce output pulses with high peak energy which can easily be used to control triacs and other types of thyristor. The thyristors themselves can be used to switch mains power to electric lamps, heaters, motors, etc. Although the UJT circuits provide high peak output power, via the rapid discharge of a timing capacitor, they consume only a low level of mean power in slowly charging up the timing capacitor in the first place and thus have easily satisfied power supply requirements.

Figures 14 to 16 show four relatively simple ways of using UJTs to control triac power switches. The Fig 14 circuit is a simple on/off unit, in which the UJT circuitry is electrically fully isolated from the high voltage triac system via pulse transformer T1 (this type of transformer is available from Watford Electronics and some of the other large mail order companies that advertise in this magazine).

When S1 of the Fig 14 circuit is closed, the UJT oscillates and its output pulses are coupled to the gate of the triac via T1, so the triac turns on and applied power to the mains load. The UJT, which is powered from a low

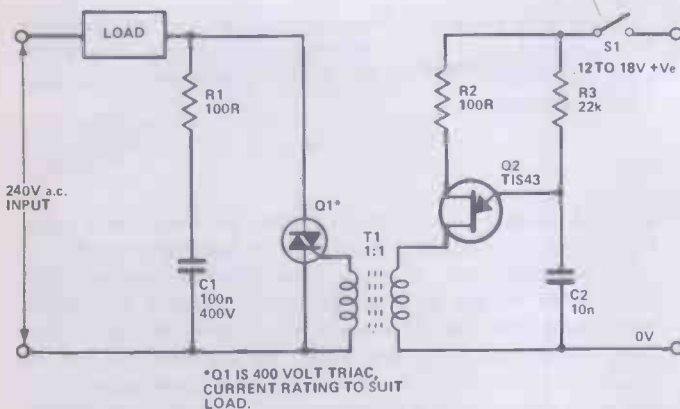

Fig. 14. Isolated input AC power switch.

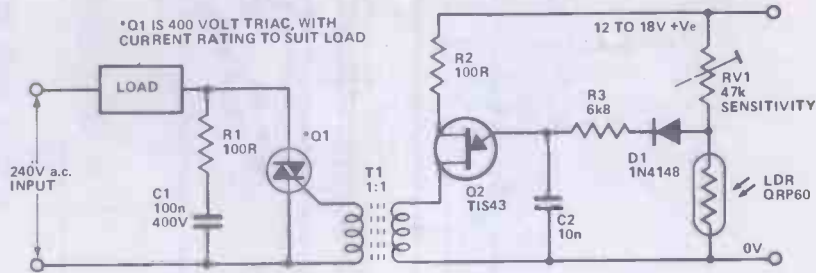

Fig. 15. Simple isolated-input AC power switch.

voltage DC supply, can in turn be activated by additional electronic circuitry, as shown in the example of Fig 15.

In the Fig 15 circuit RV1 and the LDR form a light-sensitive potential divider which has its output taken to the UJT timing resistor via D1. Under bright conditions the LDR resistance is low and the output voltage of the potential divider is insufficient to enable the UJT to trigger, so the triac is off. Under dark conditions the LDR resistance is high and the output of the potential divider enables the UJT to oscillate, so the triac turns on and applies power to the load. The circuit thus acts as a light-sensitive AC power switch.

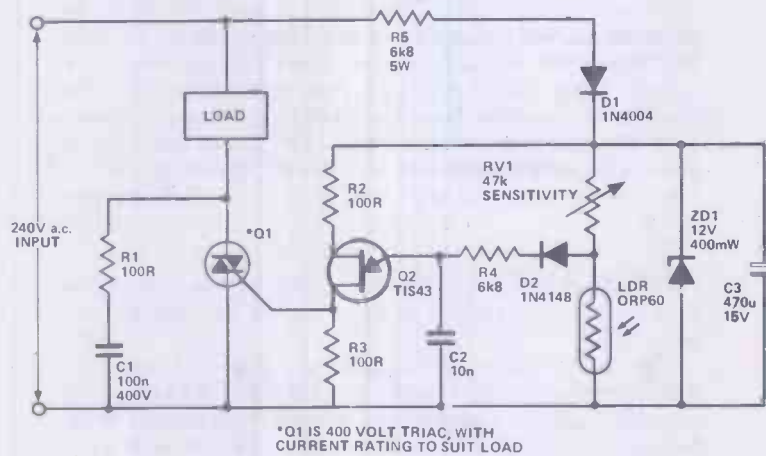
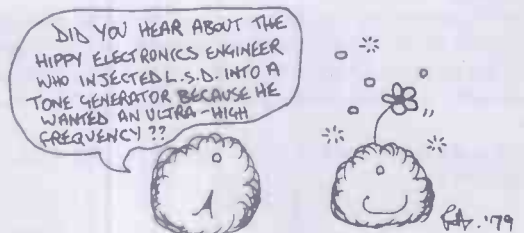
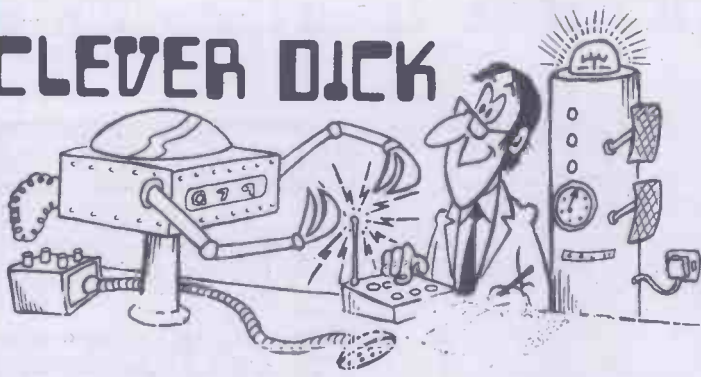

Fig. 16. Light activated AC power switch with non-isolated input.

Fig 16 shows an alternative version of the above circuit in which the UJT is not electrically isolated from the triac. In this case the UJT output pulses are fed directly into the gate of the triac and the UJT is powered from a 12 volt DC supply that is derived from the mains via the R5-D1-ZD1-C3 network. **HE**



CLEVER DICK



A good selection this month, we are also pleased to announce the birth of the HE Binders to keep your copies in good condition. For anyone interested in Ni-Cad batteries we suggest a modification to a charger circuit published some time ago. What more could anyone ask?

Sometimes it's not our fault, take the comments from Mr Scotney of Nottingham, he says;

Dear Dick,

I write regarding a couple of articles in HE that have, possibly through my own ignorance, given me a fair bit of trouble.

The first point is in the Multi Option Siren. (Oct HE). In the parts list, PCB overlay and circuit diagram you show four potentiometers but there does not appear to be more than three on the completed unit. Secondly, there is only one connection shown to switch two. Is this correct and always the case, taking for granted that the other terminal is connected to the supply.

My final point is regarding the siren circuit published in conjunction with the Burglar Alarm in the August HE. After constructing this (the siren) it was found to be non-operational. Upon close inspection of the PCB it was found that D1 and D2 had not been connected to the supply. After connecting the two relevant tracks the alarm was found to function perfectly. I hope you can clear up these two points so that I can put to use several pounds of components and also satisfy my eager son.

*K B Scotney
Nottingham.*

We must admit that we put the control on the rear of the case but this can clearly be seen on the photograph on page 60.

The switch connects between pin 3 of IC1 and C2, the upper position (IC1) is the square wave. As you point out on the burglar alarm siren the track does appear to be missing but this was a printing problem and only happened on a few copies — sorry.

The energy crises have reared their unhappy heads again in the shape of battery power. The rising costs of dry batteries have made the Nickle Cadmium rechargeable battery a more attractive proposition. Even taking into account their initial cost they will more than repay themselves in only a very short time.

All of this brings us to a question from Mr N G Corbett, he asks:

Dear Dick,

With reference to the Ni-Cad battery charger that appeared in the Short Circuits feature in the September HE. Can this circuit be used to charge A PP3 type battery, if not why not and how about a more useful circuit that can.

How about an AF signal generator as one of your projects?

*N G Corbett
Birmingham.*

After a degree of head scratching we came to the conclusion that virtually any Ni-Cad (within reason) can be efficiently charged with this circuit. The limiting factor is resistor R2, this determines how much current is passed through the battery. Our calculations show that as the optimum charging current is around ten times less for a PP3 type battery than for an HP7, the value of R2 needs to be increased by a factor of ten so it should now be 100R. As for AF signal generators we have published two so far in the February and August issues.

Burglar alarms are always popular projects so we were not surprised to receive this letter from Mr Deans:

Dear CD,

Would you please refer me to any of your publications which give constructional details of a 'secret ray' type of burglar alarm.

Any other information on this matter would be appreciated.

*D H Deans
W. Sussex.*

We haven't published anything along these lines as yet but don't despair our workshop are currently experimenting with Infra-Red devices with a view to producing a highly sophisticated burglar alarm, look out for that in the coming months.

Now it's pat our back time. George Bell from Cornwall asks a most opportune question to which we are only too happy to reply.

Dear Dick,

Could you please tell me the price and department from which I may obtain HE magazine binders. I have not seen any adverts for them in HE (perhaps I have not looked hard enough).

*George Bell
Liskeard.*

What a lovely excuse to tell you all about our new binders (Actually that's a bit untrue because we didn't have any old ones). We are now offering custom built binders for Hobby in a rather stunning Blue with gold embossed lettering. They will be on sale at the end of next month and will be all yours for the miserly sum of £3.20 including VAT etc. If you are interested please see the ad in this issue but do allow three weeks for delivery.

One of our most popular projects in recent months has proved to be the Hobbytune. Electronic music is a very recent newcomer to our hobby it is a field that has still plenty of room for experiment so it would seem quite natural for someone to want to take the Hobbytune a stage further. This letter from Mr Tibbings poses an interesting question.

Dear HE

I am building your Hobbytune from the October issue and am planning to build the ADSR envelope generator straight into the same box.

Is it possible to supply me with information on how to connect the two units together. Is it possible to run both units from the same battery and is it possible to connect the ADSR output stage into the Hobbytube amplifier itself, without having to build a separate amplifier, if so how?

M. Tibbings
Stockport

In reply to your interesting question Mr Tibbings we're cornered John FitzGerald (the designer of the ADSR and Hobbytune) to come up with a few ideas. His scribbblings appear below. Hope it's OK.

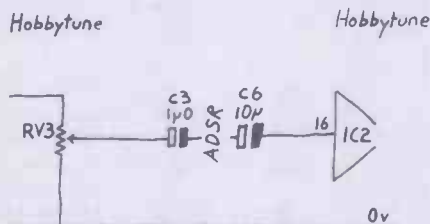

Connect ADSR at input of Hobbytune Amplifier as shown above.

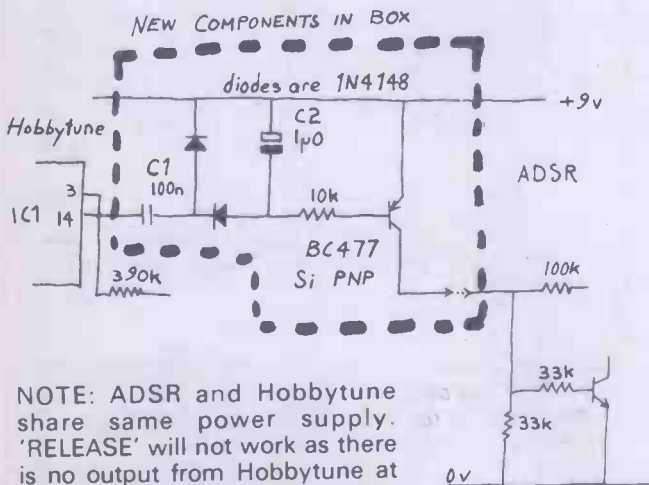

NOTE: ADSR and Hobbytune share same power supply. 'RELEASE' will not work as there is no output from Hobbytune at this time. Attack, Decay and Sustain all work. You may have to experiment with the values of C1, 2.

Well, that's about it for another month, thanks for keeping your letters a bit shorter this month as you can see it enables us to get several more in as well as the circuit diagram. We will try to incorporate more things like that in the future. See you next month Dick.

THE NEW

EUROSOLDERSUCKER

This 195mm long, all metal, high suction, desoldering tool with replaceable Teflon tip enables removal of molten solder from all sizes of pcb pads. Primed and released by thumb, it incorporates an anti-recoil system and built-in safety guard. **Only £7.25 inc. VAT & P.A.**

THE UNIQUE

EUROBREADBOARD

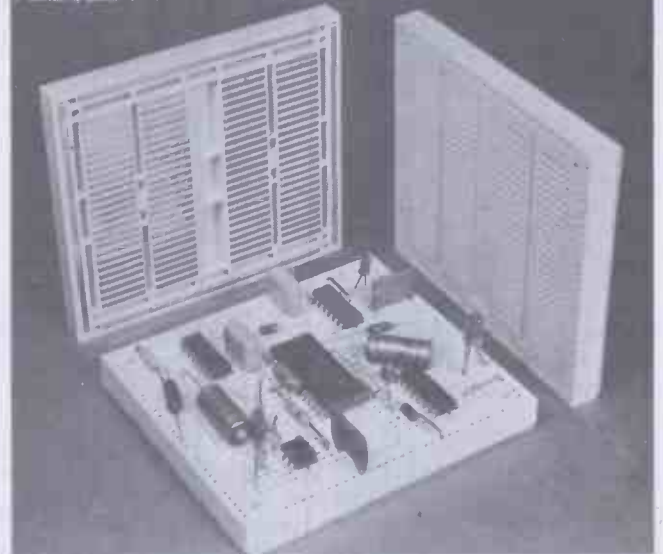

Logically laid out to accept both 0.3" and 0.6" pitch DIL packages as well as Capacitors, Resistors, LEDs, Transistors and components with leads up to 85mm dia.

500 individual connections in the central breadboarding area, spaced to accept all sizes of DIL package without running out of connection points, plus 4 Integral Power Bus Strips around all edges for minimum inter-connection lengths.

All connection rows and columns are not numbered or lettered enabling exact location indexing.

Double-sided nickel silver contacts for long life (10K insertions) and low contact resistance (< 10m, ohms).

Easily removable, non-slip rubber backing allows damaged contacts to be rapidly replaced.

No other breadboard has as many individual contacts, offers all these features and costs only £6.20 each or £11.70 for 2 — inclusive of VAT and P.P.

Snip out and Post

David George Sales, r/o 74 Crayford High St., Crayford
Kent DA1 4EF

David George Sales
r/o 74 Crayford High Street,
Crayford, Kent, DA1 4EF.

HG.12.79

Please send me 1 EuroSolderSucker @ £7.25 Please
or 1 EuroBreadBoard @ £6.20
or 2 EuroBreadBoards @ £11.70 Tick

(All prices are applicable from July 1st, 1979 and include VAT & P.P., but add 15% for overseas orders).

Name

Company

Address

.....

.....

Tel. No.

Please make cheque/P.O. payable to David George Sales.

Hebot II

Continuing story of home Hebotics

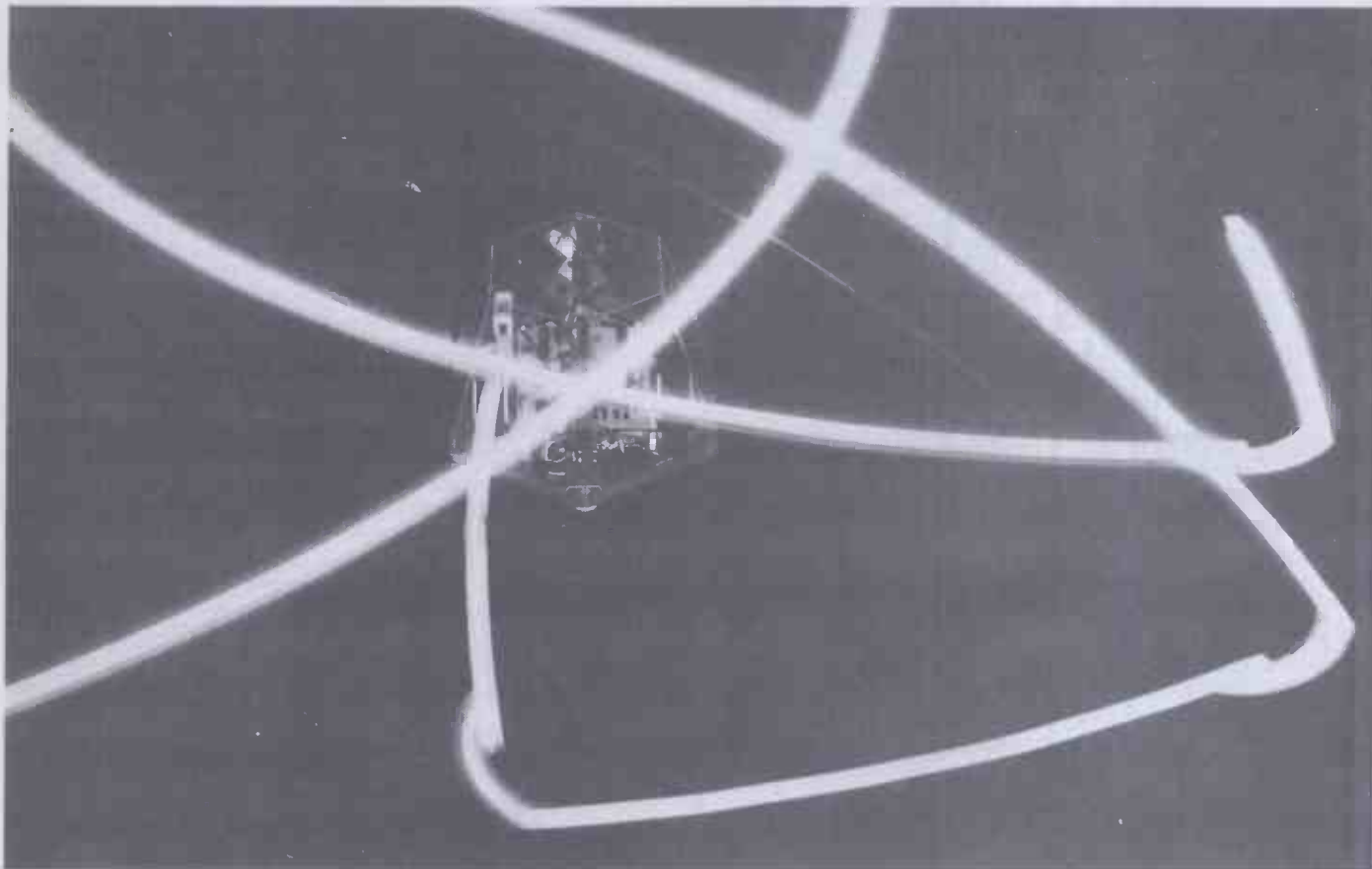

Time-lapse photography shows HEBOT exploring a maze.

THIS MONTH we will begin to describe how to add sound to the Hebot and sensitise it to light, sound and electromagnetic radiation enabling Hebot to search for and find a recharging nest.

Before describing these functions in more detail, we will take a look at some of the points arising from last month's feature. As described in the text, unused inputs of IC3 should be connected to minus five volts to ensure proper operation of the chip. The uncommitted inputs of IC's 4, 5 may be left floating without any problems. As transmission gates, they are designed to accept any voltage within the supply range at their signal inputs anyway. The motor-servo-amps are very simple and depend for their proper operation on use of a split supply. If Hebot were to travel in one direction only for most of the time then only one half of the battery supply would be discharged. This is unlikely to cause any problems; however, to allow for any subsequent design changes in this section of the circuitry, this month's board has been designed to operate from a single supply voltage. The 'mid-rail' zero volt line is generated electronically 'on-board'. All the CMOS chips are buffered; 'B series', and the capacitors should be sixteen volts working or higher.

TWIST AND SHOUT

The circuitry on the second board described here is mostly concerned with searching and driving towards a light (phototropism) and tracking a cable by detecting an AC energising signal. The details of operation of these circuits will be dealt with fully next month.

The rest of the circuitry enables Hebot to perform a random walk, generate a short tone and respond to loud noises. 'Random walk' is something of a misnomer as Hebot actually executes a series of spirals as shown in our photos enabling him to 'look around' his environment. The circuit which generates this motion is very simple and quite elegant consisting of a single op-amp connected as a conventional astable oscillator. To operate, all you need to do is connect pin 10, IC3 to plus five volts and connect pins A, B to pins 1, 12, IC4 (X 0 Y, 0). It does not matter whether A or B goes to pin 1 or 12. This only affects the direction of the spiral motion.

We have also given Hebot a voice. The circuitry around IC5 accomplishes this. IC5 is a 555 timer connected as an astable oscillator whose output is gated on and off by driving the reset input via transistors Q6, 7. Whenever input pin Y is driven to plus five volts, a

How it Works

All the circuitry on this board is powered from the plus and minus five volt supply. Although the junction of the batteries (0 V) is available, an artificial 0 V is generated on-board by R2, 3, C2 and appears at pin 1, IC1. The op-amp is connected as a voltage follower and merely provides a low impedance output to drive other circuitry. This feature enables the board to be operated from a single supply ensuring a more flexible system.

The 'random walk' is produced by driving the servo-amps with signals from an astable oscillator formed by components R4, 5, 6, C1 and one of IC1's amplifiers. The outputs are taken from C1 and the junction of R5, 6 and appear at A and B. Resistors R1, 7 protect the diode networks inside the CMOS multiplexer chips IC4, 5 to which these outputs will be connected. Note that the bottom of R6 goes to pin 1, IC1; effectively 0 V.

The remaining two amps in IC1 and all of IC3 together form the wire tracking circuitry enabling the Hebot to follow a cable back to its nest by detecting an AC signal. There are two identical input stages whose outputs are pins 7, 8, IC1. An AC signal from the sensor coils is coupled to the inputs (pins 6, 9, IC1) by capacitor Cx or directly. Each amplifier operates as a current-to-voltage converter and produces an alternating voltage output. The detection stages are identical. The signal at pin 8, IC1 is coupled via C3 to rectifiers D1, 3 and charges C5 producing a DC voltage which is proportional to the strength of the input signal from the sensor coils. This voltage varies between -5 V and approximately +1 V and app-

ears at pins E, F where it should be coupled to pins G, H. Two of the amps in IC3 are used with resistors R16, 17, 18, 19 to convert the output voltages from C5, 6 to signals swinging between 0 V and +3.5 V suitable for driving the motors forward via the multiplexers and servo amps. The signals appear at pins I and J.

Hebot needs to know whether there is any useful signal at these outputs and this is accomplished by measuring the average voltage across capacitors C5, 6. This signal appears at pin 14, IC3. When it rises above about 0.7 V (measured with respect to Q1 emitter) transistor Q1 is biased 'on' and the voltage at its collector will fall towards -5 V. This signal is input to the Schmitt trigger (pin 9, IC3) and appears inverted at pin M. An identical signal appears at pin L. However, this output may be disabled by pulling pin K to -5 volts. Resistors R25, 26 and capacitor C7 provide a bias voltage for the Schmitt trigger.

The circuitry around IC2 enables Hebot to detect and steer towards a source of light. The two input stages are identical. A current flows through Q2 which is proportional to the incident light. This is converted to a voltage which varies between 0V and +3.5 V and is output at pin 1, IC2 (pin P). The output from Q3 appears at pin Q.

The output levels at P, Q are suitable for driving the motors forward via the multiplexers and servo-amps. Resistors R27, 28, 29 form a potential divider which drives the Schmitt trigger (input pin 9, IC2) whose output is normally 'high' (at about +3.5 volts). When the average voltage at P, Q rises

NOTES:
IC1,3 IS LM324 (pin 4 IS +Ve; pin 11 IS -Ve SUPPLY)
Q1 IS BC107
ALL DIODES ARE 1N4148

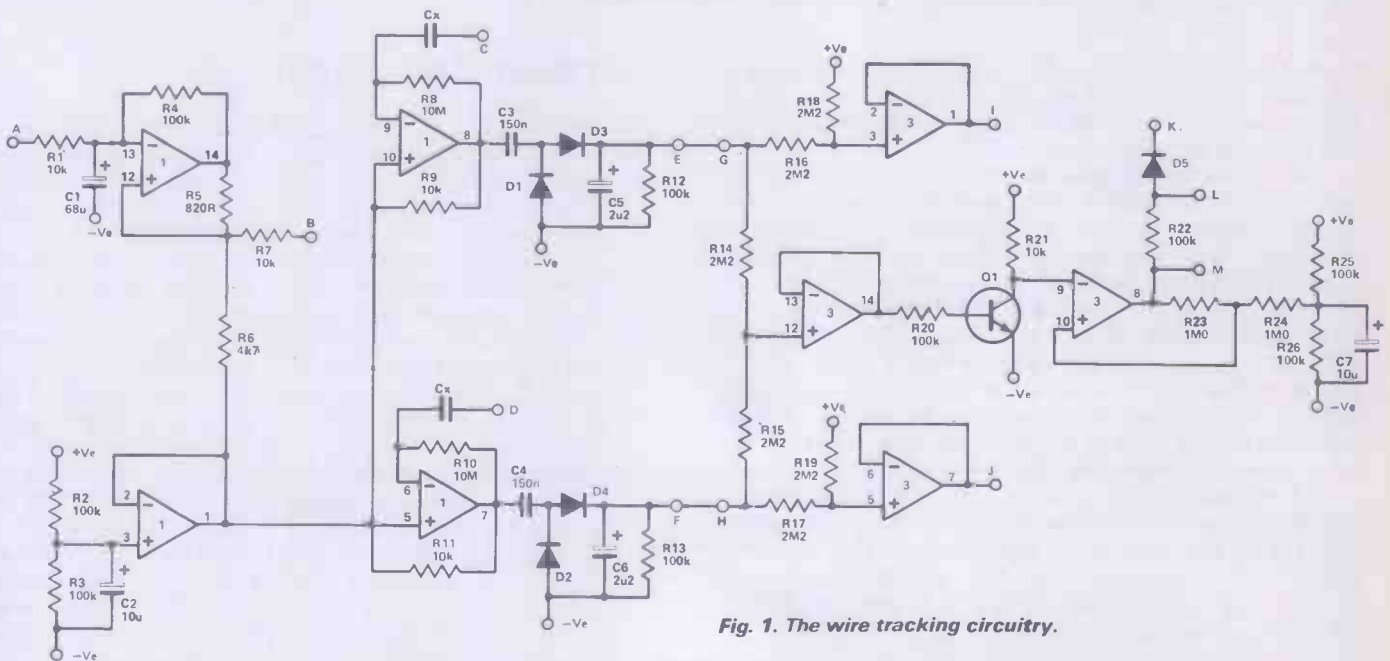

Fig. 1. The wire tracking circuitry.

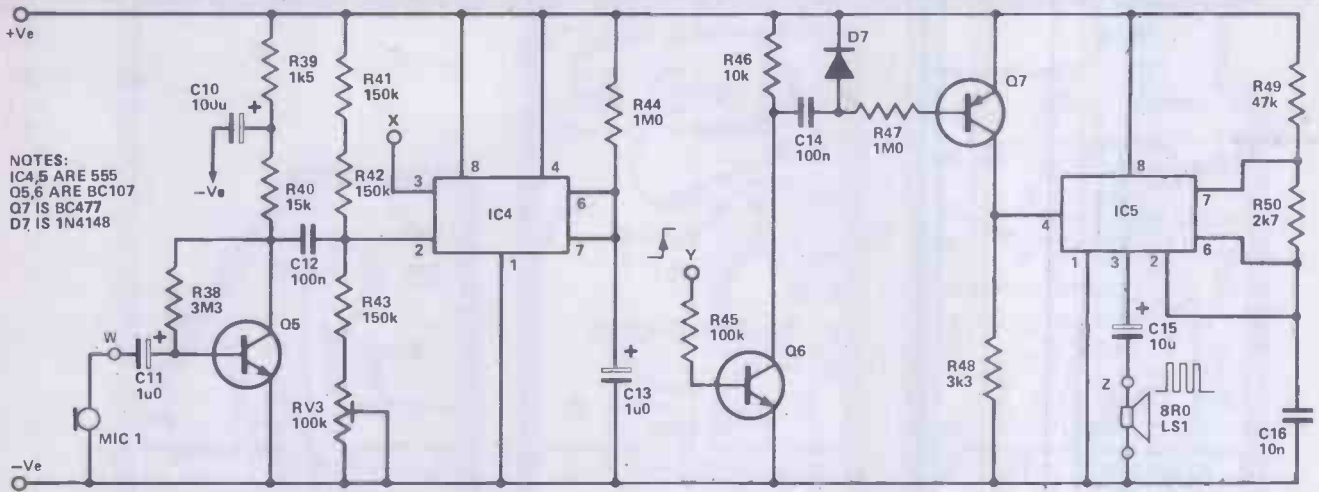

Fig. 2. Sound detection and generation circuitry.

above about 0.5 volts, ie when Hebot sees light, the output of the Schmitt trigger goes 'low' (to about -5 volts) biasing off Q4 and causing the voltage at its collector (pin T) to rise from -5 V to +5 V. This signal is repeated at pin U but may be disabled by pulling pin K to -5 volts.

The remaining section of IC2 may be used to give a visual indication of operation of other parts of the circuit. It is connected as a conventional inverting amplifier with an input resistance of ten million ohms.

With the input (pin S) disconnected, the LED will glow at medium brilliance. Connecting pin S to pin V will cause it to glow brightly indicating a positive input, while connecting a negative input (pin R) will extinguish the LED.

Integrated circuits IC4, 5 enable Hebot to detect and generate sound. Both devices are 555 timers. IC4 will produce a positive output at pin X of monostable period determined by R44, C13 (about one second with the values shown) when triggered by a sound at the microphone, MIC1. The sensitivity of the circuit is set by adjustment of

RV3. The trigger input of the chip (pin 2, IC4) is normally held above the trigger voltage of one-third of the supply voltage by bias resistors R41, 42, 43, RV3. Any sound picked up by the microphone produces an alternating voltage at Q5 collector which is coupled to the trigger by C12. A loud noise will produce a signal of sufficient amplitude to trigger IC4. The output signal (pin X) could be used to throw Hebot into reverse, a spin, or just stop him in his tracks.

IC5 produces a short burst of sound each time input Y is taken from -5 volts to +5 volts. Each positive transition of this input causes Q6 collector to go low to -5 volts. This signal, coupled to Q7 by C14, R47 causes the reset input (pin 4, IC5) to be pulled to +5 volts enabling the oscillator to produce a short tone burst. Any digital signal may be input to pin Y. If 'avoid' (pin 12, IC11 board one) is connected, a tone will be produced each time Hebot encounters an obstacle. The loudspeaker is AC coupled to IC5 to avoid excessive current flow. The frequency can be changed by adjustment of R49 or C16.

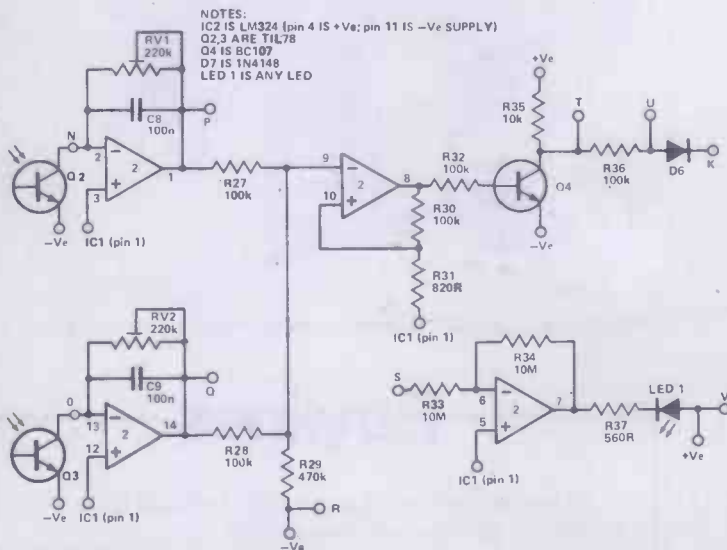
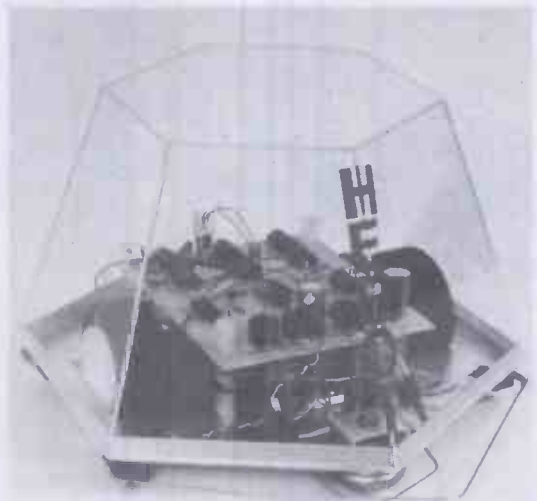

Fig. 3. The light seeking circuitry.



The HEBOT, conceived by the HE design team led by Ray Marston

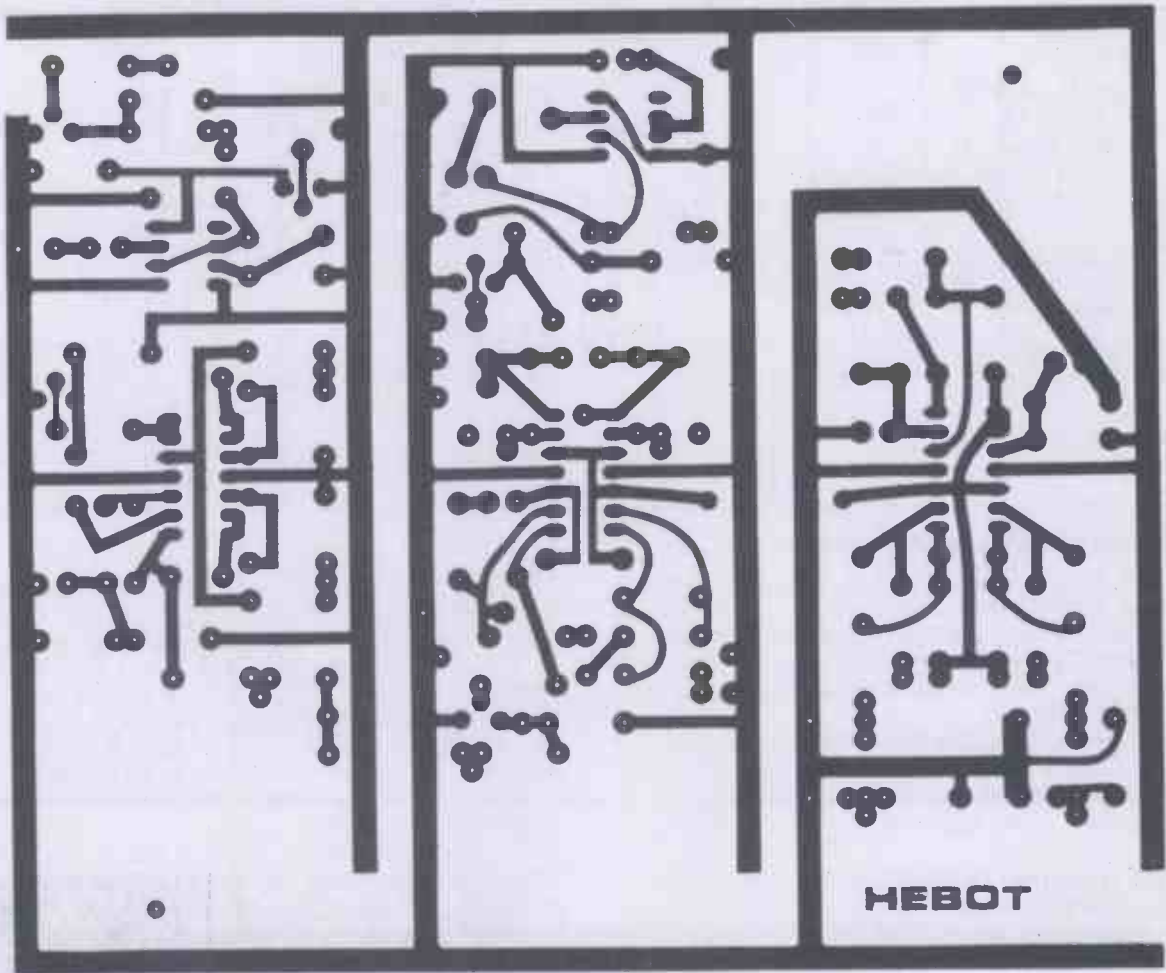

Fig. 4. PCB foil pattern for HEBOT.

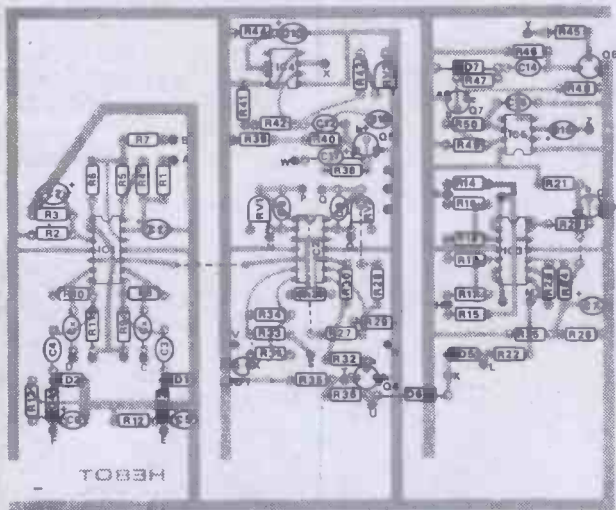
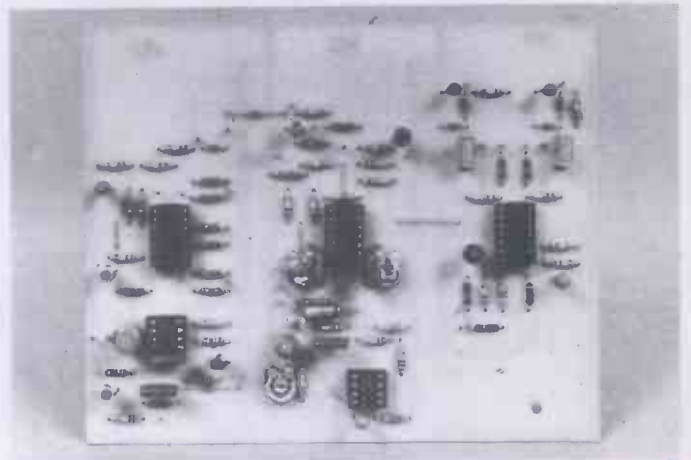

Fig. 5. PCB overlay for HEBOT.



HEBOT's second board contains mostly analogue circuitry.

Buylines

All the components for this board should be readily available from your usual suppliers.

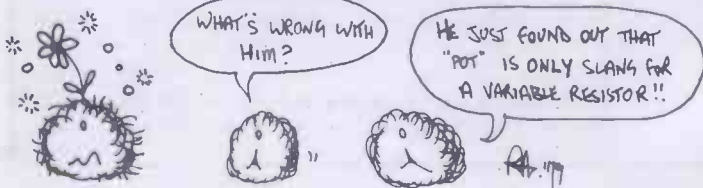



Parts List

RESISTORS (all 1/4W 5%)

R1, 7, 9, 11, 21, 35, 46	10k
R2, 3, 4, 12, 13, 20, 22, 25, 26, 27, 28, 30, 32, 36, 45	100k
R5, 31	820R
R6	4k7
R8, 10, 33, 34	10M
R14, 15, 16, 17, 18, 19	2M2
R23, 24, 44, 47	1M0
R29	470k
R37	560R
R38	3M3
R39	1k5
R40	15k
R41, 42, 43	150k
R48	3k3
R49	47k
R50	2k7

POTENTIOMETERS

RV1, 2	220k
RV3	100k

CAPACITORS

C1	68μ tantalum
----	--------------

C2, 7

C3, 4

C5, 6

C8, 9, 12, 14

C10

C11

C13

C15

10μ tantalum

150n polyester

2μ2 tantalum

100n polyester

100μ tantalum

1μ0 electrolytic

1μ0 tantalum

10μ electrolytic

SEMICONDUCTORS

Q1, 4, 5, 6

Q2, 3

Q7

D1 thru D7

IC1, 2, 3

IC4, 5

BC107

TIL 78

BC 477

all 1N4148

LM324

555

MISCELLANEOUS

MIC1

any microphone (crystal or balanced armature inserts work well)

LS1

any loudspeaker (we used an 8 ohm 1 1/2 inch loudspeaker)

PCB, IC sockets, terminal pins

LED1

any LED (we used TIL 220)

short tone is produced. If you connect pin Y to the 'avoid' output of last month's board, Hebot will emit a surprised squeak following each collision.

The other 555 is used with Q5 to detect sounds. Hebot can be made sensitive to loud noises by adjustment of RV3. Any sufficiently loud noise will cause the 555 output (pin X) to rise from minus to plus five volts for about one second. Pin X may be connected to any of the inputs of IC3 (only one connection to each input though!) to make Hebot select control from any X, Y set of inputs. If pin X were connected to input '7' (pin 4, IC3 board one) and X7 (pin 4, IC5) were connected to plus five volts with Y7 (pin 11, IC5) connected to minus five volts then Hebot would execute a spin following each loud noise. Note that in this case, the avoid manoeuvre circuitry would be inoperative as level seven has the highest priority.

CONSTRUCTION

Use of our PCB is essential (try putting it together on 'S-DEC!'). The wire links should be inserted first; note that one passes beneath an IC holder. Sockets are recommended though none of the chips on this board are sensitive to static discharge. The other components may be inserted in the usual order; resistors, capacitors and semiconductors. Take care not to overheat any components and beware of shorting copper tracks with solder bridges as some of them pass quite close to each other. Also, of course, note the polarity of the semiconductors, IC 1, 2, 3 point up while IC4, 5 point down.

Do not be afraid to experiment with other configurations than the ones described and try designing your own circuitry. Make Hebot a vehicle for *YOUR* ideas.



HEBOT's avoidance manoeuvre (above) and the 'random walk' (below).

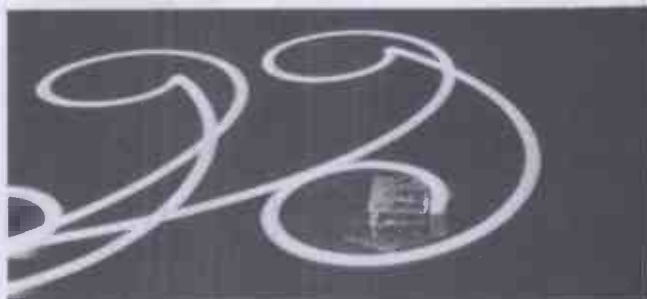

Next month's article will describe the beacon circuitry and ni-cad charging unit with a pin by pin account of how to get the rest of the circuitry up and running and elicit express action from the educated electrons as they run around the tracks. Chips with everything ... don't miss it!

HE

STEVENSON

Electronic Components

CMOS			
4020	50p	4050	25p
4022	50p	4060	80p
4023	13p	4066	30p
4024	40p	4068	13p
4025	13p	4069	13p
4026	90p	4070	13p
4027	28p	4071	13p
4028	45p	4072	13p
4029	50p	4081	13p
4040	55p	4093	36p
4041	55p	4510	60p
4042	55p	4511	60p
4043	50p	4518	65p
4046	90p	4520	60p
4049	25p	4528	60p

FULL DETAILS IN CATALOGUE!

TTL			
7473	20p	74141	55p
7474	22p	74145	55p
7475	25p	74148	90p
7476	20p	74150	55p
7485	55p	74151	40p
7486	20p	74154	65p
7489	135p	74157	40p
7490	25p	74164	55p
7492	30p	74165	55p
7493	25p	74170	100p
7494	45p	74174	55p
7495	35p	74177	50p
7496	45p	74190	50p
74121	25p	74191	50p
74122	35p	74192	50p
74123	38p	74193	50p
74125	35p	74196	50p
74126	35p	74197	50p
74132	45p	74199	90p

OPTO			
LED's:	0.125in	0.2in	each 100
Red	TIL209	TIL220	9p 7.5p
Green	TIL211	TIL221	13p 12p
Yellow	TIL213	TIL223	13p 12p
Clips:	3p	3p	
DISPLAYS			
DL704	0.3 in CC	130p	120p
DL707	0.3 in CA	130p	120p
FND500	0.5 in CC	100p	80p

SKTS			
8pin	8p	18pin	14p
14pin	10p	20pin	16p
16pin	11p	22pin	17p
24pin	18p	28pin	22p
40pin	32p		
3 lead T018 or T05 socket. 10p each			
Soldercon pins: 100:50p 1000:370p			

PCBS			
VEROBOARD			
Size in	0.1in	0.15in	Vero Cutter 80p
25 x 1	14p	14p	
2.5 x 3.75	45p	45p	
2.5 x 5	54p	54p	Pin insertion tool 108p
3.75 x 5	64p	64p	
3.75 x 17	205p	185p	
Single sided pins per 100 40p 40p			
Top quality fibre glass copper board Single sided Size 203 x 95mm 60p each			
'Data' pens 75p each			
Five mixed sheets of Altac 145p 100p 100p 100p 100p			

RESISTORS			
Carbon film resistors. High stability, low noise 5%			
E12 series. 4.7 ohms to 10M. Any mix	each	100+	1000+
0.25W	1p	0.9p	0.8p
0.5W	1.5p	1.2p	1p
Special development packs consisting of 10 of each value from 4.7 ohms to 1 Meg-ohm (650 resist) 0.5W £7.50. 0.25W £5.70.			
METAL FILM RESISTORS			
Very high stability, low noise rated at 1% 1%. Available from 51ohms to 330k in E24 series Any mix.			
0.25W	4p	3.5p	3.2p

PLEASE WRITE FOR YOUR FREE COPY OF OUR 80 PAGE CATALOGUE OF COMPONENTS.

CONTAINS OVER 2500 STOCK ITEMS.

LINEAR			
LF356	80p	NE531	98p
LM301AN	26p	NE555	23p
LM308	60p	NE556	60p
LM318N	75p	NE567	100p
LM324	45p	RC4136	100p
LM339	45p	SN76477	230p
LM378	230p	TB8800	70p
LM379S	410p	TB8810S	100p
LM380	75p	TD1022	620p
LM3900	50p	TL081	45p
LM3909	65p	TL084	125p
LM3911	100p	ZN414	80p
MC1458	32p	ZN425E	390p
MM57160	590p	ZN1034E	200p

TRANSISTORS			
AC127	17p	BCY72	14p
AC128	16p	BD131	35p
AC176	18p	BD132	35p
AD161	38p	BD140	35p
AD162	38p	BFY50	15p
BC107	8p	BFY51	15p
BC108	8p	BFY52	15p
BC108C	10p	MJ2955	98p
BC109	8p	MPSA06	20p
BC109C	10p	MPSA56	20p
BC147	7p	TIP29C	60p
BC148	7p	TIP30C	70p
BC177	14p	TIP31C	65p
BC178	14p	TIP32C	80p
BC179	14p	TIP2955	65p
BC182	10p	TIP3055	55p
BC182L	10p	ZTX107	14p
BC184	10p	ZTX108	14p
BC212	10p	ZTX300	16p
BC212L	10p		
BC214	10p		
BC214L	10p		
BC477	19p	1N914	3p
BC478	19p	1N4001	4p
BC548	10p	1N4002	4p
BCY70	14p	ITT Full spec. product	
BCY71	14p	1N4148	£1 40 100 £11 1000

CAPACITORS			
TANTALUM BEAD			
0.1, 0.15, 0.22, 0.33, 0.47, 0.68, 1 & 2.2uF @ 35V			each 8p
4.7, 6.8, 10uF @ 25V			13p
22 @ 16V, 47 @ 6V, 100 @ 3V			16p
MYLAR FILM			
0.001, 0.01, 0.022, 0.033, 0.047, 0.068, 0.1			3p
			4p
POLYESTER			
Mullard C280 series			
0.01, 0.015, 0.022, 0.033, 0.047, 0.068, 0.1			5p
0.15, 0.22			7p
0.33, 0.47			10p
0.68			14p
1.0uF			17p
CERAMIC			
Plate type 50V. Available in E12 series from 22pF to 1000pF and E6 series from 1500pF to 0.047uF			
RADIAL LEAD ELECTROLYTIC			
63V	0.47	1.0	2.2
			4.7
			10
			22
			33
			47
			5p
			7p
			13p
			20p
25V	10	22	33
			47
			5p
			8p
			10p
			15p
			23p

CONNECTORS			
JACK PLUGS AND SOCKETS			
	screened	unscreened	socket
2.5mm	9p	13p	7p
3.5mm	9p	14p	8p
Standard	16p	30p	15p
Stereo	23p	36p	18p
DIN PLUGS AND SOCKETS			
	plug	chassis socket	line socket
2pin	7p	7p	7p
3pin	11p	9p	14p
5pin 180°	11p	10p	14p
5pin 240°	13p	10p	16p
1mm PLUGS AND SOCKETS			
Suitable for low voltage circuits. Red & black Plugs 6p each Sockets 7p each			
4mm PLUGS AND SOCKETS			
Available in blue, black, green, brown, red, white and yellow Plugs 11p each Sockets 12p each			
PHONO PLUGS AND SOCKETS			
Insulated plug in red or black			9p
Screened plug			13p
Single socket	7p	Double socket	10p

SOLDERING IRONS

ANTEX X25 (25W) or ANTEX CX (17W) 390p each
Reel of solder (39.6M) 240p each

LOUDSPEAKERS

56mm dia. 8ohms. 70p 64mm dia. 64ohms. 75p
64mm dia. 8ohms. 75p 70mm dia. 8ohms. 100p
Magnetic earpiece including 2.5 or 3.5mm plug. 15p each
Crystal earpiece including 3.5mm plug. 30p each

SWITCHES

Subminiature toggle. SPDT 70p. DPDT 80p
Standard toggle. SPST 34p. DPDT 48p.

Slide switches (DPDT) miniature or standard 15p.
Push to make switch. 15p. Push to break switch. 20p.
Wavechange switches: 1P12W, 2P6W, 3P4W, 4P3W. 43p

CONTROL KNOBS

Ideal for use on mixers etc. Push on type with black base and marked position line. Cap available in red, blue, green, grey, yellow & black. 14p

MISCELLANEOUS

Connection cable available in single or stranded packs of eight colours.
Single Stranded
8 metre pack 18p 18p
40 metre pack 85p 80p

BATTERY CLIPS

Battery clips for PP3 with lead. 6p each.
Battery clips for PP9 with lead. 10p each.
Miniature crocodile clips in red or black. 8p each.
Red or black probe clips. 20p each.
Murata Ultrasonic Transducers. 180p each. 350p pair.

PANEL METERS

High quality 2" wide view meters.
Zero adjustment. Back illumination wiring.
Available in 50 uA, 100 uA, 500 uA, 1mA, 100mA, 500mA, 1A. £4.75 ea.
VU meter similar style. £1.40 ea.

SLIDE POTENTIOMETERS

Good quality 60mm travel slider with 80mm fixing centres.
Available from 5k - 500k in log and linear. 55p each.
Suitable black knobs 6p ea. Coloured knobs 10p ea.

We now offer one of the widest ranges of components at the most competitive prices in the U.K. See catalogue for full details. We welcome callers at our shop in College Rd, Bromley, from Mon-Sat, 9am-6pm (8pm on Weds and Fridays). Special offers always available.
We also provide an express telephone order service. Orders received before 5pm are shipped same day. Contact our sales office now with your requirements.
TELEPHONE: 01-464 2951/5770.

Quantity discounts on any mix TTL, CMOS, 74LS and Linear circuits: 100+ 10%, 1000+ 15%. Prices VAT inclusive. Please add 30p for carriage. All prices valid to April 1980. Official orders welcome.

BARCLAYCARD & ACCESS WELCOME

Mail orders to: STEVENSON (Dept. HE)



76 College Road, Bromley, Kent BR1 1DE.

ALL PRICES INCLUDE 15% V.A.T.

Television Receivers

Have you ever wondered how a swiftly moving spot of light can make a picture? Well, switch off the telly, sit back and find out now. Rick Maybury explains.

SO WHAT HAPPENS when a TV set is switched on? Quite a lot really. If you consider that a modern domestic TV receiver is one-third ordinary radio receiver (but operating at a much higher frequency) and nearly two-thirds solely devoted to driving and controlling the large glass object in the centre of the box, it seems appropriate that we should confine ourselves to this aspect of TV as there are more than enough descriptions of the operation of radio receivers.

Producing the picture is undoubtedly the tricky bit. Until the much promised (but rarely seen) solid-state, flat screen appears we must make do with the rather 'brutal' method of image production known as the Cathode Ray Tube or CRT.

To display a picture on a CRT we must have three things. The first is a source of very high voltage or EHT (Extra High Tension). This is fed to the final anode (often the metalised face plate of the screen). Its purpose is to attract a fine stream of electrons through the near vacuum of the tube, from the cathode of the electron gun, onto the phosphor-coated face-plate. This will glow when 'struck' by the electron beam. A typical black and white set requires something in the order of 5-10 thousand (or kilo) volts to achieve this. A colour $\frac{5}{8}$ V is somewhat more demanding, needing around 25kV. Something like one-third of the bulk of a TV set is used to generate and control these substantial voltages.

MIGHTY MAGNETS

The second requirement is for two highly intense and accurately controlled magnetic fields. These are generated in two sets of coils wound around the neck of the CRT. They are concerned with moving the electron beam around the inside of the tube. The 'line' scan coils deflect the beam from side to side and the 'frame' scan coils move it up and down.

Our last requirement is to be able to vary the intensity or modulate the brightness of the spot. This is accomplished by changing the applied voltage to either the electron guns control grid or cathode. It does this on instruction from the transmitted signal from the studio after being suitably decoded.

FLYING SPOT

To combine all of these elements we must first arrange to produce what is called a raster, this is basically a blank screen that can be lit or modulated according to our



The business end of a TV receiver. This particular model is a particularly good example of state-of-the-art TV technology. It is the Rank Toshiba X53 colour set. In this picture the set has been stripped down to show the various parts of the receiver. Inside the cabinet are the tube and speaker. The main board in the foreground contains all of the electronics for signal demodulation and tube drive, the tuner unit can be seen on the flying lead (far left).

requirements. This involves scanning the tube. We must ensure that the two magnetic fields make the electron beam run across the width of the screen and when they have reached the other side to switch off and go back to the left hand side, go down a little, switch on and cross the screen again. If you can persuade the electron beam to do this very quickly it will eventually cover the whole screen area. Do it 50 times a second and the human eye cannot detect the movement and the screen will appear to be one solid light. It's only when you get close you can distinguish individual lines — 625 of them in a modern British TV picture, 405 lines if you've got a very old set (you had better get a new one soon if you've got one of these as the 405 service is due to be discontinued in the next year or so), and various other numbers, depending upon which part of the world you happen to live in.

For our next trick we will 'modulate' or vary the brightness of the spot, if we can do this very, very quickly and at the same time as a similar spot is flying about inside the tube of the camera at the TV studio we

'have a picture. Add some sound and we have Television, simple isn't it?

If only it was that simple, unfortunately we have to contend with something called 'Synchronisation'. 'Sync.' is the technique employed to ensure that the picture that originates from the TV studio is in perfect step with the picture on your TV. If at any given instant the spot on your screen is exactly dead centre, (say) you can be sure that the spot within the camera tube is in exactly the same position. If it is not you will almost certainly be suffering from frame roll where a broad band splits two halves of the picture at the top and bottom of the screen, or 'tear' where the picture seems to be trying to escape through the side of the set. In severe cases of sync loss you may suffer a combination of both and the picture ceases to be at all recognisable looking like a complete mess.

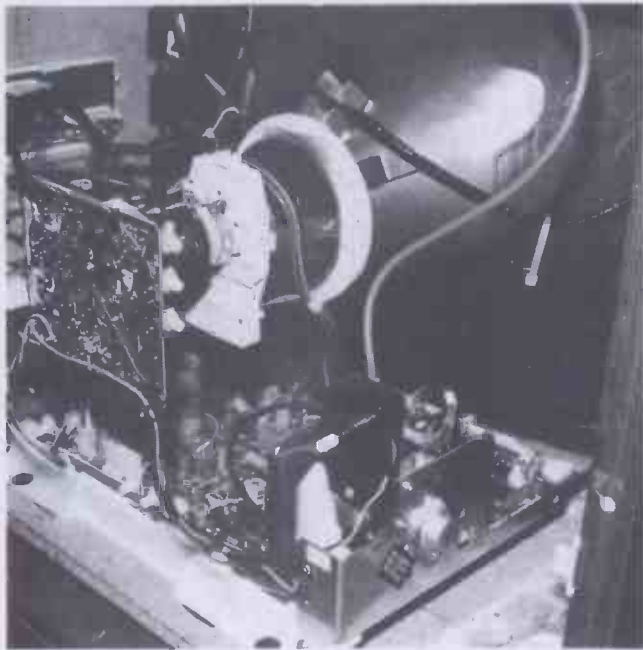

Close-up of the 'scan' coils (around the tube neck) and the EHT and scan drive circuitry. The light coloured lead on the left of the picture carries the EHT to the final anode button on the top of the tube.

A SYNC IN THE LIVING ROOM

The mechanism of synchronisation is fairly simple, at the beginning of each line a large pulse is added to the signal at the transmitter. It is in the opposite polarity to the picture information at what is called below 'black level', this is to prevent it appearing on the screen during viewing. This pulse is detected by circuitry within the set and upon receiving it, will instruct the horizontal deflection circuitry or Line Time Base (LTB) to commence a 'scan' and deflect the dot across the screen. At the same time the vertical deflection circuitry or Frame Time Base is generating a magnetic field within the 'Field' coils to deflect the spot downwards. A further, much longer pulse from the transmitter instructs the Frame Time Base when it should have reached the bottom of the screen and tells it to allow the spot to return to its starting position at the top left hand corner of the screen. The two

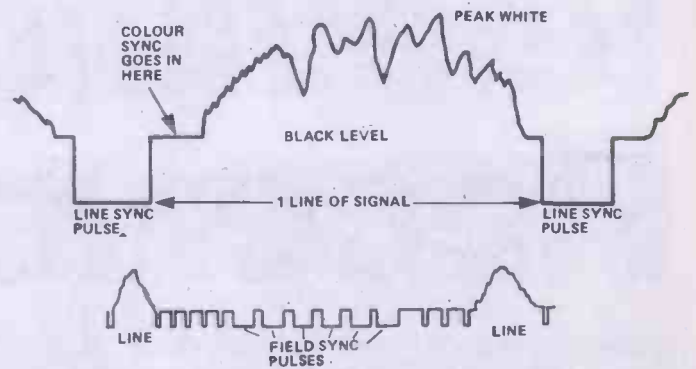
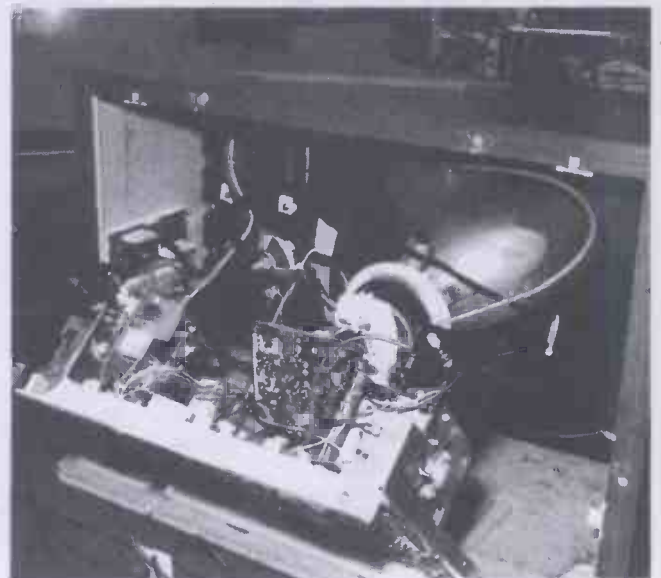

Fig. 1. The TV signal waveform (top) the lower diagram shows the position of the frame sync pulses at the end of the last line of the frame.

timebases will operate in the absence of sync pulses using a system called 'Flywheel' sync, this means that the timebases are running at their appropriate rates or frequencies but will change 'speed' upon getting sync information from the transmitter. Rather like a flywheel that runs at a constant speed but can be 'sped up or slowed down' to match the speed of another flywheel.

The combined effect of these two circuits is to produce a 'frame' that is repeated 50 times a second. To prevent an unnecessary amount of radio space or bandwidth being taken up a simple technique called 'interlace' is employed. This works by sending the picture in two halves, the first half consists of lines 1, 3, 5, 7 etc. until the screen has been filled, then the missing lines 2, 4, 6, 8 etc. are transmitted to fill in the gaps. This is done at the rate of 25 times a second—twice, the overall effect is to produce an image repetition rate of 50 frames a second.



The chassis tilted into its 'service' position. The engineer can gain access to both sides of the set, again this is the Rank Toshiba X53.

INTERESTING INTEGERS

Time for some statistics. The frequency of the 'frame' timebase is 50 Hz, the Line Timebase runs at 15.65 kHz, the dot takes exactly 64 microseconds to traverse the

width of the screen. If all of these figures seem a bit 'arbitrary' to you, try relating them to each other, remembering that frequency = 1/time, you should get some interesting results, showing that an awful lot of thought has gone into what we glibly call TV.

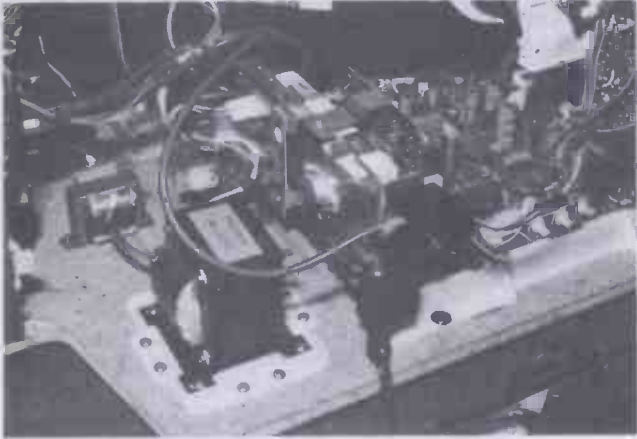

Close-up of the 'signal' circuitry. This side of the main board is primarily concerned with processing the incoming signal from the tuner and de-coding it into its various components to operate the rest of the circuits.

CUNNING COLOUR

Colour TV is worth a mention (though not an explanation, as it would take a book equivalent to at least one entire volume of HE to do that). Colour TV is basically reliant upon another quirk of human eyesight, our ability to 'mix' colours. This is similar in concept to colour printing, next time you look at a colour picture in a magazine take a closer look, you should be able to see that the picture is made up of millions of little dots that merge into a colour image when viewed at a distance. If you look closely at the screen of a colour TV you should be able to see thousands of little red, green and blue dots or strips.

Three separate electron guns are focused onto all of these dots by a cunning device variously known as a Shadowmask or Aperture Grille. (Incidentally this is why it requires a higher EHT as the thin perforated plate that makes up the Shadowmask or Aperture Grille tends to absorb much of the energy of the three electron beams).

Apart from a much more complicated decoder circuit and the duplication of the electron gun and drive circuitry, a colour TV is exactly the same when it comes to scanning, synchronisation and sound.

Up until only a few years ago quite a large percentage of colour TVs had additional circuitry for something called convergence. This was wave-shaping circuitry designed to ensure that the three colour images that went to produce a colour picture, fell exactly on top of each other. A mis-converged set is usually detected by looking for 'fringe' areas and colours around the edges of objects on the screen. However, do not attempt to adjust the convergence on a colour set unless you know what you're doing, nine times out of ten it will end up worse than when you started. Many of the colour TVs made in the last five years now use a TV tube called the Precision In Line (or PIL) and this effectively reduces the convergence circuitry by about three-quarters. Because of the greatly increased deflection angles (110 degrees is the norm), the modern sets tend to be a lot slimmer than their counterparts of only five years ago.

REPAIRS

The trend of simplification and standardisation has given the TV industry some unexpected headaches. Up until only a few years ago a service engineer could reasonably hope to be able to fault find a TV to component level. Today with the ever increasing use of ICs and modular construction it makes it both impractical and undesirable to do this. Indeed many of today's so-called TV engineers are little more than 'board-changers', a faulty board once located and replaced will be returned to the service centre or factory, where someone with specialist knowledge on that particular board only will make the repair.

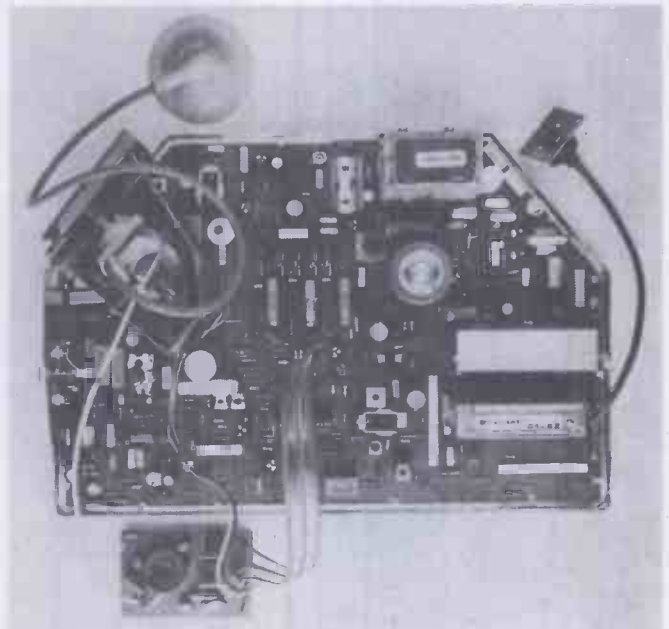

Another one-board colour TV chassis. This time it's the Thorn TX 9 TV. The bulk of the board is taken up with the generation of EHT and the line and frame scan circuitry. The EHT tripler/output transformer can be seen inside the screened box on the top left hand side. The flying lead is the EHT, final anode connection. The screened can on the bottom right is the varicap tuner box. The small board at the bottom connects to the tube base, the three wire ribbon cable is the Red, Green, Blue or RGB drive. The flying lead on the extreme right is for the aerial socket.

THE FUTURE

The growth in IC technology has been fairly slow to affect the TV industry, apart from a few sound-output ICs nothing much really happened until a couple of years ago. Modern colour TVs now bristle with them, especially if they sport remote control or teletext decoders. This has turned the TV into something more aptly called a home video display unit. TV games, home computers, video tape recorders and of course Teletext and Prestel all use the TV to display their wares. If you are lucky enough to own a TV camera you can even make your own TV programmes. Where will it all end. Keep reading HE and find out.

HE

HE MARKET

LCD CHRONO



We feel we've got to tell you carefully about this offer. Why? Because our price is so enormously lower than anywhere else you may suspect the quality.

The display is LCD and shows the seconds as well as the hours — and minutes — press a button and you'll get the date and the day of the week.

Press another button for a couple of seconds and you have a highly accurate stopwatch and hundredths of a second displayed and giving the time up to an hour. There is a lap time facility as well — and of course a back light.

Our Chrono comes complete with a high grade adjustable metal strap and is fully guaranteed.

£11.95

ALARM-CHRONO LCD



This new addition to our unbeatable selection of bargains is no ordinary LCD watch. It's a slim, multi-function, dual time chronograph alarm watch, no less.

This model will show hours, minutes, seconds, date, day of the week, stop watch, split time, alarm and alternate dual time zone — not all at once, of course. There is also a night light.

Hours, minutes, seconds and day of the week are displayed continuously, while the date will appear at the touch of a button. The day of the week is indicated by a flag. When used as a stopwatch, the maximum count is 0.1 secs. short of thirteen hours.

£19.95

To:
LCD Watch Offer
HE Magazine
145 Charing Cross Road
London WC2H 0EE

Please find enclosed my cheque / PO for £11.95 (payable to HE Magazine) for my LCD Chronograph.

Name

Address

.....

.....

To:
ALARM/CHRONO LCD WATCH Offer
HE Magazine
145 Charing Cross Road
London WC2H 0EE

Please find enclosed my cheque / PO for £19.95 (payable to HE Magazine) for my Alarm / Chrono LCD watch.

Name

Address

.....

.....

Please allow 28 days for delivery

PLACE

DIGITAL ALARM



THIS IS THE THIRD digital alarm clock that we are offering (we regret the earlier versions are no longer available). We have sold thousands and thousands of these and our buying power enables us to offer a first rate branded product at a really excellent price.

The Hanimex HC-1100 is designed for mains operation only (240V/50Hz) with a 12 hour display, AM/PM and Alarm Set indicators incorporated in the large display. A switch on the top controls a Dim-Bright display function.

Setting up both the time and alarm is simplicity itself as buttons are provided for both fast and slow setting and there's no problem about knocking these accidentally as a 'locking' switch is provided under the clock. A 9-minute 'snooze' switch is located at the top.

An example of this clock can be seen and examined at our Charing Cross Road offices.

£10.60

CLOCK RADIO



You probably won't believe us as we're selling the goods but we're going to tell you anyway! We have *rejected* eight clock radios for Marketplace, they were all cheap enough but the quality was so poor that we couldn't have lent our name to them. However, we are now able to offer another portable LCD Clock Radio to you which meets our standards.

The clock is a 12-hour one with AM/PM indicated and a back light. The radio is Medium Wave with very nice quality for a small speaker. The alarm can be either a beep-beep type or the radio, there's also a snooze facility.

The cylindrical construction is in keeping with the very modern styling. The tuning dial is actually incorporated into one of the end caps!

We won't even mention the RRP — but just check on comparable prices — you'll find ours a bargain.

An example of this Clock Radio can be seen and examined at our Charing Cross Road offices.

£17.95

To: Hanimex Alarm Offer
HE Magazine
145 Charing Cross Road
London WC2H 0EE

Please find enclosed my cheque/PO for £10.60 (payable to HE Magazine) for a Hanimex Digital Alarm Clock.

Name

Address

To: CLOCK RADIO Offer
HE Magazine
145 Charing Cross Road
London WC2H 0EE

Please find enclosed my cheque/PO for £17.95 (payable to HE Magazine) for my Clock Radio.

Name

Address

All offers inclusive of 15% VAT and Postage

Car Audio

Manual MW/LW

Full medium and long wave tuning. Complete with speaker and mountings. Suitable for positive or negative chassis: Latest model.

£10.25 + £1.00 Post

Push-Button MW/LW

One LW, four MW buttons plus manual tuning. Complete with speaker and mountings. Latest model, negative chassis only.

£15.95 + £1.00 Post

Stereo FM/Cassette + MW

Standard cassettes and FM in stereo plus medium wave. Tone and balance controls. Fast forward facility on tape. Adjustable shafts. Suitable for 4 or 8 ohm speakers (not supplied). This model is discounted elsewhere at £50 up.

£40.95 + £1.00 Post

Stereo Speaker Set

Suitable for above stereo unit. Good quality in surface mounted casing. 5W nominal, 8W peak.

£4.00 (pair)

+ 70p Post

Telescopic Car Antenna

Multi-section standard type, suitable for angled mounting with locking key.

£1.60 + 30p Post

Metal Detectors

Treasure Tracer Mk III

The original Treasure Tracer. Sales exceed 7,000. 5-transistor circuit with Varicap tuning. Sensitive, stable BFO design. Built-in speaker and earphone. Fitted with Faraday shield. Kit supplied with pre-built search head.

Kit, **£18.60 + £1.00 Post**
Built **£23.95 + £1.00 Post**

★ Induction Balance Model

Built with sensitivity up to 10in on single coin; fitted with speaker and meter; PP3 battery; 7in dia. search head. Telescopic stem. Excellent pin-pointing, positive reaction to non-ferrous, negative reaction to iron. This model's normal price is £39.95!

£24.50 + £1.00 Post

All goods guaranteed one year. 10-day money-back offer. Goods ex-stock at time of going to press. Callers by appointment only please. Send s.a.e. for illustrated leaflet.

Minikits Electronics Ltd.

6H Cleveland Road
S. Woodford
London E18 2AN

HE BINDERS



This simple questionnaire will establish whether you are eligible to buy one of the new HE Binders.

- (1) Do you use HE as a convenient place to flick molten solder?
- (2) Does the paper crumble when exposed to ferric chloride?
- (3) Does your dog use HE to sharpen his teeth on?
- (4) Do your copies of HE bear circular coffee stains?
- (5) Do you lose copies of HE?

If you can answer yes to any of these questions then send us £3.20 without delay. By return we will despatch a handsome blue bound binder embossed with gold lettering. You can have any words you like embossed on the binder as long as it's HOBBY ELECTRONICS.

Send your cheque or postal order, gold sovereigns, false teeth or anything we can change into money to:

Hobby Electronics Binders,
145 Charing Cross Road,
London WC2H 0EE.

Price includes VAT and P&P.

Hand held Computer games
We have selected the best
available
It's you against the computer!

UFO MASTER BLASTER STATION

More sophisticated than DESTROYER. Guide missiles to destroy UFOs which may change course or disappear!

£22.50



GRANDSTAND 4-in-1

Calculator / Auto Race / Code Breaker (as Digits) / Blackjack. Convenience — skill — Brainpower — Luck?

£22.50

AMAZE-A-TRON

Over 1 million mazes to defeat! 1 or 2 players Electronic sound effects

£17.25

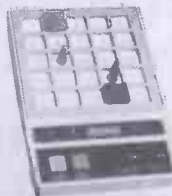

MICROPROCESSORS

FAIRCHILD GRANDSTAND

Video Entertainment Computer £74.50

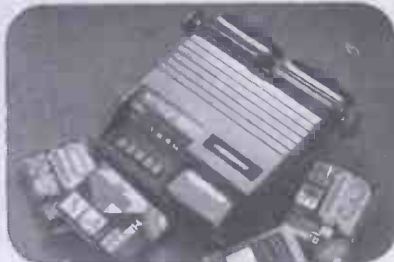

19 plug-in pre-programmed memory cartridges now available. Each £12.50



SOLITAIRE

Absorbing and challenging.

£14.95

DESTROYER

Protect your convoy against enemy torpedoes. Compete against the clock.

£14.95



DIGITS

(As Mastermind) Deduce four random numbers.

£13.95

CASIO CLOCK/ CALCULATORS

THE INCREDIBLE AQ-2000

Watch, full calendar, two alarms, stopwatch, time memory, count-down alarm, 8 digit calculator.

Displays any monthly calendar from 1901 to 2099. Memories and displays 3 optional important dates. Full memory, %, K, square roots. One year battery life. 7/16th x 2 1/2 x 4 7/16th ins. Wallet. (RRP £27.95.)

£24.95

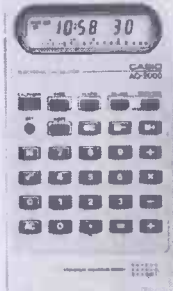

MICRO MQ-11

Specifications as AQ-2000 but with "kiss" keys and smaller case 3/16th x 2 1/2 x 3 1/2 ins. Wallet with window for display. (RRP £29.95.)

£26.95

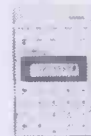

MELODY 80 Electronic Melody Maker

Clock, auto-calendar. Two alarms, alarm/timer (3 different tunes). Stopwatch measuring net, lap and 1st and 2nd place times from 1/10th second to 24 hours. Calculator with full memory, %, square roots. One year battery life. 5/16th x 4 1/2 x 2 1/4 ins. Wallet. Desk stand. (RRP £25.95)

£23.95



CQ-82 Multi Alarm Clock

4 independent alarms, one with snooze feature. Nightlight. Calculator with %, square roots. One year battery life. 1 3/4 x 5 1/2 x 2 3/4 ins. (RRP £22.95)

£19.95

NEW SCIENTIFICS

COLLEGE FX-80

6 + 2 digit LC Display. Approx. 4,000 hrs. continuous use from 2 AA size batteries. 37 scientific functions, P to R, R to P, ENG key, Pi, cube root, 6 levels (). Memory. 3/4 x 3 x 5 1/2 ins. (RRP £17.95)

£15.95

FX-68 Card

As FX-80 but without ENG key. 500 hrs. battery. 3/16th x 2 1/2 x 3 1/8 ins. Wallet. (RRP £22.95)

£19.95



CASIO FX-2600

Ultra slim—5/32in. 6 + 2 digit LC Display. 43 scientific functions. Non volatile memory. Auto power off 6 levels parenthesis. Standard deviations. R to P, O to R, ENG, FIX, SCI, RND and Random number keys. 5/32in x 2 3/4 x 4 7/8 in.

£19.95

CASIO FX-3200

As above but 10 digits

£21.95

CASIO FX-310

As FX-2600 but 50 scientific functions. 1/4 x 2 3/8 x 5 1/4 in.

£17.95

CASIO FX-510

10 digit version of above

£19.95

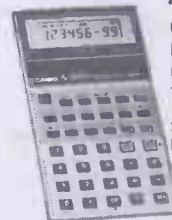

TEMPUS

SEE OPPOSITE PAGE
FOR ORDERING DETAILS

From Casio's New Collection we present some of the most sophisticated executive watches available today.

FROM CASIO — THE NEXT STEP FORWARD IN TIME

New Lithium batteries, lasting up to 5 years or more, totally eclipse most SOLAR watches

ALARM CHRONOGRAPHS

STAR BUY

LATEST MODEL

Displaying hours, minutes, seconds, date, am/pm; or hours, minutes, alpha day, date, am/pm. With automatic 28, 30, 31 day calendar.

83QS-27B

4 year battery, 1/10th second chrono to 12 hrs., measuring net, lap and 1st and 2nd place times. 24 hour alarm. Hourly chimes. Backlight. Mineral glass. Stainless steel encased. Water resistant to 66 feet (RRP £31.95)

£27.95



You cannot fight against the future. Time is on our side

(W E Gladstone)

Displaying hours, minutes, seconds, day; and with day, date, month and year automatic calendar, pre-programmed to the year 2030.

(Available soon)



81QS-33B

5 year battery. Chrome plated case, water resistant to 66 feet. (RRP £31.95)

£27.95

1/100th second chrono to seven hours. Net, lap and 1st and 2nd place times. Selectable 12 or 24 hour display.

24 hour alarm. Selectable hourly chime facility. Backlight. Mineral glass face.

81CS-36B

As above but: Stainless steel case, water resistant to 100ft. (RRP £39.95.)

£35.95



There is no present like the time

F-8C TIME/DATE WATCH

3 year battery. Hours, minutes, seconds, date, day, am/pm. Auto 28, 30, 31 day calendar. Backlight. Resin case/strap. Mineral glass. water resistant to 55 feet. (RRP £12.95.)

£10.95

N.B. This watch does **NOT** have a stopwatch. If you have been misled by others, you are legally entitled to your money back and costs.



We are never knowingly undersold and will try and match or beat any other advertised price providing the advertiser has stocks.

**If you want a watch with Chrome Plating that may wear off after a few months
A Plastic Glass that will scratch and scuff and you may not be able to replace
A Module with around 25% failure rate that may take weeks to repair
A dubious or non-existent Spares Service
Do you want a watch that the manufacturer doesn't put his name on?**

THEN DON'T BUY A CASIO

CASIO LADIES' WATCHES

Superbly styled stainless steel cases, with mineral glass face, water resistant to 100 feet. LC Display of hours, minutes, 10 seconds, seconds by flash, am/pm; And with day, date and month.



86CL-22B
£37.25

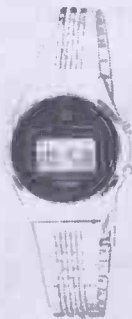

86QL-12B
£31.95



86QL-10B
£26.50

Most CASIO products available from stock. Send 25p for illustrated brochures and membership of our CHRISTMAS CLUB. EXTRA DISCOUNTS on many items.

CASIO CHRONOGRAPHS

Constant LC Display of hours, minutes, seconds, am/pm and day (12 or 24 hour). Dual time (12 or 24 hour). Automatic day, date, month and year calendar, pre-programmed to year 2030. Chronograph measures net, lap and 1st and 2nd place times from 1/100th second to 7 hours. Backlight. Mineral glass face. Guaranteed water resistant.

NEW MODEL 95QS-32B

4 year battery. Superbly styled brass case, heavily chrome plated. Water resistant to 66 feet. (RRP £27.95.)

£23.95



95QS-31B

4 year battery. Stainless steel encased. Water resistant to 66 feet. (RRP £27.95.)

£23.95



95CS-31B

Solid stainless steel case.

Water resistant to 100 feet.

(RRP £34.95.)

£29.95



Time never stands still with Casio

F.200 SPORTS CHRONOGRAPH

Hours, minutes, seconds, am/pm; and with day, date and month auto calendar. 1/100 sec chrono to 1 hour. Net, lap and 1st and 2nd place times. Resin case and matching strap. Mineral glass. Water resistant to 66 ft (2 at.). Silver oxide battery. RRP £17.95

£15.95



Price includes VAT, P&P. Send your cheque, P.O. or phone your ACCESS or B*CARD number to: —

TEMPUS

Dept. ETI, Beaumont Centre, 164-167 East Rd., Cambridge CB1 1DB. Tel. 0223 312866

SINGLE IC POWER SUPPLY

Although variable voltage power supplies having good regulation and electronic overload protection used to be fairly complex pieces of equipment, using modern circuitry it is possible to build such a unit using just one IC and a few passive components. The unit described here has an output voltage which is variable from 5 to 15 volts, and a maximum output current of 500mA, can be provided. The output is extremely well stabilised and the output noise is well below 1mV.

The mains supply is connected to the primary winding of isolation and step-down transformer T1 through on/off switch SW1. The centre tapped secondary of T1 feeds a standing fullwave rectifier and smoothing circuit which uses D1, D2 and C1.

IC1 is the voltage regulator chip, and this has four terminals. The unregulated input voltage is applied to the "IN" and "COM" terminals, while the stabilised output is taken from the "OUT" and "COM" terminals. The fourth terminal is the "CONT" one, and if this is fed from the output via a potential divider, a negative feedback action will stabilise the voltage at this terminal at a nominal level of 5 volts. In this case the potential

Short Circuit

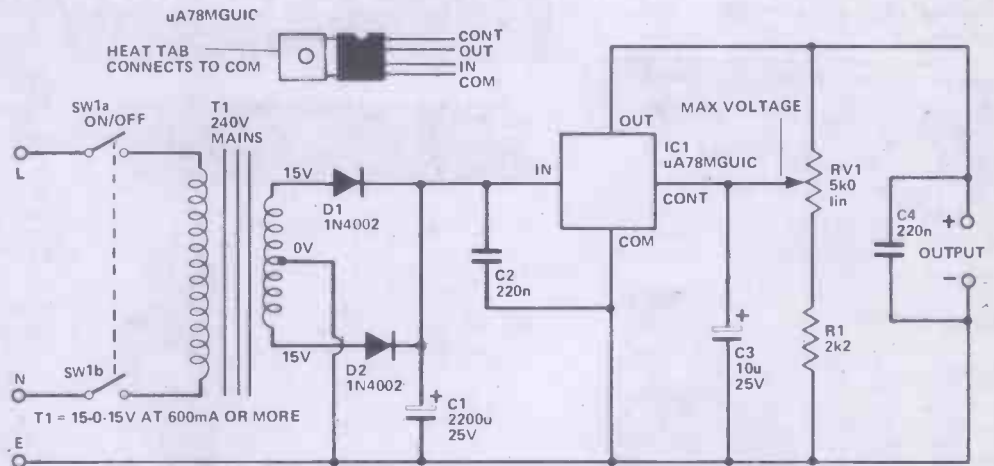

divider is formed by RV1 and R1. If RV1 slider is at the top of its track the output will be stabilised at 5 volts. A higher voltage would take the "CONT" terminal (which is directly connected to the output) above 5 volts, causing the error to be sensed and corrected. Similarly, a lower voltage would take the "CONT" terminal below 5 volts, causing the output to swing more positive and correct the error.

If RV1 slider is moved down its track, the voltage fed to the "CONT" terminal will decrease,

sending the output higher in order to return this potential to 5 volts. Thus RV1 can be used to vary the output voltage, with a maximum potential of about 16 volts or so appearing at the output when RV1 slider is at the bottom of its track. The feedback action accurately stabilises the output at the potential set using RV1, but only at output levels up to about 15 volts. Above this level, at high output currents, there will be insufficient input voltage from the rectifier and smoothing circuit to properly

maintain the output voltage.

The regulator device has built-in foldback current limiting which prevents the output from much exceeding 500 mA in the event of a minor overload. Stronger overloads result in decreased output current, the short circuit current being only about 200 mA!

Decoupling capacitors C2 and C3 should be mounted physically close to IC1. IC1 must be mounted on a substantial heat-sink, which can be the metal case of the unit.

The NEW Marshall's 79/80 catalogue is just full of components

and that's not all...

... our new catalogue is bigger and better than ever. Within its 60 pages are details and prices of the complete range of components and accessories available from Marshall's.

These include Audio Amps, Connectors, Boxes, Cases, Bridge Rectifiers, Cables, Capacitors, Crystals, Diacs, Diodes, Displays, Heatsinks, I.Cs, Knobs, LEDs, Multimeters, Plugs, Sockets, Pots, Publications, Relays, Resistors, Soldering Equipment, Thyristors, Transistors, Transformers, Voltage Regulators, etc., etc.

Plus details of the NEW Marshall's 'budget' Credit Card. We are the first UK component retailer to offer our customers our own credit card facility.

Plus — Twin postage paid order forms to facilitate speedy ordering.

Plus — Many new products and data.

Plus 100s of prices cut on our popular lines including I.Cs, Transistors, Resistors and many more.

If you need components you need the new Marshall's Catalogue.

Available by post 65p post paid from **Marshall's, Kingsgate House, Kingsgate Place, London NW6 4TA**. Also available from any branch to callers 50p.



Retail Sales: London: 40 Cricklewood Broadway, NW2 3ET. Tel: 01-452 0161/2. Also 325 Edgware Road, W2. Tel: 01-723 4242. Glasgow: 85 West Regent Street, G2 2QD. Tel: 041-332 4133. And Bristol: 108A Stokes Croft, Bristol. Tel: 0272 426801/2.

DATA SUPPLEMENT PART 2

PRESENTED FREE WITH DECEMBER HOBBY ELECTRONICS

As promised we now proudly present part two of our sixteen page data supplement. This month we cover such diverse subjects as Batteries, what they do and what they are good for, and MPU glossary, we hope to be dealing with these beasts in some detail in the not-too-distant future, so keep it handy. TTL Pin-Outs, they may not be as popular as CMOS but there's still a lot that only TTL devices can do,

so they'll be with us for some time yet.

We hope you will keep this supplement handy, you should be able to find out just about anything you will ever need to know but just in case we've left anything out we will be updating these pages from time to time and you can be sure that if anything radically new comes along we will be amongst the first to tell you about it. Pull it out and staple it to part one.

INDEX

ix	Op Amp Circuits	xiii	TTL Pin Outs
x	Logic Truth Tables	xiv	Batteries
xi	PSU's, TTL Functions	xv	MPM Glossary
xii	TTL Pin-Outs	xvi	Errata 78/79

STANDARD OPERATIONAL AMPLIFIER CIRCUITS

Non-Inverting Buffer

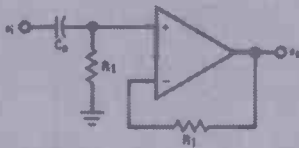

$$A_v = 1$$

$$R_{in} = R_1$$

$$f_o = \frac{1}{2\pi R_1 C_0}$$

Definitions:
 A_v = Closed loop AC Gain
 f_o = Low frequency -3dB corner
 R_{in} = Input Impedance

Non-Inverting AC Amplifier

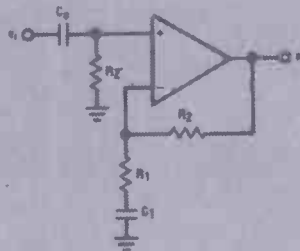

$$A_v = 1 + \frac{R_2}{R_1}$$

$$R_{in} = R_2$$

$$f_o = \frac{1}{2\pi R_2 C_0} = \frac{1}{2\pi R_1 C_1}$$

Difference Amplifier

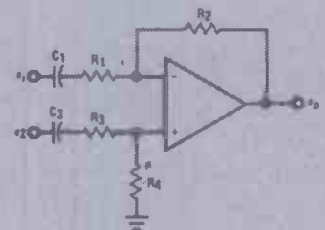

$$e_o = \left(\frac{R_1 + R_2}{R_3 + R_4} \right) \frac{R_2}{R_1} e_2 - e_1$$

IF $R_1 = R_3$ AND $R_2 = R_4$ THEN

$$e_o = \frac{R_2}{R_1} (e_2 - e_1)$$

$$f_o = \frac{1}{2\pi R_1 C_1} = \frac{1}{2\pi (R_3 + R_4) C_2}$$

$R_2 = R_4$ FOR MINIMAL OFFSET ERROR

Inverting Buffer

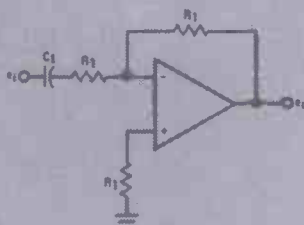

$$A_v = -1$$

$$R_{in} = R_1$$

$$f_o = \frac{1}{2\pi R_1 C_1}$$

Inverting AC Amplifier

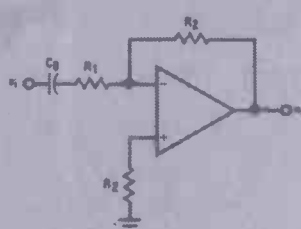

$$A_v = -\frac{R_2}{R_1}$$

$$R_{in} = R_1$$

$$f_o = \frac{1}{2\pi R_1 C_0}$$

Inverting Summing Amplifier

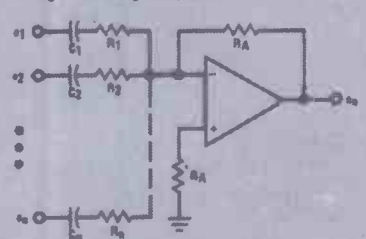

$$e_o = -R_A \left(\frac{e_1}{R_1} + \frac{e_2}{R_2} + \dots + \frac{e_n}{R_n} \right)$$

IF $R_1 = R_2 = \dots = R_n$ THEN

$$e_o = -\frac{R_A}{R_1} (e_1 + e_2 + \dots + e_n)$$

THE SUPPLY CONNECTIONS HAVE BEEN OMITTED IN THE ABOVE CONFIGURATIONS FOR THE SAKE OF CLARITY.

LOGIC GATE TRUTH TABLES

BUFFER

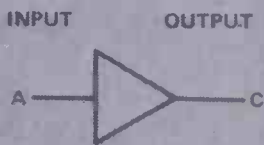

A	C
0	0
1	1

INVERTER

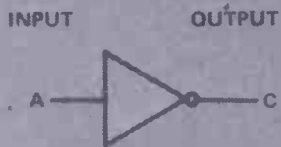

A	C
0	1
1	0



A	B	C
0	0	0
1	0	0
0	1	0
1	1	1

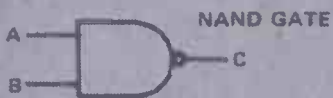

A	B	C
0	0	1
1	0	1
0	1	1
1	1	0



A	B	C
0	0	0
1	0	1
0	1	1
1	1	1



A	B	C
0	0	1
1	0	0
0	1	0
1	1	0

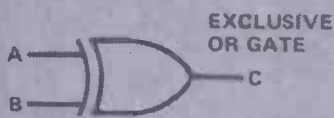

A	B	C
0	0	0
1	0	1
0	1	1
1	1	0

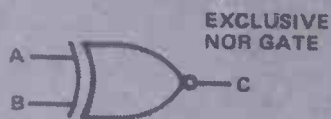

A	B	C
0	0	1
1	0	0
0	1	0
1	1	1

LAWS OF BOOLEAN ALGEBRA

- $A + 0 = A$
- $A + 1 = 1$
- $A \cdot 0 = 0$
- $A + A = A$
- $A \cdot B + A \cdot C = A(B + C)$
- $A + B \cdot C = (A + B)(A + C)$
- $\overline{A \cdot B \cdot C} = \overline{A} + \overline{B} + \overline{C}$
- $\overline{\overline{A \cdot B \cdot C}} = A + B + C$
- $A \cdot A = A$
- $A + \overline{A} = 1$
- $A \cdot \overline{A} = 0$
- $A \cdot 1 = A$
- $A \cdot 1 = A$

J.K. Flip Flop

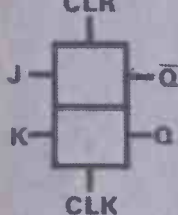

INPUTS				OUTPUTS	
CLR	CLK	J	K	Q	\overline{Q}
0	X	X	X	0	1
1	High Pulse	0	0	Q_0	$\overline{Q_0}$
1	High Pulse	1	0	1	0
1	High Pulse	0	1	0	1
1	High Pulse	1	1	TOGGLE	

- HIGH LEVEL PULSE, DATA IS TRANSFERRED ON FALLING EDGE OF PULSE.
- Q_0 —THE LEVEL OF Q BEFORE INDICATED INPUT CONDITIONS WHERE ESTABLISHED.
- TOGGLE —EACH OUTPUT CHANGES TO ITS COMPLEMENT ON EACH ACTIVE TRANSIENT (PULSE OF CLOCK).

STANDARD POWER SUPPLY CONFIGURATIONS

FULL-WAVE BRIDGE - CAPACITIVE INPUT FILTER



$$V_{d.c.} = 1.41 \times V_{a.c.}$$

$$I_{d.c.} = 0.92 \times I_{a.c.}$$

FULL-WAVE BRIDGE - RESISTIVE LOAD

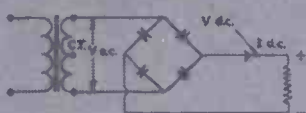

$$V_{d.c.} = 0.90 \times V_{a.c.}$$

$$I_{d.c.} = 0.90 \times I_{a.c.}$$

HALF-WAVE - CAPACITIVE INPUT FILTER

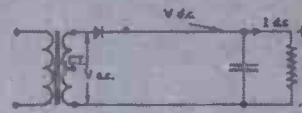

$$V_{d.c.} = 1.41 \times V_{a.c.}$$

$$I_{d.c.} = 0.28 \times I_{a.c.}$$

FULL-WAVE - CAPACITIVE INPUT FILTER

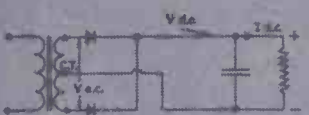

$$V_{d.c.} = 0.71 \times V_{a.c.}$$

$$I_{d.c.} = 1.0 \times I_{a.c.}$$

FULL-WAVE - RESISTIVE LOAD



$$V_{d.c.} = 0.45 \times V_{a.c.}$$

$$I_{d.c.} = 1.27 \times I_{a.c.}$$

HALF-WAVE - RESISTIVE LOAD

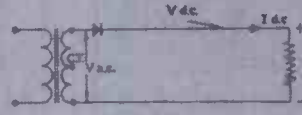

$$V_{d.c.} = 0.45 \times V_{a.c.}$$

$$I_{d.c.} = 0.64 \times I_{a.c.}$$

TTL FUNCTIONS

Device	Description	7481	16-bit Active Element Memory
7400	Quad 2-input Positive NAND Gate	7482	2-bit Binary Full Adder
7401	Quad 2-input Positive NAND Gate (open collector o/p)	7484	16-bit Active Element Memory
7401A	Quad 2-input Positive NAND Gate (open collector o/p)	7485	4-bit Comparator
7402	Quad 2-input Positive NOR Gate (open collector o/p)	7486	Quad 2-input Exclusive Or Gate
7403	Quad 2-input Positive NAND Gate (open collector o/p)	7489	64-bit RAM (16 x 4W)
7404	Hex Inverter	7490	Decade Counter
7405A	Hex Inverter (open collector o/p)	7491	8-bit Shift Registers
7406	Hex Inverter/Buffer 30V o/p	7492	Divide-by-twelve Counter
7407	Hex Buffer 30V o/p	7493	4-bit Binary Counter
7408	Quad 2-input Positive AND Gate	7494	4-bit Shift Registers (Parallel-In, Serial-Out)
7409	Quad 2-input Positive AND Gate	7495	4-bit Right Shift, Left Shift Register
7410	Triple 3-input Positive NAND Gate	7496	5-bit Shift Registers (Dual Para-in, Para-Out)
7412	Triple 3-input NAND Gate (open collector o/p)	74100	8-bit Bistable Latch
7413	Dual 4-input Schmitt Trigger	74107	Dual J-K Master Slave Flip Flop
7414	Schmitt Hex Inverter Buffer	74121	Monostable Multivibrator
7416	Hex Inverter/Buffer 15V o/p	74122	Monostable Multivibrator with reset
7417	Hex Buffer 15V o/p	74123	Dual Monostable Multivibrator with reset
7420	Dual 4-input Positive NAND Gate	74124	Universal Pulse Generator
7421	Dual 4-input AND Gate	74138	3 line to 8 line Decoder/Demultiplexer
7426	Quad 2-input High Voltage Interface NAND Gate	74141	BCD-to-Decimal Decoder/Driver
7427	Triple 3-input NOR Gate	74145	BCD-to-Seven Segment Decoder/Driver 15V output
7428	Quad 2-input NOR Buffer (Fan Out 30)	74150	16-bit Data Selector
7430	8-input Positive NAND Gate	74151	8-bit Data Selector (with strobe)
7432	Quad 2-input OR Gate	74153	Dual 4 to 1 line Data Selector 1 MPX
7433A	Quad 2-input NOR Buffer 15V	74154	4 line to 16 line Decoder
7437	Quad 2-input NAND Buffer	74155	Dual 2-to-4 line Decoder/DeMPX (totem pole output)
7438A	Quad 2-input NAND Buffer 15V	74156	Dual 2-to-4 line Decoder/DeMPX (open collector output)
7441A	BCD-to-Decimal Decoder/Nixie Driver	74157	Quad 2 line to 1 line Selector
7442	BCD-to-Decimal Decoder	74160	Synchronous Decade Counter
7445	BCD-to-Decimal Decoder/Driver 30V output o/c	74162	Synchronous Decade Counter
7446A	BCD-to-Seven Segment Decoder/Driver 30V/40mA	74163	Synchronous Binary Counter
7447	BCD-to-Seven Segment Decoder/Driver 15V/20mA	74164	8-bit Shift Register, Serial In-Parallel Out
7447A	BCD-to-Seven Segment Decoder/Driver 15V/40mA	74165	8-bit Shift Register, Parallel In-Serial Out
7448	BCD-to-Seven Segment Decoder/Driver	74174	Hex Type "D" Flip Flop
7450	Expandable Dual 2 wide, 2 i/p AND-OR-INVERT Gate	74175	Quad "D" Flip Flop with common reset
7451	Dual 2 wide, 2 i/p AND-OR-INVERT Gate	74180	8-bit Odd/Even Parity Generator/Checkers
7453	Expandable 4 wide, 2 i/p AND-OR-INVERT Gate	74181	4-bit Arithmetic Logic Unit
7454	4 wide 2-input AND-OR-INVERT Gate	74182	Carry-Look-Ahead Unit
7450	Dual 4-input Expander	74190	Synchronous Up/Down Decade Counter (Single Clock Unit)
7470	Positive Edge-triggered J-K Flip Flops	74191	Synchronous Up/Down 4-bit Binary Counter
7472	J-K Master-Slave Flip Flops (AND inputs)	74192	Synchronous 4-bit Up/Down Counter
7473	Dual J-K Master Slave Flip Flops	74193	Synchronous 4-bit Up/Down Counter
7474	Dual D-Type Edge Triggered Flip Flops	74195	Synchronous 4-bit Parallel Shift Register with J-K inputs
7475	4-bit bistable latch= Quad bistable latch	74196	50Mhz Presettable Decade Counter/Latch (Bi-Quinary)
7476	Dual J-K Master Slave Flip Flops+ preset and clear	74200	256-bit Random Access Memory (RAM)

TTL PIN-OUTS

TTL devices are almost as numerous as CMOS ICs, so we've had to condense this section of the Data Supplement into what we consider are the most popular or yet to be rivalled devices. Manufacturers are making extravagant new claims for their new devices almost daily but we firmly believe that TTL will be with us for some time to come. The high frequency ability and their inherent ruggedness in the face of high voltages or

static discharge make them indispensable for many applications.

For further information on these devices see page xi in this supplement. For a comparison of the various functions between CMOS and TTL see page 111 in last month's data supplement. The truth tables on page x apply equally to both TTL and CMOS so will give you a clearer insight into the operation of these devices.

SN7400 QUADRUPLE 2-INPUT POSITIVE NAND GATES

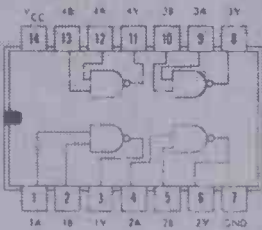

SN7401 QUADRUPLE 2-INPUT OPEN-COLLECTOR NAND GATES

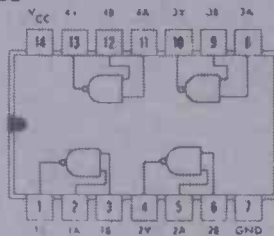

SN7410 TRIPLE 3-INPUT POSITIVE NAND GATES

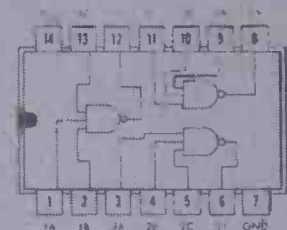

SN7402 QUADRUPLE 2-INPUT POSITIVE NOR GATES

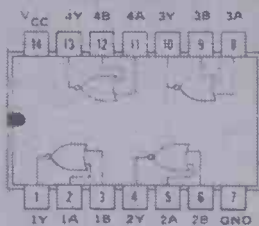

SN7404 HEX INVERTERS

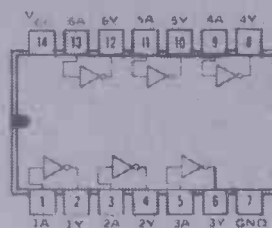

SN7420 DUAL 4-INPUT POSITIVE NAND GATES

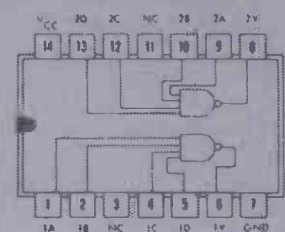

SN7413 DUAL NAND SCHMITT TRIGGERS

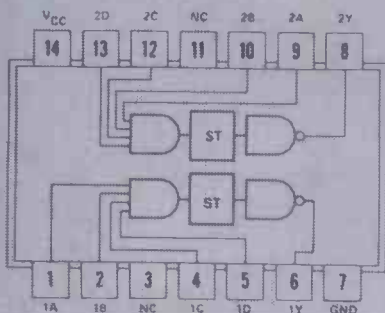

SN7472 J-K MASTER SLAVE FLIP-FLOPS

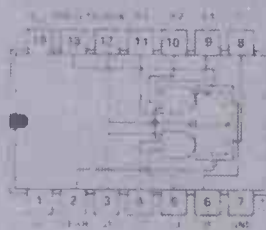

SN7447A SEVEN-SEGMENT DECODER/DRIVE

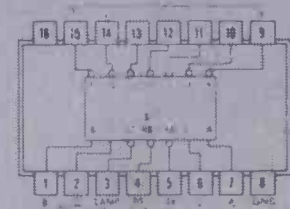

SN7470 EDGE-TRIGGERED J-K FLIP-FLOPS

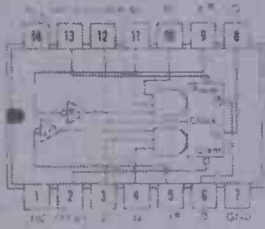

SN7476 DUAL J-K MASTER-SLAVE FLIP-FLOPS WITH PRE-SET AND CLEAR

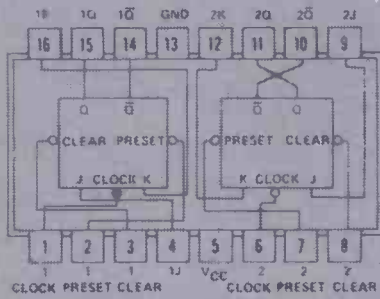

SN7432 QUADRUPLE 2-INPUT POSITIVE-OR GATES

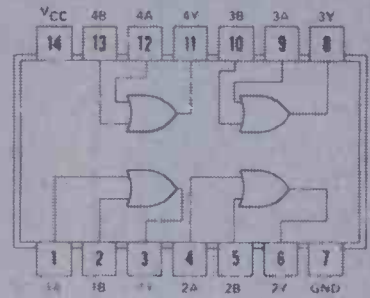

SN7427 TRIPLE 3-INPUT POSITIVE-NOR GATES

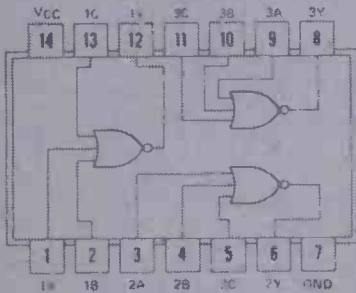

SN7475 4-BIT BISTABLE LATCHES

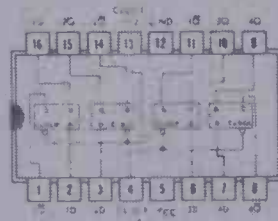

SN7445, SN74145 BCD-TO-DECIMAL DECODER/DRIVERS

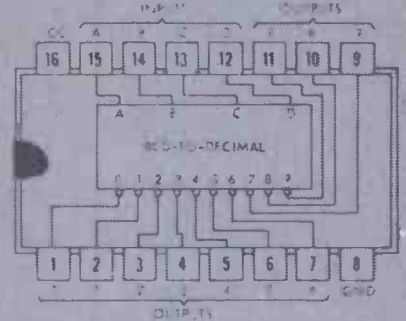

SN7486 QUADRUPLE 2-INPUT EXCLUSIVE-OR GATES

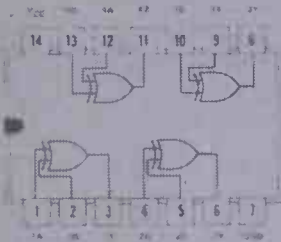

SN7490 DECADE COUNTERS

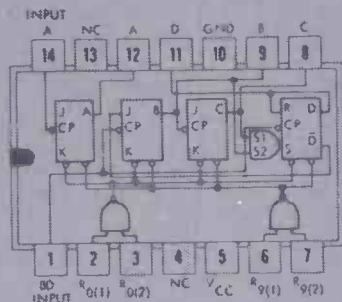

SN7491A 8-BIT SHIFT REGISTERS

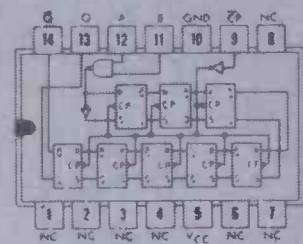

SN7492 DIVIDE-BY-TWO AND DIVIDE-BY-SIX COUNTERS

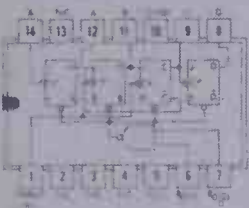

SN7495A 4-BIT RIGHT-SHIFT LEFT-SHIFT REGISTERS

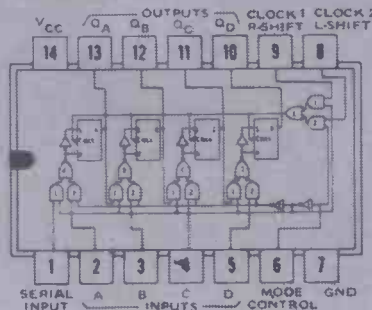

SN74175 QUAD D-TYPE FLIP-FLOP

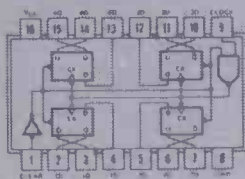

SN74121 MONOSTABLE MULTIVIBRATORS

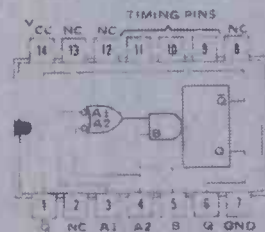

System	Anode	Cathode	Electrolyte	Open current voltage,	Typical operating voltage,	Capacity Ah/lb ^a Wh/lb ^b		Remarks
<i>Primary systems</i> Leclanche	Zn(Hg)	MnO ₂ (C)	NH ₄ Cl-ZnCl ₂	1.6	0.9-1.4	23	30	most common form of the dry cell; extensive applications; sloping discharge curve
Alkaline Zn-MnO ₂	Zn(Hg)	MnO ₂ (C)	KOH	1.62	0.9-1.2	30	33	suitable for greater drain rates than Leclanche cells; sloping discharge curve
mercury cell (Rubin)	Zn(Hg)	HgO(C)	KOH-ZnO	1.35	1.30	40	53	constant voltage during discharge; heavier drains and higher capacity than Leclanche cells
Mg-MnO ₂	Mg	MnO ₂ (C)	MgBr ₃ , Li ₂ CrO ₄	2.0	1.6-1.8	30	46	higher capacity and voltage than Leclanche cell; 35-40% of magnesium consumed in hydrogen liberation during discharge
air-depolarised Zn	Zn(Hg)	O ₂ (C)	KOH	1.36	1.1-1.2	60 ^b	70 ^b	utilizes oxygen from air; wet type used for railway signals, home radios; dry type available but moisture loss a problem
Zn-AgO	Zn	AgO	KOH	1.8	1.4-1.5	35	53	one-shot, high-drain-rate reserve cell; also available in another form as a secondary battery
Zn-PbO ₂	Zn	PbO ₂	H ₂ SO ₄	2.5	2.0-2.3	12	26	one-shot, high-drain-rate reserve cell
Zn-CuO	Zn(Hg)	CuO	NaOH	1.06	0.9-1.0			low operating voltage; used principally for railway signals
Zn-Cl ₂	Zn	ZnCl ₂	Cl ₂	2.1	1.5-1.9			one-shot, high-drain-rate cell
Pb-PbO ₂ -HClO ₄	Pb	PbO ₂	HClO ₄	2.0	1.6-1.8	11	19	one-shot, high-drain reserve types used for military applications
thermal cell	Ce	PbCrO ₄ (Ni)	LiCl, KCl fused	2.8	2.2			must be heated to melt electrolyte, one-shot, high-drain, military type cell
Mg-Cu ₂ Cl	Mg	Cu ₂ Cl	MgCl ₂	1.4	1.1-1.3	25	30	one-shot, high-drain reserve cell; may be activated with sea water
Mg-AgCl	Mg	AgCl	MgCl ₂	1.6	1.3-1.5	54	75	one-shot, high-drain reserve cell with very high capacity; may be activated with sea water
Zn-V ₂ O ₃	Zn	V ₂ O ₃	NH ₄ OH, ethylene glycol, boric acid	1.2	1.2			available commercially as a blea cell providing stable voltage at zero current over long periods used as a voltage standard
Weston standard solid electrolyte	Cd(Hg) Ag	Hg CuBr ₂	HgSO ₄ , CdSO ₄ AgBr	1.019 0.75	1.2			power source for radiation warning devices; charging source for low-leakage capacitors
Fery cell	Zn	O ₂ (C)	NH ₄ Cl	1.2	0.7			used extensively in foreign countries for telegraphy and telephone service; performs efficiently at low drains
Zn-Ag ₂ O	Zn	Ag ₂ O	KOH or NaOH	1.6	1.5	33	49	small sealed primary cell for electric wrist watch or hearing aid use; hermetically sealed
In-HgO	In	HgO	KOH	1.15	1.05			electric wrist watch battery; hermetically sealed
<i>Experimental cells (primary) organic cathode</i>	Mg	m-dinitrobenzene	MgBr ₂	1.65	1.15 ^d	56	65	one of the more promising of a large number of organic compounds being considered; multistep discharge
solid electrolyte	Ag	V ₂ O ₃	AgI	0.46	0.38-0.46 ^d			typical of a variety of similar systems that could be made commercially if applications warranted; thin flat cells providing 100 V/in. of battery length
Al-MnO ₂	Al	MnO ₂	AlCl ₃ .(NH ₄) ₂ Cr ₂ O ₇	1.7	1.3			higher capacity and voltage than Leclanche cell; wasteful corrosion of aluminium remains a major problem
Mg-Bi ₂ O ₃	Mg	Bi ₂ O ₃	MgBr ₂	1.6	1.0	6		operates 0.2-0.3 V lower potential than HgO-Zn system but otherwise has similar voltage-time discharge characteristics
<i>Secondary cells</i> lead acid	Pb	PbO ₂	H ₂ SO ₄	2.2	1.95-2.05	10	20	conventional lead storage cell
Edison	Fe	Ni oxides	KOH	1.6	1.2-1.4	10	13	much longer useful life than lead storage cell but lower capacity and more expensive
	Cd	Ni oxides	KOH	1.35	1.1-1.3	10	12	available as a completely sealed cell
Cd-NiO Zn-AgO	Zn	AgO	KOH, ZnO	1.8	1.4-1.5	35	53	very high capacity and suitable for high discharge rates but smaller number of cycles than Ni-Cd or lead storage cells
Cd-AgO	Cd	AgO	KOH	1.4	1.0-1.1	30	33	greater number of cycles than Zn-AgO secondary cell
MnO-Zn	Zn	MnO ₂	KOH	1.5		8	9	available only as a completely sealed cell

a Based on total weight of commonly available size of commercial cells.

b Exclusive of O₂ consumed from air.

c Average voltage for light-drain application.

d 2×10^{-10} A/in.² drain for the first 7 yr of cell life.

MPU GLOSSARY

- ACCUMULATOR** The register where arithmetic or logic results are held. Most MPU instructions manipulate or test the accumulator contents.
- ACCESS TIME** Time taken for specific byte of storage to become available to processor.
- ACIA** Asynchronous Communication Inter-face Adapter. Inter-face between asynchronous peripheral and an MPU.
- ALU** Arithmetic and Logic Unit. The part of the MPU where arithmetic and logic functions are performed.
- ASCII** American Standard Code for Information Interchange. Binary code to represent alphanumeric, special and control characters.
- ASSEMBLER** Software which converts assembly language statements into machine code and checks for non valid statements or incomplete definitions.
- ASSEMBLY LANG** Means of representing programs in mnemonics and conventional handling memory addressing by use of symbolic terms.
- ASYNCHRONOUS** Operations that initiate a new operation immediately upon completion of current one — not timed by system clock.
- BASIC** Beginner's All Purpose Symbolic Instruction Code. An easy to learn widely used high level language.
- BAUD** Measure of speed of transmission line. Number of times a line changes state per second. Equal to 100 per second if each line state represents logic 0 or 1.
- BAUDOT CODE** 5 bit code used to encode alphanumeric data.
- BCD** Binary Coded Decimal. Means of representing decimal numbers where each figure is replaced by a binary equivalent.
- BENCHMARK** A common task for the implementation of which programmes can be written for different MPUs in order to determine the efficiency of the different MPUs in the particular application.
- BINARY** The two base number system. The digits are 0 or 1. They are used inside a computer to represent the two states of an electric circuit.
- BIT** A single binary digit.
- BREAKPOINT** Program address at which execution will be halted to allow debugging or data entry.
- BUFFER** Circuit to provide isolation between sensitive parts of a system and the rest of that system.
- BUG** A program error that causes the program to malfunction.
- BUS** The interconnections in a system that carry parallel binary data. Several bus users are connected to the bus, but generally only one sender and one receiver are active at any one instant.
- BYTE** A group of bits — the most common byte size is 8 bits.
- CLOCK** The basic timing for a MPU chip.
- COMPILER** Software which converts high level language statements into either assembly language statements or into machine code.
- CPU** Central processor unit. The part of a system which performs calculation and data manipulation functions.
- CROM** Control Read Only Memory.
- CRT** Cathode Ray Tube. Often taken to mean complete output device.
- CUTS** Computer Users Tape System. Definition of system for storing data on cassette tape as series of tones to represent binary 1s and 0s.
- DEBUG** The process of checking and correcting any program errors either in writing or in actual function.
- DIRECT ADDRESSING** An addressing mode where the address of the operand is contained in the instruction.
- DMA** Direct Memory Access.
- DUPLEX** Transfer of data in two directions simultaneously.
- ENVIRONMENT** The conditions of all registers flags etc. at any instant in program.
- EPROM** Electrically Programmable Read Only Memory. Memory that may be erased (usually by ultra violet light) and reprogrammed electrically.
- EXECUTE** To perform a sequence of program steps.
- EXECUTION TIME** The time taken to perform an instruction in terms of clock cycles.
- FIRMWARE** Instructions or data permanently stored in ROM.
- FLAG** A flip flop that may be set or reset under software control.
- FLIP-FLOP** Two state device that changes state when clocked.
- FLOPPY (DISK)** Mass storage which makes use of flexible disks made of a material similar to magnetic tape.
- FLOW CHART** A diagram representing the logic of a computer program.
- GLITCH** Noise pulse.
- HALF DUPLEX** Data transfer in two directions but only one way at a time.
- HAND SHAKE** System of data transfer between CPU and peripheral whereby CPU asks peripheral if it will accept data and only transfers data if answer is yes.
- HARD COPY** System output that is printed on paper.
- HARDWARE** All the electronic and mechanical components making up a system.
- HARD WIRE** Circuits that are comprised of logic gates wired together, the wiring pattern determining the overall logic operation.
- HASH** Noisy signal.
- HEXADECIMAL** The base 16 number system. Character set is decimal 0 to 9 and letters A to F.
- HIGH LEVEL LANGUAGE** Computer language that is easy to use but which requires compiling into machine code before it can be used by an MPU.
- HIGHWAY AS BUS**
- IMMEDIATE ADDRESSING** Addressing mode which uses part of the instruction itself as the operand data.
- INDEXED ADDRESSING** A form of indirect addressing which uses an Index Register to hold the address of the operand.
- INDIRECT ADDRESSING** Addressing mode where the address of the location where the address of the operand may be found is contained in the instruction.
- INITIALISE** Set up all registers flag etc. to defined conditions.
- INSTRUCTION** Bit pattern which must be supplied to an MPU to cause it to perform a particular function.
- INSTRUCTION REGISTER** MPU register which is used to hold instructions fetched from memory.
- INSTRUCTION SET** The repertoire of instructions that a given MPU can perform.
- INTERFACE** Circuit which connects different parts of system together and performs any processing of signals in order to make transfer possible (e.g. serial — parallel conversion).
- INTERPRETER** An interpreter is a software routine which accepts and executes a high level language program but unlike a compiler does not produce intermediate machine code listing but converts each instruction as received.
- INTERRUPT** A signal to the MPU which will cause it to change from its present task to another.
- I/O** Input/Output.
- K** Abbreviation for 2¹⁰ = 1028.
- KANSAS CITY (Format)** Definition of a CUTS based cassette interface system.
- LANGUAGE** A systematic means of communicating with an MPU.
- LATCH** Retains previous input state until overwritten.
- LIFO** Last In First Out. Used to describe data stack.
- LOOPING** Program technique where one section of program the loop is performed many times over.
- MACHINE LANG** The lowest level of program. The only language an MPU can understand without interpreter.
- MASK** Bit pattern used in conjunction with a logic operation to select a particular bit or bits from machine word.
- MEMORY** The part of a system which stores data working data or instruction object code.
- MEMORY MAP** Chart showing the memory allocation of a system.
- MEMORY MAPPED I/O** A technique of implementing I/O facilities by addressing I/O ports as if they were memory locations.
- MICRO CYCLE** Single program step in an MPUs Micro program. The smallest level of machine program step.
- MICRO PROCESSOR** A CPU implemented by use of large scale integrated circuits. Frequently implemented on a single chip.
- MICRO PROGRAM** Program inside MPU which controls the MPU chip during its basic fetch execute sequence.
- MNEMONIC** A word or phrase which stands for another longer phrase and is easier to remember.
- MODEM** Modulator demodulator used to send and receive serial data over an audio link.
- NON VOLATIVE** Memory which will retain data content after power supply is removed (e.g. ROM).
- OBJECT CODE** To bit patterns that are presented to the MPU as instructions and data.
- O/C** Open Collector. Means of tying together O/P's from different devices on the same bus.
- OCTAL** Base 8 number system. Character set is decimal 0-8.
- OP CODE** Operation Code. A bit pattern which specifies a machine operation in the CPU.
- OPERAND** Data used by machine operations.
- PARALLEL** Transfer of two or more bits at the same time.
- PARITY** Check bit added to data. Can be odd or even parity. In odd parity sum of data 1s + parity bit is odd.
- PERIPHERAL** Equipment for inputting to or outputting from the system (e.g. teletype VDU etc.).
- PIA** Peripheral Inter-face Adapter.
- POP** Operation of removing data word from LIFO stack.
- PORT** A terminal which the MPU uses to communicate with the outside world.
- PROGRAMS** Set of MPU instructions which instruct the MPU to carry out a particular task.
- PROGRAM COUNTER** Register which holds the address of next instruction (or data word) of the program being executed.
- PROM** Programmable read only memory. Proms are special form of ROM which can be individually programmed by user.
- PUSH** Operation of putting data to LIFO stack.
- RAM** Random Access Memory. Read write memory. Data may be written to or read from any location in this type of memory.
- REGISTER** General purpose MPU storage location that will hold one MPU word.
- RELATIVE ADDRESSING** Mode of addressing whereby address of operand is formed by combining current program count with a displacement value which is part of the instruction.
- ROM** Read Only Memory. Memory device which has its data content established as part of manufacture and cannot be changed.
- SCRATCH PAD** Memory that has short access time and is used by system for short term data storage.
- SERIAL** Transfer of data one bit at a time.
- SIMPLEX** Data transmission in one direction only.
- SOFTWARE** Programs stored on any media.
- SOURCE CODE** The list of statements that make up a program.
- STACK** A last in first out store made up of registers or memory locations used for stack.
- STATUS REGISTER** Register that is used to store the condition of the accumulator after an instruction has been performed (e.g. A = 0).
- SUB ROUTINE** A sequence of instructions which perform an often required function, which can be called from any point in the main program.
- SYNTAX** The grammar of a programming language.
- TRAP Vector** Pre-defined location in memory which the processor will read as a result of particular condition or operation.
- TRI STATE** Description of logic devices whose outputs may be disabled by placing them in a high impedance state.
- TTY** Teletype.
- TWO'S COMPLEMENT ARITHMETIC** System of performing signed arithmetic with binary numbers.
- UART** Universal Asynchronous Receiver Transmitter.
- VDU** Video Display Unit.
- VECTOR** Memory address provided to the processor to direct it to a new area in memory.
- VOLATILE** Memory devices that will lose data content if power supply is removed (e.g. RAM).
- WORD** Parallel collection of binary digits such as a byte.

AMBIT INTERNATIONAL

2 Gresham Road,
Brentwood,
Essex

GREENBANK

92 New Chester Road,
New Ferry,
Wirral,
Merseyside,
L62 5AG

STEVENSON ELECTRONIC COMPONENTS

76 College Road,
Bromley,
Kent,
BR1 1DE

BI-PAK

PO Box 6,
Ware,
Herts

MAPLIN ELECTRONICS

PO Box 3,
Rayleigh,
Essex,
SS6 8LR

TECHNOMATIC LTD

17, Burnley Road,
London,
NW10

GMT ELECTRONICS

PO Box 290,
8 Hampton Street,
Birmingham,
B19 3JR

MARSHALLS

Kingsgate House,
Kingsgate Place,
London,
NW6 4TK

WATFORD ELECTRONICS

33/35 Cardiff Road,
Watford,
Herts

ERRATA—HE COMES CLEAN

To date we have made one or two errors, so for everyone that may have missed our regular Errata update in our Monitor pages, we've decided to own up and publish all of the errors we've managed to track down. Obviously

during the course of a year, especially our first year, there are quite a few but we think we've got most of them. Rest assured though, if we do this, on our second birthday there won't be enough to fill one line — we hope.

NOV 78

HOBBIT

RV1, RV2 — 100k lin.
RV3 — 47k lin.
RV4 — 47k lin.

WAA-WAA

Bottom of RV2 connected to IC1 pin 3.
Overlay, input and output from C1 and C4 are via SW2.

DEC 78

LED DICE

Pin-outs on LEDs as shown are not universal — reverse if inoperative.

SHORT CIRCUIT — ONE TRANSISTOR AMPLIFIER

R1 and R2 = 100k, current = 10 μ A.

FEB 79

SINE/SQUARE GENERATOR

SW1b. Invert position of Cs 5-8 with switch.
SW2b. Position 3 disconnect, connect 1 and 2.

MAY 79

DIGIBELL

Link missing between D1 and IC2 pin 1 on PCB.
Connect pins 5, 6, 8, 9, 12, 13 to 0V line to reduce current consumption.

WHITE NOISE GENERATOR

PCB foil pattern reversed.

AUGUST 79

INJECTOR/TRACER

PCB overlay 180° out of registration.

SEPT 79

ULTRASONIC REMOTE CONTROL

Values of C5 and 6 correct on parts list.

COMBINATION LOCK

Connection D to tag 1 on SW2.
Connection F to tag 11 on SW2.
Connection C to tag 8 on SW1.
Connection E to tag 4 on SW2.

STARBURST

R14, 13, and 12 should read R7, 8, and 9. 0V and 9V connections on overlay reversed.

NOW THIS IS SOMETHING NEW! and so simple to construct

CONTROL UNIT CONSTRUCTION KIT for DISCO LIGHTS, GROUPS, HOME DISPLAYS etc.

A new world in lighting effects is opened to the amateur. Interested in miniature electronics evolved for the space and computer programmes. This comes to you NOW, in kit form, an easy to construct 4-Channel 'Chaser' Unit, which when connected to a light display of your own design, will supply an on/off sequence giving the effect of chasing or moving lights. It has a speed control and has the ability to automatically make the lights appear to move forwards, backwards or alternate between the two. The unit is designed to fit into your equipment or into a box of its own. Size of completed unit 180x95x30mm. Price £15.95 including VAT. P & P 30p extra. The 4-Channel 'Chaser' Unit can also be purchased assembled, tested and guaranteed by qualified staff. Special price £21.95 including VAT. P & P 30p extra.



KIT £15.95 inc. VAT



Send today cheque/postal order to —
COOK ELECTRONICS
304A HIGH STREET, WATFORD, HERTS. WD1 2JE

TUNE IN!

Build the World Famous CHROMA-CHIME

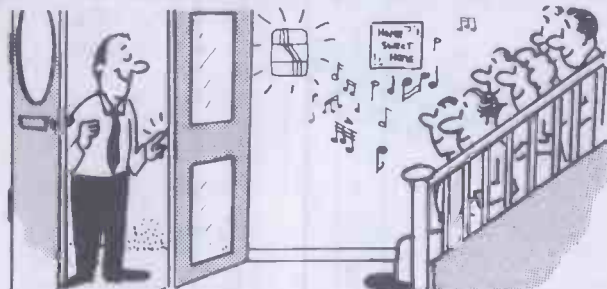

Give your friends a warm welcome

This kit has been carefully prepared so that practically anyone capable of neat soldering will have complete success in building it. The kit manual contains step by step constructional details together with a fault finding guide, circuit description, installation details and operational instructions all well illustrated with numerous figures and diagrams.

- Handsome purpose built ABS cabinet
- Easy to build and install
- Uses Texas Instruments TMS1000 microcomputer
- Absolutely all parts supplied including I.C. socket
- Ready drilled and legended PCB included
- Comprehensive kit manual with full circuit details
- No previous microcomputer experience necessary
- All programming permanently retained is on chip ROM
- Can be built in about 3 hours!
- Runs off 2 PP3 type batteries.
- Fully Guaranteed

ONLY £9.95 + 75p p&p UK ONLY

* Save pounds on normal retail price by building yourself.

TMS 1000N — MP0027A Micro-computer chip available separately if required. Full 24 tune spec device supplied with data sheet and fully guaranteed.



New low price only **£4.95 inc. p&p**

R/C MODELLERS - LISTEN FOR THE C.B. MENACE GET A 27MHZ MONITOR

- ★ Audibly confirm your channel's clear.
- ★ Tunes over whole 27mhz model band. (CB)
- ★ Receives normal broadcast AM/FM bands as well.
- ★ Sensitive with telescopic aerial.
- ★ Totally portable.
- ★ Runs on standard batteries.

ONLY £17.95 INC. V.A.T. AND P. & P.



This neat three band Superhet receiver not only provides an invaluable service, checking your channel and TX, but gives normal broadcast reception when you need it as well. Costing less than a decent Servo, you'll find it cheap and reassuring insurance!

ALL CHROMATRONICS PRODUCTS SUPPLIED WITH MONEY BACK GUARANTEE PLEASE ALLOW 7-21 DAYS FOR DELIVERY

Please send me:
TO: CHROMATRONICS, RIVER WAY, HARLOW, ESSEX.

HE/12/79

NAME _____
ADDRESS _____

I enclose cheque/PO value £ _____
or debit my ACCESS/BARCLAYCARD account no. _____

Signature _____

CHROMATRONICS

TANTALUM	RADIAL ELECTROLYTICS	2200 40V	.84	POLYESTER	
.1 35V	.47 50V	4700 6.3	.38	10% Tolerance	
.15 35V	1 50V	TAG 2200 63V	1.72	Radial Lead	
.22 35V	2.2 50 63V	TAG 4700 63V	1.99	001	.03
.33 35V	3.3 50V			0022	.03
.47 35V	4.7 35V			0047	.03
.68 35V	10 16V			01	.03
1 35V	10 25V			022	.03
1.5 35V	10 50V			047	.03
2.2 16V	22 10V			068	.02
2.2 35V	22 16V			.1	.04
3.3 16V	22 35V			.22	.06
3.3 35V	22 50V			.33	.06
4.7 10V	33 16V			.47	.06
4.7 25V	33 25V			.68	.06
4.7 35V	47 16V				
6.8 35V	47 25V				
10 6.3V	47 63/50				
10 16V	100 10V				
10 25V	100 16V				
10 35V	100 25V				
15 16V	100 50V				
15 25V	220 10V				
22 10V	220 16V				
22 16V	220 25V				
22 25V	330 10V				
33 10V	330 16V				
33 16V	330 25V				
47 6.3V	470 6.3				
47 10V	470 16V				
47 16V	470 25V				
68 3V	470 50V				
100 3V	1000 16V				
100 6.3V	1000 25V				
100 10V	2200 6.3				
	2200 16V				

MINI FITCH CERAMIC CAPACITORS TUBULAR RADIAL 250V	Ceramic Capacitors EDPU 63V Stock Values µf	NOISE SUPPRESSION CAPACITORS 250V AC PCB 15mm 22, 22.5
Stock Values	1; 2.2; 3.3; 4.7; 5.6; 6.8; 8.2; 10; 15; 18; 22; 27; 33; 39; 47; 56; 52; 100; 120; 150; 180; 220; 270; 330; 390; 470; 560; 680; 820; 1000; 2200; 3300; 4700; 10,000; 22,000	Radial
15, 47, 56, 100, 1000, 1500, 2200, 2700, 3300, 4700, 5600, 6800, 8200, 10,000, 100,000*	1-47µf 2% (Low K)	0.015 .13 0.058
*New Addition (63V)	56-100µf 2% (Low K)	0.022 .13 0.1
Prices	100-150µf 2% (Low K)	0.033 .14 0.15
15 100µf .03	180-820µf 10% (Med. K)	0.047 .15 0.22
220 470µf .04	1000-2200µf 10% (Med. K)	
1000 2200µf .035	3300-4700µf 10% (Med. K)	
2700 10,000µf .04	10,000-20 + 80 40V	
.1 .08	22,000 20 + 80 40V	
	Alternatives 625/630/632 Series	

GREENWAY ELECTRONIC COMPONENTS 62 MAYPOLE RD ASHURST WOOD EAST GRINSTEAD SX RH19 3RB.
Tel: Forest Row (034-282) 3712

Project Fault Finding

One of the backroom boys on the Project Team, Keith Brindley, comes up front to discuss a largely ignored topic in the art of project building and gives a few hints how to go about fault finding.

IN THE BEGINNING there's the first project — a fuzz box, a light chaser or a photographic timer — and it doesn't work!! You spend hours going through the circuit, checking that you have got all the components in as the diagram says and you *still* can't figure out what the fault is. Blast — throw it in the bin. But wait a minute, it cost you £6.50. Well maybe you can re-use the components in your next project. Let's see, what's in this month's copy of Hobby?

Bang — and before you know it, you have caught the bug (No, not 'flu' you fool — the electronics bug). And if you are like countless thousands of others you'll never get rid of it. Every time you go into a newsagent's your eyes will wander to the magazine section looking for the new edition of Hobby or ETI. You may even sink low enough to look at some of our competitors — not buy, just look (of course, you will *only* buy Hobby).

Be that as it may, your first project doesn't work and what is more your second probably won't either. But don't let me put you off or depress you. After all, YOU are our livelihood. In fact, figures would probably show that a beginner only stands about a one in 10 chance of first time success. However, looking on the brighter side, the chances are that the reasons for your circuit not working are only minor.

The trick is to be able to detect a fault, because unfortunately they don't jump up and shout to be found. Normally this knack will only be acquired with practice of building circuits, but that is not to say that it can't be learned!

TROUBLESOME TWOSOME

Faults can broadly be classified into two groups:

- 1) user induced
- 2) component fault

Of the two groups, the most likely to cause a fault would be group one — user induced faults. This is mainly to do with the fact that the beginner, not knowing the right techniques, can make unintentional mistakes to his or her disadvantage. The obvious example of a fault in this category is a dry soldered joint.

Components, if bought from reliable stockists are not normally prone to faults if handled correctly, but it has been known.

Sometimes the two groups overlap — the reason being that the user has somehow induced a component fault. An example of this might be damage of a transistor by overheating when soldering.

A FAULT IS A FAULT IS A FAULT

Anyway, however caused, once the fault is there, it is not going to remove itself! It has to be located and repaired and the aim of this article is to suggest a few hints and clues how to go about this.



Every home should have one. The multimeter is the first and probably most useful piece of test-gear you can buy.

The best technique is to adopt a system of logical progression, eventually isolating the cause, or causes of non-function. There should be no guesswork involved.

First check the printed circuit board, making sure that all components are in their correct place. What about electrolytic capacitors — are they the right way round?

Are all semiconductors ie diodes, transistors, integrated circuits in the correct way? Remember that there is a possibility that a semiconductor which had previously been inserted incorrectly, could be damaged by this, and reinsertion in the correct manner may not repair the fault. A new component may be necessary.

As a matter of good practice it is better to undertake all of these suggested checks before even the first switch on — it may save the expense of a replaced component.

Look for dry joints (they have a knurled, grey appearance). Later in this article we look at a simple procedure for isolation of dry joints, which a visual check might not find.

Next, get a good idea of how the circuit works. This is done by reading the "How It Works" section which we publish with every project in Hobby. You may even have to read it a few times before it sinks in. As a general rule we try to describe a circuit in as simple a fashion as space allows, to help the amateur constructor. Try to picture what is going on in there eg in an audio amplifier bear in mind that a small input produces a large output. The input signal may be about 200 mv, but the output signal could be 10 volts. The popular integrated circuit amplifier, the LM 380 provides a useful case-study. Figure 1 shows the IC in a typical circuit, a two watt audio amplifier.

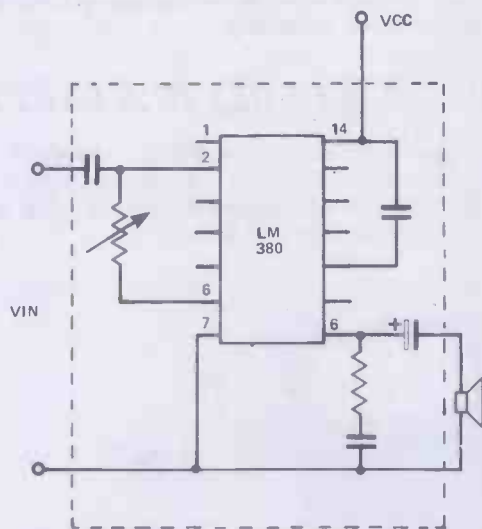

Fig. 1. The area inside the broken lines can be regarded as a 'Black Box' amplifier.

ALL BOXED UP

It can, however, be visualised in a much simpler fashion, the "black box". This term probably arises from the work of H. S. Black, who designated boxes into his circuit diagrams to represent complete amplifiers. In fact the modern representation of an operational amplifier in a circuit, as in figure 4, is really only a 'Black Box'. The area in broken lines in figure 1 can be termed a black box and can be redrawn as in figure 2. In order for the black box amplifier to function correctly, certain connections obviously have to be made — power supply, volume control, i/p and o/p capacitors, etc, as shown in figure 1, although they are not shown in figure 2. But as

long as we appreciate this then there is no reason why we can't think of an amplifier as a box. The same logic can be applied to literally any electronic circuit. As an aside, it is well worth remembering that a fault in a circuit using ICs, is much more likely to arise from these peripheral connections and components than from the main IC.



Fig. 2. A 'Black Box' amplifier. Note the complete lack of external circuitry.

LET YOUR MIND DO THE WORK

Try to reduce the whole circuit in your own mind to a number of black boxes, (as many as you need) say 2 or 3. Let us take for an example a typical mains to low voltage D.C. power supply as in figure 3.

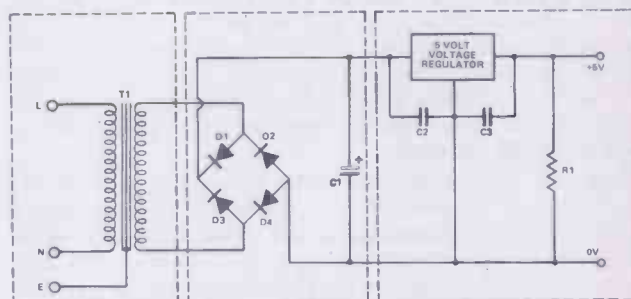

Fig. 3. Circuit diagram of a simple 5Vdc power supply.

Reducing the circuit diagram, which consists of ten components to black box symbols gives us something as in figure 4. The supply can be seen to have three main stages; a method of reducing the high voltage A.C. to low voltage, an A.C. to D.C. converter and a method of regulating the voltage. This is a much simpler representation of the supply than its corresponding circuit diagram but if we remember that there are certain peripherals to connect then it is every bit as accurate.



Fig. 4. Black box representation of mains power supply.

If the supply is malfunctioning then we should begin to check each individual black box in turn. It is wise to start at the first box and work to the last, because if the first box is not working then any following it won't either. In the example, therefore, we would look at the input to the transformer first (be careful — mains voltage can be lethal!). An A.C. voltmeter should give a reading of 240 V.C. If not, the fault is prior to this — perhaps a blown fuse?

Project Fault Finding

Next, measure the output voltage of the transformer, which will depend on the transformer itself. In our theoretical example it should be about 6 volts. If all is correct so far we can move on to the next black box, the A.C. and D.C. converter, whose output voltage should be approximately $\sqrt{2} \times$ transformer output voltage = 8 volts D.C. After verifying the second black box is operational then we move to the final one and check this.

If you obtain any results at all from your project, for instance the power supply output might be 8 volts, then knowing this may help you to reduce the fault. In this example the problem is probably the IC voltage regulator itself, not functioning.

Remember, there may be more than one fault, in which case you will have to repair one at a time until the project fully works. The idea at this stage is to be as methodical as possible, isolating the area in which the fault lies and then finally pin-pointing the fault itself.

The worst faults of all to find are intermittents. There one minute — gone the next. These were often caused in old valve circuits by rising temperature as the valves warmed up. Happily, a disappearing problem with the almost universal use of solid-state electronics.

TO (V)BE OR NOT TO (V)BE

In transistor circuits the voltage from base to emitter (Vbe) can be measured, giving a clue as to whether it works or not. In a silicon transistor this should be about 0.6 volts (see figure 5).

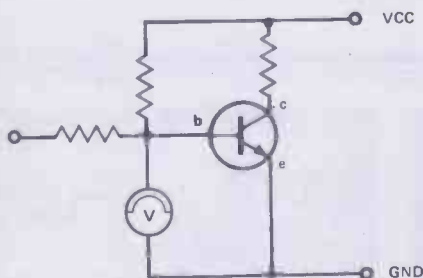

Fig. 5. The voltage from base to emitter for a silicon transistor should be 0.6 volts.

You can estimate unknown voltages, as in figure 6 and measure them to see if they correspond. Of course this is only an approximate method because the voltage depends on the resistance of the next stage after point A (which should if possible be taken into account in the voltage calculation).

With the use of a resistance meter, soldered joints can be checked in the vicinity of the fault by touching the probes onto component leads, which should be connected underneath the board by joints and copper track (see figure 7). If the meter shows zero resistance than all well and good, but if it shows a high resistance or even one of just a few ohms (probably due to dirt on the copper underneath the solder) then you have located a faulty joint.

If the fault still remains stubbornly hidden, the next step is to sub-divide the black boxes into smaller and smaller sections, checking each in turn, until finally you

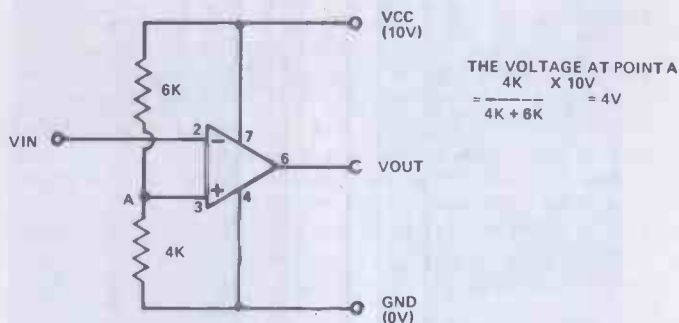
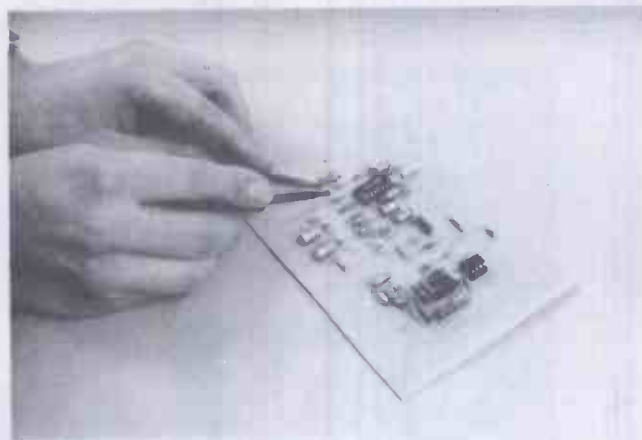

Fig. 6. Estimation of the voltage at point A. (With respect to 0 V.)

are considering individual components. These can be unsoldered and tested out of the printed circuit board if necessary.

Non electrolytic capacitors can be checked out of circuit with a resistance meter, they should have a high (almost infinite), resistance. Electrolytics, when measured, should normally appear to have a lower resistance then slowly increase to a high one lower values, 1-10uF will change considerably faster. This is because they charge up using the current available from the meter. Again, the ideal procedure is to check all of this before construction, in an attempt to reduce possible causes of faults. However, a component which seems perfect on insertion, can be damaged if there is a fault nearby, by high current, temperature etc. So testing of a component before use only reduces risks of faults and doesn't eliminate it.



Take care not to short any components with the test clips when probing your circuit.

THE LAST STRAW

Finding faults in a project can be a very difficult task, but one which every aspiring electronics genius will have to go through! There are no easy methods — although a logical approach to the symptoms is advisable. Remember also that fault finding can be very rewarding and great pride can be taken in the finished article.

However, if after all this time, energy and strenuous brain activity you still haven't got a working project — the alternative is still the bin!

HE

TEE SHIRTS

We won't guarantee HE Tee-Shirts will make your soldering any better, we won't even claim it will make your projects work first time. What we will say is that it will protect your body from harmful Ultra-Violet radiation from the sun, embarrassing Tomato Ketchup stains on your hairy chest and overweight wallets (if bought as directed in sufficient quantity).

Yes folks, for just £2 all inclusive you can be the first kid on your block to own a brand new HE Tee Shirt. If you buy more than one your torso need never be left unprotected whilst your other one is in the wash.

Send your cheque, PO or anything negotiable to:
HE TEE SHIRTS, 145 Charing Cross Rd, London WC2H 0EE.



PRECISION POLYCARBONATE CAPACITORS

Axial Leads & Radial Leads

	1%	2%	5%
0.01µ	£1.88	£1.53	£1.39
0.1µ	£1.90	£1.54	£1.43
0.22	£1.99	£1.61	£1.46
0.33	£2.30	£1.85	£1.76
0.47	£2.65	£2.18	£1.94
0.68	£2.93	£2.40	£2.14
1.0	£3.15	£2.54	£2.31
1.5	£3.34	£2.74	£2.46
2.2	£3.65	£3.06	£2.73
3.3	£4.71	£3.85	£3.34
4.7	£6.39	£4.46	£3.65
6.8	£8.34	£5.20	£4.54
10.0	£7.95	£5.53	£5.02
15.0	£12.42	£8.65	£7.58
22.0	£16.19	£11.28	£9.90

See also lists for details of our range of 1/2µ capacitors.

RESISTORS 1/2W @ 40C, 1/3W @ 70C. 5% Tolerance and high stability. Low Noise 2.2R, 2.7R, 3.3R, 3.9R, 4.7R, 5.6R, 6.8R, 8.2R, 10R etc. Full E24 series 2p each, 10 for 15p, 100 of one value 95p, 1,000 mixed in 100s £8.00. Special Development Pack: 10 of every value 2.2R to 2M2 (730 resistors) £6.00.

Rotary Pots

Single Less Switch: Log and Lin, 4K7 to 2M2. All @ 27p each.

TANTALUM BEAD CAPACITORS

35V: 0.1, 0.15, 0.22, 0.33, 0.47, 0.68, 1.0, 1.5, All 10p each, 2.2/35v 14p; 4.7/10V 12p; 10/35V 17p; 22/16V 22p; 33/10V 20p; 47/6V3 35p; 68/3V 35p; 100/3V 28p.

Toggle Switches

Sub Miniature	SPST	DPDT	Centre off DPDT	Standard
SPST	68p	75p	83p	46p
DPDT				52p

0.1W Pre-sets

Vertical/Horizontal available: 100, 220R, 470R, 680R, 1K, 2K2, 4K7, 6K8, 10K, 15K, 22K, 47K, 68K, 100K, 220K, 470K, 680K, 1M. All @ 6p each, 100 mixed £4.50.

Push Switches

Standard:	Push to make (spring off)	Push to make (spring off) 18p (Available in Red, Yellow, Black)	Push to make Spring off (Red only)	Push to Push off (Red only)
			60p	65p
Slide switch: 250V 1A DPDT				18p

SPECIAL OFFER

SANYO STK015 Power amplifier 10W 8Ω only: £3.50 each
 Radio Spares Edge Meter (MR100) 0-10uA RS number 259-561. Brand new/Boxed £3.50 each.

TRANSISTORS		BRIDGES						
AC154	18p	BC301	36p	2N3053	18p	1.5A	200V	40p
AD161	45p	BC131/2	35p	2N3055	48p	400V	47p	
AD162	44p	BF115	32p	2N3819	20p	600V	48p	
AF114	52p	BF190/1/2/3	28p	2N3901	11p			
AF116	58p	TIP31A	38p	2N3904	15p			
BC107/8/9	10p	TIP32A	40p	1N4001	5p	2.0A	50V	35p
BC114	9p	TIP33A	65p	1N4005	8p		200V	47p
BC147/8/9	8p	TIP41A	45p	1N914	3p		600V	58p
BC153	10p	TIP42A	40p	1N5400	15p		800V	85p
BC182/3/4	9p	TIP3055	65p	1N5404	18p			
182L/3L/4L	10p	TIS43	34p	1N5405	24p			
BC300	34p	2N2926GO/Y	18p	1N5408	27p			

Our latest FREE lists are available (31 packed pages). Send SAE. Please add 25p P/P and 15% VAT to all orders. Return of mail service. Send your orders to: **MARCO TRADING, Dept. H1, The Old School, Edgaston, Nr. Wem, Salop SY9 5RJ. Tel: Whixall (084872) 464/465.**

computing today



computing today

APR 1979
50p



HOME COMPUTERS:
A SURVEY

A TOUCH OF ASCII
\$100 VDU PROJECT
NASCOM PACKAGE

computing today

MAY 1979
50p



16K Ram Card For \$100
Tunes On NASCOM I
TECS—How Good?
12 PAGE SOFTSPOT SPECIAL
Readers' Programs For You To Run

First there was ETI, catering for the same stable. CT covers the area of small-middle-range to advanced electronics enthusiast. Then there was HE which was aimed at the newcomer to the field.

Now there is Computing Today from the

same stable. CT covers the area of small-business and amateur computing and deals with both software and hardware.

CT's third issue (cover date of May) is out now — 50p at your newsagent.

**Next
Month**

Hobby Electronics

How do we do it? Next month at great expense to life, limb and sanity we hope to present you, the loyal readers, with an issue yet to be surpassed in the history of magazine publishing. Extravagant claims? We think not, just feast your eyes on this little lot.

RADIO CONTROL



Do-it-yourself radio control systems always tend to be less attractive to build when confronted with hundreds of components, so for everyone that has ever promised themselves a system HE proudly present a Multi-Function digital R/C system using the latest 'dedicated' state-of-the-art ICs in both the decoder and encoder to make this system possibly the easiest and cheapest system yet published anywhere!

KIT REVIEW



Next month in conjunction with the Radio Control project we are reviewing a new servo kit. This easy to build kit is ideal for use in our project car and will not leave you broke. Before you start though it would be as well to arm yourself with a fine-point soldering iron and a new pair of glasses as this kit calls for some pretty accurate soldering.

MINIATURE TV SURVEY



For people with very small eyes from people with very small brains (no offence meant) we have great pleasure in presenting this review of all of the latest titchy tellies on sale at the moment, from the miniscule Sinclair to the somewhat larger offerings from our Oriental cousins. We have drawn a limit at anything exceeding a screen size of five inches, you would be surprised what you can cram in such a small box, one model combines a TV with a FM/AM radio cassette recorder. The kitchen sink is an optional extra.

CMOS SPECIAL

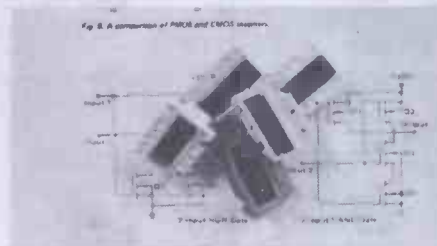

Next month we present another in our very popular series highlighting a particular component or device. This time it's the turn of the CMOS IC. As usual we show lots of practical, buildable circuits with the accent on the functional and novel side of our hobby.

CROSSHATCH GENERATOR

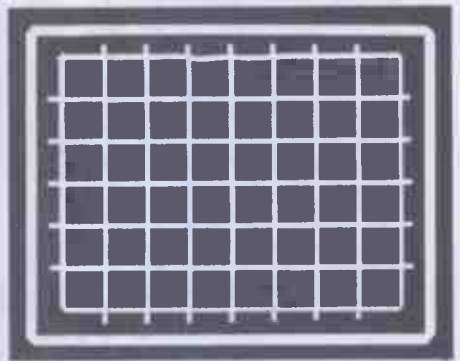

To make this something of a TV special we have decided to include in this month's projects one of the most useful pieces of test gear available to the TV engineer. It will produce a grid pattern onto the screen of a TV set, this is particularly useful if you happen to be setting up the convergence on a colour set or the picture size and shape on a black and white set.

If you're very clever it can also be used as a TV game, how does multi-layer noughts and crosses sound?

SPACELAB

Look out for a major feature on one of the proposed payloads for the Shuttle, this new orbiting laboratory will enable scientists, rather than astronauts, to carry out their experiments in a near-Earth environment.

DIGITAL DICE

Groan, not another dice project, but wait, our researches have shown that dice projects are amongst the most popular electronic systems to build. Why? Simply because they are easy to build, ideal for a newcomer to electronics, easy to understand, and they work. They actually do something. Our project next month uses a rather novel circuit that will be of interest to beginners and 'old hands' alike.

The January issue will be on sale December 14th

The items mentioned here are those planned but circumstances may affect the actual contents

Short Circuit

LOW BATTERY VOLTAGE INDICATOR

This circuit can be used to monitor a supply voltage of between about 5 and 25 volts (30 V absolute maximum) and will switch on a warning light if the supply falls below some predetermined threshold level.

Although only five components are used, the circuit is actually quite sophisticated, giving good reliability and precision. This is due to the use of an 8112 voltage detector IC. A comparator forms the heart of the device, and a highly stable internally generated reference voltage is fed to the inverting (-) input of the comparator. Its non-inverting (+) input is available at pin 3, and in this circuit it is fed from the supply lines via the potential divider circuit which consists of R1 and RV1. The output of the comparator is available at pin 4, but is obtained by way of a constant current generator which limits the output current to a nominal figure of 7 mA.

If the voltage at the non-inverting input exceeds the reference voltage, the output assumes the high state and LED indicator D1 is not switched on. If

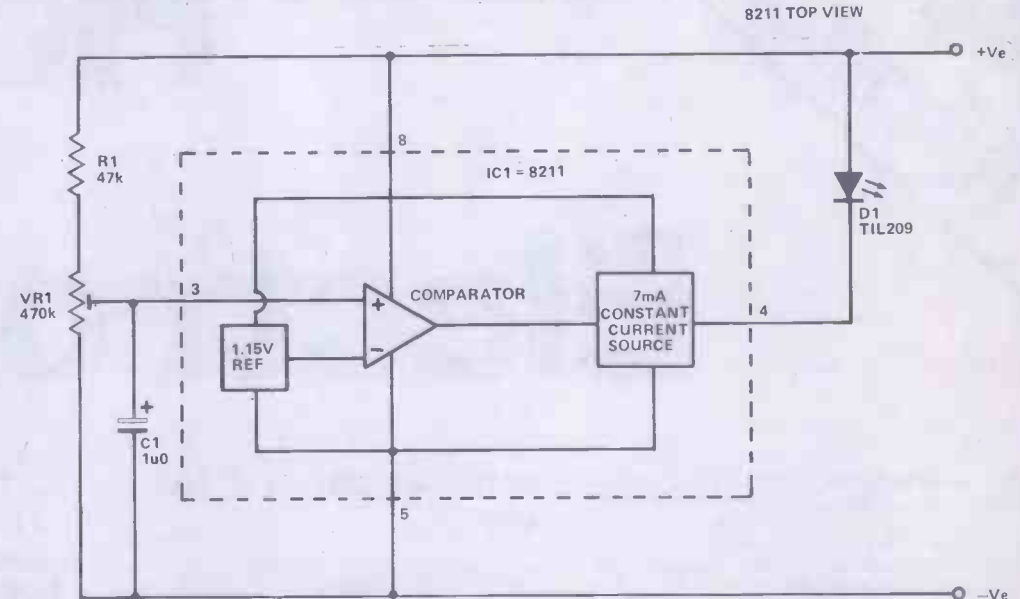

the non-inverting input voltage falls below the reference level, the output then goes low and power is applied to D1. The constant current source limits the LED current to a suitable level. In practice RV1 is adjusted so that with the supply voltage at its minimum

acceptable level the non-inverting input is at a potential just marginally higher than the reference voltage. In other words it is adjusted for the lowest voltage that does not cause D1 to be switched on. A fall in supply voltage below the threshold level then takes the

non-inverting input below the reference voltage and switches on the warning light. C1 decouples any stray pick-up which could otherwise cause spurious triggering of the circuit. The quiescent current consumption is typically only about 50 uA.

GAMES OFFER...



We could fill this advert with a load of fancy descriptions telling you how marvellous this offer is. How it plays three very exciting/brain stimulating/skilful games as well as being a full four function calculator with memory but we won't, we think it speaks for itself. Instead we'll just say that if you're in the market for a hand-held game this Christmas, look no further. It's just about the best one we've seen so far.

This game is called the Enterprise, it comes from no less a manufacturer than Videomaster and we're selling it for the rock-bottom price of £20.95 including VAT and P&P for a limited period only. So if you've ever wanted to be a speedway rider, play pontoon against a computer or guess the hidden code using logic or sheer luck, all with realistic sound effects, then this is the game for you. Send your cheque or postal order to:

To: Enterprise Game Offer
HE Magazine
145 Charing Cross Road
London WC2H 0EE

Name

Address

Please find enclosed my cheque/PO for £20.95 (payable to HE Magazine) for a Videomaster 'Enterprise' Game.

All offers inclusive of 15% VAT and Postage.

Ring Modulator

Enjoy SCI-FI from your HI-FI with HE's ring modulator audio effects unit.

Now you can create the unique "Dalek" sound in the comfort and privacy of your own home. This is THE special effects unit that turns talk into squawk and mutter into stutter. With only two simple to operate controls and featuring a convenient built-in oscillator; the project is a cinch to build. Only four common IC's are used with a handful of passive components keeping the cost down without sacrificing performance.

GIGO

There is an old computing term, GIGO, which stands for garbage in — garbage out. This unit is a little different . . . you get garbage out no matter what you put in!

There are two inputs and one output. Input signals should be between one and two volts peak to peak for satisfactory operation. The output level is variable by adjustment of RV2. To set up the unit, a signal is injected into the X input with the Y input disconnected, then RV1 should be adjusted until the output diminishes to a quiet hiss. It should be possible to completely null out the X input signal. If you cannot, then there is probably stray coupling between your connecting leads. We used screened cable for the audio signals and connected one end of each braid to a common-earth point on the metal case. A metal case is recommended to reduce hum and noise pick up.

Once you have made this adjustment, a signal can be connected to the Y input and a modulated version of the



The oscillator in the Ring Modulator produces an approximate sawtooth waveform which can be simply modified to a square wave for further effects.

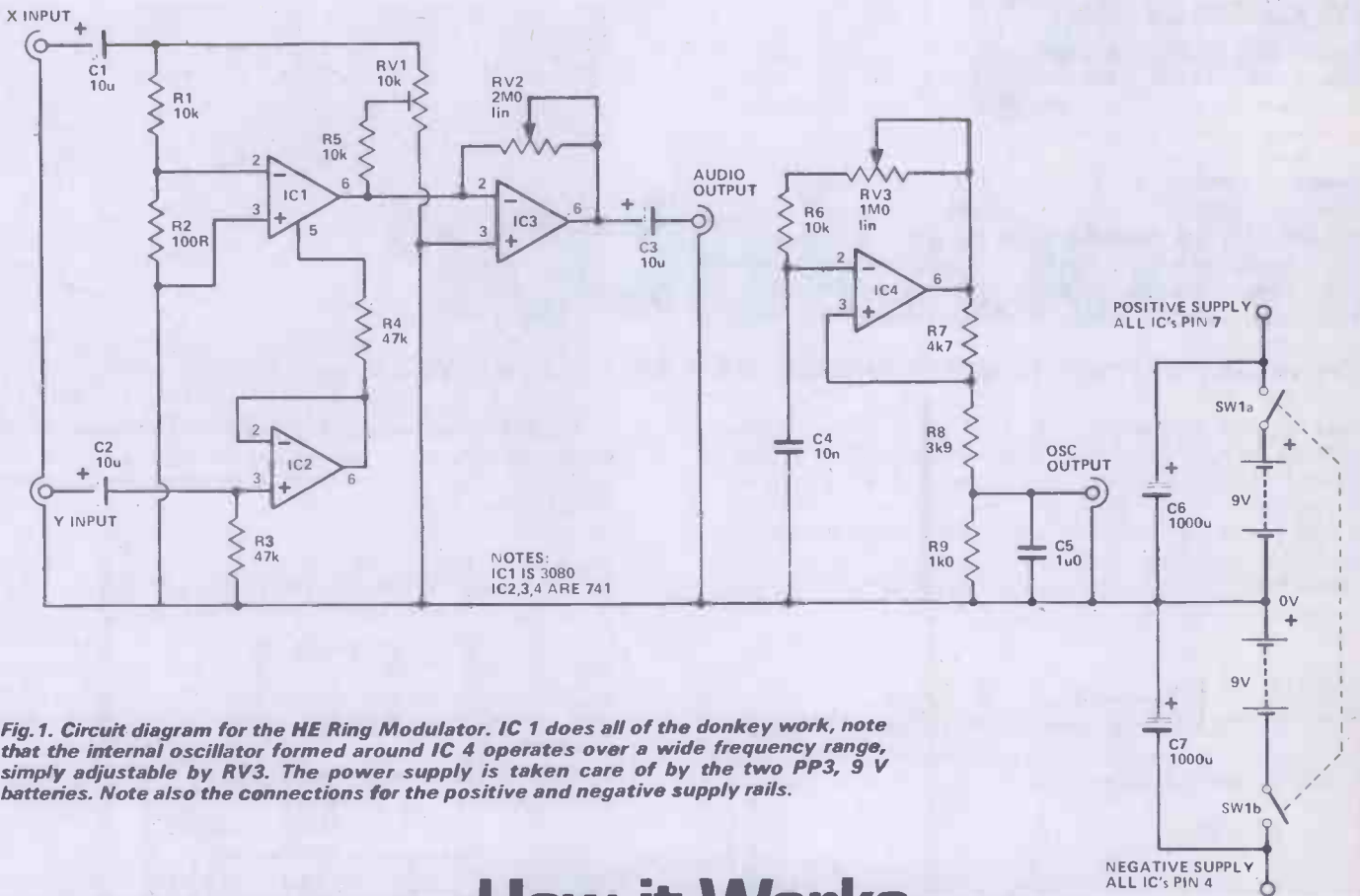

Fig. 1. Circuit diagram for the HE Ring Modulator. IC 1 does all of the donkey work, note that the internal oscillator formed around IC 4 operates over a wide frequency range, simply adjustable by RV3. The power supply is taken care of by the two PP3, 9 V batteries. Note also the connections for the positive and negative supply rails.

How it Works

The principal active element in this circuit is IC1, a 3080 operational transconductance amplifier whose gain is controlled by the current flowing into pin 5. This current flows through R4 and is determined by the voltage at the output of IC2, pin 6. When there is no signal at the Y input, a steady current flows through R4 giving IC1 a certain gain.

Any signal at the X input appears inverted at the output of IC1 as a varying current. It is converted to a voltage by IC3 whose gain is controlled by adjustment of RV2. With no signal at the Y input, RV1 is adjusted so that it feeds a portion of the

non-inverted X input into IC3 exactly cancelling the inverted X signal from IC1. Any signal at the Y input will then modulate the gain of IC1 to produce the familiar 'ring modulator' sound.

An oscillator is built into the unit and comprises IC4 and associated components connected in a standard astable multivibrator configuration. A portion of the squarewave output is tapped off by potential divider R7, 8, 9. Capacitor C5 smooths the wave form to give an approximate sawtooth and frequency is variable by adjustment of RV3. Capacitors C6, 7 provide overall smoothing.

X input will appear at the output. The internal oscillator is a very simple affair consisting of one 741 op-amp connected in a standard astable oscillator circuit. Its output is an approximate sawtooth whose frequency is adjusted by RV3. Owing to the simple filtering employed, the output level falls as the frequency is increased. The output level can be increased by increasing the value of R9 and decreasing R8 keeping their total resistance to around five thousand ohms. By omitting or disconnecting C5, a squarewave output will be obtained. If you have a signal generator, you can experiment with different waveforms and amplitudes — or try connecting the Hobby Siren or Hobbytune to the unit!



The circuit is powered by two PP3 batteries. All of the inputs and outputs are available on the rear panel. They are from left to right: X', 'Y', OUT and OSC.

Ring Modulator

CONSTRUCTION

A metal box is the ideal enclosure and use of our PCB should prevent any problems with layout. However, the circuit is quite simple and Veroboard or other constructional techniques can be employed if desired.

Follow the usual practice when assembling the unit. Insert the wire link, resistors, capacitors and IC sockets before fitting the IC's. Use of sockets adds very little to the cost of the unit and greatly facilitates fault finding as well as enabling the chips to be easily removed for use in other projects. None of the chips used here are sensitive to static discharge and no special handling precautions are necessary.

When complete, the unit may be set up and tested. If you do not have a monitor amplifier, the output will drive a crystal earphone satisfactorily . . . the cheap eight ohm earphones will not work in this application. Suitable inputs include amplifier "line" outputs and transistor radio "earphone" outputs.

You will not put the Radiophonic workshop out of business probably; but you can create a winter-wonderland of effects for a cybernetic Christmas! **HE**

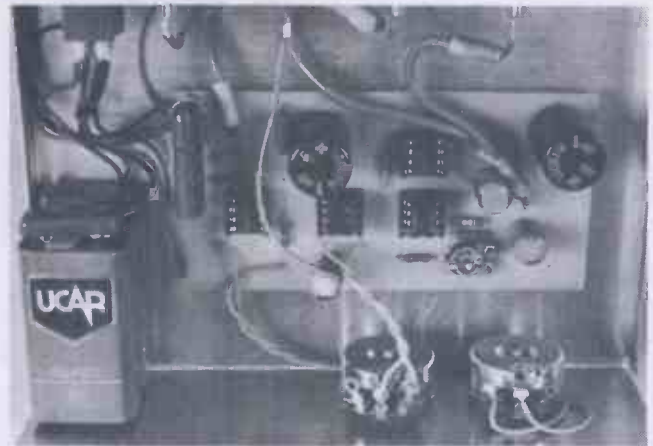

Keep all of the interconnecting leads short so as to prevent stray signal pick up. Note the use of screened cable to couple signal inputs and outputs.

Parts List

RESISTORS (All 1/4W, 5%)

R1, R5, R6	10k
R2	100R
R3, R4	47k
R7	4k7
R8	3k9
R9	1k0

POTENTIOMETERS

RV1	10k min preset
RV2	2MΩ 1in
RV3	1MΩ 1in

CAPACITORS

C1, C2, C3	10μ electrolytic
C4	10n polyester
C5	1μ0 polyester
C6, C7	1,000μ electrolytic

SEMICONDUCTORS

IC1	3080
IC2, IC3, IC4	741

MISCELLANEOUS

SW1 DPST connectors, PCB, 2 PP3 or equiv.

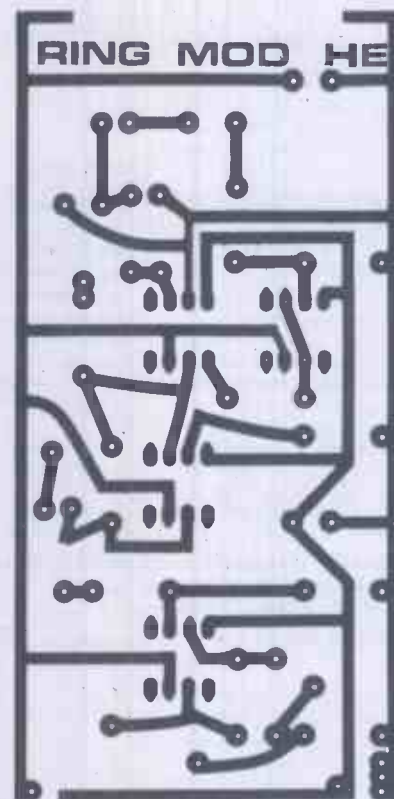

Fig.2. PCB foil pattern for the HE Ring Modulator.

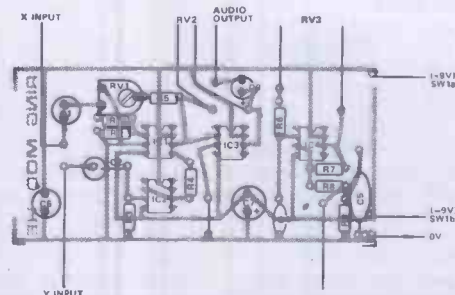

Fig.3. Overlay diagram for the Ring Modulator, as usual be sure to observe all of the rules when inserting polarised components, to avoid any headaches **DOUBLE CHECK** before switching on.

Buylines

All the components should be readily available from the larger mail-order companies.

Short Circuits

A.F. SIGNAL GENERATOR



One of the most useful items of test equipment to have, especially if one has an interest in any type of audio gear, is an AF signal generator. The circuit shown here provides a good quality sinewave output over three continuously variable ranges (Range 1, below 20Hz to above 200Hz; Range 2, below 200Hz to over 2kHz; and Range 3, below 2kHz to over 20kHz) covering more than the entire audio frequency spectrum.

The circuit uses the usual Wien Bridge type circuit, and this form of oscillator consists of an amplifier having frequency selective positive feedback provided via a C-R network. The capacitive elements of this network are whichever two capacitors are selected by SW1, the three sets of capacitors giving the unit its

three ranges. The resistive elements are R6, R7 and RV1, the latter permitting the unit to be tuned over the ranges quoted above. This network provides positive feedback over operational amplifier IC1, which is a FET type giving low noise and distortion levels. VR1a and R6 also bias the non-inverting input of IC1 to a central tapping on the supply produced by R1, R2 and C2.

The closed loop gain of IC1 must be maintained at precisely the correct level if good results are to be attained. Insufficient gain would lead to less than full

compensation for the losses through the C-R Wien network, with insufficient feedback and consequent violent oscillation with the output signal becoming clipped and seriously distorted. An automatic gain control (AGC) circuit is used to maintain stable operating conditions and a constant output level. R5, R4 and the drain to source resistance of Q1 form a negative feedback network which controls the closed loop gain of IC1. Initially Q1 is forward biased by R3 so that there is enough gain to give strong oscillation. Some of the output from IC1 is coupled by R8

and C10 to a rectifier and smoothing network comprised of D1, D2 and C3. These produce a positive bias which tends to cut off Q1, producing reduced circuit gain. The stronger the circuit oscillates, the larger the bias, and the lower the gain becomes. Lack of oscillation produces reduced bias, more gain, and stronger oscillation. The required stabilising action is thus obtained.

Variable attenuator VR2 enables the output to be adjusted from zero up to about 1.5V RMS. The current consumption of the circuit is about 7 mA.

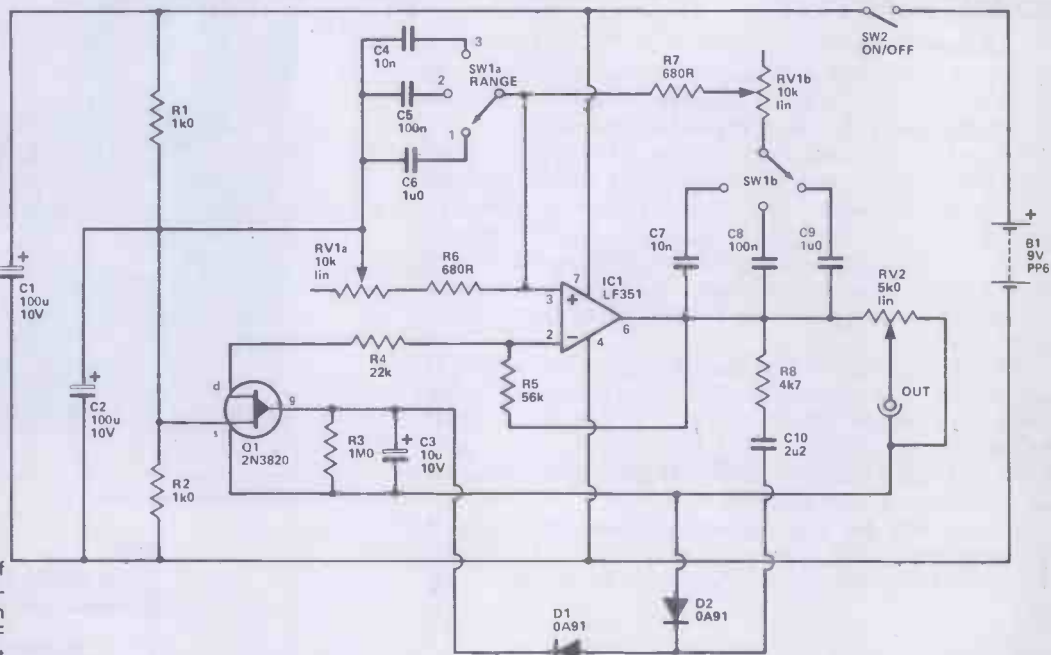

SINE TO SQUARE CONVERTER

This circuit provides an optional squarewave of about 1.2 volts peak to peak when used with the signal generator circuit described above. The above circuit requires no modification, other than the omission of output attenuator potentiometer RV2 which is included in this section of the unit instead.

The squaring circuit is based on operational transconductance amplifier IC1. This device is in some ways similar to an ordinary operational amplifier, but it is the output current rather than the output voltage that is a function of the input voltages. The inverting input of the device is biased to the central tapping on the supply lines, and the non-inverting input is fed with the sinewave output from the main signal generator circuit. When fed with positive going half cycles, the non-inverting input is taken to a higher voltage than the inverting one, resulting in a forward bias being

applied to D2 by way of current limiting resistor R2. This produces a positive potential of about 0.6 volts across D2. When the circuit is fed with negative going half cycles the non-inverting input is taken to a lower potential than the inverting one, causing a forward bias to be applied to D1, and producing a negative output potential of about 0.6 volts.

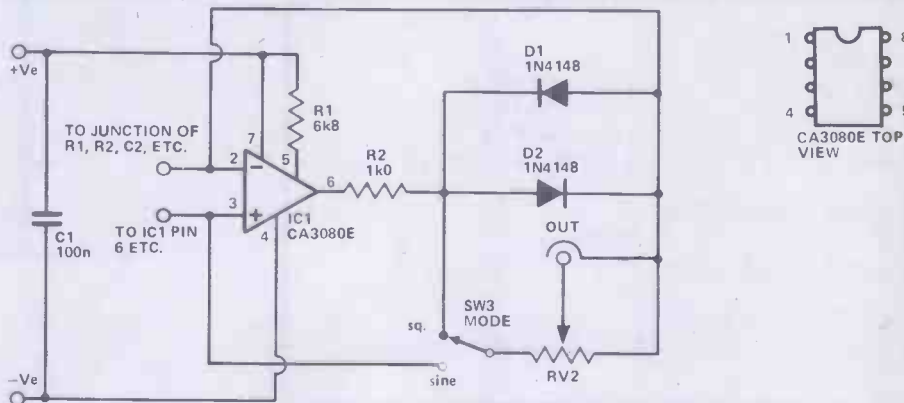

Thus the output is switched from one polarity to the other as the input signal changes polarity, producing the desired squarewave signal. The CA3080E device has a high slew rate (50 V/μs) and is therefore capable of producing a high quality squarewave signal even at the higher frequencies covered by the unit. The gain of the CA3080E can be varied by altering the bias fed to its pin 5,

but this feature is of no use in this application and R1 provides a strong bias to the device so that it operates at high gain. SW3 is the mode switch, and merely connects RV2 to the output of the sinewave generator or squaring circuit, as required. The squaring circuitry only adds about 3 mA or so to the current consumption of the unit.

ELECTRONI-KIT

DENSHI KITS SPECIAL OFFER



"... fun and entertainment as well as education"

(EVERYDAY ELECTRONICS mag.)

The SR-3A kit (over 100 circuits) and the SR-3A de luxe kit (over 105 circuits) are available again, at little more than their 1977 prices!

Circuits are constructed by plugging the encapsulated components into the boards provided, following the instruction manual. Technical details are also given concerning each project. The components are used over and over again and you can design your own circuits too, or use the kit as a useful testing board.

No previous experience of electronics is required but you learn as you build — and have a lot of fun, too. The kits are safe for anyone.

SR-3A KIT

16½x10x2½" £29.95

Build over 100 projects including 3-TR reflex radio receiver, 3-TR radio receiver with RF amplifier, 2-TR reflex radio receiver, 3-TR amplifier for crystal mike, 3-TR amplifier for speaker / mike, 3-TR signal tracer, Morse Code trainer, 2-TR electronic organ, electronic metronome, electronic bird, electronic cat, electronic siren, electronic gun, 2-TR sleeping aid, high voltage generator, discontinuity warning device, water supply warning device, photoelectric alarming device, 3-TR burglar alarm, 3-TR water supply warning device, 3-TR water level warning device, 3-TR photo-electric alarming device, Morse Code trainer with sound and light, discontinuity warning device with sound and light, water level warning device with sound and light, electronic metronome with sound and light, buzzer with sound and light, wireless mike, wireless telegraph set, wireless discontinuity warning device, wireless water level warning device, wireless water supply warning device, and wireless photoelectric warning device, etc, etc.

SR-3A de luxe KIT

(Illustrated 16x14x3½") £39.95

Similar to SR-3A, more components including solar cell and additional Speaker unit plus sophisticated control panel.

All kits are guaranteed and supplied complete with extensive construction manuals PLUS Hamlyn's "All colour" 160-page book "Electronics" (free of charge) whilst stocks last.

Prices include batteries, educational manuals, free book, VAT, P&P (in the UK), free introduction to the British Amateur Electronics Club.

Cheque/P.O./Access/Barclaycard (or 16p for illustrated literature) to DEPT. HE.

ELECTRONI-KIT LTD.
RECTORY COURT, CHALVINGTON,
E.SUSSEX, BN27 3TD (032 183 579)

C. B. CITY LTD.

5 Highland Road
ALDERSHOT, Hants

C. B. CITY is dedicated to all present and future Citizen Band Users.

Until legislation allows, we will not sell rigs (transceivers) but we do stock a full range of aerials (fixed, mag-mounts, clip-ons, and electrically operated), S.W.R. meters, amplifiers, suppressors, connectors, custom-made aerial extension leads plus many other goodies. If you require anything not listed we can obtain it for you.

Just send 3x10p stamps for our comprehensive catalogue.

Access, Credit Cards accepted
Duff Rig?? Then why not take advantage of our repair service — absolute confidence guaranteed.

REMEMBER!! Until C.B. becomes legal we **DO NOT** sell rigs

MiniM



LET US TURN YOUR HI-FI ON with our DIGITAL TIMER

The Minim Digital Timer is an accurate 24 hour clock, with the facility to switch mains operated equipment ON and OFF at independently pre-set times; it can switch appliances up to 1.5 kW — the biggest hi-fi, TV, heaters, lights, etc. It is very easy to set the time and lights illuminate to clearly show the settings. Housed in an attractive teak veneered cabinet size 7in. x 5in. x 2in. approximately

Price £39.95

Please send me further details of your Digital Timer and other products in your range.

Name

Address

H3

***MINIM AUDIO LIMITED**
Lent Rise Road, Bumham, Slough SL1 7NY
Telephone: Bumham 63724

Back Numbers From HE

We regret to say that copies of the November, December and January issues of Hobby Electronics have sold out (we did warn you!) However Hobbyprints A B C, F and G are still available.



FEBRUARY 79 (Hobbyprint D)

Projects: Short Wave Radio, Sine/Square Generator, Scratch/Rumble Filter, Car Alarm Project.
Features: Video Tape Recorders, Radioactivity, CA 3130 Circuits, Computer Glossary etc.



MARCH 79 (Hobbyprint E)

Projects: Light Chaser, Tone Controller, Photographic Timer, Cassanova's Candle.
Features: TV Signals, Test Gear, SW Aerials, Interfering Waves, Communications Satellites, etc.



APRIL 79 (Hobbyprint F)

Projects: Model Train Controller, Alarm, Transistor Tester.
Features: TV Aerials, Electronics in Catalogue Survey etc.

SOLD OUT



MAY 79 (Hobbyprint G)

Projects: Power Supply, Digibell, White Noise.
Features: Electronic Music, AB Circuits, 555 Circuits, Aerial Tuners, Varicap Diodes etc.

SOLD OUT



JUNE 79 (Hobbyprint H)

Projects: GSR Monitor, Envelope Generator, Drill Speed Controller.
Features: Citizen Banned, Display Techniques, Moving Coil Meter, Electronics in Music Pt 2, etc.

Shown here are most of the past issues with their major features and projects. The issues available are now priced £1.00 each including post and packing. Send your order to:

**Hobby Electronics
Backnumbers Dept.
145 Charing Cross Road
London, WC2H 0EE**

Shown next to each issue is the relevant code letter to use when ordering Hobbyprints. (See Hobbyprints ad. elsewhere in this issue.)



JULY 79 (Hobbyprint I)

Projects: Shark, Baby Alarm, Point Controller, Linear Scale Ohmmeter.
Features: Cassette Decks and Tapes, Binary Numbers, Fixed Resistors, Short Circuits Special, etc.



AUGUST 79 (Hobbyprint J)

Projects: Home Security System, LED Tachometer, Injector/Tracer, Constant Volume Amplifier.
Features: Security Installation, Variable Resistors, Tools, Satellite Power etc.



SEPTEMBER 79 (Hobbyprint K)

Projects: Combination lock, Light dimmer, Starburst, Ultrasonic Switch.
Features: Electronic Timekeeping, Thyristors, Radio Control, FET Spécial.



OCTOBER 79 (Hobbyprint L see Hobbyprint Ad)

Projects: Tantrum, Hobbytune, Analogue Frequency Meter, Multi Siren.
Features: Home Computing, Electronic Games, Microwave Cooking, Breaker One-Four.



NOVEMBER 79 (Hobbyprint M)

Projects: Hebot, R2, D2 Radio, Guitar Tuner.
Features: Data Supplement, TV Broadcasting, Miniboards.

SUBSCRIPTIONS

WHY MISS OUT?

To: Subscriptions
Hobby Electronics
P.O. Box 35
Bridge Street
Hemel Hempstead
Herts

I would like a postal subscription to HE starting with the issue. I enclose payment (£6.50 for UK and Eire, £7.50 elsewhere, £11.50 air mail).

Name

Address

Hobby Chit~Chat

In this month's 'Chit-Chat' Ray Marston takes an in-depth look at the LM3914 IC and shows a variety of ways of using it as an indicating instrument in the car and the workshop.

IF YOU LOOK at this month's 'Car Voltmeter' project you'll notice that it is based on the LM3914 Dot/Bar Display Driver IC from National Semiconductors. We've used this IC in several projects in HE and ETI (our sister magazine) over the last few months and are greatly impressed with the device. We regard it as a very important new tool in the field of amateur and professional electronics.

The LM3914 is a highly versatile IC that is designed to sense an analogue input voltage and drive a line of 10 LEDs to give a visual analogue display of that voltage. The unit can give either a 'Dot' or 'Bar' display of the voltage. Figure 1 illustrates the appearance of the two alternative display modes when used to indicate 5 volts on a 10 volt scale. The unit acts as an inexpensive and superior alternative to the conventional analogue-indicating moving-coil meter. It does not suffer from 'sticking' problems, is unaffected by vibration and can be used in any attitude.

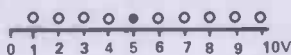

Fig. 1a. 'Dot' indication of 5 volts on a 10 volt LED scale.

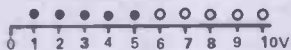

Fig. 1b. 'Bar' indication of 5 volts on a 10 volt LED scale.

The LM3914 can readily be used as the basis of a wide variety of 'indicator' and instrumentation projects in the home, the car, the workshop and in miscellaneous audio and musical projects. One of the great attractions of the device is that it is very easy to understand and use. You don't need to be a BA or MSc to be able to fully comprehend its operating principle and learn to adapt it to suit your own particular circuit requirement. We explain the essential details of the device and show several practical ways of using it in the next few pages.

THE LM3914: BASIC PRINCIPLES

Figure 2 shows the equivalent internal circuit of the LM3914 IC, together with the connections for making it

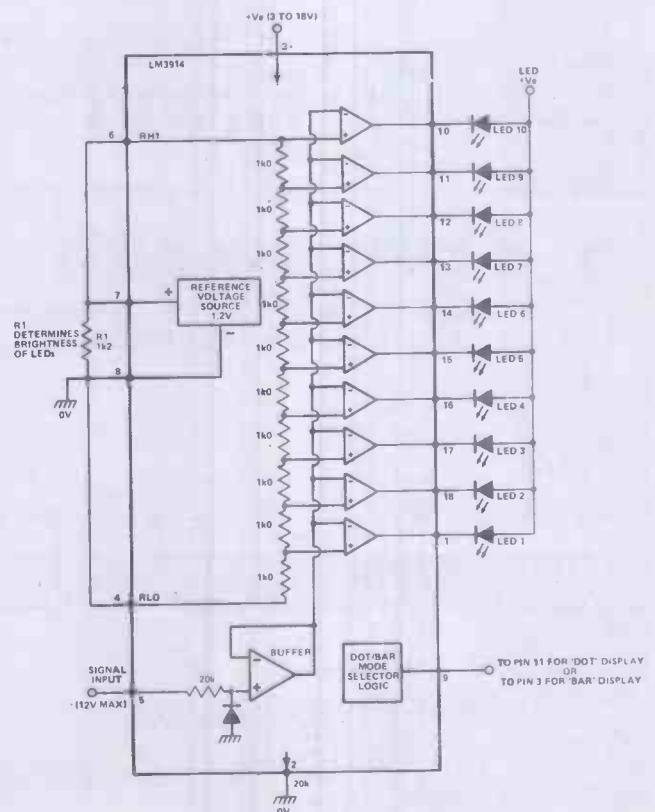

Fig. 2. Equivalent internal circuit of the LM 3914 with connections for making a 0-12 volt dot or bar meter.

act as a 10-LED voltmeter with a full-scale sensitivity of 1.2 volts.

The first point to note about the IC is that it contains a 10-resistor potential divider, wired between pins 4 and 6. The IC also contains ten voltage comparator circuits, each with its non-inverting (+) terminal taken to its own particular tap on the potential divider, but with all inverting (-) terminals of the comparators joined together and taken to the output of an input buffer amplifier. This buffer amplifier gives an output that is, for all practical purposes, identical to the voltage applied to input terminal 5 of the IC. The output of each one of the ten

voltage comparators is individually available on one of the pins of the IC (pin 1 and pins 10 to 18) and is capable of 'sinking' a current of up to 30 mA.

The next point to notice is that the IC contains a built-in reference voltage source that provides a highly stable potential of 1.2 volts between pins 7 and 8. This source is of the 'floating' type, so that 1.2 volts is developed between pins 7 and 8 irrespective of whether pin 8 is tied to ground or is held at some voltage above ground. In the diagram of Fig 2 we've shown pins 7 and 8 externally connected to potential divider pins 6 and 4 respectively, so in this particular case 1.2 volts is developed across the 10-resistor potential divider network of the IC.

The final point to notice about the IC is that it contains an internal logic network that can be externally programmed to give either a 'dot' or a 'bar' display or action from the outputs of the ten voltage comparators. In the 'dot' mode, only one of the ten outputs is enabled at any one time. In the 'bar' mode all outputs below and including the highest 'energised' output are enabled at any one time.

At this point, let's put together the basic information that we have already learned about the LM3914 and the circuit of Fig 2, and see how the entire circuit functions. Let's assume that the logic is set for 'bar' mode operation.

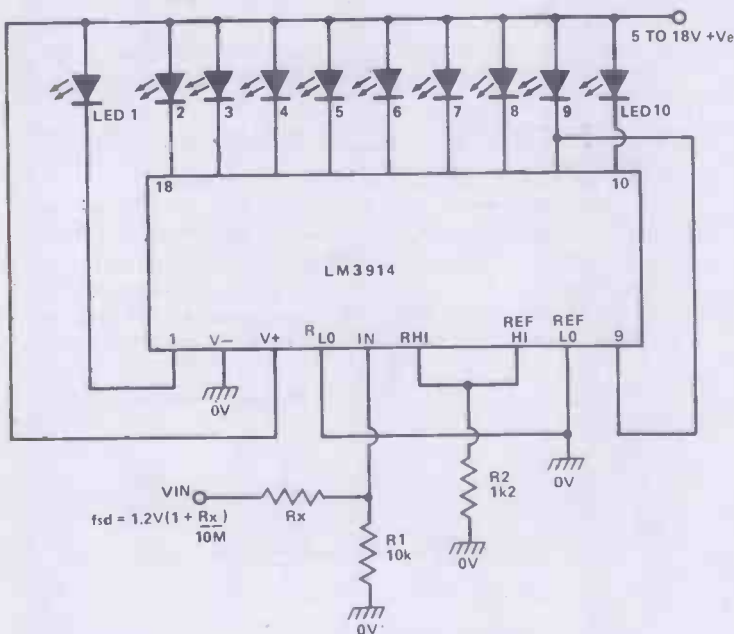

Fig.3. 1.2 V to 1000 V FSD 'Dot' mode voltmeter.

We already know that a reference of 1.2 volts has been set up across the 10-resistor divider, with the low (pin 4) end of the divider tied to ground (zero) volts. Consequently, 0.12 V is applied to the '+' input of the lowest voltage comparator, 0.24 V to the next, 0.36 V to the next and so on. If we now apply a slowly rising voltage to input pin 5 of the IC, the following sequence of events takes place:

When the input voltage is zero, the outputs of all ten voltage comparators are high and none of the external LEDs are turned on. As the input voltage is slowly increased it eventually reaches and then rises above the 'reference' 0.12 volts value of the first comparator,

which then turns on (it's output conducts) and energises LED 1. As the input is further increased it eventually reaches the 0.24 V of the second comparator, which then also turns on and energises LED 2. At this stage both LED 1 and LED 2 are on. As the input voltage is further increased progressively more and more comparators and LEDs are turned on, until eventually, when the input rises to and then exceeds 1.2 volts, the last comparator and LED 10 turn on, at which stage all ten LEDs are illuminated.

A similar kind of action is obtained when the LM3914 logic is set for 'dot' mode operation, except that only one LED turns on at any given time. At zero volts, none of the LEDs are on. At voltages above 1.2 (or whatever reference value is applied to the last comparator) only LED 10 is turned on.

At this stage, then, you can see that the LM3914 is a reasonably easy device to understand. Let's move on, then, and look at some of the finer details of its operation.

THE LM3914: A CLOSER LOOK

There is one component in Fig 2 that we have not yet mentioned and that is R1. This resistor is wired between the pin 7 and pin 8 output terminals of the reference voltage source and determines or 'programmes' the ON currents of the LEDs. The on current of each LED in fact approximates ten times the output current of the reference voltage source. The reference can supply up to 3 mA of current, so the LEDs can be programmed to pass currents up to 30 mA.

Remembering that the reference develops 1.2 V, you can see that if a total resistance of 1k2 is placed across the pin 7 — pin 8 terminals the reference will pass 1 mA and each LED will pass 10 mA in the ON mode. In Fig 2 the total resistance across the reference terminals is equal to the 1k2 of R1 shunted by the 10k of the IC's internal potential divider, so the reference actually passes about 1.1 mA and the LEDs conduct 11 mA. If R1 were removed from the circuit the LEDs would still pass 1.2 mA due to the resistance loading of the internal potential divider on pins 7 and 8.

You'll notice from the above description that the IC can pass total currents up to 300 mA when it is used in the 'bar' mode with all ten LEDs on. The IC has a maximum power rating of only 660 mW, so there is a danger of exceeding this rating when the IC is used in the 'bar' mode. We'll return to this point later.

The LM3914 IC can be powered from any d.c. supply in the range 3 to 25 volts. The LEDs can use the same supply as the IC or can be independently powered from supplies with voltages up to a maximum of 25 V. The voltage across the internal potential divider can have any value up to 25 volts maximum.

The internal reference amplifier produces a basic nominal output of 1.28 volts (limits are 1.2 V to 1.32 V), but can be externally 'programmed' to produce effective reference values up to 12 V (we'll show how later).

The input buffer of the IC has integral overload protection and can withstand inputs of up to plus or minus 35 V without damage.

The IC can be made to give either a 'dot' display by wiring pin 9 to pin 11, or a 'bar' display by wiring pin 9 to positive-supply pin 3.

PRACTICAL CIRCUITS: SIMPLE 'DOT' mode voltmeters

The basic circuit of Fig 2 acts as a voltmeter that reads full-scale at an input of 1.2 volts. The range of the circuit can be changed in a variety of ways. The sensitivity can be increased, for example, by either interposing a d.c. amplifier between the input signal and pin 5 of the IC, or by reducing the reference voltage that is applied to the pin 4 — pin 6 terminals of the IC: in this latter case the IC will operate quite well with a reference voltage down to a couple of hundred mV.

The easiest and best way to reduce the sensitivity of the meter is to use the connections shown in Fig 3. Here, the basic circuit is that of a 1.2 V meter, but the input signal is applied to the IC via a potential divider formed by R_x and R_1 . Thus, the circuit can be made to read 12 volts full scale by giving R_x a value of 90k, so that R_x - R_1 act as a 10:1 divider. This circuit can be used to read full scale voltages from 1.2 V up to about 1000V.

An alternative connection is shown in Fig 4. In this case the input voltage is applied directly to pin 5 of the IC, but the reference voltage on the internal divider is made variable from 1.2 V to 10 V via RV_1 . You'll remember that the 'reference voltage' develops 1.2 V between pins 7 and 8, but this voltage is fully floating. By wiring RV_1 between pin 8 and ground we can ensure that the output current of the reference flows to ground via RV_1 , thus providing a voltage that raises the pin 8 (and also pin 7) value considerably above zero volts. This increased voltage is applied to the top (pin 6) end of the internal potential divider, which has its low end (pin 4) grounded, and determines the full scale sensitivity of the circuit. This circuit has a useful voltage range of only 1.2 V to 10V. The IC supply voltage must be greater than the required full scale voltage.

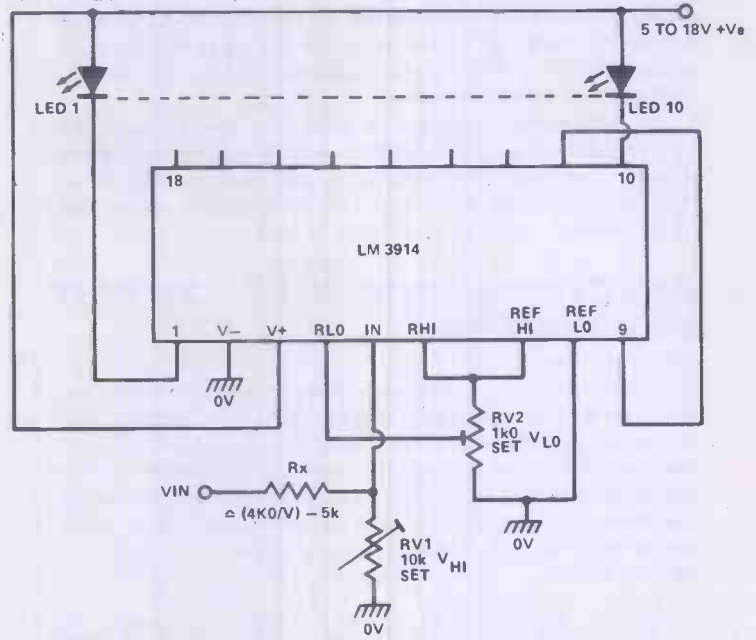

Fig.5. Expanded scale (10 V-15 V etc) 'Dot' mode voltmeter.

the slider of RV_2 . The external input signal is applied to the IC via the R_x - R_1 potential divider. Thus, if 1.2V is set to the top of the divider and 0.8 V is set to the bottom and the input divider has a ratio of 20:1, the circuit will read 24 V at full scale and 16 V at minimum scale.

PRACTICAL CIRCUITS: 'BAR' MODE OPERATION

The three basic voltmeter circuits of Figs 3 to 5 can be used with the IC connected in either the 'dot' or the 'bar' mode. When using the bar mode, however, it must be remembered that the power rating of the IC can easily be exceeded when all ten LEDs are on if an excessive voltage is allowed to develop across the output terminals

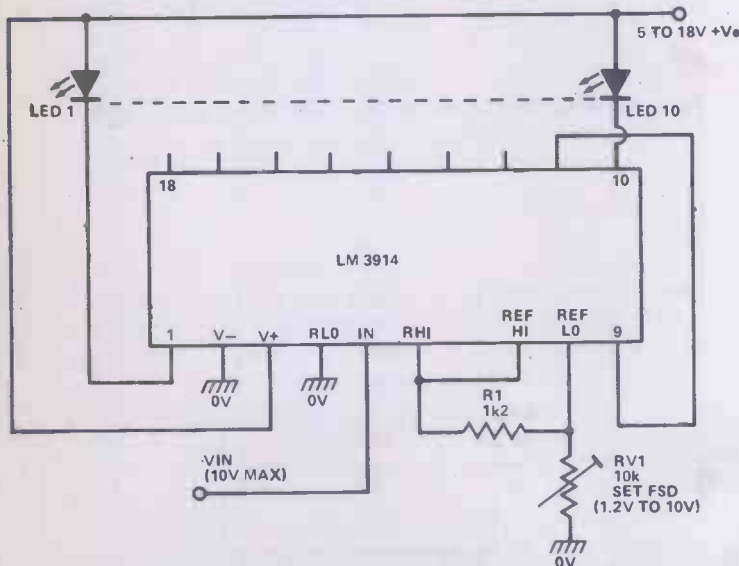

Fig.4. An alternative 1.2 to 10 V FSD 'Dot' mode voltmeter.

Figure 5 shows how the LM3914 can be used as an expanded scale voltmeter that reads (say) 10V at minimum scale but 15 V at full scale. The secret of this circuit is that both the top and bottom ends of the internal potential divider (pins 6 and 4) of the IC are externally available, so the top and bottom limits of the scale can be individually set. In the diagram the top of the divider is fed from the 1.2 V reference, but the bottom is fed from

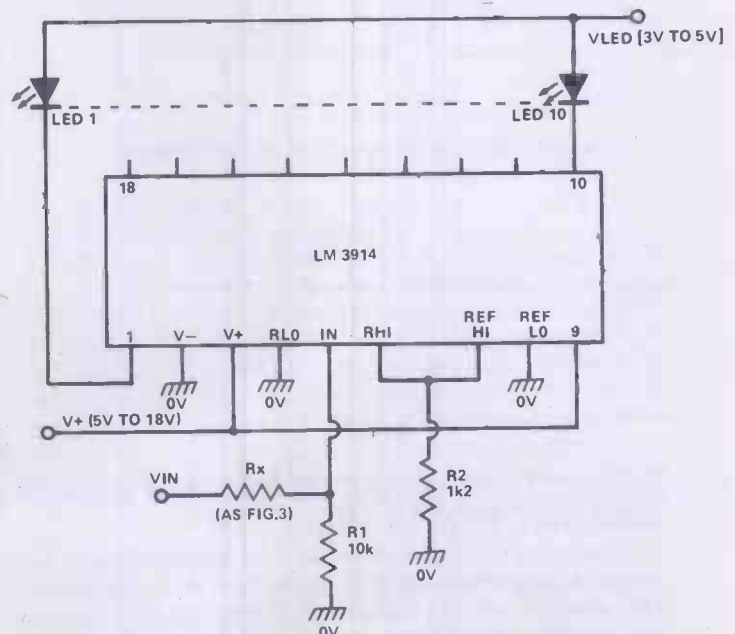

Fig.6. Bar-display voltmeter with separate LED supply.

of the IC. LEDs normally 'drop' about 2 volts when they are conducting, so one way around this problem is to power the LEDs from their own low-voltage (3 to 5 V) supply, as shown in Fig 6.

An alternative solution is to power the IC and the LEDs from the same source but to wire a current-limiting resistor in series with each LED, as shown in Fig 7, so that the output terminals of the IC saturate when the LEDs are on.

PRACTICAL CIRCUITS: 20-LED VOLTMETERS

Figure 8 shows how two LM3914s can be inter-connected to make a 20-LED dot mode voltmeter. Here, the input terminals of the two ICs are wired in parallel, but IC1 is configured so that it reads 0 to 1.2 volts and IC2 is configured so that it reads 1.2 volts to 2.4 volts. In the latter case, the low end of the IC2 internal potential divider is coupled to the 1.2 V reference of IC1 and the top of the divider is taken to the 'top' of the 1.2 V reference of IC2, which is raised 1.2 V above that of IC1.

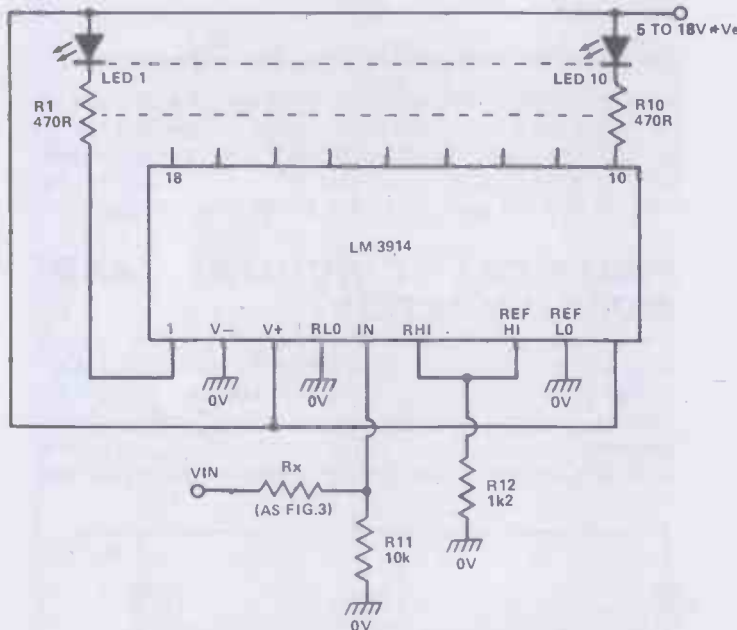

Fig. 7. Bar-display voltmeter with common LED supply.

The Fig 8 circuit is wired for 'dot' mode operation. In this case pin 9 of IC1 is wired to pin 1 of IC2 and pin 9 of IC2 is wired to pin 11 of IC2. Note that a 22k resistor is wired in parallel with LED 9 of IC1 in this mode.

Fig 9 shows the connections for making a 20-LED 'bar' mode voltmeter. The connections are similar to those of Fig 8, except that pin 9 is taken to pin 3 on each IC, and a 470R current limiting resistor is wired in series with each LED to reduce the power dissipation of the ICs.

PRACTICAL CIRCUITS: A 20-LED CAR TACHOMETER

The LM3914 can be made to act as a car tachometer by simply wiring a frequency-to-voltage converter between the vehicles contact breaker points and the input pin of the IC. Fig 10 shows the practical circuit of such a converter, designed to interface with either of the

20-LED voltmeter circuits of Figs 8 or 9. Note the LM2917 IC used in this circuit is a 14-pin device. The C2 value of 22n is the 'optimum' value for a full scale range of approximately 10 000 RPM on a 4-cylinder 4-stroke engine. For substantially lower full scale RPM values, the value of C2 may have to be increased. The value may have to be reduced on vehicles with 6 or more cylinders.

A more detailed description of this particular circuit is given in the August '79 issue of Hobby Electronics.

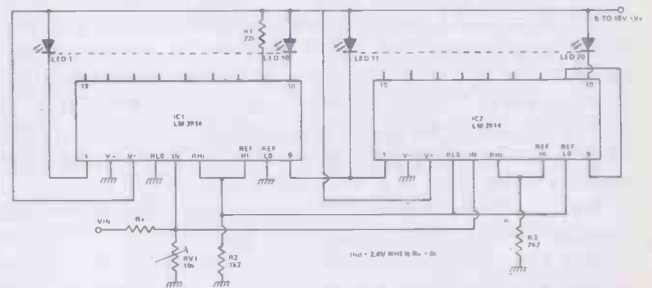

Fig. 8. Dot-mode 20 LED voltmeter. (FSD = 2.4 V when $R_x = 0$).

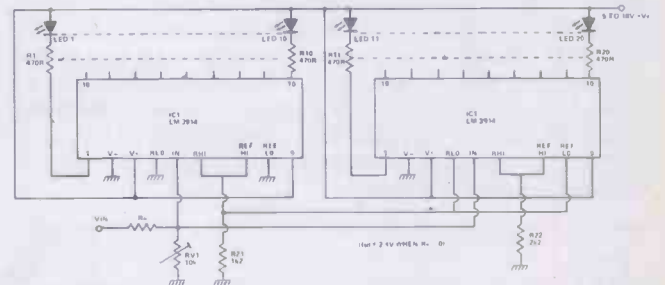

Fig. 9. Bar-mode 20-LED voltmeter. (FSD = 2.4 V when $R_x = 0$).

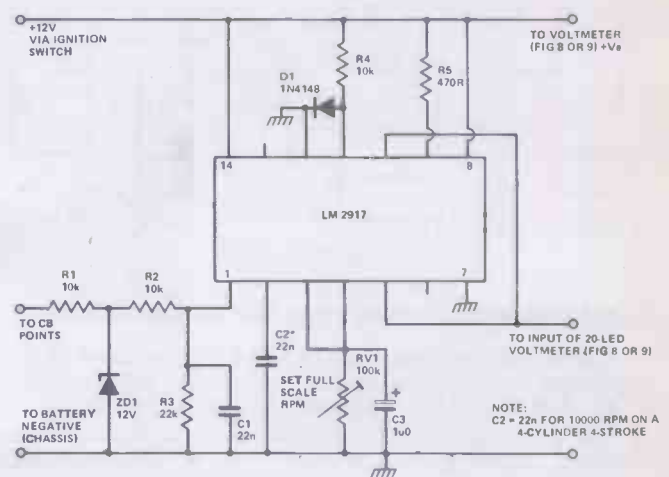

Fig. 10. Car tachometer conversion circuit for use with a 20 LED voltmeter. (Fig. 8 or 9).

SPECIALS FROM MODMAGS

Mark your envelopes Specials, and send them to: Specials, Modmags Ltd, 145 Charing Cross Road, London, WC2H 0EE.

ETI CIRCUITS Books 1 & 2.

Each volume contains over 150 circuits, mainly drawn from the best of our Tech-Tips. The circuits are indexed for rapid selection and an additional section is included which gives transistor specs, and plenty of other useful data. Sales of this publication have been phenomenal — hardly surprising when the circuits cost under 1p each!
£1.50 + 25p P&P each.



ELECTRONICS TOMORROW

Comprised entirely of new material, the edition covers such diverse topics as Star Wars and HI-FI! The magazine contains projects for everyone — none of which have appeared in ETI — and a look at the future of MPUs, audio, calculators and video. How can you not read it?

75p + 25p P&P.



TOP PROJECTS

Book 1 + 2: £2.50 + 25p P&P.

Master mixer, 100W guitar amp, low power laser, printmeter, transistor tester, mixer preamp., logic probe, Ni-Cad charger, loudhailer, 'scope calibrator, electronic ignition, car theft alarm, turn indicator cancellor, brake light warning, LM3800 circuits, temperature alarm, aerial matcher, UHF-TV preamp., metal locator, four input mixer, IC power supply, rumble filter, IC tester, ignition timing light, 50W stereo amp. and many more.

Book 3: SOLD OUT! Book 4: £1.00 + 25p P&P. Book 5: £1.00 + 25p P&P. Book 6: £1.00 + 25p P&P.

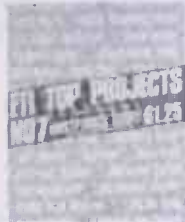

TOP PROJECTS

Book 7: £1.25 + 25p P&P.

ER II loudspeaker, CCD phaser, 3-channel tone control, bass enhancer, continuity tester, bench supply, LCD digital multimeter, digital frequency meter, wide range oscillator, ETI wet, egg timer, house alarm, porch light, torch finder, light dimmer, IB metal locator, electronic bongos, puzzle of the drunken sailor, race track, ultrasonic switch, tic-tac radio, rev counter, Transcendent 2000, spirit level.



ELECTRONICS — IT'S EASY

This very successful beginners' series has now been reprinted in one volume. The book covers just about every aspect of electronic theory and is ideal for anyone just starting out in this fascinating hobby.

£3.60 + 25p P&P each



INTO ELECTRONICS PLUS

The complete series of Ian Sinclair's series Into Electronics Plus a selection of some of the most popular and informative articles from HE. Everything from Home Computing to making your own PCBs.
£1 + 25p P&P.

All these advantages...

- Instant all-weather starting
- Smoother running
- Continual peak performance
- Longer battery & plug life
- Improved fuel consumption
- Improved acceleration/top speed
- Extended energy storage

..in kit form

SPARKRITE X5 is a high performance, top quality inductive discharge electronic ignition system designed for the electronics D I Y world. It has been tried, tested and proven to be utterly reliable. Assembly only takes 1-2 hours and installation even less due to the patented 'clip on' easy fitting.

The superb technical design of the Sparkrite circuit eliminates problems of the contact breaker. There is no misfire due to contact breaker bounce which is eliminated electronically by a pulse suppression circuit which prevents the unit firing if the points bounce open at high R.P.M. Contact breaker burn is eliminated by reducing the current by 95% of the norm.

There is also a unique extended dwell circuit which allows the coil a longer period of time to store its energy before discharging to the plugs. The unit includes built in static timing light, systems function light, and security changeover switch. Will work all rev counters.



Fits all 12v negative-earth vehicles with coil/distributor ignition up to 8 cylinders.

THE KIT COMPRISES EVERYTHING NEEDED

Die pressed case, Ready drilled, aluminium extruded base and heat sink, coil mounting clips and accessories. All kit components are guaranteed for a period of 2 years from date of purchase. Fully illustrated assembly and installation instructions are included.



Roger Clark the world famous rally driver says "Sparkrite electronic ignition systems are the best you can buy."

Sparkrite

HIGH PERFORMANCE ELECTRONIC IGNITION

Electronics Design Associates, Dept. HW12
 82 Bath Street, Walsall, WS1 3DE. Phone: (0922) 614791

Name _____
 Address _____

Phone your order with Access or Barclaycard

I enclose cheque/PO's for

Inc. V.A.T. and P.P.

QUANTITY REQ'D.

X5 KIT £16.95

£

Cheque No.

ACCESS OR BARCLAY CARD No.

Send SAE if brochure only required

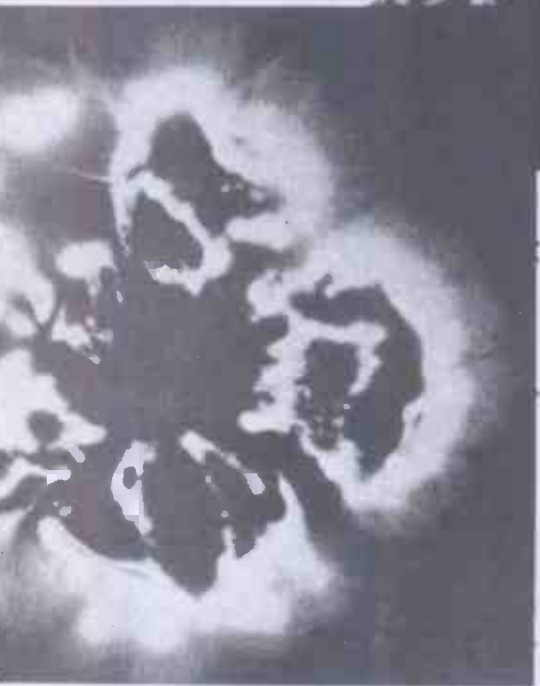
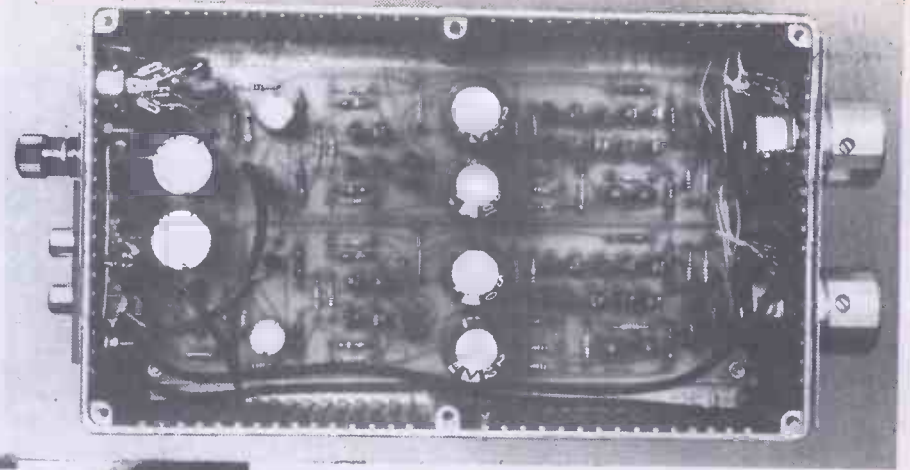

electronics today international

January issue on sale December 7th

Containing constructional details of five projects including a superb DIGITAL FREQUENCY METER and a very hi-fi MOVING COIL PREAMP. Amongst the usual array of brilliant features you will find KIRLIAN PHOTOGRAPHY full explained and DEEP SPACE PROBES beautifully detailed. Miss a single page and you will weep long into the cold winter nights.



Bargraph Car Voltmeter

A 'must' for the motoring enthusiast. An all solid-state 10-LED expanded-scale car voltmeter or battery-condition indicator.

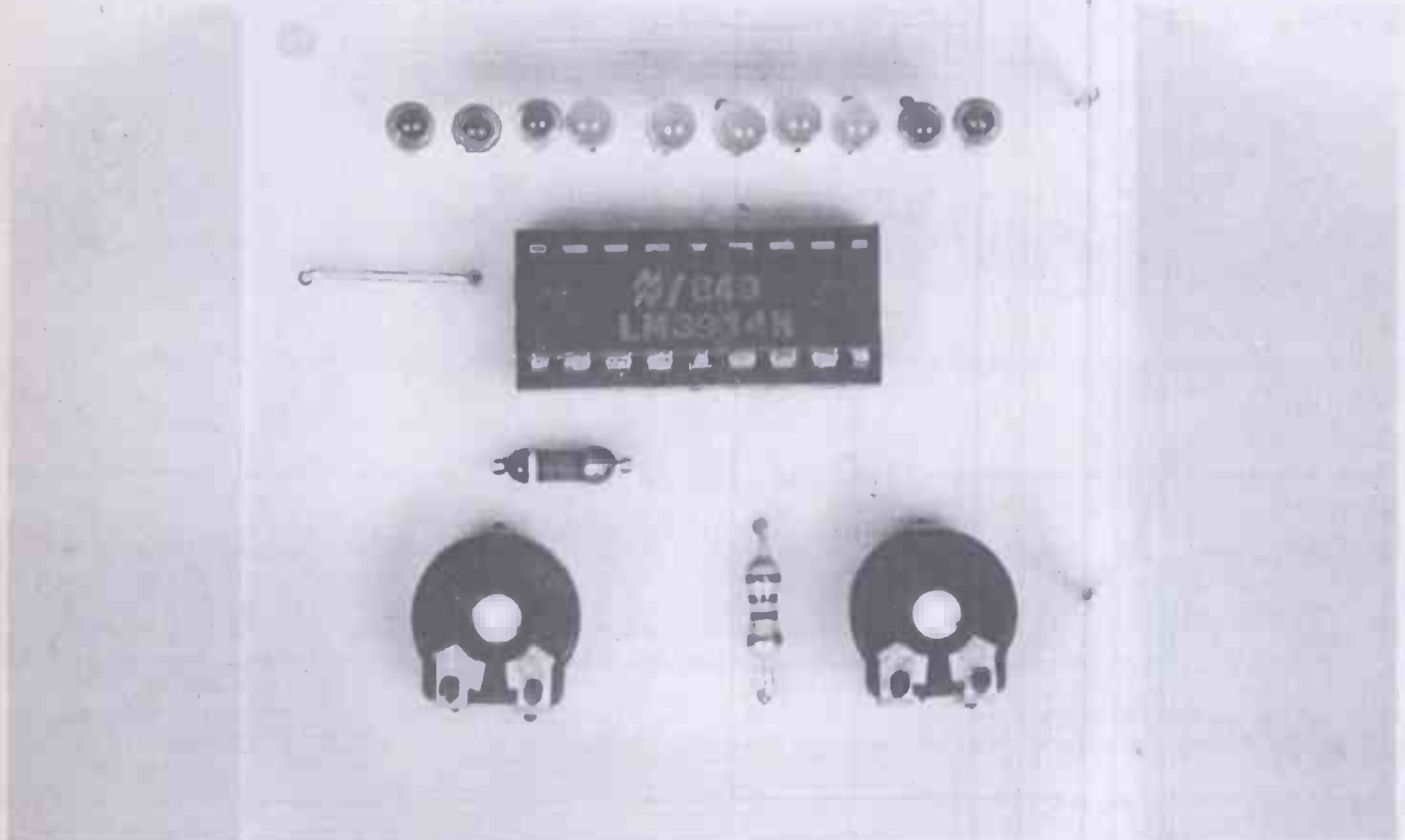

A VOLTMETER IS A USEFUL accessory to have fitted to a car, since it can, when properly used, give the owner an excellent indication of the state of the battery and its charging circuit. Under no-load conditions, with the engine turned off, a sound and well charged battery will give a reading of 12 to 13 volts. Any value lower than 12 volts indicates a defective battery.

With the engine turned off and all lights switched on, the battery reading should fall to 11 to 12 volts. Again, any reading lower than this indicates a faulty battery.

With the engine running at a fast idle and the electrical system lightly loaded, the battery reading should rise to between 13 and 14 volts. A reading below the lower value indicates a faulty dynamo / alternator or a defective regulator. A reading above the upper value indicates a defective regulator.

You'll notice from the above statement that the range of voltmeter readings that are of interest span only a very limited range, from say 10.5 volts minimum to 15 volts

maximum, so a special type of 'suppressed zero' voltmeter should ideally be used in the car.

Our HE car voltmeter is very special. It is an all solid-state design that gives a readout on a two-coloured line of ten LEDs (light emitting diodes). The unit has excellent long-term and thermal accuracy once it has been initially calibrated to span the range 10.5 to 15 volts. The unit is very easy to install in the vehicle and has a total building cost of only three or four pounds. The unit gives a 'dot' display in which only one of the ten LEDs is illuminated at any one time.

CONSTRUCTION AND USE

The entire circuit, including the ten LEDs, is built up on a small PCB and construction should present very few problems. Note that IC1 is an 18-pin device and also that it should be fitted to the PCB via a suitable holder. We

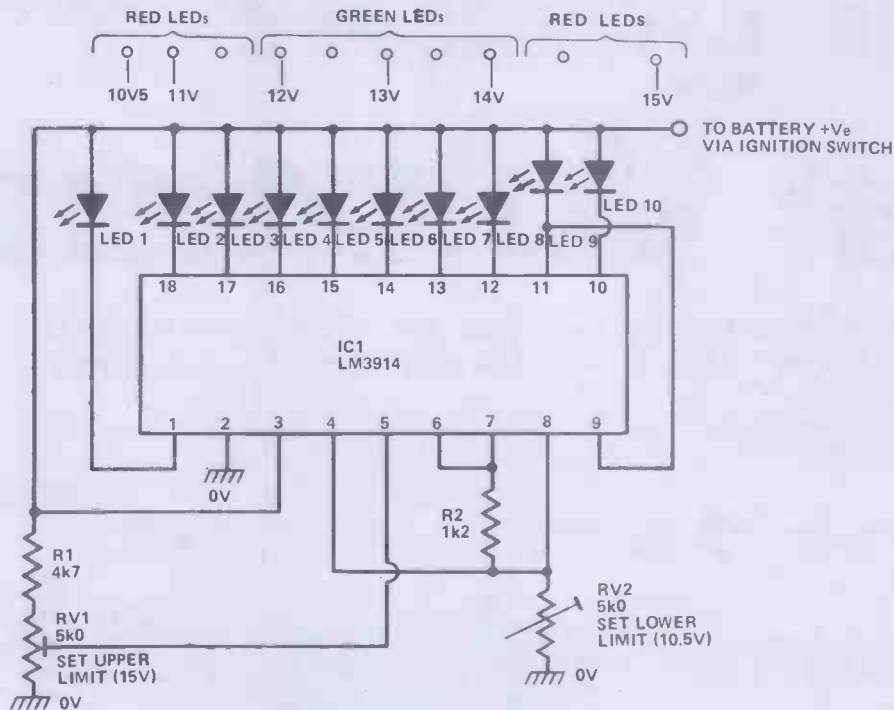

Fig. 1. Circuit diagram of the HE Bargraph Car Voltmeter, the choice of a box is decided by the type of installation required.

How It Works

There is little we can say other than the IC1 acts as a LED-driving voltmeter that has its basic maximum and minimum readings determined by the values of R2 and RV2. When correctly adjusted, the unit actually spans the approximate range 2.5 volts to 3.6 volts, but is made to read a supply voltage span of 10-10.5 volts to 15 volts by interposing potential divider R1-RV1 between the sup-

ply line and the pin-5 input terminal of the IC.

The IC is configured to give a 'dot' display, in which only one of the ten LEDs is illuminated at any given time. If the supply voltage is below 10.5 volts none of the LEDs illuminate. If the supply equals or exceeds 15 volts, LED 10 illuminates.

A comprehensive description of the functioning of the LM3914 IC is given in this month's 'Hobby Chit-Chat' feature.

advise testing each one of the LEDs, to confirm it's functioning and polarity, before fitting it to the PCB.

To check each LED, connect it in series with a 470R resistor and then connect the combination across a 12-volt supply. If necessary switch the LED connections until the LED illuminates, under which condition the lead closest to the positive supply rail is the anode.

When construction is complete, double-check the circuit wiring and connect the unit to a variable voltage DC supply that can span the 10-15 volt range. Monitor the supply voltage with a reasonably accurate meter and calibrate the unit as follows.

Set the supply to 15 volts and adjust RV1 so that LED 10 just turns on. Reduce the supply to 10 volts and adjust RV2 so that LED 1 just turns on. Recheck the settings of RV1 and RV2. The calibration is then complete and the unit can be installed in the vehicle by taking the '0' volt lead to chassis and the '+12 volt' lead to the vehicles battery via the ignition switch. **HE**

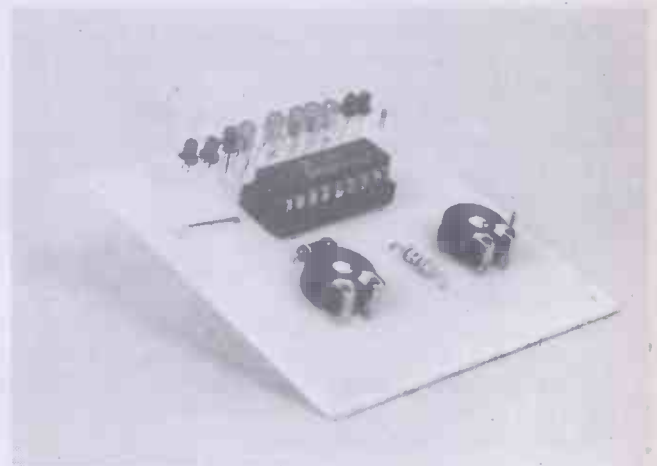

The HE LED Voltmeter, see text for the setting-up procedure.

Bargraph Car Voltmeter

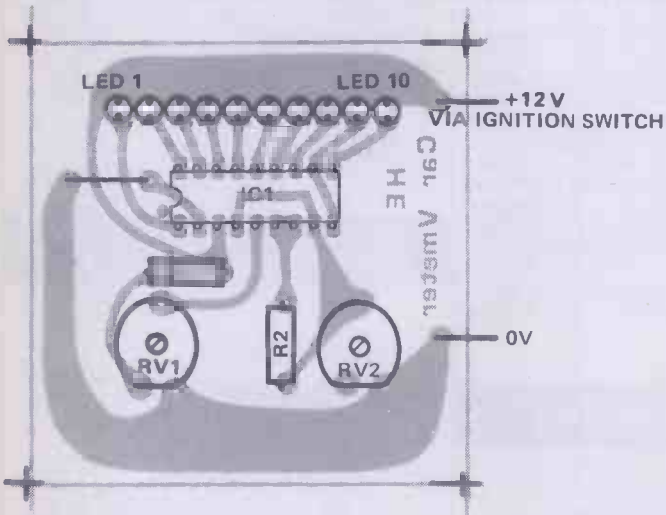

PCB overlay for the Voltmeter, note the position of IC1. Right (lower) PCB foil pattern, take care to avoid solder splashes.

Parts List

RESISTORS (all 1/4W 5%)

R1	4x7
R2	1x2

POTENTIOMETERS

RV1, 2	4x7 preset
--------	------------

SEMICONDUCTORS

IC1	LM3914
LEDs 1, 2, 3, 9, 10	TIL 209
LEDs 4, 5, 6, 7 8	TIL 211

Buylines

None of the components should be difficult to obtain. As is usual practice with HE all of the components should be available from most of the larger mail-order-houses, ie Maplin, Watford, Stevenson etc.

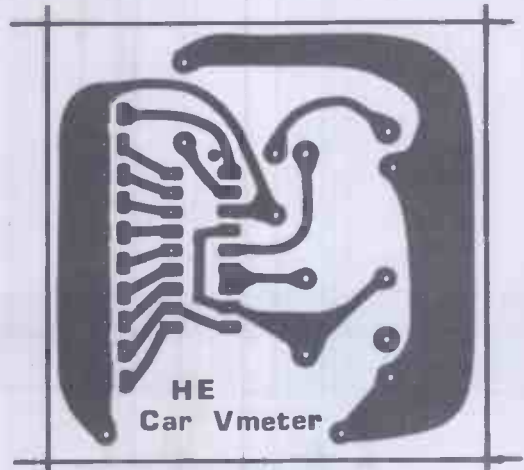

Tee-Hee-bot

Well, you've got to laugh, did you see HEBOT on BBC's Blue Peter.



DISPLAY LIGHTING KITS

Each unit has 4 channels (rated at 1kW at 240V per channel) which switch lamps to provide sequencing effects, controlled manually or by an optional opto-isolated audio input.

DL1000K
This kit features a bi-directional sequence, speed of sequence and frequency of direction change being variable by means of potentiometers. Incorporates master dimming control **£14.60**

DL21000K
A lower cost version of the above, featuring unidirectional channel sequence with speed variable by means of a preset pot. Outputs switched only at mains zero crossing points to reduce radio interference to minimum **£8.00**
Optional Opto Input (DLA1) **60p**

RESISTORS

1/4W 22 ohm-10M E12 Series
Pack of 10 (one value) **10p**
10 Packs **80p**

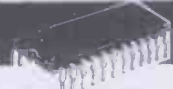

INTEGRATED CIRCUITS

555 Timer	21p
741 Op. Amp	18p
AY-3-1270 Thermometer Controller	£8.60
AY-5-1224 Clock	£2.60
AY-5-1230 Clock / Timer	£4.50
AY-5-1232 Clock / Timer	£4.50
ICL7106 D.V.M. (LCD drive)	£7.00
TDA1024 Zero Voltage Switch	£1.20
LM3911 Thermometer	£1.00
LM3914 Dot/bar Driver	£2.60
MMS7160 (stac) Timer	£5.95
SS688 Touchdimmer	£2.60
S9263 Touchswitch	£4.85
ZN1034E Timer	£1.80
All ICs supplied with data and circuit. Data only	5p
LM10 Op. Amp. 1V-7V	£2.99

LEDs

0.1" Red	9p
0.2" Red	9p
Green	12p
Yellow	12p
Square Red	20p
5x2.5x9mm	20p

SPECIAL OFFER

25 off 0.2"
Red **£1.50**
Green **£2.00**
Yellow **£2.00**

DISPLAYS

DL727 0.5" 2-digit CA **£1.25**
DL304 (pin compatible with DL704) 0.3" CC Red **70p**
DL847 / DL850 (pin compatible with DL747/750) 0.8" CA/CC **£1.80**
LIQUID CRYSTAL DISPLAY 3 1/2 digit 40 pin dil **£8.10**
SPECIAL IL74 Opto Isolator **45p**

DIGITAL VOLTMETER/ THERMOMETER KIT



Based on the ICL7106. This kit contains a PCB resistor, presets, capacitors, diodes, IC and 0.5" liquid crystal display. Components are also included to enable the basic DV kit to be modified to a Digital Thermometer, using a single diode as the sensor. Requires a 3mA 9V supply (PP3 battery) **£20.75**

24 HOUR CLOCK/ APPLIANCE TIMER KIT



Switches any appliance up to 1kW on and off at preset times once per day. Kit contains AY-5-1230 IC, 0.5" LED display, mains supply, display drivers, switches, LEDs, triac. PCBs & full instructions.

CT1000K Basic Kit **£14.90**
CT1000KB with white box (56 x 131 x 71mm) **£17.40**
Ready Built **£22.50**

LIGHTING CONTROL KITS

Directly replace conventional light switches and control up to 300W of lighting. No mains rewiring. Insulated touchplates. Easy to follow instructions.
TD300K TOUCHDIMMER. Single touchplate with alternate action. Brief touch switches lamp on and off, longer touch dims or brightens lamp. Neon lamp helps find the switch in the dark **£6.50**
TDE/K Extension kit for TD300K for 2-way switching etc. **£1.50**
TSD300K — TOUCHSWITCH & DIMMER. Single touchplate, small knob controls brightness **£5.50**
TS300K — ON/OFF TOUCHSWITCH. Two touchplates **£4.30**
TSA300K — AUTOMATIC. Single touchplate. Time delay variable 2 secs to 3 1/2 mins. **£4.30**
LD300K — LIGHTDIMMER KIT **£2.90**

TRIACS

400V Plastic Case (Texas)



3A	49p	16A	90p
8A	62p	20A	165p
12A	70p	25A	190p
6A with trigger			80p
8A isolated tab			82p
Diac			18p

ALL COMPONENTS ARE BRAND NEW AND TO SPECIFICATION. ADD VAT AT CURRENT RATE TO ABOVE PRICES PLUS 30p P&P. MAIL ORDER — CALLERS WELCOME BY APPOINTMENT.



TK Electronics

(H.E.), 106 STUDLEY GRANGE ROAD
LONDON W7 2LX. TEL. 01-579 9794



Master Electronics

The **practical** way

No maths needed~
No dull theory~

Step by step we take you through all the fundamentals of electronics and show you how easily the subject can be mastered.

- 1) BUILD AN OSCILLOSCOPE
- 2) READ, DRAW AND UNDERSTAND CIRCUIT DIAGRAMS
- 3) CARRY OUT OVER £) EXPERIMENTS ON BASIC ELECTRONIC CIRCUITS AND SEE HOW THEY WORK

Also

- We provide practical tuition for:-
- 3) Digital Electronics
 - 1) Radio amateurs licence.
 - 4) Computer Technology
 - 2) City and Guilds certificates.
 - 5) Test instrument kits

Mark your interest(s) with an x in box provided.

British National Radio & Electronics School,

NAME _____ P.O. Box 156, Jersey, Channel Islands

ADDRESS _____

HE11/12 _____ (block caps please).



From Kam
Circuits
a new p.c.b.
battery
operated
Mini-Drill

Available with or without a portable stand this new powerful precision drill will enable you to drill holes in p.c.b.'s, metal, wooden panels or anywhere that small holes are needed. Bit sizes 0.6mm, 1.0mm and 1.5mm.

Power supply 4 x UM3 batteries.

Price without stand £19.02 (inclusive of p.p. and VAT).

Stand price £8.63 (inclusive of p.p. & VAT).

Write for technical brochure now:



Kam Circuits Limited
Porte Marsh Road, Calne, Wilts. SN11 9BW
Telephone: (0249) 815262 Telex: 444218

Breaker One-Four

Send any news, comments, or information you may have to:
**Breaker One Four,
Hobby Electronics,
145 Charing Cross Road,
London WC2H 0EE.**

This month Breaker-One-Four comes from the USA where our roving reporter Rick Maybury has been looking at CB in the land of its birth.

THE FIRST THING that struck me about America was the fact that everybody (well, nearly everybody) has some kind of personal radio. Of course they're not all CB but for a country with such dense population centres they can still find room for even the most humble bus conductor or street cleaner (yes, even street cleaners in New York have two-way radios).

CB itself has been going through something of a recession in the last few years, that doesn't mean it's died out, far from it, it just means that people that had only a fringe interest, the loonies etc have now given it up and the dedicated hard core continue to use CB in a responsible and intelligent way.

My first indication that CB was alive and well was in the shape of advertisement hoardings for hotels and restaurants, many had displays to the effect that they would monitor a particular channel so that any road-weary traveller could book a room or order a meal several miles before they reached their destination — now isn't that a good idea?

Listening to CB on the road revealed that the 'Truckers' channel-19 was particularly busy, you could hear evidence of actual 'convoys' being formed, reports of police activity, although I didn't actually hear any emergencies being reported I was reliably informed by some American friends that it does indeed save lives, several to their knowledge in the past year.

This particular aspect of CB is one of the most contentious subjects on British CB, people claim that in our small over-populated island the need for such a service does not exist, well, that is just not true, accidents happen everywhere, a telephone is not always at hand (or working) and these days with the improvements in medical care, seconds, not minutes can and do count when it comes to saving lives and we can all remember the winter of 78/79 and all of the stranded motorists and elderly people who lost their lives. Enough of the propaganda, I think we all know the arguments by now.

I was told that during the 'boom' of 76-78 CBs were so popular and in demand that they were literally ripped out of cars, leaving other valuables untouched, indeed, the car itself, probably a lot easier to steal was safer than a CB in the car. The situation has settled down now, almost 75% of all cars on the road sport some kind of CB antenna, and that doesn't include all of the 'disguised' or 'Hidden Ears' that are used.

Buying rigs couldn't be easier or cheaper, most shops and that includes food stores, sell CB equipment, the

most amusing retailer of CB was good old Woolies, they offered a quite creditable range in most of their stores, the one oddity was the cost of aerials, they were in many cases up to 50% of the cost of the rig. An average rig, 40 channel, 4 watts with a digital readout, the type that sells over here for around £100 on the black market could be seen almost everywhere for about £20-25. The largest chain of CB stores was our old friend Tandy or Radio Shack as they are known in the US. A typical Radio Shack rig would go for about 69 dollars or about £34. Antennas tended to be quite expensive in Radio Shack, around £10-30 for mobiles and £25-50 for base stations. This, however, was not representative as many 'local' shops would quite readily undercut Radio Shack.

The latest trend would seem to be the 'scanner'. This is a cunning type of tuner that offers several advantages over a manually tuned rig. A typical scanner can be programmed to look for vacant channels, monitor certain channels, ie 9 for emergencies, go to a particular channel at a particular time or just scan up and down the spectrum looking for a nearby contact. All of this is usually looked after by the ubiquitous Microprocessor and will typically sell for around £100-150 for a mobile rig.

Another development of CB has been the upsurge of mobile telephones, in the US you can connect a wide range of devices to your phone without incurring the wrath of the telephone company, so small pocket transceivers with a full dialling capability can be kept in the pocket in constant touch with a base station connected to the phone. The pocket TX/RX can both receive incoming calls and make outgoing calls within about a quarter-mile radius, the transceiver is put into a Charger/holder at night ready for the next day, all for around £75-£150.

SIDEBANNED

Perhaps one of the more surprising aspects of American CB was the almost total disinterest in Sideband operation. I was unable to discover any concrete reason, after all Sideband rigs don't cost significantly more than straight AM rigs, the only reason I could see was the lack of convenience in operation, the almost continual twiddling of clarifiers and the difficulty in holding three or more conversations simultaneously. However, if the rather poor American CB magazines are to be believed rigs with automatic clarifiers are on the way.

INTERFERENCE

From my brief visit I learned that the Americans are almost obsessed with communications, their 'Phone system must surely be one of the most sophisticated, anywhere you go within the States you can always receive at least a dozen radio and a similar number of TV stations. Granted that they are a much larger country but America has cities much larger and more densely populated than our own. I saw absolutely no evidence of frequency overcrowding, no-one I spoke to had any complaints, although to be fair I was told that TVI was a problem some years ago but all modern TV sets are fitted with high pass filters, literally adding a few pennies to the cost of a set and this problem has completely disappeared.

In conclusion I have seen CB working and working well, I saw no evidence of the widespread chaos and abuse that exists in the States, or so we are told by people that for reasons best known to themselves do not want CB. America isn't that different from us, just bigger.

BACK HOME

By the time you read this there's a very good chance that the Government will have made some kind of announcement regarding CB. We at HE believe that should a statement be made it will be to the effect that a two-way radio system similar to CB but operating on a much higher frequency may be introduced within the next six months. What this means (if we are right) is that you the readers of BOF, those of you that took the trouble to fill out our petition and wrote to your MP or the Home Secretary have helped change the law. If we're wrong it wasn't for the want of trying and we shouldn't give up.

Back to more mundane matters now. Thanks to all concerned at the Guardian newspaper for their excellent article (incidentally BOF made quite a considerable contribution to that story). We've had to hold over entries for the slang competition till next month due to pressure of space. The long awaited Tape competition should make a welcome appearance next month courtesy of our old friend Dave Mills.

BITS AND PIECES

Another dealer to add to your list. This time it's RP Automobile Engineers Ltd, who claim that they can sell you just about everything legal related to CB. That includes SWR bridges, connectors and aerials as well as a couple of other things that are best not mentioned. They can be found lurking at Dept CB, 25 Rosebery Crescent, Kingfield, Woking, Surrey. Call Andy Marshall on Woking 20024 for more details.

GET TOGETHER

At last something seems to be happening after that letter from Keith Townsend last month. A meeting will be held on Sunday 25th November at the Woodhayes pub (good choice) in Woodhayes Lane, 1 mile from junction 11 on the M1/M6 (turn left if you're coming from the south). Two or three members of each club are invited to attend (around lunchtime) to thrash out some common policy. Members of the press, media are also invited to attend and with a bit of luck Breaker One Four will be there too.

CB CLUBS

Still more club information keeps arriving. Before we get down to this month's selection, we've had quite a few enquiries from the northern end of the country asking if we knew of any clubs, so if there are any clubs in Manchester, Tyne and Weir and Newcastle areas please let us know.

United Breakers Association (UBA)
Chairman: Andy Donovan,
c/o 50 Gaskell Street,
Clapham, SW4.

UBA (Essex)
Chairman: Ted Cheneler,
24 Bryony Close,
Witham, Essex.

Steel City CB Club.
Chairman Alan Taylor
SSCBC, CBA.
PO Box 123.
Reading.

Glasgow CB Club.
Chairman Normund Cram
3 Erskine Road,
Whitecraigs,
Glasgow.
G46 6TQ

Breaker Break, stay lucky and see you next month.

CB SPECIAL LAST FEW COPIES

Yes, it's true, the CB Special has been so successful it's virtually unobtainable at the newsagents. Our distributors have said it has been the fastest selling Special ever. We have managed to get together the last remaining copies from around the country in our offices and it's now a case of first come first served. The price for these 'collectors items' is still only 75 pence plus 25 pence post and packing.

So why miss out? Send your order in today before it's too late. Write to: CB Special, Hobby Electronics, 145 Charing Cross Road, London WC2H 0EE.

Books from the HE Book Service

28 Tested Transistor Project £1.25
Richard Torrens. The projects can be split down into simple building blocks which can be recombined for ideas of your own.

Electronic Projects for Beginners £1.65
F. G. Rayer. Divided into 'No Soldering Projects,' Radio and Audio Frequency, Power Supplies and Miscellaneous.

Practical Electronic Calculations and Formulae £2.55
F. A. Wilson. A valuable reference for the home and laboratory, containing all the most frequently used, and some of the less well known electronic formulae and calculations.

Popular Electronic Projects £1.75
R. A. Penfold. A collection of the most popular types of circuits and projects using modern, inexpensive and freely available components.



Digital IC Equivalents and Pin Connections ... £2.85
Adrian Michaels. Covers most popular types and gives details of packaging, families, functions, country of origin and manufacturer.

Radio Stations Guide £1.75
B. Babani and M. Jay. An invaluable aid to everyone with a radio receiver helping them to obtain maximum entertainment, value and enjoyment from their set.

Linear IC Equivalents and Pin Connections ... £3.10
Adrian Michaels. Gives most essential data for popular devices.

Electronic Security Devices £1.75
R. A. Penfold. Full of constructional circuits covering the most basic security systems to the Ultrasonic and Doppler Shift systems.

How To Build Your Own Solid State Oscilloscope £1.80
F. G. Rayer. The book contains concise practical instructions so that even an inexperienced hobbyist can construct a fairly sophisticated instrument with the minimum of difficulty and expense.

50 FET (Field Effect Transistor) Project £1.55
F. G. Rayer. Contains something of interest for every class of enthusiast. Short Wave Listener, Radio Amateur, Experimenter or audio devotee.

50 Circuits Using 7400 Series ICs £1.65
R. N. Soar. The author has managed to compile no less than 50 interesting and useful circuits using this range of devices, covering many different aspects of electronics.

Essential Theory for the Electronics Hobbyist £1.55
G. T. Rubaroe gives the hobbyist a background knowledge tailored to meet his specific needs.

Beginners Guide to Building Electronic Projects £1.55
R. A. Penfold. Covers component identification, tools, soldering, constructional methods and examples of simple projects are given.

50 Projects using IC CA3130 £1.25
R. A. Penfold. Describes audio projects, RF project, Test Equipment, Household and miscellaneous circuits.

IC 555 Project £2.10
E. A. Parr. Circuits are given for the car, model railways, alarms and noise makers. Also covers the related devices 556, 558 and 559.

Second Book of CMOS IC Projects £1.80
R. A. Penfold. Following in the success of the original CMOS projects book we present the second volume covering all aspects of CMOS technology from multivibrators to triggering devices.

Note that all prices include postage and packing. Please make cheques etc. payable to Hobby Electronics Book Service (in Sterling only please) and send to:

Hobby Electronics Book Service, P.O. Box 79 Maidenhead, Berks.

27MHz MONITOR £18.70

LOOK!
SPECIAL OFFER. Limited quantity. **MARKSMAN** electronic game. Consists of a Pistol and an Owl target. Shoot the owl dead centre and it responds with flashing eyes and a chirping noise.

Sells in shops for £10-£14
Now Only **£5.90**
SPACE ALERT **AUTO RACE**
ONLY £15.90 EACH

FOOTBALL VERSION £21.50
All prices inclusive - D & P free
N.I.C. MODELS
27 Sidney Road, London N22 4LT
01-889-9736

CB CAR AERIALS (GUTTER MOUNTING) £13.90

CHESSE CHAMPION NEW PRICE
6-Level Chess Computer.
New Low Price £54.95, with adaptor.
STAR CHESSE colour TV Game. A space age Chess game
£69.10. Our Price £63.35, with adaptor.
ELECTRONIC MASTERMIND SAVE £3
Play nine games against the computer. 3 4 or 5 digits. £15.95. Now £12.90.
CHROMA-CHIME 24-tune door chimes. KIT £10.50. BUILT £15.95.
LOOK!!!
5-pin DIN to 4 x 3.5mm JACK PLUGS. Leads can be used for Audio by replacing Jack Plugs with Phono plugs or use it with your computer by changing DIN plug to Phono plugs. ONLY £1.25.

Please allow up to 21 days for delivery

HOME COMPUTING BARGAINS. Full keyboard, cassette interface, use your tv as vdu: — Ohio Scientific Superboard II fully built 8K basic 4K ram £188 + vat. Tandy TRS80 level 2 basic 16K ram £450 + vat.
SIMILAR PRODUCTS. New 10MHz scope £149. PFM200 £52.69, case £3.40, adaptor £3.40, connector kit £11.27. Microvision tv £91, adaptor £6.88. PDM35 £29.78, adaptor £3.40, case £3.40. OM350 £71.8, OM450 £102.17, OM235 £52.68, rechargeable bats £7.99, adaptor £3.94, case £9. Enterprise prog calculator + accessories £23.27.
COMPUTER GAMES Chess Challenger 7 £84, Star Chess £52, Voice Challenger £239. Chess Champion 6 £49.95, Atari video computer £147, cartridges £14.32.
COMPONENTS 1N4148 0.9p, 1N4002 3.1p, 741 18p, bc182, bc184, bc212, bc214, bc548 5p, resistors 1/4W 5% £12 10R to 10M 1p, 0.8p for 50+ of one value. 16V electrolytics .5, 1, 2, 5, 10, 22mf 5p, 100mf 8p, 1000mf 10p, 1 lb FeCl £1.30, dato pen 84p, 40 sq ins pcb 66p, polystyrene capacitors £12 63V 10 to 10000 3p, 1n2 to 10n 4p, ceramic capacitors 50V E6 22pf to 47n 2p, tenors 400mW E24 2V to 33V 7p.
TV GAMES AY-3-8500 + kit £9.53. Rifle kit £5.27. AY-3-8610 + kit £17.28. Stunt cycle chip + kit £10.72. AY-3-8603 chip £13.63.
TRANSFORMERS 0-0.6V 100ma 76p, 1 1/2 £2.80, 0-0.9V 75ma 76p, 1a £2.22, 2a £2.80, 12-0-12V 100ma 92p, 1a £2.75.

IC AUDIO AMPS with pcb. JC12 6W £2.08, JC20 10W £3.14.
BATTERY ELIMINATORS 3-way type 6 7/7 1/9V 300ma £3.14, 100ma radio type with press studs 9V £3.57, 9-9V £6.79. Car converter 12V input, output 4 1/2 6 7/7 1/9V 800ma £2.66.
BATTERY ELIMINATOR KITS 100ma radio types with press-studs 4 1/2V £1.49, 6V £1.49, 9V £1.49, 4 1/2 + 4 1/2V £1.92, 6 + 6V £1.92, 9 + 9V £1.92. Stabilized 8-way types 3 1/4 1/2 6 7/7 1/9 12 1/15 18V 100ma £2.50, 1 Amp £5.10. Stabilized power kits 2-18V 100ma £2.98, 1-30V 1A £5.95, 1-30V 2A £11.24, 12V Car converter 6 7/7 1/9V 1A £1.35.
T-DEC AND CSC BREADBOARDS s-dc £3.79, i-dc £4.59, u-deca £4.89, u-decb £7.16, 16 dll adaptor £2.31, exp4b £2.54, exp300 £8.61, exp350 £3.62, exp325 £1.84.
81-PAK AUDIO MODULES s450 £25.06, AL60 £5.06, pa100 £17.33, spm80 £4.74, bmt80 £6.08, stereo 30 £21.57, al30A £4.08, pa12 £8.38, ps12 £1.58, ma60 £38.27.

SWANLEY ELECTRONICS
Dept. HE, 32 Goldsai Rd., Swanley, Kent
Post 30p extra. Prices include VAT unless stated. Official and overseas orders welcome. Lists 24p post free.

Random Electronic EASY DICE

Build your own 'EASY DICE' from the 5 integrated circuits and full components supplied, including box and descriptive instructions.

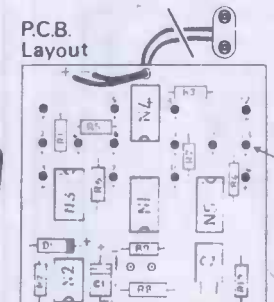

All you need is a soldering iron
TWO DICE FACES TOUCH CONTROL...

a *Self Assemble Dice £3.95
b *Ready built Dice £4.75 (INCL. P+P)

Order now from **Fringewood Electronics Ltd**
1 Hatton Court Ipswich Suffolk O473 210151

Amount enclosed £ _____
Name _____
Address _____

please state amount required in appropriate box a b

Short Circuit

SIMPLE PHOTOGRAPHIC TIMER

Although this timing device may seem to be rather unsophisticated, it is a handy little gadget for timing darkroom exposures, or time exposures, or time exposures made on a camera with the shutter set to the "B" position. The unit simply flashes a LED indicator briefly at 1 second intervals. If, for example, one wishes to make a ten second time exposure, then the shutter is opened during any convenient flash produced by the unit, and then closed after a further ten flashes have been produced. Adequate accuracy for normal requirements can be obtained in this way.

The circuit is based on the CMOS version of the well known 555 timer device. The CMOS version has the advantage of having a current consumption which is only about one hundredth of that taken by the conventional version, and this is obviously beneficial in a battery powered piece of equipment such as this one. The average current consumption of the unit is actually less than 1mA., giving an extremely long battery life.

The CMOS version of the 555 operates in the same basic man-

ner as the ordinary version, with timing capacitor C2 first charging up to $\frac{2}{3} V+$ by way of the timing resistors — R1 — R2 — R3. The device is then triggered into the discharge mode, resulting in C2 being discharged through R4 to a potential of $\frac{1}{3} V+$ whereupon the circuit reverts to its original state with C2 charging up once again. Continuous oscillation thus results. The frequency of operation is adjusted to 1 HZ by adjusting R1, and in practice this is adjusted by trial and error to obtain (say) 60 flashes in a one

minute period. Longer calibration periods can be used if better accuracy is required.

The output of IC1 assumes the high state while C2 is charging, and the low state while it is discharging. As C2 charges via R1, R2 and R3, but only discharges through R4, the discharge time is therefore much shorter than the charge time. By connecting LED indicator D1 and its current limiting resistor R4 between the output of the IC1 and the positive supply the required brief flashes are thus obtained.

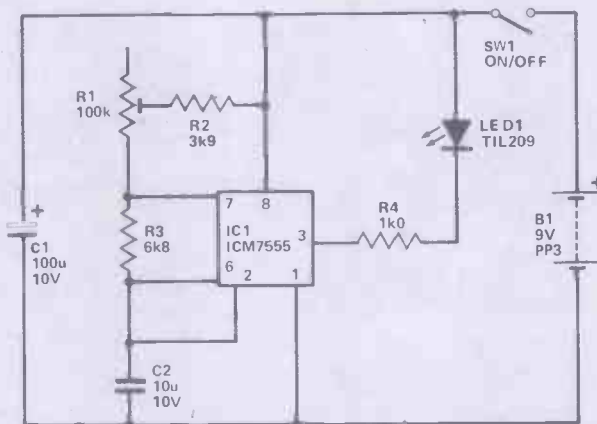

ICM7555 TOP VIEW

D'YA WANNA BE IN PICTURES?



Afraid of the dark? If so this is no job for you. Modmags' photographer will spend half his time in our darkroom, printing pictures and working our graphics camera.

When let loose on the real world he will be working under the direction of our editorial and art departments: taking photos for Electronics Today, Hobby Electronics and Computing Today. So if you think you can make pictures as good as (or probably better than) those in this magazine if you're not afraid of the darkroom and £3400 salary sounds right, write now to Diego Rincon, Art Director, Modmags Ltd., 145 Charing Cross Road, London, WC2H 0EE.



AMERICA'S NO. 1 GUIDE The Big Dummy's GUIDE TO C.B. RADIO

MORE THAN EVERYTHING YOU NEED TO KNOW IN A SIMPLE DOWN HOME STYLE.

San Francisco Examiner

ALL THE INSIDE COPY ON
★ CB Slang ★ Installing Your Rig
★ Power, Modulation ★ Troubleshooting ★ S.W.R. ★ Emergency Procedures.

£2.50 PLUS 45p P&P

Not Only But Also
For the more technically minded
THE BEST BOOK ON CB RADIO
Covers all the more technical aspects of CB Radio including:

SIDEBANDS Feature evaluations
Q SIGNALS Comparative Field Tests

Upgrading your SYSTEM

£3.95 PLUS 70p P&P

KONA PUBLICATIONS, 335 CITY ROAD, LONDON, EC1
Send me copy(ies) Big Dummy's Guide to CB at **£2.50** each
Send me copy(ies) The Best Book on CB at **£3.95** each

NAME

ADDRESS

Into Linear ICs

By Ian Sinclair Part 6

With only one more episode to go Ian Sinclair takes a long hard look at the world of the IC amplifier and suggests a few more practical circuits for you to experiment with.

THE 741 OPERATIONAL AMPLIFIER is useful, as we've seen, for several audio-frequency projects, but specially designed audio amplifier ICs are usually superior, particularly as far as noise is concerned. Amplifier noise is the rushing sound which you hear from the loudspeaker when the volume control of an amplifier is turned all the way up with no signal coming in. The noise comes from an unwanted electrical signal which is generated in all conductors, but particularly in transistors and ICs. The 741 was originally designed for uses (in computers) in which the electrical noise signals are not a serious problem, and it generates too much noise to be of much use at the input of a high-quality amplifier. Several ICs have therefore been designed to replace the 741 in audio amplifiers, so that in this part we're going to take a look at four preamplifier ICs, each with its own particular advantages. Later on in this part we'll also look at ICs which give a power output suitable for driving a loudspeaker directly.

THE MC1303L STEREO PREAMPLIFIER

As the MC letters proclaim, this linear IC is manufactured by Motorola, and the package contains two identical preamplifiers on a single fourteen-pin chip, so making it ideal for stereo preamplifiers. Unlike most audio ICs, the MC1303 (the L means the package style) needs a dual power supply of +12 V and -12 V in addition to a common earth connection. In common with most modern audio amplifier ICs, the MC1303 has internal protection against short circuits at the outputs. Unusually for such an IC, loudspeakers can be driven directly at power levels.

The circuitry which is needed is shown in Fig. 6.1, assuming that the inputs are from a stereo magnetic cartridge which will be designed to feed into a resistance of around 47k. The capacitor C1 isolated this input from the bias at the input of the IC; this bias comes from R2. Feedback is applied at pin 8 through the network consisting of R4, C3, R5, C4 and C2, R3. Some explanation of this little lot is needed if you're not familiar with preamplifier circuits.

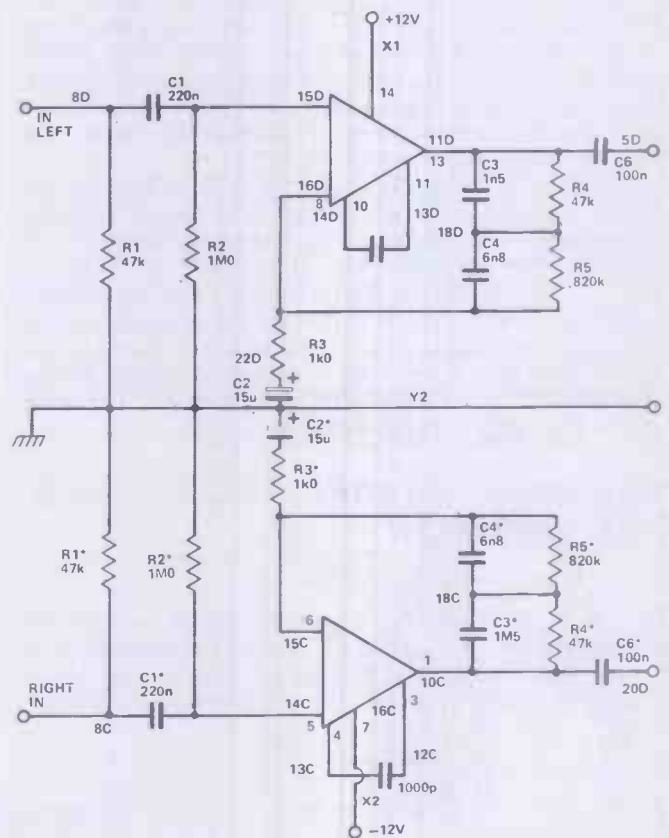

Fig. 6.1 MC1303L stereo preamplifier circuit. The complete Eurobreadboard layout is shown. Note that pin 1 of the IC is on line 10C.

When discs are recorded, we find that we can't just record the signals from the microphone by amplifying them and using them to drive the disc cutter. There are two problems. One is that the low bass frequencies cause excessive cutting width, so that one groove cuts through into the next. The other problem is that the uncut groove will still cause a signal, a noise signal, if it's played, and this noise signal can be louder than some of the high notes that we're trying to record.

Recording engineers get round these problems by a technique called pre-emphasis and equalisation. Before recording, the signal is deliberately distorted, so that the

low frequencies are attenuated (their amplitudes reduced) and the high frequencies boosted (amplitudes increased) leaving the middle frequencies unaffected. This isn't done any old how, but by using filter networks whose values are internationally specified. To recover the original signal, then, we must reverse this process, using an equalising network.

C4 and R5 in parallel ensure that the gain is very high at low frequencies around 30 Hz, but the gain decreases at higher frequencies because C4 offers less impedance to feedback signal than does R5. The gain at a frequency of around 500 Hz is the "normal" gain of the amplifier; but at higher frequencies the combination of C3 and R4 causes the gain to decrease. The combined effect of the network is to reverse the attenuation and boosting processes that were carried out during recording, so restoring the signal to the correct amplitude at each frequency — we hope. The values which are shown in the circuit are those used for the signals from magnetic pick-up cartridges, since other types of cartridges are much less common, even on low-quality equipment. No values for tape or cassette signals have been given because the equalising values have to be matched to the type of replay head which is used, and there is much less international agreement about the amounts of boost and the frequencies at which they start.

C6 has been included in case the preamplifier is to be used to drive an amplifying stage which has a DC bias voltage present at the input. The voltage at the output of the MC1303, as used in this circuit, will normally be earth voltage, so that this preamplifier can be directly coupled to most of the output stages illustrated later in this part. There aren't many components needed to try out the MC1303, so it doesn't take very long to knock up the circuit on the Eurobreadboard, and it will operate with +9 V and -9 V supplies.

THE LM381 STEREO PREAMPLIFIER

The letters LM reveal that this chip is made by National Semiconductors, and this particular one is another dual preamplifier which is intended for stereo use. Once again, the circuit arrangements for a magnetic pickup

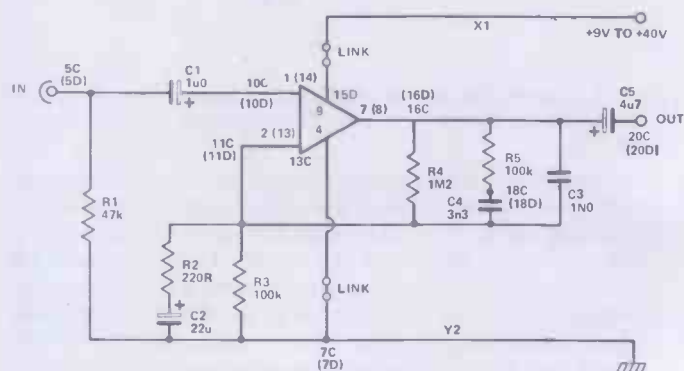

Fig. 6.2 Circuit and Eurobreadboard layout for the LM381 preamp. The layout is shown mainly for one channel, figures in brackets are the corresponding points for the other channel.

cartridge have been illustrated (Fig. 6.2), with R1 set at 47 k to match most popular types of magnetic cartridge. This particular IC, however, differs from the Motorola one in several ways, not least in using a single supply which may be of anything from 9 V to 40 V, making battery or mains use simple. The bias is set by R3 and R4 applied to the input on pin 2 (pin 13 on the other part of the circuit), and the equalisation is carried out by R5, C3, C4 and R4 feeding back a fraction of the output signal across R2. Note that R2 does not affect the bias, since C2 is connected in series so as not to block DC though it passes signals. The circuit, incidentally, needs twice as many components as are shown if it's going to be used for stereo. Since the two parts are identical, there isn't much point in showing both parts. The Eurobreadboard numbers are shown for one part, with the numbers for the other section in brackets. The output signal from each section is taken through a capacitor (C5) which has to be used because the output pins (7 and 8) are not at earth voltage.

This chip has a low-noise input stage, claimed as the equivalent of 0.5 μ V of noise signal, as compared to about 1 mV of normal signal from the cartridge, so that its noise performance is a lot better than that of the 741. The 381 is not sensitive to hum on the supply, so that

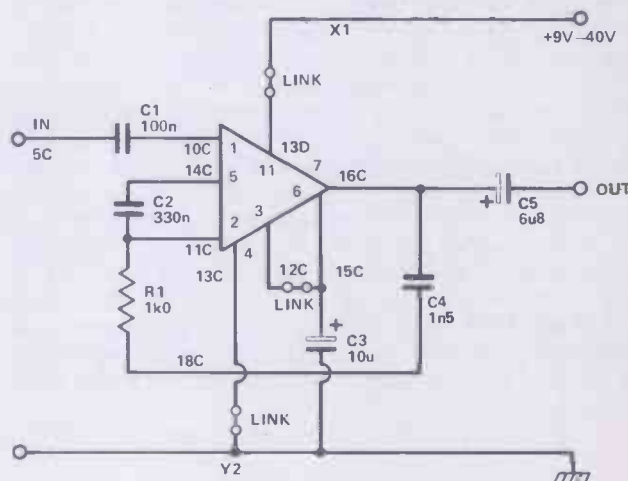

Fig. 6.3 Circuit and layout for one half of the LM382 stereo preamplifier. The pin numbers and Eurobreadboard layout for the second half are also shown.

mains supplies which are not too well smoothed can still be used.

THE LM382 PREAMPLIFIER

This IC is a design which is intended for simple record-players, using the smallest possible number of components. Like its stable-companion, the LM381, it uses a single power supply line which may be anything from 9

V to 40 V. The simplicity of the circuit makes it particularly suitable for low voltage operation from a single 9 V battery. No external bias components are needed, so that the circuit shows only the equalising and coupling components. C1 is the input coupling capacitor and C5 the output coupling capacitor.

Equalisation is carried out by C2, R1 and C4, with C3 used to decouple unwanted signals from the internal circuits. The claimed noise signal at the input is slightly higher than that of the 381 at $0.8 \mu\text{V}$, but the same excellent standard of mains hum rejection allows the chip to be used with poorly-smoothed mains supplies. Like its companion, the 382 is internally protected against short circuits at its output, so that it isn't easy to burn out the IC because of such accidental short-circuits.

TREBLE TROUBLE AND BASS BASE?

Amplifiers and loudspeakers which might sound good out in a field somewhere often sound a bit peculiar in your own room. The reason is the way that sound waves bounce off the hard surfaces, like walls and windows, inside a room, and are absorbed by curtains and soft furnishings (no, not her!). To restore things back to something which pleases us more, though not necessarily like the original sound, we use tone controls.

A tone control reduces (cuts) or increases (boosts) the gain of the amplifier for a chosen range of frequencies. Most tone controls leave the "mid-range" frequencies of 400 Hz to around 1.5 kHz alone, and boost or cut the bass frequencies below 200 Hz or the treble frequencies above about 4 kHz. What about the ones in between, I hear you ask? They are affected to some extent by the tone controls, but not so much as the intended frequencies.

Tone controls come in two basic types, active or passive. Passive tone controls can never increase the amplitude of a signal, and are best suited to a part of a circuit where you have a fairly large signal voltage, a volt or so, to play with. Fig. 6.4 shows an example which

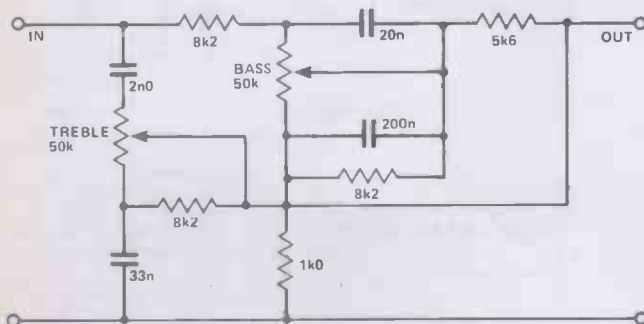

Fig. 6.4 One form of a passive tone-control circuit.

uses four capacitors, five resistors and two potentiometers — the reason for the complicated circuit is to try to ensure that the controls don't affect each other. It's a bit of a nuisance if twiddling the bass control changes the treble, just to take one example.

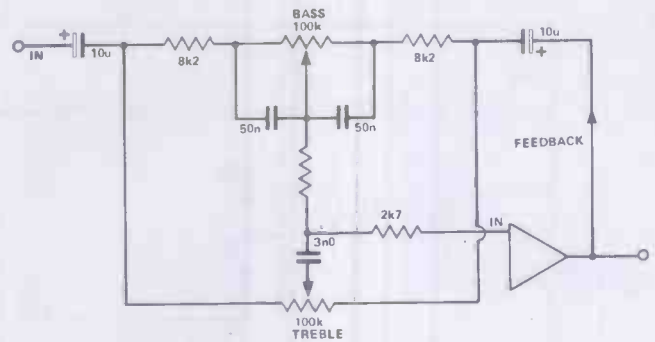

Fig. 6.5 The Baxendall tone-control circuit.

Fig. 6.5 shows the most famous of active tone control, the Baxendall circuit. This little lot is always operated as a feedback network, and can permit amplification, unlike the passive type of circuit.

THE TBA 231 PREAMPLIFIER

The previous preamplifiers have been intended as low-noise mono or stereo preamplifier stages which amplify and equalise an input signal from a magnetic cartridge to the level at which volume and tone controls can be used and a power amplifier driven.

This circuit (Fig. 6.6) uses its two stages to provide pre-amplification and tone/volume controls of the type used in Hi-Fi amplifiers, so that two chips of this type with corresponding power stages would be needed to perform creditably along with efficient good-quality speakers. That word efficient is important — most high quality speaker units are anything but efficient. A single power supply is used, but the inputs of each half of the chip have to be biased to half of the supply voltage.

Resistors R2 and R4 supply this bias voltage, with C2 decoupling the bias supply. R1 then supplies bias to the input pin (9) of the first half of the chip, and R5 supplies bias to the input pin (5) of the second half. The input signal is applied through C1, and equalisation is carried out by R7, R8, C6, C7 and R9 feeding pin 8, with a signal return to earth through R3, C3. The network made up from R6, C4 and C5 is a correction network designed to keep the circuit stable when feedback is applied. The output from this first stage is at pin 13, and a coupling capacitor C8 is needed because the DC level at pin 13 is approximately half of the supply voltage.

The signal through C8 feeds the volume control RV1, and the amount of signal which is selected by this potentiometer is passed through coupling capacitor C9 into pin 5, the input pin for the second section of the preamplifier. Only five pins are used in this stage, with C10 acting as a correction capacitor to assist stability. The feedback circuit which is connected between pins 1 (output) and 6 is a type of Baxendall tone control circuit, with RV2 acting as the bass control and RV3 as the treble control. This type of tone control is very widely used in high quality preamplifier designs because the two controls do not interact. In addition, both boost and cut of treble or bass can be obtained. This control network is always connected as a feedback loop, which makes it ideal for use with IC preamplifiers. The final

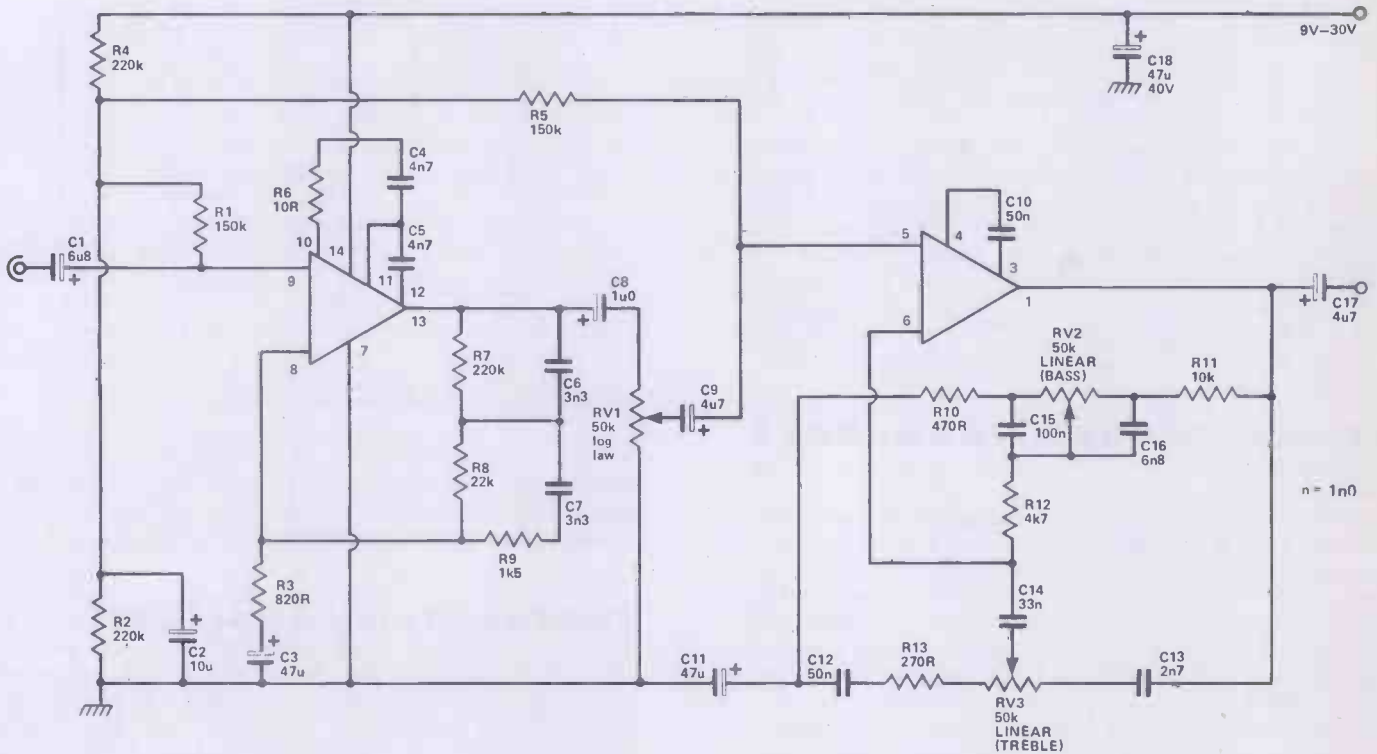

Fig. 6.6 The TBA231 preamplifier circuit, including volume and tone controls. No layout has been shown for this much more complicated circuit.

output signal is then coupled by C17 to the power output IC.

POWER OUTPUT ICs

Power output stages present the linear IC designer with his most difficult problem. Any power output stage must pass much larger signal currents than a pre-amplifier stage, so that much more heat is generated inside the IC. Unless this heat can be removed, the temperature inside the material of the IC will rise so high that the chip will be destroyed, and no repair is possible. At very low output power levels of a watt or less, we can make use of the air around the chip to remove the heat, along with the small amount of heat which flows from the pins to the printed circuit board. For higher power outputs, some sort of metal contact to the silicon of the IC is needed so that some power ICs are fitted with thick metal "wings" which can be used to dissipate heat, or which can be bolted to metal sheets or fins to create a large area to expose to the cool air. Other ICs are fitted with threaded studs so that fins can be bolted directly to the ICs. Both of these methods rely on attaching a larger area of metal to the semiconductor, so that the air has a better chance to cool the IC.

Whatever method of cooling is used, high temperatures inside the chip must be avoided, so that most power output ICs have also built-in thermal protection circuits which act to bias-off the final stages of the IC when the temperature is too high. This type of circuit is very often combined with a short-circuit protection as well, so that the IC is very well protected against all likely

forms of overload.

All IC power output circuits use Class B, meaning that the output signal is shared between two transistors, with each transistor conducting for only half the signal wave time. Fig. 6.7 shows a typical circuit of this type using separate transistors so as to show the action.

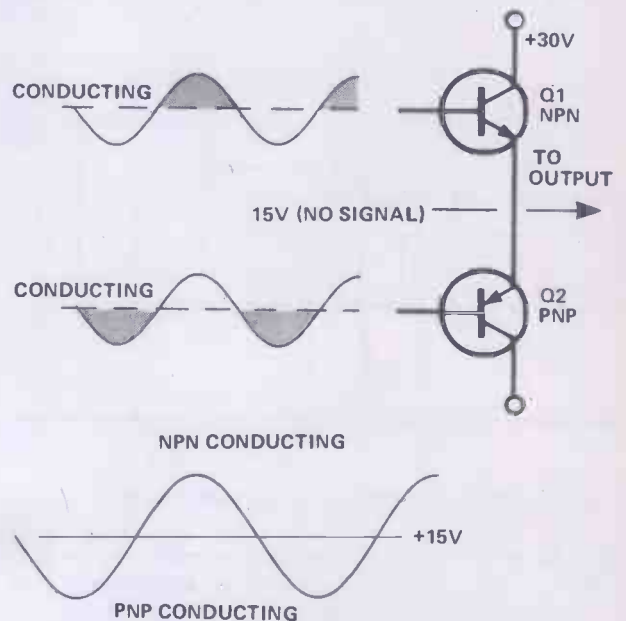

Fig. 6.7 The Class B principle for power amplifiers.

The PNP transistor conducts when its base voltage is about 0.5 V less than its emitter voltage, and the NPN transistor conducts when its base voltage is about 0.5 V more (positive) than its emitter voltage, so that Q1 passes current during the positive half of the cycle, and Q2 passes current during the negative half of the cycle. In theory, this circuit could be arranged so that neither transistor passed current when there was no input signal, but an unbiased stage of this type causes considerable distortion, called cross-over distortion, which cannot be completely corrected by the use of negative feedback. For this reason, a small amount of bias is always applied. The feature of the Class B circuit which makes it so attractive for IC power amplifiers is that its efficiency is high — the amount of power delivered to the loudspeaker is almost as much as is taken from the power supply, and up to five times the amount of power which is wasted in heating each output transistor. Unlike a separate-transistor (discrete) output stage, though, both of the output transistors of the IC are on one block of silicon, so that they can't be connected to separate heat-radiating fins.

USING THE LM380

The National Semiconductor LM380 power output IC is a particularly simple device which nevertheless gives a 2W output to a 4-ohm loudspeaker. A single-ended power supply is used, whose voltage has to be matched to the resistance of the loudspeaker which is used. A 12 V supply is used for a 4-ohm loudspeaker, a 14 V supply for an 8-ohm loudspeaker, and an 18 V supply for a 16-ohm loudspeaker. The maximum power output is 2W in each case, but will be less if lower voltage power supplies are used for a given loudspeaker resistance. If a higher voltage power supply is used, however, the power output will not be noticeably increased, because the chip has current limiting and heating overload protection circuits.

With no signal input, the IC takes only 7 mA total current, so that this IC is ideal for battery operation, though its output on the 6 V batteries which are used for cassette recorders is a bit low. The voltage gain is around 50 times, so that, typically, for a 2 W output into a 4 ohm loudspeaker, the signal input is about 0.16 V peak-to-peak. This is an amount which can be supplied easily by any of the pre-amplifiers discussed earlier in this part, even when we allow for some losses in volume and tone controls. In the circuit of Fig. 6.8 the signal input is through the isolating capacitor C1 to pin 2 of the IC, with R1 acting as the earth return resistor. C2 is a frequency correcting capacitor which is needed to prevent oscillation, and C4 is the coupling capacitor for the loudspeaker. The DC level at pin 8, with no signal input, is about half of the supply voltage. The very small number of components makes this a particularly attractive output IC to use and it forms the basis of a useful utility amplifier, needing only a volume control for bench use and general test purposes. Note that seven of the pins of the IC are earthed. The positive feedback input connection comes into its own when the IC is used in cassette recorders, when the output stage is used as an oscillator during recording.

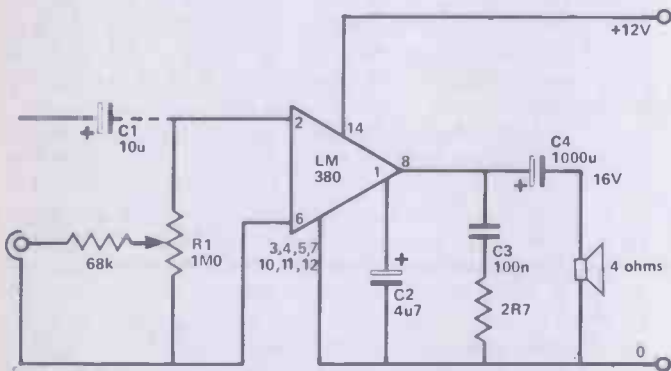

Fig. 6.8 The LM380 output IC. A volume control is shown, but if this is already incorporated in a preamplifier circuit, the dotted input circuit can be used and the 25k potentiometer replaced by a 22k fixed resistor.

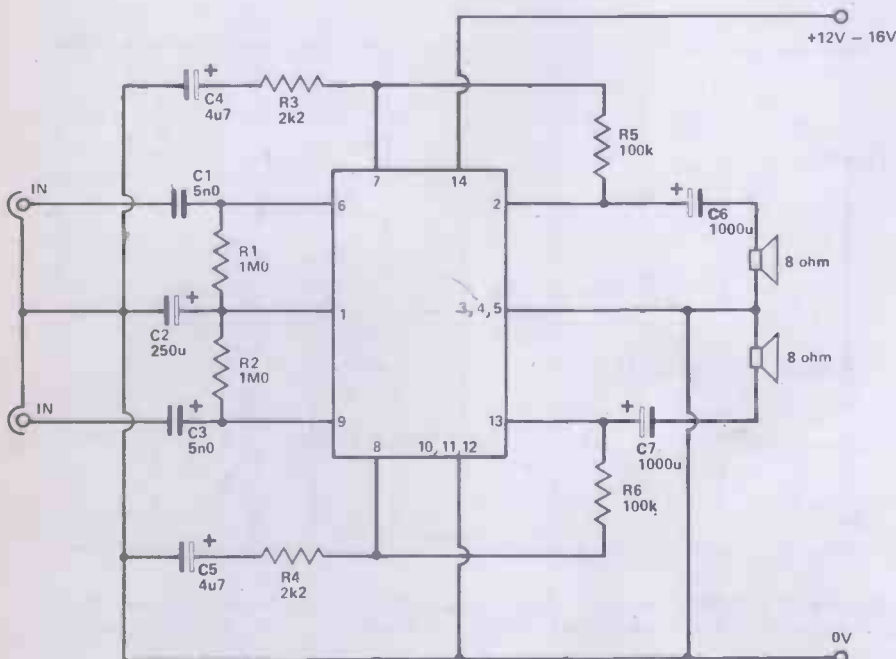

Fig. 6.9 The circuit diagram for the LM377 dual audio output IC.

STEREO POWER AMPLIFIER IC LM377

This is a 2 x 2W stereo IC output chip which is useful for small stereo amplifiers or even for adding a headphone output to a cassette deck. It's yet another National Semiconductor IC, and contains two power amplifier stages each with a claimed low distortion figure of 0.1% at 2W output. The power supply is single-ended and can have voltage levels of 12 V to 16 V, the best results are obtained at the higher voltage. Like its stablemates, the LM3777 is internally protected against overheating or accidental short-circuits on the output leads. The voltage gain of each channel is fixed by the feedback to pins 7 and 8, and is 45 times in the circuit of Fig. 6.9. Once again, this is adequate to allow the unit to be driven by any of the preamplifiers which were described earlier. The current taken from the power supply, with no input signal, is 15 mA.

In the circuit of Fig. 6.9, the input signals are taken through coupling capacitors C1 and C2, which can be of low values because the input resistance of the IC is high. R1 and R2 are load resistors, 1M each, and the signal common pin is earthed through C2 — note that this pin must not be earthed directly since to do so would upset the bias voltages inside the IC. Feedback is applied from each output to the feedback pin for each channel. For the stereo channel whose input is at pin 6, feedback is from pin 8 through R5 to pin 7, and the gain is set by the ratio of R5 to R3. R3 is returned to earth through C4 to avoid upsetting the bias. Similarly for the other channel whose input is on pin 9, the output from pin 13 is fed back through R6 to pin 8 with R4, C5 to earth. A loudspeaker resistance of 8 ohms gives the best results, and no special heat-dissipating arrangements are needed despite the comparatively high total power output. The IC should be placed, however, where air can circulate freely around it.

THE PLESSEY SL415

This one is a home-grown chip, a complete preamplifier and power amplifier IC. The maximum power output is 5W, with an 8-ohm speaker, and a single-ended 24 V power supply. As shown in Fig. 6.10 the circuit is for a single-channel (mono) amplifier. A simpler version, omitting the tone controls, can also be built. Two SL415's make a useful small stereo amplifier, and with a reasonably small number of components, construction is not too difficult. It's usually an advantage when you're making up a soldered version to have the control potentiometer separate, and some constructors prefer to have all the tone-control components on a separate piece of board.

The input (Fig. 6.10) is taken directly to RV1, the volume control, so that this input is suitable only for signals which have already been equalised by a preamplifier. C1 is a coupling capacitor and C2 a high-frequency decoupling capacitor which prevents oscillation. The input signal is taken to pin 6, and the output from pin 5 is used for DC feedback through R2 and RV2 to the inputs. RV2 is used to adjust the bias on pin 7, with C3 decoupling any signal from this point. RV2 is adjusted so that the steady voltage on pin 10 (the final output) with no signal input is exactly half of the supply voltage.

In the final stage, C9 is used to prevent oscillations, along with the network C11, R8. Another essential aid to stability is the connection of C13 between pins 9 and 1 as close to the IC as possible. Pins 1 and 3 are both directly earthed, but pin 1 is the earth for the output stage and should be connected directly to the supply negative. Pin 3 should then be connected to pin 1 with as short a lead as possible. This is important, as connecting the negative supply line to pin 3 can cause oscillation. Heat-sink fins can be connected to the SL415 by making use of the stud which makes contact to the silicon of the chip, and several manufacturers offer printed circuit boards ready-made for this IC and its surrounding components. **HE**

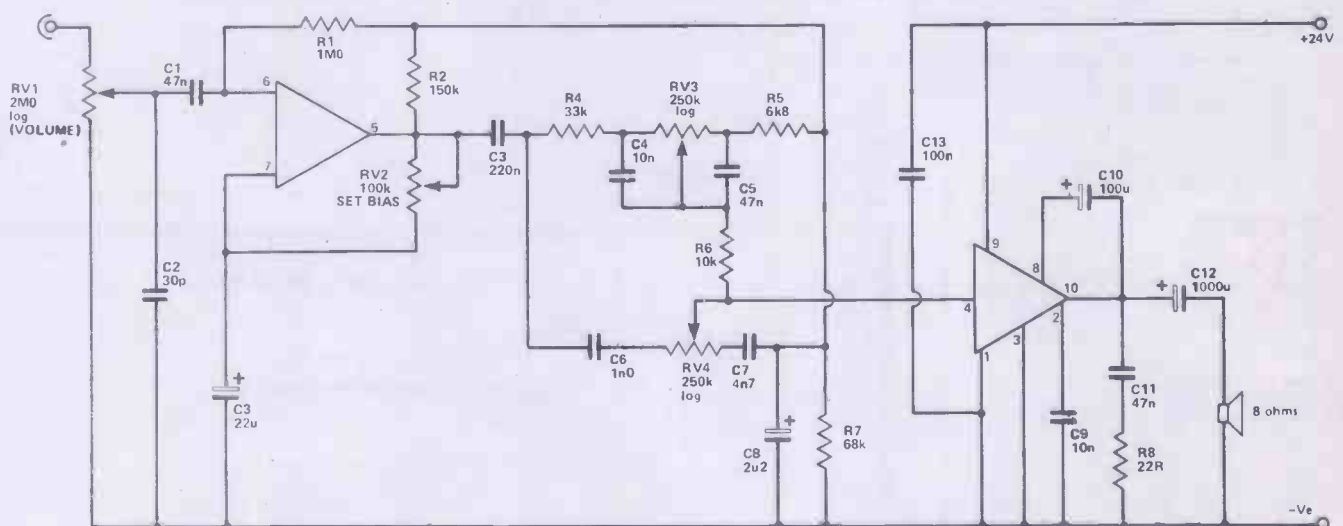

Fig. 6.10 The circuit diagram for a complete amplifier using a SL415. The maximum output power is 5W. No Eurobreadboard layout is shown, because the arrangement of components is critical, and a ready-made PCB is preferable except for experimental purposes.

PRINTED CIRCUITS and HARDWARE

Comprehensive range Constructors' Hardware and accessories.

Selected range of popular components
Full range of HE printed circuit boards, normally ex-stock, same day despatch at competitive prices.
P.C. Boards to individual designs
Resist-coated epoxy glass laminate for the d.i.y. man with full processing instructions (no unusual chemicals required).

Alfarc range of etch resist transfers, and other drawing materials for p.c. boards.

Send 15p for catalogue.

**RAMAR CONSTRUCTOR
SERVICES**
MADON ROAD
STRATFORD-ON-AVON
WARWICK CV34 4BT

ELECTRONIC TECHNICIANS Grades 3 and 4 required to assist in the construction, modification and maintenance of electronic equipment for use in teaching and research carried out in the Psychology Dept. of U.C.L. The work is varied and interesting and covers a wide range of analogue and digital techniques. ONC, C&G or equivalent required. The Grade 3 technician could have an electrical/mechanical background. Salary in range Grade 4: £3432-£3950. Grade 3: £3122-£3553 plus £524 London Weighting (under review). Application form from Personnel Officer (Technical Staff CK3), University College London, Gower Street, London WC1E 6BT.



Digital Capacitance Meter 1pF to 2µF in 5 ranges. Onboard switch, precision resistor network and 0.8" LEDs give direct readout in pF, nF and µF Basic acc. 0.5% Assembled and tested ONLY £29.92 inc. VAT. Precision Measurements, P.O. Box 70, St. Stephens Ct., Canterbury CT1 2UU. (Callers by appointment only).

BARGAINS FOR THE ELECTRONIC HANDYMAN BRANDED LED DIGITAL ALARM CLOCKS



Returned to Service Department within guarantee period.

- (1) With alarm repeat — S.R.S.P. of £17.00 offered at £3.95 inc. VAT.
- (2) With luxury lamp and repeat alarm as featured in most major U.K. Mail Order catalogues, S.R.S.P. £31.00—offered at £7.95 inc. V.A.T.
- (3) With integral luxury light and repeat alarm also as featured in most major U.K. Mail Order catalogues, S.R.S.P. of £32.00—offered at £7.25 inc. V.A.T.

These will be sold as received from our customers with the existing fault(s) and without guarantee.

Discounts available on large bulk purchases.

**PRESCOTT CLOCK AND
WATCH COMPANY LIMITED**
Prescott House, Humber Road, London NW2 6ER

CLASSIFIED INFORMATION

Semi-Display:

- 1-3 insertions — £4.00 per single column centimetre
- 4-11 insertions — £3.50 per s.c.c.
- 12 insertions — £3.00 per s.c.c.

Classified:

- 15 pence per word (minimum 25 words)
- Box number £1.00 extra.

ALL ADVERTISEMENTS IN THIS SECTION MUST BE PRE-PAID

Closing date: 2nd Friday in month preceding publication.

Advertisements are accepted subject to the terms and conditions printed on the advertisement rate card (available on request).

Cheques and postal orders should be crossed and made payable to "Hobby Electronics".

CLASSIFIED ADS, HOBBY ELECTRONICS
145 Charing Cross Road, London WC2H 0EE
(Telephone: 01-437 1002)

AD. INDEX

AJD DIRECT SUPPLIES .. 24	MARSHALLS 38
AMBIT INTERNATIONAL .. 2	MENOCREST 65
B.N.R.S. 62	METAC 74 & 75
CHROMATRONICS 39	MINICOST TRADING 73
COOK ELECTRONICS 39	MINIKITS 34
C.S.C. 15	MINIM AUDIO 51
DAVID GEORGE SALES ... 23	NIC MODELS 65
E.D.A. 57	S & G SERVICES 73
ELECTRONI-KIT 51	STEVENSON 30
GREENWAY 39	SWANLEY 65
GREENWELD 40	TECHNOMATIC 24
ILP ELECTRONICS 4 & 5	TEMPUS 36 & 37
KAM CIRCUITS 62	TK ELECTRONICS 62
KONA PUBLICATIONS ... 73	VIDEOTIME PRODUCTS .. 10
LEDARE LTD. 51	WATFORD ELECTRONICS .. 7
MAPLIN ELECTRONICS 9 & 76	

INTRODUCTION TO MICROPROCESSORS AND COMPUTING. 50 pages of diagrams and explanation to get you started. Price £2.30 + 45p postage.

EDUCATIONAL DATA AND TECHNICAL SERVICES

59 Station Road, Cogenhoe, Northampton NN7 1LU

1000 MIXED RESISTORS (5% carbon film) for £3. 1N4148 SPECIFICATION DIODES on bandolier: 50, 150, 500, 1000 for 50p, £1, £3, £5. NYLON KNOBS, 20mm diameter for 1/4" shafts, 30p for five. Post free from D. Johnston, 12 Balgillo Road, Dundee DD5 3LU.

Until April 1st this month's p.c.b.s to which Hobby Electronics have the copyright may be purchased for only 10p per square inch (incl. VAT, P&P).

E.G. A board the size of this ad = 110p (take to nearest sq. inch)

MAIL ORDER ONLY — CASH WITH ORDER TO:

S&G SERVICES (HULL)

43 Wheeler Street, Hull, North Humberside

**QUARTZ LCD
5 Function**

Hours, mins, secs, month, date, auto calendar, back light, fully adjustable bracelet to fit all wrists.

£6.65

Guaranteed same day despatch.
Very slim, only 6mm thick



M1

**SOLAR QUARTZ LCD
5 Function**

Genuine solar panel with battery back-up. Hours, mins, secs. Day/date. Fully adjustable bracelet. Back-light. Only 7mm thick.

£8.65

Guaranteed same day despatch.



M2

**QUARTZ LCD
11 Function SLIM CHRONO**

6 digit, 11 functions. Hours, mins., secs., day, date, day of week. 1/100th, 1/10th, secs.; 10X secs., mins. Split and lap modes. Back-light, auto calendar. Only 8mm thick. Stainless steel bracelet and back. Adjustable bracelet. Metac Price

£10.65 Thousands sold!

Guaranteed same day despatch



M3

**QUARTZ LCD
ALARM 7 Function**

Alarm. Hours, mins., secs. Month, date, day. 6 digits. 3 flags plus continuous display of day and date or seconds. Back-light. Only 9mm thick

£12.65

Guaranteed same day despatch



M4

**MULTI ALARM
6 Digits
10 Functions**

- ★ Hours, mins, secs
- ★ Month, date, day
- ★ Basic alarm
- ★ Memory date alarm
- ★ Timer alarm with dual time and 5 country zone.
- ★ Back light.
- ★ 8mm thick.

£18.65



M5

**FRONT-BUTTON ALARM
Chrono Dual Time**

6 digits, 5 flags, 22 functions. Constant display of hours and mins, plus optional seconds or date display. AM/PM indication. Month, date. Continuous display of day. Stop-watch to 12 hours 59.9 secs in 1/10 second steps. Split and lap timing modes. Dual time zones. Only 8mm thick. Back-light.

£22.65

Guaranteed same day despatch.



M6

**SOLAR QUARTZ LCD
Chronograph with Alarm
Dual Time Zone Facility**

6 digits, 5 flags, 22 functions. Solar panel with battery back-up. 6 basic functions stop-watch to 12 hours 59.9 secs. in 1/10 sec. steps. Split and lap timing modes. Dual time zones. Alarm. 9mm thick. Back-light. Fully adjustable bracelet.

£27.95

M7



**ALARM CHRONO
with 9 World
Time Zones**

- ★ 6 digits, 5 flags.
- ★ 6 basic functions.
- ★ 8 further time zones.
- ★ Count-down alarm
- ★ Stop-watch to 12 hours 59.9 secs. in 1/10 sec. steps.
- ★ Split and lap timing modes.
- ★ Alarm
- ★ 9mm thick.
- ★ Back-light
- ★ Fully adjustable bracelet.

£29.65

M8

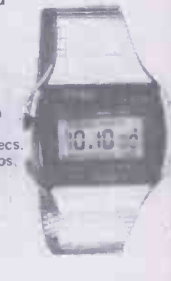

**SOLAR QUARTZ LCD
Chronograph**

Powered from solar panel with battery back-up. 6 digit, 11 functions. Hours, mins, secs., day date, day of week. 1/100th, 1/10th secs., 10X secs., mins. Split and lap modes. Back light. Auto calendar. Only 8mm thick. Stainless steel bracelet and back. Adjustable bracelet. Metac Price

£13.65

Guaranteed same day despatch

M9



**LADIES DAY WATCH
QUARTZ LCD**

Ladies Day Watch only 25 x 20mm and 6mm thick. Hours, minutes, seconds, day, date, backlight and auto calendar. Elegant metal bracelet in silver or gold fully adjustable to suit very slim wrists. State colour preference.

£9.95

Guaranteed same day despatch

M15



**LADIES FASHION WATCH
QUARTZ LCD**

Lady's Fashion Watch. Elegant bracelet in bronze/gold finish or silver colour. Hours, minutes, seconds, day, date, backlight and auto calendar. Adjustable for the slimmest of wrists.

State colour preference.

£14.95

Guaranteed same day despatch

M17



**LADIES COCKTAIL WATCH
QUARTZ LCD**

Lady's Cocktail Watch. Highly functional watch which also suits those special occasions. Beautifully designed with a very thin bracelet which retains strength as well as elegance. Hours, mins, secs., day, date, backlight and autocalendar. Bracelet fully adjustable to suit slim wrists. State gold or silver finish.

£19.95

Guaranteed same day despatch

M18

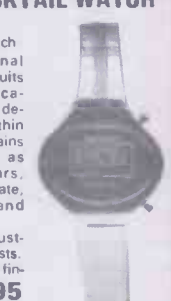

**HANIMEX
Electronic
LED Alarm Clock**

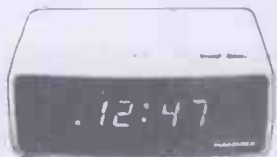

Features and Specification
Hour, minute display. Large LED display with p.m. and alarm indicator. 24 Hours alarm with on/off control. Display flashing for power loss indication. Repeatably 9-minute snooze. Display bright, dim, modes control. Size: 8.15" x 3.93" x 2.36" (131mm x 11mm x 60mm). Weight: 1.43 lbs (0.65 kg).

£10.20 Thousands sold!

Mains operated

Guaranteed same day despatch.

M13

**EXECUTIVE
ALARM WATCH**

6 functions plus alarm: Conference signal, 5 minute snooze alarm. Conference signal sounds 4 secs. before main alarm to give advance warning and option to cancel. Snooze sounds 5 mins. after main alarm and is always preceded by the conference signal.

£14.95

M60



**MACY QUARTZ
ANALOGUE**

Automatic calendar day and date, infinite bracelet. This man's watch has elegance as well as the robust appearance provided by a watch with traditional features. Accuracy is provided by a quartz crystal powered by a long life miniature battery.

£24.95

M21



**Metac price break-through for an
Alarm Chrono-
graph with
Dual Time
Only £16.95**



- OUTSTANDING FEATURES**
- ★ **DUAL TIME.** Local time always visible and you can set and recall any other time zone (such as GMT). Also has a light for night viewing
 - ★ **CALENDAR FUNCTIONS** include the date and day in each time zone.
 - ★ **CHRONOGRAPH/STOPWATCH** displays up to 12 hours, 59 minutes and 59.9 seconds. On command, stopwatch display freezes to show intermediate (split/lap) time while stopwatch continues to run. Can also switch to and from timekeeping and stopwatch modes without affecting either's operation.
 - ★ **ALARM** can be set to any time within a 24-hour period. At the designated time, a pleasant, but effective buzzer sounds to remind or awaken you!
- Guaranteed same day despatch

M16

HOW TO ORDER

Payment can be made by sending cheque, postal order, Barclay, Access or American Express card numbers. Write your name, address and order details clearly, enclose 40 pence per single item for post and packing or the amount stated in the advert. All products carry 1 year written guarantee and full money-back 10 day reassurance. Battery fitting and electronic calibration service is available to customers at any Metac shop. All prices include VAT currently at 15%.

Metac Wholesale:

Trade enquiries — send for a complete list of prices for all the goods advertised plus many more not shown, also minimum order details. Telephone orders: Credit card customers can telephone orders direct to Daventry (03272) 76545 or Edgware Road 01-723 4753 24 hours a day.



Service Enquiries: 03272-77659
CALLERS WELCOME. Shops open 9.30am-6.00pm.

Metac

**ELECTRONICS
& TIME CENTRES**

North & Midlands
67 High Street, DAVENTRY
Northamptonshire
Telephone: 03272-76545

South of England
327 Edgware Road
LONDON W.2
Telephone: (01) 723 4753

SEIKO MEMORY BANK

Calendar watch M354
Hours, mins., secs.
Month, day, date in
12 or 24 hour format
all indicated continuously.
Monthly calendar display
month, year and all dates
or any selected month over
80 year period.
Memory bank function.
Any desired dates up to 11
can be stored in advance.
2 year battery life.
Water resistant.



Metac Price **£79.50** **M11**

SEIKO ALARM CHRONOGRAPH

With WEEKLY Alarm.
Hours, mins, Secs.
month, date, day,
am/pm.
Weekly alarm — can
be set for every day at
designated time, e.g.
6.30am on Mon.
Wed. and Friday.
Alarm set time
displayed above time of
day.
Full stopwatch
functions, laptime,
split, etc.



Price **£89.95** **M10**

SEIKO MELODY ALARM CHRONOGRAPH

Chiming Alarm, plus
chrono. Hours, mins,
secs, date, day.
24-hour alarm, 12
hour chronograph,
1/10th secs, laptime,
back light, stainless
steel, mineral glass.

Metac Price **£92.95** **M19**

SEIKO CALCULATOR WATCH

Full specification
calculator with
memory, plus multi
function watch.
Hours, mins, secs,
day, date, backlight.
Automatic calendar.
Long-life battery.



Price **£96.20** **M27**

CASIO CHRONO 95QS-3LB

Stainless steel case,
water resistant to 66
feet. Hours, mins, secs,
am/pm, year, month,
date, day. Auto-calendar
pre-programmed until
year 2029. 12/24 hour
stopwatch function.
Range 7 hours, 1/100
sec. (Mode). Net
time/lap-time/1st-2nd
place times. Accuracy
15secs. per month.
Battery life approx. 4
years.



Price **£22.95** **M22**

CASIO LADIES 86CL-23B-1

Elegant slim line stainless
steel bracelet, fully
adjustable. Hours, mins,
10 sec. symbol second by
flash, am/pm. Month,
date, day. Auto-calendar
pre-programmed for 28th
day in Feb. Accuracy per
month 15 secs., battery life
approx. 15 months.



Price **£29.95** **M23**

CASIO F-200 SPORTS CHRONO

Attractive man's watch
in black resin with
mineral glass. Hours,
mins, secs, am/pm.
Month, date,
alpha-numeric day.
Auto-calendar set 28th
Feb. Stopwatch
working range 1 hour
units 1/100 sec.
Mode, Net time/lap
time/1st-2nd place
times. Accuracy
approx. 15 secs. per
month. Battery 12
months.



Price **£14.95** **M24**

CASIO ALARM CHRONO 81CS-36B

Hours, mins, secs,
day, and also day,
month and year
perpetual automatic
calendar. 100th sec.
chronograph to 7
hours. Net time/lap
time/1st and 2nd
place times. User
optional 12/24 hr.
display. 24 Alarm.
User optional, hourly
chime. Backlight,
mineral glass, stainless
steel. Water resistant to
100ft. Battery life
approx. 4 years.



Price **£34.95** **M25**

BELTIME CHRONOGRAPH

9 Functions
Hours, mins, secs,
day, date, month,
interchange feature,
automatic calendar,
backlight; net time/lap
time. Stainless steel
bracelet. Battery life 1
year.



Price **£14.95** **M34**

BELTIME MULTI ALARM

29 Functions
Hours, mins, secs,
date, day. Alarm,
chronograph, light.
Watch 8 functions,
Alarm 4 functions,
chronograph 17
functions. Stainless
steel bracelet.



Price **£29.95** **M35**

CASIO F-8C

3 Year Battery Life

Hours, mins, secs,
am/pm, date, day.
Auto calendar set.
28th Feb. Stopwatch
function. Accuracy 15
secs. per month.
Battery life approx. 3
years.



Price **£9.95** **M36**

CASIO CALENDAR 200

47CS-23B-1 Black
Stainless steel. Hours,
mins, 10 second symbol,
second (by flash),
am/pm. Month, day,
date. Auto calendar set
from 1901 to 2009. Full
month calendar display,
dual time function.
Accuracy 10 secs. per
month. Battery life
approx. 15 months.

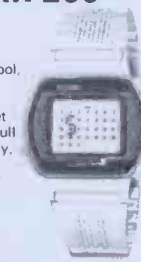

Price **£59.95** **M37**

MELODY MULTI-ALARM CHRONOGRAPH



Hours, mins, secs, day, date, countdown
alarm, dual time zone, 1/100th sec.
stopwatch. Lap/split time, 1st and 2nd
place times. Melody test function.

Price **£26.95** **M30**

DUAL TIME-ALARM CHRONOGRAPH



Incorporating module of world-famous
Japanese watch manufacture: Hours,
mins, secs, day of week, month, day and
date. 24 hour alarm, 12 hour chrono-
graph, 1/10th secs, lap time, backlight,
stainless steel case and bracelet, mineral
glass, battery hatch, long life battery.

Price **£35.00** **M12**

PICOQUARTZ MICROPROCESSOR ALARM CHRONOGRAPH



Multi-language — day of the week can be
set to English, French, German, Italian or
Spanish. Chime — every full hour com-
bined with a response signal, beeping at
every pressing of the functions. Can be
switched off. 12-24 hour format, back-
light, Chrono — 1 full-scale chrono with
lap, counting hours, up to 24 hours.
Minutes, secs, 1/100th secs. Two Alarm
systems. Two time zones.

Price **£37.95** **M32**

SEIKO CHRONOGRAPH



Hours, mins, secs and day of the week.
Month, date and day of the week. Stop-
watch display. Hours, mins, secs up to 12
hours (minutes, secs, 1/100 secs up to
20 minutes). Lap timing, continuous time
measurement of two competitors. Stain-
less steel, mineral glass.

Price **£56.00** **M33**

Metac

ELECTRONICS
& TIME CENTRES

North & Midlands
67 High Street, DAVENTRY
Northamptonshire
Telephone: 03272 76545

South of England
327 Edgware Road
LONDON W.2
Telephone: (01) 723 4753

MAPLIN



This superb organ – build the first working section for just over £100. Full specification in our catalogue.



Touch operated rhythm generator, the 'Drumsette'. Construction details 25p. (Leaflet MES49). Specification in our catalogue.



Multimeters, analogue and digital, frequency counter, oscilloscopes, and lots, lots more at excellent prices. See cat. pages 106 and 183 to 188 for details.



61-note touch-sensitive piano to build yourself. Full specification in our catalogue.



Our bi-monthly newsletter contains guaranteed prices, special offers and all the latest news from Maplin

A massive new catalogue from Maplin that's even bigger and better than before. If you ever buy electronic components, this is the catalogue you must not be without. Over 280 pages – some in full colour – it's a comprehensive guide to electronic components with hundreds of photographs and illustrations and page after page of invaluable data.



A range of highly attractive knobs is described in our catalogue. Our prices are very attractive too!



The 3800 synthesiser build it yourself at a fraction of the cost of one ready-made with this specification. Full details in our catalogue.



A pulse width train controller for smooth slow running plus inertia braking and acceleration. Full construction details in our catalogue.



Speakers from 1½ inch to 15 inch; megaphone. PA horns, crossovers etc. They're all in our catalogue. Send the coupon now!



Post this coupon now for your copy of our 1979-80 catalogue price 70p.

Please send me a copy of your 280 page catalogue. I enclose 70p (plus 37p p&p). If I am not completely satisfied I may return the catalogue to you and have my money refunded. If you live outside the U.K. send £1.35 or ten International Reply Coupons. I enclose £1.07.

NAME

ADDRESS

HE 12 79



A wide range of disco accessories at marvellous prices. Our catalogue has all the details.



A very high quality 40W per channel stereo amplifier with a superb specification and lots of extras. Full construction details in our catalogue.

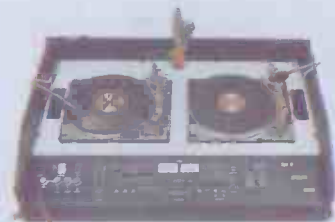

A genuine 150W per channel stereo disco to build yourself. Full specification in our catalogue.

MAPLIN

ELECTRONIC SUPPLIES LTD

All mail to:-
 P.O. Box 3, Rayleigh, Essex SS6 8LR.
 Telephone: Southend (0702) 554155.
 Shop: 284 London Road, Westcliff-on-Sea, Essex.
 (Closed on Monday).
 Telephone: Southend (0702) 554000.