

Compact Automatic
Bread Maker

CUCKOO

사용설명서
USER MANUAL

CBM-AAB101S

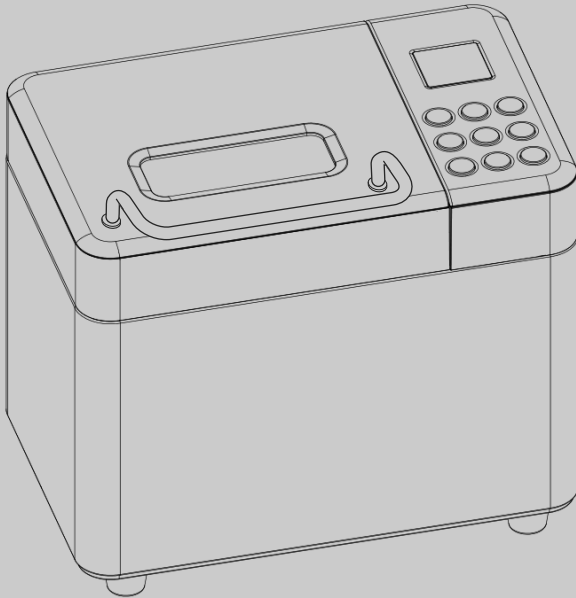

CUCKOOELECTRONICS CO.,LTD.

CONTENTS

CONTENTS

CONTENTS.....	2
IMPORTANT SAFEGUARDS.....	3
SPECIFICATIONS.....	5
PART DESCRIPTION.....	6
QUICK GUIDE.....	7~8
HOW TO CLEAN AND USE ENVIRONMENT.....	9
FUNCTION INTRODUCTION.....	10~11
DETAILED INSTRUCTIONS.....	12~14
INGREDIENTS INTRODUCTION.....	15~16
TROUBLESHOOTING.....	17~18
RECIPE.....	19~21

CONTENU

CONTENU.....	2
GARANTIES IMPORTANTES.....	4
L'ENVIRONNEMENT.....	9

IMPORTANT SAFEGUARDS

To prevent personal injury or property damage, read and follow all instructions and warnings.

When using electrical appliances, basic safety precautions should always be followed including the following:

- When using electrical appliances, basic safety precautions should always be followed including the following:
 - Read all instructions.
 - Do not touch hot surfaces. Use handle or knobs. Always use hot pads or oven mitts when handling hot bread and bread pan.
 - To protect against electric shock, do not immerse cord, plugs, or other electric parts in water or other liquids.
 - Close supervision is necessary when this appliance is used by or near children.
 - Unplug the appliance from the outlet when not in use or before cleaning. Allow to cool before attaching or removing parts.
 - Do not operate the appliance if the plug or cord is damaged, if the device malfunctions, or if it's dropped or damaged by any manner. If you experience any problems with your appliance, unplug it immediately from the electrical outlet. For service information see warranty page.
 - The use of accessory attachments not recommended by West Bend may cause fire, electric shock, or injury to persons.
 - Do not use this appliance outdoors.
 - Do not let cord hang over the edge of a table or counter, or touch hot surfaces.
 - Do not place on or near a hot gas or electric burner, or in a heated oven.
 - Use extra precaution when moving the bread maker during operation.
 - To disconnect, turn control to "OFF," then remove plug from wall outlet.
 - Do not use appliance other than its intended purpose.
 - Avoid touching moving parts.
 - Do not let the cord touch any hot surfaces.
 - This appliance has a polarized plug (one blade is wider than the other). To reduce the risk of electric shock, this plug is intended to only fit the polarized outlet one way. If the plug does not completely fit into the outlet, reverse the plug. If it still does not fit, contact a qualified electrician. Do not attempt to modify the plug in any way.
 - Set the bread pan on a hot pad, trivet, or other heat protective surface. Do not set hot bread pan directly onto the counter, table, or other surface.
 - Do not put hand inside oven chamber after bread pan is removed. Heating unit will still be hot.
 - Do not use your bread maker with a converter or transformer. This will destroy the electronic controls.
 - Do not attempt to repair this appliance yourself.
 - A short power-supply cord is included to reduce any risks from entanglement or tripping over a longer cord.
 - Longer, detachable power-supply cords or extension cords are available. They may be used if proper care is exercised. Using an extension cord is not recommended. If you must use one though, the marked electrical rating of the detachable power-supply cord or extension cord should be at least as great as the electrical rating of the appliance. If you're using a grounded appliance, then use a grounded 3 wire extension cord. To avoid tripping or any unsafe pulling, the cord should not hang over any counter or table top.
 - For household use only.
 - This appliance is not intended for those (including children) who have reduced physical, sensory, or mental capabilities; or those who lack experience or knowledge of the product unless they supervised or given instruction by those who are responsible for their safety.
 - Children should be supervised to ensure they do not misuse the appliance.
 - This appliance is not designed to operate with any external timer or separate remote-control system.

GARANTIES IMPORTANTES

Pour empêcher toute blessure physique ou tout dommage matériel, lisez et suivez toutes les consignes et mises en garde.

Lorsque vous utilisez des appareils électriques, les précautions de sécurité élémentaires devraient toujours être respectées, notamment:

- Lisez toutes les instructions.
- Ne touchez pas les surfaces à haute température. Utilisez les poignées carrées ou rondes. Utilisez toujours des maniques ou des gants de cuisine lorsque vous manipulez du pain chaud et le moule à pain.
- Pour vous protéger contre tout choc électrique, n'immergez pas le cordon, les fiches ni aucune autre pièce électrique dans l'eau ni dans tout autre liquide.
- Une surveillance étroite est nécessaire lorsque vous cet appareil est utilisé par ou à proximité d'enfants.
- Débranchez l'appareil de la prise électrique lorsqu'il n'est pas utilisé et avant de le nettoyer. Laissez l'appareil refroidir avant la mise en place ou le retrait de pièces et avant tout nettoyage.
- N'utilisez pas cet appareil avec un cordon abîmé ou une fiche détériorée, si l'appareil a connu un dysfonctionnement ou si l'appareil est tombé ou a été détérioré de quelque manière que ce soit. Si vous rencontrez un problème quel qu'il soit avec votre appareil, débranchez-le immédiatement de la prise secteur. Pour des informations sur les réparations, voir la page de garantie.
- L'utilisation d'accessoires non recommandés par West Bend risque de causer un incendie, une électrocution ou des blessures.
- N'utilisez pas cet appareil à l'extérieur.
- Ne laissez pas pendre le cordon du bord du plan de travail ou de la table et assurez-vous qu'il ne touche pas de surface chaude.
- Ne le placez pas sur ou près d'un brûleur à gaz ou électrique chaud ou dans un four chauffé.
- Vous devez faire preuve d'une extrême prudence lorsque vous déplacez un appareil électrique en fonctionnement.
- Pour débrancher l'appareil, tournez toute commande sur «OFF »(arrêt) puis retirez la fiche de la prise murale.
- N'utilisez pas l'appareil pour une autre utilisation que l'utilisation indiquée.
- Évitez tout contact avec les pièces mobiles.
- Ne laissez pas le cordon électrique entrer en contact avec une surface à haute température, y compris la gazinière.
- Cet appareil est pourvu d'une fiche polarisée (une lame est plus large que l'autre). Pour réduire le risque d'électrocution, cette fiche est conçue pour s'encaster dans une prise secteur polarisée dans un sens uniquement. Si la fiche ne s'insère pas complètement dans la prise secteur, retournez la fiche. Si elle ne s'encastre toujours pas, contactez un électricien qualifié. Ne tentez pas de modifier la fiche de quelque manière que ce soit.
- Placez le plat à pain sur la grille à pain, une grille ou toute autre surface résistante à la chaleur. Ne posez pas le plat à pain à haute température directement sur le plan de travail, la table ou toute autre surface.
- Ne placez pas la main à l'intérieur du compartiment du four une fois que le pain a été retiré. L'élément de chauffage sera toujours chaud.
- N'utilisez pas votre machine à pain avec un convertisseur ou un transformateur. Ceci détruirait les commandes électroniques.
- N'essayez pas de réparer cet appareil vous-même.
- Le cordon d'alimentation fourni est court pour réduire les risques qu'une personne se prenne les pieds ou trébuche sur un cordon plus long.
- Des cordons d'alimentations plus longs détachables ou des cordons de rallonge sont disponibles et peuvent être utilisés à condition de faire preuve de prudence lors de leur utilisation. Bien que l'utilisation d'un cordon de rallonge ne soit pas recommandée, si vous devez en utiliser un, la puissance nominale indiquée pour le cordon d'alimentation détachable ou pour le cordon de rallonge devrait être au moins aussi importante que la puissance nominale de l'appareil. Si l'appareil est de type raccordé à la terre, le cordon de rallonge devrait être relié à la terre et composé de trois fils. Le cordon devrait être disposé de manière à ne pas pendre depuis le plan de travail d'où il risque d'être tiré par des enfants ou d'où quelqu'un pourrait s'y prendre les pieds.
- Pour une utilisation domestique uniquement.
- Cet appareil n'est pas destiné à être utilisé par des personnes (y compris des enfants) dont les capacités physiques, sensorielles ou mentales sont réduites ou qui manquent d'expérience et de connaissances, sauf si elles ont été supervisées ou ont reçu des instructions concernant l'utilisation de l'appareil par une personne responsable de leur sécurité.
- Les enfants doivent être surveillés afin de s'assurer qu'ils ne jouent pas avec l'appareil.
- Les appareils ne sont pas conçus pour être commandés au moyen d'une minuterie externe ou d'un système de commande à distance séparé.

SPECIFICATIONS

Model name	CBM-AAB101S
Power supply	120V / 60Hz
Power consumption	600W
Baking capacity (Bread pan)	2 lb
Power cord length	3.3ft(1m)
Dimension	350mm(W) x 225mm(D) x 290mm(H)
Weight	12.4lb(5.6kg)

PART DESCRIPTION

Parts



Accessories



Measuring cup



Measuring spoon



Hook
(Kneading paddle
remover)



Kneading paddle

	CAUTION	• During baking please do not touch or place anything on the steam vent, lid, body or viewing window, as they will become hot.
	MISES EN GARDE	• Pendant la cuisson, veuillez ne rien toucher ni placer sur l'orifice d'aération, le couvercle, la structure ou la fenêtre d'observation, car ils deviendront chauds.

HOW TO ASSEMBLE THE BREAD PAN

- 1 To use the bread pan handle, turn the bread pan counter-clockwise, then pull it out of the device.

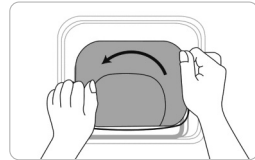

- 2 Place the bread pan back into the bread maker. Ensure the pan is firmly locked into place by turning it clockwise. Then, close the lid.

NOTE : Bread pan must lock into place for proper mixing and kneading.

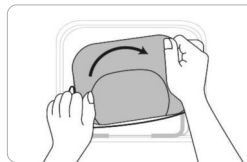

CAUTION : Be careful as the product may be hot.

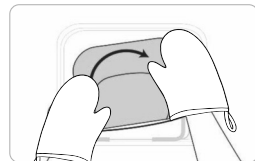

- 3 Push the kneading paddle onto the drive shaft inside the bread pan.



QUICK GUIDE

Using the fruit & nut dispenser

If you wish to add nuts or seeds to your loaf, it is not recommended to dispense them into the flour at first preparation. This may cause the nuts or seeds to lose flavor and texture due to over stirring.

The automatic dispenser function will help you add fruits, nuts, raisins, or other add-ins without waiting by the bread maker. Pour the nuts or seeds in the dispenser, then install it below the lid. After installation, close the lid and start the program. After approximately 30 minutes (time may differ) of baking, the nut dispenser will operate 3 times. To ensure all contents are dispensed, the dispenser will push the bottom cover open. The dispensing function is automatically set in menus 1-7 and 13.

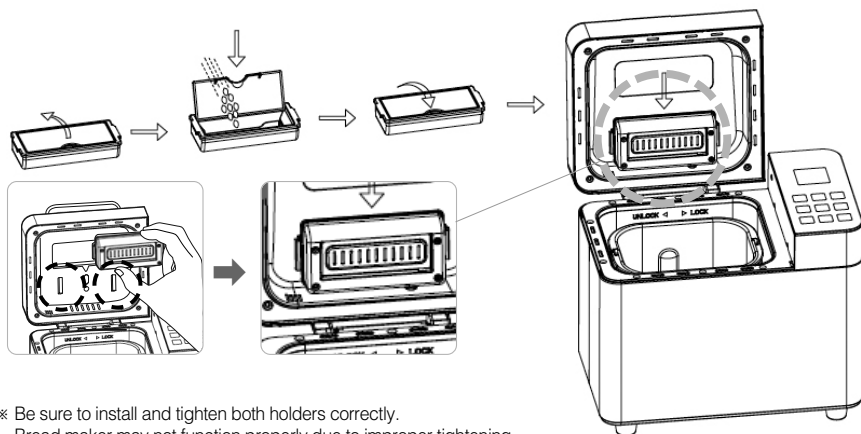

※ Be sure to install and tighten both holders correctly.
Bread maker may not function properly due to improper tightening.

REMOVING BREAD

Oven mitts should be used as the bread pan and baking chamber will be hot. To remove the bread pan, lift the handle, turn it counterclockwise to unlock, and lift the pan straight up from the base of the chamber.

After you remove the pan, carefully shake the bread upside down until it falls out. Let the bread cool on a wire rack for 10 minutes before you slice it with a bread knife.

TIP: If the kneading paddle is stuck in the loaf, remove it with a hook (or kneading paddle remover).

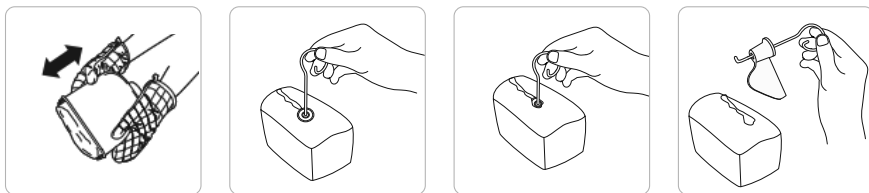

TIP: If needed, when the paddle signal alerts, pause the unit by pressing the START/STOP button. After pausing, remove the dough and kneading paddle, reshape the dough, and replace the bread pan. To continue, press the START/STOP button

HOW TO CLEAN AND USE ENVIRONMENT

CLEANING YOUR BREADMAKER

1. Unplug the cord from the electrical outlet and allow the appliance to cool completely before cleaning.
2. After the bread is removed from the bread pan, and the pan has cooled, fill it half-full with warm water and a small amount of dish soap. Allow the bread pan to soak for 5 to 20 minutes, or until the knead blades can be lifted off of the shafts. You may need to twist the knead blades slightly to loosen. If the knead blades are difficult to remove after soaking, secure the cross bar on the underside of the bread pan while twisting the knead blades to loosen. Wash the inside of the bread pan and knead blades with a soft cloth, then rinse and dry. Use a mild detergent. Never use chemical cleaning agents, oven cleaners, abrasive scouring pads, or cleansers on the bread pan or knead blades as it may damage the coating or finish. Replace the knead blades on the shaft.
3. Never immerse the bread pan in water or wash in an automatic dishwasher as it may damage the bearing that turns the knead blade. If necessary, wipe the inside of the oven chamber and the outside surfaces of the bread maker with a damp cloth. Never dip the appliance or fill the baking compartment with water! The lid cannot be removed for cleaning.

USE ENVIRONMENT

Although the bread maker can work well in a wide range of temperatures, loaf sizes may differ depending on room temperature. We suggest that the room temperature should be between 15 °C to 34°C.

LA LIMPIEZA DE SU MÁQUINA DE HACER PAN

1. Desenchufe el cordón eléctrico del tomacorriente y permita que el artefacto se enfríe completamente antes de limpiarlo.
2. Una vez que se ha sacado el pan del molde de pan, y el molde se ha enfriado, llene éste hasta la mitad con agua tibia y una pequeña cantidad de jabón para platos. Deje el molde de pan en remojo durante 5 a 20 minutos o hasta que las cuchillas de amasar puedan sacarse de los ejes. Quizás necesite torcer ligeramente las cuchillas de amasar para aflojarlas. Si se dificulta sacar las cuchillas de amasar después del remojo, asegure la barra transversal en la cara inferior del molde a la vez que tuerce las cuchillas de amasar para aflojarlas. Con un pañ suave lave la parte interna del molde y la cuchilla de amasar; enjuáguelas y séquelas. Use un detergente suave. No use ningún agente de limpieza químico, limpiadores de hornos, almohadillas de limpieza abrasivas o limpiadores en el molde de pan o las cuchillas de amasar pues podría dañar el recubrimiento o acabado. Vuelva a colocar las cuchillas de amasar en el eje.
3. No sumerja el molde de pan en agua ni lo lave en un lavavajillas automático ya que podría dañar el cojinete que hace girar la cuchilla de amasar. Si fuese necesario, limpie el interior de la cámara del horno y las superficies externas de la máquina de hacer pan con un pañ húmedo. ¡nunca sumerja el artefacto electrodoméstico en agua o llene el compartimiento de hornado de agua! La tapa no puede retirarse para su limpieza.

ENVIRONNEMENT D'UTILISATION

La machine peut bien fonctionner dans une large plage de températures, mais il y aura une différence de taille de pain entre une pièce très chaude et une pièce froide. Nous suggérons que la température ambiante soit comprise entre 15 °C et 34 °C.

FUNCTION INTRODUCTION

Control Panel Description

AFTER POWER ON

Plug the bread maker into a power supply. A beep will sound and "3:10" will display. The colon will flash, but the "3" and "10" will not.

"1" is the default program. The arrows will point to "1 ½LB" and "MEDIUM" as they are default settings.

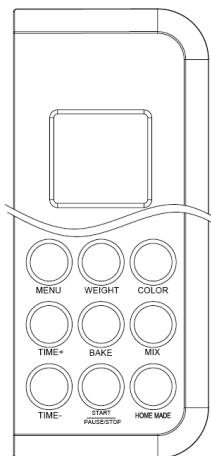

START/STOP BUTTON

Press the START/STOP button once to start a program. The indicator will light up, and the colon in the time display begin to flash and the program will start. Any other button is inactivated except the START/STOP button after a program has begun.

Press the START/STOP button for 0.5 seconds to pause the program. If there is no operation within 3 minutes, the program will continue processing until the setting program is completed. Press and hold the START/STOP button for 3 seconds to cancel a program. This will help prevent any unintentional disruption to the operating program. To remove bread, press the START/STOP button to end baking cycle.

PREPROGRAMMED MENU

Press MENU button to select your desired programs. The program will change each time you press the MENU button (A short beep will accompany each time you press the button). When cycling, each corresponding program number will be shown on the LCD display.

CRUST COLOR

Press COLOR button to select your desired setting: Light, Medium, or Dark crust. This button is adjustable in programs menu 1-7

WEIGHT

Press the Weight button to choose your desired gross weight (1LB, 1½LB, 2LB) This button is adjustable in programs Menu 1-7

DELAY TIMER (" + or - ")

Use the DELAY TIMER feature to start the bread maker at a later time. Press " + or - " buttons to increase the cycle time shown on the LCD display. The delay timer can add up to 15 hours. Set time will also include the bread making process.

NOTES:

- ▶ Set the Delay Time after selecting PROGRAM MENU, WEIGHT, and CRUST COLOR.
- ▶ Do not use the timer function with recipes that include dairy or other ingredients, such as eggs, milk, cream, or cheese.
- ▶ Press the " + or - " buttons to decide when you want your bread will finish. Please note the delay time should include baking time. After baking program is complete, the bread maker will shift to its Keep Warm setting for 1 hour. Before you start making the bread, ensure the program and crust color are selected first. Press the " + or - " to change the delay time in 10-minute increments. The maximum delay time is 15 hours.

POWER INTERRUPTION

In the event of a power outage, the process of making bread will automatically continue within 10 minutes, even if you don't press the START/STOP button. If the interruption time is longer than 15 minutes, the unit will not continue running and the LCD display will revert back to its default setting. If the dough has started rising, discard the ingredients in the bread pan and start over. If the dough has not started rising when power was interrupted, press the START/STOP button to continue the program from the beginning.

WARNING DISPLAY

This warning means that the temperature inside of the bread pan is too high. Press START/STOP button to stop the program, unplug the power cord, open the top lid, and let the machine cool down completely for 10-20 minutes before restarting.



This warning means that the temperature sensor is disconnected. Press the START/STOP button to stop the program, then unplug the power cord. Please check the sensor with the nearest authorized service agent for any examination, repair, or electrical /mechanical adjustment.



KEEP WARM

After baking program is complete, the bread machine will beep 10 times and shift to its Keep Warm setting for 1 hour. After 60 minutes, 0:00 will be shown on the LCD display.

To cancel the Keep Warm setting, press and hold the START/STOP button for 3 seconds.

TIP: Removing bread immediately after baking program is complete will prevent the crust from getting darker.

BEFORE THE FIRST USE

Wash and dry the bread pan and kneading paddle

Note: Do not use metal utensils in bread pan since they may damage the non-stick surface.

CAUTION! Falling Object Hazard. Bread maker can wobble and walk during kneading cycle. Always position it in the center of counter away from the edge.

1. Check for any missing or damaged parts.
2. Clean all the parts according to "CLEANING AND MAINTENANCE".
3. Set the bread maker on bake mode and let it bake empty for about 10 minutes. Once you let it cool, clean all the detached parts again. The appliance may emit a little smoke and/or odor when you turn it on after the first time. This is normal, and it will subside after the first or second use. Make sure the appliance has sufficient ventilation.
4. Once you dry all parts thoroughly and assemble them, the appliance is ready for use.

DETAILED BREAD MAKING INSTRUCTIONS

- 1 To use the bread pan handle, turn the bread pan counter-clockwise, then pull it out of the device.

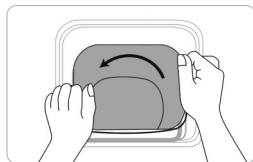

- 2 Press the kneading paddle into the drive shaft located inside the bread pan.

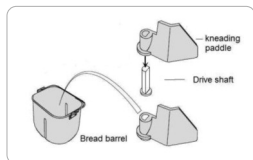

- 3 Add the ingredients to the bread pan in order listed in the recipe. First, add the liquids, sugar, and salt; then the flour; and last the yeast.

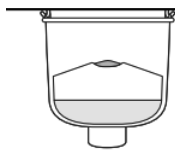

LAST: Yeast. **MUST** be separate from wet ingredients
SECOND: Dry ingredients (sugar, salt, shortening, flour)
FIRST: Liquid ingredients – room temperature

- 4 Carefully measure and add ingredients to the bread pan in the EXACT order given in the recipe.



- 5 **NOTE:** Make a small indent on top of the flour with your finger, then add yeast into it. Make sure that yeast does not come into contact with any salt or liquids.

TIP: Before you begin, pre-measure all ingredients, including add-ins (nuts, raisins, etc).

- 6 Place the bread pan back into the bread maker. Ensure the pan is firmly locked into place by turning it clockwise. Then, close the lid.

NOTE: Bread pan must be locked into place for proper mixing and kneading.

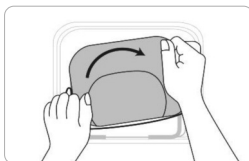

DETAILED BREAD MAKING INSTRUCTIONS

- 7 Once you plug in the appliance, you'll hear a beep and the LCD display will default to program 1.
- 8 Continuously press the PROGRAM MENU button until your desired program is displayed.
- 9 Press the WEIGHT button to cycle the arrow through the 1LB, 1½LB, or 2LB options. (WEIGHT is not an option in program 8-15.)
- 10 Press the CRUST button to move the arrow to desired setting: Light, Medium, Dark crust. (Crust is not adjustable in program 8-15.)
- 11 If desired, set the DELAY TIMER button. Press + and – buttons to adjust the time shown on the LCD display. (Delay function is not available in program 13)

12 **NOTE:** Do not use the delayed timer when adding dairy, eggs, etc.
You may skip this step if you want to start your bread maker immediately.

13 Press the START/STOP button once to start program. The bread maker will beep once as the indicator arrows and colon between the "3" and "10" will start blinking. The kneading paddle will begin mixing your ingredients. If you set the delay timer, the kneading paddle will not mix ingredients until it reaches your set time.

14 Once the process is complete, the maker will sound 10 beeps and then shift to its keep warm setting for 1 hour. Press and hold the START/STOP button for 3 seconds to end the Keep Warm setting.

TIP : If needed, when the paddle signal alerts, pause the unit by pressing the START/STOP button. After pausing, remove the dough and kneading paddle, reshape the dough, and replace the bread pan. To continue, press the START/STOP button

15 Let the bread pan cool down slightly before moving the bread.
Using oven mitts, carefully turn the bread pan counterclockwise to unlock. Then, lift up the handle and remove the pan from the machine.

CAUTION: the Bread pan and bread may be very hot!
Always handle with care.

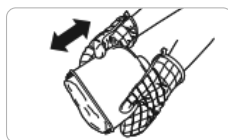

16 Using oven mitts, turn the bread pan upside down (with the bread pan handle folded down) onto a wire cooling rack or clean cooking surface and gently shake until bread falls out. Use a non-stick spatula to gently loosen the sides of the bread from the bread pan.

17 Let the bread cool for about 20 minutes before slicing. It is recommended to slice bread with an electric or dentate cutter rather than a fruit or kitchen knife as it may lead to deformation.

18 If kneading paddle gets stuck inside the bread, gently pry it out using a spatula or small utensil. Never use your hands to remove the kneading paddle as the bread is hot. When not in use or if operation is complete, unplug the power cord.

NOTE: Store remaining bread in a sealed plastic bag for up to three days at room temperature.
For longer storage time, placed seal plastic bag in a refrigerator for up to 10 days.

DETAILED INSTRUCTIONS

Using the fruit & nut dispenser

If you wish to add nuts or seeds to your loaf, it is not recommended to dispense them into the flour at first preparation. This may cause the nuts or seeds to lose flavor and texture due to over stirring.

The automatic dispenser function will help you add fruits, nuts, raisins, or other add-ins without waiting by the bread maker. Pour the nuts or seeds in the dispenser, then install it below the lid. After installation, close the lid and start the program. After approximately 30 minutes (time may differ) of baking, the nut dispenser will operate 3 times. To ensure all contents are dispensed, the dispenser will push the bottom cover open. The dispensing function is automatically set in menus 1-7 and 13.

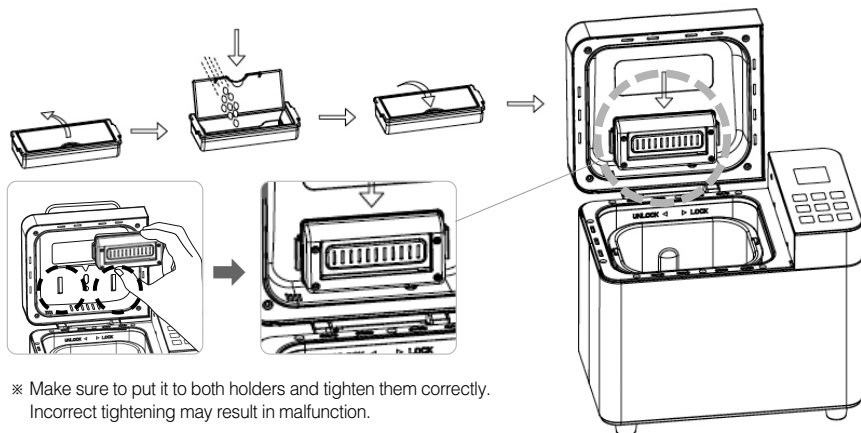

REMOVING BREAD

Oven mitts should be used as the bread pan and baking chamber will be hot. To remove the bread pan, lift the handle, turn it counterclockwise to unlock, and lift the pan straight up from the base of the chamber.

After you remove the pan, carefully shake the bread upside down until it falls out. Let the bread cool on a wire rack for 10 minutes before you slice it with a bread knife.

TIP: If the kneading paddle is stuck in the loaf, remove it with a hook (or kneading paddle remover).

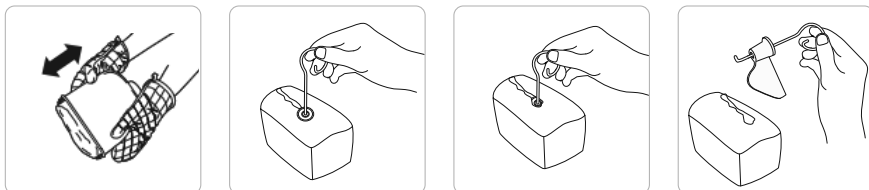

TIP: If needed, when the paddle signal alerts, pause the unit by pressing the START/STOP button. After pausing, remove the dough and kneading paddle, reshape the dough, and replace the bread pan. To continue, press the START/STOP button

1. Bread Flour

Bread flour is the most important ingredient in making bread. It is also recommended to include in most yeast-bread recipes. Also called high-gluten flour due to its higher gluten and protein contents, this can help keep the bread from collapsing after rising. Flour varies by region. Bread flour has a higher gluten content than all-purpose flour, so it can be used for baking larger bread loaves with higher inner fiber content.

2. All-Purpose Flour

All-purpose flour contains no baking powder. This flour is suitable for "quick breads", or bread made with the quick settings. Bread flour is better suited for yeast breads.

3. Whole-Wheat Flour

Whole-wheat flour is grounded from an entire wheat kernel. Bread that contains whole-wheat flour typically has higher fiber and nutritional contents. Whole-wheat tends to be heavier than other flours. As a result, loaves are usually smaller in size and are heavier in texture.

Whole-wheat flour contains wheat skin and gluten. Many recipes add whole-wheat flour or Bread Flour for better baking results.

4. Black Wheat Flour

Also called "rye flour", black wheat flour contains a high amount of fiber similar to whole-wheat flour. To increase loaf size, black wheat flour must be combined with a large amount of bread flour.

5. Self-rising flour

Typically used for baking cakes, self-rising flour contains baking powder. Do not use self-rising flour with yeast.

6. Corn flour and oatmeal flour

Corn flour and oatmeal flour are grounded from corn and oatmeal separately. They are used as additive ingredients for making rough bread. They help enhance flavor and texture.

7. Sugar

Sometimes described as "food" for yeast, sugar increases the sweetness and color of your bread. It is also a crucial element in the bread rising process. White sugar is typically used. However, some recipes may call for brown sugar, powdered sugar, or cotton sugar.

8. Yeast

Yeast is a living organism that should be kept in the refrigerator to maintain its freshness. It needs carbohydrates found in sugar and flour for nourishment. Yeast used in bread makers are sometimes sold under several different names: Bread machine yeast (preferred), active-dry yeast, and instant yeast.

After the yeasting process, the yeast will produce carbon dioxide. The carbon dioxide will expand bread and soften the inner fibers.

1 tbsp dry yeast = 3 tsp dry yeast

1 tbsp dry yeast = 15ml yeast

1 tsp dry yeast = 5ml

Before using, check the expiration date and storage time of the yeast. Store the yeast back into refrigerator immediately after each use. If not, the higher temperature may kill the fungus needed for bread rising.

TIP: To check on your yeast to see if it is fresh and active:

(1) Pour 1 cup (237ml) of warm water (45-50°C) into a measuring cup.

(2) Add 1 teaspoon (5ml) of white sugar into the cup and stir. Then, add 1 tablespoon (15ml) of yeast into the water.

(3) Place the measuring cup in a warm place for about 10min. Do not stir the water.

(4) Fresh, active yeast will begin to bubble or "grow". If it does not, the yeast is dead or inactive.

INGREDIENTS INTRODUCTION

9. Salt

Although bread tends to grow larger when salt isn't added to the recipe, do not add too much salt to your recipe.

10. Egg

Eggs can improve the bread's texture, add more nourishment, and increase its size. The egg must be whisked in with the other liquid ingredients.

11. Grease, Butter and Vegetable Oil

Grease can soften the bread and extend its storage life. Butter should be melted or chopped into small pieces before adding to liquid.

12. Baking Powder

Baking powder is used for rising the Ultra Fast bread and cake. When using baking powder, rising time is not needed. Instead, it helps produce air. The air created forms bubbles, which will help soften the bread's texture.

13. Baking Soda

It is similar with baking powder. It can also be used in combination with baking powder.

14. Water and Other Liquids (always add first)

Water is an essential ingredient for making bread. Generally, water should be between 20°C and 25°C, or around room temperature. To enhance bread flavor, some recipes may call for milk or other liquids. Never use dairy with the Delay Timer option.

USE EXACT MEASUREMENT

TIPS: One of the most important steps of making good bread is using the proper measurement of ingredients. Measure each ingredient carefully and add to your bread pan in the order given in the recipe.

It is strongly recommended to use a measuring cup or measuring spoon to ensure accuracy. Inaccurate measurements may negatively affect bread quality.

Adding Sequence

Always add ingredients in the order given in the recipe.

FIRST: Liquid ingredients

SECOND: Dry ingredients

LAST: Yeast

The yeast should only be placed on the dry flour and never come in contact with the liquid or salt. When setting the Delay Timer function for an extended period of time, do not add perishable ingredients such as eggs or milk. After the initial kneading of the flour is complete, a beep will go off and the fruit ingredients will automatically dispense into the mixture. If the fruit ingredients are added too early, the flavor will diminish due to over stirring.

Liquid Ingredients

Water, fresh milk or other liquids should be measured with measuring cups with clear markings and a spout. Set the cup on the counter and lower yourself to check the liquid level. When measuring cooking oil or other ingredients, clean the measuring cup thoroughly.

Dry measurements

Measure dry ingredients by gently spooning them into a measuring cup. Once filled, level off any excess ingredients with a knife. Never use the measuring cup to scoop the dry ingredients directly from its container. This could add up to 1 tablespoon of extra ingredients. Do not tap the bottom of the measuring cup or pack it down.

HINT: Before measuring, stir the flour to aerate it. When measuring small amounts of dry ingredients, such as salt or sugar, use a measuring spoon. Make sure you are leveling off your dry ingredients when measuring.

Troubleshooting

▼ If there is anything wrong with the product, check the following points before contacting the customer service center.

No	PROBLEM	PROBLEM CAUSE	SOLUTION
1	Odor or burning smell	<ul style="list-style-type: none"> Flour or other ingredients have spilled into the baking chamber. 	<ul style="list-style-type: none"> Stop the bread maker and allow to cool completely. Wipe excess ingredients from the baking chamber with a paper towel.
2	Ingredients not blending/can hear motor burning	<ul style="list-style-type: none"> Bread pan or kneading paddle may not be installed properly. Too many ingredients. 	<ul style="list-style-type: none"> Make sure kneading paddle is set all the way on shaft. Measure ingredients accurately.
3	"HHH" displays when START/STOP button is pressed.	<ul style="list-style-type: none"> Internal temperature of bread maker is too high. 	<ul style="list-style-type: none"> Allow unit to cool down in between programs. Unplug unit, open lid, and remove bread pan. Let it cool for 15-30 minutes before beginning a new program.
4	Window is cloudy or covered with condensation.	<ul style="list-style-type: none"> May occur during mixing or rising programs. 	<ul style="list-style-type: none"> Condensation usually disappears during baking programs. Clean window well in between uses.
5	Kneading paddle comes out with the bread.	<ul style="list-style-type: none"> Thicker crust with dark crust setting. 	<ul style="list-style-type: none"> It is not uncommon for the kneading paddle to come out with the bread loaf. Once the loaf cools, remove the paddle with a spatula.
6	Dough is not blending thoroughly; flour and other ingredients are built up on sides of pan; bread loaf is coated with flour	<ul style="list-style-type: none"> Bread pan or kneading paddle may not be installed properly. Too many ingredients. Gluten-free dough is typically very wet. It may need additional help by scraping sides with a rubber spatula. 	<ul style="list-style-type: none"> Make sure bread pan is securely set in unit and kneading paddle is firmly on shaft. Make sure ingredients are measured accurately and added in the proper order. Excess flour can be removed from loaf once baked and cooled. Add water, one tablespoon at a time, until dough has formed into a ball.
7	Bread raised too high or pushed lid up.	<ul style="list-style-type: none"> Ingredients not measured properly (too much yeast, flour). Kneading paddle not in bread pan. Forgot to add salt. 	<ul style="list-style-type: none"> Measure all ingredients accurately and make sure sugar and salt have been added. Try decreasing yeast by 1/4 teaspoon (1.2ml). Check installation of kneading paddle.
8	Bread does not rise; loaf short.	<ul style="list-style-type: none"> inaccurate measurement of ingredients or inactive yeast. Lifting lid during programs. 	<ul style="list-style-type: none"> Measure all ingredients accurately Check expiration date of yeast and flour. Liquids should be room temperature.

Troubleshooting

▼ If there is anything wrong with the product, check the following points before contacting the customer service center.

No	PROBLEM	PROBLEM CAUSE	SOLUTION
9	Bread has a crater in the top of the loaf once baked.	<ul style="list-style-type: none"> • Dough has risen too fast. • Too much yeast or water. • Incorrect program chosen for the recipe. 	<ul style="list-style-type: none"> • Do not open lid during baking. • Select a darker crust option.
10	Crust color is too light	<ul style="list-style-type: none"> • Opening the lid during baking. 	<ul style="list-style-type: none"> • Do not open lid during baking. • Select a darker crust option.
11	Crust color is too dark	<ul style="list-style-type: none"> • Too much sugar in the recipe. 	<ul style="list-style-type: none"> • Decrease sugar amount slightly. • Select a lighter crust option
12	Bread loaf is lopsided.	<ul style="list-style-type: none"> • Too much yeast or water. • Kneading paddle pushed dough to one side before rising and baking. 	<ul style="list-style-type: none"> • Measure all ingredients accurately. • Decrease yeast or water slightly. • Some loaves may not be evenly shaped, particularly with whole-grain flour.
13	Loaves made are different shapes.	<ul style="list-style-type: none"> • Varies by the type of bread. 	<ul style="list-style-type: none"> • Whole-grain and multi-grain bread tend to be denser and shorter than basic white bread
14	Bottom is hollow or holey inside.	<ul style="list-style-type: none"> • Dough too wet, has too much yeast, or has no salt. • Water too hot. 	<ul style="list-style-type: none"> • Measure all ingredients accurately. • Decrease yeast or water slightly. Check salt measurement. • Use room temperature water.
15	Under baked or sticky, dough bread.	<ul style="list-style-type: none"> • Too much liquid; incorrect program chosen. 	<ul style="list-style-type: none"> • Decrease liquid and measure ingredients carefully. *Check program chosen for recipe.
16	Bread mashes down when slicing.	<ul style="list-style-type: none"> • Bread is too hot. 	<ul style="list-style-type: none"> • Allow bread to cool on wire rack for 15-30 minutes before slicing.
17	Bread has a heavy, thick texture.	<ul style="list-style-type: none"> • Too much flour, old flour. • Not enough water. 	<ul style="list-style-type: none"> • Try increasing water or decreasing flour. • Whole-grain breads will have a heavier texture.
18	Base of bread pan has darkened or is spotted.	<ul style="list-style-type: none"> • After washing in dishwasher. 	<ul style="list-style-type: none"> • This is normal and will not affect the bread pan.

ENVIRONMENT FRIENDLY DISPOSAL

You can help protect the environment!

Please remember to respect the local regulations: please dispose any non-working electrical equipments to an appropriate waste disposal center.



No	Menus	Ingredient	Volume	Volume	Volume	Remark	
1	Basic Bread	bread weight	2lb/1000g	1.5lb/750g	1lb/500g		
		1	water	10.1oz/300ml	8.1oz/240ml	6.1oz/180ml	
		2	salt	1.5 teaspoons	1 teaspoons	0.5 teaspoons	put on the corner
		3	sugar	3 tablespoons	2.5 tablespoons	2 tablespoons	put on the corner
		4	oil	4 tablespoons	3 tablespoons	2 tablespoons	
		5	Flour (high gluten)	3.5cups/1.1lb/500g	2.75cups/0.9lb/400g	2.25cups/0.7lb/300g	
2	French Bread	instant yeast	0.8 teaspoon	0.8 teaspoon	0.5 teaspoon	put on the dry flour, do not let it touch any liquid	
		bread weight	2lb/1000g	1.5lb/750g	1lb/500g		
		1	water	10.1oz/300ml	7.8oz/230ml	5.4oz/160ml	
		2	salt	2 teaspoons	1.5 teaspoons	1 teaspoons	put on the corner
		3	sugar	3 tablespoons	2 tablespoons	1.5 tablespoons	put on the corner
		4	oil	2 tablespoons	1.5 tablespoons	1.25 tablespoons	
3	Whole-wheat bread	5	Flour (high gluten)	3.5cups/1.1lb/500g	2.75cups/0.9lb/400g	2.25cups/0.7lb/300g	
		6	instant yeast	0.8 teaspoons	0.8 teaspoons	0.5 teaspoons	put on the dry flour, do not let it touch any liquid
		bread weight	2lb/1000g	1.5lb/750g	1lb/500g		
		1	water	10.1oz/300ml	8.1oz/240ml	6.1oz/180ml	
		2	salt	1 teaspoon	1 teaspoon	0.5 teaspoon	put on the corner
		3	sugar	6 tablespoons	5 tablespoons	4 tablespoons	put on the corner
4	Quick Bread	4	oil	3 tablespoons	2.5 tablespoons	2 tablespoons	
		5	Flour (high gluten)	1.75cups/0.5lb/200g	1.5cups/0.5/160g	1.25cups/0.3lb/120g	
		6	whole-wheat flour	1.75cups/0.7lb/300g	1.5cups/0.6lb/240g	1.5cups/0.6lb/120g	
		7	instant yeast	2.0 teaspoons	2 teaspoons	2.5 teaspoons	put on the dry flour, do not let it touch any liquid
		bread weight	2lb/1000g	1.5lb/750g	1lb/500g		
		1	water	10.8oz/320ml	8.1oz/240ml	6.1oz/180ml	water temperature 40-50°C
5	Sweet bread	2	salt	1.5 teaspoons	1 teaspoons	0.5 teaspoons	put on the corner
		3	sugar	3 tablespoons	2.5 tablespoons	2 tablespoons	put on the corner
		4	oil	4 tablespoons	3 tablespoons	2.5 tablespoons	
		5	Flour (high gluten)	3.5cups/1.1lb/500g	2.75cups/0.9lb/400g	2.25cups/0.7lb/300g	
		6	instant yeast	2.5 teaspoons	2 teaspoons	2 teaspoons	put on the dry flour, do not let it touch any liquid
		bread weight	2lb/1000g	1.5lb/750g	1lb/500g		
6	Sand- wich Bread	1	water	10.8oz/320ml	8.1oz/240ml	5.4oz/160ml	
		2	salt	1 teaspoon	1 teaspoon	0.75 teaspoon	put on the corner
		3	sugar	0.4 cup	0.3 cup	0.2 cup	put on the corner
		4	oil	5 teaspoon	3 teaspoon	2.5 teaspoon	
		5	Flour (high gluten)	3.5cups/1.1lb/500g	2.75cups/0.9lb/400g	2.25cups/0.7lb/300g	
		6	Milk powder	2 tablespoons	1.5 tablespoons	1 tablespoons	
		7	instant yeas	0.8 teaspoon	0.8 teaspoon	0.5 teaspoon	put on the dry flour, do not let it touch any liquid
6	Sand- wich Bread	bread weight	2lb/1000g	1.5lb/750g	1lb/500g		
		1	water	10.1oz/300ml	8.1oz/240ml	5.4oz/160ml	
		2	butter	3 tablespoons	2.5 tablespoons	2.5 tablespoons	put on the corner
		3	sugar	3 teaspoon	2.5 teaspoon	2 teaspoon	put on the corner
		4	salt	1 teaspoon	1 teaspoon	3/4 teaspoon	
		5	high gluten flour	3.5cups/1.1lb/500g	2.75cups/0.9lb/400g	2.25cups/0.7lb/300g	
		6	Milk powder	2 tablespoons	1.5 tablespoons	1 tablespoons	
7	instant yeas	0.8 teaspoon	0.8 teaspoon	0.5 teaspoon	put on the dry flour, do not let it touch any liquid		

RECIPE

No	Menus	Ingredient	Volume	Volume	Volume	Remark	
7	Gluten free bread	bread weight	2lb/1000g	1.5lb/750g	1lb/500g		
		1	water	8.1oz/240ml	6.1oz/180ml	4oz/120ml	
		2	salt	1.5 teaspoon	1 teaspoon	0.7 teaspoon	put on the corner
		3	sugar	3.5 tablespoons	3tablespoons	2tablespoons	put on the corner
		4	oil	3 tablespoons	2.5 tablespoons	2 tablespoons	
		5	Flour (high gluten)	2cups/0.7lb/280g	1.5cups/0.5lb/200g	1cup/0.3lb/130g	
		6	corn flour	2cups/0.7lb/280g	1.5cups/0.5lb/200g	1cup/0.3lb/130g	Can be replaced with oat flour
		instant yeast	1 teaspoon	1 teaspoon	1 teaspoon	put on the dry flour, do not let it touch any liquid	
8	Mix	Milk	2.7oz/60ml	1. Stir unsalted cream until it becomes sticky. 2. Mash the strawberry and thoroughly mix it with the milk, sugar, and the sticky cream. Put the mixture into fridge, let it cool to 5-10°C. 3. Install ice cream barrel, press I Mix, set the time to 25-30min, start the program, and then pour the mixture slowly into ice cream barrel. 4. Wait until the program is complete. A beep will sound.			
		Sugar	0.07lb/30g				
		Unsalted cream	4.4oz/130ml				
		Strawberry	0.13lb/60g				
9	Yogurt	time	8:00				
		1	milk	33.80oz/1000ml			
		2	Lactic acid bacteria (yogurt culture)	3.4oz/100ml			
10	Dessert	time	1:40				
		1	egg	2pcs			
		2	milk	1cups			
		3	cooked rice	1.5 cups			
		4	sugar	0.5 cups			
11	Dough	time	1:30				
		1	water	11.2oz/330ml			
		2	salt	1 teaspoon			put on the corner
		3	oil	3 teaspoons			
		4	Flour (high gluten)	4cups/560g			
		instant yeast	0.5 teaspoon			put on the dry flour, do not let it touch any liquid.	
12	Jam	time	1:20				
		1	pulp	3 cups			stir until it's mushy. Add water if desired.
		2	starch	0.5cups			
		sugar	1cups			up to flavor	
13	Cake	bread weight	1lb/500g				
		time	2:20				
		1	water	1oz/30ml			
		2	egg	3pcs			
		3	sugar	0.5cups			put on the corner
		4	oil	2 tablespoons			
		5	self-rising flour	2cups/0.61lb/280g			
		instant yeast	1 teaspoon			put on the dry flour, do not let it touch any liquid	
14	Bake	00:30;adjust baking temperature by pressing crust button:100°C(light);150°C(medium);200°C(dark), default 150 °C					
15	Home made	time	3:00				
		1	Press this button to enter the home-made menu. In this menu, users can set the time for each of these processes: knead, ferment, and bake. Table for DIY bread				

HOMEMADE PROGRAM

Program Setting	Default time (min)	Adjustable time (min)
Stir 1	15	1-30
Rest 1	3	0-30
Stir 2	20	0-30
Rest 2	10	0-30
Stir 3	0	0-25
Ferment 1	42	0-60
Ferment 2	40	0-60
Ferment 3	0	0-60
Bake	50	0-80
	Three crust color	Medium
Keep warm	60	0-60

MEMO

CUCKOO

Adress : 3530 Wilshire blvd.
#1655 LA CA 90010

Z0383-0120A0