

# Impella<sup>®</sup> RP

with the Automated Impella<sup>®</sup> Controller

**Circulatory Support System**

## **INSTRUCTIONS FOR USE & CLINICAL REFERENCE MANUAL**

(United States only)

Humanitarian Device. Authorized by Federal law (USA) to provide circulatory assistance for up to 14 days in pediatric or adult patients with a body surface area  $\geq 1.5 \text{ m}^2$  who develop acute right heart failure or decompensation following left ventricular assist device implantation, myocardial infarction, heart transplant, or open-heart surgery. The effectiveness of this device for this use has not been demonstrated.

**IMPORTANT NOTICE:** Read this entire manual before using the Automated Impella® Controller and Impella® RP Circulatory Support System (Impella® RP System). The Impella® RP System is to be used only in accordance with this manual. This manual is only applicable to Impella® systems using the Automated Impella® Controller.

Information contained in this document is subject to change without notice.

©2012 Abiomed®, Inc. All rights reserved.

The ABIOMED logo and ABIOMED are registered trademarks of Abiomed, Inc. in the U.S.A. and certain foreign countries.

Recovering hearts. Saving lives. is a trademark of Abiomed, Inc.

Impella is a registered trademark of Abiomed Europe GmbH, a wholly owned subsidiary of Abiomed, Inc., in the U.S.A. and certain foreign countries.

---

# IMPELLA<sup>®</sup> RP WITH THE AUTOMATED IMPELLA<sup>®</sup> CONTROLLER INSTRUCTIONS FOR USE & CLINICAL REFERENCE MANUAL

(UNITED STATES ONLY)

---

**Rx Only**

**Abiomed, Inc.**  
22 Cherry Hill Drive  
Danvers, MA 01923  
978-777-5410 (voice)  
978-777-8411 (fax)  
clinical@abiomed.com (email)

**Abiomed Europe GmbH**  
Neuenhofer Weg 3  
52074 Aachen, Germany  
+49 (241) 8860-0 (voice)  
+49 (241) 8860-111 (fax)  
europe@abiomed.com (email)

[www.abiomed.com](http://www.abiomed.com)

**24-Hour Emergency Hotlines:**

N. America 1-800-422-8666  
Europe +49 (0) 1805 2246633

June 2012  
Document No. 0046-9051 Rev. A

---

# TABLE OF CONTENTS

## INTRODUCTION

Introduction .....	I
--------------------	---

## 1 INDICATIONS, CONTRAINDICATIONS, AND POTENTIAL ADVERSE EVENTS

Indications (United States) .....	1.1
Contraindications (United States) .....	1.1
Potential Adverse Events (United States) .....	1.2

## 2 WARNINGS AND CAUTIONS

Warnings .....	2.1
Cautions .....	2.3

## 3 THE IMPELLA® RP CATHETER AND AUTOMATED IMPELLA® CONTROLLER

Overview .....	3.1
Impella® RP Catheter .....	3.3
Automated Impella® Controller .....	3.5
Purge Cassette .....	3.6
Accessories .....	3.8

## 4 USING THE AUTOMATED IMPELLA® CONTROLLER

Overview .....	4.1
Automated Impella® Controller Features .....	4.1
Automated Impella® Controller Display .....	4.5
Placement Screen .....	4.8
Purge Screen .....	4.9
Infusion History .....	4.10
Mobile Operation .....	4.11

## 5 USING THE AUTOMATED IMPELLA® CONTROLLER WITH THE IMPELLA® RP CATHETER

Startup .....	5.1
Case Start .....	5.4
Inserting the Impella® RP Catheter .....	5.10
Positioning and Starting the Impella® RP Catheter .....	5.12
Performance Levels .....	5.13
Suction .....	5.13
Use of the Repositioning Sheath and the 23 Fr Peel-away Introducer .....	5.14
Purge Cassette Procedures .....	5.15
Troubleshooting the Purge System .....	5.18
Patient Weaning .....	5.20
Removing the Impella® RP Catheter .....	5.20

## 6 CLINICAL EXPERIENCE

Pivotal Clinical Study Design – RECOVER RIGHT .....	6.1
Accountability of Cohort .....	6.3

## 7 AUTOMATED IMPELLA® CONTROLLER ALARMS

Alarms Overview .....	7.1
Alarm Message Summary .....	7.3

## 8 GENERAL SYSTEM INFORMATION

Terminology, Abbreviations, and Symbols .....	8.1
Automated Impella® Controller Mechanical Specifications .....	8.3
Automated Impella® Controller Electrical Specifications .....	8.3
Equipment Design .....	8.4
Equipment Classifications .....	8.4
Federal Communications Commission (FCC) Notice .....	8.5
Electromagnetic Compatibility .....	8.5
Transport Between Hospitals .....	8.10
Transport Within the Hospital .....	8.11
Slave Monitor Connection .....	8.11
Alarm Delay Information .....	8.12
Patient Environment .....	8.12
White Connector Cable .....	8.13
Impella® RP Catheter Parameters .....	8.13
Cleaning .....	8.14
Storing the Automated Impella® Controller .....	8.14
Returning an Impella® RP Catheter to Abiomed (United States) .....	8.14

## APPENDICES

Appendix A: Automated Impella® Controller Menu Structure .....	A.1
--	-----

## TABLE OF CONTENTS

### FIGURES

Figure 3.1	Impella® RP Catheter in the Heart .....	3.1
Figure 3.2	Automated Impella® Controller, Impella® RP Catheter, and Accessories .....	3.2
Figure 3.3	Impella® RP Catheter .....	3.3
Figure 3.4	Automated Impella® Controller – Front View .....	3.5
Figure 3.5	Purge Cassette .....	3.6
Figure 3.6	White Connector Cable .....	3.8
Figure 3.7	Introducer kit .....	3.8
Figure 3.8	0.025 inch, 260 cm Placement Guidewire .....	3.8
Figure 3.9	Dextrose Solution .....	3.9
Figure 3.10	Automated Impella® Controller Cart .....	3.9
Figure 4.1	Automated Impella® Controller Features – Front View .....	4.1
Figure 4.2	Automated Impella® Controller Features – Side Views .....	4.3
Figure 4.3	Automated Impella® Controller Display Elements .....	4.5
Figure 4.4	Placement Screen.....	4.8
Figure 4.5	Purge Screen .....	4.9
Figure 4.6	Infusion History Screen .....	4.11
Figure 5.1	Automated Impella® Controller Power Switch .....	5.2
Figure 5.2	Automated Impella® Controller Startup Screen .....	5.3
Figure 5.3	Initial Case Start Screen .....	5.4
Figure 5.4	Inserting the Purge Cassette into the Automated Impella® Controller .....	5.5
Figure 5.5	Inserting the Catheter Plug into the Connector Cable .....	5.6
Figure 5.6	Snapping Plastic Clip to Connector Cable .....	5.6
Figure 5.7	Priming the Impella Purge Lumen .....	5.7
Figure 5.8	Connecting the Luer to the Impella® RP Catheter .....	5.7
Figure 5.9	Entering Purge Fluid Information .....	5.8
Figure 5.10	Connecting the Purge Tubing to the Connector Cable .....	5.9
Figure 5.11	Impella® RP System Configuration .....	5.9
Figure 5.12	Maximum Performance Level .....	5.12
Figure 5.13	Disconnecting the Y Connector from the Purge Cassette Tubing .....	5.15
Figure 6.1	Study Flow Schematic .....	6.3
Figure 6.2	Cardiac index and central venous pressure measured during the study .....	6.8
Figure 6.3	LVAD flow changes from baseline to on-support .....	6.8
Figure 6.4	Use of inotropes during Impella RP support .....	6.9
Figure 6.5	Right ventricular function changes .....	6.10
Figure 7.1	Alarm Window .....	7.2
Figure 8.1	Automated Impella® Controller Patient Environment .....	8.12

### TABLES

Table 3.1	Impella® RP Catheter Components .....	3.3
Table 3.2	Purge Cassette Components .....	3.7
Table 3.3	Impella® RP Catheter and Automated Impella® Controller Accessories .....	3.8
Table 4.1	Automated Impella® Controller Front View Features .....	4.2
Table 4.2	Automated Impella® Controller Side View Features .....	4.4
Table 4.3	Automated Impella® Controller Display Elements .....	4.5
Table 5.1	Performance Level Flow Rates .....	5.13
Table 6.1	Patient Characteristics .....	6.4
Table 6.2	Baseline Laboratory Parameters .....	6.5
Table 6.3	Procedural Characteristics .....	6.6
Table 6.4	Support and Hemodynamic Characteristics .....	6.6
Table 6.5	Patient Outcome .....	6.7
Table 6.6	Secondary Safety Endpoints .....	6.7
Table 7.1	Alarm Levels .....	7.1
Table 7.2	Automated Impella® Controller Alarm Messages .....	7.3

## INTRODUCTION

### PURPOSE OF MANUAL

This Instructions for Use & Clinical Reference Manual is designed for healthcare professionals. It contains clinical and technical information to guide healthcare professionals in their use of the Impella® RP Catheter with the Automated Impella® Controller. The Impella® RP System performs life-sustaining functions. To use the system you must understand and follow these instructions. The Impella® RP System may be used only for its intended purpose.

### MANUAL OVERVIEW

This manual provides instructions for use of the Impella® RP Catheter with the Automated Impella® Controller. The following summarizes the contents of each section of the manual.

- **Section 1: Indications, Contraindications, and Potential Adverse Events** discusses indications for use of the Impella® RP Catheter with the Automated Impella® Controller, contraindications, and potential adverse events that may be associated with the use of the system.
- **Section 2: Warnings and Cautions** discusses the warnings and cautions pertaining to the use of the Impella® RP Catheter with the Automated Impella® Controller.
- **Section 3: The Impella® RP Catheter and Automated Impella® Controller** provides an overview of the system and describes its major components and features.
- **Section 4: Using the Automated Impella® Controller** describes the controls and various screen types on the Automated Impella® Controller.
- **Section 5: Using the Automated Impella® Controller with the Impella® RP Catheter** provides the procedures for using the Impella® RP System.
- **Section 6: Clinical Experience** provides an overview of the RECOVER RIGHT trial, which studied the use of the Impella® RP System in a U.S. clinical trial. The results of this trial were reviewed by the FDA prior to its approval of the Impella® RP System.
- **Section 7: Automated Impella® Controller Alarms** provides a listing of Automated Impella® Controller alarms as well as information on what to do to resolve them.
- **Section 8: General System Information** contains information including definitions for key terms that appear in the manual, descriptions of the abbreviations and symbols that appear on Impella® RP Catheter and Automated Impella® Controller components and packaging, technical information pertaining to the Impella® RP Catheter and Automated Impella® Controller, and instructions on cleaning and storing system components as well as returning components to Abiomed.
- **Appendices** at the end of the manual provide supplemental information about topics including the Automated Impella® Controller menu structure.

# 1 INDICATIONS, CONTRAINDICATIONS, AND POTENTIAL ADVERSE EVENTS



INDICATIONS (UNITED STATES) .....	1.1
CONTRAINDICATIONS (UNITED STATES).....	1.1
POTENTIAL ADVERSE EVENTS (UNITED STATES) .....	1.2

---

## INDICATIONS (UNITED STATES)

The Impella RP System is indicated for providing circulatory assistance for up to 14 days in pediatric or adult patients with a body surface area  $\geq 1.5 \text{ m}^2$  who develop acute right heart failure or decompensation following left ventricular assist device implantation, myocardial infarction, heart transplant, or open-heart surgery.

---

## CONTRAINDICATIONS (UNITED STATES)

- Disorders of the pulmonary artery wall that would preclude placement or correct positioning of the Impella RP device
- Mechanical valves, severe valvular stenosis or valvular regurgitation of the tricuspid valve or pulmonary valve
- Mural thrombus of the right atrium or vena cava
- Anatomic conditions precluding insertion of the pump
- Other illnesses or therapy requirements precluding use of the pump
- Presence of a vena cava filter or caval interruption device, unless there is clear access from the femoral vein to the right atrium that is large enough to accommodate a 22 Fr catheter



---

## POTENTIAL ADVERSE EVENTS (UNITED STATES)

Below is a list of the potential adverse effects (e.g., complications) associated with the use of the Impella RP system:

- Arrhythmia
- Atrial fibrillation
- Bleeding
- Cardiac tamponade
- Cardiogenic shock
- Death
- Device Malfunction
- Hemolysis
- Hepatic failure
- Insertion site infection
- Perforation
- Phlegmasia cerulea dolens (a severe form of deep venous thrombosis)
- Pulmonary valve insufficiency
- Respiratory dysfunction
- Sepsis
- Thrombocytopenia
- Thrombotic vascular (non-central nervous system) complication
- Tricuspid valve injury
- Vascular injury
- Venous thrombosis
- Ventricular fibrillation and/or tachycardia

## 2 WARNINGS AND CAUTIONS

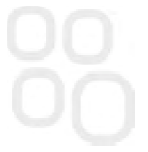

**WARNINGS** ..... 2.1

**CAUTIONS** ..... 2.3

## WARNINGS



The Impella® RP System is intended for use only by personnel trained in accordance with the Abiomed Training Program.



Fluoroscopy is required to guide placement of the Impella® RP Catheter. The small placement guidewire must be reliably observed at all times.



Be sure that the stopcock on the repositioning sheath is always kept in the closed position. Significant bleed back can result if the stopcock is open.



Avoid manual compression of the inlet, outlet, or sensor areas of the cannula assembly.



The sterile components of the Impella® RP System can be used only if the sterilization indicators show that the contents have been sterilized, the packaging is not damaged, and the expiration date has not elapsed.



Do **NOT** resterilize or reuse the Impella® RP Catheter. It is a disposable device and is intended for single use only. Reuse, reprocessing, reinserting through the introducer, or resterilization may compromise the structural integrity of the catheter and/or lead to catheter failure which, in turn, may result in patient injury, illness, or death.



Retrograde flow will occur from the pulmonary artery back into the inferior vena cava if the Impella® RP Catheter is set at performance level P0.



Do **NOT** use saline in the purge system.



Do **NOT** use an Impella® RP System if any part of the system is damaged.



To prevent the risk of explosion, do NOT operate the Impella® RP System near flammable anesthetics.



If at any time during the course of support with the Impella® RP Catheter, the Automated Impella® Controller alarms "Purge Pressure Low" or "Purge System Open," follow the instructions presented in section 5 of this manual.



Do **NOT** subject a patient who has been implanted with an Impella® RP Catheter to magnetic resonance imaging (MRI). The strong magnetic energy produced by an MRI machine may cause the Impella® RP System components to stop working, and result in injuries to the patient. An MRI may also damage the electronics of the Impella® RP System.



Cardiopulmonary support (CPR) should be initiated immediately per hospital protocol if indicated for any patient supported with the Impella® RP Catheter. When initiating CPR, reduce the Impella® RP Catheter flow rate. When cardiac function has been restored, return flow rate to the previous level and assess the placement signal on the controller.



During defibrillation, do **NOT** touch the Impella® RP Catheter, cables, or Automated Impella® Controller.

### Warnings

*Warnings alert you to situations that can cause death or serious injury. The red symbol  appears before warning messages.*



Power the Automated Impella® Controller using its internal battery if the integrity of the protective earth conductor is questionable.



Medical electrical equipment needs special precautions regarding EMC and needs to be installed and put into service according to the electromagnetic compatibility (EMC) information provided in section 7 of this manual.



During transport, the Automated Impella® Controller may be exposed to stronger electromagnetic disturbance than during in-hospital use. Strong electromagnetic disturbance may cause the Automated Impella® Controller to display soft button menu selections that were not selected by the user. Operators should be aware that, under these conditions, the operating parameters are not affected. No user intervention is required. Monitor Impella® RP Catheter flow and patient hemodynamics to confirm normal operation. The condition will resolve itself once the Automated Impella® Controller is no longer exposed to the disturbance.



Portable and mobile RF communications equipment can affect medical electrical equipment.



The equipment or system should not be used adjacent to or stacked with other equipment. If adjacent or stacked use is necessary, the equipment or system should be observed to verify normal operation in the configuration in which it will be used.



Use of cables, other than those sold by Abiomed, may result in increased emissions or decreased immunity of the Automated Impella® Controller.



The Automated Impella® Controller uses RFID (radio frequency identification) to identify and communicate with the purge cassette. Other equipment may interfere with the Automated Impella® Controller even if that other equipment complies with CISPR emission requirements.



Avoid overinserting the Impella® RP Catheter and possibly impinging the catheter tip against the walls of the vasculature, atrium, or ventricle.



Torquing the catheter should be monitored carefully using fluoroscopy.



Do **NOT** advance or withdraw the Impella® RP Catheter against resistance without using fluoroscopy to determine the cause of the resistance. Doing so could result in separation of the catheter or guidewire tip, damage to the catheter or vessel, or perforation.

## CAUTIONS



Handle with care. The Impella® RP Catheter can be damaged during removal from packaging, preparation, insertion, and removal. Do **NOT** bend, pull, or place excess pressure on the catheter or mechanical components at any time.



Patients with tricuspid or pulmonary valve stenosis or insufficiency, and patients with prosthetic tricuspid or pulmonary valves, may be compromised by the use of the Impella® RP Catheter.



Use only original accessories and replacement parts supplied by Abiomed.



Do **NOT** use damaged or contaminated connector cables.



To prevent device failure, do **NOT** start the Impella® RP Catheter until the placement guidewire has been removed.



Do **NOT** remove the Impella® RP Catheter over the length of the placement guidewire.



When replacing the purge cassette, the replacement process must be completed within 2 minutes. The Impella® RP Catheter may be damaged if replacement takes longer than 2 minutes.



To prevent malfunction of the Automated Impella® Controller, avoid long-term exposure to direct sunlight and excessive heat (40°C).



To prevent overheating and improper operation, do **NOT** block the cooling vents of the Automated Impella® Controller while it is operating.



Do **NOT** kink or clamp any part of the Impella® RP Catheter.



Do **NOT** use the Impella® RP Catheter with a damaged or kinked introducer. Replace the introducer if a kink is observed.



The Li-Ion batteries must be charged for 5 hours prior to system operation in order to meet the runtime requirement of 1 hour. Failure to do so will yield a shorter runtime. After being unplugged, the Automated Impella® Controller will operate for at least 60 minutes after the batteries have been fully charged.



Minimize exposure of Impella® RP System components to sources of electromagnetic interference (EMI). Exposure to sources of EMI, such as cell phones and two-way radios, may cause operational interference. To clear interference, either increase the distance between system components and the EMI source or turn off the EMI source.



Operation of Impella® RP System components may interfere with the operation of other devices. If interference occurs, increase the distance between the device and system components.

### Cautions

*Cautions indicate situations in which equipment may malfunction, be damaged, or cease to operate. The yellow symbol  appears before caution messages.*



Have a backup Automated Impella® Controller, purge cassette, connector cable, and Impella® RP Catheter available in the unlikely event of a device failure.



Do **NOT** use the bed mount as a handle.



Insertion through the left femoral vein may result in repeated attempts to properly position the Impella RP, which could cause excessive manipulation and pump damage. As a result, left femoral insertion should be avoided whenever possible.

### 3 THE IMPELLA® RP CATHETER AND AUTOMATED IMPELLA® CONTROLLER

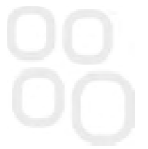

<b>OVERVIEW .....</b>	<b>3.1</b>
Reusable System Components .....	3.2
Single-use System Components .....	3.2
System Configuration.....	3.2
<b>IMPELLA® RP CATHETER .....</b>	<b>3.3</b>
Differential Pressure Sensor .....	3.4
<b>AUTOMATED IMPELLA® CONTROLLER .....</b>	<b>3.5</b>
<b>PURGE CASSETTE .....</b>	<b>3.6</b>
<b>ACCESSORIES .....</b>	<b>3.8</b>

## OVERVIEW

The Impella® RP Catheter is an intracardiac microaxial blood pump that supports a patient's pulmonary circulation. The Impella® RP Catheter is inserted percutaneously through the femoral vein and into the pulmonary artery (see Figure 3.1).

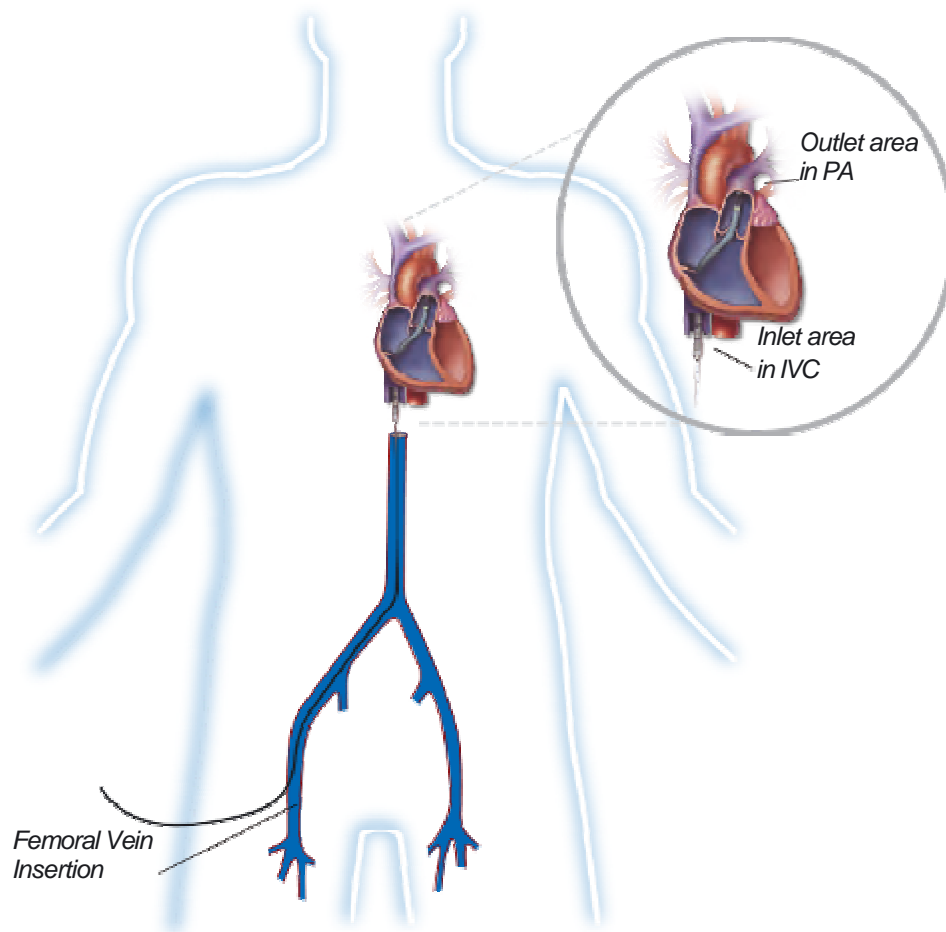

**Figure 3.1** Impella® RP Catheter in the Heart

When properly positioned, the Impella® RP Catheter delivers blood from the inlet area, which sits in the inferior vena cava, through the cannula, to the outlet opening in the pulmonary artery. Physicians and device operators monitor Impella® RP Catheter function on the display screen of the Automated Impella® Controller.

The intent of the therapy with the Impella RP System is to provide a percutaneous circulatory support system to restore normal right heart hemodynamics, reduce right ventricular work, and allow the right heart time to potentially recover adequate contractile function or to be bridged to the next therapy.

This section describes the components of the Impella® RP Catheter and the Automated Impella® Controller, as well as the accessory components.



## REUSABLE SYSTEM COMPONENTS

The Impella® RP System consists of the following reusable components:

- Automated Impella® Controller—provides the user interface, alarm indications, and portable battery
- Automated Impella® Controller cart—for easy transport of the Automated Impella® Controller

## SINGLE-USE SYSTEM COMPONENTS

The Impella® RP System also includes the following single-use components:

- Impella® RP Catheter
- Purge cassette
- Introducer kit
- Connector cable

## SYSTEM CONFIGURATION

Figure 3.2 illustrates how the Automated Impella® Controller connects to the Impella® RP Catheter and accessory components.

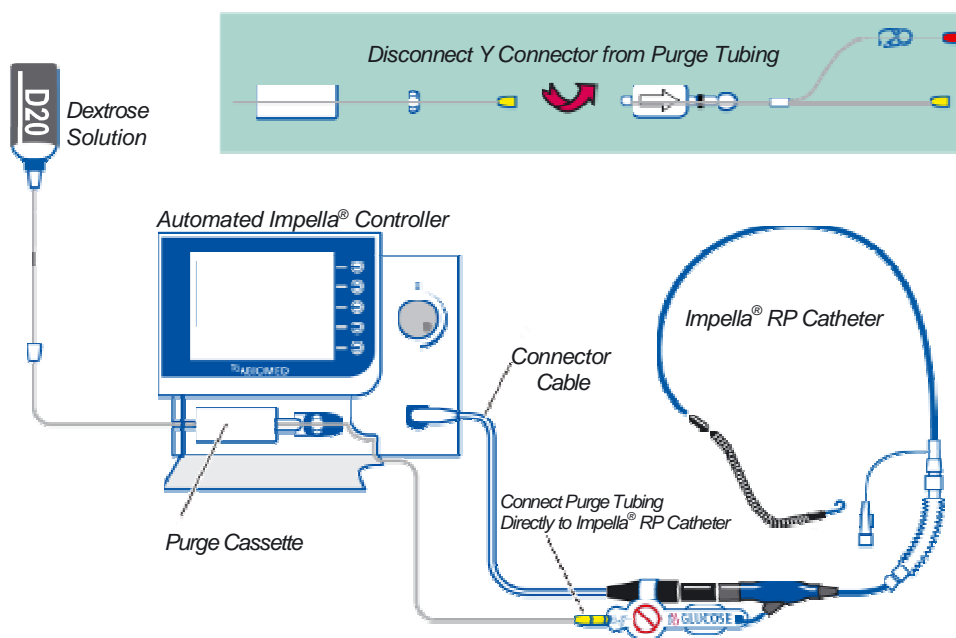

**Figure 3.2** Automated Impella® Controller, Impella® RP Catheter, and Accessories

## IMPELLA® RP CATHETER

The Impella® RP Catheter is an intracardiac microaxial blood pump that delivers up to 4.0 liters of blood per minute from the inferior vena cava into the pulmonary artery. Figure 3.3 illustrates the Impella® RP Catheter. The Impella® RP Catheter has a specially designed three dimensional cannula that is sized to fit through the vessels and hearts of pediatric and adult patients with a Body Surface Area (BSA) equal to or greater than 1.5 m<sup>2</sup>. Table 3.1 describes each component from the pigtail at one end to the check valve on the other end.

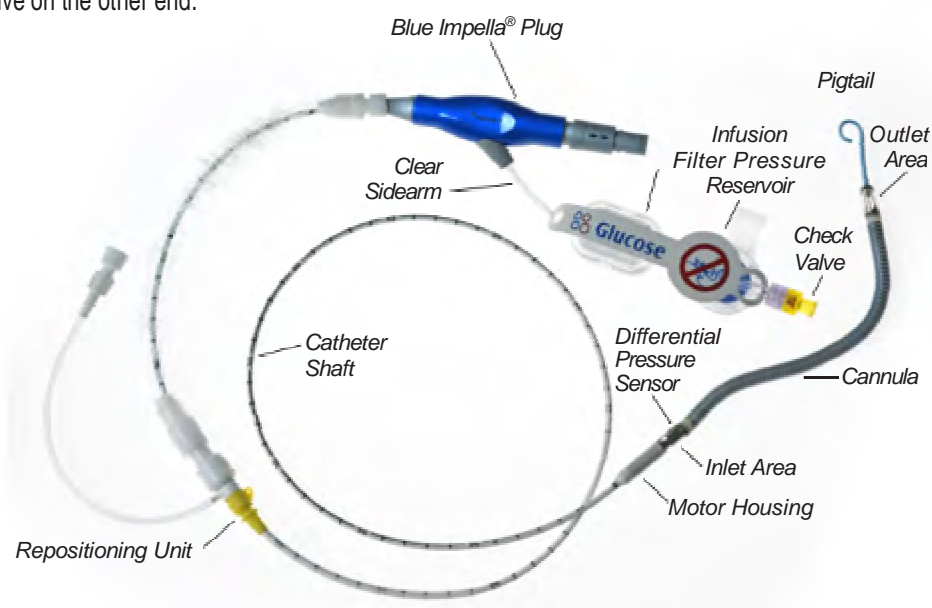

Figure 3.3 Impella® RP Catheter

Table 3.1 Impella® RP Catheter Components

Component	Description
Pigtail	The 6 Fr pigtail is attached to the cannula at the distal end of the outlet area. It assists with stabilizing the catheter in the correct position in the pulmonary artery.
Outlet area	The outlet area, located at the distal tip of the cannula, has 5 openings (windows) that allow blood to exit the cannula.
Cannula	The 22 Fr cannula is designed for the anatomy of the right heart, to provide optimal and stable position during operation. The cannula is made of nitinol and covered in polyurethane with spiral shaped reinforcement integrated into the cannula.
Differential pressure sensor	A sensor that measures the pressure difference between the inside and outside of the cannula. The pressure value is used for monitoring low during catheter operation.

**Table 3.1 Impella® RP Catheter Components (continued)**

<b>Component</b>	<b>Description</b>
Inlet area	The proximal end of the cannula is attached to the inlet area where blood enters the cannula.
Motor housing	The 21 Fr motor housing consists of an encapsulated motor.
Catheter shaft	An 11 Fr catheter shaft is located between the motor housing and the blue Impella® plug. The lumen of the catheter shaft contains a purge lumen, an electrical cable, and a differential pressure measurement cable. The catheter shaft has transversal marks: <ul style="list-style-type: none"> <li>• The transversal marks at 1 cm intervals aid in proper positioning.</li> </ul>
Repositioning unit	The repositioning unit consists of a sheath and an anticontamination sleeve with an anchoring ring. <ul style="list-style-type: none"> <li>• The 11 Fr sheath (14 Fr outer diameter) with hemostatic valve is located on the catheter shaft and allows repositioning of the catheter.</li> <li>• The anchoring ring of the anticontamination sleeve secures the sheath to the catheter; turning in the counterclockwise direction enables movement of the catheter and turning in the clockwise direction disables movement.</li> </ul>
Blue Impella® plug	The blue Impella® plug has a clear sidearm and contains memory that retains operating parameters in case the patient needs to be transferred to another controller. The plug connects the Impella® RP Catheter to the Automated Impella® Controller through a connector cable.
Clear sidearm	The clear sidearm is attached to the purge cassette tubing. It leads to the infusion filter, the pressure reservoir, and the check valve.
Infusion filter	The infusion filter prevents bacterial contamination and prevents air from entering the purge lumen.
Pressure reservoir	The pressure reservoir includes a flexible rubber diaphragm that provides additional filling volume by means of an expansion chamber during purge solution change.
Check valve	The yellow check valve ensures that purge fluid does not flow in the reverse direction when the purge solution is exchanged.

### **DIFFERENTIAL PRESSURE SENSOR**

The Impella® RP Catheter has an electronic differential pressure sensor located at the proximal end of the cannula. The purpose of the pressure sensor is to generate the placement signal used to calculate the flow generated by the Impella® RP Catheter.

The pressure sensor is a flexible membrane integrated into the cannula. One side of the sensor is exposed to the blood pressure on the outside of the inlet area and the other side is exposed to the pressure of the blood inside of the cannula. The sensor generates an electrical signal proportional to the difference between the pressure outside the inlet area and the pressure inside the cannula. This signal is displayed on the Automated Impella® Controller as the placement signal.

## AUTOMATED IMPELLA® CONTROLLER

The Automated Impella® Controller (see Figure 3.4) provides three vital functions to the operation of the Impella® RP Catheter:

- The controller provides an interface for monitoring and controlling the function of the Impella® RP Catheter
- The controller provides a fluid purge to the Impella® RP Catheter
- The controller provides backup power when the Impella® RP System is operated away from AC power

The controller weighs 26 lbs (11.8 kg) and can operate on its internal battery for at least 60 minutes when fully charged. Using the controller, the Impella RP System can be used by trained healthcare professionals in healthcare facilities and during medical transport (i.e., ambulance, helicopter, or fixed-winged aircraft) environments.

The Automated Impella® Controller operation is described in detail in section 4 of this manual.

### **Automated Impella® Controller Battery Power**

*The controller can operate on its internal lithium-ion (Li-Ion) battery for at least 60 minutes when fully charged.*



**Figure 3.4 Automated Impella® Controller – Front View**

## PURGE CASSETTE



Do **NOT** use saline in the purge system.

The purge cassette delivers rinsing fluid to the Impella® RP Catheter. The purge fluid (typically 20% dextrose solution) flows from the purge cassette through the catheter to the microaxial blood pump to prevent blood from entering the motor. When the purge cassette is properly installed in the Automated Impella® Controller, the words on it are upright and facing you. The image of the purge fluid appears on the left with arrows pointing toward the image of the person on the right. Figure 3.5 illustrates the purge cassette and related components. Table 3.2 describes each component.

### **Discard the Y Connector**

Disconnect and discard the Y connector from the purge cassette tubing. For the Impella® RP System, the yellow luer on the end of the purge tubing connects directly to the yellow luer on the Impella® RP Catheter.

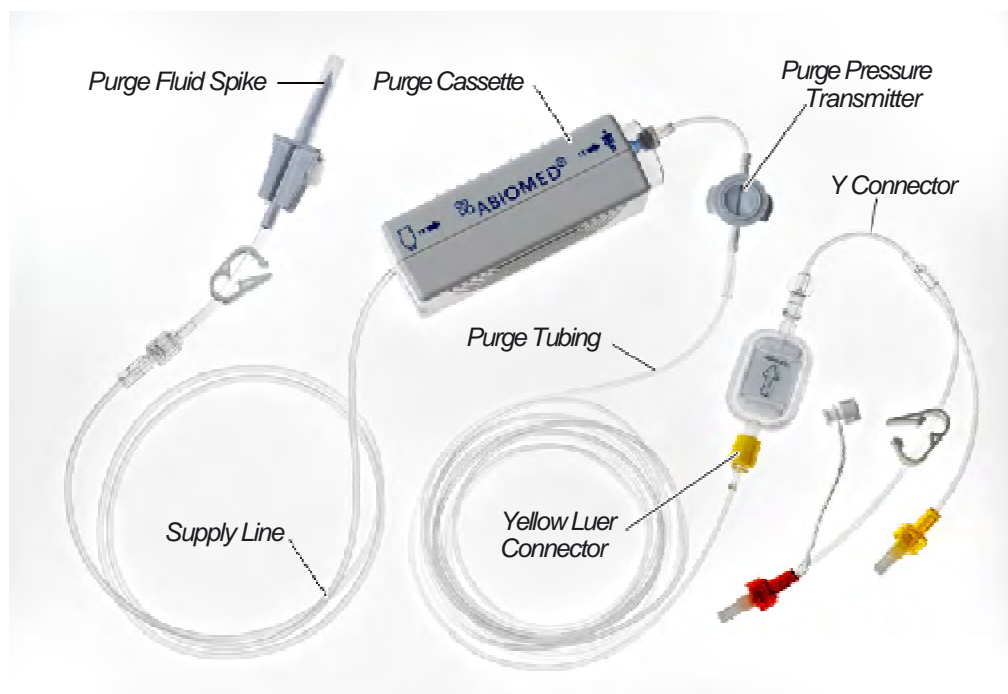

**Figure 3.5 Purge Cassette**

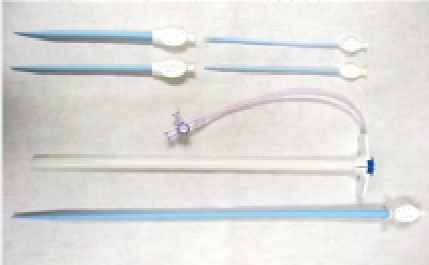

**Table 3.2 Purge Cassette Components**

<b>Component</b>	<b>Description</b>
Purge fluid spike	One end spikes the purge fluid bag and the other end connects the bag to the purge cassette supply line
Supply line	Carries fluid from the purge fluid bag to the purge cassette
Purge cassette	Contains the components for delivering the purge fluid; maintains the pressure barrier between the blood and the motor to prevent blood from entering the motor
Purge pressure transmitter	Transmits pressure to the controller based on the purge pressure in the purge tubing; a sensor in the controller measures the pressure so that it can be displayed on the screen and used by the purge pressure algorithm to maintain the purge pressure
Purge tubing	Carries purge fluid from the purge cassette to the Impella® RP Catheter
Yellow luer connector	Connects the purge tubing to the check valve (yellow luer lock) on the Impella® RP Catheter
Y connector	Adapter that connects the purge cassette tubing to the Impella® Catheter; used with the Impella® 2.5 Catheter but removed when you are using the Impella® RP Catheter

## ACCESSORIES

Table 3.3 illustrates and describes the accessories used with the Impella® RP Catheter and Automated Impella® Controller.

**Table 3.3 Impella® RP Catheter and Automated Impella® Controller Accessories**

Component	Description
 <p>A coiled white cable with a black handle and a blue connector at one end and a white plug at the other.</p>	<p>The white connector cable connects the Impella® RP Catheter to the Automated Impella® Controller. Clips on the cable are used to secure the purge tubing to the cable.</p> <ul style="list-style-type: none"><li>• The socket at the black end of the cable connects to the blue Impella® plug.</li><li>• The white plug at the opposite end of the cable is inserted into the blue catheter plug on the front of the Automated Impella® Controller.</li></ul>
 <p>A collection of medical instruments including dilators and guidewires.</p>	<p>The introducer kit is used to place the Impella® RP Catheter. It contains:</p> <ul style="list-style-type: none"><li>• 23 Fr peel-away introducer with dilator</li><li>• 8 Fr, 12 Fr, 16 Fr, and 20 Fr supplemental dilators</li><li>• 0.035 inch x 150 cm guidewire (not shown)</li></ul>
 <p>A long, thin, coiled guidewire.</p>	<p>Hospital Provided:</p> <p>A 0.025 inch, 260 cm Platinum Plus or similar stiff placement guidewire is used for the placement of the Impella® RP Catheter.</p>

**Table 3.3 Impella® RP Catheter and Automated Impella® Controller Accessories (continued)**

Component	Description
	<p>Hospital Provided:</p> <p>Dextrose solution (typically 20% dextrose in water with 50 IU/mL of heparin) is used as the purge fluid through the Impella® RP Catheter.</p>
<p><b>Figure 3.9 Dextrose Solution</b></p>	<p>The Automated Impella® Controller cart holds the Automated Impella® Controller. The cart has wheels for easy transport of the controller and a storage basket.</p>
	<p><b>Figure 3.10 Automated Impella® Controller Cart</b></p>



## 4 USING THE AUTOMATED IMPELLA® CONTROLLER



<b>OVERVIEW .....</b>	<b>4.1</b>
<b>AUTOMATED IMPELLA® CONTROLLER FEATURES.....</b>	<b>4.1</b>
<b>AUTOMATED IMPELLA® CONTROLLER DISPLAY .....</b>	<b>4.5</b>
<b>PLACEMENT SCREEN.....</b>	<b>4.8</b>
Placement Signal Waveform.....	4.8
Motor Current Waveform.....	4.9
<b>PURGE SCREEN.....</b>	<b>4.9</b>
Purge Flow .....	4.10
Purge Pressure.....	4.10
<b>INFUSION HISTORY .....</b>	<b>4.10</b>
<b>MOBILE OPERATION.....</b>	<b>4.11</b>

## OVERVIEW

The Automated Impella® Controller is the primary user control interface for the Impella® RP Catheter. It controls the Impella® RP Catheter performance and monitors the catheter for alarms. The controller can be powered by AC power or can operate on internal battery power for at least 60 minutes when fully charged.

## AUTOMATED IMPELLA® CONTROLLER FEATURES

**IMPORTANT NOTE:** The underside of the Automated Impella® Controller has a battery switch to turn on the batteries. This switch is turned off for shipping purposes. Before operating the Automated Impella® Controller for the first time, make sure you turn this switch on. If the battery switch is not turned on, the Automated Impella® Controller will not be able to operate on battery power.

### Selector Knob Function

**Rotate** the selector knob on the controller to navigate through menu items.

**Push** the selector knob to confirm your selection.

Figure 4.1 illustrates the features on the front of the Automated Impella® Controller. These features are described in Table 4.1.

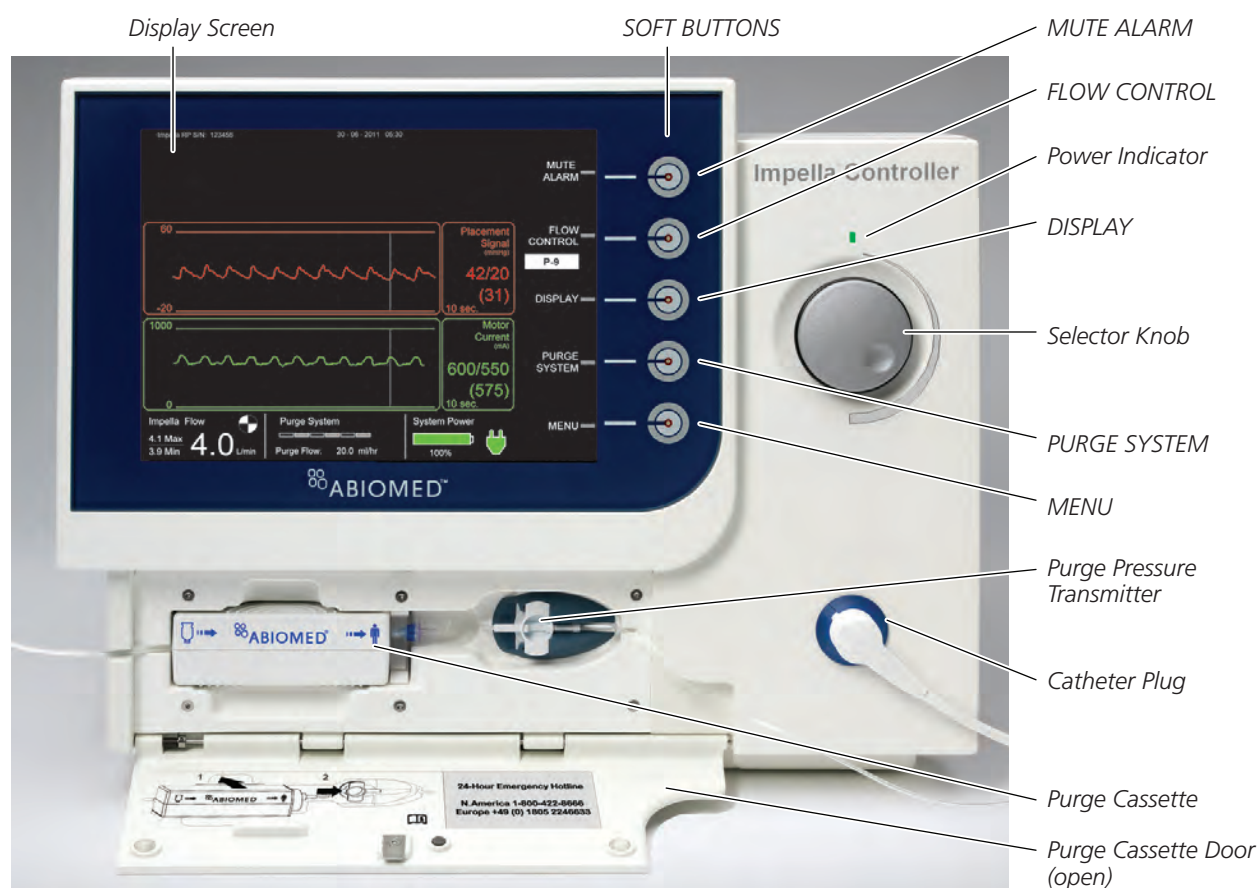

Figure 4.1 Automated Impella® Controller Features – Front View

### Display Options

If equipped with a VGA connector, the controller can be connected to a monitor to display information on another screen as described under "Slave Monitor Connection" in section 7 of this manual.

**Table 4.1 Automated Impella® Controller Front View Features**

Feature	Description
<b>Display screen</b>	Displays user information, including the labels for the soft buttons. (Display screen elements described in detail later in this section.)
<b>Soft buttons</b>	Display, open, and close menus. The function for each soft button is defined by labels adjacent to the button on the display screen; function changes depending on the screen. (Soft button functions are described in Table 4.3.) When the Impella® RP Catheter is running, the default soft button labels are as follows: <ul style="list-style-type: none"><li>• <b>MUTE ALARM</b></li><li>• <b>FLOW CONTROL</b></li><li>• <b>DISPLAY</b></li><li>• <b>PURGE SYSTEM</b></li><li>• <b>MENU</b></li></ul>
<b>Power indicator</b>	LED light above the selector knob; indicates the power status of the Automated Impella® Controller. <ul style="list-style-type: none"><li>• Green light—controller is on and plugged into AC power or running on battery power</li><li>• Amber light—controller is off but plugged into AC power</li><li>• No light—controller is off and not plugged into AC power</li></ul>
<b>Selector knob</b>	Rotating push button; turn clockwise and counterclockwise to navigate through menu items; push to make a selection.
<b>Purge pressure transmitter</b>	A flexible diaphragm on the purge cassette tubing that applies pressure to the sensor in the controller so that purge pressure can be measured.
<b>Catheter plug</b>	Connection point on the controller for the connector cable that connects to the Impella® RP Catheter.
<b>Purge cassette</b>	Contains the components for delivering the purge fluid; maintains the pressure barrier between the blood and the motor to prevent blood from entering the motor. (The purge cassette and its components are described in section 3 of this manual.)
<b>Purge cassette door</b>	Spring-loaded door that opens to provide access to the purge cassette.

Figure 4.2 illustrates the features on the left and right sides of the Automated Impella® Controller. These features are described in Table 4.2.

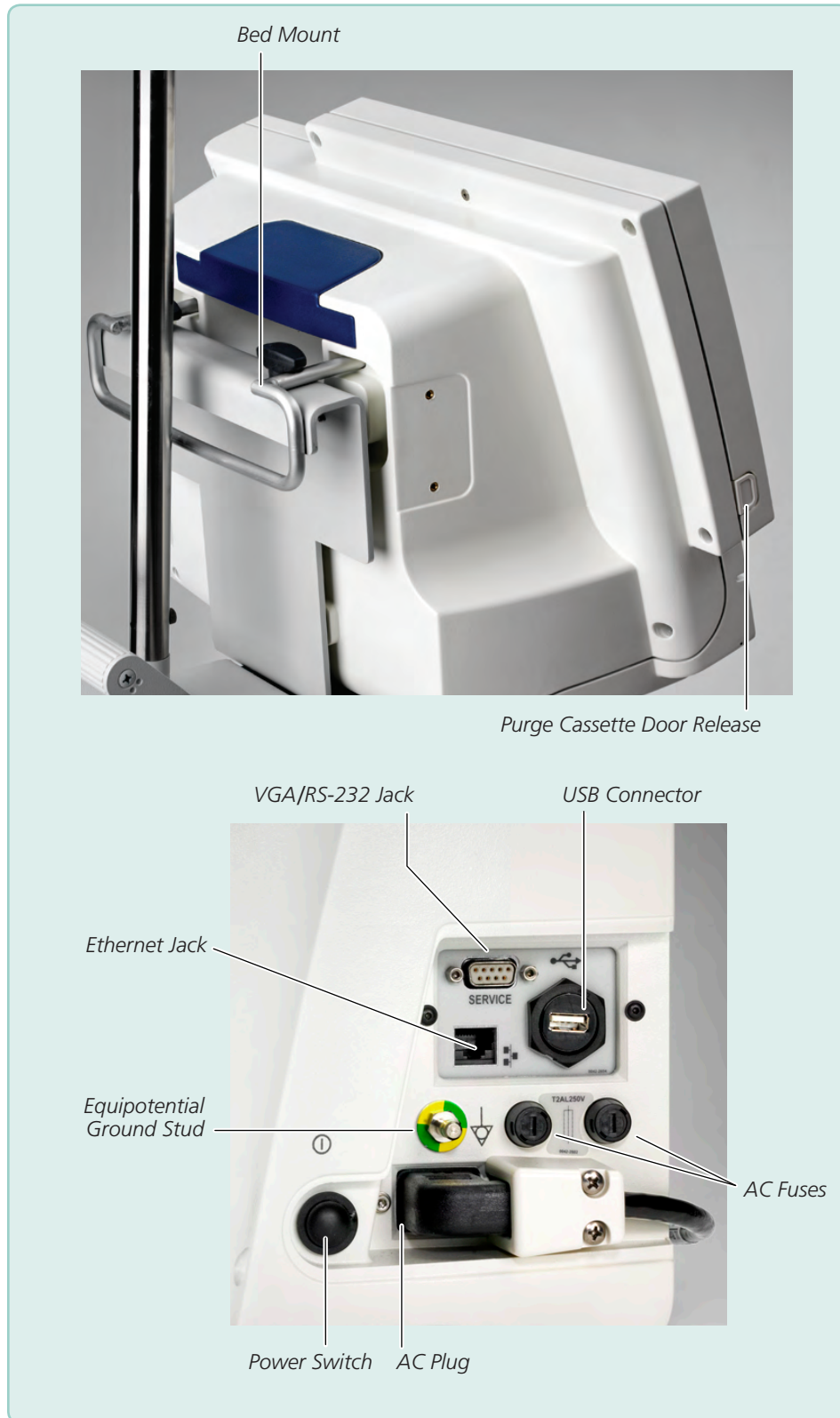

Figure 4.2 Automated Impella® Controller Features – Side Views

**Table 4.2 Automated Impella® Controller Side View Features**

<b>Feature</b>	<b>Description</b>
<b>Bed mount</b>	Metal bracket on the back of the controller; attaches controller to the cart or bed
<b>Purge cassette door release</b>	Button located on the left side of the controller; press to open the purge cassette door
<b>VGA/RS-232 jack</b>	Interface for data transfer by Abiomed maintenance or service personnel; if equipped, this interface can also be used for connecting the controller to another monitor to slave the display
<b>USB connector</b>	Connection for data downloading by Abiomed maintenance or service personnel
<b>AC fuses</b>	Electrical safety device in the event of current overload
<b>AC plug</b>	Connection point on the controller for the AC power cord
<b>Power switch</b>	Button that turns the controller on or off <ul style="list-style-type: none"><li>• ON: Press and hold the power switch for 3 seconds</li><li>• OFF: (1) Disconnect the Impella® RP Catheter from the Automated Impella® Controller (2) Press and hold the power switch for 3 seconds (3) A pop-up confirmation box will appear (4) Press <b>OK</b> using the selector knob to confirm that the controller should be turned off</li></ul> <p>NOTE: Holding down the power switch for longer than 30 seconds during operation will cause the controller to initiate an emergency shutdown</p>
<b>Equipotential ground stud</b>	Used to ground the Automated Impella® Controller according to hospital procedures
<b>Ethernet jack</b>	Connection for downloading data or software upgrades

## AUTOMATED IMPELLA® CONTROLLER DISPLAY

The Automated Impella® Controller screens have several common display elements. Each element is shown in Figure 4.3 and described in Table 4.3.

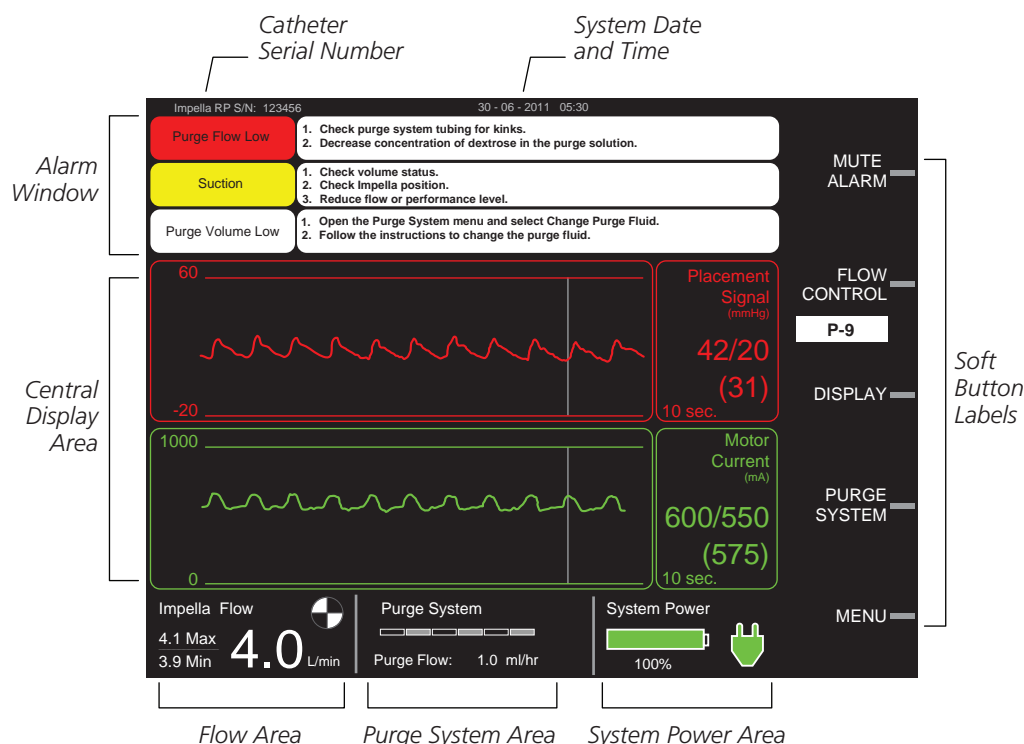

**Figure 4.3** Automated Impella® Controller Display Elements

**Table 4.3** Automated Impella® Controller Display Elements

Display Element	Description
Alarm window	<p>The alarm window displays up to 3 alarms simultaneously, in order of priority from top to bottom.</p> <p>For each alarm, the alarm window displays:</p> <ul style="list-style-type: none"> <li>Alarm header – displayed in the left column; window is color-coded red for critical alarms, yellow for serious alarms, white for advisory notifications, gray for resolved alarms</li> <li>Alarm subhead (if applicable) – further describes the alarm condition</li> <li>Detailed text – up to 3 lines of instructions for resolving the alarm condition are displayed in the right column of the alarm window next to the alarm header and subhead information</li> </ul> <p>(See section 6 of this manual for further discussion of alarms.)</p>
Catheter serial number	Displayed in the upper left of the display screen if a catheter is connected to the controller.
System date and time	The current date (DD-MM-YYYY) and time (24-hour format; HH:MM) are displayed in the upper center of the screen display. (In this example it is June 30, 2011 at 5:30am.)

### Purge System Stabilization

The purge system must stabilize after case start, a purge procedure, or resolution of a purge alarm. During this time, it may take up to 3 minutes for purge system information to display on the screen.

**Table 4.3 Automated Impella® Controller Display Elements (continued)**

Display Element	Description
Mute alarm indicator	<p>Displayed in place of the words “MUTE ALARM” when an alarm is silenced. (See section 6 of this manual for more information about the mute alarm function; Figure 6.1 illustrates the mute alarm indicator.)</p> <ul style="list-style-type: none"> <li>• Yellow bell with red X displayed when an alarm is muted</li> <li>• Not displayed when an alarm is active (but not muted) or when there are no active alarms</li> </ul>
Soft button labels	<p>The soft buttons on the Automated Impella® Controller have corresponding labels adjacent to them on the display screen. These labels change depending on the type of screen displayed. (Refer to Appendix A in this manual for more details about the menu structure.)</p> <p><b>MUTE ALARM</b></p> <ul style="list-style-type: none"> <li>• Mutes (silences) active alarms</li> </ul> <p><b>FLOW CONTROL (or NEXT)</b></p> <ul style="list-style-type: none"> <li>• <b>FLOW CONTROL</b> – Allows you to set the performance level for the Impella® RP Catheter</li> <li>• <b>NEXT</b> – Advances to the next screen</li> </ul> <p><b>DISPLAY (or BACK)</b></p> <ul style="list-style-type: none"> <li>• <b>DISPLAY</b> – Brings up the Display menu for viewing waveforms and navigating to other screen displays</li> <li>• <b>BACK</b> – Returns to the previous screen</li> </ul> <p><b>PURGE SYSTEM (or EXIT)</b></p> <ul style="list-style-type: none"> <li>• <b>PURGE SYSTEM</b> – Brings up the Purge System menu for changing the purge fluid, purge cassette, or purge system, or de-airing the purge system</li> <li>• <b>EXIT</b> – Exits the current procedure</li> </ul> <p><b>MENU</b></p> <ul style="list-style-type: none"> <li>• <b>MENU</b> – Brings up a menu of options related to controller settings, alarm history, offset adjustment, and starting a case</li> </ul>
System power area	<p>System power information is displayed to the right of the purge system information on the bottom of the display screen.</p> <p>Battery status – Bar within battery symbol indicates the overall remaining capacity of the batteries</p> <ul style="list-style-type: none"> <li>• Full green bar for fully charged battery</li> <li>• Partial green bar for battery that is at least 50% charged</li> <li>• Partial yellow bar for battery that is between 16% and 50% charged</li> <li>• Partial red bar for battery that is less than or equal to 15% charged</li> <li>• Moving gray bar for battery that is in charging mode</li> <li>• Numeric percentage of battery power remaining displayed below the battery icon</li> </ul> <p>AC plug indicator</p> <ul style="list-style-type: none"> <li>• Green plug indicates that the controller is running on AC power</li> <li>• Gray plug with a red X indicates no AC power detected and the controller is running on battery power</li> </ul>

**Table 4.3 Automated Impella® Controller Display Elements (continued)**

Display Element	Description
Purge system area	<p>Information about the purge system is displayed to the right of the flow area at the bottom of the display screen.</p> <p>Purge system marquee—scrolls from left to right when purge system is operating</p> <ul style="list-style-type: none"> <li>• Slow scrolling represents normal purge flow rate</li> <li>• Fast scrolling represents bolus flow rate</li> </ul> <p>Purge flow</p> <ul style="list-style-type: none"> <li>• Current purge flow displayed in mL/hr below the purge system marquee if the purge flow is known</li> <li>• Not displayed when the purge system is stabilizing, when there is no purge cassette, or when the procedure has not yet started</li> </ul>
Flow area	<p>Information about Impella® RP Catheter flow is displayed in the lower left corner of the display screen.</p> <p>Max/Min</p> <ul style="list-style-type: none"> <li>• Max/Min displays the range for the flow rate</li> </ul> <p>Current flow rate</p> <ul style="list-style-type: none"> <li>• Mean catheter flow displayed in liters per minute (L/min)</li> <li>• If the system is unable to calculate flow, a yellow triangular caution icon is displayed with the message “Flow Calculation Disabled”</li> </ul> <p>Catheter operation icon</p> <ul style="list-style-type: none"> <li>• The circular catheter operation icon rotates when the Impella® RP Catheter is running</li> </ul>
Central display area	<p>On the placement screen, the central display area displays two waveform signals, described in the “Placement Screen” discussion below.</p>



## PLACEMENT SCREEN

The placement screen (see Figure 4.4) displays real-time operating data for the system. The screen displays the placement signal and motor current waveforms as well as the maximum/minimum and average values for each waveform in the central display area of the screen.

Use the **DISPLAY** soft button to navigate to the placement screen.



**Figure 4.4** Placement Screen

Figure 4.4 shows two time-based waveform signals from different sources.

- Placement signal waveform
- Motor current waveform

### PLACEMENT SIGNAL WAVEFORM

The placement signal waveform displays a pressure measurement from the differential pressure sensor. The scale for the placement signal waveform is displayed to the left of the waveform. The default scaling is -20 to 60 mmHg. The scale can be adjusted in increments of 10 mmHg for a maximum range of -60 to 100 mmHg or a minimum range of 0 to 40 mmHg.

To the right of the waveform is a display that labels the waveform, provides the units of measurement, and shows the maximum and minimum values and the average value from the samples received. At the bottom of that window is the time scale, which you can set by pressing the **DISPLAY** soft button.

## MOTOR CURRENT WAVEFORM

Motor current is a measure of the energy intake of the Impella® RP Catheter motor. The energy intake varies with motor speed and the pressure difference between the inlet and outlet areas of the cannula.

The scale for the motor current waveform is displayed to the left of the waveform. The default scaling is 0–1000 mA. It is adjustable in 100 mA increments for the Impella® RP Catheter, with a minimum difference between upper and lower limits of 200 mA and a maximum difference of 1000 mA.

To the right of the waveform is a display that labels the waveform, provides the units of measurement, and shows the maximum and minimum values and the average value from the samples received. You can set the time scale at the bottom of that window by pressing the **DISPLAY** soft button.

## PURGE SCREEN

The purge screen (see Figure 4.5) displays purge system data. In the central display area of the screen, the purge flow rate and purge pressure are plotted as a function of time. To the right of the plots, the current purge flow rate and purge pressure are displayed.

Use the **DISPLAY** soft button to navigate to the purge screen.



Figure 4.5 Purge Screen

## PURGE FLOW

The purge flow rate delivered by the purge cassette is displayed in mL/hr. The standard scale for the purge flow (0–30 mL/hr) is displayed to the left of the purge flow plot. The maximum value on this scale can be adjusted from 20 mL/hr to 200 mL/hr in increments of 10 mL/hr.

To the right of the plot is a display that labels the plot and shows the most recent value update. You can set the time scale at the bottom of the window by pressing the **DISPLAY** soft button.

An advisory alarm will be displayed in the alarm window when the purge flow rate increases or decreases by 2.5 mL/h. The message is intended to aid patient management by alerting the clinician to changes in the rates of dextrose and heparin infusion through the purge fluid. The alarm clears when you press the **MUTE ALARM** button.

## PURGE PRESSURE

The purge pressure generated by the purge cassette is displayed in mmHg. The standard scale for the purge pressure (0–1500 mmHg) is displayed to the left of the purge pressure plot. The maximum value on this scale can be adjusted from 100 mmHg to 2000 mmHg in increments of 100 mmHg.

To the right of the plot is a display that labels the plot and shows the most recent value update. You can set the time scale at the bottom of the window by pressing the **DISPLAY** soft button.

---

## INFUSION HISTORY

The infusion history screen displays the infusion volume as well as the amount of heparin and dextrose infused each hour. The current time period is displayed at the top of the list. The calculations begin when the case start procedure is completed and Impella® RP Catheter flow rate is greater than 0 L/min. The infusion history screen updates after each milliliter of purge fluid is delivered and after each unit of heparin and dextrose is delivered.

Use the **DISPLAY** soft button to navigate to the infusion history screen.

Figure 4.6 shows a sample infusion history screen.

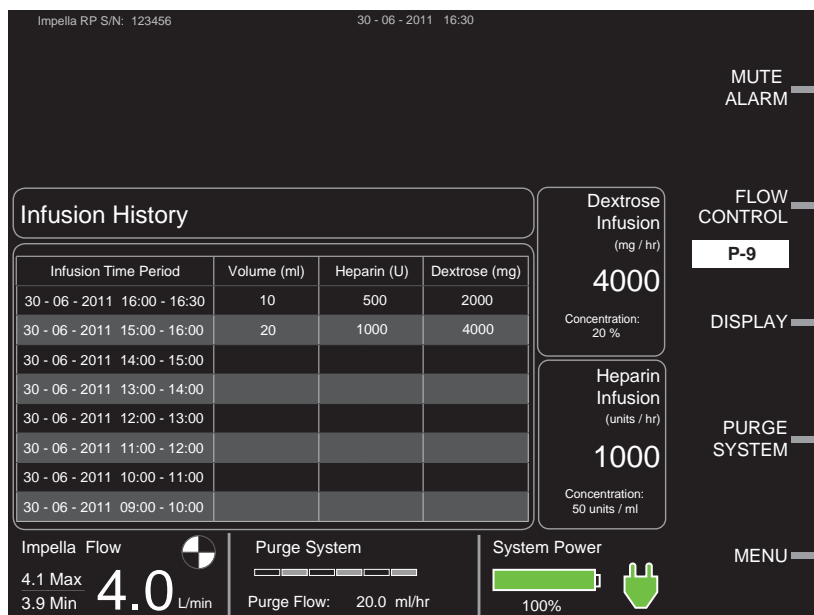

Figure 4.6 Infusion History Screen

## MOBILE OPERATION



The Li-Ion batteries must be charged for 5 hours prior to system operation in order to meet the runtime requirement of 1 hour. Failure to do so will yield a shorter runtime. After being unplugged, the Automated Impella® Controller will operate for at least 60 minutes after the batteries have been fully charged.

The Automated Impella® Controller can be operated on internal battery power when it is not connected to AC power.

Disconnect the Automated Impella® Controller from AC power.

The Automated Impella® Controller beeps once every 5 minutes to alert you that it is running on battery power and a white advisory notification appears in the alarm area on the screen. The AC power icon turns gray with an X through it.

When the Automated Impella® Controller is connected back to AC power, the white advisory notification turns gray and the AC power icon turns green.

# 5 USING THE AUTOMATED IMPELLA® CONTROLLER WITH THE IMPELLA® RP CATHETER



<b>STARTUP</b> .....	<b>5.1</b>
Supplies Needed.....	5.1
Turning on the Automated Impella® Controller.....	5.2
The Startup Screen .....	5.3
<b>CASE START</b> .....	<b>5.4</b>
Case Start.....	5.4
Insert Purge Cassette.....	5.5
Connect the Connector Cable .....	5.6
Enter Purge Fluid Data .....	5.8
Secure the Purge Tubing .....	5.9
Impella® RP System Configuration .....	5.9
<b>INSERTING THE IMPELLA® RP CATHETER</b> .....	<b>5.10</b>
<b>POSITIONING AND STARTING THE IMPELLA® RP CATHETER</b> .....	<b>5.12</b>
<b>PERFORMANCE LEVELS</b> .....	<b>5.13</b>
<b>USE OF THE REPOSITIONING SHEATH AND THE 23 FR PEEL-AWAY INTRODUCER</b> .....	<b>5.14</b>
<b>PURGE CASSETTE PROCEDURES</b> .....	<b>5.15</b>
Change Purge System .....	5.15
Change Purge Fluid .....	5.16
Change Purge Cassette .....	5.17
De-Air Purge System.....	5.17
<b>TROUBLESHOOTING THE PURGE SYSTEM</b> .....	<b>5.18</b>
Low Purge Pressure .....	5.18
Purge System Open .....	5.19
High Purge Pressure .....	5.19
Purge System Blocked.....	5.19
<b>PATIENT WEANING</b> .....	<b>5.20</b>
<b>REMOVING THE IMPELLA® RP CATHETER</b> .....	<b>5.20</b>

## STARTUP



Do **NOT** use an Impella® RP System if any part of the system is damaged.



The sterile components of the Impella® RP System can be used only if the sterilization indicators show that the contents have been sterilized, the packaging is not damaged, and the expiration date has not elapsed.



Do **NOT** resterilize or reuse the Impella® RP Catheter. It is a disposable device and is intended for single use only. Reuse, reprocessing, or resterilization may compromise the structural integrity of the catheter and/or lead to catheter failure which, in turn, may result in patient injury, illness, or death.



To prevent malfunction of the Automated Impella® Controller, avoid long-term exposure to direct sunlight and excessive heat (40°C).



To prevent overheating and improper operation, do **NOT** block the cooling vents of the Automated Impella® Controller while it is operating.



The Li-Ion batteries must be charged for 5 hours prior to system operation in order to meet the runtime requirement of 1 hour. Failure to do so will yield a shorter runtime. After being unplugged, the Automated Impella® Controller will operate for at least 60 minutes after the batteries have been fully charged.



Have a backup Automated Impella® Controller, purge cassette, connector cable, and Impella® RP Catheter available in the unlikely event of a device failure.

## SUPPLIES NEEDED

- Automated Impella® Controller
- Impella® RP Catheter and accessories
- Diagnostic catheter (AL1 or MP without side holes or pigtail with or without side holes)
- 0.025 inch, 260 cm Platinum Plus or similar stiff placement guidewire
- 500 cc bag of dextrose solution for purge solution (20% recommended; 5% to 40% acceptable) with 50 IU heparin/mL

## TURNING ON THE AUTOMATED IMPELLA® CONTROLLER

### Battery Switch

*Before operating the Automated Impella® Controller for the first time, turn on the switch on the underside of the controller to turn on the batteries.*

To turn the controller on:

1. Press and hold the power switch on the right side of the Automated Impella® Controller for 3 seconds (see Figure 5.1).



**Figure 5.1** Automated Impella® Controller Power Switch

The Automated Impella® Controller automatically performs a system test when turned on.

A display bar shows the progress of the system test. If the system test passes, the system displays the startup screen (see Figure 5.2).

If the system test fails, the controller displays a system self check failure message:

SYSTEM SELF CHECK FAILED.  
CHANGE CONSOLE IMMEDIATELY.

The controller displays the reason for the system test failure at the bottom of the screen.

## THE STARTUP SCREEN

The startup screen (see Figure 5.2) appears when you successfully turn on the Automated Impella® Controller.

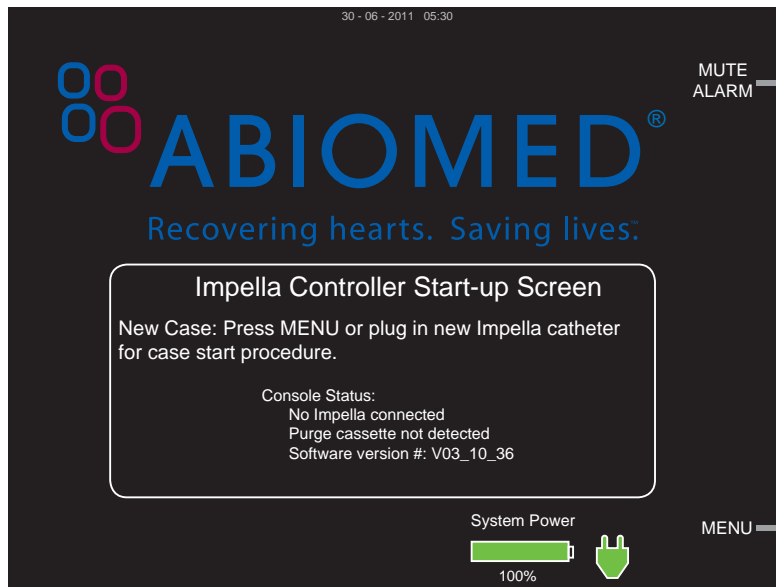

**Figure 5.2** Automated Impella® Controller Startup Screen

The startup screen displays:

- The current status of the Impella® RP Catheter (currently not connected to the Automated Impella® Controller in Figure 5.2).
- The current status of the purge cassette (no purge cassette detected in Figure 5.2).
- The current version of the software that the Automated Impella® Controller is running.

The startup screen also displays system power information along the bottom of the screen and two active soft buttons—**MUTE ALARM** and **MENU**—along the right side of the screen.

### Check Date and Time

*The current date and time appear at the top of the startup screen. Confirm that these are correct.*



## CASE START

### Sensitive Medical Device

The Impella® RP Catheter is a sensitive medical device with extremely fine tolerances. In particular, the inlet and outlet areas of the catheter assembly may be damaged if subjected to strong external forces.

### Two Ways to Start the Setup Procedure

You can start the setup procedure from the **MENU** on the startup screen (as described on this page) or when a new Impella® RP Catheter is plugged into the controller.



Fluoroscopy is required to guide placement of the Impella® RP Catheter. The small placement guidewire must be reliably observed at all times.



The sterile components of the Impella® RP System can be used only if the sterilization indicators show that the contents have been sterilized, the packaging is not damaged, and the expiration date has not elapsed.



Avoid manual compression of the inlet, outlet, or sensor areas of the cannula assembly.



Do **NOT** remove the Impella® RP Catheter over the length of the placement guidewire.



Handle with care. The Impella® RP Catheter can be damaged during removal from packaging, preparation, insertion, and removal. Do **NOT** bend, pull, or place excess pressure on the catheter or mechanical components at any time.



Do **NOT** kink or clamp any part of the Impella® RP Catheter.

## CASE START

1. Press the **MENU** soft button from the startup screen. “Case Start” is the default selection on the pop-up menu that appears on the screen.
2. Press the selector knob to select “Case Start.” The controller displays the screen shown in Figure 5.3.

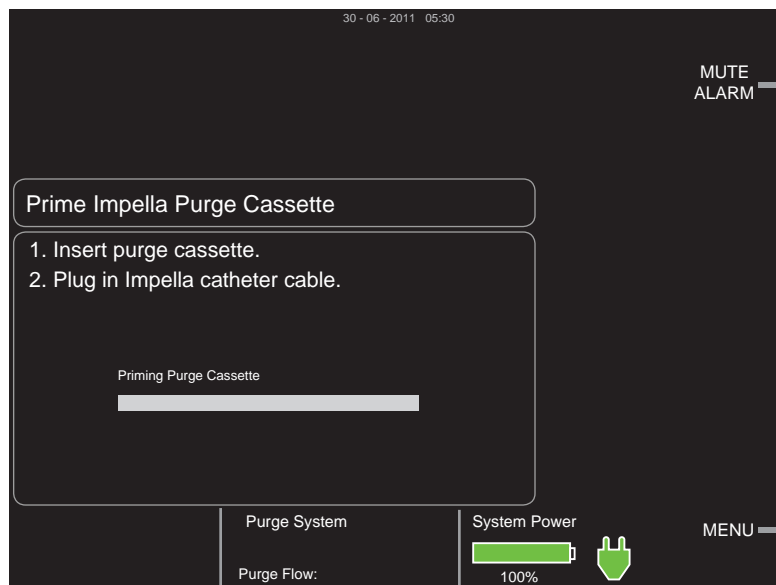

Figure 5.3 Initial Case Start Screen

## INSERT PURGE CASSETTE

1. Open the purge cassette package. Disconnect and discard the Y connector.
2. Pass the purge cassette and spike off the sterile field.
3. Spike the fluid bag/bottle.
4. Open the purge cassette door by pressing the release on the left side of the controller. Insert the purge cassette into the Automated Impella® Controller (as shown in Figure 5.4 and described in the steps that follow).



**Figure 5.4** Inserting the Purge Cassette into the Automated Impella® Controller

5. The purge cassette snaps into a molded compartment on the front of the controller. Follow the diagram on the inside of the purge cassette door for proper placement.
6. Slide the purge pressure transmitter into the slot to the right of the purge cassette until it snaps into place. The controller will automatically begin priming the purge cassette.
7. Extend the purge tubing and close the purge cassette door. There is sufficient room around the edges of the purge cassette door so that it will not pinch the purge tubing as it exits.
8. The controller automatically begins priming the purge cassette after it is inserted. The progress bar shown in Figure 5.3 marks the progress of the purge cassette priming.

### Shaded Steps

*All shaded steps require sterile technique.*

### Discard the Y Connector

*After opening the purge cassette package, disconnect and discard the Y connector. The Y connector is only used with the Impella® 2.5 Catheter.*

### Purge Solution Bottles

*If the purge solution is supplied in bottles, open the vent on the purge fluid spike and follow the same procedure as if supplied in bags.*

### Close Purge Cassette Door

*Once the purge cassette is installed, be sure to close the purge cassette door to prevent the purge cassette from being dislodged accidentally.*

## CONNECT THE CONNECTOR CABLE

1. Remove the Impella® RP Catheter from its package using sterile technique and inspect the catheter, including its connector, for damage.
2. Remove the white connector cable from its package using sterile technique.
3. Inspect the cable for damage, including damage to the connector pins at the controller end.
4. Secure the black end of the cable to the sterile field.
5. Insert the catheter plug into the connector cable socket (black end). The tab and the slot must be aligned during connection (see Figure 5.5).

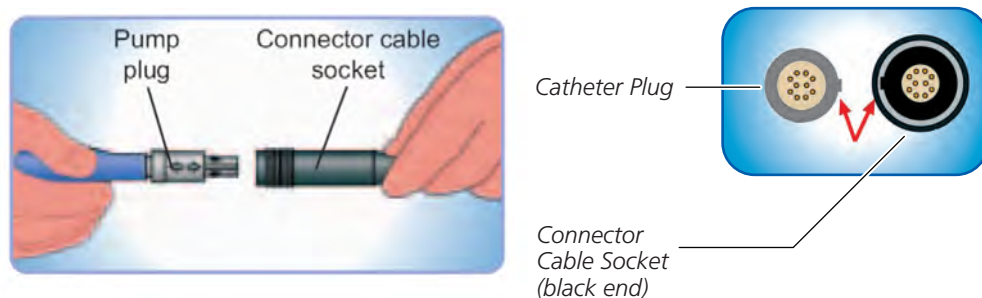

Figure 5.5 Inserting the Catheter Plug into the Connector Cable

6. Pull back on the connection to make sure that the plug has snapped into place.
7. Snap the plastic clip (located on the pressure reservoir of the clear sidearm) to the connector cable as shown in Figure 5.6.

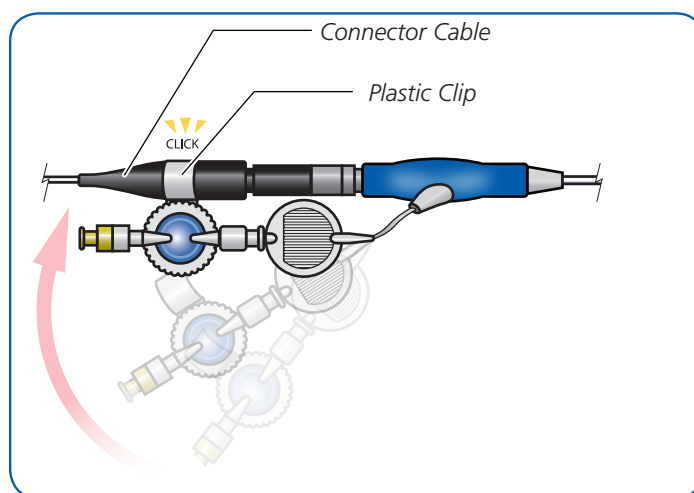

Figure 5.6 Snapping Plastic Clip to Connector Cable

8. Pass the sterile connector cable from the Impella® RP Catheter off the sterile field.
9. Line up the notch on the connector cable with the notch in the blue catheter plug on the front of the Automated Impella® Controller and plug the cable into the controller.

### Important Step

Snapping the plastic clip on the pressure reservoir to the connector cable is important to prevent the tube from kinking.

10. Once the purge cassette is primed and the controller detects that the connector cable is plugged in, it prompts you to connect the luer to the Impella® RP Catheter as shown in Figure 5.7.

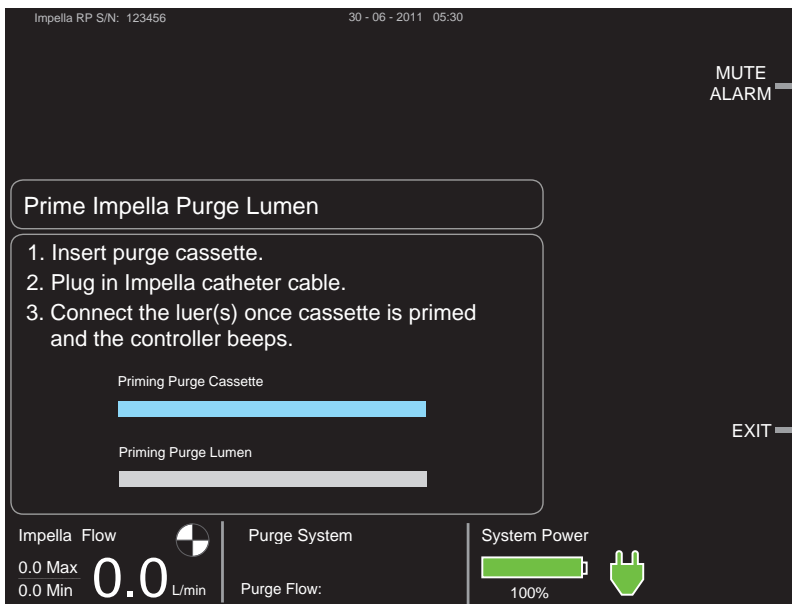

Figure 5.7 Priming the Impella Purge Lumen

11. If you have not already done so, disconnect and discard the Y connector with the red and yellow luers from the purge tubing.
12. Connect the yellow luer on the end of the purge tubing to the yellow luer on the clear sidearm of the Impella® RP Catheter as shown in Figure 5.8.

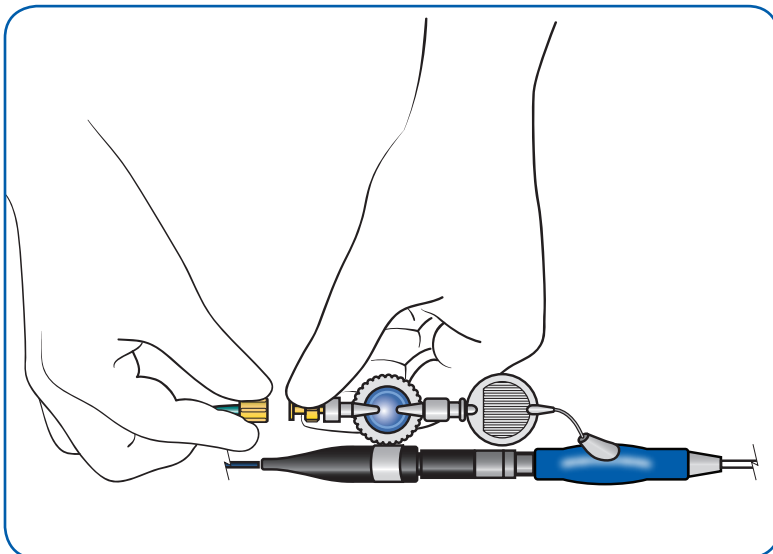

Figure 5.8 Connecting the Luer to the Impella® RP Catheter

13. When the controller detects that the luer is connected, it automatically begins priming the purge lumen at a bolus rate of greater than 250 mL/h and tracking the progress on the second progress bar.

### Error Screens

If you miss a step in the process of setting up the Impella® RP Catheter, or if you exceed the amount of time allowed to complete a step, the Automated Impella® Controller will display an error screen with instructions for continuing the setup process.

## ENTER PURGE FLUID DATA

1. After confirming that fluid is exiting the Impella® RP Catheter, enter the purge fluid information. The screen in Figure 5.9 shows a table of recommended default values for the purge fluid.

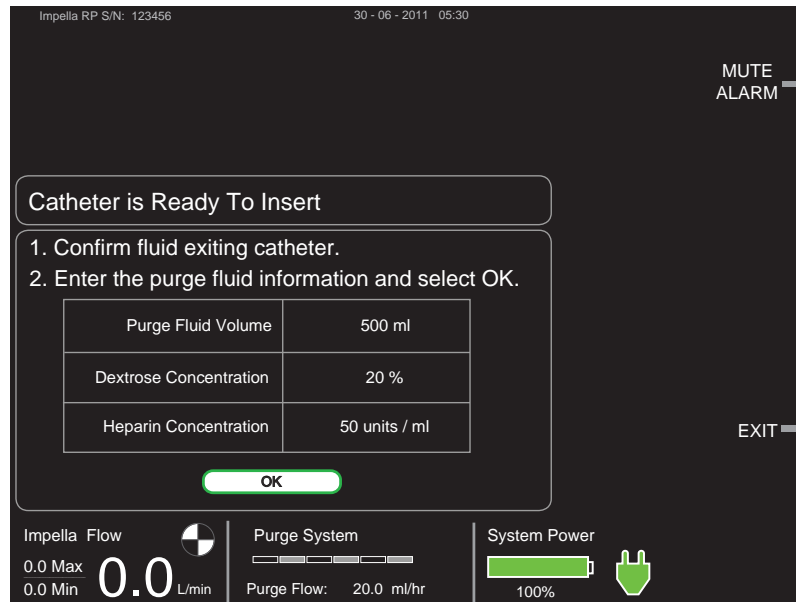

**Figure 5.9** Entering Purge Fluid Information

2. To select the default values displayed on the screen, scroll to **OK** below the table and press the selector knob. This will select those values and automatically advance to the next screen.
3. To change the purge fluid information, scroll to the appropriate item and push the selector knob to select it. Then scroll through the values and push the selector knob to make a new selection. The controller will use the default values if no other selections are made.
  - Purge fluid can be set to 50 mL, 100 mL, 250 mL, 500 mL (default), or 1000 mL.
  - Dextrose concentration can be set to 5%, 10%, 20% (default), 30%, or 40%.
  - Heparin concentration can be set to 0, 5, 10, 12.5, 15, 20, 25, or 50 units/mL (default).

## SECURE THE PURGE TUBING

1. To complete the setup, connect the purge tubing to the white connector cable by pushing the purge tubing into the clips attached to the white connector cable as shown in Figure 5.10.



Figure 5.10 Connecting the Purge Tubing to the Connector Cable

## IMPELLA® RP SYSTEM CONFIGURATION

Figure 5.11 illustrates the correct configuration of the Impella® RP System.

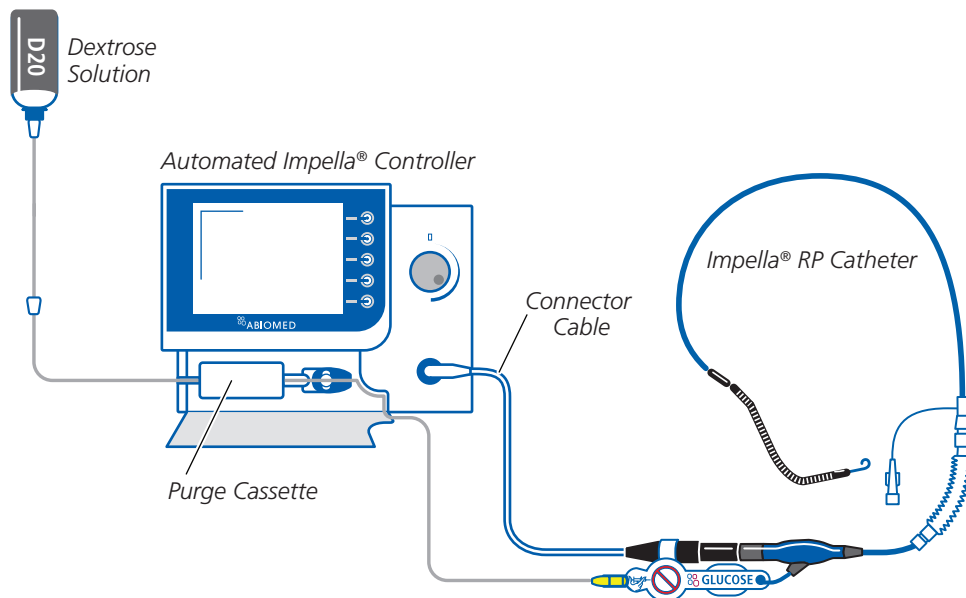

Figure 5.11 Impella® RP System Configuration

## INSERTING THE IMPELLA® RP CATHETER

**NOTE – Proper surgical procedures and techniques are the responsibility of the medical professional. The described procedure is furnished for information purposes only. Each physician must evaluate the appropriateness of the procedure based on his or her medical training and experience, the type of procedure, and the type of systems used.**



Fluoroscopy is required to guide placement of the Impella® RP Catheter. The small placement guidewire must be reliably observed at all times.



Avoid manual compression of the inlet, outlet, or sensor areas of the cannula assembly.



Do **NOT** kink or clamp any part of the Impella® RP Catheter.



Handle with care. The Impella® RP Catheter can be damaged during removal from packaging, preparation, insertion, and removal. Do **NOT** bend, pull, or place excess pressure on the catheter or mechanical components at any time.

### Shaded Steps

*All shaded steps require sterile technique.*

1. Obtain access to the femoral vein.
2. Insert a 5–8 Fr introducer over the 0.035 inch guidewire (provided) to pre-dilate the vessel.
3. Remove the 5–8 Fr introducer over the 0.035 inch guidewire. Insert the 8 Fr, 12 Fr, 16 Fr, and 20 Fr dilators sequentially, as needed. Remove the 20 Fr dilator and insert the 23 Fr introducer with dilator. While inserting the 23 Fr introducer, hold the shaft of the introducer to advance it into the vein.
4. Administer heparin. When ACT is at least 250 seconds, remove the 23 Fr dilator.
5. Insert a 5–6 Fr diagnostic catheter or a flow-directed balloon-tipped catheter into the 23 Fr introducer and advance it over a guidewire into the left (preferred) or right pulmonary artery.
6. Remove the 0.035 inch diagnostic guidewire, leaving the diagnostic or balloon-tipped catheter in the pulmonary artery. Form a curve or bend on the 0.025 inch Platinum Plus or similar stiff, 260 cm placement guidewire and then insert it.
7. Advance the placement guidewire into the pulmonary artery, avoiding overinsertion to the most distal pulmonary artery.
8. Remove the diagnostic or balloon-tipped catheter.

9. Wet the cannula with sterile water and backload the catheter onto the placement guidewire. One or two people can load the catheter on the guidewire.
  - a. Advance the guidewire into the Impella® RP Catheter and stabilize the cannula between the fingers. This prevents pinching of the outlet area. The guidewire must exit the inlet area on the inner radius of the cannula and align with the straight black line on the catheter. The cannula can be hyperextended as necessary to ensure the guidewire exits on the inner radius of the cannula.
  - b. The scrub assistant can help stabilize the catheter by holding the catheter proximal to the motor. This will allow the implanting physician to visualize the inner radius. The guidewire must exit the inlet area on the inner radius of the cannula and align with the straight black line on the catheter. The physician can focus on advancing the guidewire and, if the cannula needs to be hyperextended, the scrub assistant is available to assist.
10. Advance the catheter through the hemostatic valve into the femoral vein and along the placement guidewire using a fixed-wire technique. Follow the catheter under fluoroscopy, and rotate the catheter as it enters the right ventricle to direct the cannula tip upward and across the pulmonary valve. Position the outlet area of the cannula approximately 4 cm past the pulmonary valve annulus.
11. Remove the placement guidewire.
12. Confirm position with fluoroscopy.

### **Use Fluoroscopy for Placement**

*Impella® RP Catheter performance will be compromised if correct placement cannot be confirmed. While other imaging techniques, such as transesophageal echocardiography (TEE), can help confirm the position of the Impella® RP Catheter after placement, TEE does not allow visualization of the entire catheter assembly and is inadequate for reliably placing the Impella® RP Catheter.*



## POSITIONING AND STARTING THE IMPELLA® RP CATHETER



Retrograde flow will occur from the pulmonary artery back into the inferior vena cava if the Impella® RP Catheter is set at performance level P0.

When the Impella® RP is properly positioned across the pulmonary valve, but is not yet running, the placement signal will be similar to a pulmonary arterial waveform. After starting the Impella® RP, the amplitude of the placement signal will increase by a factor of 2 to 2.5, depending on the selected performance level.

1. Press the **FLOW CONTROL** soft button to open the menu.
2. Turn the selector knob to increase the performance level icon.
3. Press the selector knob to select the new performance level.
4. The catheter operation icon in the lower left corner of the screen begins rotating when the Impella® RP Catheter begins to operate.
5. Increase performance level to P9 to confirm correct and stable placement. Evaluate the catheter position and remove any excess slack. The catheter inlet area should be in the inferior vena cava and the outlet area in the pulmonary artery. Verify placement with fluoroscopy.



Figure 5.12 Maximum Performance Level

## USE OF THE REPOSITIONING SHEATH AND THE 23 FR PEEL-AWAY INTRODUCER

1. Flush the sidearm of the repositioning sheath located on the catheter shaft.
2. Attach a stopcock and flush the repositioning sheath prior to advancing the sheath.
3. Apply manual pressure above the puncture site and remove the 23 Fr peel-away introducer completely from the vein over the catheter shaft.
4. Grasp the two wings and bend back until the valve assembly comes apart. To do this, first stretch then snap the flexible valve mechanism that temporarily holds the two wings together. Continue to peel the two wings until the introducer is completely separated from the catheter shaft.
5. Place two dead-end caps on the repositioning sheath stopcock to prevent further usage. The sideport should not be used to give medication or draw blood because the blood could potentially clot. Pressure bags should not be connected to the sideport of the repositioning sheath. If a pressure bag is connected, the sideport must have an infusion pump or flow limiting valve in place to control the amount of fluid administered to the patient.
6. Slide the repositioning sheath over the catheter shaft and advance it into the femoral vein to the yellow eyelet.
7. Make sure there is no bleeding at the transition from the repositioning sheath to the femoral vein. Close and dress the wound.
8. Secure the yellow section of the repositioning sheath by suturing it to the skin using the provided eyelet.
9. Attach the anticontamination sleeve to the yellow section of the repositioning sheath. Lock the anchoring ring in place by turning it clockwise. Secure the catheter shaft in place by tightening the connected anchoring ring.
10. Carefully extend the anticontamination sleeve to maximum length and secure the end closest to the blue Impella plug by tightening the anchoring ring.
11. Reposition the catheter as necessary.

## PERFORMANCE LEVELS

### Retrograde flow

Retrograde flow will occur from the pulmonary artery back into the inferior vena cava if the Impella® RP Catheter is set at P0. Retrograde flow may also occur at P1.

You can select one of ten performance levels (P0 to P9) as shown in Table 5.1. Flow rate is increased by approximately 10% with every additional performance level, but depends on preload and afterload and can vary due to suction or incorrect positioning. Select the lowest performance level that will enable you to achieve the flow rate necessary for patient support.

**Table 5.1 Performance Level Flow Rates**

Performance Level	*Flow Rate (L/min)
P0	0.0
P1	0.0–1.2
P2	0.0–1.6
P3	0.0–2.0
P4	1.3–2.9
P5	1.6–3.1
P6	2.4–3.5
P7	3.0–4.0
P8	3.4–4.2
P9	3.9–4.4

*\*Flow rate depends on preload and afterload and can vary due to suction or incorrect positioning.*

At performance levels between P1 and P6, the Impella® RP operates with a regularly recurring rapid speed pulse. This minimizes stasis and reduces the risk of thrombosis in the motor area. These pulses produce peaks in the placement signal but do not have any effect on the continuous flow through the Impella® RP.

## SUCTION

If suction is an issue, the flow displayed on the controller may be higher than the actual Impella RP flow rate. If the suction alarm appears on the controller when the Impella RP is running at P-levels between P7 and P9, decrease P-level to P6, or to P5 or P4, as needed, to resolve suction. If the suction alarm continues when the P-level is between P4 and P6, momentarily stop the Impella RP to resolve the suction issue and then restart it immediately.

## PURGE CASSETTE PROCEDURES



When replacing the purge cassette, the replacement process must be completed within 2 minutes. The Impella® RP Catheter may be damaged if replacement takes longer than 2 minutes.

There are four procedures for maintaining the Impella® RP Catheter purge system:

- Change purge system (changing cassette and purge fluid)
- Change purge fluid
- Change purge cassette
- De-air purge system

Each procedure can be accessed using the **PURGE SYSTEM** soft button. This section describes each of these purge cassette procedures.

### CHANGE PURGE SYSTEM

Follow these steps to change both the purge cassette and purge fluid:

1. Press **PURGE SYSTEM** and select "Change Purge System" from the menu.
2. Open the purge cassette package. Disconnect and discard the Y connector from the end of the purge tubing as shown in Figure 5.13.

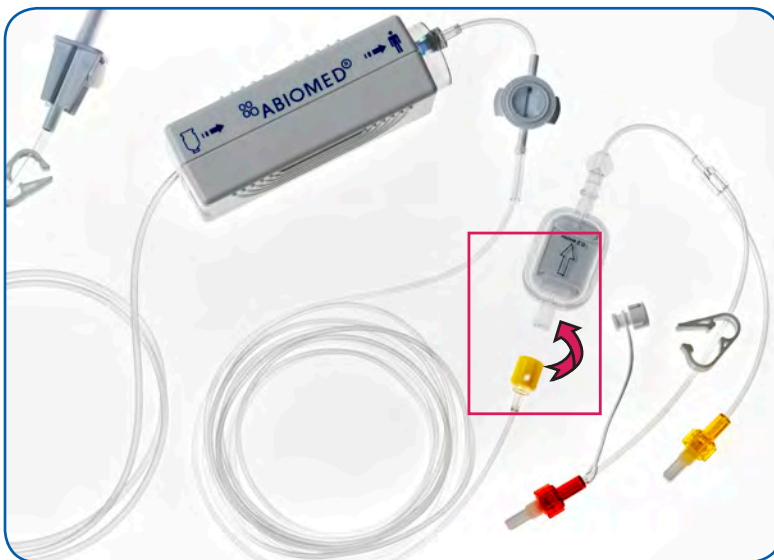

**Figure 5.13** Disconnecting the Y Connector from the Purge Cassette Tubing

3. Spike the fluid bag/bottle.
4. Select **OK** to deliver a bolus to the pressure reservoir so that the reservoir can maintain purge pressure during the change. A progress bar shows the progress of the bolus. After the bolus is delivered, the controller automatically proceeds to the next screen.
5. Disconnect the yellow luer from the Impella® RP Catheter and remove the used purge cassette.

### Replacement Time

*If the purge flow is more than 7 mL/hr or the dextrose concentration is less than 20%, replacement time will be less than 2 minutes. Replacement should always be performed as quickly as possible.*

### Discard the Y Connector

*Disconnect and discard the Y connector from the purge cassette tubing. For the Impella® RP System, the yellow luer on the end of the purge tubing connects directly to the yellow luer on the Impella® RP Catheter.*

6. Insert the new purge cassette into the controller. Be sure to slide the purge pressure transmitter into place and extend the purge tubing through the gap in the purge cassette door when you close the door.
7. The system automatically primes the purge cassette. A progress bar shows the progress of the priming. Once the priming is complete, you are prompted to connect the purge tubing to the Impella® RP Catheter.
8. Connect the yellow luer on the end of the purge tubing to the yellow luer on the Impella® RP Catheter.
9. Purge system change is complete. Enter the purge fluid information and select **OK**.
  - a. To select the default purge fluid values displayed on the screen, scroll to and select **OK**. This will select those values and automatically advance to the next screen.
  - b. To change the purge fluid information, scroll to the appropriate item and push the selector knob to select it. Then scroll through the values and push the selector knob to make a new selection. (Refer to “Entering Purge Fluid Data” in the Case Start discussion at the beginning of this section for a listing of purge fluid, dextrose concentration, and heparin concentration options.) The controller will use the default values if no other selections are made.

### Purge Solution Bottles

*If the purge solution is supplied in bottles, open the vent on the purge fluid spike and follow the same procedure as if supplied in bags.*

## CHANGE PURGE FLUID

These are the steps you will follow to change only the purge fluid.

1. Press **PURGE SYSTEM** and select “Change Purge Fluid.”
2. Select **OK** to deliver a bolus to the pressure reservoir so that the reservoir can maintain purge pressure during the change. A progress bar shows the progress of the bolus. After the bolus is delivered, the controller automatically proceeds to the next screen.
3. Clamp the supply line before removing the purge fluid bag.
4. Replace the purge fluid bag and unclamp the supply line.
5. Select **OK** to complete bag change and start purge system again.
6. Enter the purge fluid information and select **OK**.
  - a. To select the default purge fluid values displayed on the screen, scroll to and select **OK**. This will select those values and automatically advance to the next screen.
  - b. To change the purge fluid information, scroll to the appropriate item and push the selector knob to select it. Then scroll through the values and push the selector knob to make a new selection. (Refer to “Entering Purge Fluid Data” in the Case Start discussion at the beginning of this section for a listing of purge fluid, dextrose concentration, and heparin concentration options.) The controller will use the default values if no other selections are made.
7. The next screen asks whether you want to flush the fluid from the purge cassette.
  - a. To proceed with the flush, scroll to and select **OK**.
  - b. To skip the flush, press **EXIT** to complete the Change Purge Fluid procedure.

### Flushing Purge Cassette Fluid

*It may be helpful to flush the fluid from the purge cassette when you are changing dextrose concentration.*

8. If you are proceeding to flush the purge fluid from the cassette, select **OK** to deliver a bolus to the system. A progress bar shows the progress of the bolus. After the bolus is delivered, the controller automatically proceeds to the next screen.
9. Disconnect the luer from the Impella® RP Catheter and select **OK** to flush the purge cassette. A progress bar shows the progress of the flush. When complete, the controller proceeds to the next screen.
10. When the purge cassette flush is complete you can connect the luer to the Impella® RP Catheter to complete the procedure or press **BACK** to repeat the flush.

## CHANGE PURGE CASSETTE

These are the steps you will follow to replace only the purge cassette.

1. Press **PURGE SYSTEM** and select "Change Purge Cassette."
2. Open the purge cassette package. Disconnect and discard the Y connector from the purge tubing.
3. Disconnect the luer from the Impella® RP Catheter and remove the used purge cassette.
4. Spike the fluid bag.
5. Insert a new purge cassette into the controller. Be sure to slide the purge pressure transmitter into place and extend the purge tubing through the gap in the purge cassette door when you close the door.
6. The system automatically primes the purge cassette. A progress bar shows the progress of the priming. Once the priming is complete, you are prompted to connect the purge cassette to the Impella® RP Catheter.
7. Connect the yellow luer on the end of the purge tubing to the yellow luer on the Impella® RP Catheter.
8. When the purge cassette change is complete, press **OK** to exit.

### Changing the Purge Cassette

*The Change Purge Cassette procedure will only be available if the Automated Impella® Controller detects that the cassette is defective.*

## DE-AIR PURGE SYSTEM

These are the steps you will follow to de-air the purge system.

1. Press **PURGE SYSTEM** and select "De-air Purge System."
2. Make sure that the purge fluid bag is NOT empty or inverted and that the tubing is NOT clamped.
3. Disconnect the purge tubing from the Impella® RP Catheter.
4. Press **OK** to initiate the de-air function. A progress bar shows the progress of the de-air procedure. Once complete, the system advances to the next screen.
5. Confirm that no air remains in the purge tubing. If air remains, press **BACK** to repeat the air removal process.
6. Connect the yellow luer on the end of the purge tubing to the yellow luer on the Impella® RP Catheter to complete the de-air procedure.

## TROUBLESHOOTING THE PURGE SYSTEM

### LOW PURGE PRESSURE



If at any time during the course of support with the Impella® RP Catheter, the Automated Impella® Controller alarms “Purge Pressure Low,” follow the instructions below.

#### Purge Pressure

*Optimal purge pressure is different for every Impella® RP Catheter. Purge pressure can range from 300 mmHg to 1100 mmHg. While purge pressure varies during operation, the Automated Impella® Controller automatically maintains purge pressure within an acceptable range for each Impella® RP Catheter.*

1. Inspect the purge system for leaks.
2. If there are no leaks, change to a purge fluid with a higher dextrose concentration. To do this, open the **PURGE SYSTEM** menu and select “Change Purge Fluid.” Follow the instructions on the screen. (Refer to “Purge Cassette Procedures” earlier in this section of the manual.)
3. If the pressure stabilizes, no other action is required.  
**If the purge pressure is not stable, proceed to Step 4.**
4. If the low purge pressure alarm remains unresolved for more than 20 minutes, there may be a problem with the purge cassette. Replace the purge cassette. (Refer to “Change Purge Cassette” instructions on the previous page.)
5. If the low purge pressure alarm still remains unresolved for more than 20 minutes, this may be a sign of Impella® RP Catheter damage. Complete the following steps immediately:
  - a. Open the performance level icon and reduce the performance level to P1.
  - b. Slowly pull back on the Impella® RP Catheter until it is in the inferior vena cava (approximately 20 cm for an average size patient).
  - c. Turn off the Impella® RP Catheter by opening the performance level icon and reducing the P-level to P0.
  - d. Disconnect the catheter from the Automated Impella® Controller.
  - e. Remove the Impella® RP Catheter with the use of fluoroscopic imaging. If no fluoroscopy is available, leave the catheter in the inferior vena cava until imaging is available for visual assistance during removal of the Impella® RP Catheter.

## PURGE SYSTEM OPEN



If at any time during the course of support with the Impella® RP Catheter, the Automated Impella® Controller alarms “Purge System Open,” follow the instructions below.

1. Inspect the purge system for leaks.
2. If no leaks are visible, there may be a problem with the purge cassette. Replace the purge cassette. (Refer to instructions earlier in this section of the manual.)
3. If the Purge System Open alarm remains unresolved, this may be a sign of Impella® RP Catheter damage. Complete the following steps immediately:
  - a. Open the performance level icon and reduce the performance level to P1.
  - b. Slowly pull back on the Impella® RP Catheter until it is in the inferior vena cava (approximately 20 cm for an average size patient; 1 cm marks are available on the catheter).
  - c. Turn off the Impella® RP Catheter by opening the performance level icon and reducing the P-level to P0.
  - d. Disconnect the catheter from the Automated Impella® Controller.
  - e. Remove the Impella® RP Catheter with the use of fluoroscopic imaging. If no fluoroscopy is available, leave the catheter in the inferior vena cava until imaging is available for visual assistance during removal of the Impella® RP Catheter.

## HIGH PURGE PRESSURE

If the purge pressure exceeds 1100 mmHg, the Automated Impella® Controller displays the “Purge Flow Low” alarm message.

1. Inspect the purge system and check the Impella® RP Catheter for kinks in the tubing.
2. If pressure remains high, decrease the concentration of dextrose in the purge solution (eg, change from 20% dextrose to 10% dextrose).

## PURGE SYSTEM BLOCKED

If a “Purge System Blocked” alarm occurs, the purge fluid flow stops.

1. Check the purge system tubing and the Impella® RP Catheter for kinks or blockages.
2. Decrease the concentration of dextrose in the purge solution.
3. Replace the purge system.

### Purge System Open Alarm

*This alarm may occur if purge pressure is less than 100 mmHg.*

### De-air Procedure

*You may run the de-air procedure (described earlier in this section) after changing the dextrose concentration to decrease the amount of time it takes for a change in purge pressure/flow to occur.*

### Unresolved High Purge Pressure / Purge Flow Low Alarm

*If not resolved by the recommendations provided, high purge pressure—which triggers the “Purge Flow Low” alarm message—could be an indication of a kink in the Impella® RP Catheter. In this case, the motor is no longer being purged and may eventually stop. Monitor motor current and consider replacing the Impella® RP Catheter whenever a rise in motor current is seen.*



---

## PATIENT WEANING

Weaning the patient from the Impella® RP Catheter is at the discretion of the physician. Weaning may occur when right ventricular recovery is suspected and/or the patient is approaching the maximum duration of use for the Impella® RP Catheter. It should be initiated in a step-wise manner, such as described below.

***The following weaning protocol is provided as guidance only.***

### **Signs of Right Ventricular Recovery**

*As right-side support is slowly weaned, right ventricular recovery is indicated by preservation of the normal range of left-sided cardiac output as well as by a lack of severe elevation in CVP.*

1. Initiate the weaning process by temporarily reducing the Impella® RP Catheter flow to about 2 L/min.
2. Assess right ventricular function. Small changes in right ventricular systolic function as measured by echocardiography may be accompanied by significant improvement in right side forward flow; therefore, it is important to evaluate both echocardiographic evidence of improvement as well as CVP, flow rate, and overall perfusion.
3. Record available information regarding flow rate, CVP, echo parameters, and systemic hemodynamics.
4. After 15–20 minutes at the reduced flow rate, if there are signs of right ventricular recovery and no adverse effects from reduction in flow rate, continue the weaning process by reducing flow rate as tolerated to 0.5 L/min (P1). At this flow rate there will no longer be any forward flow across the right heart.
5. If the patient is maintained at a low flow rate (<1.5 L/min) for a prolonged period, increase ACT to at least 250 seconds.

---

## REMOVING THE IMPELLA® RP CATHETER

1. Wean the patient by following the steps in the previous section.
2. Leave the Impella® RP in the pulmonary artery at P2 until ACT drops below 150  
**OR**  
Reduce the performance level to P1, pull the catheter into the inferior vena cava (approximately 30 to 40 cm), and wait until ACT drops below 150.
3. When ACT is below 150 seconds and patient hemodynamics remain stable, decrease performance level to P1, pull the catheter into the inferior vena cava if it is not already there, and stop the motor by reducing the performance level to P0.
4. Remove the Impella® RP Catheter.
5. Disconnect the connector cable from the Automated Impella® Controller and turn the controller off by pressing the power switch on the side of the controller for 3 seconds.
6. Close the blood vessel.

## 6 CLINICAL EXPERIENCE



<b>PIVOTAL CLINICAL STUDY DESIGN – RECOVER RIGHT .....</b>	<b>6.1</b>
Inclusion and Exclusion Criteria .....	6.1
Study Organization .....	6.2
Statistical Considerations .....	6.3
<b>ACCOUNTABILITY OF COHORT .....</b>	<b>6.3</b>
Study Population Demographics and Baseline Characteristics .....	6.4
Procedural, Support and Hemodynamic Characteristics .....	6.5
Primary Endpoint Results .....	6.7
Secondary Safety Endpoint Results .....	6.7
Secondary Effectiveness Endpoint Results .....	6.7
Other Relevant Clinical Findings .....	6.9
Trial Conclusions .....	6.10

## PIVOTAL CLINICAL STUDY DESIGN – RECOVER RIGHT

RECOVER RIGHT was a prospective, multi-center, non-randomized study. The primary objective for the study was to assess safety and effectiveness of the use of the Impella RP device in patients with RVF refractory to medical treatment who require hemodynamic support. The intent of therapy was to restore normal right heart hemodynamics, reduce right ventricular work, and allow the right heart time to potentially recover adequate contractile function or to be bridged to the next therapy.

The primary endpoint was the survival rate at 30 days post device explant or hospital discharge (whichever is longer), or at induction of anesthesia for a longer term therapy, including heart transplant or implant of a surgical RVAD (as a bridge-to-recovery or bridge-to-transplant).

Secondary effectiveness endpoint was determined by the following:

- Central venous pressure (CVP) and cardiac index (CI) improvement post initiation of Impella RP support
- Decreased use of inotropes during support
- Improvement in LVAD flow or left ventricle pumping function secondary to the increased venous return by the Impella RP within 48 hours post implant

Secondary safety endpoint was determined by the rates of the following adverse events at 30 days or discharge (whichever is longer), or at induction of anesthesia for a longer term therapy, including heart transplant or implant of a surgical RVAD (as a bridge-to-recovery or bridge-to-transplant):

- Death (any cause of death and cardiac death)
- Major bleeding
- Hemolysis
- Pulmonary embolism
- Tricuspid/pulmonary valve dysfunction (defined as tricuspid/pulmonic valve injury resulting in increased valve regurgitation versus baseline)

### INCLUSION AND EXCLUSION CRITERIA

The study population consisted of consented patients ( $\geq 18$  years of age) who developed RVF either a) during or after durable LVAD implantation (Cohort A) or b) subsequent to post-cardiotomy cardiogenic shock or post myocardial infarction (Cohort B).

RVF was defined as:

- A CI  $< 2.2$  l/min/m<sup>2</sup> despite continuous infusion of high dose of inotropes and any of the following:
- CVP  $> 15$  mmHg or
- CVP/PCWP or LAP  $> 0.63$  or
- Moderate to severe global RV dysfunction on echocardiography defined as one of the following criteria: global RV hypokinesis, a TAPSE score of  $\leq 14$  mm, right ventricular diameter at base  $> 42$ mm, right ventricular short axis (or mid cavity) diameter  $> 35$ mm)
- High dose of inotropes was defined as Dobutamine of  $\geq 10$   $\mu$ g/kg/min or equivalent for more than 15 minutes (120 minutes for milrinone) and/or administration of more than one inotrope/vasopressor medication

## **Exclusion Criteria**

### Specific to Cohort A:

1. INTERMACS 1 patients (Critical cardiogenic shock patient who is “crashing and burning,” has life-threatening hypotension and rapidly escalating inotropic or pressor support, with critical organ hypoperfusion often confirmed by worsening acidosis and lactate levels)
2. End organ failure (defined as hepatic total bilirubin  $\geq 5$  mg/dL based on lab data within 24 hours prior to Impella RP initiation, renal: creatinine  $\geq 4$  mg/dL based on lab data within the 24 hours prior to Impella RP initiation)
3. Evidence of acute neurologic injury following LVAD implant

### Specific to Cohort B:

1. Patient in profound cardiogenic shock defined as systolic blood pressure  $< 75$  mmHg and CI  $< 1.3$  l/min/m<sup>2</sup> despite 2 or more high dose of inotropes  $\pm$  mechanical support or evidence of shock-related end-organ damage, metabolic acidosis (pH 7.1 or less) and not corrected by 100 ml NaHCO<sub>3</sub> (1mEq/ml), disseminated intravascular coagulation or clinical evidence of diffuse brain injury or in cardiogenic shock for  $> 24$  hours.
2. AMI with mechanical complications (ventricular septal defect, myocardial rupture, papillary muscle rupture)
3. Unsuccessful revascularization of the RCA (TIMI 0.1 post PCI or post-CABG)

### General – For Both Cohorts

1. Active infection, two of the following WBC  $> 12,500$ , positive blood culture, fever
2. RA, RV and/or PA thrombus
3. Prosthetic valves in the right heart (tricuspid or pulmonary valves)
4. Unrepaired atrial septal defect/ patent foramen ovale
5. Structural tricuspid valve disease
6. Severe pulmonary valve stenosis or insufficiency
7. Intolerance to anticoagulant or antiplatelet therapies
8. Severe pulmonary hypertension (PAP  $> 60$  mmHg)
9. Documented DVT and/or presence of IVC filter
10. Anatomic conditions precluding insertion of the pump or safe use of the device such as severe anomaly of the inferior vena cava, calcification or other disorders of the pulmonary artery wall
11. Pulmonary artery conduit replacement
12. Patient on right side support device or extracorporeal membrane oxygenation
13. Current diagnosis of pulmonary embolism
14. Patient with anatomic anomalies or aortic diseases like aortic dissection, Marfan-Syndrome, Morbus Erdheim-Gsell or others
15. Allergy or intolerance to contrast media
16. Thrombolysis within the previous 30 days or known existing coagulopathy such as thrombocytopenia, heparin induced thrombocytopenia (HIT), hemoglobin diseases such as sickle cell anemia or thalassemia
17. Existing congenital heart disease precluding device insertion
18. Participation in any other clinical investigation that is likely to confound study results or affect study outcome

## STUDY ORGANIZATION

ABIOMED was responsible for site management, site monitoring, data management and oversight of safety processes. The study also included an independent Echocardiography Core Laboratory (Duke Clinical Research Institute, Durham, NC) that provided imaging protocol design, site training/certification and image management/analyses. A cardiothoracic surgeon, selected as the Physician Medical Monitor, was charged with reviewing study data in order to protect the safety and well-being of human subjects and the scientific integrity of the investigation. An independent CEC was organized through Harvard Clinical Research Institute (HCRI) and comprised physicians trained in interventional cardiology, heart failure and cardiac surgery who were experienced with the safety issues specific to mechanical circulatory support. The CEC members reviewed adjudicated all adverse events and determined whether a causal relationship to either the investigational device or the procedure existed.

## STATISTICAL CONSIDERATIONS

Considering the low incidence of RVF and challenges to enroll patients in a reasonable time frame, the study was not designed to be hypothesis driven. Data were described as mean  $\pm$  standard deviation (mean  $\pm$  SD).

## ACCOUNTABILITY OF COHORT

A total of 30 subjects were enrolled into the study. Of these 30 subjects, there were 18 subjects (60%) enrolled in Cohort A and 12 subjects (40%) enrolled in Cohort B. Details are shown in Figure 6.1.

**Figure 6.1** Study flow schematic

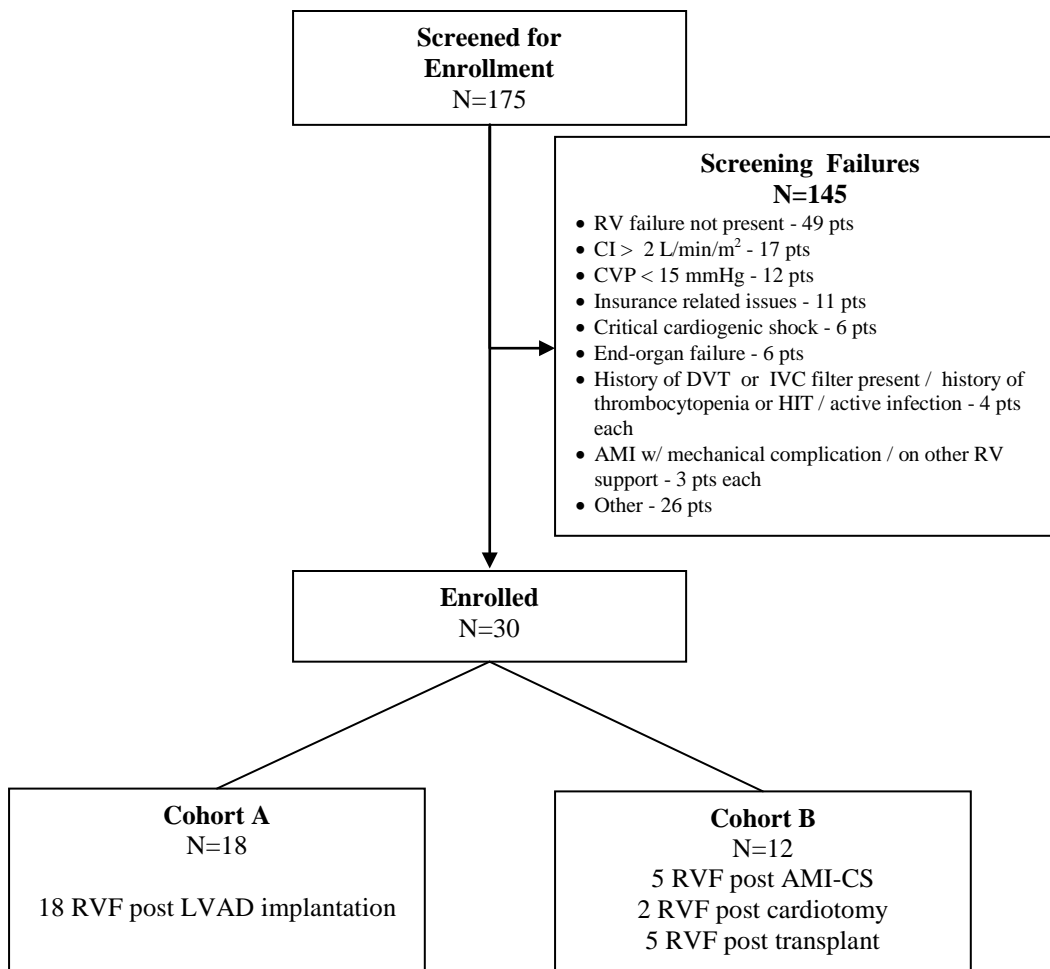

## STUDY POPULATION DEMOGRAPHICS AND BASELINE CHARACTERISTICS

The patient baseline characteristics are summarized in Table 6.1. The overall age was 59±15 years old. Among all patients, 88.5% presented with congestive heart failure (CHF), 60% had history of arrhythmia, 57% had ICD or pacemaker implanted, 53% had diabetes, 37.5% had chronic kidney disease, and 20% had prior CVA. Of note, 60% of the patients had received blood products and 78.6% were in NYHA class IV prior to device implant.

**Table 6.1 Patient characteristics**

Patient Characteristics	All Patients (N=30)	Cohort A (N=18)	Cohort B (N=12)
Age			
Mean±SD (N)	59.2±15.2 (30)	55.8±13.9 (18)	64.3±16.2 (12)
Gender			
Male	76.7% (23/30)	83.3% (15/18)	66.7% (8/12)
Female	23.3% (7/30)	16.7% (3/18)	33.3% (4/12)
Race			
White	53.3% (16/30)	55.6% (10/18)	50.0% (6/12)
Black or African American	40.0% (12/30)	38.9% (7/18)	41.7% (5/12)
Asian	6.7% (2/30)	5.6% (1/18)	8.3% (1/12)
Body Surface Area (m2)			
Mean±SD (N)	1.94±0.22 (30)	2.01±0.23 (18)	1.85±0.18 (12)
Hypertension	80.0% (24/30)	77.8% (14/18)	83.3% (10/12)
Coronary Artery Disease	66.7% (20/30)	66.7% (12/18)	66.7% (8/12)
Congenital Heart Disease	12.5% (3/24)	6.7% (1/15)	22.2% (2/9)
Congestive Heart Failure	88.5% (23/26)	100.0% (18/18)	62.5% (5/8)
NYHA Classification			
I	3.6% (1/28)	0.0% (0/18)	10.0% (1/10)
II	3.6% (1/28)	5.6% (1/18)	0.0% (0/10)
III	14.3% (4/28)	16.7% (3/18)	10.0% (1/10)
IV	78.6% (22/28)	77.8% (14/18)	80% (8/10)
Myocardial Infarction	46.7% (14/30)	50.0% (9/18)	41.7% (5/12)
PCI	46.7% (14/30)	50.0% (9/18)	41.7% (5/12)
CABG	13.3% (4/30)	5.6% (1/18)	25.0% (3/12)
Arrhythmia	60.0% (18/30)	66.7% (12/18)	50.0% (6/12)
Cerebrovascular Accident	16.7% (5/30)	5.6% (1/18)	33.3% (4/12)
Stroke	20.0% (1/5)	0.0% (0/1)	25.0% (1/4)
TIA	60.0% (3/5)	0.0% (0/1)	75.0% (3/4)
Smoking	44.8% (13/29)	52.9% (9/17)	33.3% (4/12)
Chronic Obstructive Pulmonary Disease	12.0% (3/25)	16.7% (3/16)	0.0% (0/9)
Diabetes	53.3% (16/30)	61.1% (11/18)	41.7% (5/12)
Chronic Kidney Disease	37.5% (9/24)	37.5% (6/16)	37.5% (3/8)
Subject is On Dialysis	0.0% (0/9)	0.0% (0/6)	0.0% (0/3)
LVAD Implantation	16.7% (5/30)	0.0% (0/18)	41.7% (5/12)
HeartMate (Thoratec)	40.0% (2/5)	N/A	40.0% (2/5)

Patient Characteristics	All Patients (N=30)	Cohort A (N=18)	Cohort B (N=12)
Heartware HVAD	40.0% (2/5)	N/A	40.0% (2/5)
Other	20.0% (1/5)	N/A	20.0% (1/5)
Valve Replacement/Repair	16.7% (5/30)	16.7% (3/18)	16.7% (2/12)
ICD/Pacemaker Implanted	56.7% (17/30)	72.2% (13/18)	33.3% (4/12)
Subject received any blood products within the past 48 hours			
% Received	60.0% (18/30)	61.1% (11/18)	58.3% (7/12)
LVEF (%)			
Mean±SD (N)	22.6±16.66 (24)	14.1±7.35 (16)	39.6±17.3 (8)
TAPSE (mm)			
Mean±SD (N)	8.9±4.7 (16)	8.1±4.2 (10)	10.3±5.5 (6)

Baseline laboratory parameters are provided in Table 6.2. The test results were similar between the two cohorts. Overall, patients presented with signs of tissue hypoperfusion and end-organ dysfunction at the time of implant as demonstrated by the elevated creatinine, bilirubin and lactate dehydrogenase.

**Table 6.2 Baseline laboratory parameters**

Baseline Characteristics	All Patients Mean±SD (N)	Cohort A Mean±SD (N)	Cohort B Mean±SD (N)
WBC (10 <sup>3</sup> )	11.80±6.38 (30)	11.47±7.28 (18)	12.31±5.01 (12)
Platelets (10 <sup>3</sup> )	204.09±87.24 (30)	191.76±75.24 (18)	222.58±103.42 (12)
Hemoglobin (g/dL)	10.31±2.01 (30)	10.09±1.79 (18)	10.63±2.35 (12)
Hematocrit (%)	31.40±5.84 (30)	30.84±5.41 (18)	32.24±6.58 (12)
Plasma Free Hemoglobin (mg/dL)	26.22±50.90 (16)	12.42±11.32 (11)	56.58±87.86 (5)
BUN (mg/dL)	24.98±13.47 (30)	23.58±13.19 (18)	27.08±14.19 (12)
Serum Creatinine (mg/dL)	1.40±0.60 (30)	1.37±0.57 (18)	1.43±0.65 (12)
Creatinine Clearance (mL/min)	62.82±25.33 (19)	68.40±26.73 (12)	53.26±21.12 (7)
Total Bilirubin (mg/dL)	1.27±0.84 (29)	1.46±1.04 (17)	0.99±0.32 (12)
LDH (U/L)	441.73±315.57 (21)	452.33±344.74 (15)	415.22±253.73 (6)
BNP (pg/mL)	3867±8483 (16)	1480±2125 (9)	6937±12423 (7)

WBC: White Blood Cells; BUN: Blood Urea Nitrogen; LDH: Lactate Dehydrogenase; BNP: B-type natriuretic peptide

## PROCEDURAL, SUPPORT AND HEMODYNAMIC CHARACTERISTICS

Patients procedural and support characteristics are presented in Table 6.3. Percutaneous placement of the device was attempted through right femoral vein in 96.7% (29 out of 30) cases and through the left femoral vein in 3.3% (1 out of 30) cases. There was minimal blood loss during introducer and catheter placement with less than 25 mL of blood loss recorded in 89.3% and 60.7% patients, respectively. The average duration of support with the Impella RP was 3.05±1.5 days for the entire population (ranging

from 13 hours to 8 days) and was similar between the two cohorts. The pump flow on support was 3.23±0.35 L (ranging 2.5-4.00 L/min).

**Table 6.3 Procedural characteristics**

Procedural Characteristics	All Patients (N=30)	Cohort A (N=18)	Cohort B (N=12)
Side of Implantation			
Left Femoral Vein	3.3% (1/30)	0.0% (0/18)	8.3% (1/12)
Right Femoral Vein	96.7% (29/30)	100.0% (18/18)	91.7% (11/12)
Estimated Blood Loss during Introducer Insertion			
<25mL	89.3% (25/28)	93.8% (15/16)	83.3% (10/12)
25-50 mL	3.6% (1/28)	0.0% (0/16)	8.3% (1/12)
>100 mL	7.1% (2/28)	6.3% (1/16)	8.3% (1/12)
Estimated Blood Loss during Catheter Placement			
<25mL	60.7% (17/28)	68.8% (11/16)	50.0% (6/12)
25-50 mL	32.1% (9/28)	25.0% (4/16)	41.7% (5/12)
>100 mL	7.1% (2/28)	6.3% (1/16)	8.3% (1/12)
Duration of Support (hours)			
Mean±SD (N)	73.15±37.04 (27)	76.73±31.64 (15)	68.66±43.92 (12)
Average device flow (L/min)			
Mean±SD (N)	3.23±0.35 (27)	3.14±0.39 (16)	3.35±0.26 (11)

The hemodynamic characteristics are provided in Table 6.4. All patients presented with RVF and poor hemodynamics at the time of implant, despite high dose of inotropes/pressors. The hemodynamic profile was consistent between the two cohorts.

**Table 6.4 Support and hemodynamic characteristics**

Hemodynamic Characteristics	All Patients Mean±SD (N)	Cohort A Mean±SD (N)	Cohort B Mean±SD (N)
Number of inotropes/pressors (Prior to device Insertion)	3.23±1.14 (30)	3.56±1.10 (18)	2.75±1.06 (12)
<b>Hemodynamics (Prior to device Insertion)</b>			
Cardiac Index (L/min/m <sup>2</sup> )	1.82±0.23 (30)	1.84±0.23 (18)	1.80±0.23 (12)
Cardiac Output (L/min)	3.81±1.13 (28)	4.17±1.32 (16)	3.34±0.60 (12)
Pulmonary Capillary Wedge Pressure (PCWP)/Left Arterial Pressure (LAP) (mmHg)	17.44±7.28 (16)	14.50±4.60 (8)	20.38±8.53 (8)
Right Arterial Pressure (RAP)/Central Venous Pressure (CVP) (mmHg)	19.23±3.91 (30)	19.25±4.36 (18)	19.21±3.31 (12)
<b>Pulmonary Artery Pressure (PAP)</b>			
PASP (mmHg)	40.38±12.10 (29)	41.50±13.87 (18)	38.55±8.78 (11)
PADP (mmHg)	20.21±8.62 (29)	21.33±9.16 (18)	18.36±7.70 (11)
Mean Arterial Pressure (MAP) (mmHg)	70.46±14.32 (21)	74.08±10.93 (13)	64.59±17.81 (8)
Heart Rate (BPM)	90.21±20.49 (28)	91.71±22.69 (17)	87.91±17.34 (11)
LVAD Flow (L/min) (Cohort A only)	3.96±0.64 (17)	3.96±0.64 (17)	N/A



## PRIMARY ENDPOINT RESULTS

The primary endpoint of survival at 30 days or discharge post device removal (whichever is longer), or to induction of anesthesia for the next longer-term therapy was achieved in 73 % of the study population, with 83% in cohort A and 58% in cohort B. Patient outcomes are presented in Table 6.5.

**Table 6.5 Patient outcome**

Event	All Patients (N=30)	Cohort A (N=18)	Cohort B (N=12)
Alive @ 30 days % (N)	73% (22/30)	83.3% (15/18)	58.3% (7/12)
Alive @ Discharge % (N)	70% (21/30)	77.8% (14/18)	58.3% (7/12)
Alive at 30day/DC/next therapy %(N)	73% (22/30)	83.3% (15/18)	58.3% (7/12)

## SECONDARY SAFETY ENDPOINT RESULTS

The secondary safety endpoint results are provided in Table 6.6.

**Table 6.6 Secondary safety endpoints**

Safety Endpoints	All Patients (N=30)	Cohort A (N=18)	Cohort B (N=12)
Death	26.7% (8/30)	16.7% (3/18)	41.7% (5/12)
Major Bleeding	60.0% (18/30)	55.6% (10/18)	66.7% (8/12)
Hemolysis	13.3% (4/30)	16.7% (3/18)	8.3% (1/12)
Pulmonary Embolism	0.0% (0/30)	0.0% (0/18)	0.0% (0/12)
Tricuspid & Pulmonary Valve Dysfunction*	3.3% (1/30)	5.6% (1/18)	0.0% (0/12)

\* based on echocardiographic core lab analysis

Major bleeding events, though numerically high (18/30, 60% of patients), were predominantly related to the surgical procedure with post-cardiotomy surgical bleeding accounting for 83% (15/18: LVAD implantation n=10, Cohort A; or heart transplant or valve replacement surgery n=5, Cohort B) of major bleeding events. The post-cardiotomy patients had complex surgical interventions with administration of blood products. Following these procedures, the chest was often left open and the patients required repeated wash-outs and surgical exploration to control bleeding prior to chest closure. Post surgical coagulopathy and need for blood products also contributed to these events. Bleeding events that were potentially device related were low (3/18 in Cohort B, 1/3 at access site). Overall, the amount of bleeding during insertion of the device was also low (93% of the patients lost less than 100 mL of blood for the combined introducer sheath placement and the Impella RP catheter insertion).

## SECONDARY EFFECTIVENESS ENDPOINT RESULTS

### CVP and CI improvement post initiation of Impella RP support

The hemodynamics improved in the first 24 hours of support when compared with pre-implant in the overall patient population as seen in Figure 6.2. The CI improved from  $1.82 \pm 0.04$  to  $3.3 \pm 0.23$  L/min/m<sup>2</sup>. The CVP decreased from  $19.2 \pm 0.7$  to  $12.6 \pm 1$  mmHg.

**Figure 6.2 Cardiac index (CI) and central venous pressure (CVP) measured during the study**

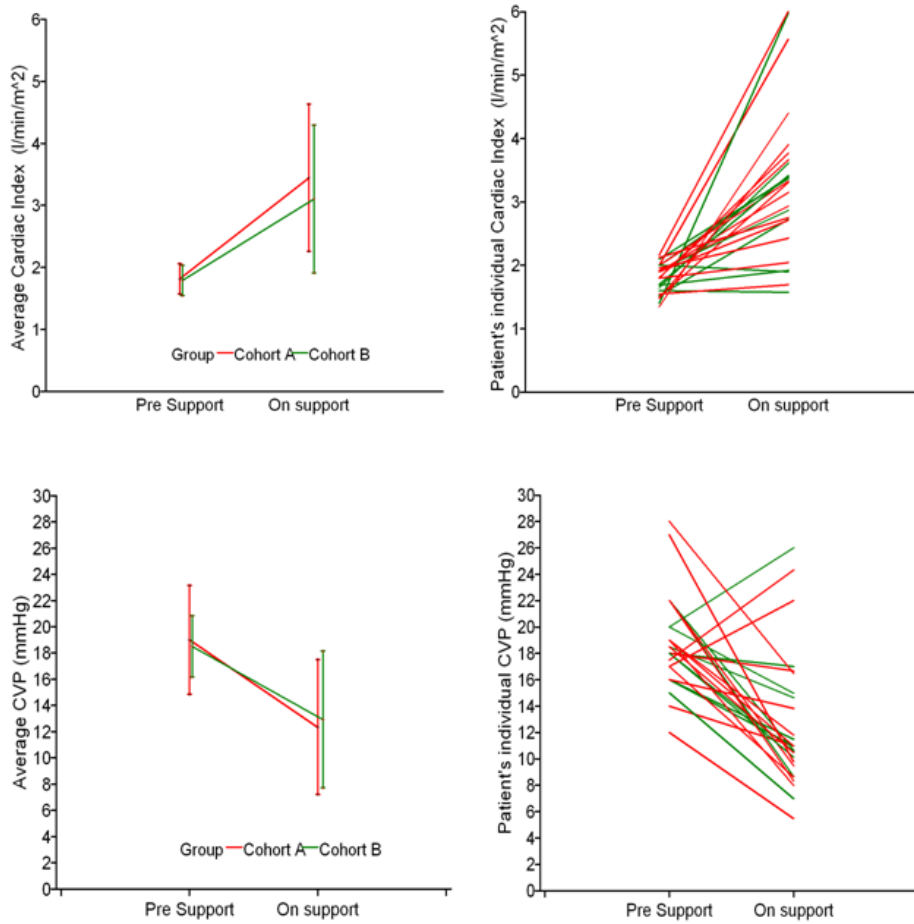

Improvement in LVAD flow or LV pumping function

The LVAD flow in Cohort A patients improved after the initiation of Impella RP from  $3.96 \pm 0.16$  L/min to  $4.62 \pm 0.14$  L/min, as depicted in Figure 6.3.

**Figure 6.3 LVAD flow changes from baseline to on-support**

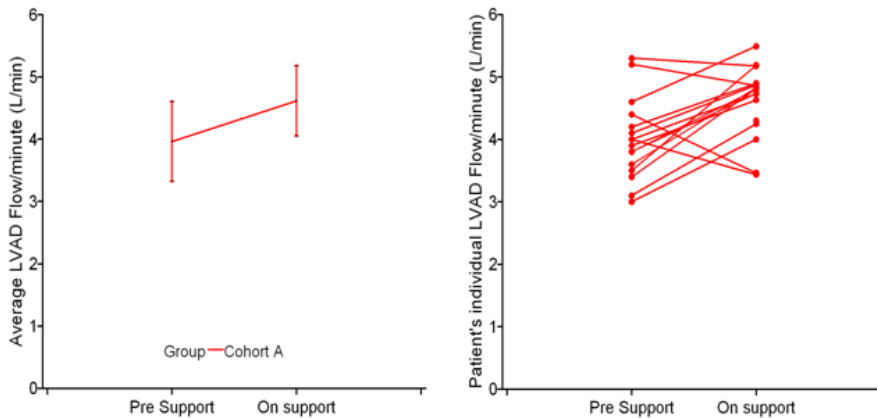

In conclusion, the use of Impella RP device improved patient hemodynamics while providing ventricular unloading in the combined cohorts. The level of support was sufficient to restore the hemodynamics of these sick patients to a normal range.

#### Decreased use of inotropes during support

The use of inotropes showed an initial increase on support then generally trended down over time during Impella RP support, as shown in Figure 6.4.

**Figure 6.4 Use of inotropes during Impella RP support**

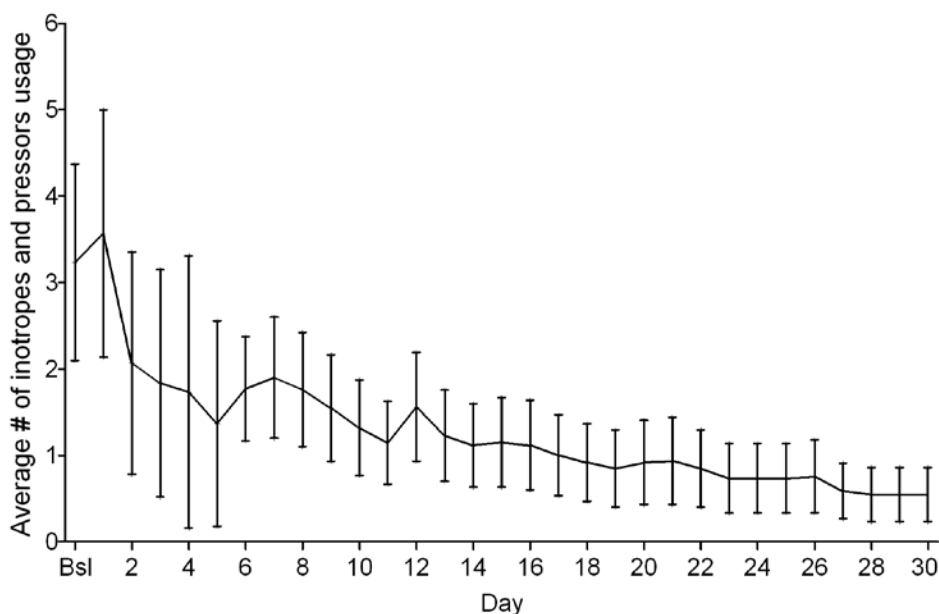

### OTHER RELEVANT CLINICAL FINDINGS

#### Safety:

- **Vascular complication**  
There were no reported vascular complications in the venous system related to use of the large bore sheath provided with the Impella RP pump.
- **Integrity of Cardiac and Valvular Structures**  
A comprehensive echocardiographic safety analysis on echocardiographic images acquired at different time points before, during and after Impella RP support performed by the Echocardiography Core Laboratory showed no evidence of any structural damage to the right ventricular chamber, tricuspid or pulmonary valves, or cordae or papillary muscles.

#### Effectiveness:

- **Right Ventricular Function**  
There were 21 patients who had paired echocardiographic images for analysis of right ventricular function. The majority of these patients showed global (versus regional) dysfunction prior to use of the Impella RP device. In 90% of the patients (19/21), there was either an improvement or maintenance of right ventricular function post device placement, as shown in Figure 6.5.

**Figure 6.5** Right ventricular function changes from baseline to 30 days or discharge

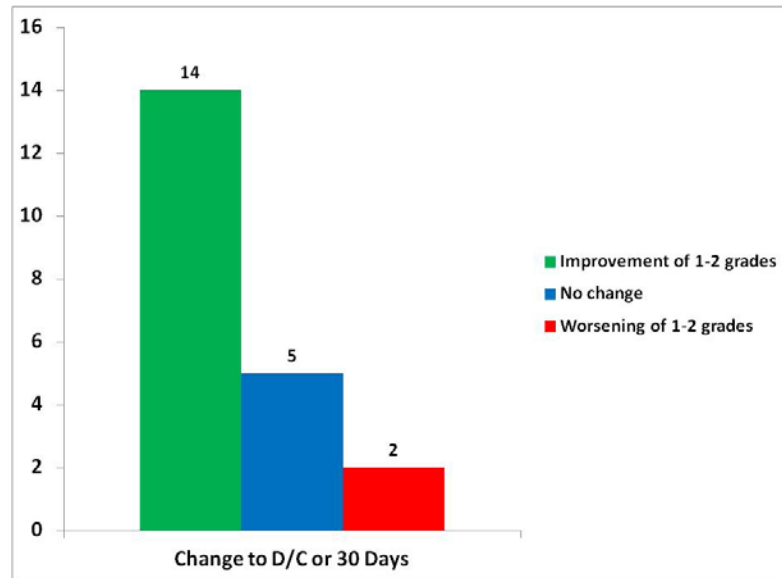

Device Malfunctions:

During the RECOVER RIGHT trial, the clinical investigators reported seven (7) device malfunctions in 7 different patients: 5 were related to the Impella RP pump, one to the AIC and one to the off the shelf introducer sheath. Only one affected patient had a device related AE, which was related to the initial insertion of the Impella RP pump, which ultimately was successfully delivered for support.

**TRIAL CONCLUSIONS**

Safety:

The nature and types of risks associated with the Impella RP System are consistent with those expected in the device treatment of this very sick patient population. Successful percutaneous insertion was achieved in 97% of the patients. The number of device related AEs was low.

Effectiveness:

In the cohorts studied, use of the Impella RP System to provide percutaneous hemodynamic support for right heart failure had a high survival rate. The 30-day survival rate in the 30 patients treated with the Impella RP System was 73%, a substantial improvement over expected survival for medically treated patients. Additional benefits relating to supplementation of right heart output, hemodynamic stability, unloading of the RV, and RV recovery or bridge to another therapy were seen in this small trial. Percutaneous insertion and removal allowed by the Impella RP design resulted in a very low incidence of bleeding and vascular complications. Support durations were relatively short, ranging from 13 hours to 8 days.

Risk Benefit:

The positive survival and hemodynamic benefits associated with use of the Impella RP System, combined with the acceptable incidence of adverse events for the patient population being treated, suggest the probable benefits of Impella RP use in the treatment of acute right or decompensation heart failure outweigh its risks. This benefit-risk determination is also acceptable when taking into account the

risks and probable benefits associated with alternative device therapies and the high morbidity and mortality associated with right heart failure, if left untreated.

Overall Summary:

RECOVER RIGHT was the first study of a percutaneous RVAD in patients with RVF refractory to medical treatment who had very limited therapeutic options. In the studied patient population, the use of the Impella RP device provided adequate circulatory support to reverse shock and to restore normal hemodynamic parameters, and achieved an overall survival rate of 73% at 30 days or discharge (whichever is longer) or to a long term therapy. The Impella RP device had a reasonable overall safety profile, with reliable percutaneous insertion and a low incidence of bleeding and vascular complications.

Therefore, it is reasonable to conclude that the probable benefit to health from using the device for the target population outweighs the risk of illness or injury, taking into account the probable risks and benefits of currently available devices or alternative forms of treatment when used as indicated in accordance with the directions for use.

## 7 AUTOMATED IMPELLA® CONTROLLER ALARMS



<b>ALARMS OVERVIEW .....</b>	<b>7.1</b>
Alarm Levels .....	7.1
Alarm Display .....	7.2
Mute Alarm Function .....	7.2
<b>ALARM MESSAGE SUMMARY .....</b>	<b>7.3</b>

## ALARMS OVERVIEW

The Automated Impella® Controller monitors various functions to determine whether specific operational parameters are within expected limits. When a parameter goes outside of its specified limits, the Automated Impella® Controller sounds an alarm tone and displays an alarm message that can be viewed on the display screen on the front of the controller. The alarm tone indicates the severity of the alarm. The alarm message on the display screen is color-coded for severity and provides details on the cause of the alarm and how to resolve the alarm. After muting an alarm, if another alarm occurs it will only be heard and displayed if it is a higher priority alarm than the one that was muted.

### ALARM LEVELS

Alarms are divided into three levels of severity:

- Advisory (white)
- Serious (yellow)
- Critical (red)

**Table 6.1 Alarm Levels**

Category	Description	Audible Indicator*	Visual Indicator
Advisory	Notification	1 beep every 5 minutes	Alarm header on white background
Serious	May become harmful or life-threatening if not addressed immediately	3 beeps every 15 seconds	Alarm header on yellow background
Critical	Immediately harmful or life-threatening	10 beeps every 6.7 seconds	Alarm header on red background

\* Sound pressure of audible alarm indicators is >80 dBA

For some alarms, there is a short delay between the triggered event and the audible annunciation and visual display of the alarm. (For more information, refer to the “Alarm Delay Information” discussion in section 7 of this manual.)

## ALARM DISPLAY

The alarm window is located in the upper left region of the display screen on the front of the Automated Impella® Controller (see Figure 7.1). Alarms are listed in order of priority, with the highest priority alarm at the top. Up to three alarms may be displayed at one time. The colored background behind the highest priority alarm will alternate between two shades of that color. The white panel displayed to the right of the alarm header contains instructions for resolving the alarm condition. The instructions should be followed in the order given.

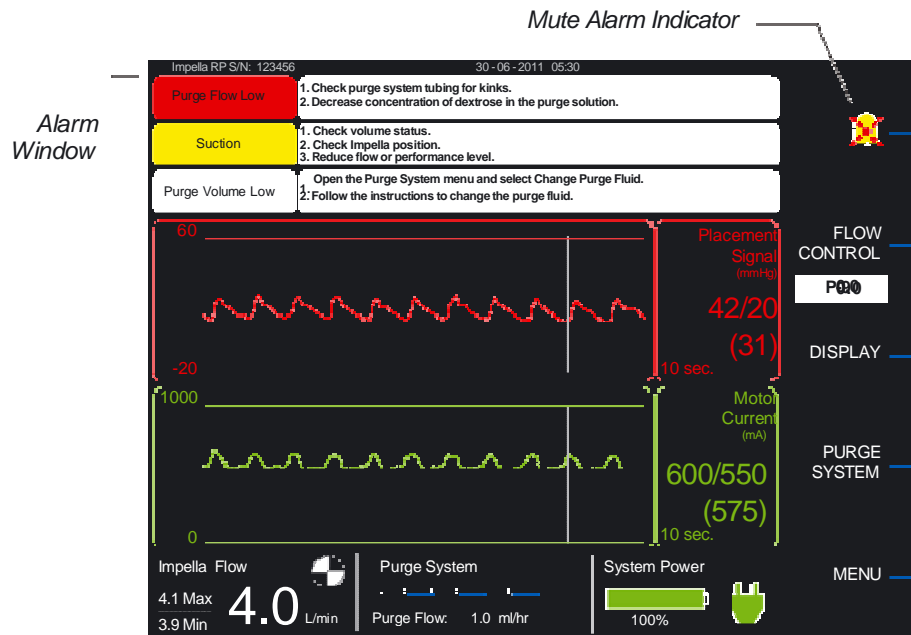

Figure 7.1 Alarm Window

### Alarms That Resolve On Their Own

The audible indicator will shut off if an alarm condition is resolved before you press **MUTE ALARM**. The visual message, however, will continue to be displayed, with the alarm header on a gray background, for 20 minutes or until you press **MUTE ALARM**. This allows you to identify the alarm that occurred.

## MUTE ALARM FUNCTION

Pressing the **MUTE ALARM** button on the upper right of the Automated Impella® Controller display screen will silence the audible alarm indicator for 2 minutes (for red or yellow alarms) or 5 minutes (for white advisory alarms). When an alarm is silenced, the words “MUTE ALARM” next to the button are replaced by the mute alarm indicator, a crossed-out bell icon (as shown in Figure 7.1).

## ALARM HISTORY SCREEN

The alarm history screen may be accessed through the **MENU**. This screen contains a log of the alarms that occurred during the case. This log is not maintained when the Automated Impella® Controller is powered down or after a power failure. The controller does, however, maintain a long-term log that is saved after the Automated Impella® Controller is powered down or after a power failure and this information may be downloaded by Abiomed personnel.



## ALARM MESSAGE SUMMARY

Table 7.2 briefly describes all of the alarm messages that may appear on the Automated Impella® Controller when used with the Impella® RP Catheter.

**Table 7.2 Automated Impella® Controller Alarm Messages**

Severity Alarm Header	Action	Cause
<b>Impella Stopped</b>	<ol style="list-style-type: none"> <li>Restart Impella.</li> <li>Replace Impella after 3rd unsuccessful restart attempt.</li> </ol>	There may be a mechanical or electrical problem in the Impella® RP Catheter.
<b>Impella Stopped Controller Failure</b>	Switch to backup controller.	There is a problem with the controller electronics.
<b>Impella Stopped</b>	<ol style="list-style-type: none"> <li>Replace white connector cable.</li> <li>Switch to backup controller.</li> <li>Replace Impella Catheter.</li> </ol>	There is a problem with the electronics.
<b>Controller Failure</b>	Switch to backup controller.	There is a problem with the controller electronics.
<b>Impella Disconnected</b>	<ol style="list-style-type: none"> <li>Check cable connection to console.</li> <li>Check Impella connection to cable.</li> </ol>	Running Impella® RP Catheter disconnected.
<b>Emergency Shutdown Imminent</b>	Release ON/OFF push button.	Power switch pressed for 15 seconds while Impella® RP Catheter still connected.
<b>Controller Failure</b>	The purge system has stopped. Switch to backup controller.	The controller has detected a purge pressure sensor defect and has stopped the purge system.
<b>Battery Failure</b>	<ol style="list-style-type: none"> <li>Plug controller into AC power.</li> <li>Press switch located on the underside of the controller.</li> <li>Switch to backup controller.</li> </ol>	A battery switch is turned off or there is a malfunction of the switch.
<b>Battery Temperature High</b>	Switch to backup controller.	Battery temperature is greater than 60°C.
<b>Battery Critically Low</b>	Plug controller into AC power.	Battery power has 15% remaining capacity.
<b>Battery Failure</b>	Plug controller into AC power.	One of the batteries has failed.
<b>Air in Purge System</b>	The purge system has stopped. Initiate the De-air Tool and follow instructions to remove the air from the system.	There is air in the purge tubing.

Critical Alarms

**Table 7.2 Automated Impella® Controller Alarm Messages (continued)**

Severity Alarm Header	Action	Cause
<b>Purge System Failure</b>	<ol style="list-style-type: none"> <li>1. Replace purge cassette.</li> <li>2. Switch to backup controller.</li> </ol>	There is a problem with the purger unit driver.
<b>Impella Stopped Reverse Flow</b>	Restart Impella, or remove Impella from ventricle.	Impella® RP Catheter is not running; possible reverse flow through Impella® RP Catheter.
<b>Reverse Flow</b>	Check for high afterload pressure.	Reverse flow detected at high motor speed.
<b>Impella Failure</b>	Replace Impella.	There is a problem with the Impella® RP Catheter motor.
<b>Impella Stopped Motor Current High</b>	<ol style="list-style-type: none"> <li>1. Restart Impella.</li> <li>2. Replace Impella after 3rd unsuccessful restart attempt.</li> </ol>	There is a problem with the Impella® RP Catheter motor.
<b>Complete Procedure</b>	<ol style="list-style-type: none"> <li>1. Follow the steps on the screen or</li> <li>2. Exit the procedure</li> </ol>	The Complete Procedure serious alarm (yellow; see next page) is active and the user has not responded for an additional 2 minutes.
<b>Purge System Open</b>	<ol style="list-style-type: none"> <li>1. Check the purge system tubing for open connections or leaks.</li> <li>2. Replace purge cassette.</li> </ol>	Purge pressure has dropped below 100 mmHg for 20 seconds or longer.
<b>Purge Pressure Low</b>	<ol style="list-style-type: none"> <li>1. Check purge system tubing for leaks.</li> <li>2. Increase concentration of dextrose in the purge solution.</li> <li>3. Replace purge cassette.</li> </ol>	Purge pressure has dropped below 300 mmHg with the purge flow $\geq 30$ mL/hr for 30 seconds or longer.
<b>Purge System Blocked</b>	<ol style="list-style-type: none"> <li>1. Check all purge system tubing for kinks or blockages.</li> <li>2. Decrease concentration of dextrose in the purge solution.</li> </ol>	<p>Purge flow has dropped below 1 mL /hr.</p> <p>Kinked or blocked purge connecting tube.</p> <p>Kinked or blocked purge lumen in Impella® RP Catheter.</p>
<b>Purge Flow Low</b>	<ol style="list-style-type: none"> <li>1. Check purge system tubing for kinks.</li> <li>2. Decrease concentration of dextrose in the purge solution.</li> </ol>	Purge pressure is $\geq 1100$ mmHg with the purge flow $< 2$ mL/hr.
<b>Purge Line Click-On Not Detected</b>	Check the purge line click-on and make sure it is fully inserted.	The controller is not detecting that the purge pressure transmitter is clicked into the front of the controller.

**Critical Alarms**

Table 7.2 Automated Impella® Controller Alarm Messages (continued)

Severity Alarm Header	Action	Cause
<b>Complete Procedure</b>	<ol style="list-style-type: none"> <li>1. Follow the steps on the screen or</li> <li>2. Exit the procedure</li> </ol>	User has not responded to a de-air or purge procedure screen for more than 1 minute or a transfer to standard configuration screen for more than 5 minutes.
<b>Controller Error</b>	Switch to backup controller.	There is a problem with the controller electronics.
<b>Impella Defective</b>	Do not use Impella. Replace Impella.	There is a problem with the Impella® RP Catheter electronics.
<b>Suction</b>	<ol style="list-style-type: none"> <li>1. Check left side filling and volume status.</li> <li>2. Check Impella position.</li> <li>3. Reduce flow or performance level.</li> </ol>	Suction is detected.
<b>Battery Temperature High</b>	<ol style="list-style-type: none"> <li>1. Check controller for blocked air vents.</li> <li>2. Switch to backup controller.</li> </ol>	Battery temperature is greater than 50°C and less than or equal to 60°C.
<b>Impella Sensor Failure</b>	Placement monitoring is suspended. <ol style="list-style-type: none"> <li>1. Monitor patient hemodynamics.</li> <li>2. Monitor Impella position with imaging.</li> </ol>	There is a problem with the Impella® RP Catheter sensor signal.
<b>Battery Level Low</b>	Plug controller into AC power.	Battery power has 50% remaining capacity.
<b>Battery Comm. Failure</b>	Plug controller into AC power.	Loss of communication to the battery.
<b>Purge Cassette Failure</b>	Replace purge cassette.	There is a problem with the purge cassette software.
<b>Purge Volume Critically Low</b>	<ol style="list-style-type: none"> <li>1. Open the <b>PURGE SYSTEM</b> menu and select Change Purge Fluid.</li> <li>2. Follow the instructions to change the purge fluid</li> </ol>	There are 15 mL (in addition to 5% of the starting bag volume) or fewer remaining in the purge fluid bag.

Serious Alarms

**Table 7.2 Automated Impella® Controller Alarm Messages (continued)**

	<b>Severity Alarm Header</b>	<b>Action</b>	<b>Cause</b>
<b>Advisory Alarms</b>	<b>Impella Flow Reduced</b>	<ol style="list-style-type: none"> <li>1. Check Impella position.</li> <li>2. Check left side filling and volume status.</li> <li>3. Reduce flow setting or performance level.</li> </ol>	Motor speed has been reduced in response to suction.
	<b>Impella Flow High</b>	<p>Unable to achieve set flow rate (or performance level). Check for high afterload pressure.</p>	Reverse flow has been detected and minimum motor speed has been increased to more than target flow (or target performance level)
	<b>Purge Volume Low</b>	<ol style="list-style-type: none"> <li>1. Open <b>PURGE SYSTEM</b> menu and select Change Purge Fluid.</li> <li>2. Follow the instructions to change the purge fluid.</li> </ol>	There are 30 mL (in addition to 5% of the starting bag volume) or fewer remaining in the purge fluid bag.
	<b>Purge Flow Increased</b>	<p>The purge flow has increased by 2.5 mL/hr or more. This is a notification only; no action is required.</p>	Purge flow has increased by $\geq 2.5$ mL/hr.
	<b>Purge Flow Decreased</b>	<p>The purge flow has decreased by 2.5 mL/hr or more. This is a notification only; no action is required.</p>	Purge flow has decreased by $\geq 2.5$ mL/hr.
	<b>Audio Off</b>	<p>The auditory signal for the following alarm has been disabled. &lt;Alarm will be listed here&gt;</p>	User has disabled audio for Impella Sensor Failure, Purge Flow Low, or Purge System Blocked alarm.
	<b>AC Power Disconnected</b>	Controller is running on battery power.	AC power was disconnected.
	<b>Purge Cassette Incompatible</b>	Contact Abiomed Service to update Impella Controller.	Incompatible purge cassette RFID version.

## 8 GENERAL SYSTEM INFORMATION











<b>TERMINOLOGY, ABBREVIATIONS, AND SYMBOLS .....</b>	<b>8.1</b>
Terminology and Abbreviations .....	8.1
Symbols .....	8.1
<b>AUTOMATED IMPELLA® CONTROLLER MECHANICAL SPECIFICATIONS .....</b>	<b>8.3</b>
<b>AUTOMATED IMPELLA® CONTROLLER ELECTRICAL SPECIFICATIONS .....</b>	<b>8.3</b>
<b>EQUIPMENT DESIGN .....</b>	<b>8.4</b>
<b>EQUIPMENT CLASSIFICATIONS .....</b>	<b>8.4</b>
<b>FEDERAL COMMUNICATIONS COMMISSION (FCC) NOTICE .....</b>	<b>8.5</b>
<b>ELECTROMAGNETIC COMPATIBILITY .....</b>	<b>8.5</b>
<b>TRANSPORT BETWEEN HOSPITALS .....</b>	<b>8.10</b>
Guidelines for Patient Transport .....	8.10
Important Transport Considerations .....	8.11
FAA Advisory .....	8.10
<b>TRANSPORT WITHIN THE HOSPITAL .....</b>	<b>8.11</b>
<b>SLAVE MONITOR CONNECTION .....</b>	<b>8.11</b>
<b>ALARM DELAY INFORMATION .....</b>	<b>8.12</b>
<b>PATIENT ENVIRONMENT .....</b>	<b>8.12</b>
<b>WHITE CONNECTOR CABLE .....</b>	<b>8.13</b>
<b>IMPELLA® RP CATHETER PARAMETERS .....</b>	<b>8.13</b>
<b>CLEANING .....</b>	<b>8.14</b>
<b>STORING THE AUTOMATED IMPELLA® CONTROLLER .....</b>	<b>8.14</b>
<b>RETURNING AN IMPELLA® RP CATHETER TO ABIOMED (UNITED STATES) .....</b>	<b>8.14</b>













## TERMINOLOGY, ABBREVIATIONS, AND SYMBOLS

### TERMINOLOGY AND ABBREVIATIONS

<b>Catheter serial number</b>	Identification number of the Impella® RP Catheter; stated on the package label, on the blue Impella® plug, and the Automated Impella® Controller display screen
<b>Dextrose and Glucose</b>	The terms “dextrose” and “glucose” are used interchangeably to refer to the solution used as purge fluid for the Impella® RP System
<b>Hz</b>	Hertz
<b>Motor housing</b>	Enclosure of the Impella® RP Catheter motor
<b>Pump</b>	Central delivery unit of the Impella® RP Catheter, consisting of the motor, motor housing, cannula with inlet and outlet, and pigtail at the tip
<b>Purge pressure</b>	Pressure present in the Impella® RP Catheter and in the infusion line
<b>Purge system</b>	Impella® purge cassette used for rinsing the Impella® RP Catheter
<b>Retrograde flow</b>	Reverse flow through the cannula when the Impella® RP Catheter is at a standstill (eg, regurgitation)
<b>V</b>	Volt
<b>VA</b>	Volt ampere (Watt)

### SYMBOLS

	Caution; consult instructions for use
	Defibrillator-proof type CF equipment
	Keep dry
	Storage temperature (eg, 10°C to 30°C)
	Declares conformity with directive 93/42/EEC for medical devices
	Date of manufacture (eg, October 1, 2014)
	Protect from sunlight
	Symbol for lot designation; the manufacturer's lot designation must be stated after the LOT symbol

<b>REF 123456</b>	Abiomed part number (eg, part number 123456)
<b>SN 123456</b>	Manufacturer's serial number (eg, serial number 123456)
<b>Non Sterile!</b>	The product is not sterile
 <b>2016-06-01</b>	Use-by date (eg, use before June 1, 2016)
	Do not reuse
	Sterilized using ethylene oxide
	Electric scrap; must be disposed of separately. Must not be disposed of as domestic waste.
	Protective Earth
	ON / OFF
	Alternating current (AC) only
	Equipotentiality
	Fuse
	Non-ionizing electromagnetic radiation
	USB port
	CAT 5 Port (Ethernet)

## AUTOMATED IMPELLA® CONTROLLER MECHANICAL SPECIFICATIONS

Parameter	Specification
<b>Temperature</b>	Operating: 10°C to 40°C (50°F to 104°F)
	Storage: -15°C to 50°C (5°F to 122°F)
<b>Relative Humidity</b>	Operating: 95%
	Storage: 95%
<b>Atmospheric Pressure</b>	Operating: 8000 ft (750 hPa) to -1000 ft (1050 hPa)
	Storage: 18,000 ft (500 hPa) to -1000 ft (1050 hPa)
<b>Dimensions</b>	Height: 351 mm (13.8 in)
	Width: 443 mm (17.4 in)
	Depth: 236 mm (9.3 in)
<b>Dimensions – Packaged</b>	Height: 508 mm (20.0 in)
	Width: 559 mm (22.0 in)
	Depth: 406 mm (15.0 in)
<b>Weight</b>	Maximum: 11.8 kg (26.1 lbs)
<b>Weight – Packaged</b>	Maximum: 13.6 kg (30 lbs)
<b>Maintenance and repair interval</b>	12 months (Work must be performed by technicians authorized by Abiomed)

## AUTOMATED IMPELLA® CONTROLLER ELECTRICAL SPECIFICATIONS

<b>AC operation</b>	100-230 V AC (nominal); 47-63 Hz; 1.1 A
<b>Internal battery operation</b>	14.4 V DC (nominal); lithium ion
<b>Characteristic values</b>	
Max. power consumption under load	120 VA
9.7 fuses	2 Amp. 250 V. 5 mm x 20 mm, slow-blow fuses
Running time without AC power with fully charged batteries	At least 60 minutes (charging duration of at least 5 hours)
<b>Electrical system</b>	Installation in accordance with pertinent regulations is required for use in medical facilities (e.g., IEC stipulations).



## EQUIPMENT DESIGN

The Automated Impella® Controller conforms to the applicable requirements of the following standards:

- IEC 60601-1 (2005/01/01) Ed:3 Medical Electrical Equipment Part 1: General Requirements for Basic Safety and Essential Performance
- CSA C22.2#60601-1 (2008) Ed:3 Medical Electrical Equipment Part 1: General Requirements for Basic Safety and Essential Performance
- CENELEC EN60601-1 (2006) Medical Electrical Equipment Part 1: General Requirements for Basic Safety and Essential Performance. Included when concurrent with IEC 60601
- AAMI ES60601-1 (2005) Medical Electrical Equipment Part 1: General Requirements for Basic Safety and Essential Performance
- UL 60601-1 (2003), +Revision (2006) 1st Edition Medical Electrical Equipment, Part 1: General Requirements for Safety
- CAN/CSA C22.2 No 601.1-M90 (1990; Reaffirmed 2005) + Amendment 2 (2006), Medical Electrical Equipment, Part 1: General Requirements for Safety
- IEC 60601-1 (1998) 2nd Edition Medical Electrical Equipment Part 1: General Requirements for Safety + (Amd. 1-1991) (CENELEC EN 60601-1: 1990) + (Amd. 2-1995) (Corrigendum-1995)
- IEC 60601-1-1 (2000), 2nd Edition Medical Electrical Equipment, Part 1-1: General Requirements for Safety – Collateral Standard: Safety Requirements for Medical Electrical Equipment
- IEC 60601-1-4 (2000), Edition 1.1 Consolidated Edition, Medical Electrical Equipment Part 1-4: General Requirements for Safety – Collateral Standard: Programmable Electrical Medical Systems
- IEC 60601-1-2:2007 Edition 3, Medical Electrical Equipment – Part 1-2: General Requirements for Basic Safety and Essential Performance – Collateral Standard: Electromagnetic Compatibility – Requirements and Tests
- IEC 60601-1-2 (2001), Medical Electrical Equipment, Part 1-2: General Requirements for Safety – Collateral Standard: Electromagnetic Compatibility – Requirements and Tests
- IEC 60601-1-6 (2010) 3rd Edition Medical Electrical Equipment – Part 1-6: General Requirements for Safety – Collateral Standard: Usability
- IEC 60601-1-6 (2004) Medical Electrical Equipment – Part 1-6: General Requirements for Safety – Collateral Standard: Usability
- IEC 60601-1-8 (2006) 2nd Edition Medical Electrical Equipment – Part 1-8: General Requirements for Basic Safety and Essential Performance – General Requirements, Tests and Guidance for Alarm Systems in Medical Electrical Equipment and Medical Electrical Systems
- IEC 60601-1-8 (2003) Medical Electrical Equipment – Part 1-8: General Requirements for Safety – Collateral Standard: General Requirements, Tests and Guidance for Alarm Systems in Medical Electrical Equipment and Medical Electrical Systems

## EQUIPMENT CLASSIFICATIONS

<b>Type of protection against electric shock</b>	IEC 60601-1: Class I degree of protection: CF defibrillation-proof and internally powered. Relies not only on basic insulation against shock but also includes additional protection. Accomplished by providing means for connecting the equipment to the protective earth conductor of the fixed wiring of the installation in a way that prevents accessible metal parts from becoming live if basic insulation fails.
<b>Degree of protection against electric shock for Automated Impella® Controller</b>	Class I Equipment
<b>Mode of operation</b>	Continuous
<b>Degree of protection against explosion hazard</b>	Not suitable for use in the presence of a flammable anesthetic mixture with air or with oxygen or nitrous oxide. Also not suitable for use in an oxygen-enriched atmosphere.
<b>Degree of protection against harmful ingress of water</b>	IEC 60529: IPX1 protected against dripping water.

## FEDERAL COMMUNICATIONS COMMISSION (FCC) NOTICE

This device complies with Part 15 of the FCC Rules. Operation is subject to the following two conditions:

1. This device may not cause harmful interference.
2. This device must accept any interference received, including interference that may cause undesired operation.

Changes or modifications not expressly approved by Abiomed, Inc. could void the user's authority to operate this device.

## ELECTROMAGNETIC COMPATIBILITY



Medical electrical equipment needs special precautions regarding EMC and needs to be installed and put into service according to the electromagnetic compatibility (EMC) information provided in this document.



Portable and mobile RF communications equipment can affect medical electrical equipment.



The equipment or system should not be used adjacent to or stacked with other equipment. If adjacent or stacked use is necessary, the equipment or system should be observed to verify normal operation in the configuration in which it will be used.



Use of cables, other than those sold by Abiomed, may result in increased emissions or decreased immunity of the Automated Impella® Controller.



The Automated Impella® Controller uses RFID (radio frequency identification) to identify and communicate with the purge cassette. Other equipment may interfere with the Automated Impella® Controller even if that other equipment complies with CISPR emission requirements.



During transport, the Automated Impella® Controller may be exposed to stronger electromagnetic disturbance than during in-hospital use. Strong electromagnetic disturbance may cause the Automated Impella® Controller to display soft button menu selections that were not selected by the user. Operators should be aware that, under these conditions, the operating parameters are not affected. No user intervention is required. Monitor Impella® RP Catheter flow and patient hemodynamics to confirm normal operation. The condition will resolve itself once the Automated Impella® Controller is no longer exposed to the disturbance.

**NOTE:** The EMC tables and other guidelines that are included in this manual provide information to the customer or user that is essential in determining the suitability of the equipment or system for the electromagnetic environment of use, and in managing the electromagnetic environment of use permit the equipment or system to perform to its intended use without disturbing other equipment and systems or non-medical electrical equipment.

**TABLE 201**

### Guidance and Manufacturer's Declaration – Emissions, All Equipment and Systems

The Automated Impella® Controller is intended for use in the electromagnetic environment specified below. The customer or user of the Automated Impella® Controller should ensure that it is used in such an environment.

#### Emissions Test

#### Compliance Electromagnetic Enforcement – Guidance

RF Emissions CISPR 11	Group 1 Class A	The Automated Impella® Controller uses RF energy only for its internal function. Therefore, its RF emissions are very low and are not likely to cause any interference in nearby electronic equipment.
Harmonics IEC 61000-3-2	Class A	The Automated Impella® Controller is suitable for use in all establishments other than domestic and those directly connected to the public low-voltage power supply network that supplies buildings used for domestic purposes.
Flicker IEC 61000-3-3	Complies	

**TABLE 202**  
**Guidance and Manufacturer's Declaration – Immunity**

The Automated Impella® Controller is intended for use in the electromagnetic environment specified below. The customer or user of the Automated Impella® Controller should ensure that it is used in such an environment.

<b>Immunity Test</b>	<b>IEC 60601 Test Level</b>	<b>Compliance Level</b>	<b>Electromagnetic Environment – Guidance</b>
Electrostatic Discharge (ESD) IEC 61000-4-2	±6 kV contact ±8 kV air	±8 kV contact ±15 kV air	Floors should be wood, concrete, or ceramic tile. If floors are synthetic, the relative humidity should be at least 30%.
Electrical Fast Transient/burst IEC 61000-4-4	±2 kV Mains ±1 kV for input/output lines	±2 kV Mains ±1 kV for input/output lines	Mains power quality should be that of a typical commercial or hospital environment.
Surge IEC 61000-4-5	±1 kV Differential ±2 kV Common	±1 kV Differential ±2 kV Common	Mains power quality should be that of a typical commercial or hospital environment.
Voltage dips, short interruptions and voltage variations on power supply input lines IEC 61000-4-11	> 95% dip for 0.5 cycle 60% dip for 5 cycles 30% dip for 25 cycles > 95% dip for 5 seconds	> 95% dip for 0.5 cycle 60% dip for 5 cycles 30% dip for 25 cycles > 95% dip for 5 seconds	Mains power quality should be that of a typical commercial or hospital environment. If the user of the Automated Impella® Controller requires continued operation during power mains interruptions, it is recommended that the Automated Impella® Controller be powered from an uninterruptible power supply or battery.
Power Frequency 50/60 Hz Magnetic Field IEC 61000-4-8	3 A/m	3 A/m	Power frequency magnetic fields should be that of a typical location in a typical commercial or hospital environment.

**TABLE 203**  
**Guidance and Manufacturer's Declaration – Emissions,**  
**Equipment and Systems that are Life-Supporting**

The Automated Impella® Controller is intended for use in the electromagnetic environment specified below. The customer or user of the Automated Impella® Controller should ensure that it is used in such an environment.

<b>Immunity Test</b>	<b>IEC 60601 Test Level</b>	<b>Compliance Level</b>	<b>Electromagnetic Environment – Guidance</b>
			Portable and mobile RF communications equipment should be separated from the Automated Impella® Controller by no less than the recommended separation distances calculated/listed below:
Conducted RF IEC 61000-4-6	10 Vrms 150 kHz to 80 MHz	10 Vrms	$d = 0.35\sqrt{P}$
Radiated RF IEC 61000-4-3	10 V/m 80 MHz to 2.5 GHz	20 V/m	$d = 0.6\sqrt{P}$ 80 to 800 MHz  $d = 1.2\sqrt{P}$ 800 MHz to 2.5 GHz  Where P is the maximum power rating in watts and d is the recommended separation distance in meters. Field strengths from fixed transmitters, as determined by an electromagnetic site survey(a), should be less than the compliance level in each frequency range.(b) Interference may occur in the vicinity of equipment marked with the following symbol:



NOTE 1: At 80 MHz and 800 MHz, the higher frequency range applies.

NOTE 2: These guidelines may not apply in all situations. Electromagnetic propagation is affected by absorption and reflection from structures, objects, and people.

(a) Field strengths from fixed transmitters, such as base stations for radio (cellular/cordless) telephones and land mobile radios, amateur radio, AM and FM radio broadcast and TV broadcast cannot be predicted theoretically with accuracy. To assess the electromagnetic environment due to fixed RF transmitters, an electromagnetic site survey should be considered. If the measured field strength in the location in which the Automated Impella® Controller is used exceeds the applicable RF compliance level above, the Automated Impella® Controller should be observed to verify normal operation. If abnormal performance is observed, additional measures may be necessary, such as re-orienting or relocating the Automated Impella® Controller.

(b) Over the frequency range 150 kHz to 80 MHz, field strengths should be less than 10 V/m

TABLE 205

### Recommended Separation Distances Between Portable and Mobile RF Communications Equipment and the Automated Impella® Controller, Equipment and Systems that are Life-Supporting

The Automated Impella® Controller is intended for use in the electromagnetic environment in which radiated disturbances are controlled. The customer or user of the Automated Impella® Controller can help prevent electromagnetic interference by maintaining a minimum distance between portable and mobile RF communications equipment and the Automated Impella® Controller as recommended below, according to the maximum output power of the communications equipment.

Rated Maximum Output Output Power of Transmitter (Watts)	Recommended Separation Distances for the Automated Impella® Controller (m)		
	150 KHz to 80 MHz $d = 0.35\sqrt{P}$	80 to 800 MHz $d = 0.6\sqrt{P}$	800 MHz to 2.5 GHz $d = 1.2\sqrt{P}$
0.01	0.04	0.06	0.12
0.1	0.11	0.19	0.38
1	0.35	0.6	1.2
10	1.11	1.9	3.8
100	3.5	6.0	12

For transmitters rated at a maximum output power not listed above, the recommended separation distance (d) in meters (m) can be determined using the equation applicable to the frequency of the transmitter, where P is the maximum output power rating of the transmitter in watts (W) according to the transmitter manufacturer.

NOTE 1: At 80 MHz and 800 MHz, the separation distance for the higher frequency range applies.

NOTE 2: These guidelines may not apply in all situations. Electromagnetic propagation is affected by absorption and reflection from structures, objects, and people.

#### RFID Transmitter / Receiver Specifications

Frequency	13.56 MHz
Receiver bandwidth	14 kHz
Effective radiated power	30 nW
Modulation	ASK

## TRANSPORT BETWEEN HOSPITALS



During transport, the Automated Impella® Controller may be exposed to stronger electromagnetic disturbance than during in-hospital use. Strong electromagnetic disturbance may cause the Automated Impella® Controller to display soft button menu selections that were not selected by the user. Operators should be aware that, under these conditions, the operating parameters are not affected. No user intervention is required. Monitor Impella® Catheter flow and patient hemodynamics to confirm normal operation. The condition will resolve itself once the Automated Impella® Controller is no longer exposed to the disturbance.

### GUIDELINES FOR PATIENT TRANSPORT

Intra-hospital transport may be required if a patient requires additional resources and specialized teams located at another hospital. The patient may be transferred to such a location using the Automated Impella® Controller for hospital-to-hospital transport via ambulance, helicopter, or fixed-wing aircraft.

Maintaining optimal patient hemodynamic status and correct Impella® Catheter position are two key factors in managing patients supported with the Impella® System during transport. Steps should be taken to eliminate or minimize any aspect of the transport that might adversely affect these factors.

The Automated Impella® Controller is designed to operate for 60 minutes on battery power. Transport teams should take this into consideration when planning the transport. If the total transport time is expected to include more than 60 minutes during which the system will be disconnected from AC power, arrangements should be made to use a vehicle with a built-in DC to AC power inverter.

### IMPORTANT TRANSPORT CONSIDERATIONS

1. Planning is critical to success. Abiomed representatives can help with planning for transport. They can be contacted 24 hours a day at 1-800-422-8666.
2. The Automated Impella® Controller should be fully charged prior to transport. Keep the Automated Impella® Controller connected to AC power (or an AC inverter) whenever possible.
3. Do not stress the connector cable from the controller to the Impella® Catheter. Such tension could move the catheter out of correct position and compromise patient circulatory support.
4. Carefully monitor purge pressures during changes in altitude.
5. The Automated Impella® Controller should be positioned to allow easy access to the display screen and soft buttons to view alarms and make any necessary changes.
6. Maintain ACTs between 160 and 180 or at the level recommended by the physician responsible for the patient.

## FAA ADVISORY

The Automated Impella® Controller has been subjected to, and passed, the EMC/EMI tests as specified in IEC 60601-1-2 (General requirements for safety—Collateral standard: Electromagnetic compatibility—Requirements and tests). The Automated Impella® Controller does not, however, meet the requirements for conducted emissions of RTCA/DO-160G section 21.4 and has not been tested for radiated emissions per RTCA/DO-160G section 21.5. Abiomed recommends that air transport carriers follow the guidance FAA Advisory Circular AC No: 91-21.1B. Section 8-a of FAA Advisory Circular AC No: 91-21.1B states:

“Equipment tested and found to exceed the section 21, Category M, emission levels are required to be evaluated in the operator’s M-PED selected model aircraft for electromagnetic interference (EMI) and radio frequency interference (RFI). All navigation, communication, engine, and light control systems will be operating in the selected aircraft during the evaluation.”

---

## TRANSPORT WITHIN THE HOSPITAL

Patients supported with the Impella® System may require transport within the hospital.

Considerations for transport within the hospital:

- The Automated Impella® Controller and Impella® Catheter are designed to operate on battery power for at least 1 hour.
- Confirm that the battery capacity displayed on the controller is 100%.
- If transport time might be longer than 1 hour, bring an extension cord or confirm that you will be able to connect the controller to AC power once you arrive at your destination.
- When rolling the Automated Impella® Controller cart across a threshold, firmly grasp the cart handle and pull it over the threshold.
- Pay close attention to all system components and connections when rolling the Automated Impella® Controller cart over thresholds and through elevator doors.
- Do not stress the connector cable from the controller to the Impella® Catheter.

---

## SLAVE MONITOR CONNECTION

If equipped with a VGA connector, the Automated Impella® Controller can be connected to a monitor to display the information from the controller to another screen at a resolution of 800 x 600 pixels. The connection between the controller and the monitor can be made using a cable up to 20 feet in length



## ALARM DELAY INFORMATION

For some Automated Impella® Controller alarms, there is a short delay between the triggered event and the audible annunciation and visual display of the alarm.

Impella Defective	8 second delay
Controller Error	12±3 second delay
Emergency Shutdown Imminent	15±1 second delay
Battery Failure	28±8 second delay
Controller Failure	38±8 second delay
Battery Comm. Failure	40±10 second delay
Purge System Blocked	75±45 second delay

## PATIENT ENVIRONMENT

The Automated Impella® Controller and the components of the Impella® RP System are approved for use within the patient environment defined in IEC 60601-1-1 and in the figure below.

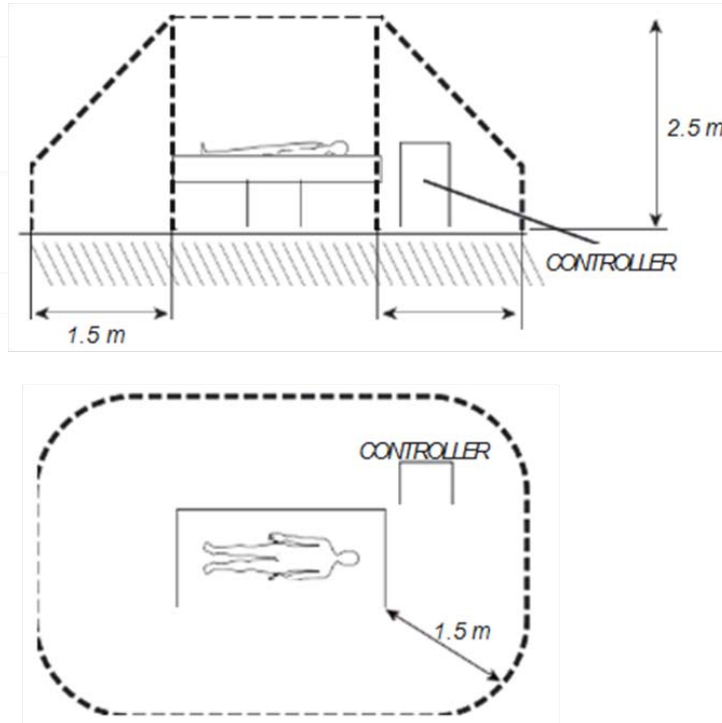

**Figure 8.1** Automated Impella® Controller Patient Environment

## WHITE CONNECTOR CABLE

Length	2.5 m
Service life	Single use only

## IMPELLA® RP CATHETER PARAMETERS

Speed range	0 to 33,000 rpm
Power consumption	Less than 23 W
Voltage	Max. 20 V DC
Flow-Maximum	4.0 L/min
<b>Purging the Impella® RP Catheter</b>	
Recommended purge fluid	20% dextrose solution with heparin concentration of 50 IU per mL
Dextrose concentration	5% to 40%
Purge pressure	300 to 1100 mmHg
Purge flow	2 to 30 mL/hr
<b>Maximum duration of use</b>	
US	Up to 14 days
<b>Dimensions of Impella® RP Catheter</b>	
Length of invasive portion (without catheter)	Approx 238 mm
Diameter	Max. 7.6 mm
Classification per DIN EN 60601-1	Protection class I, degree of protection: CF (Automated Impella® Controller and Impella® RP Catheter)
Classification per directive 93/42/EEC	Class III
Latex content	Not made with natural rubber latex

### Latex

*The Automated Impella® Controller and Impella® RP Catheter, including all accessories, are not made with natural rubber latex.*

### **Alcohol Warning**

*Do NOT clean the Impella® Catheter infusion filter or pressure reservoir with alcohol and AVOID exposing these components to products containing alcohol.*

### **Storing the Controller**

*To keep the Automated Impella® Controller battery charged, the controller should be plugged into an AC outlet. When plugged into an AC outlet, the controller battery will charge whether the controller is on or off.*

## **CLEANING**

- Clean the Automated Impella® Controller keypad and display with either 70% isopropyl alcohol or soap and water. (NOTE: Be aware that soft buttons may be activated when you spray or wipe the display.)
- Clean the Automated Impella® Controller housing with mild detergent.
- Do not allow any fluids to enter the connector sockets.
- Clean the connector cable with 70% isopropyl alcohol.

## **STORING THE AUTOMATED IMPELLA® CONTROLLER**



The Li-Ion batteries must be charged for 5 hours prior to system operation in order to meet the runtime requirement of 1 hour. Failure to do so will yield a shorter runtime. After being unplugged, the Automated Impella® Controller will operate for at least 60 minutes after the batteries have been fully charged.

- Place the Automated Impella® Controller on a horizontal surface to prevent falling.
- Connect the AC power cord to an AC outlet.
- The battery may be destroyed if the Automated Impella® Controller is stored with a depleted battery.

## **RETURNING AN IMPELLA® RP CATHETER TO ABIOMED (UNITED STATES)**

To return an Impella® RP Catheter to Abiomed, contact your local Clinical Consultant for an Abiomed-approved return kit.\* The kit includes instructions for returning the Impella® RP Catheter to Abiomed.

*\* Only available in the United States*



## APPENDIX A: AUTOMATED IMPELLA® CONTROLLER MENU STRUCTURE.. A.1

Overview .....	A.1
MUTE ALARM .....	A.1
FLOW CONTROL .....	A.1
DISPLAY .....	A.2
PURGE SYSTEM .....	A.2
MENU .....	A.3

## APPENDIX A: AUTOMATED IMPELLA® CONTROLLER MENU STRUCTURE

### OVERVIEW

The soft buttons on the Automated Impella® Controller provide access to the controller menu structure. The menu structure has 5 main elements:

- **MUTE ALARM**
- **FLOW CONTROL**
- **DISPLAY**
- **PURGE SYSTEM**
- **MENU**

This Appendix provides an overview of the Automated Impella® Controller menu structure. Many of the functions accessed through this menu structure are also discussed elsewhere in this manual.

### MUTE ALARM

The **MUTE ALARM** soft button mutes (silences) active alarms. It does not open another menu.

When you press **MUTE ALARM**, a bell icon with an X through it replaces the words "MUTE ALARM" in the upper right of the display screen. If no alarms are active, no bell icon is displayed. When you press **MUTE ALARM** it acknowledges all active alarms and silences the audible alarm indicator for 2 minutes (for red or yellow alarms) or 5 minutes (for white alarms). (Refer to section 6 of this manual for more information about Automated Impella® Controller Alarms.)

### FLOW CONTROL

The **FLOW CONTROL** soft button opens the performance level icon enabling you to select the desired performance level. The procedure for setting performance level is described in "Positioning and Starting the Impella® RP Catheter" in section 5.

## DISPLAY

The **DISPLAY** soft button opens a menu that includes the following options for viewing waveforms and navigating to other screen displays:

- **Y-axis Scale**—opens a menu from which you can select a waveform and change its appearance by adjusting the scale of the y-axis.
  - Once the waveform is selected, turn the selector knob clockwise to increase the y-axis scale and counterclockwise to decrease the y-axis scale.
  - Select **OK** to accept the new y-axis scale.
  - Select **Restore** to return to the default y-axis scale.
  - Select **Initial** to set the y-axis to the previously set scale.
  - Select **Center Signal** to center the waveform.
  - Select **Cancel** to exit the tool.
- **Time Scale**—allows you to apply different time scales to the currently displayed waveforms.
- **Center**—automatically centers the motor current waveform and adjusts the range accordingly.
- **Infusion**—opens the infusion history screen. The infusion history screen, which is discussed in section 4 of this manual, shows the volume and the amount of heparin and dextrose delivered. The top entry in the table shows the volume and amount of heparin and dextrose infused from the top of the hour through the current time.
- **Purge**—displays the purge system waveforms and pressure and flow values.
- **Placement**—opens the placement signal / motor current screen (described in section 4 under “Placement Screen”).

## PURGE SYSTEM

The **PURGE SYSTEM** soft button opens a menu that includes the following purge system procedure options:

- **Change Purge Fluid**—starts the procedure to change the purge fluid
- **Change Purge Cassette**—starts the procedure to replace the purge cassette
- **Change Purge System**—starts the procedure to change both the purge fluid and purge cassette
- **De-air Purge System**—starts the de-air procedure

These procedures are described in section 5 of this manual.

## MENU

The **MENU** soft button opens a menu of options related to controller settings, alarm history, repositioning, offset adjustment, and starting a procedure. The menu includes the following options:

- **Settings / Service**

- Service**

- System Information.** Opens the System Information table. This provides information about the software version, IP addresses, current type of Impella Catheter, and current catheter runtime.

- Set Date/Time.** Displays the menu for changing the date and time

- Service Timers.** Displays the Service Timers menu. Console operating time and purge motor operating time are displayed in hours.

- Screen Brightness.** Opens the Screen Brightness selection box. The brightness of the screen display can be set from 50% to 100%. Select **OK** to confirm selection. Select **Cancel** to cancel selection.

- Language.** Opens the Language selection box. Use the selector knob to select German, English, French, Italian, Spanish, or Dutch. The system will immediately change the language on the controller for all displayed text. This language will be used after system restart unless another language is selected.

- Log Export.** Displays the Log Export menu for exporting all logs to a USB stick.

- Disable (Enable) Placement Monitoring.**

- Disable (Enable) Reverse Flow Control.**

- Disable (Enable) Automatic Zero.**

- Disable (Enable) P-Level Suction Control.**

- Disable (Enable) Audio—Impella Sensor Failure.** Allows you to enable or disable audio for the Impella Sensor Failure alarm. This selection is available only if an Impella Sensor Failure alarm is active or the audio has been disabled for this alarm.

- Disable (Enable) Audio—Purge Flow Low/System Blocked.** Allows you to enable or disable audio for the Purge Flow Low or Purge System Blocked alarms. This selection is only available if one of these two alarms is active or the audio has been disabled for one of these alarms.

- **Alarm History**—opens the Alarm History table. This provides a visual display of the chronology of stored alarm messages. The most recently occurring alarm message is displayed at the top of the list. For each message, the date and time it occurred and the alarm message heading is displayed. You can use the selector knob to select individual alarm messages and an explanation for the selected alarm message will be displayed in the failure description box. Press **EXIT** to exit the alarm history analysis.
- **Start Timed Data Recording**—starts the timed data recording function to save real-time operating data for later analysis.
- **Start Manual Zero**—opens the procedure for manually zeroing the differential pressure sensor.
- **Case Start**—begins the case procedure. Case Start is described in section 5 of this manual under "Case Start."

---

# INDEX

**TO BE DEVELOPED**

---





Recovering hearts. Saving lives.™

Clinical support 24 hours per day, 7 days a week:

**1-800-422-8666 (US)**

**+49 (0) 1805 2246633 (EU)**

[www.abiomed.com](http://www.abiomed.com)

**Abiomed, Inc.**  
22 Cherry Hill Drive  
Danvers, Massachusetts 01923 USA  
Voice: 978-777-5410  
Facsimile: 978-777-8411  
Email: [clinical@abiomed.com](mailto:clinical@abiomed.com)

**Abiomed Europe GmbH**  
Neuenhofer Weg 3  
52074 Aachen, Germany  
Voice: +49 (241) 8860-0  
Facsimile: +49 (241) 8860-111  
Email: [europe@abiomed.com](mailto:europe@abiomed.com)