



HAAKE Phoenix II
HAAKE C/DC
HAAKE EK
HAAKE DynaMax

Circulators, Cryostats, Coolers, Sealed Systems

Thermo Scientific Temperature Control Products

HAAKE Phoenix II – HAAKE C/DC – HAAKE EK – HAAKE DynaMax

Thermo Fisher Scientific is an industry leader in laboratories all over the world and continually drives new standards for circulators, cryostats, immersion coolers and water recirculators.

The Thermo Scientific HAAKE Phoenix II range of circulators results from our philosophy to develop and implement advanced technology that is also visually attractive and easy to use.

Phoenix II products incorporate innovative and design-conscious materials such as aluminum, polymers or glass. The simple operation of the HAAKE Phoenix II circulators and their large monitors with easily visible displays demonstrates our dedication to user-friendliness.

Our products are certified according to ISO 9001. All units have the CE-mark.

CFC-free refrigerants have been used for many years as proof of our commitment to the environment.

All units can be recycled easily.

Find out more about the advanced features and flexibility of the HAAKE circulator ranges from Thermo Fisher Scientific in the next few pages.



Your Guide to the Products

In this brochure we have grouped the circulator lines separately and have described them in detail including extensive technical specifications. The ExtraPlus features of the units are included on the last two pages.

Simple to Operate

The menu structure for all digital units enables intuitive operation and is supported by the simple allocation of the individual functions to the operating keys.

Innovative Control

High temperature accuracy and the ability to reach the set temperature quickly even under difficult conditions is made possible by the new Fuzzy-Star control system.

Many Additional Functions

Additional functions such as the Real Temperature Adjustment (RTA), the Fault Identification System (FIS), the External Temperature Control (ETC) and the Turbulence Reduction System (TRS) make operation easier for the user.

Flexible Communication

Connecting the units to PCs or within networks is simple due to a range of different interfaces: RS232C, RS485, I/O, multi-functional port, Profibus.

Extensive Range of Accessories

Insert racks, lift plates, hoses or software are just some of the optional accessories which can be used to adapt the units to suit a wide range of applications.

++ ExtraPlus-Rating ++

The more functions the circulators have, the more ExtraPlus points they get. On page 35 you see which functions related to the points.

Immersion and Bridge Circulators

Introduction HAAKE C/DC-Line	4
Immersion Circulators HAAKE C/DC	5
Introduction HAAKE Phoenix II-Line	6
Bridge Circulators HAAKE Phoenix II	7

Open-bath Circulators

Open-bath Circulators HAAKE C/DC up to 100°C (water) with integral baths.	8
Open-bath Circulators HAAKE C/DC up to 60°C (water) with polyacrylic bath	9
Open-bath Circulators HAAKE C/DC up to 100°C (water) with stainless steel bath.	10 – 11
Open-bath Circulators HAAKE C/DC up to 200°C (water and oil) with stainless steel bath.	12 – 13

Heating Circulators

Heating Circulators HAAKE C/DC.	14 – 15
Open-bath and Heating Circulators HAAKE Phoenix II	16 – 17

Refrigerated Circulators and Cryostats

Refrigerated Circulators HAAKE C/DC	18 – 19
Refrigerated Circulators HAAKE Phoenix II	20 – 21

Cryostats

Cryostats	22 – 24
---------------------	---------

Shaking Waterbath HAAKE SWB25.	25
Flow-through Cooler/Immersion Cooler	26 – 27
Water Recirculators	28 – 29

Tubings/Bath Liquids	30 – 31
HAAKE DynaMax Sealed Systems	32
Pt100 Sensors/Level controller Replenishing Device.	33

Description of Functions	34
ExtraPlus-Rating System	35

Inexpensive circulators with a high power capacity

The HAAKE C/DC circulators are inexpensive units with a high power capacity. These circulators are small, slimline units which can be used for a wide range of standard applications. A powerful pump and a heating capacity of up to 2000 watts enable the safe temperature control of applications up to 200°C. Digital displays with user-preset temperatures are available for simple operation.

There are five different models:

HAAKE C10: Analog unit up to 100°C, 1.5 kW heating capacity

HAAKE DC10: Inexpensive digital unit up to 100°C, 2 kW heating capacity

HAAKE DC30: Digital unit with RS232C up to 200°C, 2 kW heating capacity

HAAKE DL30: Same as DC30, however with 200 mm immersion depth

HAAKE DC50: Same as DC30, however with connection for Pt100 sensor and external control

Highlights

- Powerful pumps with Turbulence Reduction System (TRS)
- Simple operation due to separate display panels for menu selection and temperature (except for C10)
- Microprocessor with PID control (except for C10)
- Resolution of the digital display for the set and actual temperature optionally 0.1 or 0.01°C
- Real Temperature Adjustment (RTA)
- Saving of 3 user-defined fixed temperatures with their respective RTA values
- The reason for a unit fault is shown on the display via the Fault Identification System (FIS)
- RS232C interface (except for C10, DC10), optional RS485 interface with the DC50
- External Temperature Control (ETC) for external systems (for DC50 only)
- Connection for an external Pt100 sensor (for DC50 only)

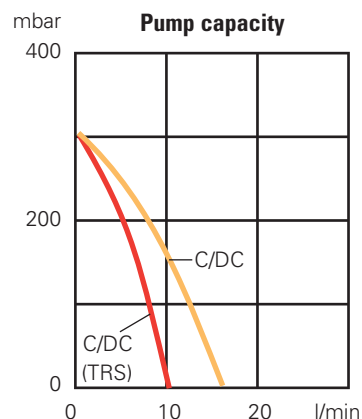

TRS (Turbulence Reduction System))

2-level-switching to avoid turbulence in open baths or to enable careful filling of external systems.

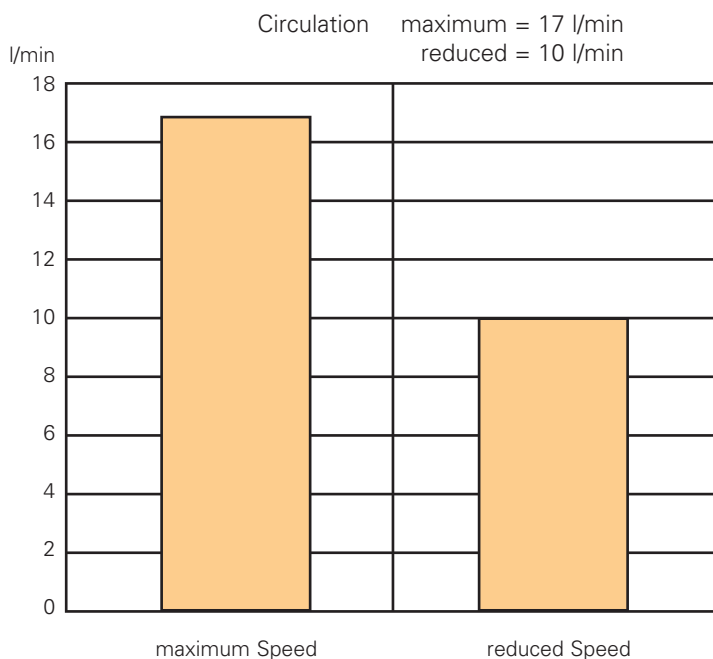

The HAAKE C/DC immersion circulators are used for the temperature control of baths up to 50 liters. They can be attached to bath walls with a thickness of up to 25 mm using a bracket clamp. A pivotal nozzle ensures even mixing and a good temperature distribution within the entire bath. The minimum depth of the bath must be 150 or 200 mm. The TRS feature can be used to avoid turbulence in the open bath.

Comes with

Screw clamp for bath wall thickness up to 25 mm and **pivotal**.

C10: plus **checking thermometer** 0 to 100°C, division 0.5°C

Optional accessories Order-No.

Tap water cooling coil (C10, DC10, DC30 and DC50) **333-0590**

Tap water cooling coil (DL30) **333-0593**

Bath liquids (s. p. 30-31)



Technical specifications acc. to DIN 12876		C10	DC10	DC30	DC50	DL30
Working temperature	°C	25..100	25..100	25..200	25..200	25..200
	with tap water cooling	°C	20..100	20..100	20..200	20..200
	with other cooling	°C	-30..100	-30..100	-50..200	-50..200
Temperature accuracy	+/- K	0.04	0.02	0.01	0.01	0.01
Heater capacity 230V/115V	kW	1.5/1.0	2.0/1.2	2.0/1.2	2.0/1.2	2.0/1.2
Pump: Pressure/Flow rate max.	mbar/l/min	300/17	300/17	300/17	300/17	300/17
Immersion depth from..to	mm	75..145	75..145	85..145	85..145	85..190
Overall dimensions: WxLxH	cm	9.5 x 15 x 32	10 x 16.5 x 32	10 x 16.5 x 32	10 x 16.5 x 32	10 x 16.5 x 37
Net weight	kg	3	3	3.2	3.2	3.6
Total wattage 230V/115V	VA	1550/1050	2050/1250	2050/1250	2050/1250	2050/1550
Order-No. for 230V/50..60Hz		425-1001	426-1001	426-3001	426-5001	427-3001
	for 115V/60Hz	425-1002	426-1002	426-3002	426-5002	427-3002
ExtraPlus-Rating (see page 35)		+	++	+++	++++	+++



HAAKE Phoenix II Series

Innovative materials combined with sophisticated technology and advanced design form the basis of the HAAKE Phoenix II circulators.

The simple operation of the units is ensured by the large graphic display that incorporates plain text dialog and a simple user interface. The Phoenix II circulators come equipped with a powerful pressure and suction pump, feature a heating capacity of up to 3000 W and a maximum bath

temperature of +280°C and are thus ideally suited to meet the extreme technical specifications that many applications require.

HAAKE Phoenix II circulators are available in two versions:

Basic version HAAKE Phoenix II P1 with a 2 kW (230V) heating capacity, up to 250°C.

Full version HAAKE Phoenix II P2 with a 3 kW (230V) heating capacity, up to 280°C and with additional functional features.

Highlights

- Large monitor with plain text display and Fault Identification System (FIS)
- FuzzyStar control with neural adaptation
- Very powerful combined pressure and suction pump with automatic speed recognition and TRS
- Display resolution of 0.01°C
- Flexible interface concept
- Direct value setting at the display via numeric input
- Up to 10 ramp programs with a maximum of 30 segments (for P2)
- 4 savable fixed temperatures
- Real Temperature Adjustment (RTA) for integration in QS systems
- External Temperature Control (ETC) with connection for an external Pt100 sensor as standard
- User can choose from 6 different dialog languages (German, English, French, Italian, Spanish, Japanese)
- Permanent display of date and time
- 3-point calibration function (for P2)
- External analog box (optional)
- Profibus interface (optional)

A more detailed explanation of the individual features and the ExtraPlus-Rating system can be found on page 35.



The units are fitted onto bath vessels with a maximum volume of 100 l.

The bridge can be adjusted to fit widths between 320 and 800 mm and is thus suitable for use with a wide range of different bath sizes.

The powerful combined pressure and suction pump enables a good heat exchange in the bath and the simultaneous temperature control of an external unit.

Comes with

Connections for tubing with 8 and 12 mm i. Ø.

Optional accessories Order-No.

External analog box 333-0685

230V Power supply
for analog box 333-0705

Tubes and Bath liquids (s. p. 30-31)
Immersion cooler (s. p. 26-27)
Pt100-sensors (s. p. 33)

Profibus-interface on request.

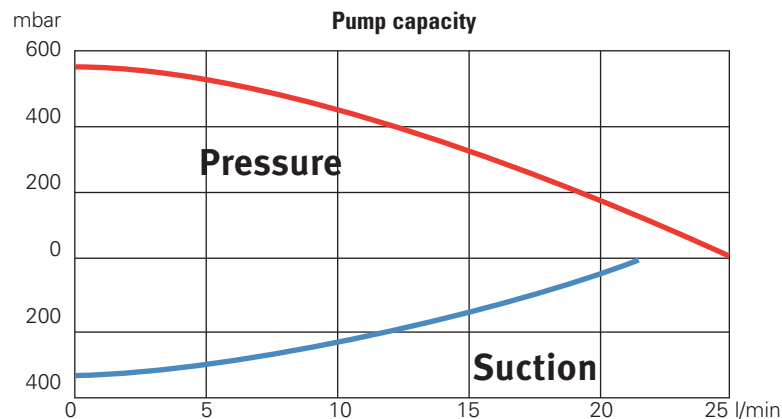

Technical specifications acc. to DIN 12876		P1-H70	P2-H70
Working temperature range	°C	30...250	30...280
with tap water cooling	°C	20...250	20...280
with other cooling	°C	-75...250	-90...280
Temperature accuracy	+/- K	0.01	0.01
Heater capacity 230V/115V	kW	2.0/1.2	3.0/1.2
Pump: Pressure max.	mbar	560	560
Flow rate max.	l/min	24	24
Suction max.	mbar	380	380
Flow rate max.	l/min	22	22
Width of the bath bridge from...to	mm	320...800	320...800
Immersion depth from...to	mm	70...150	70...150
Overall dimensions WxLxH	cm	32 x 17 x 36	32 x 17 x 36
Total wattage 230V/115V	VA	2100/1250	3100/1250
Net weight	kg	6.1	6.1
Order-No. for 230V/50-60Hz		440-0511	441-0511
Order-No. for 115V/60Hz		440-0512	441-0512
ExtraPlus-Rating (see page 35)		+++++	+++++

HAAKE C/DC open-bath circulators very rigid baths made from modified polyphenyleneoxide (PPO) that are thermally resistant up to 100°C. Used with the temperature control units C10 and DC10, they are inexpensive open-bath circulators to be used with water as the heat transfer

liquid. The baths have integrated grips and supports. They are fitted with bridge plates for locating the temperature control unit. A range of accessories is available to adapt the units to suit specific applications.

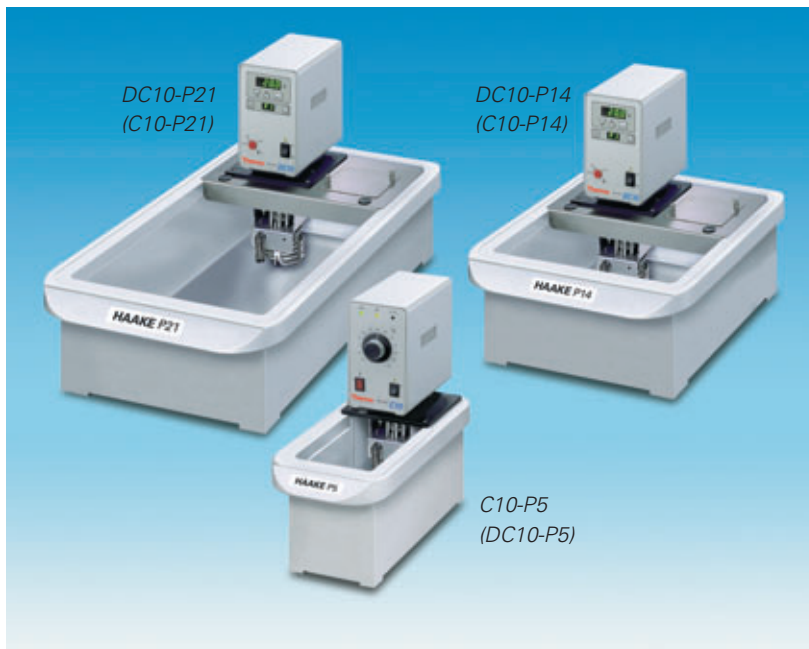

Comes with

Directable **nozzle**
All C10-combinations include a **checking thermometer** 0 to 100°C, division 0.5°C.

Optional accessories **Order-No.**

- Tap water cooling coil** **333-0589**
Instead of water cooling, an **immersion cooler EK20** can be used with baths P14 and P21 (see page 26/27)
- Set for external circulation**
to upgrade the baths **333-0586**
- Lifting platform** for C10-P14 and DC10-P14 **333-0583**

Optional accessories **Order-No.**

- Lifting platform** for C10-P21 and DC10-P21 **333-0582**
- Plastic balls as **floating bath cover** (recommended above 60°C) **827-0310**
- Bath cover** for P5 **333-0618**
- Bath cover** for P14 **333-0619**
- Bath cover** for P21 **333-0620**
- Racks** for bath P5 (fits 2 in the bath) for:
18 tubes, 16 mm Ø **333-0500**
26 micro centrifuge tubes, 10 mm Ø **333-0501**
6 centrifuge tubes, 30 mm Ø **333-0502**

Optional accessories **Order-No.**

Basic rack without inserts
(fits 1 x into P14; 2 x in P21)

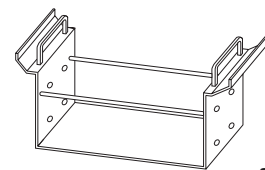

333-0129

Inserts
for tubs into basic rack

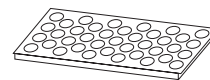

for 86 of 10 mm Ø **333-0130**

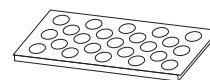

for 46 of 16 mm Ø **333-0131**

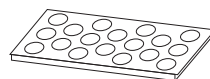

for 23 of 25 mm Ø **333-0132**

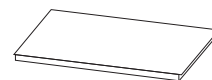

without holes **333-0151**



plastic snappers to reduce the hole Ø in the inserts from
16 to 3..10 mm, 50 pieces **333-0134**
25 to 6..17 mm, 25 pieces **333-0135**

Optional accessories
for C10-P5 and DC10-P5 (see page 9)

Technical specifications acc. to DIN 12876		C10-P5	DC10-P5	C10-P14	DC10-P14	C10-P21	DC10-P21
Working temperature range	°C	25..100	25..100	22..100	22..100	22..100	22..100
with tap water cooling	°C	20..100	20..100	20..100	20..100	20..100	20..100
with other cooling	°C	0..100	0..100	0..100	0..100	0..100	0..100
Temperature accuracy	+/- K	0.04	0.02	0.04	0.02	0.04	0.02
Heater capacity 230V/115V	kW	1.5/1.0	2.0/1.2	1.5/1.0	2.0/1.2	1.5/1.0	2.0/1.2
Pump: Pressure/Flow rate max.	mbar/l/min	300/17	300/17	300/17	300/17	300/17	300/17
Bath opening: WxLxD	cm	13 x 17 x 16	13 x 17 x 16	30 x 19 x 16	30 x 19 x 16	30 x 38 x 16	30 x 38 x 16
Bath volume	l	3.5	3.5	8..14	8..14	13..21	13..21
Overall dimensions: WxLxH	cm	16 x 33 x 36	16 x 33 x 36	33 x 38 x 36	33 x 38 x 36	33 x 54 x 36	33 x 54 x 36
Net weight	kg	4.8	4.8	6	6	6.3	6.3
Total wattage 230V/115V	VA	1550/1050	2050/1250	1550/1050	2050/1250	1050/1050	2050/1250
Order-No. for 230V/50..60Hz		425-1821	426-1821	425-1831	426-1831	425-1841	426-1841
for 115V/60Hz		425-1822	426-1822	425-1832	426-1832	425-1842	426-1842
ExtraPlus rating (see page 35)		+	++	+	++	+	++

**Open-Bath Circulators
C10- and DC10-W12P,
C10- and DC10-W18P**

These transparent baths allow clear viewing during processing.

A water cooling coil is necessary for working temperatures below 25°C. These units can also be adapted for external circulation by adding a pump set.

**Open-Bath Circulators
with a built-in recirculation pump
C10-W5P, DC10-W5P**

These circulators are used for the simultaneous temperature control of external systems such as a photometer and the insertion of flasks or test tubes within the circulator's own bath. A powerful, two-stage pressure pump is available as a standard feature.



Comes with

C10-W5P and DC10-W5P:
Each 2 **nozzles** for tubing with 8 and 12 mm i. Ø, **set for external circulation** and **tap water cooling coil**.

C10-W5P:
plus **checking thermometer** 0 to 100°C
W12P und W18P: **Bath bridge** to fix the circulator onto the bath and a **directable nozzle**.

Optional accessories **Order-No.**

Tap water cooling coil
for W12P/W18P **333-0589**

Plastic balls
as floating bath cover **827-0310**

Lifting platforms
for W12P **333-0583**
for W18P **333-0582**

Set for external circulation
for W12P/W18P **333-0586**

Reservoir drain for W12P/W18P **333-0499**

Racks for W5P-bath
(to be used max. 3 per bath) for:

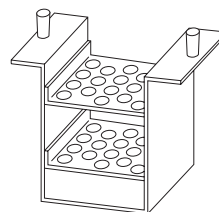

18 tubes, 16 mm Ø **333-0500**

26 micro centrifuge tubes,
10 mm Ø **333-0501**

6 centrifuge tubes,
30 mm Ø **333-0502**

Optional accessories
for DC10-W12P and DC10-W18P (see page 8)

Technical specifications acc. to DIN 12876		C10-W5P	DC10-W5P	C10-W12P	DC10-W12P	C10-W18P	DC10-W18P
Working temperature range	°C	30..60	30..60	25..60	25..60	25..60	25..60
	°C	20..60	20..60	20..60	20..60	20..60	20..60
	°C	0..60	0..60	0..60	0..60	0..60	0..60
Temperature accuracy	+/- K	0.04	0.02	0.04	0.02	0.04	0.02
Heater capacity 230V/115V	kW	1.5/1.0	2.0/1.2	1.5/1.0	2.0/1.2	1.5/1.0	2.0/1.2
Pump: Pressure/Flow rate max.	mbar/l/min	300/12,5	300/12,5	300/17	300/17	300/17	300/17
Bath opening: WxLxD	cm	12 x 24 x 15	12 x 24 x 15	30 x 17 x 15	30 x 17 x 15	30 x 34 x 15	30 x 34 x 15
Bath volume	l	4.6	4.6	8..12	8..12	12..19	12..19
Overall dimensions: WxLxH	cm	17 x 40 x 34	17 x 40 x 34	31 x 34 x 34	31 x 34 x 34	31 x 51 x 34	31 x 51 x 34
Net weight	kg	6	6.2	7	7.2	8.2	8.4
Total wattage 230V/115V	VA	1550/1050	2050/1250	1550/1050	2050/1250	1550/1050	2050/1250
Order-No. for 230V/50..60Hz		425-1051	426-1051	425-1121	426-1121	425-1181	426-1181
	for 115V/60Hz	425-1052	426-1052	425-1122	426-1122	425-1182	426-1182
ExtraPlus-Rating (see page 35)		+	++	+	++	+	++

The high-quality stainless steel used on the bath interior and exterior is characteristic of these circulators. The handles and drain nozzle enable easy handling.

The temperature control units C10 and DC10 are suitable for use with water or a mixture of water and antifreeze. A large range of accessories such as an immersion cooler, a set for external circulation, test tube racks or lift plates can be used to quickly adapt the circulator for different applications.

The bath depth for all baths is 200 mm to allow both large and long objects to be placed within. The units V15/B and V26/B are fitted with a compressor cooling unit, i.e. are independent of tap water and are therefore environmentally friendly.



Baths with angled clamps are also available for more budget-conscious customers.

Comes with

Bath bridge to attach the circulator onto the bath and a directable nozzle.

All C10-combinations include a **checking thermometer** 0 to 100°C, division 0.5°C.

Optional accessories **Order-No.**

Tap water cooling coil **333-0589**

Instead of water cooling, an immersion cooler EK20 or EK30 can be used (see page 26/27)

Set for external circulation to upgrade the baths **333-0586**

Lifting platforms for W15, V15 **333-0583**

for W26, V26 **333-0582**

for W46 **333-0584**

Bath cover out of s/s (fits 1 x onto W15, V15; 2 x onto W26, V26; 4 x onto W46) **333-0225**

Plastic balls as floating bath cover **827-0310**

Reservoir drain **333-0499**

Optional accessories **Order-No.**

Basic rack without inserts (fits 1 x into W15, V15; 2 x into W26, V26; 4 x into W46)

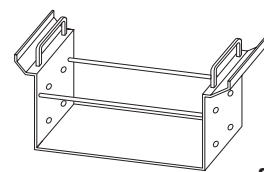

333-0129

Inserts for tubes into basic rack

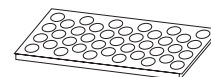

for 86 of 10 mm Ø **333-0130**

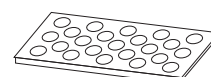

for 46 of 16 mm Ø **333-0131**

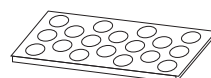

for 23 of 25 mm Ø **333-0132**



without holes **333-0151**

plastic snappers to reduce the hole Ø in the inserts from



16 to 3..10 mm, 50 pieces **333-0134**

25 to 6..17 mm, 25 pieces **333-0135**

Technical specifications acc. to DIN 12876		C10-V15/B	DC10-V15/B	C10-V26/B	DC10-V26/B	C10-W15/B
Working temperature range	°C	-5..100	-5..100	-10..100	-10..100	25..100
with tap water cooling	°C	-	-	-	-	20..100
with other cooling	°C	-	-	-	-	-30..100
Temperature accuracy	+/- K	0.04	0.02	0.04	0.02	0.04
Heater capacity 230V/115V	kW	1.5/1.0	2.0/1.2	1.5/1.0	2.0/1.2	1.5/1.0
Cooling capacity at 20°C	W	200	200	250	250	-
Pump: Pressure/Flow rate max.	mbar/l/min	300/17	300/17	300/17	300/17	300/17
Bath opening: WxLxD	cm	30 x 17.5 x 20	30 x 17.5 x 20	30 x 35 x 20	30 x 35 x 20	30 x 17.5 x 20
Bath volume	l	11..15	11..15	19..26	19..26	11..15
Overall dimensions: WxLxH	cm	36 x 59 x 40	36 x 59 x 40	36 x 75 x 40	36 x 75 x 40	34 x 36 x 40
Net weight	kg	26.1	26.1	31	31	8.3
Total wattage 230V/115V	VA	1900/1400	2400/1600	2000/1500	2500/1700	1550/1050
Order-No. for 230V/50..60Hz		425-1531	426-1531	425-1561	426-1561	425-1161
for 115V/60Hz		425-1532	426-1532	425-1562	426-1562	425-1162
ExtraPlus-Rating (see page 35)		+	++	+	++	+



DC10-W19/B	C10-W26/B	DC10-W26/B	DC10-W46/B
25..100	23..100	23..100	22..100
20..100	20..100	20..100	20..100
-30..100	-30..100	-30..100	-30..100
0.02	0.04	0.02	0.02
2.0/1.2	1.5/1.0	2.0/1.2	2.0/1.2
-	-	-	-
300/17	300/17	300/17	300/17
30 x 35 x 15	30 x 35 x 20	30 x 35 x 20	30 x 70 x 20
12..19	19..26	19..26	35..46
34 x 54 x 35	34 x 56 x 40	34 x 56 x 40	36 x 95 x 40
9	10.9	10.9	23.3
2050/1250	1550/1050	2050/1250	2050/1250
426-1191	425-1261	426-1261	426-1461
426-1192	425-1262	426-1262	426-1462
++	+	++	++

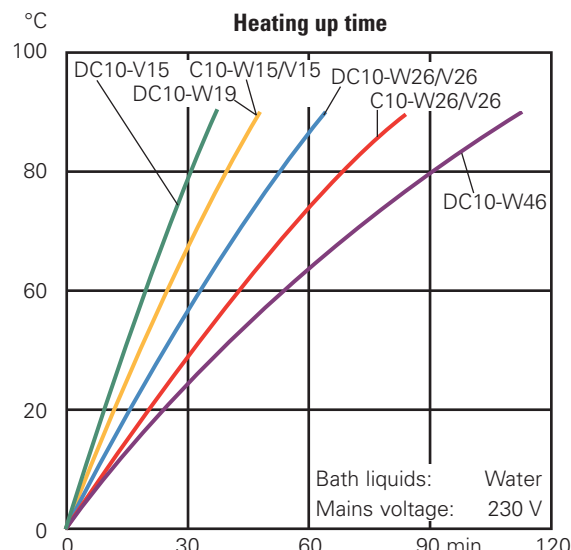

The temperature control unit is attached to the bath vessel by means of a bath bridge. The bridge is equipped with openings designed for the subsequent attachment of an immersion cooler, cooling coil and circulation set for temperature controlling external systems. The units used with the DL30 have an especially large filling range. This enables the frequent exchange of objects with a large volume without triggering level alarms.

The integrated TRS (Turbulence Reduction System) avoids excessive turbulence in the bath via a reduction of the flow rate. Full capacity is available if required.

The units V15/B and V26/B are fitted with a compressor cooling unit, i.e. are independent of tap water and are therefore environmentally friendly.

Comes with

Bath bridge to fix the circulator onto the bath and a directable nozzle

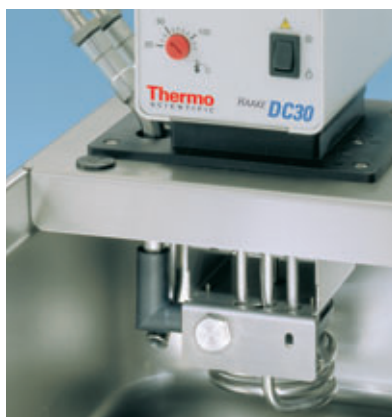

Pumpset (optional)

Optional accessories Order-No.

Lifting platforms

for W13, W15 and V15	333-0583
for W19, W26, V26	333-0582
for W46	333-0584
for W45	333-0581

Reservoir drain 333-0499

Set for external circulation to

upgrade the baths for DC30-Combinations	333-0586
for DL30-Combinations	333-0625

Basic rack without inserts (fits 1 x into W13, W15, V15; 2 x in W19, W26, W45; 4 x in W46)

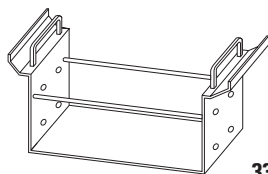

333-0129

inserts

for tubes into basic rack

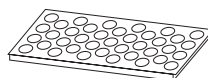

for 86 of 10 mm Ø **333-0130**

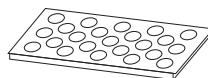

for 46 of 16 mm Ø **333-0131**

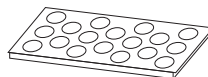

for 23 of 25 mm Ø **333-0132**



without holes **333-0151**

Optional accessories Order-No.

plastic snappers to reduce the hole Ø in the inserts from



16 to 3..10 mm, 50 pieces **333-0134**

25 to 6..17 mm, 25 pieces **333-0135**

Tap water cooling coil for DC30-Combinations **333-0589**

Tap water cooling coil for DL30-Combinations **333-0595**

Instead of water cooling, an immersion cooler EK20 or EK30 can be used (see page 26/27)

Bath cover made from stainless steel (fits 1 x onto W13, W15, V15; 2 x onto W19, W26, V26; 4 x onto W46) **333-0225**

Bath cover made from stainless steel (fits 2 x onto W45) **333-0648**



Lifting platform (optional)

Technical specifications acc. to DIN 12876		DL30-V15/B	DL30-V26/B	DC30-W13/B	DL30-W15/B
Working temperature range	°C	-5..150	-10..150	25..200	25..200
with tap water cooling	°C	-	-	20..200	20..200
with other cooling	°C	-	-	-50..200	-50..200
Temperature accuracy	+/- K	0.01	0.01	0.01	0.01
Heater capacity 230V/115V	kW	2.0/1.2	2.0/1.2	2.0/1.2	2.0/1.2
Cooling capacity at 20°C	W	200	250	-	-
Pump: Pressure/Flow rate max.	mbar/l /min	300/17	300/17	300/17	300/17
Bath opening: WxLxD	cm	30 x 17.5 x 20	30 x 35 x 20	30 x 17.5 x 15	30 x 17.5x 20
Bath volume	l	8..15	14..26	7..12	8..15
Overall dimensions: WxLxH	cm	36 x 59 x 40	36 x 75 x 40	34 x 36 x 35	34 x 36 x 40
Net weight	kg	27	32	8.8	9
Total wattage 230V/115V	VA	2400/1500	2500/1700	2050/1250	2050/1250
Order-No. for 230V/50..60Hz		427-3531	427-3561	426-3141	427-3161
for 115V/60Hz		427-3532	427-3562	426-3142	427-3162
ExtraPlus-Rating (see page 35)		+++	+++	+++	+++



DL30-W45/B

DL30-V26/B

DL30-V15/B

DC30-W19/B
(DC30-W13/B)

DL30-W15/B

DC30-W19/B	DL30-W26/B	DL30-W46/B	DL30-W45/B
25..200	23..200	22..200	22..200
20..200	20..200	20..200	20..200
-50..200	-50..200	-50..200	-50..200
0.01	0.01	0.01	0.01
2.0/1.2	2.0/1.2	2.0/1.2	2.0/1.2
-	-	-	-
300/17	300/17	300/17	300/17
30 x 35 x 15	30 x 35 x 20	30 x 70 x 20	30 x 35 x 30
12..19	14..26	27..46	30..42
34 x 54 x 35	34 x 54 x 40	36 x 95 x 40	36 x 54 x 51
9	11.2	24	23
2050/1250	2050/1250	2050/1250	2050/1250
426-3191	427-3261	427-3461	427-3451
426-3192	427-3262	427-3462	427-3452
+++	+++	+++	+++



HAAKE DC30-W26/B
with cooler
HAAKE EK30

These space-saving heating circulators are used to control temperatures in smaller external systems such as density meters, viscometers, photometers, refractometers or similar devices. A powerful pressure pump provides a good heat exchange with closed systems and thus optimum temperature accuracy.

The available bath opening also allows samples to be inserted into the circulator's own bath. Various bath volumes and depths cover a wide application range. The interior and exterior of the bath vessels are made from stainless steel for easy cleaning and durability. The bath P5 is made from polyphenyleneoxide (PPO). A built-in water cooling coil enables temperature control down to 2°C...3°C above the cooling water temperature.

Die HAAKE DC- and DL-Class

- Robust PID control
- Double display
- 3 fixed temperatures
- RS232C Interface (RS485 option)
- RTA / FIS / ESK / TRS

Comes with

Each 2 **nozzles** for tubins with 8 and 12 mm i. Ø, a **tap water cooling coil** and a **bath cover**.

C10-P5/U, C10-B3: plus **checking thermometer** 0 to 100°C, division 0.5°C.

Optional accessories Order-No.

Rack for 20 tubes/
16 mm Ø for B3-bath **333-0456**

Optional accessories Order-No.

Racks for bath B5, B7
18 tubes, 16 mm Ø **333-0500**
26 micro centrifuge tubes,
10 mm Ø **333-0501**
6 centrifuge tubes,
30 mm Ø **333-0502**
Universal hose nozzle
for tubing of 3 to 6 mm i. Ø **832-0275**
Reservoir drain

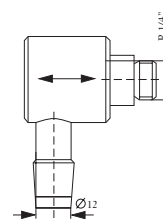

333-0499

Software for DC30, DL30, DC50 (s. p. 32)

Choose the **necessary tubes, bath liquids** or **Pt 100 sensors** on pages 30/31/33.

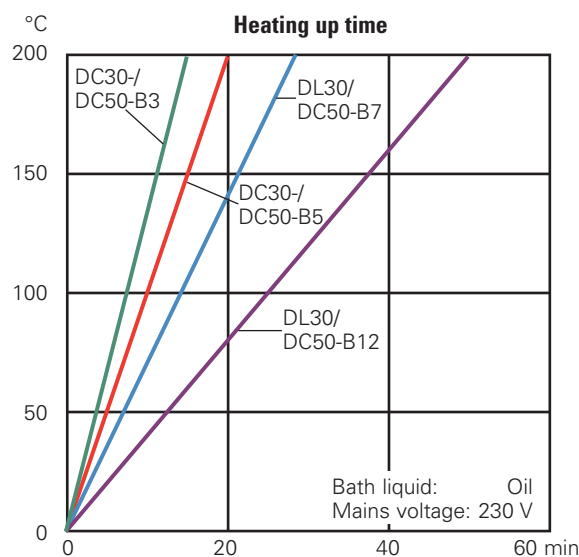
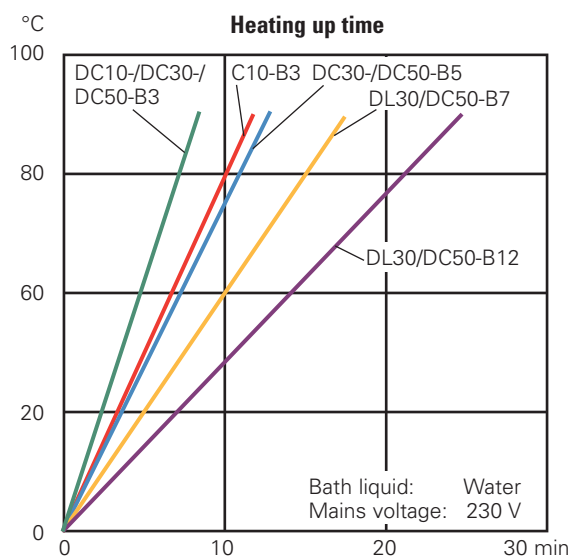

Technical specification acc. to DIN 12876		C10-P5/U	DC10-P5/U	C10-B3	DC10-B3	DC30-B3	DC50-B3
Working temperature range	°C	25..100	25..100	32..100	32..100	32..200	32..200
	°C	20..100	20..100	20..100	20..100	20..200	20..200
	°C	0..100	0..100	-30..100	-30..100	-50..200	-50..200
Temperature accuracy	+/- K	0.04	0.02	0.04	0.02	0.01	0.01
Heater capacity 230V/115V	kW	1.5/1.0	2.0/1.2	1.5/1.0	2.0/1.2	2.0/1.2	2.0/1.2
Pump: Pressure/Flow rate max.	mbar/ l/min	300/12.5	300/12.5	300/12.5	300/12.5	300/12.5	300/12.5
Bath opening: WxLxD	cm	13 x 17 x 16	13 x 17 x 16	13 x 10 x 15	13 x 10 x 15	13 x 10 x 15	13 x 10 x 15
Bath volume	l	5	5	3	3	3	3
Overall dimensions: WxLxH	cm	16 x 33 x 36	16 x 33 x 36	20 x 30 x 37	20 x 30 x 37	20 x 30 x 37	20 x 30 x 37
Net weight	kg	5.2	5.4	7.1	7.3	7.3	7.4
Total wattage 230V/115V	VA	1550/1050	2050/1250	1550/1050	2050/1250	2050/1250	2050/1250
Order-No. for 230V/50..60Hz for 115V/60Hz		425-1851	426-1851	425-1701	426-1701	426-3701	426-5701
		425-1852	426-1852	425-1702	426-1702	426-3702	426-5702
ExtraPlus-Rating (see page 35)		+	++	+	++	+++	++++



DC50-B5
(DC30-B5)

DL30-B7
(DC50-B7)

DC50-B12
(DL30-B12)

C10-B3

DC10-P5/U
(C10-P5/U)

DC30-B3
(DC50-B3)
(DC10-B3)

DC30-B5	DC50-B5	DL30-B7	DC50-B7	DL30-B12	DC50-B12
32..200 20..200 -50..200	32..200 20..200 -50..200	30..200 20..200 -50..200	30..200 20..200 -50..200	28..200 20..200 -50..200	28..200 20..200 -50..200
0.01	0.01	0.01	0.01	0.01	0.01
2.0/1.2	2.0/1.2	2.0/1.2	2.0/1.2	2.0/1.2	2.0/1.2
300/12.5	300/12.5	300/12.5	300/12.5	300/12.5	300/12.5
14 x 15 x 15	14 x 15 x 15	13 x 10 x 20	13 x 10 x 20	22 x 14 x 20	22 x 14 x 20
4.5	4.5	7	7	12	12
21 x 36 x 38	21 x 36 x 38	23 x 36 x 44	23 x 36 x 44	32 x 38 x 44	32 x 38 x 44
8.5	8.5	9.5	9.5	13.2	13.2
2050/1250	2050/1250	2050/1550	2050/1250	2050/1550	2050/1250
426-3801 426-3802	426-5801 426-5802	427-3811 427-3812	426-5811 426-5812	427-3821 427-3822	426-5821 426-5822
+++	++++	+++	++++	+++	++++



The HAAKE Phoenix II heating circulators are designed for temperature controlling external systems. The bath opening also enables the immersion of samples within the circulator bath. All units have a stainless steel bath and can be used up to 280°C. The powerful pump guarantees a good heat exchange and optimum temperature accuracy.

Innovative:

The pump automatically adapts itself to the viscosity of the bath liquid used due to the automatic speed recognition function. This guarantees constant pressure and flow rate conditions over a wide temperature range.



P1-B5/P2-B5

Compact heating circulators with a 5-liter bath, ideal for temperature controlling small open or closed systems with short heating up times and thus quick reaction times.



P1-B7/P2-B7

Slim-line heating circulators with a deep 7-liter bath for temperature controlling open and closed systems; high temperature accuracy for medium-size external systems.



P1-B12/P2-B12

Heating circulators with a 12-liter bath suitable for external systems with high volume variations; use as open-bath circulator also possible due to the large bath opening.

Technical specification acc. to DIN 12876		P1-B5	P2-B5	P1-B7	P2-B7
Working temperature range	°C	32...250	32...280	30...250	30...280
with tap water cooling	°C	20...250	20...280	20...250	20...280
with other cooling	°C	-60...250	-60...280	-60...250	-60...280
Temperature accuracy	+/- K	0.01	0.01	0.01	0.01
Heater capacity 230V/115V	kW	2.0/1.2	3.0/1.2	2.0/1.2	3.0/1.2
Pump: Pressure max.	mbar	560	560	560	560
Flow rate max.	l/min	24	24	24	24
Suction max.	mbar	380	380	380	380
Flow rate max.	l/min	22	22	22	22
Bath opening: WxLxD	cm	14 x 14.5 x 15	14 x 14.5 x 15	13 x 10 x 20	13 x 10 x 20
Bath volume max.	l	4.5	4.5	7	7
Overall dimensions: WxLxH	cm	24 x 38 x 44	24 x 38 x 44	25 x 38 x 50	25 x 38 x 50
Total wattage 230V/115V	VA	2100/1250	3100/1250	2100/1250	3100/1250
Net weight	kg	10.2	10.2	11.8	11.8
Order-No. for 230V/50-60Hz		440-0051	441-0051	440-0071	441-0071
for 115V/60Hz		440-0052	441-0052	440-0072	441-0072
ExtraPlus-Rating (see page 35)		+++++	+++++	+++++	+++++



P1-W26/P2-W26

Combined open-bath and heating circulators with a 42-liter bath. Extra deep bath (300 mm) for large objects, simultaneous temperature control of objects, simultaneous temperature control of external systems.

P1-W45/P2-W45

Combined open-bath and heating circulators with a 26-liter bath. Large bath opening for direct temperature control of objects, simultaneous temperature control of external systems.

Additional pump

If the capacity of the integrated circulator pump would not be high enough for temperature controlling an external system, this booster pump can provide up to 3 bar pressure.

Comes with

- Each 2 **nozzles**
for tubings with 8 and 12 mm i. Ø
- Bath cover** for B5, B7, B12
- Tap water cooling coil**
for B5, B7, B12

Optional accessories

- | Optional accessories | Order-No. |
|--|-----------------|
| Tap water cooling coil
for baths W26 and W45 | 333-0677 |
| Universal hose nozzle
for tubing of
3 to 6 mm i. Ø | 001-3718 |
| Reservoir drain | 333-0499 |
| Bath cover made from stainless steel
(fits 2 x onto W45) | 333-0648 |
| Bath cover made from stainless steel
(fits 2 x onto W26) | 333-0225 |
| External analog box | 333-0685 |

230V Power supply
for analog box **333-0705**

Tubing and bath liquids (s. p. 30-31)

Pt100 sensors (s. p. 33)

Additional heater B7 bath **333-0741**

Additional heater B12 **333-0743**

Solenoid valve control
for tap water cooling **333-0744**

Additional pump **333-0746**

Profibus interface on request

Optional accessories for P1/P2-W26 and P1/P2-W45 (see page 12)

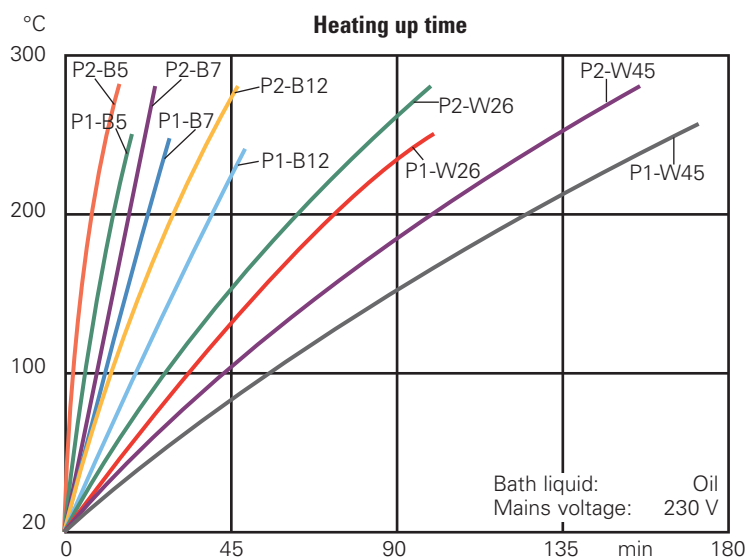

P1-B12	P2-B12	P1-W26	P2-W26	P1-W45	P2-W45
28...250	28...280	28...250	28...280	28...250	28...280
20...250	20...280	20...250	20...280	20...250	20...280
-60...250	-60...280	-60...250	-60...280	-60...250	-60...280
0.01	0.01	0.01	0.01	0.01	0.01
2.0/1.2	3.0/1.2	2.0/1.2	3.0/1.2	2.0/1.2	3.0/1.2
560	560	560	560	560	560
24	24	24	24	24	24
380	380	380	380	380	380
22	22	22	22	22	22
22 x 14 x 20	22 x 14 x 20	30 x 35 x 20	30 x 35 x 20	30 x 35 x 30	30 x 35 x 30
12	12	26	26	42	42
34 x 38 x 50	34 x 38 x 50	35 x 54 x 44	35 x 54 x 44	36 x 54 x 55	36 x 54 x 55
2100/1250	3100/1250	2100/1250	3100/1250	2100/1250	3100/1250
13	13	11	11	19	19
440-0121	441-0121	440-0261	441-0261	440-0451	441-0451
440-0122	441-0122	440-0262	441-0262	440-0452	441-0452
+++++	+++++	+++++	+++++	+++++	+++++

The powerful refrigerated circulators in the HAAKE C/DC class are available either in a space-saving vertical version or an ergonomic flat version. The K10 does not require more space than a sheet of DIN A4 paper at the bench. The units K10, K15 and K20 are primarily used at room temperature. The units also feature efficient heat removal even at high temperatures and enable the temperature controlling of external closed liquid circuits at temperatures well below 0°C. Unit selection depends mainly on the required cooling capacity and the desired temperature range.

Note:

The units K10, K15 and K20 can be combined with all circulator heads from C10 to DC50.

Comes with

Each 2 **nozzles** for tubings with 8 and 12 mm i. Ø and **bath cover**.
C10-K10, C10-K15 and C10-K20:
plus **checking thermometer**
0 to 100°C, division 0.5°C.

Optional accessories

Optional accessories	Order-No.
Universal hose nozzle for tubing of 3 to 6 mm i. Ø	832-0275
Reservoir drain	333-0499
Software for DC30, DC50 (see page 32)	
Trolley with castors for K35, K40, K41, K50	333-0508

Optional accessories

Order-No.

Rack for 20 tubes, 16 mm Ø for K10

333-0456

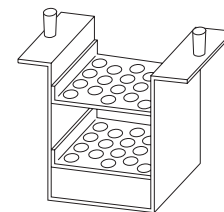

Rack for K15 and K20

18 tubes, 16 mm Ø **333-0500**

26 micro centrifuge tubes, 10 mm Ø **333-0501**

6 centrifuge tubes, 30 mm Ø **333-0502**

Choose the necessary **tubes, bath liquids** and **Pt-100 sensor** for DC50-units on pages 30/31/33.



Sealed bath cover with K10, K15 and K20

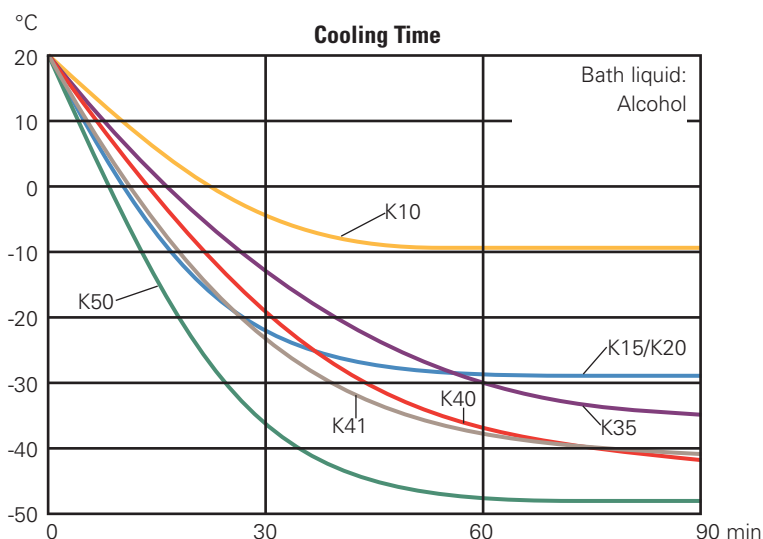

Technical specifications acc. to DIN 12876		C10-K10	DC10-K10	C10-K15	DC10-K15
Working temperature range	°C	-10..100	-10..100	-28..100	-28..100
Temperature accuracy	+/- K	0.04	0.02	0.04	0.02
Heater capacity 230V/115V	kW	1.5/1.0	2.0/1.2	1.5/1.0	2.0/1.2
Cooling capacity	at 20°C	240	240	300	300
	at 0°C	70	70	200	200
	at -20°C	-	-	70	70
Pump: Pressure/Flow rate max.	mbar/l/min	300/12.5	300/12.5	300/12.5	300/12.5
Bath opening: WxLxD	cm	13 x 10 x 15	13 x 10 x 15	13 x 10 x 15	13 x 10 x 15
Bath volume max.	l	3	3	4.5	4.5
Overall dimensions: WxLxH	cm	19.5 x 36 x 57	19.5 x 36 x 57	39 x 46 x 41	39 x 46 x 41
Net weight	kg	22.7	22.7	30.8	30.8
Total wattage 230V/115V	VA	1800/1300	2300/1500	1900/1400	2400/1600
Order-No. for 230V/50Hz for 220V/60Hz for 115V/60Hz		425-1641	426-1641	425-1501	426-1501
		425-1641	426-1641	425-1501	426-1501
		425-1642	426-1642	425-1502	426-1502
ExtraPlus-Rating (see page 35)		+	++	+	++

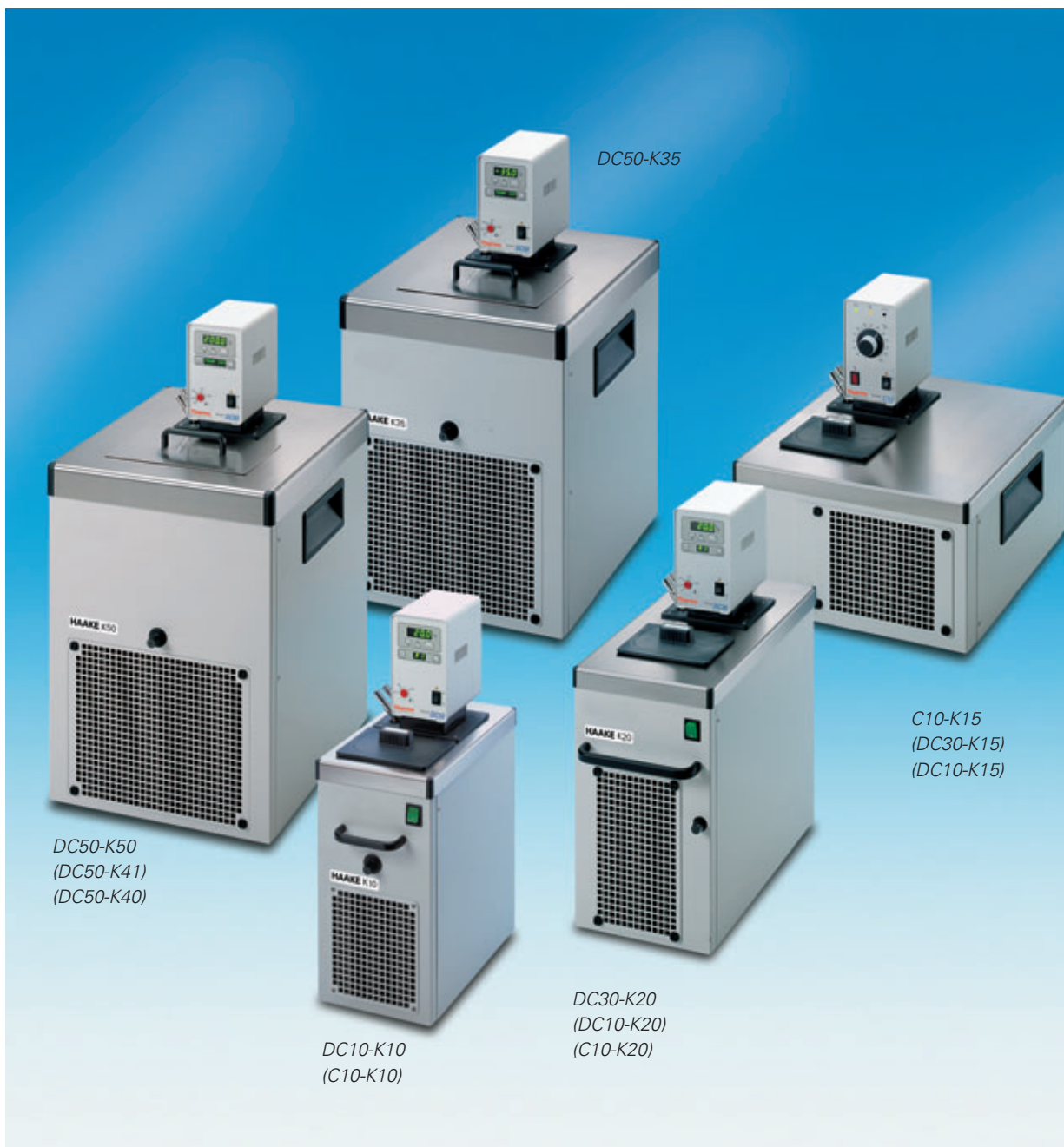

DC50-K50
(DC50-K41)
(DC50-K40)

DC50-K35

C10-K15
(DC30-K15)
(DC10-K15)

DC10-K10
(C10-K10)

DC30-K20
(DC10-K20)
(C10-K20)

DC30-K15	C10-K20	DC10-K20	DC30-K20	DC50-K35	DC50-K40	DC50-K41	DC50-K50
-28..150	-28..100	-28..100	-28..150	-35..200	-40..150	-40..150	-47..200
0.01	0.04	0.02	0.01	0.01	0.01	0.01	0.01
2.0/1.2	1.5/1.0	2.0/1.2	2.0/1.2	2.0/1.2	2.0/1.2	2.0/1.2	2.0/1.2
300 200 70	320 205 75	320 205 75	320 205 75	400 300 150	700 550 300	1000 750 400	850 700 500
300/12.5	300/12.5	300/12.5	300/12.5	300/12.5	300/12.5	300/12.5	300/12.5
13 x 10 x 15	13 x 10 x 15	13 x 10 x 15	13 x 10 x 15	22 x 14 x 15	29 x 15 x 15	29 x 15 x 20	22 x 14 x 15
4.5	4.5	4.5	4.5	8	12	15	8
39 x 46 x 41	23 x 46 x 58	23 x 46 x 58	23 x 46 x 58	38 x 46 x 68	38 x 46 x 74	38 x 46 x 74	38 x 46 x 74
31.1	29.8	29.8	30.1	37	43	50	46
2400/1600	1900/1400	2400/1600	2400/1600	2500/1700	2550/ -	2600/ -	2650/ -
426-3501 426-3501 426-3502	425-1601 425-1601 425-1602	426-1601 426-1601 426-1602	426-3601 426-3601 426-3602	426-5351 426-5351 426-5352	426-5401 426-5409 -	426-5411 426-5419 -	426-5491 426-5499 -
+++	+	++	+++	++++	++++	++++	++++

The HAAKE Phoenix II refrigerated circulators feature FuzzyStar control with neural adaptation, the tried-and-tested energy management system. External connection options greatly extend the application range.

All units are characterized by their simple operation and represent the optimum combination of design and functionality.

The refrigerated circulators are especially suited for the temperature control of open and closed

temperature control circuits due to their powerful pressure and suction pump.

Innovative:

The pump automatically adapts itself to the viscosity of the bath liquid due to the automatic speed recognition function.

This guarantees constant pressure and flow rate conditions over a wide temperature range.

Comes with
nozzles
 for tubings with 8 and 12 mm i. Ø
Bath cover

Optional accessories	Order-No.
Universal hose nozzle for tubing of 3 to 6 mm i. Ø	001-3718
Reservoir drain	333-0499
Trolley with castor for C30P, C35P, C40P, C41P, C50P	333-0678
External analog box	333-0685
230V Power supply for analog box	333-0705
 Tubes and bath liquids	(s. p. 30-31)
Pt100 sensor	(s. p. 33)
Additional heater for C25P	333-0741
Additional heater for C30P, C35P, C50P	333-0745
Additional heater for C40P, C41P	333-0742
Additional pump	333-0746

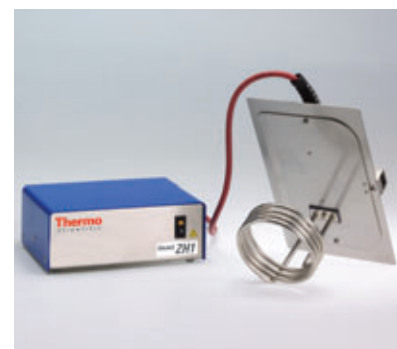
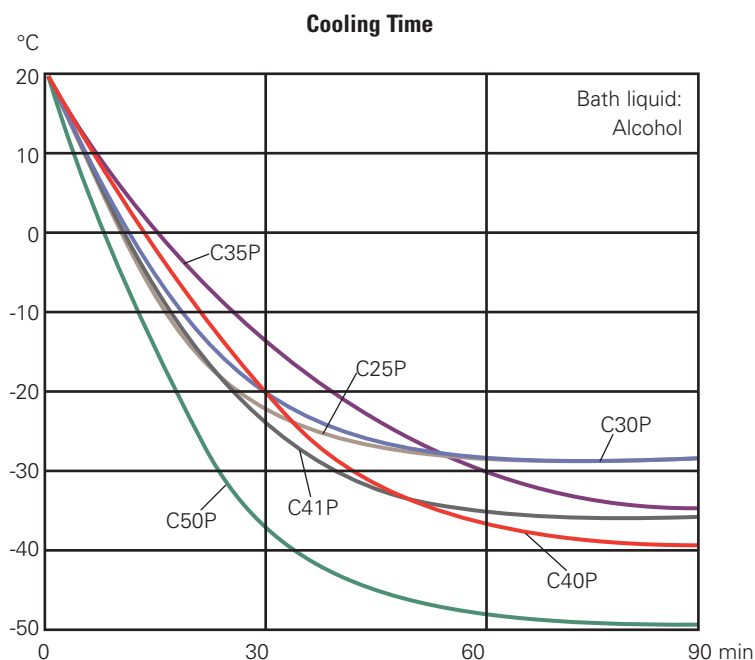

Optional accessory: Additional heater ZH1 to accelerate heating-up

Technical specifications acc. to DIN 12876		P1-C25P	P2-C25P	P1-C30P	P2-C30P	
Working temperature range	°C	-28...150	-28...150	-30...200	-30...200	
Temperature accuracy	+/- K	0.01	0.01	0.01	0.01	
Heater capacity 230V/115V	kW	2.0/1.2	2.0/1.2	2.0/-	2.0/-	
Cooling capacity	at 20°C	300	300	800	800	
	at 0°C	200	200	620	620	
	at -20°C	70	70	450	450	
Pumpe: Pressure max.	mbar	560	560	560	560	
	Flow rate max.	l/min	24	24	24	
	Suction max.	mbar	380	380	380	380
	Flow rate max.	l/min	22	22	22	22
Bath opening: WxLxD	cm	13 x 10 x 15	13 x 10 x 15	22 x 14 x 20	22 x 14 x 20	
Bath volume max.	l	4.5	4.5	12	12	
Overall dimensions: WxLxH	cm	26 x 48 x 63	26 x 48 x 63	40 x 51 x 77	40 x 51 x 77	
Total wattage 230V/115V	VA	2450/1650	2450/1650	2600/-	2600/-	
Net weight	kg	26.3	26.3	46	46	
Order-No. for 230V/50Hz for 220V/60Hz for 115V/60Hz		440-0251	441-0251	440-0301	441-0301	
		440-0251	441-0251	440-0309	441-0309	
		440-0252	441-0252	-	-	
ExtraPlus-Rating (see page 35)		+++++	+++++	+++++	+++++	



P1-C25P/P2-C25P

Compact refrigerated circulators down to -28°C with a small 4.5 liter bath for rapid cooling. 300 watt cooling capacity at 20°C.



P1-C30P/P2-C30P

Refrigerated circulators for high loads down to -30°C, reliable cooling even at high ambient temperatures. 800 watt cooling capacity at 20°C.



P1-C35P/P2-C35P

Refrigerated circulators with a wide temperature range from -35°C to +200°C. 400 watt cooling capacity at 20°C.



P1-C40P/P2-C40P

Refrigerated circulators with a large bath opening, down to -40°C ideal for the simultaneous temperature control internally and externally. 700 watt cooling capacity at 20°C.



P1-C41P/P2-C41P

High power refrigerated circulators down to -40°C. High cooling capacity for applications under 0°C. 1000 watt cooling capacity at 20°C.



P1-C50P/P2-C50P

Refrigerated circulators for extreme low temperatures down to -47°C. Inexpensive cooling alternative to a cryostat. 850 watt cooling capacity at 20°C.

P1-C35P	P2-C35P	P1-C40P	P2-C40P	P1-C41P	P2-C41P	P1-C50P	P2-C50P
-35...200	-35...200	-40...150	-40...150	-40...150	-40...150	-47...150	-47...150
0.01	0.01	0.01	0.01	0.01	0.01	0.01	0.01
2.0/1.2	2.0/1.2	2.0/-	2.0/-	2.0/-	2.0/-	2.0/-	2.0/-
400	400	700	700	1000	1000	850	850
300	300	550	550	750	750	700	700
150	150	300	300	400	400	500	500
560	560	560	560	560	560	560	560
24	24	24	24	24	24	24	24
380	380	380	380	380	380	380	380
22	22	22	22	22	22	22	22
22 x 14 x 15	22 x 14 x 15	29 x 15 x 15	29 x 15 x 15	29 x 15 x 20	29 x 15 x 20	22 x 14 x 15	22 x 14 x 15
8	8	12	12	15	15	8	8
40 x 51 x 71	40 x 51 x 71	40 x 51 x 71	40 x 51 x 71	40 x 51 x 77	40 x 51 x 77	40 x 51 x 77	40 x 51 x 77
2500/1700	2500/1700	2550/-	2550/-	2600/-	2600/-	2650/-	2650/-
40	40	41	41	45	45	46	46
440-0351	441-0351	440-0401	441-0401	440-0411	441-0411	440-0501	441-0501
440-0359	441-0359	440-0409	441-0409	440-0419	441-0419	440-0509	441-0509
440-0352	441-0352	-	-	-	-	-	-
+++++	+++++	+++++	+++++	+++++	+++++	+++++	+++++

Cryostats application and selection

Very low temperatures are best reached with both P2-CT90L and -W, the P1/P2-C75P and the DC50-K75 cryostats. The P2-CT50L and -W both deliver a high cooling capacity.

The cryostats are cooled by powerful, quiet compressors. The cooling circuits are either air-cooled (K75, C75P, CT50L, CT90L) or watercooled (CT50W, CT90W).

The powerful, water-cooled units are equipped with a water flow limiter. The water consumption is kept low, thus considerably reducing operating costs.

The cooling capacity for all HAAKE Phoenix II cryostats is controlled by a fuzzy logic-supported energy management system.

The floor-based units are fitted with stable, adjustable castors.

The cryostats HAAKE DC50-K75 and P1/P2-C75P are suitable for location either under or on the lab table.

HAAKE Phoenix II cryostats

The most user-friendly cryostat baths available to handle a wide range of applications.

The Phoenix II cryostats come equipped with a powerful pressure and suction pump, feature a cooling capacity of up to 5000 W, and are thus ideally suited to meet the extreme technical specifications that many applications require. Phoenix II circulators are available in two versions:

- Basic version Phoenix II P1 with a 1 kW heating capacity
- Full version Phoenix II P2 with 1 to 3 kW heating capacity and with additional functional features

HAAKE Phoenix II P1-C75P / P2-C75P

- Compact cryostat down to -75°C
- Unit can be placed on the lab table
- 280 W cooling capacity at 20°C

HAAKE Phoenix II P2-CT50L

- Cryostat with high capacity down to -50°C
- Air-cooled floor-based unit
- Ideal for direct temperature control in the bath
- 2500 W cooling capacity at 20°C
- Large bath volume (24 l)

HAAKE Phoenix II P2-CT50W

- Cryostat with big power down to -50°C
- Water-cooled floor-based unit
- 5000 W cooling capacity at 20°C
- Large bath volume (24 l)

HAAKE Phoenix II P2-CT90L

- Cryostat with high capacity down to -90°C
- Air-cooled floor-based unit
- Ideal for direct temperature control in the bath
- 1650 W cooling capacity at 20°C

HAAKE Phoenix II P2-CT90W

- Cryostat with big power down to -90°C
- Water-cooled floor-based unit
- 1900 W cooling capacity at 20°C
- 200 W cooling capacity at -80°C

HAAKE Phoenix II P2-CT80L

- Compact cryostat down to -80°C
- Excellent price-performance ratio
- 800 W cooling capacity at 20°C

Technical specification acc. to DIN 12876		DC50-K75	P1-C75P	P2-C75P	P2-CT80L	P2-CT50L
Working temperature range	°C	-75..100	-75..100	-75..100	-80..100	-50..100
Temperature accuracy	+/- K	0.05	0.02	0.02	0.1	0.1
Heater capacity	kW	1.5	1.0	1.0	1.0	2.0
Cooling capacity at	20°C/0°C	280/220	280/220	280/220	800/750	2500/1750
	at -20°C/-40°C	180/130	180/130	180/130	700/600	1100/300
	at -60°C/-80°C	50/-	50/-	50/-	500/50	-
Pump: Pressure/Flow rate max.	mbar/l/min	300/12.5	560/24	560/24	560/24	560/24
	Suction/Flow rate max.	-/-	380/22	380/22	380/22	380/22
Bath opening: WxLxD	cm	13 x 10 x 20	13 x 10 x 20	13 x 10 x 20	22 x 14 x 20	22 x 27 x 20
Bath volume	l	6	6	6	12	24
Overall dimensions: WxLxH	cm	38 x 46 x 72	40 x 51 x 77	40 x 51 x 77	42 x 66 x 102	50 x 75 x 109
Net weight	kg	65	68	68	107	125
Total wattage	VA	2450	2500	2500	2500	3300
Order-No. for	230V/50Hz	426-5751	440-0751	441-0751	441-0801	-
	for 220V/60Hz	-	440-0759	441-0759	441-0809	-
	for 380V/3 Ph/50Hz	-	-	-	-	446-0503
	for 220V/3 Ph/60Hz	-	-	-	-	446-0504
ExtraPlus-Rating (see page 35)		++++	+++++	++++++	++++++	++++++

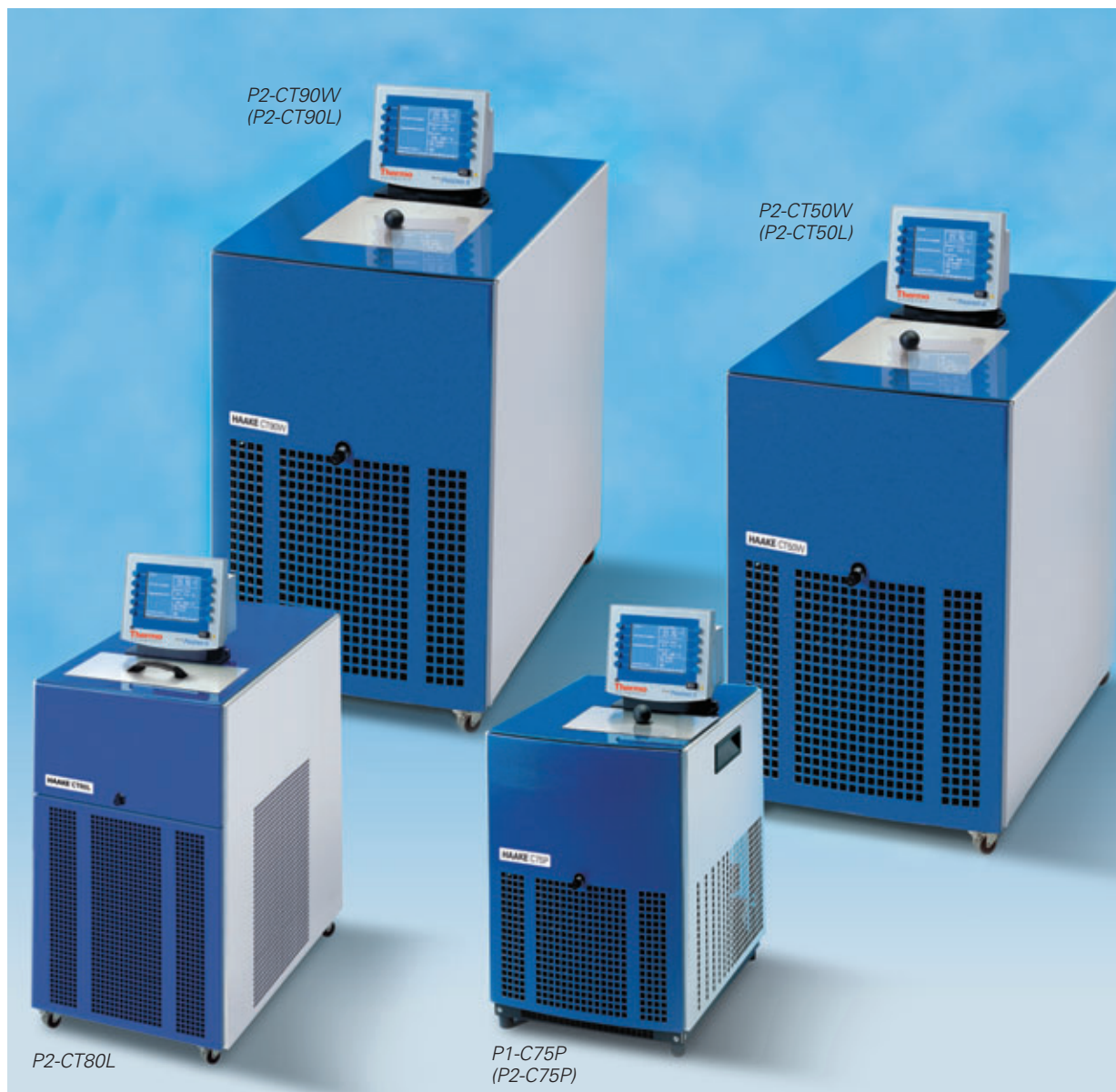

P2-CT50W	P2-CT90L	P2-CT90W
-50..100	-90..100	-90..100
0.1	0.1	0.1
3.0	2.0	2.0
5000/3000 1900/800 -	1650/1500 1300/1150 600/170	1900/1700 1500/1300 700/200
560/24 380/22	560/24 380/22	560/24 380/22
22 x 27 x 20	22 x 15 x 20	22 x 15 x 20
24	15	15
50 x 75 x 109	50 x 90 x 109	50 x 90 x 109
180	190	185
5800	5300	5300
-	-	-
447-0503 447-0504	448-0903 448-0904	449-0903 449-0904
+++++	+++++	+++++

HAAKE DC50 cryostats are used for a wide range of standard applications.

A powerful pump enables the temperature control of small, closed external systems.

The unit can be set by a push-button keypad. The read-out is shown via two separate display panels.

HAAKE DC50-K75

- Compact cryostat down to -75°C with a temperature accuracy of ± 0.05 K
- Unit can be placed on the lab table
- 280 W cooling capacity at 20°C
- 130 W cooling capacity at -40°C



HAAKE DC50 Highlights

- Powerful pumps with Turbulence Reduction System (TRS)
- Simple operation due to separate display panels for menu selection and temperature
- Microprocessor control with PID control
- Resolution of the digital display for the set and actual temperature optionally 0.1 or 0.01°C
- Real Temperature Adjustment (RTA)
- Ability to save 3 user-defined fixed temperatures with their respective RTA values
- The reason for a unit fault is shown on the display via the Fault Identification System (FIS)
- RS232C interface, optional RS485
- External Temperature Compensation (ETC) for controlling external systems with connection for an external Pt100 sensor

HAAKE Phoenix II Highlights

- FuzzyStar control with neuronal adaptation
- Easy operation of the units due to a large monitor with plain text display and direct value setting
- Very powerful combined pressure and suction pump with automatic speed recognition for the precise temperature control of external objects
- 4 savable fixed temperatures
- Flexible interface concept: RS232C (standard), multifunctional output (standard), RS485 (for P2), Profibus (optional for P2)
- External Temperature Control (ETC) with connection for an external Pt100 sensor as standard
- User can choose from 6 different dialog languages
- Permanent display of date and time
- Up to 10 ramp programs with a maximum of 30 segments (for P2)
- 3-point calibration function (for P2)

Comes with

Each 2 **nozzles** for tubings with 8 and 12 mm i. Ø

Reservoir drain for CT50L, CT50W, CT80L, CT90L and CT90W

Optional accessories

Order-No.

Rack for DC50-K75, P1-C75P and P2-C75P for:

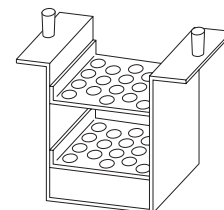

18 tubes, 16 mm Ø **333-0500**

26 micro centrifuge tubes, 10 mm Ø **333-0501**

6 centrifuge tubes, 30 mm Ø **333-0502**

Universal hose nozzle

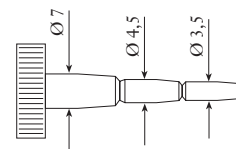

for for tubing of 3 to 6 mm Ø for Phoenix II-Cryostats **001-3718**

Universal hose nozzle for tubing of 3 to 6 mm i. Ø for DC50-K75 **832-0275**

Reservoir drain

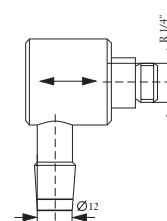

for DC50-K75, P1-C75P and P2-C75P **333-0499**

Trolley with castors for DC50-K75 **333-0508**

Trolley with castors for P1-C75P and P2-C75P **333-0678**

Choose the necessary tubes, bath liquids and Pt100 sensors on pages 30, 31 and 33.

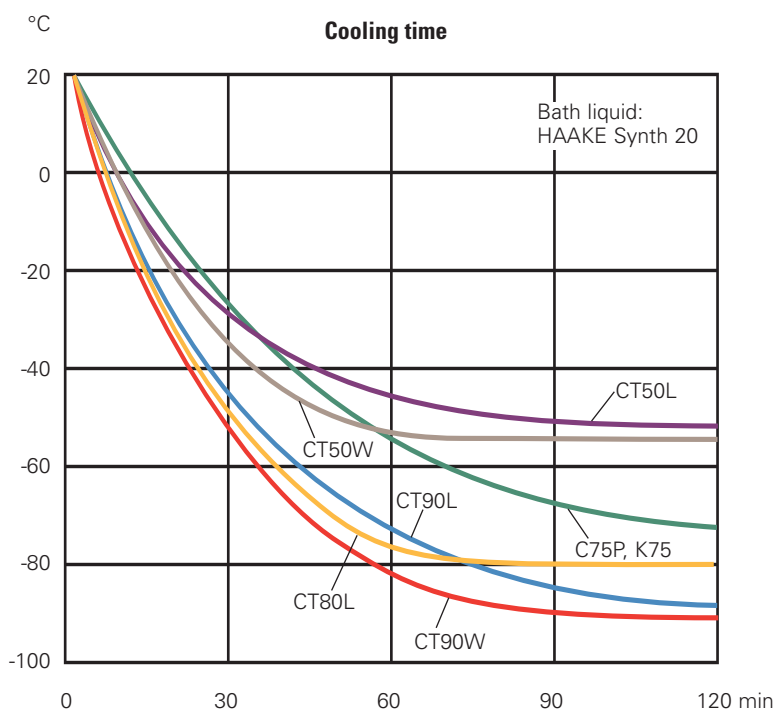

The SWB25 features a high safety level for constant operation in addition to very accurate temperature control (PID control). Shaking frequency and temperature are adjusted via a keypad and digital display. The heater and control sensor are located underneath the bath, thus guaranteeing easy cleaning.

The fluid level can vary from 50 mm to 180 mm to accommodate sample vessels of differing heights. A second shaking carriage (optional) can be inter-changed quickly and easily.

The transparent plastic gable-shaped bath cover (optional) prevents water spillage caused by turbulence. It is recommended for temperatures above 70°C.

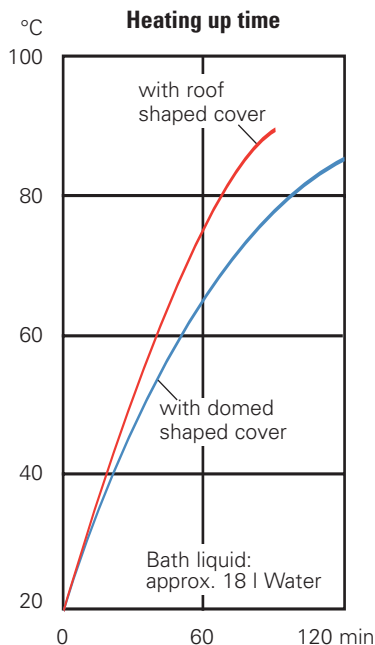

SWB25 with swivelling gabled cover

Comes with
One **Shaking carriage plate** without clamps

Optional accessories **Order-No.**
Tap water cooling coil **000-8581**

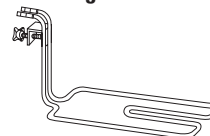

Swivelling roof-shaped **cover** (transp.) **333-0642**

Basic rack for each 2 of the following inserts **333-0259**

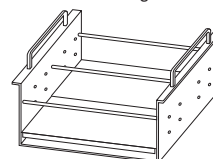

Inserts for tubes into basic rack

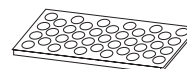

for 86 of 10 mm Ø **333-0130**

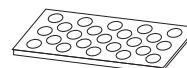

for 46 of 16 mm Ø **333-0131**

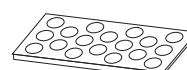

for 23 of 25 mm Ø **333-0132**



without holes **333-0151**

Plastic clip for diameter reduction in the inserts



16 to 3..10 mm, 50 St. **333-0134**

25 to 6..17 mm, 25 St. **333-0135**

Clamps to fix beakers or flasks onto the shaking carriage plate or the basic rack

flask-cont. (ml)	glas Ø (mm)	no. per carriage plate	
25	42	40	000-8732
50	51	32	000-1980
100	64	18	000-1982
250	85	12	000-1990
500	105	8	000-1994
1000	131	5	000-1995

Spare shaking carriage plate **000-8384**



SWB25 with test tube rack

Technical specification acc. to DIN 12876		SWB25
Working temperature range	°C	22..90
with tap water cooling	°C	20..90
Temperature accuracy	+/- K	0.2
Heater capacity 230V/115V	kW	1.5/1.5
Type of control		PID
Overtemperature protection		adjustable
Bath opening: WxLxD	cm	50 x 30 x 20
Bath volume	l	8..26
Shaking amplitude	mm	15
Shaking frequency (cont. adj.)	min ⁻¹	20..200
Overall dimensions: WxLxH	cm	65 x 34 x 26
Net weight	kg	18
Total wattage 230V/115V	VA	1600/1600
Order-No. for 230V/50..60Hz		375-0001
for 115V/60Hz		375-0002

These coolers are ideal for the following applications:

- to cool smaller volumes down to -90°C,
- to remove reaction heat or
- to replace tap water cooling

The lowest reachable temperature depends upon:

- the quantity of liquid
- the type of liquid and its viscosity
- the bath insulation

Immersion Coolers HAAKE EK20/EK30

Used together with the open-bath circulators, these coolers provide an alternative to tap water cooling. The lowest attainable temperature and the cooling down times are illustrated in the diagrams.

The EK20 is designed for baths with a 15 cm depth and the EK30 for baths with a depth of at least 20 cm.

Vessels can of othersizes also be cooled. End temperatures of -25°C resp. -30°C can be reached in a 5 l Dewar vessel.

Immersion Cooler HAAKE EK45

This multi-purpose cooler has its own controller with digital temperature display, reaching temperatures down to -45°C in a 5 l Dewar vessel. The controller enables temperature accuracy of approx. 1°C to 2°C. Improvement is possible using a stirrer.

Immersion Cooler HAAKE EK90

This unit is designed for working temperatures down to -90°C. The cooling coil is flexible and can therefore be adapted to suit virtually any bath shape. The minimum diameter of the vessel to be cooled is 110 mm.

Comes with

EK45 and EK90:

Electronic controller

and Pt100 sensor (Ø 6 mm, 50 mm long, cabel 2.5 m long).

Optional accessories

Order-No.

Trolley with castors for EK90

333-0508

Holder to fix a cooler EK20, EK30 or EK45 onto a wall with a thickness up to 25 mm

333-0602

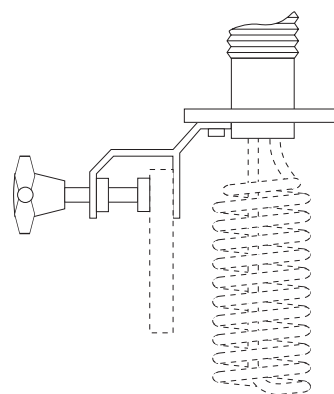

Technical specification acc. to DIN 12876		EK20	EK30	EK45	EK90
Working temperature range	°C	-25..150	-30..150	-45..40	-90..40
Cooling capacity	at 20°C	300	400	350	300
	at -10°C	150	250	250	280
	at -40°C	–	–	50	170
	at -60°C	–	–	–	100
Hose length	cm	150	150	150	150
Cooling coil dimensions (Ø x L)	mm	81 x 145	81 x 195	81 x 195	13 x 900
Smallest bending radius	mm	–	–	–	40
Overall dimensions: WxLxH	cm	23 x 46 x 38	23 x 46 x 38	23 x 46 x 38	38 x 46 x 49
Net weight	kg	22	23	30	60
Total wattage	VA	160	270	300	750
Order-No. for 230V/50..60Hz for 115V/60Hz		322-1201	323-1301	328-1451	329-1901
		322-1202	323-1302	328-1452	–



Cooling time with the EK20

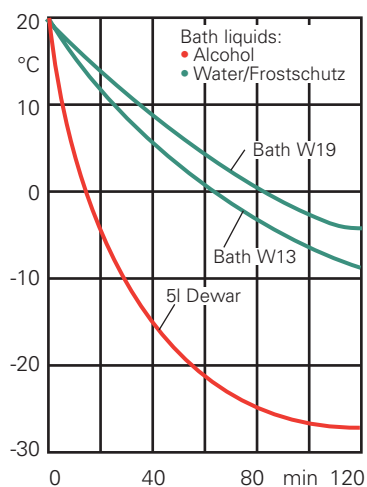

Cooling time with the EK30

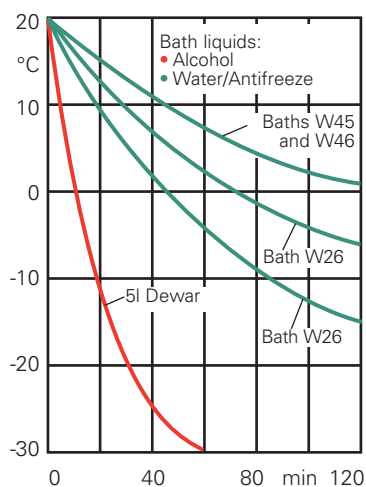

Cooling time with the EK45 and EK90

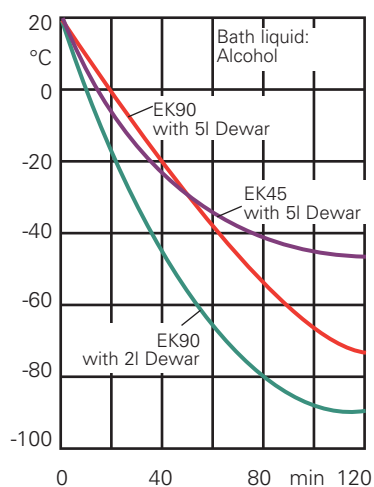

Tap water is still used far too often when measuring instruments, distillation equipment or rotary evaporators need to be cooled. This method is not only environmentally damaging, but it is also technically unsound. The presence of minerals and bacteria create problems with scaling and contamination.

Water recirculators are both an economical and ecologically sensible alternative to wasting tap water for cooling purposes.

Haake TC water recirculators are available in 5 different cooling capacity models up to 5 kW.

A variable pump and accessories program fits the units to your application. Ask for our special water recirculator brochure.



HAAKE TC water recirculators are flexible:

You can combine the available pumps and cooling compressors to suit your requirements. They are also available in two versions.

HAAKE TC water recirculators are economical:

They do more than save tap water. Short pay-back periods are guaranteed by their excellent cost/benefit ratio.

HAAKE TC water recirculators are safe and reliable:

The units are designed and manufactured according to EN 61010. A variety of safety elements guarantee reliable operation.

This low cost mini-cooler is specially designed to remove up to 240 watts of heat from connected analysis instruments, apparatus or any thermic processes.

The water recirculator HAAKE WKL 26 is a small-scale unit which can be situated practically anywhere. A high level of noise reduction is attained due to the quiet-running compressor.

HAAKE WKL 26 Highlights

- The working temperature can be variably adjusted.
- The control accuracy is approx. $\pm 1.1\text{K}$.
- The powerful pump is designed for hoses with an inner diameter of 8 to 12 mm.
- A long unit service life as the switching on and off of the compressor is avoided.
- Small and compact, the unit base takes up roughly the surface area of a DIN A4 sheet of paper.
- The ventilation grid can be removed for easy cleaning of the liquifier fins.
- All parts which come into contact with the bath liquid are made from stainless steel.
- The compressor circuit and circulation pump do not require maintenance.
- A drainage opening for easy water changing.
- A combined temperature and water level indicator is available as an optional accessory.
- The unit is CFC-free and has the CE-mark.

Comes with

Each 2 nozzles for tubes with 8 and 12 mm Inside-Ø

Optional accessories Order-No.

Combined temperature and liquid level indicator **333-0567**

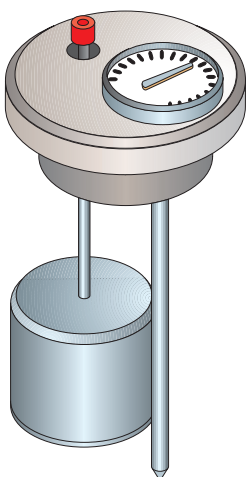

Technical Specifications		WKL 26
Working temperature range	°C	-10 to 30
Temperature accuracy	\pm K	1.0
Cooling capacity at 20°C Refrigerant (CFC-free)	W	240 R 134a
Pump capacity		
Pressure max.	mbar	300
Flow rate max.	l/min	12
Bath volume	l	3
Filling opening	mm	45 Ø
Dimensions		
Base area	mm	200 x 340
Height	mm	490
Weight	kg	22
Total wattage max.	VA	450
Max. ambient Temperature	°C	5 to 40
Order-No. for 230 V/50 Hz for 115 V/60 Hz		386-0001 386-0002

Hoses

All circulators and cryostats are always delivered with nozzles for tubings with an inner Ø of 8 and 12 mm. The tubings and insulation (if applicable) have to be ordered separately and should be selected according to the application.

Description	Order-No.
Insulated metal tubing made from stainless steel with M 16 x 1 unions on both ends. To be used from -50 to +300°C.	
50 cm long	333-0292
100 cm long	333-0293
150 cm long	333-0294
coupling to connect 2 tubings to each other	001-2560
coupling for circulation set C-/DC-line	333-0302
Insulated metal tubing made from stainless steel with M 16 x 1 unions on both ends. Especially for the low temperature range -90..105°C	
100 cm long	333-0578
150 cm long	333-0579
coupling to connect 2 tubings to each other	001-2560
coupling for circulation set C-/DC-line	333-0302
PVC tubing to be used only with water	
8 mm i. Ø; per meter	082-0745
12 mm i. Ø; per meter	082-0304
Viton tubing for a temperature range of -60 to + 200°C	
8 mm i. Ø; per meter	082-1214
12 mm i. Ø; per meter	082-1215
Silicone tubing for a temperature range of -30 to + 220°C (not to be used with any silicone oil)	
8 mm i. Ø; per meter	082-0663
12 mm i. Ø; per meter	082-0664
Perbunan tubing for a temperature range of -40 to + 100°C	
8 mm i. Ø; per meter	082-0172
12 mm i. Ø; per meter	082-0173
Foam rubber insulation for PVC, Viton, silicone and Perbunan tubings	
for tubings with 8 mm i. Ø; per meter	806-0373
for tubings with 12 mm i. Ø; per meter	806-0374

Bath Liquids

The carefully selected and proven heat transfer liquids offer the following advantages:

- Eliminates health hazards and minimizes unpleasant odors.
- High resistance against aging while retaining a low viscosity with a low corrosive tendency.

Note: Good ventilation is recommended when working at temperatures > 200°C.

1. Viscosity

For optimum temperature accuracy it is very important that the heat transfer liquid be of low viscosity.

2. Fire Point

Flammable thermal liquids can ignite when a specified temperature is surpassed. The usage of bath liquids is limited to a temperature level 25°C below the fire point as defined by the EN 61010.

3. Selection

Silicone oils (Sil):

Carry a low risk of inflammation, do not give off unpleasant odors and have a long service life.

Synthetic thermal liquids (Synth):

Are mainly produced on a hydrocarbon basis and exhibit a low viscosity within the recommended working temperature range.

4. Application Range

Working temperature range:

This is the range within which the circulator can be operated optimally over a longer period of time. The maximum viscosity is approx. 5 mPas.

Operating temperature range:

The circulator may be operated only within this range over a longer period of time under certain conditions. Viscosity may rise to a maximum of 30 mPas. The pump capacity no longer matches the specifications made in the brochure.

Heating range:

Long-term temperature control in this range is not permissible as the pump motor's excess temperature protection may switch off the pump.

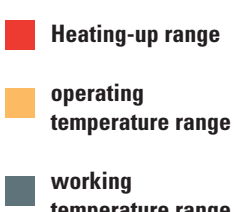

Application range		Sil 100	Sil 180	Sil 300	Synth 60	Synth 200	Synth 260
Fire point	°C	>100	> 225	>325	70	>235	275
Viscosity	at 20°C [mPas]	3	11	200	2	100	140
Density	at 20°C [kg/dm ³]	0.89	0.93	1.08	0.76	0.86	1.03
Spec. heat capacity	[kJ/kg x K]	1.67	1.51	1.56	2.1	1.96	2
Temperature ranges 	300°C			300			
	250°C						250
	200°C		200			210	
	150°C						
	100°C						
	50°C	75					
	0°C				45		
	-50°C						
	-100°C						
	Color		transparent colorless	transparent colorless	transparent colorless	transparent colorless	transparent light brown
Reacts with		Silicone	Silicone	Silicone	Rubber Silicone	Copper Light-metal Bronze	Copper Light-metal Bronze
Order-No. for 10 l Container		999-0202	999-0204	999-0206	999-0210	999-0226	999-0214
Order-No. for 5 l Container		999-0201	999-0203	999-0205	999-0209	999-0225	999-0213

EC-Safety Data Sheets will be delivered together with each container of liquid.

n.a. not applicable

HAAKE DynaMax Sealed Systems

HAAKE DynaMax sealed temperature control systems dissipate heat from chemical reactions much faster than other products in their class. The systems incorporate new Dynamic Heat Load Suppression (DHLS) technology that offers incredibly fast reactions to temperature changes while maintaining precise temperature stability. If your application limits are exceeded during exothermic reactions, the system rapidly injects fluids from the cold storage tank to bring the system back within safety limits.

HAAKE DynaMax units are easy to use and feature intuitive menu programming in any one of seven languages. The systems are self-degassing and completely self-draining for greater ease of operation. The units' sealed system design prevents hot fluids from contact with the atmosphere, preventing fumes, and it also eliminates icing at low temperatures.

Specifications	HAAKE DynaMax 1200	HAAKE DynaMax 1700
System Performance		
Temperature Range	-40 to 150°C	-45 to 150°C
Cooling Capacity at 20 K (50Hz / 60Hz)	1.2 kW	1.7 kW
Cooling Capacity at 0 K (50Hz / 60Hz)	900 W	1.25 kW
Cooling Capacity at -20 K (50Hz / 60Hz)	250 W	550 W
Cooling Capacity at -40 K (50Hz / 60Hz)	–	150 W
Heating Capacity (230V - 50Hz / 208V - 60 Hz)	2 kW / 1.6 kW	2 kW / 1.6 kW
Temperature stability	+/- 0.01 K	+/- 0.01 K
Pump Performance (with silicon oil)		
Maximum Pump Pressure (bar)	1,2	1,2
Maximum Flow Rate	20 l/min	20 l/min
Pump Performance (with water)		
Maximum Pump Pressure (bar)	1,5	1,5
Maximum Flow Rate	25 l/min	25 l/min
Electrical Performance		
Power Requirements	230V/50Hz - 1 phase, 208V/60Hz - 1 phase	230V/50Hz - 1 phase 208V/60Hz - 1 phase
Communication	RS232, RS485	RS232, RS485
General Information		
Footprint (HxWxD cm)	70 x 49 x 70	70 x 49 x 70
Fluid Connections	M30x1.5	M30x1.5
Compliance	CE, NRTL certified (CE, UL & CSA)	CE, NRTL certified (CE, UL & CSA)
System Weight	95 kg	100 kg
Order numbers		
230V/50Hz	460-0111	461-0111
208V/60Hz	460-0119	461-0119



DHLS effect (Outlet to Inlet, Sil 180 oil)

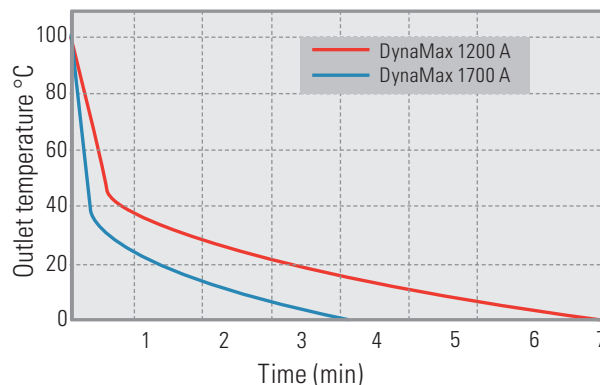

Pt100 Sensor

The following sensors are available for external temperature control applications (ETC-System) with circulators and cryostats.

Description	Order-No.
Sensor TT for Phoenix II-units Pt100 sensor in closed protection tube made from stainless steel 18/8, 150 mm long, Ø 3 mm, cable length 3 m, up to 600°C	333-0429
Sensor DTT for DC50-units Pt100 sensor in closed protection tube made from stainless steel 18/8, 150 mm long, Ø 3 mm, cable length 3 m, up to 600°C	333-0613
Sensor ST for Phoenix II-units as Sensor TT, 27 mm long, Ø 3 mm, with thread M 10 x 1, cable length 3 m, up to 600°C	333-0428
Sensor DST for DC50-units as Sensor DTT, 27 mm long, Ø 3 mm, with thread M 10 x 1, cable length 3 m, up to 600°C	333-0612
Sensor HT for Phoenix II-units as Sensor TT, only to be used with the T-piece 001-1766, cable length 3 m, up to 600°C	333-0423
T-Piece for the sensor HT to be mounted into HAAKE metal tubing connections	001-1766

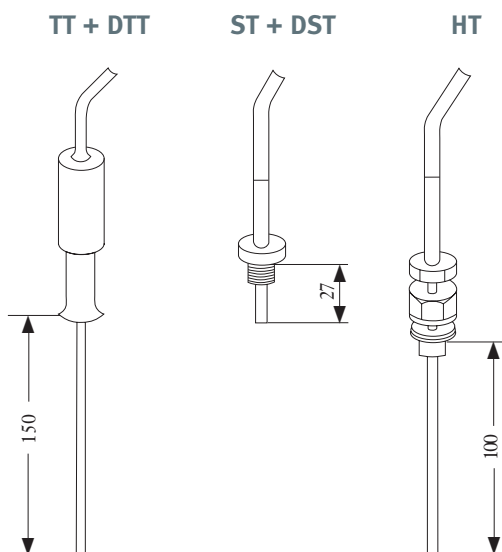

Level Control

All circulators and cryostats equipped with a combined pressure and suction pump can be used for the temperature control of external open baths. Tubing mounts with integrated level control are fitted for this purpose to make sure that the external bath will not overflow.

Replenishing Device

This device enables the user to transfer evaporated water into a bath circulator automatically. The water loss will be compensated in small amounts to avoid temperature shocks and drifts.

The device comprises a controller and a float switch. The float switch has to be mounted into the bath cover of the circulator.

Description	Order-No.
Automatic replenishing device AN2 for 230 V/50..60 Hz/60 VA	333-0752
Holder for AN2 in bath bridge H62 and H73	333-0762
Holder for AN2 in bath cover B3, B7, K10, K15, K20, C25P	333-0764
Holder for AN2 in bath cover B5	333-0765
Holder for AN2 in bath cover B12, K35, K50, C30P, C35P, C50P	333-0757
Holder for AN2 in bath cover K40, K41, C40P, C41P	333-0759

Description	Order-No.
-------------	-----------

Tubing mount for the level control in the external bath with screw clamp:

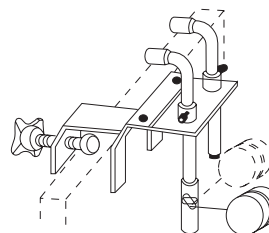

333-0587

Description	Order-No.
-------------	-----------

Tubing mount built into bath cover for level control in the circulator bath when temperature controlling external open vessels. For units with bath:

B7, C25P	333-0609
B5	333-0610
B12	333-0603
C30P, C35P, C50P	333-0591
C40P, C41P	333-0608

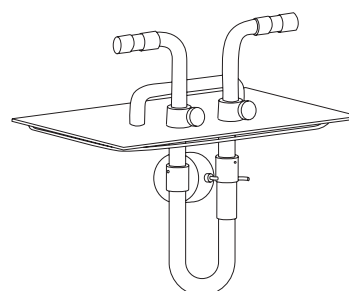

This glossary contains the most important terms used to describe the features of HAAKE circulators.

1 PID⁺⁺-control

This robust control system is specially developed for HAAKE DC circulators and adapted to each respective unit. No customer adjustments are necessary.

2 FuzzyStar-control system with neural adaptation

This intelligent control system is included in all Phoenix II circulators designed for the special demands of temperature control. This range incorporates a Fuzzy Logic control system combined with a system identification feature via neural networks.

Advantages:

- Quick heating and cooling
- Exact control without fluctuations
- Extremely robust control compensation in case of system changes
- High level of adaptability to suit a variety of applications
- Energy saving due to integrated cooling management
- Phoenix II units sense your application needs and automatically adapt for optimal results

3 TRS system

The pump capacity can be reduced with the Turbulence Reduction System (TRS) to avoid heavy turbulence in open baths.

4 ESK system with external sensor connection

The External Temperature Control (ETC) handles the temperature control of external systems when an external Pt100 is connected. The inlet temperature in the circulator is adapted so that the set temperature in the external system is maintained precisely. A Pt100 sensor is used for this purpose.

5 Direct dialog via LCD graphic display

Phoenix II circulators are equipped with a large LCD graphic display that shows the necessary operating steps in plain text. The selection of menu options is carried out via the direct assignment of the functions to keys.

6 HAAKE RTA system

The Real Temperature Adjustment (RTA) enables the difference between the actual temperature displayed and the real temperature in the bath or external system to be compensated for. To do this, the temperature difference must be measured once and entered into the circulator as a correction value. The correction of the display is then carried out automatically.

7 Safety classes NFL and FL

Units with safety elements classified according to NFL (Non Flammable Liquids) can be used only with water or water and antifreeze. Units with elements classified according to FL (Flammable Liquids) can be used with the recommended bath liquids.

8 HAAKE FIS system

The Fault Identification System (FIS) ensures that the cause for an alarm is clearly shown on the display. All safety-relevant parts are switched off.



ExtraPlus Rating System

Each circulator has been given an individual ExtraPlus rating. This rating can be found at the bottom of the specification table in the product description.

Have you already chosen your circulator?

You can now cross-reference the ExtraPlus rating with the specifications in the corresponding column of the table on this page and see which features your circulator has.

Are you looking for a circulator with special features?

Select the desired features in the first column of the table on this page, and you can then determine which ExtraPlus rating your circulator should have. Phoenix II line circulators with a rating of 5 and 6 Pluses can be found on pages with HAAKE Phoenix II circulators. Circulators with a rating of 1 and 4 stars can be found on pages with HAAKE C/DC-line circulators.

Rating	+	++	+++	++++	+++++	++++++
Control and Technology						
	✓					
1		✓	✓	✓		
2					✓	✓
					✓	✓
3	✓	✓	✓	✓	✓	✓
					✓	✓
4				✓	✓	✓
		✓	✓	✓	✓	✓
Operation						
	✓					
		✓	✓	✓		
5					✓	✓
					✓	✓
		✓	✓	✓	✓	✓
		✓	✓	✓	✓	✓
		✓	✓	✓		
				✓	✓	✓
		✓	✓	✓	✓	✓
6		✓	✓	✓	✓	✓
6				✓	✓	✓
		✓	✓	✓	✓	✓
		✓	✓	✓	✓	✓
					✓	✓
						✓
					1	10
						✓
Safety						
7	✓	✓				
7			✓	✓	✓	✓
	✓	✓	✓	✓	✓	✓
			✓	✓	✓	✓
	✓	✓	✓	✓	✓	✓
		✓	✓	✓	✓	✓
				✓	✓	✓
	✓	✓	✓	✓	✓	✓
			✓	✓	✓	✓
8		✓	✓	✓	✓	✓
Communication						
			✓	✓	✓	✓
				optional		✓
						optional
				optional		✓
						✓
						✓
Rating	+	++	+++	++++	+++++	++++++

Benelux

Thermo Fisher Scientific
Takkebijsters 1
4817 BL Breda
Tel. +31 (0) 76 579 55 55
info.tc.nl@thermofisher.com

China

Thermo Fisher Scientific
Building 6, No. 27
Xin Jinqiao Rd.
Shanghai 201206
Tel. +86 (21) 68 65 45 88
info.china@thermofisher.com

France

Thermo Fisher Scientific
16 Avenue du Québec - Silic 765
91963 Courtaboeuf Cedex
Tel. +33 (0) 1 60 92 48 00
info.tc.fr@thermofisher.com

Germany

Thermo Fisher Scientific
Dieselstr. 4
76227 Karlsruhe
Tel. +49 (0) 721 4 09 44 44
info.tc.de@thermofisher.com

India

Thermo Fisher Scientific
Plot No A-255
T.T.C Industrial Area
Mahape, Navi Mumbai 400705
Tel. +91 (22) 27 78 11 01
info.tc.in@thermofisher.com

United Kingdom

Thermo Fisher Scientific
Emerald Way, Stone
Staffordshire, ST15 0SR
Tel. +44 (0) 1785 82 52 00
info.tc.uk@thermofisher.com

USA

Thermo Fisher Scientific
25 Nimble Hill Rd.
Newington, NH 03801
Tel. 603 436 9444
info.tc.us@thermofisher.com

www.thermo.com/tc

© 2007/07 Thermo Fisher Scientific. All rights reserved. 623-1063 - BRE231063v1 DE11/03MC. This document is for informational purposes only and is subject to change without notice. Specifications, terms and pricing are subject to change. Not all products are available in all countries. Please consult your local sales representative for details.