



BOOX NovaAir
Mighty E-ink Tablet
User Manual

Contents

1. Standard Accessories.....	3
2. Safety Guide.....	4
3. Product Views.....	6
4. Main Interface.....	9
5. Library.....	25
6. Reader.....	37
7. Store.....	82
8. Notes.....	85
9. Storage.....	113
10. Apps.....	117
11. Settings.....	149
12. Specifications.....	169
13. Declaration.....	170

1. Standard Accessories

(1) BOOX NovaAir	x1
(2) Stylus Pen	x1
(3) Type-C Cable	x1
(4) Quick Start Guide	x1
(5) Warranty Sheet	x1

Optional Accessories (purchased separately)

(1) Adapter

(2) Protective Cover

(Note: The E-books in the following illustration are not pre-stored)

2. Safety Guide

Please read the Safety Guide carefully before you start to use the device. Contact your BOOX retailer if you have any technical problem, or you can dial our official service line at 4008-400-014 or 4008-860-830.



Screen protection

The device is equipped with E-ink screen, which is very fragile. Please have no shocking, squeezing, pressing against the screen, or dropping the device from a higher place. If the screen is already broken, stop using it and contact the professional or other qualified staff to replace the screen for you. Please don't dismantle the device without our permission.



Standard accessories

Only the battery, adapter, and other accessories meeting our standard safety rules can be used for the device. For details, please refer to Product Specification. We will not be responsible for any damage caused

by incompatible accessories.



Stay away from liquids

The device is not waterproof. Don't expose the device to a humid environment or use it in the rain. Please keep it away from any corrosive liquids.



Don't dismantle the device

Please don't dismantle the device in case of any damage.

Inappropriate battery model may cause explosion. Please contact official after-sale team for battery replacement if needed. Users shall undertake the responsibility and deal with the obsolete battery if users replace batteries themselves.



Using environment

The using environment of the device is 0° C-50° C.

3. Product Views

Front View

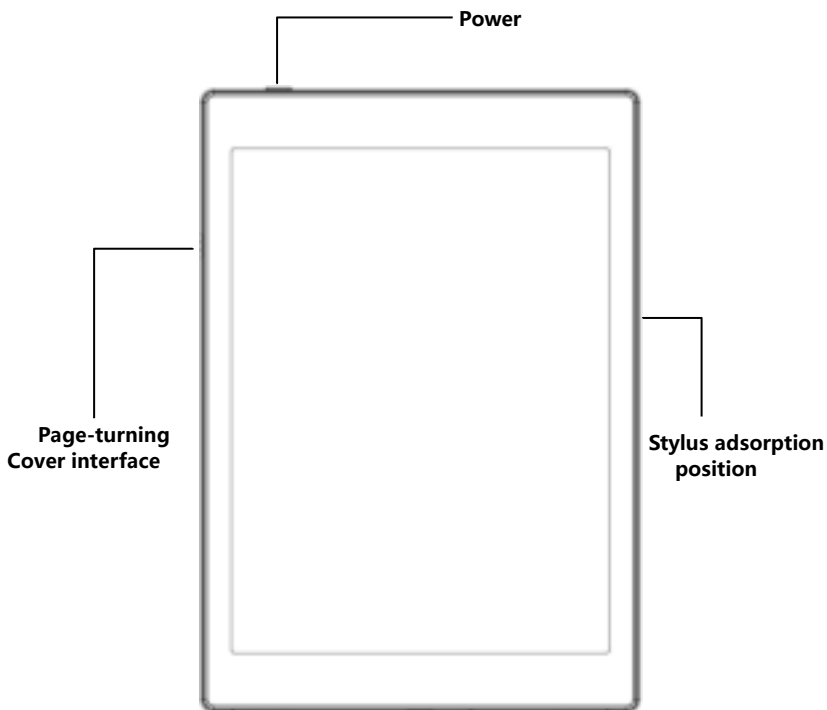

Bottom View

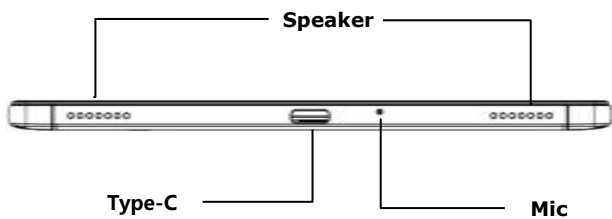

Button Function

Power/ sleep Button	<ul style="list-style-type: none">● Press the power button to turn on the device● Long-press the power button for 2 secs, then select “Power off” in the menu to turn off the device● Press the power button and release quickly to let the device goes into sleep mode● Press it again to wake up● Long-press for 10 secs to force shutdown
Microphone	<ul style="list-style-type: none">● Record voice● Recognize speech
Type-C Port	<ul style="list-style-type: none">● Connect the device with PC to transfer data or charge device.● Support Type-C earphone● Support OTG USB drive

4. Main Interface

The main interface contains a status bar, content area, and function area.

The function area contains certain modules.

Double-click icons in function area can return to the main page of the specific module.

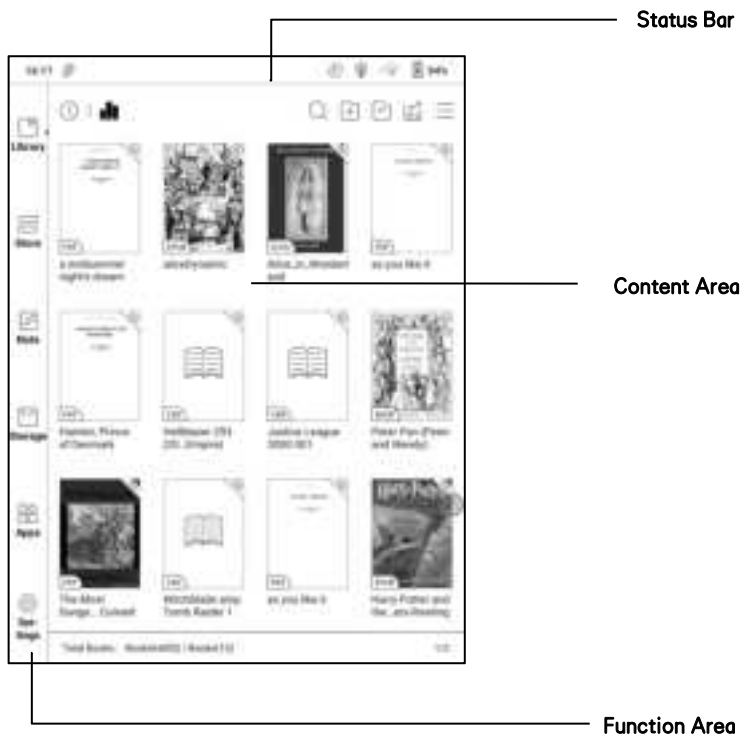

Status Bar



This section displays the current state of the device, including: Time, Notification, Refresh Mode, Wi-Fi Connection, Battery Usage. It is only for status indication.

Notification Interface

Click or pull down the Status Bar to expand a menu, which includes:

Android Shortcuts: Back button, Home button, Multi-tasking switching Button, Full refresh button.

Function Management: Wi-Fi, Bluetooth, Rotation, Refresh Mode, Finger Touch, etc. Further customize those frequent functions by pressing the “Edit” button.

Volume Adjustment: Easily adjust the media volume by moving the sliding control. Customize the notification sounds and adjust the volume of the alarm, notification and others.

Notifications: Turn on / off notifications for connecting USB, push

notification from third-party apps, etc. Jump to the corresponding page by pressing the specific notification.

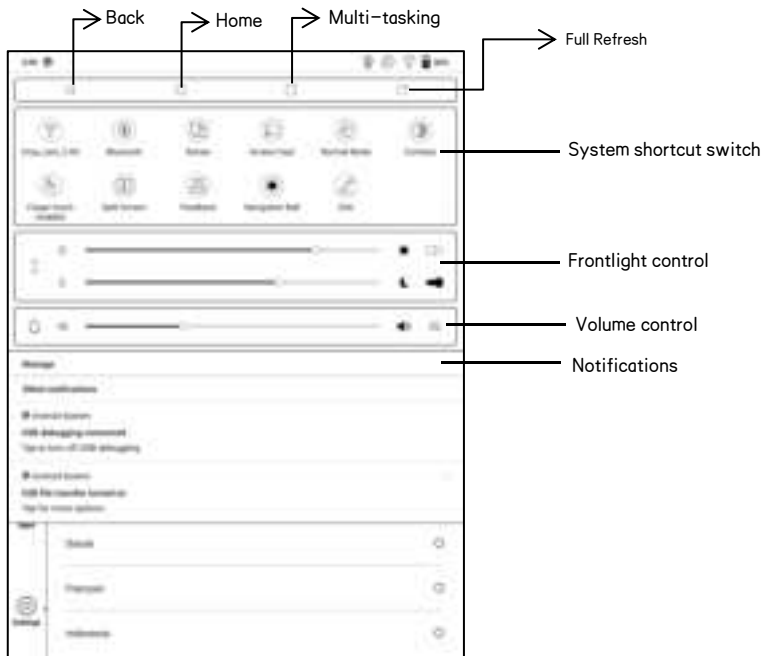

Edit

The icon in status drop-down menu can be adjusted, like add, remove, and re-order.

Multi-tasking switching

Clicking this icon, pop up the Android multi-task list to check the running applications in the background, one key to clear up all the applications to speed up the device.

Wi-Fi Setting

When using at the first time, you should enter into the Wi-Fi setting interface to get a accessible connection. Then click the icon to turn on/off the auto connection.

Bluetooth Setting

When using for the first time, you should enter into the Bluetooth setting interface to match a device you want. The matched earphone, page turner can be auto-connected by clicking the icon. Certain devices do not support auto connection after disconnected.

Rotation

Easily change the orientation of the screen by clicking the direction you want. Support auto-rotation.

Refresh Mode

Four levels of refresh mode are available.

Normal Mode: good display effect, suitable for general text reading.

Speed Mode: with slight ghosting, suitable for quickly reading image and text.

A2 Mode: Ghosting may exist, suitable for scrolling pages with image and text.

X Mode: May cause serious loss of details, suitable for web pages and video.

Normal mode is the default mode; Speed mode is used while scrolling pages;

After selecting a new mode, to adjust the contrast could get a better effect;

General contrast works for all interfaces, and other contrast adjustment in App optimization may cause superimposed effect. It is recommended to only use one of them.

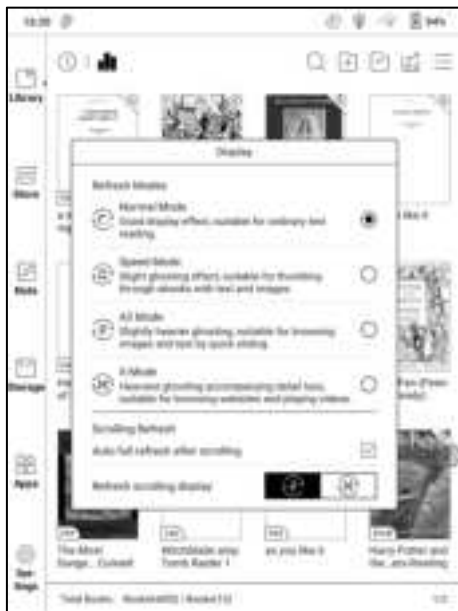

Display Control

This includes settings Color Contrast, Color Saturation, and Color Brightness, which are all global settings for the whole device.



Function Area

The function area includes Library, Store, Note, Storage, Apps, and Settings.

The default Homepage is Library. Double-tap the Navigation Ball to return to the Homepage

Users can go to Settings / More Settings to set any of the other function pages as a default Homepage.

Content Area

The contents are sorted by time by default. The contents includes the following items.

Library

All books in supported format from internal storage are displayed here.

The scanning path can be modified via Library Settings.

Store

Enter into an online eBook store. Users can view more book information and make a purchase. Purchased books will be added to the list of Library.

Note

Users can create a new note here, create folders for sort management, and export note files to third-party apps.

Storage

All folders from internal storage will be displayed here. Users can manage documents and folders from the page.

Apps

All third-party apps are displayed here. Users are allowed to manage or optimize the apps.

Settings

The list of system settings help to manage the device.

ScreenCast

1. This only supports Windows10. Win7/XP and MacOS are not supported currently.
2. Please make sure that the computer itself supports the screencast function, which can be checked in the computer system settings: System-Projecting to this PC.

Please pay attention to the 4 related settings, which will affect the results of searching the computer on the device side and the confirmation of the connection request;

This computer can support the state of screen projection



This computer does not support screen projection



3. Please make sure that the computer and your BOOX are in the same Wi-Fi environment.

If a desktop computer is connected to Wi-Fi via wireless network card, please confirm whether it is supported in step 2.

Some computer configurations and wireless network cards do not support this function;

4. On the device side, select screencast from the system drop-down list. Then the automatic search will start, and the name of the computer will be shown when found.



5. In the search window, select the found computer. If there are multiple supported computers, click Settings to enter the list of supported computers. Then select the computer that you want to project to from the list.

6. After you select the computer that you want to project to, the computer will pop up a notice to confirm whether to accept the projecting request;

7. After you confirm it, it will automatically connect and the screen will be mirrored successfully;



If the "Unable to view protected content on this device" appears on the screen, the connection may be unsuccessful. Please disconnect the device, and request the screencast connection again.



8. When the devices are connected, please tap the system bar of the device– Screencast again, and select “disconnect”. The computer cannot disconnect the connection.

If the computer supports screencast but cannot receive the request, please restart the computer and try to reconnect again and check whether the computer configuration rejects the request (see step 2).

Screen Record

Long press Recording button on the screen to enter the Screen Recording settings. You can customize Resolution, Image Quality, Screen Orientation, Sound Source, etc.;

When you use Screen Recording for the first time, you are recommended to adjust the relevant settings first.

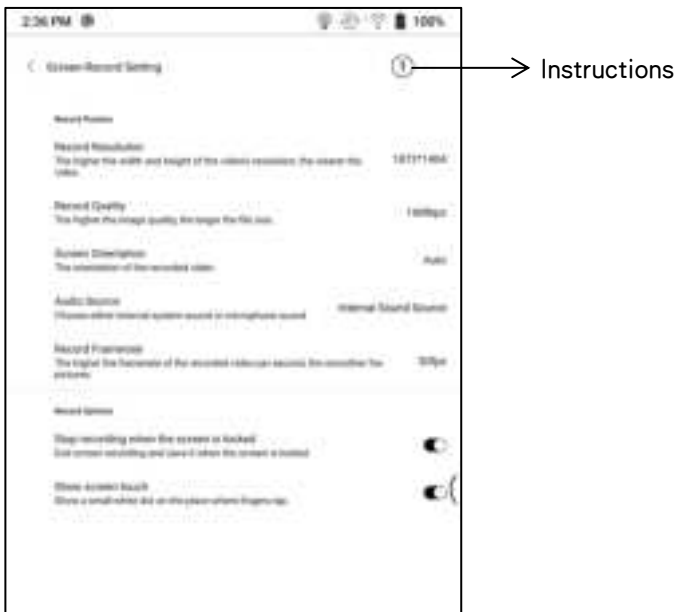

Tap the Screen Record icon to open the floating window of screen recording. Tap the “Start” icon to start recording and tap the Close icon to stop recording;

After you stop recording, there will a thumbnail displayed in the upper right corner, and you can tap it to play or share; Long press the floating window to drag it around on the screen. The floating window will not be recorded into the video;

After the Screen Record is enabled, the floating window will always stay on the upper layer of the screen. You can create new screen recordings continuously. If you need to close it, you can manually tap X to close it.

The Recordings’ format is MP4 and the save path is:

Storage/Movies/Captures

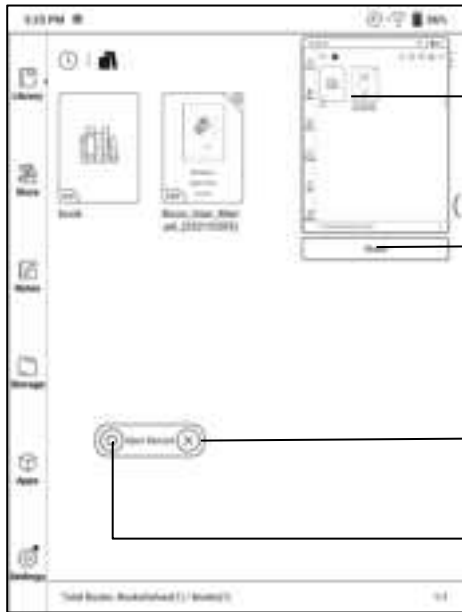

→ Preview

→ Share

→ Close

→ Start / Pause

5. Library

The library only displays E-book documents in supported formats in the storage. Book cover thumbnail is displayed by default. E-books are sorted by the creation time.

On the upper right working area of the Library, users can search, create a new bookshelf, manage books in bulk, check Reading Statistics, pop up the drop-down menu (including Filter, Refresh Library, Scan Covers, Library Setting, Switch to List View)...etc.



Library Display Switch

Click on these icons to switch the library display. By default, it auto-scans and loads all the supported documents in specified paths, sorted by a specified way.

Another one is to display the content based on the structure of storage.

The icons change after clicking on it.



Library Display Switch

Click on these icons to switch the library display. By default, it auto-scans and loads all the supported documents in specified paths, sorted by a specified way.

Another one is to display the content based on the structure of storage.

The icons change after clicking on it.



Filter & Sort

By default, it shows all books in descending order.

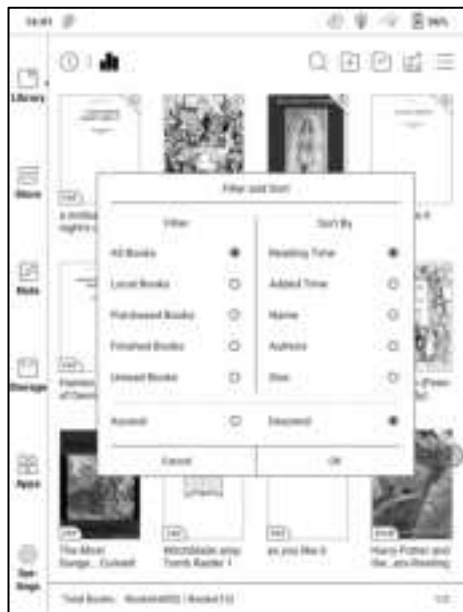

Refresh Library

“Refresh Library” gets all documents in supported formats scanned and rebuild library list. This function does not delete the reading history.

Create Sub-library

It helps to manage books by file manager.



Library Settings

Users can set book file scanning path here. It only scan the specific folders (Books, Store, WifiTransfer, Push).

Users can also select scan all folders but it would slow down the loading speed of Library.

Users can select showing books title or file name.

Sub-library Attribute

Long-press on sub-library cover to view more information about sub-library. To delete or rename sub-library are allowed. When deleting sub-library, the containing books will be moved to Library and will not be deleted with the sub-library.

E-book Attribute

Long-press on book cover to view more information about E-book name, author, format, size, reading progress, book detail(only available for the E-books of Store), open way, Lock、rename, move(to sub-library) and delete. One E-book only can be added to one Sub-library.

As for the books purchased from the Store, is allowed to view book details by jumping to the Store page.

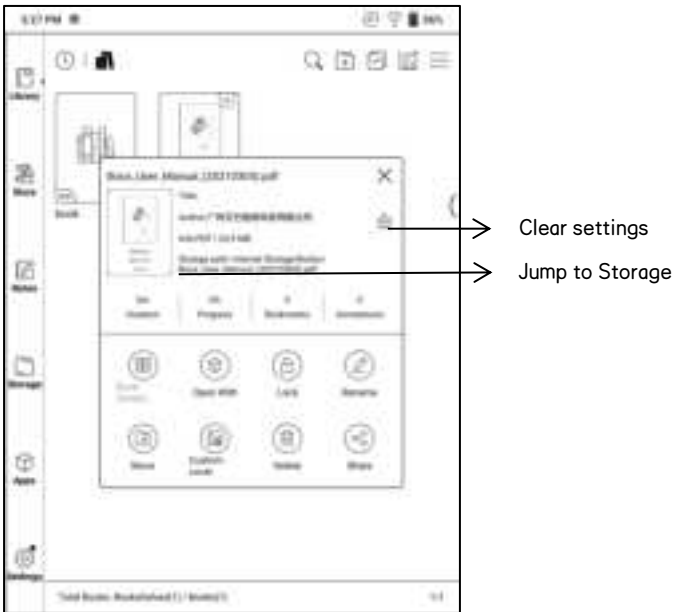

Clear settings including : clear password default settings , clear reading data , Clear Cache、 Clear book Cover ;



Lock (Reading Password)

User can add (reading) Password to lock each file in order to protect personal reading data;

The Password is used to open the file, but it only applies to the same device and NeoReader. If you copy and export the file to other devices or Apps, the Password will become invalid.

You can use the same Password as the Screen Lock. Or you can set a different digits Password.



Digits Password only support one Password. After you have set the digits Password, you do not need to set another digits Password and only need to add the Lock.

Reading Password cannot be recovered. If you forget the Password, you can only reset it through ONYX Account.

Reading Password supports individual setting or setting in bulk (setting in bulk is to add Locks). Currently It does not support to add Passwords to all files directly.

If you choose to use this Password Setting by default, you can add Password to other files quickly and do not need to re-select the Add Lock Option every time after the Password is set for the first time.

Reading Statistics

Reading Statistics is to summarize personal reading data, including

Today's Reading Time, Books that have been read, books that have been finished, Total Reading Hours, Highlights and Annotations and Average Reading Time Distribution.



Average Reading Time Distribution includes the reading time of all days since Reading Statistics is turned on.

Under Reading Statistics, only highlights and annotations can be jumped to and the books that recently have been finished can be opened. Other data is only for analysis purpose.

The reading data of each device can only be available on the same device.

You can not check the statistics of this device on another device.

Share (Third-party App)

This supports sharing files through third-party App. The sharing path is automatically obtained according to the installed Apps.

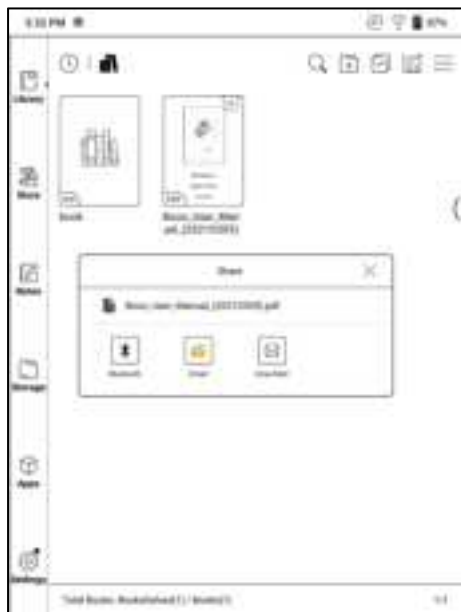

6. Reader

Tap any E-book cover to open an E-book. Full-screen reading without showing status bar is set by default.

To pull down from the top of the screen can call out the status bar.

To tap on the center of the screen can call out the menu bar for switch among different documents or other functions

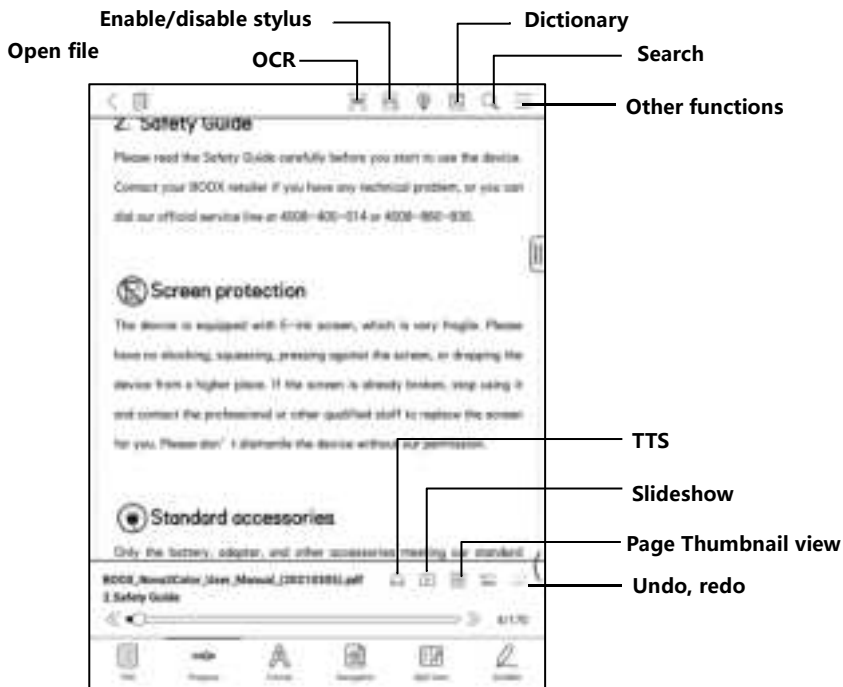

Floating Toolbar

You can choose to activate the Floating Toolbar for the first time when you open a file. Or you can go to Settings / Floating Toolbar Settings to enable it and customize the function buttons in the Floating Toolbar.



The Floating Toolbar includes: Hide, Scribble, Enable Palm Rejection, Menu, Prev Page, Next Page, Cancel (Progress)

Long press on the Floating Toolbar, you can drag it around on the screen.

You can expand or contract the Toolbar to the edge to avoid cover any text on the screen. When you need it, just swipe from either side of edge to the other side to expand it.

When the page is zoomed in, the Floating Toolbar would automatically expand proportionally in order to manage the zoomed-in page better.

Under zooming status, single tap on the screen is set for turning sub-pages of each page(each original page will require several time page-turns to be completed). But tapping the virtue page-turn buttons on the Floating Toolbar is set for turning the whole original page.



You can disable the Floating Toolbar by going to Setting – General Setting. When it is contracted to the edge, you can swipe from either side of edge to the center of the screen to expand it.

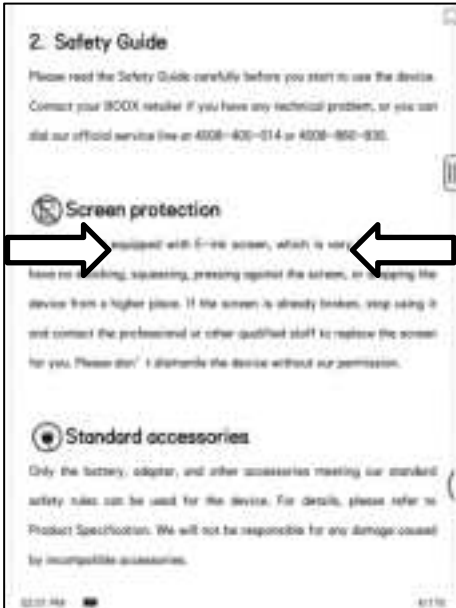

When palm rejection is enabled from the Floating Toolbar, it only applies to the reading document. The Floating Toolbar still supports hand touch, but it can remove the interference of hand when you write on the reading document.

Word Menu

Long-press on the word to pop up dictionary dialog for look-ups.

English word recognition and look-ups are supported.

Through the drop-down list on the top right of the dialog, the dictionary can be switched to others.

Users can download and install the dictionary themselves. Put dictionary file on the path root directory\dicts\xxx (e.g

Storage\dicts\English-French), or download dictionary online directly.

Dictionary is available to use after being installed.

Tap on any position out of the dialog to exit the dialog.

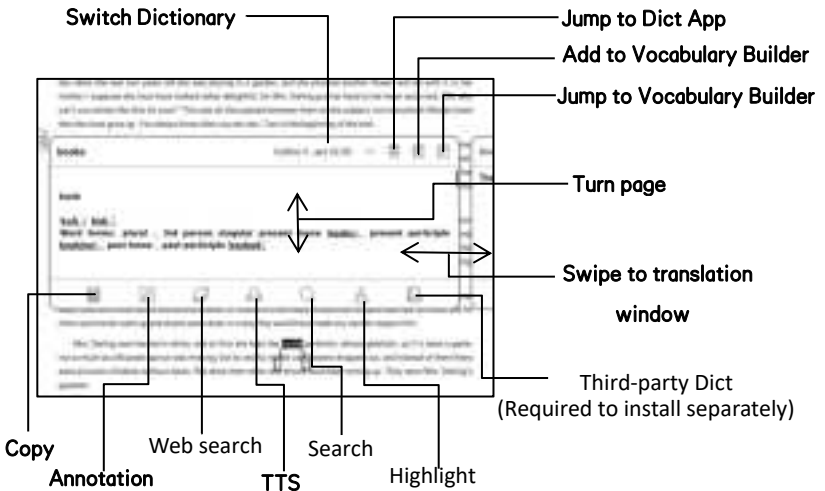

Long press on any word and drag to select the text you want to mark.

The highlight is set by default for selected text. Users can switch among highlight, underline and others, the color highlight can be in black or grey.

The mark setting remains after a change. The marks before the change will not be affected.

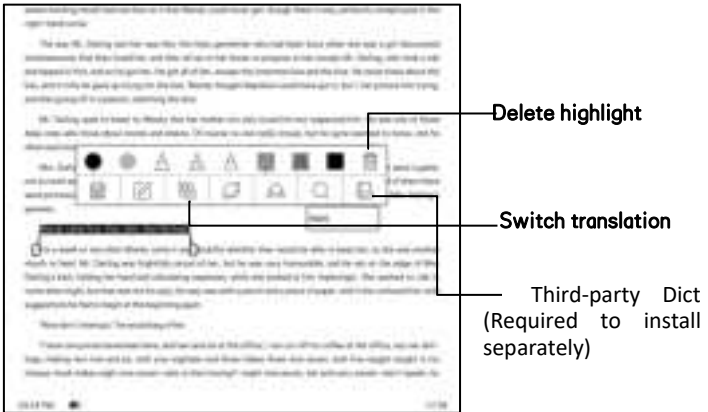

Tap on any position out of the dialog to exit the dialog.

Choose “Annotation” to pop out a text box to add notes if needed.

OCR (Beta Version)

Only supports pages in image formats PDF, CBR, CBZ, DJVU, and PNG.

Recognize one page only each time.

Choosing horizontal or vertical according to the document layout can improve the recognition accuracy.

Recognize 5 times a day when you are not logged in to your ONYX account.

Recognize 10 times a day when you are logged in to your ONYX account.



You can long-press text to add annotation and lookup dictionary on the recognized pages

If some individual characters are not recognized correctly, you can switch to the original text in the annotation pop-up window to correct them, and manually modify the recognized text content (Do not change the original page text);



Pages recognized by OCR show the recognition mark in the upper right corner, and the recognized pages can be viewed in the Directory-Bookmark, which is convenient for quick locating and jumping;

Tapping the recognition icon again will clear the OCR content;

Handwriting recognition

Double-tap the handwritten text or shapes to start AI Recognition.

In the state where hand touch is disabled, double-tap can also be used to initiate the AI Recognition

The text and shapes with 0.5cm spacing and straight lines with 0.3cm spacing can be recognized as one content area. If the spacing exceeds either of the two spacings, the content will be recognized as a different content area.

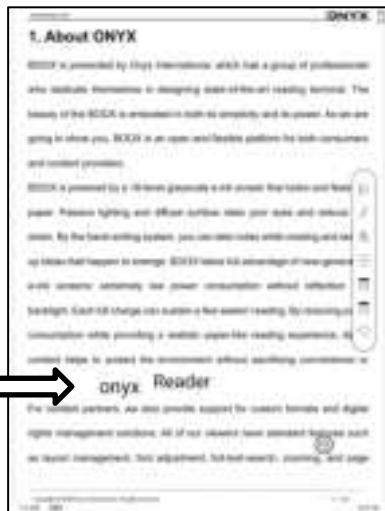

The boxes or lines near the text can be converted into underline and highlight after being double-tapped. That offers great convenience to add highlights to the converted content.

If users do not want it to be converted into highlights, you can disable this function from Handwriting recognition settings. The handwriting content will be only converted into images.

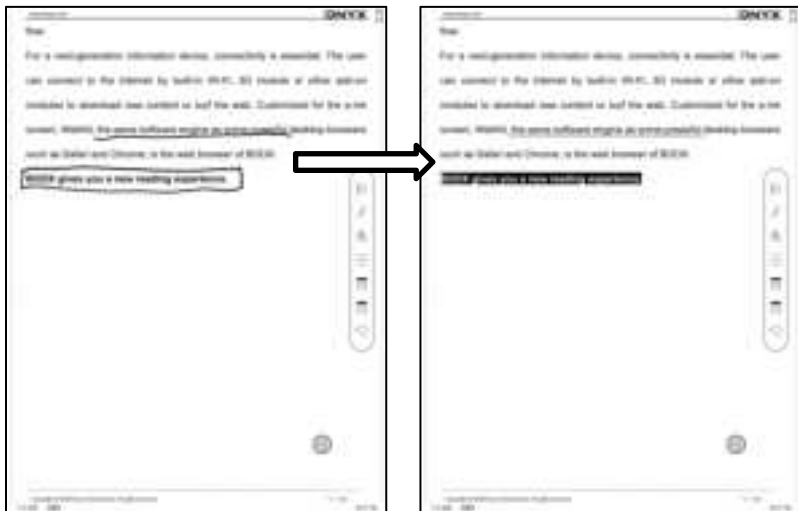

Converted to adding Bookmarks

Use stylus to click the upper right corner to add a bookmark

This area does not support page-turn by stylus.



Page-turns

Users can use the stylus to tap the 3 corners of the content area for turning pages. This offers convenience to page-turn when hand touch is disabled.

This function is on by default.



Bottom Menu Bar (PDF format)

TOC, Progress, Format, Navigation Mode, and Scribble are included.

TOC

TOC contains Table of Content, Bookmark, Annotation, and Scribble.

TOC supports three-layer hierarchy. The current layer is underlined. Jump to the corresponding page when tapping any of the layers.

Tap on any position out of the TOC to exit.

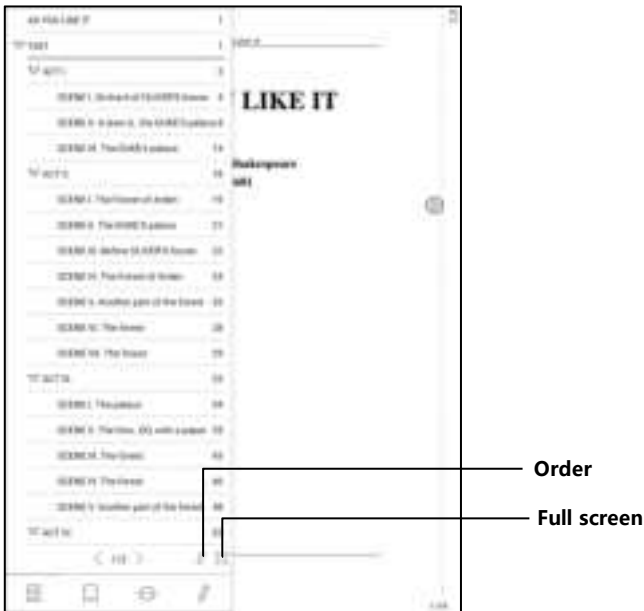

Bookmarks

Without calling out the menu, bookmark the reading page by simply tapping a tag on the top right corner of the screen. Tap it again to un-bookmark the page.

The bookmarks can be checked under the path of Doc-Bookmark, where users can delete bookmarks.

Jump to the corresponding page by tapping any of the bookmarks.

Annotation

All highlighted/underlined/annotated content would be listed under the page of Doc-Notes for further searching, editing and deleting.

Jump to the corresponding page/content by tapping any of the lists.

All contents on the Annotation page can be exported in txt format. Exported files are saved under the directory folder Storage\Note\(same name as the source file).

Scribble

All scribble and sidenote can be viewed under the page of Doc-scribble for further searching and deleting.

Jump to the corresponding page by tapping any of the pages.

All scribble contents can be exported in Png format and saved under the same directory folder Storage\Note*(same name as the source file)*.

Progress

It displays the chapter name (book name if no chapter), page progress, last/next chapter, page number, slideshow, undo, and redo.

Tap on the page number to enter a quick-flip interface. Click the page numbers again and input number to jump to the page directly.



Format

Display, Contrast, and Reflow are included. This module is just available for the E-books in the formats of PDF\DJVU\CBR\CBZ.

Display

It contains Layout, Orientation, Zoom, Crop, and Margin.

Layout: Single page, double pages 1 , double pages 2 , double page only in landscape mode .

Orientation: Allowed to switch to four different orientations, the word orientation is the same as the orientation of “T” .

Crop: Auto-crop according to the margin set by users.

Margin: The empty space at the sides of book content for auto crop.

Zoom: Zoom in, zoom out, and partial zoom are supported. Users can also pinch fingers together or apart to zoom out or in on the reading pages.

Contrast

Embolden only applies to text in PDF.

Sharpen Image can sharpen the images.

Watermark Whitening can whiten the light-colored images or background in the pages.

Dark Color Enhancement applies darker display to either the whole pages or text only.



Reflow

Reflow is only available for PDF/DJVU/CBR/CBZ documents.

Reflow allows users to further customize the layout of documents including: Line Spacing, Margin, Text Direction, Font Size, Columns, and Skew Correction (for italic documents).



Navigation

Navigation allows users to have options of Reset, Comic Mode, Article Mode, and More Settings including Crop, Split, and Subpage Order.

Comic Mode: the screen will be divided into four subpages and the reading order is upper right – upper left – bottom right – bottom left.

Article Mode: the screen will be divided into four subpages and the reading order is upper left – bottom left – upper right – bottom right.



More settings

Manually adjust the settings of area cropping, page split, and subpage order.

Crop: Manually select the cropping area for single or double pages.

Split: Split the pages into specified subpages in different ways.

Order: Decide the initial position and reading order for subpages.



Split View

It allows to respectively open current document, two different documents, or one document & Note at the same time 、 Split-View (Doc & Translation)

This function is only available in landscape mode, the later open document/Note will appear at the right side. The sides can be swapped.

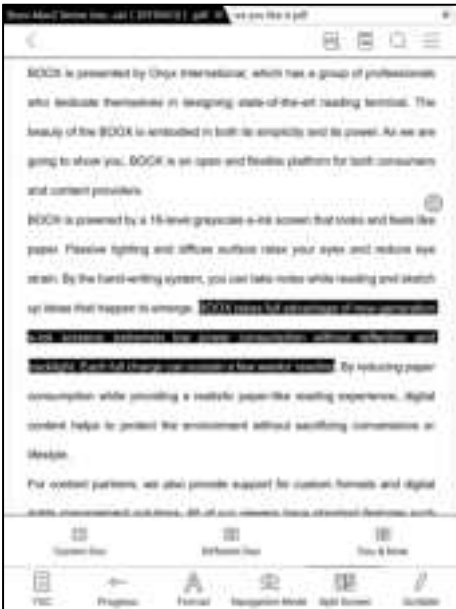

Current Doc (same doc)

The two documents are totally independent. Users can respectively turn pages and save them.

The scribble, highlight, annotation, bookmark would be synchronized to each other after page refresh.



Similar to the Current Doc, these two documents can be respectively operated. The display is also swappable. For PDF document, please try to swap them if part of them is not writable.



Doc & Note

Likewise, they are swappable.

And the Note will be created with a name same as the document. It associates with the document and can be edited in Note app.

Every document can only have an associated note. Changing the name of the note does not affect the association.



Split-View (Doc & Translation)

This supports Baidu Translate and Bing Translate and provides full page translation.

This also supports multiple target languages

Your BOOX needs to stay connected with internet



Scribble

The Scribble toolbar is floating on the screen. You can long press on it and drag it around on the screen.

Scribble is enabled by default. You can enable / disable it by tapping the Scribble icon located on the upper part of the screen.

You need to pop up the Scribble toolbar by tapping the Scribble icon located on the right bottom of the screen. Or you can also enable it from the Floating Toolbar.

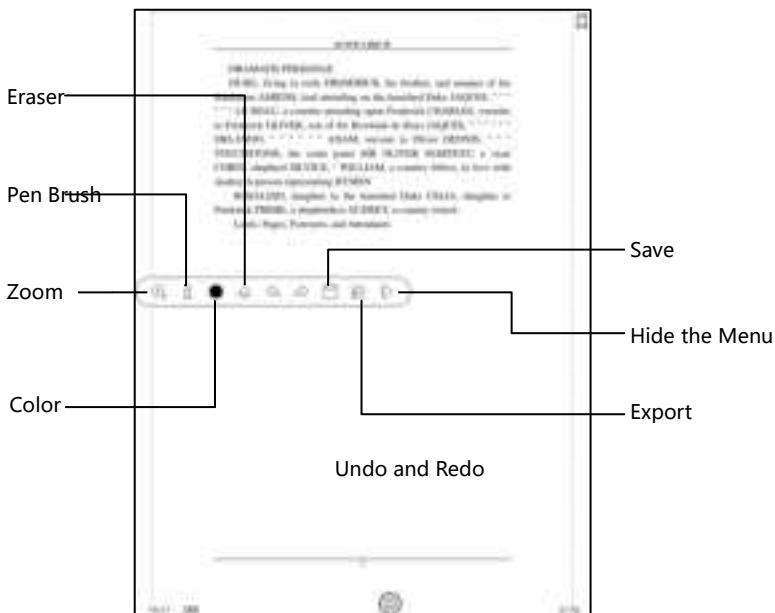

The handwritten notes are embedded to the original documents by default. It support to embed to original PDF and export as a new PDF.

The embedded PDF will be saved as the original document while the exported PDF will be saved as a new PDF file and retain the handwritten notes.

The embedded handwritten notes can be checked and edited on some PC applications such as Adobe acrobat、WPS、chrome. The notes can also be checked and edited on other BOOX devices.



Write and Erase

Click on the brush and eraser icons for the writing and erasing functions.

Double-click them to expand the sub-menu.

In the state of stroke erasing, you need to switch to the brush for go on writing.

For the “erase all” , you do not need to switch back to the brush.

Color

Black, gray, and white strokes are shown as their authentic colors. Other colors are shown as black on devices, and as their original colors after being exported to PC.

Bottom Menu (other format)

TOC, Format, Progress and Split screen are included. It supports the formats of EPUB\TXT\MOBI\AZW3,etc.

Format

The settings include Font Face, Display and Spacing.

Loading font face in the directory Storage\fronts is supported.

The settings for font size, font face, contrast, bold, spacing work on all newly opened documents, but not work on the documents before settings.



ePUB Original Layout (V2 Engine Beta Version)

The ePUB format can be switched to the V2 engine Beta version in the Reader' s Settings/other settings, and supports the original layout of the document, including Fonts, Line Spacing, Margins, Graphic-text Layout, Indentation, etc.;

After switched to the V2 engine, the document will be closed automatically. When you open the document again, it will be opened in the V2 engine. If you want to switch back to NeoReader, you can disable the V2 engine and reopen the document;

Currently, it does not support to sync NeoReader' s data such as Bookmarks, Annotations, and Handwritten notes.



After switched to V2, the document needs to be paginated again. You can check the pagination progress in the Menu / Progress. After the progress bar is loaded, it means that the pagination is complete. After the pagination is completed, you can drag the progress bar to Jump to Page;



After switched to V2 engine, Menu / Format, there is the Original Layout icon.

The Original Layout support manual modification. After modified, it can be restored to the Original Layout by tapping the Original Layout icon.

Aside from Fonts, Embolden, Spacing style, other formats all use Original Layout' s settings.

Indentation: This supports 3 modes - Close Indentation, Indent by 2 characters, and the Original Indentation



→ Indentation
→ Reset to Original Layout

Original Layout ←

Screenshot

Diagonally tap on two corners of the screen to capture the screen in PNG format. The function is only available on the reading page.

The screenshot will be saved to the local, or shared by scanning QR code.

The save path is Storage\Screenshots.



Refresh

Tap the hamburger menu located at the upper right corner to choose

Refresh and other related settings of refresh

Regal refresh and partial refresh are by default

When scrolling the page, speed mode is by default.



Settings

There are General Settings, Touch Settings, TTS Settings, Export Settings, Screenshot Settings, Floating Toolbar Settings , Other Settings and Version Name.



General Settings

There are Enable page close reminder, Enable system status bar, Enable reader status bar, Enable multiple documents, Show file borderline, Enable Floating Toolbar, Show hyperlink, Show bookmark position, Enable pinch to scale, Apply certain options to all documents、 Annotation Font Size Setting; .



Touch Settings

Users are able to customize the touch settings for different areas. There are six default touch modes can be chosen and users can customize three more.

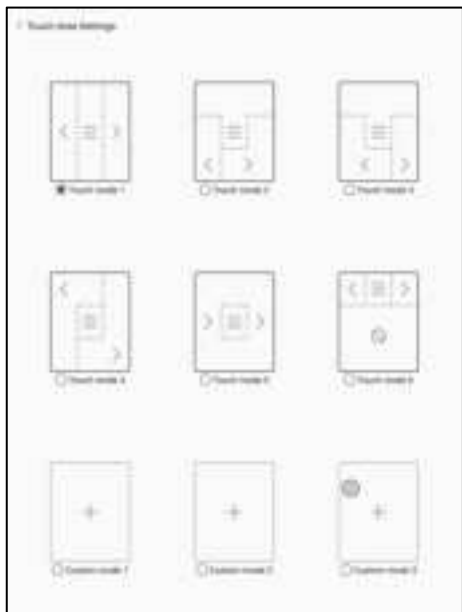

TTS Settings

The built-in Baidu TTS is set by default. English is supported. A network connection is required at first use.

Switching to third-party TTS system is allowed. The built-in TTS settings are not synchronized with the system TTS settings. The system TTS settings work on the third-party TTS by default.



Export Settings

The default storage path is Storage\Note.

The export files can be also saved to the same directory as the source file.



Floating Toolbar Settings

This page offers General Settings of Floating Toolbar, Scribble Settings, and Handwriting Recognition Settings;



General Settings

It is enabled by default and can be turned off manually. After disabled, it can no longer be called out;

It can be customized whether the indicator is displayed after it is collapsed. Call out the Floating Toolbar by swiping from the screen edges.

The Toolbar's size, display style and functions buttons are customizable.

Custom function buttons support up to 11 in horizontal style and up to 14 in vertical style;

Press and hold the function button icon to display the definition of the function button;



Scribble Toolbar Settings

The Toolbar's size, display style and function buttons are customizable.



Handwriting Recognition Settings

It is enabled by default and can be disabled manually. After disabled, it will no longer support double-tap recognition

The underline can be recognized as highlight first. It is enabled by default, and it can be turned off. After it is turned off, it is only recognized as an image;

You can set the recognition of hand-drawn symbols as adding bookmarks. It is disabled by default and can be manually enabled. After enabling, double-tap recognition of the symbol will automatically convert to adding bookmarks;



Other Settings

This setting page includes “Open ePUB documents with V2 engine” , Enable “Pinch-to-Zoom” , and Enable “Turn pages by swipes”

When “Turn pages by swipes” is disabled, you can only turn pages by tapping on the screen. This can avoid accidental page-turnings when you are taking handwritten notes.



7. Store

In the language of non-Chinese, the Store is offering free publications E-books from the Internet.



Category

Books can be screened according to different categories.



Book Detail

Click a book cover to open up book detail. The specific book information.

Click “Full Edition Download” to download the book, then you can see this book cover in Library .



8. Notes

This includes Recent Notepads, Local Notepads, and Reading Notes.

Recent Notepads include 12 Notepads that have been opened recently, including local notepads and reading Notes

The Reading Notes include the Notes created under Split View when users are reading books.

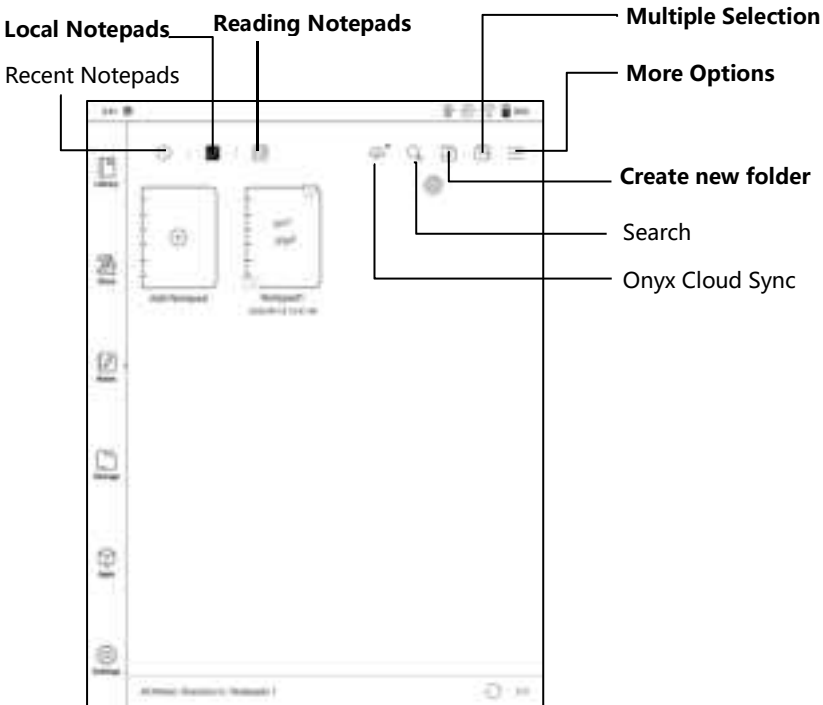

Cloud Sync (in bulk)

Notes Cloud Sync requires logging in to Onyx Account.

Sync in the background. After you are logged in to ONYX account, the notes will be automatically synced from and to Cloud when you exit a Notepad.

Sync in bulk, including Notes list, all Notes. Users can manually sync all notes in bulks.

Cloud Sync includes two-way sync between Cloud end and BOOX device. When there is any change to the Notes on either end, the other end will sync all the changes.

The deleted Notepads can be recovered within 10 days from website trash bin. If you delete the notepads by mistake, you can recover them from the trash bin, which will be emptied after 10 days.

After Notes are synced, users can check the synced notes from push.boox.com by logging in the same Onyx Account.

Currently PDF templates can not be synced and only PNG templates can be synced.

Other accounts Sync

When third-party accounts are bound, the notes will be automatically synced when you exit a Notepad. Alternatively, you can sync notes by tapping the Sync icon on the top bar.

Third-party accounts only support one-way sync and do not support syncing notes back to BOOX devices. You do not need to log in to ONYX account.

Sync Results

Long press the cover of the Notepad to pop up the Property Window and check the synced accounts and sync result list.

Tap the sync icon to sync again for the accounts with abnormal sync.



More Options

It includes Notes Sync Setting, Filter and Sort and Settings.

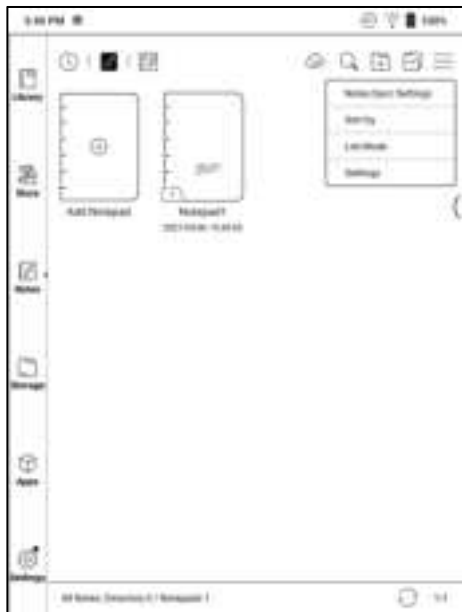

Notes Sync Setting

This includes ONYX Cloud Notes and export to other accounts.

When you export the Notes to third-party Accounts, the Notepads will be in PDF format and can not be edited.

If you export your notes to other bound accounts, the notes will be automatically synchronized to other bound cloud accounts of yours when you exit the Note. The sync icon is only applicable for the ONYX account cloud sync.



Settings

These are general settings for Stylus Calibration, Account Sync and Backup, AI recognition, Note password settings, Show Erasing Trace, Auto-turn on Wi-Fi to sync Notes, Auto-generate PDF documents after exiting Note, Auto refresh after lifting stylus.

If this device is bound with third-party accounts for file sync, and Wi-Fi is connected, the Note files will be auto-uploaded to the accounts with a PDF or PNG attachment.

If “auto-turn on Wi-Fi to sync Notes” is enabled for notes sync, the device will connect with Wi-Fi automatically and sync notes to the Cloud when exiting the Note app. If it is disabled, users need to sync to account manually by clicking an upload icon on book covers.

For the “Auto refresh after lifting stylus”, the display would refresh after users lift stylus away from the screen, making the strokes smoother.

Note Password Settings

This password is only used for protecting files on the device, not encrypting files. So the password does not work out of the device. Now this function does not support multiple passwords for one file.

This function supports specific password, which are available for all note files. Users can also set a specific password for a single file. To add, edit and remove password are allowed here.

The specific password can be different from the system password.

Enabling Lock will add locks to all existing notepads by default, and you can choose whether to add locks to new notepads by default. If you cancel this option, the new notepads will not be automatically locked, and you need to add lock to them manually



The note file has no cover thumbnail after locked.

Long-press the note file to remove and add password in the dialog.

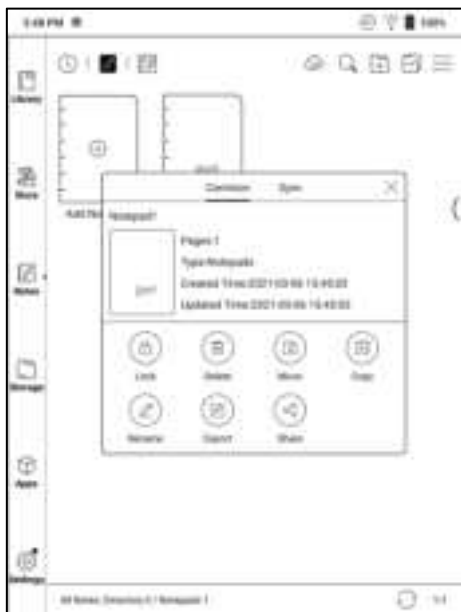

Scribble Interface

Files can be saved automatically and manually when to quit the Note.

Tap on the page number to jump to the specified page quickly.

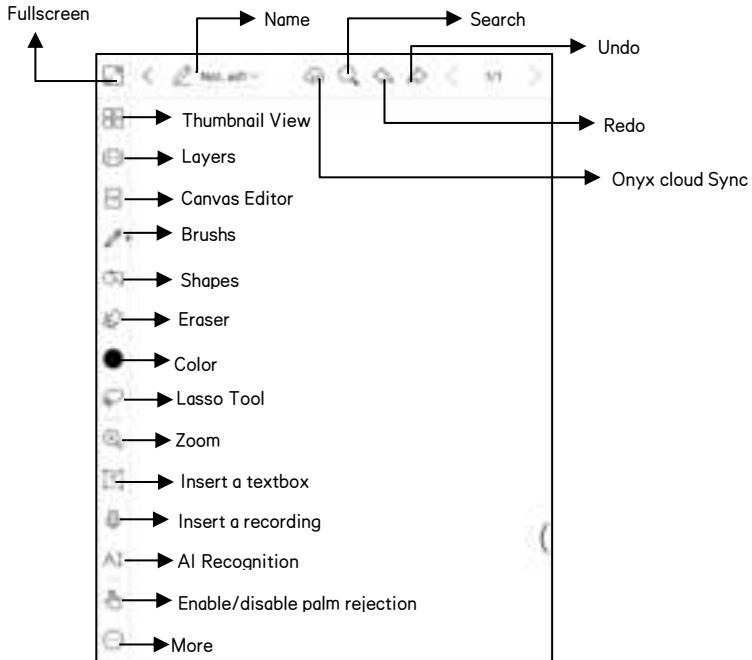

Layers

This supports template layer, 5 custom layers, hiding and adjusting layer order.

Hidden layers will not be displayed during export and recognition;

Templates can only be added at the template layer, and the template layer cannot be deleted;

You can add 5 custom layers to the inserted images

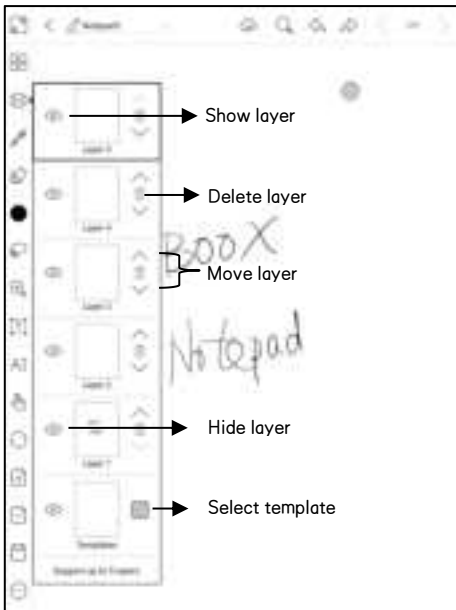

Template

It includes built-in templates, local templates (PDF\PNG format) and the Cloud templates.

The directory of the local templates is Storage\note Template.

The directory of the templates downloaded from the Cloud is Storag\noteTemplate\cloud.

The built-in templates will be used if the local template are deleted.

The template can be set to scale proportionally, splice original images, and stretch to fit the canvas size;

You are recommended to write after the template style is determined to avoid changes in the template after writing, which cannot correspond to the original position of the template;



Canvas Editor

The default canvas size is 1x1, same as the screen size.

The canvas size can be adjusted to 1x2, 2x1, 2x2 or custom size.

The max canvas size is 2x2. You can customize the canvas size within the max size. You can adjust the canvas size by dragging the canvas.

Canvas adjustment base is located at upper left corner. Drag left or downwards to expand the canvas.

When you switch from the large canvas to the small canvas, the strokes outside the canvas range will not be displayed, but will not be cleared. But the strokes can be redisplayed after you switch back to the large canvas

Canvas Adjustment will cut the redundant blank part of the canvas based on the outermost strokes position.



Horizontal Notepad

The notepad orientation is synchronized with the system rotation direction. When the system is switched to the horizontal screen, the notepads are synchronized to the horizontal screen. The created notepad under the vertical mode will retain its vertical size. The canvas size can be manually adjusted;

The newly created notepad in horizontal mode directly uses the canvas size 1x1;



Fit to Canvas and Fit to Screen

When the canvas is larger than the screen(1x1), you can go to Toolbar / Zoom to adjust the canvas size to “Fit-to-canvas” or “Fit-to-screen”.

Fit-to-canvas: the canvas will be automatically expanded to fit the whole screen. When the canvas is larger than screen, you can long press the canvas to pan it around.

Fit to screen: the canvas will zoom out to fit to screen. You cannot write on the grey area.

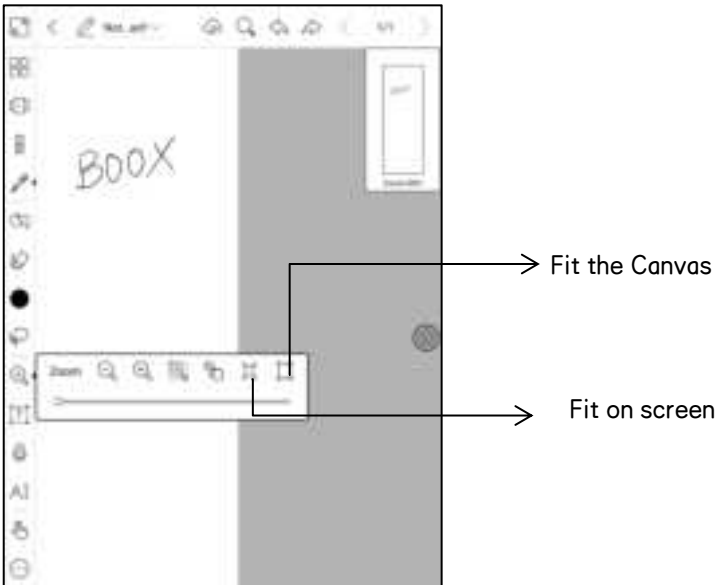

Custom Toolbar

Besides the default tools like scribble, erase, fullscreen, select, users can add, remove, adjust other tools on the toolbar.



Write and Erase

Click on the brush icons for the writing and erasing functions.

Double-click them to expand the sub-menu.

In the state of stroke erasing, you need to switch to the brush first and then write.

For the “erase all” , you do not need to switch back to the brush.



Lasso

In the Lasso mode, circle an area on the screen, then users can zoom, move, duplicate and remove the selected area.



Text Input

Users are allowed to key in words on the note by a Bluetooth keyboard.

The input box can be moved everywhere.

Users can adjust the font, line spacing, bolding, underline, italic, copy and delete.

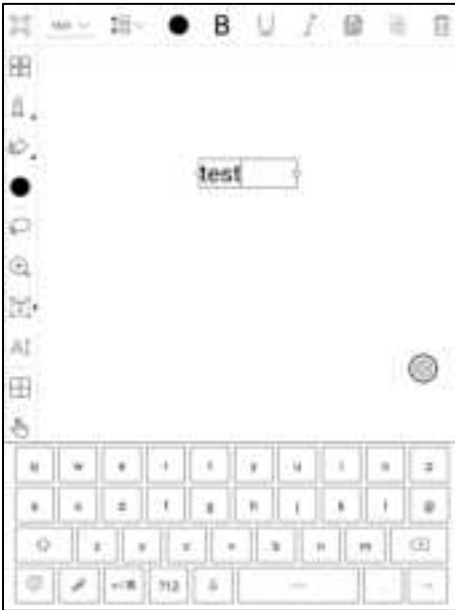

stylus touch for icons is desensitized by default, so it is better to use your fingers to adjust the position of the Navigation Ball;

when using full-screen the square icon to exit full-screen mode.

Insert a Recording

After tapping the Recording icon, the Recording will start immediately.

The recording progress bar will be shown on the top Toolbar. You can pause the recording. You can take notes while recording.

After stopping the recording, you can save or delete the recording directly.

You cannot restore the recording after you choose to delete it.

The recording window is floating on the screen. You can long press it and drag it around on the screen.



You can insert more than 1 recording on one notepad page.

Check all recordings at Toolbar/More/Recordings. You can only play recordings in current notepad. You cannot export recordings to PDF to use.

If recordings are saved to local storage, you can export recordings in MP3.



Insert Image

Users can remove, zoom, duplicate the images inserted from the local.

Select the image and then edit.



AI Recognition

Click the icon “AI” to switch to recognize the handwriting text. English is supported. To download the corresponding language package is required for other language recognition.

This function contains original recognition and reflow recognition.

Original recognition only does conversion but not changes the position of words, while reflow recognition reflows words after conversion. Users need to manually add space, line break and font size.

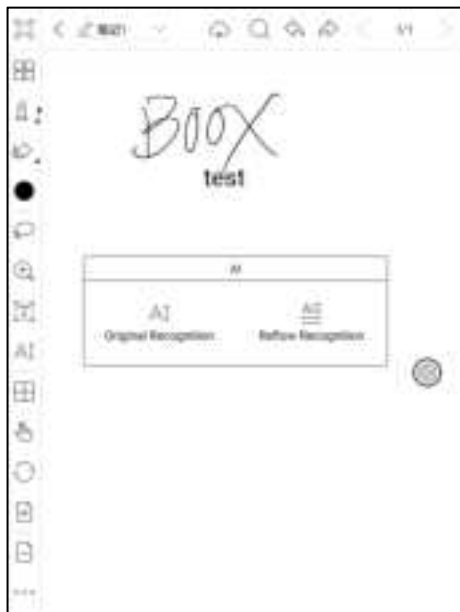

The text flows automatically after reflow. Users can manually make space, newline, and font size after that.

The accuracy of recognition depends on how normal the handwriting is.

AI recognition works based on the handwriting. If the handwriting content changes, please re-enter the function to let it convert once again. For saving the converted content, please export it.

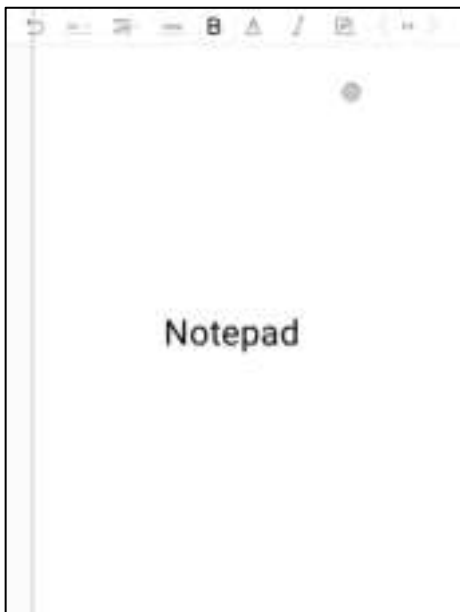

Share

Support share all pages (PDF format) and current page (PNG format);

Support scanning code sharing of Onyx account and sharing through third-party app;

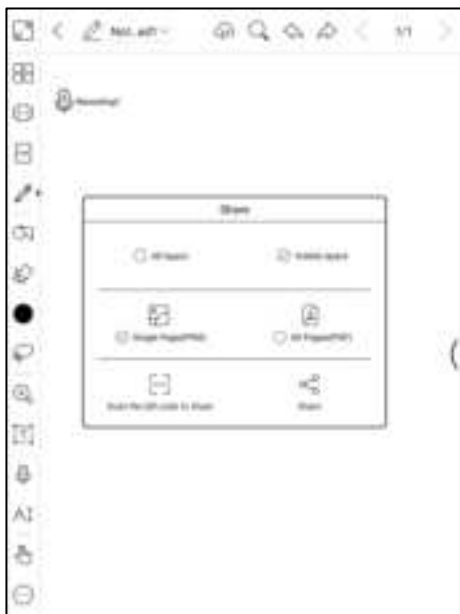

Full screen mode of Notes

When you switch to full-screen mode, you can choose whether to display the Floating Toolbar.

When it is collapsed, you can call it out by swiping from the screen edges.

Note: The full-screen mode is an independent note-taking mode. If you exit, you will exit the Notepad directly. If you need a non-full-screen mode, you can switch on the Toolbar;

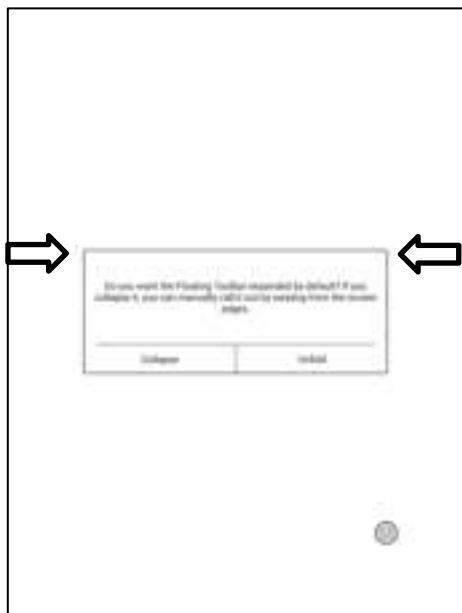

The default Floating Toolbar only includes Fullscreen, Pen, Color, Eraser, Collapse, and More. You can tap the “More” icon to customize the icons on the Floating Toolbar.

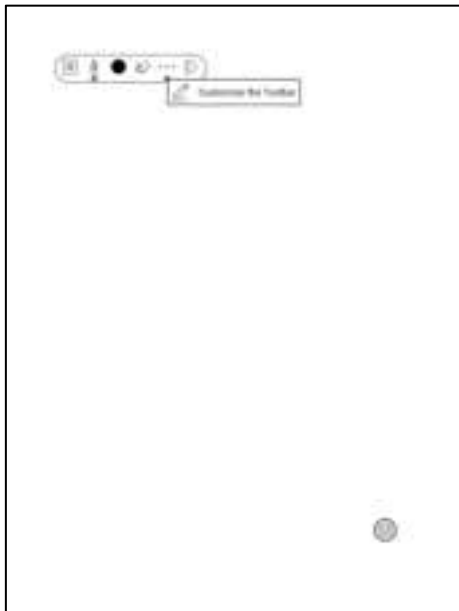

Floating Toolbar Settings

The Toolbar's size, display style and function icons can be customizable.



9. Storage

Recent Files

This section includes Shortcuts and Recently Updated Files, which are sorted in reverse order by time.

All Storage

This section includes Storage path and Categories. files will be classified according to the file formats, but the original storage location of the file will not be changed;

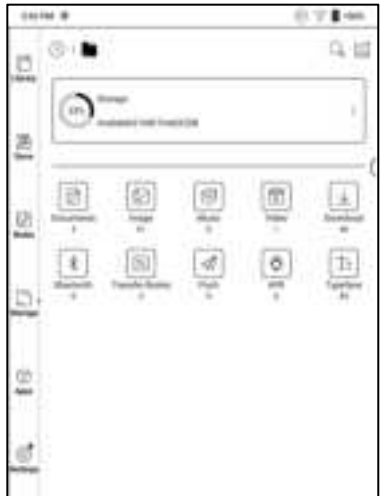
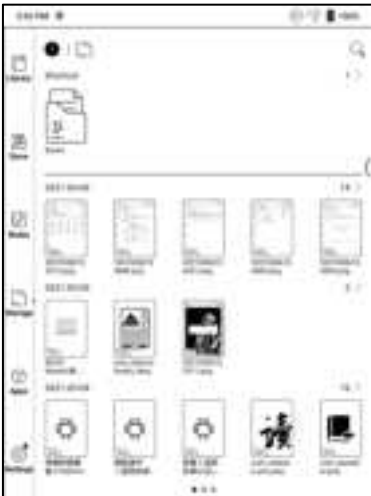

Long-press the folder to pop up Property Window and choose “Set as Shortcut” , which offers quick access to open it.

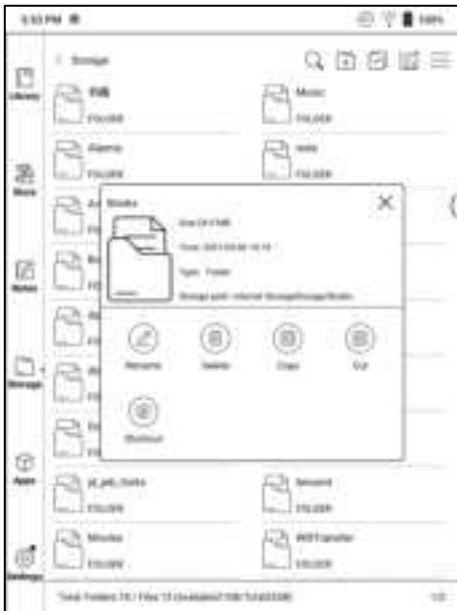

OTG External Disk

OTG is supported. Users can connect the device with USB drive through a Type-C cable. The device will detect USB drive afterwards.

The OTG feature would consume more power since it supplies power to a USB drive.

It supports analog and digital Type-C earphones (You can use 3.5mm audio jack converter);



Low storage space warning

Please reserve at least 300M of available storage space to ensure the normal operation of the system and saving related data;

When it is lower than 300M, a warning icon will be displayed in the system bar, indicating that the storage space is insufficient;



10. Apps

All installed apps are displayed in alphabetical order A-Z by default. Users can choose their preferred order.

Long press on each APP icon to pop up the Apps menu to delete or optimize. Pre-installed apps on devices are not allowed to delete.



Navigation Ball

Navigation Ball is a circular ball that floats above all the apps on the screen.

9 buttons can be customized.

Single click on the ball to expand and collapse navigation menu.

It requires to turn off and on again after the new button settings.

The Navigation Ball by fault is in Fan-shaped style. You can choose other display styles (Horizontal Style, Vertical Style) from Navigation Setting.

You can also adjust the transparency of the Navigation Ball.

This supports to set as a resident button. After being set as a resident button, the button will always be floating on the top layer;



The 9 buttons can be set as multiple common functions including system operation, app switching, app optimization and so on.



The app optimization can be called out in an app through the Navigation Ball, for real-time review after optimization.

App Optimization

Display

If some App's page content exceeds the screen and cannot be displayed, you can switch to the App's original DPI.



App Whitening

This is to adjust the color text, images and background of the App.

If some Apps have black or white icons, you can turn off Icon color or background color option of App Whitening.



Refresh

This is to set the Refresh mode to individual App. Speed Refresh Mode or X Refresh Mode is recommended for webpage and video apps.

When the system is in Normal Mode, the refresh mode of Apps will be used.

If the system is in other refresh modes(Speed Mode, A2 Mode), the system' s refresh mode will be used.



Others

For the webview page in the APP, the font size, color, boldness, etc. of the webpage can be adjusted;

Some apps need to run some services in the background, which can be enabled to allow continuous running in the background.



Dictionary

If users use dictionary apps the first time, to download dictionary package to local will be asked.

This function requires network connection.

Word pronunciation needs a dictionary file comes with voice files, currently TTS is not supported.

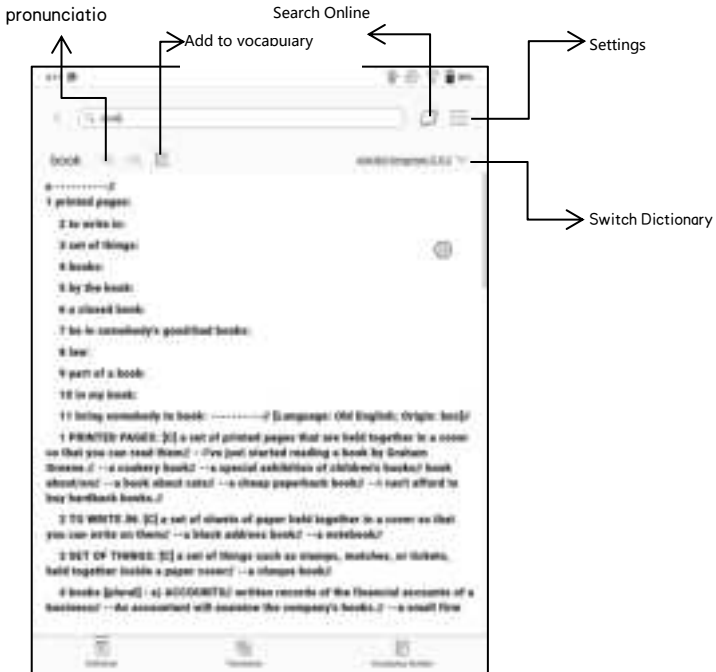

Users can install dictionaries themselves by putting the dictionary files to designated directory Storage\dicts\.

Please save the files under a folder, e.g. dicts\English-English Dictionary.



For the preferred dictionary settings, users can select up to 10 preferred dictionaries. Users will be asked to select again if the select number is less than 1 or more than 10.

After dictionaries are installed, users can look up new words in the search bar. Switch between different dictionaries by tapping a corresponding dictionary title on the bottom.

The search result is in terms of the related dictionary. If the word is unfound, try to use other dictionaries.

Looked-up words can be added to Vocabulary.

Users can divide the Vocabulary into groups. The words will be saved into the specified group once the group is selected.

Wi-Fi Transfer

This module contains Wi-Fi transfer and push.

Wi-Fi transfer allows to transfer ebooks to the device.

Please ensure that your PC or Android Phone and the device are in the uniform LAN, enter the provided IP address in a browser or scan the provided QR code to accomplish ebook transfer.



The ebooks are stored in a default path: \WifiTransfer.

Check the transfer list in “WIFI Transfer History” . You may delete the transfer history then the local files in the device would be deleted and vice versa.

Certain browsers may omits file suffix. This function does not support that kind of files. Please use other browsers (like UC, Chrome).



Push

Wi-Fi transfer allows to transfer files from PC to BOOX device. (The web push is not supported any more)

Website end address: push.boox.com

To use it for the first time, you need to log in ONYX account and bind the Boox device with PC end. One account can bind with multiple devices.

The size limit is 200M for every pushed file.



PushRead

From the Subscription section of push.boox.com or BOOX Assistant, you can enter a webpage address, push it to your BOOX, and read the page in html format.

To use the PushRead for the first time, you need to bind the same ONYX account on the website push.boox.com and your BOOX;



You need to connect your BOOX with Wi-Fi to download the pushed URLs for the first time. After loading once, it can be read offline later;

The layout of the content page defaults to Browsing Mode (the layout of the original web page), and you can choose to switch between Browsing Mode and Reading Mode from the More Menu;

The Reading Mode is a single page mode, tap the page to turn the page directly;

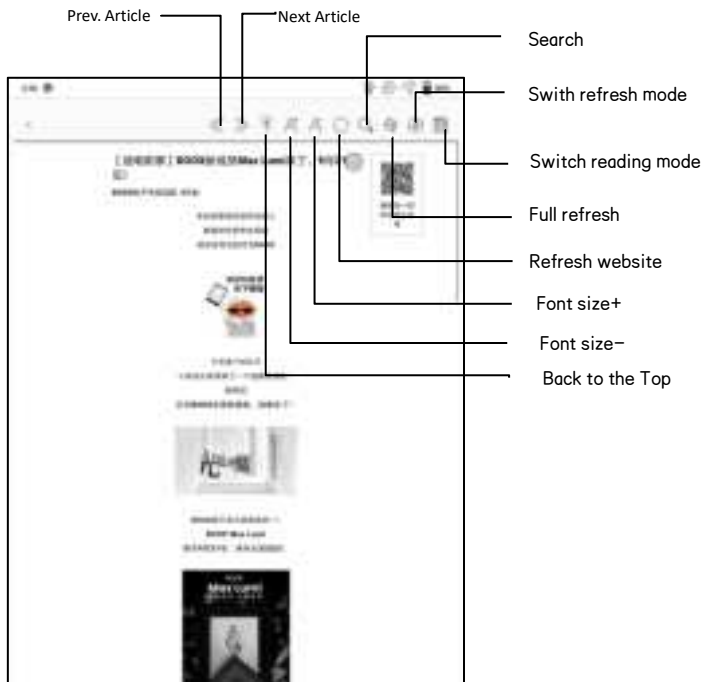

App Store (E-ink)

There are some usual third-party apps provided here. These apps are free versions from developers and their compatibility are not verified as full to the system. Paid apps download is not supported for now.

Users can choose to delete the installation package automatically after Apps are installed.



Screensaver

The screensaver and shutdown image can be customizable. The shutdown image only supports image formats.

Screensaver style

The Image Screensaver is by default.

The screensaver supports Image Screensaver, Poem Screensaver, Words Screensaver, Calendar Screensaver, Clock Screensaver, and Transparent Screensaver.

The clock, text, and Bottom Status Bar can be added to the other screensavers aside from the Transparent Screensaver.

Clock refresh intervals are customizable. After the clock is added to a screensaver, a certain frequency of refreshing screen will be retained in the standby state, and the automatic shutdown timing cannot be supported.



In Image Screensaver, when a single picture is selected, the screensaver is a fixed picture. When multiple pictures are selected, the screensaver will be shown in carousel format;

The Bottom Status Bar can display the battery status and lock screen status;

Calendar Memo

The calendar Memo can display the notes and reading records under the current date. You can open the notes or documents directly by tapping the records;

You can add handwritten notes as a memo, which can be set as a screensaver. Please go to Screensaver / Calendar Screensaver Setting for more details.

The content of Calendar Memo temporarily does not support the synchronization.



After logging in to the ONYX account, you can use the mail function to send the contents of the Memo to the designated mailbox as a PDF attachment;



Google Play Store

1.Connect your BOOX to the Internet. You will need to log in to the VPN if you are in mainland China. Please ensure that the VPN network is working and can connect to data;

2.Go to Settings / System Settings / Application Management / Enable Google Suite, tap GSF ID, then log in to Google account;



3. Verify your identity, then tap “register” (Google Frame ID is automatically obtained);



5. Go to Apps/ Google Play Store, select “update” from the drop-down menu in the upper right corner. Google Play service update can improve the probability of passing the certification.



6. After the update is complete, return to the homepage, then tap Login. If the login interface appears, it indicates that the authentication has been successful.



7. After logging in successfully, you can start to use Google Play store.



8. If it shows "This device is not authenticated by the Google Play protection mechanism", it means that the authentication has not passed. You can only wait for Google authentication to pass. After 5–20 minutes, check again. If it still has not passed, you can continue to repeat steps 3 and 4 to re-authenticate, and then tap the Play Store to log in;



Split Screen

This supports Apps Split-Screen. You can select Split-Screen from the system drop-down bar when an application is opened, and then select a document, a notepad or other application that you want to open on the other side of your screen.

The system interface does not support enabling Split-Screen directly. You need to start an application before enabling it;

The applications that do not support Split-Screen will prompt "This application does not support Split-Screen" when split screen is enabled;

Under Split-Screen mode, only the optimization and refresh setting of the main application (applications that enable split-screen) is supported. The refresh setting of the secondary screen (apps opened later) does not take effect;

Under Split-Screen mode, the optimization and display settings of the two applications take effect separately;

The default split-screen layout is clockwise. You can choose the counterclockwise direction in the Split-screen's Pop-up Window;



The Apps Split-Screen defaults to landscape mode. The left side defaults to the main application and the newly opened application is on the right side. You can swap left and right positions in the Split-Screen Menu;

Under Split-Screen mode, select Exit Split-Screen to exit the Split-screen mode from the system pull-down Split-Screen menu.

After exiting the Split-Screen, the interface will return to the main application on the left by default;



11. Settings

Model name, Android version, and Version are available on Settings. Users can click the image of the device for an online user manual and further manage settings of the whole device by clicking the below specific area.



About Device

It contains model name, Android version, MAC address and firmware version.

Click the model number for more information, including Capacitive Touch Version, VCom, Other information, Factory Reset, etc.

Note: To run the function of factory reset would remove all of the user data. Please make a data backup first.



Language settings

Users can set system language, keyboard and input method and TTS on this page;

Users can set languages of the system and virtue keyboard. The system has an Android keyboard by default. Users can install third-party Apps for more input methods.



ONYX Keyboard

Typing, handwriting input and voice input are available for ONYX keyboard, and network connection is necessary for first time.

English is the default language of the handwriting input and users need to download the corresponding language package first if they want to use handwriting input for other languages.



Handwriting Input Language Packages

Handwriting recognition package

English (United States)		★
Chinese (China)		⌵
Chinese (China - Hong Kong)	22,000	⌵
Chinese (China - Taiwan)	24,100	⌵
English (United Kingdom)	8,800	⌵
English (Canada)	8,000	⌵
Swedish (Sweden)	8,700	⌵
Japanese (Japan)	16,000	⌵
Hindi (South Korea)	10,000	⌵
French (Canada)	7,900	⌵
French (France)	8,100	⌵
German (Germany)	7,000	⌵
German (Austria)	8,000	⌵
Arabic (Saudi Arabia)	8,000	⌵

Search

Voice Input

Long press the Space button on the ONYX keyboard to enable the voice input first. Only English, Mandarin, Cantonese, and Sichuanese are supported.



Date & Time

Users can choose either auto setting or manual setting for date and time. When the device is connected with internet, it will automatically set date and time according to local time zone. Manual setting requires to set time zone, date and time, and users can select their preferred time and date display format;

Power

Users can set screen auto sleep timeout, Power off timeout, Delay disconnection when the device goes to sleep mode, Battery usage, Battery percentage, Auto-sleep when closing the cover; etc.

Network

This is for Wi-Fi \VPN\Bluetooth setting. When Wi-Fi is connected, users can browse webs and download books via the internet on the device.

Wi-Fi Settings

Slide Wi-Fi On, then available networks will be listed. Users can choose a network, then input password to connect with internet.

After Wi-Fi is connected successfully at the first time, the device will save Wi-Fi information automatically. Users only need to turn on Wi-Fi on notification bar if using the same WIFI next time.

Click the “+” button at the top right of the Wi-Fi page, users could manually connect to other network which is not listed, such as 802.1x/EAP.



Bluetooth Settings

Turn on Bluetooth, you can search for nearby Bluetooth devices and then send connection requests.

Bluetooth needs to be paired before use. Currently only support the eReader to receive documents, send documents from Boox eReader to other devices is not supported.



VPN Setting

- When the VPN is turned on for the first time, the system requires to set a password. This password needs to be used only for screen unlock or when the factory settings are restored.

More Settings

This page includes settings of Password, System Display, Custom Homepage, Server Selection, and Function area display icons only.

Lock screen password

Lock screen password requires 4–8 digital number.



Reset Password

Users could reset password by logging in ONYX account via phone number or email. (Log in via WeChat is not supported to reset password)

It is not available to reset password without logging in ONYX account first.



Gesture Manager

You can customize 3 gestures for the bottom and 2 gestures for the sides.

The default functions for the Bottom include: Back, Back Home, Multitasking Switching...etc. Swipe up from the bottom to use them.

The default functions for the sides are Volume +/-, and Frontlight +/-.

Long press the sides to slide up and down to adjust.

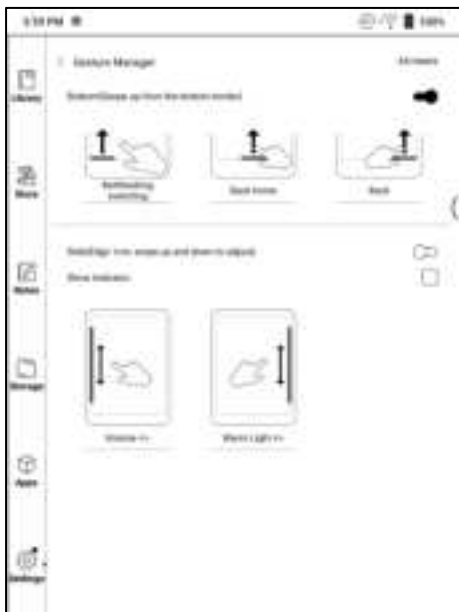

Support modification to other functions;



System Display

Support to adjust the system font size, the default is the standard font size, you can set a total of 4 sizes: small, standard, large, extra large;



Custom Homepage

The default Homepage is Library. You can set any of the other Function pages as the Homepage. You can return to the Homepage by tapping the homepage icon from the dropdown notification center.

Server Selection

The server is allocated according to the system language by default. The Chinese language system uses the Asia server, and the other language systems use US server;

After manually selecting the server, it will no longer be automatically matched according to the system language;

Please try to choose the server in your area. This will avoid the slow network connection which impacts the use of some specific functions (including bookstore, synchronization, application market, OTA detection and other functions that require networking);

Function Area display icons only

The text under the Function icon can be hidden.

Account

System account settings, ONYX account, and other account can be managed here. Users could further manage their Google account, Exchange and other accounts via System Account Settings.



ONYX Account

Users could log in the ONYX account via phone number, email, and WeChat account on BOOX devices or on push.boox.com. Users could back up and sync the notes among different devices with the ONYX account. Password reset is only available with the ONYX account logging in via phone number or email.



Three logging methods, phone number, email and WeChat account could be bound to each other. Users could unbind the phone number and email, but the WeChat account is not supported.



Application

Users can select USB debugging, enable Store, Set Back button as Homepage button、 Freeze third-party apps in the background by default、 Automatically optimize third-party optimization configs、 Enable Google Play , etc.

Users need to activate the Google Play Store first by going to Settings/ Apps/ Enable Google Play/ GSF ID with the Google account. After 5 minutes, you shall reboot your device and sign in to Google account again to use the Google Play Store.

Firmware Update

Users can get the Model number, Android version, Build number and update check. Upgrade checks the local package first then online package with a network connection. Upgrade pause and breakpoint download are allowed. Please ensure the device has more than 30% power and sufficient capacity before the update.

Update History

Check Update History and the changelog of every update.

Feedback

FAQ

If having any problems, you can directly find the questions in the FAQ, quickly locate and solve the problems.

Submit Feedback

Welcome to submit any technical problem or advice to us.

This function collects system information for problem judgment. And Onyx shall never disclose users' device information.

The related logs will be cleared after the device shuts down. If you need to send feedback after the device is off, please enable Save Logs to local in Feedback so that you can send related logs after restarting the device.

12. Specifications

	NovaAir
Processor	1.8GHz*4 + 1.6GHz*4
RAM	3G LPDDR4X
OS	Android 10
Storage	32G
Screen	E-ink display with Regal refresh
Screen Size	7.8 inch
Resolution	1404*1872
Touch	Stylus + Capacitive touch
Front Light	Support
Wireless	WIFI (2.4G+5G) + Bluetooth (5.0)
Battery	2000 mAh
G-sensor	Support Auto-Rotate
USB	Type-C (support USB OTG)
Others	Mic, Speaker
Size	194x136.5x6.3 mm
Weight	≤245 g (battery included)
Operating Temperature	0° C- 50° C
Book Formats	PDF, EPUB , TXT, DJVU, HTML, FB2, DOC, MOBI, CHM, etc.
Image Formats	PNG, JPG, BMP
Audio Formats	WAV , MP3
Apps	Third party APP installation is supported
Browser	Support

Language	Multi-language supported
Firmware Update	Locally update and OTA update are available
Certification	CE、RoHS、CCC、FCC、SRRC、TELEC

13. Declaration

Onyx International Inc. reserves the right to modify the content of the Quick Start Guide and User Manual without further notice.

For more information, please visit our website at www.boox.com.