

SX40

Dedicated Doppler Flowmeter

User Guide

P/N 1-0563-006

Revision R



SX40

Dedicated Doppler Flowmeter

User Guide

P/N 1-0563-006

Revision R

© 2018 Thermo Fisher Scientific Inc. All rights reserved.

“Sil-Glyde” is a registered trademark of American Grease Stick Company.

All other trademarks are the property of Thermo Fisher Scientific Inc. and its subsidiaries.

Thermo Fisher Scientific (Thermo Fisher) makes every effort to ensure the accuracy and completeness of this manual. However, we cannot be responsible for errors, omissions, or any loss of data as the result of errors or omissions. Thermo Fisher reserves the right to make changes to the manual or improvements to the product at any time without notice.

The material in this manual is proprietary and cannot be reproduced in any form without expressed written consent from Thermo Fisher.

This page intentionally left blank.

Contents

Chapter 1	Product Overview	1-1
	Introduction.....	1-1
	Ordering Information	1-1
	Specifications	1-2
	Performance.....	1-2
	Physical.....	1-2
	Functional.....	1-3
	Approvals	1-4
	Installation & Wiring	2-1
Chapter 2	Installing the Transducers	2-1
	Mounting the Enclosure.....	2-4
	Wiring	2-5
	AC Power.....	2-5
	DC Power.....	2-6
	Transducers.....	2-7
	Relays.....	2-9
	4–20 mA Current Loop (Rev. F or Earlier)	2-11
	4–20 mA Current Loop (Rev. G or Later).....	2-13
	Connecting a Switch to Remote Zero Feature	2-14
	Operation & Configuration	3-1
Chapter 3	The Interface.....	3-1
	Screen Contrast.....	3-1
	Configuration	3-2
	Auto Mode.....	3-2
	Manual Mode	3-3
	HydraScan	3-6
	Setup Items.....	4-1
Chapter 4	Reset	4-1
	Config.....	4-1
	I/O Test.....	4-1
	Relays.....	4-1
	4–20 mA Loop Calibration	4-1
	4–20 mA Loop Test	4-2
	Flow.....	4-2
	Rate.....	4-2

	Max.....	4-2
Chapter 5	Flow Menu Items	5-1
	Setup.....	5-1
	FFT.....	5-1
	Logset.....	5-1
	Accessing, Saving, & Loading Log Files.....	5-1
	Trend.....	5-1
	Rate.....	5-1
	Max.....	5-2
Chapter 6	Troubleshooting & Maintenance	6-1
	General Troubleshooting	6-1
	Learn Mode Warnings	6-2
	Operating Mode Warnings	6-2
	Variable Frequency Drives (VFDs).....	6-3
	Checking the FFT	6-3
	Signal Quality & Strength.....	6-5
	Maintenance	6-6
	General	6-6
	Replacing the Relays.....	6-6
	Replacing the 4–20 mA Board	6-7
	Replacing the Fuse	6-8
	Upgrades.....	6-9
	Contact Information	6-9
	Warranty.....	6-10
Appendix A	Hazardous Area Installations	A-1
Appendix B	Obtaining Pipe ID	B-1
Appendix C	Toxic & Hazardous Substances Tables	C-1

Chapter 1

Product Overview

Introduction

Thermo Fisher Scientific's SX40 dedicated Doppler flowmeter generates two independent ultrasonic signals at different frequencies. By correlating these frequencies, the instrument automatically identifies and eliminates noise errors from sources such as variable frequency drives.

In addition, operation of the instrument is enhanced by an Expert System that allows the flowmeter to automatically "learn" the application parameters. As a result, the flowmeter can be easily commissioned in a fraction of the time required to configure competitive ultrasonic flowmeters.

Ordering Information

Refer to the following list of part numbers to order spare parts for your instrument.

Table 1–1.

Part Number	Description
22767-0001	Poly CD, specification sheet, meter installation video CD
1-0563-006	User guide
1-0561-005	HydraScan software manual
01008-0006	RS232 cable, standard serial, 6-ft, female to male, DB9
10241-0003	Hazardous area relay, 3 A, SPDT
10261-0013	Fuse, 1 A, time delay, AC input
10396-0194	Power cord connector, CGB, for 6 ft. AC power cord
10605-0001	Pipe strap, SS, 32-inch with 3/8 SS screw
10605-0003	Pipe strap, SS, 67-inch with 3/8 SS screw
10705-0003	Nut driver, 3/8-inch
10808-0002	Coupling compound, silicone RTV108, 2.8 oz.
10823-0005	Coupling compound, Sil-Glyde®, 4 oz.
20192-0001	SS tag
22061-0001	Heater assembly suitable for -40°F to 140°F (-40°C to 60°C) operation, 100–120 Vac

Part Number	Description
22061-0002	Heater assembly suitable for -40°F to 140°F (-40°C to 60°C) operation, 220–240 Vac
22204-0003	Mounting feet, set of 4
22262-0006	PCB assembly, 4–20 mA output (applicable with firmware v. 2.03)
22302-0002	PCB assembly, motherboard (specify input voltage)
22366-0002	Cable adapter, dedicated transducer to portable meter
22490-0001	Cable adapter set, portable transducer to dedicated meter
22511-0020	Intrinsically Safe barrier kit, universal
22686-0002	PCB assembly, Doppler
22703-0002	Transducer assembly (set of 2), 30-ft cable length
22705-0002	PCB assembly, CPU
22714-0002	PCB assembly, adapter board
22732-0001	Front panel assembly, includes keypad and display
22801-0002	PCB assembly, 4–20 mA output (applicable with firmware v. 3.03)
22061-0003	Heater assembly suitable for -40°F to 140°F (-40°C to 60°C) operation, 24 Vdc

Specifications

Performance

Velocity Range: 0.2–18 ft./sec. (0.06–5.5 m/sec.)

Accuracy: ±1% of velocity full scale

Fluids: Liquids containing particulate or entrained gas bubbles

Pipe Size: 0.5–200 in. (12–5000 mm)

Physical

Transmitter: NEMA 4X (IP65), flame retardant, fiberglass reinforced polyester

Transducers

Two encapsulated dual frequency sensor heads suitable for submersible/underground service

Encased in stainless steel shrouds, with stainless steel straps and quick clamps

Cable length: 30 ft. (9 m)

Weight: 12 lb. (5.4 kg)

Dimensions: Refer to Figure 1–1

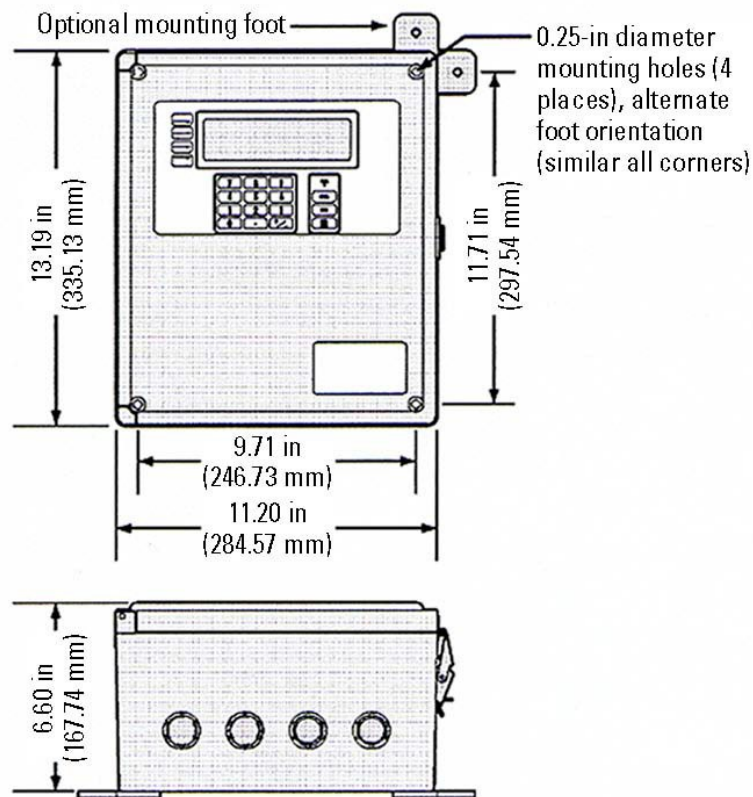

Figure 1-1.

Functional

Outputs: 4–20 mA (into 750 ohms), 12-bit, 5 kV opto-isolated; loop or self-powered

Optional Relay: 5 A, SPDT, programmable relay; maximum of 4 **Power**

Supply

DC Power: 11–28 Vdc 1.0A Max

AC Power: 90–132 Vac or 190–250 Vac (switch selectable), 50/60 Hz 0.14A Max

Keypad: 19-key with tactile action

Display: Backlit, 240 x 60 dot, high resolution graphics display

Data Logger: 90000 points, programmable in intervals of 30 s, 1, 5, 15, 30, and 60 min

Programming: Via HydraScan software or integral keypad

Serial Interface: RS232

Temperature Range

Transducers: -40°F to 250°F (-40°C to 121°C); coax cable limited to 176°F (80°C)

Electronics: -20°F to 140°F (-29°C to 60°C)

With integral heater: -40°F to 140°F (-40°C to 60°C)

Approvals Hazardous Area Certification

Optional: CSA Class I, Div. 2

Optional: CSA Class I, Div. 2 provides Intrinsically Safe Class I, Div. 1; Class II, Div. 1

Optional: Non-hazardous area provide Intrinsically Safe Class I, Div. 1; Class II, Div. 1

Conditions of Acceptability: The SX40 must not be powered by more than 120Vac or be connected to any equipment which generates more than 120Vac when installed in a Class, Division 2 hazardous area.

Chapter 2

Installation & Wiring

Installing the Transducers

1. Select an installation site:

Keep the following questions in mind when choosing a proper installation site:

- Is the chosen section of pipe always full of liquid?
- Are there at least 5 pipe diameters upstream and 3 pipe diameters downstream from any directional changes, pipe joints, or narrowing/widening of the pipe?

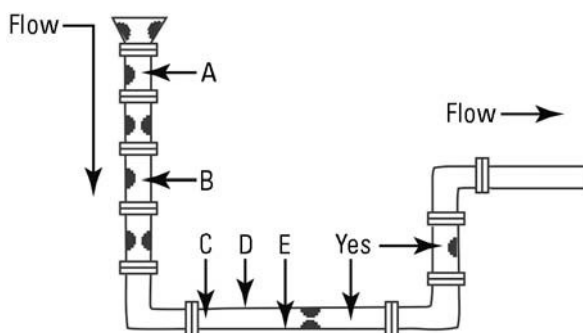

Figure 2–1. Recommended installation locations

Conditions at locations A, B, C, D, and E can interfere with the transmission of the ultrasonic wave and yield inaccurate or unreliable flow readings:

- A: Pipe may not be full
- B: Down flow
- C: Too close to elbow
- D: Air collects at the top of the horizontal pipe
- E: Sediment collects at the bottom of the horizontal pipe



Note Selecting the proper installation location is essential to flow measurement reliability. Each application is unique and may require a variation of installation locations. ▲

2. Select a transducer orientation:

Refer to Figure 2–2. If your application allows, install the transducers at the 3 and 9 o'clock locations. Ensure the transducers are parallel to each other along the pipe circumference.

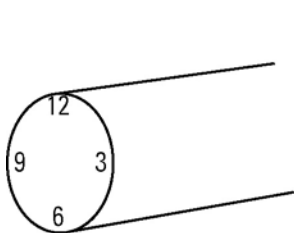

Transducer orientations on horizontal pipes

Good: 3 and 4 o'clock;
9 and 8 o'clock

Better: 2 and 4 o'clock;
10 and 8 o'clock

Best: 3 and 9 o'clock

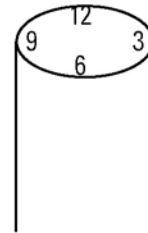

Transducer orientations on vertical pipes

Good: 2 and 3 o'clock;
10 and 9 o'clock

Better: 2 and 4 o'clock;
10 and 8 o'clock

Best: 3 and 9 o'clock;
Another directly
opposite position

Figure 2–2. Recommended transducer orientations

3. Attach the transducers to the pipe strap:

- a. Use a screwdriver to loosen the mounting screw and slide the lock back on each transducer.

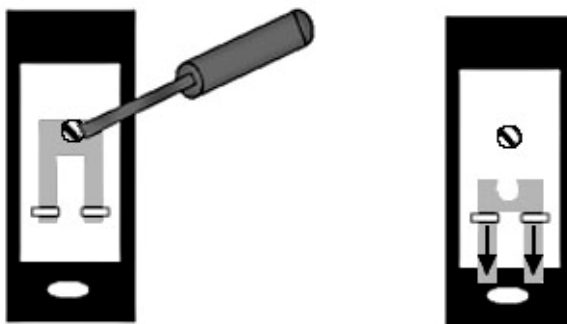

Figure 2–3.

- b. Place the pipe strap across the mounting, and slide the lock back into place.

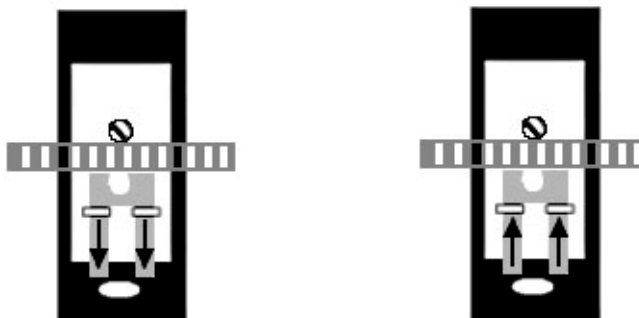

Figure 2-4.

- c. Tighten the screws.

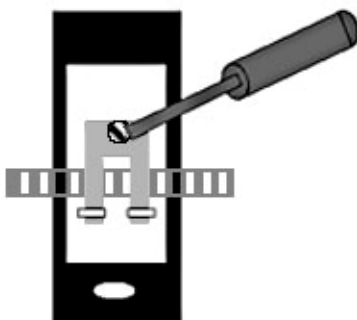

Figure 2-5.

4. Mount the transducers, ensuring the transducers face the same direction (as shown in [Figure 2-6](#)):
 - a. Wrap the pipe strap around the pipe, and slide the end of the pipe strap through the tension nut assembly.
 - b. Pull the strap tightly, and clamp the tension nut down to secure the strap to the pipe.
 - c. Loosen the mounting screw of a transducer, and move the transducer to the 3 o'clock position on the pipe. Tighten the mounting screw to secure the transducer.
 - d. Loosen the mounting screw of the second transducer, and move the transducer to the 9 o'clock position. Tighten the mounting screw to secure the transducer.
 - e. Remove the strap from the pipe, and apply sonic coupling compound to each transducer surface.
 - f. Reposition the strap on the pipe, placing the transducers in the proper positions.

- g. Tighten the tension nut assembly with a 3/8-inch hex nut driver to secure the strap.



Note Increasing the pipe strap tension improves signal transmission. ▲

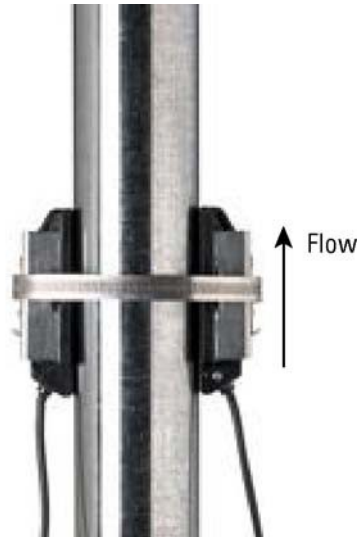

Figure 2-6.

Mounting the Enclosure



Warning To prevent the possibility of electrical shock and/or damage to the meter, do not mount the enclosure where it can be submerged or partially submerged. ▲

1. Locate a sturdy, vertical mounting surface.
2. Remove the meter access cover, and locate the 4 mounting holes (1 in each corner of the cover).
3. Attach the enclosure to the wall using the mountingscrews.
4. Replace the meter access cover.



Note An optional mounting ear package is also available. ▲

Wiring

AC Power



Warning Prevent possible electrical shock and/or damage to the meter: Disconnect power to the meter PRIOR TO wiring. ▲



Caution Connecting AC power to a DC power meter may damage the meter. ▲



Note CE certifications require that a switch or circuit breaker be installed in close proximity to the instrument and be labeled as the instrument disconnect. ▲

Refer to the following instructions and [Figure 2-7](#) when wiring the instrument for AC power.

1. Remove the meter access cover.
2. Locate the AC input voltage selector, and turn the switch to 110 or 220 V to match the power line voltage.
3. Locate the L1, L2/N, and GND connections within power input block.
4. Turn the terminal screws on top of the input block counterclockwise to fully open the wire connections.
5. Make the following connections:
 - a. Ground wire to GND (CE certification requires less than 1 ohm between terminal and ground)
 - b. Hot wire to L1
 - c. If the input voltage is 110 V, neutral wire to L2/N
 - d. If the input voltage is 220 V, second hot wire to L2/N
6. Turn the terminal screws clockwise to close them connections.
7. Ensure the wires are securely connected to the input block, and replace the meter access cover.

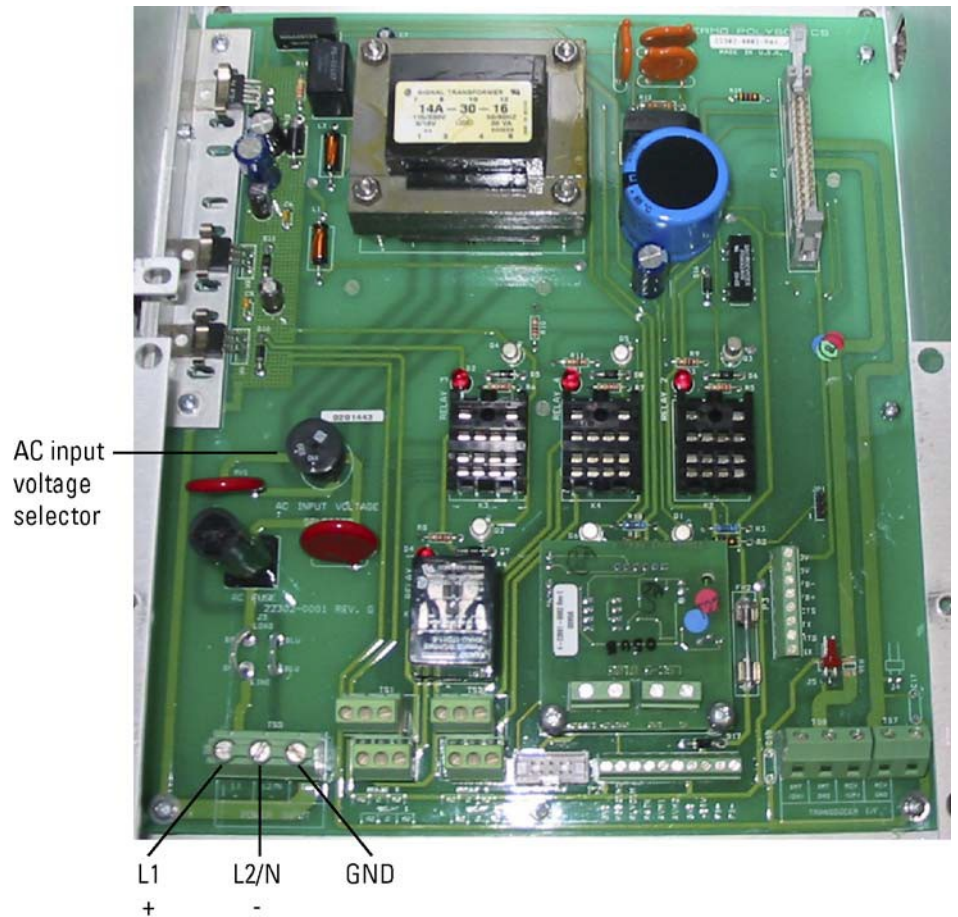

Figure 2-7. AC power connections

DC Power Later versions of the instrument (those with P/N 22302-0002 Rev. G and later) have DC operation built into the instrument. Refer to the following instructions and [Figure 2-8](#).

1. Remove the meter access cover.
2. Locate the power input block, and turn the terminal screws on top of the input block counterclockwise to fully open the wire connections.
3. Make the following connections:
 - a. +24VDC to P2 +24
 - b. 24 VDC return to either of the P2 GND connections
4. Turn the terminal screws clockwise to close themconnections.

5. Ensure the wires are securely connected to the input block, and replace the meter access cover.

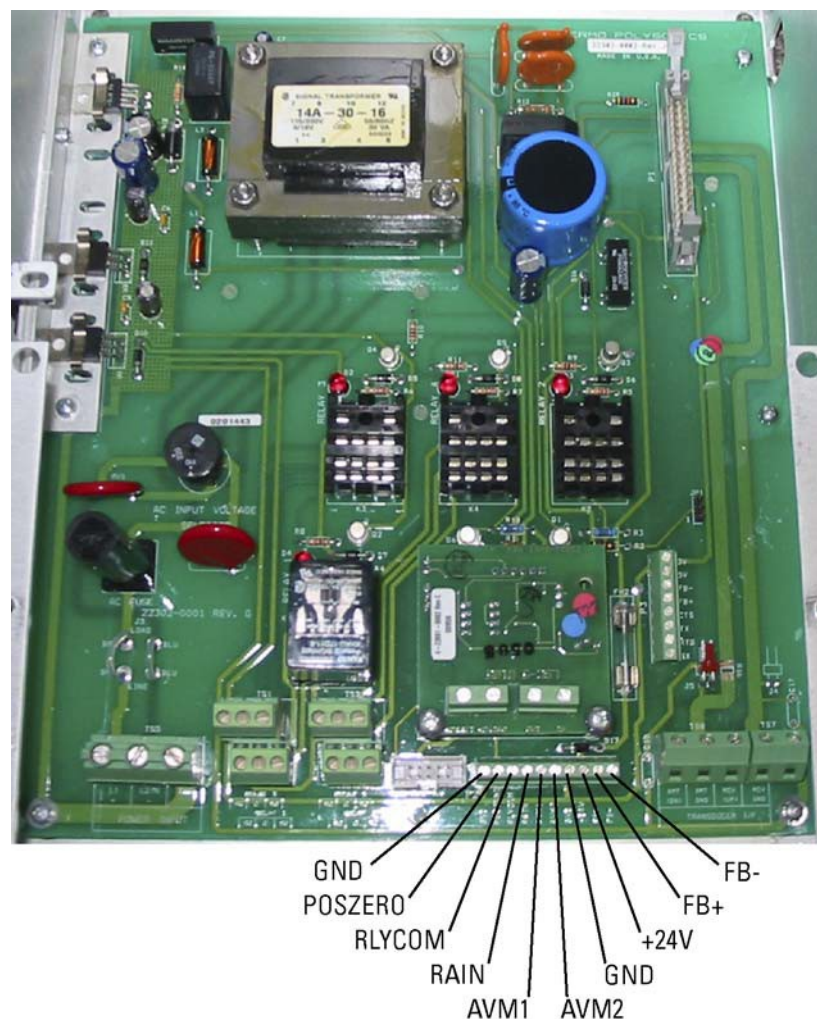

Figure 2–8. DC power connections

Transducers



Warning Prevent possible electrical shock and/or damage to the meter: Disconnect power to the meter PRIOR TO wiring. ▲

1. Refer to [Figures 2–9](#) and [2–10](#).
2. Remove the meter access cover.
3. Remove the nut from the transducer cable connector, and draw the cable through the opening in the meter enclosure.
4. Thread the nut onto the cable connector to the inside of the enclosure.

5. Tighten the nut to 15 ft-lb of torque using a torque wrench.
6. Locate the XMT (DN), XMTGND, RCV (UP), and RCVGND wire connections within the transducer I/F block.
7. Turn the screws on top of the transducer block counterclockwise to fully open the connections.
8. Identify the transducer's 2 signal wires and 2 braided ground wires.
9. Make the following connections:
 - a. First signal wire to XMT (DN)
 - b. First braided ground wire to XMT GND
 - c. Second signal wire to RCV (UP)
 - d. Second braided ground wire to RCV GND
10. Turn each screw clockwise to close the connections.
11. Ensure the wire connections are secure, and replace the meter access cover.

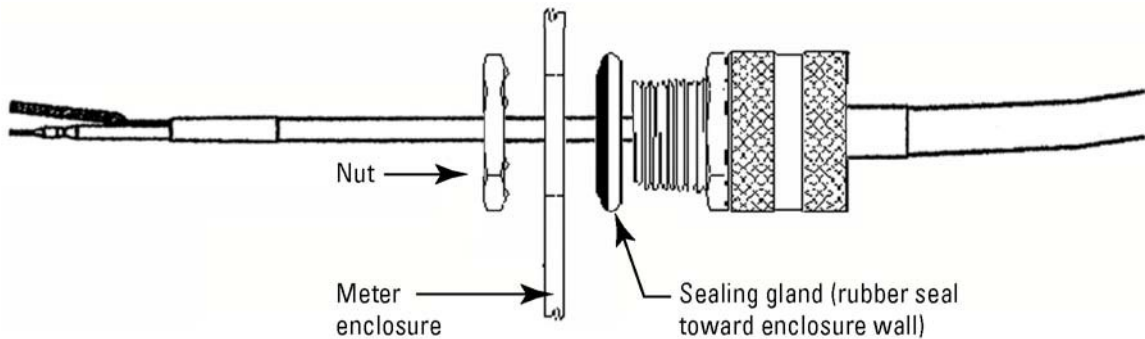

Figure 2–9. Transducer cable seal assembly

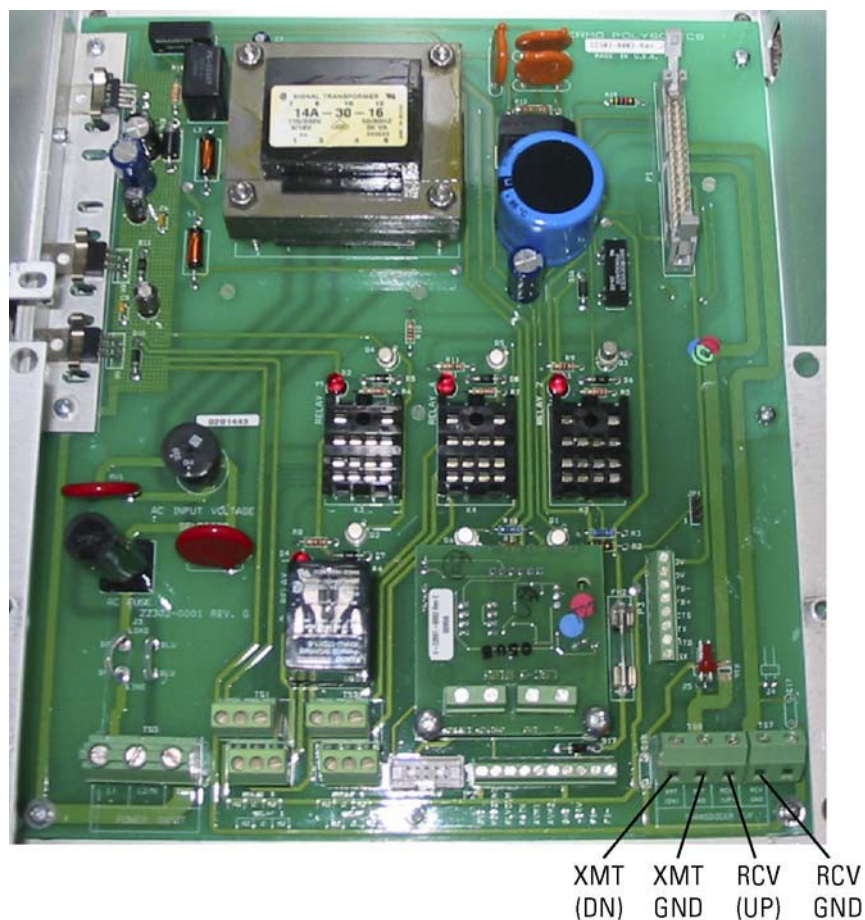

Figure 2–10. Transducer connections

Relays



Warning Prevent possible electrical shock and/or damage to the meter: Disconnect power to the meter PRIOR TO wiring. ▲

Refer to step 10 of “Manual Mode” in Chapter 2 for instructions on relay configuration.

1. Refer to [Figures 2–11](#) and [2–12](#).
2. Remove the meter access cover.
3. Locate the 4 relay terminals blocks, and select the relay you are going to wire.
4. Locate the Normally Closed (NC), Common (C), and Normally Open (NO) relay contacts on the terminal block.



Note When the relay is at rest, the circuit is closed between the NC and C terminals and open between the NO and C terminals. When the relay is energized, the circuit is open between the NC and C terminals and closed between the NO and C terminals. ▲

5. Turn the terminal screw on top of each connection counterclockwise to fully open the connections.
6. Insert the wires for your control system into the corresponding wire connections.
7. Turn the terminal screws clockwise to close the connections.
8. Ensure the wire connections are secure, and test the relay (see “I/O Test” in Chapter 4).
9. Replace the meter access cover.

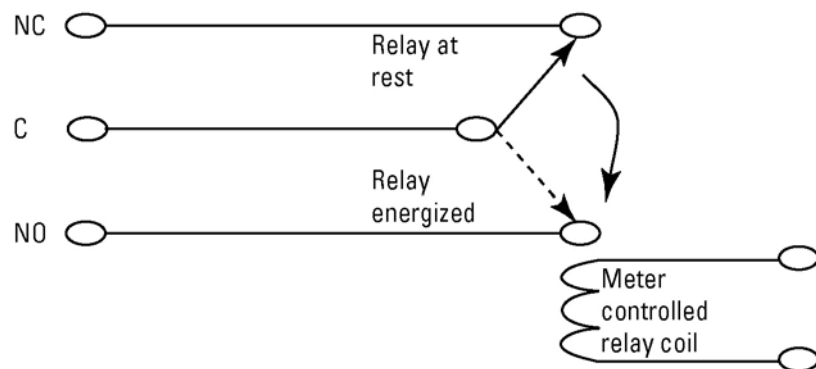

Figure 2–11. Relay schematic

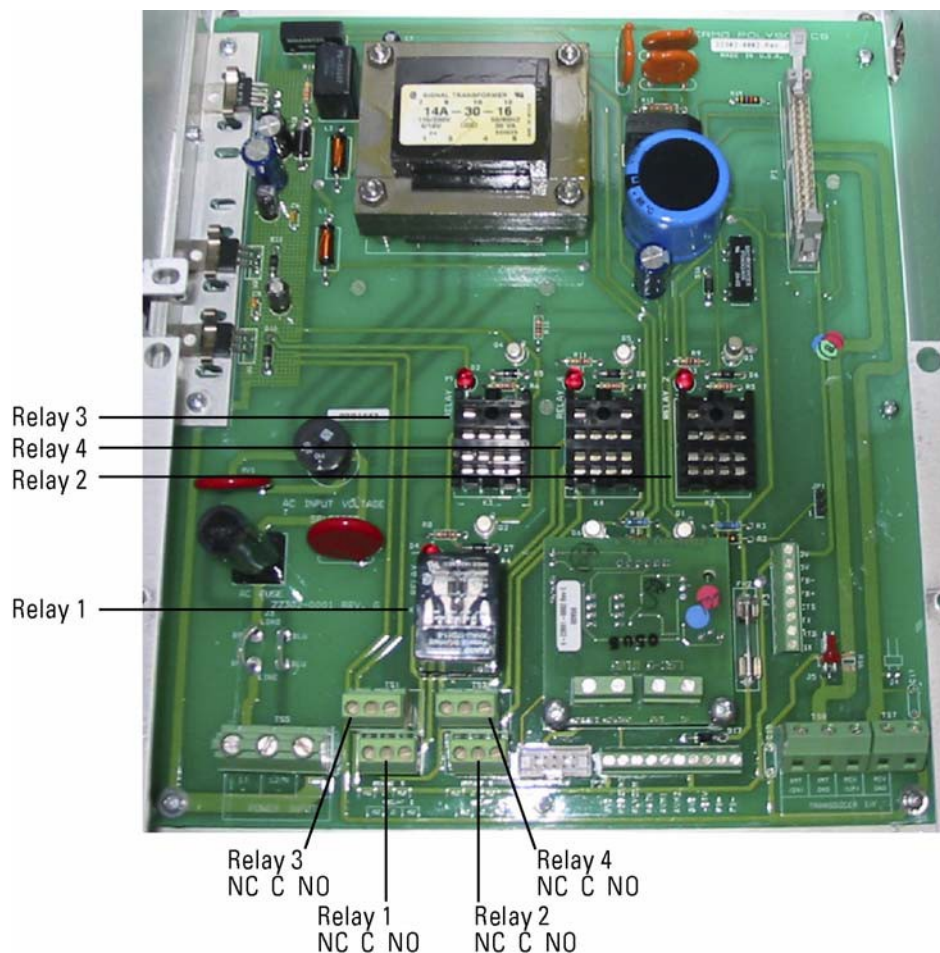

Figure 2–12. Relays & relay terminal connections

4–20 mA Current Loop (Rev. F or Earlier)



Warning Prevent possible electrical shock and/or damage to the meter:
Disconnect power to the meter PRIOR TO wiring. ▲



Warning Use shielded twisted pair wires for this connection. If the meter is installed near VFDs, install wiring in grounded metal conduit. ▲



Note These instructions for instruments with main PCB 22302-0002 Rev. F or earlier. ▲

For instructions on performing a 4–20 mA calibration and/or test, refer to “I/O Test” in Chapter 4.

1. Refer to Figures 2–13 and 2–14. Select a power option for the 4–20 mA loop, and remove the meter access cover.
2. Use jumpers to configure the pins on the 4–20 mA card according to the power option selection.
3. Connect the wiring to the module.
4. Replace the access cover.

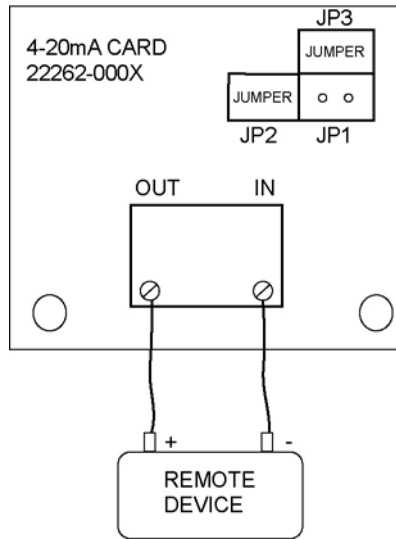

Figure 2–13. Self-powered current loop & pin configuration

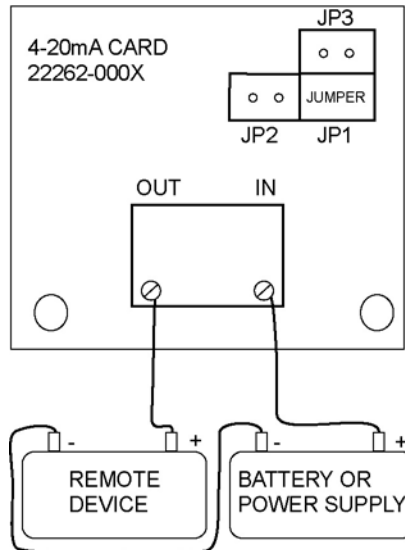

Figure 2–14. Externally powered current loop & pin configuration

4–20 mA Current Loop (Rev. G or Later)



Warning Prevent possible electrical shock and/or damage to the meter: Disconnect power to the meter PRIOR TO wiring. ▲



Warning Use shielded twisted pair wires for this connection. If the meter is installed near VFDs, install wiring in grounded metal conduit. ▲



Note These instructions for instruments with main PCB 22302-0002 Rev. G or later. ▲

For instructions on performing a 4–20 mA calibration and/or test, refer to “I/O Test” in Chapter 4.

1. Refer to Figures 2–15 and 2–16. Select a power option for the 4–20 mA loop, and remove the meter access cover.
2. Use jumpers to configure the pins on the 4–20 mA card according to the power option selection.
3. Connect the wiring to the module.
4. Replace the access cover.

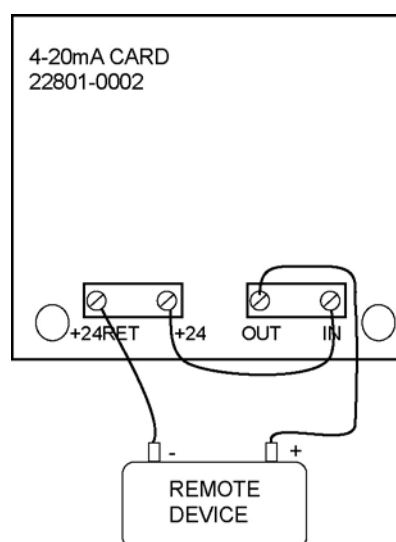

Figure 2–15. Self-powered current loop

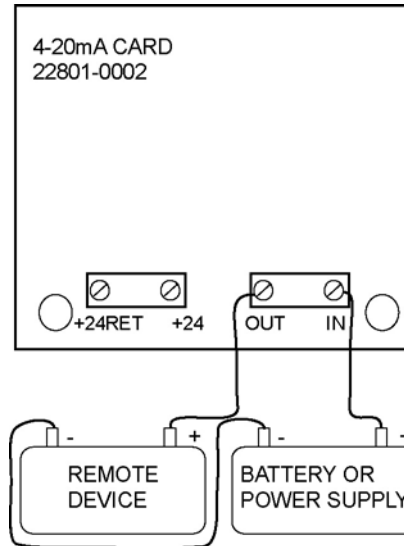

Figure 2–16. Externally powered current loop

Connecting a Switch to Remote Zero Feature



Warning Prevent possible electrical shock and/or damage to the meter: Disconnect power to the meter PRIOR TO wiring. ▲

Refer to step 9 in “Manual Mode” (Chapter 3) for instructions on enabling the remote zero function.

1. Refer to [Figure 2–17](#).
2. Remove the meter access cover.
3. Locate the POSZERO and RLYCOM wire connections within the same block used for connecting DC power.
4. Turn the screws on top of the transducer block counterclockwise to fully open the connections.
5. Make the following connections:
 - a. First switch wire to RLYCOM
 - b. Second switch wire to POSZERO

6. Turn the screws clockwise to close the connections.
7. Ensure the wire connections are secure, and replace the meter access cover.

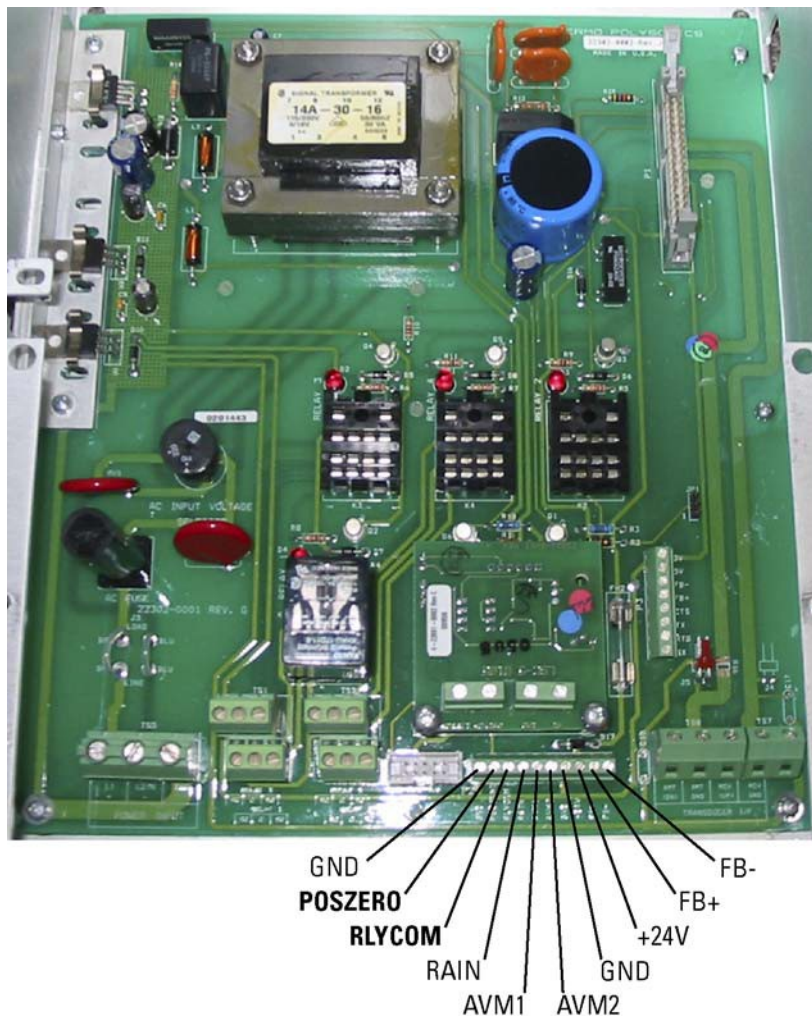

Figure 2–17. Remote zero connections

This page intentionally left blank.

Chapter 3

Operation & Configuration

The Interface

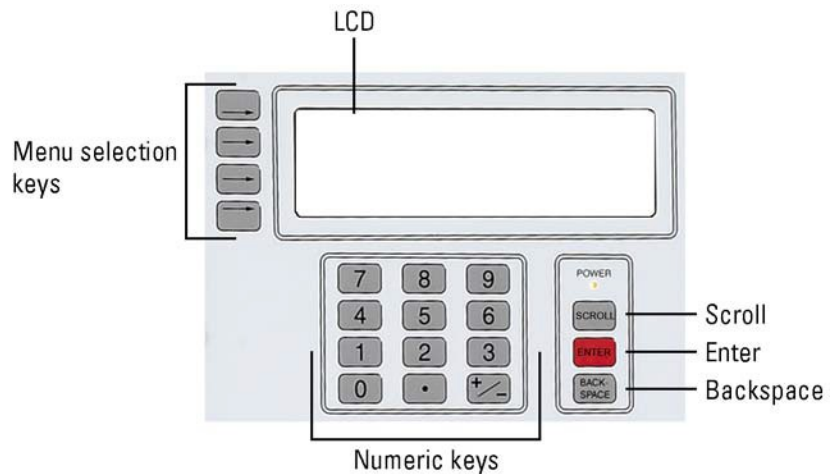

Figure 3–1. Keypad features

Following is a description of the components called out in Figure 3–1.

- LCD: Displays menu items.
- Scroll: Press to scroll to the next parameter displayed on the LCD
- Enter: Press once you have made an entry.
- Backspace: Deletes the last value entered.
- Numeric keys: Use to enter values when configuring the meter
- Menu selection keys: Press to select the corresponding menu item displayed on the LCD

Screen Contrast

1. Press the +/- key.
2. When the Adjust Contrast screen appears, press the +/- key again, and the software scrolls through the levels of contrast. Press the +/- key to stop the scrolling.
3. Use the scroll and backspace keys to make fine adjustments to the contrast.

Configuration

Note the following before configuring the meter:

- You must know the pipe internal diameter (ID) to ensure reliable flow measurements. If you do not know the pipe ID, go to [Appendix B](#).
- There must be flow in the pipe when you start the meter.

There are two modes of operation. Consider using auto mode if your application is a constant process. The instrument default is the auto mode.

Apply power to the meter, and begin the configuration process by selecting Auto or Manual operating mode. Once you have completed the configuration process, you can access these screens from the Flow screen by selecting Setup > **Config**.

Auto Mode

1. Pipe ID screen:
 - a. Enter the pipe ID, and press Enter.
 - b. Use the scroll key to select the measurement units (inches, mm). Press Enter to select the unit.
 - c. Scroll through the available wall material options (carbon steel, cast iron, concrete liner, stainless steel, copper, plastic), and press Enter to select.
2. Select Next to move to the next screen. At the Flow Units screen:
 - d. Use the scroll key to select the flow units (US gallons, million gallons, cubic meters, oil barrels, Imperial gallons, cubic feet, liters, liquid barrels), and press Enter.
 - e. Use the scroll key to select the time base for flow measurement (seconds, minutes, hours, days), and press Enter.
3. Select Next to enter learn mode.
4. The meter displays status of the learning process. Refer to “[Learn Mode Warnings](#)” (Table 6–2 in Chapter 6) if you receive one of the following messages:
 - Invalid Signal, Can’t Learn
 - No Flow, Can’t Learn
 - Warning Low S Strength
 - Warning Poor S Strength

5. Once the meter completes the learning process, the Flow screen appears.
 - a. If the flow reading is not accurate and you can verify the flow from a calibrated flowmeter or other certified source, perform a calibration.
 - b. Refer to “Operating Mode Warnings” (Table 6–3 in Chapter 6) if the meter displays any of the following warnings:
 - Warning
 - Alarm
 - Failed/No Flow

Manual Mode

1. Pipe ID screen:
 - a. Enter the pipe ID, and press Enter.
 - b. Use the scroll key to select the measurement units (inches, mm). Press Enter to select the unit.
 - c. Scroll through the available wall material options (carbon steel, cast iron, concrete liner, stainless steel, copper, plastic), and press Enter to select.
2. Select Next to move to the next screen. At the Flow Units screen:
 - a. Use the scroll key to select the flow units (US gallons, million gallons, cubic meters, oil barrels, Imperial gallons, cubic feet, liters, liquid barrels), and press Enter.
 - b. Use the scroll key to select the time base for flow measurement (seconds, minutes, hours, days), and press Enter.
3. Select Next to continue, and enter the Maximum Flow Rate.
4. Select Next. At this screen:
 - a. Scroll through the options available for the Velocity Range (2, 4, 8, 16, 32 ft/s) and press Enter to select. Scroll to the next parameter.
 - b. Enter a damping coefficient (0–99, 1 unit = 15 s). The damping coefficient suppresses short term fluctuations in the indicated flow rate. Increasing the coefficient increases the response time to changes. Keep damping at a minimum unless the flow rate fluctuates wildly. In this case, increase damping just enough to reduce the fluctuation to an acceptable degree. Press Enter, and scroll to the next parameter.



Note The Smart Filter used by the meter allows the damping function to smooth small fluctuations without diminishing the meter's response to large flow changes, even when configured with a high damping coefficient. ▲

- c. Select regular or high Transmit Power, and press Enter.

In applications where the signal strength is low, the meter automatically selects high transmit power. You can manually select regular or high power in applications where the signal strength is marginal or where you feel increased or decreased power output may improve signal quality.

5. At the next screen:

- a. Enter the low flow cutoff. Press Enter, and scroll to the next parameter.

When a zero flow condition occurs, internal sloshing and other fluid movement can prevent the flowmeter from reading total zero. This can result in totalizer errors. Minimize these errors by setting a low flow cutoff which drives the flowmeter to zero for flow rates at or below specified value.

- b. Enter the signal strength cutoff, and press Enter.

6. Select Next to continue. At this screen:

- a. Enter the signal quality cutoff, and press Enter.
- b. Enter the SNR (signal-to-noise ratio), and press Enter.

7. Select Next. This screen displays flow and velocity readings. You can also enter a site calibration factor:

- a. Determine the flow using another source, and calculate the site calibration adjustment by dividing the actual flow by the meter flow.
- b. Enter the site calibration adjustment.

8. Select Next. At this screen:

- a. Scroll to the required totalizer unit (US gallons, Imperial gallons, million gallons, cubic feet, cubic meters, liters, oil barrels, liquid barrels) and press Enter.
- b. Scroll through the available scale factors (x 1, 10, 100, 1000, 10000), and press Enter to select.

- c. Determine whether to reset the totalizer and scroll to the appropriate selection. Press Enter.
9. Select Next. At this screen:
 - a. To keep relay 1 as the pulse totalizer, scroll to and select $x1$.
 - b. To keep relay 4 as the lost power monitor, select Y.
 - c. To enable the remote zero feature, scroll to On.

The lost power feature is designed to trigger a warning signal (alarm or warning light) when the meter loses power and is no longer reading flow. The meter records the number of power losses, and relay 4 is the dedicated lost power relay. For example, a warning light in a control room that is powered by an independent source can indicate when the meter loses power. This feature is ideal for applications where flowmeter operation is critical.
 - d. Reset the power monitor by selecting Yes.
10. Select Next. The next four screens enable you to configure the relays. Determine which relay you want to configure, and move to that screen.
 - a. Determine the maximum allowable flow. If you want the relay to energize when flow is greater than maximum acceptable flow, select On. If the relay should de-energize, select Off.
 - b. Enter the maximum and minimum allowable flows in the corresponding text boxes.
 - c. Activate the relay and press Enter.
11. Select Next to continue. Set the range at this screen:
 - a. Enter the flow rate that equals the 4 mA (minimum) reading, and press Enter.
 - b. Enter the flow rate that equals the 20 mA (maximum) reading, and press Enter.
12. Select Next, and if a password is required, enter it here.
13. Select Next to move to the final setup screen.
14. Set the time and date at this screen, and press Next to complete the configuration process.

HydraScan

You can also use the HydraScan software to configure the instrument. Refer to the HydraScan user guide (P/N 1-0563-005).

Chapter 4

Setup Items

You can access the Setup menu from the main Flow screen. The Setup menu displays the instrument version and serial number. It also contains 3 submenus: Reset, Config, and I/O Tst.

Reset Select this item to reset all configuration parameters to defaults.

Config Refer to Chapter 3 for details on setting configuration parameters. Each parameter is discussed in the section “[Manual Mode](#).”

I/O Test

Relays Access this screen to test the relays. Relays do not have to be configured in order for you to test them.



Note Exiting this screen returns all relays to the OFF positions. Activate the relays according to step 10 of “[Manual Mode](#)” in Chapter 3. ▲

At the Relay Test screen, scroll to the relay you want to test. Press Enter to switch the relay on (energize), and press Enter again to switch the relay off (de-energize).

4–20 mA Loop Calibration



Note You will need a calibrated current meter to perform this procedure. If you are using the loop-powered configuration, you will also need a DC power source. ▲

For wiring instructions, refer to [Chapter 2](#).

1. Set up a calibration current loop.

2. Access the mA Cal screen, and enter the value in mA from the current meter that corresponds to the zero scale.
3. Press Enter.
4. Enter the value in mA from the current meter that corresponds to the full scale.
5. Press Enter, and continue to the next section to test the loop.

4–20 mA Loop Test

For wiring instructions, refer to Chapter 2.

Access the mA Tst screen. Use the scroll and backspace keys to move the current bar. Verify the meter follows the changes. If the meter does not follow the changes, repeat the calibration.

Flow

Flow menu items are covered in the following chapter.

Trend runs at a real-time rate of action. To view the flow trend, select Trend from the Flow menu.

Rate

From the Trend screen, select Rate. Scroll through the available rate options (0.1, 0.5, 1, 5, 15, 60 minutes/reading). Press Enter.

Max

The meter records the maximum flow, date, and time of the maximum flow since the last reset. You can view this information from the Max screen.

Reset the data by changing the Max field selection from “Set” to “Clear.”

Chapter 5

Flow Menu Items

Setup Setup menu items are covered in the [previous chapter](#).

FFT Refer to “[Checking the FFT](#)” in Chapter 6.

Logset To set up the data logging function using the instrument:

1. Select LogSet from the Flow screen.
2. The screen displays the number log points remaining. Select the log rate (intervals of 0.5, 1, 5, 15, or 60 minutes) and press Enter.
3. Turn the logger on.
4. Select Flow to return to the Flow screen.



Note You cannot select the file in which you want to store a specific log set. The meter saves the data in sequenced files (0 to 9). The meter advances to the next file each time the logger is turned on or when a file logs more than 9000 points. ▲

Accessing, Saving, & Loading Log Files

You can use HydraScan to download, save, load, and erase log files. Refer to the HydraScan user manual (1-0563-005).

Trend Trend runs at a real-time rate of action. To view the flow trend, select Trend from the Flow menu.

Rate From the Trend screen, select Rate. Scroll through the available rate options (0.1, 0.5, 1, 5, 15, 60 minutes/reading). Press Enter.

Max The meter records the maximum flow, date, and time of the maximum flow since the last reset. You can view this information from the Max screen.

Reset the data by changing the Max field selection from “Set” to “Clear.”

Chapter 6

Troubleshooting & Maintenance

General Troubleshooting

The instrument has 4 modes of operation:

- Setup
- Learn
- Operating
- Manual (used by factory trained personnel primarily for application troubleshooting)

Use the following table in conjunction with the learn mode and operating mode warning tables.

Table 6–1. Action codes

Action	Description
A	<ol style="list-style-type: none">1. Turn meter off.2. Apply more compound.3. Tighten the pipe strap.4. Restart the meter to see if warning clears.
B	<ol style="list-style-type: none">1. Reposition transducers.2. See if signal strength increases.3. See if warning clears.4. Restart the meter.
C	<ol style="list-style-type: none">1. Relocate transducers.2. See if signal strength increases.3. See if warning clears.4. Restart meter.
D	<ol style="list-style-type: none">1. Turn meter off, and remove the transducers.2. Grind the pipe surface if it is rough or coated.3. Remount the transducers.4. Restart the meter. See if warning clears.

Learn Mode Warnings

The following table describes the learn mode warnings and appropriate corrective actions. Complete the corrective actions in the order presented.

Table 6–2. Learn mode warnings & corrective actions

Warning	Corrective Action
Invalid Signal, Can't Learn	<ol style="list-style-type: none"> 1. Refer to Table 6–1 and complete actions A–D, checking the meter after performing each action to see if the problem was corrected. 2. Contact Thermo Fisher.
No Flow, Can't Learn	<ol style="list-style-type: none"> 1. Check for flowing fluid. 2. Make sure the pipe is full. 3. Check connections. 4. Restart meter. See if warning clears. 5. Contact Thermo Fisher.
Warning Low S Strength	<ol style="list-style-type: none"> 1. Turn meter off. 2. Refer to Table 6–1 and complete actions A–D, checking the meter after performing each action to see if the problem was corrected. 3. Contact Thermo Fisher.
Warning Poor S Quality	<ol style="list-style-type: none"> 1. Go into operating mode. 2. Check the FFT.

Operating Mode Warnings

Table 6–3. Operating mode warnings & corrective actions

Warning	Corrective Action
PQ – Poor Signal Quality	<ol style="list-style-type: none"> 1. Check the FFT. 2. Refer to Table 6–1 and complete actions B–D, checking the meter after performing each action to see if the problem was corrected. 3. Contact Thermo Fisher.
FS – Failed Signal Status	<ol style="list-style-type: none"> 1. Refer to Table 6–1 and complete actions B–D, checking the meter after performing each action to see if the problem was corrected. 2. Check the FFT. 3. Contact Thermo Fisher.
IS – Invalid Signal	<ol style="list-style-type: none"> 1. Check the FFT. 2. Contact Thermo Fisher.

Variable Frequency Drives (VFDs)

Doppler flowmeters are often used in installations which use VFDs. VFDs can cause significant noise, EMI, and voltage spikes. If there are spikes on the 4–20 mA signal line while the displayed flow rate is stable, there are two actions you can take. Both actions may be required in order to resolve the problem:

1. Disconnect the 4–20 mA loop wiring and connect an ammeter with short wires directly to the 4–20 mA terminal block. Monitor the meter to see if the spikes are reduced. Installing a twisted pair shielded loop wiring in grounded metal conduit may be required.
2. Disconnect power wiring from the meter and connect to an uninterruptible power supply which is not connected to the facility wiring. Monitor the 4–20 mA output to see if the spikes are reduced. Installing the power mains in grounded metal conduit may be required.

Checking the FFT

1. From the Flow screen, select FFT.
2. Refer to [Figures 6–1 through 6–6](#) to determine the FFT condition.
3. Refer to the table below to determine the corrective action.
4. Return to the Flow screen.

Table 6–4.

FFT Shape	Possible Cause	Corrective Action
Ideal Doppler	N/A	1. Restart the meter.
Broadband noise	Poor pipe coupling or multiple noise generators	1. Refer to Table 6–1 and complete action codes A-D, checking the meter after performing each action to see if the problem was corrected. 2. Relocate transducers. 3. Turn off source of noise.
Steady noise spike	Electromagnetic noise	1. Turn off source of noise. 2. Relocate transducers.
Fluctuating Doppler	Constantly changing flow or noise	1. Increase damping (reference “Configuration” in chapter 3). 2. Relocate transducers.
No Doppler reflection I or II	Ultrasound signal not transmitting	1. Refer to Table 6–1 and complete action codes A-D, checking the meter after performing each action to see if the problem was corrected.

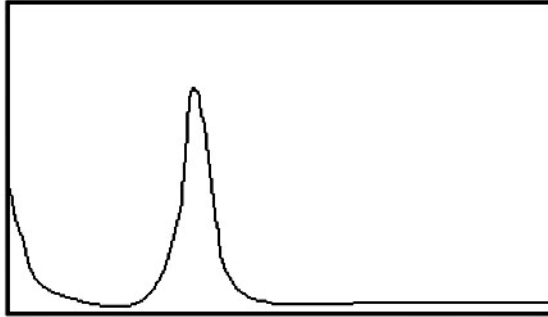

Figure 6–1. Ideal Doppler shape



Figure 6–2. Broadband noise

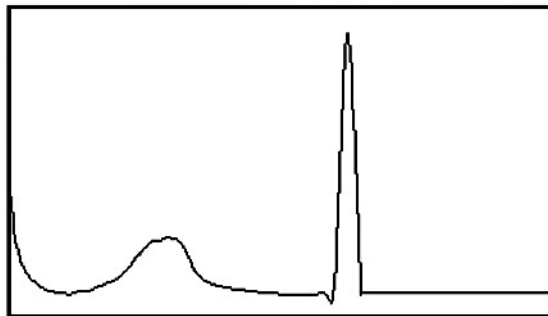

Figure 6–3. Steady noise spike with Doppler

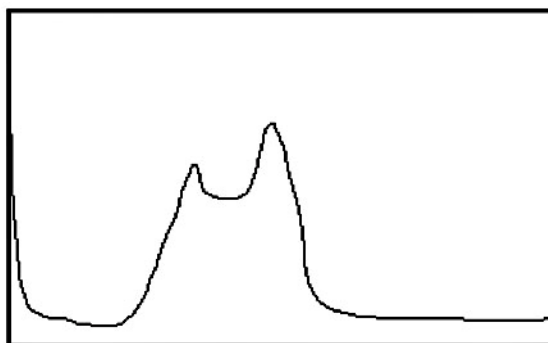

Figure 6–4. Fluctuating Doppler profile

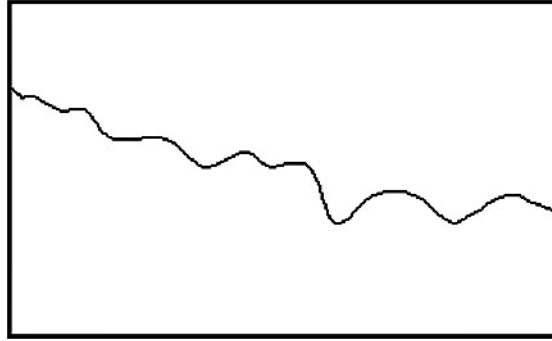

Figure 6-5. No Doppler reflection I

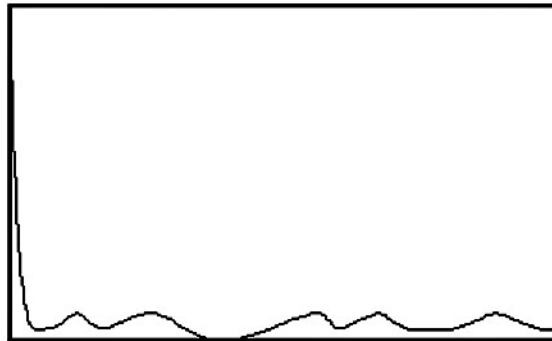

Figure 6-6. No Doppler reflection II

Signal Quality & Strength

Signal quality and signal strength are indicators of how well suited an application is for a Doppler flowmeter. To determine the quality of your application, go to the Flow screen. Note the %SS and SQ numbers in the bottom right corner. Refer to the following figure to determine the quality of the application. Also refer to [Table 6-1](#) for actions you can take to attempt to improve signal quality and strength.

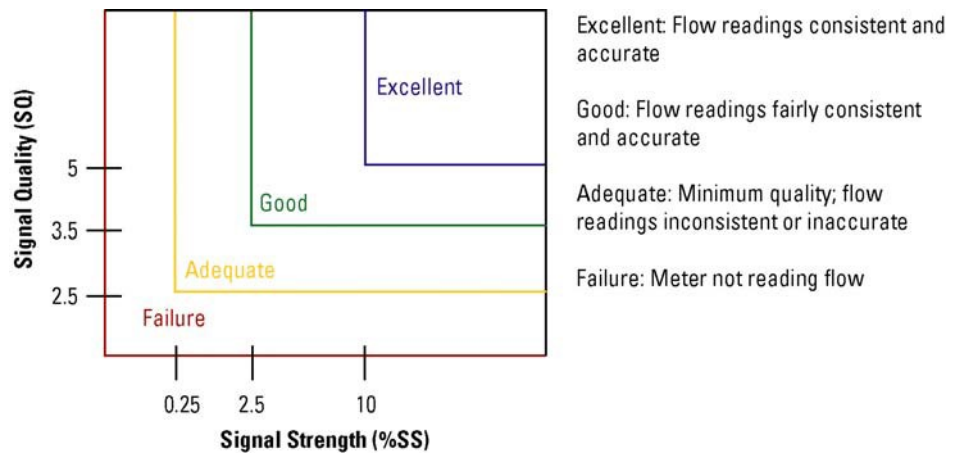

Figure 6-7.

Maintenance

General

The instrument is easy to maintain. The transducers and flowmeter are factory service only components and maintenance free. The following table describes the instrument components, appropriate maintenance, and a recommended schedule.

Table 6–5. Suggested maintenance

Component	Maintenance	How Often
Transducers	None: Factory service item	N/A
Coupling compound	Add more compound.	Annually, or whenever: 1. Compound diminishes 2. Repositioning transducers. 3. Relocating meter.
Flowmeter	None: Factory service item.	N/A
Cable connections	Ensure connections are secure. Remove any buildup within the connections.	Complete as part of your facility's routine maintenance.

Replacing the Relays



Warning Prevent possible electrical shock and/or damage to the meter: Disconnect power to the meter PRIOR TO wiring. ▲

1. Disconnect the power, externally if possible.
2. Remove the meter access cover.
3. Locate the relay sockets (reference [Figure 2–11](#)), and remove the relay.
4. Push the replacement relay into the socket until it is secure.
5. Replace the access cover.

Replacing the 4–20 mA Board



Warning Prevent possible electrical shock and/or damage to the meter: Disconnect power to the meter PRIOR TO wiring. ▲

1. Remove the meter access cover.
2. Locate the 4–20 mA board (reference [Figure 6–8](#)) and disconnect the wiring to the current loop module.
3. Remove the 2 screws in the lower corners of the module, and lift the module straight out to prevent damage to the connector on the main board.
4. Align the pins on the replacement module with the connector on the main board.
5. Press the module straight in toward the board.
6. Ensure the screw holes in the mounting posts on the main board align exactly with the screw holes in the module, and replace the screws.
7. Wire and configure the 4–20 mA loop (reference [Chapter 2](#)).
8. Reconnect power, and calibrate the current loop according to “[4–20 mA Loop Calibration](#)” in [Chapter 4](#).
9. Replace the access cover.

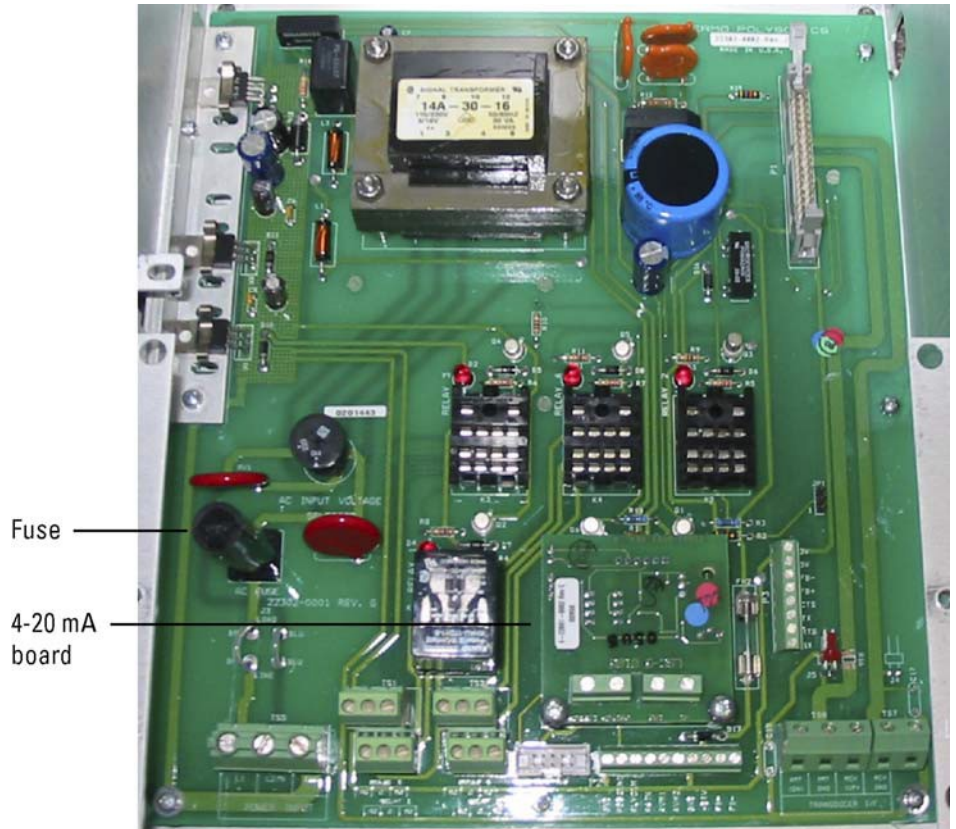

Figure 6–8. Locations of 4-20 mA board & fuse

Replacing the Fuse



Warning Prevent possible electrical shock and/or damage to the meter: Disconnect power to the meter PRIOR TO wiring. ▲

1. Locate the hole in the meter access cover marked FUSE, or remove the access cover and locate the fuse holder (shown in Figure 6–8).
2. Use a small, flat blade screwdriver to depress and turn the fuse holder counterclockwise until the holder pops up.
3. Insert a similar fuse of the same rating (see Figure 6–9).
4. Replace the fuse holder. Depress and turn the holder clockwise until it locks in place.
5. Replace the access cover if removed.

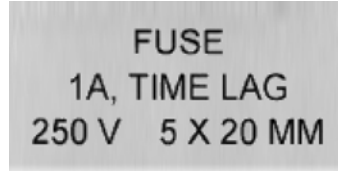

Figure 6–9. Fuse access hole label

Upgrades

The most current software is installed in the instrument prior to shipment. You can use the RS232 port and a remote terminal to upgrade the software as newer versions become available. Contact Thermo Fisher to obtain the most recent versions of the following software:

- WinLoader (used to upgrade metersoftware)
- Meter software
- HydraScan (data logging software)

Contact Information

The local representative is the first contact for support and is well equipped to answer questions and provide application assistance. Your representative also has access to product information and current software revisions. You can also contact Thermo Fisher directly.

Process Instruments		
12320 Cardinal Meadow Drive Suite 150 Sugar Land, TX 77478 USA +1 (800) 437-7979 +1 (713) 4573 fax	Ion Path, Road Three Winsford, Cheshire CW7 3GA UNITED KINGDOM +44 (0) 1606 548700 +44 (0) 1606 548711 fax	Unit 702-715, 7/F Tower West Yonghe Plaza No. 28 Andingmen East Street, Beijing 100007 CHINA +86 (10) 8419-3588 +86 (10) 8419-3580 fax
A-101, 1CC Trade Tower Senapati Bapat Road Pune 411 016 Maharashtra, INDIA +91 (20) 6626 7000 +91 (20) 6626 7001 fax		
www.thermoscientific.com		

If it becomes necessary to return an instrument:

1. Contact Thermo Fisher for a Return Material Authorization (RMA) number. **You must have the RMA number to return an instrument. The receiving dock will not accept shipments without the RMA number.**
2. Ensure the instrument is well packed, in its original shipping box if available.
3. Include a letter fully explaining the symptoms of the failure as well as detail describing the application where the unit was being operated. Also include a contact name, phone number, and purchase order authorizing repairs.
4. Write the RMA number on the outside of the shipping box.
5. Send the unit freight-paid to the address above.

Warranty

Thermo Scientific products are warranted to be free from defects in material and workmanship at the time of shipment and for one year thereafter. Any claimed defects in Thermo Scientific products must be reported within the warranty period. Thermo Fisher shall have the right to inspect such products at Buyer's plant or to require Buyer to return such products to Thermo Fisher plant.

In the event Thermo Fisher requests return of its products, Buyer shall ship with transportation charges paid by the Buyer to Thermo Fisher plant. Shipment of repaired or replacement goods from Thermo Fisher plant shall be F.O.B. Thermo Fisher plant. A quotation of proposed work will be sent to the customer. Thermo Fisher shall be liable only to replace or repair, at its option, free of charge, products which are found by Thermo Fisher to be defective in material or workmanship, and which are reported to Thermo Fisher within the warranty period as provided above. This right to replacement shall be Buyer's exclusive remedy against Thermo Fisher.

Thermo Fisher shall not be liable for labor charges or other losses or damages of any kind or description, including but not limited to, incidental, special or consequential damages caused by defective products. This warranty shall be void if recommendations provided by Thermo Fisher or its Sales Representatives are not followed concerning methods of operation, usage and storage or exposure to harsh conditions.

Materials and/or products furnished to Thermo Fisher by other suppliers shall carry no warranty except such suppliers' warranties as to materials and workmanship. Thermo Fisher disclaims all warranties, expressed or implied, with respect to such products.

EXCEPT AS OTHERWISE AGREED TO IN WRITING BY Thermo Fisher, THE WARRANTIES GIVEN ABOVE ARE IN LIEU OF ALL OTHER WARRANTIES, EXPRESSED OR IMPLIED, AND Thermo Fisher HEREBY DISCLAIMS ALL OTHER WARRANTIES, INCLUDING THOSE OF MERCHANTABILITY AND FITNESS FOR PURPOSE.

This page intentionally left blank.

Appendix A

Hazardous Area Installations

HAZARDOUS AREA:
 CLASS I, DIV 1, GROUPS C & D
 CLASS II, DIV 1, GROUPS E, F, & G

NON-HAZARDOUS AREA: ⚠
 OR
HAZARDOUS AREA:
 CLASS I, DIV 2, GROUPS A, B, C, & D ⚠

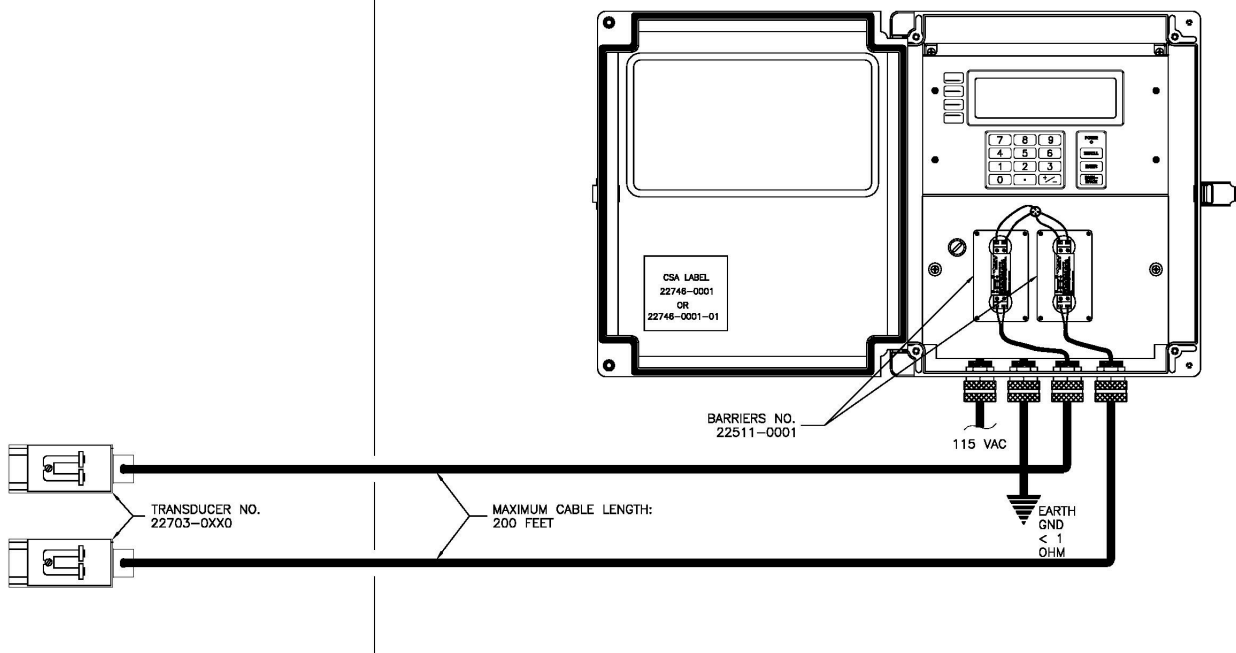

NOTES:

1. INSTALL IN ACCORDANCE WITH THE CANADIAN ELECTRICAL CODE, PART I OR THE NATIONAL ELECTRICAL CODE.
2. RESISTANCE BETWEEN INT. SAFE GND. AND EARTH GROUND MUST BE LESS THAN 1 OHM.
3. EQUIPMENT CONNECTED TO MODEL SX-40 MUST NOT GENERATE MORE THAN 120 VAC.
- ⚠ GENERAL PURPOSE AND HERMETICALLY SEALED RELAY ARE ALLOWED
- ⚠ ONLY HERMETICALLY SEALED RELAY IS ALLOWED

Figure A-1. Hazardous area installation with barriers

Hazardous Area Installations

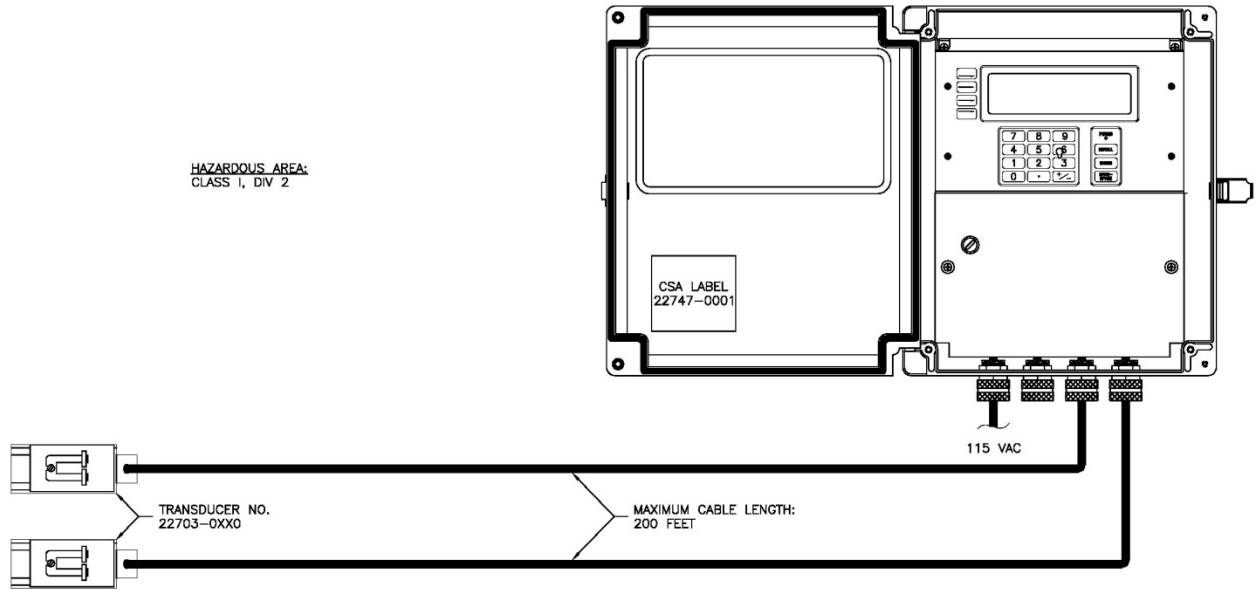

NOTES:

1. INSTALL IN ACCORDANCE WITH THE CANADIAN ELECTRICAL CODE, PART I OR THE NATIONAL ELECTRICAL CODE.

Figure A-2. Hazardous area installation without barriers

Appendix B

Obtaining Pipe ID

If you do not know the pipe ID, try to get pipe OD using one of the following methods:

- Read the pipe OD and schedule on the pipe.
- Read the OD and schedule from system drawings.
- Use a tape measure to measure the pipe circumference and divide the measured circumference by 3.14.
- Use Thermo Fisher's Ultrasonic pipe Thickness Gauge (P/N 0704/0187), and perform the following calculation:

$$\text{Pipe ID} = \text{Pipe OD} - (2 \times \text{Pipe Thickness}).$$

Table B–1. Steel, stainless steel, & PVC pipe standard schedules¹

Nominal Pipe Size	OD	Sch. 5	Sch. 10 (light wall)	Sch. 20	Sch. 30	Sch. 40	Sch. 60	Sch. 80	Sch. 100	Sch. 120	Sch. 140	Sch. 160	Std. Wall	XSTG
1	1.315	1.185	1.097			1.049		0.957				0.815	1.049	0.957
1.25	1.660	1.530	1.442			1.380		1.278				1.160	1.380	1.278
1.5	1.900	1.770	1.682			1.610		1.500				1.338	1.610	1.500
2	2.375	2.245	2.157			2.067		1.939				1.687	2.067	1.939
2.5	2.875	2.709	2.635			2.469		2.323				2.125	2.469	2.323
3	3.500	3.334	3.260			3.068		2.900				2.624	3.068	2.900
3.5	4.000	3.834	3.760			3.548		3.364					3.548	3.364
4	4.500	4.334	4.260			4.026		3.826		3.624		3.438	4.026	3.826
5	5.563	5.345	5.295			5.047		4.813		4.563		4.313	5.047	4.813
6	6.625	6.407	6.357			6.065		5.761		5.501		5.187	6.065	5.761
8	8.625	8.407	8.329	8.125	8.071	7.981	7.813	7.625	7.437	7.187	7.001	6.813	7.981	7.625
10	10.750	10.482	10.420	10.250	10.136	10.020	9.750	9.562	9.312	9.062	8.750	8.500	10.020	9.750
12	12.750	12.438	12.390	12.250	12.090	11.938	11.626	11.374	11.062	10.750	10.500	10.126	12.000	11.750
14	14.000		13.500	13.376	13.250	13.124	12.812	12.500	12.124	11.876	11.500	11.188	13.250	13.000
16	16.000	15.670	15.500	15.376	15.250	15.000	14.688	14.312	13.938	13.562	13.124	12.812	15.250	15.000
18	18.000	17.670	17.500	17.376	17.124	16.876	16.500	16.124	15.688	15.255	14.876	14.438	17.250	17.000
20	20.000	19.634	19.500	19.250	19.000	18.812	18.376	17.938	17.438	17.000	16.500	16.062	19.250	19.000
24	24.000	23.564	23.500	23.250	22.876	22.624	22.062	21.562	20.938	20.376	19.876	19.312	23.250	23.000

Obtaining Pipe ID

Nominal Pipe Size	OD	Sch. 5	Sch. 10 (light wall)	Sch. 20	Sch. 30	Sch. 40	Sch. 60	Sch. 80	Sch. 100	Sch. 120	Sch. 140	Sch. 160	Std. Wall	XSTG	
30	30.000	29.500	29.376	29.000	28.750	28.500							29.250	29.000	
36	36.000		35.376	35.000	34.750	34.500						31.876	31.312	35.250	36.000
42	42.000			41.000	40.750	40.500								41.250	41.000
48	48.000					47.250								47.250	47.000

¹All measurements in inches

Table B-2. Cast iron pipe standard classes¹

Nom Pipe Size	Class A		Class B		Class C		Class D		Class E		Class F		Class G		Class H	
	OD	ID	OD	ID	OD	ID	OD	ID	OD	ID	OD	ID	OD	ID	OD	ID
3	3.80	3.02	3.96	3.12	3.96	3.06	3.96	3.00								
4	4.80	3.96	5.00	4.10	5.00	4.04	5.00	3.96								
6	6.90	6.02	7.10	6.14	7.10	6.08	7.10	6.00	7.22	6.06	7.22	6.00	7.38	6.08	7.38	6.00
8	9.05	8.13	9.05	8.03	9.30	8.18	9.30	8.10	9.42	8.10	9.42	8.10	9.60	8.10	9.60	8.00
10	11.10	10.10	11.10	9.96	11.40	10.16	11.40	10.04	11.60	10.12	11.60	10.00	11.84	10.12	11.84	10.00
12	13.20	12.12	13.20	11.96	13.50	12.14	13.50	12.00	13.78	12.14	13.78	12.00	14.08	12.14	14.08	12.00
14	15.30	14.16	15.30	13.98	15.65	14.17	15.65	14.01	15.98	14.18	15.98	14.00	16.32	14.18	16.32	14.00
16	17.40	16.20	17.40	16.00	17.80	16.20	17.80	16.02	18.16	16.20	18.16	16.00	18.54	16.18	18.54	16.00
18	19.50	18.22	19.50	18.00	19.92	18.18	19.92	18.00	20.34	18.20	20.34	18.00	20.78	18.22	20.78	18.00
20	21.60	20.26	21.60	20.00	22.06	20.22	22.06	20.00	22.54	20.24	22.54	20.00	23.02	20.24	23.02	20.00
24	25.80	24.28	25.80	24.02	26.32	24.22	26.32	24.00	26.90	24.28	26.90	24.00	27.76	24.26	27.76	24.00
30	31.74	28.98	32.00	29.94	32.40	30.00	32.74	30.00	33.10	30.00	33.46	30.00				
36	37.96	35.98	38.30	36.00	38.70	35.98	39.16	36.00	39.60	36.00	40.04	36.00				
42	44.20	42.00	44.50	41.94	45.10	42.02	45.58	42.02								
48	50.50	47.98	50.80	47.96	51.40	47.98	51.98	48.00								
54	56.66	53.96	57.10	57.10	57.80	54.00	58.40	53.94								
60	62.80	60.02	63.40	60.06	64.20	60.20	64.82	60.06								
72	75.34	72.10	76.00	72.10	76.88	72.10										
84	87.54	84.10	88.54	84.10												

¹All measurements in inches



Note For pipes with cement linings, reduce the pipe ID by twice the lining thickness. Standard and double cement lining thicknesses are listed in the next table. ▲

Table B–3. Ductile iron pipe standard classes¹

Nominal Pipe Size	Inside Diameter								Cement Lining	
	OD	Class 50	Class 51	Class 52	Class 53	Class 54	Class 55	Class 56	Std. Thickness	Double Thickness
3	3.96		3.46	3.40	3.34	3.28	3.22	3.16	0.125	0.250
4	4.80		4.28	4.22	4.16	4.10	4.04	3.98		
6	6.90	6.40	6.34	6.28	6.22	6.16	6.10	6.04		
8	9.05	8.51	8.45	8.39	8.33	8.27	8.21	8.15		
10	11.10	10.52	10.46	10.40	10.34	10.28	10.22	10.16		
12	13.20	12.58	12.52	12.46	12.40	12.34	12.28	12.22		
14	15.30	14.64	14.58	14.52	14.46	14.40	14.34	14.28	0.1875	0.375
16	17.40	16.72	16.66	16.00	16.54	16.48	16.42	16.36		
18	19.50	18.80	18.74	18.68	18.62	18.56	18.50	18.44		
20	21.60	20.88	20.82	20.76	20.70	20.64	20.58	20.52		
24	25.80	25.04	24.98	24.92	24.86	24.80	24.74	24.68		
30	32.00	31.22	31.14	31.06	30.98	30.90	30.82	30.74	0.250	0.500
36	38.30	37.44	37.34	37.06	37.14	37.04	36.94	36.84		
42	44.50	43.56	43.44	43.32	43.20	43.08	42.96	42.84		
48	50.80	49.78	49.64	49.50	49.36	49.22	49.08	48.94		
54	57.10	55.96	55.80	55.64	55.48	55.32	55.16	55.00		

¹All measurements in inches

Note For pipes with cement linings, reduce the pipe ID by twice the lining thickness listed above. ▲

This page intentionally left blank.

Appendix C

Toxic & Hazardous Substances Tables

The English and Chinese versions of the Toxic and Hazardous Substances tables are shown below.

Toxic & Hazardous Substances Table – SX40

For Chinese Regulation: Administrative Measure on the Control of Pollution Caused by Electronic Information Products

Names and Content of Toxic and Hazardous Substances or Elements

Parts Name	Toxic and Hazardous Substances or Elements (SX40)					
	Pb	Hg	Cd	Cr6+	PBB	PBDE
Housing	o	o	o	x	o	o
4-20 mA Output Board	x	o	o	o	o	o
Adapter Board	x	o	o	x	o	o
CPU Board	x	o	o	o	o	o
Doppler Board	x	o	o	o	o	o
Motherboard	x	o	o	o	o	o
Key Pad Assembly	x	o	o	o	o	o
Cabling	x	o	o	o	o	o

o: Indicates that this toxic or hazardous substance contained in all of the homogeneous materials for this part is below the limit requirement in **SJ/T11363-2006**
 X: Indicates that this toxic or hazardous substance contained in at least one of the homogeneous materials used for this part is above the limit requirement in **SJ/T11363-2006**

有毒有害物质名称及含量的标识格式

部件名称	有毒有害物质或元素 (SX40)					
	铅 (Pb)	汞 (Hg)	镉 (Cd)	六价铬 (Cr6+)	多溴联苯 (PBB)	多溴二苯醚 (PBDE)
外壳	o	o	o	x	o	o
4-20 mA 输出电路板	x	o	o	o	o	o
适配器电路板	x	o	o	x	o	o
CPU 电路板	x	o	o	o	o	o
多普勒电路板	x	o	o	o	o	o
主板	x	o	o	o	o	o
键盘组件	x	o	o	o	o	o
缆线连接	x	o	o	o	o	o

o: 表示该有毒有害物质在该部件所有均质材料中的含量均在**SJ/T 11363-2006**标准规定的限量要求以下
 x: 表示该有毒有害物质至少在该部件的某一均质材料中的含量超出**SJ/T 11363-2006**标准规定的限量要求

This page intentionally left blank.

ThermoFisher Scientific
81 Wyman Street
P.O. Box 9046
Waltham, Massachusetts 02454-9046
United States

www.thermofisher.com