

USER'S MANUAL

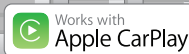
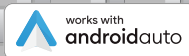

P9900CPA

**BLUETOOTH® MP3-COMPATIBLE AM/FM RECEIVER
FEATURING 6.75" (171 mm) CAPACITIVE TOUCHSCREEN**

Planet Audio®





Thank you for choosing Planet Audio

IMPORTANT! Fill Out And Keep For Your Records.



IMPORTANT

Record the serial number of the product:

Model:

Serial Number:

Date of Purchase:

The serial number is located on the top part of the chassis.

Contents

Contents	2	CarPlay Display.....	16	Media Player Source Switching.....	20
Notes.....	4	Disable Apps.....	16	Media	21
Cautions.....	5-7	Android Auto	17	Warnings.....	21
About this Manual.....	7	Warnings.....	17	USB Playback.....	21
California Prop. 65.....	7	Using Android Auto.....	17	Navigating Menu.....	21
Basic Product Operation	8	Bluetooth®	18	Photos.....	21
What comes in the box.....	8	Cautions.....	18	Radio	22
Product Basics.....	9-14	Setup & Connections.....	18	Display Overview.....	22
Using/Caring for the Touchscreen.....	12	Phonebook.....	18	Controls.....	22
Product Setup.....	13	Device Status.....	18	Tuning.....	22
Navigating the Menus.....	14	Calling.....	19	Bands.....	22
Apple CarPlay	15	History.....	19	Presets.....	22
Warnings.....	15	Private Mode.....	19	Favorites.....	22
Using CarPlay.....	15	Audio.....	20		
Gestures & Control.....	15	Track Control.....	20		

Contents

AV IN23	Display Settings.....26	Connections.....28
Playback.....23	Illumination Control.....26	Cautions & Warnings..... 28-33
Camera.....23	Gamma.....26	Power/SWC 28
Warnings.....23	LED Touch Buttons.....26	Speaker.....29
Reverse View.....23	LED Animation.....26	Audio Pre-amp/AV IN/ Radio.....30
General Settings24	Bluetooth® Settings.....27	Camera/USB/MIC.....31
Cautions.....24	Device Name.....27	Parking Brake.....32
System Language.....24	Camera.....27	Hands-free Mic.....33
Time Zone.....24	Rear Camera input.....27	Troubleshooting.....34
Date & Time.....24	Front Camera input.....27	Specifications.....36
Auto Adjust Daylight Saving.....24	Parking Assist Guide.....27	
System Tone.....24	Parking Assist Guide Adjust.....27	
Power Off Delay.....24	Rear View delay.....27	
Parental Disc Lock.....24	Radio Settings.....27	
Audio.....25	Region.....27	
EQ.....25		
Balance/Fader.....25		
Subwoofer.....25		
Loudness.....25		
Internal Amp.....25		
Volume.....25		
Source level.....25		

Important

This symbol with “WARNING” is intended to alert the user to the presence of critical instructions/procedures. Failure to observe the instructions/procedures can result in injury, death, damage to the product and/or property.



This symbol with “CAUTION” is intended to alert the user to the presence of important instructions/procedures. Failure to observe the instructions/procedures can result in injury or damage to the product and/or property.



Use of the Apple CarPlay logo means that a vehicle user interface meets Apple performance standards. Apple is not responsible for the operation of this vehicle or its compliance with safety and regulatory standards. Please note that the use of this product with iPhone or iPod may affect wireless performance.

iPhone® is trademark of Apple Inc., registered in the U.S. and other countries.

Apple CarPlay is a trademark of Apple Inc.

The *Bluetooth*® word mark and logos are registered trademarks owned by Bluetooth SIG, Inc. and any use of such marks by Planet Audio is under license.

Other trademarks and trade names are those of their respective owners

Caution

Precautions

BE SURE TO OBSERVE THE FOLLOWING GUIDELINES: Do not turn up the volume so high that you can't hear what's around you.

Use caution or temporarily discontinue use in potentially hazardous situations.

Do not operate mobile video equipment while driving a motorized vehicle – safe driving and safety consideration of others should always be your highest priority.

Set your volume control at a low setting, then slowly increase the sound until you can hear it comfortably without distortion, or ear discomfort.

In the event you should notice smoke, strange noises or odor from this product, or any other abnormal signs, immediately turn off the power and consult your dealer or the nearest authorized **Planet Audio** Service Center.

Using this product in this condition may result in permanent damage to the system.

Installation Precautions

Planet Audio does not recommend to install the product yourself.

We recommend to have it professionally installed by a certified professional.

Always consult with a professional installer .

Do not attempt to install or service this product by yourself. Installation or servicing of this product by persons without professional training and experience in electronic equipment and motorized vehicle accessories may be dangerous and could expose you to the risk of electric shock, injury or other hazards

Refer any repairs to a qualified Planet Audio Service Center

Caution

Before Installing

To avoid potential shorts in the electrical system, be sure to disconnect the (-) battery cable before installation.

Use this unit with a 12-volt battery and negative grounding only. Failure to do so may result in a fire or malfunction.

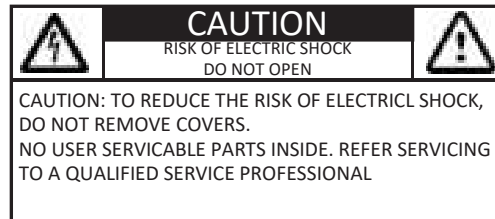

Product Safety

It is against Federal and Local laws for video to be viewed by the driver while the vehicle is in motion. This video product was intended to be used with the parking brake safety feature. Video cannot be seen without the proper parking brake powered connection. Tampering or disabling this feature will void any and all warranty. Please check with a professional installer to have your product installed properly.



Important Note

Due to ongoing enhancements, example images on screens may slightly differ from actual product.

Caution

Images and Video

Watching video while driving is against Federal, State, and Local laws.

Drive safely, know and obey traffic rules. Watching this screen and making selections while driving can lead to a serious accident.

Check surroundings for safety while camera images are displayed.

Do not use features of this product while driving if it cannot be operated safely and legally in your location. Before operation of smartphone Apps accessible from this device, read safety instructions in your Owner's Manual. When using navigation Apps stay alert to observe real world conditions.

About this manual

To entirely understand how to properly use your new Planet Audio product, it is recommended to read this entire user's manual, and keep it in a safe place for future reference.

- Read the entire manual
- Keep the manual
- Follow all instructions
- Clean with a dry cloth only
- Do not use or operate near water
- Do not defeat any safety features

California Residents (Proposition 65)

This product may contain chemicals known to the State of California to cause cancer, birth defects or other reproductive harm.

Basic Product Operation

What comes in the box

Hardware

Qty 1 P9900CPA

Qty 1 Trim Ring

Qty 1 Mounting Hardware Set

-M5 x 6mm Bolts (8)

-Brackets (2)

Connections

Qty 1 Power/Harness

Qty 1 Hands-free Microphone

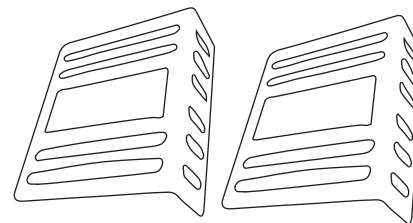
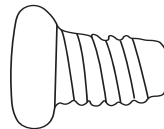
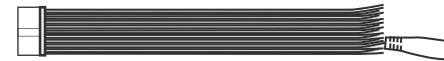
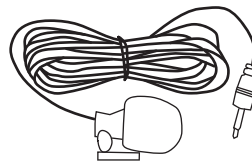
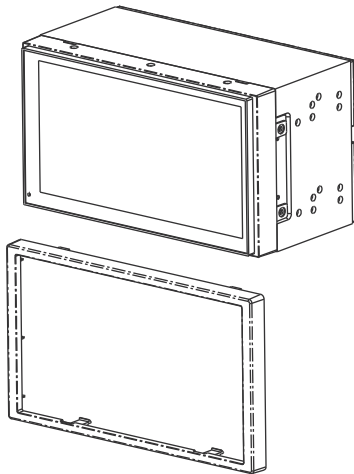

Basic Product Operation

Front Detail

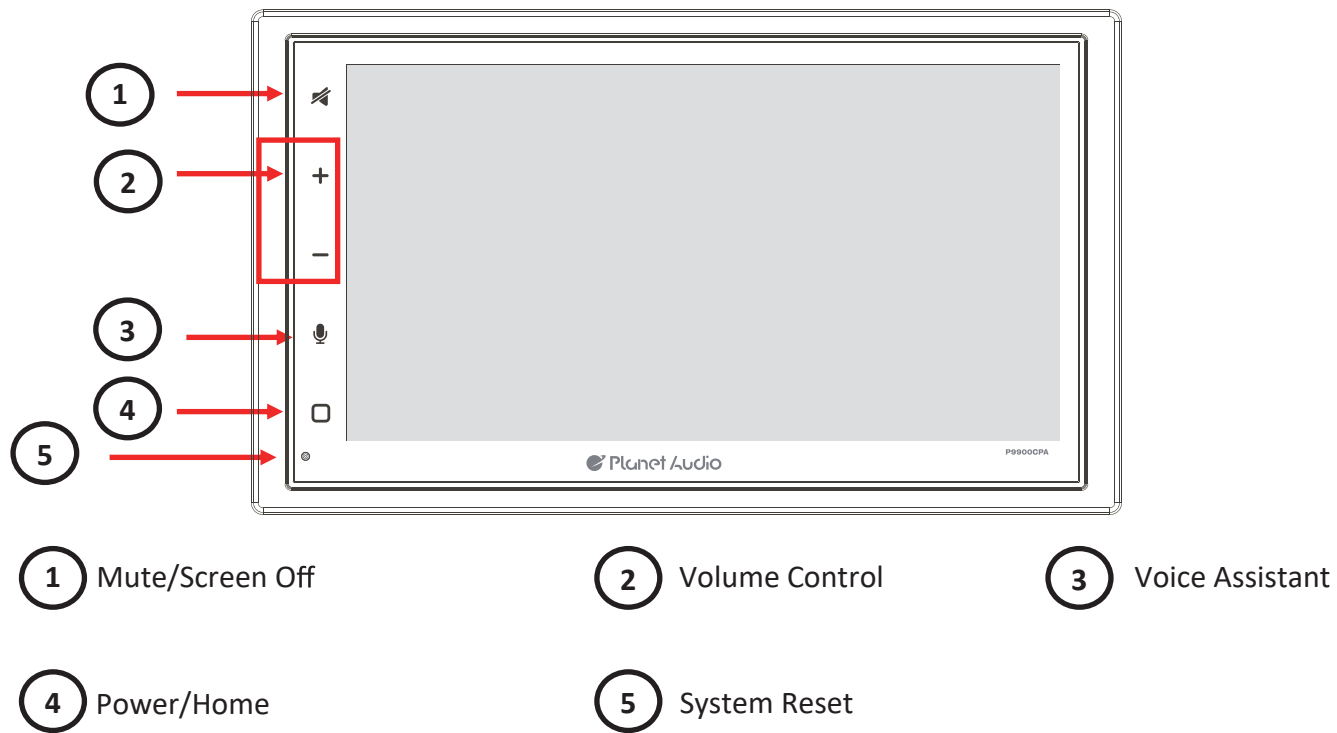

Basic Product Operation

Rear Detail

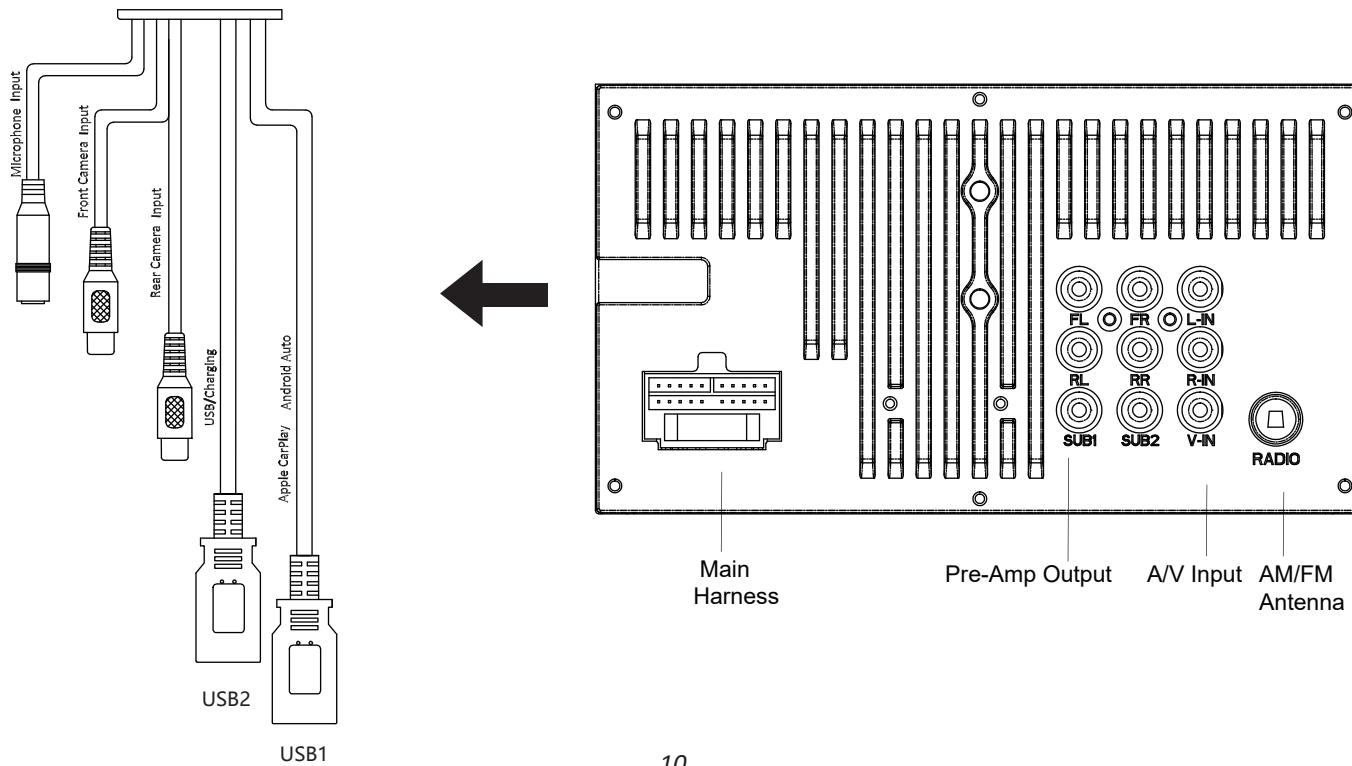

Basic Product Operation

Product Basics

Mute

1. Touch to Mute

Volume

1. Touch once on either "+" / "-"
2. Touch and Hold for quicker operation

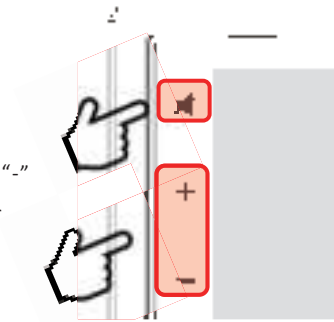

Voice Assistant

- Touch to command

NOTE

CarPlay must be active

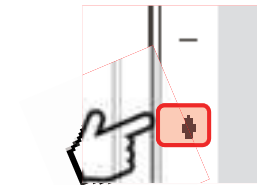

Display Off

- Touch and Hold Mute

Display On

- Touch the display to reactivate

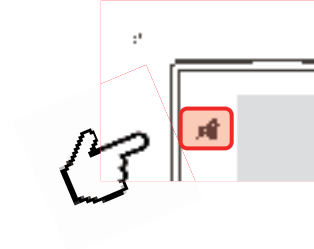

Power On /Standby

1. Touch once to Power ON
2. Touch and Hold for Standby

NOTE

In **Standby Mode**, the LED will slowly pulse on and off.

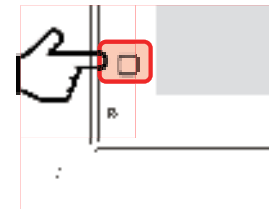

Basic Product Operation

Using and Caring for the Touchscreen



Use:

This head unit utilizes a Capacitive Touchscreen, the same type that is used on high-end mobile devices. It should be used for and cared for like that type of device. As with all capacitive type technology, if your fingers are wet or sweaty, it will not function properly.

Do not allow any sharp objects to come in contact with the screen glass.

Care and Cleaning:

To clean the screen, use a dry microfiber type cloth to clean. Do not use ammonia, window cleaner, or any other type of household chemicals to clean the screen. Abrasives should not be used at all.

Basic Product Operation

Product Setup (Date & Time)

Setup Option A: CarPlay Method

Connect your Apple® device using a Lightning® cable. The CarPlay USB port must be used.

This will automatically setup the time and date.

User must set Time Zone manually.

Default is Pacific Time Zone

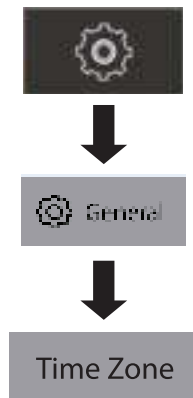

Setup Option B: Date and Time

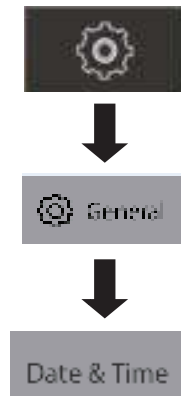

Additional Setup

General > Language

Audio > EQ, Other Audio Settings

Display > Illumination, Brightness

Basic Product Operation

Navigating the Menus

Android Auto

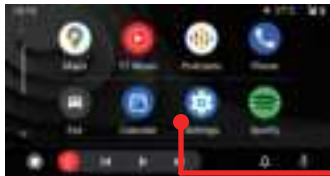

Media



Camera



CarPlay



Home

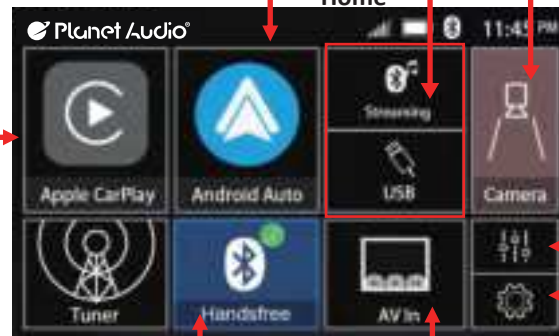

EQ



Tuner



Hands-free

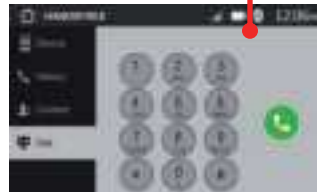

AV IN

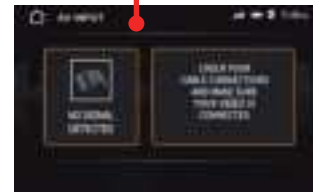

Settings

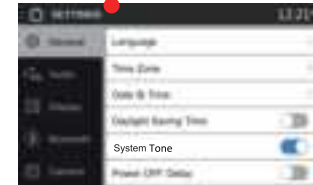

Apple CarPlay

Using CarPlay

Note

Apple CarPlay usage is limited while driving.

Functions, contents, and usability is determined by the App provider(s).

Controls will vary with each App that is available for CarPlay.

For more details visit:

<http://www.apple.com/ios/carplay>

WARNING

Familiarize yourself with your Local and State laws regarding mobile devices.

Certain functions of an iPhone might be prohibited and or illegal while driving in your location.

When in doubt, park the vehicle and engage the parking brake first before performing the function(s).

Connecting to CarPlay USB Port

1. Connect the CarPlay compatible device via LIGHTNING[®] cable (not included).
2. The iPhone will load the CarPlay function.
3. On the display, the CarPlay will illuminate green, touch it to enter the CarPlay menu.
4. To return to the product Home menu,

Touch



NOTE

The product's Bluetooth will turn **OFF** automatically when CarPlay is in use. Hands-free phoning will function through the CarPlay feature.

When using CarPlay, there is no need to pair your iPhone, the USB cable connected through the USB Port (1) will enable this feature.

If other devices are connected via Bluetooth, they will be disconnected for the duration of CarPlay use.

Gestures & Control

Basic controls, but not limited to:

Touch



Swipe



Dragging



Other gestures and controls might differ on each App.

NOTE

Volume control is handled exclusively by the product.

Apple CarPlay

Using CarPlay

CarPlay Display Setup

1. Using your iPhone:

Settings > General > CarPlay

2. **Touch and Hold** each App icon to move.

To remove an App, **Touch** 



NOTE

Only Apps with the  icon can be removed from CarPlay.

Only Apps with the  icon can be added in carplay.

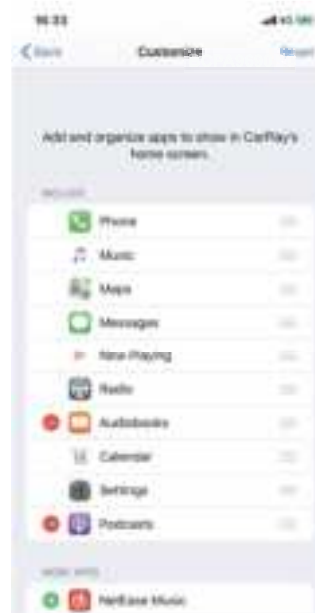

How to Disable Apps

1. Using your iPhone:

Settings > Notifications > App to Disable

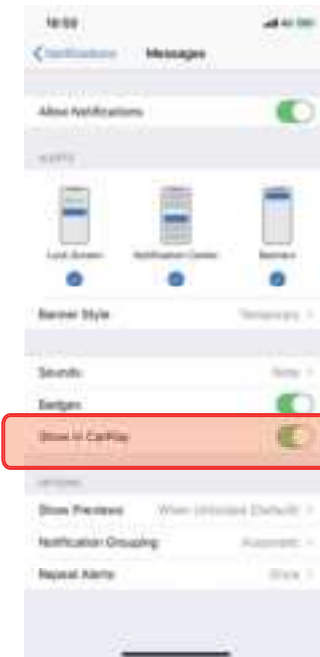

Android Auto

Using Android Auto

Note

Android Auto usage is limited while driving. Functions, contents, and usability is determined by the App provider(s).

Controls will vary with each App that is available for Android Auto.

For more details visit:

<https://www.android.com/auto/>

WARNING

Familiarize yourself with your Local and State laws regarding mobile devices.

Certain functions of the mobile device might be prohibited and or illegal while driving in your location.

When in doubt, park the vehicle and engage the parking brake first before performing the function(s).

NOTE

To complete the setup properly, the Parking Brake status wire must be connected.

WARNING

For your safety, the setup process **MUST** be accomplished while the vehicle is **Parked and Parking Brake Engaged**.

Android Auto App

1. For Android 9.0 or earlier, download and install the Android Auto app from Google Play. For smartphone with Android 10.0 or later, plug in your phone and follow the prompts on your phone to accept the permissions that Android Auto requires



Minimum Requirements:

Android 5.0 Lollipop

For a list of compatible devices:

<https://www.android.com/auto/>

Updating Related Apps

1. During the first start up and setup of the Android Auto app, the Maps, Music, Google apps will install/update automatically.

Connecting to Android Auto USB Port

1. Connect the Android compatible device via the appropriate USB cable (not included).
2. The Android device will load the Android Auto function.
3. Bluetooth will connect automatically when the setup is completed.

Android Auto Permissions Permissions

Several features can be allowed or denied access to customize your usability of the product.

The access can always be modified in Settings on the Android device.

Bluetooth®

Setup & Connection

Hands-Free Menu

Touch



NOTE

CarPlay must not be active. If being used, disconnect the iPhone to start Bluetooth.

Compatibility with all mobile devices is not guaranteed. Please read through the user's guide of the mobile device.

CAUTION

For your safety, the setup process should be accomplished while the vehicle is parked and parking brake engaged.

First time Pairing

Using your phone, media or other Bluetooth device, try to connect to this headunit.

Mobile Device:
Search for *Planet Audio P9900CPA*

iOS Devices: **Settings > Bluetooth**

Android Devices: **Settings > Connections > Bluetooth**

A passcode is generated and will display on both the head unit and mobile device for secure pairing.

Touch  to confirm

Every time the product is powered ON, the mobile device will automatically connect if within range.

NOTE

Once paired and connected, the device list will display the available Bluetooth profiles.



Phonebook and History

To **Download Phonebook**:

1. Touch **Contact > Download**

To **Download History**

1. Touch **History > Download**

Device Status

Battery and Cellular Strength is displayed on the top right of the Home menu.

GATT Profile support is required on the mobile device.



Bluetooth®

Hands-Free

Calling

Making & Receiving Calls

1. Dialing from the dial pad

Touch  to make call

2. Contacts

Touch the contact name

3. History

Choose the name, then

To End a call Touch 

To Mute a call Touch 

Dial pad



To use the dial pad while on a call

Touch 

Searching History

Swipe Up or Down to search 

History

1. Outgoing Call 
2. Incoming Call 
3. Missed Call 

Private Mode

When a call needs to be transferred to the mobile device:

Touch  to switch the mobile device

Touch  to return to hands-free mode

Searching Contacts

Contacts must be downloaded to search.

1. Touch 

2. Enter the Contact Name, then

Connection: **ON**

Auto Connect: **ON**

Auto Answer: **OFF**

Device Name: **Planet Audio P9900CPA**

Clear Records

Bluetooth®

Audio

Audio Streaming

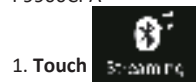

To play media through Bluetooth, the mobile device must be **Paired and Connected** to the P9900CPA



1. Touch

The music will play automatically.

Track Control

1. Play/Pause 
2. Track Fwd / Rev 
3. **Swipe** to Fwd/Rev 

Note

For best performance, your mobile device volume setting should be set to maximum.

All volume adjustments for the system should be controlled from the product.

The unit will recall the last volume setting on your mobile device every time it connects.

Formats

Playback is supported from the mobile device with any format it can play.

Audio will only be played by the product.

Video cannot be viewed on the unit.

Switching Media



Touch

Available sources will display **(Bluetooth and USB)**

Note

USB source will only be displayed if a USB drive is inserted and has playable media.

Display

Track info will be displayed when available.

Track, Album and Artist.

Album art is not supported via Bluetooth playback.

Media

USB

USB Playback



The music will play automatically.

Audio Control

1. Play/Pause 
2. Track Fwd / Rev 
3. Repeat ALL 
4. Repeat One 
5. Random 

Note

If there are other files in the USB, music files will play first.

Video Control











1. Play/Pause 
2. Track Forward/Backward 
3. Repeat All 
4. Repeat one 
5. SETUP 

Photo Control

1. Play/Pause 
2. Track Forward/Backward 
3. Repeat All 
4. Repeat One 
5. Rotate 

Navigating Menu



To browse contents **Swipe**



To return to the current file playing,



WARNING

Watching videos or photos while driving is against Federal, State, and Local laws.

Do not use features of this product if it cannot be operated safely and legally in your location.

Note

Review the connections of this product, to properly integrate the parking brake wire to the vehicle.

Video and or photos cannot be viewed while driving. The vehicle must be stationary and the parking brake applied to enable viewing.

Radio

AM/ FM

Controls



Tuning

To search for stations:

Search



Manual Seek

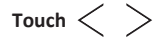

Auto Search & Store: Touch 

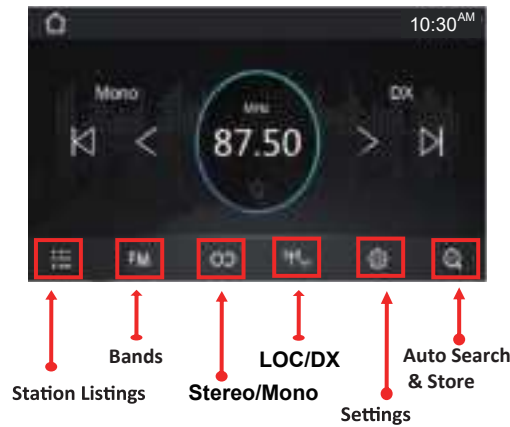

Band & Settings

Touch FM to switch bands

To change radio settings



Favorites and Presets

Settings Favorites



To remove a favorite, Touch 

Browsing Favorites

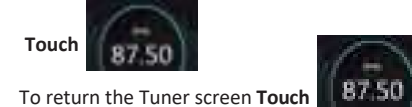

To return the Tuner screen Touch 

Changing Presets



To list all Stored Stations



Stereo/Mono

To turn on/off stereo when receiving a stereo signal ,

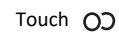

LOC/DX

To select Local or Distant broadcasting stations,

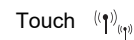

AV In/Camera

External Source

Playback

Touch



Media must be controlled from the external device.

Track functions are not controlled from the product.

Note

To adjust the volume level properly, the carry-in device volume should be set between 50% - 75%. The volume level should remain at that level for the remainder of the time it is connected to the product.

WARNING

Never rely solely on the rear view camera; always check your surroundings before proceeding.

Images may appear reversed

Do not use features of this product if it cannot be operated safely and legally in your location.

Rear View

The rear view camera can be displayed on demand.

Touch



If the user opens the SETTINGS interface and turn on both FRONT CAMERA and REAR CAMERA functions, you can choose REAR CAMERA and FRONT CAMERA casually.



To return to the Home screen

Touch



Reverse View

When the vehicle is put into reverse gear, the camera will display the image on the screen.

CHECK SURROUNDINGS BEFORE PROCEEDING



Rear View Delay

Due to varying vehicle configurations, the rear view trigger can be delayed to best suit the vehicle.

Default setting: 0 Sec Delay

Note

The rear view camera will still function normally, if the product is in standby mode

Settings

General

System Language

Touch to change

English (Default), Spanish

Note

CarPlay is independent of the system language setting.

Time Zone

Adjust to correctly display time

Default Setting: **(GMT-08:00) Pacific Time (US&Canada)**

Date & Time

24H Mode



Auto Adjust Daylight Saving



Note

If using an CarPlay, the iPhone will automatically set date & time. Time Zone needs to be adjusted manually.

System Tone



Power Off Delay

Some vehicles during crank to start will interrupt the accessory power.

If the product re-boots during crank to start, Turn **ON** delay

The delay can select 1, 2 or 3 sec.

Default Setting: **OFF**

Note

Power Off Delay **ON** will also delay when the vehicle is turned OFF.

This might affect hands-free functionality during a call.

Factory Settings

To restore settings to default:



Will restore all settings to factory defaults. All settings and presets will be lost.

Setting

Audio

EQ

To access the EQ menu

Touch



Note

The EQ can also be directly accessed while changing the volume. The volume display will show the EQ icon, you can touch to access the Audio Settings.



Preset EQ

Jazz, HipHop, Pop,Rock, R&B

Balance/Fader

Left/Right Balance, Touch



Swipe for quick adjustment



Front/Rear Fader, Touch



Swipe for quick adjustment



Subwoofer

The level and filter can be adjusted for the Sub pre-amp output.

Level, 1-14 dB

Swipe



Filter: 50Hz, 80 Hz, 120 Hz, 160 Hz

Touch +/- Subwoofer Frequency

Loudness

Enhances and gently boosts low and high freq.

Touch



Internal Amp

To reduce the possibility of noise entering the signal chain when utilizing the audio pre-amp outputs, the internal amp can be turned OFF

Touch



Volume

Settings are for default volumes for Main (Radio, Media), Hands-free (BT Ring, BT Talking), Apple CarPlay/Android Auto (Navi, Voice).

Source Level

The source mode (Radio, USB, BT Audio, AV Input, Apple CarPlay, Android Auto) gain control.

Settings

Display

Bluetooth

Illumination Control



When the vehicle lights are on, the products illumination can be customized for night use.

Gamma



Gamma can be adjusted for both day and night settings.

Screen Brightness



LED Touch Buttons



Six preset colors can be chosen for Touch buttons, or chose below...



LED Animation



Will cycle through all colors on LED touch buttons.

Default Setting: ON

UI settings

Wall paper

Touch to change
User can change the background picture by inserting a USB with photos.

Background Brightness



Connection



Power On/Off Bluetooth

Default Setting: ON



Bluetooth will turn OFF automatically when CarPlay is in use. If other devices are connected via Bluetooth, they will be disconnected for the duration of CarPlay use.

Auto Connect



Auto connects to the device when the product is powered ON

Default Setting: ON

Auto Answer



Auto answers when there is an incoming call.

Default Setting: OFF

Settings

Bluetooth

Device Name

Planet Audio P9900CPA

Rear Camera input

Turn on if you have a rear view camera, turn off if you have not.

Front Camera Input

Turn on if you have a front view camera, turn off if you have not.

Parking Assist guide

Turn off if your rear view camera have parking assist guide, turn on if you have not.

Camera

Parking Assist guide Adjust

If your rear view camera does not have parking guide lines, turn on the parking guide lines built in this unit and adjust the guide lines if found necessary.



Touch and drag a square icon to reposition the related guide line. Repeatedly touch an arrow icon to fine tune positioning of the related guide line. Touch the OK icon to confirm the adjustment. To reset to the default positioning of the guide lines, touch the Reset icon.

Radio

Rear View Delay

0 Sec (Default), 0.1 Sec, 0.5 Sec, 1 Sec, 2 Sec
When switching from Park to Drive, or vice versa, the camera should not trigger on the display.

Sensitivity should be adjusted to trigger only on reverse gear selector.

Region

Touch 

Default Setting: **USA 2**

US Tuner Spacing: FM (200 KHz), AM (10 KHz)

European Spacing: FM (50 KHz), AM (9 KHz)

Connections

Power/SWC

CAUTION

It is recommended to have the product installed by a certified installation professional.

CAUTION

Before installation, or wiring connections, disconnect the negative (-) battery terminal to prevent damage to the product, and/or possible injury.



CAUTION

Remote Out is 500 mA max output rating. If several amplifiers are to be used, it is recommended to use a relay for the Remote Out trigger.

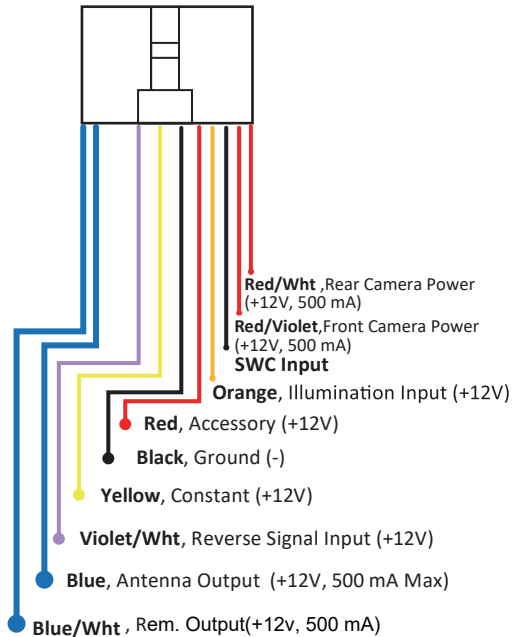

Note

Unused input/output wires need be insulated with tape, heat shrink, or crimp connectors. **Never use wire nuts.**

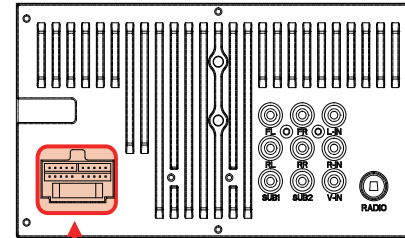

Location to plug in

Note

A separate interface might be needed for your vehicle application. It is recommended that you consult with a professional installer.

Note

When replacing the fuse, always do so with the same type and value (15 A).

Connections

Speakers

CAUTION

Do not chassis ground any speaker wire leads.

CAUTION

Only use 4-8 Ω Speakers
Do not use 1-3 Ω Speakers

CAUTION

Do not bridge any of the channels, they are only to be wired in stereo mode.

Note

Unused speaker wires need be insulated with tape, heat shrink, or crimp connectors.

Never use wire nuts.

If the speaker outputs are not used, turn **Off** the internal amp to reduce the possibility of noise entering the signal chain.

Note

Observe speaker polarity when making connections.

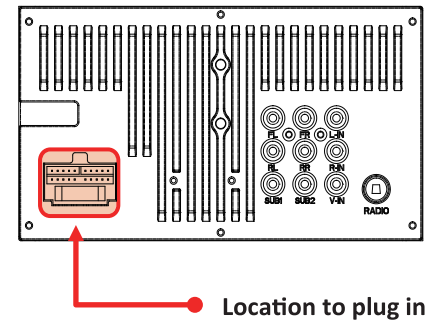
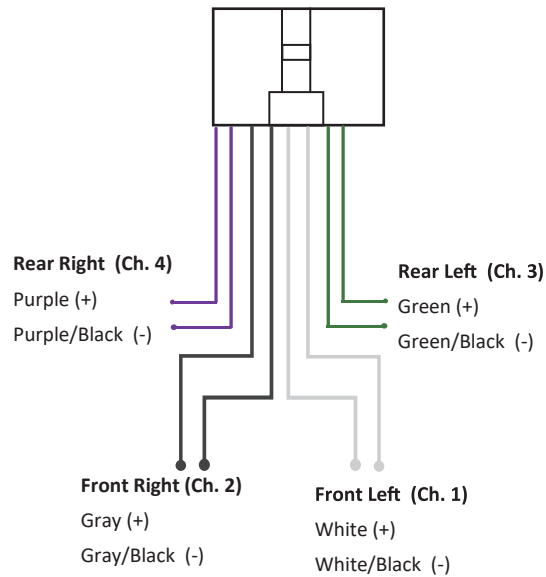

Connections

Audio Pre-amp/AV IN/ Radio

Note

Subwoofer Pre-amp is a non-fading mono output.

Note

Always run signal wires away from power cables to reduce the possibility of noise.

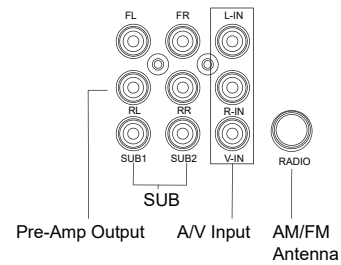

Note

If pre-amp outputs are being used exclusively, turn **Off** the internal amp of the product, to reduce the possibility of noise entering the signal chain.

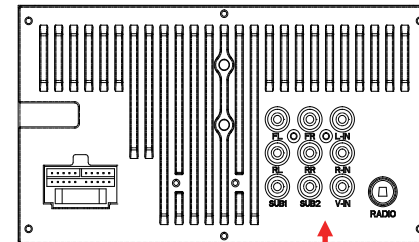

Location to plug in

Connections

Camera/USB/MIC

⚠ WARNING

Never rely solely on the rear view camera; always check your surroundings before proceeding.

Images may appear reversed

Do not use a feature of this product if it cannot be operated safely and legally in your location.

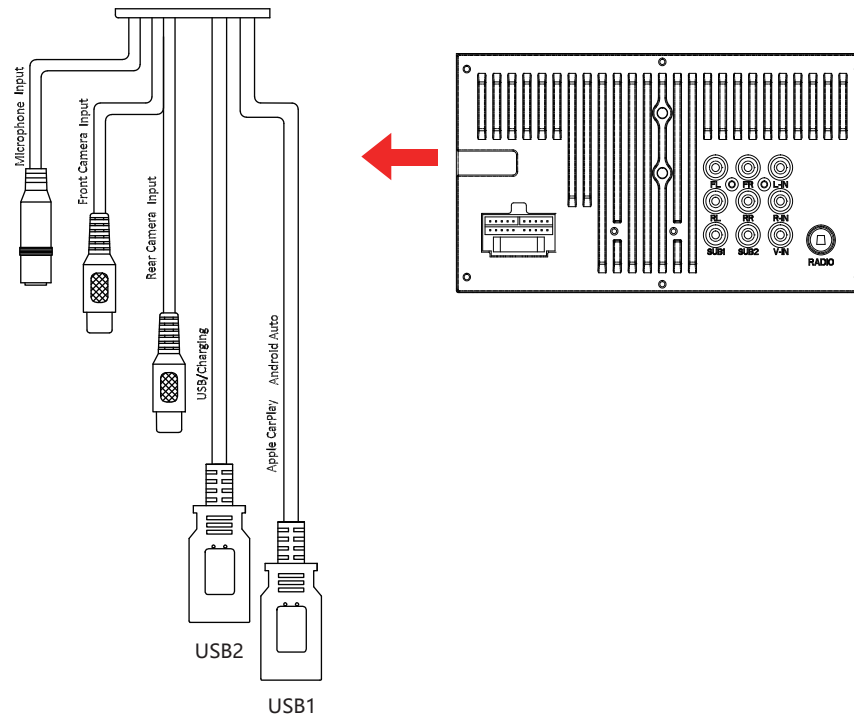

Connections

Parking Brake

 **WARNING**

Improper connection or use of the parking brake status wire, (i.e. defeating the safety feature) violates Federal, State, and Local laws. This may lead to injury, property damage, and/or death.

 **WARNING**

Watching videos or photos while driving is against Federal, State, and Local laws.

 **Note**

For Android Auto setup, the parking brake status wire **MUST** be connected.

 **Note**

Review the connections of this product, to properly integrate the parking brake wire to the vehicle.

Video and or photos cannot be viewed while driving. The vehicle must be stationary and the parking brake applied to enable viewing.

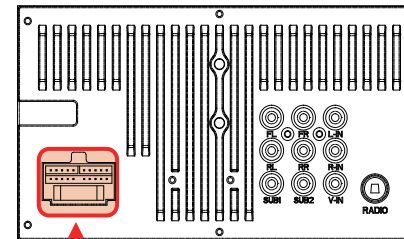

 **Power/Speaker/SWC
Harness**

 **Note**

The parking brake input needs to be connected to the power side of the parking brake.

 **Note**

Every vehicle has a different type of parking brake connection; consult a certified professional installer.

Connections

Hands-free Mic

Placement

Every vehicle will perform differently due to layout, interior materials, etc...

The **Red** shaded areas are the recommended locations for best microphone performance.

Items to look for before placement:

1. Do not place in front of air vents.
2. If the vehicle has tweeters placed on sail panels, do **NOT** locate the mic on steering column area.
3. Front of mic must not be blocked.
4. Mic should be firmly attached to mounting location.
5. Do not cover the grille openings surrounding the mic.
6. To avoid excessive wind noise, do not place near the sunroof opening

WARNING

Run microphone wire where it will **NOT** impede the operation of any safety items, i.e. Airbags, Knee Airbags, etc...

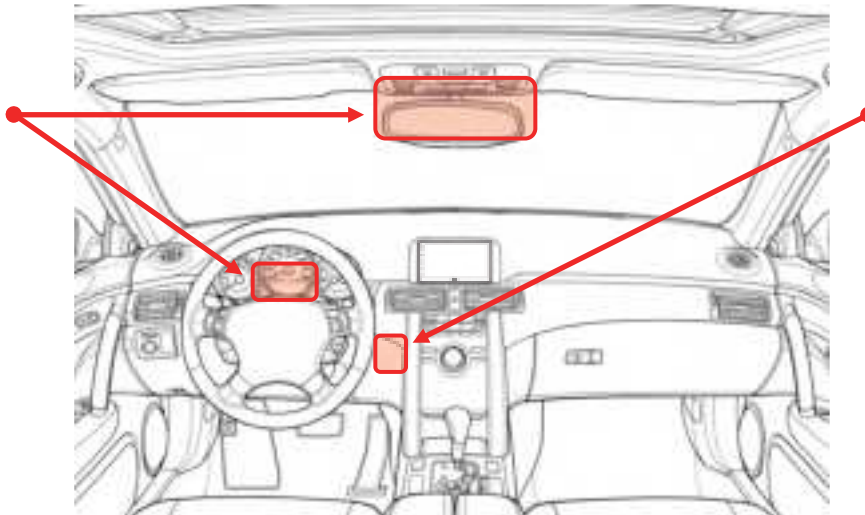

Troubleshooting

Issues	Cause	Solution
No Sound	Internal amplifier is off Product is muted External amplifiers Audio source	Go to Settings > Audio > Internal Amp ON Touch the volume. Check the external amplifiers are on. Check the remote output wire has voltage Change the audio source
Media Not Supported	Media on USB flash drive	Change the media format on the USB device Change the USB device
Bad Radio Reception	Radio area Antenna	Change the station Antenna output wire isn't connected Connect Antenna to product
Apple CarPlay/Android Auto will not start	Bad Lightning®/USB cable Locked device Not charged CarPlay/Android Auto frozen	Replace the cable Device needs to be unlocked Device needs to be powered ON for CarPlay/ Android Auto to function. Allow it to charge and power on. Unplug the device, close all Apps and plug it in again.
Bluetooth	Not connecting to device	Make sure the device is within range. Devices' Bluetooth connection needs to be turned ON

Troubleshooting

Issues	Cause	Solution
Bluetooth	Not connecting to device	Go to Setting >Connection >Power ON Pair and Connect the device like new.
Hands-free call quality	Mobile device Microphone	Check cellular strength on mobile device. End call and redial number. Microphone placement needs to be relocated. Microphone needs to be firmly attached to location it's mounted on. Check to see if microphone is properly plugged in.
Unit is unresponsive	Processor has frozen	Press the RESET button on the front panel



If you have questions about this product:

Customer Service

805-751-4854

M-F 8:30a-5:00p (PST)

Tech Support: www.planetaudio.com/support

Specifications

General

Power Input.....8.5 V—18 V DC
 Nominal.....14.4 V DC
 Current Consumption.....15A
 Fuse Type.....15A
 Dimensions (H x W x D).....3.8"x6.71"x3.59"
 Head Unit Weight..... 1.96 lbs.
 Operational Temperature.....-4—140°F

Display

Screen Size..... 6.75"
 Aspect Ratio.....16 x 9
 Resolution.....1024x600
 Screen Type.....TFT-LED Active Matrix

Audio

Max Power.....80 W x 4 Ch.
 Acceptable Speaker Load.....4-8 Ω
 Preset EQ.....5
 JAZZ, HIPHOP, POP, ROCK, R&B
 EQ Bands, Adjustable.....10
 32, 63, 125, 250Hz, 500Hz
 1KHz, 2KHz, 4KHz, 8KHz, 16KHz
 EQ Boost/Cut.....± 6 dB

Audio Cont'd

Pre-amp Output.....3 Pairs
 Front.....4V, Full-Range
 Rear.....4V, Full-Range
 Sub (Mono).....4V, LPF
 Sub LPF.....50 Hz, 80 Hz, 120 Hz, 160 Hz
 Sub Level.....+1-14dB

Radio Tuner

Freq. Range.....87.5 MHz-108 MHz (FM)
 Freq. Range.....522 kHz-1710 kHz (AM)
 USA 1 Range (FM).....100 kHz Spacing
 USA 2 Range (FM).....200 kHz Spacing
 Europe Range (FM).....50 kHz Spacing

Apple CarPlay

iPhone Support.....iPhone 5 or Newer
 iOS.....iOS 7.1 or Newer

Android Auto

Supported.....(5.0) Lollipop or Newer

USB

USB Spec.....USB 2.0 (High-Speed)
 USB Port 1: Carplay & Android Auto.....
 Current Output 1.5A
 USB Port 2: Media & 1.5A Charging
 Current Output 1.5A
 File System.....FAT32
 Audio Playback.....WAV, MP3
 Video Playback.....AVI, MKV, WMV
 Picture Playback.....JPG, PNG, BMP

*Not all listed compressed files guaranteed to play due to different creation methods or file contents.

Bluetooth®

Version.....v4.2+E.D.R.
 Audio Codec.....S.B.C.
 Profiles.....
 HFP v1.6,A2DP v1.2,AVRCP v1.5,PBAP v1.1

User's Notes



USER'S MANUAL

P9900CPA

BLUETOOTH® MP3-COMPATIBLE AM/FM RECEIVER
FEATURING 6.75" (171 mm) CAPACITIVE TOUCHSCREEN

www.planetaudio.com

TELEPHONE

805-751-4854 Customer Service

TECHNICAL SUPPORT

www.planetaudio.com/support



0621

iPod® is a trademark of Apple, Inc. registered in the U.S. and other countries.
Planet Audio is not affiliated with Apple, Inc.
The Bluetooth® word mark and logos are registered trademarks owned by Bluetooth SIG, Inc.
and any use of such marks by Planet Audio is under license. Other trademarks and trade
names are those of their respective owners.