

**Yealink**

# T48G Skype for Business<sup>®</sup> Edition User Guide



Version 8.70  
Mar.2017

# Copyright

**Copyright © 2017 YEALINK(XIAMEN) NETWORK TECHNOLOGY CO., LTD.**

Copyright © 2017 Yealink(Xiamen) Network Technology CO., LTD. All rights reserved. No parts of this publication may be reproduced or transmitted in any form or by any means, electronic or mechanical, photocopying, recording, or otherwise, for any purpose, without the express written permission of Yealink(Xiamen) Network Technology CO., LTD. Under the law, reproducing includes translating into another language or format.

When this publication is made available on media, Yealink(Xiamen) Network Technology CO., LTD. gives its consent to downloading and printing copies of the content provided in this file only for private use but not for redistribution. No parts of this publication may be subject to alteration, modification or commercial use. Yealink(Xiamen) Network Technology CO., LTD. will not be liable for any damages arising from use of an illegally modified or altered publication.

## Warranty

THE SPECIFICATIONS AND INFORMATION REGARDING THE PRODUCTS IN THIS GUIDE ARE SUBJECT TO CHANGE WITHOUT NOTICE. ALL STATEMENTS, INFORMATION, AND RECOMMENDATIONS IN THIS GUIDE ARE BELIEVED TO BE ACCURATE AND PRESENTED WITHOUT WARRANTY OF ANY KIND, EXPRESS OR IMPLIED. USERS MUST TAKE FULL RESPONSIBILITY FOR THEIR APPLICATION OF PRODUCTS.

YEALINK(XIAMEN) NETWORK TECHNOLOGY CO., LTD. MAKES NO WARRANTY OF ANY KIND WITH REGARD TO THIS GUIDE, INCLUDING, BUT NOT LIMITED TO, THE IMPLIED WARRANTIES OF MERCHANTABILITY AND FITNESS FOR A PARTICULAR PURPOSE. Yealink(Xiamen) Network Technology CO., LTD. shall not be liable for errors contained herein nor for incidental or consequential damages in connection with the furnishing, performance, or use of this guide.

## Declaration of Conformity



Hereby, Yealink(Xiamen) Network Technology CO., LTD. declares that this phone is in conformity with the essential requirements and other relevant provisions of the CE, FCC.

You can find the CE and FCC information from the label on the back of the IP phone.

Statements of compliance can be obtained by contacting [support@yealink.com](mailto:support@yealink.com).

## CE Mark Warning

This device is marked with the CE mark in compliance with EC Directives 2014/30/EU and 2014/35/EU.

## Part 15 FCC Rules

Any changes or modifications not expressly approved by the party responsible for compliance could void the user's authority to operate the equipment.

This device is compliant with Part 15 of the FCC Rules. Operation is subject to the following two conditions:

1. This device may not cause harmful interference, and
2. This device must accept any interference received, including interference that may cause undesired operation.

## Industry Canada (IC)

This Class [B] digital apparatus complies with Canadian ICES-003 Rules.

## Class B Digital Device or Peripheral

Note: This device is tested and complies with the limits for a Class B digital device, pursuant to Part 15 of the FCC Rules. These limits are designed to provide reasonable protection against harmful interference in a residential installation. This equipment generates, uses, and can radiate radio frequency energy and, if not installed and used in accordance with the instructions, may cause harmful interference to radio communications. However, there is no guarantee that interference will not occur in a particular installation. If this equipment does cause harmful interference to radio or television reception, which can be determined by turning the equipment off and on, the user is encouraged to try to correct the interference by one or more of the following measures:

1. Reorient or relocate the receiving antenna.
2. Increase the separation between the equipment and receiver.
3. Connect the equipment into an outlet on a circuit different from that to which the receiver is connected.
4. Consult the dealer or an experience radio/TV technician for help.

## WEEE Warning



To avoid the potential effects on the environment and human health as a result of the presence of hazardous substances in electrical and electronic equipment, end users of electrical and electronic equipment should understand the meaning of the crossed-out wheeled bin symbol. Do not dispose of WEEE as unsorted municipal waste and have to collect such WEEE separately.

## Customer Feedback

We are striving to improve our documentation quality and we appreciate your feedback. Email your opinions and comments to [DocsFeedback@yealink.com](mailto:DocsFeedback@yealink.com).

## GNU GPL INFORMATION

Yealink T48G Skype for Business phone firmware contains third-party software under the GNU General Public License (GPL). Yealink uses software under the specific terms of the GPL. Please refer to the GPL for the exact terms and conditions of the license.

The original GPL license, source code of components licensed under GPL and used in Yealink products can be downloaded online:

<http://www.yealink.com/GPLOpenSource.aspx?BaseInfoCateId=293&NewsCateId=293&CateId=293>.

## About This Guide

Yealink T48G phone with the Skype for Business firmware enables a new era in unified communications. It is designed to work with the Skype for Business Server. Connecting a Yealink T48G Skype for Business phone to the Skype for Business Server allows you to place regular and Voice over Internet Protocol (VoIP) calls, answer calls, forward calls, conduct a Skype for Business conference call, and dial from your Skype for Business directory list through integration with Microsoft's Active Directory.

This guide provides everything you need to quickly use your new phone. First, verify with your system administrator that the network is prepared for configuring your Yealink T48G Skype for Business phone, and your network is correctly configured. Also be sure to read the **Packaging Contents** and **Regulatory Notices** sections in this guide before you set up and use the Yealink T48G Skype for Business phone.

## In This Guide

Topics provided in this guide include:

- Chapter 1 [Overview](#)
- Chapter 2 [Getting Started](#)
- Chapter 3 [Customizing Your Phone](#)
- Chapter 4 [Basic Call Features](#)
- Chapter 5 [Common Area Phone](#)
- Chapter 6 [Better Together over Ethernet](#)
- Chapter 7 [EXP40 Expansion Module](#)
- Chapter 8 [Troubleshooting](#)

## Summary of Changes

This section describes the changes to this guide for each release and guide version.

### Changes for Release 8, Guide Version 8.70

The following sections are new for this edition:

- [Team-Call Group](#) on page 147
- [Response Group Ringtone](#) on page 149
- [Boss-Line Ringtone](#) on page 163

- [Delegates-call Ringtone](#) on page 164

## Changes for Release 8, Guide Version 8.60

The following sections are new for this edition:

- [Connecting to the Network](#) on page 17
- [Key Tone](#) on page 64
- [Disabling BToE on Your Phone](#) on page 220
- [Exiting BToE on Your Computer](#) on page 220
- [Uninstalling the Yealink BToE Connector](#) on page 221

Major updates have occurred to the following section:

- [Phone Installation](#) on page 14
- [Bluetooth Headset](#) on page 92
- [Better Together over Ethernet](#) on page 205

## Changes for Release 8, Guide Version 8.50

The following sections are new for this edition:

- [Remembering Password](#) on page 60
- [Private Line Tones](#) on page 166
- [Hotline](#) on page 109
- [Shared Line Appearance for Skype for Business](#) on page 150
- [Join Calls into a Conference](#) on page 173
- [Monitoring Skype for Business Contacts for Status Changes](#) on page 227

Major updates have occurred to the following sections:

- [Signing into Skype for Business](#) on page 18
- [Entering Data and Editing Fields](#) on page 38
- [Phone Lock](#) on page 57
- [Emergency Call](#) on page 104
- [Working with Schedule Reminders](#) on page 130
- [Joining Skype Conferences from the Calendar](#) on page 132
- [Consultative Transfer](#) on page 168
- [Better Together over Ethernet](#) on page 205
- [Troubleshooting Solutions](#) on page 231

## Changes for Release 8, Guide Version 8.21

The following sections are new for this edition:

- [Web Sign-in](#) on page 22
- [Skype for Business Directory](#) on page 65
- [Local Directory](#) on page 70
- [Headset Use](#) on page 89
- [Bluetooth Headset](#) on page 92
- [Hotline](#) on page 109
- [Calendar](#) on page 122
- [Reloading the Location Information from the Skype for Business Server](#) on page 102
- [Group Call Pickup](#) on page 169
- [Skype for Business Conference](#) on page 170
- [Multicast Paging](#) on page 193
- [Branch Office Resiliency](#) on page 199
- [Common Area Phone](#) on page 201
- [EXP40 Expansion Module](#) on page 223
- [Signing in via PC](#) on page 215

Major updates have occurred to the following sections:

- [Phone Ringtone](#) on page 62
- [Response Groups](#) on page 148
- [Boss-Admin Feature](#) on page 149
- [Inbound Private Line](#) on page 165
- [Call Transfer](#) on page 167
- [Voice Mail](#) on page 189
- [Troubleshooting](#) on page 231

## Changes for Release 7, Guide Version 7.50

Major update has occurred to the following section:

- [Troubleshooting](#) on page 231

## Changes for Release 7, Guide Version 7.35

The following sections are new for this edition:

- [Account Lock](#) on page 29
- [Phone Lock](#) on page 57
- [Always Online](#) on page 28
- [E911](#) on page 98
- [Dial-now](#) on page 106
- [Static Forwarding](#) on page 138
- [Response Groups](#) on page 148
- [Boss-Admin Feature](#) on page 150
- [Inbound Private Line](#) on page 165
- [Call Park](#) on page 187

Major updates have occurred to the following sections:

- [Icon Instructions](#) on page 3
- [Signing into Skype for Business](#) on page 18
- [Changing Presence Status](#) on page 26
- [Entering Data and Editing Fields](#) on page 38



# Table of Contents

## About This Guide ..... v

In This Guide .....	v
Summary of Changes .....	v
Changes for Release 8, Guide Version 8.70 .....	v
Changes for Release 8, Guide Version 8.60 .....	vi
Changes for Release 8, Guide Version 8.50 .....	vi
Changes for Release 8, Guide Version 8.21 .....	vii
Changes for Release 7, Guide Version 7.50 .....	vii
Changes for Release 7, Guide Version 7.35 .....	vii

## Table of Contents ..... ix

## Overview ..... 1

Hardware Component Instructions .....	1
Icon Instructions .....	3
LED Instructions .....	6
User Interfaces .....	6
Phone User Interface .....	7
Web User Interface .....	8
Documentations .....	10

## Getting Started ..... 11

Packaging Contents .....	11
Optional Accessories .....	12
Phone Installation .....	14
Attaching the Stand or the Optional Wall Mount Bracket .....	14
Connecting the Handset and Optional Headset .....	15
Connecting the Optional Bluetooth USB Dongle .....	15
Connecting the Power .....	16
Connecting to the Network .....	17
Phone Initialization .....	18
Signing into Skype for Business .....	18
User Sign-in .....	19
PIN Authentication .....	21
Web Sign-in .....	22
Signing in via PC .....	26

Signing Out of Skype for Business.....	26
Changing Presence Status.....	26
Always Online.....	28
Account Lock.....	29
Touch Screen Display.....	31
Favorites Screen.....	34
History Screen.....	34
Contacts Screen.....	36
Menu Screen.....	36
Navigating Menus and Fields.....	37
Entering Data and Editing Fields.....	38
Using the Phone Keypad.....	38
Using the On-screen Keyboard.....	40
Phone Status.....	43
Basic Network Settings.....	44
<b>Customizing Your Phone.....</b>	<b>49</b>
General Settings.....	49
Backlight.....	49
Contrast.....	50
Language.....	51
Time & Date.....	52
Administrator Password.....	55
Key as Send.....	56
Phone Lock.....	57
Remembering Password.....	60
Audio Settings.....	61
Volume.....	61
Phone Ringtone.....	62
Key Tone.....	64
Contact Management.....	64
Skype for Business Directory.....	65
Local Directory.....	70
Placing Calls to Contacts.....	84
Searching for Contacts.....	85
Call History Management.....	86
Headset Use.....	89
Headset Mode Activation/Deactivation.....	89
Headset Prior.....	90
Dual Headset.....	91
Bluetooth Headset.....	92
E911.....	98
E911 Location Tip.....	98
Location Notification.....	99

Adding the Location Information.....	102
Viewing the Location Information.....	104
Emergency Call .....	104
Dial-now .....	106
Live Dialpad.....	108
Hotline.....	109
Privacy Mode.....	110
Modifying the Privacy Mode from the Phone.....	110
Modifying the Privacy Mode from the Skype for Business Client.....	111
<b>Basic Call Features.....</b>	<b>113</b>
Placing Calls.....	114
Answering Calls.....	117
Ending Calls.....	118
Redialing Numbers.....	118
Auto Answer.....	118
Call Waiting.....	119
Call Mute.....	120
Call Hold/Resume.....	121
Calendar.....	122
Setting up a Skype Conference in Outlook.....	122
Setting up an Appointment in Outlook.....	123
Setting up a Meeting in Outlook.....	123
Setting up an Event in Outlook.....	124
Using the Calendar.....	125
Call Forward.....	136
Static Forwarding.....	136
Dynamic Forwarding.....	145
Team-Call Group.....	147
Team-Call Ringtone.....	147
Response Groups.....	148
Response Group Ringtone.....	149
Shared Line Appearance for Skype for Business.....	150
Answering SLA Calls.....	150
Placing a SLA Call on Hold.....	150
Resuming Held SLA Calls.....	150
Boss-Admin Feature.....	150
Assigning/Removing Delegates.....	151
Viewing the Bosses/Delegates.....	153
Using the Boss-Admin Feature.....	154
Boss-Line Ringtone.....	163
Delegates-call Ringtone.....	164
Inbound Private Line.....	165
Private Line Tones.....	166

Call Transfer .....	167
Blind Transfer.....	167
Consultative Transfer.....	168
Group Call Pickup .....	169
Skype for Business Conference .....	170
Initiating a Skype for Business Conference Call.....	170
Viewing the Dial-in Number and Conference ID .....	178
Viewing the Conference Participants.....	178
Managing the Conference Participants .....	179
Call Park.....	187
Voice Mail.....	189
Leaving the Voice Mail .....	189
Managing the Voice Mail .....	190
Multicast Paging.....	193
Sending RTP Stream.....	194
Receiving RTP Stream .....	196
Using Multicast Paging.....	197
Branch Office Resiliency.....	199
<b>Common Area Phone.....</b>	<b>201</b>
Signing into a Common Area Phone .....	201
Using a Common Area Phone .....	202
Switching to a Skype for Business Account.....	202
Signing Out of a Common Area Phone .....	203
<b>Better Together over Ethernet.....</b>	<b>205</b>
Getting Started with Better Together over Ethernet.....	205
Installing the Yealink Better Together over Ethernet Connector .....	205
Enabling Better Together over Ethernet.....	211
Paired Status.....	211
Pairing Your Phone with Your Computer .....	212
Signing in via PC .....	215
Setting Your Phone as Your Primary Audio Device.....	217
Using Better Together over Ethernet.....	218
Placing BToE Calls.....	218
Answering BToE Calls.....	218
Pausing BToE Calls .....	219
Resuming BToE Calls .....	219
Moving Call Audio between Your Phone and Computer: .....	219
Using BToE to Lock and Unlock Your Phone .....	219
Disabling BToE on Your Phone.....	220
Exiting BToE on Your Computer.....	220
Uninstalling the Yealink BToE Connector .....	221

---

<b>EXP40 Expansion Module</b> .....	<b>223</b>
Connecting the EXP40 to Your Phone.....	223
EXP40 Hardware Features.....	226
Assigning Contacts to the EXP40.....	226
Monitoring Skype for Business Contacts for Status Changes.....	227
Using the EXP40.....	228
Placing a Call Using the EXP40.....	229
Initiating a Conference Call Using the EXP40.....	229
Transferring a Call Using the EXP40.....	229
<b>Troubleshooting</b> .....	<b>231</b>
Troubleshooting Solutions.....	231
<b>Regulatory Notices</b> .....	<b>245</b>
Service Agreements .....	245
Limitations of Liability.....	245
Safety Instructions .....	245
<b>Appendix A - Time Zones</b> .....	<b>247</b>
<b>Index</b> .....	<b>249</b>



## Overview

This chapter provides the overview of the T48G Skype for Business phone. Topics include:

- [Hardware Component Instructions](#)
- [Icon Instructions](#)
- [LED Instructions](#)
- [User Interfaces](#)
- [Documentations](#)





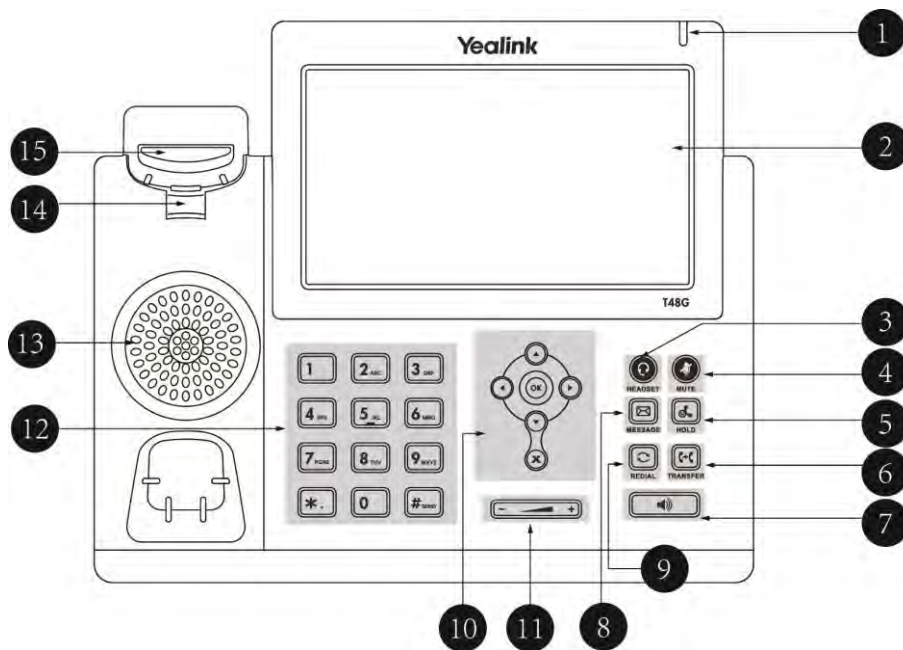

If you require additional information or assistance with your new phone, contact your system administrator.

## Hardware Component Instructions

The main hardware components of the T48G Skype for Business phone are the touch screen and the keypad.



Hardware component instructions of the T48G Skype for Business phone are:















	Item	Description
①	Power Indicator LED	Indicates phone power and some feature statuses. <ul style="list-style-type: none"> <li>• Receives an incoming call—Fast flashing</li> <li>• Receives a voice mail—Slow flashing</li> </ul>
②	Touch Screen	The screen is touch-sensitive. Tap to select and highlight screen items. Shows information about calls, messages, soft keys, time, date and other relevant data: <ul style="list-style-type: none"> <li>• Call information—caller ID, call duration</li> <li>• Icons (for example, )</li> <li>• Missed call text or second incoming caller information.</li> <li>• Prompt text (for example, "Saving config file!")</li> <li>• Time and date</li> </ul>
③	HEADSET Key	Toggles and indicates the headset mode. The key LED illuminates solid green when headset mode is activated.
④	MUTE Key	Toggles and indicates mute feature. The key LED illuminates solid red when the call is muted.
⑤	HOLD Key	Places a call on hold or resumes a held call.
⑥	TRANSFER Key	Transfers a call to another party.
⑦	Speakerphone Key	Toggles and indicates the hands-free (speakerphone) mode. The key LED illuminates solid green when the speakerphone mode is activated.
⑧	MESSAGE Key	Accesses voice messages.
⑨	REDIAL Key	Redials a previously dialed number.
⑩	 	Position the cursor within text you're updating. Enable or disable fields.
	 	Turn pages or scroll through values for a field. Scroll through items.
		Confirms actions or answers incoming calls.
		Cancels actions or rejects incoming calls.
⑪	Volume Key	Adjusts the volume of the handset, headset, speakerphone and ringer.
⑫	Keypad	Provides the digits, letters and special characters in context-sensitive applications.
⑬	Speaker	Provides hands-free (speakerphone) audio output.
⑭	Hookswitch Tab	Secures the handset in the handset cradle when the Skype for Business phone is mounted vertically. For more information on how to adjust the hookswitch tab, refer to <a href="#">Yealink Wall</a>









































	Item	Description
		<a href="#">Mount Quick Installation Guide for SIP-T29 T27 T46 T48 IP Phones.</a>
⑮	Hookswitch	<ul style="list-style-type: none"> <li>• Picking up the handset from the handset cradle, the hookswitch bounces and the phone connects to the line.</li> <li>• Laying the handset down on the handset cradle, the phone disconnects from the line.</li> </ul>



## Icon Instructions

Icons appearing on the touch screen are described in the following table:

Icons	Description
	Local Favorites
	Search Contacts
	Call Mute
	Call Forward
	Answer a call
	Place a call/ Place an emergency call
	Call Hold
	Call resume
	Add a new call
	View more soft keys
	Consultative transfer
	Blind transfer
	Call Park
	View the conference participants

Icons	Description
	View the conference dial-in number and conference ID
	Forward incoming calls to voice mail
	Invite a new call to the Skype for Business conference
	The delegate invites the boss to join conference call
	Lock the conference
	Unlock the conference
	Conference Lobby
	Allow a new call to join the locked conference
	Reject a new call to join the locked conference
	Enable the announcement
	Disable the announcement
	Conference presenter
	Conference attendee
	The conference participant is unmuted
	The conference participant conference is muted
	Connect to message center
	Unread voice mail
	Read voice mail
	Bluetooth mode is on

Icons	Description
	Bluetooth headset is both paired and connected
	Delete the Bluetooth headset
	Reject or cancel a call
	Received Calls
	Placed Calls
	Missed Calls
	Return to previous screen
	Receive a call
	Make a call
	Handset mode
	Headset mode
	Hands-free speakerphone mode
	Location is not set
	Phone Lock
	Conference reminder
	Optima HD voice
	Available
	Busy
	DND (Do Not Disturb)

Icons	Description
	Be Right Back/Off Work/Away
	Off Line
	Unknown

## LED Instructions

### Power Indicator LED

LED Status	Description
Solid red	The phone is initializing.
Fast flashing red	The phone is ringing.
Slow flashing red	The phone receives a voice mail.
Off	<p>The phone is powered off.</p> <p>The phone is idle.</p> <p>The phone is busy.</p> <p>The call is placed on hold or is held.</p> <p>The call is muted.</p>

### Note

The above introduces the default power indicator LED status. The status of the power indicator LED is configurable via web user interface. For more information, refer to [Yealink\\_Skype\\_for\\_Business\\_HD\\_IP\\_Phones\\_Administrator\\_Guide](#).

## User Interfaces

Two ways to customize configurations of your T48G Skype for Business phone:

- The user interface on the Skype for Business phone.
- The user interface in a web browser on your PC.

The hardware components keypad and touch screen constitute the phone user interface, which allows the user to execute all call operation tasks and basic configuration changes directly on the phone. In addition, you can use the web user interface to access all configuration settings. In many cases, it is possible to use either the phone user interface and/or the web user interface interchangeably. However, in some cases, it is only possible to use one or the other interface to operate the phone and change settings.

## Phone User Interface

You can customize your phone by tapping **•••** to access the phone user interface. The **Advanced** option is only accessible to the administrator, and the default administrator password is "admin" (case-sensitive). For more information on customizing your phone with the available options from the phone user interface, refer to [Customizing Your Phone](#) on page 49.

Menus are used to access information and configure the phone.

The figure below shows the phone's menus and submenus.

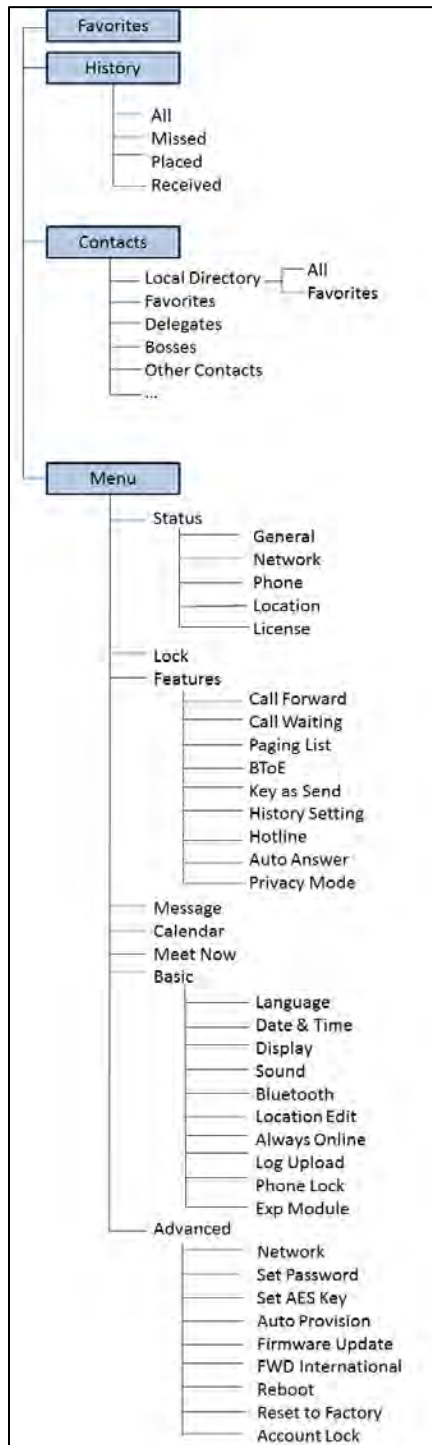

## Web User Interface

In addition to the phone user interface, you can also customize your phone via web user interface. In order to access the web user interface, you need to know the IP address of your new phone. To obtain the IP address, press  on the phone when the phone is idle. Enter the IP address (e.g., http://192.168.0.10 or 192.168.0.10) in the address bar of web browser on your PC. The default administrator user name and password are both "admin" (case-sensitive).

The main options you can use to customize the Skype for Business phone via phone user interface and/or via web user interface are listed in the following table:

Options	Phone User Interface	Web User Interface
<b>Status</b>		
--IP Address		
--MAC		
--Firmware		
--Network	√	√
--Phone		
--Location		
--License		
<b>Basic Phone Settings</b>		
--Language	√	
--Time & Date	√	
--Backlight	√	
--Contrast	√	√
--Administrator Password	√	
--Key as Send	√	
--Phone Lock	√	
--Account Lock	√	
--Audio Settings		
--Volume	√	×
--Ring Tones	√	√
--Key Tone	√	√
--Private Line Ring Tones	√	√
--Contact Management		
--Skype for Business Directory	√	×
--Local Directory	√	√
--Call History Management	√	√
--Headset Use		
--Headset Mode	√	×
--Headset Prior	×	
--Dual Headset	×	√
--Bluetooth Headset	√	

Options	Phone User Interface	Web User Interface
--Calendar	√	
--Always Online	√	
--Log Upload	√	
--E911 Location Tip	√	
--Dial-now	×	
--Live Dialpad	×	
--Hotline	√	
--Privacy Mode	√	×
<b>Basic Call Features</b>		
--Redialing Numbers	√	×
--Auto Answer	√	×
--Call Waiting	√	√
--Call Mute	√	
--Call Hold/Resume	√	×
--Call Forward	√	
--Call Transfer	√	
--Multicast Paging	√	√
--BToE	√	
<b>Skype for Business Account</b>		
--PIN Authentication		
--Extension	√	
--PIN	√	
--User Sign-in		√
--Sign-in Address	√	
--User Name	√	
--Password	√	
--Web Sign-in	√	
--Sign in via PC	√	×
--Remember Password	√	√

**Note**

The table above lists most of the feature options. Please refer to the relevant sections for more information.

## Documentations

The following table shows documentations available for the T48G Skype for Business phone.

Name	Contents	Where found	Language
Quick Start Guide	Basic call features and phone customizations	In the package/ On the website	English/Chinese
User Guide	Phone/Web user interface settings Basic call features and BToE (Better Together over Ethernet) feature	On the website	English/Chinese

**Note**

You can download the latest documentations online:<http://support.yealink.com/documentFront/forwardToDocumentDetailPage?documentId=121>.



## Getting Started

This chapter provides the following basic installation instructions and information for obtaining the best performance with the T48G Skype for Business phone. Topics include:

- [Packaging Contents](#)
- [Phone Installation](#)
- [Phone Initialization](#)
- [Signing into Skype for Business](#)
- [Changing Presence Status](#)
- [Account Lock](#)
- [Touch Screen Display](#)
- [Navigating Menus and Fields](#)
- [Entering Data and Editing Fields](#)
- [Phone Status](#)
- [Basic Network Settings](#)

If you require additional information or assistance with your new phone, contact your system administrator.

## Packaging Contents

The following components are included in your T48G Skype for Business phone package:

- **T48G Skype for Business Phone**

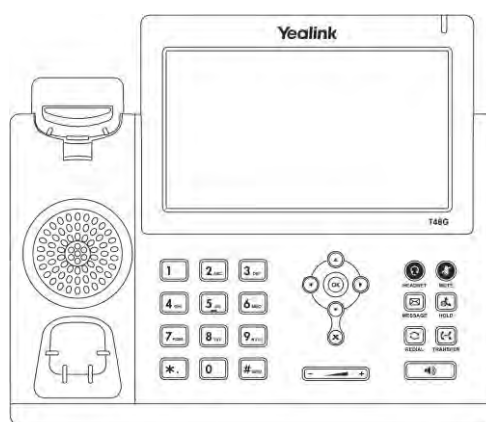

- **Phone Stand**

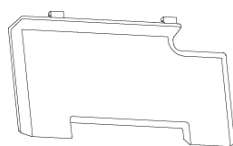

- **Handset & Handset Cord**

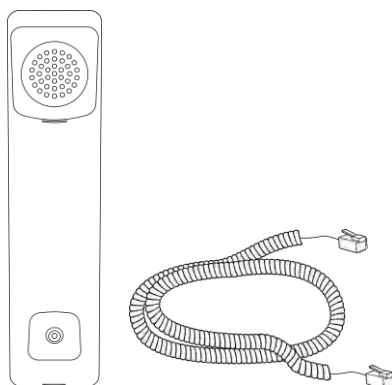

- **Ethernet Cable**

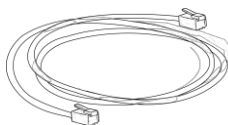

- **Quick Start Guide**



Check the list before installation. If you find anything missing, contact your system administrator.

## Optional Accessories

The following items are optional accessories for your T48G Skype for Business phone. You need to purchase them separately if required.

- **Power Adapter (5.5mm DC plug)**

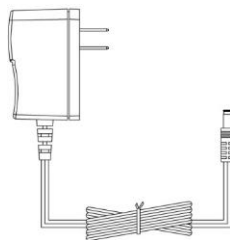

- **Wall Mount Bracket**

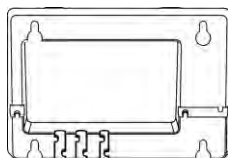

- **Headset**



- **Wireless Headset Adapter EHS36**



- **Bluetooth USB Dongle BT40**

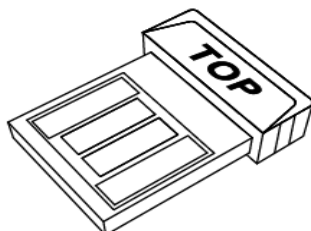

- **EXP40 Expansion Module**

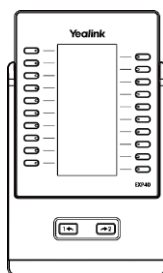

**Note**

We recommend that you use the accessories provided or approved by Yealink. The use of unapproved third-party accessories may result in reduced performance.

## Phone Installation

If your phone is already installed, proceed to [Phone Initialization](#) on page 17.

This section introduces how to install the phone:

- 1) Attach the stand or the optional wall mount bracket
- 2) Connect the handset and optional headset
- 3) Connect the optional Bluetooth USB Dongle
- 4) Connect the power
- 5) Connect to the Network

## Attaching the Stand or the Optional Wall Mount Bracket

### Desk Mount Method

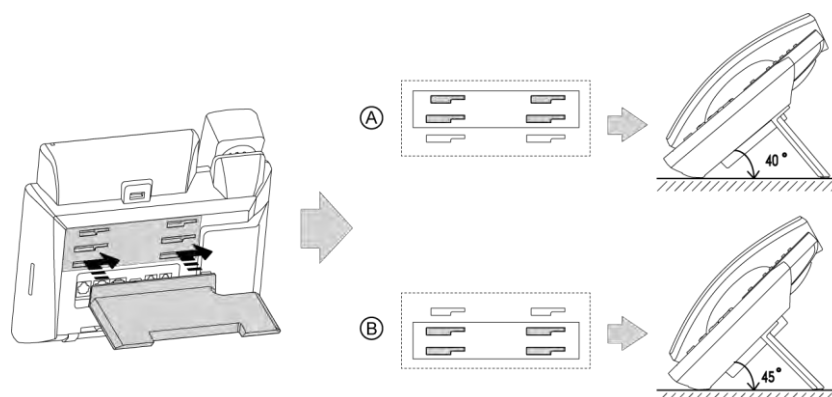

### Wall Mount Method (Optional)

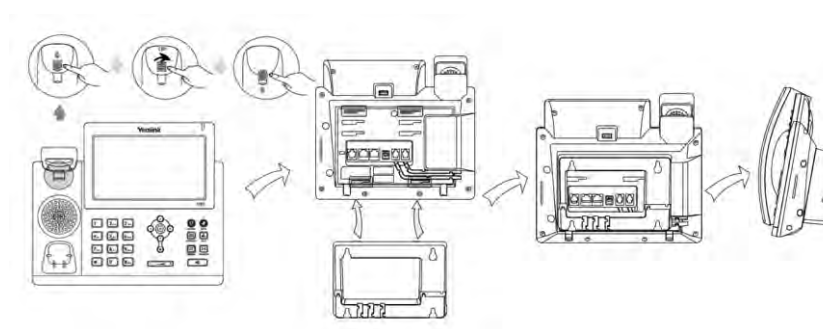

#### Note

The hookswitch tab has a lip which allows the handset to stay on-hook when the Skype for Business phone is mounted vertically.

For more information on how to attach the wall mount bracket, refer to [Yealink Wall Mount Quick Installation Guide for SIP-T29 T27 T46 T48 IP Phones](#).

### Connecting the Handset and Optional Headset

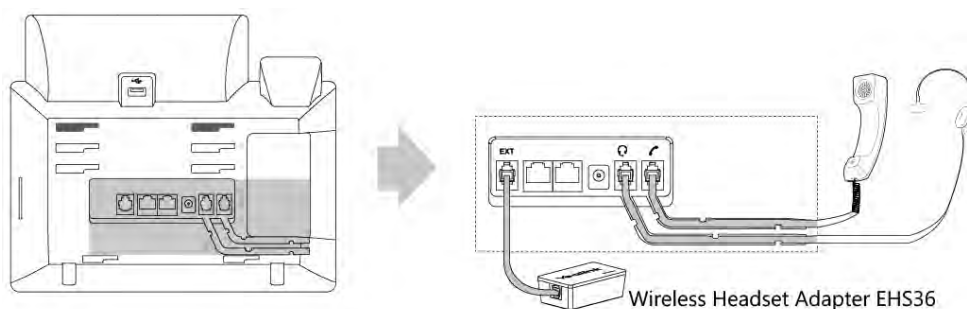

#### Note

The EXT port can also be used to connect an expansion module EXP40.

For more information on how to use EHS36, refer to [Yealink EHS36 User Guide](#).

### Connecting the Optional Bluetooth USB Dongle

You can connect a Bluetooth USB dongle to T48G Skype for Business phones for connecting a Bluetooth headset.

**To connect a Bluetooth USB dongle:**

1. Insert a BT40 Bluetooth USB dongle into the USB port on the phone.

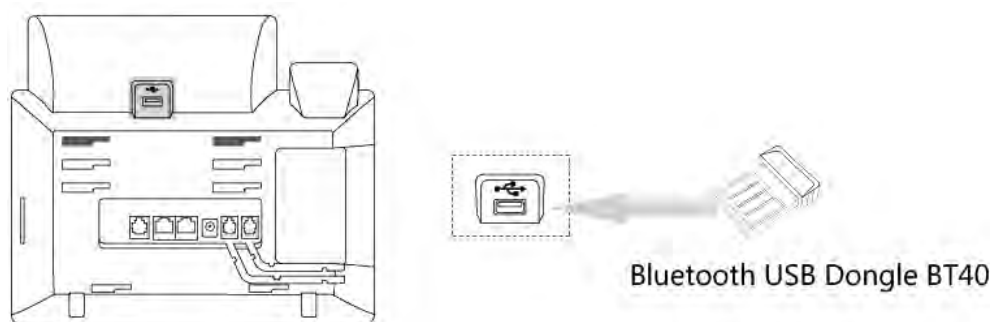

**Note** The Bluetooth USB dongle BT40 should be purchased separately. For more information on how to use the BT40, refer to [Yealink Bluetooth USB Dongle BT40 User Guide](#).

## Connecting the Power

You have two options for power and network connections. Your system administrator will advise you which one to use.

- AC power (Optional)
- Power over Ethernet (PoE)

### AC Power (Optional)

**To connect the AC power:**

1. Connect the DC plug on the power adapter to the DC5V port on the phone and connect the other end of the power adapter into an electrical power outlet.

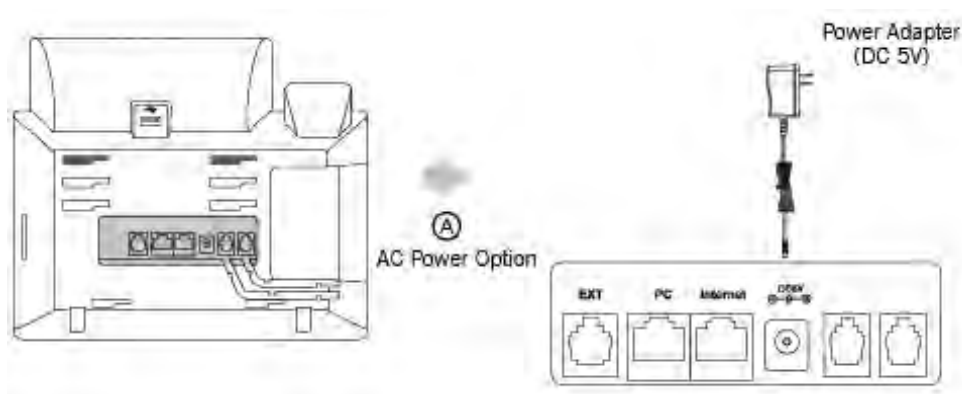

**Note** The Skype for Business phone should be used with Yealink original power adapter (5V/2A) only. The use of the third-party power adapter may cause the damage to the phone.

## Power over Ethernet

With the included or a regular Ethernet cable, the T48G Skype for Business phone can be powered from a PoE-compliant switch or hub.

### To connect the PoE:

1. Connect the Ethernet cable between the Internet port on the phone and an available port on the in-line power switch/hub.

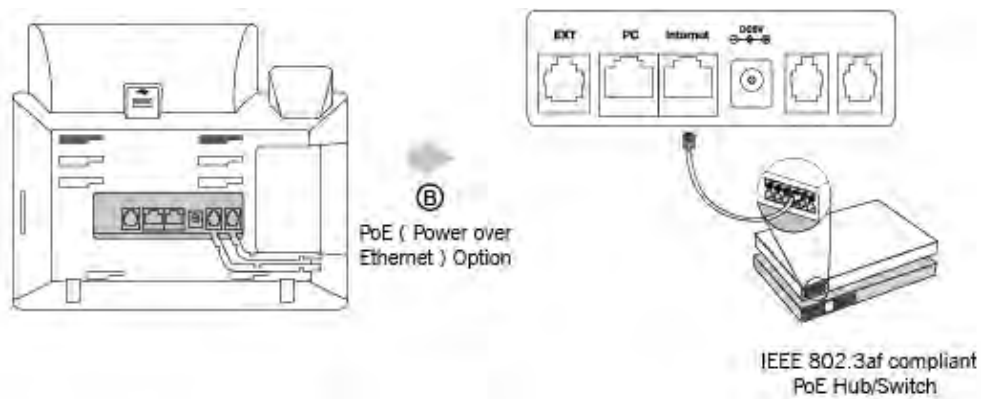

### Note

If in-line power is provided, you don't need to connect the phone to the power adapter. Make sure the switch/hub is PoE-compliant.

**Important!** Do not remove power to the phone while it is updating firmware and configurations.

## Connecting to the Network

Connect your phone to the network.

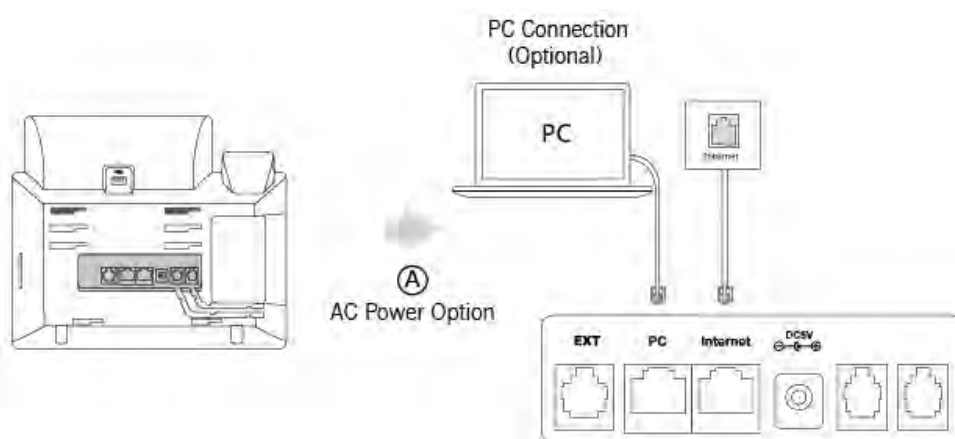

### Note

The phone can also share the network with another network device such as a PC (personal computer). This is an optional connection. For more information on this function, contact your system administrator.

## Phone Initialization

After your phone is powered on, the system boots up and performs the following steps:

### Automatic Phone Initialization

The phone finishes the initialization by loading the saved configuration. The touch screen displays "Welcome Initializing...Please wait" during the initialization.

### DHCP (Dynamic Host Configuration Protocol)

The phone attempts to contact a DHCP server in your network to obtain valid IPv4 network settings (e.g., IP address, subnet mask, default gateway address and DNS address) by default.

After the phone finishes the initialization, the sign-in screen appears on the touch screen.

### Note

If your network does not use DHCP, proceed to [Basic Network Settings](#) on page 44.

## Signing into Skype for Business

After the initialization, the sign-in screen appears. The screen will be shown as below:



The screenshot shows the Skype for Business sign-in interface. It features a blue background with a 'Menu' icon in the top left corner. The main heading is 'Skype for Business'. Below this, there are four input fields: 'Login Type' (a dropdown menu currently set to 'User Sign-in'), 'Sign-in Address' (with the placeholder text 'name@company.com'), 'User Name', and 'Password'. A 'Sign in' button is located at the bottom center of the form.



You can tap  to enter the menu screen before signing into the Skype for Business Server. The menu screen is shown as below:

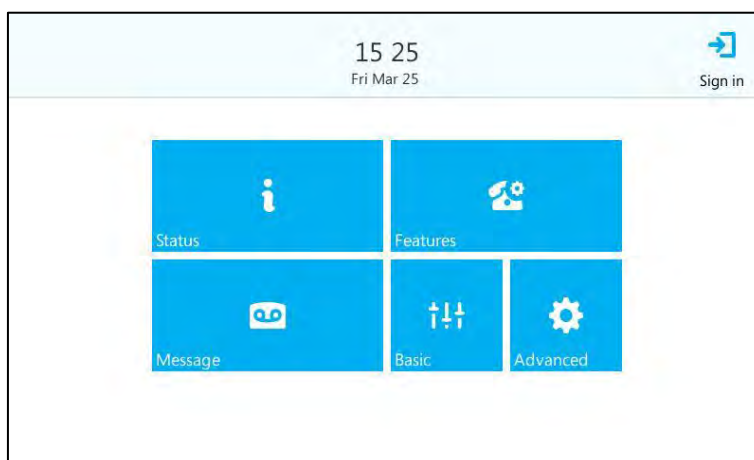

From the menu screen, you can view phone status, configure call features or phone settings.

Tap  to return to the sign-in screen.

Skype for Business users are authenticated against Microsoft Active Directory Domain Service. The following four sign-in methods are available:

- **User Sign-in:** This method uses the user's credentials (sign-in address, user name, and password) to sign into Skype for Business Server. This sign-in method is applicable to Onprem account and Online account.
- **PIN Authentication:** This method uses the user's phone number (or extension) and personal identification number (PIN) to sign into Skype for Business Server. This sign-in method is only applicable to Onprem account.
- **Web Sign-in:** This method uses the unique website shown on the phone to sign in. This sign-in method is only applicable to Online account.
- **Sign in via PC:** when your phone is paired with your computer using Better Together over Ethernet (BToE), use the Skype for Business client to sign in. This sign-in method is applicable to Onprem account and Online account.

If the Skype for Business Server is configured to forcibly lock the phone. You need to configure an unlock PIN at the initial sign-in. For more information, refer to [Phone Lock](#) on page 57.

#### Note

If the phone reboots after successful login, the login credentials from the previous Sign-In will be cached. User can sign in successfully without reentering the credentials.

## User Sign-in

You can sign into Microsoft Skype for Business on your phone with your login credentials, which includes your address, username, and password. Your system administrator provides you with your login credentials.

**To sign into the Skype for Business Server using User Sign-in method via phone user interface:**

1. Select **User Sign-in** from the pull-down list of **Login Type** field.
2. Tap the **Sign-in Address** field.  
The on-screen keyboard appears. For more information on how to use the on-screen keyboard, refer to [Using the On-screen Keyboard](#) on page 40.
3. Enter your Skype for Business user's sign-in address (e.g., 2216@yealinkuc.com) in the **Sign-in Address** field by the on-screen keyboard.
4. Enter your Skype for Business user name (e.g., 2216@yealinkuc.com) in the **User Name** field.
5. Enter the sign-in password in the **Password** field.



6. Tap **Sign in**.

**To sign into the Skype for Business Server using User Sign-in method via web user interface:**

1. Click on **Account->Register**.
2. Select **User Sign in** from the pull-down list of **Mode**.
3. Enter your Skype for Business user's sign-in address (e.g., 2216@yealinkuc.com) in the **Login address** field.
4. Enter your Skype for Business user name (e.g., 2216@yealinkuc.com) in the **Register Name** field.

5. Enter the sign-in password in the **Password** field.

The screenshot shows the Yealink T48G web interface. The 'Account' tab is selected. The 'Mode' dropdown is set to 'User Sign in'. The 'Register Status' is 'Disabled'. The 'Login address' field contains '2216@yealinkuc.com'. The 'Register Name' field contains '2216@yealinkuc.com'. The 'Password' field contains a masked password. The 'Sign In' button is visible at the bottom.

6. Click **Sign In** to accept the change.

## PIN Authentication

You can sign into Skype for Business on your phone with your PIN Authentication credentials. Your system administrator provides you with your PIN Authentication credentials.

**To sign into Skype for Business Server using PIN Authentication method via phone user interface:**

1. Select **PIN Authentication** from the pull-down list of **Login Type** field.
2. Tap the **Extension** field.  
The on-screen keyboard appears. For more information on how to use the on-screen keyboard, refer to [Using the On-screen Keyboard](#) on page 40.
3. Enter your phone number or extension (e.g., 2216) by the on-screen keyboard.
4. Enter your PIN the **PIN** field.

The screenshot shows the Skype for Business mobile app login screen. The 'Login Type' dropdown is set to 'PIN Authentication'. The 'Extension' field contains '2216'. The 'PIN' field contains a masked PIN. The 'Sign in' button is visible at the bottom.

5. Tap **Sign in**.

**To sign into the Skype for Business Server using PIN Authentication method via web user interface:**

1. Click on **Account->Register**.
2. Select **Pin Authentication** from the pull-down list of **Mode**.
3. Enter your Skype for Business user's phone number or extension (e.g., 2216) in the **Extension** field.
4. Enter your personal identification number (e.g., user2216) in the **Pin** field.

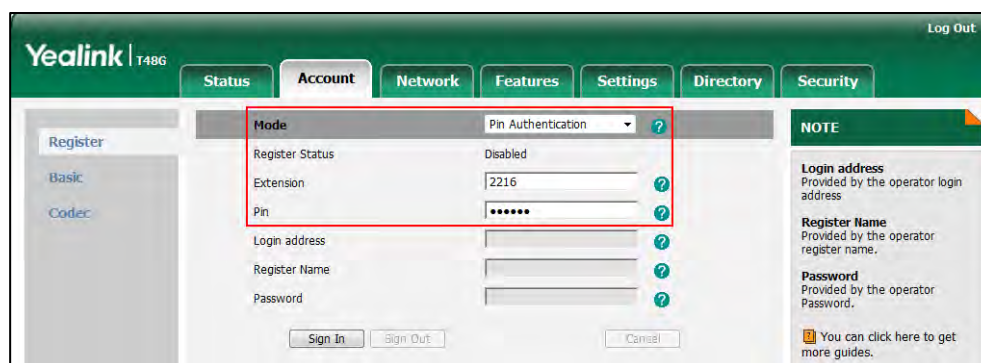

5. Click **Sign In** to accept the change.

## Web Sign-in

You can sign into your Skype for Business Online account using the Web Sign-In method, which allows you to sign into the phone with your Skype for Business Online account using a web browser. Your system administrator provides you with your login credentials.

**To configure Web Sign-in method via web user interface:**

1. Click on **Features->General Information**.
2. Select the desired value from the pull-down list of **Web Sign in**.
  - If it is enabled, you can sign into the Skype for Business Server using Web sign-in method.

- If it is disabled, you cannot sign into the Skype for Business Server using Web sign-in method.

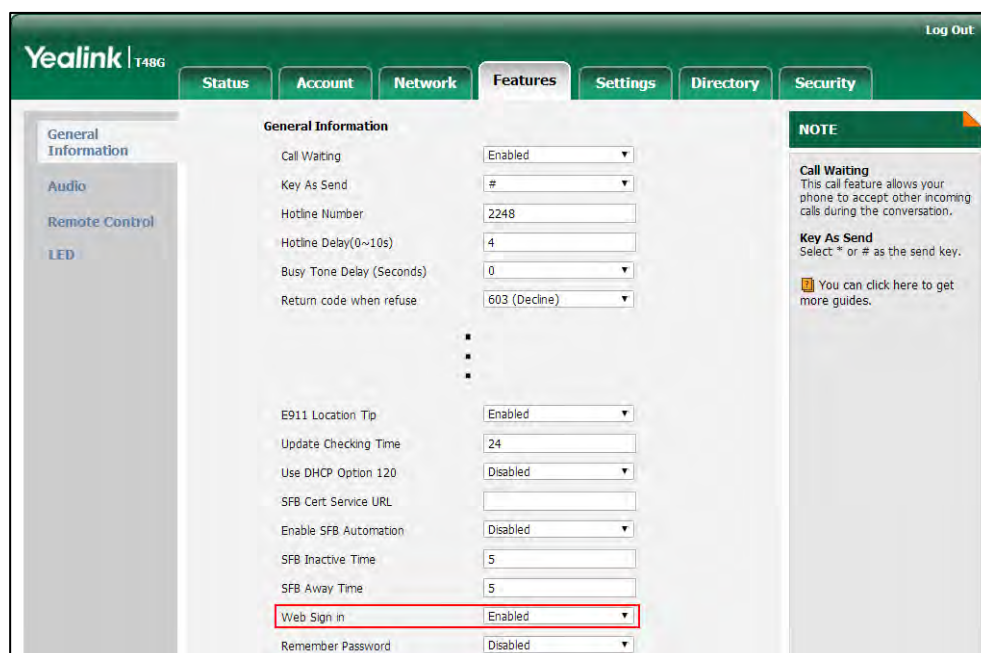

3. Click **Confirm** to accept the change.

**To sign into Skype for Business Server using Web Sign-in method via phone user interface:**

1. Select **Web Sign-in** from the pull-down list of **Login Type** field..

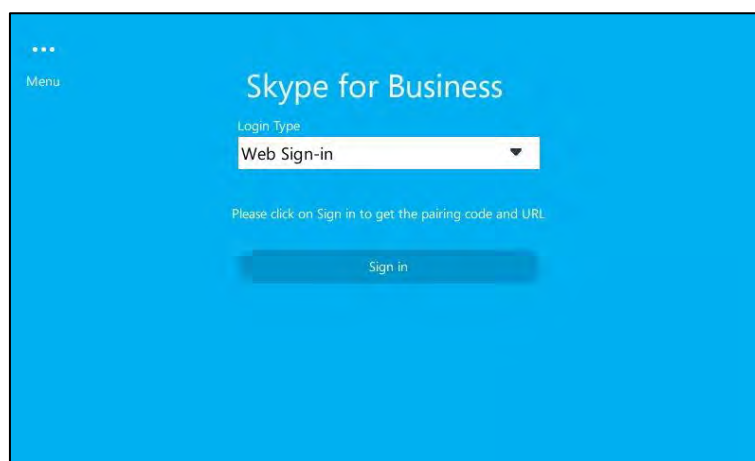

2. Tap **Sign in**.

The screen will show the pairing code and URL.

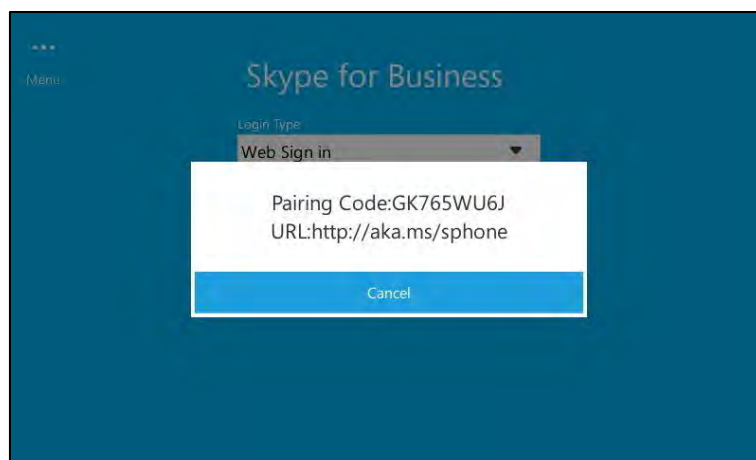

3. Enter the URL (e.g., <http://aka.ms/sphone>) into your web browser.

4. On the Skype for Business Authentication website, enter your email address (e.g., [zhangdx@example.com](mailto:zhangdx@example.com)) in the **Email address** field.

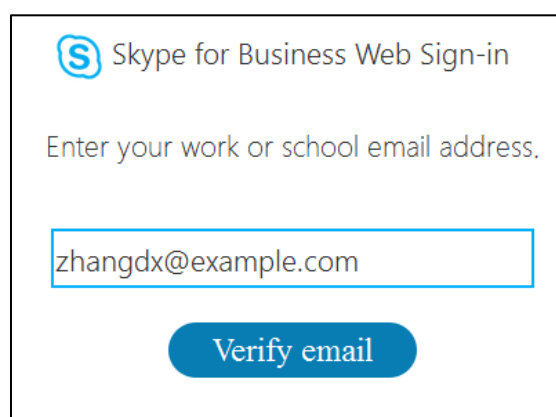

5. Click **Verify email** to check the validity of the email address.

The sign-in screen will appear if the email address is valid.

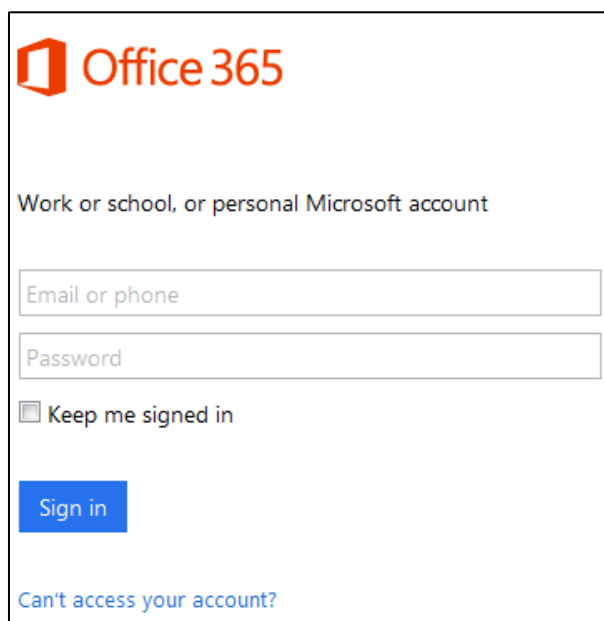

The image shows the Office 365 sign-in interface. At the top left is the Office 365 logo. Below it, the text reads "Work or school, or personal Microsoft account". There are two input fields: "Email or phone" and "Password". Below the password field is a checkbox labeled "Keep me signed in". A blue "Sign in" button is positioned below the checkbox. At the bottom left, there is a link that says "Can't access your account?".

6. Enter your Online account and password.
7. (Optional) Check the **Keep me signed in** checkbox, so that you don't need to enter a password next time.
8. Click **Sign in**.
9. Enter the pairing code generated on the phone (e.g., GK765WU6J) into the web browser.

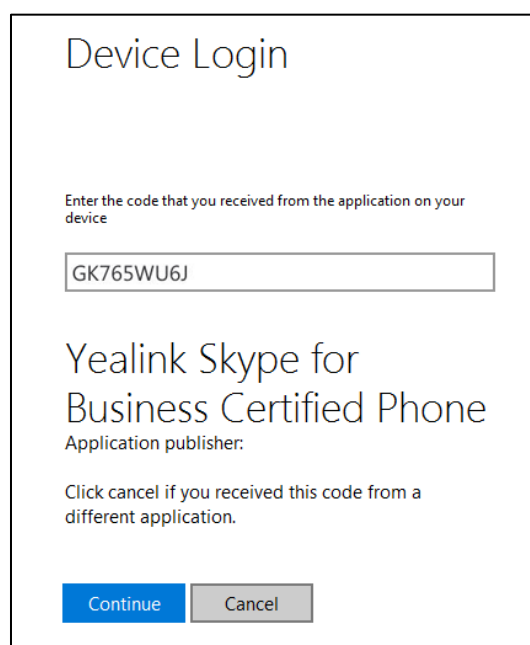

The image shows a "Device Login" screen. The title "Device Login" is at the top. Below it, the text says "Enter the code that you received from the application on your device". There is an input field containing the code "GK765WU6J". Below the input field, the text reads "Yealink Skype for Business Certified Phone" and "Application publisher:". At the bottom, there is a note: "Click cancel if you received this code from a different application." There are two buttons: a blue "Continue" button and a grey "Cancel" button.

10. Click **Continue**.
11. Click the account to sign in.  
A confirmation message is displayed when your phone successfully signs into Skype for Business.

## Signing in via PC

When your phone and your computer are paired using Better Together over Ethernet (BToE), you can sign into your phone using the Skype for Business client on your computer. For more information, refer to [Better Together over Ethernet](#) on page 205.

## Signing Out of Skype for Business

**To sign out of Skype for Business Server:**

1. Tap your avatar at the top-right corner of the touch screen.
2. Tap **Sign Out** from the pull-down list of status.

The phone signs out of Skype for Business Server.

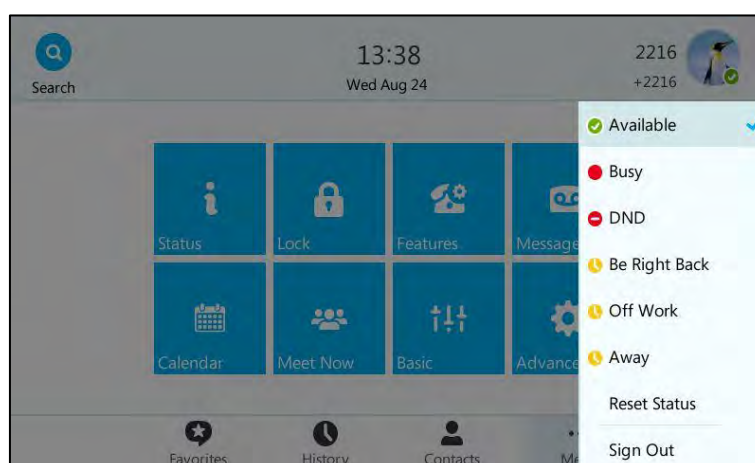

After you sign out of Skype for Business, the account-related features (calling, viewing Skype for Business contacts, calendar, etc.) are not available. However, you can still use other phone features.

Signing out via web user interface at the path: **Account->Register->Sign Out**.

## Changing Presence Status





After signing in successfully, your account and presence status display on the top-right corner of the screen by default.

User's presence information is constantly synchronized with the Skype for Business Server based on a variety of factors. However, you can change your presence information manually on the



phone. For example, when you are busy with urgencies, you can change your status to DND to avoid being disturbed.

The following table lists the status that the contact can change on the phone:

Icon	Status	Description
	Available	The contact is online and available to contact.
	Busy	The contact is available but engaged in another activity. Those activities include: <ul style="list-style-type: none"> <li>• In a call</li> <li>• In a conference</li> </ul>
	DND	If the contact doesn't want to be disturbed and DND is activated, callers will hear a tone indicating that the contact's phone is busy. The incoming call will be forwarded to contact's voice mail directly. The contact can receive calls from the work group only.
	Be Right Back	The contact is engaged in another activity and will return shortly.
	Off Work	The contact is not working and not available to contact.
	Away	The contact is probably not available. This status is displayed for the following reasons: <ul style="list-style-type: none"> <li>• The contact's phone has been idle for more than the idle time period setting—10 minutes by default.</li> <li>• The contact's Microsoft Office Outlook calendar indicates that the contact is out of the office.</li> <li>• The contact is temporarily unavailable. As soon as activity is detected on the contact's phone, the Skype for Business Server automatically resets the presence status to Available.</li> </ul>

### To change your presence status:

1. Tap your avatar at the top-right corner of the touch screen.

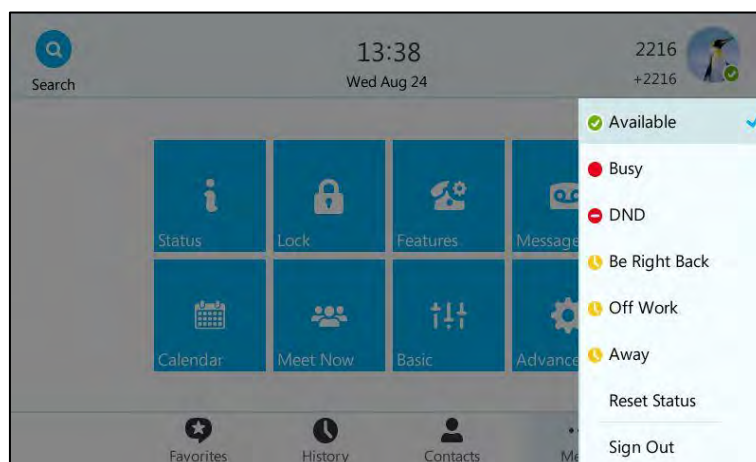

2. Tap the desired status from the pull-down list.  
The presence status will be changed on the phone and be synchronized to the Skype for Business Server.

### To reset your presence status to the default:

1. Tap your avatar at the top-right corner of the touch screen.
2. Tap the **Reset status** soft key from the pull-down list.

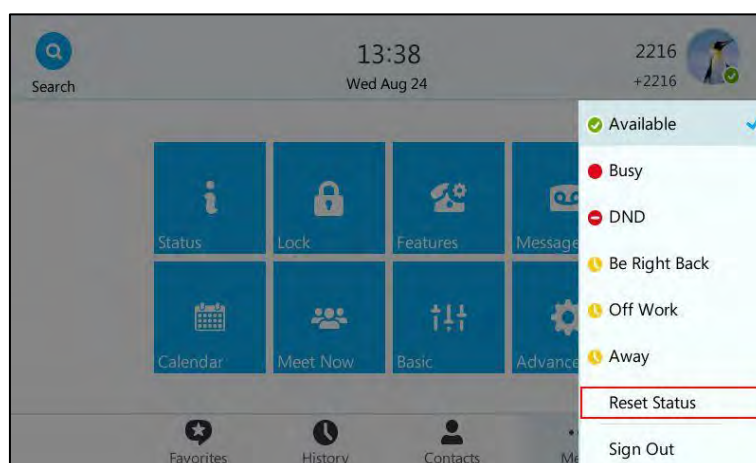

Your status will be reset to "Available".

## Always Online

Always online feature can maintain current status of the phone until you manually change status. For example, the current status of the phone is available, if the always online feature is enabled, then the phone status will stay available until you manually change it. You can configure this feature via phone user interface or web user interface.

**To enable the always online via phone user interface:**

1. Tap ... -> **Basic**-> **Always Online**.
2. Mark the **On** radio box of **Always Online**.

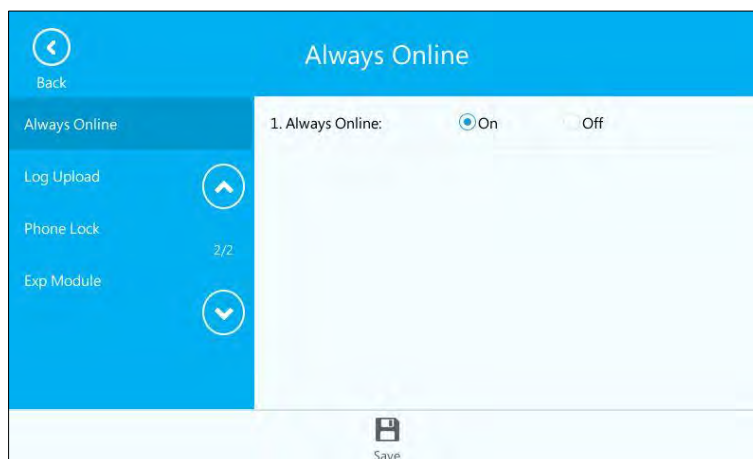

3. Tap  to accept the change.

Always online is configurable via web user interface at the path **Account->Basic->Always Online**.

**Note**

If your phone status is DND before dialing an emergency number, then the phone status will be changed to available after the emergency call even if always online feature is enabled. For more information on emergency call, refer to [Emergency Call](#) on page 104.

## Account Lock

You can lock your account to prevent your account being signed in or signed out randomly. If account lock feature is enabled, users are prompted for administrator password to sign in or sign out. Note that if you sign into Skype for Business Server using **User Web Sign-in** or **Sign in via PC** method, account lock feature is not applicable.



Account lock feature is disabled by default. You can configure it via phone user interface or web user interface.

**To configure the account lock feature via phone user interface:**

1. Tap ... -> **Advanced** (default password: admin) -> **Account Lock**.

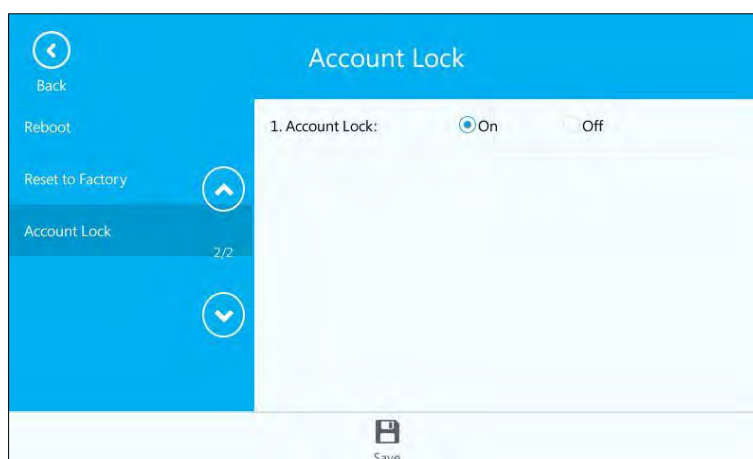
2. Mark the **On** radio box of **Account Lock**.



3. Tap  to accept the change or tap  to cancel.

Account lock is configurable via web user interface at the path **Account->Basic->Account Lock**.

**To sign out when account lock is enabled via phone user interface:**

1. Tap your avatar at the top-right corner of the touch screen.
2. Tap **Sign Out** from the pull-down list of status.

The screen will be shown as below:

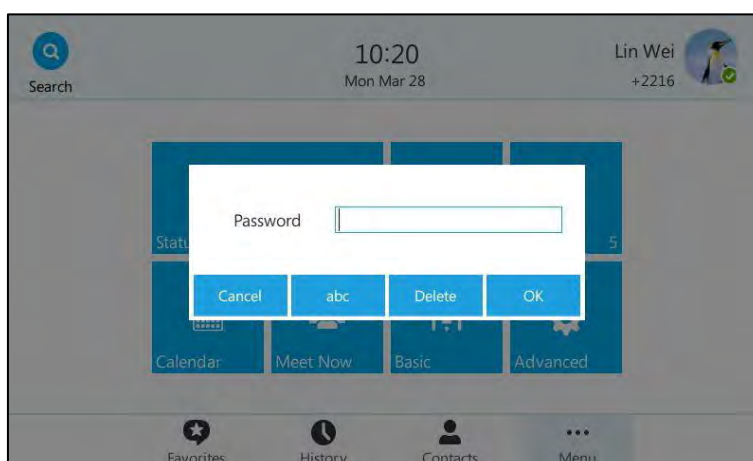

3. Enter the administrator password.
4. Tap the **OK** soft key to sign out.

**To sign in when account lock is enabled via phone user interface:**

1. Select the desired sign-in method.
2. Enter the authentication information in the corresponding field respectively.
3. Tap the **Sign in** soft key.

The screen will be shown as below:

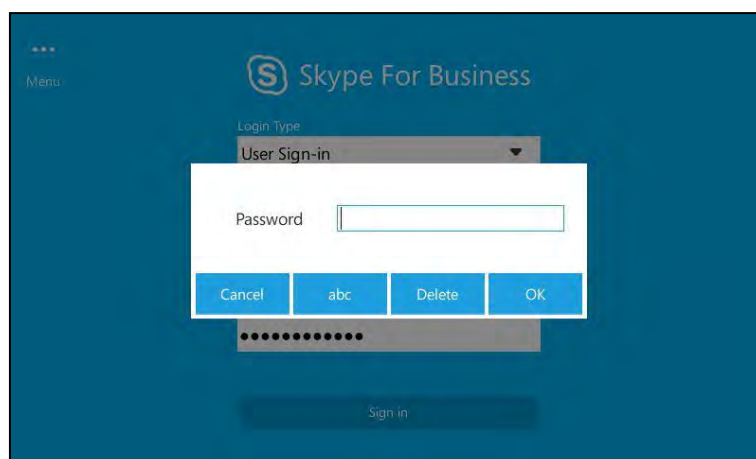



4. Enter the administrator password.
5. Tap the **OK** soft key.
  - If phone lock feature is enabled, you will enter the unlock PIN settings screen.
  - If phone lock feature is disabled, you will sign in successfully.



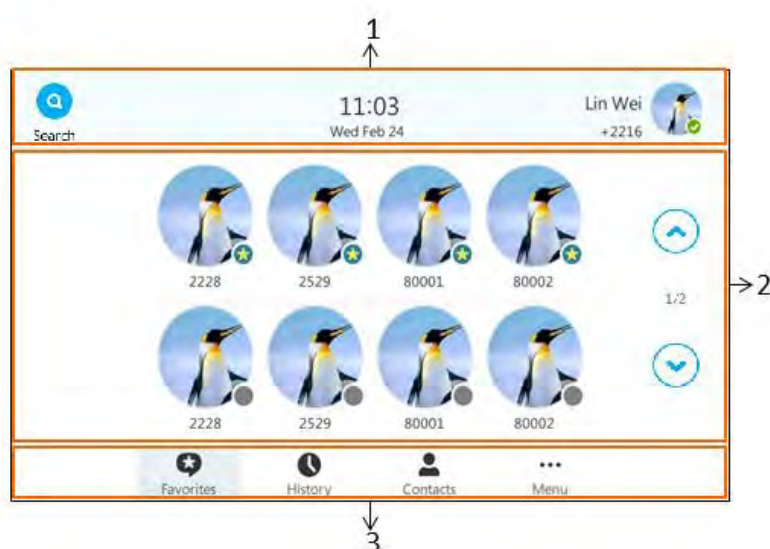

For more information on phone lock, refer to [Phone Lock](#) on page 57.



## Touch Screen Display



If the phone has successfully started up, and a Skype for Business user signs into the Skype for Business Server on the phone, the screen will be shown as below:



No.	Name	Description
1	Screen Title Area	Shows the display name, avatar, prompt message, time and date and  .

No.	Name	Description
2	Main Window	Displays the <b>Favorites</b> , <b>History</b> , <b>Contacts</b> or <b>Menu</b> screen content.
3	Shortcut Keys	Tap  to enter the <b>Favorites</b> screen and view favorite contacts. Tap  to enter the <b>History</b> screen and view call history. Tap  to enter the <b>Contacts</b> screen and view contacts. Tap  to enter the <b>Menu</b> screen.

When the phone missed calls, a number icon (indicating the number of missed calls) will appear on . If you tap  (indicating 1 missed call), the number icon will disappear.

When the phone receives voice mails, a number icon (indicating the number of the voice mails you haven't retrieved) will appear on . If you tap  (Indicating 1 voice mail you haven't retrieved), the number icon will disappear.

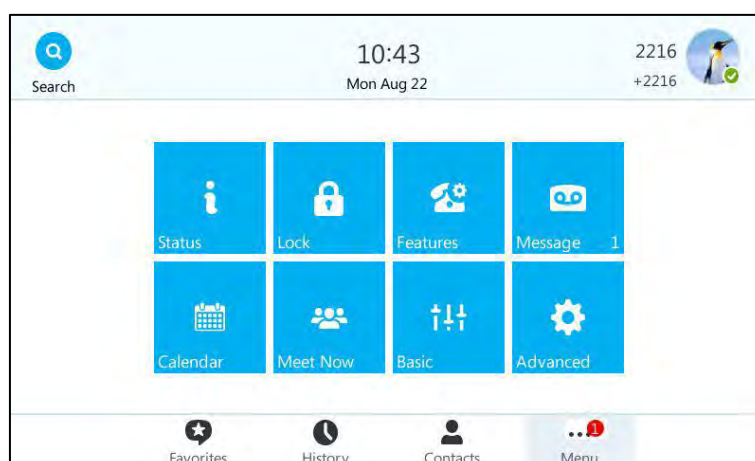



**Note**

If the phone is in the History screen when the phone missed calls, the  will not appear a number icon.

If the phone is in the Menu screen when the phone receives voice mails, the  will not appear a number icon.

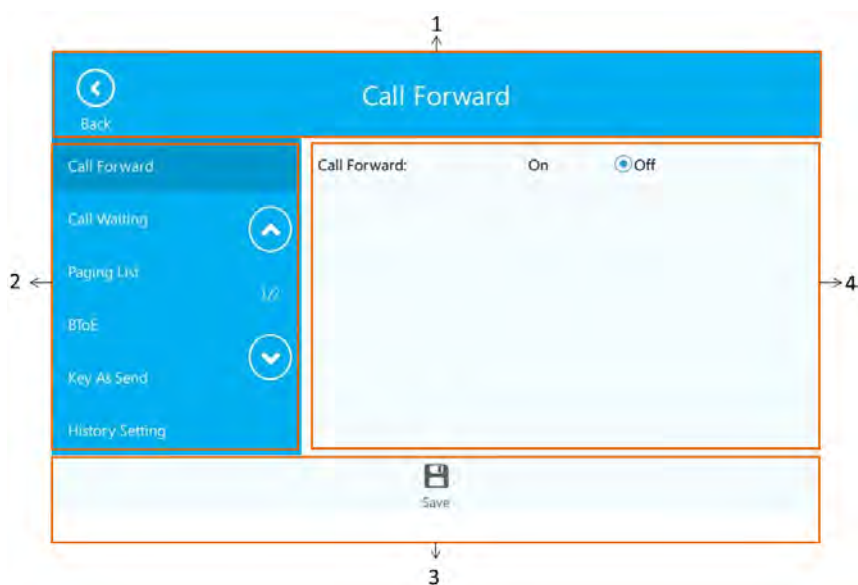



## Configuration Screen Display



No.	Name	Description
1	Screen Title Area	Displays the title of the access menu screen and the  icon.
2	Menu Tree Area	Displays menu items. You can tap the desired menu item to enter the corresponding feature configuration screen.
3	Soft Keys	Label automatically to identify their context-sensitive features.
4	Configuration Area	Displays configuration items of the highlighted menu item in the menu tree area. You can configure feature settings in this area.

## Favorites Screen



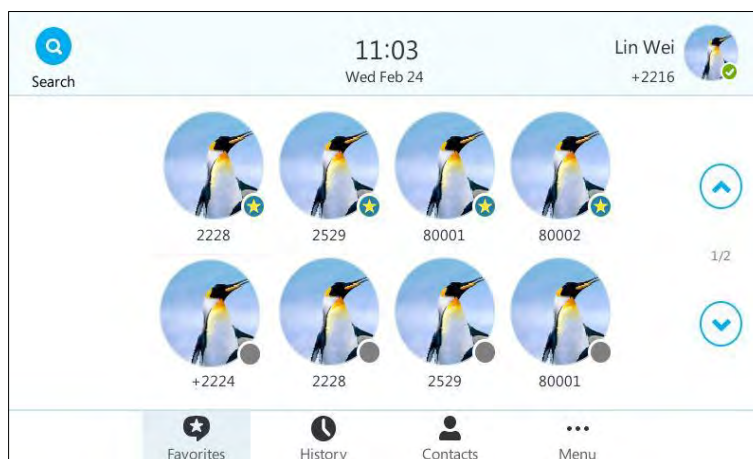

The phone will enter the **Favorites** screen by default after login.

The main window displays the avatar, display name and status icon of the favorite contacts. When the number of favorite contacts is more than 8, the page switch keys will appear on the right side of the main window. You can tap ,  or press ,  to turn pages to view other favorites.



## History Screen

Tap  to enter the History screen. You can view **All**, **Missed**, **Placed** and **Received** lists.

When the number of call records in each list is more than 12, the page switch keys will appear on the right side of the main window. You can tap ,  or press ,  to turn pages to view other records.

- 1) Tap **All** to view all calls.

The touch screen displays the contact avatar, display name, status icon and time information of all calls.

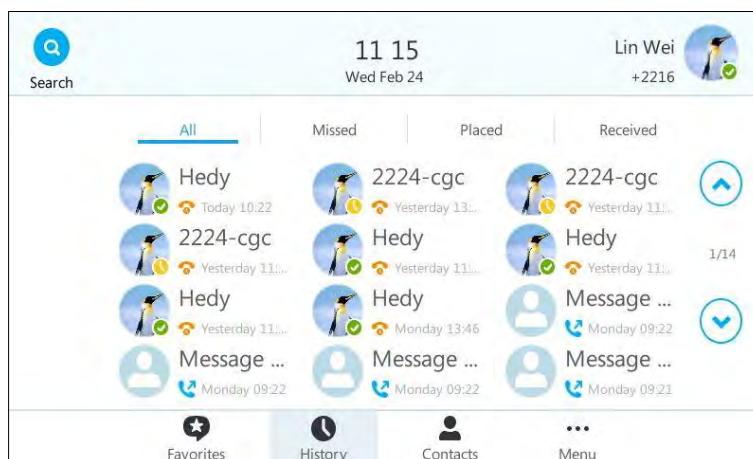



- 2) Tap **Missed** to view missed calls.

The touch screen displays the contact avatar, display name, status icon and time information of the missed calls.

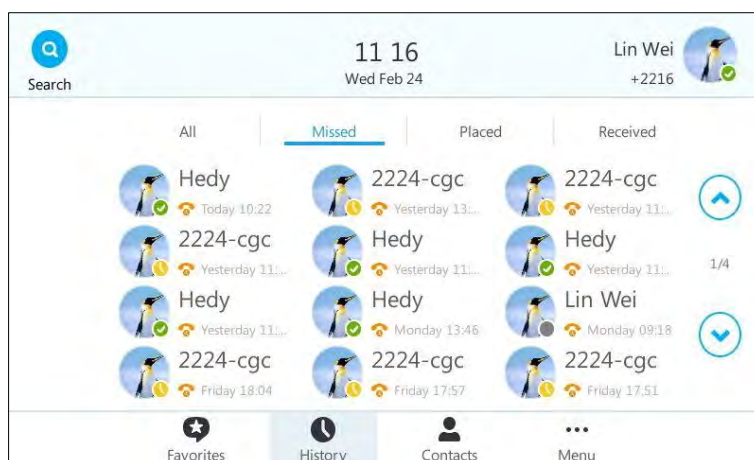

- 3) Tap **Placed** to view placed calls.

The touch screen displays the contact avatar, display name, status icon and time information of the placed calls.

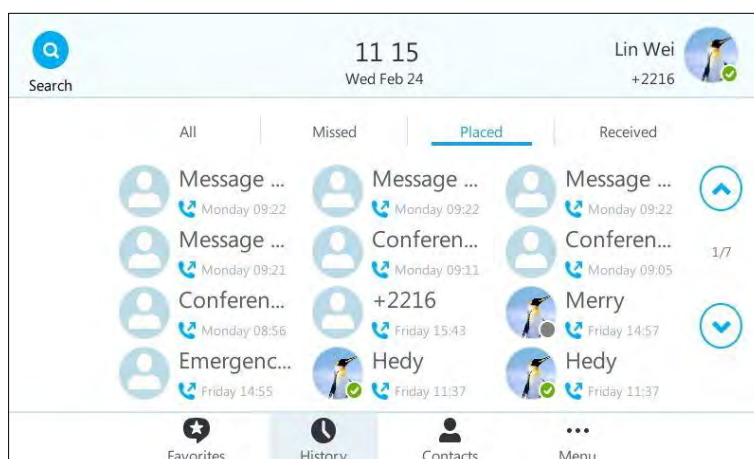

- 4) Tap **Received** to view received calls.

The touch screen displays the contact avatar, display name, status icon and time information of the received calls.



## Contacts Screen

Tap  to enter the Contacts screen.

The main window displays the groups and the number of member. When the number of contact groups is more than 9, the page switch keys will appear on the right side of the main window.

You can tap ,  or press ,  to turn pages to view other groups.

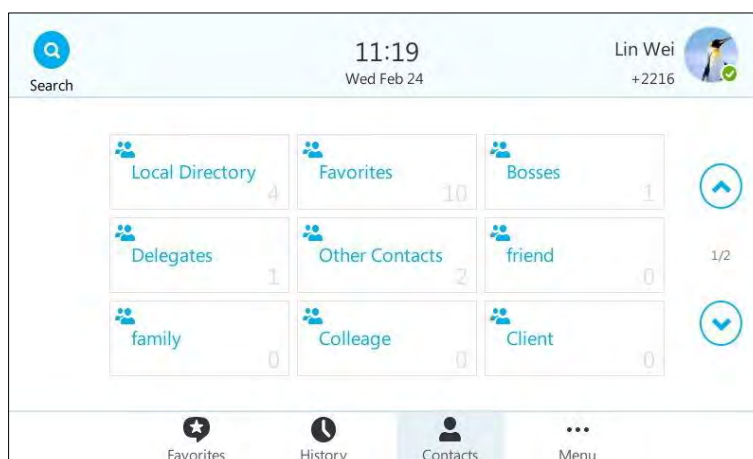

## Menu Screen

Tap  to enter the Menu screen.

The menu screen consists of eight menu items: Status, Lock, Features, Message, Calendar, Meet Now, Basic and Advanced.

When the phone receives voice mails, a number (indicating the number of voice messages you haven't retrieved) will appear on the **Message** menu. When all new voice mails are retrieved, the number will disappear.

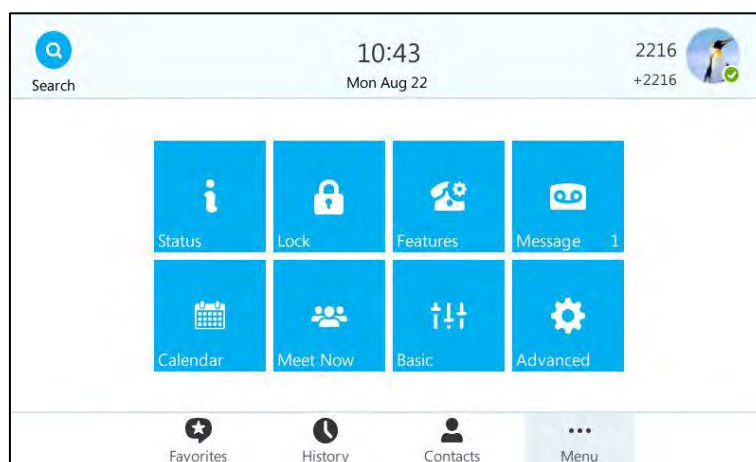

## Navigating Menus and Fields



To navigate menus and fields, you can:

- Tap soft keys on the touch screen.
- Tap menu items, fields, and arrows on the touch screen.
- Press keys on the phone keypad or tap the on-screen keyboard to enter desired numbers or characters.

**Note** The menu system will automatically exit to the idle screen after 60 seconds of inactivity.

To operate your phone, follow these tips:

If you want to	Then you can
Enter the main menu.	Tap <b>...</b> .
Go back to the previous menu.	Tap <b>&lt;</b> or press <b>×</b> .
Select an item.	Tap the item. Scroll to the item by pressing <b>▲</b> or <b>▼</b> .
Scroll through items page by page.	If you are in the Favorites, History, Contacts or Menu screen, you can press <b>▲</b> , <b>▼</b> or tap <b>▲</b> , <b>▼</b> to scroll through items page by page. If you are in the language or ring tones configuration screen, you can press <b>▲</b> , <b>▼</b> or tap <b>▲</b> , <b>▼</b> to scroll through items page by page.

If you want to	Then you can
	page.
Scroll through values for a field.	Tap the field's highlighted gray box. From the pull-down list, tap <b>▲</b> or <b>▼</b> to scroll through values page by page, or press  or  to scroll values one by one.
Select a value for a field.	From the pull-down list, tap the value or scroll to the value and then press  .







## Entering Data and Editing Fields

You can enter data and edit fields using the phone keypad or using the on-screen keyboard.

### Using the Phone Keypad

Keypad on the phone can provide different characters when using the **2aB**, **abc**, **ABC** or **123** input mode. You can change the following input modes to enter data and edit fields on your phone. When your phone keypad matches the input mode, you can press the keypad repeatedly to view the character (or numbers) options and stop to select. When the character (or numbers) you want to enter displays in the field, wait one second, and enter the next character (or numbers).

The following table lists the input modes and character (or numbers) options for the keypad:









Input Mode Keypad	2aB	abc	ABC	123
	1			1
	2abcABC	abc2äæääá ääç	ABC2Ä/ÆÄÀ ÁÂÃÇ	2
	3defDEF	def3èéëëö	DEF3ÈÉÊËÏ	3
	4ghiGHI	ghi4íîï	GHI4ÌÍÎ	4
	5jklJKL	jkl5£	JKL5£	5
	6mnoMNO	mno6öøòó ôõñ	MNO6ÖØÒ ÓÔÕÑ	6
	7pqrsPQRS	pqrs7ßŠ	PQRS7Š	7

Input Mode Keypad	2aB	abc	ABC	123
	8tuvTUV	tuv8ùúúü	TUV8ÙÚÛÜ	8
	9wxyzWXYZ	wxyz9ýþ	WXYZ9ÝÞ	9
	0	space	space	0
	*.,?!\\-()@/:;. +&%=<> £ \$ ¥ ¢ [] {} ~ ^ ¡ ¢ § # "	*.,?!\\-()@/:;. +&%=<> £ \$ ¥ ¢ [] {} ~ ^ ¡ ¢ § # "	*.,?!\\-()@/:;. +&%=<> £ \$ ¥ ¢ [] {} ~ ^ ¡ ¢ § # "	.*/@[]
	#	#	#	#

**To enter or edit data:**

Do one of the following:

If you want to	Then you can
Enter only digits (1), uppercase (A) characters, lowercase (a) characters, or alphanumeric (2aB) characters.	<p>Press a keypad key one or more times (depending what input mode you're in) to enter the characters that is displayed on the keypad key.</p> <p>You can tap  or the  key one or more times to switch among uppercase (<b>ABC</b> soft key), alphanumeric (<b>2aB</b> soft key), numeric (<b>123</b> soft key) and lowercase (<b>abc</b> soft key) input modes.</p> <p>For example, if the input mode is <b>ABC</b>:</p> <ul style="list-style-type: none"> <li>- To enter "A", press  once.</li> <li>- To enter "B", press  twice quickly.</li> <li>- To enter "C", press  three times quickly.</li> <li>- To enter "2ÄÆÅÀÁÂÃÇ", press  more than three times quickly.</li> </ul> <p><b>Note:</b> When you are in the uppercase (<b>ABC</b> soft key) or lowercase (<b>abc</b> soft key) input mode,  is not available.</p>
Enter special characters.	<p>Press the keypad key  or , or long press .</p> <p><b>For  Key:</b></p> <ul style="list-style-type: none"> <li>- If it is the uppercase (<b>ABC</b> soft key), or lowercase (<b>abc</b> soft key) input mode, it will provide the space character.</li> </ul>

If you want to	Then you can
	<ul style="list-style-type: none"> <li>- If it is the numeric (<b>123</b> soft key) or alphanumeric (<b>2aB</b> soft key) input mode, it will only provide the digit 0.</li> <li>- Long press  on the pre-dialing screen will provide the special character "+".</li> </ul> <p><b>For  key:</b></p> <ul style="list-style-type: none"> <li>- It only provides the pound character "#".</li> </ul> <p><b>For  key:</b></p> <ul style="list-style-type: none"> <li>- If it is the uppercase (<b>ABC</b> soft key), lowercase (<b>abc</b> soft key) or alphanumeric (<b>2aB</b> soft key) input mode, it will provide the following special characters: <code>.,?!\-'()@/:-;+&amp;%=&lt;&gt;£\$¥▣[]{}~^_`¡;§#"  </code>.</li> <li>- If it is the numeric (<b>123</b> soft key) input mode, it will provide the following special characters: <code>.*:/@[]</code>.</li> </ul>
Delete text you entered.	Press  or  to position the cursor to the right of the text you want to delete, and then tap the <b>Delete</b> soft key or  to delete one character at a time. You can also press  to delete one character in the sign-in screen and phone unlock screen.
Delete an entire field of data.	Swipe your finger to the left or right to select the entire field of data, so that the data is highlighted, and then tap the <b>Delete</b> soft key or  .

**Note** When the phone is on the pre-dialing screen, characters can be entered using the on-screen keypad.

## Using the On-screen Keyboard

The on-screen keyboard will appear when one of the following situations occurs:

- In the dialing or pre-dialing screen.
- Tap the edit field in the sign-in screen.
- Tap the PIN input field when the phone is locked.
- In the configuration screen of call forward, tap the radio box of **Forward Calls to Number or Contact** or **Simultaneously Ring**.

Before using the on-screen keyboard to enter data, you need to know the function of the keys on the on-screen keyboard:



No.	Item	Description
1	26 English letters	Enter letters
2	Delete key	Delete the entered characters
3	Dial key	Place a call
4	Shift key	Switch between the uppercase input mode and the lowercase input mode
5	Input mode	Change input mode
6	Space key	Enter spaces
7	Left and right arrow keys	Position the cursor
8	Four special characters	Enter special characters
9		Hide the on-screen keyboard

When you tap **&123**, the on-screen keyboard is shown as below:

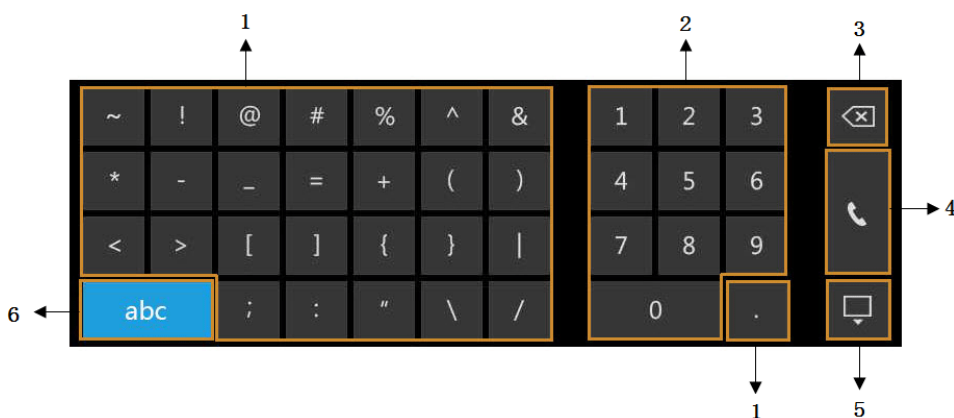





No.	Item	Description
1	Special characters	Enter special characters



No.	Item	Description
2	Numbers	Enter numbers
3	Delete key	Delete the entered characters
4	Dial key	Place a call
5		Hide the on-screen keyboard
6	Input mode	Change input mode

**To enter or edit data:**

1. Tap the field.
2. Do one of the following:

If you want to	Then you can
Enter lowercase characters	Tap the lowercase characters.
Enter uppercase characters	Tap  to switch to the uppercase input mode, and then tap the uppercase characters.
Enter numbers	Tap <b>&amp;123</b> , and then tap the numbers you want to enter.
Enter special characters	Tap <b>&amp;123</b> , and then tap the characters you want to enter.
Delete text you entered.	Tap  or  to position the cursor to the right of the text you want to delete, and then tap  .
Delete an entire field of data.	Swipe your finger to the left or right to select the entire field of data, so that the data is highlighted, and then tap  .



You can tap  or  to hide the on-screen keyboard, and then tap  to reopen the on-screen keyboard.



## Phone Status

You can view phone status via phone user interface or web user interface.

Available information of phone status includes:

- General information (IP address, MAC address and firmware version)
- Network status (e.g., IPv4 status, IP mode and MAC address)
- Phone status (e.g., product name, hardware version, firmware version, product ID MAC address and device certificate status)
- Location information (location is set to assist emergency responder)
- License (device license status)

**To view the phone status via phone user interface:**

1. Press , or tap **...**->**Status**.

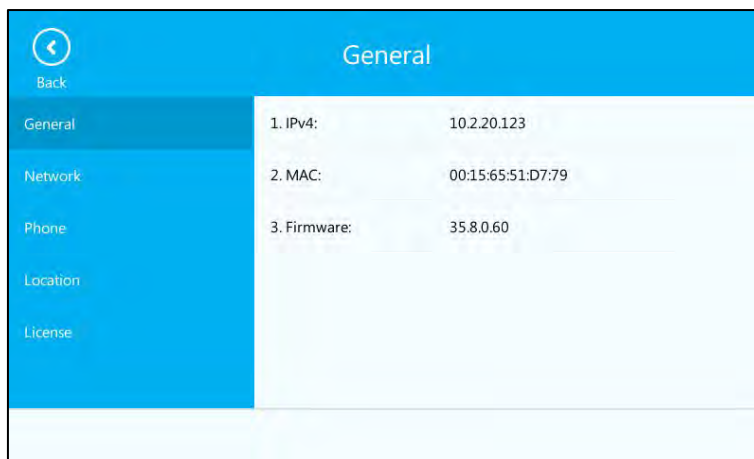

2. Tap the desired item to view the specific information.

**To view the phone status via web user interface:**

1. Open the web browser on your PC.
2. Enter the IP address in the browser's address bar, and then press the **Enter** key.
3. Enter the user name (admin) and password (admin) in the login page.

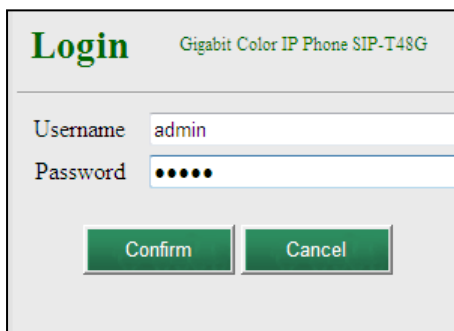

4. Click **Confirm** to login.

The phone status is displayed on the first page of the web user interface.

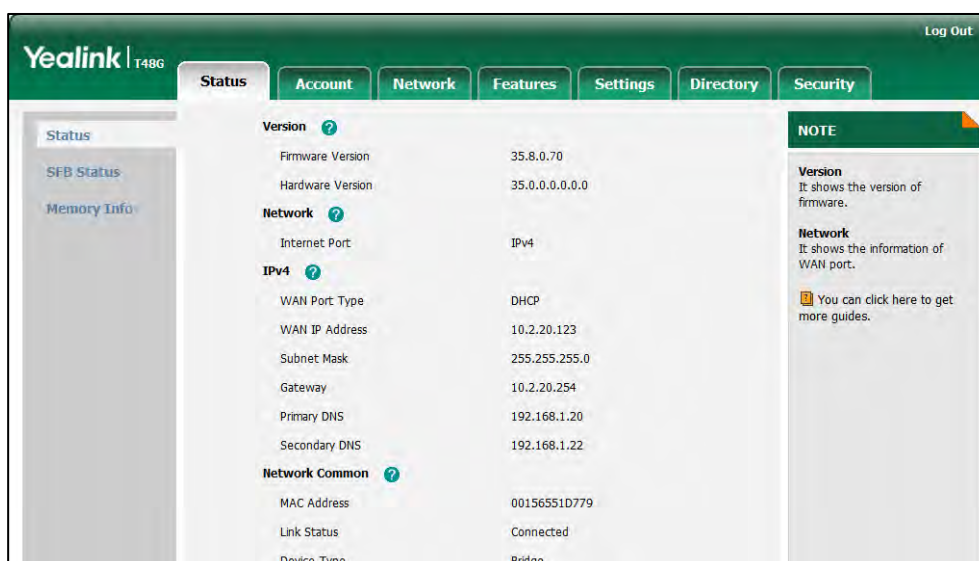

Version	
Firmware Version	35.8.0.70
Hardware Version	35.0.0.0.0.0.0

Network	
Internet Port	IPv4

IPv4	
WAN Port Type	DHCP
WAN IP Address	10.2.20.123
Subnet Mask	255.255.255.0
Gateway	10.2.20.254
Primary DNS	192.168.1.20
Secondary DNS	192.168.1.22

Network Common	
MAC Address	00156551D779
Link Status	Connected
Device Type	Bridge

**NOTE**  
**Version**  
It shows the version of firmware.  
**Network**  
It shows the information of WAN port.  
You can click here to get more guides.



## Basic Network Settings

If your phone cannot contact a DHCP server for any reason, you need to configure network settings manually. The Skype for Business phone can support either or both IPv4 and IPv6 addresses.

### To configure the IP mode via phone user interface:

1. Tap **...** -> **Advanced** (default password: admin) -> **Network**-> **WAN Port**.





2. Tap the desired value (**IPv4**, **IPv6** or **IPv4 & IPv6**) from the pull-down list of **IP Mode**.
3. Tap  to accept the change or tap  to cancel.

You can configure a static IPv4 address for the Skype for Business phone. Before configuring it, make sure that the IP mode is configured as **IPv4** or **IPv4 & IPv6**.

### To configure a static IPv4 address via phone user interface:

1. Tap **...**-> **Advanced** (default password: admin) -> **Network**-> **WAN Port**-> **IPv4**.
2. Tap **Static IP** from the pull-down list of **Type**.
3. Enter the desired value in the **IP Address**, **Subnet Mask**, **Gateway**, **Pri.DNS** and **Sec.DNS** field respectively.



4. Tap  to accept the change or tap  to cancel.

You can configure a static IPv6 address for the Skype for Business phone. Before configuring it, make sure that the IP mode is configured as **IPv6** or **IPv4 & IPv6**.

**To configure a static IPv6 address via phone user interface:**

1. Tap **...**->**Advanced** (default password: admin) ->**Network**->**WAN Port**->**IPv6**.
2. Tap **Static IP** from the pull-down list of **Type**.
3. Enter the desired value in the **IP address**, **IPv6 IP Prefix**, **Gateway**, **Pri.DNS** and **Sec.DNS** field respectively.





4. Tap **Save** to accept the change or tap **Back** to cancel.

If you are using an xDSL modem for IPv4 network connection, you can connect your phone to the Internet via PPPoE mode. Set the WAN port as a PPPoE port. The PPPoE port will perform a PPP negotiation to obtain the IP address. Contact your system administrator for the PPPoE user name and password.

**To configure PPPoE via phone user interface:**

1. Tap **...**->**Advanced** (default password: admin) ->**Network**->**WAN Port**->**IPv4**.
2. Tap **PPPoE** from the pull-down list of **Type**.
3. Enter the PPPoE user name and password in the corresponding fields.



4. Tap  to accept the change or tap  to cancel.

**Note**

Wrong network settings may result in inaccessibility of your phone and may also have an impact on your network performance. For more information on these parameters, contact your system administrator.



---

# Customizing Your Phone

---

You can customize your T48G Skype for Business phone by personally configuring certain settings, for example, backlight, time & date, ring tones and E911. You can also manage the contacts and call history.

This chapter provides basic operating instructions for customizing your phone. Topics include:

- [General Settings](#)
- [Audio Settings](#)
- [Contact Management](#)
- [Call History Management](#)
- [Headset Use](#)
- [E911](#)
- [Dial-now](#)
- [Live Dialpad](#)
- [Hotline](#)
- [Privacy Mode](#)

If you require additional information or assistance with your new phone, contact your system administrator.

## General Settings

### Backlight

Backlight has two options:

**Backlight Active Level:** The intensity of the touch screen when the phone is active. You can change the intensity of the touch screen. Digits (1-10) represent different intensities. 10 is the highest intensity.

**Inactive Level:** The intensity of the touch screen when the phone is inactive for a designated backlight time. You can select a low intensity or turn off the backlight.

You can also change the intensity of the LCD screen of EXP40 connected to the T48G Skype for Business phone.



#### Note

Backlight time is configurable on Skype for Business Server only. Contact your system administrator for more information.

**To configure the backlight via phone user interface:**

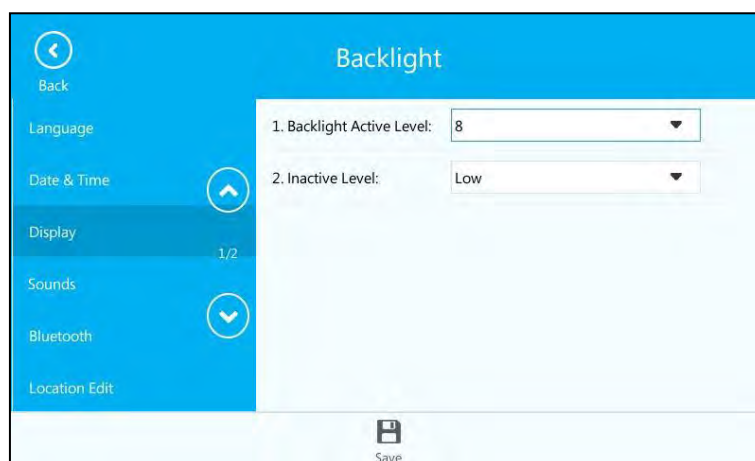
1. Tap **...** -> **Basic**-> **Display**-> **Backlight**.
2. Select the desired level from the pull-down list of **Backlight Active Level**.
3. Select the desired value from the pull-down list of **Inactive Level**.



4. Tap  to accept the change or tap  to cancel.

Backlight is configurable via web user interface at the path **Settings->Preference**.

## Contrast

You can only configure the contrast of the expansion module EXP40 connected to the T48G Skype for Business phone to a comfortable level on the phone. Ensure that the expansion module has been connected to the phone before configuration. The intensity of contrast ranges from 1 to 10 and the highest intensity is 10.



**To configure the contrast via phone user interface:**

1. Tap **...** -> **Basic**-> **Display**-> **Contrast**.  
If EXP40 is not connected to the phone, the Contrast Setting screen displays "No EXP".
2. Select the desired value from the pull-down list **Contrast**.

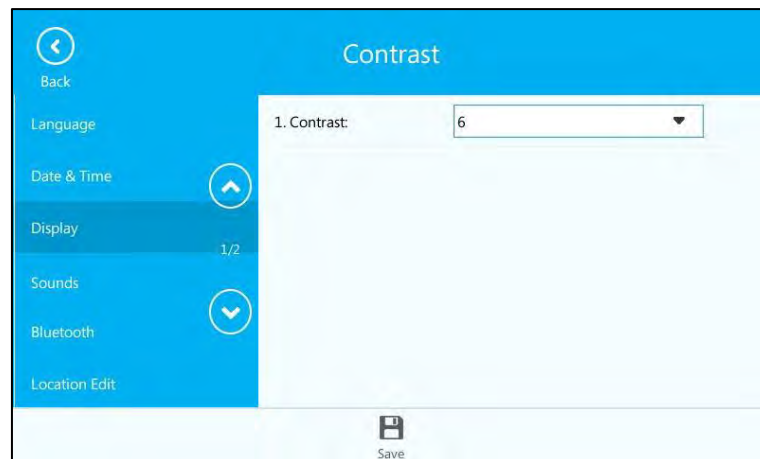

The default contrast level is "6".





3. Tap  to accept the change or tap  to cancel.

## Language

The default language of the phone user interface is English. If the language of your web browser is not supported by the phone, the web user interface will use English by default. You can change the language for the phone user interface and the web user interface respectively.

### To change the language for the phone user interface:

1. Tap **...** -> **Basic**-> **Language**.
2. Tap  or  to scroll through the list of available languages.
3. Tap the desired language.



4. Tap  to accept the change.

Text displayed on the phone user interface will change to the selected language.

**To change the language for the web user interface:**

1. Click on **Settings**->**Preference**.
2. Select the desired language from the pull-down list of **Language**.

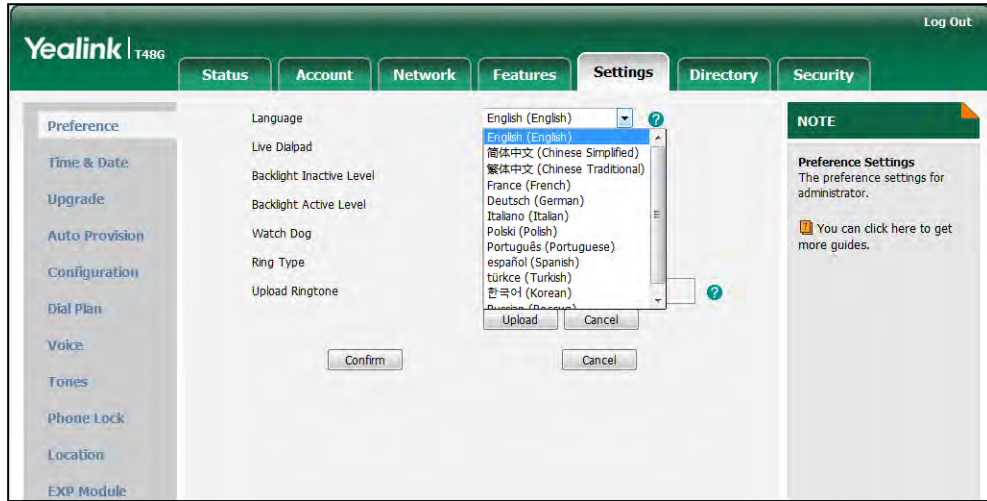

3. Click **Confirm** to accept the change.  
Text displayed on the web user interface will change to the selected language.

## Time & Date



The time and date are displayed in the middle of the status bar. You can configure the phone to obtain the time and date from the SNTP server automatically, or configure the time and date manually. If the phone cannot obtain the time and date from the Simple Network Time Protocol (SNTP) server, contact your system administrator for more information.

**To configure the SNTP settings via phone user interface:**

1. Tap **...** -> **Basic**->**Date & Time**->**General**.
2. Tap **SNTP Settings** from the pull-down list of **Type**.
3. Select the time zone that applies to your area from the pull-down list of **Time Zone**.  
The default time zone is "GMT+8".
4. Enter the domain names or IP addresses of SNTP servers in the **NTP Server1** and **NTP Server2** field respectively.
5. Select the desired value from the pull-down list of **Daylight Saving**.
6. Tap **Location**.  
This field appears only if **Daylight Saving** field is selected as **Automatic**.
7. Tap the desired time zone name from the pull-down list.

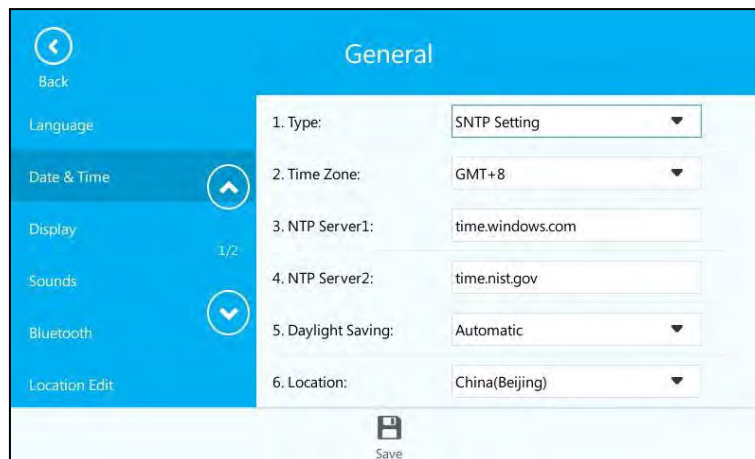
The default time zone name is “China(Beijing)”.



8. Tap  to accept the change or tap  to cancel.

### Note

Please refer to [Appendix A - Time Zones](#) for the list of available time zones on the Skype for Business phone.

### To configure the date and time manually via phone user interface:

1. Tap **...** -> **Basic**->**Date & Time**->**General**.
2. Tap **Manual Setting** from the pull-down list of **Type**.
3. Enter the specific date and time in the corresponding fields.

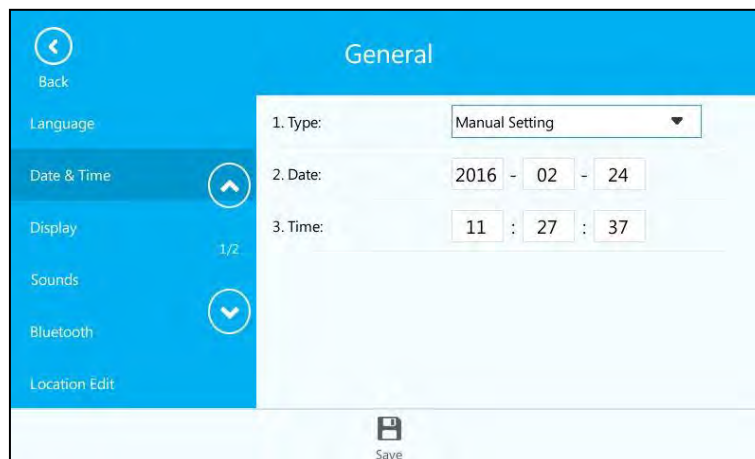

4. Tap  to accept the change.



The time and date displayed on the touch screen will change accordingly.

### To configure the time and date format via phone user interface:

1. Tap **...** -> **Basic**->**Date & Time**->**Format**.
2. Select the desired date format from the pull-down list of **Date Format**.

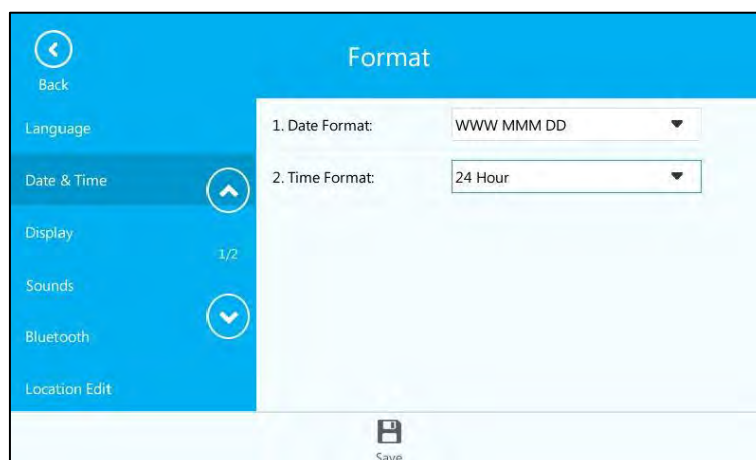
3. Select the desired time format (**12 Hour** or **24 Hour**) from the pull-down list of **Time Format**.



4. Tap  to accept the change or tap  to cancel.

There are 7 available date formats. For example, for the date format “WWW DD MMM”, “WWW” represents the abbreviation of the week, “DD” represents the two-digit day, and “MMM” represents the first three letters of the month.

The date formats available:

Date Format	Example (2016-8-19)
WWW MMM DD	Fri Aug 19
DD-MMM-YY	19-Aug-16
YYYY-MM-DD	2016-08-19
DD/MM/YYYY	19/08/2016
MM/DD/YY	08/19/16
DD MMM YYYY	19 Aug 2016
WWW DD MMM	Fri 19 Aug



Time and date format is configurable via web user interface at the path **Settings->Time & Date**.

**To configure the DHCP Time via phone user interface:**

1. Tap **⋮->Basic->Date & Time->DHCP Time**.

2. Mark the **On** radio box of the **DHCP Time** field.



3. Tap  to accept the change or tap  to cancel.

The time and date displayed on the touch screen will change according to time zone automatically.

DHCP time is configurable via web user interface at the path **Settings->Time & Date->DHCP Time**.

## Administrator Password



The **Advanced** option is only accessible to the administrator. The default administrator password is "admin". For security reasons, you should change the default administrator password as soon as possible.

**To change the administrator password via phone user interface:**

1. Tap **...**->**Advanced** (default password: admin) ->**Set Password**.
2. Enter the current password in the **Current Password** field.
3. Enter the new password in the **New Password** field.

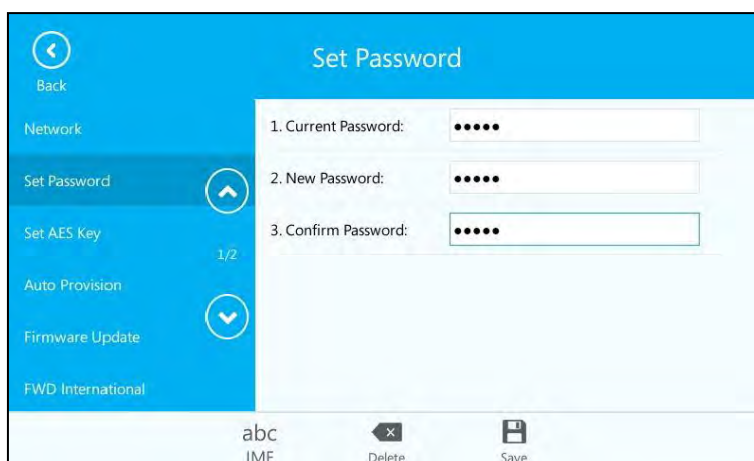
4. Re-enter the new password again in the **Confirm Password** field.



5. Tap  to accept the change or tap  to cancel.

Administrator password is configurable via web user interface at the path **Security->Password**.



## Key as Send

You can set the "#" key or "\*" key to perform as a send key while dialing.

**To configure key as send via phone user interface:**

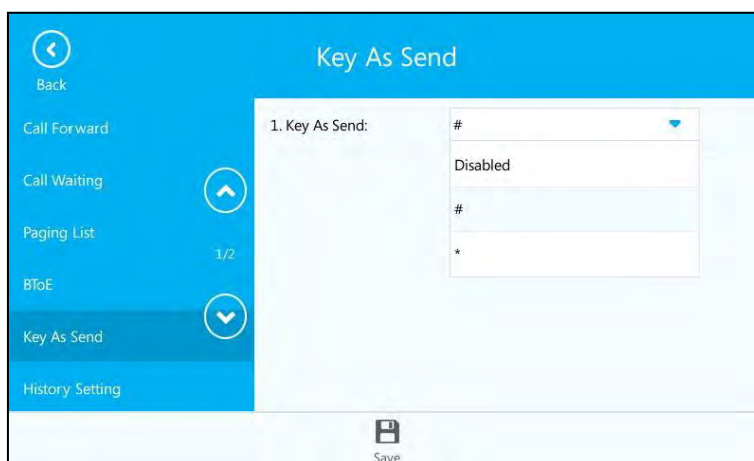
1. Tap ... -> **Features->Key As send**.
2. Select # or \* from the pull-down list of **Key As Send** field, or select **Disabled** to disable this feature.



3. Tap  to accept the change or tap  to cancel.

Key as send is configurable via web user interface at the path **Features->General Information**.

## Phone Lock

If the Skype for Business Server is configured to forcibly lock the phone, user can use phone lock feature to lock the phone to prevent it from unauthorized use. And the Skype for Business phone will prompt the user to configure an unlock PIN at the initial sign-in.



### To set unlock PIN:

1. Enter the unlock PIN (PIN's length must be from 6 to 15) in the **New PIN** field.
2. Tap the **Confirm PIN** field.
3. Enter the unlock PIN again in the **Confirm PIN** field.
4. Tap **Save**.

When the unlock PIN is configured successfully, you can do one of the following to lock your phone:

- Long press  for two seconds to lock the phone immediately when the phone is idle.
- Tap **...**->**Lock**.
- Tap **...**->**Basic**->**Phone Lock**, and then mark the **On** radio box of **Lock the phone**.
- The phone will be locked automatically when it has been inactive for the designated time (in seconds). The time is configurable on the Skype for Business Server only.

### When the locked phone is making a call:

- You can pick up the handset or press the speakerphone key to enter the pre-dialing screen.
- You can tap  (**Emerg Call** soft key) to select an emergency number.
- When the parameter **DisableHandsetOnLockedMachine** is set to **True** on the Skype for Business Server, the locked phone can only place an emergency call and cannot make other outgoing calls. When the parameter **DisableHandsetOnLockedMachine** is set to **False** on the Skype for Business Server, the locked phone can place an emergency call and other outgoing calls. By default the locked phone can only place an emergency call and

cannot make other outgoing calls.

- You cannot search contacts on the pre-dialing screen.

**When the locked phone is idle:**

Digit keys, # key, \* key, volume key, HEADSET key, navigation keys, OK key and speakerphone key are available and other keys on the phone are locked.

**When the locked phone receives an incoming call:**

You can answer, reject or mute the incoming calls only.

**When the locked phone engages in a call:**

You can place the call on hold, mute or unmute the call, end the call or dial emergency numbers (whether the phone can make other outgoing calls depends on the value of

**DisableHandsetOnLockedMachine**) only.

**Note**

Phone status will change to Away after the phone is locked and the phone will revert to previous status when unlocked. For more information, refer to [Changing Presence Status](#) on page 26.

**To change the phone Unlock PIN via phone user interface:**

1. Tap ... -> **Basic**-> **Phone Lock**.
2. Select **Enabled** from the pull-down list of **Phone Lock** field.
3. Enter the current PIN in the **Current PIN** field.
4. Enter the new PIN in the **New PIN** field.
5. Enter the new PIN again in the **Confirm PIN** field.

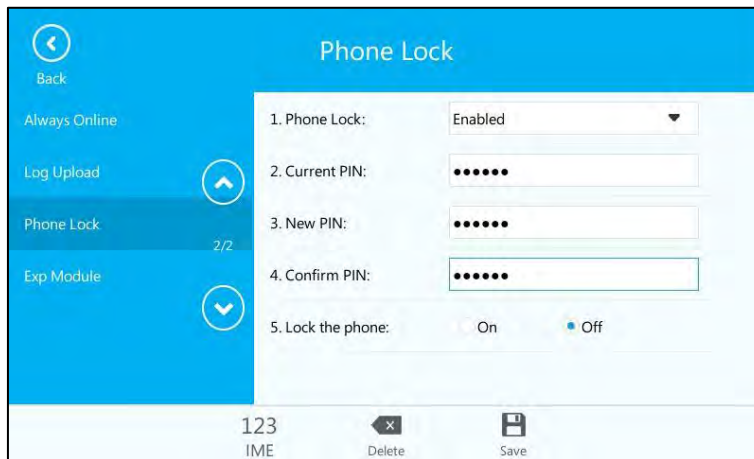

6. Tap  to change the unlock PIN.

Unlock PIN is configurable via web user interface at the path **Settings->Phone Lock**.



**To unlock the phone via phone user interface:**

1. When the phone is locked, enter the PIN in the input field.

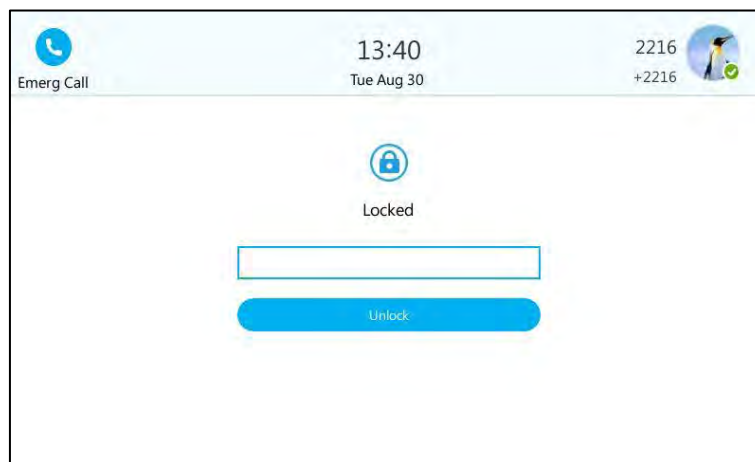

2. Tap **Unlock** or press .

**Note**

You can also unlock the phone by administrator password.

**To disable the phone lock feature via phone user interface:**

1. Tap **...** -> **Basic**-> **Phone Lock**.
2. Select **Disabled** from the pull-down list of **Phone Lock** field.

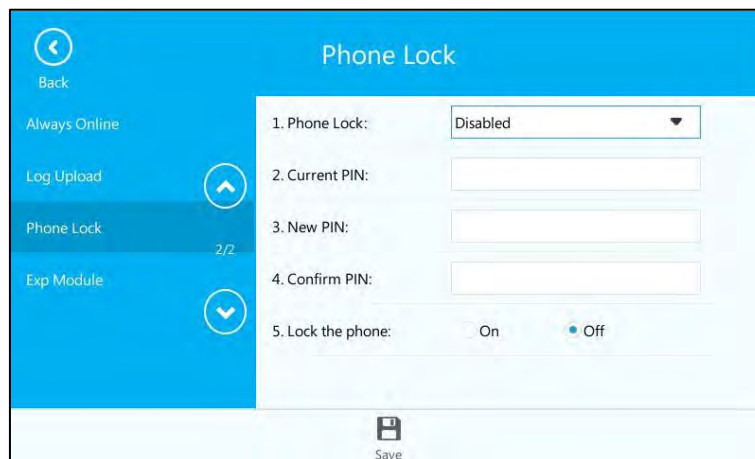

3. Tap the **Save** soft key to accept the change.  
The phone user interface prompts "Reboot now?".

4. Tap **OK**.  
The phone lock feature will be disabled after a reboot.

Phone lock is configurable via web user interface at the path **Settings**-> **Phone Lock**.

## Remembering Password

You can enable the remember password feature, so that a **Remember Password** option will appear at the phone login screen.



The screenshot shows the Skype For Business login interface. At the top left is a 'Menu' icon. The main heading is 'Skype For Business'. Below this, there is a 'Login Type' dropdown menu set to 'User Sign in'. The 'Sign-in Address' field contains '2216@yealinkuc.com'. The 'User Name' field also contains '2216@yealinkuc.com'. The 'Password' field is masked with dots. A 'Remember Password' checkbox is checked. At the bottom is a 'Sign in' button.

(User Sign-in method)



The screenshot shows the Skype For Business login interface. At the top left is a 'Menu' icon. The main heading is 'Skype For Business'. Below this, there is a 'Login Type' dropdown menu set to 'PIN Authentication'. The 'Extension' field contains '2216'. The 'PIN' field is masked with dots. A 'Remember Password' checkbox is checked. At the bottom is a 'Sign in' button.

(PIN Authentication method)

Remember password feature is disabled by default, and it is configurable via web user interface only.

**To configure remember password feature via web user interface:**

1. Click on **Features->General Information**.

2. Select **Enabled** from the pull-down list of **Remember Password**.

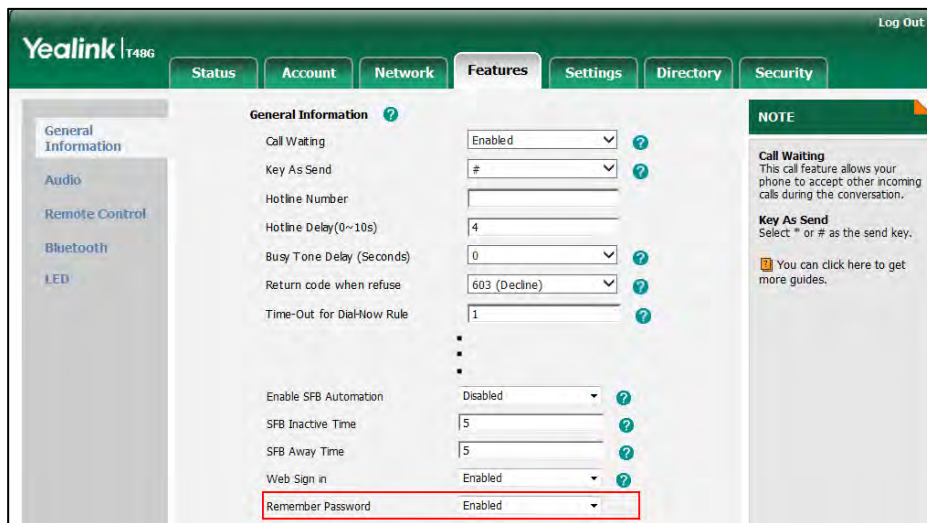

3. Click **Confirm** to accept the change.  
A dialog box pops up to prompt you that this configuration will take effect after a reboot.
4. Click **OK** to reboot the phone.

## Audio Settings

### Volume

You can press the volume key to adjust the ringer volume when the phone is idle or is ringing. You can also press the volume key to adjust the receiver volume of currently engaged audio device (handset, speakerphone or headset) when the phone is in use.

#### To adjust the volume when the phone is idle:

1. Press  to adjust the ringer volume.

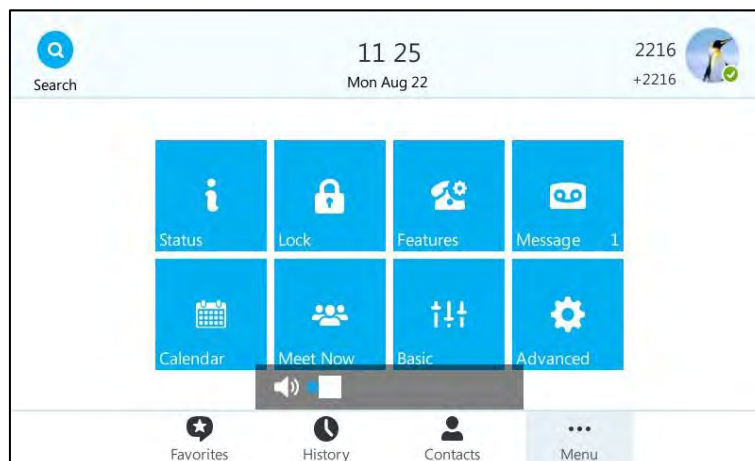

**To adjust the volume when the phone is ringing:**

1. Press  to adjust the ringer volume.

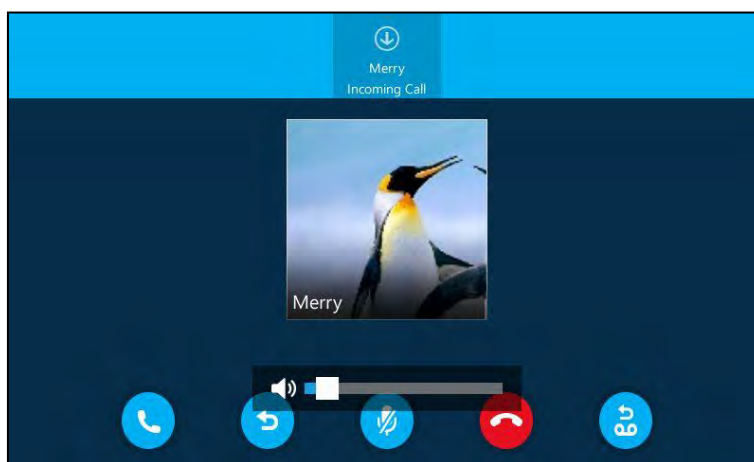

**To adjust the volume when the phone is during a call:**

1. Press  to adjust the volume of currently engaged audio device (handset, speakerphone or headset).

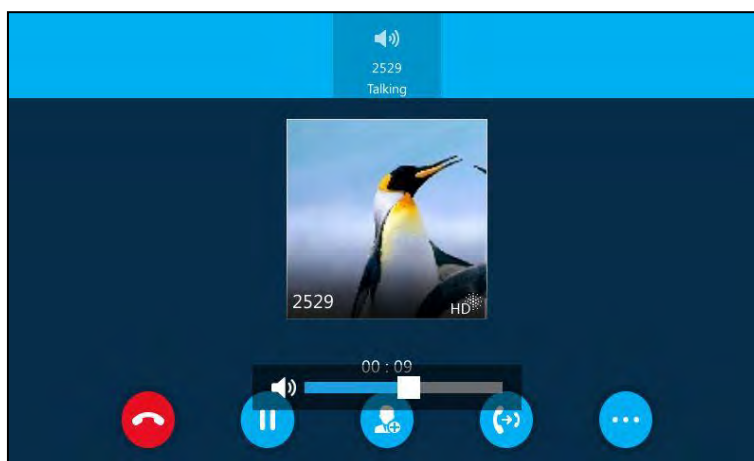



## Phone Ringtone

Phone ringtones are used to indicate incoming calls and distinguish your phone from your neighbor's.

**To select a ring tone for the phone via phone user interface:**

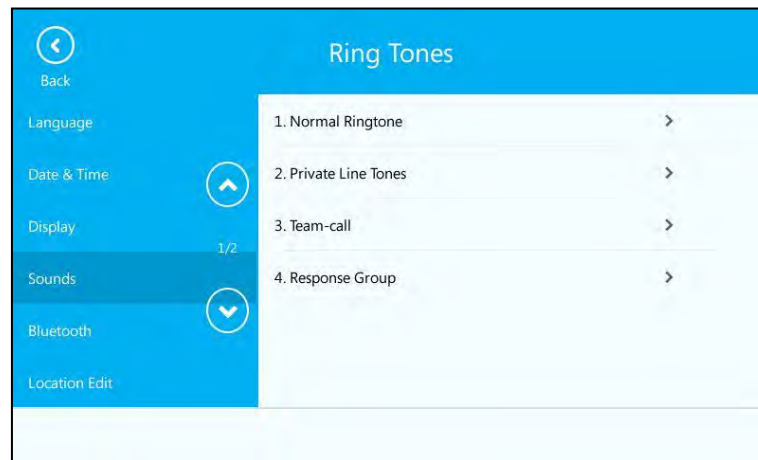
1. Tap **...** -> **Basic**->**Sounds**->**Ring Tones**->**Normal Ringtone**.



2. Tap the desired ring tone.
3. Tap  to accept the change or tap  to cancel.

Phone ringtone for the phone is configurable via web user interface at the path **Settings**->**Preference**->**Ring Type**.

**To upload a custom ring tone for the phone via web user interface:**

1. Click on **Settings**->**Preference**.
2. In the **Upload Ringtone** field, click **Browse...** to locate a ring tone file (the file format must be \*.wav) from your local system.

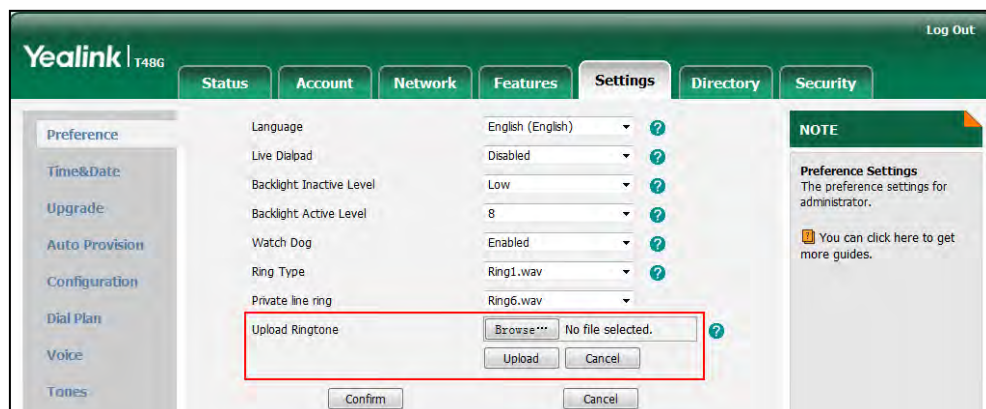

3. Click **Upload** to upload the file.  
The custom ring tone appears in the pull-down list of **Ring Type**.

**Note** The priority of ring tone for an incoming call on the phone is as follows: Contact ring tone (refer to [Adding Local Contacts](#)) -> Phone ring tone.

Single custom ring tone file must be within 8MB and total custom ring tone files must be within 20MB. Uploading custom ring tones for your phone is configurable via web user interface only.



## Key Tone

If you enable key tone, the phone will produce a sound when you press the keypad.

**To configure key tone via phone user interface:**

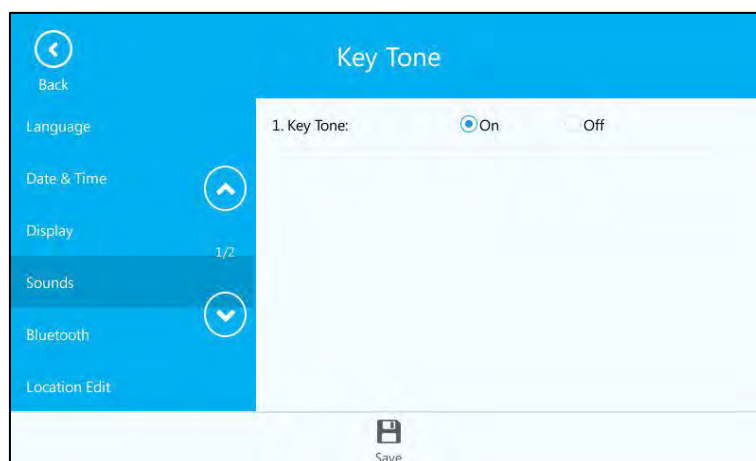
1. Tap **•••** -> **Basic**-> **Sounds**-> **Key Tone**.
2. Tap **On** radio box of the **Key Tone** field.



3. Tap  to accept the change or tap  to cancel.

Key tone is configurable via web user interface at the path **Features**-> **Audio**.

## Contact Management

The phone directory contains local directory and Skype for Business directory.

- Local directory (All or Favorites)
- Skype for Business directory (e.g., Favorites, Delegates, Bosses or Other Contacts)

If boss-admin is configured, the Bosses or Delegates group appears depending on your role. For more information on boss-admin feature, refer to [Boss-Admin Feature](#) on page 150. You can add more Skype for Business groups via Skype for Business client.



#### Note

Skype for Business Server and Exchange Server are integrated. You can search Outlook contacts on your phone. For more information, refer to [Searching for Contacts](#) on page 85.

## Skype for Business Directory

The Skype for Business directory on your phone displays all Skype for Business contacts of your Skype for Business client. You can store up to 1000 Skype for Business contacts in your phone's Skype for Business directory. You can view Skype for Business contacts on the phone, but you cannot add, edit or delete Skype for Business contacts on the phone.

### Adding Skype for Business Contacts

#### To add contacts via Skype for Business client:

1. Enter a few continuous characters of the contact name or continuous numbers of the contact number in the Search field.

The contacts whose name or phone number matches the characters entered will appear in your contacts list.

2. Right-click the contact, and then click **Add to Contacts List**.

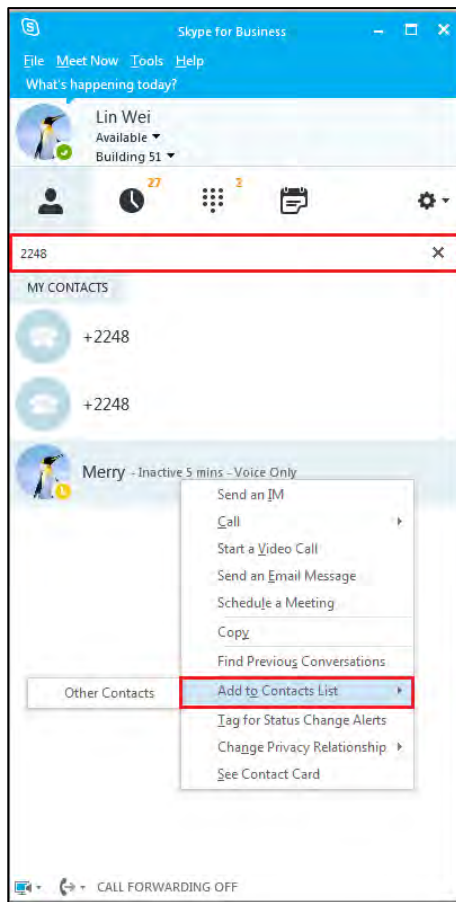

3. Select the desired group.  
The contact is added to the selected group.

## Viewing Skype for Business Contacts

You can view the following information about each contact on the phone:

- The contact's presence icon
- The contact's display name
- The contact's avatar
- The detailed information of the contact (e.g., name, mail address)

**Note** For more information on the presence icon, refer to [Icon Instructions](#) on page 3.

### To view the Skype for Business contacts:

1. Tap .
2. Tap the Skype for Business group (e.g., Favorites or Other Contacts) that contains the desired contact.

If boss-admin is configured, the Bosses or Delegates group appears depending on your



role. For more information on boss-admin feature, refer to [Boss-Admin Feature](#) on page 150.

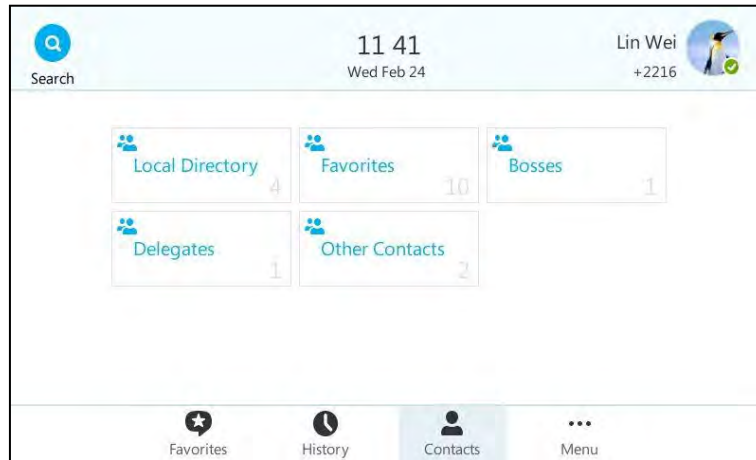

3. Tap the avatar of the desired contact.  
The detailed information (e.g., display name, address and email) of the contact appears on the touch screen.
4. Tap the grey area on the right side or press  to return to the previous screen.

## Skype for Business Favorites

You can add your Skype for Business contacts as favorites via your Skype for Business client only. You can view Skype for Business favorites on the phone.

### Adding Skype for Business Favorites

**To add contacts as favorites via Skype for Business client:**

1. Right-click a contact.

2. Click **Add to Favorites**.

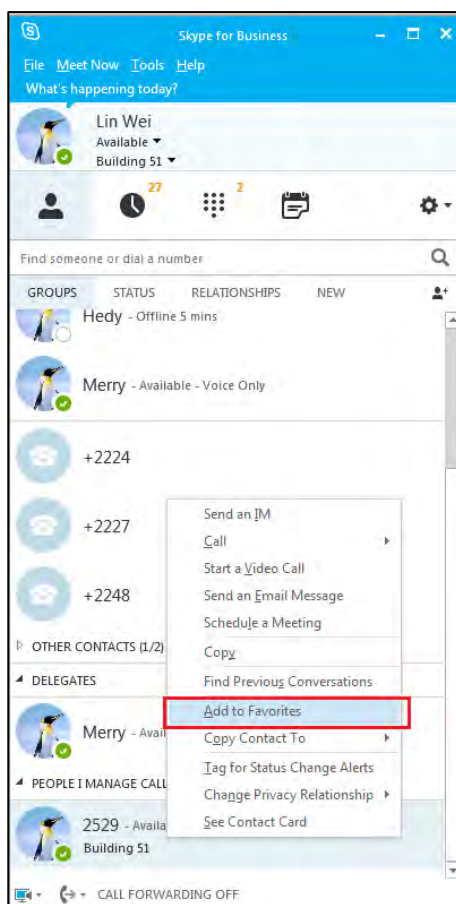

### Viewing Skype for Business Favorites

You can view the Skype for Business favorites on the Favorites screen or Contacts screen.

**To view the Skype for Business favorites on the Favorites screen:**

1. Tap .

By default, Skype for Business favorites are displayed behind the local favorites on the idle screen (local favorites are indicated by the icon , Skype for Business favorites are indicated by the status icon).



**To view the Skype for Business favorites on the Contacts screen:**

1. Tap ->**Favorites**.

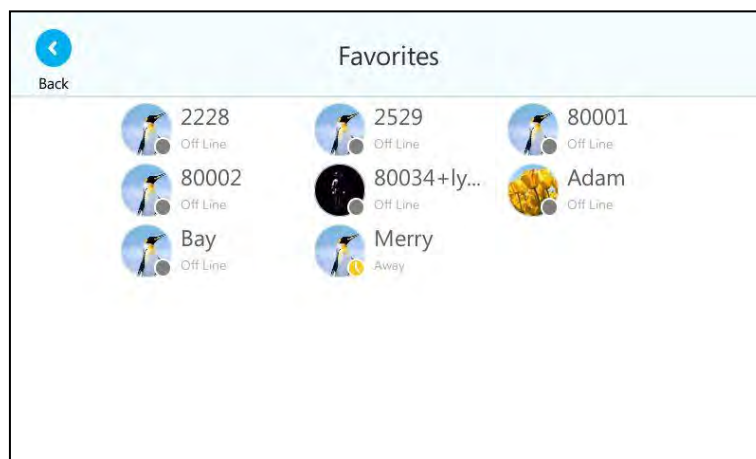

2. Tap the avatar of the desired contact.

The detailed information (e.g., display name, address or email) of the contact appears on the touch screen.

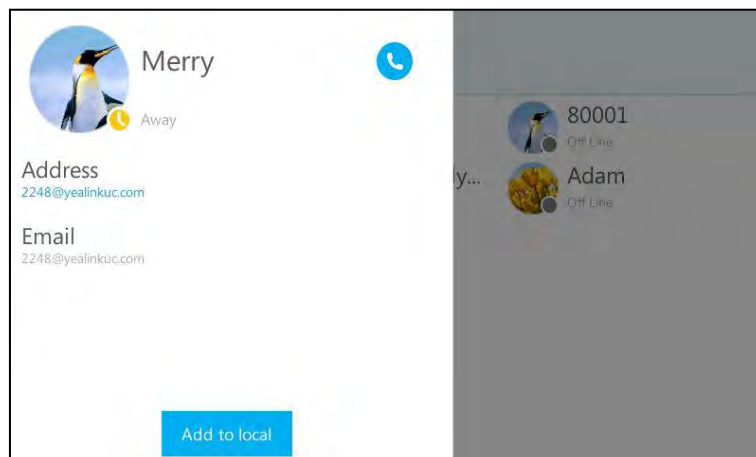

3. Tap the grey area on the right side or press  to return to the previous screen.

## Local Directory

Yealink Skype for Business phones also maintain a local directory. The local directory can store up to 1000 contacts. When adding a contact to the local directory, in addition to name and phone numbers, you can also specify the ring tone and group for the contact. Contacts can be added either one by one or in batch using a local contact file. Yealink Skype for Business phones support both \*.xml and \*.csv format contact files, but only support \*.xml format download for local contact file.

## Adding Local Contacts

You can add contacts to the local directory in the following ways:

- Manually
- From Skype for Business directory

## Adding Local Contacts Manually



To add a contact to the local directory manually:

1. Tap  -> **Local Directory** -> **All**.

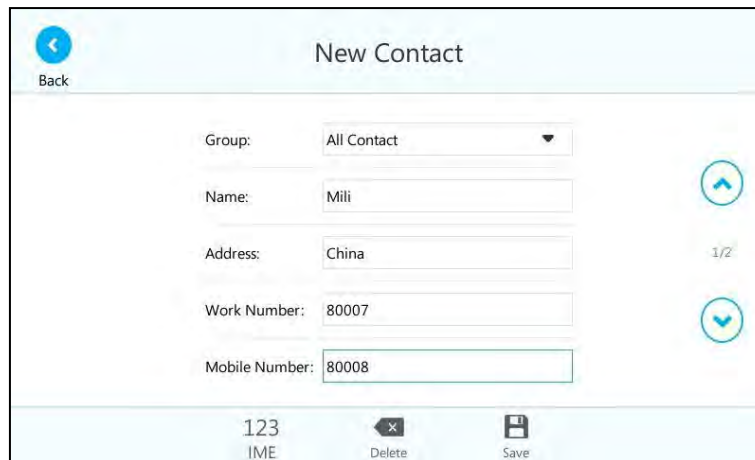

2. Tap .
3. Enter name, address, work number, mobile number, title and email in the corresponding fields.

 A screenshot of the 'New Contact' form. The title bar shows 'New Contact' with a 'Back' button on the left. The form has several input fields: 'Group' (set to 'All Contact'), 'Name' (set to 'Mili'), 'Address' (set to 'China'), 'Work Number' (set to '80007'), and 'Mobile Number' (set to '80008'). On the right side of the form, there are two circular buttons: a top one with an upward arrow and a bottom one with a downward arrow. At the bottom of the screen, there is a status bar with '123 IME', a 'Delete' button with an 'x' icon, and a 'Save' button with a floppy disk icon.

4. Select the desired ring tone from the pull-down list of **Ring**.
5. Tap  to accept the change or  to cancel.

### Note

If the contact name already exists in the directory, the touch screen will prompt "Contact name existed!".

Local directory is configurable via web user interface at the path **Directory**-> **Local Directory**.

## Adding Local Contacts from Skype for Business Directory

To add a local contact from Skype for Business directory via phone user interface:

1. Tap .
2. Tap the Skype for Business group (e.g., Favorites or Other Contacts) that contains the desired contact.

If boss-admin is configured, the Bosses or Delegates group appears depending on your role. For more information on boss-admin feature, refer to [Boss-Admin Feature](#) on page 150.

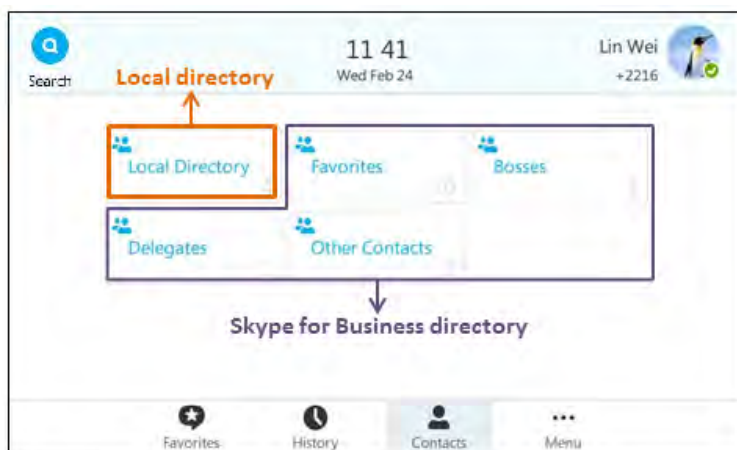

3. Tap the avatar of the desired contact.
4. Tap the **Add to local** soft key.

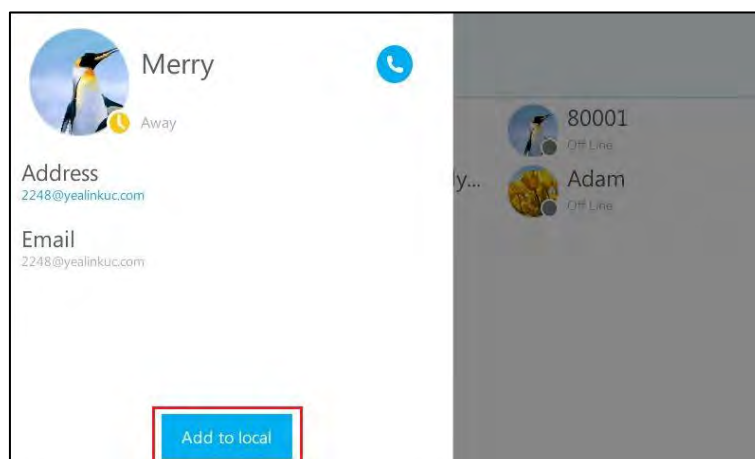

5. Tap the desired field to edit the contact information.
6. Tap the  soft key to add the contact to the local directory.  
The entry is successfully saved to the local directory.

## Viewing Local Contacts

You can view the following information about each local contact on the phone:

- The contact's display name

- The contact's avatar
- The detailed information of the contact (e.g., name, mail address)

**To view the local directory:**

1. Tap  -> **Local Directory**.

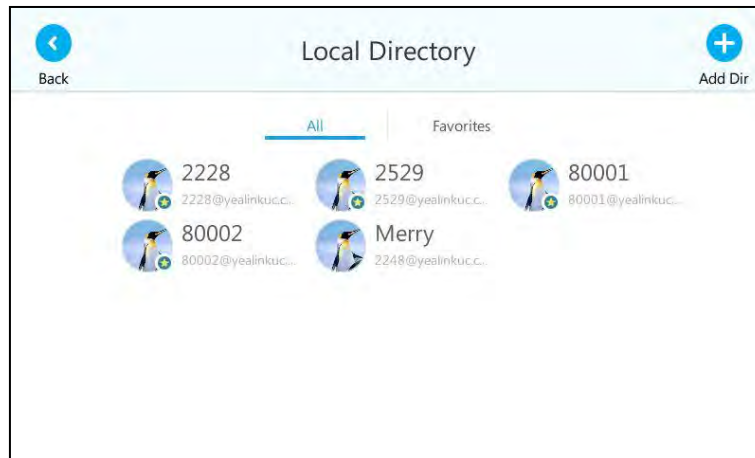

2. Tap the desired group.
3. Tap the avatar of the desired contact.

The detailed information (e.g., display name, address, work number, mobile number, home number and email address) of the contact appears on the touch screen.

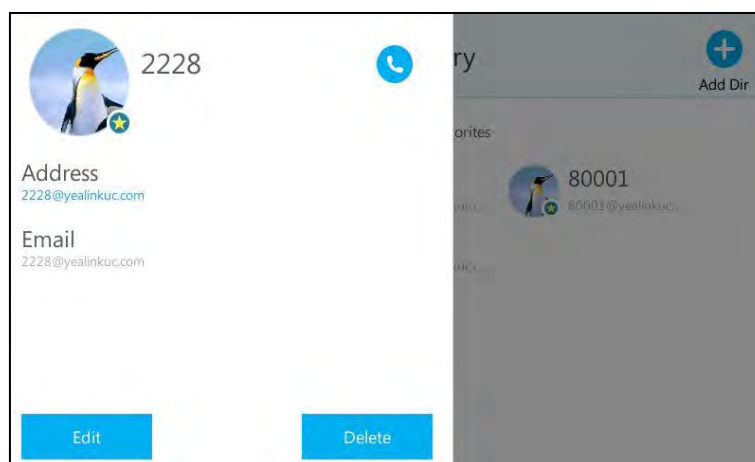

4. Tap the grey area on the right side or press  to return to the previous screen.

## Editing Local Contacts

**To edit a contact in the local directory:**

1. Tap  -> **Local Directory**.
2. Tap the desired group.
3. Tap the avatar of the desired contact.

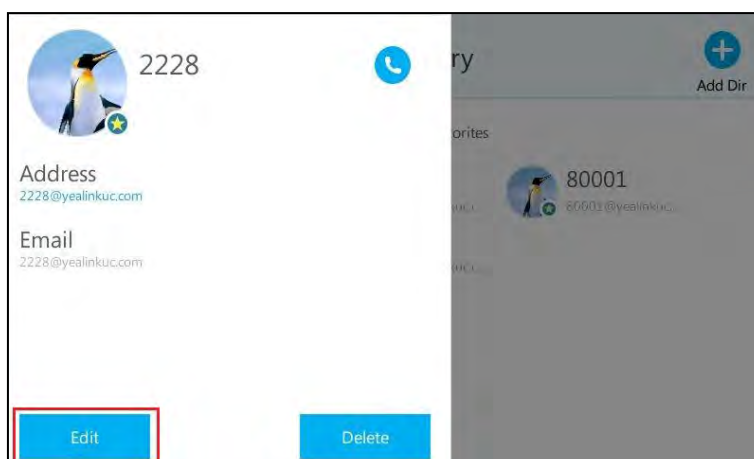

4. Tap the **Edit** soft key to edit the contact you selected.

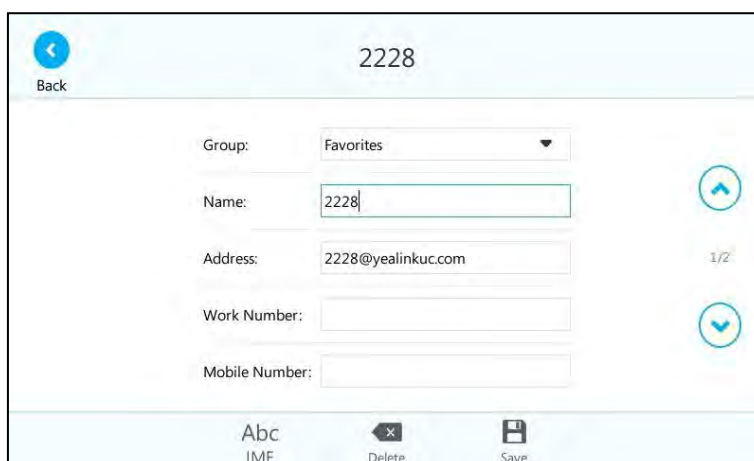

5. Tap the desired field to edit the contact information.

You can edit name, address, work number, mobile number, home number, title and email in the corresponding fields.



6. Tap  to accept the change or  to cancel.

Local directory is configurable via web user interface at the path **Directory->Local Directory**.

## Deleting Local Contacts

**To delete a contact from the local directory:**

1. Tap  -> **Local Directory**.
2. Tap the desired group.
3. Tap the avatar of the desired contact.
4. Tap **Delete**.



The touch screen prompts "Delete Selected Item?".

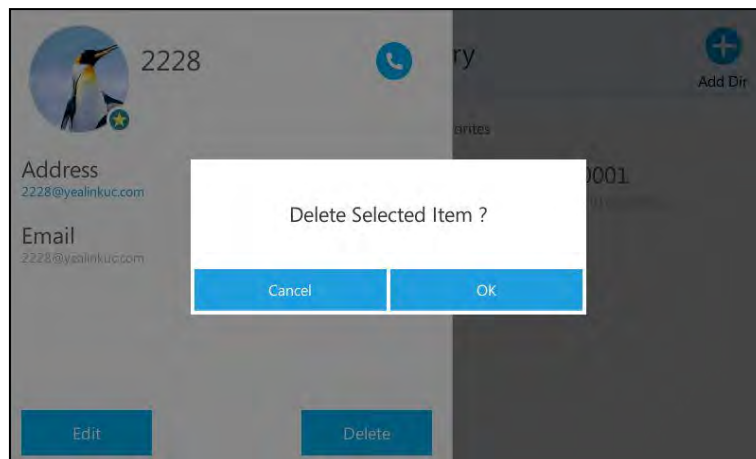

5. Tap the **OK** soft key to confirm the deletion or the **Cancel** soft key to cancel.

Deleting the contact is configurable via web user interface at the path **Directory->Local Directory**.

**To delete all contacts via web user interface:**

1. Click on **Directory->Local Directory**.
2. Click **Delete All** to delete all contacts.

The web user interface prompts "Do you want to delete all contacts in ContactList?".

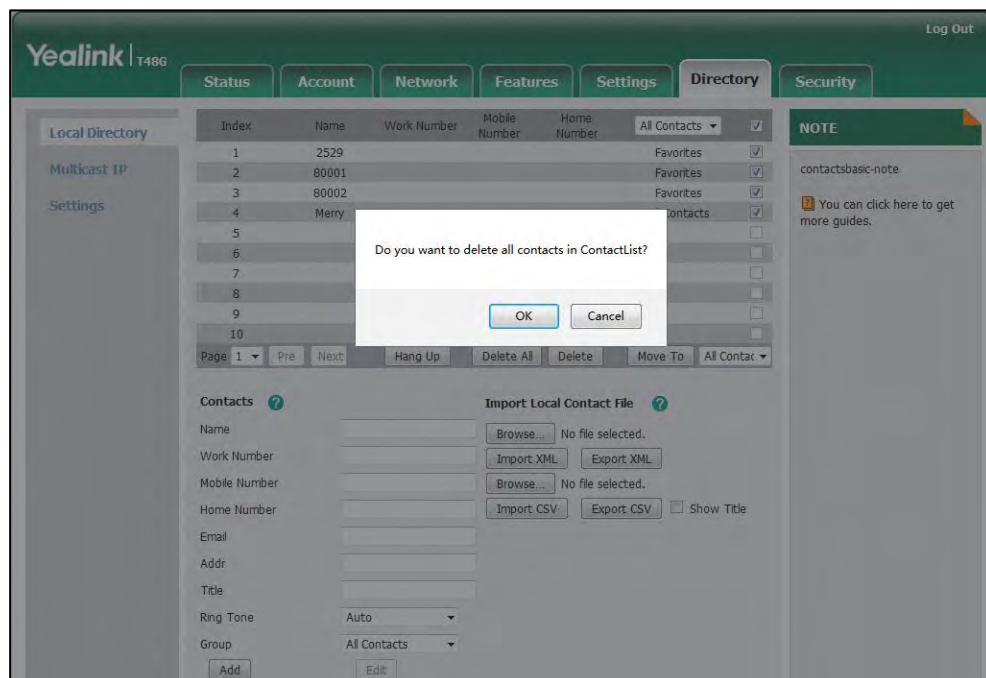

3. Click **OK** to complete deleting the contact list.

**Note**

Delete all contacts is available via web user interface only.

## Importing/Exporting Contact Lists

You can manage your phone's local directory via phone user interface or web user interface. But you can only import or export the contact list via web user interface.

### To import an XML contact list file via web user interface:

1. Click on **Directory->Local Directory**.
2. Click **Browse...** to locate a contact list file (the file format must be \*.xml) from your local system.
3. Click **Import XML** to import the contact list.

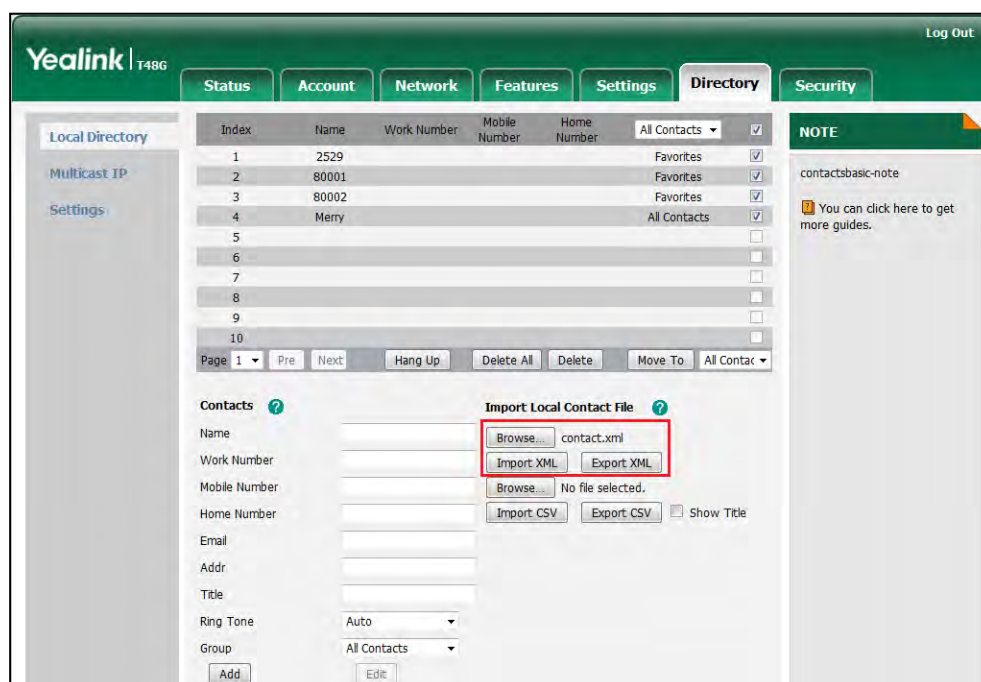

The web user interface prompts "The original contact will be covered, continue?".

4. Click **OK** to complete importing the contact list.

### To import a CSV contact list file via web user interface:

1. Click on **Directory->Local Directory**.
2. Click **Browse...** to locate a contact list file (the file format must be \*.csv) from your local system.
3. (Optional) Check the **Show Title** checkbox.

It will prevent importing the title of the contact information which is located in the first line of the CSV file.

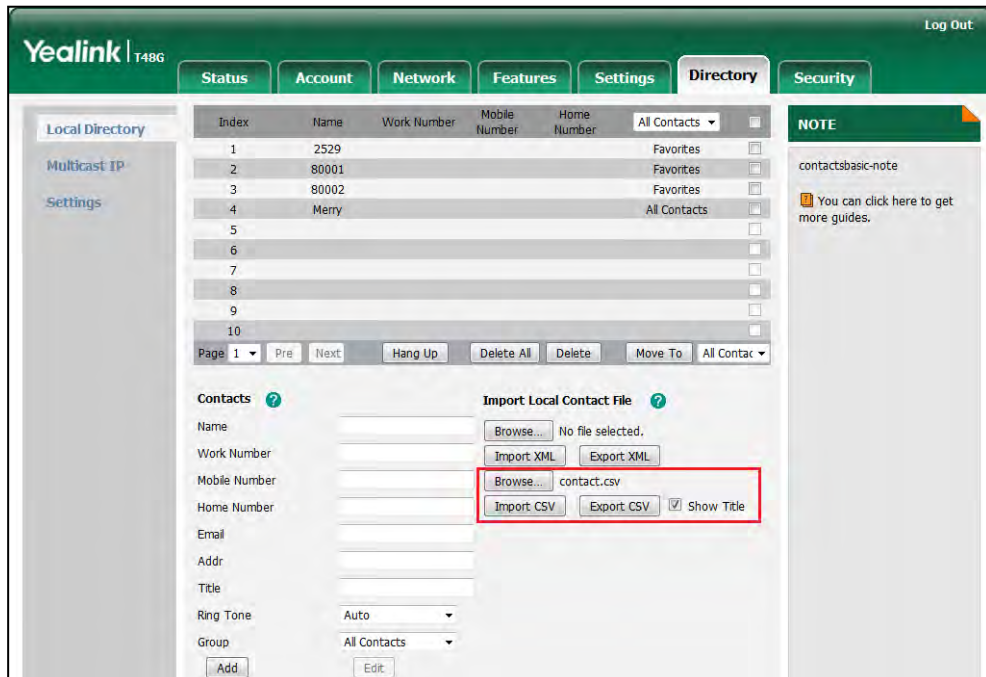

4. Click **Import CSV** to import the contact list.
5. (Optional) Mark the **On** radio box in the **Del Oldcontact** field.  
It will delete all existing contacts while importing the contact list.
6. Select the contact information you want to import into the local directory from the pull-down list of **Index**.  
At least one item should be selected to be imported into the local directory.

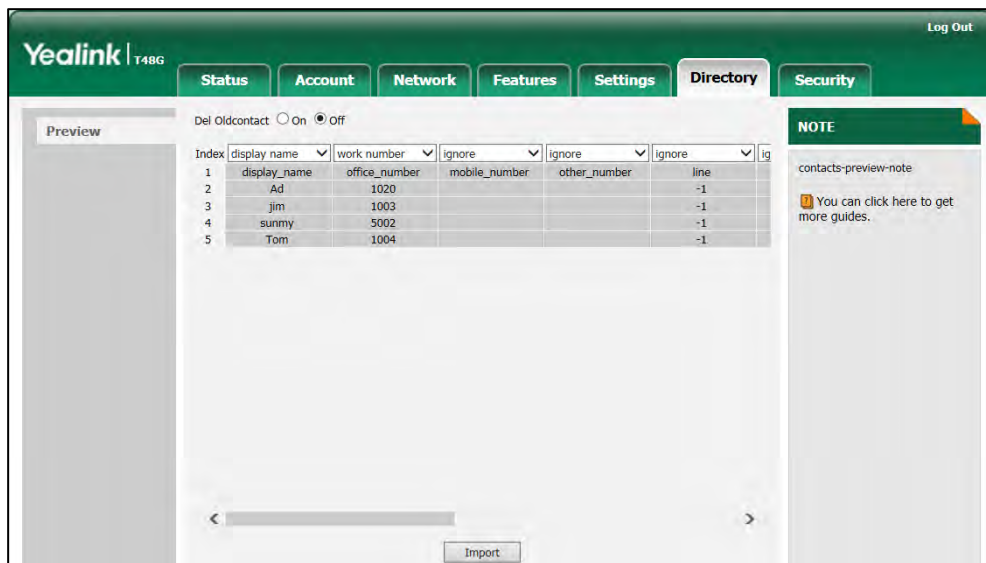

7. Click **Import** to complete importing the contact list.

**To export a contact list via web user interface:**

1. Click on **Directory**->**Local Directory**.
2. Click **Export XML** (or **Export CSV**).
3. Click **Save** to save the contact list to your local system.

## Local Favorites

Favorites are the contacts in your directory that you call most often. You can assign a index number to a favorite. Local favorites display consecutively according to their index number, and the contact with the lowest number displays first.

## Adding Local Favorites

You can add the local favorites manually or add local contacts as favorites.

**To add a local favorite via phone user interface:**

1. Tap  ->**Local Directory**->**Favorites**.

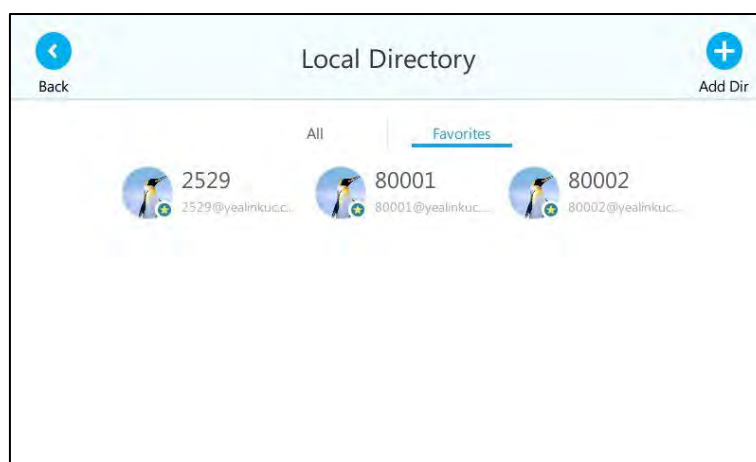



2. Tap  .

3. Enter the contact name, office, mobile, other numbers, Email, address and title in the corresponding fields.

4. Select the desired ring tone from the pull-down list of **Ring**.
5. Select the desired index number from the pull-down list of the **Index**.

The valid value of index number ranges from Null to 32 and the lowest number is Null. The contact with the lowest index number displays first.

6. Tap  to accept the change or  to cancel.

Adding a local favorite is configurable via web user interface at the path **Directory->Local Directory**.

**To add a local contact as the local favorite via phone user interface:**

1. Tap  -> **Local Directory**.
2. Tap the avatar of the desired contact.
3. Tap **Add to favorite**.

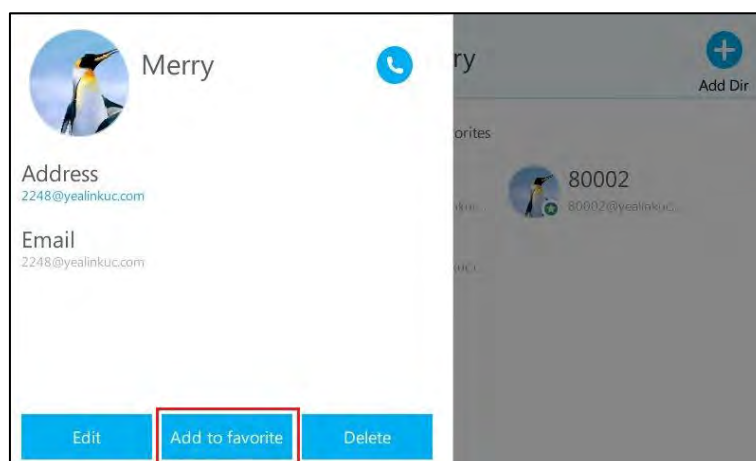



4. Select the desired index number from the pull-down list of the **Index**.
5. Tap  to accept the change.  
The entry is successfully saved to the local favorite.

Adding a local contact as the local favorites is configurable via web user interface at the path **Directory->Local Directory**.

### Viewing Local Favorites

You can view the local favorites on the Favorites screen or Contacts screen.

**To view the local favorites on the Favorites screen:**

1. Tap .  
Contacts that have a favorite index number display with the icon . By default, local favorites are displayed before the Skype for Business favorites.



**To view the local favorites on the Contacts screen:**

1. Tap  -> **Local Directory**-> **Favorites**.

Contacts that have a favorite index number display with the icon .

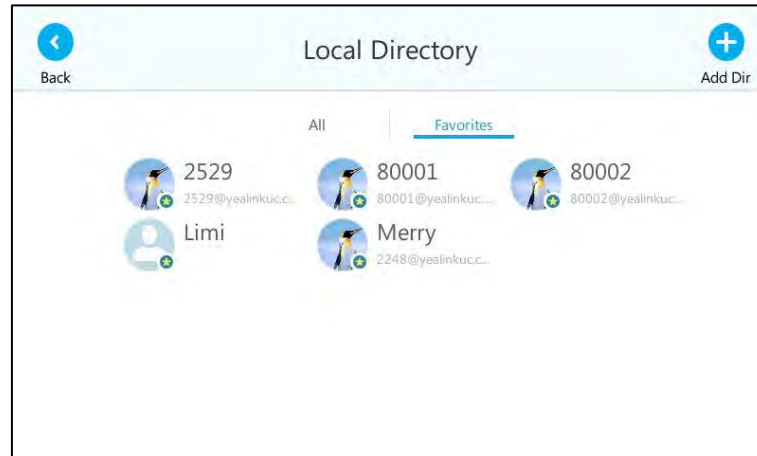

2. Tap the avatar of the desired contact.  
The detailed information (e.g., display name, address or email) of the contact appears on the touch screen.
4. Tap the grey area on the right side or press  to return to the previous screen.

**Reordering Local Favorites**

To reorder your local favorites, assign the local favorite a different index number.

**To reorder your local favorites:**



1. Tap  -> **Local Directory**-> **Favorites**.

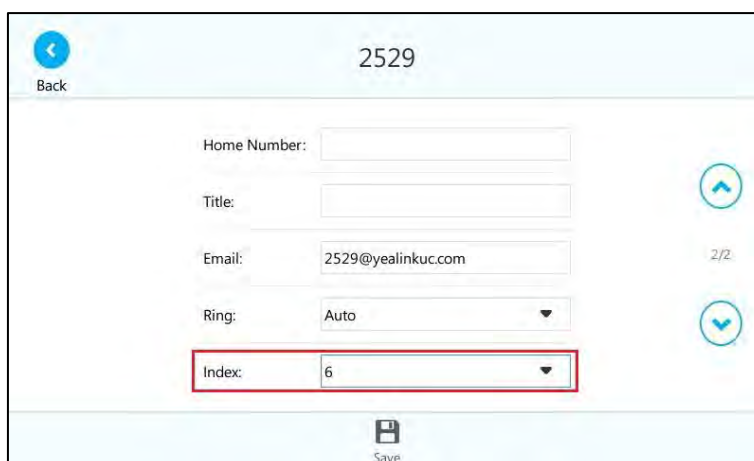

2. Tap the avatar of the desired contact.
3. Tap the **Edit** soft key to edit the contact you selected.

4. Select the desired index number from the pull-down list of **Index**.



5. Tap  to accept the change or  to cancel.  
The phone uses the new index number to order the favorite.

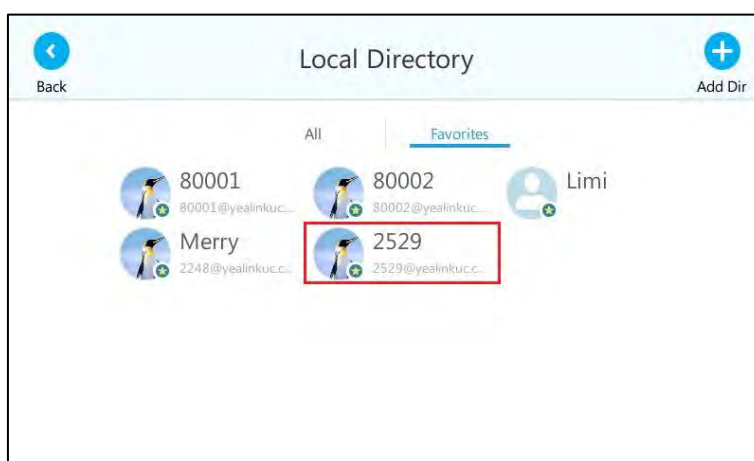

## Managing Local Favorites

Local favorites and Skype for Business favorites of T48G Skype for Business phones are displayed on the idle screen. By default, local favorites are displayed before the Skype for Business favorites.

You can configure whether to display local favorites on the idle screen and configure the display order of the local favorites.

**Example:** 2228, 2529, 80001 and 80002 are your local favorites. 80001, Daisy, Hedy and Merry are your Skype for Business favorites.



Local favorite is indicated by the icon . The following figure shows a sample Favorites list on the idle screen.

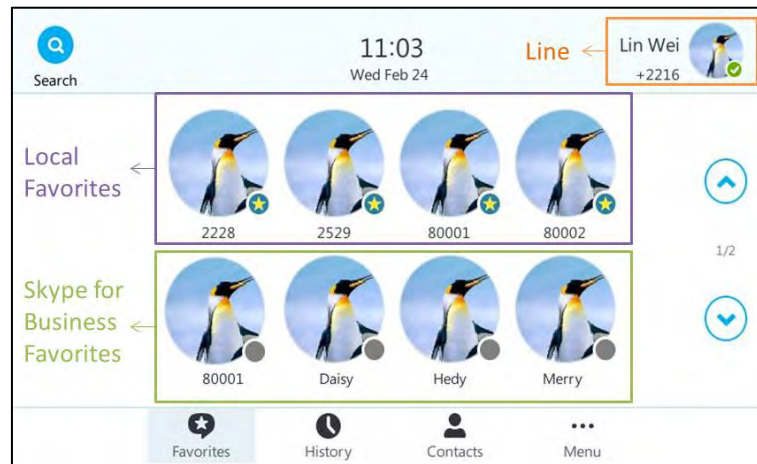

When the number of favorite contacts is more than 8, the page switch keys will appear on the right side of the main window.

You can tap ,  or press ,  to turn pages to view other favorites.

**To configure the display priority of local favorite via web user interface:**

1. Click on **Directory->Settings**.
2. Select the desired value from the pull-down list of **Local Favorite**.
3. Depending on your selection:
  - If **Disabled** is selected, only the Skype for Business favorites are displayed on the idle screen.
  - If **Preferential** is selected, local favorites will be displayed before the Skype for Business favorites on the idle screen.
  - If **General** is selected, the local favorites will be displayed behind the Skype for Business favorites on the idle screen.

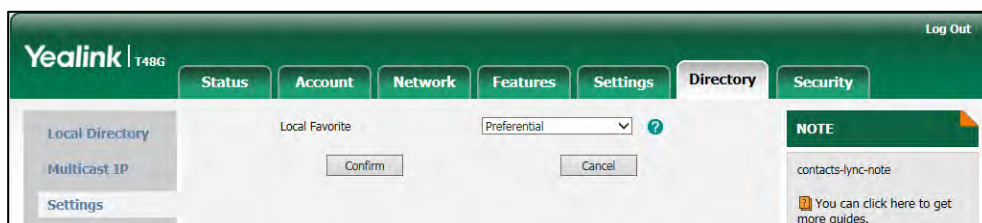

4. Click **Confirm** to accept the change.

**Note**



You can configure the display priority of local favorite via web user interface only.

## Placing Calls to Contacts

**To place a call from the Favorites screen:**

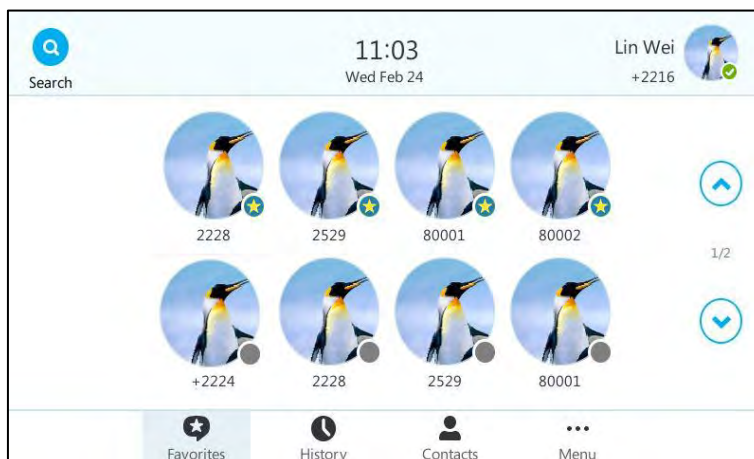
1. Tap .





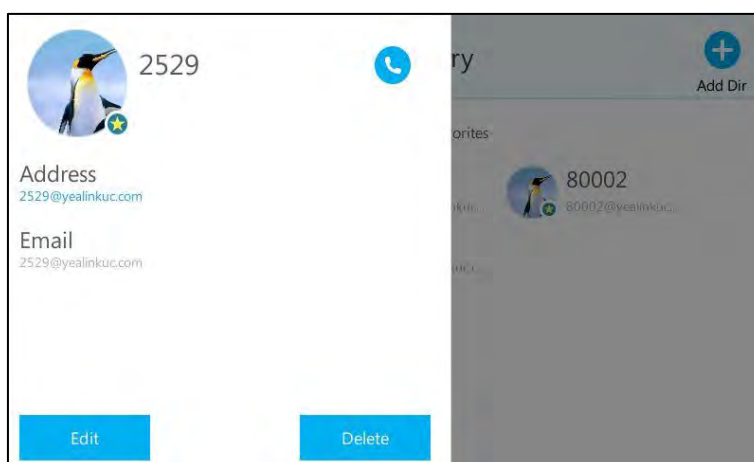

2. Tap the avatar of the desired contact.
  - If a contact has only one number, the contact number will be dialed out directly.
  - If a contact has multiple numbers, press  or tap , the first number will be dialed out by default.

**To place a call from the directory:**

1. Tap .
2. Tap the group that contains the desired contact.
3. Tap the avatar of the desired contact, the detailed information of the contact appears on the touch screen.



4. Press  or tap  or tap the desired number to place a call.
 

If a contact has multiple numbers, press  or tap , the first number will be dialed

out by default.

## Searching for Contacts

You can search for Skype for Business contacts, local contacts and Microsoft Outlook contacts on the pre-dialing screen. You can also configure the Skype for Business phone to search for contacts after the designated time.

### Search for a contact on the pre-dialing screen:

1. Tap .
2. Press the keypad keys to enter the first few continuous characters of the contact name or the contact number.

The phone performs an Intelligent search (e.g., press the digit key 2 to search the letters "2, a, b and c").

The entries whose name or phone number matches the characters entered will appear on the touch screen. You can dial from the result list.

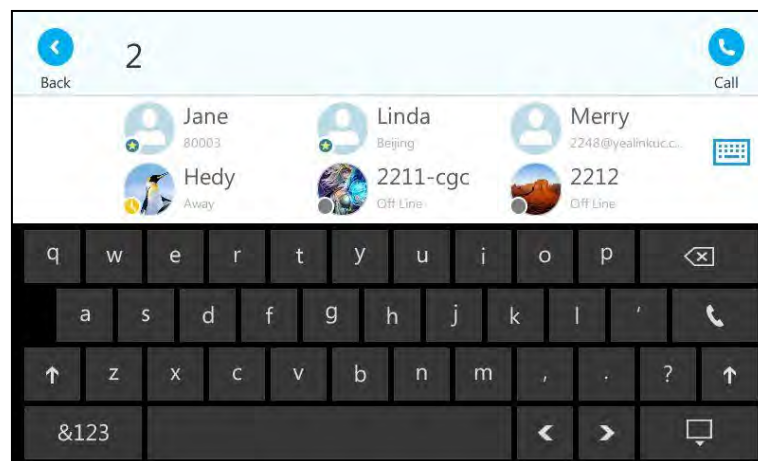

### To configure dial search delay via web user interface:

1. Click on **Features->General information**.
2. Enter the desired value (in seconds) in the **Dial Search Delay** field.

The default value is "1".

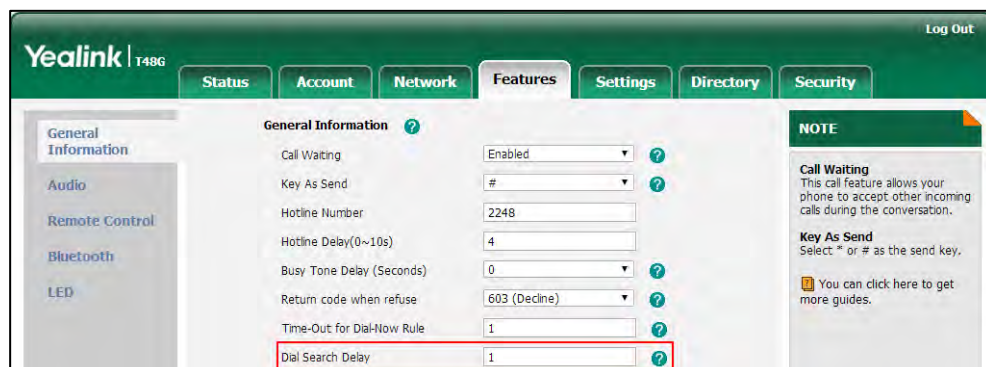

3. Click **Confirm** to accept the change.

**Note**

Dial search delay feature is configurable via web user interface only.

## Call History Management

The T48G Skype for Business phone maintains call history lists of Missed, Placed and Received. Each call history list supports up to 100 entries. You can view the call history, place a call, or delete an entry from the call history list.



History record feature is enabled by default, if you don't want to save the call history, you can disable this feature.

Contacts avatar allows the call history to display the contact avatars. It is enabled by default, if you don't need contact avatars of the call history, you can disable this feature.

**To disable history record via phone user interface:**

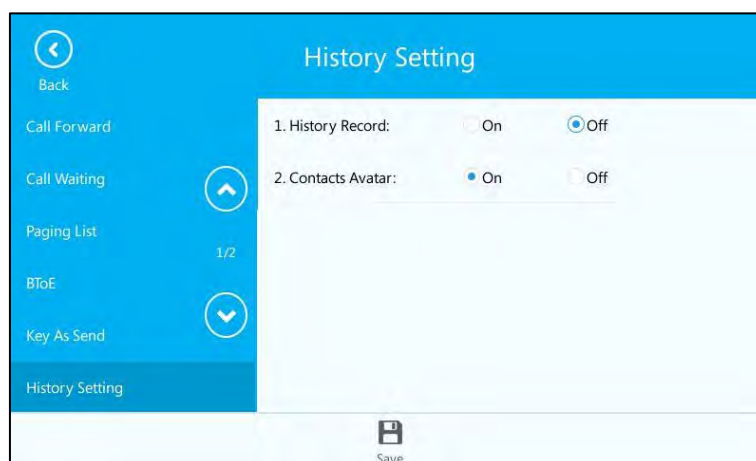
1. Tap **...** -> **Features**>**History Setting**.
2. Tap the **Off** radio box of the **History Record** field.





3. Tap  to accept the change or tap  to cancel.

**To disable contact avatar via phone user interface:**

1. Tap **...** -> **Features**>**History Setting**.

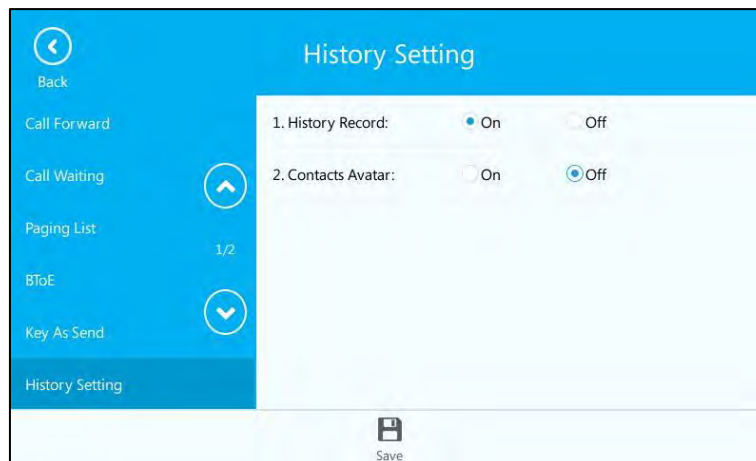
2. Tap the **Off** radio box of the **Contact Avatar** field.



3. Tap  to accept the change or tap  to cancel.

Contact avatar is configurable via web user interface at the path **Features->General Information**.

**To view the call history:**

1. Tap .

The touch screen displays all call records.

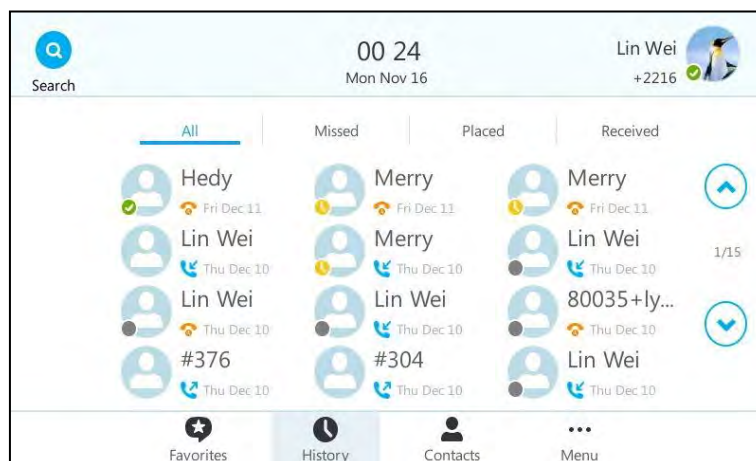

2. Tap ,  or press ,  to turn pages.

You can tap **All**, **Missed**, **Placed** or **Received** to view entries in each call list directly.

3. Tap the desired entry.

The detailed information (e.g., avatar, display name or number) of the entry appears on the touch screen.

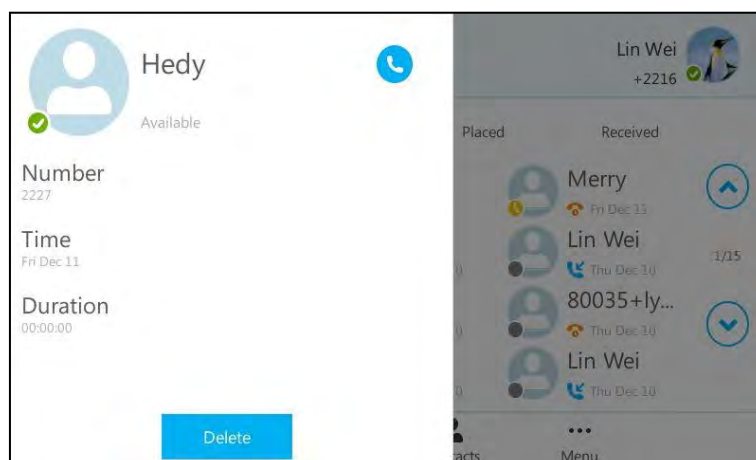

4. Tap the grey area of the right side or press to return to the previous screen.

**To place a call from the call history list:**

1. Tap .  
The touch screen displays all call records.
2. Tap or or press or to turn pages.  
You can tap **All**, **Missed**, **Placed** or **Received** to view entries in each call list directly.
3. Tap the desired entry.  
The detailed information (e.g., avatar, display name or number) of the entry appears on the touch screen.
4. Tap or press to place a call.

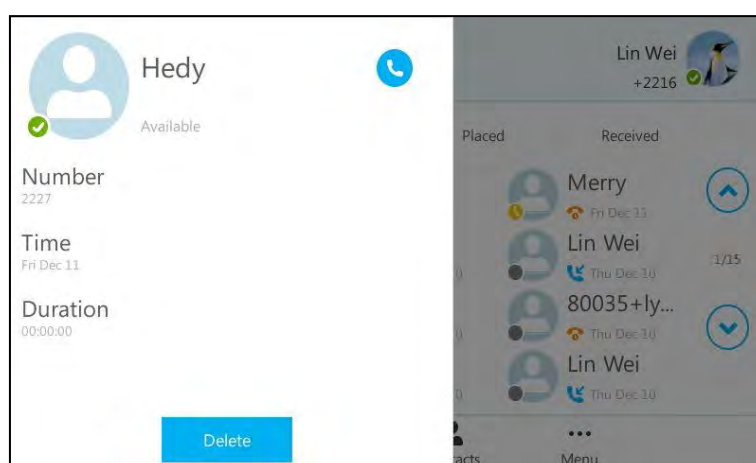

**To delete an entry from the call history list:**

1. Tap .
2. Tap , or press , to turn pages.

You can tap **All**, **Missed**, **Placed** or **Received** to view entries in each call list directly.

3. Tap the desired entry.
4. Tap **Delete**.

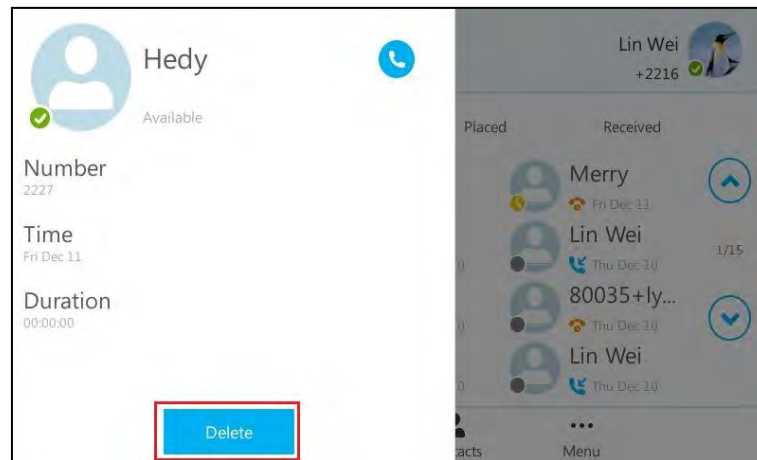

The touch screen prompts "Delete the selected record?".

5. Tap the **OK** soft key to confirm the deletion or the **Cancel** soft key to cancel.

#### Note

The above introduces the default power indicator LED status. The status of the power indicator LED is configurable via web user interface. For more information, refer to [Yealink\\_Skype\\_for\\_Business\\_HD\\_IP\\_Phones\\_Administrator\\_Guide](#).

## Headset Use

If you want to use a wired headset, physically connect your headset to the phone and activate the headset mode for use. For more information on physically connecting a headset, refer to [Phone Installation](#) on page 14.

If you want to use a wireless headset, insert the Bluetooth USB dongle into the USB port on the back of the phone. For more information on using a Bluetooth headset, refer to [Bluetooth Headset](#) on page 92.

This section provides an introduction to wired headset use.

#### Note

If both a Bluetooth headset and a wired headset are connected, only the Bluetooth headset can be used.

## Headset Mode Activation/Deactivation

**To activate the headset mode:**

1. Press  on the phone.

The HEADSET key LED illuminates solid green when the headset mode is activated. When you tap  to answer an incoming call, the call is connected to your headset automatically.

For more information on using the headset to answer a call, refer to [Answering Calls](#) on page 117.

With the handset on-hook, enter the desired number and tap  , the phone will then place a call using the headset automatically. For more information on using the headset to place a call, refer to [Placing Calls](#) on page 114.

**To deactivate the headset mode:**

1. Press  again on the phone.

The HEADSET key LED goes out when the headset mode is deactivated.

## Headset Prior

You can use headset in priority when headset prior feature is enabled. This feature is especially useful for permanent or full-time headset users.

**To enable headset prior via web user interface:**

1. Click on **Features**->**General Information**.
2. Select **Enabled** from the pull-down list of **Headset Prior**.

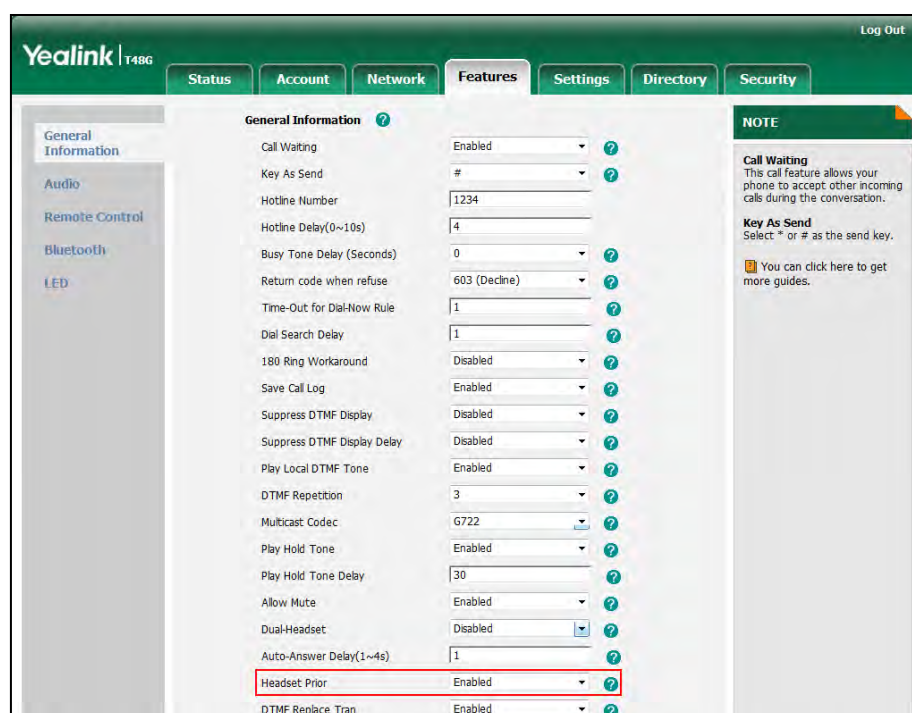

3. Click **Confirm** to accept the change.

**To use headset prior, you should activate the headset mode in advance:**

1. Physically connect the headset.



- Press  to activate the headset mode.

**Note**

If headset prior is enabled, the headset mode will not be deactivated until you press the **HEADSET** key again.

If headset prior is disabled, the headset mode can be deactivated by pressing the speakerphone key or the **HEADSET** key.

Headset prior is configurable via web user interface only.

## Dual Headset

You can use two headsets when dual headset feature is enabled. To use this feature, you must physically connect headsets to the headset jack and handset jack respectively. Once the phone connects to a call, the headset connected to the headset jack will have full-duplex capabilities, while the one connected to the handset jack will only be able to listen.

**To enable dual headset via web user interface:**

- Click on **Features**->**General Information**.
- Select **Enabled** from the pull-down list of **Dual-Headset**.

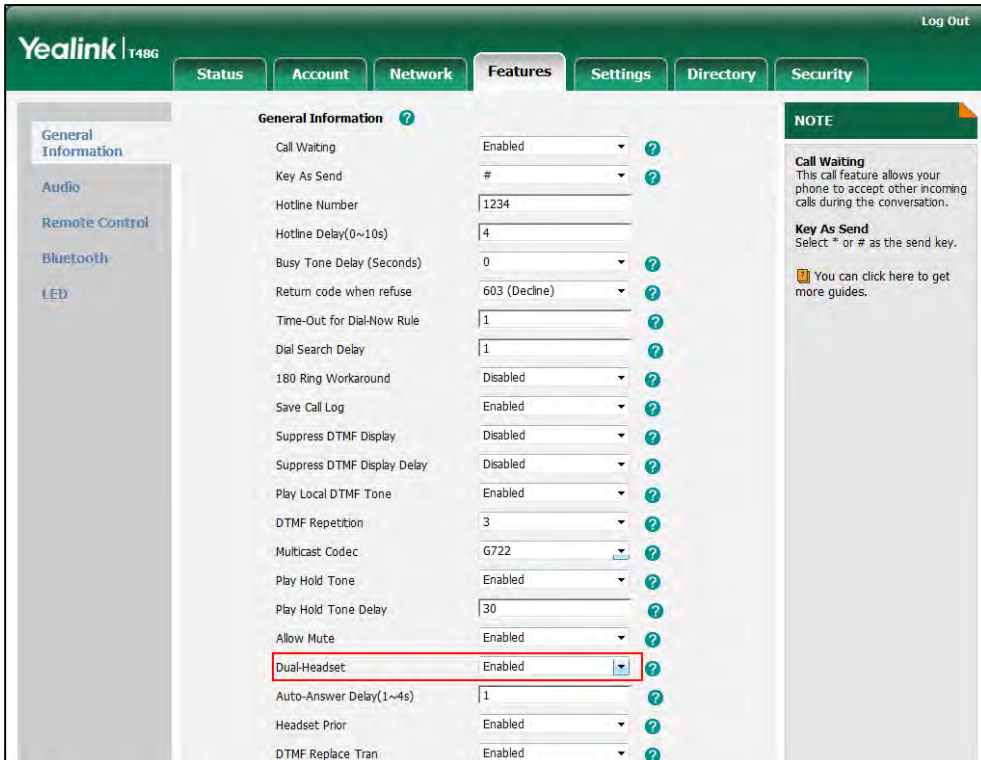

The screenshot shows the Yealink T48G web user interface. The 'Features' tab is selected, and the 'General Information' section is expanded. The 'Dual-Headset' option is highlighted with a red box and is set to 'Enabled'. Other options include Call Waiting, Key As Send, Hotline Number, Hotline Delay, Busy Tone Delay, Return code when refuse, Time-Out for Dial-Now Rule, Dial Search Delay, 180 Ring Workaround, Save Call Log, Suppress DTMF Display, Suppress DTMF Display Delay, Play Local DTMF Tone, DTMF Repetition, Multicast Codec, Play Hold Tone, Play Hold Tone Delay, Allow Mute, Auto-Answer Delay, Headset Prior, and DTMF Replace Tran.

Feature	Value
Call Waiting	Enabled
Key As Send	#
Hotline Number	1234
Hotline Delay(0~10s)	4
Busy Tone Delay (Seconds)	0
Return code when refuse	603 (Decline)
Time-Out for Dial-Now Rule	1
Dial Search Delay	1
180 Ring Workaround	Disabled
Save Call Log	Enabled
Suppress DTMF Display	Disabled
Suppress DTMF Display Delay	Disabled
Play Local DTMF Tone	Enabled
DTMF Repetition	3
Multicast Codec	G722
Play Hold Tone	Enabled
Play Hold Tone Delay	30
Allow Mute	Enabled
<b>Dual-Headset</b>	<b>Enabled</b>
Auto-Answer Delay(1~4s)	1
Headset Prior	Enabled
DTMF Replace Tran	Enabled

- Click **Confirm** to accept the change.

**Note**

Dual headset is configurable via web user interface only.

## Bluetooth Headset

The T48G Skype for Business phone supports Bluetooth. Bluetooth enables low-bandwidth wireless connections within a range of 10 meters (32 feet). The best performance is in the 1 to 2 meter (3 to 6 feet) range.

You can activate/deactivate the Bluetooth mode on the phone, and then pair and connect the Bluetooth headset with your phone. You can pair up to 30 Bluetooth headsets with your phone. However, only one headset can be connected at a time. You can also disconnect and delete your Bluetooth headset from the phone.

### Note

Ensure that the Bluetooth USB dongle is properly connected to the USB port on the back of the phone. For more information, refer to [Phone Installation](#) on page 14.

## Activating the Bluetooth Mode

When you insert Bluetooth USB dongle BT40 into the USB port at the back of the IP phone, the touch screen prompts “Adapter has been added, scanning the bluetooth devices right now?”. You can tap **OK** to activate Bluetooth mode directly and then scan Bluetooth devices automatically.

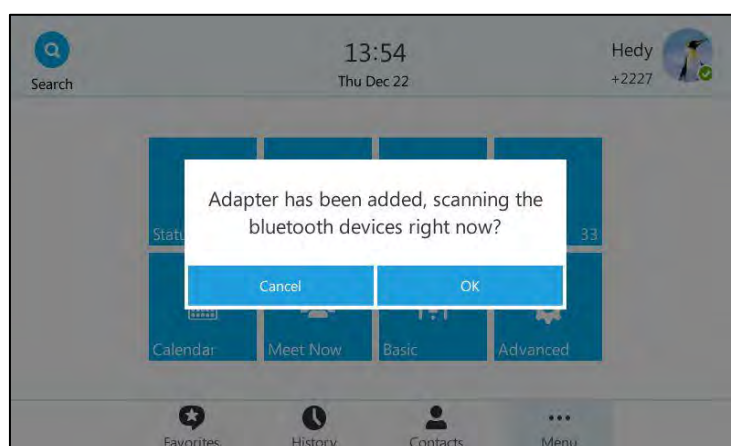

### To activate the Bluetooth mode via phone user interface:

1. Tap **...**->**Basic**->**Bluetooth**.
2. Tap **On** radio box of the **Bluetooth** field.

The Skype for Business phone scans the available Bluetooth headset automatically.

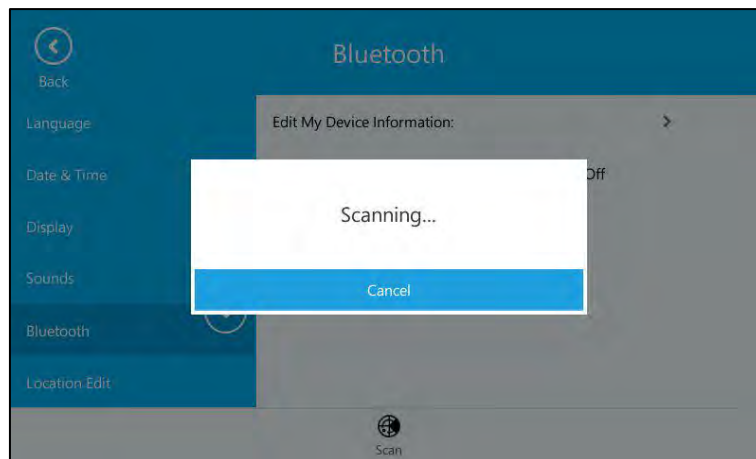

The touch screen displays the Bluetooth device information (device name and MAC address).

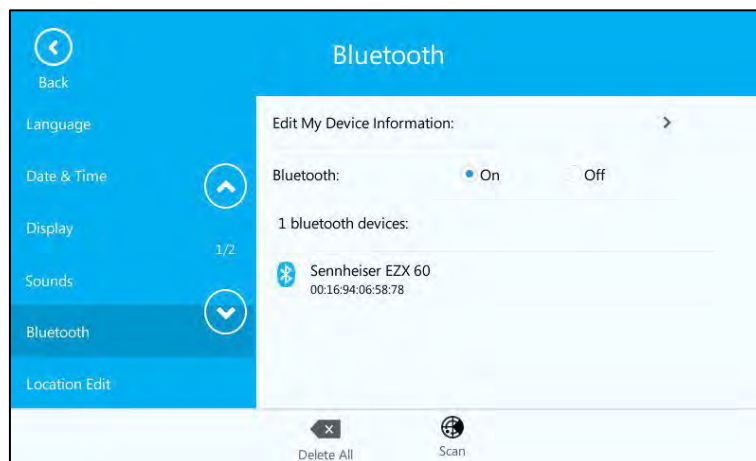

Bluetooth mode is configurable via web user interface at the path **Features->Bluetooth**.

## Pairing and Connecting the Bluetooth Headset

Before you pair a Bluetooth headset, check the indicator on the Bluetooth headset to make sure that the Bluetooth headset is discoverable. For more information, refer to the documentation from the Bluetooth headset manufacturer.

**To pair and connect your Bluetooth headset to your phone:**

1. Tap **...** -> **Basic**-> **Bluetooth**.
2. Tap the Bluetooth device to connect the Bluetooth headset to your phone.

If there is no Bluetooth device available on the touch screen, tap  to search for the Bluetooth device again.

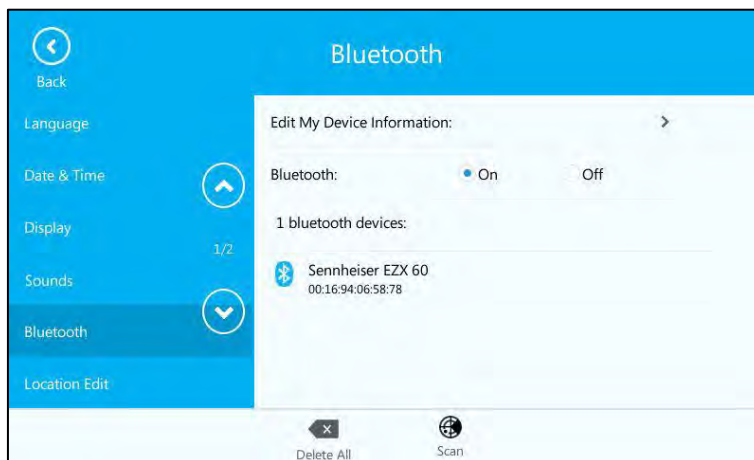

3. Enter the PIN (e.g., 0000) in the prompted **Password** field.

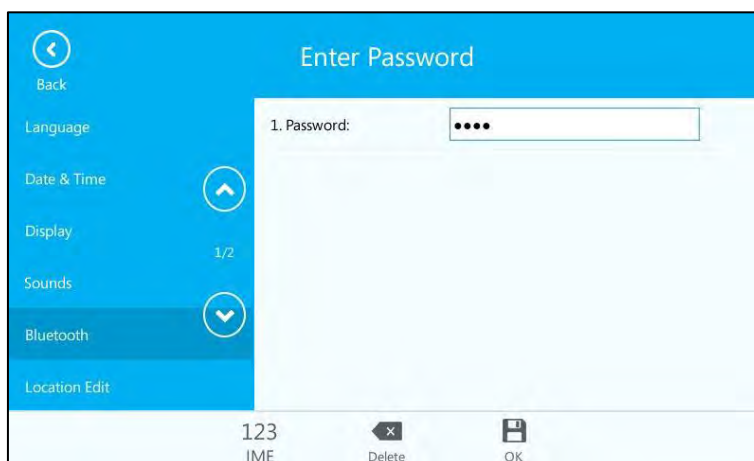

4. Tap .

The Bluetooth headset is then automatically connected to your phone. The touch screen displays as below:

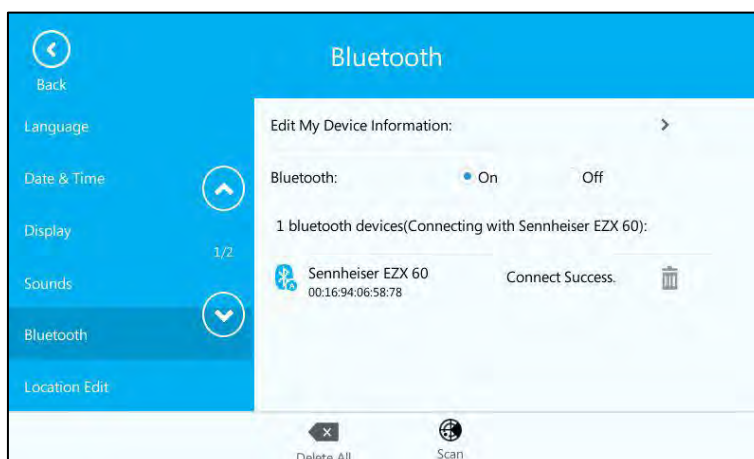

The prompting message “Bluetooth connect” appears on the touch screen.

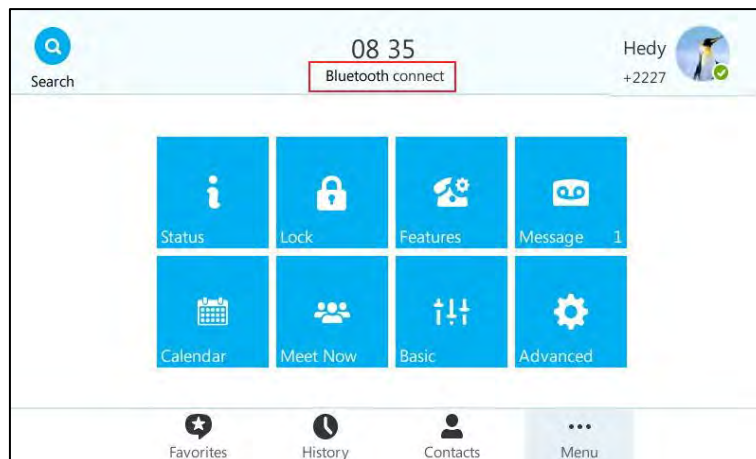

With the Bluetooth headset paired and connected, you can use the Bluetooth headset to place and answer calls. For more information, refer to the documentation from the Bluetooth headset manufacturer.

## Viewing the Bluetooth headset information

**To view the Bluetooth headset information:**

1. Tap **...** -> **Basic**-> **Bluetooth**.
2. Tap the **On** radio box of the **Bluetooth** field.  
The touch screen displays a list of Bluetooth headsets.
3. You can view the Bluetooth headset information from the Bluetooth devices field.
  - **Device Name:** the name of the Bluetooth headset.
  - **MAC Address:** the MAC address of the Bluetooth headset.
  - **Connection:** the connection status of Bluetooth headset with your phone.

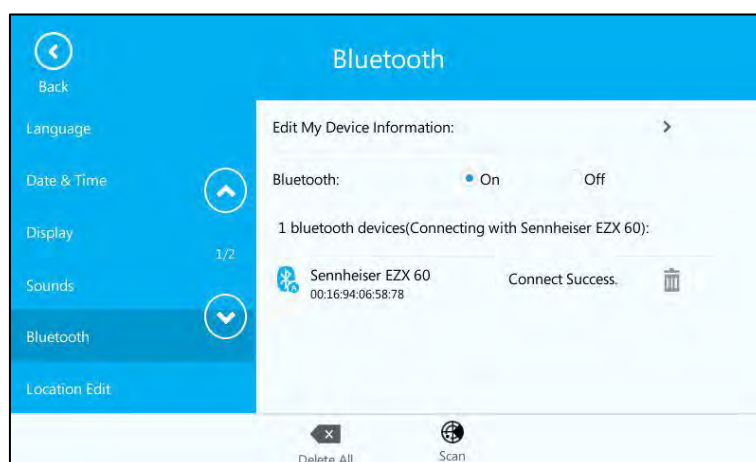

## Editing Device Information

### To edit device information via phone user interface:

1. Tap **⋮** ->**Basic**->**Bluetooth**.
2. Tap the **Edit My Device Information** field.

The touch screen displays the device name and MAC address. The MAC address cannot be edited.

3. Enter the desired name in the **Device Name** field.

The default device name is "Yealink-T48G".

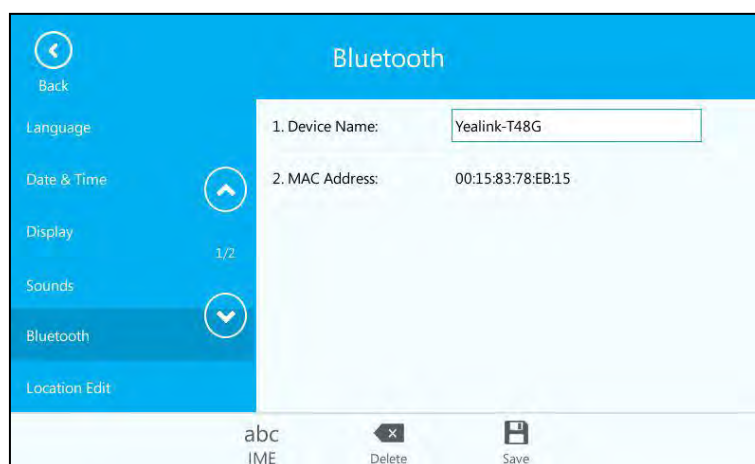

4. Tap **Save** to accept the change or **Back** to cancel.

The preconfigured Bluetooth device name will display in scanning list of other device.

## Disconnecting the Bluetooth Headset

You can disconnect the Bluetooth headset from your phone. After you disconnect the Bluetooth headset, it will still remain paired and be displayed in the **Paired Bluetooth Device** list. So you can easily connect it to your phone again.

### To disconnect your Bluetooth headset from your phone:

1. Tap **⋮** ->**Basic**->**Bluetooth**.

2. Tap the connected Bluetooth headset.

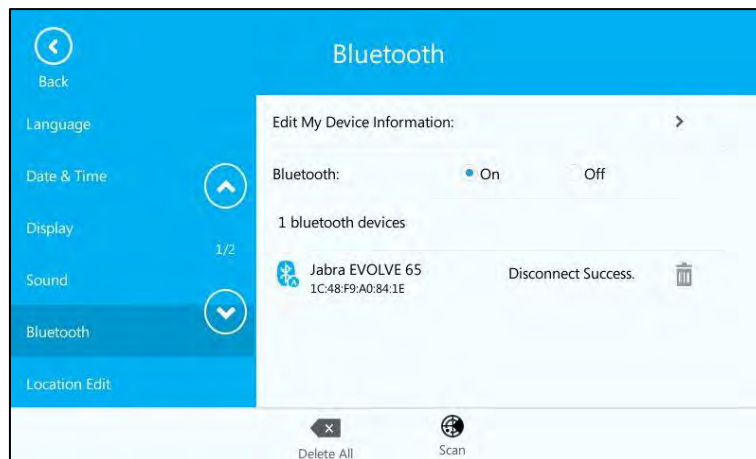

The Bluetooth headset is disconnected. To connect it to your phone again, tap the Bluetooth headset again.

## Deleting the Paired Bluetooth Headset

You can delete your Bluetooth headset from your phone. When you delete the Bluetooth headset, it disappears from the **Paired Bluetooth Device** list. To connect it to your phone again, you need to scan and connect it again.

### To delete your Bluetooth headset from your phone:

1. Tap **...**-> **Basic**-> **Bluetooth**.
2. Tap  after the desired Bluetooth headset you want to delete.

The touch screen prompts the following warning "Delete selected item?".

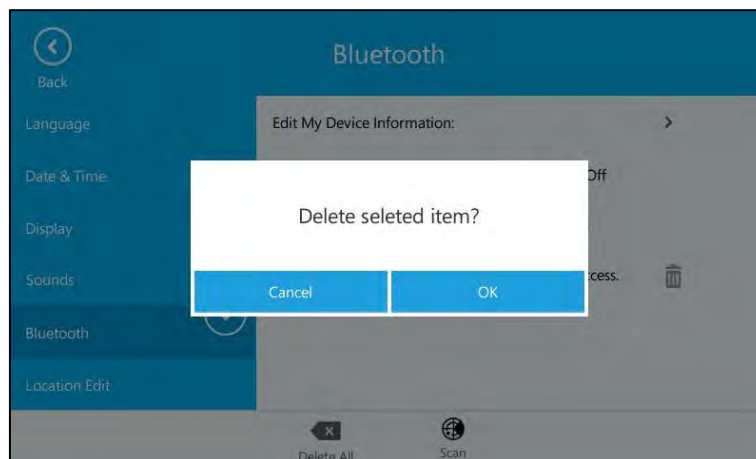

3. Tap the **OK** soft key to confirm the deletion or the **Cancel** soft key to cancel. You can also delete all headsets by tapping the **Delete All** soft key.

## Deactivating the Bluetooth Mode

To deactivate the Bluetooth mode via phone user interface:

1. Tap **...** -> **Basic**-> **Bluetooth**.
2. Tap the **Off** radio box of the **Bluetooth** field.

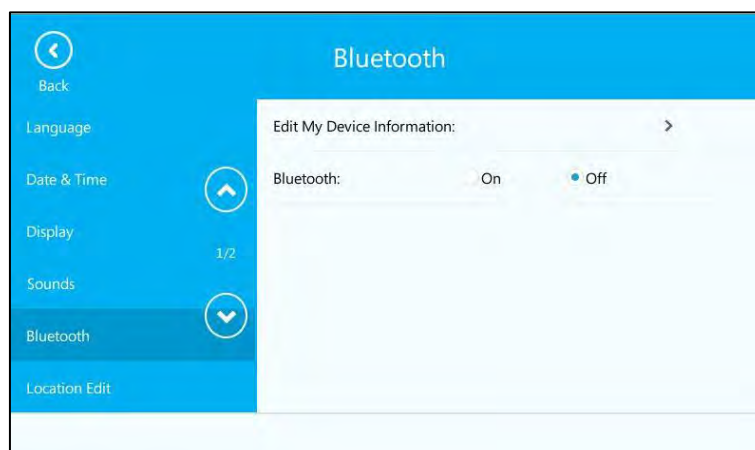

The Bluetooth headset won't be connected anymore, but it will still be paired. When you activate the Bluetooth mode again, the paired Bluetooth headset will appear in the **Bluetooth Device(s)** list.

Bluetooth mode is configurable via web user interface at the path **Features**-> **Bluetooth**.

## E911

E911 (Enhanced 911) is a location technology that enables the called party to identify the geographical location of the calling party. For example, if a caller makes an emergency call to E911, the feature extracts the caller's information for the police department to immediately identify the caller's location.

## E911 Location Tip

The system administrator configures geographical location for users on the Skype for Business Server. After user signs in, the geographical location is downloaded to the phone. If geographical location is not provisioned by the server, an E911 location tip will appear to prompt the user that the location of the phone is not set.

To configure E911 location tip via web user interface:

1. Click on **Features**->**General information**.
2. Select desired value from the pull-down list of **E911 Location Tip**.
  - If you select **Enabled** from the pull-down list of **E911 Location Tip**.

When the location is not set, location notification depends on the configuration on the Skype for Business Server.



- If you select **Disabled** from the pull-down list of **E911 Location Tip**.  
No matter whether the location is not set, the touch screen will not prompt the location notification.

For more information, refer to [Location Notification](#) on page 99.

The screenshot shows the Yealink T48G web interface with the 'Features' tab selected. The 'General Information' section contains the following settings:

Setting	Value
Call Waiting	Enabled
Key As Send	#
Hotline Number	
Hotline Delay(0~10s)	4
Busy Tone Delay (Seconds)	0
Return code when refuse	603 (Decline)
Diversion/History-Info	Enabled
Auto-Logout Time(1~1000min)	5
Call Number Filter	
Voice Mail Tone	Enabled
DHCP Hostname	SIP-T48G
<b>E911 Location Tip</b>	<b>Enabled</b>
Update Checking Time	24
Use DHCP Option 120	Disabled
SFB Cert Service URL	
Enable SFB Automation	Disabled
SFB Inactive Time	5
SFB Away Time	5
Web Sign in	Enabled
Remember Password	Disabled
History Record Contacts Avatar	Enabled

The 'NOTE' sidebar on the right contains the following information:

**Call Waiting**  
This call feature allows your phone to accept other incoming calls during the conversation.

**Key As Send**  
Select \* or # as the send key.  
You can click here to get more guides.

3. Click **Confirm** to accept the change.

**Note** When the location is set, no matter whether E911 location tip is enabled or disabled, the touch screen will not prompt the location notification.

E911 location tip feature is configurable via web user interface only.

## Location Notification

When E911 location tip feature is enabled and the location of the phone is not set, the location notification depends on the configuration on the Skype for Business Server.

- a) When the parameter **Location Required** is set to **Yes** on the Skype for Business Server, the **Status** menu will display  icon. The touch screen is shown as below after login:

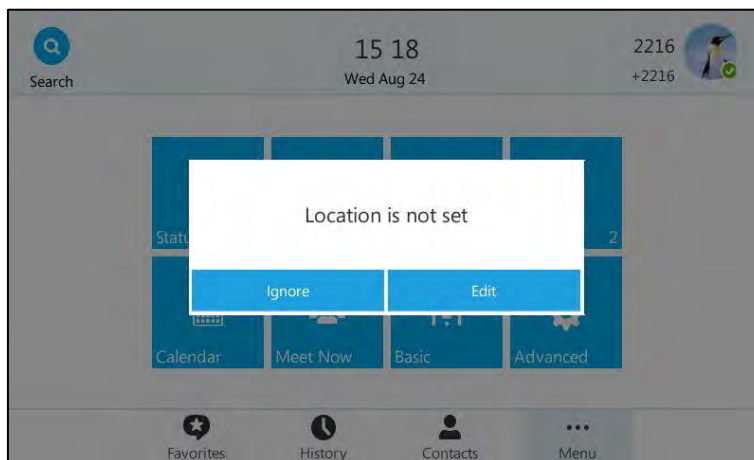

You can do one of the following:

- Tap the **Ignore** soft key.  
The phone will return to the idle screen.
  - Tap the **Edit** soft key.  
The phone will enter the **Location Edit** screen.
- b) When the parameter **Location Required** is set to **Disclaimer** on the Skype for Business Server, the **Status** menu will display  icon. The touch screen is shown as below after login:

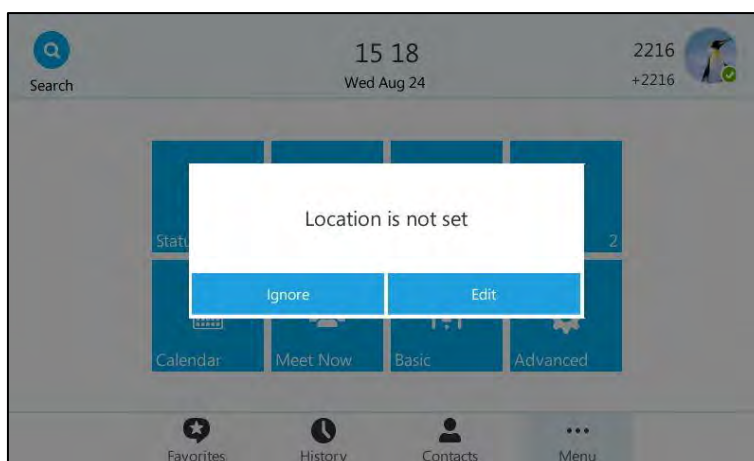

- You can do one of the following:  
Tap the **Ignore** soft key.

The phone will display the disclaimer configured on the Skype for Business Server.

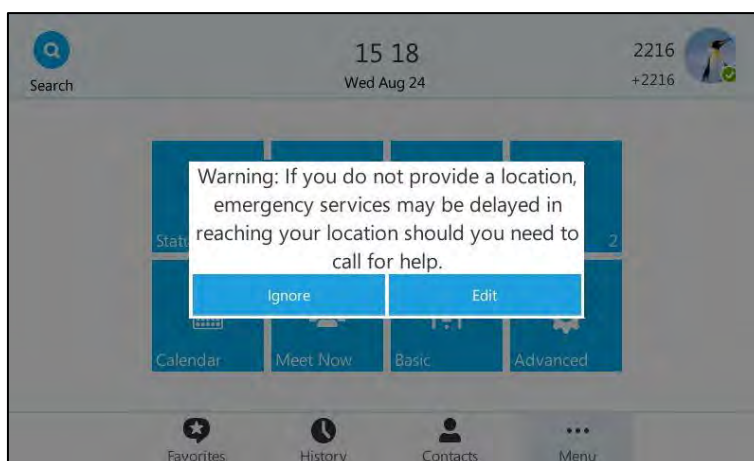

You can tap the **Ignore** soft key to return to the idle screen or tap the **Edit** soft key to enter the **Location Edit** screen.

- Tap the **Edit** soft key.

The phone will enter the **Location Edit** screen.

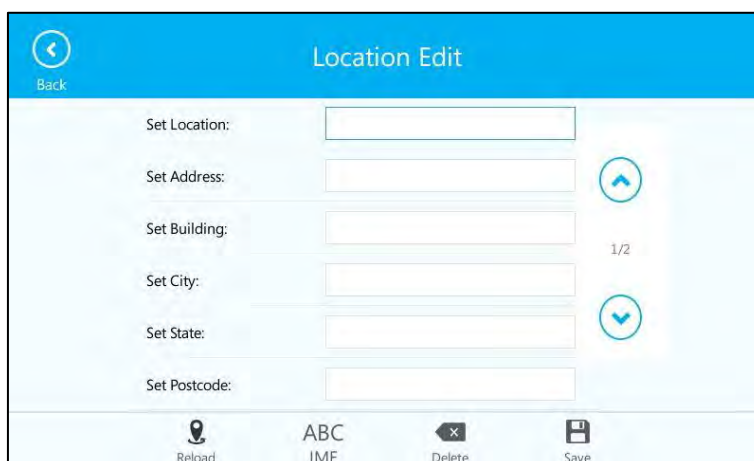

- c) When the parameter **Location Required** is set to **No** on the Skype for Business Server, the Status menu will not display  icon. The touch screen is shown as below after login:



## Adding the Location Information

You can add the location information in one of the two ways:

- Reload the location information from the Skype for Business Server.
- Add the location information manually.

## Reloading the Location Information from the Skype for Business Server

The network administrator configures geographical location on the Skype for Business Server for the phone. After the phone signs in or reboots, the geographical location is downloaded automatically. The phone will update the geographical location every 4 hours automatically. If the geographical location configured on the server updates, you can also reload it via phone user interface manually.

**To reload the location information via phone user interface:**

1. Tap **...** -> **Basic** -> **Location Edit**.
2. Tap the **Reload** soft key to reload the location information from the Skype for Business Server.

Location set on the phone will be covered by location set on the Skype for Business Server.

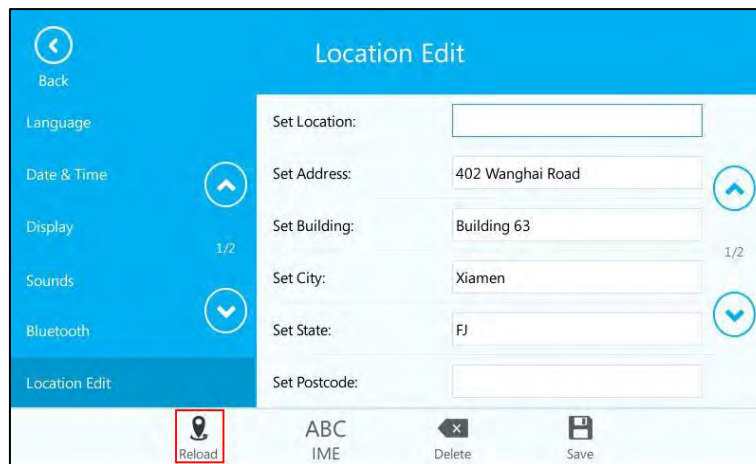



## Adding the Location Information Manually

If geographical location is not provisioned on the Skype for Business Server, you can add the location information manually via phone user interface.

**To add the location information manually via phone user interface:**

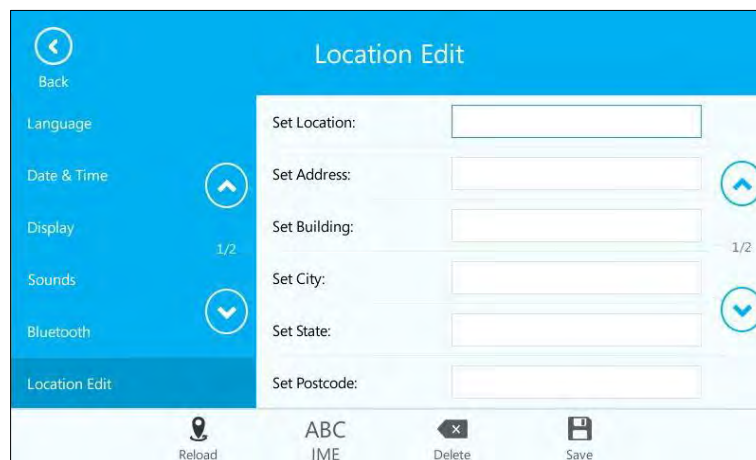
1. Tap ... -> **Basic**-> **Location Edit**.



2. Enter the location name in the **Set Location** field.
3. Enter the address name in the **Set Address** field.
4. Enter the building name in the **Set Building** field.
5. Enter the city name in the **Set City** field.
6. Enter the state name in the **Set State** field.
7. Enter the postcode in the **Set Postcode** field.
8. Select the country from the pull-down list of **Set Country**.
9. Tap  to accept the change.

Location is configurable via web user interface at the path **Settings->Location**.

**Note** T48G Skype for Business phone has 24 country locations for you to choose. The country names are displayed in alphabetical order.

## Viewing the Location Information

**To view the location information via phone user interface:**

Do one of the following:

- Tap **...** ->**Status->Location**.
- Press  ->**Location**.

## Emergency Call

You can dial emergency numbers for assistance whether you set the location or not.

You can dial an Emergency Dial String number or Emergency Dial String Mask number even if the phone is locked. Keypad is available during an emergency call.

**To place an emergency call when the phone is locked:**

1. Tap  (**Emerg Call** soft key).

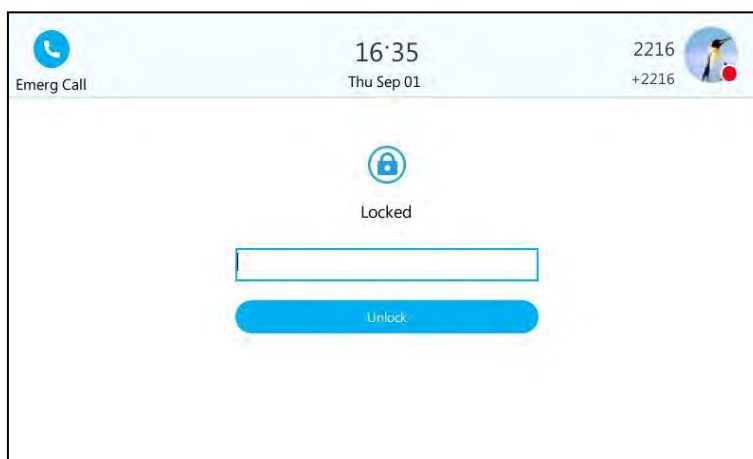

2. Tap the desired emergency number.



The touch screen is shown as below:



You can cancel or hold the emergency call only.

If call forward feature is configured in advance, the call forward feature will be disabled automatically after calling the emergency number. If the call forward feature is not manually enabled again after the emergency call, it will be enabled automatically after two hours and its settings will also be restored.

If the phone status is DND before dialing an emergency number, then the phone status will change to available after the emergency call. And the phone status will restore to DND status in two hours. Other statuses will not be affected by the emergency call.

**Note**

Emergency Dial String number and Emergency Dial String Mask number are configurable on the Skype for Business Server only. Contact your system administrator for more information.

## Dial-now

You can configure one or more dial-now rules (up to 100) on your phone. When the dialed number matches the dial-now string, the number will be dialed out automatically. For example, a dial-now rule is configured as "1xxx", any entered four-digit string beginning with 1 will then be dialed out automatically on the phone.

Basic expression syntaxes you need to know:

Syntax	Description
.	The dot "." can be used as a placeholder or multiple placeholders for any character. Example: "12." would match "123", "1234", "12345", "12abc", etc.
x	An "x" can be used as a placeholder for any character. Example: "12x" would match "121", "122", "123", "12a", etc.
-	Numeric ranges are allowed within the brackets: Digit "-" Digit. Example: "[5-7]" would match the number "5", "6" or "7".
[]	The square brackets "[]" can be used as a placeholder for a single character which matches any of a set of characters. Example: "91[5-7]1234" would match "9151234", "9161234", "9171234".
()	The parentheses "()" can be used to group together patterns, for instance, to logically combine two or more patterns. Example: "([1-9])([2-7])3" would match "923", "153", "773", etc.
\$	The "\$" followed by the sequence number of a parenthesis means the characters placed in the parenthesis. The sequence number stands for the corresponding parenthesis. Example: A replace rule configuration, Prefix: "001(xxx)45(xx)", Replace: "9001\$145\$2". When you dial out "0012354599" on your phone, the Skype for Business phone will replace the number with "90012354599". "\$1" means 3 digits in the first parenthesis, that is, "235". "\$2" means 2 digits in the second parenthesis, that is, "99".

### To add a dial-now rule via web user interface:

1. Click on **Settings**->**Dial Plan**.



2. Enter the desired value (e.g., 1xxx) in the **Rule** field.

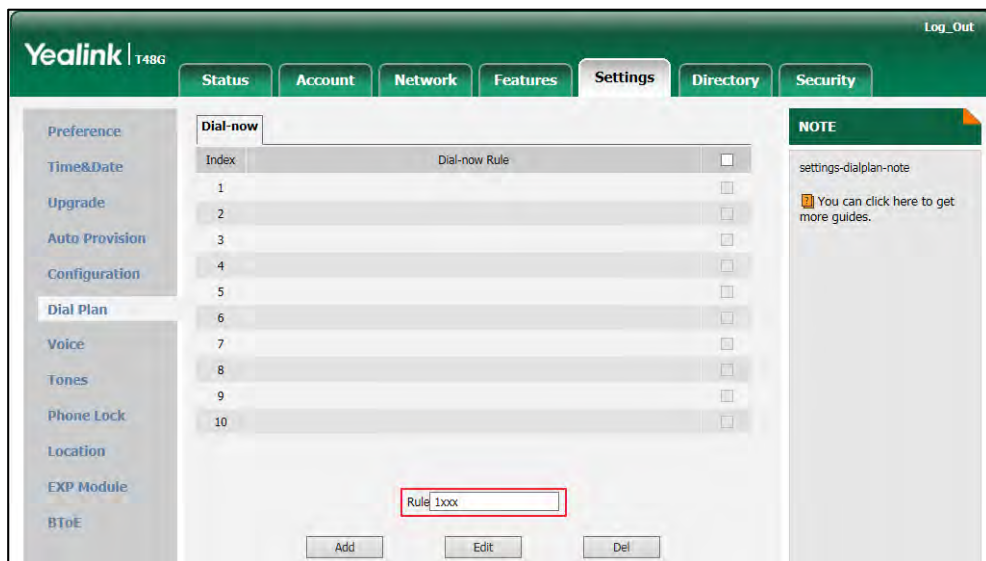

3. Click **Add** to add the dial-now rule.

For example: when you enter the number "1234" using the keypad, the phone will dial out "1234" automatically without pressing any key.

#### Note

Dial-now rule is configurable via web user interface only.

### Delay Time for Dial-Now Rule

You can configure the delay time for dial-now rules. That is, you can configure your phone to automatically dial out the phone number which matches a dial-now rule, after the designated delay time.

#### To configure the delay time for dial-now rule via web user interface:

1. Click on **Features**->**General Information**.

2. Enter the time between 1 and 14 (seconds) in the **Time-Out for Dial-Now Rule** field.

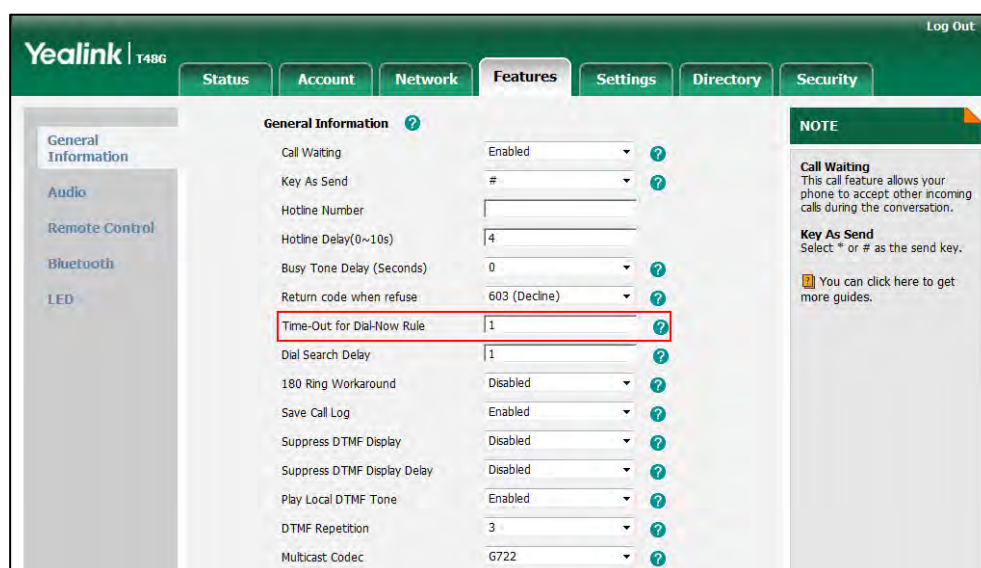

3. Click **Confirm** to accept the change.

For example: when you enter the number "1234" using the keypad, the phone will dial out "1234" automatically after 1 second without pressing any key.

#### Note

Delay time for dial-now rule is configurable via web user interface only.

## Live Dialpad

You can enable live dialpad feature on the T48G Skype for Business phone, which enables the Skype for Business phone to automatically dial out a phone number without pressing the send key. You can also configure a delay, and then the phone will dial out the phone number automatically after the designated period of time. The delay time is configurable on the Skype for Business Server only.

#### To enable live dialpad via web user interface:

1. Click on **Settings->Preference**.

2. Select **Enabled** from the pull-down list of **Live Dialpad**.

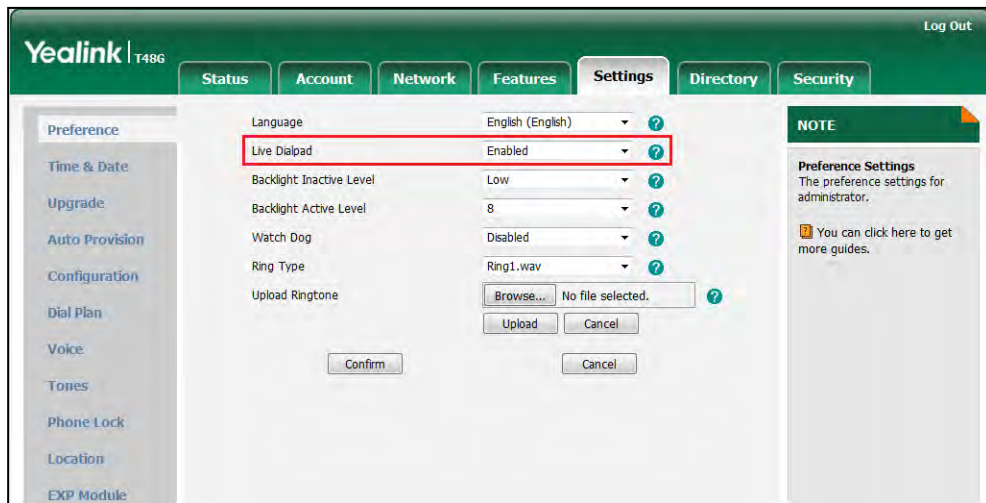

3. Click **Confirm** to accept the change.

**Note** Live dialpad is configurable via web user interface only.

## Hotline

You can dial a hotline number immediately upon lifting the handset or pressing the Speakerphone key. You can also configure a delay, and then the phone will dial out the hotline number automatically after a designated period of time.

### To configure the hotline number via phone user interface:

1. Tap **...** -> **Features** -> **Hotline**.
2. Enter the desired number in the **Hot Number** field.
3. Enter the desired delay time in the **HotLine Delay** field.

The valid values range from 0 to 10 (seconds) and the default value is "4".

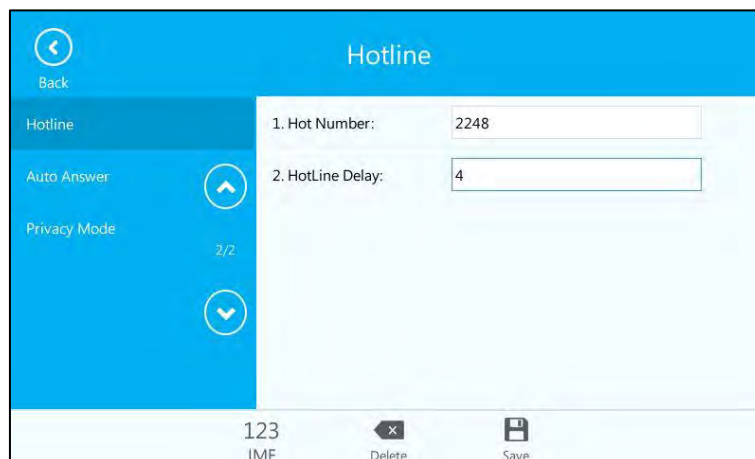

4. Tap  to accept the change.

Hotline is configurable via web user interface at the path **Features->General Information**.

## Privacy Mode

Privacy mode allows you to restrict your presence information, so that it is visible only to the contacts in your Skype for Business directory.

### Note

Microsoft Active Directory includes all Skype for Business users configured by the system administrator. You can add them as your Skype for Business contacts. For more information on how to add Skype for Business contacts, refer to [Adding Skype for Business Contacts](#) on page 65.

When the privacy mode is disabled on the Skype for Business Server, you can see the following two options available on the phone/Skype for Business client:

- **Everyone Can See My Status Regardless Of System Settings/I want everyone to be able to see my presence regardless of system settings (override default settings):** Everyone in my Microsoft Active Directory Domain can see my presence regardless of system settings.
- **Only Contacts Can See My Status If System Setting/I want the system administrator to decide:** Currently everyone can see my presence but this could be change in the future.

When the privacy mode is enabled on the Skype for Business Server, you can see the following two options available on the phone or Skype for Business client:

- **Everyone can see my status/I want everyone to be able to see my presence:** Everyone in my Microsoft Active Directory Domain can see my presence.
- **Only contacts can see my status/I only want people in Contacts to see my presence:** Only the contacts in my Skype for Business directory can see my presence. The other contacts in my Microsoft Active Directory Domain see my presence is offline.

## Modifying the Privacy Mode from the Phone

**To modify the privacy mode from the phone:**

1. Tap **⋮->Features->Private Mode**.
2. Do one of the following:

- a) If the privacy mode is disabled on the Skype for Business Server, the phone touch screen displays as below:

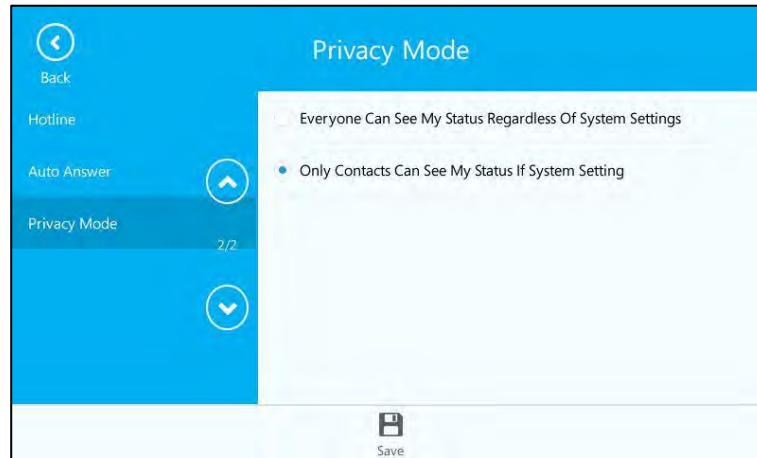

Mark the desired radio box.

- b) If the privacy mode is enabled on the Skype for Business Server, the phone touch screen displays as below:

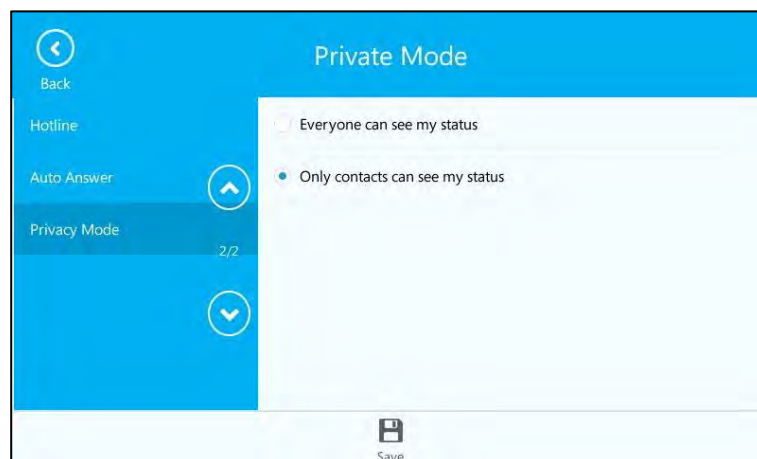

Mark the desired radio box.

3. Tap  to accept the change.

## Modifying the Privacy Mode from the Skype for Business Client

**To modify the privacy mode from the Skype for Business client:**

1. Open Skype for Business client.
2. Click .
3. In the **Skype for Business - Options** dialog box, click **Status**.
4. Do one of the following:

- a) If the privacy mode is disabled on the Skype for Business Server:

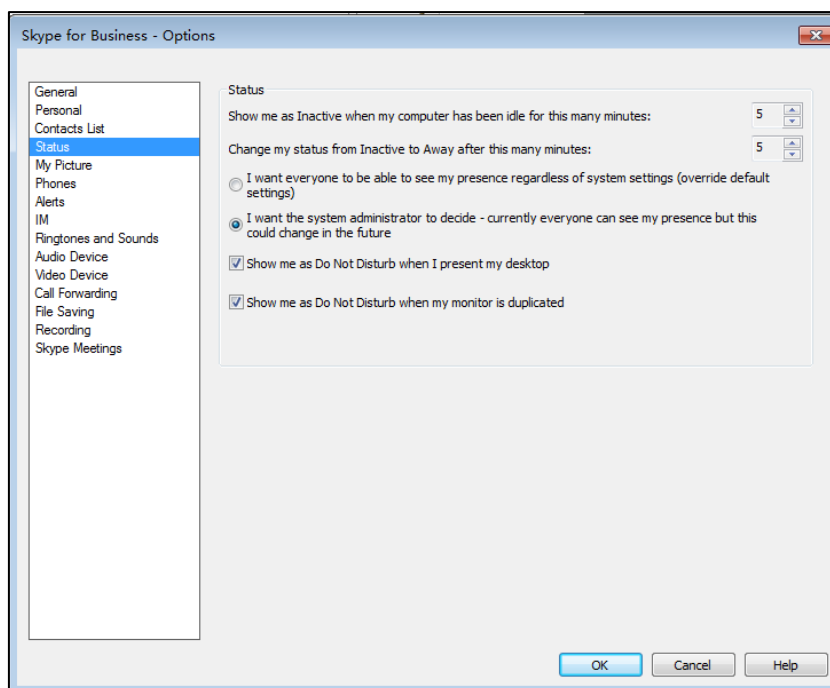

Mark the desired radio box.

- b) If the privacy mode is enabled on the Skype for Business Server:

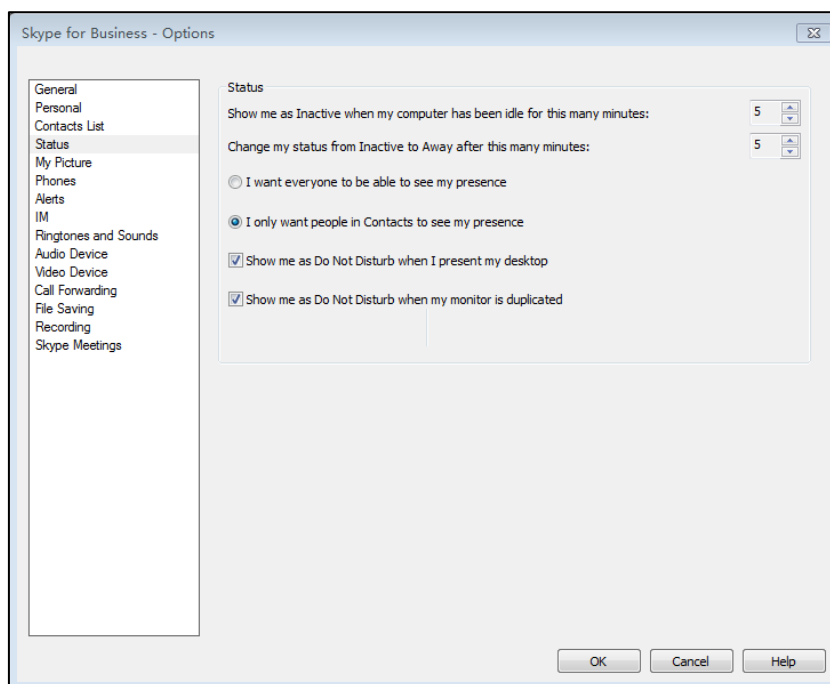

Mark the desired radio box.

5. Click **OK** to accept the change.

## Basic Call Features

---

The T48G Skype for Business phone is designed to be easily used like a regular phone on a public switched telephone network (PSTN). You can place calls, answer calls, transfer a call to someone else, or conduct a Skype for Business conference call. You can also use calendar, response groups or boss-admin Skype for Business feature.

This chapter provides basic operating instructions for the T48G Skype for Business phone. Topics include:

- [Placing Calls](#)
- [Answering Calls](#)
- [Ending Calls](#)
- [Redialing Numbers](#)
- [Auto Answer](#)
- [Call Waiting](#)
- [Call Mute](#)
- [Call Hold/Resume](#)
- [Calendar](#)
- [Call Forward](#)
- [Team-Call Group](#)
- [Response Groups](#)
- [Shared Line Appearance for Skype for Business](#)
- [Boss-Admin Feature](#)
- [Inbound Private Line](#)
- [Call Transfer](#)
- [Group Call Pickup](#)
- [Skype for Business Conference](#)
- [Call Park](#)
- [Voice Mail](#)
- [Multicast Paging](#)
- [Branch Office Resiliency](#)

If you require additional information or assistance with your new phone, contact your system administrator.

## Placing Calls

You can place a call in three ways using your T48G Skype for Business phone:

- Using the handset
- Using the speakerphone
- Using the headset

You can also dial the number first, and then choose the way you want to speak to the other party.

You can search for the contacts and then dial from the result list. For more information, refer to [Searching for Contacts](#) on page 85.

During a call, you can alternate between Speakerphone, Headset, and Handset modes by pressing the Speakerphone key, the HEADSET key, or picking up the handset.

The call duration of the call, the talking mode and the avatar of the contact are visible on the touch screen. In the figure below, the call to "Merry" has lasted 7 seconds.





### To place a call using the handset:

1. Pick up the handset.
2. Do one of the following:
  - Enter the desired number using the phone keypad or the on-screen keyboard.  
Press or tap or on the on-screen keyboard.
  - Enter the first few continuous characters of the contact name or the contact number, tap the desired entry from the result list, and then tap or press .
  - Tap to return to the **Favorites** screen. From the **Favorites** screen, tap the avatar of the desired contact.
  - Tap to return to the **Favorites** screen, and then tap to access the History screen.



Tap the desired entry from the call history list.

Tap  or press .

- Tap  to return to the Favorites screen, and then tap  to access the Contacts screen.

Tap the desired contact from the desired group.

Tap  or press .

The # key is configured as a send key by default. You can also set the \* key as the send key, or set neither. For more information, refer to the [Key as Send](#) on page 56.

### To place a call using the hands-free speakerphone mode:



1. With the handset on-hook, do one of the following:

- Tap the avatar of the desired contact on the **Favorites** screen.

- Tap  to enter the pre-dialing interface.

Enter the desired number using the phone keypad or the on-screen keyboard.



Press  or , or tap  or  on the on-screen keyboard.

You can also enter the first few continuous characters of the contact name or the contact number, tap the desired entry from the result list, then tap  or press .

- Press .



Enter the desired number using the phone keypad or the on-screen keyboard.

Press  or tap  or  on the on-screen keyboard.

You can also enter the first few continuous characters of the contact name or the contact number, tap the desired entry from the result list, then tap  or press .



- Enter the desired number using the phone keypad or the on-screen keyboard.

Press  or , or tap  or  on the on-screen keyboard.

You can also enter the first few continuous characters of the contact name or the contact number, tap the desired entry from the result list, then tap  or press .

- Tap .

Tap the desired entry from the call history list













Tap  or press .

- Tap .

Tap the desired contact from the desired group.

Tap  or press .















### To place a call using the headset:

1. With the optional headset connected, press  to activate the headset mode.
2. Do one of the following:
  - Tap  to enter the pre-dialing screen.  
Enter the desired number using the phone keypad or the on-screen keyboard.  
Press  or tap  or  on the on-screen keyboard.
  - Enter the first few continuous characters of the contact name or the contact number, tap the desired entry from the result list, and then tap  or press .
  - Tap the avatar of the desired contact on the **Favorites** screen.
  - Tap .  
Tap the desired entry from the call history list.  
Tap  or press .
  - Tap .  
Tap the desired contact from the desired group.  
Tap  or press .

The T48G Skype for Business phone can handle multiple calls at a time. However, only one active call (the call that has audio associated with it) can be in progress at any time.

### To place multiple calls:

You can have more than one call on your T48G Skype for Business phone. To place a new call during an active call, do the following:

1. Press  or tap . The active call is placed on hold.
2. Tap .
3. Do one of the following to place a new call:
  - Tap the avatar of the desired contact on the Favorites screen.
  - Enter the contact number using the phone keypad or on-screen keyboard.  
Press  or tap  or  on the on-screen keyboard.
  - Enter the first few continuous characters of the contact name or the contact number, tap the desired entry from the result list, and then tap  or press .
  - Tap .  
Tap the desired contact from the desired call history list.  
Tap  or press .
  - Tap .  
Tap the desired contact from the desired group.  
Tap  or the desired number or press .



You can tap the held call, and then tap  or press  to resume the held call.



## Answering Calls

When you are not in another call, you can answer a call in three ways:

- Using the handset
- Using the speakerphone
- Using the headset

### Note

You can ignore incoming calls by tapping ,  or pressing . You can also change your status to DND to ignore the incoming calls without ring on your phone. For more information, refer to [Changing Presence Status](#) on page 26.

You can forward incoming calls to someone else by tapping , or to voice mail by tapping . For more information, refer to [Call Forward](#) on page 136.

### Answering When Not In Another Call



Call duration and destination will always appear on the touch screen for the active call.

#### To answer a call using the handset:

1. Pick up the handset.



#### To answer a call using the hands-free speakerphone mode:

Do one of the following:

- Press  .
- With the handset on-hook and the headset mode deactivated, tap  .

#### To answer a call using the headset:

Do one of the following:

- Press  .
- With the headset mode activated, tap  .

### Answering When In Another Call

If you have an active call, and an incoming call arrives on the phone:







1. Tap  or press  .

The incoming call is answered and the original call is placed on hold.



## Ending Calls

### To end a call:

Do one of the following:

- If you are using the handset, press  or hang up the handset or tap .
- If you are using the headset, press  or tap .
- If you are using the speakerphone, press  or , or tap .

### Note

When a call is placed on hold, you cannot press  to end it. You should tap  to resume the call, and then press  to end it.

## Redialing Numbers

### To redial the last dialed number from your phone:

1. Press .  
A call to your last dialed number is attempted.



## Auto Answer

You can use auto answer feature to automatically answer an incoming call.

### To configure auto answer via phone user interface:

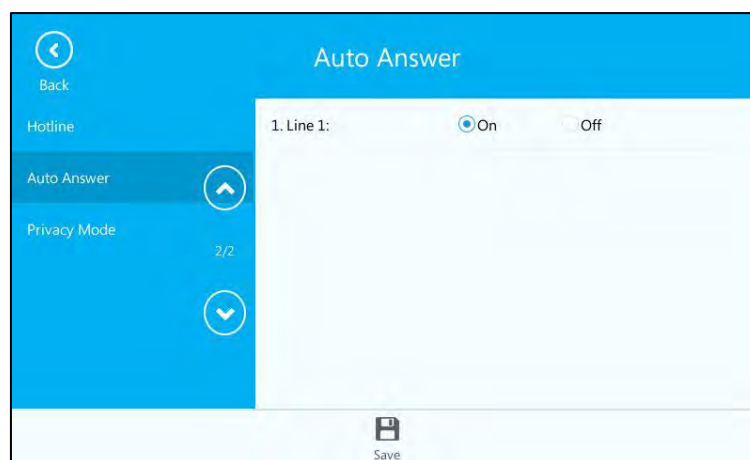
1. Tap ... -> **Features**->**Auto Answer**.
2. Mark the **On** radio box of **Line1** field.



3. Tap  to accept the change or  to cancel.

The prompting message “Auto Answer Mode” appears on the touch screen.

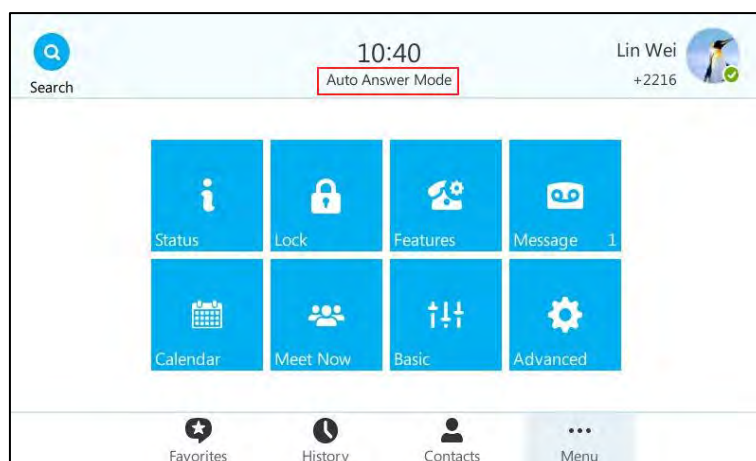

Auto answer is configurable via web user interface at the path **Account->Basic->Auto Answer**.

### Note

Auto answer is only applicable when there is no other call in progress on the phone.



## Call Waiting

You can enable or disable call waiting on the phone. If call waiting is enabled, you can receive another call while there is already an active call on the phone. Otherwise, another incoming call is automatically rejected by the phone with a busy message when there is an active call on the phone. You can also enable or disable the phone to play a warning tone when receiving another call.

**To configure call waiting via phone user interface:**

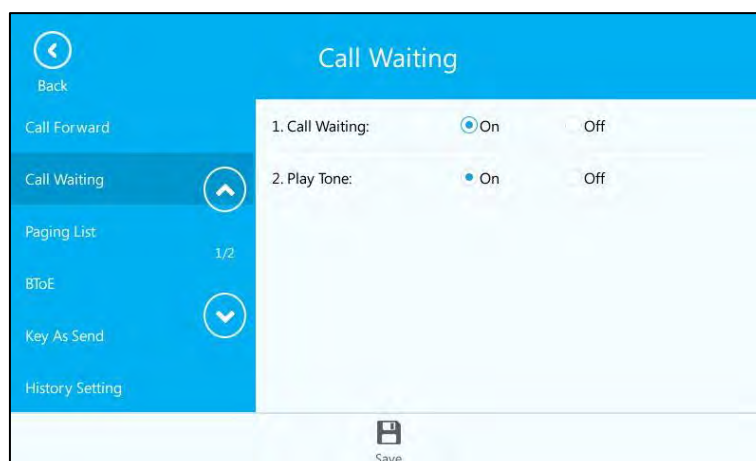
1. Tap ... -> **Features->Call Waiting**.
2. Mark the **On** radio box of the **Call Waiting** field.
3. Mark the **On** radio box of the **Play Tone** field.





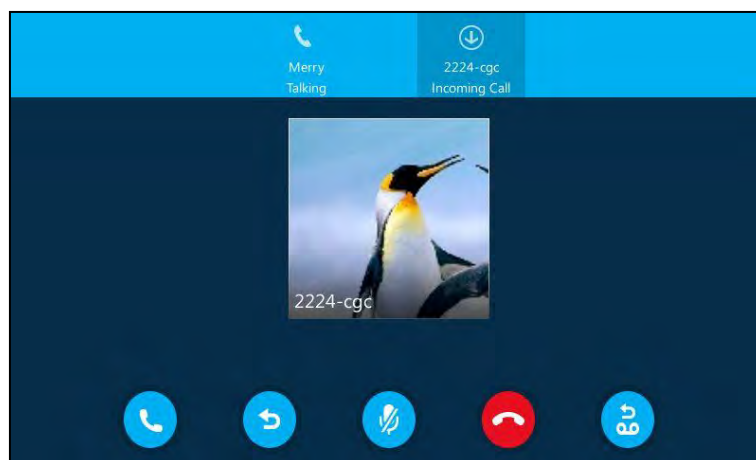

4. Tap  to accept the change or tap  to cancel.

If you have an active call, and an incoming call arrives on the phone, the touch screen is shown as below:



You can do one of the following:

- Tap  to answer the incoming call.  
The original call will be placed on hold.
- Tap  to forward the incoming call to another contact.
- Tap  to ignore the incoming call.
- Tap  to reject the incoming call.
- Tap  to forward the incoming call to voice mail.

Call waiting is configurable via web user interface at the path **Features->General Information->Call Waiting**.

Call waiting tone is configurable via web user interface at the path **Features->Audio->Call Waiting Tone**.

## Call Mute

You can mute the microphone of the active audio device during an active call, and then the other party cannot hear you. Call mute applies to all modes (Handset, Headset and Speakerphone).

### To mute a call:

1. Press  during an active call.

The touch screen indicates that the call is muted. The mute key LED illuminates solid red when the call is muted.

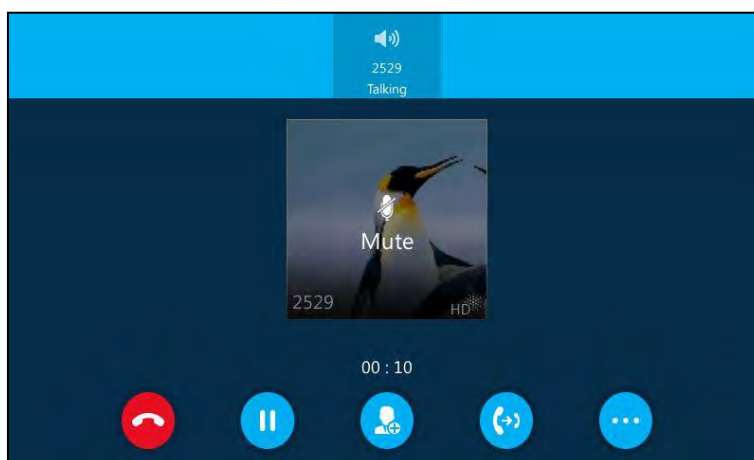



#### To un-mute a call:

1. Press  again to un-mute the call.

## Call Hold/Resume

You can place an active call on hold. Only one active call can be in progress on the phone at any time. Other calls can be made and received while placing the original call on hold. If **Music on Hold** feature is enabled, the phone will play built-in music when an active call is placed on hold. For more information, contact your system administrator.

#### To place a call on hold:

1. Press  or tap  during a call.

The touch screen indicates that the call is on hold.

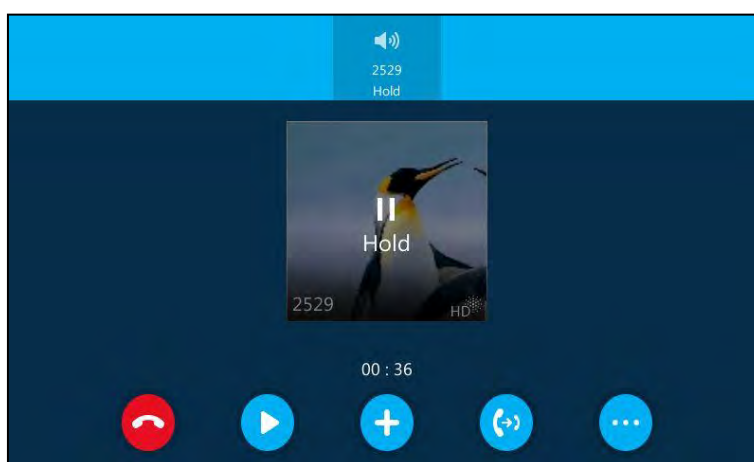



The phone will beep softly every 30 seconds to remind you that you still have a call on hold.

**To resume a held call:**

1. Press  or tap .

**Multiple Calls on Hold:**

1. If multiple calls are placed on hold, tap the desired call and then press  or tap  to retrieve it.

## Calendar

Yealink Skype for Business phones integrates with the Microsoft Exchange calendar feature. If your phone is configured to connect to the Microsoft Exchange Server, and the Microsoft® Outlook® application is installed at your site, you can view Skype conference, appointment, meeting and event, or join the Skype conference in your Microsoft Outlook application from your phone.

## Setting up a Skype Conference in Outlook

**To set up a Skype conference in outlook:**

1. Open Outlook and go to your calendar.



2. Click **HOME>New Skype Meeting**.

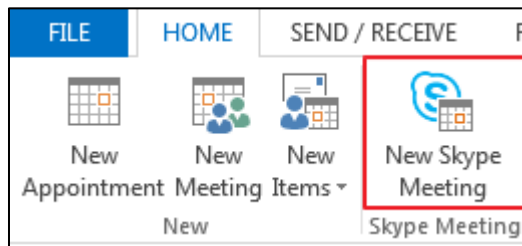

3. In the **To** box, enter the email addresses of your invitees.
4. Enter a subject, location, and then select the start and end time.
5. Enter the content about the Skype conference.
6. Click **Send**.

A Skype conference reminder will display on the phone screen of organizer and invitees 15 minutes before the Skype conference starts.

**Note**

If you change the Skype conference content (e.g., location, subject, time) via outlook after you have sent the invitation, the phone will update the Skype conference content.



## Setting up an Appointment in Outlook

To set up an appointment in outlook:

1. Open Outlook and go to your calendar.



2. Click **Home->New Items->More Items->Recurring Appointment**.

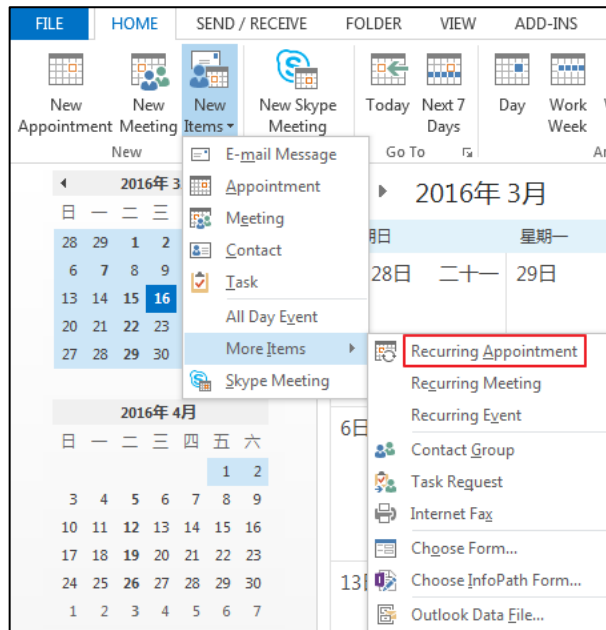

3. Enter the appointment time.
4. Click **OK**.
5. Enter a subject, location and the appointment content.
6. Click **Save & Close**.

An appointment reminder will display on the phone screen 15 minutes before the appointment starts.

## Setting up a Meeting in Outlook

To set up a meeting in outlook:

1. Open Outlook and go to your calendar.



2. Click **Home->New Items->More Items->Recurring Meeting**.

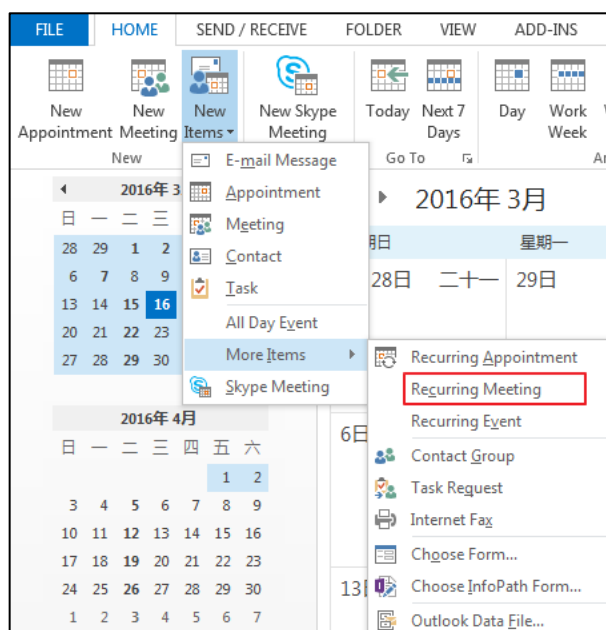

3. Enter the meeting time.
4. Click **OK**.
5. In the **To** box, enter the email addresses of your invitees.
6. Enter a subject, location and the meeting content.
7. Click **Send**.

A meeting reminder will display on the phone screen of organizer and invitees 15 minutes before the meeting starts.

## Setting up an Event in Outlook

**To set up an event in outlook:**

1. Open Outlook and go to your calendar.



- Click **Home->New Items->More Items->Recurring Event**.

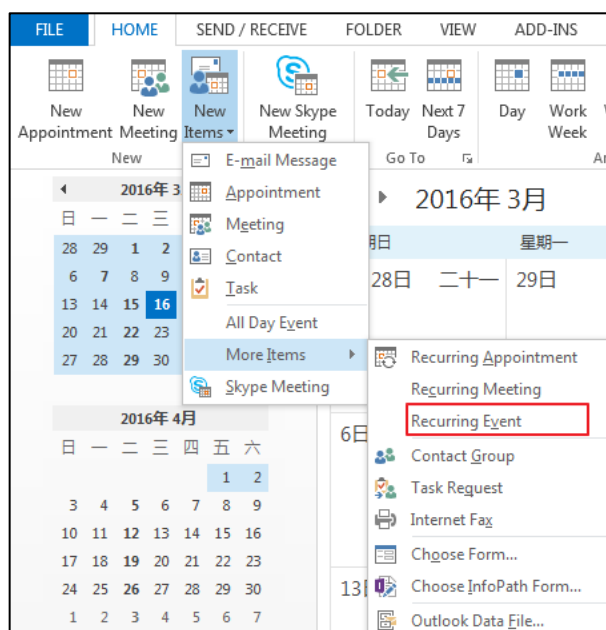

- Enter the event time.
- Click **OK**.
- Enter a subject, location and the event content.
- Click **Save & Close**.

An event reminder will display on the phone screen 15 minutes before the event starts.

## Using the Calendar

To use the calendar feature on your phone, you must sign into the phone using [User Sign-in](#), [Web Sign-in](#) or [Signing in via PC](#) method. So the phones can display the Microsoft Exchange calendar which gives you quick access to Skype conference, appointment, meeting and event.

## Viewing the Calendar

**To view the calendar via phone user interface:**

- Tap **...** -> **Calendar**.

The calendar displays the schedules of today by default. You can view 2000 schedules at most on your T48G Skype for Business phone.

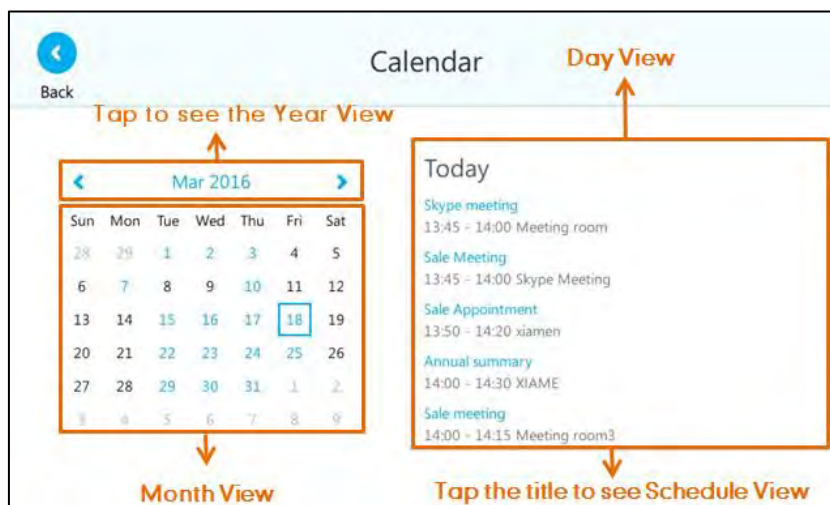

Name	Description
Year View	Shows all the months in a Year. The month within a blue frame indicates a selected month.
Month View	Shows all the days in a month. The day in blue indicates a day which has a schedule. The day within a blue frame indicates a selected day.
Day View	Shows all schedules of the selected day, including the subject, start and end time and location.
Schedules View	Shows the details of the selected schedule, including the subject, participants, organizer, start and end time, location and content.

2. Tap  to close the calendar and display the idle screen.

## Navigating Year View

Year view displays all the months in a year. The selected month is always within a blue frame.

**To navigate Year view:**

1. Tap **...** -> **Calendar**.

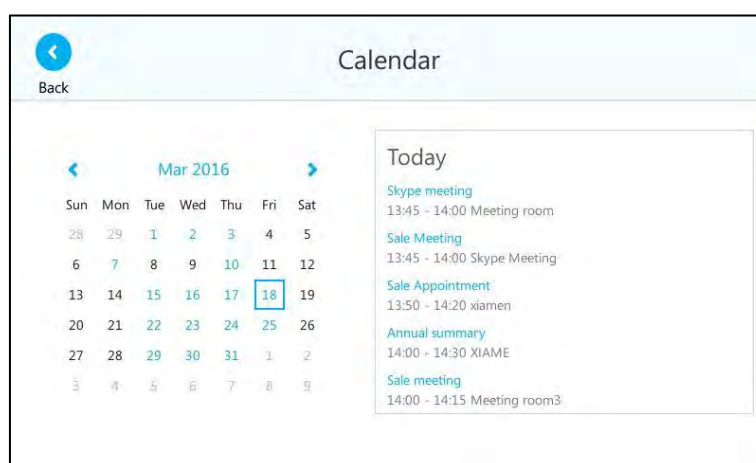

2. Tap the date at the top of the Month view.

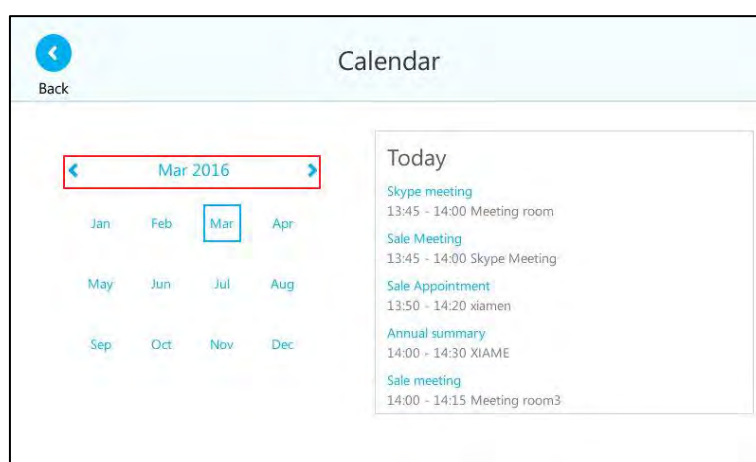

3. Do one of the following:
  - Tap **<** to view the previous year.
  - Tap **>** to view the upcoming year.
  - Tap the month to select another month.

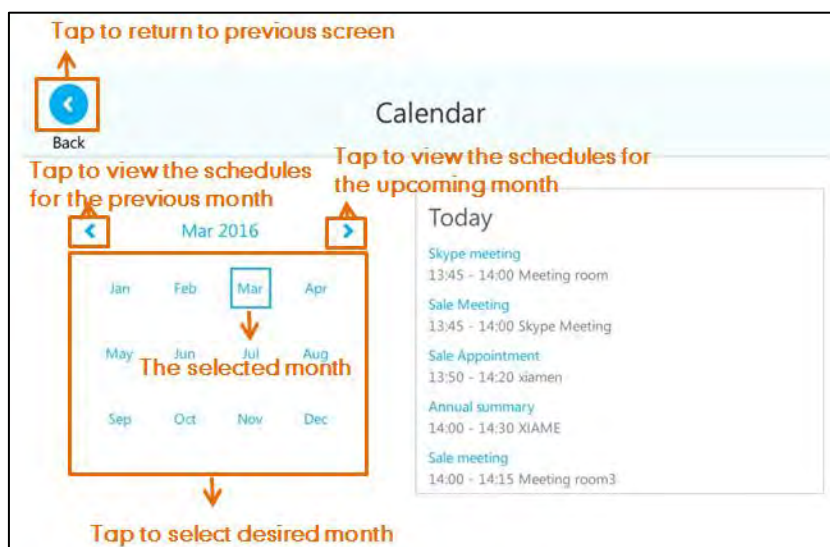

- Tap  to close the calendar and display the idle screen.



## Navigating Month View

Month view displays all the days in a month. The days have schedules are indicated in blue and the selected day is always within a blue frame.

### To navigate Month view:

1. Tap **...** -> **Calendar**.
2. Do one of the following:
  - Tap  to view the previous month.
  - Tap  to view the upcoming month.
  - Tap the day to select the desired day.
  - Tap  to close the calendar and display the idle screen.

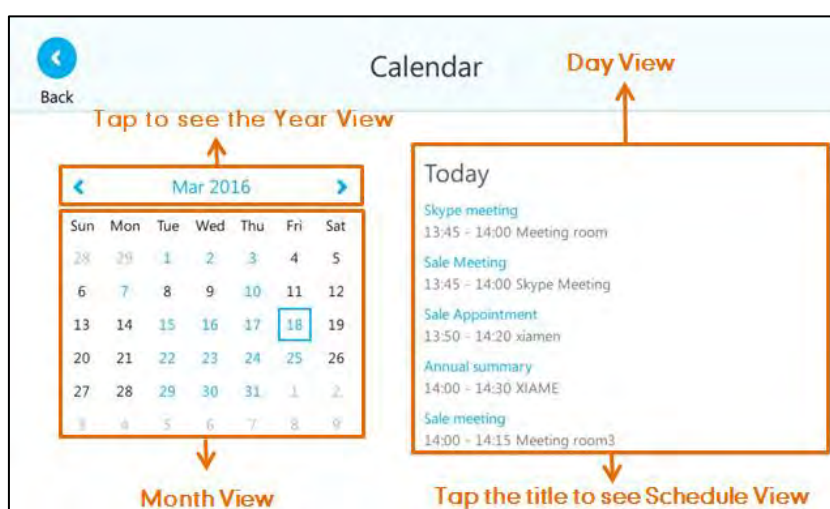

## Navigating Day View

Day view shows all schedules of the selected day, including the date and time, subject, start and end time, and location of each schedule.

### To navigate Day view:

1. Tap **☰** -> **Calendar**.
2. Do one of the following:
  - Press **◀** to view the schedules of the previous day.
  - Press **▶** to view the schedules of the upcoming day.
  - Tap **▲** or **▼** to select the day's schedule when the number of schedules is more than 5.
  - Tap the schedule to view detail for specific schedule.
  - Tap **◀** to close the calendar and display the idle screen.

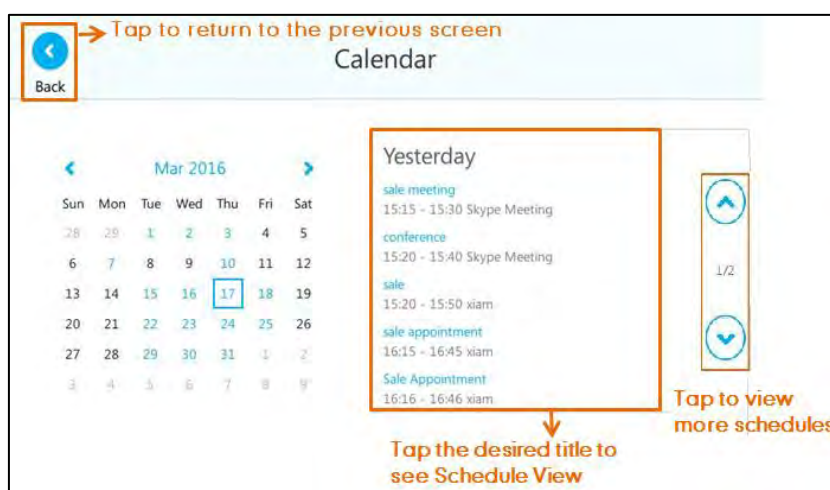



## Navigating Schedule View

Schedule view displays the details of a selected schedule. You can view the schedules' subject, participants, organizer, start and end time, location and content.

### To view schedules via phone user interface:

1. Tap **☰** -> **Calendar**.
2. Tap a desired month.
3. Tap a desired day.
4. Tap a desired schedule.

5. Tap  or  to view the schedule details.

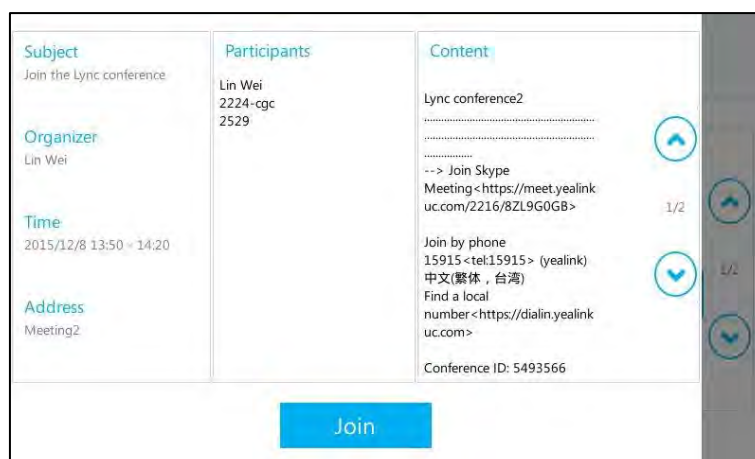

6. Tap the grey area on the right side or press  to return to the previous screen.

## Working with Schedule Reminders

If you have a schedule, a reminder pop-up is displayed 15 minutes before it starts. The reminder shows the main information of the conference, including subject and the rest time.

**If you receive a reminder of an appointment, meeting or event, you can:**

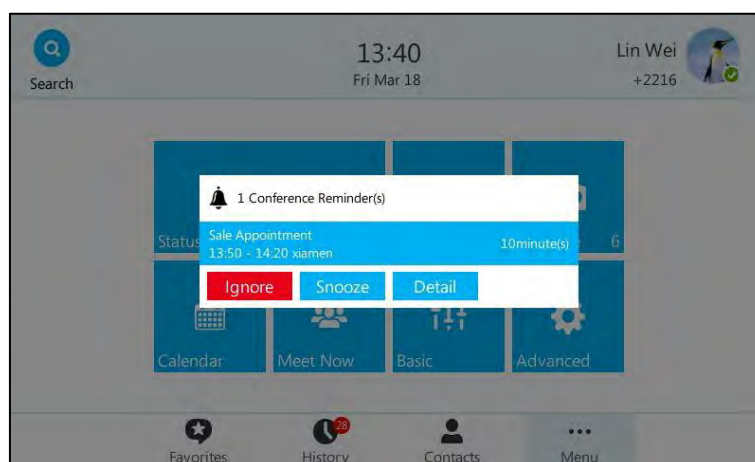

- Tap the **Ignore** soft key to permanently remove the reminder from the screen and stop all future reminders for this schedule.
- Tap the **Snooze** soft key to temporarily remove the reminder from the screen, until the next schedule reminder. The reminder will appear every 5 minutes and also appear 1 minute before the schedule starts.
- Tap the **Detail** soft key to view specific information.



**If you receive a reminder of a Skype conference, you can:**

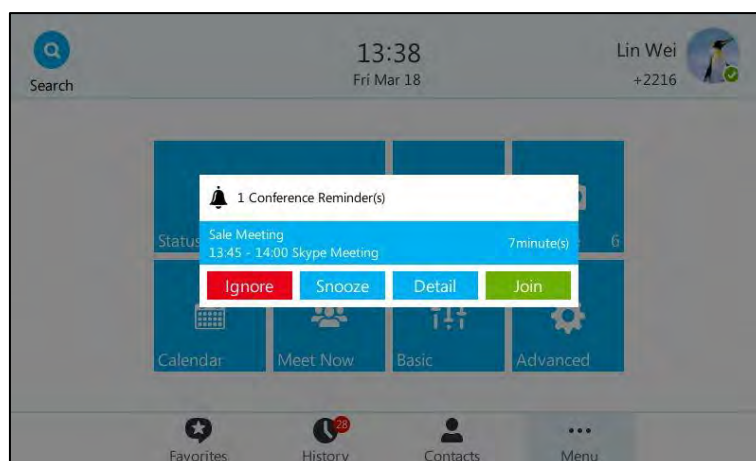

- Tap the **Ignore** soft key to permanently remove the reminder from the screen and stop all future reminders for the Skype conference.
- Tap the **Snooze** soft key to temporarily remove the reminder from the screen, until the next schedule reminder. The phone will pop up the reminder before 15 minutes, 10 minutes, 5 minutes and 1 minute before Skype conference.
- Tap the **Detail** soft key to view specific information about the Skype conference, including the Skype conference's subject, participants, organizer, start and end time, location and content.
- Tap the **Join** soft key to join the Skype conference.

**Note**

When the phone is locked, you can tap **Ignore** or **Snooze** soft key without unlocking the phone. But you need to unlock the phone to view detailed information and join the Skype conference.

If you do not deal with the reminder when rest time ends, the "immediately" will replace the rest time.

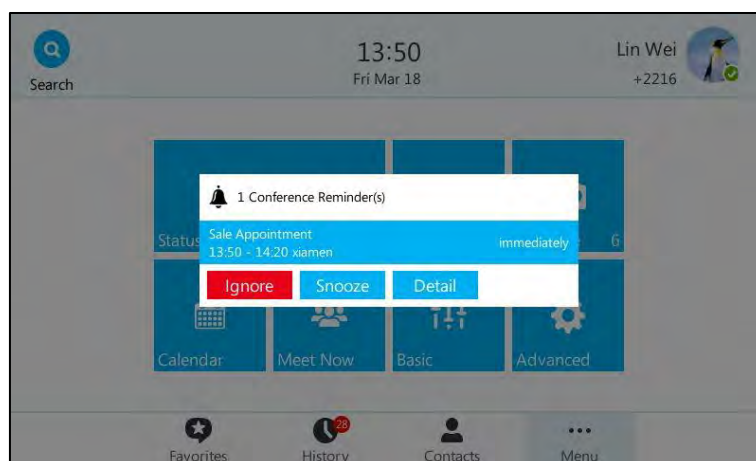

The reminder will show “overdue” when the schedule is overdue.

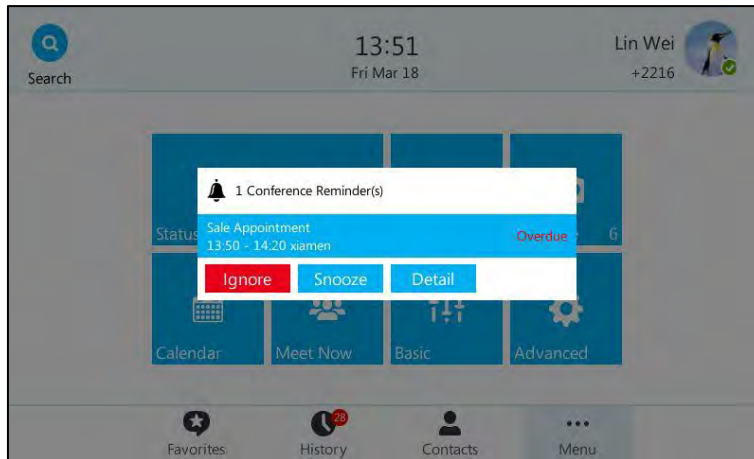



**Note**

You can press  on the phone to ignore all reminders. When receives a Skype conference reminder during a call, you can tap the **Join** soft key to join the Skype conference directly. Current call will be held and you can resume it after the Skype conference.

### Joining Skype Conferences from the Calendar

There are three roles in a conference:

- **Organizer:** A user who creates a conference. Organizer can manage the presenters and attendees.
- **Presenter** (  ): The participant who is invited to the conference will be a presenter by default. The presenter can only manage other presenters and attendees.
- **Attendee** (  ): A user who is invited to a conference but is not authorized to act as a presenter. The attendee can hold or resume himself, mute or unmute himself and leave the conference only.

You can join the Skype conferences from calendar in following three ways:

- **Joining a Skype conference from a conference reminder** (Once joined, presenter and attendee will be muted automatically, organizer will not be muted).
- **Joining a Skype conference from Schedule view** (Once joined, presenter and attendee will be muted automatically, organizer will not be muted).
- **Dialing the conference dial-in number to join a Skype conference** (Once joined, presenter, attendee and organizer will not be muted).

**Note**

When the organizer sets up a conference in Outlook and enables **Mute all attendees** feature, all conference participants will be muted automatically once join the Skype conferences in above ways.

## Joining a Skype Conference from a Conference Reminder

To join a Skype conference from a conference reminder:

Do one of the following:

- Tap the **Join** soft key.

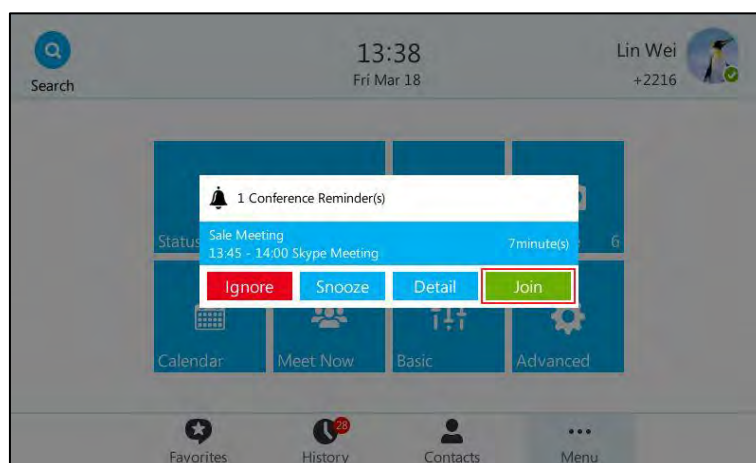

- Tap the **Detail** soft key to view detail for a specific Skype conference, and then tap the **Join** soft key.

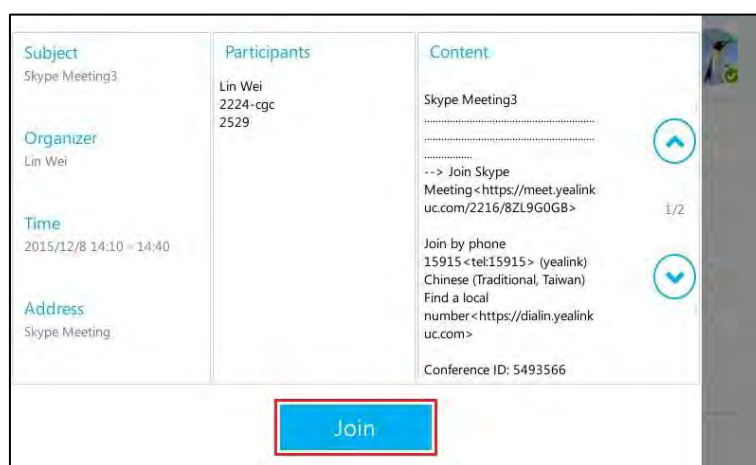

## Joining a Skype Conference from Schedule View

To join a Skype conference from Schedule View:

1. Tap ... -> **Calendar**.

The current day is always within a blue frame.

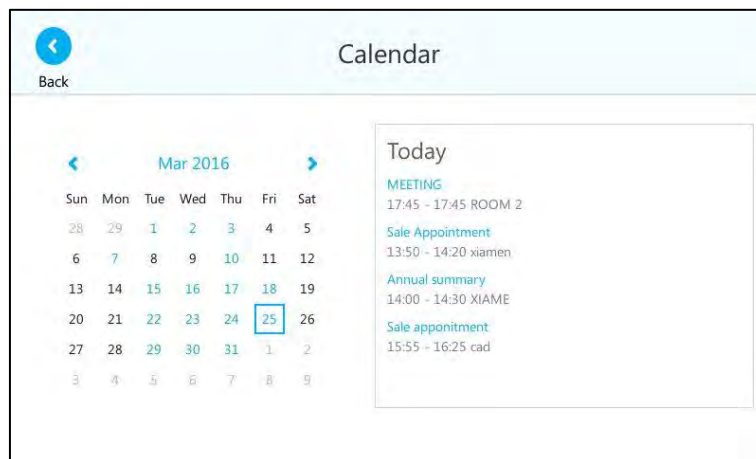

2. Tap a desired month.
3. Tap a desired day.
4. Tap a conference to view specific information about the Skype conference.

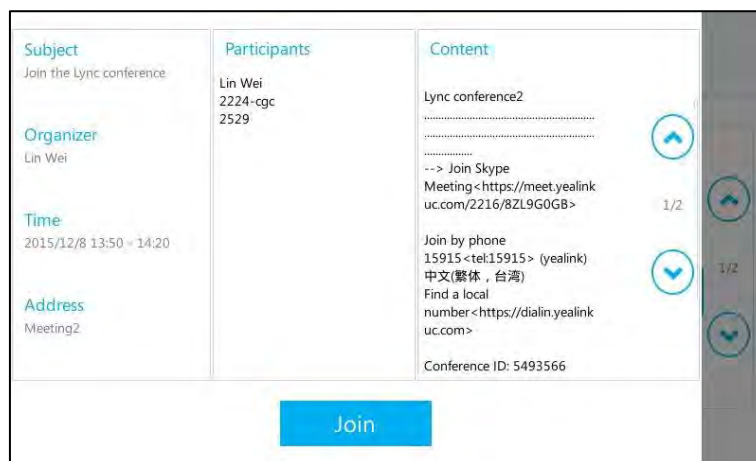

5. Tap the **Join** soft key to join the Skype conference.

## Joining a Skype Conference by Dialing the Conference Dial-in Number

If you schedule a Skype conference call via Microsoft Outlook Conferencing (Plug-In), dial-in number and Conference ID will be sent to invitees in an email. Invitees can join the Skype conference from phone by dialing dial-in number and Conference ID.

You can also obtain the dial-in number and Conference ID from the phone.

### To obtain the dial-in number and Conference ID form the phone:

1. Tap ... -> **Calendar**.

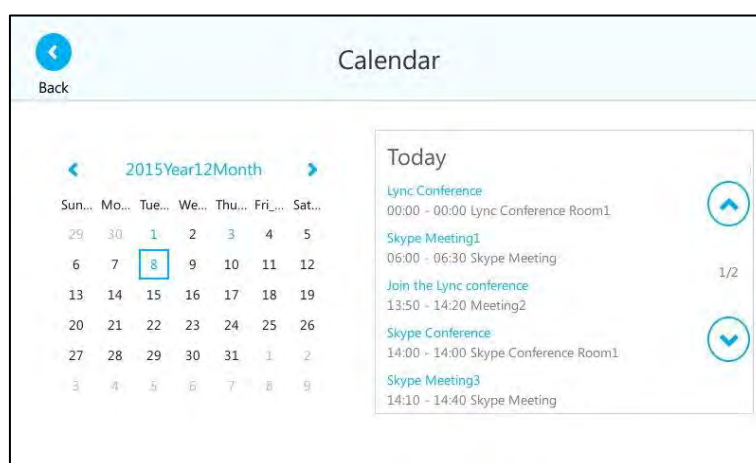

2. Tap a desired month.
3. Tap a desired day.
4. Tap a conference to view the content.
5. You can view the conference dial-in number or Conference ID.

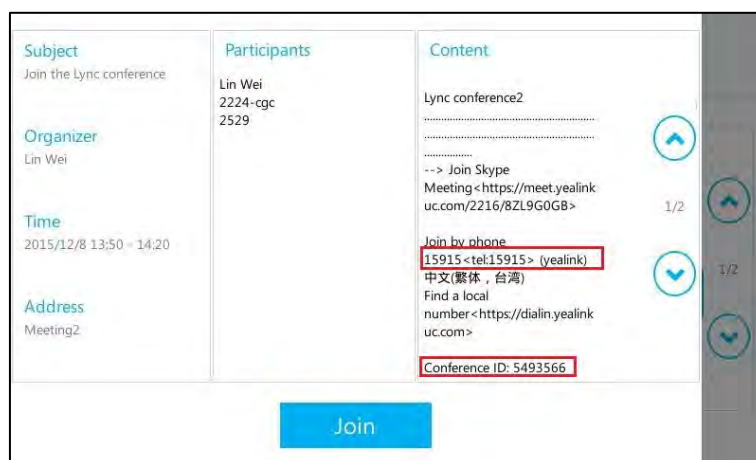

You can also view the dial-in number and Conference ID during a conference call. For more information, refer to [Viewing the Dial-in Number and Conference ID](#) on page 178.

### To join a Skype conference by dialing the conference dial-in number:

1. Dial the conference dial-in number (e.g., 15915).
2. Enter the Conference ID (e.g., 5493566), and the press  to join the Skype conference.
3. More participants can repeat steps 1-2 to join the Skype conference.

For more information on managing the Skype conference participants, refer to [Managing the Conference Participants](#) the on page 179.

## Call Forward

You can configure your phone to forward incoming calls to another party or voice mailbox by the static forwarding. You can also forward calls while your phone is ringing, refer to the [Dynamic Forwarding](#).

## Static Forwarding

### Static Forwarding on T48G Skype for Business phone

T48G Skype for Business phone supports the following static forwarding ways:

- **Forward to Voice Mail:** incoming calls are forwarded to voice mailbox.
- **Forward Calls to Number or Contact:** incoming calls are forwarded to the preset number.
- **Simultaneously Ring:** the preset number will ring simultaneously when you receive an incoming call.

#### To enable call forward:

1. Tap ...->**Features**->**Call Forward**.

You can also press  when the phone is idle.

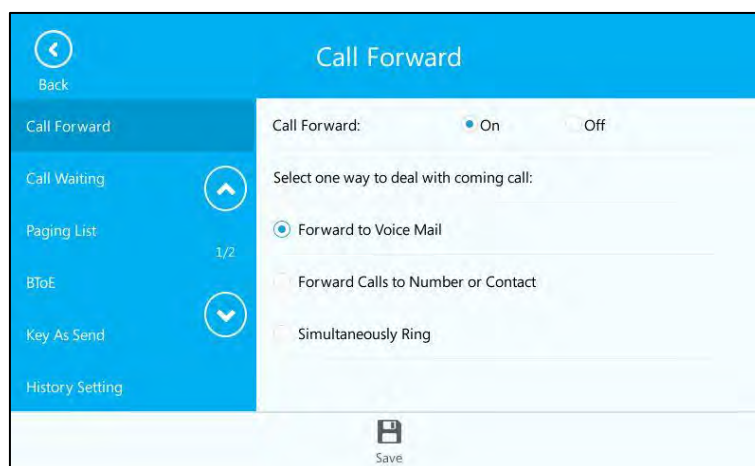

2. Mark the **On** radio box of the **Call Forward** field.



3. Tap the desired forwarding type.

Depending on your selection:



- a) If you tap **Forward to Voice Mail**:

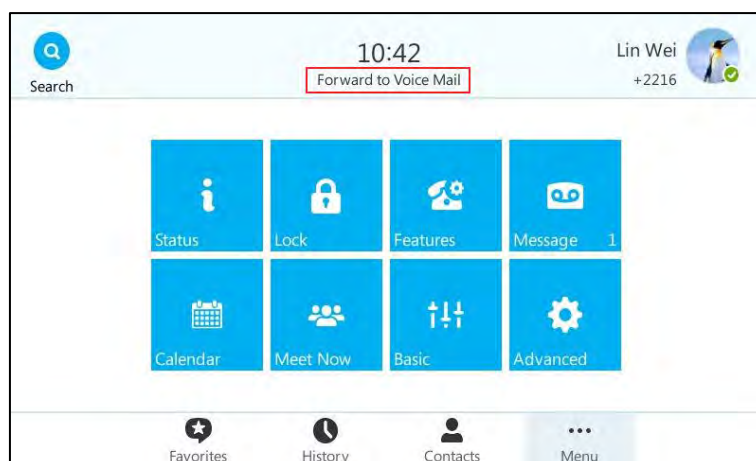

Tap  or press .

The prompting message “Forward to Voice Mail” appears on the touch screen.



b) If you tap **Forward Calls to Number or Contact:**

- 1) Enter the desired number that you want to forward incoming calls to, and then tap  or press .



You can also enter the first few continuous characters of the contact name or the contact number, and then tap the desired entry from the result list, and then tap  or press .

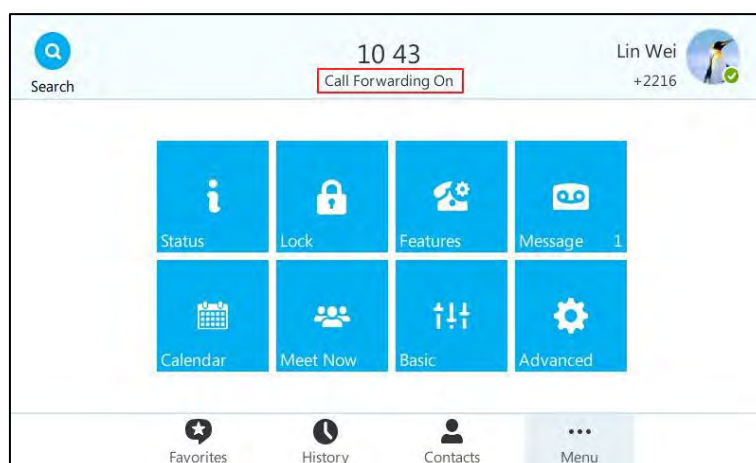

- 2) Tap  or press .

The prompting message “Call Forwarding On” appears on the touch screen.



c) If you tap **Simultaneously Ring:**

- 1) Enter the desired number that you want to ring simultaneously, and then tap  or press .

You can also enter the first few continuous characters of the contact name or the contact number, and then tap the desired entry from the result list, and then tap  or press .

- 2) Tap  or press .

The prompting message “Simultaneous Ring On” appears on the touch screen.

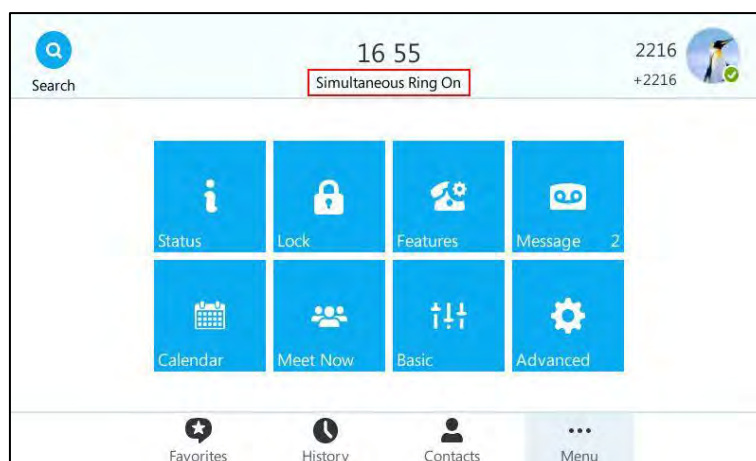

**To disable call forward:**

1. Tap ... -> **Features**->**Call Forward**.

You can also press  when the phone is idle.

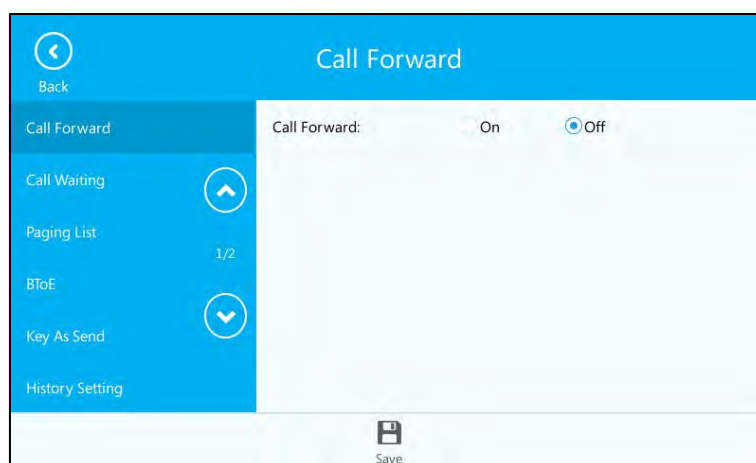

2. Mark the **Off** radio box of the **Call Forward** field.
3. Tap  to accept the change.

## Static Forwarding on the Skype for Business client

You can assign static forwarding feature using the Skype for Business client:

- a) **Forward my calls to:**
  - **Voice Mail:** incoming calls are forwarded to voice mailbox.
  - **New Number or Contact:** incoming calls are forwarded to the preset number or contact.
  - **My Delegates:** incoming calls are forwarded to designated delegates.



b) **Simultaneously ring:**

- **New Number:** the preset number will ring simultaneously when you receive an incoming call.
- **My delegates:** the phones of designated delegates will ring simultaneously when you receive an incoming call.
- **My Team-Call Group:** all members in the designated group will ring simultaneously when you receive an incoming call.

## Configuring Call Forwarding on Skype for Business Client

To forward incoming calls immediately without ringing your phone:

1. In Skype for Business client, click  and then select **Call Forwarding Settings**.

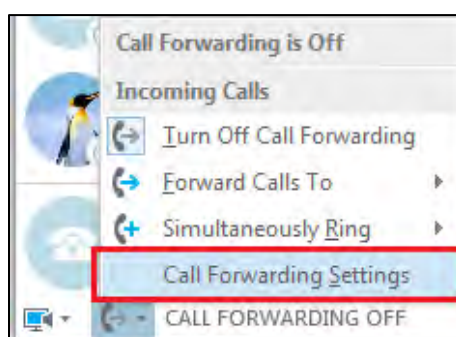

2. Mark the radio box of the **Forward my calls to** field.
3. Select the desired forwarding type from the pull down-list of **Forwarding my calls to**.  
Depending on your selection:

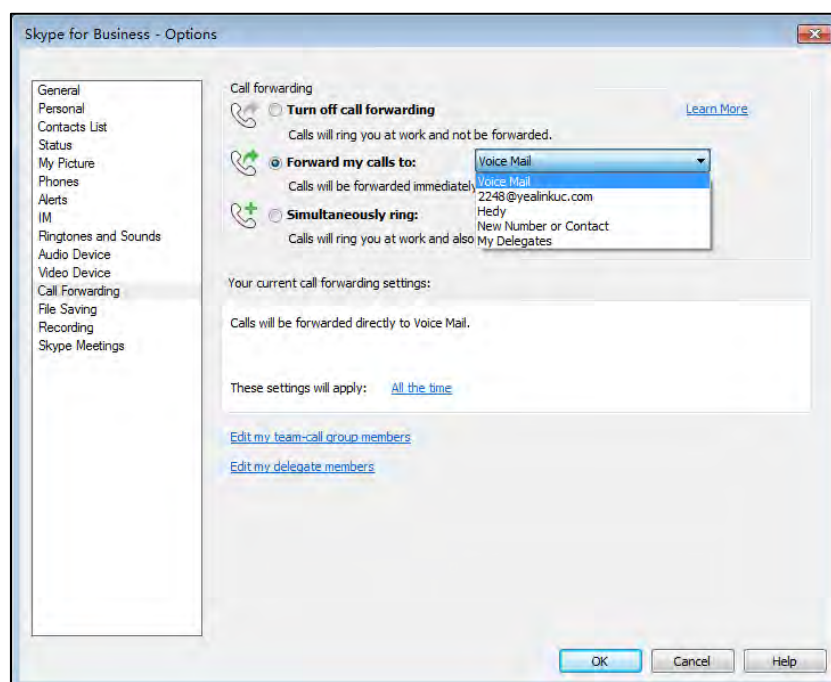

- a) If you select **Voice Mail**:

Incoming calls are forwarded directly to the voice mailbox. The touch screen is shown as below:

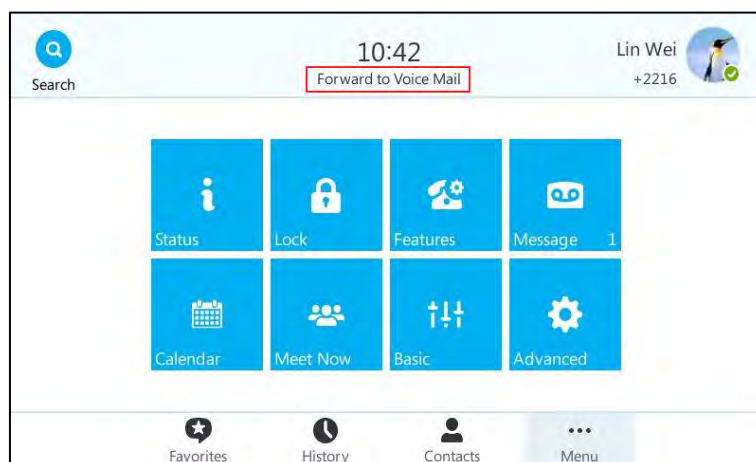

- b) If you select **New Number or Contact**:

Select the contact or enter the phone number you want to forward calls to.

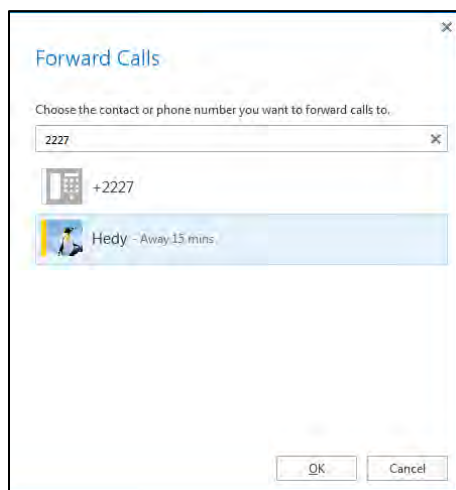

After configuration, incoming calls are forwarded to the preset number or contact.

The touch screen is shown as below.

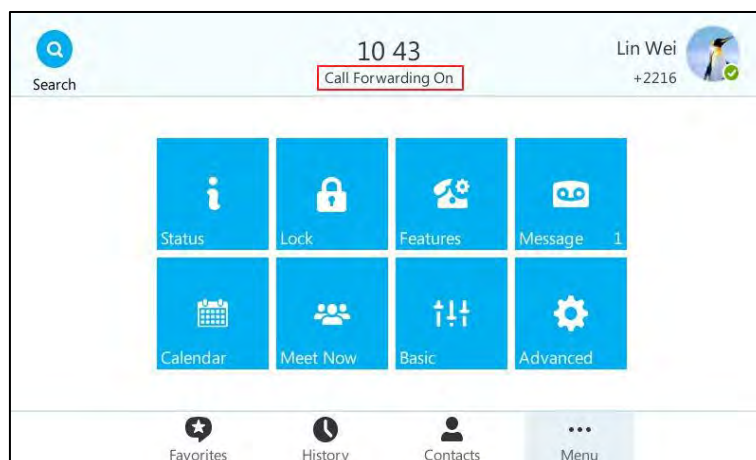

c) If you select **My Delegates**:

Add the delegates you want to forward calls to when you receive an incoming call. The phone of the delegates will ring after the time specified by you.

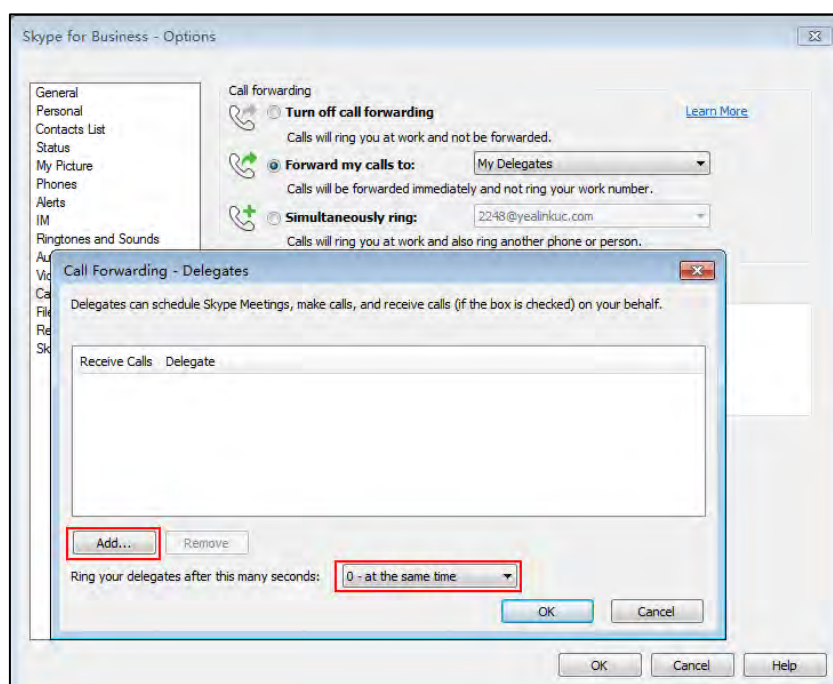

The touch screen is shown as below:

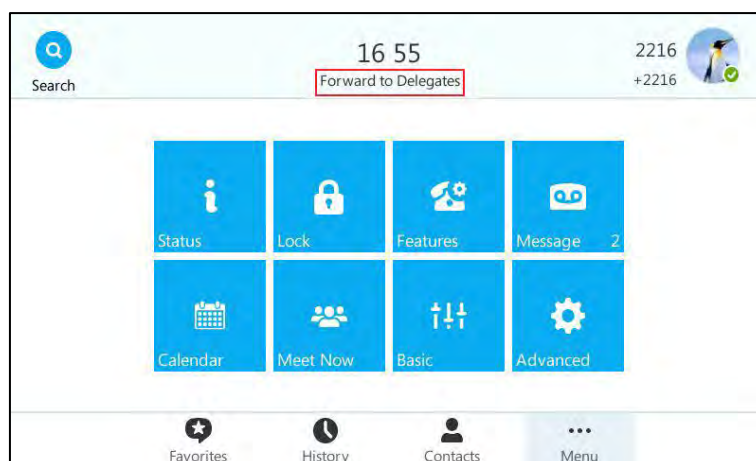

## Configuring Simultaneously Ring on Skype for Business Client

**To ring other phones simultaneously when your phone is ringing:**

1. In Skype for Business client, click  and then click **Call Forwarding Settings**.
2. Mark the radio box of the **Simultaneously ring** field.

Depending on your selection:

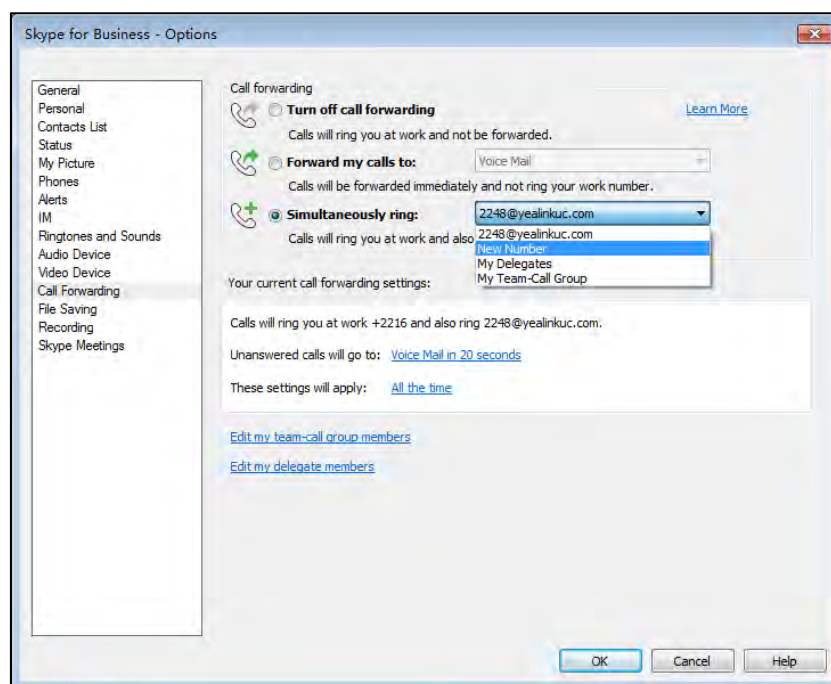

- a) If you select **New Number**:

Enter the phone number in the pop-up window, and then click **OK** to accept the change. The number will ring simultaneously when you receive an incoming call.

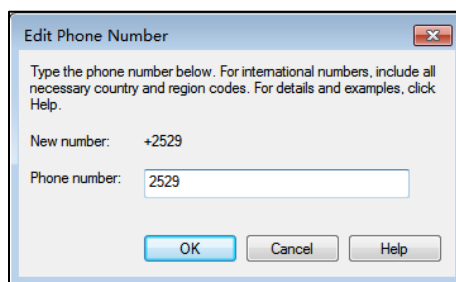

b) If you select **My Delegates**:

Add the delegates you want to ring simultaneously when you receive an incoming call. The phone of the delegates will ring after the time specified by you.

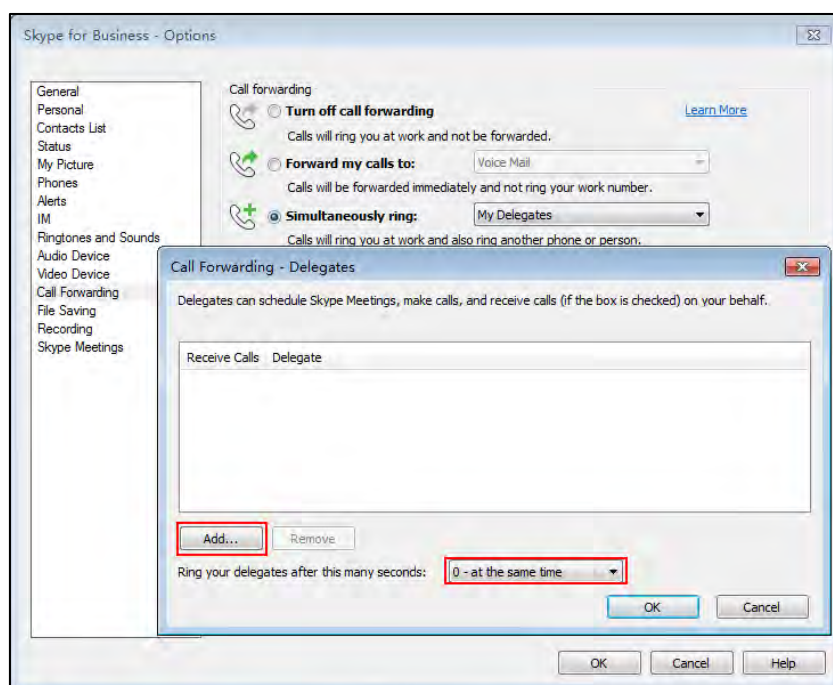

c) If you select **My Team-Call Group**:

Add the contacts in the Team-Call Group. All members in the group will ring simultaneously when you receive an incoming call. The phone of the members in the group will ring after the time specified by you.

For more information on how to assign a distinct ringtone to team-call group, refer to [Team-Call Ringtone](#) on page 147.

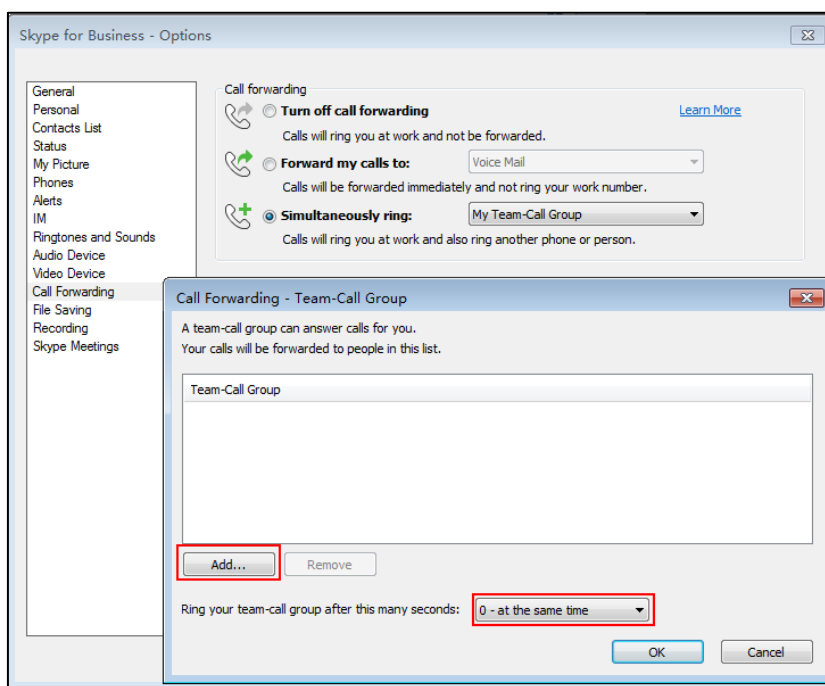

When simultaneously ring feature is enabled, the touch screen is shown as below:

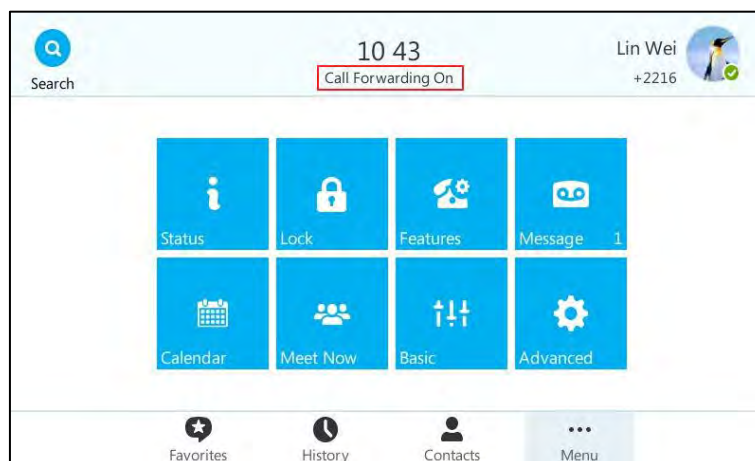

If one member answers the call, other phones will stop ringing.





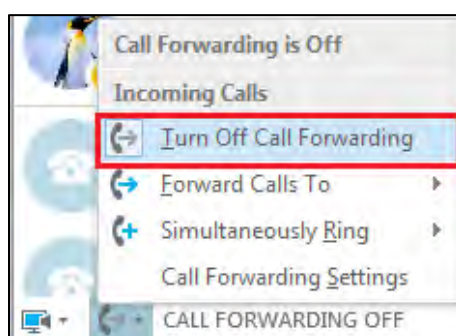







**To turn off the call forwarding:**

1. In Skype for Business client, click  and then select **Turn Off Call Forwarding**.



## Dynamic Forwarding

**To forward an incoming call to another party:**

1. When the phone is ringing, tap .
2. Do one of the following to forward the incoming call:
  - Tap the avatar of the desired contact in Favorites screen.
  - Enter the contact number that you want to forward the incoming call to, and then press  or tap  or  on the on-screen keyboard.
  - Enter the first few characters of the contact name or the contact number, and then tap the desired contact from the result list.  
Press  or tap  or tap the desired number.
  - Tap .  
Tap the desired contact from the desired call history list.  
Tap  or press .
  - Tap .  
Tap the desired contact from the desired group.  
Tap  or tap the desired number or press .

**To forward an incoming call to voice mail directly:**

1. When the phone is ringing, tap  .



The incoming call will be forwarded to your voice mail directly.

### Forward International

Forward international allows you to forward an incoming call to an international phone number. This feature is enabled by default.

**To disable forward international via phone user interface:**

1. Tap **...** -> **Advanced** (default password: admin) -> **FWD International**.
2. Select **Disabled** from the pull-down list of **FWD International**.



3. Tap .

Forward international is configurable via web user interface at the path **Features->General Information**.



## Team-Call Group

A team-call group is a team of people who can answer your work calls. You can use Skype for Business client to add or remove members, and select when they can answer calls for you. For more information on how to configure team-call group, refer to [Configuring Simultaneously Ring on Skype for Business Client](#) on page 142.

Assume that you have a team of people working on the same project or tasks. If one of your team members is away from his desk and his phone rings, anyone in the team-call group can answer the call for him. As soon as a team member picks up the phone, the other phones stop ringing.

For example, a user (phone number:2529) calls a user named "Hedy", other members in the same team-call group as "Hedy" will ring too, their phones' screens are shown as below:

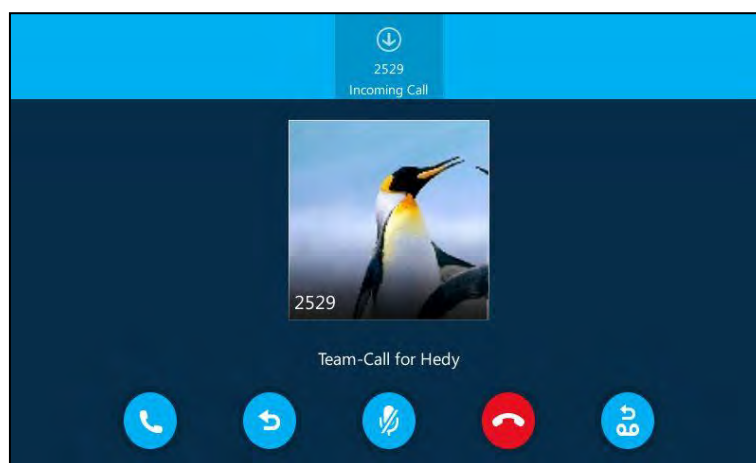



## Team-Call Ringtone

Team-call ring tone feature allows the phone to play a distinct ringtone when receiving a team-call.

**To set a ringtone for the team-call via phone user interface:**

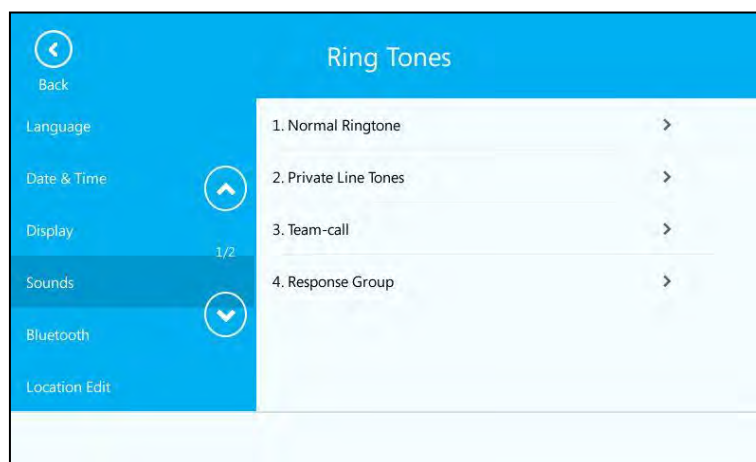
1. Tap ... -> **Basic**->**Sounds**-> **Ring Tones**->**Team-call**.



2. Tap the desired ring tone.
3. Tap  to accept the change or tap  to cancel.

## Response Groups

If you sign into the phone using Onprem account, you can use response groups feature. Current Online environment does not support this feature.

If your organization has groups of people who answer and manage certain types of calls, such as for customer service, an internal help desk, or general telephone support for a department, you can deploy the Response Group application to manage these types of calls. The Response Group application routes and queues incoming calls to designated persons, who are known as agents. You can increase the use of telephone support services and reduce the overhead of running these services by using response groups.

For example, a response group named “yealink” is configured on Skype for Business Server in advance. When a user named “Hedy” calls the response group, the screens of other agents’ phones are shown as below:



#### Note

Response group can be configured via by Skype for Business Server only. Contact your system administrator for more information.



## Response Group Ringtone

Response group ring tone feature allows the phone to play a distinct ringtone when receiving a response group calls.

**To set a ringtone for the response group via phone user interface:**

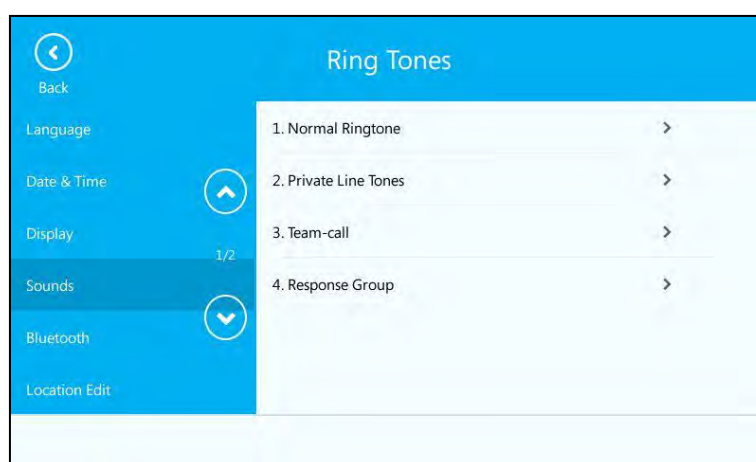
1. Tap **...** -> **Basic**-> **Sounds**-> **Ring Tones**-> **Response Group**.



2. Tap the desired ring tone.
3. Tap  to accept the change or tap  to cancel.

## Shared Line Appearance for Skype for Business

When your phone is registered with the Skype for Business Server, you can use the Shared Line Appearance (SLA) feature to share a single line with other contacts as a member of a group. System administrators assign members to SLA groups. Any SLA group member can place, answer, hold, or resume calls on the line, and all group members can view the call held by the shared line on their phones. Each line supports up to 24 call appearances. Only one call at a time can be active on the shared line appearance. If a call is placed to the shared line with an active call in place, the incoming call is sent to another shared line.

### Answering SLA Calls

Any incoming call to the shared line rings on all group members' phones simultaneously, the call is displayed on all members' screens.

Any group member can respond to an incoming call to the shared line.

### Placing a SLA Call on Hold

**To place a SLA call on hold:**

1. Press  or tap  to place the call on hold.

A red **Boss/Admin** soft key appears at the bottom of the phone screen.

### Resuming Held SLA Calls

Any SLA member can resume a held call on the shared line.

**To resume a call on the shared line:**

1. Tap **Boss/Admin** soft key to view the call held by other member.
2. Tap the avatar of the caller to resume the held call.

## Boss-Admin Feature

The boss-admin feature, which is also called boss-delegate feature, enables a "boss" phone and delegates' phones to ring simultaneously when a user calls the boss. When one party answers the call, the other phone will stop ringing. A boss can assign delegates and manage calls on the delegate's line.

Delegates can place, answer or hold the call. Delegates can also make a safe transfer to boss's voice mail or call on behalf of the boss's line. The boss can pick up held calls on a delegate's line. What's more, the boss can hold the calls, and the delegate can pick up held calls on the boss's line.

**Boss-Admin Scenario:** The system administrator has configured the phone number 2248 to be the delegate of phone number 2216. For more information on how to assign delegates on the Skype for Business client, refer to [Assigning/Removing Delegate](#) on page 151.

- **Boss:** Lin Wei (phone number: 2216)
- **Delegate:** Hedy (phone number: 2227)
- **Other:** 2224-cgc (phone number: 2224)

#### Note

Boss-admin feature is configurable via Skype for Business client only.

## Assigning/Removing Delegates

You can assign delegates to your line using the Skype for Business client. However, you cannot assign yourself as a delegate. As a delegate, you can be assigned to multiple bosses' lines.

#### To assign delegates using Skype for Business client:

1. Open Skype for Business client.
2. Sign into Skype for Business client as the person who wants to assign a delegate.
3. Click the  button, and then click **Call Forwarding Settings**.
4. Mark the radio box in **Simultaneously ring** field.
5. Select **My Delegates** from the pull-down list of **Simultaneously ring**.

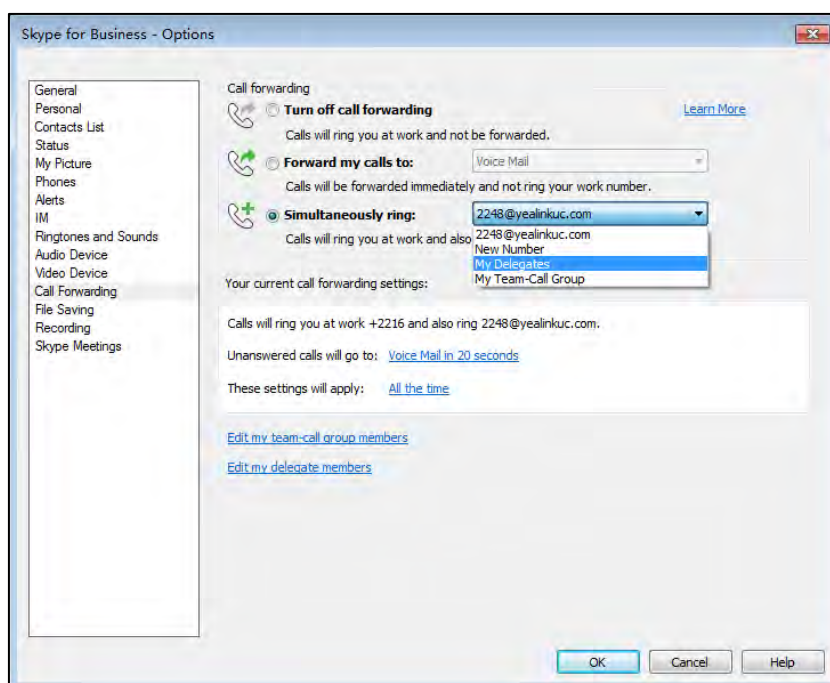

6. In the **Delegates** dialog box, click **Add**. Each delegate must be a Skype for Business contact.
7. Click the **Ring your delegates after this many seconds** pull-down list to determine when

your delegates' phones ring.

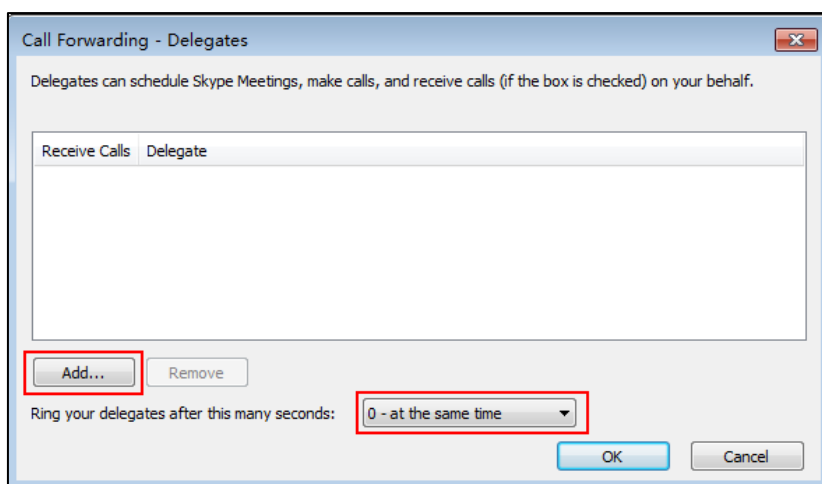

8. Click **OK**.
9. Click **OK** in the **Delegates** dialog box.
10. Click **OK** in the **Options** dialog box.

**To remove a delegate from Skype for Business client:**

1. Open Skype for Business client.
2. Sign into Skype for Business client as the person who wants to remove a delegate.  
Make sure **My Delegates** option is not selected in either the **Simultaneously ring** or **Forward my calls to** list.
3. Click **Edit my delegate members**.

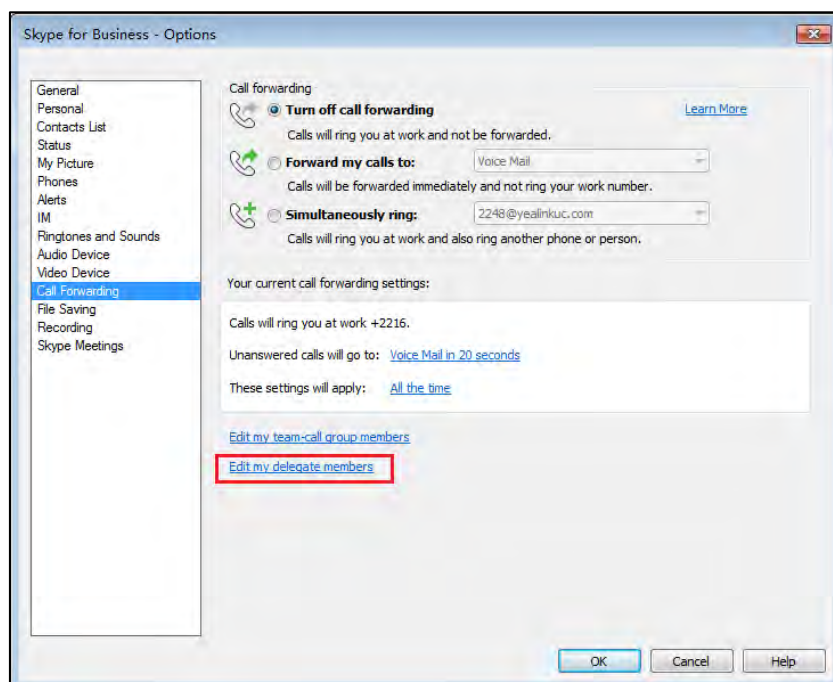

4. Check the checkbox of the delegate you want to remove.

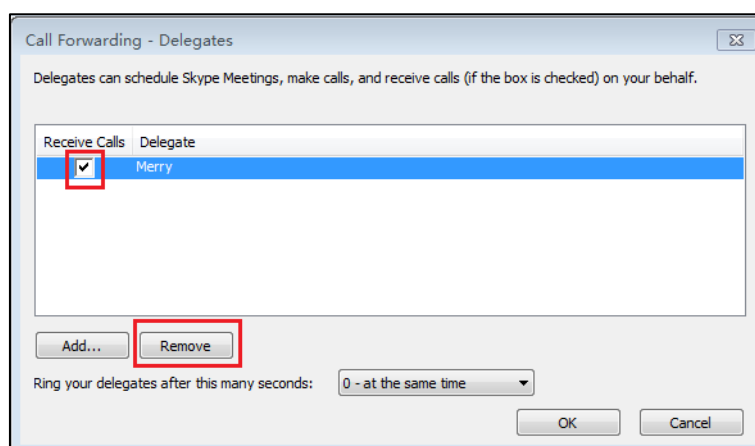

5. Click **Remove**.
6. Click **OK** in the **Delegates** dialog box.
7. Click **OK** in the **Options** dialog box.

## Viewing the Bosses/Delegates

### Viewing the Bosses

Once a user is assigned to be a delegate of the bosses on the Skype for Business client, a **Bosses** group will appear on the delegate's phone automatically.

#### To view your bosses:

1. Tap .
2. Tap the **Bosses** group.  
Your boss(es) will be displayed.



## Viewing the Delegates

Once a boss is assigned delegates on the Skype for Business client, a **Delegates** group will appear on the boss's phone automatically.

### To view your delegates:

1. Tap .
2. Tap the **Delegates** group.

Your delegate(s) will be displayed.

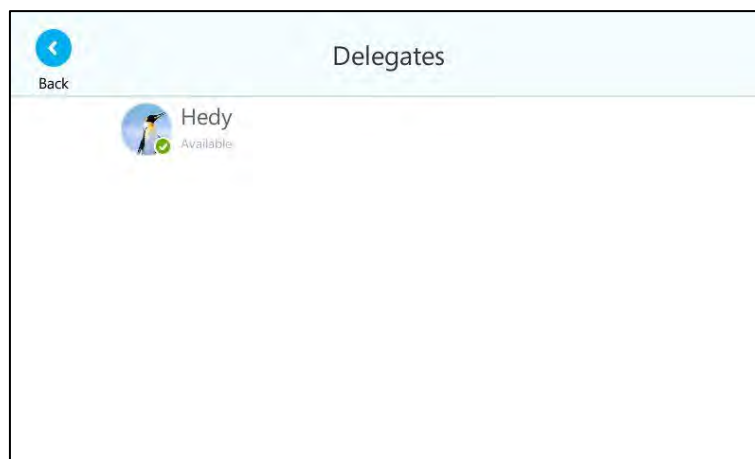

## Using the Boss-Admin Feature

### Answering Incoming Calls

When a user calls the boss, both boss's and delegate's phones will ring simultaneously.

### To answer an incoming call on a boss's phone:

1. Tap  or press .



The delegate's phone stops ringing and the touch screen of the delegate's phone is shown below:

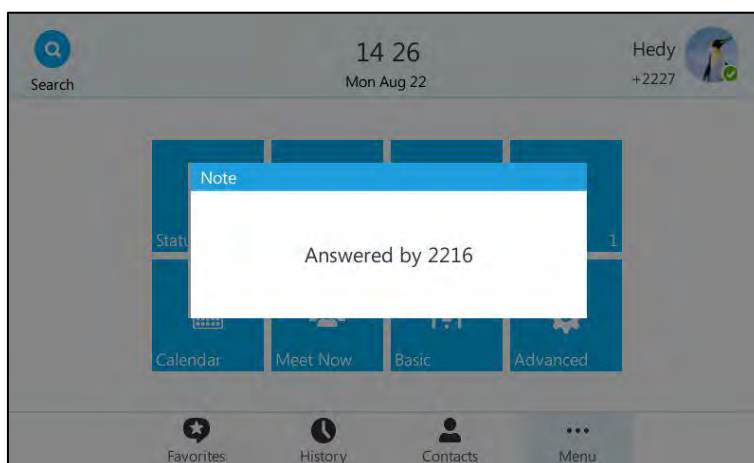

#### To answer an incoming call on a delegate's phone:

1. Tap  or press .

The boss's phone stops ringing and the touch screen of the boss's phone is shown below:

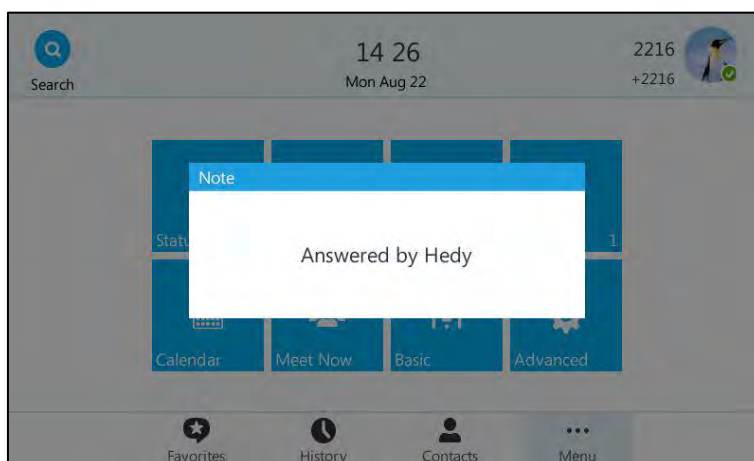

## Placing the Calls on Hold

#### To place a call on hold on a boss's phone:

1. Tap  or press  to place the call on hold.

A red **Boss/Admin** soft key appears at the bottom of the delegate's phone screen.

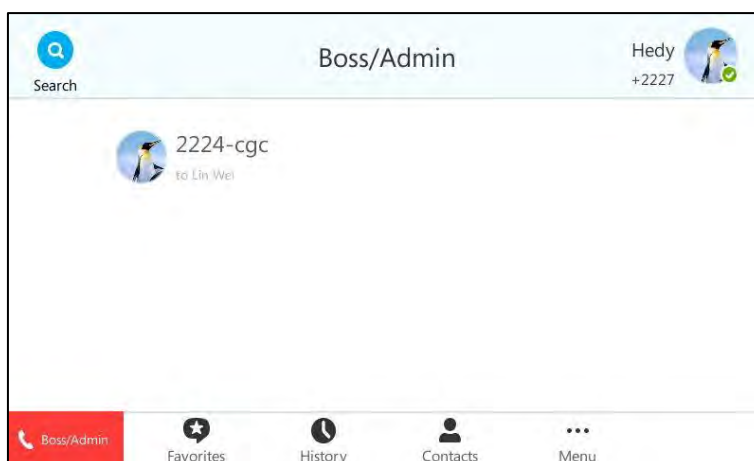

**To place a call on hold on a delegate's phone:**

1. Tap  or press  to place the call on hold.

A red **Boss/Admin** soft key appears at the bottom of the boss's phone screen.





## Resuming the Held Calls

Either boss or delegate can resume the held call. Once one party resumes the call, the other party will drop the call automatically.

**To resume a call held on a boss's phone:**

Do one of the following:

- The boss taps  or presses  to resume the held call.

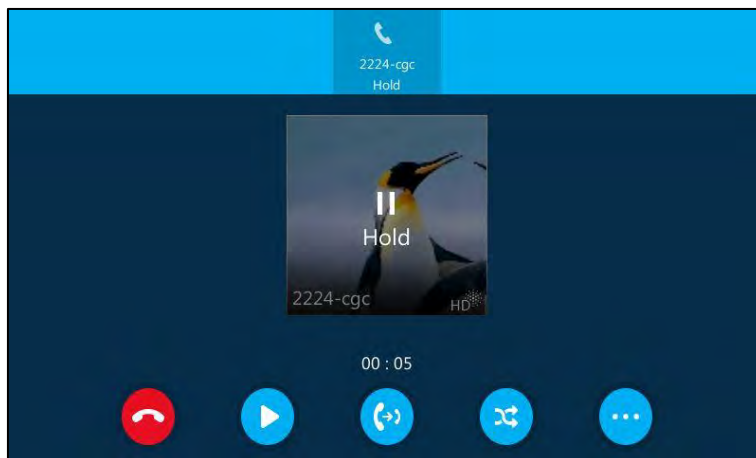



- The delegate taps the red **Boss/Admin** soft key to view the calls that are held by boss.



Tap the avatar of the caller. The call will be resumed by the delegate, and the boss will drop the call automatically.

**To resume a call held on a delegate's phone:**

Do one of the following:

- The delegate taps  or presses  to resume the held call.



- The boss taps the red **Boss/Admin** soft key to view the calls that are held by delegate.

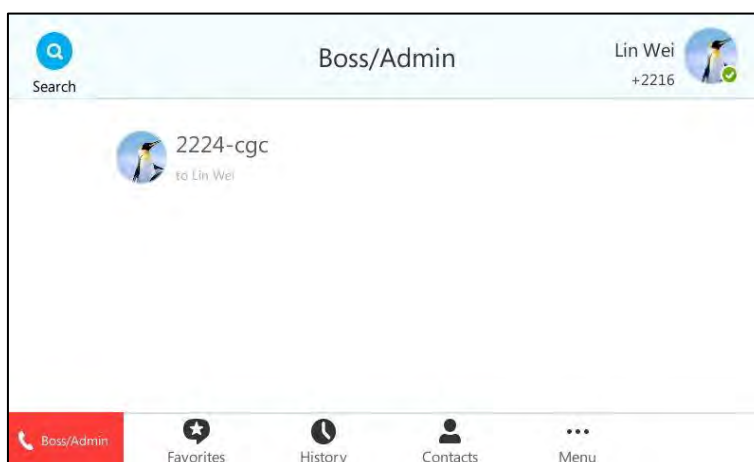

Tap the avatar of the caller. The call will be resumed by boss, and the delegate will drop the call automatically.

## Transferring Calls to Boss Voicemails

If a boss is unavailable to take calls, delegates can transfer the calls directly to a boss's voicemail. The caller can follow the voice prompt to leave the voice mail.

**To transfer a call to the boss's voicemail:**

Do one of the following:

- Before the delegate answers the incoming call:  
Tap  to forward the incoming call to boss's voice mail directly.

The touch screen of the delegate's phone is shown below:

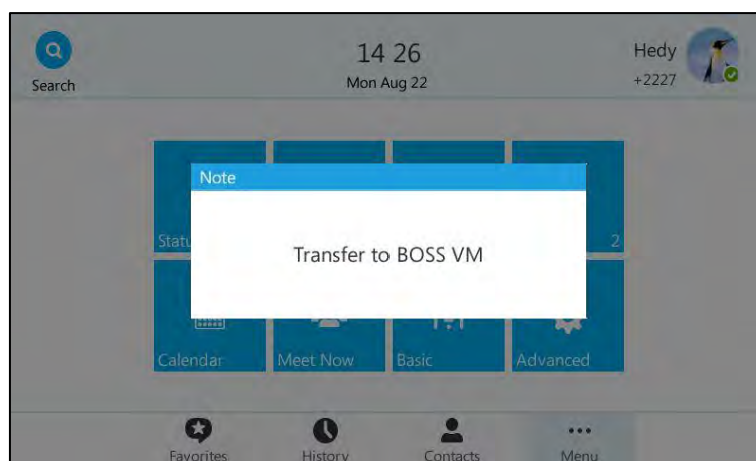

- After the delegate answers the call:

Tap  -> .

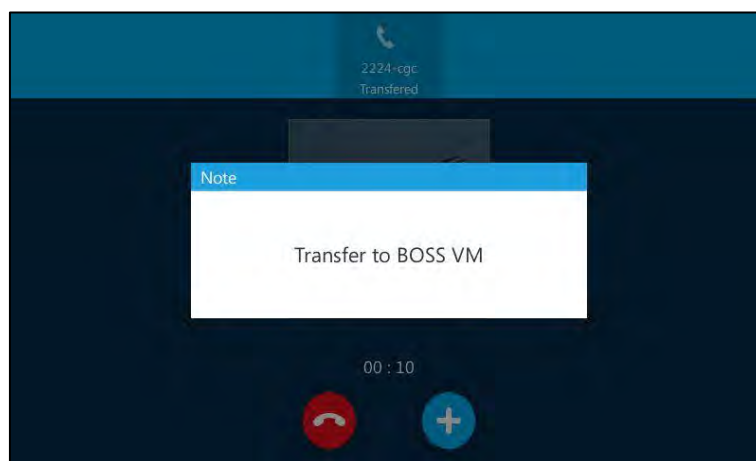

The touch screen of the delegate's phone is shown below:



## Making a Safe Transfer to Boss

After a delegate answers the call, the delegate can transfer the call to the boss's phone using Safe Transfer, which enables the delegate to transfer the call to the boss's phone and prevent the call from going to voicemail if the boss does not answer the call.

**To make a safe transfer to a boss's phone:**

1. Tap  ->  during a call. The call is placed on hold.

When the boss answers the call, the call will be transferred to the boss successfully.



When the boss is not available to answer the transferred call or rejects the transferred call, the delegate's phone displays as "Transfer failed". The delegate can tap  to resume the call.

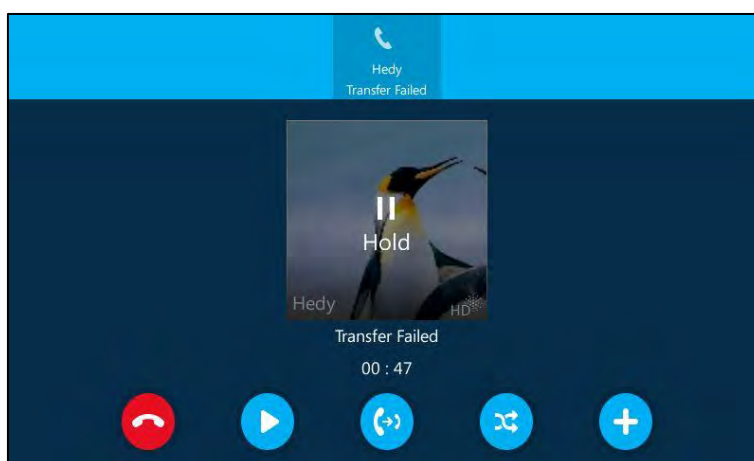

## Calling on Behalf of a Boss

The delegate can make calls on behalf of his assigned boss's lines.

**To place a call on behalf of a boss's line:**

1. Tap  -> **Bosses**.



2. Tap the avatar of the desired boss.
3. Tap the **On behalf** soft key.

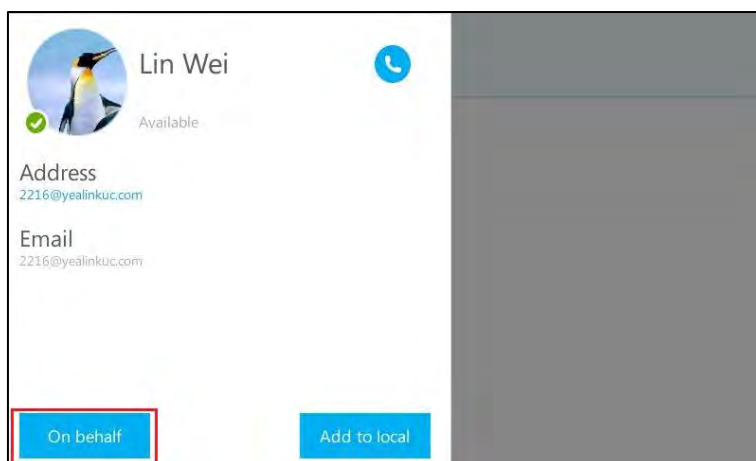

4. Tap the desired contact or enter the desired number, and then press  or tap .

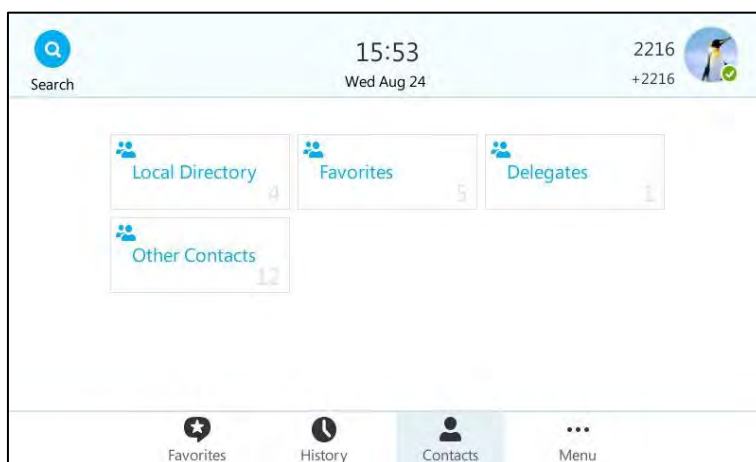

The call displays “Calling On behalf of XXX” on the delegate’s phone.

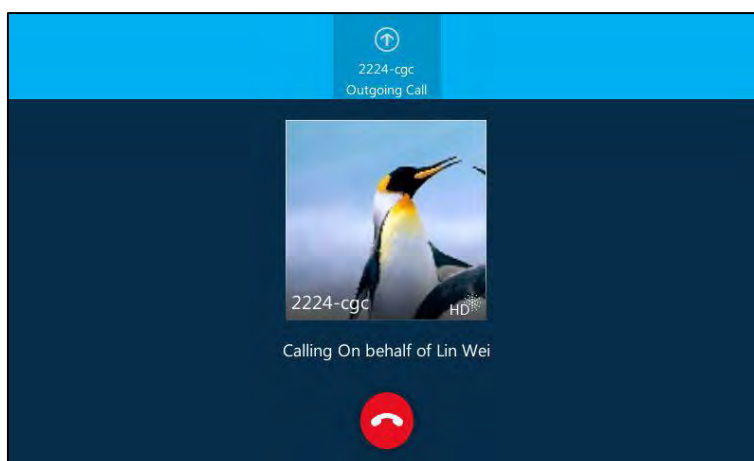



The delegate displays a notification after the third-party answers the call. As shown below:



## Joining Conference Calls

The delegate can join an incoming conference call on behalf of a boss’s line and add the boss to the conference call.

### To add a boss’s line to a conference call:

1. Tap  or  to join an incoming conference call.
2. If the conference needs the boss to be present, tap  to add the boss’s line to the conference.



The touch screen of the delegate's phone is shown below:

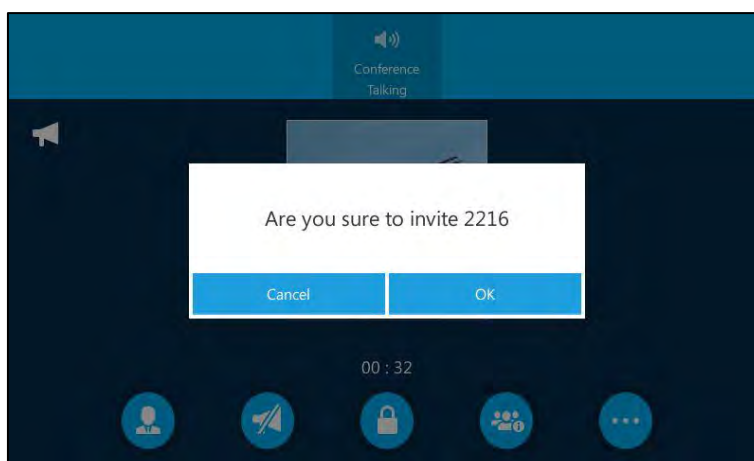

3. Tap the **OK** soft key.

The touch screen of the delegate's phone is shown below:

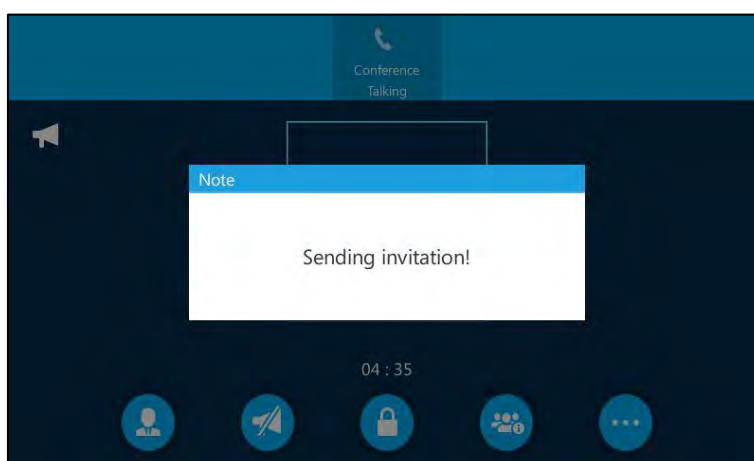

When the boss joins the conference call, the delegate can choose to continue or leave the conference.



## Boss-Line Ringtone

As a delegate, you can set a distinct ringtone for your assigned boss's line. When you receive incoming calls from your assigned boss or your assigned boss receives an incoming call, your phone will play this ringtone.

**To set a ringtone for the boss's line via phone user interface:**

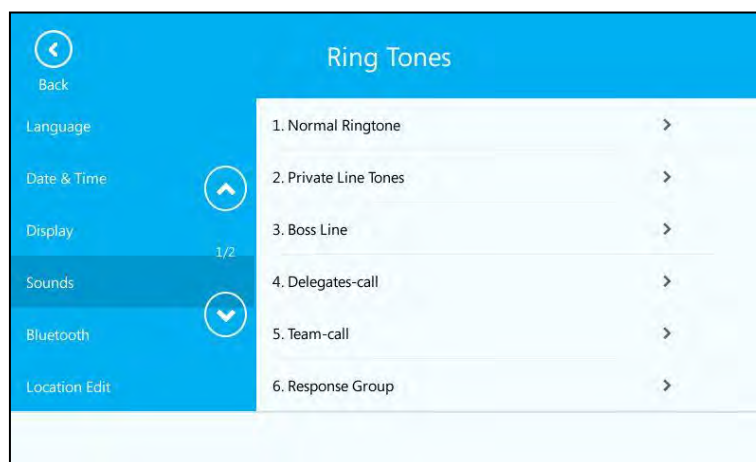
1. Tap ...->**Basic**->**Sounds**-> **Ring Tones**->**Boss Line**.



2. Tap the desired boss.
3. Tap the desired ring tone.
4. Tap  to accept the change or tap  to cancel.



## Delegates-call Ringtone

As a boss, you can set a distinct ringtone for incoming calls from your assigned delegate's line.

**To set a ringtone for the delegate's line via phone user interface:**

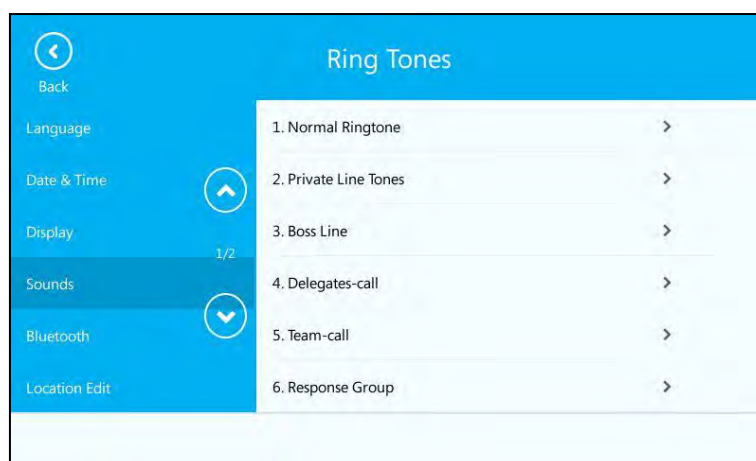
1. Tap ...->**Basic**->**Sounds**->**Ring Tones**->**Delegates-call**.



2. Tap the desired boss.
3. Tap the desired ring tone.
4. Tap  to accept the change or tap  to cancel.

## Inbound Private Line

If you sign into the phone using Onprem account, you can use inbound private line feature. Current Online environment does not support this feature.

The Skype for Business Server enables the system administrator to give users a second, private telephone line in addition to their primary telephone line. Private telephone lines are often assigned to bosses who want an unlisted telephone number at which they can be reached directly.

When the boss receives a private call, the private line will bypass call delegation and only his/her phone rings even though a secretary has been designated as his/her delegate for ring simultaneously feature.

The system administrator can assign a private line to boss in one of the following situations occurs:

- The boss doesn't want to miss important calls denied by his DND status.
- The boss doesn't want the delegate to answer some important or confidential calls for him.
- The boss wishes his friends and families to reach him directly or bypass his delegate.

In many organizations, bosses have administrative secretaries who answer their office phones for them. This is easily accomplished on the Skype for Business Server by using call delegation. As a result, if one people dial the primary line of the boss, the phones of the delegate will ring simultaneously. If the people dial the private line of the boss, only boss's phone rings.

### **Characteristics of Private Lines:**

- A user can have only one private line.
- A user with a private line has only one voice mailbox.
- Calls to the private telephone line ring through. They do not follow "Do Not Disturb" rules.
- Private lines are inbound only and cannot be used to make outgoing calls.
- None of the following features are available with a private telephone line: delegation, and Response Group application.

For more information on planning for private telephone lines, refer to [Plan for private telephone lines](#).

When receiving a private call, the touch screen of the phone will prompt “Call for private line”:

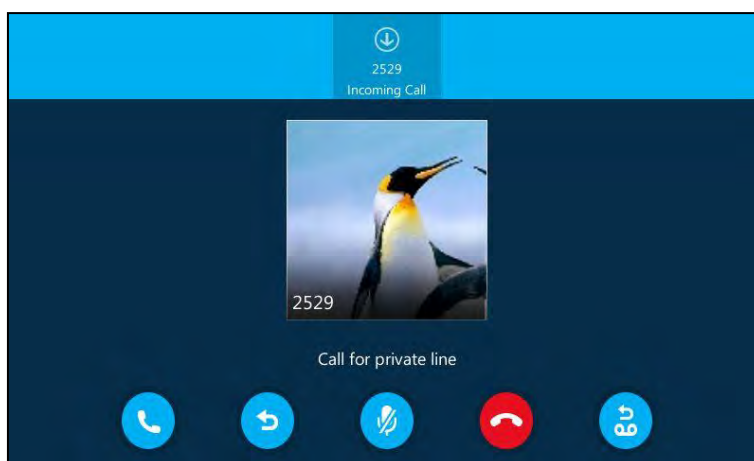

**Note**

Private lines can only be configured on the Skype for Business client only. Contact your administrator for more information.



## Private Line Tones

Private line tone feature allows the Skype for Business phone to play a specific ring tone when receiving a private call.

**To select a ring tone for the private line via phone user interface:**

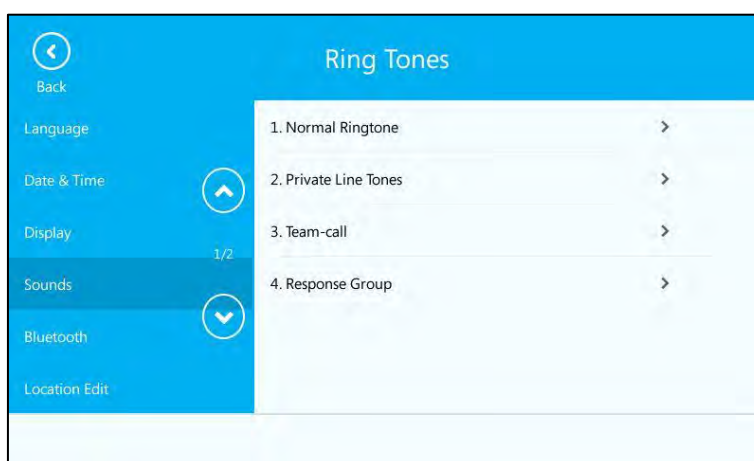
1. Tap **...** -> **Basic**-> **Sounds**-> **Ring Tones**-> **Private Line Tones**.



2. Tap the desired ring tone.
3. Tap  to accept the change or tap  to cancel.

A ring tone for the private line is configurable via web user interface at the path **Settings**-> **Preference**-> **Private line ring**.



## Call Transfer

You can transfer a call to another party in one of the two ways:







- **Blind Transfer:** Connect a second party to a third party before the third party answers.
- **Consultative Transfer:** Connect a second party to a third party after the third party answers and agrees to take the call from the second party.

### Blind Transfer

**To perform a blind transfer during a call:**

1. Press  or tap  during a call.



2. Do one of the following:
  - Enter the number you want to transfer the call to.  
Press  or tap  to complete the transfer.
  - Tap , and then tap the desired contact from the desired group.  
Press  or tap  to complete the transfer.
  - Tap , and then tap the desired entry from the desired call history list.

Press  or tap  to complete the transfer.

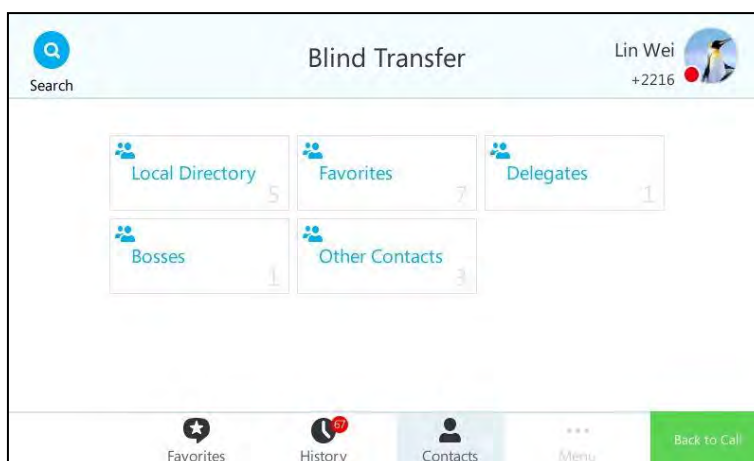

Then the call is connected to the number to which you are transferring.





## Consultative Transfer





**To perform a consultative transfer:**

1. Tap  during a call.



2. Do one of the following:

- Tap the avatar of the desired contact in **Favorites** screen.
- Enter the number you want to transfer the call to.  
Press  or tap  on the on-screen keyboard.
- Enter the first few characters of the contact name or the contact number, then tap the desired contact from the result list, and then press  or tap  or tap the desired number.
- Tap , and then tap the desired entry from the desired call history list.

- Press  or tap  .
- Tap  , and then tap the desired contact from the desired group.
- Press  or tap  or tap the desired number.

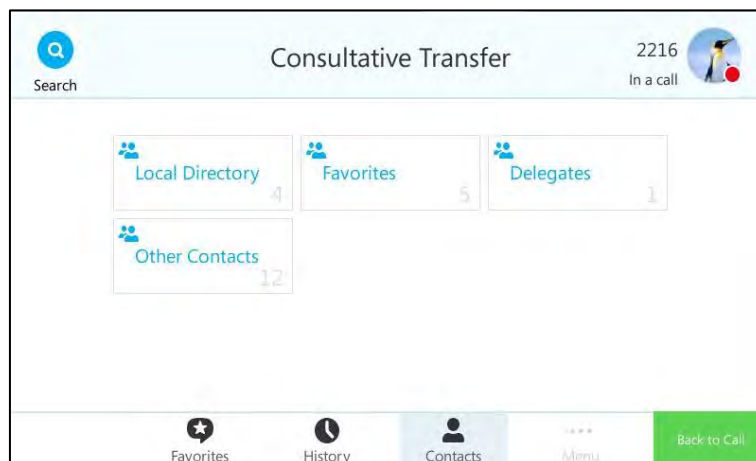

3. After the party answers the call, press  or tap  to complete the transfer.

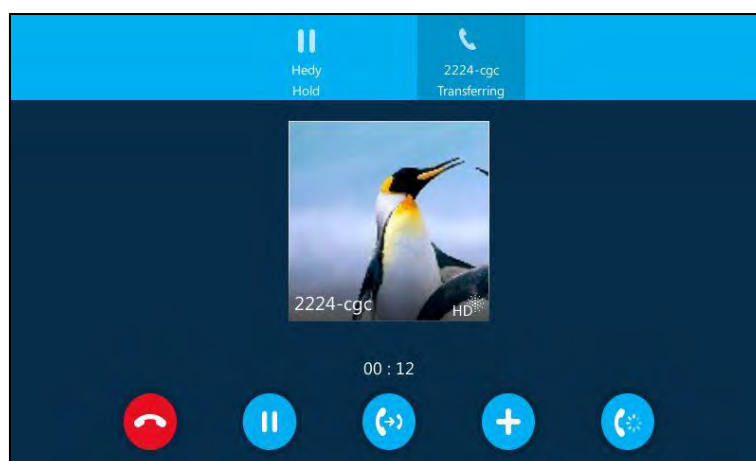

## Group Call Pickup

If you sign into the phone using Onprem account, you can use group call pickup feature. Current Online environment does not support this feature.

Group call pickup is used for picking up incoming calls within a pre-defined group. If the group receives many incoming calls at once, the user will pick up the first incoming call, by dialing the group pickup code. This feature depends on support from the Skype for Business Server.

### Note

Group and group pickup code are configurable on the Skype for Business Server only. Contact your system administrator for more information.

**To use group pickup via phone user interface:**

1. Enter the group pickup code (e.g., #505) on your phone when a phone number in your group receives an incoming call.

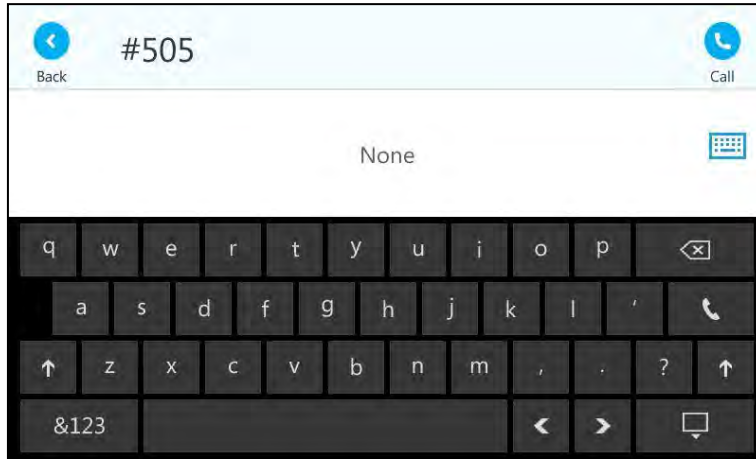

2. Tap .  
The call is answered on your phone.

## Skype for Business Conference

This chapter provides basic operating instructions for managing Skype for Business conference. You can initiate a Skype for Business conference call on your phone or on the Skype for Business client. You can view the conference participants. And you can also manage the conference participants (e.g., promote or demote conference participants, enable or disable announcements).

### Initiating a Skype for Business Conference Call

You can initiate a Skype for Business conference call on your phone or on the Skype for Business client.

**Note** You can join a conference from the calendar. For more information, refer to [Joining Skype Conferences from the Calendar](#) on page 132.





### Initiating a Conference Call during a Call



#### Initiating a Conference Call from the Phone

You can initiate a Skype for Business conference call, add and invite contacts to a conference call from phone.





**To initiate a Skype for Business conference call via phone user interface:**

1. Place a call to the first party.
2. When the first party answers the call, tap  to invite a new call to the Skype for Business conference.
3. Enter the number of the third party and press  or tap  or  on the on-screen keyboard.

You can also enter the first few characters of the contact name or the contact number, then tap the desired contact from the result list, and then press  or tap  tap the desired number.

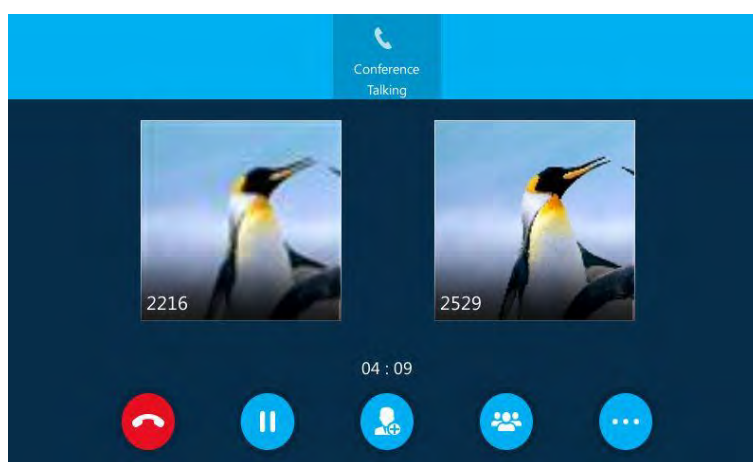
4. When the third party answers, three parties are now joined in the conference.



5. Tap  to invite a new party.
6. Repeat the steps 3-4 to add more parties to the conference.

**Initiating a Conference Call from the Skype for Business Client**

You can initiate a conference call on the Skype for Business client.

**To initiate a Skype for Business conference call from the Skype for Business Client:**

1. Place a call to the first party.

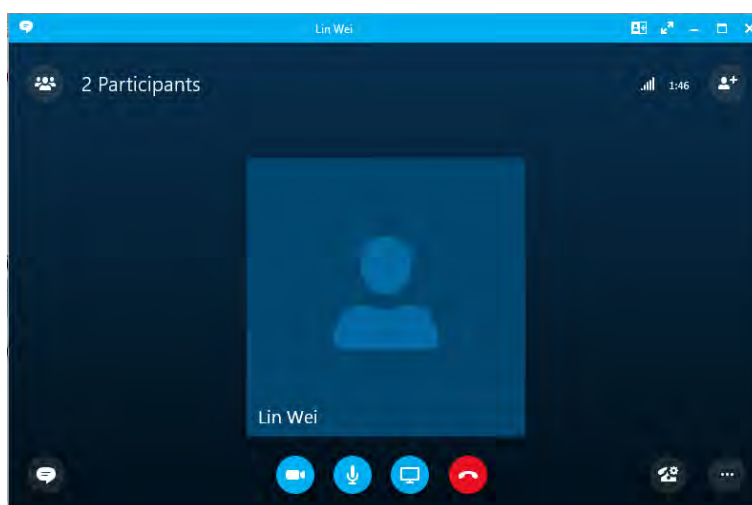

2. Click  to enter the number or name of the third party, and then click **OK** to invite a new call to the Skype for Business conference.

You can also enter the first few characters of the contact name or the contact number. Then click the desired contact from the result list, the call will be placed directly.

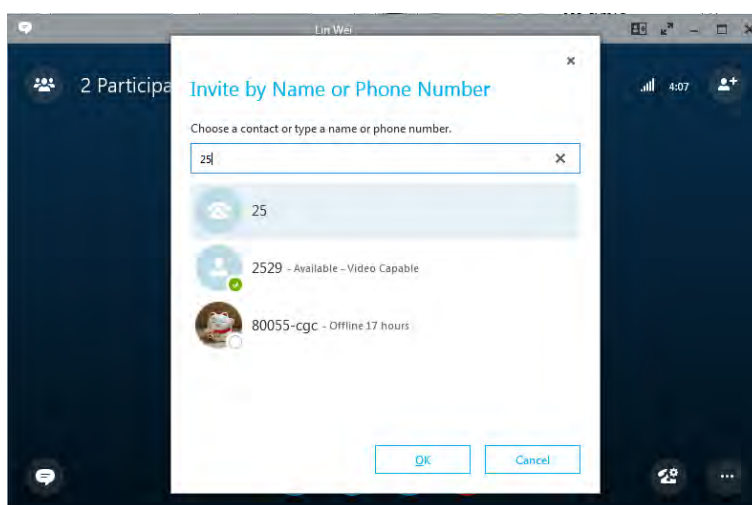

3. When the third party answers, there parties are now joined in the conference.
4. Click  to invite a new party.

- Repeat the steps 2-3 to add more parties to the conference.



## Join Calls into a Conference





### Joining Two Calls into a Conference from the Phone

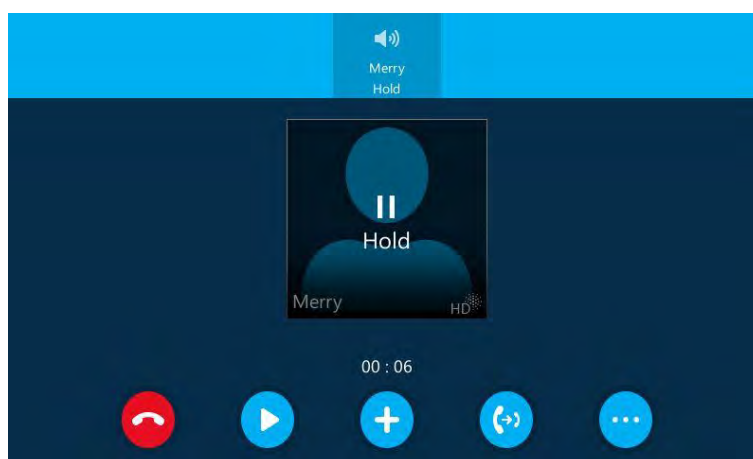

You can join an active call and a held call into a conference call from the phone.

**To join two calls into a conference call from the phone:**



- Place a call to the first party.
- When the first party answers the call, tap  to place the call on hold.

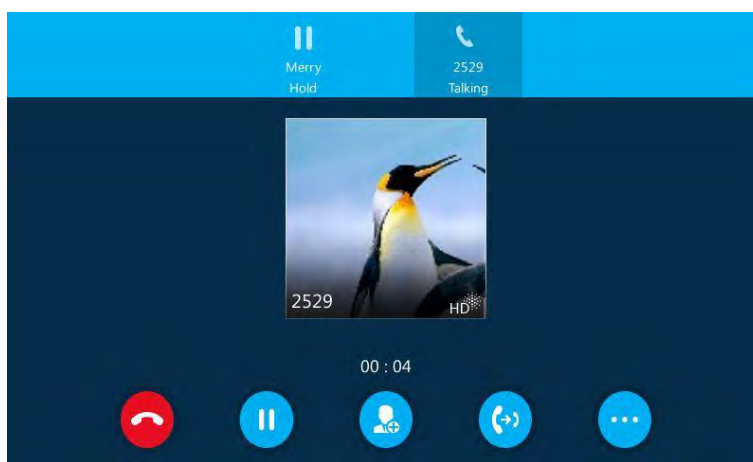

- Tap  to place a new call.
- Enter the number of the third party and press  or tap  or  on the on-screen keyboard.

You can also enter the first few characters of the contact name or the contact number, then tap the desired contact from the result list, and then press  or tap  or tap the desired number.



5. When the third party answers, tap .
6. Tap .

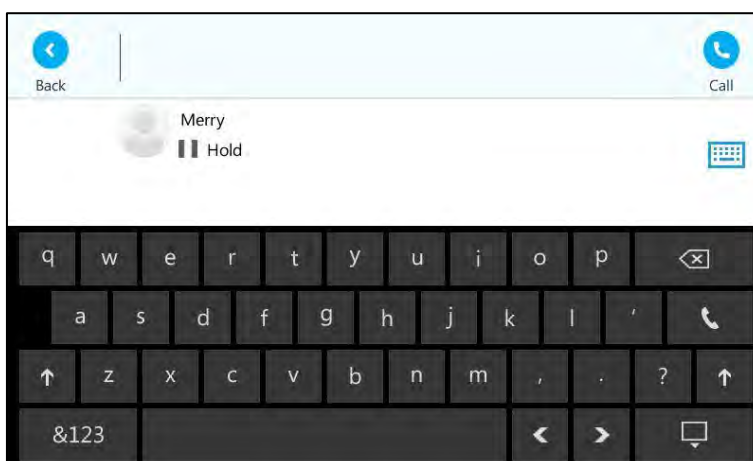

7. Tap the avatar of the contact that is held.  
The active call and the held call are joined into a conference.







8. Tap , and dial other numbers to invite more parties.

## Joining Two Calls into a Conference from the Skype for Business Client

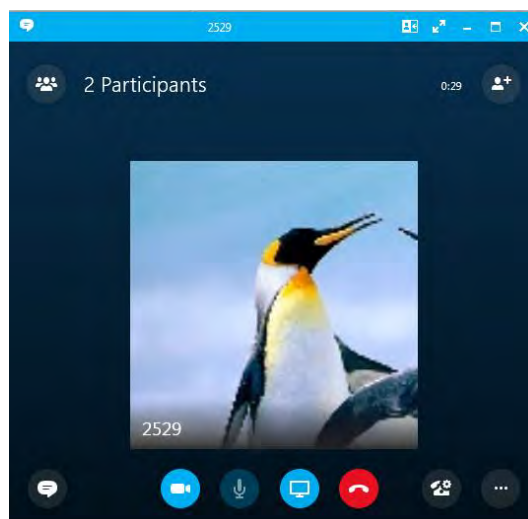
**To initiate a Skype for Business conference call from the Skype for Business Client:**

1. Place a call to the first party.



2. Click  ->  to place the call on hold.
3. Enter the first few characters of the contact name or the contact number in the search box.
4. Hover the mouse over the avatar of the contact, and then click .

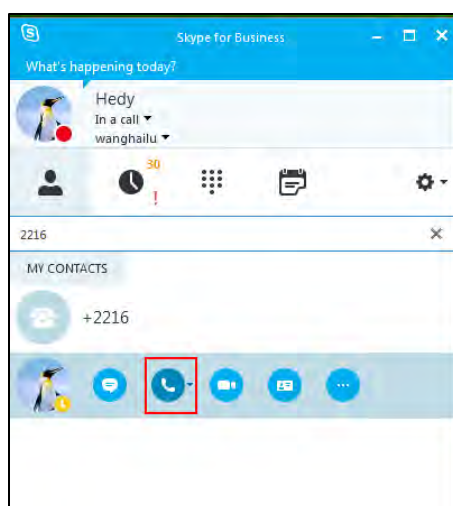

5. When the third party answers, click .

6. Select **Merge This Call Into**, and then click the held call.

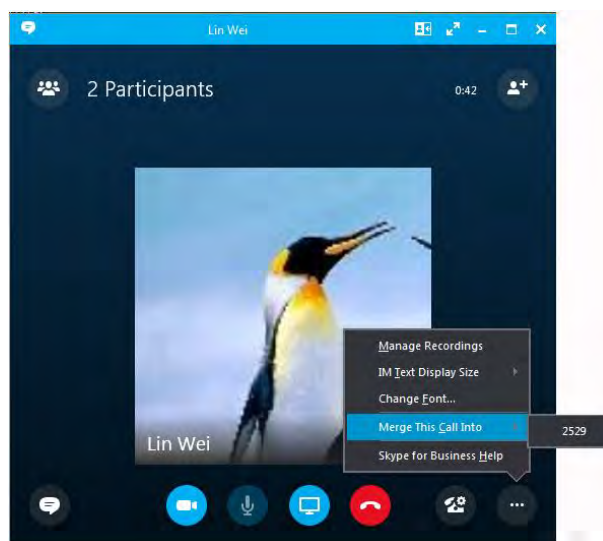

Three parties are now joined in the conference.

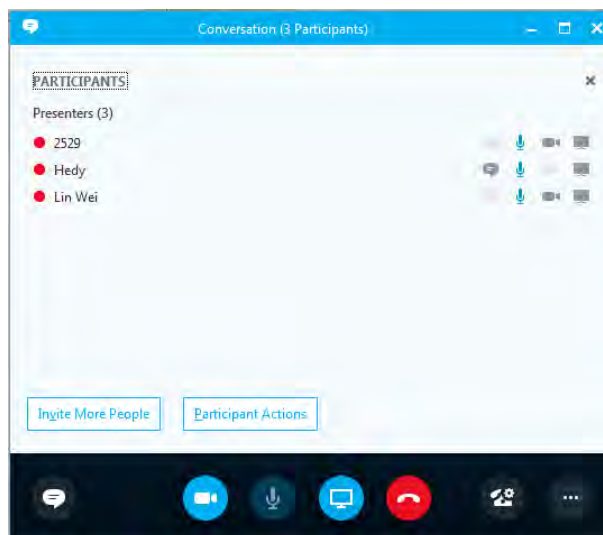

7. Click **Invite More People** to add more parties to the conference.

## Initiating a Skype Conference Call by Meet Now



### Initiating a Skype Conference Call from the Phone

To initiate a Skype for Business conference call by meet now via phone user interface:

1. Tap **...** -> **Meet Now**.



You will initiate a Skype for Business conference call directly.

2. Tap .
3. Enter the desired number, and then tap .

You can also select the desired contact from Favorites, History or Contacts.

4. Repeat steps 2-3 to add more parties to the conference.

### Initiating a Skype Conference Call from the Skype for Business Client

To initiate a Skype for Business conference call by meet now from the Skype for Business client:

1. Click  on the Skype for Business client, and then select **Meet Now**.

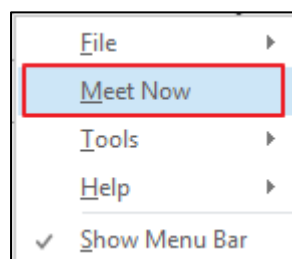

You will initiate a Skype for Business conference call directly.

2. Click  to enter the number or name of the third party, and then click **OK** to invite a new call to the Skype for Business conference.

You can also enter the first few characters of the contact name or the contact number.



Then select the desired contact from the result list, the call will be placed directly.

3. Repeat step 2 to add more parties to the conference.

## Viewing the Dial-in Number and Conference ID

You can view the dial-in number and conference ID when you initiate or join a Skype for Business conference.

**To view the dial-in number and conference ID via phone user interface:**

1. During a Skype for Business conference, tap  ->  to view the dial-in number and conference ID.

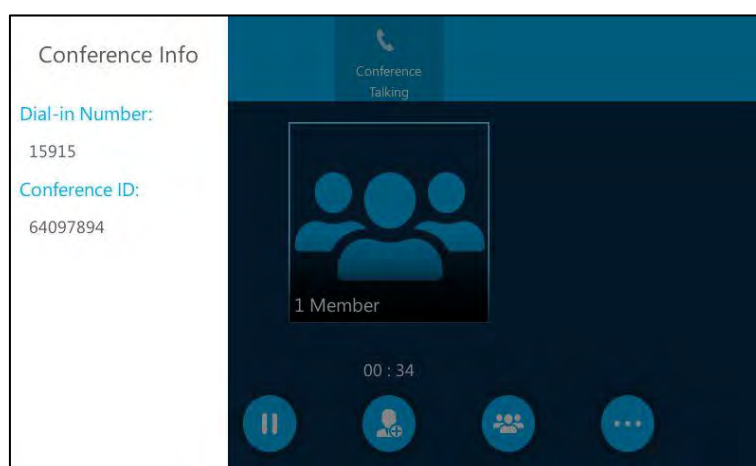

2. Notify other parties of the dial-in number and conference ID, other parties can use the dial-in number and conference ID to join this Skype for Business conference. If this conference is locked, anyone that tries to join the call will enter the lobby until the organizer or presenters accept(s) the call. For more information, refer to [Locking or Unlocking the Conference](#) on page 184.

## Viewing the Conference Participants

When you initiate or join a conference call, you can view the conference participants.





### To view the conference participants via phone user interface:

1. Tap  to view the conference participants' information during a conference.

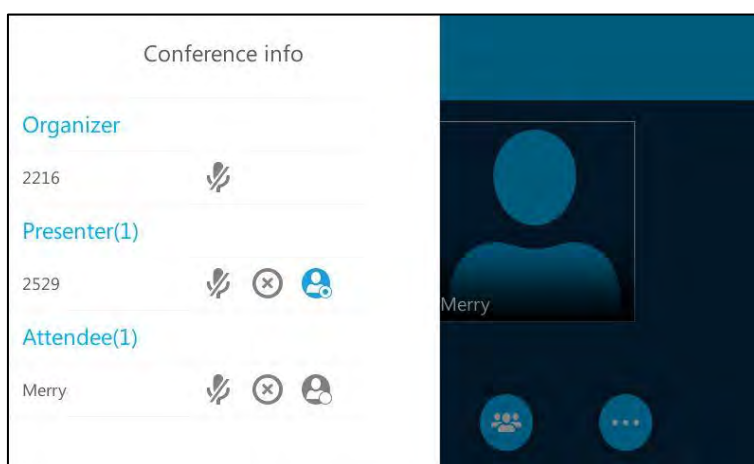

You can view the conference participants' information on the left of the screen.



The conference information includes organizer, presenter () and attendee (). For more information on conference roles, refer to [Joining Skype Conferences from the Calendar](#) on page 132.

2. Tap the grey area on the right side or press  to return to the previous screen.

## Managing the Conference Participants

When you initiate a Skype for Business conference call, you will be an organizer and other participants are listed as presenters by default.

## Holding or Resuming the Conference Call

All participants can place the conference call on hold.

### To place the conference call on hold:

1. Press  or tap  during an active conference call.

Other participants can hear each other.

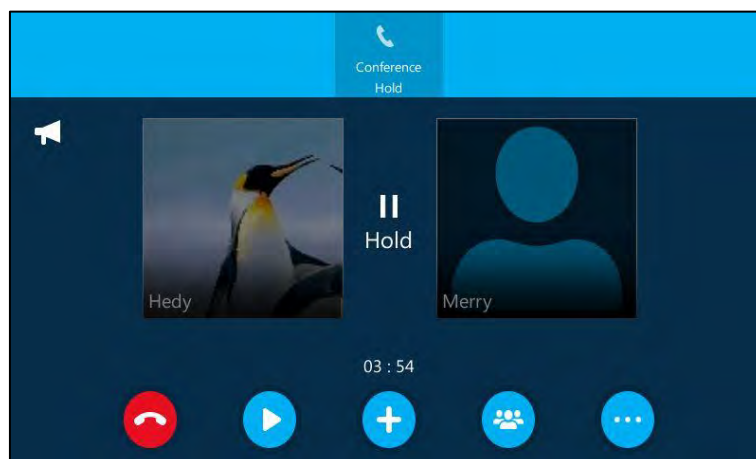

### Note

The phone will beep softly every 30 seconds to remind you that you still have a call on hold.

### To resume the held conference call:

1. Press  or tap .

## Muting or Unmuting Conference Participants

All participants can mute or unmute themselves. But only the organizer and presenters can mute or unmute other conference participants.

### To mute the conference participants by organizer or presenters:

1. Tap .
2. Select desired participant, tap  to forbid the participant from speaking.

The muted participant can hear other participants, but other participants cannot hear the muted participant.

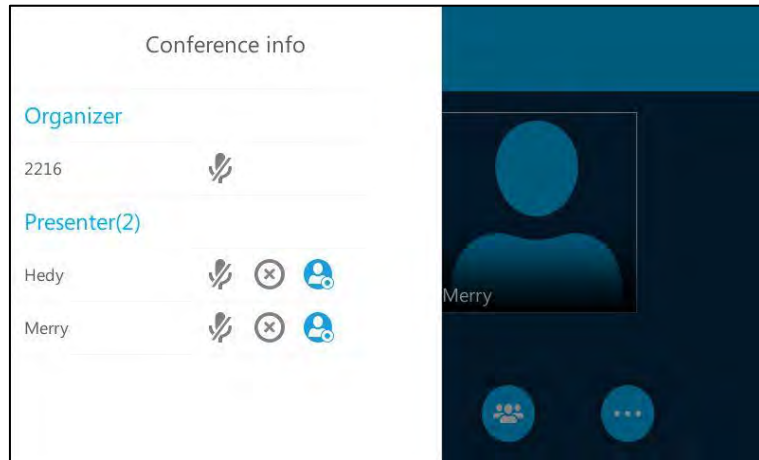

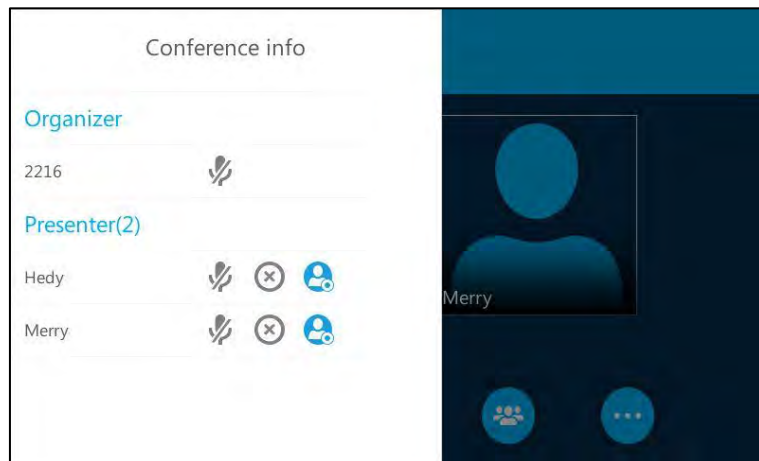

A red mute icon  is displayed under the person who is muted.

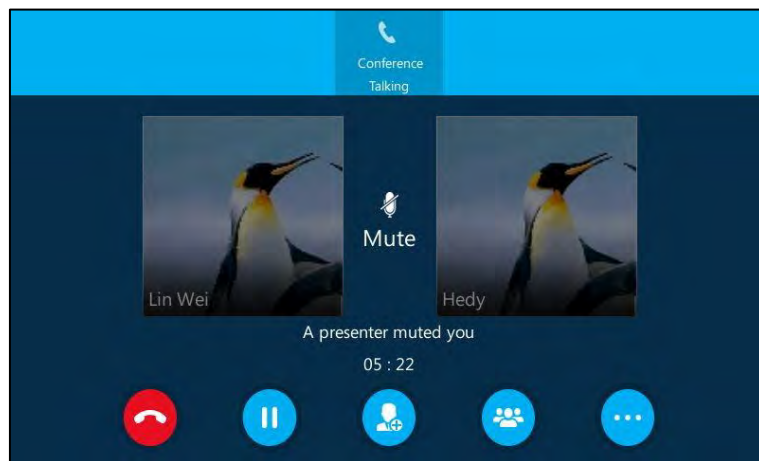

The mute key LED of the muted participant's phone illuminates solid red. The touch screen of the muted participant's phone is shown below:



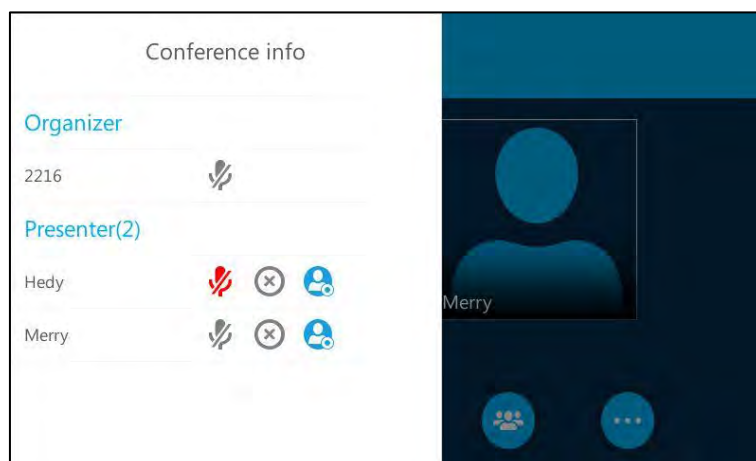

**To unmute the conference participants by organizer or presenters:**

1. Tap .
2. Select desired muted participant, tap .

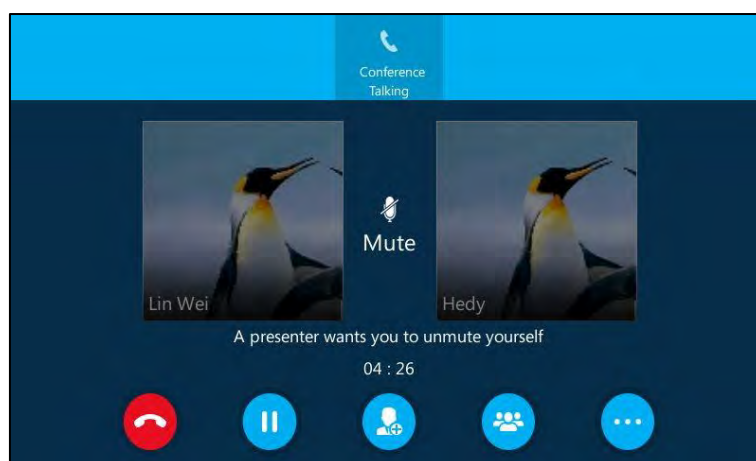

The touch screen of the muted participant's phone is shown below:





3. The muted participant presses  to unmute himself.

## Promoting or Demoting Conference Participants

The organizer and presenters can promote other conference participants from attendees to presenters, or demote conference participants from presenters to attendees. But they cannot demote or promote themselves. The presenters cannot demote or promote the organizer. The attendees cannot promote or demote every participant.



**To demote a conference participant:**

1. Tap .

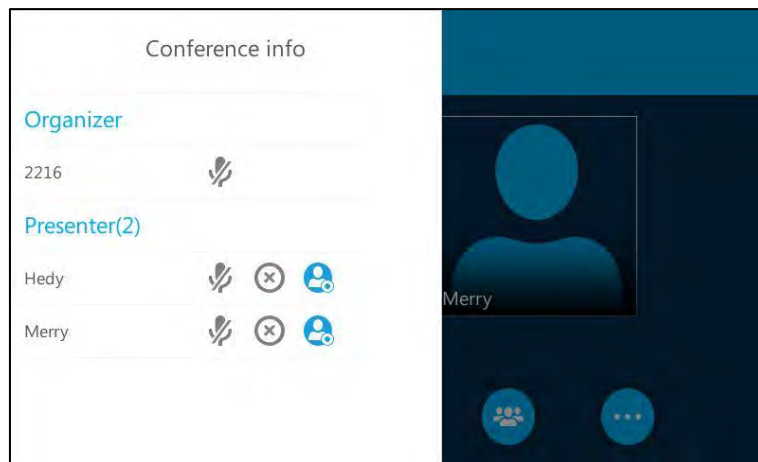
2. Tap  to demote a presenter to an attendee (  ).



#### To promote a conference participant:

1. Tap  .
2. Tap  to promote an attendee to a presenter (  ).

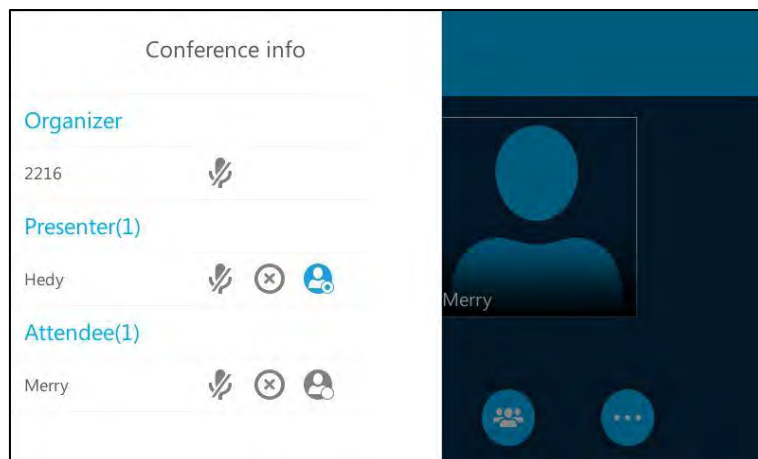

## Enabling or Disabling the Announcement

Only the organizer and presenters can enable or disable the announcement. When the announcement feature is enabled, the phone will issue a voice message to announce that a participant joins or leaves the conference.

**To disable conference announcements:**

1. During a conference call, tap  ->  to disable announcement.



**To enable conference announcements:**

1. During a conference call, tap  ->  to enable announcement.

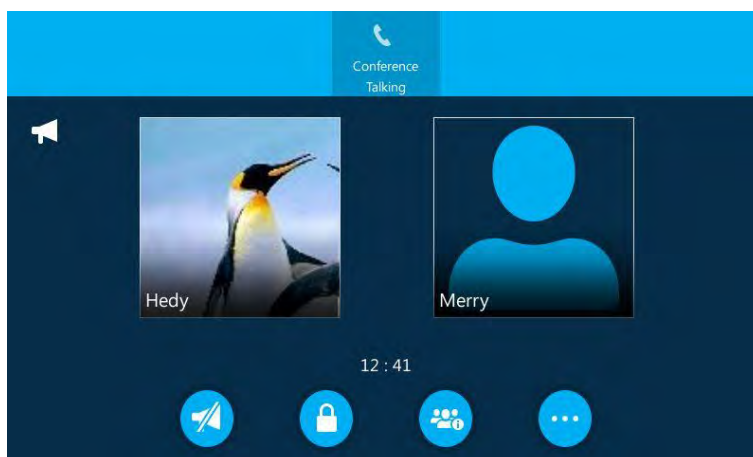

## Locking or Unlocking the Conference

Only the organizer and presenters can lock or unlock the conference.

The organizer and presenters can lock a conference call to prevent other people from joining the conference call without an organizer's or presenter's approval.

**To lock a conference:**

1. During an active conference, tap  ->  to lock the conference.

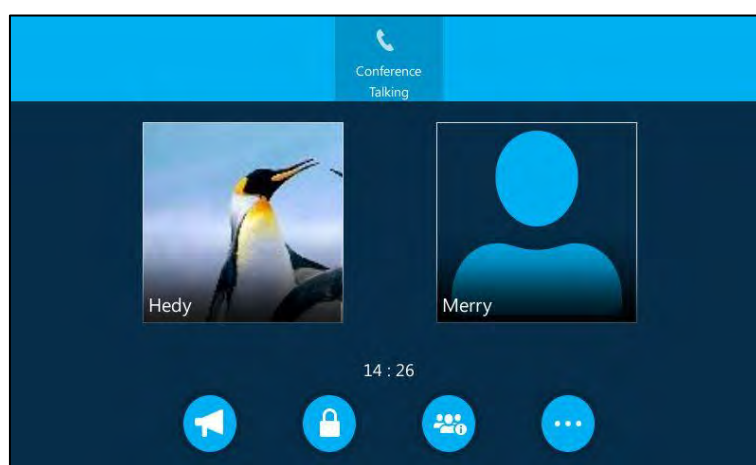

The lock icon  appears on the touch screen, anyone that tries to join the call will enter the lobby until the organizer or presenters accept the call.

**To unlock a conference:**

1. During an active conference, tap  ->  to unlock the conference..

The icon  disappears from the touch screen.

**Joining a Locked Conference Call**

The conference participants can invite you to join a locked conference, you can also join locked conference by dialing dial-in number and Conference ID. For more information, please refer to [Joining a Skype Conference by Dialing the Conference Dial-in Number](#) on page 134.

**The participant invites a new call to a locked conference:**

1. Taps  to invite a new call.

The invitee will enter the lobby until the organizer or presenters accept the call. The touch screen of the organizer's or presenters' phones is shown below:



**The organizer or presenters admit a new call to join a locked conference:**

When the locked conference receives a call, a number icon (indicating the number of calls waiting in the lobby) will appear on . When the organizer admits or rejects the caller to join the locked conference, the number icon will disappear.

1. Tap -> to view the caller waiting in the lobby.

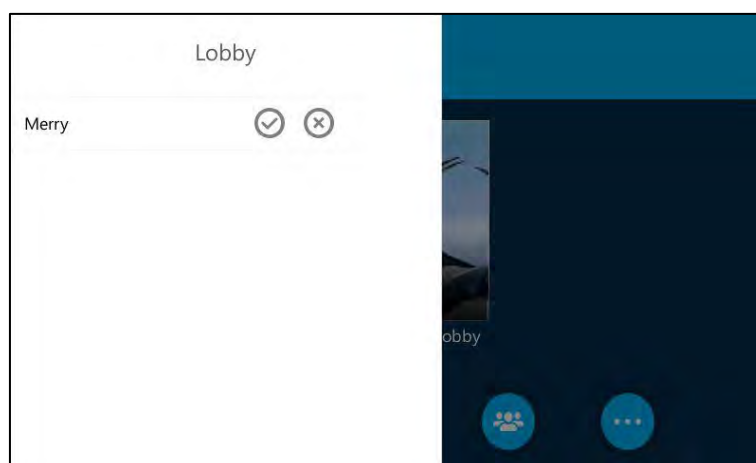

2. Do one of the following:
  - Tap . The caller joins the locked conference as a presenter successfully.
  - Tap . The caller fails to join the locked conference, and the caller drops the call automatically.

**Removing Conference Participants**

An organizer can remove presenters and attendees. A presenter can remove other presenters



and attendees. An attendee cannot remove other participants.

**To remove a conference participant:**

1. Tap .
2. Select the desired participant, and tap  to remove the participant from the conference call.

A notification prompts that the participant is removed.

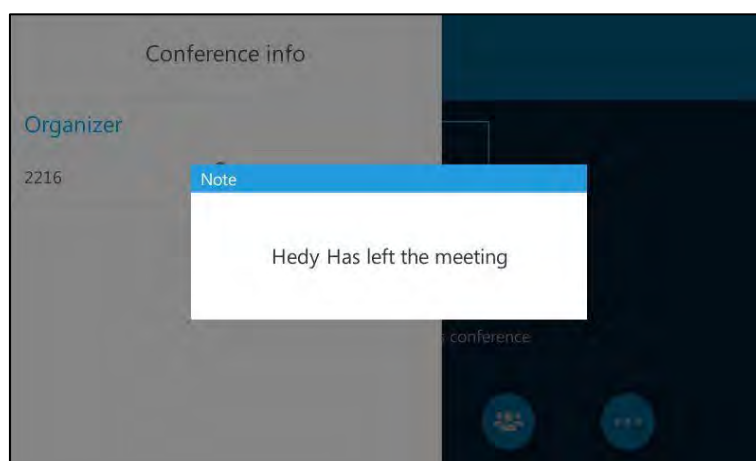

## Leaving the Conference

All participants can leave the conference at any moment.

**To leave the conference:**

1. Tap  to leave the conference.  
Other participants remain connected.

## Call Park



You can use call park feature to place a call on hold, and then retrieve the call later or from another phone in the system (for example, a phone in another office or conference room). You can park an active call by tapping  (the Park soft key) on the phone. If the call is parked successfully, a visible prompt will be displayed on the touch screen of each party confirming that the call was parked.

Call park is different from call hold. Call hold keeps the held call on the same line, while call park places the call in a call orbit on the Skype for Business Server. Calls placed in the call orbit are given an orbit number and can be retrieved by any Skype for Business -compatible phone with access to the orbit.

**Note**

Call park is not available on all servers. Contact your system administrator for more information.

**To use call park:**

1. User on phone A is during a call with user on phone B.
2. User on phone A wants to deal with some things or take the call in a conference room for privacy, then taps , and then tap , on phone A.

The touch screen of phone A displays the call park orbit number.

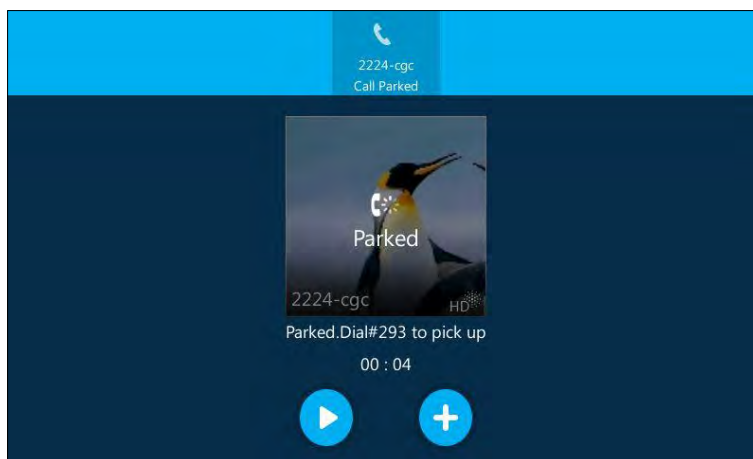

**To retrieve the parked call on phone A:**

After things are processed, user on phone A taps  to retrieve the parked call.

**To retrieve the parked call on phone C:**

User walks to an available conference room where the phone is designated as phone C. The user uses phone C to dial the call park orbit number (appearing on phone A) to retrieve the parked call.

The touch screen of phone A will prompt that the parked call is retrieved by phone C.

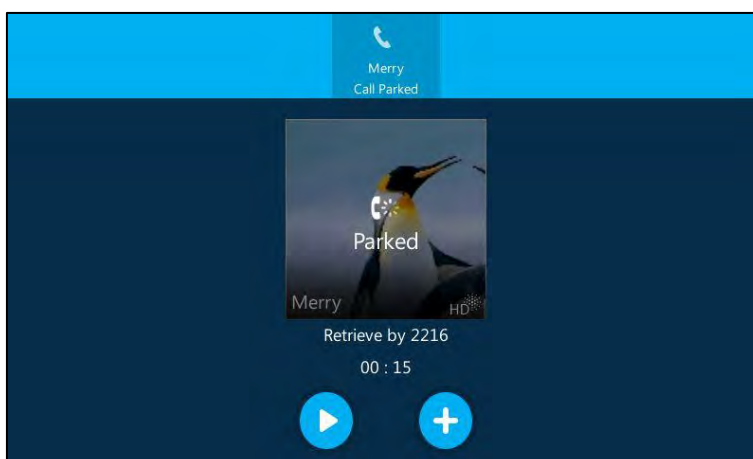

Two-way voice path is established between phone C and B.

### Note

If the call is hung up by the other party before parker retrieves the parked call, the prompting message "Parked user ended call before being retrieved" will be displayed on the touch screen of parker.

The parker will receive a ring back if the parked call is not retrieved by anyone after timeout expires. If the parker does not answer or reject the ring back, the call will be terminated and will not get redirected to voice mail.

## Voice Mail

You can leave voice mails for someone else using the T48G Skype for Business phone. You can also listen to voice mails that are stored in a voice mailbox. When receiving a new voice mail, the phone will play a warning tone. A number icon (indicating the number of voice mails you haven't retrieved) appears on the top-right of the **Message** menu.

Tap **Message** (indicating 1 voice mail you haven't retrieved) to enter the **Menu** screen, and the number icon also appears on the right of the **Message** menu.

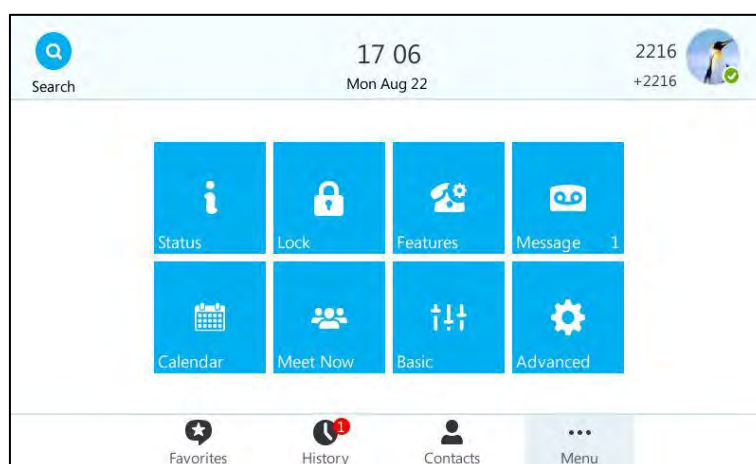

### Note

First time you listen to your voice mails, the message center will ask you to configure a voice mail access PIN.

When all new voice mails are retrieved, the flashing power indicator LED will go out and the number on **Message** menu icon will disappear.

## Leaving the Voice Mail

You can leave a voice mail for someone else when he/she is busy or inconvenient to answer the call. Follow the voice prompt from the system server to leave a voice mail, and then hang up.

## Managing the Voice Mail

### PIN Authentication

When you sign into the phone using [PIN Authentication](#) method, you can follow the voice prompts to listen to voice mails.

**To listen to the voice mail when sign into the phone using PIN Authentication, do the following:**

1. When the phone prompts receiving a new voice mail and the power indicator LED illuminates solid red, press  or tap **Message**.
2. Follow the voice prompt to listen to your voice mails.

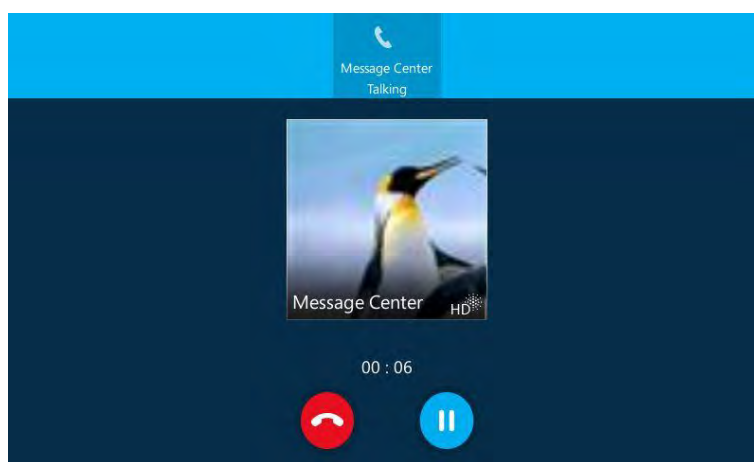

### User Sign-in/Web Sign-in/Sign in via PC

When you sign into the phone using [User Sign-in](#), [Web Sign-in](#) or [Signing in via PC](#) method, you can manage the voice mail, includes viewing a list of voice mails, call back to those who left the voice mails list, mark voice mails as read, delete voice mails and follow the voice prompts to listen to voice mails, etc.

## Accessing the Message Center

To access the message center:

1. When the phone prompts receiving a new voice mail and the power indicator LED illuminates solid red, tap **...**->**Message**->  .

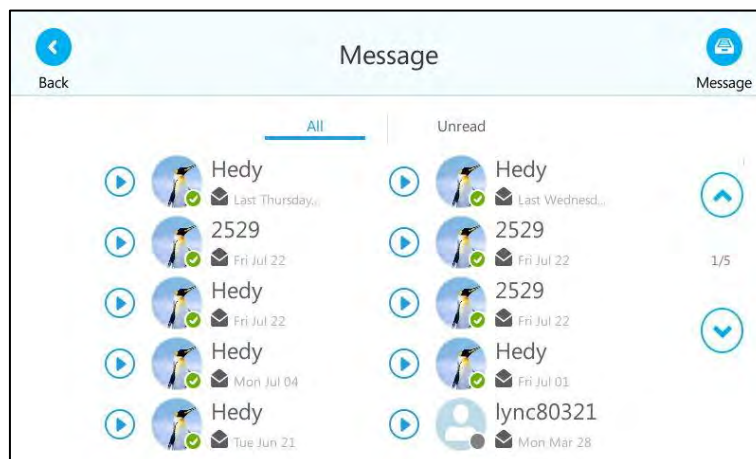

2. Follow the voice prompts to listen to the voice mails.

## Listening to the Voice Mail

To listen to the voice mail:

1. Tap **...**->**Message**.
2. Tap  to play the selected voice mail.

You can also tap the desired voice mail, and then tap the **Play Message** soft key.

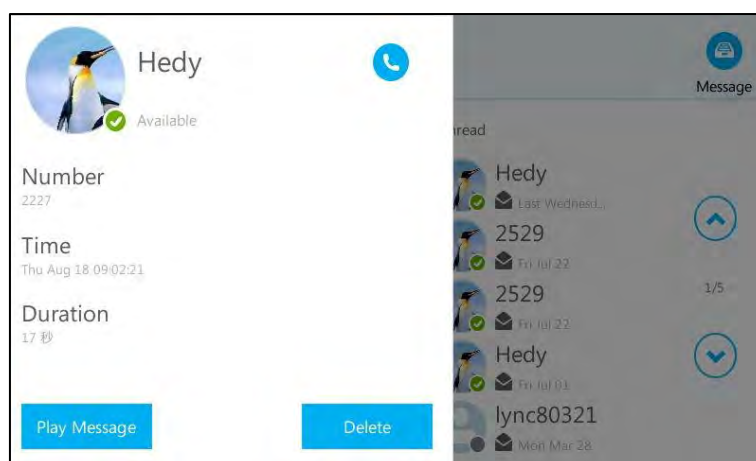

### Note

The phone can accept an incoming call while it is connected to Exchange to play a single or all voice mails. The call with the exchange becomes hold when the phone accepts the incoming call.

## Calling a Contact

### To call a contact:

1. Tap ...->**Message**.
2. Tap the desired voice mail.
3. Tap  to call the contact.

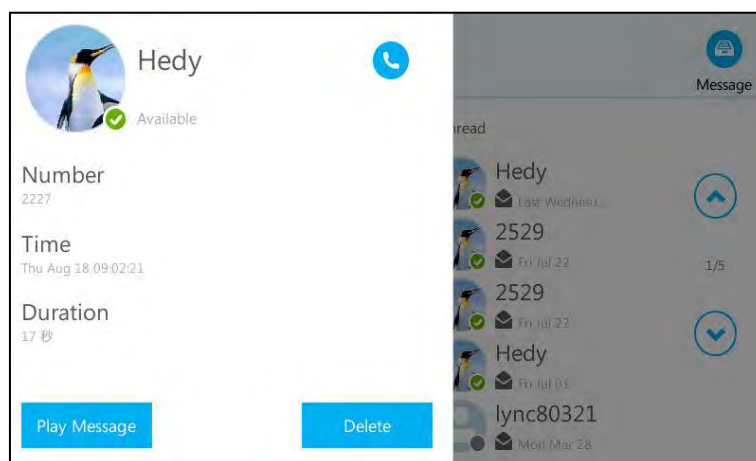



## Marking the Voice Mail as Read

The following icons indicate the status of the voice mail:

-  **Unread voice mail**
-  **Read voice mail**

### To mark the voice mail as read:

1. Tap ...->**Message**.
2. Tap the **Unread** list.
3. Tap the unread voice mail.
4. Tap the **Mark As Read** soft key.

The voice mail icon will change from  to .

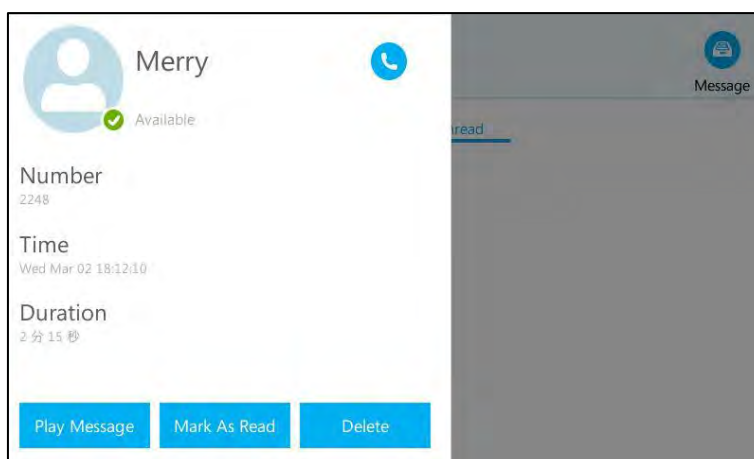

## Deleting the Voice Mail

**To delete the voice mail:**

1. Tap ...->**Message**.
2. Tap the desired voice mail.
3. Tap the **Delete** soft key.

The voice mail you selected will be deleted directly.

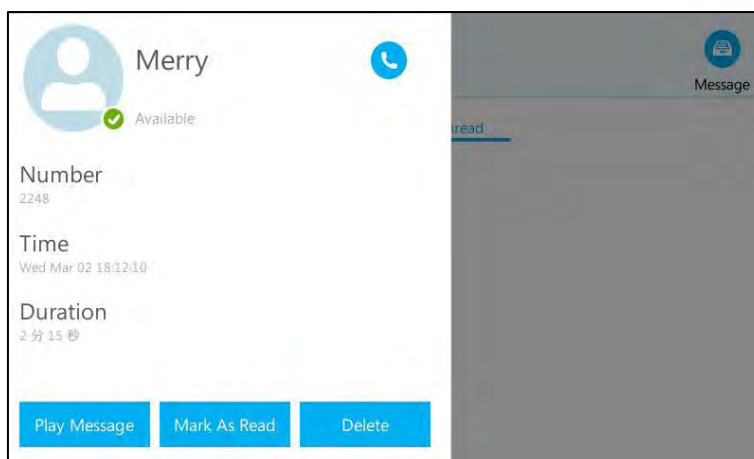

## Multicast Paging

You can use multicast paging to quickly and easily broadcast time sensitive announcements to users who are listening to a specific multicast group. You can configure the paging list on the phone, which allows you to send a Real Time Transport Protocol (RTP) stream to the pre-configured multicast address(es) without involving SIP signaling. You can configure the phone to receive an RTP stream from pre-configured multicast listening address(es) without involving SIP signaling. You can specify up to 10 multicast listening addresses.

## Sending RTP Stream

**To configure paging list via phone user interface:**

1. Tap **...** -> **Features**-> **Paging List**.

2. Tap a desired paging group.

The default tag is Empty if it is not configured before.

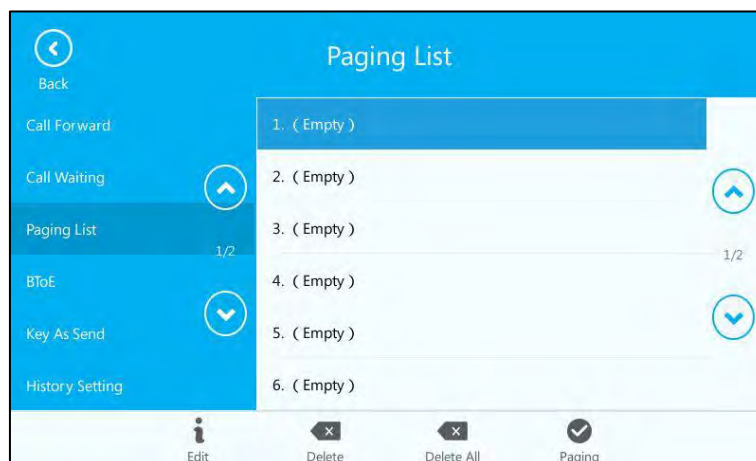

3. Tap the **Edit** soft key.

4. Enter the multicast IP address and port number (e.g., 224.5.6.20:10008) in the **Address** field.

The valid multicast IP addresses range from 224.0.0.0 to 239.255.255.255.

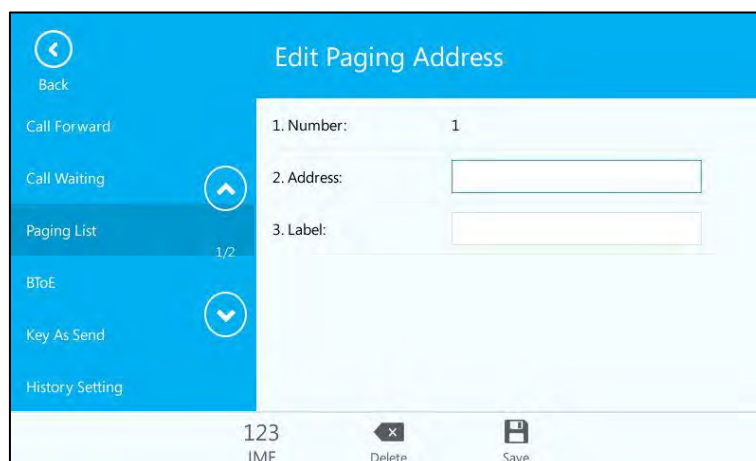

5. Enter the group name in the **Label** field.

6. Tap  to accept the change.

7. Repeat steps 2 to 6, you can add more paging groups.

**To delete a paging group via phone user interface:**

1. Tap **...**-> **Features**-> **Paging List**.



2. Tap a desired paging group.
3. Tap the **Delete** soft key.

The touch screen prompts "Delete selected paging group?".

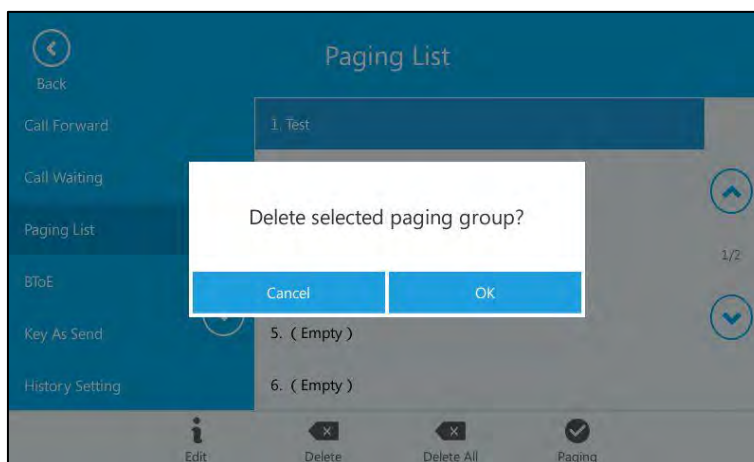

4. Tap the **OK** soft key to accept the change or the **Cancel** soft key to cancel.

If you want to delete all paging groups, you can tap the **Delete All** soft key.

Paging list is configurable via web user interface at the path **Directory->Multicast IP**.

You can also configure the phone to use a codec for sending multicast RTP stream via web user interface.

#### To configure a default codec for multicast paging via web user interface:

1. Click on **Features->General Information**.
2. Select the desired codec from the pull-down list of **Multicast Codec**.

The default codec is G722.

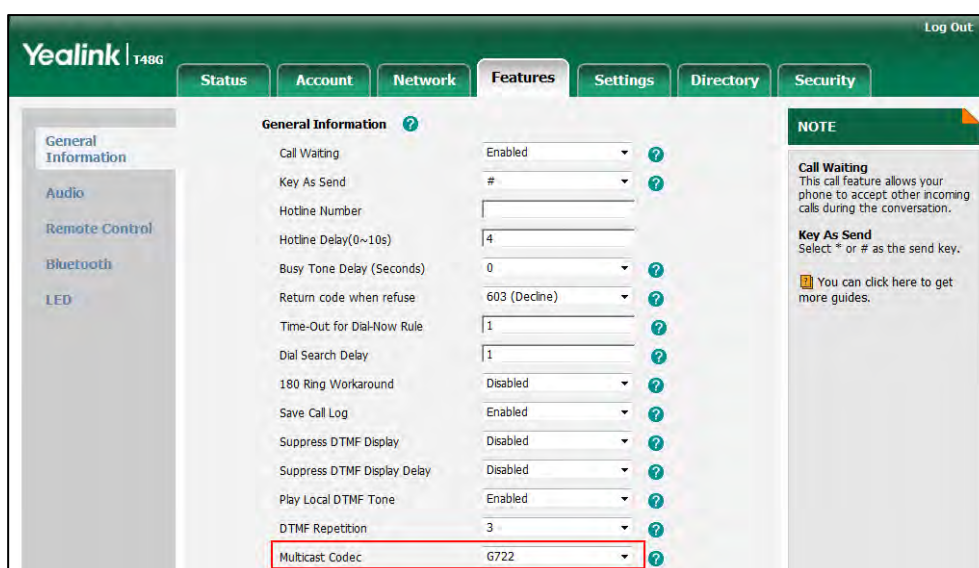

3. Click **Confirm** to accept the change.

**Note** If G722 codec is used for multicast paging, the touch screen will display the **HD** icon to indicate that it is providing high definition voice.

Default codec for multicast paging is configurable via web user interface only.

## Receiving RTP Stream

You can configure the phone to receive a Real Time Transport Protocol (RTP) stream from the pre-configured multicast address(es) without involving SIP signaling. You can specify up to 10 multicast addresses that the phone listens to on the network.

How the phone handles incoming multicast paging calls depends on Paging Barge and Paging Priority Active parameters configured via web user interface.

### Paging Barge

The Paging Barge parameter defines the priority of the voice call in progress. If the priority of an incoming multicast paging call is lower than that of the active call, it will be ignored automatically. If Disabled is selected from the pull-down list of Paging Barge, the voice call in progress will take precedence over all incoming multicast paging calls. Valid values in the Paging Barge field:

- **1 to 10:** Define the priority of the active call, 1 with the highest priority, 10 with the lowest.
- **Disabled:** The voice call in progress will take precedence over all incoming paging calls.

### Paging Priority Active

The Paging Priority Active parameter decides how the phone handles incoming multicast paging calls when there is already a multicast paging call on the phone. If enabled, the phone will ignore incoming multicast paging calls with lower priorities, otherwise, the phone will answer incoming multicast paging calls automatically and place the previous multicast paging call on hold. If disabled, the phone will automatically ignore all incoming multicast paging calls.

### To configure multicast listening addresses via web user interface:

1. Click on **Directory->Multicast IP**.
2. Select the desired value from the pull-down list of **Paging Barge**.
3. Select the desired value from the pull-down list of **Paging Priority Active**.
4. Enter the multicast IP address(es) and port number (e.g., 224.5.6.20:10008) which the phone listens to for incoming RTP multicast in the **Listening Address** field.
5. Enter the label in the **Label** field.

Label will appear on the touch screen when receiving the multicast RTP stream.

**Multicast Listening**

Paging Barge: 10  
Paging Priority Active: Enabled

IP Address	Listening Address	Label	Priority
1 IP Address	224.5.6.20:10008	123	1
2 IP Address			2
3 IP Address			3
4 IP Address			4
5 IP Address			5
6 IP Address			6
7 IP Address			7
8 IP Address			8
9 IP Address			9
10 IP Address			10

**NOTE**  
**Multicast Paging**  
Multicast paging allows IP phones to send/receive Real-time Transport Protocol (RTP) streams to/from the pre-configured multicast address(es) without involving SIP signaling. Up to 10 listening multicast addresses can be specified on the IP phone.  
You can click here to get more guides.

6. Click **Confirm** to accept the change.

**Note** The priorities of listening addresses are predefined: 1 with the highest priority, 10 with the lowest. Multicast listening addresses are configurable via web user interface only.

## Using Multicast Paging

**To send RTP stream via the paging list:**

- Do one of the following to enter the paging list.
  - When the phone is idle, tap **••• -> Features -> Paging List**.

**Paging List**

1. Test

2. ( Empty )

3. ( Empty )

4. ( Empty )

5. ( Empty )

6. ( Empty )

Back

Call Forward

Call Waiting

Paging List 1/2

BToE



Key As Send

History Setting

Edit Delete Delete All Paging

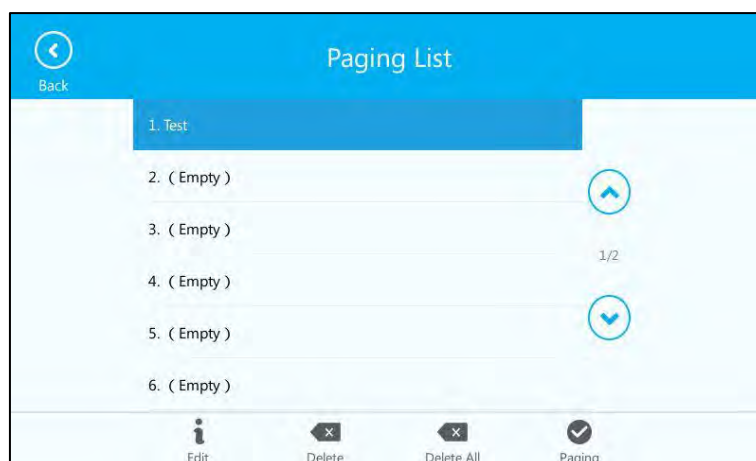
- During a call, tap  ->  ->  -> **Paging.**







2. Select a desired paging group.
3. Tap  or the desired paging group or press  to send RTP.

Both the sender's and receiver's phones play a warning tone and the receiver automatically answers the multicast RTP session in the speakerphone mode.

The following figure shows a multicast RTP session on the phone:



4. To place the current multicast RTP session on hold, press  or tap  .  
The sender's phone places the multicast RTP session on hold and receiver's phone releases the session.
5. To resume the held multicast RTP session, press  or tap  .  
The multicast RTP session is established again.
6. To end the multicast RTP session, tap  .

**Note**

Multicast RTP is one way only from the sender to the multicast address(es) (receiver). For outgoing RTP multicasts, all other existing calls on the phone will be placed on hold.

## Branch Office Resiliency

If you sign into the phone using Onprem account, you can use branch office resiliency feature. Current Online environment does not support this feature.

Branch office resiliency is critical for multi-site deployments of Skype for Business where the control servers are located at a central site or data center. It allows branch site users to continue to have Enterprise Voice service and voice mail (if voice mail rerouting settings are configured) when the branch site loses the connection to the central site.

When the WAN connection between the branch site and central site is unavailable, the phone goes into resiliency mode:

- Branch site user on the phone stays signed in with an indication of “Limited service due to outage”.
- Call between branch site users is established successfully with 2-way audio.
- Conference between branch site users can be established successfully.
- The call history cannot get modified. (Already downloaded call log entries will not be deleted).
- Calls can be placed from the call history on the phone.
- Contact list is unavailable but you can search for a contact on the phone.
- Presence icon on the phone touch screen is displayed as ● (Unknown).
- User is not able to change his presence status manually.
- User is not able to use calendar feature.
- User is not able to receive the voice mail as exchange is unreachable.
- Calls between the branch office phones can be transferred to another branch site user.
- Call forward settings cannot be changed.

When the WAN connection between the branch site and central site becomes available, the phone comes out of resiliency mode automatically. Notification of resiliency is automatically dismissed, and you can use phone features as normal.

### Note

For more information on branch office resiliency, contact your system administrator.



## Common Area Phone

Common area phones are Skype for Business phones that are not associated with an individual user. Instead of being located in someone's office, common area phones are typically located in building lobbies, cafeterias, employee lounges, conference rooms, and other locations where a large number of people are likely to gather. Unlike other phones on the Skype for Business Server, which are typically maintained by using voice policies and dial plans that are assigned to individual users, common area phones do not have individual users assigned to them.

This chapter explains how to use the Common Area Phone. Topics include:

- [Signing into a Common Area Phone](#)
- [Using a Common Area Phone](#)
- [Switching to a Skype for Business Account](#)
- [Signing Out of a Common Area Phone](#)

## Signing into a Common Area Phone

To use the Common Area Phone, you must sign into the phone using [PIN Authentication](#) or [Web Sign-in](#) method.

You need to configure an unlock PIN at the initial sign-in. And it is used to enter the **Advanced** settings.

If the phone signs into a CAP account, the idle screen will be shown as below:

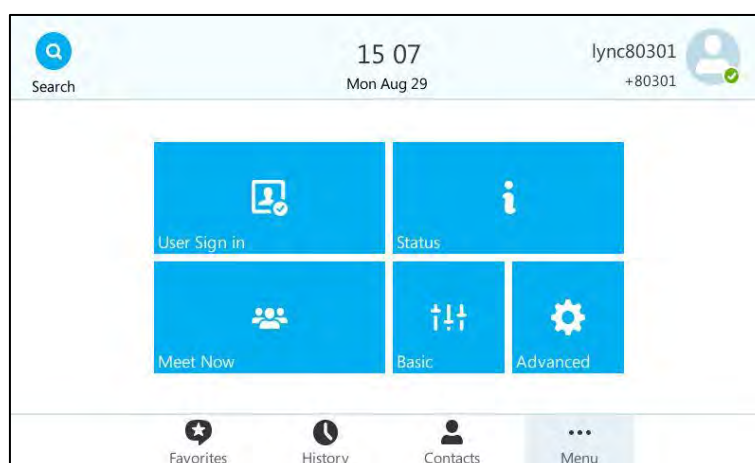

**Note** Your system administrator provides you with login credentials that you can use to sign into a Common Area Phone.

## Using a Common Area Phone

Users should pay attention to the following points when using the Common Area Phone:

- The phone can sign into the last CAP account automatically after the phone recovers from network failure, sever failure or being off line. The phone can sign into the last CAP account automatically after rebooting.
- The phone will not sign into the last CAP account automatically after being reset to factory.

### **Available features of the Common Area Phone:**

- The Common Area Phone supports the basic call features, including placing the call, answering the call, placing the call on hold, resuming the call, muting or un-muting the call and ending the call like a regular phone.
- The Common Area Phone supports switching between a CAP account and a Skype for Business account.
- The Common Area Phone supports the local directory feature.
- The Common Area Phone will switch to away status when screen free time reaches to the set time of the Skype for Business Server.
- If the network administrator enables the advanced feature (e.g., Skype for Business conference, the call park feature, transferring the call) on the Skype for Business Server, you can use these authorized features.

### **Unavailable features of the Common Area Phone:**

- The Common Area Phone doesn't have Skype for Business directory.
- The Common Area Phone doesn't have call history feature.
- The Common Area Phone doesn't have phone lock feature, the unlock PIN is used as the administrator password to access the **Advanced** settings.
- The Common Area Phone doesn't have calendar feature.
- The Common Area Phone doesn't have voice mails feature.
- You can't change your presence manually.
- If the network administrator disables the advanced feature (e.g., Skype for Business conference, the call park feature, transferring the call) on the Skype for Business Server, you can't use these unauthorized features.

## Switching to a Skype for Business Account

If the network administrator enables the sign-in configuration on the Skype for Business Server, users can sign into their own Skype for Business account to use Skype for Business features and their own user profile settings.



### To switch a CAP account to a Skype for Business account:

1. Tap **User Sign in**.

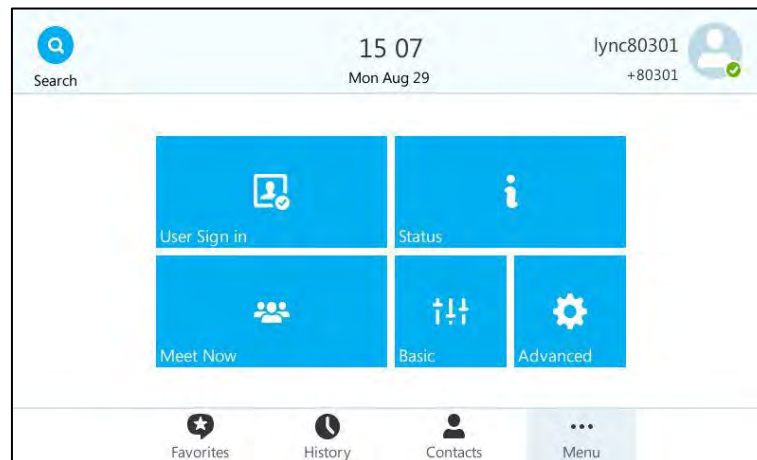

2. Select the desired sign-in method, and then enter your information to sign in a Skype for Business account.

For more information on sign-in, refer to [Signing into Skype for Business](#) on page 18.



3. Tap the **Sign in** soft key.

No matter whether you sign out of the Skype for Business account, the phone will sign into the last CAP account automatically after a period of time. The time is specified on the Skype for Business Server by system administrator.

#### Note

If you switch to another CAP account, your phone will never sign into the last CAP account again.

## Signing Out of a Common Area Phone

System administrator can sign out of the CAP account. Once the CAP account is signed out, the phone will not sign into the last CAP account automatically. User can sign into other CAP

account or Skype for Business account.

**To sign out of a Common Area Phone:**

1. Tap **...** -> **Advanced** (default password: admin or the unlock PIN) -> **CAP Sign Out**.



2. Mark the **On** radio box of **Sign Out** field.

The current CAP account will sign out.

## Better Together over Ethernet

---

Better Together over Ethernet (BToE) feature on Yealink T48G Skype for Business phones enables you to control call activity from your phones and your computer using your Skype for Business client. You can also use BToE to sign into your phone using your Skype for Business credentials. In order to use BToE, you need to download and install the Yealink BToE Connector application.

This chapter explains how to download and install the Yealink BToE Connector application, and how to enable and use BToE feature. Topics include:

- [Getting Started with Better Together over Ethernet](#)
- [Installing the Yealink Better Together over Ethernet Connector](#)
- [Enabling Better Together over Ethernet](#)
- [Using Better Together over Ethernet](#)
- [Disabling BToE on Your Phone](#)
- [Exiting BToE on Your Computer](#)
- [Uninstalling the Yealink BToE Connector](#)

If you require additional information or assistance, contact your system administrator.

## Getting Started with Better Together over Ethernet

To enable and use BToE, you need to ensure the following requirements are available on your PC:

- Skype for Business client
- A registered Skype for Business user (Obtain Skype for Business credentials from your system administrator)
- Running Windows Vista or later
- Administrator privileges are needed to install the Yealink BToE Connector

## Installing the Yealink Better Together over Ethernet Connector

The Yealink BToE Connector enables you to use BToE feature on your Skype for Business client and T48G Skype for Business phone. You need to download, install, and start the Yealink BToE Connector application before enabling BToE and pairing your phone with the Skype for Business client. This section shows you how to download and install the Yealink BToE Connector

application on your PC.

Ask the Yealink FAE or reseller for the BToE Connector application, or download it online:

<http://support.yealink.com/documentFront/forwardToDocumentFrontDisplayPage>.

**To install the Yealink BToE Connector on your PC:**

1. Unzip the downloaded file.
2. Double click the installation application **Yealink BToE Connector**.

A User Account Control dialog is displayed as below:

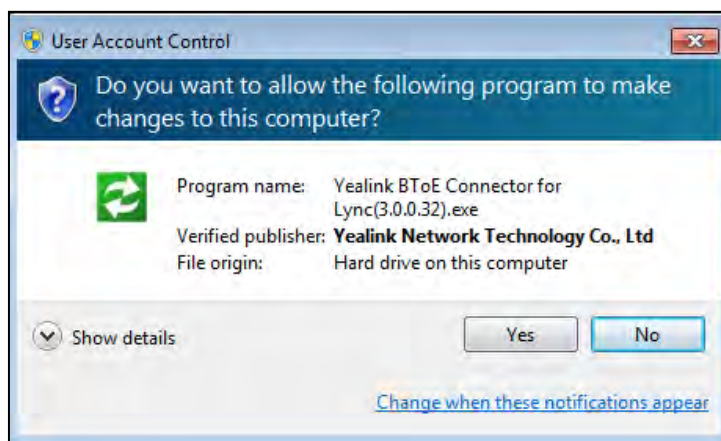

3. Ensure that the dialog lists **YEALINK NETWORK TECHNOLOGY CO., LTD.** as the verified publisher and click **Yes**.

If the YEALINK NETWORK TECHNOLOGY CO., LTD. is not listed as the publisher, click **No** and download the application again from the Yealink website.

The Yealink BToE Connector Setup Wizard is displayed as below:

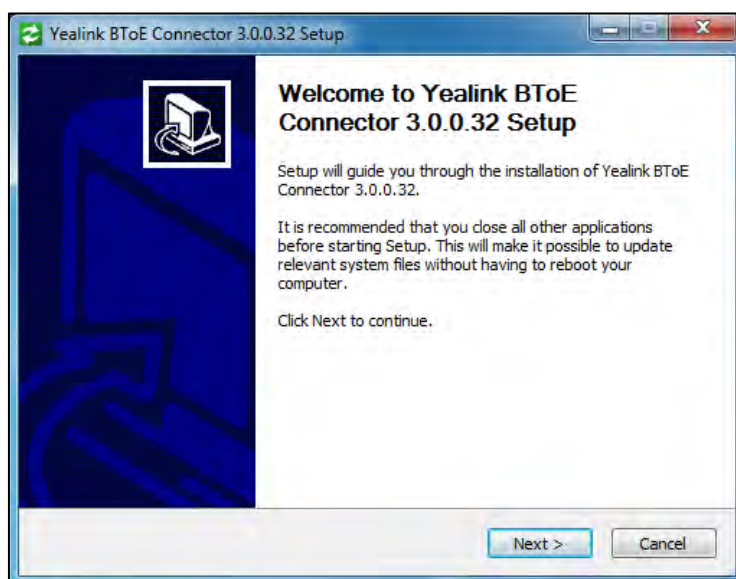

4. Click **Next** to continue.

The License Agreement dialog is displayed as below:

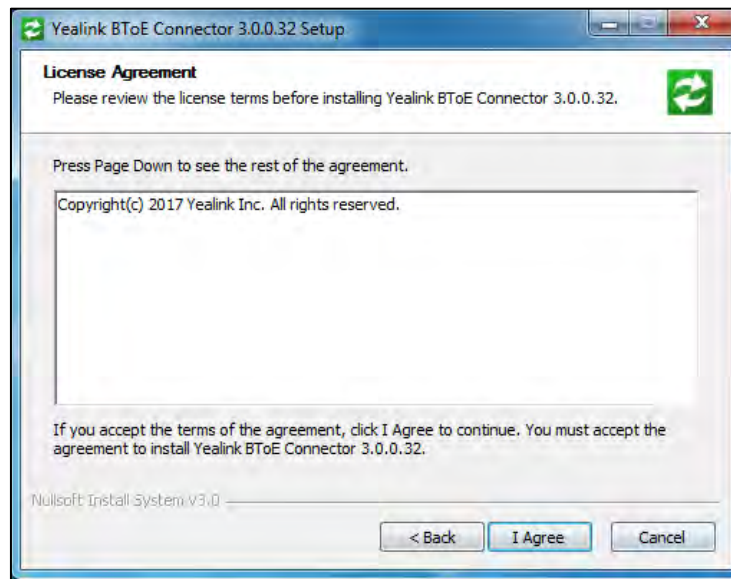

5. Click **I Agree** to accept the agreement.

The Yealink BToE Connector Setup Wizard is displayed as below:

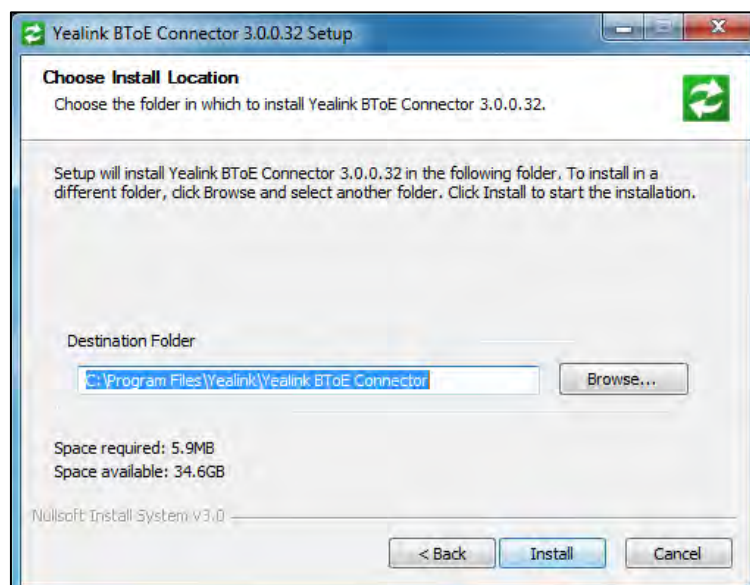

6. Click **Browse...** to select an installation folder and click **Install** to begin the installation.

By default, the Yealink BToE Connector application is installed in the directory C:\Program Files\Yealink\Yealink BToE Connector\.

A status bar showing the Yealink BToE Connector installation's progress is displayed as below:

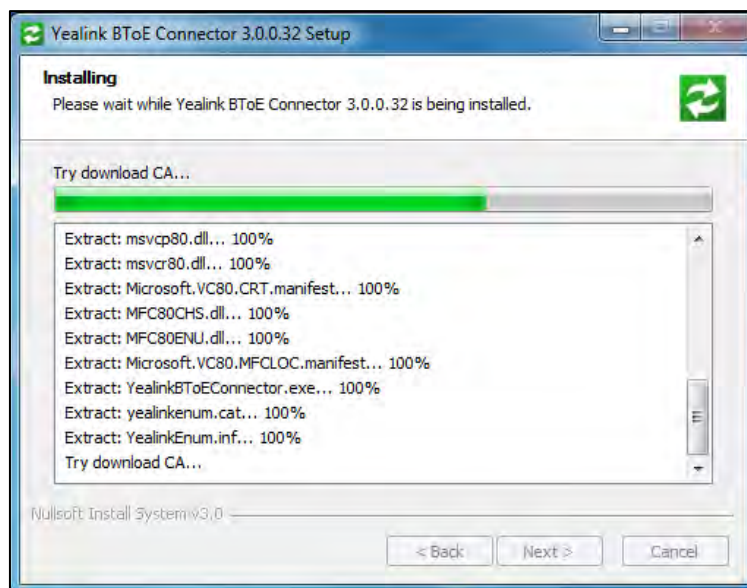

The installation may take several minutes. A Windows Security is displayed as below during installation:

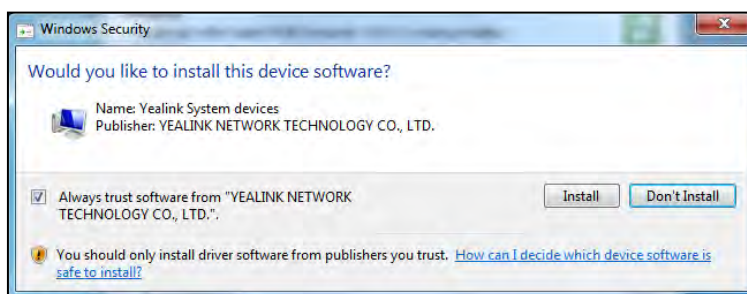

7. Click **Always trust software from "YEALINK NETWORK TECHNOLOGY CO., LTD"**, and then click **Install** to install the driver software.

After the software has completed installing, a dialog is displayed as below:

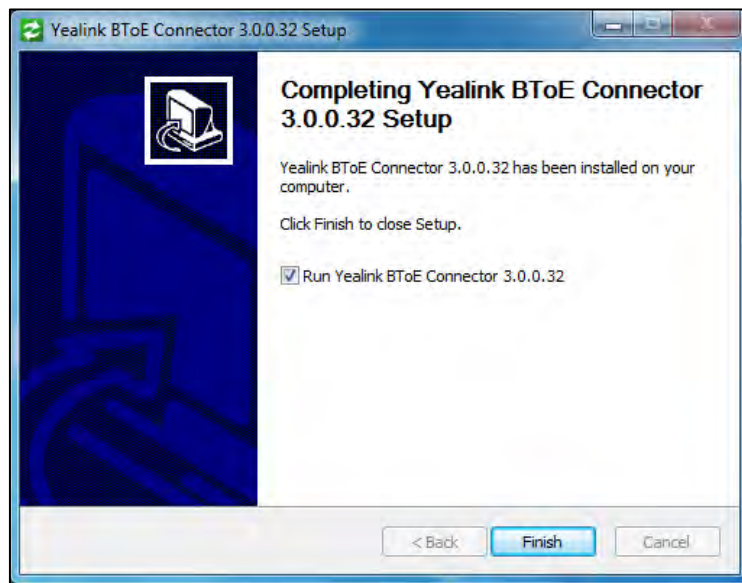

The checkbox of **Run Yealink BToE Connector 3.0.0.32** is checked by default, as shown above. If the checkbox of **Run Yealink BToE Connector 3.0.0.32** is not checked, you need to start the Yealink BToE Connector manually.

**8. Click Finish.**

The Yealink BToE Connector starts on your PC automatically, the following window will appear:



**To set up the Yealink BToE connector:**

Right-click  in the system tray, you can do the following:



- Click **Show/Hide(S)**, the Yealink BToE Connector interface will be shown or hidden.
- Click **Pair & Sign in(G)**, you can pair your phone with your Skype for Business client.
- Click **Sign in via client(L)**, after your phone pairs with Skype for Business client, but your phone and Skype for Business client are signed into with different user accounts, you can use BToE to sign into the Skype for Business client and the connected phone with the same account. For more information, refer to [Signing in via PC](#) on page 215.
- Click **Settings(P)**, you can set up the Yealink BToE Connector, and then click **OK** to save.

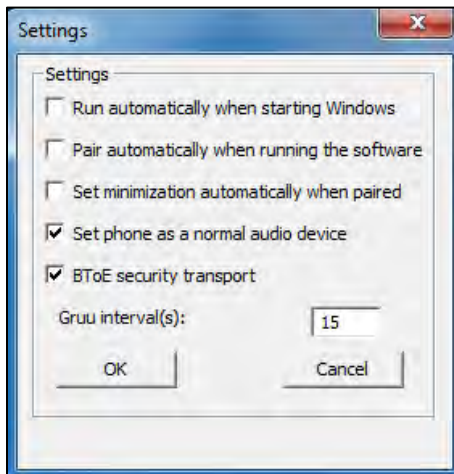

- a) Check the **Run automatically when starting Windows** checkbox, the Yealink BToE Connector software will run automatically when your computer boots up.
- b) Check the **Pair automatically when running the software** checkbox, the Yealink BToE Connector software will attempt to pair with the phone IP address when you start Yealink BToE Connector software.
- c) Check the **Set minimization automatically when paired** checkbox, the Yealink BToE Connector software will be minimized to the system tray after your phone and computer are paired.
- d) Check the **Set phone as a normal audio device** checkbox, your phone will act as the audio output device for your computer after your phone and computer are paired successfully.



- e) Check the **BToE security transport** checkbox, your phone and connected computer will use TLS encryption transmission. If it is unchecked, TCP transmission will be used instead.
- Click **About(A)**, you can view the information of Yealink BToE Connector.
- Click **Exit(E)**, you can close the software.

## Enabling Better Together over Ethernet

You need to pair your phone with your Skype for Business client to enable BToE. This section provides information on how to pair your phone with the Skype for Business client.

### Paired Status

Before you pair your phone with the Skype for Business client, you need to be familiar with the following paired status:

- **Unpaired:** Your phone and your Skype for Business client are not paired.

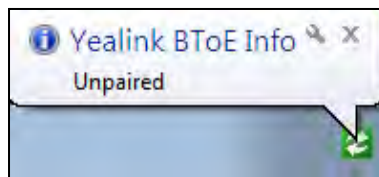

- **Paired (Sign Out):** Your phone and your Skype for Business client are paired but failing to sign in. The reason may be that the user signing on your phone differs from the one signing on the Skype for Business client, or there is no user signing on your phone.

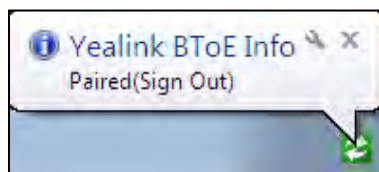

- **Paired (Sign In):** Your phone and your Skype for Business client are paired and sign in successfully. This means the Skype for Business user signing on the phone is the same as the one signing on the Skype for Business client.

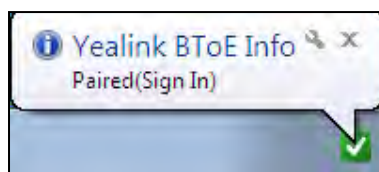

You can view the paired status via phone user interface or PC.

**To view the paired status via phone user interface:**

1. Tap **...** ->**Features**->**BToE**.
2. View the BToE paired status in the **BToE Pairing Status** field.

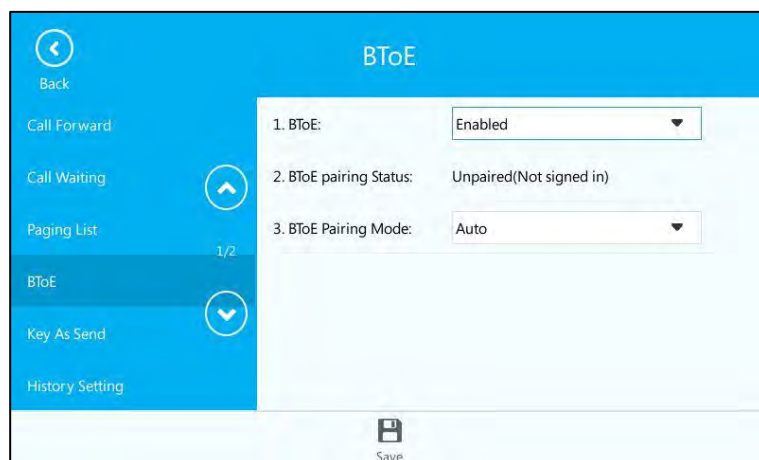

**To view the paired status on PC:**

1. Double left-click on BToE icon.
2. View the BToE paired status in the **BToE Status** field.



## Pairing Your Phone with Your Computer

There are two BToE Pairing modes on the phone. If **BToE Pairing Mode** is **Auto**, your phone will pair with your computer directly without a pairing code. If **BToE Pairing Mode** is **Manual**, You need to use a pairing code generated by your phone to manually pair your phone with your computer.

**To configure BToE feature via phone user interface:**

1. Tap **...** ->**Features** ->**BToE**.

2. Select **Enabled** from the pull-down list of **BToE**.
3. Select the desired value from the pull down-list of the **BToE Pairing mode**.

The default value is **Auto**.

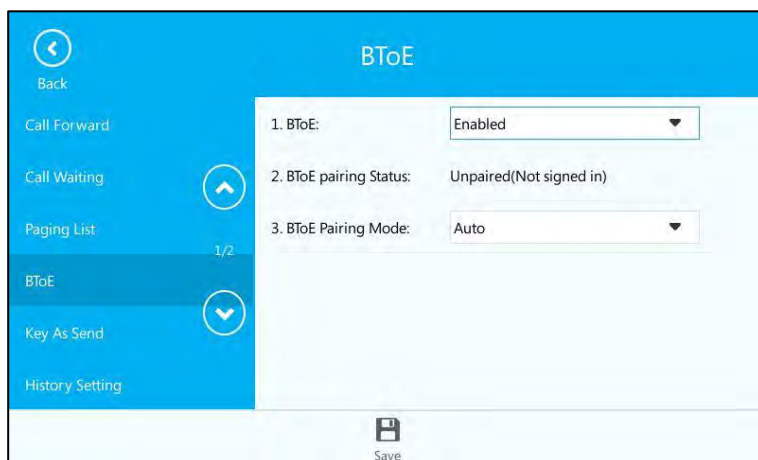

4. Tap  to accept the change.

Ensure that the Yealink BToE Connector application is running on your PC. To pair your phone with your Skype for Business client, do one of the following on your PC:

- a) **Connect an Ethernet cable from your computer to the PC port on your phone (network of the PC will be provided by the PC port of the phone).**
  1. As the checkbox of **Wired** is checked by default, the IP address of your phone is automatically filled in the **Phone IP** field.
  2. Click **Pair**.



- If **BToE Pairing Mode** is **Auto**, your phone will pair with Skype for Business client directly.

- If **BToE Pairing Mode** is **Manual**, a six-digit pairing code displays. You should enter the six-digit pairing code shown on the phone into the notification on your computer.

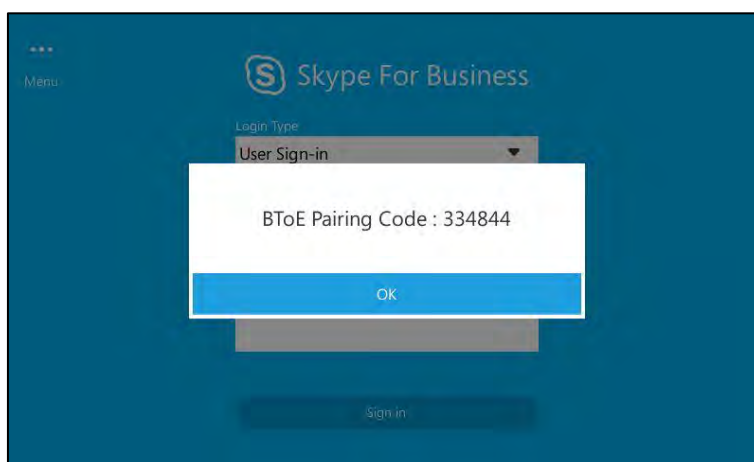

(A six-digit pairing code displays on your phone)

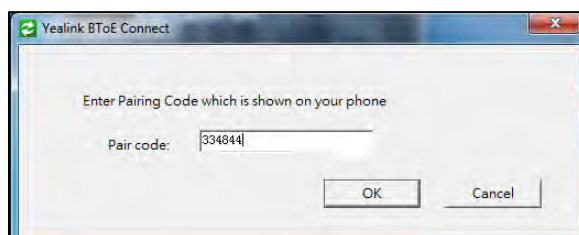

(Enter the pairing code shown on the phone into the notification on your computer)

**b) If your PC is not connected to the PC port on your phone using an Ethernet cable, do the following:**

1. Uncheck the **Wired** checkbox.
2. Enter the IP address of the phone that you want to pair in the **Phone IP** field.
3. Click **Pair**.



- If **BToE Pairing Mode** is **Auto**, your phone will pair with Skype for Business client directly.
- If **BToE Pairing Mode** is **Manual**, a six-digit pairing code displays. You should enter the six-digit pairing code shown on the phone into the notification on your computer.

**Note** The pairing code is case-sensitive.

BToE is configurable via web user interface at the path: **Settings->BToE**.

## Signing in via PC

After you carry out the above steps, the computer and phone are paired. However if the phone and Skype for Business client are signed into with different user accounts, the BToE is not activated.

To activate the BToE, you can sign into the phone via your computer.

### To sign into the phone via PC:

- a) **If the Skype for Business client is already logged on, but the phone is not signed in:**
  1. A dialog box is displayed on your computer asking for your Skype for Business login credentials.

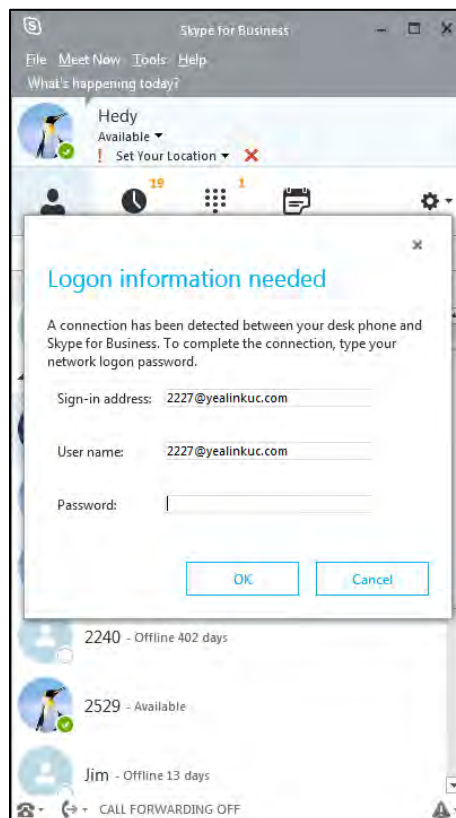

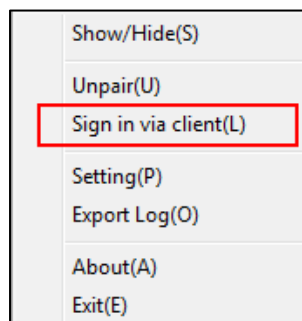

If you click **Cancel**, the dialog box will disappear. You can do one of the following to display the dialog box again:

- On your computer, right-click  on the system tray, and then select **Sign in via client(L)**.

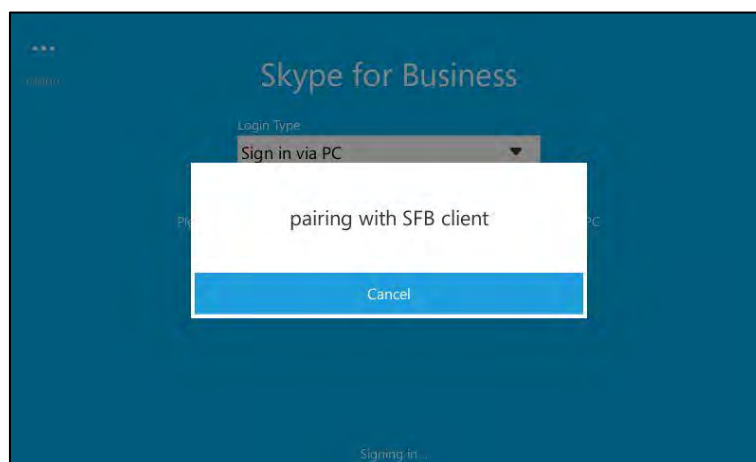

- On your phone, select **Sign in via PC** from the **Login Type** pull-down list, and then tap the **Sign in** soft key.



2. Enter your login credentials into the dialog displayed on your computer, click **OK**.
- b) **If the phone and Skype for Business client are signed into with different accounts:**
1. Right-click  on the system tray, and then select **Sign in via client(L)**.

A dialog box is displayed on your computer asking for your Skype for Business login credentials.

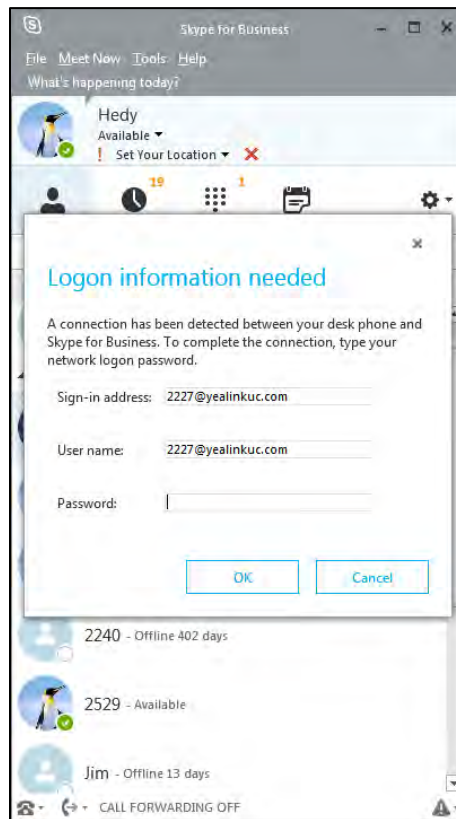

2. Enter your login credentials into the dialog displayed on your computer, click **OK**.

When the same user account is signed into the phone and the Skype for Business client, your computer and phone are paired, and BToE is activated. The paired status changes to **Paired (Sign In)** and the BToE icon changes to .

## Setting Your Phone as Your Primary Audio Device

Before you begin using the BToE feature, you need to ensure that your Skype for Business phone is set as your primary audio device in your Skype for Business client.

### To set your phone as your primary audio device

1. In your Skype for Business client, click the audio device icon.

2. Select your phone as your primary device, as shown next.

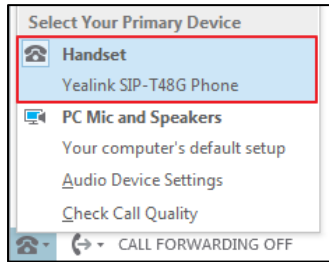

**Note**

If **Yealink SIP-T48G Phone** is not selected as audio device, you will not be able to use BToE feature (for example, calls made on the Skype for Business client will not be displayed on the phone).



## Using Better Together over Ethernet

This section provides information on how to use BToE on your phone and the Skype for Business client.

BToE enables you to call Skype for Business contacts using your Skype for Business client while providing you with quality audio through your phone. After BToE is enabled, you can answer, place, hold and resume calls with your Skype for Business contacts on your phone and the Skype for Business client on your PC simultaneously. What's more, your phone will be locked once paired PC is locked or in sleep mode.

## Placing BToE Calls

**Do one of the following:**



- Select a contact or enter the phone number, then tap  , or you can tap the avatar of the contact in **Favorites** screen.
- Hover the mouse over the avatar of the contact, and then click  in your Skype for Business client.

Your phone and the client are in the Calling state.

## Answering BToE Calls

When you receive an incoming call, the incoming call information is displayed on your phone and your Skype for Business client.

**Do one of the following:**





- Tap  or press  on your phone.
- Click  in your Skype for Business client.



The incoming call is answered both on the phone and the Skype for Business client. The established call uses the phone as audio device by default.

## Pausing BToE Calls





**Do one of the following:**

- Tap  or press  on your phone.
- Click  to display the control panel, and then click  in your Skype for Business client.

The call is placed on hold on your phone and your Skype for Business client.

## Resuming BToE Calls



**Do one of the following:**

- Tap  or press  on your phone.
- Click  to display the control panel, and then click  in your Skype for Business client.

The call is resumed on your phone and your Skype for Business client.

## Moving Call Audio between Your Phone and Computer:

During an active Skype for Business call, you can move the call audio from your phone to your computer or from your computer to your phone. Do the following:

1. Click  to display the control panel, and then click  in your Skype for Business client.
2. Click the desired audio device.
  - Click **PC MIC and Speakers** to move the call audio from your phone to your PC.  
The call on the phone will be released. The Skype for Business client uses the selected audio device to continue the call.
  - Click **Handset** to move the call audio from your PC to your phone.

## Using BToE to Lock and Unlock Your Phone

When your phone is paired with your computer and phone lock is enabled, you can lock and unlock your phone automatically when you lock or unlock your computer.

**To lock you phone:**

**When BToE status is Paired (Sign In), your phone will be locked automatically in following situation:**

- The paired PC gets locked.
- The paired PC enters sleep mode.
- The paired PC starts the screen saver.
- The account status of Skype for Business client changes from active to inactive.
- BToE status changes from **Paired (Sign In)** to **Paired (Sign Out)** or **Unpaired**.

**To unlock you phone:**

If you do not connect an Ethernet cable from your computer to the PC port on your phone, the phone will not be unlocked automatically.

**If you connect an Ethernet cable from your computer to the PC port on your phone and the BToE status is Paired (Sign In), your phone can be unlocked automatically in following situation:**

- The paired PC gets unlocked.
- The paired PC wakes up and is not locked.
- The paired PC stops the screen saver and is not locked.
- The account status of Skype for Business client changes from inactive to active.
- BToE status changes from **Paired (Sign Out)** or **Unpaired** to **Paired (Sign In)** and the paired PC is unlocked, does not in sleep mode, does not start the screen saver and the Skype for Business account is active.

## Disabling BToE on Your Phone

You can disable the BToE feature on your phone and unpair your phone from the computer. When you disable BToE, you can no longer use BToE functions.

**Do one of the following:**

- Disconnect the Ethernet cable from the PC port on your phone.
- Click **Unpair** on the Yealink BToE Connector.
- Tap **⋮** > **Features**->**BToE** on your phone, select **Disabled** from the pull-down list of **BToE**.  
Tap  to accept the change.

## Exiting BToE on Your Computer

You can exit the Yealink BToE Connector at any time. When you exit the application, you can no longer use the BToE functions on your phone and computer.

**To exit BToE on your computer:**

1. Right-click BToE icon (  ) in the system tray and click **Exit(E)**.

## Uninstalling the Yealink BToE Connector

**To uninstall the Yealink BToE connector:**

1. Click the **Start** button .
2. Click **All Programs->Yealink BToE Connector->Uninstall**.

A dialog box asking if you're sure you want to uninstall this product is displayed.

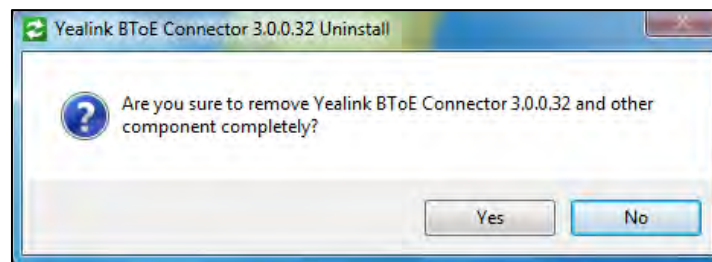

3. Click **Yes** to uninstall the Yealink BToE connector.

A dialog box showing the progress of the application uninstall is displayed.



---

## EXP40 Expansion Module

---

The Yealink EXP40 is ideal for receptionists, administrative assistants, call center agents, power-users, and executives who need to place a large volume of calls on a regular basis. When your T48G is registered with a Skype for Business Server, you can assign contacts to EXP keys on your EXP40, so that you can quickly call contact by pressing the corresponding EXP key. You can also monitor your contacts' presence status from your expansion module. For more information on contact's presence, refer to [Changing Presence Status](#) on page 26.

This chapter explains how to use the EXP40. Topics include:

- [Connecting the EXP40 to Your Phone](#)
- [EXP40 Hardware Features](#)
- [Assigning Contacts to the EXP40](#)
- [Monitoring Skype for Business Contacts for Status Changes](#)
- [Using the EXP40](#)

### Connecting the EXP40 to Your Phone

If you want to use an EXP40, physically connect the EXP40 to the phone firstly.

The EXP40 applies to T48G Skype for Business phone. To easily connect the EXP40 to the phone, please unplug the phone stand from the T48G Skype for Business phone.

**To unplug the stand from the T48G Skype for Business phone:**

1. Unplug the power adapter and Ethernet cable from the Skype for Business phone.
2. Unplug the handset attached to the Skype for Business phone.
3. Turn the Skype for Business phone over and lay it on a non-slip, flat surface.
4. Unplug the stand from the Skype for Business phone.

**To connect the EXP40:**

1. Turn over the phone and the expansion module, and lay them on a flat, non-slip surface.

2. Connect the EXP40 and the Skype for Business phone using the supplied connecting sheet and screws.

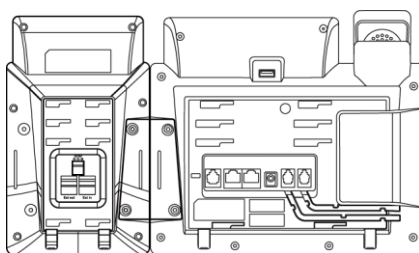

If you want to connect two or more expansion modules, connect two expansion modules as below:

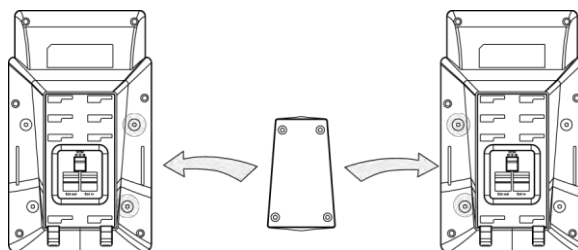

Connecting two expansion modules on a single phone is shown as below:

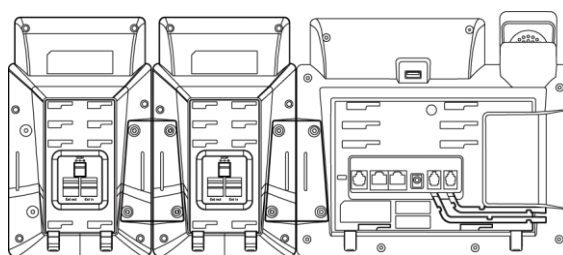

3. Connect the Ext jack of the Skype for Business phone and the Ext in jack of the expansion module using one supplied cord.

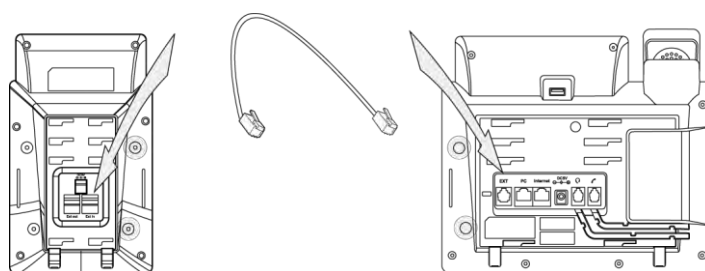

If you connect two expansion modules, connect the Ext out jack of the previous expansion module and the Ext in jack of the second expansion module using another supplied cord.

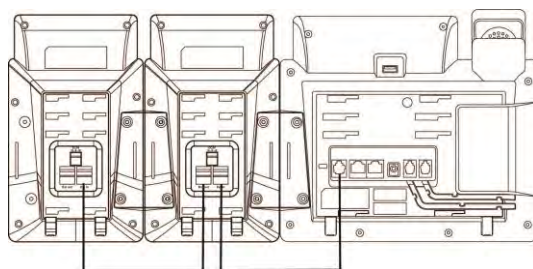
**Note**

Up to six expansion modules can be connected to the T48G Skype for Business phone. If you use more than two expansion modules on a single phone, you need to connect an additional power adapter to any one of the expansion modules.

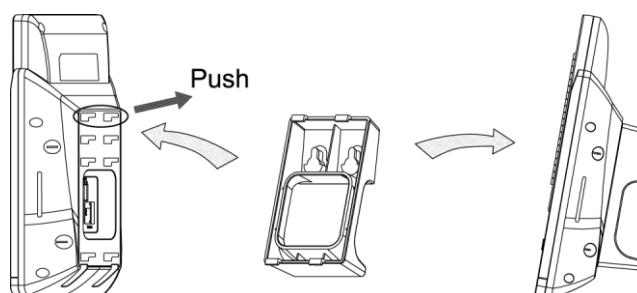
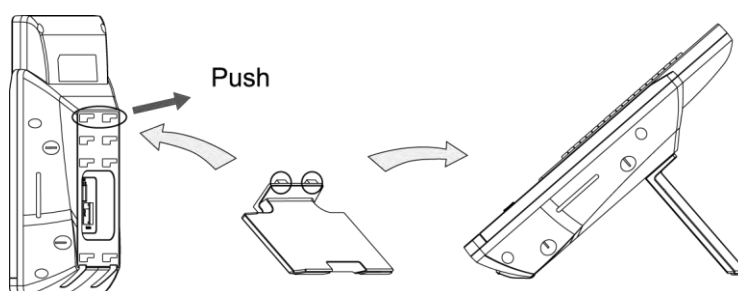
**To attach the stand of the expansion module:****a) Wall mount method (Optional)****b) Desk mount method**

## EXP40 Hardware Features

The following figure illustrates the features, components, and keys available on the EXP40. The table lists each numbered feature shown in this figure.

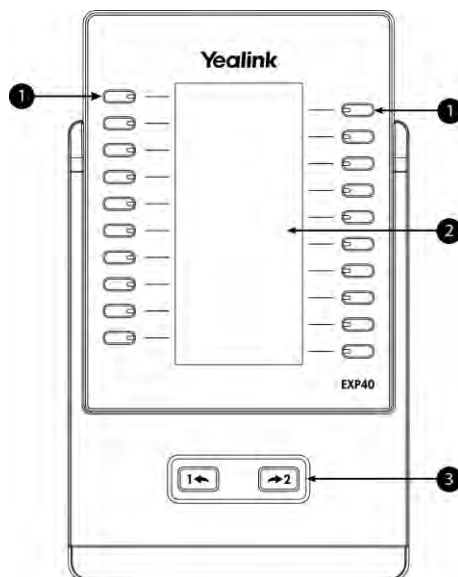

	Item	Description
①	EXP Keys	Select available contacts.
②	LCD Screen	Displays name and presence status of Skype for Business contacts.
③	Page Keys	Navigates between pages on the expansion module.

## Assigning Contacts to the EXP40

Each EXP40 provides you with 20 EXP keys and 2 display pages, supporting a total of 40 lines that you can set up as contacts. You can connect up to 6 EXP40 to your phone to support a maximum of 240 EXP keys per phone.

You can assign the desired contacts to be displayed on the EXP40. The contacts in the selected group are assigned to EXP keys on your EXP40.

### To assign contacts to the EXP40:



1. Tap **...**->**Basic**->**Exp Module**.
2. Select the desired contacts group from the pull-down list of **ModuleX**.

X ranges from 1 to 6. The value of X depends on the sequence number of the connected EXP40.

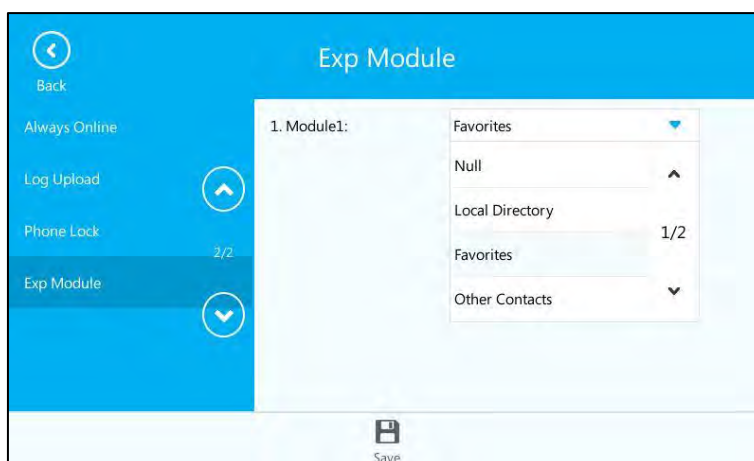

Null is selected by default, and it means that the EXP40 doesn't display contacts.



3. Tap  to accept the change or  to cancel.

The selected contacts group will be displayed on the expansion module.

EXP Module is configurable via web user interface at the path **Settings->EXP Module**.

If you connect more than one expansion module to a single phone, and a group A that has more than 40 contacts is assigned to be displayed on the module1, you need to understand the following tips:

- If another group B is assigned to be displayed on the next module, the rest contacts of the group1 will be ignored. The next module only displays contacts in group B.
- If group A is also assigned to be displayed on the next module or no group is assigned to be displayed on the next module, the rest contacts of the group A will be displayed on the next module.

## Monitoring Skype for Business Contacts for Status Changes

EXP40 can display local contacts or Skype for Business contacts, but you can only use EXP40 to monitor Skype for Business contacts for status changes on the phone. For example, you assign a Skype for Business contact to the EXP40 to monitor the status of his line (busy or idle). The EXP key LED illuminates solid red when his line is busy.

**To configure the EXP key LED via web user interface:**

1. Click on **Features->LED**.
2. Select the desired value from the pull-down list of **Exp Led Light On**.
  - If it is enabled, the EXP key LEDs vary depending on the status of your Skype for Business contacts.

- If it is disabled, the EXP key LEDs corresponding to your Skype for Business contacts are off.

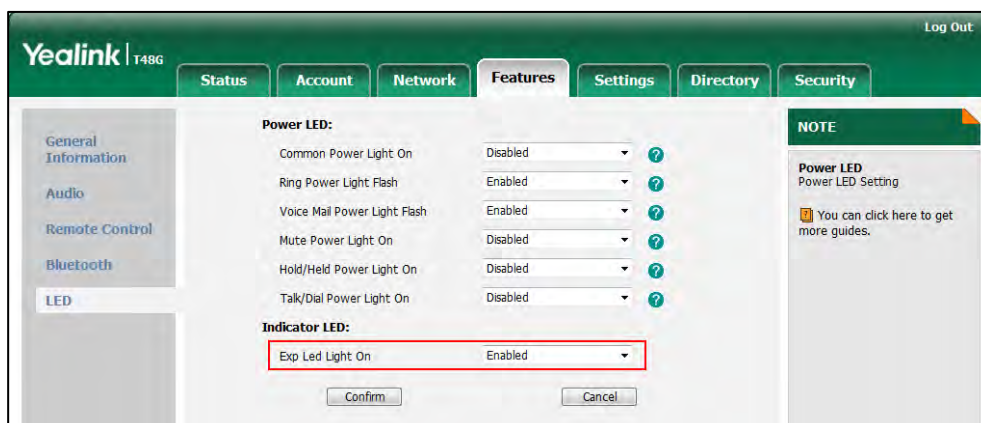

3. Click **Confirm** to accept the change.

**The EXP key LED on the EXP40:**

LED Status	Description
Solid green	The Skype for Business contact is available.
Solid red	The Skype for Business contact is busy. The Skype for Business contact is Do Not Disturb. The call of your Skype for Business contact is parked. The call of your Skype for Business contact is placed on hold. The held call of your Skype for Business contact is resumed. The Skype for Business contact is in a Skype for Business conference.
Solid yellow	The Skype for Business contact is right back. The Skype for Business contact is off work. The Skype for Business contact is away.
Stay the original LED status	The Skype for Business contact is placing a call. The Skype for Business contact is receiving a call. The parked call of your Skype for Business contact is retrieved.
Off	The Skype for Business contact is unknown. The Skype for Business contact is offline. Your phone is locked.

## Using the EXP40

When your phone is connected to the EXP40, you can assign contacts to EXP keys on your EXP40. You can quickly call contacts, initiate a conference call or transfer a call by pressing the

corresponding EXP key on the expansion module. You can also view your contacts' presence status and name from your expansion module.

## Placing a Call Using the EXP40

You can place a call or add a new call quickly using the hard keys on the EXP40.

### To place a call when the phone is idle using the EXP40:

1. Press an EXP key corresponding to the contact you want to call.

You can press the page key to turn pages.

### To add a new call during a call using the EXP40:

1. Press an EXP key corresponding to the contact you want to add.

The call will be placed directly.

## Initiating a Conference Call Using the EXP40

You can initiate a conference call quickly using the hard keys on the EXP40.

### To initiate a conference call using the EXP40:

1. Tap  during a call.
2. Press an EXP key corresponding to the contact you want to call.



You can press the page key to turn pages.

After the party answers the call, three parties are now joined in the conference.

## Transferring a Call Using the EXP40

You can transfer a call quickly using the EXP keys on the EXP40.

**To perform a blind transfer during a call:**

1. Press  or tap  during a call.

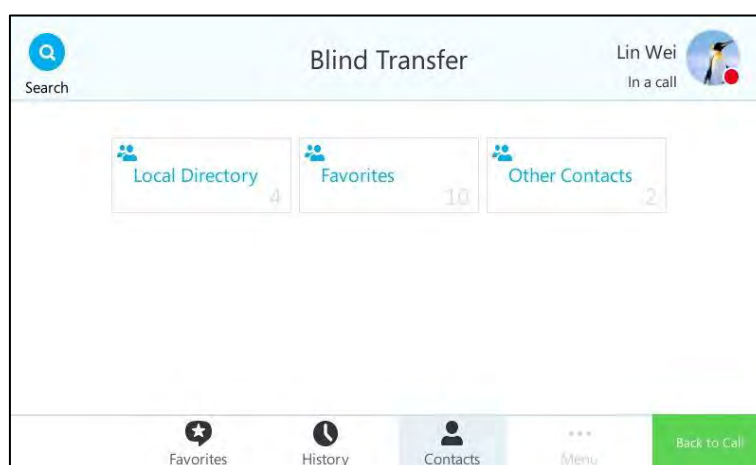

2. Press an EXP key corresponding to the contact you want to transfer to.

You can press the page key to turn pages.

After the party answers the call, the call is connected to the number to which you are transferring.

**To perform a consultative transfer during a call:**

1. Tap  during a call.

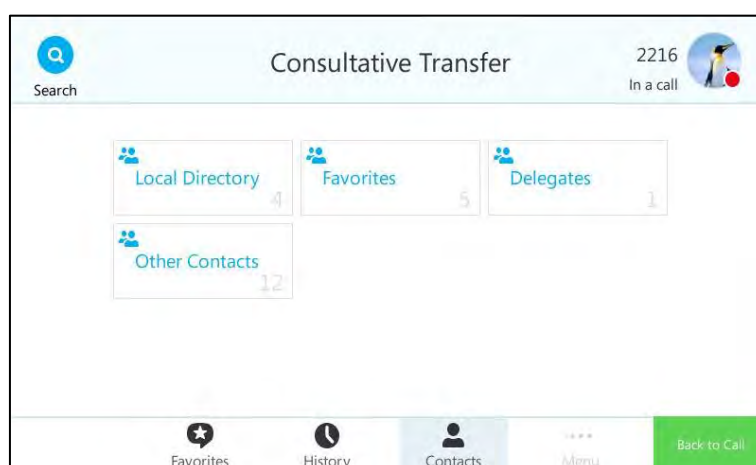

2. Press an EXP key corresponding to the contact you want to transfer to.

You can press the page key to turn pages.

3. After the party answers the call, press  or tap  to complete the transfer.

The call is connected to the number to which you are transferring.

# Troubleshooting

---

This chapter provides general troubleshooting information to help you solve the problems you might encounter when using your T48G Skype for Business phone.

If you require additional information or assistance with your new phone, contact your system administrator.

## Troubleshooting Solutions

### Why is the touch screen blank?

- Ensure that the phone is properly plugged into a functional AC outlet.
- Ensure that the phone is plugged into a socket controlled by a switch that is on.
- If the phone is plugged into a power strip, try to plug it directly into a wall outlet instead.
- If the phone is powered from PoE, ensure you use a PoE-compliant switch or hub.

### Why does the phone display “Network Unavailable”?

- Ensure that the Ethernet cable is plugged into the Internet port on the phone and the Ethernet cable is not loose.
- Ensure that the switch or hub in your network is operational.
- Contact your system administrator for more information.

### Why doesn't the phone display time and date correctly?

Check if you have configured the phone to obtain the time and date from the SNTP server automatically. If the phone fails to connect the SNTP server, contact your system administrator for more information. You can also configure the time and date manually. For more information, refer to [Time & Date](#) on page 52.

### How can I find the basic information of the Skype for Business phone?

Press the  key when the phone is idle to check the basic information of the Skype for Business phone, such as IP address and firmware version. For more basic information, refer to [Phone Status](#) on page 43.

### How to obtain the MAC address of a phone when the phone is not powered on?

Three ways to obtain the MAC address of a phone:

- You can ask your supplier for shipping information sheet which includes MAC addresses according to the corresponding PO (Purchase Order).

- You can find the MAC address in the label of carton box.
- You can also find the MAC address from the phone's bar code on the back of the phone.

#### **Why can't I sign into Skype for Business Server on the phone?**

- Check your phone is properly connected to the switch or hub.
- Validate your domain name and sign-in information are correct.
- Ensure that DNS address is properly configured on the phone, or DHCP is configured to provide DNS address as part of DHCP response.

#### **How to check if the application driver of the Yealink BToE Connector is installed on the PC?**

Do one of the following:

- After installation, if the Yealink BToE Connector and the application driver run successfully, the notification area of the system tray will prompt: **Device driver software installed successfully.**

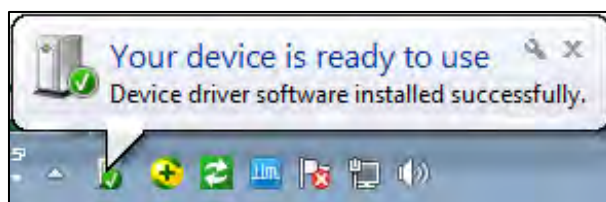

- Do the following steps to check if the application driver is installed (take the Windows 2007 operating system as an example):
  1. Click the **Start** button .
  2. Click **Control Panel**->**Device Manager**.
  3. Double click **System devices**.
  4. Check if the driver **Yealink BToE Enumerator** is displayed.

If Yealink BToE Enumerator is not displayed, reinstall the Yealink BToE Connector application, and ensure that the application driver is installed during the installation process.

#### **How to cancel auto-start for the Yealink BToE connector?**

1. Right-click  in the system tray.
2. Click **Settings(P)**.

3. Uncheck **Run automatically when starting Windows** to cancel the auto-start feature.  
As shown below:

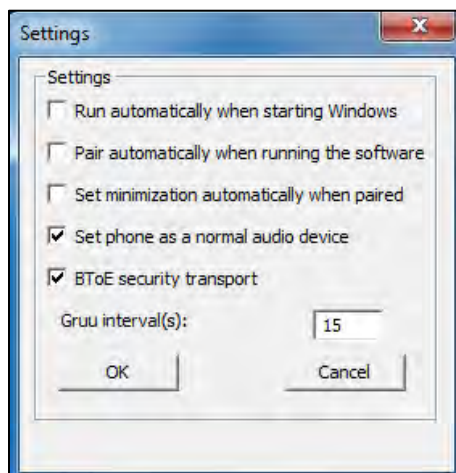

#### **Why can't the phone pair with my Skype for Business client?**

- Ensure that your Skype for Business client is installed on your PC and a Skype for Business user signs into Skype for Business Server successfully.
- Ensure that the user signing on the phone is the same as the one signing on the Skype for Business client.
- Re-pair the phone and Skype for Business client manually.
- Ensure that Yealink BToE Connector and application driver are successfully installed on your PC, and both of them start successfully. If the phone still cannot pair with the Skype for Business client, reboot the PC.
- After reboot, if the phone still cannot pair with the Skype for Business client, uninstall the Yealink BToE Connector and application driver, and then reinstall them.
- Ensure that Yealink BToE Connector is an allowed program in your system's firewall on your PC.

#### **Why doesn't the phone display the Calendar menu?**

- Ensure that your phone has signed in successfully.

#### **Why doesn't the Skype conference, appointment, meeting or event set up in outlook display on the Calendar menu?**

- Ensure that your sign into the phone using [User Sign-in](#), [Web Sign-in](#) or [Signing in via PC](#) method.

#### **Why can't I get a dial tone?**

- Check for any loose connections and that the phone has been installed properly. For the installation instructions, refer to [Phone Installation](#) on page 14.

- Switch between the Handset, Headset (if present) or Hands-Free Speakerphone to check whether the dial tone is present for one of the audio modes.

If the dial tone exists on another audio mode, connect a different handset or headset to isolate the problem.

#### **Why doesn't the phone ring?**

Check the ringer volume on the phone. To adjust the ringer volume setting, press the **Volume** key when the phone is on-hook and idle. For more information, refer to [Volume](#) on page 61.

#### **Why can't I receive calls?**

- Check that whether your status is DND mode, if it is, you should reset status. Refer to [Changing Presence Status](#) on page 26.
- Check that whether call forward is disabled on the phone. Refer to [Call Forward](#) on page 136.

#### **Why doesn't my headset work?**

- Check that the headset cord is fully connected to the headset jack on the phone. Refer to [Phone Installation](#) on page 14.
- Check that the headset volume is adjusted to an appropriate level. Refer to [Volume](#) on page 61.

#### **Why does the phone play a tone when there is a call on hold? How to disable it?**

When there is a call on hold, the phone will play a hold tone every 30 seconds. Call hold tone is enabled by default. Call hold tone and the interval of playing a hold tone are configurable via web user interface only.

#### **To configure call hold tone and call hold tone delay via web user interface:**

1. Click on **Features->General Information**.
2. Select the desired value from the pull-down list of **Play Hold Tone**.



3. Enter the desired time in the **Play Hold Tone Delay** field.

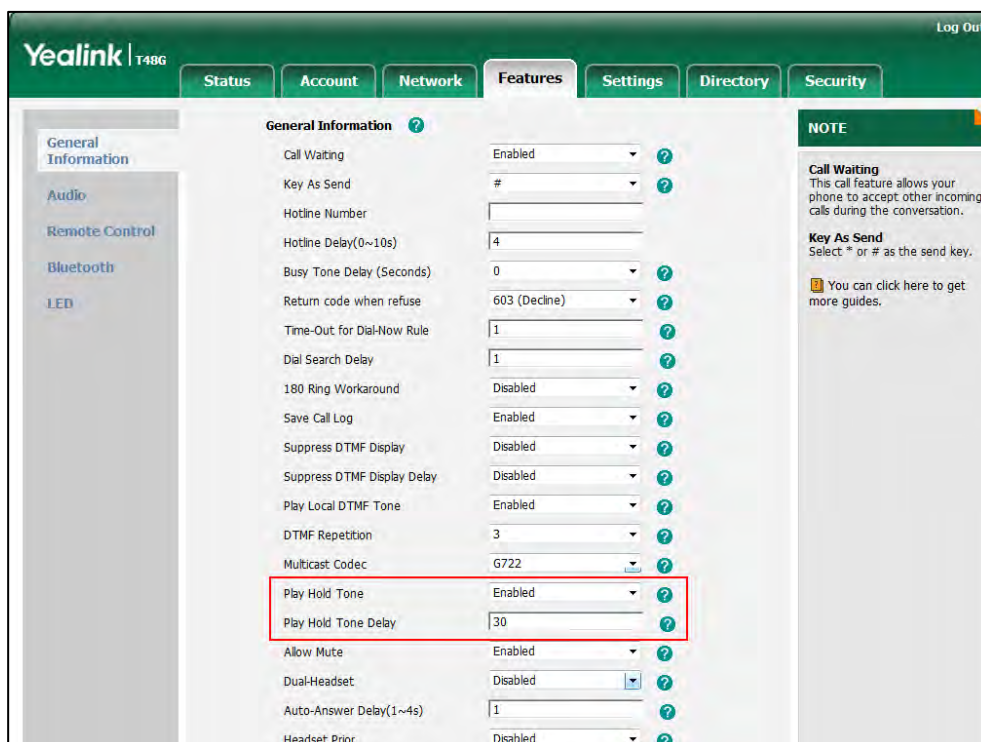

4. Click **Confirm** to accept the change.

### How to change the user password?

To change the user password via web user interface:

1. Click on **Security**->**Password**.
2. Select **User** from the pull-down list of **User Type**.
3. Enter the new user password in the **New Password** field and **Confirm Password** field.

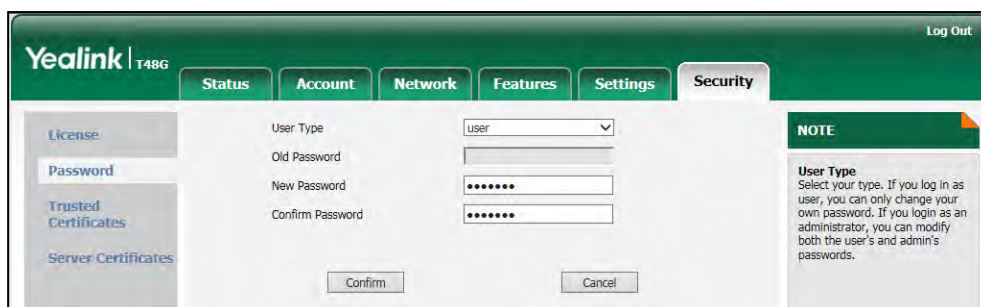

4. Click **Confirm** to accept the change.

You can also contact your system administrator for help.

**Note**

If signing into the web user interface of the phone with the user credential, you need to enter the current user password in the **Old Password** field.

User password is configurable via web user interface only.

**How to reboot the phone?**

**To reboot the phone via web user interface:**

1. Click on **Settings->Upgrade**.
2. Click **Reboot** to reboot the Skype for Business phone.

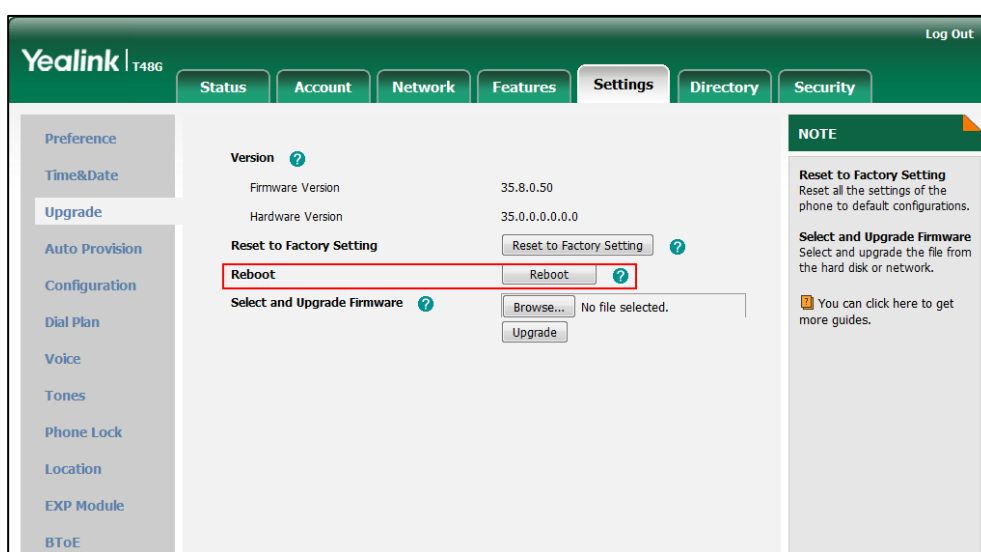

Any reboot of the phone may take a few minutes.

**How to export PCAP trace?**

We may need you to provide a PCAP trace to help analyze your problem.

**To export a PCAP trace via web user interface:**

1. Click on **Settings->Configuration**.
2. Click **Start** to begin capturing signal traffic.
3. Recreate the error to be documented in the trace.
4. Click **Stop** to stop the capture.

- Click **Export** to open file download window, and then save the file to your local system.

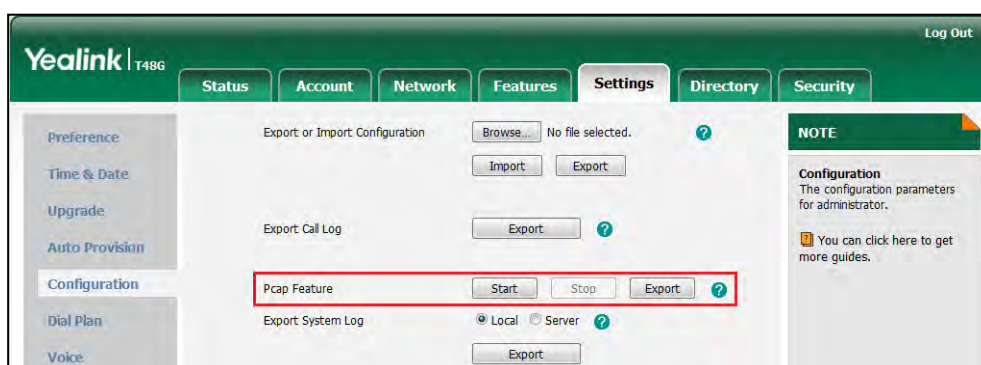

### How to configure the severity level of the log?

If your Skype for Business phone encounters some problems, commonly the global log files are needed. You can export the global log files to a local system, a syslog server or the Skype for Business Server. You can also specify the severity level of the global log and module log to be reported. The default global log and module log are 3.

Log parameters are described below:

Parameter	Description	Configuration Method
<b>Global Log Level</b>	Configure the severity level of the global logs to be reported to a log file. <b>Default: 3</b>	Web User Interface
<b>Max Log File Size (1-5120KB)</b>	Configure the size of the global log files. <b>Default: 5120KB</b> <b>Note:</b> The Skype for Business phone will reboot to make the change take effect.	Web User Interface
<b>Register Log Level</b>	Configure the severity level of the register logs to be reported to a log file. <b>Default: 3</b>	Web User Interface
<b>Subscribe Log Level</b>	Configure the severity level of the subscribe logs to be reported to a log file. <b>Default: 3</b>	Web User Interface
<b>Call Log Level</b>	Configure the severity level of the call logs to be reported to a log file. <b>Default: 3</b>	Web User Interface

Parameter	Description	Configuration Method
<b>Ice Log Level</b>	Configure the severity level of the Ice logs to be reported to a log file. <b>Default: 3</b>	Web User Interface
<b>BToE Log Level</b>	Configure the severity level of the BToE logs to be reported to a log file. <b>Default: 3</b>	Web User Interface
<b>Exchange Log Level</b>	Configure the severity level of the Exchange logs to be reported to a log file. <b>Default: 3</b>	Web User Interface

**Note** Global Log consists of Module logs. The severity level of the exported Module Log will not be greater than the Global Log Level. For example, if you set Global Log Level to 3 and set ICE log Level to 6, the exported ICE log Level will be 3.

**To configure the level of the log files log via web user interface:**

1. Click on **Settings->Configuration**.
2. Select the desired level from the pull-down list of corresponding log levels.
3. Enter the desired maximum size of global log in the **Max Log File Size(1-3072KB)** field.

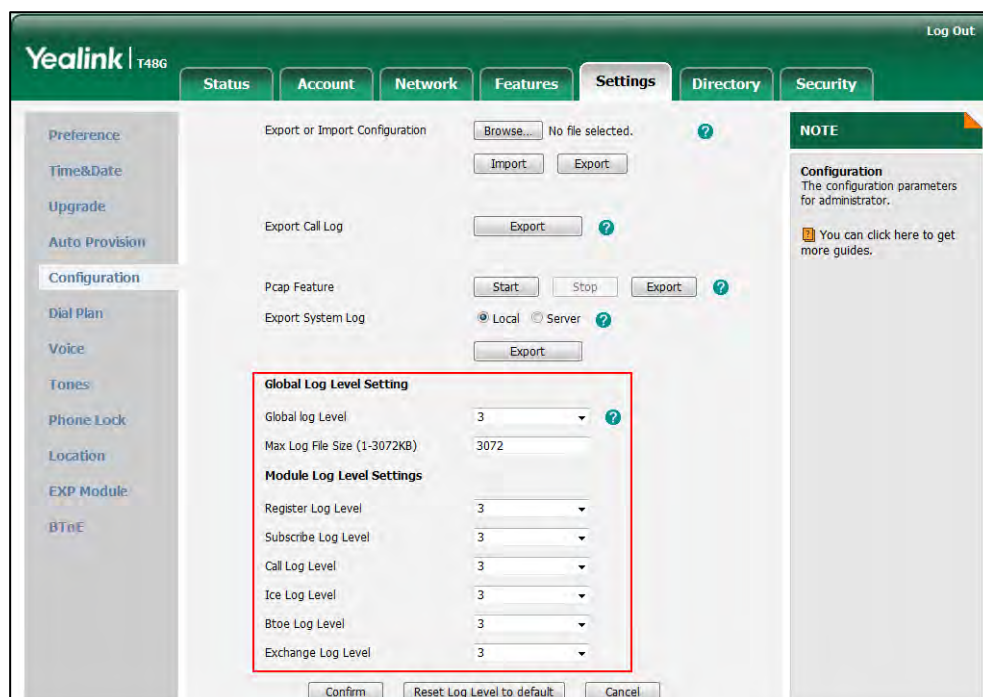

4. Click **Confirm** to accept the change.

## How to export global log?

### a) Exporting the global Log File to the Skype for Business Server

You can upload global log file to the Skype for Business Server via phone user interface only.

**To export a global log file to the Skype for Business Server via the phone user interface:**

1. Tap **...**->**Basic**->**Log Upload**.

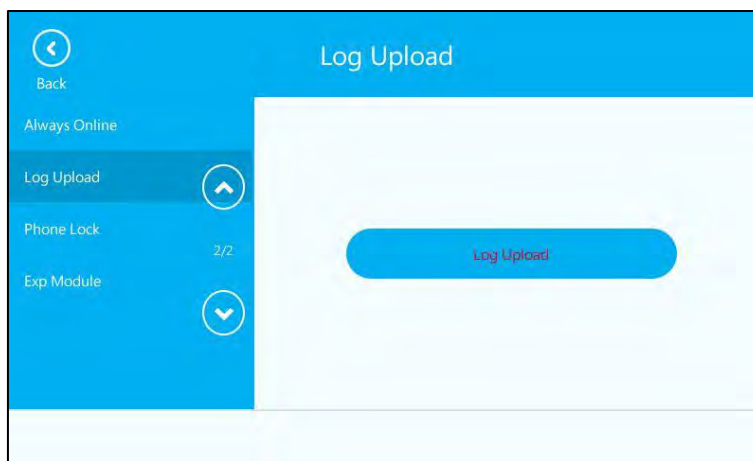

2. Tap the **Log Upload** soft key.

A dialog box pops up to prompt "Log Upload Success!".

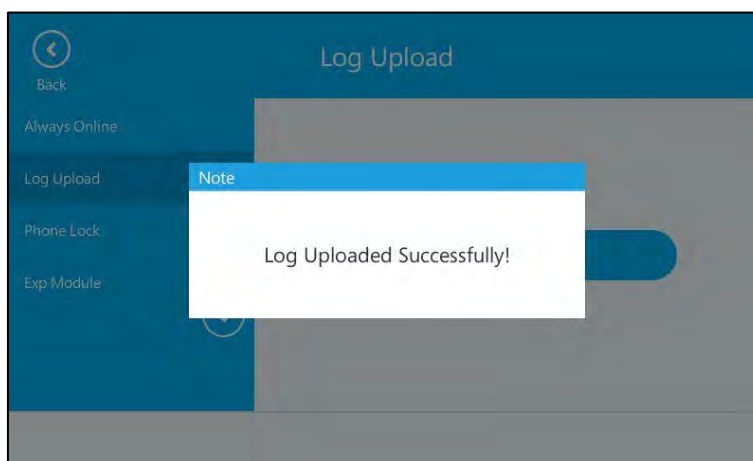

### b) Exporting the global log file to the local system:

**To export a global log file to the local system via web user interface:**

1. Click on **Settings**->**Configuration**.
2. Mark the **Local** radio box in the **Export System Log** field.

3. Click **Export** to open file download window, and then save the file to your local system.

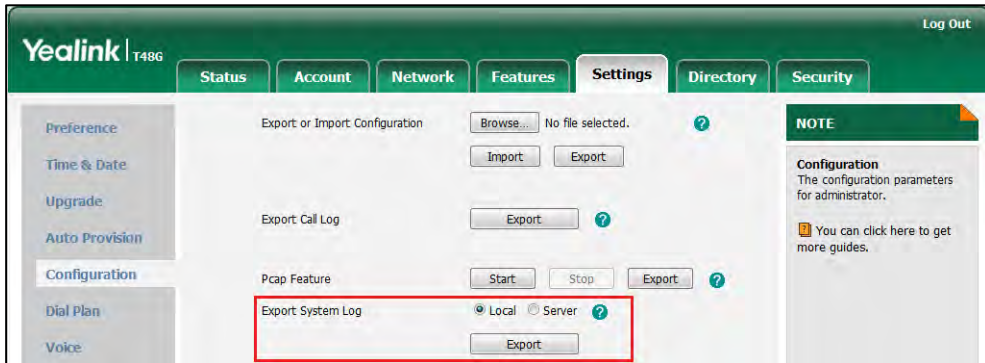

A log file named "MAC address-sys.log" is successfully exported to your local system.

**c) Exporting the global Log File to a Syslog Server**

**To configure the phone to export the global log file to a syslog server via web user interface:**

1. Click on **Settings->Configuration**.
2. Mark the **Server** radio box in the **Export System Log** field.
3. Enter the IP address or domain name of the syslog server in the **Server Name** field.  
For example, the IP address of your syslog server is 192.168.1.100.

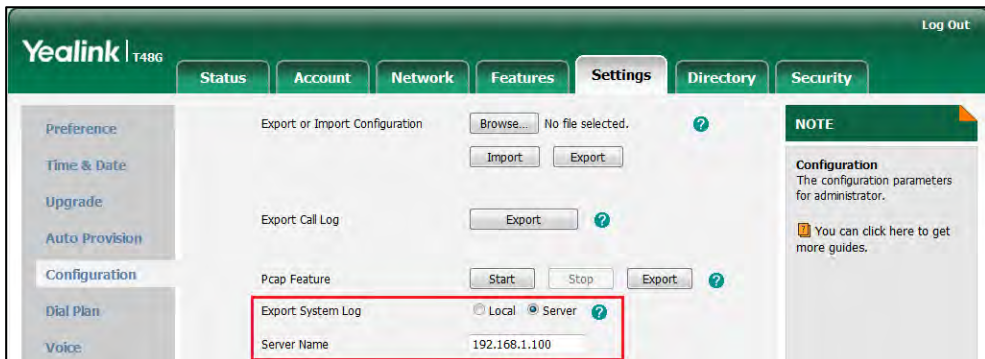

4. Click **Confirm** to accept the change.  
A dialog box pops up to prompt "Do you want to restart your machine?". The configuration will take effect after a reboot.
5. Click **OK** to reboot the phone.  
The system log will be exported successfully to the desired syslog server (192.168.1.100) after a reboot.

High level may make some sensitive information accessible (e.g., password and dial number), we recommend that you reset the log level to 3 after providing the global log for troubleshooting purpose.

**To reset severity level of all logs via web user interface:**

1. Click on **Settings->Configuration**.

2. Click **Reset Log Level To Default**.

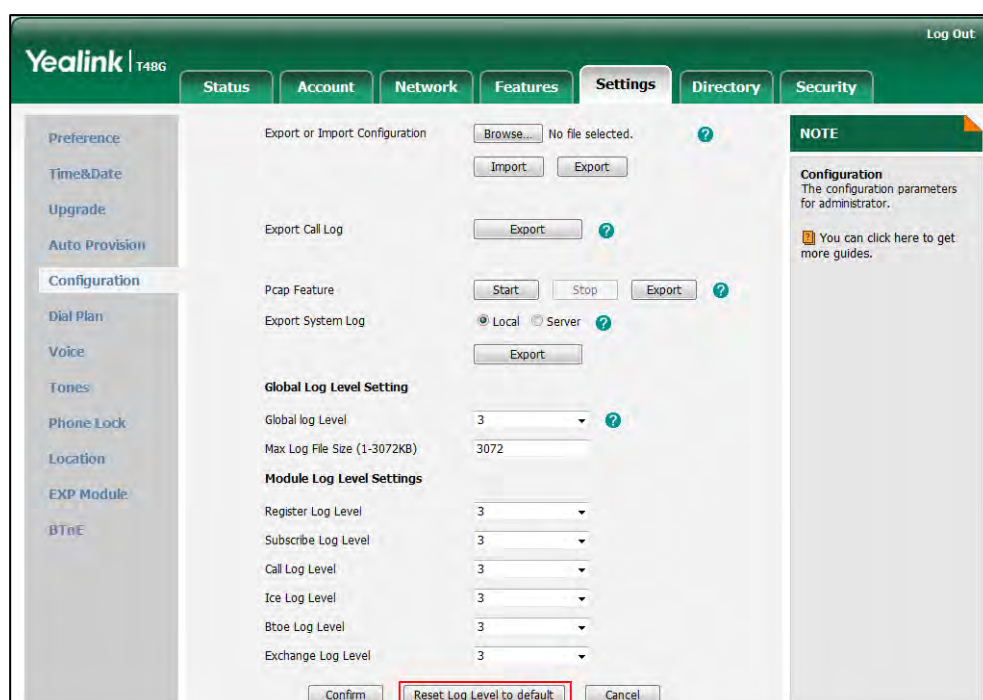

All log level will reset to 3.

**How to export/import the phone configurations?**

We may need you to export the phone configurations to help analyze problem. In some instances, you may need to import configurations to your phone.

**To export the phone configurations via web user interface:**

1. Click on **Settings->Configuration**.
2. Click **Export** to open file download window, and then save the file to your local system.

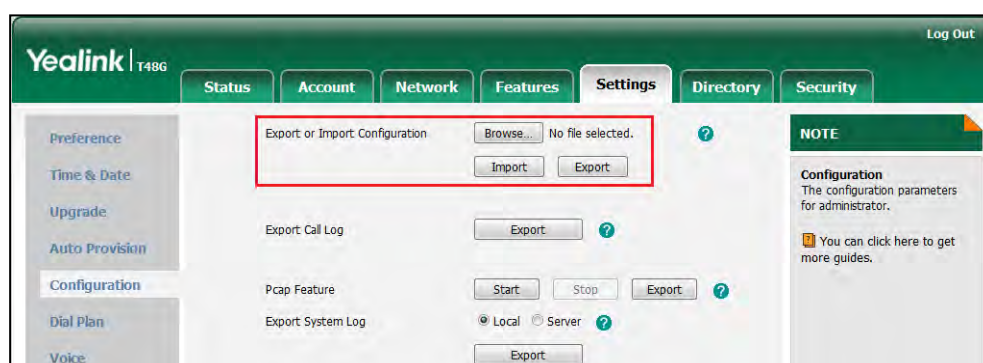

**To import the phone configurations via web user interface:**

1. Click on **Settings->Configuration**.
2. Click **Browse...** to locate a configuration file from your local system.

3. Click **Import** to import the configuration file.

**Note** The file format of configuration file must be \*.bin.

### How to export call log?

User can access call logs by downloading them to the local system for diagnosis purpose.

#### To export the call log via web user interface:

1. Click on **Settings->Configuration**.
2. Click **Export** to open file download window, and then save the file to your local system.

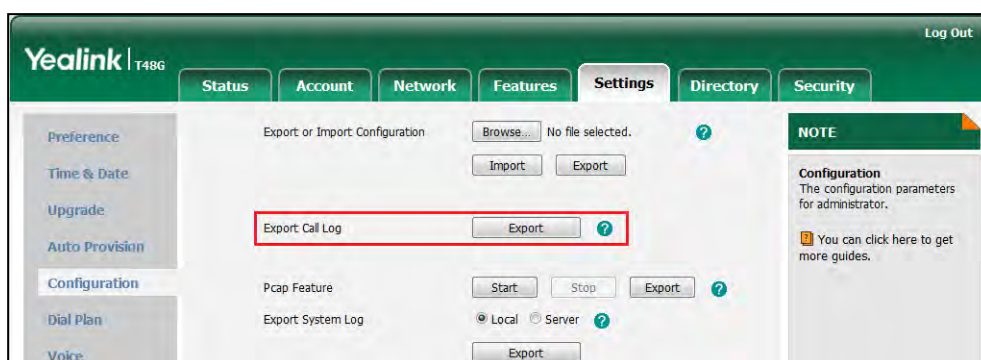

### How to upgrade firmware?

#### To upgrade firmware via web user interface:

1. Click on **Settings->Upgrade**.
2. Click **Browse...** to locate the firmware from your local system.

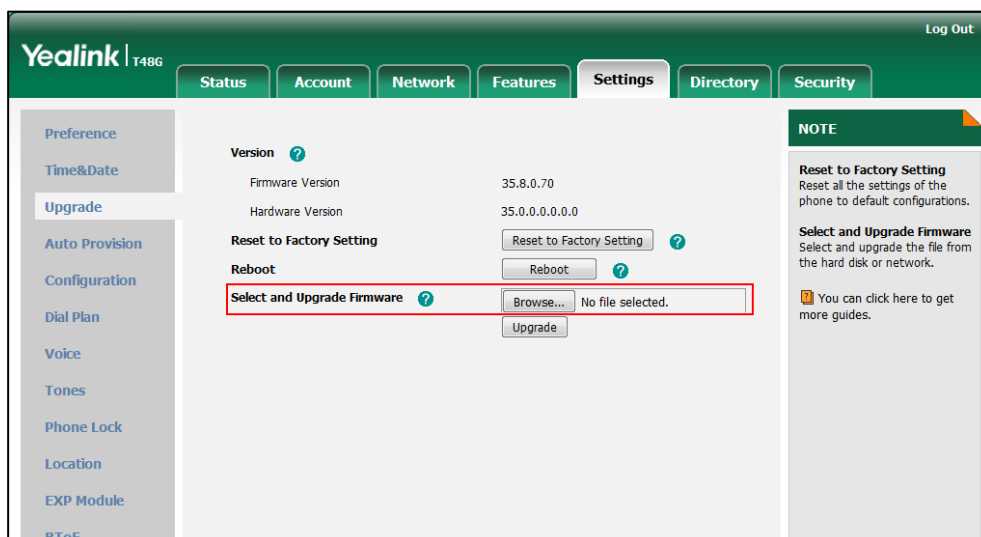

3. Click **Upgrade** to upgrade the firmware.

The browser pops up the dialog box "Firmware of the SIP Phone will be updated. It will take 5 minutes to complete. Please don't power off!".



4. Click **OK** to confirm upgrading.

T48G Skype for Business phone can be also upgraded from the Skype for Business Server. For more information on how to upgrade the T48G Skype for Business phone from the Skype for Business Server, refer to [Updating Phone Firmware from Microsoft Skype for Business Server](#).

### How to reset the phone?

Reset the phone to factory configurations after you have tried almost all troubleshooting suggestions but do not solve the problem.

Three ways to reset the phone:

- **Full Reset:** All configurations and userdata on the phone will be reset.
- **Configuration Reset:** All configurations (e.g., account, call history) set on the phone will be reset.
- **Userdata Reset:** All custom data (e.g., ring tone) set on the phone will be reset.

Contact your system administrator before resetting the phone.

### To reset the phone via phone user interface:

1. Tap **...** -> **Advanced** (default password: admin) -> **Reset to Factory**.
2. Select the desired reset option from the pull-down list of **Reset Option**.
3. Tap the **Reset** key.

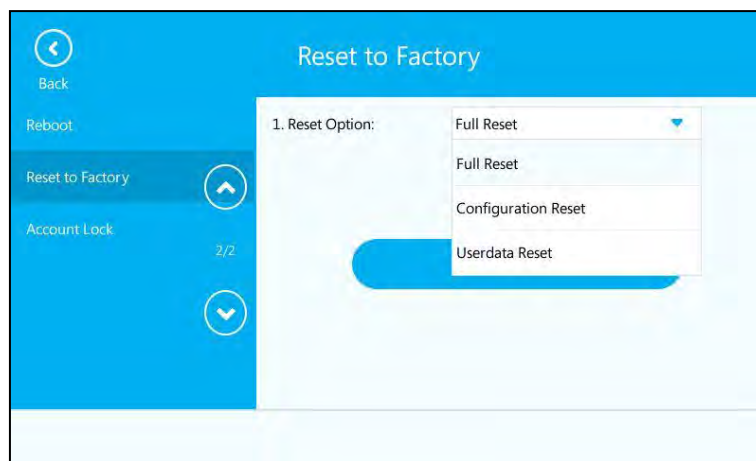

The touch screen prompts the following warning:

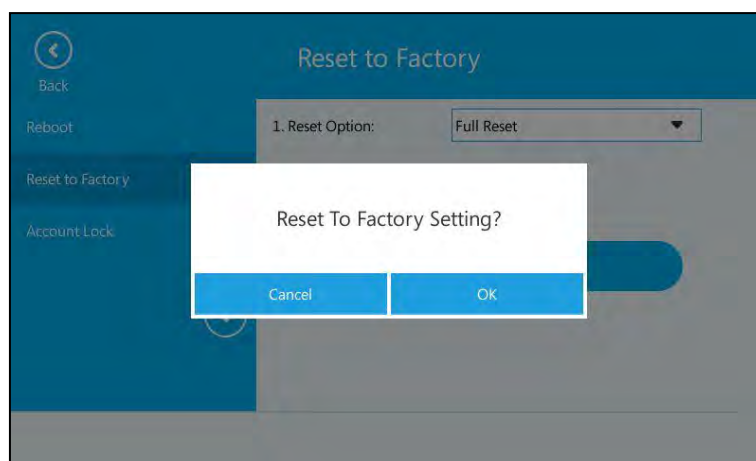

4. Tap the **OK** soft key.

The phone begins resetting.

After reset, the touch screen prompts "Welcom Initializing...Please wait".

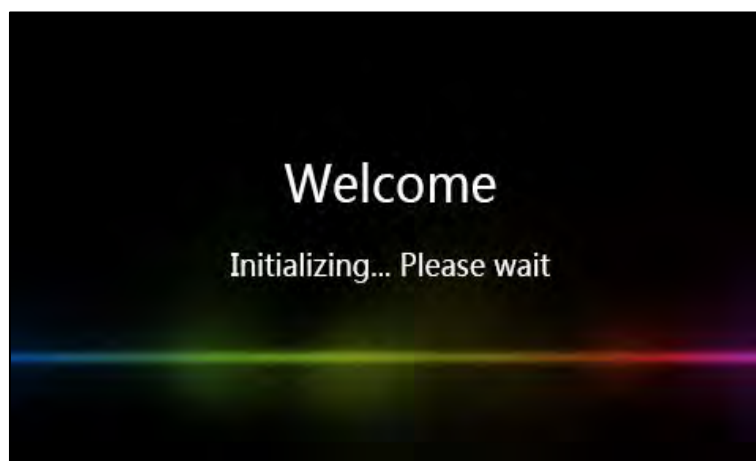

The phone will be reset to factory successfully after startup.

**Note**

You can also long press the  soft key to perform the full reset function when the phone is idle.

Reset of the phone may take a few minutes. Do not power off until the phone starts up successfully.

## Regulatory Notices

### Service Agreements

Contact your Yealink Authorized Reseller for information about service agreements applicable to your product.

### Limitations of Liability

TO THE FULL EXTENT ALLOWED BY LAW, YEALINK EXCLUDES FOR ITSELF AND ITS SUPPLIERS ANY LIABILITY, WHETHER BASED IN CONTRACT OR TORT (INCLUDING NEGLIGENCE), FOR INCIDENTAL, CONSEQUENTIAL, INDIRECT, SPECIAL, OR PUNITIVE DAMAGES OF ANY KIND, OR FOR LOSS OF REVENUE OR PROFITS, LOSS OF BUSINESS, LOSS OF INFORMATION OR DATA, OR OTHER FINANCIAL LOSS ARISING OUT OF OR IN CONNECTION WITH THE SALE, INSTALLATION, MAINTENANCE, USE, PERFORMANCE, FAILURE, OR INTERRUPTION OF ITS PRODUCTS, EVEN IF YEALINK OR ITS AUTHORIZED RESELLER HAS BEEN ADVISED OF THE POSSIBILITY OF SUCH DAMAGES, AND LIMITS ITS LIABILITY TO REPAIR, REPLACEMENT, OR REFUND OF THE PURCHASE PRICE PAID, AT YEALINK'S OPTION. THIS DISCLAIMER OF LIABILITY FOR DAMAGES WILL NOT BE AFFECTED IF ANY REMEDY PROVIDED HEREIN SHALL FAIL OF ITS ESSENTIAL PURPOSE.

### Safety Instructions

**Save these instructions. Read these safety instructions before use!**

The following basic safety precautions should always be followed to reduce risk of fire, electrical shock, and other personal injury.

#### General Requirements

- Before you install and use the device, read the safety instructions carefully and observe the situation during operation.
- During the process of storage, transportation, and operation, please always keep the device dry and clean.
- During the process of storage, transportation, and operation, please avoid collision and crash of the device.
- Please attempt not to dismantle the device by yourself. In case of any discrepancy, please contact the appointed maintenance center for repair.
- Without prior written consent, no organization or individual is permitted to make any change to the structure or the safety design of the device. Yealink is under no circumstance liable to consequences or legal issues caused by such changes.
- Please refer to the relevant laws and statutes while using the device. Legal rights of others should be respected as well.

#### Environmental Requirements

- Place the device at a well-ventilated place. Do not expose the device under direct sunlight.
- Keep the device dry and free of dusts.
- Place the device on a stable and level platform.

- Please place no heavy objects on the device in case of damage and deformation caused by the heavy load.
- Keep at least 10 cm between the device and the closest object for heat dissipation.
- Do not place the device on or near any inflammable or fire-vulnerable object, such as rubber-made materials.
- Keep the device away from any heat source or bare fire, such as a candle or an electric heater.
- Keep the device away from any household appliance with strong magnetic field or electromagnetic field, such as a microwave oven or a refrigerator.

### **Operating Requirements**

- Do not let a child operate the device without guidance.
- Do not let a child play with the device or any accessory in case of accidental swallowing.
- Please use the accessories provided or authorized by the manufacturer only.
- The power supply of the device shall meet the requirements of the input voltage of the device. Please use the provided surge protection power socket only.
- Before plugging or unplugging any cable, make sure that your hands are completely dry.
- Do not spill liquid of any kind on the product or use the equipment near water, for example, near a bathtub, washbowl, kitchen sink, wet basement or near a swimming pool.
- Do not tread on, pull, or over-bend any cable in case of malfunction of the device.
- During a thunderstorm, stop using the device and disconnect it from the power supply. Unplug the power plug and the Asymmetric Digital Subscriber Line (ADSL) twisted pair (the radio frequency cable) to avoid lightning strike.
- If the device is left unused for a rather long time, disconnect it from the power supply and unplug the power plug.
- When there is smoke emitted from the device, or some abnormal noise or smell, disconnect the device from the power supply, and unplug the power plug immediately. Contact the specified maintenance center for repair.
- Do not insert any object into equipment slots that is not part of the product or auxiliary product.
- Before connecting a cable, connect the grounding cable of the device first. Do not disconnect the grounding cable until you disconnect all other cables.

### **Cleaning Requirements**

- Before cleaning the device, stop using it and disconnect it from the power supply.
- Use a piece of soft, dry and anti-static cloth to clean the device.
- Keep the power plug clean and dry. Using a dirty or wet power plug may lead to electric shock or other perils.

## Appendix A - Time Zones

Time Zone	Time Zone Name
-11	Samoa
-10	United States-Hawaii-Aleutian, United States-Alaska-Aleutian
-9:30	French Polynesia
-9	United States-Alaska Time
-8	Canada(Vancouver,Whitehorse), Mexico(Tijuana,Mexicali), United States-Pacific Time
-7	Canada(Edmonton,Calgary), Mexico(Mazatlan,Chihuahua), United States-MST no DST, United States-Mountain Time
-6	Canada-Manitoba(Winnipeg), Chile(Easter Islands), Mexico(Mexico City,Acapulco), United States-Central Time
-5	Bahamas(Nassau), Canada(Montreal,Ottawa,Quebec), Cuba(Havana), United States-Eastern Time
-4:30	Venezuela(Caracas)
-4	Canada(Halifax,Saint John), Chile(Santiago), Paraguay(Asuncion), United Kingdom-Bermuda(Bermuda), United Kingdom(Falkland Islands), Trinidad&Tobago
-3:30	Canada-New Foundland(St.Johns)
-3	Argentina(Buenos Aires), Brazil(DST), Brazil(no DST), Denmark-Greenland(Nuuk)
-2:30	Newfoundland and Labrador
-2	Brazil(no DST)
-1	Portugal(Azores)
0	Denmark-Faroe Islands(Torshavn), GMT, Greenland, Ireland(Dublin), Morocco, Portugal(Lisboa,Porto,Funchal), Spain-Canary Islands(Las Palmas), United Kingdom(London)
+1	Albania(Tirane), Austria(Vienna), Belgium(Brussels), Caicos, Chad, Croatia(Zagreb), Czech Republic(Prague), Denmark(Kopenhagen), France(Paris), Germany(Berlin), Hungary(Budapest), Italy(Rome), Luxembourg(Luxembourg), Macedonia(Skopje), Namibia(Windhoek), Netherlands(Amsterdam), Spain(Madrid)
+2	Estonia(Tallinn), Finland(Helsinki), Gaza Strip(Gaza), Greece(Athens), Israel(Tel Aviv), Jordan(Amman), Latvia(Riga), Lebanon(Beirut), Moldova(Kishinev), Romania(Bucharest), Russia(Kaliningrad), Syria(Damascus), Turkey(Ankara), Ukraine(Kyiv, Odessa)
+3	East Africa Time, Iraq(Baghdad), Russia(Moscow)
+3:30	Iran(Teheran)
+4	Armenia(Yerevan), Azerbaijan(Baku), Georgia(Tbilisi), Abu Dhabi, Kazakhstan(Aktau), Russia(Samara)
+4:30	Afghanistan(Kabul)
+5	Kazakhstan(Aqtobe), Kyrgyzstan(Bishkek), Pakistan(Islamabad), Russia(Chelyabinsk)
+5:30	India(Calcutta)
+5:45	Nepal(Katmandu)
+6	Kazakhstan(Astana, Almaty), Russia(Novosibirsk,Omsk)
+6:30	Myanmar(Naypyitaw)
+7	Russia(Krasnoyarsk), Thailand(Bangkok)
+8	Australia(Perth), China(Beijing), Russia(Irkutsk, Ulan-Ude), Singapore(Singapore)
+8:45	Eucla
+9	Japan(Tokyo), Korea(Seoul), Russia(Yakutsk,Chita)
+9:30	Australia(Adelaide), Australia(Darwin)
+10	Australia(Brisbane), Australia(Hobart),

<b>Time Zone</b>	<b>Time Zone Name</b>
	Australia(Sydney,Melbourne,Canberra), Russia(Vladivostok)
+10:30	Australia(Lord Howe Islands)
+11	New Caledonia(Noumea), Russia(Srednekolymsk Time)
+11:30	Norfolk Island
+12	New Zealand(Wellington,Auckland), Russia(Kamchatka Time)
+12:45	New Zealand(Chatham Islands)
+13	Tonga(Nukualofa)
+13:30	Chatham Islands
+14	Kiribati

# Index

## A

About This Guide [v](#)  
 Account Lock [29](#)  
 Adding the Location Information [102](#)  
 Administrator password [55](#)  
 Always Online [28](#)  
 Answering Calls [117](#)  
 Answering SLA Calls [150](#)  
 Appendix A-Time Zone [247](#)  
 Assigning Contacts to the EXP40 [226](#)  
 Assigning/Removing Delegates [151](#)  
 Attaching the Stand or the Optional Wall Mount Bracket [14](#)  
 Audio Settings [61](#)  
 Auto Answer [118](#)

## B

Backlight [49](#)  
 Basic Network Settings [44](#)  
 Basic Call Features [113](#)  
 Better Together over Ethernet [205](#)  
 Boss-Admin Feature [150](#)  
 Boss-Line Ringtone [163](#)  
 Bluetooth Headset [92](#)  
 Blind Transfer [167](#)  
 Branch Office Resiliency [199](#)

## C

Calendar [122](#)  
 Call Forward [136](#)  
 Call History Management [86](#)  
 Call Hold/Resume [121](#)  
 Call Mute [120](#)  
 Call Park [187](#)  
 Call Transfer [167](#)  
 Call Waiting [119](#)  
 Change Presence Status [26](#)  
 Contrast [50](#)  
 Connecting the EXP40 to Your Phone [223](#)  
 Contact Management [64](#)  
 Common Area Phone [201](#)  
 Connecting the Handset and Optional Headset [15](#)  
 Connecting the Optional Bluetooth USB Dongle [15](#)  
 Connecting the Power [16](#)  
 Connecting to the Network [17](#)  
 Consultative Transfer [168](#)  
 Customizing Your Phone [49](#)

## D

Declaration of Conformity [vi](#)  
 Delegates-call Ringtone [164](#)  
 Dial-now [106](#)

Disabling BToE on Your Phone [220](#)  
 Documentation [10](#)  
 Dual Headset [91](#)

## E

E911 [98](#)  
 Emergency Call [104](#)  
 Enabling Better Together over Ethernet [211](#)  
 Ending Calls [118](#)  
 Entering Data and Editing Fields [38](#)  
 Exiting BToE on Your Computer [220](#)  
 EXP40 Expansion Model [223](#)  
 EXP40 Hardware Features [226](#)

## F

Favorites Screen [34](#)

## G

General Settings [49](#)  
 Getting Started [11](#)  
 Getting Started with Better Together over Ethernet [205](#)  
 Group Call Pickup [169](#)

## H

Hardware Component Instructions [1](#)  
 Headset Mode Activation/Deactivation [89](#)  
 Headset Prior [90](#)  
 Headset Use [89](#)  
 History Screen [34](#)

## I

Icon Instructions [3](#)  
 In This Guide [v](#)  
 Inbound Private Line [163](#)  
 Initiating a Conference Call [170](#)  
 Installing the Yealink Better Together over Ethernet [205](#)

## K

Key as Send [56](#)

## L

Language [51](#)  
 LED Instructions [6](#)  
 Limitation of Liability [245](#)  
 Local Directory [70](#)  
 Location Notification [99](#)  
 Listening to the Voice Mail [191](#)  
 Live Dialpad [108](#)

## M

- Managing the Conference Participants [179](#)
- Managing the Favorites [82](#)
- Menu Screen [36](#)
- Modifying the Privacy Mode from the Phone [110](#)
- Modifying the Privacy Mode from the Skype for Business client [111](#)
- Monitoring Skype for Business Contacts for Status Changes [227](#)
- Multicast Paging [193](#)

## N

- Navigating Menus and Fields [37](#)

## O

- Overview [1](#)

## P

- Packaging Contents [11](#)
- Phone Initialization [18](#)
- Phone Installation [14](#)
- Phone Lock [57](#)
- Phone Ringtone [62](#)
- Phone Status [43](#)
- PIN Authentication [21](#)
- Placing a SLA Calls on Hold [150](#)
- Placing Calls [114](#)
- Placing Calls to Contacts [84](#)
- Privacy Mode [110](#)
- Private Line Tones [166](#)

## R

- Redialing Numbers [118](#)
- Receiving RTP Stream [196](#)
- Remembering Password [60](#)
- Response Group [147](#)
- Response Group Ringtone [149](#)
- Resuming Held SLA Calls [150](#)
- Regulatory Notices [245](#)

## S

- Safety Instructions [245](#)
- Searching for Contacts [85](#)
- Sending RTP Stream [194](#)
- Setting up a Meeting in Outlook [123](#)
- Setting up a Skype Conference in Outlook [122](#)
- Setting up an Appointment in Outlook [123](#)
- Setting up an Event in Outlook [124](#)
- Service Agreements [245](#)
- Shared Line Appearance for Skype for Business [149](#)
- Signing into Skype for Business [18](#)
- Signing in via PC [215](#)

- Signing into a Common Area Phone [201](#)
- Signing Out of Skype for Business [26](#)
- Signing Out of a Common Area Phone [203](#)
- Skype for Business Conference [170](#)
- Skype for Business Directory [65](#)
- Switch to Skype for Business Accounts [202](#)

## T

- Table of Contents [ix](#)
- Team-Call Group [147](#)
- Time & Date [52](#)
- Touch Screen Display [31](#)
- Troubleshooting [231](#)

## U

- Uninstalling the Yealink BToE Connector [221](#)
- User Interfaces [6](#)
- User Sign-in [19](#)
- Using Better Together over Ethernet [218](#)
- Using a Common Area Phone [202](#)
- Using Multicast Paging [197](#)
- Using the Calendar [125](#)
- Using the Boss-Admin Feature [154](#)
- Using the EXP40 [228](#)

## V

- Volume [61](#)
- Voice Mail [189](#)
- Viewing the Bosses/Delegates [153](#)
- Viewing the Conference Participants [178](#)
- Viewing the Location Information [104](#)

## W

- Web Sign-in [22](#)
- Web User Interface [8](#)
- Working With Schedule Reminders [130](#)