

## SIMATIC NET

### Industrial Ethernet switches SCALANCE XC-200

#### Operating Instructions

|  |           |
|--|-----------|
| <u>Introduction</u>                        | <b>1</b>  |
| <u>Safety notices</u>                      | <b>2</b>  |
| <u>Recommendations on network security</u> | <b>3</b>  |
| <u>Description of the device</u>           | <b>4</b>  |
| <u>Mounting</u>                            | <b>5</b>  |
| <u>Connecting up</u>                       | <b>6</b>  |
| <u>Maintenance</u>                         | <b>7</b>  |
| <u>Troubleshooting</u>                     | <b>8</b>  |
| <u>Technical specifications</u>            | <b>9</b>  |
| <u>Dimension drawings</u>                  | <b>10</b> |
| <u>Certifications and approvals</u>        | <b>11</b> |

## Legal information

### Warning notice system

This manual contains notices you have to observe in order to ensure your personal safety, as well as to prevent damage to property. The notices referring to your personal safety are highlighted in the manual by a safety alert symbol, notices referring only to property damage have no safety alert symbol. These notices shown below are graded according to the degree of danger.

|  |
|--|
|  <b>DANGER</b>        |
| indicates that death or severe personal injury <b>will</b> result if proper precautions are not taken. |

|   |
|---|
|  <b>WARNING</b>      |
| indicates that death or severe personal injury <b>may</b> result if proper precautions are not taken. |

|  |
|--|
|  <b>CAUTION</b> |
| indicates that minor personal injury can result if proper precautions are not taken.             |

|  |
|--|
| <b>NOTICE</b>  |
| indicates that property damage can result if proper precautions are not taken. |

If more than one degree of danger is present, the warning notice representing the highest degree of danger will be used. A notice warning of injury to persons with a safety alert symbol may also include a warning relating to property damage.

### Qualified Personnel

The product/system described in this documentation may be operated only by **personnel qualified** for the specific task in accordance with the relevant documentation, in particular its warning notices and safety instructions. Qualified personnel are those who, based on their training and experience, are capable of identifying risks and avoiding potential hazards when working with these products/systems.

### Proper use of Siemens products

Note the following:

|  |
|--|
|  <b>WARNING</b>   |
| Siemens products may only be used for the applications described in the catalog and in the relevant technical documentation. If products and components from other manufacturers are used, these must be recommended or approved by Siemens. Proper transport, storage, installation, assembly, commissioning, operation and maintenance are required to ensure that the products operate safely and without any problems. The permissible ambient conditions must be complied with. The information in the relevant documentation must be observed. |

### Trademarks

All names identified by ® are registered trademarks of Siemens AG. The remaining trademarks in this publication may be trademarks whose use by third parties for their own purposes could violate the rights of the owner.

### Disclaimer of Liability

We have reviewed the contents of this publication to ensure consistency with the hardware and software described. Since variance cannot be precluded entirely, we cannot guarantee full consistency. However, the information in this publication is reviewed regularly and any necessary corrections are included in subsequent editions.

# Table of contents

|          |   |           |
|----------|---|-----------|
| <b>1</b> | <b>Introduction .....</b>                               | <b>7</b>  |
| <b>2</b> | <b>Safety notices .....</b>                             | <b>13</b> |
| <b>3</b> | <b>Recommendations on network security .....</b>        | <b>15</b> |
| <b>4</b> | <b>Description of the device .....</b>                  | <b>21</b> |
| 4.1      | Product overview .....                                  | 21        |
| 4.2      | Device views .....                                      | 27        |
| 4.2.1    | SCALANCE XC206-2 (ST/BFOC) .....                        | 27        |
| 4.2.2    | SCALANCE XC206-2 (SC) .....                             | 28        |
| 4.2.3    | SCALANCE XC206-2G PoE .....                             | 29        |
| 4.2.4    | SCALANCE XC206-2SFP .....                               | 30        |
| 4.2.5    | SCALANCE XC208 .....                                    | 30        |
| 4.2.6    | SCALANCE XC208G PoE .....                               | 32        |
| 4.2.7    | SCALANCE XC216 .....                                    | 33        |
| 4.2.8    | SCALANCE XC216-3G PoE .....                             | 34        |
| 4.2.9    | SCALANCE XC216-4C .....                                 | 34        |
| 4.2.10   | SCALANCE XC224 .....                                    | 36        |
| 4.2.11   | SCALANCE XC224-4C .....                                 | 37        |
| 4.3      | Accessories .....                                       | 37        |
| 4.4      | SELECT / SET button .....                               | 42        |
| 4.5      | LED display .....                                       | 44        |
| 4.5.1    | Overview .....  | 44        |
| 4.5.2    | "RM" LED .....  | 45        |
| 4.5.3    | "SB" LED .....  | 45        |
| 4.5.4    | "F" LED .....   | 45        |
| 4.5.5    | LEDs "DM1" and "DM2" .....                              | 45        |
| 4.5.6    | LEDs "L1" and "L2" .....                                | 46        |
| 4.5.7    | Port LEDs .....   | 47        |
| 4.6      | C-PLUG .....  | 48        |
| 4.6.1    | Function of the C-PLUG .....                            | 48        |
| 4.6.2    | Replacing the C-PLUG .....                              | 50        |
| 4.7      | Combo ports .....                                       | 51        |
| 4.8      | Power over Ethernet (PoE) .....                         | 52        |
| 4.8.1    | Power and voltage range according to the standard ..... | 52        |
| 4.8.2    | PoE properties of the devices .....                     | 52        |
| 4.8.3    | Power transfer and pin assignment (30 W) .....          | 54        |
| 4.8.4    | Power transfer and pin assignment (60 W) .....          | 54        |
| 4.8.5    | Configuration .....                                     | 55        |
| <b>5</b> | <b>Mounting .....</b>                                   | <b>57</b> |
| 5.1      | Safety notices for installation .....                   | 57        |

|          |   |           |
|----------|---|-----------|
| 5.2      | General notes for SFP transceivers .....                              | 60        |
| 5.3      | Types of installation .....   | 60        |
| 5.4      | Installation on a DIN rail .....                                      | 61        |
| 5.4.1    | Top-hat rail mounting with fastening plate .....                      | 61        |
| 5.4.2    | Top-hat rail mounting without fastening plate .....                   | 62        |
| 5.5      | Installation on a standard S7-300 rail .....                          | 64        |
| 5.5.1    | Installation on a standard rail S7-300 with fastening plate .....     | 64        |
| 5.5.2    | Installation on a standard rail S7-300 without fastening plate .....  | 65        |
| 5.6      | Installation on a standard rail S7-1500 .....                         | 66        |
| 5.6.1    | Installation on a standard rail S7-1500 with fastening plate .....    | 66        |
| 5.6.2    | Installation on a standard rail S7-1500 without fastening plate ..... | 67        |
| 5.7      | Wall mounting with fastening plate .....                              | 68        |
| 5.8      | Changing the position of the securing bar .....                       | 69        |
| <b>6</b> | <b>Connecting up .....</b>  | <b>71</b> |
| 6.1      | Wiring rules .....  | 75        |
| 6.2      | 24 V DC power supply .....  | 76        |
| 6.3      | 54 V DC power supply .....  | 77        |
| 6.4      | Signaling contact .....   | 79        |
| 6.5      | Functional ground .....   | 80        |
| 6.6      | Industrial Ethernet .....   | 82        |
| 6.6.1    | Electrical .....  | 82        |
| 6.6.2    | Optical .....   | 84        |
| 6.7      | Serial interface .....  | 85        |
| <b>7</b> | <b>Maintenance .....</b>  | <b>87</b> |
| <b>8</b> | <b>Troubleshooting .....</b>  | <b>89</b> |
| 8.1      | Downloading new firmware using TFTP without WBM and CLI .....         | 89        |
| 8.2      | Restoring the factory settings .....                                  | 90        |
| <b>9</b> | <b>Technical specifications .....</b>                                 | <b>91</b> |
| 9.1      | Technical specifications SCALANCE XC206-2 (ST/BFOC) .....             | 91        |
| 9.2      | Technical specifications SCALANCE XC206-2 (SC) .....                  | 93        |
| 9.3      | Technical specifications of SCALANCE XC206-2G PoE .....               | 96        |
| 9.4      | Technical specifications of SCALANCE XC206-2G PoE (54 V) .....        | 98        |
| 9.5      | Technical specifications of SCALANCE XC206-2G PoE EEC (54 V) .....    | 100       |
| 9.6      | Technical specifications SCALANCE XC206-2SFP .....                    | 103       |
| 9.7      | Technical specifications of SCALANCE XC206-2SFP G .....               | 105       |
| 9.8      | Technical specifications of SCALANCE XC206-2SFP EEC .....             | 107       |
| 9.9      | Technical specifications of SCALANCE XC206-2SFP G EEC .....           | 110       |

---

|           |  |            |
|-----------|--|------------|
| 9.10      | Technical specifications of the SCALANCE XC208 .....           | 113        |
| 9.11      | Technical specifications of SCALANCE XC208G.....               | 115        |
| 9.12      | Technical specifications of SCALANCE XC208G PoE .....          | 117        |
| 9.13      | Technical specifications of SCALANCE XC208G PoE (54 V) .....   | 119        |
| 9.14      | Technical specifications of SCALANCE XC208EEC .....            | 121        |
| 9.15      | Technical specifications of SCALANCE XC208G EEC.....           | 123        |
| 9.16      | Technical specifications of the SCALANCE XC216 .....           | 125        |
| 9.17      | Technical specifications of SCALANCE XC216EEC .....            | 127        |
| 9.18      | Technical specifications of SCALANCE XC216-3G PoE .....        | 128        |
| 9.19      | Technical specifications of SCALANCE XC216-3G PoE (54 V) ..... | 130        |
| 9.20      | Technical specifications of SCALANCE XC216-4C.....             | 133        |
| 9.21      | Technical specifications of SCALANCE XC216-4C G.....           | 135        |
| 9.22      | Technical specifications of SCALANCE XC216-4C G EEC .....      | 137        |
| 9.23      | Technical specifications of the SCALANCE XC224 .....           | 140        |
| 9.24      | Technical specifications of SCALANCE XC224-4C G.....           | 142        |
| 9.25      | Technical specifications of SCALANCE XC224-4C G EEC .....      | 144        |
| 9.26      | Mechanical stability (in operation) .....                      | 147        |
| 9.27      | RF radiation according to NAMUR NE21 .....                     | 147        |
| 9.28      | Cable lengths.....   | 147        |
| 9.29      | Switching properties.....                                      | 148        |
| <b>10</b> | <b>Dimension drawings .....</b>                                | <b>149</b> |
| <b>11</b> | <b>Certifications and approvals .....</b>                      | <b>157</b> |
|           | <b>Index.....</b>  | <b>165</b> |



# Introduction

## Purpose of the Operating Instructions

These operating instructions support you when installing and connecting up devices of the SCALANCE XC-200 product group.

The configuration and the integration of the devices in a network are not described in these operating instructions.

## Validity of the Operating Instructions

These operating instructions apply to the following devices:

- SCALANCE XC206-2 (ST/BFOC)
- SCALANCE XC206-2 (SC)
- SCALANCE XC206-2G PoE
- SCALANCE XC206-2G PoE (54 V)
- SCALANCE XC206-2G PoE EEC (54 V)
- SCALANCE XC206-2SFP
- SCALANCE XC206-2SFP G
- SCALANCE XC206-2SFP EEC
- SCALANCE XC206-2SFP G EEC
- SCALANCE XC208
- SCALANCE XC208G
- SCALANCE XC208G PoE
- SCALANCE XC208G PoE (54 V)
- SCALANCE XC208EEC
- SCALANCE XC208G EEC
- SCALANCE XC216
- SCALANCE XC216EEC
- SCALANCE XC216-3G PoE
- SCALANCE XC216-3G PoE (54 V)
- SCALANCE XC216-4C
- SCALANCE XC216-4C G
- SCALANCE XC216-4C G EEC
- SCALANCE XC224

- SCALANCE XC224-4C G
- SCALANCE XC224-4C G EEC

Unless mentioned otherwise, the descriptions in these operating instructions refer to all devices of the SCALANCE XC-200 product group named above in the section on validity.

## Designations used

Table 1-1 Explanation of designations used

| Classification | Description   | Terms used                            |
|----------------|---|---------------------------------------|
| Product line   | The product line includes all devices and variants of all product groups.<br>If information applies to all product groups within the product line, the term SCALANCE X-200 is used.   | SCALANCE X-200                        |
| Product group  | If information applies to all devices and variants of a product group, the term SCALANCE XC-200 is used.  | SCALANCE XC-200                       |
| Device         | If information relates to a specific device, the device name is used.   | e.g. SCALANCE XC206-2SFP              |
| Device group   | If information applies to a specific group of devices, a corresponding abbreviation is used.  |                                       |
|                | If information applies to all gigabit variants of SCALANCE XC-200, the following terms are used.<br>You can recognize the gigabit variants by the suffix "G" in the type designation.<br>Devices that only support gigabit via SFPs are not considered gigabit variants (e.g. SCALANCE XC206-2SFP). | SCALANCE XC-200G,<br>gigabit variants |
|                | If information applies to all SCALANCE XC-200 with coated circuit boards, the following terms are used.<br>You can recognize the EEC variants by the suffix "EEC" in the type designation.  | SCALANCE XC-200EEC,<br>EEC variants   |
|                | If information applies to all SCALANCE XC-200 with combo ports, the following term is used.<br>You recognize devices with combo ports by the suffix "C" in the type designation.  | Devices with combo ports              |
|                | If information applies to all SCALANCE XC-200 with Power over Ethernet, the following terms are used.<br>You can recognize the PoE variants by the suffix "PoE" in the type designation.  | SCALANCE XC-200PoE,<br>PoE variants   |

## Additional documentation

In addition, note the Operating Instructions of the pluggable transceivers.

You will find the supplementary documentation here:

- On the data medium that ships with some products:
  - Product CD / product DVD
  - SIMATIC NET Manual Collection
- On the Internet pages of Siemens Industry Online Support (<https://support.industry.siemens.com/cs/ww/en/ps/15247>)



## Documentation on configuration

You will find detailed information on configuring the devices in the following configuration manuals:

- SCALANCE XB-200/XC-200/XF-200BA/XP-200/XR-300WG Web Based Management
- SCALANCE XB-200/XC-200/XF-200BA/XP-200/XR-300WG Command Line Interface

You will find the configuration manuals here:

- on the data medium that ships with some products:
  - Product CD / product DVD
  - SIMATIC NET Manual Collection
- On the Internet pages of Siemens Industry Online Support (<https://support.industry.siemens.com/cs/ww/en/ps/24185/man>).

## Further documentation

In the system manuals "Industrial Ethernet / PROFINET Industrial Ethernet" and "Industrial Ethernet / PROFINET passive network components", you will find information on other SIMATIC NET products that you can operate along with the devices of this product line in an Industrial Ethernet network.

There, you will find among other things optical performance data of the communications partner that you require for the installation.

You will find the system manuals here:

- On the data medium that ships with some products:
  - Product CD / product DVD
  - SIMATIC NET Manual Collection
- On the Internet pages of Siemens Industry Online Support:
  - Industrial Ethernet / PROFINET Industrial Ethernet System Manual (<https://support.industry.siemens.com/cs/ww/en/view/27069465>)
  - Industrial Ethernet / PROFINET Passive Network Components System Manual (<https://support.industry.siemens.com/cs/ww/en/view/84922825>)

## SIMATIC NET manuals

You will find the SIMATIC NET manuals here:

- On the data medium that ships with some products:
  - Product CD / product DVD
  - SIMATIC NET Manual Collection
- On the Internet pages of Siemens Industry Online Support (<https://support.industry.siemens.com/cs/ww/en/ps/15247>).

## SIMATIC NET glossary

Explanations of many of the specialist terms used in this documentation can be found in the SIMATIC NET glossary.

You will find the SIMATIC NET glossary here:

- SIMATIC NET Manual Collection or product DVD  
The DVD ships with certain SIMATIC NET products.
- On the Internet under the following address:  
50305045 (<https://support.industry.siemens.com/cs/ww/en/view/50305045>)

## Security information

Siemens provides products and solutions with industrial security functions that support the secure operation of plants, systems, machines and networks.

In order to protect plants, systems, machines and networks against cyber threats, it is necessary to implement – and continuously maintain – a holistic, state-of-the-art industrial security concept. Siemens' products and solutions constitute one element of such a concept.

Customers are responsible for preventing unauthorized access to their plants, systems, machines and networks. Such systems, machines and components should only be connected to an enterprise network or the internet if and to the extent such a connection is necessary and only when appropriate security measures (e.g. firewalls and/or network segmentation) are in place.

For additional information on industrial security measures that may be implemented, please visit <http://www.siemens.com/industrialsecurity> (<https://www.siemens.com/industrialsecurity>)

Siemens' products and solutions undergo continuous development to make them more secure. Siemens strongly recommends that product updates are applied as soon as they are available and that the latest product versions are used. Use of product versions that are no longer supported, and failure to apply the latest updates may increase customers' exposure to cyber threats.

To stay informed about product updates, subscribe to the Siemens Industrial Security RSS Feed under <http://www.siemens.com/industrialsecurity> (<https://www.siemens.com/industrialsecurity>)

## Catalogs

You will find the article numbers for the Siemens products of relevance here in the following catalogs:

- SIMATIC NET Industrial Communication / Industrial Identification, catalog IK PI
- SIMATIC Products for Totally Integrated Automation and Micro Automation, catalog ST 70
- Industry Mall - catalog and ordering system for automation and drive technology, Online catalog (<https://mall.industry.siemens.com/goos/WelcomePage.aspx?regionUrl=/de&language=en>)

You can request the catalogs and additional information from your Siemens representative.

## Device defective

If a fault develops, send the device to your SIEMENS representative for repair. Repairs on-site are not possible.

## Decommissioning

Shut down the device properly to prevent unauthorized persons from accessing confidential data in the device memory.

To do this, restore the factory settings on the device.

Also restore the factory settings on the storage medium.

## Recycling and disposal



The products are low in pollutants, can be recycled and meet the requirements of the WEEE directive 2012/19/EU for the disposal of electrical and electronic equipment.

Do not dispose of the products at public disposal sites.

For environmentally friendly recycling and the disposal of your old device contact a certified disposal company for electronic scrap or your Siemens contact (Product return (<https://support.industry.siemens.com/cs/ww/en/view/109479891>)).

Note the different national regulations.

## Trademarks

The following and possibly other names not identified by the registered trademark sign ® are registered trademarks of Siemens AG:

SIMATIC NET, SCALANCE, C-PLUG, OLM

## Electrostatic discharge



### NOTICE

#### Electrostatic sensitive devices (ESD)

Electronic modules contain electrostatic sensitive components

These components can easily be destroyed if handled incorrectly.

Note the following instructions to avoid damage.

- Touch electronic modules only when you absolutely need to work on them.
- If electronic modules need to be touched, the body of the person involved must first be electrostatically discharged and grounded.
- Do not bring electronic modules in contact with electrically isolating materials such as plastic film, isolating table top pads or clothing made of synthetic fibers.
- Place the modules only on conductive surfaces.
- Pack, store and transport electronic modules and components only in conductive packaging such as metalized plastic or metal containers, conductive foam or household aluminum foil.



## Safety notices

### Read the safety notices

Note the following safety notices. These relate to the entire working life of the device.

You should also read the safety notices relating to handling in the individual sections, particularly in the sections "Installation" and "Connecting up".

|  |
|--|
|  <b>CAUTION</b> |
| To prevent injury, read the manual before use.   |

### Safety notices on use in hazardous areas

#### General safety notices relating to protection against explosion

|   |
|---|
|  <b>WARNING</b> |
| <b>EXPLOSION HAZARD</b>   |
| Do not open the device when the supply voltage is turned on.                                      |

#### Safety instructions for use in hazardous locations according to UL/FM HazLoc

If you use the device under UL or FM HazLoc conditions, you must also adhere to the following safety instructions in addition to the general safety instructions for protection against explosion:

This equipment is suitable for use in Class I, Division 2, Groups A, B, C and D or non-hazardous locations only.

This equipment is suitable for use in Class I, Zone 2, Group IIC or non-hazardous locations only.



## Recommendations on network security

|  |
|--|
| <b>NOTICE</b>  |
| <b>Information security</b>  |
| Connect to the device and change the standard password for the user set in the factory "admin" and "" before you operate the device. |

To prevent unauthorized access, note the following security recommendations.

### General

- You should make regular checks to make sure that the device meets these recommendations and/or other security guidelines.
- Evaluate your plant as a whole in terms of security. Use a cell protection concept with suitable products (<https://www.industry.siemens.com/topics/global/en/industrial-security/pages/default.aspx>).
- When the internal and external network are disconnected, an attacker cannot access internal data from the outside. Therefore operate the device only within a protected network area.
- For communication via non-secure networks use additional devices with VPN functionality to encrypt and authenticate the communication.
- No product liability will be accepted for operation in a non-secure infrastructure.
- Terminate management connections correctly (WBM, Telnet, SSH etc.).

### Physical access

- Restrict physical access to the device to qualified personnel because the plug-in data medium can contain sensitive data.
- Lock unused physical interfaces on the device. Unused interfaces can be used to gain access to the plant without permission.

### Software (security functions)

- Keep the firmware up to date. Check regularly for security updates for the device. You can find information on this at the Industrial Security (<https://www.siemens.com/industrialsecurity>) website.
- Inform yourself regularly about security recommendations published by Siemens ProductCERT (<https://www.siemens.com/cert/en/cert-security-advisories.htm>).
- Only activate protocols that you require to use the device.
- Restrict access to the management of the device with rules in an access control list (ACL).

- The option of VLAN structuring provides protection against DoS attacks and unauthorized access. Check whether this is practical or useful in your environment.
- Use a central logging server to log changes and accesses. Operate your logging server within the protected network area and check the logging information regularly.

## Passwords

- Define rules for the assignment of passwords.
- Regularly change your passwords to increase security.
- Use passwords with a high password strength.
- Make sure that all passwords are protected and inaccessible to unauthorized persons.
- A password must be changed if it is known or suspected to be known by unauthorized persons.
- Do not use the same password for different users and systems.

## Certificates and keys

- The device contains a pre-installed certificate with key. Replace this certificate with a self-made certificate with key. We recommend that you use a certificate signed either by a reliable external or by an internal certification authority. You can install the certificate via the WBM (System > Load and Save).
- Use the certification authority including key revocation and management to sign the certificates.
- Make sure that user-defined private keys are protected and inaccessible to unauthorized persons.
- Verify certificates and fingerprints on the server and client to prevent "man in the middle" attacks.
- It is recommended that you use password-protected certificates in the PKCS#12 format.
- It is recommended that you use certificates with a key length of at least 2048 bits.
- Change keys and certificates immediately if there is a suspicion of compromise.



## Secure/non-secure protocols and services

- Avoid or disable non-secure protocols and services, for example HTTP, Telnet and TFTP. For historical reasons, these protocols are available, however not intended for secure applications. Use non-secure protocols on the device with caution.
- Check whether use of the following protocols and services is necessary:
  - Non authenticated and unencrypted ports
  - MRP, HRP
  - IGMP snooping
  - LLDP
  - Syslog
  - RADIUS
  - DHCP Options 66/67
  - TFTP
  - GMRP and GVRP
- The following protocols provide secure alternatives:
  - HTTP → HTTPS
  - Telnet → SSH
  - SNMPv1/v2c → SNMPv3  
Check whether use of SNMPv1/v2c. is necessary. SNMPv1/v2c is classified as non-secure. Use the option of preventing write access. The device provides you with suitable setting options.  
If SNMP is enabled, change the community names. If no unrestricted access is necessary, restrict access with SNMP.  
Use the authentication and encryption mechanisms of SNMPv3.
- Use secure protocols when access to the device is not prevented by physical protection measures.
- If you require non-secure protocols and services, operate the device only within a protected network area.
- Restrict the services and protocols available to the outside to a minimum.
- For the DCP function, enable the "Read Only" mode after commissioning.
- If you use RADIUS for management access to the device, activate secure protocols and services.

## Interfaces security

- Disable unused interfaces.
- Use IEEE 802.1X for interface authentication.
- Use the function "Locked Ports" to block interfaces for unknown nodes.
- Use the configuration options of the interfaces, e.g. the "Edge Type".
- Configure the receive ports so that they discard all untagged frames ("Tagged Frames Only").

## Available protocols

The following list provides you with an overview of the open protocol ports.

The table includes the following columns:

- **Protocol**
- **Port**
- **Default port status**
  - Open  
The factory setting of the port is "Open".
  - Closed  
The factory setting of the port is "Closed".
- **Configurable port**
  - ✓  
The port status can be changed.
  - --  
The port status cannot be changed.
- **Authentication**  
Specifies whether the communication partner is authenticated.
- **Encryption**  
Specifies whether or not the transfer is encrypted.

## List of available protocols (local access via a local network)

The following is a list of all available protocols and their ports through which the device can be accessed.

| Protocol      | Protocol/<br>Port number           | Default port status                           | Configurable port | Authentication | Encryption |
|---------------|------------------------------------|---|-------------------|----------------|------------|
| DHCPv4 Server | UDP/67                             | Closed  | ✓                 | No             | No         |
| DHCPv4 Client | UDP/68                             | Open  | ✓                 | No             | No         |
| Discard       | TCP/9                              | Open, filtered                                | --                | No             | No         |
| Echo IP       | UPD/TCP/9                          | Open  | --                | No             | No         |
| EtherNet/IP   | TCP/44818<br>UDP/2222<br>UDP/44818 | Closed<br>(Open with<br>EtherNet/IP variants) | ✓                 | No             | No         |
| HTTP          | TCP/80                             | Open  | ✓                 | Yes            | No         |
| HTTPS         | TCP/443                            | Open  | ✓                 | Yes            | Yes        |
| Kerberos      | TCP/464                            | Open, filtered                                | --                | No             | No         |
| NTP<br>SNTP   | UDP/123                            | Closed  | ✓                 | No             | No         |
| NTP (secure)  | UDP/123                            | Closed  | ✓                 | Yes            | No         |

| Protocol | Protocol/<br>Port number                       | Default port status | Configurable port | Authentication | Encryption            |
|----------|--|---------------------|-------------------|----------------|-----------------------|
| PROFINET | UDP/34964<br>UDP/49151 ... 49159 <sup>1)</sup> | Open                | ✓                 | No             | No                    |
| RADIUS   | UPD/1812,1813                                  | Closed              | ✓                 | Yes            | Yes                   |
| SMTP     | TCP/25<br>TCP/465                              | Closed              | ✓                 | Yes            | Yes                   |
| SNMP     | UDP/161  | Open                | ✓                 | Yes            | Yes (when configured) |
| SSH      | TCP/22   | Open                | ✓                 | Yes            | Yes                   |
| Syslog   | UPD/514<br>TCP/6514                            | Closed              | ✓                 | Yes            | Yes                   |
| TELNET   | TCP/23   | Open                | ✓                 | Yes            | No                    |
| TFTP     | UDP/69   | Open                | ✓                 | No             | No                    |

<sup>1)</sup> Port number can be configured via the WBM.



## Description of the device

### 4.1 Product overview

#### Article numbers

There are two variants of some devices with different article numbers. The two variants differ only in their factory settings. All other properties are identical.

| Device                           | Description   | Article number  |
|----------------------------------|---|---|
| SCALANCE XC206-2 (ST/BFOC)       | <ul style="list-style-type: none"> <li>6 x 10/100 Mbps RJ45 ports</li> <li>2 x 100 Mbps ST/BFOC ports, multimode fiber-optic cable</li> </ul>   | PROFINET:<br>6GK5 206-2BB00-2AC2  |
| SCALANCE XC206-2 (SC)            | <ul style="list-style-type: none"> <li>6 x 10/100 Mbps RJ45 ports</li> <li>2 x 100 Mbps SC ports, multimode fiber-optic cable</li> </ul>  | PROFINET:<br>6GK5 206-2BD00-2AC2  |
| SCALANCE XC206-2G PoE            | <ul style="list-style-type: none"> <li>6 x 10/100/1000 Mbps RJ45 ports</li> <li>2 x pluggable transceiver slots with 1000/10000 Mbps (SFP+)</li> <li>Power over Ethernet at 6 ports</li> <li>Rated voltage 24 V DC</li> </ul>                                       | PROFINET:<br>6GK5 206-2RS00-2AC2  |
| SCALANCE XC206-2G PoE (54 V)     | <ul style="list-style-type: none"> <li>6 x 10/100/1000 Mbps RJ45 ports</li> <li>2 x pluggable transceiver slots with 1000/10000 Mbps (SFP+)</li> <li>Power over Ethernet at 6 ports</li> <li>Rated voltage 54 V DC</li> </ul>                                       | PROFINET:<br>6GK5 206-2RS00-5AC2  |
| SCALANCE XC206-2G PoE EEC (54 V) | <ul style="list-style-type: none"> <li>6 x 10/100/1000 Mbps RJ45 ports</li> <li>2 x pluggable transceiver slots with 1000/10000 Mbps (SFP+)</li> <li>Power over Ethernet at 6 ports</li> <li>Rated voltage 54 V DC</li> <li>Coated printed circuit board</li> </ul> | PROFINET:<br>6GK5 206-2RS00-5FC2  |
| SCALANCE XC206-2SFP              | <ul style="list-style-type: none"> <li>6 x 10/100 Mbps RJ45 ports</li> <li>2 x pluggable transceiver slots with 100/1000 Mbps</li> </ul>  | PROFINET:<br>6GK5 206-2BS00-2AC2  |
| SCALANCE XC206-2SFP G            | <ul style="list-style-type: none"> <li>6 x 10/100/1000 Mbps RJ45 ports</li> <li>2 x pluggable transceiver slots with 1000 Mbps</li> </ul>   | PROFINET:<br>6GK5 206-2GS00-2AC2<br>EtherNet/IP:<br>6GK5 206-2GS00-2TC2 |
| SCALANCE XC206-2SFP EEC          | <ul style="list-style-type: none"> <li>6 x 10/100 Mbps RJ45 ports</li> <li>2 x pluggable transceiver slots with 100/1000 Mbps</li> <li>Coated printed circuit board</li> </ul>  | PROFINET:<br>6GK5 206-2BS00-2FC2  |
| SCALANCE XC206-2SFP G EEC        | <ul style="list-style-type: none"> <li>6 x 10/100/1000 Mbps RJ45 ports</li> <li>2 x pluggable transceiver slots with 1000 Mbps</li> <li>Coated printed circuit board</li> </ul>   | PROFINET:<br>6GK5 206-2GS00-2FC2  |

## Description of the device

### 4.1 Product overview

| Device                       | Description  | Article number  |
|------------------------------|--|---|
| SCALANCE XC208               | <ul style="list-style-type: none"> <li>8 x 10/100 Mbps RJ45 ports</li> </ul>   | PROFINET:<br>6GK5 208-0BA00-2AC2  |
| SCALANCE XC208G              | <ul style="list-style-type: none"> <li>8 x 10/100/1000 Mbps RJ45 ports</li> </ul>  | PROFINET:<br>6GK5 208-0GA00-2AC2<br>EtherNet/IP:<br>6GK5 208-0GA00-2TC2 |
| SCALANCE XC208G PoE          | <ul style="list-style-type: none"> <li>8 x 10/100/1000 Mbps RJ45 ports</li> <li>Power over Ethernet at 6 ports</li> <li>Rated voltage 24 V DC</li> </ul>   | PROFINET:<br>6GK5 208-0RA00-2AC2  |
| SCALANCE XC208G PoE (54 V)   | <ul style="list-style-type: none"> <li>8 x 10/100/1000 Mbps RJ45 ports</li> <li>Power over Ethernet at 6 ports</li> <li>Rated voltage 54 V DC</li> </ul>   | PROFINET:<br>6GK5 208-0RA00-5AC2  |
| SCALANCE XC208EEC            | <ul style="list-style-type: none"> <li>8 x 10/100 Mbps RJ45 ports</li> <li>Coated printed circuit board</li> </ul>   | PROFINET:<br>6GK5 208-0BA00-2FC2  |
| SCALANCE XC208G EEC          | <ul style="list-style-type: none"> <li>8 x 10/100/1000 Mbps RJ45 ports</li> <li>Coated printed circuit board</li> </ul>  | PROFINET:<br>6GK5 208-0GA00-2FC2  |
| SCALANCE XC216               | <ul style="list-style-type: none"> <li>16 x 10/100 Mbps RJ45 ports</li> </ul>  | PROFINET:<br>6GK5 216-0BA00-2AC2  |
| SCALANCE XC216EEC            | <ul style="list-style-type: none"> <li>16 x 10/100 Mbps RJ45 ports</li> <li>Coated printed circuit board</li> </ul>  | PROFINET:<br>6GK5 216-0BA00-2FC2  |
| SCALANCE XC216-3G PoE        | <ul style="list-style-type: none"> <li>16 x 10/100/1000 Mbps RJ45 ports</li> <li>1 x pluggable transceiver slots with 1000 Mbps</li> <li>2 x pluggable transceiver slots with 1000/10000 Mbps</li> <li>Power over Ethernet at 14 ports</li> <li>Rated voltage 24 V DC</li> </ul> | PROFINET:<br>6GK5 216-3RS00-2AC2  |
| SCALANCE XC216-3G PoE (54 V) | <ul style="list-style-type: none"> <li>16 x 10/100/1000 Mbps RJ45 ports</li> <li>1 x pluggable transceiver slots with 1000 Mbps</li> <li>2 x pluggable transceiver slots with 1000/10000 Mbps</li> <li>Power over Ethernet at 14 ports</li> <li>Rated voltage 54 V DC</li> </ul> | PROFINET:<br>6GK5 216-3RS00-5AC2  |
| SCALANCE XC216-4C            | <ul style="list-style-type: none"> <li>12 x 10/100 Mbps RJ45 ports</li> <li>4 x combo ports (4 x 10/100 Mbps RJ45 ports/4 x pluggable transceiver slots with 1000 Mbps)</li> </ul>   | PROFINET:<br>6GK5 216-4BS00-2AC2  |
| SCALANCE XC216-4C G          | <ul style="list-style-type: none"> <li>12 x 10/100/1000 Mbps RJ45 ports</li> <li>4 x combo ports (4 x 10/100/1000 Mbps RJ45 ports/4 x pluggable transceiver slots with 1000 Mbps)</li> </ul>   | PROFINET:<br>6GK5 216-4GS00-2AC2<br>EtherNet/IP:<br>6GK5 216-4GS00-2TC2 |
| SCALANCE XC216-4C G EEC      | <ul style="list-style-type: none"> <li>12 x 10/100/1000 Mbps RJ45 ports</li> <li>4 x combo ports (4 x 10/100/1000 Mbps RJ45 ports/4 x pluggable transceiver slots with 1000 Mbps)</li> <li>Coated printed circuit board</li> </ul>   | PROFINET:<br>6GK5 216-4GS00-2FC2  |

| Device                  | Description   | Article number  |
|-------------------------|---|---|
| SCALANCE XC224          | <ul style="list-style-type: none"> <li>24 x 10/100 Mbps RJ45 ports</li> </ul>   | PROFINET:<br>6GK5 224-0BA00-2AC2  |
| SCALANCE XC224-4C G     | <ul style="list-style-type: none"> <li>20 x 10/100/1000 Mbps RJ45 ports</li> <li>4 x combo ports (4 x 10/100/1000 Mbps RJ45 ports/4 x plug-gable transceiver slots with 1000 Mbps)</li> </ul>                                       | PROFINET:<br>6GK5 224-4GS00-2AC2<br>EtherNet/IP:<br>6GK5 224-4GS00-2TC2 |
| SCALANCE XC224-4C G EEC | <ul style="list-style-type: none"> <li>20 x 10/100/1000 Mbps RJ45 ports</li> <li>4 x combo ports (4 x 10/100/1000 Mbps RJ45 ports/4 x plug-gable transceiver slots with 1000 Mbps)</li> <li>Coated printed circuit board</li> </ul> | PROFINET:<br>6GK5 224-4GS00-2FC2  |

## Factory settings

### EtherNet/IP variants

- Industrial Ethernet protocol: EtherNet/IP
- Base Bridge Mode: 802.1Q VLAN Bridge
- Redundancy mode: RSTP
- Trust mode: Trust CoS-DSCP
- IGMP Snooping/IGMP Querier: On
- IPv4 Address Collision Detection: Attempt to defend

### PROFINET variants

- Industrial Ethernet protocol: PROFINET
- Base Bridge Mode: 802.1D transparent bridge

4.1 Product overview

- Redundancy mode: Ring redundancy

| Device   | Factory setting ring ports   |  |               |
|--|--|--|---------------|
| <ul style="list-style-type: none"> <li>• XC206-2 (ST/BFOC)</li> <li>• XC206-2 (SC)</li> </ul>  | P0.7 and P0.8  |  |               |
| <table border="0"> <tr> <td> <ul style="list-style-type: none"> <li>• XC206-2G PoE</li> <li>• XC206-2G PoE (54 V)</li> <li>• XC206-2G PoE EEC (54 V)</li> <li>• XC206-2SFP</li> <li>• XC206-2SFP G</li> <li>• XC206-2SFP EEC</li> <li>• XC206-2SFP G EEC</li> <li>• XC208</li> <li>• XC208G</li> <li>• XC208EEC</li> <li>• XC208G EEC</li> <li>• XC208G PoE</li> <li>• XC208G PoE (54 V)</li> </ul> </td> <td> <ul style="list-style-type: none"> <li>• XC216</li> <li>• XC216EEC</li> <li>• XC216-4C</li> <li>• XC216-4C G</li> <li>• XC216-4C G EEC</li> <li>• XC224</li> <li>• XC224-4C G</li> <li>• XC224-4C G EEC</li> </ul> </td> </tr> </table> | <ul style="list-style-type: none"> <li>• XC206-2G PoE</li> <li>• XC206-2G PoE (54 V)</li> <li>• XC206-2G PoE EEC (54 V)</li> <li>• XC206-2SFP</li> <li>• XC206-2SFP G</li> <li>• XC206-2SFP EEC</li> <li>• XC206-2SFP G EEC</li> <li>• XC208</li> <li>• XC208G</li> <li>• XC208EEC</li> <li>• XC208G EEC</li> <li>• XC208G PoE</li> <li>• XC208G PoE (54 V)</li> </ul> | <ul style="list-style-type: none"> <li>• XC216</li> <li>• XC216EEC</li> <li>• XC216-4C</li> <li>• XC216-4C G</li> <li>• XC216-4C G EEC</li> <li>• XC224</li> <li>• XC224-4C G</li> <li>• XC224-4C G EEC</li> </ul> | P0.1 and P0.2 |
| <ul style="list-style-type: none"> <li>• XC206-2G PoE</li> <li>• XC206-2G PoE (54 V)</li> <li>• XC206-2G PoE EEC (54 V)</li> <li>• XC206-2SFP</li> <li>• XC206-2SFP G</li> <li>• XC206-2SFP EEC</li> <li>• XC206-2SFP G EEC</li> <li>• XC208</li> <li>• XC208G</li> <li>• XC208EEC</li> <li>• XC208G EEC</li> <li>• XC208G PoE</li> <li>• XC208G PoE (54 V)</li> </ul>   | <ul style="list-style-type: none"> <li>• XC216</li> <li>• XC216EEC</li> <li>• XC216-4C</li> <li>• XC216-4C G</li> <li>• XC216-4C G EEC</li> <li>• XC224</li> <li>• XC224-4C G</li> <li>• XC224-4C G EEC</li> </ul>   |  |               |
| <ul style="list-style-type: none"> <li>• XC216-3G PoE</li> <li>• XC216-3G PoE (54 V)</li> </ul>  | P0.4 and P0.5  |  |               |

- Trust mode: Trust CoS
- IGMP Snooping/IGMP Querier: Off
- IPv4 Address Collision Detection: Never give up

Type designation

The type designation of a SCALANCE XC-200 is made up of several parts that have the following meaning:

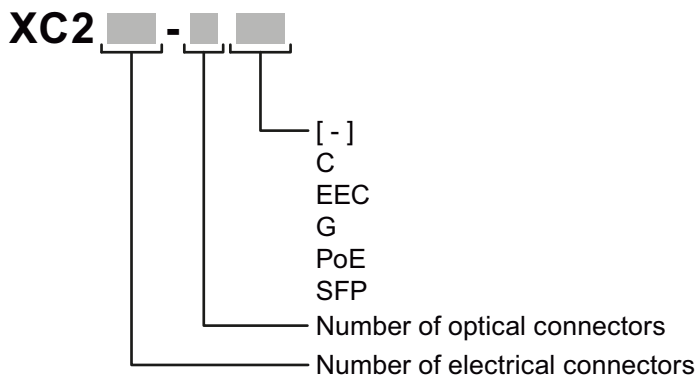



Interfaces of devices with optical connectors:

| Interface | Property                                     |
|-----------|--|
| C         | Combo port                                   |
| EEC       | Enhanced Environment Conditions (coated PCB) |
| G         | Gigabit                                      |
| PoE       | Power over Ethernet                          |
| SFP       | Pluggable transceiver slot                   |

## Unpacking and checking

|  <b>WARNING</b>  |
|---|
| <p><b>Do not use any parts that show evidence of damage</b></p> <p>If you use damaged parts, there is no guarantee that the device will function according to the specification.</p> <p>If you use damaged parts, this can lead to the following problems:</p> <ul style="list-style-type: none"> <li>• Injury to persons</li> <li>• Loss of the approvals</li> <li>• Violation of the EMC regulations</li> <li>• Damage to the device and other components</li> </ul> <p>Use only undamaged parts.</p> |

1. Make sure that the package is complete.
2. Check all the parts for transport damage.

## Components of the product

The following components are supplied with a SCALANCE XC-200:

- One IE switch
- A 4-pin terminal block for the power supply
- A 2-pin terminal block for the signaling contact
- One product DVD with documentation and software

The following components are also included in the product package of a SCALANCE XC-200 with plug-in transceiver slots (SFPs):

- One cover for each plug-in transceiver slot

The following components are also supplied with a SCALANCE XC206-2:

- 2 covers for optical ports

## Spare parts

The following spare parts are available for SCALANCE XC-200:

| Component                                 | Description  | Article number      |
|---|--|---------------------|
| Spring-loaded terminal block, 4 terminals | 4-terminal spring-loaded terminal block to connect the power supply (24 VDC), for SCALANCE X/W/S/M, pack of 5      | 6GK5 980-1DB10-0AA5 |
| Spring-loaded terminal block, 2 terminals | 2-terminal spring-loaded terminal block to connect the signaling contact (24 VDC), for SCALANCE X/W/S/M, pack of 5 | 6GK5 980-0BB10-0AA5 |

## 4.2 Device views

### 4.2.1 SCALANCE XC206-2 (ST/BFOC)

The following figure shows an overview of the components of the SCALANCE XC206-2 (ST/BFOC).

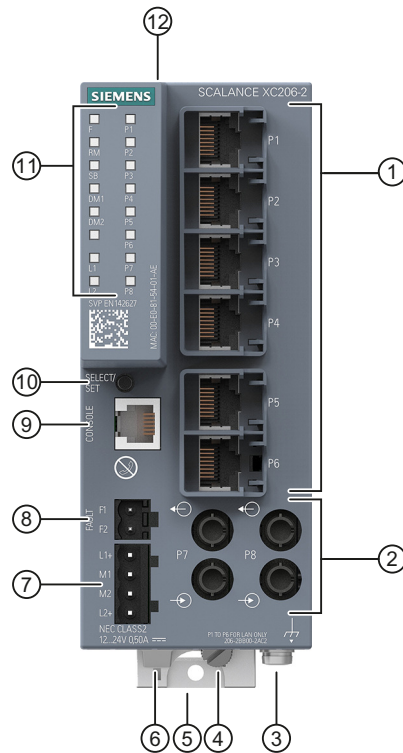

- |   |                         |
|---|-------------------------|
| ① Electrical ports  | ⑦ Power supply          |
| ② Optical ports   | ⑧ Signaling contact     |
| ③ Grounding screw   | ⑨ Serial interface      |
| ④ Knurled screw   | ⑩ "SELECT / SET" button |
| ⑤ Securing bar  | ⑪ LED display           |
| ⑥ Levering aid for moving the securing bar with a screwdriver | ⑫ C-PLUG slot           |

### 4.2.2 SCALANCE XC206-2 (SC)

The following figure shows an overview of the components of the SCALANCE XC206-2 (SC).

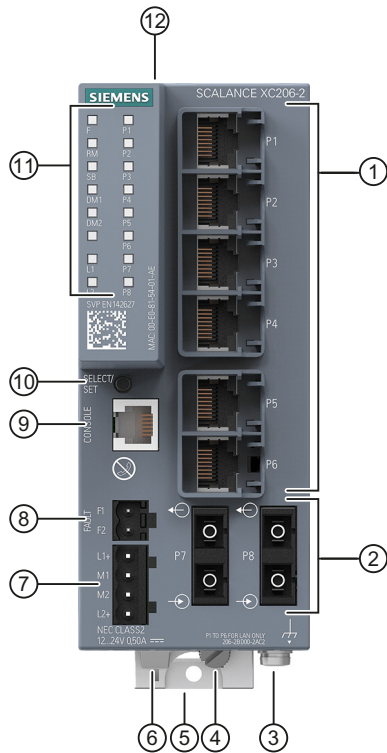

- |   |                         |
|---|-------------------------|
| ① Electrical ports  | ⑦ Power supply          |
| ② Optical ports   | ⑧ Signaling contact     |
| ③ Grounding screw   | ⑨ Serial interface      |
| ④ Knurled screw   | ⑩ "SELECT / SET" button |
| ⑤ Securing bar  | ⑪ LED display           |
| ⑥ Levering aid for moving the securing bar with a screwdriver | ⑫ C-PLUG slot           |

### 4.2.3 SCALANCE XC206-2G PoE

The following figure shows an overview of the components of the SCALANCE XC206-2G PoE depending on the rated voltage.

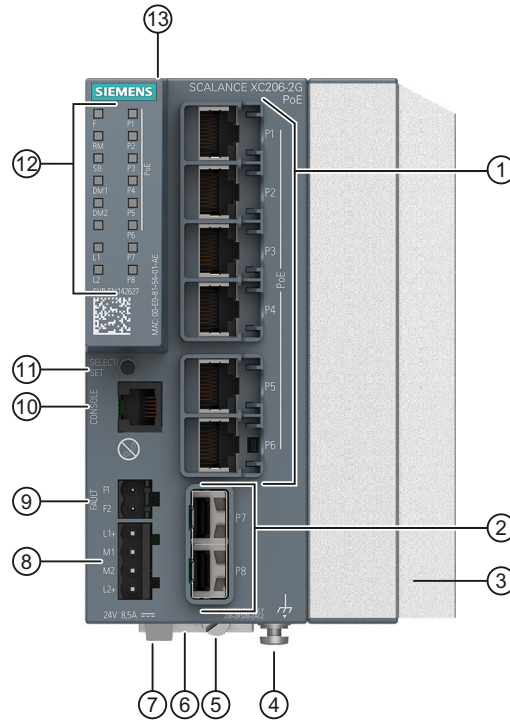

SCALANCE XC206-2G PoE (24 V)

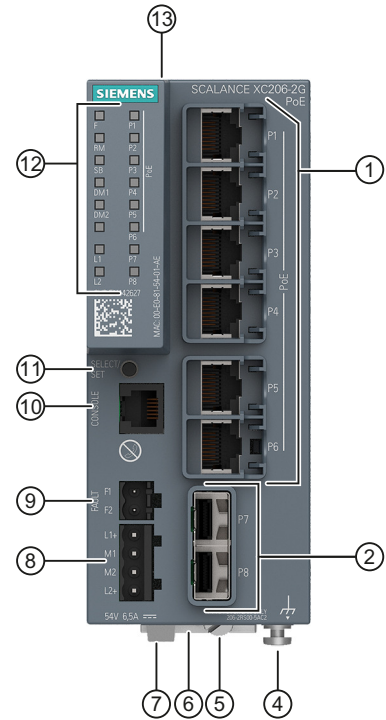

SCALANCE XC206-2G PoE (54 V) and  
SCALANCE XC206-2G PoE EEC (54 V)

- |   |                         |
|---|-------------------------|
| ① Electrical ports with PoE                                   | ⑧ Power supply          |
| ② Pluggable transceiver slots                                 | ⑨ Signaling contact     |
| ③ Cooling element (cooling fin)                               | ⑩ Serial interface      |
| ④ Grounding screw   | ⑪ "SELECT / SET" button |
| ⑤ Knurled screw   | ⑫ LED display           |
| ⑥ Securing bar  | ⑬ C-PLUG slot           |
| ⑦ Levering aid for moving the securing bar with a screwdriver |                         |

### 4.2.4 SCALANCE XC206-2SFP

The following figure provides an overview of the components of SCALANCE XC206-2SFP and the following devices:

- SCALANCE XC206-2SFP G
- SCALANCE XC206-2SFP EEC
- SCALANCE XC206-2SFP G EEC

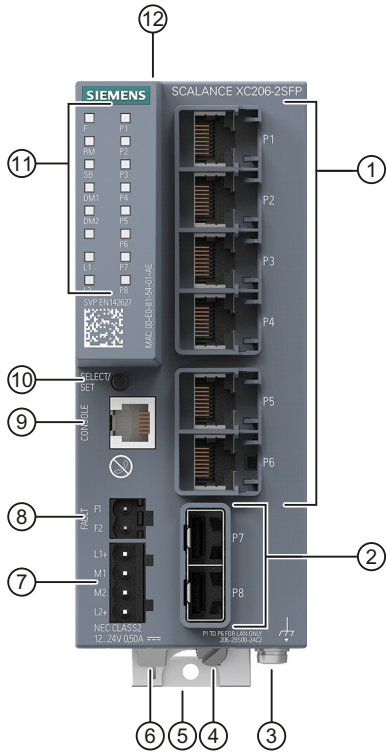

- |   |                         |
|---|-------------------------|
| ① Electrical ports  | ⑦ Power supply          |
| ② Pluggable transceiver slots                                 | ⑧ Signaling contact     |
| ③ Grounding screw   | ⑨ Serial interface      |
| ④ Knurled screw   | ⑩ "SELECT / SET" button |
| ⑤ Securing bar  | ⑪ LED display           |
| ⑥ Levering aid for moving the securing bar with a screwdriver | ⑫ C-PLUG slot           |

### 4.2.5 SCALANCE XC208

The following figure provides an overview of the components of SCALANCE XC208 and the following devices:

- SCALANCE XC208G
- SCALANCE XC208EEC
- SCALANCE XC208G EEC

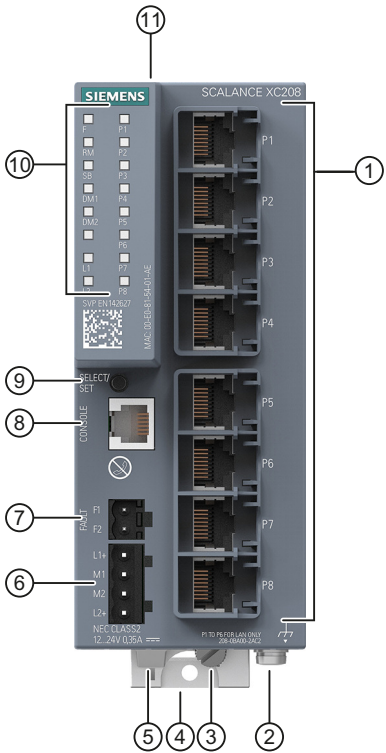

- ① Electrical ports
- ② Grounding screw
- ③ Knurled screw
- ④ Securing bar
- ⑤ Levering aid for moving the securing bar with a screwdriver
- ⑥ Power supply
- ⑦ Signaling contact
- ⑧ Serial interface
- ⑨ "SELECT / SET" button
- ⑩ LED display
- ⑪ C-PLUG slot

### 4.2.6 SCALANCE XC208G PoE

The following figure shows an overview of the components of the SCALANCE XC208G PoE depending on the rated voltage.

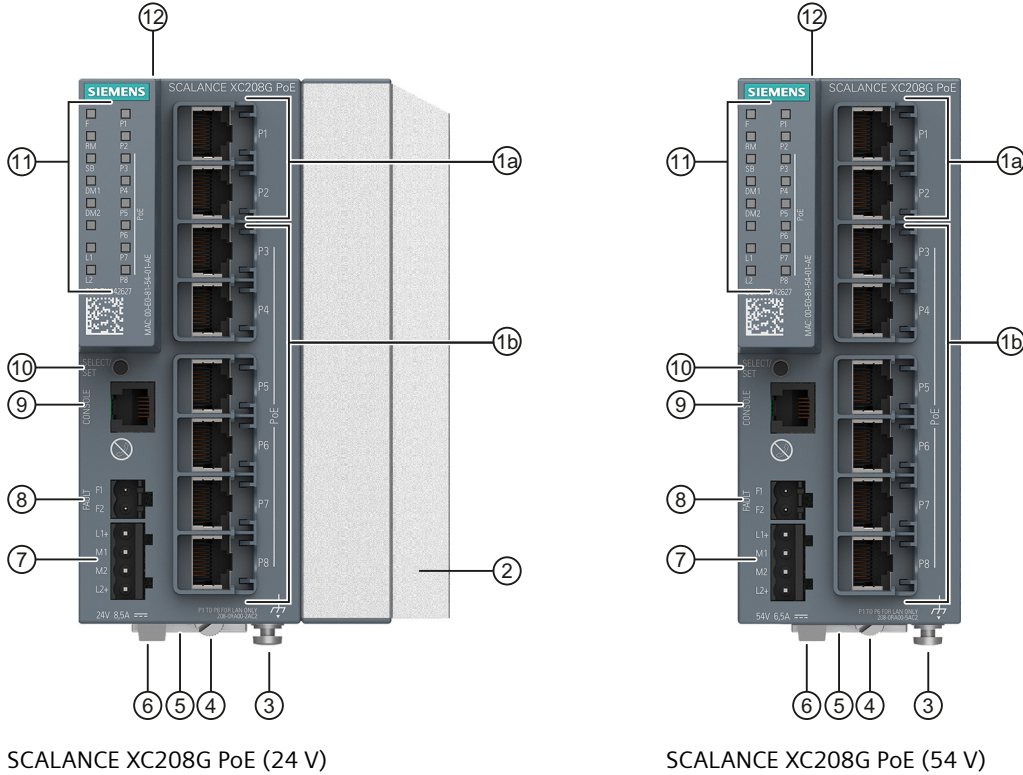

SCALANCE XC208G PoE (24 V)

SCALANCE XC208G PoE (54 V)

- ① a Electrical ports
- b Electrical ports with PoE
- ② Cooling element (cooling fin)
- ③ Grounding screw
- ④ Knurled screw
- ⑤ Securing bar
- ⑥ Levering aid for moving the securing bar with a screwdriver

- ⑦ Power supply
- ⑧ Signaling contact
- ⑨ Serial interface
- ⑩ "SELECT / SET" button
- ⑪ LED display
- ⑫ C-PLUG slot



### 4.2.7 SCALANCE XC216

The following figure provides an overview of the components of SCALANCE XC216 and SCALANCE XC216EEC.

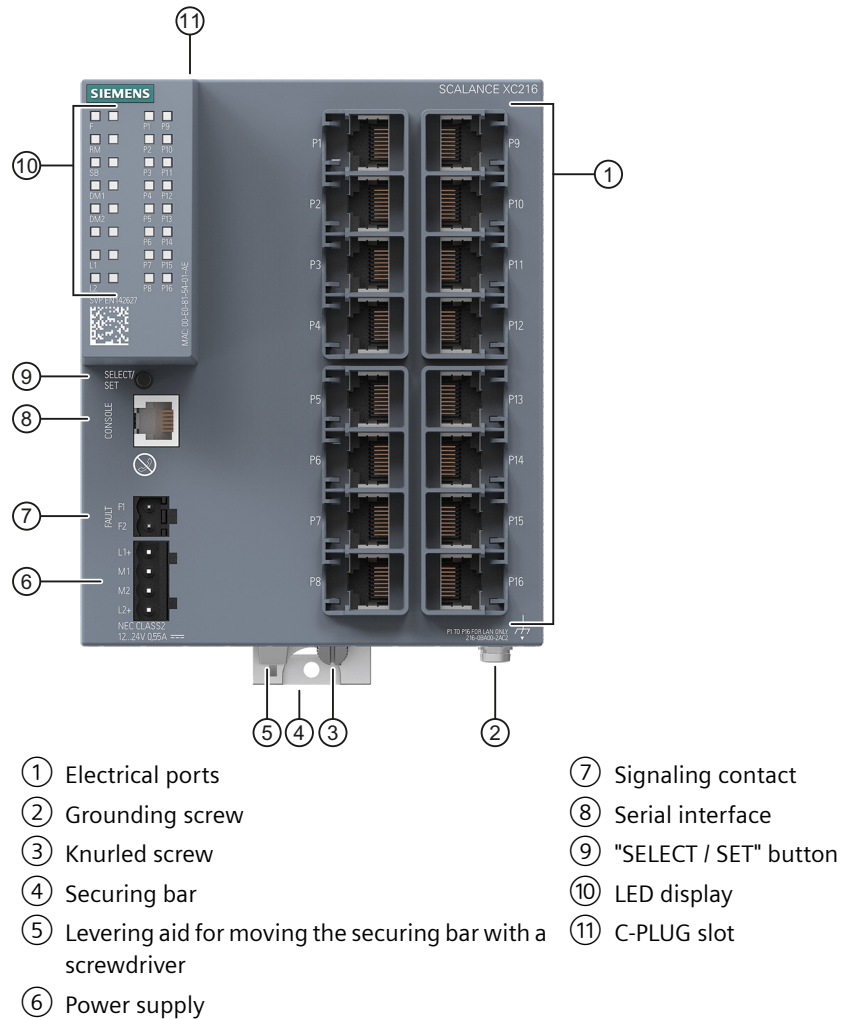

4.2 Device views

4.2.8 SCALANCE XC216-3G PoE

The following figure shows an overview of the components of the SCALANCE XC216-3G PoE depending on the rated voltage.

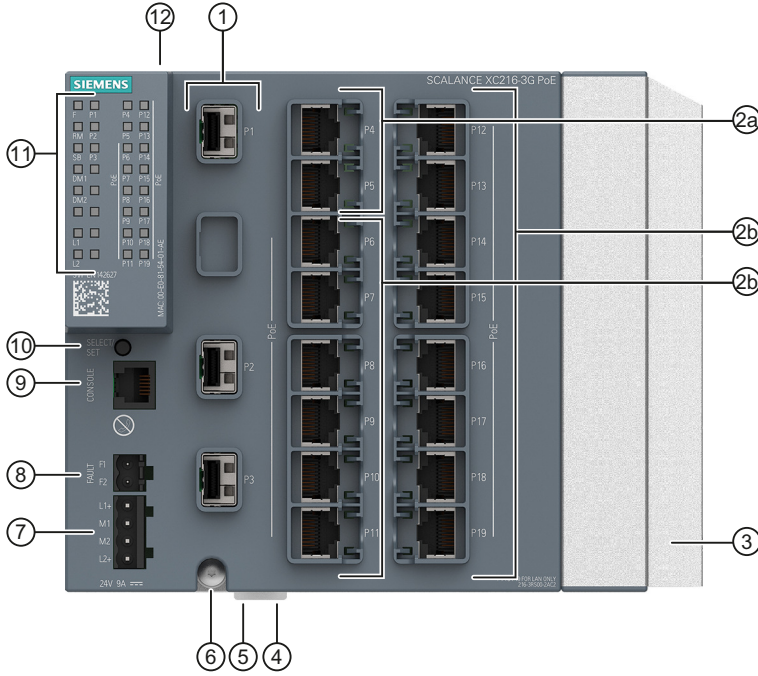

SCALANCE XC216-3G PoE (24 V)

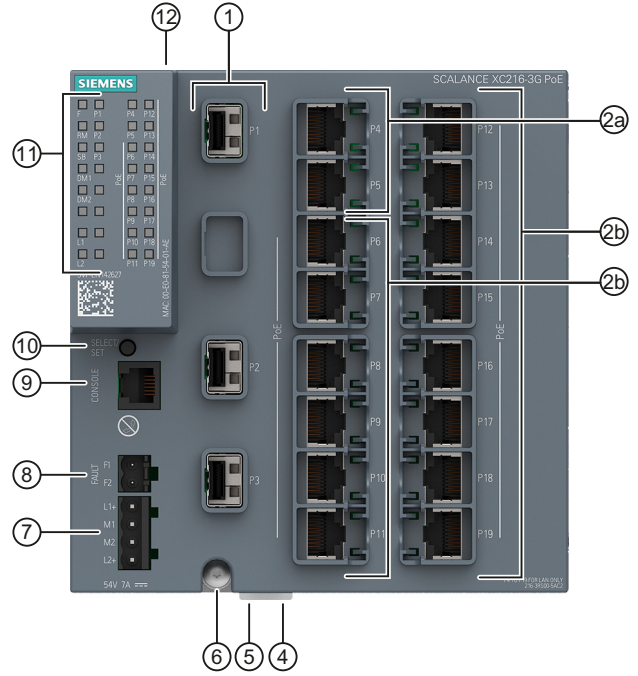

SCALANCE XC216-3G PoE (54 V)

- |   |                         |
|---|-------------------------|
| ① Pluggable transceiver slots   | ⑦ Power supply          |
| ② a Electrical ports  | ⑧ Signaling contact     |
| b Electrical ports with PoE   | ⑨ Serial interface      |
| ③ Cooling element (cooling fin)   | ⑩ "SELECT / SET" button |
| ④ Unlocking the top-hat rail latch  | ⑪ LED display           |
| ⑤ Location for mounting to an S7 standard rail<br>(on bottom of the device, not in picture) | ⑫ C-PLUG slot           |
| ⑥ Grounding screw   |                         |

4.2.9 SCALANCE XC216-4C

The following figure provides an overview of the components of SCALANCE XC216-4C and the following devices:

- SCALANCE XC216-4C G
- SCALANCE XC216-4C G EEC

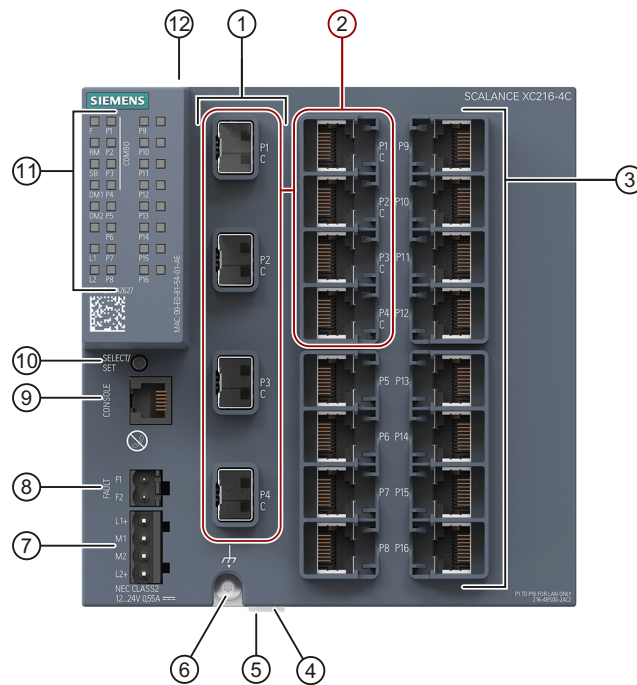

- |   |                         |
|---|-------------------------|
| ① Pluggable transceiver slots   | ⑦ Power supply          |
| ② Combo ports   | ⑧ Signaling contact     |
| ③ Electrical ports  | ⑨ Serial interface      |
| ④ Unlocking the top-hat rail latch  | ⑩ "SELECT / SET" button |
| ⑤ Location for mounting to an S7 standard rail<br>(on bottom of the device, not in picture) | ⑪ LED display           |
| ⑥ Grounding screw   | ⑫ C-PLUG slot           |

### 4.2.10 SCALANCE XC224

The following figure shows an overview of the components of the SCALANCE XC224.

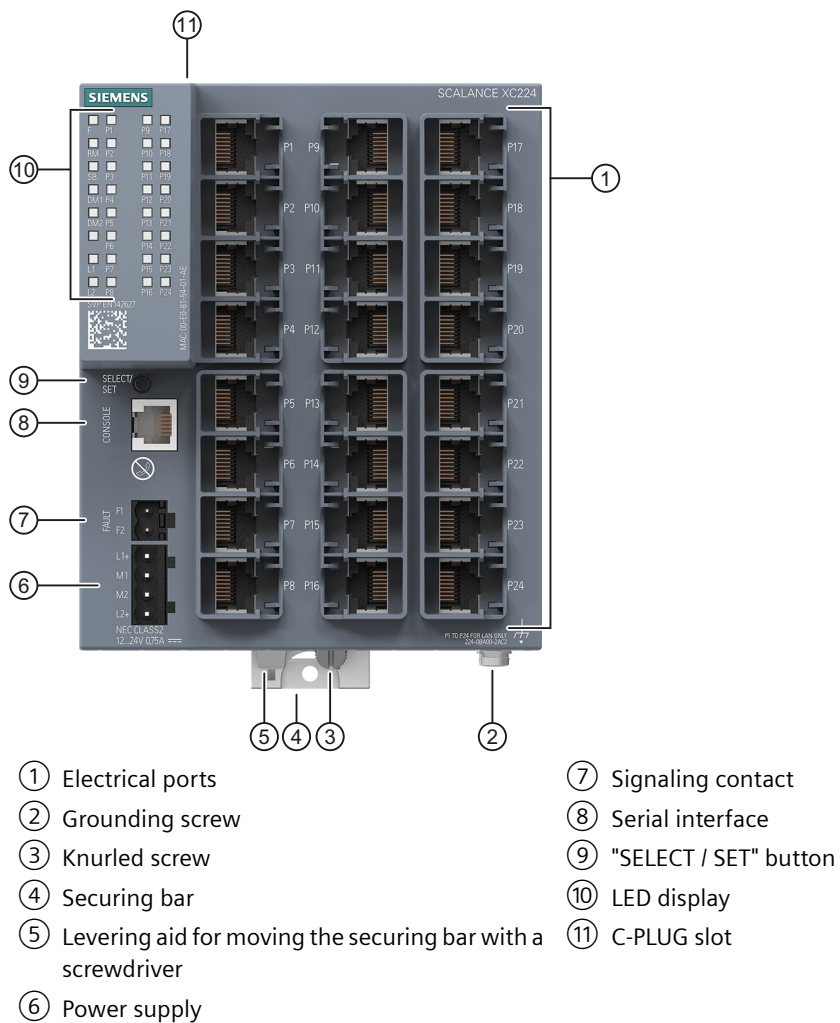

### 4.2.11 SCALANCE XC224-4C

The following figure provides an overview of the components of SCALANCE XC224-4C G and SCALANCE XC224-4C G EEC

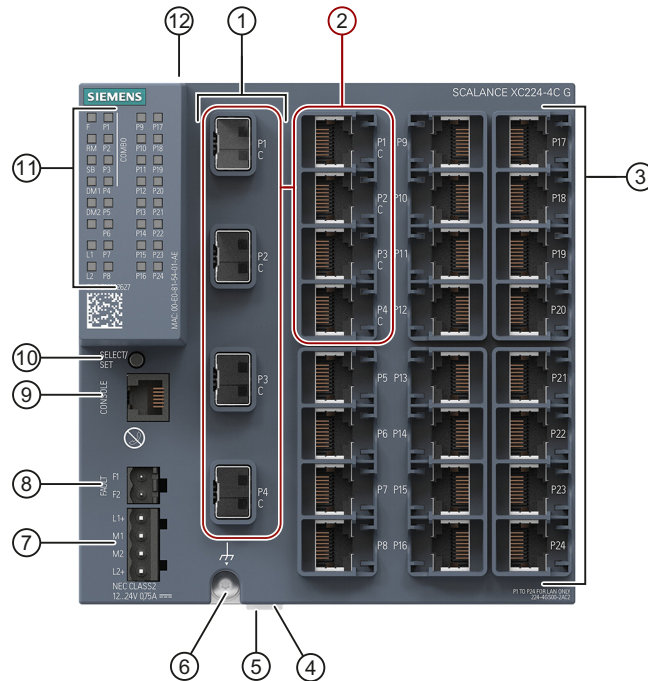

- |   |                         |
|---|-------------------------|
| ① Pluggable transceiver slots   | ⑦ Power supply          |
| ② Combo ports   | ⑧ Signaling contact     |
| ③ Electrical ports  | ⑨ Serial interface      |
| ④ Unlocking the top-hat rail latch  | ⑩ "SELECT / SET" button |
| ⑤ Location for mounting to an S7 standard rail<br>(on bottom of the device, not in picture) | ⑪ LED display           |
| ⑥ Grounding screw   | ⑫ C-PLUG slot           |

## 4.3 Accessories

The following accessories are available for SCALANCE XC-200:

**C-PLUG**

| Component | Description  | Article number |
|-----------|--|----------------|
| C-PLUG    | Configuration plug, exchangeable storage medium for saving configuration data, 32 MB                             | 6GK1 900-0AB00 |
|           | Configuration plug, exchangeable storage medium for saving configuration data, 32 MB, coated (conformal coating) | 6GK1 900-0AQ00 |
|           | Configuration plug, exchangeable storage medium for saving configuration data, 256 MB                            | 6GK1 900-0AB10 |

**Cable**

| Component                          | Description  | Article number      |
|------------------------------------|--|---------------------|
| Connecting cable<br>(RJ-11/RS-232) | Preassembled, serial cable with RJ-11 and RS-232 plug,<br>Length: 3 m<br>pack of 1 | 6GK5 980-3BB00-0AA5 |

**Pluggable transceiver SFP (100 Mbps)**

| Type           | Property  | Article number      |
|----------------|---|---------------------|
| SFP991-1       | 1 x 100 Mbps, LC port optical for glass FO cable (multimode), up to max. 5 km             | 6GK5 991-1AD00-8AA0 |
|                | 10 packing unit (VPE 10)  | 6GK5 991-1AD00-8AC0 |
| SFP991-1 (C)   | 1 x 100 Mbps, SC port optical, for glass FO cable (multimode), up to max. 5 km, varnished | 6GK5 991-1AD00-8FA0 |
| SFP991-1LD     | 1 x 100 Mbps LC port optical for glass FO cable (single mode) up to max. 26 km            | 6GK5 991-1AF00-8AA0 |
|                | 10 packing unit (VPE 10)  | 6GK5 991-1AF00-8AC0 |
| SFP991-1LD (C) | 1 x 100 Mbps LC port optical for glass FO cable (single mode) up to max. 26 km, varnished | 6GK5 991-1AF00-8FA0 |
| SFP991-1LH+    | 1 x 100 Mbps LC port optical for glass FO cable (single mode) up to max. 70 km            | 6GK5 991-1AE00-8AA0 |
| SFP991-1ELH200 | 1 x 100 Mbps LC port optical for glass FO cable (single mode) up to max. 200 km           | 6GK5 991-1AE30-8AA0 |

The SFP plug-in transceiver (100 Mbps) cannot be operated in SFP+ slots.

Pluggable transceivers with the supplement (C) in the type name have varnished printed circuit boards (conformal coating).

**Note****Restriction for pluggable transceivers**

The maximum ambient temperature changes if you use pluggable transceivers.

You can find the corresponding values for the ambient temperature in the section "Technical specifications (Page 91)".

**Note**

You cannot use the pluggable transceiver SFP (100 Mbps) with the following devices:

- Gigabit versions (suffix "G" in the type designation)
- Devices with combo ports (suffix "C" in the type designation)

Use active pluggable transceivers to connect these devices via optical 100 Mbps connections.

**Active plug-in transceiver SFP (100 Mbps)**

With active plug-in transceivers, Gigabit slots can be used as Fast Ethernet interfaces.

| Type         | Property   | Article number      |
|--------------|--|---------------------|
| SFP991-1A    | 1 x 100 Mbps, LC port optical for glass FO cable (multimode), up to max. 5 km  | 6GK5 991-1AD00-8GA0 |
| SFP991-1LD A | 1 x 100 Mbps LC port optical for glass FO cable (single mode) up to max. 26 km | 6GK5 991-1AF00-8GA0 |

**Note****Restriction for pluggable transceivers**

The maximum ambient temperature changes if you use pluggable transceivers.

You can find the corresponding values for the ambient temperature in the section "Technical specifications (Page 91)".

**Note**

Active plug-in transceivers can be used with the following devices:

- SCALANCE XC206-2G PoE
- SCALANCE XC206-2G PoE (54 V)
- SCALANCE XC206-2G PoE EEC (54 V)
- SCALANCE XC-206-2SFP G
- SCALANCE XC-206-2SFP G EEC
- SCALANCE XC208G PoE
- SCALANCE XC208G PoE (54 V)
- SCALANCE XC216-3G PoE
- SCALANCE XC216-3G PoE (54 V)
- SCALANCE XC-216-4C
- SCALANCE XC-216-4C G
- SCALANCE XC-216-4C G EEC
- SCALANCE XC-224-4C G
- SCALANCE XC-224-4C G EEC

### Pluggable transceiver SFP (1000 Mbps)

| Type           | Property  | Article number      |
|----------------|---|---------------------|
| SFP992-1       | 1 x 1000 Mbps, LC port optical for glass FO cable (multimode), up to max. 750 m             | 6GK5 992-1AL00-8AA0 |
|                | 10 packing unit (VPE 10)  | 6GK5 992-1AL00-8AC0 |
| SFP992-1 (C)   | 1 x 1000 Mbps, LC port optical, for glass FO cable (multimode), up to max. 750 m, varnished | 6GK5 992-1AL00-8FA0 |
| SFP992-1+      | 1 x 1000 Mbps, LC port optical for glass FO cable (multimode), up to max. 2 km              | 6GK5 992-1AG00-8AA0 |
| SFP992-1LD     | 1 x 1000 Mbps LC port optical for glass FO cable (single mode) up to max. 10 km             | 6GK5 992-1AM00-8AA0 |
|                | 10 packing unit (VPE 10)  | 6GK5 992-1AM00-8AC0 |
| SFP992-1LD (C) | 1 x 1000 Mbps LC port optical for glass FO cable (single mode) up to max. 10 km, varnished  | 6GK5 992-1AM00-8FA0 |
| SFP992-1LD+    | 1 x 1000 Mbps LC port optical for glass FO cable (single mode) up to max. 30 km             | 6GK5 992-1AM30-8AA0 |
| SFP992-1LH     | 1 x 1000 Mbps LC port optical for glass FO cable (single mode) up to max. 40 km             | 6GK5 992-1AN00-8AA0 |
| SFP992-1LH+    | 1 x 1000 Mbps LC port optical for glass FO cable (single mode) up to max. 70 km             | 6GK5 992-1AP00-8AA0 |
| SFP992-1ELH    | 1 x 1000 Mbps LC port optical for glass FO cable (single mode) up to max. 120 km            | 6GK5 992-1AQ00-8AA0 |

Pluggable transceivers with the supplement (C) in the type name have varnished printed circuit boards (conformal coating).

#### Note

##### Restriction for pluggable transceivers

The maximum ambient temperature changes if you use pluggable transceivers.

You can find the corresponding values for the ambient temperature in the section "Technical specifications (Page 91)".

### Bidirectional plug-in transceiver SFP

Bidirectional plug-in transceivers feature only one fiber connection. They transmit and receive on two different wavelengths. To establish a connection, you need two matching bidirectional SFPs. The connected SFPs must respectively transmit on the wavelength at which the connection partner receives.

| Type         | Properties   | Article number      |
|--------------|--|---------------------|
| SFP992-1BXMT | 1 x 1000 Mbps LC port optical for glass FO (multi-mode) with max. 500 m, transmits at 1550 nm, receives at 1310 nm | 6GK5 992-1AL00-8TA0 |
| SFP992-1BXMR | 1 x 1000 Mbps LC port optical for glass FO (multi-mode) with max. 500 m, transmits at 1310 nm, receives at 1550 nm | 6GK5 992-1AL00-8RA0 |



| Type          | Properties  | Article number      |
|---------------|---|---------------------|
| SFP992-1BX10T | 1 x 1000 Mbps LC port optical for glass FO (single mode) with max. 10 km, transmits at 1550 nm, receives at 1310 nm | 6GK5 992-1AM00-8TA0 |
| SFP992-1BX10R | 1 x 1000 Mbps LC port optical for glass FO (single mode) with max. 10 km, transmits at 1310 nm, receives at 1550 nm | 6GK5 992-1AM00-8RA0 |

**Note****Restriction for pluggable transceivers**

The maximum ambient temperature changes if you use pluggable transceivers.

You can find the corresponding values for the ambient temperature in the section "Technical specifications (Page 91)".

**SFP+ transceiver**

| Type       | Properties  | Article number      |
|------------|---|---------------------|
| SFP993-1   | 1 x 10 Gbps, LC port optical for glass FO cable (multimode), up to max. 550 m   | 6GK5 993-1AT00-8AA0 |
| SFP993-1LD | 1 x 10 Gbps, LC port optical for glass FO cable (single mode), up to max. 10 km | 6GK5 993-1AU00-8AA0 |

Can only be operated in SFP+ slots.

**Note****Restriction for pluggable transceivers**

The maximum ambient temperature changes if you use pluggable transceivers.

You can find the corresponding values for the ambient temperature in the section "Technical specifications (Page 91)".

**Preassembled IE cable with SFP+ plugs**

| Component          | Description   | Article number |                     |
|--------------------|---|----------------|---------------------|
| IE Cable SFP+/SFP+ | Preassembled IE cable with two permanently mounted SFP+ plugs, electrical, 10 Gbps, pack of 1 | Length 1 m     | 6GK5 980-3CB00-0AA1 |
|                    |   | Length 2 m     | 6GK5 980-3CB00-0AA2 |
|                    |   | Length 7 m     | 6GK5 980-3CB00-0AA7 |

## 4.4 SELECT / SET button

### Position

The "SELECT/SET" button is located on the front of the device.

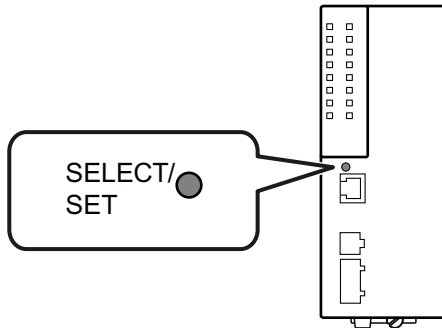

Figure 4-1 Position of the "SELECT/SET" button, for example on the SCALANCE XC-200 with 8 ports

### Setting the display mode

To set the required display mode, press the "SELECT/SET" button.

For more detailed information on the display modes, refer to the section "LEDs "DM1" and "DM2" (Page 45)".

### Resetting the device to factory defaults

|   |
|---|
| <b>NOTICE</b>   |
| <b>Previous settings</b><br>If you reset, all the settings you have made will be overwritten by factory defaults. |

|   |
|---|
| <b>NOTICE</b>   |
| <b>Inadvertent reset</b><br>An inadvertent reset can cause disturbances and failures in the configured network. |

**Requirement**

- The device is in operation.
- The function "Reset to Factory Defaults" is enabled for the "SELECT / SET" button.

**Note****Reset despite disabled "SELECT/SET" button**

If you have disabled the "Restore Factory Defaults" function for the "SELECT/SET" button in the configuration, this does not apply during the startup phase, see section "Restoring the factory settings (Page 90)".

If the function has been disabled in the configuration, it is only disabled on completion of the startup phase.

---

**Procedure**

To reset the device to the factory defaults during operation, follow the steps below:

1. Switch to display mode A.  
Display mode A is active if the LEDs "DM1" and "DM2" are unlit.  
If the "DM1" and "DM2" LEDs are lit or flashing, you will need to press the "SET/SELECT" repeatedly until the "DM1" and "DM2" LEDs go off.  
If you do not press the "SELECT/SET" button for longer than 1 minute, the device automatically changes to display mode A.
2. Hold down the "SELECT/SET" button for 12 seconds.  
After 9 seconds, the "DM1" and "DM2" LEDs start to flash for 3 seconds. At the same time, the port LEDs go on one after the other.  
After you have held down the button for 12 seconds, the device restarts and the factory defaults are restored.  
If you release the button before the 12 seconds have elapsed, the reset is canceled.

**Enabling and disabling the functions of the button**

In the configuration, you can enable or disable the functions of the button.

**Defining the fault mask**

Using the fault mask, you specify an individual "good status" for the connected ports and the power supply. Deviations from this status are displayed as errors/faults.

You configure newly plugged-in connections in the configuration.

### 4.5 LED display

To define the fault mask, follow the steps below:

1. Switch to display mode D.  
Display mode D is active if the "DM1" and "DM2" LEDs are lit green..  
If another display mode is active, you will need to press the "SET/SELECT" button repeatedly until the "DM1" and "DM2" LEDs are lit green.
2. Hold down the "SELECT/SET" button for 5 seconds.  
After 2 seconds, the "DM1" and "DM2" LEDs start to flash for 3 seconds. At the same time, the port LEDs go on one after the other.  
After you have held down the button for 5 seconds, the current settings are stored as the "good status".  
If you release the button before the 5 seconds have elapsed, the previous fault mask will be retained.

## 4.5 LED display

### 4.5.1 Overview

The following figure shows the arrangement of the LEDs based on the example of a SCALANCE XC-200 with 8 ports.

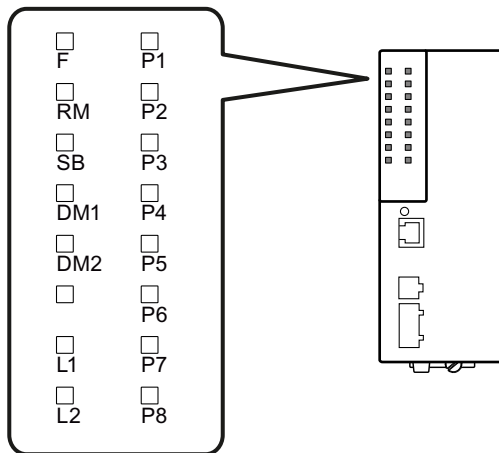

- F LED for displaying the fault/error status
- RM LED for displaying the "redundancy manager" function
- SB LED for displaying the "standby" function
- DM1/DM2 LEDs for displaying the display mode
- L1/L2 LEDs for displaying the power supply
- P LEDs for displaying the port status \*)
- COMBO Indicates that the LEDs belong to combo ports

\*) The number of port LEDs depends on the device.

### 4.5.2 "RM" LED

The "RM" LED indicates whether or not the device is a redundancy manager and whether or not the ring is operating free of error.

| LED color | LED status | Meaning   |
|-----------|------------|---|
| -         | Off        | The device is not a redundancy manager.   |
| Green     | On         | The device is a redundancy manager.<br>The ring is working without problems, monitoring is activated.                     |
| Green     | Flashing   | The device is a redundancy manager.<br>An interruption has been detected on the ring and the device has switched through. |

### 4.5.3 "SB" LED

The "SB" LED shows the status of the standby function.

| LED color | LED status | Meaning  |
|-----------|------------|--|
| -         | Off        | The standby function is disabled.                                |
| Green     | On         | The standby function is enabled. The standby section is passive. |
| Green     | Flashing   | The standby function is enabled. The standby section is active.  |

### 4.5.4 "F" LED

The "F" LED shows the fault/error status of the device.

#### Meaning during device startup

| LED color | LED status | Meaning during device startup                                |
|-----------|------------|--|
| -         | Off        | Device startup was completed successfully.                   |
| Red       | On         | Device startup is not yet completed or errors have occurred. |
| Red       | Flashing   | There are errors in the firmware.                            |

#### Meaning during operation

| LED color | LED status | Meaning during operation   |
|-----------|------------|--|
| -         | Off        | The device is operating free of errors. The signaling contact is closed. |
| Red       | On         | The device has detected a problem. The signaling contact has opened.     |

### 4.5.5 LEDs "DM1" and "DM2"

The "DM1" and "DM2" LEDs indicate which display mode is set.

4.5 LED display

There are 5 display modes (A, B, C, D, and E). Display mode A is the default mode.

Depending on the set display mode, the "L1", "L2" LEDs and the port LEDs show different information.

| LED color | LED status |         | Meaning        |
|-----------|------------|---------|----------------|
|           | DM1 LED    | DM2 LED |                |
| -         | Off        |         | Display mode A |
| Green     | On         | Off     | Display mode B |
| Green     | Off        | On      | Display mode C |
| Green     | On         |         | Display mode D |
| Green     | Flashing   | Off     | Display mode E |

Setting the display mode

To set the required display mode, press the "SELECT/SET" button.

If you do not press the "SELECT/SET" button for longer than 1 minute, the device automatically changes to display mode A.

| Pressing SELECT/SET button starting at display mode A | LED status |     | Display mode   |
|---|------------|-----|----------------|
|   | DM1        | DM2 |                |
| -   | Off        |     | Display mode A |
| Press once  | On         | Off | Display mode B |
| Press twice   | Off        | On  | Display mode C |
| Press three times                                     | On         |     | Display mode D |
| Press four times                                      | Flashing   | Off | Display mode E |

4.5.6 LEDs "L1" and "L2"

The "L1" and "L2" LEDs indicate the current range of the power supply at connectors L1 and L2.

The meaning of the "L1" and "L2" LEDs depends on the set display mode, see section "LEDs "DM1" and "DM2" (Page 45)".

Meaning in display modes A, B, C and E

In the display modes A, B, C and E, you can determine whether the power supply is connected by observing LEDs "L1" and "L2" .

| L1/L2 LED |            | L1/L2 connector                    |
|-----------|------------|------------------------------------|
| LED color | LED status |                                    |
| -         | Off        | No external power supply connected |
| Green     | On         | Power supply connected to L1/L2    |

### Meaning in display mode D

In display mode D, the "L1" and "L2" LEDs indicate whether the power supply is monitored.

| L1/L2 LED |            | L1/L2 connector  |
|-----------|------------|--|
| LED color | LED status |  |
| -         | Off        | Power supply is not monitored.<br>The signal contact does not respond if neither L1 nor L2 is connected to an adequate power supply. |
| Green     | On         | Power supply is monitored.<br>The signal contact responds if neither L1 nor L2 is connected to an adequate power supply.             |

## 4.5.7 Port LEDs

The port LEDs "P1", "P2" etc. show information about the corresponding ports.

The meaning of the Port LEDs depends on the set display mode, see section "LEDs "DM1" and "DM2" (Page 45)".

### Meaning in display mode A

In display mode A, the port LEDs indicate whether a valid link exists.

| LED color | LED status                      | Meaning   |
|-----------|---------------------------------|---|
| -         | Off                             | No valid link to the port (for example communications partner turned off or cable not connected).                           |
| Green     | On                              | Link exists and port in normal status. In this status, the port can receive and send data.                                  |
|           | Flashes once per period*        | Link exists and port in "Blocking" status. In this status, the port only receives management data (no user data).           |
|           | Flashes three times per period* | Link exists and port turned off by management. In this status, no data is sent or received via the port.                    |
|           | Flashes four times per period*  | Link exists and is in the "Monitor Port" status. In this status, the data traffic of another port is mirrored to this port. |
| Yellow    | Flashing / lit                  | Receiving data at port  |

\* 1 period  $\hat{=}$  2.5 seconds

### Meaning in display mode B

In display mode B, the port LEDs indicate the transmission speed.

| LED color | LED status | Meaning                     |
|-----------|------------|-----------------------------|
| -         | Off        | Port operating at 10 Mbps   |
| Green     | On         | Port operating at 100 Mbps  |
| Orange    | On         | Port operating at 1000 Mbps |
| Green     | Flashing   | Port operating at 10 Gbps   |

If there is a connection problem and the type of transmission is fixed (auto negotiation off), the desired status, in other words the set transmission speed (10 Gbps, 1000 Mbps, 100 Mbps, 10

## 4.6 C-PLUG

Mbps) continues to be displayed. If there is a connection problem and auto negotiation is active, the port LED goes off.

**Meaning in display mode C**

In display mode C, the port LEDs indicate the mode.

| LED color | LED status | Meaning                            |
|-----------|------------|------------------------------------|
| -         | Off        | Port operating in half duplex mode |
| Green     | On         | Port operating in full duplex mode |

**Meaning in display mode D**

In display mode D, the port LEDs indicate whether the port is monitored.

| LED color | LED status | Meaning  |
|-----------|------------|--|
| -         | Off        | Port is not monitored.<br>If no link was established at the port the signaling contact does not indicate an error. |
| Green     | On         | Port is monitored.<br>If no link was established at the port the signaling contact indicates an error.             |

**Meaning in display mode E**

In display mode E, the port LEDs indicate whether the connected device is supplied using PoE.

| LED color | LED status | Meaning   |
|-----------|------------|---|
| -         | Off        | The connected device is not supplied using PoE. |
| Green     | On         | The connected device is supplied via PoE.       |

## 4.6 C-PLUG

### 4.6.1 Function of the C-PLUG

**NOTICE****Do not remove or insert a C-PLUG during operation**

A C-PLUG may only be removed or inserted when the device is turned off.



## Saving the configuration data

A C-PLUG is an exchangeable storage medium for storing the configuration data of the device. This allows fast and uncomplicated replacement of a device. The C-PLUG is taken from the previous device and inserted in the new device. The first time it is started up, the replacement device has the same configuration as the previous device except for the device-specific MAC address set by the vendor.

A C-PLUG stores the current information about the configuration of a device.

---

### Note

The device can also be operated without a C-PLUG.

---

## How it works

### Operating mode

In terms of the C-PLUG, there are three modes for the device:

- Without C-PLUG  
The device stores the configuration in internal memory.  
This mode is active if no C-PLUG is inserted.
- With unwritten C-PLUG  
If an unwritten C-PLUG (factory status or deleted with Clean function) is used, the local configuration already existing on the device is automatically stored on the inserted C-PLUG during startup.  
This mode is active as soon as an unwritten C-PLUG is inserted.
- With written C-PLUG  
A device with a written and accepted C-PLUG uses the configuration data of the C-PLUG automatically when it starts up. The requirement for acceptance is that the data was written by a compatible device type.  
If there is configuration data in the internal memory of the device this is overwritten.  
This mode is active as soon as a written C-PLUG is inserted.

### Operation with C-PLUG

The configuration stored on the C-PLUG is displayed over the user interfaces.

If changes are made to the configuration, the device stores the configuration directly on the C-PLUG, if this is in the "ACCEPTED" status and in internal memory.

## Response to errors

Inserting a C-PLUG that does not contain the configuration of a compatible device type and inadvertently removing the C-PLUG, or general malfunctions of the C-PLUG are indicated by the diagnostic mechanisms of the device.

- Fault LED
- Web Based Management (WBM)
- SNMP

## 4.6 C-PLUG

- Command Line Interface (CLI)
- PROFINET diagnostics

The user then has the choice of either removing the C-PLUG again or selecting the option to reformat the C-PLUG.

### 4.6.2 Replacing the C-PLUG

#### Position of the C-PLUG

**NOTICE**

**Do not remove or insert a C-PLUG during operation**

The C-PLUG may only be removed or inserted when the device is turned off.

The C-PLUG slot is on the top of the device housing.

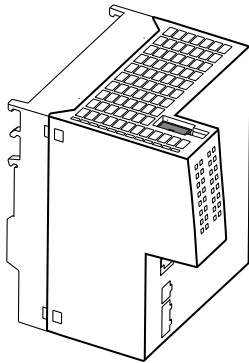

#### Replacing a C-PLUG.

##### Removing a C-PLUG

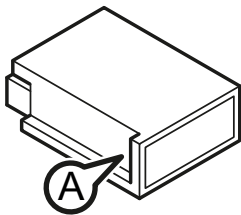

1. Turn off the power to the device.
2. Insert a screwdriver between the front edge of the C-PLUG (A) and the slot and release the C-PLUG.
3. Remove the C-PLUG.

### Inserting a C-PLUG

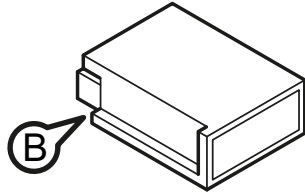

1. Turn off the power to the device.
2. The housing of the C-PLUG has a protruding ridge on the long side (B). The slot has a groove at this position. Insert the C-PLUG correctly oriented into the slot.

## 4.7 Combo ports

### Characteristics

Combo port is the name for two communication ports. A combo port has the two following jacks:

- a fixed RJ-45 port
- an SFP transceiver slot that can be equipped individually

Of these two ports, only one can ever be active. Using the mode, you can decide how the ports are prioritized.

The port name is the same on both jacks of the combo port, for example "PxC".

There is an LED for each combo port. The LEDs for the combo ports can be identified by a vertical line and the word "COMBO". The labeling of the combo port LEDs does not differ from that of the other LEDs, e.g. "P3".

### Setting the mode

The following modes can be configured for a combo port:

- **Mode 1: auto**  
The SFP transceiver port has priority. As soon as an SFP transceiver is plugged in, an existing connection at the fixed RJ-45 port is terminated. If no SFP transceiver is plugged in, a connection can be established via the fixed RJ-45 port.
- **Mode 2: rj45**  
The fixed RJ-45 port is independent of the SFP transceiver port.
- **Mode 3: sfp**  
The pluggable transceiver port is used independent of the fixed RJ-45 port.

The factory setting for the combo ports is mode 1: auto

You configure the mode with Web Based Management or the Command Line Interface.

## 4.8 Power over Ethernet (PoE)

### Function

The "Power over Ethernet" function supplies connected devices with power via the Ethernet cable. Devices supplied with power via an Ethernet cable do not require a separate voltage source.

PoE-compliant devices can be divided into the following groups:

- Power source (PSE - Power Sourcing Equipment)  
These inject power onto the Ethernet cable.
- Power consumer (PD - Powered Device)  
These are supplied with power via the Ethernet cable.

### 4.8.1 Power and voltage range according to the standard

Note the values specified for the power of the power source, so that the power supply is ensured at the power consumers according to the standard.

| PoE class | Power supplied by the power source | Available power at the power source | Type | Standard    | Designation |
|-----------|------------------------------------|-------------------------------------|------|-------------|-------------|
| 0         | 15.4 W                             | 12.95 W                             | 1    | IEEE802.3af | PoE         |
| 1         | 4                                  | 3.84 W                              |      |             |             |
| 2         | 7                                  | 6.49 W                              |      |             |             |
| 3         | 15.4 W                             | 12.95 W                             |      |             |             |
| 4         | 30                                 | 25.5 W                              | 2    | IEEE802.3at | PoE+        |
| 5         | 45                                 | 40 W                                | 3    | IEEE802.3bt | 4-pair PoE  |
| 6         | 60                                 | 51 W                                |      |             |             |
| 7         | 75                                 | 62 W                                |      |             |             |
| 8         | 90                                 | 73 W                                | 4    |             |             |

### 4.8.2 PoE properties of the devices

#### Note

Turn off the power source before you disconnect the PoE cable of a power consumer.

**Power source**

- The device can supply energy consumers of the standards IEEE802.af Type 1, IEEE802.at Type 2 or IEEE802.3bt Type 3.
- In total, a power source can make the following PoE power available (incl. line losses):
  - PoE variants with 24 V DC: 120 W
  - SCALANCE XC206-2G PoE with 54 V DC: 240 W
  - SCALANCE XC216-3G PoE with 54 V DC: 300 W

The power can be distributed to the ports as desired.

Note that the PoE power is reduced for installation positions other than horizontal; see sections "Technical specifications (Page 91)" and "Types of installation (Page 60)".

**PoE ports**

- The PoE ports are not isolated from each other. This means that they meet the conditions named in Environment A (IEEE 802.3): Power supply over Ethernet within a power supply system.
- The electrical isolation of the ports from functional grounding is designed for 1500 Vrms (1 minute) (according to Section 5.2.2 of IEC 60950-1:2001).
- The following ports support PoE classes 0 to 4:

| Device  | Port              |
|---|-------------------|
| SCALANCE XC206-2G PoE<br>SCALANCE XC206-2G PoE (54 V)<br>SCALANCE XC206-2G PoE EEC (54 V) | Port 1 to port 4  |
| SCALANCE XC208G PoE<br>SCALANCE XC208G PoE (54 V)   | Port 3 to port 6  |
| SCALANCE XC216-3G PoE<br>SCALANCE XC216-3G PoE (54 V)                                     | Port 8 to port 19 |

The ports supply connected devices with up to 30 W per port (according to IEEE802.3af and IEEE802.3at).

- The following ports support PoE classes 0 to 6:

| Device  | Port              |
|---|-------------------|
| SCALANCE XC206-2G PoE<br>SCALANCE XC206-2G PoE (54 V)<br>SCALANCE XC206-2G PoE EEC (54 V) | Port 5 and port 6 |
| SCALANCE XC208G PoE<br>SCALANCE XC208G PoE (54 V)   | Port 7 and port 8 |
| SCALANCE XC216-3G PoE<br>SCALANCE XC216-3G PoE (54 V)                                     | Port 6 and port 7 |

They supply connected devices with up to 60 W per port (according to IEEE802.3af, IEEE802.3at and IEEE802.3bt).

### 4.8.3 Power transfer and pin assignment (30 W)

The table below shows the most important power transfer and pin assignment of the following ports:

| Device  | Port              |
|---|-------------------|
| SCALANCE XC206-2G PoE<br>SCALANCE XC206-2G PoE (54 V)<br>SCALANCE XC206-2G PoE EEC (54 V) | Port 1 to port 4  |
| SCALANCE XC208G PoE<br>SCALANCE XC208G PoE (54 V)   | Port 3 to port 6  |
| SCALANCE XC216-3G PoE<br>SCALANCE XC216-3G PoE (54 V)                                     | Port 8 to port 19 |

| Pin number | Assignment            |
|------------|-----------------------|
| Pin 1      | Positive power supply |
| Pin 2      | Positive power supply |
| Pin 3      | Negative power supply |
| Pin 4      | -                     |
| Pin 5      | -                     |
| Pin 6      | Negative power supply |
| Pin 7      | -                     |
| Pin 8      | -                     |

### 4.8.4 Power transfer and pin assignment (60 W)

The table below shows the most important power transfer and pin assignment of the following ports:

| Device  | Port              |
|---|-------------------|
| SCALANCE XC206-2G PoE<br>SCALANCE XC206-2G PoE (54 V)<br>SCALANCE XC206-2G PoE EEC (54 V) | Port 5 and port 6 |
| SCALANCE XC208G PoE<br>SCALANCE XC208G PoE (54 V)   | Port 7 and port 8 |
| SCALANCE XC216-3G PoE<br>SCALANCE XC216-3G PoE (54 V)                                     | Port 6 and port 7 |

| Pin number | Assignment            |
|------------|-----------------------|
| Pin 1      | Positive power supply |
| Pin 2      | Positive power supply |
| Pin 3      | Negative power supply |
| Pin 4      | Positive power supply |

|       |                       |
|-------|-----------------------|
| Pin 5 | Positive power supply |
| Pin 6 | Negative power supply |
| Pin 7 | Negative power supply |
| Pin 8 | Negative power supply |

### 4.8.5 Configuration

How you activate and configure PoE is described in the configuration manuals, see section "Introduction", section "Documentation on configuration".

*4.8 Power over Ethernet (PoE)*





# Mounting

## 5.1 Safety notices for installation

### Safety notices

When installing the device, keep to the safety notices listed below.

|  |
|--|
|  <b>WARNING</b>   |
| If a device is operated in an ambient temperature of more than 55 °C, the temperature of the device enclosure may be higher than 70 °C. The device must therefore be installed so that it is only accessible to service personnel or users that are aware of the reason for restricted access and of the required safety measures at an ambient temperature higher than 55 to 70 °C. |

|   |
|---|
|  <b>WARNING</b>                                    |
| If the device is installed in a cabinet, the inner temperature of the cabinet corresponds to the ambient temperature of the device. |

|  |
|--|
|  <b>WARNING</b>   |
| If the cable or conduit entry point exceeds 70 °C or the branching point of conductors exceeds 80 °C, special precautions must be taken. If the equipment is operated in an air ambient in excess of 60 °C, only use cables with admitted maximum operating temperature of at least 80 °C. |

### Safety notices on use in hazardous areas

#### General safety notices relating to protection against explosion

|  |
|--|
|  <b>WARNING</b> |
| <b>EXPLOSION HAZARD</b>  |
| Replacing components may impair suitability for Class 1, Division 2 or Zone 2.                     |

|  |
|--|
|  <b>WARNING</b> |
| The device is intended for indoor use only.  |

 **WARNING**

The device may only be operated in an environment of contamination class 1 or 2 (see EN/IEC 60664-1, GB/T 16935.1).

 **WARNING**

When used in hazardous environments corresponding to Class I, Division 2 or Class I, Zone 2, the device must be installed in a cabinet or a suitable enclosure.

**Notes for use in hazardous locations according to ATEX, IECEx, UKEX and CCC Ex**

If you use the device under ATEX, IECEx, UKEX or CCC Ex conditions you must also keep to the following safety instructions in addition to the general safety instructions for protection against explosion:

 **WARNING**

To comply with EC Directive 2014/34/EU (ATEX 114) or the conditions of IECEx, this enclosure or cabinet must meet the requirements of at least IP 54 (according to EN/IEC 60529, GB/T 4208) in compliance with EN IEC/IEC 60079-7, GB 3836.3.

 **WARNING**

The equipment shall only be used in an area of not more than pollution degree 2, as defined in EN/IEC 60664-1, GB/T 16935.1.

**Safety notices when using according to FM**

If you use the device under FM conditions you must also keep to the following safety notices in addition to the general safety notices for protection against explosion:

 **WARNING**

**EXPLOSION HAZARD**

For operation the device is intended to be installed within an enclosure/control cabinet. The inner temperature of the enclosure/control cabinet corresponds to the ambient temperature of the device. Use installation wiring connections with admitted maximum operating temperature of at least 30 °C higher than maximum ambient temperature.

 **WARNING**

Wall mounting outside of the control cabinet or housing does not fulfill the requirements of the FM approval.

** WARNING**

Wall mounting is only permitted if the requirements for the housing, the installation regulations, the clearance and separating regulations for the control cabinets or housings are adhered to. The control cabinet cover or housing must be secured so that it can only be opened with a tool. An appropriate strain-relief assembly for the cable must be used.

**Safety notices when using the device as industrial control equipment according to UL 61010-2-201**

If you use the device under UL 61010-2-201 conditions you must also keep to the following safety notices in addition to the general safety notices for protection against explosion:

** WARNING****Open equipment**

The devices are "open equipment" according to the standard IEC 61010-2-201 or UL 61010-2-201 / CSA C22.2 No. 61010-2-201. To fulfill requirements for safe operation with regard to mechanical stability, flame retardation, stability, and protection against contact, the following alternative types of installation are specified:

- Installation in a suitable cabinet.
- Installation in a suitable enclosure.
- Installation in a suitably equipped, enclosed control room.

** WARNING**

If the cable or housing socket exceeds 70 °C or the branching point of the cables exceeds 60 °C, special precautions must be taken. If the equipment is operated in an air ambient in excess of 40 °C, only use cables with admitted maximum operating temperature of at least 80 °C.

**Further notes****NOTICE****Warming and premature aging of the network component due to direct sunlight**

Direct sunlight can heat up the device and can lead to premature aging of the network component and its cabling.

Provide suitable shade to protect the network component against direct sunlight.

## 5.2 General notes for SFP transceivers

 **WARNING**

**Use only approved SFP transceivers**

If you use SFP transceivers that have not been approved by Siemens AG, there is no guarantee that the device will function according to its specifications.

If you use unapproved SFP transceivers, this can lead to the following problems:

- Damage to the device
- Loss of the approvals
- Violation of the EMC regulations

Use only approved pluggable transceivers.

---

**Note**

**Plugging and pulling during operation**

You can plug and pull pluggable transceivers with the device in operation.

---

### Documentation for SFP transceivers

You will find detailed information in the operating instructions of the pluggable transceivers, see the chapter "Introduction (Page 7)" section "Additional documentation".

## 5.3 Types of installation

---

**Note**

**Devices with or without fastening plate**

During installation, check whether the device has a fastening plate or not. Refer to section "Device views (Page 27)" to learn which devices have a fastening plate.

---

All SCALANCE XC-200 devices allow the following mounting methods:

- DIN rail
- S7-300 standard rail
- S7-1500 standard rail

Only devices with a fastening plate additionally permit the following mounting type:

- Wall mounting

**Installation clearance**

Keep to the minimum clearances so that the convection ventilation of the device is not blocked.

- Below at least 10 cm
- Above at least 10 cm

**Installation position**

The following installation position is recommended:



Note that different values for temperature and PoE power may apply to installation positions other than horizontal; see section "Technical specifications (Page 91)".

## 5.4 Installation on a DIN rail

### 5.4.1 Top-hat rail mounting with fastening plate

#### Installation

**Note**

Note the position of the securing bar, see also section "Dimension drawings (Page 149)".

When supplied, the securing bar is in the wall mounting position. To change the position of the securing bar, refer to the section "Changing the position of the securing bar (Page 69)".

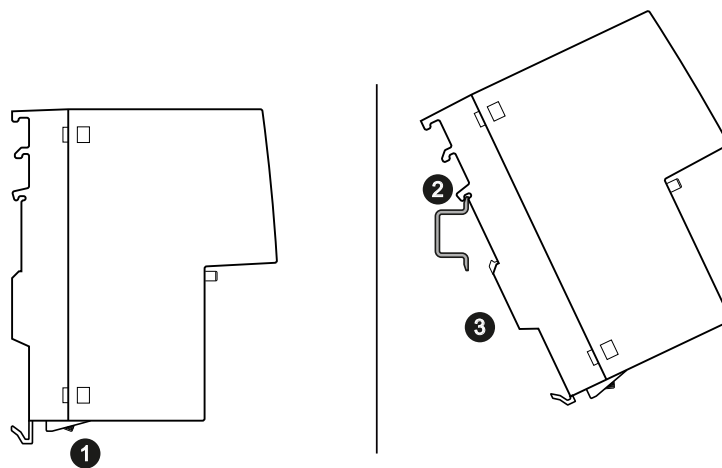

Figure 5-1 DIN rail mounting with securing bar in the wall mounting position.

**Securing bar in the wall mounting position (as supplied).**

To install the device on a 35 mm DIN rail complying with DIN EN 60715, follow the steps below:

1. Loosen the knurled screw with your hand or a screwdriver.
2. Place the third housing guide of the device on the top edge of the DIN rail.
3. Press the device down against the DIN rail until the spring securing bar locks in place.
4. When you tighten the knurled screw, you cannot release the securing bar (torque 0.5 Nm). The device is additionally fixed.
5. Connect the electrical connecting cables, refer to the section "Connecting up (Page 71)".

**Removal**

To remove the device from a DIN rail, follow the steps below:

1. Disconnect all connected cables.
2. If necessary, loosen the knurled screw with your hand or a screwdriver.
3. Lever the securing bar down using a screwdriver as far as it will go.
4. Pull the device away from the bottom of the DIN rail with the bar pulled.

**5.4.2 Top-hat rail mounting without fastening plate**

**Installation**

|  |
|--|
|  <b>WARNING</b>   |
| <b>Danger of injury by falling objects</b>   |
| The 35 mm DIN rail does not provide adequate support in shipping or when there is severe vibration (> 10 g). When used under these conditions, the device can detach itself and may cause injury to persons.<br>When used in shipbuilding or when extreme vibration can be expected, mount the device on a S7 standard rail. |

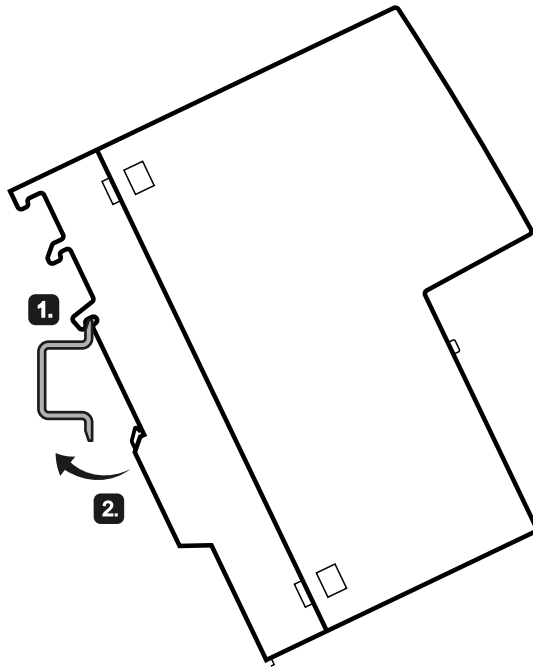

Figure 5-2 DIN rail mounting

To install the device on a 35 mm DIN rail complying with DIN EN 60715, follow the steps below:

1. Place the third housing guide of the device on the top edge of the DIN rail ①.
2. Press the device down against the DIN rail until the spring catch locks in place ②.
3. Connect the electrical connecting cables; refer to the section "Connecting up (Page 71)".

## Removal

To remove the device from a DIN rail, follow the steps below:

1. Disconnect all connected cables.
2. Release the DIN rail catch on the bottom of the device using a screwdriver.
3. Pull lower part of the device away from the DIN rail.

## 5.5 Installation on a standard S7-300 rail

### 5.5.1 Installation on a standard rail S7-300 with fastening plate

#### Installing on an S7-300 standard rail

---

**Note**

Note the position of the securing bar, see also section "Dimension drawings (Page 149)".

When supplied, the securing bar is in the wall mounting position. To change the position of the securing bar, refer to the section "Changing the position of the securing bar (Page 69)".

---

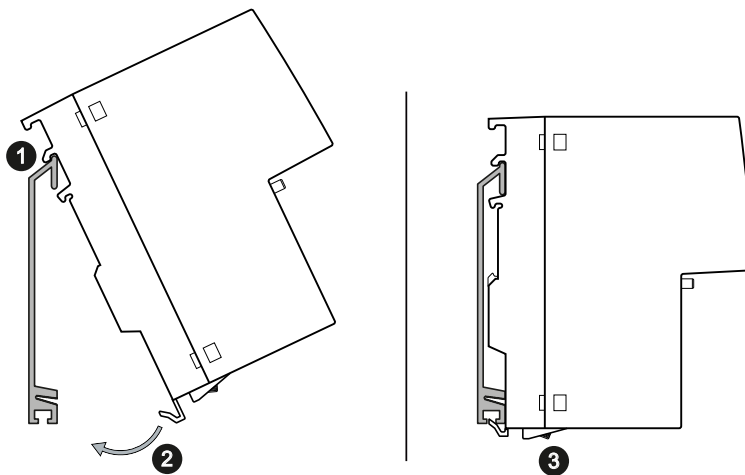

Figure 5-3 S7-300 mounting rail installation with the securing bar in the wall mounting position.

#### **Securing bar in the wall mounting position (as supplied).**

To install the device on an S7-300 standard rail, follow the steps below:

1. Place the second housing guide of the device on the top edge of the standard rail.
2. Swing the device down towards the back against the mounting rail.
3. Loosen the knurled screw with your hand or a screwdriver. The spring mounted securing bar locks in place.
4. When you tighten the knurled screw, you cannot release the securing bar (torque 0.5 Nm). The device is additionally fixed.
5. Connect the electrical connecting cables, refer to the section "Connecting up (Page 71)".



## Removal

To remove the device from a standard rail, follow the steps below:

1. Disconnect all connected cables.
2. If necessary, loosen the knurled screw with your hand or a screwdriver.
3. Lever the securing bar down using a screwdriver as far as it will go.
4. Remove the device from the mounting rail with the bar pulled.

## 5.5.2 Installation on a standard rail S7-300 without fastening plate

### Installing on an S7-300 standard rail

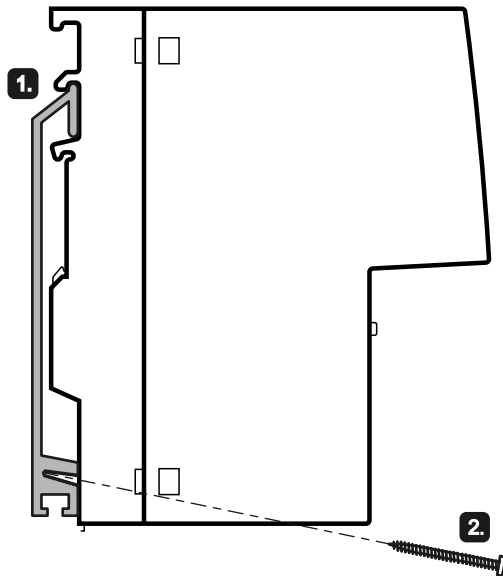

Figure 5-4 S7-300 standard rail mounting

To screw the device to an S7-300 standard rail, you require a securing screw with the following properties:

- Self-tapping screw 4 x 45 mm
- Screw head diameter: max. 7 mm

To install the device on an S7-300 standard rail, follow the steps below:

1. Place the second housing guide of the device on the top edge of the standard rail ①.
2. Screw the device to the lower part of the standard rail with the supplied securing screw ② (tightening torque 1.5 Nm), see also "Device views (Page 27)".
3. Connect the electrical connecting cables; refer to the section "Connecting up (Page 71)".

### Removal

To remove the device from a standard rail, follow the steps below:

1. Disconnect all connected cables.
2. Release the screw on the underside of the standard rail.
3. Remove the device from the standard rail.

## 5.6 Installation on a standard rail S7-1500

### 5.6.1 Installation on a standard rail S7-1500 with fastening plate

#### Installing on an S7-1500 standard rail

---

##### Note

Note the position of the securing bar, see also section "Dimension drawings (Page 149)".

When supplied, the securing bar is in the wall mounting position. To change the position of the securing bar, refer to the section "Changing the position of the securing bar (Page 69)".

---

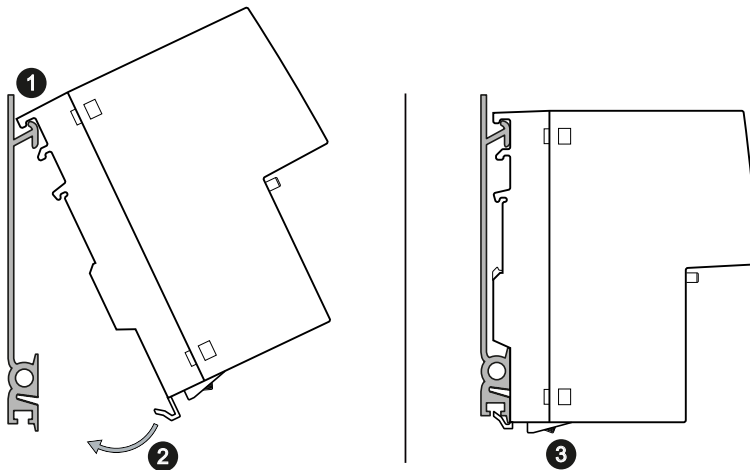

Figure 5-5 S7-1500 mounting rail installation with the securing bar in the wall mounting position.

##### Securing bar in the wall mounting position (as supplied).

To install the device on an S7-1500 standard rail, follow the steps below:

1. Place the first housing guide of the device on the top edge of the standard rail.
2. Swing the device down towards the back against the mounting rail.
3. Loosen the knurled screw with your hand or a screwdriver. The spring mounted securing bar locks in place.

4. When you tighten the knurled screw, you cannot release the securing bar (torque 0.5 Nm). The device is additionally fixed.
5. Connect the electrical connecting cables, refer to the section "Connecting up (Page 71)".

## Removal

To remove the device from a standard rail, follow the steps below:

1. Disconnect all connected cables.
2. If necessary, loosen the knurled screw with your hand or a screwdriver.
3. Lever the securing bar down using a screwdriver as far as it will go.
4. Remove the device from the mounting rail with the bar pulled.

## 5.6.2 Installation on a standard rail S7-1500 without fastening plate

### Installing on an S7-1500 standard rail

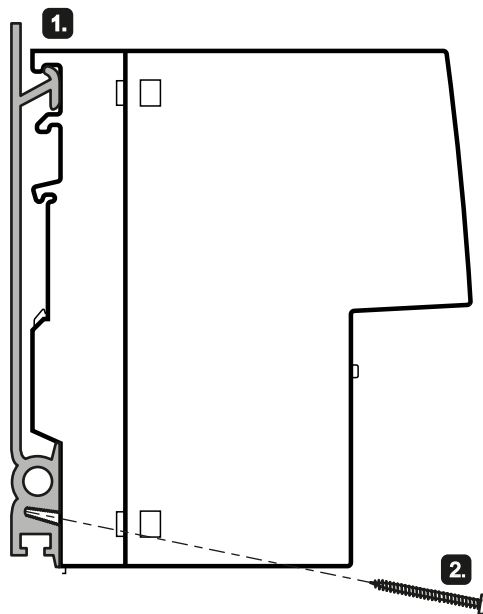

Figure 5-6 S7-1500 standard rail mounting

To screw the device to an S7-1500 standard rail, you require a securing screw with the following properties:

- Self-tapping screw 4 x 45 mm
- Screw head diameter: max. 7 mm

To install the device on an S7-1500 standard rail, follow the steps below:

1. Place the first housing guide of the device on the top edge of the standard rail ①.
2. Screw the device to the lower part of the standard rail with the supplied securing screw ② (tightening torque 1.5 Nm), see also "Device views (Page 27)".
3. Connect the electrical connecting cables; refer to the section "Connecting up (Page 71)".

## Removal

To remove the device from a standard rail, follow the steps below:

1. Disconnect all connected cables.
2. Release the screw on the underside of the standard rail.
3. Remove the device from the standard rail.

## 5.7 Wall mounting with fastening plate

### Preparation

Note the position of the securing bar, see also section "Dimension drawings (Page 149)".

When supplied, the securing bar is in the wall mounting position. You do not need to prepare the device any further.

If the securing bar is in the rail mounting position, note the section "Changing the position of the securing bar (Page 69)".

### Tools

To mount the device on a wall, you require the following:

- 2 wall plugs
- 2 fillister head screws

---

#### Note

Depending on the mounting surface, use suitable fittings.

---

### Assembly

---

#### Note

The wall mounting must be capable of supporting at least four times the weight of the device.

---

To mount the device on a wall, follow the steps below:

1. Prepare the wall mounting with drilled holes and plugs. For the precise dimensions, refer to the section "Dimension drawings (Page 149)".
2. Turn the upper screw in to the wall so that 10 mm remains jutting out.
3. Hang the device with the keyhole hanging mechanism on the rear on the screw.
4. Fix the device to the wall with the lower screw.
5. Connect the electrical connecting cables, refer to the section "Connecting up (Page 71)".

## 5.8 Changing the position of the securing bar

### Rail mounting position - wall mounting position

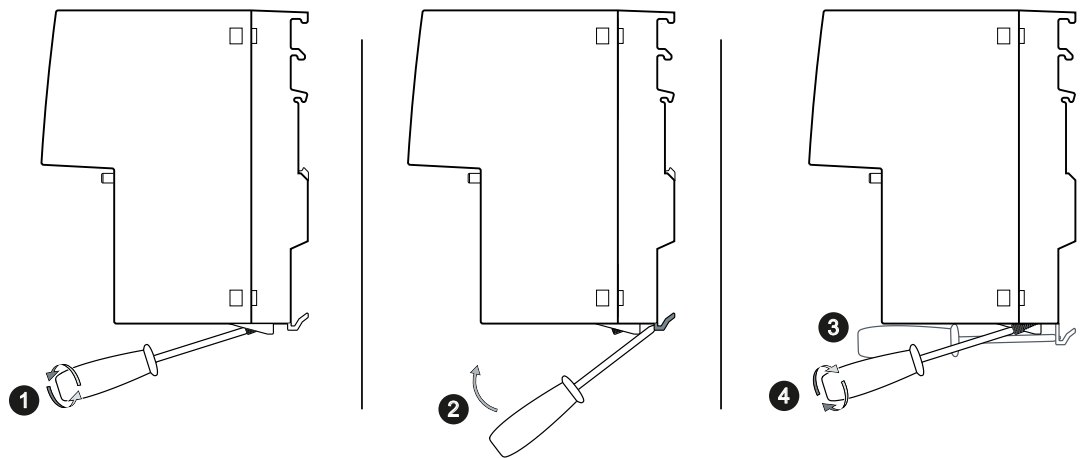

To change the securing bar from the rail mounting position to the wall mounting position follow the steps below:

1. If necessary, loosen the knurled screw with your hand or a screwdriver.
2. Move the securing bar down as far as it will go.
  - Use the levering aid and level the securing bar down using a screwdriver into this position.
  - Push the securing bar down using your hand.
3. Hold the securing bar in this position.
  - Hold the securing bar with the screwdriver.
  - Use the gap on the rear of the device and fix the securing bar briefly with a pin.
4. Tighten the knurled screw (torque 0.5 Nm).  
The securing bar is fixed in the wall mounting position.
5. Remove the pin.

### Wall mounting position - rail mounting position

To move the securing bar from the wall mounting position to the rail mounting position, loosen the knurled screw.



## Connecting up

The following table shows which requirements apply to the power supply of the respective devices. Observe the corresponding safety instructions.

| Power supply | PoE ports | Power   | Requirements for the power supply    |
|--------------|-----------|---------|--------------------------------------|
| 24 V DC      | No        | < 100 W | NEC Class 2/Limited Energy (Page 71) |
| 24 V DC      | Yes       | > 100 W | SELV (Page 72)                       |
| 54 V DC      | Yes       | > 100 W | SELV (Page 72)                       |

### Safety notices for operation with a power supply according to NEC Class 2

Operate the device with a power supply according to NEC Class 2. When connecting up the device, keep to the safety notices listed below.

For devices that must be operated with a NEC Class 2 power supply, you can also connect a fuse in front of the power supply that meets the following requirements. The power supply must then meet the requirements for operation with SELV, see "Safety instructions for operation with a power supply according to SELV (Page 72)".

|  <b>WARNING</b>  |
|---|
| <p>The equipment is designed for operation with Safety Extra-Low Voltage (SELV) by a Limited Power Source (LPS).</p> <p>This means that only SELV / LPS complying with IEC 60950-1 / EN 60950-1 / VDE 0805-1 must be connected to the power supply terminals, or the power supply unit for the equipment power supply must comply with NEC Class 2, as described by the National Electrical Code (r) (ANSI / NFPA 70).</p> <p>If the equipment is connected to a redundant power supply (two separate power supplies), both must meet these requirements.</p> |

|  <b>WARNING</b>  |
|---|
| <p><b>Safety extra low voltage</b></p> <p>The device is designed for operation with a directly connectable safety extra-low voltage (SELV) according to UL/IEC 61010-1 and UL/IEC 61010-2-201 whose output power corresponds to "Limited Energy" according to UL/IEC 61010-1.</p> |

**NOTICE****Suitable fuse for the power supply cables (corresponds to "Limited Energy")**

The current on the terminal may not exceed 3 A. Use a fuse for the power supply that is suitable for protection of AC/DC power supply circuits <sup>\*)</sup> and protects against currents > 3 A.

- In areas subject to the NEC or CEC, the fuse must meet the following requirements:
  - Suitable for AC/DC <sup>\*)</sup> (min. 60 V / 3 A)
  - Breaking current at least 10 kA
  - Approval according to ANSI/UL 248-14 (suppl. fuses), ANSI/UL 248-4 (Class CC), ANSI/UL 248-8 (J), ANSI/UL 248-15 (T), or CSA C22.2-4 No. 248.14 (suppl. fuses), No. 248-4 (Class CC), No. 248-8 (J), No. 248-15 (T)
- In other areas, the fuse must meet the following requirements:
  - Suitable for AC/DC <sup>\*)</sup> (min. 60 V / 3 A)
  - Breaking current at least 10 kA
  - Approval according to IEC/EN 60947-1/2/3 or IEC/EN 60898-1/2 for circuit breakers
  - Breaking characteristics: B or C
  - Approval according to IEC/EN 60127-1 for fuses
  - Breaking characteristics: max. 120 s at  $2 \times I_n$  (corresponds to melting integral  $I^2t < 4320$ )

If the properties of the supplying current source are known, the following fuse is also possible:

- In areas subject to the NEC or CEC, the fuse must meet the following requirements:
  - Suitable for AC/DC <sup>\*)</sup> (min. 60 V / 3 A)
  - Breaking current > highest possible current of the current source (incl. short circuit current and fault)
  - Approval according to UL 1077 or CSA C22.2 No. 235
- In other areas, the fuse must meet the following requirements:
  - Suitable for AC/DC <sup>\*)</sup> (min. 60 V / 3 A)
  - Breaking current > highest possible current of the current source (incl. short circuit current and fault)
  - Approval according to IEC/EN 60934
  - Breaking characteristics: max. 120s at  $2 \times I_n$

<sup>\*)</sup> AC or DC depending on availability

## Safety instructions for operation with a power supply according to SELV

Operate the device with a power supply according to SELV. When connecting up the device, keep to the safety notices listed below.



**⚠ WARNING****Power supply**

The device is designed for operation with a directly connectable safety extra-low voltage (Safety Extra Low Voltage, SELV) according to UL/IEC 61010-1 and UL/IEC 61010-2-201.

**Further notes****⚠ WARNING****Insulation of external power supplies**

Ext. circuits intended to be connected to this device shall be galv. separated from hazardous live voltage by reinforced or double insulation.

**⚠ WARNING****Safety notice for connecting with a LAN ID (Local Area Network)**

A LAN or LAN segment with all the interconnected devices should be contained completely in a single low voltage power distribution in a building. The LAN is designed either for "Environment A" according to IEEE802.3 or "Environment 0" according to IEC TR 62102.

Do not connect any electrical connectors directly to the telephone network (telephone network voltage) or a WAN (Wide Area Network).

The following table shows which ports fulfill the conditions of Environment A or B:

| Galvanically isolated environment | Ethernet ports | Ethernet ports with PoE |
|-----------------------------------|----------------|-------------------------|
| Environment A (IEEE 802.3)        | Yes            | Yes                     |
| Environment B (IEEE 802.3)        | Yes            | No                      |

**Note****Protective ground**

A PELV circuit contains a connection to protective ground. Without a connection to protective ground, or in case there is a fault in the connection to the protective ground, the voltage for the circuit is not stabilized.

**Note**

Minimum temperature rating of the cable to be connected to the field wiring terminals, 90 °C.

## Safety notices on use in hazardous areas

### General safety notices relating to protection against explosion

|  |
|--|
|  <b>WARNING</b>                 |
| <b>EXPLOSION HAZARD</b>  |
| Do not connect or disconnect cables to or from the device when a flammable or combustible atmosphere is present. |

|  |
|--|
|  <b>WARNING</b> |
| <b>EXPLOSION HAZARD</b>  |
| Do not press the SELECT/SET button when there is an explosive atmosphere.                        |

### Notes for use in hazardous locations according to ATEX, IECEx, UKEX and CCC Ex

If you use the device under ATEX, IECEx, UKEX or CCC Ex conditions you must also keep to the following safety instructions in addition to the general safety instructions for protection against explosion:

|   |
|---|
|  <b>WARNING</b>   |
| Take measures to prevent transient voltage surges of more than 40% of the rated voltage. This is the case if you only operate devices with SELV (safety extra-low voltage). |

|   |
|---|
|  <b>WARNING</b>                      |
| Provisions shall be made to prevent the rated voltage from being exceeded by transient disturbances of more than 119 V. |

|  |
|--|
|  <b>WARNING</b>   |
| At an ambient temperature of more than 60 °C, use heat-resistant cables designed for an ambient temperature at least 20 °C higher. The cable entries used on the enclosure must comply with the IP degree of protection required by EN IEC / IEC 60079-0, GB 3836.1. |

### Safety instructions for use in hazardous locations according to UL/FM HazLoc

If you use the device under UL or FM HazLoc conditions, you must also adhere to the following safety instructions in addition to the general safety instructions for protection against explosion:

|   |
|---|
|  <b>WARNING</b>  |
| <b>EXPLOSION HAZARD</b>   |
| You may only connect or disconnect cables carrying electricity when the power supply is switched off or when the device is in an area without inflammable gas concentrations. |

**Safety notices when using according to FM**

If you use the device under FM conditions you must also keep to the following safety notices in addition to the general safety notices for protection against explosion:

|  |
|--|
|  <b>WARNING</b> |
| <b>EXPLOSION HAZARD</b>  |
| Do not disconnect while circuit is live unless area is known to be non-hazardous.                |

## 6.1 Wiring rules

When wiring use cables with the following AWG categories or cross sections.

| Wiring rules for ...   |   | Screw/spring-loaded terminals              |
|--|---|--|
| connectable cable cross sections for flexible cables ...       | without wire end ferrule                        | 0.25 - 2.5 mm <sup>2</sup><br>AWG: 24 - 13 |
|  | with wire end ferrule with plastic ferrule**    | 0.25 - 2.5 mm <sup>2</sup><br>AWG: 24 - 13 |
|  | with wire end ferrule without plastic ferrule** | 0.25 - 2.5 mm <sup>2</sup><br>AWG: 24 - 13 |
|  | with TWIN wire end ferrule**                    | 0.5 - 1 mm <sup>2</sup><br>AWG: 20 - 17    |
| Stripped length of the cable                                   |   | 8 - 10 mm                                  |
| Wire end ferrule according to DIN 46228 with plastic ferrule** |   | 8 - 10 mm                                  |

\* AWG: American Wire Gauge

\*\* See note "Wire end ferrules"

**Note**

**Wire end ferrules**

Use crimp shapes with smooth surfaces, such as provided by square and trapeze shaped crimp cross sections.

Crimp shapes with wave-shaped profile are unsuitable.

---

**Note**

**Wiring with PoE variants**

PoE variants have a high current consumption. Design the cable cross-section based on the maximum current consumption.

---

## 6.2 24 V DC power supply

### Notes on the power supply

 **WARNING**

**Incorrect power supply**

When the device is connected to a redundant power supply (two separate power supplies), both must meet these requirements.

Never operate the device with AC voltage or DC voltage higher than 32 V DC.

 **CAUTION**

**Damage to the device due to overvoltage**

The connector of the external power supply is not protected against strong electromagnetic pulses that can, for example, result from lightning strikes or switching large loads.

One of the tests used to attest the immunity of devices of the IE switches SCALANCE XC-200 to electromagnetic interference was the "surge immunity test" according to EN61000-4-5. This test requires overvoltage protection for the power supply lines. A suitable device is, for example, the Dehn Blitzductor BVT AVD 24, article number 918 422 or a comparable protective element.

Manufacturer: DEHN+SOEHNE GmbH+Co. KG, Hans-Dehn-Str.1, Postfach 1640, D92306 Neumarkt, Germany

Operate the SCALANCE XC-200 with suitable overvoltage protection.

---

**Note**

The device can be disconnected from the power supply by pulling off the terminal block.

---

### Information on the power supply

- The "L1" and "L2" LEDs indicate the current range of the power supply, see the section "LEDs "L1" and "L2" (Page 46)".
- The power supply is connected using a 4-pin plug-in terminal block (spring-loaded terminal). The terminal block ships with the device and can also be ordered as a spare part, see section "Product overview (Page 21)".

- The power supply can be connected redundantly. Both inputs are isolated. There is no distribution of load. When a redundant power supply is used, the power supply unit with the higher output voltage supplies the device alone.
- The power supply is connected over a high resistance with the enclosure to allow an ungrounded set up. The two power inputs are non-floating.
- Note the wiring rules (Page 75).

### Position and assignment

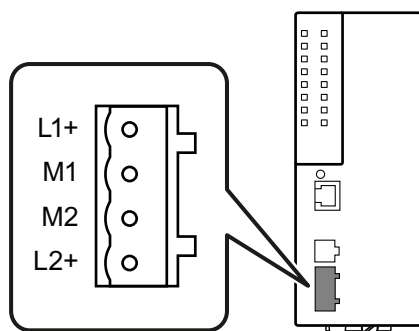

Figure 6-1 Position of the power supply based, for example on the SCALANCE XC-200 with 8 ports and assignment of the terminal block

| Contact | Assignment |
|---------|------------|
| L1+     | 24 VDC     |
| M1      | Ground     |
| M2      | Ground     |
| L2+     | 24 VDC     |

## 6.3 54 V DC power supply

### Notes on the power supply

| <b>! WARNING</b>  |
|---|
| <p><b>Incorrect power supply</b></p> <p>When the device is connected to a redundant power supply (two separate power supplies), both must meet these requirements.</p> <p>Never operate the device with AC voltage or DC voltage higher than 57 V DC.</p> |



**CAUTION**

**Damage to the device due to overvoltage**

The connector of the external power supply is not protected against strong electromagnetic pulses that can, for example, result from lightning strikes or switching large loads.

One of the tests used to attest the immunity of devices of the IE switches SCALANCE XC-200 to electromagnetic interference was the "surge immunity test" according to EN61000-4-5.

**Note**

The device can be disconnected from the power supply by pulling off the terminal block.

**Information on the power supply**

- Make sure that among other things the external power supply unit meets the following basic requirements:
  - The output voltage (PoE voltage) is a safety extra-low voltage (SELV).
  - The output voltage (PoE voltage) meets the isolation requirements according to IEEE 802.3at (in other words 1500 VAC or 2250 VDC) to ground, to touchable conductive parts and (if they exist) other secondary voltages.
  - Fuse the output voltage (PoE voltage) externally, see the section "Connecting up (Page 71)".
- Select a suitable power of the external power supply unit, so that the power supply to the power consumers is ensured, see the section "Power over Ethernet (PoE) (Page 52)".
- For the cable supplying the power supply, use a cable with a length of max. 3 m.
- The power supply is connected using a 4-pin plug-in terminal block (spring-loaded terminal). The terminal block ships with the device and can also be ordered as a spare part, see section "Product overview (Page 21)".
- The power supply can be connected redundantly. Both inputs are isolated. There is no distribution of load. The power supply unit with the higher output voltage supplies the device alone.
- The power supply is connected over a high resistance with the enclosure to allow an ungrounded set up. The two power inputs are non-floating.
- The "L1" and "L2" LEDs indicate the current range of the power supply, see the section "LEDs "L1" and "L2" (Page 46)".
- Note the wiring rules (Page 75).

## Position and assignment

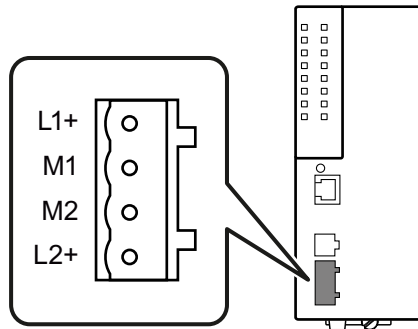

Figure 6-2 Position of the power supply based, for example on the SCALANCE XC-200 with 8 ports and assignment of the terminal block

| Contact | Assignment |
|---------|------------|
| L1+     | 54 V DC    |
| M1      | Ground     |
| M2      | Ground     |
| L2+     | 54 V DC    |

## Connecting multiple to a 54 V DC power supply unit

If you connect multiple devices with a 54 V DC power supply (e.g. XC-200G PoE) to a 54 V DC power supply, note the following for the communication connection between these devices:

- Use ports that do not support PoE for the communication connection, if possible.
- If you connect the devices via PoE ports, the PoE ports must be galvanically isolated (e.g. via a network disconnecter).

## 6.4 Signaling contact

### Information on the signaling contact

- The signaling contact is a floating switch that signals error statuses by opening the contact. The signaling contact must be operated within the range of the operating voltage. If an error/fault occurs, the signaling contact opens. In normal operation, the signaling contact is closed.
- The signaling contact is connected using a 2-pin plug-in terminal block (spring-loaded terminal). The terminal block ships with the device and can also be ordered as a spare part, see section "Product overview (Page 21)".
- Note the wiring rules (Page 75).

**NOTICE****Damage due to voltage being too high**

You can load the signaling contact with the operating voltage of the device and a maximum of 100 mA.

Higher voltages or currents can damage the device.

**Position and assignment**

Figure 6-3 Position of the signaling contact based, for example on the SCALANCE XC-200 with 8 ports and assignment of the terminal block

| Contact | Assignment      |
|---------|-----------------|
| F1      | Fault contact 1 |
| F2      | Fault contact 2 |

**Signaling faults**

- The signaling of errors by the signaling contact is synchronized with the fault LED "F", see section "'F" LED (Page 45)".  
All errors that the fault LED "F" indicates (freely configurable) are also signaled by the signaling contact.
- If an internal fault occurs, the fault LED "F" lights up and the signaling contact opens.
- If you connect a communications node to an unmonitored port or disconnect it, this does not cause an error message.
- The signaling contact remains open until one of the following events occurs:
  - The problem is eliminated.
  - The current status is entered in the fault mask as the new desired status.

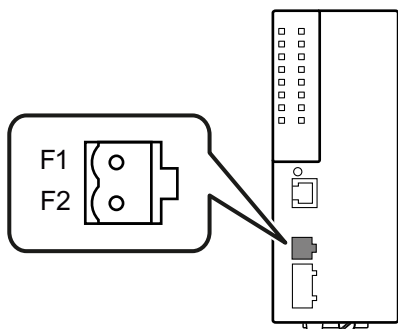
**6.5 Functional ground**

EMC disturbances are diverted to ground via the functional ground. This ensures the immunity of the data transmission.



The functional ground must be implemented with low impedance. The connection of the functional ground must be established directly on the mounting plate or the DIN rail terminal.

The IE switch has a grounding screw (fillister head screw with clamping washer und disk) for functional ground, refer to the section "Device views (Page 27)".

The grounding screw is identified by the following symbol for the functional ground  $\perp$ .

Follow the steps below to connect the functional ground:

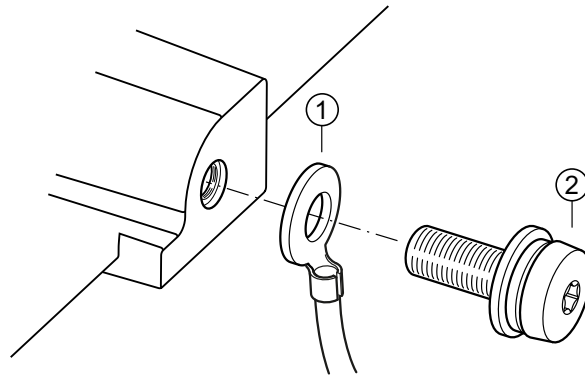

- ① Grounding terminal with cable
- ② Fillister head screw with spring washer and washer

1. Loosen the grounding screw).
2. Put the grounding terminal and grounding screw together.
3. Tighten the grounding screw with a maximum torque of 0.75 Nm.

## Protective/functional ground

The connection of the reference potential surface with the protective ground system is normally in the cabinet close to the power feed-in. This ground conducts fault currents to ground safely and according DIN/VDE 0100 is a protective ground to protect people, animals and property from too high contact voltages.

Apart from the protective ground, there is functional grounding in the cabinet. According to EN60204-1 (DIN/VDE 0113 T1) electrical circuits must be grounded. The chassis (0 V) is grounded at one defined point. Here, once again the grounding is implemented with the lowest leakage resistance to ground in the vicinity of the power feed-in.

With automation components, functional ground also ensures interference-free operation of a controller. Via the functional ground, interference currents coupled in via the connecting cables are discharged to ground.

## 6.6 Industrial Ethernet

### 6.6.1 Electrical

---

#### Note

##### Strain relief for the Ethernet cables

In order to avoid mechanical stress on the Ethernet cables and resulting interruption of the contact, fasten the cables at a short distance from the connector using a cable guide or busbar.

---

#### Note

##### Unlocking the plug with a screwdriver

If installation space is limited, you can unlock the connectors using a screwdriver, see also "SIMATIC NET: IE FC RJ45 Plug 4x2 CAT 6A (<https://support.industry.siemens.com/cs/ww/en/view/102047916>)".

---

### R-45 connector technology

The attachment to Industrial Ethernet uses RJ-45 connected technology with MDI-X assignment.

### Pin assignment

The following table shows the pin assignment of the R-45 connectors.

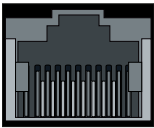
| Pin number | Assignment            |                  | R-45 connector  |
|------------|-----------------------|------------------|---|
|            | 10/100 Mbps           | 10/100/1000 Mbps |   |
| Pin 1      | RD+                   | D1+              |  |
| Pin 2      | RD-                   | D1-              |   |
| Pin 3      | TD+                   | D2+              |   |
| Pin 4      | n. c. (Not connected) | D3+              |   |
| Pin 5      | n. c. (Not connected) | D3-              |   |
| Pin 6      | TD-                   | D2-              |   |
| Pin 7      | n. c. (Not connected) | D4+              |   |
| Pin 8      | n. c. (Not connected) | D4-              |   |

## MDI / MDI-X autocrossover

With the MPI/MDI-X autocrossover function, the send and receive contacts of an Ethernet port are assigned automatically. The assignment depends on the cable with which the communications partner is connected. This means that it does not matter whether the port is connected using a patch cable or crossover cable. This prevents malfunctions resulting from mismatching send and receive wires. This makes installation much easier for the user.

---

### Note

#### Formation of loops

Please note that the direct connection of two ports on the IE switch or accidental connection over several IE switches causes an illegal loop. Such a loop can lead to network overload and network failures.

---

## Autonegotiation

Autonegotiation means the automatic detection/negotiation of the transmission rate and the operating mode of ports at the opposite end. This makes it possible to configure different devices automatically.

Two components connected to a link segment can exchange information about the transfer and can adapt their settings to each other. The mode with the highest possible speed is set.

---

### Note

- If a port is set permanently to full duplex, the connected partner port must also be set to full duplex.
  - If a port operating in the "Auto negotiation" mode is connected to a partner port that is not operating in the "Auto negotiation" mode, the partner port setting must be fixed at 100 Mbps or 10 Mbps half duplex mode.
  - If you disable the "Auto negotiation" function, the "MDI/MDI-X autocrossover" function is also turned off. Then use a crossover cable.
-

### 6.6.2 Optical

|  |
|--|
| <b>NOTICE</b>  |
| <b>Failure of the data traffic due to contamination of optical plug-in connections</b>   |
| Optical sockets and plugs are sensitive to contamination of the end face. Contamination can lead to the failure of the optical transmission network. Take the following precautions to avoid functional impairments:   |
| <ul style="list-style-type: none"><li>• Clean the end face of field-assembled connectors carefully before connecting. No residues of processing may remain on the connector.</li><li>• Only remove the dust caps of optical transceivers and pre-configured cables shortly before connecting the cables.</li><li>• Close unused optical sockets and plugs as well as pluggable transceivers and slots with the supplied protective caps.</li></ul> |

**Note**

**No light power measurement (PROFINET diagnostics)**

The devices do not support diagnostics with light power measurement.

#### SC connectors

The attachment to Industrial Ethernet uses SC connector technology (Subscriber Connector).

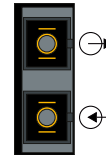

#### ST/BFOC connectors

The attachment to Industrial Ethernet uses ST/BFOC connector technology (Straight Tip/Bayonet Fiber Optic Connector).

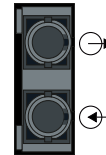

#### LC connector technology

The attachment to Industrial Ethernet uses LC connector technology (Lucent Connector).



Pluggable transceiver slot/  
plugged in transceiver

## 6.7 Serial interface

### Information on the serial interface

- Via the serial interface on the device (RJ-11 jack), you can access the Command Line Interface of the device directly via an RS-232 (115200 8N1) connection without assigning an IP address.
- Access to the device is possible independent of the Ethernet ports.
- To connect the serial interface to a PC, you require a cable with an RJ-11 plug and 9-pin D-sub female connector. The connecting cable for the serial interface can be ordered as an accessory, see section "Accessories (Page 37)".

### Position and assignment

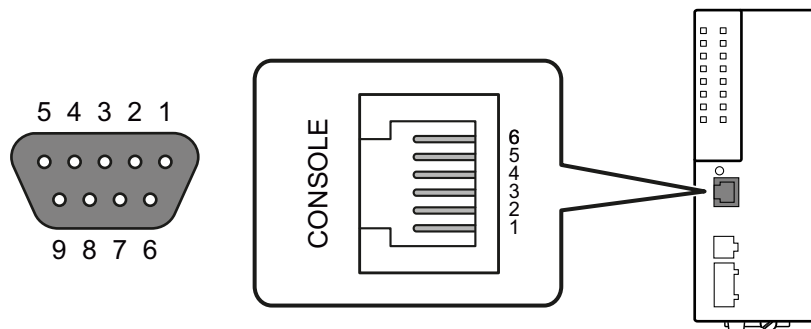

Figure 6-4 Position and pin assignment of the serial interface (RJ-11 jack), based for example on the XC-200 with 8 ports as well as the pin assignment of the D-sub socket.

### Assignment of the terminal block

The connecting cable has the following assignment:

| Contact | Pin assignment of the RJ-11 plug | Pin assignment of the D-sub female connector |
|---------|----------------------------------|--|
| 1       | -                                | -  |
| 2       | -                                | TD (Transmit Data)                           |
| 3       | TD (Transmit Data)               | RD (Receive Data)                            |
| 4       | SG (Signal Ground)               | -  |
| 5       | RD (Receive Data)                | SG (Signal Ground)                           |
| 6       | -                                | -  |
| 7       |                                  | -  |
| 8       |                                  | -  |
| 9       |                                  | -  |

---

**Note**

**Pin assignment of the RJ-11 jack on the device**

The RJ-11 jack on the device has a pinout to match the RJ-11 plug of the connecting cable.

---

## Maintenance

|   |
|---|
| <b>NOTICE</b>   |
| <b>Cleaning the housing</b><br>Only clean the outer parts of the housing with a dry cloth.<br>Do not use any liquids or solvents. |





# Troubleshooting

## 8.1 Downloading new firmware using TFTP without WBM and CLI

### Firmware

The firmware is signed and encrypted. This ensures that only firmware created by Siemens can be downloaded to the device.

### Procedure with Microsoft Windows

You can download new firmware to the device using TFTP. To do this, the device does not need to be reachable either using Web Based Management (WBM) or using the Command Line Interface (CLI). This can be the case if there was a power failure during a firmware update.

When pressing the button, observe the information in the section "AUTOHOTSPOT".

Follow the steps below to load new firmware using TFTP:

1. Turn off the power to the device.
2. Press the "SELECT/SET" button and reconnect the power supply to the device while holding down the button.
3. Hold down the button until the red fault LED "F" starts to flash.
4. Release the button as long as the red error LED is still flashing..  
This time only lasts a few seconds.  
The bootloader of the device waits in this status for a new firmware file that you can download by TFTP.
5. Connect a PC to an Ethernet port of the device with an Ethernet cable.
6. Assign an IP address to the device using DHCP or SINEC PNI.
7. Open a Windows command prompt and change to the directory where the file with the new firmware is located and then execute the following command :  

```
tftp -i <IP address> put <firmware file>
```

---

#### Note

You can enable TFTP in Microsoft Windows as follows:

"Control Panel" > "Programs and Features" > "Turn Windows features on or off" > "TFTP Client".

Once the firmware has been transferred completely to the device and validated, the device restarts. This may take a few minutes.

## 8.2 Restoring the factory settings

|  |
|--|
| <b>NOTICE</b>  |
| <p><b>Previous settings</b></p> <p>If you reset, all the settings you have made will be overwritten by factory defaults.</p> |

|  |
|--|
| <b>NOTICE</b>  |
| <p><b>Inadvertent reset</b></p> <p>An inadvertent reset can cause disturbances and failures in the configured network.</p> |

### Restoring the factory settings during the startup phase

|  |
|--|
| <b>NOTICE</b>  |
| <p><b>Reset despite disabled "SELECT/SET" button</b></p> <p>Using the "SELECT/SET" button, you can always reset the device parameters to the factory defaults during the startup phase of the device. This applies also if the "Reset to Factory Defaults" function was disabled in the configuration. This allows you to reset the device to the factory defaults in an emergency.</p> <p>If the function has been disabled in the configuration, it is only disabled on completion of the startup phase.</p> |

To reset the device to the factory defaults during the startup phase, follow the steps below:

1. Turn off the power to the device.
2. Now press the "SELECT/SET" button and reconnect the power to the device while holding down the button.
3. Hold down the button until the red error LED "F" stops flashing and is permanently lit.
4. Now release the button and wait until the fault LED "F" goes off again.
5. The device starts automatically with the factory defaults.

### Restoring the factory defaults during operation

You can also reset the device to the factory defaults during operation, see section "SELECT / SET button (Page 42)".

## Technical specifications

### 9.1 Technical specifications SCALANCE XC206-2 (ST/BFOC)

The following technical specifications apply to the SCALANCE XC206-2 (ST/BFOC).

| <b>Technical specifications</b>       |   |   |
|---------------------------------------|---|---|
| <b>Diagnostics interface</b>          |   |   |
| Serial interface                      | Quantity                                    | 1   |
|                                       | Connector                                   | RJ-11 jack  |
| <b>Electrical data</b>                |   |   |
| Power supply <sup>1)</sup>            | Rated voltage                               | 12 to 24 V DC   |
|                                       | Voltage range (incl. tolerance)             | 9.6 to 31.2 V DC Safe Extra Low Voltage (SELV)  |
|                                       | Design                                      | Terminal block, 4 terminals   |
|                                       | Properties                                  | Implemented redundantly;<br>The connected power supply must meet the requirements of NEC Class 2. |
| Current consumption                   | 12 VDC                                      | 500 mA  |
|                                       | 24 VDC                                      | 250 mA  |
| Effective power loss                  |   | 6 W   |
| Overvoltage category                  |   | CAT II  |
| Fusing                                |   | 2.5 A / 125 V   |
| Signaling contact <sup>1)</sup>       | Quantity                                    | 1   |
|                                       | Design                                      | Terminal block, 2 terminals   |
|                                       | Permitted voltage range                     | 24 VDC  |
|                                       | Load capability                             | max. 100 mA   |
| <b>Permitted ambient conditions</b>   |   |   |
| Ambient temperature                   | With operation up to 2000 m above sea level | During operation in horizontal installation position:<br>-40 °C to +70 °C                         |
|                                       |   | During operation in a different installation position:<br>-40 °C to +60 °C                        |
|                                       | During storage                              | -40 °C to +85 °C  |
|                                       | During transportation                       | -40 °C to +85 °C  |
| Relative humidity                     | During operation at 25 °C                   | ≤ 95% without condensation  |
| <b>Housing, dimensions and weight</b> |   |   |
| Design                                | compact                                     |   |
| Housing material                      | Basic housing                               | Die cast aluminum, powder coated  |
|                                       | Front cover                                 | Polycarbonate (PC-GF10)   |
| Degree of protection                  | IP20  |   |

Technical specifications

9.1 Technical specifications SCALANCE XC206-2 (ST/BFOC)

| Technical specifications         |  |
|----------------------------------|--|
| Dimensions (W x H x D)           | 60 x 147 x 125 mm  |
| Weight                           | 540 g  |
| Installation options             | <ul style="list-style-type: none"> <li>• Wall mounting</li> <li>• Installation on a DIN rail</li> <li>• Mounting on an S7-300 standard rail</li> <li>• Mounting on an S7-1500 standard rail</li> </ul> |
| Mean time between failure (MTBF) |  |
| MTBF (EN/IEC 61709; 40 °C)       | > 46 years   |

<sup>1)</sup> Note the wiring rules (Page 75).

Connection to Industrial Ethernet

Electrical connectors

| Properties         |                                 |
|--------------------|---------------------------------|
| Quantity           | 6                               |
| Connector          | RJ-45 jack                      |
| Properties         | Half/full duplex, MDI-X pinning |
| Transmission speed | 10 / 100 Mbps                   |

Optical connectors

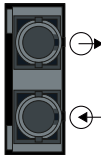
| Optical connectors |  |
|--------------------|--|
| Quantity           | 2  |
| Connectors         |  |

The attachment to Industrial Ethernet uses ST/BFOC connector technology (Straight Tip/Bayonet Fiber Optic Connector).

| Properties                        |                                      |      |
|-----------------------------------|--------------------------------------|------|
| Transmission mode                 | 100Base-FX complying with IEEE 802.3 |      |
| Transmission rate                 | 100 Mbps (Fast Ethernet)             |      |
| Transmission medium               | Multimode fiber-optic cable          |      |
| Light source                      | LED/Class1-LASER "Eye safe"          |      |
| Wavelength                        | 1300 nm                              |      |
| Cable length (max.) <sup>*)</sup> | At 50 µm fiber core diameter         | 3 km |
|                                   | At 62.5 µm fiber core diameter       | 3 km |

| Properties                   |                  |            |         |
|------------------------------|------------------|------------|---------|
| Transmitter output (optical) | Minimum          | At 50 µm   | -24 dBm |
|                              |                  | At 62.5 µm | -20 dBm |
|                              | Maximum          |            | -14 dBm |
| Receiver input               | Sensitivity min. |            | -31 dBm |
|                              | Input power max. |            | -12 dBm |

\*) Depending on the cable used:

- If you are using at least OM1 fibers (attenuation  $\leq 1.5$  dB/km, bandwidth length product  $\geq 500$  MHz\*km), you can reach a cable length of up to 3 km.
- When are using fibers with attenuation values  $\leq 1$  dB/km, you can reach a cable length of up to 5 km.

You can find additional information in the "Industrial Ethernet / PROFINET Passive network components" System Manual, see also section "Introduction", paragraph "Additional documentation".

## 9.2 Technical specifications SCALANCE XC206-2 (SC)

The following technical specifications apply to the SCALANCE XC206-2 (SC).

| Technical specifications            |                                 |   |
|-------------------------------------|---------------------------------|---|
| <b>Diagnostics interface</b>        |                                 |   |
| Serial interface                    | Quantity                        | 1   |
|                                     | Connector                       | RJ-11 jack  |
| <b>Electrical data</b>              |                                 |   |
| Power supply <sup>1)</sup>          | Rated voltage                   | 12 to 24 V DC   |
|                                     | Voltage range (incl. tolerance) | 9.6 to 31.2 V DC Safe Extra Low Voltage (SELV)  |
|                                     | Design                          | Terminal block, 4 terminals   |
|                                     | Properties                      | Implemented redundantly;<br>The connected power supply must meet the requirements of NEC Class 2. |
| Current consumption                 | 12 VDC                          | 500 mA  |
|                                     | 24 VDC                          | 250 mA  |
| Effective power loss                |                                 | 6 W   |
| Overvoltage category                |                                 | CAT II  |
| Fusing                              |                                 | 2.5 A / 125 V   |
| Signaling contact <sup>1)</sup>     | Quantity                        | 1   |
|                                     | Design                          | Terminal block, 2 terminals   |
|                                     | Permitted voltage range         | 24 VDC  |
|                                     | Load capability                 | max. 100 mA   |
| <b>Permitted ambient conditions</b> |                                 |   |

9.2 Technical specifications SCALANCE XC206-2 (SC)

| Technical specifications         |  |  |
|----------------------------------|--|--|
| Ambient temperature              | With operation up to 2000 m above sea level  | During operation in horizontal installation position:<br>-40 °C to +70 °C  |
|                                  |  | During operation in a different installation position:<br>-40 °C to +60 °C |
|                                  | During storage   | -40 °C to +85 °C   |
|                                  | During transportation  | -40 °C to +85 °C   |
| Relative humidity                | During operation at 25 °C  | ≤ 95% without condensation   |
| Housing, dimensions and weight   |  |  |
| Design                           | compact  |  |
| Housing material                 | Basic housing  | Die cast aluminum, powder coated   |
|                                  | Front cover  | Polycarbonate (PC-GF10)  |
| Degree of protection             | IP20   |  |
| Dimensions (W x H x D)           | 60 x 147 x 125 mm  |  |
| Weight                           | 540 g  |  |
| Installation options             | <ul style="list-style-type: none"> <li>• Wall mounting</li> <li>• Installation on a DIN rail</li> <li>• Mounting on an S7-300 standard rail</li> <li>• Mounting on an S7-1500 standard rail</li> </ul> |  |
| Mean time between failure (MTBF) |  |  |
| MTBF (EN/IEC 61709; 40 °C)       | > 46 years   |  |

<sup>1)</sup> Note the wiring rules (Page 75).

## Connection to Industrial Ethernet

### Electrical connectors

| Properties         |                                 |
|--------------------|---------------------------------|
| Quantity           | 6                               |
| Connector          | RJ-45 jack                      |
| Properties         | Half/full duplex, MDI-X pinning |
| Transmission speed | 10 / 100 Mbps                   |

**Optical connectors**

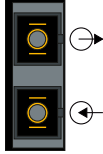
| Optical connectors  |   |
|---|---|
| Quantity  | 2   |
| Connectors  |  |
| <p>The attachment to Industrial Ethernet uses SC connector technology (Subscriber Connector).</p> |   |

| Properties                   |                                      |                    |
|------------------------------|--------------------------------------|--------------------|
| Transmission mode            | 100Base-FX complying with IEEE 802.3 |                    |
| Transmission rate            | 100 Mbps (Fast Ethernet)             |                    |
| Transmission medium          | Multimode fiber-optic cable          |                    |
| Light source                 | LED/Class1-LASER "Eye safe"          |                    |
| Wavelength                   | 1300 nm                              |                    |
| Cable length (max.) *)       | At 50 µm fiber core diameter         | 3 km               |
|                              | At 62.5 µm fiber core diameter       | 3 km               |
| Transmitter output (optical) | Minimum                              | At 50 µm -24 dBm   |
|                              |                                      | At 62.5 µm -20 dBm |
|                              | Maximum                              | -14 dBm            |
| Receiver input               | Sensitivity min.                     | -31 dBm            |
|                              | Input power max.                     | -12 dBm            |

\*) Depending on the cable used:

- If you are using at least OM1 fibers (attenuation ≤ 1.5 dB/km, bandwidth length product ≥ 500 MHz\*km), you can reach a cable length of up to 3 km.
- When are using fibers with attenuation values ≤ 1 dB/km, you can reach a cable length of up to 5 km.

You can find additional information in the "Industrial Ethernet / PROFINET Passive network components" System Manual, see also section "Introduction", paragraph "Additional documentation".

## 9.3 Technical specifications of SCALANCE XC206-2G PoE

The following technical specifications apply to the SCALANCE XC206-2G PoE.

| <b>Technical specifications</b>          |                                 |   |
|--|---------------------------------|---|
| <b>Connection to Industrial Ethernet</b> |                                 |   |
| Electrical connectors                    | Quantity                        | 6   |
|  | Connector                       | RJ45 jack   |
|  | Properties                      | Half/full duplex, MDI-X pinning   |
|  | Transmission speed              | 10 / 100 / 1000 Mbps  |
| Slots for pluggable transceivers         | Quantity                        | 2   |
|  | Connector                       | SFP transceivers (LC port)  |
|  | Transmission speed              | 1000 / 10000 Mbps<br>100 Mbps also possible via active SFPs   |
| <b>Diagnostics interface</b>             |                                 |   |
| Serial interface                         | Quantity                        | 1   |
|  | Connector                       | RJ-11 jack  |
| <b>Electrical data</b>                   |                                 |   |
| Power supply <sup>1)</sup>               | Rated voltage                   | 24 V DC   |
|  | Voltage range (incl. tolerance) | 19.2 to 31.2 V DC Safe Extra Low Voltage (SELV)   |
|  | Design                          | Terminal block, 4 terminals   |
|  | Properties                      | Implemented redundantly   |
| Current consumption                      | At 19.2 V DC                    | Max. 7.5 A  |
| Effective Power                          | At max PoE load                 | Max. 144 W  |
| Thermal Design Power                     |                                 | Max. 18 W   |
| Overvoltage category                     |                                 | CAT II  |
| Fusing                                   | Basic device                    | 2.5 A / 125 V   |
|  | PoE consumers                   | 15 A / 125 V  |
| PoE power per device                     | At 24 V DC                      | With horizontal mounting position and operation without pluggable transceiver: <ul style="list-style-type: none"> <li>• 120 W</li> </ul> In other installation position: <ul style="list-style-type: none"> <li>• 90 W</li> </ul> |
| Signaling contact <sup>1)</sup>          | Quantity                        | 1   |
|  | Design                          | Terminal block, 2 terminals   |
|  | Permitted voltage range         | 24 V DC   |
|  | Load capability                 | Max. 100 mA   |
| <b>Permitted ambient conditions</b>      |                                 |   |



| <b>Technical specifications</b>         |  |   |
|---|--|---|
| Ambient temperature <sup>2)</sup>       | During LAN operation with RJ45 connector with max. PoE load up to 2000 m above sea level   | During operation in horizontal installation position:<br>• -40 °C to +60 °C<br><br>During operation in a different installation position:<br>• -40 °C to +50 °C   |
|   | When operating with pluggable transceivers of the types:<br>• [-] Standard version<br>• LD<br>Up to 2000 m above sea level   | During operation in horizontal installation position:<br>• -40 °C to +60 °C<br>• Max. PoE power: 90 W<br><br>During operation in a different installation position:<br>• -40 °C to +50 °C<br>• Max. PoE power: 60 W |
|   | When operating with pluggable transceivers of the types:<br>• LH<br>• LH+<br>• ELH<br>• SFP992-1+<br>Up to 2000 m above sea level  | During operation in horizontal installation position:<br>• -40 °C to +55 °C<br>• Max. PoE power: 90 W<br><br>Other mounting positions are not permitted.  |
|   | During storage   | -40 °C to +85 °C  |
|   | During transportation  | -40 °C to +85 °C  |
| Relative humidity                       | During operation at 25 °C  | ≤ 95% without condensation  |
| <b>Housing, dimensions and weight</b>   |  |   |
| Design                                  | Compact  |   |
| Housing material                        | Basic housing  | Die cast aluminum, powder coated  |
|   | Front cover  | Polycarbonate (PC-GF10)   |
| Degree of protection                    | IP20   |   |
| Dimensions (W x H x D)                  | 100 x 147 x 125 mm   |   |
| Weight                                  | 955 g  |   |
| Installation options                    | <ul style="list-style-type: none"> <li>• Wall mounting</li> <li>• Installation on a DIN rail</li> <li>• Mounting on an S7-300 standard rail</li> <li>• Mounting on an S7-1500 standard rail</li> </ul> |   |
| <b>Mean time between failure (MTBF)</b> |  |   |
| MTBF (EN/IEC 61709; 40 °C)              | > 37 years   |   |

<sup>1)</sup> Note the wiring rules (Page 75).

<sup>2)</sup> Depending on which pluggable transceiver you use, the maximum ambient temperature can change, see section "Accessories", "SFP transceiver (Page 37)".

## 9.4 Technical specifications of SCALANCE XC206-2G PoE (54 V)

The following technical specifications apply to the SCALANCE XC206-2G PoE (54 V).

| <b>Technical specifications</b>          |                                 |   |
|--|---------------------------------|---|
| <b>Connection to Industrial Ethernet</b> |                                 |   |
| Electrical connectors                    | Quantity                        | 6   |
|  | Connector                       | RJ45 jack   |
|  | Properties                      | Half/full duplex, MDI-X pinning                             |
|  | Transmission speed              | 10 / 100 / 1000 Mbps  |
| Slots for pluggable transceivers         | Quantity                        | 2   |
|  | Connector                       | SFP transceivers (LC port)                                  |
|  | Transmission speed              | 1000 / 10000 Mbps<br>100 Mbps also possible via active SFPs |
| <b>Diagnostics interface</b>             |                                 |   |
| Serial interface                         | Quantity                        | 1   |
|  | Connector                       | RJ-11 jack  |
| <b>Electrical data</b>                   |                                 |   |
| Power supply <sup>1)</sup>               | Rated voltage                   | 54 V DC   |
|  | Voltage range (incl. tolerance) | 52 to 57 V DC Safe Extra Low Voltage (SELV)                 |
|  | Design                          | Terminal block, 4 terminals                                 |
|  | Properties                      | Implemented redundantly                                     |
| Current consumption                      | At 52 V DC                      | Max. 5 A  |
| Effective Power                          | At max PoE load                 | Max. 260 W  |
| Thermal Design Power                     |                                 | Max. 10 W   |
| Overvoltage category                     |                                 | CAT II  |
| Fusing                                   | Basic device                    | 2.5 A / 125 V   |
|  | PoE consumers                   | 15 A / 125 V  |
| PoE power per device                     | At 54 V                         | 240 W   |
| Signaling contact <sup>1)</sup>          | Quantity                        | 1   |
|  | Design                          | Terminal block, 2 terminals                                 |
|  | Permitted voltage range         | 54 V DC   |
|  | Load capability                 | max. 100 mA   |
| <b>Permitted ambient conditions</b>      |                                 |   |

| <b>Technical specifications</b>         |  |   |                            |
|---|--|---|----------------------------|
| Ambient temperature <sup>2)</sup>       | During LAN operation with RJ45 connector with max. PoE load up to 2000 m above sea level   | During operation in horizontal installation position:<br>-40 °C to +60 °C<br><br>During operation in a different installation position:<br>-40 °C to +50 °C |                            |
|   | When operating with pluggable transceivers of the types:<br>• [-] Standard version<br>• LD<br>Up to 2000 m above sea level   | During operation in horizontal installation position:<br>-40 °C to +60 °C<br><br>During operation in a different installation position:<br>-40 °C to +50 °C |                            |
|   | When operating with pluggable transceivers of the types:<br>• LH<br>• LH+<br>• ELH<br>• SFP992-1+<br>Up to 2000 m above sea level  | During operation in horizontal installation position:<br>-40 °C to +55 °C<br><br>During operation in a different installation position:<br>-40 °C to +50 °C |                            |
|   | During storage   | -40 °C to +85 °C  |                            |
|   | During transportation  | -40 °C to +85 °C  |                            |
|   | Relative humidity  | During operation at 25 °C   | ≤ 95% without condensation |
|   | <b>Housing, dimensions and weight</b>  |   |                            |
| Design                                  | compact  |   |                            |
| Housing material                        | Basic housing  | Die cast aluminum, powder coated  |                            |
|   | Front cover  | Polycarbonate (PC-GF10)   |                            |
| Degree of protection                    | IP20   |   |                            |
| Dimensions (W x H x D)                  | 60 x 147 x 125 mm  |   |                            |
| Weight                                  | 540 g  |   |                            |
| Installation options                    | <ul style="list-style-type: none"> <li>• Wall mounting</li> <li>• Installation on a DIN rail</li> <li>• Mounting on an S7-300 standard rail</li> <li>• Mounting on an S7-1500 standard rail</li> </ul> |   |                            |
| <b>Mean time between failure (MTBF)</b> |  |   |                            |
| MTBF (EN/IEC 61709; 40 °C)              | > 42.8 years   |   |                            |

<sup>1)</sup> Note the wiring rules (Page 75).

<sup>2)</sup> Depending on which pluggable transceiver you use, the maximum ambient temperature can change, see section "Accessories", "SFP transceiver (Page 37)".

## 9.5 Technical specifications of SCALANCE XC206-2G PoE EEC (54 V)

The following technical specifications apply to the SCALANCE XC206-2G PoE EEC (54 V).

| <b>Technical specifications</b>          |                                 |   |
|--|---------------------------------|---|
| <b>Connection to Industrial Ethernet</b> |                                 |   |
| Electrical connectors                    | Quantity                        | 6   |
|  | Connector                       | RJ45 jack   |
|  | Properties                      | Half/full duplex, MDI-X pinning                             |
|  | Transmission speed              | 10 / 100 / 1000 Mbps  |
| Slots for pluggable transceivers         | Quantity                        | 2   |
|  | Connector                       | SFP transceivers (LC port)                                  |
|  | Transmission speed              | 1000 / 10000 Mbps<br>100 Mbps also possible via active SFPs |
| <b>Diagnostics interface</b>             |                                 |   |
| Serial interface                         | Quantity                        | 1   |
|  | Connector                       | RJ-11 jack  |
| <b>Electrical data</b>                   |                                 |   |
| Power supply <sup>1)</sup>               | Rated voltage                   | 54 V DC   |
|  | Voltage range (incl. tolerance) | 52 to 57 V DC Safe Extra Low Voltage (SELV)                 |
|  | Design                          | Terminal block, 4 terminals                                 |
|  | Properties                      | Implemented redundantly                                     |
| Current consumption                      | At 52 V DC                      | Max. 5 A  |
| Effective Power                          | At max PoE load                 | Max. 260 W  |
| Thermal Design Power                     |                                 | Max. 10 W   |
| Overvoltage category                     |                                 | CAT II  |
| Fusing                                   | Basic device                    | 2.5 A / 125 V   |
|  | PoE consumers                   | 15 A / 125 V  |
| PoE power per device                     | At 54 V                         | 240 W   |
| Signaling contact <sup>1)</sup>          | Quantity                        | 1   |
|  | Design                          | Terminal block, 2 terminals                                 |
|  | Permitted voltage range         | 54 V DC   |
|  | Load capability                 | max. 100 mA   |
| <b>Permitted ambient conditions</b>      |                                 |   |

9.5 Technical specifications of SCALANCE XC206-2G PoE EEC (54 V)

| <b>Technical specifications</b>         |  |   |
|---|--|---|
| Ambient temperature <sup>2)</sup>       | During LAN operation with RJ45 connector with max. PoE load up to 2000 m above sea level   | During operation in horizontal installation position:<br>-40 °C to +60 °C<br><br>During operation in a different installation position:<br>-40 °C to +50 °C |
|   | When operating with pluggable transceivers of the types:<br>• [-] Standard version<br>• LD<br>Up to 2000 m above sea level   | During operation in horizontal installation position:<br>-40 °C to +60 °C<br><br>During operation in a different installation position:<br>-40 °C to +50 °C |
|   | When operating with pluggable transceivers of the types:<br>• LH<br>• LH+<br>• ELH<br>• SFP992-1+<br>Up to 2000 m above sea level  | During operation in horizontal installation position:<br>-40 °C to +55 °C<br><br>During operation in a different installation position:<br>-40 °C to +50 °C |
|   | With operation between 2000 m and 3000 m above sea level   | The maximum ambient temperature is reduced by 5 °C <sup>3)</sup>  |
|   | With operation between 3000 m and 4000 m above sea level   | The maximum ambient temperature is reduced by 10 °C <sup>3)</sup>   |
|   | During storage   | -40 °C to +85 °C  |
|   | During transportation  | -40 °C to +85 °C  |
| Relative humidity                       | During operation at 25 °C  | ≤ 95% without condensation  |
| <b>Housing, dimensions and weight</b>   |  |   |
| Design                                  | compact  |   |
| Housing material                        | Basic housing  | Die cast aluminum, powder coated  |
|   | Front cover  | Polycarbonate (PC-GF10)   |
| Properties                              | Coated printed circuit board (conformal coating)   |   |
| Degree of protection                    | IP20   |   |
| Dimensions (W x H x D)                  | 60 x 147 x 125 mm  |   |
| Weight                                  | 540 g  |   |
| Installation options                    | <ul style="list-style-type: none"> <li>• Wall mounting</li> <li>• Installation on a DIN rail</li> <li>• Mounting on an S7-300 standard rail</li> <li>• Mounting on an S7-1500 standard rail</li> </ul> |   |
| <b>Mean time between failure (MTBF)</b> |  |   |
| MTBF (EN/IEC 61709; 40 °C)              | > 42.8 years   |   |

<sup>1)</sup> **Wiring rules**

Observe the wiring rules (Page 75).

**2) Ambient temperature with SFP**

The maximum ambient temperature during operation depends on the operating elevation and the installed pluggable transceivers, see also the section "SFP transceiver (Page 37)" in the "Accessories" section.

**3) Derating**

The derating values depend on the maximum ambient temperatures during operation up to 2000 m.

## 9.6 Technical specifications SCALANCE XC206-2SFP

The following technical specifications apply to the SCALANCE XC206-2SFP.

| Technical specifications                 |                                 |   |        |
|--|---------------------------------|---|--------|
| <b>Connection to Industrial Ethernet</b> |                                 |   |        |
| Electrical connectors                    | Quantity                        | 6   |        |
|  | Connector                       | RJ-45 jack  |        |
|  | Properties                      | Half/full duplex, MDI-X pinning   |        |
|  | Transmission speed              | 10 / 100 Mbps   |        |
| Slots for pluggable transceivers         | Quantity                        | 2   |        |
|  | Connector                       | SFP transceivers (LC port)  |        |
|  | Transmission speed              | 100 / 1000 Mbps   |        |
| <b>Diagnostics interface</b>             |                                 |   |        |
| Serial interface                         | Quantity                        | 1   |        |
|  | Connector                       | RJ-11 jack  |        |
| <b>Electrical data</b>                   |                                 |   |        |
| Power supply <sup>1)</sup>               | Rated voltage                   | 12 to 24 V DC   |        |
|  | Voltage range (incl. tolerance) | 9.6 to 31.2 V DC Safe Extra Low Voltage (SELV)  |        |
|  | Design                          | Terminal block, 4 terminals   |        |
|  | Properties                      | Implemented redundantly;<br>The connected power supply must meet the requirements of NEC Class 2. |        |
| Current consumption                      | 12 VDC                          | Without SFP   | 400 mA |
|  |                                 | With SFP <sup>2)</sup>  | 500 mA |
|  | 24 VDC                          | Without SFP   | 200 mA |
|  |                                 | With SFP <sup>2)</sup>  | 250 mA |
| Effective power loss                     | Without SFP                     | 4.8 W   |        |
|  | With SFP <sup>2)</sup>          | 6 W   |        |
| Overvoltage category                     | CAT II                          |   |        |
| Fusing                                   | 2.5 A / 125 V                   |   |        |
| Signaling contact <sup>1)</sup>          | Quantity                        | 1   |        |
|  | Design                          | Terminal block, 2 terminals   |        |
|  | Permitted voltage range         | 24 VDC  |        |
|  | Load capability                 | max. 100 mA   |        |
| <b>Permitted ambient conditions</b>      |                                 |   |        |

| Technical specifications          |  |   |
|-----------------------------------|--|---|
| Ambient temperature <sup>3)</sup> | During LAN operation with RJ45 connector up to 2000 m above sea level  | During operation in horizontal installation position:<br>-40 °C to +70 °C<br>During operation in a different installation position:<br>-40 °C to +70 °C |
|                                   | When operating with pluggable transceivers of the types:<br>• [-] Standard version<br>• LD<br>Up to 2000 m above sea level   | During operation in horizontal installation position:<br>-40 °C to +70 °C<br>During operation in a different installation position:<br>-40 °C to +60 °C |
|                                   | When operating with pluggable transceivers of the types:<br>• LH<br>• LH+<br>• ELH<br>• ELH200<br>• SFP992-1+<br>Up to 2000 m above sea level  | During operation in horizontal installation position:<br>-40 °C to +65 °C<br>During operation in a different installation position:<br>-40 °C to +60 °C |
|                                   | During storage   | -40 °C to +85 °C  |
|                                   | During transportation  | -40 °C to +85 °C  |
|                                   | Relative humidity  | During operation at 25 °C   |
| Housing, dimensions and weight    |  |   |
| Design                            | compact  |   |
| Housing material                  | Basic housing  | Die cast aluminum, powder coated  |
|                                   | Front cover  | Polycarbonate (PC-GF10)   |
| Degree of protection              | IP20   |   |
| Dimensions (W x H x D)            | 60 x 147 x 125 mm  |   |
| Weight                            | 520 g  |   |
| Installation options              | <ul style="list-style-type: none"> <li>• Wall mounting</li> <li>• Installation on a DIN rail</li> <li>• Mounting on an S7-300 standard rail</li> <li>• Mounting on an S7-1500 standard rail</li> </ul> |   |
| Mean time between failure (MTBF)  |  |   |
| MTBF (EN/IEC 61709; 40 °C)        | > 47 years   |   |

<sup>1)</sup> Note the wiring rules (Page 75).

<sup>2)</sup> Detected with the SFP992-1ELH. You will find the precise values in the operating instructions of the pluggable transceivers, see the section "Introduction", Additional documentation (Page 7).

<sup>3)</sup> Depending on which pluggable transceiver you use, the maximum ambient temperature can change, see section "Accessories", "SFP transceiver (Page 37)".



## 9.7 Technical specifications of SCALANCE XC206-2SFP G

The following technical specifications apply to SCALANCE XC206-2SFP G.

| <b>Technical specifications</b>          |                                 |   |        |
|--|---------------------------------|---|--------|
| <b>Connection to Industrial Ethernet</b> |                                 |   |        |
| Electrical connectors                    | Quantity                        | 6   |        |
|  | Connector                       | RJ45 jack   |        |
|  | Properties                      | Half/full duplex, MDI-X pinning   |        |
|  | Transmission speed              | 10 / 100 / 1000 Mbps  |        |
| Slots for pluggable transceivers         | Quantity                        | 2   |        |
|  | Connector                       | SFP transceivers (LC port)  |        |
|  | Transmission speed              | 1000 Mbps   |        |
|  |                                 | 100 Mbps also possible via active SFPs  |        |
| <b>Diagnostics interface</b>             |                                 |   |        |
| Serial interface                         | Quantity                        | 1   |        |
|  | Connector                       | RJ-11 jack  |        |
| <b>Electrical data</b>                   |                                 |   |        |
| Power supply <sup>1)</sup>               | Rated voltage                   | 12 to 24 V DC   |        |
|  | Voltage range (incl. tolerance) | 9.6 to 31.2 V DC Safe Extra Low Voltage (SELV)  |        |
|  | Design                          | Terminal block, 4 terminals   |        |
|  | Properties                      | Implemented redundantly;<br>The connected power supply must meet the requirements of NEC Class 2. |        |
| Current consumption                      | 12 VDC                          | Without SFP   | 400 mA |
|  |                                 | With SFP <sup>2)</sup>  | 500 mA |
|  | 24 V DC                         | Without SFP   | 200 mA |
|  |                                 | With SFP <sup>2)</sup>  | 250 mA |
| Effective power loss                     | Without SFP                     | 4.8 W   |        |
|  | With SFP <sup>2)</sup>          | 6 W   |        |
| Overvoltage category                     | CAT II                          |   |        |
| Fusing                                   | 2.5 A / 125 V                   |   |        |
| Signaling contact <sup>1)</sup>          | Quantity                        | 1   |        |
|  | Design                          | Terminal block, 2 terminals   |        |
|  | Permitted voltage range         | 24 V DC   |        |
|  | Load capability                 | max. 100 mA   |        |
| <b>Permitted ambient conditions</b>      |                                 |   |        |

| Technical specifications          |  |   |
|-----------------------------------|--|---|
| Ambient temperature <sup>3)</sup> | During LAN operation with RJ45 connector up to 2000 m above sea level  | During operation in horizontal installation position:<br>-40 °C to +70 °C<br>During operation in a different installation position:<br>-40 °C to +70 °C |
|                                   | When operating with pluggable transceivers of the types:<br>• [-] Standard version<br>• LD<br>Up to 2000 m above sea level   | During operation in horizontal installation position:<br>-40 °C to +65 °C<br>During operation in a different installation position:<br>-40 °C to +60 °C |
|                                   | When operating with pluggable transceivers of the types:<br>• LH<br>• LH+<br>• ELH<br>• SFP992-1+<br>Up to 2000 m above sea level  | During operation in horizontal installation position:<br>-40 °C to +60 °C<br>During operation in a different installation position:<br>-40 °C to +60 °C |
|                                   | During storage   | -40 °C to +85 °C  |
|                                   | During transportation  | -40 °C to +85 °C  |
|                                   | Relative humidity  | During operation at 25 °C   |
| Housing, dimensions and weight    |  |   |
| Design                            | compact  |   |
| Housing material                  | Basic housing  | Die cast aluminum, powder coated  |
|                                   | Front cover  | Polycarbonate (PC-GF10)   |
| Degree of protection              | IP20   |   |
| Dimensions (W x H x D)            | 60 x 147 x 125 mm  |   |
| Weight                            | 520 g  |   |
| Installation options              | <ul style="list-style-type: none"> <li>• Wall mounting</li> <li>• Installation on a DIN rail</li> <li>• Mounting on an S7-300 standard rail</li> <li>• Mounting on an S7-1500 standard rail</li> </ul> |   |
| Mean time between failure (MTBF)  |  |   |
| MTBF (EN/IEC 61709; 40 °C)        | > 55 years   |   |

<sup>1)</sup> Note the wiring rules (Page 75).

<sup>2)</sup> Detected with the SFP992-1ELH. You will find the precise values in the operating instructions of the pluggable transceivers, see the section "Introduction", Additional documentation (Page 7).

<sup>3)</sup> Depending on which pluggable transceiver you use, the maximum ambient temperature can change, see section "Accessories", "SFP transceiver (Page 37)".

## 9.8 Technical specifications of SCALANCE XC206-2SFP EEC

The following technical specifications apply to SCALANCE XC206-2SFP EEC.

| <b>Technical specifications</b>          |                                 |                        |   |
|--|---------------------------------|------------------------|---|
| <b>Connection to Industrial Ethernet</b> |                                 |                        |   |
| Electrical connectors                    | Quantity                        |                        | 6   |
|  | Connector                       |                        | RJ-45 jack  |
|  | Properties                      |                        | Half/full duplex, MDI-X pinning   |
|  | Transmission speed              |                        | 10 / 100 Mbps   |
| Slots for pluggable transceivers         | Quantity                        |                        | 2   |
|  | Connector                       |                        | SFP transceivers (LC port)  |
|  | Transmission speed              |                        | 100 / 1000 Mbps   |
| <b>Diagnostics interface</b>             |                                 |                        |   |
| Serial interface                         | Quantity                        |                        | 1   |
|  | Connector                       |                        | RJ-11 jack  |
| <b>Electrical data</b>                   |                                 |                        |   |
| Power supply <sup>1)</sup>               | Rated voltage                   |                        | 12 to 24 V DC   |
|  | Voltage range (incl. tolerance) |                        | 9.6 to 31.2 V DC Safe Extra Low Voltage (SELV)  |
|  | Design                          |                        | Terminal block, 4 terminals   |
|  | Properties                      |                        | Implemented redundantly;<br>The connected power supply must meet the requirements of NEC Class 2. |
| Current consumption                      | 12 VDC                          | Without SFP            | 400 mA  |
|  |                                 | With SFP <sup>2)</sup> | 500 mA  |
|  | 24 VDC                          | Without SFP            | 200 mA  |
|  |                                 | With SFP <sup>2)</sup> | 250 mA  |
| Effective power loss                     | Without SFP                     |                        | 4.8 W   |
|  | With SFP <sup>2)</sup>          |                        | 6 W   |
| Overvoltage category                     |                                 |                        | CAT II  |
| Fusing                                   |                                 |                        | 2.5 A / 125 V   |
| Signaling contact <sup>1)</sup>          | Quantity                        |                        | 1   |
|  | Design                          |                        | Terminal block, 2 terminals   |
|  | Permitted voltage range         |                        | 24 VDC  |
|  | Load capability                 |                        | max. 100 mA   |
| <b>Permitted ambient conditions</b>      |                                 |                        |   |

| <b>Technical specifications</b>         |  |   |
|---|--|---|
| Ambient temperature <sup>3)</sup>       | During LAN operation with RJ45 connector up to 2000 m above sea level  | During operation in horizontal installation position:<br>-40 °C to +70 °C<br>During operation in a different installation position:<br>-40 °C to +70 °C |
|   | When operating with pluggable transceivers of the types:<br>• [-] Standard version<br>• LD<br>Up to 2000 m above sea level   | During operation in horizontal installation position:<br>-40 °C to +70 °C<br>During operation in a different installation position:<br>-40 °C to +60 °C |
|   | When operating with pluggable transceivers of the types:<br>• LH<br>• LH+<br>• ELH<br>• ELH200<br>• SFP992-1+<br>Up to 2000 m above sea level  | During operation in horizontal installation position:<br>-40 °C to +65 °C<br>During operation in a different installation position:<br>-40 °C to +60 °C |
|   | With operation between 2000 m and 3000 m above sea level   | The maximum ambient temperature is reduced by 5 °C <sup>4)</sup>  |
|   | With operation between 3000 m and 4000 m above sea level   | The maximum ambient temperature is reduced by 10 °C <sup>4)</sup>   |
|   | During storage   | -40 °C to +85 °C  |
|   | During transportation  | -40 °C to +85 °C  |
| Relative humidity                       | During operation at 25 °C  | ≤ 95% without condensation  |
| <b>Housing, dimensions and weight</b>   |  |   |
| Design                                  | compact  |   |
| Housing material                        | Basic housing  | Die cast aluminum, powder coated  |
|   | Front cover  | Polycarbonate (PC-GF10)   |
| Properties                              | Coated printed circuit board (conformal coating)   |   |
| Degree of protection                    | IP20   |   |
| Dimensions (W x H x D)                  | 60 x 147 x 125 mm  |   |
| Weight                                  | 520 g  |   |
| Installation options                    | <ul style="list-style-type: none"> <li>• Wall mounting</li> <li>• Installation on a DIN rail</li> <li>• Mounting on an S7-300 standard rail</li> <li>• Mounting on an S7-1500 standard rail</li> </ul> |   |
| <b>Mean time between failure (MTBF)</b> |  |   |
| MTBF (EN/IEC 61709; 40 °C)              | > 47 years   |   |

**1) Wiring rules**

Observe the wiring rules (Page 75).

**2) Pluggable transceiver**

Detected with the SFP992-1ELH. You will find the precise values in the operating instructions of the pluggable transceivers, see the section "Introduction", Additional documentation (Page 7).

**3) Ambient temperature with SFP**

The maximum ambient temperature during operation depends on the operating elevation and the installed pluggable transceivers, see also the section "SFP transceiver (Page 37)" in the "Accessories" section.

**4) Derating**

The derating values depend on the maximum ambient temperatures during operation up to 2000 m.

## 9.9 Technical specifications of SCALANCE XC206-2SFP G EEC

The following technical specifications apply to SCALANCE XC206-2SFP G EEC.

| <b>Technical specifications</b>          |                                 |   |        |
|--|---------------------------------|---|--------|
| <b>Connection to Industrial Ethernet</b> |                                 |   |        |
| Electrical connectors                    | Quantity                        | 6   |        |
|  | Connector                       | RJ45 jack   |        |
|  | Properties                      | Half/full duplex, MDI-X pinning   |        |
|  | Transmission speed              | 10 / 100 / 1000 Mbps  |        |
| Slots for pluggable transceivers         | Quantity                        | 2   |        |
|  | Connector                       | SFP transceivers (LC port)  |        |
|  | Transmission speed              | 1000 Mbps<br>100 Mbps also possible via active SFPs   |        |
| <b>Diagnostics interface</b>             |                                 |   |        |
| Serial interface                         | Quantity                        | 1   |        |
|  | Connector                       | RJ-11 jack  |        |
| <b>Electrical data</b>                   |                                 |   |        |
| Power supply <sup>1)</sup>               | Rated voltage                   | 12 to 24 V DC   |        |
|  | Voltage range (incl. tolerance) | 9.6 to 31.2 V DC Safe Extra Low Voltage (SELV)  |        |
|  | Design                          | Terminal block, 4 terminals   |        |
|  | Properties                      | Implemented redundantly;<br>The connected power supply must meet the requirements of NEC Class 2. |        |
| Current consumption                      | 12 VDC                          | Without SFP   | 400 mA |
|  |                                 | With SFP <sup>2)</sup>  | 500 mA |
|  | 24 V DC                         | Without SFP   | 200 mA |
|  |                                 | With SFP <sup>2)</sup>  | 250 mA |
| Effective power loss                     | Without SFP                     |   | 4.8 W  |
|  | With SFP <sup>2)</sup>          |   | 6 W    |
| Overvoltage category                     | CAT II                          |   |        |
| Fusing                                   | 2.5 A / 125 V                   |   |        |
| Signaling contact <sup>1)</sup>          | Quantity                        | 1   |        |
|  | Design                          | Terminal block, 2 terminals   |        |
|  | Permitted voltage range         | 24 V DC   |        |
|  | Load capability                 | max. 100 mA   |        |
| <b>Permitted ambient conditions</b>      |                                 |   |        |

| <b>Technical specifications</b>         |  |   |
|---|--|---|
| Ambient temperature <sup>3)</sup>       | During LAN operation with RJ45 connector up to 2000 m above sea level  | During operation in horizontal installation position:<br>-40 °C to +70 °C<br>During operation in a different installation position:<br>-40 °C to +70 °C |
|   | When operating with pluggable transceivers of the types:<br>• [-] Standard version<br>• LD<br>Up to 2000 m above sea level   | During operation in horizontal installation position:<br>-40 °C to +65 °C<br>During operation in a different installation position:<br>-40 °C to +60 °C |
|   | When operating with pluggable transceivers of the types:<br>• LH<br>• LH+<br>• ELH<br>• SFP992-1+<br>Up to 2000 m above sea level  | During operation in horizontal installation position:<br>-40 °C to +60 °C<br>During operation in a different installation position:<br>-40 °C to +60 °C |
|   | With operation between 2000 m and 3000 m above sea level   | The maximum ambient temperature is reduced by 5 °C <sup>4)</sup>  |
|   | With operation between 3000 m and 4000 m above sea level   | The maximum ambient temperature is reduced by 10 °C <sup>4)</sup>   |
|   | During storage   | -40 °C to +85 °C  |
|   | During transportation  | -40 °C to +85 °C  |
|   | Relative humidity  | During operation at 25 °C   |
| <b>Housing, dimensions and weight</b>   |  |   |
| Design                                  | compact  |   |
| Housing material                        | Basic housing  | Die cast aluminum, powder coated  |
|   | Front cover  | Polycarbonate (PC-GF10)   |
| Properties                              | Coated printed circuit board (conformal coating)   |   |
| Degree of protection                    | IP20   |   |
| Dimensions (W x H x D)                  | 60 x 147 x 125 mm  |   |
| Weight                                  | 520 g  |   |
| Installation options                    | <ul style="list-style-type: none"> <li>• Wall mounting</li> <li>• Installation on a DIN rail</li> <li>• Mounting on an S7-300 standard rail</li> <li>• Mounting on an S7-1500 standard rail</li> </ul> |   |
| <b>Mean time between failure (MTBF)</b> |  |   |
| MTBF (EN/IEC 61709; 40 °C)              | > 55 years   |   |

**<sup>1)</sup> Wiring rules**

Observe the wiring rules (Page 75).

**2) Pluggable transceiver**

Detected with the SFP992-1ELH. You will find the precise values in the operating instructions of the pluggable transceivers, see the section "Introduction", Additional documentation (Page 7).

**3) Ambient temperature with SFP**

The maximum ambient temperature during operation depends on the operating elevation and the installed pluggable transceivers, see also the section "SFP transceiver (Page 37)" in the "Accessories" section.

**4) Derating**

The derating values depend on the maximum ambient temperatures during operation up to 2000 m.



## 9.10 Technical specifications of the SCALANCE XC208

The following technical specifications apply to the SCALANCE XC208.

| Technical specifications                 |   |   |
|--|---|---|
| <b>Connection to Industrial Ethernet</b> |   |   |
| Electrical connectors                    | Quantity                                    | 8   |
|  | Connector                                   | RJ-45 jack  |
|  | Properties                                  | Half/full duplex, MDI-X pinning   |
|  | Transmission speed                          | 10 / 100 Mbps   |
| <b>Diagnostics interface</b>             |   |   |
| Serial interface                         | Quantity                                    | 1   |
|  | Connector                                   | RJ-11 jack  |
| <b>Electrical data</b>                   |   |   |
| Power supply <sup>1)</sup>               | Rated voltage                               | 12 to 24 V DC   |
|  | Voltage range (incl. tolerance)             | 9.6 to 31.2 V DC Safe Extra Low Voltage (SELV)  |
|  | Design                                      | Terminal block, 4 terminals   |
|  | Property                                    | Implemented redundantly;<br>The connected power supply must meet the requirements of NEC Class 2. |
| Current consumption                      | 12 VDC                                      | 350 mA  |
|  | 24 VDC                                      | 175 mA  |
| Effective power loss                     |   | 4.2 W   |
| Overvoltage category                     |   | CAT II  |
| Fusing                                   |   | 2.5 A / 125 V   |
| Signaling contact <sup>1)</sup>          | Quantity                                    | 1   |
|  | Design                                      | Terminal block, 2 terminals   |
|  | Permitted voltage range                     | 24 VDC  |
|  | Load capability                             | max. 100 mA   |
| <b>Permitted ambient conditions</b>      |   |   |
| Ambient temperature                      | With operation up to 2000 m above sea level | During operation in horizontal installation position:<br>-40 °C to +70 °C                         |
|  |   | During operation in a different installation position:<br>-40 °C to +70 °C                        |
|  | During storage                              | -40 °C to +85 °C  |
|  | During transportation                       | -40 °C to +85 °C  |
| Relative humidity                        | During operation at 25 °C                   | ≤ 95% without condensation  |
| <b>Housing, dimensions and weight</b>    |   |   |
| Design                                   | compact                                     |   |
| Housing material                         | Basic housing                               | Die cast aluminum, powder coated  |
|  | Front cover                                 | Polycarbonate (PC-GF10)   |
| Degree of protection                     | IP20  |   |

## Technical specifications

### 9.10 Technical specifications of the SCALANCE XC208

| <b>Technical specifications</b>         |   |
|---|---|
| Dimensions (W x H x D)                  | 60 x 147 x 125 mm   |
| Weight                                  | 520 g   |
| Installation options                    | <ul style="list-style-type: none"><li>• Wall mounting</li><li>• Installation on a DIN rail</li><li>• Mounting on an S7-300 standard rail</li><li>• Mounting on an S7-1500 standard rail</li></ul> |
| <b>Mean time between failure (MTBF)</b> |   |
| MTBF (EN/IEC 61709; 40 °C)              | > 48 years  |

<sup>1)</sup> Note the wiring rules (Page 75).

## 9.11 Technical specifications of SCALANCE XC208G

The following technical specifications apply to SCALANCE XC208G.

| <b>Technical specifications</b>          |   |   |
|--|---|---|
| <b>Connection to Industrial Ethernet</b> |   |   |
| Electrical connectors                    | Quantity                                    | 8   |
|  | Connector                                   | RJ-45 jack  |
|  | Properties                                  | Half/full duplex, MDI-X pinning   |
|  | Transmission speed                          | 10 / 100 / 1000 Mbps  |
| <b>Diagnostics interface</b>             |   |   |
| Serial interface                         | Quantity                                    | 1   |
|  | Connector                                   | RJ-11 jack  |
| <b>Electrical data</b>                   |   |   |
| Power supply <sup>1)</sup>               | Rated voltage                               | 12 to 24 V DC   |
|  | Voltage range (incl. tolerance)             | 9.6 to 31.2 V DC Safe Extra Low Voltage (SELV)  |
|  | Design                                      | Terminal block, 4 terminals   |
|  | Property                                    | Implemented redundantly;<br>The connected power supply must meet the requirements of NEC Class 2. |
| Current consumption                      | 12 VDC                                      | 400 mA  |
|  | 24 VDC                                      | 200 mA  |
| Effective power loss                     |   | 4.3 W   |
| Overvoltage category                     |   | CAT II  |
| Fusing                                   |   | 2.5 A / 125 V   |
| Signaling contact <sup>1)</sup>          | Quantity                                    | 1   |
|  | Design                                      | Terminal block, 2 terminals   |
|  | Permitted voltage range                     | 24 VDC  |
|  | Load capability                             | max. 100 mA   |
| <b>Permitted ambient conditions</b>      |   |   |
| Ambient temperature                      | With operation up to 2000 m above sea level | During operation in horizontal installation position:<br>-40 °C to +70 °C                         |
|  |   | During operation in a different installation position:<br>-40 °C to +70 °C                        |
|  | During storage                              | -40 °C to +85 °C  |
|  | During transportation                       | -40 °C to +85 °C  |
| Relative humidity                        | During operation at 25 °C                   | ≤ 95% without condensation  |
| <b>Housing, dimensions and weight</b>    |   |   |
| Design                                   | compact                                     |   |
| Housing material                         | Basic housing                               | Die cast aluminum, powder coated  |
|  | Front cover                                 | Polycarbonate (PC-GF10)   |
| Degree of protection                     | IP20  |   |

## Technical specifications

### 9.11 Technical specifications of SCALANCE XC208G

| Technical specifications         |   |
|----------------------------------|---|
| Dimensions (W x H x D)           | 60 x 147 x 125 mm   |
| Weight                           | 520 g   |
| Installation options             | <ul style="list-style-type: none"><li>• Wall mounting</li><li>• Installation on a DIN rail</li><li>• Mounting on an S7-300 standard rail</li><li>• Mounting on an S7-1500 standard rail</li></ul> |
| Mean time between failure (MTBF) |   |
| MTBF (EN/IEC 61709; 40 °C)       | > 54 years  |

<sup>1)</sup> Note the wiring rules (Page 75).

## 9.12 Technical specifications of SCALANCE XC208G PoE

The following technical specifications apply to SCALANCE XC208G PoE.

| <b>Technical specifications</b>          |  |  |
|--|--|--|
| <b>Connection to Industrial Ethernet</b> |  |  |
| Electrical connectors                    | Quantity   | 8  |
|  | Connector  | RJ45 jack  |
|  | Properties   | Half/full duplex, MDI-X pinning  |
|  | Transmission speed   | 10 / 100 / 1000 Mbps   |
| <b>Diagnostics interface</b>             |  |  |
| Serial interface                         | Quantity   | 1  |
|  | Connector  | RJ-11 jack   |
| <b>Electrical data</b>                   |  |  |
| Power supply <sup>1)</sup>               | Rated voltage  | 24 V DC  |
|  | Voltage range (incl. tolerance)                                | 19.2 to 31.2 V DC Safe Extra Low Voltage (SELV)                            |
|  | Design   | Terminal block, 4 terminals  |
|  | Property   | Implemented redundantly  |
| Current consumption                      | At 19.2 V DC   | Max. 7.5 A   |
| Effective Power                          | At max PoE load  | Max. 144 W   |
| Thermal Design Power                     |  | Max. 18 W  |
| Overvoltage category                     |  | CAT II   |
| Fusing                                   | Basic device   | 2.5 A / 125 V  |
|  | PoE consumers  | 15 A / 125 V   |
| PoE power per device                     | At 24 V DC   | In horizontal installation position:<br>120 W                              |
|  |  | In other installation position:<br>90 W                                    |
| Signaling contact <sup>1)</sup>          | Quantity   | 1  |
|  | Design   | Terminal block, 2 terminals  |
|  | Permitted voltage range  | 24 VDC   |
|  | Load capability  | Max. 100 mA  |
| <b>Permitted ambient conditions</b>      |  |  |
| Ambient temperature                      | With operation with max. PoE load up to 2000 m above sea level | During operation in horizontal installation position:<br>-40 °C to +60 °C  |
|  |  | During operation in a different installation position:<br>-40 °C to +50 °C |
|  | During storage   | -40 °C to +85 °C   |
|  | During transportation  | -40 °C to +85 °C   |
| Relative humidity                        | During operation at 25 °C                                      | ≤ 95% without condensation   |
| <b>Housing, dimensions and weight</b>    |  |  |
| Design                                   | Compact  |  |

## Technical specifications

### 9.12 Technical specifications of SCALANCE XC208G PoE

| Technical specifications         |   |                                  |
|----------------------------------|---|----------------------------------|
| Housing material                 | Basic housing   | Die cast aluminum, powder coated |
|                                  | Front cover   | Polycarbonate (PC-GF10)          |
| Degree of protection             | IP20  |                                  |
| Dimensions (W x H x D)           | 100 x 147 x 125 mm  |                                  |
| Weight                           | 955 g   |                                  |
| Installation options             | <ul style="list-style-type: none"><li>• Wall mounting</li><li>• Installation on a DIN rail</li><li>• Mounting on an S7-300 standard rail</li><li>• Mounting on an S7-1500 standard rail</li></ul> |                                  |
| Mean time between failure (MTBF) |   |                                  |
| MTBF (EN/IEC 61709; 40 °C)       | > 37.3 years  |                                  |

<sup>1)</sup> Note the wiring rules (Page 75).

## 9.13 Technical specifications of SCALANCE XC208G PoE (54 V)

The following technical specifications apply to SCALANCE XC208G PoE (54 V).

| Technical specifications                 |  |  |
|--|--|--|
| <b>Connection to Industrial Ethernet</b> |  |  |
| Electrical connectors                    | Quantity   | 8  |
|  | Connector  | RJ45 jack  |
|  | Properties   | Half/full duplex, MDI-X pinning  |
|  | Transmission speed   | 10 / 100 / 1000 Mbps   |
| <b>Diagnostics interface</b>             |  |  |
| Serial interface                         | Quantity   | 1  |
|  | Connector  | RJ-11 jack   |
| <b>Electrical data</b>                   |  |  |
| Power supply <sup>1)</sup>               | Rated voltage  | 54 V DC  |
|  | Voltage range (incl. tolerance)                                | 52 to 57 V DC Safe Extra Low Voltage (SELV)                                |
|  | Design   | Terminal block, 4 terminals  |
|  | Property   | Implemented redundantly  |
| Current consumption                      | At 52 V DC   | Max. 5 A   |
| Effective Power                          | At max PoE load  | Max. 260 W   |
| Thermal Design Power                     |  | Max. 10 W  |
| Overvoltage category                     |  | CAT II   |
| Fusing                                   | Basic device   | 2.5 A / 125 V  |
|  | PoE consumers  | 15 A / 125 V   |
| PoE power per device                     | At 54 V  | 240 W  |
| Signaling contact <sup>1)</sup>          | Quantity   | 1  |
|  | Design   | Terminal block, 2 terminals  |
|  | Permitted voltage range  | 54 V DC  |
|  | Load capability  | max. 100 mA  |
| <b>Permitted ambient conditions</b>      |  |  |
| Ambient temperature                      | With operation with max. PoE load up to 2000 m above sea level | During operation in horizontal installation position:<br>-40 °C to +60 °C  |
|  |  | During operation in a different installation position:<br>-40 °C to +50 °C |
|  | During storage   | -40 °C to +85 °C   |
|  | During transportation  | -40 °C to +85 °C   |
| Relative humidity                        | During operation at 25 °C                                      | ≤ 95% without condensation   |
| <b>Housing, dimensions and weight</b>    |  |  |
| Design                                   | compact  |  |
| Housing material                         | Basic housing  | Die cast aluminum, powder coated   |
|  | Front cover  | Polycarbonate (PC-GF10)  |
| Degree of protection                     | IP20   |  |

## Technical specifications

### 9.13 Technical specifications of SCALANCE XC208G PoE (54 V)

| Technical specifications         |   |
|----------------------------------|---|
| Dimensions (W x H x D)           | 60 x 147 x 125 mm   |
| Weight                           | 540 g   |
| Installation options             | <ul style="list-style-type: none"><li>• Wall mounting</li><li>• Installation on a DIN rail</li><li>• Mounting on an S7-300 standard rail</li><li>• Mounting on an S7-1500 standard rail</li></ul> |
| Mean time between failure (MTBF) |   |
| MTBF (EN/IEC 61709; 40 °C)       | > 42.6 years  |

<sup>1)</sup> Note the wiring rules (Page 75).



## 9.14 Technical specifications of SCALANCE XC208EEC

The following technical specifications apply to SCALANCE XC208EEC.

| Technical specifications                 |  |   |
|--|--|---|
| <b>Connection to Industrial Ethernet</b> |  |   |
| Electrical connectors                    | Quantity   | 8   |
|  | Connector  | RJ-45 jack  |
|  | Properties   | Half/full duplex, MDI-X pinning   |
|  | Transmission speed                                       | 10 / 100 Mbps   |
| <b>Diagnostics interface</b>             |  |   |
| Serial interface                         | Quantity   | 1   |
|  | Connector  | RJ-11 jack  |
| <b>Electrical data</b>                   |  |   |
| Power supply <sup>1)</sup>               | Rated voltage  | 12 to 24 V DC   |
|  | Voltage range (incl. tolerance)                          | 9.6 to 31.2 V DC Safe Extra Low Voltage (SELV)  |
|  | Design   | Terminal block, 4 terminals   |
|  | Property   | Implemented redundantly;<br>The connected power supply must meet the requirements of NEC Class 2. |
| Current consumption                      | 12 VDC   | 350 mA  |
|  | 24 VDC   | 175 mA  |
| Effective power loss                     |  | 4.2 W   |
| Overvoltage category                     |  | CAT II  |
| Fusing                                   |  | 2.5 A / 125 V   |
| Signaling contact <sup>1)</sup>          | Quantity   | 1   |
|  | Design   | Terminal block, 2 terminals   |
|  | Permitted voltage range                                  | 24 VDC  |
|  | Load capability  | max. 100 mA   |
| <b>Permitted ambient conditions</b>      |  |   |
| Ambient temperature                      | With operation up to 2000 m above sea level              | During operation in horizontal installation position:<br>-40 °C to +70 °C                         |
|  |  | During operation in a different installation position:<br>-40 °C to +70 °C                        |
|  |  | With operation between 2000 m and 3000 m above sea level  |
|  | With operation between 3000 m and 4000 m above sea level | The maximum ambient temperature is reduced by 10 °C <sup>2)</sup>                                 |
|  | During storage   | -40 °C to +85 °C  |
|  | During transportation                                    | -40 °C to +85 °C  |
| Relative humidity                        | During operation at 25 °C                                | ≤ 95% without condensation  |
| <b>Housing, dimensions and weight</b>    |  |   |
| Design                                   | compact  |   |

## Technical specifications

### 9.14 Technical specifications of SCALANCE XC208EEC

| Technical specifications         |   |                                  |
|----------------------------------|---|----------------------------------|
| Housing material                 | Basic housing   | Die cast aluminum, powder coated |
|                                  | Front cover   | Polycarbonate (PC-GF10)          |
| Properties                       | Coated printed circuit board (conformal coating)  |                                  |
| Degree of protection             | IP20  |                                  |
| Dimensions (W x H x D)           | 60 x 147 x 125 mm   |                                  |
| Weight                           | 520 g   |                                  |
| Installation options             | <ul style="list-style-type: none"><li>• Wall mounting</li><li>• Installation on a DIN rail</li><li>• Mounting on an S7-300 standard rail</li><li>• Mounting on an S7-1500 standard rail</li></ul> |                                  |
| Mean time between failure (MTBF) |   |                                  |
| MTBF (EN/IEC 61709; 40 °C)       | > 48 years  |                                  |

<sup>1)</sup> Note the wiring rules (Page 75).

<sup>2)</sup> The derating values depend on the maximum ambient temperatures during operation up to 2000 m.

## 9.15 Technical specifications of SCALANCE XC208G EEC

The following technical specifications apply to SCALANCE XC208G EEC.

| <b>Technical specifications</b>          |  |   |
|--|--|---|
| <b>Connection to Industrial Ethernet</b> |  |   |
| Electrical connectors                    | Quantity   | 8   |
|  | Connector  | RJ-45 jack  |
|  | Properties   | Half/full duplex, MDI-X pinning   |
|  | Transmission speed                                       | 10 / 100 / 1000 Mbps  |
| <b>Diagnostics interface</b>             |  |   |
| Serial interface                         | Quantity   | 1   |
|  | Connector  | RJ-11 jack  |
| <b>Electrical data</b>                   |  |   |
| Power supply <sup>1)</sup>               | Rated voltage  | 12 to 24 V DC   |
|  | Voltage range (incl. tolerance)                          | 9.6 to 31.2 V DC Safe Extra Low Voltage (SELV)  |
|  | Design   | Terminal block, 4 terminals   |
|  | Property   | Implemented redundantly;<br>The connected power supply must meet the requirements of NEC Class 2. |
| Current consumption                      | 12 VDC   | 400 mA  |
|  | 24 VDC   | 200 mA  |
| Effective power loss                     |  | 4.3 W   |
| Overvoltage category                     |  | CAT II  |
| Fusing                                   |  | 2.5 A / 125 V   |
| Signaling contact <sup>1)</sup>          | Quantity   | 1   |
|  | Design   | Terminal block, 2 terminals   |
|  | Permitted voltage range                                  | 24 VDC  |
|  | Load capability  | max. 100 mA   |
| <b>Permitted ambient conditions</b>      |  |   |
| Ambient temperature                      | With operation up to 2000 m above sea level              | During operation in horizontal installation position:<br>-40 °C to +70 °C                         |
|  |  | During operation in a different installation position:<br>-40 °C to +70 °C                        |
|  |  | With operation between 2000 m and 3000 m above sea level  |
|  | With operation between 3000 m and 4000 m above sea level | The maximum ambient temperature is reduced by 10 °C <sup>2)</sup>                                 |
|  | During storage   | -40 °C to +85 °C  |
|  | During transportation                                    | -40 °C to +85 °C  |
| Relative humidity                        | During operation at 25 °C                                | ≤ 95% without condensation  |
| <b>Housing, dimensions and weight</b>    |  |   |
| Design                                   | compact  |   |

9.15 Technical specifications of SCALANCE XC208G EEC

| Technical specifications         |   |                                  |
|----------------------------------|---|----------------------------------|
| Housing material                 | Basic housing   | Die cast aluminum, powder coated |
|                                  | Front cover   | Polycarbonate (PC-GF10)          |
| Properties                       | Coated printed circuit board (conformal coating)  |                                  |
| Degree of protection             | IP20  |                                  |
| Dimensions (W x H x D)           | 60 x 147 x 125 mm   |                                  |
| Weight                           | 520 g   |                                  |
| Installation options             | <ul style="list-style-type: none"><li>• Wall mounting</li><li>• Installation on a DIN rail</li><li>• Mounting on an S7-300 standard rail</li><li>• Mounting on an S7-1500 standard rail</li></ul> |                                  |
| Mean time between failure (MTBF) |   |                                  |
| MTBF (EN/IEC 61709; 40 °C)       | > 54 years  |                                  |

<sup>1)</sup> Note the wiring rules (Page 75).

<sup>2)</sup> The derating values depend on the maximum ambient temperatures during operation up to 2000 m.

## 9.16 Technical specifications of the SCALANCE XC216

The following technical specifications apply to the SCALANCE XC216.

| <b>Technical specifications</b>          |   |   |
|--|---|---|
| <b>Connection to Industrial Ethernet</b> |   |   |
| Electrical connectors                    | Quantity                                    | 16  |
|  | Connector                                   | RJ-45 jack  |
|  | Properties                                  | Half/full duplex, MDI-X pinning   |
|  | Transmission speed                          | 10 / 100 Mbps   |
| <b>Diagnostics interface</b>             |   |   |
| Serial interface                         | Quantity                                    | 1   |
|  | Connector                                   | RJ-11 jack  |
| <b>Electrical data</b>                   |   |   |
| Power supply <sup>1)</sup>               | Rated voltage                               | 12 to 24 V DC   |
|  | Voltage range (incl. tolerance)             | 9.6 to 31.2 V DC Safe Extra Low Voltage (SELV)  |
|  | Design                                      | Terminal block, 4 terminals   |
|  | Properties                                  | Implemented redundantly;<br>The connected power supply must meet the requirements of NEC Class 2. |
| Current consumption                      | 12 VDC                                      | 550 mA  |
|  | 24 VDC                                      | 275 mA  |
| Effective power loss                     |   | 6.6 W   |
| Overvoltage category                     |   | CAT II  |
| Fusing                                   |   | 2.5 A / 125 V   |
| Signaling contact <sup>1)</sup>          | Quantity                                    | 1   |
|  | Design                                      | Terminal block, 2 terminals   |
|  | Permitted voltage range                     | 24 VDC  |
|  | Load capability                             | max. 100 mA   |
| <b>Permitted ambient conditions</b>      |   |   |
| Ambient temperature                      | With operation up to 2000 m above sea level | During operation in horizontal installation position:<br>-40 °C to +70 °C                         |
|  |   | During operation in a different installation position:<br>-40 °C to +70 °C                        |
|  | During storage                              | -40 °C to +85 °C  |
|  | During transportation                       | -40 °C to +85 °C  |
| Relative humidity                        | During operation at 25 °C                   | ≤ 95% without condensation  |
| <b>Housing, dimensions and weight</b>    |   |   |
| Design                                   | compact                                     |   |
| Housing material                         | Basic housing                               | Die cast aluminum, powder coated  |
|  | Front cover                                 | Polycarbonate (PC-GF10)   |
| Degree of protection                     | IP20  |   |

## Technical specifications

### 9.16 Technical specifications of the SCALANCE XC216

| <b>Technical specifications</b>         |   |
|---|---|
| Dimensions (W x H x D)                  | 120 x 147 x 125 mm  |
| Weight                                  | 800 g   |
| Installation options                    | <ul style="list-style-type: none"><li>• Wall mounting</li><li>• Installation on a DIN rail</li><li>• Mounting on an S7-300 standard rail</li><li>• Mounting on an S7-1500 standard rail</li></ul> |
| <b>Mean time between failure (MTBF)</b> |   |
| MTBF (EN/IEC 61709; 40 °C)              | > 48 years  |

<sup>1)</sup> Note the wiring rules (Page 75).

## 9.17 Technical specifications of SCALANCE XC216EEC

The following technical specifications apply to SCALANCE XC216EEC.

| <b>Technical specifications</b>          |  |   |
|--|--|---|
| <b>Connection to Industrial Ethernet</b> |  |   |
| Electrical connectors                    | Quantity   | 16  |
|  | Connector  | RJ-45 jack  |
|  | Properties   | Half/full duplex, MDI-X pinning   |
|  | Transmission speed                                       | 10 / 100 Mbps   |
| <b>Diagnostics interface</b>             |  |   |
| Serial interface                         | Quantity   | 1   |
|  | Connector  | RJ-11 jack  |
| <b>Electrical data</b>                   |  |   |
| Power supply <sup>1)</sup>               | Rated voltage  | 12 to 24 V DC   |
|  | Voltage range (incl. tolerance)                          | 9.6 to 31.2 V DC Safe Extra Low Voltage (SELV)  |
|  | Design   | Terminal block, 4 terminals   |
|  | Properties   | Implemented redundantly;<br>The connected power supply must meet the requirements of NEC Class 2. |
| Current consumption                      | 12 VDC   | 550 mA  |
|  | 24 VDC   | 275 mA  |
| Effective power loss                     |  | 6.6 W   |
| Overvoltage category                     |  | CAT II  |
| Fusing                                   |  | 2.5 A / 125 V   |
| Signaling contact <sup>1)</sup>          | Quantity   | 1   |
|  | Design   | Terminal block, 2 terminals   |
|  | Permitted voltage range                                  | 24 VDC  |
|  | Load capability  | max. 100 mA   |
| <b>Permitted ambient conditions</b>      |  |   |
| Ambient temperature                      | With operation up to 2000 m above sea level              | During operation in horizontal installation position:<br>-40 °C to +70 °C                         |
|  |  | During operation in a different installation position:<br>-40 °C to +70 °C                        |
|  |  | With operation between 2000 m and 3000 m above sea level  |
|  | With operation between 3000 m and 4000 m above sea level | The maximum ambient temperature is reduced by 10 °C <sup>2)</sup>                                 |
|  | During storage   | -40 °C to +85 °C  |
|  | During transportation                                    | -40 °C to +85 °C  |
| Relative humidity                        | During operation at 25 °C                                | ≤ 95% without condensation  |
| <b>Housing, dimensions and weight</b>    |  |   |
| Design                                   | compact  |   |

9.18 Technical specifications of SCALANCE XC216-3G PoE

| Technical specifications         |  |                                  |
|----------------------------------|--|----------------------------------|
| Housing material                 | Basic housing  | Die cast aluminum, powder coated |
|                                  | Front cover  | Polycarbonate (PC-GF10)          |
| Properties                       | Coated printed circuit board (conformal coating)   |                                  |
| Degree of protection             | IP20   |                                  |
| Dimensions (W x H x D)           | 120 x 147 x 125 mm   |                                  |
| Weight                           | 800 g  |                                  |
| Installation options             | <ul style="list-style-type: none"> <li>• Wall mounting</li> <li>• Installation on a DIN rail</li> <li>• Mounting on an S7-300 standard rail</li> <li>• Mounting on an S7-1500 standard rail</li> </ul> |                                  |
| Mean time between failure (MTBF) |  |                                  |
| MTBF (EN/IEC 61709; 40 °C)       | > 48 years   |                                  |

<sup>1)</sup> Note the wiring rules (Page 75).

<sup>2)</sup> The derating values depend on the maximum ambient temperatures during operation up to 2000 m.

## 9.18 Technical specifications of SCALANCE XC216-3G PoE

The following technical specifications apply to SCALANCE XC216-3G PoE.

| Technical specifications          |                                 |   |   |  |
|-----------------------------------|---------------------------------|---|---|--|
| Connection to Industrial Ethernet |                                 |   |   |  |
| Electrical connectors             | Quantity                        | 16  |   |  |
|                                   | Connector                       | RJ45 jack                                       |   |  |
|                                   | Properties                      | Half/full duplex, MDI-X pinning                 |   |  |
|                                   | Transmission speed              | 10 / 100 / 1000 Mbps                            |   |  |
| Slots for pluggable transceivers  | Quantity                        | 3   |   |  |
|                                   | Connector                       | SFP transceivers (LC port)                      |   |  |
|                                   | Transmission speed              | Port P1   | 1000 Mbps<br>100 Mbps also possible via active SFPs         |  |
|                                   |                                 | Port P2 and P2                                  | 1000 / 10000 Mbps<br>100 Mbps also possible via active SFPs |  |
| Diagnostics interface             |                                 |   |   |  |
| Serial interface                  | Quantity                        | 1   |   |  |
|                                   | Connector                       | RJ-11 jack                                      |   |  |
| Electrical data                   |                                 |   |   |  |
| Power supply <sup>1)</sup>        | Rated voltage                   | 24 V DC   |   |  |
|                                   | Voltage range (incl. tolerance) | 19.2 to 31.2 V DC Safe Extra Low Voltage (SELV) |   |  |
|                                   | Design                          | Terminal block, 4 terminals                     |   |  |
|                                   | Properties                      | Implemented redundantly                         |   |  |
| Current consumption               | At 19.2 V DC                    | Max. 7.8 A                                      |   |  |



| <b>Technical specifications</b>     |   |  |                            |
|-------------------------------------|---|--|----------------------------|
| Effective Power                     | At max PoE load   | Max. 150 W   |                            |
| Thermal Design Power                |   | Max. 28 W  |                            |
| Overvoltage category                |   | CAT II   |                            |
| Fusing                              | Basic device  | 2.5 A / 125 V  |                            |
|                                     | PoE consumers   | 15 A / 125 V   |                            |
| PoE power per device                | At 24 V DC  | With horizontal mounting position and operation without pluggable transceiver: <ul style="list-style-type: none"> <li>• 120 W</li> </ul> In other installation position: <ul style="list-style-type: none"> <li>• 90 W</li> </ul>  |                            |
| Signaling contact <sup>1)</sup>     | Quantity  | 1  |                            |
|                                     | Design  | Terminal block, 2 terminals  |                            |
|                                     | Permitted voltage range   | 24 V DC  |                            |
|                                     | Load capability   | Max. 100 mA  |                            |
| <b>Permitted ambient conditions</b> |   |  |                            |
| Ambient temperature <sup>2)</sup>   | During LAN operation with RJ45 connector with max. PoE load up to 2000 m above sea level  | During operation in horizontal installation position: <ul style="list-style-type: none"> <li>• -40 °C to +60 °C</li> </ul> During operation in a different installation position: <ul style="list-style-type: none"> <li>• -40 °C to +50 °C</li> </ul>   |                            |
|                                     | When operating with pluggable transceivers of the types: <ul style="list-style-type: none"> <li>• [-] Standard version</li> <li>• LD</li> </ul> Up to 2000 m above sea level                    | During operation in horizontal installation position: <ul style="list-style-type: none"> <li>• -40 °C to +60 °C</li> <li>• Max. PoE power: 90 W</li> </ul> During operation in a different installation position: <ul style="list-style-type: none"> <li>• -40 °C to +50 °C</li> <li>• Max. PoE power: 60 W</li> </ul> |                            |
|                                     | When operating with pluggable transceivers of the types: <ul style="list-style-type: none"> <li>• LH</li> <li>• LH+</li> <li>• ELH</li> <li>• SFP992-1+</li> </ul> Up to 2000 m above sea level | During operation in horizontal installation position: <ul style="list-style-type: none"> <li>• -40 °C to +55 °C</li> <li>• Max. PoE power: 90 W</li> </ul> Other mounting positions are not permitted.   |                            |
|                                     | During storage  | -40 °C to +85 °C   |                            |
|                                     | During transportation   | -40 °C to +85 °C   |                            |
|                                     | Relative humidity   | During operation at 25 °C  | ≤ 95% without condensation |
|                                     | <b>Housing, dimensions and weight</b>   |  |                            |
| Design                              | Compact   |  |                            |
| Housing material                    | Basic housing   | Die cast aluminum, powder coated   |                            |
|                                     | Front cover   | Polycarbonate (PC-GF10)  |                            |

9.19 Technical specifications of SCALANCE XC216-3G PoE (54 V)

| Technical specifications         |  |
|----------------------------------|--|
| Degree of protection             | IP20   |
| Dimensions (W x H x D)           | 180 x 147 x 125 mm   |
| Weight                           | 1560 g   |
| Installation options             | <ul style="list-style-type: none"> <li>• Wall mounting</li> <li>• Installation on a DIN rail</li> <li>• Mounting on an S7-300 standard rail</li> <li>• Mounting on an S7-1500 standard rail</li> </ul> |
| Mean time between failure (MTBF) |  |
| MTBF (EN/IEC 61709; 40 °C)       | > 24.6 years   |

<sup>1)</sup> Note the wiring rules (Page 75).

<sup>2)</sup> Depending on which pluggable transceiver you use, the maximum ambient temperature can change, see section "Accessories", "SFP transceiver (Page 37)".

## 9.19 Technical specifications of SCALANCE XC216-3G PoE (54 V)

The following technical specifications apply to SCALANCE XC216-3G PoE (54 V).

| Technical specifications          |                                 |   |   |  |
|-----------------------------------|---------------------------------|---|---|--|
| Connection to Industrial Ethernet |                                 |   |   |  |
| Electrical connectors             | Quantity                        | 16  |   |  |
|                                   | Connector                       | RJ45 jack                                   |   |  |
|                                   | Properties                      | Half/full duplex, MDI-X pinning             |   |  |
|                                   | Transmission speed              | 10 / 100 / 1000 Mbps                        |   |  |
| Slots for pluggable transceivers  | Quantity                        | 3   |   |  |
|                                   | Connector                       | SFP transceivers (LC port)                  |   |  |
|                                   | Transmission speed              | Port P1                                     | 1000 Mbps<br>100 Mbps also possible via active SFPs         |  |
|                                   |                                 | Port P2 and P2                              | 1000 / 10000 Mbps<br>100 Mbps also possible via active SFPs |  |
| Diagnostics interface             |                                 |   |   |  |
| Serial interface                  | Quantity                        | 1   |   |  |
|                                   | Connector                       | RJ-11 jack                                  |   |  |
| Electrical data                   |                                 |   |   |  |
| Power supply <sup>1)</sup>        | Rated voltage                   | 54 V DC                                     |   |  |
|                                   | Voltage range (incl. tolerance) | 52 to 57 V DC Safe Extra Low Voltage (SELV) |   |  |
|                                   | Design                          | Terminal block, 4 terminals                 |   |  |
|                                   | Properties                      | Implemented redundantly                     |   |  |
| Current consumption               | At 52 V DC                      | Max. 6.5 A                                  |   |  |
| Effective Power                   | At max PoE load                 | Max. 338 W                                  |   |  |
| Thermal Design Power              |                                 | Max. 28 W                                   |   |  |
| Overvoltage category              |                                 | CAT II                                      |   |  |

## 9.19 Technical specifications of SCALANCE XC216-3G PoE (54 V)

| Technical specifications          |  |   |                            |
|-----------------------------------|--|---|----------------------------|
| Fusing                            | Basic device   | 2.5 A / 125 V   |                            |
|                                   | PoE consumers  | 15 A / 125 V  |                            |
| PoE power per device              | At 54 V  | 300 W   |                            |
| Signaling contact <sup>1)</sup>   | Quantity   | 1   |                            |
|                                   | Design   | Terminal block, 2 terminals   |                            |
|                                   | Permitted voltage range  | 54 V DC   |                            |
|                                   | Load capability  | max. 100 mA   |                            |
| Permitted ambient conditions      |  |   |                            |
| Ambient temperature <sup>2)</sup> | During LAN operation with RJ45 connector with max. PoE load up to 2000 m above sea level   | During operation in horizontal installation position:<br>-40 °C to +60 °C<br>During operation in a different installation position:<br>-40 °C to +50 °C |                            |
|                                   | When operating with pluggable transceivers of the types:<br>• [-] Standard version<br>• LD<br>Up to 2000 m above sea level   | During operation in horizontal installation position:<br>-40 °C to +60 °C<br>During operation in a different installation position:<br>-40 °C to +50 °C |                            |
|                                   | When operating with pluggable transceivers of the types:<br>• LH<br>• LH+<br>• ELH<br>• SFP992-1+<br>Up to 2000 m above sea level  | During operation in horizontal installation position:<br>-40 °C to +55 °C<br>During operation in a different installation position:<br>-40 °C to +50 °C |                            |
|                                   | During storage   | -40 °C to +85 °C  |                            |
|                                   | During transportation  | -40 °C to +85 °C  |                            |
|                                   | Relative humidity  | During operation at 25 °C   | ≤ 95% without condensation |
|                                   | Housing, dimensions and weight   |   |                            |
| Design                            | compact  |   |                            |
| Housing material                  | Basic housing  | Die cast aluminum, powder coated  |                            |
|                                   | Front cover  | Polycarbonate (PC-GF10)   |                            |
| Degree of protection              | IP20   |   |                            |
| Dimensions (W x H x D)            | 140 x 147 x 125 mm   |   |                            |
| Weight                            | 1140 g   |   |                            |
| Installation options              | <ul style="list-style-type: none"> <li>• Wall mounting</li> <li>• Installation on a DIN rail</li> <li>• Mounting on an S7-300 standard rail</li> <li>• Mounting on an S7-1500 standard rail</li> </ul> |   |                            |
| Mean time between failure (MTBF)  |  |   |                            |
| MTBF (EN/IEC 61709; 40 °C)        | > 23 years   |   |                            |

*9.19 Technical specifications of SCALANCE XC216-3G PoE (54 V)*

- 1) Note the wiring rules (Page 75).
- 2) Depending on which pluggable transceiver you use, the maximum ambient temperature can change, see section "Accessories", "SFP transceiver (Page 37)".

## 9.20 Technical specifications of SCALANCE XC216-4C

The following technical specifications apply to SCALANCE XC216-4C.

| Technical specifications                 |                                 |                        |   |
|--|---------------------------------|------------------------|---|
| <b>Connection to Industrial Ethernet</b> |                                 |                        |   |
| Electrical connectors                    | Quantity                        |                        | 12  |
|  | Connector                       |                        | RJ45 jack   |
|  | Properties                      |                        | Half/full duplex, MDI-X pinning   |
|  | Transmission speed              |                        | 10 / 100 Mbps   |
| Combo ports                              | Quantity                        |                        | 4   |
|  | Electrical connectors           | Quantity               | 4   |
|  |                                 | Connector              | RJ45 jack   |
|  |                                 | Properties             | Half/full duplex, MDI-X pinning   |
| Transmission speed                       |                                 | 10 / 100 / 1000 Mbps   |   |
| Slots for pluggable transceivers         | Quantity                        |                        | 4   |
|  | Connector                       |                        | SFP transceivers (LC port)  |
|  | Transmission speed              |                        | 1000 Mbps<br>100 Mbps also possible via active SFPs   |
|  | <b>Diagnostics interface</b>    |                        |   |
| Serial interface                         | Quantity                        |                        | 1   |
|  | Connector                       |                        | RJ-11 jack  |
| <b>Electrical data</b>                   |                                 |                        |   |
| Power supply <sup>1)</sup>               | Rated voltage                   |                        | 24 V DC   |
|  | Voltage range (incl. tolerance) |                        | 19.2 to 31.2 V DC Safe Extra Low Voltage (SELV)   |
|  | Design                          |                        | Terminal block, 4 terminals   |
|  | Properties                      |                        | Implemented redundantly;<br>The connected power supply must meet the requirements of NEC Class 2. |
| Current consumption                      | 24 V DC                         | Without SFP            | 450 mA  |
|  |                                 | With SFP <sup>2)</sup> | 550 mA  |
| Effective power loss                     |                                 | Without SFP            | 10.8 W  |
|  |                                 | With SFP <sup>2)</sup> | 13.2 W  |
| Overvoltage category                     |                                 |                        | CAT II  |
| Fusing                                   |                                 |                        | 3.15 A / 125 V  |
| Signaling contact <sup>1)</sup>          | Quantity                        |                        | 1   |
|  | Design                          |                        | Terminal block, 2 terminals   |
|  | Permitted voltage range         |                        | 24 V DC   |
|  | Load capability                 |                        | max. 100 mA   |
| <b>Permitted ambient conditions</b>      |                                 |                        |   |

| <b>Technical specifications</b>         |   |   |
|---|---|---|
| Ambient temperature <sup>3)</sup>       | During LAN operation with RJ45 connector up to 2000 m above sea level   | During operation in horizontal installation position:<br>-40 °C to +70 °C<br>During operation in a different installation position:<br>-40 °C to +70 °C |
|   | When operating with pluggable transceivers of the types:<br>• [-] Standard version<br>• LD<br>Up to 2000 m above sea level  | During operation in horizontal installation position:<br>-40 °C to +65 °C<br>During operation in a different installation position:<br>-40 °C to +60 °C |
|   | When operating with pluggable transceivers of the types:<br>• LH<br>• LH+<br>• ELH<br>• SFP992-1+<br>Up to 2000 m above sea level   | During operation in horizontal installation position:<br>-40 °C to +60 °C<br>During operation in a different installation position:<br>-40 °C to +60 °C |
|   | During storage  | -40 °C to +85 °C  |
|   | During transportation   | -40 °C to +85 °C  |
|   | Relative humidity   | During operation at 25 °C   |
| <b>Housing, dimensions and weight</b>   |   |   |
| Design                                  | compact   |   |
| Housing material                        | Basic housing   | Die cast aluminum, powder coated  |
|   | Front cover   | Polycarbonate (PC-GF10)   |
| Degree of protection                    | IP20  |   |
| Dimensions (W x H x D)                  | 140 x 147 x 125 mm  |   |
| Weight                                  | 1200 g  |   |
| Installation options                    | <ul style="list-style-type: none"> <li>• Installation on a DIN rail</li> <li>• Mounting on an S7-300 standard rail</li> <li>• Mounting on an S7-1500 standard rail</li> </ul> |   |
| <b>Mean time between failure (MTBF)</b> |   |   |
| MTBF (EN/IEC 61709; 40 °C)              | > 46 years  |   |

<sup>1)</sup> Note the wiring rules (Page 75).

<sup>2)</sup> Detected with the SFP992-1ELH. You will find the precise values in the operating instructions of the pluggable transceivers, see the section "Introduction", Additional documentation (Page 7).

<sup>3)</sup> Depending on which pluggable transceiver you use, the maximum ambient temperature can change, see section "Accessories", "SFP transceiver (Page 37)".

## 9.21 Technical specifications of SCALANCE XC216-4C G

The following technical specifications apply to SCALANCE XC216-4C G.

| Technical specifications                 |                                 |                        |   |                                 |
|--|---------------------------------|------------------------|---|---------------------------------|
| <b>Connection to Industrial Ethernet</b> |                                 |                        |   |                                 |
| Electrical connectors                    | Quantity                        |                        | 12  |                                 |
|  | Connector                       |                        | RJ45 jack   |                                 |
|  | Properties                      |                        | Half/full duplex, MDI-X pinning   |                                 |
|  | Transmission speed              |                        | 10 / 100 / 1000 Mbps  |                                 |
| Combo ports                              | Quantity                        |                        | 4   |                                 |
|  | Electrical connectors           | Quantity               | 4   |                                 |
|  |                                 | Connector              |   | RJ45 jack                       |
|  |                                 | Properties             |   | Half/full duplex, MDI-X pinning |
| Transmission speed                       |                                 |                        | 10 / 100 / 1000 Mbps  |                                 |
| Slots for pluggable transceivers         | Quantity                        |                        | 4   |                                 |
|  | Connector                       |                        | SFP transceivers (LC port)  |                                 |
|  | Transmission speed              |                        | 1000 Mbps   |                                 |
|  |                                 |                        | 100 Mbps also possible via active SFPs  |                                 |
| <b>Diagnostics interface</b>             |                                 |                        |   |                                 |
| Serial interface                         | Quantity                        |                        | 1   |                                 |
|  | Connector                       |                        | RJ-11 jack  |                                 |
| <b>Electrical data</b>                   |                                 |                        |   |                                 |
| Power supply <sup>1)</sup>               | Rated voltage                   |                        | 24 V DC   |                                 |
|  | Voltage range (incl. tolerance) |                        | 19.2 to 31.2 V DC Safe Extra Low Voltage (SELV)   |                                 |
|  | Design                          |                        | Terminal block, 4 terminals   |                                 |
|  | Properties                      |                        | Implemented redundantly;<br>The connected power supply must meet the requirements of NEC Class 2. |                                 |
| Current consumption                      | 24 V DC                         | Without SFP            | 450 mA  |                                 |
|  |                                 | With SFP <sup>2)</sup> | 550 mA  |                                 |
| Effective power loss                     |                                 | Without SFP            | 10.8 W  |                                 |
|  |                                 | With SFP <sup>2)</sup> | 13.2 W  |                                 |
| Overvoltage category                     |                                 |                        | CAT II  |                                 |
| Fusing                                   |                                 |                        | 3.15 A / 125 V  |                                 |
| Signaling contact <sup>1)</sup>          | Quantity                        |                        | 1   |                                 |
|  | Design                          |                        | Terminal block, 2 terminals   |                                 |
|  | Permitted voltage range         |                        | 24 V DC   |                                 |
|  | Load capability                 |                        | max. 100 mA   |                                 |
| <b>Permitted ambient conditions</b>      |                                 |                        |   |                                 |

| <b>Technical specifications</b>         |   |   |
|---|---|---|
| Ambient temperature <sup>3)</sup>       | During LAN operation with RJ45 connector up to 2000 m above sea level   | During operation in horizontal installation position:<br>-40 °C to +70 °C<br>During operation in a different installation position:<br>-40 °C to +70 °C |
|   | When operating with pluggable transceivers of the types:<br>• [-] Standard version<br>• LD<br>Up to 2000 m above sea level  | During operation in horizontal installation position:<br>-40 °C to +65 °C<br>During operation in a different installation position:<br>-40 °C to +60 °C |
|   | When operating with pluggable transceivers of the types:<br>• LH<br>• LH+<br>• ELH<br>• SFP992-1+<br>Up to 2000 m above sea level   | During operation in horizontal installation position:<br>-40 °C to +60 °C<br>During operation in a different installation position:<br>-40 °C to +60 °C |
|   | During storage  | -40 °C to +85 °C  |
|   | During transportation   | -40 °C to +85 °C  |
|   | Relative humidity   | During operation at 25 °C   |
| <b>Housing, dimensions and weight</b>   |   |   |
| Design                                  | compact   |   |
| Housing material                        | Basic housing   | Die cast aluminum, powder coated  |
|   | Front cover   | Polycarbonate (PC-GF10)   |
| Degree of protection                    | IP20  |   |
| Dimensions (W x H x D)                  | 140 x 147 x 125 mm  |   |
| Weight                                  | 1200 g  |   |
| Installation options                    | <ul style="list-style-type: none"> <li>• Installation on a DIN rail</li> <li>• Mounting on an S7-300 standard rail</li> <li>• Mounting on an S7-1500 standard rail</li> </ul> |   |
| <b>Mean time between failure (MTBF)</b> |   |   |
| MTBF (EN/IEC 61709; 40 °C)              | > 46 years  |   |

<sup>1)</sup> Note the wiring rules (Page 75).

<sup>2)</sup> Detected with the SFP992-1ELH. You will find the precise values in the operating instructions of the pluggable transceivers, see the section "Introduction", Additional documentation (Page 7).

<sup>3)</sup> Depending on which pluggable transceiver you use, the maximum ambient temperature can change, see section "Accessories", "SFP transceiver (Page 37)".



## 9.22 Technical specifications of SCALANCE XC216-4C G EEC

The following technical specifications apply to SCALANCE XC216-4C G EEC.

| Technical specifications                 |                                  |                        |   |  |
|--|----------------------------------|------------------------|---|--|
| <b>Connection to Industrial Ethernet</b> |                                  |                        |   |  |
| Electrical connectors                    | Quantity                         |                        | 12  |  |
|  | Connector                        |                        | RJ45 jack   |  |
|  | Properties                       |                        | Half/full duplex, MDI-X pinning   |  |
|  | Transmission speed               |                        | 10 / 100 / 1000 Mbps  |  |
| Combo ports                              | Quantity                         |                        | 4   |  |
|  | Electrical connectors            | Quantity               |   | 4                                      |
|  |                                  | Connector              |   | RJ45 jack                              |
|  |                                  | Properties             |   | Half/full duplex, MDI-X pinning        |
|  |                                  | Transmission speed     |   | 10 / 100 / 1000 Mbps                   |
|  | Slots for pluggable transceivers | Quantity               |   | 4                                      |
|  |                                  | Connector              |   | SFP transceivers (LC port)             |
|  |                                  | Transmission speed     |   | 1000 Mbps                              |
|  |                                  |                        |   | 100 Mbps also possible via active SFPs |
|  | <b>Diagnostics interface</b>     |                        |   |  |
|  | Serial interface                 | Quantity               |   | 1                                      |
|  |                                  | Connector              |   | RJ-11 jack                             |
| <b>Electrical data</b>                   |                                  |                        |   |  |
| Power supply <sup>1)</sup>               | Rated voltage                    |                        | 24 V DC   |  |
|  | Voltage range (incl. tolerance)  |                        | 19.2 to 31.2 V DC Safe Extra Low Voltage (SELV)   |  |
|  | Design                           |                        | Terminal block, 4 terminals   |  |
|  | Properties                       |                        | Implemented redundantly;<br>The connected power supply must meet the requirements of NEC Class 2. |  |
| Current consumption                      | 24 V DC                          | Without SFP            | 450 mA  |  |
|  |                                  | With SFP <sup>2)</sup> | 550 mA  |  |
| Effective power loss                     |                                  | Without SFP            | 10.8 W  |  |
|  |                                  | With SFP <sup>2)</sup> | 13.2 W  |  |
| Overvoltage category                     |                                  |                        | CAT II  |  |
| Fusing                                   |                                  |                        | 3.15 A / 125 V  |  |
| Signaling contact <sup>1)</sup>          | Quantity                         |                        | 1   |  |
|  | Design                           |                        | Terminal block, 2 terminals   |  |
|  | Permitted voltage range          |                        | 24 V DC   |  |
|  | Load capability                  |                        | max. 100 mA   |  |
| <b>Permitted ambient conditions</b>      |                                  |                        |   |  |

| Technical specifications          |   |   |
|-----------------------------------|---|---|
| Ambient temperature <sup>3)</sup> | During LAN operation with RJ45 connector up to 2000 m above sea level   | During operation in horizontal installation position:<br>-40 °C to +70 °C<br>During operation in a different installation position:<br>-40 °C to +70 °C |
|                                   | When operating with pluggable transceivers of the types:<br>• [-] Standard version<br>• LD<br>Up to 2000 m above sea level  | During operation in horizontal installation position:<br>-40 °C to +65 °C<br>During operation in a different installation position:<br>-40 °C to +60 °C |
|                                   | When operating with pluggable transceivers of the types:<br>• LH<br>• LH+<br>• ELH<br>• SFP992-1+<br>Up to 2000 m above sea level   | During operation in horizontal installation position:<br>-40 °C to +60 °C<br>During operation in a different installation position:<br>-40 °C to +60 °C |
|                                   | With operation between 2000 m and 3000 m above sea level  | The maximum ambient temperature is reduced by 5 °C <sup>4)</sup>  |
|                                   | With operation between 3000 m and 4000 m above sea level  | The maximum ambient temperature is reduced by 10 °C <sup>4)</sup>   |
|                                   | During storage  | -40 °C to +85 °C  |
|                                   | During transportation   | -40 °C to +85 °C  |
| Relative humidity                 | During operation at 25 °C   | ≤ 95% without condensation  |
| Housing, dimensions and weight    |   |   |
| Design                            | compact   |   |
| Housing material                  | Basic housing   | Die cast aluminum, powder coated  |
|                                   | Front cover   | Polycarbonate (PC-GF10)   |
| Properties                        | Coated printed circuit board (conformal coating)  |   |
| Degree of protection              | IP20  |   |
| Dimensions (W x H x D)            | 140 x 147 x 125 mm  |   |
| Weight                            | 1200 g  |   |
| Installation options              | <ul style="list-style-type: none"> <li>• Installation on a DIN rail</li> <li>• Mounting on an S7-300 standard rail</li> <li>• Mounting on an S7-1500 standard rail</li> </ul> |   |
| Mean time between failure (MTBF)  |   |   |
| MTBF (EN/IEC 61709; 40 °C)        | > 46 years  |   |

<sup>1)</sup> **Wiring rules**

Observe the wiring rules (Page 75).

**2) Pluggable transceiver**

Detected with the SFP992-1ELH. You will find the precise values in the operating instructions of the pluggable transceivers, see the section "Introduction", Additional documentation (Page 7).

**3) Ambient temperature with SFP**

The maximum ambient temperature during operation depends on the operating elevation and the installed pluggable transceivers, see also the section "SFP transceiver (Page 37)" in the "Accessories" section.

**4) Derating**

The derating values depend on the maximum ambient temperatures during operation up to 2000 m.

## 9.23 Technical specifications of the SCALANCE XC224

The following technical specifications apply to the SCALANCE XC224.

| <b>Technical specifications</b>          |   |   |
|--|---|---|
| <b>Connection to Industrial Ethernet</b> |   |   |
| Electrical connectors                    | Quantity                                    | 24  |
|  | Connector                                   | RJ-45 jack  |
|  | Properties                                  | Half/full duplex, MDI-X pinning   |
|  | Transmission speed                          | 10 / 100 Mbps   |
| <b>Diagnostics interface</b>             |   |   |
| Serial interface                         | Quantity                                    | 1   |
|  | Connector                                   | RJ-11 jack  |
| <b>Electrical data</b>                   |   |   |
| Power supply <sup>1)</sup>               | Rated voltage                               | 12 to 24 V DC   |
|  | Voltage range (incl. tolerance)             | 9.6 to 31.2 V DC Safe Extra Low Voltage (SELV)  |
|  | Design                                      | Terminal block, 4 terminals   |
|  | Property                                    | Implemented redundantly;<br>The connected power supply must meet the requirements of NEC Class 2. |
| Current consumption                      | 12 VDC                                      | 750 mA  |
|  | 24 VDC                                      | 375 mA  |
| Effective power loss                     |   | 9 W   |
| Overvoltage category                     |   | CAT II  |
| Fusing                                   |   | 2.5 A / 125 V   |
| Signaling contact <sup>1)</sup>          | Quantity                                    | 1   |
|  | Design                                      | Terminal block, 2 terminals   |
|  | Permitted voltage range                     | 24 VDC  |
|  | Load capability                             | max. 100 mA   |
| <b>Permitted ambient conditions</b>      |   |   |
| Ambient temperature                      | With operation up to 2000 m above sea level | During operation in horizontal installation position:<br>-40 °C to +70 °C                         |
|  |   | During operation in a different installation position:<br>-40 °C to +70 °C                        |
|  | During storage                              | -40 °C to +85 °C  |
|  | During transportation                       | -40 °C to +85 °C  |
| Relative humidity                        | During operation at 25 °C                   | ≤ 95% without condensation  |
| <b>Housing, dimensions and weight</b>    |   |   |
| Design                                   | compact                                     |   |
| Housing material                         | Basic housing                               | Die cast aluminum, powder coated  |
|  | Front cover                                 | Polycarbonate (PC-GF10)   |
| Degree of protection                     | IP20  |   |

---

**Technical specifications**

---

|                        |  |
|------------------------|--|
| Dimensions (W x H x D) | 120 x 147 x 125 mm   |
| Weight                 | 880 g  |
| Installation options   | <ul style="list-style-type: none"> <li>• Wall mounting</li> <li>• Installation on a DIN rail</li> <li>• Mounting on an S7-300 standard rail</li> <li>• Mounting on an S7-1500 standard rail</li> </ul> |

---

**Mean time between failure (MTBF)**

---

|                            |            |
|----------------------------|------------|
| MTBF (EN/IEC 61709; 40 °C) | > 41 years |
|----------------------------|------------|

---

<sup>1)</sup> Note the wiring rules (Page 75).

## 9.24 Technical specifications of SCALANCE XC224-4C G

The following technical specifications apply to SCALANCE XC224-4C G.

| <b>Technical specifications</b>          |                                 |                        |   |                                 |
|--|---------------------------------|------------------------|---|---------------------------------|
| <b>Connection to Industrial Ethernet</b> |                                 |                        |   |                                 |
| Electrical connectors                    | Quantity                        |                        | 20  |                                 |
|  | Connector                       |                        | RJ45 jack   |                                 |
|  | Properties                      |                        | Half/full duplex, MDI-X pinning   |                                 |
|  | Transmission speed              |                        | 10 / 100 / 1000 Mbps  |                                 |
| Combo ports                              | Quantity                        |                        | 4   |                                 |
|  | Electrical connectors           | Quantity               | 4   |                                 |
|  |                                 | Connector              |   | RJ45 jack                       |
|  |                                 | Properties             |   | Half/full duplex, MDI-X pinning |
| Transmission speed                       |                                 |                        | 10 / 100 / 1000 Mbps  |                                 |
| Slots for pluggable transceivers         | Quantity                        |                        | 4   |                                 |
|  | Connector                       |                        | SFP transceivers (LC port)  |                                 |
|  | Transmission speed              |                        | 1000 Mbps<br>100 Mbps also possible via active SFPs   |                                 |
|  |                                 |                        |   |                                 |
| <b>Diagnostics interface</b>             |                                 |                        |   |                                 |
| Serial interface                         | Quantity                        |                        | 1   |                                 |
|  | Connector                       |                        | RJ-11 jack  |                                 |
| <b>Electrical data</b>                   |                                 |                        |   |                                 |
| Power supply <sup>1)</sup>               | Rated voltage                   |                        | 24 V DC   |                                 |
|  | Voltage range (incl. tolerance) |                        | 19.2 to 31.2 V DC Safe Extra Low Voltage (SELV)   |                                 |
|  | Design                          |                        | Terminal block, 4 terminals   |                                 |
|  | Properties                      |                        | Implemented redundantly;<br>The connected power supply must meet the requirements of NEC Class 2. |                                 |
| Current consumption                      | 24 V DC                         | Without SFP            | 600 mA  |                                 |
|  |                                 | With SFP <sup>2)</sup> | 700 mA  |                                 |
| Effective power loss                     |                                 | Without SFP            | 14.4 W  |                                 |
|  |                                 | With SFP <sup>2)</sup> | 16.8 W  |                                 |
| Overvoltage category                     |                                 |                        | CAT II  |                                 |
| Fusing                                   |                                 |                        | 3.15 A / 125 V  |                                 |
| Signaling contact <sup>1)</sup>          | Quantity                        |                        | 1   |                                 |
|  | Design                          |                        | Terminal block, 2 terminals   |                                 |
|  | Permitted voltage range         |                        | 24 V DC   |                                 |
|  | Load capability                 |                        | max. 100 mA   |                                 |
| <b>Permitted ambient conditions</b>      |                                 |                        |   |                                 |

| <b>Technical specifications</b>         |   |   |                            |
|---|---|---|----------------------------|
| Ambient temperature <sup>3)</sup>       | During LAN operation with RJ45 connector up to 2000 m above sea level   | During operation in horizontal installation position:<br>-40 °C to +70 °C<br>During operation in a different installation position:<br>-40 °C to +70 °C |                            |
|   | When operating with pluggable transceivers of the types:<br>• [-] Standard version<br>• LD<br>Up to 2000 m above sea level  | During operation in horizontal installation position:<br>-40 °C to +65 °C<br>During operation in a different installation position:<br>-40 °C to +60 °C |                            |
|   | When operating with pluggable transceivers of the types:<br>• LH<br>• LH+<br>• ELH<br>• SFP992-1+<br>Up to 2000 m above sea level   | During operation in horizontal installation position:<br>-40 °C to +60 °C<br>During operation in a different installation position:<br>-40 °C to +60 °C |                            |
|   | During storage  | -40 °C to +85 °C  |                            |
|   | During transportation   | -40 °C to +85 °C  |                            |
|   | Relative humidity   | During operation at 25 °C   | ≤ 95% without condensation |
|   | <b>Housing, dimensions and weight</b>   |   |                            |
| Design                                  | compact   |   |                            |
| Housing material                        | Basic housing   | Die cast aluminum, powder coated  |                            |
|   | Front cover   | Polycarbonate (PC-GF10)   |                            |
| Degree of protection                    | IP20  |   |                            |
| Dimensions (W x H x D)                  | 140 x 147 x 125 mm  |   |                            |
| Weight                                  | 1300 g  |   |                            |
| Installation options                    | <ul style="list-style-type: none"> <li>• Installation on a DIN rail</li> <li>• Mounting on an S7-300 standard rail</li> <li>• Mounting on an S7-1500 standard rail</li> </ul> |   |                            |
| <b>Mean time between failure (MTBF)</b> |   |   |                            |
| MTBF (EN/IEC 61709; 40 °C)              | > 20 years  |   |                            |

<sup>1)</sup> Note the wiring rules (Page 75).

<sup>2)</sup> Detected with the SFP992-1ELH. You will find the precise values in the operating instructions of the pluggable transceivers, see the section "Introduction", Additional documentation (Page 7).

<sup>3)</sup> Depending on which pluggable transceiver you use, the maximum ambient temperature can change, see section "Accessories", "SFP transceiver (Page 37)".

## 9.25 Technical specifications of SCALANCE XC224-4C G EEC

The following technical specifications apply to SCALANCE XC224-4C G EEC.

| Technical specifications                 |                                 |                        |   |                                 |
|--|---------------------------------|------------------------|---|---------------------------------|
| <b>Connection to Industrial Ethernet</b> |                                 |                        |   |                                 |
| Electrical connectors                    | Quantity                        |                        | 20  |                                 |
|  | Connector                       |                        | RJ45 jack   |                                 |
|  | Properties                      |                        | Half/full duplex, MDI-X pinning   |                                 |
|  | Transmission speed              |                        | 10 / 100 / 1000 Mbps  |                                 |
| Combo ports                              | Quantity                        |                        | 4   |                                 |
|  | Electrical connectors           | Quantity               | 4   |                                 |
|  |                                 | Connector              |   | RJ45 jack                       |
|  |                                 | Properties             |   | Half/full duplex, MDI-X pinning |
| Transmission speed                       |                                 |                        | 10 / 100 / 1000 Mbps  |                                 |
| Slots for pluggable transceivers         | Quantity                        |                        | 4   |                                 |
|  | Connector                       |                        | SFP transceivers (LC port)  |                                 |
|  | Transmission speed              |                        | 1000 Mbps<br>100 Mbps also possible via active SFPs   |                                 |
|  | <b>Diagnostics interface</b>    |                        |   |                                 |
| Serial interface                         | Quantity                        |                        | 1   |                                 |
|  | Connector                       |                        | RJ-11 jack  |                                 |
| <b>Electrical data</b>                   |                                 |                        |   |                                 |
| Power supply <sup>1)</sup>               | Rated voltage                   |                        | 24 V DC   |                                 |
|  | Voltage range (incl. tolerance) |                        | 19.2 to 31.2 V DC Safe Extra Low Voltage (SELV)   |                                 |
|  | Design                          |                        | Terminal block, 4 terminals   |                                 |
|  | Properties                      |                        | Implemented redundantly;<br>The connected power supply must meet the requirements of NEC Class 2. |                                 |
| Current consumption                      | 24 V DC                         | Without SFP            | 600 mA  |                                 |
|  |                                 | With SFP <sup>2)</sup> | 700 mA  |                                 |
| Effective power loss                     |                                 | Without SFP            | 14.4 W  |                                 |
|  |                                 | With SFP <sup>2)</sup> | 16.8 W  |                                 |
| Overvoltage category                     |                                 |                        | CAT II  |                                 |
| Fusing                                   |                                 |                        | 3.15 A / 125 V  |                                 |
| Signaling contact <sup>1)</sup>          | Quantity                        |                        | 1   |                                 |
|  | Design                          |                        | Terminal block, 2 terminals   |                                 |
|  | Permitted voltage range         |                        | 24 V DC   |                                 |
|  | Load capability                 |                        | max. 100 mA   |                                 |
| <b>Permitted ambient conditions</b>      |                                 |                        |   |                                 |



| <b>Technical specifications</b>         |   |   |
|---|---|---|
| Ambient temperature <sup>3)</sup>       | During LAN operation with RJ45 connector up to 2000 m above sea level   | During operation in horizontal installation position:<br>-40 °C to +70 °C<br>During operation in a different installation position:<br>-40 °C to +70 °C |
|   | When operating with pluggable transceivers of the types:<br>• [-] Standard version<br>• LD<br>Up to 2000 m above sea level  | During operation in horizontal installation position:<br>-40 °C to +65 °C<br>During operation in a different installation position:<br>-40 °C to +60 °C |
|   | When operating with pluggable transceivers of the types:<br>• LH<br>• LH+<br>• ELH<br>• SFP992-1+<br>Up to 2000 m above sea level   | During operation in horizontal installation position:<br>-40 °C to +60 °C<br>During operation in a different installation position:<br>-40 °C to +60 °C |
|   | With operation between 2000 m and 3000 m above sea level  | The maximum ambient temperature is reduced by 5 °C <sup>4)</sup>  |
|   | With operation between 3000 m and 4000 m above sea level  | The maximum ambient temperature is reduced by 10 °C <sup>4)</sup>   |
|   | During storage  | -40 °C to +85 °C  |
|   | During transportation   | -40 °C to +85 °C  |
| Relative humidity                       | During operation at 25 °C   | ≤ 95% without condensation  |
| <b>Housing, dimensions and weight</b>   |   |   |
| Design                                  | compact   |   |
| Housing material                        | Basic housing   | Die cast aluminum, powder coated  |
|   | Front cover   | Polycarbonate (PC-GF10)   |
| Properties                              | Coated printed circuit board (conformal coating)  |   |
| Degree of protection                    | IP20  |   |
| Dimensions (W x H x D)                  | 140 x 147 x 125 mm  |   |
| Weight                                  | 1300 g  |   |
| Installation options                    | <ul style="list-style-type: none"> <li>• Installation on a DIN rail</li> <li>• Mounting on an S7-300 standard rail</li> <li>• Mounting on an S7-1500 standard rail</li> </ul> |   |
| <b>Mean time between failure (MTBF)</b> |   |   |
| MTBF (EN/IEC 61709; 40 °C)              | > 20 years  |   |

<sup>1)</sup> **Wiring rules**

Observe the wiring rules (Page 75).

**2) Pluggable transceiver**

Detected with the SFP992-1ELH. You will find the precise values in the operating instructions of the pluggable transceivers, see the section "Introduction", Additional documentation (Page 7).

**3) Ambient temperature with SFP**

The maximum ambient temperature during operation depends on the operating elevation and the installed pluggable transceivers, see also the section "SFP transceiver (Page 37)" in the "Accessories" section.

**4) Derating**

The derating values depend on the maximum ambient temperatures during operation up to 2000 m.

## 9.26 Mechanical stability (in operation)

SCALANCE XC-200 meets the following requirement relating to mechanical stability in operation:

- **IEC 60068-2-27 shock**
  - 15 g, 11 ms duration
  - 6 shocks per axis
- **IEC 60068-2-6 vibration**
  - 10 - 58 Hz: 0.075 mm
  - 85 - 150 Hz: 1 g
  - 1 octave/min, 20 sweeps

## 9.27 RF radiation according to NAMUR NE21

SCALANCE XC-200 fulfills the following requirement regarding RF radiation.

| RF radiation according to IEC 61000-4-3/NAMUR NE21 |                   |
|--|-------------------|
| 80 MHz - 2.0 GHz                                   | 2.0 GHz - 2.7 GHz |
| 10 V/m   | 3 V/m             |
| 80% AM (1kHz)                                      |                   |

## 9.28 Cable lengths

The cable lengths listed below apply to the SCALANCE XC-200.

| Cable                                       | Permitted cable length |
|---|------------------------|
| IE TP torsion cable                         | 0 to 45 m              |
| with IE FC Outlet RJ-45 + 10 m TP cord      | + 10 m TP cord         |
| IE TP torsion cable                         | 0 to 55 m              |
| with IE FC RJ-45 Plug 180                   |                        |
| IE FC TP Marine / Trailing / Flexible cable | 0 to 75 m              |
| with IE FC Outlet RJ-45 + 10 m TP cord      | + 10 m TP cord         |
| IE FC TP Marine / Trailing / Flexible cable | 0 to 85 m              |
| with IE FC RJ-45 Plug 180                   |                        |
| IE FC TP standard cable                     | 0 to 90 m              |
| with IE FC Outlet RJ-45 + 10 m TP cord      | + 10 m TP cord         |
| IE FC TP standard cable                     | 0 to 100 m             |
| with IE FC RJ-45 Plug 180                   |                        |

## 9.29 Switching properties

The switching properties listed below apply to the SCALANCE XC-200. The following device versions differ from the other SCALANCE XC-200 devices in some switching properties:

- Gigabit versions (Page 7) (suffix "G" in the type designation)
- Devices with combo ports (Page 7) (suffix "C" in the type designation)

You will find additional information on the devices in the section "Product overview (Page 21)".

| Switching properties                  | SCALANCE XC-200                               | Gigabit versions/<br>Devices with combo ports |
|---------------------------------------|---|---|
| Aging time                            | Can be configured (default value: 30 seconds) |   |
| Maximum frame size                    | 1632  | 10240   |
| Max. number of learnable addresses    | 8192  | 16000   |
| Response to LLDP frames               | Blocking                                      |   |
| Response to spanning tree BPDU frames | Forwarding                                    |   |
| CoS acc. to IEEE 802.1Q               | Yes   |   |
| QoS priority queues                   | 4   | 8   |
| Switching technique                   | Store and forward                             |   |
| Latency                               | 10 microseconds                               |   |

### Full wire speed switching

| Frame length (bytes) | Number of frames per second |              |               |
|----------------------|-----------------------------|--------------|---------------|
|                      | At 100 Mbps                 | At 1000 Mbps | At 10000 Mbps |
| 64                   | 148810                      | 1488095      | 14880952      |
| 128                  | 84459                       | 844594       | 8445946       |
| 256                  | 45290                       | 452898       | 4528986       |
| 512                  | 23496                       | 234962       | 2349664       |
| 1024                 | 11973                       | 119731       | 1197318       |
| 1280                 | 9615                        | 96153        | 961538        |
| 1518                 | 8127                        | 81274        | 811688        |

### Note

The number of SCALANCE XC-200 modules connected in a line influences the entire frame delay. When a frame passes through the IE switch, this is delayed by the store-and-forward function of the SCALANCE XC-200 by 10-130 microseconds (at 100 Mbps).

## Dimension drawings

---

**Note**

Dimensions are specified in mm.

---

**Front view**

This front view applies to the following devices:

- SCALANCE XC206-2 (ST/BFOC)
- SCALANCE XC206-2 (SC)
- SCALANCE XC206-2G PoE (54 V)
- SCALANCE XC206-2G PoE EEC (54 V)
- SCALANCE XC206-2SFP
- SCALANCE XC206-2SFP G
- SCALANCE XC206-2SFP EEC
- SCALANCE XC206-2SFP G EEC
- SCALANCE XC208
- SCALANCE XC208G
- SCALANCE XC208G PoE (54 V)
- SCALANCE XC208EEC
- SCALANCE XC208G EEC

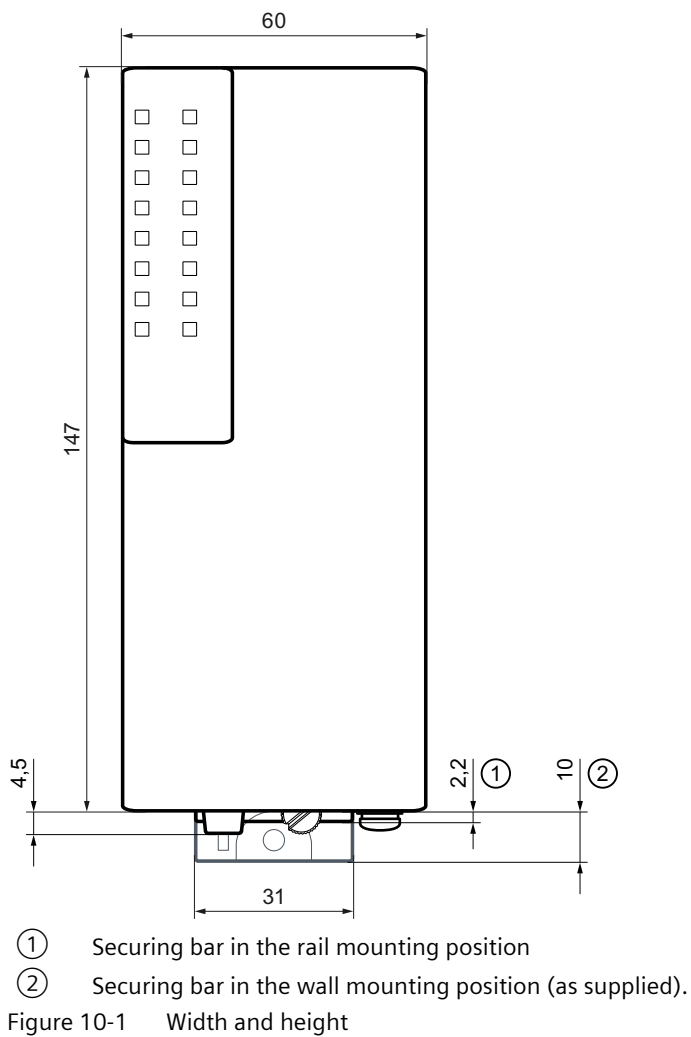

### Front view

This front view applies to the following devices:

- SCALANCE XC206-2G PoE
- SCALANCE XC208G PoE

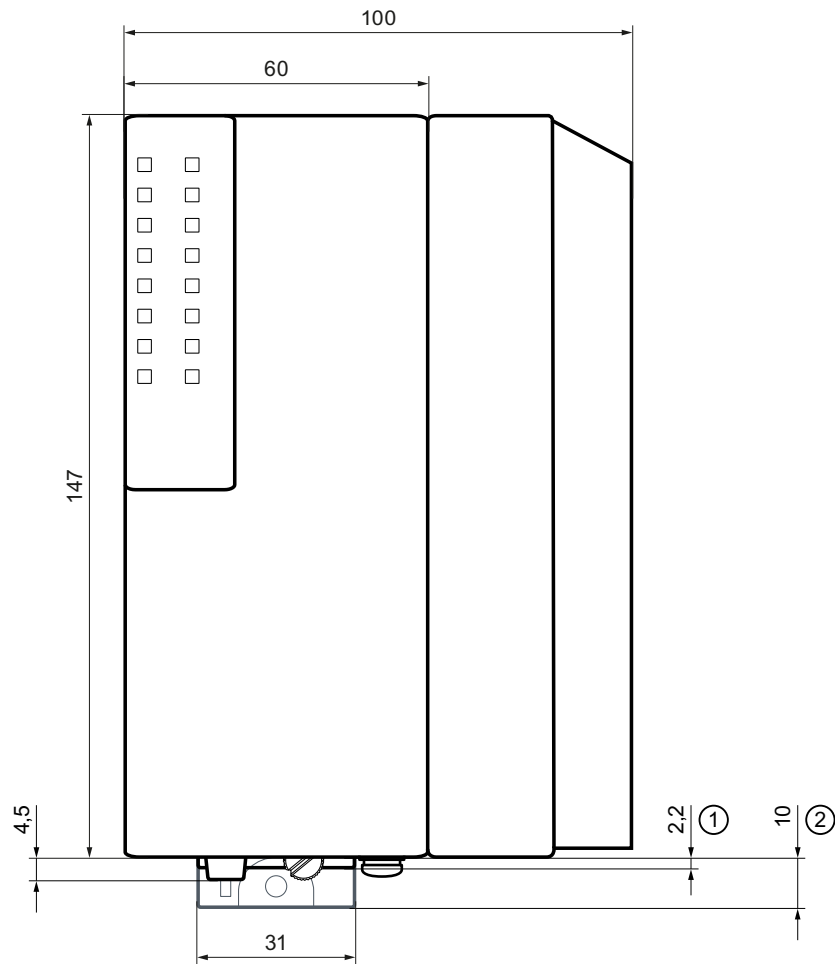

- ① Securing bar in the rail mounting position
- ② Securing bar in the wall mounting position (as supplied).

Figure 10-2 Width and height

### Front view

This front view applies to the following devices:

- SCALANCE XC216
- SCALANCE XC216EEC
- SCALANCE XC224

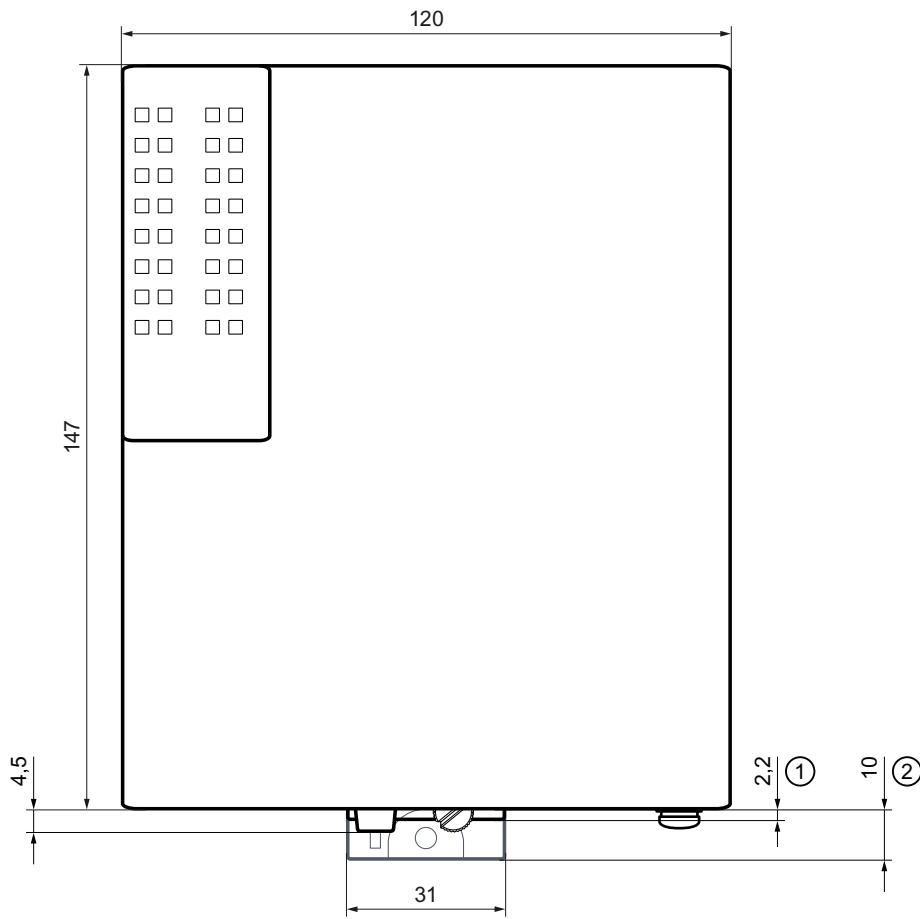

- ① Securing bar in the rail mounting position
- ② Securing bar in the wall mounting position (as supplied).

Figure 10-3 Width and height

## Front view

This front view applies to the following devices:

- SCALANCE XC216-3G PoE (54 V)
- SCALANCE XC216-4C
- SCALANCE XC216-4C G
- SCALANCE XC216-4C G EEC
- SCALANCE XC224-4C G
- SCALANCE XC224-4C G EEC



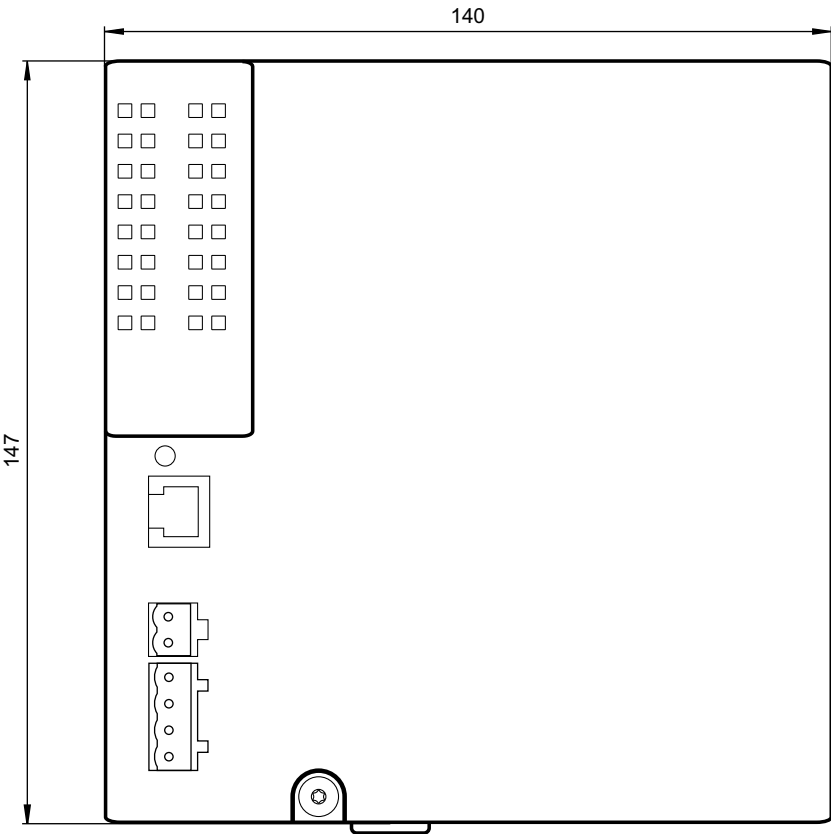

Figure 10-4 Width and height

**Front view**

This front view applies to the following devices:

- SCALANCE XC216-3G PoE

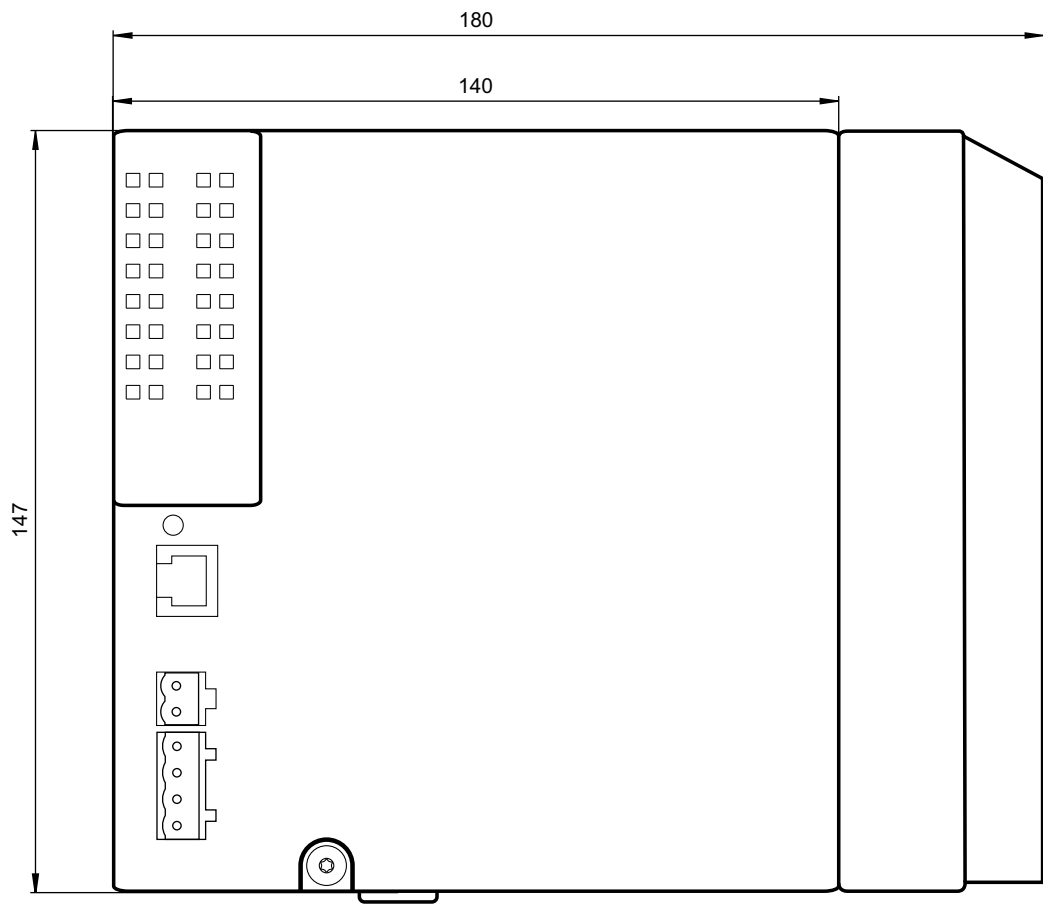
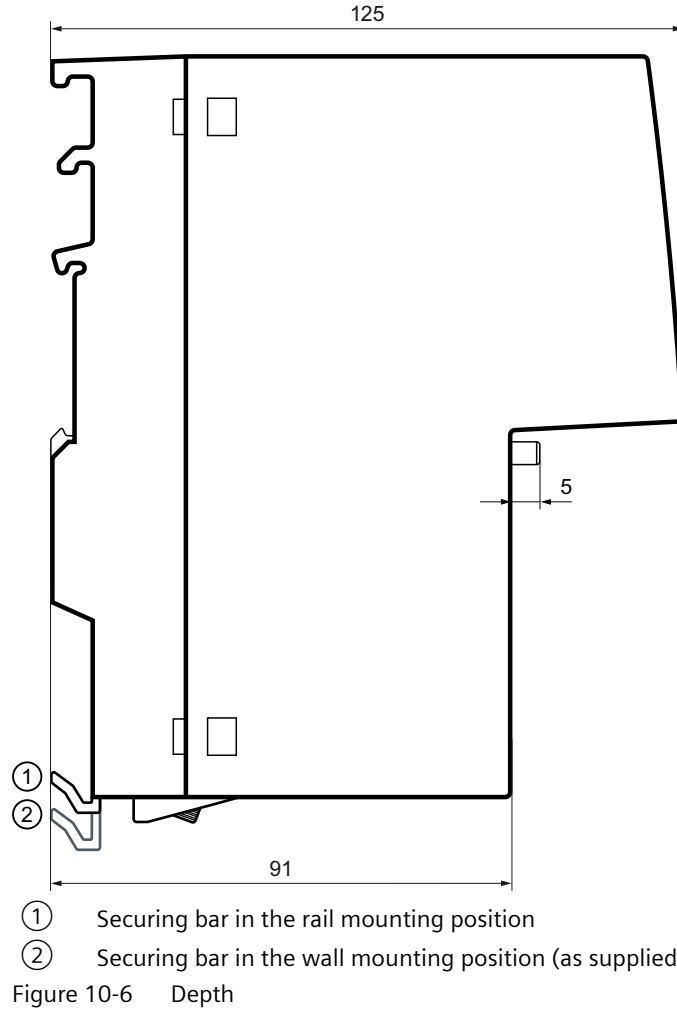

Figure 10-5 Width and height

**Side view of the SCALANCE XC-200**

This side view applies to all SCALANCE XC-200. Devices without fastening plate have the same dimensions in relation to depth.



① Securing bar in the rail mounting position  
 ② Securing bar in the wall mounting position (as supplied).  
 Figure 10-6 Depth

### Drilling template for wall mounting

The drilling pattern applies to all devices with a fastening plate.

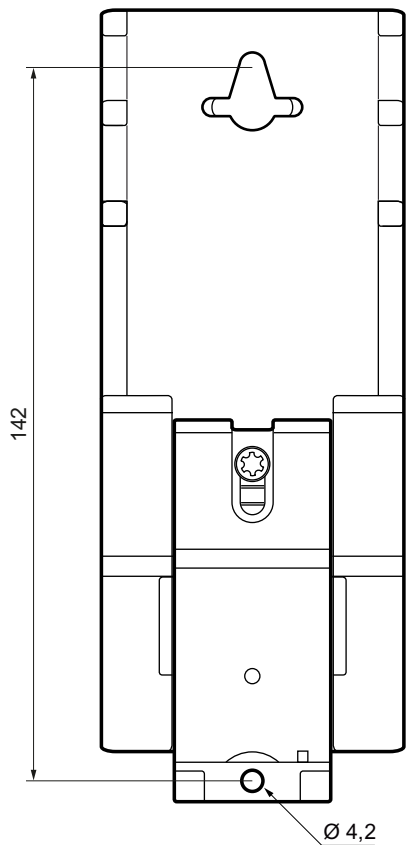

Figure 10-7 Drilling template with securing bar in the wall mounting position (as supplied)

## Certifications and approvals

The SIMATIC NET products described in these Operating Instructions have the approvals listed below.

---

### Note

#### Issued approvals on the type plate of the device

The specified approvals apply only when the corresponding mark is printed on the product. You can check which of the following approvals have been granted for your product by the markings on the type plate.

---

### Current approvals on the Internet

You will find the current approvals for the product on the Internet pages of Siemens Industry Online Support (<https://support.industry.siemens.com/cs/ww/en/ps/15273/cert>).

### Notes for the manufacturers of machines

The devices are not machines in the sense of the EC Machinery Directive. There is therefore no declaration of conformity relating to the EC Machinery Directive 2006/42/EC for these devices.

If the devices are part of the equipment of a machine, they must be included into the EU declaration of conformity procedure by the manufacturer of the machine.

### EC declaration of conformity



The SIMATIC NET products described in these operating instructions meet the requirements and safety objectives of the following EC directives and comply with the harmonized European standards (EN) which are published in the official documentation of the European Union and here.

- **2014/34/EU (ATEX explosion protection directive)**  
Directive of the European Parliament and the Council of 26 February 2014 on the approximation of the laws of the member states concerning equipment and protective systems intended for use in potentially explosive atmospheres, official journal of the EU L96, 29/03/2014, pages. 309-356
- **2014/30/EU (EMC)**  
EMC directive of the European Parliament and of the Council of February 26, 2014 on the approximation of the laws of the member states relating to electromagnetic compatibility; official journal of the EU L96, 29/03/2014, pages. 79-106
- **2011/65/EU (RoHS)**  
Directive of the European Parliament and of the Council of 8 June 2011 on the restriction of the use of certain hazardous substances in electrical and electronic equipment, official journal of the EC L174, 01/07/2011, pages 88-110

You will find the EC declaration of conformity for these products on the Internet pages of Siemens Industry Online Support (<https://support.industry.siemens.com/cs/ww/en/ps/15273/cert>).

The EC Declaration of Conformity is available for all responsible authorities at:

Siemens Aktiengesellschaft

Digital Industries  
DE-76181 Karlsruhe  
Germany

### UK Declaration of Conformity



The UK declaration of conformity is available to all responsible authorities at:

Siemens Aktiengesellschaft  
Process Industries and Drives,

Process Automation  
DE-76181 Karlsruhe  
Federal Republic of Germany

#### UK Importer:

Siemens PLC,  
Manchester M20 2UR, UK

You can find the current UK Declaration of Conformity for these products on the Internet pages under Siemens Industry Online Support (<https://support.industry.siemens.com/cs/ww/en/ps/15273/cert>)

The SIMATIC NET products described in this document meet the requirements of the following directives:

- Equipment and Protective Systems Intended for use in Potentially Explosive Atmospheres Regulations 2016
- Electromagnetic Compatibility Regulations 2016
- The Restriction of the Use of Certain Hazardous Substances in Electrical and Electronic Equipment Regulations 2012

## ATEX, IECEx, UKEX and CCC Ex certification

|  |
|--|
| <p><b>⚠ WARNING</b></p> <p><b>Risk of explosion in hazardous areas</b></p> <p>When using SIMATIC NET products in hazardous area zone 2, make absolutely sure that the associated conditions in the following document are adhered to:</p> <p>"SIMATIC NET Product Information Use of subassemblies/modules in a Zone 2 Hazardous Area".</p> <p>You will find this document</p> <ul style="list-style-type: none"> <li>• on the data medium that ships with some devices.</li> <li>• on the Internet pages under Siemens Industry Online Support (<a href="https://support.industry.siemens.com/cs/ww/en/view/78381013">https://support.industry.siemens.com/cs/ww/en/view/78381013</a>).</li> </ul> <p>Enter the document identification number C234 as the search term.</p> |
|--|

The markings of the electrical devices are:



II 3G Ex ec IIC T4 Gc

DEKRA 18ATEX0025X

DEK 18.0017X



Ex ec IIC T4 Gc

DEKRA 21UKEX00xx X

UK Importer:

Siemens plc,

Manchester

M20 2UR, UK



(Ex na IIC T4 Gc, not on the nameplate)

The products meet the requirements of the following standards:

- EN/IEC 60079-7, GB 3836.3
- EN IEC/IEC 60079-0, GB 3836.1

You will find the current versions of the standards in the currently valid certificates.

## Note for devices with CLASS 1 LASER

Important note on products certified according to Type Examination Certificate KEMA 07ATEX0145 X as of Issue 95 / DEKRA 18ATEX0025 X and IECEx Certificate of Conformity DEK 14.0025X as of Issue 43 / DEK 18.0017X and containing Class 1 optical radiation sources.

---

### Note

#### CLASS 1 LASER

The device contains optical radiation sources which comply with the limits of Class 1 according to IEC 60825-1. Fiber-optic cables connected to these optical radiation sources may therefore be routed either to or through hazardous areas requiring Category 2G, 3G, 2D or 3D equipment.

---

## EMC directive (electromagnetic compatibility)

The SIMATIC NET products described in these operating instructions meet the requirements of EU directive 2014/30/EU "Electromagnetic Compatibility" (EMC Directive).

Applied standards:

- EN 61000-6-2 Electromagnetic compatibility (EMC) - Part 6-2: Generic standards - Immunity for industrial environments
- EN 61000-6-4 Electromagnetic compatibility (EMC) - Part 6-4: Generic standards - Emission standard for industrial environments

You will find the current versions of the standards in the currently valid EC declaration of conformity.

## EMC directive (railway application)

The device versions EEC also meet the requirements of the EU Directive 2014/30/EU "Electromagnetic Compatibility" (EMC Directive).

Applied standards:

- EN 50121-3-2 Railway applications - Electromagnetic compatibility - part 3-2: Rolling stock - Devices
- EN 50121-4 Railway applications - Electromagnetic compatibility - part 4: Interference emissions and immunity of signal telecommunications equipment

You will find the current versions of the standards in the currently valid EC declaration of conformity.

## RoHS

The SIMATIC NET products described in these operating instructions meet the requirements of the EC directive 2011/65/EC for the restriction of the use of certain hazardous substances in electrical and electronic equipment:

Applied standard:

- EN 50581



## FM

The product meets the requirements of the standards:

- Factory Mutual Approval Standard Class Number 3611
- FM Hazardous (Classified) Location Electrical Equipment:  
Non Incendive / Class I / Division 2 / Groups A,B,C,D / T4 and  
Non Incendive / Class I / Zone 2 / Group IIC / T4

## cULus approval for industrial control equipment

cULus Listed IND. CONT. EQ.

Underwriters Laboratories Inc. complying with

- UL 61010-2-201
- CAN/CSA-IEC 61010-2-201

Report no. E85972

## cULus Approval for Information Technology Equipment

cULus Listed I. T. E.

Underwriters Laboratories Inc. complying with

- UL 60950-1 (Information Technology Equipment)
- CSA C22.2 No. 60950-1-03

Report no. E115352

## cULus Approval Hazardous Location

cULus Listed I. T. E. FOR HAZ. LOC.

Underwriters Laboratories Inc. complying with

- UL 60950-1 (Information Technology Equipment)
- ANSI/ISA 12.12.01-2007
- CSA C22.2 No. 213-M1987

Approved for use in

Cl. 1, Div. 2, GP A, B, C, D T4

Cl. 1, Zone 2, GP IIC T4

Report no. E240480

## Note for Australia - RCM

The product meets the requirements of the RCM standard.

Applied standards:

- AS/NZS CISPR11 (Industrial, scientific and medical equipment - Radio-frequency disturbance characteristics - Limits and methods of measurement).
- EN 61000-6-4 Electromagnetic compatibility (EMC) - Part 6-4: Generic standards - Emission standard for industrial environments

You will find the current versions of the standards in the currently valid RCM SDoCs (Self-Declaration of Conformity).

**MSIP 요구사항 - For Korea only**

**A급 기기(업무용 방송통신기자재)**

이 기기는 업무용(A급) 전자파 적합기기로서 판매자 또는 사용자는 이 점을 주의하시기 바라며, 가정 외의 지역에서 사용하는 것을 목적으로 합니다.

**Marking for the customs union**



EAC (Eurasian Conformity)

Eurasian Economic Union of Russia, Belarus, Armenia, Kazakhstan and Kyrgyzstan

Declaration of conformity according to the technical regulations of the customs union (TR ZU)

**FDA and IEC marking**

The following devices meet the FDA and IEC requirements listed below:

| Device                           | CLASS 1 LASER PRODUCT |
|----------------------------------|-----------------------|
| SCALANCE XC206-2 (ST/BFOC)       | ●                     |
| SCALANCE XC206-2 (SC)            | ●                     |
| SCALANCE XC206-2G PoE            | (*)                   |
| SCALANCE XC206-2G PoE (54 V)     | (*)                   |
| SCALANCE XC206-2G PoE EEC (54 V) | (*)                   |
| SCALANCE XC206-2SFP              | (*)                   |
| SCALANCE XC206-2SFP G            | (*)                   |
| SCALANCE XC206-2SFP EEC          | (*)                   |
| SCALANCE XC206-2SFP G EEC        | (*)                   |
| SCALANCE XC208                   | -                     |
| SCALANCE XC208G                  | -                     |
| SCALANCE XC208G PoE              | -                     |
| SCALANCE XC208G PoE (54 V)       | -                     |
| SCALANCE XC208EEC                | -                     |
| SCALANCE XC208G EEC              | -                     |
| SCALANCE XC216                   | -                     |
| SCALANCE XC216EEC                | -                     |
| SCALANCE XC216-3G PoE            | (*)                   |
| SCALANCE XC216-3G PoE (54 V)     | (*)                   |

| Device                  | CLASS 1 LASER PRODUCT |
|-------------------------|-----------------------|
| SCALANCE XC216-4C       | (*)                   |
| SCALANCE XC216-4C G     | (*)                   |
| SCALANCE XC216-4C G EEC | (*)                   |
| SCALANCE XC224          | -                     |
| SCALANCE XC224-4C G     | (*)                   |
| SCALANCE XC224-4C G EEC | (*)                   |

\* In modular devices, you can find the marking on the pluggable transceiver used or in the relevant operating instructions.



Figure 11-1 FDA and IEC approvals

|  |
|--|
| <p><b>⚠ CAUTION</b></p> <p>Use of controls or adjustments or performance of procedures other than those specified herein may result in hazardous radiation exposure.</p> |
|--|

## Installation guidelines

The devices meet the requirements if you adhere to the installation and safety instructions contained in this documentation and in the following documentation when installing and operating the devices.

- "Industrial Ethernet / PROFINET Industrial Ethernet" System Manual (<https://support.industry.siemens.com/cs/ww/en/view/27069465>)
- "Industrial Ethernet / PROFINET - Passive Network Components" System Manual (<https://support.industry.siemens.com/cs/ww/en/view/84922825>)
- "EMC Installation Guidelines" configuration manual (<https://support.industry.siemens.com/cs/ww/en/view/60612658>)

|  |
|--|
| <p><b>⚠ WARNING</b></p> <p><b>Personal injury and property damage can occur</b></p> <p>The installation of expansions that are not approved for SIMATIC NET products or their target systems may violate the requirements and regulations for safety and electromagnetic compatibility.</p> <p>Only use expansions that are approved for the system.</p> |
|--|

---

**Note**

The test was performed with a device and a connected communications partner that also meets the requirements of the standards listed above.

When operating the device with a communications partner that does not comply with these standards, adherence to the corresponding values cannot be guaranteed.

---

# Index

## A

Approvals, 157  
Article numbers, 21  
Autonegotiation, 83

## C

CE mark, 157  
Combo port, 51  
Command Line Interface (CLI), 50, 85, 89  
Components of the product, 25  
Configuration, 43  
Connecting cable, 85  
Connecting up  
    Grounding, 81  
Connection to Industrial Ethernet, 96, 98, 100, 103, 105, 107, 110, 113, 115, 117, 119, 121, 123, 125, 127, 128, 130, 133, 135, 137, 140, 142, 144  
C-PLUG  
    Configuration, 49

## D

Dimensions, 91, 94, 97, 99, 101, 104, 106, 108, 111, 113, 115, 117, 119, 121, 123, 125, 127, 129, 131, 134, 136, 138, 140, 143, 145  
Display mode, 42, 45

## E

Electrical data, 91, 93, 96, 98, 100, 103, 105, 107, 110, 113, 115, 117, 119, 121, 123, 125, 127, 128, 130, 133, 135, 137, 140, 142, 144  
Environmental conditions, 38, 39, 40, 41, 91, 93, 96, 98, 100, 103, 105, 107, 110, 113, 115, 117, 119, 121, 123, 125, 127, 129, 131, 133, 135, 137, 140, 142, 144  
ESD directives, 11

## F

Factory defaults, 42, 90  
Factory setting, 90  
Factory settings, 42, 90  
Fault mask, 43

Fault/error status, 45  
Firmware, 45

## G

Glossary, 10  
Grounding, 27, 28, 29, 30, 31, 32, 33, 34, 35, 36, 37, 81  
Grounding screw, 27, 28, 29, 30, 31, 32, 33, 34, 35, 36, 37

## H

Housing, 91, 94, 97, 99, 101, 104, 106, 108, 111, 113, 115, 117, 119, 121, 123, 125, 127, 129, 131, 134, 136, 138, 140, 143, 145

## I

Installation, 91, 94, 97, 99, 101, 104, 106, 108, 111, 113, 115, 117, 119, 121, 123, 125, 127, 129, 131, 134, 136, 138, 140, 143, 145  
    Installation on a DIN rail, 62, 63  
    Installation on a standard rail, 64, 65, 66, 68  
    Wall mounting, 68  
Installation on a DIN rail, 62, 63  
Installation on a standard rail, 64, 65, 66, 68

## K

Knurled screw, 27, 28, 29, 30, 31, 32, 33, 36, 62, 64, 66

## L

LED display, 27, 28, 29, 30, 31, 32, 33, 34, 35, 36, 37, 44  
Levering aid, 27, 28, 29, 30, 31, 32, 33, 36, 69

## M

MDI / MDI-X autocrossover, 83  
MTBF, 92, 94, 97, 99, 101, 104, 106, 108, 111, 114, 116, 118, 120, 122, 124, 126, 128, 130, 131, 134, 136, 138, 141, 143, 145

## P

Permitted ambient conditions, 38, 39, 40, 41, 91, 93, 96, 98, 100, 103, 105, 107, 110, 113, 115, 117, 119, 121, 123, 125, 127, 129, 131, 133, 135, 137, 140, 142, 144  
Pin assignment, 82  
PLUG, 49  
Pluggable transceiver  
    SFP, 8, 38, 39, 40, 41  
    SFP active, 39  
Plug-in transceiver  
    SFP bidirectional, 40  
PoE, 52  
Power over Ethernet, 52  
Power supply, 25, 27, 28, 29, 30, 31, 32, 33, 34, 35, 36, 37, 76, 78

## R

Reset device, 42, 90  
Reset to Factory Defaults, 43, 90

## S

S7-1500, 66, 68  
S7-300, 64, 65  
Safety instructions  
    Use in hazardous areas, 72  
    when connecting up, 72  
Safety notices  
    for installation, 57  
    general, 13  
    Use in hazardous areas, 13, 57, 71  
    when connecting up, 71  
Securing bar, 27, 28, 29, 30, 31, 32, 33, 36, 62, 64, 66, 150, 151, 152, 155  
Securing location, 65, 68  
Securing screw, 65, 68  
SELECT/SET button, 27, 28, 29, 30, 31, 32, 33, 34, 35, 36, 37, 42, 46, 89, 90  
Serial interface, 85  
SFP transceiver, 8, 38, 39, 40, 41  
SFP+ transceiver, 41  
Signaling contact, 25, 27, 28, 29, 30, 31, 32, 33, 34, 35, 36, 37, 45, 79  
SIMATIC NET glossary, 10  
SIMATIC NET manual, 9  
Spare parts, 26  
Spring-loaded terminal, 25, 76, 78, 79

Startup phase, 43, 45, 90  
System manual, 9, 163

## W

Web Based Management (WBM), 50, 89  
Weight, 91, 94, 97, 99, 101, 104, 106, 108, 111, 113, 115, 117, 119, 121, 123, 125, 127, 129, 131, 134, 136, 138, 140, 143, 145  
Wiring rules, 77, 78, 79