

## VOICE RECOGNITION TIPS

### BLUETOOTH®

**Command**      **Example**  
Dial <Phone #> — “Dial  
7-1-4-0-0-8-8-8”

Call <Name> — “Call John Smith”

Improving how you store your contacts can optimize your Bluetooth® Voice Recognition performance:

- Use full names instead of short or single-syllable names (“John or Dad”)
- Avoid using special characters/emojis or abbreviations (“Dr.”) when saving contacts

### NAVIGATION

**Command**      **Example**  
Find Address — “1-2-3-4-5 1st Street,  
<House #, Street, Fountain Valley”  
City, State>

Find <POI Name> — “Find McDonald’s”

Located on Rearview Mirror  
**DESTINATION SEARCH BY VOICE** 

**Command**      **Example**  
Find <POI Name> — “Find Lowe’s® near me”  
<POI Name> — “Starbucks®”

## Genesis Connected Services

- Assist with creating a Genesis Owners account
- Assist with Genesis Connected Services enrollment
- Show Genesis Connected Services Users Manual
- Encourage customer to download the Genesis Intelligent Assistant App

## Explain Drive mode Functions including Custom mode selections and features.

## Introduction and location of the Service Department

## Set first service valet appointment

## Review factory recommended maintenance schedule

## Was the condition of your vehicle (at delivery) to your satisfaction?

## MAINTENANCE

Scheduled Maintenance (Normal Usage)		3.3T		5.0L
Engine Oil & Filter	Replace	6,000 or 12 mos.	Replace	7,500 or 12 mos.
Fuel Additives	Add	6,000 or 12 mos.	Add	7,500 or 12 mos.
Tire Rotation	Perform	6,000 or 12 mos.	Perform	7,500 or 12 mos.
Vacuum Hose				
Air Conditioning Refrigerant				
Brake Hoses & Lines				
Drive Shafts & Boots				
Exhaust Pipe & Muffler				
Front Brake Disc/Pads, Calipers	Inspect	6,000 or 12 mos.	Inspect	7,500 or 12 mos.
Rear Brake Disc/Pads				
Steering Gear Box, Linkage & Boots, Lower Arm Ball Joint, Upper Arm Ball Joint				
Suspension Mounting Bolts				
Propeller Shaft				
Air Cleaner Filter	Inspect	6,000 or 12 mos.	Inspect	7,500 or 12 mos.
	Replace	18,000 or 36 mos.	Replace	22,500 or 36 mos.
Climate Control Air Filter (For Evaporator and Blower Unit)	Replace	12 mos.	Replace	12 mos.
Fuel Tank Air Filter				
Vapor Hose, Fuel Tank Cap, Fuel Tank				
Brake Fluid		12,000 or 24 mos.	Inspect	15,000 or 24 mos.
Parking Brake				
Fuel Filter				
Fuel Lines, Fuel Hoses & Connections	Inspect	24,000 or 48 mos.	Inspect	30,000 or 48 mos.
Front(AWD)/Rear Differential Oil				
Valve Clearance	Inspect	60,000 or 72 mos.	-	-
Drive Belts	Inspect	First 60,000 or 72 mos. Subsequent, every 12,000 or 24 mos.	Inspect	First 60,000 or 72 mos. Subsequent, every 15,000 or 24 mos.
Spark Plugs (Iridium Coated)	Replace	42,000	Replace	105,000
Coolant	Replace	First 120,000 or 120 mos. Subsequent, every 30,000 or 24 mos.	Replace	First 120,000 or 120 mos. Subsequent, every 30,000 or 24 mos.
Automatic Transmission Fluid	No check or services required for Normal Usage driving.			

\*See Owner's Manual for details.

Looking for more detailed information? This Quick Reference Guide does not replace your vehicle's Owner's Manual. If you require additional information or are unsure of a specific item, you should always refer to the vehicle's Owner's Manual or contact your authorized Dealer of Genesis Brand Products.

The information contained in this Quick Reference Guide was correct at the time of printing; however, specifications and equipment can change without notice. No warranty or guarantee is being extended in this Quick Reference Guide, and Genesis Motors USA reserves the right to change product specifications and equipment at any time without incurring obligations. Some vehicles are shown with optional equipment. Specifications apply to U.S. vehicles only. Please contact your Dealer of Genesis Brand Products for current vehicle specifications.

\_\_\_\_\_  
Sales Experience Manager      Date      Retail Sales Manager      Date

\_\_\_\_\_  
Guest      Date

\_\_\_\_\_  
Guest Email      @

NP150-G2020-Q  
(Rev 08/18/20)  
Printing 08/21/20

# GENESIS G90

## QUICK REFERENCE GUIDE



## GENESIS BRANDED VEHICLE OWNER PRIVACY POLICY

Your Genesis Branded vehicle may be equipped with technologies and services that use information collected, generated, recorded or stored by the vehicle. We have created a Vehicle Owner Privacy Policy to explain how these technologies and services collect, use, and share this information.

You may read our Vehicle Owner Privacy Policy on the GenesisMotorsUSA.com website at <http://www.genesismotorsusa.com/privacy-policy.html>  
If you would like to receive a hard copy of our Vehicle Owner Privacy Policy, please contact Customer Care at:

Genesis Customer Care  
P.O. Box 20850  
Fountain Valley, CA 92728  
844-340-9741  
CustomerCare@genesismotorsusa.com

Genesis Customer Care representatives are available Monday through Friday, between the hours of 5:00 AM and 7:00 PM PST and Saturday and Sunday between 6:30 AM and 3:00 PM PST (English).  
For Customer Care assistance in Spanish or Korean, representatives are available Monday through Friday between 6:30 AM and 3:00 PM PST.

Roadside Assistance: **1-844-340-9742**  
SiriusXM® Radio: **1-800-967-2346**  
Genesis Customer Care &  
Connected Services: **1-844-340-9741**  
**www.MyGenesisusa.com**

Instrument cluster  
Pages 15

Climate controls  
Pages 19

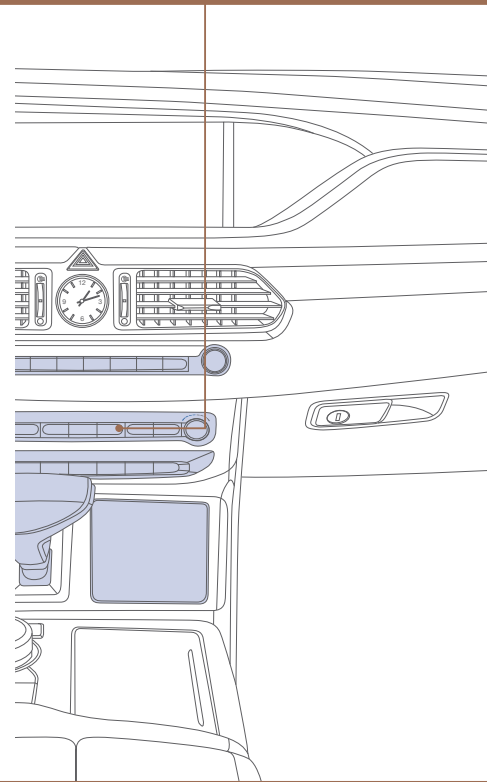
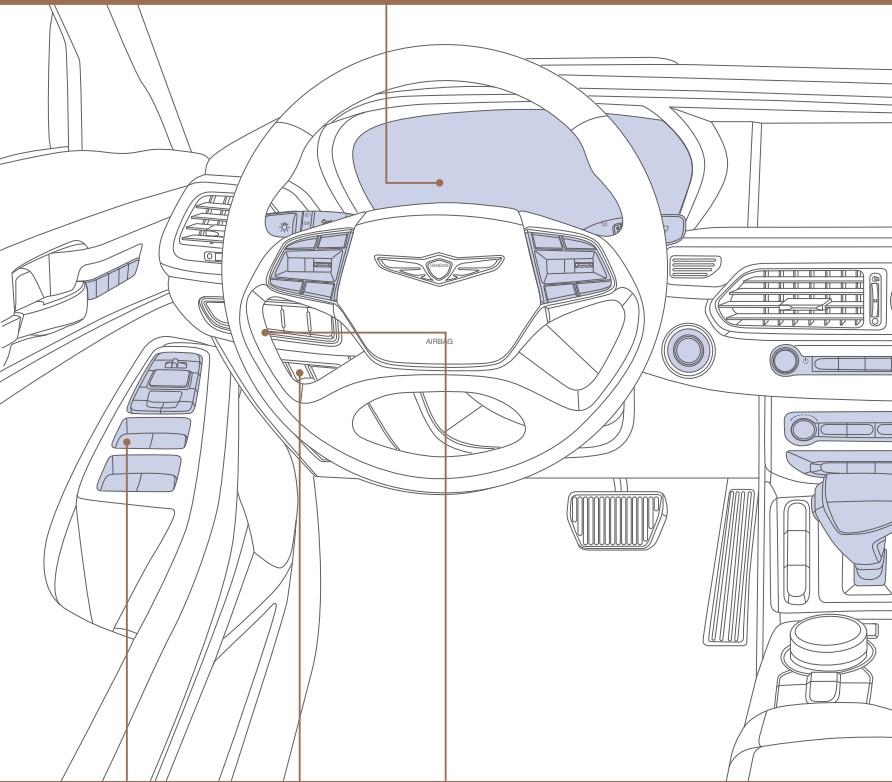

Driver's main controls  
Page 08

Trunk operation  
Page 09

Steering wheel adjustment  
Page 02

**WARNING!**

To reduce the risk of serious injury to yourself and others, read and understand the important SAFETY INFORMATION in your Owner's Manual.

Use this Quick Reference Guide to learn about the features that will enhance your enjoyment of your Genesis. More detailed information about these features are available in your Owner's Manual.

**FEATURES AND CONTROLS**

Climate controls	19
Driver's main controls	08
Headlights	13
Head-up display	18
Heated steering wheel	07
Homelink wireless garage control system	21
Instrument cluster	15
Instrument panel illumination	16
Interior light	12
LCD display control	17
LCD display modes	17
Occupant classification system	06
Panoramic sunroof	11
Seat-Front seat adjustment	03
Seat-Head restraints	05
Seat-Rear seat controls	04
Seat-Seat warmers and coolers (front seat)	07
Seat-Seat warmers and coolers (rear seat)	07
Smart key	01
Smart trunk	10
Steering wheel adjustment	02
Trunk lid control button	10
Trunk operation	09
Warnings and indicators	15
Wiper and washer	14

**INFOTAINMENT**

Android Auto	25
Apple CarPlay™	27
Audio mode	34
Bluetooth operational tips	31
Bluetooth phone pairing	33
Genesis connected services	22
Navigation	35
Rear seat controls	37
Rear USB port	36
USB port	36
Voice recognition tips	32
Wireless cellular phone charging system	36

**DRIVING**

Auto hold	49
Blind-spot collision warning (BCW)	43
Electric parking brake (EPB)	49
Electric stability control (ESC)	41
Forward Collision-avoidance assist (FCA)	42
Highway driving assist (HDA)	46
Lane following assist (LFA)	43
Lane keep assist system (LKA)	42
Leading vehicle departure alert	46
Paddle shifter	41
Parking assist system (PAS)	45
Rear cross-traffic collision-avoidance Assist (RCCA)	47
Rear view monitor	44
Safe exit assist (SEA)	48
Surround view monitor	45
Tire pressure monitoring system (TPMS)	50
Transmission	40

\*Some vehicles may not be equipped with all the listed features.

This QRG provides instructional videos that are accessible by scanning the QR Codes found throughout the QRG with your smartphone/tablet.

In order to scan a QR Code, you will need to use a QR Code Reader App on your mobile device. You can download the app onto your device through an app store or marketplace.

### SMART KEY

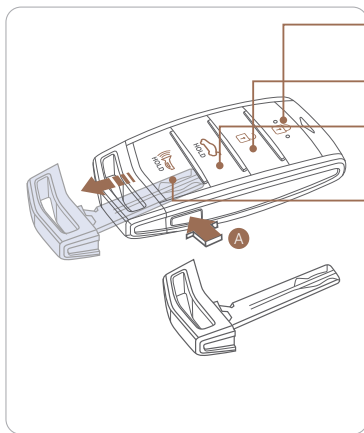

- Lock
- Unlock
- Trunk Open
- Panic

#### Mechanical key

Press and hold the release button **A** and remove the key.

#### NOTE:

User-selectable option; see the Owner's Manual for more details.

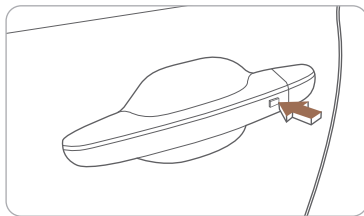

#### Door Lock/Unlock

Smart key must be within range  
 Insert hand into door handle:  
 Once – Unlock driver's door  
 Twice – Unlock all doors  
 Press the button to lock all doors.

### STEERING WHEEL ADJUSTMENT

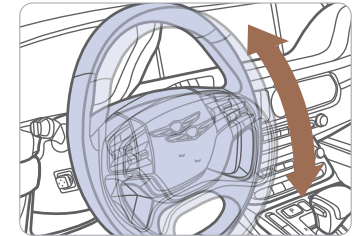
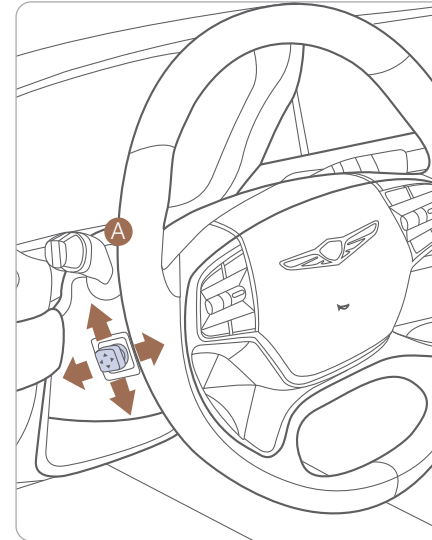

Tilt

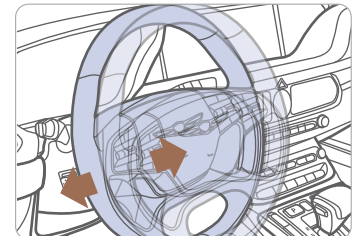

Telescope

**NOTE:** Do not adjust while driving. Toggle switch **A** to adjust steering wheel.



## FRONT SEAT ADJUSTMENT

### Front Seat controls

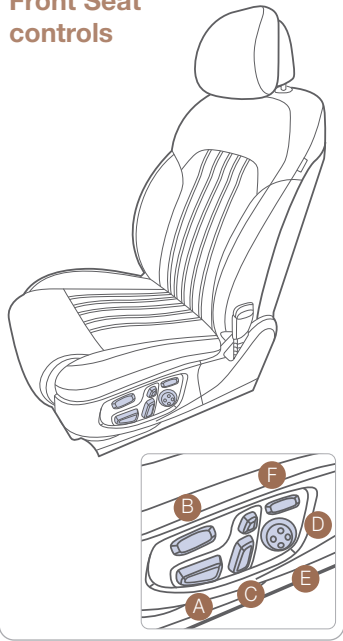

**A** Forward and rearward



**B** Seat cushion length (for driver's seat)

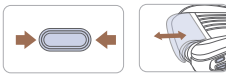

**C** Seatback angle



**A** Seat cushion height and tilt

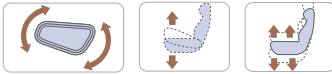

**D** Lumbar support



**E** Seat bolster adjustment (for driver's seat, if equipped)

Rotate outer ring to adjust seat bolster



**F** Seat shoulder adjustment (for driver's seat, if equipped)



Scan to view a video of: Front seat adjustment

### Easy Access Function (Driver's Seat)

#### Entering the vehicle

The driver's seat and steering wheel will move back to its original position when the Engine Start/Stop button is in the OFF position and the driver's door is closed with the smart key in possession.

#### Exiting the vehicle

The driver's seat will move rearward and the steering wheel will move upward when the driver's door is opened and the Engine Start/Stop button is in the OFF position with the gear in P (Park).

**NOTE:** The driver's seat may not move rearward if there is not enough space between the driver's seat and the rear seat.

You can activate or deactivate this function from the settings menu in the AVN system screen.

Seat Easy Access:

Setup > Vehicle > Convenience > Seat/Steering > Seat Easy Access > Off/Normal/Extended

Steering Easy Access:

Setup > Vehicle > Convenience > Seat/Steering > Steering Easy Access > On/Off

## REAR SEAT CONTROLS

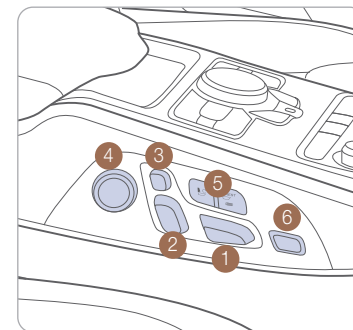

- 1 Forward or rearward seat sliding adjustment
- 2 Seatback angle adjustment
- 3 Headrest adjustment
- 4 Lumbar support adjustment
- 5 Seat mode switches
- 6 FRONT button (to control front passenger seat)

**NOTE:** Rear door must be closed for all rear seat controls to operate.

## HEAD RESTRAINTS (Front seat)

Forward and rearward adjustment      Up and down adjustment

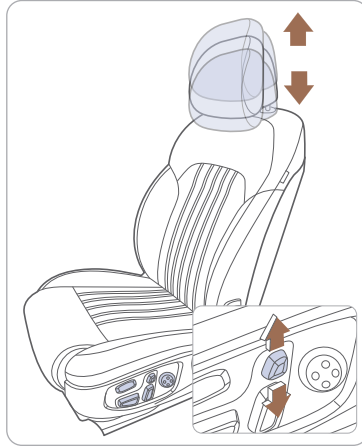

## HEAD RESTRAINTS (Rear seat)

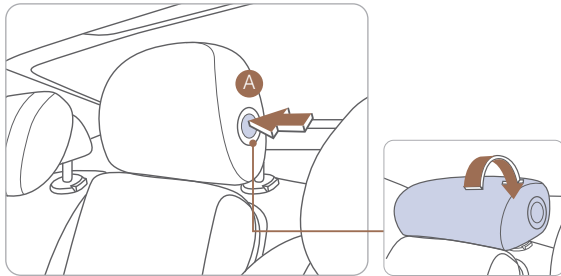

### Folding the center head restraint

To fold the center head restraint:

- When the rear-center head restraint is not used, manually fold back the rear-center head restraint while pressing the release button **A** located on the side. To use the rear-center head restraint again, manually pull up the rear-center head restraint, until it is securely latched.
- You can remove the rear-center head restraint by manually pulling up the rear-center head restraint, while pressing the release button.

## OCCUPANT CLASSIFICATION SYSTEM (OCS)

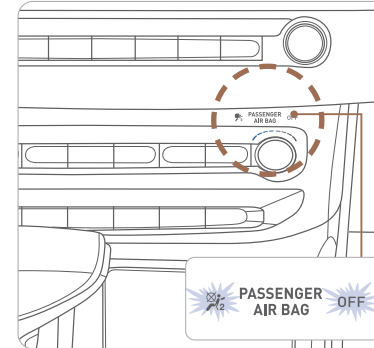

Your vehicle is equipped with an Occupant Classification System (OCS) in the front passenger's seat that detects whether the passenger air bag system should be activated or deactivated.

The following items may affect the OCS operation:

- Car seat accessories such as thick blankets and cushions which cover up the car seat surface
- Placing materials such as water bottles on the seat
- Using electronic devices such as laptops and satellite radios which use inverter chargers
- Wet towels or liquid that has been spilled on the seat. Make sure the seat has been completely dried before driving the vehicle

## HEATED STEERING WHEEL

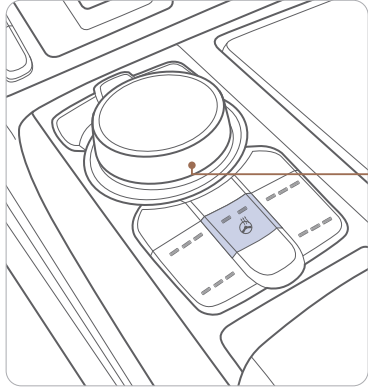

Pressing the heated steering wheel button warms the steering wheel. The indicator light on the button is illuminated when this feature is turned on.



Heated steering wheel button

**NOTES:** Heated steering wheel includes Smart Logic that automatically adjust setting. Please refer to your Owner's Manual for further information.

## SEAT WARMERS AND COOLERS (FRONT SEATS)

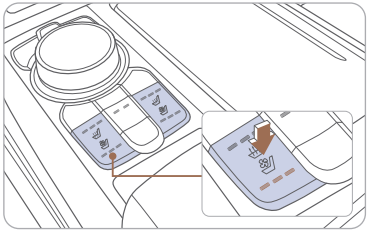

- Heat
- Air Ventilation

Each time you push the button, the setting is changed as follows:



## SEAT WARMERS AND COOLERS (REAR SEATS)(if equipped)

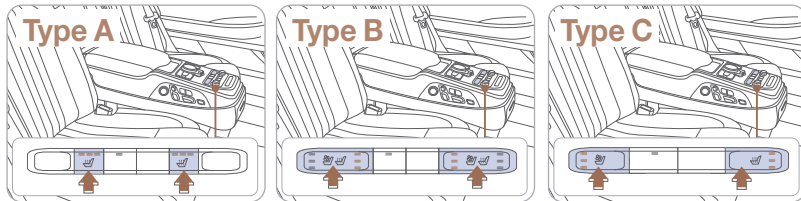

To turn off immediately, press and hold the button.

**NOTES:** Vehicle may be equipped with Auto Heated/Ventilated features located in the vehicle setting options. Please refer to your Owner's Manual for further information.

## DRIVER'S MAIN CONTROLS

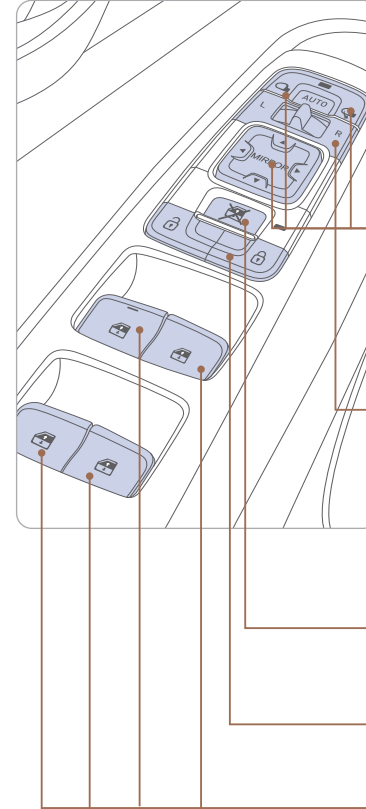

Scan to view a video of: Outside mirrors adjustment

### Outside Rearview Mirror

- Press switch left/right to unfold/fold mirrors.  
Press the lock or unlock button on the smart key, and the mirrors will be folded or unfolded when AUTO is set.
- Press the L or R button to adjust the mirror by using the directional switch. If L or R button is still selected, both mirrors will tilt downward when reversing. Deselect L or R will disable the auto tilt down feature.

### Power window lock button

- Disables the power window switches on the rear passenger doors.

### Door Lock

- Locks/unlocks all doors.

### Window Switches

- Front power window switches.
- Rear power window switches.

## TRUNK OPERATION

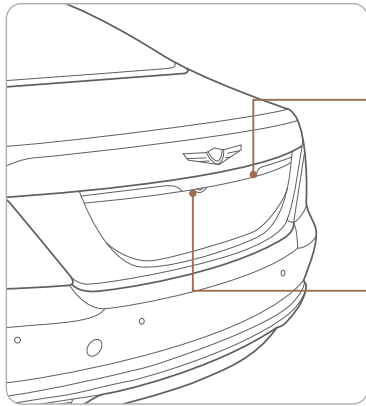

### Power trunk open button

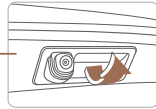

Press to open.  
Smart key needs to be within the range.

### Power trunk open button on the smart key



Press and hold.

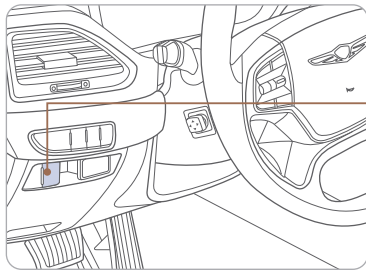

### Power trunk main control button

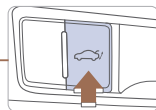

Press to open.  
Press and hold to close.

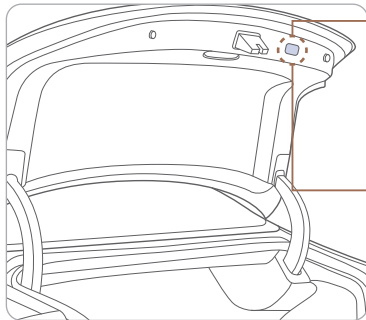

### Power trunk close button

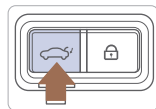

Press to close.

### Power trunk lock button

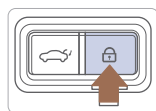

Press to lock the trunk and doors will lock as well.  
Smart key needs to be within range.

**NOTES:** Trunk opening height adjustment is available in the Vehicle setup options. Please refer to your Owner's Manual for further information.

## TRUNK LID CONTROL BUTTON

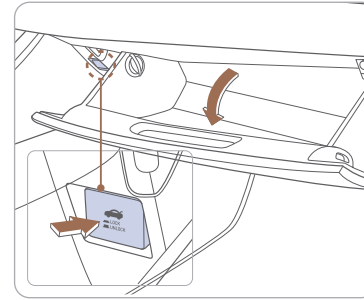

The trunk lid control button is used to prevent unauthorized access to the trunk.

1. Open the glove box.
2. Press the trunk lid control button. In this LOCK position, the trunk can only be opened with the mechanical key.
3. Close and lock the glove box with the mechanical key.

**NOTE:** Without the mechanical key, the smart key can only start the engine and operate door locks. Please refer to your Owner's manual to learn how to access the mechanical key.

## SMART TRUNK

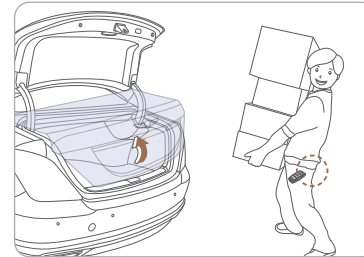

Scan to view a video of: Smart Trunk

### Smart Trunk

When smart key is within range for 3 seconds, the trunk will automatically open.

### To enable Smart Trunk function:

Vehicle must be in P (Park) to adjust the settings located in the setup menu in the AVN system screen.

1. Select Setup > Vehicle > Door/Trunk
2. Check "Smart Trunk".

**NOTE:** Function is active after 15 seconds when all doors are closed and locked. The vehicle will also provide an audible and visual alarm while activating. Please refer to your Owner's Manual for further information.

## PANORAMIC SUNROOF

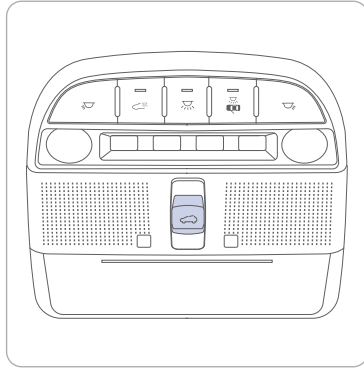

### Sunshade



To open the sunshade, pull the sunroof control lever lightly backward to the first detent position. Push the sunroof control lever forward to close.

### Sliding the sunroof

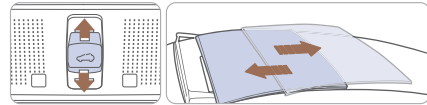

Pull the sunroof control lever backward past the first detent to slide open the sunroof control lever forward to the second detent position to close sunroof glass with the sunshade.

### Tilting the sunroof

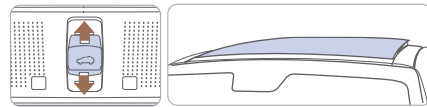

Push the sunroof control lever upward to tilt open the sunroof. Push again the sunroof control lever upward to tilt the sunroof glass closed.

## INTERIOR LIGHTS

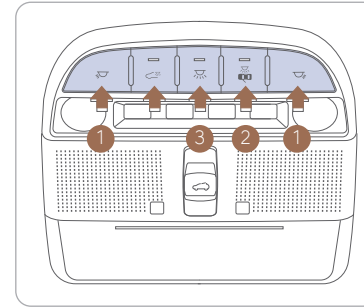

### Front map lamp ①

Press the button to turn the map lamp on or off.

### Front door lamp (☞) ②

Lights will turn on when any door is open.

### Front room lamp (☞) ③

Push the switch to turn the room lamp on.

### Front room lamp (☞) ④

Push the switch to turn the room lamp off.

## HEADLIGHTS

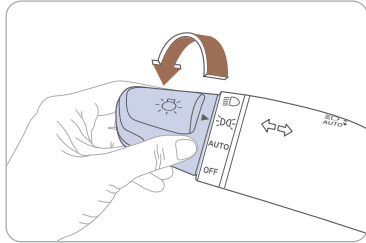

- ▶ | Headlights
- ▶ | Parking lights
- ▶ | **AUTO** Auto headlights
- ▶ | **OFF** All lights Off

### Headlight delay

Headlights may stay on for 15 seconds after exiting and locking up the vehicle. Press the remote lock button twice to turn the headlights off. Please refer to your Owner's Manual for further information.

Turn signals **A** and lane change **B** signals

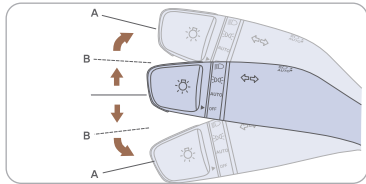

Flashing headlights

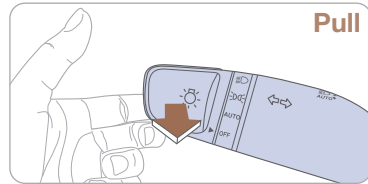

High beam

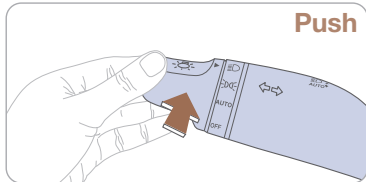

**NOTE:** To turn off the high beam, pull the lever towards you.

Smart high beam

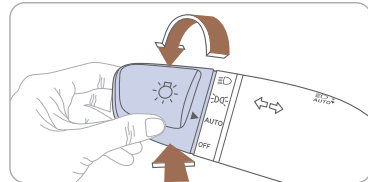

Smart high beam function

1. Select the AUTO position on stalk.
2. Push the lever forward to engage the Auto high beam.
3. Push the lever forward again to disengage.

## WIPER AND WASHER

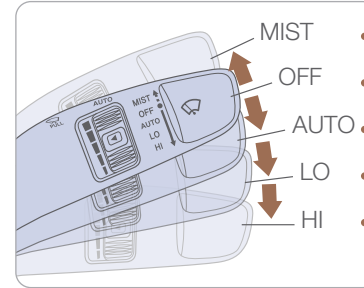

- MIST - Single wipe
- OFF - OFF
- AUTO - Auto wipe
- LO - Low wiper speed
- HI - High wiper speed

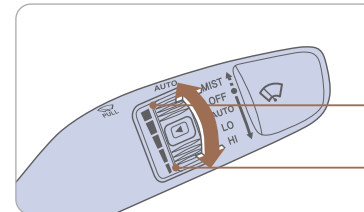

Auto control wipe interval adjustment

Fastest wiper speed

Slowest wiper speed

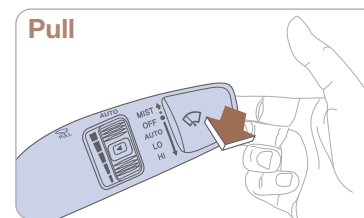

Front windshield wash with brief wipes

## INSTRUMENT CLUSTER

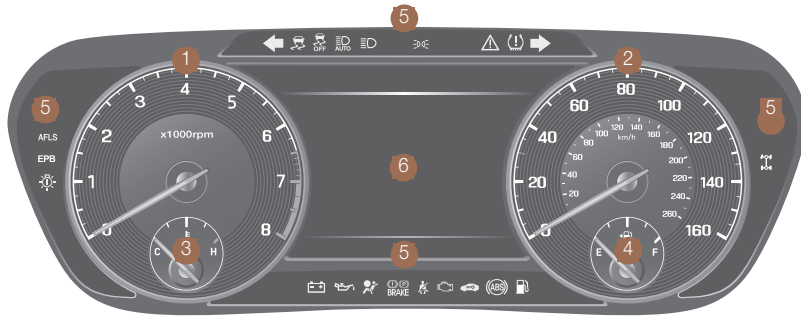

- 1 Tachometer
- 2 Speedometer
- 3 Engine coolant temperature gauge
- 4 Fuel gauge
- 5 Warning and indicator lights
- 6 LCD display (including trip computer)

## WARNINGS AND INDICATORS

Air bag warning light	Seat belt warning light	Parking brake & brake fluid warning light
ABS warning light	Electronic Brake Force Distribution (EBD) System warning light	
Malfunction Indicator Lamp (MIL)	Charging system warning light	Motor-Driven Power Steering (MDPS) warning light
Engine oil pressure warning light	Low fuel level warning light	Low Tire Pressure warning light
<b>EPB</b> Electric Parking Brake (EPB) warning light	Forward Collision-Avoidance Assist (FCA) Warning Light	<b>AFLS</b> Adaptive Front Lighting System (AFLS) warning light
All Wheel Drive (AWD) warning light	Master warning light	Electronic Stability Control (ESC) indicator
Electronic Stability Control (ESC) OFF indicator	Immobilizer indicator	Turn signal indicator
High beam indicator	Light ON indicator	Smart high beam indicator
<b>SPORT</b> SPORT mode drive indicator	<b>SMART</b> SMART mode drive indicator	<b>ECO</b> ECO mode drive indicator
<b>INDIVIDUAL</b> INDIVIDUAL mode indicator	<b>AUTO HOLD</b> AUTO HOLD indicator	Lane Keeping Assist System (LKAS) indicator

## INSTRUMENT PANEL ILLUMINATION

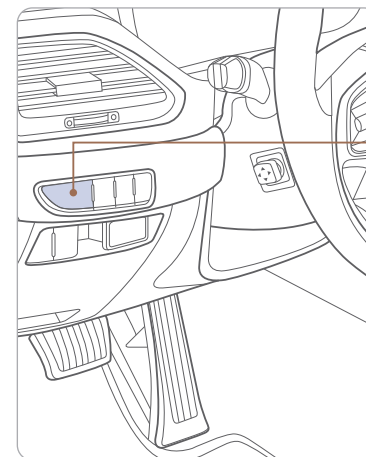

Press the illumination control button to adjust the brightness.

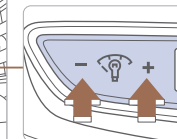



## LCD DISPLAY CONTROL

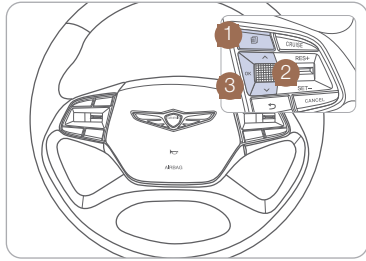

- 1 : **MODE button**  
Press to change modes.
- 2 : **MOVE switch**  
Rotate to change items.
- 3 **OK** : **OK button**  
Push button for setting or resetting the selected item.

## LCD DISPLAY MODES

Modes	Symbol	Description
Trip Computer		This mode displays driving information such as tripmeter, fuel economy, etc.
Turn By Turn (TBT) (if equipped)		This mode displays the state of the navigation.
Assist		This mode displays the state of the Smart Cruise Control (SCC) and Lane Keeping Assist System (LKAS), Driver Attention Alert (DAA), and Tire Pressure Monitoring System (TPMS).
Warning		Displays warning messages.

## HEAD-UP DISPLAY

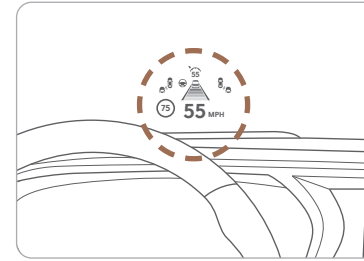

The Head-Up Display is a transparent display which projects a shadow of information of the instrument cluster and navigation on the windshield glass.

The Head-up display can be activated by selecting “Enable Head-Up Display” from the settings menu in the AVN system screen:

Setup > Vehicle Settings > Head-Up Display > Enable Head-Up Display

Head-Up Display information

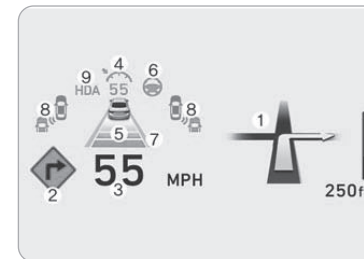

1. Turn-by-turn (TBT) navigation information
2. Road information
3. Speedometer
4. Cruise system set speed
5. Smart Cruise Control (SCC) information
6. Lane Following Assist (LFA) system information
7. Lane Keeping Assist (LKA) system information
8. Blind-spot Collision Warning (BCW) system information
9. Highway Driving Assist (HDA) system information

**NOTE:** If you wear polarizing-filter sunglasses, it may be difficult to read the Head Up Display information.

## CLIMATE CONTROLS

### Front

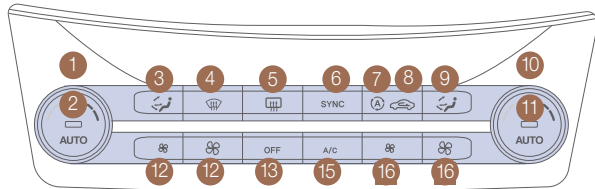

- 1 Driver's temperature control knob
- 2 Driver's AUTO button
- 3 Driver's mode selection button
- 4 Front windshield defroster button
- 5 Rear window defroster button
- 6 SYNC button
- 7 AQS (Air quality system) button
- 8 Air intake control button
- 9 Passenger's mode selection button
- 10 Passenger's temperature control knob
- 11 Passenger's AUTO button
- 12 Driver's fan speed control button
- 13 OFF button
- 14 Climate control information screen selection button
- 15 Air conditioning button
- 16 Passenger's fan speed control button

### DEFOGGING/DEFROSTING



1. Press the front windshield defrost button.

**NOTE:** Outside (fresh) air position will be selected when front defrost button is selected.



2. Set the temperature to the warmest desired setting.

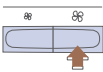

3. Set the fan speed to the highest setting.

**NOTE:** Smart Vent, Auto Defog, and Carbon Dioxide Monitor features are available in the Climate Control display. Please refer to your Owner's Manual for further information.

### SYSTEM OFF

Pressing the OFF button will place the system to the OFF mode.

- Blower will turn off.
- Outside (fresh) air position will be selected.
- Vented air will be at last set temperature.

### MODE SELECTION

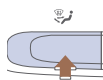

Changes the direction of air flow.

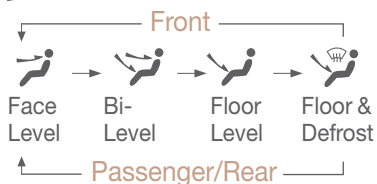

### Rear

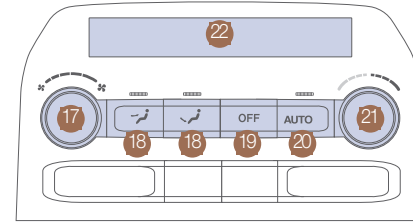

- 11 Passenger's AUTO button
- 12 Driver's fan speed control button
- 13 OFF button
- 14 Climate control information screen selection button
- 15 Air conditioning button
- 16 Passenger's fan speed control button
- 17 Rear fan speed control knob
- 18 Rear mode selection button
- 19 Rear OFF button
- 20 Rear AUTO button
- 21 Rear temperature control knob
- 22 LCD display

### AIR INTAKE CONTROL



Recirculated air position



Outside (fresh) air position



AQS activated (auto air intake control)

### SYNC BUTTON

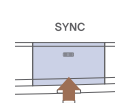

Press the SYNC button to adjust the driver and front/rear passenger side temperature and air flow direction with the same settings."

### AUTOMATIC HEATING/ AIR CONDITIONING

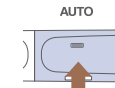

1. Press the AUTO button.



2. Set the temperature control to the desired setting.

The modes, fan speeds, air intake, and air-conditioning will adjust automatically according to the temperature setting.

### REAR WINDOW DEFROSTER



Press to activate/deactivate the rear window and outside mirrors defroster.

## HOMELINK WIRELESS GARAGE CONTROL SYSTEM

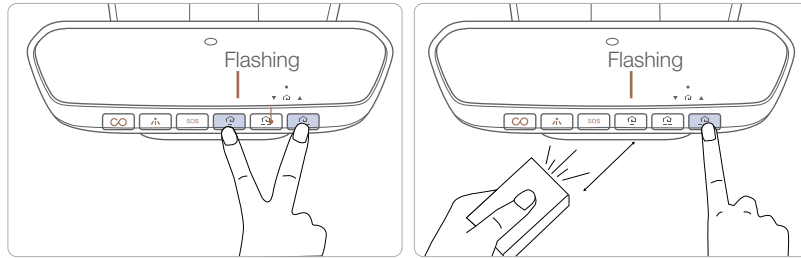

### Standard Programming

1. For first time programming, press and hold the two outside buttons ( , ) until the indicator light starts to flash. (to reprogram buttons, skip this step)
2. Press and hold the desired button ( , or ) and your transmitter's button at the same time until the Homelink indicator light changes from a slow to a rapid blink.  
(The transmitter has to be 1 to 3 inches away from the mirror)The desired Homelink button is now programmed.

NOTE: If you have a rolling code garage door opener, complete additional steps:

3. Locate the “Learn” or “Smart” button on your garage door opener. Press and release the button and complete Step 4 within 30 seconds.
4. Return to the vehicle and press the programmed Homelink button up to 4 times (or until the garaged door operates)

For more detailed information, please refer to your Owner's manual or visit [www.homelink.com](http://www.homelink.com) or call (800) 355-3515

## GENESIS CONNECTED SERVICES

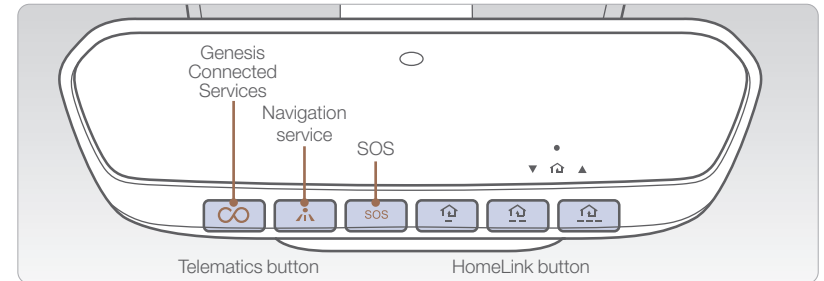

Genesis Connected Services subscription is required. To enroll, please visit your dealership or [MyGenesisUSA.com](http://MyGenesisUSA.com).

Press the button for access to the voice-response menu of services.

- You can say:

Roadside Assistance  
Service Link  
Account Assistance

Press the button for Destination Search by Voice.

Press the **SOS** button for SOS Emergency Assistance.

Visit [MyGenesisUSA.com](http://MyGenesisUSA.com) for more information or refer to your Genesis Connected Services User's Manual for detailed information on system operation.

For immediate assistance with subscription services, please call 1-844-340-9741.

### Destination Search powered by Voice for Navigation system

Genesis Connected Services allows you to search and download location information for points of interest, businesses, and specific addresses.

### Using Destination Search In Your Vehicle

- Press the Navigation Service button on your rearview mirror and state your destination when prompted.
- If the voice search does not return the desired destination, you can also use the keyboard to search if vehicle is in P (Park).
- When you route to a destination, the destination is saved in your POI history.

## Genesis Intelligent Assistant App



You can download the Genesis Intelligent Assistant App to your compatible smart phone from the following sites:

- iPhone® — Apple® App Store
- Android™ — Google Play™

## Remote Start

Remote Start enables you to remotely start your vehicle virtually from anywhere. For vehicles equipped with full-automatic temperature control, you can also enable climate control remotely, turn on the seat warmers/coolers, and turn on the front window defroster, ensuring a warm or cool car is ready to go when you are.

-  To use this feature, you must have a Genesis Connected Services Personal Identification Number (PIN). To create or change your PIN, log in to [MyGenesisUSA.com](http://MyGenesisUSA.com).

## Remember:

- Remote Start will automatically shut off after 10 minutes or after selected engine timer runs out in navigation vehicles.
- While this feature is active, the parking lights will blink until the vehicle is turned off or when vehicle is in operation.
- To continue to operate the vehicle, the proximity key must be inside the vehicle with the driver, prior to pressing the brake and being able to move the gearshift from the P (Park) position.

## Preconditions:

- Ignition is OFF
- Alarm is armed (i.e., vehicle locked by key fob Remote Door Lock)
- Gearshift level is in the P (Park) position
- Brake pedal is not depressed
- Engine hood is securely closed
- All the doors are closed and locked
- The tailgate or trunk lid is closed
- The security / panic system is not activated
- The proximity key is not inside the vehicle
- The battery power is not low
- Vehicle is located in an open area
- It has been less than 7 days since last vehicle ignition off
- Vehicle located in area with good cell reception

## Remote Start will terminate:

- After 10 minutes or after selected engine timer runs out in navigation vehicles
- Brake is pressed without the proximity key inside the vehicle
- Alarm is triggered without the proximity key inside the vehicle
- Door / trunk is opened from inside the vehicle

**Notice:** Laws in some communities may restrict the use of the features that remotely start the engine. For example, some laws may require a person using the remote start feature to have the vehicle in view when doing so, or limit the length of time a vehicle engine may idle. Please check local and state regulations for any requirements and restrictions on remote starting of vehicles and engine idling time.

### WARNING!

Do not remote start vehicle in an enclosed environment (i.e., closed garage). Prolonged operation of a motor vehicle in an enclosed environment can cause a harmful build-up of carbon monoxide. Carbon monoxide is harmful to your health. Exposure to high levels of carbon monoxide can cause headaches, dizziness or in extreme cases unconsciousness and / or death. Do not leave children or animals unattended in a vehicle while using the remote start function.

### CAUTION!

If the vehicle's windshield wipers are left on when the vehicle was last driven, then the wipers will turn on if the remote start function is activated. To avoid damage to the wiper blades (i.e., due to heavy ice or snow accumulated on the windshield), please always turn the vehicle's windshield wipers off when parking the vehicle.

## ANDROID AUTO™

### REQUIREMENTS:

- USB cable
- OS Android™ 5.0 or higher
- Compatible Android Phone
- Data and wireless plan for applicable features

### BEFORE YOU BEGIN:

- Android Auto features may operate differently than on your phone.
- Message and data charges may apply when using Android Auto.
- Android Auto relies on the performance of your phone. If you experience performance issues:
  - Close all apps and then restart them or
  - Disconnect and then reconnect your phone
- Using the USB cable that was provided with your phone is recommended.
- When Android Auto is active, your in-vehicle voice recognition system is disabled and you will be using talk to Google™ to make your requests.

### ANDROID AUTO SUPPORT



<https://support.google.com/androidauto/>

## PHONE SETUP

Activate Bluetooth on your phone and connect the USB cable from your mobile device to the USB Port in your vehicle.

Phone will prompt you to download the Android Auto app and update other needed apps (i.e. Google Maps™, Google Play Music™, Google Now™).

**NOTE:** Vehicle must be parked.

- Location mode setting should be set to High accuracy.
- Car and phone setup should be completed in one sitting. If phone setup needs to be resumed, recommend to Force Stop the Android Auto app on the Phone then reopen the app and accept the Disclaimer notifications.

## CAR SETUP

1. Press the SETUP button.
2. Select the “Phone Projection” icon on screen.
3. Select “On” for Android Auto.
4. Connect your Android phone to the vehicle USB port. Agree to the notification and disclaimers on your phone then the “Android Auto” icon will appear confirming the setup.

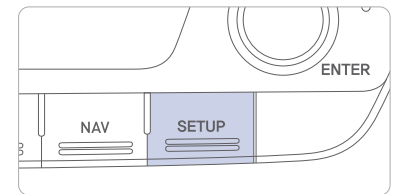

For more detailed information on how to operate Android Auto, please refer to your navigation manual.

For additional Android Auto support, please refer to the Android Auto Support Website  
<https://support.google.com/androidauto/>

Android Auto, Google Play, Android, and other marks are trademarks of Google Inc.

## APPLE CARPLAY™

### REQUIREMENTS

- Apple Lightning® cable
- Latest iOS
- iPhone® 5 or above
- Data and wireless plan for applicable features

### BEFORE YOU BEGIN

- Apple® CarPlay features may operate differently than on your phone.
- Message and data charges may apply when using Apple CarPlay.
- Apple CarPlay relies on the performance of your phone. If you experience performance issues:
  - Close all apps and then restart them or
  - Disconnect and then reconnect your phone
- Using the Apple Lightning cable that was provided with your phone is recommended.
- When Apple CarPlay is active, your voice recognition system is disabled and you will be using Siri® to make your requests.

### PHONE SETUP

On your phone, go to Settings > General > CarPlay to allow CarPlay access.

On your phone, go to Settings > Siri and ensure Siri is turned ON.

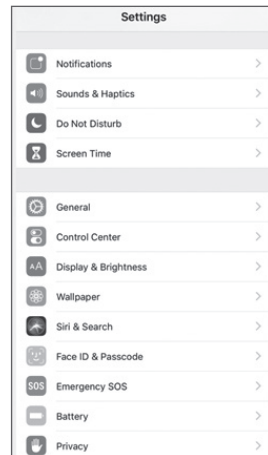

## CAR SETUP

1. Press the SETUP button.
2. Select the “Phone Projection” icon on the screen.
3. Select “Apple CarPlay” on the Connectivity Settings screen. Then select “On” to enable Apple CarPlay.
4. Connect your Apple iPhone to the vehicle USB port then select ‘OK’ when the pop-up message appears. The Apple CarPlay icon will now appear on the vehicle Home screen confirming the setup.

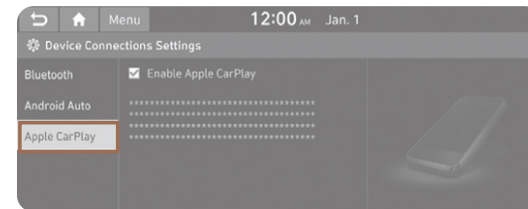

Apple CarPlay, Apple, and other marks are trademarks of Apple Inc.

## CarPlay Home Screen

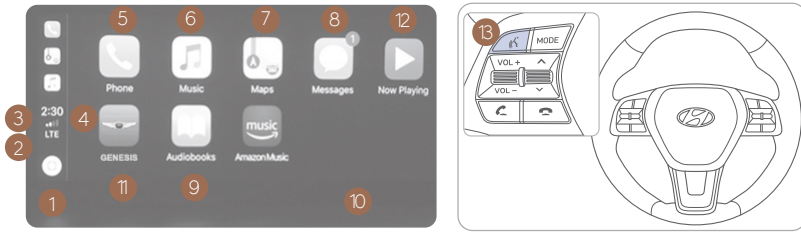

- |                         |                                  |
|-------------------------|----------------------------------|
| 1 HOME ICON             | 7 APPLE MAPS                     |
| 2 WIRELESS CONNECTIVITY | 8 MESSAGES                       |
| 3 CELLULAR SIGNAL       | 9 3RD PARTY APPS                 |
| 4 PHONE TIME            | 10 SCREEN PAGE INDICATOR         |
| 5 PHONE                 | 11 EXIT TO HOME SCREEN           |
| 6 APPLE MUSIC™          | 12 CURRENT CARPLAY AUDIO PLAYING |
|                         | 13 VOICE RECOGNITION TIPS        |

## SIRI

Apple CarPlay uses Siri to perform many actions like sending messages, placing calls, and looking up/setting POI/Destinations. A Siri session can be initiated on any screen by:

1. Touch and holding the HOME icon (1) on the CarPlay screen or
2. Press the steering wheel VOICE RECOGNITION (13) button.

Note: Ensure Siri feature is set to ON in your phone (Go to Settings > Siri).

3. Say any of the following commands;

- “Text <John Smith> ‘Call you later’” to send a text message.
- “Read text messages” to read available text message.
- “Call <John Smith>” to make a phone call.
- “Find <POI/Destination>” to locate a POI/Destination.

## PHONE

Touch the PHONE (5) icon to access the Phone screen. Siri will automatically asks ‘Who do you want to call’ when the PHONE (5) icon is selected.

NOTE: Phone call sound quality is dependent on the wired connection. Using the Lightning cable that came with the phone is recommended.

## APPLE MUSIC

Touch the APPLE MUSIC (6) icon to access the Apple Music screen.

## APPLE MAPS

Touch the APPLE MAPS (7) icon to access the Apple Map screen.

## MESSAGES

Touch the MESSAGES (8) icon to access the Message screen. Siri will automatically asks ‘Want to hear unread messages or create a new one’ when the MESSAGE icon is selected.

## 3rd PARTY APPS

Supported CarPlay apps that are downloaded on your phone will appear on the CarPlay screen. Touch the apps icons to access those supported apps.

NOTE: A list of the supported CarPlay supported apps can be found at <http://www.apple.com/ios/carplay/>

Ensure phone has latest version of the 3rd Party Apps.



## BLUETOOTH® OPERATIONAL TIPS

In the following situations you or the other party may have difficulty hearing each other:

1. When the Bluetooth® volume is too high. High level volume may result in distortion and echo.
2. When driving on a rough road, high speeds and / or with the window open.
3. When the air conditioning vents are facing the microphone.

## Steering wheel control using Bluetooth®

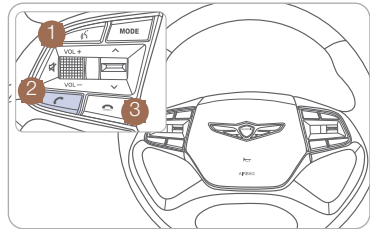

- 1 **TALK**  
Activates voice recognition.
- 2 **CALL**  
Places and transfers calls.
- 3 **END CALL**  
Ends calls or cancels functions.

### To Answer a Call:

- Press the button on the steering wheel.

### To Reject a Call:

- Press the button on the steering wheel.

### To Adjust Ring Volume:

- Scroll the VOLUME wheel on the steering wheel.

### To Transfer a Call to the Phone

(Private call on handset – do not use while driving):

- Press and hold the button on the steering wheel until the audio system transfers a call to the phone.

### To Finish a Call:

- Press the button on the steering wheel.

## Making a call using voice recognition:

The menu tree identifies available voice recognition Bluetooth® functions.

### Calling by Name:

1. Press the button.
2. Say the following command:
  - “Call <John>”: Connects the call to John.
  - “Call <John> <on Mobile/at Home/at Work>”:

Connects the call to John’s Mobile, Home, or Work phone number.

### Dialing by Number:

1. Press the button.
2. Say “Dial Number”.
3. Say the desired phone numbers.

For a complete list of commands, please refer to your Owner’s Manual.

## VOICE RECOGNITION TIPS

Your vehicle is equipped with Voice Recognition technology which allows drivers to operate their phones without having to take their eyes off the road to help minimize distractions.

Voice recognition performance may be affected if:

- Driving with the windows and sunroof open
- the heating-cooling system is on
- passing through a tunnel
- driving on rugged and uneven roads

To start a voice command, press the button and say a command.

The following phone commands are available:

Command	Function
Call	Displays downloaded Contacts.
Calls <Name>	Calls <Name> saved in Contacts.
Dial Number	Displays a screen when you can say a phone number to dial.
Dial <Phone number>	You can directly say the number to call. ex) Dial 111 555 1234
Redial	Directly calls at the number that you have last dialed.
Call History	Displays your Call History.

### NOTE:

For a complete list of commands, please refer to your Owner’s Manual.

## BLUETOOTH® PHONE PAIRING

**NOTE:** Vehicle must be parked to complete the pairing process.

1. Press the call/answer  button on the steering wheel.

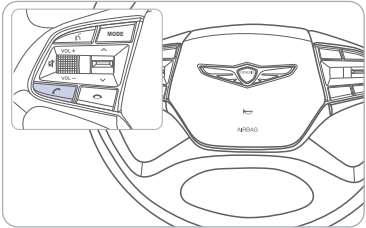

2. Within the Bluetooth® pairing screen in your Bluetooth® device, search and select the name of the vehicle. The default vehicle name is “GENESIS G90”.
3. Verify the passkey and proceed with pairing from your Bluetooth® device. The default passkey is “0000”.
4. The system will confirm the device has been successfully paired.

Please refer to your Owner’s Manual for further information.

## AUDIO MODE

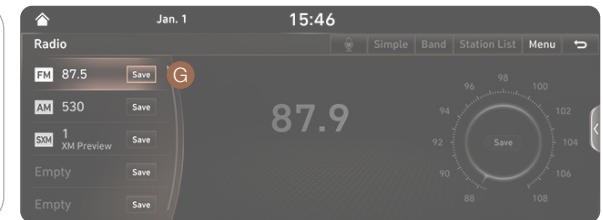
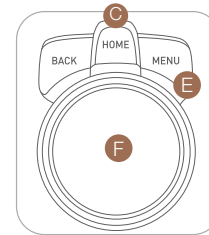
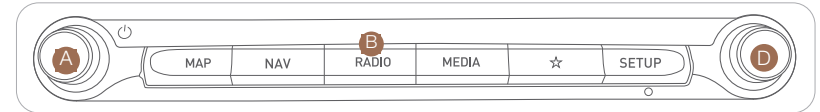

### Radio Mode

1. Press **A** POWER button to turn on the radio.
2. Press the **B** RADIO on the navigation unit. Or press **C** HOME on the controller then, select [Radio]. The most recently played channel will start.
3. Each press of the **B** RADIO will change the mode in order of FM → AM → SiriusXM → FM.
4. Select the channel you wish to listen to.

### How to set Preset

1. Press the **B** RADIO button.
2. Rotate **D** TUNE knob to select desired station from FM/AM/SiriusXM.
3. Press the **E** MENU button from the DIS controller. Rotate the **F** DIS knob to highlight **G** Save as Preset and press DIS knob to select.
4. Rotate the **F** DIS knob to select Preset Location and press DIS knob to save.

**NOTE:** A clear view of the southern sky is recommended to ensure XM® radio reception.

## NAVIGATION

### Basic features on the map screen



- |                              |                                                                |
|------------------------------|----------------------------------------------------------------|
| 1 Home Button                | 10 Pause Route                                                 |
| 2 Map Display                | 11 Route Options                                               |
| 3 Navigation Volume          | 12 Destination Menu                                            |
| 4 Zoom in the map            | 13 Find a POI (Point of Interest) around the current position. |
| 5 Map scale display          | 14 Save frequently used addresses to address book.             |
| 6 Zoom out the map           | 15 Traffic information                                         |
| 7 Menu Button                |                                                                |
| 8 Current Vehicle Position   |                                                                |
| 9 Remaining distance display |                                                                |

## USB PORT

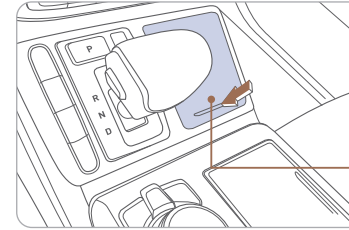

Use the jack to connect an external audio device and listen to it through the audio speakers in your vehicle.



## REAR USB PORT (if equipped)

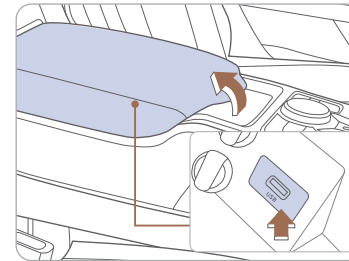

There is an additional USB port located in the rear center console that can connect to the audio system.

## WIRELESS CELLULAR PHONE CHARGING SYSTEM

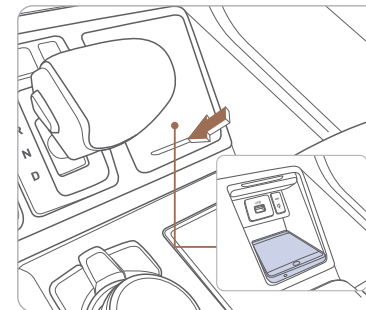

**NOTE:** The wireless cellular phone charging system supports only the Qi-enabled cellular phones (Qi).

The system operates when all doors are closed, and the Engine Start/Stop button is in the ACC/ON position. When the charging process is completed, the indicator color changes to green from orange. If there is a malfunction, the indicator blinks in orange for 10 seconds. In this case, temporarily stop the charging process, by removing the phone from the charge pad then placing it back on the pad. The wireless charging function can be turned ON or OFF in the user settings mode on the instrument cluster.

## REAR SEAT CONTROLS

### Type A

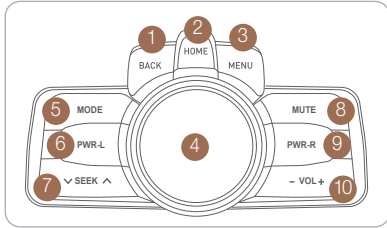

- 1 BACK: Displays the previous screen.
- 2 HOME: Displays the HOME screen.
- 3 MENU: Displays selectable menus by mode.
- 4 Controller: Various functions can be operated by turning, pushing or pressing the controller.
- 5 MODE: Each press of the key will change the mode in order of FM → AM → SiriusXM → Disc → Jukebox → USB/iPod → AUX → Bluetooth Audio
- 6 PWR-L: Turns the rear left display On/Off.
- 7 ^SEEK V: Used to search and select frequencies, channels, and files.
- 8 MUTE: Mutes the volume.
- 9 PWR-R: Turns the rear right display On/Off.
- 10 -VOL+: Adjust the volume.

### Type B

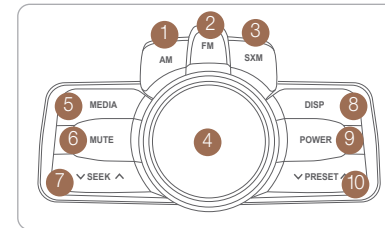

- 1 AM: Operates AM mode.
- 2 FM: Operates FM mode.
- 3 SXM: Operates SiriusXM mode.
- 4 Volume: Adjusts the volume.
- 5 MEDIA: Displays the Media screen.
- 6 MUTE: Mutes the volume.
- 7 ^SEEK V: Used to search and select frequencies, channels, and files.
- 8 DISP: Turns the display on/off.
- 9 POWER:
  - When shortly pressed: Turns the AV on/off.
  - When pressed and held: Turns the system on/off.
- 10 ^PRESET V:
  - FM/AM: Used to select the Preset list.
  - Media: Used to search and select frequencies and files

Turn ON/OFF Rear Seat Controls from the front DIS controller

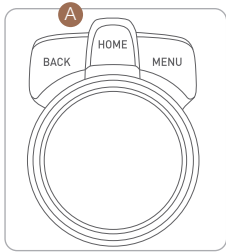

1. Press the **A** HOME button
2. Select setup > General settings > Lock Rear Controls.
3. Select or deselect “Lock Rear Controls” to turn ON/OFF.

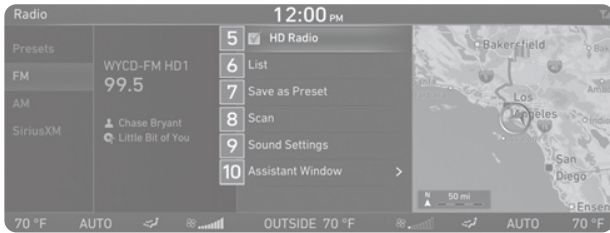

4. The indicator located on the rear center controller will be illuminated. Note: this is not a button.

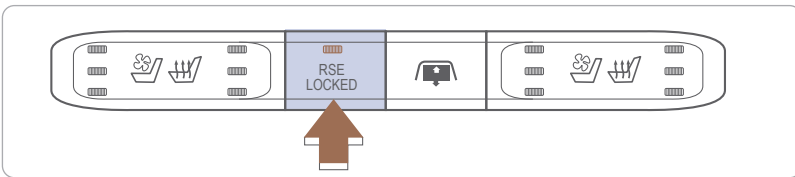

TRANSMISSION

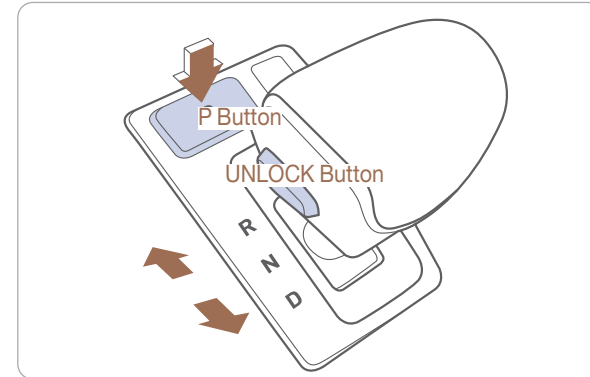

When you move the shift lever, depress the brake pedal while pressing the UNLOCK button.

The automatic transmission has eight forward speeds and one reverse speed. The individual speeds are selected automatically in the D (Drive) position.

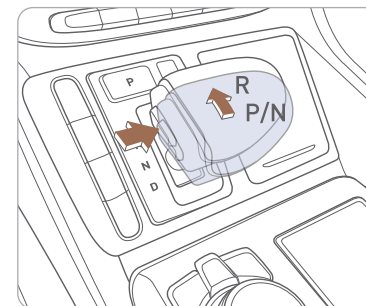

**P (Park)**  
Always stop completely before shifting into P (Park). To shift the gear from R (Reverse), N (Neutral), D (Drive) or Manual mode to P(Park), press the [P] button while depressing the brake pedal.

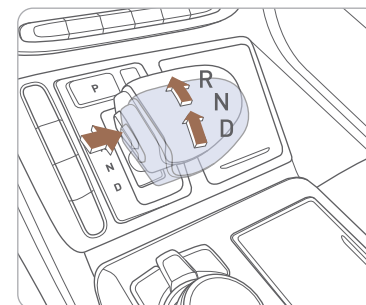

**R (Reverse) / N (Neutral) / D (Drive)**  
To select gear, press the [UNLOCK] button while depressing the brake pedal and then move the shift lever forward (R side) or backward (D side).

## PADDLE SHIFTER (Manual Mode)

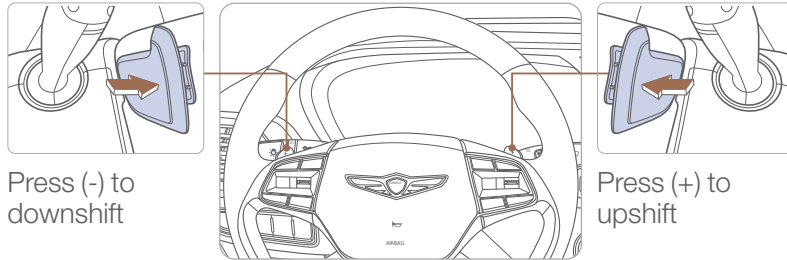



The paddle shifter is available when the shift lever is in the D (Drive) position. Press the [+] or [-] paddle shifter once to shift up or down one gear.

### NOTE:

To disengage Manual mode (and engage Auto mode), press and hold [+] paddle shifter.

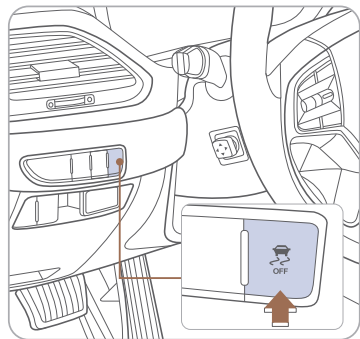
## ELECTRONIC STABILITY CONTROL (ESC)



The ESC system is an electronic system designed to help the driver maintain vehicle control under adverse conditions. Press  to turn ESC on or off.

## FORWARD COLLISION-AVOIDANCE ASSIST (FCA)



The Forward Collision Avoidance (FCA) system is designed to detect and monitor the vehicle ahead and warn the driver if a collision is imminent. On vehicles equipped with both camera and radar sensor, pedestrian detection is also available.

The Forward Collision Avoidance (FCA) can be activated from the Settings menu in the AVN system screen by following the procedure:

1. Set the Engine Start/Stop button to the ON or START position.
2. Select 'Setup → Vehicle Settings → Driver Assistance → Forward Safety → Active Assist / Warning Only / Off' in the AVN system screen.

**NOTE:** Warning Timing, Warning Volume, and Haptic Warning levels are all adjustable. Please refer to your Owner's Manual for further information.

## LANE KEEP ASSIST SYSTEM (LKA)

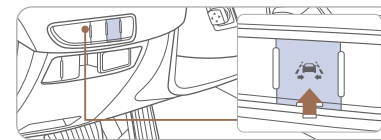

**NOTE:** LKA settings can be activated from the settings menu on the AVN screen by the following procedure:

1. Set the Engine Start/Stop button to the ON or START position.
2. Select 'Setup → Vehicle Settings → Driver Assistance → Lane Safety → Lane Keeping Assist in the AVN system screen.
3. Select Lane Keeping Assist, Lane Departure Warning, or OFF.

**NOTE:** Please refer to your Owner's Manual for additional information.

The Lane Keep Assist detects lane markers on the road, and assists the driver's steering to help keep the

vehicle between the lanes. LKA will not operate properly if the lane line is not clear, sharp bend in the road, or in heavy fog. To activate, press the LKA button with the Engine Start/Stop button in the ON position. LKA operates only when the vehicle speed is between 40 mph and 110 mph.



Scan to view a video of: Lane Keep Assist (LKA)

## LANE FOLLOWING ASSIST (LFA)

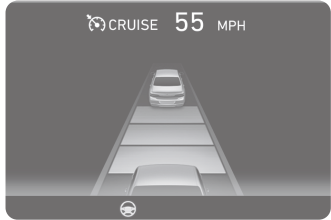

The Lane Following Assist (LFA) system helps detect lane markers on the road with a front view camera and assists the driver's steering to help keep the vehicle between lanes.

With the ignition switch in the ON position, the Lane Following Assist can be activated in the Vehicle Settings menu on the head unit by selecting the following:  
 Vehicle Settings > Driver Assistance > Driving Assist > Lane Following Assist  
 Deselect the setting to turn off the system.

## BLIND-SPOT COLLISION WARNING (BCW)

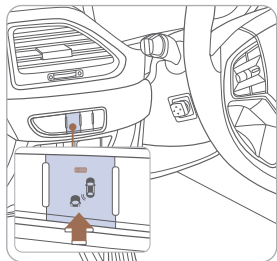

The BCW system monitors the rear area of the vehicle and provides information to the driver. Press the BCW switch. If vehicle speed exceeds 20 mph the system will activate. Press the switch again to deactivate the system.



**A BCW (Blind-Spot Collision Warning)**  
 Warning range is dependent on your vehicle speed. If your vehicle speed is much faster than other vehicles, the warning is not active.



**B LCA (Lane Change Assist)**  
 When the vehicle is approaching at high speed, the warning is active.

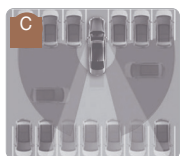

**C RCTA (Rear Cross-Traffic Alert)**  
 When your vehicle moves (below 6 mph) in Reverse, the sensor detects the approaching vehicles and the warning is active.

## REAR VIEW MONITOR

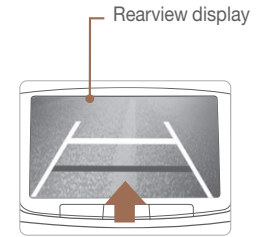
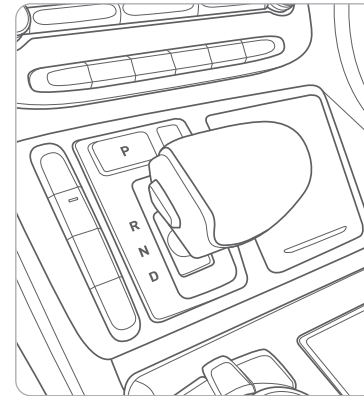

The rearview camera will activate when the engine is running and the shift lever is in the R (Reverse) position.

**NOTE:** Rearview display is selectable, see Owner's Manual for further details.

The image displayed on the screen may become difficult to see under the following conditions:

- In the dark or at night.
  - When it is raining, or when water droplets are on the camera.
  - When the sun or the beam of headlights are shining into the camera lens.
- Use care to keep the camera lens clean and avoid applying any type of solvents, car wax, or window cleaners to the camera lens. If the lens becomes dirty, wipe the lens with a clean, soft cloth.



## SURROUND VIEW MONITOR

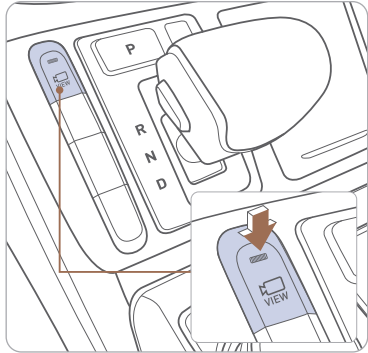

This parking support system displays an all-around view of the vehicle when parking. Press the switch to activate/deactivate the system.

### Operating conditions

- When the shift lever is in the R (reverse) position, the system is always turned ON.
- When it is in N (neutral) or D (drive) position, the switch has to be turned ON.
- The vehicle speed is less than 9 mph.



## PARKING ASSIST SYSTEM (PAS)

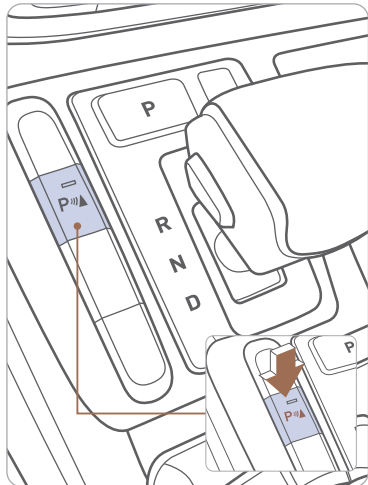

The parking assist system assists the driver during movement of the vehicle by chiming if any object is sensed within the distance of 3.3 ft in front and 4 ft behind the vehicle.

Press button to turn ON/OFF:

- ON – indicator light on
- OFF – indicator light off

If the PAS is OFF, the system will turn ON automatically when the shift lever is in R (reverse).

The system will automatically turn OFF when vehicle is driven forward at speed above 6 mph.

**NOTE:** Front parking sensor will not operate if the PAS is OFF.

## LEADING VEHICLE DEPARTURE ALERT

The Leading Vehicle Departure Alert system alerts the driver of the departure of the vehicle in front when the vehicle is stopped and the Smart Cruise Control (SCC) is in activation.

### To activate

Select the following items in the Vehicle Settings menu on the infotainment screen by selecting the following:

1. Vehicle Settings
2. Driver Assistance
3. Leading Vehicle Departure Alert

The system stops operation when the setting is deactivated. However, if the engine is turned off then on again, the system maintains in the previous state.

## HIGHWAY DRIVING ASSIST (HDA) (if equipped)



The Highway Driving Assist (HDA) system helps keep the vehicle between lanes, maintain a distance with the vehicle ahead, and automatically adjusts the vehicle speed to the speed limit while driving on the highway.

**NOTE:** If the engine is turned off then on again, the system maintains the last setting.

With the Engine Start/Stop button in the ON or START position, the Highway Driving Assist can be activated from the Settings menu in the infotainment system screen by selecting the following:  
'Setup → Vehicle Settings → Driver Assistance → Highway Driving Assist' Deselect the setting to turn off the system.

### Operating Conditions:

- Driving on the highway main line.
- Smart Cruise Control is operating.
  - If the Smart Cruise Control is in the READY state the Highway Driving Assist will be in the READY state. The indicator on the cluster will illuminate white.
- Vehicle speed is under 95 mph (153 km/h).

If all the mentioned conditions are satisfied, the system is ENABLED and the indicator on the cluster will illuminate green.

## REAR CROSS-TRAFFIC COLLISION-AVOIDANCE ASSIST (RCCA)

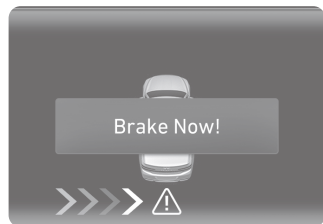
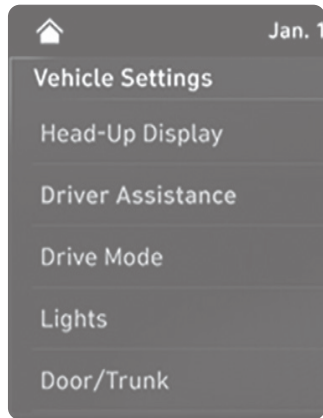

The RCCA system uses radar sensors to monitor approaching vehicles to the left and right while your vehicle is in reverse. If the risk of collision is detected while the RCCW is generated, brake is controlled. The instrument cluster will inform the driver of the brake control. If the rear view monitor system is in activation, a message will also appear on the audio or AVN screen.

### Activate/Deactivate

Select the following items in the Vehicle Settings menu on the infotainment screen by selecting the following:

1. Select Vehicle Settings
2. Select Driver Assistance
3. Select Parking Safety
4. Select Rear Cross-Traffic Safety

## SAFE EXIT ASSIST (SEA)

The Safe Exit Assist system helps prevent passengers from opening the door when a vehicle is approaching from the rear area. After the vehicle stops and an approaching vehicle from the rear area is detected, the rear door does not open from the inside handle. A “check surroundings then try again” warning message will appear on the cluster and a warning sound will go off.

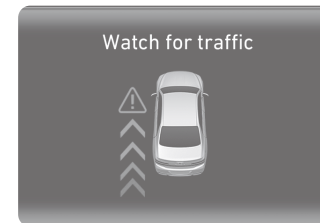

When an approaching vehicle from the rear is detected and the door is already opened, a “watch for traffic” warning message appears and a warning sound will go off.

### Activate/Deactivate

Select the following items in the Vehicle Settings menu on the infotainment screen by selecting the following:

1. Select Vehicle Settings
2. Select Driver Assistance
3. Select Blind-Spot Safety
4. Select Safe Exit Assist

## ELECTRIC PARKING BRAKE (EPB)

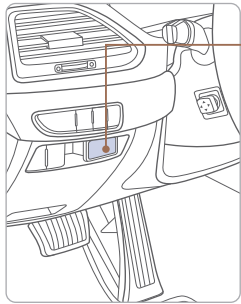

Applying

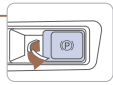

Stop the vehicle then pull the EPB switch.

Releasing

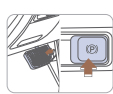

Press the EPB switch while depressing the brake pedal.

**NOTE:** If necessary, emergency braking is possible by pulling and holding the EPB switch.

## AUTO HOLD

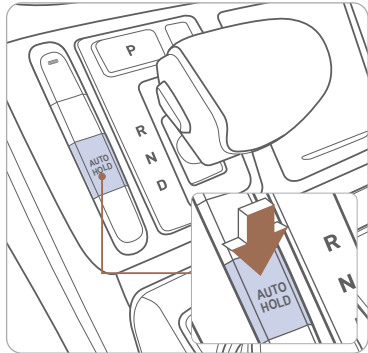

The Auto Hold feature assists in steep hill areas. It holds the brake until the accelerator pedal is pressed.

WHITE  
AUTO  
HOLD

1. Press the AUTO HOLD switch.

GREEN  
AUTO  
HOLD

2. Stop the vehicle by pressing the brake pedal. The brakes will remain engaged even if the brake pedal is released.

WHITE  
AUTO  
HOLD

3. The brakes will release when the accelerator pedal is pressed with transmission in D, R or manual mode.

To cancel the AUTO HOLD operation, press the AUTO HOLD switch again.

## TIRE PRESSURE MONITORING SYSTEM (TPMS)

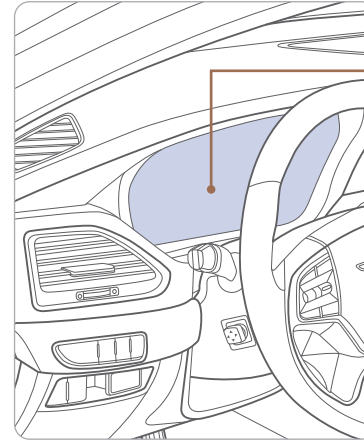

Low Tire Pressure Indicator / TPMS Malfunction Indicator



Low Tire Pressure / Tire Pressure Monitor / TPMS Malfunction Display (shown on the cluster LCD display)

### LOW TIRE PRESSURE INDICATOR

Illuminates if one or more of your tires are significantly under-inflated.

### TPMS MALFUNCTION INDICATOR

Blinks for approximately one minute, then remains illuminated when there is a malfunction with the TPMS. Inspect all tires and adjust tire pressure to specification. If the lamp remains illuminated, have the system checked by an authorized retailer of Genesis Brand Products as soon as possible.

### LOW TIRE PRESSURE POSITION INDICATOR AND TIRE PRESSURE INDICATOR (LCD DISPLAY)

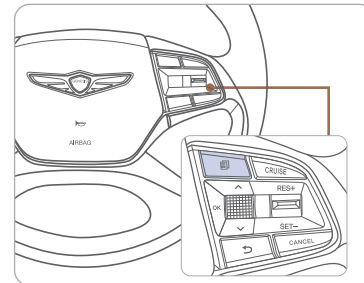

To access the TPMS menu within the LCD display, press the Assist mode button on the steering wheel to display tire pressure.

Tire pressures will display after driving a short distance. If a tire pressure drops lower than predetermined specification, the Low Tire Pressure Indicator (🚗) will illuminate and the LCD (📺) display will indicate tire(s) requiring air.

## Program Coverage Summary

The Genesis Service Valet Program is included for the first 3 years or 36,000 miles, whichever comes first, of ownership.				
Complimentary Services	Service Valet	Complimentary Loaner Vehicle	Maintenance	Wear Items
Original Owner or Lessee	Yes	Yes	Yes	Yes
Subsequent Owner or Lessee	Warranty Only	Warranty Only	No	No

See below for program terms and conditions.

## SERVICE VALET

Service Valet is available while your vehicle is receiving complimentary maintenance, wear items, or warranty repairs by an authorized Genesis retailer. Simply contact your authorized Genesis retailer's Service Experience Manager or contact the Customer Care Center at 844-340-9741 to make your appointment. The retailer will work with you to arrange your pickup and delivery time and location.

- Valet appointments must be made at least 2 business days in advance.
- Valet area of coverage is valid only within an estimated 1 hour drive time distance (based on traffic, weather, and road conditions) from the participating retailer location to the pickup/delivery location.
- Valet pickup and delivery must occur during normal business hours. After-hours pickup and delivery are at the discretion of your participating retailer.
- You must notify your Genesis Service Experience Manager 1 business day in advance if location or time of valet services changes. If a change or cancellation is not made at least 1 business day in advance, you may be charged a fee, or Service Valet may be cancelled.
- You will be charged a fee if you elect to extend the use of the courtesy replacement vehicle or delay the delivery of your vehicle.
- Prior to or at the time of your vehicle pickup, you will need to provide your valet with the following information if a courtesy replacement vehicle is needed:
  - Insurance company name, policy number, and expiration date
  - Driver's license number, state, expiration, and date of birth.
  - Credit card number and expiration date (standard requirement for rental car use)
  - The above information for any additional drivers

Genesis brand vehicle owner must provide the valet with the Genesis brand vehicle that is currently registered in compliance with local and state laws. Road tolls incurred during the Service Valet may be charged to the vehicle owner.

## COMPLIMENTARY LOANER VEHICLE

We come to you and provide you with alternative transportation. While your vehicle is being serviced under this program, qualified drivers will be provided a courtesy replacement Genesis brand vehicle at no additional cost. You must be at least 25 years of age (in most states) with a valid driver's license to drive a loaner vehicle. Please provide your Service Advocate with the following information:

- Insurance company name, policy number, and expiration date
- Driver's license number, state, expiration and birth date
- Credit card number and expiration date (standard requirement for rental car use)
- The above information for any additional drivers

## COMPLIMENTARY MAINTENANCE AND WEAR COVERAGE

### Vehicle Eligibility

For original retail owners of Genesis vehicles, all factory-recommended scheduled maintenance and normal wear parts replacement are covered for the first 3 years or 36,000 miles, whichever comes first. The Service Valet Program is applicable to all 2017 – 2020 model year Genesis brand vehicle United States specification vehicles purchased in the United States from authorized Genesis retailers. The program is not in effect outside of the United States.

- Vehicle coverage begins on the date of first retail sale. Fleet vehicles are excluded from this program.
- If the vehicle becomes damaged (such as by accident, fire, act of nature, etc.) and is subsequently titled salvaged, flooded, or reconstructed, it is no longer eligible for the benefits of the Genesis G90 complimentary maintenance Program.

### Guidelines for Scheduling Maintenance

The Service Valet Program covers factory-recommended scheduled maintenance for the first 3 years or 36,000 miles, whichever comes first. Covered maintenance costs include all labor and parts necessary to complete the factory recommended service. Having your vehicle serviced at the specified time/mile intervals is critical in maintaining long-term durability. Failure to have your vehicle serviced at the specified interval may invalidate the warranty under certain circumstances.

If for any reason a service is missed, the authorized Genesis retailer will perform the next or missed major service.

Some owners may wish to have their oil changed more frequently. The customer must pay for any additional services performed on the vehicle. Service procedures not specifically referenced in the Genesis Customer Care Quick Reference Guide must be preauthorized by a Genesis District Parts and Service Manager.

