

MIO-9290

Intel® 3rd Core™ i7/i5/i3 rPGA988,
5.25" MI/O SBC, DDR3/DDR3L, DP,
HDMI, DVI-I, 48-bit LVDS, 2 GbE, 4
USB3.0, 2 Mini PCIe, mSATA,
iManager, MIOe

Copyright

The documentation and the software included with this product are copyrighted 2014 by Advantech Co., Ltd. All rights are reserved. Advantech Co., Ltd. reserves the right to make improvements in the products described in this manual at any time without notice. No part of this manual may be reproduced, copied, translated or transmitted in any form or by any means without the prior written permission of Advantech Co., Ltd. Information provided in this manual is intended to be accurate and reliable. However, Advantech Co., Ltd. assumes no responsibility for its use, nor for any infringements of the rights of third parties, which may result from its use.

Acknowledgements

Intel® is a trademark of Intel® Corporation.

AMI is a trademark of American Megatrends, Inc.

IBM, PC, PS/2 and VGA are trademarks of International Business Machines Corporation.

Microsoft Windows® is a registered trademark of Microsoft Corp.

All other product names or trademarks are properties of their respective owners.

For more information on this and other Advantech products, please visit our websites at:

<http://www.advantech.com>

<http://www.advantech.com/eplatform>

For technical support and service, please visit our support website at:

<http://support.advantech.com/>

This manual is for the MIO-9290.

Product Warranty (2 years)

Advantech warrants to you, the original purchaser, that each of its products will be free from defects in materials and workmanship for two years from the date of purchase.

This warranty does not apply to any products which have been repaired or altered by persons other than repair personnel authorized by Advantech, or which have been subject to misuse, abuse, accident or improper installation. Advantech assumes no liability under the terms of this warranty as a consequence of such events.

Because of Advantech's high quality-control standards and rigorous testing, most of our customers never need to use our repair service. If an Advantech product is defective, it will be repaired or replaced at no charge during the warranty period. For out-of-warranty repairs, you will be billed according to the cost of replacement materials, service time and freight. Please consult your dealer for more details.

If you think you have a defective product, follow these steps:

1. Collect all the information about the problem encountered. (For example, CPU speed, Advantech products used, other hardware and software used, etc.) Note anything abnormal and list any onscreen messages you get when the problem occurs.
2. Call your dealer and describe the problem. Please have your manual, product, and any helpful information readily available.
3. If your product is diagnosed as defective, obtain an RMA (return merchandise authorization) number from your dealer. This allows us to process your return more quickly.
4. Carefully pack the defective product, a fully-completed Repair and Replacement Order Card and a photocopy proof of purchase date (such as your sales receipt) in a shippable container. A product returned without proof of the purchase date is not eligible for warranty service.
5. Write the RMA number visibly on the outside of the package and ship it prepaid to your dealer.

Declaration of Conformity

CE

This product has passed the CE test for environmental specifications. Test conditions for passing included the equipment being operated within an industrial enclosure. In order to protect the product from being damaged by ESD (Electrostatic Discharge) and EMI leakage, we strongly recommend the use of CE-compliant industrial enclosure products.

FCC Class A

This equipment has been tested and found to comply with the limits for a Class A digital device, pursuant to part 15 of the FCC Rules. These limits are designed to provide reasonable protection against harmful interference when the equipment is operated in a commercial environment. This equipment generates, uses, and can radiate radio frequency energy and, if not installed and used in accordance with the instruction manual, may cause harmful interference to radio communications. Operation of this equipment in a residential area is likely to cause harmful interference in which case the user will be required to correct the interference at his own expense.

Caution! *There is a danger of a new battery exploding if it is incorrectly installed. Do not attempt to recharge, force open, or heat the battery. Replace the battery only with the same or equivalent type recommended by the manufacturer. Discard used batteries according to the manufacturer's instructions.*



Technical Support and Assistance

1. Visit the Advantech website at <http://support.advantech.com> where you can find the latest information about the product.
2. Contact your distributor, sales representative, or Advantech's customer service center for technical support if you need additional assistance. Please have the following information ready before you call:
 - Product name and serial number
 - Description of your peripheral attachments
 - Description of your software (operating system, version, application software, etc.)
 - A complete description of the problem
 - The exact wording of any error messages

Packing List

Before you begin installing your card, please make sure that the following materials have been shipped:

- 1 x MIO-9290 SBC
- 1 x SATA Cable 30cm (p/n: 1700002155-01)
- 1 x SATA Power Cable 35cm (p/n: 1700018785)
- 1 x Audio Cable 20cm (p/n: 1700019584)
- 2 x COM RS-232/422/485 Cable 22cm (p/n: 1701200220)
- 1 x Startup Manual (p/n: 2006929000)
- 1 x Mini Jumper(10pcs package) (p/n: 9689000002)
- 1 x Screw and stud pack (4 screws for Mini PCIe, 4 M3 studs and screws for MIOe module) (p/n: 9666929000E)

If any of these items are missing or damaged, contact your distributor or sales representative immediately.

Optional MIOe Module

Part Number	Description
MIOe-210-D6A1E	4 x RS232/422/485 2x RS422/485 with DSUB connector, 8-bit GPIO
MIOe-220-L3A1E	3 x GbE with RJ45 connector
MIOe-230-L0A1E	48-bit LVDS (default) or Display port (by request), backlight power, 2 x USB 2.0
MIOe-DB5000-01A1E	MIO extension evaluation board

Optional Accessories

Part number	Description
1700002155-01	SATA cable 30cm
1700018785	SATA power cable 35cm
1703100260	Internal USB cable 26cm
1700021399-01	RS-232 Tx/Rx only(COM5/6) cable 25cm
1910002596-01	POST F=M3*10L M=M3*5L B=5 H=19 ST Ni
96MPI3M-2.4-3M9T	CPU i3-3120ME 2.4G 3M Dual Core
96MPI5-2.7-3M9T	CPU i5-3610ME 2.7G 3M Dual Core
96MPI7M-2.3-6M9T	CPU i7-3610QE 2.3G 6M Quad Core
96MPCM-2.2-2M9T	CPU CELERON-1020E 2.2G 2M Dual Core

Contents

Chapter 1	General Information	1
1.1	Introduction	2
1.2	Specifications	2
1.2.1	Functional Specifications	2
1.2.2	OS Support	4
1.2.3	Mechanical Specifications.....	5
1.2.4	Electrical Specifications	5
1.2.5	Environmental	5
1.3	Block Diagram.....	6
1.4	Board Layout: Dimensions	6
	Figure 1.1 MIO-9290 Mechanical Drawing (Top Side)	6
	Figure 1.2 MIO-9290 Mechanical Drawing (Bottom Side)	7
	Figure 1.3 MIO-9290 Mechanical Drawing (Coastline).....	7
Chapter 2	Installation.....	9
2.1	Jumpers and Switches	10
	Table 2.1: Jumpers	10
	Table 2.2: Switches	10
2.2	Connectors.....	10
	Table 2.3: Connectors	10
2.3	Locating Connectors & Block Diagram	11
	Figure 2.1 MIO-9290L Connector Locations (Top Side).....	11
	Figure 2.2 MIO-9290 Connector Locations (Bottom Side).....	12
	Figure 2.3 MIO-9290U Connector Locations (Coastline).....	12
2.4	Setting Jumpers	13
2.4.1	Jumper List and Setting	13
2.4.2	Switch List and Setting.....	17
Chapter 3	AMI BIOS Setup	19
3.1	Introduction	20
	Figure 3.1 Setup program initial screen	20
3.2	Entering Setup	21
3.2.1	Main Setup.....	21
	Figure 3.2 Main setup screen	21
3.2.2	Advanced BIOS Features Setup.....	22
	Figure 3.3 Advanced BIOS features setup screen	22
	Figure 3.4 ACPI Setting	23
	Figure 3.5 CPU Configuration.....	24
3.2.3	SATA Configuration	25
	Figure 3.6 SATA Configuration.....	25
	Figure 3.7 AMT Configuration.....	26
	Figure 3.8 PCH-FW Configuration	27
	Figure 3.9 USB Configuration	28
	Figure 3.10 SMART Settings	29
	Figure 3.11 Embedded Controller Configuration	30
	Figure 3.12 Super IO Configuration	31
	Figure 3.13 Platform Misc Configuration	32
	Figure 3.14 Serial Port Console Redirection	33
	Figure 3.15 CPU PPM Configuration	34
3.2.4	Chipset.....	35
	Figure 3.16 Chipset Setup	35

	Figure 3.17 System Agent (SA) Configuration	36
	Figure 3.18 Intel IGFX Configuration	37
	Figure 3.19 LCD Control	38
	Figure 3.20 PCH-IO Configuration	39
3.2.5	Boot Settings	40
	Figure 3.21 Boot Setup Utility	40
3.2.6	Security Setup	41
	Figure 3.22 Password Configuration	41
3.2.7	Save & Exit	42
	Figure 3.23 Save & Exit	42

Appendix A Pin Assignments 45

A.1	Connector Tables	46
-----	------------------------	----

Appendix B System Assignments 71

B.1	System I/O Ports	72
	Table B.1: System I/O Ports	72
B.2	DMA Channel Assignments	72
	Table B.2: DMA Channel Assignments	72
B.3	1st MB Memory Map	73
	Table B.3: 1st MB Memory Map	73
B.4	Interrupt Assignments	73
	Table B.4: Interrupt Assignments	73

Appendix C Watchdog Timer Sample Code 75

C.1	Watchdog Timer Sample Code	76
-----	----------------------------------	----

Chapter 1

General Information

This chapter gives background information on the MIO-9290.

Sections include:

- Introduction
- Specifications
- Block diagram
- Board layout and dimensions

1.1 Introduction

The MI/O Extension Single Board Computer MIO-9290 based on the 3rd generation Intel® Core™ i3/i5/i7/Celeron rPGA988 processors with QM77 chipset, supports either 2 channel 1600MHz DDR3 or low power DDR3L, 4 USB3.0, 2 SATA III (600 MB/s), AMT 8.0, and can drive three independent displays (DVI-I, Display Port, HDMI) and Dual Display by any combination interface from the board.

MIO-9290 provides not only the powerful computing capability but is also a great graphic capable platform. It is aimed at various high level embedded applications. MIO-9290 adapts the newest solution from Intel with 22nm process, up to 15% CPU performance gain over previous generation and contains the latest generation graphics core (Intel® HD Graphics 4000) with DXVA (full AVC/VC-1/MPEG2 Hardware Acceleration), OpenGL* 3.1 and DirectX 11 support. MIO-9290 is high-end level and rich expansion positioning in 5.25" SBC product line, the rich I/O including 4 USB 3.0/2.0, 2 USB2.0, 2 SATA port up to 6Gb/s, 2 GbE, HD Audio, 6 COM, 2 full-size Mini PCIe with mSATA support. Users also can extend Display port, 3 USB2.0, SMBus, LPC and 4 x PCIe1 through Advantech's innovative MI/O Extension interface. MIO-9290 can help customers easily to implement high quality video or graphic applications along with single and simple integrated solution.

1.2 Specifications

1.2.1 Functional Specifications

- **Processor:** Mobile 3rd Generation Intel® Core™ Processor (rPGA)
 - i7 3610QE / i5 3610ME / i3 3120ME / Celeron 1020E
 - Cache Hierarchy
 - * A 32-KB instruction and 32-KB data first-level cache (L1) for each core
 - * A 256-KB shared instruction/data second-level cache (L2) for each core
 - * 6MB / 3MB / 2MB Intel® Smart Cache for i7 / i5, i3 / Celeron series, shared among all cores
 - Direct Media Interface (DMI)
 - * DMI 2.0 support
 - * Four lanes in each direction
 - * 5 GT/s point-to-point DMI interface to PCH is supported
 - Advanced Technologies
 - * Intel® Hyper-Threading Technology 2-threads per core
 - * Intel® Active Management Technology 8.0 (Intel® AMT 8.0, i7, i5 series only)
 - * Intel® Trusted Execution Technology (Intel® TXT)
 - * Intel® 64 Architecture
 - * Thermal Monitoring Technologies
 - * Enhanced Intel® SpeedStep® Technology
 - * Intel® Turbo Boost Technology

- **Chipset: Intel® QM77 I/O Controller**
 - Direct Media Interface
 - * Up to 20 Gb/s each direction, full duplex
 - * Transparent to software
 - Integrated Serial ATA Host Controller
 - * Data transfer rates up to 6.0 Gb/s (600 MB/s)
 - * Integrated AHCI controller
 - USB
 - * NEW: xHCI Host Controller, supporting SuperSpeed USB 3.0 ports
 - * Two EHCI Host Controllers, supporting HighSpeed USB 2.0 ports
 - * Supports wake-up from sleeping states S1–S4
 - * Supports legacy Keyboard/Mouse software
 - Power Management Logic
 - * Supports Advanced Configuration and Power Interface (ACPI), Version 4.0a
 - * ACPI-defined power states (processor driven C states)
 - * ACPI Power Management Timer
 - * SMI# generation
- **System Memory Support**
 - Non-ECC, DDR3/DDR3L memory with two SODIMM up to 16GB
 - DDR3/DDR3L/DDR3L-RS at 1.35 V / 1.5 V Data Transfer Rates
 - * 1333 MT/s (PC3-10600), 1600 MT/s (PC3-12800)
 - 64-bit wide channels
 - Intel® Fast Memory Access (Intel® FMA):
 - * Just-in-Time Command Scheduling
 - * Command Overlap
 - * Out-of-Order Scheduling
 - DDR3/DDR3L default is auto select, but have an option that can select as DDR3/DDR3L by jumper (J1).
- **Graphic Engine**
 - DirectX* Video Acceleration (DXVA) support for accelerating video processing
 - * Full AVC/VC1/MPEG2 Hardware Acceleration
 - OpenGL* 3.1 and OpenCL 11 support
 - DirectX* 11, DirectX* 10.1, DirectX* 10, DirectX* 9 support
- **Display**
 - Multi-display interfaces: DVI-I, HDMI, display port on rear I/O, dual channel 24-bit LVDS on internal connector, display port from MIOe
 - Support Extend and Clone mode with multi-display device
 - Dual Independent Display
 - * Any two combination between: VGA, LVDS, HDMI, display port (from Rear I/O), display port (from MIOe)
 - Triple Independent Display:
 - * DVI-I + HDMI + display port
 - * Triple independent display is not supported under XP with Ivy Bridge processor
 - * Sandy Bridge CPU didn't support triple independent display.
 - Integrated Dual LVDS channel support resolution up to 1920 x1080 at 60 Hz
 - DVI-I output up to resolution 2560x1600 at 60 Hz. Can support Analog RGB display (VGA) through adaptor.
 - Display Port (DP) supports resolution up to 1920 x 1200 at 60 Hz.
 - * Ivy Bridge CPU didn't support DP display under DOS
 - * Display Port on rear I/O didn't support hot plug and audio function because it used Embedded DisplayPort (eDP) from processor connecting to DP connector, Intel eDP didn't support it.

- HDMI interface supports the HDMI 1.4a specification with audio up to 2560x1600 at 60 Hz
- **Gigabit Ethernet**
 - Port1: QM77 (MAC) + 82579LM GbE (PHY)
 - * Integrated ASF Management Controller
 - * 10/100/1000 BASE-T IEEE 802.3 specification conformance
 - * Energy Efficient Ethernet (EEE) IEEE802.3az support [Low Power Idle (LPI) mode]
 - * Supports up to 9 KB jumbo frames (full duplex)
 - Port2: I210-IT Gigabit Ethernet Controller
 - * IEEE 802.3az Energy Efficient Ethernet (EEE)
 - * Audio-video bridging
 - * IEEE 1588/802.1AS precision time synchronization
 - * EEE 802.3Qav traffic shaper (with software extensions)
 - * Supports up to 9.5 KB jumbo frames
- **Peripheral interface**
 - MIOe Expansion
 - * Display Port
 - * 4 PCIe x1
 - * 3 USB 2.0
 - * LPC
 - * HD Audio: Line out
 - * SMBus
 - * Power: +5/+12Vsb
 - 2 x Serial-ATA port, up to 6.0 Gb/s (600 MB/s)
 - 4 x USB 3.0/USB2.0 compliant ports on rear I/O, 2 x USB2.0 compliant ports for internal connection
 - 2 RS-232 from COM1/2, 2 RS-232/422/485 from COM3/4 (ESD protection for RS-232: Air gap ±15kV, Contact ±8kV), 2 RS-232 from COM5/6 with Tx/Rx only
 - 16-bit Programmable General Purpose Input/ Output
 - Watchdog timer: Output System Reset, Programmable counter from 1 ~ 255 minutes/ seconds
 - Mini PCIe
 - * 2 x Full-size Mini PCIe (Both support mSATA, one is with SIM holder)
 - * Mini PCIe/mSATA default is auto select, but have an option that can select as mini-PCIe or mSATA by 4pins switch, default as Mini PCIe.
- **High Definition Audio:**
 - Intel® High Definition Audio Interface
 - High Definition Audio Codec with Realtek proprietary loss-less content protection technology
 - Support 1 x Line-input, 1 x Line output, 1 x Mic-input
- **BIOS**
 - AMI 64-Mbit SPI Flash BIOS

1.2.2 OS Support

MIO-9290 supports Win 8, Win 7, Win XP, WES7 and WE8S.

For further information about OS support of MIO-9290, please Advantech website: <http://support.advantech.com.tw/> or contact the technical support center.

1.2.3 Mechanical Specifications

- **Dimensions:** 203 x 146 mm (8" x 5.75")
- **Height:** Top Side: 33.12 mm (with cooler); Bottom Side: 9.9 mm
- **Weight:** 0.9 kg (1.98 lb) (reference weight of total package)

1.2.4 Electrical Specifications

- **Power Requirement:** Single +12V DC \pm 10% power input
- **Power Consumption:**
 - Max load
 - * i7 3610QE w/DDR3: 3.759 A @ 12 V (45.11 W), w/DDR3L: 3.675 A @ 12 V (44.1 W)
 - * i5 3610ME w/DDR3: 2.375 A @ 12 V (28.5 W), w/DDR3L: 2.336 A @ 12 V (28.03 W)
 - * i3 3120ME w/DDR3: 1.675 A @ 12 V (20.1 W), w/DDR3L: 1.656 A @ 12 V (19.87 W)
 - * Celeron 1020E w/DDR3: 1.595 A @ 12 V (19.14 W), w/DDR3L: 1.548 A @ 12 V (18.58 W)
 - Idle mode
 - * i7 3610QE w/DDR3: 0.646 A @ 12 V (7.75 W), w/DDR3L: 0.662 A @ 12 V (7.94 W)
 - * i5 3610ME w/DDR3: 0.614 A @ 12 V (7.37 W), w/DDR3L: 0.606 A @ 12 V (7.27 W)
 - * i3 3120ME w/DDR3: 0.622 A @ 12 V (7.46 W), w/DDR3L: 0.612 A @ 12 V (7.34 W)
 - * Celeron 1020E w/DDR3: 0.632 A @ 12 V (7.58 W), w/DDR3L: 0.623 A @ 12 V (7.48 W)
- **Power Consumption Conditions:**
 - Max. load: Measure the current value when system in windows mode and running HCT12 system stress
 - Idle mode: Measure the current value when system in windows mode and without running any program
- **RTC Battery:**
 - Typical Voltage: 3.0 V
 - Normal discharge capacity: 210 mAh

1.2.5 Environmental

- **Operating Temperature:** 0 ~ 60°C (32 ~ 140°F)
- **Operating Humidity:** 40°C @ 85% RH Non-Condensing
- **Storage Temperature:** Storage temperature: -40~85°C
- **Storage Humidity:** Relative humidity: 95% @ 60°C

1.3 Block Diagram

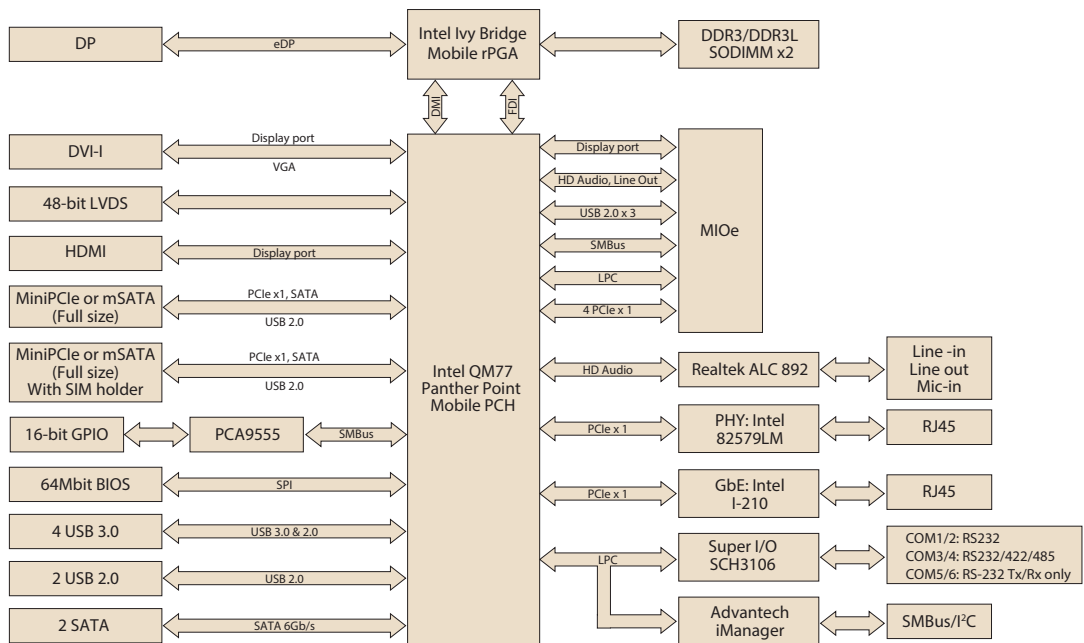

1.4 Board Layout: Dimensions

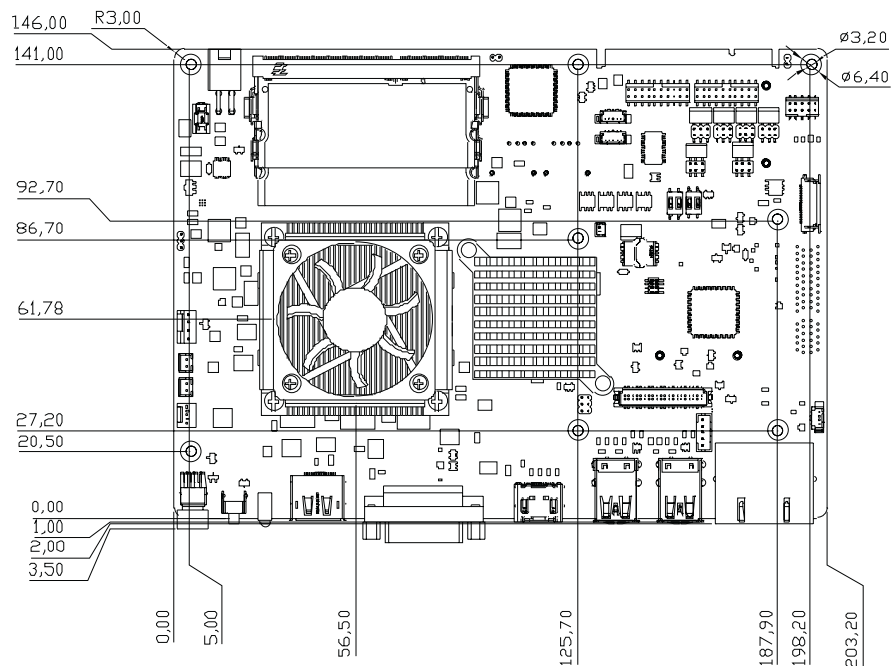

Figure 1.1 MIO-9290 Mechanical Drawing (Top Side)

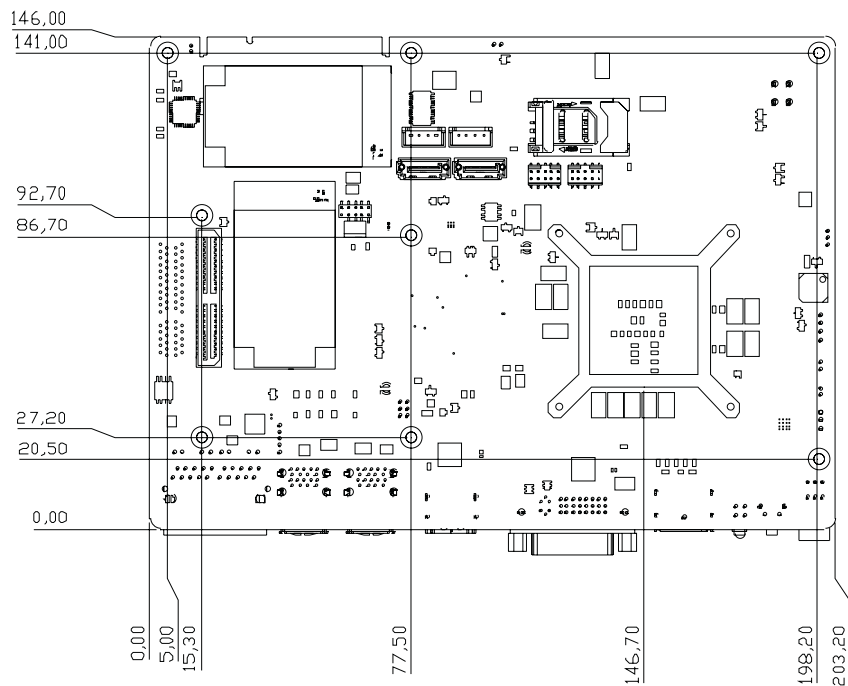

Figure 1.2 MIO-9290 Mechanical Drawing (Bottom Side)

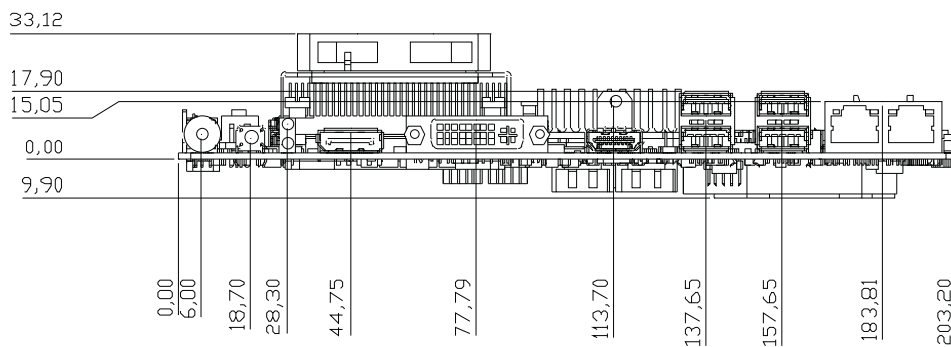

Figure 1.3 MIO-9290 Mechanical Drawing (Coastline)

Chapter 2

Installation

This chapter explains the setup procedures of the MIO-9290 hardware, including instructions on setting jumpers and connecting peripherals, switches and indicators. Be sure to read all safety precautions before you begin the installation procedure.

2.1 Jumpers and Switches

The MIO-9290 has a number of jumpers and switches that allow you to configure your system to suit your application. The table below lists the functions of the various jumpers.

Table 2.1: Jumpers

J1	DDR3/DDR3L Setting *
J2	Auto Power On Setting
J3	COM4 RS232/422/485 Setting
J4	COM4 RS232/422/485 Setting
J5	COM4 RS232/422/485 Setting
J6	COM3 RS232/422/485 Setting
J7	COM4 RS232/422/485 Setting
J8	COM3 RS232/422/485 Setting
J9	Clear CMOS
J10	LCD Power

* DDR3/DDR3L default is auto select, but have an option that can select as DDR3/DDR3L by jumper.

Table 2.2: Switches

SW1	COM4 RS485 TERMINATION PU/PD
SW2	COM3 RS485 TERMINATION PU/PD
SW5	CN38 PCIE/ mSATA SELECTION
SW6	CN29 PCIE/ mSATA SELECTION

2.2 Connectors

Onboard connectors link the MIO-9290 to external devices such as hard disk drives, a keyboard, or floppy drives. The table below lists the function of each of the board's connectors.

Table 2.3: Connectors

Label	Function
CN1	12V Power Input
CN2	COM3/COM4
CN3	COM1/COM2
CN5	Audio
CN7	COM5 TX/RX
CN8	COM6 TX/RX
CN14	CPU Socket
CN15	CPU FAN
CN16	Reset
CN17	Power Switch
CN18	48 bits LVDS Panel
CN19	System FAN
CN20	SMBus
CN21	Inverter Power Output

Table 2.3: Connectors

CN22	LAN
CN23	External USB2.0+USB3.0
CN24	External USB2.0+USB3.0
CN25	Display Port
CN26	HDMI
CN27	DVI-I
CN29	Mini PCIE
CN30	SATA
CN31	SATA
CN32	GPIO
CN33	GPIO
CN34	SATA Power
CN35	SATA Power
CN36	SIM Card
CN37	Internal USB
CN38	Mini PCIE
CN39	MIOe

2.3 Locating Connectors & Block Diagram

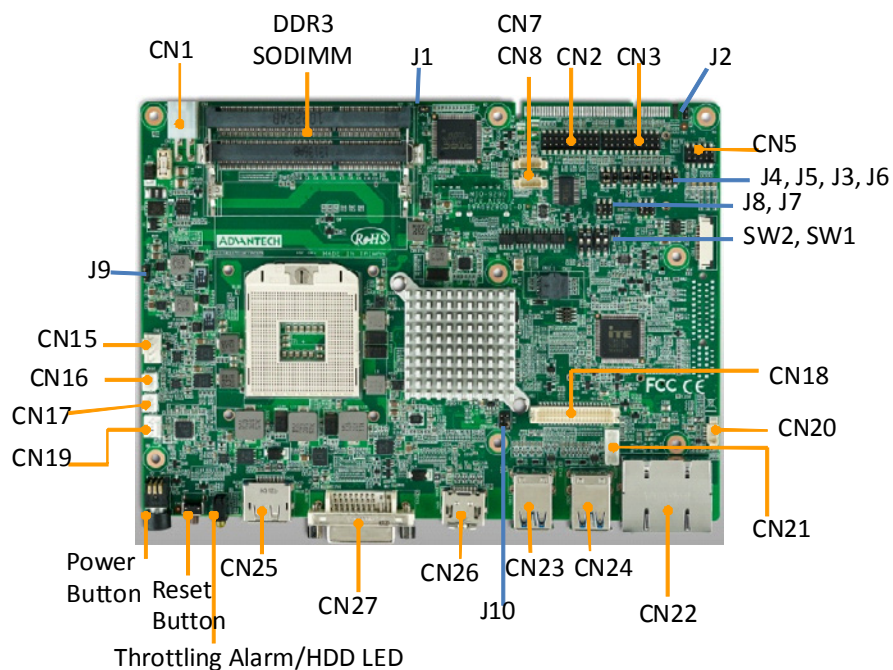
**Figure 2.1 MIO-9290L Connector Locations (Top Side)**

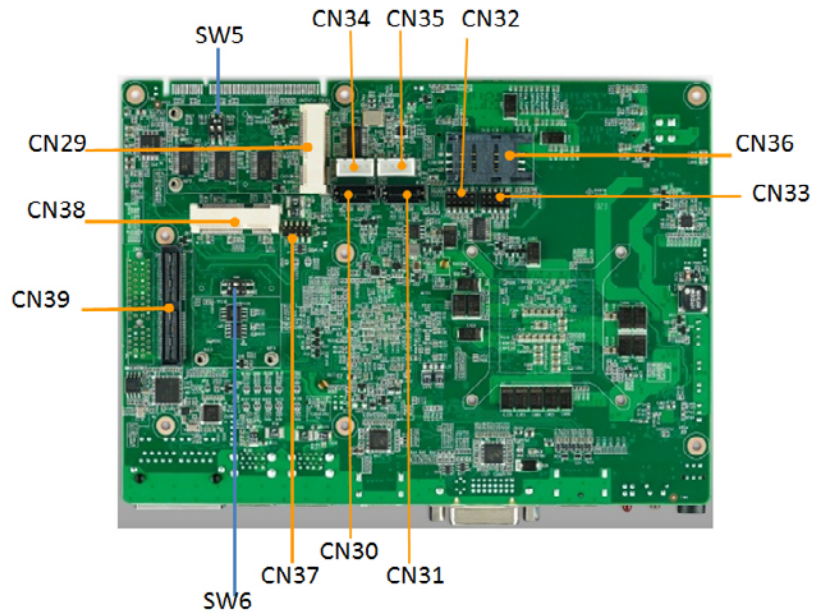

Figure 2.2 MIO-9290 Connector Locations (Bottom Side)

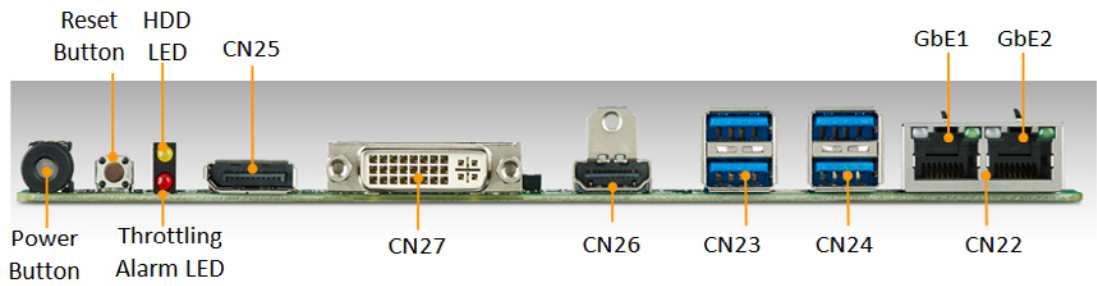
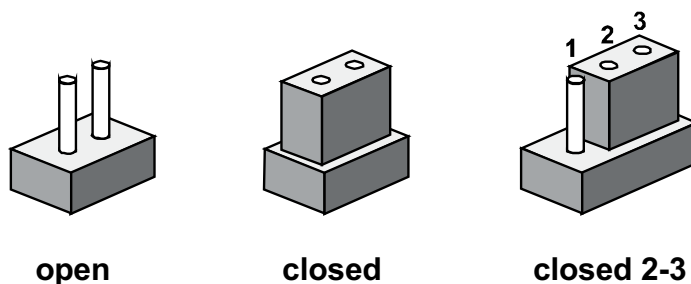

Figure 2.3 MIO-9290U Connector Locations (Coastline)

2.4 Setting Jumpers

You may configure your card to match the needs of your application by setting jumpers. A jumper is a metal bridge used to close an electric circuit. It consists of two metal pins and a small metal clip (often protected by a plastic cover) that slides over the pins to connect them. To “close” a jumper, you connect the pins with the clip. To “open” a jumper, you remove the clip. Sometimes a jumper will have three pins, labeled 1, 2 and 3. In this case you would connect either pins 1 and 2, or 2 and 3.



The jumper settings are schematically depicted in this manual as follows:



A pair of needle-nose pliers may be helpful when working with jumpers. If you have any doubts about the best hardware configuration for your application, contact your local distributor or sales representative before you make any changes. Generally, you simply need a standard cable to make most connections.

2.4.1 Jumper List and Setting

J1	DDR3/DDR3L Setting
Part Number	1653002101
Footprint	HD_2x1P_79_D
Description	PIN HEADER 2*1P 180D(M)SQUARE 2.0mm DIP W/O Pb
Setting	Function
Open	DDR3 Memory module (Default)*
Closed	DDR3L Memory module

* DDR3/DDR3L default is auto select, but have an option that can select as DDR3/DDR3L by jumper.

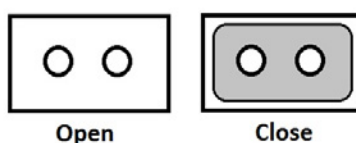

J2	Auto Power On Setting
Part Number	1653002101
Footprint	HD_2x1P_79_D
Description	PIN HEADER 2*1P 180D(M)SQUARE 2.0mm DIP W/O Pb
Setting	Function
Open	Power Button for Power On (Default)
Closed	Auto Power On

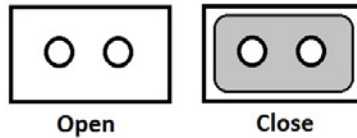

J3 & J5	COM4 RS232/422/485 Setting
Part Number	1653003260
Footprint	HD_3x2P_79
Description	PIN HEADER 3x2P 2.0mm 180D(M) SMD 21N22050
Setting	Function
(1-3)*(2-4)	COM4 RS232 (Default)
(3-5)*(4-6)	COM4 RS422/485

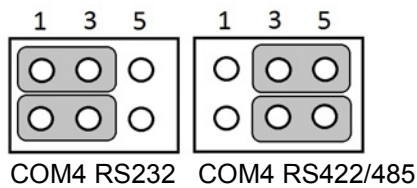

J4 & J6	COM3 RS232/422/485 Setting
Part Number	1653003260
Footprint	HD_3x2P_79
Description	PIN HEADER 3x2P 2.0mm 180D(M) SMD 21N22050
Setting	Function
(1-3)*(2-4)	COM3 RS232 (Default)
(3-5)*(4-6)	COM3 RS422/485

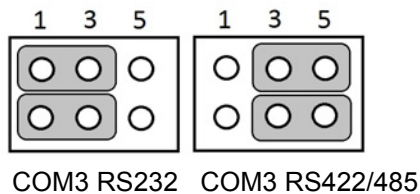

J7	COM4 RS232/422/485 Setting
Part Number	1653003260
Footprint	HD_3x2P_79
Description	PIN HEADER 3x2P 2.0mm 180D(M) SMD 21N22050
Setting	Function
(1-2)	COM4 RS232 (Default)
(3-4)	COM4 RS485
(5-6)	COM4 RS422

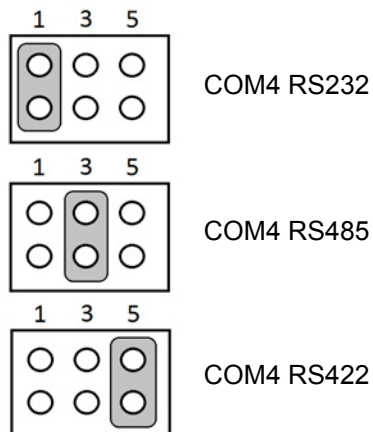

J8	COM3 RS232/422/485 Setting
Part Number	1653003260
Footprint	HD_3x2P_79
Description	PIN HEADER 3x2P 2.0mm 180D(M) SMD 21N22050
Setting	Function
(1-2)	COM3 RS232 (Default)
(3-4)	COM3 RS485
(5-6)	COM3 RS422

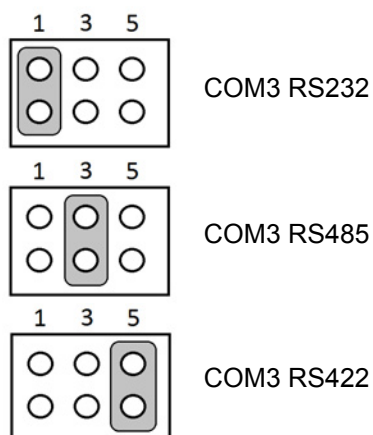

J9	Clear CMOS
Part Number	1653003101
Footprint	HD_3x1P_79_D
Description	PIN HEADER 3x1P 2.0mm 180D(M) DIP 2000-13 WS
Setting	Function
(1-2)	Normal (Default)
(2-3)	Clear COMS

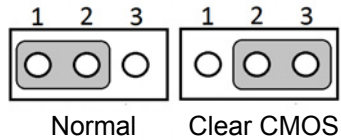

J10	LCD Power
Part Number	1653003201
Footprint	HD_3x2P_79_D
Description	PIN HEADER 3x2P 2.0mm 180D(M) DIP 21N22050
Setting	Function
(1-3)	+3.3V (Default)
(3-5)	+5V
(3-4)	+12V

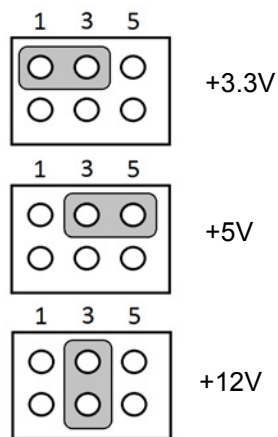

2.4.2 Switch List and Setting

SW1	COM4 RS485 Termination PU/PD
Part Number	1600003089-01
Footprint	SW_2x2P_100_198x378
Description	DIP SW ESD102LTZ SMD 2x2P 5.04X6.6X3.1mm
Setting	Function
(OFF)1*(OFF)2	NO TERMINATION (Default)
(OFF)1*(ON)3	TERMINATION PU
(OFF)2*(ON)4	TERMINATION PD

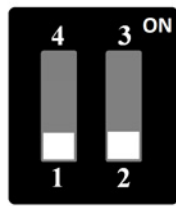

(OFF)1*(OFF)2



(OFF)1*(ON)3

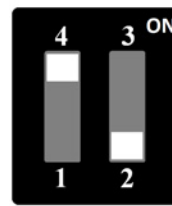

(OFF)2*(ON)4

SW2	COM3 RS485 Termination PU/PD
Part Number	1600003089-01
Footprint	SW_2x2P_100_198x378
Description	DIP SW ESD102LTZ SMD 2x2P 5.04X6.6X3.1mm
Setting	Function
(OFF)1*(OFF)2	NO TERMINATION (Default)
(OFF)1*(ON)3	TERMINATION PU
(OFF)2 (ON)4	TERMINATION PD

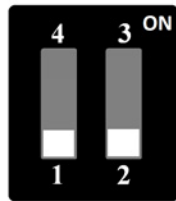

(OFF)1*(OFF)2



(OFF)1*(ON)3

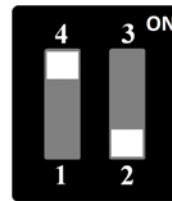

(OFF)2 (ON)4

SW5	PCIe/ mSATA Selection
Part Number	1600003089-01
Footprint	SW_2x2P_100_198x378
Description	DIP SW ESD102LTZ SMD 2x2P 5.04X6.6X3.1mm
Setting	Function
(OFF)1*(ON)3	AUTO-DETECTION (Default)
(OFF)1*(OFF)2	PCIe CARD
(OFF)2*(ON)4	mSATA

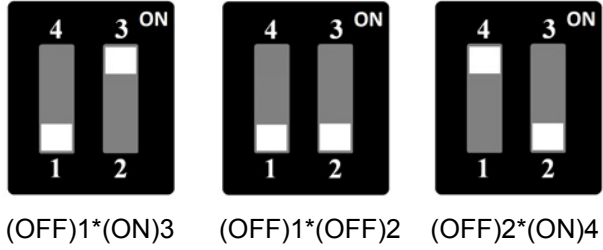

SW6	PCIE/ mSATA Selection
Part Number	1600003089-01
Footprint	SW_2x2P_100_198x378
Description	DIP SW ESD102LTZ SMD 2x2P 5.04X6.6X3.1mm
Setting	Function
(OFF) 1 * (ON) 3	AUTO-DETECTION(Default)
(OFF)1 * (OFF)2	PCIE CARD
(OFF)2 * (ON)4	mSATA

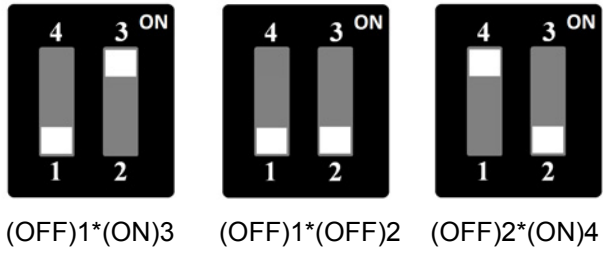

Chapter 3

AMI BIOS Setup

3.1 Introduction

AMIBIOS has been integrated into many motherboards for over a decade. With the AMIBIOS Setup program, you can modify BIOS settings and control the various system features. This chapter describes the basic navigation of the MIO-9290 BIOS setup screens.

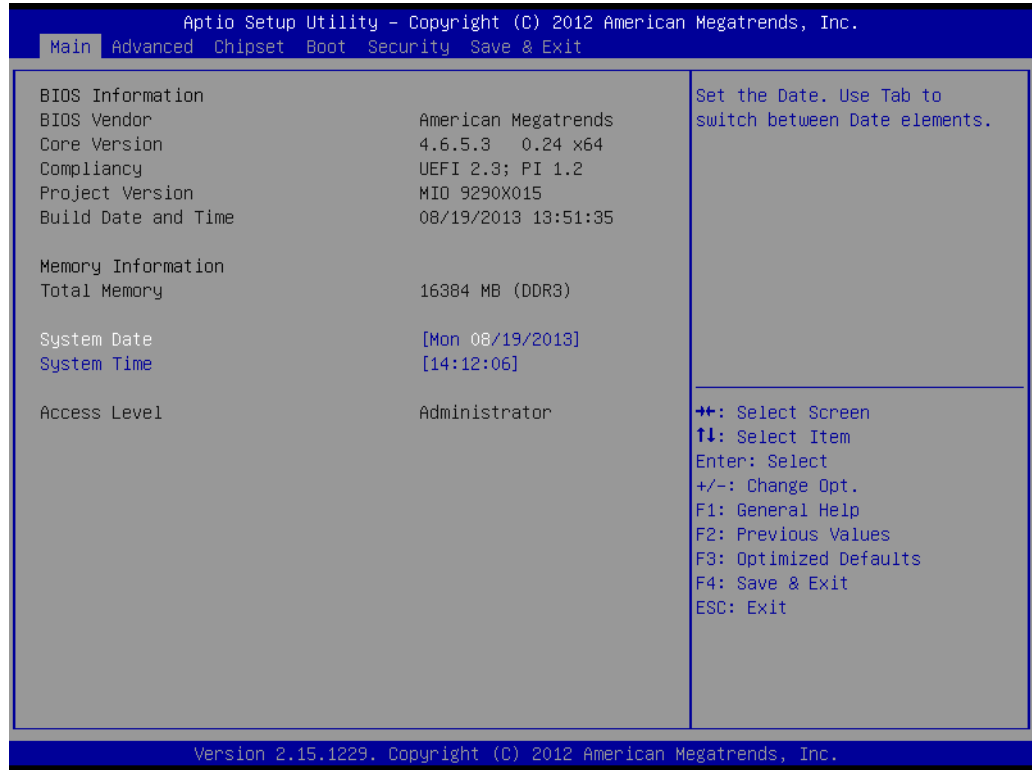

Figure 3.1 Setup program initial screen

AMI's BIOS ROM has a built-in Setup program that allows users to modify the basic system configuration. This information is stored in battery-backed CMOS so it retains the Setup information when the power is turned off.

3.2 Entering Setup

Turn on the computer and then press <F2> or to enter Setup menu.

3.2.1 Main Setup

When you first enter the BIOS Setup Utility, you will encounter the Main setup screen. You can always return to the Main setup screen by selecting the Main tab. There are two Main Setup options. They are described in this section. The Main BIOS Setup screen is shown below.



Figure 3.2 Main setup screen

The Main BIOS setup screen has two main frames. The left frame displays all the options that can be configured. Grayed-out options cannot be configured; options in blue can. The right frame displays the key legend.

Above the key legend is an area reserved for a text message. When an option is selected in the left frame, it is highlighted in white. Often a text message will accompany it.

3.2.1.1 System time / System date

Use this option to change the system time and date. Highlight System Time or System Date using the <Arrow> keys. Enter new values through the keyboard. Press the <Tab> key or the <Arrow> keys to move between fields. The date must be entered in MM/DD/YY format. The time must be entered in HH:MM:SS format.

3.2.2 Advanced BIOS Features Setup

Select the Advanced tab from the MIO-9290 setup screen to enter the Advanced BIOS Setup screen. You can select any of the items in the left frame of the screen, such as CPU Configuration, to go to the sub menu for that item. You can display an Advanced BIOS Setup option by highlighting it using the <Arrow> keys. All Advanced BIOS Setup options are described in this section. The Advanced BIOS Setup screens is shown below. The sub menus are described on the following pages.

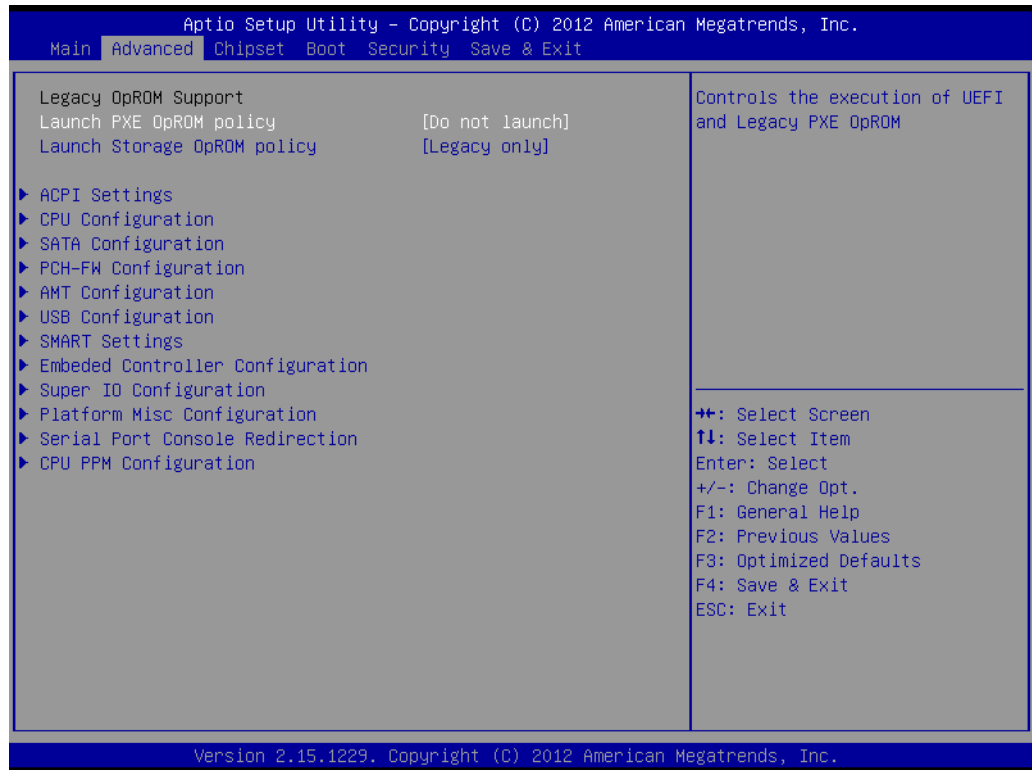

Figure 3.3 Advanced BIOS features setup screen

- **Launch PXE OpROM**
This item allows users to enable or disable launch PXE OpROM if available.
- **Launch Storage OpROM**
This item allows users to enable or disable launch storage OpROM if available.

3.2.2.1 ACPI Settings

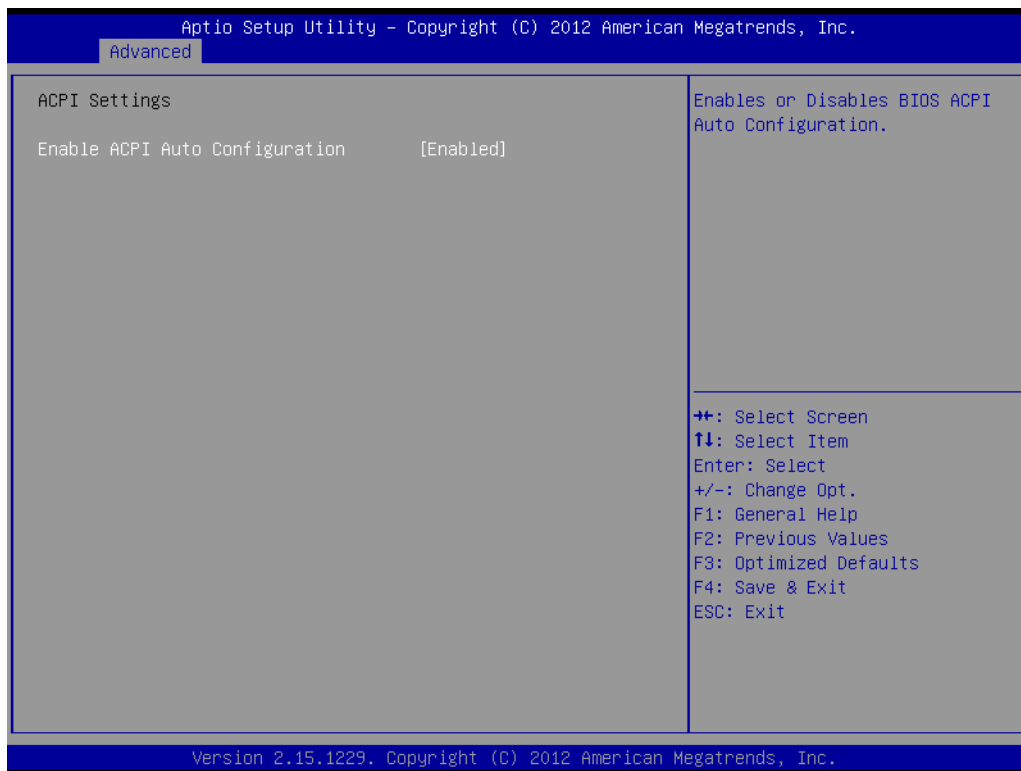

Figure 3.4 ACPI Setting

- **Enable ACPI Auto Configuration**
This item allows users to enable or disable BIOS ACPI auto configuration.
- **Enable Hibernation**
This item allows users to enable or disable hibernation.
- **ACPI Sleep State**
This item allows users to set the ACPI sleep state.
- **Lock Legacy Resources**
This item allows users to lock legacy devices' resources.
- **S3 Video Repost**
This item allows users to enable or disable VBIOS run after S3 resume.

3.2.2.2 CPU Configuration

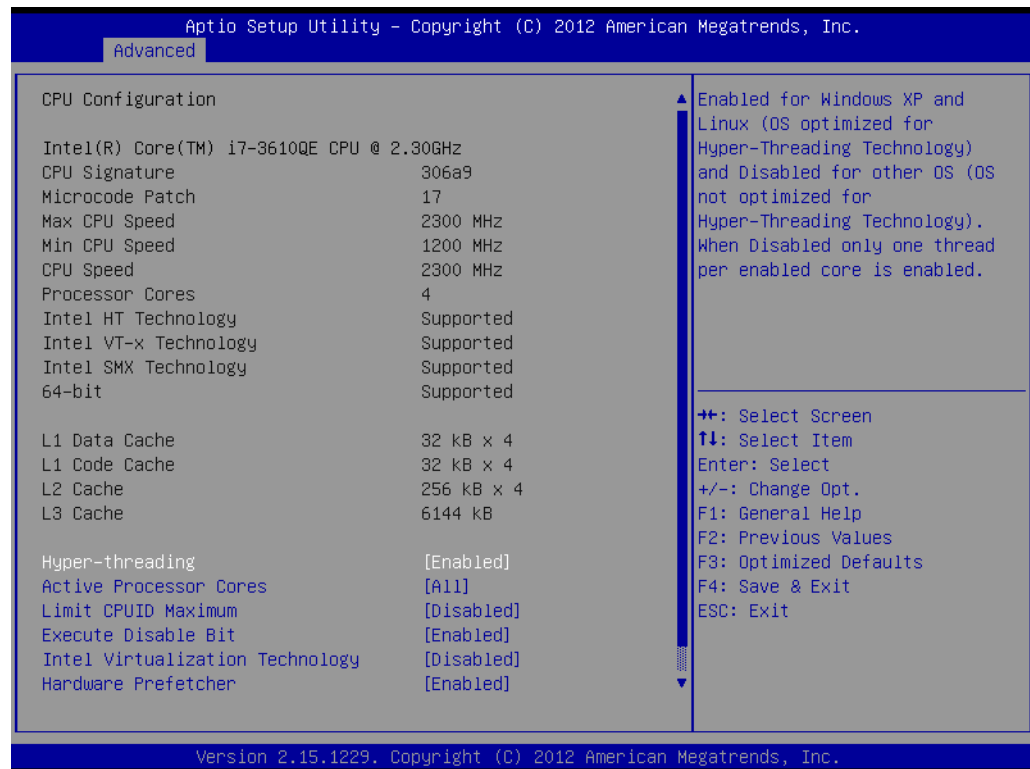

Figure 3.5 CPU Configuration

- **Hyper Threading Technology**
This item allows users to enable or disable Intel? Hyper Threading technology.
- **Active Processor Cores**
This item allows users to set how many processor cores should be active.
- **Limit CPUID Maximum**
This item allows users to limit the maximum value of CPUID.
- **Execute Disable Bit**
This item allows users to enable or disable the No-Execution page protection technology.
- **Intel Virtualization Technology**
This item allows users to enable or disable the intel virtualization technology.
- **Hardware Prefetcher**
This item allows users to enable or disable the hardware prefetcher feature.
- **Adjacent Cache Line Prefetch**
This item allows users to enable or disable the adjacent cache line prefetch feature.

3.2.3 SATA Configuration

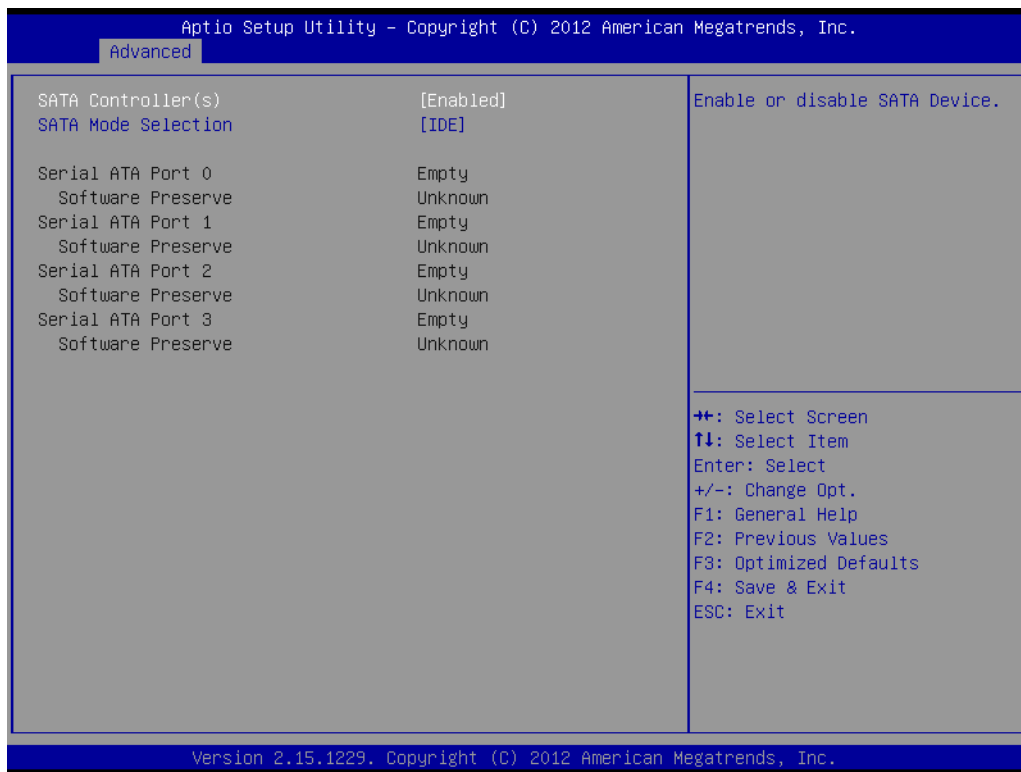

Figure 3.6 SATA Configuration

- **SATA Controller(s)**
This item allows users to enable or disable the SATA controller(s).
- **SATA Mode Selection**
This item allows users to select mode of SATA controller(s).

3.2.3.1 AMT Configuration

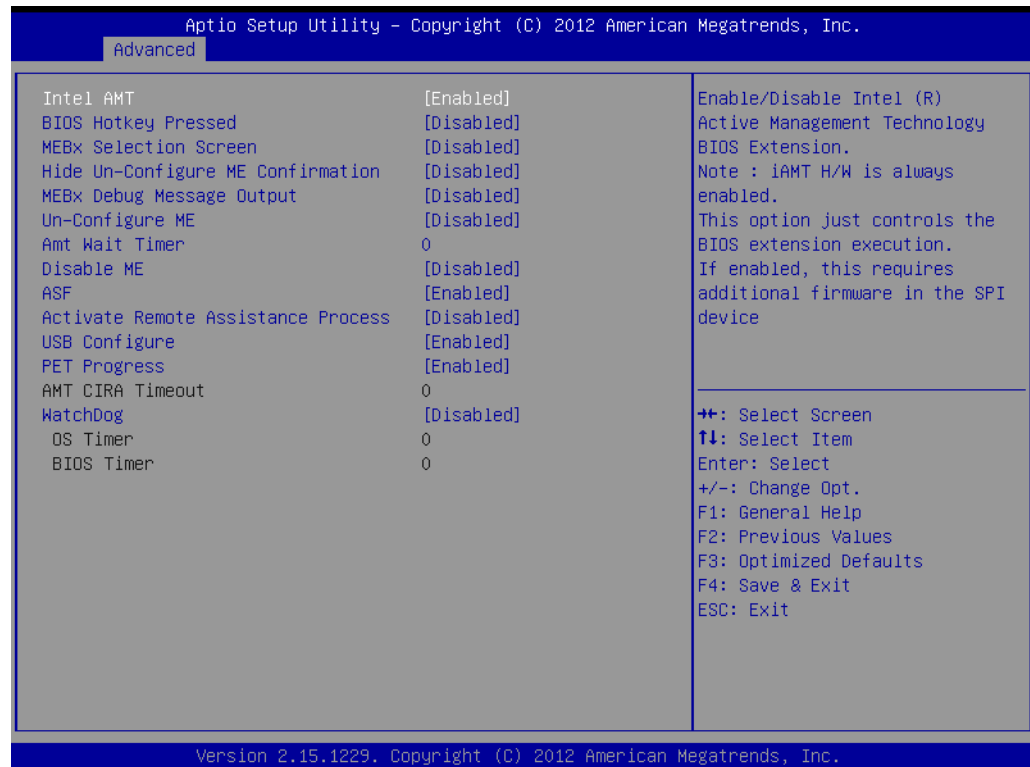

Figure 3.7 AMT Configuration

- **Intel AMT**
This item allows users to enable or disable Intel AMT BIOS extension.
- **BIOS Hotkey Pressed**
This item allows users to enable or disable BIOS hotkey press.
- **MEBx Selection Screen**
This item allows users to enable or disable MEBx selection screen.
- **Hide Un-Configuration ME Confirmation**
This item allows users to hide un-configure ME without password confirmation prompt.
- **MEBx Debug Message Output**
This item allows users to enable or disable MEBx debug message.
- **Un-Configure ME**
This item allows users to un-configure ME without password.
- **Amt Wait Timer**
Set timer to wait before sending ASF_GET_BOOT_OPTIONS.
- **Disable ME**
This item allows users to enable or disable Intel ME.
- **ASF**
This item allows users to enable or disable Alert Specification Format.
- **Activate Remote Assistance Process**
This item allows users to enable or disable trigger CIRA boot.
- **USB Configure**
This item allows users to enable or disable USB configure function.

- **PET Progress**
This item allows users to enable or disable PET events progress to receive PET events or not.
- **AMT CIRA Timeout**
OEM defined timeout for MPS connection to be established.
- **WatchDog**
This item allows users to enable or disable WatchDog Timer.
- **OS Timer**
Set OS watchdog timer.
- **BIOS Timer**
Set BIOS watchdog timer.

3.2.3.2 PCH-FW Configuration

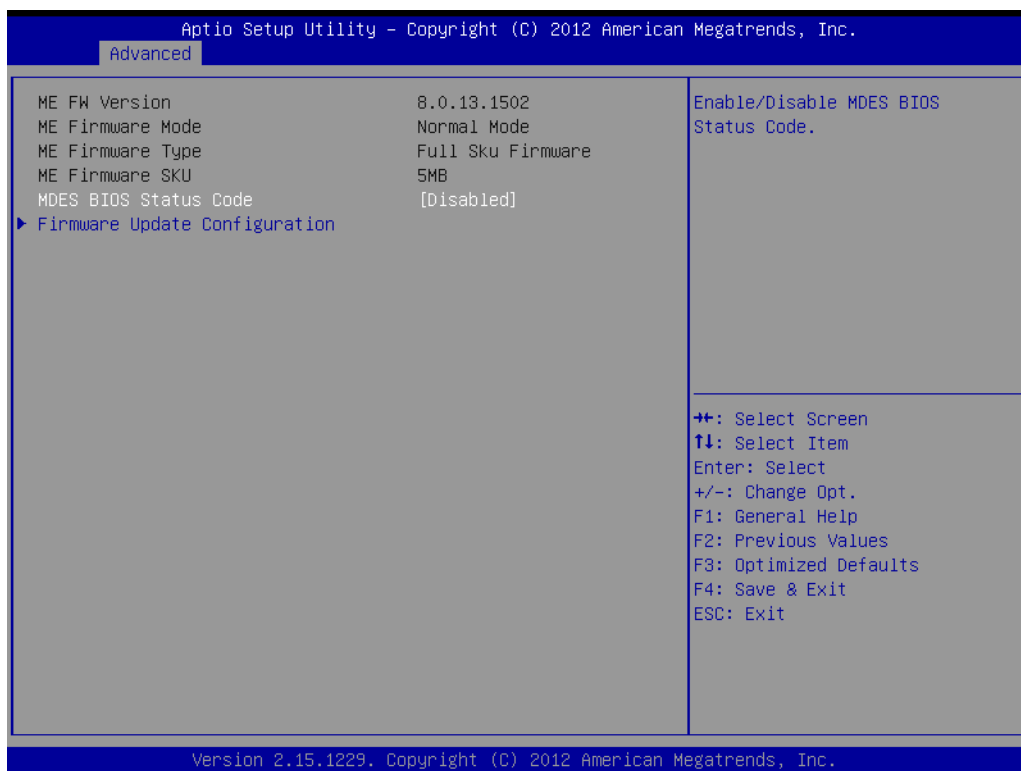

Figure 3.8 PCH-FW Configuration

- **MDES BIOS Status Code**
This item allows users to enable or disable MDES BIOS Status Code function.
- **Firmware Update Configuration**
This item allows users to enable or disable ME FW image re-flash function.

3.2.3.3 USB Configuration

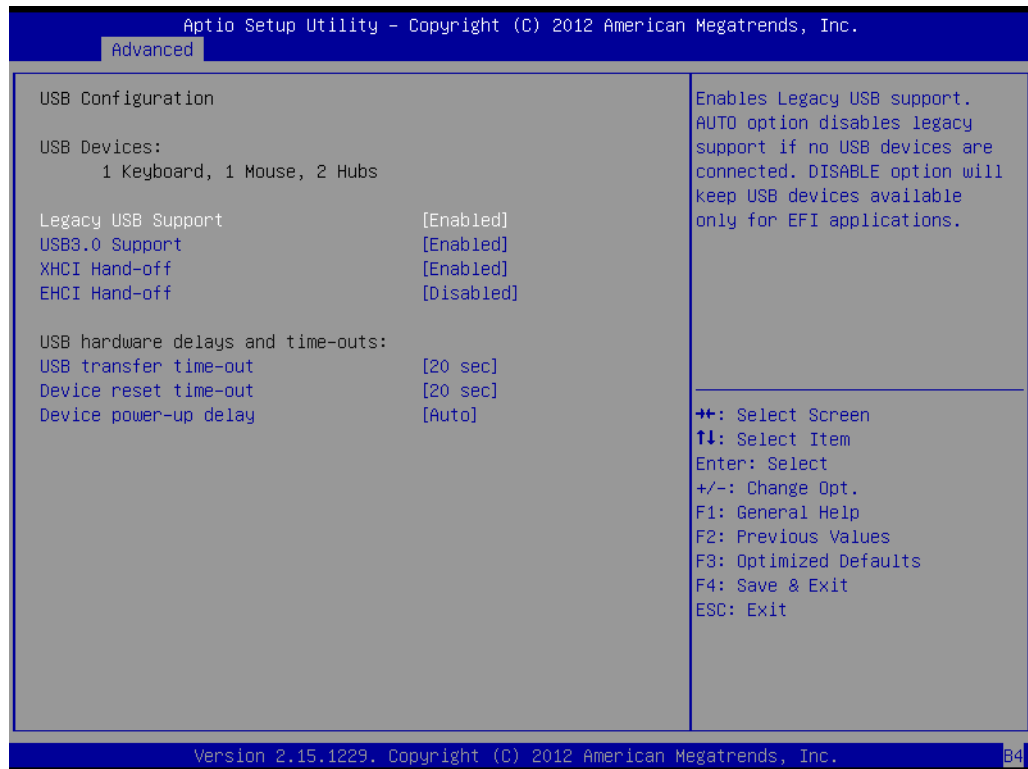

Figure 3.9 USB Configuration

- **Legacy USB Support**
Enable the support for legacy USB. Auto option disables legacy support if no USB devices are connected.
- **USB3.0 Support**
This item allows users to enable or disable USB3.0 support.
- **XHCI Hand-Off**
This is a workaround for the OS without XHCI hand-off support. The XHCI ownership change should claim by XHCI driver.
- **EHCI Hand-Off**
This is a workaround for the OS without EHCI hand-off support. The EHCI ownership change should claim by EHCI driver.
- **USB transfer time-out**
Set the time-out value for Control, Bulk, and Interrupt transfers.
- **Device reset time-out**
Set USB mass storage device Start Unit command time-out value.
- **Device power-up delay**
Set the maximum time of the device will take before it properly reports itself to the Host Controller. 'Auto' uses default value: for a Root port it is 100 ms, for a Hub port the delay is taken from Hub descriptor.

3.2.3.4 SMART Settings



Figure 3.10 SMART Settings

- **SMART Self Test**

This item allows users to enable or disable SMART Self Test.

3.2.3.5 Embedded Controller Configuration

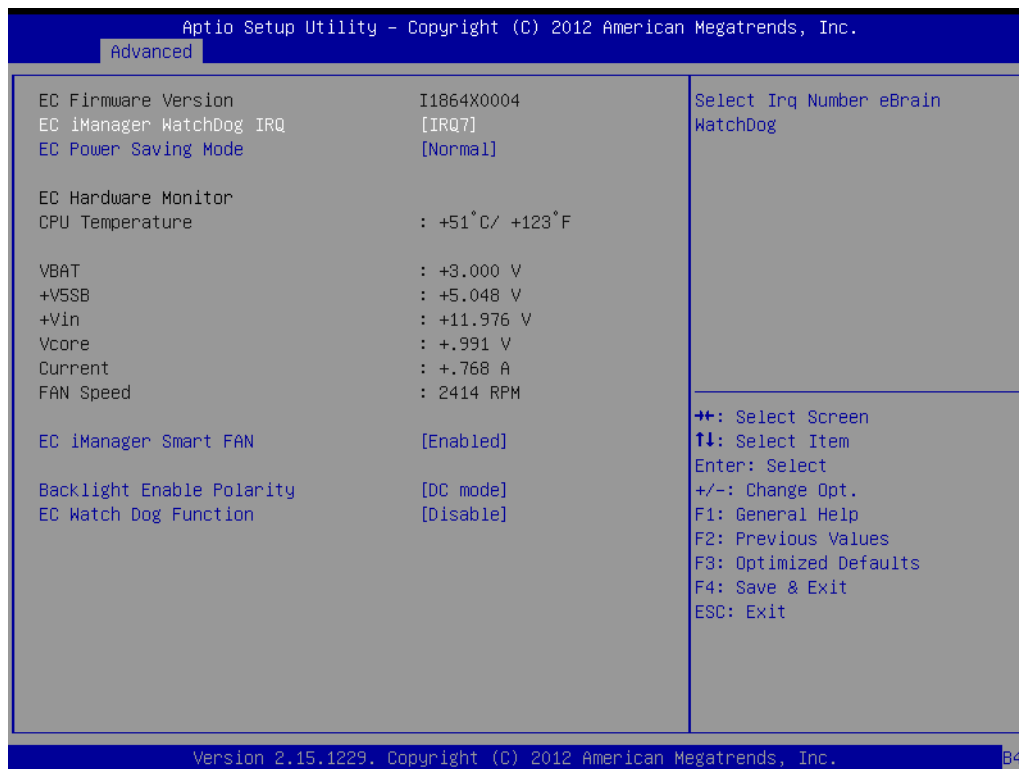

Figure 3.11 Embedded Controller Configuration

- **EC iManager WatchDog IRQ**
This item allows users to set the IRQ number of EC watchdog.
- **EC Power Saving Mode**
This item allows users to set board's power saving mode when off.
- **EC iManager Smart FAN**
This item allows users to enable or disable EC iManager smart FAN feature.
This item allows users to enable or disable EC serial port B.
- **Backlight Mode**
This item allows users to set backlight Function.
- **EC Watch Dog Function**
This item allows users to select EC watchdog timer.

3.2.3.6 Super IO Configuration

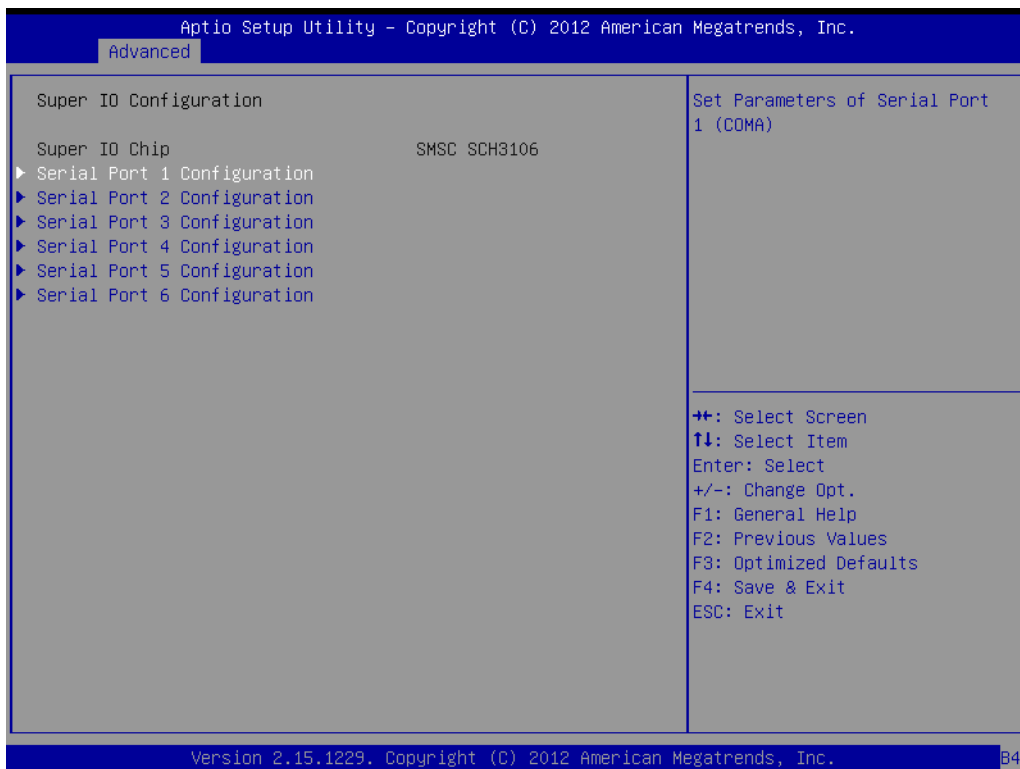

Figure 3.12 Super IO Configuration

- **Serial Port 1 Configuration**
This item allows users to configure serial port 1.
- **Serial Port 2 Configuration**
This item allows users to configure serial port 2.
- **Serial Port 3 Configuration**
This item allows users to configure serial port 3.
- **Serial Port 4 Configuration**
This item allows users to configure serial port 4.
- **Serial Port 5 Configuration**
This item allows users to configure serial port 5.
- **Serial Port 6 Configuration**
This item allows users to configure serial port 6.

3.2.3.7 Platform Misc Configuration



Figure 3.13 Platform Misc Configuration

- **Native PCIE Enable**
This item allows users to enable or disable native PCIE support feature.

3.2.3.8 Serial Port Console Redirection

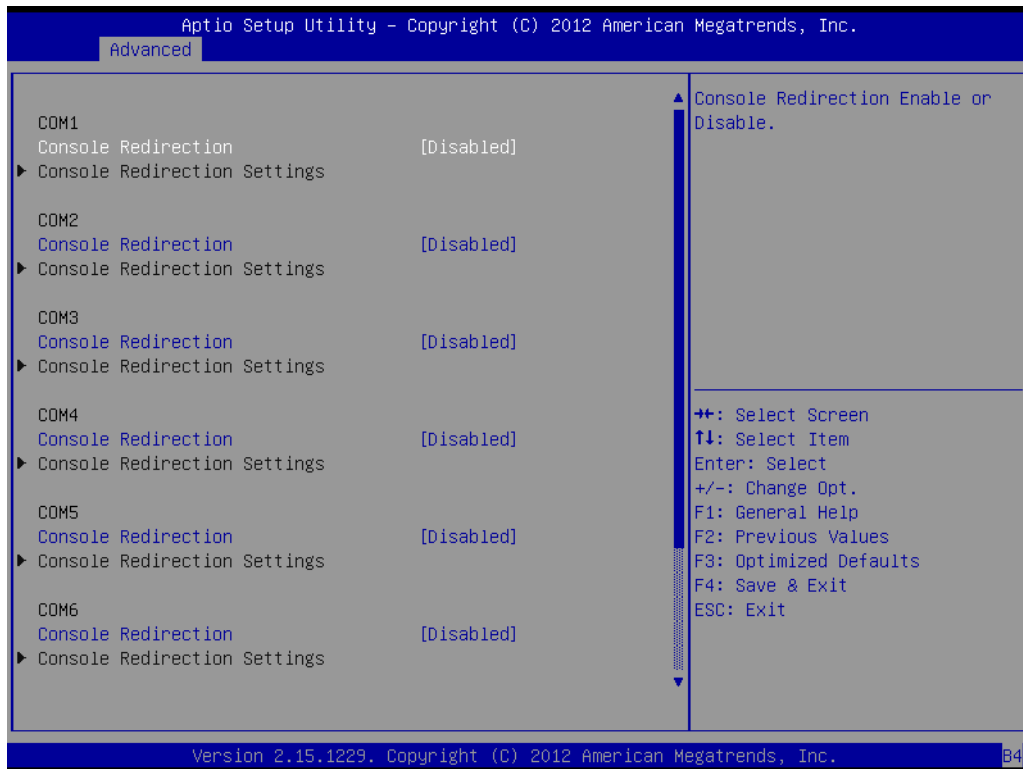

Figure 3.14 Serial Port Console Redirection

- **Console Redirection**
This item allows users to enable or disable console redirection for Microsoft Windows Emergency Management Services (EMS).
- **Console Redirection**
This item allows users to configuration console redirection detail settings.

3.2.3.9 CPU PPM Configuration

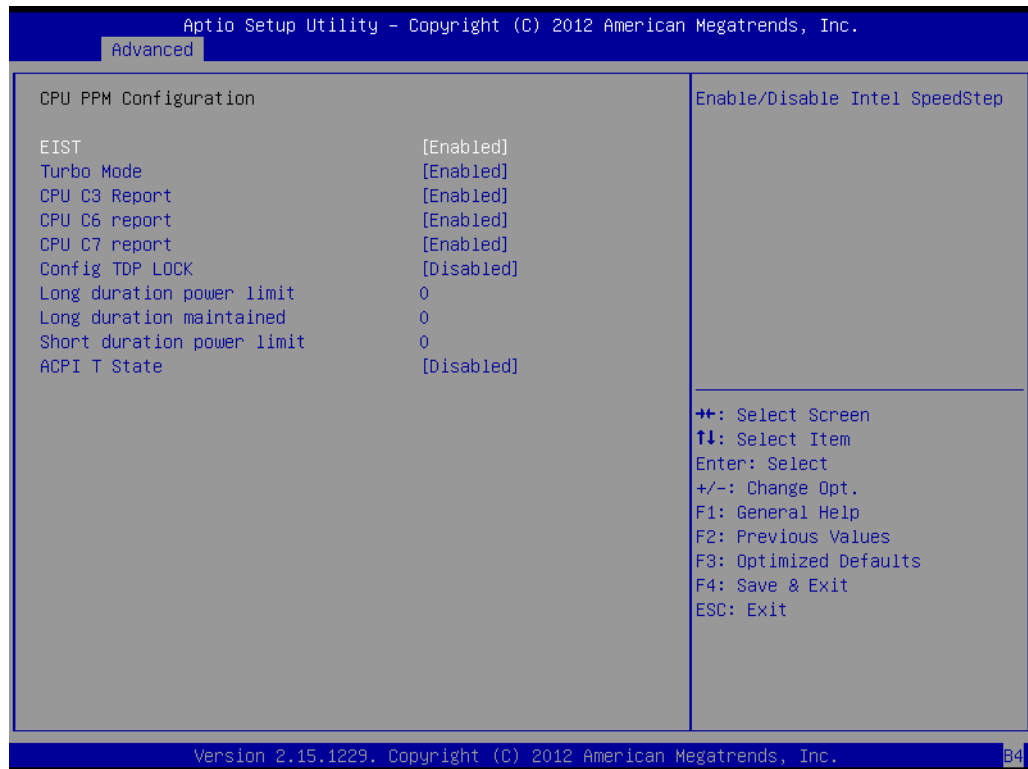

Figure 3.15 CPU PPM Configuration

- **EIST**
CPU runs at its default speed if disabled; CPU speed is controlled by the operating system if enabled.
- **Turbo Mode**
This item allows users to enable or disable turbo mode.
- **CPU C3/C6/C7 Report**
This item allows users to enable or disable CPU C-state support.
- **Config TDP LOCK**
This item allows users to enable or disable Config TDP LOCK.
- **Long duration power limit**
Long duration power limit in Watts, 0 means use factory default.
- **Long duration maintained**
Time window which the long duration power is maintained.
- **Short duration power limit**
Short duration power limit in Watts, 0 means use factory default.
- **ACPI T State**
This item allows users to enable or disable ACPI T State.

3.2.4 Chipset

Select the Chipset tab from the MIO-9290 setup screen to enter the Chipset BIOS Setup screen. You can display a Chipset BIOS Setup option by highlighting it using the <Arrow> keys. All Plug and Play BIOS Setup options are described in this section. The Plug and Play BIOS Setup screen is shown below.

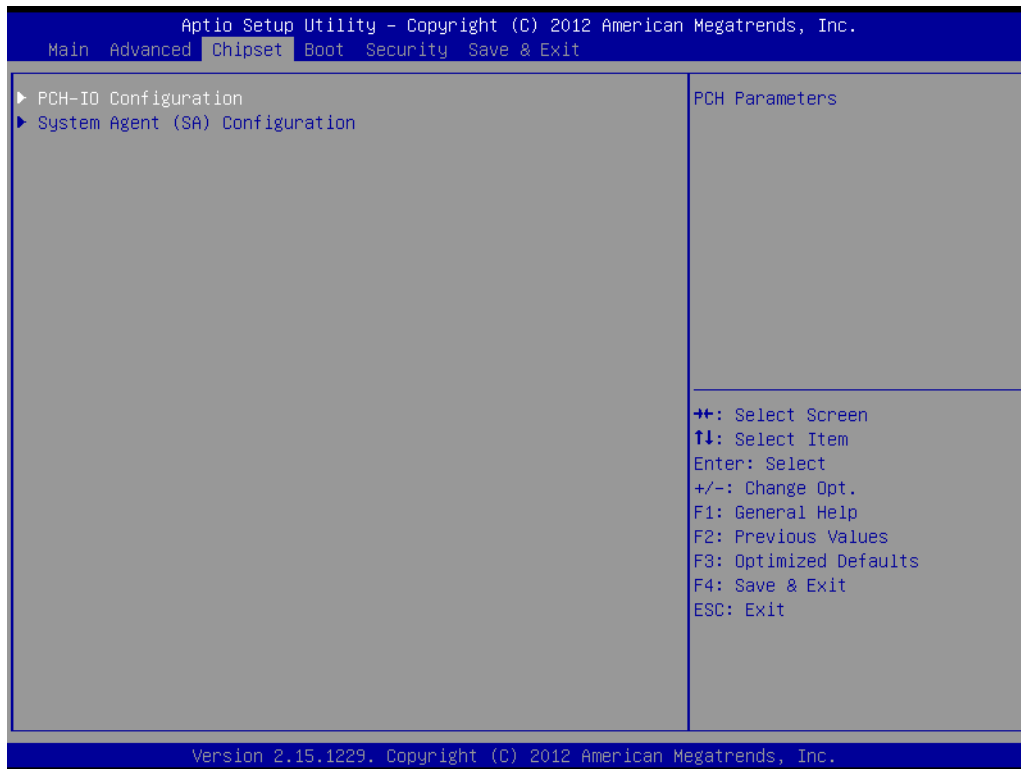

Figure 3.16 Chipset Setup

3.2.4.1 System Agent (SA) Configuration



Figure 3.17 System Agent (SA) Configuration

- **VT-d**
This item allows users to enable or disable VT-d.
- **DDR Selection**
This item allows users to select which DDR or DDRL voltage.

3.2.4.2 Intel IGFX Configuration

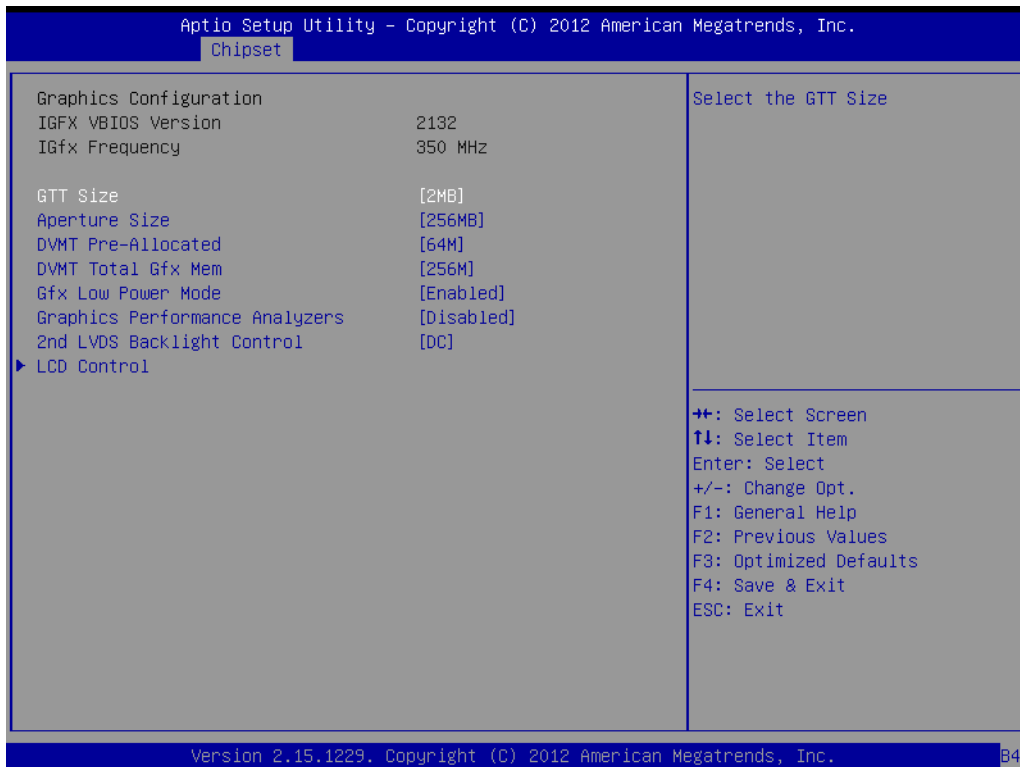

Figure 3.18 Intel IGFX Configuration

- **GTT Size**
This item allows users to select GTT size.
- **Aperture Size**
This item allows users to select aperture size.
- **DVMT Pre-Allocated**
This item allows users to select DVMT pre-allocated memory size.
- **DVMT Total Gfx Mem**
This item allows users to select DVMT total memory size.
- **Gfx Low Power Mode**
This item allows users to enable or disable IGD low power mode.
- **Graphics Performance Analyzers**
This item allows users to enable or disable Graphics Performance Analyzers
- **2nd LVDS Backlight Control**
This item allows users to select 2nd backlight control mode.

■ LCD Control

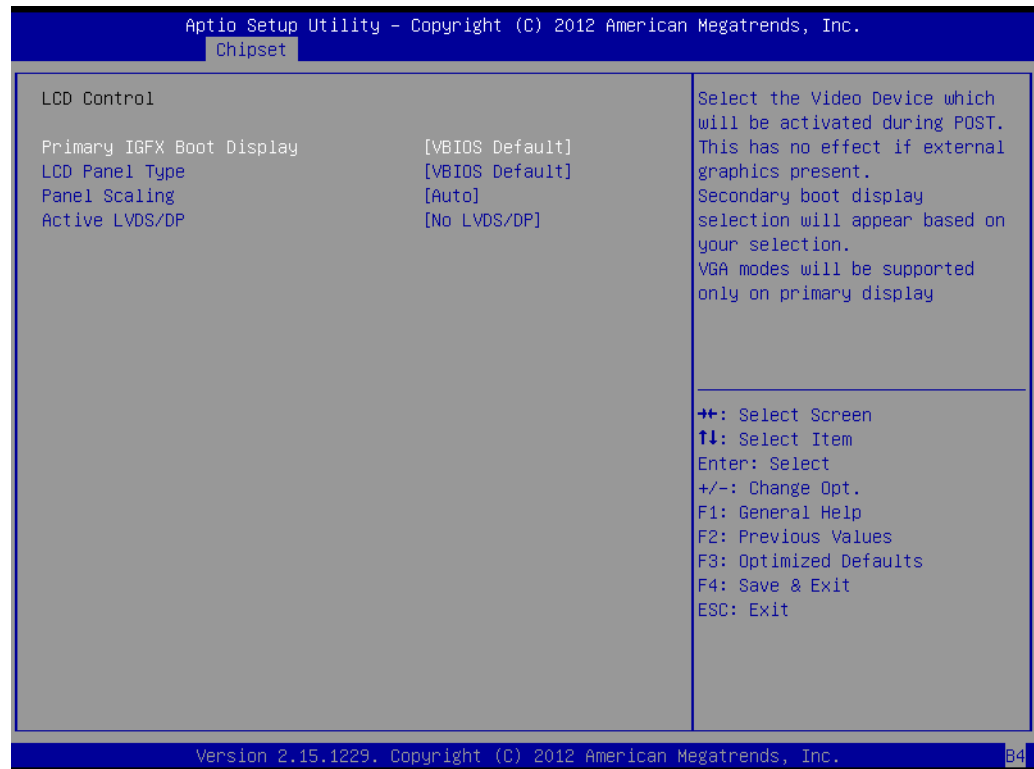

Figure 3.19 LCD Control

- **Primary IGFX Boot Display**
Select boot display device at post stage.
- **LCD Panel Type**
This item allows users to select panel resolution.
- **Panel Scaling**
This item allows users to enable or disable panel scaling.
- **Active LVDS/DP**
This item allows users to select the Active LVDS/DP Configuration.

3.2.4.3 PCH-IO Configuration

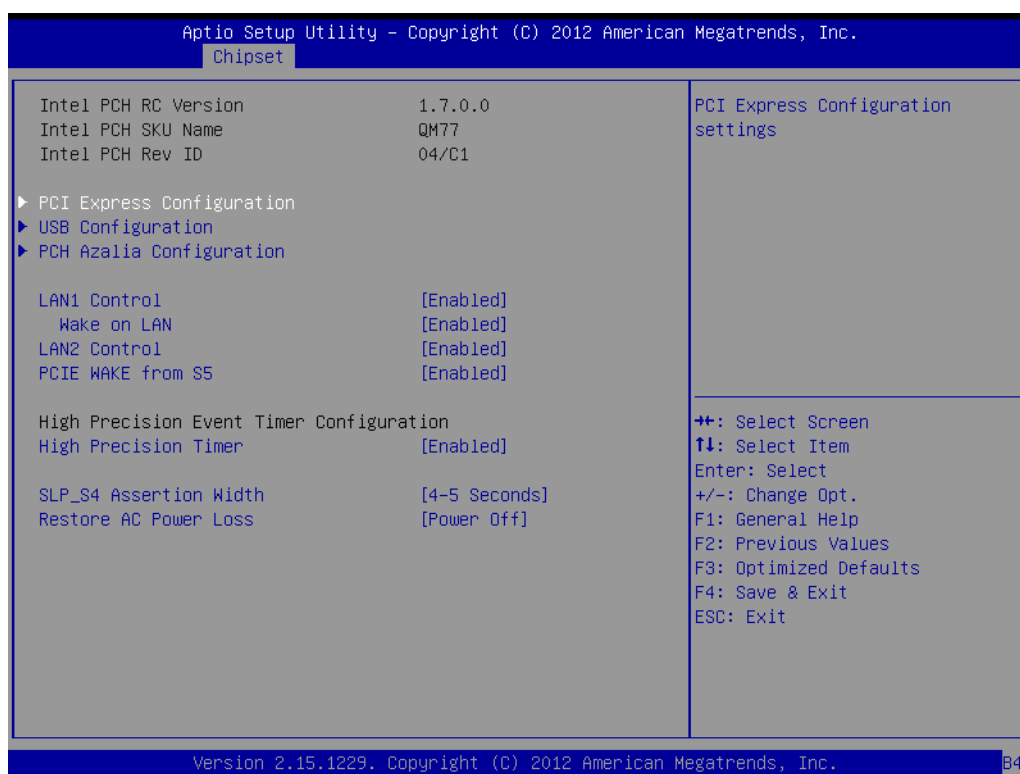

Figure 3.20 PCH-IO Configuration

- **PCI Express Configuration**
This item allows users to configuration PCIE1~PCIE8 root port detail settings.
- **USB Configuration**
This item allows users to configuration detail of USB functions.
- **PCH Azalia Configuration**
This item allows users to configuration detail of azalia functions.
- **LAN1 control**
Enables or disables the PCH LAN controller.
- **Wake on LAN**
Enables or disables PCH LAN wake up from sleep state.
- **LAN2 control**
Enables or disables the Onboard PCIE LAN controller.
- **PCIE WAKE from S5**
PCIE WAKE Enable/Disable from S5.
- **High Precision Timer**
Enables or disables the high precision timer.
- **SLP_S4 Assertion Width**
This item allows users to set a delay of sorts.
- **Restore AC Power Loss**
This item allows users to select off, on and last state.

3.2.5 Boot Settings

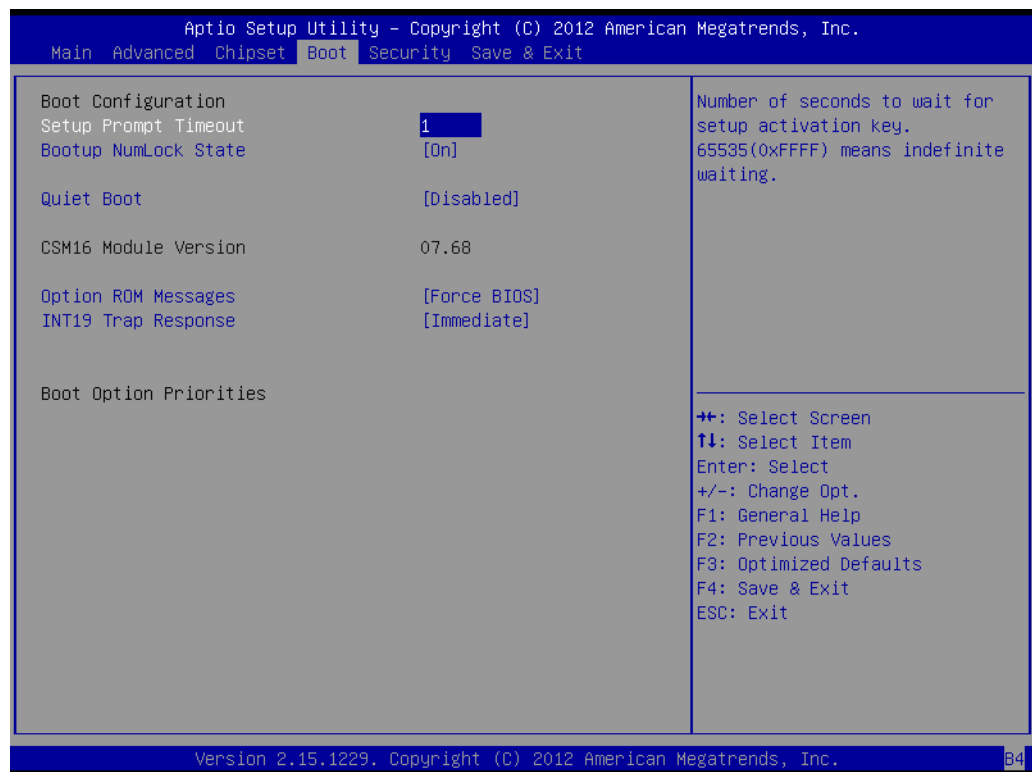

Figure 3.21 Boot Setup Utility

- **Setup Prompt Timeout**
This item allows users to select the number of seconds to wait for setup activation key.
- **Bootup NumLock State**
Select the Power-on state for Numlock.
- **Quiet Boot**
If this option is set to Disabled, the BIOS displays normal POST messages. If Enabled, an OEM Logo is shown instead of POST messages.
- **Option ROM Message**
Set display mode for option ROM.
- **INT19 Trap Response**
This item allows option ROMs to trap interrupt 19.

3.2.6 Security Setup



Figure 3.22 Password Configuration

Select Security Setup from the MIO-9290 Setup main BIOS setup menu. All Security Setup options, such as password protection is described in this section. To access the sub menu for the following items, select the item and press <Enter>:

Change Administrator / User Password: Select this option and press <ENTER> to access the sub menu, and then type in the password.

3.2.7 Save & Exit

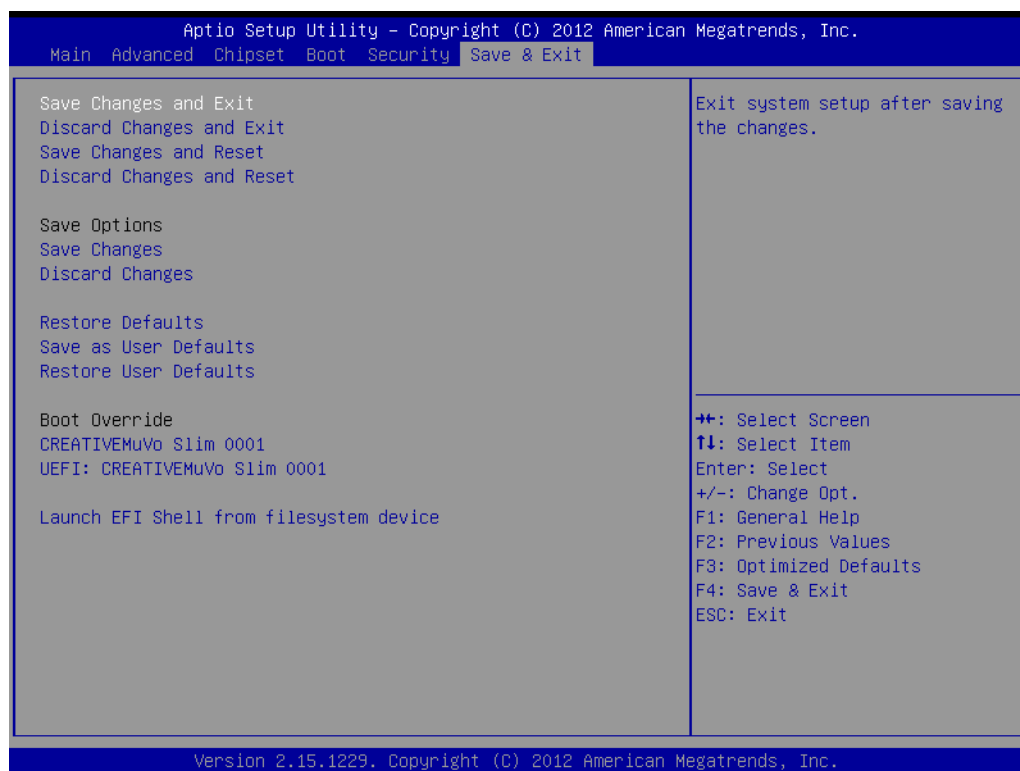

Figure 3.23 Save & Exit

3.2.7.1 Save Changes and Exit

When users have completed system configuration, select this option to save changes, exit BIOS setup menu and reboot the computer if necessary to take effect all system configuration parameters.

3.2.7.2 Discard Changes and Exit

Select this option to quit Setup without making any permanent changes to the system configuration.

3.2.7.3 Save Changes and Reset

When users have completed system configuration, select this option to save changes, exit BIOS setup menu and reboot the computer to take effect all system configuration parameters.

3.2.7.4 Discard Changes and Reset

Select this option to quit Setup without making any permanent changes to the system configuration and reboot the computer.

3.2.7.5 Save Changes

When users have completed system configuration, select this option to save changes without exit BIOS setup menu.

3.2.7.6 Discard Changes

Select this option to discard any current changes and load previous system configuration.

3.2.7.7 Restore Defaults

The MIO-9290 automatically configures all setup items to optimal settings when users select this option. Optimal Defaults are designed for maximum system performance, but may not work best for all computer applications. In particular, do not use the Optimal Defaults if the user's computer is experiencing system configuration problems.

3.2.7.8 Save User Defaults

When users have completed system configuration, select this option to save changes as user defaults without exit BIOS setup menu.

3.2.7.9 Restore User Defaults

The users can select this option to restore user defaults.

Appendix **A**

Pin Assignments

This appendix contains information of a detailed or specialized nature.

Sections include:

- Connector Tables

A.1 Connector Tables

CN1	12V Power Input
Part Number	1655003861
Footprint	WF_2x2P_165_BOX_RA_D_740-77
Description	ATX PWR Conn. 2x2P 4.2mm 90D(M) DIP 740-77-04TS0
Pin	Pin Name
1	GND
2	GND
3	+12V
4	+12V

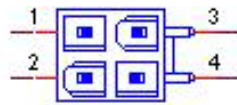

CN2	COM3/COM4
Part Number	1653004793
Footprint	HD_10x2P_79_23N685B-20M10
Description	BOX HEADER 10x2P 2.0mm 180D(M)SMD 23N685B-20M10B
Pin	Pin Name
1	DCD3#
2	DSR3#
3	RXD3
4	RTS3#
5	TXD3
6	CTS3#
7	DTR3#
8	RI3#
9	GND
10	GND
11	DCD4#
12	DSR4#
13	RXD4
14	RTS4#
15	TXD4
16	CTS4#
17	DTR4#
18	RI4#
19	GND
20	GND

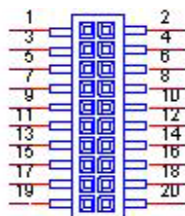

Matching Cable: 1701200220

CN3	COM1/COM2
Part Number	1653004793
Footprint	HD_10x2P_79_23N685B-20M10
Description	BOX HEADER 10x2P 2.0mm 180D(M)SMD 23N685B-20M10B
Pin	Pin Name
1	DCD1#
2	DSR1#
3	RXD1
4	RTS1#
5	TXD1
6	CTS1#
7	DTR1#
8	RI1#
9	GND
10	GND
11	DCD2#
12	DSR2#
13	RXD2
14	RTS2#
15	TXD2
16	CTS2#
17	DTR2#
18	RI2#
19	GND
20	GND

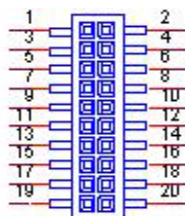

Matching Cable: 1701200220

CN4	SODIMDDR3_204
Part Number	1651001649
Footprint	DDR3_204P_2-2013310-1
Description	DDR3 SODIMM H=9.2mm 204P SMD 2-2013310-1
Pin	Pin Name

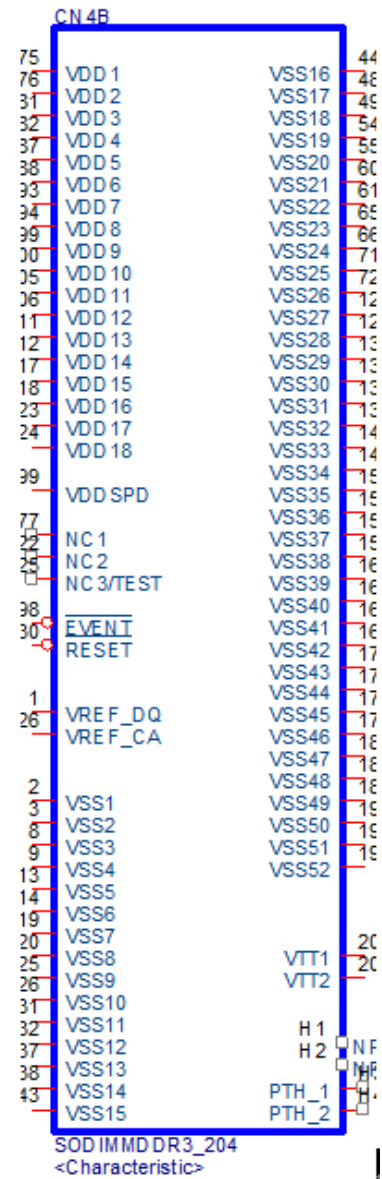
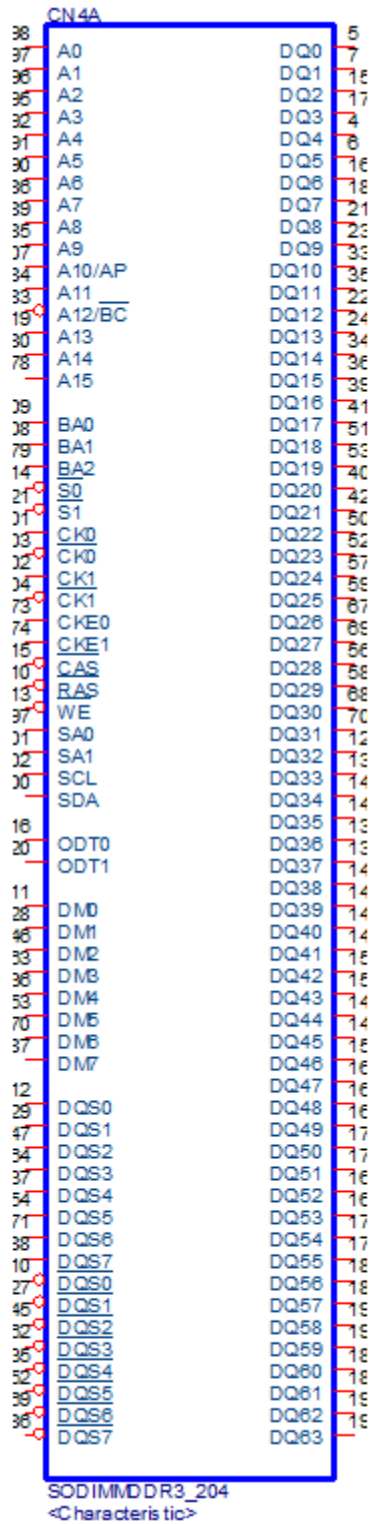

CN5	Audio
Part Number	1653004099
Footprint	HD_5x2P_79_23N685B-10M10
Description	BOX HEADER 5x2P 2.00mm 180D(M) SMD 23N685B-10M10
Pin	Pin Name
1	LOUTR
2	LINR
3	GND
4	GND
5	LOUTL
6	LINL
7	GND
8	GND
9	MIC1R
10	MIC1L

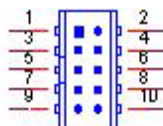

Matching Cable: 1703100152

CN7	COM5 TX/RX
Part Number	1655004032
Footprint	WF_5P_49_BOX_85205
Description	WAFER 5P 1.25mm 180D(M) SMD 85205-05701
Pin	Pin Name
1	TXD
2	RTS#
3	RXD
4	CTS#
5	GND

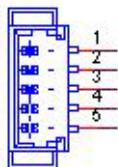

Matching Cable: 1700021399-01

CN8	COM6 TX/RX
Part Number	1655004032
Footprint	WF_5P_49_BOX_85205
Description	WAFER 5P 1.25mm 180D(M) SMD 85205-05701
Pin	Pin Name
1	TXD
2	RTS#
3	RXD
4	CTS#
5	GND

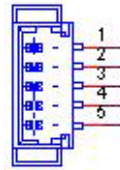

Matching Cable : 1700021399-01

CN9	SODIMDDR3_204
Part Number	1651001904
Footprint	DDR3_204P_2-2013289-1
Description	DDR3 SODIMM H=5.2mm 204P SMD 2-2013289-1
Pin	Pin Name

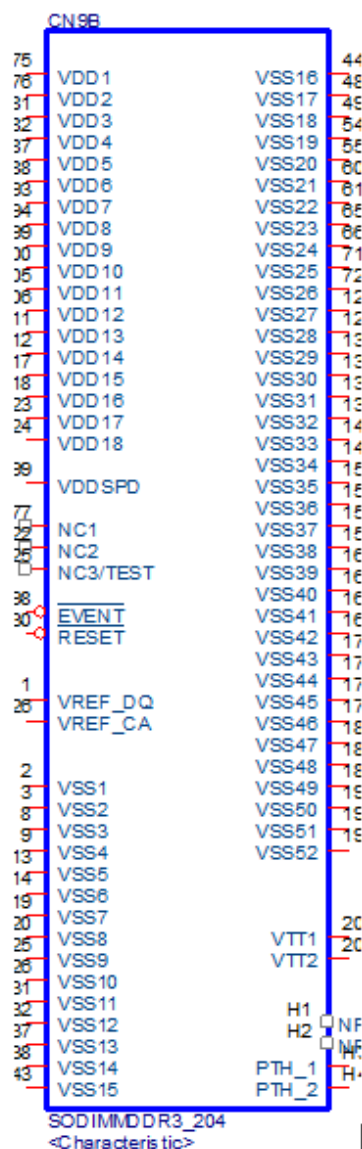
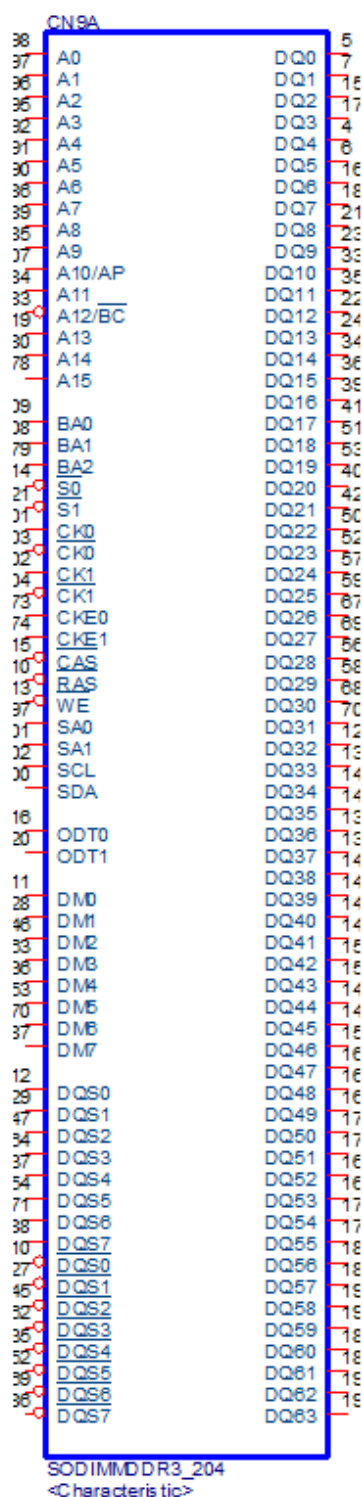

CN14	CPU Socket
Part Number	1651002177
Footprint	SOCKET_PGA989
Description	CPU Socket rPGA988B 988P SMD 100361HK988J2S6PQ

CN15	CPU FAN
Part Number	1655004347
Footprint	WF_4P_100_D_744-81-04TW30
Description	WAFER 2.54 1*4P 180D(M) DIP 744-81-04TW30
Pin	Pin Name
1	GND
2	+12V
3	SPEED
4	PWM

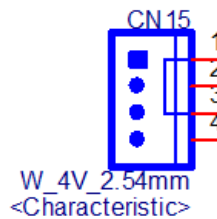

CN16	Reset
Part Number	1655302020
Footprint	WF_2P_79_BOX_R1_D
Description	WAFER BOX 2P 2.0mm 180D(M) DIP A2001WV2-2P
Pin	Pin Name
1	RESET#
2	GND



CN17	Power Switch
Part Number	1655302020
Footprint	WF_2P_79_BOX_R1_D
Description	WAFER BOX 2P 2.0mm 180D(M) DIP A2001WV2-2P
Pin	Pin Name
1	PSIN
2	GND



CN18	48 bits LVDS Panel
Part Number	1653920200
Footprint	SPH20X2
Description	B/B Conn. 40P 1.25mm 90D SMD DF13-40DP-1.25V(91)
Pin	Pin Name
1	+5V or +3.3V or +V12
2	+5V or +3.3V or +V12
3	GND
4	GND
5	+5V or +3.3V or +V12
6	+5V or +3.3V or +V12
7	LVDS0_D0-
8	LVDS1_D0-
9	LVDS0_D0+
10	LVDS1_D0+
11	GND
12	GND
13	LVDS0_D1-
14	LVDS1_D1-
15	LVDS0_D1+
16	LVDS1_D1+
17	GND
18	GND
19	LVDS0_D2-
20	LVDS1_D2-
21	LVDS0_D2+
22	LVDS1_D2+
23	GND
24	GND
25	LVDS0_CLK-
26	LVDS1_CLK-
25	LVDS0_CLK-
26	LVDS1_CLK-
27	LVDS0_CLK+
28	LVDS1_CLK+
29	GND
30	GND
31	NC
32	NC
33	GND
34	GND
35	LVDS0_D3-
36	LVDS1_D3-
37	LVDS0_D3+
38	LVDS1_D3+
39	NC
40	NC

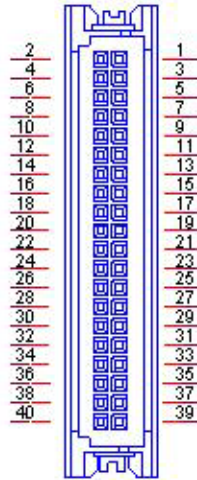

CN19	System FAN
Part Number	1655003010
Footprint	WHP3VA
Description	Wafer 2.54mm 3P 180D(M) DIP 22-27-2031
Pin	Pin Name
1	GND
2	+12V
3	NC

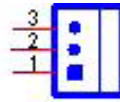

CN20	SMBus
Part Number	1655904020
Footprint	FPC4V-125M
Description	WAFER 4P 1.25mm 180D(M) SMD 85205-04001
Pin	Pin Name
1	GND
2	SMB_DAT
3	SMB_CLK
4	+5V

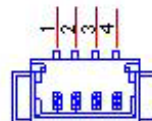

CN21	Inverter Power Output
Part Number	1655000453
Footprint	WHL5V-2M-24W1140
Description	WAFER BOX 2.0mm 5P 180D(M) DIP WO/Pb JIH VEI
Pin	Pin Name
1	+12V
2	GND
3	ENABKL
4	VBR
5	+5V



CN22	LAN
Part Number	1652003274
Footprint	RJ45_28P_RTB-19GB9J1A
Description	PHONE JACK RJ45 28P DIP RTB-19GB9J1A
Pin	Pin Name
1	TX+(10/100),BI_DA+(GHz)
2	TX-(10/100),BI_DA-(GHz)
3	RX+(10/100),BI_DB+(GHz)
4	BI_DC+(GHz)
5	BI_DC-(GHz)
6	RX-(10/100),BI_DB-(GHz)
7	BI_DD+(GHz)
8	BI_DD-(GHz)

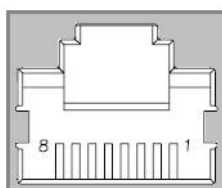

CN23	External USB2.0+USB3.0
Part Number	1654009860
Footprint	USB_9x2P_2360009-603-R
Description	USB 3.0 CONN 18P 2.0mm 90D(F) DIP 2360009-603-R
Pin	Pin Name
1	+5V
2	D-
3	D+
4	GND
5	SSRX-
6	SSRX+
7	GND
8	SSTX-
9	SSTX+

CN24	External USB2.0+USB3.0
Part Number	1654009860
Footprint	USB_9x2P_2360009-603-R
Description	USB 3.0 CONN 18P 2.0mm 90D(F) DIP 2360009-603-R
Pin	Pin Name
1	+5V
2	D-
3	D+
4	GND
5	SSRX-
6	SSRX+
7	GND
8	SSTX-
9	SSTX+

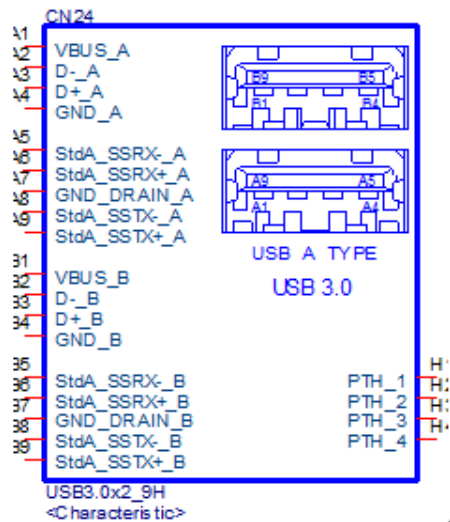

CN25	Display Port
Part Number	1654010437
Footprint	DPCON_20P_3VD51203-H7JJ-7H
Description	Displayport Conn. 20P 0.5mm 90D(F) SMD 3VD51203
Pin	Pin Name
1	ML_Lane0(p)
2	GND
3	ML_Lane0(n)
4	ML_Lane1(p)
5	GND
6	ML_Lane1(n)
7	ML_Lane2(p)
8	GND
9	ML_Lane2(n)
10	ML_Lane3(p)
11	GND
12	ML_Lane3(n)
13	CONFIG1
14	CONFIG2
15	AUX CH(p)
16	GND
17	AUX CH(n)
18	Hot Plug Detect
19	GND
20	+3.3V

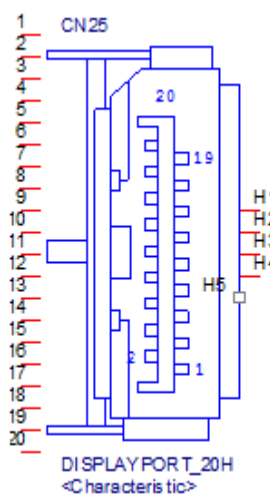

CN26		HDMI	
Part Number	1654002198		
Footprint	HDMI19P-471511002		
Description	HDMI Conn. 19P 0.5mm 90D(F) SMD 471511002		
Pin	Pin Name		
1	TMDS Data2+		
2	TMDS Data2 Shield		
3	TMDS Data2-		
4	TMDS Data1+		
5	TMDS Data1 Shield		
6	TMDS Data1-		
7	TMDS Data0+		
8	TMDS Data0 Shield		
9	TMDS Data0-		
10	TMDS Clock+		
11	TMDS Clock Shield		
12	TMDS Clock-		
13	Reserved		
14	Reserved		
15	SCL		
16	SDA		
17	DDC Ground		
18	+5V Power		
19	Hot Plug Detect		

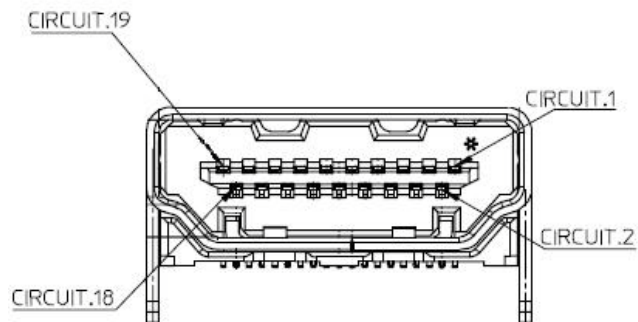

CN27	DVI-I
Part Number	1654004671
Footprint	DVI_29P_QH11121-FAT0-4F
Description	DVI Conn. 29P 90D(F) DIP QH11121-DAT0-4F
Pin	Pin Name
1	TMDS Data 2-
2	TMDS Data 2+
3	TMDS Data 2/4 Shield
4	TMDS Data 4-
5	TMDS Data 4+
6	DDC Clock
7	DDC Data
8	Analog Vertical Sync
9	TMDS Data 1-
10	TMDS Data 1+
11	TMDS Data 1/3 Shield
12	TMDS Data 3-
13	TMDS Data 3+
14	+5V
15	Ground
16	Hot Plug Detect
17	TMDS Data 0-
18	TMDS Data 0+
19	TMDS Data 0/5 Shield
20	TMDS Data 5-
21	TMDS Data 5+
22	TMDS Clock Shield
23	TMDS Clock+
24	TMDS Clock-
C1	Analog Red
C2	Analog Green
C3	Analog Blue
C4	Analog Horizontal Sync
C5	Analog Ground

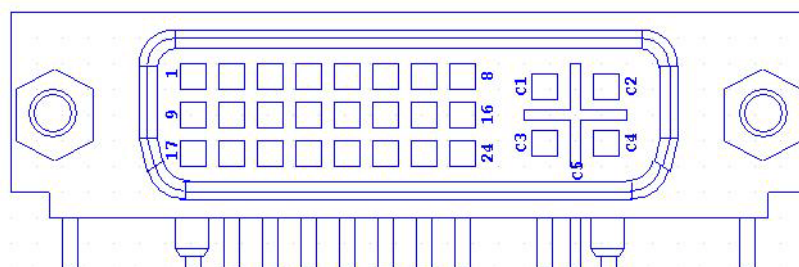

CN29	Mini PCIE
Part Number	1654006715
Footprint	MINIPCIE_FULL_HALF_STANDARD
Description	MINI PCI Express 52P 9.0mm 90D SMD 88911-5204M
Pin	Pin Name
1	WAKE#
2	+3.3VSB
3	NC
4	GND
5	NC
6	+1.5V
7	NC
8	UIM_PWR
9	GND
10	UIM_DATA
11	REFCLK-
12	UIM_CLK
13	REFCLK+
14	UIM_RESET
15	GND
16	UIM_VPP
17	NC
18	GND
19	NC
20	W_DISABLE#
21	GND
22	PERST#
23	PERn0
24	+3.3VSB
25	PERp0
26	GND
27	GND
28	+1.5V
29	GND
30	SMB_CLK
31	PETn0
32	SMB_DAT
33	PETp0
34	GND
35	GND
36	USB D-
37	GND
38	USB D+
39	+3.3VSB
40	GND
41	+3.3VSB

42	NC
43	MSATA/PCIe card detect
44	NC
45	NC
46	NC
47	NC
48	+1.5V
49	NC
50	GND
51	NC
52	+3.3

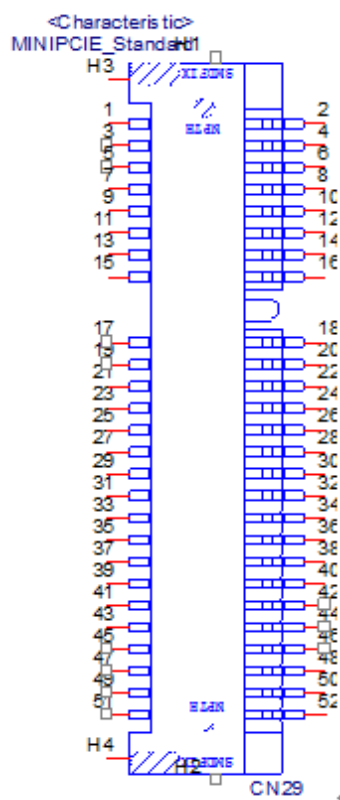

CN30	SATA
Part Number	1654007578
Footprint	SATA_7P_WATF-07DBN6SB1U
Description	Serial ATA 7P 1.27mm 180D(M) SMD WATF-07DBN6SB1U
Pin	Pin Name
1	GND
2	TX+
3	TX-
4	GND
5	RX-
6	RX+
7	GND

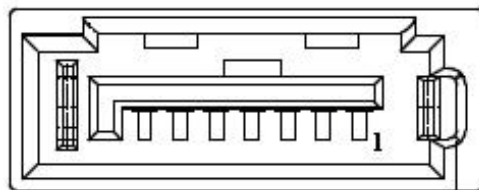

CN31	SATA
Part Number	1654007578
Footprint	SATA_7P_WATF-07DBN6SB1U
Description	Serial ATA 7P 1.27mm 180D(M) SMD WATF-07DBN6SB1U
Pin	Pin Name
1	GND
2	TX+
3	TX-
4	GND
5	RX-
6	RX+
7	GND

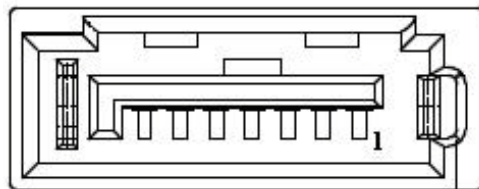

CN32	GPIO
Part Number	1653004099
Footprint	HD_5x2P_79_23N685B-10M10
Description	BOX HEADER 5x2P 2.00mm 180D(M) SMD 23N685B-10M10
Pin	Pin Name
1	+5V
2	GPIO4
3	GPIO0
4	GPIO5
5	GPIO1
6	GPIO6
7	GPIO2
8	GPIO7
9	GPIO3
10	GND

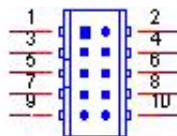

CN33	GPIO
Part Number	1653004099
Footprint	HD_5x2P_79_23N685B-10M10
Description	BOX HEADER 5x2P 2.00mm 180D(M) SMD 23N685B-10M10
Pin	Pin Name
1	+5V
2	GPIO4
3	GPIO0
4	GPIO5
5	GPIO1
6	GPIO6
7	GPIO2
8	GPIO7
9	GPIO3
10	GND

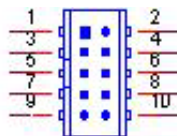

CN34	SATA Power
Part Number	1655001154
Footprint	WF_4P_98_BOX_R1_D
Description	WAFER BOX 4P 2.50mm 180D(M) DIP 24W1170-04S10-01
Pin	Pin Name
1	+5V
2	GND
3	GND
4	+12V



CN35	SATA Power
Part Number	1655001154
Footprint	WF_4P_98_BOX_R1_D
Description	WAFER BOX 4P 2.50mm 180D(M) DIP 24W1170-04S10-01
Pin	Pin Name
1	+5V
2	GND
3	GND
4	+12V



CN36	SIM Card
Part Number	1654010809-01
Footprint	SIM_6P_5210622-SINR03
Description	SIM card conn. 6p 2.54mm 90D(F) SMD 5210622-SINR
Pin	Pin Name
C1	UIM_PWR
C2	UIM_RESET
C3	UIM_CLK
C5	GND
C6	UIM_VPP
C7	UIM_DATA

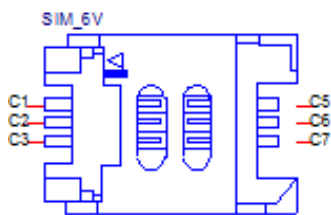

CN37	Internal USB
Part Number	1653005260
Footprint	HD_5x2P_79_N10
Description	PIN HEADER 2x5P 2.0mm 180D(M) SMD 21N22050
Pin	Pin Name
1	+5V
2	+5V
3	A_D-
4	B_D-
5	A_D+
6	B_D+
7	GND
8	GND
9	GND

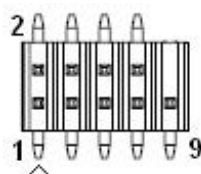

Matching Cable : 1703100260, 1703100121

CN38	Mini PCIE
Part Number	1654006715
Footprint	MINIPCIE_FULL_HALF_STANDARD
Description	MINI PCI Express 52P 9.0mm 90D SMD 88911-5204M
Pin	Pin Name
1	WAKE#
2	+3.3VSB
3	NC
4	GND
5	NC
6	+1.5V
7	NC
8	UIM_PWR
9	GND
10	UIM_DATA
11	REFCLK-

12	UIM_CLK
13	REFCLK+
14	UIM_RESET
15	GND
16	UIM_VPP
17	NC
18	GND
19	NC
20	W_DISABLE#
21	GND
22	PERST#
23	PERn0
24	+3.3VSB
25	PERp0
26	GND
27	GND
28	+1.5V
29	GND
30	SMB_CLK
31	PETn0
32	SMB_DAT
33	PETp0
34	GND
35	GND
36	USB D-
37	GND
38	USB D+
39	+3.3VSB
40	GND
41	+3.3VSB
42	NC
43	MSATA/PCIe card detect
44	NC
45	NC
46	NC
47	NC
48	+1.5V
49	NC
50	GND
51	NC
52	+3.3VSB

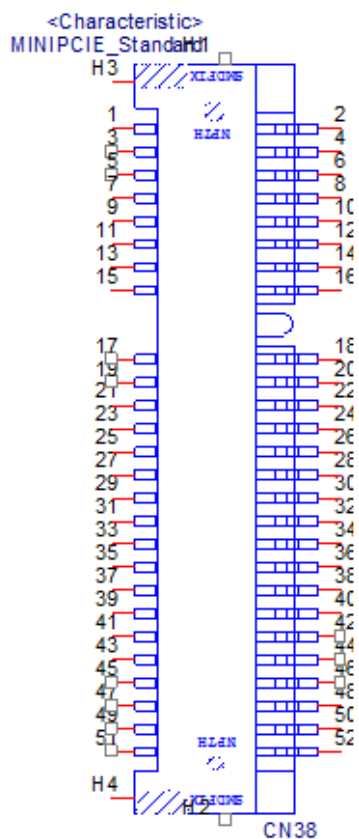

CN39	MIOe
Part Number	1654006235
Footprint	BB_40x2P_32_1625x285_2HOLD
Description	B/B Conn. 40x2P 0.8mm 180D(F) SMD QSE-040-01-L-D
Pin	Pin Name
1	GND
2	GND
3	PCIE_RX0+
4	PCIE_TX0+
5	PCIE_RX0-
6	PCIE_TX0-
7	GND
8	GND
9	PCIE_RX1+
10	PCIE_TX1+
11	PCIE_RX1-
12	PCIE_TX1-
13	GND
14	GND
15	PCIE_RX2+
16	PCIE_TX2+
17	PCIE_RX2-
18	PCIE_TX2-
19	GND
20	GND

21	PCIE_RX3+
22	PCIE_TX3+
23	PCIE_RX3-
24	PCIE_TX3-
25	GND
26	GND
27	PCIE_CLK+
28	LOUTL
29	PCIE_CLK-
30	LOUTR
31	GND
32	AGND
33	SMB_CLK
34	NC
35	SMB_DAT
36	NC
37	PCIE_WAKE#
38	NC
39	RESET#
40	NC
41	SLP_S3#
42	CLK33M
43	NC
44	LPC_AD0
45	DDP_HPD
46	LPC_AD1
47	GND
48	LPC_AD2
49	DDP_AUX+
50	LPC_AD3
51	DDP_AUX-
52	LPC_DRQ#0
53	GND
54	LPC_SERIRQ
55	DDP_D0+
56	LPC_FRAME#
57	DDP_D0-
58	GND
59	GND
60	USB0_D+
61	DDP_D1+
62	USB0_D-
63	DDP_D1-
64	GND
65	GND
66	USB1_D+/USB_SSTX+
67	DDP_D2+
68	USB1_D-/USB_SSTX-

69	DDP_D2-
70	GND
71	GND
72	USB2_D+/USB_SSRX+
73	DDP_D3+
74	USB2_D-/USB_SSRX-
75	DDP_D3-
76	GND
77	GND
78	USB_OC#
79	+12VSB
80	+12VSB
83	GND
84	GND
85	GND
86	GND
87	+5VSB
88	+5VSB
89	+5VSB
90	+5VSB

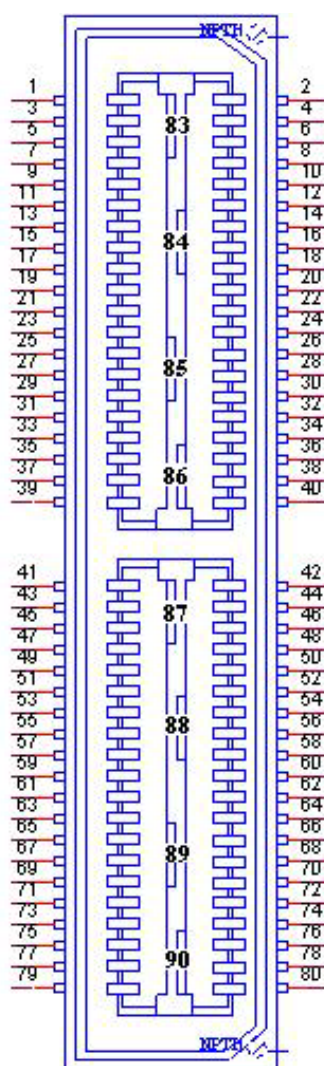

Appendix **B**

System Assignments

This appendix contains information of a detailed nature.

Sections include:

- System I/O Ports
- DMA Channel Assignments
- 1st MB Memory Map
- Interrupt Assignments

B.1 System I/O Ports

Table B.1: System I/O Ports

Addr. Range (Hex)	Device
00-1F	DMA Controller
20-2D	Interrupt Controller
50-52	Timer/Counter
60-6F	8042 (keyboard controller)
70-7F	Real-time clock, non-maskable interrupt (NMI) mask
80-9F	DMA page register
A0-BF	0A0-0BF
C0-DF	DMA controller
200-207	Communications Port (COM5)
208-20F	Communications Port (COM6)
2E8-2EF	Communications Port (COM4)
299-29A	EC HM Index port and Data port
29C-29D	EC Index port and Data port
2F8-2FF	Communications Port (COM2)
3B0-3DF	Motherboard resources
3E8-3EF	Communications Port (COM3)
3F8-3FF	Communications Port (COM1)
400-4FF	Motherboard resources
500-57F	Motherboard resources

B.2 DMA Channel Assignments

Table B.2: DMA Channel Assignments

Channel	Function
0	Available
1	Available
2	Available
3	Available
4	Direct memory access controller
5	Available
6	Available
7	Available

B.3 1st MB Memory Map

Table B.3: 1st MB Memory Map

Addr. Range (Hex)	Device
E0000h - FFFFFh	PCI Bus
D0000h - DFFFFh	PCI Bus
C0000h - CFFFFh	System board
A0000h - BFFFFh	PCI Bus
A0000h - BFFFFh	Intel® HD Graphics
00000h - 9FFFFh	System board

B.4 Interrupt Assignments

Table B.4: Interrupt Assignments

Interrupt#	Interrupt Source
NMI	Parity error detected
IRQ0	System timer
IRQ1	Standard 101/102-Key or Microsoft Natural PS/2 Keyboard
IRQ2	Interrupt from controller 2 (cascade)
IRQ3	Communications Port (COM2)
IRQ4	Communications Port (COM1)
IRQ5	EC Watch DOG
IRQ6	Available
IRQ7	Communications Port (COM4), Communications Port (COM3)
IRQ8	System CMOS/real time clock
IRQ9	Microsoft ACPI-Compliant System
IRQ10	Communications Port (COM6), Communications Port (COM5)
IRQ11	Advantech EC Controller
IRQ12	PS/2 Compatible Mouse
IRQ13	Numeric data processor
IRQ14	Primary IDE
IRQ15	Secondary IDE

Appendix **C**

Watchdog Timer
Sample Code

C.1 Watchdog Timer Sample Code

```
EC_Command_Port = 0x29Ah
EC_Data_Port = 0x299h
Write EC HW ram = 0x89
Watch dog event flag = 0x57
Watchdog reset delay time = 0x5E (high byte), 0x5F (low byte)
Reset event = 0x04
Start WDT function = 0x28
Stop WDT function = 0x29
Reset WDT function = 0x2A
```

```
=====
.model small
.486p
.stack 256
.data
.code
org 100h
.STARTup

mov dx, EC_Command_Port
mov al,89h ; Write EC HW ram.
out dx,al

mov dx, EC_Data_Port
mov al, 5Fh ; Watchdog reset delay time low byte (5Eh is high byte) index, Time-
base: 100ms
out dx,al

mov dx, EC_Data_Port
mov al, 64h ;Set 10 seconds delay time.
out dx,al

mov dx, EC_Command_Port
mov al,89h ; Write EC HW ram.
out dx,al

mov dx, EC_Data_Port
mov al, 57h ; Watch dog event flag.
out dx,al

mov dx, EC_Data_Port
mov al, 04h ; Reset event.
out dx,al

mov dx, EC_Command_Port
```

```
mov al,28h ; start WDT function. (Stop: 0x29, Reset: 0x2A)
out dx,al

.exit
END
```

ADVANTECH

Enabling an Intelligent Planet

www.advantech.com

Please verify specifications before quoting. This guide is intended for reference purposes only.

All product specifications are subject to change without notice.

No part of this publication may be reproduced in any form or by any means, electronic, photocopying, recording or otherwise, without prior written permission of the publisher.

All brand and product names are trademarks or registered trademarks of their respective companies.

© Advantech Co., Ltd. 2014