

Operation Manual

EL6910

TwinSAFE Logic Terminal

Version: 1.9.0
Date: 2020-07-01

BECKHOFF

Table of contents

1	Foreword	5
1.1	Notes on the documentation.....	5
1.2	Safety instructions	6
1.2.1	Delivery state	6
1.2.2	Operator's obligation to exercise diligence	6
1.2.3	Description of instructions.....	7
1.3	Documentation issue status	8
1.4	Version history of the TwinSAFE product.....	9
1.5	References	10
2	TwinSAFE System Description	11
2.1	Extension of the Beckhoff I/O system with safety functions	11
2.2	Safety concept.....	11
3	Product description.....	12
3.1	EL6910 - TwinSAFE logic terminal	12
3.2	Intended use	13
3.3	Technical data	15
3.4	Safety parameters	16
3.5	Dimensions	17
4	Operation.....	18
4.1	Environmental conditions	18
4.2	Installation	18
4.2.1	Safety instructions	18
4.2.2	Transport / storage	18
4.2.3	Mechanical installation.....	18
4.2.4	Electrical installation	25
4.2.5	TwinSAFE reaction times	28
4.3	Operation in potentially explosive atmospheres (ATEX)	30
4.3.1	Special conditions.....	30
4.3.2	Identification.....	30
4.3.3	Date code and serial number.....	31
4.3.4	Further ATEX documentation	31
4.4	Configuration of the terminal in TwinCAT	32
4.4.1	Configuration requirements	32
4.4.2	Adding an EtherCAT coupler	32
4.4.3	Adding an EtherCAT Terminal.....	32
4.4.4	Adding an EL6910	32
4.4.5	Address settings on TwinSAFE terminals with 1023 possible addresses	34
4.4.6	Creating a safety project in TwinCAT 3	35
4.4.7	Downloading the safety application	63
4.4.8	Online Mode	67
4.4.9	New features in TC3.1 Build 4022.....	70
4.5	Info Data	89
4.5.1	Info data for the connection	89

4.5.2	Info data for function blocks	91
4.5.3	Info data for the TwinSAFE group	92
4.5.4	Info data for the device	93
4.6	Version history	93
4.7	User Administration	94
4.8	Backup/Restore	97
4.9	Export/import of the safety project.....	100
4.10	Diag History tab	102
4.11	PROFIsafe configuration	103
4.11.1	Correct configuration of the complete system	103
4.11.2	Configuration of an EL6910 as a PROFIsafe Master	106
4.11.3	Configuration of an EL6910 as a PROFIsafe Slave	109
4.12	TwinSAFE SC - configuration.....	117
4.13	Customizing / disabling TwinSAFE groups.....	120
4.14	Saving the analog group inputs persistently.....	123
4.15	Project design limits of EL6910/EJ6910	124
4.16	Sync-Manager Configuration	124
4.17	Diagnostics	127
4.17.1	Diagnostic LEDs	127
4.17.2	Status LEDs.....	128
4.17.3	Diagnostic objects.....	129
4.17.4	Cycle time of the safety project.....	131
4.18	Diagnosis History.....	131
4.19	Maintenance	134
4.20	Service life	135
4.21	Decommissioning	135
5	Appendix	136
5.1	Support and Service	136
5.2	Certificates.....	137
5.2.1	EN 81-20, EN 81-22 and EN 81-50	139

1 Foreword

1.1 Notes on the documentation

Intended audience

This description is only intended for the use of trained specialists in control and automation engineering who are familiar with the applicable national standards.

It is essential that the following notes and explanations are followed when installing and commissioning these components.

The responsible staff must ensure that the application or use of the products described satisfy all the requirements for safety, including all the relevant laws, regulations, guidelines and standards.

Origin of the document

This original documentation is written in German. All other languages are derived from the German original.

Currentness

Please check whether you are using the current and valid version of this document. The current version can be downloaded from the Beckhoff homepage at <http://www.beckhoff.com/english/download/twinsafe.htm>. In case of doubt, please contact Technical Support [▶ 136].

Product features

Only the product features specified in the current user documentation are valid. Further information given on the product pages of the Beckhoff homepage, in emails or in other publications is not authoritative.

Disclaimer

The documentation has been prepared with care. The products described are subject to cyclical revision. For that reason the documentation is not in every case checked for consistency with performance data, standards or other characteristics. We reserve the right to revise and change the documentation at any time and without prior announcement. No claims for the modification of products that have already been supplied may be made on the basis of the data, diagrams and descriptions in this documentation.

Trademarks

Beckhoff®, TwinCAT®, EtherCAT®, EtherCAT G®, EtherCAT G10®, EtherCAT P®, Safety over EtherCAT®, TwinSAFE®, XFC®, XTS® and XPlanar® are registered trademarks of and licensed by Beckhoff Automation GmbH. Other designations used in this publication may be trademarks whose use by third parties for their own purposes could violate the rights of the owners.

Patent Pending

The EtherCAT Technology is covered, including but not limited to the following patent applications and patents: EP1590927, EP1789857, EP1456722, EP2137893, DE102015105702 with corresponding applications or registrations in various other countries.



EtherCAT® and Safety over EtherCAT® are registered trademarks and patented technologies, licensed by Beckhoff Automation GmbH, Germany.

Copyright

© Beckhoff Automation GmbH & Co. KG, Germany.

The reproduction, distribution and utilization of this document as well as the communication of its contents to others without express authorization are prohibited.

Offenders will be held liable for the payment of damages. All rights reserved in the event of the grant of a patent, utility model or design.

Delivery conditions

In addition, the general delivery conditions of the company Beckhoff Automation GmbH & Co. KG apply.

1.2 Safety instructions

1.2.1 Delivery state

All the components are supplied in particular hardware and software configurations appropriate for the application. Modifications to hardware or software configurations other than those described in the documentation are not permitted, and nullify the liability of Beckhoff Automation GmbH & Co. KG.

1.2.2 Operator's obligation to exercise diligence

The operator must ensure that

- the TwinSAFE products are only used as intended (see chapter Product description);
- the TwinSAFE products are only operated in sound condition and in working order.
- the TwinSAFE products are operated only by suitably qualified and authorized personnel.
- the personnel is instructed regularly about relevant occupational safety and environmental protection aspects, and is familiar with the operating instructions and in particular the safety instructions contained herein.
- the operating instructions are in good condition and complete, and always available for reference at the location where the TwinSAFE products are used.
- none of the safety and warning notes attached to the TwinSAFE products are removed, and all notes remain legible.

1.2.3 Description of instructions

In these operating instructions the following instructions are used.
These instructions must be read carefully and followed without fail!

DANGER

Serious risk of injury!

Failure to follow this safety instruction directly endangers the life and health of persons.

WARNING

Risk of injury!

Failure to follow this safety instruction endangers the life and health of persons.

CAUTION

Personal injuries!

Failure to follow this safety instruction can lead to injuries to persons.

NOTE

Damage to the environment/equipment or data loss

Failure to follow this instruction can lead to environmental damage, equipment damage or data loss.



Tip or pointer

This symbol indicates information that contributes to better understanding.

1.3 Documentation issue status

Version	Comment
1.9.0	<ul style="list-style-type: none"> • Extension TwinSAFE product version history • Restructuring of PROFIsafe configuration
1.8.0	<ul style="list-style-type: none"> • Description <i>Multiple Download</i> added • Note added to <i>Project Settings</i> • Description of mounting rail installation updated
1.7.0	<ul style="list-style-type: none"> • Note added to <i>Customizing</i> • Description of firmware update added • Version history of the TwinSAFE product added • Note EN 81 updated • Foreword updated • Safety instructions adapted to IEC 82079-1.
1.6.0	<ul style="list-style-type: none"> • Description of the new features in TwinCAT 3.1 Build 4022 added • Notes for the extension of certificates with EN 81-20, EN 81-22 and EN 81-50 added • Notes on diagnostic history added • Project design limits updated • Notes on the arrangement of TwinSAFE components added • References and note for info data added
1.5.0	<ul style="list-style-type: none"> • Explanatory text and sequence chart added under Backup/Restore • Explanatory text for input and output process image added • Description added to Sync Manager configuration • TwinSAFE SC description updated
1.4.1	<ul style="list-style-type: none"> • Technical data for <i>permissible air pressure</i> expanded
1.4.0	<ul style="list-style-type: none"> • User administration screenshots updated • State and Diag of the TwinSAFE group updated • Type examination certificate added
1.3.0	<ul style="list-style-type: none"> • Screenshots updated • Certificate added
1.2.0	<ul style="list-style-type: none"> • Standards reference updated • Safety parameters updated
1.1.0	<ul style="list-style-type: none"> • Description of diagnostic object 0xFEAO expanded
1.0.0	<ul style="list-style-type: none"> • First released version • Backup/Restore description expanded

Version	Comment
0.5.0	<ul style="list-style-type: none"> • Descriptions of external connections, properties of FB ports, parameterization of Alias Devices, Variable Mapping and Customizing updated
0.4.0	<ul style="list-style-type: none"> • Description of the group sequence added • <i>Check Safe Addresses</i> description added
0.3.0	<ul style="list-style-type: none"> • System description added
0.2.0	<ul style="list-style-type: none"> • Screenshots for TwinCAT release adapted • Description of info data revised • LED description added
0.1.0	<ul style="list-style-type: none"> • Migration and structural adaptation
0.0.7	<ul style="list-style-type: none"> • System description updated
0.0.6	<ul style="list-style-type: none"> • Online View extended
0.0.5	<ul style="list-style-type: none"> • TwinSAFE group description extended
0.0.4	<ul style="list-style-type: none"> • PROFIsafe master/slave description extended
0.0.3	<ul style="list-style-type: none"> • Customizing extended
0.0.2	<ul style="list-style-type: none"> • Creating network and group descriptions
0.0.1	<ul style="list-style-type: none"> • Creation of the document

1.4 Version history of the TwinSAFE product

This version history lists the software and hardware version numbers. A description of the changes compared to the previous version is also given.

● Updated hardware and software

I TwinSAFE products are subject to a cyclical revision. We reserve the right to revise and change the TwinSAFE products at any time and without prior notice.

No claims for changes to products already delivered can be asserted from these hardware and/or software changes.

A description of how a firmware (software) update can be performed can be found in chapter Firmware update of TwinSAFE products.

Date	Software version	Hardware version	Modifications
25.01.2017	01	00	First release
06.02.2017	02	00	<ul style="list-style-type: none"> • Time stamp of diag messages optimized • Revision display implemented
03.08.2018	03	00	<ul style="list-style-type: none"> • Swapping of data bytes for PROFIsafe implemented • Update of the CoE Online display • Optimization in case of communication errors at low temperatures • FB Muting: After an FB error in Backwards mode, the FB error can be acknowledged without restarting the TwinSAFE group. • An error acknowledgement is now required after a user has logged into the logic without deleting the project.
16.03.2020	04	00	<ul style="list-style-type: none"> • FBTon: New time base of 100 ms and 1000 ms • FBTon2: New FB Ton with saving of the residual running time for next start • FBXor: New FB for exclusive OR • FBSLI2: New FB SLI with handling of an overflow

1.5 References

No	Version	Title / description
[1]	3.1.0 or newer	Documentation – TwinSAFE Logic FB This document describes the safety-related function blocks that are available in the TwinSAFE Logic and form the safety-related application.
[2]	1.8.0 or newer	TwinSAFE Application Guide The application guide provides the user with examples for the calculation of safety parameters for safety functions according to the standards DIN EN ISO 13849-1 and EN 62061 or EN 61508:2010 (if applicable), such as are typically used on machines.

2 TwinSAFE System Description

2.1 Extension of the Beckhoff I/O system with safety functions

The TwinSAFE products from Beckhoff enable convenient expansion of the Beckhoff I/O system with safety components, and integration of all the cabling for the safety circuit within the existing fieldbus cable. Safe signals can be mixed with standard signals as required. The transfer of safety-related TwinSAFE telegrams is handled by the standard controller. Maintenance is simplified significantly thanks to faster diagnosis and simple replacement of components.

The following basic functionalities are included in the TwinSAFE components: digital inputs (e.g. EL19xx, EP1908), digital outputs (e.g. EL29xx), drive components (e.g. AX5805) and logic units (e.g. EL6900, EL6910). For a large number of applications, the complete safety sensor and actuator technology can be wired on these components. The required logical link of the inputs and the outputs is handled by the EL69xx. In addition to Boolean operations, the EL6910 now also enables analog operations.

2.2 Safety concept

TwinSAFE: Safety and I/O technology in one system

- Extension of the familiar Beckhoff I/O system with TwinSAFE components
- Safe and non-safe components can be combined as required
- Logical link of the I/Os in the EL69xx TwinSAFE logic terminal
- Suitable for applications up to SIL 3 according to EN 61508:2010 and Cat 4, PL e according to DIN EN ISO 13849-1:2016-06
- Safety-relevant networking of machines via bus systems
- In the event of an error, all TwinSAFE components always switch to the wattless and therefore safe state
- No safety requirements for the higher-level standard TwinCAT system

Safety over EtherCAT protocol (FSoE)

- Transfer of safety-relevant data via any media (“genuine black channel”)
- TwinSAFE communication via fieldbus systems such as EtherCAT, Lightbus, PROFIBUS, PROFINET or Ethernet
- IEC 61508:2010 SIL 3 compliant
- FSoE is IEC standard (IEC 61784-3-12) and ETG standard (ETG.5100)

Fail-safe principle (fail stop)

The basic rule for a safety system such as TwinSAFE is that failure of a part, a system component or the overall system must never lead to a dangerous condition. The safe state is always the switched off and wattless state.

CAUTION

Safe state

For all TwinSAFE components the safe state is always the switched-off, wattless state.

3 Product description

3.1 EL6910 - TwinSAFE logic terminal

The TwinSAFE Logic terminal is the link unit between the TwinSAFE inputs and outputs.

The EL6910 meets the requirements of EN 62061:2005/A2:2015 and EN 61508:2010 SIL 3, EN 81-20:2014, EN 81-22:2014, EN 81-50:2014 and EN ISO 13849-1:2015 (Cat 4, PL e).

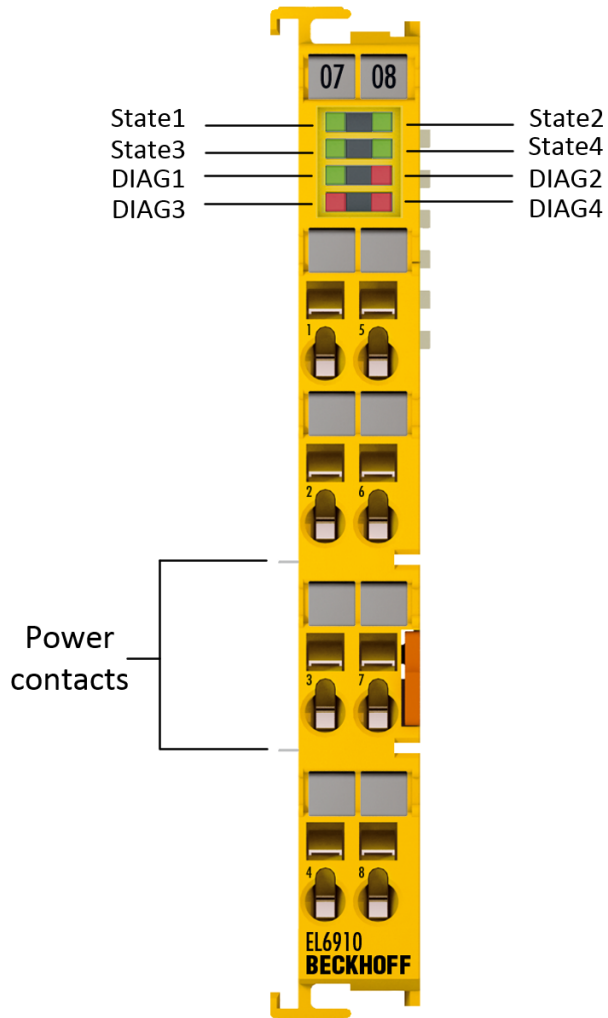

Fig. 1: EL6910 - TwinSAFE Logic terminal

3.2 Intended use

WARNING

Caution - Risk of injury!

TwinSAFE components may only be used for the purposes described below!

The TwinSAFE terminals expand the application range of Beckhoff Bus Terminal system with functions that enable them to be used for machine safety applications. The TwinSAFE terminals are designed for machine safety functions and directly associated industrial automation tasks. They are therefore only approved for applications with a defined fail-safe state. This safe state is the wattless state. Fail-safety according to the relevant standards is required.

The EL6910 TwinSAFE Logic terminal is suitable for operation at the

- Beckhoff Bus Couplers, EK1xxx series
- Beckhoff CXxxxx series Embedded PCs with E-bus connection

WARNING

System limits

The TÜV SÜD certificate applies to the EL6910, the function blocks available in it, the documentation and the engineering tool. Approved engineering tools are *TwinCAT 3.1*, *TwinSAFE Loader* and *CODESYS Safety for EtherCAT Safety Module*. Any deviations from these procedures or tools, particularly externally generated xml files for TwinSAFE import or externally generated automatic project creation procedures, are not covered by the certificate.

WARNING

Power supply from SELV/PELV power supply unit!

The TwinSAFE components must be supplied with 24 V_{DC} by an SELV/PELV power supply unit with an output voltage limit U_{max} of 36 V_{DC}. Failure to observe this can result in a loss of safety.

CAUTION

Follow the machinery directive!

The TwinSAFE components may only be used in machines as defined in the machinery directive.

CAUTION

Ensure traceability!

The buyer has to ensure the traceability of the device via the serial number.

⚠ CAUTION**Note on approval according to EN 81-20, EN 81-22 and EN 81-50**

- The TwinSAFE components may only be used in machines that have been designed and installed in accordance with the requirements of the EN 60204-1 standard.
- Provide a surge filter for the supply voltage of the TwinSAFE components against overvoltages. (Reduction to overvoltage category II)
- EN 81 requires that in the case of devices with internal temperature monitoring, a stop must be reached in the event of an overtemperature. In this case, passengers must be able to disembark (see EN 81-20 chapter 5.10.4.3, for example). To ensure this, application measures are necessary. The internal terminal temperature of the TwinSAFE components can be read out by the user. There is a direct switch-off at the maximum permissible temperature of the respective TwinSAFE component (see chapter Temperature measurement).
The user must select a temperature threshold below the maximum temperature such that a stop can be reached in all cases before the maximum temperature is reached. Information on the optimum terminal configuration can be found under Notes on the arrangement of TwinSAFE components and under Example configuration for temperature measurement.
- For the use of the TwinSAFE components according to EN 81-22 and EN 81-50, the conditions described in the manuals for achieving category 4 according to EN ISO 13849-1:2015 **must be** observed.
- The use of TwinSAFE components is limited to indoor applications.
- Basic protection against direct contact must be provided, either by fulfilling protection class IP2X or by installing the TwinSAFE components in a control cabinet which corresponds at least to protection class IP54 according to EN 60529.
- The ambient conditions regarding temperature, humidity, heat dissipation, EMC and vibrations, as specified in the operating instructions under technical data, must be observed.
- The operating conditions in potentially explosive atmospheres (ATEX) are specified in the operating instructions.
- The safe state (triggering) of the application must be the de-energized state. The safe state of the TwinSAFE components is always the de-energized, switched-off state, and this cannot be changed.
- The service life specified in the operating instructions must be observed.
- If the TwinSAFE component is operated outside the permissible temperature range, it changes to "Global Shutdown" state.
- The TwinSAFE components must be installed in a control cabinet with protection class IP54 according to EN 60529, so that the requirement for contamination level 3 according to EN 60664-1 can be reduced to level 2.
- The TwinSAFE components must be supplied by a SELV/PELV power supply unit with a maximum voltage of $U_{\max} \leq 36 \text{ V}_{\text{DC}}$.

3.3 Technical data

Product designation	EL6910
Number of inputs	0
Number of outputs	0
Status display	4 diagnostic LEDs
Minimum/maximum cycle time	approx. 1 ms / according the project size
Fault response time	≤ watchdog times
Watchdog time	min. 2 ms, max. 60000 ms
Input process image	Dynamic, according to the TwinSAFE configuration in TwinCAT 3
Output process image	Dynamic, according to the TwinSAFE configuration in TwinCAT 3
Supply voltage (SELV/PELV)	24 V _{DC} (-15% / +20%)
Current consumption via E-bus	approx. 160 mA
Power dissipation of the terminal	typically 1 W
Dimensions (W x H x D)	12 mm x 100 mm x 68 mm
Weight	approx. 50 g
Permissible ambient temperature (operation)	-25°C to +55°C (see notes in section Sample configuration for temperature measurement [► 20])
Permissible ambient temperature (transport/storage)	-40 °C to +70 °C
Permissible air humidity	5% to 95%, non-condensing
Permissible air pressure (operation/storage/transport)	750 hPa to 1100 hPa (this corresponds to an altitude of approx. -690 m to 2450 m above sea level, assuming an international standard atmosphere)
Climate category according to EN 60721-3-3	3K3 (the deviation from 3K3 is possible only with optimal environmental conditions and also applies only to the technical data which are specified differently in this documentation)
Permissible level of contamination according to EN 60664-1	Contamination level 2 (note chapter Maintenance [► 134])
Inadmissible operating conditions	TwinSAFE Terminals must not be used under the following operating conditions: <ul style="list-style-type: none"> • under the influence of ionizing radiation (exceeding the natural background radiation) • in corrosive environments • in an environment that leads to unacceptable soiling of the Bus Terminal
Vibration / shock resistance	conforms to EN 60068-2-6 / EN 60068-2-27
EMC immunity / emission	conforms to EN 61000-6-2 / EN 61000-6-4
Shocks	15 g with pulse duration 11 ms in all three axes
Protection class	IP20
Permitted operating environment	In the control cabinet or terminal box, with minimum protection class IP54 according to IEC 60529
correct installation position	see chapter Installation position and minimum distances [► 19]
Approvals	CE, cULus, TÜV SÜD

3.4 Safety parameters

Characteristic numbers	EL6910
Lifetime [a]	20
Proof test interval [a]	not required ¹⁾
PFH _D	1.79E-09
%SIL3 of PFH _D	1.79%
PFD _{avg}	2.54E-05
%SIL3 of PFD _{avg}	2.54%
MTTF _D	high
DC	high
Performance level	PL e
Category	4
HFT	1
Classification element ²⁾	Type B

1. Special proof tests are not required during the entire service life of the EL6910 EtherCAT Terminal.
2. Classification according to IEC 61508-2:2010 (see chapters 7.4.4.1.2 and 7.4.4.1.3)

The EL6910 EtherCAT Terminal can be used for safety-related applications according to IEC62061 and IEC 61508:2010 up to SIL3 and EN ISO 13849-1:2015 up to PL e (Cat4).

Further information on calculating or estimating the MTTF_D value from the PFH_D value can be found in the TwinSAFE Application Guide or in EN ISO 13849-1:2015, Table K.1.

In terms of safety-related parameters, the Safety-over-EtherCAT communication is already considered with 1% of SIL3 according to the protocol specification.

3.5 Dimensions

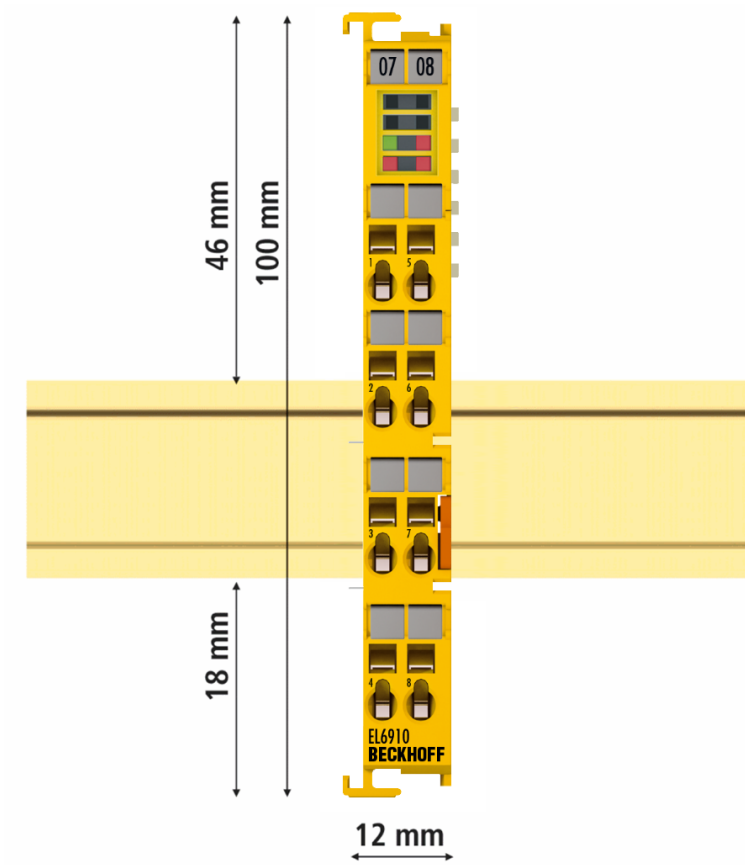

Fig. 2: Dimensions of the EL6910

Width: 12 mm (side-by-side installation)
 Height: 100 mm
 Depth: 68 mm

4 Operation

4.1 Environmental conditions

Please ensure that the TwinSAFE components are only transported, stored and operated under the specified conditions (see technical data)!

WARNING

Risk of injury!

The TwinSAFE components must not be used under the following operating conditions.

- under the influence of ionizing radiation (that exceeds the level of the natural environmental radiation)
- in corrosive environments
- in an environment that leads to unacceptable soiling of the TwinSAFE component

NOTE

Electromagnetic compatibility

The TwinSAFE components comply with the current standards on electromagnetic compatibility with regard to spurious radiation and immunity to interference in particular.

However, in cases where devices such as mobile phones, radio equipment, transmitters or high-frequency systems that exceed the interference emissions limits specified in the standards are operated near TwinSAFE components, the function of the TwinSAFE components may be impaired.

4.2 Installation

4.2.1 Safety instructions

Before installing and commissioning the TwinSAFE components please read the safety instructions in the foreword of this documentation.

4.2.2 Transport / storage

Use the original packaging in which the components were delivered for transporting and storing the TwinSAFE components.

CAUTION

Note the specified environmental conditions

Please ensure that the digital TwinSAFE components are only transported and stored under the specified environmental conditions (see technical data).

4.2.3 Mechanical installation

WARNING

Risk of injury!

Bring the bus system into a safe, de-energized state before starting installation, disassembly or wiring of the devices!

4.2.3.1 Control cabinet / terminal box

The TwinSAFE terminals must be installed in a control cabinet or terminal box with IP54 protection class according to IEC 60529 as a minimum.

4.2.3.2 Installation position and minimum distances

For the prescribed installation position the mounting rail is installed horizontally and the mating surfaces of the EL/KL terminals point toward the front (see illustration below). The terminals are ventilated from below, which enables optimum cooling of the electronics through convection. The direction indication “down” corresponds to the direction of positive acceleration due to gravity.

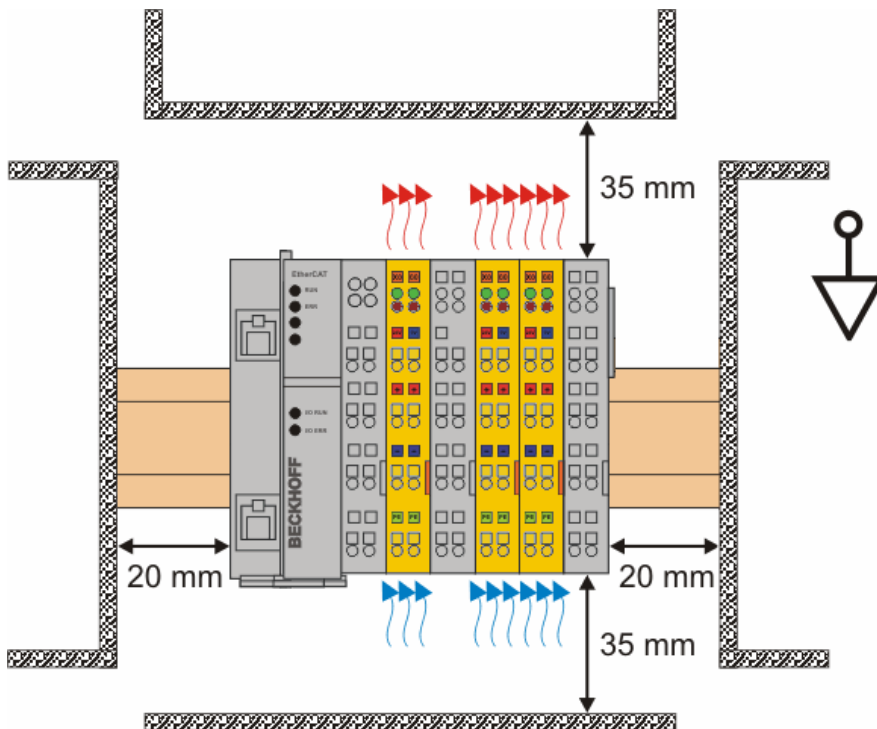

Fig. 3: Installation position and minimum distances

In order to ensure optimum convection cooling, the distances to neighboring devices and to control cabinet walls must not be smaller than those shown in the diagram.

4.2.3.3 Sample configuration for temperature measurement

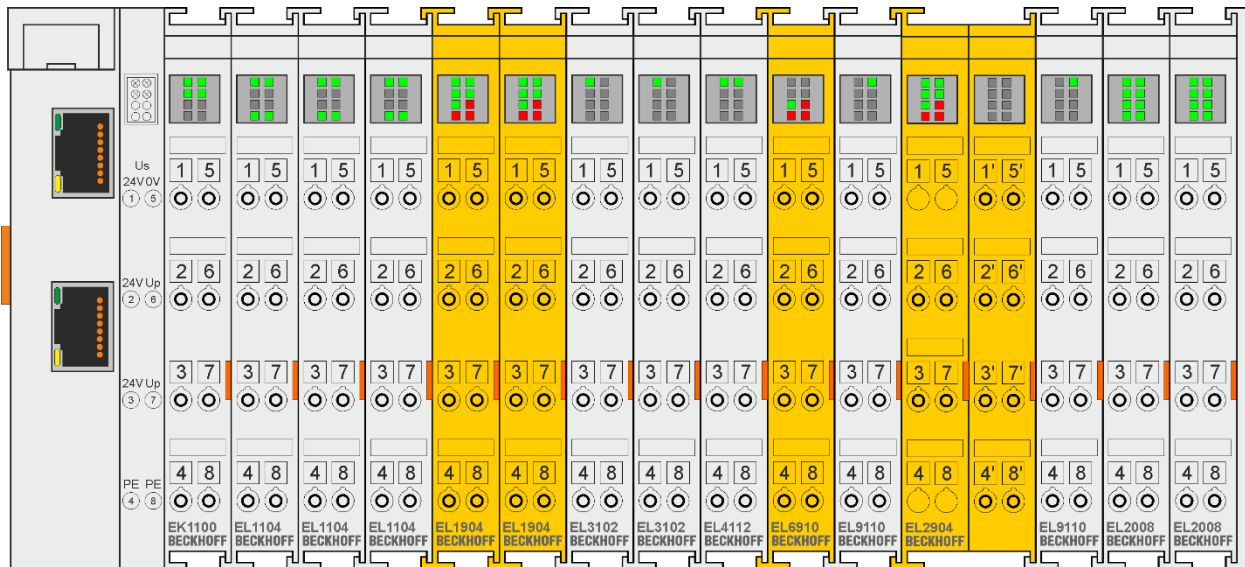

Fig. 4: Sample configuration for temperature measurement

The sample configuration for the temperature measurement consists of an EK1100 EtherCAT coupler with connected terminals that match the typical distribution of digital and analog signal types at a machine. On the EL6910 a safety project is active, which reads safe inputs and enables all 4 safe outputs during the measurement.

i External heat sources / radiant heat / impaired convection

The maximum permissible ambient temperature of 55°C was checked with the above sample configuration. Impaired convection, an unfavorable location near heat sources or an unfavorable configuration of the EtherCAT Terminals may result in overheating of the terminals.

The key parameter is always the maximum permitted internally measured temperature of 95°C, above which the TwinSAFE terminals switch to safe state and report an error. The internal temperature can be read from the TwinSAFE components via CoE.

4.2.3.4 Installation on mounting rails

⚠ WARNING

Risk of electric shock and damage of device!

Bring the bus terminal system into a safe, powered down state before starting installation, disassembly or wiring of the Bus Terminals!

Mounting

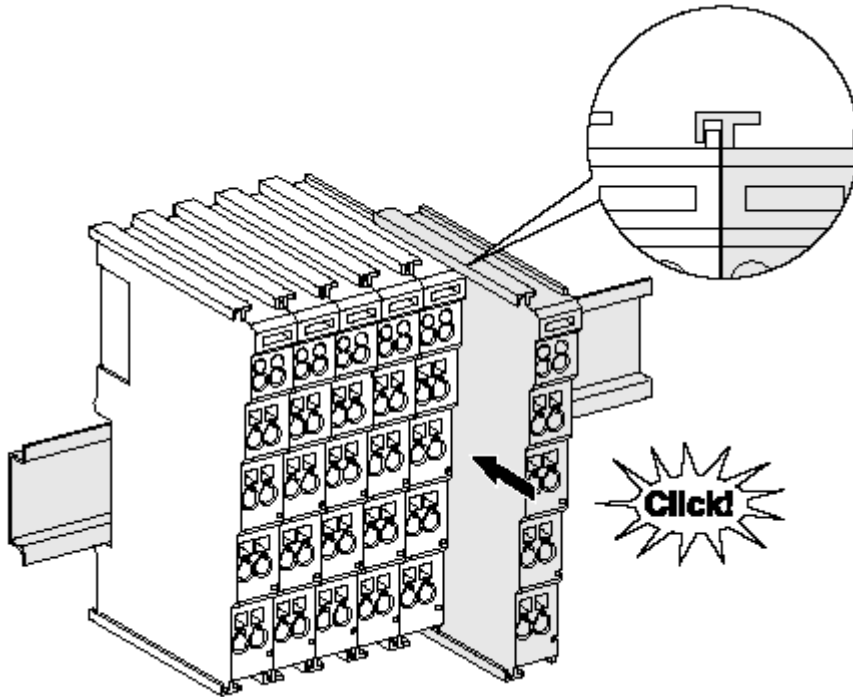

Fig. 5: Installation on the mounting rail

The Bus Couplers and Bus Terminals are attached to commercially available 35 mm mounting rails (DIN rail according to EN 60715) by applying slight pressure:

1. First attach the Fieldbus Coupler to the mounting rail.
2. The Bus Terminals are now attached on the right-hand side of the Fieldbus Coupler. Join the components with slot and key and push the terminals against the mounting rail, until the lock clicks onto the mounting rail.

If the terminals are clipped onto the mounting rail first and then pushed together without slot and key, the connection will not be operational! When correctly assembled, no significant gap should be visible between the housings.

● Fastening of mounting rails

i The locking mechanism of the terminals and couplers protrudes into the profile of the mounting rail. When installing the components, make sure that the locking mechanism doesn't come into conflict with the fixing bolts of the mounting rail. For fastening mounting rails with a height of 7.5 mm under the terminals and couplers, use flat fastening components such as countersunk head screws or blind rivets.



Disassembly

Fig. 6: Removal from mounting rail

Each terminal is secured by a lock on the mounting rail, which must be released for disassembly:

1. Pull down the terminal at its orange-colored straps from the mounting rail by approx. 1 cm. The rail locking of this terminal is automatically released, and you can now pull the terminal out of the Bus Terminal block with little effort.
2. To do this, grasp the unlocked terminal simultaneously at the top and bottom of the housing surfaces with your thumb and index finger and pull it out of the Bus Terminal block.

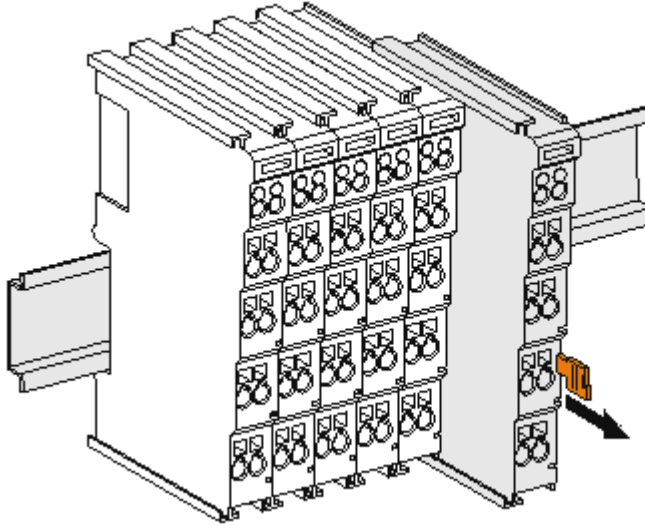
4.2.3.5 Notes on the arrangement of TwinSAFE components

The following notes show favorable and unfavorable arrangement of the terminals in relation to thermal aspects. Components with higher waste heat are marked with a red symbol  and components with low waste heat with a blue symbol .

EtherCAT coupler EK11xx and power supply terminal EL9410

The more terminals are connected behind an EtherCAT coupler or a power supply terminal, the higher is the E-Bus current, which must be supplied by their power supply units. As the current increases, the waste heat of the power supply units is also increased..

EL69x0

The EL69x0 has a rather high waste heat because it has a high internal clock and high logic power.

EL2904

The EL2904 has a rather high waste heat, due to the possibly high output current of the connected actuators.

EL1904

Even the EL1904 has a rather high waste heat, although the external load by clock outputs and safe inputs is rather low.

Thermally unfavorable arrangement of the TwinSAFE terminals

The following structure is rather unfavorable, since terminals with rather high waste heat are connected directly to couplers or power supply terminals with high E-Bus load. The additional external heating of the TwinSAFE terminals by the adjacent power supply units increases the internal terminal temperature, which can lead to the maximum permissible temperature being exceeded. This leads to a diagnosis message "overtemperature".

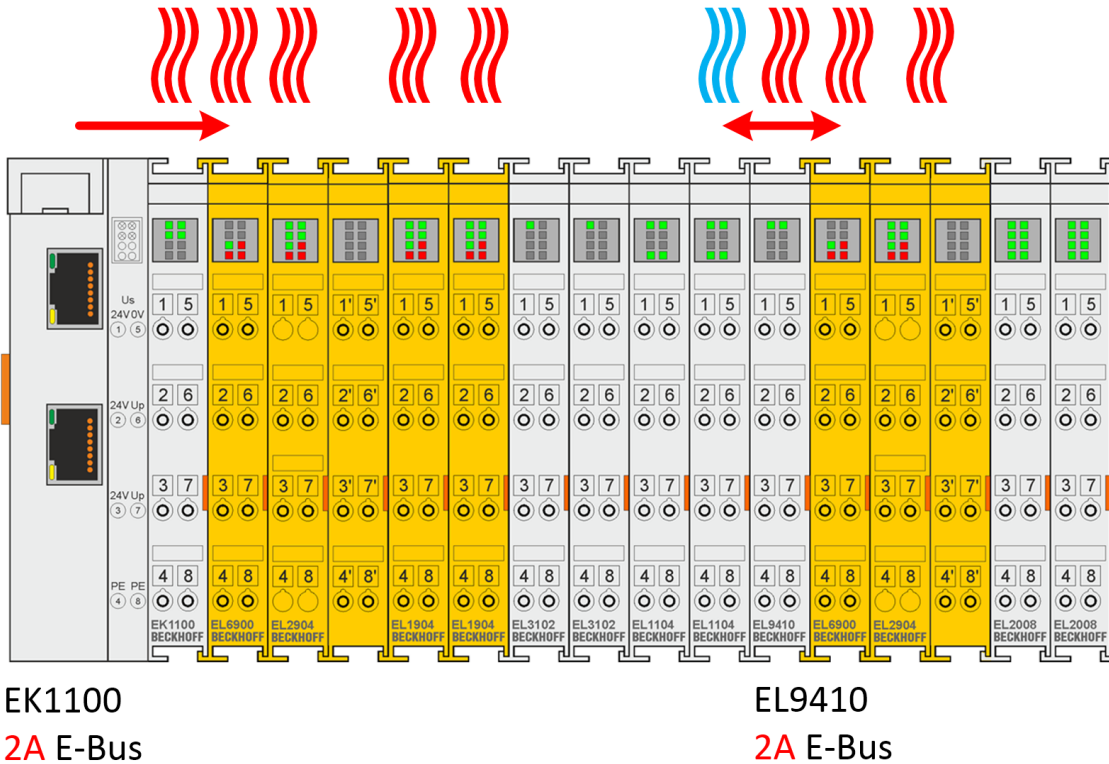

Fig. 7: Thermally unfavorable arrangement of the TwinSAFE terminals

Thermally favorable arrangement of the TwinSAFE terminals

The following structure is thermally favorable, since between the coupler / power supply terminal and terminals with rather high waste heat, terminals with low current consumption and thus rather low waste heat are placed.

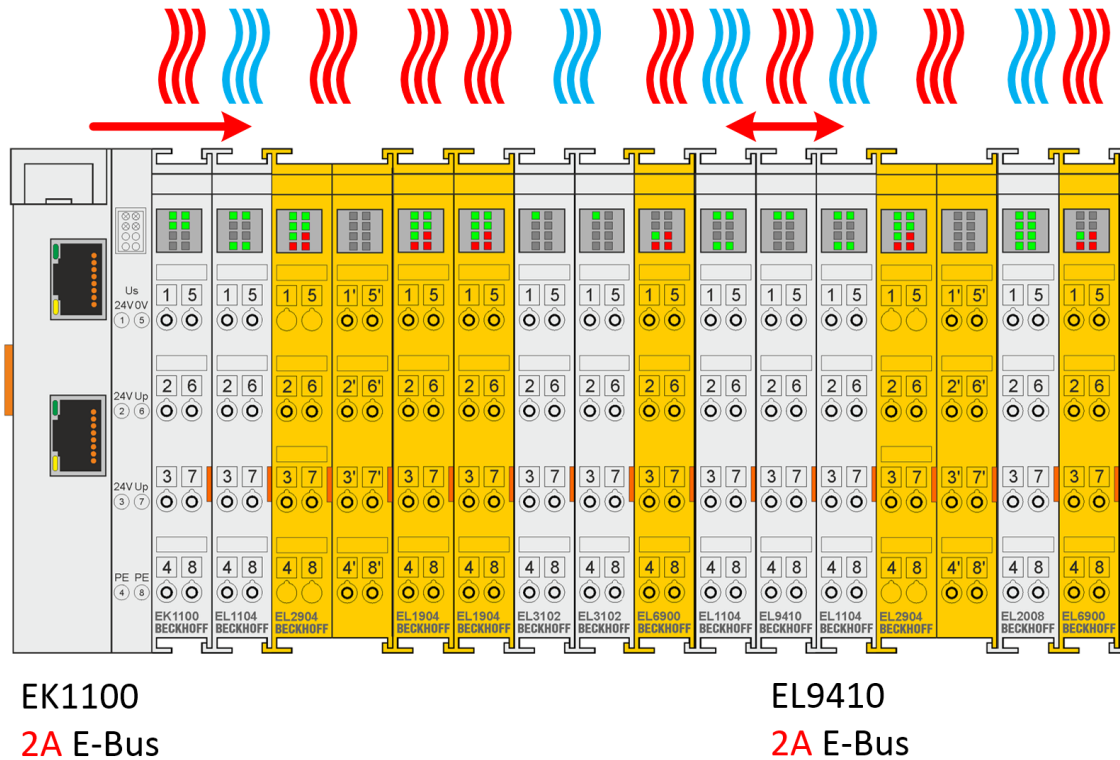

Fig. 8: Thermally favorable arrangement of the TwinSAFE terminals

4.2.4 Electrical installation

4.2.4.1 Connections within a Bus Terminal block

The electric connections between the Bus Coupler and the Bus Terminals are automatically realized by joining the components:

Spring contacts (E-bus)

The six spring contacts of the E-bus deal with the transfer of the data and the supply of the Bus Terminal electronics.

NOTE

Observe the E-bus current

Observe the maximum current that your Bus Coupler can supply to the E-bus! Use the EL9410 Power Supply Terminal if the current consumption of your terminals exceeds the maximum current that your Bus Coupler can feed to the E-bus supply.

Power contacts

The power contacts deal with the supply for the field electronics and thus represent a supply rail within the Bus Terminal block. The power contacts are supplied via terminals on the Bus Coupler.

i Note the connection of the power contacts

During the design of a Bus Terminal block, the pin assignment of the individual Bus Terminals must be taken account of, since some types (e.g. analog Bus Terminals or digital 4-channel Bus Terminals) do not or not fully loop through the power contacts.

Potential supply terminals (EL91xx, EL92xx) interrupt the power contacts and thus represent the start of a new supply rail.

PE power contact

The power contact labelled PE can be used as a protective earth. For safety reasons this contact mates first when plugging together, and can ground short-circuit currents of up to 125 A.

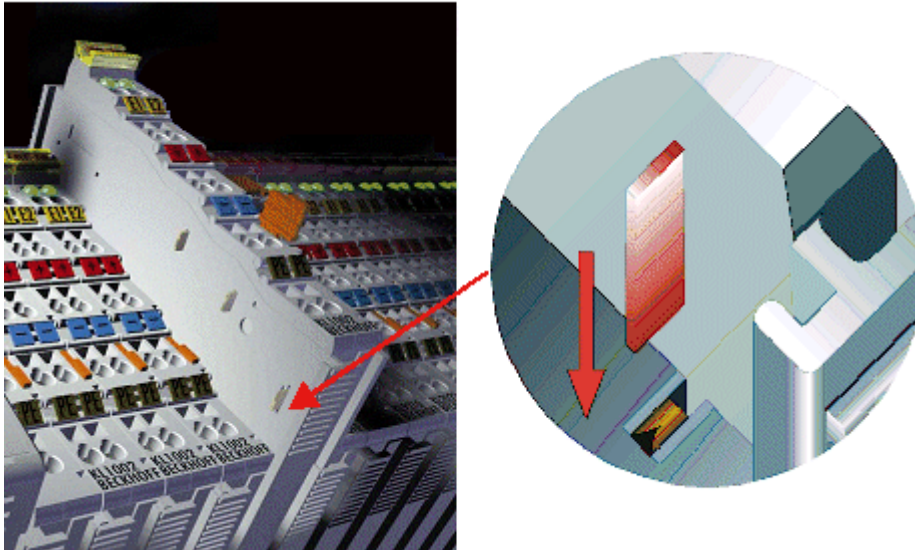

Fig. 9: PE power contact

⚠ CAUTION

Insulation tests

Note that, for reasons of electromagnetic compatibility, the PE contacts are capacitatively coupled to the mounting rail. This may lead to incorrect results during insulation testing or to damage on the terminal (e.g. disruptive discharge to the PE line during insulation testing of a consumer with a rated voltage of 230 V). For insulation testing, disconnect the PE supply line at the Bus Coupler or the Potential Supply Terminal! In order to decouple further feed points for testing, these Power Feed Terminals can be released and pulled at least 10 mm from the group of terminals.

⚠ DANGER

Serious risk of injury!

The PE power contact must not be used for other potentials!

4.2.4.2 Overvoltage protection

If protection against overvoltage is necessary in your plant, provide a surge filter for the voltage supply to the Bus Terminal blocks and the TwinSAFE terminals.

4.2.4.3 EL6900/EL6910 pin assignment

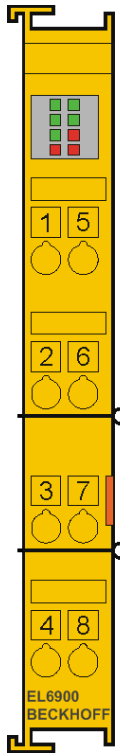

Fig. 10: EL6900/EL6910 pin assignment

Terminal point	Output	Signal
1	-	not used, no function
2	-	not used, no function
3	-	not used, no function
4	-	not used, no function
5	-	not used, no function
6	-	not used, no function
7	-	not used, no function
8	-	not used, no function

4.2.5 TwinSAFE reaction times

The TwinSAFE terminals form a modular safety system that exchanges safety-oriented data via the Safety-over-EtherCAT protocol. This chapter is intended to help you determine the system's reaction time from the change of signal at the sensor to the reaction at the actuator.

Typical reaction time

The typical reaction time is the time that is required to transmit information from the sensor to the actuator, if the overall system is working without error in normal operation.

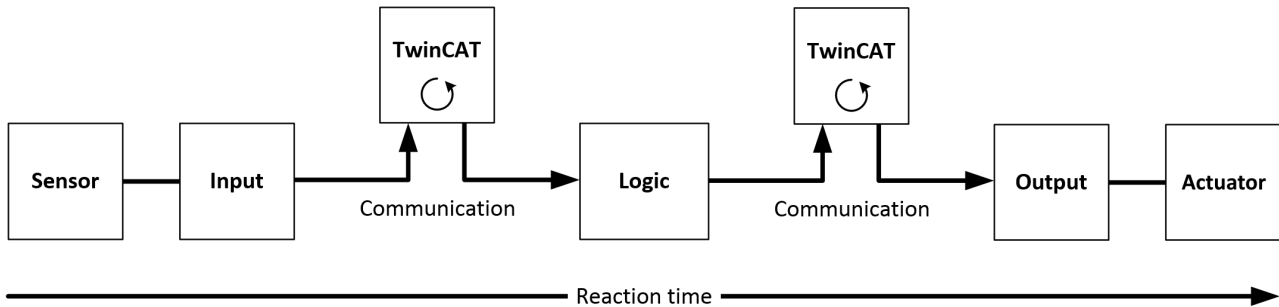

Fig. 11: Typical reaction time

Definition	Description
RTSensor	Reaction time of the sensor until the signal is provided at the interface. Typically supplied by the sensor manufacturer.
RTInput	Reaction time of the safe input, such as EL1904 or EP1908. This time can be found in the technical data. In the case of the EL1904 it is 4 ms.
RTComm	Reaction time of the communication This is typically 3x the EtherCAT cycle time, because new data can only be sent in a new Safety-over-EtherCAT telegram. These times depend directly on the higher-level standard controller (cycle time of the PLC/NC).
RTLogic	Reaction time of the logic terminal. This is the cycle time of the logic terminal and typically ranges from 500 µs to 10 ms for the EL6900, depending on the size of the safety project. The actual cycle time can be read from the terminal.
RTOutput	Reaction time of the output terminal. This typically lies within the range of 2 to 3 ms.
RTActor	Reaction time of the actuator. This information is typically supplied by the actuator manufacturer
WDComm	Watchdog time of the communication

This results in the following equation for the typical reaction time:

$$ReactionTime_{typ} = RT_{Sensor} + RT_{Input} + 3 * RT_{Comm} + RT_{Logic} + 3 * RT_{Comm} + RT_{Output} + RT_{Actor}$$

with, for example

$$ReactionTime_{typ} = 5ms + 4ms + 3 * 1ms + 10ms + 3 * 1ms + 3ms + 20ms = 48ms$$

Worst-case reaction time

The worst case reaction time is the maximum time required to switch off the actuator in the case of an error.

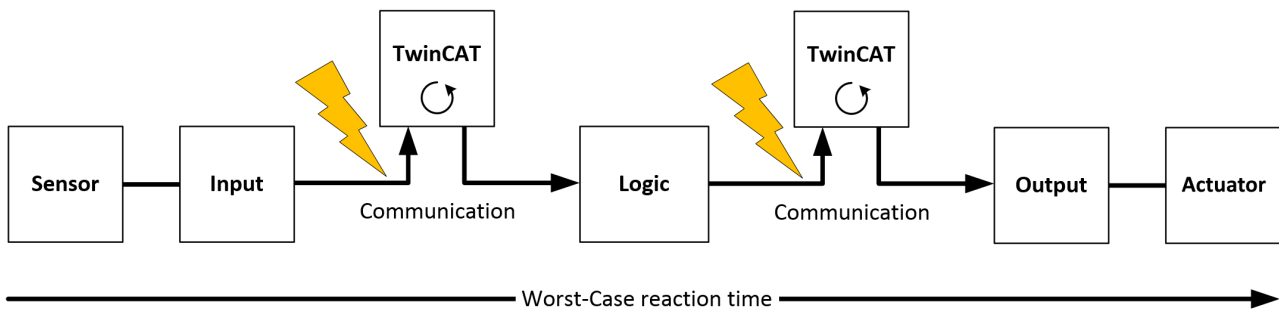

Fig. 12: Worst-case reaction time

This assumes that a signal change occurs at the sensor and is transmitted to the input. A communication error occurs at precisely the moment when the signal is to be transferred to the communication interface. This is detected by the logic following the watchdog time of the communication link. This information should then be transferred to the output, but a further communication error occurs here. This error is detected at the output following the expiry of the watchdog time and leads to the switch-off.

This results in the following equation for the worst-case reaction:

$$ReactionTime_{max} = WD_{Comm} + WD_{Comm} + RT_{Actor}$$

with, for example

$$ReactionTime_{max} = 2 * 15ms + 20ms = 50ms$$

4.3 Operation in potentially explosive atmospheres (ATEX)

4.3.1 Special conditions

⚠ WARNING

Observe the special conditions for the intended use of Beckhoff fieldbus components in potentially explosive atmospheres (directive 2014/34/EU)!

The certified components are to be installed in a suitable housing that guarantees a protection class of at least IP54 in accordance with EN 60529! The environmental conditions during use are thereby to be taken into account.

If the temperatures during rated operation are higher than 70°C at the feed-in points of cables, lines or pipes, or higher than 80°C at the wire branching points, then cables must be selected whose temperature data correspond to the actual measured temperature values!

Observe the permissible ambient temperature range of 0 to 55 °C when using Beckhoff fieldbus components in potentially explosive atmospheres!

Measures must be taken to protect against the rated operating voltage being exceeded by more than 40% due to short-term interference voltages!

The individual terminals may only be unplugged or removed from the Bus Terminal system if the supply voltage has been switched off or if a non-explosive atmosphere is ensured!

The connections of the certified components may only be connected or disconnected if the supply voltage has been switched off or if a non-explosive atmosphere is ensured!

The fuses of the EL92xx power feed terminals may only be exchanged if the supply voltage has been switched off or if a non-explosive atmosphere is ensured!

Address selectors and ID switches may only be adjusted if the supply voltage has been switched off or if a non-explosive atmosphere is ensured!

The fundamental health and safety requirements are fulfilled by compliance with the following standards:

- EN 60079-0 : 2103
- EN 60079-15 : 2011

4.3.2 Identification

Beckhoff fieldbus components that are certified for use in potentially explosive atmospheres bear one of the following markings:



II 3 G Ex nA IIC T4 Gc KEMA 10ATEX0075 X
Ta: 0 ... 55 °C

or



II 3 G Ex nA nC IIC T4 Gc KEMA 10ATEX0075 X
Ta: 0 ... 55 °C

4.3.3 Date code and serial number

The TwinSAFE terminals bear a date code, which is composed as follows:

Date code: CW YY SW HW

Legend:	Sample: Date code 29 10 02 01
CW: Calendar week of manufacture	Calendar week: 29
YY: Year of manufacture	Year: 2010
SW: Software version	Software version: 02
HW: Hardware version	Hardware version: 01

In addition the TwinSAFE terminals bear a unique serial number.

4.3.4 Further ATEX documentation

● **Please also refer to the further documentation**

i Notes regarding application of the Bus Terminal system in areas potentially explosive atmosphere are available in the [Download](#) section of the Beckhoff website at <http://www.beckhoff.de>.

4.4 Configuration of the terminal in TwinCAT

⚠ CAUTION

Do not change CoE objects!

Do not change any of the CoE objects in the TwinSAFE terminals. Any modifications of the CoE objects (e.g. via TwinCAT) will permanently set the terminals to the Fail-Stop state or lead to unexpected behavior of the terminals!

4.4.1 Configuration requirements

Version 3.1 Build 4020 or higher of the TwinCAT automation software is required for configuring the EL6910. The current version is available for download from the Beckhoff website (www.beckhoff.de).

NOTE

TwinCAT support

The EL6910 cannot be used under TwinCAT 2.

4.4.2 Adding an EtherCAT coupler

See TwinCAT 3 automation software documentation.

4.4.3 Adding an EtherCAT Terminal

See TwinCAT 3 automation software documentation.

4.4.4 Adding an EL6910

An EL6910 is added in exactly the same way as any other Beckhoff EtherCAT Terminal. In the list, open *Safety Terminals* and select the EL6910.

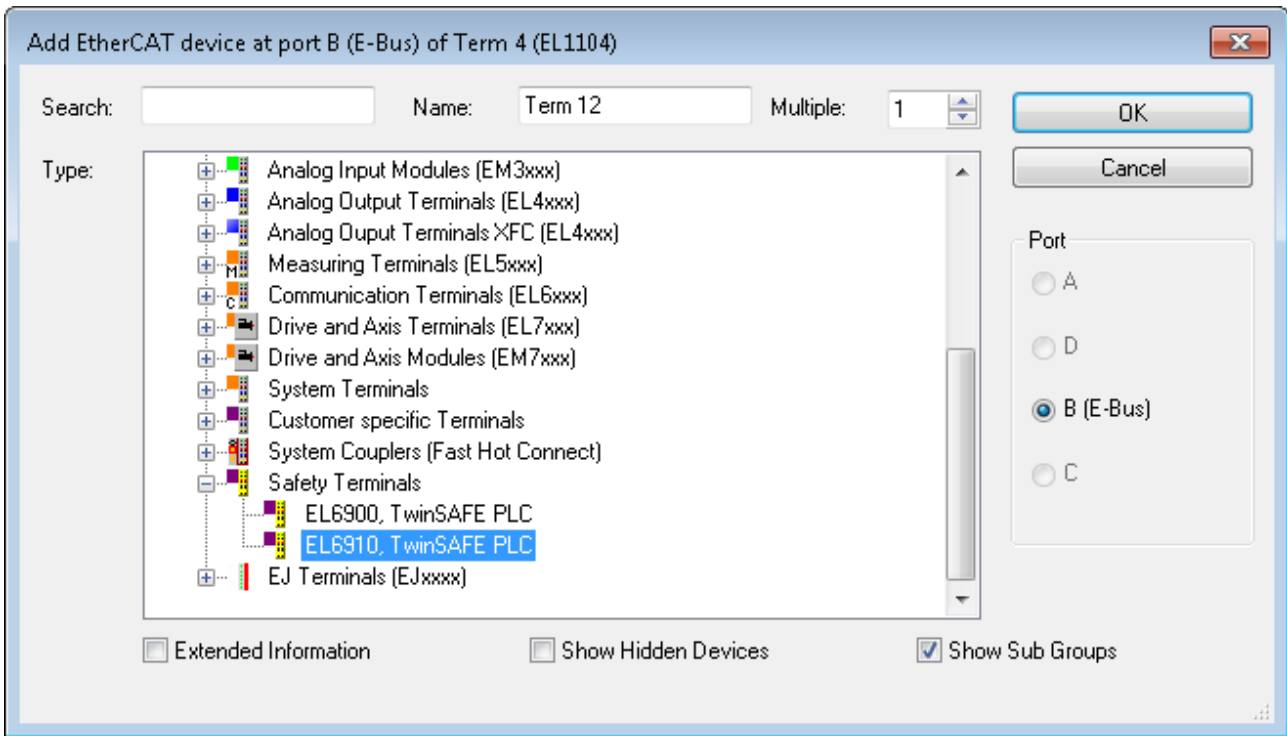

Fig. 13: Adding an EL6910

● Size of the process image

i The process image of the EL6910 is adjusted dynamically, based on the TwinSAFE configuration created in TwinCAT 3.

4.4.5 Address settings on TwinSAFE terminals with 1023 possible addresses

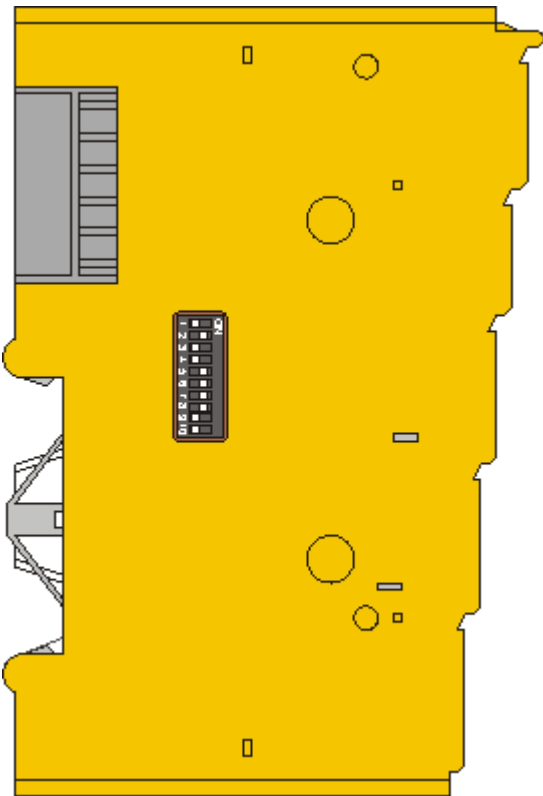

Fig. 14: Address settings on TwinSAFE terminals with 1023 possible addresses

The TwinSAFE address of the terminal is set via the 10-way DIP switch on the left-hand side of the TwinSAFE terminal. TwinSAFE addresses between 1 and 1023 are available.

DIP switch										Address
1	2	3	4	5	6	7	8	9	10	
ON	OFF	OFF	OFF	OFF	OFF	OFF	OFF	OFF	OFF	1
OFF	ON	OFF	OFF	OFF	OFF	OFF	OFF	OFF	OFF	2
ON	ON	OFF	OFF	OFF	OFF	OFF	OFF	OFF	OFF	3
OFF	OFF	ON	OFF	OFF	OFF	OFF	OFF	OFF	OFF	4
ON	OFF	ON	OFF	OFF	OFF	OFF	OFF	OFF	OFF	5
OFF	ON	ON	OFF	OFF	OFF	OFF	OFF	OFF	OFF	6
ON	ON	ON	OFF	OFF	OFF	OFF	OFF	OFF	OFF	7
...
ON	ON	ON	ON	ON	ON	ON	ON	ON	ON	1023

⚠ WARNING

TwinSAFE address

Each TwinSAFE address may only be used once within a network / a configuration!
The address 0 is not a valid TwinSAFE address!

4.4.6 Creating a safety project in TwinCAT 3



Further documentation

Information on TwinSAFE function blocks, groups and connections can be found in the *TwinSAFE Logic FB* documentation on the Beckhoff website under <http://www.beckhoff.com/english/download/twinsafe.htm>.

4.4.6.1 Add new item

In TwinCAT 3 a new project can be created via *Add New Item...* in the context menu of the *Safety* node.

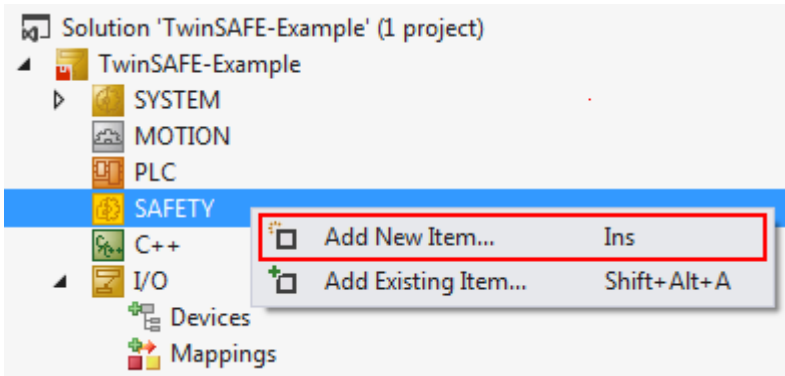

Fig. 15: Creating a safety project - Add New Item

The project name and the directory can be freely selected.

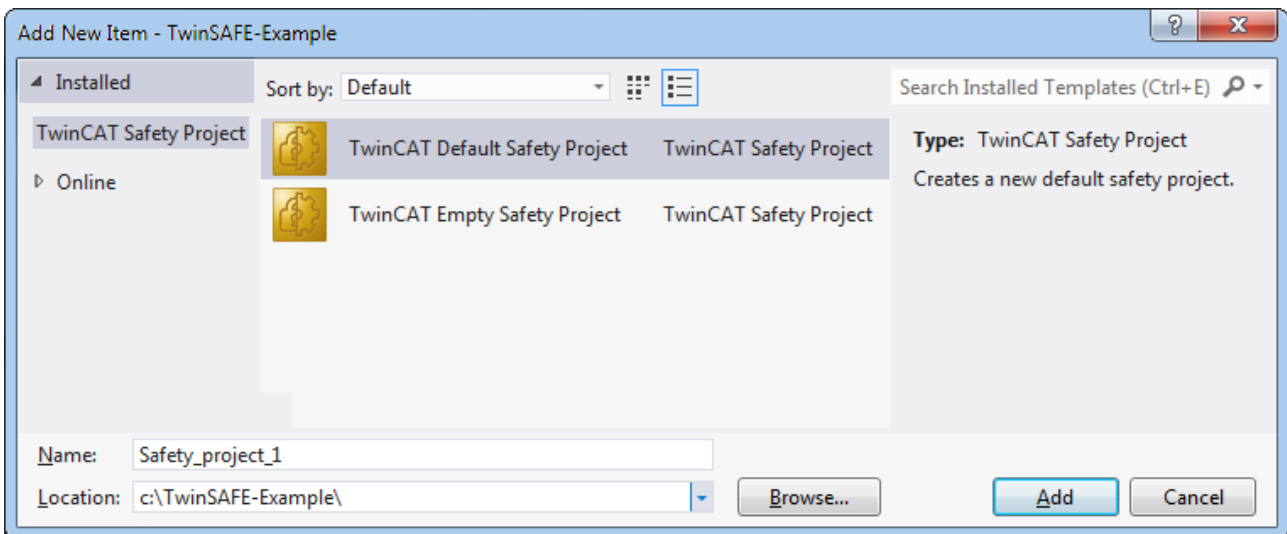

Fig. 16: Creating a safety project - project name and directory

4.4.6.2 TwinCAT Safety Project Wizard

In the TwinCAT Safety Project wizard you can then select the target system, the programming language, the author and the internal project name. Select the setting *Hardware Safety PLC* as the target system and the graphical editor as the programming language. The author and the internal project name can be freely selected by the user.

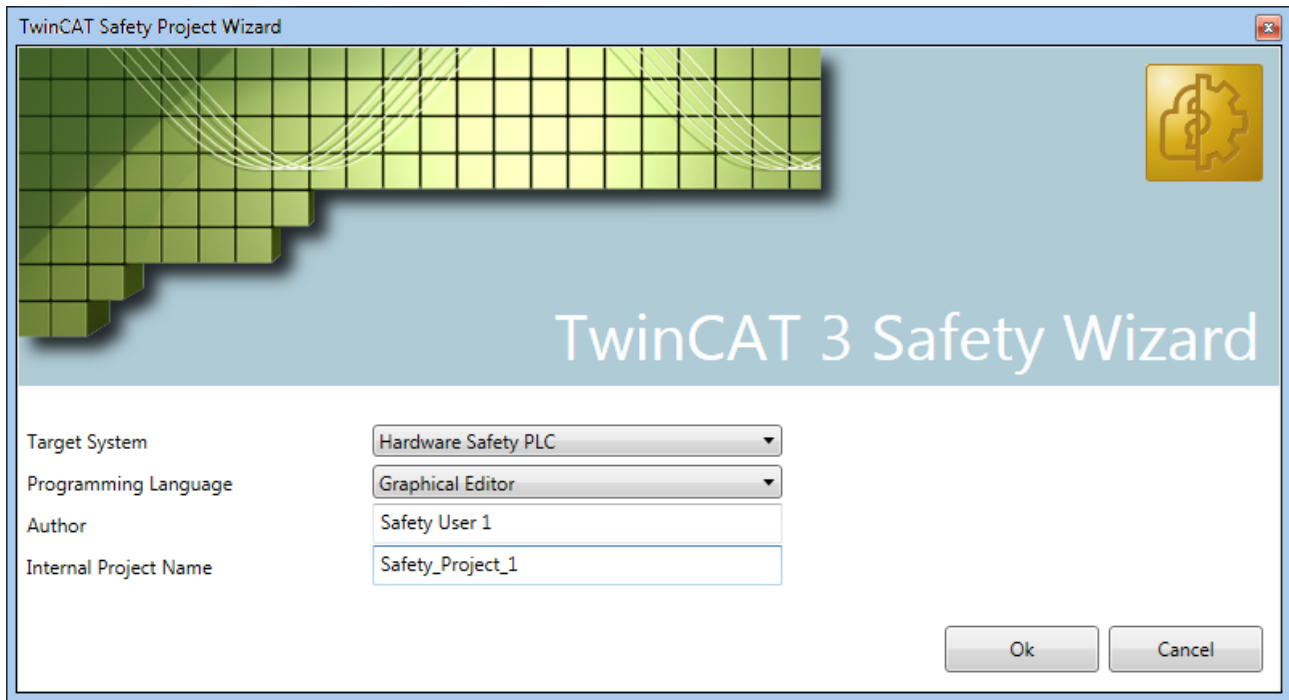

Fig. 17: TwinCAT Safety Project Wizard

4.4.6.3 Target System

Once the project has been created with the project wizard, the safety project can be assigned to the physical TwinSAFE terminal EL6910 by selecting the *Target System* node.

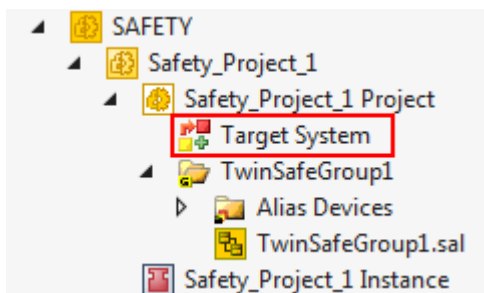



Fig. 18: Selecting the Target System node

Set the target system to EL6910 via the drop-down list and link it with the EL6910 terminal via the Link

button  next to *Physical Device*. If online ADS access to the terminal is possible, the software version, serial number, online project CRC and hardware address are automatically read from the terminal. The hardware address must match the *Safe Address* set by the user.

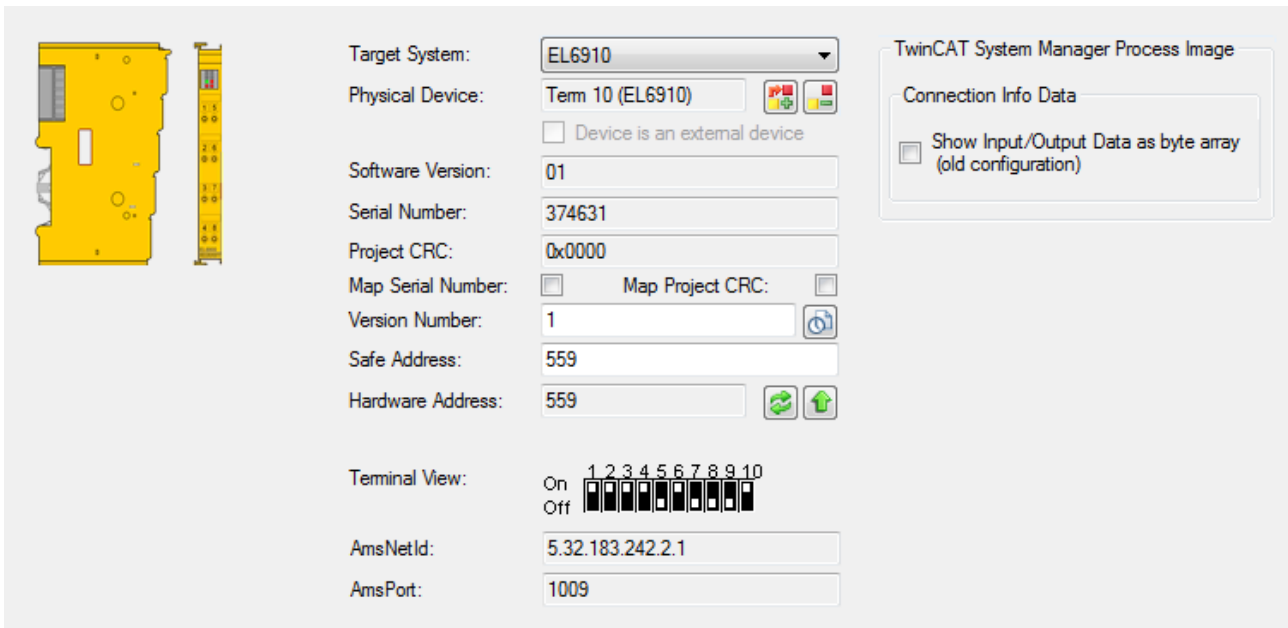

Fig. 19: Linking of target system and TwinSAFE terminal

4.4.6.4 Alias devices

The communication between the safety logic and the I/O level is realized via an alias level. At this alias level (subnode *Alias Devices*) corresponding alias devices are created for all safe inputs and outputs, and also for standard signal types. For the safe inputs and outputs, this can be done automatically via the I/O configuration.

The connection- and device-specific parameters are set via the alias devices.

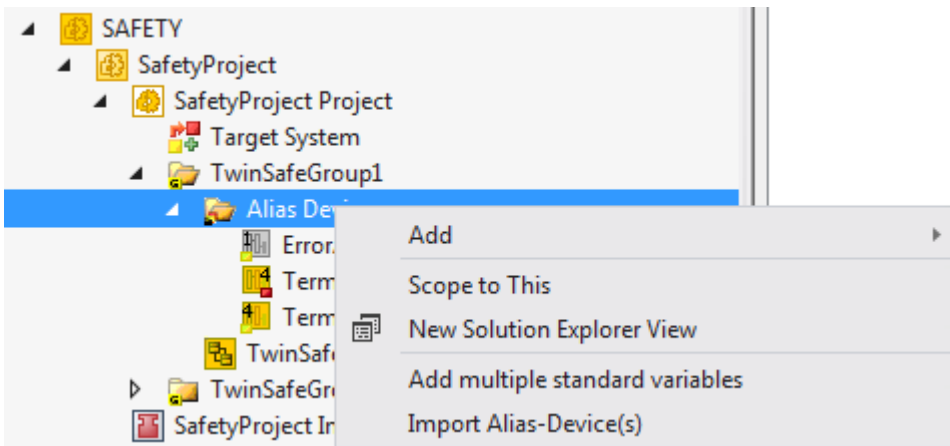

Fig. 20: Starting the automatic import from the I/O configuration

If the automatic import is started from the I/O configuration, a selection dialog opens, in which the individual terminals to be imported can be selected.

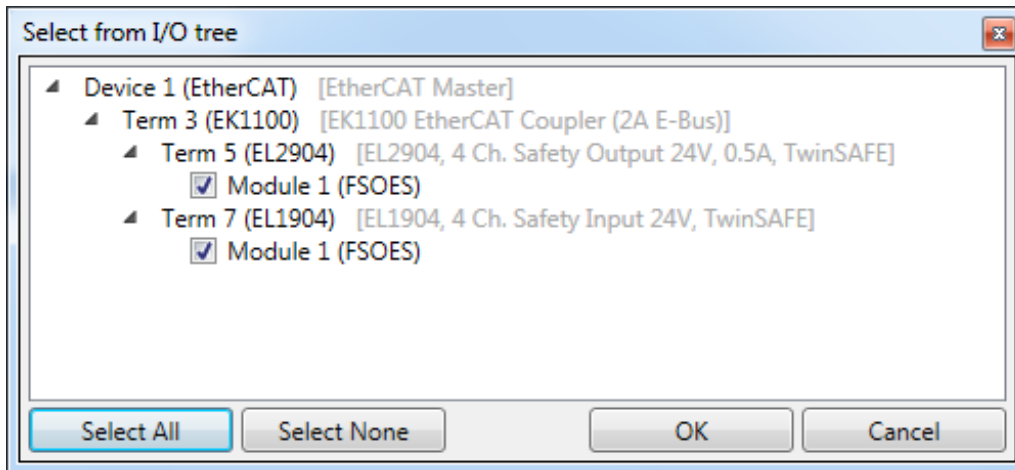

Fig. 21: Selection from the I/O tree

The alias devices are created in the safety project when the dialog is closed via OK.

Alternatively, the user can create the alias devices individually. To this end select *Add* and *New item* from the context menu, followed by the required device.

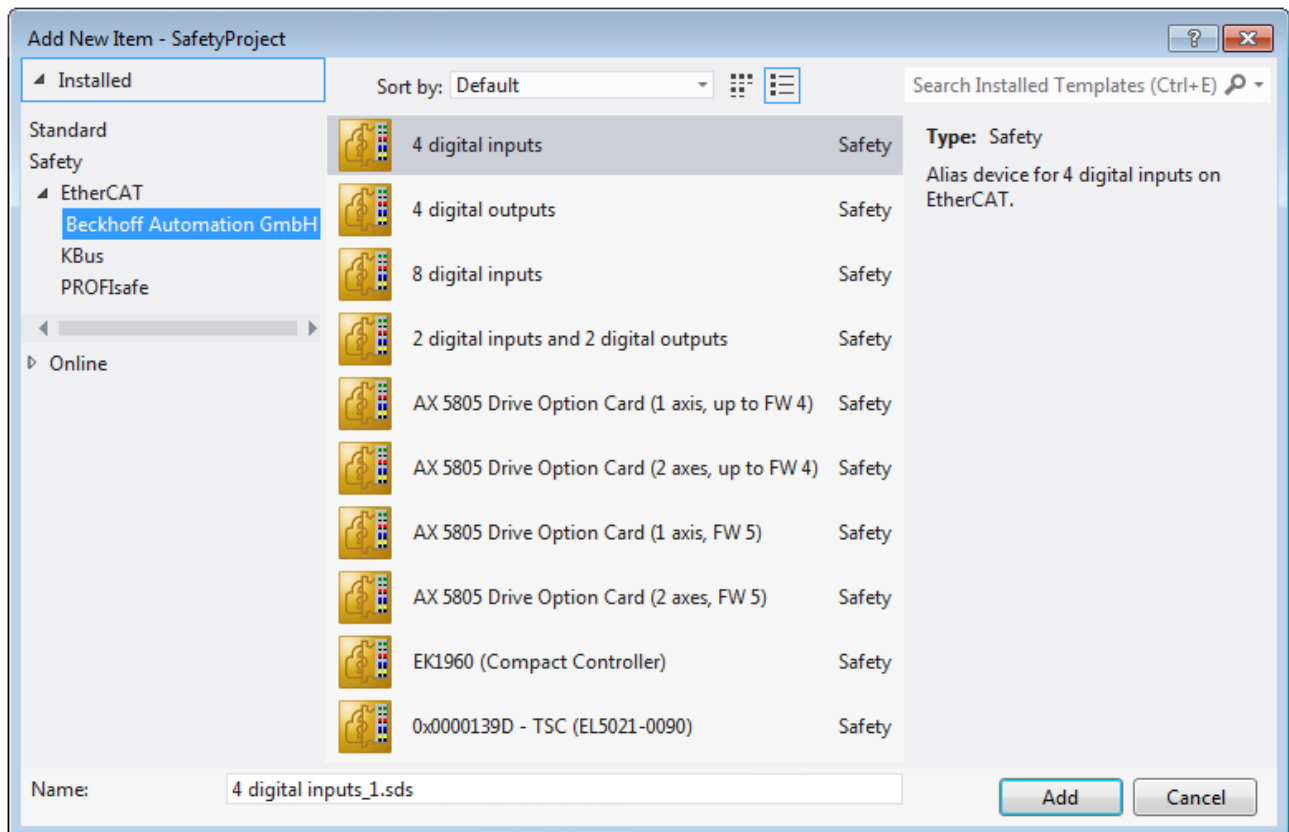

Fig. 22: Creating alias devices by the user

4.4.6.5 Parameterization of the alias device

The settings can be opened by double-clicking on the Alias Device in the safety project structure.

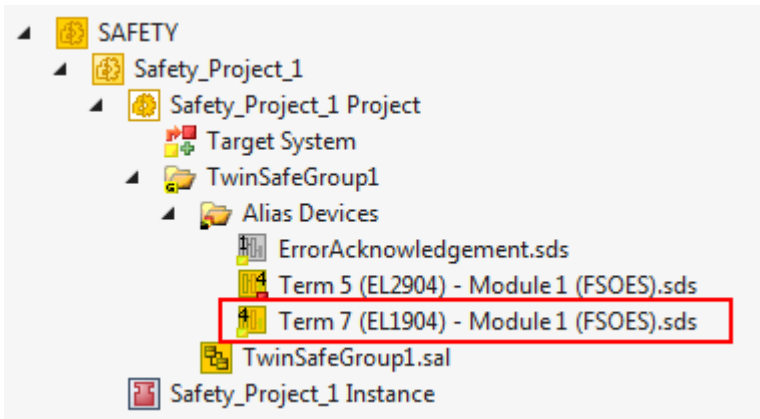



Fig. 23: Alias Device in the safety project structure

The *Linking* tab contains the FSoE address, the checkbox for setting as *External Device* and the link to the physical I/O device. If an ADS online connection to the physical I/O device exists, the DIP switch setting is

displayed. Re-reading of the setting can be started via the button . The links to the EL6910/EJ6910 process image are displayed under *Full Name (input)* and *Full Name (output)*.

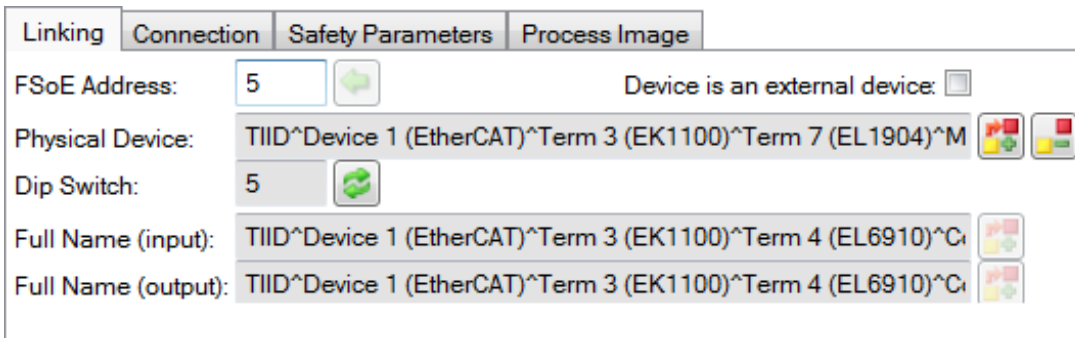

Fig. 24: Links to EL6910/EJ6910 process image

The *Connection* tab shows the connection-specific parameters.

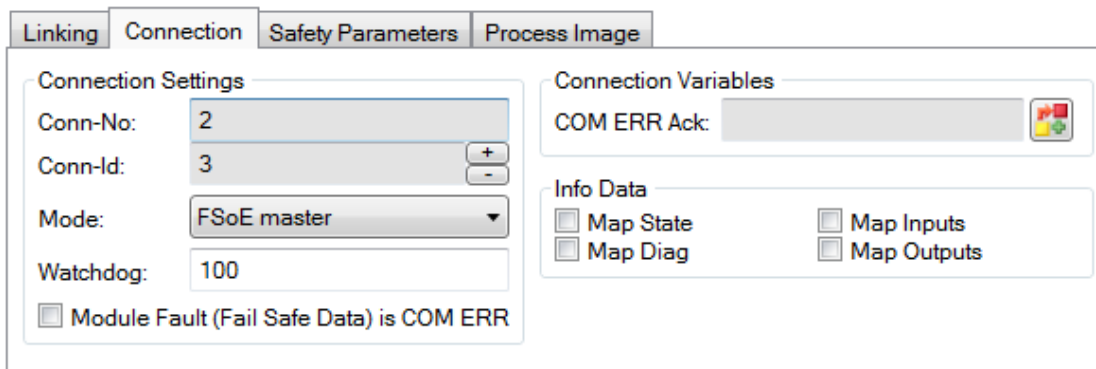



Fig. 25: Connection-specific parameters

Parameter	Description	User interaction required
Conn. no.	Connection number - automatically assigned by the TwinCAT system	No
Conn ID	Connection ID: preallocated by the system, but can be changed by the user. A Conn ID must be unique within a configuration. Duplicate connection IDs result in an error message.	Check
Mode	FSoE master: EL6910/EJ6910 is FSoE master for this device. FSoE slave: EL6910/EJ6910 is FSoE slave for this device.	Check
Watchdog	Watchdog time for this connection. A ComError is generated if the device fails to return a valid telegram to the EL6910/EJ6910 within the watchdog time.	Yes
Module Fault is ComError	This checkbox is used to specify the behavior in the event of an error. If the checkbox is ticked and a module error occurs on the Alias Device, this also leads to a connection error and therefore to disabling of the TwinSAFE group, in which this connection is defined.	Yes
ComErrAck	If ComErrAck is linked to a variable, the connection must be reset via this signal in the event of a communication error.	Yes
Info data	The info data to be shown in the process image of the EL6910/EJ6910 can be defined via these checkboxes. Further information can be found in the documentation for <i>TwinCAT function blocks for TwinSAFE Logic terminals</i> .	Yes

The EL6910/EJ6910 support activation of a ComErrAck at each connection. If this signal is connected, the respective connection must be reset after a communication error via the signal ComErrAck, in addition to the

ErrAck of the TwinSAFE group. This signal is linked via the link button  next to COM ERR Ack. The following dialog can be used for selecting an alias device. The signal can be cancelled via the *Clear* button in the *Map to* dialog.

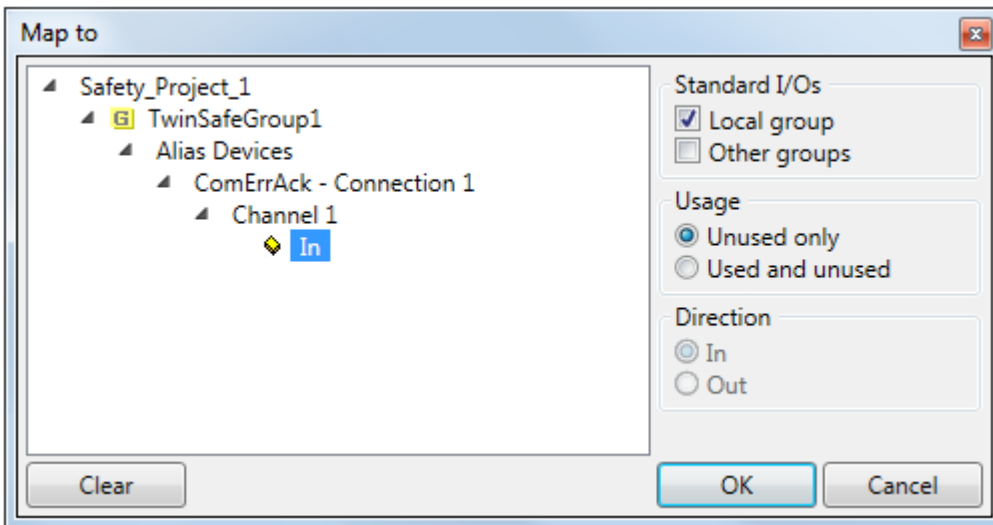

Fig. 26: Selecting an alias device

The safety parameters matching the device are displayed under the *Safety Parameters* tab. They have to be set correctly to match the required performance level. Further information can be found in the TwinSAFE application manual.

Index	Name	Value	Unit
8000:0	FS Operating Mode	>1<	
8000:01	Operating Mode	digital (0)	
8001:0	FS Sensor Test	>5<	
8001:01	Sensor test Channel 1 active	TRUE (1)	
8001:02	Sensor test Channel 2 active	TRUE (1)	
8001:03	Sensor test Channel 3 active	TRUE (1)	
8001:04	Sensor test Channel 4 active	TRUE (1)	
8002:0	FS Logic of Input pairs	>5<	
8002:01	Logic of Channel 1 and 2	single logic ch...	
8002:03	Logic of Channel 3 and 4	single logic ch...	

Edit

Fig. 27: Safety parameter for the device

4.4.6.6 Connection to AX5805/AX5806

There are separate dialogs for linking an AX5805 or AX5806 TwinSAFE Drive option card, which can be used to set the safety functions of the AX5000 safety drive options.

Creating and opening of an alias device for an AX5805 results in five tabs; the *Linking*, *Connection* and *Safety Parameters* tabs are identical to other alias devices.

Drive Option Card -...(2 axes, FW 5)_1.sds

Linking | Connection | Safety Parameters | **General AX5805 Settings** | Process Image

FSoE Address: 1 Linking Mode: Automatic

Physical Device: TIID^Device 1 (EtherCAT)^Drive 5 (AX5206-0000-0203)^Term 6 (

Dip Switch: n.a.

Full Name (input): TIID^Device 1 (EtherCAT)^Term 1 (EK1100)^Term 2 (EL6900)^C

Full Name (output): TIID^Device 1 (EtherCAT)^Term 1 (EK1100)^Term 2 (EL6900)^C

Fig. 28: AX5000 safety drive functions

The *General AX5805 Settings* tab can be used to set the motor string and the SMS and SMA functions for one or two axes, depending on the added alias device.

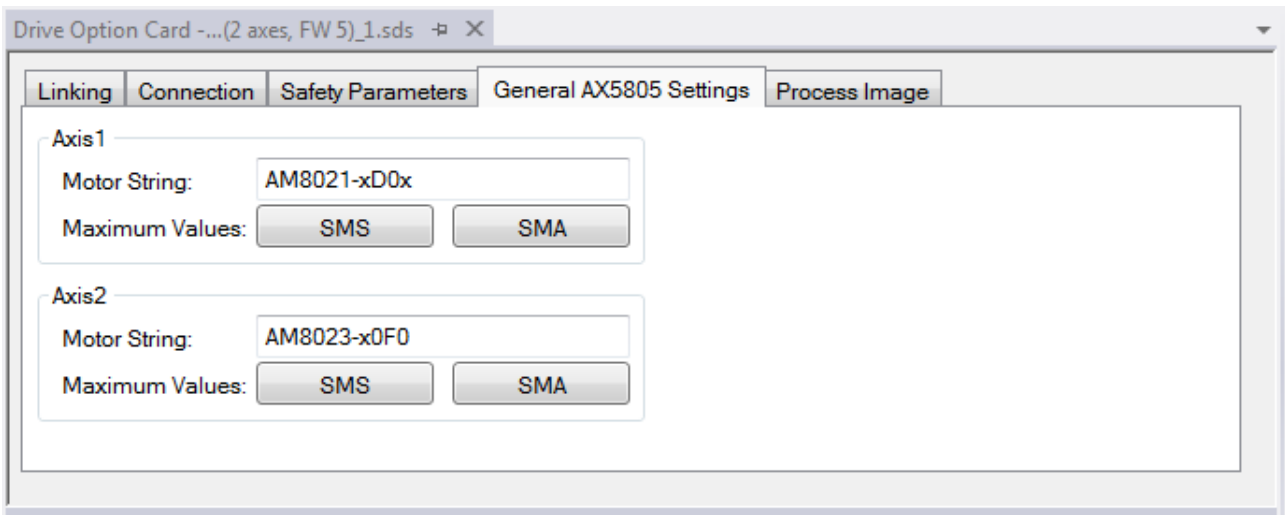

Fig. 29: AX5000 safety drive options - general AX5805 settings

The Process Image tab can be used to set the different safety functions for the AX5805.

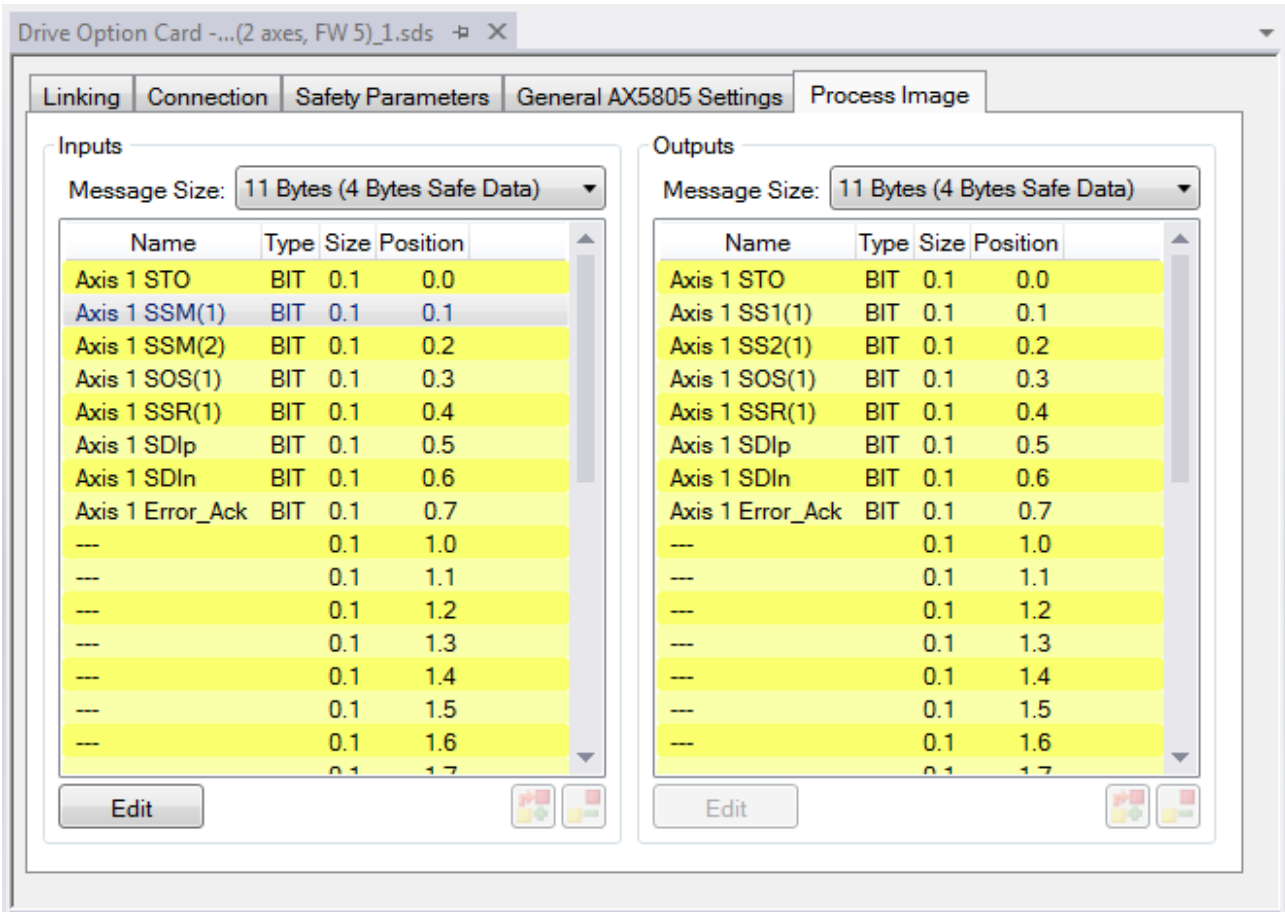

Fig. 30: AX5000 safety drive options - Process Image

The parameters under the *General AX5805 Settings* and *Process Image* tabs are identical to the parameters under the *Safety Parameters* tab. Offers user-friendly display and editing of the parameters. The parameters under the *Safety Parameters* tab can also be edited.

The parameters for this function can be set by selecting a function in the inputs or outputs and pressing the *Edit* button. New safety functions can be added in the process image by selecting an empty field (---) and pressing *Edit*.

The parameter list corresponding to the safety function can be shown; in addition, an optional diagram of the function can be shown. At present the diagram is still static and does not show the currently selected values.

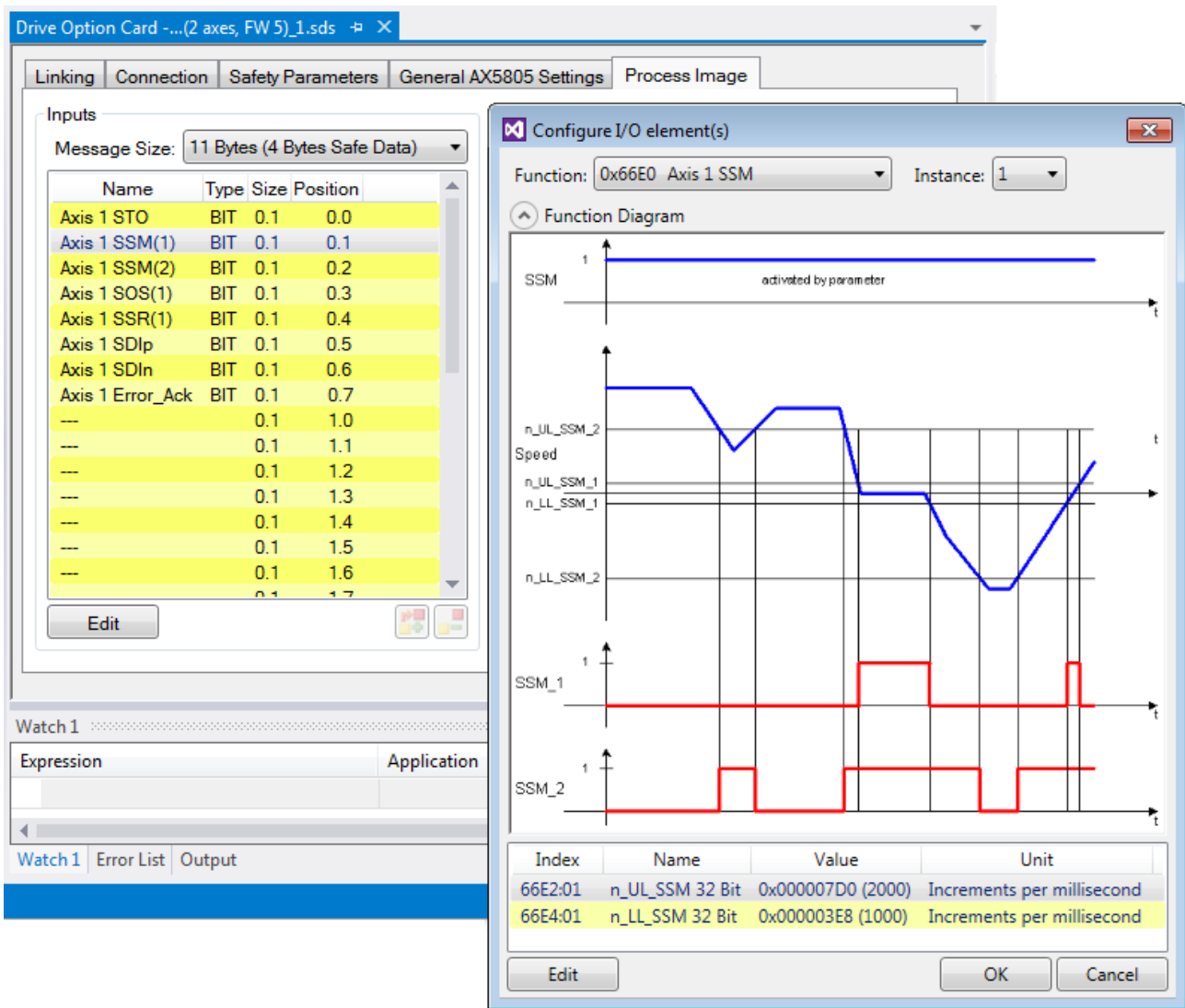

Fig. 31: AX5000 safety drive options - Function Diagram

4.4.6.7 External connection

An external *Custom FSoE Connection* can be created for a connection to a further EL69x0, EJ6910, KL6904 or third-party device. If a dedicated ESI file exists for a third-party device, the device is listed as a selectable safety device, and the *Custom FSoE Connection* option is not required.

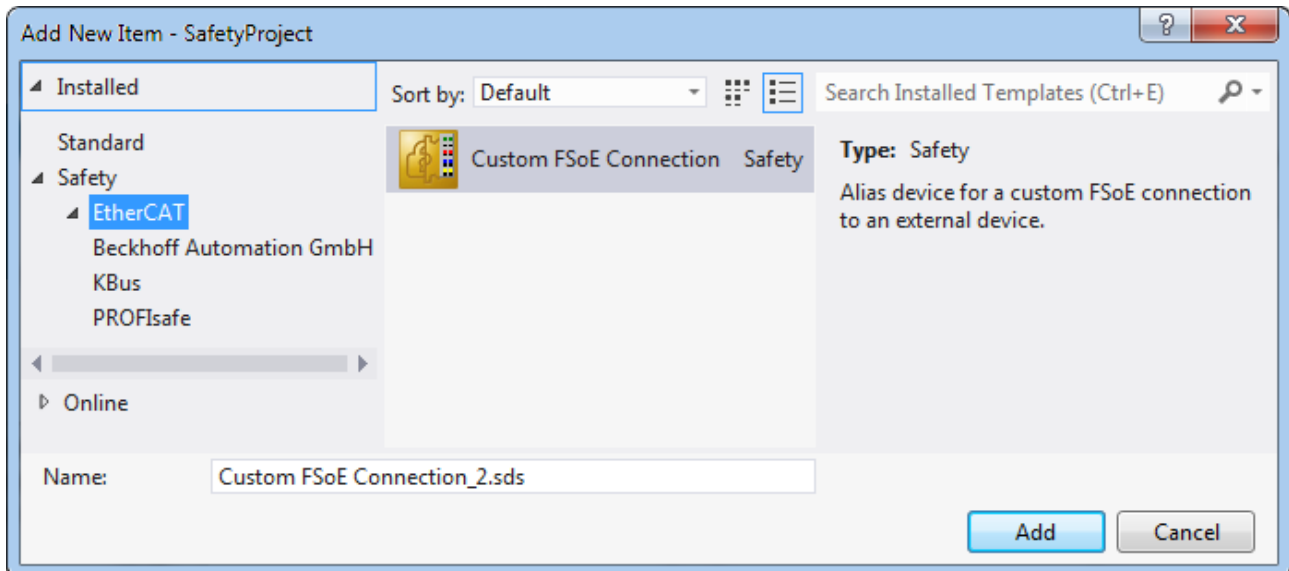

Fig. 32: Creating an external connection (Custom FSoE Connection)

Before the connection can be used and linked further, the process image size must be parameterized. This can be set under the *Process Image* tab. Suitable data types for different numbers of safety data are provided in the dropdown lists for the input and output parameters.

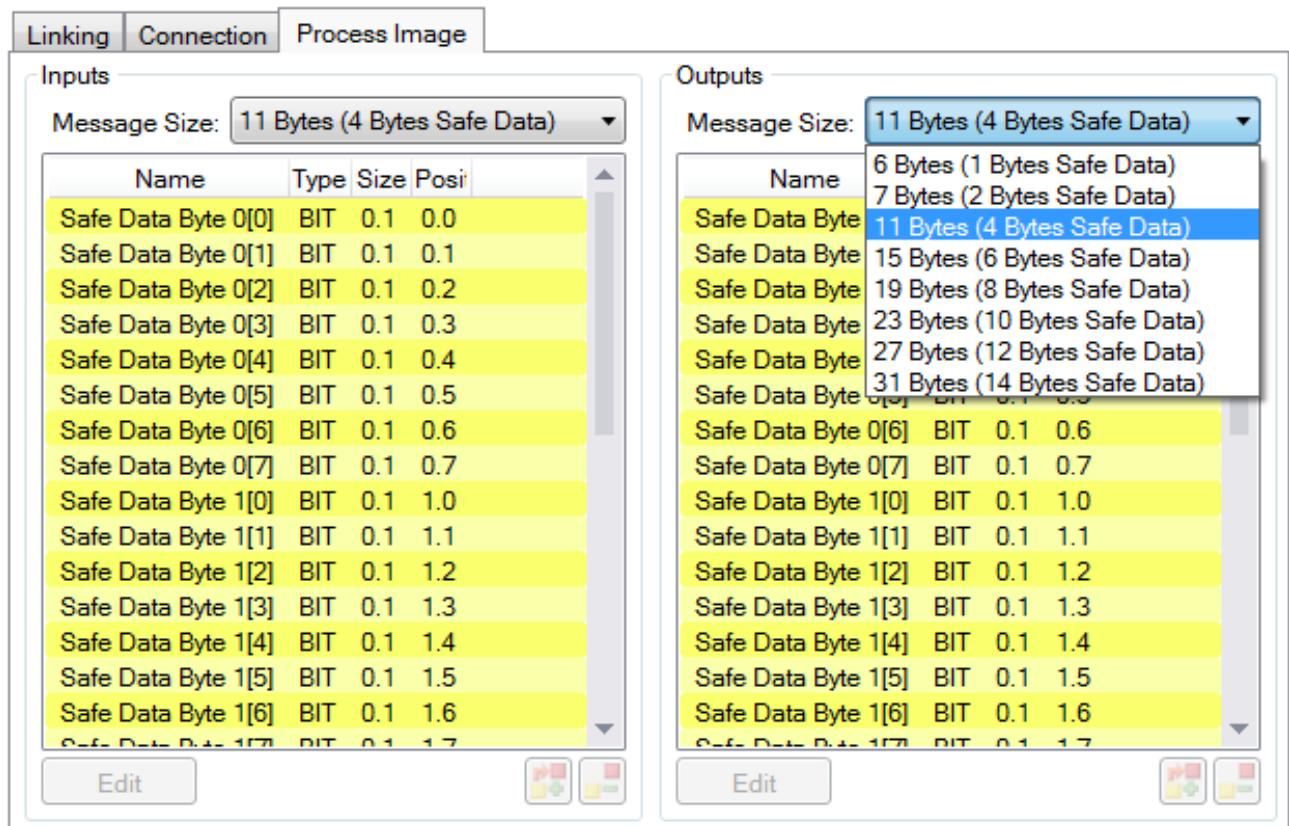

Fig. 33: Parameterization of the process image size

Once the size is selected, the individual signals within the telegram can be renamed, so that a corresponding plain text is displayed when these signals are used in the logic. If the signals are not renamed, the default name is displayed in the editor (Safe Data Byte 0[0], ...).

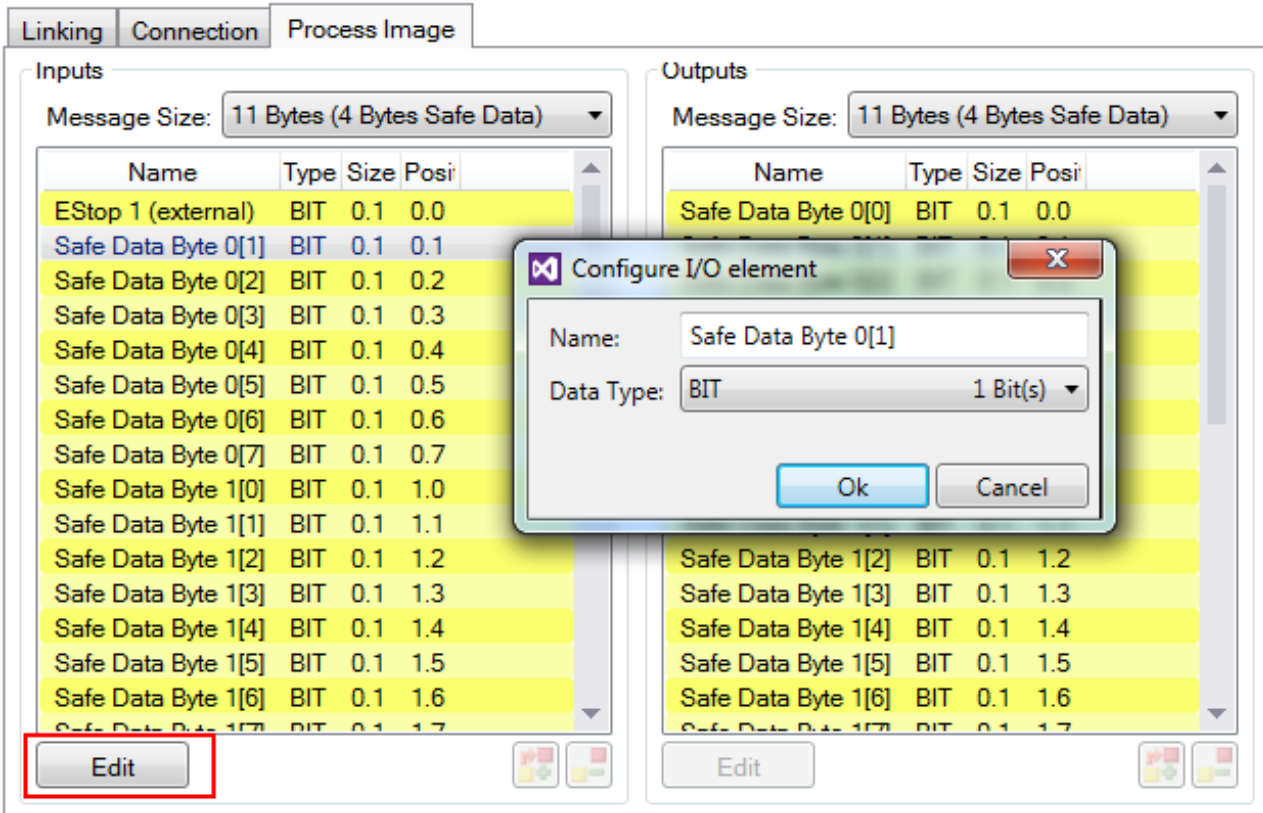



Fig. 34: Renaming the individual signals within the telegram

The connection is linked under the *Linking* tab. The Link button  next to *Full Name (input)* and *Full Name (output)* can be used to select the corresponding variable.

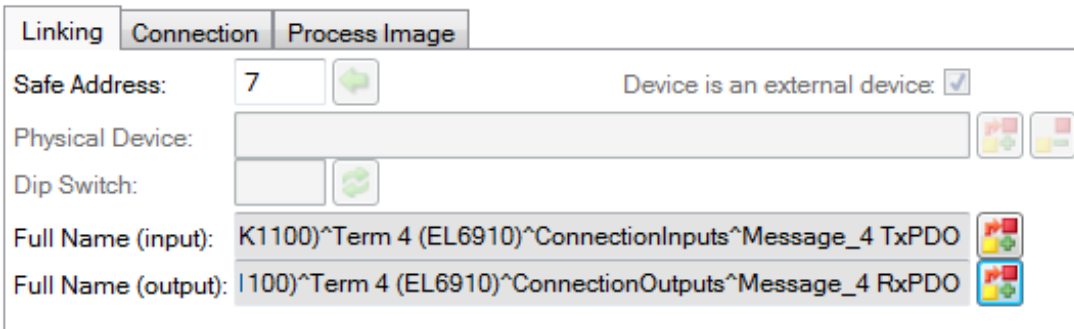

Fig. 35: Selecting the variables

This can be a PLC variable, for example, which is then forwarded to the remote device or can be linked directly with the process image of an EtherCAT Terminal (e.g. EL69x0 or EL6695).

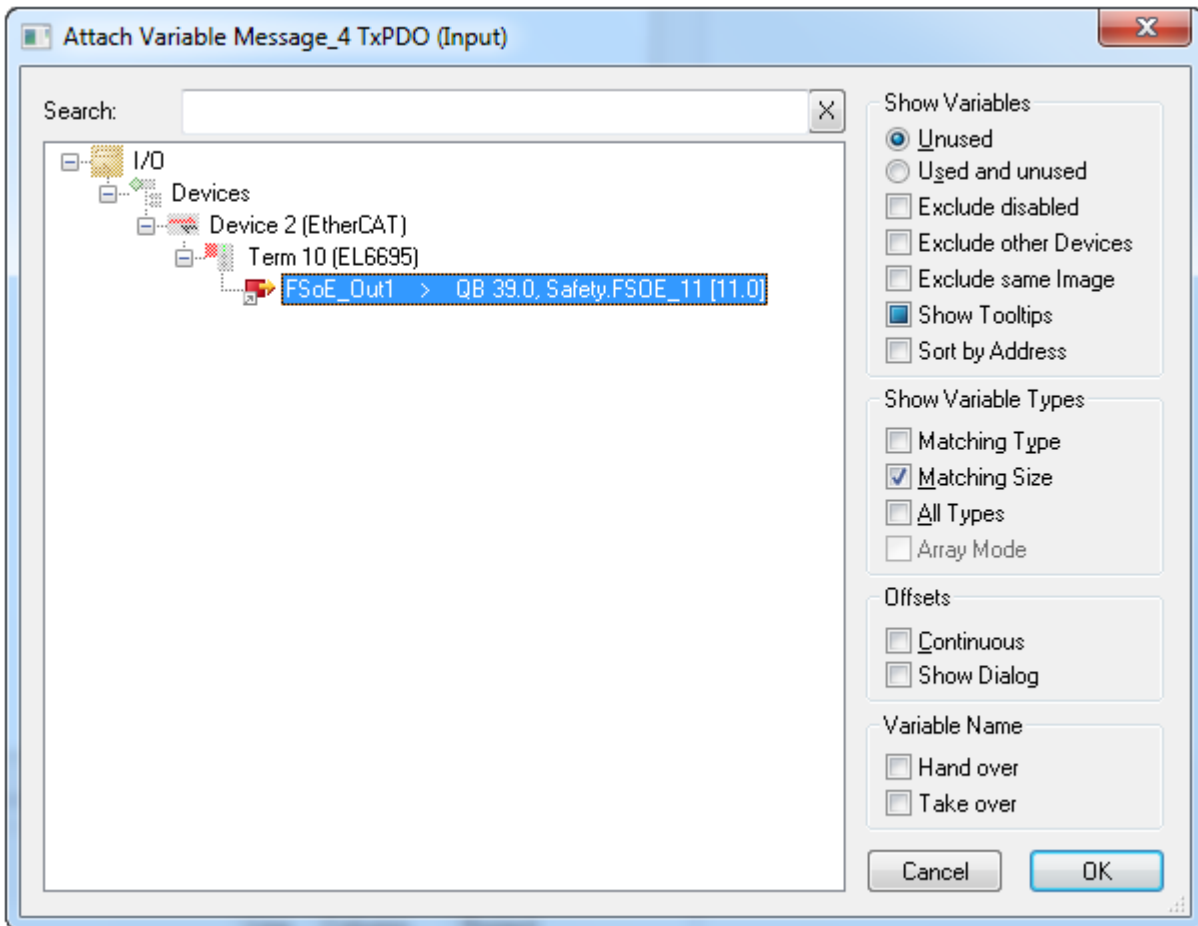

Fig. 36: Direct linking with the process image of an EtherCAT Terminal

Further information can be found in the TwinCAT documentation for the variable selection dialog.

The *Connection* tab is used to set the connection-specific parameters.

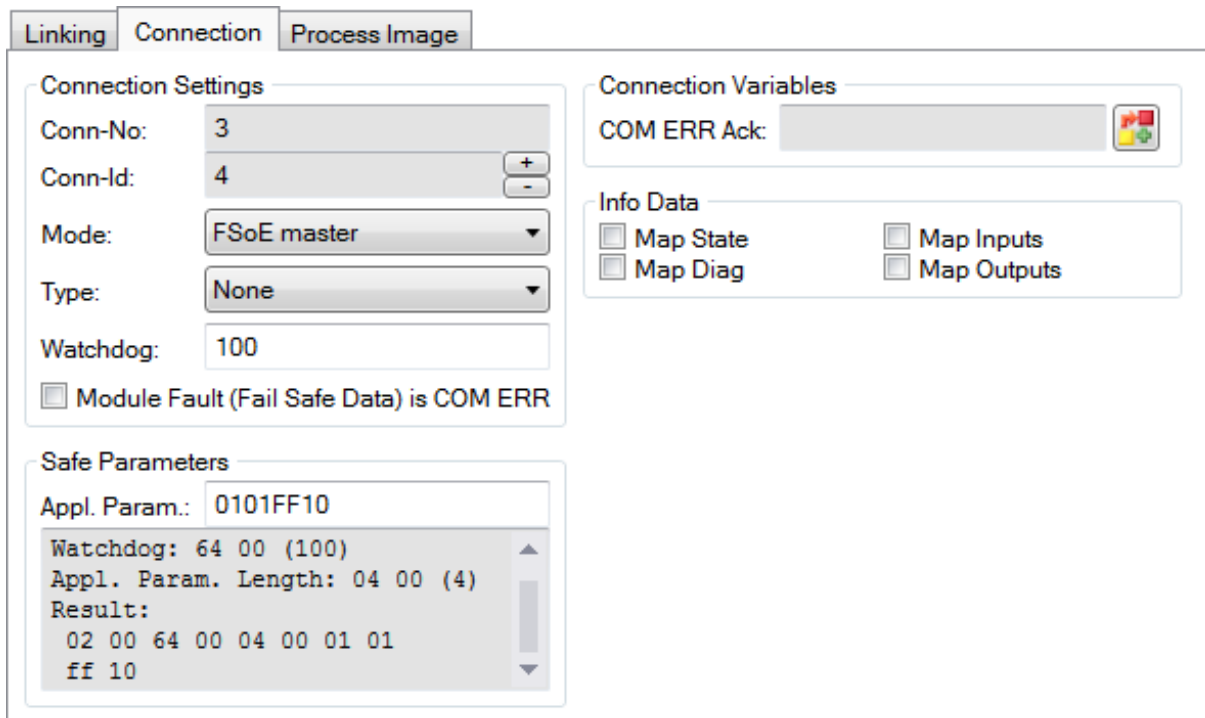

Fig. 37: Connection-specific parameters

Detailed information about the individual settings can be found in the following table.

Parameter	Description	User interaction required
Conn. no.	Connection number: is automatically assigned by the TwinCAT system	No
Conn ID	Connection ID: preallocated by the system, but can be changed by the user. A Conn ID must be unique within a configuration. Duplicate connection IDs result in an error message	Check
Mode	FSoE master: EL6910/EJ6910 is FSoE master for this device. FSoE slave: EL6910/EJ6910 is FSoE slave for this device.	Check
Type	None: Setting for third-party equipment, for which no ESI file is available. KL6904: Setting for KL6904 (safety parameter inactive) EL69XX: Setting for EL6900/EL6930/EL6910/EJ6910 (safety parameter inactive)	Yes
Watchdog	Watchdog time for this connection: A ComError is generated, if the device fails to return a valid telegram to the EL6910 within the watchdog time.	Yes
Module Fault is ComError	This checkbox is used to specify the behavior in the event of an error. If the checkbox is ticked and a module error occurs on the Alias Device, this also leads to a connection error and therefore to disabling of the TwinSAFE group, in which this connection is defined.	Yes
Safe Parameters (Appl. Param)	Device-specific parameters: The parameter length is automatically calculated from the number of characters that is entered. This information will typically be provided by the device manufacturer.	Yes
ComErrAck	If ComErrAck is linked to a variable, the connection must be reset via this signal in the event of a communication error.	Yes
Info data	The info data to be shown in the process image of the EL6910/EJ6910 can be defined via these checkboxes. Further information can be found in the documentation for <i>TwinCAT function blocks for TwinSAFE Logic terminals</i> .	Yes

4.4.6.8 Creating the safety application

The safety application is realized in the SAL worksheet pertaining to the TwinSAFE group (SAL - **S**afety **A**pplication **L**anguage).

The toolbox provides all the function blocks available on the EL6910/EJ6910.

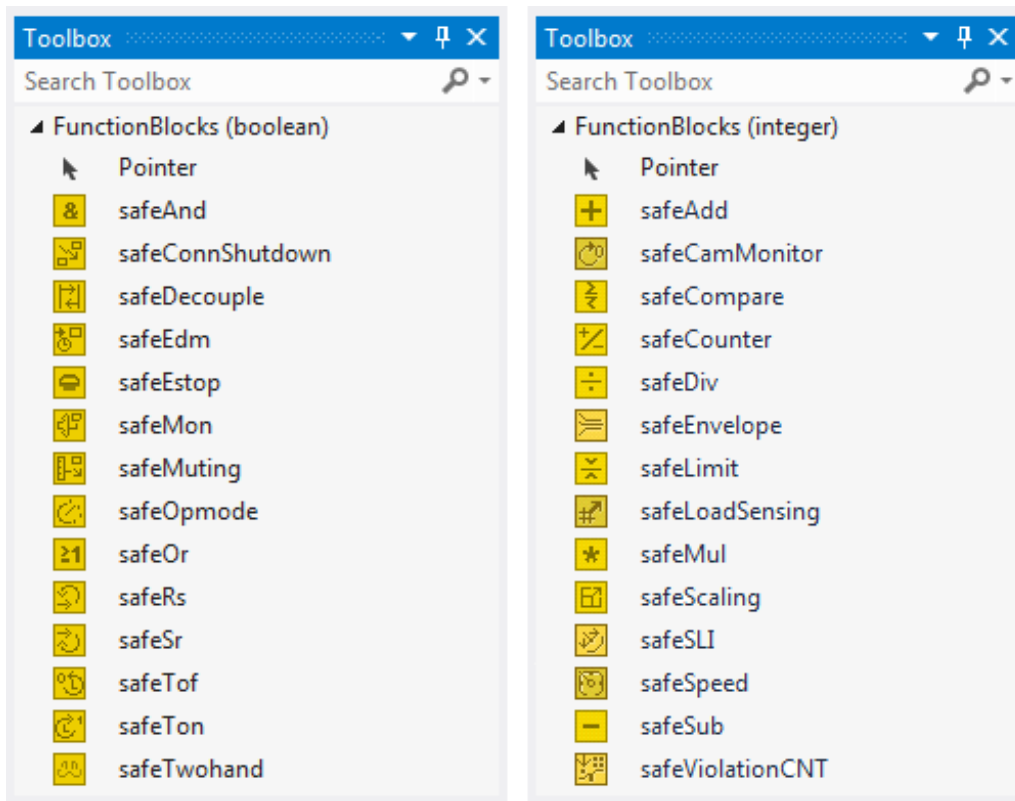

Fig. 38: Function blocks available for EL6910/EJ6910

The function blocks can be moved from the toolbox into the SAL worksheet via drag and drop. Variables can be created by clicking next to a function block input or output, which can then be linked with alias devices in the *Variable Mapping* dialog.

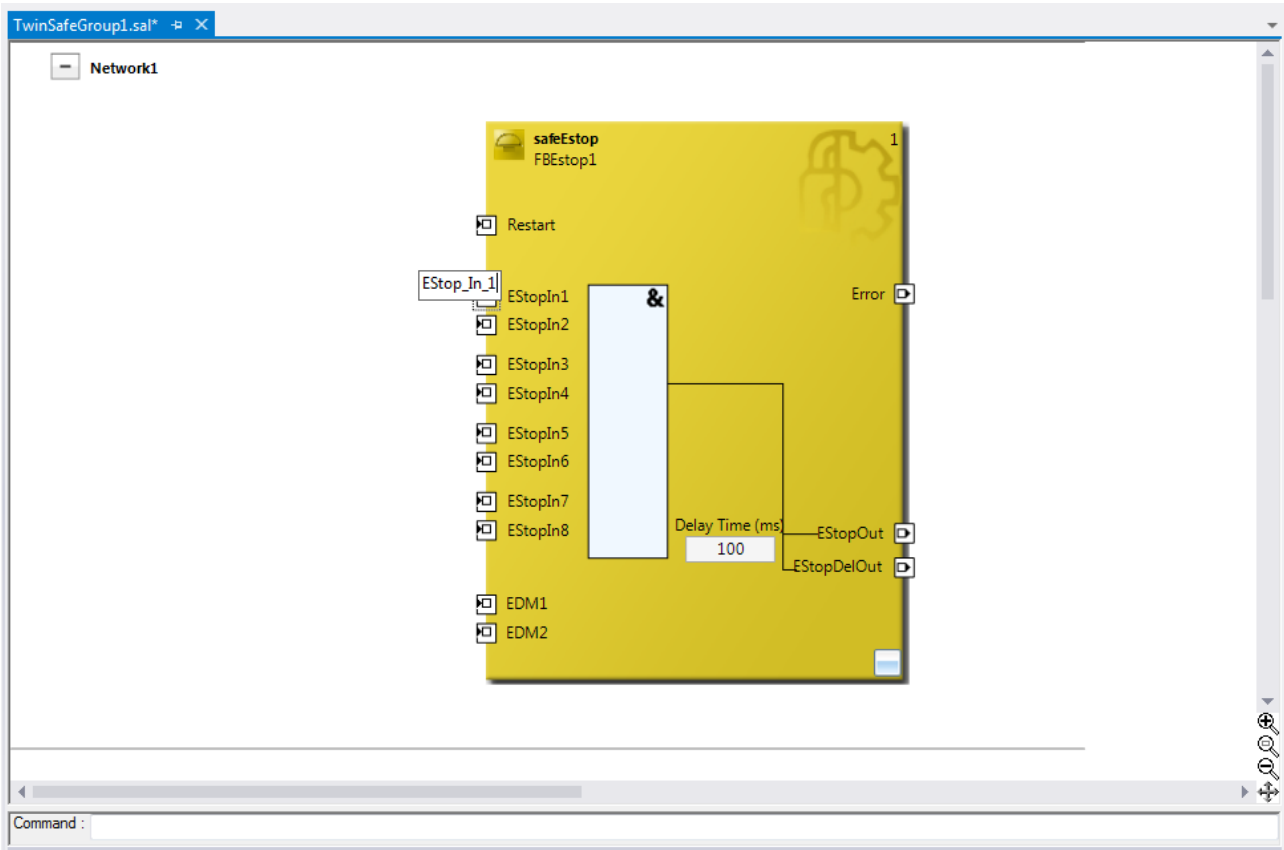



Fig. 39: Function block on the SAL worksheet

Once the pointer connector  **Pointer** has been selected from the toolbox, connections between the input and output ports of the function blocks can be dragged with the mouse.

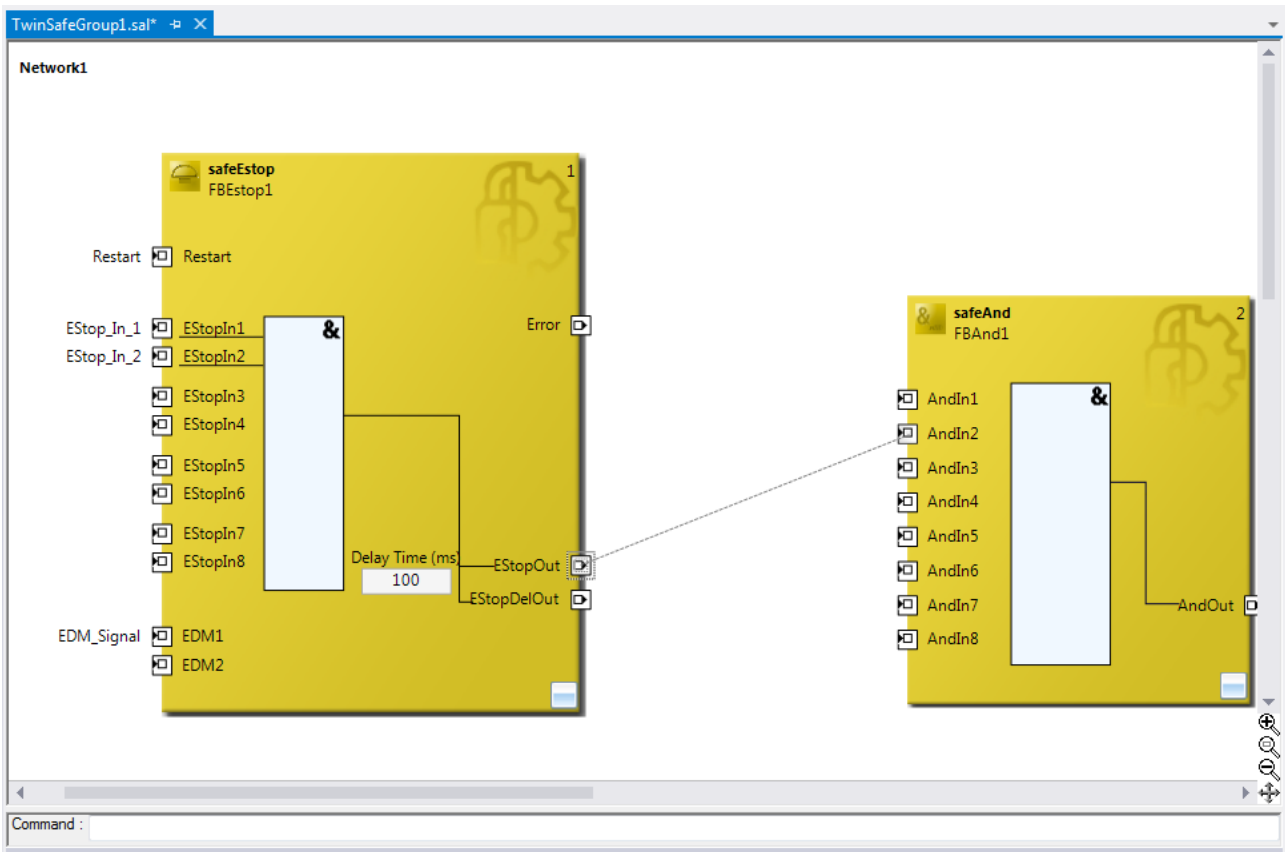

Fig. 40: Dragging a connection between two function blocks

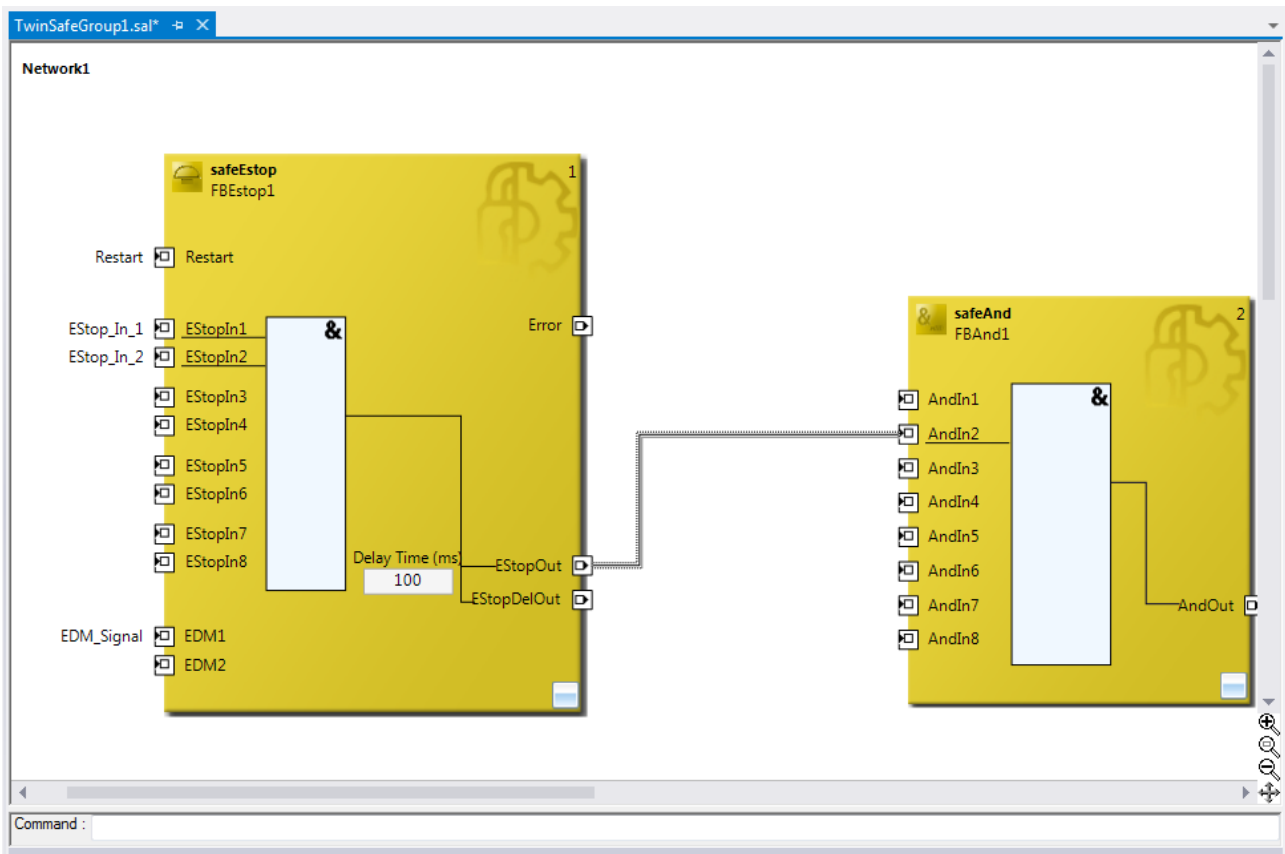

Fig. 41: Connection between two function blocks

4.4.6.9 Networks

For structuring the safety application, several networks can be created within a sal worksheet. Right-click in the worksheet and select *Add After* and *Network* or *Add Before* and *Network* to create a network after or before the current network.

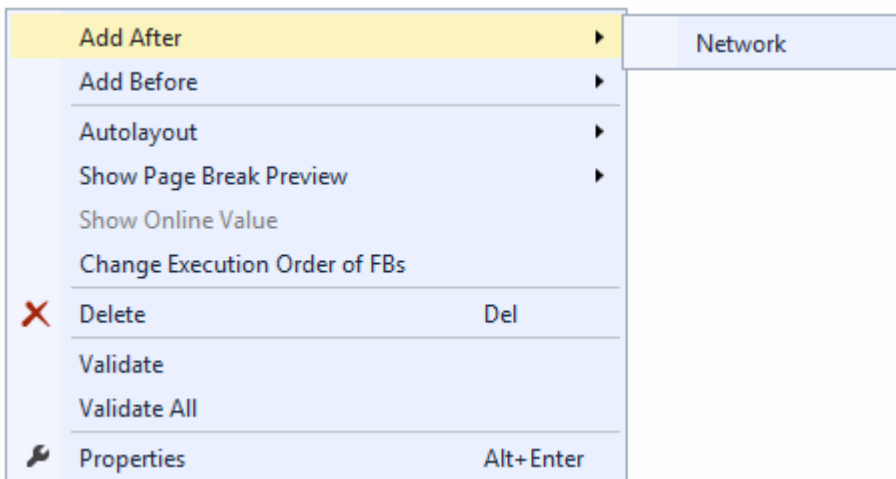

Fig. 42: Creating a network

The instance path to the FB port to be linked can be specified, in order to exchange signals between the networks. The instance path consists of the network name, the FB name and the FB port, each separated by a dot. The input of the instance path is case-sensitive.

<Network name>.<FB name>.<FB port name>

Sample: Network1.FBEstop1.EStopIn3

Alternatively, *Change Link* can be selected by opening the context menus next to the FB port.

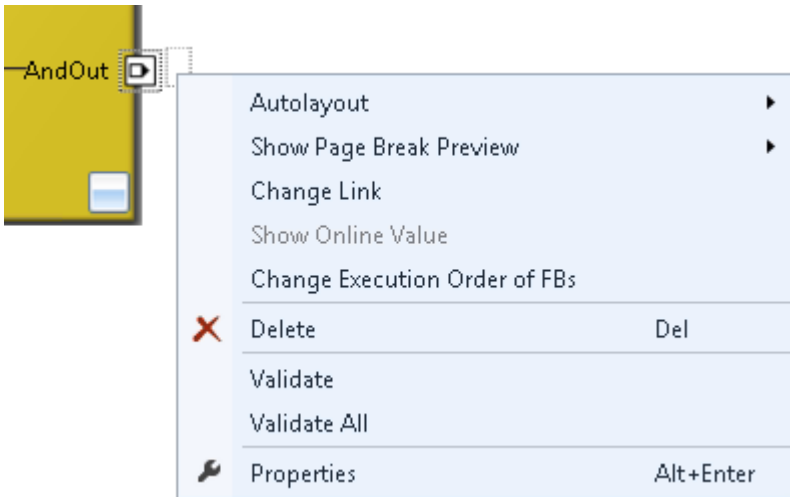

Fig. 43: Change Link

This function opens a dialog for selecting a suitable FB port.

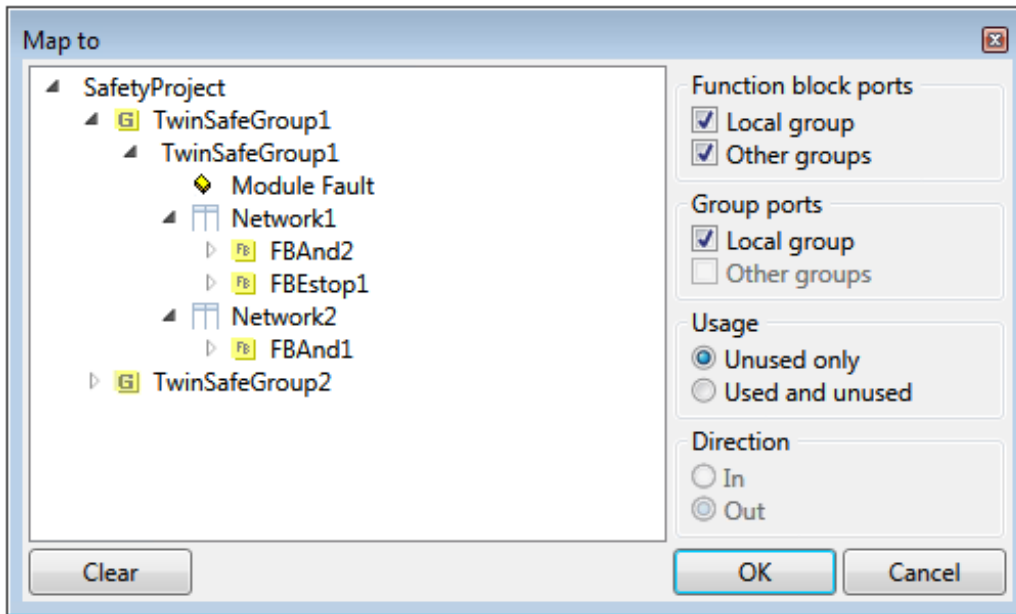

Fig. 44: Dialog for selecting a suitable FB port

Once the link has been created on one side of the connection, the link is automatically set/displayed on the opposite side.

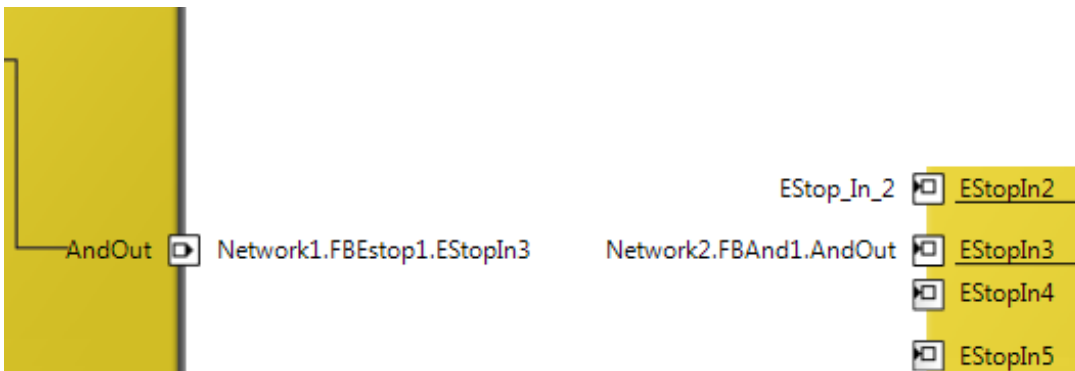

Fig. 45: Link display

4.4.6.10 TwinSAFE groups

It makes sense to create TwinSAFE groups in cases where different machine safety zones are to realize, or simply in order to separate the fault behavior. Within a group, a FB or connection error (here: alias device) leads to a group error and therefore to switching off all outputs for this group. If an error output of an FB is set, it will be forwarded as a logical 1 signal.

A group can be created by opening the context menu of the safety project and selecting *Add and New Item....*

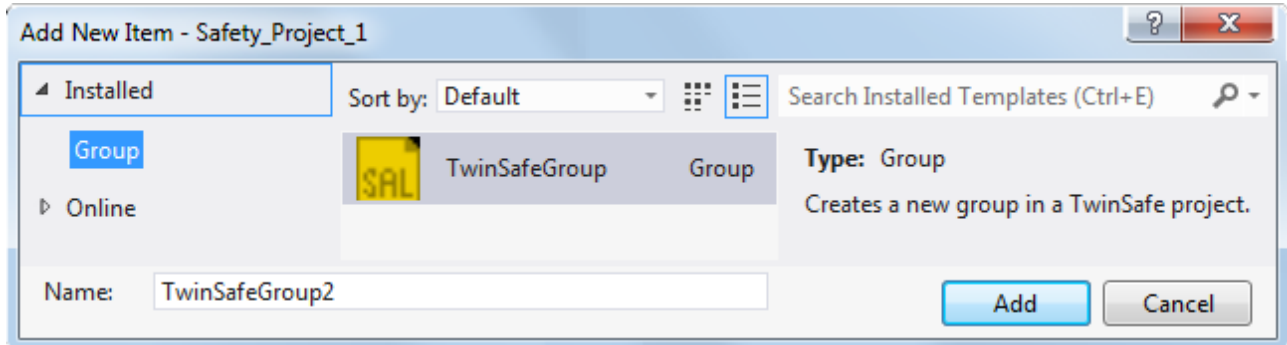

Fig. 46: Creating a TwinSAFE group

Like the first group, the group of a subitem for the alias devices and a sal worksheet.

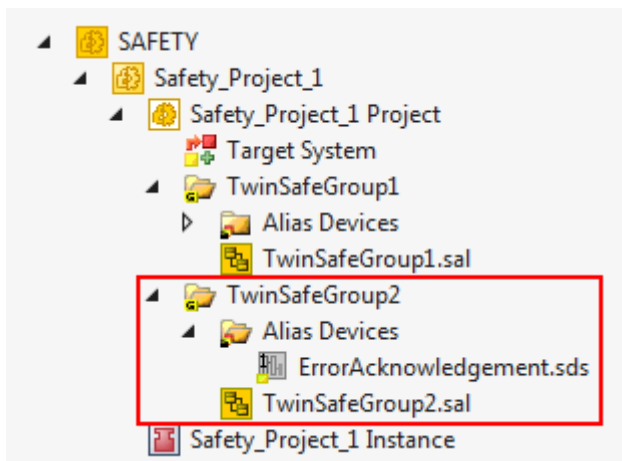

Fig. 47: Components of the TwinSAFE group

The instance path to the FB port to be linked can be specified, in order to exchange signals between the groups. The instance path consists of the group name, the FB name and the FB port, each separated by a dot. The input of the instance path is case-sensitive.

<group name>.<network name>.<FB name>.<FB port name>

Sample: TwinSafeGroup1.Network1.FBStop1.EStopIn3

Alternatively, *Change Link* can be selected by opening the context menus next to the FB port.

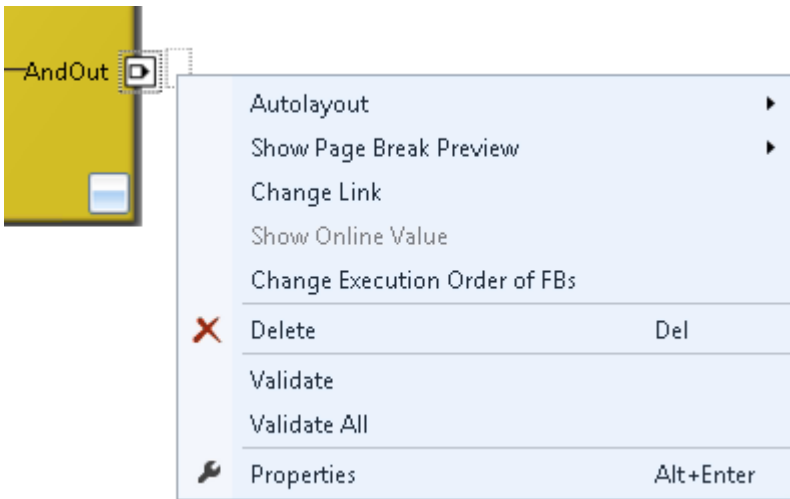

Fig. 48: Change Link

This function opens a dialog for selecting a suitable FB port.

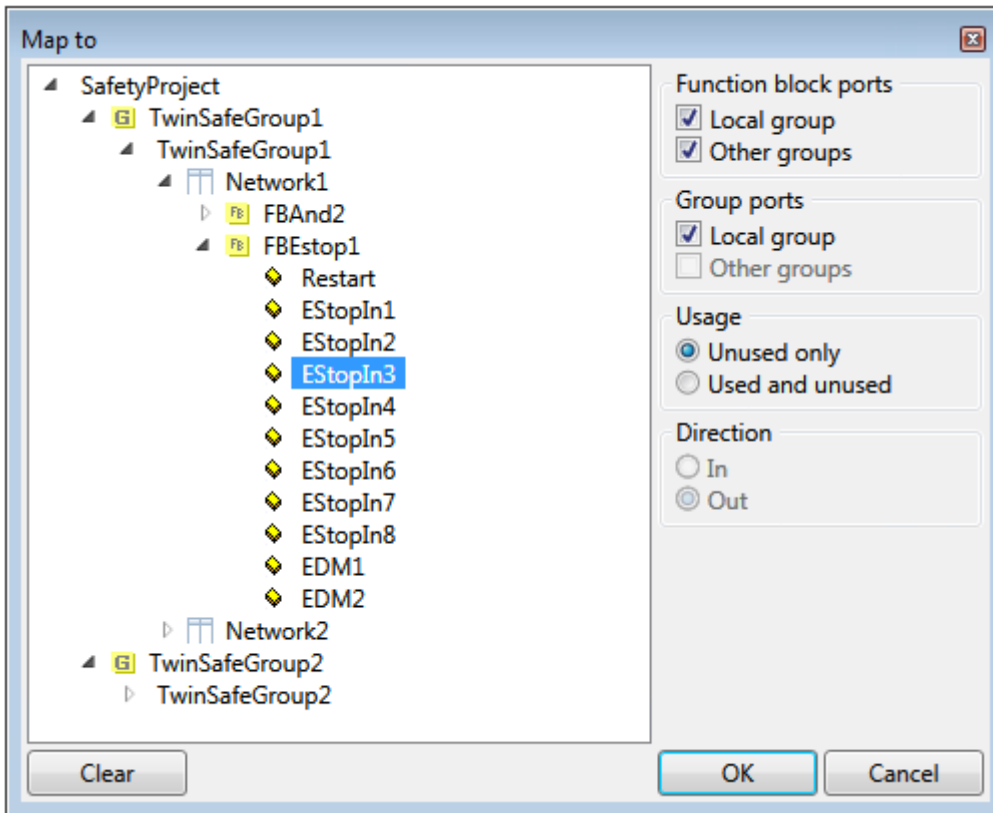

Fig. 49: Dialog for selecting a suitable FB port

Once the link has been created on one side of the connection, the link is automatically set/displayed on the opposite side.



Fig. 50: Link display

4.4.6.11 Variables of the TwinSAFE group

The inputs and outputs of the TwinSAFE groups are consolidated under the *Group Ports* tab of the *Variable Mapping* dialog.

● Group inputs EL6910/EJ6910

i For a project to be valid, as a minimum the signals *Run/Stop* and *ErrAck* must be linked.

Variable Mapping			
Variables	Group Ports	Replacement Values	Max Start Deviation
Group Port	Direction	Alias Port	
Err Ack	input	ErrorAck.In (TwinSafeGroup2)	
Run/Stop	input	Run.In (TwinSafeGroup2)	
Module Fault	input		
Com Err	output		
FB Err	output		
Out Err	output		
Other Err	output		
Com Startup	output		
FB Deactive	output		
FB Run	output		
In Run	output		

Safety Project Online View | Variable Mapping | Error List | Output

Fig. 51: The Variable Mapping dialog

Group Port	Direction	Description
Err Ack	IN	Error Acknowledge for resetting errors within the group - Signal must be linked with a standard variable
Run/Stop	IN	1 - Run; 0 – Stop - Signal must be linked with a standard variable
Module Fault	IN	Input for an error output of another module that is connected, e.g. EK1960
Com Err	OUT	Communication error in one of the connections
FB Err	OUT	Error at one of the FBs used
Out Err	OUT	not used
Other Err	OUT	ModuleFault OR AnalogValueFault OR WaitComTimeoutFault
Com Startup	OUT	At least one of the connections of this group is in startup
FB Deactive	OUT	The group was deactivated. (See also chapter Customizing / disabling TwinSAFE groups [► 120])
FB Run	OUT	FBs of the TwinSAFE group are processed
In Run	OUT	TwinSAFE group is in RUN state

Group State

Value	Status	Description
1	RUN	Input RUN=1, no error in the group, and all connections have started up without error
2	STOP	Input RUN = 0
4	ERROR	Group is in error, see Diagnostic information
5	RESET	After an error has occurred, all errors have been rectified and the Err Ack signal is 1
6	START	The group remains in this state as long as not all connections have started up after the start of the group (RUN=1)
7	STOPERROR	When the group is started or initialized, it assumes the STOPERROR status if the TwinSAFE connections are assigned to the group. The group switches from STOPERROR state into ERROR state if the Run input is TRUE.
16	DEACTIVE	Group was deactivated via customizing
17	WAITCOMERROR	This state is set when the customizing function "Passivate" is selected and the system waits for ComError of the group

Group Diag

Value	Status	Description
0	-	No error
1	FBERROR	at least one FB is in ERROR state
2	COMERROR	at least one connection is faulty
3	MODULEERROR	the input ModuleFault is 1
4	CMPERROR	On startup, at least one analog FB input deviates from the last saved value (Power-On Analog Value Check Error)
5	DEACTIVATE ERROR	In "passivate manual control unit" mode the timeout has elapsed while waiting for the COM error
6	RESTARTERROR	The TwinSAFE Logic program was restarted because the EtherCAT connection was restarted or a user logged in without reloading the TwinSAFE Logic program (or parts of it).

4.4.6.12 Order of the TwinSAFE groups

The order of the groups can be changed, in order to realize a defined processing sequence of the safety application.

To this end, select the entry *Edit TwinSAFE Group Order* via the node menu of the safety project node. A dialog opens, in which the order of the groups can be changed. The individual groups do not necessarily have to be numbered in consecutive ascending order. The numbering can contain gaps.

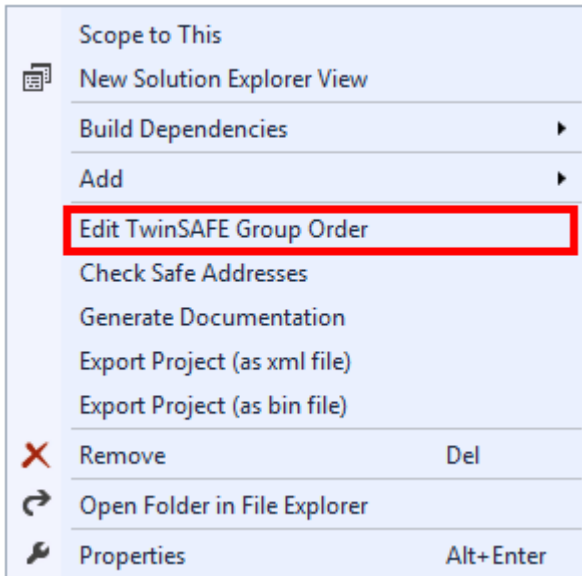

Fig. 52: Context menu Edit TwinSAFE Group Order

The current group order is shown in the column *Current Value*. The new order is specified by entering a value in the column *New Value*, followed by *OK*.

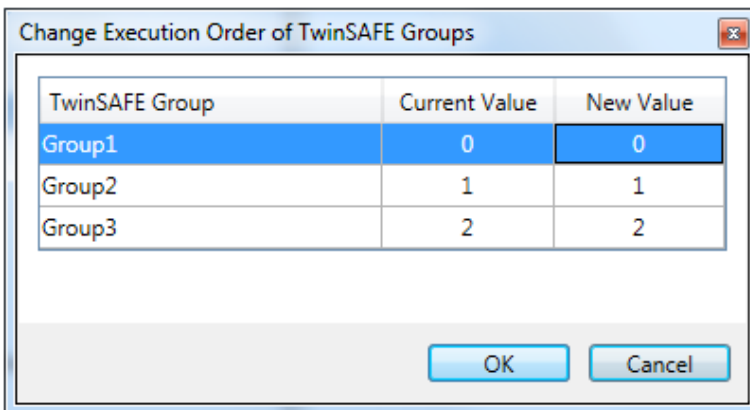

Fig. 53: Dialog Change Execution Order of TwinSAFE Groups

4.4.6.13 Command line

The *command line* below the SAL worksheet can be used to enter commands for executing functions.

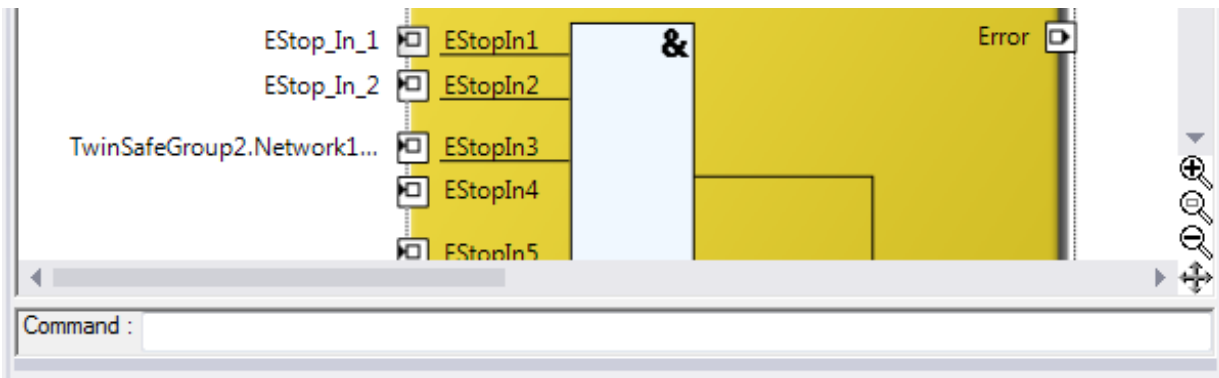

Fig. 54: The command line below the SAL worksheet

Currently the commands listed in the following table are supported.

Command	Description
FBNAME FB_INSTANCENAME NETWORKNAME;	Adding a function block Sample: safeAnd FBAnd1 Network1
FB_INSTANCENAME->PORTNAME = VARIABLE_NAME;	Creating a variable mapping Sample: FBAnd1->AndIn1 = testVariable
FB_INSTANCENAME->PORTNAME = FB_INSTANCENAME->PORTNAME;	Creating a connection between two FBs Sample: FBAnd1->AndIn1 = FBO1->OrOut;

4.4.6.14 FB port properties

The behavior of the inputs can be parameterized by opening the properties for the upper input of an input pair or an individual input of the function block. For an input group, such as the function block ESTOP, the individual inputs to be activated or deactivated, and single- or two-channel evaluation can be set.

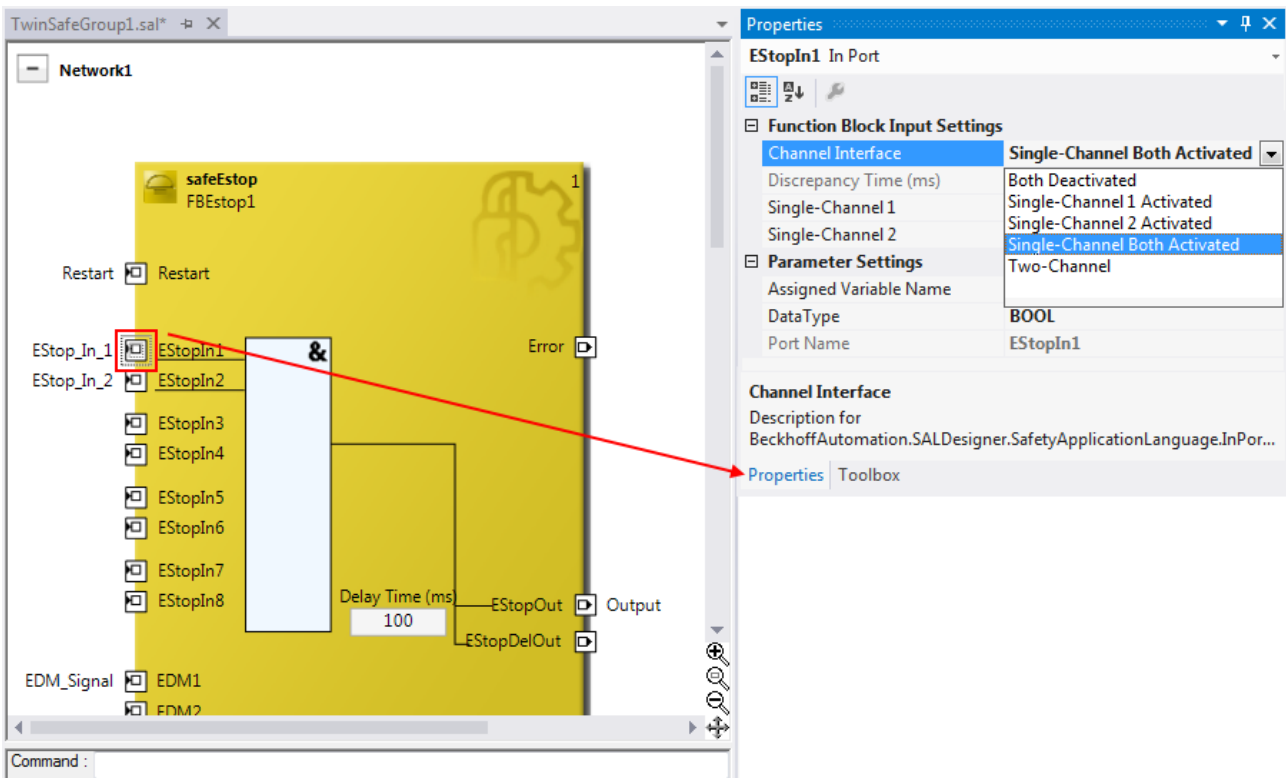

Fig. 55: FB port properties

Channel Interface	Description
Both Deactivated	Both inputs are deactivated
Single-Channel 1 Activated	Channel 1: Single-channel evaluation Channel 2: deactivated
Single-Channel 2 Activated	Channel 1: deactivated Channel 2: Single-channel evaluation
Single-Channel Both Activated	Channel 1: Single-channel evaluation Channel 2: Single-channel evaluation
Two-Channel	Both inputs are activated, and two-channel evaluation with <i>Discrepancy Time (ms)</i>

If the *Two-Channel* evaluation is enabled, the corresponding *Discrepancy time (ms)* can be set in milliseconds. For each input there is a setting to indicate whether the input should be evaluated as *Break Contact (NC)* or *Make Contact (NO)*. When a variable or a connecting line is connected to the function block, the corresponding channel is enabled automatically.

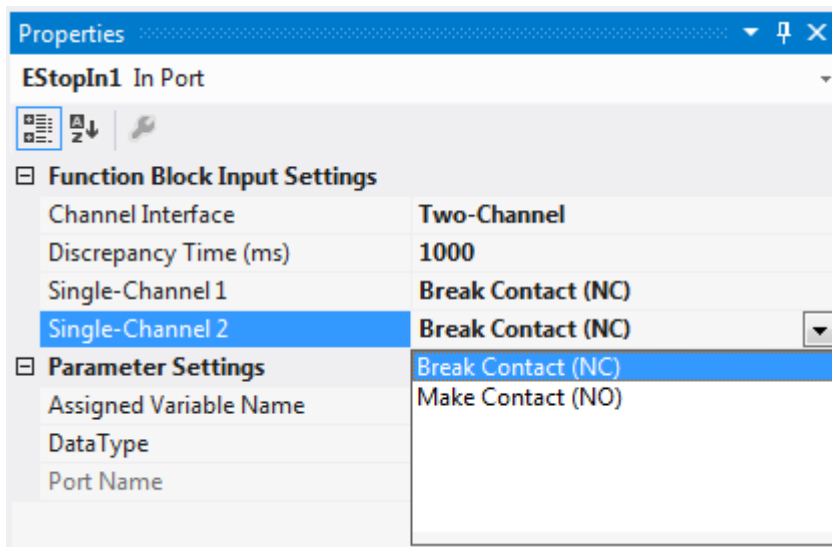

Fig. 56: Make Contact (NO) / Break Contact (NC) setting

These settings are also accessible for each individual port of an FB via the context menu item *Change InPort Settings*.

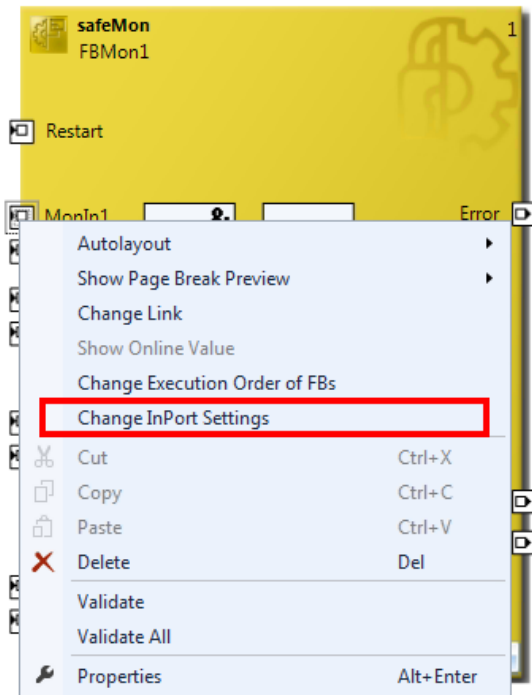

Fig. 57: Menu Change Inport Settings

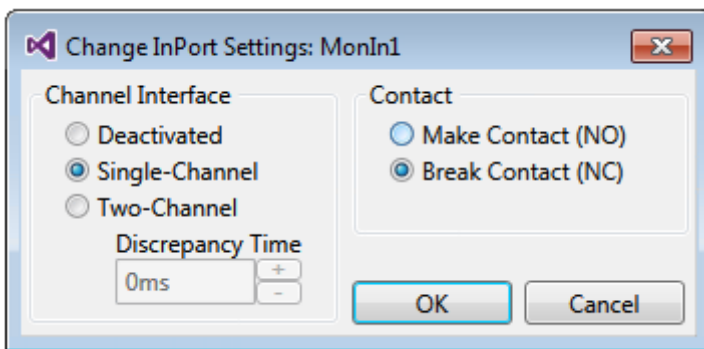



Fig. 58: Dialog Change InPort Settings

4.4.6.15 Variable Mapping

Variable Mapping						
Variables	Group Ports	Replacement Values	Max Start Deviation			
Assigned Variable	Direction	Alias Port		Port Name	Instance Name	Function Name
EStop_In_1	input	Term 7 (EL1904) - Module 1 (FSOES).InputChannel1 (TwinSafeGroup1)		EStopIn1	FBEStop1	safeEstop
EStop_In_2	input			EStopIn2	FBEStop1	safeEstop
Restart	input	RestartForEstop.In (TwinSafeGroup1)		Restart	FBEStop1	safeEstop
EDM_Signal	input			EDM1	FBEStop1	safeEstop
Output	output			EStopOut	FBEStop1	safeEstop

Fig. 59: Variable Mapping

Variables are linked to the alias devices in the *Variable Mapping* window. Use the Link button  to open the selection dialog for the alias port. Safe only signal types or safe and standard signal types are offered in the selection dialog, depending on the port setting of the FB. Safe Boolean signals are shown with a yellow background, standard signal types with a white background.

If several outputs are to be written by one variable, these signals can be assigned by holding down the CTRL key and selecting the channels.

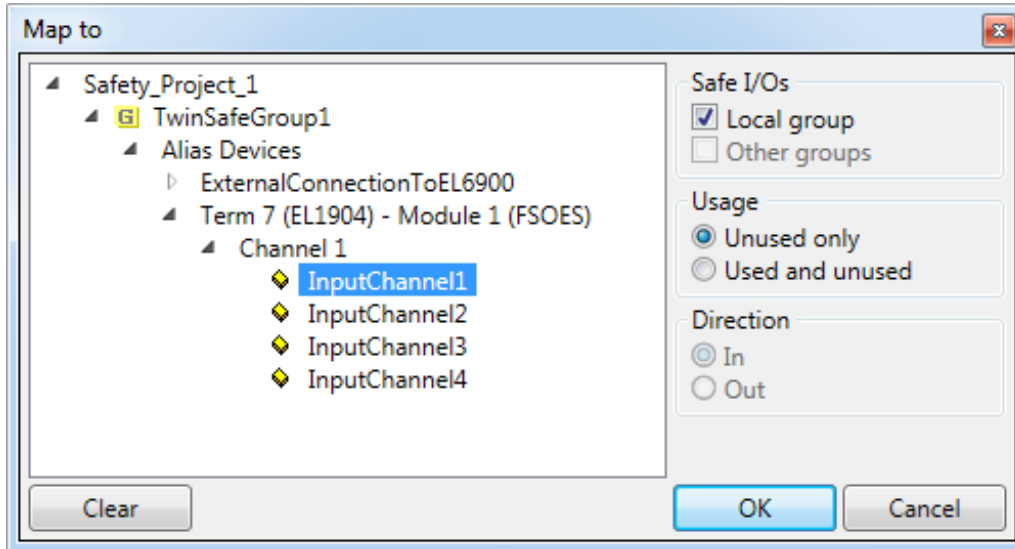

Fig. 60: Selection dialog for the alias port

4.4.6.16 Safety toolbars

Once the development of the safety project is complete, the project has to be loaded onto the target system, in this case EL6910/EJ6910. To this end the toolbars *TwinCAT Safety* and *TwinCAT Safety CRC* have to be added.

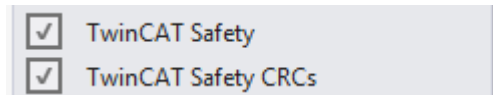







Fig. 61: Activation of the TwinCAT Safety and TwinCAT Safety CRC toolbars

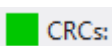
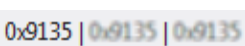
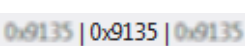
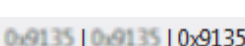

Fig. 62: Display of the TwinCAT Safety and TwinCAT Safety CRC toolbars

Toolbar TwinCAT Safety

Icon	Name	Description
	Verify Safety Project	The safety project is checked for validity.
	Verify Complete Safety Project	The safety project including the hardware level is checked for validity.
	Download Safety Project	Loading the safety project onto the target system, here EL6910/EJ6910
	Delete Safety Project	Deleting the safety project from the target system, here EL6910/EJ6910
	Show Online Data of Safety Project	Switching on the Online View for the safety project.
	Customize Safety Project	Customizing the safety project (switching off TwinSAFE groups and setting of safe substitute values for the group outputs). This is possible if the online and offline CRC are the same and at least one group has been configured for customizing.

Toolbar TwinCAT Safety CRC

Icon	Name	Description
	CRC Toolbar	Left-click on the toolbar to initiate an update of the CRCs by the user. Red icon: CRCs are different
	CRC Toolbar	Green icon: All CRCs are identical
	Online CRC	CRC of the safety project on EL6910/EJ6910. This value is read online by the EL6910/EJ6910. In the absence of an ADS connection to the EL6910/EJ6910, this value is displayed with <code>0x----</code> .
	Downloaded CRC	CRC of the safety project that was loaded last. If no safety project is loaded when the TwinCAT project is opened, the value is displayed with <code>0x----</code> .
	Offline CRC	CRC of the current safety project, as stored in the safety editor. A CRC is displayed, if the stored project is valid. If the project is invalid, <code>0x----</code> is displayed as CRC.

4.4.6.17 Checking the TwinSAFE addresses

The hardware addresses of the alias devices used can be checked and set via the dialog *Check Safe Addresses*.

To this end, select the entry *Check Safe Addresses* via the node menu of the safety project node. A dialog opens, which lists all alias devices that use hardware addresses. The addresses set in the software (*Safe/FSoE Address*) and the hardware addresses (*Hardware Address*) are shown in separate columns for each alias device and for the target system. In the column *Take Hardware Address* the user can specify whether the hardware addresses for the alias devices settings are applied when the dialog is closed via the *OK* button.

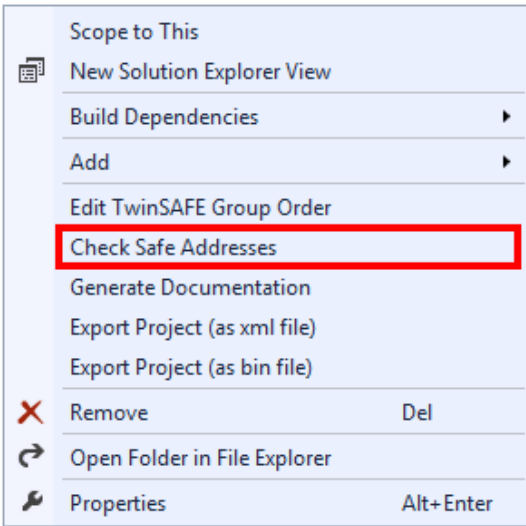

Fig. 63: Check Safe Addresses context menu

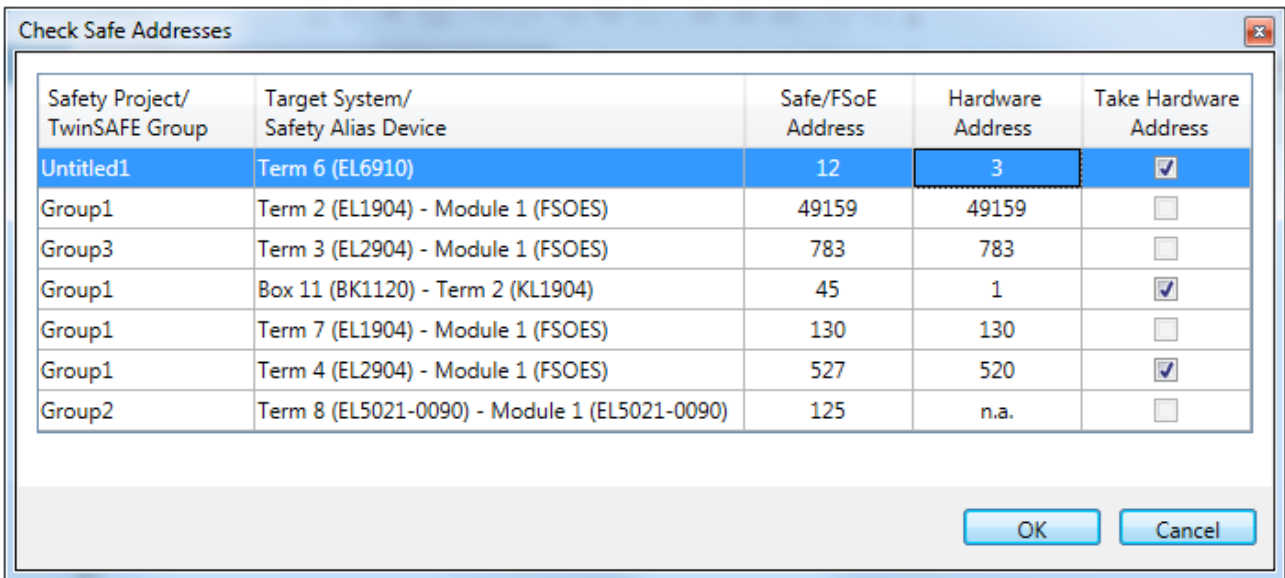





Fig. 64: Check Safe Addresses dialog

4.4.7 Downloading the safety application

Before downloading the safety project to the EL6910/EJ6910 or a logic component, the project should first be checked for validity. If the hardware is complete, the hardware level  can be used for checking, or checking can take place at the project level , if online access is only available for the EL6910/EJ6910 or the logic component. If the check returns no errors, the project download  can continue.

⚠ CAUTION

Use only qualified tools
 Only use a qualified tool (see note on system limits) for loading, verifying and enabling the project on the EL6910/EJ6910 or the logic component!

i **User name and password are case-sensitive**
 Pay attention to upper/lower case characters for the user name and password. The standard user is *Administrator*, the standard password is *TwinSAFE*.

NOTE

Power supply during download
 Make sure that the TwinSAFE Logic is not switched off during the download. This can lead to unexpected behavior or permanently disable the TwinSAFE Logic.

⚠ WARNING

Execution of the safety application
 During a login or download of a safety application, the execution of the current project is stopped on the TwinSAFE Logic.

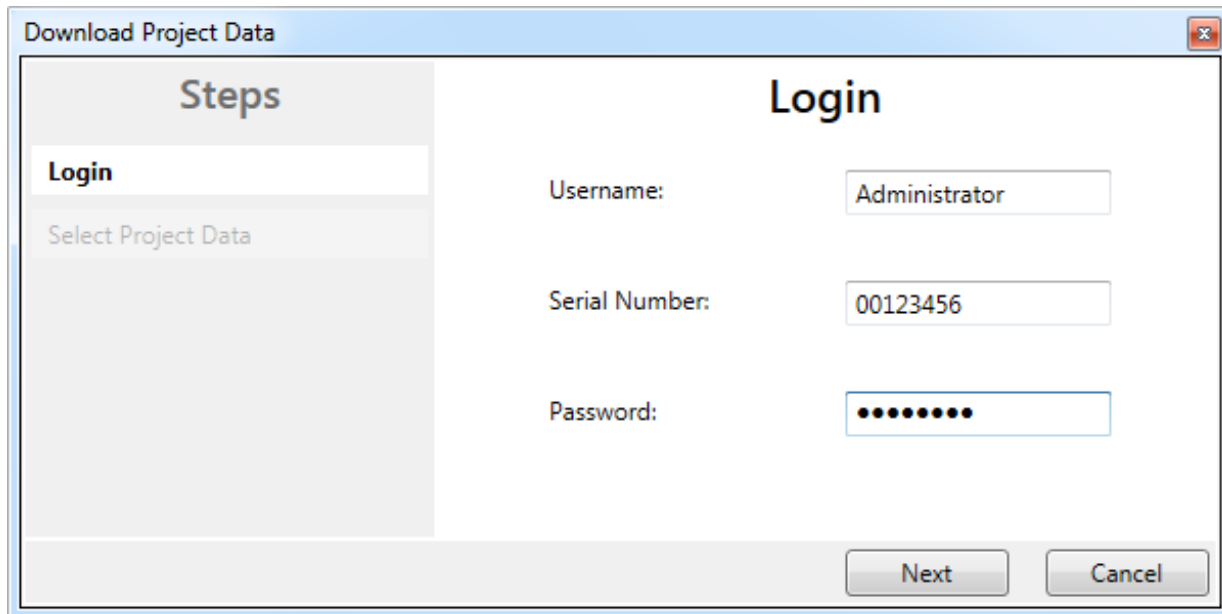

Fig. 65: Download Project Data – The Login dialog

In the *Download Project Data* dialog specify the user name, the serial number of the EL6910/EJ6910 or the logic component onto which the project is to be loaded, and the user password. The default user name is *Administrator*, the default-password is *TwinSAFE*. Use the *Next* button to move to the next dialog.

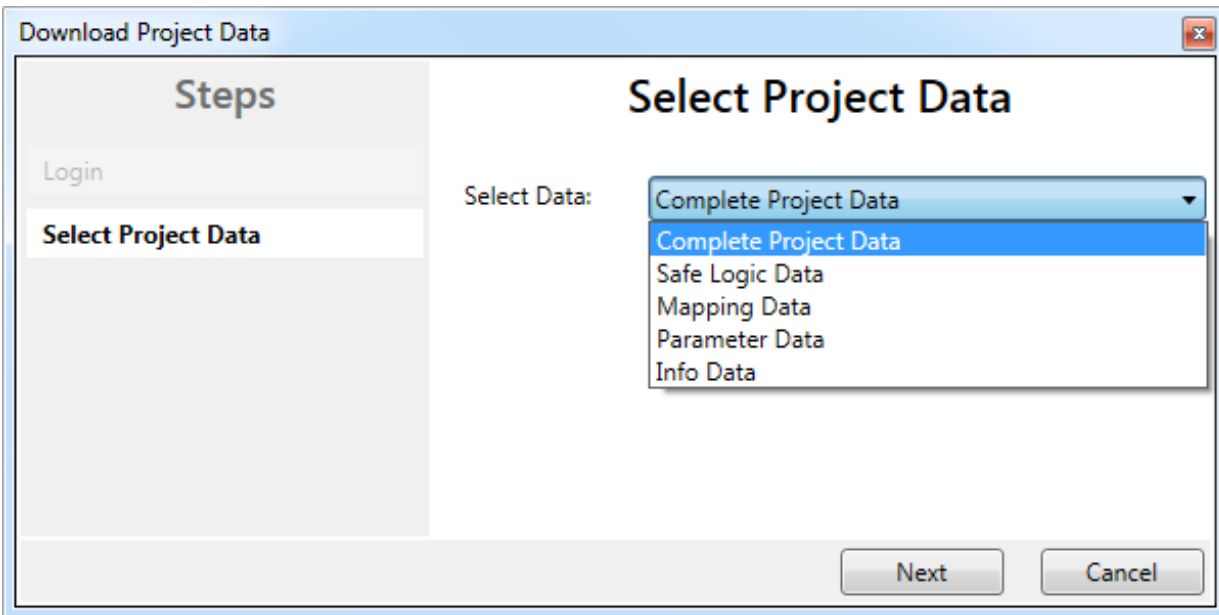

Fig. 66: Download Project Data – The Select Project Data dialog

In the *Select Project Data* dialog select *Complete Project Data* to load the whole project onto the EL6910/EJ6910 or the logic component. Use the *Next* button to move to the next dialog.

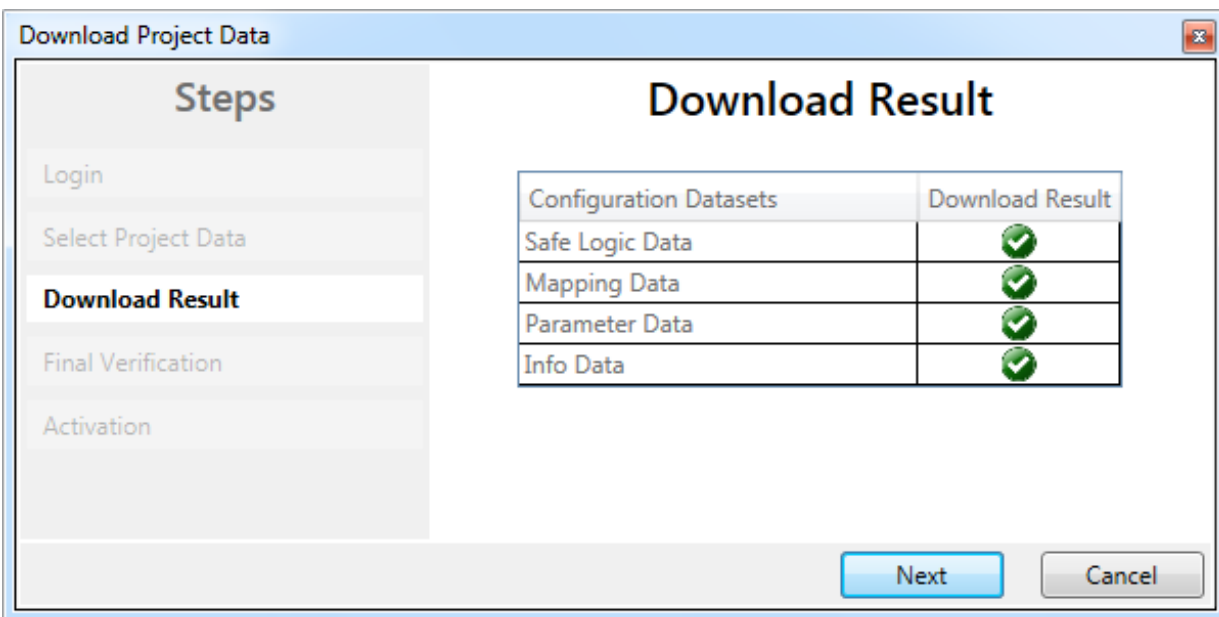

Fig. 67: Download Project Data – The Download Result dialog

Once the download is complete, the download results are displayed. Use the *Next* button to move to the next dialog.

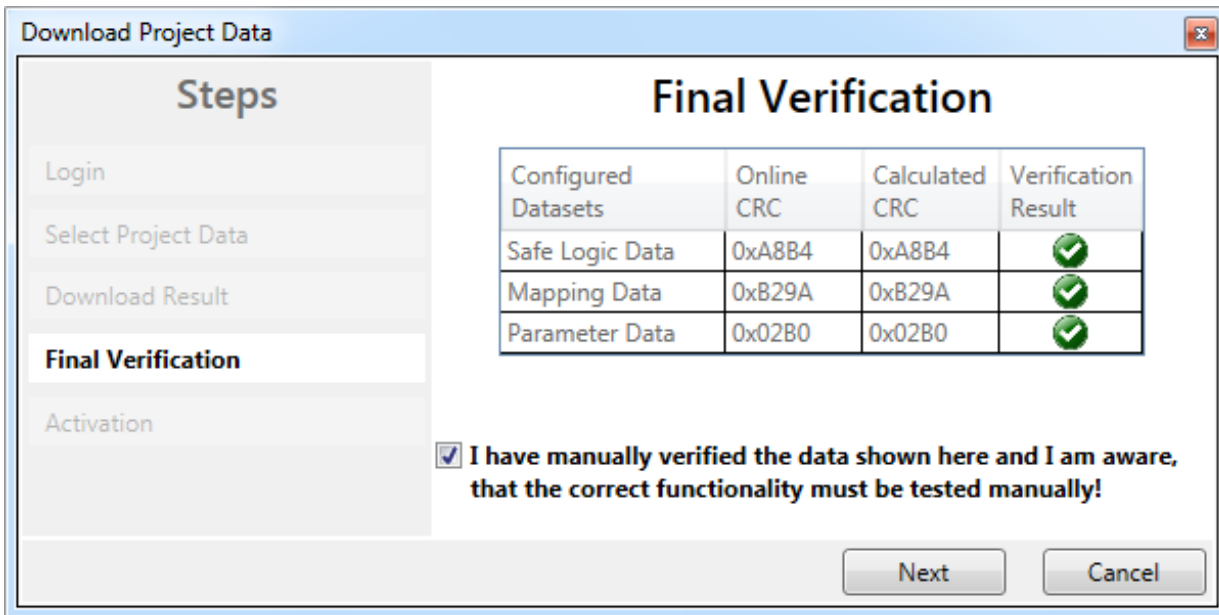

Fig. 68: Download Project Data – The Final Verification dialog

The locally calculated CRCs and the online CRCs of the safety project are displayed in the *Final Verification* dialog. They are automatically checked for equality and displayed via the column *Verification Result*. The user must also check these data for equality and then confirm this by ticking the checkbox. Use the *Next* button to move to the next dialog.

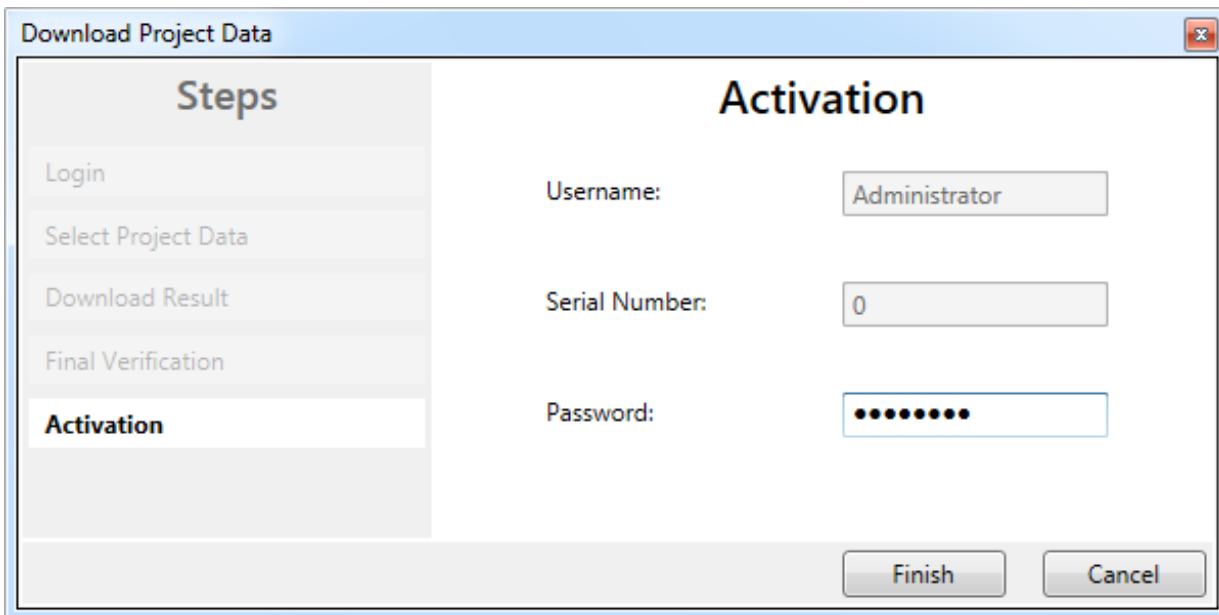

Fig. 69: Download Project Data – The Activation dialog

In the *Activation* dialog the user re-enters the password to activate the safety project on the EL6910/EJ6910 or the logic component. Use the *Finish* button to complete the download of the safety project.

⚠ WARNING

Verification of the input and output process data

After downloading the safety-related program to the TwinSAFE logic, the user must check that the input and output process data of the TwinSAFE logic are plausible, within the valid value range and in the expected magnitude. This is especially true for analog signals, which are transmitted via e.g. PROFIsafe, FSoE sensors, TwinSAFE SC terminals or external control systems to the TwinSAFE logic. It is particularly important to check whether the device uses the Motorola or the Intel format or Big or Little Endian.

Project data	Description
Safe Logic Data	Safe Logic Data contains the safety related program.
Mapping Data	Mapping Data contains the link data for inputs, outputs, function blocks, connections etc.
Parameter Data	Parameter Data contains the safe user parameters that are stored on the TwinSAFE Logic. These can be safe substitute values and the user parameters of the connections.
Info Data	Info Data contains the settings which Info Data for connections, function blocks, groups etc. are activated and have to be filled by the TwinSAFE Logic.

i Info Data of the safety project

The Info Data will NOT take effect to the calculation of the project CRC. This allows the Info Data to be changed at a later stage without changing the project CRC.

If the Info Data for an existing project are changed, a project download including at least the Info Data must be carried out, despite the fact that the CRC is unchanged, otherwise the Info Data will not be filled. In addition, the TwinCAT configuration must be activated so that the process image size in TwinCAT matches the expected size within the TwinSAFE Logic.

4.4.8 Online Mode

In Online mode  the current values of the safety project are displayed. A green color change indicates logical 1 within the SAL worksheet and the variable mapping. No color change means logical 0.

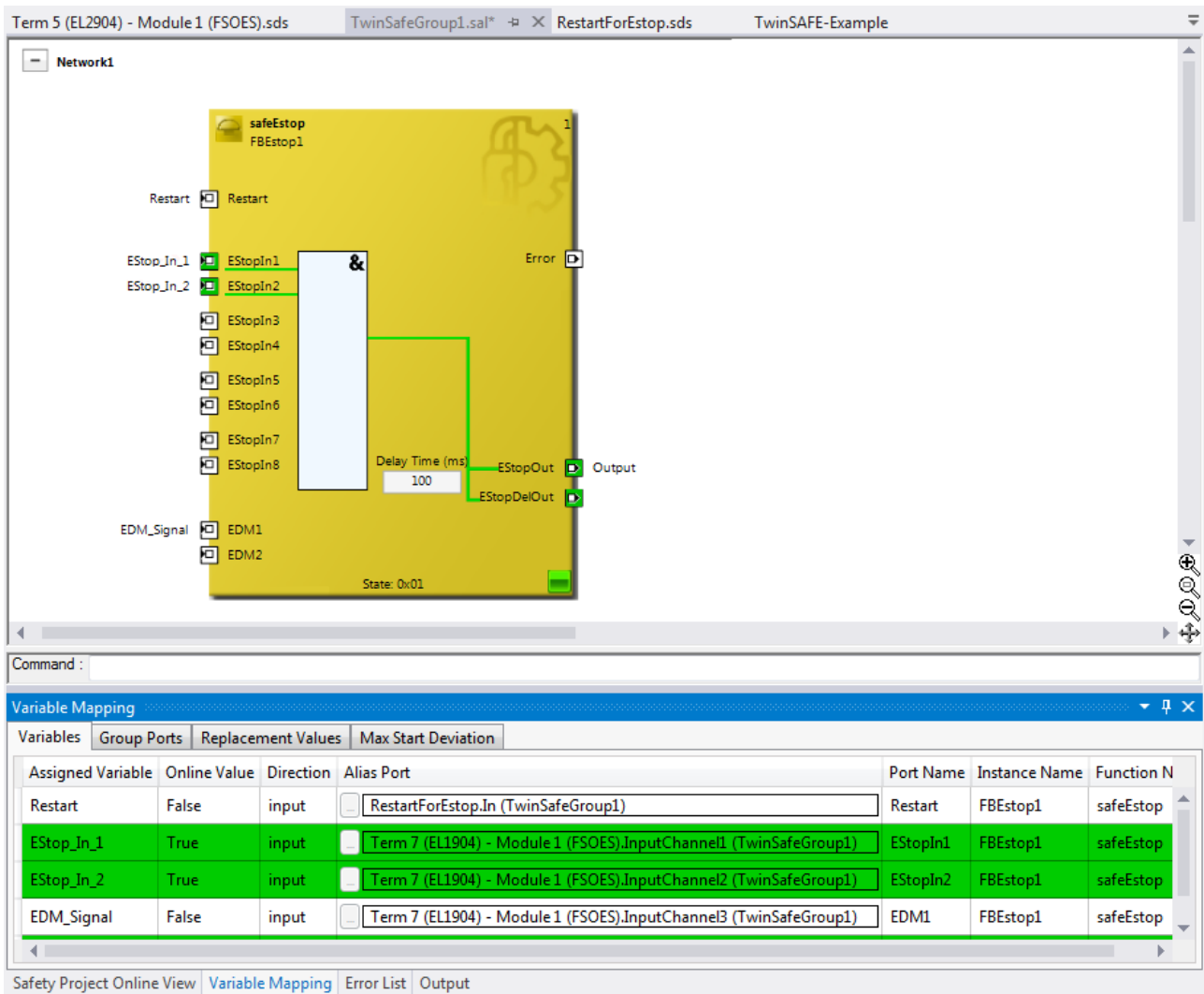
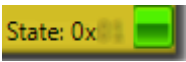
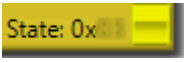
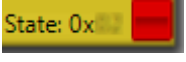

Fig. 70: SAL worksheet and variable mapping in online mode

On each function block the current FB state is shown as text and in the form of an icon. The different states are listed in the FB documentation. The following table describes the icons.

FB Icon	Description
	FB State: RUN In RUN state no error is present, and the output of the FB is set.
	FB State: SAFE In SAFE state no error is present, and the output of the FB is NOT set.
	FB State: ERROR/STOP In ERROR/STOP state an FB error is present or the FB is still in STOP state. This is the case if the group has not yet been started.

In addition, the online display can be extended by displaying analog and digital values. To this end the function can be enabled or disabled by selecting *Show Online Values* from the context menu in the SAL worksheet.

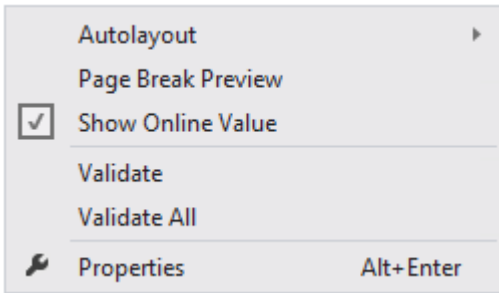

Fig. 71: Activation of Show Online Values

In online mode the analog and digital values are then displayed as text next to the respective variables.

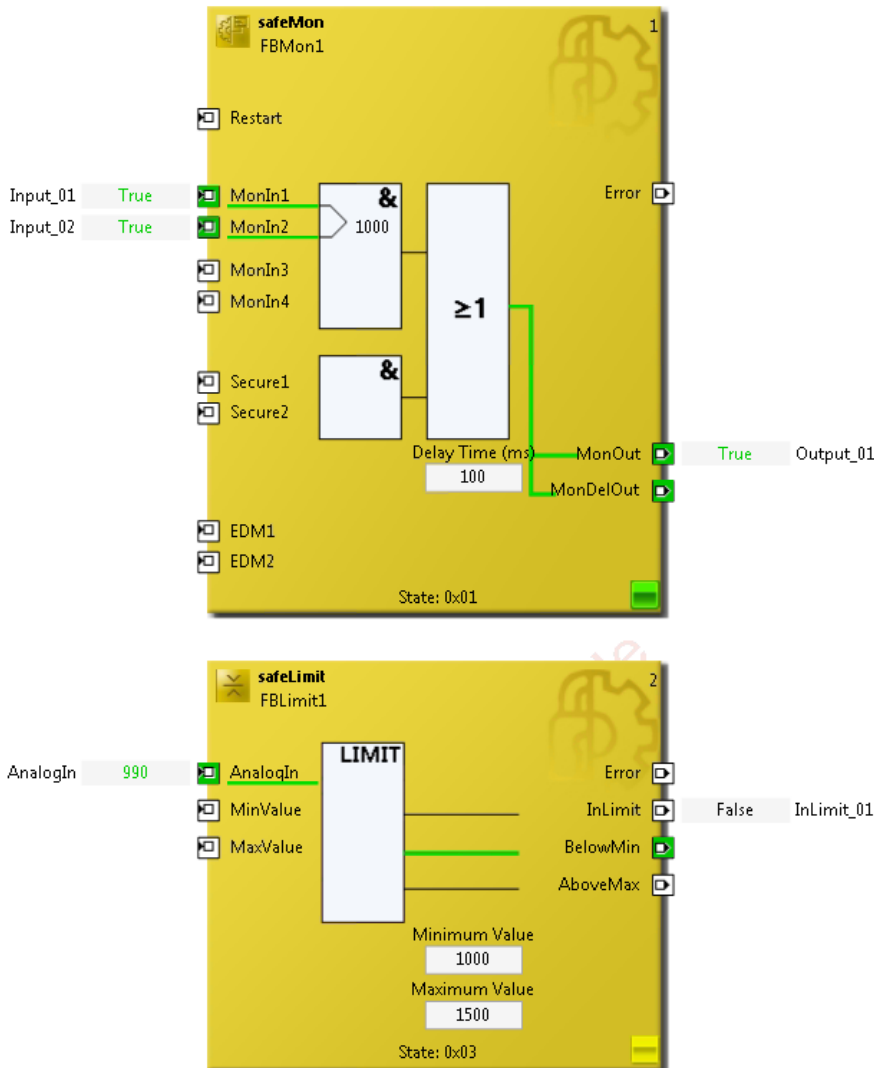

Fig. 72: Display of the analog and digital values in online mode

Detailed information about the whole safety project is shown on the *Safety Project Online View* tab. Any errors in the connections or function blocks are displayed in plain text.

Safety Project Online View	
Name	Value
<ul style="list-style-type: none"> ▲ TwinSafeGroup1 <ul style="list-style-type: none"> State Diag ▲ Inputs <ul style="list-style-type: none"> RUN Error Acknowledgement ▲ Outputs <ul style="list-style-type: none"> Fb Err Com Err Other Err ▲ Alias Devices <ul style="list-style-type: none"> ▲ Term 5 (EL2904) - Module 1 (FSOES) <ul style="list-style-type: none"> State ▲ Diag <ul style="list-style-type: none"> xxxx 0000₂ 1xxx xxxx₂ ▲ Term 7 (EL1904) - Module 1 (FSOES) <ul style="list-style-type: none"> State ▲ Diag <ul style="list-style-type: none"> xxxx 0000₂ 1xxx xxxx₂ ▲ Function Blocks <ul style="list-style-type: none"> ▲ FBStop1 (safeEstop) <ul style="list-style-type: none"> State ▲ Diag <ul style="list-style-type: none"> xxxx xxxx xxx1 xxxx₂ 	State: ERROR (0/2 connections not running, 1/1 functions blocks in error) 0x04 (ERROR) 0x01 (00000001 ₂), FB Error 1 0 1 0 0 Conn-Name: Message_2, Conn-No: 1 0x68 (Data) 0x80 (10000000 ₂) No Diagnosis info Master reports Failsafe Value active Conn-Name: Message_3, Conn-No: 2 0x68 (Data) 0x80 (10000000 ₂) No Diagnosis info Master reports Failsafe Value active 0x04 (ERROR) 0x0010 (0000000000010000 ₂) EDM monitoring error EDM1
Safety Project Online View Variable Mapping Error List Output	

Fig. 73: The Safety Project Online View tab

4.4.9 New features in TC3.1 Build 4022

In the TwinCAT Version 3.1 Build 4022 some extensions have been implemented for the TwinSAFE editor. With the release of the TwinCAT version, these are available to the user. This chapter lists the new features.

4.4.9.1 Group status

The status of the TwinSAFE group is displayed as a color-coded frame in online mode.

The RUN state is marked with a green one, the ERROR state with a red frame, and all other states with a blue frame.

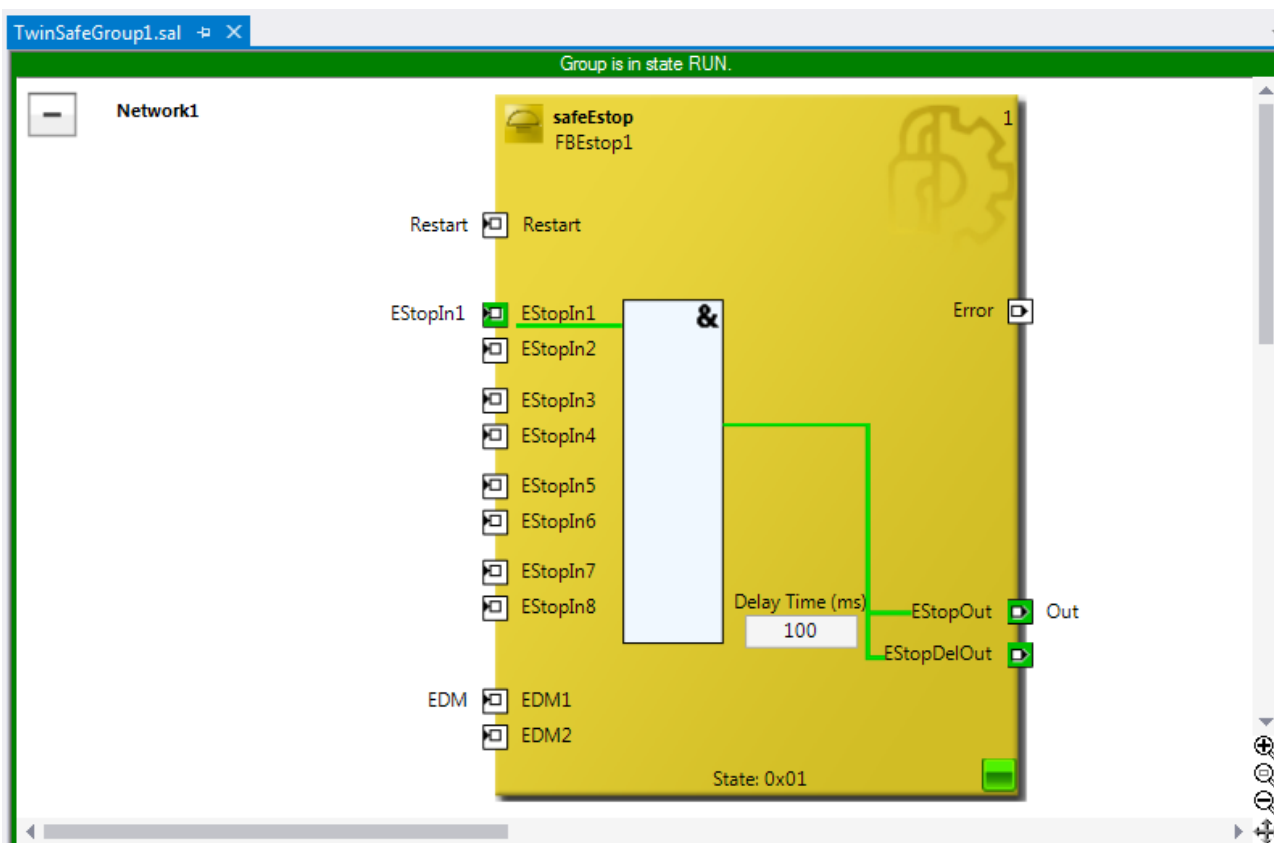

Fig. 74: Group Status Online RUN

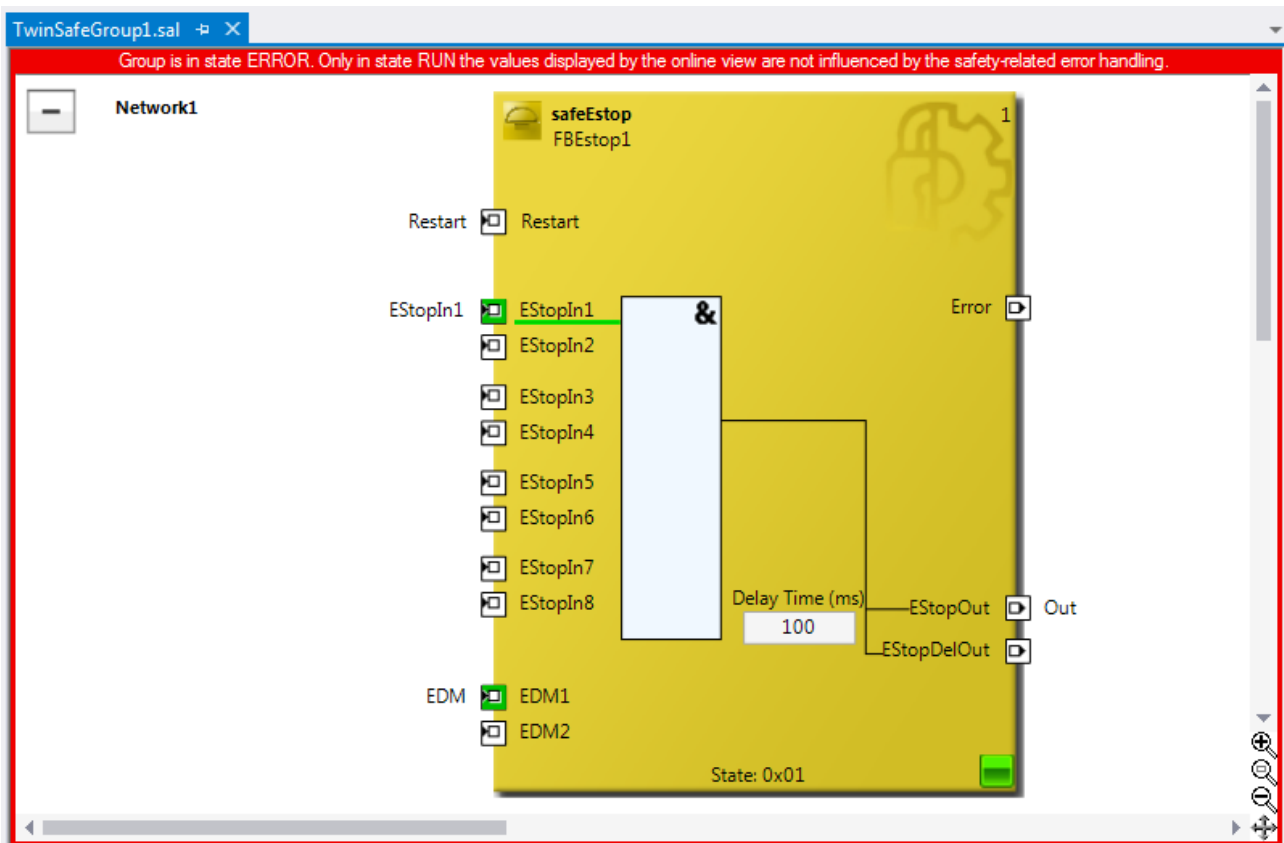

Fig. 75: Group Status Online ERROR

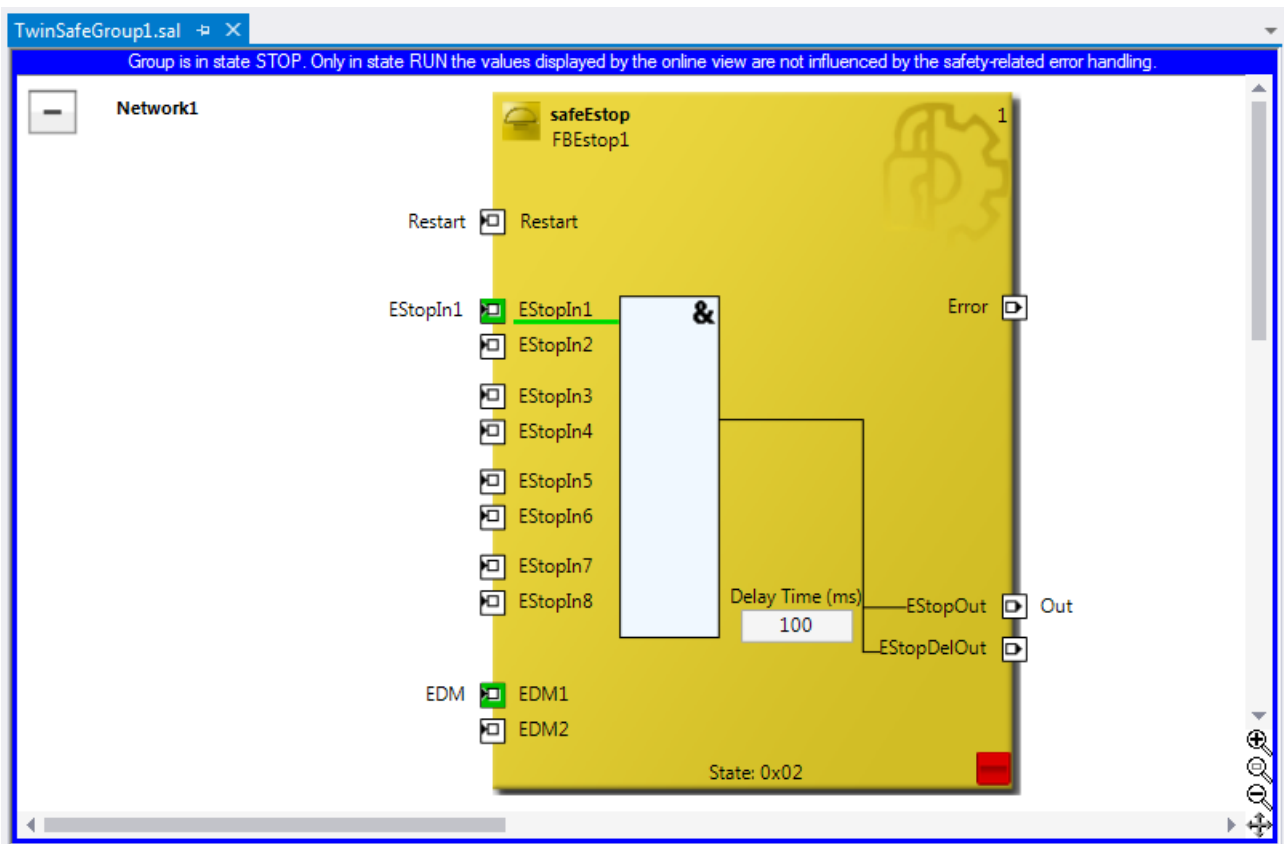

Fig. 76: Group Status Online STOP

4.4.9.2 Online view group ports

In online mode the group inputs and outputs are marked according to their signal status. A logical 1 of the signal is represented with a green background, a logical 0 with a white background. Error information is displayed with a red background.

Group Port	Online Value	Direction	Alias Port
Err Ack	False	input	ErrAck.In (TwinSafeGroup1)
Run/Stop	True	input	Run.In (TwinSafeGroup1)
Module Fault	False	input	
Com Err	True	output	
FB Err	True	output	
Other Err	False	output	
Com Startup	False	output	
FB Deactive	False	output	
FB Run	True	output	
In Run	False	output	

Fig. 77: Online View Group Ports

4.4.9.3 Group templates

The user has a choice between three templates.

The templates differ by the number of already existing links (none, ErrAck created and linked to group port, ErrAck and Run created and linked to group ports).

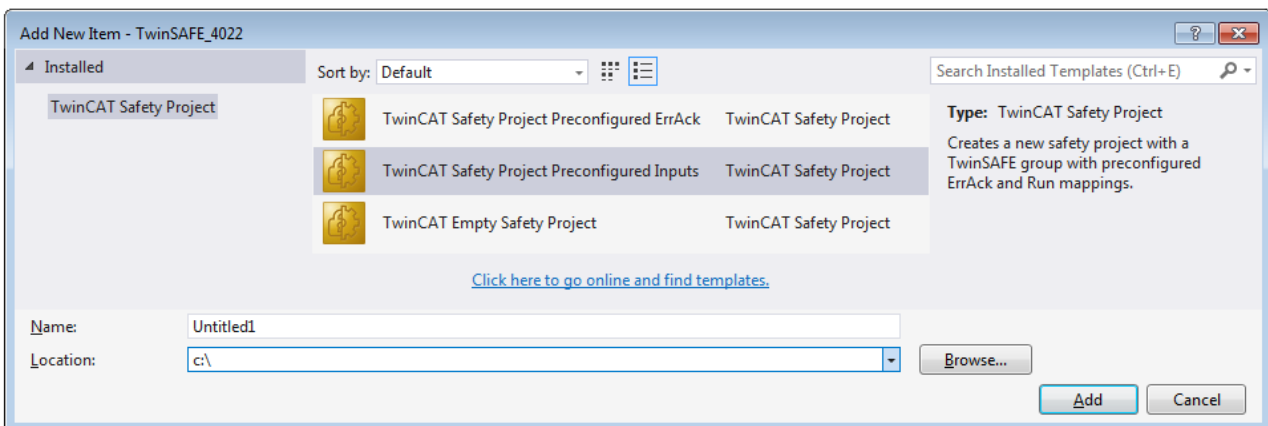

Fig. 78: Templates for Safety Projects

4.4.9.4 Networks collapsable

The networks defined in a TwinSAFE group can be collapsed.

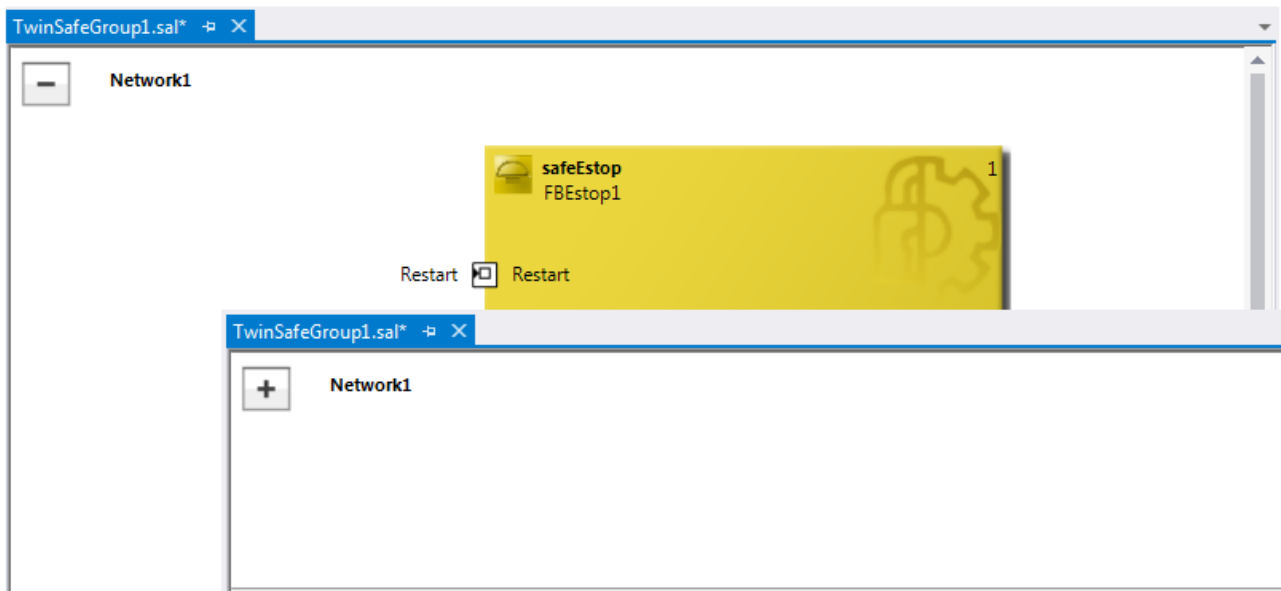

Fig. 79: Collapsing networks

4.4.9.5 Subfolder Alias Devices

Under the node *Alias Devices*, further subfolders can be created. After the subfolder has been created, it can be renamed, here for example to *Drives*.

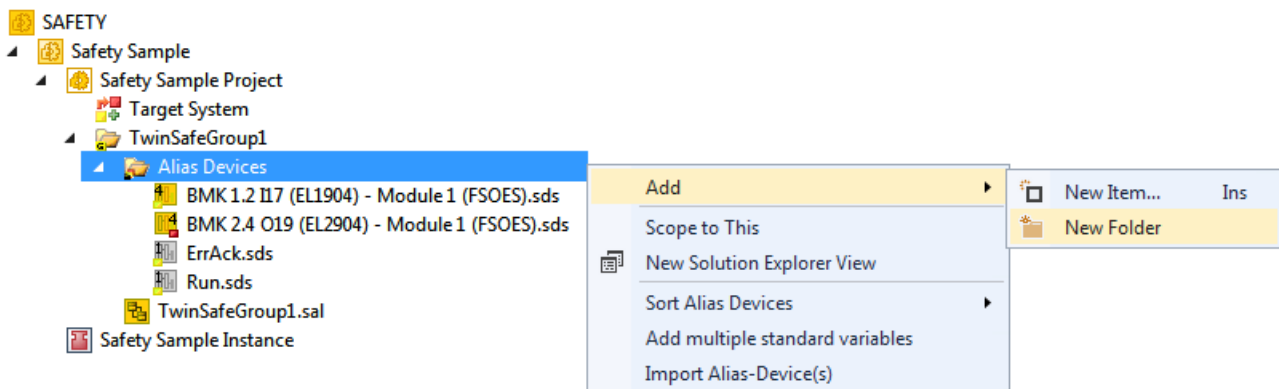

Fig. 80: Adding a subfolder

After adding a subfolder, *Alias Devices* can be added in this folder.

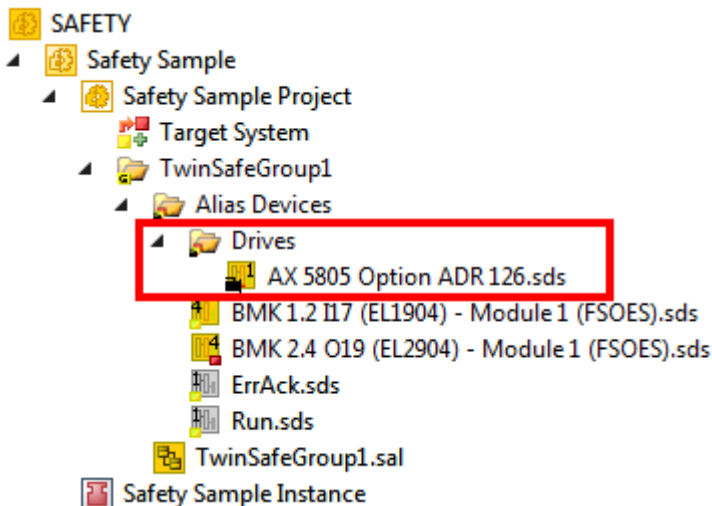

Fig. 81: Subfolder e.g. Drives

4.4.9.6 Goto linked element

The entry *Goto Linked Element* can be called via the context menu. All links and variables used on that port are listed. Selecting an entry triggers a jump to the corresponding position in the network, a TwinSAFE group or variable mapping.

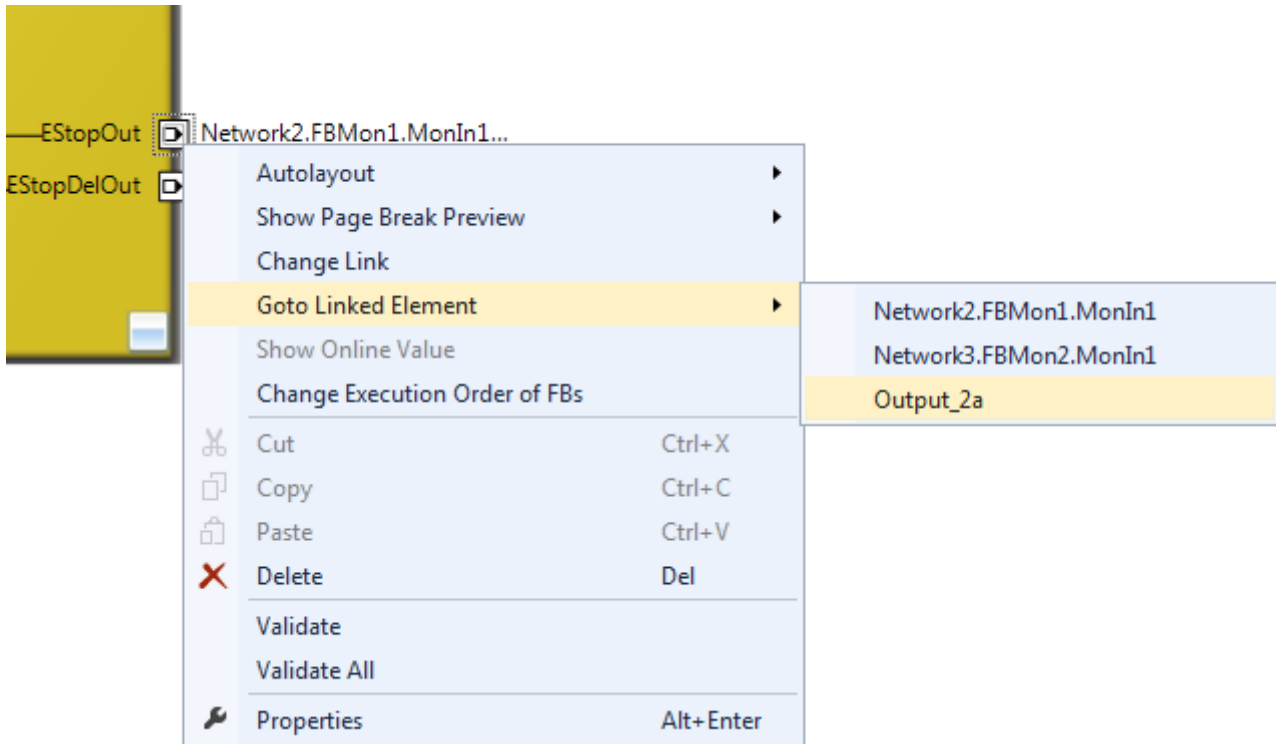

Fig. 82: Goto Linked Element

4.4.9.7 Path view to linked signal

The *Linking* tab of the *Alias Devices* displays the links to the PLC and to the I/O devices. The name in the process image of the TwinSAFE logic is displayed under the entry *Name*.

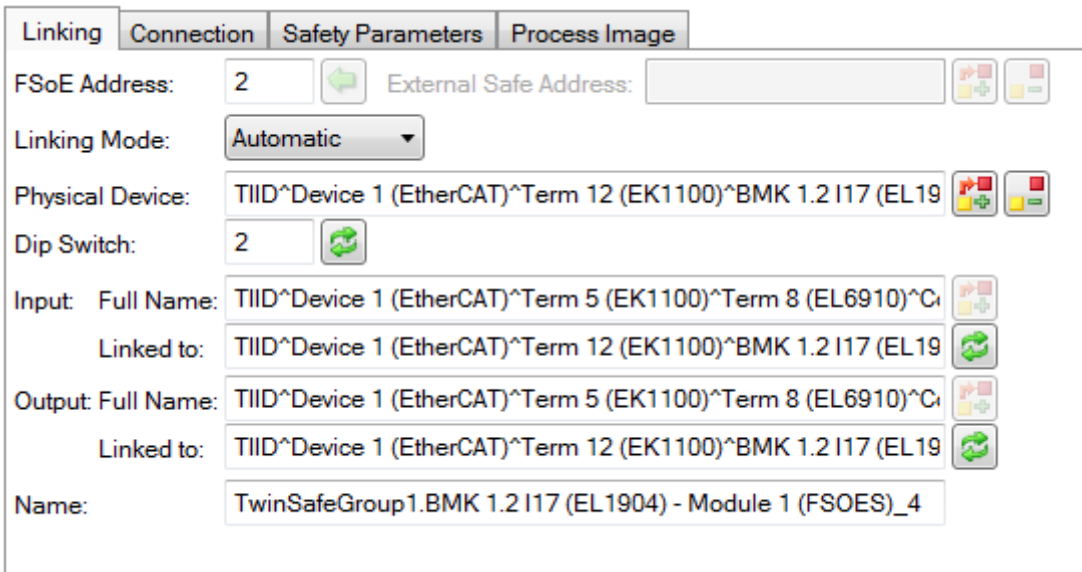

Fig. 83: Path view for safety Alias Devices

For the *Standard Alias Devices*, the path to the signal below the TwinSAFE logic (full name), the link to the PLC (Linked to), and the name in the process image of the TwinSAFE logic are displayed.

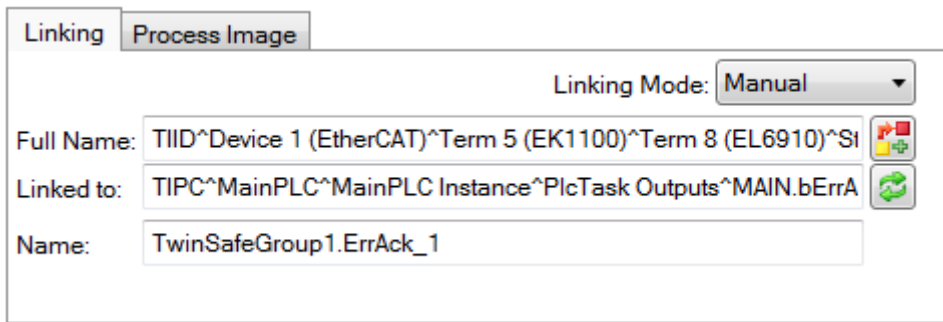

Fig. 84: Path view for Standard Alias Devices

4.4.9.8 Multiline comments

Comments in the TwinSAFE project may now be multiline.

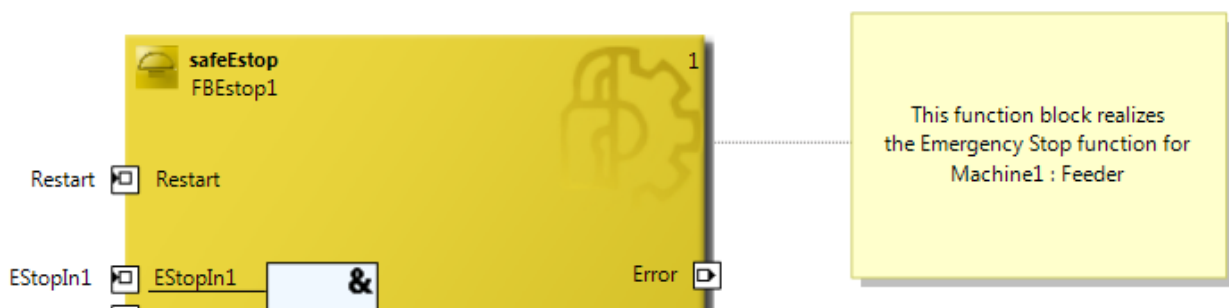

Fig. 85: Multiline comments

4.4.9.9 Names of Alias Devices in the process image

The user has now the option of adapting the naming of process data below the TwinSAFE logic in the I/O tree. For this purpose, checkboxes are available on the *Target System* dialog to accept the naming of TwinSAFE connections and standard inputs and outputs from the respective *Alias Device* names.

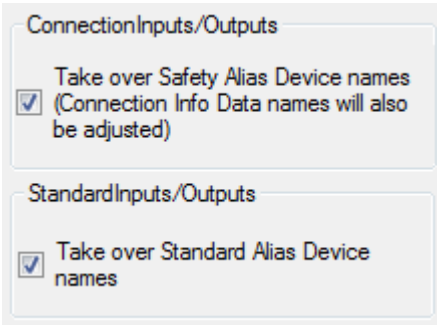

Fig. 86: Properties under Target System

After the checkboxes are set, the names of the alias devices are taken.

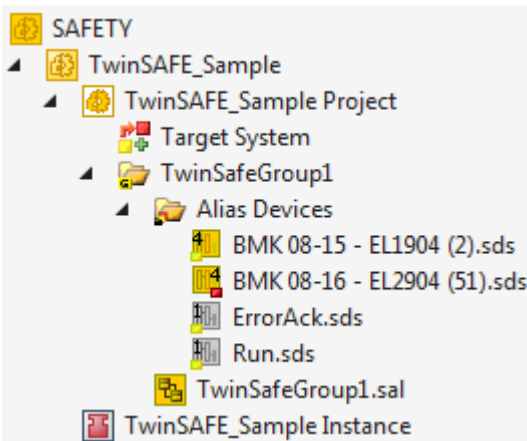

Fig. 87: Take Alias Device Name - Safety Project

In the I / O tree below the TwinSAFE logic, the project is shown in the following screenshot. The name consists of the group name, alias device name, and a running index.

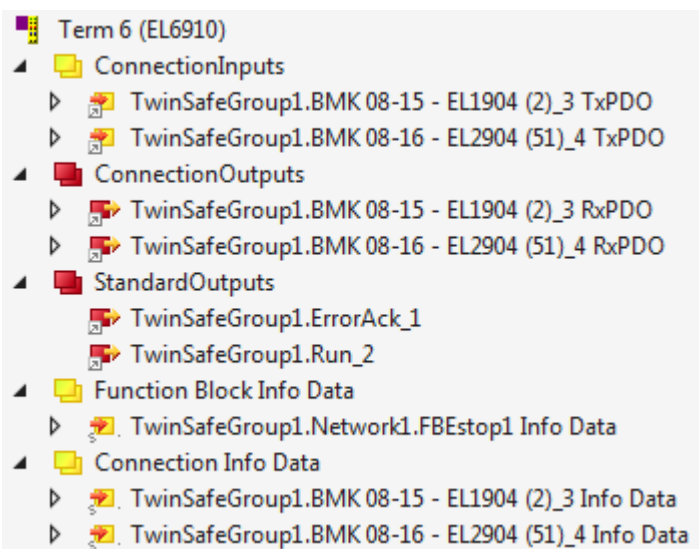

Fig. 88: Take Alias Device Name - TwinSAFE logic process image

4.4.9.10 Project settings - Verification

The project settings can be found below the target system.

Safe Address Verification

The *Safe Address Verification* entry is used to set how the safety addresses are checked.

- Project wide unique (recommended) - Unique safety addresses within the entire solution
- Similar to TwinCAT 2 - Unique addresses per TwinSAFE Logic
- Allow multiple usage - Multiple safety addresses are possible (user evaluation required)

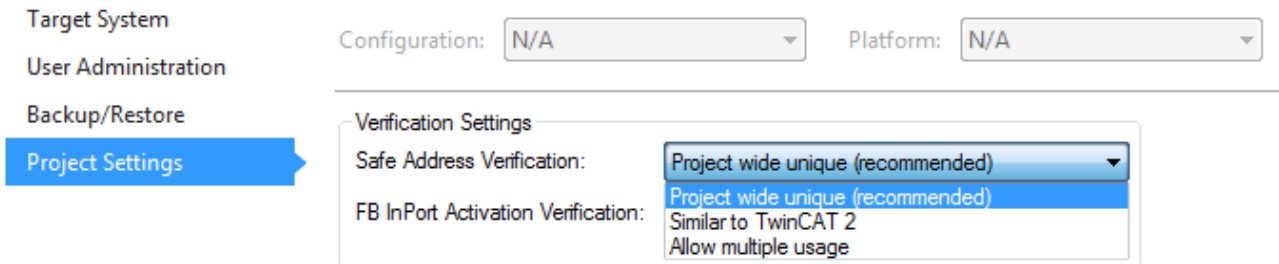

Fig. 89: Safe Address Verification

FB InPort Activation Verification

The *FB InPort Activation Verification* entry is used to set how the input ports of TwinSAFE FBs are checked.

- Strict activated & connected (recommended) - Each activated port must be connected, and each connected port must be activated.
- Activated or connected allowed - If a port is only activated or only connected, this does not lead to an error message.

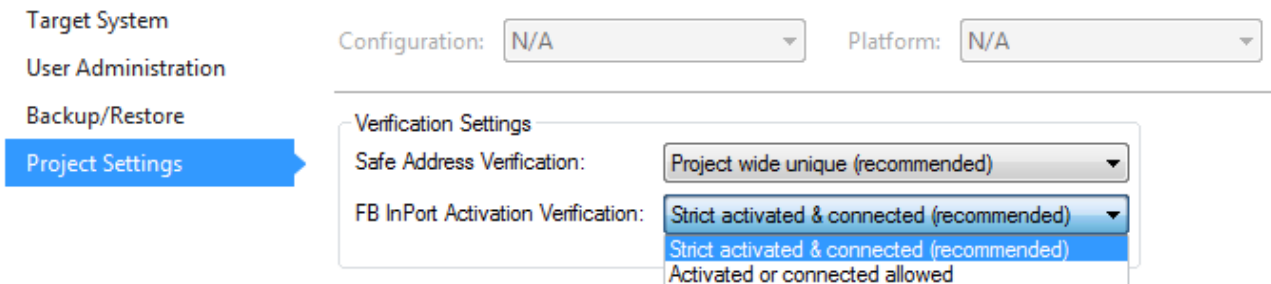

Fig. 90: FB InPort Activation Verification

NOTE

Support of project settings

The settings are supported from software version 03 of the EL6910 (SW03) and EK1960 (SW03). Furthermore, all newer logic components, such as the EL1918, are supported.

4.4.9.11 Displaying the project size

Diagnostic Properties of the project node

If the project node of the TwinSAFE project is selected, the properties under the entry Diagnostic show the current project parameters. These are e.g. the project size in bytes, the number of connections, the number of function blocks, or the number of TwinSAFE groups.

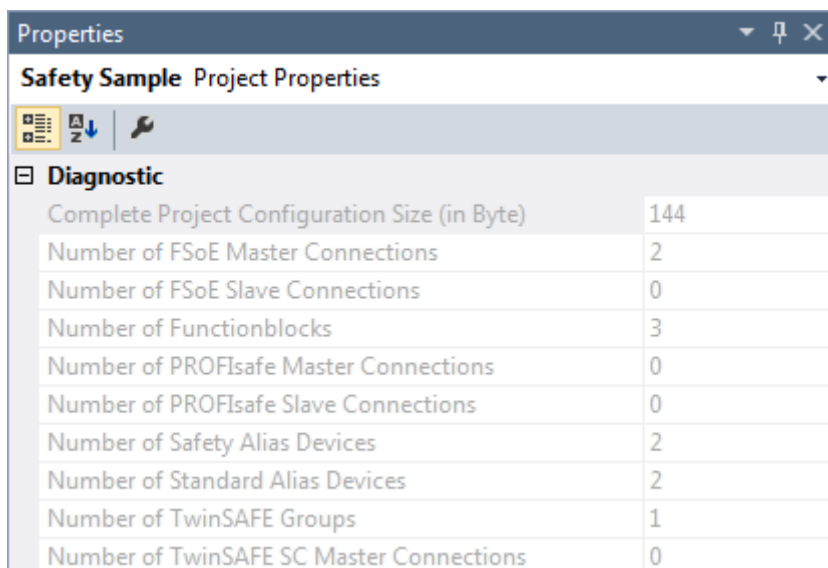

The screenshot shows a 'Properties' window titled 'Safety Sample Project Properties'. Under the 'Diagnostic' section, the following data is displayed:

Complete Project Configuration Size (in Byte)	144
Number of FSoE Master Connections	2
Number of FSoE Slave Connections	0
Number of Functionblocks	3
Number of PROFI-safe Master Connections	0
Number of PROFI-safe Slave Connections	0
Number of Safety Alias Devices	2
Number of Standard Alias Devices	2
Number of TwinSAFE Groups	1
Number of TwinSAFE SC Master Connections	0

Fig. 91: Project Properties - Diagnostic

Diagnostic Properties of the group node

If the group node of the TwinSAFE project is selected, the properties under the entry Diagnostic display the current TwinSAFE group parameters. These are e.g. the number of connections, the number of function blocks, or the number of standard signals.

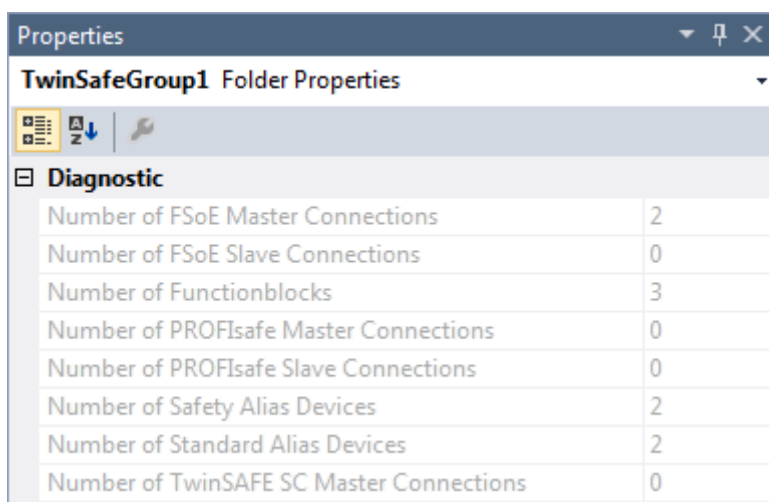

The screenshot shows a 'Properties' window titled 'TwinSafeGroup1 Folder Properties'. Under the 'Diagnostic' section, the following data is displayed:

Number of FSoE Master Connections	2
Number of FSoE Slave Connections	0
Number of Functionblocks	3
Number of PROFI-safe Master Connections	0
Number of PROFI-safe Slave Connections	0
Number of Safety Alias Devices	2
Number of Standard Alias Devices	2
Number of TwinSAFE SC Master Connections	0

Fig. 92: Group Properties - Diagnostic

4.4.9.12 Copy and Paste for FBs and comments

The copy and paste function refers to function blocks, comments and connections between function blocks. The copied variable names and links remain unchanged, the FB instances are automatically incremented (here FB_Estop1 becomes FB_Estop2).

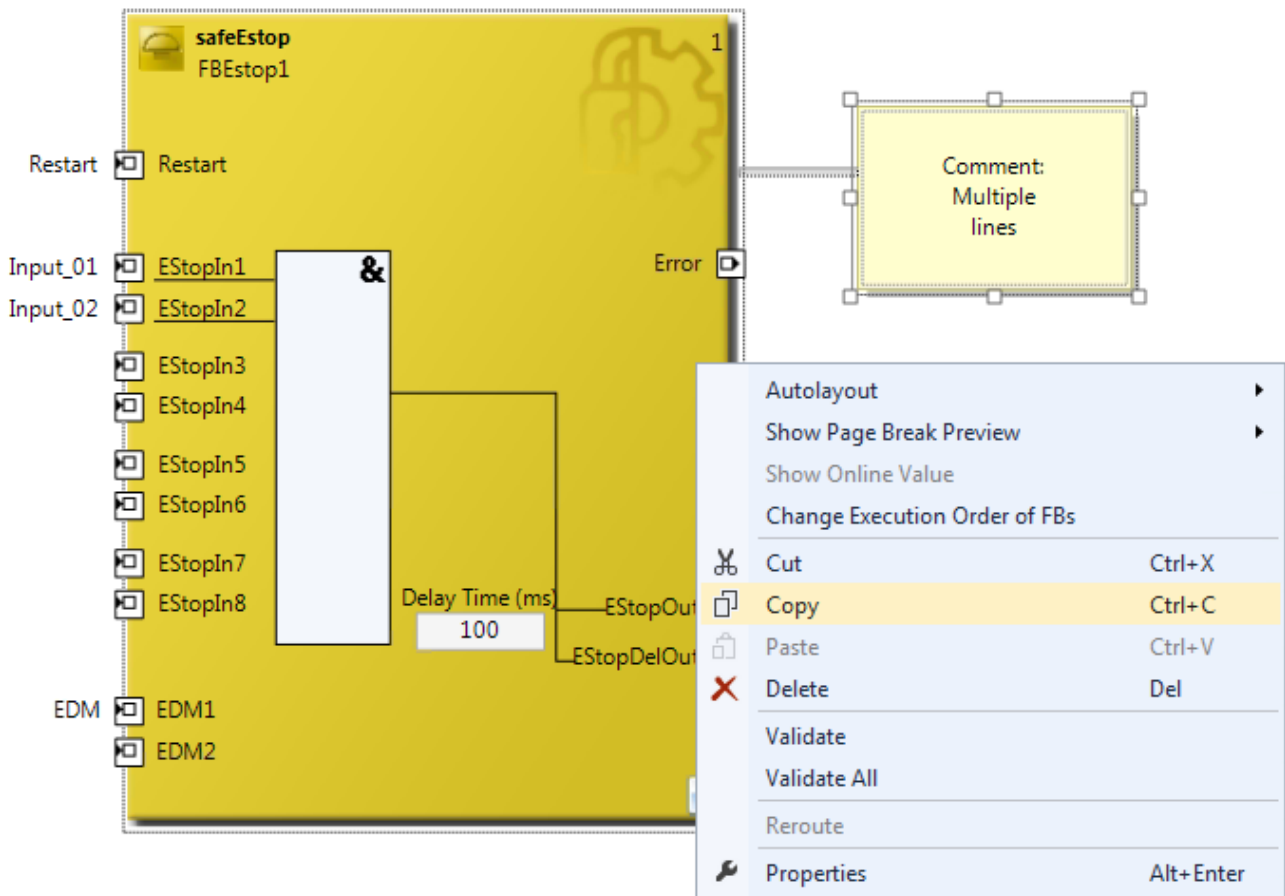

Fig. 93: Copying the data

After inserting the data, the following message appears. The user may have to adjust copied variable names.

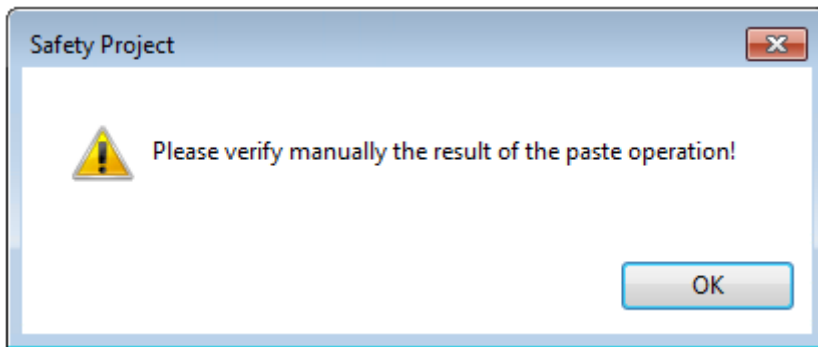

Fig. 94: Message box after inserting the data

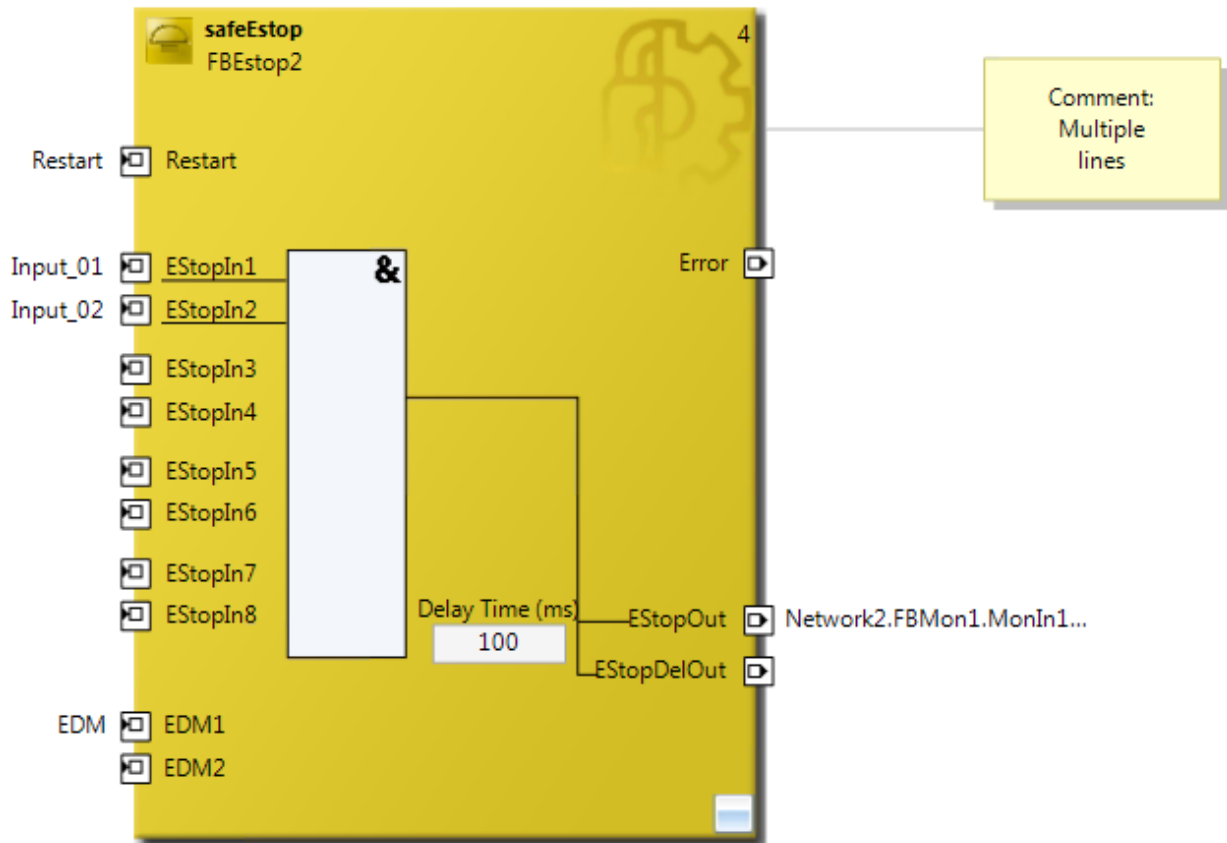

Fig. 95: Inserted data

Here, in the example, the user must adapt the links of the output EStopOut and change the variable names Restart, Input_01, Input_02 and EDM so that no duplicate names are assigned.

4.4.9.13 Global settings in Visual Studio

Options can be selected under the Tools menu in Visual Studio. In these options, settings for the TwinSAFE environment can be made.

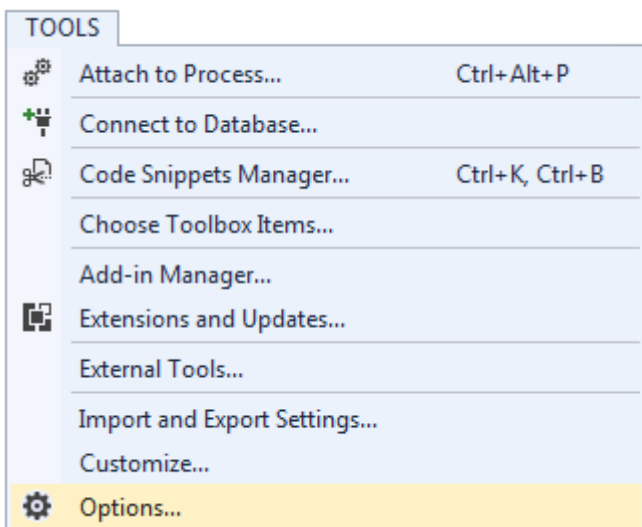

Fig. 96: Visual Studio - Menu Tools / Options

Under *TwinCAT / TwinSAFE Environment / Default Info Data* you can configure which info data should be activated automatically when TwinSAFE projects, groups, connections or FBs are created.

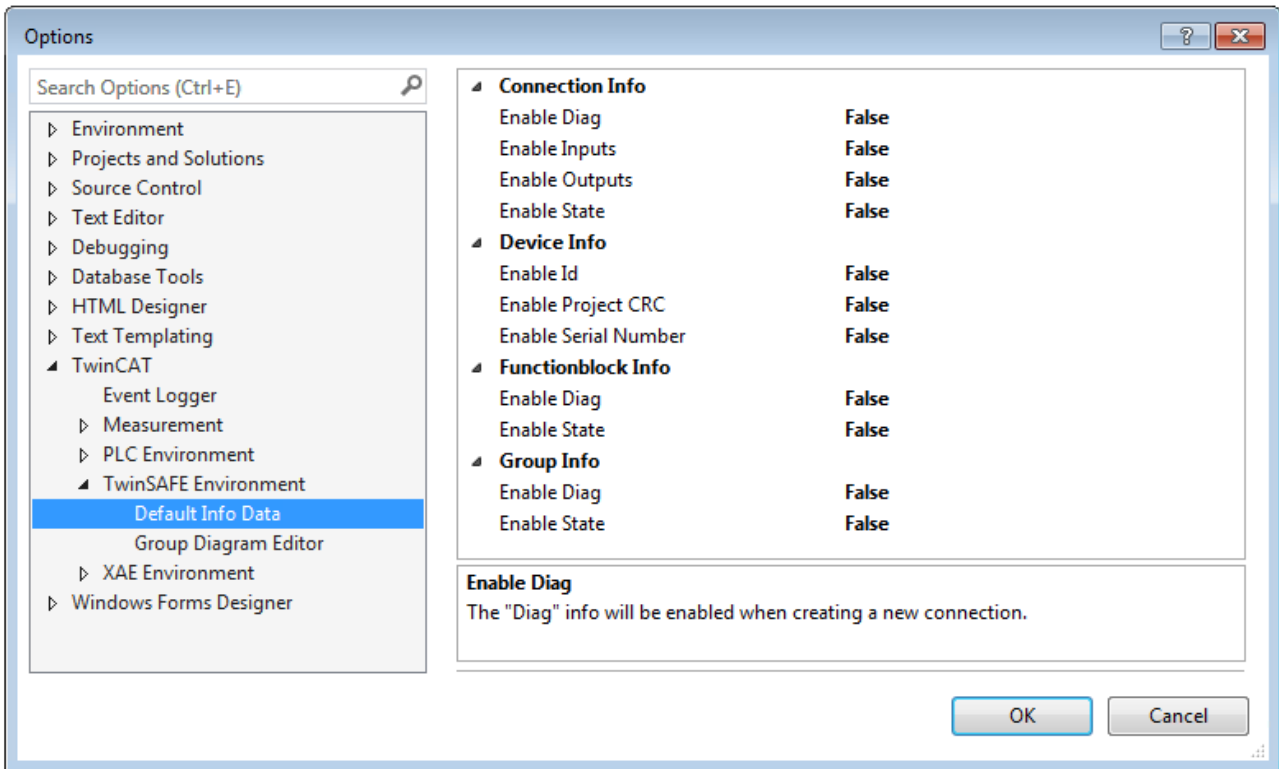

Fig. 97: Global setting - Default Info Data

Under *TwinCAT / TwinSAFE Environment / Group Diagram Editor* you can specify whether the Undo / Redo function should automatically zoom and scroll into the area that has changed.

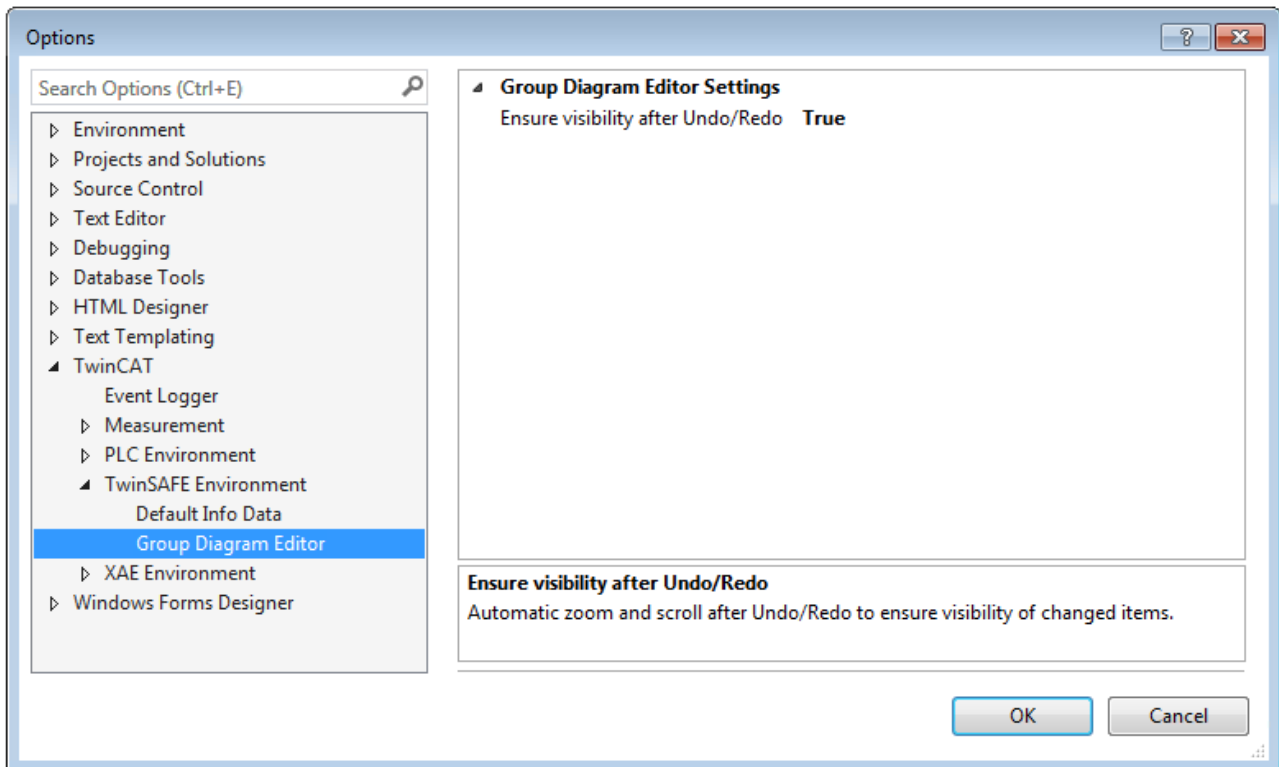

Fig. 98: Global Setting - Group Diagram Editor

4.4.9.14 Sorting

Setting the execution order of the groups via dialog

The context menu of the project node can be used to access the execution order of the TwinSAFE groups.

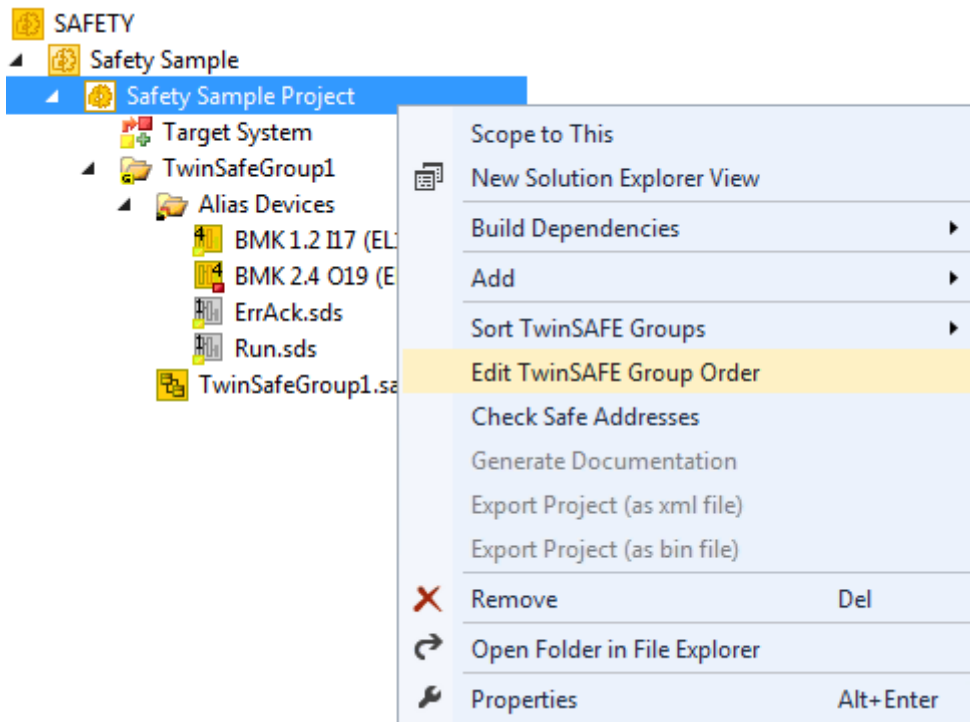

Fig. 99: Context menu - Edit TwinSAFE Group Order

By selecting a group and then holding and dragging an entry with the mouse, the execution order of the groups can be changed. The new order is accepted with the OK button.

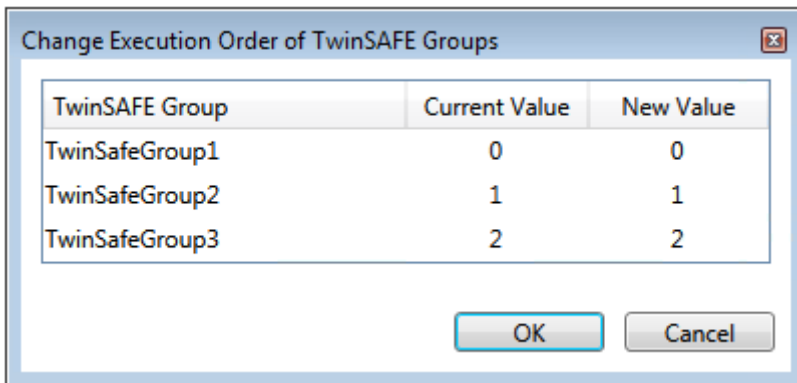

Fig. 100: Execution order for TwinSAFE groups

Sorting of Alias Devices

You can use the context menu of the Alias Devices node to configure the display order of the alias devices.

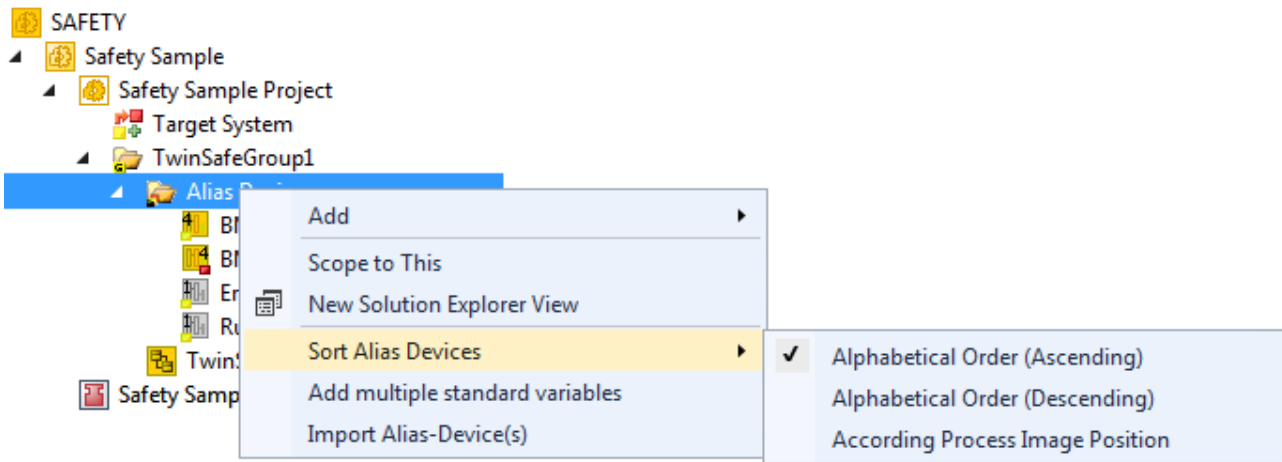

Fig. 101: Sorting of Alias Devices

Sorting of FBs (execution order)

The execution order of the function blocks can be accessed via the context menu within the graphical worksheet.

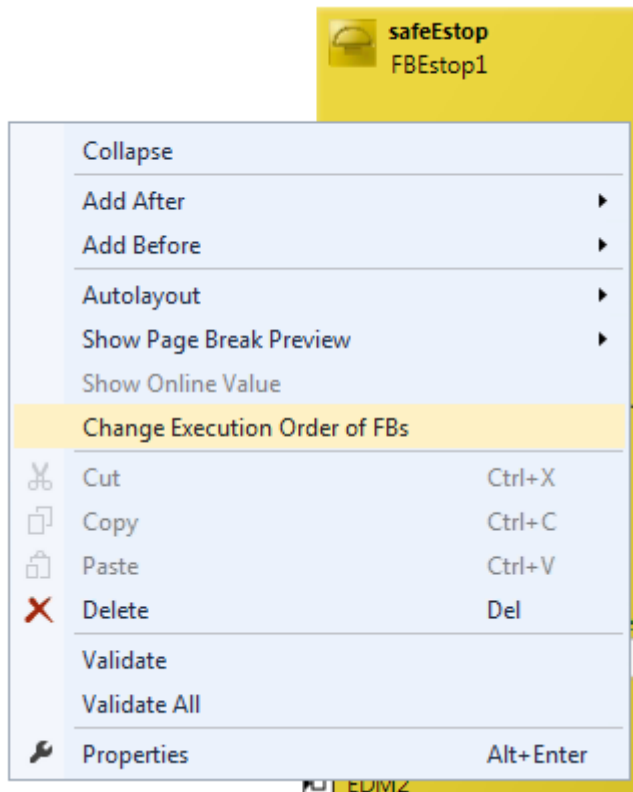

Fig. 102: Context Menu - Change Execution Order of FBs

By selecting an FB and then holding and dragging an entry with the mouse, the execution order of the function blocks can be changed. The new order is accepted with the OK button.

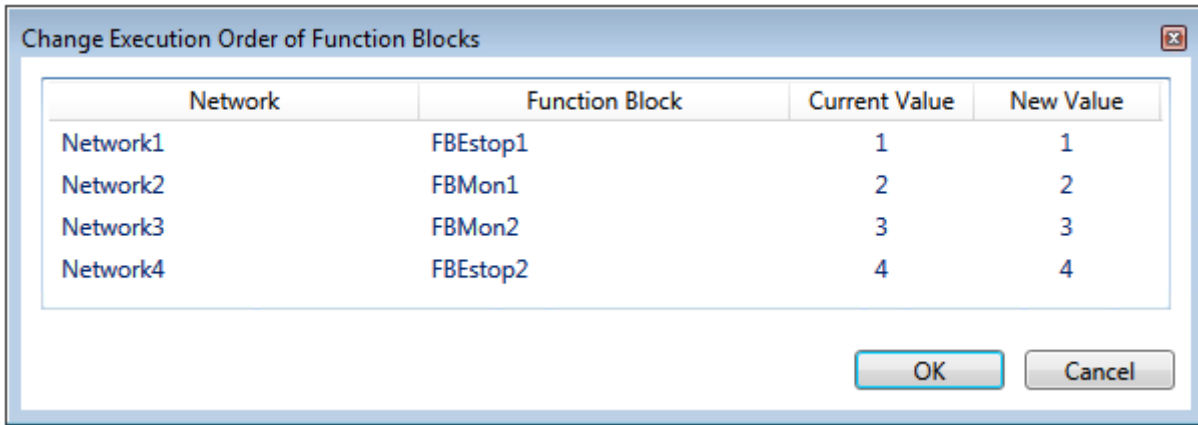

Fig. 103: Execution order FBs

4.4.9.15 Direct mapping of local I/Os

If a TwinSAFE Logic has local inputs and outputs, e.g. an EK1960, an assignment to safe and non-safe signals can be made by the user via the *Internal Direct Mapping* tab of the alias device. These direct assignments have the advantage that no logic program has to be created by the user for this purpose.

To be able to use the internal direct mapping, the Linking mode of the Alias Device must be set to *local*.

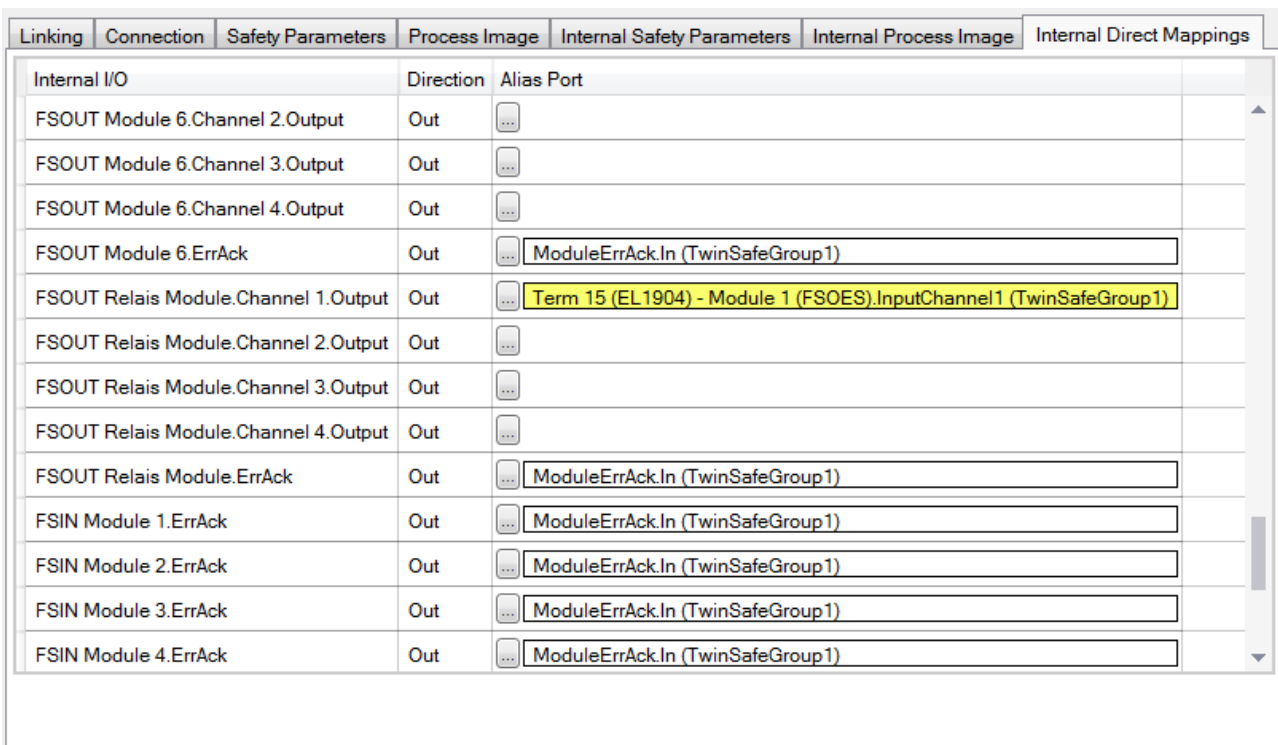

Fig. 104: Dialog - Internal Direct Mapping

Typical applications are linking the ErrAck signals of the modules with a Standard Alias Device or switching an output due to a safe input signal.

In the figure the relay output *FSOUT Relay Module Channel 1.Output* is switched by the safe input *Term(15) (EL1904) - Module 1 (FSOES) InputChannel 1*.

4.4.9.16 Backup/Restore settings

Backup/restore settings have been extended so that TwinSAFE logic components can also be used to store a TwinSAFE project CRC. The following table describes the settings for each TwinSAFE connection listed in the Backup/Restore dialog.

Checkbox	Description	Available in
Store Project CRC in Slave	<p>Only active when FSoE Connection Type is set to Master.</p> <p>The CRC of the local project is stored on the target slave and can be used for the backup/restore mechanism.</p> <p>Now, besides the EL1904 and EL2904, TwinSAFE logics are also supported for storing the CRC.</p>	EL69xx, EL1904, EL2904, EP1908
Store Slave Project CRC in Master	<p>Only active when FSoE Connection Type is set to Master.</p> <p>If the target slave is a logic component that uses the backup/restore mechanism, the project CRC of the logic project of the target slave must be entered manually here.</p>	EL691x, EK1960, EJx9xx and newer products
Store Master Project CRC in Slave	<p>Only active if FSoE Connection Type is set to Slave.</p> <p>The FSoE master sends a CRC to be stored on the local TwinSAFE component so that it can be used for a restore function on the remote FSoE master. This checkbox can be used even if the local backup/restore function is not active.</p>	EL691x, EK1960, EJx9xx and newer products
Read Project CRC from Master	<p>Only active if FSoE Connection Type is set to Slave.</p> <p>The CRC, which is entered on the FSoE master (see Store Slave Project CRC in Master), can be read by the FSoE slave for the local restore function.</p>	EL691x, EK1960, EJx9xx and newer products

Target System Configuration: Platform:

User Administration

Backup/Restore

Project Settings Activate Backup/Restore

Available Alias Devices for Backup/Restore-Mode

Alias Device	Store Project CRC in Slave	Store Slave Project CRC in Master	Store Master Project CRC in Slave	Read Project CRC from Master
Term 13 (EL1904) - Module 1 (FSOES) (TwinSafeGroup1)	<input checked="" type="checkbox"/>	<input type="checkbox"/>	<input type="checkbox"/>	<input type="checkbox"/>
Term 15 (EL2904) - Module 1 (FSOES) (TwinSafeGroup1)	<input checked="" type="checkbox"/>	<input type="checkbox"/>	<input type="checkbox"/>	<input type="checkbox"/>
Term 16 (EL1904) - Module 1 (FSOES) (TwinSafeGroup1)	<input checked="" type="checkbox"/>	<input type="checkbox"/>	<input type="checkbox"/>	<input type="checkbox"/>
Term 17 (EL1904) - Module 1 (FSOES) (TwinSafeGroup1)	<input checked="" type="checkbox"/>	<input type="checkbox"/>	<input type="checkbox"/>	<input type="checkbox"/>
EL6910 FSoE Connection (TwinSafeGroup1)	<input checked="" type="checkbox"/>	0x67A6	<input type="checkbox"/>	<input type="checkbox"/>

Restore, if from FSoE-Connections have the correct CRC stored

User Administration Restore User Administration

Fig. 105: Backup/Restore settings

4.4.9.17 Multiple download

New TwinSAFE products typically also support the use of a local logic function. Thus the number of necessary downloads can increase significantly. In TwinCAT 3.1 Build 4022 it is now also possible to load several safety projects simultaneously onto the corresponding logic components via the *Multiple Download* feature.

This feature can be selected in the toolbar and via the TwinSAFE menu.



Fig. 106: Multiple Download - Toolbar

After selecting the function, select the projects for which a simultaneous download of the safety project is to be carried out and confirm the selection with the *Next* button.

NOTE

Multiple downloads for different users

If safety projects are to be loaded onto logic components with different users, the multiple download with selection of the respective suitable logic components must be carried out several times.

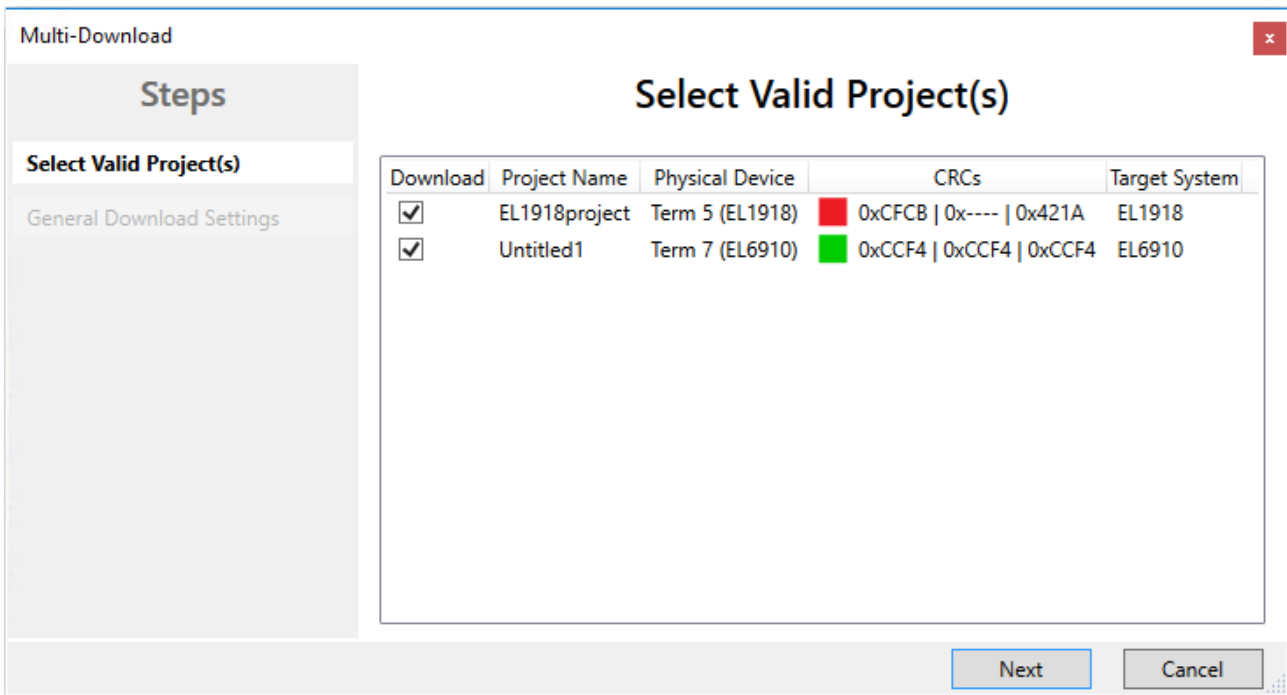

Fig. 107: Multiple Download - Selection of projects

In the general settings, enter the user name and password and check the displayed serial numbers of the logic components. Use the *Verified* checkbox to confirm that the correct serial numbers are displayed and used. Click the *Next* button to start the download.

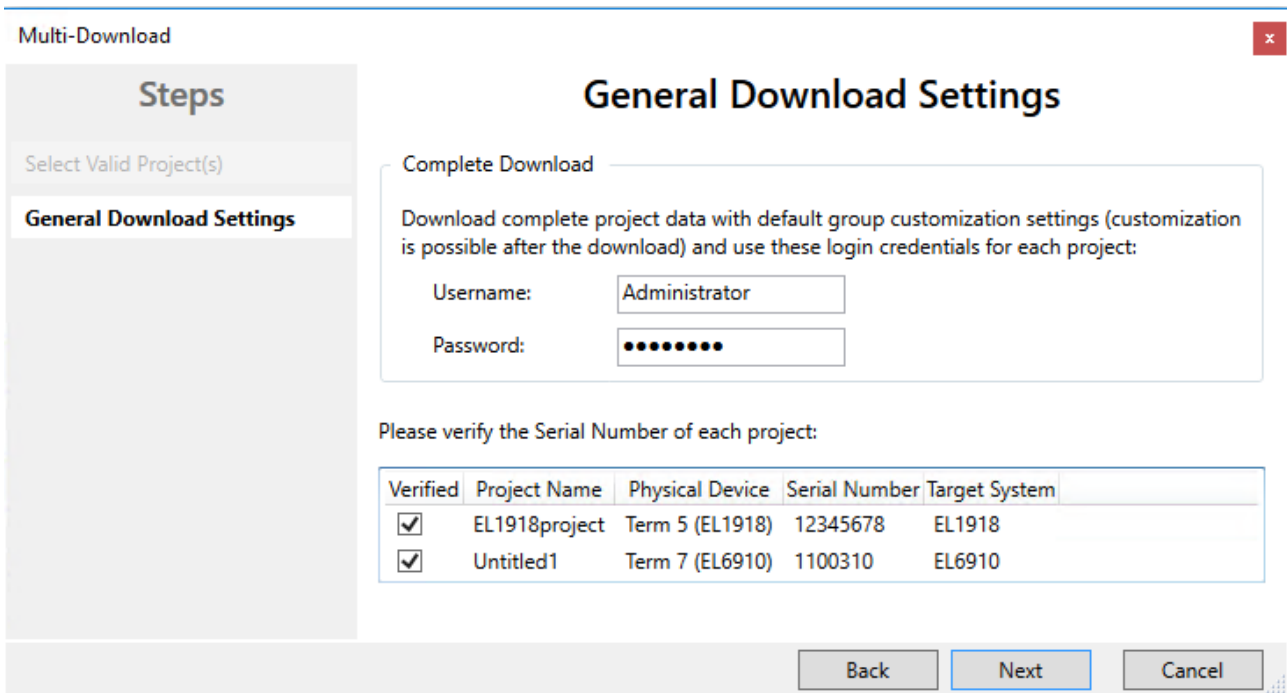

Fig. 108: Multiple Download - general settings

In the Final Verification dialog confirm the correctness of the online and calculated CRCs by checking the checkbox. Click the *Next* button to switch to the Activation dialog.

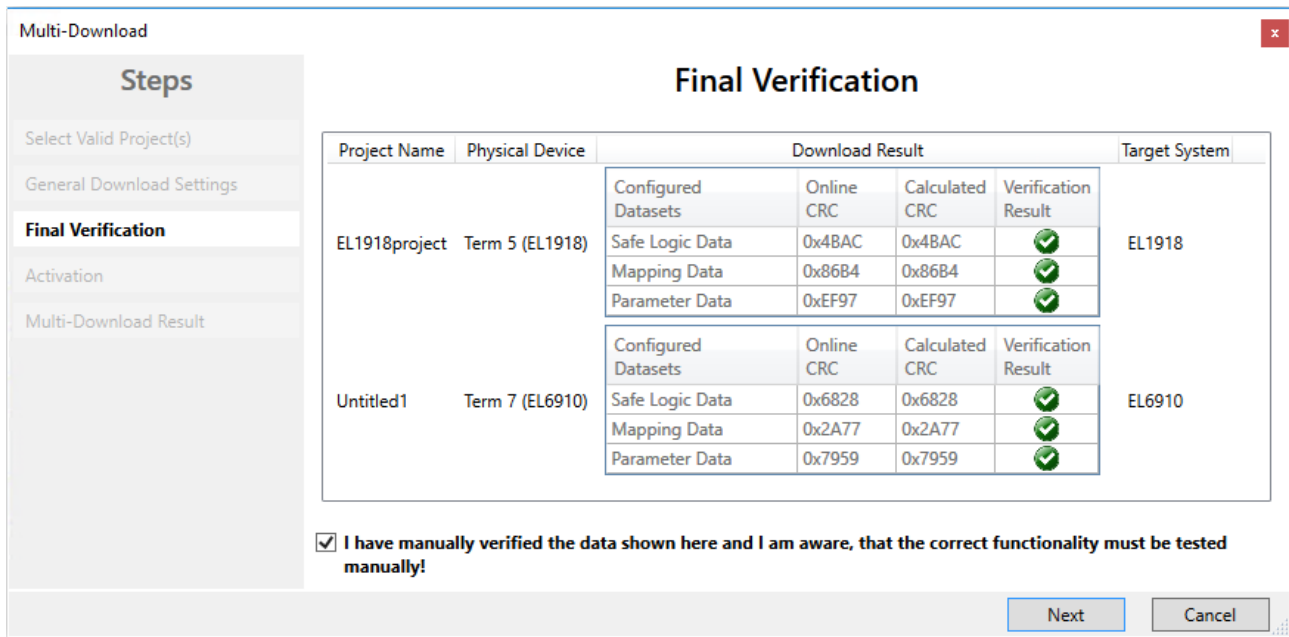

Fig. 109: Multiple Download - Final Verification

To activate the safety projects, enter the password for the current user again and confirm with the *Next* button.

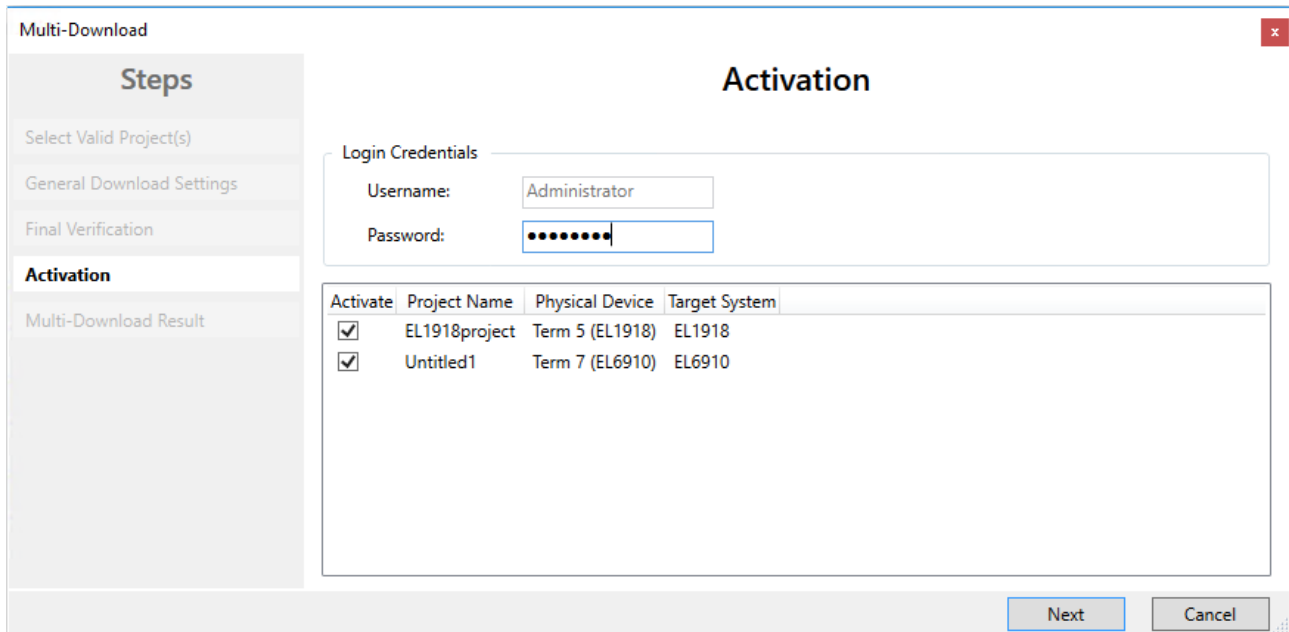

Fig. 110: Multiple Download - Activation

The Result dialog lists all safety projects with the status *Activated* and *Downloaded*. Click the *Finish* button to finish the multiple download.

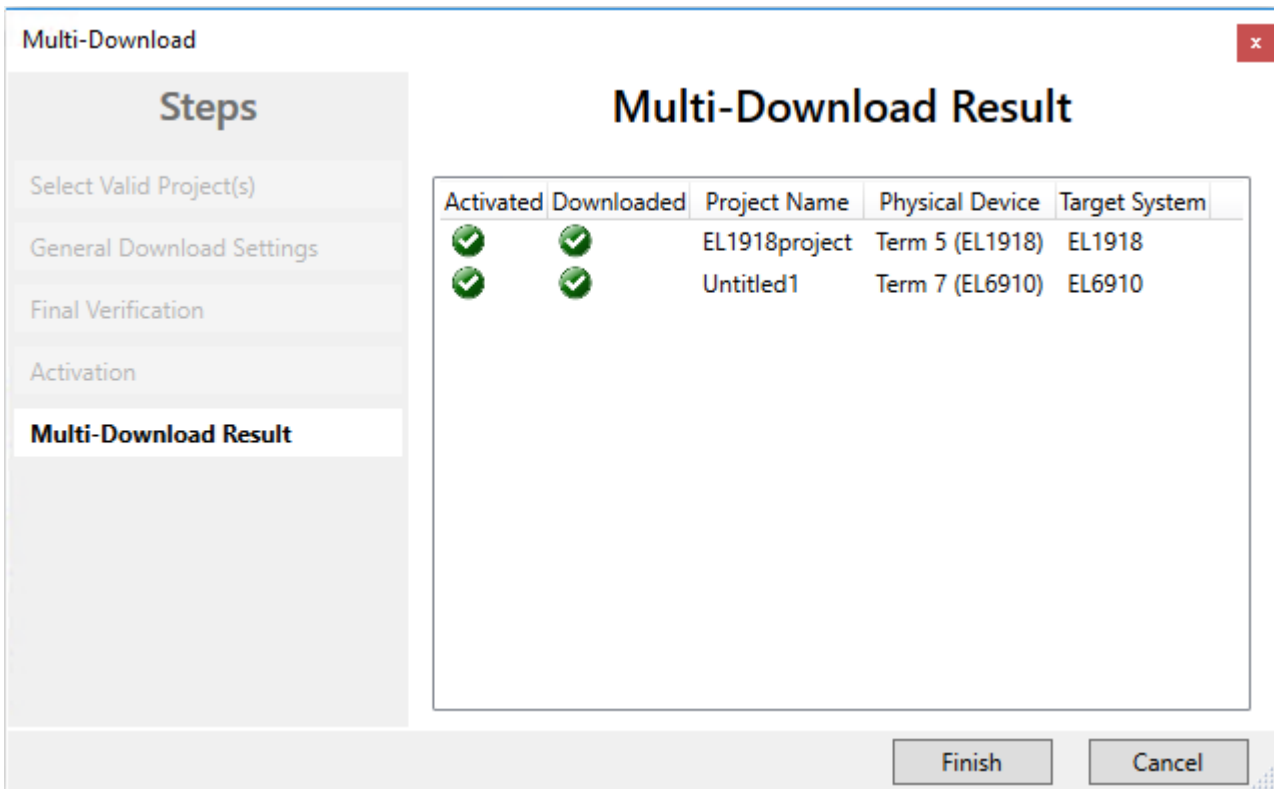

Fig. 111: Multiple Download - Result

4.5 Info Data

i Further Information

Information on the contents of the info data can be found in the TwinSAFE Logic FB documentation (see [References \[▶ 10\]](#))

4.5.1 Info data for the connection

Info data for connections can be enabled on the *Connection* tab of the alias device.

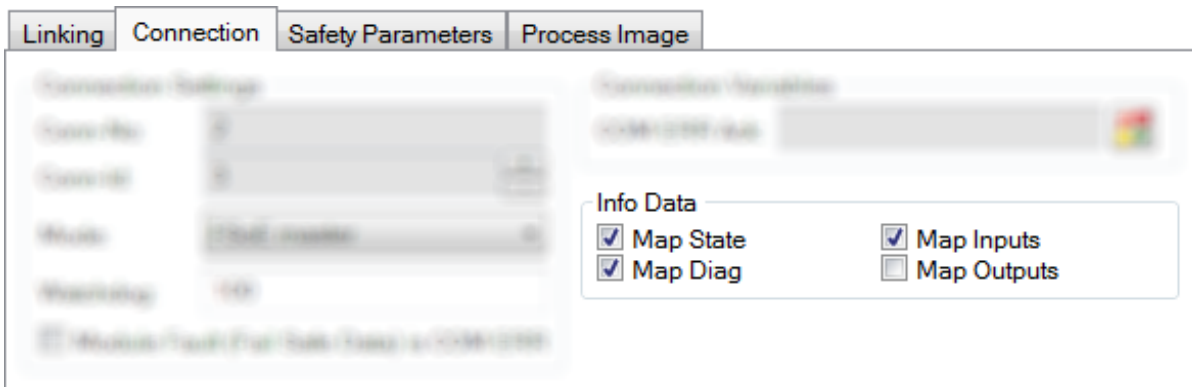

Fig. 112: Enabling the info data for connections

The info data are shown in the I/O tree structure below the EL6910 in the process image. From here, these signals can be linked with PLC variables. Further information on the included data can be found in the documentation for *TwinCAT function blocks for TwinSAFE logic terminals*. Use the checkbox *Show Input/Output Data as byte array* under *Target System* to adjust the process image.

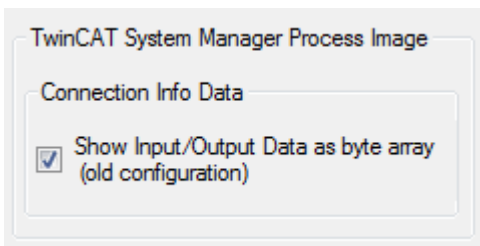

Fig. 113: Checkbox for the connection info data

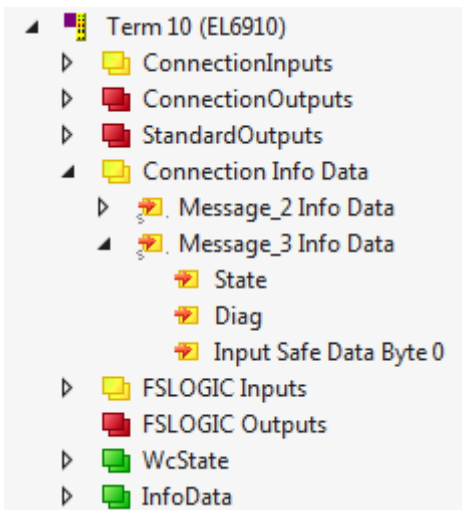

Fig. 114: Info data for the connection in the I/O tree structure as byte array

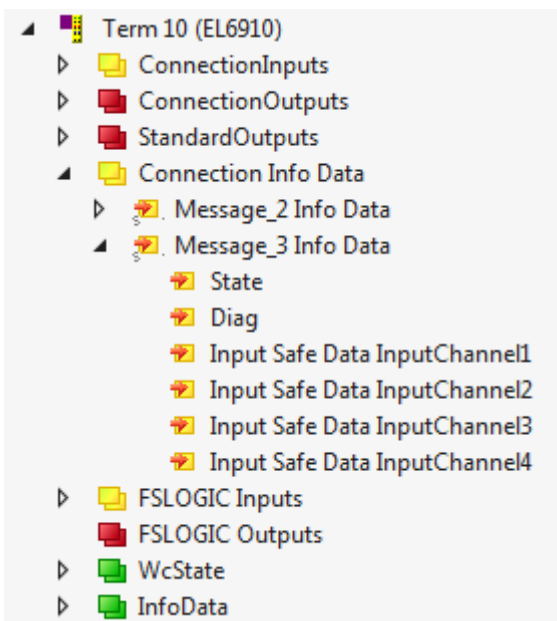

Fig. 115: Info data for the connection in the I/O tree structure as individual data

4.5.2 Info data for function blocks

For function blocks, info data can be enabled in the properties of the function block.

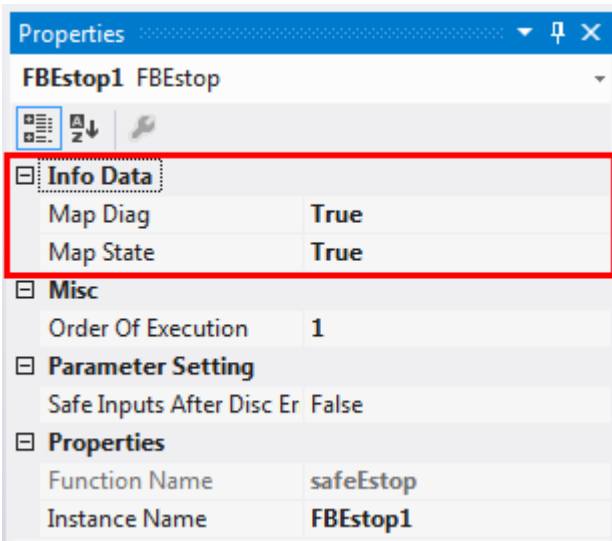

Fig. 116: Enabling the info data for function blocks

The info data are shown in the I/O tree structure below the EL6910 in the process image. From here, these signals can be linked with PLC variables. Further information on the included data can be found in the documentation for *TwinCAT function blocks for TwinSAFE logic terminals*.

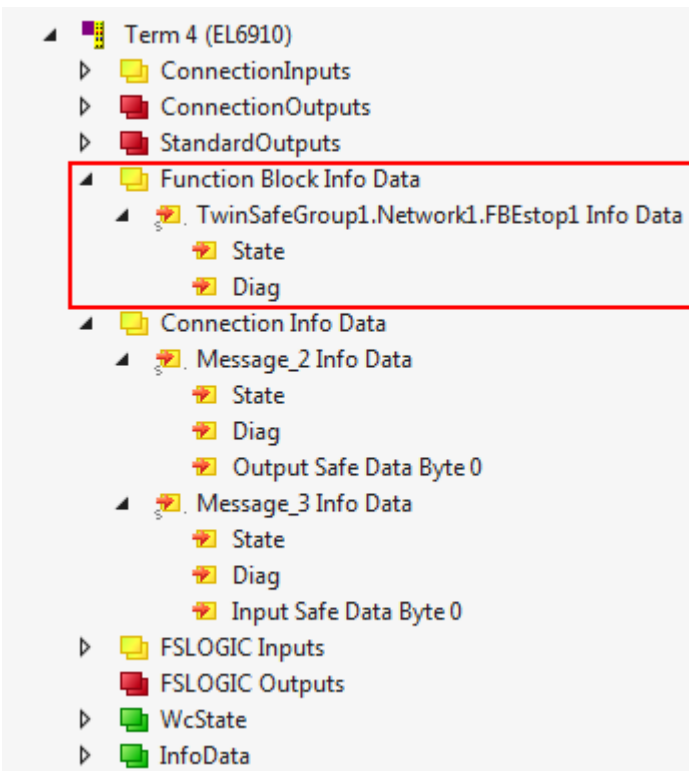

Fig. 117: Info data for the function block in the I/O tree structure

4.5.3 Info data for the TwinSAFE group

For TwinSAFE groups, info data can be enabled via the properties of the TwinSAFE group.

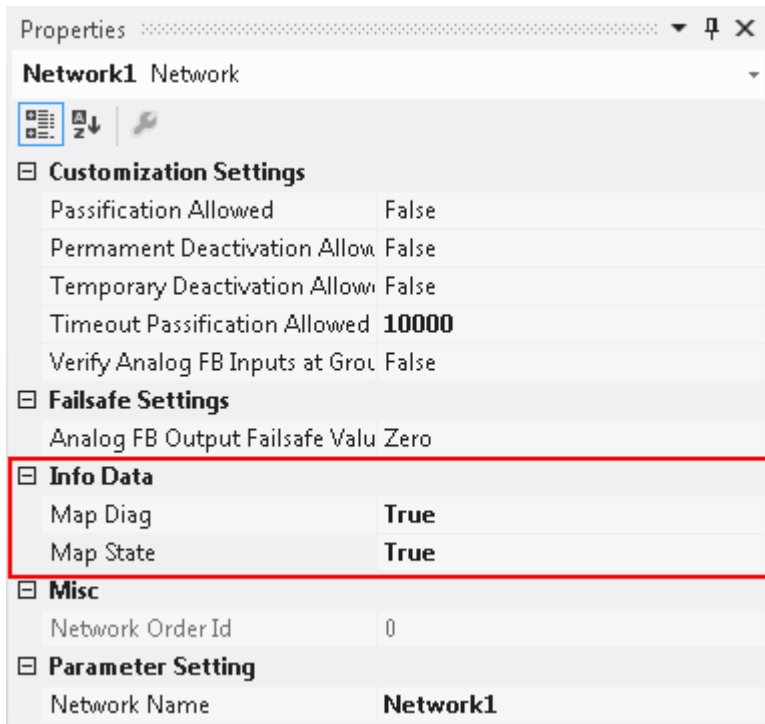

Fig. 118: Enabling the info data in the properties of the TwinSAFE group

The info data are shown in the I/O tree structure below the I/O device in the process image. From here, these signals can be linked with PLC variables. Further information on the included data can be found in the documentation for *TwinCAT function blocks for TwinSAFE logic terminals*.

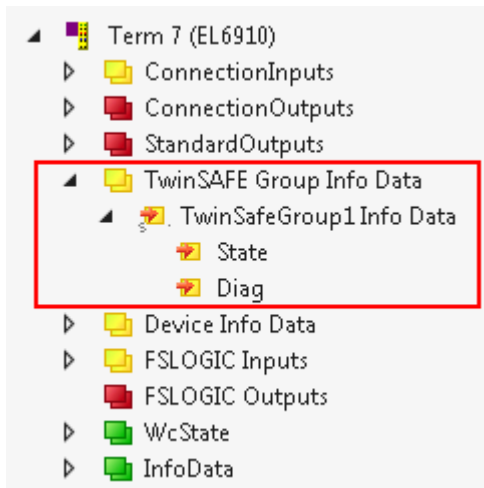

Fig. 119: Info data for the TwinSAFE group in the tree structure

4.5.4 Info data for the device

The info data for the EL6910 can be enabled on the *Target System* tab. These are the serial number of the EL6910 and the current online CRC of the safety project.

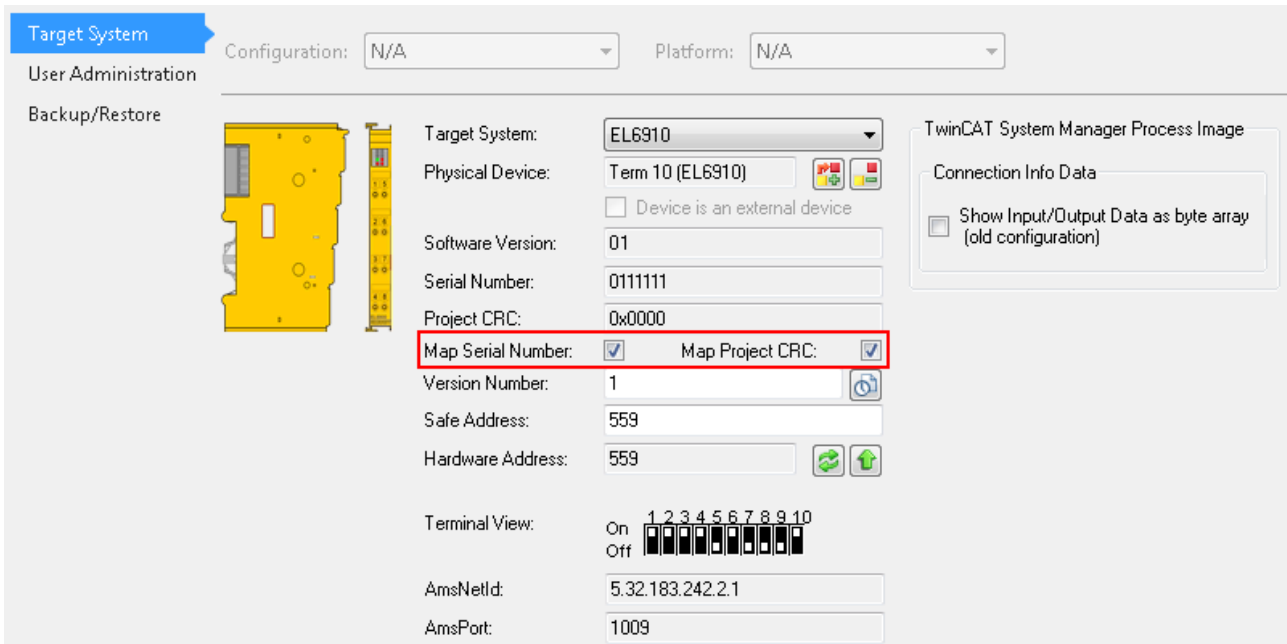

Fig. 120: Enabling the info data for the EL6910

The info data are shown in the I/O tree structure below the EL6910 in the process image. From here, these signals can be linked with PLC variables.

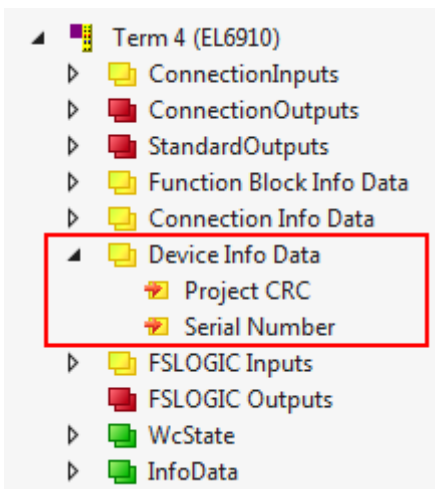



Fig. 121: Info data of the EL6910 in the tree structure

4.6 Version history

The *version history* button  under *Target System* can be used to read the version history of the EL6910, EJ6910 or EK1960. It includes the user, the date, the version and the CRC of the safety projects loaded on the EL6910, EJ6910 or EK1960.

User Name	Date	Version	Project CRC
User1	3/2/2016 4:13 PM	1	0xE0A9
User1	3/3/2016 12:43 PM	2	0xE9D9
User1	3/3/2016 12:45 PM	3	0x5DDB
User1	3/3/2016 12:47 PM	4	0xB423
User1	3/3/2016 12:48 PM	5	0xB04D

OK

Fig. 122: Version History

4.7 User Administration

User administration is called up via the *Target System* tree item. Use *Get User List* to read the current list of users of the EL6910, EJ6910 or EK1960. The user *Administrator* cannot be deleted. The default password can and should be replaced with a customer-specific password. This is done via the *Change Password* button. The default password is *TwinSAFE*. The password must be at least 6 characters long. A maximum of 40 users can be created.

Target System Configuration: N/A Platform: N/A

User Administration

Backup/Restore

Target System: EL6910
 Physical Device: Tern 4 (EL6910)
 Serial Number: 00123456

User List

Administrator	Get User List
	Add User(s)
	Delete User(s)
	Change Password
	Change Access Rights

Fig. 123: User Administration

The administrator password is required to create or delete users. Open the *Login* dialog by left-clicking on *Add User(s)*.

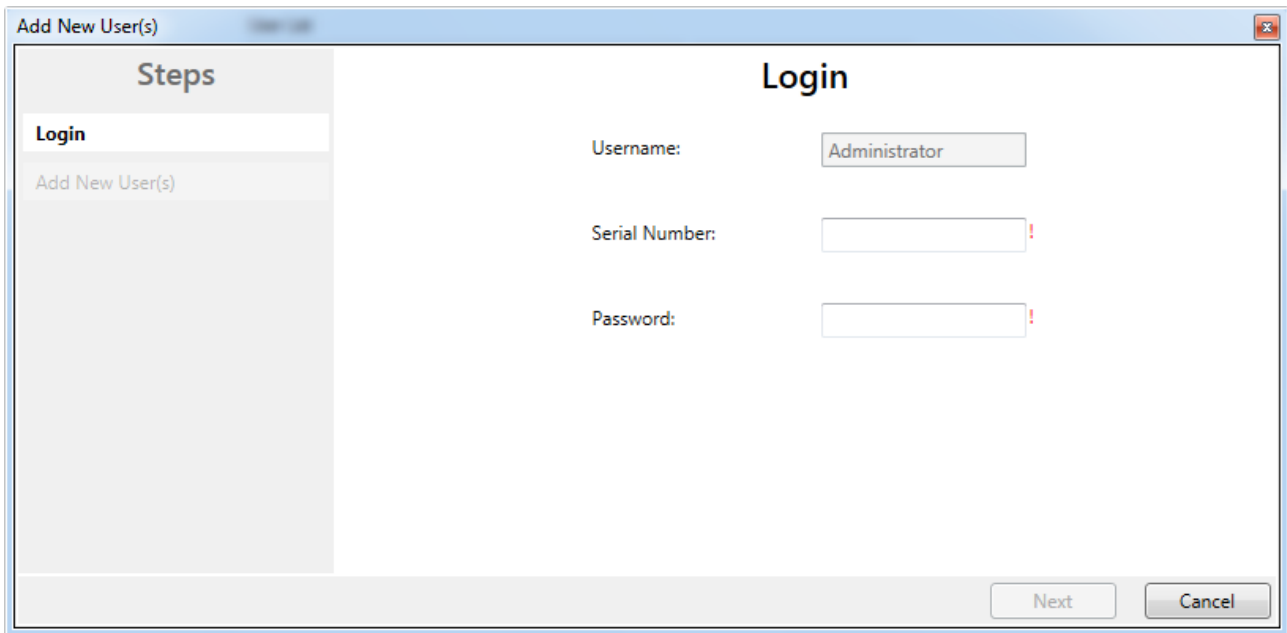

Fig. 124: User Administration - Login

The *Add User* dialog opens once the correct serial number and administrator password have been entered.

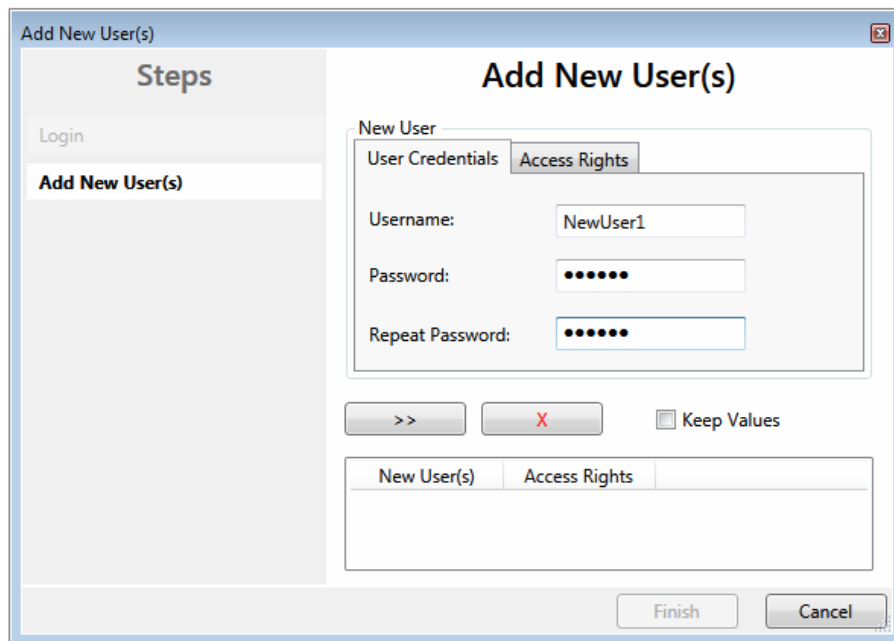

Fig. 125: User Administration - Add New User(s) - User Credentials

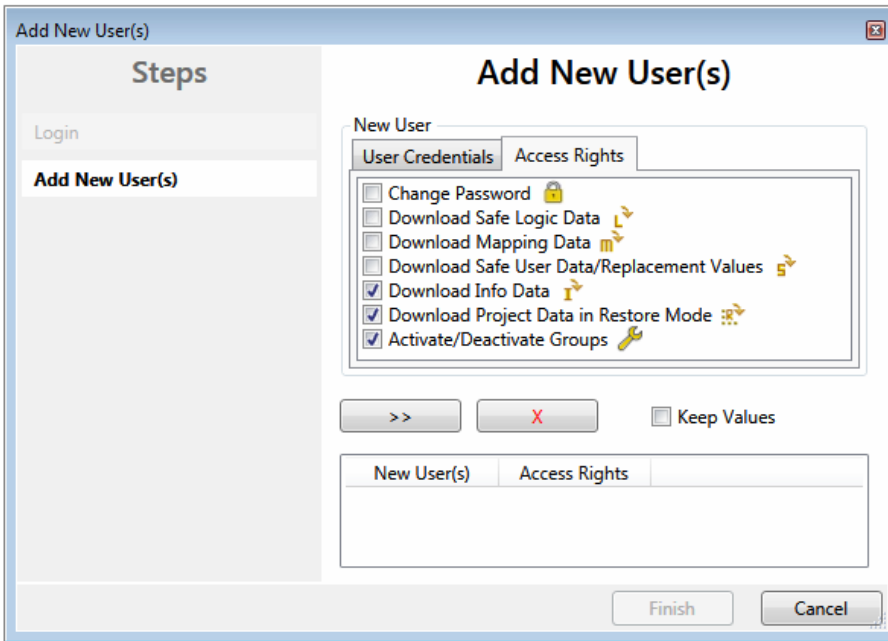
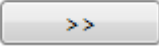

Fig. 126: User Administration - Add New User(s) - Access Rights

Enter the new user and the corresponding password (twice). The password must be at least 6 characters long. In addition, select the rights for the new user. Use the  button to apply these data and display them in the New User list.

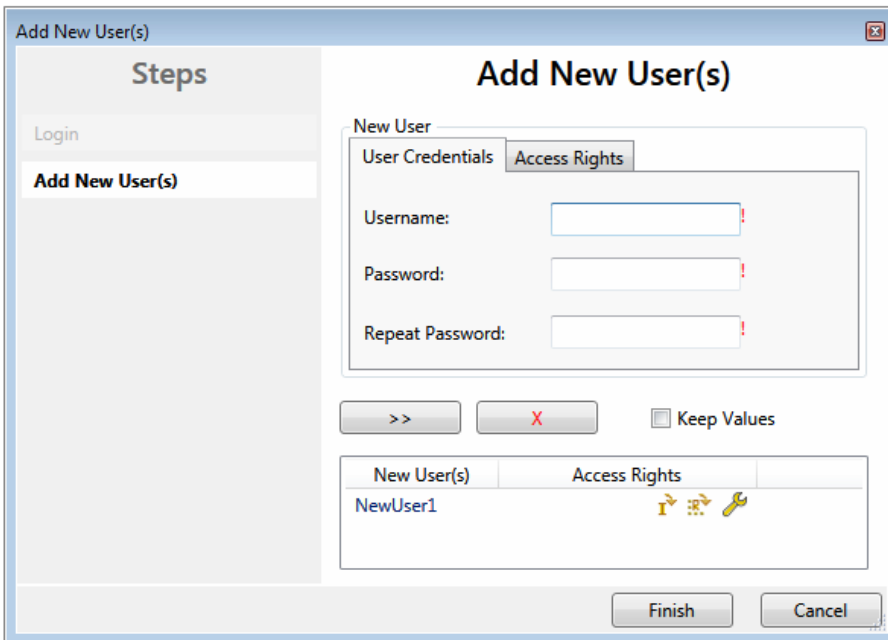

Fig. 127: User Administration - New User added

Several users can be created before leaving the dialog via the *Finish* button.

Access Rights	Description
Change Password	Users can change their password.
Download Safe Logic Data	The user can load the safety-related program onto the EL6910, EJ6910 or EK1960.
Download Mapping Data	The user can load the mapping data for inputs, outputs, FBs etc. onto the EL6910, EJ6910 or EK1960.
Download Safe User Data / Replacement Values	The user can change safe user parameters on the EL6910, EJ6910 or EK1960 and also change and load safe substitute values
Download Info Data	The user can activate and load the info data for connections and FBs on the EL6910, EJ6910 or EK1960.
Download Project Data in Restore Mode	The user can perform a restore. Not currently supported.
Activate / Deactivate Groups	The user can execute Customizing (enable and disable TwinSAFE groups) on the EL6910, EJ6910 or EK1960.

4.8 Backup/Restore

Following the exchange of an EL6910, EJ6910 or EK1960, the previous project can be loaded to the new device using the *Backup/Restore* mechanism.

In order to be able to use this functionality, the *Backup/Restore* mechanism must be enabled in the safety project, and the terminals must be selected, on which the current CRC of the safety project is to be stored.

For a restore operation the user can specify the minimum number of selected terminals on which the correct CRC must be stored.

Using the checkbox *Restore User Administration* the user can specify whether the user administration should be transferred to the new device via the restore mechanism.

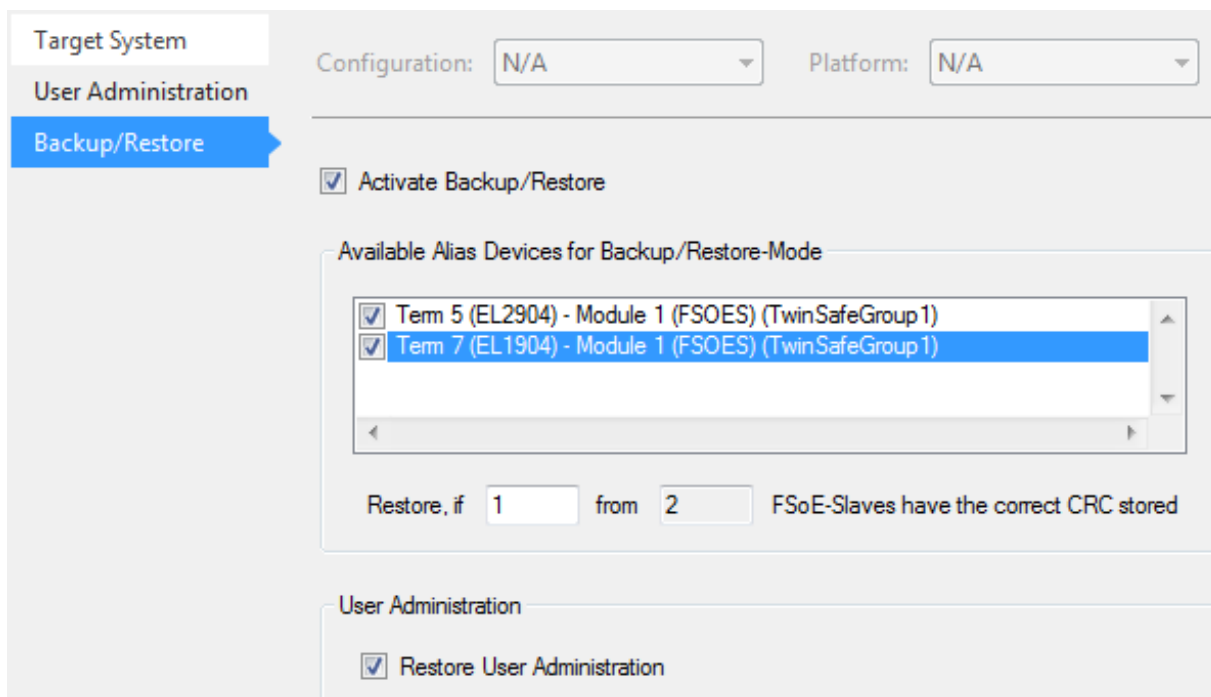

Fig. 128: Backup/Restore

In order to be able to use the *Backup/Restore* mechanism, create a backup of the current safety project and store it on the hard disk of the controller, for sample. To carry out a restore, the user can either check when starting the controller whether the serial number of the EL6910, EJ6910 or EK1960 has changed, or start the restore manually via a service menu, e.g. in the visualization.

i Restore

If a project that doesn't match the system is loaded during a *restore*, this will only be detected when the distributed CRCs are checked. The previous project is then deleted from the logic terminal. This cannot be undone.

One possible sequence for checking whether a restore is carried out is shown in the following sequence chart.

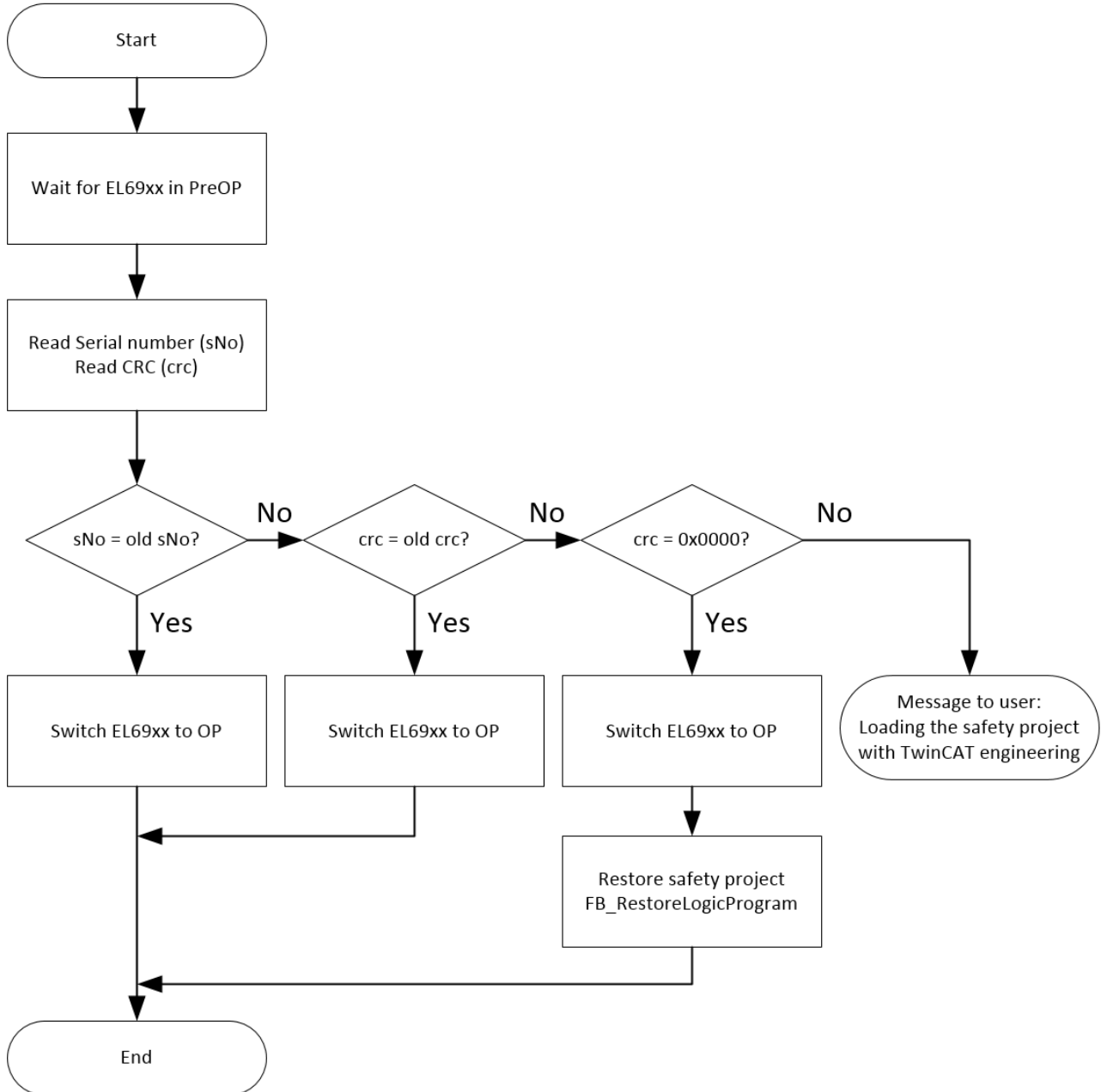

Fig. 129: Restore check sequence chart

Function blocks for backup/restore

The PLC function blocks with which a backup and restore can be performed on a TwinSAFE logic component (currently EL6910, EJ6910 or EK1960), can be found on the Beckhoff homepage. This is a compiled library that can be installed in the TwinCAT Library Repository.

The TC3_EL6910_Backup_Restore library contains 2 PLC function blocks. FB_SAVELOGICPROGRAM and FB_RESTORELOGICPROGRAM.

FB_SAVELOGICPROGRAM

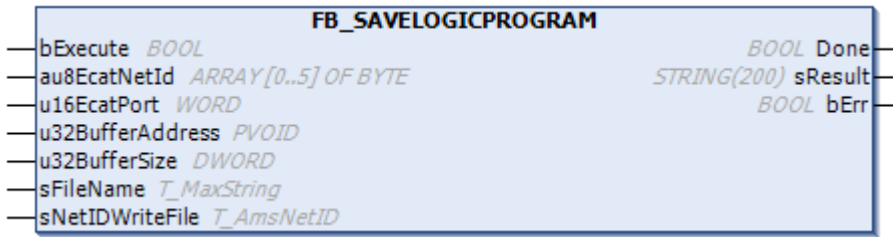

Fig. 130: FB_SAVELOGICPROGRAM illustration

FUNCTION_BLOCK FB_SAVELOGICPROGRAM

Name	Type	Inherited from	Address	Initial	Comment
bExecute	BOOL			FALSE	Positive edge starts the backup process
au8EcatNetId	ARRAY [0..5] OF BYTE				EtherCAT Net-ID of the TwinSAFE Logic - link to e.g. EL6910/InfoData/AdsAddr/netId
u16EcatPort	WORD				Port of TwinSAFE-Logic - link to e.g. EL6910/InfoData/AdsAddr/port
u32BufferAddress	PVOID				Address of buffer, in which the TwinSAFE Logic program should be stored temporarily - buffer e.g. ARRAY[0..16#FFFF] OF BYTE
u32BufferSize	DWORD				size of buffer
sFileName	T_MaxString				File, in which the TwinSAFE Logic program should be stored
sNetIDWriteFile	T_AmsNetID				AmsNetID of device where the file should be written to
Done	BOOL			FALSE	User information that the FB finished the operation
sResult	STRING(200)				FB Result
bErr	BOOL				An error occurred during operation, details in sResult

Fig. 131: FB_SAVELOGICPROGRAM parameters

FB_RESTORELOGICPROGRAM

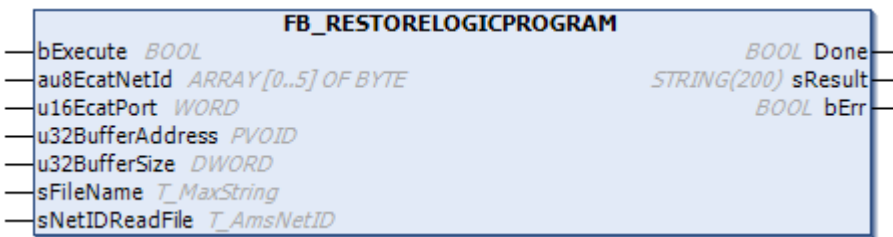

Fig. 132: FB_RESTORELOGICPROGRAM illustration

FUNCTION_BLOCK FB_RESTORELOGICPROGRAM

Name	Type	Inherited from	Address	Initial	Comment
bExecute	BOOL			FALSE	Positive edge starts the restore process
au8EcatNetId	ARRAY [0..5] OF BYTE				EtherCAT-Net-ID of the TwinSAFE Logic - link to e.g. EL6910/InfoData/AdsAddr/netId
u16EcatPort	WORD				Port of TwinSAFE-Logic - link to e.g. EL6910/InfoData/AdsAddr/port
u32BufferAddress	PVOID				Address to buffer, in which the TwinSAFE Logic program should be stored - buffer e.g. ARRAY[0..16#FFFF] OF BYTE
u32BufferSize	DWORD				size of buffer
sFileName	T_MaxString				File which contains the TwinSAFE logic program and should be restored
sNetIDReadFile	T_AmsNetID				AmsNetID of device where the file is stored
Done	BOOL			FALSE	User information that the FB finished the operation
sResult	STRING(200)				FB result
bErr	BOOL				An error occurred during operation, details in Result

Fig. 133: FB_RESTORELOGICPROGRAM parameters

Sample

```
PROGRAM MAIN
VAR
    fb_save: FB_SAVELOGICPROGRAM;
    fb_restore: FB_RESTORELOGICPROGRAM;
    StartBackup: BOOL;
    EL6910AmsNetID AT %I*: ARRAY [0..5] OF BYTE;
    EL6910port AT %I*: WORD;
    internalBuffer: array[0..16#FFFF] of byte;
    FileString: T_MaxString := 'c:\temp\safety\complibTest_EL6910.bin';
    LocalAmsNetID: T_AmsNetID := '172.55.76.53.1.1';
    SaveDone: BOOL;
    SaveResult: STRING(200);
    SaveErr: BOOL;
    StartRestore: BOOL;
    internalbuffer2: array[0..16#FFFF] of Byte;
    RestoreDone: BOOL;
```

```

RestoreResult: STRING(200);
RestoreErr: BOOL;
END_VAR

// Backup of the TwinSAFE logic program
fb_save(
    bExecute:=          StartBackup,
    au8EcatNetId:=      EL6910AmsNetID,
    u16EcatPort:=       EL6910port,
    u32BufferAddress:=  ADR(internalBuffer),
    u32BufferSize:=    SIZEOF(internalBuffer),
    sFileName:=         FileString,
    sNetIDWriteFile:=   LocalAmsNetID,
    Done=>              SaveDone,
    sResult=>          SaveResult,
    bErr=>              SaveErr);

// Restore of the TwinSAFE logic program
fb_restore(
    bExecute:=          StartRestore,
    au8EcatNetId:=      EL6910AmsNetID,
    u16EcatPort:=       EL6910port,
    u32BufferAddress:=  ADR(internalbuffer2),
    u32BufferSize:=    SIZEOF(internalBuffer2),
    sFileName:=         FileString,
    sNetIDReadFile:=   LocalAmsNetID,
    Done=>              RestoreDone,
    sResult=>          RestoreResult,
    bErr=>              RestoreErr);

```

4.9 Export/import of the safety project

The safety project can be archived via the context menu of the safety project. The data type of this archive is *.tzip.

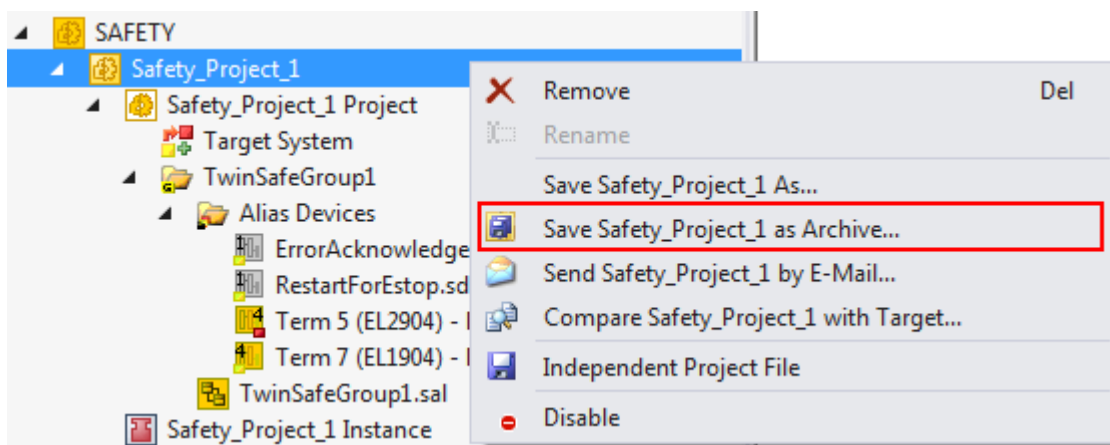

Fig. 134: Archiving the safety project

The safety project can be exported to XML format one level below the safety project node. This XML format can be used for exchange between TwinCAT 3 and TwinCAT 2.

The menu item *Export project (as bin file)* can be used to save the safety project in a binary format, so that it can be used by the TwinSAFE loader, for sample.

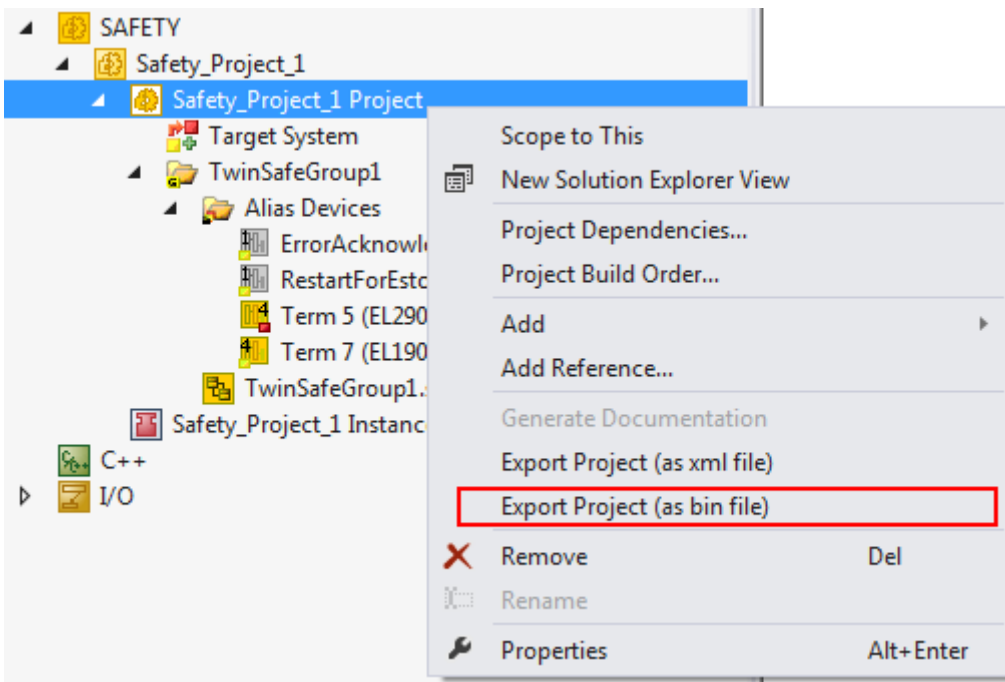

Fig. 135: Saving the safety project in a binary format (e.g. for the TwinSAFE loader)

A previously exported safety project can be imported via the context menu of the main Safety entry in the TwinCAT project structure. *Add Existing Item...* can be used to select the file type for the import.

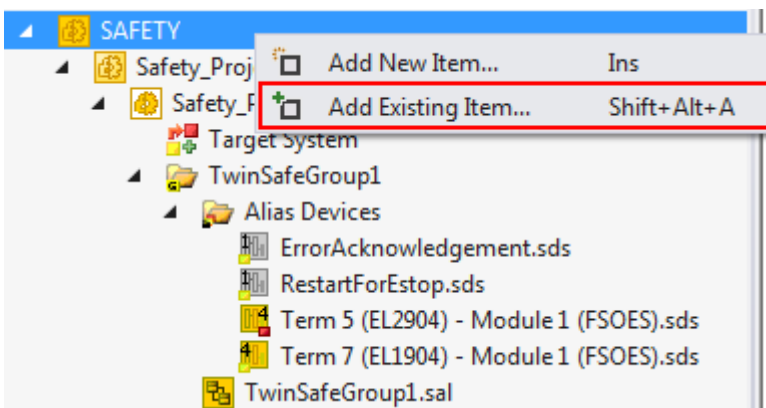

Fig. 136: Selecting the file type for importing a safety project

The following file types are supported:

- Safety project files *.splc,
- Safety project archives *.tfzip
- Safety projects in XML format

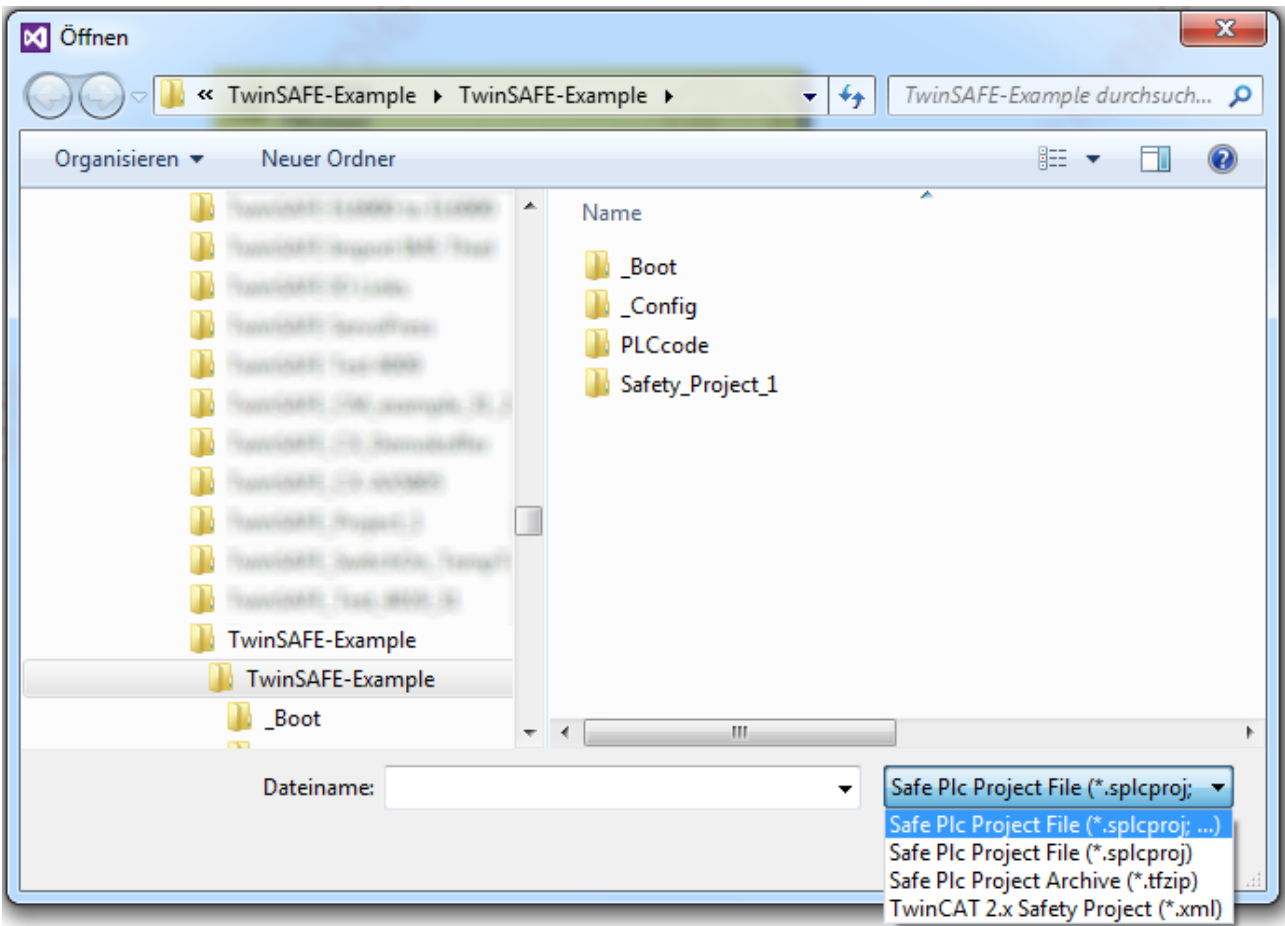

Fig. 137: Importing a safety project

4.10 Diag History tab

Any errors that occur in the EL6910, EJ6910 or EK1960 are stored in the their diag history. The diag history can be viewed by selecting the EL6910, EJ6910 or EK1960 in the I/O tree structure and then selecting the *Diag History* tab. Use the *Update History* button to fetch the current from the EL6910, EJ6910 or EK1960. Error within the logic; the function blocks and the connections are stored with a corresponding timestamp.

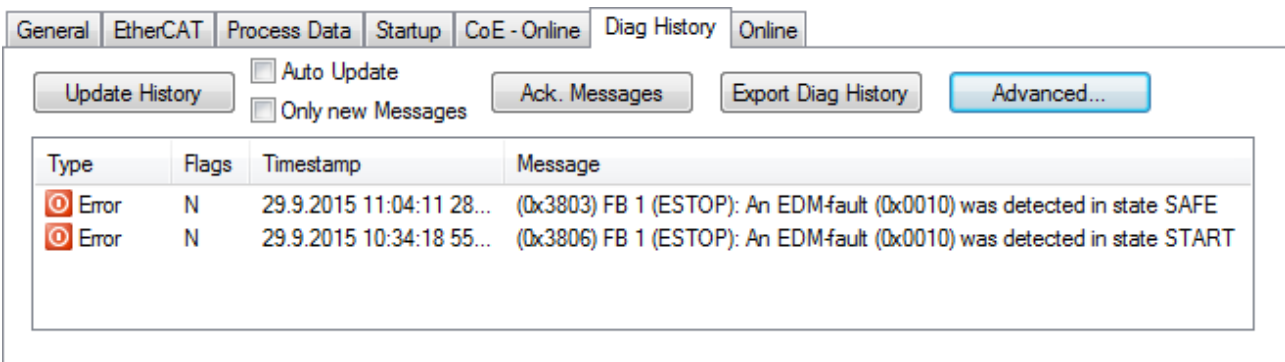

Fig. 138: Diag History

Use the *Advanced...* button to open the advanced settings. Here, the user can customize the behavior of the diag history.

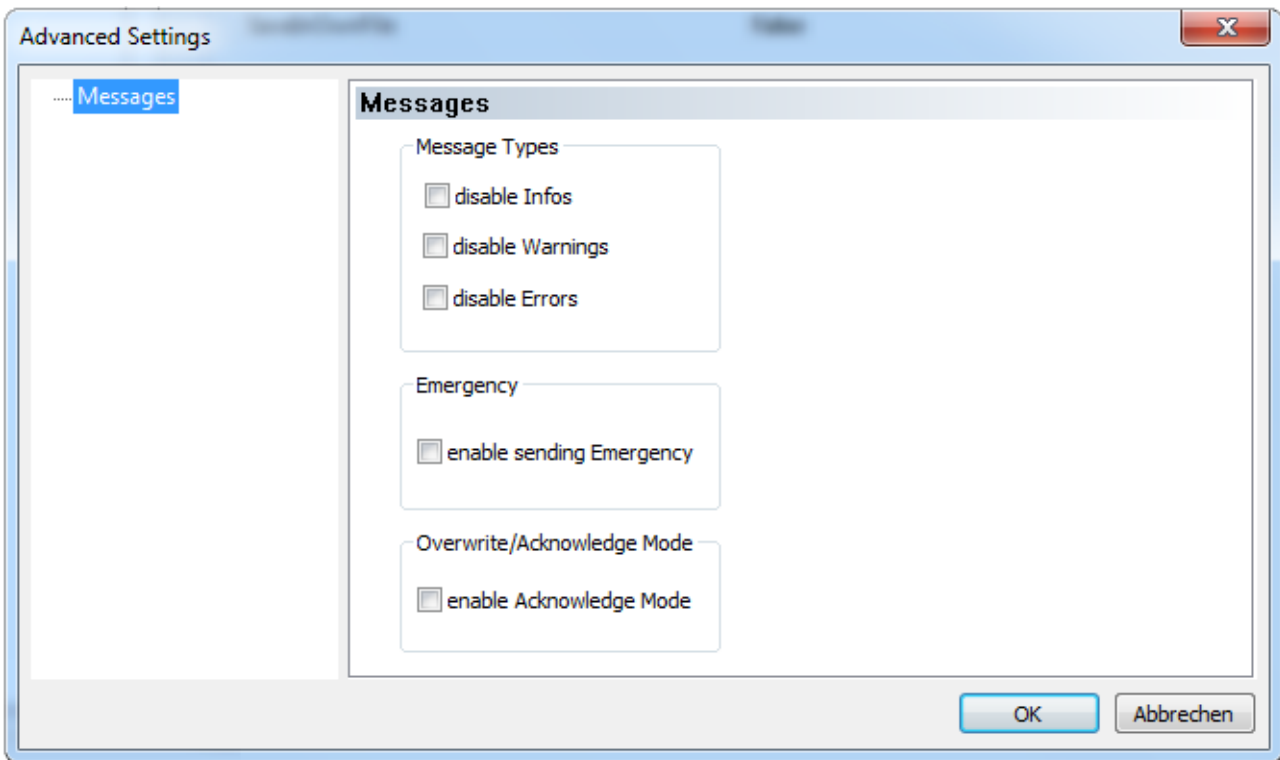

Fig. 139: Diag History - Advanced Settings

Advanced Settings

Setting	Description
Message Types	<ul style="list-style-type: none"> • disable Info Messages with status <i>Info</i> are not stored in the diag history • disable Warnings Messages with status <i>Warning</i> are not stored in the diag history • disable Errors Messages with status <i>Error</i> are not stored in the diag history
Emergency	In addition to saving the message in the diag history, an emergency object is sent, which is displayed in the logger window of TwinCAT.
Overwrite / Acknowledge Mode	This setting is currently not supported.

4.11 PROFIsafe configuration

4.11.1 Correct configuration of the complete system

The following information must be observed when implementing a PROFIsafe communication within a TwinCAT application.

⚠ CAUTION
<p>PROFIsafe implementation</p> <p>The PROFIsafe protocol version 2.5 is implemented in the EL6910.</p>

In addition, there is a restriction with regard to the transmission of PROFIsafe within EtherCAT.

i PROFIsafe telegram only via E-bus and PROFINET/PROFIBUS

On account of the PROFIsafe policy, the use of PROFIsafe is permitted only via the PROFIBUS and PROFINET fieldbuses or via a backplane bus, in this case for example the E-bus. The use of PROFIsafe via other fieldbuses is impermissible for reasons connected with patent law. This must be ensured through the use of the EL9930 segment end terminal.

The following Siemens AG patents are relevant according to the PROFIsafe profile:

- EP1267270-A2 Method for data transfer
- WO00/045562-A1 Method and device for determining the reliability of data carriers
- WO99/049373-A1 Shortened data message of an automation system
- EP1686732 Method and system for transmitting protocol data units
- EP1802019 Identification of errors in data transmission
- EP1921525-A1 Method for operation of a safety-related system
- EP13172092.2 Method and system for detection of errors

Depending on the architecture of the application, appropriate measures must therefore be taken. Permissible and impermissible system configurations are explained below for greater detail.

4.11.1.1 Valid PROFIsafe configurations

The following notes apply to PROFIsafe Master and PROFIsafe Slave configurations. PROFIsafe can be used if a CX controller is used, which only has EtherCAT Terminals attached and only exchanges data with a device via PROFIBus, for sample.

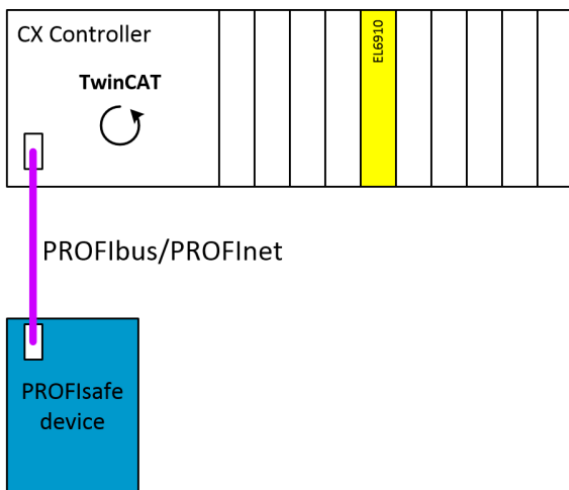

Fig. 140: Valid PROFIsafe configuration - sample 1

If a TwinCAT PC is used, which exchanges data with EtherCAT Terminals via EtherCAT, for sample, the PROFIsafe telegram must not leave the EK1100 station. To this end the EL6910 is connected to an EK1100 station together with an EL6731 PROFIBus master, for sample. In addition, an EL9930 PROFIsafe segment end terminal is used in the station before and after the two terminals. The following configuration is therefore valid.

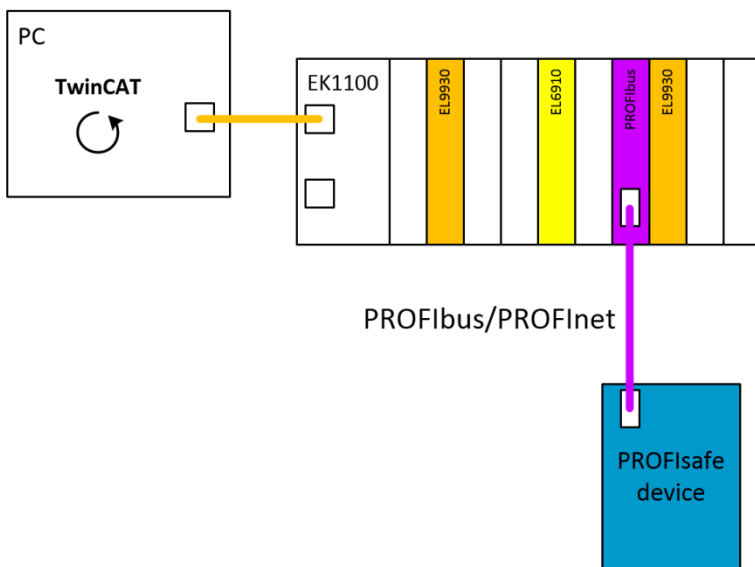

Fig. 141: Valid PROFIsafe configuration - sample 2

A detailed description of the correct application of an EL9930 can be found in the respective documentation.

4.11.1.2 Invalid PROFIsafe configurations

The following configuration is not permitted according to the PROFIsafe policy, since the PROFIsafe telegram leaves the EK1100 via EtherCAT, is copied via the TwinCAT PC and is only then sent to the PROFIsafe slave via PROFIBus.

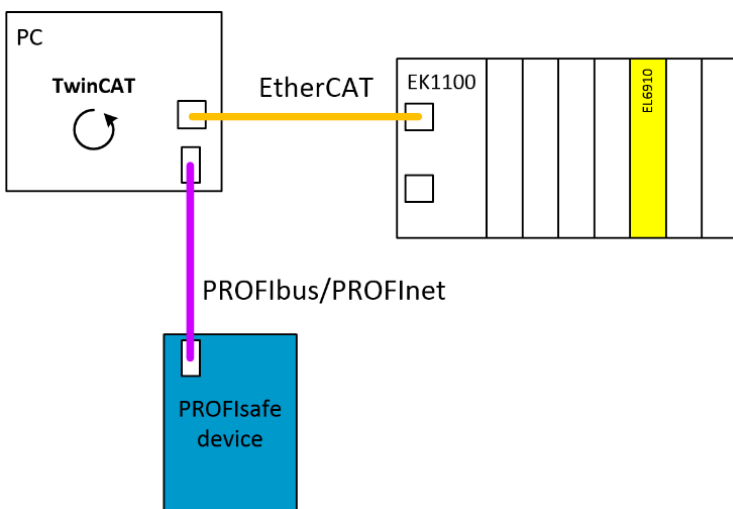

Fig. 142: Invalid PROFIsafe configuration - sample 1

The following configuration is not permitted according to the PROFIsafe policy, since the PROFIsafe telegram leaves the EK1100 via EtherCAT, is received on the second EK1100 and is only then sent to the PROFIsafe slave via PROFIBus.

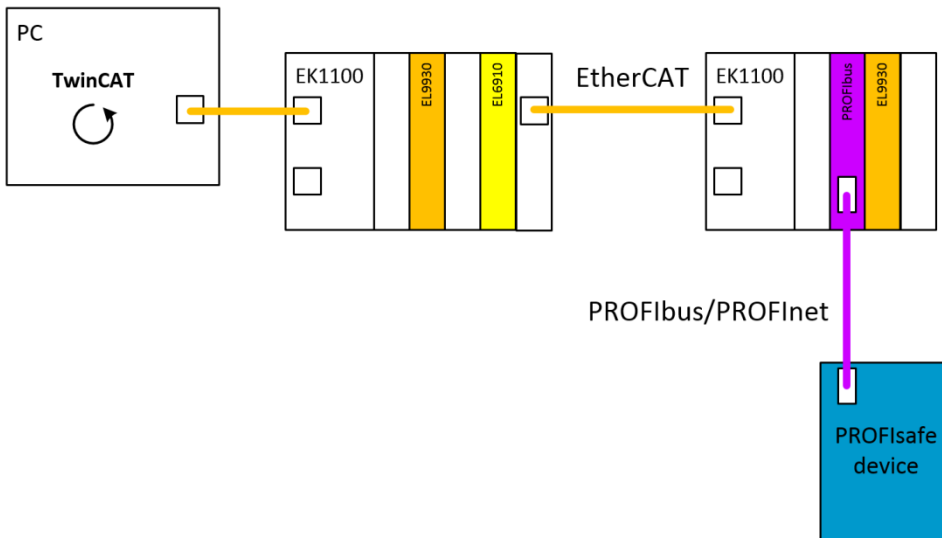

Fig. 143: Invalid PROFIsafe configuration - sample 2

4.11.2 Configuration of an EL6910 as a PROFIsafe Master

The method of creating a connection between the EL6910 as the PROFIsafe Master and a PROFIsafe Slave is described below.

4.11.2.1 Configuration of a safety project

The configuration of the connection is realized as usual via an *Alias Device*. A *Custom PROFIsafe Connection* can be created via the context menu of the node *Alias Devices* selecting *Add* and *New item*....

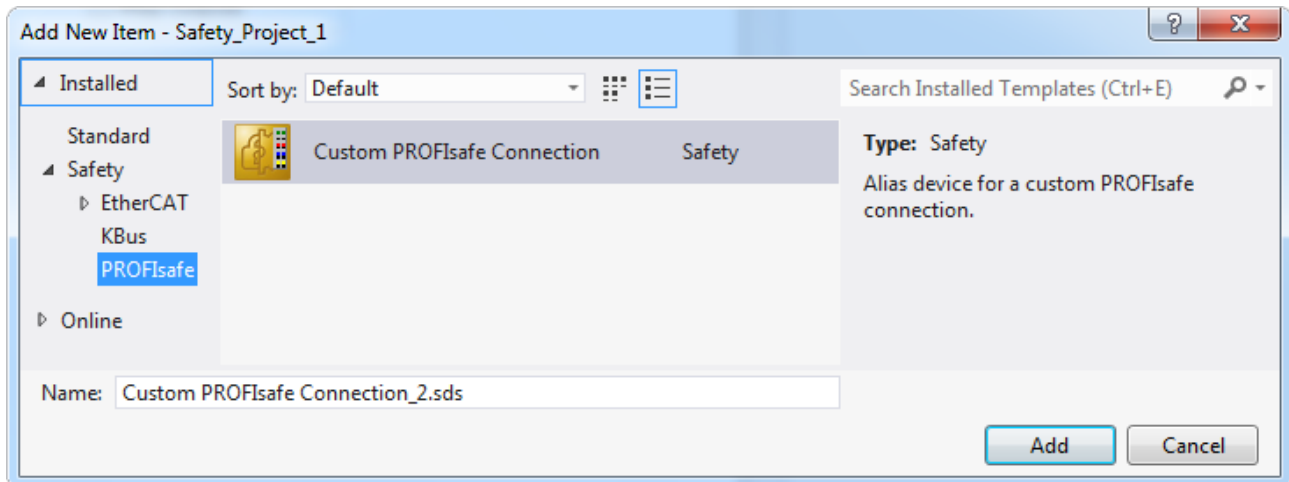

Fig. 144: Creating a Custom PROFIsafe connection

After opening the alias device, the process image size of the connection can be set via the *Process Image* tab. The individual signals can be renamed so that this text is ultimately displayed as the signal name within the safety application.

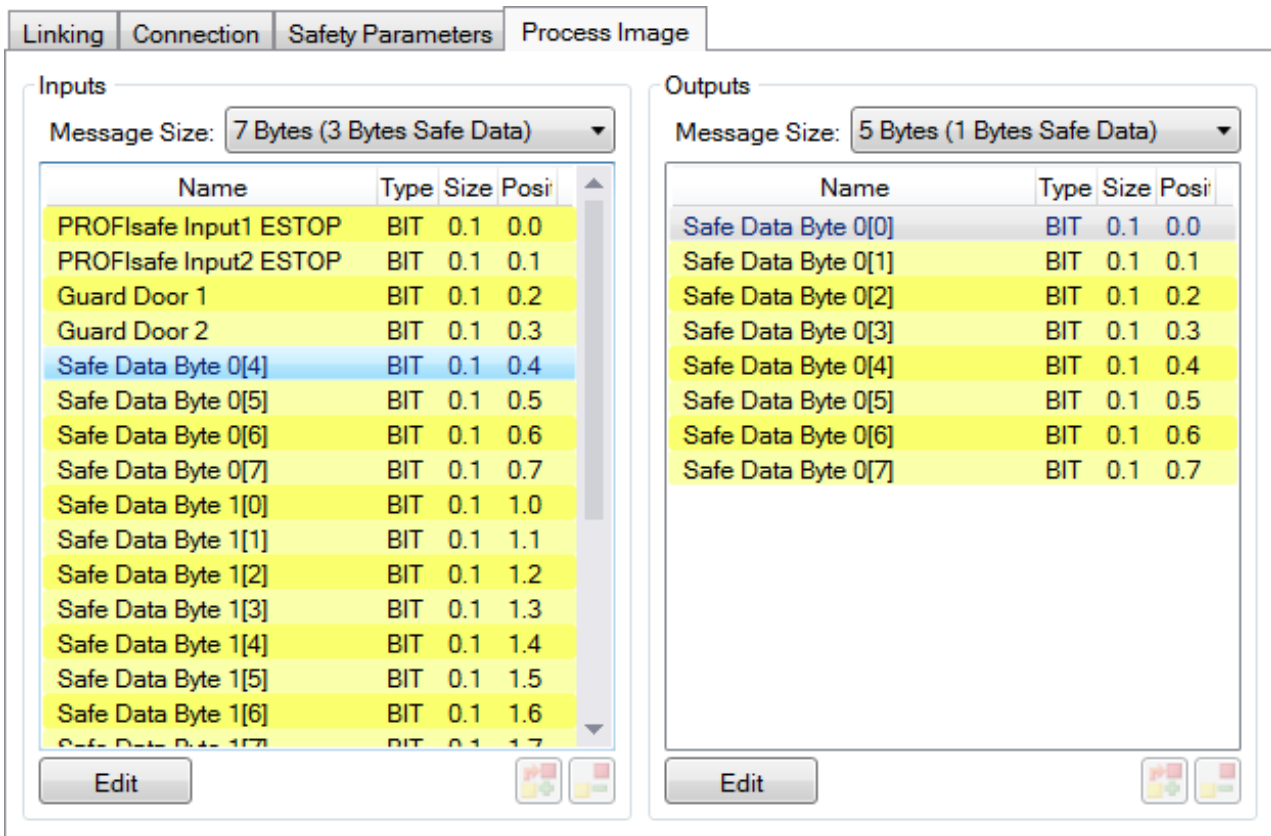

Fig. 145: Setting the process image size

Set the safe address on the *Linking* tab. Under *Full Name (input)* and *Full Name (output)* it contains information on which process data have to be linked with the corresponding signals of the PROFIsafe control. The setting Linking Mode *Automatic* is necessary in order to enable the simple transfer of the safety parameters to the corresponding device in the I/O tree.

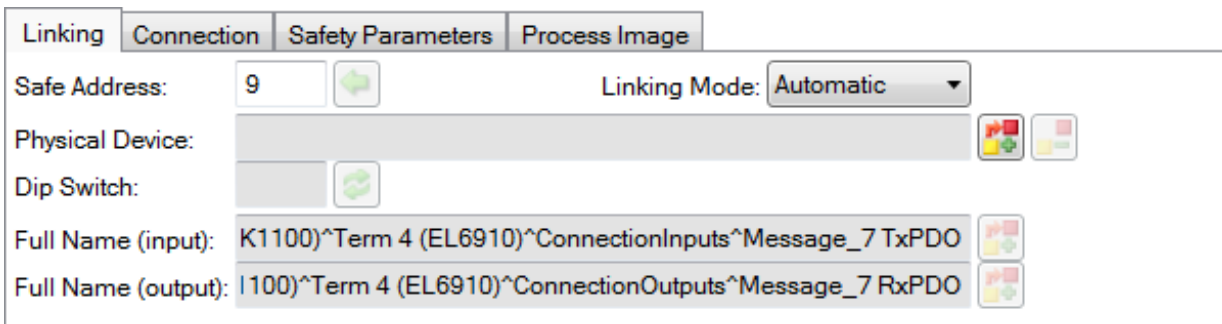

Fig. 146: Setting the safe address

Select the PROFIsafe master on the *Connection* tab under mode.

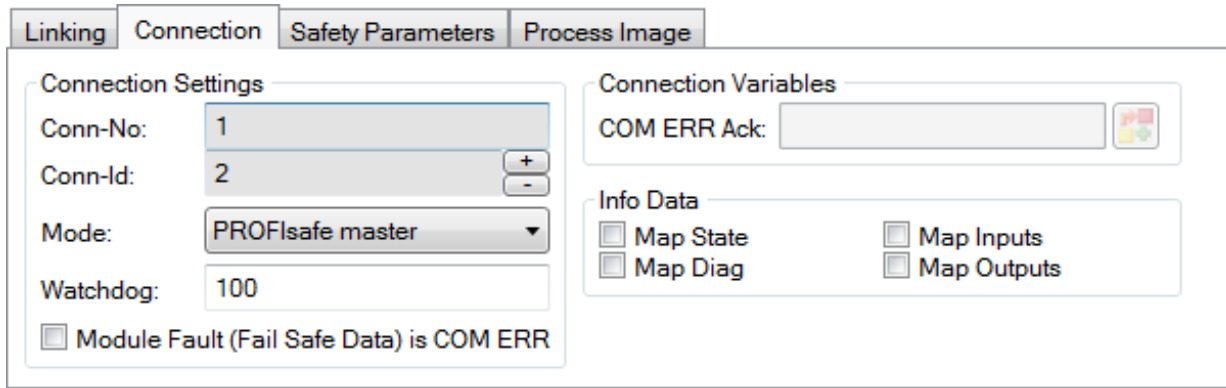

Fig. 147: Selecting the PROFIsafe master

Parameter	Description	User interaction required
Conn. no.	Connection number: is automatically assigned by the TwinCAT system	No
Conn ID	Connection ID: preallocated by the system, but can be changed by the user. A Conn ID must be unique within a configuration. Duplicate connection IDs result in an error message	Control
Mode	PROFIsafe master: The EL6910 is PROFIsafe master for this device.	Yes
Watchdog	Watchdog time for this connection. A ComError is generated, if the device fails to return a valid telegram to the EL6910 within the watchdog time.	Yes
Module Fault is ComError	This checkbox is used to specify the behavior in the event of an error. If the checkbox is ticked and a module error occurs on the alias device, this also leads to a connection error and therefore to switching off the TwinSAFE group, in which this connection is defined.	Yes
Info data	The info data to be shown in the process image of the EL6910 can be defined via these checkboxes. Further information can be found in the FB documentation.	Yes

The *Safety Parameters* tab provides the parameters for the PROFIsafe master connection.

Name	RW	Current Value	IO Treeitem Value	Default Value
F_Check_Seq_Nr	R/W	0 (0)		
F_Check_iPar	R/W	0 (0)		
F_SIL	R/W	SIL3 (2)		
F_CRC_Length	R	3-Byte-CRC (0)		
F_Block_ID	R	0 (0)		
F_Par_Version	R	V2-mode (1)		
F_Source_Add	R/W	0x0001 (1)		
F_Dest_Add	R/W	0x0009 (9)		
F_WD_Time	R/W	0x0064 (100)		
F_iPar_CRC	R/W	0x00000000 (0)		
F_Par_CRC	R	0x0B3E (2878)		

Fig. 148: Parameters for the PROFIsafe master connection

Parameter	Description
F_Check_Seq_Nr	Setting (0/1) to indicate whether the sequence number of the connection should be checked.
F_Check_iPar	Setting (0/1) to indicate whether the parameterization should take place via an iPar server.
F_SIL	Selecting the required SIL level (SIL1, SIL2, SIL3, NoSIL)
F_CRC_Length	Display of the CRC length
F_Block_ID	always 0
F_Par_Version	PROFIsafe version used (typically V2 mode)
F_Source_Add	Setting the PROFIsafe source address
F_Dest_Add	Setting the PROFIsafe destination address
F_WD_Time	Setting the watchdog time
F_iPar_CRC	i-parameter(s) for the PROFIsafe slave
F_Par_CRC	Calculated CRC across all parameters

The parameter *F_iPar_CRC* refers to the *iParameters* of the PROFIsafe device. These must be set directly in the I/O configuration on the PROFIsafe device. Additional third-party software from the vendor may be necessary for the calculation of the iPar CRC. The CRC calculated there must be entered accordingly under *F_iPar_CRC* on the *Safety Parameters* tab.

After completion of the configuration of the parameters, they must be transferred to the I/O configuration by clicking the button *Update IO TreeItem* final.

4.11.2.2 Configuration of TwinCAT I/O

⚠ CAUTION

Data type WORD!

An additional configuration may have to be done when using WORD data types within the process image.

If no EL9930 is used within the configuration according to the instructions in the section *Correct configuration of the complete system*, the swapping of the high and low byte portions must be configured as part of the I/O configuration of the PROFIsafe device for the signals with WORD data type contained in the process image. This is done by checking the *Swap LOBYTE and HIBYTE* checkbox directly on the data values (on the *Flags* tab).

⚠ CAUTION

iParameters

The identical parameters as on the *Alias Device* must be configured on the PROFIsafe I/O device so that communication can start correctly.

4.11.3 Configuration of an EL6910 as a PROFIsafe Slave

The method of creating a connection between the EL6910 as the PROFIsafe Slave and a PROFIsafe Master is described below.

Unlike the configuration of the EL6910 as a PROFIsafe Master, several steps are necessary at this point.

4.11.3.1 Configuration of a safety project

The connection to the PROFIsafe Master is realized as usual via an *Alias Device*. A *Custom PROFIsafe Connection* can be created via the context menu of the node *Alias Devices* selecting *Add and New item....*

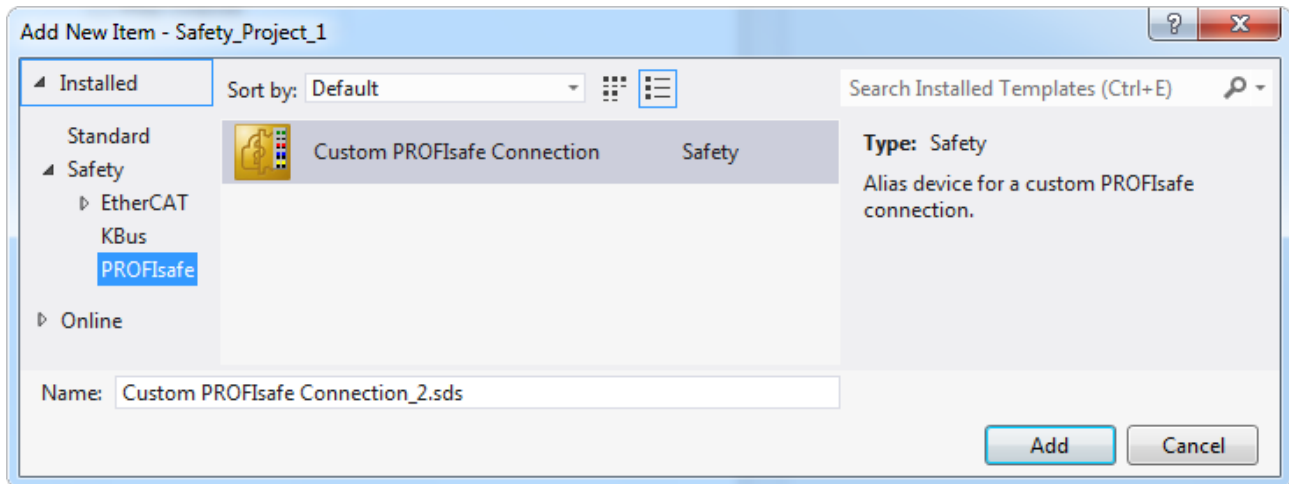

Fig. 149: Creating a Custom PROFIsafe connection

After opening the alias device, the process image size of the connection can be set via the *Process Image* tab. The individual signals can be renamed so that this text is ultimately displayed as the signal name within the safety application.

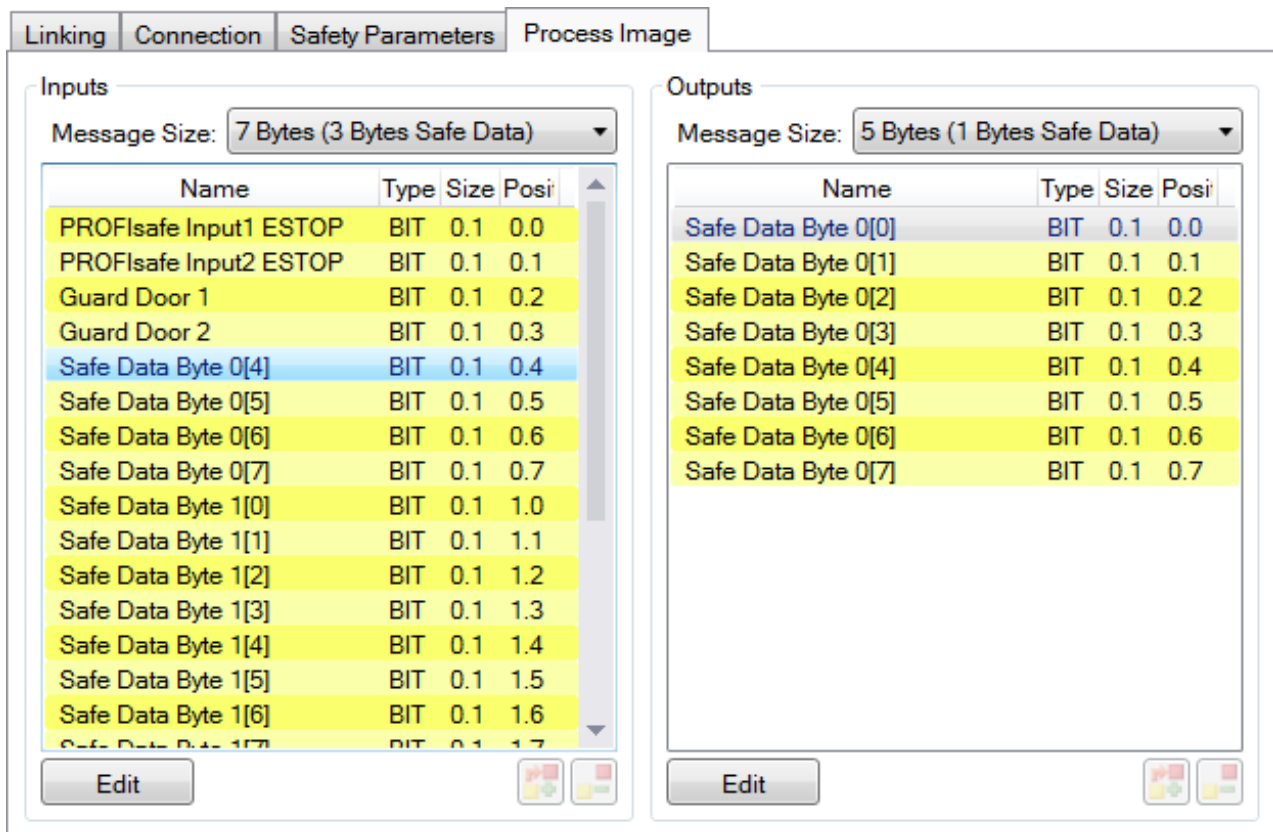

Fig. 150: Process image

Set the safe address on the *Linking* tab. Under Full Name (input) and Full Name (output) it contains information on which process data have to be linked with the corresponding signals of the PROFIsafe control. The entry *Safe Address* must be used as F_Dest_Add on the master side.

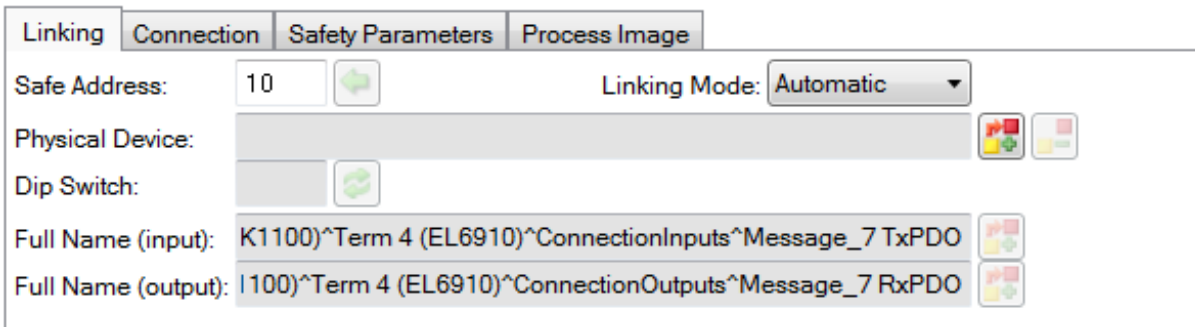

Fig. 151: Safe Address setting

Select the PROFIsafe slave on the *Connection* tab under Mode. No further settings are required.

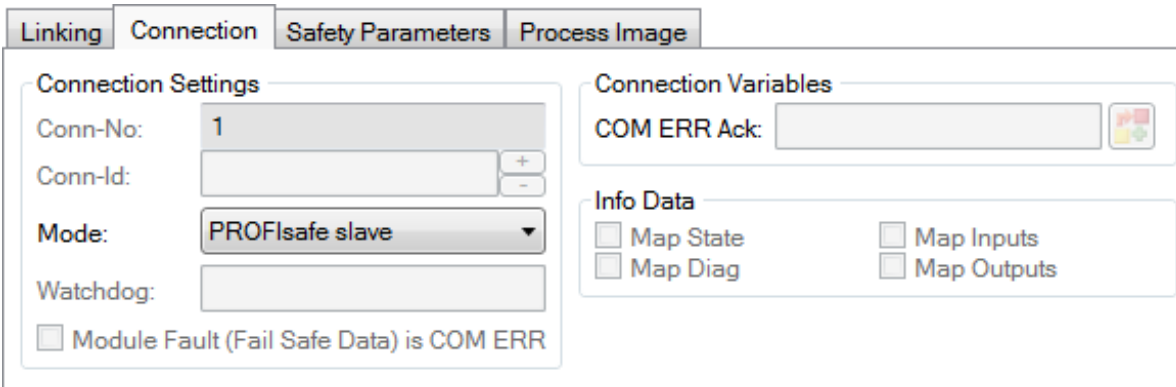

Fig. 152: Connection setting

No *Safety Parameters* need to be set if using the EL6910 as a PROFIsafe Slave.

4.11.3.2 Configuration of TwinCAT I/O

⚠ CAUTION

Data type WORD!

An additional configuration may have to be done when using WORD data types within the process image.

If no EL9930 is used within the configuration according to the instructions in the section Correct configuration of the complete system, the swapping of the high and low byte portions must be configured as part of the I/O configuration of the PROFIsafe device for the signals with WORD data type contained in the process image. This is done by checking the *Swap LOBYTE and HIBYTE* checkbox directly on the data values (on the *Flags* tab).

4.11.3.3 Configuration of the process image PROFIsafe Gateway

For the use of the PROFIsafe protocol via one of the available Beckhoff PROFIsafe Gateways (e.g. EL6631), the latter must be configured for the use of PROFIsafe. A corresponding GSDML file with PROFIsafe support is needed for this. A current version for the corresponding type of gateway can be found on the Beckhoff homepage.

So that the PROFIsafe configuration can be processed successfully by the PROFIsafe Gateway in use (e.g. EL6631), the PROFIsafe telegram must be configured in the process image of the EL6631. By using the correct GSDML file, all possible combinations of telegram size are made available and can then be connected with the *Alias Device*.

4.11.3.4 Configuration of the PROFIsafe Master

The PROFIsafe slave is configured in the parameterization software of the PROFIsafe master. The telegram length selected in the Alias Device and in the PROFIsafe Gateway must be observed accordingly.

F_Dest_Add, which is configurable in the PROFIsafe Master, must correspond to the *Safe Address* in the Alias Device (in this case 10).

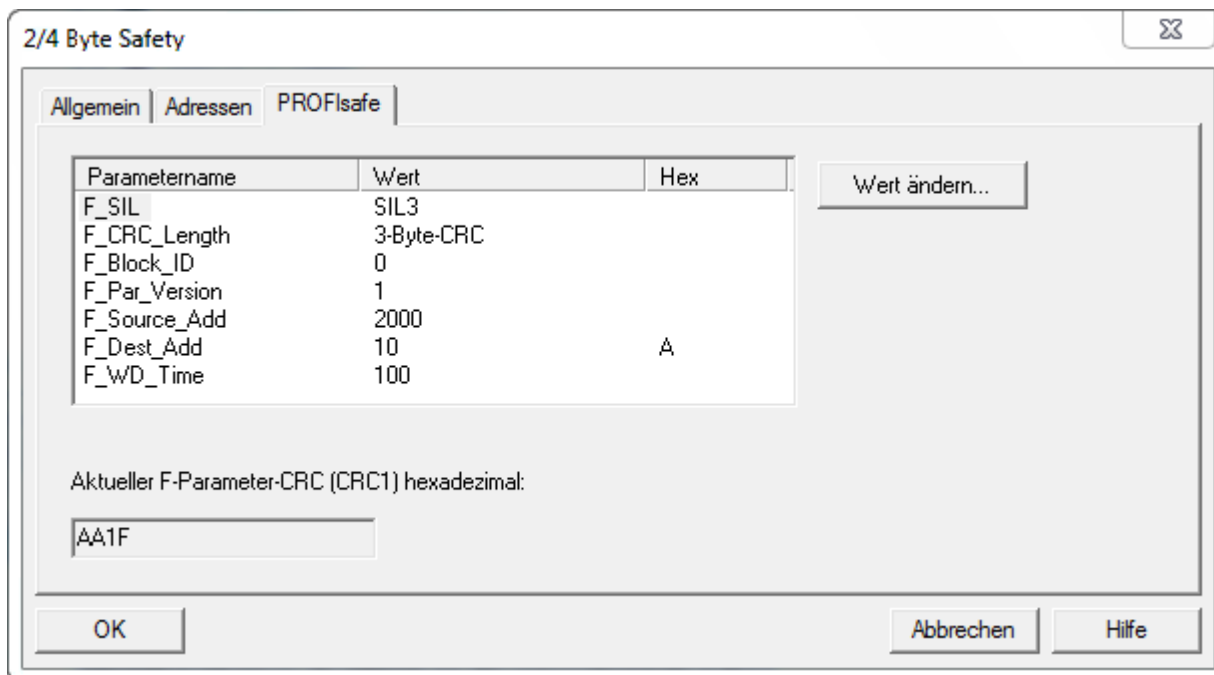

Fig. 153: Configuration of the slave connection in the PROFIsafe master software

The parameters shown here are sent together with the CRC as a 10-byte parameter to the PROFIsafe Slave when starting the PROFIsafe Master.

4.11.3.5 Configuration of PROFIsafe Gateway communication

The PROFIsafe Master transfers the configuration data of the connection via acyclic services. These must be forwarded via the Gateway (e.g. EL6631) to the EL6910. This is usually realized inside the standard controller. To do this the Gateway must first be configured so that the data can be forwarded via the standard controller.

4.11.3.5.1 Gateway configuration

Within the TwinCAT configuration, the PROFINET device (in the PROFINet subtree of the I/O configuration) must be configured for the parameterization of the PROFIsafe Slave. To do this, the AmsNetID and the port must be set to the task that initiates the program sample below. For the first task in the first runtime system this is port 851 under TwinCAT 3 and port 802 under TwinCAT 2.

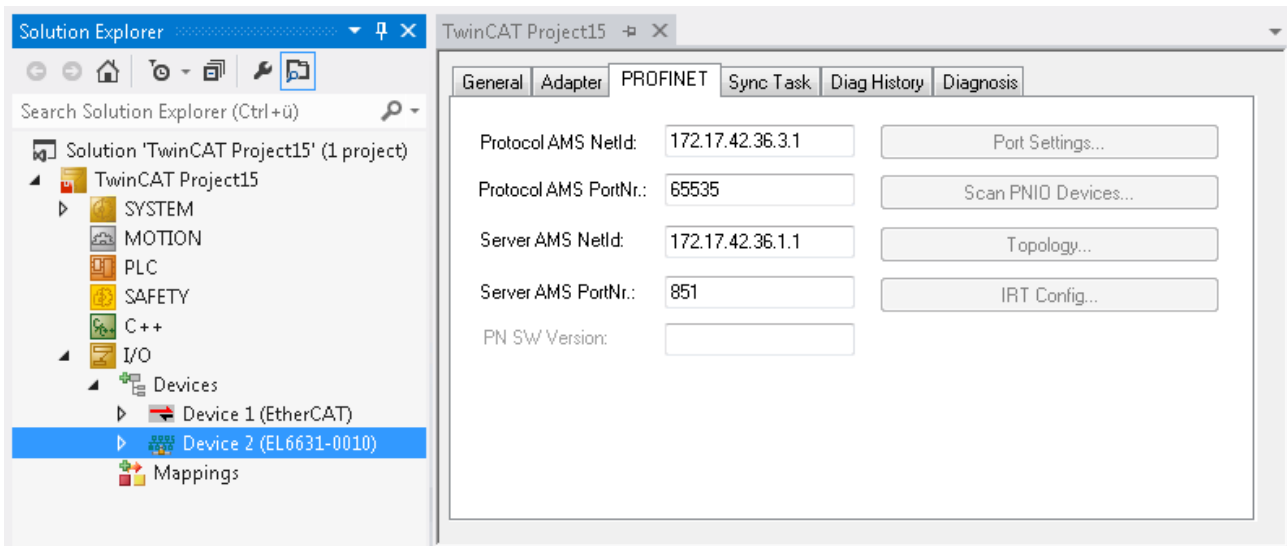

Fig. 154: Configuration of the PROFINET device

The *Protocol AMS NetId* of the PROFINET device is located in the advanced EtherCAT settings of the EL6631-0010 (in the EtherCAT subtree of the I/O configuration) under the entry *Mailbox AoE*.

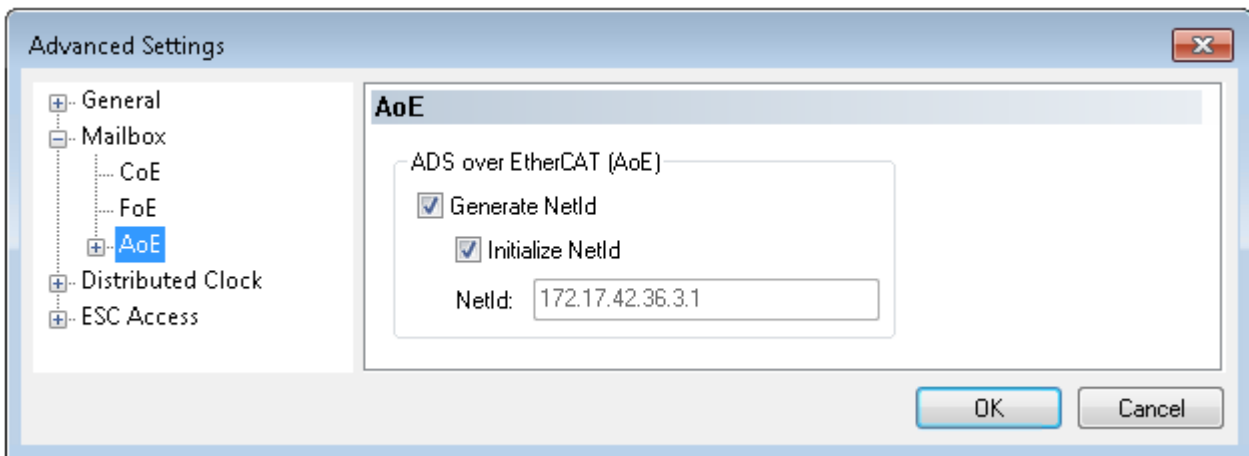

Fig. 155: Protocol AMS NetID of the PROFINET device

4.11.3.5.2 Sample program for parameterization

With the following program sample, the parameter data are received and saved in the PLC as persistent data. Each time the EL6910 is started, the parameters are transmitted to the EL6910 again and saved there in the CoE object 0x8005.

● Saving PROFIsafe parameters persistently

I The safety parameters for the slave connection transferred by the PROFIsafe master to the EL6910 are only transferred once when the PROFIsafe master starts up. If the EL6910 is restarted, these parameters are not transmitted again. Therefore, the saved data must be transferred again. If this is not done, the master must be restarted when the slave restarts.

Variable declaration

```
PROGRAM F_Parameter_El69x0
VAR
    FbWriteInd: ADWRITEIND;
    FbWriteRes: ADWRITERES;
    FbWrite: ADWRITE;
    au8EL6930NetId AT %I*: ARRAY[0..5] OF BYTE;
    u16EL6930Port AT %I*: WORD;
    u16EL6930State AT %I*: WORD;
    u16OldState: WORD;
```

```
bWriteFPar: BOOL;  
sNetId: STRING(23);  
bNetIdInitialized: BOOL;  
i: INT;  
au16FParameter: ARRAY [0..7] OF WORD;  
END_VAR  
VAR_PERSISTENT  
    au8FParameter: ARRAY[0..9] OF BYTE;  
END_VAR
```

Program sample

```
(* Setting AmsNetID of EL69x0 *)
IF NOT bNetIdInitialized THEN
  sNetId := '';
  FOR i := 0 TO 5 DO
    sNetId := CONCAT(sNetId, BYTE_TO_STRING(au8EL6930NetId[i]));
    sNetId := CONCAT(sNetId, '.');
  END_FOR
  bNetIdInitialized := TRUE;
END_IF

(* ADS Write Indication - Reading parameter data *)
FbWriteInd();
IF FbWriteInd.VALID THEN
  IF FbWriteInd.LENGTH = 10 THEN
    FW_MemCpy(ADR(au8FParameter), FbWriteInd.DATAADDR, 10);
    bWriteFPar := TRUE;
  END_IF
  FbWriteRes(
    NETID := FbWriteInd.NETID,
    PORT := FbWriteInd.PORT,
    INVOKEID := FbWriteInd.INVOKEID,
    RESULT := 0,
    RESPOND := TRUE
  );
  FbWriteRes(RESPOND := FALSE);
  FbWriteInd(CLEAR := TRUE);
  FbWriteInd(CLEAR := FALSE);
END_IF
memcpy(ADR(au16FParameter), ADR(au8FParameter), SIZEOF(au8FParameter));

(* Calculate parameter CRC in case of EL6910 *)
au16FParameter[7] := F_CalcCrc011B(u16Size:=14, u32DataAdr:= ADR(au16FParameter));

(* ADS Write - Write parameter to EL69x0 *)
FbWrite(
  NETID := sNetId,
  PORT := u16EL6930Port,
  IDXGRP := 16#F302,
  IDXOFFS := 16#FE220001,
  LEN := SIZEOF(au16Fparameter),
  SRCADDR := ADR(au16FParameter),
  WRITE := bWriteFPar
);
IF bWriteFPar AND NOT FbWrite.BUSY THEN
  IF NOT FbWrite.ERR THEN
    bWriteFPar := FALSE;
  END_IF
  FbWrite(WRITE := FALSE);
END_IF

(* Write parameter each startup of the EL69x0 *)
IF (u16OldState AND 16#0F) <> (u16EL6930State AND 16#0F) THEN
  IF (u16OldState AND 16#0F) <> 2
    AND (u16OldState AND 16#0F) <> 4
    AND (u16OldState AND 16#0F) <> 8 THEN
    IF (u16EL6930State AND 16#0F) = 2
      OR (u16EL6930State AND 16#0F) = 4
      OR (u16EL6930State AND 16#0F) = 8 THEN
      bWriteFPar := TRUE;
    END_IF
  END_IF
  u16OldState := u16EL6930State;
END_IFs
```

When using this program sample, the index offset must be adapted to suit the configured PROFIsafe connection for successful writing of the parameters to the EL6910. The value in the sample shown here is *FE220001*. The last two digits are the connection number of the PROFIsafe connection (in this case *01*). This is to be taken from the corresponding *Alias Device* of the safety project (on the *Connection* tab).

In order to calculate the CRC of the parameters, an additional function is required for the EL6910 (in the sample program it is the call *F_CalcCrc011B*).

Variable declaration

```

FUNCTION F_CalcCrc011B : WORD
VAR_INPUT
    u16Size: WORD;
    u32DataAdr: POINTER TO DWORD;
END_VAR
VAR
    i: WORD;
    b1,b2: BYTE;
    u16Crc: WORD;
    w1,w2: WORD;
    aul6CrcTab: ARRAY[0..255] OF WORD :=
        [16#0000,16#011B,16#0236,16#032D,16#046C,16#0577,16#065A,16#0741,
        16#08D8,16#09C3,16#0AEE,16#0BF5,16#0CB4,16#0DAF,16#0E82,16#0F99,
        16#11B0,16#10AB,16#1386,16#129D,16#15DC,16#14C7,16#17EA,16#16F1,
        16#1968,16#1873,16#1B5E,16#1A45,16#1D04,16#1C1F,16#1F32,16#1E29,
        16#2360,16#227B,16#2156,16#204D,16#270C,16#2617,16#253A,16#2421,
        16#2BB8,16#2AA3,16#298E,16#2895,16#2FD4,16#2ECF,16#2DE2,16#2CF9,
        16#32D0,16#33CB,16#30E6,16#31FD,16#36BC,16#37A7,16#348A,16#3591,
        16#3A08,16#3B13,16#383E,16#3925,16#3E64,16#3F7F,16#3C52,16#3D49,
        16#46C0,16#47DB,16#44F6,16#45ED,16#42AC,16#43B7,16#409A,16#4181,
        16#4E18,16#4F03,16#4C2E,16#4D35,16#4A74,16#4B6F,16#4842,16#4959,
        16#5770,16#566B,16#5546,16#545D,16#531C,16#5207,16#512A,16#5031,
        16#5FA8,16#5EB3,16#5D9E,16#5C85,16#5BC4,16#5ADF,16#59F2,16#58E9,
        16#65A0,16#64BB,16#6796,16#668D,16#61CC,16#60D7,16#63FA,16#62E1,
        16#6D78,16#6C63,16#6F4E,16#6E55,16#6914,16#680F,16#6B22,16#6A39,
        16#7410,16#750B,16#7626,16#773D,16#707C,16#7167,16#724A,16#7351,
        16#7CC8,16#7DD3,16#7EFE,16#7FE5,16#78A4,16#79BF,16#7A92,16#7B89,
        16#8D80,16#8C9B,16#8FB6,16#8EAD,16#89EC,16#88F7,16#8BDA,16#8AC1,
        16#8558,16#8443,16#876E,16#8675,16#8134,16#802F,16#8302,16#8219,
        16#9C30,16#9D2B,16#9E06,16#9F1D,16#985C,16#9947,16#9A6A,16#9B71,
        16#94E8,16#95F3,16#96DE,16#97C5,16#9084,16#919F,16#92B2,16#93A9,
        16#AEE0,16#AFFB,16#ACD6,16#ADCD,16#AA8C,16#AB97,16#A8BA,16#A9A1,
        16#A638,16#A723,16#A40E,16#A515,16#A254,16#A34F,16#A062,16#A179,
        16#BF50,16#BE4B,16#BD66,16#BC7D,16#BB3C,16#BA27,16#B90A,16#B811,
        16#B788,16#B693,16#B5BE,16#B4A5,16#B3E4,16#B2FF,16#B1D2,16#B0C9,
        16#CB40,16#CA5B,16#C976,16#C86D,16#CF2C,16#CE37,16#CD1A,16#CC01,
        16#C398,16#C283,16#C1AE,16#C0B5,16#C7F4,16#C6EF,16#C5C2,16#C4D9,
        16#DAF0,16#DBEB,16#D8C6,16#D9DD,16#DE9C,16#DF87,16#DCAA,16#DBB1,
        16#D228,16#D333,16#D01E,16#D105,16#D644,16#D75F,16#D472,16#D569,
        16#E820,16#E93B,16#EA16,16#EB0D,16#EC4C,16#ED57,16#EE7A,16#EF61,
        16#E0F8,16#E1E3,16#E2CE,16#E3D5,16#E494,16#E58F,16#E6A2,16#E7B9,
        16#F990,16#F88B,16#FBA6,16#FABD,16#FDFC,16#FCE7,16#FFCA,16#FED1,
        16#F148,16#F053,16#F37E,16#F265,16#F524,16#F43F,16#F712,16#F609];
END_VAR

```

Program sample

```

u16Crc := 0;
FOR i := 0 TO (u16Size-1) DO
    b1 := WORD_TO_BYTE(SHR((u16Crc AND 16#FF00), 8));
    FW_MemCpy(ADR(b2), u32DataAdr+WORD_TO_DWORD(i), 1);
    w1 := aul6CrcTab[b1];
    w2 := aul6CrcTab[b2];
    w1 := w1 XOR w2;
    u16Crc := SHL(((SHR((w1 AND 16#FF00), 8) XOR (u16Crc AND 16#FF)) AND 16#FF),8)
        + (w1 AND 16#FF);
END_FOR

F_CalcCrc011B := u16Crc;

```

4.12 TwinSAFE SC - configuration

The TwinSAFE SC technology enables communication with standard EtherCAT terminals via the Safety over EtherCAT protocol. These connections use another checksum, in order to be able to distinguish between TwinSAFE SC and TwinSAFE. Eight fixed CRCs can be selected, or a free CRC can be entered by the user.

By default the TwinSAFE SC communication channel of the respective TwinSAFE SC component is not enabled. In order to be able to use the data transfer, the corresponding TwinSAFE SC module must first be added under the Slots tab. Only then is it possible to link to a corresponding alias device.

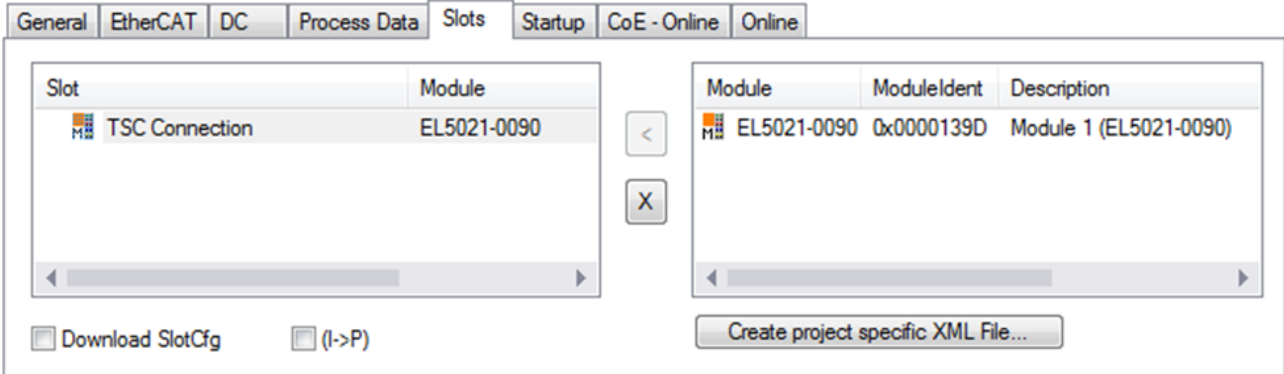

Fig. 156: Adding the TwinSAFE SC process data under the component, e.g. EL5021-0090

Additional process data with the ID TSC Inputs, TSC Outputs are generated (TSC - TwinSAFE Single Channel).

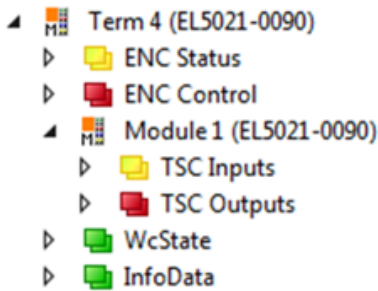

Fig. 157: TwinSAFE SC component process data, example EL5021-0090

A TwinSAFE SC connection is added by adding an alias devices in the safety project and selecting TSC (*TwinSAFE Single Channel*)

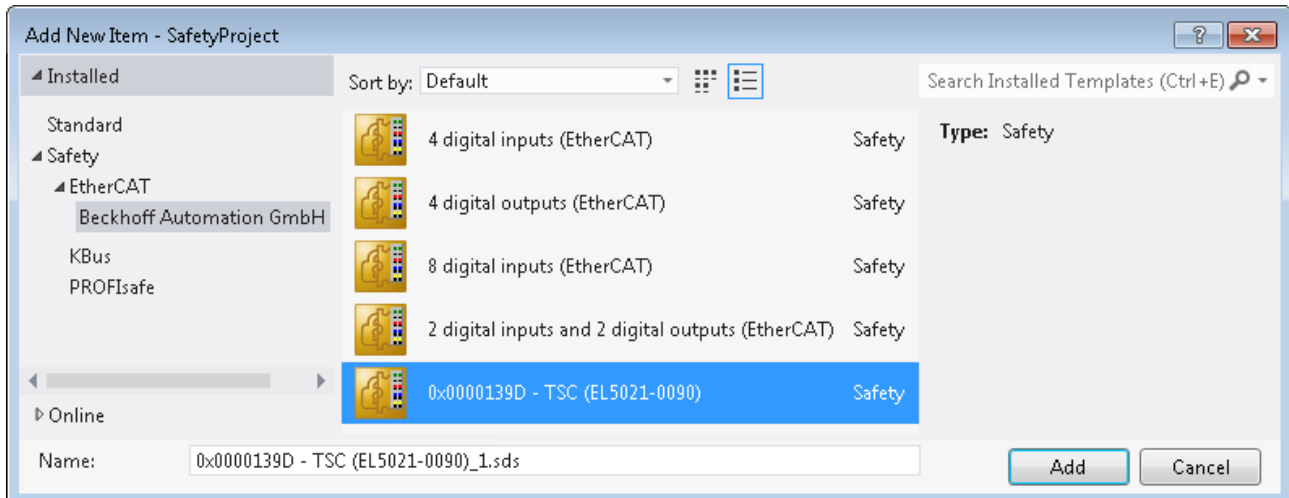



Fig. 158: Adding a TwinSAFE SC connection

After opening the alias device by double-clicking, select the Link button  next to *Physical Device*, in order to create the link to a TwinSAFE SC terminal. Only suitable TwinSAFE SC terminals are offered in the selection dialog.

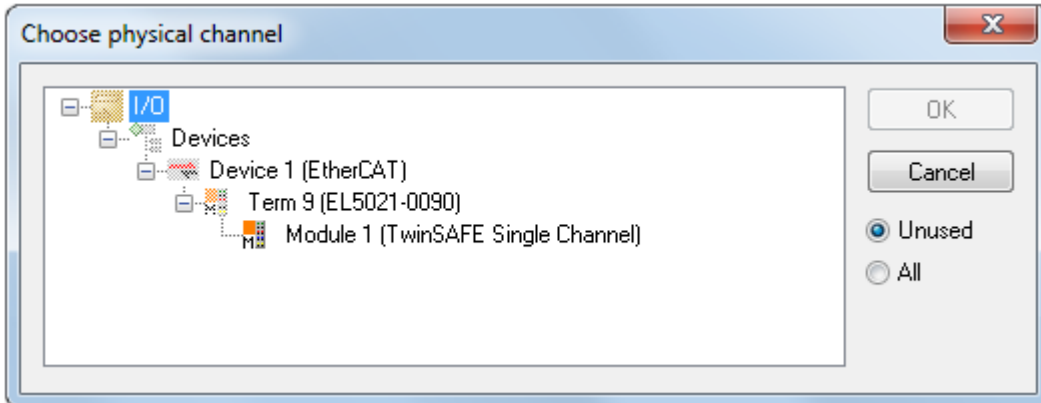

Fig. 159: Creating a link to TwinSAFE SC terminal

The CRC to be used can be selected or a free CRC can be entered under the Connection tab of the alias device.

Entry Mode	Used CRCs
TwinSAFE SC CRC 1 master	0x17B0F
TwinSAFE SC CRC 2 master	0x1571F
TwinSAFE SC CRC 3 master	0x11F95
TwinSAFE SC CRC 4 master	0x153F1
TwinSAFE SC CRC 5 master	0x1F1D5
TwinSAFE SC CRC 6 master	0x1663B
TwinSAFE SC CRC 7 master	0x1B8CD
TwinSAFE SC CRC 8 master	0x1E1BD

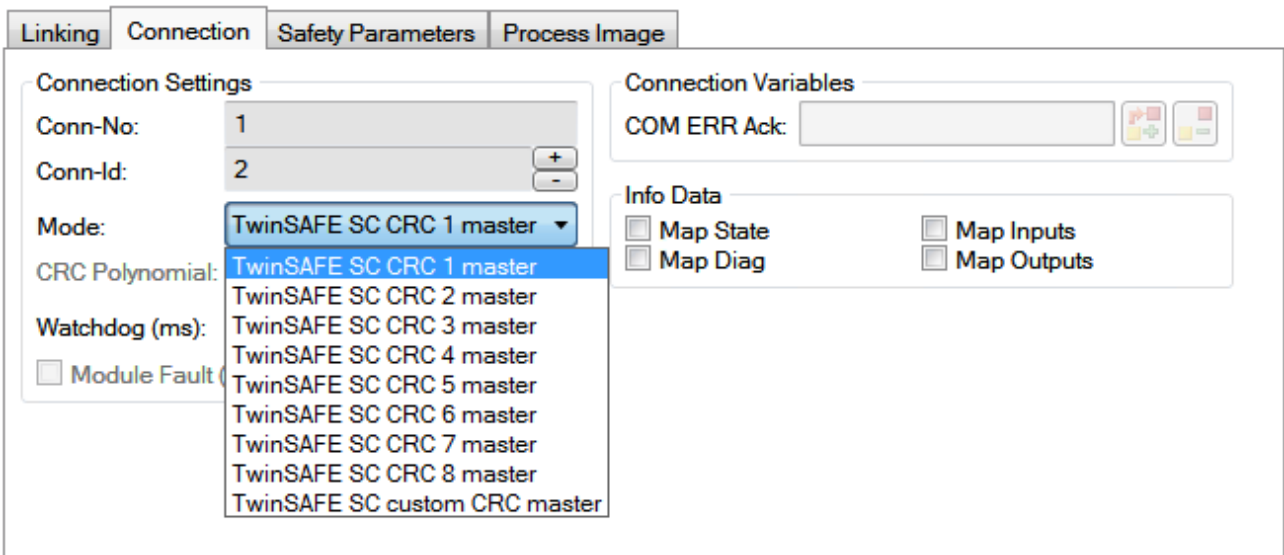

Fig. 160: Selecting a free CRC

These settings must match the settings in the CoE objects of the TwinSAFE SC component. The TwinSAFE SC component initially makes all available process data available. The *Safety Parameters* tab typically contains no parameters. The process data size and the process data themselves can be selected under the *Process Image* tab.

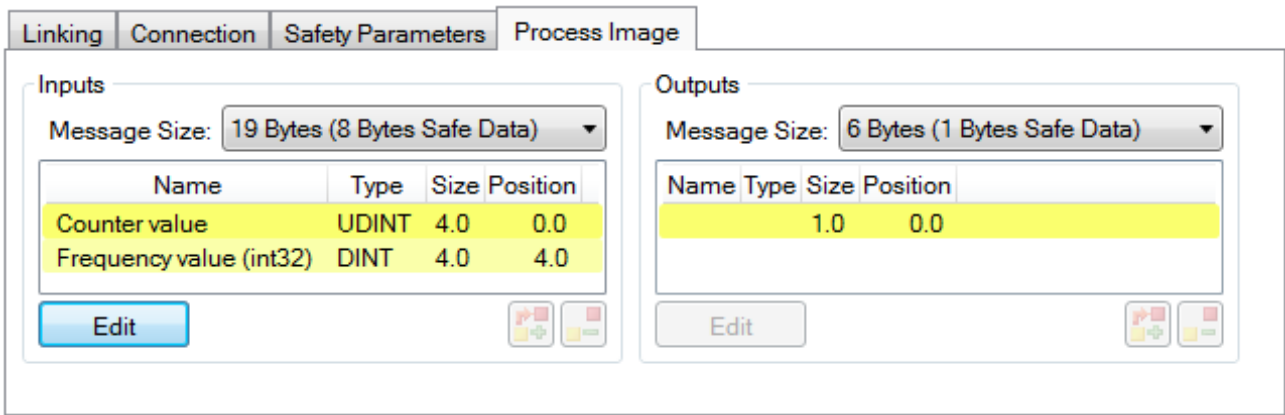

Fig. 161: Selecting the process data size and the process data

The process data (defined in the ESI file) can be adjusted to user requirements by selecting the *Edit* button in the dialog *Configure I/O element(s)*.

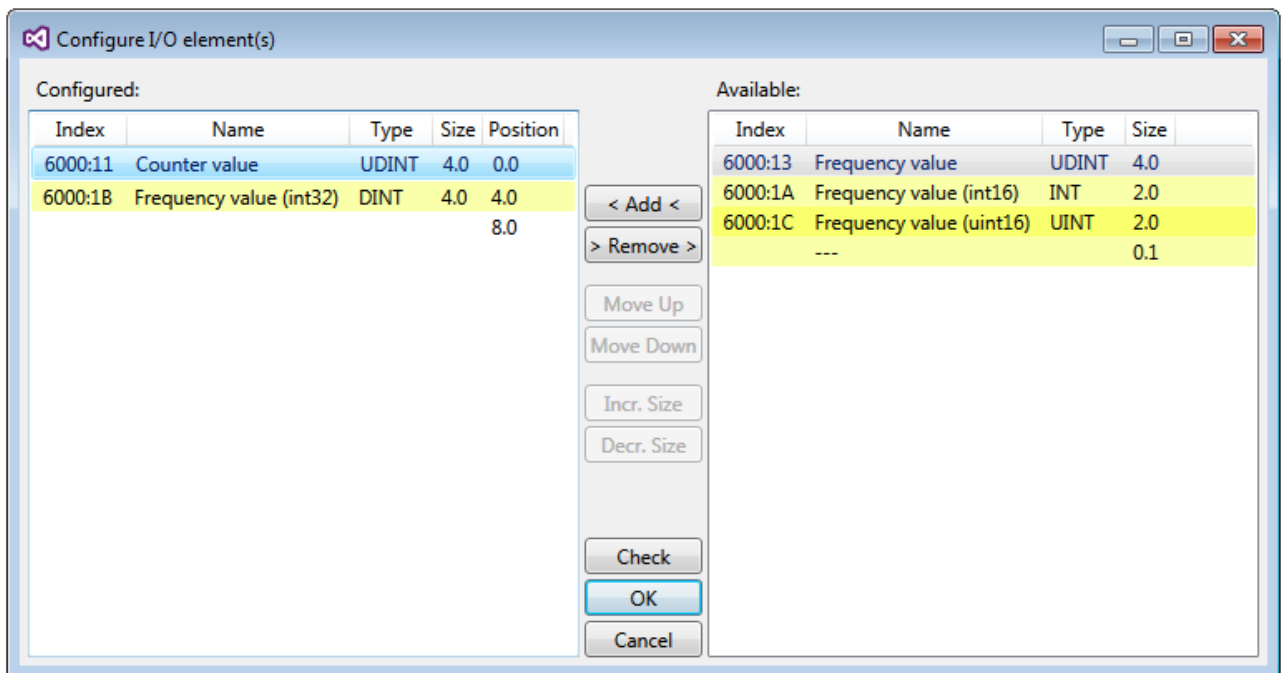

Fig. 162: Selection of the process data

The safety address together with the CRC must be entered on the TwinSAFE SC slave side. This is done via the CoE objects under *TSC settings* of the corresponding TwinSAFE SC component (here, for example, EL5021-0090, 0x8010: 01 and 0x8010: 02). The address set here must also be set in the *alias device* as *FSoE* address under the *Linking* tab.

Under the object 0x80n0:02 Connection Mode the CRC to be used is selected or a free CRC is entered. A total of 8 CRCs are available. A free CRC must start with 0x00ff in the high word.

8010:0	TSC Settings	RW	> 2 <
8010:01	Address	RW	0x0000 (0)
8010:02	Connection Mode	RW	TwinSAFE SC CRC1 master (97039)

Fig. 163: CoE objects 0x8010:01 and 0x8010:02

Object TSC Settings

Depending on the terminal, the index designation of the configuration object *TSC Settings* can vary. Example:

- EL3214-0090 and EL3314-0090, TSC Settings, Index 8040
- EL5021-0090, TSC Settings, Index 8010
- EL6224-0090, TSC Settings, Index 800F

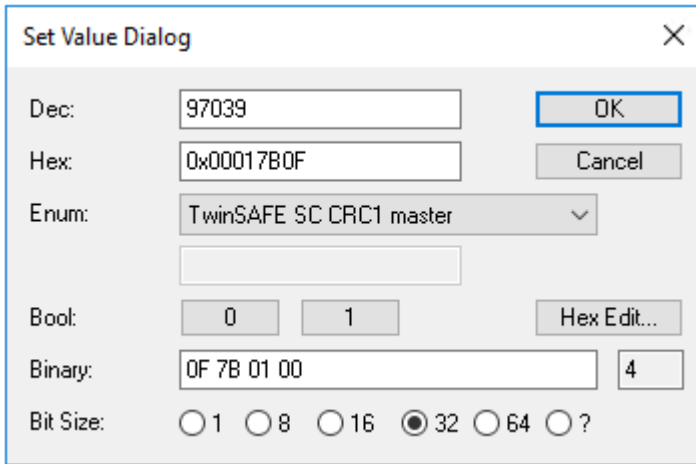



Fig. 164: Entering the safety address and the CRC

TwinSAFE SC connections

If several TwinSAFE SC connections are used within a configuration, a different CRC must be selected for each TwinSAFE SC connection.

4.13 Customizing / disabling TwinSAFE groups

The function Customizing  can be selected in the safety toolbars or via the TwinSAFE menu. It can be used to enable and disable groups. There are different deactivation methods, as shown in the following table.

Deactivation	Description
Permanent deactivation	The TwinSAFE group is permanently disabled by the user. The substitute values parameterized for the group are set for the group outputs. If this group is enabled again, the RUN signal for this group must change from 0 to 1, in order for the group to start. Parameter: <i>Permanent Deactivation Allowed</i> : TRUE/FALSE
Deactivation until the EL6910 is switched off and back on again	The TwinSAFE group is disabled until the EL6910 is switched on again. The substitute values parameterized for the group are set for the group outputs. This setting cannot be used as default setting for the safety program download. If this group is enabled again (other than by switching off and on again), the RUN signal for this group must change from 0 to 1, in order for the group to start. Parameter: <i>Temporary Deactivation Allowed</i> : TRUE/FALSE
Deactivation of manual control unit	After starting the deactivation, the connection defined in the group must report a COM error after a period of 10 seconds, for sample (default setting). If this is not the case, a group error set and corresponding diagnostic message is generated. Only one connection may be defined in the group, which must be a master connection. Parameter: <i>Passification Allowed</i> : TRUE/FALSE <i>Timeout Passification Allowed</i> : Time in ms

The customization can also be carried out during the download of the safety application.

In order to be able to perform a customization, the groups must be set accordingly. This is done via the group properties.

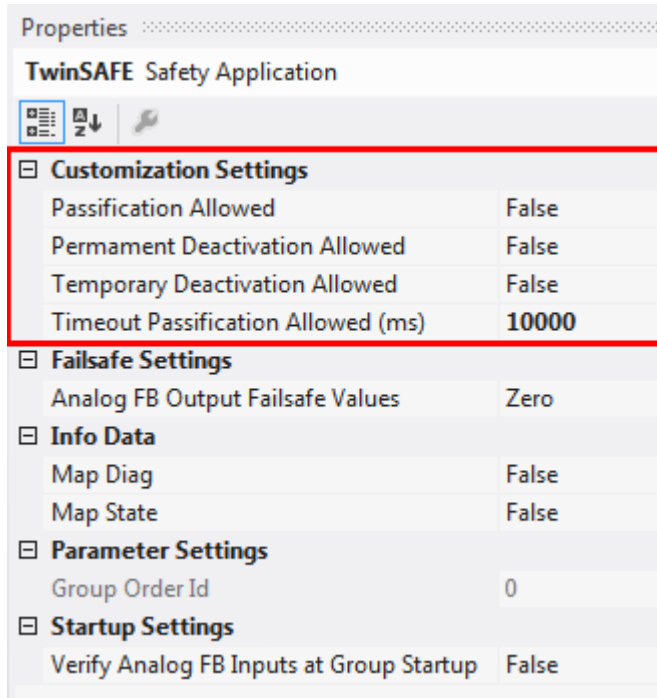

Fig. 165: Properties of the TwinSAFE group

If one of the Customizing parameters (*Passification Allowed*, *Permanent Deactivation Allowed* or *Temporary Deactivation Allowed*) is set to TRUE, all outputs of the TwinSAFE group that are not Safety Alias Devices are listed in the list of *Replacement Values*. Here you can parameterize the substitute values to be written to the output in the event of deactivation of the group.

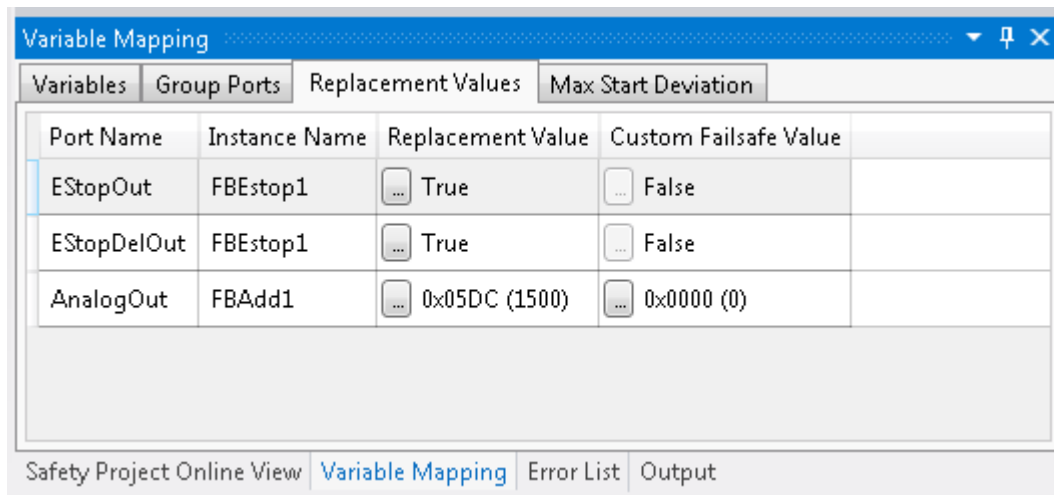



Fig. 166: Replacement values for the TwinSAFE group

When the Customizing function  is selected, the login dialog opens for the user to enter their login data. This login must give permission for customizing.

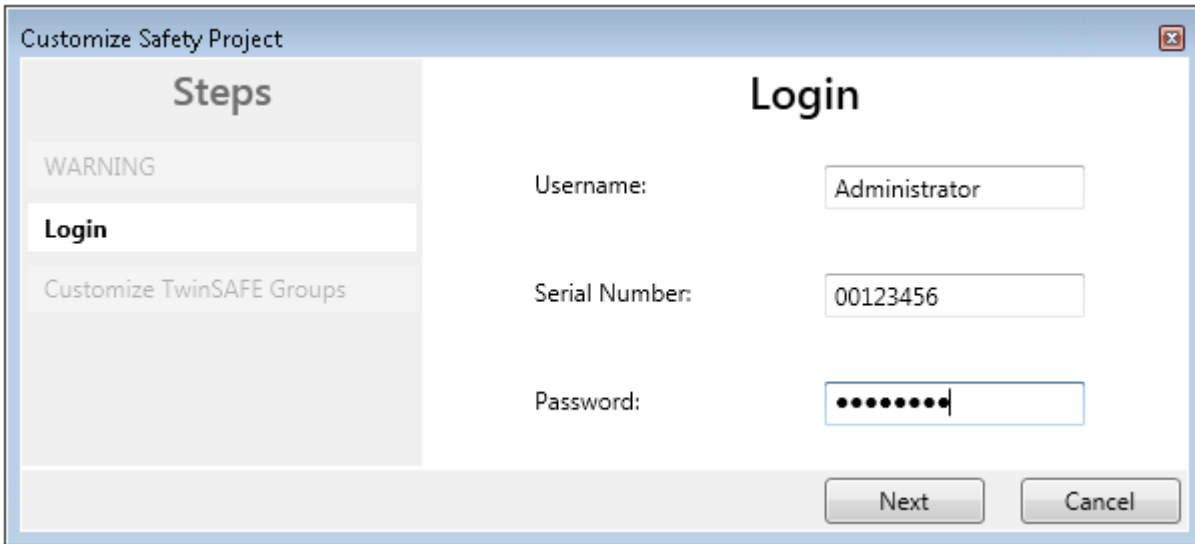

Fig. 167: Login

The Customizing dialog opens once the user has entered the data and selected *Next*.

The current group status is indicated with a green background.



Fig. 168: Customizing TwinSAFE Groups

The user can select the new status via the option area. In the sample below *Deactivate Temporarily* is selected. Use the *Finish* button to close the dialog and execute the required option.



Fig. 169: Customized TwinSAFE Group

i TwinSAFE Logic in PreOP state

If Customizing is carried out on a TwinSAFE Logic with EtherCAT status PreOP, the customizing of a group does not become active. Customizing must be carried out again if the TwinSAFE Logic is in the EtherCAT status SafeOP or OP.

4.14 Saving the analog group inputs persistently

EL6910, EJ6910 and EK1960 support persistent saving of analog input values in an internal memory. When the group starts up, the stored data are compared with the current data. Under the tab *Max Start Deviation*, a corresponding deviation can be specified for each defined analog input value of the group.

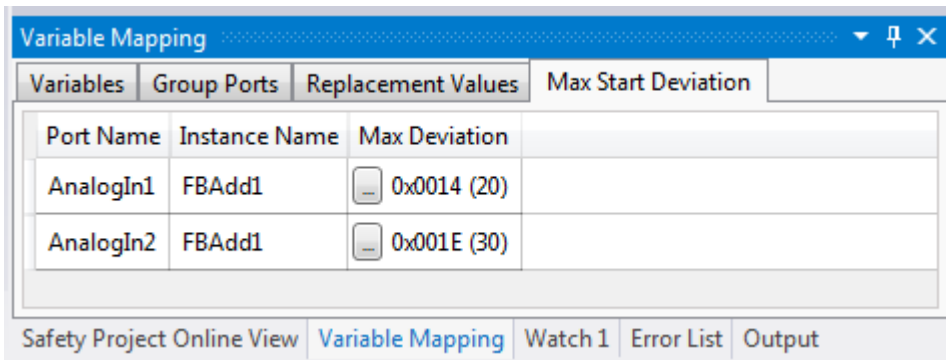

Fig. 170: Specifying deviations for analog input values

In the group properties the general settings for setting substitute values and checking the analog values on group startup can be parameterized. Setting the parameter *Verify Analog FB Inputs at Group Startup* to TRUE activates saving of all analog group inputs.

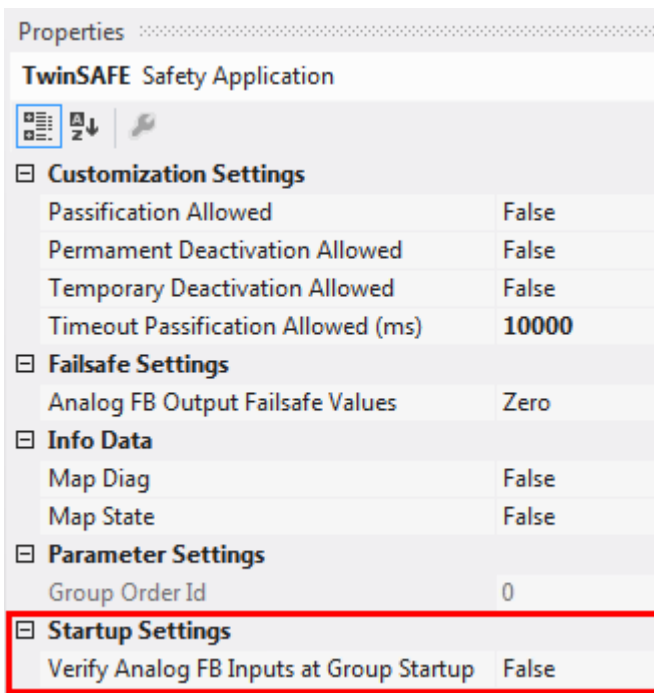

Fig. 171: Activate saving of all analog group inputs

4.15 Project design limits of EL6910/EJ6910

● Project design limits

i The maximum project design size for EL6910/EJ6910 is determined by the available memory. This is managed dynamically. The values specified in the following table are therefore only guide values and may differ from the actual values, depending on the safety project.

Process image size	max. 1486 bytes per data direction (max. memory size 0x1E00 for three buffers, i.e. with identical input and output process data sizes, the maximum size is 1280 bytes per data direction. Only even start addresses are possible, therefore fill bytes may have to be considered)
TwinSAFE connections	maximum 212 (up to 255 CRCs in total; 1 CRC is required for a TwinSAFE connection with 1 or 2 byte safe data.)
Supported hardware for TwinSAFE connections of the EL6910/EJ6910	EL1904 (all) EL2904 (all) EL2902 (all) EL6900 (all - max. 14 byte safe data) EL6930 (all - max. 14 byte safe data) EL6910 (all - max. 126 byte safe data) EL6910 (all - max. 126 byte safe data) KL1904 (from 2008) KL2904 (from 2008) KL6904 as slave (from 2008) AX5805 (all) AX5806 (all)
Safe data per TwinSAFE connection	maximum 126 byte (telegram length 255 byte)
PROFIsafe telegram length	4 to 16 byte PROFIsafe telegram length (user data 0 - 12 byte)
TwinSAFE function blocks	maximum 512 (ESTOP with complete input and output mapping)
TwinSAFE groups	maximum 128
TwinSAFE user	maximum 40
Standard PLC inputs	dynamic (memory-dependent), max. 1024 byte
Standard PLC outputs	dynamic (memory-dependent), max. 1024 byte

● TwinSAFE connection

i Only one TwinSAFE connection between two TwinSAFE terminals is possible. For communication with a EL6900, for sample, a connection with up to 14 bytes safe user data can be used.

4.16 Sync-Manager Configuration

Depending on the size of the TwinSAFE project on the TwinSAFE logic, it may be necessary to adjust the sync manager configuration.

As soon as the following message appears during the saving or downloading of the project, the sync manager configuration for the device has to be adapted.

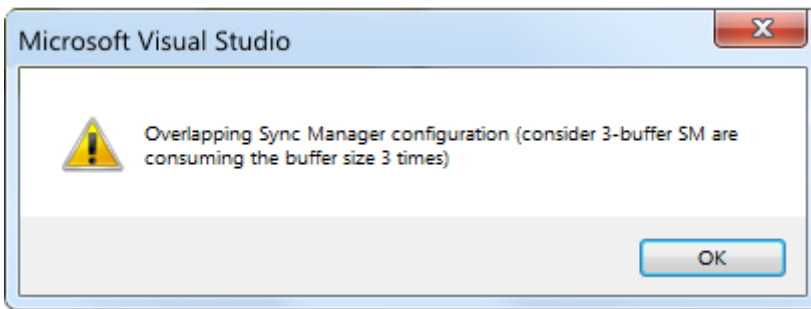

Fig. 172: Overlapping Sync Manager

Adapting the Sync-Manager configuration

The Sync Manager settings can be made via the *Advanced Settings...* of the TwinSAFE logic.

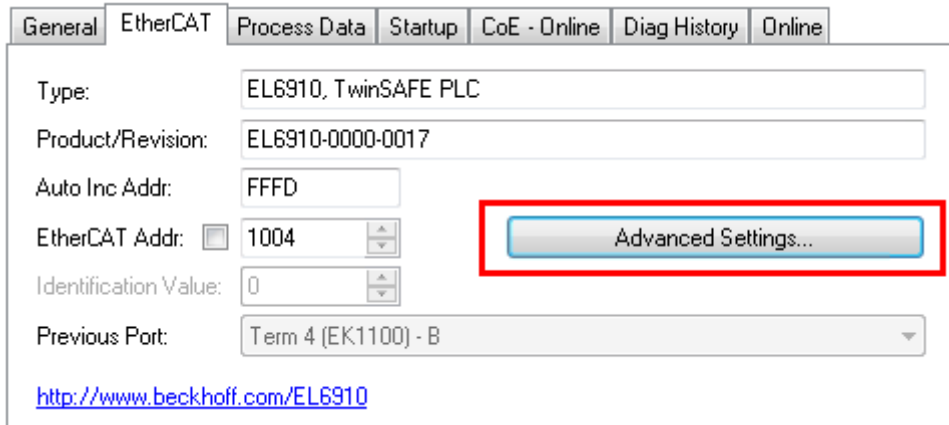

Fig. 173: EtherCAT Advanced Settings

To calculate the smallest start address of SM3, the length of SM2 is multiplied by 3 and added to the start address of SM2.

$$\text{Start SM3} \geq \text{Start SM2} + 3 * \text{Length SM2}$$

In addition, the starting address, together with 3 times the length of SM3, must not be larger than the address 0x3000.

$$\text{Start SM3} + 3 * \text{Length SM3} \leq 0x3000$$

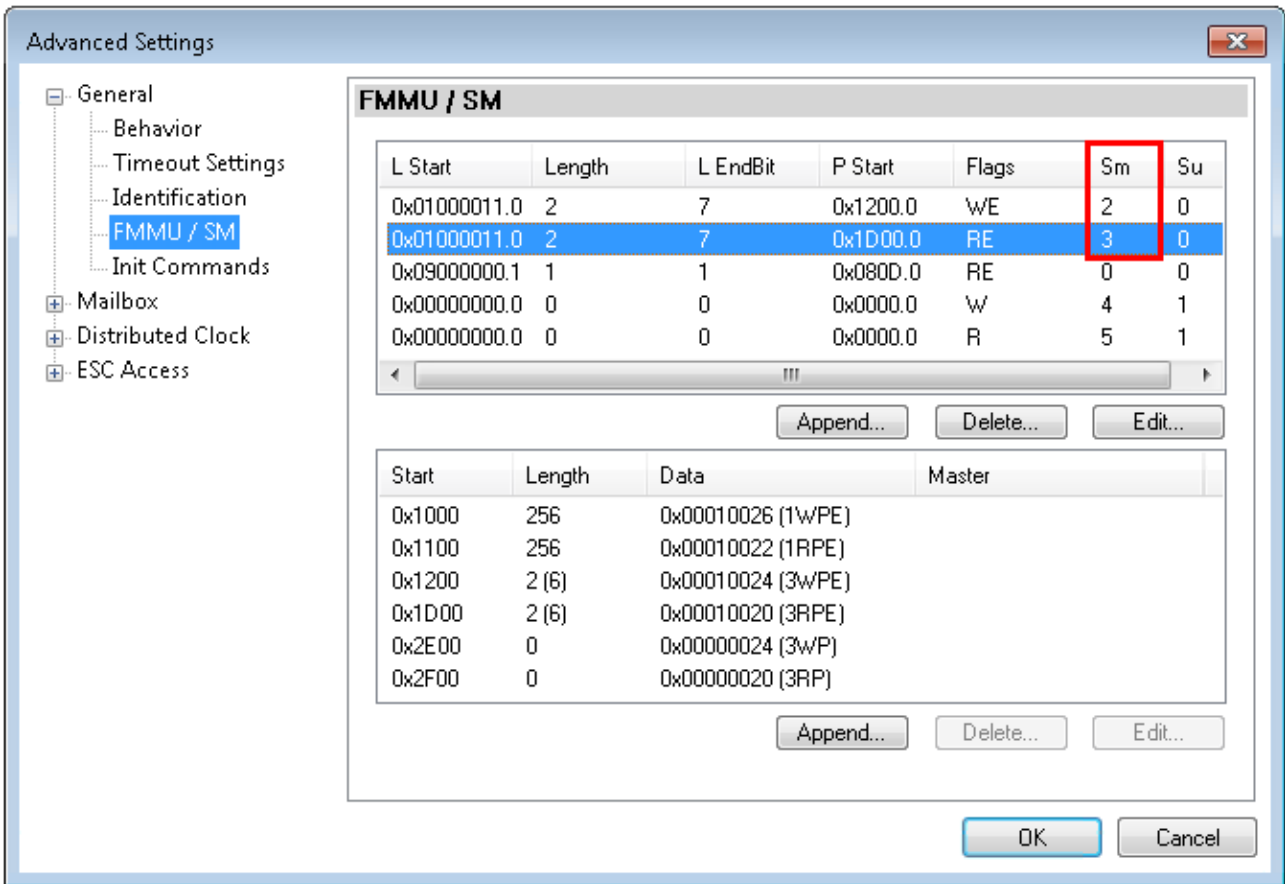

Fig. 174: Sync Manager settings

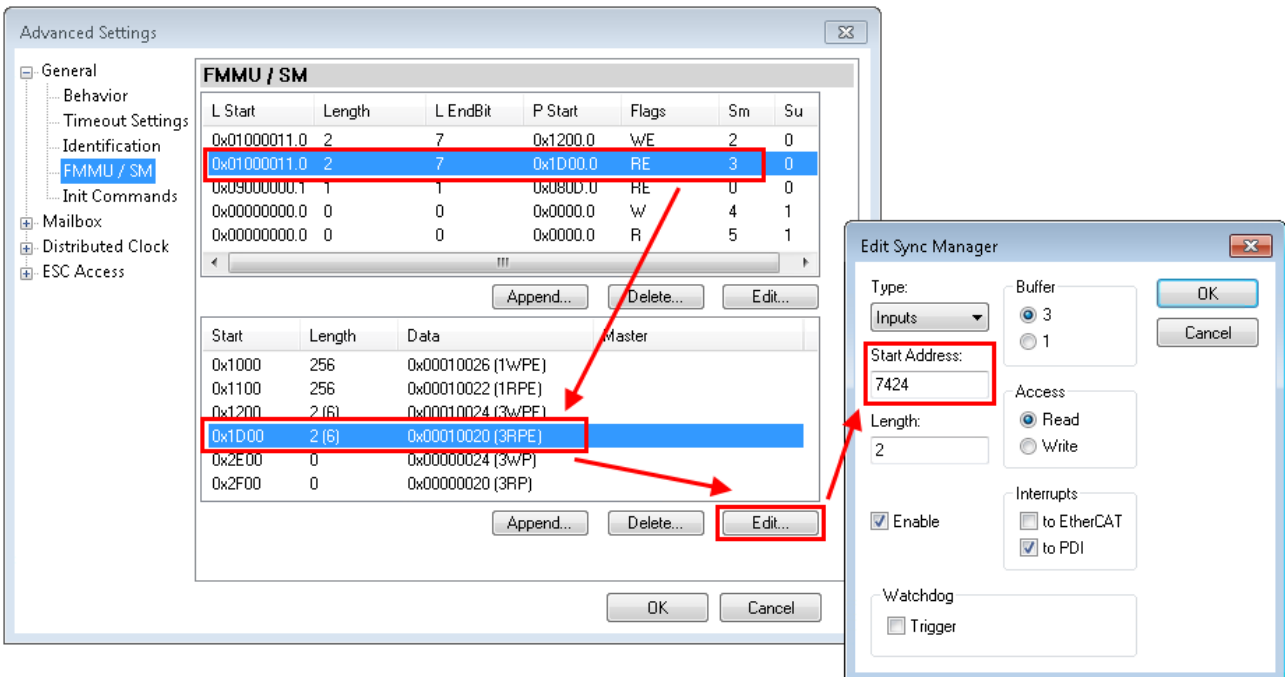

Fig. 175: Setting the start address for SM3

After changing the start address, all dialogs are closed with OK, the TwinCAT project is saved and the configuration is activated. If the calculation was carried out correctly, no error message should now be displayed and the project should be executed without errors.

4.17 Diagnostics

4.17.1 Diagnostic LEDs

The LEDs Diag 1 to Diag 4 display diagnostic information for the EL6910.

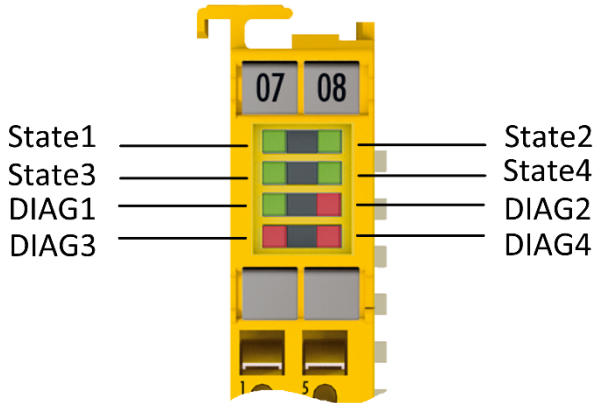

Fig. 176: EL6910 diagnostic LEDs

4.17.1.1 LED indicators

Diagnostic LEDs

LED	lit	flashing	off
Diag 1 (green)	Environment variables, operating voltage and internal tests are in the valid range <ul style="list-style-type: none"> If Diag 2 flashes, a logic error code applies 	-	Environment variables, operating voltage and internal tests are outside the valid range <ul style="list-style-type: none"> If Diag 2 flashes, an environment error code applies
Diag 2 (red)	Together with Diag 3 and 4: Global shutdown ¹⁾ has occurred. (see diag history of the TwinSAFE components)	Logic or environment error code according to Diag1 and tables below is output	Together with Diag 3 and 4: Global fault ¹⁾ has occurred. (see diag history of the TwinSAFE components)
Diag 3 (red)	Global fault or global shutdown on $\mu C1$ ¹⁾	-	No global fault or global shutdown on $\mu C1$ ¹⁾
Diag 4 (red)	Global fault or global shutdown on $\mu C2$ ¹⁾	-	No global fault or global shutdown on $\mu C2$ ¹⁾

1. A global fault permanently disables the TwinSAFE component, so that it has to be replaced. A global shutdown temporarily disables the TwinSAFE component. The error can be reset by switching off and back on again.



Logic error codes of LED Diag 2 (if LED Diag 1 is lit)

Flashing Code	Description
1	Function block error in one of the TwinSAFE groups
2	Communication error in one of the TwinSAFE groups
3	Error combination: Function block and communication
4	General error in one of the TwinSAFE groups
5	Error combination: General and function block
6	Error combination: General and communication
7	Error combination: General, function block and communication

Environment error codes of LED Diag 2 (if LED Diag 1 is off)

Flashing Code	Description
1	Maximum supply voltage μ C1 exceeded
2	Supply voltage μ C1 below minimum value
3	Maximum supply voltage μ C2 exceeded
4	Supply voltage μ C2 below minimum value
5	Maximum internal temperature exceeded
6	Internal temperature below minimum value
7	Valid temperature difference between μ C1 and μ C2 exceeded
8	not used
9	not used
10	General error

4.17.1.2 Flash code display

LED	Display	Description
flashing		400 ms ON / 400 ms OFF 1 second pause between the flash codes
flickering		50 ms ON / 50 ms OFF

4.17.2 Status LEDs

The LEDs State 1 to State 4 indicate the current status of the EL6910.

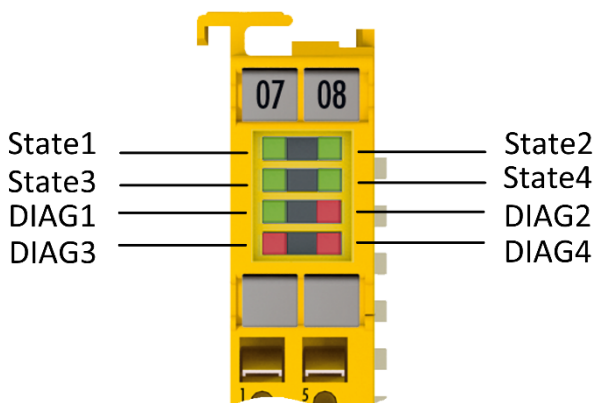

Fig. 177: EL6910 status LEDs

LED Display

State 1	State 2	State 3	State 4	Meaning
Off	Off	Off	lit	No TwinSAFE project available on the component
Off	Off	lit	lit	TwinSAFE project loaded, but not yet in RUN state
lit	Off	lit	lit	TwinSAFE project loaded and in RUN state. Customization is active for at least one TwinSAFE group
lit	lit	lit	lit	TwinSAFE project loaded and in RUN state. Customization is NOT active

4.17.3 Diagnostic objects

⚠ CAUTION

Do not change CoE objects!

Do not make any modifications to the CoE objects in the TwinSAFE components! Any modifications (e.g. using TwinCAT) of the CoE objects will permanently set the TwinSAFE components to the Fail-Stop state.

Index F984_{hex}: Device Info Data C1

The CoE object F984_{hex} displays current internal temperature and voltage values of the TwinSAFE components.

Index	Name	Meaning	Flags	Default
F984:01	Voltage C2	Voltage μ C2	RO	0 _{dec}
F984:02	Temperature C1	Temperature μ C1	RO	0 _{dec}
F984:03	Firmware CRC C1	CRC Firmware μ C1	RO	0 _{dec}
F984:04	Vendor data CRC C1	CRC Vendor data μ C1	RO	0 _{dec}

Index F985_{hex}: Device Info Data C2

The CoE object F985_{hex} displays current internal temperature and voltage values of the TwinSAFE components.

Index	Name	Meaning	Flags	Default
F985:01	Voltage C1	Voltage μ C1	RO	0 _{dec}
F985:02	Temperature C2	Temperature μ C2	RO	0 _{dec}
F985:03	Firmware CRC C2	CRC Firmware μ C2	RO	0 _{dec}
F985:04	Vendor data CRC C2	CRC Vendor data μ C2	RO	0 _{dec}

● i Diagnostics history

Errors occurring during the operation of the TwinSAFE components, such as overtemperature or undervoltage, are entered in the diagnostic history with a corresponding timestamp.

Index F100_{hex}: FSLOGIC status

The CoE object F100_{hex} shows the current status of the TwinSAFE component.

Index	Name	Meaning	Flags	Default
F100:01	Safe Logic State	Status of the internal logic: 0: OFFLINE 1: RUN 3: SAFE 6: START 8: PREPARE 10: RESTORE 11: PROJECT-CRC-OK	RO	0 _{bin}
F100:02	Cycle Counter	Life cycle counter, which is incremented with each TwinSAFE logic cycle.	RO	0 _{bin}

The following table contains a description of all values of the index F100_{hex} SubIndex 01.

Index	Value	Description
F100:01	0: OFFLINE	In the OFFLINE state no TwinSAFE logic program is loaded. No TwinSAFE groups and no TwinSAFE connections are processed.
	1: RUN	In the RUN state all TwinSAFE groups and all TwinSAFE connections configured in the TwinSAFE logic program are processed.
	3: SAFE	The SAFE state is assumed from the RUN state when the TwinSAFE logic program is stopped. If the TwinSAFE logic program is restarted without a new TwinSAFE logic program having been transferred, the TwinSAFE logic should switch again from SAFE to RUN. All TwinSAFE groups should be initialized with the initial state STOPERROR, so that an error acknowledgement occurs before safe outputs are connected again. In the SAFE state no TwinSAFE groups and no TwinSAFE connections are processed.
	6: START	The START state is assumed if the TwinSAFE logic program is loaded but the standard communication channel (e.g. EtherCAT) is not yet in process data exchange or the process data lengths configured via the standard communication channel do not match the process data lengths calculated using the TwinSAFE logic program. The START state is also assumed when a user is logged in for the purpose of deleting the current TwinSAFE logic program or transferring the user list. In the START state no TwinSAFE groups and no TwinSAFE connections are processed.
	8: PREPARE	The PREPARE state is assumed at the transition from START to RUN or from SAFE to RUN. In the PREPARE state, the stored data read in from the FRAM is checked and then the RUN state is assumed. If an error is detected during checking of the stored data, all TwinSAFE groups assume the initial state STOPERROR. If no error is detected during checking of the stored data, all TwinSAFE groups assume the initial state STOP.
	10: RESTORE	In the RESTORE state the loaded TwinSAFE restore program is to be checked by comparing its project CRC with the project CRCs read in via the corresponding TwinSAFE connections. In the RESTORE state all TwinSAFE connections configured in the TwinSAFE Restore program are processed.
	11: PROJECT-CRC-OK	The PROJECT-CRC-OK state is assumed once the project CRC of the loaded TwinSAFE restore program has been successfully checked via the TwinSAFE connections. In the PROJECT-CRC-OK state no TwinSAFE groups and no TwinSAFE connections are processed.

This CoE object is additionally copied into the cyclic process image of the TwinSAFE component. From there, this information can be directly linked into the PLC.

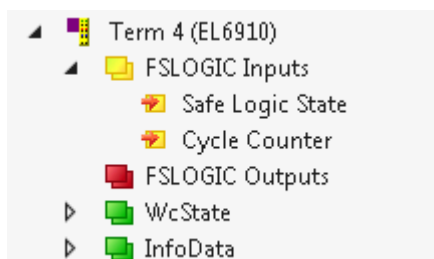

Fig. 178: Diagnostic object - FSLOGIC Status (F100_{hex}) in the process image of the TwinSAFE component

4.17.4 Cycle time of the safety project

The processing time of the EL6910/EJ6910 can be obtained from the CoE objects below. To determine the cycle time, it has to be multiplied with 1.25, because this is the factor used internally for generating a delay time before the next cycle.

4.17.4.1 Index FEA0hex: CTRL Diag Data

Index	Name	Meaning	Flags	Default
FEA0:09	Actual Safety Control Task Execution Time	Current processing time of the EL6910/EJ6910 when logic state = 1 (RUN) cycle time = 1.25 * value (average value of 64 cycles)	RO	0 _{hex}
FEA0:0A	Min Safety Control Task Execution Time	Minimum processing time of the EL6910/EJ6910 when logic state = 1 (RUN) cycle time = 1.25 * value	RO	0 _{hex}
FEA0:0B	Actual Safety Control Task Execution Time	Maximum processing time of the EL6910/EJ6910 when logic state = 1 (RUN) cycle time = 1.25 * value	RO	0 _{hex}
FEA0:15	Actual Safety Control Task Execution Time	Current processing time of the EL6910/EJ6910 when logic state <> 1 cycle time = 1.25 * value (average value of 64 cycles)	RO	0 _{hex}
FEA0:16	Min Safety Control Task Execution Time	Minimum processing time of the EL6910/EJ6910 when logic state <> 1 cycle time = 1.25 * value	RO	0 _{hex}
FEA0:17	Actual Safety Control Task Execution Time	Maximum processing time of the EL6910/EJ6910 when logic state <> 1 cycle time = 1.25 * value	RO	0 _{hex}

The minimum and maximum values can be reset by writing a value to CoE object 0x1C32:08.

4.18 Diagnosis History

The diagnostic history of the TwinSAFE devices that support this function is implemented in accordance with the ETG guideline ETG.1020 Chapter 13 "Diagnosis Handling". The diagnostic messages are saved by the TwinSAFE device in a dedicated CoE object under 0x10F3 and can be read out by the application or by TwinCAT.

Both the control entries and the history itself can be found in the CoE object 0x10F3. The entry Newest Message (0x10F3:02) contains the subindex of 0x10F3, which contains the latest diagnostic message, e.g. 0x06 for diagnostic message 1.

Index 10F3_{hex} Diagnosis History

Index (hex)	Name	Meaning	Data type	Flags	Default
10F3:0	Diagnosis History				
10F3:01	Maximum Messages	Maximum number of stored messages. A maximum of 64 messages can be stored. After that the respective oldest messages are overwritten.	UINT8	RO	0x40 (64 _{dec})
10F3:02	Newest Message	Subindex of the latest message	UINT8	RO	0x00 (0 _{dec})
10F3:03	Newest Acknowledged Message	Subindex of the last confirmed message	UINT8	RW	0x00 (0 _{dec})
10F3:04	New Messages Available	Indicates that a new message is available	BOOLEAN	RO	0x00 (0 _{dec})
10F3:05	Flags	Set via the startup list. If set to 0x0001, the diagnostic messages are additionally sent by emergency to the EtherCAT master	UINT16	RW	0x0000 (0 _{dec})
10F3:06	Diagnosis Message 001	Diagnostic message 1	BYTE[32]	RO	{0}
...
10F3:45	Diagnosis Message 064	Diagnostic message 64	BYTE[32]	RO	{0}

Structure of the diagnostic messages

- DiagCode (4 bytes) – in this case always 0x 0000 E000
- Flags (2 bytes) - diagnosis type (info, warning or error), timestamp and number of parameters contained (see the following table)
- Text ID (2 bytes) – ID of the diagnostic message as a reference to the message text from the ESI/XML
- Timestamp (8 bytes) – local slave time in ns since switching on the TwinSAFE device
- dynamic parameters (16 bytes) – parameters that can be inserted in the message text (see following table)

Flags in diagnostic messages

Data type	Offset	Description	
UINT16	Bits 0 to 3	DiagType (value)	
		0	Info message
		1	Warning message
		2	Error message
	3... 15	reserved	
	Bit 4	If the bit = 1, the timestamp contained in the message is the local timestamp of the TwinSAFE device. The age of the diagnostic message can be deduced by calculation with the current timestamp from the CoE object 0x10F8.	
	Bits 5 to 7	reserved	
	Bits 8 to 15	Number of parameters in this diagnostic message	

Dynamic parameters in the diagnostic messages

Type	Data type	Description
Flags parameter 1	UINT16	Describes the type of parameter 1 Bits 12 to 15 = Bits 0 to 11 = data type of parameter 1 0 0x0001 - BOOLEAN 0x0002 - INT8 0x0003 - INT16 0x0004 - INT32 0x0005 - UINT8 0x0006 - UINT16 0x0007 - UINT32 0x0008 - REAL32 0x0011 - REAL64 0x0015 - INT64 0x001B - UINT64 Text parameters and formats are specified in ETG.2000.
Parameter 1	Data type in accordance with flags	Value of parameter 1
Flags parameter 2	UINT16	see Flags parameter 1
Parameter 2	Data type in accordance with flags	Value of parameter 2
...		

The diagnostic messages are saved in text form in the ESI/XML file belonging to the TwinSAFE device. On the basis of the Text ID contained in the diagnostic message, the corresponding plain text message can be found in the respective languages. The parameters can be inserted in the appropriate positions. In the following example, %x is used for a hexadecimal representation of the parameters.



Fig. 179: ESI/XML message text

Via the entry *New Messages Available* the user receives information that new messages are available. The messages can be read out via CompleteAccess (a CoE read command for the complete CoE object 0x10F3). The *New Messages Available* bit is reset after reading the messages.

The sending of emergency messages to the EtherCAT master is activated by adding the CoE object 0x10F3:05 to the startup list (Transition IP, value 0x0001). If new diagnostic messages arrive, they are entered in object 0x10F3 and additionally sent by emergency to the EtherCAT master.

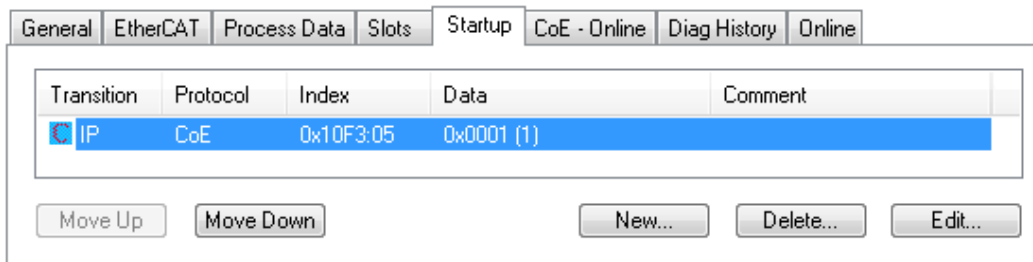

Fig. 180: Startup list

4.19 Maintenance

Maintenance

The TwinSAFE components are maintenance-free!

Environmental conditions

⚠ WARNING

Observe the specified environmental conditions!

Please ensure that the TwinSAFE components are only stored and operated under the specified conditions (see technical data).

If the TwinSAFE component is operated outside the permitted temperature range it will switch to *Global Shutdown* state.

Cleaning

Protect the TwinSAFE component from unacceptable soiling during operation and storage!

If the TwinSAFE component was subjected to unacceptable soiling it may no longer be operated!

⚠ WARNING

Have soiled terminals checked!

Cleaning of the TwinSAFE component by the user is not permitted!
Please send soiled terminals to the manufacturer for inspection and cleaning!

4.20 Service life

The TwinSAFE terminals are designed for a service life of 20 years.

Due to the high diagnostic coverage within the lifecycle no special proof tests are required.

The TwinSAFE terminals bear a date code, which is composed as follows:

Date code: CW YY SW HW

Legend:	Sample: Date Code 17 11 05 00
CW: Calendar week of manufacture	Calendar week: 17
YY: Year of manufacture	Year: 2011
SW: Software version	Software version: 05
HW: Hardware version	Hardware version: 00

In addition the TwinSAFE terminals bear a unique serial number.

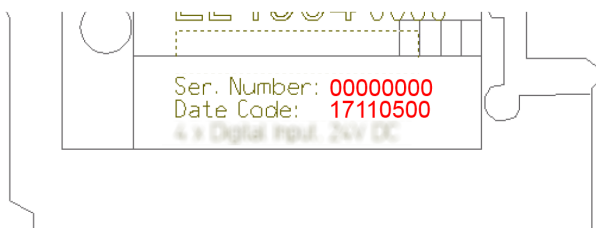

Fig. 181: Unique serial number of a TwinSAFE terminal

4.21 Decommissioning

⚠ WARNING

Risk of electric shock!

Bring the bus system into a safe, de-energized state before starting disassembly of the devices!

Disposal

In order to dispose of the device, it must be removed.

In accordance with the WEEE Directive 2012/19/EU, Beckhoff takes back old devices and accessories in Germany for proper disposal. Transport costs will be borne by the sender.

Return the old devices with the note "for disposal" to:
 Beckhoff Automation GmbH & Co. KG
 Service Department
 Stahlstrasse 31
 D-33415 Verl

Observe the applicable national laws and guidelines for disposal!

- Housing components (polycarbonate, polyamide (PA6.6)) are suitable for plastic recycling.
- Metal parts can be sent for metal recycling.
- Electronic parts such as circuit boards must be disposed of in accordance with national electronics scrap regulations.

5 Appendix

5.1 Support and Service

Beckhoff and their partners around the world offer comprehensive support and service, making available fast and competent assistance with all questions related to Beckhoff products and system solutions.

Beckhoff's branch offices and representatives

Please contact your Beckhoff branch office or representative for local support and service on Beckhoff products!

The addresses of Beckhoff's branch offices and representatives round the world can be found on her internet pages:

<http://www.beckhoff.com>

You will also find further documentation for Beckhoff components there.

Beckhoff Headquarters

Beckhoff Automation GmbH & Co. KG

Huelshorstweg 20
33415 Verl
Germany

Phone: +49 5246 963 0
Fax: +49 5246 963 198
e-mail: info@beckhoff.com

Beckhoff Support

Support offers you comprehensive technical assistance, helping you not only with the application of individual Beckhoff products, but also with other, wide-ranging services:

- support
- design, programming and commissioning of complex automation systems
- and extensive training program for Beckhoff system components

Hotline: +49 5246 963 157
Fax: +49 5246 963 9157
e-mail: support@beckhoff.com

Beckhoff Service

The Beckhoff Service Center supports you in all matters of after-sales service:

- on-site service
- repair service
- spare parts service
- hotline service

Hotline: +49 5246 963 460
Fax: +49 5246 963 479
e-mail: service@beckhoff.com

5.2 Certificates

ZERTIFIKAT ◆ CERTIFICATE ◆ 認証証書 ◆ CERTIFICADO ◆ CERTIFICAT



Product Service

CERTIFICATE

No. Z10 16 11 62386 034

Holder of Certificate: Beckhoff Automation GmbH & Co. KG

Hülshorstweg 20
33415 Verl
GERMANY

Factory(ies): 62386

Certification Mark:



Product: Safety components

Model(s): EJ6910, EL6910

Parameters:

Supply voltage:	24VDC (-15%/+20%)
Temperature range	-5°C ... +55°C
Protection Class:	IP20

Tested according to:

- EN 61508-1:2010 (SIL1-3)
- EN 61508-2:2010 (SIL1-3)
- EN 61508-3:2010 (SIL1-3)
- EN 61508-4:2010 (SIL1-3)
- EN ISO 13849-1:2015 (up to Cat 4, PL e)
- EN 61326-3-1:2008
- EN 62061:2005/A2:2015

The product was tested on a voluntary basis and complies with the essential requirements. The certification mark shown above can be affixed on the product. It is not permitted to alter the certification mark in any way. In addition the certification holder must not transfer the certificate to third parties. See also notes overleaf.

Test report no.: BV88453T

Valid until: 2021-12-14

Date, 2016-12-15

(Christian Dirmeier)



Page 1 of 1

TÜV SÜD Product Service GmbH · Zertifizierstelle · Ridlerstraße 65 · 80339 München · Germany

TÜV®

A1 / 04.11

certificate
no. **HSM 17002**
dated 2017-01-10



Translation In any case, the German original shall prevail.

Type Test Certificate

Name and address of the holder of the certificate (customer): Beckhoff Automation GmbH
Huelshorstweg 20
33415 Verl

Product designation: **Function block Electronic cam arrangement**

Type: *./.*

Testing based on:
- GS-HSM-01 "Presses", 04-2015
- GS-HSM-30 "Electrical, electronic and programmable control systems and bus systems", 04-2015
- IEC 62061:2005 + A1:2012 + A2:2015; EN 692:2005+A1:2009

Test Report: No. 032/2014 dated 10.01.2017

Further details: Intended use:
FB Cam Monitor is an evaluation unit which, in acc. with the set fixed values and depending on the current position, is capable of safely evaluating the cams (TDC, BDC, Upwards-Move).

Remarks:
The current position value must be safely determined; this was not included in the testing.

The type tested complies with the provisions laid down in the directive 2006/42/EC (**Machinery**).

The present certificate is valid until: **2022-01-09**

The type test certificate is not entitled to use a test mark.

Further provisions concerning the validity, the extension of the validity and other conditions are laid down in the Rules of Procedure of Testing and Certification.

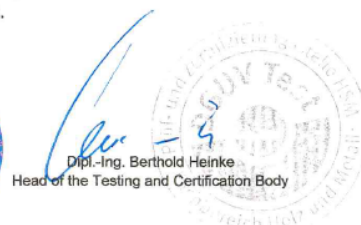

PZB10E Deutsche Gesetzliche Unfallversicherung (DGUV) e.V.
11.14 Spitzenverband der gewerblichen Berufsgenossenschaften
und der Unfallversicherungsträger der öffentlichen Hand
Vereinsregister-Nr. VR 751 B, Amtsgericht Charlottenburg

DGUV Test Prüf- und Zertifizierungsstelle Hebezeuge, Sicherheitskomponenten und Maschinen • Fachbereich Holz und Metall
Kreuzstraße 45 • 40210 Düsseldorf • Deutschland
Telefon: +49 (0) 211 8224-16910 • Fax: +49 (0) 211 8224-26910



5.2.1 EN 81-20, EN 81-22 and EN 81-50

The TwinSAFE components KLx9xx, ELx9xx and EK1960 meet the requirements of EN 81-20, EN 81-22 and EN 81-50. The conformity evaluation is based on the existing certificates.

- Z10 14 12 62386 022
- Z10 14 12 62386 023
- Z10 15 03 62386 033
- Z10 16 11 62386 034
- Z10 17 04 62386 036

The list of components and the corresponding manuals can be found in the following table.

No.	Product name	Description
KL1	KL1904	TwinSAFE input terminals with 4 fail-safe inputs
KL2	KL2904	TwinSAFE output terminal with 4 fail-safe outputs
KL3	KL6904	TwinSAFE Logic terminal with 4 fail-safe outputs
KL1-3	Operating instructions KL1904, version: 2.3.1, date: 2017-02-08 KL2904, version: 2.2.1, date: 2017-02-08 KL6904, version: 2.2.1, date: 2017-02-08	
EL1	EL1904	TwinSAFE Terminal with 4 digital fail-safe inputs
EL2	EL2904	TwinSAFE Terminal with 4 digital fail-safe outputs
EL3	EL6900	TwinSAFE Logic Terminal
EL4	EL6910	TwinSAFE Logic Terminal
EL5	EL6930	TwinSAFE Logic Terminal with PROFIsafe gateway
EL1-5	Operating instructions EL1904, version: 2.1.1, date: 2017-02-07 EL2904, version: 2.1.1, date: 2017-02-07 EL6900, version: 2.2.0, date: 2017-05-10 EL6910, version: 1.5.0, date: 2017-06-01 EL6930, version: 1.2.0, date: 2016-03-15	
EK1	EK1960	TwinSAFE Compact Controller
EK1	Operating instructions EK1960, version: 1.1.0, date: 2017-06-01	

The following operating conditions must be adhered to:

1. For the use of the modules according to EN 81-22 and EN 81-50, the conditions described in the manuals for achieving category 4 according to EN 13849-1 **must be** observed.
2. The use of the modules is limited to indoor applications.
3. Basic protection against direct contact must be provided, either by meeting protection class IP2X or by installing the modules in a control cabinet which corresponds at least to protection class IP54 according to EN 60529.
4. The ambient conditions regarding temperature, humidity, heat dissipation, EMC and vibrations, as specified in the operating instructions under technical data, must be observed.
5. The operating conditions in potentially explosive atmospheres (ATEX) are specified in the operating instructions.
6. The safe state (triggering) of the application must be the non-energized state (the safe state of the devices is always the non-energized, switched off state; this cannot be changed).
7. The service life specified in the operating instructions must be observed.
8. If the module is operated outside the permissible temperature range, it changes to "Global Shutdown" state.

Table of figures

Fig. 1	EL6910 - TwinSAFE Logic terminal.....	12
Fig. 2	Dimensions of the EL6910.....	17
Fig. 3	Installation position and minimum distances	19
Fig. 4	Sample configuration for temperature measurement	20
Fig. 5	Installation on the mounting rail	21
Fig. 6	Removal from mounting rail.....	22
Fig. 7	Thermally unfavorable arrangement of the TwinSAFE terminals	24
Fig. 8	Thermally favorable arrangement of the TwinSAFE terminals	25
Fig. 9	PE power contact.....	26
Fig. 10	EL6900/EL6910 pin assignment.....	27
Fig. 11	Typical reaction time.....	28
Fig. 12	Worst-case reaction time	29
Fig. 13	Adding an EL6910	33
Fig. 14	Address settings on TwinSAFE terminals with 1023 possible addresses	34
Fig. 15	Creating a safety project - Add New Item	35
Fig. 16	Creating a safety project - project name and directory	35
Fig. 17	TwinCAT Safety Project Wizard	36
Fig. 18	Selecting the Target System node.....	36
Fig. 19	Linking of target system and TwinSAFE terminal.....	37
Fig. 20	Starting the automatic import from the I/O configuration	37
Fig. 21	Selection from the I/O tree.....	38
Fig. 22	Creating alias devices by the user.....	38
Fig. 23	Alias Device in the safety project structure.....	39
Fig. 24	Links to EL6910/EJ6910 process image	39
Fig. 25	Connection-specific parameters	39
Fig. 26	Selecting an alias device	40
Fig. 27	Safety parameter for the device.....	41
Fig. 28	AX5000 safety drive functions	41
Fig. 29	AX5000 safety drive options - general AX5805 settings.....	42
Fig. 30	AX5000 safety drive options - Process Image.....	42
Fig. 31	AX5000 safety drive options - Function Diagram	43
Fig. 32	Creating an external connection (Custom FSoE Connection).....	44
Fig. 33	Parameterization of the process image size.....	44
Fig. 34	Renaming the individual signals within the telegram	45
Fig. 35	Selecting the variables.....	45
Fig. 36	Direct linking with the process image of an EtherCAT Terminal.....	46
Fig. 37	Connection-specific parameters	46
Fig. 38	Function blocks available for EL6910/EJ6910.....	48
Fig. 39	Function block on the SAL worksheet	48
Fig. 40	Dragging a connection between two function blocks.....	49
Fig. 41	Connection between two function blocks.....	50
Fig. 42	Creating a network.....	50
Fig. 43	Change Link.....	51
Fig. 44	Dialog for selecting a suitable FB port.....	51

Fig. 45	Link display	51
Fig. 46	Creating a TwinSAFE group	52
Fig. 47	Components of the TwinSAFE group	52
Fig. 48	Change Link.....	53
Fig. 49	Dialog for selecting a suitable FB port.....	53
Fig. 50	Link display	54
Fig. 51	The Variable Mapping dialog	54
Fig. 52	Context menu Edit TwinSAFE Group Order	56
Fig. 53	Dialog Change Execution Order of TwinSAFE Groups	56
Fig. 54	The command line below the SAL worksheet.....	57
Fig. 55	FB port properties	57
Fig. 56	Make Contact (NO) / Break Contact (NC) setting.....	58
Fig. 57	Menu Change Inport Settings	59
Fig. 58	Dialog Change InPort Settings	59
Fig. 59	Variable Mapping.....	59
Fig. 60	Selection dialog for the alias port.....	60
Fig. 61	Activation of the TwinCAT Safety and TwinCAT Safety CRC toolbars.....	60
Fig. 62	Display of the TwinCAT Safety and TwinCAT Safety CRC toolbars	60
Fig. 63	Check Safe Addresses context menu.....	62
Fig. 64	Check Safe Addresses dialog.....	62
Fig. 65	Download Project Data – The Login dialog	63
Fig. 66	Download Project Data – The Select Project Data dialog	64
Fig. 67	Download Project Data – The Download Result dialog	64
Fig. 68	Download Project Data – The Final Verification dialog.....	65
Fig. 69	Download Project Data – The Activation dialog.....	65
Fig. 70	SAL worksheet and variable mapping in online mode.....	67
Fig. 71	Activation of Show Online Values	68
Fig. 72	Display of the analog and digital values in online mode	68
Fig. 73	The Safety Project Online View tab	69
Fig. 74	Group Status Online RUN	70
Fig. 75	Group Status Online ERROR	71
Fig. 76	Group Status Online STOP	71
Fig. 77	Online View Group Ports	72
Fig. 78	Templates for Safety Projects.....	72
Fig. 79	Collapsing networks.....	73
Fig. 80	Adding a subfolder.....	73
Fig. 81	Subfolder e.g. Drives	73
Fig. 82	Goto Linked Element	74
Fig. 83	Path view for safety Alias Devices.....	74
Fig. 84	Path view for Standard Alias Devices.....	75
Fig. 85	Multiline comments	75
Fig. 86	Properties under Target System.....	76
Fig. 87	Take Alias Device Name - Safety Project.....	76
Fig. 88	Take Alias Device Name - TwinSAFE logic process image	76
Fig. 89	Safe Address Verification	77
Fig. 90	FB InPort Activation Verification	77

Fig. 91	Project Properties - Diagnostic	78
Fig. 92	Group Properties - Diagnostic	78
Fig. 93	Copying the data.....	79
Fig. 94	Message box after inserting the data.....	79
Fig. 95	Inserted data.....	80
Fig. 96	Visual Studio - Menu Tools / Options	80
Fig. 97	Global setting - Default Info Data.....	81
Fig. 98	Global Setting - Group Diagram Editor	81
Fig. 99	Context menu - Edit TwinSAFE Group Order.....	82
Fig. 100	Execution order for TwinSAFE groups	82
Fig. 101	Sorting of Alias Devices.....	83
Fig. 102	Context Menu - Change Execution Order of FBs	83
Fig. 103	Execution order FBs	84
Fig. 104	Dialog - Internal Direct Mapping	84
Fig. 105	Backup/Restore settings.....	86
Fig. 106	Multiple Download - Toolbar	86
Fig. 107	Multiple Download - Selection of projects.....	87
Fig. 108	Multiple Download - general settings.....	87
Fig. 109	Multiple Download - Final Verification.....	88
Fig. 110	Multiple Download - Activation.....	88
Fig. 111	Multiple Download - Result.....	89
Fig. 112	Enabling the info data for connections.....	89
Fig. 113	Checkbox for the connection info data	90
Fig. 114	Info data for the connection in the I/O tree structure as byte array.....	90
Fig. 115	Info data for the connection in the I/O tree structure as individual data.....	90
Fig. 116	Enabling the info data for function blocks	91
Fig. 117	Info data for the function block in the I/O tree structure.....	91
Fig. 118	Enabling the info data in the properties of the TwinSAFE group	92
Fig. 119	Info data for the TwinSAFE group in the tree structure	92
Fig. 120	Enabling the info data for the EL6910	93
Fig. 121	Info data of the EL6910 in the tree structure	93
Fig. 122	Version History	94
Fig. 123	User Administration	94
Fig. 124	User Administration - Login	95
Fig. 125	User Administration - Add New User(s) - User Credentials.....	95
Fig. 126	User Administration - Add New User(s) - Access Rights.....	96
Fig. 127	User Administration - New User added	96
Fig. 128	Backup/Restore	97
Fig. 129	Restore check sequence chart	98
Fig. 130	FB_SAVELOGICPROGRAM illustration.....	99
Fig. 131	FB_SAVELOGICPROGRAM parameters.....	99
Fig. 132	FB_RESTORELOGICPROGRAM illustration.....	99
Fig. 133	FB_RESTORELOGICPROGRAM parameters.....	99
Fig. 134	Archiving the safety project.....	100
Fig. 135	Saving the safety project in a binary format (e.g. for the TwinSAFE loader).....	101
Fig. 136	Selecting the file type for importing a safety project	101

Fig. 137 Importing a safety project	102
Fig. 138 Diag History	102
Fig. 139 Diag History - Advanced Settings	103
Fig. 140 Valid PROFIsafe configuration - sample 1.....	104
Fig. 141 Valid PROFIsafe configuration - sample 2.....	105
Fig. 142 Invalid PROFIsafe configuration - sample 1	105
Fig. 143 Invalid PROFIsafe configuration - sample 2	106
Fig. 144 Creating a Custom PROFIsafe connection.....	106
Fig. 145 Setting the process image size.....	107
Fig. 146 Setting the safe address	107
Fig. 147 Selecting the PROFIsafe master	108
Fig. 148 Parameters for the PROFIsafe master connection.....	108
Fig. 149 Creating a Custom PROFIsafe connection.....	110
Fig. 150 Process image	110
Fig. 151 Safe Address setting.....	111
Fig. 152 Connection setting	111
Fig. 153 Configuration of the slave connection in the PROFIsafe master software	112
Fig. 154 Configuration of the PROFINET device.....	113
Fig. 155 Protocol AMS NetID of the PROFINET device	113
Fig. 156 Adding the TwinSAFE SC process data under the component, e.g. EL5021-0090	117
Fig. 157 TwinSAFE SC component process data, example EL5021-0090	117
Fig. 158 Adding a TwinSAFE SC connection	117
Fig. 159 Creating a link to TwinSAFE SC terminal	118
Fig. 160 Selecting a free CRC	118
Fig. 161 Selecting the process data size and the process data	119
Fig. 162 Selection of the process data	119
Fig. 163 CoE objects 0x8010:01 and 0x8010:02.....	119
Fig. 164 Entering the safety address and the CRC	120
Fig. 165 Properties of the TwinSAFE group	121
Fig. 166 Replacement values for the TwinSAFE group.....	121
Fig. 167 Login	122
Fig. 168 Customizing TwinSAFE Groups	122
Fig. 169 Customized TwinSAFE Group.....	122
Fig. 170 Specifying deviations for analog input values.....	123
Fig. 171 Activate saving of all analog group inputs	123
Fig. 172 Overlapping Sync Manager	125
Fig. 173 EtherCAT Advanced Settings	125
Fig. 174 Sync Manager settings	126
Fig. 175 Setting the start address for SM3	126
Fig. 176 EL6910 diagnostic LEDs	127
Fig. 177 EL6910 status LEDs	128
Fig. 178 Diagnostic object - FSLOGIC Status (F100hex) in the process image of the TwinSAFE component.....	130
Fig. 179 ESI/XML message text	133
Fig. 180 Startup list.....	133
Fig. 181 Unique serial number of a TwinSAFE terminal.....	135